



# User Manual

# About this manual

- This user manual is specially designed to detail the computer's functions and features.
- The user manual supplied with the computer may vary depending on the model.
- Please read this manual before using the computer to ensure safe and proper use.
- Optional items, some devices and software referred to in the user manual may not be provided or subject to upgrades. Note that the computer environment referred in the user manual may not be the same as your environment.
- Descriptions are based on the computer's default settings and Windows 8.1 operating system. Available features and additional services may vary by computer or operating system.
- This user manual describes procedures for using the touchpad, mouse, and touch screen. Instructions for using the touch screen are for models with the touch screen feature.
- Images and screenshots are those of the representative model of the series and may differ in appearance from the actual product.
- Content may differ from the final product and is subject to change without prior notice. For the latest version of the manual, refer to the Samsung website, [www.samsung.com](http://www.samsung.com).

## Instructional icons and expressions



**Warning:** situations that could cause injury to yourself or others



**Caution:** situations that could cause damage to the computer or other equipment



**Note:** notes, usage tips, or additional information



The order of options or menus you must select to perform a step. For example, select the **Settings** charm → **Power** (represents select the **Settings** charm and then **Power**).

**Select** Click or touch. For example, when using a mouse or touchpad, select **Settings** means click **Settings**. When using a touch screen, it means touch **Settings**.

## Copyright

© 2013 Samsung Electronics Co., Ltd.

This manual is protected under international copyright laws.

No part of this manual may be reproduced, distributed, translated, or transmitted in any form or by any means, electronic or mechanical, including photocopying, recording, or storing in any information storage and retrieval system, without the prior written permission of Samsung Electronics.

Computer specifications or the contents of this manual may be changed without prior notice due to an upgrade of the computer's functions.

## Trademarks

- Samsung and the Samsung logo are trademarks or registered trademarks of Samsung Electronics.
- Intel and Core are trademarks or registered trademarks of the Intel Corporation.
- Microsoft, MS-DOS, and Windows are trademarks or registered trademarks of the Microsoft Corporation.
- Bluetooth® is a registered trademark of Bluetooth SIG, Inc. worldwide.



- Wi-Fi®, Wi-Fi Protected Setup™, Wi-Fi Direct™, Wi-Fi CERTIFIED™, and the Wi-Fi logo are registered trademarks of the Wi-Fi Alliance.
- All other trademarks and copyrights are the property of their respective owners.

HDMI, the HDMI logo, and the term High Definition Multimedia Interface are trademarks or registered trademarks of HDMI Licensing LLC.



As an ENERGY STAR® Partner, Samsung has determined that this product meets the ENERGY STAR® guidelines for energy efficiency.



- The ENERGY STAR Program has reduced greenhouse gas emissions and saved energy through voluntary labeling.
- Power management setting of this product have been enabled by default, and have various timing settings from 1 minute to 5 hours.
- The product can wake with a button press on the chassis from sleep mode.



## Caution for the data

Samsung Electronics shall not be liable for any data loss. Please take care to avoid losing any important data and back up your data to prevent any such data loss.

## Operating system and software support

If you change the product's factory OS (Operating System) to another OS or if you install software which is not supported by the product's original factory OS, you will not receive any technical support, product exchange or refund, and a fee will be charged when requesting a service.

Please use your computer with the original factory OS. If you install an OS other than the factory OS, data may be deleted or the computer may not start.

## Recommended screen resolutions

The recommended screen resolution for Windows is "FHD" (1,920x1,080) and for Windows 8.1 is "QHD+" (3,200x1,800).

If you set the resolution higher than the recommended value, it may result in problems with some applications, due to limitations of the operating system.

## Product capacity representation

### Storage capacity representation

The capacity of the storage device (HDD, SSD) of the manufacturer is calculated assuming that 1KB=1,000 Bytes.

However, the operating system (Windows) calculates the storage device capacity assuming that 1KB=1,024 Bytes, and therefore the capacity representation of the HDD in Windows is smaller than the actual capacity due to the difference in capacity calculation. For example, for a 80GB HDD, Windows represents the capacity as 74.5GB,  $80 \times 1,000 \times 1,000 \times 1,000 \text{ byte} / (1,024 \times 1,024 \times 1,024) \text{ byte} = 74.505\text{GB}$ .

In addition, the capacity representation in Windows may be even smaller because some programs such as Recovery may reside in a hidden area of the HDD.

### Memory capacity representation

The memory capacity reported in Windows is less than the actual capacity of memory. This is because BIOS or a video adapter uses a portion of memory or claims it for further use. For example, for 1GB(=1,024MB) memory installed, Windows may report the capacity as 1,022MB or less.

# Table of contents

## Getting started

- 7 Layout
- 13 Connecting the AC adapter
- 16 Turning the computer on and off
- 19 Unlocking the screen

## Windows

- 20 About Windows
- 22 Desktop
- 23 Start screen
- 25 The Charms
- 28 Applications
- 34 Microsoft account
- 34 Store

## Basics

- 35 Touch screen (optional)
- 44 Keyboard
- 47 Touchpad
- 50 LCD brightness
- 52 Volume
- 53 Setup utility (BIOS)

## Network & Internet

- 59 Wired LAN
- 62 Wireless LAN
- 64 Mobile broadband (Wireless WAN, optional)

## Applications

- 66 Using applications
- 67 Settings
- 68 Software Update
- 69 Support Center
- 70 S Player+
- 71 TPM security solution (optional)

## External devices

- 81 External CD/DVD drive
- 83 Memory card
- 86 External display
- 88 Slim security slot

## Troubleshooting

- 89 Recover/Backup
- 96 Windows recovery function
- 96 Q&A

## Appendix

- 101 Product specifications
- 102 Ergonomic tips
- 106 Battery
- 108 Safety precautions
- 121 Important safety information
- 124 Replacement parts and accessories
- 126 Regulatory compliance statements
- 144 WEEE symbol information
- 146 Samsung package Take-Back program
- 147 TCO certified (for corresponding models only)

# Getting started

## Layout



- Features or options may differ depending on the model.
- The items marked as optional may not be provided or may be provided in different locations.
- Since some space on the SSD is reserved for system recovery and operations, the displayed capacity of the SSD may be less than the actual capacity.

## Front view

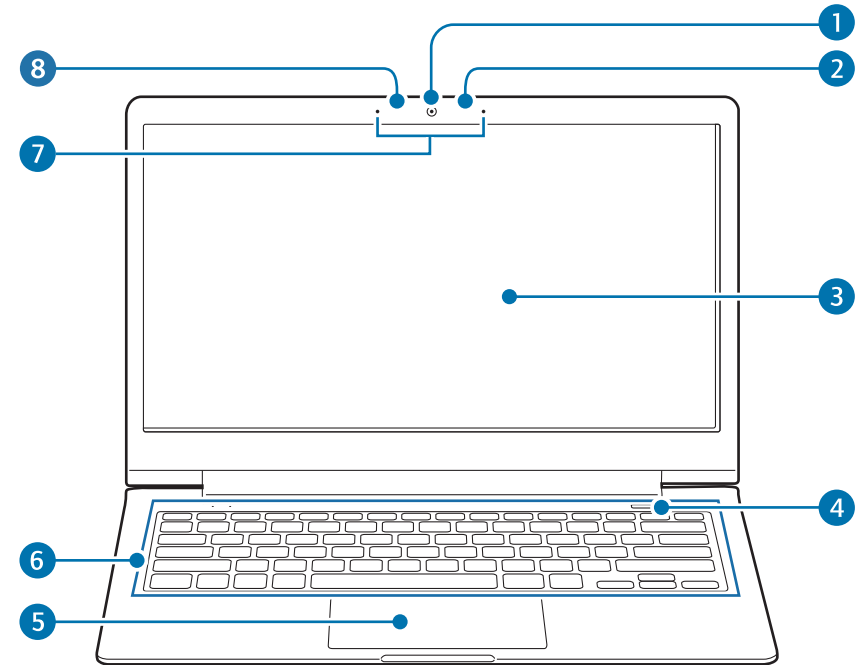



Number/Name	Description
<b>1 Camera</b>	<ul style="list-style-type: none"> <li>• Takes photos or videos.</li> <li>• Use the camera application on the <b>Start</b> screen to take photos or videos.</li> </ul>
<b>2 Light sensor</b>	<ul style="list-style-type: none"> <li>• This sensor detects the ambient illumination of the computer. If the ambient illumination becomes dark, the LCD becomes dimmer and the keyboard backlight is lit. On the contrary, if the ambient illumination becomes brighter, the LCD becomes brighter and the keyboard backlight is turned off.</li> <li>• Do not cover the sensor.</li> </ul>

Number/Name	Description
<b>3 LCD/Touch screen (optional)</b>	<ul style="list-style-type: none"> <li>• Displays the user interface.</li> <li>• Recognizes touches on the screen. (Only for models with the touch screen.)</li> </ul>
<b>4 Power button</b>	<ul style="list-style-type: none"> <li>• Press to turn the computer on.</li> </ul>
<b>5 Touchpad</b>	<ul style="list-style-type: none"> <li>• Move the cursor and click options.</li> <li>• Works actions as those of a mouse.</li> </ul>
<b>6 Keyboard</b>	<ul style="list-style-type: none"> <li>• Press keys to enter data.</li> </ul>
<b>7 Microphone</b>	<ul style="list-style-type: none"> <li>• Use the built-in microphone.</li> </ul>
<b>8 Camera indicator light</b>	<ul style="list-style-type: none"> <li>• Indicates the camera status.</li> </ul>

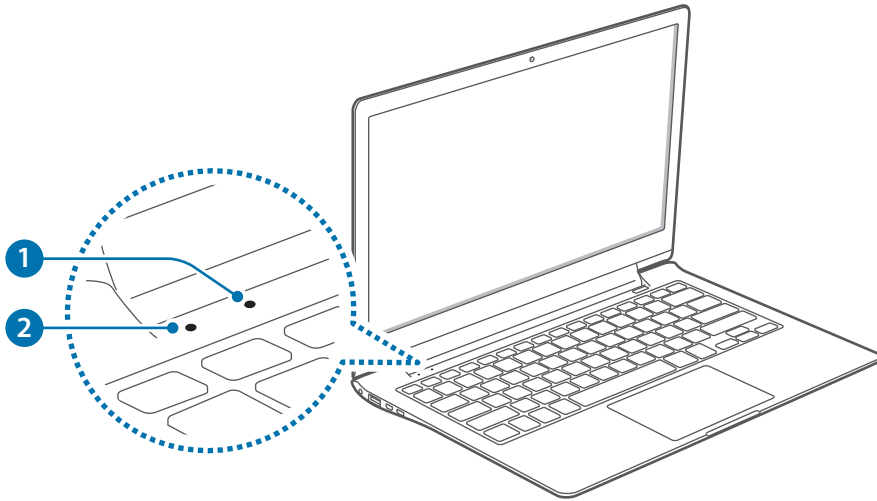



## Operating indicator light

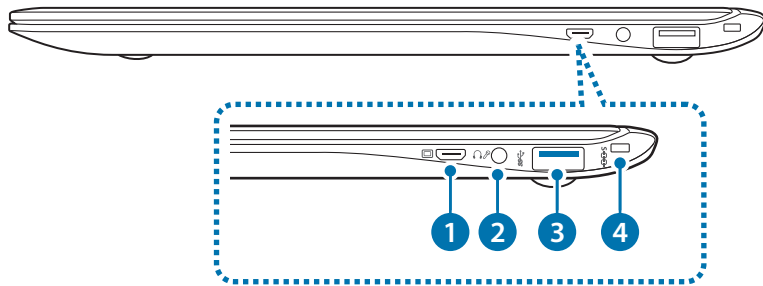

Number/Name	Description
1 Power LED 	<ul style="list-style-type: none"><li>• Turns on when the computer is turned on.</li></ul>
2 Charge LED 	<ul style="list-style-type: none"><li>• Shows the battery's charging status.<ul style="list-style-type: none"><li>- <b>Red or Orange:</b> While charging is in progress</li><li>- <b>Green:</b> When charging is complete or the battery is not installed</li><li>- <b>Off:</b> When the AC adapter is disconnected and the computer is running on the battery</li></ul></li></ul>

## Right view





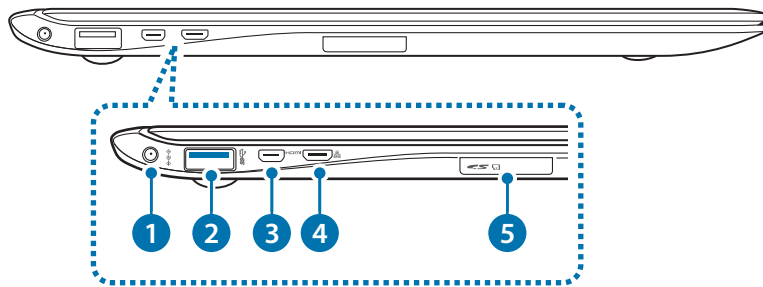

Number/Name	Description
1 Monitor port 	<ul style="list-style-type: none"><li>• Connect external display devices that support a 15-pin analog connector.</li><li>• You can connect a VGA adapter (optional).</li></ul>
2 Ear-set/Headset jack 	<ul style="list-style-type: none"><li>• Connect a headset or ear-set.</li></ul>
3 USB 3.0 port 	<ul style="list-style-type: none"><li>• Connect a USB device.</li></ul>
4 Slim security slot 	<ul style="list-style-type: none"><li>• Secure the computer by connecting an optional lock and cable to it.</li></ul>

## Left view



### About the chargeable USB port

- It may take longer to charge the battery when charging a USB device.
- The battery power level may be reduced when charging a USB device while the computer is powered by the battery.
- The charging status of the USB device is not displayed on the computer.
- To turn on the chargeable function while the computer is turned off:  
Open the **Settings** application and select **Power Management** → **USB Charging** → **ON**.
- This feature may not be available with some USB devices.

Number/Name	Description
1 DC jack 	• Connect the AC adapter to supply the power to the computer.
2 Chargeable USB 3.0 port (optional) 	• Connect and charge a USB device.
3 Micro HDMI port <b>HDMI</b>	• Connect external display devices that support HDMI.
4 Wired LAN port 	• Connect an Ethernet cable to this port when connecting to the Internet via a wired LAN. Use a LAN adapter (optional) to connect to a wired LAN.
5 Memory card slot 	• Insert a memory card into the slot.

## Bottom view

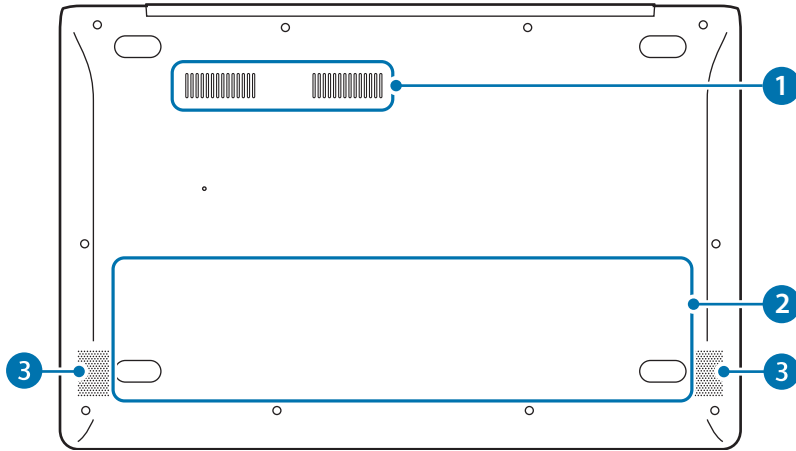

Number/Name	Description
<b>1 Fan vents</b>	<ul style="list-style-type: none"> <li>The internal heat of the computer is emitted through these holes.</li> <li>If the vents are blocked the computer may overheat. Avoid blocking the vents as this may be dangerous.</li> </ul>
<b>2 Internal battery</b>	<ul style="list-style-type: none"> <li>Provides power to the computer when not connected to an AC adapter.</li> <li>To remove or replace the internal battery, take it to the Samsung Service Center. You will be charged for this service.</li> </ul>
<b>3 Speaker</b>	<ul style="list-style-type: none"> <li>Emits sound from the computer.</li> </ul>



After replacing the bottom of the computer, the model name, serial number and some logos on will no longer be present. For more information, contact the Samsung Service Center to request assistance.



## Connecting the AC adapter

Charge the battery before using it for the first time. Use the AC adapter to charge the battery.



- Use only Samsung-approved AC adapters, batteries, and cables. Unapproved adapters or cables can cause the battery to explode or damage the computer.
- Incorrectly connecting the charger may cause serious damage to the computer.



To restore the battery power after cutting it, connect the AC adapter.

- 1 Connect the power cable to the AC adapter.
- 2 Connect the AC adapter to the DC jack of the computer.

- 3 Plug the power cable into an electric socket.

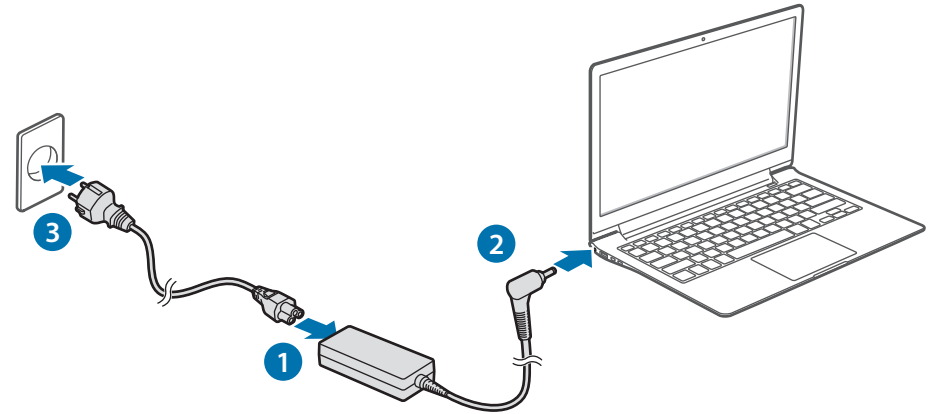

When charging is complete, the charge status turns green.

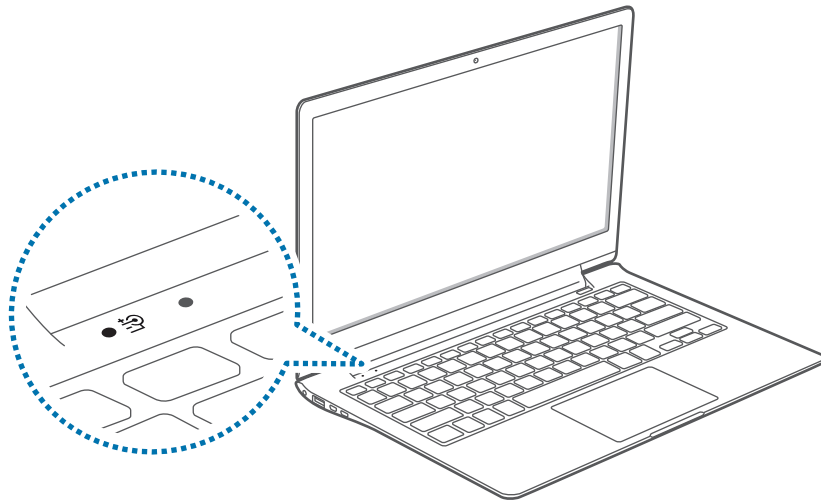





4 After charging, disconnect the AC adapter from the computer.

5 Unplug it from the electric socket.



- This computer is equipped with an internal battery. The battery is not user-serviceable or user-replaceable.
- To have battery removed or replaced safely, take the device to a Samsung Service Center. You will be charged for this service.
- You can use the computer while it is charging, but the battery charging time may increase. If the battery temperature rises too much, the charging may stop as a safety measure.

Charge LED 	Status
	• <b>Red or Orange:</b> Charging
	• <b>Green:</b> Fully charged
	• <b>No color:</b> AC adapter not connected

## Battery status

Move the cursor over the battery icon on the taskbar to view the current battery charge when disconnecting the AC adapter from the computer.

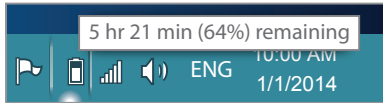

## Viewing the current battery charge when the computer is turned off

Connect or disconnect the AC adapter from the computer to view the current battery charge when the computer is turned off.

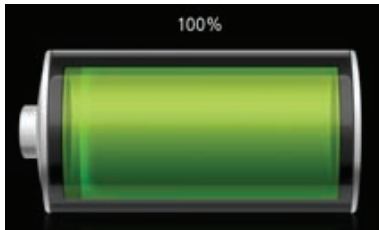

## Battery usage time

Batteries are replacement items and over time the battery's capacity to hold a charge and its power level is reduced. If a battery can only hold its charge for half of the time that it could when new, it is recommended to purchase a new, replacement battery.

When not using the battery for extended periods, charge the battery to 30-40% of full charge before storing it. This extends battery life.

## Turning the computer on and off

### Turning on

- 1 Before turning on the computer, charge the battery.
- 2 Open the LCD panel.

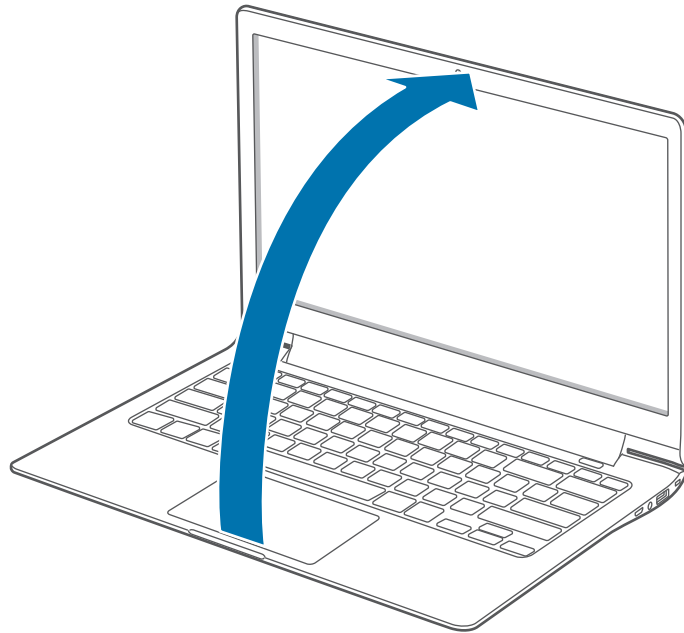

- 3 Press the Power button.  
The Power LED turns on.

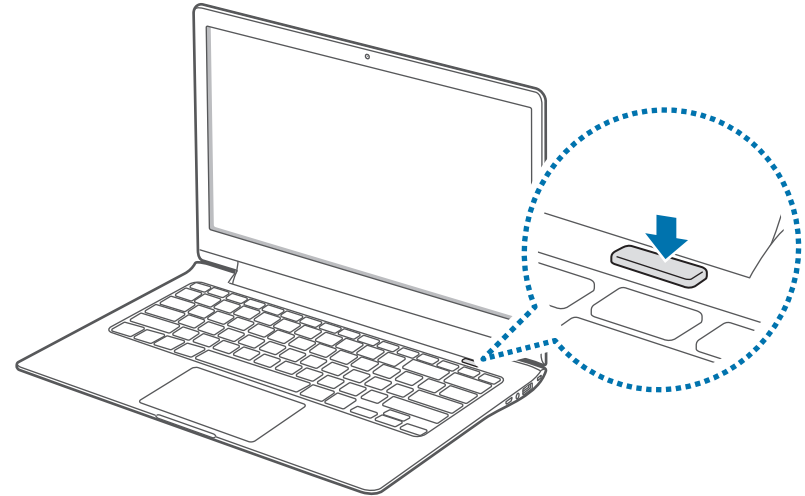

#### 4 Activate Windows by following the on-screen instructions.

- The Windows activation screen appears only when turning on the computer for the first time.
- The computer's date and time may be incorrect when you turn it on for the first time. They may also be incorrect if the battery has been fully discharged or removed. To set the date and time, go to the desktop taskbar and right-click the clock area. Then, click **Adjust date/time** and set the current date and time



- To adjust the brightness of the screen, see LCD brightness.
- To adjust the sound, see Volume.

## Turning off

### Turning off on the desktop

1 To select the Start button, do one of the following:

- **Touch screen:** Touch and hold the Start button (☰) at the lower-left edge of the desktop.
- **Mouse:** Right-click the Start button (☰) at the lower-left edge of the desktop.

2 Select **Shut down or sign out** → **Shut down**.

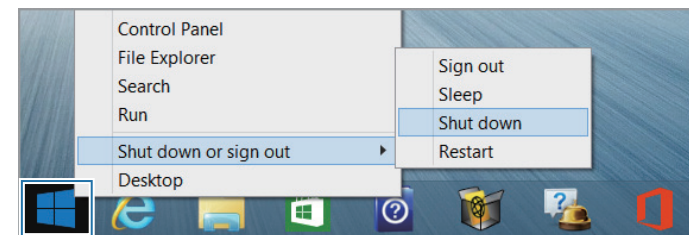

- Save all the data before turning off the computer.
- Since the procedures to turn the computer off may differ depending on the installed operating system, please turn the computer off according to the procedures for the purchased operating system.

## Turning off on the Start screen

- 1 Select **Power** (⏻) at the upper-right corner of the **Start** screen.



- 2 Select **Shut down**.

## Turning off on the Charms

- 1 To open the Charms, do one of the following:
  - **Touch screen:** Swipe inward from the right edge of the touch screen.
  - **Touchpad/Mouse:** Move the cursor to the upper- or lower-right edge of the screen.

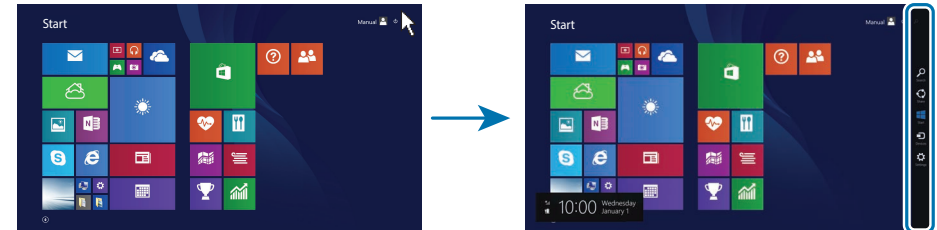

- 2 Select the **Settings** charm → **Power** → **Shut down**.

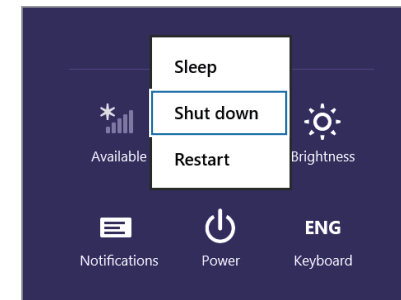

## Unlocking the screen

To unlock the lock screen, do one of the following:

- **Touch screen:** Swipe the lock screen from bottom to top.
- **Mouse:** Click the lock screen.
- **Keyboard:** Press any key.
- **Touchpad:** Tap the touchpad.



If the account has a password, enter the password to log in after unlocking the screen.

# Windows

## About Windows

Microsoft Windows is an operating system that is used to control a computer. For optimal use of the computer, learn how to use the operating system properly. It is best to learn how to use Windows by using **Windows Help and Support**, and **Help+Tips**.



- Images and available features may differ depending on the model and operating system.
- This manual is designed for Windows 8.1 and content may differ depending on the OS version.
- The image displayed on the desktop screen may differ between models and OS versions.

## Help

To access the help, do one of the following:

- **Keyboard:** Press the **F1** key.
- **Touch screen:** Swipe inward from the right edge of the touch screen to open the Charms and select the **Settings** charm → **Help**.
- **Mouse:** Move the cursor to the upper- or lower-right edge of the screen to open the Charms and select the **Settings** charm → **Help**.



## Help+Tips

On the **Start** screen, select **Help+Tips**.

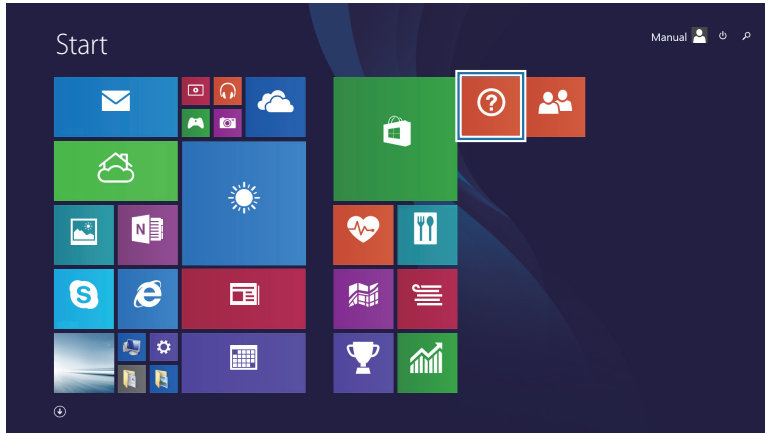

You can control Windows menus with the mouse or with gestures.

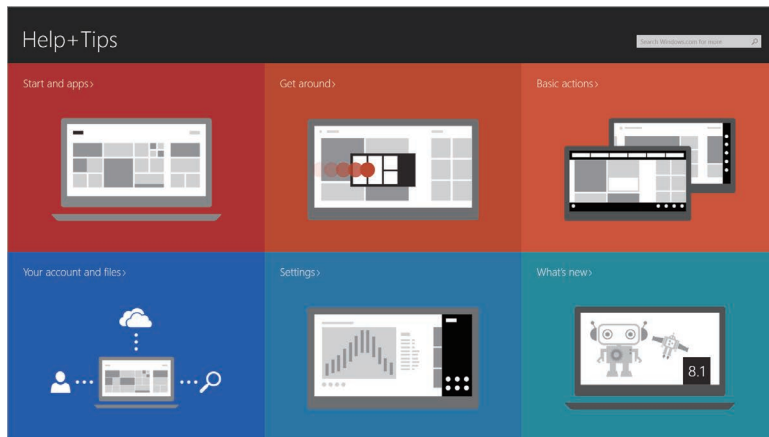

## Screens in Windows 8.1

The following two screens are provided: the **Start** screen and the desktop.

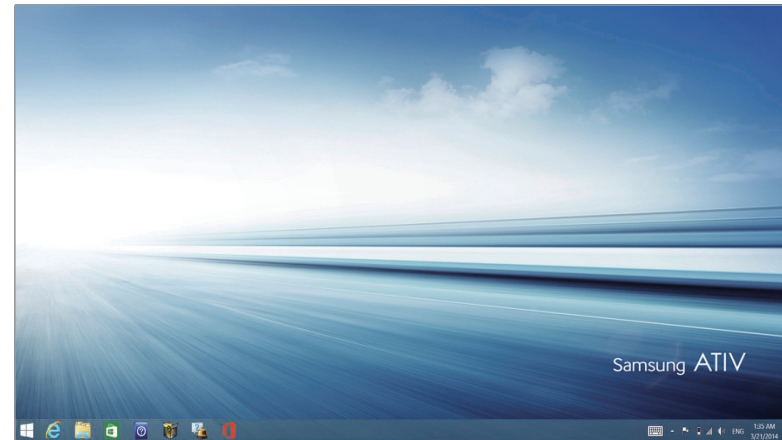

Desktop

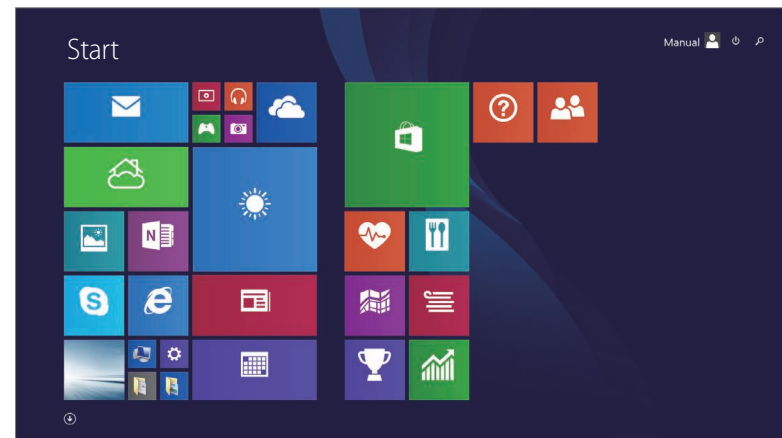

Start screen

# Desktop

The desktop provides a layout that is similar to earlier versions of Windows.

On the **Start** screen, select **Desktop** from the tiles.

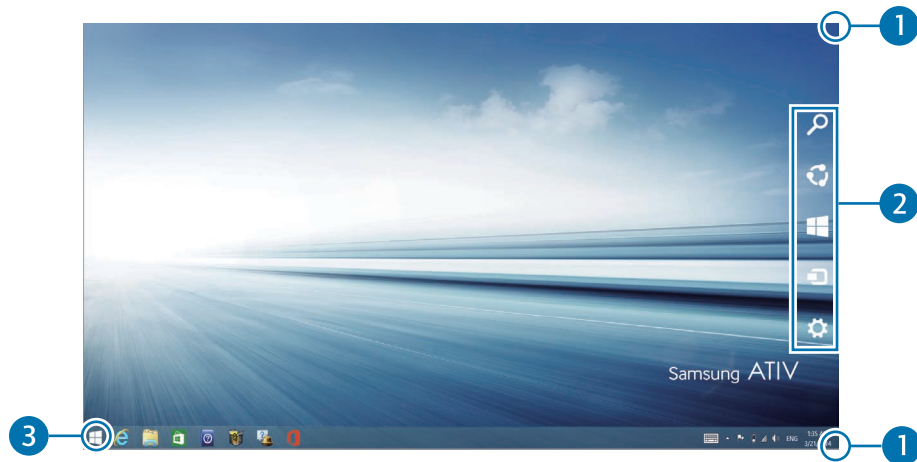

Number/Name	Description
1 Open the Charms	<ul style="list-style-type: none"> <li>• Opens the Charms that are hidden at the right of the screen.</li> <li>• To open the Charms, do one of the following: <ul style="list-style-type: none"> <li>– <b>Touch screen:</b> Swipe inward from the right edge of the touch screen.</li> <li>– <b>Touchpad/Mouse:</b> Move the cursor to the upper- or lower-right edge of the screen.</li> </ul> </li> </ul>
2 The Charms	<ul style="list-style-type: none"> <li>• Refers to the menu that allows you to search, share, connect to devices, configure settings or switch to the <b>Start</b> screen.</li> </ul>
3 Start button	<ul style="list-style-type: none"> <li>• Move to the <b>Start</b> screen. Right-click or touch and hold this button to access Windows features, such as shutting down the system or opening the Control Panel.</li> </ul>

## Using the Start button

To quickly and conveniently access various features of Windows, do one of the following:

- **Touch screen:** Touch and hold the Start button (☰).
- **Touchpad/Mouse:** Right-click the Start button (☰).

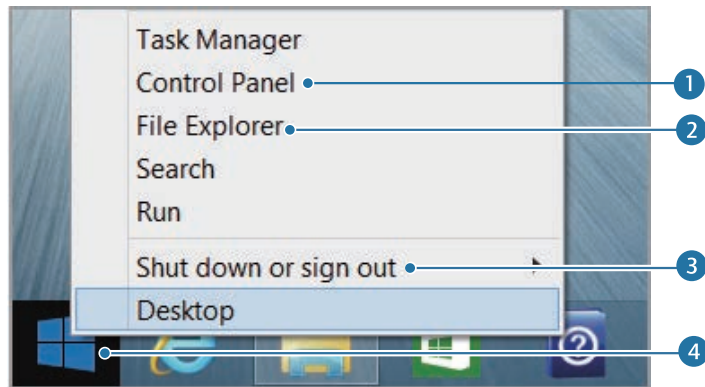



Number	Name
1	• Control Panel
2	• File Explorer
3	• Power menu
4	• Start button

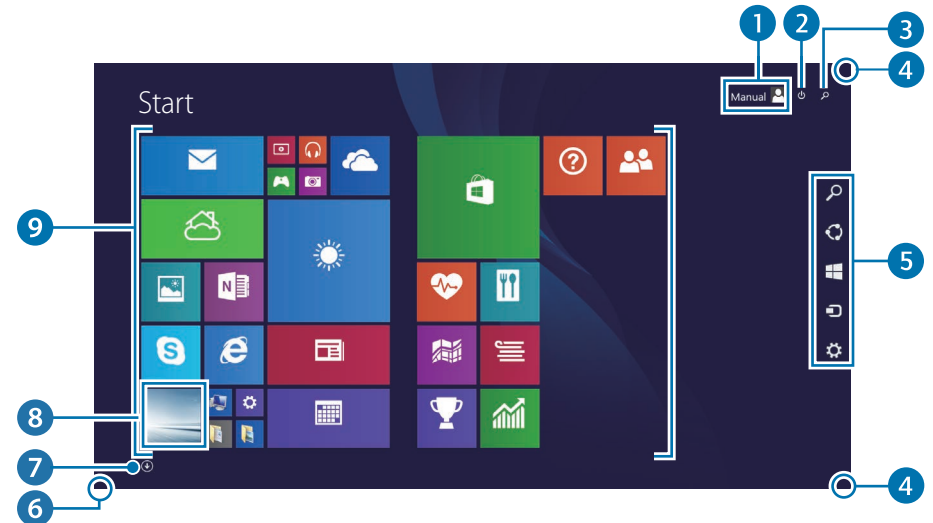

## Start screen

Launch applications on the **Start** screen.

On the desktop, click the Start button (☰) or open the Charms and select the **Start** charm.



Number/Name	Description
1 User account	<ul style="list-style-type: none"> <li>Refers to the currently-used user account.</li> </ul>
2 Power 	<ul style="list-style-type: none"> <li>Turn off the computer or select <b>Sleep</b> mode and <b>Restart</b>.</li> </ul>
3 Search 	<ul style="list-style-type: none"> <li>Search for applications, files, or websites by entering keywords.</li> </ul>
4 Open the Charms	<ul style="list-style-type: none"> <li>Opens the Charms that are hidden at the right of the screen.</li> <li>To open the Charms, do one of the following: <ul style="list-style-type: none"> <li><b>Touch screen:</b> Swipe inward from the right edge of the touch screen.</li> <li><b>Touchpad/Mouse:</b> Move the cursor to the upper- or lower-right edge of the screen.</li> </ul> </li> </ul>
5 The Charms	<ul style="list-style-type: none"> <li>Refers to the menu that allows you to search, share, connect to devices, configure settings or switch to the <b>Start</b> screen.</li> </ul>

Number/Name	Description
6 Start button 	<ul style="list-style-type: none"> <li>The Start button can be accessed only with the mouse. Move the cursor to the lower-left edge of the screen to view the Start button . Click the button to switch to the most recent application screen or the desktop. Right-click this button to access other Windows features, such as shutting down the system or opening the Control Panel.</li> </ul>
7 	<ul style="list-style-type: none"> <li>The application screen appears where the list of applications installed on the computer is displayed. The application screen can be accessed only with the touchpad or mouse.</li> </ul>
8 Desktop	<ul style="list-style-type: none"> <li>Switches to the desktop.</li> </ul>
9 App tiles	<ul style="list-style-type: none"> <li>Refers to the tiles of installed applications.</li> <li>Samsung Apps supplied with the original factory product are compatible with the product's supported OS. Changing the OS may result in limited use of the Apps.</li> </ul>

## The Charms

The Charms let you search, share links and photos, connect devices, and change settings. The Charms functions available may differ between the **Start** screen and the desktop or applications.

### Opening the Charms

To open the Charms, do one of the following:

- **Mouse:** Move the cursor to the upper- or lower-right edge of the screen.

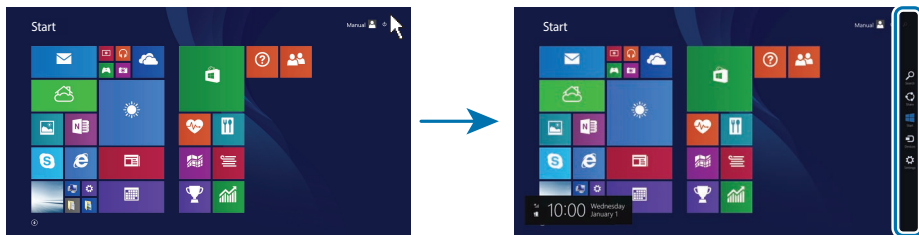

- **Keyboard:** Hold down the Windows key () and press the C key.

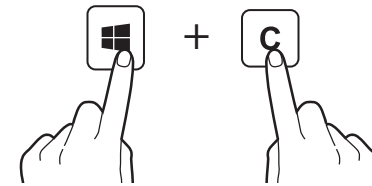

- **Touchpad:** Swipe inward from the right edge of the touchpad.

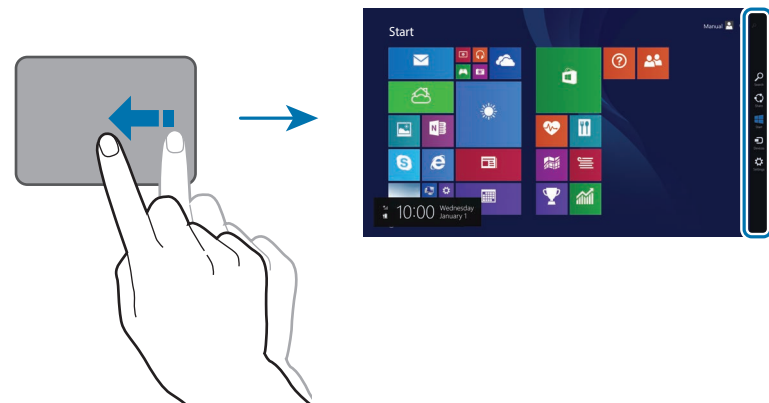



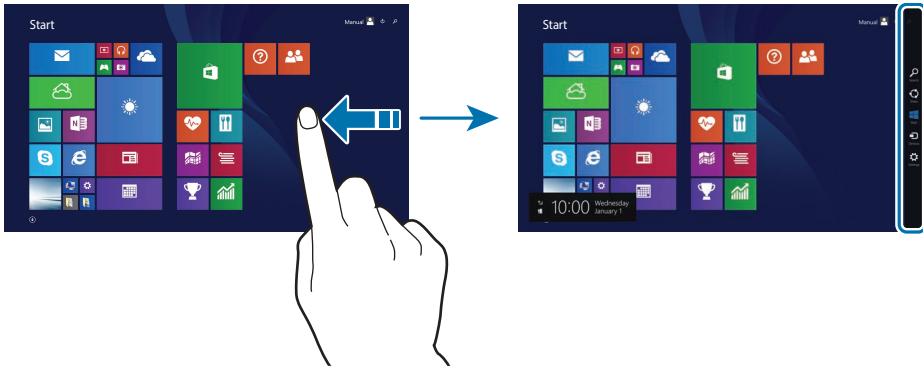

- **Touch screen:** Swipe inward from the right edge of the touch screen.







## Learning about the Charms

Use the following Charms to control the computer:

Charm	Description
 <b>Search</b>	• Search for applications, files, or websites by entering keywords.
 <b>Share</b>	• Share various files with others.
 <b>Start</b>	• Return to the <b>Start</b> screen or open the most recent application.
 <b>Devices</b>	• Connect devices, such as printers or displays or sync files with a mobile device.
 <b>Settings</b>	• Configure the computer, set application options, or add accounts. See Settings charm.

## Settings charm

To configure the computer, open the Charms and then select the **Settings** charm → an option.

Option	Description
 <b>Network</b>	<ul style="list-style-type: none"><li>• Connect the computer to a network to use the Internet or share files with other devices.</li></ul>
 <b>Volume</b>	<ul style="list-style-type: none"><li>• Adjust the volume level.</li></ul>
 <b>Brightness</b>	<ul style="list-style-type: none"><li>• Set the brightness of the screen.</li></ul>
 <b>Notifications</b>	<ul style="list-style-type: none"><li>• Set the interval at which an application sends notices.</li></ul>
 <b>Power</b>	<ul style="list-style-type: none"><li>• Turn off the computer or select <b>Sleep</b> mode and <b>Restart</b>.</li></ul>
<b>ENG</b> <b>Keyboard</b>	<ul style="list-style-type: none"><li>• Set a language to enter text.</li></ul>
<b>Change PC settings</b>	<ul style="list-style-type: none"><li>• Change more settings and personalize the computer.</li></ul>

# Applications

## Opening or closing applications

On the **Start** screen, select an application icon to open it.

- **Touchpad/Mouse:** Select  at the lower-left edge of the desktop to view all applications.
- **Touch screen:** Swipe upwards on the touch screen.

## Closing an application

To close an application, do one of the following:

- **Touch screen:** Swipe downward from the top edge of the screen.

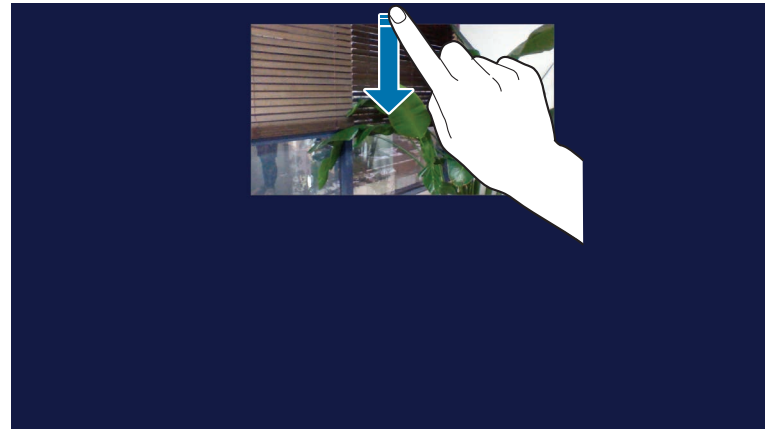

- **Touchpad/Mouse:** Move the cursor to the upper-right edge of the application screen and select .



## Opening running applications

- 1 On the **Start** screen, place the cursor in the upper-left corner of the screen until a small application image appears.  
Swipe from the left edge of the touchpad or screen towards the middle of the touchpad or screen to show running applications.
- 2 Move the cursor down to display a list of running applications.
- 3 Select an application to open it.  
Right-click over an application in the list and click **Close** to exit the application.



## App tiles

### Tile position

To change the position of an app tile on the **Start** screen, select and hold the tile and then drag it to a new position.



## Grouping tiles

To group tiles, select and hold a tile and drag it to an open space. Then, drag other tiles to the new group.



## Naming a group

- 1 To open menu items, do one of the following:
  - **Touch screen:** On the **Start** screen, swipe upwards from the bottom edge of the touch screen.
  - **Touchpad/Mouse:** On the **Start** screen, right-click any area.
- 2 Select **Customize**.
- 3 Select **Name group** on each group.
- 4 Enter a name with the keyboard or the on-screen keyboard, and then press the **Enter** key.

## Editing tiles

- 1 To select a tile and then an option, do one of the following:
  - **Touch screen:** Press and hold the tile to edit.
  - **Touchpad/Mouse:** Right-click on the tile to edit.
- 2 Select an option.
  - **Unpin from Start:** Delete the tile from the **Start** screen.
  - **Resize:** Change the size of the tile.

## Using split screens

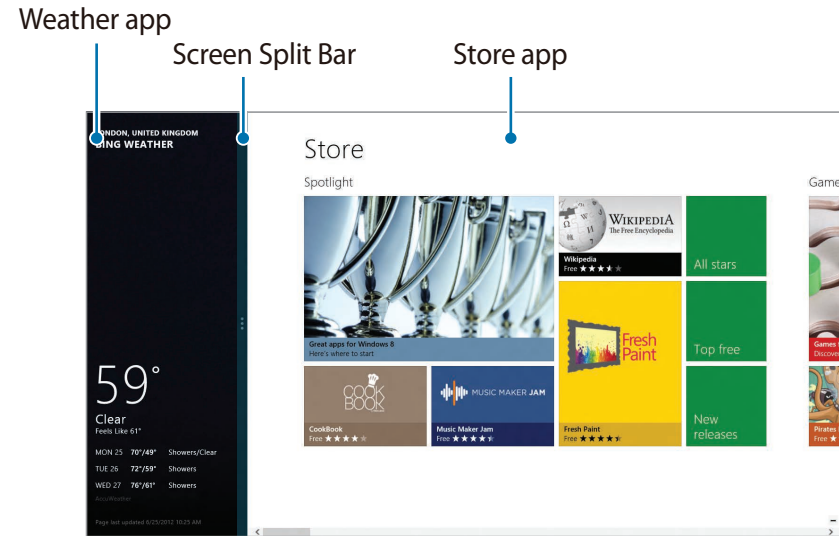

- 1 On the **Start** screen, select an application.
- 2 To enter the split mode, do one of the following:
  - **Touch screen:** Put your finger on the top edge of the screen, and swipe to the left or right.
  - **Touchpad/Mouse:** Place the cursor at the top corner of the screen. Drag the cursor to the left or right.
- 3 Arrange the position of each split screen as desired.

- 4 Drag the **Screen Split Bar** to change the screen split ratio.



Example: If the Weather application and the Store application are running at the same time

## Adding or removing an application on the Start screen

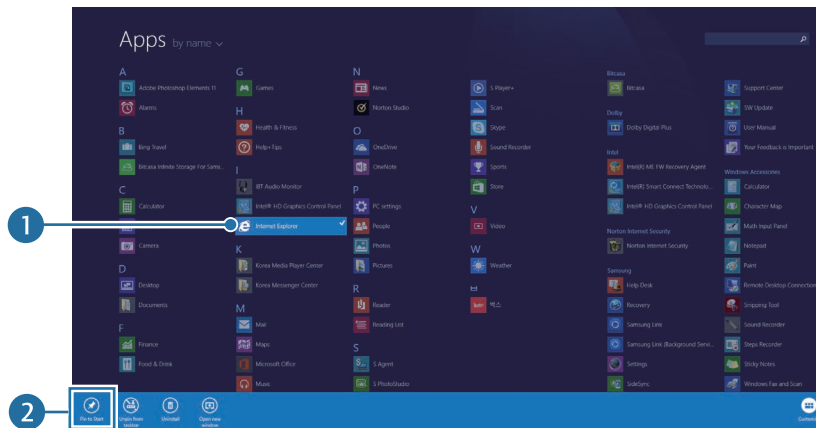

- To move to the applications screen, do one of the following:
  - Touch screen:** Swipe upwards on the **Start** screen.
  - Touchpad/Mouse:** Select  at the lower-left edge of the **Start** screen.
- Touch and hold or right-click an application.  
Menu items will appear at the bottom of the screen.
- Select **Pin to start** () or **Unpin from Start** ()



Example: When removing an application on the **Start** screen

## Using the camera application

Use the camera application provided by Windows to take photos or videos or edit photos.

- On the **Start** screen, select **Camera** ()
- Select  to take photos or select  to take videos.



## Viewing photos or videos

To view photos or videos, do one of the following:

- **Touch screen:** Swipe from the left edge of the screen to the right.
- **Mouse:** Click the arrow symbol on the left of the screen.

Or, on the **Start** screen, select **Photos**  → **Camera Roll**.

## Editing photos

- 1 Select a photo.
- 2 Swipe downward from the bottom edge of the screen. Alternatively, right-click the photo.
- 3 Select **Edit** and edit the photo.



### Camera etiquette

- Do not take photos or videos of other people without their permission.
- Do not take photos or videos where prohibited.
- Do not take photos or videos in places where doing so may violate other people's privacy.

## Microsoft account

Some Microsoft services, such as the **Store**, require a Microsoft account. Create a Microsoft account to get the most from the computer.



Before creating an account, the internet must be connected.

- 1 Open the Charms and select the **Settings** charm → **Change PC settings**. Or select **PC settings** on the **Start** screen.
- 2 Select **Accounts** → **Connect to a Microsoft account**, and then follow the on-screen instructions to complete the account setup.
  - If you already have an account, sign in with the Microsoft account.
  - The registered Microsoft account on the computer cannot be removed.
  - Select **Switch to a Local account** to sign in the computer with a Windows account.

## Store

Purchase and download applications for the computer. Create a Microsoft account to use this feature. See Microsoft account.

On the **Start** screen, select **Store**.



- This feature may not be available depending on the operating system.
- Samsung cannot resolve problems with applications installed from the Store. Contact customer support for the application.

# Basics

## Touch screen (optional)

Only use fingers to use the touch screen.

## Touch screen gestures

### Swiping

- To open the Charms, swipe from the right edge of the touch screen to the middle.

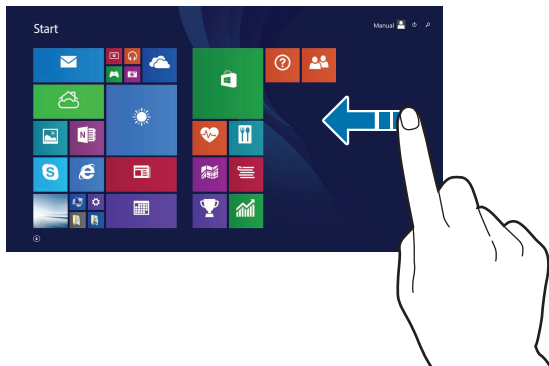

- To open the most-recently used application, swipe from the left edge of the touch screen to the middle.

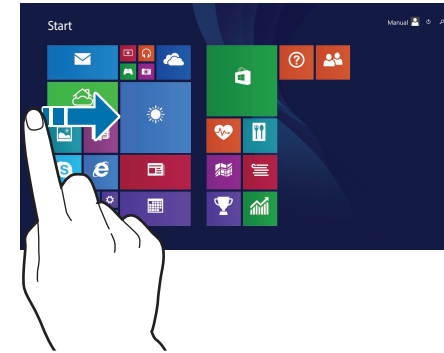

- To bring up the app commands, swipe downwards from the top edge of the touch screen or swipe upwards from the bottom edge of the touch screen.

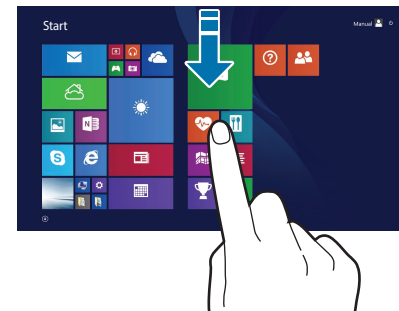

or

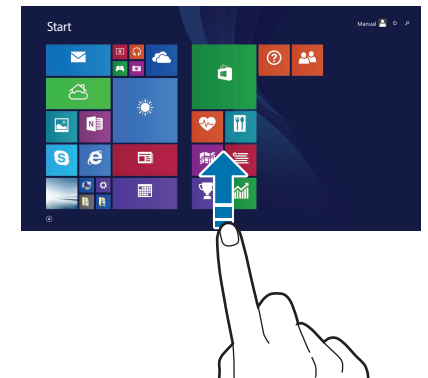

- To view all installed applications, swipe upwards on the **Start** screen.

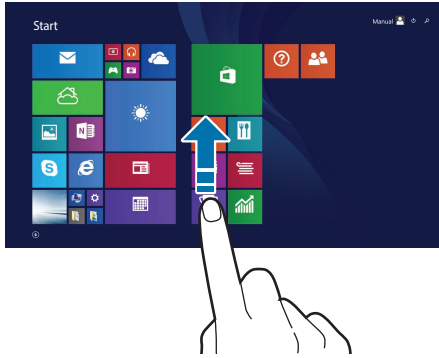

- To close an application, swipe downward from the top edge to the bottom edge of the touch screen.

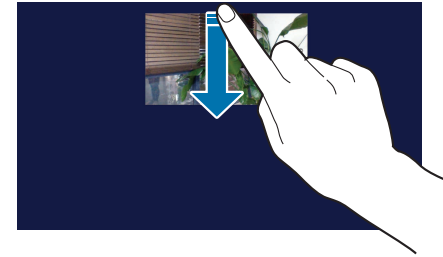

- To switch from the applications screen to the **Start** screen, swipe downward on the applications screen.

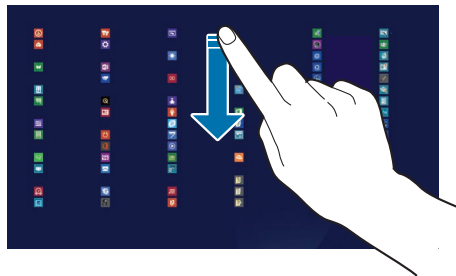



- To scroll up, down, left or right, swipe with two fingers on the touch screen.

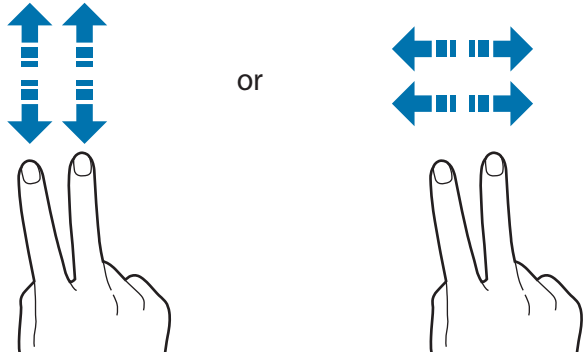

## Tapping

To open an application, select a menu item, press an on-screen button, or enter a character using the on-screen keyboard, tap it with a finger on the touch screen.



## Double-tapping

To zoom in a part or double-click an item, double-tap on the touch screen.

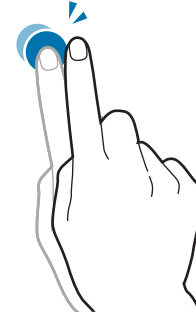

## Tapping and holding

To perform the right-clicking function, tap and hold an item on the touch screen.

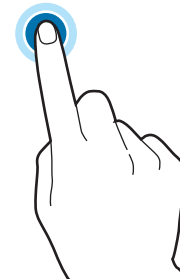

## Dragging

To move an icon, app tile, or preview to a new location, touch and hold it, and then drag it to the target position on the touch screen.

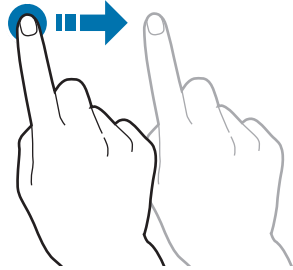

## Pinching

To zoom in, spread two fingers apart on a website, map, or image. Pinch to zoom out.

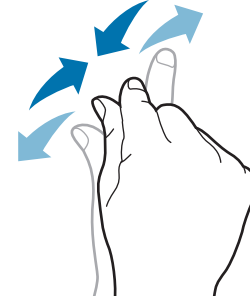



- Do not apply a severe impact to the touch screen or press it with a sharp object. Doing so may damage the touch screen.
- Do not allow the touch screen to come into contact with other electrical devices. Electrostatic discharges can cause the touch screen to malfunction.
- Do not allow the touch screen to contact water. The touch screen may malfunction in humid conditions or when exposed to water.
- Do not spray liquid cleansing solutions directly onto the touch screen. The solution may enter the touch screen or cause undesired operation. To clean the screen, dampen a cloth with the solution and wipe the screen gently. Do not use solutions or cloths that contain abrasive materials, as they may damage the touch screen.
- Do not damage the edges of the touch screen. Doing so may damage the touch screen.



- Leaving the touch screen idle for extended periods may result in afterimages (screen burn-in) or ghosting. Turn off the touch screen when you do not use the computer.
- Touch the touch screen with clean and dry hands. Remove the moisture from your hands and the touch screen surface before use.
- Avoid contacting the computer with a foreign substance. Doing so may cause the touch screen to malfunction.
- Very light touches on the touch screen may not be recognized.
- On the touch screen, press over an item precisely.
- The touch screen sensors are located at the edges of the touch screen. Therefore, do not cover the edges of the touch screen with protective covers or accessories.
- Touch screen gestures are available for touch screen models running Windows and work only with some applications.

## Calibrating the screen

Calibrate the touch settings to make the screen sense accurately when using a finger.



This feature may differ or may not be available depending on the operating system.

- 1 On the desktop, open the Charms and then select the **Settings** charm → **Control Panel** → **Hardware and Sound** → **Tablet PC Settings** → **Calibrate...**

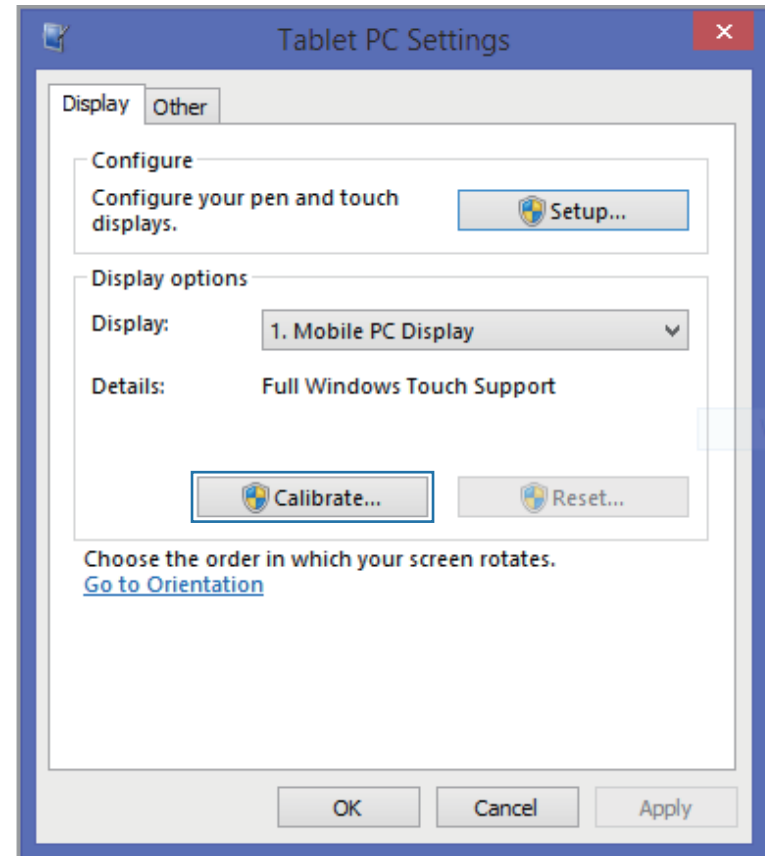

2 Select **Yes** when a pop-up appears.

3 Touch **+** on the calibration screen.

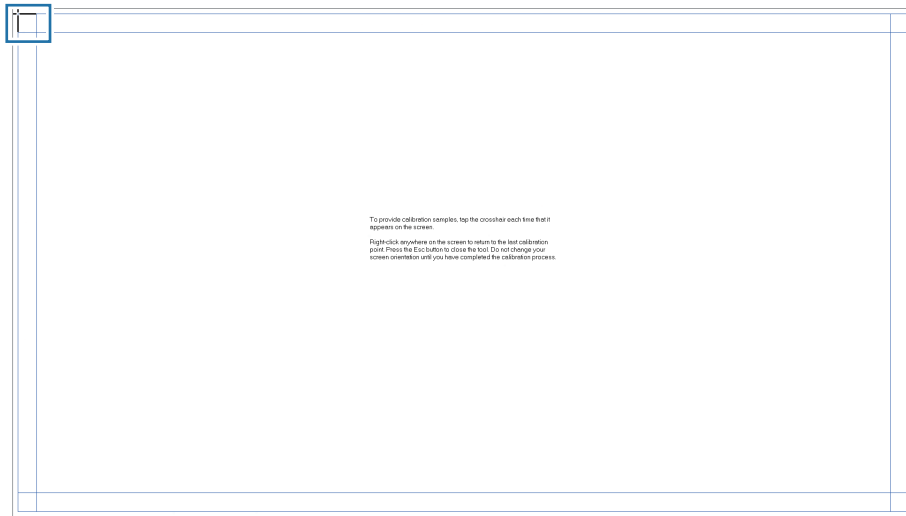

- **+** appears sequentially from the upper-left to the lower-right on the screen. Touch **+** each time it appears.
- To return to the last calibration point, right-click or touch and hold anywhere.
- To close the calibration screen, press the **Esc** key.

4 When finishing calibrating and a pop-up appears, select **Yes**.

## Entering text



Use the virtual keyboard to enter text.



- Text entry is not supported in some languages. To enter text, change the input language to one of the supported languages.
- Enter text with the keyboard when using the computer for a long time.

## Changing the keyboard layout

To change the keyboard layout, touch  and select one of the following:

- : Simplified Qwerty keyboard.
- : Split Qwerty keyboard for entering text with two hands.
- : Standard Qwerty keyboard.

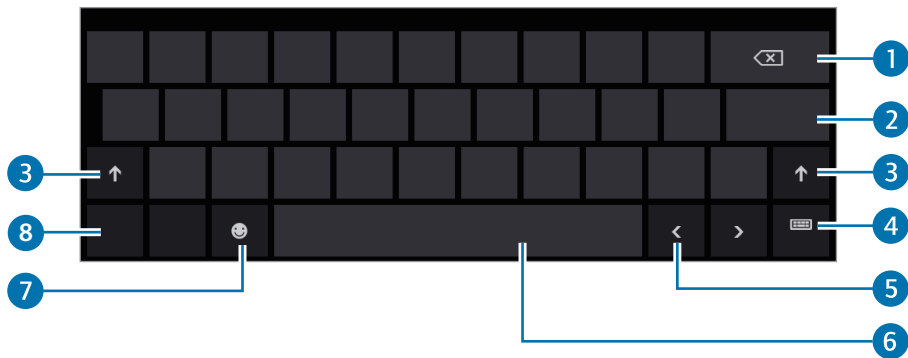

Number	Description
1	• Delete a preceding character.
2	• Break to the next line.
3	• Enter uppercase. For all caps, press and hold it.
4	• Change the keyboard layout.
5	• Move the cursor.
6	• Enter a space.
7	• Enter emoticons.
8	• Enter numerals and punctuation marks.



## Entering uppercase

Touch  before entering a character. For all caps, touch it twice.

## Changing language keyboards

Add keyboards to enter text in other languages. Open the Charms and select the **Settings** charm → **Change PC settings** → **Time and language** → **Region and languages** → **Add a language** → a language → **Add**.

## Handwriting

Touch  → , write a word with a finger, and then touch **Insert**.

To view the handwriting help, touch .



Handwriting is not supported in some languages.

## Copying and pasting

- 1 Touch and drag your finger across the text to select it.
- 2 Touch and hold the text to open the options pop-up.
- 3 Touch **Copy** or **Cut**.
- 4 Touch and hold a text input field and then touch **Paste**.

# Keyboard

Enter text or access computer functions with the keyboard.



- Images and available features may differ depending on the model and operating system.
- The keyboard layout may differ depending on the country.

## Using hot keys

To use keyboard hot keys, do one of the following:

- Hold down the **Fn** key and press a hot key.

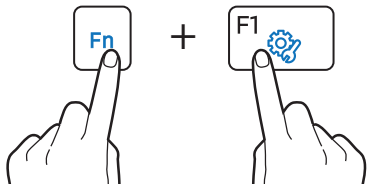



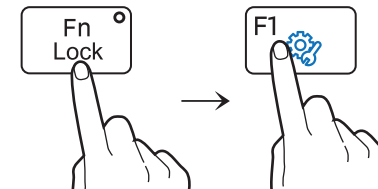

- Press the **Fn Lock** key. When the **Fn Lock** key LED turns on, press a hot key.











- When the **Fn Lock** key is on, hot keys are activated without pressing the **Fn** key.



## Hot key functions

Key/Icon	Description
F1 	<ul style="list-style-type: none"> <li>• <b>Settings:</b> Launch the <b>Settings</b> application.</li> </ul>
F2 	<ul style="list-style-type: none"> <li>• <b>Screen brightness control:</b> Adjust the brightness level.</li> </ul>
F3 	
F4 	<ul style="list-style-type: none"> <li>• <b>LCD/External monitor:</b> Switch between the LCD and an external display device when an external display device is connected to the computer.</li> </ul>
F5 	<ul style="list-style-type: none"> <li>• <b>Touchpad:</b> Turn on or off the touchpad function.</li> <li>• When the LED is turned on, the touchpad function is disabled.</li> </ul>

Key/Icon	Description
F6 	<ul style="list-style-type: none"> <li>• <b>Mute:</b> Mute or unmute the audio.</li> </ul>
F7 	<ul style="list-style-type: none"> <li>• <b>Volume Control:</b> Adjust the volume level.</li> </ul>
F8 	
F9 	<ul style="list-style-type: none"> <li>• <b>Keyboard backlight control:</b> Adjust the keyboard backlight brightness.</li> </ul>
F10 	
F11 	<ul style="list-style-type: none"> <li>• <b>Silent mode:</b> Reduce the fan noise.</li> </ul>
F12 	<ul style="list-style-type: none"> <li>• <b>Wi-Fi:</b> Turn a Wi-Fi network on or off.</li> <li>• When the LED is turned on, the Wi-Fi network function is disabled.</li> </ul>
Fn + 	<ul style="list-style-type: none"> <li>• <b>Right-click:</b> Perform the right-click function.</li> <li>• Open the app commands of the selected application on the <b>Start</b> screen.</li> </ul>









If the hot keys do not work properly, install the **Settings** application.

## Windows hot keys

Use hot keys to access functions conveniently in Windows.

Press the Windows key () or the **Alt** key, and a hot key simultaneously.

Key	Description
Windows key (  )	<ul style="list-style-type: none"><li>• Switch to the <b>Start</b> screen or the most recent application.</li></ul>
Windows key (  ) + D	<ul style="list-style-type: none"><li>• Switch to the desktop.</li></ul>
Windows key (  ) + C	<ul style="list-style-type: none"><li>• Open the Charms.</li></ul>
Windows key (  ) + L	<ul style="list-style-type: none"><li>• Lock the screen.</li></ul>
Windows key (  ) + U	<ul style="list-style-type: none"><li>• Open <b>Ease of Access Center</b>.</li></ul>
Windows key (  ) + P	<ul style="list-style-type: none"><li>• Opens the project menu (external display connection) in the <b>Devices</b> charm.</li></ul>
Windows key (  ) + X	<ul style="list-style-type: none"><li>• Open advanced management tools.</li></ul>
Alt + F4	<ul style="list-style-type: none"><li>• Close a running application.</li><li>• To use this function, the <b>Fn Lock</b> key must be turned off.</li></ul>

# Touchpad

Use the touchpad to move the cursor or select an item. The left and right buttons of the touchpad act the same as the left and right buttons of a mouse.



- Use the touchpad only with fingers. The touchpad will not recognize actions of other objects.
- Images and the touchpad layout may differ depending on the model.

## Basic touchpad functions

### Moving

To move the cursor, move a finger on the touchpad.

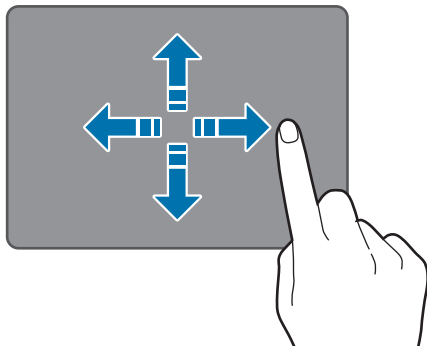

### Clicking function

Tap the touchpad or press the left touchpad button.

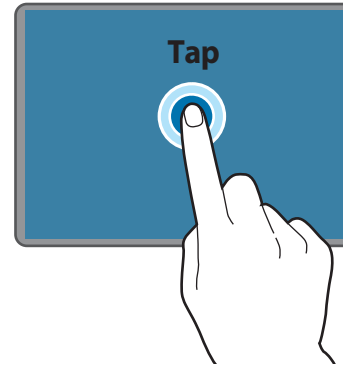

or

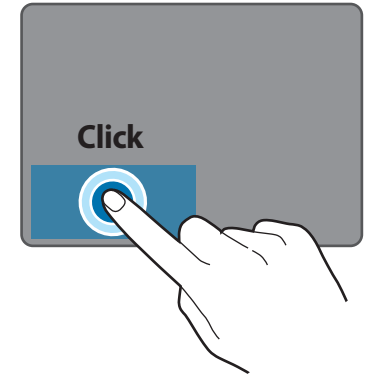

### Double-clicking function

Double-tap the touchpad or press the left touchpad button twice.

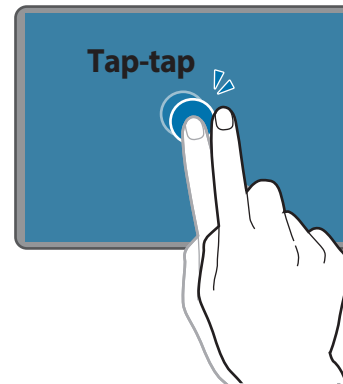

or



## Right-clicking function

To right-click an item, press the right touchpad button.

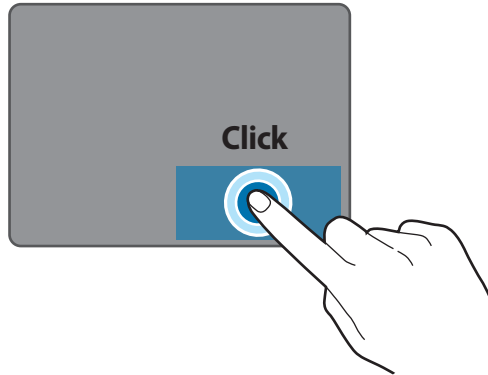

## Dragging function

To move an icon or an app tile to a desired location, press and hold it and then drag it to the target position with the left touchpad button pressed.

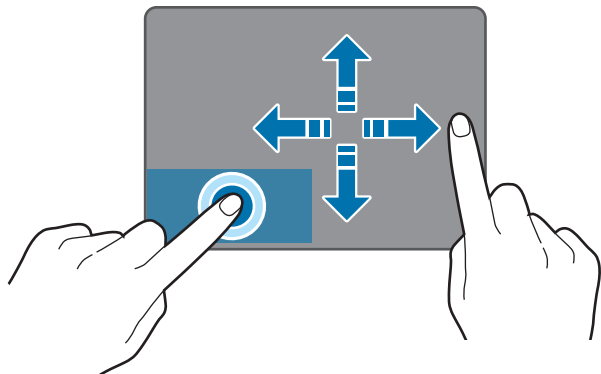

## Gesture functions

### Swiping

- To open the Charms, swipe from the right edge of the touchpad to the middle.

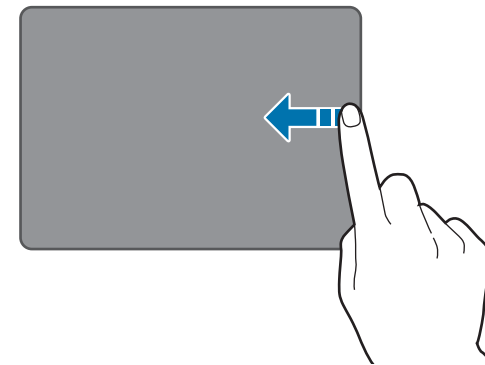

- To open the most-recently used application, swipe from the left edge of the touchpad to the middle.

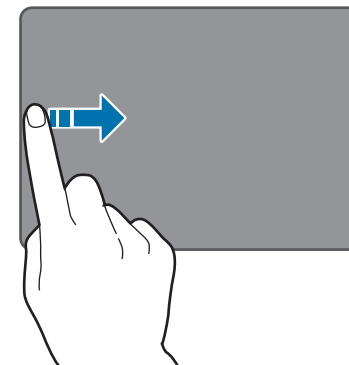

- To scroll up, down, left or right, swipe with two fingers on the touchpad.

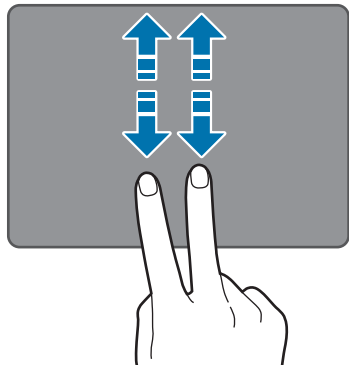

or

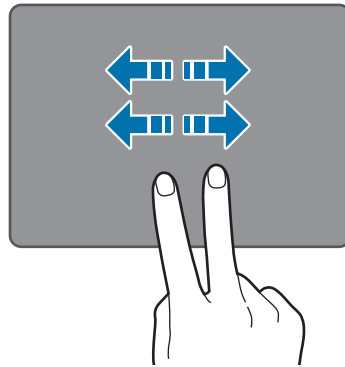

## Pinching

To zoom in, spread two fingers apart on a website, map, or image. Pinch to zoom out.

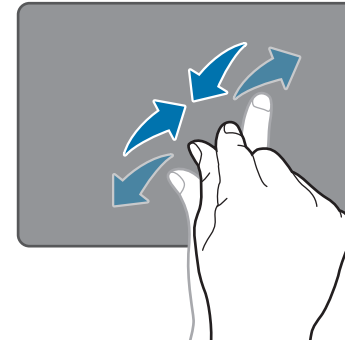

Gesture functions using three or more fingers on the touchpad are not available.

## Configuring touchpad gestures

Configure touchpad gestures to use the touchpad more efficiently.

Open the Charms and then select the **Settings** charm → **Control Panel** → **Hardware and Sound** → **Touchpad** → desired options.

To cancel touchpad gestures, deselect check boxes for the corresponding options in the **Touchpad** window.



Some options in the touchpad settings may not be available depending on the model.

## Touchpad lock

Hold down the **Fn** key and press the **F5** key. You can lock the touchpad.

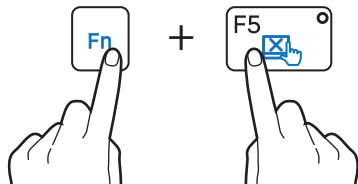

## LCD brightness

Adjust the LCD brightness to reduce eye strain and save power.

### Controlling with keyboard

- To dim the LCD screen, hold down the **Fn** key and press the **F2** key.

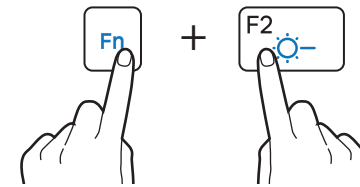

- To brighten the LCD screen, hold down the **Fn** key and press the **F3** key.

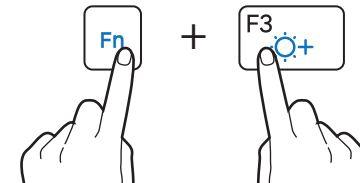

## Controlling with Charms

Open the Charms, select the **Settings** charm → ☰, and drag the slider.

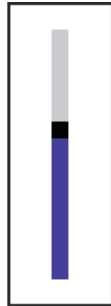

- The LCD screen is set to the brightest level automatically when the AC adapter is connected. The LCD screen gets dimmer automatically when the AC adapter is disconnected to preserve battery power.
- The computer has an automatic screen brightness adjustment to extend the battery usage time. When necessary, the screen brightness is gradually adjusted. To turn off this function, right-click any area on the desktop and set at **Graphics Properties**.

## Changing display mode

Set the optimal conditions for the screen, based on the activity.

- 1 On the **Start** screen, select ⌵.
- 2 Select **Settings**.
- 3 Select **Display** → **Display Color** → an option.
  - **Standard:** Appropriate for normal environments and convenient for most situations.
  - **Movie:** Appropriate for dark surroundings or when watching a movie.
  - **Movie (Bright):** Adjusts colors and brightness for better viewing, particularly for dark scenes in movies.
  - **Dynamic:** Makes scenes more vivid and clear.
  - **Reading mode:** Appropriate for reading documents.
  - **No Effect:** Uses the display defaults.

# Volume

Adjust the system volume or sound volume when playing music or video.

## Controlling with keyboard

- To turn down the volume, hold down the **Fn** key and press the **F7** key.

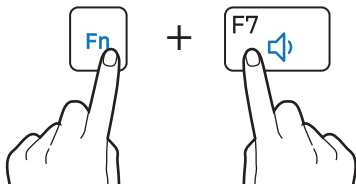

- To turn up the volume, hold down the **Fn** key and press the **F8** key.

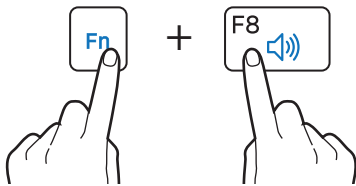

- To mute or unmute the volume, hold down the **Fn** key and press the **F6** key.

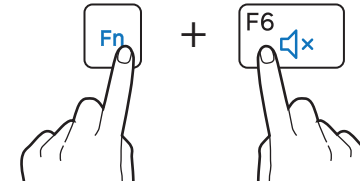

## Controlling with Charms

Open the Charms, select the **Settings** charm → , and drag the slider.

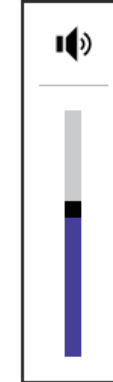



## Setup utility (BIOS)

Define a boot password, change the boot priority, or configure the installed chipsets.



- Incorrect settings may cause the system to malfunction or crash.
- The BIOS setup screens, menus, and items may appear differently depending on the model and BIOS version.
- BIOS setup functions are subject to upgrades.

## Entering the BIOS screen

- 1 Turn on the computer.
- 2 Before the Samsung logo appears, press the **F2** key several times.
  - If the computer is password-protected, press the **F2** key several times before the password screen appears.
  - If the password screen or the Windows start screen appears, restart the computer and try again.

## Learning the BIOS screen

The BIOS setup screen appears as shown below.

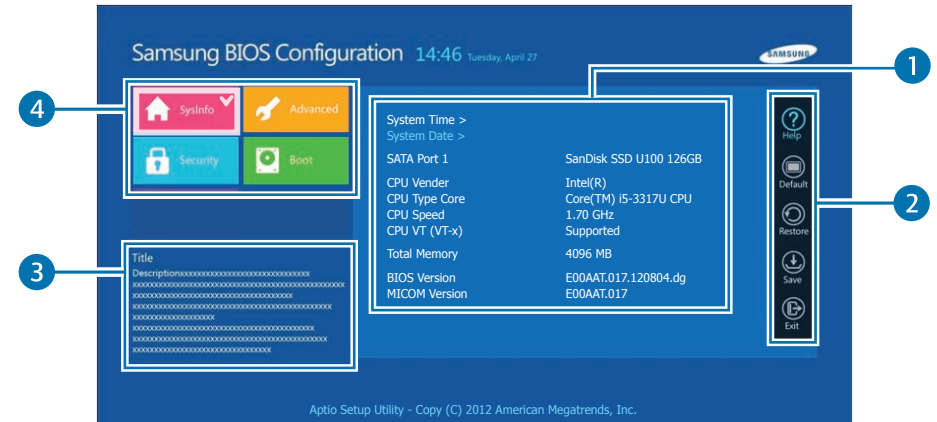

Number	Name
1	<ul style="list-style-type: none"> <li>• Setup items</li> </ul>
2	<ul style="list-style-type: none"> <li>• Setup tools               <ul style="list-style-type: none"> <li>– <b>Help:</b> View the help for BIOS set up.</li> <li>– <b>Default:</b> Return to default settings.</li> <li>– <b>Restore:</b> Cancel changes.</li> <li>– <b>Save:</b> Save settings.</li> <li>– <b>Exit:</b> Exit BIOS setup.</li> </ul> </li> </ul>
3	<ul style="list-style-type: none"> <li>• Help</li> </ul>

Number	Name
4	<ul style="list-style-type: none"> <li>• Setup menu               <ul style="list-style-type: none"> <li>– <b>SysInfo:</b> View the basic specifications of the computer.</li> <li>– <b>Advanced:</b> Configure the chipsets and additional functions.</li> <li>– <b>Security:</b> Configure security functions.</li> <li>– <b>Boot:</b> Configure peripherals and boot-related settings.</li> </ul> </li> </ul>



- The BIOS setup screen appears only in English.
- When using a keyboard, only certain keys will control the BIOS setup screen.

## BIOS setup keys

Key	Description
▲ / ▼	• Change values.
◀ / ▶	• Move to another menu.
Enter	• Select an item or enter a sub-menu.
Space	• Change the slide button.
Esc	• Return to a higher level menu or to the <b>Exit</b> menu.
F1	• View the setup help.
F3	• Load the previous settings.
F9	• Load the default settings.
F10	• Save changes and exit the BIOS setup.

## Boot password

Setting a password with the BIOS enhances protection against viruses and hacking attacks.



- Do not forget your password or expose it to others.
- If you forget the **Supervisor Password** or **HDD Password**, request assistance from the service center. In this case, a service fee will be charged.
- When you forget the **User Password**, disable the **Supervisor Password**, and the **User Password** is also automatically disabled.

## Setting passwords

There are three password settings available; Supervisor Password, User Password, and HDD Password.

- **Supervisor Password** (low security level): This password is required when turning on the computer or attempt to enter the BIOS setup.
- **User Password** (low security level): This password is required to enter the BIOS setup. This password will be deactivated automatically if the Supervisor Password is disabled.
- **HDD Password** (high security level): This password is required to access the hard disk drive (HDD) from another computer. This password may not be supported, depending on the model.

## Setting a boot password

- 1 Turn on the computer.
- 2 Before the Samsung logo appears, press the **F2** key several times.
- 3 Access the **Security** menu.
- 4 Select a password type (**Supervisor Password**, **User Password**, or **HDD Password**).

If you cannot select an item or the **HDD Password Frozen** message appears, restart the computer. Then, press the **F2** key several times before the Samsung logo appears to enter the BIOS setup screen.

- 5 Enter a password and select **Ok**.  
The password can be up to 20 characters.

- 6 Enter the password again to confirm it and select **Ok**.

- 7 Select **Save** → **Yes** to save and restart.



- To enable the **Password on boot** option, set a **Supervisor Password** and enter the password when starting up the computer.
- To change the **HDD Password** after setting it, restart the computer.
- For some models, when the password entered message appears in the Setup Notice window, select **Ok** to complete the setup.

## Removing a password

- 1 Turn on the computer.
  - 2 Before the Samsung logo appears, press the **F2** key several times.
  - 3 Access the **Security** menu.
  - 4 Select a password type (**Supervisor Password**, **User Password**, or **HDD Password**).
  - 5 Enter the current password and select **Ok**.
  - 6 Without entering any characters, select **Ok** → **Ok**.
-  For some models, to cancel the password, select **Cancel** in the Setup Notice window.

## Boot priority

Change the boot priority from the BIOS setup.

- 1 Turn on the computer.
  - 2 Before the Samsung logo appears, press the **F2** key several times.
  - 3 Access the **Boot** menu.
  - 4 Select **Boot Device Priority**.
  - 5 Click an option menu to open the list.
  - 6 Select an option.
  - 7 Select **Save** → **Yes** to save and restart.  
Select **Exit** → **Yes** to restart without saving the changes.
-  To boot to DOS when using a USB device, enter the BIOS setup, select the **Boot** menu, and set the **Fast BIOS Mode** item to **Off**.

## Using the Battery Calibration Function

When charging/discharging the battery repeatedly for a short time only, the battery usage time may be reduced by the difference between the actual battery charge and the remaining charge display.

In this case, the actual battery charge and the remaining charge display will be the same by discharging the battery completely using the Battery Calibration function, and then recharging it again.



The screen images and terms may differ from actual product depending on the computer model and driver version.

- 1 Disconnect the AC power adapter after turning off the computer.
- 2 Turn the computer back on, and press the **F2** key to enter the Setup screen.

- 3 Select **Advanced** → **Smart Battery Calibration**.

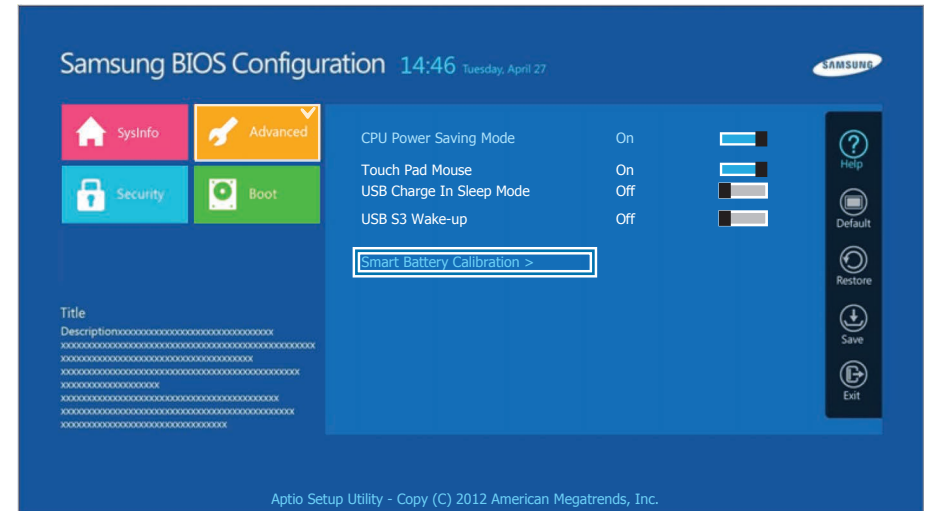

- 4 The Battery Calibration function is activated and the battery is forcefully discharged. To stop the operation, press the **<Esc>** button.

This operation requires 3~5 hours depending on the battery capacity and the remaining battery charge.

# Network & Internet

## Wired LAN

To access the Internet at home, set up an account with an Internet service provider (ISP). To purchase Internet service and a modem, contact a local ISP.



- Some features or procedures may differ depending on the model.
- These descriptions are written for Windows 8.1, so some figures and descriptions may differ from your operating system. Since the procedures for other Windows operating systems are similar, use the computer referring to these descriptions.

## Wired LAN

- 1 Connect a LAN adapter to the wired LAN port of the computer.

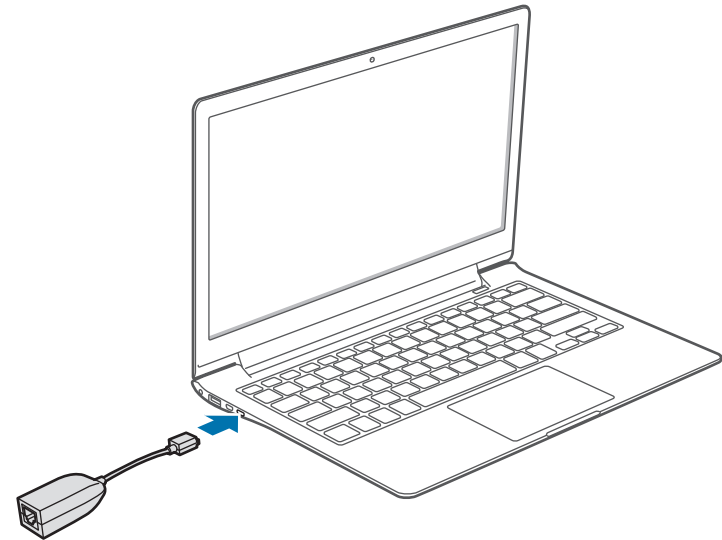

- 2 Connect the LAN cable to the LAN adapter.

- 3 On the desktop, open the Charms and select the **Settings** charm → **Control Panel** → **Network and Internet** → **Network and Sharing Center** → **Change adapter settings**.

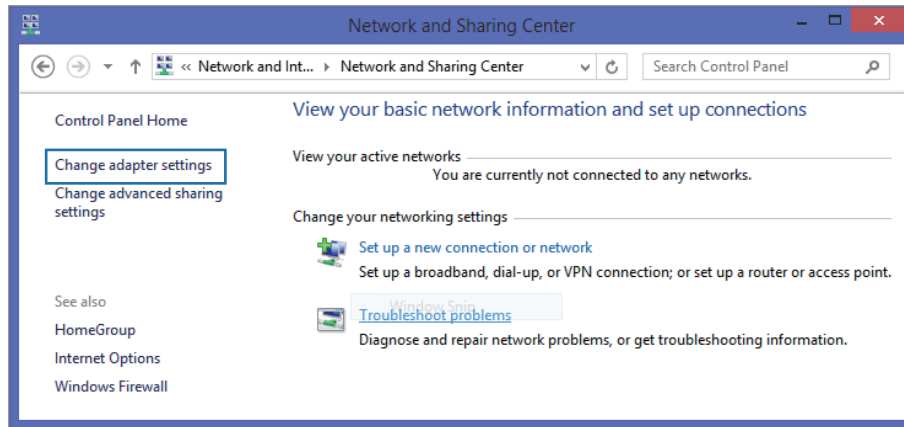

- 4 Right-click **Ethernet** and select **Properties**.  
The LAN device name may differ depending on the computer's network device.

- 5 Select **Internet Protocol Version 4 (TCP/IPv4)** from the list of network settings → **Properties**.

- The Network Component name may differ depending on the operating system installed.

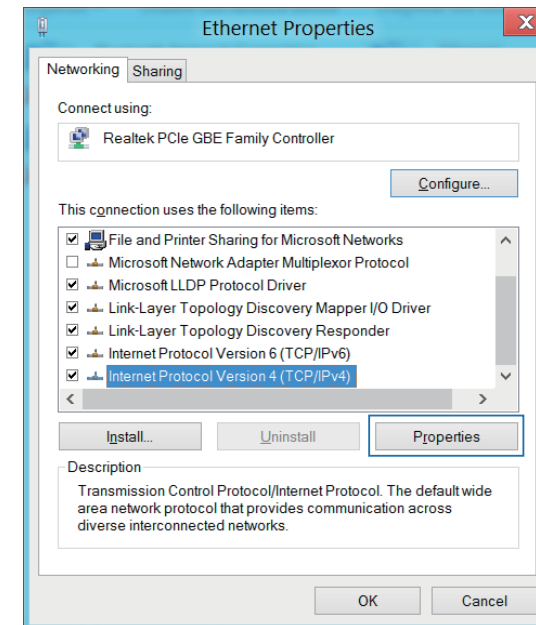

- To add a network item such as a client, service, or protocol, select **Install** under the list of network items.



## 6 Configure the IP settings.

- When using DHCP, select **Obtain an IP address automatically**.
- When not using DHCP, contact the network administrator for the IP address. To use a static IP address, select **Use the following IP address** and set the IP address manually.

## 7 Select **OK** to save the settings.

## Wake on LAN (WOL) feature

Activate the system remotely from sleep mode when a signal, such as a ping or magic packet command, is received via a wired LAN.

- 1 On the desktop, open the Charms and select the **Settings** charm → **Control Panel** → **Network and Internet** → **Network and Sharing Center** → **Change adapter settings**.
- 2 Right-click **Ethernet** and select **Properties**.
- 3 Select **Configure...** → **Power Management** → **Allow this device to wake the computer** → **OK**.
- 4 Restart the computer.
  - If the computer wakes up from sleep mode inadvertently, disable the Wake on LAN feature.
  - This feature may not work while using other power saving features. To disable other sleep functions, select the **Settings** charm → **Control Panel** → **Hardware and Sound** and then set **Power Options**.



- When connected to a 100Mbps/1Gbps wired LAN , a message appears informing the user of connection to a 10Mbps/100Mbps wired LAN when the computer wakes from sleep mode. This happens because restoring the network takes about 3 seconds. When the network is restored, the computer will be connected to the 100Mbps/1Gbps LAN.
- When the system is running on battery power, it may take a few seconds for the connection to be established when connecting a LAN cable. This is the result of power saving features designed to reduce battery consumption.
- When the system is running on battery power, the speed of a wired LAN is decreased automatically to reduce battery consumption. In this case, a 1Gbps/100Mbps LAN would function at the speed of a 100Mbps/10Mbps connection.

## Wireless LAN

Connect the computer to a wireless network to use the Internet.



The descriptions below are for computer models with a Wireless LAN card or device. A Wireless LAN device is optional. The pictures in this manual may differ from the actual product depending on the wireless LAN device model.

## About Access Point (AP)

An Access Point (AP) is a network device that bridges wired and wireless LANs and corresponds to a wireless hub in a wired network. Multiple devices can be connected to an AP.

## Wi-Fi networks

1 Open the Charms and then select **Settings** charm → .

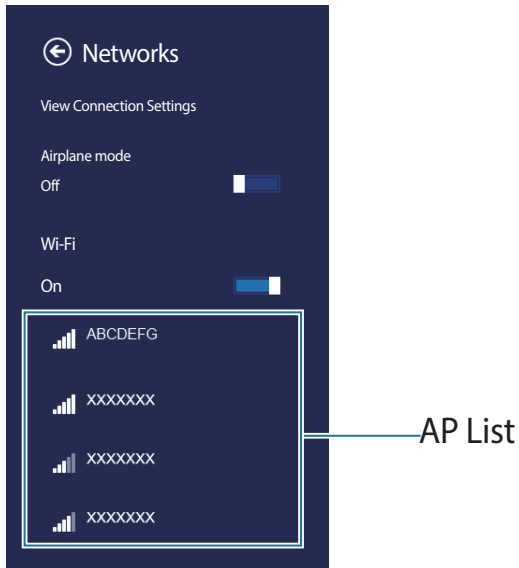

2 Select a network from the list of detected wireless networks → **Connect automatically** → **Connect**.

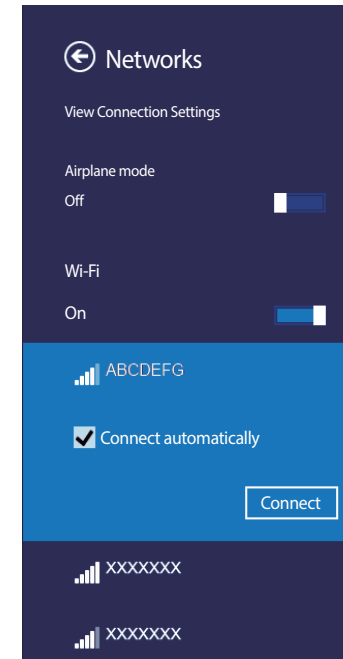

3 Enter a password, if necessary, and select **Next**.  
Once the computer has been connected to a wireless network, it will attempt to connect to it automatically when it is available. For the network key, please ask the network administrator.

## Airplane mode

Airplane mode disables all wireless functions on the computer. Only non-network services are available in Airplane mode.

To turn on Airplane mode, hold down the **Fn** key and press the **F12** key.



- This computer uses a non-harmonized frequency and is intended for use in all European countries. The WLAN can be operated in the EU without restriction indoors, but cannot be operated outdoors.
- Turn off the WLAN feature when not in use to save battery power.

## Mobile broadband (Wireless WAN, optional)

A wireless wide area network (WWAN) is a mobile broadband network that is available in mobile phone service areas.



- The descriptions below are for computer models with mobile broadband devices. A mobile broadband device is optional.
- Contact the Samsung Service Center to receive service for computer models with mobile broadband devices.
- Depending on the version of the operating system, some functions may not be provided or different functions may be provided.
- The pictures in this manual may differ from the actual product depending on your WWAN device model.
- Contact your service provider for inquiries about mobile broadband services.

- You must subscribe first to use mobile broadband services. To learn more, open the Charms and select the **Settings** charm → **Change PC settings** → **View mobile broadband hardware information** under **Wireless**. You can view the IMEI, phone number, and SIM ICC ID information. The carrier serial number can be found on the bottom of the computer (corresponding models only).
- Set a SIM card password for security. Open the Charms and select the **Settings** charm → **Network**, and then touch and hold **Mobile broadband provider**. Select **View connection properties** → **Security** to set the password.

1 Open the Charms and then select **Settings** charm → .

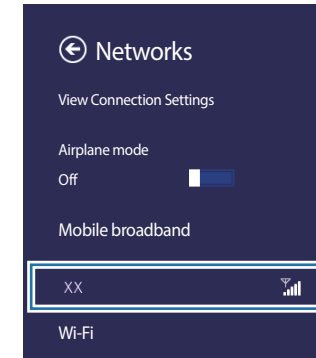

If there are no available network service providers listed under **Mobile broadband**, turn off the computer, and insert the SIM card correctly, and then turn on the computer.

2 Select a carrier name → **Connect**.



Selecting **Connect** overseas will automatically start roaming. In this case, a service fee will be charged.

3 If the **Profile** settings screen appears, follow the on-screen instructions to enter the required information.

When the connection is made, **Connected** appears beside the network name and Internet access is available.

# Applications

## Using applications

Applications include the software that make up the operating system. Windows provides basic applications for frequently-performed tasks.



- Some applications are available only in Windows 8.1 desktop mode.
- Images and features may differ depending on the model and the application version.
- **Third-party software related services**  
For descriptions about and service requests for third-party applications, please contact the relevant manufacturer. Some troubleshooting actions in response to service requests may not work depending on the application manufacturer.
- Applications that are provided by Samsung can be installed from **SW Update**.
- Some applications may not be supported depending on the model.

# Settings

**Settings**, a Samsung integrated settings application, offers various settings functions.



Images and features may differ depending on the model and the application version.

- 1 On the **Start** screen, click  at the lower-left edge, and select **Settings**.
- 2 Select an option to configure the corresponding function.

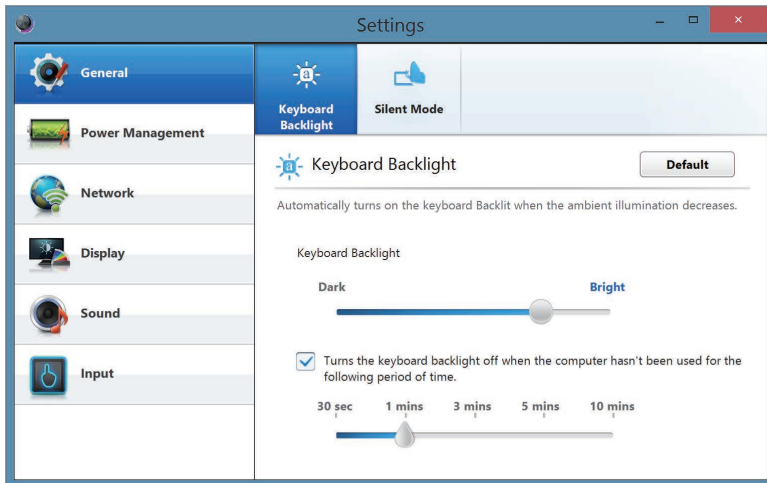

Menu	Description
General	• Set general settings.
Power Management	• Set power related settings.
Network	• Set network functions and settings.
Display	• Set the screen brightness and color.
Sound	• Set sound functions and settings.
Input	• Set input functions and settings.

## Software Update

Install and update Samsung applications and drivers on the computer easily and conveniently. This application enables the user to search for or download the BIOS, drivers, and applications over the Internet. Keep the computer performing better and more stably with **SW Update**.



- To check for available updates, the computer must be connected to the Internet.
- Only applications that have been installed with this application can be updated.
- Images and features may differ depending on the model and the application version.

1 On the **Start** screen, click  at the lower-left edge, and select **SW Update**.

2 Read and agree to the User Agreement.

This step appears only when the application runs for the first time.

3 Select **Install & Update**.

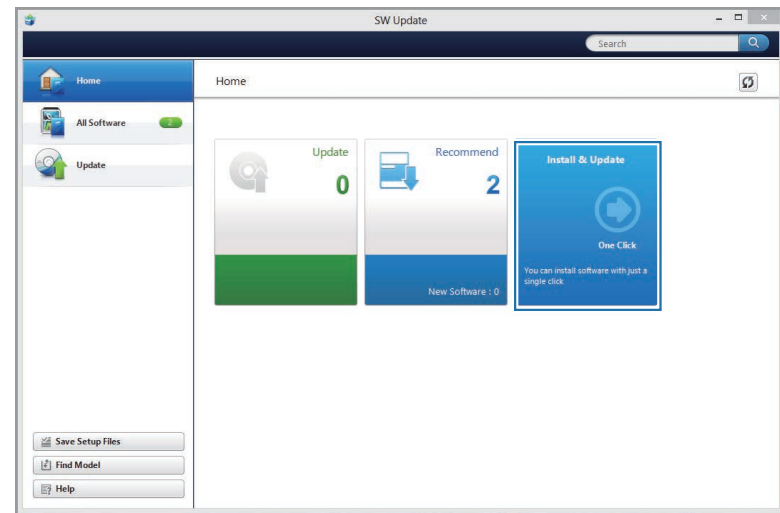

4 Select items to update → **OK**.



# Support Center

Diagnose the performance, security, and status of the computer and fix any problems it may have. Additionally, access the FAQ and search features to find solutions for the problems.



- The **Support Center** application may not be provided or may be a different version depending on the model.
- Images and features may differ depending on the model and the application version.

- 1 On the **Start** screen, click  at the lower-left edge, and select **Support Center**.
- 2 Select **Resolve** to correct the problems.

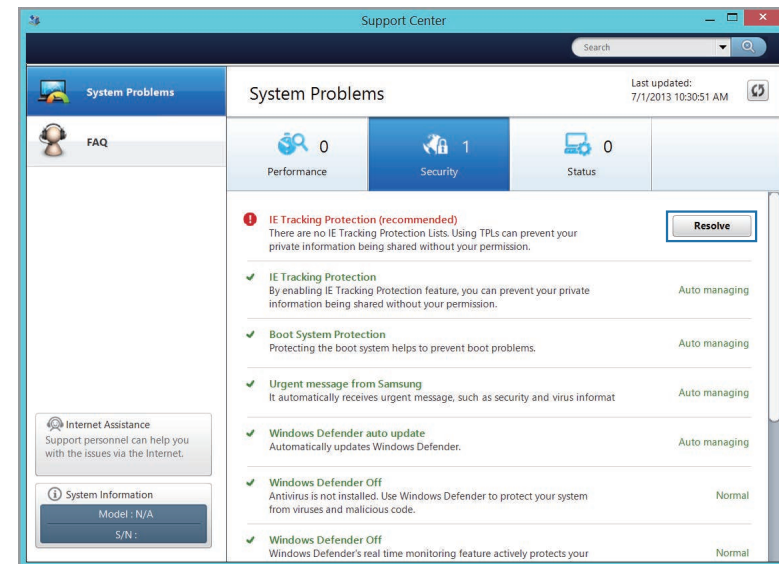

## S Player+

A variety of file types, including multimedia formats, are available with **S Player+**.

1 On the **Start** screen, select **S Player+**.

2 Click to play a file.

Only files in the Video or Music folder are available for playback. Move the selected file to a corresponding folder.



- Move any subtitle files to the Video or Music folder.
- Some files may not be played properly depending on the encoding type.

## Playing another video while playing the current video file

1 Right-click on the screen, or swipe downwards from the top edge.

A list of videos will appear at the top of the screen.

2 Select a video to play.

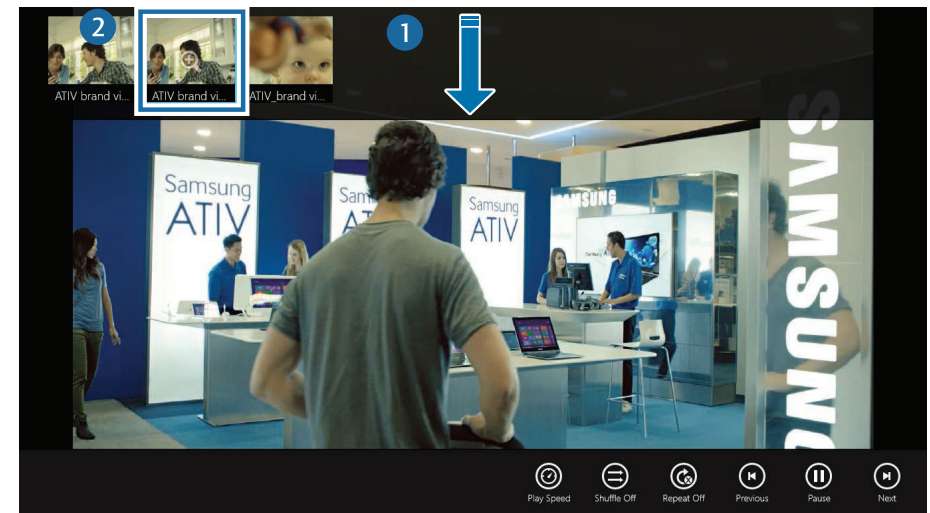

## TPM security solution (optional)

Protect the user's personal information by saving user authentication data on a Trusted Platform Module (TPM) chip installed in the computer. The Trusted Platform Module checks the system integrity and authenticates third-party users who would like to access the security features, while remaining under complete control of its primary user.



- Images and features may differ depending on the model and the application version.
- Refer to the security solution help for more information.
- This function is only supported for models with TPM (security chip).

## Configuring the security solution

To use the TPM security solution, initialize the TPM chip in the BIOS Setup, initialize the TPM solution, and then register a user. To use the TPM function, complete the following steps.

### Step 1: Initializing the TPM chip

When using the TPM solution for the first time or registering a user again, initialize the TPM chip.



- Initializing the TPM chip deletes all authentication data on the chip.
- If the TPM chip is initialized after the security solution is configured, decrypting any existing folders or files that have been encrypted by the security solution may not be possible. Failure to do so may lead to inaccessibility to the folder and files after initialization.

- 1 Turn on the computer.
- 2 Before the Samsung logo appears, press the **F2** key several times.
- 3 Access the **Security** menu.

4 Select **TPM Configuration**.

5 Set **TPM Device** to **Enabled**.



6 Set **TPM State** to **Clear**.

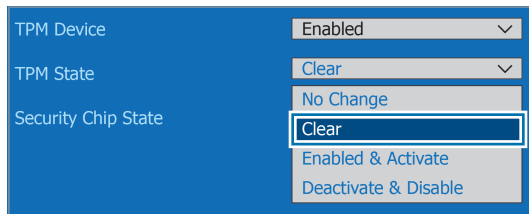

7 Select **Save**.

The computer restarts.

8 When the system reboots, press the corresponding keys by following the on-screen instructions.

9 Before the Samsung logo appears, press the **F2** key several times.

10 On the BIOS setup screen, access the **Security** menu.

11 Select **TPM Configuration**.

12 Set **TPM State** to **Enable and Activate**.

13 Select **Save**.

The computer restarts.

14 When the system reboots, press the corresponding keys by following the on-screen instructions.

15 Select **Save**.

The computer restarts.

## Step 2: Installing the TPM solution

Install the TPM solution according to the procedures below.

 This solution is provided only for models with Recovery and the TPM solution.

1 Run **Recovery** and select **System Software**.

2 Select **System Software Installation**.

3 Select **TPM Host SW** → **Install Now**.

The **SW Update** application will be launched.

 If the system software media is supplied with the product, install the application by using the system software media (only when supplied.)

4 After the installation, select **OK**.

The computer restarts.

## Step 3: Registering a user

Register a user according to the procedures below.

1 On the **Start** screen, click  at the lower-left edge.

2 Select **Manage Security Platform** → **User Settings**.

3 When the initialization wizard appears, select an initialization method → a drive → **Next**.

 • Back up the emergency recovery file to an external storage device according to the instructions of the initialization wizard to use the TPM security device more safely.

• If **Not initialized** pop-up message appears, select **Yes**.



- 4 When the security platform screen appears, select **Next**.
- 5 Select a security platform feature and set a user password.
- 6 Follow the on-screen instructions to complete the registration.  
To use the virtual drive feature, select **Security Platform Features** and then select **Personal Secure Drive (PSD)**.

## Encrypting folders and files

Encrypt folders and files with the Encrypt Files System (EFS). EFS is available for the following operating systems:



- Windows 7 Professional / Windows 7 Enterprise / Windows 7 Ultimate
- Windows 8 Pro / Windows 8 Enterprise
- Windows 8.1

1 Right-click a folder or file and then select **Encrypt**.

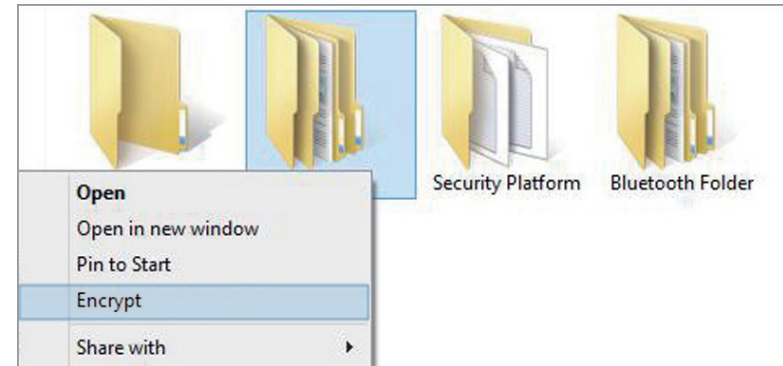

2 Select a security type → **OK**.



3 The color of the encrypted folder or name of the encrypted file changes to green.

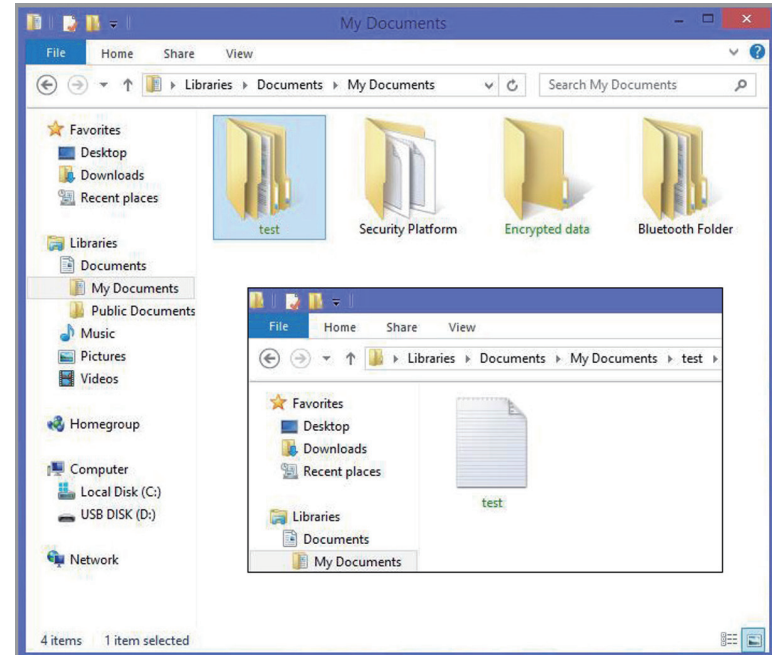

## Opening encrypted folders and files

- 1 Double-click an encrypted folder or a file.
- 2 Enter the basic user password on the user account control window and select **OK**.

## Decrypting folders and files

- 1 Right-click an encrypted folder or file and then select **Decrypt**.
- 2 When the User Account Control window appears, select **Continue**.
- 3 Enter a password and select **OK**.





## Using the virtual drive (Personal Secure Drive)

The virtual drive is a space to save and manage confidential data. In the created virtual drive (PSD), it is possible to create files and folders as with a normal drive and to use confidential data saved on another drive by copying the data to the virtual drive (PSD).

To use the virtual drive, select **Personal Secure Drive (PSD)** when registering the security solution, and then load the virtual drive.

To load a virtual drive,

- 1 On the taskbar, right-click  and select **Personal Secure Drive** → **Load....**

- 2 Enter a password and click **OK**.

- The virtual drive (Personal Secure Drive) is created.
- Note that when copying confidential data to the Personal Security Drive, the original data files are not encrypted.

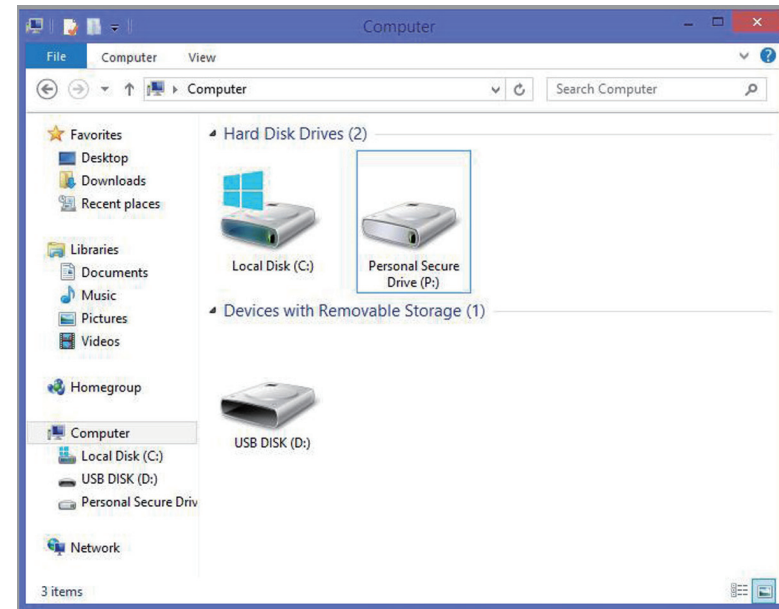

## When the virtual drive (PSD) does not appear

The virtual drive (PSD) is available only when the Personal Secure Drive (PSD) option is selected during the program registration. Complete the following steps to select the Personal Secure Device option from the user settings.

- 1 On the **Start** screen, click  at the lower-left edge.
- 2 Select **Manage Security Platform** → **User Settings**.
- 3 Select **Configure...** under **Security Platform Features**.
- 4 When the initialization wizard appears, select **Personal Secure Drive (PSD)** → **Next**.
- 5 Enter the user password.
- 6 Follow the on-screen instructions to complete the configuration.

## Registering a new user to the security solution

To register an existing user, delete the existing authentication information saved on the TPM chip, and then clear the TPM chip.

Register the user in the following order.

## Step 1: Deleting a virtual drive

If a virtual drive has been created, delete the virtual drive before deleting the existing authentication information saved on the TPM chip.

- 1 On the taskbar, right-click  and select **Personal Secure Drive** → **Create/Manage...**
- 2 Select **Next**.
- 3 Enter the current password and select **Next**.
- 4 Select **Delete selected PSD** → **Next**.
- 5 Select a deletion type and select **Next**.
- 6 Select **Next** → **Finish**.  
The virtual drive is deleted.

## Step 2: Deleting authentication information

To delete the existing authentication information, uninstall the TPM security solution and delete the solution data.

- 1 On the desktop, open the Charms and select the **Settings** charm.
- 2 Select **Control Panel** → **Programs** → **Uninstall a program**.
- 3 Right-click **Infineon TPM Professional Package** → **Uninstall**.
- 4 If the message window appears, select **Yes**.
- 5 If the **Infineon Security Platform** message appears, select **No**.
- 6 On the taskbar, select File Explorer (.

- 7 Select **View** → **Options** → **View** → **Hidden files and folders**.
- 8 Select the **Show hidden files, folders, and drives** option and select **OK**.
- 9 Open the **Computer** window and select **Local disk (C:)** → **ProgramData**.
- 10 Delete the **Infineon** folder.  
The security solution is deleted.

### **Step 3: Configuring the security solution (TPM)**

To use the TPM security solution, see [Configuring the security solution](#).

# External devices

## External CD/DVD drive

This computer supports external CD/DVD drives with USB interfaces (optional). Check if the interface type of the external CD-ROM drive is a USB type.

### Connecting the drive

Connect the drive to the USB port of the computer.

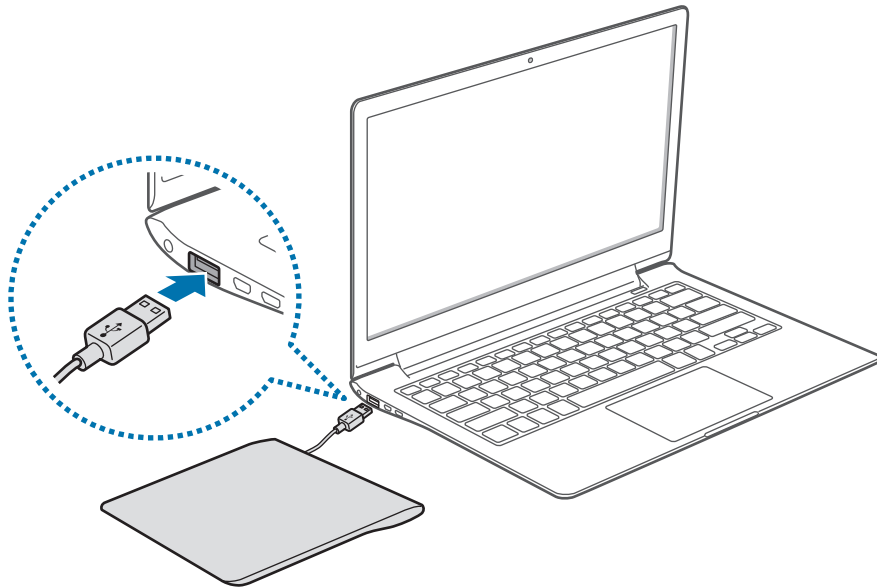

## Inserting and ejecting a CD or DVD

1 Press the Eject button to open the tray.

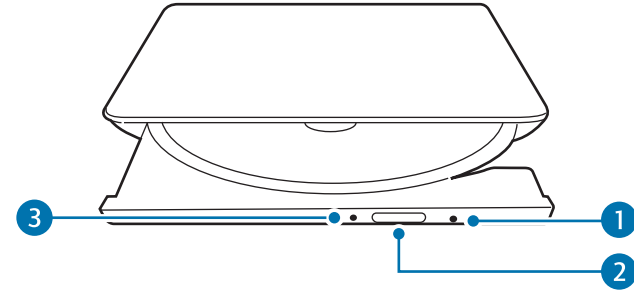

Number	Description
1	• Emergency aperture
2	• Eject button
3	• Status indicator light

2 Insert a CD or DVD.

3 Push the tray inward until it clicks.  
The status indicator turns on.



- Do not insert warped, cracked, or heavily scratched disks. Doing so can damage the drive.
- Do not eject disks while the status indicator light is on.



- Your external drive may differ from the images used in this manual.
- If the drive will not open when the power is off, insert the end of a paper clip (  ) into the emergency aperture to open the tray manually.
- When cleaning a CD or DVD, wipe it with a soft cloth from the inside edge towards the outside edge.
- Reading and writing speeds may differ depending on the condition and type of media.
- A CD or DVD that is not in the shape of a circle is not recommended.

## Memory card

Use a memory card to transfer data to other devices, such as digital cameras or MP3 players. Memory cards are sold separately. Purchase a memory card with the necessary capacity for the requirement.

This computer supports the following types of memory cards.

Abbreviation	Description
SD	• Secure Digital
mini SD	• mini Secure Digital
micro SD	• micro Secure Digital
SDHC	• Secure Digital High Capacity
mini SDHC	• mini Secure Digital High Capacity
micro SDHC	• micro Secure Digital High Capacity
SDXC	• Secure Digital eXtended Capacity
micro SDXC	• micro Secure Digital eXtended Capacity

To use a mini or micro card, insert the card into an adapter before inserting it into the memory card slot.



- Some memory cards may not be fully compatible with the computer. Using an incompatible card may damage the computer or the memory card, or corrupt the data stored in it.
- Use caution to insert the memory card in the indicated direction.
- Store the card separately to prevent losing the card when moving the computer.
- Memory card speeds vary.

## Inserting a memory card

- 1 If a dummy card is inserted in the memory card slot, remove it.
- 2 Insert a memory card into the memory card slot in the indicated direction.

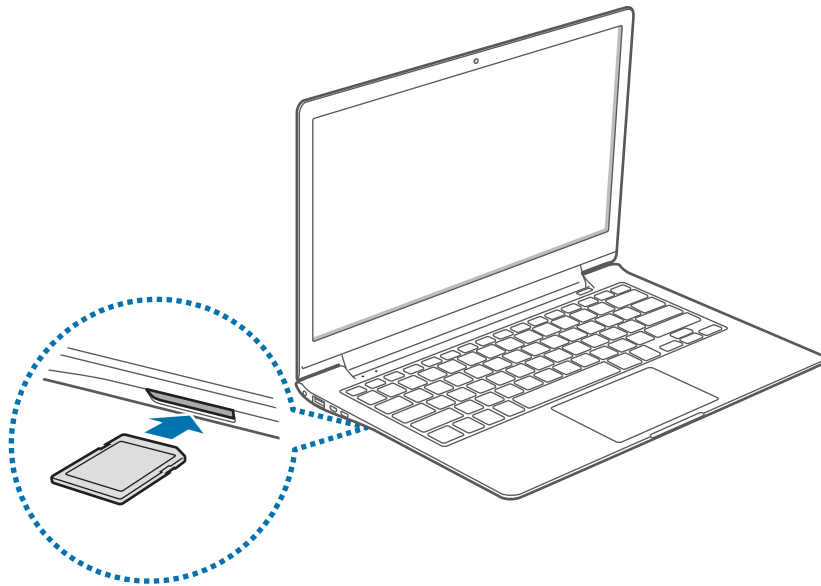

- 3 Select the pop-up message to open the memory card folder.  
If a pop-up message appears, click the corresponding window  
→ **Continue without scanning.**
- 4 Select **Open folder to view files.**
- 5 Save, move, or delete data on the memory card.  
The memory card folder opens only on the desktop.

## Removing a memory card

Grasp the end of the card and pull it out of the slot.



## Formatting a memory card

Format the memory card to remove all data or before using it for the first time.



Formatting a memory card deletes all data saved on the card. If necessary, back up important data before formatting the card.

- 1 On the taskbar, select File Explorer ()
- 2 Right-click the memory card drive, and then select **Format**.
- 3 Select **Start**.



- To use a memory card to exchange data with a digital device, such as a digital camera, formatting the data with the digital device is recommended.
- When trying to use a formatted memory card in another digital device, format the memory card again in the device.
- Inserting and removing a memory card repeatedly may damage the memory card.
- Secure Digital Input Output (SDIO) is not supported.
- If the write-protect tab is in the locked position, you cannot format, write, or delete data on the card.

## External display

Connecting the computer to an external display device can be useful for presentations or when watching a movie. The cables required to connect an external display are sold separately. The computer supports either VGA or micro HDMI cables.

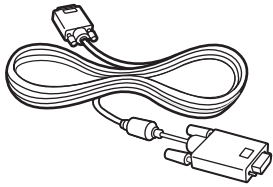

VGA cable

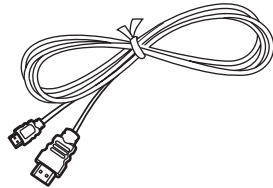

Micro HDMI cable



- Check the available ports on the display device to ensure that it is compatible with the computer.
- If both types of ports are available, the micro HDMI port is recommended for better audio and video quality.
- An external display is not supported when using DOS or the Command Prompt window.
- Simultaneous output to all three (LCD + CRT + HDMI) is not supported depending on the model.

## Connecting to a display

- 1 Connect the VGA cable or micro HDMI cable to the corresponding port of the computer.

When using a VGA cable, connect the VGA adapter to the computer first.



A VGA adaptor is an optional item and may not be provided for some models.

2 Connect the other end of the cable to the D-SUB port or HDMI port of the external display.

If the display has several HDMI ports, connect the cable to the DVI IN port.

<When using a VGA cable>

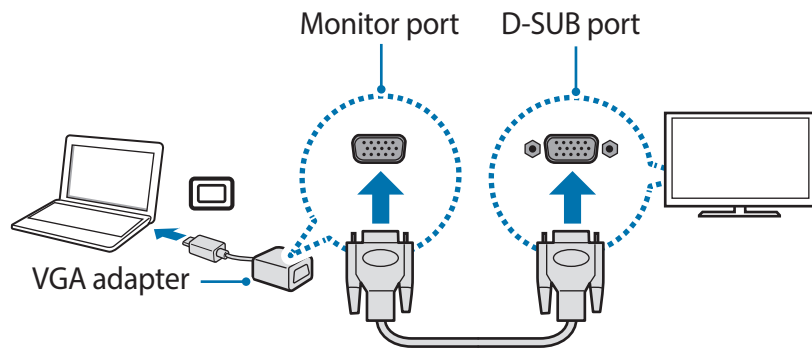

<When using a Micro HDMI cable>

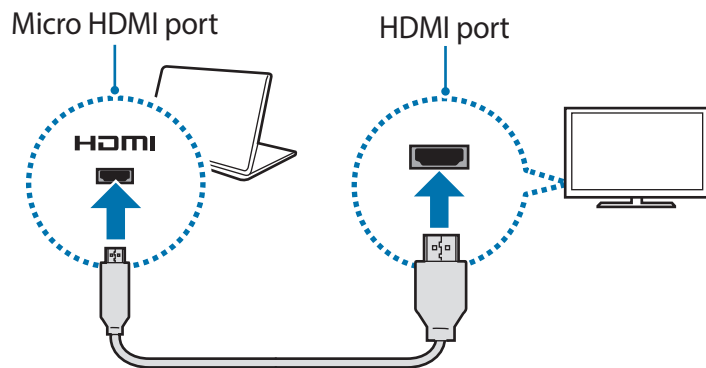





3 Connect the power cord to the external display.

4 Turn on the display and change its display mode to one that supports an external input.

5 On the computer, open the Charms and select the **Devices** charm → **Project** → **Second screen**.

6 Select a mode.

-  **PC screen only:** Show the interface on the computer monitor only.
-  **Duplicate:** Show the interface on both the computer and the external display.
-  **Extend:** Extend the screen to the external display.
-  **Second screen only:** Show the interface only on the external display.

 Alternatively, on the desktop, open the Charms and select the **Settings** charm → **Control Panel** → **Appearance and Personalization** → **Display** → **Change display settings** → **Display** → an option. For more information, refer to OS help.

## Slim security slot

Secure the computer to an object by connecting the security lock (optional) to the security slot. The security slot is designed for Samsung Security Locks only, which are sold separately. Other security locks will not fit in the slot.

Loop the Samsung Security Lock around a secure object and connect it to the security slot on the computer.

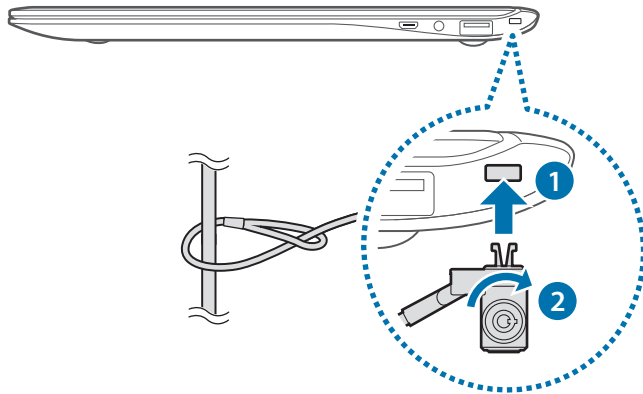

# Troubleshooting

## Recover/Backup

When a problem occurs with the computer, it is possible to easily recover the computer back to the factory default settings by using the **Recovery** application (Recover/Backup). It is also possible to recover the computer to a previously backed up point. Back up important data regularly before a problem occurs with the computer.



- The **Recovery** application may not be provided in models with less than 64 GB of memory. For models with less than 64 GB of memory, recover the computer to the factory default settings by reinstalling Windows.
- Some functions may differ or may be unavailable, depending on the version. Refer to the application's help for more information.
- Run the **Recovery** application with administrator privileges.
- CD/DVD drives are not supported by the **Recovery** application.
- Recovering the computer erases the data or applications saved after a backup point. Therefore, back up important data regularly before a problem occurs with the computer.

## Recovering to factory default

Recover the computer to factory default settings. If necessary, back up important data to an external storage device before restoring the system. See Backing up the current system.

**1 When the computer starts Windows:** On the **Start** screen, click  at the lower-left edge, and select **Recovery**.

**When the computer does not start Windows:** Turn on the computer and press the **F4** key several times before the Samsung logo appears.

## 2 Select **Recover**.

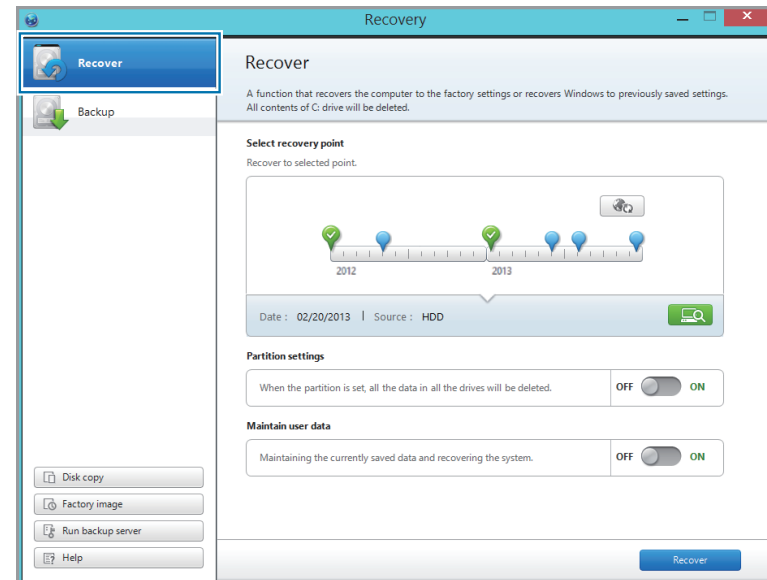

### 3 Select the first point → **Recover**.

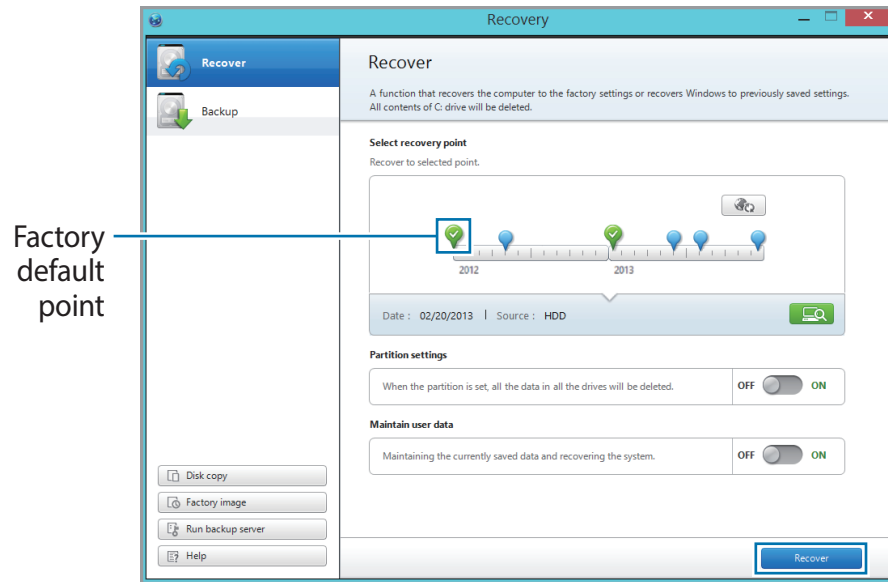

 Set **Maintain user data** to **ON** to recover the computer while maintaining the current user data.

### 4 Follow the on-screen instructions to complete the recovery.

## Backing up the current system

Back up important data to an alternate internal drive or an external storage device regularly to prevent data loss.

- 1 When backing up to an external storage device, connect the device to the computer.
- 2 On the initial Recovery screen, select **Backup**.

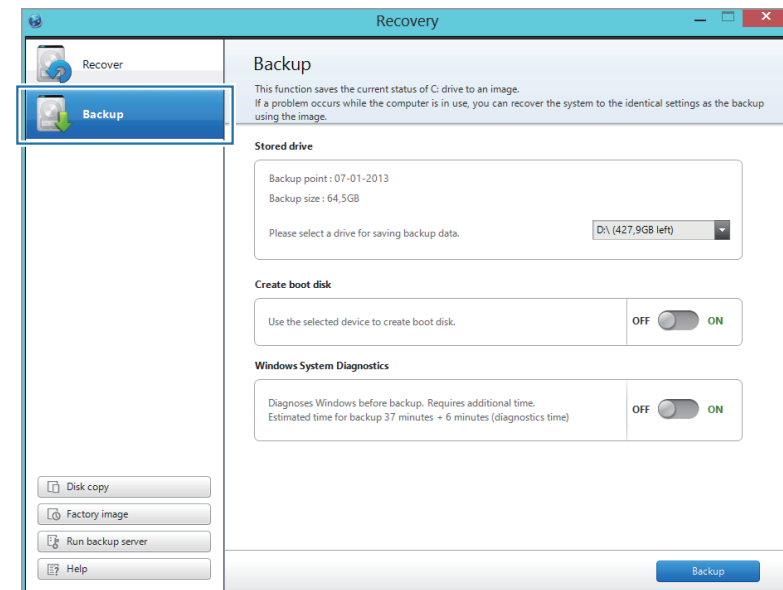

### 3 Select a drive under **Stored drive** → **Backup**.

- When backing up to an external storage device, connect the device to the computer and then select the external drive.
- CD/DVD drive cannot be selected.

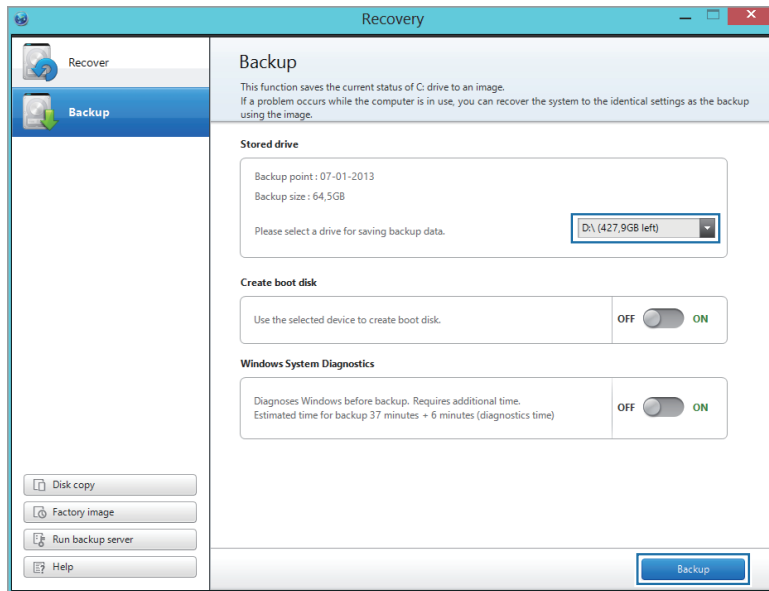

### 4 Follow the on-screen instructions to complete the backup.

## Recovering after a backup

Select a backup point saved on an alternate internal drive or an external storage device to recover the computer to the point.

- 1 When backing up to an external storage device, connect the device to the computer.
- 2 On the **Start** screen, click  at the lower-left edge, and select **Recovery**.
- 3 Select **Recover**.



#### 4 Select a point to recover → **Recover**.

- Select one of your backup points.
- If a backup data is stored on an internal drive, select  → the drive.

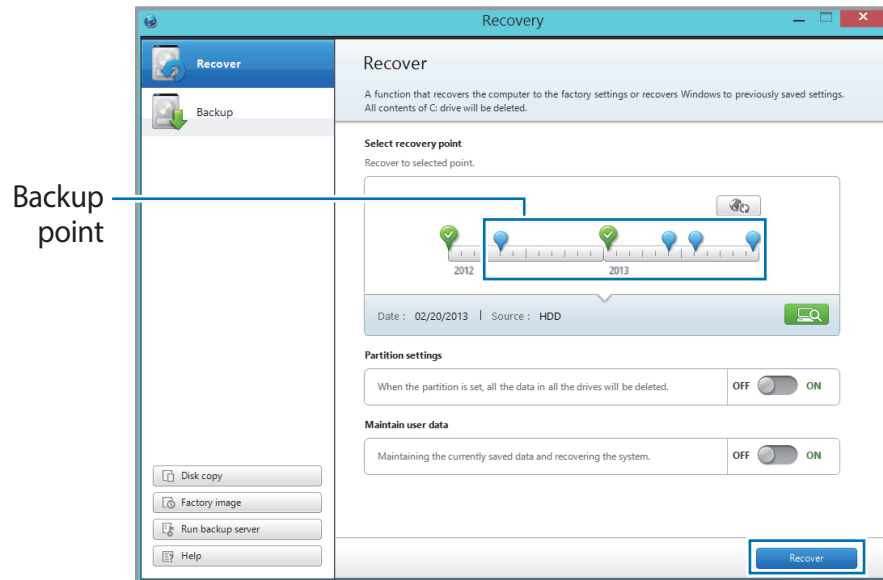

#### 5 Follow the on-screen instructions to complete the restoration.

## Copying the hard drive (making a disk image)

To replace the hard drive, move the data to the new drive by making a disk image. The new drive must be large enough to hold the data from the current drive.

Purchase an external hard drive connector separately to connect the new drive to the computer.

- 1 Connect the new drive to the computer with an external hard drive connector.
- 2 On the **Start** screen, click  at the lower-left edge, and select **Recovery**.
- 3 Select **Disk copy**.

4 Select an option under **Disk recovery point** → **Disk copy**.

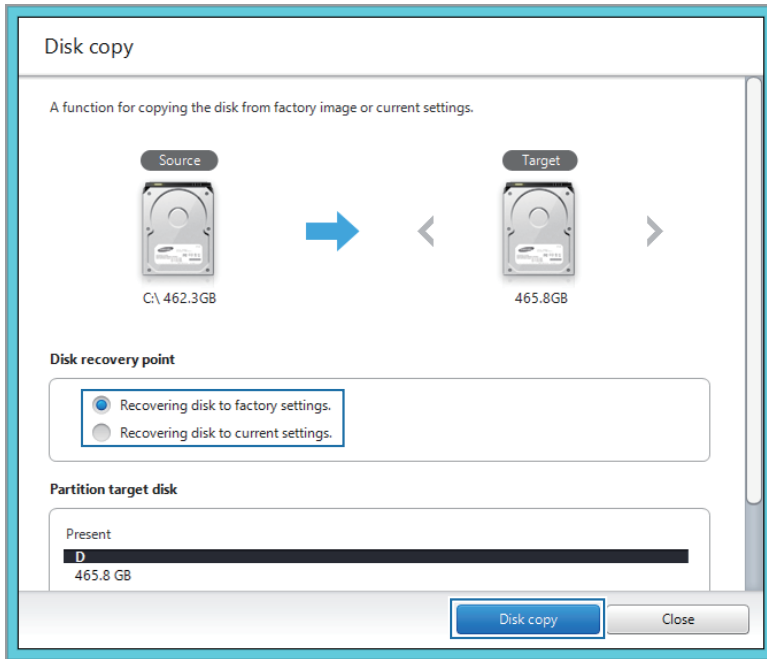

The data on the current hard disk is copied to the new hard disk.

5 After the data is saved to another drive, open the cover at the bottom of the computer and replace the existing drive with the new one.

If the cover is difficult to open, contact the Samsung Service Center to request assistance. You will be charged for this service.

## Making a disk image of factory default settings

Create a factory disk image to simplify the restoring process.

- 1 Connect an external storage device.
- 2 On the **Start** screen, click  at the lower-left edge, and select **Recovery**.
- 3 Select **Factory image**.
- 4 Select an external drive → **Run**.

- 5 Follow the on-screen instructions to complete creating the disk image.

- 6 Disconnect the external storage device and store it in a safe place.

To recover the computer to the factory default settings with the factory image, connect the external storage device. Start the **Recovery** application and select the upper-left **Recover** → factory default point → the lower-right **Recover**.

## Windows recovery function

If the **Recovery** application is not supported by the computer, recover system to factory default settings using the recovery function of Windows.



Reinstalling Windows will erase all data saved on the computer. Back up application and personal data to an external storage device before reinstalling Windows.

**1** Open the Charms and select the **Settings** charm → **Change PC settings** → **Update and recovery** → **Recovery**.

**2** Select **Get Started** under **Remove everything and reinstall Windows**.

Select **Get Started** under **Refresh your PC without affecting your files** to recover the computer while keeping photos, videos, music files, and documents.

**3** Follow the on-screen instructions to proceed with the reinstallation.



After a recovery, on the **Start** screen, click  at the lower-left edge, and select **SW Update** to install the necessary Samsung applications.

## Q&A

When experiencing problems with the computer, try these solutions.

### Windows

#### Where is the Shut down button?

##### Touch screen:

- At the upper-right corner of the **Start** screen, select **Power** (⏻) → **Shut down**.
- Open the Charms and select the **Settings** charm → **Power** → **Shut down**.
- Touch and hold the Start button, and then select **Shut down or sign out** → **Shut down**.

##### Mouse:

- At the upper-right corner of the **Start** screen, select **Power** (⏻) → **Shut down**.
- Open the Charms and select the **Settings** charm → **Power** → **Shut down**.
- Right-click the Start button, and then click **Shut down or sign out** → **Shut down**.

## My application disappeared from the Start screen. How can I correct this?

### Touch screen:

- 1 On the **Start** screen, swipe upward.
- 2 All installed applications will appear.
- 3 Touch and hold an application, and then select **Pin to start**.

### Mouse:

- 1 On the **Start** screen, click  at the lower-left edge to view installed applications.
- 2 Right-click an application, and then select **Pin to start**.

## How can I uninstall an application?

- 1 On the desktop, open the Charms and select the **Settings** charm.
- 2 Select **Control Panel** → **Programs** → **Uninstall a program** → an application → **Uninstall**.  
Alternatively, right-click the Start button, and then select **Programs and Features**.  
Select an application to uninstall → **uninstall**.

## How can I change the screen settings, environment settings, color, and so on?

Configure the lock screen, **Start** screen, and account picture by opening the Charms and selecting the **Settings** charm → **Change PC settings** → **PC and devices**. To configure any other features, on the desktop, open the Charms and select the **Settings** charm → **Control Panel**.

## Why am I unable to run Active X in Internet Explorer when I launch it on the Start screen?

The version of Internet Explorer that appears on the **Start** screen complies with HTML5 web standards, so it does not support Active X. Launch Internet Explorer on the desktop to view websites that require Active X.

## Can I remove Windows 8 or Windows 8.1 and install a different operating system?

To install a different operation system on the computer, change the BIOS settings first. For more information, visit <http://www.samsung.com> → Customer support → Troubleshooting and search for **Windows 8** or **Windows 8.1**.

## How can I start my computer in DOS?

To start the computer in DOS via a USB device:

- 1 Turn on the computer.
- 2 Before the Samsung logo appears, press the **F2** key several times.
- 3 Select the **Boot** menu.
- 4 Set **Fast BIOS Mode** to **Off**.
- 5 Set **Secure boot Control** to **Off**.
- 6 Set **OS Mode Selection** to **CSM mode** and then restart the computer.

## Touch screen resolution

### Text on the screen overlaps or looks small.

If the font size is set too large or small, text may not fit or may not be legible on the screen.

In this case, on the desktop, right-click any area and select **Personalize** → **Display** → an option under **Change the size of all items** → **Apply** → **Sign out now**.

## Recovery

### What is a Recovery Area?

The computer has an additional partition for restoring data or saving backup files (only for models with the **Recovery** application). This partition is called a Recovery Area and it includes a recovery image comprised of the operating system and applications.

### Why is the capacity representation of the hard disk drive (HDD) in Windows different from the product specifications?

The capacity of the storage device (HDD or SSD) of the manufacturer is calculated assuming that 1KB=1,000 Bytes. However, the operating system (Windows) calculates the storage device capacity assuming that 1KB=1,024 Bytes, and therefore the capacity representation of the HDD in Windows is smaller than the actual capacity. The capacity representation in Windows may be smaller than the actual capacity because some applications occupy a certain area of the HDD outside of Windows.

For models with the **Recovery** application, the HDD capacity representation in Windows may be smaller than the actual capacity because the **Recovery** application uses a hidden area of 5-20 GB of the HDD to save the recovery image, and that hidden area is not counted towards the total size available to Windows. The size of the **Recovery** application varies by model.

## **What is a recovery image?**

This refers to specifications about the operating system, drivers, and software that are converted to a data image. It is required to recover the computer and is embedded in the computer's HDD. However, this is not provided for storage devices where the capacity is less than 64 GB, due to their small capacities.

## **How can I recover a computer that does not have the Recovery application?**

Recover the computer with the recovery function provided by Windows. Refer to the Recover Functionality item in the help for more details.



# Appendix

## Product specifications

The system specifications may differ depending on the derived models. For detailed system specifications, refer to the product catalogue.

Item	Specification
CPU	<ul style="list-style-type: none"><li>• Intel Core i5/i7 Processor</li></ul>
Main memory	<ul style="list-style-type: none"><li>• Memory type: DDR3L SDRAM</li></ul>
Storage device	<ul style="list-style-type: none"><li>• SSD</li></ul>
Graphics	<ul style="list-style-type: none"><li>• Intel HD Graphics (Internal)</li></ul>
Operating environment	<ul style="list-style-type: none"><li>• Temperature: -5–40 °C for storage, 10–35 °C when operating</li><li>• Humidity: 5–90 % for storage, 20–80 % when operating</li></ul>
AC/DC rating	<ul style="list-style-type: none"><li>• Input: 100–240 VAC, 50–60 Hz</li><li>• Output: 19 VDC, 2.1 A</li></ul>
PC rating	<ul style="list-style-type: none"><li>• 19 VDC 2.1 A (40 W)</li></ul>



- Optional components may not be provided or different components may be provided depending on the model.
- The system specifications are subject to change without notice.
- The Storage device capacity of a computer in which **Recovery** is installed, is represented as smaller than the product specification.
- Replacement, addition, or upgrade of memory is unavailable for this computer hardware.
- The amount of memory that Windows can use may be smaller than the actual amount of memory available.

## Ergonomic tips

Maintaining a proper posture during computer use is very important to prevent physical injury. Improper or prolonged keyboard use may result in repetitive strain injury. Viewing the monitor screen for extended periods of time may result in eye strain. Therefore, please follow these guidelines carefully when setting up and using the computer.

### Back and neck

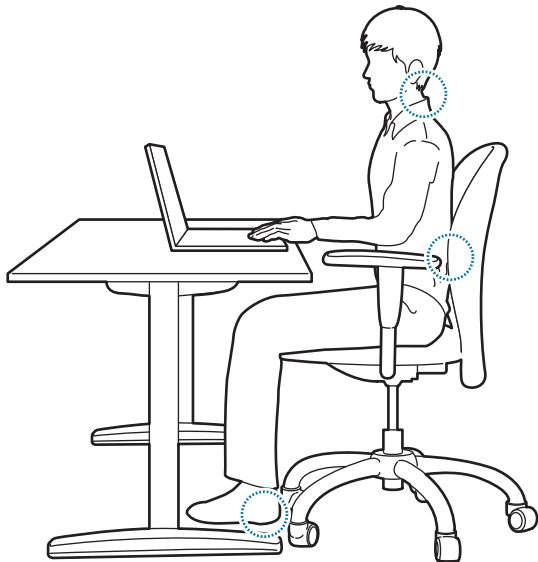

- Use an adjustable chair with firm, comfortable support.
- Adjust the height of your chair so that thighs are horizontal to the floor and feet are flat on the floor.
- The back of the chair should support the lower back. Adjust the backrest to fit your body properly.
- Sit back fully in your chair and straighten the back and neck. Avoid leaning forward or craning your neck toward the computer screen.
- Avoid using the computer while lying down or on your lap. If the computer's temperature increases, there is a danger of burn injury.



- The instructions in this manual have been prepared so that they can be applied to the range of needs of general users. If the user is not included in the range, the recommendations should be applied according to the user's needs.
- Images may differ from actual products.

## Arms and hands

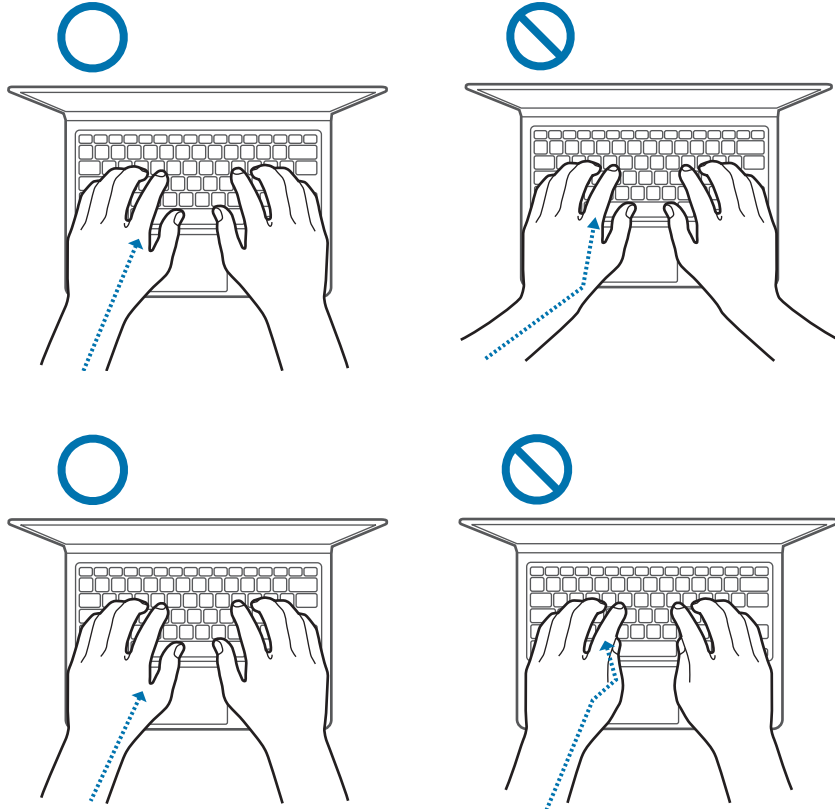

- When using the keyboard and touchpad, the shoulders should be relaxed. The upper arm and forearm should form an angle that is slightly greater than a right angle, with the wrist and hand in almost a straight line.
- Use a light touch when typing or using the touchpad and keep the hands and fingers relaxed. Avoid rolling the thumbs under your palms or supporting the wrists on the desk while typing.
- Use an external keyboard and mouse when using the computer for long periods. When using an external keyboard and mouse, position the devices at the same height as the computer and within comfortable reach.

## Eye position and display illumination



- Position the screen at least 50 cm away from your eyes.
- Adjust the height of the screen so that its top edge is equal to or just below the level of your eyes.
- Avoid setting the screen's brightness settings excessively high.
- Keep the screen clean.
- If wearing glasses, clean them before using the computer.
- When referring to printed content while typing, use a static paper holder to hold the paper at about the same height as the monitor.

## Hearing and volume control

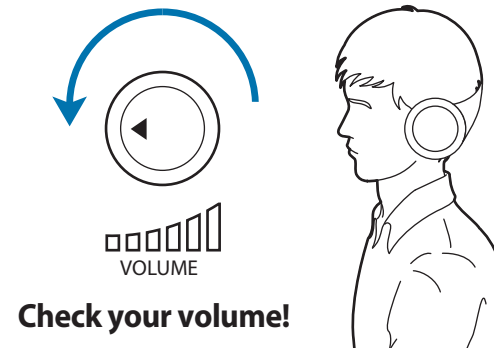

- Ensure that volume is not too loud before using headphones.
- Avoid using headphones for long periods of time.
- Default audio settings can be changed by software and driver updates without your knowledge. Always recheck equalizer and volume settings before listening to audio.
- To prevent possible hearing damage, do not listen at high volume levels for long periods.



## Operating conditions

- Take at least a 10 minute break every hour.
- Avoid using the computer in dark locations. Use the computer with as much ambient light as you would when reading a book.
- Indirect illumination is recommended. Use a curtain to prevent reflections and glare on the screen.
- While operating a computer and talking on the phone, use a headset. Using the computer while holding a phone on your shoulder or with your neck may lead to muscle strain or injury.
- Keep frequently used items within reach.
- Use the computer only within the temperature and humidity ranges specified in this manual.

## Battery

### Charging the battery on an airplane

Power outlets may vary by airplane. Choose the connection method that fits your circumstances.



The power plug and auto adapter figures may differ from the actual products.

### Using an AC power plug

Insert the power plug pins into the center of the power outlet.

- If the pins are not inserted into the centers of the holes, they will not be fully connected. In this case, reconnect the power plug.
- You must insert the power plug when the power indicator light (LED) is lit green. If the plug is connected properly, the power indicator light remains green.

Otherwise, the power indicator light turns off. In this case, disconnect the plug, verify that the power indicator light is green and then reconnect the power plug.

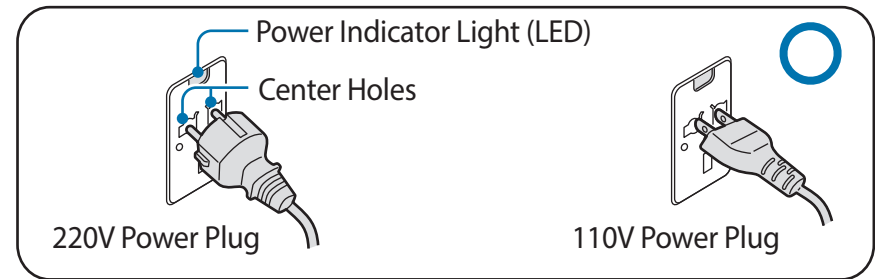

Good Example O

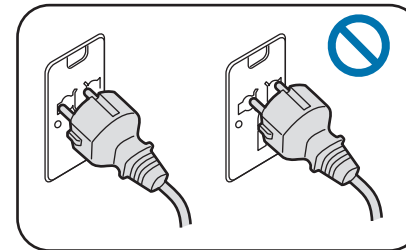

Wrong Example X

## Using an auto adapter

When a 12VDC power supply is available a cigarette lighter socket will be provided. Use the optional auto adapter to use the 12VDC power supply.

- 1 Insert the cigarette lighter plug of the auto adapter into the cigarette lighter socket.
- 2 Connect the DC plug of the auto adapter to the power input port of the computer.

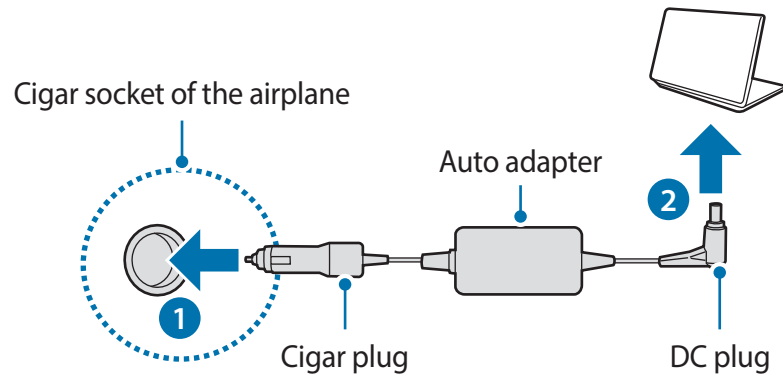

## Using an airplane charging converter

Depending on the type of airplane you are travelling on, use the auto adapter and charging converter. Insert the airplane power input jack into the airplane's power outlet.

- 1 Connect the auto adapter's DC plug to the computer.
- 2 Connect the airplane charging converter (optional) to the auto adapter (optional).
- 3 Insert the airplane power input jack into the power outlet.

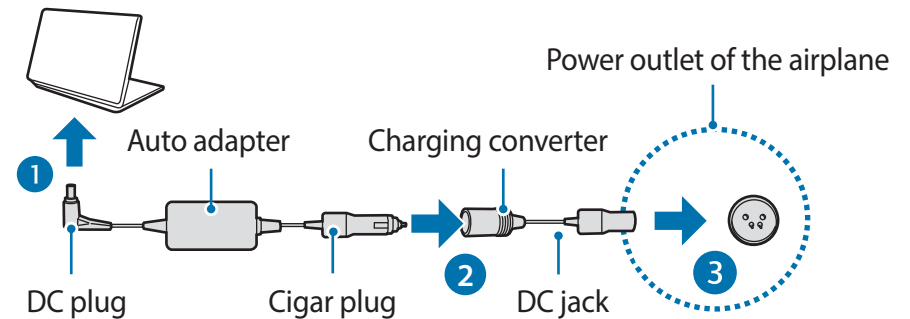

## Safety precautions

This safety information relates to computer use. Some of the content may be not applicable to your computer. To prevent injury or damage to your computer, read the safety information before using it.



- Since this is commonly applied to Samsung Computers, some pictures may differ from actual products.
- The term “product,” as used in this manual, refers to basic components, such as the computer, battery, adapter and optional accessories provided by Samsung.



### Warning

Failure to follow instructions marked with this symbol may cause personal injury and even fatality.

### Installation related

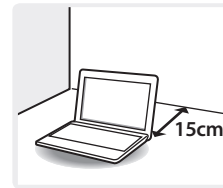

**Keep the computer at least 15 cm away from any object.**

Failure to do so may result in computer malfunction or injury.



**Do not place or use the computer on slanted or vibrating places.**

Failure to do so may result in computer malfunction or damage.



**To avoid danger of suffocation, keep the plastic bag away from infants and children.**

Putting a plastic bag over the head may result in suffocation.



## Power related



The power plug and wall outlet figures may differ depending on the country specifications and the product model.

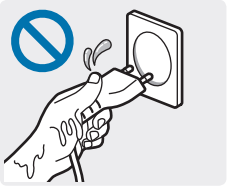

**Handle the power cord with care.**

- Do not touch with wet hands.
- Do not use a damaged or loose power cord.
- Use only specified voltage/capacity.
- Firmly insert the power cable into the AC adapter.
- Do not unplug the power cord by pulling the cable only.
- Unplug the wall-mount AC adapter (adapter and plug integrated type) from the wall outlet while holding the body and pulling it.

Failure to do so may result in electric shock or fire.

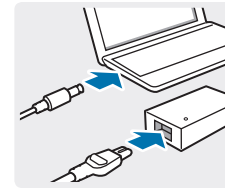
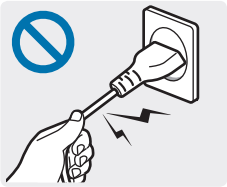
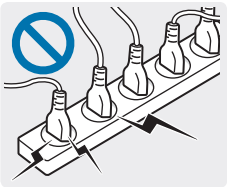

**Connect the power cord to the AC adapter firmly.**

Otherwise, there is a danger of fire due to an incomplete contact.

**Use only the AC adapter supplied with the product.**

Using another adapter may cause the screen to flicker.

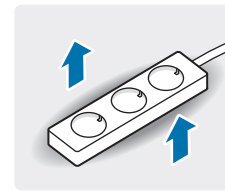

**Use only properly earthed electric sockets or extension cords.**

Connecting to ungrounded electric sockets or extension cords does not protect users from earth faults. Ungrounded electric sockets or extension cords may cause electric shock or fire.



**If water or another substance enters the product, disconnect the power cord and contact the Samsung Service Center. For notebook computers that are provided with an external removable battery, separate the battery also.**

Damage to the device within the computer may cause electric shock or fire.

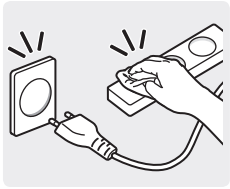

**Keep the power cord or outlet clean with a dry towel so that they are not covered with dust.**

Failure to do so may result in electric shock or fire.

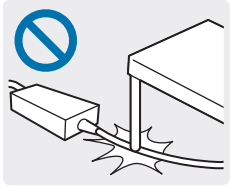

**Do not bend or damage the power cable or the AC adapter with a heavy or sharp-edged object.**

A damaged cable or cord may result in electric shock or fire.

## Battery usage related



**Keep the battery, AC adapter, and the power cord away from infants and pets.**

Failure to do so may result in electric shock or computer malfunction.

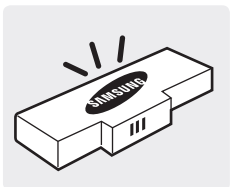

**Use only Samsung-approved battery and AC adapter.**

Batteries or AC adapters that are not approved by Samsung may malfunction from a defective safety device, resulting in an explosion or fire.

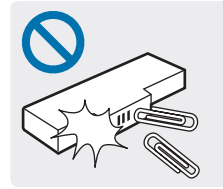

**Take care not to allow metal objects such as a key or clip to touch the battery terminal (metal parts).**

This may cause excessive current and result in fire, burns, or damage to the battery.



**If the product leaks, emits strange odors, or swells, immediately stop using the product and contact the Samsung Service Center.**

Failure to do so may result in an explosion or fire.

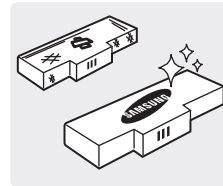

**To use the computer safely, replace a dead battery with a new, authorized battery.**

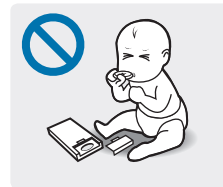

**When removing the real time clock (RTC) battery, keep it away from infants and children.**

If a child swallows the battery, the child may suffocate. If this happens, immediately contact a doctor.

## Usage related



**Do not use the computer on heated floors or electric pads, or on beds, blankets, or cushions that block the ventilation of the computer.**

In these environments, be careful not to block the vent of the computer, which is normally at the side or bottom of the computer. A blocked vent causes the computer to overheat, resulting in an explosion, fire, burns, or computer malfunction.

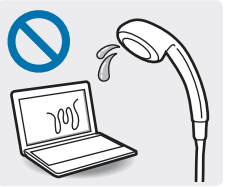

**Do not use the computer in very damp locations such as a bathroom.**

Failure to do so may result in computer malfunction or electric shock. Use the computer within the recommended temperature and humidity range (10–35 °C, 20–80 % RH).



**Never heat the product or put the product into a fire. Do not put or use the product in a hot location such as a sauna, inside a vehicle exposed to heat, and so on.**

There is a danger of explosion or fire.

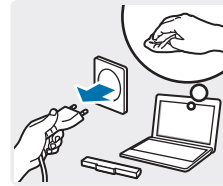

**Before cleaning the computer, disconnect all the cables that are connected to the computer. For notebook computers that are provided with an external removable battery, separate the battery also.**

Failure to do so may result in electric shock or fire.



**Keep the product away from water or liquid.**

Water or liquid entering the computer may cause a short circuit inside the product, resulting in electric shock or fire.



**If the product is dropped or broken, disconnect the power cord and contact the Samsung Service Center. For notebook computers that are provided with an external removable battery, separate the battery also.**

Using a broken computer may result in electric shock or fire.

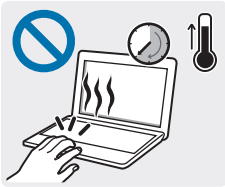

**Do not touch the computer vents or the connected AC adapter for extended periods while the computer is on.**

Contact with the vent or the connected AC adapter for extended periods may result in low-temperature burns, such as redness on the skin.

## Upgrade related



**Do not attempt to upgrade the computer, unless you are qualified.**

Contact the Samsung Service Center or an electrician.

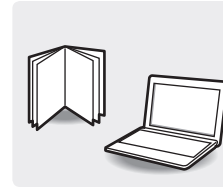

**Follow all instructions as specified in the user manual.**

Do not disassemble any other parts by yourself. Failure to do so may result in computer malfunction, electric shock, or fire.

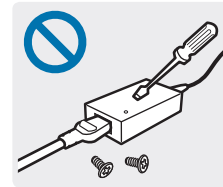

**Do not disassemble the power supply unit, the AC adapter, or the battery under any circumstances.**

Failure to do so may result in electric shock, fire, or an explosion.

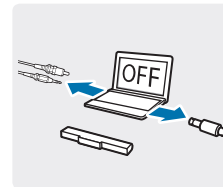

**Shut down the computer and disconnect all cables before disassembling the computer. If the notebook is an external and removable battery type, remove the external battery.**

Failure to do so, may cause electric shock.

## Storage and movement related

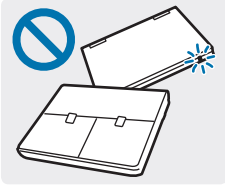

**Do not close the LCD panel and put the computer into a bag to move it when it is still turned on.**

The computer may overheat and there is a danger of fire. Shut the computer down properly before moving it.



**When using wireless communication (LAN, Bluetooth, etc) always follow applicable instructions. For example, airlines and hospitals have strict requirements.**



**Avoid exposing a drive to magnetic fields. Security devices with magnetic fields include airport walk-through devices and security wands. The airport security devices that check carry-on luggage, such as conveyor belts, use x-rays instead of magnetism and will not damage a drive.**

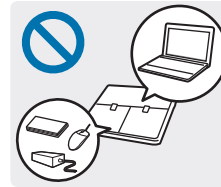

**When carrying the notebook computer with other items, such as the adapter, mouse, books etc, take care not to press anything against the notebook computer.**

If a heavy object is pressed against the notebook computer, a white spot or stain may appear on the LCD. Therefore, take care not to apply any pressure to the notebook.

In this case, place the notebook computer in a separate compartment away from the other objects.

## **Caution**

Failure to follow instructions marked with this symbol may cause slight injury or damage to the product.

### **Installation related**

**Do not block the ports (holes), vents, etc. of the product and do not insert objects.**

Damage to a component within the computer may cause electric shock or fire.

**When using the computer with it lying on its side, place it so that the vents face upwards.**

Failure to do so, may cause the internal temperature of the computer to rise and the computer to malfunction or halt.

**Do not place a heavy object over the product.**

This may cause a problem with the computer. In addition, the object may fall and cause injury, or damage the computer.

**Connect the power cord to a nearer consent when installing the computer.**

If a problem occurs to the computer and disconnection from the consent is delayed, there is a danger of electric shock or fire.

**Dispose of worn-out batteries properly.**

- There is a danger of fire or explosion.
- The battery disposal method may differ depending on your country and region. Dispose of the used battery in an appropriate way.

**Do not throw or disassemble the battery and do not put it into water.**

This may cause an injury, fire or explosion.

**Use only a battery authorized by Samsung.**

Failure to do so may cause an explosion.

**Avoid contact with metal objects such as car keys or clips when keeping or carrying a battery.**

Contact with a metal may cause excessive current and a high temperature and may damage the battery or cause a fire.

**Charge the battery according to the instructions in the manual.**

Failure to do so, may cause an explosion or fire from damage to the product.

**Do not heat the product(or battery) or expose it to heat (e.g. inside a vehicle during the summer).**

There is a danger of explosion or fire.

**Usage related**

**Use the pen for its intended purpose only.**

Using the pen improperly may cause physical injury.

**Do not place a candle, light cigar, etc. over or on the product.**

There is a danger of fire.

**Make sure to have the product tested by a safety service engineer after repairing the product.**

Authorized Samsung Repair Centers will carry out safety checks after a repair. Using a repaired product without testing it for safety may cause an electric shock or fire.

**In case of lightning, immediately turn the system off, disconnect the power cord from the wall outlet and phone line from modem. Do not use a modem or phone.**

There is a danger of electric shock or fire.

**Connect only permitted devices to the connectors or ports of the computer.**

Failure to do so, may cause electric shock and fire.

**Close the LCD panel only after checking if the notebook computer is turned off.**

The temperature may rise and it may cause deformation of the product.

**Do not press the Eject Button while the CD-ROM drive is in operation.**

You might lose data and the disk might be suddenly ejected and could cause an injury.

**Do not drop, hit, or apply excessive force to the computer.**

Failure to do so may result in physical injury or data loss.

**Do not touch the antenna with electricity facility such as the power outlet.**

There is a danger of electric shock.

**When handling computer parts, follow the instructions on the manual supplied with the parts.**

Failure to do so, may cause damage to the product.

**If the computer emits smoke, or there is a burning smell, disconnect the power plug from the wall outlet and contact the Samsung Service Center immediately. If the notebook is external, and removable battery type, remove the external battery.**

There is a danger of fire.

**Do not use a damaged or modified CD.**

There is a danger of damaging the product or personal injury.



**Do not insert the fingers into the PC Card Slot.**

There is a danger of injury or electric shock.

**Use recommended computer cleansing solution when cleaning the product and only use the computer when it is completely dried.**

Failure to do so may cause electric shock or fire.

**Emergency disk eject method using paperclip should not be used while the disk is in motion. Make sure to use the emergency disk eject method only when the Optical Disk Drive has stopped.**

There is a danger of injury.

**Do not place your face close to the Optical Disk Drive tray when it is operating.**

There is a danger of injury due to an abrupt ejection.

**Keep the product away from magnetic fields.**

- Magnetic materials may cause the product malfunction or cause the battery to discharge.
- The magnetism in the computer may damage the information in the magnetic stripe cards such as credit cards.

**Upgrade Related**

**Take care when touching the product or parts.**

The device may be damaged or you may be injured.

**Take care not to throw or drop a computer part or device.**

This may cause injury or damage to the product.

**Make sure to close the computer cover before connecting the power after a reassembly.**

There is a danger of electric shock if your body touches an internal part.

**Use parts authorized by Samsung only.**

Failure to do so, may cause fire or damage the product.

**Never disassemble or repair the product by yourself.**

If the computer serviced or repaired by an unqualified technician, the warranty will not cover the repair fees. There is a danger of accident. Use authorized Samsung Service Centers.

**To connect a device that is not manufactured or authorized by Samsung, enquire at the Samsung Service Center before connecting the device.**

There is a danger of damaging the product.

## **Storage and movement related**

**Properly shut down, disconnect and secure the computer cables before moving it.**

Failure to do so may damage the computer or cause someone to trip over a loose cable.

**For long periods of not using the notebook computer, discharge the battery and preserve as it is detached. (For external and removable battery type)**

The battery will be preserved at its best condition.

**Do not operate or watch the computer while driving a vehicle.**

There is a danger of a traffic accident. Please concentrate on driving.

## **Cautions on preventing data loss (Hard disk management)**

### **Take care not to damage the data on a hard disk drive.**

- A hard disk drive is so sensitive to external impact that an external impact may cause loss of data on the surface of the disk.
- Take extra care, because moving the computer or an impact on the computer when it is turned on may damage the data of the hard disk drive.
- Samsung is not liable for any loss of data on the hard disk drive.

### **Causes that may damage the data of a hard disk drive and the hard disk drive itself.**

- The data may be lost when an external impact is applied to the disk while disassembling or assembling the computer.
- The data may be lost when the computer is turned off or reset by a power failure while the hard disk drive is operating.
- The data may be lost and irrecoverable due to a computer virus infection.
- The data may be lost if the power is turned off while running an application.
- Sudden impact or movement to the computer while the hard disk drive is operating, may cause files to be corrupted or bad sectors on the hard disk.

**To prevent data loss due to damage to the hard disk drive, please back up the data frequently.**

## **LCD bad pixels principle of the computer**

Samsung observes strict specifications regarding the quality and reliability of the LCD. However, there is a small chance that a few pixels may be bad. A large number of bad pixels can cause problems with the display, but a small number of bad pixels does not generally affect computer performance.

Samsung's quality standards for bad pixels are as follows:

- Bright dot: 2 or fewer
- Black dot: 4 or fewer
- Combination (bright and dark): 4 or fewer

## **Cleaning the LCD screen**

Clean the LCD screen with a soft cloth dampened with computer cleansing detergent. When cleaning the screen, move the cloth in one direction. Do not use excessive force. Doing so may damage the LCD screen.

## Important safety information

### Safety instructions

The system is designed and tested to meet the latest standards for safety of information technology equipment. However, to ensure safe use of this product, it is important that the safety instructions marked on the product and in the documentation are followed.



Always follow these instructions to help guard against personal injury and damage to the system.

### Setting up the system

- Read and follow all instructions marked on the product and in the documentation before operating the system. Retain all safety and operating instructions for future use.
- Do not use this product near water or a heat source such as a radiator.
- Set up the system on a stable work surface.
- The product should be operated only with the type of power source indicated on the rating label.
- Ensure that the electrical outlet to power the equipment is easily accessible in case of fire or short circuit.
- If the computer has a voltage selector switch, make sure that the switch is in the proper position for your area.
- Openings in the computer case are provided for ventilation. Do not block or cover these openings. Make sure you provide adequate space, at least 6 inches (15 cm), around the system for ventilation when setting up your work area. Never insert objects of any kind into the computer ventilation openings.

- Ensure that the fan vents on the bottom of the casing are clear at all times. Do not place the computer on a soft surface, doing so will block the bottom vents.
- When using an extension cord with this system, make sure that the total power rating on the products plugged into the extension cord does not exceed the extension cord power rating.
- For Notebooks with glossy display bezels the user should consider the placement of the Notebook as the bezel may cause disturbing reflections from surrounding light and bright surfaces.

### Care during use

- Do not walk on the power cord or allow anything to rest on it.
- Do not spill anything on the system. The best way to avoid spills is to not eat or drink near the system.
- Some products have a replaceable CMOS battery on the system board. There is a danger of explosion if the CMOS battery is replaced incorrectly. Replace the battery with the same or equivalent type recommended by the manufacturer. Dispose of batteries according to the manufacturers instructions. If the CMOS battery requires replacement insure that a qualified technician performs the task.
- When the computer is turned off, a small amount of electrical current still flows through the computer.

To avoid electrical shock, always unplug all power cables, remove the battery and modem cables from the wall outlets before cleaning the system.

- Unplug the system from the wall outlet and refer servicing to qualified personnel if:
  - The power cord or plug is damaged.
  - Liquid has been spilled into the system.
  - The system does not operate properly when the operating instructions are followed.
  - The system was dropped or the casing is damaged.
  - The system performance changes.

## **The instruction on safety operation of the computer**

- 1** When installing and operating devices please refer to safety requirements in the user manual.
- 2** Devices can be used only with the equipment specified in the technical specifications of the devices.
- 3** If any smell of burning or smoke is detected from the computer the unit should be switched off and battery removed. The unit should be checked by a qualified technician before reuse.
- 4** Service and repair of devices should be carried out by authorized service centers.
- 5** Do not allow the portable computer to operate with the base resting directly on exposed skin for extended periods of time. The surface temperature of the base will rise during normal operation (particularly when AC Power is present). Allowing sustained contact with exposed skin can cause discomfort or eventually a burn.

## Replacement parts and accessories

Use only replacement parts and accessories recommended by manufacturer.

 To reduce the risk of fire, use only No. 26 AWG or larger telecommunications line cord.

 Do not use this product in areas classified as hazardous. Such areas include patient care areas of medical and dental facilities, oxygen rich environments, or industrial areas.

## Battery disposal

 Do not put rechargeable batteries or products powered by non-removable rechargeable batteries in the garbage.

Contact the Samsung Service Center for information on how to dispose of batteries that you cannot use or recharge any longer. Follow all local regulations when disposing of old batteries.

 THERE IS RISK OF EXPLOSION IF BATTERY IS REPLACED BY AN INCORRECT TYPE.

DISPOSE OF USED BATTERIES ACCORDING TO THE INSTRUCTIONS.



## Laser safety

All systems equipped with CD or DVD drives comply with the appropriate safety standards, including IEC 60825-1. The laser devices in these components are classified as “Class 1 Laser Products” under a US Department of Health and Human Services (DHHS) Radiation Performance Standard. Should the unit ever need servicing, contact an authorized service location.



- **Laser Safety Note:** Use of controls or adjustments or performance of procedures other than those specified in this manual may result in hazardous radiation exposure. To prevent exposure to laser beams, do not try to open the enclosure of a CD or DVD drive.
- Class 1M laser radiation when operating part is open. Do not view directly with optical instruments.
- Class 3B invisible laser radiation when open. Avoid exposure to the beam.

## Connect and disconnect the AC adapter

The socket-outlet shall be installed near the equipment and shall be easily accessible.

**Do not unplug the power cord by pulling the cable only.**

## Power cord requirements

The power cord set (all plug, cable and AC adapter plug) you received with your computer meets the requirements for use in the country where you purchased your equipment.

Power cord sets for use in other countries must meet the requirements of the country where you use the computer. For more information on power cord set requirements, contact your authorized dealer, reseller, or service provider.

## General requirements

The requirements listed below are applicable to all countries:

- All power cord sets must be approved by an acceptable accredited agency responsible for evaluation in the country where the power cord set will be used.
- The power cord set must have a minimum current capacity of 7A and a nominal voltage rating of 125 or 250 volts AC, as required by each country's power system. (USA only)
- The appliance coupler must meet the mechanical configuration of an EN 60 320/IEC 320 Standard Sheet C7 (or C5) connector, for mating with appliance inlet on the computer.

## Regulatory compliance statements

### Wireless guidance

(If fitted with 2.4G band or 5G band)

Low power, Radio LAN type devices (radio frequency (RF) wireless communication devices), operating in the 2.4GHz/5GHz Band, may be present (embedded) in the notebook system. The following section is a general overview of considerations while operating a wireless device.

Additional limitations, cautions, and concerns for specific countries are listed in the specific country sections (or country group sections). The wireless devices in the system are only qualified for use in the countries identified by the Radio Approval Marks on the system rating label. If the country you will be using the wireless device in, is not listed, please contact your local Radio Approval agency for requirements. Wireless devices are closely regulated and use may not be allowed.

The RF field strength of the wireless device or devices that may be embedded in the notebook are well below all international RF exposure limits as known at this time. Because the wireless devices (which may be embedded into the notebook) emit less energy than is allowed in radio frequency safety standards and recommendations, manufacturer believes these devices are safe for use. Regardless of the power levels, care should be taken to minimize human contact during normal operation.

Some circumstances require restrictions on wireless devices.

Examples of common restrictions are listed on the next page:



- Radio frequency wireless communication can interfere with equipment on commercial aircraft. Current aviation regulations require wireless devices to be turned off while traveling in an airplane. 802.11ABGN (also known as wireless Ethernet or Wi-Fi) and Bluetooth communication devices are examples of devices that provide wireless communication.
- In environments where the risk of interference to other devices or services is harmful or perceived as harmful, the option to use a wireless device may be restricted or eliminated. Airports, Hospitals, and Oxygen or flammable gas laden atmospheres are limited examples where use of wireless devices may be restricted or eliminated. When in environments where you are uncertain of the sanction to use wireless devices, ask the applicable authority for authorization prior to use or turning on the wireless device.
- Every country has different restrictions on the use of wireless devices. Since your system is equipped with a wireless device, when traveling between countries with your system, check with the local Radio Approval authorities prior to any move or trip for any restrictions on the use of a wireless device in the destination country.

- If the system came equipped with an internal embedded wireless device, do not operate the wireless device unless all covers and shields are in place and the system is fully assembled.
- Wireless devices are not user serviceable. Do not modify them in any way. Modification to a wireless device will void the authorization to use it. Please contact the manufacturer for service.
- Only use drivers approved for country in which the device will be used. See the manufacturer System Restoration Kit, or contact the manufacturer's technical support for additional information.

## United States of America

### USA and Canada Safety Requirements and Notices

Do not touch or move antenna while the unit is transmitting or receiving.

Do not hold any component containing the radio such that the antenna is very close to touching any exposed parts of the body, especially the face or eyes, while transmitting.

Do not operate the radio or attempt to transmit data unless the antenna is connected; if not, the radio may be damaged.

#### Use in specific environments:

The use of wireless devices in hazardous locations is limited by the constraints posed by the safety directors of such environments.

The use of wireless devices on airplanes is governed by the Federal Aviation Administration (FAA).

The use of wireless devices in hospitals is restricted to the limits set forth by each hospital.



### **Explosive Device Proximity Warning**

Do not operate a portable transmitter (such as a wireless network device) near unshielded blasting caps or in an explosive environment unless the device has been modified to be qualified for such use.



### **Use On Aircraft Caution**

Regulations of the FCC and FAA prohibit airborne operation of radio-frequency wireless devices because their signals could interfere with critical aircraft instruments.

## **Other wireless devices**

### **Safety notices for other devices in the wireless network:**

Refer to the documentation supplied with wireless Ethernet adapters or other devices in the wireless network.



The Part 15 radio device operates on a non-interference basis with other devices operating at this frequency. Any changes or modification to said product not expressly approved by Intel could void the user's authority to operate this device.

## **Unintentional emitter per FCC Part 15**

This device complies with Part 15 of the FCC Rules. Operation is subject to the following two conditions: (1) this device may not cause harmful interference, and (2) this device must accept any interference received, including interference that may cause undesired operation.



This equipment has been tested and found to comply with the limits for a Class B digital device pursuant to Part 15 of the FCC Rules. These limits are designed to provide reasonable protection against harmful interference in a residential installation. This equipment generates, uses, and can radiate radio frequency energy. If not installed and used in accordance with the instructions, it may cause harmful interference. If this equipment does cause harmful interference to radio or television reception, which can be determined by turning the equipment off and on, the user is encouraged to try to correct the interference by one or more of the following measures:

- Reorient or relocate the receiving antenna.
- Increase the separation between the equipment and receiver.
- Connect the equipment into an outlet on a circuit different from that to which the receiver is connected.
- Consult the dealer or an experienced radio/TV technician for help.

If necessary, the user should consult the dealer or an experienced radio/television technician for additional suggestions. The user may find the following booklet helpful: "Something About Interference."

This is available at FCC local regional offices. Our company is not responsible for any radio or television interference caused by unauthorized modifications of this equipment or the substitution or attachment of connecting cables and equipment other than those specified by our company. The correction will be the responsibility of the user. Use only shielded data cables with this system.

## Intentional emitter per FCC Part 15

(If fitted with 2.4 G band or 5 G band)

Low power, Radio LAN type devices (radio frequency (RF) wireless communication devices), operating in the 2.4 GHz/5 GHz Band, may be present (embedded) in the notebook system. This section is only applicable if these devices are present. Refer to the system label to verify the presence of wireless devices.

Wireless devices that may be in the system are only qualified for use in the United States of America if an FCC ID number is on the system label.

This device is restricted to indoor use due to its operation in the 5.15 to 5.25 GHz frequency range. FCC requires this product to be used indoors for the frequency range 5.15 to 5.25 GHz to reduce the potential for harmful interference to co-channel Mobile Satellite systems. High power radars are allocated as primary users of the 5.25 to 5.35 GHz and 5.65 to 5.85 GHz bands. These radar stations can cause interference with and/or damage this device.

Operation of this device is subject to the following two conditions:

(1) This device may not cause harmful interference, and (2) this device must accept any interference received, including interference that may cause undesired operation of the device.



Wireless devices are not user serviceable. Do not modify them in any way.

Modification to a wireless device will void the authorization to use it. Contact manufacturer for service.

## Health and safety information

### Exposure to Radio Frequency (RF) Signals Certification Information

This product can contain an embedded radio transmitter and receiver. It is designed and manufactured not to exceed the exposure limits for radio frequency (RF) energy set by the Federal Communications Commission (FCC) of the U.S. government. These FCC exposure limits are derived from the recommendations of two expert organizations, the National Council on Radiation Protection and Measurement (NCRP) and the Institute of Electrical and Electronics Engineers (IEEE). In both cases, the recommendations were developed by scientific and engineering experts drawn from industry, government, and academia after extensive reviews of the scientific literature related to the biological effects of RF energy.

Before a new model is available for sale to the public, it must be certified to the FCC that it does not exceed the exposure limit established by the FCC. Evaluation per each model is performed in positions and locations (e.g. at the bottom on the body) as required by the FCC.

For body worn operation, this model meets the FCC RF exposure guidelines when used with Samsung accessory designated for this product. Non-compliance with the above restrictions may result in violation of FCC RF exposure guidelines.

RF exposure or SAR information can viewed on-line at <http://www.fcc.gov/oet/ea/fccid/>. This site uses this product FCC ID number on the outside of the product. Sometimes it may be necessary to remove the battery pack to find number. Once you have the FCC ID number for a particular product, follow the instructions on the website and it should provide RF exposure information or values for typical or maximum SAR for particular product.

For corresponding model only

The Specific Absorption Rate (SAR) is a measure of the rate of absorption of RF energy by the human body expressed in units of watts per kilogram (W/kg). The FCC wireless devices to comply with a safety limit of 1.6 watts per kilogram (1.6W/kg).

SAR level of this device while operating can be well below the maximum value. This is because the device is designed to operate at multiple power levels so as to use only the power required to reach the network. In general, the closer you are to a wireless base station antenna, the lower the power output.



## Canada

### **Unintentional emitter per ICES-003**

This digital apparatus does not exceed the Class B limits for radio noise emissions from digital apparatus as set out in the radio interference regulations of Industry Canada.

### **Intentional emitter per RSS 210**

This device complies with RSS 210 of Industry Canada. Operation is subject to the following two conditions: (1) this device may not cause interference, and (2) this device must accept any interference, including interference that may cause undesired operation of this device.

The term “IC” before the equipment certification number only signifies that the Industry Canada technical specifications were met. To reduce potential radio interference to other users, the antenna type and its gain should be so chosen that the equivalent isotropically radiated power (EIRP) is not more than that required for successful communication. To prevent radio interference to the licensed service, this device is intended to be operated indoors and away from windows to provide maximum shielding. Equipment (or its transmit antenna) that is installed outdoors is subject to licensing.

(If fitted with 2.4G band or 5G band)

Low power, Radio LAN type devices (radio frequency (RF) wireless communication devices), operating in the 2.4GHz/5GHz Band, may be present (embedded) in your notebook system. This section is only applicable if these devices are present. Refer to the system label to verify the presence of wireless devices.

Wireless devices that may be in your system are only qualified for use in Canada if an Industry Canada ID number is on the system label.

When using IEEE 802.11a wireless LAN, this product is restricted to indoor use due to its operation in the 5.15 to 5.25 GHz frequency range. Industry Canada requires this product to be used indoors for the frequency range of 5.15 GHz to 5.25 GHz to reduce the potential for harmful interference to co-channel mobile satellite systems. High power radar is allocated as the primary user of the 5.25 to 5.35 GHz and 5.65 to 5.85 GHz bands. These radar stations can cause interference with and/or damage to this device.

The maximum allowed antenna gain for use with this device is 6dBi in order to comply with the E.I.R.P limit for the 5.25 to 5.35 and 5.725 to 5.85 GHz frequency range in point-to-point operation.

The power output of the wireless device (or devices), which may be embedded in your notebook, is well below the RF exposure limits as set by Industry Canada.

Operation of this device is subject to the following two conditions:

(1) This device may not cause harmful interference, and (2) this device must accept any interference received, including interference that may cause undesired operation of the device.



To prevent radio interference to licensed service, this device is intended to be operated indoors and away from windows to provide maximum shielding. Equipment (or its transmit antenna) that is installed outdoors is subject to licensing.



Wireless devices are not user serviceable. Do not modify them in any way. Modification to a wireless device will void the authorization to use it. Contact manufacturer for service.

## Brazil

Este produto está homologado pela ANATEL, de acordo com os procedimentos regulamentados pela Resolução 242/2000, e atende aos requisitos técnicos aplicados.

Este equipamento opera em caráter secundário, isto é, não tem direito a proteção contra interferência prejudicial, mesmo de estações do mesmo tipo, e não pode causar interferência a sistemas operando em caráter primário.

## European Union

### European Union CE marking and compliance notices

Products intended for sale within the European Union are marked with the Conformité Européene (CE) Marking, which indicates compliance with the applicable Directives and European standards and amendments identified below. This equipment also carries the Class 2 identifier.

The following information is only applicable to systems labeled with the CE mark .

### European Directives

This Information Technology Equipment has been tested and found to comply with the following European directives:

- EMC Directive 2004/108/EC
- Low Voltage Directive 2006/95/EC
- R&TTE Directive 1999/5/EC

### Samsung Electronics (UK) Ltd, Euro QA Lab.

Blackbushe Business Park Saxony Way, Yateley,  
Hampshire GU46 6GG United Kingdom

### European radio approval information (for products fitted with EU-approved radio devices)

This Product is a Notebook computer; low power, Radio LAN type devices (radio frequency (RF) wireless communication devices), operating in the 2.4GHz/5GHz band, may be present (embedded) in your notebook system which is intended for home or office use. This section is only applicable if these devices are present. Refer to the system label to verify the presence of wireless devices.





Wireless devices that may be in your system are only qualified for use in the European Union or associated areas if a CE mark  with a Notified Body Registration Number and the Alert Symbol is on the system label.



The power output of the wireless device or devices that may be embedded in you notebook is well below the RF exposure limits as set by the European Commission through the R&TTE directive. The low band 5.15 - 5.35 GHz is for indoor use only.









See 802.11b and 802.11g restrictions for specific countries or regions within countries under the heading “European Economic Area Restrictions” below.





## EU R&amp;TTE compliance statements



Nation	Description
 <b>Česky[Czech]</b>	Samsung tímto prohlašuje, že tento Notebook PC je ve shodě se základními požadavky a dalšími příslušnými ustanoveními směrnice 1999/5/ES.
 <b>Dansk[Danish]</b>	Undertegnede Samsung erklærer herved, at følgende udstyr Notebook PC overholder de væsentlige krav og øvrige relevante krav i direktiv 1999/5/EF.
 <b>Deutsch[German]</b>	Hiermit erklärt Samsung, dass sich das Gerät Notebook PC in Übereinstimmung mit den grundlegenden Anforderungen und den übrigen einschlägigen Bestimmungen der Richtlinie 1999/5/EG befindet.

Nation	Description
 <b>Eesti[Estonian]</b>	Käesolevaga kinnitab Samsung seadme Notebook PC vastavust direktiivi 1999/5/EÜ põhinõuetele ja nimetatud direktiivist tulenevatele teistele asjakohastele sätetele.
 <b>English</b>	Hereby, Samsung, declares that this Notebook PC is in compliance with the essential requirements and other relevant provisions of Directive 1999/5/EC.
 <b>Español[Spanish]</b>	Por medio de la presente Samsung declara que el Notebook PC cumple con los requisitos esenciales y cualesquiera otras disposiciones aplicables o exigibles de la Directiva 1999/5/CE.

Nation	Description
 <b>Ελληνική</b> [Greek]	ΜΕ ΤΗΝ ΠΑΡΟΥΣΑ Samsung ΔΗΛΩΝΕΙ ΟΤΙ Notebook PC ΣΥΜΜΟΡΦΩΝΕΤΑΙ ΠΡΟΣ ΤΙΣ ΟΥΣΙΩΔΕΙΣ ΑΠΑΙΤΗΣΕΙΣ ΚΑΙ ΤΙΣ ΛΟΙΠΕΣ ΣΧΕΤΙΚΕΣ ΔΙΑΤΑΞΕΙΣ ΤΗΣ ΟΔΗΓΙΑΣ 1999/5/ΕΚ.
 <b>Français</b> [French]	Par la présente Samsung déclare que l'appareil Notebook PC est conforme aux exigences essentielles et aux autres dispositions pertinentes de la directive 1999/5/CE.
 <b>Italiano</b> [Italian]	Con la presente Samsung dichiara che questo Notebook PC è conforme ai requisiti essenziali ed alle altre disposizioni pertinenti stabilite dalla direttiva 1999/5/CE.
 <b>Latviski</b> [Latvian]	Ar šo Samsung deklarē, ka Notebook PC atbilst Direktīvas 1999/5/EK būtiskajām prasībām un citiem ar to saistītajiem noteikumiem.

Nation	Description
 <b>Lietuvių</b> [Lithuanian]	Šiuo Samsung deklaruoja, kad šis Notebook PC atitinka esminius reikalavimus ir kitas 1999/5/EB Direktyvos nuostatas.
 <b>Nederlands</b> [Dutch]	Hierbij verklaart Samsung dat het toestel Notebook PC in overeenstemming is met de essentiële eisen en de andere relevante bepalingen van richtlijn 1999/5/EG.
 <b>Malti</b> [Maltese]	Hawnhekk, Samsung, jiddikjara li dan Notebook PC jikkonforma mal-ħtiājiet essenzjali u ma provvedimenti oħrajn relevanti li hemm fid-Dirrettiva 1999/5/EC.

Nation	Description
 Magyar[Hungarian]	Alulírott, Samsung nyilatkozom, hogy a Notebook PC megfelel a vonatkozó alapvető követelményeknek és az 1999/5/EC irányelv egyéb előírásainak.
 Polski[Polish]	Niniejszym Samsung oświadcza, że Notebook PC jest zgodny z zasadniczymi wymogami oraz pozostałymi stosownymi postanowieniami Dyrektywy 1999/5/EC.
 Português[Portuguese]	Samsung declara que este Notebook PC está conforme com os requisitos essenciais e outras disposições da Directiva 1999/5/CE.
 Slovensko[Slovenian]	Samsung izjavlja, da je ta Notebook PC v skladu z bistvenimi zahtevami in ostalimi relevantnimi določili direktive 1999/5/ES.

Nation	Description
 Slovensky[Slovak]	Samsung týmto vyhlasuje, že Notebook PC spĺňa základné požiadavky a všetky príslušné ustanovenia Smernice 1999/5/ES.
 Suomi[Finnish]	Samsung vakuuttaa täten että Notebook PC tyyppinen laite on direktiivin 1999/5/EY oleellisten vaatimusten ja sitä koskevien direktiivin muiden ehtojen mukainen.
 Svenska[Swedish]	Härmed intygar Samsung att denna Notebook PC står i överensstämmelse med de väsentliga egenskapskrav och övriga relevanta bestämmelser som framgår av direktiv 1999/5/EG.

Nation	Description
Íslenska[Icelandic]	Hér með lýsir Samsung yfir því að Notebook PC er í samræmi við grunnkröfur og aðrar kröfur, sem gerðar eru í tilskipun 1999/5/EC.
 Norsk[Norwegian]	Samsung erklærer herved at utstyret Notebook PC er i samsvar med de grunnleggende krav og øvrige relevante krav i direktiv 1999/5/EF.
Türkiye[Türkçe]	Bu belge ile, Samsung bu Notebook PC'nin 1999/5/EC Yönetmeliğinin temel gerekliliklerine ve ilgili hükümlerine uygun olduğunu beyan eder.

To view the EU Declaration of Conformity for this product (in English only), go to: <http://www.samsung.com/uk/support/main/supportMain.do> or <http://www.samsung.com/uk/support> then search the model number of the product.

If the Declaration of Conformity for the model you are interested in is not available on our web-site, please contact your distributor or below address.

[doc.eu@samsung.com](mailto:doc.eu@samsung.com)

### Manufacturer information

#### **Samsung Electronics Co., Ltd.**

129, Samsung-Ro, Yeongtong-Gu, Suwon-City, Gyeonggi-Do, 443-742, Korea

#### **Samsung Electronics Suzhou Computer Co., Ltd.**

No. 198, Fangzhou Road, Suzhou Industrial Park, Jiangsu Province, 215021, China

Tel: +86-0512-6253-8988

#### **Samsung Electronics Vietnam Co., Ltd.**

Yen Phong 1, I.P Yen Trung Commune, Yen Phong Dist., Bac Ninh Province, Vietnam

For the web or the phone number of the Samsung Service Center, see the Warranty or contact the retailer where you purchased your product.



## European economic area restrictions

### Local restriction of 802.11b/802.11g radio usage

Note to integrator: The following statements on local restrictions must be published in all end-user documentation provided with the system or product incorporating the wireless product.



Due to the fact that the frequencies used by 802.11b/802.11g wireless LAN devices may not yet be harmonized in all countries, 802.11b/802.11g products are designed for use only in specific countries or regions, and are not allowed to be operated in countries or regions other than those of designated use.

As a user of these products, you are responsible for ensuring that the products are used only in the countries or regions for which they were intended and for verifying that they are configured with the correct selection of frequency and channel for the country or region of use. Any deviation from permissible settings and restrictions in the country or region of use could be an infringement of local law and may be punished as such.

The European variant is intended for use throughout the European Economic Area. However, authorization for use is further restricted in particular countries or regions within countries, as follows:

### General

European standards dictate maximum radiated transmit power of 100 mW effective isotropic radiated power (EIRP) and the frequency range 2400 – 2483.5 MHz.

The low band 5.15 - 5.35 GHz is for indoor use only.

## Belgium

For private use outdoors in public spaces, no registration is necessary for distances less than 300 m. For distances greater than 300 m, you must register with the Belgian Institute for Postal services and Telecommunications (BIPT). For commercial use outdoors, you must obtain a license from the BIPT. For registration or licensing, please contact the BIPT.

For other languages, refer to the corresponding manuals.

## France

The low band 5.15 - 5.35 GHz is for indoor use only.

## RF Exposure

### General Statement on RF energy

Your Notebook or Tablet PC contains a transmitter and a receiver. When it is ON, it receives and transmits RF energy. When you communicate with your Notebook or Tablet PC, the system handling your connection controls the power level at which your Notebook or Tablet PC transmits.

### Specific Absorption Rate (SAR) certification information

This Notebook or Tablet PC embedded with wireless WAN or wireless LAN is included a radio transmitter and receiver. It is designed not to exceed the limits for exposure to radio waves recommended by international guidelines. These guidelines were developed by the independent scientific organization ICNIRP and include safety margins designed to assure the protection of all persons, regardless of age and health.

The guidelines use a unit a measurement known as the Specific Absorption Rate, or SAR. The SAR limit for mobile devices is 2.0 W/kg and the highest SAR value for this device when tested at the body was 0.423 W/kg.

As SAR is measured utilizing the devices highest transmitting power the actual SAR of this device while operating is typically below that indicated above. This is due to automatic changes to the power level of the device to ensure it only uses the minimum level required to reach the network.

The World Health Organization has stated that present scientific information does not indicate the need for any special precautions for the use of mobile devices. The note that if you want to reduce your exposure then you can do so by limiting the length of calls to keep the mobile devices away from the head and body.

### **Limiting exposure to radio frequency (RF) fields**

For individuals concerned about limiting their exposure to RF fields, the World Health Organisation (WHO) provides the following advice:

Precautionary measures: Present scientific information does not indicate the need for any special precautions for the use of the Notebook PC. If individuals are concerned, they might choose to limit their own or their children's RF exposure by limiting the length of connections, or using 'hands-free' devices to keep your Notebook PC away from the head and body.

Further information on this subject can be obtained from the WHO home page <http://www.who.int/peh-emf>

WHO Fact sheet 193: June 2000.

## RTC caution

**CAUTION** : Danger of explosion if battery is incorrectly replaced. Replace only with the same or equivalent type recommended by the manufacturer. Discard used batteries according to the Manufacturer's instruction.

## WEEE symbol information



**Correct disposal of this product (Waste Electrical & Electronical Equipment)**

**(Applicable in countries with separate collection systems)**

This marking on the product, accessories or literature indicates that the product and its electronic accessories (for example, charger, headset, USB cable) should not be disposed of with other household waste at the end of their working life.

To prevent possible harm to the environment or human health from uncontrolled waste disposal, please separate these items from other types of waste and recycle them responsibly to promote the sustainable reuse of material resources.

Household users should contact either the retailer where they purchased this product, or their local government office, for details of where and how they can take these items for environmentally safe recycling.

Business users should contact their supplier and check the terms and conditions of the purchase contract. This product and its electronic accessories should not be mixed with other commercial wastes for disposal.

## India only

For more information on safe disposal and recycling visit our website [www.samsung.com/in](http://www.samsung.com/in) or contact our Helpline numbers - 18002668282, 180030008282.

This product is RoHS compliant.



**Correct disposal of batteries in this product  
(Applicable in countries with separate collection systems)**

This marking on the battery, manual or packaging indicates that the batteries in this product should not be disposed of with other household waste at the end of their working life. Where marked, the chemical symbols Hg, Cd or Pb indicate that the battery contains mercury, cadmium or lead above the reference levels in EC Directive 2006/66. If batteries are not properly disposed of, these substances can cause harm to human health or the environment.

To protect natural resources and to promote material re-use, please separate batteries from other types of waste and recycle them through your local, free battery return system.

## USA only



This Perchlorate warning applies only to primary CR (Manganese Dioxide) Lithium coin cells in the product sold or distributed ONLY in California USA.

“Perchlorate Material- special handling may apply, see [www.dtsc.ca.gov/hazardouswaste/perchlorate](http://www.dtsc.ca.gov/hazardouswaste/perchlorate).”

Dispose unwanted electronics through an approved recycler.

To find the nearest recycling location, go to our website:

[www.samsung.com/recyclingdirect](http://www.samsung.com/recyclingdirect)

Or call, (877) 278-0799.

For battery recycling go to [call2recycle.org](http://call2recycle.org); or call 1-877-723-1297.

Warning : This product contains chemicals known to the state of California to cause cancer and reproductive toxicity.

## Samsung package Take-Back program

In partnering with select recyclers, Samsung offers packaging take-back at no cost to you.

Simply call the following number for the locations nearest you.

CRT Processing, LLC

(877) 278-0799

Kathy Severson – Logistics contact

Dispose unwanted electronics through an approved recycler.

To find the nearest recycling location, go to our website:

[www.samsung.com/recyclingdirect](http://www.samsung.com/recyclingdirect) Or call, (877) 278-0799

## TCO certified (for corresponding models only)

**Congratulations! This product is TCO certified for usability and the environment.**



The product you have just purchased carries the TCO Certified label. This means that your computer is designed, manufactured and tested according to some of the strictest performance and environmental criteria in the world. That makes for a high performance product designed with the user in focus and one that also minimizes the impact on the climate and our natural environment.

TCO Certified is a third party verified program, where every product model is tested by an accredited impartial test laboratory. All criteria have been developed by TCO Development in collaboration with scientists, product experts, users as well as manufacturers all over the world.

Here are some of the features offered with this product:

### Usability – Designed for You

- Good visual ergonomics and image quality, ensuring top performance and reduced risk of eye strain. Several requirements within the area of luminance, contrast, resolution and color
- Designed with the option to connect an external display, keyboard and mouse (recommended when working with a notebook or netbook for longer periods)
- Ergonomic keyboard design – for ease of use and good readability
- Fully tested according to rigorous safety standards
- Low Electric and Magnetic field emissions. Low acoustic noise levels

## Environment– Designed for the Planet

- Brand demonstrates corporate social responsibility and has a certified environmental management system (EMAS or ISO 14001)
- Very low energy consumption both in idle- and standby mode, reducing climate impact
- Restrictions on hazardous materials: chlorinated and brominated flame retardants, plasticizers, plastics and heavy metals such as cadmium, mercury, lead and hexavalent chromium (mercury ban and limits on hazardous flame retardants go beyond RoHS compliance)
- Both product and product packaging are designed for recycling
- The brand company offers take-back options

For more information, please visit

*[www.tcodevelopment.com](http://www.tcodevelopment.com)*

TCO Certified – Technology for You and the Planet

TCOF1190 TCO Document Version 2.0



Some content may differ from the computer depending on the region, service provider, software version, or computer model, and is subject to change without prior notice.

