

# **Applications Using the TMS320C6000 Enhanced DMA**

---

*David Bell*
*Digital Signal Processing Solutions*

## **ABSTRACT**

The enhanced direct memory access (EDMA) controller is the backbone of the two-level cache architecture for the TMS320C6000™ DSPs. The EDMA performs:

- cache servicing
- host-port servicing
- user-programmable data transfers

Through proper configuration, EDMA channels can be set up to operate continuously without requiring CPU intervention or reprogramming. This allows the CPU to use its MIPS for data processing, while the EDMA handles data management in the background. Either 16 or 64 channels, plus a Quick DMA (QDMA) register set, are programmable to perform data transfers during CPU operation. EDMA channels and QDMA register sets are useful to transfer data to/from any location in the DSP's memory map. All transfers are synchronized and each channel has a dedicated synchronization event. Note that QDMA transfers are synchronized by the CPU. Each requestor (L2 controller, EDMA channel, HPI) submits a transfer request to be processed by the EDMA. The requests are queued according to priority, with higher priority requests serviced first. Because of the EDMA's structure, transfers requested through different queues (though submitted according to priority) can occur simultaneously. This maximizes the bandwidth available to data transfers and allows for efficient transferring of data without hindering the performance of the cache. EDMA channels are configured in a special on-chip parameter RAM (PaRAM), with the capacity for multiple transfers for a particular channel to be stored in linked-list fashion. Transfer chaining allows EDMA channels to be synchronized by the completion of other channels. Data transferred by the EDMA is either one-dimensional (1-D) or two-dimensional (2-D) for both the source and the destination. The number of dimensions and the synchronization selected determine the method by which the data is transferred. Each of the EDMA channels and the QDMA report completion to a status register available to the CPU. There is a shared interrupt, EDMA\_INT, by which the channels are able to interrupt the CPU for processing. In conclusion, proper configuration of EDMA channels enables servicing of all incoming and outgoing data streams to/from the DSP, without requiring significant processing time by the CPU to manage the transfers. Thus, the CPU is primarily left to focus on data processing. The sample code described in this application report can be downloaded from <http://www.ti.com/lit/zip/SPRA636>.

## **Contents**

<b>1</b>	<b>TMS320C6000 Enhanced DMA Example Applications.....</b>	<b>6</b>
	1.1 Synchronous Background Data Transfers.....	6
	1.2 CPU-Initiated Transfers .....	7

TMS320C6000 is a trademark of Texas Instruments.

Trademarks are the property of their respective owners.

1.3	Host Porting Servicing .....	7
1.4	Cache Servicing .....	7
<b>2</b>	<b>Enhanced DMA Functionality .....</b>	<b>7</b>
2.1	Transfer Request Submission.....	9
2.1.1	L2 Controller Transfer Requests .....	10
2.1.2	HPI Transfer Requests.....	10
2.1.3	EDMA Channel Transfer Requests .....	10
2.2	Transfer Crossbar.....	11
2.2.1	Address Generation/Transfer Logic.....	11
2.3	EDMA Channel Parameters .....	12
2.4	QDMA Parameters .....	17
2.5	Synchronization.....	19
2.5.1	Element/Array Synchronization .....	22
2.5.2	Frame/Block Synchronization.....	22
2.6	Dimensioned Transfers.....	22
2.6.1	1-D Transfers .....	22
2.6.2	2-D Transfers .....	23
2.7	Address Updates.....	23
2.8	Transfer Linking.....	26
2.9	Transfer Chaining.....	27
2.10	C64x DSP Advanced Features .....	28
<b>3</b>	<b>CPU Interrupt Service Routines .....</b>	<b>28</b>
<b>4</b>	<b>Transfer Examples .....</b>	<b>31</b>
4.1	Block Move Examples .....	31
4.2	Subframe Extraction Examples.....	33
4.3	Data Sorting Examples.....	34
4.4	Peripheral Servicing Examples .....	36
4.4.1	Nonbursting Peripherals .....	36
4.4.2	Bursting Peripherals.....	37
4.4.3	Continuous Operation .....	39
4.4.4	Ping-Pong Buffering.....	41
4.5	Endian Mode Considerations.....	44
<b>5</b>	<b>Chip Support Library .....</b>	<b>45</b>
<b>6</b>	<b>Conclusion.....</b>	<b>46</b>
<b>Appendix A</b>	<b>Example Code.....</b>	<b>47</b>
A.1	Block Move.....	47
A.2	Subframe Extraction .....	49
A.3	Sorting.....	52
A.4	Servicing a Non-Bursting Peripheral.....	55
A.5	Servicing a Bursting Peripheral.....	60
A.6	Continuous Operation.....	62
A.7	Ping Pong Buffering.....	67
<b>Appendix B</b>	<b>Element-Synchronized 1-D to 1-D Transfers.....</b>	<b>74</b>
<b>Appendix C</b>	<b>Frame-Synchronized 1-D to 1-D Transfers .....</b>	<b>78</b>
<b>Appendix D</b>	<b>Array-Synchronized 2-D to 2-D Transfer1 .....</b>	<b>82</b>
<b>Appendix E</b>	<b>Block-Synchronized 2-D to 2-D Transfers .....</b>	<b>85</b>

<b>Appendix F</b>	<b>Array-Synchronized 1-D to 2-D Transfers</b>	<b>88</b>
<b>Appendix G</b>	<b>Block-Synchronized 1-D to 2-D Transfers</b>	<b>91</b>
<b>Appendix H</b>	<b>Array-Synchronized 2-D to 1-D Transfers</b>	<b>94</b>
<b>Appendix I</b>	<b>Block-Synchronized 2-D to 1-D Transfers</b>	<b>97</b>

**List of Figures**

Figure 1.	Enhanced DMA Block Diagram	9
Figure 2.	Address Generation/Transfer Logic Block Diagram	11
Figure 3.	Parameter Storage for an EDMA Event	14
Figure 4.	EDMA Options Parameter Register	14
Figure 5.	QDMA Registers	18
Figure 6.	1-D Transfer Data Frame	22
Figure 7.	2-D Transfer Data Block	23
Figure 8.	1-D Transfer With Element Synchronization	24
Figure 9.	2-D Transfer With Array Synchronization	25
Figure 10.	1-D Transfer With Frame Synchronization	25
Figure 11.	2-D Transfer With Block Synchronization	26
Figure 12.	EDMA Linked List of Transfers	26
Figure 13.	C621x/C671x EDMA Interrupt Service Routine	29
Figure 14.	C64x EDMA Interrupt Service Routine	30
Figure 15.	Block Move Diagram	31
Figure 16.	Block Move QDMA Register Parameters	32
Figure 17.	Subframe Extraction	33
Figure 18.	Subframe Extraction QDMA Register Parameters	33
Figure 19.	Data Sorting Example Diagram	34
Figure 20.	Sorting QDMA Register Parameters	35
Figure 21.	McBSP Servicing for Incoming Data	36
Figure 22.	EDMA Register Parameters for Servicing Incoming McBSP Data	37
Figure 23.	Bursting Peripheral	38
Figure 24.	EDMA Register Parameters to Service Peripheral Bursts	39
Figure 25.	Continuous McBSP Servicing by EDMA	40
Figure 26.	EDMA Register Parameters for Continuous McBSP Servicing	40
Figure 27.	Ping-Pong Buffering for McBSP Data	42
Figure 28.	EDMA Parameters for Ping-Pong Buffering	43
Figure 29.	DXR Byte Locations	44
Figure 30.	DRR Byte Locations	44
Figure B–1.	Element-Synchronized 1-D (SUM=00b) to 1-D (DUM=00b)	74
Figure B–2.	Element-Synchronized 1-D (SUM=00b) to 1-D (DUM=01b)	74
Figure B–3.	Element-Synchronized 1-D (SUM=00b) to 1-D (DUM=10b)	74
Figure B–4.	Element-Synchronized 1-D (SUM=00b) to 1-D (DUM=11b)	74

Figure B–5. Element-Synchronized 1-D (SUM=01b) to 1-D (DUM=00b).....	74
Figure B–6. Element-Synchronized 1-D (SUM=01b) to 1-D (DUM=01b).....	75
Figure B–7. Element-Synchronized 1-D (SUM=01b) to 1-D (DUM=10b).....	75
Figure B–8. Element-Synchronized 1-D (SUM=01b) to 1-D (DUM=11b).....	75
Figure B–9. Element-Synchronized 1-D (SUM=10b) to 1-D (DUM=00b).....	75
Figure B–10. Element-Synchronized 1-D (SUM=10b) to 1-D (DUM=01b).....	75
Figure B–11. Element-Synchronized 1-D (SUM=10b) to 1-D (DUM=10b).....	76
Figure B–12. Element-Synchronized 1-D (SUM=10b) to 1-D (DUM=11b).....	76
Figure B–13. Element-Synchronized 1-D (SUM=11b) to 1-D (DUM=00b).....	76
Figure B–14. Element-Synchronized 1-D (SUM=11b) to 1-D (DUM=01b).....	76
Figure B–15. Element-Synchronized 1-D (SUM=11b) to 1-D (DUM=10b).....	77
Figure B–16. Element-Synchronized 1-D (SUM=11b) to 1-D (DUM=11b).....	77
Figure C–1. Frame-Synchronized 1-D (SUM=00b) to 1-D (DUM=00b).....	78
Figure C–2. Frame-Synchronized 1-D (SUM=00b) to 1-D (DUM=01b).....	78
Figure C–3. Frame-Synchronized 1-D (SUM=00b) to 1-D (DUM=10b).....	78
Figure C–4. Frame-Synchronized 1-D (SUM=00b) to 1-D (DUM=11b).....	78
Figure C–5. Frame-Synchronized 1-D (SUM=01b) to 1-D (DUM=00b).....	78
Figure C–6. Frame-Synchronized 1-D (SUM=01b) to 1-D (DUM=01b).....	79
Figure C–7. Frame-Synchronized 1-D (SUM=01b) to 1-D (DUM=10b).....	79
Figure C–8. Frame-Synchronized 1-D (SUM=01b) to 1-D (DUM=11b).....	79
Figure C–9. Frame-Synchronized 1-D (SUM=10b) to 1-D (DUM=00b).....	79
Figure C–10. Frame-Synchronized 1-D (SUM=10b) to 1-D (DUM=01b).....	79
Figure C–11. Frame-Synchronized 1-D (SUM=10b) to 1-D (DUM=10b).....	80
Figure C–12. Frame-Synchronized 1-D (SUM=10b) to 1-D (DUM=11b).....	80
Figure C–13. Frame-Synchronized 1-D (SUM=11b) to 1-D (DUM=00b).....	80
Figure C–14. Frame-Synchronized 1-D (SUM=11b) to 1-D (DUM=01b).....	80
Figure C–15. Frame-Synchronized 1-D (SUM=11b) to 1-D (DUM=10b).....	81
Figure C–16. Frame-Synchronized 1-D (SUM=11b) to 1-D (DUM=11b).....	81
Figure D–1. Array-Synchronized 2-D (SUM=00b) to 2-D (DUM=00b).....	82
Figure D–2. Array-Synchronized 2-D (SUM=00b) to 2-D (DUM=01b).....	82
Figure D–3. Array-Synchronized 2-D (SUM=00b) to 2-D (DUM=10b).....	82
Figure D–4. Array-Synchronized 2-D (SUM=01b) to 2-D (DUM=00b).....	82
Figure D–5. Array-Synchronized 2-D (SUM=01b) to 2-D (DUM=01b).....	83
Figure D–6. Array-Synchronized 2-D (SUM=01b) to 2-D (DUM=10b).....	83
Figure D–7. Array-Synchronized 2-D (SUM=10b) to 2-D (DUM=00b).....	83
Figure D–8. Array-Synchronized 2-D (SUM=10b) to 2-D (DUM=01b).....	83
Figure D–9. Array-Synchronized 2-D (SUM=10b) to 2-D (DUM=10b).....	84
Figure E–1. Block-Synchronized 2-D (SUM=00b) to 2-D (DUM=00b).....	85
Figure E–2. Block-Synchronized 2-D (SUM=00b) to 2-D (DUM=01b).....	85
Figure E–3. Block-Synchronized 2-D (SUM=00b) to 2-D (DUM=10b).....	85
Figure E–4. Block-Synchronized 2-D (SUM=01b) to 2-D (DUM=00b).....	85

Figure E–5. Block-Synchronized 2-D (SUM=01b) to 2-D (DUM=01b)	86
Figure E–6. Block-Synchronized 2-D (SUM=01b) to 2-D (DUM=10b)	86
Figure E–7. Block-Synchronized 2-D (SUM=10b) to 2-D (DUM=00b)	86
Figure E–8. Block-Synchronized 2-D (SUM=10b) to 2-D (DUM=01b)	86
Figure E–9. Block-Synchronized 2-D (SUM=10b) to 2-D (DUM=10b)	87
Figure F–1. Array-Synchronized 1-D (SUM=00b) to 2-D (DUM=00b)	88
Figure F–2. Array-Synchronized 1-D (SUM=00b) to 2-D (DUM=01b)	88
Figure F–3. Array-Synchronized 1-D (SUM=00b) to 2-D (DUM=10b)	88
Figure F–4. Array-Synchronized 1-D (SUM=01b) to 2-D (DUM=00b)	88
Figure F–5. Array-Synchronized 1-D (SUM=01b) to 2-D (DUM=01b)	89
Figure F–6. Array-Synchronized 1-D (SUM=01b) to 2-D (DUM=10b)	89
Figure F–7. Array-Synchronized 1-D (SUM=10b) to 2-D (DUM=00b)	89
Figure F–8. Array-Synchronized 1-D (SUM=10b) to 2-D (DUM=01b)	89
Figure F–9. Array-Synchronized 1-D (SUM=10b) to 2-D (DUM=10b)	90
Figure G–1. Block-Synchronized 1-D (SUM=00b) to 2-D (DUM=00b)	91
Figure G–2. Block-Synchronized 1-D (SUM=00b) to 2-D (DUM=01b)	91
Figure G–3. Block-Synchronized 1-D (SUM=00b) to 2-D (DUM=10b)	91
Figure G–4. Block-Synchronized 1-D (SUM=01b) to 2-D (DUM=00b)	91
Figure G–5. Block-Synchronized 1-D (SUM=01b) to 2-D (DUM=01b)	92
Figure G–6. Block-Synchronized 1-D (SUM=01b) to 2-D (DUM=10b)	92
Figure G–7. Block-Synchronized 1-D (SUM=10b) to 2-D (DUM=00b)	92
Figure G–8. Block-Synchronized 1-D (SUM=10b) to 2-D (DUM=01b)	92
Figure G–9. Block-Synchronized 1-D (SUM=10b) to 2-D (DUM=10b)	93
Figure H–1. Array-Synchronized 2-D (SUM=00b) to 1-D (DUM=00b)	94
Figure H–2. Array-Synchronized 2-D (SUM=00b) to 1-D (DUM=01b)	94
Figure H–3. Array-Synchronized 2-D (SUM=00b) to 1-D (DUM=10b)	94
Figure H–4. Array-Synchronized 2-D (SUM=01b) to 1-D (DUM=00b)	94
Figure H–5. Array-Synchronized 2-D (SUM=01b) to 1-D (DUM=01b)	95
Figure H–6. Array-Synchronized 2-D (SUM=01b) to 1-D (DUM=10b)	95
Figure H–7. Array-Synchronized 2-D (SUM=10b) to 1-D (DUM=00b)	95
Figure H–8. Array-Synchronized 2-D (SUM=10b) to 1-D (DUM=01b)	95
Figure H–9. Array-Synchronized 2-D (SUM=10b) to 1-D (DUM=10b)	96
Figure I–1. Block-Synchronized 2-D (SUM=00b) to 1-D (DUM=00b)	97
Figure I–2. Block-Synchronized 2-D (SUM=00b) to 1-D (DUM=01b)	97
Figure I–3. Block-Synchronized 2-D (SUM=00b) to 1-D (DUM=10b)	97
Figure I–4. Block-Synchronized 2-D (SUM=01b) to 1-D (DUM=00b)	97
Figure I–5. Block-Synchronized 2-D (SUM=01b) to 1-D (DUM=01b)	98
Figure I–6. Block-Synchronized 2-D (SUM=01b) to 1-D (DUM=10b)	98
Figure I–7. Block-Synchronized 2-D (SUM=10b) to 1-D (DUM=00b)	98
Figure I–8. Block-Synchronized 2-D (SUM=10b) to 1-D (DUM=01b)	98
Figure I–9. Block-Synchronized 2-D (SUM=10b) to 1-D (DUM=10b)	99

## List of Tables

Table 1. Data Transfer Requests Priority.....	10
Table 2. EDMA Channel Parameter RAM.....	13
Table 3. EDMA Channel Parameters.....	14
Table 4. EDMA Channel Options Field Values .....	15
Table 5. QDMA Transfer Length.....	18
Table 6. EDMA Channel Synchronization Events (C621x and C671x) .....	19
Table 7. EDMA Channel Synchronization Events (C64x) .....	20
Table 8. Address Update Modes .....	24
Table 9. Possible DMA Source and Destination Addresses for Servicing McBSP0 .....	45

## 1 TMS320C6000 Enhanced DMA Example Applications

The on-chip Enhanced Direct Memory Access (EDMA) Controller is the backbone of the architecture used by the two-level cache architecture TMS320C6000™ DSPs, including the low-cost C621x, C671x, and C64x™ devices and all next-generation C6000™ devices. The EDMA is used to perform synchronous background data transfers, CPU-initiated transfers, host port servicing, and cache servicing.

The *TMS320C6000 Peripherals Reference Guide*, literature number SPRU190, gives a complete description of the EDMA and should be used in conjunction with this application report.

### 1.1 Synchronous Background Data Transfers

Synchronous background data transfers are configurable in a special on-chip parameter RAM (PaRAM). Depending on the device, there are either 16 channels (C621x and C671x devices) or 64 channels (C64x devices) that can be configured in PaRAM, with each channel corresponding to a specific synchronization event to trigger the transfer. The RAM-based structure of the EDMA allows for a great deal of flexibility, in that all channels are orthogonal to one another. Each channel has a complete parameter set and does not rely on shared resources. Once exhausted, the channel parameters may be reloaded with a new set that has been saved in PaRAM through linking.

Each EDMA channel contains the following parameters that must be configured for the transfer to be properly performed:

- Options – transfer configuration settings
- Source address – the memory location from which the elements are transferred
- Destination address – the memory location to which the elements are transferred
- Array/frame count – the number of arrays or frames to be transferred minus 1

TMS320C6000, C6000, and C64x are trademarks of Texas Instruments.

- Element count – the number of elements in an array or frame
- Array/frame index – the offset used to calculate the starting address of each array/frame
- Element index – the spacing between the addresses of elements within a frame
- Count reload – the reload value for the number of elements within a frame
- Link address – the parameter RAM address of the parameters to be loaded upon completion of the current transfer

In order to enable and monitor the status of the EDMA channels, there are several control registers:

- Priority Queue Status Register (PQSR) – a transfer queue monitor to determine transfer activity
- Channel Interrupt Pending Register (CIPR) – indicates that a transfer has completed
- Channel Interrupt Enable Register (CIER) – enables a channel to interrupt the CPU
- Channel Chain Enable Register (CCER) – enables channel to be synchronized by another
- Event Register (ER) – indicates a synchronization event has been received
- Event Enable Register (EER) – enables a channel to be synchronized by its event
- Event Clear Register (ECR) – enables a synchronization event to be cleared
- Event Set Register (ESR) – enables a synchronization event to be set

For details on EDMA registers, see the *TMS320C6000 Peripherals Reference Guide*, literature number SPRU190.

## 1.2 CPU-Initiated Transfers

The CPU may initiate transfers as needed during system operation through a set of memory-mapped registers. The registers are referred to as quick DMA (QDMA) registers because the CPU is able to quickly dispatch a data transfer request without needing to configure a specific EDMA channel. The QDMA is essentially an additional EDMA channel that is synchronized by the CPU. The parameters of the QDMA registers are identical to those of an EDMA channel's parameter set, with the exception that there is no element count reload and no link address.

## 1.3 Host Porting Servicing

Host port servicing is performed without any user intervention. An EDMA channel invisible to the user is set aside for this task and is not configurable. For this reason, host servicing is not discussed in detail in this application report.

## 1.4 Cache Servicing

The level two (L2) cache controller initiates cache servicing by the EDMA. The EDMA services cache misses, data flushes from the cache to its physical memory location, and accesses to noncacheable memory. This functionality is not programmable (with the exception of defining noncacheable memory and configuring portions of L2 as SRAM) and is not discussed in detail in this application report.

The *TMS320C6000 Peripherals Reference Guide* (literature number SPRU190) gives a complete description of the EDMA and should be used in conjunction with this document.

## 2 Enhanced DMA Functionality

The EDMA channels may be configured to access any location in the device's memory map. This includes internal memory, external memories, on-chip peripherals, and external analog front-end (AFE) circuits. Typically the EDMA is used to:

- transfer blocks of data between memory locations
- continuously service a multichannel buffered serial port (McBSP) or AFE
- page program/data from external memory to internal L2 SRAM

All accesses to external memory must go through the external memory interface (EMIF). External memory types that are supported on a C6000 DSP include synchronous DRAM (SDRAM), sync-burst SRAM (SBSRAM), and asynchronous memories. To understand how to configure different memory spaces, see the *TMS320C6000 Peripherals Reference Guide*, literature number SPRU190.

The multichannel buffered serial ports (McBSPs) are the only on-chip peripherals that are likely to require servicing by the EDMA. Each McBSP has a data receive register (DRR), a data transmit register (DXR), a receive-event signal (REVT), and a transmit-event signal (XEVT). The DRR and DXR are memory-mapped registers, and the events are set when data is transferred in to (REVT) or out of (XEVT) the McBSP.

External analog front-end (AFE) circuits predominantly use the asynchronous memory interface of the C6000 DSP. A typical AFE configuration is similar to that of the McBSPs, with data receive and transmit registers, along with read and write synchronization event signals. The event signals are connected to the C6000 DSP through external interrupts (EXT\_INT[7:4]).

Internal memory is divided into two levels: level 1 (L1) and level 2 (L2). L1 consists of separate program and data caches. These caches are always enabled and are not accessible by the EDMA. An L1 cache miss requests servicing directly from the L2 cache controller. Each L1 cache has a dedicated port to the L2 memory.

L2 is a unified memory space for both program and data. It can be configured as either memory-mapped SRAM or cache, or a combination of the two. For all portions of L2 configured as cache, the EDMA only accesses the memory block to service a cache miss or to flush data from the cache to its physical memory location. For all portions of L2 configured as SRAM, the EDMA accesses the memory to transfer data or program sections. A block diagram of the EDMA is shown in Figure 1.



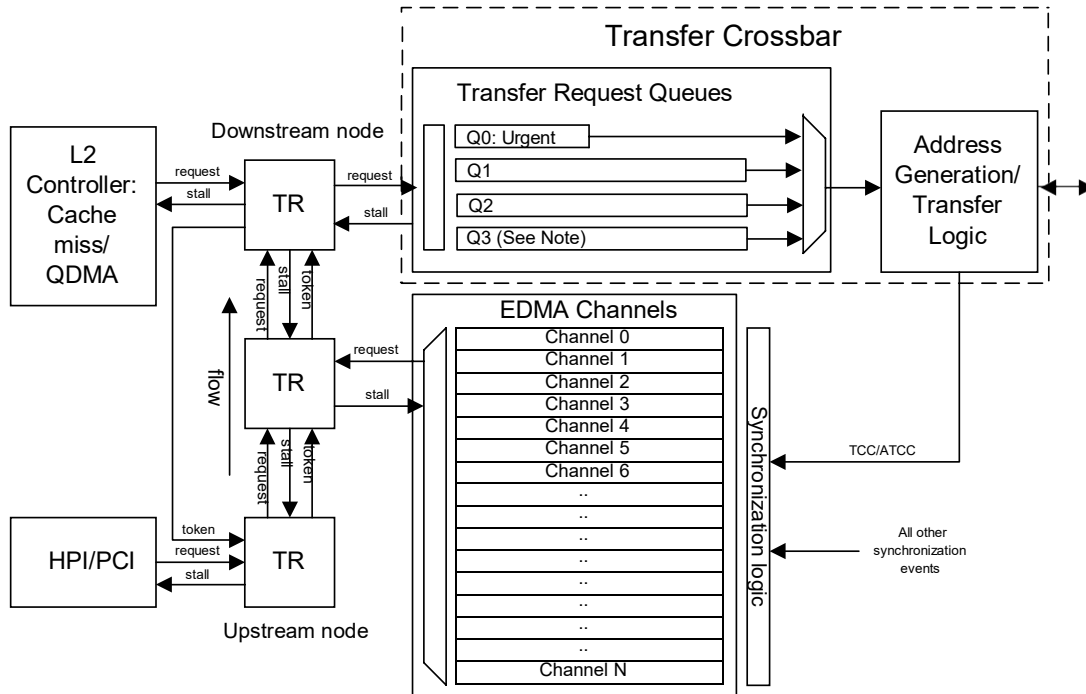

NOTE: Q3 is available to C64x only. See the *TMS320C6000 Peripherals Reference Guide* (SPRU190) for details.

**Figure 1. Enhanced DMA Block Diagram**

## 2.1 Transfer Request Submission

All transfer requestors to the EDMA are connected to the transfer request chain. A transfer request, once submitted, is shifted through the chain to the transfer crossbar (TC), where it is prioritized and processed. The transfer request can be for a single data element or for a large number of elements. For descriptions, see section 2.5, *Synchronization*, and section 2.6, *Dimensioned Transfers*.

The request chain provides an inherent priority scheme to the requestors. Assuming each makes a submission on the same cycle, the requestor closest to the TC (downstream requestor) arrives first, and the farthest (upstream requestor) arrives last. Once a request is within the request chain, it has priority over new submissions, such that the requests at the end of the chain do not get starved for servicing.

To prevent possible deadlock situations that would occur if a downstream requestor were held off from submission due to continuous submissions by upstream requestors, there is a round-robin scheme implemented within the chain's logic. A token is passed around the chain (for the token, it is a loop) in the downstream direction. The transfer request node that has the token inverts the priority levels of its two requestors. Rather than giving priority to an existing request in the chain, located in the upstream node, priority is given to the local requestor to submit a new request. Although this is a safeguard implanted into the EDMA, the high bandwidth of the EDMA relative to the speed at which requests are submitted has shown this to be inconsequential.

### 2.1.1 L2 Controller Transfer Requests

The L2 controller submits all transfer requests for cache servicing, for accessing noncacheable memory, and for QDMA transfers. On the C621x and C671x devices, cache servicing requests are always made on the urgent priority level and are not visible to the user. On the C64x devices, cache servicing requests can be programmed on any one of the queues via the cache configuration register (CCFG). The cache controller always requests an L2 line in two parts, requesting the “missed” portion of the line first. The data transfers requested are based on the data location within the L2 line as shown in Table 1.

**Table 1. Data Transfer Requests Priority**

Data Location	First Transfer	Second Transfer
First ¼	Front ½ line	Back ½ line
Second ¼	Back ¾ line	Front ¼ line
Third ¼	Back ½ line	Front ½ line
Fourth ¼	Back ¼ line	Front ¾ line

For write requests, as a result of flush/clean operations or eviction, the burst size is one complete L2 line.

The transfer requests are always made for a burst of elements equal in length to ¼, ½, ¾, or 1 (one) L2–line size for read requests (cache miss) and equal in length to the L2-line size for write requests (data flush).

Transfer requests by the L2 controller for noncacheable memory are always equal to a single element and are used to load/store data from/to a noncacheable location in external memory. On the C621x and C671x devices, these requests are only submitted with an urgent priority and are not visible to the user.

QDMA transfer requests, explained in section 2.4, *QDMA Parameters*, have the same restrictions as the EDMA channels. On the C621x and C671x devices, they must be submitted with either a high or low priority but are completely programmable. The transfer can be to or from any location in the memory map, with configurable dimensions and data arrangement.

### 2.1.2 HPI Transfer Requests

The HPI automatically generates transfer requests to service host activity. On the C621x and C671x devices, these transfer requests are submitted only with a high priority and are not visible to the user. On the C64x devices, these transfer requests are submitted only with a medium priority. The HPI submits a transfer request for:

- a single-element read or write for nonautoincrement host accesses
- a transfer request for a short data burst for autoincrement transfers

The burst size is always for eight or fewer elements.

### 2.1.3 EDMA Channel Transfer Requests

The EDMA channels can each generate transfer requests for a wide variety of transfers. On the C621x and C671x devices, the transfers can be submitted with either high or low priority, with the following recommendations:

- *high priority* reserved for short bursts and single-element transfers
- *low priority* used for longer (background) block moves

On the C64x devices, EDMA transfers can be submitted on any of the following priority levels, with longer transfers submitted to the lower priority levels: *urgent priority, high priority, medium priority, and low priority*.

It is also recommended that transfers be divided among all of the priority levels when applicable, to maximize the device performance.

## 2.2 Transfer Crossbar

Once a transfer request is at the end of the request chain, it is sent to the transfer crossbar (TC). Within the TC, the transfer request is shifted into one of the transfer request queues to await processing. The queue to which it is submitted is determined by the priority associated with it.

There are three queues on the C621x and C671x devices, corresponding to three priority levels:

- Urgent (Q0): reserved for cache service requests submitted by the L2 controller
- High (Q1): used for host port servicing and high-priority EDMA transfers (PRI = 001b)
- Low (Q2): used for low-priority EDMA transfers (PRI = 010b)

There are four queues on the C64x devices, corresponding to four priority levels:

- Urgent (Q0): used for urgent L2 controller/QDMA and EDMA transfers (PRI = 000b)
- High (Q1): used for high-priority EDMA and L2 controller/QDMA transfers (PRI = 001b)
- Medium (Q2): used for host port servicing and medium-priority EDMA and L2 controller/QDMA transfers (PRI = 010b)
- Low (Q3): used for low-priority EDMA and L2 controller/QDMA transfers (PRI = 011b)

Once the transfer request reaches the head of its queue, it is submitted to the address generation/transfer logic to be processed. Only one transfer request from each queue can be serviced at a time by the address generation/transfer logic. To maximize the data transfer bandwidth in a system, all queues should be utilized.

### 2.2.1 Address Generation/Transfer Logic

The address generation/transfer logic block diagram, Figure 2, controls the transferring of data by the EDMA. The register sets, one for each priority queue, monitor the progress of a transfer. Within the register set for a particular queue, the current source address, destination address, and count are maintained for a transfer. These registers are unavailable to the CPU.

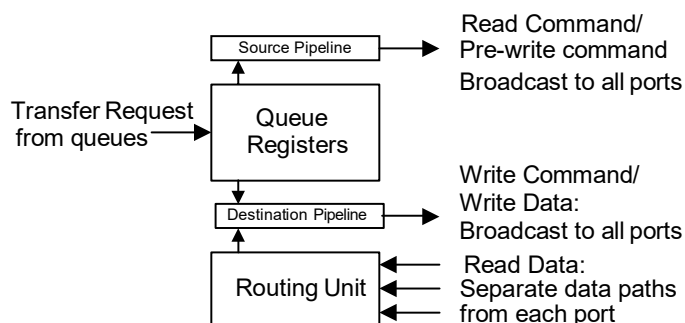

Figure 2. Address Generation/Transfer Logic Block Diagram

The queue registers essentially function as a traditional DMA. They maintain the transfer parameters (source, destination, count, etc.) during the data transfer. The queue registers send requests for data to be transferred. These requests are for small bursts, which are less than or equal to the total data size of the submitted transfer request. The actual size depends on the port performing the data reads or writes and is fixed by the hardware to maximize performance. This allows transfers initiated by different queues to occur simultaneously to one another. Because the registers send requests for data transfers, the actual data movement occurs as soon as the ports are ready. Thus, if the different queues request transfers to/from different ports, then the transfers can occur at the same time. Transfer requests made to the same port(s) are arbitrated for priority.

Each queue register set submits its transfer request to the appropriate pipeline to initiate a data transfer. There are three commands generated by the queue registers: pre-write, read, and write. Commands can be submitted to both pipelines once per cycle by any of the queue registers. The TC arbitrates every cycle (separately for each pipeline) to allow the highest priority command that is pending to be submitted. The pre-write command is issued to notify the destination that it is going to receive data. All ports have a small buffer available to receive a burst of data at the internal clock rate. Once the destination has available space to accommodate the incoming data, it sends an acknowledgement to the EDMA that it is ready.

After receiving the acknowledgement from the destination, a read command is issued to the data source. Data is read at the maximum frequency of the source and passed to the EDMA routing unit to be sent to the destination.

Once the routing unit receives the data, the data is sent along with a write command to its destination.

Because the EDMA's capability to wait for the destination to be ready to receive data, the source resource is free to be accessed for other transfers until the destination is ready. This provides an excellent utilization of resources, and is referred to as write-driven processing. All commands and write data are sent from the EDMA to all resources on a single bus. The information is passed at the clock speed of the EDMA, and data from multiple transfers are interlaced when occurring simultaneously. Provided that multiple transfers (from different queues) have different sources, the transfers occur simultaneously.

The read data arrives on unique buses from each resource. This is to prevent contention and to ensure that data can be read at the maximum rate possible. Once the data arrives to the routing unit, the data that is available for the highest priority transfer is moved from its read bus to the write bus and sent to the destination.

## 2.3 EDMA Channel Parameters

EDMA channels are configured in a parameter table. The table is a 2-Kbyte block of on-chip parameter RAM (PaRAM) located within the EDMA. The table consists of 16 six-word parameter sets (entries), one set per channel, for the C621x and C671x devices; and 64 six-word parameter sets, one set per channel, for the C64x devices. The remaining PaRAM space is available for linked parameter sets for the channels. There is space for 69 (C621x and C671x devices) or 21 (C64x devices) linked parameter sets. The last eight bytes of the PaRAM are unused (since 2 Kbytes are not evenly divisible by 24 bytes), but are accessible by the CPU and host and can be used as a scratch area. The parameter RAM is listed in Table 2, parameter sets and options parameter register (OPT) are shown in Figure 3 and Figure 4, respectively.

**Table 2. EDMA Channel Parameter RAM**

<b>Address</b>	<b>Parameters</b>
01A0 0000h to 01A0 0017h	Parameters for event 0 (6 words)
01A0 0018h to 01A0 002Fh	Parameters for event 1 (6 words)
01A0 0030h to 01A0 0047h	Parameters for event 2 (6 words)
01A0 0048h to 01A0 005Fh	Parameters for event 3 (6 words)
01A0 0060h to 01A0 0077h	Parameters for event 4 (6 words)
01A0 0078h to 01A0 008Fh	Parameters for event 5 (6 words)
01A0 0090h to 01A0 00A7h	Parameters for event 6 (6 words)
01A0 00A8h to 01A0 00BFh	Parameters for event 7 (6 words)
01A0 00C0h to 01A0 00D7h	Parameters for event 8 (6 words)
01A0 00D8h to 01A0 00EFh	Parameters for event 9 (6 words)
01A0 00F0h to 01A0 0107h	Parameters for event 10 (6 words)
01A0 0108h to 01A0 011Fh	Parameters for event 11 (6 words)
01A0 0120h to 01A0 0137h	Parameters for event 12 (6 words)
01A0 0138h to 01A0 014Fh	Parameters for event 13 (6 words)
01A0 0150h to 01A0 0167h	Parameters for event 14 (6 words)
01A0 0168h to 01A0 017Fh	Parameters for event 15 (6 words)
01A0 0180h to 01A0 0197h	Parameters for event 16† (6 words)
01A0 0198h to 01A0 01AFh	Parameters for event 17† (6 words)
...	...
...	...
01A0 05D0h to 01A0 05E7h	Parameters for event 62† (6 words)
01A0 05E8h to 01A0 05FFh	Parameters for event 63† (6 words)
01A0 0600h to 01A0 0617h	Reload/link parameters for event N (6 words)
01A0 0618h to 01A0 062Fh	Reload/link parameters for event M (6 words)
...	...
01A0 07E0h to 01A0 07F7h	Reload/link parameters for event Z (6 words)
01A0 07F8h to 01A0 07FFh	Scratch pad area (2 words)

† The C64x devices support up to 64 synchronization events. For the C621x/C671x device, these PaRAM locations (01A0 0180h - 01A0 05FFh) can be used for reload/link parameters.

31	16	15	0	
Options (OPT)				Word 0
Source Address (SRC)				Word 1
Array/frame count (FRMCNT)		Element count (ELECNT)		Word 2
Destination address (DST)				Word 3
Array/frame index (FRMIDX)		Element index (ELEIDX)		Word 4
Element count reload (ELERLD)		Link address (LINK)		Word 5

**Figure 3. Parameter Storage for an EDMA Event**

31	29	28	27	26	25	24	23	22	21	20	19	16							
PRI		ESIZE		2DS		SUM		2DD		DUM		TCINT		TCC					
R/W-0		R/W-0		R/W-0		R/W-0		R/W-0		R/W-0		R/W-0		R/W-0					
15	14	13	12	11	10			5	4	3	2	1	0						
—		TCCM <sup>†</sup>		ATCINT <sup>†</sup>		—		ATCC <sup>†</sup>		—		PDTST <sup>†</sup>		PDTD <sup>†</sup>		LINK		FS	
R-0		R/W-0		R/W-0		R-0		R/W-0		R-0		R/W-0		R/W-0		R/W-0		R/W-0	

<sup>†</sup> Available only on C64x devices.

**Legend:** R = Read only; W = Write only; R/W = Read/Write; -n = value after reset; — = reserved

**Figure 4. EDMA Options Parameter Register**

Each EDMA channel entry consists of several parameters that are used to configure the data transfer. These parameters are described in Table 3.

**Table 3. EDMA Channel Parameters**

Offset Address <sup>†</sup> (bytes)	Parameter	As defined for...	
		1-D transfer	2-D transfer
0	Options	Transfer configuration options. See Table 4.	Transfer configuration options. See Table 4.
4	Source address	Address from which data is transferred.	Address from which data is transferred.
8	Element count	Number of elements per frame.	Number of elements per array.
10	Frame count (1D), Array count (2D)	Number of frames per block minus 1.	Number of arrays per frame minus 1.
12	Destination address	Address to which data is transferred.	Address to which data is transferred.
16	Element index	Address offset of elements within a frame.	—
18	Frame index (1D), Array index (2D)	Address offset of frames within a block.	Address offset of arrays within a frame.

<sup>†</sup> The offset provided assumes little-endian mode of operation. All control registers are 32-bits wide, and the physical location of parameters that share a single register are fixed, regardless of endian mode. Control registers should always be accessed as 32-bit words. The specific offset address entries that this note applies to are 8, 10, 16, 18, 20, and 22.

<sup>‡</sup> This field is only valid for element-synchronized transfers.

Offset Address† (bytes)	Parameter	As defined for...	
		1-D transfer	2-D transfer
20	Link address	PaRAM address containing the parameter set to be linked.	PaRAM address containing the parameter set to be linked.
22	Element count reload	Count value to be loaded at the end of each frame.‡	—

† The offset provided assumes little-endian mode of operation. All control registers are 32-bits wide, and the physical location of parameters that share a single register are fixed, regardless of endian mode. Control registers should always be accessed as 32-bit words. The specific offset address entries that this note applies to are 8, 10, 16, 18, 20, and 22.

‡ This field is only valid for element-synchronized transfers.

The options parameter (Figure 4) is made up of several fields that determine the way in which data is arranged in memory, as well as the way in which the data is transferred. The C64x devices have five additional fields in the option register as a result of its enhanced features. All of these fields are described in Table 4.

**Table 4. EDMA Channel Options Field Values**

Field	Value	Description
PRI		Priority levels for EDMA events.
		<b>For C621x and C671x only:</b>
	000	Reserved. Urgent priority level reserved for cache servicing. Not valid for EDMA transfer requests.
	001	High priority EDMA transfer. Transfer requests submitted to Q1.
	010	Low priority EDMA transfer. Transfer requests submitted to Q2.
	011-111	Reserved
		<b>For C64x only:</b>
	000	Urgent priority.
	001	High priority EDMA transfer.
	010	Medium priority EDMA transfer.
011	Low priority EDMA transfer.	
100-111	Reserved	
ESIZE		Element size.
	00	32-bit element (word)
	01	16-bit element (half-word)
	10	8-bit element (byte)
	11	Reserved
2DS		Source dimension.

**Table 4. EDMA Channel Options Field Values (Continued)**

Field	Value	Description
	0	1-dimensional source
	1	2-dimensional source
SUM		Source address update mode.
	00	Fixed address mode. No source address modification.
	01	Source address increment depends on 2DS and FS bits.
	10	Source address decrement depends on 2DS and FS bits.
	11	Source address modified by the element index/frame index depending on 2DS and FS bits.
2DD		Destination dimension.
	0	1-dimensional destination
	1	2-dimensional destination
DUM		Destination address update mode.
	00	Fixed address mode. No destination address modification.
	01	Destination address increment depends on 2DD and FS bits.
	10	Destination address decrement depends on 2DD and FS bits.
	11	Destination address modified by the element index/frame index depending on 2DD and FS bits.
TCINT		Transfer complete interrupt.
	0	Transfer complete indication is disabled. CIPR bits are not set upon completion of a transfer.
	1	CIPR bit is set on channel transfer completion. The bit (position) set in the CIPR is specified by the TCC value.
TCC	0–1111	Transfer complete code. This 4-bit value (0–15) is used to set the bit in CIPR (CIPR[TCC] bit) provided TCINT = 1, when the current set is exhausted. For C64x, TCC works in conjunction with TCCM to provide a 6-bit transfer complete code.
TCCM	0–11	<b>For C64x only:</b> Transfer complete code most-significant bits. TCCM works in conjunction with TCC to provide a 6-bit transfer complete code. The 6-bit code is used to set the relevant bit in CIPRL or CIPRH provided TCINT = 1, when the current set is exhausted.
ATCINT		<b>For C64x only:</b> Alternate transfer complete interrupt.
	0	Alternate transfer complete indication is disabled. CIPR bits are not set upon completion of intermediate transfers in a block.
	1	The CIPR bit is set upon completion of intermediate transfers in a block. The bit (position) set in the CIPR is the ATCC value specified.
ATCC	0–111111	<b>For C64x only:</b> Alternate transfer complete code. The 6-bit value (0–63) is used to set the bit in CIPRL or CIPRH (CIP[ATCC] bit) provided ATCINT = 1, upon completion of an intermediate transfer in a block.
PDTS		<b>For C64x only:</b> Peripheral device transfer (PDT) mode for source.



**Table 4. EDMA Channel Options Field Values (Continued)**

Field	Value	Description
	0	PDT read is disabled.
	1	PDT read is enabled.
PDTD		<b>For C64x only:</b> Peripheral device transfer (PDT) mode for destination.
	0	PDT write is disabled.
	1	PDT write is enabled.
LINK		Linking of event parameters enable.
	0	Linking of event parameters is disabled. Entry is not reloaded.
	1	Linking of event parameters is enabled. After the current set is exhausted, the channel entry is reloaded with the parameter set specified by the link address. The link address must be on a 24-byte boundary and within the EDMA PaRAM. The link address is a 16-bit address offset from the PaRAM base address.
FS		Frame synchronization.
	0	Channel is element/array synchronized.
	1	Channel is frame/block synchronized.

## 2.4 QDMA Parameters

The EDMA also has the capability of performing unsynchronized transfers through the use of a QDMA request by the CPU. The QDMA is used to issue single, independent transfers to quickly move data, rather than to perform periodic or repetitive transfers like the EDMA channels.

Since the QDMA is used for quick, one-time transfers it does not have the capability to reload a count or link. The count reload/link address register is, therefore, not available to the QDMA. The QDMA can be used for chaining transfers, which is described later in this document. The QDMA registers are not updated during or after a transfer by the hardware. They retain the values that were submitted.

The QDMA consists of two sets of memory-mapped, write-only registers, as shown in Figure 5(a). The first set is a direct mapping of the five QDMA registers required to configure a transfer. There is no count reload, no link address, and the LINK field (bit 1) of the options parameter, Figure 5(b), is reserved. Writing to these registers configures, but does not submit, a QDMA transfer request.

(a) QDMA registers and QDMA pseudo-registers

0200 0000h	QDMA Options (OPT)		QDMA Registers	
	Source Address (SRC)			
	Array/frame count (FRMCNT)	Element count (ELECNT)		
	Destination address (DST)			
0200 0010h	Array/frame index (FRMIDX)	Element index (ELEIDX)		
	Reserved			
0200 0020h	QDMA Options (OPT)			QDMA Pseudo-registers
	Source Address (SRC)			
	Array/frame count (FRMCNT)	Element count (ELECNT)		
	Destination address (DST)			
0200 0030h	Array/frame index (FRMIDX)	Element index (ELEIDX)		

(b) QDMA options parameter register

31	29	28	27	26	25	24	23	22	21	20	19	16	15	14	13	12	1	0
PRI	ESIZE	2DS	SUM	2DD	DUM	TCINT	TCC	—	TCCM <sup>†</sup>	reserved	FS							
W-0	W-0	W-0	W-0	W-0	W-0	W-0	W-0	0	W-0	0	1							

<sup>†</sup> Available only on C64x devices.

Legend: W = Write only; -n = value after reset; — = reserved

**Figure 5. QDMA Registers**

The second register set is a pseudo-mapping of the QDMA registers, and is available to enable more efficient transfer request submission by the CPU. Writing to any one of the pseudo-registers not only configures the selected register but also submits a transfer request.

A QDMA transfer requires only one to five cycles to submit, depending on the number of registers that need to be configured. A typical QDMA transfer is performed by writing four of the parameter values to their registers followed by the write of the fifth parameter to its corresponding pseudo-register. All QDMA transfers are submitted using frame synchronization; therefore, the QDMA always requests a transfer of one complete frame of data. Only one request is sent for any QDMA submission, and the number of elements transferred is shown in Table 5.

**Table 5. QDMA Transfer Length**

Transfer Dimension	Elements Transferred
1-D to 1-D	One frame, regardless of frame count
Other	One frame, all arrays transferred

All of the QDMA registers retain their value after the request is submitted, so if a second transfer is to be performed with any of the same parameter settings, they do not need to be rewritten by the CPU. Only the changed registers must be rewritten, with the final parameter written to the appropriate pseudo-register to submit the transfer.

## 2.5 Synchronization

In the C621x and C671x devices, all EDMA channels are tied to a specific synchronization event. In the C64x devices, some EDMA channels are tied to a specific synchronization event and some EDMA channels are not. A channel requests a data transfer only when it receives its event, is chained to or from another channel, or when the CPU synchronizes it manually (by writing to the ESR). The amount of data to be transferred depends on the channel's configuration. A channel can submit an entire frame when frame synchronized or can submit a subset of a frame (element or array, depending on dimension) when element/array synchronized. Even the QDMA is synchronized, with its event being a CPU store to one of its pseudo-registers.

Table 6 and Table 7 list the synchronization events associated with each of the programmable EDMA channels.

**Table 6. EDMA Channel Synchronization Events (C621x and C671x)**

EDMA Channel Number	Event	Event Description
0	DSPINT	Host-to-DSP interrupt
1	TINT0	Timer 0 interrupt
2	TINT1	Timer 1 interrupt
3	SD_INT	SDRAM timer interrupt
4	EXT_INT4	External interrupt pin 4
5	EXT_INT5	External interrupt pin 5
6	EXT_INT6	External interrupt pin 6
7	EXT_INT7	External interrupt pin 7
8	EDMA_TCC8	Any QDMA/EDMA channel with TCC = 1000b
9	EDMA_TCC9	Any QDMA/EDMA channel with TCC = 1001b
10	EDMA_TCC10	Any QDMA/EDMA channel with TCC = 1010b
11	EDMA_TCC11	Any QDMA/EDMA channel with TCC = 1011b
12	XEVT0	McBSP0 DXR-to-XSR copy
13	REVT0	McBSP0 RBR-to-DRR copy
14	XEVT1	McBSP1 DXR-to-XSR copy
15	REVT1	McBSP1 RBR-to-DRR copy

**Table 7. EDMA Channel Synchronization Events (C64x)**

<b>EDMA Channel Number</b>	<b>Event</b>	<b>Event Description</b>
0	DSPINT	Host-to-DSP interrupt
1	TINT0	Timer 0 interrupt
2	TINT1	Timer 1 interrupt
3	SD_INTA	EMIFA SDRAM timer interrupt
4	GPINT4/EXT_INT4	GPIO event 4/External interrupt 4
5	GPINT5/EXT_INT5	GPIO event 5/External interrupt 5
6	GPINT6/EXT_INT6	GPIO event 6/External interrupt 6
7	GPINT7/EXT_INT7	GPIO event 7/External interrupt 7
8	GPINT0	GPIO event 0
9	GPINT1	GPIO event 1
10	GPINT2	GPIO event 2
11	GPINT3	GPIO event 3
12	XEVT0	McBSP0 transmit event
13	REVT0	McBSP0 receive event
14	XEVT1	McBSP1 transmit event
15	REVT1	McBSP1 receive event
16	–	None
17	XEVT2	McBSP2 transmit event
18	REVT2	MCBSP2 receive event
19	TINT2	Timer 2 interrupt
20	SD_INTB	EMIFB SDRAM timer interrupt
21	PCI	PCI Wakeup Interrupt
22	–	None
23	–	None
24	–	None
25	–	None
26	–	None
27	–	None

**Table 7. EDMA Channel Synchronization Events (C64x) (Continued)**

EDMA Channel Number	Event	Event Description
28	–	None
29	–	None
30	–	None
31	–	None
32	UREVT	UTOPIA receive event
33	–	None
34	–	None
35	–	None
36	–	None
37	–	None
38	–	None
39	–	None
40	UXEVT	UTOPIA transmit event
41	–	None
42	–	None
43	–	None
44	–	None
45	–	None
46	–	None
47	–	None
48	GPINT8	GPIO event 8
49	GPINT9	GPIO event 9
50	GPINT10	GPIO event 10
51	GPINT11	GPIO event 11
52	GPINT12	GPIO event 12
53	GPINT12	GPIO event 13
54	GPINT14	GPIO event 14
55	GPINT15	GPIO event 15
56	–	None

**Table 7. EDMA Channel Synchronization Events (C64x) (Continued)**

EDMA Channel Number	Event	Event Description
57	–	None
58	–	None
59	–	None
60	–	None
61	–	None
62	–	None
63	–	None

### 2.5.1 Element/Array Synchronization

Element/array synchronization means that for each synchronization event received, one subframe is transferred. A subframe is the number of elements defined by the second dimension of a particular transfer: a single element (for 1-D transfers) or an array of elements (for 2-D transfers).

### 2.5.2 Frame/Block Synchronization

Frame/block synchronization means that for each synchronization event received, an entire frame/block is transferred. For 1-D transfers, this is a frame of elements; for 2-D transfers, this is a frame of arrays (block).

## 2.6 Dimensioned Transfers

Transfers performed by the EDMA have dimension: either one-dimensional (1-D) or two-dimensional (2-D). The 1-D transfers correspond to those performed by traditional DMAs like that of the TMS320C6201 DSP. The 2-D transfers allow additional functionality not previously available.

The number of dimensions a transfer has determines the makeup of a frame/block of data. In a 1-D transfer, frames are made up of a number of individual elements. In a 2-D transfer, blocks are made up of a number of arrays, each of which is made up of a number of elements.

### 2.6.1 1-D Transfers

One-dimensional transfers focus on individual elements. Each frame of data to be transferred is associated with a single dimension that indicates the number of elements per frame. EDMA channels may be configured to transfer multiple frames (or a block of frames), but each frame is handled individually. A 1-D transfer can be considered two dimensional, with the second dimension fixed at 1. A sample 1-D frame is shown in Figure 6, with an element count of  $n$ .

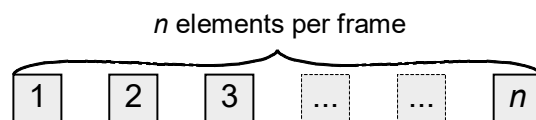
**Figure 6. 1-D Transfer Data Frame**

The elements within a frame can be all located at the same address, at contiguous addresses, or at a configurable offset from one another. The addresses of elements within a frame can be located at a specific distance apart (determined by element index, EIX), while the address of the first element of each frame is a set distance from a particular element of the previous frame (determined by frame index, FIX).

The value of the frame index (FIX) depends on the synchronization mode of the transfer. Transfers may be submitted as one of the following:

- one element at a time—when element synchronized
- one frame at a time—when frame synchronized

### 2.6.2 2-D Transfers

Two-dimensional transfers assume a slightly different arrangement of elements. Each block of data to be transferred has two dimensions: the number of arrays within the block, and the number of elements within an array. Elements within an array are contiguous, and arrays are offset from one another by a fixed amount. A sample 2-D block is shown in Figure 7, with an array count of  $n$  and an element count of  $m$ .

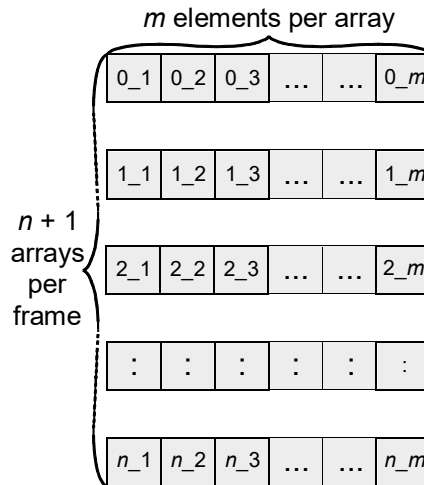

Figure 7. 2-D Transfer Data Block

The offset of the arrays is determined by the array index (AIX). The value of the array index depends on the synchronization mode of the transfer. Transfers may be submitted as one of the following:

- one array at a time—when array synchronized
- one frame at a time—when block synchronized

### 2.7 Address Updates

The relative addresses of the elements to be transferred by the EDMA are configurable within each channel's parameter set, and are based on the settings of the source and destination address update modes (SUM and DUM, respectively). The update modes determine how the elements are arranged in memory. The data elements can be at the same memory address, at contiguous memory addresses, or at a specified offset from one another using programmable index values. Table 8 gives the possible address update modes for a transfer.

**Table 8. Address Update Modes**

SUM/DUM	1-D	2-D
00: No modification	All elements located at the same address.	All elements in an array are at the same address.
01: Increment	All elements are contiguous, with subsequent elements located at a higher address than the previous.	All elements within an array are contiguous, with subsequent elements located at a higher address than the previous. Arrays are offset by AIX.
10: Decrement	All elements are contiguous, with subsequent elements located at a lower address than the previous.	All elements within an array are contiguous, with subsequent elements located at a lower address than the previous. Arrays are offset by AIX.
11: Index	All elements within a frame are offset from one another by EIX. Frames are offset by FIX.	Reserved

The indexes described in the table (EIX, FIX, and AIX) have slightly different connotations depending on the synchronization of a channel. In order to understand what value the index must have, it is important to know where the address update is to take place. Address updates can occur in two places:

- within the parameter set of an EDMA channel
- within the address generation/transfer logic

Within the parameter table, the addresses are updated following the submission of each transfer request. The starting address of a transfer request is based on the starting address of the previous submission. The address generation/transfer logic manages the address updates within a burst—the address of each element being based on the address of the previous element.

If a channel is configured to be an element-synchronized 1-D transfer, then the source and destination addresses are updated within the parameter table following the transfer request submission for each element. Therefore, the element index (EIX) and frame index (FIX) should be based on the difference between element addresses, as shown in Figure 8.

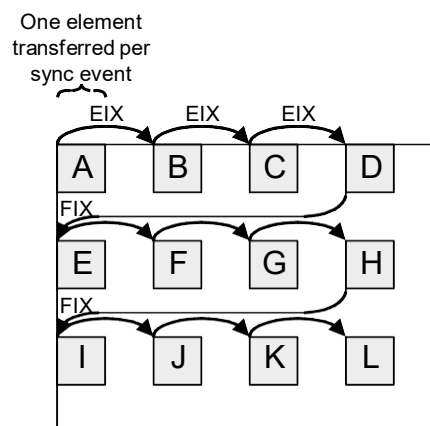
**Figure 8. 1-D Transfer With Element Synchronization**



A channel that is configured to perform a 2-D transfer with array synchronization updates its source and destination registers after the transfer request for each array is submitted. The array index (AIX) is the difference between the starting addresses for each array of the block, as shown in Figure 9.

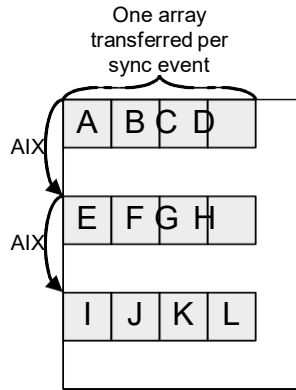
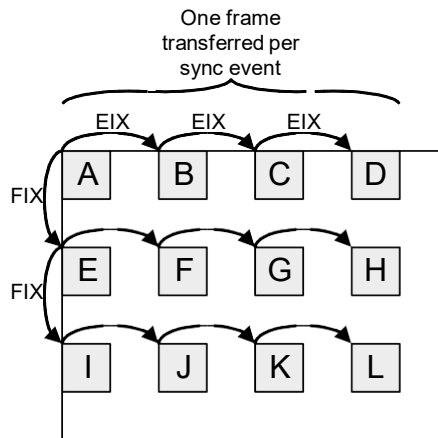

**Figure 9. 2-D Transfer With Array Synchronization**

Frame/block synchronization allows a channel to request the transfer of an entire frame of elements or block of arrays. For a 1-D transfer, this means that the frame index (FIX) no longer represents the difference between the address of the last element of a frame and the address of the first element of the subsequent frame, but rather the difference between the starting addresses of each frame. A frame-synchronized 1-D transfer is functionally identical to an array-synchronized 2-D transfer (assuming EIX equals the number of bytes per element). For reference:

frame-synchronized 1-D transfer = array-synchronized 2-D transfer  
(where EIX = number of bytes per element)

The address indexing for a frame-synchronized 1-D transfer is shown in Figure 10.



**Figure 10. 1-D Transfer With Frame Synchronization**

For a 2-D transfer, block synchronization causes the array index (AIX) to be implemented by the address generation/transfer logic. The address is updated after each element in a burst. The logic first updates the addresses according to the setting of SUM/DUM. If an element is the last in a particular array and an update mode is selected (SUM/DUM  $\neq$  00b), the address(es) are indexed according to AIX. AIX is added to the address after the address update occurs. AIX is equal to the space between arrays of a block, as shown in Figure 11.

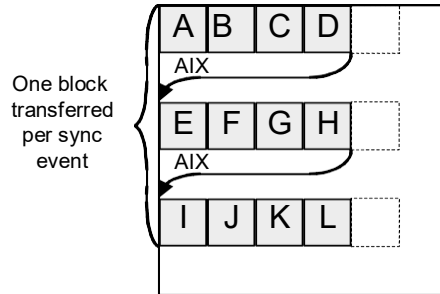

**Figure 11. 2-D Transfer With Block Synchronization**

## 2.8 Transfer Linking

An important capability of the EDMA is that of linking. Linking is an enhancement beyond the autoinitialization feature of the C6201 DMA. By providing a link address and setting LINK = 1 in the transfer options, an EDMA channel loads a new entry from PaRAM and begins performing the new transfer. The linked list is traversed until LINK = 0. If the linked list is a closed loop, the EDMA channel runs continuously throughout the DSP operation. A sample of a linked list is shown in Figure 12.

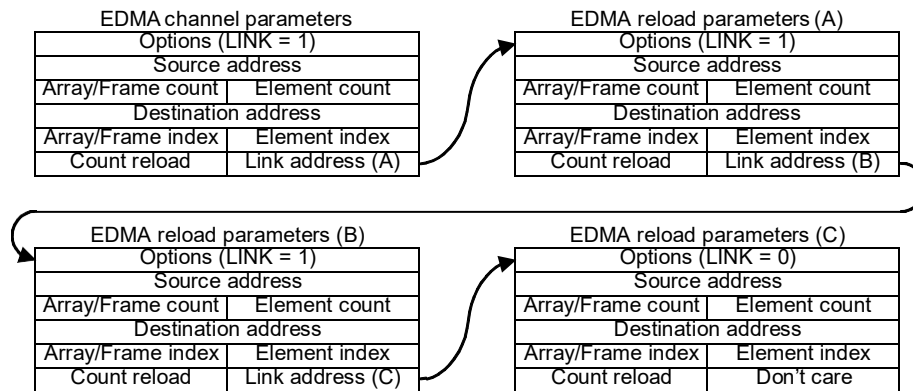

**Figure 12. EDMA Linked List of Transfers**

Linking an entry to itself replicates the behavior of autoinitialization to facilitate the use of circular buffering and repetitive transfers. After an EDMA channel exhausts its current entry, the parameter set is reloaded and the transfer begins again.

Linking also provides the ability to string several entries together, such that multiple transfers are performed using the same synchronization event. This is a useful feature for managing multiple data buffers for incoming/outgoing data (such as in a ping-pong buffer scheme) and performing continuous transfers. After an EDMA channel exhausts its current entry, the next parameter set is loaded and begun.

Since each channel is capable of linking together a list of transfers, it is often possible to initialize all of the transfers that are required throughout system operation at once. This removes the overhead associated with reprogramming a DMA channel.

## 2.9 Transfer Chaining

In the C621x and C671x devices, four of the EDMA channels are synchronized upon the completion of transfers by other channels. In the C64x devices, all EDMA channels can be programmed to be synchronized upon the completion of transfers by other channels. This functionality corresponds to the synchronization of a channel in the C6201 DMA to an interrupt by another channel. Through the use of a transfer completion code (TCC), any EDMA channel (or a QDMA transfer) can synchronize any of these channels. This is referred to as chaining.

In the C621x and C671x devices, EDMA channels 8 through 11 are used for chaining and are synchronized by TCC values 8 (1000b) through 11 (1011b). In the C64x devices, all EDMA channels (0–63) can be used for chaining and are synchronized by TCC values 0 (00 0000b) through 63 (11 1111b). The C64x devices contain two additional TCC bits than the other devices to allow support for all 64 channels. In addition, C64x devices allow for alternate transfer complete chaining. When this is enabled, the next EDMA channel (specified by the ATCC of the current channel) is synchronized upon completion of each intermediate transfer of the current channel. Alternate transfer complete chaining is useful for such applications as servicing input/output FIFOs with a single event and breaking up large transfers. It is important to note that alternate transfer complete chaining is not applicable to block-synchronized 2-D transfers and is superseded by transfer complete chaining upon completion of the entire transfer. To enable chaining functionality, the EDMA channel whose transfer completion triggers the chained transfer must have both:

- TCC set to the appropriate value
- TCINT bit of the options field set to 1

and/or (C64x only):

- ATCC set to the appropriate value
- ATCINT bit of the options field set to 1

The chaining functionality must also be enabled. Since TCC values are not restricted to chaining only, the chaining enable is separate from the event enable. This allows a channel to report a TCC value without synchronizing the corresponding channel, while still allowing these channels to be used. These channels could be used with manual synchronization while another channel reports a TCC value corresponding to these channels without conflict by not enabling chaining. Setting the appropriate bits in the channel chain enable register (CCER) enables chaining.

By using the chaining functionality, several things are possible:

- An **EDMA transfer can be synchronized by the completion of another EDMA transfer** to allow sequential transfers to be performed based on a single event. For example, use an EDMA channel to receive a frame of input data, then automatically trigger an output frame of data to be transferred immediately afterward.

- An **EDMA channel can synchronize itself to traverse through its linked list automatically**. For example:

<b>if...</b>	<b>then...</b>
Multiple entries are linked together on one of the channels available for chaining <b>AND...</b>	Each entry will submit a transfer request as soon as the previous completes. Valid only if each entry exhausts its full parameter set upon submission.
Each entry provides a TCC value equal to its channel number	

This is a way to perform complicated transfers based on a single event (either by the CPU, QDMA, or another EDMA channel).

## 2.10 C64x DSP Advanced Features

The C64x EDMA has many advanced features not found in the C621x/C671x EDMA. The C64x has 64 channels, allows transfer chaining on all channels, and allows L2 controller transfers and EDMA transfers on all four priority levels. In addition, the C64x devices support Peripheral Device Transfers, event polarity selection, Alternate Transfer Complete Chaining and Interrupt, and have programmable queue lengths and readable QDMA registers. Information on all of these advanced features can be found in the *TMS320C6000 Peripherals Reference Guide SPRU190*.

## 3 CPU Interrupt Service Routines

There is one interrupt from the EDMA to the CPU, EDMA\_INT, which can be triggered by any of the EDMA channels or the QDMA. A channel interrupt is passed to EDMA\_INT when enabled in the channel interrupt enable register (CIER). If the CIE bit is set for a particular TCC, then EDMA\_INT is set when this code is received. The CPU then branches to the corresponding interrupt vector, providing that a CPU interrupt is configured for EDMA\_INT and is enabled. <sup>1</sup>

A TCC is issued when provided by a QDMA/EDMA channel transfer request, along with TCINT set to 1. Providing a TCC value and setting the TCINT bit enables a channel to signal to the EDMA controller that it has completed its transfer. This causes a flag to be set in the channel interrupt pending register (CIPR). The bit that is set is determined by the TCC configured in the channel options. The CPU must manually clear the CIPR.

To configure the EDMA for any channel (or QDMA request) to interrupt the CPU:

- Set CIE<sub>n</sub> to 1 in the CIER
- Set TCINT to 1 in channel options
- Set TCC to *n* in channel options

Anytime a TCC is reported after a completed transfer, the CPU is interrupted. More than one QDMA/EDMA channel can use the same TCC value, and the TCC value is not required to be equal to the channel number.

Since all EDMA channels and the QDMA share the same CPU interrupt, the CPU must poll the CIPR to determine the interrupt source. One possible ISR is shown in Figure 13 (C621x and C671x devices) and in Figure 14 (C64x devices). The ISR clears the CIP bits and branches to a C routine for a particular channel.

1. See the *TMS320C6000 Peripherals Reference Guide (SPRU190)* and the *TMS320C6000 CPU and Instruction Set Reference Guide (SPRU189)* for chapters on configuring CPU interrupts.

```

// C621x/C671x EDMA interrupt service routine
// Service all pending EDMA interrupts. In this ISR, the highest
// priority interrupt that is pending is isolated, and the routine
// EDMA_CH_ISR is called to service it.
interrupt void
EDMA_INT_ISR(void)
{
    Uint32 CIPR_val,
           mask_high;
    Int16 channel_num;
    do{
        IRQ_clear(IRQ_EVT_EDMAINT);           // Clear EDMA_INT bit
        CIPR_val = EDMA_RGET(CIPR);           // Get latest CIPs
        while(CIPR_val){                       // Loop through CIPs
            mask_high = (-CIPR_val) & CIPR_val; // isolate high-pri CIP
            channel_num = 31 - _lmbd(1, mask_high); // Get high-pri ch num
            EDMA_RSET(CIPR, mask_high);        // Clear CIP from CIPR
            CIPR_val ^= mask_high;             // Clear from CIPR_val
            if (channel_num >= 0){             // If valid channel
                EDMA_CH_ISR(channel_num);      // Service high-pri ch
            }                                   // End if
        }                                       // End while (CIPR)
    } while (IRQ_test(IRQ_EVT_EDMAINT));      // Poll IFR for new
}                                              // End EDMA_INT_ISR
    
```

**Figure 13. C621x/C671x EDMA Interrupt Service Routine**

```

// C64x EDMA interrupt service routine
// Service all pending EDMA interrupts. In this ISR, the highest
// priority interrupt that is pending is isolated, and the routine
// EDMA_CH_ISR is called to service it.
interrupt void
EDMA_INT_ISR(void)
{
  Uint32 CIPRL_val,
         CIPRH_val,
         mask_high;
  Int16 channel_num;
  do{
    IRQ_clear(IRQ_EVT_EDMAINT);           // Clear EDMA_INT bit
    CIPRL_val = EDMA_RGET(CIPRL);         // Get latest CIPs
    CIPRH_val = EDMA_RGET(CIPRH);         // Get latest CIPs
    while(CIPRL || CIPRH){                // Loop through CIPs
      if(CIPRL){
        mask_high = (-CIPRL_val) & CIPRL_val; // isolate high-pri CIP
        channel_num = 31 - _lmbd(1, mask_high); // Get high-pri ch num
        EDMA_RSET(CIPRL, mask_high);        // Clear CIP from CIPRL
        CIPRL_val ^= mask_high;             // Clear from CIPRL_val
      }
      else{
        mask_high = (-CIPRH_val) & CIPRH_val; // isolate high-pri CIP
        channel_num = 63 - _lmbd(1, mask_high); // Get high-pri ch num
        EDMA_RSET(CIPRH, mask_high);        // Clear CIP from CIPRH
        CIPRH_val ^= mask_high;             // Clear from CIPRH_val
      }
      if (channel_num >= 0){                // If valid channel
        EDMA_CH_ISR(channel_num);           // Service high-pri ch
      }
    }                                       // End while
  } while (IRQ_test(IRQ_EVT_EDMAINT));     // Poll IFR for new
}                                           // End EDMA_INT_ISR

```

**Figure 14. C64x EDMA Interrupt Service Routine**

Some special considerations must be made for an ISR that services multiple interrupts. The ISR shown in Figure 13 and Figure 14 addresses the following concerns:

- Multiple sources generate EDMA\_INT

- The ISR does not know the interrupt source prior to execution
- New EDMA interrupts can be generated during ISR

Because multiple EDMA channels can trigger the same interrupt, it should be assumed that a new EDMA interrupt can occur in the time between the CPU interrupt flag being cleared and the CIPR being read within the ISR (the interrupt flag is cleared when the branch is taken to the interrupt vector). If a new EDMA interrupt is received during that time, the CPU services it without clearing the interrupt flag. This results in an additional CPU delay caused by branching back to the main code body and immediately returning to the ISR for an interrupt that has already been serviced. By checking for a new CPU flag posting at the end of the ISR, the CPU knows if additional events have been received.

## 4 Transfer Examples

A wide variety of transfers can be performed by the EDMA depending on the parameter configuration. Basic transfers can be performed either by an EDMA channel or by submitting a QDMA. Complicated transfers or repetitive transfers require an EDMA channel to be used.

### 4.1 Block Move Examples

The most basic transfer performed by the EDMA is that of a block move. Often during device operation it is necessary to transfer a block of data from one location to another, usually between on- and off-chip memory.

In this example, a section of data is to be copied from external memory to internal L2 SRAM. The data block is 256 words and resides at address 8000 0000h (CE0). It is to be transferred to internal address 0000 8000h (L2 cache). The data transfer is shown in Figure 15.

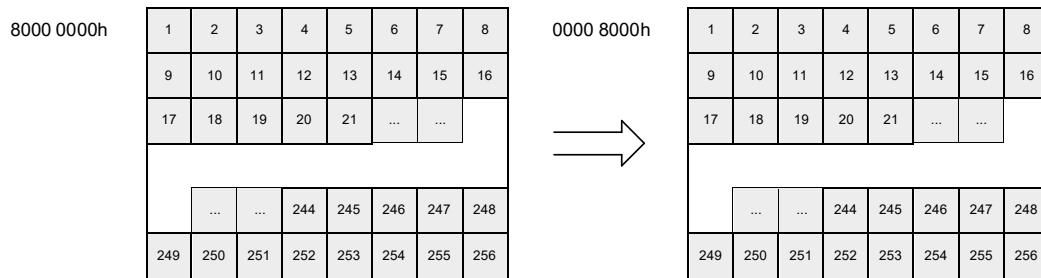

**Figure 15. Block Move Diagram**

The fastest way to perform this transfer is through a QDMA request. The QDMA request can be submitted in several different ways, the most basic being a frame-synchronized 1-D to 1-D transfer. This type of transfer is valid for block sizes of less than 64K elements. The transfer must be frame-synchronized so that all of the elements are transferred once the entry is submitted. If the transfer were to be configured as an element-synchronized transfer, only the first element would be transferred.

The register parameters for this block move transfer are shown in Figure 16. Parameters that must be configured are: QDMA options, source address, destination address, and element count.

Register Contents		Register
8000 0000h		QDMA Source Address Register
0000h	0100h	QDMA (Array/Element) Transfer Count Register
0000 8000h		QDMA Destination Address Register
Don't care	Don't care	QDMA (Array/Element) Index Register
2120 0001h		QDMA Options Register



31	29	28	27	26	25	24	23	22	21	20	19	16	15	14	13	12	1	0
001	0	0	0	01	0	01	0	0000	0	00	0 000	0 000	0	00	0 000	0 000	0	X
PRI	ESIZE		2DS	SUM	2DD	DUM	TCINT	TCC	—	TCCM <sup>†</sup>	reserved		FS					

<sup>†</sup> Available only on C64x devices.

**Figure 16. Block Move QDMA Register Parameters**

The source address for the QDMA is set to the start of the data block in external memory, and the destination address is set to the data block in L2. Since all data is contiguous, SUM and DUM are both set to 01b (increment). The priority is set to 001b to indicate a high-priority transfer. The block move request is submitted to the high-priority queue (Q1).

The CPU requires four cycles to submit the request for this transfer, one cycle for each register write.<sup>2</sup> Three of the QDMA parameters must be written to their proper QDMA registers, and one parameter must be written to its pseudo-register, which initiates the transfer. A sample QDMA submission for the above transfer is:

```

...
EDMA_RSET(QDMA_SRC, 0x80000000); /* Set source address */
EDMA_RSET(QDMA_DST, 0x00008000); /* Set destination address */
EDMA_RSET(QDMA_CNT, 0x00000100); /* Set frame/element count */
EDMA_RSET(QDMA_S_OPT, 0x21200001); /* Set options and submit */
...
    
```

A block that contains greater than 64k elements requires the use of both element count and array/frame count. Since the element count field is only 16 bits, the largest count value that can be represented is 65535. Any count larger than this needs to be represented with an array count as well. In order to transmit this amount of data, a QDMA can still be used. Rather than a frame-synchronized 1-D to 1-D transfer, the QDMA needs to be configured as a block-synchronized 2-D to 2-D transfer.

2. Fewer cycles are required if any of the QDMA registers are already configured. A minimum of one cycle is required.



### 4.2 Subframe Extraction Examples

The EDMA has an efficient way of extracting a small frame of data from a larger one. By performing a 2-D to 1-D transfer, the EDMA can retrieve a portion of data for the CPU to process. In this example, a 640 x 480-pixel frame of video data is stored in external memory, CE2. Each pixel is represented by a 16-bit halfword. A 16 x 12-pixel subframe of the image is extracted for processing by the CPU. To facilitate more efficient processing time by the CPU, the EDMA places the subframe in internal L2 SRAM. Figure 17 shows the transfer of the subframe from external memory to L2.

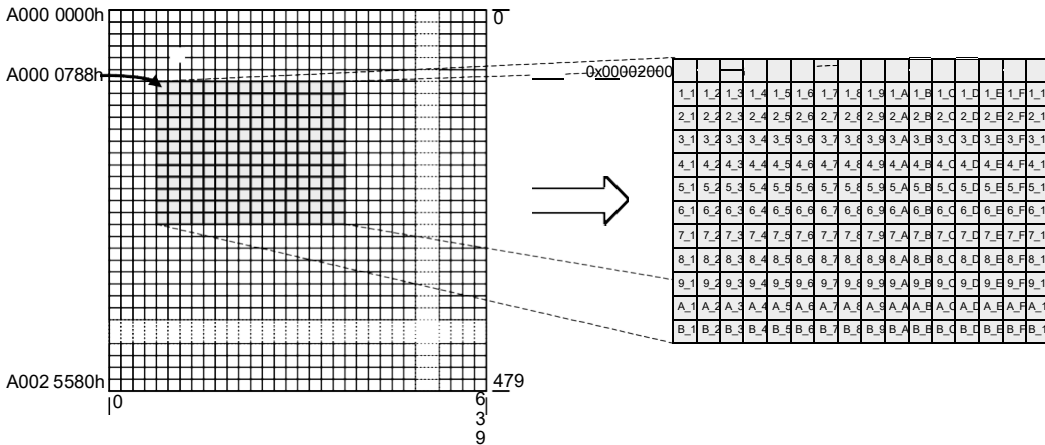

Figure 17. Subframe Extraction

To perform this transfer, the CPU can issue a QDMA request for a frame-synchronized 2-D to 1-D transfer. Since the source is 2-D and the transfer is block-synchronized, the QDMA requests a transfer of the entire subframe. The parameters required for the QDMA registers to request this transfer are shown in Figure 18.

Register Contents		Register
A000 0788h		QDMA Source Address Register
000Bh	0010h	QDMA (Array/Element) Transfer Count Register
0000 2000h		QDMA Destination Address Register
04E0h	Don't care	QDMA (Array/Element) Index Register
4D20 0001h		QDMA Options Register

31	29	28	27	26	25	24	23	22	21	20	19	16	15	14	13	12	1	0
010	0	1	1	01	0	01	0	0000	0	00	0 000	1						
PRIT†	ESIZE	2DS	SUM	2DD	DUM	TCINT	TCC	—	TCCM‡	reserved	FS							

† Program to 011 on C64x devices.

‡ Available only on C64x devices.

Figure 18. Subframe Extraction QDMA Register Parameters

All of the address updates occur within the address generation/transfer logic. The array index provided is therefore the space *between* arrays of the subframe. Since each array of the video image is 640 pixels in length and each array of the subframe is 16 pixels in length, the array index is set to:

$$2 \text{ bytes/element} * (640 - 16) \text{ elements} = 1248 \text{ bytes}$$

The subframe is transferred to a block of contiguous memory. The element count is set to 16, the number of elements per subframe array, and the frame count is set to 11, one less than the number of arrays. The QDMA request is sent to the low-priority queue, Q2, so that it does not interfere with any data acquisition that could be occurring.

Inversely, a 1-D to 2-D transfer can be used to perform the *insertion* of a subframe into a larger frame of data. For instance, with this example the subframe could be inserted back into the larger image after some processing by the CPU.

### 4.3 Data Sorting Examples

Many applications require the use of multiple data arrays. It is often desirable to have the arrays arranged so that the first elements of each array are adjacent, the second elements are adjacent, and so on. Often this is not the format in which the data is presented to the device. Either data is transferred via a peripheral, with the data arrays arriving one after the other, or the arrays are located in memory, with each array occupying a portion (frame) of contiguous memory spaces. For these instances, the DMA can be configured to reorganize the data into the desired format. Figure 19 shows the data sorting of element arrays.

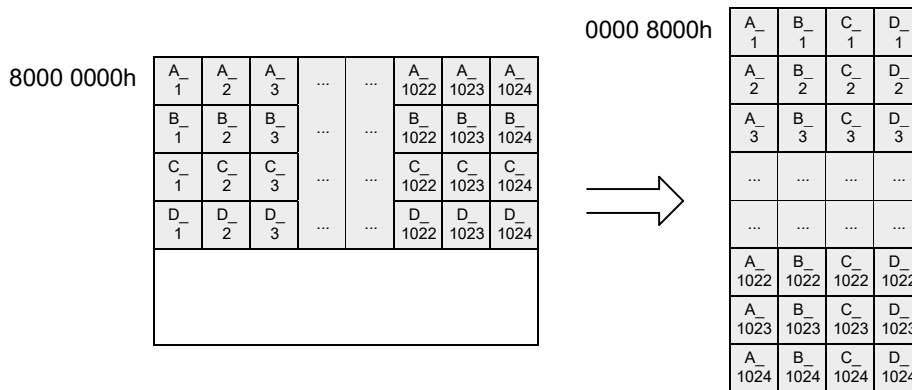

**Figure 19. Data Sorting Example Diagram**

The following values can be used to determine the fields required to use QDMA requests to organize the data in memory by ordinal position:

- F = The initial value of Frame Count
- E = The initial value of Element Count, as well as the Element Count Reload value
- S = The element size in bytes

The QDMA can again be used to transfer this data. However, due to the arrangement of the data in the destination, it is not possible to accomplish this with a single submission. Instead a separate QDMA transfer request must be submitted for each frame. If it is necessary to use an EDMA channel to perform this transfer, then an entry must be provided for each frame in the transfer in PaRAM. Also, the transfer must use the chaining feature to self-synchronize each frame on the completion of the previous (only channels 8–11 on C621x/C671x devices). See *Transfer Chaining*, section 2.9, for details.

This example focuses on the second case mentioned previously, in which data arrays of equal size are located in external memory. It is not necessary for the arrays to be of equal length. In the case that the lengths vary, each QDMA submission or each EDMA reload parameter set in PaRAM would contain the corresponding new count value.

For this example, it is assumed that the 16-bit data is located in external RAM, beginning at address A000 0000h (CE2). The QDMA is used to bring four frames of 1k half-words from their locations in RAM to internal data memory beginning at 0000 8000h. The index value required is  $EIX = F \times S = 4 \times 2 = 8$ .

Since separate QDMA transfer requests are to be submitted for each frame, only the EIX value is used in the QDMA parameters. The CPU updates the destination address for each new frame. For the first frame of data, the values shown in Figure 20 must be assigned to the QDMA registers.

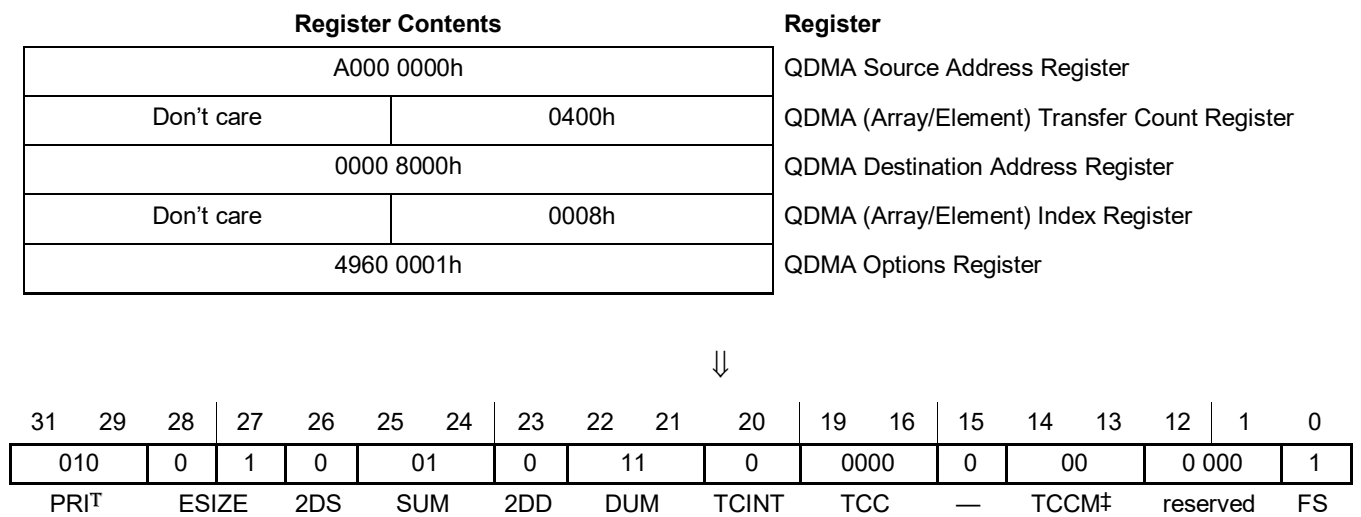

† Program to 011 on C64x devices.

‡ Available only on C64x devices.

**Figure 20. Sorting QDMA Register Parameters**

The QDMA, submitted with the parameters shown in Figure 21, only transfers the first frame. For each subsequent frame, the CPU must perform two stores to change the source address and the destination address manually. It is *not* necessary for the CPU to wait for each frame to complete before submitting a request for the next. The subsequent transfer requests submitted are stored in the transfer queues to await processing.

To summarize, the CPU performs four writes to configure the options field, the source address, the count, and the destination address (or any four of the five fields). The CPU then performs a write to the index pseudo-register (or the register still not configured) to submit the transfer request for the first frame. For each additional frame, the CPU increments the source address by  $E \times S$  ( $1024 \times 2 = 2048$ ) and stores this value to the source address register. The CPU also increments the destination address by  $S$  and stores this value to the destination address *pseudo*-register to submit the transfer request.

If it is desired to have the EDMA notify the CPU when all of the transfers have completed, then the transfer request for the last frame should also have a modified options field to include a TCC value (and have TCINT = 1). See *CPU Interrupt Service Routines*, section 3, for details on this.

## 4.4 Peripheral Servicing Examples

An important capability of the EDMA is its ability to service peripherals (in the background of CPU operation) without requiring any CPU intervention. Through proper initialization of the EDMA channels, they can be configured to continuously service on- and off-chip peripherals throughout the device operation. Each event available to the EDMA has its own dedicated channel, and all channels operate simultaneously. This means that all data streams can be handled independently with little or no consideration for what else is going on in the EDMA.

Since all EDMA channels are always synchronized, there are no special setups required to configure a channel to properly service a particular event. The only requirements are to use the proper channel for a particular transfer and to enable the channel's event in the EER or CCER (unless the CPU synchronizes the channel).

When programming an EDMA channel to service a peripheral, it is necessary to know how data is to be presented to the DSP. Data is always provided with some kind of synchronization event, and is either one element per event (non-bursting), or multiple elements per event (bursting).

### 4.4.1 Nonbursting Peripherals

Non-bursting peripherals include the on-chip McBSPs and many external devices such as codecs. Regardless of the peripheral, the EDMA channel configuration is the same.

The on-chip McBSPs are the most commonly used peripherals in a C6000 system. EDMA channels 12 and 13 are dedicated to McBSP0 transmit and receive events, and channels 14 and 15 are dedicated to McBSP1 transmit and receive events. In addition, the C64x devices dedicate channels 17 and 18 to McBSP2 transmit and receive events. The transmit and receive data streams are treated independently by the EDMA. While a standard DMA channel could be used in split-mode to handle transmit and receive data, there are a number of restrictions with this because of the sharing of resources. The EDMA channels do not have these restrictions. Although most serial applications call for similar data formats both to and from the McBSP, this is not a requirement for reliable operation with the EDMA. The transmit and receive data streams can have completely different counts, data sizes, and formats.

If the previous block move example were changed so that the 256 words were received by McBSP0 to be transferred to internal L2 SRAM, the transfer would easily be handled by EDMA channel 13, which is synchronized by REVT0. Figure 21 shows a block diagram of this transfer.

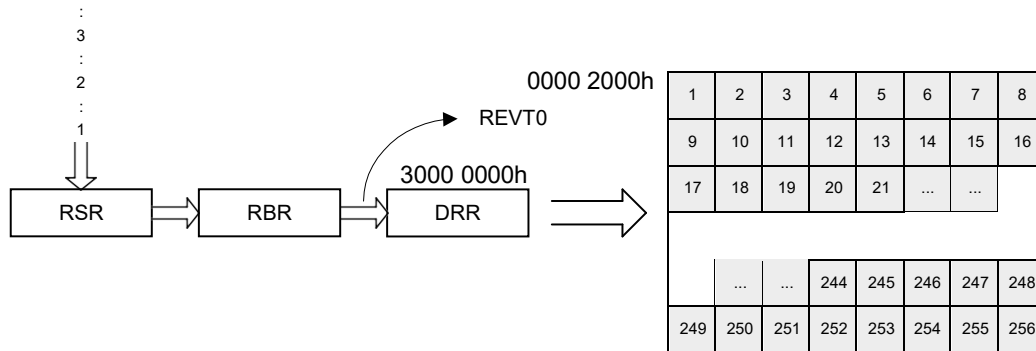
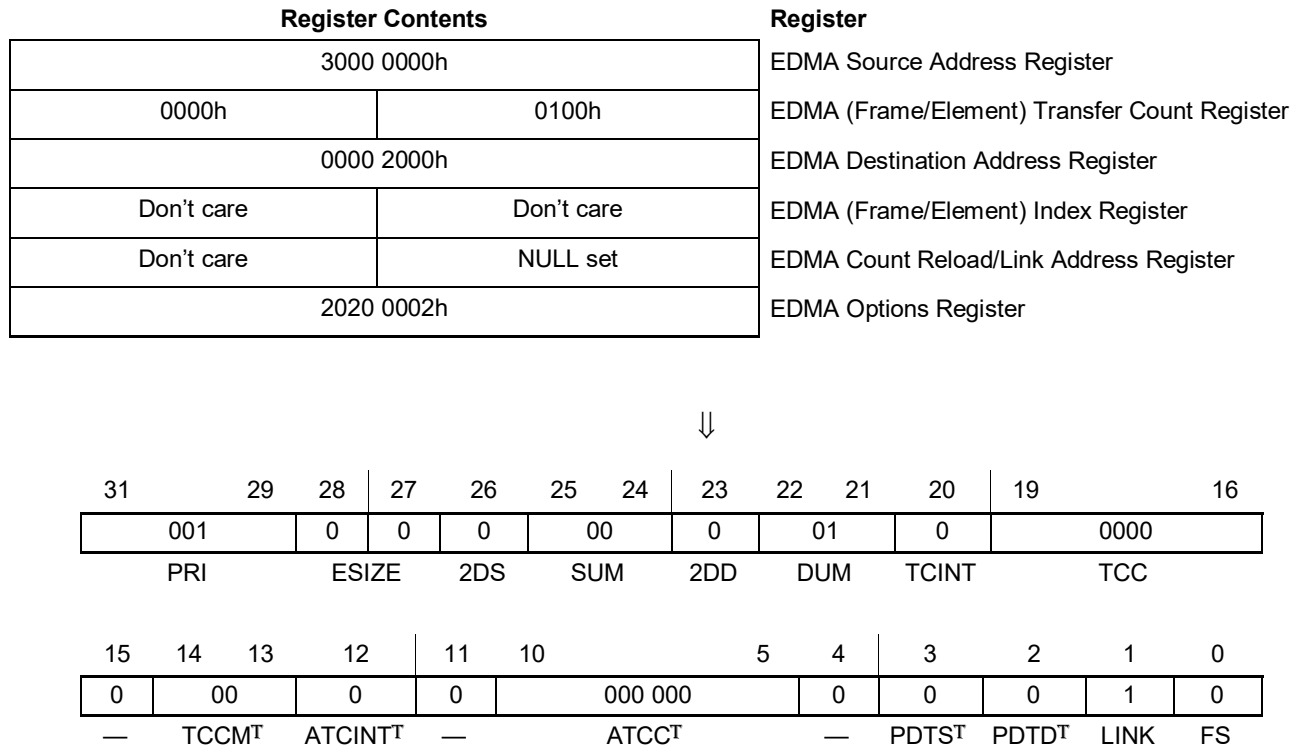

Figure 21. McBSP Servicing for Incoming Data

To transfer the incoming data stream to its proper location in L2 memory, the EDMA channel must be set up for a 1-D to 1-D transfer with element synchronization. Since an event (REVT0) is generated for every word as it arrives, it is necessary to have the EDMA issue the transfer request for each element individually. The channel entry for this transfer is shown in Figure 22.



† Available only on C64x devices.

**Figure 22. EDMA Register Parameters for Servicing Incoming McBSP Data**

The source address of the EDMA channel is set to the DRR address for McBSP0, and the destination address is set to the start of the data block in L2. Since the address of the DRR is fixed, SUM is set to 00b (no modification). The destination address is left at 01b (increment) as in the previous example. The priority level chosen in this example is based on the premise that serial data is typically a high priority, so that samples are not missed. Each transfer request by this channel is made on the high-priority queue (Q1).

All EDMA transfers are terminated by linking to a NULL parameter set after the last transfer. A NULL parameter set is defined as an EDMA parameter set where all the parameters are set to zero. Therefore, the link address in the configuration above must be set to a parameter set in the PaRAM that has been configured to zero, and the LINK bit in the Options register must be set to 1. This will allow for proper termination of the EDMA transfer.

#### 4.4.2 Bursting Peripherals

Higher bandwidth applications require that multiple data elements be presented to the DSP for every sync event. This frame of data can either be from multiple sources that are working simultaneously or a single high-throughput peripheral that streams data to/from the DSP.

In this example, a video framer is receiving a video frame from a camera and presenting it to the DSP one array at a time. The video image is 640 x 480 pixels, with each pixel represented by a 16-bit element. The image is to be stored in external memory. A diagram depicting this situation is shown in Figure 23.

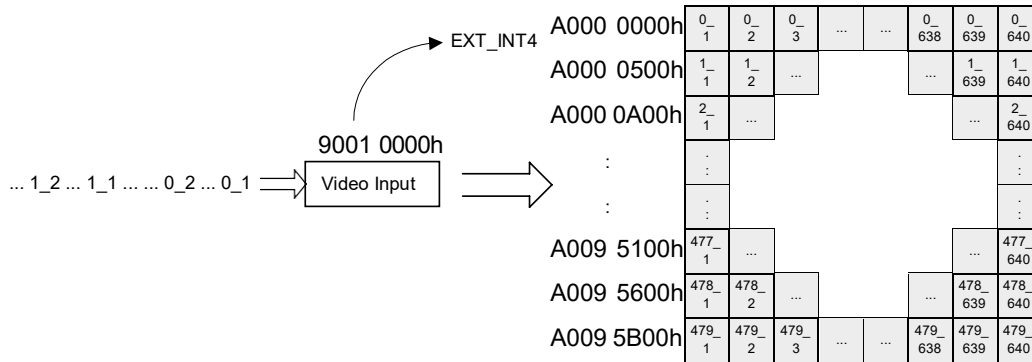

**Figure 23. Bursting Peripheral**

Channel 4 must be configured to transfer data from an external peripheral to an external buffer (one array at a time based on EXT\_INT4). There are two types of transfers that are suitable for this:

- a 1-D to 1-D transfer with frame synchronization
- or a 1-D to 2-D transfer with array synchronization

They are functionally identical. Because of the nature of the data (a video frame made up of arrays of pixels) the destination is essentially a 2-D entity. The parameter options to service the incoming data with a 1-D to 2-D transfer are shown in Figure 24.

Register Contents		Register
9001 0000h		EDMA Source Address Register
01DFh	0280h	EDMA (Frame/Element) Transfer Count Register
A000 0000h		EDMA Destination Address Register
0500h	Don't care	EDMA (Frame/Element) Index Register
Don't care	NULL set	EDMA Count Reload/Link Address Register
28A0 0003h		EDMA Options Register



31	29	28	27	26	25	24	23	22	21	20	19	16
001	0	1	0	00	1	01	0	0000				
PRI	ESIZE		2DS	SUM	2DD	DUM	TCINT	TCC				
15	14	13	12	11	10	5	4	3	2	1	0	
0	00	0	0	000 000			0	0	0	0	1	1
—	TCCM <sup>†</sup>	ATCINT <sup>†</sup>	—	ATCC <sup>†</sup>			—	PDTST <sup>†</sup>	PDTD <sup>†</sup>	LINK	FS	

<sup>†</sup> Available only on C64x devices.

**Figure 24. EDMA Register Parameters to Service Peripheral Bursts**

The source address is set to the location of the video framer peripheral, and the destination address to the start of the data buffer. Since the input address is static, SUM is set to 00b. The destination is made up of arrays of contiguous, linear elements. Therefore DUM is set to 01b (increment). The element count is equal to the number of pixels in an array (640). The array count is equal to one less than the total number of arrays in the frame (479). An array index, equal to the difference between the starting addresses of each array, is required. Since each pixel is represented by a halfword, the array index is equal to twice the element count (or 1280 bytes).

#### 4.4.3 Continuous Operation

Configuring an EDMA channel to receive a single frame of data can be useful, and is applicable to some systems. A majority of the time, however, data is going to be continuously transmitted and received throughout the entire operation of the DSP. In this case, it is necessary to implement some form of linking such that the EDMA channels continuously reload the necessary parameter sets.

In this example, McBSP0 is configured to transmit and receive data on a T1 array. To keep the example simple, only two channels are active for both transmit and receive data streams. Each channel receives packets of 128 elements. The packets are transferred from the serial port to L2 memory and from L2 memory to the serial port, as shown in Figure 25.

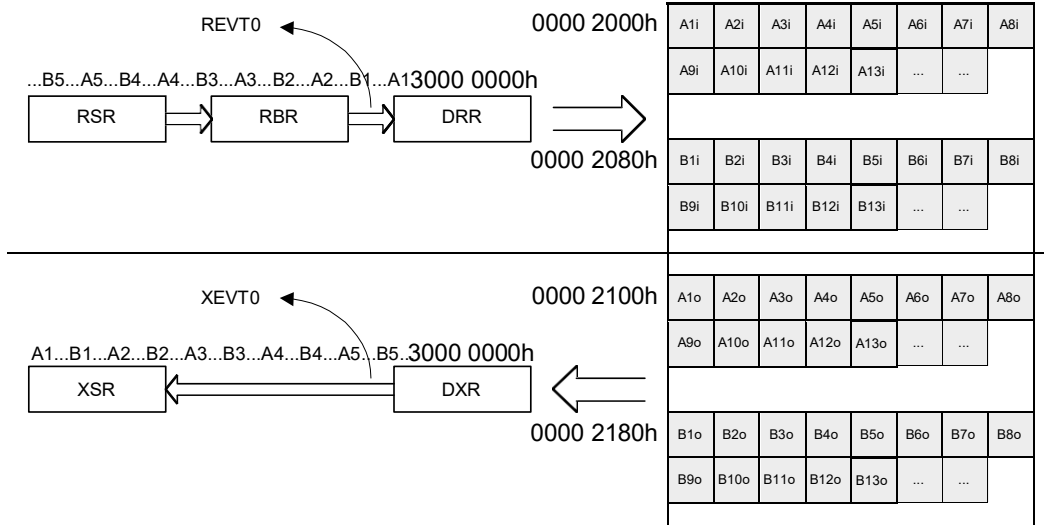

**Figure 25. Continuous McBSP Servicing by EDMA**

The McBSP generates REVT0 for every element received and XEVT0 for every element transmitted. To service the data streams, EDMA channels 12 and 13 must be set up for 1-D to 1-D transfers with element synchronization. In order to service the McBSP continuously throughout DSP operation, the channels must be linked to a duplicate entry in the parameter RAM. After all frames have been transferred, the EDMA channels reload and continue. The channel entries for these transfers are shown in Figure 26.

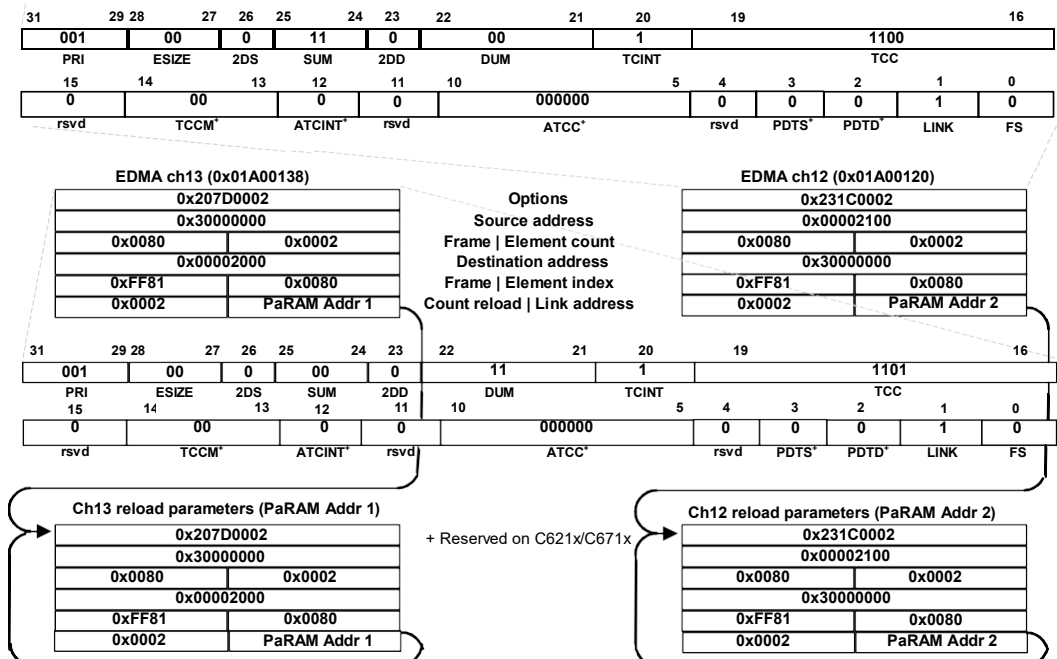

**Figure 26. EDMA Register Parameters for Continuous McBSP Servicing**



#### 4.4.3.1 Receive Channel

EDMA channel 13 is used to service the incoming data stream of McBSP0. As in the previous example, the source address is set to that of the DRR register, and the destination address is set to the first element of the data block. Since there are two data channels being serviced, A and B, and they are to be located separately within the L2 SRAM, the destination address update mode uses element and frame indexing (DUM = 11b). The element index is set to the offset between the first element of each channel's data section and the frame index is the offset between the second element of channel A and the first element of channel B. Since elements are 32-bit, the ESIZE field is set to 00b.

In order to facilitate continuous operation, a copy of the channel entry is placed in PaRAM. The LINK option is set and the link address is provided in the entry. Upon exhausting channel 13's element and frame counts, the parameters located at the link address are loaded into channel 13's parameter set and operation continues. This function continues throughout DSP operation until halted by the CPU.

The parameter table must keep track of the element count within the frame since each element is sent individually (FS = 0). It is therefore required that an element count reload is provided in the parameter set. This value is reloaded to the element count field every time the element count reaches zero.

#### 4.4.3.2 Transmit Channel

EDMA channel 12 services the outgoing data stream of McBSP0. Its configuration is essentially the opposite of channel 13's for this application since the input and output data is symmetrical. The element and frame counts are identical, as are the index values. The options are reversed, such that the source is updated using the programmed index values while the destination address is held constant. The source address provided to the channel is that of the beginning of channel A's output data, and the destination address is that of the DXR. Linking is also used to allow for continuous operation by the EDMA channel, with a duplicate entry in the PaRAM.

#### 4.4.4 Ping-Pong Buffering

Although the configuration presented in section 4.4.3 allows the EDMA to service a peripheral continuously, there are a number of restrictions it presents to the CPU. Since the input and output buffers are continuously being filled/emptied, in order for the CPU to process the data, it must match the pace of the EDMA very closely. The EDMA receive data must always be placed in memory before the CPU accesses it, and the CPU must provide the output data before the EDMA transfers it. Though not impossible, this is an unnecessary challenge. It is particularly difficult in a two-level cache system.

A simple technique to implement, which allows the CPU activity to be distanced from the EDMA activity, is to use ping-pong buffering. This simply means that there are multiple (usually two) sets of data buffers for all incoming and outgoing data streams. While the EDMA is transferring data in to and out of the ping buffers, the CPU is manipulating the data in the pong buffers. When CPU and EDMA activities complete, they switch. The EDMA then writes over the old input data and transfers the new output data. The ping-pong scheme for this example is shown in Figure 27.

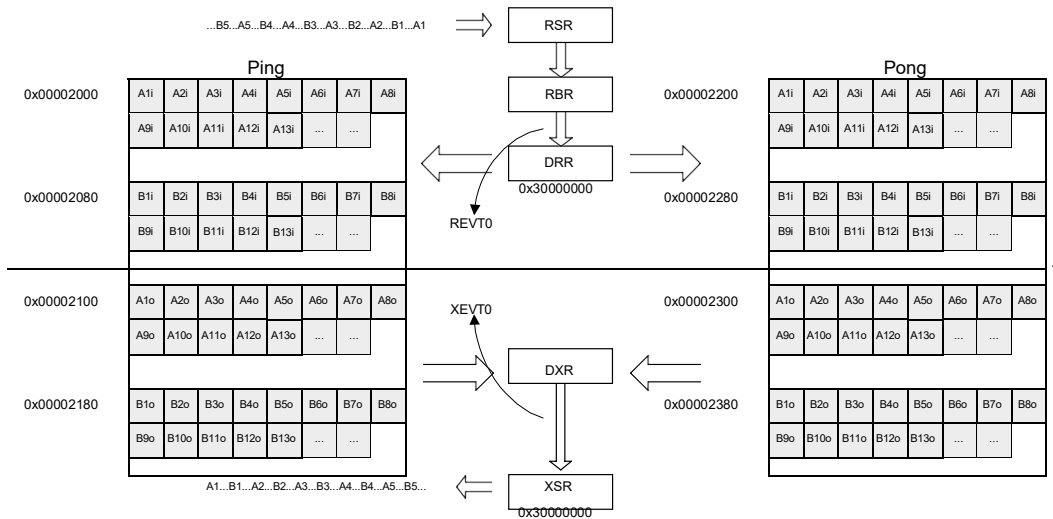

**Figure 27. Ping-Pong Buffering for McBSP Data**

To change the continuous operation example such that a ping-pong buffering scheme is used, the EDMA channels need only a moderate change. Instead of one parameter set, there are two:

- one for transferring data to/from the ping buffers
- one for transferring data to/from the pong buffers

As soon as one transfer completes, the channel loads the entry for the other and the data transfers continue. The EDMA channel configuration required for this is shown in Figure 28.

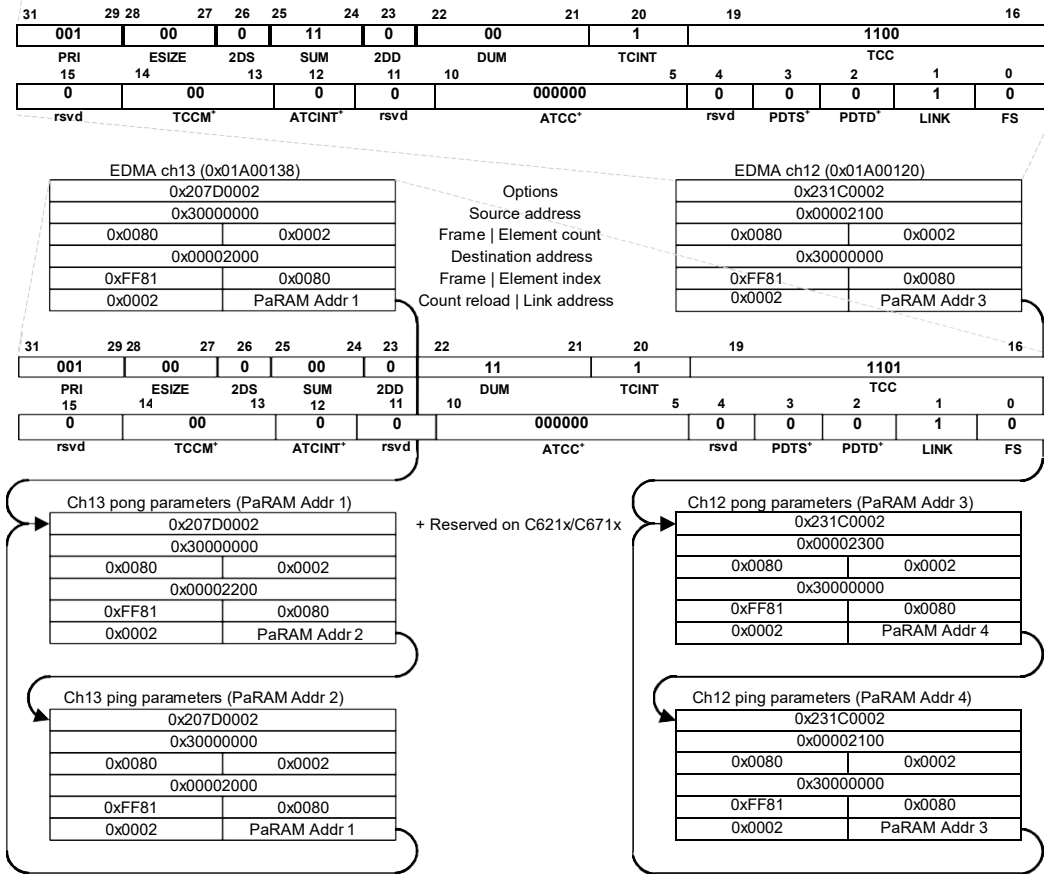

Figure 28. EDMA Parameters for Ping-Pong Buffering

Each channel has two parameter sets: ping and pong. The EDMA channel is initially loaded with the ping parameters. The link address for the ping entry is set to the PaRAM offset of the pong parameter set, and vice versa. The channel options, count values, and index values are all identical between the ping and pong parameters for each channel. The only differences are the link address provided and the address of the data buffer in internal memory.

#### 4.4.4.1 Synchronization with the CPU

In order to utilize the ping-pong buffering technique, it is necessary to signal to the CPU when it can begin to access the new data set. After the CPU finishes processing an input buffer (ping), it waits for the EDMA to complete before switching to the alternate (pong) buffer.

In this example, both channels provide their channel numbers as their report word and set TCINT to '1' to generate an interrupt after completion. When channel 13 fills an input buffer, CIP13 is set to '1'. When channel 12 empties an output buffer, CIP12 is set to '1'. The CPU must manually clear these bits.

With the channel parameters set as stated previously, the CPU can simply poll the CIPR to determine when to switch. The EDMA and CPU could alternatively be configured so that the channel completion interrupts the CPU. By doing this, the CPU would be able to service a background task while waiting for the EDMA to complete.

## 4.5 Endian Mode Considerations

When using a peripheral for element sizes other than 32-bits, endianness plays an important role. This is usually only true for the McBSPs, as external peripherals typically match the endianness of the entire system. In a system that operates in little endian, external peripherals should have the least significant bit (LSB) located at ED0. In big endian systems, the most significant bit (MSB) should always be located at ED31 (the MSB should either be bit 31, 15, or 7 only. If a peripheral that is not 32-, 16-, or 8-bits wide is used, the upper data bits should be unconnected). If a non-32 bit peripheral were connected to the EMIF with the LSB at ED0 for a big endian system, then there are other considerations for byte ordering according to the endian mode. Refer to the remaining paragraphs, and see Figure 30 and Figure 31 for byte locations.

The McBSPs are easiest to picture as a physical register set with a right and left side. The “right” side corresponds to data bit 0, and the “left” side corresponds to bit 31. The McBSP, by default, assumes the LSB of the element transferred to be located in bit 0. Data is always transmitted out from the right side of the DXR.

By default, data is received from the right side of the DRR, with the LSB of the element at bit 0. The data justification of received data is programmable to be left justified, as well. It is possible to configure the McBSP such that received data always has the MSB at bit 31.

The DXR and DRR (in its default state) hold the LSB in the right-most position, and the MSB on the left side (actual bit location depends on the element size to be transferred). The byte that accesses the right-most location of the McBSP registers depends on which endian mode the DSP is in. The DXR and DRR of the McBSPs are depicted in Figure 29 and Figure 30, with the byte ordering for each endian mode shown.

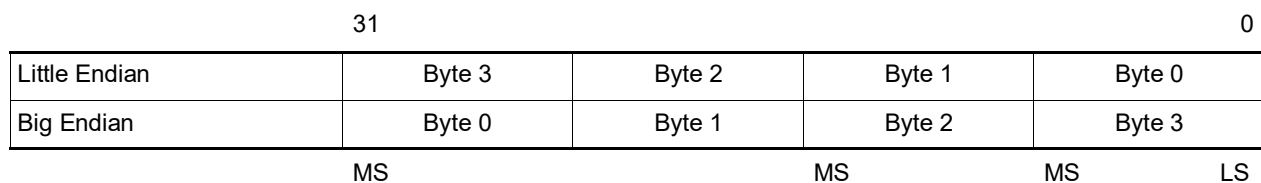

**Figure 29. DXR Byte Locations**

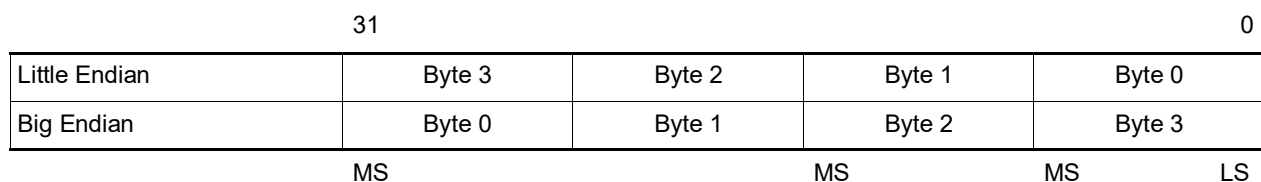

**Figure 30. DRR Byte Locations**

When in little-endian mode, the right-most data location is the base address of the DXR, so no matter what the element size, a write to the DXR base address properly aligns the element. In big-endian mode, however, this is the upper portion of the register. Depending on the size of the element, the write must be made to the address of either Byte 0 (32-bit), Byte 2 (16-bit) or to Byte 3 (8-bit). It is not possible to left-justify outgoing data.

The DRR is configurable to either right- or left-justify the incoming data. The justification determines the source address of the data element. For right-justified data (default), the source address is always Byte 0 in little endian mode. It is in Byte 0 (32-bit), Byte 2 (16-bit) or Byte 3 (8-bit) in big-endian mode. For left-justified data, the reverse is true.

Table 9 shows the possible element size, endian mode, and DRR justification combinations that can be encountered in a system. Only the source and destination addresses are given for each. All of the necessary configurations described previously still apply.

**Table 9. Possible DMA Source and Destination Addresses for Servicing McBSP0**

Element Size	Endian Mode	DRR Justification	Source Address	Destination Address
8-bit	Little	Right	3000 0000h	3000 0004h
		Left	3000 0003h	3000 0004h
	Big	Right	3000 0003h	3000 0007h
		Left	3000 0000h	3000 0007h
12-bit 16-bit	Little	Right	3000 0000h	3000 0004h
		Left	3000 0002h	3000 0004h
	Big	Right	3000 0002h	3000 0006h
		Left	3000 0000h	3000 0006h
20-bit 24-bit 32-bit†	Little	Right	3000 0000h	3000 0004h
		Left	3000 0000h	3000 0004h
	Big	Right	3000 0000h	3000 0004h
		Left	3000 0000h	3000 0004h

† The Source Addresses and Destination Addresses are identical for both the big- and little-endian modes when transferring 32-bit elements.

The addresses shown in Table 9 are not the only possible addresses. The EDMA can actually use any address in the 3000 0000h to 33FF FFFF range for McBSP0. In Table 9, the important part of the address is that of the two least significant bits. Transfers work properly provided that:

- address used matches the LSB values of that in the appropriate table location
- address used is in the appropriate address range for the McBSP data registers

## 5 Chip Support Library

The Chip Support Library (CSL) provides a C-language interface to configuring and controlling on-chip peripherals. By using data types and macros defined in the CSL header files, your code is much easier to read and modify. They provide a standard protocol for programming the on-chip peripherals and allow for symbolic description of all of the peripheral registers and register fields. In general, the CSL makes it easier for you to get your algorithms up and running in the shortest amount of time.

To use the CSL, you must first include the relevant header files in your code. In addition to the mandatory `csl.h` file, the header file of the module/peripheral you will use should also be included. For the EDMA, this file is named `csl_edma.h`. With these header files included, you are now able to take advantage of the CSL's data types and macros.

The second step in using the CSL is to define a `DMA_Handle` pointer. This pointer will allow you to access and modify the EDMA channel that you wish to use. After you have the pointer defined, you must next set up the configuration structure for the desired channel. This can be done in a variety of ways, all of which are outlined in the *TMS320C6000 Chip Support Library API User's Guide* (literature number SPRU401). The configuration structure contains the values for all six of the parameter fields for an EDMA channel and will later be applied to the channel you desire to use.

Inside of the `main()` function of your program, the CSL library must be initialized. This is done by placing a call to the function `CSL_init()` at the beginning of your code. With everything set up properly, you can now open, configure, and enable the desired EDMA channel. To do this, first use the CSL function `EDMA_open()` to open the EDMA channel for use. Once opened, there are a variety of ways to configure the channel for proper operation. Among these are the CSL functions `EDMA_config()` and `EDMA_configArgs()`. To learn more about these functions, refer to the *TMS320C6000 Chip Support Library API User's Guide* (literature number SPRU401). Once configured, the EDMA channel can be enabled by using the CSL function `EDMA_enableChannel()`.

With the channel enabled, an event sent to that channel of the EDMA will cause the channel to begin operation based on its configuration. Once all desired transfers have completed, the CSL functions `EDMA_disableChannel()` and `EDMA_close()` should be executed to close the channel. This is the basic structure of an EDMA transfer using the CSL. Please refer to the *TMS320C6000 Chip Support Library API User's Guide* (literature number SPRU401) to learn about more advanced CSL functions available for the EDMA.

## 6 Conclusion

The EDMA is the primary component of the two-level cache architecture devices. It performs cache servicing, host-port servicing, and user-programmable data transfers. All of the EDMA channels, plus a QDMA register set, are programmable to perform data transfers in the background of CPU operation. Very little CPU intervention is required. Through proper configuration, the EDMA channels can be set up to service all of the incoming/outgoing data streams to/from the DSP, without requiring significant processing time by the CPU to manage the transfers. The CPU is primarily left to focus on the data processing, with all of the data management handled in the background by the EDMA.

## Appendix A Example Code

### A.1 Block Move

```

/*****
/* block.c
/* written by David Bell
/* on 6/24/99
/* last modified 12/19/00 : Use CSL
/*
/* block.c uses the QDMA to perform a simple block transfer from external (CE2)
/* to internal (L2) memory.
*****/
#include <cs1.h>
#include <cs1_dat.h>
#include <cs1_edma.h>
/* definitions */
#define MEM_SRC 0x80000000 /* Source address for transfer */
#define MEM_DST 0x00008000 /* Destination address for transfer */
#define EL_COUNT 0x0100 /* Element count for transfer */
/* prototypes */
void cfg_data(void);
void submit_qdma(void);
void wait(void);
int check_data(void);
/*****cfg_data*****/
/* Store a data ramp in the source memory space. This data will be transferred
/* by the EDMA.
*****/
void
cfg_data()
{
unsigned short *val;
unsigned short i = 0;
    val = (unsigned short *)MEM_SRC;

    /* Set up transfer data */
    for (i = 0; i < (EL_COUNT<<1); i++){
        *val++ = i;
    } /* end for */

} /* end cfg_data */
/*****submit_qdma*****/
/* Submit a QDMA request to transfer the data.
*****/
void
submit_qdma(void)
{
EDMA_Config config;
    config.opt = (Uint32)
        ( (EDMA_OPT_PRI_HIGH << _EDMA_OPT_PRI_SHIFT )
        | (EDMA_OPT_ESIZE_32BIT << _EDMA_OPT_ESIZE_SHIFT )
        | (EDMA_OPT_2DS_NO << _EDMA_OPT_2DS_SHIFT )
        | (EDMA_OPT_SUM_INC << _EDMA_OPT_SUM_SHIFT )
        /* 0x21200001 */

```

```

        | (EDMA_OPT_2DD_NO          << _EDMA_OPT_2DD_SHIFT   )
        | (EDMA_OPT_DUM_INC         << _EDMA_OPT_DUM_SHIFT   )
        | (EDMA_OPT_TCINT_NO       << _EDMA_OPT_TCINT_SHIFT )
        | (EDMA_OPT_TCC_DEFAULT    << _EDMA_OPT_TCC_SHIFT   )
#if (C64_SUPPORT)
        | (EDMA_OPT_TCCM_DEFAULT   << _EDMA_OPT_TCCM_SHIFT  )
        | (EDMA_OPT_ATCINT_NO     << _EDMA_OPT_ATCINT_SHIFT)
        | (EDMA_OPT_ATCC_DEFAULT   << _EDMA_OPT_ATCC_SHIFT  )
        | (EDMA_OPT_PDTS_DISABLE  << _EDMA_OPT_PDTS_SHIFT  )
        | (EDMA_OPT_PDTD_DISABLE  << _EDMA_OPT_PDTD_SHIFT  )
#endif

        | (EDMA_OPT_LINK_NO       << _EDMA_OPT_LINK_SHIFT  )
        | (EDMA_OPT_FS_YES        << _EDMA_OPT_FS_SHIFT    ));
config.src = (unsigned int)MEM_SRC;          /* 0x80000000 */
config.cnt = (unsigned int)EL_COUNT;        /* 0x00000100 */
config.dst = (unsigned int)MEM_DST;        /* 0x00002000 */
config.idx = (unsigned int)0;              /* 0x00000000 */
EDMA_qdmaConfig(&config);

} /* end submit_qdma */
/*****wait*****/
/* Wait until the transfer completes, as indicated by the status of the low- */
/* priority queue in the queue status register (QSR). */
/******/
void
wait(void)
{
    while (!(EDMA_getPriQStatus() & EDMA_OPT_PRI_HIGH));
} /* end wait */
/*****check_data*****/
/* Verify that the data was properly transferred by comparing the source data */
/* to the destination data. */
/******/
int
check_data(void)
{
    unsigned short *src = (unsigned short *)MEM_SRC,
                  *dst = (unsigned short *)MEM_DST,
                  source = 0,
                  dest = 0;
    short i = 0;
    int err = 0;

    for (i = 0; i < (EL_COUNT<<1); i++){
        dest = *dst;
        source = *src;
        if (dest != source){
            /* Set error value if incorrect data */
            err = i;
            break;
        } /* end if */
        dst += 1;
        src += 1;
    } /* end for i */
}

```



```

        return(err);
    } /* end check_data */
    /*****main*****/
    /* Main code body. */
    /******/
    void
    main(void)
    {
    Uint32 xfr_id = 0;
    Uint32 error = 0;
        cfg_data();
    #if 0
        submit_qdma();
        wait();
    #else
        DAT_open(DAT_CHAANY, DAT_PRI_HIGH, 0);
        xfr_id = DAT_copy((void *)MEM_SRC, (void *)MEM_DST, (Uint16)(EL_COUNT<<2));
        DAT_wait(xfr_id);
        DAT_close();
    #endif
        error = check_data();

        while(error);
        while(!error);
    } /* end main */

```

## A.2 Subframe Extraction

```

    /*****
    /* sf_extract.c
    /* written by David Bell
    /*      on 6/24/99
    /* last modified 12/19/00 : Use CSL
    /*
    /* sf_extract uses the QDMA to extract a subframe of data from an
    /* array stored in external (CE0) memory. The data is transferred to
    /* a buffer in internal (L2) memory.
    *****/

    #include <cs1.h>
    #include <cs1_dat.h>

    /* definitions */
    #define MEM_SRC      0x80000000      /* Source address for transfer */
    #define MEM_DST      0x00008000      /* Destination address for transfer */
    #define EL_COUNT     16              /* Number of 16-bit elements per line */
    #define LN_COUNT     12              /* Number of lines */
    #define LN_PITCH     32              /* Pitch between lines (start->start) */

    /* prototypes */
    void cfg_data(void);
    void submit_qdma(Uint32 xfr_id);
    void wait(Uint32 xfr_id);
    int check_data(void);

```

```

/*****cfg_data*****/
/* Store a data ramp in the source memory space. This data will be trans- */
/* ferred by the EDMA. */
/******/
void
cfg_data()
{
    unsigned short *val;
    unsigned short i = 0;

    val = (unsigned short *)MEM_SRC;

    /* Set up transfer data */
    for (i = 0; i < (LN_COUNT * LN_PITCH); i++){
        *val++ = i;
    } /* end for */

} /* end cfg_data */

/*****submit_qdma*****/
/* Submit a QDMA request to extract a subframe of data from a 640x480 video */
/* image. The subframe is transferred from external (CE2) to internal (L2) */
/* memory. */
/******/
void
submit_qdma(Uint32 xfr_id)
{
    EDMA_Config config;

    config.opt = (Uint32)
        ((EDMA_OPT_PRI_LOW << _EDMA_OPT_PRI_SHIFT )
         | (EDMA_OPT_ESIZE_16BIT << _EDMA_OPT_ESIZE_SHIFT )
         | (EDMA_OPT_2DS_YES << _EDMA_OPT_2DS_SHIFT )
         | (EDMA_OPT_SUM_INC << _EDMA_OPT_SUM_SHIFT )
         | (EDMA_OPT_2DD_NO << _EDMA_OPT_2DD_SHIFT )
         | (EDMA_OPT_DUM_INC << _EDMA_OPT_DUM_SHIFT )
         | (EDMA_OPT_TCINT_YES << _EDMA_OPT_TCINT_SHIFT )
         | (EDMA_OPT_TCC_OF(xfr_id) << _EDMA_OPT_TCC_SHIFT )
#ifdef C64_SUPPORT
         | (EDMA_OPT_TCCM_DEFAULT << _EDMA_OPT_TCCM_SHIFT )
         | (EDMA_OPT_ATCINT_NO << _EDMA_OPT_ATCINT_SHIFT)
         | (EDMA_OPT_ATCC_DEFAULT << _EDMA_OPT_ATCC_SHIFT )
         | (EDMA_OPT_PDTS_DISABLE << _EDMA_OPT_PDTS_SHIFT )
         | (EDMA_OPT_PDTD_DISABLE << _EDMA_OPT_PDTD_SHIFT )
#endif
         | (EDMA_OPT_LINK_NO << _EDMA_OPT_LINK_SHIFT )
         | (EDMA_OPT_FS_YES << _EDMA_OPT_FS_SHIFT ) );

    config.src = (Uint32)MEM_SRC; /* 0x80000000 */
    config.cnt = (Uint32)((LN_COUNT-1)<<16 | EL_COUNT); /* 0x000B0010 */
    config.dst = (Uint32)MEM_DST; /* 0x00008000 */
    config.idx = (Uint32)((LN_PITCH - EL_COUNT)<<1<<16); /* 0x00200000 */

    EDMA_qdmaConfig(&config);
}

```

```

} /* end submit_qdma */

/*****wait*****/
/* Wait until the transfer completes, as indicated by the status of the low- */
/* priority queue in the queue status register (QSR). */
/******/
void
wait(Uint32 xfr_id)
{
//     while (!(EDMA_getPriQStatus() & EDMA_OPT_PRI_LOW));
//     while (!(EDMA_CIPR)&(1<<xfr_id));
//     EDMA_CIPR = EDMA_CIPR_OF(1<<xfr_id);
} /* end wait */

/*****check_data*****/
/* Verify that the data was properly transferred by comparing the source data*/
/* to the destination data. */
/******/
int
check_data(void)
{
unsigned short *src = (unsigned short *)MEM_SRC,
               *dst = (unsigned short *)MEM_DST,
               source = 0,
               dest = 0;
short         i, j = 0;
int           err = 0;

    for (i = 0; i < LN_COUNT; i++){
        for (j = 0; j < EL_COUNT; j++){
            dest = dst[j];
            source = src[j];

            if (dest != source){
                /* Set error value if incorrect data */
                err = (i<<16) | j;
                break;
            } /* end if */
        } /* end for j */
        if (err) break;
        dst += EL_COUNT;
        src += LN_PITCH;
    } /* end for i */
    return(err);
} /* end check_data */

/*****main*****/
/* Main code body. */
/******/
void
main(void)

```

```

{
  Uint32 xfr_id = 1;
  Uint32 error = 0;

  cfg_data();
  #if 1
    submit_qdma(xfr_id);
    wait(xfr_id);
  #else
    DAT_open(DAT_CHAANY, DAT_PRI_LOW, 0);
    xfr_id = DAT_copy2d(DAT_2D1D, (void *)MEM_SRC, (void *)MEM_DST,
                      (Uint16)(EL_COUNT<<1), (Uint16)LN_COUNT, (Uint16)(LN_PITCH<<1));
    DAT_wait(xfr_id);
    DAT_close();
  #endif

  error = check_data();

  while(error);
  while(!error);

} /* end main */

```

### A.3 Sorting

```

/*****
/* sorting.c
/* written by David Bell
/* on 12/20/00
/*
/* sorting.c uses the QDMA to perform a transfer from external (CE0) memory to
/* internal (L2) memory. The data is arranged in contiguous arrays and is to be
/* re-ordered according to position within the array.
/* i.e. from A0, A1, ..., An to A0, B0, ..., N0
/* B0, B1, ..., Bn A1, B1, ..., N1
/* : : : : : : : :
/* N0, N1, ..., Nn An, Bn, ..., Nn
*****/
#include <csl.h>
#include <csl_dat.h>
#include <csl_edma.h>
/* definitions */
#define MEM_SRC 0x80000000 /* Source address for transfer */
#define MEM_DST 0x00008000 /* Destination address for transfer */
#define EL_COUNT 32 /* Element count per array */
#define AR_COUNT 12 /* Number of arrays */
#define EL_SIZE 2 /* Element size in bytes */
#define EL_INDEX AR_COUNT * EL_SIZE /* Index equals the array length */
/* prototypes */
void cfg_data(void);
void submit_qdma(void);
void wait(void);
Int32 check_data(void);
/*****cfg_data*****/
/* Store a data ramp in the source memory space. This data will be transferred */

```

```

/* by the EDMA.                                                                                               */
/*****                                                                                                       */
void
cfg_data()
{
  Uint16  *val;
  Uint16   i = 0;
      val = (Uint16 *)MEM_SRC;

      /* Set up transfer data */
      for (i = 0; i < (AR_COUNT * EL_COUNT); i++){
          *val++ = i;
      } /* end for */

} /* end cfg_data */
/*****submit_qdma*****/
/* Submit a QDMA request to transfer the data.                                                                */
/*****

void
submit_qdma(void)
{
  Uint16   i;
  EDMA_Config config;
      config.opt = (Uint32)
          ( (EDMA_OPT_PRI_LOW      << _EDMA_OPT_PRI_SHIFT  )
            | (EDMA_OPT_ESIZE_16BIT << _EDMA_OPT_ESIZE_SHIFT)
            | (EDMA_OPT_2DS_NO      << _EDMA_OPT_2DS_SHIFT  )
            | (EDMA_OPT_SUM_INC      << _EDMA_OPT_SUM_SHIFT  )
            | (EDMA_OPT_2DD_NO      << _EDMA_OPT_2DD_SHIFT  )
            | (EDMA_OPT_DUM_IDX      << _EDMA_OPT_DUM_SHIFT  )
            | (EDMA_OPT_TCINT_NO     << _EDMA_OPT_TCINT_SHIFT )
            | (EDMA_OPT_TCC_DEFAULT  << _EDMA_OPT_TCC_SHIFT  )

#ifdef C64_SUPPORT
            | (EDMA_OPT_TCCM_DEFAULT << _EDMA_OPT_TCCM_SHIFT )
            | (EDMA_OPT_ATCINT_NO    << _EDMA_OPT_ATCINT_SHIFT)
            | (EDMA_OPT_ATCC_DEFAULT << _EDMA_OPT_ATCC_SHIFT )
            | (EDMA_OPT_PDTS_DISABLE << _EDMA_OPT_PDTS_SHIFT )
            | (EDMA_OPT_PDTD_DISABLE << _EDMA_OPT_PDTD_SHIFT )

#endif

            | (EDMA_OPT_LINK_NO      << _EDMA_OPT_LINK_SHIFT )
            | (EDMA_OPT_FS_YES       << _EDMA_OPT_FS_SHIFT  ) );
      config.src = (Uint32)MEM_SRC;
      config.cnt = (Uint32)EL_COUNT;
      config.dst = (Uint32)MEM_DST;
      config.idx = (Uint32)EL_INDEX;
      EDMA_qdmaConfig(&config);

#ifdef 1
      for (i = 0; i < AR_COUNT - 1; i++){
          config.src += EL_COUNT * EL_SIZE;
          config.dst += EL_SIZE;
          EDMA_qdmaConfig(&config);
          /*****
          /* To reduce the number of additional writes to only two */
          /* For each array, you can specify the updates rather    */

```

```

        /* than using qdmaConfig. To do so, replace the above */
        /* line with: */
        /* base = (volatile Uint32 *) (_EDMA_QOPT_ADDR); */
        /* base[_EDMA_QSRC_OFFSET] = config.src; */
        /* base[_EDMA_QSDST_OFFSET] = config.dst; */
        /* Note that you must declare base above */
        /*******/
    } /* end for i */
#endif

} /* end submit_qdma */
/*****wait*****/
/* Wait until the transfer completes, as indicated by the status of the low- */
/* priority queue in the queue status register (QSR). */
/******/
void
wait(void)
{
    while (!(EDMA_getPriQStatus() & EDMA_OPT_PRI_HIGH));
} /* end wait */
/*****check_data*****/
/* Verify that the data was properly transferred by comparing the source data */
/* to the destination data. */
/******/
Int32
check_data(void)
{
    Uint16 *src = (unsigned short *)MEM_SRC,
          *dst = (unsigned short *)MEM_DST,
          source = 0,
          dest = 0;
    Uint16 i, j;
    Int32 err = 0;

    for (i = 0; i < AR_COUNT; i++){
        for (j = 0; j < EL_COUNT; j++){
            dest = dst[AR_COUNT * j];
            source = src[j];
            if (dest != source){
                /* Set error value if incorrect data */
                err = i;
                break;
            } /* end if */
        } /* end for j */
        dst += 1;
        src += EL_COUNT;
    } /* end for i */
    return(err);
} /* end check_data */
/*****main*****/
/* Main code body. */
/******/
void
main(void)

```

```

{
Uint16 i;
Uint32 xfr_id = 0;
Uint32 error = 0;
Uint8 *source = (Uint8 *)MEM_SRC;
Uint8 *dest = (Uint8 *)MEM_DST;
    cfg_data();
#ifdef 1
    submit_qdma();
    wait();
#else
    DAT_open(DAT_CHAANY, DAT_PRI_LOW, 0);
    for (i = 0; i < AR_COUNT ; i++){
        xfr_id = DAT_copy2d(DAT_1D2D, (void *)source, (void *)dest,
            (Uint16)EL_SIZE, (Uint16)(EL_COUNT*EL_SIZE),
            (Uint16)(AR_COUNT*EL_SIZE));
        source += EL_COUNT * EL_SIZE;
        dest += EL_SIZE;
    } /* end for i */
    DAT_wait(xfr_id);
    DAT_close();
#endif
    error = check_data();

    while(error);
    while(!error);
} /* end main */

```

## A.4 Servicing a Non-Bursting Peripheral

```

/*****
/* nb_perph.c
/* written by David Bell
/* on 12/20/00
/*
/* nb_perph uses two EDMA channels to service McBSP0. Channel 12 is used to
/* transmit a frame of data from L2 to the DXR. Channel 13 is used to transmit
/* a frame of data from the DRR to L2.
*****/
#include <csl.h>
#include <csl_edma.h>
#include <csl_mcbbsp.h>
/* definitions */
#define MEM_SRC 0x80000000 /* Source address for transfer */
#define MEM_DST 0x00008000 /* Destination address for transfer */
#define EL_COUNT 0x0100 /* Element count for transfer */
/* prototypes */
void cfg_data(void);
Int32 cfg_edma(EDMA_Handle *hEdma_ch12, EDMA_Handle *hEdma_ch13);
void wait(void);
Int32 check_data(void);
extern void cfg_mcbbsp(MCBSP_Handle *hMcbbsp_ch0);
extern void start_mcbbsp(MCBSP_Handle *hMcbbsp_ch0);
/*****cfg_data*****/

```

```

/* Store a data ramp in the source memory space. This data will be transferred */
/* by the EDMA.                                                                */
/*****
void
cfg_data()
{
unsigned short  *val;
unsigned short   i = 0;
    val = (unsigned short *)MEM_SRC;

    /* Set up transfer data */
    for (i = 0; i < (EL_COUNT<<1); i++){
        *val++ = i;
    } /* end for */

} /* end cfg_data */
/*****cfg_edma*****/
/* Program EDMA channels 12 and 13 to service McBSP0. Both channels terminate */
/* by linking to a NULL parameter set.                                       */
/*****
Int32
cfg_edma(EDMA_Handle *hEdma_ch12, EDMA_Handle *hEdma_ch13)
{
Uint32 link_address;
EDMA_Config config;
EDMA_Handle hEdma_NULL;
    if (!EDMA_allocTableEx(1, &hEdma_NULL)) return(-1);
    EDMA_reset(hEdma_NULL);
    link_address = EDMA_getTableAddress(hEdma_NULL);

    *hEdma_ch12 = EDMA_open(12, EDMA_OPEN_RESET);
    *hEdma_ch13 = EDMA_open(13, EDMA_OPEN_RESET);
    /* Configure the transmit channel (13) */
    config.opt = (Uint32)
        ((EDMA_OPT_PRI_HIGH      << _EDMA_OPT_PRI_SHIFT  )
         | (EDMA_OPT_ESIZE_32BIT << _EDMA_OPT_ESIZE_SHIFT )
         | (EDMA_OPT_2DS_NO      << _EDMA_OPT_2DS_SHIFT  )
         | (EDMA_OPT_SUM_INC     << _EDMA_OPT_SUM_SHIFT  )
         | (EDMA_OPT_2DD_NO      << _EDMA_OPT_2DD_SHIFT  )
         | (EDMA_OPT_DUM_NONE    << _EDMA_OPT_DUM_SHIFT  )
         | (EDMA_OPT_TCINT_YES   << _EDMA_OPT_TCINT_SHIFT )
         | (EDMA_OPT_TCC_OF(13) << _EDMA_OPT_TCC_SHIFT  )

#ifdef C64_SUPPORT
         | (EDMA_OPT_TCCM_DEFAULT << _EDMA_OPT_TCCM_SHIFT )
         | (EDMA_OPT_ATCINT_NO    << _EDMA_OPT_ATCINT_SHIFT)
         | (EDMA_OPT_ATCC_DEFAULT << _EDMA_OPT_ATCC_SHIFT )
         | (EDMA_OPT_PDTS_DISABLE << _EDMA_OPT_PDTS_SHIFT )
         | (EDMA_OPT_PDTD_DISABLE << _EDMA_OPT_PDTD_SHIFT )

#endif
         | (EDMA_OPT_LINK_YES    << _EDMA_OPT_LINK_SHIFT  )
         | (EDMA_OPT_FS_NO       << _EDMA_OPT_FS_SHIFT   )
        );
    config.src = (Uint32)MEM_SRC;          /* 0xA0000000 */
    config.cnt = (Uint32)EL_COUNT;        /* 0x00000100 */
    config.dst = (Uint32)_MCBSP_DXR0_ADDR; /* 0x30000000 */
}

```



```

config.idx = (Uint32)0; /* 0x00000000 */
config.rld = (Uint32)link_address & 0xffff; /* &NULL */
EDMA_config(*hEdma_ch12, &config);

config.opt = (Uint32) /* 0xA0000000 */
    (EDMA_OPT_PRI_HIGH << _EDMA_OPT_PRI_SHIFT )
    | (EDMA_OPT_ESIZE_32BIT << _EDMA_OPT_ESIZE_SHIFT )
    | (EDMA_OPT_2DS_NO << _EDMA_OPT_2DS_SHIFT )
    | (EDMA_OPT_SUM_NONE << _EDMA_OPT_SUM_SHIFT )
    | (EDMA_OPT_2DD_NO << _EDMA_OPT_2DD_SHIFT )
    | (EDMA_OPT_DUM_INC << _EDMA_OPT_DUM_SHIFT )
    | (EDMA_OPT_TCINT_YES << _EDMA_OPT_TCINT_SHIFT )
    | (EDMA_OPT_TCC_OF(12) << _EDMA_OPT_TCC_SHIFT )
#if (C64_SUPPORT)
    | (EDMA_OPT_TCCM_DEFAULT << _EDMA_OPT_TCCM_SHIFT )
    | (EDMA_OPT_ATCINT_NO << _EDMA_OPT_ATCINT_SHIFT)
    | (EDMA_OPT_ATCC_DEFAULT << _EDMA_OPT_ATCC_SHIFT )
    | (EDMA_OPT_PDTN_DISABLE << _EDMA_OPT_PDTN_SHIFT )
    | (EDMA_OPT_PDTD_DISABLE << _EDMA_OPT_PDTD_SHIFT )
#endif
    | (EDMA_OPT_LINK_YES << _EDMA_OPT_LINK_SHIFT )
    | (EDMA_OPT_FS_NO << _EDMA_OPT_FS_SHIFT ) );
config.src = (Uint32)_MCBSP_DRR0_ADDR; /* 0x30000000 */
config.cnt = (Uint32)EL_COUNT; /* 0x00000100 */
config.dst = (Uint32)MEM_DST; /* 0x00009000 */
config.idx = (Uint32)0; /* 0x00000000 */
config.rld = (Uint32)link_address & 0xffff; /* &NULL */
EDMA_config(*hEdma_ch13, &config);

return(0);

} /* end cfg_edma */
/*****wait*****/
/* Wait until the transfer completes, as indicated by bit 12 of the Channel
/* Interrupt Pending Register (CIPR).
/******/
void
wait(void)
{
    while (!(Uint32)EDMA_RGET(CIPR) & (1 << 12));
} /* end wait */
/*****check_data*****/
/* Verify that the data was properly transferred by comparing the source data
/* to the destination.
/******/
int
check_data(void)
{
    unsigned short *src = (unsigned short *)MEM_SRC,
        *dst = (unsigned short *)MEM_DST,
        source = 0,
        dest = 0;
    short i = 0;
    int err = 0;

```

```

    for (i = 0; i < (EL_COUNT<<1); i++){
        dest = *dst;
        source = *src;
        if (dest != source){
            /* Set error value if incorrect data */
            err = i;
            break;
        } /* end if */
        dst += 1;
        src += 1;
    } /* end for i */
    return(err);
} /* end check_data */
/*****main*****/
/* Main code body. */
/*****/
void
main(void)
{
    Uint32 error = 0;
    EDMA_Handle hEdma_ch12;
    EDMA_Handle hEdma_ch13;
    MCBSP_Handle hMcbbsp_ch0;
    cfg_data();
    error = cfg_edma(&hEdma_ch12, &hEdma_ch13);
    if (!error){
        cfg_mcbbsp(&hMcbbsp_ch0);
        EDMA_enableChannel(hEdma_ch12);
        EDMA_enableChannel(hEdma_ch13);
        start_mcbbsp(&hMcbbsp_ch0);
        wait();
        EDMA_close(hEdma_ch12);
        EDMA_close(hEdma_ch13);
        MCBSP_close(hMcbbsp_ch0);
    } /* end if !error */
    if (!error) error = check_data();

    while(error);
    while(!error);
} /* end main */
/*****/
/* Project: EDMA Test */
/* mcbbsp.c */
/* written by David Bell */
/* on 6/21/99 */
/* */
/* mcbbsp.c configures the McBSPs as required for the EDMA transfers on channels */
/* 12 - 15. The McBSP in use is configured to operate in digital loopback (DLB) */
/* mode, such that the data transferred is looped back to the receive port in- */
/* ternally. */
/* */
/*****/
#include <csl.h>

```

```

#include <csl_mcbasp.h>
/* prototypes */
void cfg_mcbasp(MCBSP_Handle *hMcbasp_ch0);
void start_mcbasp(MCBSP_Handle *hMcbasp_ch0);
/*****cfg_mcbasp*****/
/* Program McBSP0 to transmit and receive 32-bit elements in digital loopback. */
/******/
void
cfg_mcbasp(MCBSP_Handle *hMcbasp_ch0)
{
    MCBSP_Config config;
    *hMcbasp_ch0 = MCBSP_open(0, MCBSP_OPEN_RESET);

    /* Set up Serial Port Control Register */
    config.spcr = (Uint32)
        ((MCBSP_SPCR_XINTM_XRDY    << _MCBSP_SPCR_XINTM_SHIFT)
         | (MCBSP_SPCR_RINTM_RRDY  << _MCBSP_SPCR_RINTM_SHIFT)
         | (MCBSP_SPCR_DLB_ON      << _MCBSP_SPCR_DLB_SHIFT  ));

    /* Set up Pin Control Register */
    config.pcr = (Uint32)
        ((MCBSP_PCR_FSXM_INTERNAL  << _MCBSP_PCR_FSXM_SHIFT)
         | (MCBSP_PCR_FSRM_INTERNAL << _MCBSP_PCR_FSXM_SHIFT)
         | (MCBSP_PCR_CLKXM_OUTPUT  << _MCBSP_PCR_CLKXM_SHIFT)
         | (MCBSP_PCR_CLKRM_OUTPUT  << _MCBSP_PCR_CLKRM_SHIFT)
         | (MCBSP_PCR_FSXP_ACTIVEHIGH << _MCBSP_PCR_FSXP_SHIFT)
         | (MCBSP_PCR_FSRP_ACTIVEHIGH << _MCBSP_PCR_FSRP_SHIFT)
         | (MCBSP_PCR_CLKXP_RISING  << _MCBSP_PCR_CLKXP_SHIFT)
         | (MCBSP_PCR_CLKRP_FALLING << _MCBSP_PCR_CLKRP_SHIFT));

    /* Set up Receive Control Register */
    config.rcr = (Uint32)
        ((MCBSP_RCR_RPHASE_SINGLE  << _MCBSP_RCR_RPHASE_SHIFT )
         | (MCBSP_RCR_RFIG_YES      << _MCBSP_RCR_RFIG_SHIFT  )
         | (MCBSP_RCR_RDATDLY_1BIT  << _MCBSP_RCR_RDATDLY_SHIFT )
         | (MCBSP_RCR_RFRLLEN1_OF(0) << _MCBSP_RCR_RFRLLEN1_SHIFT )
         | (MCBSP_RCR_RWDLEN1_32BIT << _MCBSP_RCR_RWDLEN1_SHIFT )
         | (MCBSP_RCR_RCOMPAND_MSB  << _MCBSP_RCR_RCOMPAND_SHIFT));

    /* Set up Transmit Control Register */
    config.xcr = (Uint32)
        ((MCBSP_XCR_XPHASE_SINGLE  << _MCBSP_XCR_XPHASE_SHIFT )
         | (MCBSP_XCR_XFIG_YES      << _MCBSP_XCR_XFIG_SHIFT  )
         | (MCBSP_XCR_XDATDLY_1BIT  << _MCBSP_XCR_XDATDLY_SHIFT )
         | (MCBSP_XCR_XFRLLEN1_OF(0) << _MCBSP_XCR_XFRLLEN1_SHIFT )
         | (MCBSP_XCR_XWDLEN1_32BIT << _MCBSP_XCR_XWDLEN1_SHIFT )
         | (MCBSP_XCR_XCOMPAND_MSB  << _MCBSP_XCR_XCOMPAND_SHIFT));

    /* Set up Sample Rate Generator Register */
    config.srgr = (Uint32)
        ((MCBSP_SRGR_CLKSM_INTERNAL << _MCBSP_SRGR_CLKSM_SHIFT )
         | (MCBSP_SRGR_FSGM_DXR2XSR << _MCBSP_SRGR_FSGM_SHIFT  )
         | (MCBSP_SRGR_CLKGDV_OF(7) << _MCBSP_SRGR_CLKGDV_SHIFT));

    MCBSP_config(*hMcbasp_ch0, &config);
} /* end config_mcbasp */
void

```

```

start_mcbasp(MCBSP_Handle *hMcbasp_ch0)
{
    /* Bring McBSPPs out of reset */
    MCBSP_enableSrrgr(*hMcbasp_ch0);           /* Start Sample Rate Generator */
    MCBSP_enableFsync(*hMcbasp_ch0);          /* Enable Frame Sync pulse */
    MCBSP_enableRcv(*hMcbasp_ch0);           /* Bring Receive out of reset */
    MCBSP_enableXmt(*hMcbasp_ch0);           /* Bring Transmit out of reset */
} /* end start_mcbasp */

```

## A.5 Servicing a Bursting Peripheral

```

/*****
/* b_perph.c
/* written by David Bell
/* on 01/09/01
/*
/* b_perph uses a single EDMA channel to service an external AFE. Channel 4 is
/* used to burst a frame of data for every EXT_INT4 event received. The data is
/* transferred from the AFE to L2 memory.
*****/
#include <csl.h>
#include <csl_edma.h>
/* definitions */
#define MEM_SRC 0x80000000 /* Source address for transfer */
#define MEM_DST 0x00008000 /* Destination address for transfer */
#define EL_COUNT 16 /* Element count for transfer */
#define FR_COUNT 16
/* prototypes */
void cfg_data(void);
Int32 cfg_edma(EDMA_Handle *hEdma_ch4);
void wait(EDMA_Handle *hEdma_ch4);
Int32 check_data(void);
/*****cfg_data*****/
/* Store a data ramp in the source memory space. This data will be transferred
/* by the EDMA.
*****/
void
cfg_data()
{
    Uint16 *val;
    Uint16 i = 0;
    val = (unsigned short *)MEM_SRC;

    /* Set up transfer data */
    for (i = 0; i < (FR_COUNT * EL_COUNT)<<1; i++){
        *val++ = i;
    } /* end for */

} /* end cfg_data */
/*****cfg_edma*****/
/* Program EDMA channels 4 to service an external AFE. The channel will submit
/* a transfer request to read a frame of data from the external AFE to inter-
/* nal L2 memory for every EXT_INT4 event received.
*****/

```

```

Int32
cfg_edma(EDMA_Handle *hEdma_ch4)
{
  Uint32 link_address;
  EDMA_Config config;
  EDMA_Handle hEdma_NULL;
  if (!EDMA_allocTableEx(1, &hEdma_NULL)) return(-1);
  EDMA_reset(hEdma_NULL);
  link_address = EDMA_getTableAddress(hEdma_NULL);

  *hEdma_ch4 = EDMA_open(4, EDMA_OPEN_RESET);
  /* Configure channel (4) */
  config.opt = (Uint32) /* 0x41340003 */
    ((EDMA_OPT_PRI_LOW      << _EDMA_OPT_PRI_SHIFT  )
     | (EDMA_OPT_ESIZE_32BIT << _EDMA_OPT_ESIZE_SHIFT)
     | (EDMA_OPT_2DS_NO     << _EDMA_OPT_2DS_SHIFT  )
     | (EDMA_OPT_SUM_INC    << _EDMA_OPT_SUM_SHIFT  )
     | (EDMA_OPT_2DD_NO     << _EDMA_OPT_2DD_SHIFT  )
     | (EDMA_OPT_DUM_INC    << _EDMA_OPT_DUM_SHIFT  )
     | (EDMA_OPT_TCINT_YES  << _EDMA_OPT_TCINT_SHIFT)
     | (EDMA_OPT_TCC_OF(4)  << _EDMA_OPT_TCC_SHIFT  )

#ifdef C64_SUPPORT
     | (EDMA_OPT_TCCM_DEFAULT << _EDMA_OPT_TCCM_SHIFT )
     | (EDMA_OPT_ATCINT_NO   << _EDMA_OPT_ATCINT_SHIFT)
     | (EDMA_OPT_ATCC_DEFAULT << _EDMA_OPT_ATCC_SHIFT )
     | (EDMA_OPT_PDTS_DISABLE << _EDMA_OPT_PDTS_SHIFT )
     | (EDMA_OPT_PDTD_DISABLE << _EDMA_OPT_PDTD_SHIFT )
#endif

     | (EDMA_OPT_LINK_YES   << _EDMA_OPT_LINK_SHIFT  )
     | (EDMA_OPT_FS_YES     << _EDMA_OPT_FS_SHIFT    ));
  config.src = (Uint32)MEM_SRC; /* 0x80000000 */
  config.cnt = (Uint32)((FR_COUNT - 1)<< 16) | /* 0x000F */ \
    (EL_COUNT & 0xffff); /* 0x0010 */
  config.dst = (Uint32)MEM_DST; /* 0x00008000 */
  config.idx = (Uint32)0; /* 0x00000000 */
  config.rld = (Uint32)link_address & 0xffff; /* &NULL */
  EDMA_config(*hEdma_ch4, &config);

  return(0);

} /* end cfg_edma */
/*****wait*****/
/* Wait until the transfer completes, as indicated by bit 12 of the Channel */
/* Interrupt Pending Register (CIPR). */
/******/
void
wait(EDMA_Handle *hEdma_ch4)
{
  Uint16 i;
  for (i=0; i<FR_COUNT; i++){
    EDMA_setChannel(*hEdma_ch4);
    while (!(EDMA_getPriQStatus() & EDMA_OPT_PRI_LOW));
  } /* end for */
}

```

```

        while (!(Uint32)EDMA_RGET(CIPR) & (1 << 4));
    } /* end wait */
    /*****check_data*****/
    /* Verify that the data was properly transferred by comparing the source data */
    /* to the destination data. */
    /******/
    Int32
    check_data(void)
    {
    Uint16 *src = (Uint16 *)MEM_SRC,
        *dst = (unsigned short *)MEM_DST,
        source = 0,
        dest = 0,
        i = 0;
    Uint32 err = 0;

        for (i = 0; i < (FR_COUNT * EL_COUNT)<<1; i++){
            dest = *dst;
            source = *src;
            if (dest != source){
                /* Set error value if incorrect data */
                err = i;
                break;
            } /* end if */
            dst += 1;
            src += 1;
        } /* end for i */
        return(err);
    } /* end check_data */
    /*****main*****/
    /* Main code body. */
    /******/
    void
    main(void)
    {
    Int32 error = 0;
    EDMA_Handle hEdma_ch4;
        cfg_data();
        error = cfg_edma(&hEdma_ch4);
        if (!error){
            EDMA_enableChannel(hEdma_ch4);
            wait(&hEdma_ch4);
            EDMA_close(hEdma_ch4);
        } /* end if !error */
        if (!error) error = check_data();

        while(error);
        while(!error);
    } /* end main */

```

## A.6 Continuous Operation

```

    /******/
    /* nb_perph_cont.c */

```

```

/* written by David Bell */
/*      on 01/09/01      */
/* */
/* nb_perph_cont uses two EDMA channels to service McBSP0. Channel 12 is used */
/* to transmit frames of data from L2 to the DXR. Channel 13 is used to trans- */
/* mit frames of data from the DRR to L2. After the frames are transmitted 10 */
/* times the channels are disabled and the data is verified. */
/*****/
#include <csl.h>
#include <csl_edma.h>
#include <csl_mcbbsp.h>
/* definitions */
#define MEM_SRC      0x80000000      /* Source address for transfer */
#define MEM_DST      0x00008000      /* Destination address for transfer */
#define EL_COUNT     0x0100        /* Element count for transfer */
#define ITERATE      10            /* Number of frames to iterate */
/* prototypes */
void cfg_data(void);
Int32 cfg_edma(EDMA_Handle *hEdma_ch12, EDMA_Handle *hEdma_ch13);
void wait(void);
Int32 check_data(void);
extern void cfg_mcbbsp(MCBSP_Handle *hMcbbsp_ch0);
extern void start_mcbbsp(MCBSP_Handle *hMcbbsp_ch0);
/*****cfg_data*****/
/* Store a data ramp in the source memory space. This data will be transferred */
/* by the EDMA. */
/*****/
void
cfg_data()
{
    unsigned short *val;
    unsigned short i = 0;
        val = (unsigned short *)MEM_SRC;

        /* Set up transfer data */
        for (i = 0; i < (EL_COUNT<<1); i++){
            *val++ = i;
        } /* end for */

} /* end cfg_data */
/*****cfg_edma*****/
/* Program EDMA channels 12 and 13 to service McBSP0. Two sets must be used */
/* from the PaRAM reload space to allow continuous operation. */
/*****/
Int32
cfg_edma(EDMA_Handle *hEdma_ch12, EDMA_Handle *hEdma_ch13)
{
    Uint32 link_xmt;
    Uint32 link_rcv;
    EDMA_Config config;
    EDMA_Handle hEdma_xmt;
    EDMA_Handle hEdma_rcv;
        if (!EDMA_allocTableEx(1, &hEdma_xmt)) return(-1);
        link_xmt = EDMA_getTableAddress(hEdma_xmt);

```

```

if (!EDMA_allocTableEx(1, &hEdma_rcv)) return(-1);
link_rcv = EDMA_getTableAddress(hEdma_rcv);

*hEdma_ch12 = EDMA_open(12, EDMA_OPEN_RESET);
*hEdma_ch13 = EDMA_open(13, EDMA_OPEN_RESET);
/* Configure the transmit channel (12) */
config.opt = (Uint32)
    ((EDMA_OPT_PRI_HIGH      << EDMA_OPT_PRI_SHIFT  )
 | (EDMA_OPT_ESIZE_32BIT    << EDMA_OPT_ESIZE_SHIFT)
 | (EDMA_OPT_2DS_NO         << EDMA_OPT_2DS_SHIFT  )
 | (EDMA_OPT_SUM_INC        << EDMA_OPT_SUM_SHIFT  )
 | (EDMA_OPT_2DD_NO         << EDMA_OPT_2DD_SHIFT  )
 | (EDMA_OPT_DUM_NONE       << EDMA_OPT_DUM_SHIFT  )
 | (EDMA_OPT_TCINT_YES      << EDMA_OPT_TCINT_SHIFT)
 | (EDMA_OPT_TCC_OF(12)    << EDMA_OPT_TCC_SHIFT  )
#if (C64_SUPPORT)
 | (EDMA_OPT_TCCM_DEFAULT   << EDMA_OPT_TCCM_SHIFT  )
 | (EDMA_OPT_ATCINT_NO      << EDMA_OPT_ATCINT_SHIFT)
 | (EDMA_OPT_ATCC_DEFAULT   << EDMA_OPT_ATCC_SHIFT  )
 | (EDMA_OPT_PDTS_DISABLE   << EDMA_OPT_PDTS_SHIFT  )
 | (EDMA_OPT_PDTD_DISABLE   << EDMA_OPT_PDTD_SHIFT  )
#endif
 | (EDMA_OPT_LINK_YES       << EDMA_OPT_LINK_SHIFT  )
 | (EDMA_OPT_FS_NO          << EDMA_OPT_FS_SHIFT   ));
config.src = (Uint32)MEM_SRC;          /* 0x80000000 */
config.cnt = (Uint32)EL_COUNT;        /* 0x00000100 */
config.dst = (Uint32)_MCBSP_DXR0_ADDR; /* 0x30000000 */
config.idx = (Uint32)0;               /* 0x00000000 */
config.rld = (Uint32)link_xmt & 0xffff; /* &reload */
EDMA_config(*hEdma_ch12, &config);
EDMA_config(hEdma_xmt, &config);

/* Configure the receive channel (13) */
config.opt = (Uint32)
    ((EDMA_OPT_PRI_HIGH      << EDMA_OPT_PRI_SHIFT  )
 | (EDMA_OPT_ESIZE_32BIT    << EDMA_OPT_ESIZE_SHIFT)
 | (EDMA_OPT_2DS_NO         << EDMA_OPT_2DS_SHIFT  )
 | (EDMA_OPT_SUM_NONE       << EDMA_OPT_SUM_SHIFT  )
 | (EDMA_OPT_2DD_NO         << EDMA_OPT_2DD_SHIFT  )
 | (EDMA_OPT_DUM_INC        << EDMA_OPT_DUM_SHIFT  )
 | (EDMA_OPT_TCINT_YES      << EDMA_OPT_TCINT_SHIFT)
 | (EDMA_OPT_TCC_OF(13)    << EDMA_OPT_TCC_SHIFT  )
#if (C64_SUPPORT)
 | (EDMA_OPT_TCCM_DEFAULT   << EDMA_OPT_TCCM_SHIFT  )
 | (EDMA_OPT_ATCINT_NO      << EDMA_OPT_ATCINT_SHIFT)
 | (EDMA_OPT_ATCC_DEFAULT   << EDMA_OPT_ATCC_SHIFT  )
 | (EDMA_OPT_PDTS_DISABLE   << EDMA_OPT_PDTS_SHIFT  )
 | (EDMA_OPT_PDTD_DISABLE   << EDMA_OPT_PDTD_SHIFT  )
#endif
 | (EDMA_OPT_LINK_YES       << EDMA_OPT_LINK_SHIFT  )
 | (EDMA_OPT_FS_NO          << EDMA_OPT_FS_SHIFT   ));
config.src = (Uint32)_MCBSP_DRR0_ADDR; /* 0x30000000 */
config.cnt = (Uint32)EL_COUNT;        /* 0x00000100 */
config.dst = (Uint32)MEM_DST;         /* 0x00008000 */

```



```

        config.idx = (Uint32)0;                               /* 0x00000000 */
        config.rld = (Uint32)link_rcv & 0xffff; /* &reload */
        EDMA_config(*hEdma_ch13, &config);
        EDMA_config(hEdma_rcv, &config);

        return(0);

} /* end cfg_edma */
/*****wait*****/
/* Wait until the transfer completes, as indicated by bit 13 of the Channel */
/* Interrupt Pending Register (CIPR). */
/******/
void
wait(void)
{
    while (1){
        if ((Uint32)EDMA_RGET(CIPR) & (1 << 13)){
            EDMA_RSET(CIPR, (1 << 13));
            break;
        } /* end if */
    } /* end while */
} /* end wait */
/*****check_data*****/
/* Verify that the data was properly transferred by comparing the source data */
/* to the destination data. */
/******/
int
check_data(void)
{
    unsigned short *src = (unsigned short *)MEM_SRC,
                  *dst = (unsigned short *)MEM_DST,
                  source = 0,
                  dest = 0;
    short          i = 0;
    int            err = 0;

    for (i = 0; i < (EL_COUNT<<1); i++){
        dest = *dst;
        source = *src;
        if (dest != source){
            /* Set error value if incorrect data */
            err = i;
            break;
        } /* end if */
        dst += 1;
        src += 1;
    } /* end for i */
    return(err);
} /* end check_data */
/*****main*****/
/* Main code body. */
/******/
void
main(void)

```

```

{
Uint16 i;
Uint32 error = 0;
EDMA_Handle hEdma_ch12;
EDMA_Handle hEdma_ch13;
MCBSP_Handle hMcbbsp_ch0;
    cfg_data();
    error = cfg_edma(&hEdma_ch12, &hEdma_ch13);
    if (!error){
        cfg_mcbbsp(&hMcbbsp_ch0);
        EDMA_enableChannel(hEdma_ch12);
        EDMA_enableChannel(hEdma_ch13);
        start_mcbbsp(&hMcbbsp_ch0);
        for(i=0; i<ITERATE; i++) wait();

        EDMA_disableChannel(hEdma_ch12);
        EDMA_disableChannel(hEdma_ch13);
        EDMA_close(hEdma_ch12);
        EDMA_close(hEdma_ch13);
        MCBSP_close(hMcbbsp_ch0);
    } /* end if !error */
    if (!error) error = check_data();

    while(error);
    while(!error);
} /* end main */
/*****
/* Project: EDMA Test */
/* mcbbsp.c */
/* written by David Bell */
/*      on 6/21/99 */
/*
/* mcbbsp.c configures the McBSPs as required for the EDMA transfers on channels */
/* 12 - 15. The McBSP in use is configured to operate in digital loopback (DLB) */
/* mode, such that the data transferred is looped back to the receive port in- */
/* ternally. */
/*
/*****
#include <csl.h>
#include <csl_mcbbsp.h>
/* prototypes */
void cfg_mcbbsp(MCBSP_Handle *hMcbbsp_ch0);
void start_mcbbsp(MCBSP_Handle *hMcbbsp_ch0);
/*****cfg_mcbbsp*****/
/* Configure McBSP0 to transmit and receive 32-bit elements in digital loopback */
/*****
void
cfg_mcbbsp(MCBSP_Handle *hMcbbsp_ch0)
{
MCBSP_Config config;
    *hMcbbsp_ch0 = MCBSP_open(0, MCBSP_OPEN_RESET);

    /* Set up Serial Port Control Register */
    config.spcr = (Uint32)

```

```

                ((MCBSP_SPCR_XINTM_XRDY << _MCBSP_SPCR_XINTM_SHIFT)
                | (MCBSP_SPCR_RINTM_RRDY << _MCBSP_SPCR_RINTM_SHIFT)
                | (MCBSP_SPCR_DLB_ON << _MCBSP_SPCR_DLB_SHIFT ));
/* Set up Pin Control Register */
config.pcr = (Uint32)
                ((MCBSP_PCR_FSXM_INTERNAL << _MCBSP_PCR_FSXM_SHIFT)
                | (MCBSP_PCR_FSRM_INTERNAL << _MCBSP_PCR_FSXM_SHIFT)
                | (MCBSP_PCR_CLKXM_OUTPUT << _MCBSP_PCR_CLKXM_SHIFT)
                | (MCBSP_PCR_CLKRM_OUTPUT << _MCBSP_PCR_CLKRM_SHIFT)
                | (MCBSP_PCR_FSXP_ACTIVEHIGH << _MCBSP_PCR_FSXP_SHIFT)
                | (MCBSP_PCR_FSRP_ACTIVEHIGH << _MCBSP_PCR_FSRP_SHIFT)
                | (MCBSP_PCR_CLKXP_RISING << _MCBSP_PCR_CLKXP_SHIFT)
                | (MCBSP_PCR_CLKRP_FALLING << _MCBSP_PCR_CLKRP_SHIFT));

/* Set up Receive Control Register */
config.rcr = (Uint32)
                ((MCBSP_RCR_RPHASE_SINGLE << _MCBSP_RCR_RPHASE_SHIFT )
                | (MCBSP_RCR_RFIG_YES << _MCBSP_RCR_RFIG_SHIFT )
                | (MCBSP_RCR_RDATDLY_1BIT << _MCBSP_RCR_RDATDLY_SHIFT )
                | (MCBSP_RCR_RFRLEN1_OF(0) << _MCBSP_RCR_RFRLEN1_SHIFT )
                | (MCBSP_RCR_RWDLEN1_32BIT << _MCBSP_RCR_RWDLEN1_SHIFT )
                | (MCBSP_RCR_RCOMPAND_MSB << _MCBSP_RCR_RCOMPAND_SHIFT));
/* Set up Transmit Control Register */
config.xcr = (Uint32)
                ((MCBSP_XCR_XPHASE_SINGLE << _MCBSP_XCR_XPHASE_SHIFT )
                | (MCBSP_XCR_XFIG_YES << _MCBSP_XCR_XFIG_SHIFT )
                | (MCBSP_XCR_XDATDLY_1BIT << _MCBSP_XCR_XDATDLY_SHIFT )
                | (MCBSP_XCR_XFRLEN1_OF(0) << _MCBSP_XCR_XFRLEN1_SHIFT )
                | (MCBSP_XCR_XWDLEN1_32BIT << _MCBSP_XCR_XWDLEN1_SHIFT )
                | (MCBSP_XCR_XCOMPAND_MSB << _MCBSP_XCR_XCOMPAND_SHIFT));
/* Set up Sample Rate Generator Register */
config.srgr = (Uint32)
                ((MCBSP_SRGR_CLKSM_INTERNAL << _MCBSP_SRGR_CLKSM_SHIFT )
                | (MCBSP_SRGR_FSGM_DXR2XSR << _MCBSP_SRGR_FSGM_SHIFT )
                | (MCBSP_SRGR_CLKGDV_OF(7) << _MCBSP_SRGR_CLKGDV_SHIFT));
MCBSP_config(*hMcbbsp_ch0, &config);

} /* end cfg_mcbbsp */
void
start_mcbbsp(MCBSP_Handle *hMcbbsp_ch0)
{
    /* Bring McBSPs out of reset */
    MCBSP_enableSrgr(*hMcbbsp_ch0); /* Start Sample Rate Generator */
    MCBSP_enableFsync(*hMcbbsp_ch0); /* Enable Frame Sync pulse */
    MCBSP_enableRcv(*hMcbbsp_ch0); /* Bring Receive out of reset */
    MCBSP_enableXmt(*hMcbbsp_ch0); /* Bring Transmit out of reset */
} /* end start_mcbbsp */

```

## A.7 Ping Pong Buffering

```

/*****
/* nb_perph_ping.c
/* written by David Bell
/* on 01/09/01

```

```

/*                                                                 */
/* nb_perph_ping uses two EDMA channels to service McBSP0. Channel 12 is used */
/* to transmit frames of data from L2 to the DXR. Channel 13 is used to trans- */
/* mit frames of data from the DRR to L2. After each frame is transferred, the */
/* input/output buffers toggle between ping and pong. This allows the CPU to */
/* access one buffer while the EDMA accesses the other. After the frames are */
/* transmitted 10 times the channels are disabled and the data is verified. */
/***** */
#include <csl.h>
#include <csl_edma.h>
#include <csl_mcbbsp.h>
/* definitions */
#define PING_SRC      0x80000000          /* Ping source address for transfer */
#define PONG_SRC      0x80001000          /* Pong source address for transfer */
#define PING_DST      0x0000D000          /* Ping dest address for transfer */
#define PONG_DST      0x0000E000          /* Pong dest address for transfer */
#define EL_COUNT      0x0100            /* Element count for transfer */
#define ITERATE        10                /* Number of frames to iterate */
/* prototypes */
void cfg_data(void);
Int32 cfg_edma(EDMA_Handle *hEdma_ch12, EDMA_Handle *hEdma_ch13);
void wait(void);
Int32 check_data(void);
extern void cfg_mcbbsp(MCBSP_Handle *hMcbbsp_ch0);
extern void start_mcbbsp(MCBSP_Handle *hMcbbsp_ch0);
/*****cfg_data*****/
/* Store a data ramp in the source memory space. This data will be transferred */
/* by the EDMA. */
/***** */
void
cfg_data()
{
    unsigned short *pingval;
    unsigned short *pongval;
    unsigned short i = 0;
        pingval = (unsigned short *)PING_SRC;
        pongval = (unsigned short *) (PONG_SRC + (EL_COUNT<<1));
        /* Set up transfer data */
        for (i = 0; i < (EL_COUNT<<1); i++){
            *pingval++ = i;
            *--pongval = i;
        } /* end for */

} /* end cfg_data */
/*****cfg_edma*****/
/* Program EDMA channels 12 and 13 to service McBSP0. Four sets must be used */
/* from the PaRAM reload space to allow ping pong operation. */
/***** */
Int32
cfg_edma(EDMA_Handle *hEdma_ch12, EDMA_Handle *hEdma_ch13)
{
    Uint32 link_ping_xmt;
    Uint32 link_ping_rcv;
    Uint32 link_pong_xmt;

```

```

Uint32 link_pong_rcv;
EDMA_Config config;
EDMA_Handle hEdma_ping_xmt;
EDMA_Handle hEdma_ping_rcv;
EDMA_Handle hEdma_pong_xmt;
EDMA_Handle hEdma_pong_rcv;
    if (!EDMA_allocTableEx(1, &hEdma_pong_xmt)) return(-1);
    link_pong_xmt = EDMA_getTableAddress(hEdma_pong_xmt);

    if (!EDMA_allocTableEx(1, &hEdma_ping_xmt)) return(-1);
    link_ping_xmt = EDMA_getTableAddress(hEdma_ping_xmt);
    if (!EDMA_allocTableEx(1, &hEdma_pong_rcv)) return(-1);
    link_pong_rcv = EDMA_getTableAddress(hEdma_pong_rcv);

    if (!EDMA_allocTableEx(1, &hEdma_ping_rcv)) return(-1);
    link_ping_rcv = EDMA_getTableAddress(hEdma_ping_rcv);
    *hEdma_ch12 = EDMA_open(12, EDMA_OPEN_RESET);
    *hEdma_ch13 = EDMA_open(13, EDMA_OPEN_RESET);
    /* Configure the transmit channel (13) */
    config.opt = (Uint32)
        ((EDMA_OPT_PRI_HIGH      << _EDMA_OPT_PRI_SHIFT  )
         | (EDMA_OPT_ESIZE_32BIT << _EDMA_OPT_ESIZE_SHIFT )
         | (EDMA_OPT_2DS_NO      << _EDMA_OPT_2DS_SHIFT  )
         | (EDMA_OPT_SUM_INC     << _EDMA_OPT_SUM_SHIFT  )
         | (EDMA_OPT_2DD_NO      << _EDMA_OPT_2DD_SHIFT  )
         | (EDMA_OPT_DUM_NONE    << _EDMA_OPT_DUM_SHIFT  )
         | (EDMA_OPT_TCINT_YES   << _EDMA_OPT_TCINT_SHIFT )
         | (EDMA_OPT_TCC_OF(12)  << _EDMA_OPT_TCC_SHIFT  )

#ifdef C64_SUPPORT
         | (EDMA_OPT_TCCM_DEFAULT << _EDMA_OPT_TCCM_SHIFT )
         | (EDMA_OPT_ATCINT_NO    << _EDMA_OPT_ATCINT_SHIFT)
         | (EDMA_OPT_ATCC_DEFAULT << _EDMA_OPT_ATCC_SHIFT  )
         | (EDMA_OPT_PDTN_DISABLE << _EDMA_OPT_PDTN_SHIFT  )
         | (EDMA_OPT_PDTD_DISABLE << _EDMA_OPT_PDTD_SHIFT  )

#endif
         | (EDMA_OPT_LINK_YES    << _EDMA_OPT_LINK_SHIFT  )
         | (EDMA_OPT_FS_NO       << _EDMA_OPT_FS_SHIFT   )
        );
    config.src = (Uint32) PING_SRC;          /* 0x80000000 */
    config.cnt = (Uint32) EL_COUNT;         /* 0x00000100 */
    config.dst = (Uint32) MCBSP_DXR0_ADDR; /* 0x30000000 */
    config.idx = (Uint32) 0;               /* 0x00000000 */
    config.rld = (Uint32) link_pong_xmt & 0xffff; /* &pong */
    EDMA_config(*hEdma_ch12, &config);
    EDMA_config(hEdma_ping_xmt, &config);
    config.src = (Uint32) PONG_SRC;        /* 0x80001000 */
    config.rld = (Uint32) link_ping_xmt & 0xffff; /* &ping */
    EDMA_config(hEdma_pong_xmt, &config);

    config.opt = (Uint32)
        ((EDMA_OPT_PRI_HIGH      << _EDMA_OPT_PRI_SHIFT  )
         | (EDMA_OPT_ESIZE_32BIT << _EDMA_OPT_ESIZE_SHIFT )
         | (EDMA_OPT_2DS_NO      << _EDMA_OPT_2DS_SHIFT  )
         | (EDMA_OPT_SUM_NONE    << _EDMA_OPT_SUM_SHIFT  )
         | (EDMA_OPT_2DD_NO      << _EDMA_OPT_2DD_SHIFT  )
    
```

```

        | (EDMA_OPT_DUM_INC      << _EDMA_OPT_DUM_SHIFT  )
        | (EDMA_OPT_TCINT_YES   << _EDMA_OPT_TCINT_SHIFT )
        | (EDMA_OPT_TCC_OF(13) << _EDMA_OPT_TCC_SHIFT  )
#if (C64_SUPPORT)
        | (EDMA_OPT_TCCM_DEFAULT << _EDMA_OPT_TCCM_SHIFT )
        | (EDMA_OPT_ATCINT_NO    << _EDMA_OPT_ATCINT_SHIFT)
        | (EDMA_OPT_ATCC_DEFAULT << _EDMA_OPT_ATCC_SHIFT  )
        | (EDMA_OPT_PDTS_DISABLE << _EDMA_OPT_PDTS_SHIFT )
        | (EDMA_OPT_PDTD_DISABLE << _EDMA_OPT_PDTD_SHIFT )
#endif

        | (EDMA_OPT_LINK_YES    << _EDMA_OPT_LINK_SHIFT  )
        | (EDMA_OPT_FS_NO       << _EDMA_OPT_FS_SHIFT   ));
config.src = (Uint32)_MCBSP_DRR0_ADDR;      /* 0x30000000 */
config.cnt = (Uint32)EL_COUNT;              /* 0x00000100 */
config.dst = (Uint32)PING_DST;              /* 0x0000D000 */
config.idx = (Uint32)0;                     /* 0x00000000 */
config.rld = (Uint32)link_pong_rcv & 0xffff; /* &pong */
EDMA_config(*hEdma_ch13, &config);
EDMA_config(hEdma_ping_rcv, &config);
config.dst = (Uint32)PONG_DST;              /* 0x0000E000 */
config.rld = (Uint32)link_ping_rcv & 0xffff; /* &ping */
EDMA_config(hEdma_pong_rcv, &config);

return(0);

} /* end cfg_edma */
/*****wait*****/
/* Wait until the transfer completes, as indicated by bit 13 of the Channel */
/* Interrupt Pending Register (CIPR). */
/******/
void
wait(void)
{
    while (1){
        if ((Uint32)EDMA_RGET(CIPR) & (1 << 13)){
            EDMA_RSET(CIPR, (1 << 13));
            break;
        } /* end if */
    } /* end while */
} /* end wait */
/*****check_data*****/
/* Verify that the data was properly transferred by comparing the source data */
/* to the destination data. */
/******/
int
check_data(void)
{
    Uint16 *src,
           *dst,
           source = 0,
           dest = 0,
           i;
    Uint32 err = 0;
    src = (Uint16 *)PING_SRC;

```

```

    dst = (Uint16 *)PING_DST;
    for (i = 0; i < (EL_COUNT<<1); i++){
        dest = *dst++;
        source = *src++;
        if (dest != source){
            /* Set error value if incorrect data */
            err = i + 0x1000;
            break;
        } /* end if */
    } /* end for i */
    src = (Uint16 *)PONG_SRC;
    dst = (Uint16 *)PONG_DST;
    for (i = 0; i < (EL_COUNT<<1); i++){
        dest = *dst++;
        source = *src++;
        if (dest != source){
            /* Set error value if incorrect data */
            err = i + 0x2000;
            break;
        } /* end if */
    } /* end for i */
    return(err);
} /* end check_data */
/*****main*****/
/* Main code body. */
/******/
void
main(void)
{
    Uint16 i;
    Uint32 error = 0;
    EDMA_Handle hEdma_ch12;
    EDMA_Handle hEdma_ch13;
    MCBSP_Handle hMcbssp_ch0;
    cfg_data();
    error = cfg_edma(&hEdma_ch12, &hEdma_ch13);
    if (!error){
        cfg_mcbssp(&hMcbssp_ch0);
        EDMA_enableChannel(hEdma_ch12);
        EDMA_enableChannel(hEdma_ch13);
        start_mcbssp(&hMcbssp_ch0);
        for(i=0; i<ITERATE; i++) wait();

        EDMA_disableChannel(hEdma_ch12);
        EDMA_disableChannel(hEdma_ch13);
        EDMA_close(hEdma_ch12);
        EDMA_close(hEdma_ch13);
        MCBSP_close(hMcbssp_ch0);
    } /* end if !error */
    if (!error) error = check_data();

    while(error);
    while(!error);
} /* end main */

```

```

/*****
/* Project: EDMA Test
/* mcbbsp.c
/* written by David Bell
/*      on 6/21/99
/*
/* mcbbsp.c configures the McBSPs as required for the EDMA transfers on channels
/* 12 - 15. The McBSP in use is configured to operate in digital loopback (DLB)
/* mode, such that the data transferred is looped back to the receive port in-
/* ternally.
/*
/*****
#include <csl.h>
#include <csl_mcbbsp.h>
/* prototypes */
void cfg_mcbbsp(MCBSP_Handle *hMcbbsp_ch0);
void start_mcbbsp(MCBSP_Handle *hMcbbsp_ch0);
/*****cfg_mcbbsp*****/
/* Configure McBSP0 to transmit and receive 32-bit elements in digital loopback */
/*****
void
cfg_mcbbsp(MCBSP_Handle *hMcbbsp_ch0)
{
MCBSP_Config config;
    *hMcbbsp_ch0 = MCBSP_open(0, MCBSP_OPEN_RESET);

    /* Set up Serial Port Control Register */
    config.spcr = (Uint32)
        ((MCBSP_SPCR_XINTM_XRDY    << _MCBSP_SPCR_XINTM_SHIFT)
         | (MCBSP_SPCR_RINTM_RRDY  << _MCBSP_SPCR_RINTM_SHIFT)
         | (MCBSP_SPCR_DLB_ON      << _MCBSP_SPCR_DLB_SHIFT  ));

    /* Set up Pin Control Register */
    config.pcr = (Uint32)
        ((MCBSP_PCR_FSXM_INTERNAL  << _MCBSP_PCR_FSXM_SHIFT)
         | (MCBSP_PCR_FSRM_INTERNAL  << _MCBSP_PCR_FSXM_SHIFT)
         | (MCBSP_PCR_CLKXM_OUTPUT   << _MCBSP_PCR_CLKXM_SHIFT)
         | (MCBSP_PCR_CLKRM_OUTPUT   << _MCBSP_PCR_CLKRM_SHIFT)
         | (MCBSP_PCR_FSXP_ACTIVEHIGH << _MCBSP_PCR_FSXP_SHIFT)
         | (MCBSP_PCR_FSRP_ACTIVEHIGH << _MCBSP_PCR_FSRP_SHIFT)
         | (MCBSP_PCR_CLKXP_RISING   << _MCBSP_PCR_CLKXP_SHIFT)
         | (MCBSP_PCR_CLKRP_FALLING  << _MCBSP_PCR_CLKRP_SHIFT));

    /* Set up Receive Control Register */
    config.rcr = (Uint32)
        ((MCBSP_RCR_RPHASE_SINGLE   << _MCBSP_RCR_RPHASE_SHIFT )
         | (MCBSP_RCR_RFIG_YES       << _MCBSP_RCR_RFIG_SHIFT  )
         | (MCBSP_RCR_RDATDLY_1BIT   << _MCBSP_RCR_RDATDLY_SHIFT )
         | (MCBSP_RCR_RFRLEN1_OF(0)  << _MCBSP_RCR_RFRLEN1_SHIFT )
         | (MCBSP_RCR_RWDLEN1_32BIT  << _MCBSP_RCR_RWDLEN1_SHIFT )
         | (MCBSP_RCR_RCOMPAND_MSB   << _MCBSP_RCR_RCOMPAND_SHIFT));

    /* Set up Transmit Control Register */
    config.xcr = (Uint32)
        ((MCBSP_XCR_XPHASE_SINGLE   << _MCBSP_XCR_XPHASE_SHIFT )
         | (MCBSP_XCR_XFIG_YES       << _MCBSP_XCR_XFIG_SHIFT  ));

```



```

        | (MCBSP_XCR_XDATDLY_1BIT      << _MCBSP_XCR_XDATDLY_SHIFT )
        | (MCBSP_XCR_XFRLLEN1_OF(0)   << _MCBSP_XCR_XFRLLEN1_SHIFT )
        | (MCBSP_XCR_XWDLEN1_32BIT    << _MCBSP_XCR_XWDLEN1_SHIFT )
        | (MCBSP_XCR_XCOMPAND_MSB     << _MCBSP_XCR_XCOMPAND_SHIFT));
/* Set up Sample Rate Generator Register */
config.srgr = (Uint32)
    ( (MCBSP_SRGR_CLKSM_INTERNAL << _MCBSP_SRGR_CLKSM_SHIFT )
      | (MCBSP_SRGR_FSGM_DXR2XSR << _MCBSP_SRGR_FSGM_SHIFT )
      | (MCBSP_SRGR_CLKGDV_OF(7)  << _MCBSP_SRGR_CLKGDV_SHIFT));
MCBSP_config(*hMcbasp_ch0, &config);

} /* end cfg_mcbasp */
void
start_mcbasp(MCBSP_Handle *hMcbasp_ch0)
{
    /* Bring McBSPs out of reset */
    MCBSP_enableSrgr(*hMcbasp_ch0);          /* Start Sample Rate Generator */
    MCBSP_enableFsync(*hMcbasp_ch0);        /* Enable Frame Sync pulse */
    MCBSP_enableRcv(*hMcbasp_ch0);         /* Bring Receive out of reset */
    MCBSP_enableXmt(*hMcbasp_ch0);         /* Bring Transmit out of reset */
} /* end start_mcbasp */

```

## Appendix B Element-Synchronized 1-D to 1-D Transfers

The following figures depict the possible 1-D to 1-D transfers, along with the necessary parameters, using element synchronization. For each, only one element is transferred per synchronization event.

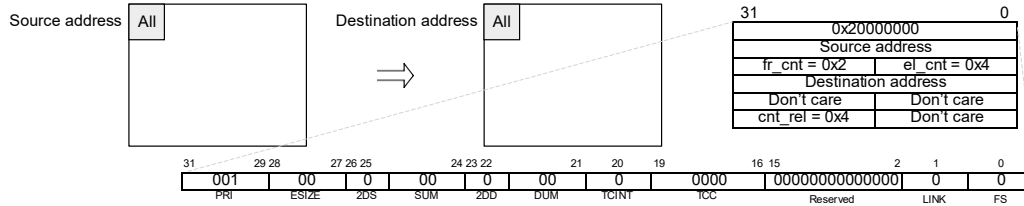

Figure B-1. Element-Synchronized 1-D (SUM=00b) to 1-D (DUM=00b)

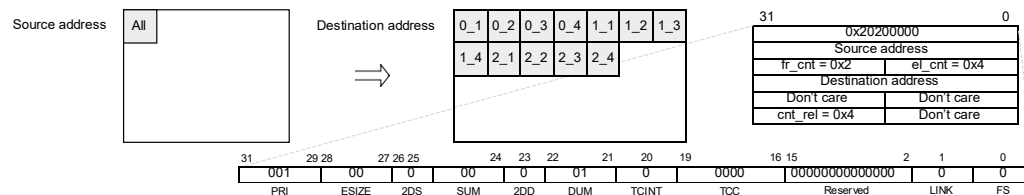

Figure B-2. Element-Synchronized 1-D (SUM=00b) to 1-D (DUM=01b)

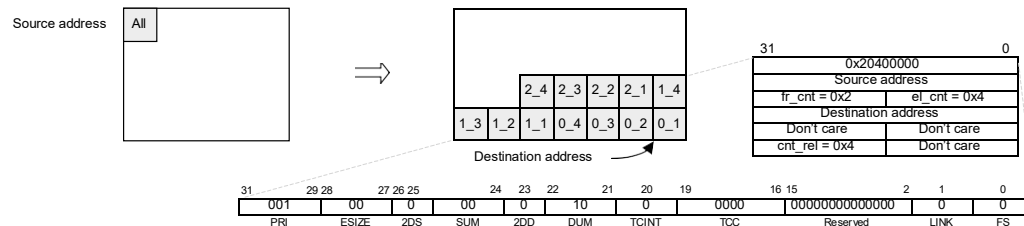

Figure B-3. Element-Synchronized 1-D (SUM=00b) to 1-D (DUM=10b)

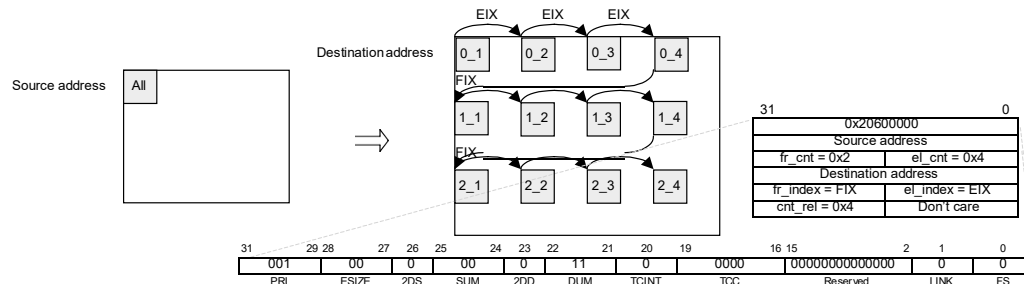

Figure B-4. Element-Synchronized 1-D (SUM=00b) to 1-D (DUM=11b)

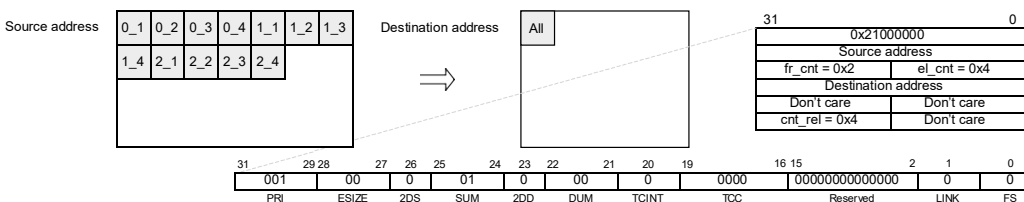

Figure B-5. Element-Synchronized 1-D (SUM=01b) to 1-D (DUM=00b)

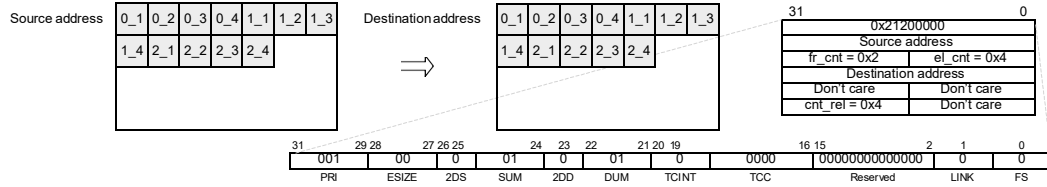

Figure B-6. Element-Synchronized 1-D (SUM=01b) to 1-D (DUM=01b)

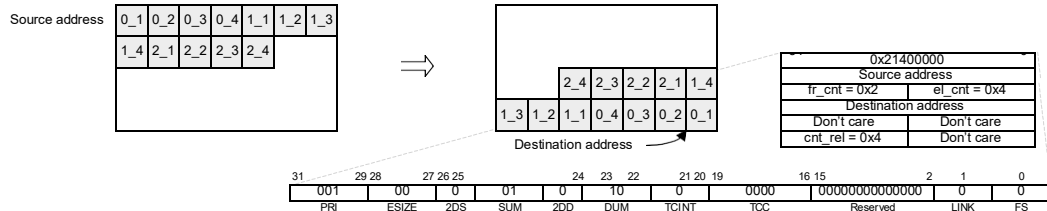

Figure B-7. Element-Synchronized 1-D (SUM=01b) to 1-D (DUM=10b)

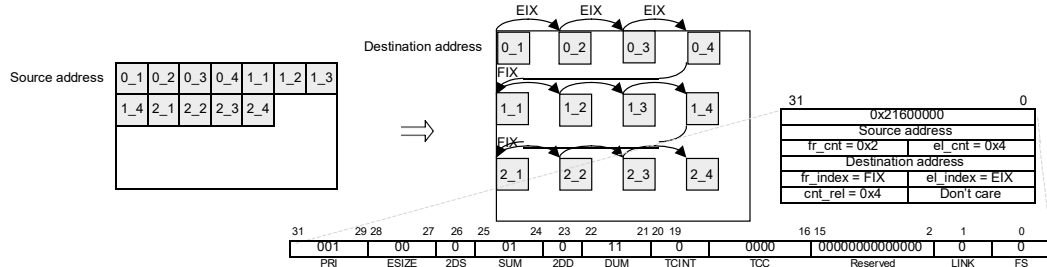

Figure B-8. Element-Synchronized 1-D (SUM=01b) to 1-D (DUM=11b)

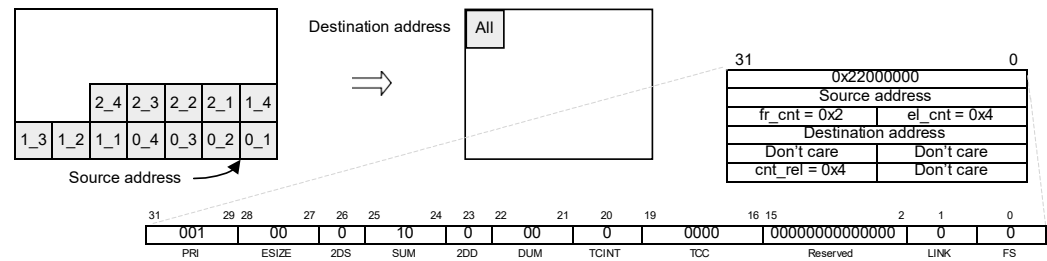

Figure B-9. Element-Synchronized 1-D (SUM=10b) to 1-D (DUM=00b)

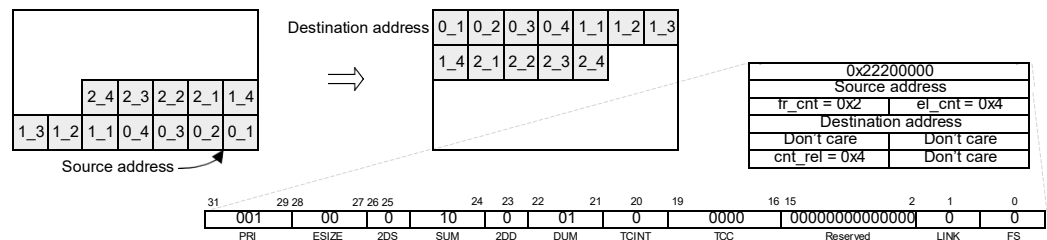

Figure B-10. Element-Synchronized 1-D (SUM=10b) to 1-D (DUM=01b)

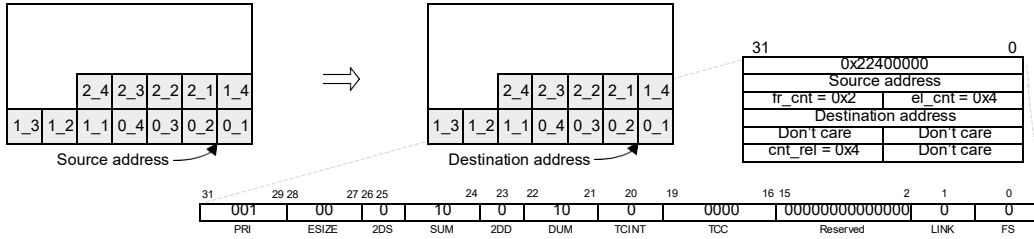

Figure B-11. Element-Synchronized 1-D (SUM=10b) to 1-D (DUM=10b)

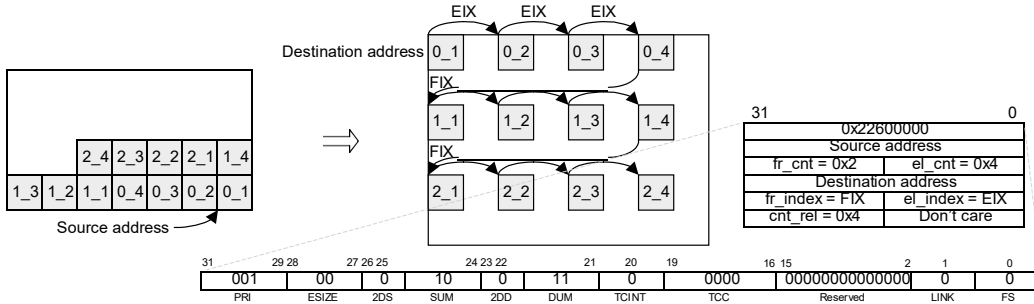

Figure B-12. Element-Synchronized 1-D (SUM=10b) to 1-D (DUM=11b)

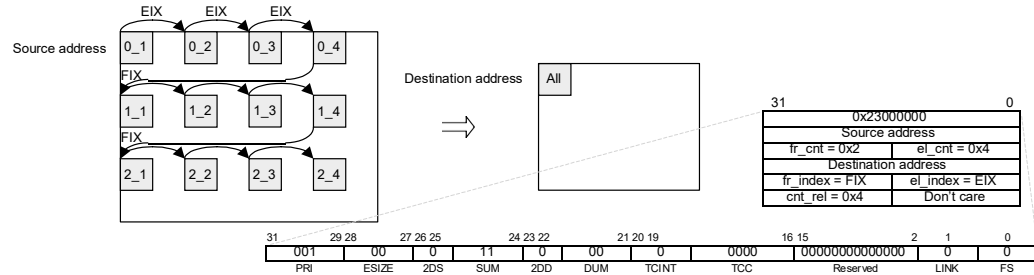

Figure B-13. Element-Synchronized 1-D (SUM=11b) to 1-D (DUM=00b)

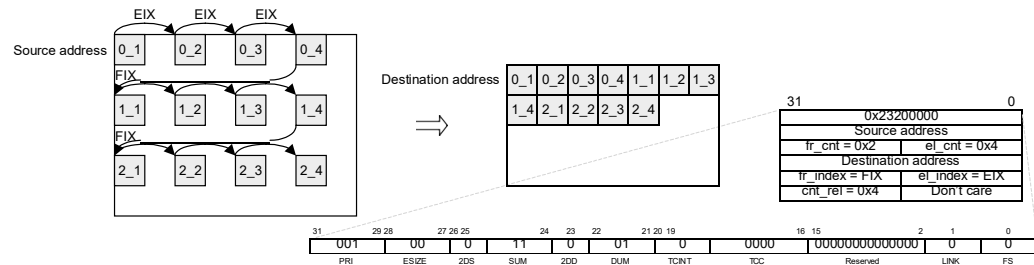

Figure B-14. Element-Synchronized 1-D (SUM=11b) to 1-D (DUM=01b)

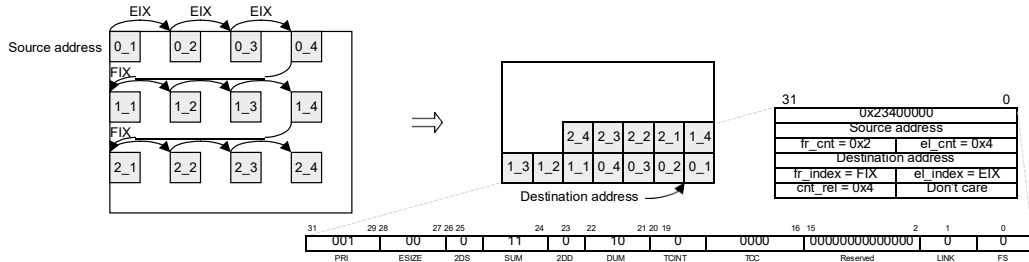

Figure B–15. Element-Synchronized 1-D (SUM=11b) to 1-D (DUM=10b)

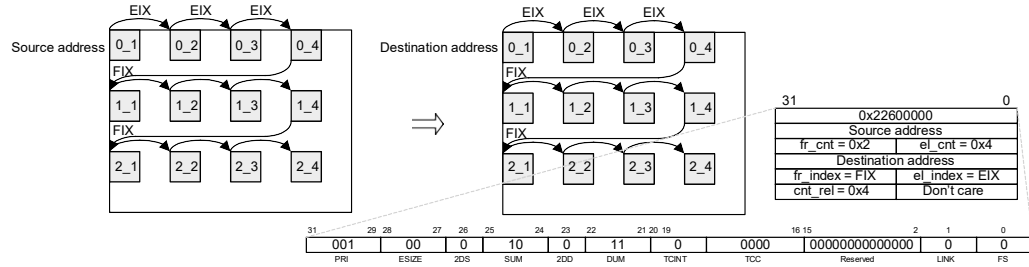
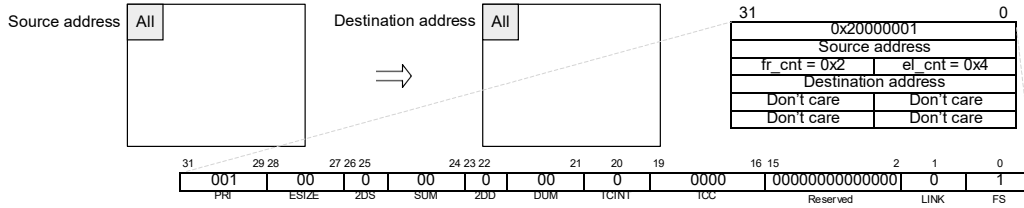

Figure B–16. Element-Synchronized 1-D (SUM=11b) to 1-D (DUM=11b)

## Appendix C Frame-Synchronized 1-D to 1-D Transfers

The following figures depict the possible 1-D to 1-D transfers, along with the necessary parameters, using frame synchronization. For each, an entire frame of elements is transferred per synchronization event.



**Figure C-1. Frame-Synchronized 1-D (SUM=00b) to 1-D (DUM=00b)**

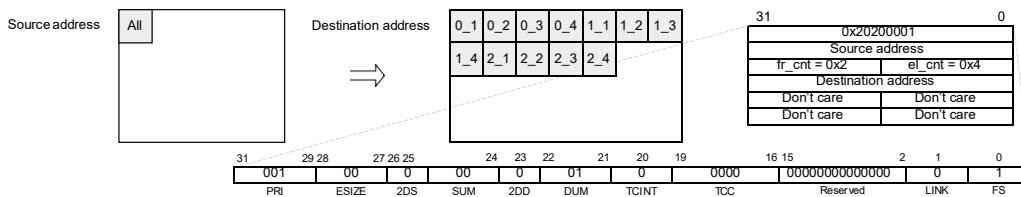

**Figure C-2. Frame-Synchronized 1-D (SUM=00b) to 1-D (DUM=01b)**

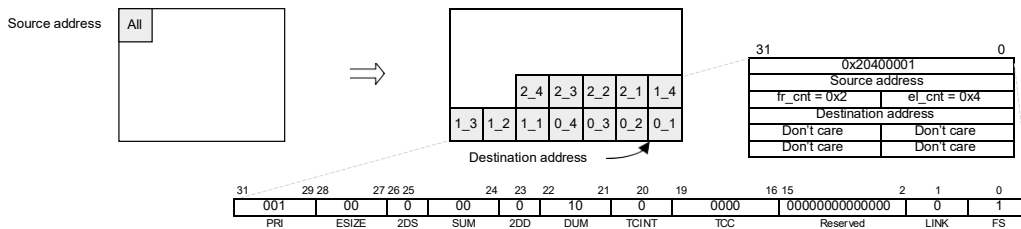

**Figure C-3. Frame-Synchronized 1-D (SUM=00b) to 1-D (DUM=10b)**

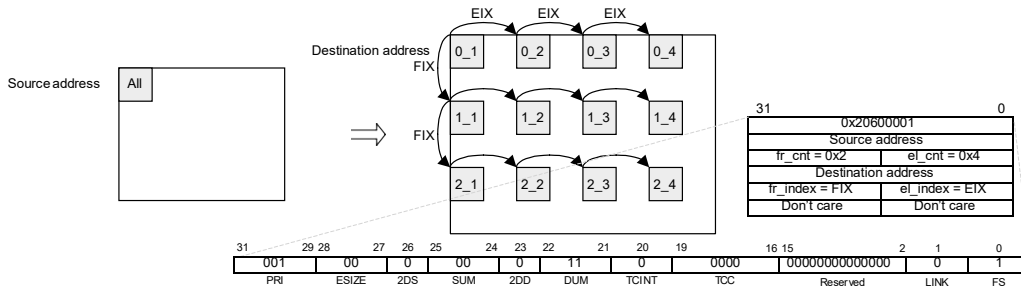

**Figure C-4. Frame-Synchronized 1-D (SUM=00b) to 1-D (DUM=11b)**

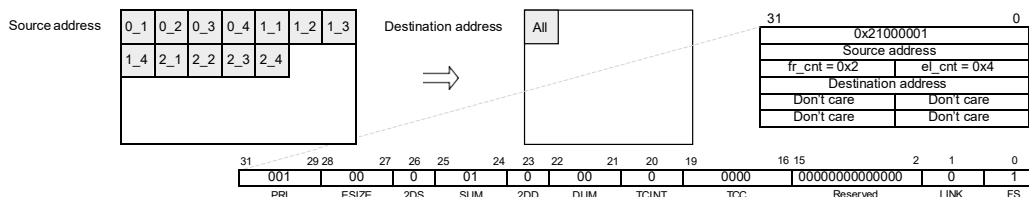

**Figure C-5. Frame-Synchronized 1-D (SUM=01b) to 1-D (DUM=00b)**

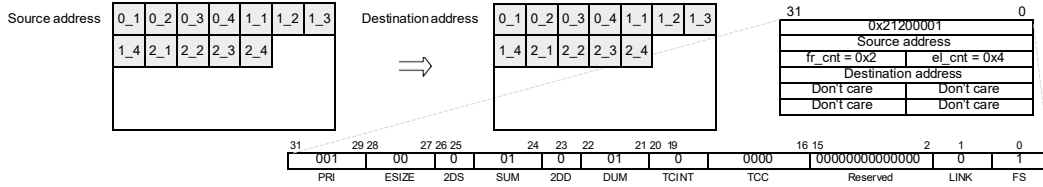

Figure C-6. Frame-Synchronized 1-D (SUM=01b) to 1-D (DUM=01b)

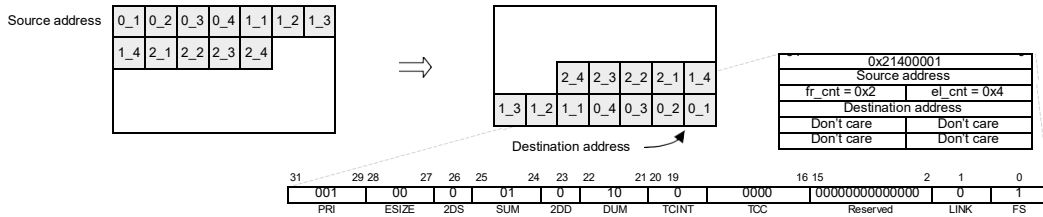

Figure C-7. Frame-Synchronized 1-D (SUM=01b) to 1-D (DUM=10b)

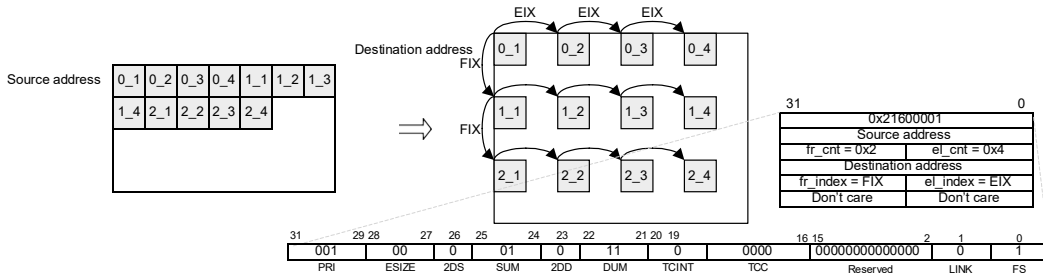

Figure C-8. Frame-Synchronized 1-D (SUM=01b) to 1-D (DUM=11b)

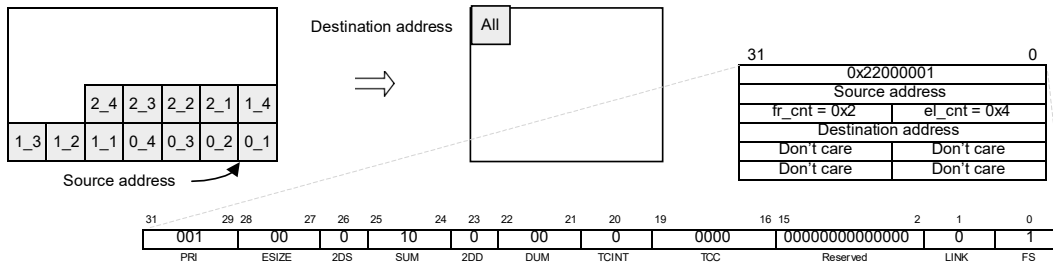

Figure C-9. Frame-Synchronized 1-D (SUM=10b) to 1-D (DUM=00b)

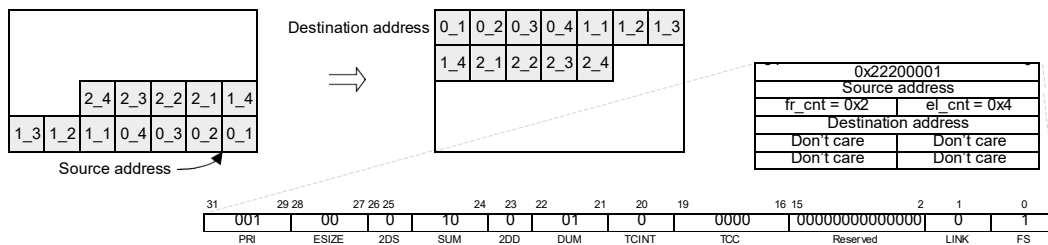

Figure C-10. Frame-Synchronized 1-D (SUM=10b) to 1-D (DUM=01b)

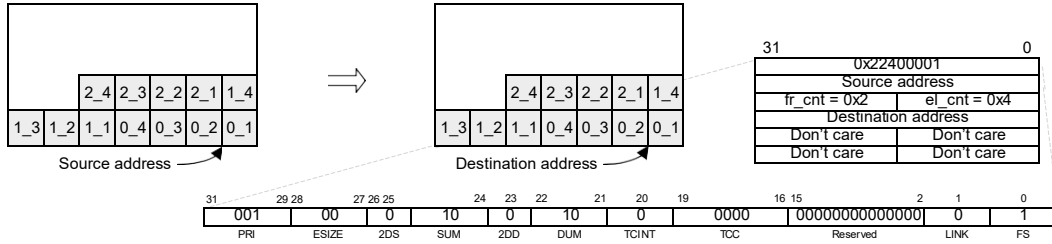

Figure C-11. Frame-Synchronized 1-D (SUM=10b) to 1-D (DUM=10b)

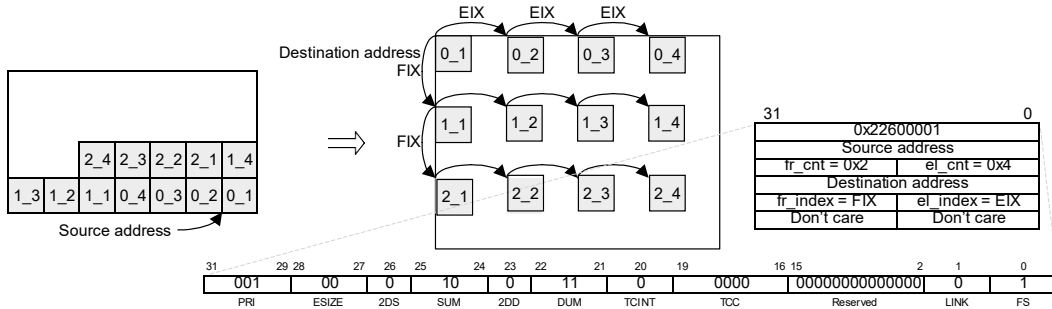

Figure C-12. Frame-Synchronized 1-D (SUM=10b) to 1-D (DUM=11b)

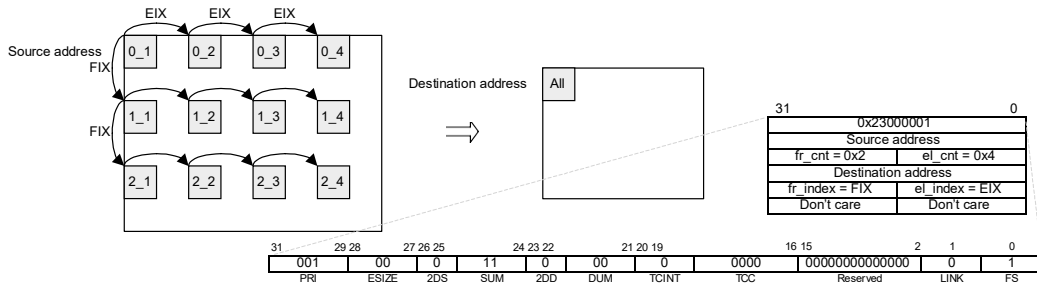

Figure C-13. Frame-Synchronized 1-D (SUM=11b) to 1-D (DUM=00b)

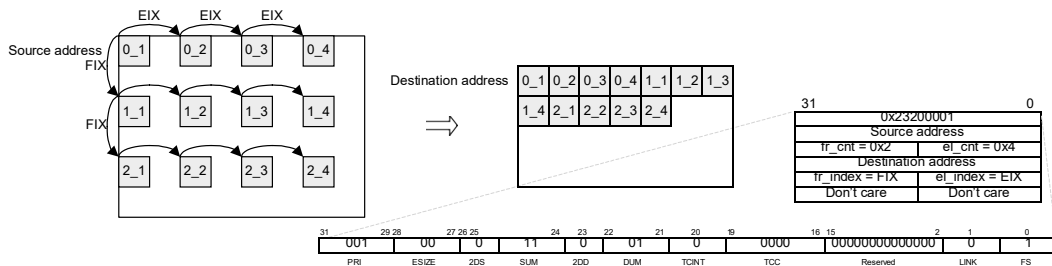

Figure C-14. Frame-Synchronized 1-D (SUM=11b) to 1-D (DUM=01b)



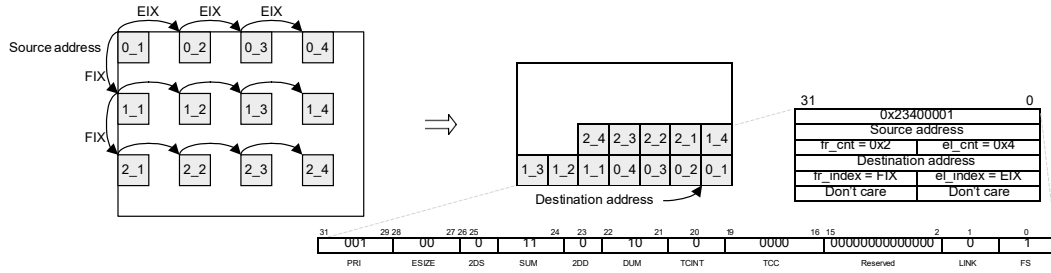

Figure C-15. Frame-Synchronized 1-D (SUM=11b) to 1-D (DUM=10b)

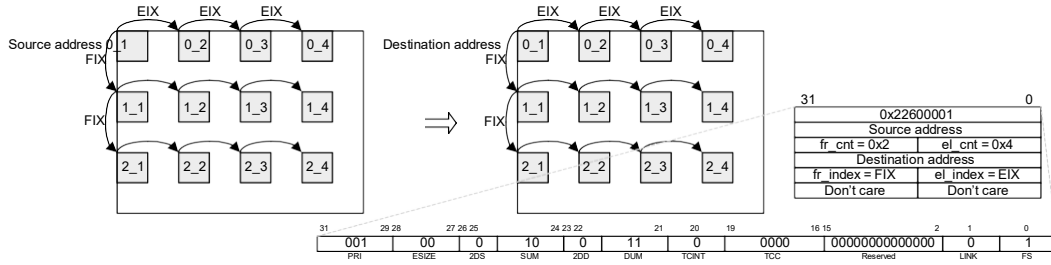

Figure C-16. Frame-Synchronized 1-D (SUM=11b) to 1-D (DUM=11b)

## Appendix D Array-Synchronized 2-D to 2-D Transfer1

The following figures depict the possible 2-D to 2-D transfers, along with the necessary parameters, using array synchronization. For each, a single array of elements is transferred per synchronization event.

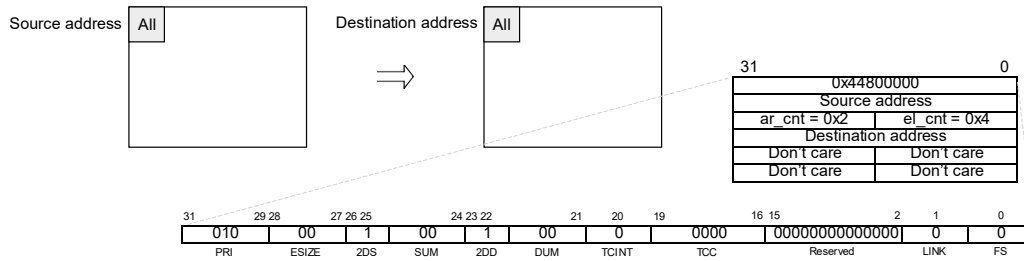

Figure D-1. Array-Synchronized 2-D (SUM=00b) to 2-D (DUM=00b)

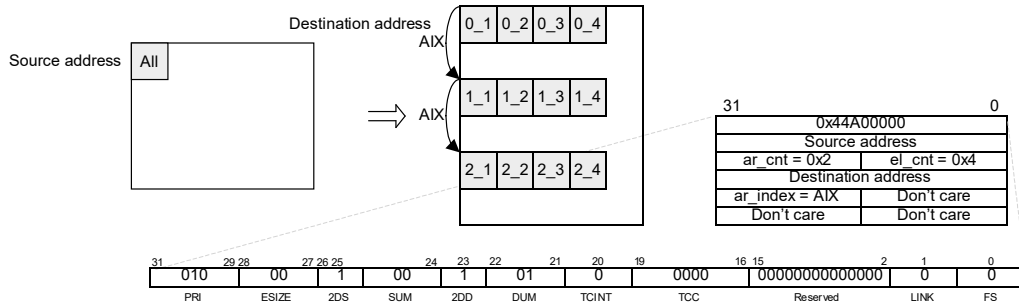

Figure D-2. Array-Synchronized 2-D (SUM=00b) to 2-D (DUM=01b)

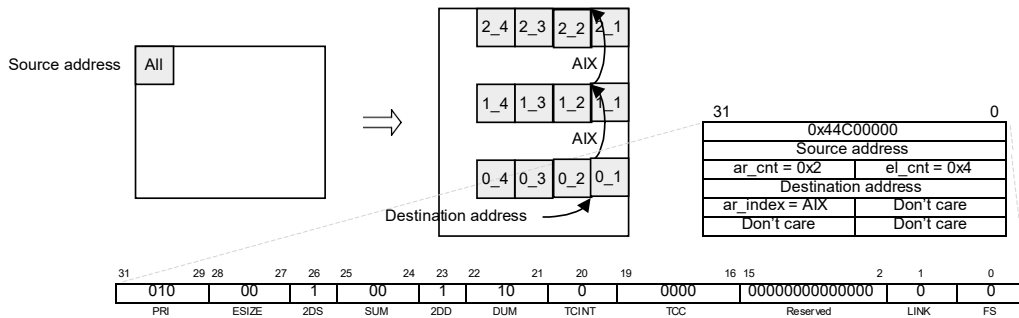

Figure D-3. Array-Synchronized 2-D (SUM=00b) to 2-D (DUM=10b)

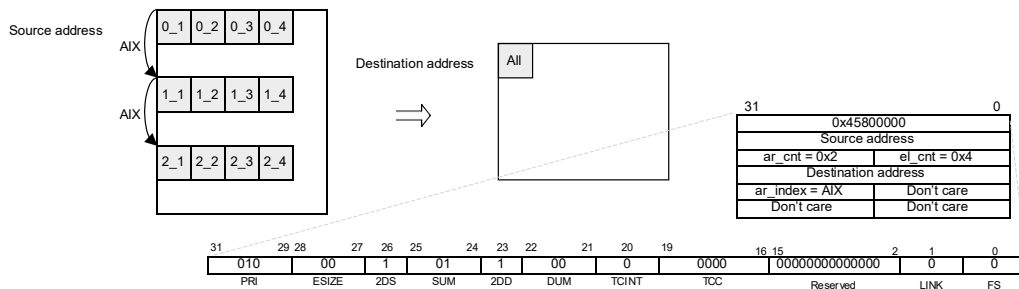

Figure D-4. Array-Synchronized 2-D (SUM=01b) to 2-D (DUM=00b)

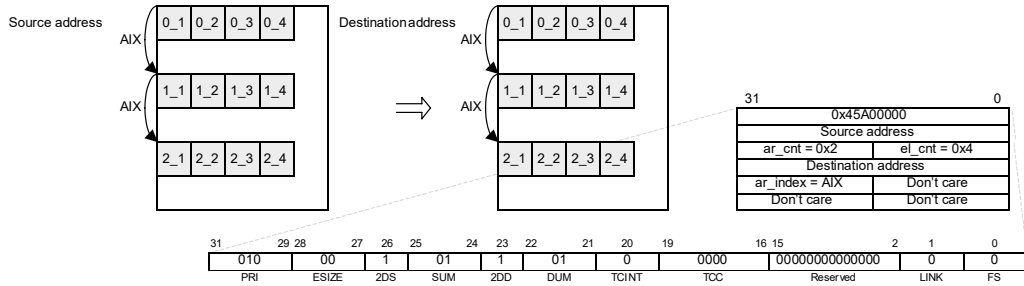

Figure D-5. Array-Synchronized 2-D (SUM=01b) to 2-D (DUM=01b)

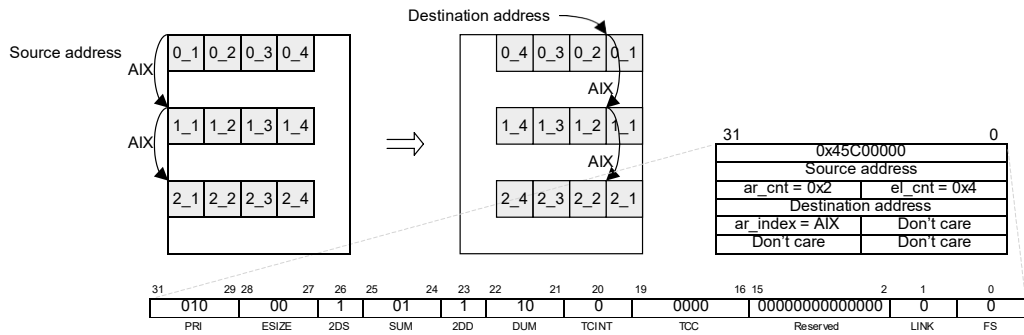

Figure D-6. Array-Synchronized 2-D (SUM=01b) to 2-D (DUM=10b)

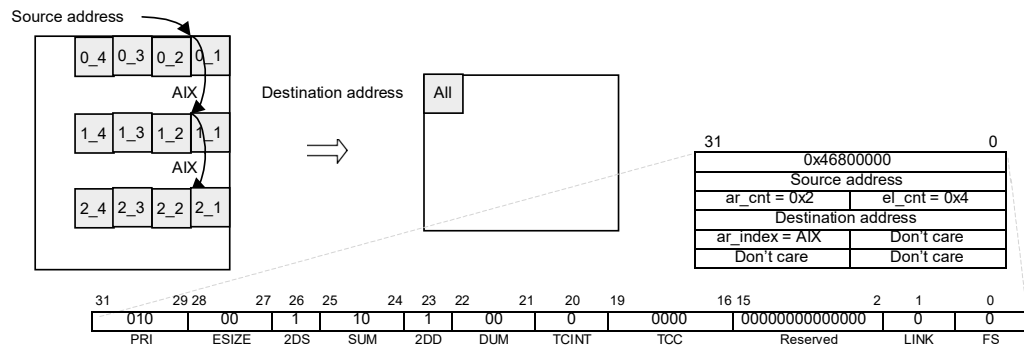

Figure D-7. Array-Synchronized 2-D (SUM=10b) to 2-D (DUM=00b)

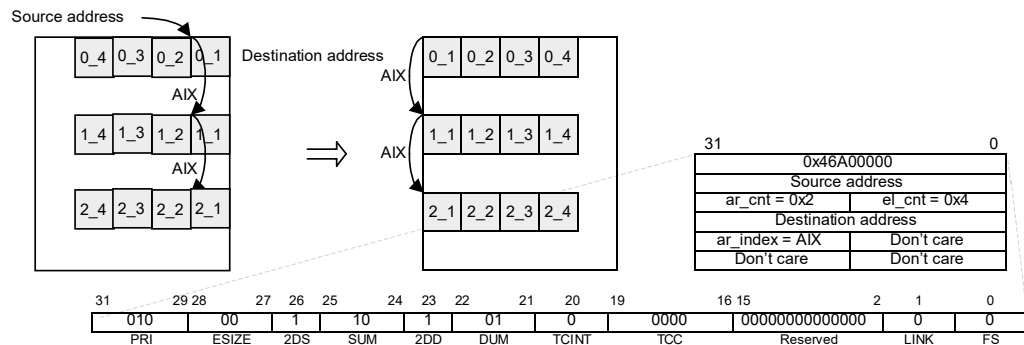
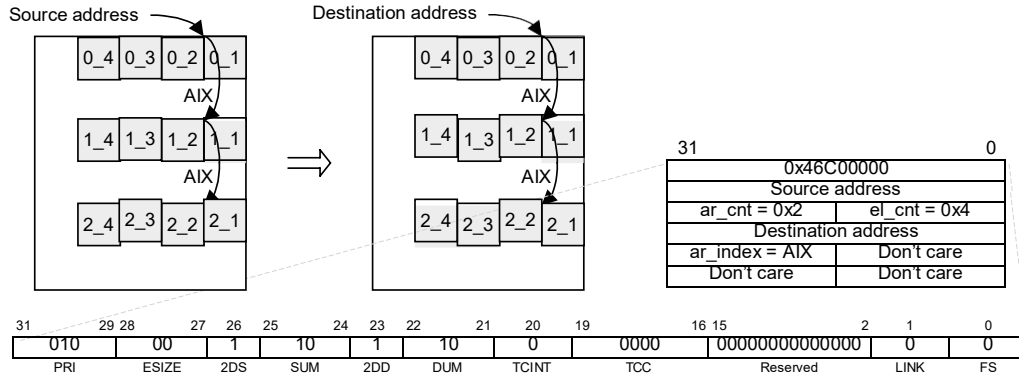

Figure D-8. Array-Synchronized 2-D (SUM=10b) to 2-D (DUM=01b)



**Figure D-9. Array-Synchronized 2-D (SUM=10b) to 2-D (DUM=10b)**

## Appendix E Block-Synchronized 2-D to 2-D Transfers

The following figures depict the possible 2-D to 2-D transfers, along with the necessary parameters, using block synchronization. For each, an entire block of arrays is transferred per synchronization event.

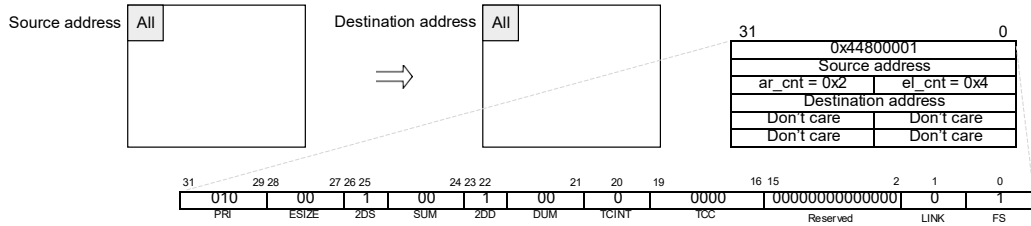

Figure E-1. Block-Synchronized 2-D (SUM=00b) to 2-D (DUM=00b)

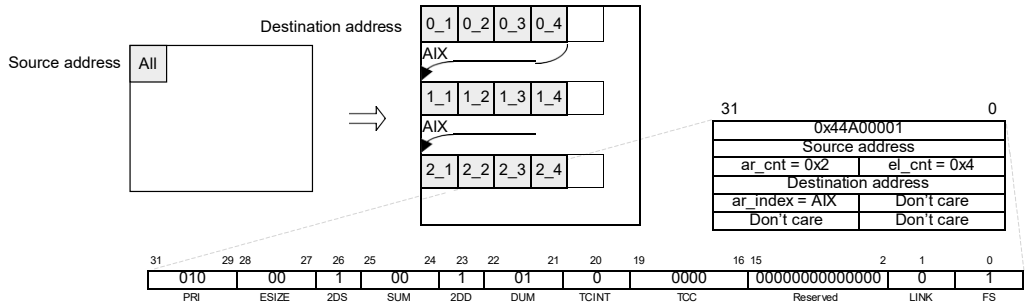

Figure E-2. Block-Synchronized 2-D (SUM=00b) to 2-D (DUM=01b)

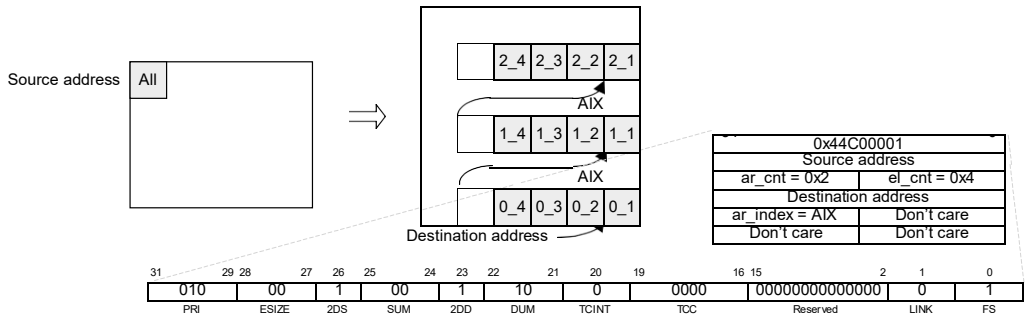

Figure E-3. Block-Synchronized 2-D (SUM=00b) to 2-D (DUM=10b)

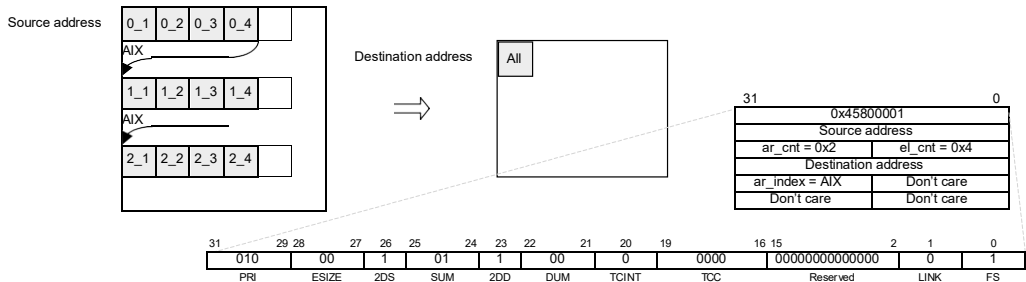

Figure E-4. Block-Synchronized 2-D (SUM=01b) to 2-D (DUM=00b)

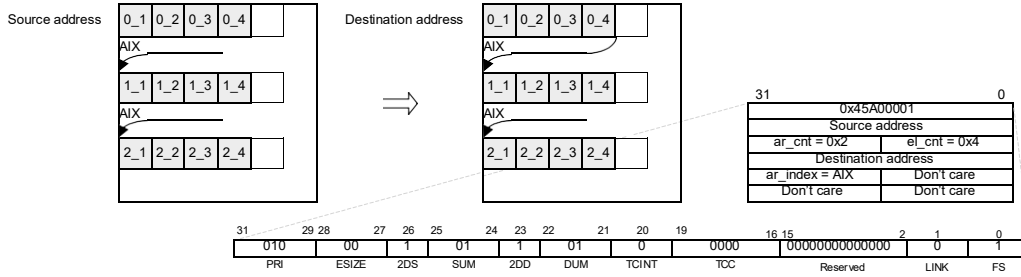

Figure E-5. Block-Synchronized 2-D (SUM=01b) to 2-D (DUM=01b)

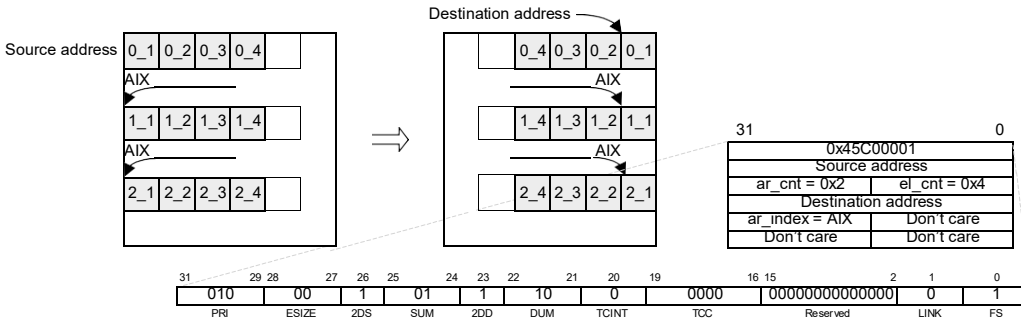

Figure E-6. Block-Synchronized 2-D (SUM=01b) to 2-D (DUM=10b)

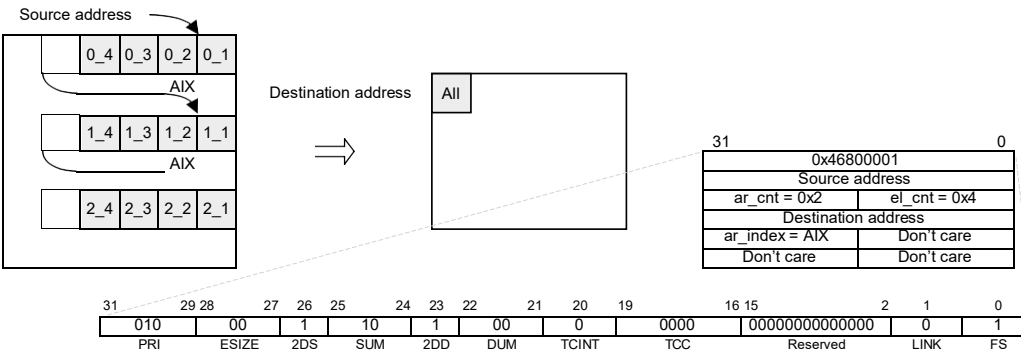

Figure E-7. Block-Synchronized 2-D (SUM=10b) to 2-D (DUM=00b)

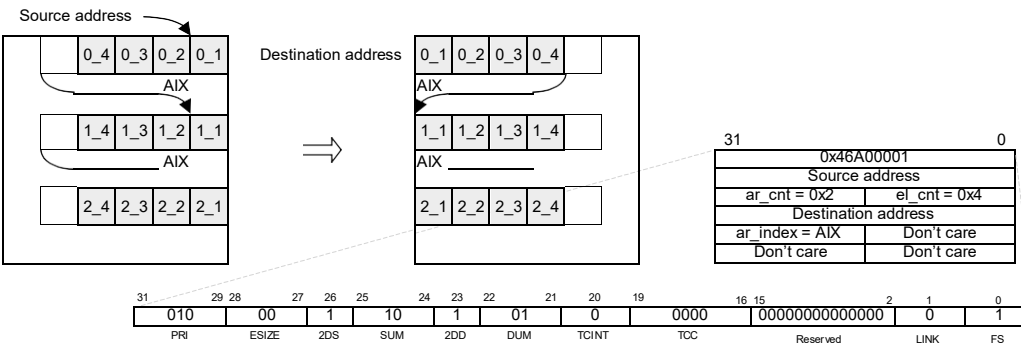

Figure E-8. Block-Synchronized 2-D (SUM=10b) to 2-D (DUM=01b)

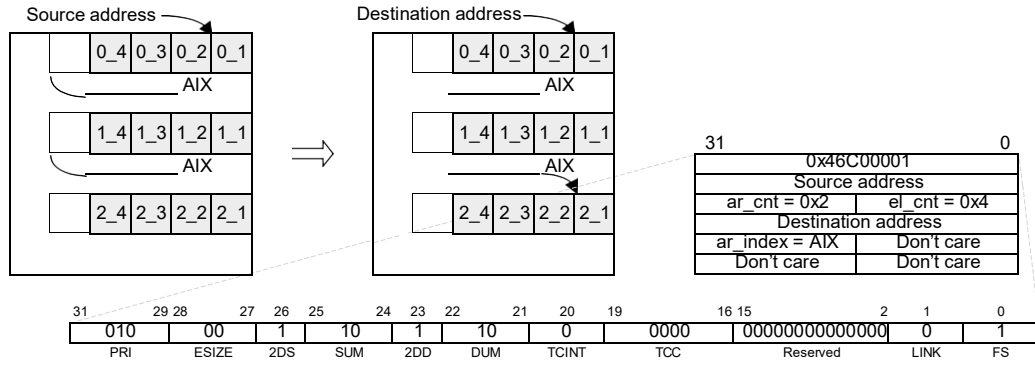

Figure E-9. Block-Synchronized 2-D (SUM=10b) to 2-D (DUM=10b)

## Appendix F Array-Synchronized 1-D to 2-D Transfers

The following figures depict the possible 1-D to 2-D transfers, along with the necessary parameters, using array synchronization. For each, a single array of elements is transferred per synchronization event.

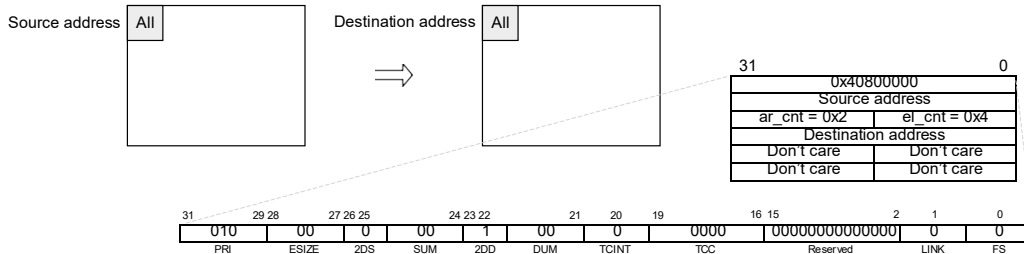

Figure F-1. Array-Synchronized 1-D (SUM=00b) to 2-D (DUM=00b)

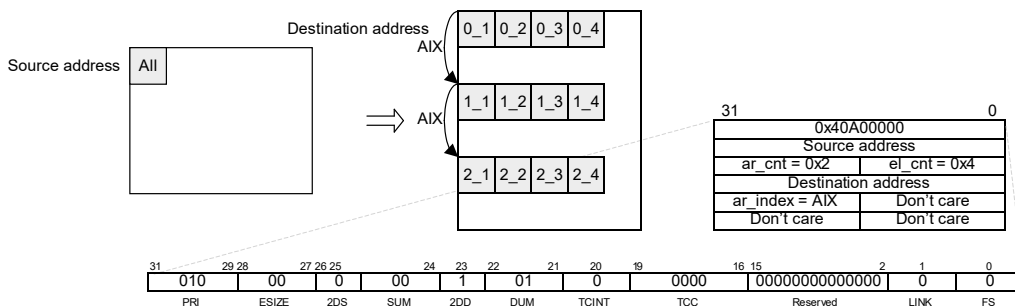

Figure F-2. Array-Synchronized 1-D (SUM=00b) to 2-D (DUM=01b)

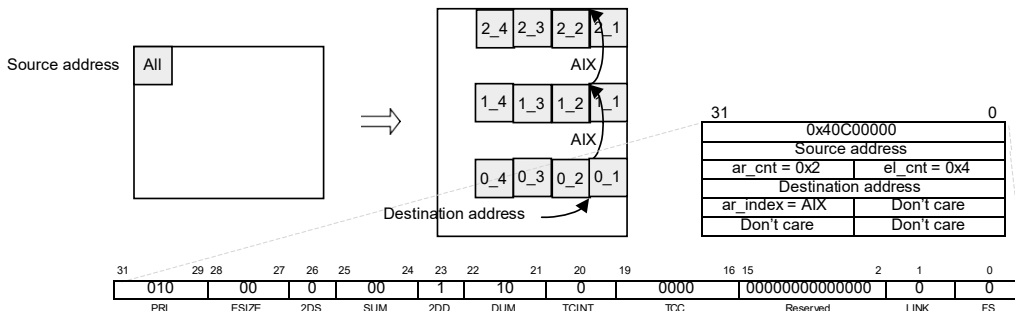

Figure F-3. Array-Synchronized 1-D (SUM=00b) to 2-D (DUM=10b)

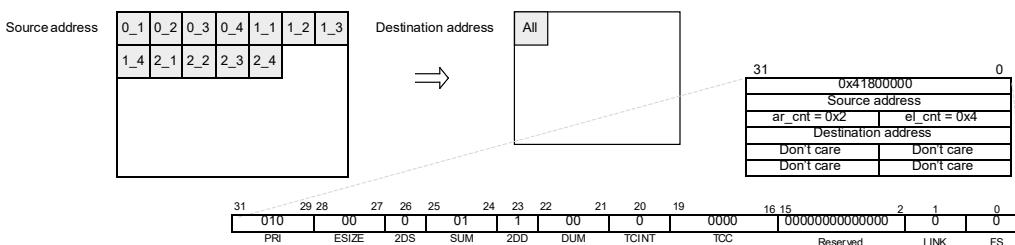

Figure F-4. Array-Synchronized 1-D (SUM=01b) to 2-D (DUM=00b)



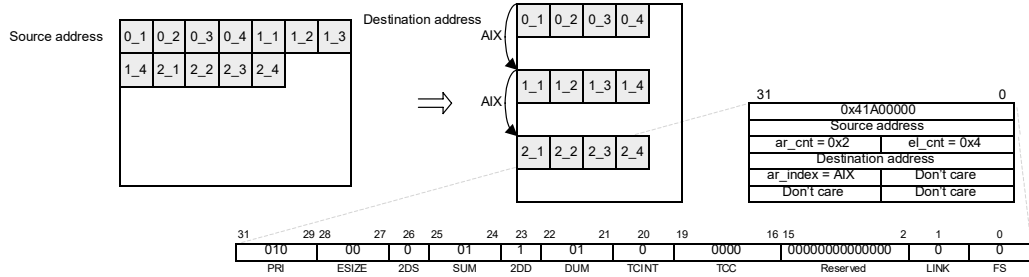

Figure F-5. Array-Synchronized 1-D (SUM=01b) to 2-D (DUM=01b)

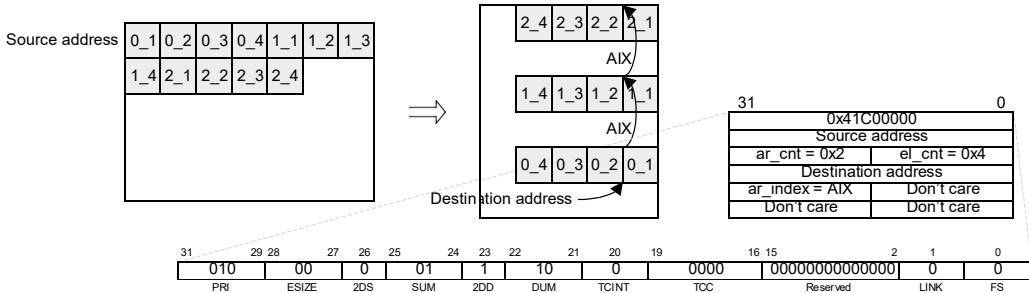

Figure F-6. Array-Synchronized 1-D (SUM=01b) to 2-D (DUM=10b)

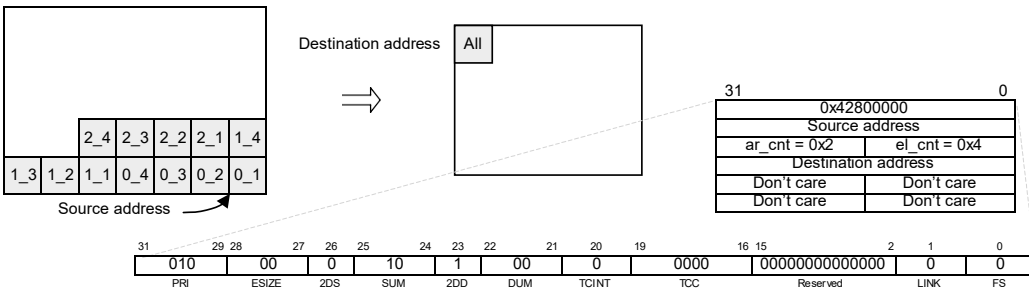

Figure F-7. Array-Synchronized 1-D (SUM=10b) to 2-D (DUM=00b)

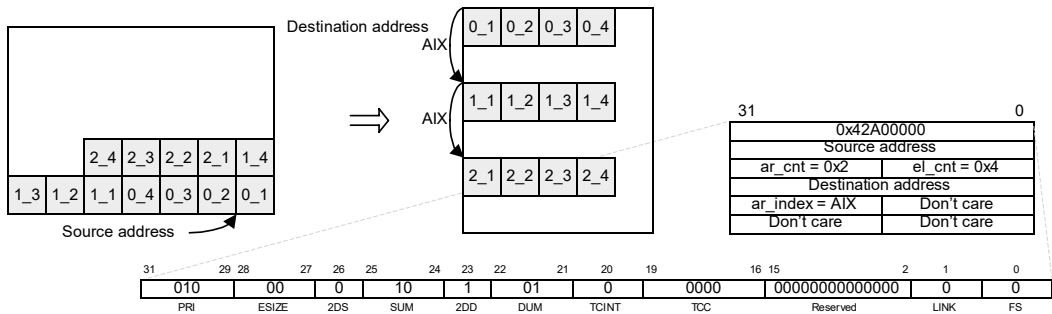

Figure F-8. Array-Synchronized 1-D (SUM=10b) to 2-D (DUM=01b)

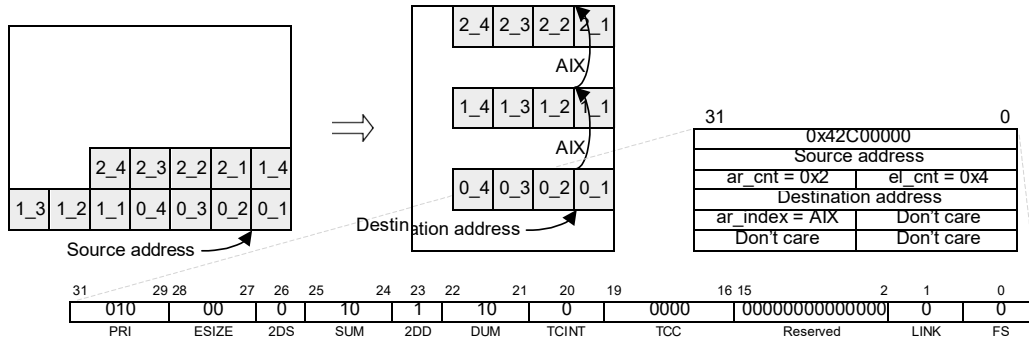

Figure F-9. Array-Synchronized 1-D (SUM=10b) to 2-D (DUM=10b)

## Appendix G Block-Synchronized 1-D to 2-D Transfers

The following figures depict the possible 1-D to 2-D transfers, along with the necessary parameters, using block synchronization. For each, an entire block of arrays is transferred per synchronization event.

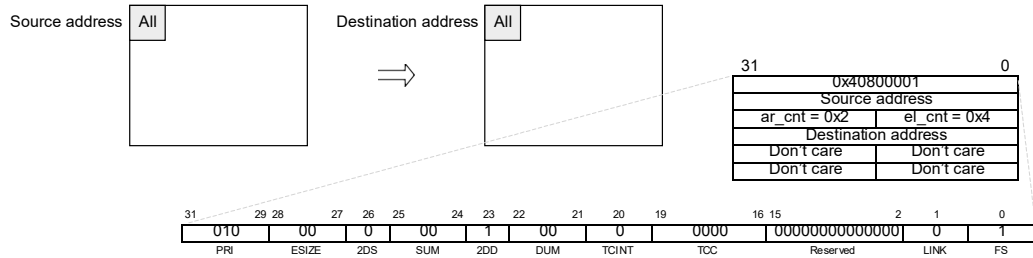

Figure G-1. Block-Synchronized 1-D (SUM=00b) to 2-D (DUM=00b)

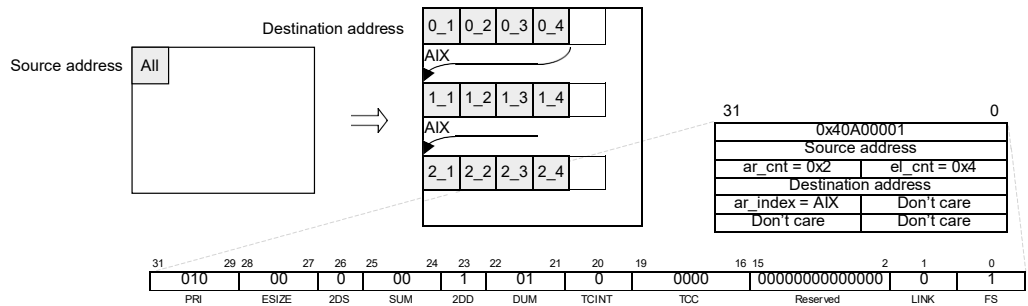

Figure G-2. Block-Synchronized 1-D (SUM=00b) to 2-D (DUM=01b)

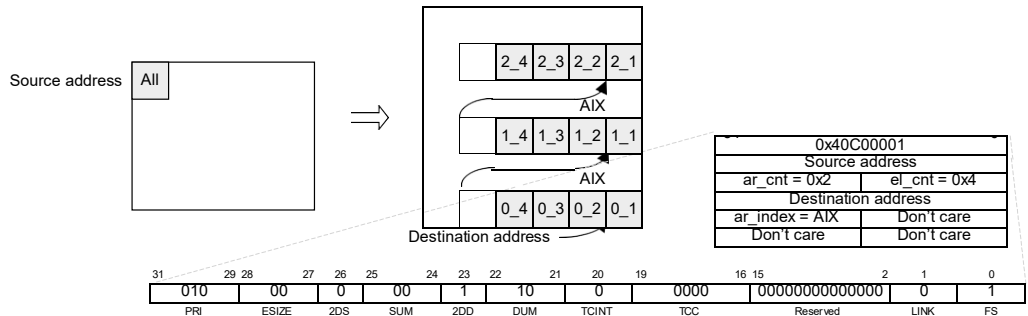

Figure G-3. Block-Synchronized 1-D (SUM=00b) to 2-D (DUM=10b)

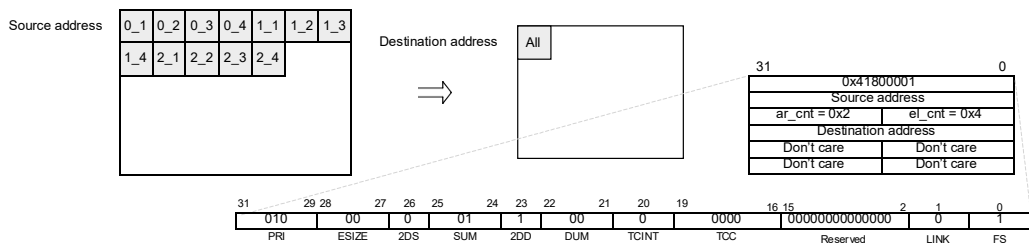

Figure G-4. Block-Synchronized 1-D (SUM=01b) to 2-D (DUM=00b)

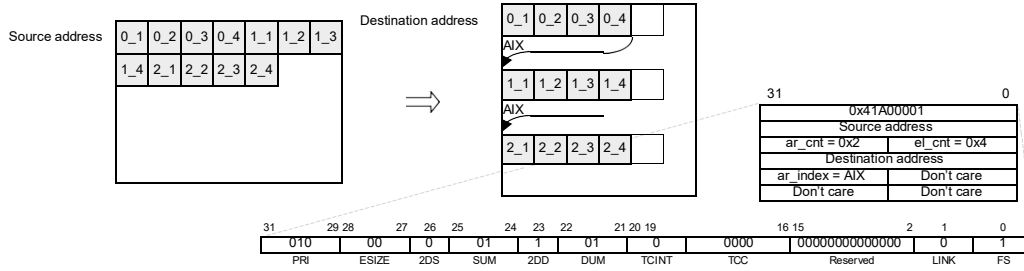

Figure G-5. Block-Synchronized 1-D (SUM=01b) to 2-D (DUM=01b)

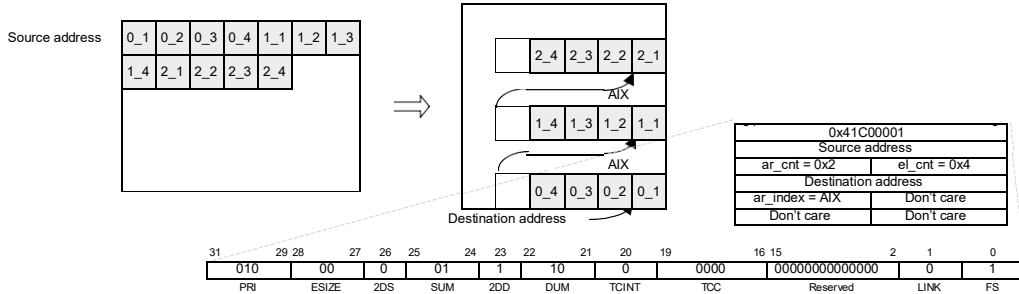

Figure G-6. Block-Synchronized 1-D (SUM=01b) to 2-D (DUM=10b)

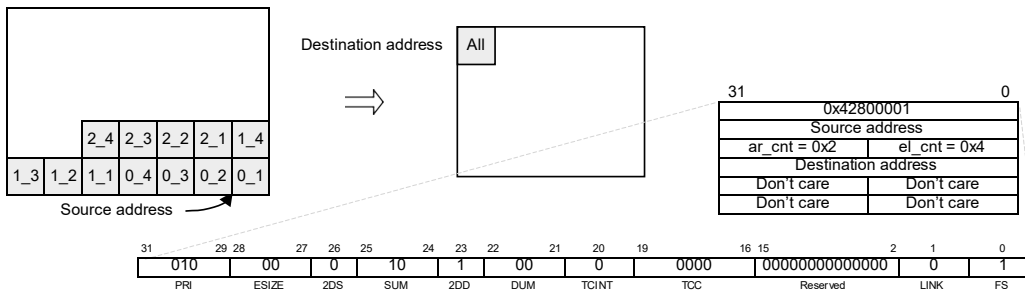

Figure G-7. Block-Synchronized 1-D (SUM=10b) to 2-D (DUM=00b)

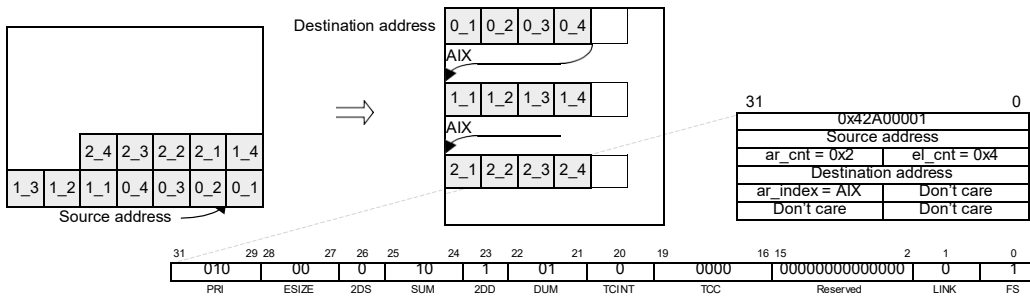

Figure G-8. Block-Synchronized 1-D (SUM=10b) to 2-D (DUM=01b)

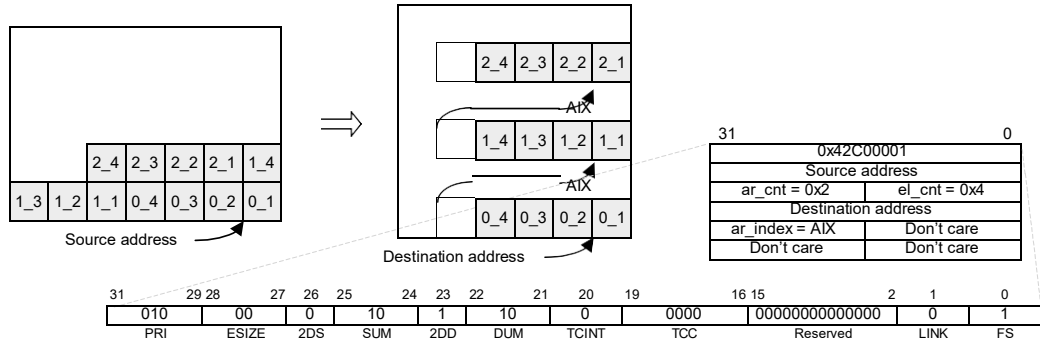

Figure G-9. Block-Synchronized 1-D (SUM=10b) to 2-D (DUM=10b)

## Appendix H Array-Synchronized 2-D to 1-D Transfers

The following figures depict the possible 2-D to 1-D transfers, along with the necessary parameters, using array synchronization. For each, an single array of elements is transferred per synchronization event.

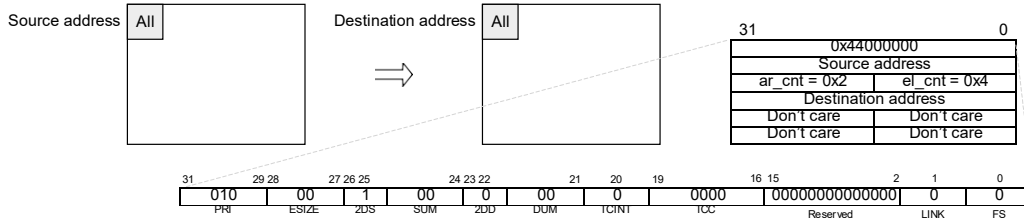

Figure H-1. Array-Synchronized 2-D (SUM=00b) to 1-D (DUM=00b)

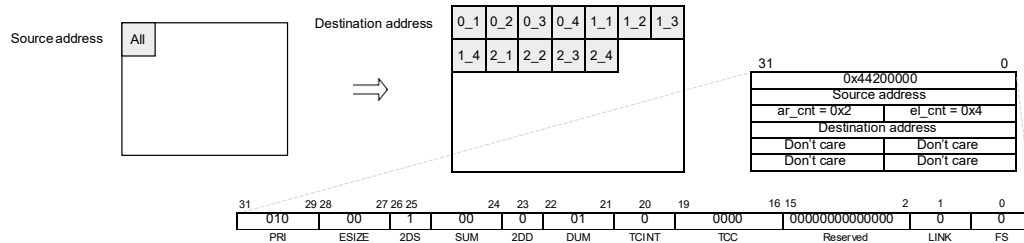

Figure H-2. Array-Synchronized 2-D (SUM=00b) to 1-D (DUM=01b)

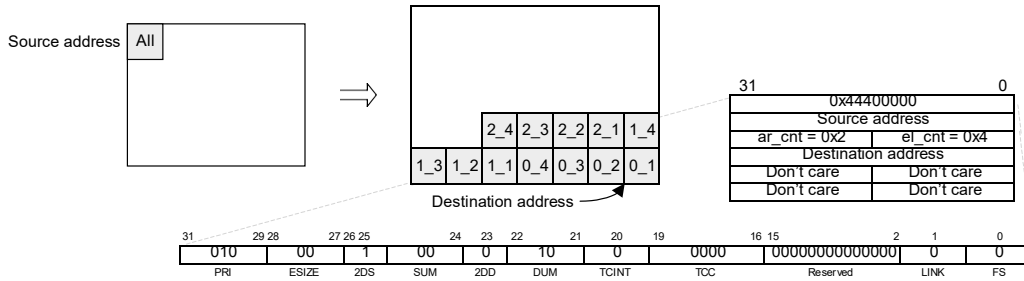

Figure H-3. Array-Synchronized 2-D (SUM=00b) to 1-D (DUM=10b)

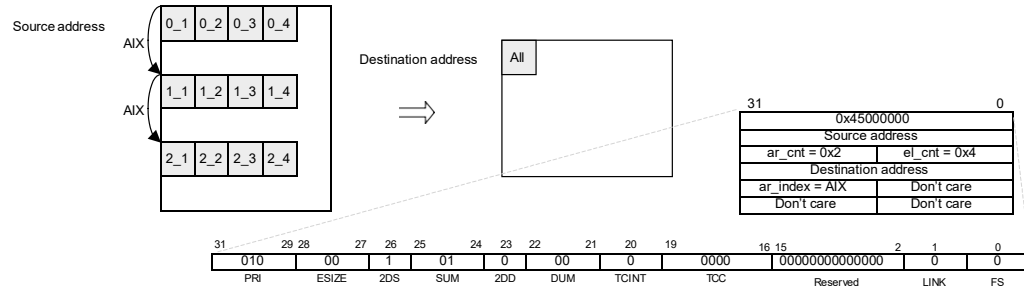

Figure H-4. Array-Synchronized 2-D (SUM=01b) to 1-D (DUM=00b)

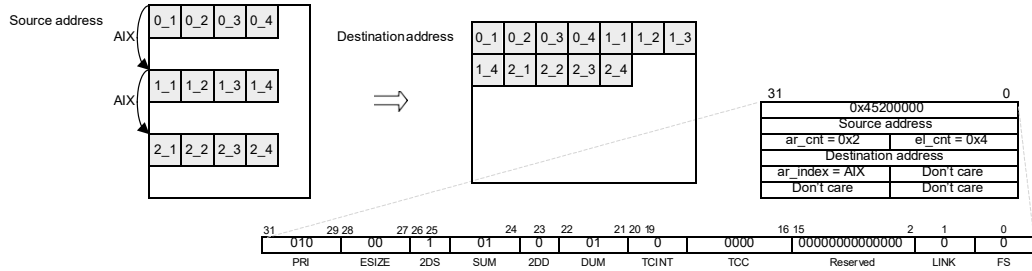

Figure H-5. Array-Synchronized 2-D (SUM=01b) to 1-D (DUM=01b)

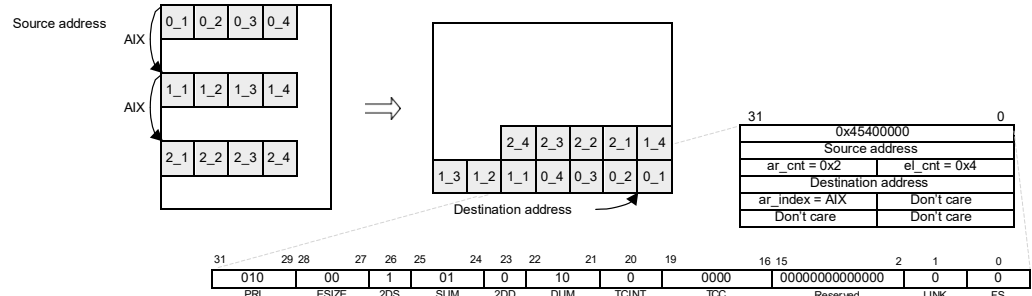

Figure H-6. Array-Synchronized 2-D (SUM=01b) to 1-D (DUM=10b)

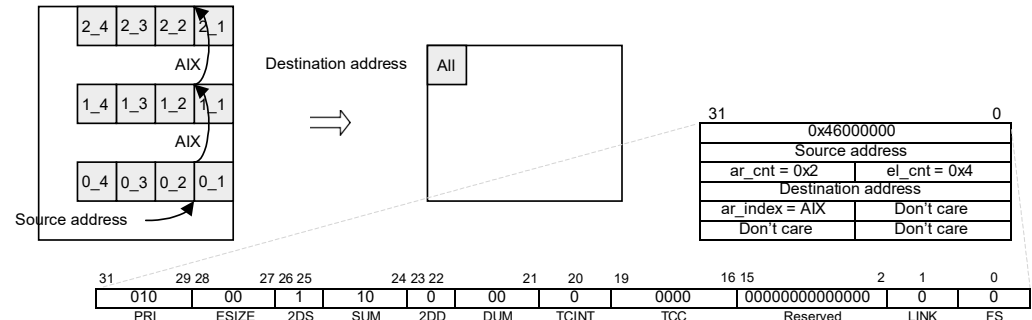

Figure H-7. Array-Synchronized 2-D (SUM=10b) to 1-D (DUM=00b)

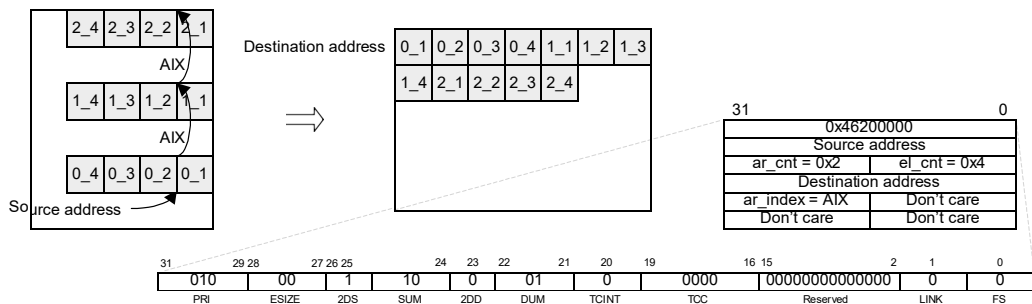

Figure H-8. Array-Synchronized 2-D (SUM=10b) to 1-D (DUM=01b)

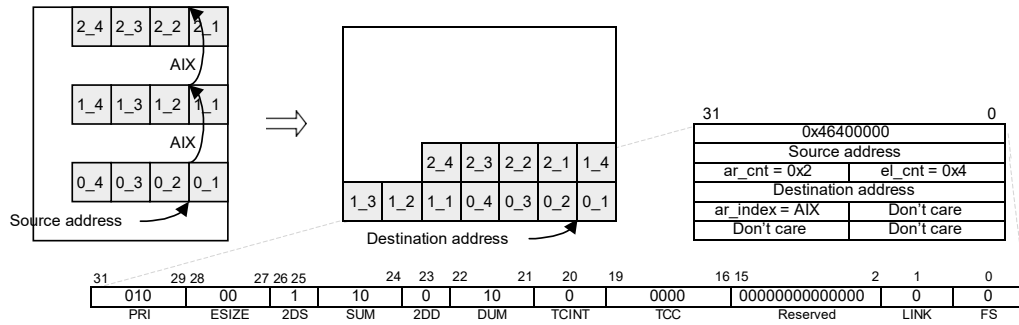

Figure H-9. Array-Synchronized 2-D (SUM=10b) to 1-D (DUM=10b)



## Appendix I Block-Synchronized 2-D to 1-D Transfers

The following figures depict the possible 2-D to 1-D transfers, along with the necessary parameters, using block synchronization. For each, an entire block of arrays is transferred per synchronization event.

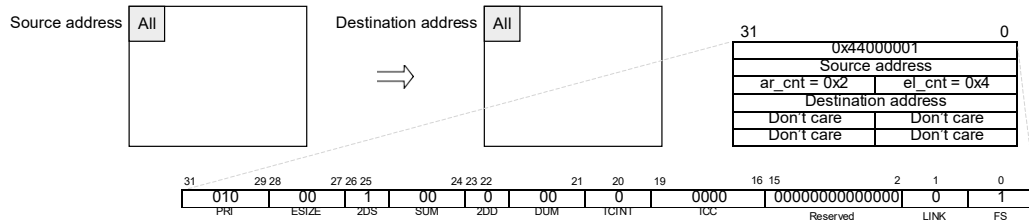

Figure I-1. Block-Synchronized 2-D (SUM=00b) to 1-D (DUM=00b)

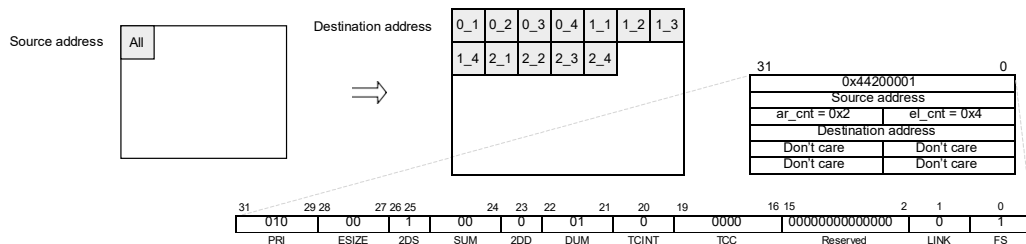

Figure I-2. Block-Synchronized 2-D (SUM=00b) to 1-D (DUM=01b)

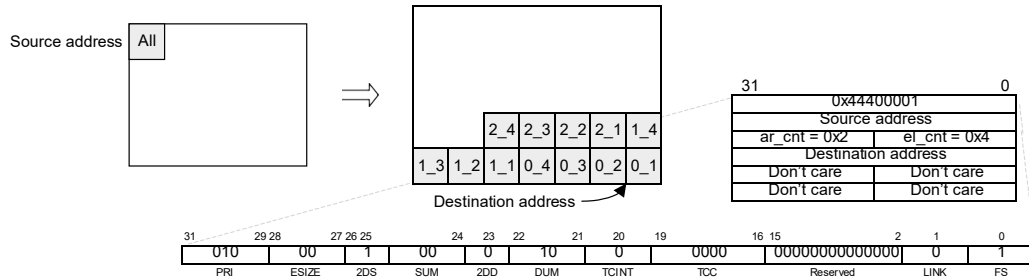

Figure I-3. Block-Synchronized 2-D (SUM=00b) to 1-D (DUM=10b)

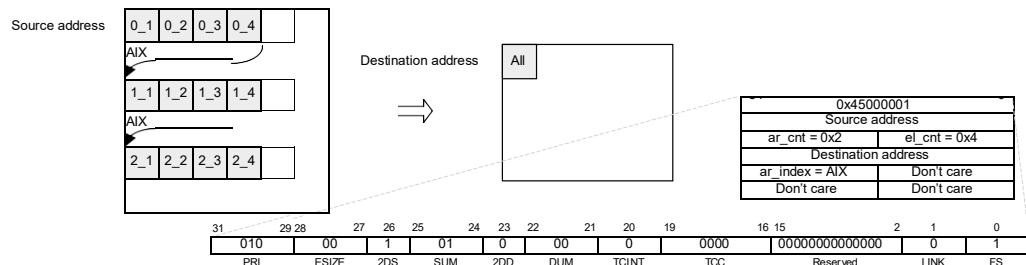

Figure I-4. Block-Synchronized 2-D (SUM=01b) to 1-D (DUM=00b)

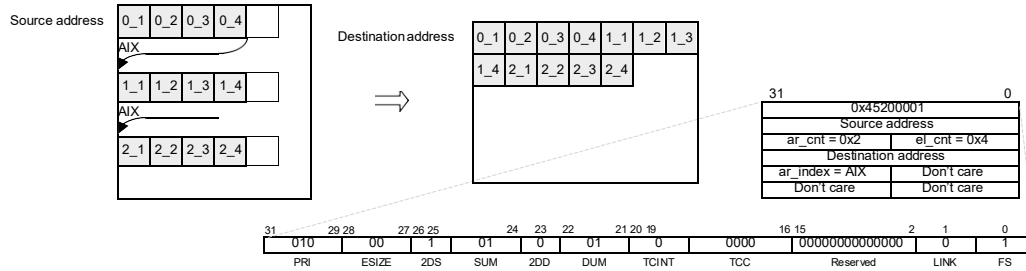

Figure I-5. Block-Synchronized 2-D (SUM=01b) to 1-D (DUM=01b)

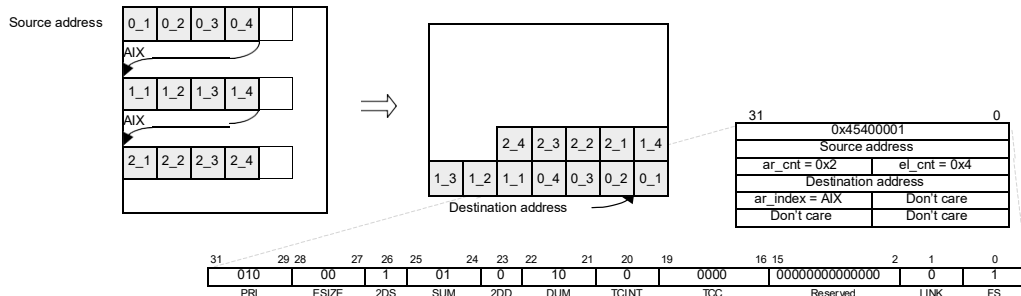

Figure I-6. Block-Synchronized 2-D (SUM=01b) to 1-D (DUM=10b)

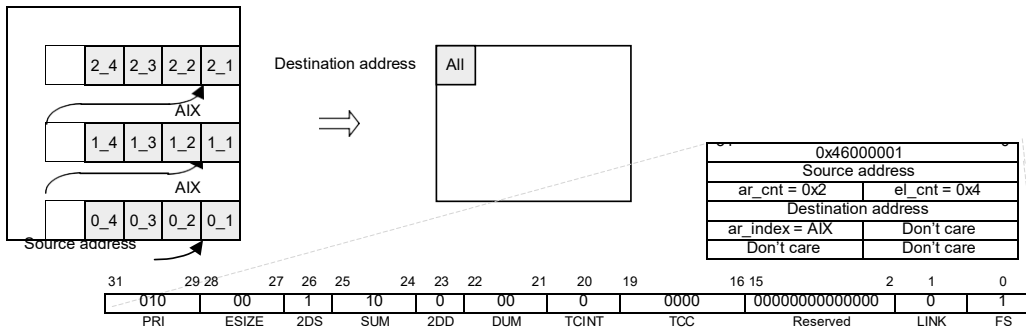

Figure I-7. Block-Synchronized 2-D (SUM=10b) to 1-D (DUM=00b)

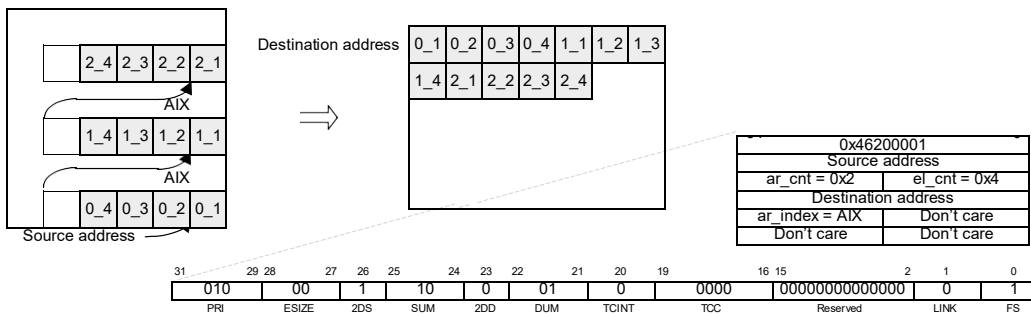

Figure I-8. Block-Synchronized 2-D (SUM=10b) to 1-D (DUM=01b)

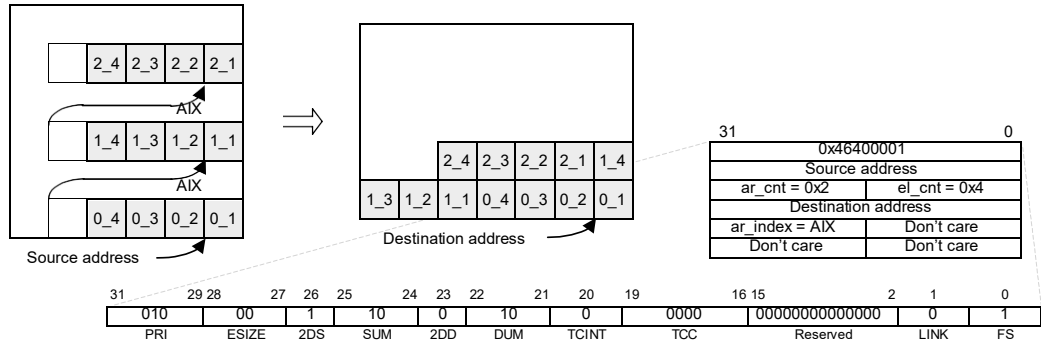

Figure I-9. Block-Synchronized 2-D (SUM=10b) to 1-D (DUM=10b)

## IMPORTANT NOTICE AND DISCLAIMER

TI PROVIDES TECHNICAL AND RELIABILITY DATA (INCLUDING DATASHEETS), DESIGN RESOURCES (INCLUDING REFERENCE DESIGNS), APPLICATION OR OTHER DESIGN ADVICE, WEB TOOLS, SAFETY INFORMATION, AND OTHER RESOURCES "AS IS" AND WITH ALL FAULTS, AND DISCLAIMS ALL WARRANTIES, EXPRESS AND IMPLIED, INCLUDING WITHOUT LIMITATION ANY IMPLIED WARRANTIES OF MERCHANTABILITY, FITNESS FOR A PARTICULAR PURPOSE OR NON-INFRINGEMENT OF THIRD PARTY INTELLECTUAL PROPERTY RIGHTS.

These resources are intended for skilled developers designing with TI products. You are solely responsible for (1) selecting the appropriate TI products for your application, (2) designing, validating and testing your application, and (3) ensuring your application meets applicable standards, and any other safety, security, or other requirements. These resources are subject to change without notice. TI grants you permission to use these resources only for development of an application that uses the TI products described in the resource. Other reproduction and display of these resources is prohibited. No license is granted to any other TI intellectual property right or to any third party intellectual property right. TI disclaims responsibility for, and you will fully indemnify TI and its representatives against, any claims, damages, costs, losses, and liabilities arising out of your use of these resources.

TI's products are provided subject to TI's Terms of Sale ([www.ti.com/legal/termsofsale.html](http://www.ti.com/legal/termsofsale.html)) or other applicable terms available either on [ti.com](http://ti.com) or provided in conjunction with such TI products. TI's provision of these resources does not expand or otherwise alter TI's applicable warranties or warranty disclaimers for TI products.

Mailing Address: Texas Instruments, Post Office Box 655303, Dallas, Texas 75265  
Copyright © 2019, Texas Instruments Incorporated