

NOVEMBER • 1957 25 CENTS



PHOTOFACT

RF

# REPORTER

FOR THE ELECTRONIC SERVICE INDUSTRY

# PREVIEW OF 1958 TV SETS

LATEST IN REMOTE TUNING

INDUSTRIAL "HEAT NERVES"  
VHF TUNER ALIGNMENT

PLUS NOVEMBER SUPPLEMENT  
TO SAMS MASTER INDEX

• AU1

• TWIN

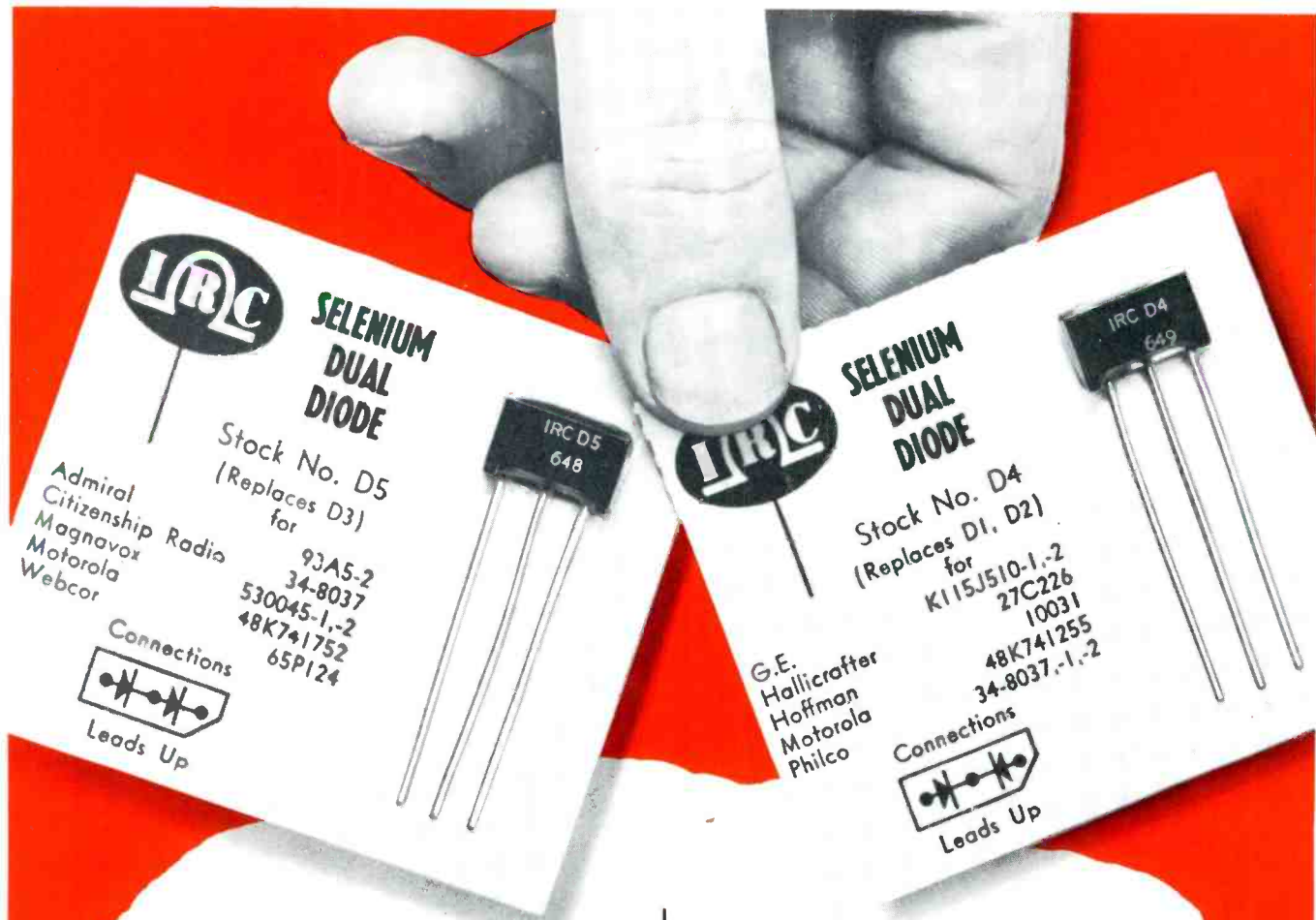

#### TYPE D5 SERIES CONNECTED DIODE

Universal replacement for following Manufacturers' Parts: Admiral (93A5-2, 93B5-3, 93B5-4 and 93B5-5), Citizenshship Radio (34-8037), Emerson (817062), Magnavox (530045-1 and 530045-2), Motorola (48K741752, 48B742698), Silvertone (B48-110), Webcor (65P124), Zenith (63-3977).  
New Type D5 takes place of IRC Type D3.

#### TYPE D4 COMMON CATHODE DIODE

Universal replacement for following Manufacturers' Parts: G. E. (K115J510-1 and K115J510-2), Hallicrafter (27C226), (027-300-226), Hoffman (10031), (744002), Motorola (48K741255), Philco (34-8037, 34-8037-1, 34-8037-2 and 34-8037-3), Muntz ([2] SR-0004, SR-0006).  
Type D4 takes place of IRC Types D1 and D2.

## NEW IRC® DUAL DIODES

meet replacement requirements  
of 24 manufacturers' parts

- Only two IRC Universal Selenium Dual Diodes are now necessary to meet the replacement requirements of most big name TV sets, phonographs, hi-fi sets, plus model airplane radio controls and other circuits.
- Mounted on cards with a special plastic "skin" that seals out dust, dirt and handling . . . peels off quickly, easily and neatly.

ORDER FROM YOUR IRC DISTRIBUTOR



INTERNATIONAL RESISTANCE CO., Dept. 364, 401 N. Broad St., Phila. 8, Pa.



**MODEL 280SW** (shown right)

- Double stacked array PLUS high frequency elements.
- All Aluminum Construction.
- Mounts on any mast up to 1 3/4"
- QUICK-RIG design for speedy one man installation.
- Complete with stacking bars.

**MODEL 180SW** . . . same as 280SW only not double stacked.

**MODEL 180** . . . QUICK-RIG 8 element "Lazy-X" Conical.

**MODEL 280** . . . QUICK-RIG double stacked "Lazy-X" Conical.

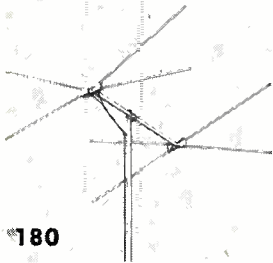

180

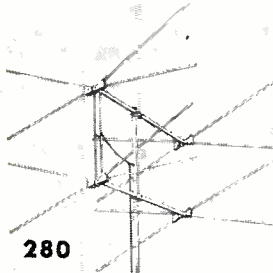

280

# 12 NEW RADIART TV ANTENNAS

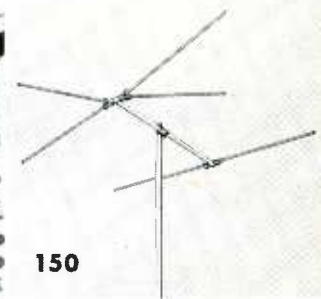

150

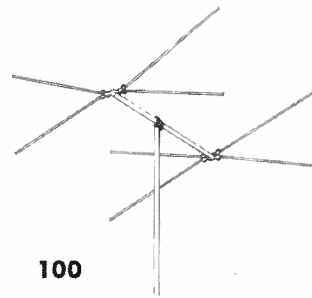

100

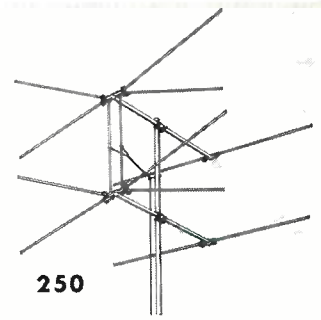

250

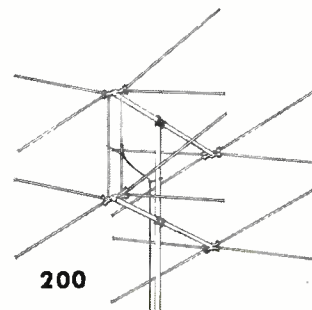

200

Proven Unquestionably . . .  
the best performing at  
the lowest possible price!

RADIART . . . the name you can depend upon for QUALITY and VALUE . . . offers a COMPLETE . . . and NEWLY ENGINEERED line of superbly performing TV antennas at an economy price. Carefully tested under all conditions . . . each of these new models is guaranteed to be the best performing at the lowest possible price.

- LZX 100 single array
- LZX 101 single array, unassembled
- LZX 200 8 element conical completely assembled, stacked array
- LZX 201 8 element conical unassembled, stacked array
- LZX 150 single array
- LZX 151 single array, unassembled
- LZX 250 6 element conical assembled, stacked array
- LZX 251 6 element conical unassembled, stacked array



SUBSIDIARY OF

THE RADIART CORPORATION / CLEVELAND 13, OHIO

**Sprague Service-Aids for servicemen:**



**... versatile CERA-MITE\* CERAMIC CAPACITORS with handy identification tags**

Sprague's complete ceramic capacitor line is now individually tagged for quick, *complete* identification—capacitance, tolerance, voltage, and type. No fumbling, no guessing about ratings ... you're always sure with Sprague *tagged* disc capacitors. Use them all the time. You'll find that they also make excellent replacements for molded mica, ceramic tubular, and paper tubular capacitors in many applications

**Stock up today! Ask your distributor about Sprague CERAMIKITS ... they contain the ceramic disc capacitors you need most ... they keep them in order ... ready to use.**

\*Trademark

**... helpful INFORMATION on what, when, and how of ceramic capacitors**

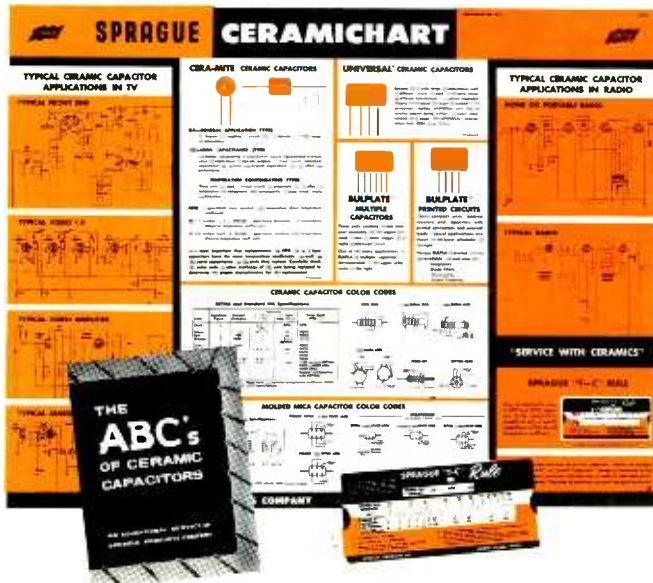

Sprague offers you plenty of service information ... the kind you need and use everyday:

*Sprague CERAMICHART:* illustrates various types of ceramic capacitors and shows where to use them; details color codes.—FREE

*Sprague "ABC's of Ceramic Capacitors":* a compact booklet containing basic facts on all types of ceramic capacitors.—FREE

*Sprague "T-C" Slide Rule:* shows at a glance the values of the N750 and NP0 type ceramic capacitors to connect in parallel to equal a capacitor of desired intermediate temperature coefficient of the required capacitance; available from your distributor for only 15c.

**Be sure you get this useful and valuable information from your Sprague distributor, today! Or write Sprague Products Co., Distributors' Division of Sprague Electric Company, 105 Marshall Street, North Adams, Mass.**

**Pioneer in ceramic capacitors ... First in ceramic capacitor information**

**don't be vague ... insist on**



**SPRAGUE RESEARCH IS CONSTANTLY PRODUCING NEW AND BETTER CAPACITORS FOR YOU**



PUBLISHER  
Howard W. Sams  
GENERAL MANAGER  
Mal Parks, Jr.

EDITOR  
Verne M. Ray

ASSOCIATE EDITORS  
Leslie D. Deane  
Thomas A. Lesh  
Calvin C. Young, Jr.

CONSULTING EDITORS  
William E. Burke C. P. Oliphant  
Robert B. Dunham George B. Mann  
Paul C. Smith

ART DIRECTOR EDITORIAL ASSISTANT  
Don W. Bradley Judy Ann Hurley

PHOTOGRAPHY CIRCULATION  
Robert W. Reed Pat Tidd

ADVG. PRODUCTION ART ASSISTANT  
Carol B. Gadbury Phillip W. Lee

ADVERTISING SALES OFFICES

MIDWESTERN

PF REPORTER,  
2201 East 46th Street, Indianapolis 5, Ind.  
Clifford 1-4531

EASTERN

Paul S. Weil and Donald C. Weil,  
39-01 Main Street, Flushing 54, New York.  
Independence 3-9098.

WESTERN

The Maurice A. Kimball Co., Inc.  
2550 Beverly Blvd., Los Angeles 57, Calif.  
Dunkirk 8-6178; and 681 Market Street,  
San Francisco 5, Calif. EXbrook 2-3365.

Published monthly by Howard W. Sams & Co.,  
Inc., at Indianapolis 5, Indiana.  
Entered as second class matter October 11,  
1954, at the Post Office at Indianapolis, Indiana,  
under the Act of March 3, 1879.

Copyright 1957 by Howard W. Sams & Co., Inc.  
No part of the PF REPORTER may be repro-  
duced without written permission. No patent  
liability is assumed with respect to the use of  
information contained herein.

Subscription prices in U.S.A. and possessions:  
1 yr., \$3.00; 2 yrs., \$5.00; 3 yrs., \$7.00. In  
Canada and Pan America: 1 yr., \$3.60; 2 yrs.,  
\$6.00; 3 yrs., \$8.50. Foreign subscriptions:  
1 yr., \$6.00; 2 yrs., \$11.00; 3 yrs., \$15.00.  
A limited quantity of back issues are available  
at 35c per copy.

## next month

### THE TROUBLESHOOTER

A new monthly feature, presenting expert answers to difficult field-servicing problems submitted by readers.

### SCOPE-WAVEFORM CALIBRATION

How to use the internal calibrating features of your scope or a peak-to-peak reading voltmeter as an aid in cutting down troubleshooting time.

### TRACKING SUPERHETS

This one will make even many of the old-timers sit up and take notice, explaining some common misconceptions about "tracking," and outlining the adjustment procedure by which it can be properly obtained.

VOLUME 7, No. 11



NOVEMBER, 1957

# PF REPORTER

FOR THE ELECTRONIC SERVICE INDUSTRY

## CONTENTS

Letters to the Editor .....	8
Shop Talk .....	12
Transistorized vertical deflection systems	Milton S. Kiver
Servicing Industrial Electronics .....	14
Photoconductive cells used as high-temperature sensing devices	Melvin Whitmer
Dollar & Sense Servicing .....	16
John Markus	
Previews of 1958 TV Sets .....	18
Nine information-packed pages presenting the receivers you'll be servicing next year	
Quicker Servicing .....	28
Interesting color TV troubles	Calvin C. Young, Jr.
Troubleshooting With George .....	32
A contrast control that affects volume—backwards!	Les Deane
Notes on Test Equipment .....	38
Reports on a new scope, transistor power supply, in-circuit capacitor checker and tube-transistor tester	Les Deane
Latest in Remote Tuning .....	50
All about the Westinghouse "Picture Pilot" and Hoffman "BeamRider"	Thomas A. Lesh
Inside TV Tuners .....	60
Data on the alignment of VHF units	Calvin C. Young, Jr.
Product Report .....	77
Free Catalog & Literature Service .....	80
Supplement to SAMS Master Index .....	81

## SUBJECT REFERENCE INDEX

AUDIO		SERVICING	
FM quadrature detector trouble ..	76	Color TV .....	28
BUSINESS		Industrial Electronics .....	14
Budget percentages .....	16	Printed board .....	31
Expansion opportunities .....	16	TV, 1958 model .....	18-26
Used TV merchandising .....	16	Tuners, alignment of .....	60
Why an employee quits .....	16	Tuning devices, remote .....	50
CIRCUITS		TEST EQUIPMENT	
Chroma oscillator .....	28	Century in-circuit capacitor checker .....	44
FM detector, 6BN6 .....	32	Hickok general purpose scope .....	38
Motor-speed control .....	73	Perma-Power transistor power supply .....	40
Remote control .....	50	Precision App. tube-transistor tester .....	46
Temperature-controlling, phototube .....	72	THEORY	
Transistorized vertical sweep .....	12	Optical pyrometer .....	71
Tuner, VHF .....	60	Photoconductive cell .....	14
COLOR TV		Photovoltaic cell .....	71
Fine-tuning trouble .....	30	Remote tuning .....	50
Loss of color .....	28	Transistor circuit .....	12
COMPONENTS		TRANSISTOR CIRCUITS	
In 1958 sets .....	18	Blocking oscillator .....	12
Photoconductive cells .....	14	Vertical sweep output .....	12
RADIO		TUBES	
Portable, printed-board trouble in .....	31	Chroma oscillator, Gm of .....	28
		New, in 1958 sets .....	18-26

USE HANDY CARD AT BACK TO ENTER YOUR SUBSCRIPTION

# WEN

# Again!

## new feather-light 100 WATT ELECTRONIC SOLDERING GUN

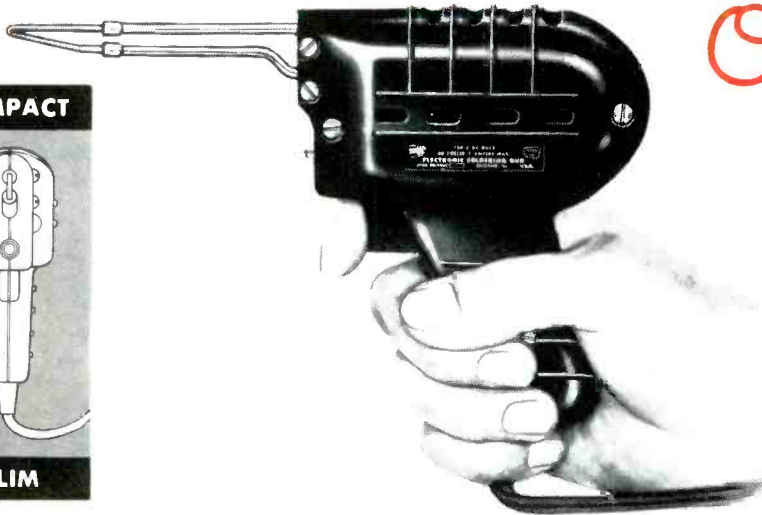
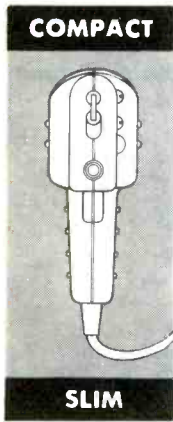

Only  
**\$5<sup>95</sup>**  
LIST

### IT'S SMALLER, LIGHTER, HANDY AS YOUR HAND, IDEAL FOR THE WORK YOU DO

Weighs only 19 oz. . . . Heats in 3 seconds on ordinary 110-120 V. A.C. 60 cycle . . . Cools quickly too . . . Automatic spotlight . . . Long reach, long life tips . . . Soldering tips interchangeable with hot-cutting or flat iron finish-repair tips . . . Ebony black plastic handle and housing are heat and impact resistant . . . Beautifully balanced — easy to use . . . Ideal for service calls, bench repairs, home work shops. Lowest priced soldering gun on record.

**3/8"**  
120 V. — AC/DC

Only **\$29.95**

LIST

*Also*

## 2 SPEED POWER DRILL

1000 - 3000 RPM as needed. Speed change quick, positive. Provides just the right speeds for different jobs. Geared Jacobs chuck. All you need in an electric drill in this 1 tool. With attachments — it is a whole work shop.

*And*

## ALL PURPOSE POWER SAW

Has no equal. Cuts anything smoothly, swiftly — 2 x 4's in seconds, 1/2" steel, plastics, conduits. Cuts circles, scrolls, dovetails, straight lines or angles. Makes own starting holes. Blows off sawdust. 3 blades — coarse, medium, fine.

**8 SAWS IN 1**  
120 V. — AC/DC

Just **\$29.95**

LIST

Also ask about other WEN "Quick-Hot" Soldering Guns & Kits from \$7.95 to \$12.95. Also fine finish and heavy duty Sander-Polishers and Kits from \$13.95 to \$19.95. They'd help in your work.

# WEN

**PRODUCTS, INC.** 5808 NORTHWEST HIGHWAY, CHICAGO 31, ILL.

(Export sales, Scheel International, Inc., Chicago)

ALL WEN PRODUCTS ARE SUPERBLY MADE — U. L. APPROVED — FULLY GUARANTEED.



# GOOD-ALL CAPACITORS



The "Capacitor of Tomorrow"

## 600-UE Mylar\* Dielectric • Molded in Epoxy\*\*

**NEW** to the replacement market! Widely used by leading equipment manufacturers.

The 600-UE is created by the skillful combination of new "wonder materials," and Good-All's advanced design, exclusive production technique and tight quality control. It is ideal for replacement use in today's modern circuitry.

**FEATURES:** • Low leakage • High stability • Long, trouble-free life • Rugged construction • Extremely reliable service in humid climates

**SUPERIOR QUALITY • COMPETITIVE PRICE**

## DU PONT

\***MYLAR**® is DuPont's trade name for their amazing space-saving polyester film. This thin, tough film makes an ideal capacitor dielectric. Its inherent electrical stability and exceptional dielectric strength contribute greatly to the trouble-free service of the 600-UE.

## SHELL

\*\***EPON**® is Shell's trade name for their epoxy resin wonder plastic molding compound base. Far superior to common molding materials, Epon forms an extremely rugged moisture-tight case. Leads adhere securely to the compound. High dielectric strength is also an attractive feature of this tough, dense material.



**GOOD-ALL ELECTRIC MFG. CO.**

*Distributor's Division* • 26 RITTENHOUSE PLACE • ARDMORE, PENNSYLVANIA

# Sylvania TV Tuner Tubes



“R-X metered” at

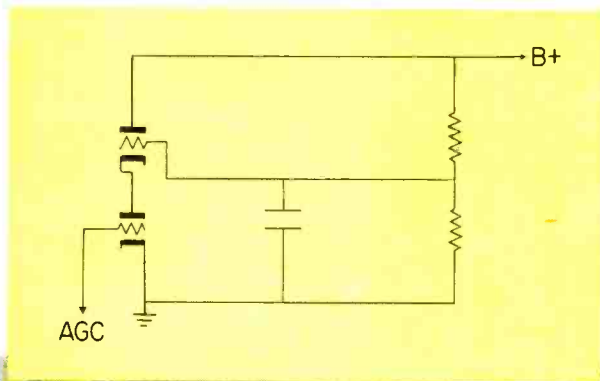

Simplified schematic is a typical cascode circuit in which double-triode amplifiers are tested for transconductance and plate current under actual operating conditions. In this way, Sylvania offers you maximum assurance of proper circuit performance when you repair TV tuners. Regardless of make or model TV, Sylvania tuner tubes mean dependability backed by industry's most exhaustive dynamic testing program.

Type by type, Sylvania's own JEMC (Joint Engineering and Manufacturing Committee) establishes test conditions which represent the most realistic measure of a tube's ability to stand up in the sets you service. Their working knowledge of the needs of TV tuner manufacturers eventually means greater service profits through less call-backs for you.





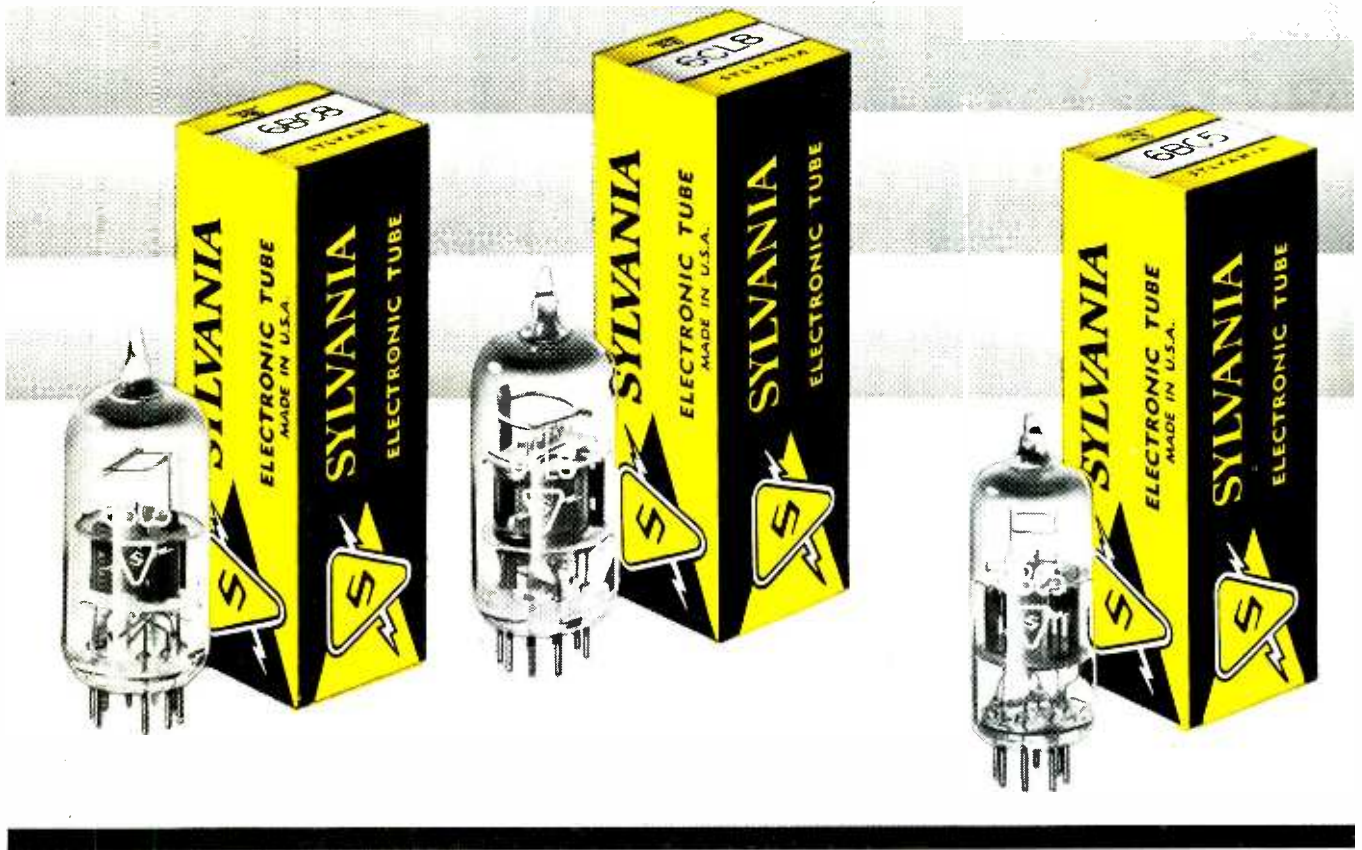

## 200 mc for controlled, dependable performance

Measuring input resistance and capacitance of all TV tuner tubes at 200 mc, places important controls over gain and tuning characteristics. This and many other tuner tube tests have been developed by Sylvania to provide you with maximum assurance of dependable performance regardless of make, model, or age of the TV sets you service.

All tuner tubes are fixed-bias tested under conditions which simulate actual

applications in TV sets. Cascode types are subjected to series Gm and series Ib tests in typical circuits. In addition, all types are checked both before and during life tests for serviceability at high and low line voltages.

Protect yourself against costly and unnecessary callbacks. Specify Sylvania TV Tuner Tubes in the new yellow and black carton.



# SYLVANIA

SYLVANIA ELECTRIC PRODUCTS INC.  
1740 Broadway, New York 19, N. Y.  
In Canada: Sylvania Electric (Canada) Ltd.  
University Tower Bldg., Montreal

LIGHTING • RADIO • ELECTRONICS • TELEVISION • ATOMIC ENERGY

# PROFITABLE COLOR SERVICING Starts Here!



MODEL 250  
NET \$129.95

## Wintronix

### COLOR CONVERGENCE DOT GENERATOR

A MUST for color jobs... a real time-saver for black & white. Used by leading TV manufacturers. Incorporates complete standard sync chain with AFC for optimum white dots, cross hatch, vertical or horizontal bars. Enables fast, callback-free troubleshooting and adjustment of: *Dynamic Convergence • D-C Convergence • Beam Magnets • Dynamic Amplitude & Tilt • Deflection Coil Positioning • White Balance & "Y" Matrix • Focus • Linearity and Pix size • etc.* Ultra-stable, automatically-locked circuits guarantee "jitter-free" dot patterns regardless of pix tube size. Preset r-f output, variable 30 db.



MODEL 150  
NET \$49.95

### Wintronix RAINBOW GENERATOR

New Wintronix "Linear Phase Sweep" Circuit produces vertical color bars of all possible hues representing 360 degrees of phase sweep. Simplifies home and shop alignment, adjustment or troubleshooting of any color TV. Detailed, well-illustrated instructions. The equal of color pattern generators costing many times more.

At Leading Parts Distributors Everywhere

**WINSTON  
ELECTRONICS INC.**

4312 Main St., Phila. 27, Pa.

## Letters to the EDITOR

Dear Editor:

I have a Tele-King Model 114 in my shop, and this is my trouble: When I turn the set on, I get no raster. A check shows no high voltage. I took a number of voltage readings and found, in the process, that when I touched either pin 2 or 5 (the plates) of the 6SN7 horizontal oscillator, the set began to operate and I got a good picture. Hope you can help me.

HARRY CHAMPA

Harry's Radio Shack  
Woburn, Mass.

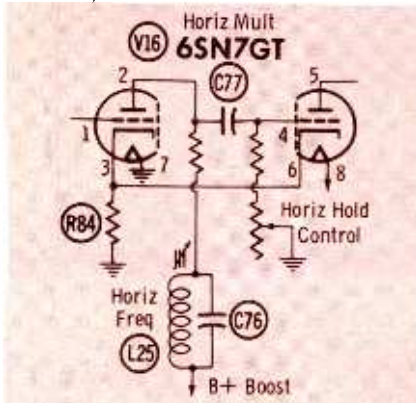

The oscillator is not functioning normally; however, when pins 2 and 5 are touched, it is shocked into operation. Possible sources for this trouble are defects in C77, R84, C76, or L25 (see schematic).—Editor

Dear Editor:

Every article I read in the PF REPORTER is of great interest to me—I have learned something new from every issue. Your "Pinpointing Troubles in Vertical Sweep Systems" (June issue) was of great help to me. I had been searching a long time for an elusive intermittent, and by using your pinpoint system, the trouble was located in thirty minutes.

I am having trouble with a Motorola TV set and your help would be appreciated. The picture is good but, when tuned to channel 2, there is a vertical line on the left side of the raster. Adjusting the horizontal size will not remove this line, but on other channels the line does not occur.

E. V. BARKER

Barker TV  
Vancouver, B. C.  
Canada

The line is probably caused by Barkhausen oscillation. This may be cured by dressing the antenna lead-in to the

tuner away from the flyback section, by checking to see that all shields are properly in place in the tuner and high-voltage sections, by repositioning leads emerging from the high-voltage section, or by placing 50-ohm resistors in series with the plate leads to the horizontal-output and HV-rectifier tubes. You can also reduce Barkhausen by placing a single-magnet ion trap over the 6BG6 output tube and positioning it for minimum interference. Check for a poor solder connection in the flyback circuit; a faulty contact can cause excessive Barkhausen radiation.—Editor

Dear Editor:

The "TV Waveforms" coverage in your July issue is something I have looked forward to for a long time. Let's have more on this!

GEORGE MILLER

M & K Radio & TV Service  
Denver 3, Colorado

Our Editors are diligently at work studying WAVE (and WAC) forms, and will present their findings early next year.—Editor

Dear Editor:

In the interest of quicker servicing, I'd like to pass on this hint to readers of PF REPORTER.

When confronted with the selection of a wrench or a nut driver for under-chassis bolts, nuts, etc., obtain a size impression on your finger and match it to the appropriate tool.

THOMAS J. OWENS

Maxwell Radio & TV Co.  
Mojave, Calif.

A worthy suggestion, providing your finger holds out.—Editor

Dear Editor:

Is it possible to obtain a good color-bar pattern by feeding the video signal in at the CRT grids, and yet not have good color reproduction during regular programming because of improper band-pass alignment? A lot of times I notice that parts of the face—such as ears—look reddish, while other flesh tones are normal.

SUBURBAN TELEVISION

Hudson Falls, N. Y.

Yes, it is possible to produce a proper pattern with the signal fed to the CRT grids, yet obtain poor color reproduction when the signal is fed to the antenna terminals. Thus, in checking the capabilities of a color receiver, the signal should pass through the RF, IF, video and chroma circuits.





✓  
**for all set replacement work!**

You'll save yourself trouble if you standardize on Raytheon "All-Set" Tubes for replacement work.

Here's why:

Raytheon "All-Set" Tubes are designed to give perfect service in many makes and models of receivers because Raytheon sells Tubes to almost

every set manufacturer. To satisfy the many and varying needs of so many manufacturers, these tubes must combine top quality performance and dependability. This successful combination makes Raytheon "All-Set" Tubes tops for replacement.

Always use Raytheon "All-Set" Tubes to satisfy your "all-set" customers.

**TV-Radio service is your business . . . serving you is ours**



**RAYTHEON MANUFACTURING COMPANY**  
Receiving and Cathode Ray Tube Operations  
Newton, Mass. • Chicago, Ill. • Atlanta, Ga. • Los Angeles, Calif.

Raytheon makes all these	<div style="display: flex; align-items: center;"> <span style="font-size: 2em; margin-right: 5px;">}</span> <div> <p>Receiving and Picture Tubes, Reliable Subminiature and Miniature Tubes, Semiconductor Diodes and Transistors, Nucleonic Tubes, Microwave Tubes.</p> </div> </div>
--------------------------	--

*Excellence in Electronics*

it's  
**new**

The **TRC**  
triple-duty microphone

by  
**American**



Actual size of new TRC microphone

for hand ...



stand ...



or lavalier



it's versatile ...  
lightweight ...  
low cost, too!

Elgin's new TRC dynamic microphone offers faithful audio reproduction in the 80-8500 cps range, yet lists from \$11.50. It is designed for use with tape recorders ... yet has the versatility to perform ideally at meetings and assemblies, wherever p.a. systems are used. The TRC is less than five inches long, weighs only nine ounces, has a polished, chromeplated case. It is omnidirectional and picks up voices within a radius of ten feet under average conditions.

The TRC is also available in crystal and ceramic types.

Get the facts on this new addition to Elgin's complete line of "American" microphones. Write today for specifications and complete descriptive literature.

**ELECTRONICS DIVISION**

ELGIN NATIONAL WATCH COMPANY  
107 National Street, Elgin, Illinois



Don't worry about the slight flesh tone differences (unless you start seeing pink elephants)—this is normal. Because of lighting difficulties in the studio, the camera is often "fooled" with respect to colors which are shadowed.—Editor

Dear Editor:

In this area (Detroit), we have an interesting UHF channel 56 operated by the Board of Education. Interest is quite high; however, so is the cost. Some viewers would like to get this station and would even buy a new set to receive it, if it weren't for the fact that many are holding out for color, too. What with special antennas, rotors, several lead-ins and the converter, no wonder they shy away.

Is there a less expensive way? I think I have read of an antenna mounted matching transformer that will allow the use of one lead-in. I wonder if this would work on Standard Coil tuners.

CLARE E. WEST

Detroit, Mich.

There are antenna couplers which can be used to connect UHF and VHF antennas to the same transmission line. These couplers may not be readily available in areas which have a low UHF set circulation, but they could be specially ordered. In Standard Coil strip conversions, the single transmission line can be attached directly to the tuner; but in receivers that have separate UHF and VHF antenna terminals, another coupler is needed as a signal splitter at the lower end of the transmission line.—Editor

Dear Editor:

I like your magazine very much, but why do you publish such articles as "Let's Pull Less Chassis" (August, 1957). I'm sure Mr. Margolis is quite adept in his techniques, but why encourage doing work in the home that should be done in the shop?

I was of the opinion that PF REPORTER was for the serviceman, not for the customer, and most TV men should be capable of classifying between a home call and shop job.

I feel better now.

Thanks,  
C. W. DILLMAN

Whether a set is to be serviced in the home or shop is a decision for the technician himself to make. As a serviceman's magazine, we feel duty-bound to acquaint our readers with various successful servicing techniques. Just for the record, "Let's Pull Less Chassis" was one of the most popular articles in the August issue.—Editor

PF REPORTER · November, 1957



# TRANSMIT *PICTURE and SOUND*

AT ANY TIME—TO ANY TV SETS



Displays any pattern, picture, or message for TV servicing or for closed-circuit telecasting

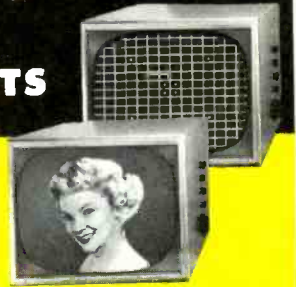

Provides crystal-controlled, full color rainbow display for complete color TV testing



Provides FM sound carrier. Has built-in audio tone generator plus input for tape, tuner, mike

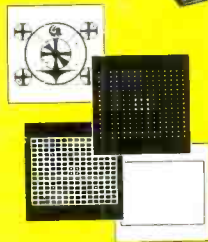
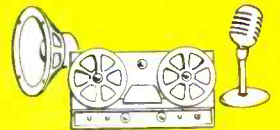

**3** Slide Transparencies and One Clear Acetate Supplied with Dyna-Scan Includes one Indian Head, one White Dot, and one White Line crosshatch pattern, plus one clear acetate for messages



MODEL 1000



C15

S16

## **B&K** *NEW* MODEL 1050 **DYNA-SCAN** PORTABLE VIDEO and AUDIO GENERATOR

**THE FLYING SPOT SCANNER** produces a composite video and sync signal that operates any standard black & white or color TV receiver, at any VHF television frequency. Reproduces your own test pattern or picture on the TV screen with high definition, anytime, anywhere, from any slide transparency—or transmits messages typed or written on clear acetate. Can be used with one or more TV sets or fed into a master or community antenna system. Maximum resolution capability is well in excess of 450 lines at video.

**BUILT-IN COLOR-SCAN** provides crystal-controlled, full color rainbow display of orange, red, magenta, blue, cyan, green. Enables you to test color sync circuits—check range of hue control—align color demodulators, etc.

**BUILT-IN AUDIO-SCAN** provides FM sound transmission exactly like a TV station, 4.5 megacycles above video carrier, with modulation from any available audio source. Enables you to combine speech or music with the video display. Can be modulated with built-in 400 cycle tone generator for test signal or from external signal source such as microphone, tape recorder, FM-AM tuner, or from audio oscillator. Has built-in audio amplifier and volume control.

*Facilitates servicing, installation or demonstration of black & white and color TV receivers. Provides closed-circuit TV system with both video and audio for commercial, industrial, and educational applications. Allows convenient stand-by and break-in, or distribution line check, for community antenna system operation.*

**Model 1050 DYNA-SCAN** complete portable video and audio generator, with built-in Color-Scan and Audio-Scan. Includes 3 test pattern slide transparencies, one clear acetate and slide holder. Comes with 6 ft. r.f. cable. Size 16½ x 10½ x 9½ in. Net, **\$259<sup>95</sup>**

**Model 1000 DYNA-SCAN** picture and pattern video generator. Has all the features of the Model 1050 above, except without the Color-Scan and Audio-Scan sections. Net, **\$199<sup>95</sup>**

**Color-Scan or Audio-Scan or both can easily be added to the Model 1000 at any time.**

**Model C15 COLOR-SCAN** for Model 1000. Net, **\$19.95**

**Model S16 AUDIO-SCAN** for Model 1000. Net, **\$29.95**

Available from most Electronic Parts Distributors on easy time-pay plan.

See your B&K Distributor, or write for Bulletin 1050-R

**B & K MANUFACTURING CO.**  
3726 N. Southport Ave. • Chicago 13, Illinois

Canada: Atlas Radio Corp., 50 Wingold, Toronto 10, Ont. Export: Empire Exporters, 458 Broadway, New York 13, N.Y.



# ShopTalk

MILTON S. KIVER

Author of *How to Understand and Use TV Test Instruments and Analyzing and Tracing TV Circuits*

## Transistorized Vertical Deflection Systems

Last month we investigated the circuits of several transistorized blocking oscillators suitable for use in the vertical deflection system of television receivers. We saw that the same RC network controlling the timing (or frequency) of the oscillator also developed the sawtooth deflection waveform. We noted, too, that this wave could be developed either in the emitter leg or in the collector circuit. Now let us investigate the remainder of the circuit found in the vertical system.

In a vacuum-tube deflection circuit, the vertical oscillator is followed by the output amplifier. In order to develop the necessary current swing, this stage requires a certain amount of driving voltage. In transistor circuitry, a similar 2-stage arrangement requires that a power transistor be

used in the oscillator stage because of the power needed by the output amplifier in delivering sufficient sweep current to the vertical deflection yoke.

A suitable 2-stage vertical deflection system for a 21", 90° tube is shown in Fig. 1.\* The oscillator, using a power transistor, develops a negative-going sawtooth wave (across C1), which is applied to the base of the output amplifier. (Note that this is a forward-biasing wave because it is being fed to a p-n-p transistor.) Frequency control of the oscillator is achieved by varying its base bias resistor R1, and synchronization is accomplished by coupling a negative triggering pulse into the base via a tertiary winding on the pulse transformer.

The waveform of the voltage fed to X2 is sawtooth, as shown

\* "Transistorized Television Vertical Deflection System," by W. Palmer and G. Schiess, Sylvania Electric Products, Inc.

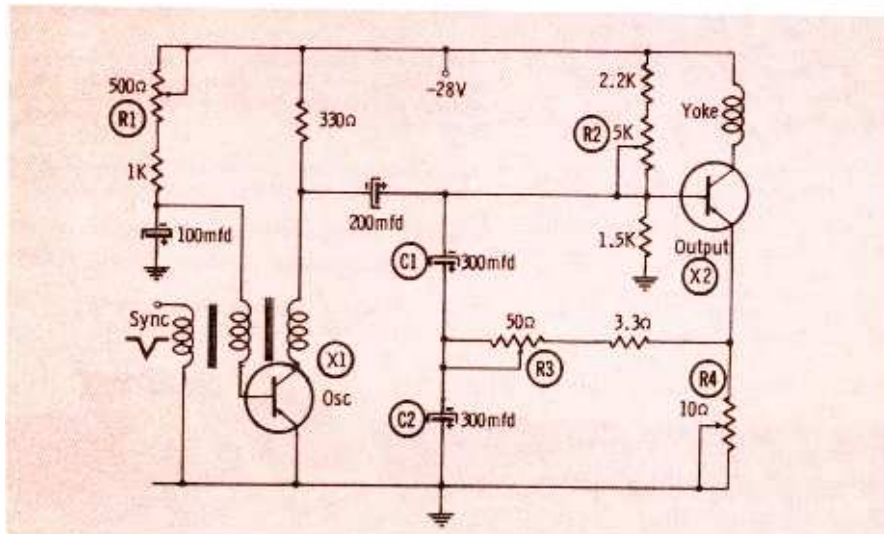

Fig. 1. A 2-stage transformerless vertical deflection system.

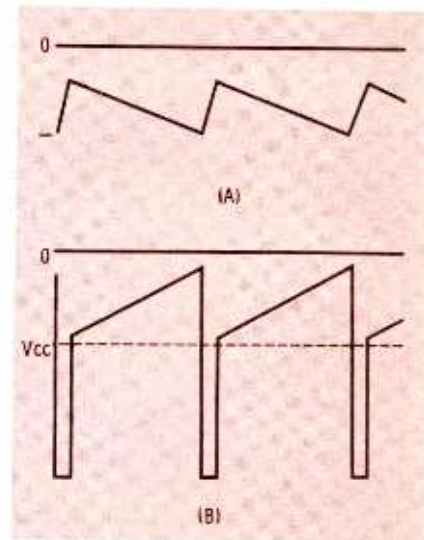

Fig. 2. (A) Sawtooth voltage applied to base of X2, Fig. 1. (B) Yoke voltage. Vcc is battery voltage.

in Fig. 2A. This differs from conventional vacuum-tube practice where the input wave to the output amplifier is usually peaked. The reason for the difference is that, comparatively, collector resistance for a common-emitter transistor stage is much higher than the plate resistance of a triode tube. In a triode vertical output circuit, both plate resistance and plate-load inductance must be considered; i.e., to obtain sawtooth deflection current, a sawtooth voltage must be applied across the resistive portion and a square-wave voltage must be applied across the inductive portion. If, however, the ohmic value of the resistance is at least ten times that of the inductance, a sawtooth driving voltage must be used.

Returning to Fig. 1, we find that C2 and R3 form a linearity correction network. The sawtooth current flowing through emitter resistor R4 is integrated into a parabola across C2 and fed back to the base through capacitor C1. The special correction is needed to compensate for the nonlinear characteristics of transistor X2. Adjustment of linearity control R3 affects the amplitude of the parabola and hence the degree of linearity compensation. It will be found that the linearity control also affects the amplitude of the yoke current; hence, readjustment of the amplitude (height) control R4 is necessary with each linear-

• Please turn to page 66



# ASTRON

## "Staminized" CAPACITORS HAVE

# stability

### SAFETY MARGIN\* CONSTRUCTION ASSURES CAPACITANCE STABILITY

Real staying-power after installation is what you need in a replacement capacitor . . . consistent characteristics maintain top circuit performance . . . and Astron builds them just that way!

Astron's exclusive "Safety Margin" construction withstands ripple currents, vibration, and wide temperature changes. Minimum leakage and impedance is assured by special processing methods. Only the very finest of raw materials pass Astron's "Selected Purchasing System". Special production techniques, strict quality controls, meticulously clean assembly methods and 100% final inspection before shipment assure you top performance from every Astron capacitor.

There is an Astron "Staminized" Capacitor built especially to fill the specific, exacting replacement requirements of any job you tackle.

Remember, **your** reputation is **our** business. Build it, guard it, protect it . . . buy Astron capacitors, **they have stability.**



SAFETY MARGIN "SM" MINIMATE\*



CERAMIC CASED TUBULAR TYPE AP



#### FREE SERVICING AID

Save time, use handy Astron pocket-sized Replacement Catalog and Pricing Guide (AC-4D) — Write Today!

# ASTRON

C O R P O R A T I O N  
255 GRANT AVENUE EAST NEWARK, N. J.



\*Trade-mark

Export Division: Rocke International Corp., 13 East 40th St., N. Y., N. Y. In Canada: Charles W. Pointon, 6 Alcina Ave., Toronto 10, Ontario

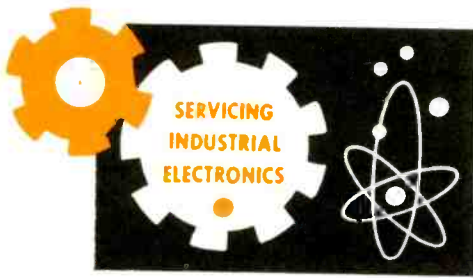

**part - 3**

by Melvin Whitmer

# HEAT NERVES

instruments  
for  
the  
control  
of  
high  
temperature

In the last installment, several devices which respond to changes in ambient temperature were described. These units (mercury switches, bi-metal thermostats and thermocouples) must come in contact with the heat they are to control, thus limiting the maximum controllable temperature to about 1,000°F, since the units themselves cannot withstand higher temperatures. The ther-



Courtesy Leeds and Northrup Co.

Portable optic pyrometer being used to measure temperature of molten glass.

mistor was described as both an environmental and radiated-heat detector. The thermistor bolometer responds when the radiation characteristics change, which happens whenever the temperature changes; thus the sensing unit can be kept at room temperature while detecting temperatures above 1,000°. Additional radiation devices comprise the topic of this article.

The radiation characteristics of heated bodies were studied in 1879, by Stefan, who is credited with the formulation of the fourth power law. Five years later, Boltzman derived the same law theoretically. Using the Stefan-Boltzman law, the Fery pyrometer (1902) was designed to respond to total radiation.

During the late 1800's and early 1900's, Planck studied the radiation emitted by every mass having a temperature above absolute zero. His experiments led to the theory that all energy is transmitted in distinct "packets," with the energy contained in any packet determined by the temperature of the emitting body. This theory is opposed by the wave

theory which has been used to account for radio transmission; however, physicists are sure that a composite theory which will satisfy both radio-wave experiments and the packet theory can be found. Currently, these packets of energy are called photons, a quantum of radiant energy.

A body at a particular temperature emits a variety of energy levels. The curve of Fig. 1 represents the spectrum of photons emitted and their energy levels. Notice the maximum point of the curve, indicating that the greatest number of photons are emitted with a particular energy level. This point shifts up or down the energy axis for an increase or decrease in temperature. When the temperature and the energy change, the sensing unit will generate a signal proportional to the amount and direction of that change. As described previously, thermocouples can be used to respond to heat radiation, or to ambient temperatures. The radiation energy increases electron activity in the thermocouple as does the actual increase in its own tem-

• Please turn to page 70



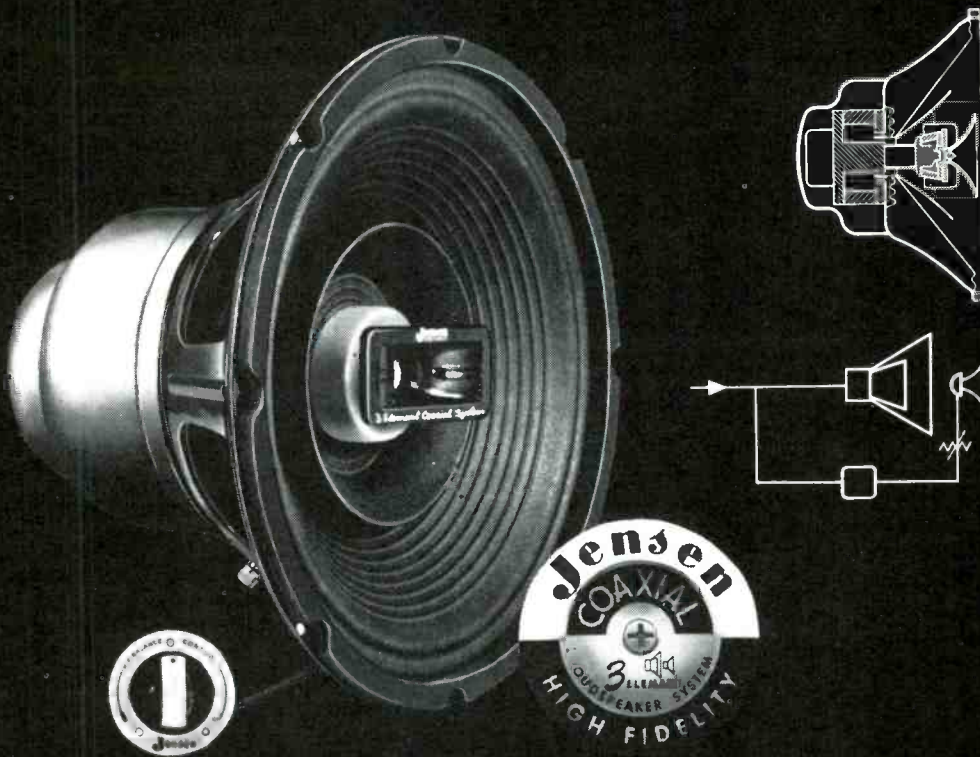

# NEW Jensen COAXIAL 3-ELEMENT HI-FI LOUDSPEAKERS

**You'll spend less for more performance  
... get traditional Jensen quality!**

If you're looking for hi-fi performance outclassing anything remotely similar on the market today ... with more performance ... more easy-on-the-ears listening quality ... at less than you'd expect to pay, then don't fail to investigate Jensen's 4 new Coaxial 3-Element models.

There are three radiating elements driven by two voice coils. H-F unit is a compression driver supertweeter 4000-15000 cycles; woofer-midchannel is a separately driven dual cone unit, with the small cone dispersing and smoothing the 2000-4000 cps. region. The whole skillfully blended combination rates at 30-15000, low end depending on enclosure. H-F control tunes it up smoothly to suit the ear. Choice of 12-inch CX-120 (1 lb. magnet) at \$49.50 or CX-225 (1 1/4 lb.) at \$59.50; 15-inch CX-150 (1 lb.) is \$66.50, CX-255 (1 1/4 lb.) only \$76.50. Write now for free complete condensed Catalog 165-B.



#### KTX-3 "STEP-UP" KIT

If you have the urge to improve your speaker later, you can have a full 3-way system by adding this compression horn midrange unit (600-4000 cps). Net \$62.50.

# Jensen

**MANUFACTURING COMPANY**  
6601 South Laramie Ave., Chicago 38, Illinois

Division of The Muter Co. In Canada: J. R. Longstaffe Co., Ltd., Toronto  
In Mexico: Radios Y Television, S.A., Mexico D.F.

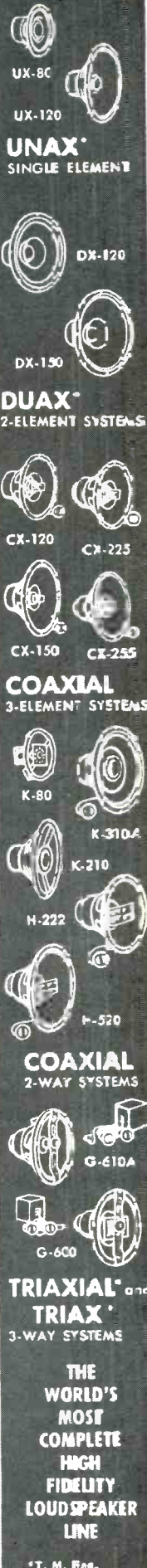

**THE  
WORLD'S  
MOST  
COMPLETE  
HIGH  
FIDELITY  
LOUDSPEAKER  
LINE**

\*T. M. Reg.





## BY JOHN MARKUS

*Editor-in-Chief, McGraw-Hill TV, Radio and Changer Servicing Course*

**The Boss.** It is often difficult to find the true reason why an employee quits to take another job. Some of the reasons discovered for this are listed as follows in "NEDA Journal": 1. To get greater security elsewhere. 2. Better opportunity elsewhere. 3. Unreliability of boss, who said one thing and did another. 4. Bad disposition of boss. 5. Not progressive enough. 6. Lack of appreciation of good work by employees. 7. Inadequate compensation (a boss who milks the business dry for himself without dividing fairly with his employees is building up trouble for the future). 8. Internal politics. 9. The boss's relatives (if they are the only ones who advance, the ambitious employee sees his future blocked and goes elsewhere.)

Recognition of the above items can mean the difference between success and failure in a servicing business.



**Grandmother.** Can grandmother sell used TV sets better than a regular store? Why not run an inexpensive classified ad for just one set at a time, giving her telephone number or home address, and let her do the rest? People seem to have more confidence in a set which is demonstrated right in the home—or perhaps they feel that the set is comparable to the automobile driven only 3,000 miles by a little old lady.

At least, this technique proved highly successful for R. C. Reiter of the Regina Agency in St. Paul in selling completely overhauled vacuum cleaners. He used 50¢ ads in a local throwaway shopping news, as well as free ads in a food market shopping news. In addition to selling a number of cleaners, Reiter found that retired relatives enjoyed the visits of prospective purchasers.

**Drive-in Wireless.** By replacing loudspeakers on cords with transistorized wireless speakers costing \$25 each, a new drive-in theatre in Dover, N. J., is saving around \$75,000 in initial wiring costs. A single master oscillator and transmitter puts the movie sound track on the air, with radiation limited so that FCC approval is unnecessary. The battery-operated receivers in cars pick up the signals. If the experiment succeeds from an economical operating standpoint, here is another business opportunity for servicemen.



**Predictions.** Hi-Fi sales will reach an all-time high this fall. Color TV will continue slow but steady growth, without quite coming out from behind that corner. Black-and-white set sales will be around 7 million for the year, almost equalling 1956. Transistor radio boom will continue, but still without appreciably affecting servicing income.



**Outgo.** According to R. C. Hansen, Service Coordinator for RCA Service, Inc., total servicing income should be roughly allocated as follows:

Wages for service—40-45% of income

Materials—20-25%

Rent, insurance, lights, etc.—12-15%

Truck or car—6-8%

Employment benefits—5-7%

Do your own figures fall in these ranges? Note that if you're at the upper end of the range for all five items, your net operating profit for the business is exactly zero!

**Scrapping Rate.** This year about 2 million TV sets will be retired to the junk pile, according to Sylvania. At midyear, the total for sets scrapped since TV's debut in 1946 reached 8.25 million. In practically every case, the set is scrapped either on the recommendation of a serviceman or because the customer decides the estimate for needed repairs is too high in relation to the cost of a new set.

**IDEA**—why don't set manufacturers offer a reward for each old set brought in by servicemen to be smashed up? Could be a way of creating a market for more new sets.



**Gripping.** Management of one large company discovered as the result of a survey that their best supervisors were the ones who griped the most about management. These men achieved their high production records by giving their workers a pretty free hand. They encouraged the employees to have pride in their immediate work group, and this in turn boosted their productive efficiency.

Remember that it's results that count. Don't judge a man by what he says, as much as by what he does and how he affects his co-workers. This is particularly important in a servicing organization, where teamwork and a swapping of ideas on tough sets can really keep things moving.



**Traffic Stopper.** For a Saturday afternoon crowd-stopper, put an outdoor chaise lounge in your show window, coax some portly gentleman into it, plunk one of the new portable TV sets on his tummy, place liquid refreshments at his side, then tune in the football game so that he can watch it in complete relaxation. You may want to let the price tag for the portable dangle toward the audience, but it's not really needed; this display will speak for itself.



**Color Fee.** Finding the public hesitant to accept free demonstrations of color TV, Bruno-N.Y., RCA distributor, is now charging a demonstration fee of \$15. This is credited toward the cost if the set is bought.



# HICKOK

## DYNAMIC MUTUAL CONDUCTANCE



Model 6000

- Grid Current (Gas) Test
- Constant Indication of Line Voltage
- Filament Continuity Test
- New Roll Chart Grouping of Popular Tubes
- Faster and More Sensitive Shorts Test

### Also Available as Model 6005 TUBE and SET TESTER

Contains all tube test features of the Model 6000 and, in addition, includes a built-in 20,000 ohm-per-volt multimeter for measuring AC or DC Volts, Megohms, Microfarads, and DC Milliamperes.

Test leads are included . . . . . \$224 Net

... Choice of the Experts

# New, High-Speed TUBE TESTER

*in a Popular-Price Portable*

**NEW SOCKET DESIGN:** The HICKOK 6000 is the only tube tester available with a snap-in master socket panel that easily removes to expose the new type 11 pin socket that will accommodate other adapters for checking such tubes as foreign tubes and older seldom used tubes. Saves time in replacement of worn out sockets.

**SCALE READINGS IN MICROMHOS—**Tube quality evaluations are read directly on the 3-range micromho scales. (0 to 3000, 6000, 15000.)

**RESERVE CATHODE CAPACITY TEST—**By merely turning a selector control on the panel; the reserve capacity of the tube under test can be determined to weed-out those tubes which very possibly could cause trouble in the very near future.

**NEW ROLL CHART DESIGN—**All the most used tubes are grouped into a separate section of the roll chart to speed their location for test information.

**DETECTS MORE TUBES WITH PROFESSIONAL ACCURACY—**This entirely new tester features a much faster test without sacrifice to accuracy since it retains the time proven HICKOK method of Dynamic Mutual Conductance.

**HIGH SENSITIVITY METER—**HICKOK-built high quality 5-inch meter with large easy-to-read multi-color scales.

**NEW HIGH-SPEED, EXTRA SENSITIVE SHORTS TEST (12-Times More Sensitive)—**Five neon lights automatically indicate shorts or leakage between elements, and identify which elements are shorted. This new test is entirely automatic.

**CONSTANT INDICATION OF LINE VOLTAGE—**The line voltage is indicated constantly so that when a tube is under test, the line adjust can be made very quickly.

**NEW GRID CURRENT (Gas) TEST —**By merely depressing one push-button, the gas content (grid current) is measured very accurately on the meter in terms of actual microamps. This is a very sensitive test and will indicate even the slightest amount of gas.

**FILAMENT CONTINUITY TEST—**A common failure of many tubes is an open filament. In the 6000, as soon as the tube is plugged into the test socket, user may depress the Filament Continuity button to immediately determine whether the filament is "open" or not.

**FILAMENT VOLTAGE—**From 0.6 to 117 volts in 18 steps.

**TESTS AND REJUVENATES TV PICTURE TUBES—**Readily accommodates the low cost HICKOK CRT Adapter for evaluating TV Picture tubes and rejuvenating their internal coating.

**POPULARLY PRICED—**Complete with 6-socket removable socket plate that accommodates over 95% of all tubes in active use today. Attractive red leatherette covered portable case with detachable lid. 16¾" W., 11¾" L., 7½" D. 16 pounds net. 105-125 VAC, 60 cycles, 40 watts. Panel is gold anodized with red and black lettering. Includes HICKOK World Famous guarantee.

**\$182.25 Net**

Ask your jobber for a free demonstration  
in your shop.

## THE HICKOK ELECTRICAL INSTRUMENT CO.

*First in Tube Testing*

10566 DUPONT AVENUE • CLEVELAND 8, OHIO  
Stark Electronic Sales Co., P.O. Box 2407, Ajax, Ontario, Canada  
Export Department, 431 Fifth Avenue, New York 16, N. Y.

# PREVIEW OF 1958 TV SETS

## INTRODUCTION

Ever walked confidently into a customer's home on a rush call, and suddenly been confronted by a brand-new receiver about which you knew absolutely nothing?

If you have, you're undoubtedly aware of the time involved in fully familiarizing yourself with a new chassis—not to mention your rather awkward appearance as far as the customer is concerned.

To assist you over the most difficult servicing hurdles of the 1958 TV sets, this special 9-page picture presentation covers the pertinent points of 16 of the more popular 1958 chassis. Note that these chassis differ rather markedly from earlier models in their new features.

Thus, here in one handy package—in advance—is the information which will help you in the servicing of next year's sets.

Admiral

Portable

Model P14D11

(Chassis 16H1)



The safety glass on this receiver, which is in reality a molded piece of plexiglass, can be removed from the front for cleaning. However, only a mild soap and cool water should be used for cleaning the glass since abrasives can scratch the surface and cleaning solutions may soften the plastic.

Except for tube replacement, the cabinet must be removed for chassis servicing. The usual service adjustments—horizontal drive, horizontal frequency, height and vertical linearity—can also be made without cabinet removal.

In removing the cabinet, it is necessary to take off the two metal plates from the upper corners of the cabinet, as well as the safety glass, rear cover, screw behind handle and screws that secure the cabinet to the bottom plate.

Plug-in silicon rectifiers are featured in this receiver, and should their replacement be required, it will be necessary to remove the cabinet. These units are mounted on the metal strap that supports the tuner and cannot be replaced without removing either the cabinet or the tuner—and it's easier to remove the cabinet. The 7.5-ohm, 5-watt fusible resistor is soldered to a terminal strip near the rear edge of the tuner.

The horizontal drive control is a potentiometer of the screwdriver-adjust type and is located just below the 12DQ6 horizontal output tube.

This set employs one of the new 110° 14ASP4 picture tubes, and no ion trap is used. The straight electron gun and aluminumized screen are features that make the ion trap unnecessary.

Some of these portables employ the Admiral tuner, which is of the combination turret and incremental-inductance type; local oscillator adjustment in this unit is slightly different from that employed with the standard turret tuner. On some high channels, two slugs will be seen in the three holes above the tuner control knobs; but only the top slug should be adjusted.

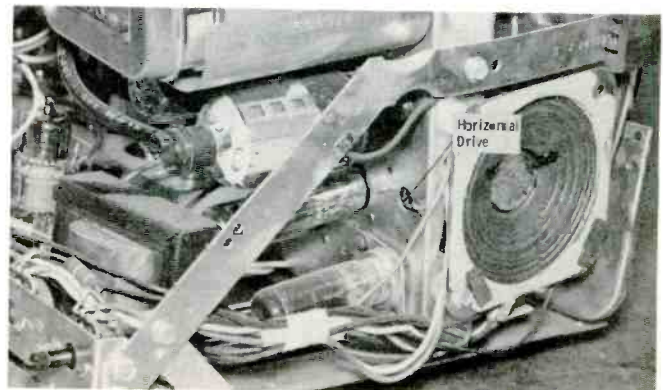
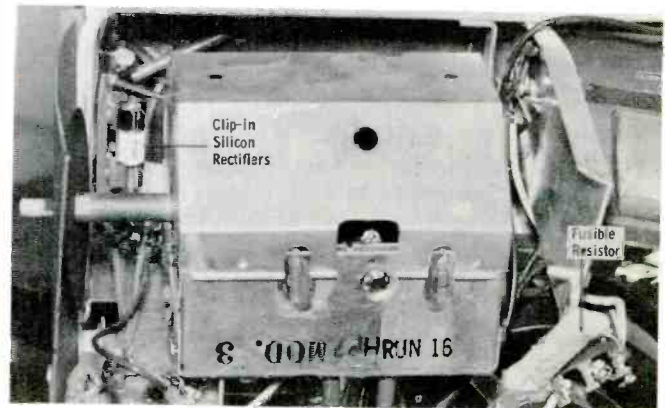
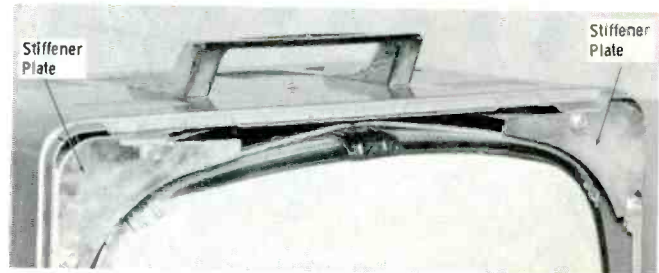



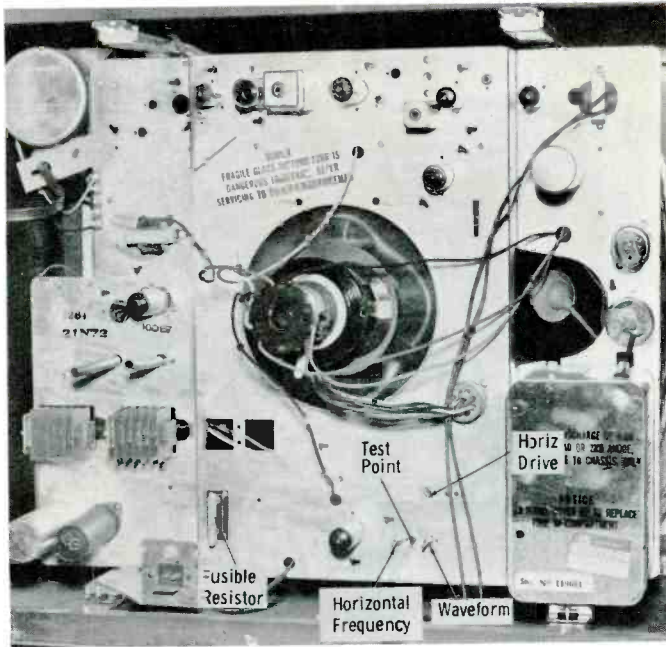

**Airline**  
**Model WG-5041A**



This set employs a 21CBP4 short-neck 90° aluminized picture tube that has a straight electron gun. The magnet on the neck of the picture tube should be adjusted for best over-all focus.

The horizontal oscillator is of the pulse-width variety and has both frequency and waveform adjustments. These adjustments, plus an isolated test point, are located between the horizontal oscillator and the high-voltage cage.

The horizontal-drive control located between the frequency and waveform adjustment and the yoke plug, and the height and vertical linearity controls located just above the selenium rectifiers, round out the service adjustments.

Also visible in the picture are the 7.5-ohm, plug-in fusible resistor and the new turret tuner. The tuner is the round object in the upper left corner. The local oscillator adjustments are accessible through a hole in the side of the tuner and should be adjusted just as you would any turret tuner.



**Andrea**  
**Model VQ21**

This receiver has an added customer control called "pix fidelity." This is actually a switch that connects an 800-mmf capacitor across the cathode-load resistance of the 12BY7 video output stage to vary the frequency response of the video circuit.

A service adjustment called the "detector level set control" is located on top of the chassis. In reality, this control sets the bias for the AGC keyer and thus acts as an AGC control.

The remaining service adjustments and the vertical-hold control are arranged across the rear of the horizontal chassis.

An AC line fuse (2.5 amps) is provided in the fuse holder, and the B+ is fused by a ¼-amp pigtail fuse in the high voltage cage.

A spot remover circuit that includes a switch ganged with the AC power switch prevents a spot of light from lingering on the picture tube screen when power is removed.

This receiver is one of the few in the 1958 line-up that employs a conventional horizontal chassis.

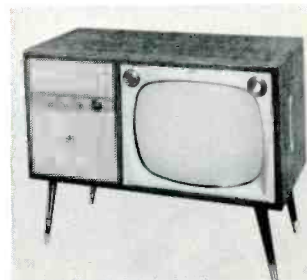
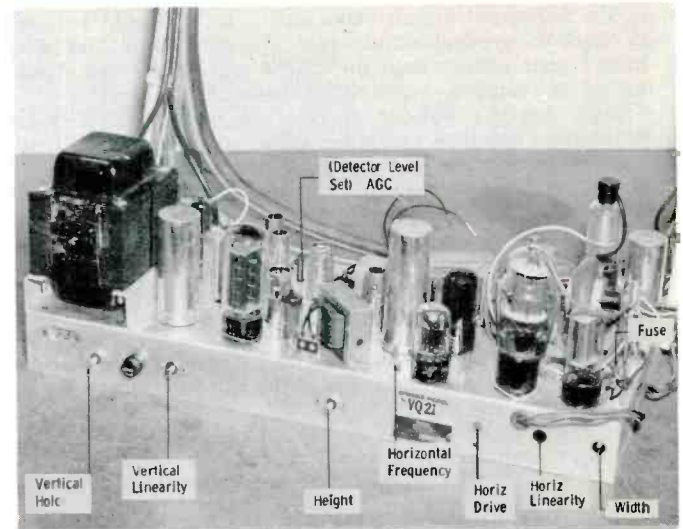

**Emerson**  
**Combination**  
**Model 1280**

This lowboy combination with side-mounted operating controls employs a 21BTP4 picture tube.

Features include separate video-detector and AGC-rectifier crystals, as well as a combination horizontal and vertical chassis. The power supply occupies the horizontal portion of the chassis, and the B+ fuse, an N6/10 unit, is mounted in a holder forward from the 5U4GB rectifier.

The service adjustments include a horizontal range control (called horizontal balance by manufacturer) and a horizontal frequency coil that is adjustable with a standard hex-type alignment tool.

A heat baffle is used above the 6W6 vertical-output amplifier to keep excess heat away from the printed-board assembly.

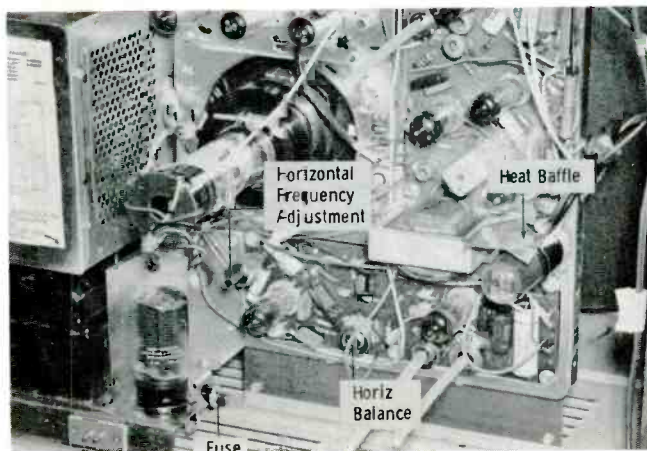



**GE Portable  
Model 14P1210  
(Chassis "Q2")**



The 14AJP4 picture tube in this receiver is an aluminized 110° type which uses an ion trap. Whether or not a picture tube requires an ion trap can be easily determined by examining the electron-gun assembly. If the front surfaces of all the elements are not perpendicular to the electron beam path, an ion trap is required.

In addition to the new picture tube, the 25EC6 horizontal output, 12R5 vertical output, 12CA5 audio output, and 5DH8 vertical oscillator and 1st video IF are tubes recently designed for use in TV portables. If you don't have the above tubes in your caddy, and are called in to service one of these receivers, a 25DN6 could be temporarily substituted in the horizontal-output stage and a 12CA5 could be used to check the vertical output stage. The 25EC6 and 12R5 tubes have higher ratings than the 25DN6 and 12CA5 and should not be permanently replaced by these units.

Since this is a hot-chassis receiver, the tube shields are captive and are thus prevented from jarring loose and lodging between chassis and metal cabinet. The horizontal-hold, height, and vertical-linearity controls are located on the metal bracket that supports the antenna terminals and AC interlock plug.

The horizontal-frequency adjustment (ringing coil) is accessible through a hole in the printed board just above the 19AU4 damper tube. A hex alignment tool is required for the adjustment.

The ratio-detector adjustment, accessible through a hole in the printed board to the left of the 5T8 tube, also requires the use of a hex alignment tool.

On the component side of the printed board, we see that two semiconductor diodes are used in the horizontal AFC circuit and a single germanium rectifier functions as a half-wave rectifier in the B+ supply.

Also visible in the upper left hand corner is a couplate used in the audio amplifier circuit. This unit incorporates the resistive-capacitive plate and grid networks between the 1st audio and output amplifiers.

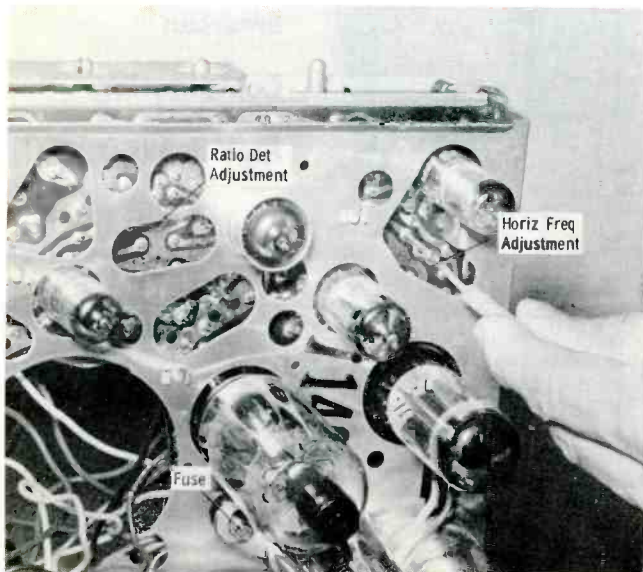
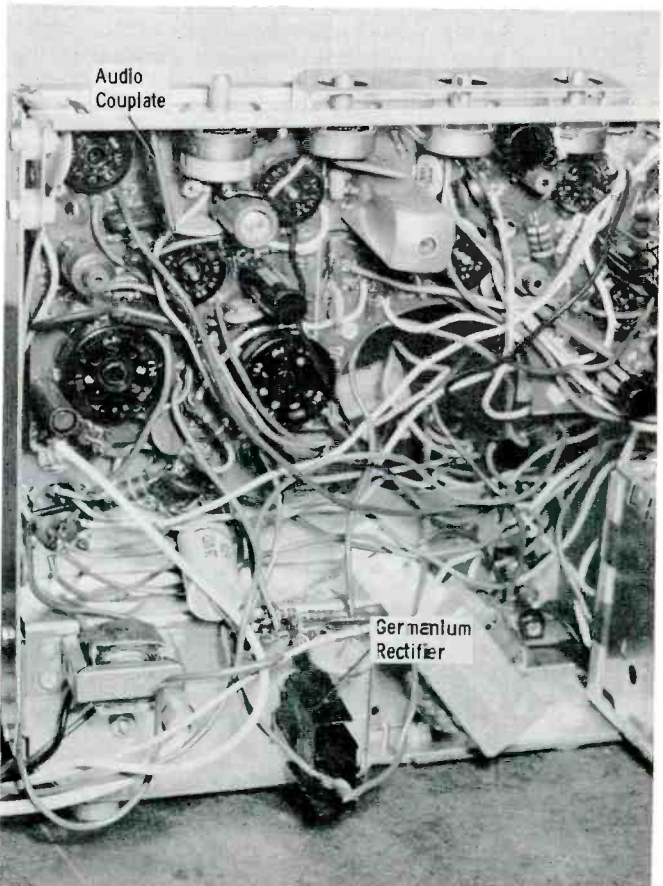
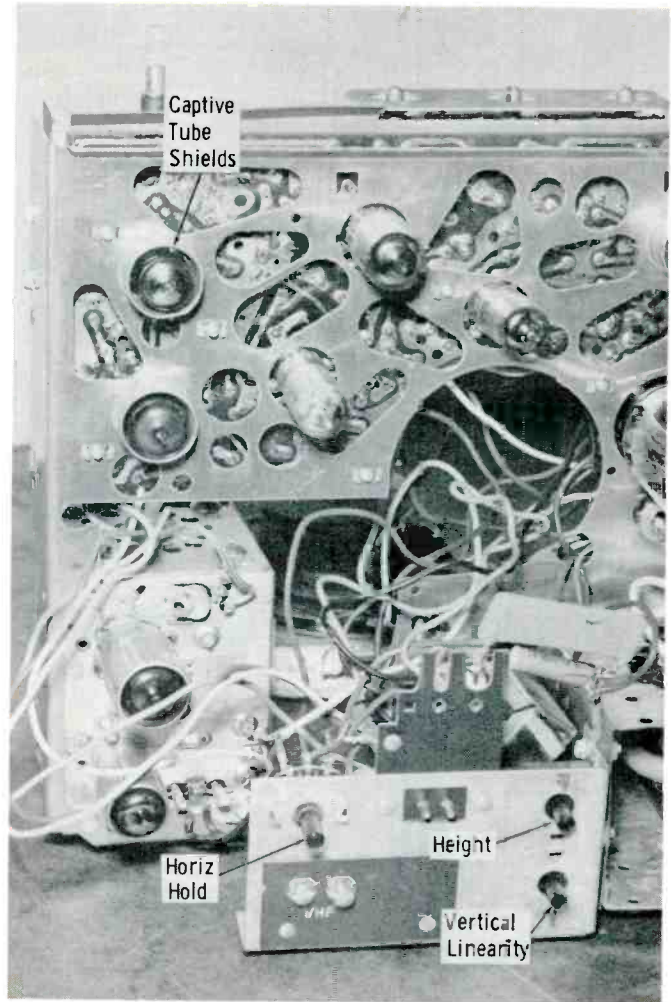



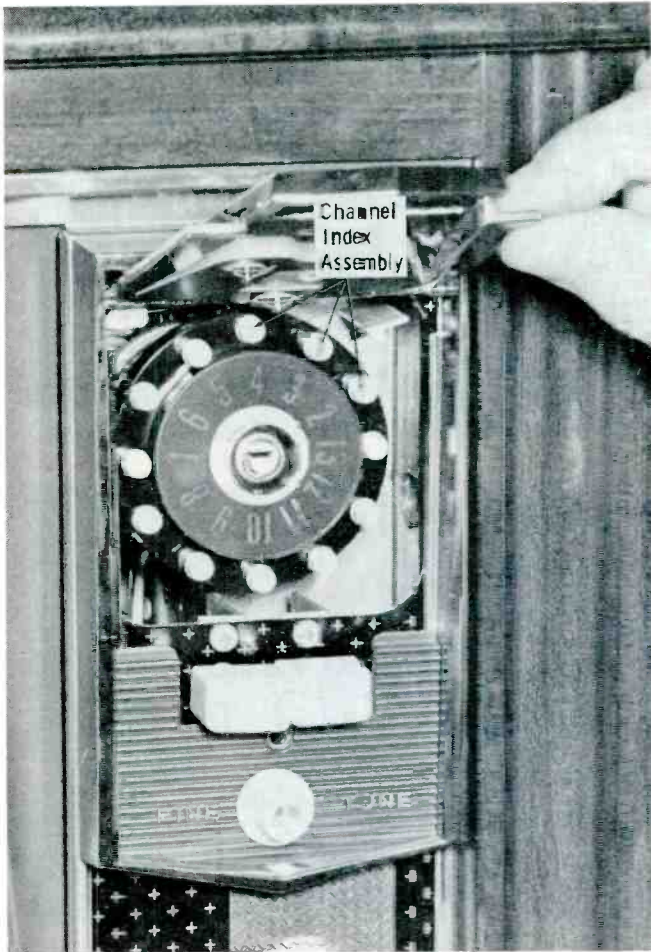

**Hoffman**  
**Consolette**  
**Model M3357**  
**(Chassis 422)**

No manual channel selector is provided in this Hoffman set; selection is automatic and operated by an electric motor. The channel indexing mechanism is accessible by lifting the chrome cover located above the fine tuning knob. The round pins are depressed for desired channels and are pulled to the outer position for undesired channels.

Circuitwise, this receiver is not unusual; however, there are several tubes that are new in TV usage. The 5V3 low-voltage rectifier has the same basing as a 5U4 but a higher current capacity—380 DC milliamperes as compared to 225 for the 5U4G and 275 for the 5U4GB. In the audio amplifier section, three foreign-made tubes are employed. These are the ECC83/12AX7 in the audio amplifier and phase inverter stages and the two EL84/6BQ5's in the push-pull output stage. In addition, a 6BJ8 is used as a sync separator and horizontal-phase detector, and a 6AS8 is used as the 3rd video IF and video detector.

Multiple speakers are employed, requiring that the leads be properly connected for in-phase operation. This is simplified by color markings on the speaker terminals and on the leads from the output transformer.

As the knobs on the front indicate, the chassis is side-mounted and of conventional layout and construction.

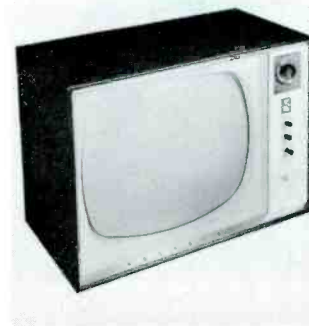
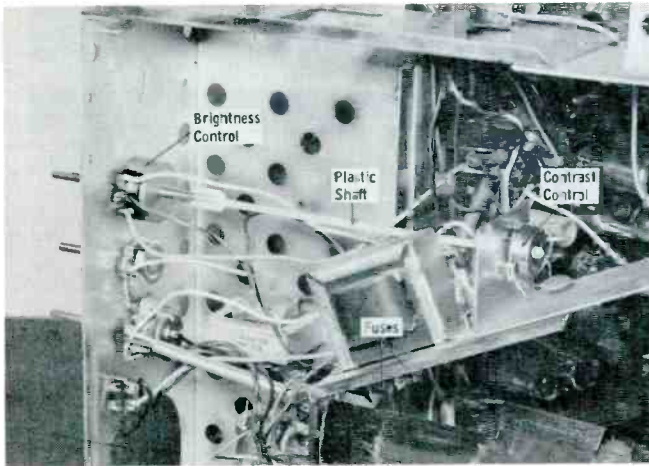

**Hotpoint**  
**Model 21S406**  
**(Chassis "U2")**

This receiver employs an aluminized 21DEP4 110° tube of the straight-gun design; thus, no ion trap is required.

A power transformer is employed along with a 5U4GB low-voltage rectifier. There are two fuses, a 4-amp in the AC line and a 1/10-amp in the B+ line, both located just above the 5U4GB rectifier.

Also shown in the photograph are the tandem brightness and contrast controls. The contrast control is the rear unit and is actuated by the long plastic shaft. The brightness control is a part of the horizontal screen-grid divider network and is a 15K-ohm, 2-watt unit.

Another prominent circuit feature consists of a 2.2- and a 20-megohm resistor in series between the 275-volt supply and the AGC line. The 2.2-meg resistor may be shorted out by a wire jumper as shown; if the set overloads, the jumper should be removed. This reduces the amount of delay in the tuner AGC voltage, reducing the gain and eliminating the overload effect.

A 6CX8 tube is used in the video-amplifier and noise-cancellation circuits, and a 6BW8 is employed as a sound IF amplifier and horizontal-phase detector.

Also featured are 2,200-ohm damping resistors across the vertical deflection coils and specially-constructed capacitors and coils on the printed-board assembly.

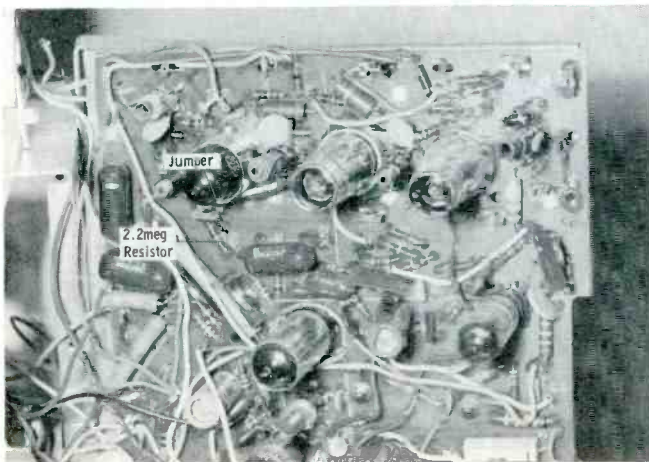



## Motorola

### Model 21T377

(Chassis T5542A)

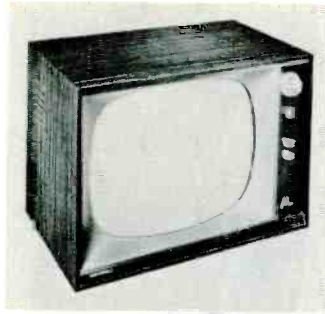

This chassis features a 7.5-ohm, 10-watt surge limiter in the B+ circuit, a 200- to 6-ohm negative temperature resistor for filament protection, plus a 1.6-amp fuse of the LC type in the B+ circuit. The fuse (not shown) is mounted in a holder to the rear of the electrolytic capacitor.

The three sockets shown on top of the chassis accommodate the control panel, tuner and yoke assembly. The signal from the tuner is coupled into the chassis through a shielded cable that plugs into the front of the chassis just below the tuner power jack.

The test receptacle on the rear of the chassis permits many service adjustments to be made without removal of the chassis from the cabinet.

To adjust the horizontal oscillator for maximum stability, short the terminal labeled "horiz AFC" to ground; connect a .1-mfd, 400-volt capacitor between the horizontal oscillator coil and B+ (on jack); adjust the horizontal hold control to lock in the picture; remove the .1 capacitor and adjust the horizontal oscillator coil to stabilize the picture (without moving the hold control); then remove the short from the AFC terminal and readjust the hold control.

Focus is adjustable by shifting the jumper on the base of the picture tube to connect either pin 10 or pin 1 to the focus anode, pin 6.

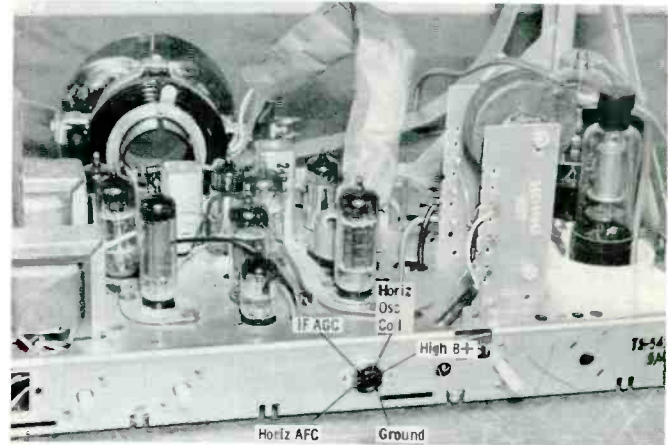
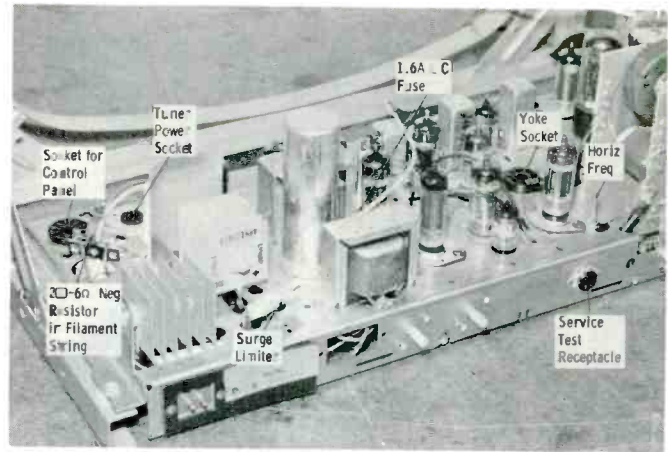

## Olympic

### Portable

#### Model

(Chassis GT)



The plastic inserts in the knob cutouts of the cabinet are designed to keep the customer from coming in contact with the "hot" chassis.

The height and vertical linearity controls are on the chassis but are widely separated, the vertical linearity control being at top. Both rectifiers in the half-wave doubler circuit are contained in a single three-terminal unit. Except for mounting considerations, two units could be used for replacement purposes.

This portable also features a horizontal drive control mounted adjacent to the horizontal output tube, plus a plug-in 7.5-ohm fusible resistor.

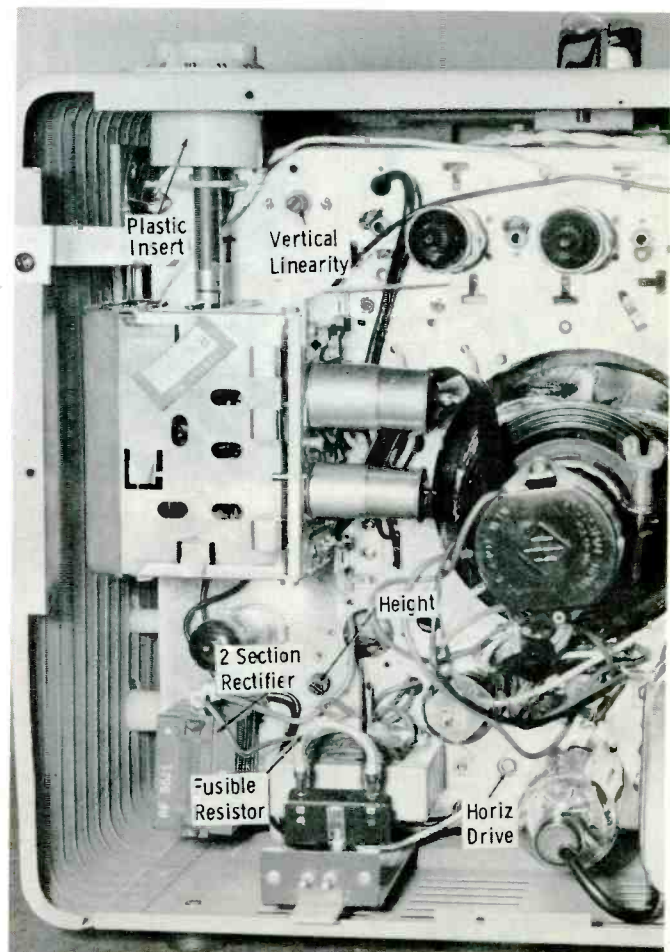



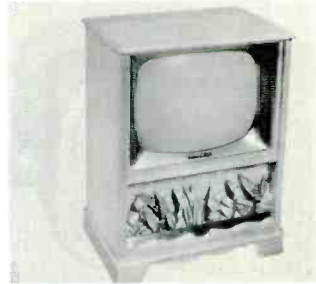
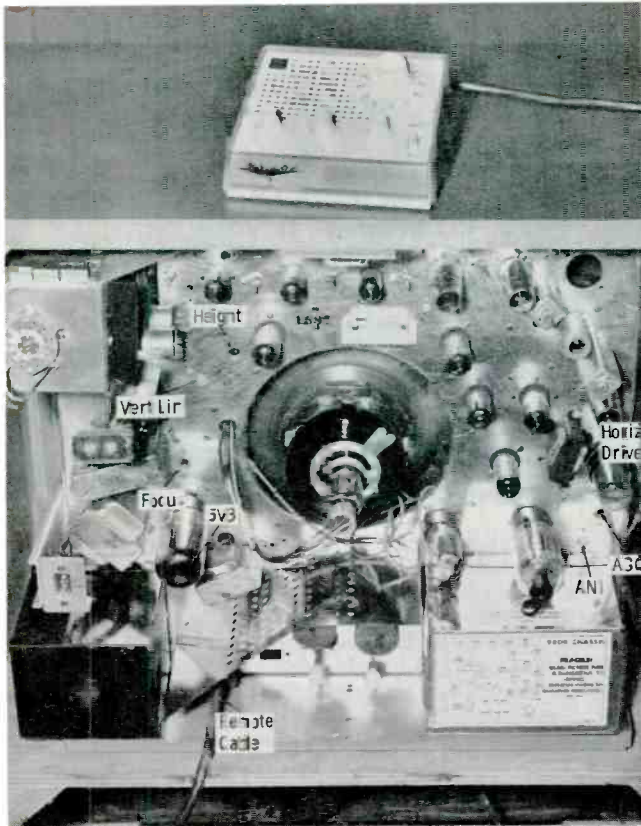

**Packard-Bell**  
**Model 21DC6**  
**(Chassis 98D3)**

A remote-control operated receiver, as indicated by the absence of controls on the cabinet, this set features a built-in planter complete with artificial flowers.

The remote unit is cable-connected to the receiver and features an on-off switch, volume control, fine tuning control, brightness control, channel selector switch, remote speaker and switch to select either the remote speaker or speakers in the receiver. Note: The AC switch actuates a relay on the TV chassis instead of being directly connected into the AC line; thus only 24V AC is sent through the remote cable.

The chassis, really "loaded for bear," features a neutrode tuner, four video IF stages, two audio IF stages, two stages of video, an AGC keyer, delay amplifier, an automatic noise inverter, and a 5V3 low voltage rectifier stage.

Service adjustments include an ANI control, AGC control, horizontal drive control and the usual height and vertical linearity controls.

The tuner circuit is new only in the sense that fine tuning is obtained by varying a potentiometer on the remote control box.

The customer controls, not found on the remote control, (tone, vertical hold, horizontal hold and contrast) are mounted on the vertical chassis below the two electrolytic capacitors. The remote control unit plugs into socket to the left of these controls.

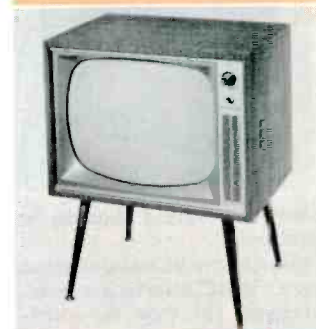
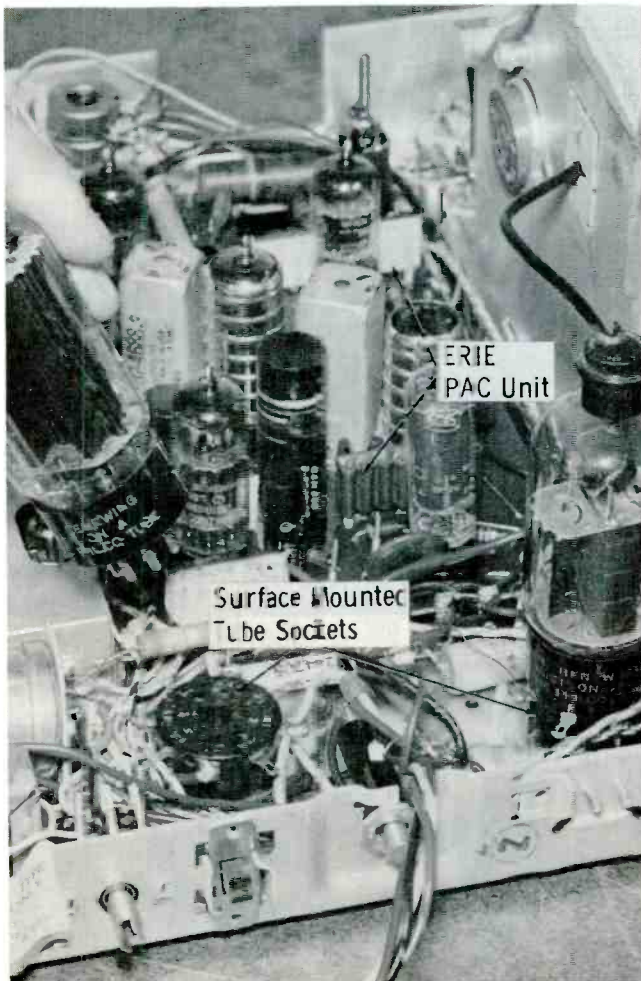

**Philco**  
**Model F4212**  
**(Chassis 8L41)**

This table model has many console features, such as supporting legs and a front-mounted speaker of a relatively large size (3 x 10 inches). This speaker is one of the recently-developed rectangular units, and it provides an amazing range of audio reproduction.

The 5U4GB, 6DQ6 and 6AU4 tubes use surface-mounted tube sockets that snap into the chassis. All connections are made to the metal ears that fan out from the socket. Incidentally, these ears make very handy test terminals.

The printed wiring board assembly employs several of the Erie PAC units which have the circuits either printed directly on them or on tape that is cemented to the unit.

A horizontal range potentiometer is connected in series with the horizontal hold control. Horizontal frequency, height and vertical linearity are the remaining service controls.

A 6BY8 employed as a pentode sound IF and diode limiter, and a 6CU5 audio output amplifier, are the only new tube types employed in this chassis.

The 8L41 is the basic chassis used in "Deluxe" model receivers.

8L42 is the 8L41 with automatic tuning.

8L43 is the 8L41 with phono facilities.

8L51 is the 8L41 with 24" CRT.

8L52 is the 8L51 with automatic tuning.

The picture tube is a 21CMP4 short-neck 90° unit and is aluminized.



RCA

Portable

Model 14PD8053U

(Chassis

KCS-111D)



The picture tube, a short-neck 90° 14ATP4, requires no ion-trap. 110° tubes haven't dominated the portable field yet.

The cabinet must be removed for any servicing other than tube replacement. This may be done by removing the handle, rear cover, knobs, safety glass, and eight screws that secure the metal cabinet to the bottom plate.

The fusible resistor, a plug-in 5.6-ohm unit, is located to the rear of the speaker and may also be replaced without removing the cabinet.

Service adjustments consist of an adjustable horizontal waveform inductor, width coil, and height and vertical linearity controls. The horizontal hold control is actually the horizontal frequency coil of the pulse-width AFC circuit with a knob attached to its adjustable core. The waveform adjustment is accessible through a hole in the printed wiring board, and a hex alignment tool is required.

The width coil should be set to fill the picture tube screen at 105 volts AC input. This will produce about 3/4-inch over-scan at 117 volts AC.

The following procedure is recommended to adjust the horizontal oscillator for the most stable operation: First, make sure the width coil is properly adjusted. Set the wave-

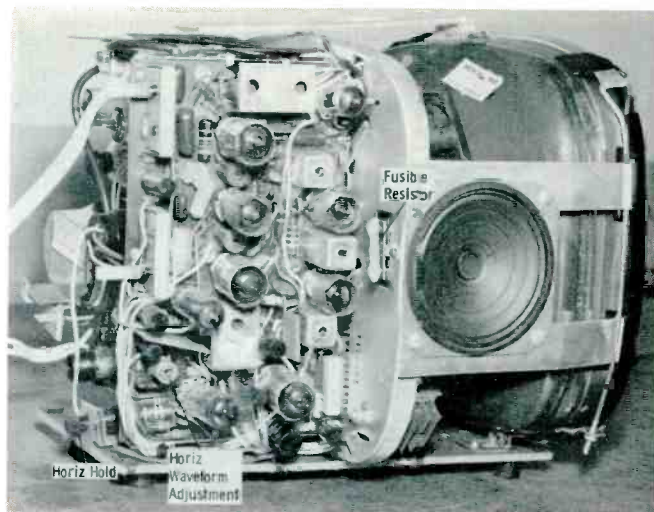

form coil fully clockwise, adjust the horizontal hold control in a counterclockwise direction until motor-boating occurs, and then back off until it stops. Note how many bars were present just before motor-boating began. Adjust the waveform coil until three bars are present just before motor-boating occurs, at which time the horizontal hold control is rotated counterclockwise from the fall-out point. This gives stable operation without using the oscilloscope method of adjusting the waveform coil to produce equal peaks on the signal.

The safety glass is a plastic unit and should be cleaned with only a mild soap and cool water.

Silvertone

Model 8190

(Chassis

528.51160)



This chassis is used in a number of different models, in this case a lowboy TV-phono combination.

Should it become necessary to remove the chassis, observe the following procedure. (1) Remove the AC interlock assembly located in the phono compartment. (2) Pass the cardboard cover and attached AC cord into the TV compartment. (3) Remove the AC interlock and thermal cutout assembly. (4) Unsolder speaker wires from the output transformer. (5) Remove bonding wires from between the control panel and picture-tube mount; also from between picture-tube mount and chassis mount. (6) Remove screw securing isolation network to chassis mounting rail. (7) Remove knobs (8) Remove two nuts that secure the control panel to cabinet front. (9) Remove screws in tuner mounting bracket. (10) Remove plugs that connect switches and phono to control panel. (11) Remove chassis bolts at bottom and screws at top. (12) Remove picture-tube socket and loosen yoke clamp. (13) Remove anode connector from picture tube. The chassis may now be removed.

The switch assembly for the automatic channel changer as shown is set up to stop on channels 4, 6, 8, and 13.

Circuitwise, four Erie PAC units are employed, consisting of resistors and capacitors encased in an insulating material and having rigid, spear-type terminals for printed-board mounting.

The compression-type trimmer is the horizontal-drive control, which may be adjusted from either side of the board.

This receiver features a pulse-width horizontal AFC and oscillator circuit of the "synchro guide" type and should be adjusted with the aid of an oscilloscope. However, instead of adjusting for equal peaks, the pointed peaks should be set 10% higher than the rounded ones.

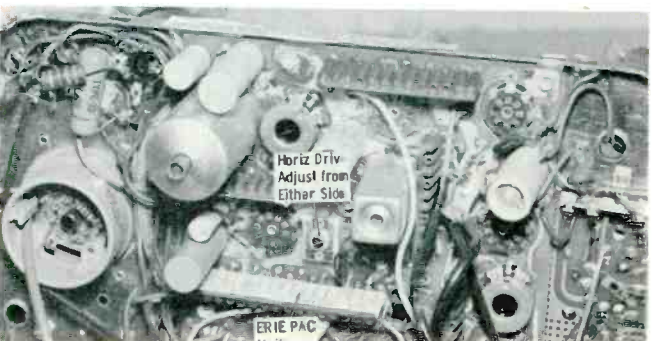
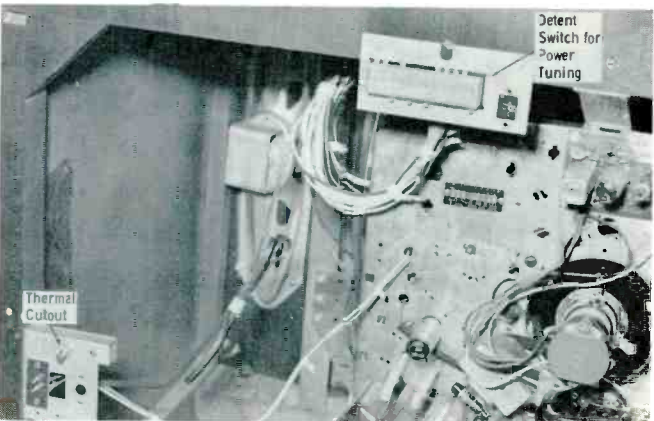



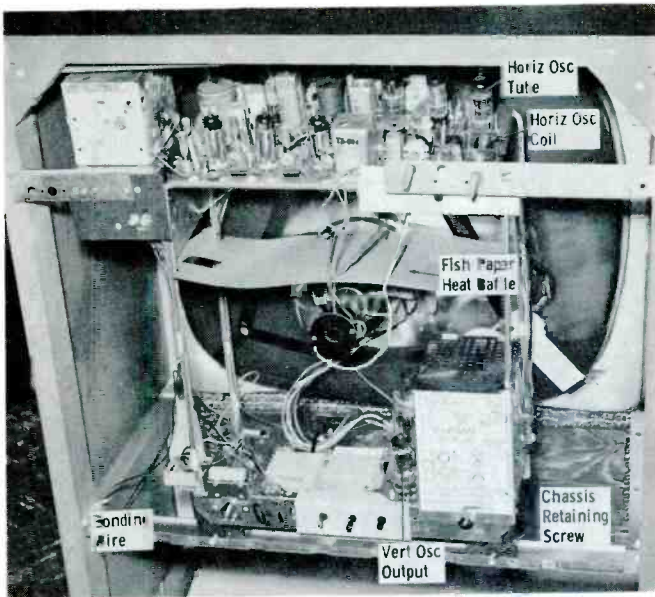

**Sylvania**  
**Model 21C407M**  
 (Chassis  
 1-540-1,-2)

Featured is a 21CQP4 110° picture tube that has a smaller 7-pin version of the standard base.

Construction of this receiver is unique in that it employs stacked horizontal chassis. The lower chassis is all metal and includes the power-supply and high-voltage circuits. Without referring to the tube location guide, you might think that the shock-mounted 10DE7 located immediately behind the horizontal output tube is the horizontal oscillator. It isn't; it's the vertical oscillator. The horizontal oscillator is located on the upper printed-board chassis along with the AFC network and oscillator coil.

The fish-paper heat shield between the two chassis deflects the heat rising from the lower chassis so that it will not cause overheating of components on the printed board above. Therefore, it should not be removed.

Removal of this chassis is fairly simple, but only if you know how. As shown, the front panel controls can be disconnected from the chassis and the tuner. The control shafts simply clip to the extension shafts and the U-shaped bracket that secures the tuner to its shaft is simply squeezed while gently pulling on the tuner body. Be sure to unplug the "HaloLight" and its switch from the chassis. Remove the picture-tube socket, anode connector, yoke, bonding wire and speaker leads. The chassis may now be removed by slipping the insulated mounting feet at the rear out of their slots.

A word of caution on handling small-necked 110° picture tubes. Never grasp the neck; it can snap off very easily. Use BOTH HANDS to grasp the tube bell, which is thin enough to be conveniently handled in this manner.

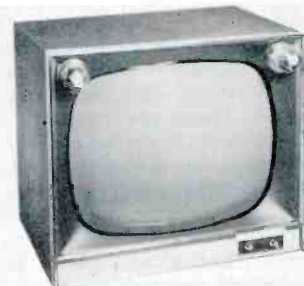
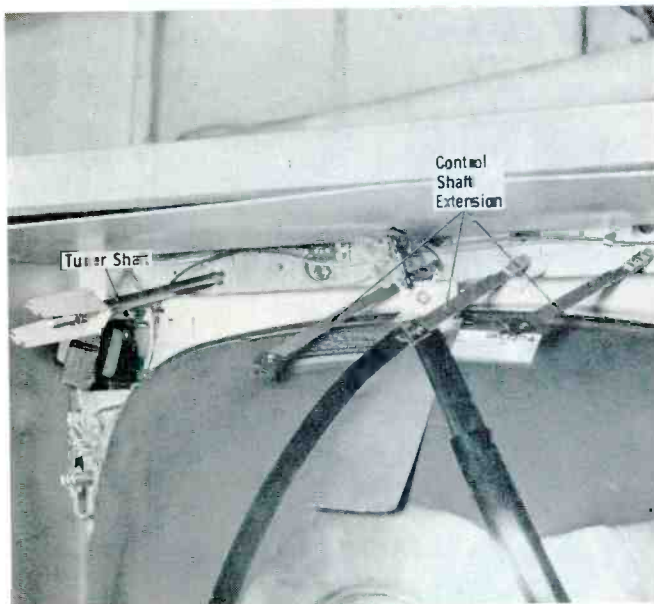

**Zenith**  
**Model A2330H**  
 (Chassis 19A20)

In this receiver, the accent is on the audio section, which features twin 8" speakers, prominent bass and treble controls and an EL84/6BQ5 audio-output tube. This tube, manufactured in Holland, is receiving wide acceptance in the audio field and is used in TV sets made by at least two different manufacturers. The tone controls plug into a jack on the rear of the chassis near the audio-output tube.

The power transformer is used in conjunction with a 5AU4 rectifier tube and looks slightly weird with its heat-radiating fins.

The tube line-up across the rear of the chassis is as follows. Beginning at the left, we have three 6BZ6 video-IF amplifiers. Then comes a 6CX8 AGC and video amplifier, a 6BY6 sync clipper, 6AU6A audio IF, 6BN6 audio detector and EL84/6BQ5 audio output.

To remove this chassis, it is necessary to remove the upper knobs and the knobs behind the front control panel (do not remove knobs on the bass and treble controls), the jam nut on the volume-contrast control, the tuner (2 screws at rear, power cable and signal lead), and both speakers. The tone control cable is then unplugged from its jack and the chassis bolts are removed.

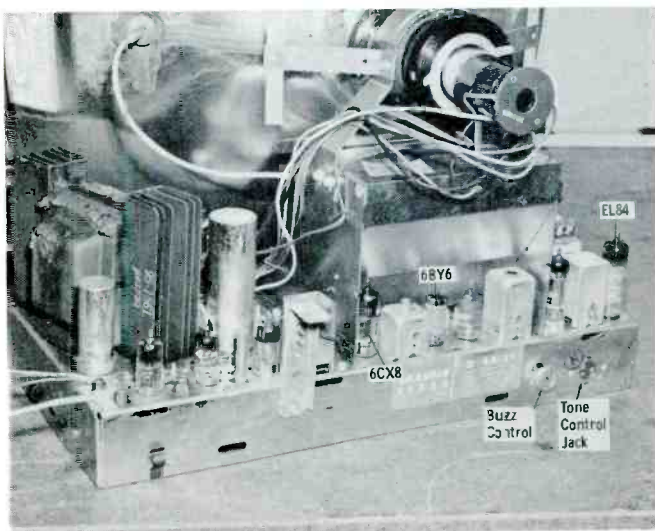



**Westinghouse**  
**Model H21T219A**  
**(Chassis V2372)**

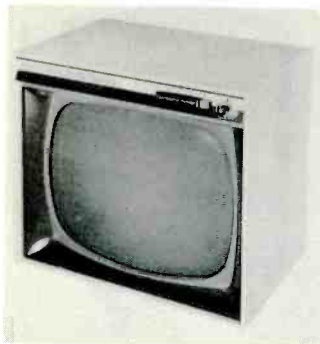

This table model features a 2½" × 10" speaker mounted at the front upper-left hand corner, plus a 21CEP4 110° straight-gun tube.

Most unique is the power-operated tuner mounted vertically at the rear of the chassis. The beaded plastic chain that drives the channel indicator and the programming-index wheel are standout features of the power-driven tuner which incorporates both manual and automatic fine tuning. A single potentiometer ganged with a two-section switch simplifies the change-over between manual and automatic fine tuning. Both video and audio muting are employed during channel changing.

A 5CZ5 tube is employed as the vertical-output amplifier and a 5BT8 serves as the AGC keyer and horizontal-AFC discriminator.

The horizontal multivibrator features both an adjustable ringing coil and an adjustable trimmer in the RC time-constant network between the two halves of the oscillator. To adjust this oscillator for the most stable operation, use the following procedure; (1) Short out the ringing coil with a short jumper wire. (2) Set the horizontal hold control to the center of its range. (3) Connect a VTVM between pin 7 of the horizontal oscillator tube and B minus. (4) Tune in a local station and adjust the trimmer capacitor for a zero-volt reading on the meter. (If this reading cannot be obtained, turn the horizontal hold control slightly to one side of center.) (5) Remove the jumper from the ringing coil and adjust the coil slug for a zero-volt reading. (6) Check adjustment by momentarily switching off-channel. If correct, picture should synchronize immediately.

Should it become necessary to remove the tuner or the channel indicator, use the following procedure in replacing the beaded chain to insure that the channel numbers on the dial will be in step with the tuner. There are two black beads in the chain. Place one of these beads in the hole under the notch (above channel 13) in the indicator sprocket wheel. Now turn the sprocket wheel (keeping the bead chain engaged) until the other black bead falls into the hole under the notch in the tuner sprocket wheel.

The nylon sliders on the program wheel should be set to the outermost position for all undesired channels.

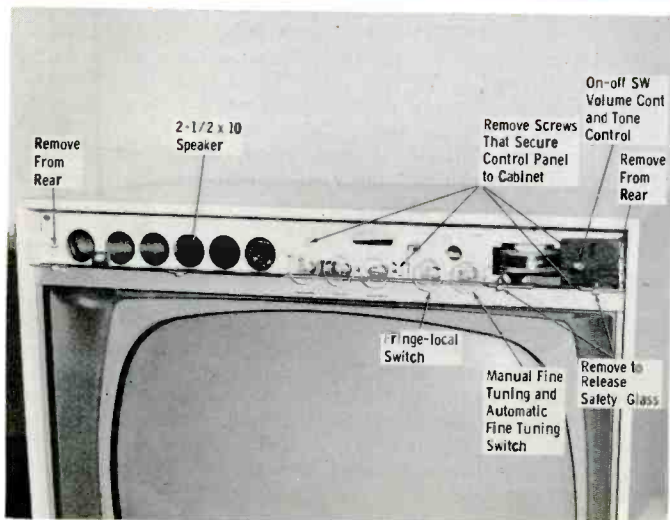
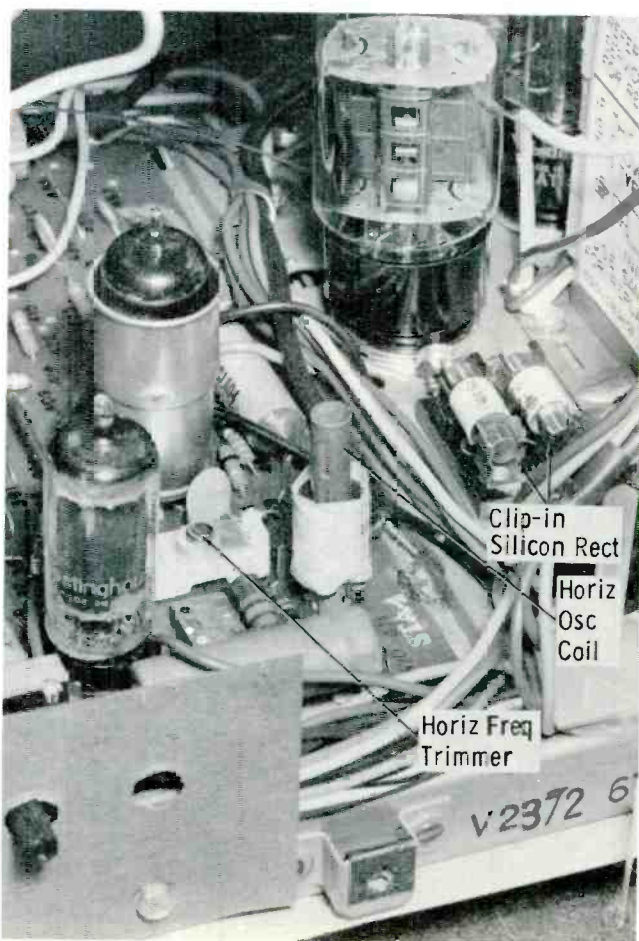
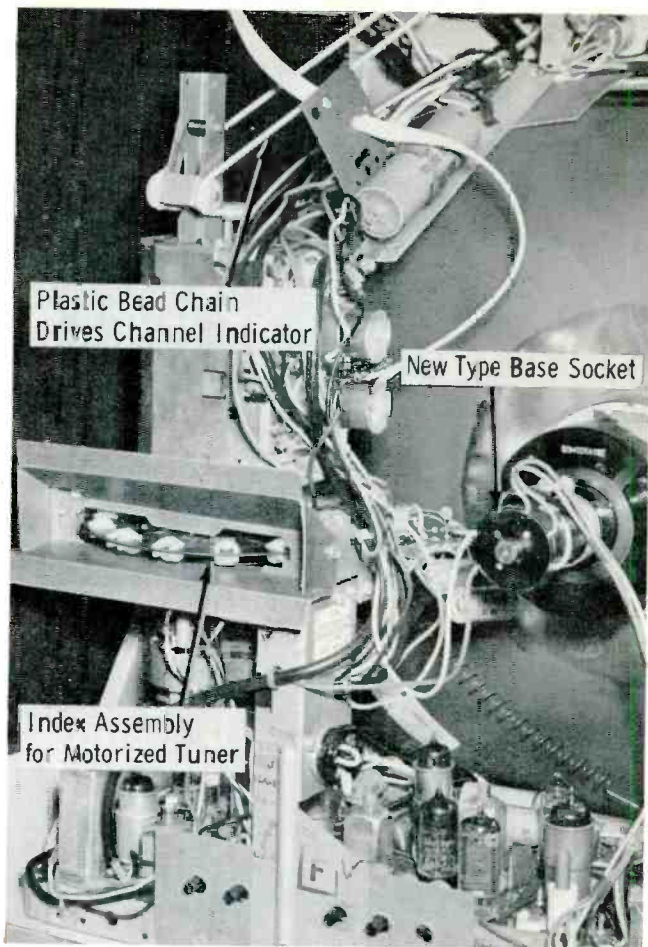



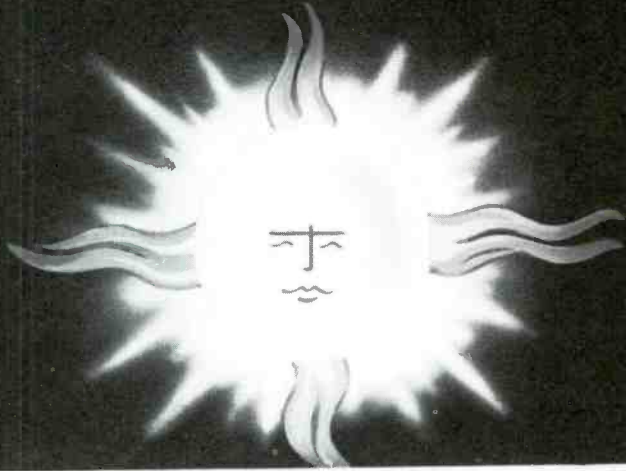

**YOU SAVE  
TIME**  
when you use  
**STANCOR**  
CONSERVATIVELY RATED  
**EXACT REPLACEMENTS**

No re-wiring, no circuits to change, because almost all STANCOR transformers are exact replacements, built for quality from original manufacturers' physical and electrical specifications. At better distributors everywhere. Write for your free catalog.

**CHICAGO STANDARD  
TRANSFORMER CORPORATION**  
3503 ADDISON STREET • CHICAGO 18, ILLINOIS  
Export Sales: Roburn Agencies, Inc., 431 Greenwich St., New York 13, N.Y.





# QUICKER SERVICING

by Calvin C. Young, Jr.

## Loss of Color

This trouble symptom usually points to a defect in the color-sync section of a TV receiver; thus, the fact that the 3.58-mc oscillator was dead wasn't a surprise to the technician servicing this set. Neither did he place too much significance on the broken glass envelope of the tube (a 6CB6). He wasn't even too surprised when a replacement tube failed to cure the trouble, but, being naturally cautious, he also tried a second tube. This time he carefully watched the tube to see if it might provide a clue to the trouble. I'm sure all of you have seen the blue haze often present just inside the glass envelope of a tube such as a 6CB6 that is passing a reasonable amount of plate current. The technician reasoned that since this 6CB6 was being used as an oscillator, it should be passing an average of 10 milliamps, an amount sufficient to pro-

duce the telltale glow. Subdued lighting was employed to make it easier to see the glow if it existed. Instead of the glow he had expected to see, the plate of the tube began to glow cherry red—a sure sign that it was conducting too heavily.

Color operation had been fine before the tube failure, and since monochrome reception was not affected, only the chassis (an RCA CTC5N) was taken into the shop. Of course, there was another TV set in the shop that could be used to test the chassis when it had been repaired.

A thorough check of the schematic and service literature proved that the chassis could be operated without the yoke, tuner or convergence assembly. Use of the video output signal from a color bar generator made a very satisfactory bench setup, and in only a short time it was found that

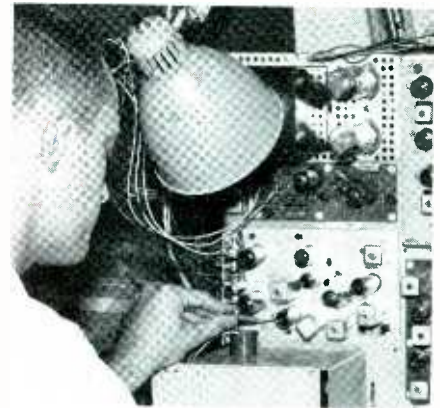

Fig. 2. Adjusting the 3.58-mc feedback.

the 1K, ½-watt resistor in the plate circuit of the 3.58 oscillator (Fig. 1) had burned and changed value when the original tube failed. No other defects were located, so the resistor was replaced and the oscillator tube again checked for the cherry-red plate condition. The technician was somewhat chagrined to find that the plate still glowed red.

A rapid check of the stage operating potentials revealed that the negative grid voltage was too low. Substitution of the 3.58 crystal and other tubes in the section were of no avail. The service manual was read from one end to the other in search of some clue to the trouble. Just when the technician was about to give up, he noticed an adjustable coil in the screen-grid circuit of the 3.58 oscillator, and in a flash realized that this inductor was part of the feedback network and that its ad-

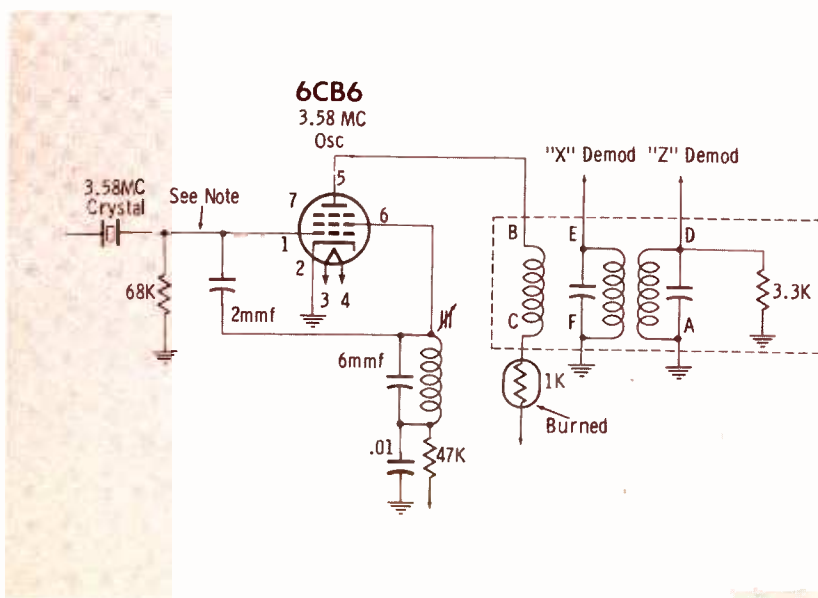

Fig. 1. Schematic of 3.58 oscillator circuit in RCA CTC5N chassis.

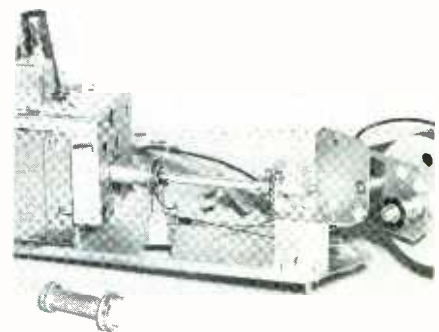

Fig. 3. Fine tuning mechanism in RCA color set.



Practical CBS Transistor Home-Study Course

# Learn all about transistors by using them



## PREPARE NOW FOR THE FUTURE!

Let's face it. Transistors are here . . . now! Advancement opportunities are waiting for those who know all about their basic fundamentals. Are *you* ready?

This new, profusely illustrated Transistor Home-Study Course, a CBS first, was written to make it easy for you to learn by using transistors. Service-dealers . . . technicians . . . and engineers find this residence-course-at-home both fast and fascinating. What you learn you remember because you do it yourself . . . by making several practical transistor devices which you can keep and use. Course was written for CBS by A. C. W. Saunders, a well-known educator and author.

Check the table of contents. Then read how easy it is for you to start your Transistor Course today.

### CBS Transistor Course Includes

Ten intensive lessons (with 3-ring binder) . . . up-to-date, complete

Simplified basic theory . . . how transistors work  
Practical experiments and servicing techniques for: Amplifiers . . . applications in all fundamental circuits

Oscillators . . . a-f, r-f, relaxation, multivibrator, special TV

Rectifiers . . . diode and transistor rectifiers and detectors

Practical commercial applications . . . immediate and future

With free correction and consulting service . . . and up-to-date supplements for certified graduates

### HOW TO GET IT

Call your CBS Tube distributor. He'll tell you how to get the CBS Transistor Home-Study Course, PA-175. See him, or write us . . . today!



**CBS-HYTRON**, Danvers, Mass.  
A Division of  
Columbia Broadcasting System, Inc.

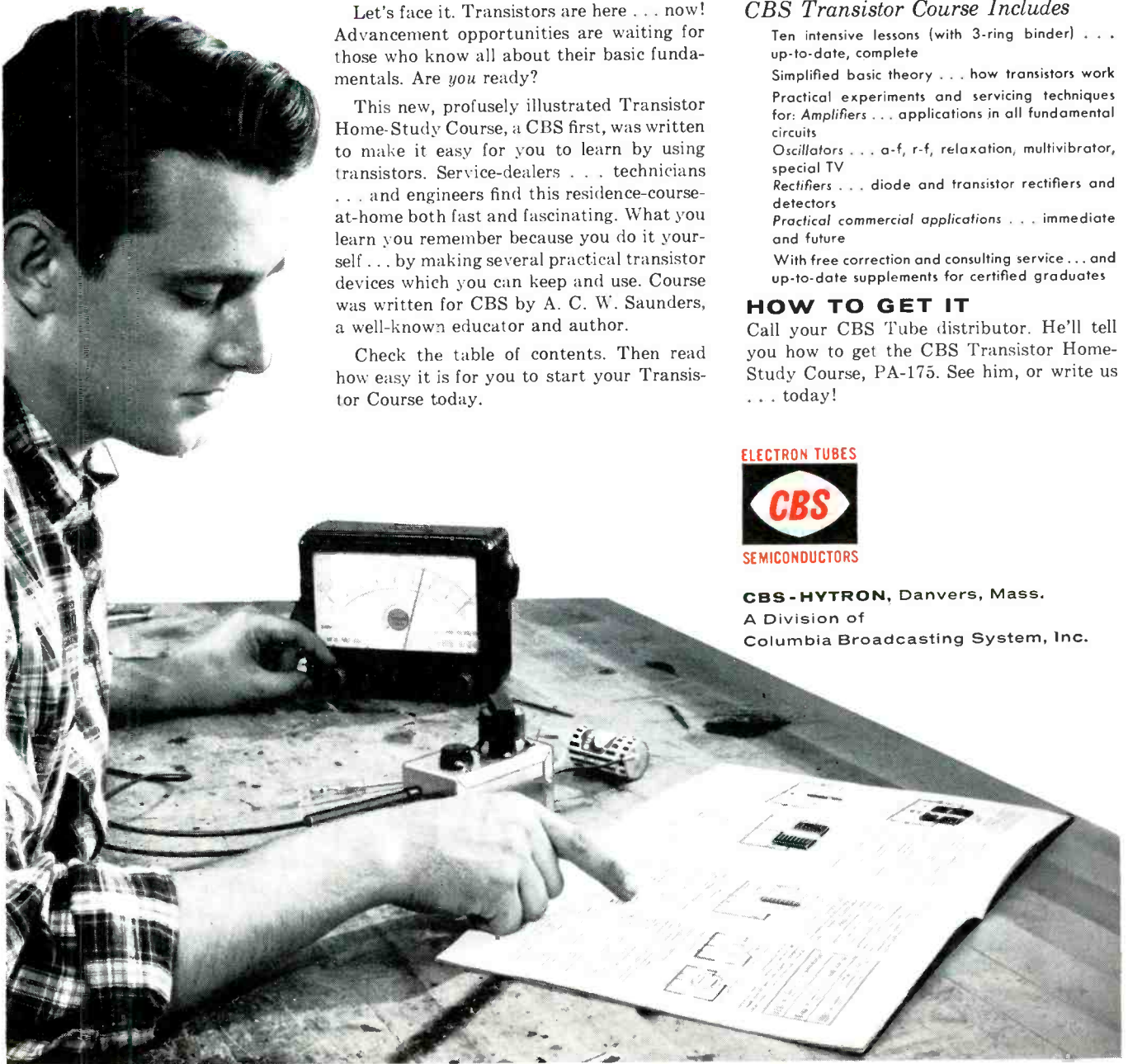

# MALLORY Clippings

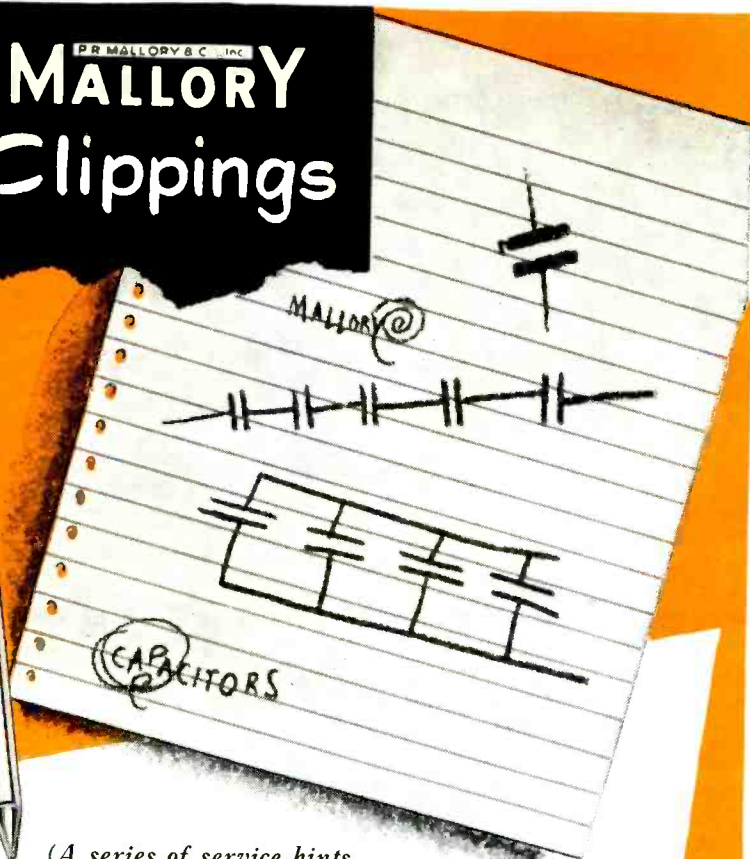

*(A series of service hints  
gleaned from the notebooks of  
Mallory design and application engineers)*

Sometimes you can't find exact-replacement capacitors, especially for some of the older or less popular equipment. Here are a few rules regarding simple substitutions. Obviously, some of these call for physically larger or slightly more expensive capacitors—but that's better than throwing away perfectly good equipment.

In virtually all radio and TV applications, higher voltage ratings or higher capacities can be used at any time.

Individual sections of multiple units can be connected together in parallel to obtain needed capacity, even though they are of different voltage ratings. The lowest voltage rating of all capacitors connected in parallel applies.

Two like capacitors may be connected in series to provide a capacitor with a voltage rating twice as high. The capacity of each section must be twice the actual capacity required. Insulate lead between units and case of capacitor above ground potential. Equalizing resistors are not required.

Regardless of the circuit—you can count on Mallory capacitors to do any service job—right. See your Mallory Distributor, today, and lay in a working replacement stock.

P. R. MALLORY & CO. Inc.  
**MALLORY**

P. R. MALLORY & CO. Inc., INDIANAPOLIS 6, INDIANA

Capacitors • Controls • Vibrators • Resistors • Switches • Rectifiers  
Power Supplies • Filters • Mercury and Zinc-Carbon Batteries

justment could affect the oscillator grid voltage. The technician adjusted the coil (Fig. 2) until the correct control grid voltage (minus 2 to 3 volts with no burst present) was obtained, and was much relieved to find that the red glow was no longer evident.

But now comes the question, "Why had the receiver operated satisfactorily for almost 6 months without any trouble?" In search of the answer, ten 6CB6 tubes were tested in a mutual conductance checker and graded according to their Gm values. The tube with the highest Gm was installed in the set and the inductor adjusted for correct control grid voltage—no plate glow. Without changing the adjustment, the other 9 tubes were substituted in turn. Everything was fine until the tube with the lowest Gm rating (slightly above that given on the tube tester chart) was installed. The cherry-red glow then returned. At this point, the technician reasoned that a tube with a high Gm rating had been installed at the factory. When this high rating had dropped to a lower value, the feedback signal and the grid bias decreased, allowing the tube to conduct excessively.

Finally, a 6CB6 was installed in a video IF strip of a monochrome set which was operated 8 hours a day for 3 days. This tube was then checked for its Gm value, which was found to be about half-way between the highest and lowest ratings of the group of ten tested earlier. This tube was then inserted in the set and the inductor adjusted for correct grid bias. The tube with the lowest Gm rating was again installed, and this time it operated without the excessive current condition previously observed.

## Loss of Color Due to Mechanical Failure

In another case, the customer complained of loss of color and poor monochrome reception. The technician found that an attempt to tune in the picture with the fine tuning control produced no effect. The rear cover of the set was removed and the fine tuning control again rotated. The pulley operated, yet there was something strange about the way the control



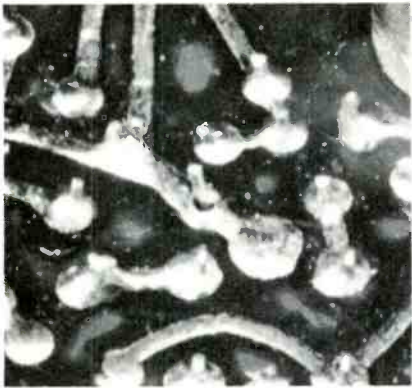

Fig. 4. Loose connection on printed board of transistorized portable.

turned—it seemed too easy. Since the tuner was mounted to the side of the cabinet and not attached to the chassis except by plug-in cables, it was removed. The trouble turned out to be a mechanical failure of the fine tuning cam-and-pulley assembly (Fig. 3). The pulley, which had been swaged to the pot-metal cam assembly, rotated freely and did not actuate cam movement. A call to the local distributor confirmed that this had happened on a few other occasions and also revealed the reason—the customer or his children had probably forced the control past its normal stopping point. The knob is very large and capable of developing a terrific drive on the pulley, so be sure to caution your customers on the proper use of this control.

#### Intermittent in Transistor Radio

A transistorized portable came in with the complaint that it squealed and popped after a very short period of normal operation. Since a printed wiring board was employed, the technician suspected a loose connection. The case was removed and a point-by-point check of the board was made; everything seemed okay. Still not satisfied that the trouble wasn't a poor connection on the printed board, the technician began to wiggle each part on the mounting side of the board while watching the soldered connections on the other side. Sure enough, moving one of the disc capacitors moved a lead that had appeared to be securely soldered (Fig. 4). Resoldering this lead cured the trouble, which proves how carefully you must inspect a board for such defects. ▲

... another  
**P. R. MALLORY & CO. Inc.**  
**MALLORY**  
 service-engineered  
 product



Stop  
 touring'  
 the town  
 for  
 dual control  
 replacements ...

get the *NEW*  
**MALLORY**  
**Dual Controls**

**the newest and surest solution  
 to an old service problem**

Here's how you can put a stop to those time-consuming shopping tours and special orders ... eliminate those "awaiting-parts" delays. Get Mallory dual control replacements ... the newest and surest solution to the age-old servicing problem of where to find *exact* dual control replacements.

Your Mallory Distributor can assemble a custom-made dual concentric control, with or without a switch, in just 30 seconds ... with the new Mallory components and technique. You'll get a control to meet original specifications ... to service just about any make or model TV set, or home or auto radio. The finished part will be as rigid as a one-piece control ... won't come apart in service.



P. R. MALLORY & CO. Inc., INDIANAPOLIS 6, INDIANA

- Capacitors • Vibrators • Resistors • Controls • Switches • Filters
- Rectifiers • Power Supplies • Mercury and Zinc-Carbon Batteries

# trouble - shooting with **GEORGE**

## the case of the

# **CRaZy**

## mixed-up symptom



by Leslie D. Deane

George Fleiback has run across many an odd-ball trouble in his somewhat brief but interesting role as a one-man Scotland Yard for the service industry. This month we find the sleuth perched at his bench, surrounded by test equipment and faced with another baffling case. His trouble? A 17-inch portable about two years old.

George first encountered the set on a routine call. It was raining, and he had a feeling that things weren't going to suit him—and he was so right! Wiping his muddy feet and carefully hanging up his wet raincoat, he entered the customer's home and approached a portable TV resting on a swivel-type table in one corner of a small recreation room. After familiarizing himself with the set, he questioned the owner about the trouble symptom. The complaint was straightforward and very simple—no sound. This sort of symptom had given George little trouble in the past, so he immediately removed the rear cover, plugged in a cheater cord, and fired up the set. After a few seconds, he turned the volume control all the way up. The picture looked normal, but there was no station sound—only a slight buzz from the speaker. He adjusted the fine tuning and also checked operation on all other channels, but the sound was still definitely *snafu*.

George wasn't too well acquainted with the set's tube layout—but who is nowadays, with so many dual-purpose tubes in use? From a small tube guide on the rear cover, he located the

stages in question and proceeded to replace all the tubes associated with the sound section. This approach ended in a blind alley—the sound had not improved, nor had any new clues appeared.

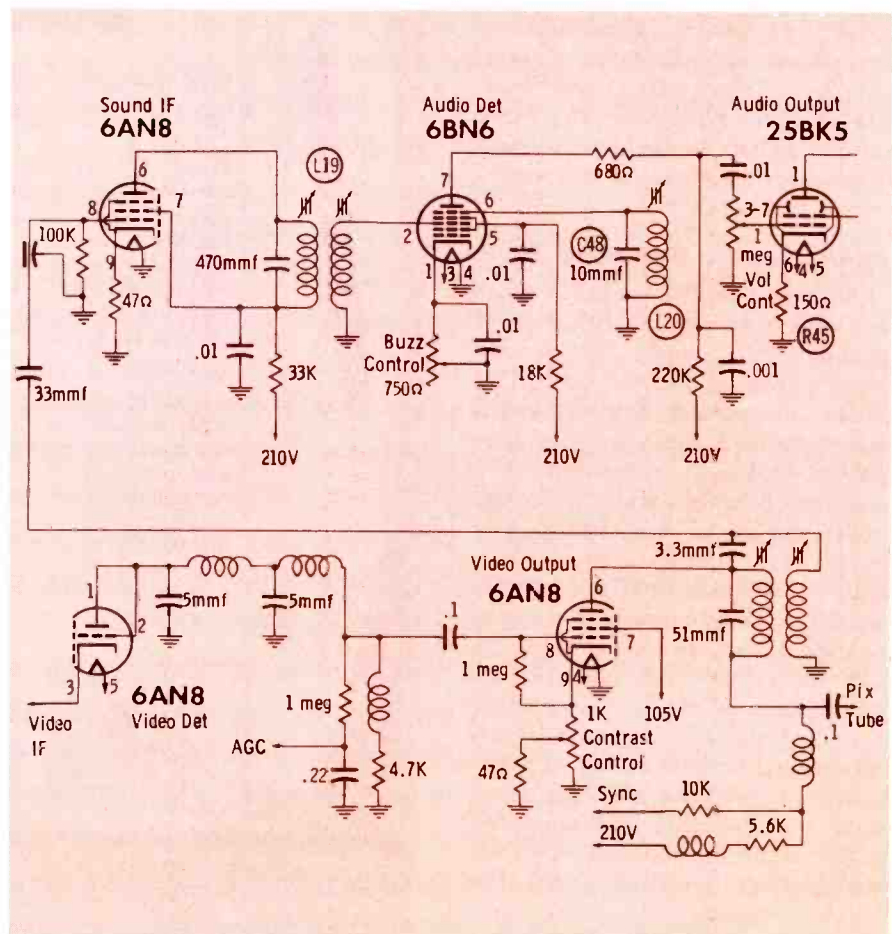

Fig. 1. George's headache in schematic form.



# Count on Clarostat®

## FOR WIRE-WOUND CONTROLS



### SERIES A43

2-watt, 1½" diameter, available in resistance values from 5 ohms to 10K ohms. Also with factory-attached switch.



### SERIES A10

4-watt, 1½" diameter, available in resistance values from 1 ohm to 100K ohms. Also with factory-attached switch.



## Pick-A-Shaft® Controls

with every Clarostat Pick-A-Shaft control you get your choice of shaft.



### SERIES A58

3-watt, 1½" diameter, available in resistance values from 1 ohm to 50K ohms. Also with factory-attached switch.



### SERIES 39

Not a Pick-A-Shaft control. Screwdriver adjustment. Contact arm grounded to housing. 2-watt, available in resistance values from 5 ohm to 5000 ohms.



## Controls and Resistors

CLAROSTAT MFG. CO., INC., DOVER, NEW HAMPSHIRE  
In Canada: Canadian Marconi Co., Ltd., Toronto, Ontario



**Service Dealers  
who stock and sell**



**TRANSISTORS  
earn extra profits!**

**Here's why:** There's a lucrative business in Transistor Receiver servicing building up, and since many receivers use Raytheon Transistors, the Service Dealer who features Raytheon is getting a generous share of this profitable new business.

More than that, his sales of Raytheon Transistors are growing because thousands of hobbyists, experimenters and engineers are using low-cost Raytheon Transistors for their transistor circuits.

Get in touch with your Raytheon Tube Supplier. He'll show you why *now* is the time to stock and sell Raytheon Transistors.

**Raytheon Transistor Applications  
Books Vol. I and Vol. II**

Musts for Service Dealers . . . Full of practical circuit design information, transistor theory and shop practice . . . Many circuit applications including circuits for making useful transistorized shop equipment. Buy from your Raytheon Tube Supplier or send 50¢ for each book to Department PF2.



*Excellence in Electronics*

**RAYTHEON MFG. CO.**

Receiving and Cathode Ray Tube Operations  
Newton 58, Massachusetts

Since buzz could be detected in the speaker, George thought he might try adjusting the buzz control which was located on the chassis close to the 6BN6 sound detector tube. Turning the small pot with a screwdriver, he found that he could rid the set of the slight buzz but that the sound was still missing. Then, one of the oddest things George had ever encountered set him back on his heels. When he reduced the contrast setting, the sound came in—not strong, but clearly audible. Turning the contrast up again, he found that the sound vanished entirely, with only a trace of speaker noise remaining.

At first, George thought that perhaps the volume and contrast knobs (mounted on the same dual control shaft) were binding and turning together. However, after prying the inner (volume) knob slightly outward and then readjusting the contrast control, he found that it still changed the sound level as well as producing a normal range of picture contrast. Several possibilities raced through George's mind. "Maybe it's AGC trouble—poor alignment—or even a defect in the dual control itself!"

Not wanting to give up, George located the video amplifier stage (a portion of a 6AN8) and tried another tube in its place; however, this did not change the peculiar action of the contrast control on the sound. George continued his tube-pulling spree by substituting tubes in the video detector and IF strip. Since the set used an intercarrier design and he thought there might be alignment trouble, George also replaced both tubes in the tuner. The criminal escaped detection, however, and

George knew he would have to further his investigation in the shop.

When he returned to the familiar surroundings of the shop and placed the set on his bench, George thought that perhaps he'd been fooled by the strange symptom witnessed in the customer's home. He checked it once again, and sure enough, the contrast had a direct effect on the sound. Turn the control down, and the sound would come in; turn it up, and it would disappear, leaving only a small trace of buzz.

George removed the chassis from its cabinet and made a thorough check of voltages in the video and sound sections. Finding voltage readings all within normal tolerance, our sleuth then investigated the contrast-control circuit by making a number of resistance measurements. Thinking that perhaps there might be a high-resistance short between the volume and contrast controls, he finally decided to use two temporary replacements. Substituting individual controls for the suspected units, he still found no change in operation. "Maybe the video or sound alignment is off," George said to himself, "but before I start turning slugs, I'd better take a look at the video response."

Referring to a portion of the alignment instructions in the service literature, he then set up his sweep generator and scope and viewed the video response at the plate of the video output tube. The over-all curve appeared pretty good, although it was peaked a little too much on the high side. Using the variable-marker provision of his generator, he threw in a marker signal approximately where the sound carrier would appear on the curve. He then varied the contrast control, which apparently had no effect on the shape of the response—the marker remained down in the dip at the high-frequency end of the curve. Of course, the over-all amplitude changed as he varied the control, so he was forced to continually adjust the scope's vertical positioning control to keep the pattern on the screen.

Again he was stumped, but only temporarily. While he had the generator handy, George decided





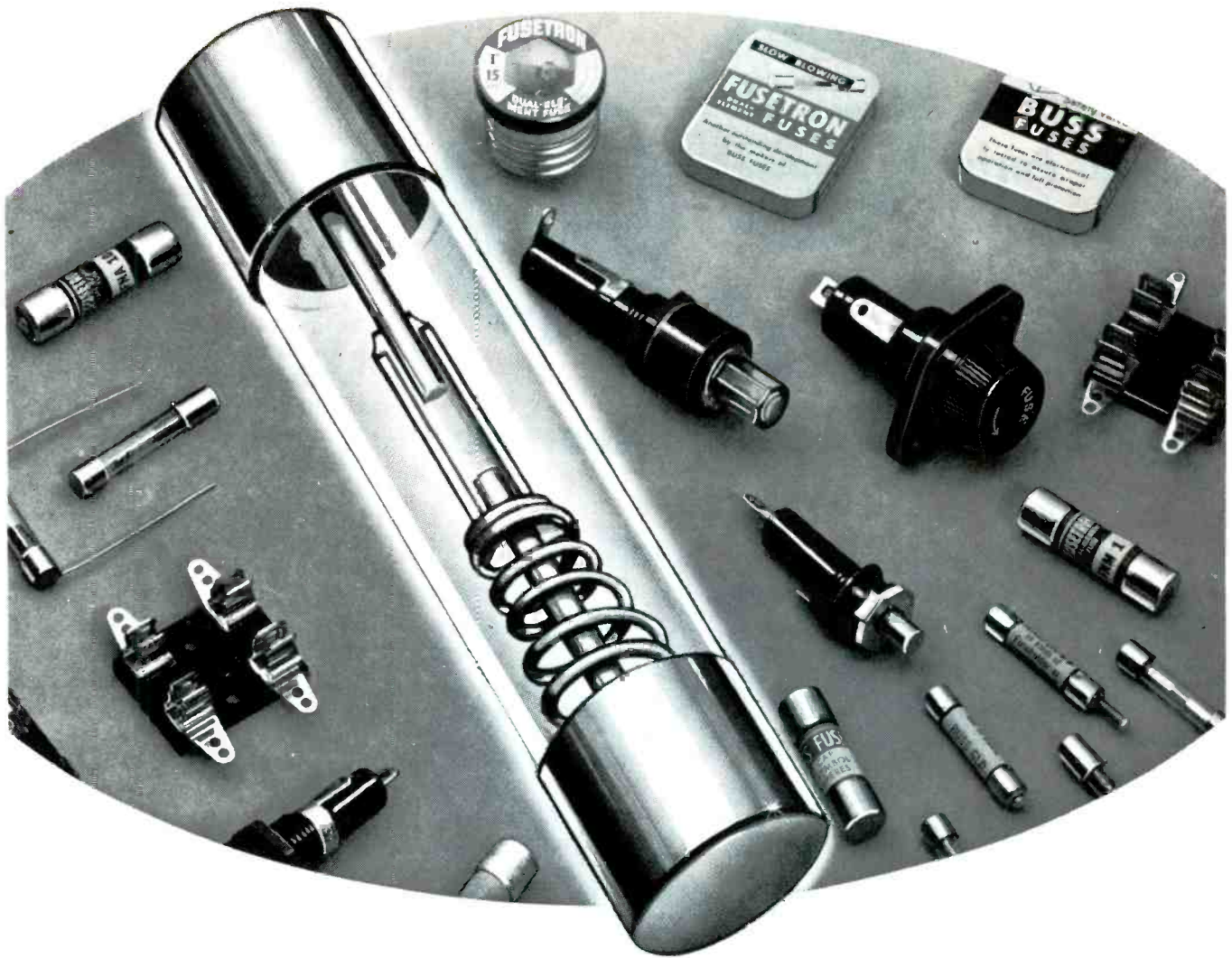

## Save Time and Trouble by Standardizing on BUSS Fuses

**YOU'LL FIND THE RIGHT FUSE EVERYTIME . . . IN THE COMPLETE BUSS LINE**

By using BUSS as your source for fuses, you can quickly and easily find the type and size fuse you need. The complete BUSS line of fuses includes: dual-element (slow blowing), renewable and one-time types . . . in sizes from 1/500 amp. up — plus a companion line of fuse clips, blocks and holders.

**BUSS TRADEMARK  
IS YOUR ASSURANCE OF FUSES OF  
UNQUESTIONED HIGH QUALITY**

Over the past 43 years, millions upon millions of BUSS fuses have operated properly under all service conditions.

Thus, BUSS fuses have earned a reputation for accurate and dependable electrical protection.

To make sure this high standard of dependability is maintained . . . BUSS fuses are tested in a sensitive electronic device. Any fuse not correctly calibrated, properly constructed and right in all physical dimensions is automatically rejected.

**LET BUSS FUSES HELP PROTECT YOUR PROFITS . . .** The dependability of BUSS fuses helps you avoid 'kicks' and complaints that the fuses you sold or

installed failed to protect or blew needlessly. This safeguards you against costly adjustments and 'call-backs'. It pays to refuse to take a chance with anything less than BUSS quality in fuses.

For more information on BUSS and FUSETRON Small Dimension fuses and fuseholders . . . Write for bulletin SFB. Bussmann Mfg. Division McGraw-Edison Co., University at Jefferson, St. Louis 7, Mo.

*BUSS fuses are made to protect — not to blow, needlessly*

1057



MAKERS OF A COMPLETE LINE OF FUSES FOR HOME, FARM, COMMERCIAL, ELECTRONIC, AUTOMOTIVE AND INDUSTRIAL USE.

**NOW—  
Get it from  
your Parts  
Jobber!**

**Admiral—  
rated by servicemen  
as the most foolproof  
and trouble-free of  
all changers!**

**Admiral—  
built into more  
phonos and combinations  
than any other  
changer in the world!**

# Admiral®

## 4-Speed Record Changer

*Hi Fidelity*



Beige and Coral  
with Golden trim  
(Base Optional).

- **PLAYS ALL FOUR SPEEDS—** 33 $\frac{1}{3}$ , 45, and 78 plus "talking book" 16 $\frac{2}{3}$  r.p.m. Has neutral position. Changes 12 to 14 records; intermixes those of same speed. Automatic 2-way shut-off after last record. Returns tone arm to rest, stops turntable motor completely. NOTE: Can be wired to shut-off radio or amplifier chassis.
- **RUBBER TURNTABLE MAT**
- **FEATHERWEIGHT TONE ARM—**new resonance-free design. Less than  $\frac{1}{3}$  oz. pressure. Positive tracking . . . no "skip" or "jump" on loud passages.
- **DIAMOND LP STYLUS—**separate LP diamond and 78 r.p.m. sapphire needles for finest sound reproduction, long record life.
- **ATTACHED 40" SHIELDED AMPLIFIER CABLE—**eliminates pickup of unwanted noise. Cable has phono tip plug for quick easy connection into standard input phono-tip jack.

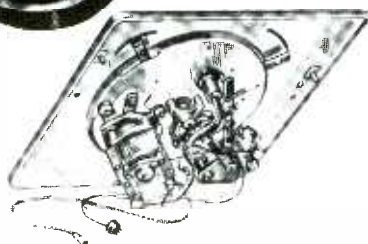

**HEAVY DUTY MOTOR—**powerful 4-pole constant speed shaded pole induction type motor. Operates without hum, rumble or "wows" (as little as 0.1590). Maintains even speed even if line voltage varies. Six foot line cord attached.



**CERAMIC PICK-UP CARTRIDGE—**twin lever hi-fi cartridge changes with flick of the finger from LP to 78 r.p.m. needle. Impervious to heat and humidity. High lateral compliance minimizes wear, eliminates hum and distortion. Smooth even response ( $\pm 3$ db) over the full high-fidelity frequency range (30-15,000 c.p.s.).

Write for Illustrated Specification Sheet.

**Admiral®** / SPECIAL PRODUCTS DIVISION  
3800 West Cortland Street  
Chicago 47, Illinois

to feed in a frequency-modulated 4.5-mc signal to the sound pick-up coil L15. He accomplished this by using the 60-cycle FM sweep of his generator. Reducing sweep width to minimum and setting the mean frequency of the sweep at 4.5 mc, he applied the signal to the receiver. This was the first real piece of detective work George had done since assigned to the case. Turning the volume to maximum, he noted that with a low setting of generator output, the 60-cycle hum could be heard in the speaker. When he started to increase the output level, however, the hum dropped out completely. Analyzing the condition, George figured that the sound section was being swamped or cut off by the strong input signal.

His next step was to feed in an audio signal at the plate of the 6BN6 audio detector. With the volume control still in its maximum position, the tone came through loud and clear. When he increased the signal level, the sound did not cut out; instead, it almost drove him out of the shop. Rising up from his bench for a moment, George knew this was the break he had been waiting for and that the case was near a solution.

Using the FM sweep signal once again, George isolated the fault to the 6BN6 detector stage. After repeated voltage measurements in this circuit led to no new clues, he began spot-checking resistances. Charlie Chan's number one son finally detected an infinite reading to chassis on pin 6—the quadrature grid. A normal reading according to the service literature is 5.4 ohms. Further examination revealed that the quadrature coil, L20, was open. Scrutinizing the component closely, George detected a loose connection between one of the leads and a contact terminal on the coil form. A quick solder job and readjustment of the buzz control restored the set to normal operation.

As far as troubleshooting is concerned, the case was closed; but to George (and perhaps some of our readers) the full facts in the case of the crazy mixed-up control remain a mystery. An explanation of the strange symptom can be found on page 76. ▲



# BELDEN 8275 CELLULINE® LEAD-IN

U. S. PATENT NO. 2,782,251 AND CANADIAN  
PATENT NO. 516,068 AND FURTHER  
U. S. AND CANADIAN APPLICATIONS PENDING



Thousands of separately sealed tiny cells, filled with inert gas, make this waterproof cable stable, efficient electrically.

This heavy wall of brown virgin polyethylene protects the cable against mechanical abuse and damage from ultraviolet sun rays.

## Lead-In Wire for Every Need

... For Standard Installations



— 8225

For standard installations where strength is required



— 8230

Belden Weldohm Transmission Line withstands 2½ times the abuse of all copper cable

... But for the good jobs where the situation is critical—use 8275

Specify Belden Rotor Cables  
Every type—Round and Flat

## The lead-in with proved superiority for VHF & UHF

With *Patented* Belden Celluline, lowest possible losses are assured because each separate cell of the cellular plastic core is filled with sealed-in inert gas. Absolutely waterproof, no end sealing necessary. Thick outer wall protects cable from abrasion and sun damage. Non-kinking.

Weldohm conductor has great strength—long life. Stripping is simplified for fast installation.

## CELLULINE. LEAD-IN

by



14-8

Magnet Wire • Lead Wire • Power Supply Cords, Cord Sets and Portable Cord • Aircraft Wires  
Welding Cable • Electrical Household Cords • Electronic Wires • Automotive Wire and Cable

Notes On

# TEST EQUIPMENT

Latest Information on Application,  
Maintenance and Adaptability  
of Service Instruments

by Leslie D. Deane

## Hickok's Latest In CRO's

The cathode ray oscilloscope pictured in Fig. 1 is manufactured by the Hickok Electrical Instrument Co., Cleveland, Ohio. Designed for general-purpose as well as industrial use, the Model 685 features a 5" tube with an illuminated and calibrated screen.

Electrical specifications are:

1. Power Requirements—115 volts  $\pm 10\%$ , 50/60–400 cps, power consumption 95 watts.
2. Vertical Input System—sensitivity of .02 volts RMS/inch, response from zero or DC to 750 kc  $\pm 3$  db, maximum input voltage of 500 volts peak-to-peak, input impedance (less probe) of 1 megohm shunted by 25 mmf, 4-step vertical attenuator with 10-to-1 gain control.
3. Horizontal Input System—sensitivity of .03 volts RMS/inch, response from zero or DC to 750 kc  $\pm 3$  db, maximum input voltage of 500 volts peak-to-peak, input impedance of 1 megohm shunted by 25 mmf, sweep expansion 10 times full screen with complete positioning control.
4. Sweep Frequency System—internal range from 1 cps to 100 kc, sinusoidal sweep at line and twice line frequencies with variable phase, provisions for lower sweep frequencies using external capacitor input, 4-step external sweep attenuator.
5. Z-Axis Modulation—input impedance 1 megohm; maximum input voltage, 500 volts peak-to-peak.

6. External Sync—input impedance 220K ohms; maximum input voltage, 1 volt peak-to-peak.

Trying out the Model 685 in the lab, I first consulted the instruction manual to familiarize myself with all of its operating adjustments. When I fired up the instrument, I found that the on-off knob also controls the amount of light appearing on the illuminated calibration screen. The vertical and horizontal lines etched on the screen can, of course, be used as general reference marks and for

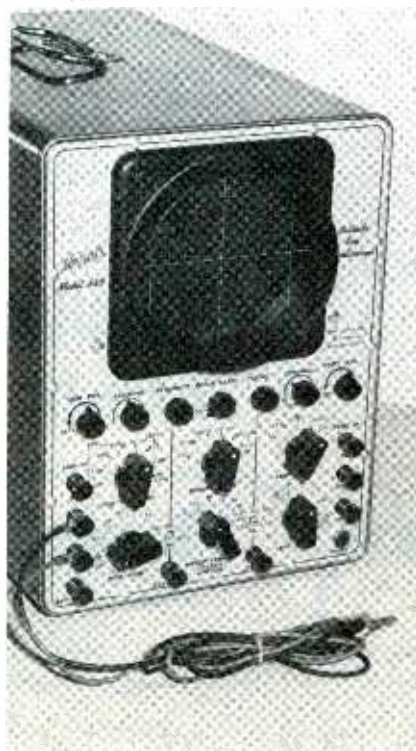

Fig. 1. The Hickok Model 685 general-purpose oscilloscope.

voltage calibration of waveforms. The screen also has a green-tinted filter for reducing reflected light and improving trace contrast.

After a short warm-up period, I obtained a clearly defined trace by properly adjusting the intensity, focus, and positioning controls. One particular discovery I made was that the horizontal sweep width in any of the four internal sweep positions can never be reduced to absolute zero. The gain control is so designed to eliminate the possibility of a single spot burning the screen.

I found the sensitivity and response of the scope satisfactory for general TV troubleshooting and alignment applications by examining various waveforms in a normal operating receiver. Using a general-purpose probe, I connected the cable to the vertical-input terminals of the instrument and viewed the composite video signal at both a 30- and 7,875-cps sweep-rate. At the 30-cycle rate, vertical sync as well as video information was clearly reproduced on the screen, although a slight rounding of sync pulse edges was evident. By expanding the sweep, I could plainly see the horizontal pulses and was able to count equalizing and serration pulses on the vertical pedestal.

Next, I placed the sweep-range selector in the 1K-10K position and adjusted the vernier for a 7,875-cps sweep. After I locked in the pattern, two horizontal sync pulses with video between appeared on the screen. The signal was steady and I could distinguish both front and back porch formations in the sync pulse reproduction. I also set up the Model 685 to check a typical video-IF alignment curve. Following instructions, I was able to reproduce a response very similar to that shown in the receiver's service literature.

Considering some of the physical aspects of the instrument, I decided to remove the scope chassis from its case. A tilt-back view of the assembly is shown in Fig. 2. Like many of the newer pieces of equipment, the instrument makes use of printed wiring and other compact design features. Of particular interest is the shock-mounted printed-board housing the DC amplifier section. As



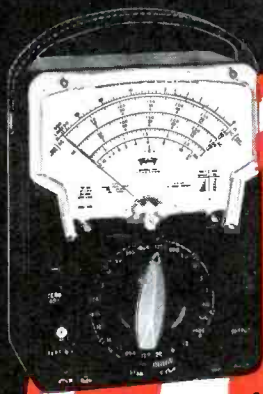

631



630-NA



630



630-A



630-T



310



666-R



666-HH



625-NA

# TRIPLET

Triplet Electrical Instrument Company  
Bluffton, Ohio  
53 years of experience.

# THE MIGHTY NINE

Only Triplet affords you such a wide choice of VOMs. Whatever your application—broad or limited—there is a Triplet VOM particularly suited for it.

**631**  
Combination  
V-O-M—VTVM

**630-NA**  
For Best Testing  
Around the Lab,  
Production Line  
or Bench

**630**  
The Popular  
All-Purpose  
V-O-M

**630-A**  
A Good Lab and  
Production Line  
V-O-M

**310**  
The Smallest  
Complete V-O-M  
with Switch

**630-T**  
For Telephone  
Service

**666-HH**  
Medium Size  
for  
Field Testing

**625-NA**  
The First V-O-M  
with 10,000  
Ohms/Volt AC

**666-R**  
Medium Size  
with  
630 Features



*Dave Rice's*  
**OFFICIAL**  
**ORDER BOOK**  
 for every TV-Radio  
 service call



Triplicate forms serve as order form, invoice and office record with spaces for complete information on every job. Separate listings for receiving tubes, pix tube, parts, serial numbers, labor and tax charges, signatures, etc. 75c a book, \$6.50 for dust-proof box of 10.

... and for customer's prices on every replacement part, Dave Rice's

**OFFICIAL PRICING DIGEST**

listing over 60,000 items. \$2.50

In stock at your distributor, or write

**ELECTRONIC PUBLISHING CO. INC.**

180 North Wacker Drive Chicago 6, Illinois

**HI-FI ACCESSORIES BY**



**ELECTRONICS**

**FOR BETTER RESULTS**

**Record Compensator**

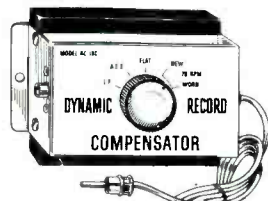

Finest precision accessory to obtain maximum quality for all types of recordings—European—Domestic LP's, old and new 78's, etc. To be used with all types of reluctance cartridges.

• Shielded Lead & Molded Pin Plug.  
 • Pin Jack & Rotary Switch.

**Model RC 180 . . . \$9.50 List**

**THERE IS A DYNAMIC ACCESSORY FOR ALMOST EVERY NEED . . . SOLD AT A MONEY BACK GUARANTEE!**

At leading distributors everywhere.

Full Line Catalog on Request!

Manufactured By . . .

**DYNAMIC ELECTRONICS-NEW YORK, INC.**  
 Forest Hills, Long Island, N. Y.

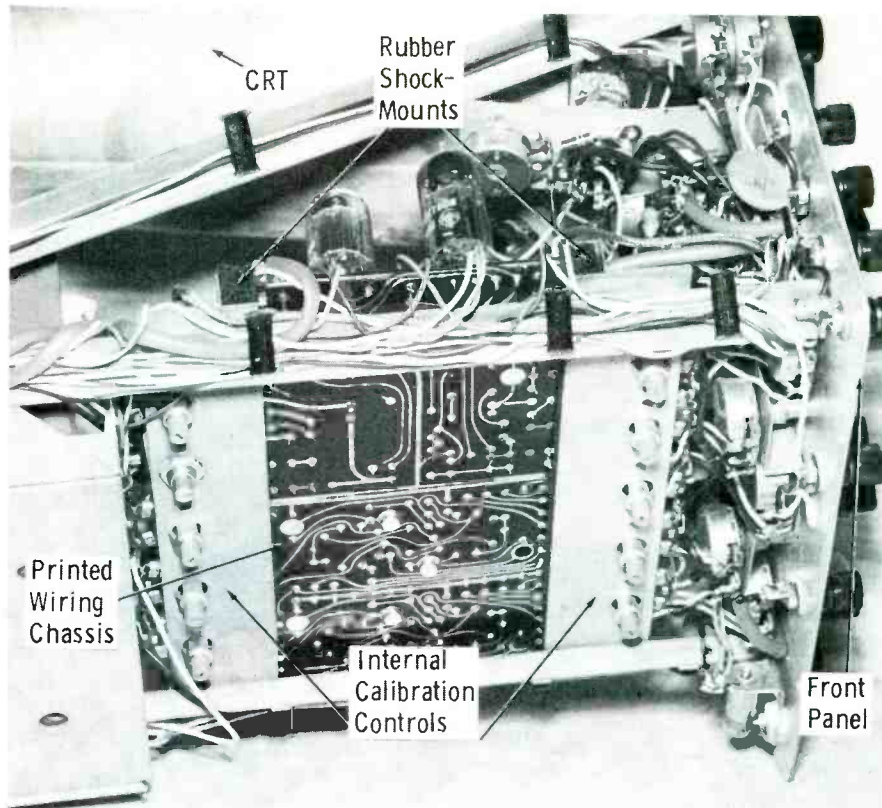

Fig. 2. The chassis of the Hickok scope reflects compactness of design.

shown in Fig. 2, the board is supported by two foam-rubber strips which afford a certain amount of protection for the somewhat delicate board and reduce the possibility of microphonic vibration.

The calibrating controls are conveniently located on two separate strips on the underside of the chassis. A complete calibration procedure together with troubleshooting chart and schematic are given in the instruction manual supplied with the instrument.

**Variable Battery for Bench Servicing**

A variable battery? Not exactly, but the instrument pictured in Fig. 3 will certainly take the place of any battery up to 30 volts within an operating range of 0 to 60 ma. Designated as the Model A-400 Transistor Power Supply, the unit is manufactured by Perma-Power Co., Chicago. It is especially designed to operate and aid in the servicing of portable transistor radios and other low-power transistor circuits.

Specification Features are:

1. Power Requirements—115 volts 50/60-cps, power consumption variable with load, internal line fuse provided.
2. DC voltage Output—two adjustable ranges from 0 to 15 volts and 0 to 30 volts for currents up to 60 ma, AC ripple less than 500 mv or .002% at full output, output impedance less than 20 ohms from DC to RF.
3. Panel Meters—DC voltmeter with 0 to 15 and 0 to 30 volt scales, DC milliammeter with 0 to 15 and 0 to 60 ma scales, voltage and current accuracy of 2%, separate fuse provided for milliammeter circuit.

Examining the Model A-400 in the lab recently, I found it exceptionally useful in servicing transistor radios. In my estimation, the two most outstanding features of the unit are its low AC ripple content and the two easy-to-read meters built into the front panel. Voltage regulation and good ripple filtering in an instrument of this type is very important, especially when operating transistor-



# Bull's-eye every time!

We hit the target again . . .  
with this new, modern version of the  
most wanted service-test instrument.

Pyramid introduces the CRA-2 Capacitor-Resistor Analyzer, a versatile, up-to-date, moderately priced test instrument. The CRA-2 is the perfect multi-purpose analyzer for the technician, serviceman and engineer, in industrial and military electronics, black and white, and color television, and all related fields.

The guesswork has been removed from circuit trouble shooting. When making leakage-current measurements, the values are read directly from the meter while the rated operating voltage is applied to the capacitor. A vacuum-tube ohmmeter circuit displays accurate insulation-resistance values on the meter for many types of capacitors. The extended range calibrated power factor control permits power factor measurements of electrolytic capacitors rated as low as 6 volts DC working and as high as 600 volts DC working. This special "QUICK CHECK" circuit performs rapid "IN CIRCUIT" test for short, open, intermittent high RF impedance and high power factor without removing or disconnecting the component from its operating circuit.

**MODERN DESIGN**  
**VERSATILE**  
**DEPENDABLE**  
**TIME SAVING**

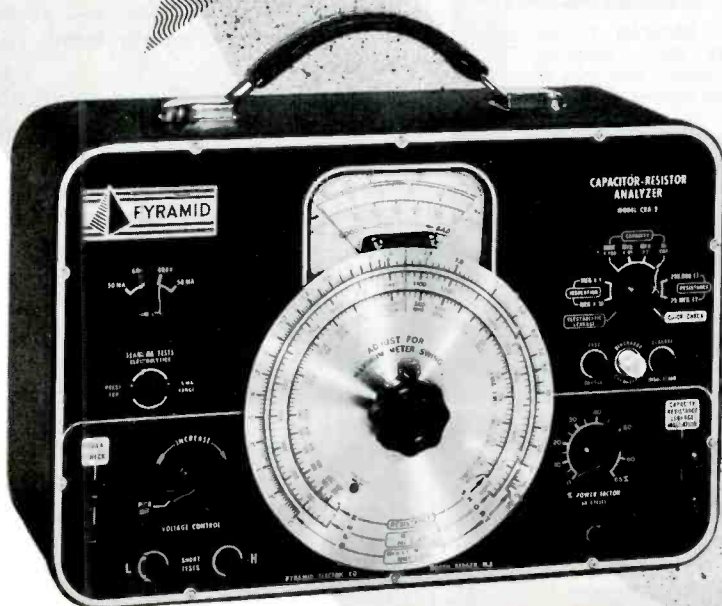

## FEATURES

- "Quick Check" in circuit test for Open Circuits. Short Circuits. Intermittents. High RF Impedance. High Power Factor.
- Speedily and accurately checks: Capacitance. Power Factor. Resistance. Insulation-Resistance. Leakage Current.
- Precision meter for accurate readings of leakage current, applied voltage and insulation resistance.
- Combination Wien and Wheatstone bridge.
- Accurate vacuum-tube meter circuit.
- Parts of the highest quality are used. Wire and wiring meet military specifications.

Examine it today  
Being introduced by leading Electronic Parts Distributors

# PYRAMID ELECTRIC COMPANY

1445 Hudson Blvd., North Bergen, New Jersey

Hudson Browne / New York

# 4 IDEAS

for getting even more use from your  
*Weller* SOLDERING GUN

Your Weller Soldering Gun is the most useful tool in your shop. Service technicians find new, practical uses for it every day. Here are some time-saving applications:

**1 CIRCUIT AND COMPONENT DEFECT ANALYSIS.** Energized tip of Weller Gun is substituted for signal generator to find defective components in both audio amplifier section and picture circuit. Quickly uncovers thermal intermittance trouble.

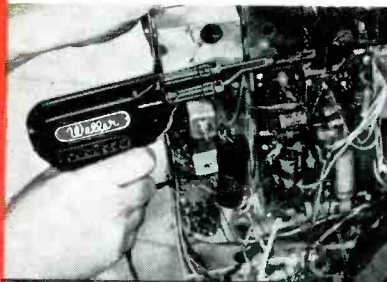

**2 REACHES COMPONENTS THROUGH CHASSIS CUT-OUTS.** Weller Guns, with their long, thin electrodes, reach recessed tube sockets and connections through small chassis cut-outs. Pre-focused twin spotlights light up this hard-to-get-at work.

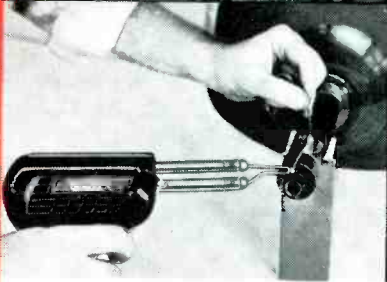
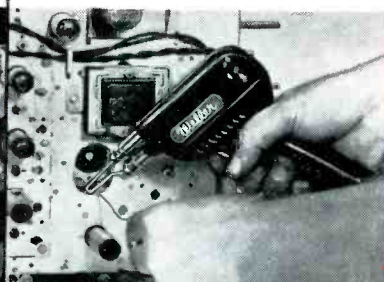

**3 NEW SOLDER FOR CATHODE TUBE BASE PIN.** Defectively soldered (or loose) base pin is re-sweated to remove imperfections. New solder is then applied to establish uninterrupted contact. Weller Gun is ideal for this type of repair.



**4 SOLDERING BROKEN TERMINAL LEADS.** Weller Soldering Gun permits controlled application of heat. Solder is maintained at correct viscosity. This enables serviceman to produce rounded joints and prevent corona discharge in high-voltage compartment.

*Weller* SOLDERING KIT 8100K IDEAL FOR

ALL SERVICE WORK



Complete kit for the price of the gun alone! Latest type Weller Gun—Model 8100, over 100 watts, with triggermatic heat control. 2 pre-focused spotlights. Reaches through small openings into dark places. Kit includes Wire Soldering Brush, wire-twisting Soldering Aid, Kester Solder. Top value at \$7.95 list.

SEE THE FULL LINE OF PROFESSIONAL MODEL WELDER GUNS AT YOUR ELECTRONIC PARTS DISTRIBUTOR

*Weller* ELECTRIC CORP. • EASTON, PA.  
601 Stone's Crossing Road



Fig. 3. The Perma-Power Model A-400 Power Supply.

ized equipment. A power supply having a high ripple content will either produce so much hum that the desired signal is lost, or cause permanent damage to transistors and miniature electrolytic capacitors.

In analyzing troubleshooting procedures for transistor radios, monitoring both supply current and voltage comes in mighty handy. A built-in voltmeter and milliammeter, such as featured in the Model A-400, can tell you a number of facts about a defective transistor radio. As an example, the voltmeter will indicate the DC power applied to the set at all times during operation. Variations in supply voltage can be interpreted directly from the meter scale; thus, an operational check of receiver sensitivity and selectivity at precise power levels can be made.

In many cases, the service technician may be without a suitable transistor checker; however, it is often possible to locate defective transistors by removing them from the circuit one at a time and measuring the total current drain of the set. In such cases, a bench supply with a built-in milliammeter is ideal.

Within certain limits, transistors of each type are designed to draw a certain amount of current; so as each one is pulled, the total drain should drop proportionately. If current remains unchanged, or decreases by an amount exceeding the unit's capabilities, then it is either defective or improperly biased. When performing a test of this nature, always remember to turn the set or power supply off before plac-



**NEW**

**ONLY  
PUBLICATION  
OF ITS KIND!**

*Howard W. Sams* 1958

# Test Equipment Annual



**MOST COMPLETE AND AUTHORITATIVE  
GUIDE TO TEST INSTRUMENTS EVER PUBLISHED**

**Nothing else like it!** A completely NEW and DIFFERENT publication bringing you the most needed, most requested information about all types of Test Equipment and accessories. A 100% practical guide for anyone who uses test equipment—written in down-to-earth language and profusely illustrated.

## 8 FACT-PACKED SECTIONS:

- Test Equipment Methods, Measurement Analysis and General Information
- Using Test Equipment for Alignment
- Using Test Equipment for Troubleshooting
- Use and Selection of Test Equipment for Color TV
- Test Equipment for Special Applications
- Test Equipment Maintenance
- Questions and Answers About Test Equipment

You get *all* the useful information you need on theory, operation and maintenance of Test Equipment. Each section of the book is packed with data that will save you time and money—techniques to make your present equipment more versatile and valuable—full information about new equipment designed for service of new chassis and components.

*Only*  
**\$1.00**

**THE BIGGEST DOLLAR'S WORTH  
OF USEFUL, PRACTICAL DATA  
ON TEST EQUIPMENT  
EVER MADE AVAILABLE!**

120 8½" X 11" pages

*Plus*

Complete specifications on over 300 current models of test equipment and accessories! Includes full manufacturers' specifications—and more than 300 photos of equipment. For the first time anywhere—a complete presentation of test equipment grouped by logical instrument type classification (not by brand name). Covers everything:

- Pattern Generators
- AM, FM, Sweep & Marker Generators
- Audio & Square-Wave Generators
- Oscilloscopes
- VOM's
- VTVM's
- Power Meters
- Field Strength Meters
- Decade & Substitution Boxes
- Power Supply Equipment
- Tube Testers
- Transistor Testers
- CRT Testers
- Component Testers
- Other Meters & Probes
- Other Bench Equipment

**ALL THE FACTS YOU WANT!**

**LIMITED EDITION**

**Order Your Copy Today!**

**\$1.00**

## HOWARD W. SAMS & CO., INC.

Order from your Parts Jobber today, or mail to Howard W. Sams & Co., Inc., Dept. 3-LL7, 2201 East 46th St., Indianapolis 5, Ind.

Send \_\_\_\_\_ copy(ies) of "Test Equipment Annual."

My (check) (money order) for \$ \_\_\_\_\_ is enclosed

Name \_\_\_\_\_

Address \_\_\_\_\_

City \_\_\_\_\_ Zone \_\_\_\_\_ State \_\_\_\_\_

(outside U. S. A. priced slightly higher)



**HOWARD W. SAMS & CO., INC.**  
Indianapolis 5, Indiana

# YOU CAN STOP A FLUCTUATING VOLTAGE CONDITION

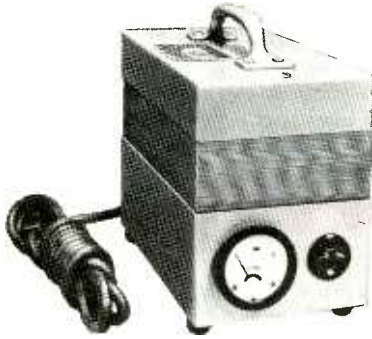

# WITH THIS ACME ELECTRIC AUTOMATIC VOLTAGE STABILIZER

If you're harassed with a television or other electronic equipment installation that just won't operate right, chances are that a fluctuating voltage condition exists and prevents tubes and other components from functioning properly.

One sure way of making voltage behave is with the Acme Electric automatic voltage stabilizer. Regardless whether the input voltage ranges from 95 to 130 volts, the output voltage will automatically be corrected to 115 volts  $\pm$  3%.

Another feature to remember, this unit uses no current unless the TV set is in operation. An automatic relay disconnects primary circuit under "no load" conditions and automatically connects circuit when load is applied to the secondary circuit. Secondary voltage is indicated on voltmeter while unit is in operation. Furnished complete, ready to plug-in. See this Acme Electric Automatic Voltage Stabilizer at your dealer.

ACME ELECTRIC CORPORATION  
94 WATER STREET CUBA, NEW YORK



ing any transistor back in the circuit. With power applied, surge currents may cause permanent damage.

Reading over the operating manual for the Model A-400, I came across some interesting "do's and don'ts" concerning power supplies in general. If you plan to service any transistorized equipment using a bench supply, you might keep these five points in mind.

1. Always reduce voltage to zero before connecting supply to circuit under test.
2. Observe battery polarity required by instrument or circuit before making connections.
3. To prevent overload, increase voltage output slowly while observing meters.
4. Never connect a transistor into a circuit before removing supply voltage.
5. Always reduce supply voltage to zero when investigating circuit components which might alter current consumption.

### In-Circuit Cap Checker Speeds Servicing

Century Electronics Co., Inc. Mineola, N. Y., has recently developed a piece of test equipment known as the Model CT-1 In-Circuit Condenser Tester, pictured in operation in Fig. 4.

Test features are:

1. *In-Circuit Checks*—values of capacitors from 200 mmf to .5 mfd; quality, shorts, and opens for a wide range of circuit shunt resistances; electrolytic quality; intermittents.
2. *Out-of-Circuit Checks*—values of capacitors from 50 mmf to .5 mfd; quality, shorts, and opens in all capacitors; electrolytic quality; intermittents.
3. *Other*—checks for leakage in

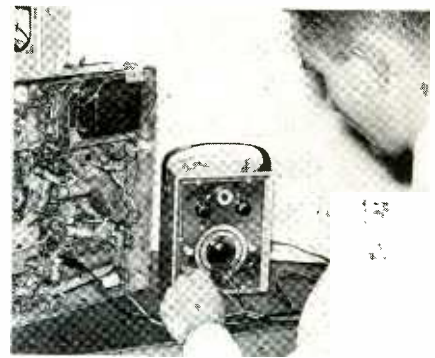

Fig. 4. Checking electrolytic "in-circuit" using the Century Model CT-1.

tubes, insulators, sockets, capacitors, transformers, etc.; leakage measurement up to 300 megohms.

Since many of our readers have expressed a desire to learn more about in-circuit capacitor checkers, I thought you might like to see how this one operates.

In the first place, I found that the instrument has a value selector, two controls, a tuning eye, two slide-type switches, two input jacks to accommodate test leads and two jeweled indicators all on the front panel. The two main adjustment knobs are labeled "VALUE" and "QUALITY." The value selector is calibrated in capacity and tells the operator the approximate capacitance of the circuit or component under test.

The quality control has three large circular scales. The two outer scales are marked off in sections of "good," "leaky," and "bad;" one scale is used for testing coupling capacitors and the other for bypass types. The inner scale is calibrated in ohms and denotes the amount of leakage.

Value and quality of a capacitor are measured simultaneously by setting both value and quality adjustments for the widest eye opening. The tuning eye will give an

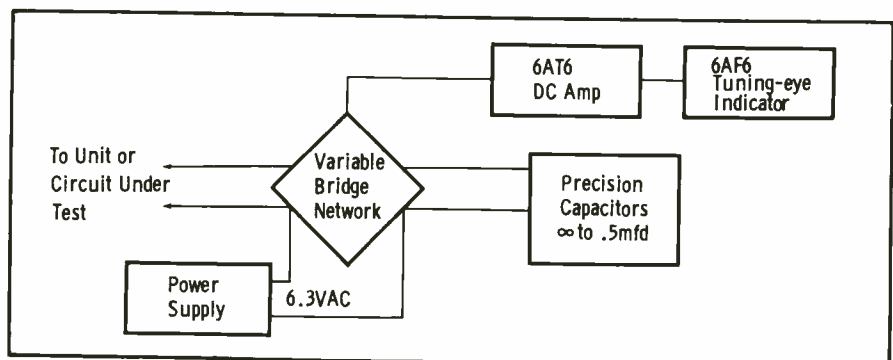
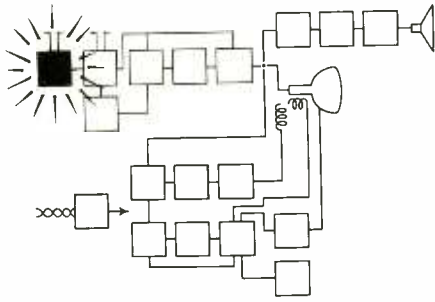
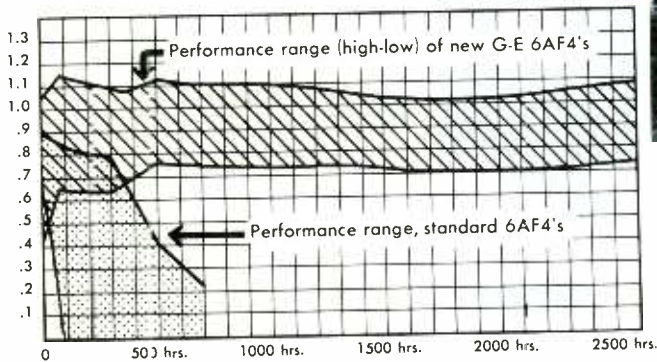

Fig. 5. Block diagram of the sections used during the value-quality test with the CT-1.





Life-test comparison chart below shows oscillator activity versus hours of life of new G-E 6AF4's and standard 6AF4's.



ABOVE: General Electric Design Engineer J. G. Tucker checks, for oscillator activity, new G-E 6AF4 tubes that are undergoing life test.

LEFT: Effect of tube operation over long periods on new vs. standard 6AF4's is shown by the chart. Tests of many thousand tubes are represented. Note that the oscillator activity of new G-E 6AF4's averages a straight horizontal line, whereas standard 6AF4's show a sharp, sudden drop . . . meaning rapid loss of picture quality.

## Now . . . from General Electric . . . a long-life 6AF4 for sustained high-quality u-h-f TV reception!

Only General Electric can give you . . . in the long-life 6AF4 u-h-f oscillator tube . . . the tube industry's newest, most effective means for making friends of service customers. Installing a new General Electric 6AF4 cuts snow, brings a clear picture that will retain its high quality. Tests prove that after 2500 hours and more of service, this u-h-f oscillator tube performs just as well as one freshly taken from a carton!

Virtually no receiving tube is called on to undergo the same electrical "stresses" as a 6AF4. With small electrodes and close spacing to meet low-inductance, low-capacitance demands of up-to-900-mc operation, current density is 5 to 6 times that of other triodes.

Consequently, extremely high cathode emission is called for. The plate and grid, subjected to high tem-

peratures, must resist gas-forming tendencies that would destroy tube efficiency. Stiff requirements like these have meant short life for 6AF4's. Now General Electric, through creative design, combines new materials with new manufacturing and test methods to give TV-technicians and set-owners a 6AF4 that *for the first time* is fully as efficient and dependable as other tubes.

The same long-life performance is being built into General Electric's 2AF4, 2AF4-A, 3AF4-A, and 6AF4-A.

Outstanding examples like this of ever-higher quality, of design steadily improved, make General Electric tubes the best you can install. Phone your G-E tube distributor at your earliest opportunity! *Distributor Sales, Electronic Components Division, General Electric Company, Owensboro, Kentucky.*

*Progress Is Our Most Important Product*

GENERAL  ELECTRIC

161-1A10

# AMPHENOL

# vi-fi

## Indoor Antenna true VIDEO FIDELITY

**Announcing Vi-Fi**—two years in development, a new Indoor TV Antenna with new ideas in appearance, electrical and mechanical performance, and mounting versatility.

**True Video Fidelity:** powerful picture-pull for sharper images, on color or black & white, 'slide rule' tuning and transformer coupling for best impedance matching and maximum signal pickup.

**Slender Line Styling:** only nine and a half inches long, as thin and as modern as the new TV sets.

**Fold-from-sight Elements:** shorter, easier-to-handle antenna elements hidden from sight when not in use.

**3-Way Mounting:** on top, flush or hidden in back for consoles, table models and portables.

**Vi-Fi** is available in three color choices and in VHF and VHF/UHF models—there are many other features you will want to know about. You and Vi-Fi will want to get acquainted!

contact your **AMPHENOL** distributor



SLENDER LINE  
*styling*

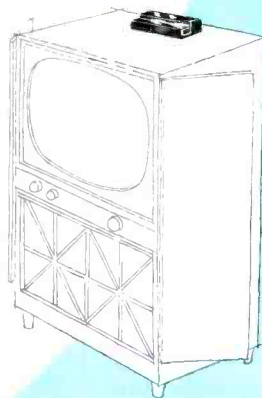

accurate indication only when both are set to the proper position.

The "FINE ADJ." control, located just right of the tuning eye, is the on-off switch and also works in conjunction with the value selector. After the value switch has been set for the widest eye opening, the fine adjustment is varied for still a wider indication. Measured circuit capacity falling between the calibrations on the value scale can then be interpreted by the position of the "FINE ADJ." control ( $\pm$  the value calibration).

The tuning eye serves as a null indicator, telling the operator when the circuit within the instrument is balanced reactance-wise with the one under test.

I next examined the function selector, which is a slide-type switch located to the lower right of the panel. With this switch in the "QUAL. & VALUE" position, the instrument is able to check paper, ceramic, and mica capacitors. In its other position, "HI-LK & ELEC. QUAL," checks of electrolytic quality and high-resistance leakage are made.

The other slide-type switch at the lower left of the panel is a spring return device and must be pressed down when performing leakage and electrolytic tests.

I also noticed a neon indicator labeled "HI-LK" on the panel. This is used only during the leakage measurement and reveals whether a capacitor is shorted, leaky, or good. The other neon jewel is a power indicator and, of course, only glows when the instrument is turned on.

Curious to know how this particular checker functions internally, I studied the schematic for a moment and then drew the simple block diagram in Fig. 5, which shows the instrument sections used during the value-quality test of coupling or bypass capacitors.

As in most bridge instruments, the Model CT-1 compares the circuit or component under test with a self-contained precision circuit. When the questionable circuit is connected to the test leads, it becomes a part of the variable bridge network which is also connected to a bank of precision capacitors within the instrument. A small voltage from the power sup-



ply is impressed across the entire system, and the bridge containing the "FINE ADJ." and "QUALITY" controls is then adjusted for a balance between the two circuits. The balanced or null condition is transformed into a visible indication by the 6AT6 DC amplifier and the 6AF6 tuning-eye. Although I found the operating and setup procedures relatively simple, the main problem in checking capacitors in-circuit is interpreting and analyzing the instruments findings. To help solve this problem, the instruction manual for the Model CT-1 explains in detail the results of each test.

### Tubes-Transistors-Diodes and CRT's

A new instrument incorporating test features for all of these items is being manufactured by Precision Apparatus Co., Inc., Glendale, Long Island.

In addition to testing all popular receiving tubes, transistors, crystal diodes, and TV picture tubes, the Model 660 will check pilot lights, ballast, special-purpose, and gas-filled rectifier tubes. In Fig. 6, the Tube and Transistor Tester is shown being used to test the "cathode conductance" of a 6U8 triode-pentode.

Specifications and test features are:

1. Power Requirements—110 to 120 volts AC, 60-cps, line fuse provided.
2. Carrying Case—Portable leatherette-covered 18"×10"×6¼", tool compartment and removable cover.
3. Panel Meter—5¼" Pace meter,

4 scales, 100 microamp sensitivity, accuracy ±2%.

4. Pin Straighteners — built-in miniature 7 and 9 pin types.
5. Tube Test — shorts, leakage, continuity, and cathode emission; 22 individual filament voltages and 8 test sockets provided.
6. Transistor Test — checks  $I_{co}$ , shorts and leakage for all RF, power and tetrode transistors of both n-p-n and p-n-p types; conventional and special sockets provided with universal test cable.
7. Crystal Diode Test — forward and reverse current indications at specified voltages; special panel sockets provided.
8. Picture Tube Test — checks for picture-producing beam current and shorts, uses optional accessory picture-tube adapter cable Model PTA.

The specifications and test features listed for the Model 660 speak for themselves. All tubes can be checked for shorts, leakage, and cathode emission by a simple lever and switch setup. Of particular interest is the picture tube "beam current" test. In order to test a picture tube using this instrument, a separate adapter cable is necessary. This item, Model "PTA," is available as an accessory. The cable can also be used to check picture tubes on all precision 600-, 900-, and 10-series of tube testers. Following the test procedures outlined in the 660 manual, I placed all levers in the proper positions and connected the adapter cable between

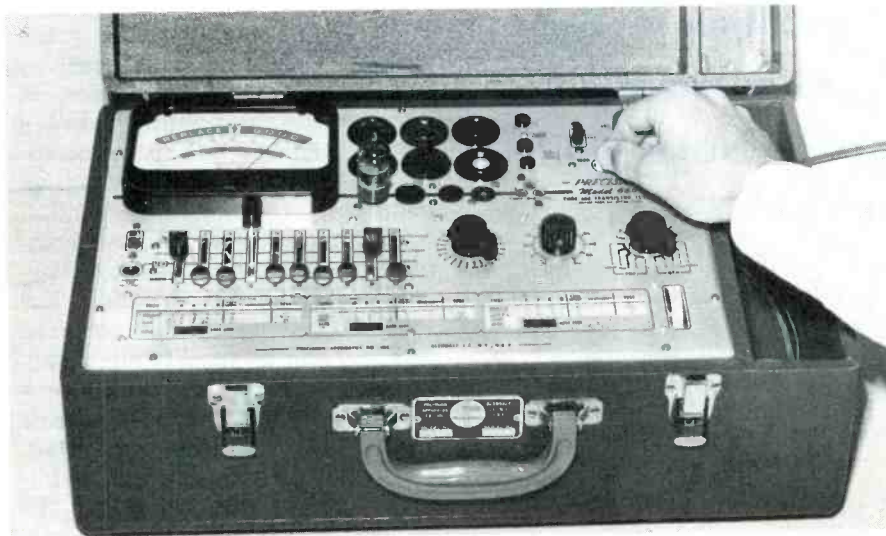
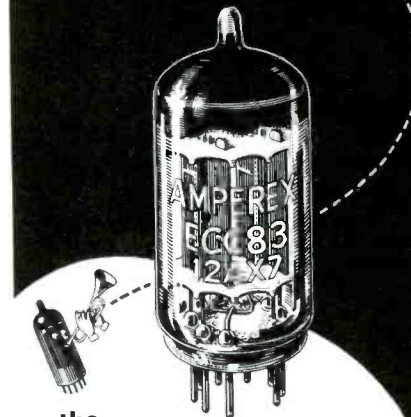

Fig. 6. Precision's new Model 660 Tube-Transistor Tester.

for

# LOWEST hum...noise... microphonics

in a high- $\mu$  dual triode . . .



the

## Amperex®

**ECC83** A PLUG-IN  
REPLACEMENT FOR THE 12AX7

### MICROPHONICS:

Negligible in amplifiers requiring an input voltage of at least 50 mv for an output of 5 watts. No special precautions against microphonics necessary even though the tube is mounted in the near vicinity of a loud-speaker with 5% acoustical efficiency.

### HUM AND NOISE LEVEL:

Better than —60 db relative to 50 mv when the grid circuit impedance is no greater than 0.5 megohms (at 60 cps), the center tap of the heater is grounded and the cathode resistor is by-passed by a capacitor of at least 100 mfd.

### OTHER Amperex TUBES FOR HIGH-FIDELITY AUDIO APPLICATIONS:

EL84/6BQ5	9-pin power pentode; 17 W PP
6CA7/EL34	High-power pentode; 100 W PP
EF86/6267	Low-noise high- $\mu$ pentode
ECC81/12AT7	Low-noise medium- $\mu$ dual triode
ECC82/12AU7	Low-noise low- $\mu$ dual triode
GZ34	Cathode-type rectifier; 250 ma.
EZ80/6V4	9-pin rectifier; cathode; 90 ma.
EZ81/6CA4	9-pin rectifier; cathode; 150 ma.

At All Leading Electronic  
Parts Distributors

**Amperex**  
**ELECTRONIC CORP.**  
230 Duffy Ave., Hicksville, Long Island, N.Y.



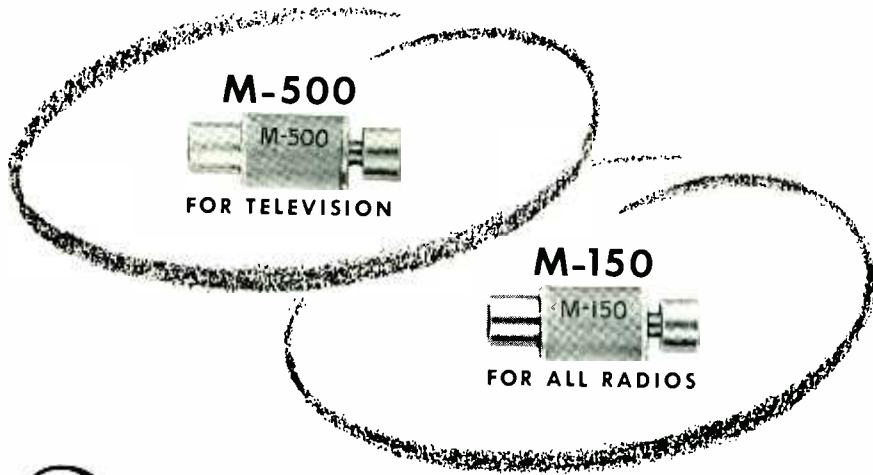

# 2 Types Silicon Rectifiers Replace 95% of All Selenium Types Used in Radio and Television Sets

- **Save Shelf Space**
- **Save Mounting Time**
- **Lower Inventory Investment**

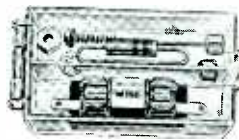

Simplify rectifier replacement by using Sarkes Tarzian Silicon Rectifiers... Get better performance, too, at no additional cost... Send for Service Notes No. 1 and No. 4 for complete details.

**Sarkes Tarzian** RECTIFIER DIVISION  
INC.

DEPT. PF4, 415 NORTH COLLEGE AVE., BLOOMINGTON, INDIANA

IN CANADA: 700 WESTON RD., TORONTO 9, TEL. ROGERS 2-7535  
EXPORT: AD AURIEMA, INC., NEW YORK CITY

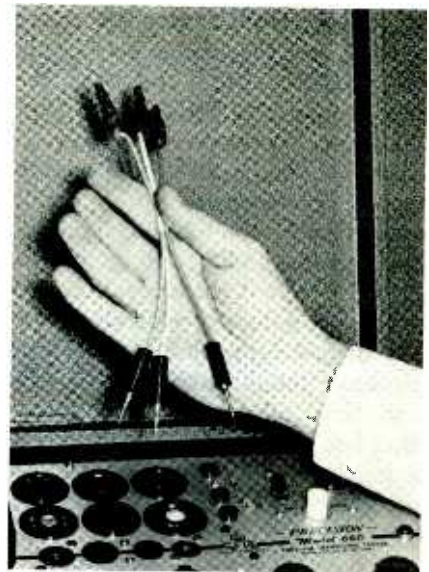

Fig. 7. Adapter cable employed with the Model 660 to test transistors not suited for direct socket insertion.

picture tube base and the octal socket on the front panel of the instrument. I next connected the cable's alligator clip to the high-voltage anode of the picture tube, turned on the instrument and adjusted line voltage.

I performed the shorts test first, as recommended in the instructions. If the tube was shorted, the neon indicator on the 660 panel was supposed to glow. I noticed no glow as each lever was thrown, so I proceeded with the "beam current" test. Placing the No. 6 lever in the test position, I pressed the "READ METER" button and obtained the tube's relative brightness expressed on the panel meter. The arc scale marked "picture tubes" is divided into three colored sections, (red-Reject, yellow-?, green-Bright). The particular tube I tested produced a reading near the center of the green section, indicating a satisfactory beam current or brightness. A guide to the relationship between meter readings and tube condition is given in the instruction manual.

The manual also contains a complete discussion on transistor characteristics and test methods. The special three-wire cable pictured in Fig. 7 can be used to adapt any transistor to the test sockets provided on the 660 panel. The leads are supplied with the instrument, and due to their universal application, will enable the Model 660 to test transistors of future design. ▲



# how long would it take you to solve this service problem?

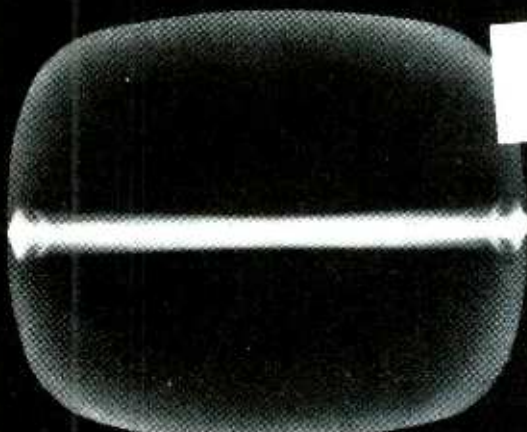

(Based on an actual case history taken from the Howard W. Sams book "TV Servicing Guide")

**SYMPTOM:**  
Loss of Vertical Sweep

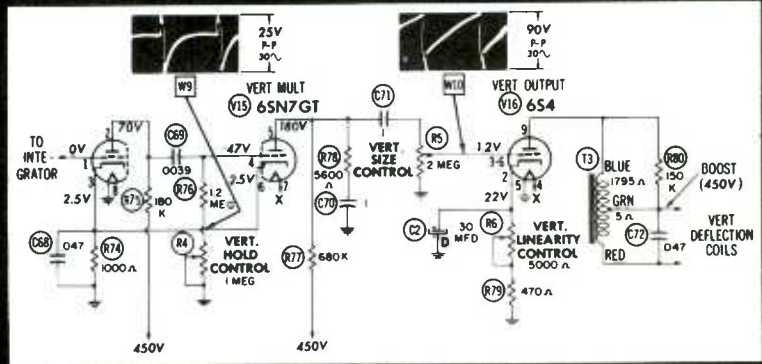

## PHOTOFACT helps you lick problems like this in just minutes for only \*2½¢ per model!

Let's take a look at this problem: This trouble symptom is present when there is no driving signal to the vertical deflection coils and when the horizontal scanning is normal. Look for the following possible causes:

1. Defective multivibrator or output tubes
2. Open coupling capacitors C71 or C69
3. Open linearity control R6 or cathode resistor R79
4. Open size control R5
5. Open output transformer T3

With the applicable PHOTOFACT Folder at your fingertips, you trouble-shoot and solve this problem in just minutes. Here's how:

Using the Tube Placement chart (you'll find it in every PHOTOFACT TV Folder) you can quickly locate and check

the multivibrator and output tubes.

Tubes okay?—then: Check waveform at grid of vertical output tube (W10). Wave shapes and peak-to-peak values appear right on the PHOTOFACT Standard Notation schematic. Waveform correct?—then: Check for open R6, or R79 or for faulty components in the output plate circuit. The DC resistance of the vertical output transformer and the lead colors are also shown right on the schematic.

Waveform incorrect?—then: Check voltages at the pins of the multivibrator tube. They're right on the exclusive Standard Notation schematic.

Whatever the trouble, you'll locate it faster and easier with a PHOTOFACT Folder by your side. Be sure to use the complete Replacement Parts List to select the proper replacement for the repair.

Use the servicing method you prefer—checking of waveform, voltage or resistance—you'll find all the information you need at your finger-tips in PHOTOFACT.  
For only \*2½¢ per model, PHOTOFACT helps you solve your service problems in just minutes—helps you service more sets and earn more daily!

\*Based on the average number of models covered in a single set of PHOTOFACT Folders.



**MONEY BACK  
GUARANTEE!**

Got a tough repair? Try this—at Howard W. Sams' own risk: see your Parts Distributor and buy the proper PHOTOFACT Folder Set covering the receiver. Then use it on the actual repair. If PHOTOFACT doesn't save you time, doesn't make the job easier and more profitable for you, Howard W. Sams wants you to return the complete Folder Set direct to him and he'll refund your purchase price promptly. **GET THE PROOF FOR YOURSELF—TRY PHOTOFACT NOW!**

**FREE**



**FOR SERVICE  
TECHNICIANS ONLY**

Fill out and mail coupon today for Free subscription to the Sams Photofact Index — your up-to-date guide to virtually any receiver model ever to come into your shop. Send coupon now.

**HOWARD W. SAMS & CO., INC.**

Howard W. Sams & Co., Inc.  
2201 E. 46th St. Indianapolis 5, Ind.

Put me on your mailing list to receive the Sams Photofact Index and Supplements. My (letterhead) (business card) is attached.

I'm a Service Technician:  full time;  part time

My Distributor is: \_\_\_\_\_

Shop Name \_\_\_\_\_

Attn: \_\_\_\_\_

Address: \_\_\_\_\_

City \_\_\_\_\_ Zone \_\_\_\_\_ State \_\_\_\_\_

# the newest in remote tuning

**latest design and service data for radio-controlled tv's** by Thomas A. Lesh

## Westinghouse "Picture Pilot"

Now that cables, flashlights, supersonic gongs, and tiny radio transmitters have all been put to use as TV remote-control devices, it might seem as if every practical method of across-the-

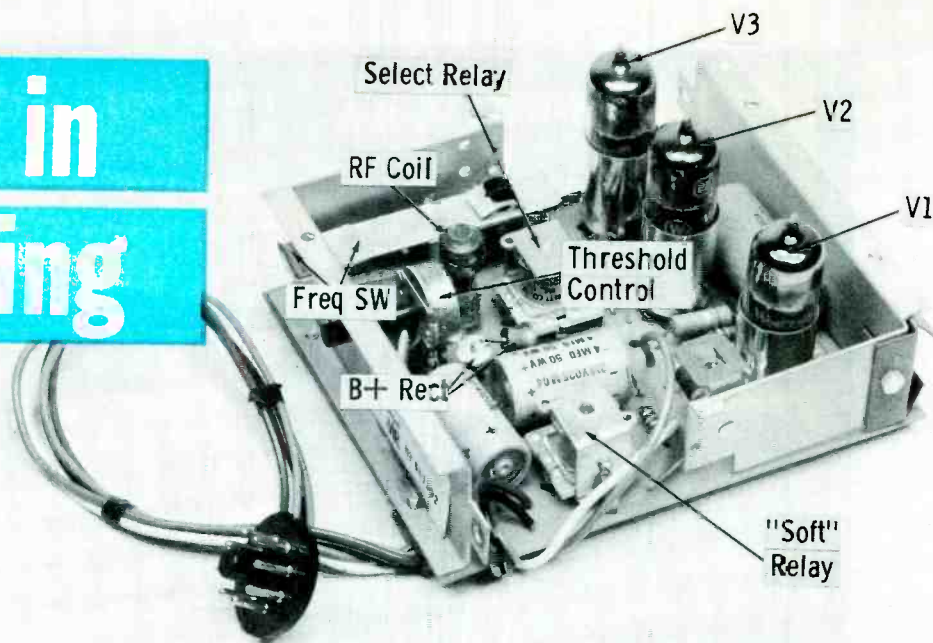

Fig. 1. A remote control receiver from a Westinghouse TV set.

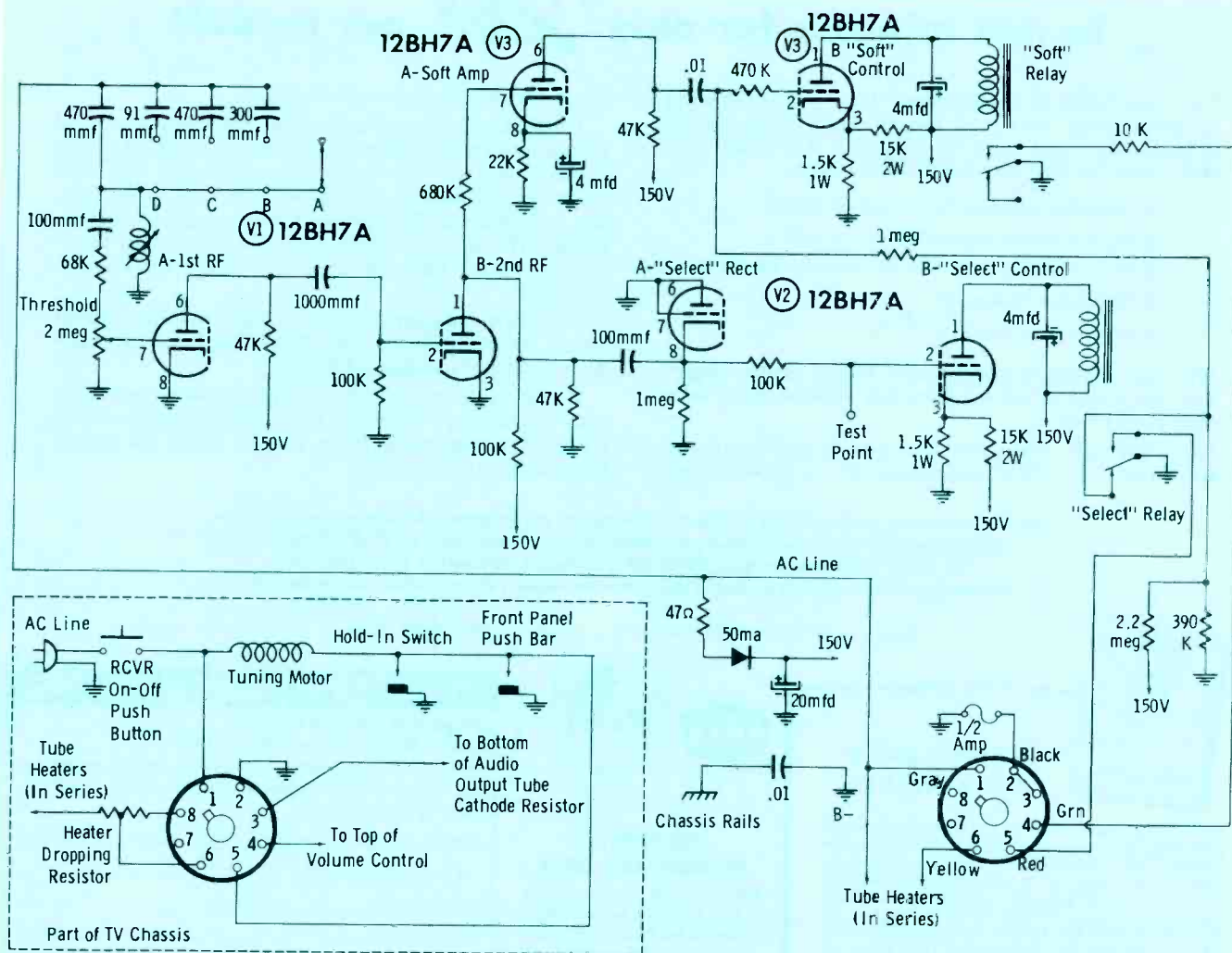
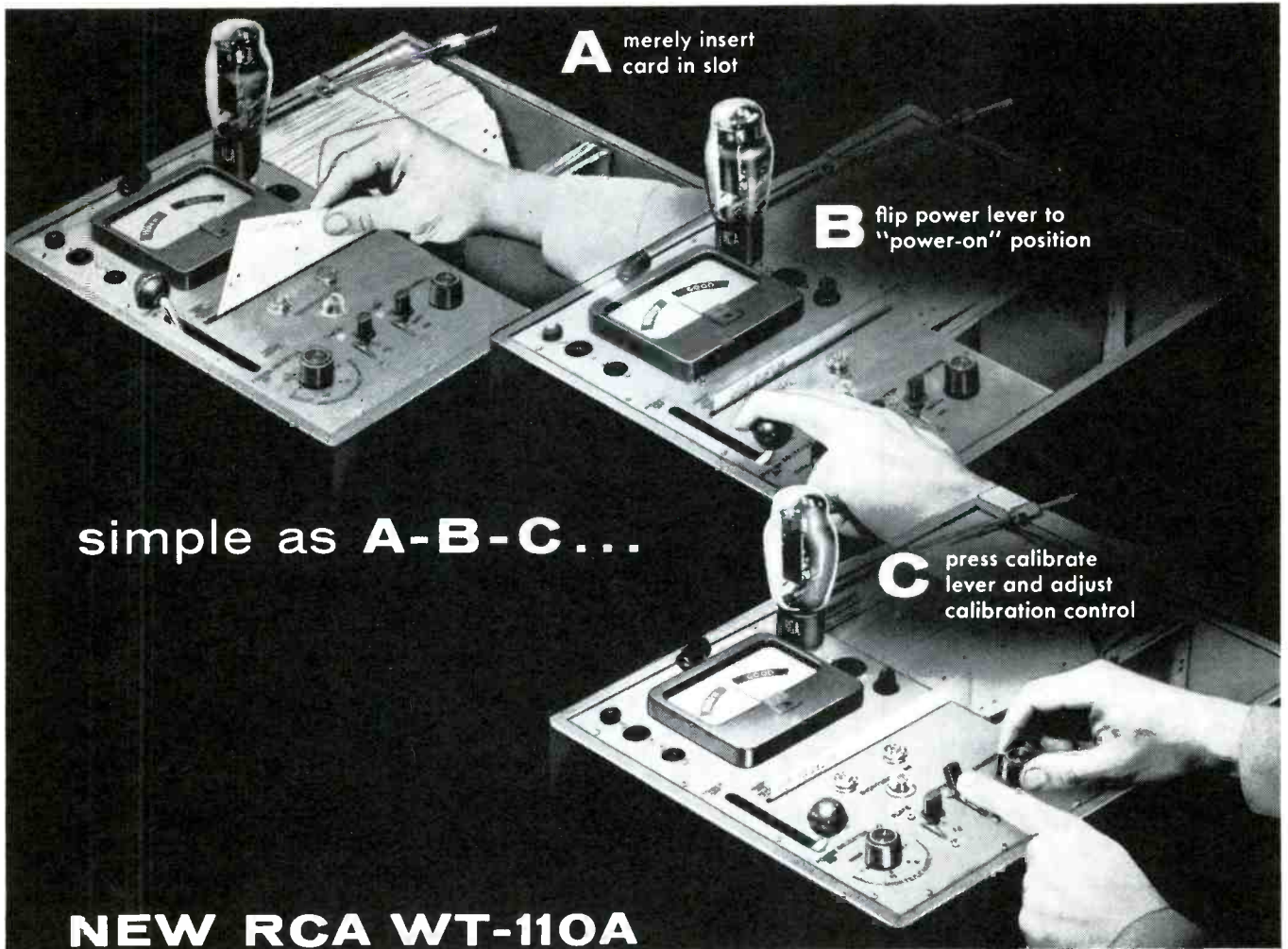

Fig. 2. Schematic of Westinghouse "Picture Pilot" receiver for remote control of channel selection and sound quieting.





**A** merely insert card in slot

**B** flip power lever to "power-on" position

**C** press calibrate lever and adjust calibration control

simple as **A-B-C...**

# NEW RCA WT-110A AUTOMATIC TUBE-TESTER

means more service profits!

Dollar for dollar, feature for feature, you'll find RCA's WT-110A the fastest, most accurate automatic punched-card tester you can buy today. It's a virtually *obsolescence-proof design* . . . from the exclusive RCA 700-card capacity magazine file that always keeps the pre-punched cards in type number sequence, to the fully automatic circuit setup (including *all* operating voltages) and the easy, do-it-yourself punch card accessories available to keep the tube-card file up-to-date!

See and test the WT-110A at your local RCA Distributor. Prove to yourself what a boost in business, prestige, profits the RCA-WT-110A can mean!



**TEST EQUIPMENT  
RADIO CORPORATION OF AMERICA**  
Electron Tube Division, Harrison, N. J.

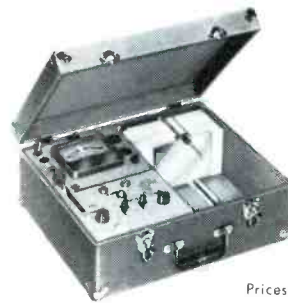

All this for  
**\$199.50**

USER PRICE (Optional)  
Prices higher in Hawaii and Alaska

- automatically sets up socket connections, and all operating voltages such as heater, signal, plate and screen voltages, and bias (both fixed and cathode).
- checks tubes for transconductance, gas, shorts, and leakage between elements.
- automatically selects correct conditions from 220 possible combinations of heater voltage (from 0.1 volt to 120 volts) at currents up to 4 amps., 10 bias voltages and 11 values of cathode resistors.
- tubes, such as rectifiers, tested under heavy load currents up to 140 ma per plate.
- high-and-low sensitivity ranges for leakage tests.
- 12-volt plate and screen supply for testing new auto-radio tubes.
- meter protected against burnout.
- test card provided for checking instrument.
- 239 pre-punched cards supplied with instrument cover 95% of currently active TV tubes. Pre-punched accessory cards available.
- active card magazine capacity—350; storage capacity—350...a total capacity of 700 cards.

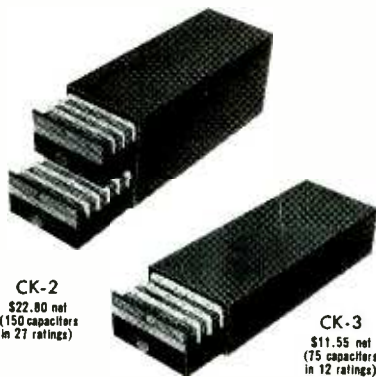

CK-2  
\$22.80 net  
(150 capacitors  
in 27 ratings)

CK-3  
\$11.55 net  
(75 capacitors  
in 12 ratings)

## SPRAGUE CERAMIKITS\* help speed TV-Radio servicing

Sprague CERAMIKITS contain *all* the popular ceramic capacitor ratings . . . neatly stored and indexed in sturdy steel cabinets . . . ready to use. There's no fumbling or confusion . . . the ceramic capacitors you need most are at your finger tips. Pay only for the capacitors . . . *get the cabinets free.* • Be sure to see the Sprague CERAMIKITS at your distributor, or write for Data Sheet M-711, Sprague Products Company, 105 Marshall St., North Adams, Mass.

\*Trademark

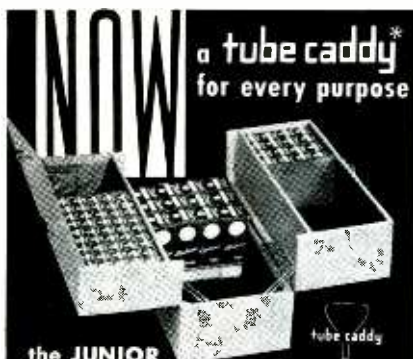

a tube caddy\*  
for every purpose

the JUNIOR  
\$10.50 Dir. Net. Ideal for quick trips. 15¼ x 12½ x 8 in. Model TC-2A

the CARRY-ALL \$15.95 Dir. Net. Takes tubes, tools, meter. 21 x 15 x 8 in. Model TC-4

NEW SUPER \$21.95 Dir. Net. Holds ½ more. Separate tool tray. 24 x 16½ x 8½ in. Model TC-5

\*Reg. TM of Argos Products Co., originators and leading manufacturers of tube cases for the electronic technician.

**Argos**  
PRODUCTS COMPANY

310 MAIN STREET • GENOA, ILLINOIS

*Craftsmanship in Cabinets*

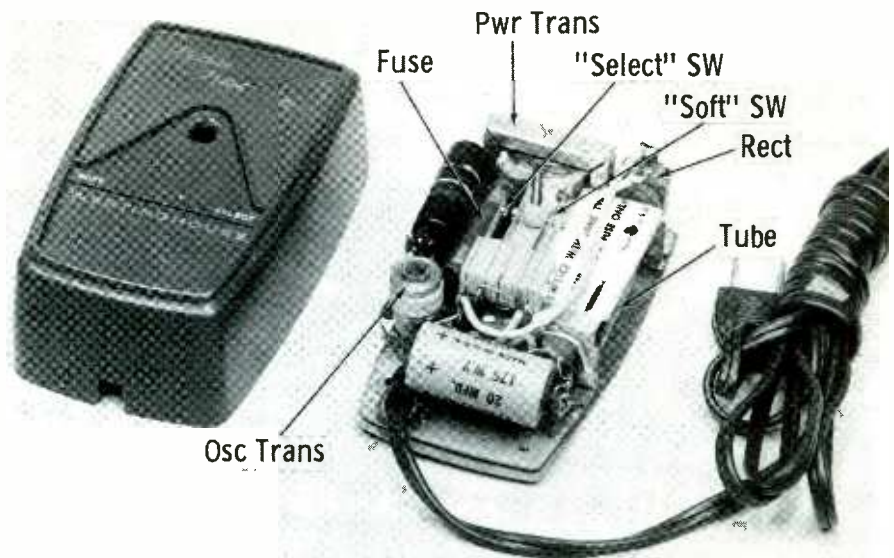

Fig. 3. "Picture Pilot" transmitter plugs into AC power outlet.

room tuning has already been utilized; but manufacturers continue to come out with new systems based on different operating principles. Newest in the parade is the Westinghouse Model H-988 "Picture Pilot," which employs carrier-current operation, or transmission of RF signals over the AC power line.

The device consists of a hand-held transmitter with 7' line cord, plus a control receiver which can be plugged into any 1958 Westinghouse TV set equipped with motorized tuning. A switch on the transmitter has two operating

positions—"Select" for changing channels and "Soft" for reducing audio volume. The RF oscillator in the transmitter generates a CW signal in "Select" or a signal modulated at 60 cps in "Soft." Power output of the transmitter is approximately 12 mw for CW (less during modulation) and is sufficient to control a TV receiver plugged into the same AC power circuit as the transmitter. The control unit is tuned to 73.5 kc as shipped from the factory, but it can be adjusted to any one of three other frequencies to permit interference-free operation of up

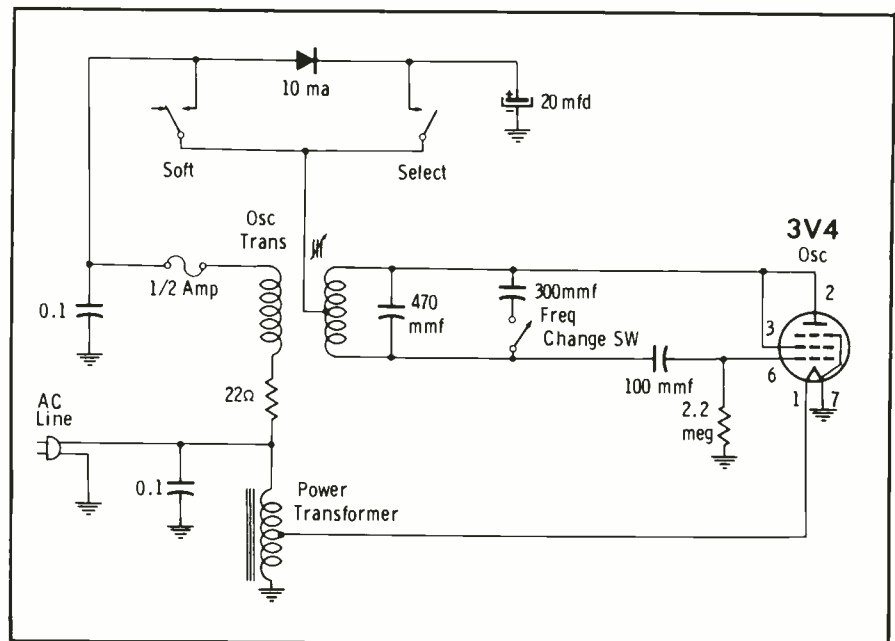

Fig. 4. Schematic of "Picture Pilot" transmitter circuit.



to four different sets on the same line, each controlled by a separate transmitter.

#### Receiver Circuits

The H-988 receiver (Fig. 1) is located just inside the back cover of the TV set, next to the tuner, and it can be removed for servicing by taking out one screw and disconnecting a cable. For operation of the TV set without the control receiver, a dummy octal plug having jumpers from pins 1 to 8 and 2 to 3 must be inserted in the remote socket in place of the control receiver cable.

A schematic of the "Picture Pilot" receiver is shown in Fig. 2. One side of the AC line (pin 1 of plug) goes to a selenium or silicon rectifier that supplies 150 volts DC to the B+ bus of the control receiver, and this same lead is also connected to the input of RF amplifier V1A. A four-position switch in this circuit is used for frequency adjustments. In the A position (shown), a single 470-mmf capacitor is used to tune the RF grid circuit to 73.5 kc; but, in the B, C, and D positions, various capacitors are placed in parallel with the 470-mmf unit to change the resonance of the input circuit to 57.5, 52.5, and 67.5 kc, respectively. The coil in series with this bank of capacitors is adjustable to permit accurate alignment of the RF circuit. A "threshold" control is included so that input signal level of V1A can be regulated. Two stages of RF amplification are provided by V1, a 12BH7A dual triode.

Two other 12BH7A's, V2 and V3, are control tubes for the two relays that perform the channel-changing and sound-muting functions. In each case, the relay is in the plate circuit of the tube's B section, which operates near cut-off under no-signal conditions. An input signal produces a positive swing in grid voltage, thereby increasing plate current through the tube and energizing a relay.

The diode-connected A section of the "Select" control tube (V2) rectifies incoming RF signals and develops a positive voltage in proportion to signal strength. During CW reception, the resulting positive shift of voltage at the grid of V2B is sufficient to operate the

November, 1957 • PF REPORTER

# PHAOSTRON

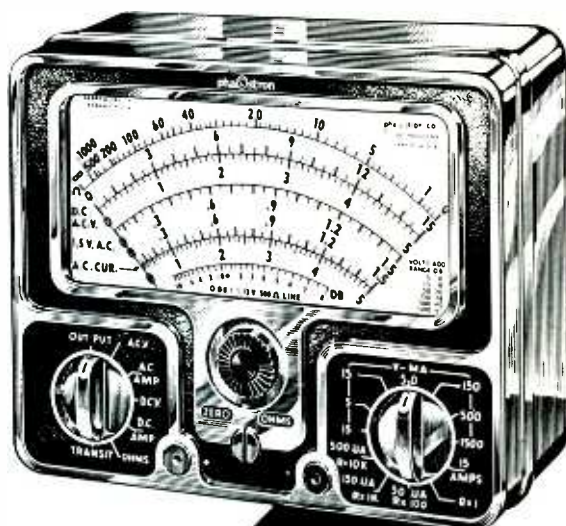

Here Is The Best Value Ever Offered In An Electrical Measuring Instrument...

#### METER PROTECTION

The meter movement is protected up to 1000 times overload by rectifier network.

**"555A"**  
A.C.-D.C. V.O.M.

**ONLY THE PHAOSTRON "555A" V.O.M. (VOLT OHM MILLIAMMETER) MEASURES A. C. and D. C. CURRENT AND VOLTAGE AS WELL AS RESISTANCE AND HAS ALL THESE FEATURES:**

- Unbreakable Metal Case of Highly Polished Chrome
- Separate Range and Function Switches
- Anti Magnetic Shielding
- Easy-to-Read, Large 4-Color Scales
- 43 Unduplicated Ranges
- Only 2 jacks
- 3% D. C. ... 4% A. C. Permanent Accuracy

#### Other Fine Phaostron Products

**MODEL "777"**—Vacuum Tube Voltmeter... 42 unduplicated ranges with permanent accuracy—3% D.C., 5% A.C.

**CUSTOM PANEL INSTRUMENTS**—2½", 3½", 4½", 6"... all shielded by their metal cases from stray magnetic fields. 2½" and 3½" models available in round or square face.

**PORTABLE LABORATORY INSTRUMENT**...with double probe outlets and full overload protection.

**RUGGEDIZED AND SEALED PANEL INSTRUMENTS**...available in 1½" (Square Bezel) and 2½", 3½", 4½" Round Bezel models in AC, DC or Null Indicators.

#### ACCESSORIES AVAILABLE

Genuine Leather Carrying Case \$7.95  
Panel Mounting Adapter \$1.50

#### NEW LOW PRICE

Not \$49.50, but priced lower than ever before. Complete with probes and batteries. (Replaces former model 555)

NOW ONLY

**\$44<sup>95</sup>**

Write today for full details or ask your dealer

**PHAOSTRON INSTRUMENT AND ELECTRONIC COMPANY**  
151 Pasadena Avenue, South Pasadena, California

# It's no trick to save time replacing dual controls



## with Centralab Fastatch® FR-22A Control Kit

Why waste time with special trips to jobbers every time you need a dual-concentric, when — at a fraction of the cost — you can stock a complete line within arm's reach?

The handy Fastatch® FR-22A kit puts 570 dual-control variations at your fingertips — gives you the replacement you need for 85% of your TV, radio, and auto-set service calls . . . and all this for only \$28.51!

Make it a point to pick up a Fastatch® FR22A dual-control kit at your Centralab distributor the next time you need supplies.



Each Fastatch® FR-22A kit contains 22 control units, 4 Fastatch® switches, and 2 auto-adaptor bushings that you can combine to get 570 of the most popular dual controls. Each control is factory-assembled, tested, and guaranteed by Centralab.



# Centralab

A DIVISION OF GLOBE-UNION INC.  
942K EAST KEEFE AVENUE • MILWAUKEE 1, WISCONSIN  
IN CANADA: 804 MT. PLEASANT ROAD • TORONTO, ONTARIO

"Select" relay. The modulated "Soft" signal produces a lower average amplitude of rectified signal, which does not increase V2B plate current enough to energize the relay.

Contacts on the "Select" relay are wired in parallel with the control switches of the tuning motor in the TV set, and closure of these contacts causes the motor to rotate the TV tuner to the next active channel. Incidentally, motor operation is governed by a programming wheel, accessible from the rear of the TV set. A group of three-position switches on this wheel are used to set up individual channels for bypassing or for fringe- or local-area reception.

Westinghouse sets with motorized tuners also feature an automatic fine tuning circuit (basically a type of AFC), in which a control voltage is developed at the video detector and fed back to the local oscillator. This AFT system will be described in detail in a future issue.

When the modulated "Soft" signal is applied to the control receiver, V1B acts as a grid-leak detector and recovers the 60-cps modulation of the RF carrier. The resulting signal is amplified by V3A and fed to the grid of the control tube V3B, making the average grid voltage more positive. Plate current then increases and the "Soft" relay operates, shunting a 10K-ohm resistor across the volume control of the TV set, thus reducing the audio output. Sound may remain faintly audible, or it may be cut off entirely, depending upon the volume control setting.

The 1-megohm grid leak resis-

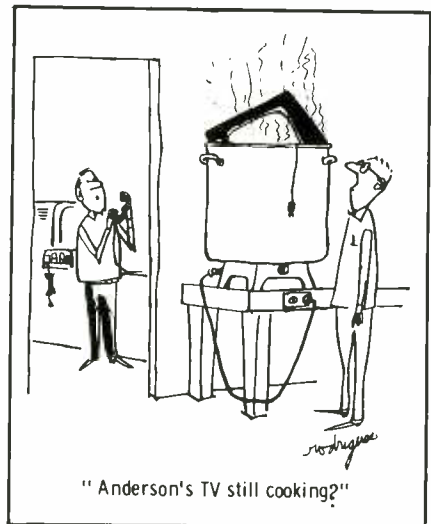

"Anderson's TV still cooking?"



tor of V3B is returned to ground through an extra contact on the "Select" relay. Whenever this relay is energized, the resistor is ungrounded and connected through a 1-meg resistor to the midpoint of a voltage divider across B+. A positive voltage then appears on the grid of V3B, energizing the "Soft" relay to prevent bursts of sound that might occur while the receiver is being tuned.

When the control receiver is plugged into the TV set, its three tube heaters are added to the series string in the set. At the same time, a portion of the dropping resistor is cut out of the TV heater circuit so that additional voltage will be available for the extra tubes.

#### Transmitter Circuit

The transmitter (Figs. 3 and 4) contains a 3V4 tube wired in a Hartley oscillator circuit. Note the frequency-change switch in the tuned circuit, which serves as a coarse frequency adjustment. On either of the two highest operating frequencies (A and D), the switch is open. If it is desired to set up the unit for operation on one of the lower frequencies (B or C), the switch is closed and the 470-mmf tuning capacitor is shunted by 300 mmf. Fine adjustment of frequency is made by tuning the slug in the oscillator transformer.

The function switch keys the transmitter by applying plate voltage to the oscillator. In the "Select" position, line voltage is rectified and then applied to the tube, and CW oscillation is produced. But, in the "Soft" position, AC line voltage is applied directly to the oscillator plate; providing 60-cycle modulation of the RF signal. Since the "power transformer" is included in the oscillator circuit, RF energy is coupled into the power line and will reach a control receiver on the same power circuit.

#### Service Notes

A test point, located on the receiver chassis alongside the "Select" relay, is directly connected to the grid of V2B. For alignment of the transmitter, the switch can be held in "Select" and the test-point voltage monitored with a VTVM while the slug in the oscil-

November, 1957 • PF REPORTER

**It's a sure thing  
...the odds are 4 to 1  
in your favor!**



**Put your  
money on  
Wirewounds...  
out of  
Centralab**

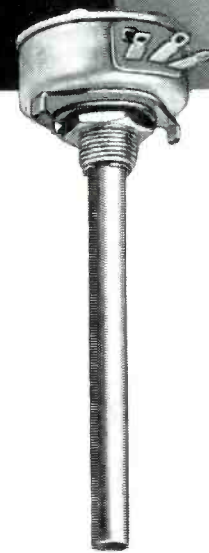

Stable mates in Centralab's long line of champions—Model WW and WN Wirewounds pack a 5-watt control into a 2-watt size, in short- or long-shaft styles. Now, one size takes care of 2-, 3-, 4-, and 5-watt replacements in TV, hi-fi, home and auto radio sets.

Every Centralab Wirewound is a real thoroughbred — and gives you a winning ticket that cuts inventory, helps save time, helps you make more money.

Here's another sure thing — Centralab Wirewounds are favorites in the rich industrial handicap.

Ask your Centralab distributor about these versatile controls. Complete information on these and other top-quality Centralab components can be found in Centralab's new catalog 30.

**Centralab**

A DIVISION OF GLOBE-UNION INC.  
942K EAST KEEFE AVENUE • MILWAUKEE 1, WISCONSIN

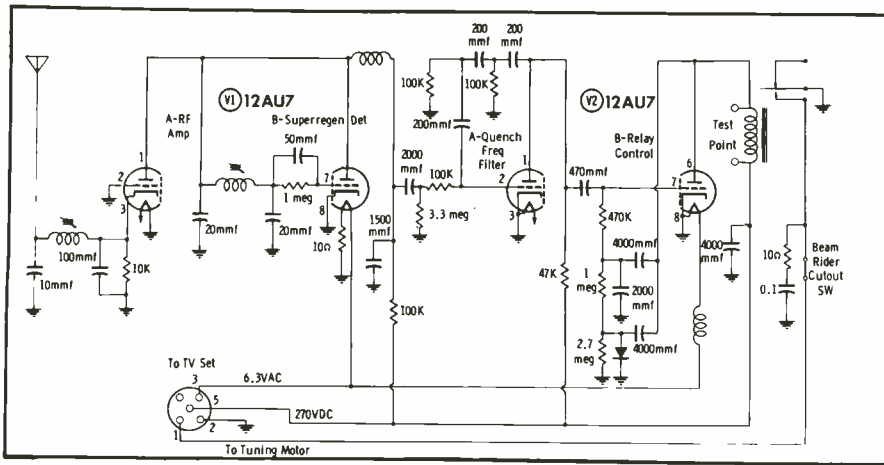

Fig. 5. Schematic diagram of Hoffman "BeamRider" receiver.

**ALL OVER THE U.S.**  
*utah* STANDS for  
**UNSURPASSED SERVICE**

Yes...  
**ALL OVER THE U.S.**  
**UTAH STANDS for UNSURPASSED SERVICE**

Yes, all over the U. S.—Utah stands for Unsurpassed Service.

US—Utah and the Service Man—because Utah stands behind you—the Service Man.

Utah stands behind you—with a speaker name that for over 30 years has signified the finest in quality, design, engineering and production.

Utah stands behind you with a speaker that gives installation performance. You can sell customer satisfaction with a Utah—because Utah gives performance satisfaction.

Utah stands behind you—with a secure source of supply. Leading jobbers all over the U. S. handle Utah—because Utah has the finest and widest line of replacement speakers available to the trade.

Utah your one complete speaker source auto • Rear Deck Kits • Standard Replacement • Television • Public Address • High Fidelity • Outdoor • Inter-Com • Wood & Metal Baffles

Utah is your one, complete satisfactory speaker source. When you order speakers today — **THINK**—then order Utah.

Get your **FREE** copy of the latest Utah Catalog S-157 listing over 100 replacement speakers. Available at your distributors or write direct.

**utah** RADIO PRODUCTS CORPORATION  
 HUNTINGTON • INDIANA

Export Dept. Fidevox International, Chicago, Illinois

lator transformer is adjusted for a peak reading. The voltage at this same point also helps to indicate whether or not the RF stages of the receiver are functioning. Application of a "Select" signal to the receiver should cause an increase in the test-point voltage, and application of a "Soft" signal should produce a similar (but smaller) shift in voltage.

Waveform checks will yield some information when the signal is being lost or severely distorted in the receiver, but some 60-cps sawtooth-shaped distortion should be anticipated because a slight sawtooth voltage is normally present on the B+ line. This exists because the B+ filter capacitor is rather low in value (20 mfd).

Readjustment of the threshold control may be necessary to compensate for conditions such as tube aging. If the setting is too low, the input signal will be weak and the "Select" relay will fail to operate; on the other hand, an excessively high setting will permit the "Soft" signal to reach V2 in sufficient amplitude that undesired operation of the "Select" relay will occur. If either one of the relays will not operate, and the trouble cannot be cleared up by adjustment of the threshold control, the relay control tube and its B+ supply should be checked.

#### Hoffman "BeamRider"

A wireless remote control, the Model RP409 "BeamRider," is available for use with recent







Fig. 6. Hoffman remote control receiver (with cover removed).

model Hoffman TV sets having "Dyna-Touch" automatic tuning. The system consists of a hand-held transmitter that emits a CW radio signal, and a control receiver which picks up this signal and activates a tuning-motor relay.

The receiver, a two-tube unit designed to hang on the back cover of the TV set, obtains B+ and heater power from the TV set through a plug. (See Figs. 5 and 6.) A whip antenna picks up the transmitted signal and applies it to the cathode of a grounded-grid RF stage, V1A. Output of this tube section is fed to V1B, a superrenerative detector.

When no transmitted signal is present, the V1B circuit oscillates because of regenerative feedback from plate to grid, producing a noise signal at its output. Oscillation is not continuous, however, since such a circuit is characteristically designed to break in and out of oscillation at a definite rate called the "quench frequency" in order to increase its sensitivity.

V2A filters out the "quench frequency" and amplifies the noise signal, feeding it to the relay control tube V2B. A selenium diode in the grid circuit of V2B rectifies the signal by shorting positive peaks to ground. A negative bias voltage is thereby developed on the grid of V2B, keeping it near cutoff and the relay in its plate circuit deenergized.

When a signal is received, the output of V1A loads the detector and reduces its noise output. Since the noise voltage arriving at the rectifier diode becomes progressively lower in amplitude as RF signal strength increases, the bias on V2B is decreased. Plate current of the tube soon becomes heavy enough to energize the relay which completes the tuning motor circuit.



**"MEET MY NEW PARTNER!"**  
**NEW WEBSTER V-8 PLUG-IN CERAMIC"**

We'll be going out on a lot of jobs together—this new V-8 cartridge and me. And the kind of performance it gives . . . well, I'll be a hero to my customers. Folks like the V-8 because it makes their phonos sound better than new . . . gets the most out of the new hi-fi records. You'll like 'em because they're so easy to install . . . fit right into the brackets now used in VM and Webcor changers. And with the bracket available, you can modernize all obsolete 3- and 4-speed changers.

New V-8 ceramic cartridge and needle combination is available in three basic models—square cartridge, with or without turn-under bracket, and round cartridge without bracket. All three models are available with two sapphire needles or 1-mil diamond and 3-mil sapphire needles. Cartridge is installed as a unit when needles are replaced.

Why don't you buddy-up to this new Webster V-8? You can go places together!

**STOCK WISELY...STOCK WEBSTER!**



New V-8 plug-in cartridges

ELECTRONICS DIVISION  
**WEBSTER ELECTRIC**  
RACINE · WIS

**XCELITE Hand Tools**  
PREFERRED BY THE EXPERTS

## HANDY POCKET NUTDRIVERS

FOR EASY ACCESS  
TO YOUR

# MINIATURE CHASSIS!



With the increasing trend toward miniaturization, we at XCELITE realized that smaller precision tools would be welcomed for servicing those tricky jobs involving printed circuits, transistors and other miniature and sub-miniature parts. So... we were ready for you with our line of compact, convenient XCELITE Pocket Nutdrivers with the handy pocket clip. XCELITE Pocket Nutdrivers are available in the four most-needed sizes: 1/8", 1/4", 3/16" and 3/8" Hex.

You'll want to keep all four of these "just-right-hex-sized" XCELITE Pocket Nutdrivers clipped in your shirt pocket.

They're ideal to reach those "hard-to-get-at" places in the new miniature sets.

Fact is, XCELITE Pocket Nutdrivers are just like all the other quality hand tools in the line — XCELITE screwdrivers, pliers, reamers, adjustable wrenches, kits — all the other items precision made especially for professional radio, TV and electronics servicemen. Remember, XCELITE always brings you the *finest tools first!*

Call or see your dealer today... order all four of these handy XCELITE Pocket Nutdrivers. And, while you're at it, check your needs and order all the XCELITE Tools that will help you do your job better, easier, more profitably!

### XCELITE, INCORPORATED

Dept. Q, Orchard Park, N. Y.

In Canada: Charles W. Pointon, Ltd.,  
6 Alcina Ave., Toronto, Ont.

For Originality  
LOOK TO XCELITE

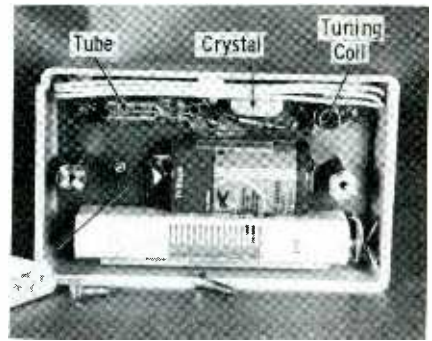

Fig. 7. Hoffman remote transmitter.

The "BeamRider" transmitter (Figs. 7 and 8), which features a crystal-controlled oscillator using a subminiature 1A4 tube, is powered by a 1½-volt "A" battery and a 45-volt "B" battery. The output signal is radiated from a loop antenna connected in the oscillator plate tank circuit. A tunable coil in series with this loop allows adjustment of the transmitter to the correct frequency, 27.12 mc. (Units marked "Code 2" employ 26.25 mc instead.) The transmitter is keyed by pressing a button that completes the 1A4 filament circuit.

#### Service Information

Since the "BeamRider" operates by low-power RF radiation, several measures can be taken to increase the signal actually arriving at the control receiver and therefore the effective range of the unit. Here are a few suggestions:

1. Disconnect the built-in antenna of the TV set.
2. Shift the position of the control receiver to a different spot on the back cover of the TV set.
3. Be sure the transmitter is pointed directly at the TV set while being keyed.

SAVE  
with  
SECURITY

Because Wright Wire Strand comes to you pre-measured and uncoils without snarling, it gives to you unique economy. Quality wire, perfectly stranded and heavily galvanized, the bright Wright way. SAVE with Wright.



Prompt deliveries from stocks in Worcester, Chicago, Atlanta, New Orleans, Houston, Dallas and Los Angeles.

**G. F. WRIGHT STEEL & WIRE CO.**  
249 Stafford St. • Worcester, Mass.





4. Keep the control receiver away from large metal objects and other electronic equipment.

Alignment of the oscillator plate circuit may improve transmitter operation. The slug-tuned coil is adjusted for minimum "B" battery drain (about 3.5 to 4 ma), and then the slug is backed off about  $\frac{1}{8}$  turn counterclockwise. The final adjustment should be checked to make sure that hand capacitance does not kill the oscillations.

A pair of test leads are brought out to the top of the receiver chassis to provide a convenient place for checking the voltage across the relay. This should be about 3 to 5 volts until the relay is energized, and then it should increase to more than 20 volts.

The voltage across these leads is also measured during receiver alignment. While the transmitter is being keyed, the slugs in the RF and detector coils are adjusted for a maximum voltage reading.

In case the tuning motor operates without being keyed by the transmitter, try disconnecting or shortening the receiver antenna. If the motor keeps running, check for trouble within the receiver—for example, diode failure or a loss of oscillation in the super-regenerative detector. However, motor stoppage indicates that the spurious operation of the relay is probably being caused by stray RF signals from sources other than the transmitter. ▲

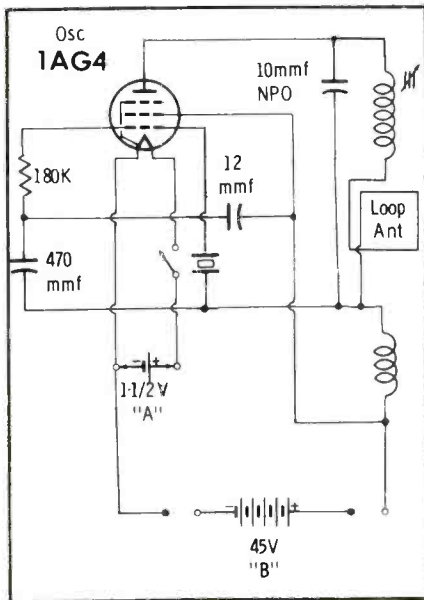

Fig. 8. "BeamRider" transmitter is keyed by closing tube filament circuit.

# Simpson

announces

## NEW

### HANDISCOPE

model 466

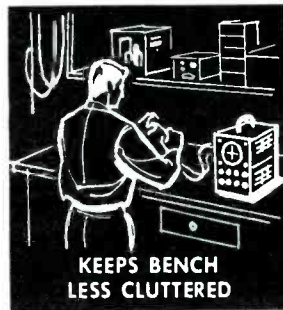

perfect for:

- Hi-Fi troubleshooting
- Industrial maintenance
- Production line tests
- Communications equipment checks
- AM & FM radio servicing
- Useful for black and white TV, too

**MEASURES ONLY 8" x 12 1/4" x 16 1/2"**—Use this rugged little instrument for the 101 jobs where a big specialized scope isn't needed. It brings you quality features such as a filter type graticule, universal-fit bezel, and 5" screen, yet is economically priced. And like other Simpson test equipment, Model 466 is built to give you years of hard service.

**Frequency Response of Vertical Amplifier:** From 15 cycles/sec to 100 Kc/sec, flat within  $\pm 1$  db; 6 db down at 250 Kc/sec; useable to 1 Mc/sec.

**Maximum Vertical Deflection Sensitivity:** 30 Millivolts RMS/inch.

**Frequency Response of Horizontal Amplifier:** From 15 cycles/sec to 20 Kc/sec, flat within  $\pm 1$  db; 6 db down at 100 Kc/sec.

**Maximum Horizontal Deflection Sensitivity:** 0.7 volt RMS/inch.

**Z-Axis Sensitivity (Voltage Required to Extinguish Beam):** 20 volts RMS.

**Calibrating Voltage (at 117.5 VAC power source):** 1 volt P-P  $\pm 10\%$ .

**Maximum Input Voltage:** 400 volts peak.

**Input Resistance:** 0.1 Meg (at atten. x 1); 0.5 Meg (at atten. x 100).

**Input Capacitance:** 40 uuf (at atten. x 1); 35 uuf (at atten. x 100).

**Sawtooth Sweep Range:** 15 cycles/sec to 80 Kc/sec.

**Power Consumption (at 117.5 volts AC):** 50 watts.

Model 466 with Lead, Operator's Manual.....

**\$144<sup>95</sup>**

See your Electronic Distributor, or write

**SIMPSON ELECTRIC COMPANY**

5200 W. Kinzie Street • Chicago 44, Illinois • Phone: EStebrook 9-1121

In Canada: Bach-Simpson Ltd., London, Ontario



**WORLD'S LARGEST MANUFACTURER OF ELECTRONIC TEST EQUIPMENT**

# inside TV tuners

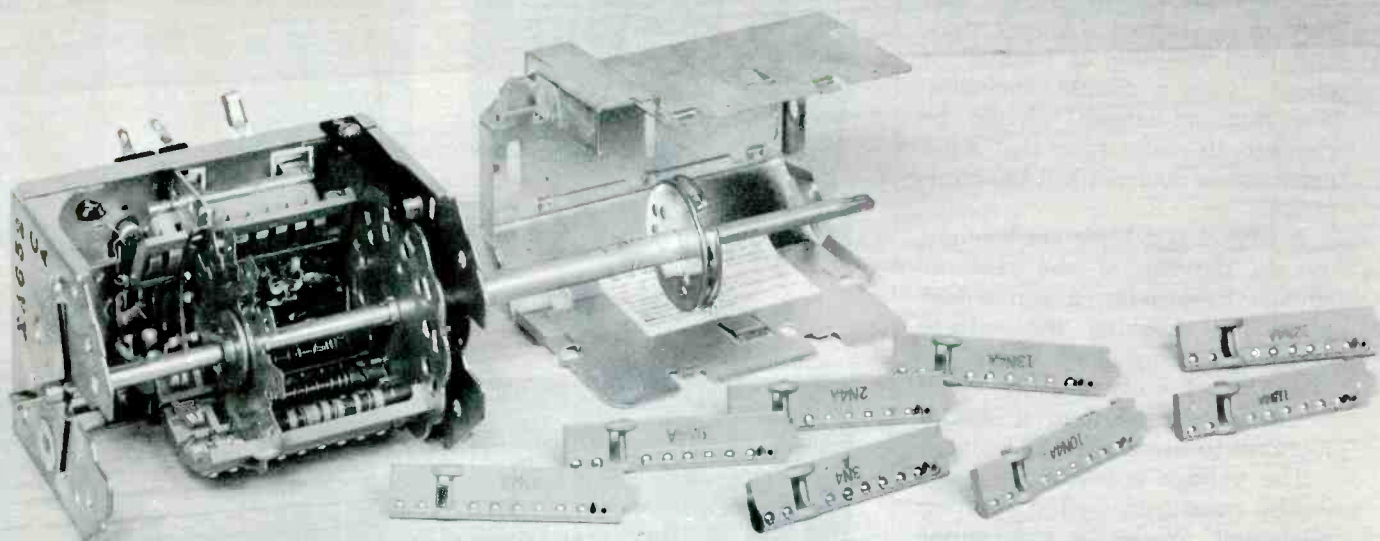

## part 4 Aligning VHF Front Ends

by Calvin C. Young, Jr.

First of all, let's set the record straight: tuner alignment isn't impossible for the average service shop . . . nor is it often required. The fact that some manufacturers fail to include tuner alignment data in their service literature is an indication of its infrequent necessity, rather than an attempt to make the job of alignment more difficult. It is the purpose of this article to show you how to determine when alignment is required, what test equipment is needed, and how to perform the alignment.

Does the tuner really need alignment? This is a question which can't always be answered just by looking at the picture on the screen. However, an understanding of the following symp-

toms can be very valuable. One symptom that is almost always an indication of the need for tuner alignment is the lack of sound when the picture is tuned in. Other symptoms, such as interference in the picture, and loss of picture detail, are symptomatic of troubles which may or may not be the result of tuner misalignment.

Once you have decided that the symptoms could be caused by tuner malfunction, what do you do? Why, you simply use a process of elimination to determine whether the tuner or something else is the source of the trouble. Naturally, you make the checks that require the least work; and, in most cases, the tuner is easiest

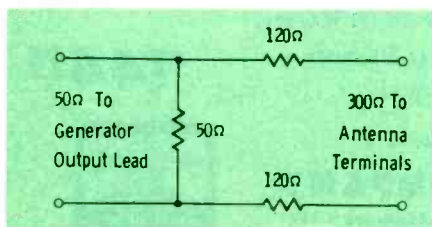

Fig. 1. Resistive network used to match impedances between sweep generator and antenna.

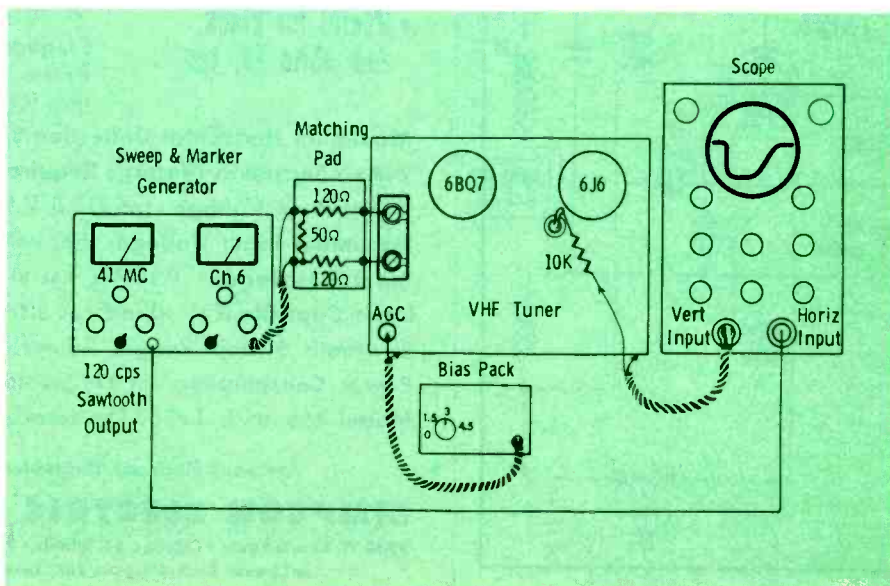

Fig. 2. Tuner alignment test setup.



to check. But before we can go into the actual checking of tuner alignment, let's discuss test equipment requirements.

### Major Equipment

The major items of equipment required are the sweep signal generator, marker generator, oscilloscope and VTVM. The sweep generator must be able to produce a .1 volt (100,000 microvolts) swept signal output 10 mc wide for each TV channel frequency between 54 and 216 mc. It goes without saying that the signal output must be flat over the swept range being used, since a non-linear output (peaked or dipped) will provide erroneous indications and cause you to misalign the tuner (attempting to obtain a flat response curve in spite of generator non-linearity).

The marker generator (which may either be an integral part of the sweep generator or a separate unit) must provide a reasonably strong marker signal at any frequency between 54 and 216 mc. Some generators have a built-in crystal oscillator for calibration purposes—a most desirable feature. Find out how this feature works and use it. If you have no way of calibrating your marker generator (and you should have), you'll just have to assume that it is calibrated correctly.

The oscilloscope doesn't have to be a wide-band type such as might be used for viewing composite signals or color TV work; however, it should be reasonably sensitive—on the order of 25 millivolts RMS per inch of vertical deflection. If your service scope isn't sensitive enough, there are pre-amplifiers designed to amplify low-level signals before they are applied to the scope, thereby effectively increasing the oscilloscope's sensitivity.

Your standard service VTVM is suitable for all tuner alignment and service needs. The unit should, of course, be in good working order and properly calibrated.

### Miscellaneous Items

Now for the smaller items. A bias pack is always required, and it should have an output which is variable from 1.5 to 7.5 volts. A

7.5-volt "C" battery and a 500K potentiometer function very well in this application. A crystal-demodulator probe of the high-impedance variety is also a necessity in tuner alignment. In addition, a 50-ohm and a matched pair of 120-ohm carbon resistors should be used between the antenna terminals and the sweep output cable. Another standard resistor needed is a 10K, 1-watt unit for isolation between the scope and the mixer injection point (tuner test point in mixer grid circuit). One such matching unit (Fig. 1) could be assembled and mounted on a phenolic board. The 50-ohm resistor could be either a 50- or 51-ohm 1% precision carbon resistor and the two 120-ohm units can be selected from 10% composition units. The 120-ohm resistors should be matched in value at between 120 and 125 ohms; thus, when they are used in series with the 50-ohm resistor, the total resistance will be very near 300 ohms. If a number of 47 ohm composition resistors are available, a unit between 50 and 52 ohms could be selected, eliminating the need for a precision resistor. This affords the best impedance match, and therefore the maximum transfer of energy from the generator cable (usually 52 ohms) to the antenna input (300 ohms). Last but not least, you'll need an array of alignment tools, insulated so that the tool itself will not detune the circuit being adjusted.

### Checking Alignment

Checking tuner alignment is a most important step, because the results will be used to determine whether or not alignment will be required. It is at this stage that the technician must exercise all his skill if unnecessary waste of time and labor is to be avoided. Most important of all is the correct application of test equipment.

Test equipment is connected to the tuner as shown in Fig. 2. The bias level, scope-isolation resistor, and impedance-matching pad are in accordance with the instructions given in the service literature. After allowing about 15 minutes for the equipment to warm up, we can begin the alignment check. During the warm-up period, the tuner should be set

## AEROVOX CERAMIC CAPACITORS

You can be sure that Aerovox Ceramic Capacitors are exactly right for your service applications because of the extra-care taken in the manufacturing of these capacitors to provide you with trouble-free, exact-duplicate replacements. This extra-care assures your customers of stay-put installations saving you time and money on costly call-backs.

The Aerovox line of ceramic capacitors is the most complete on the market. A type for every application is available to you for prompt delivery from the complete stock selection carried by your local Aerovox Distributor.

**DISTRIBUTOR DIVISION**  
NEW BEDFORD, MASS.

In Canada: AEROVOX CANADA LTD., Hamilton, Ont.  
Export: Ad Autiero, Inc., 89 Broad St., New York, N. Y.  
Cable: Autiero, N. Y.

**SPOT  
INTERMITTENTS  
FAST!**



**\$89<sup>95</sup>**  
NET

**NEW**

**Wintronix  
INTERMITTENT  
CONDITION  
ANALYZER**

Makes any TV or Radio Super-Sensitive to Intermittents & Noisy Components . . .

**NO WAITING**



**NO "COOKING"**



**NO "FREEZING"**



Save valuable time and bench space when troubleshooting intermittents. Just connect output of Model 828 to Radio or TV receiver antenna terminals, and use exclusive "Electro-Wand" (for tubes) or "Electro-Probe" (for components) to quickly pinpoint intermittent or noisy tubes, capacitors, resistors, coils, transformers, defective connections, etc. No direct circuit connection needed.

Special Wintronix circuit immediately makes any receiver super-sensitive to intermittents. Lets you *hear* intermittents through built-in speaker. Reduces callbacks by detecting borderline components *before* they fail.

See the Wintronix Model 828 at your local parts distributor or write for free literature.

**WINSTON  
ELECTRONICS INC.**

4312 Main St., Phila. 27, Pa.

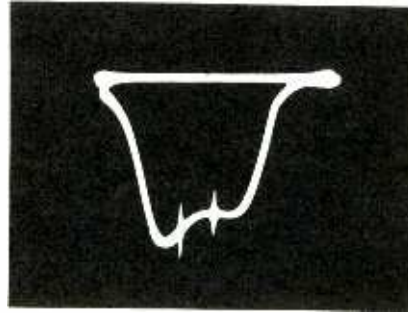

C h 4

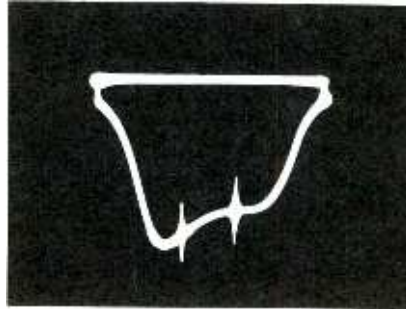

C h 6

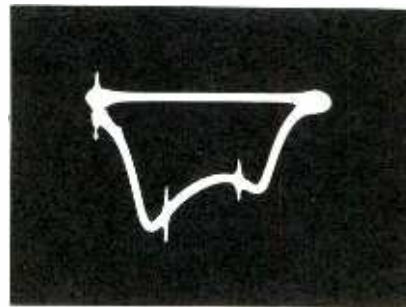

C h 8

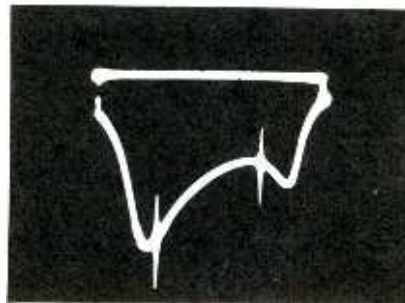

C h 13

**Fig. 3. Comparison of tuner bandpass curves before alignment.**

on channel 13 and the center-range frequency of the sweep generator adjusted for a channel 13 sweep frequency.

After the test equipment has warmed up and stabilized, the sweep frequency should be varied slightly to center the response curve on the scope screen; also, the phasing control on the sweep generator should be adjusted until the two curves coincide. If the sweep generator has a blanking

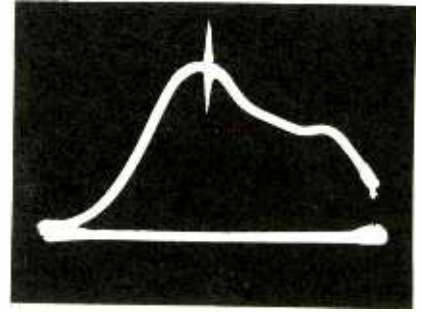

**Fig. 4. Response with sound marker at left.**

switch, it may then be used to eliminate the second curve. After calibration of the marker generator, its frequency should be tuned to, first, the picture, and then the sound carrier frequencies for that channel, while the respective marker locations on the response curve are noted. This process must be repeated for all channels received in the area. The curves may be similar to those in Fig. 3, and a comparison of the various responses will tell you if the tuner needs alignment. Since the curves are obtained at the mixer grid circuit, the effect of the mixer plate circuit is not included. However, since tuning of the mixer plate circuit is part of the IF alignment, we will not deal with it here.

There are a number of tuners with complex input circuits designed to reject FM and other interfering signals. In testing the alignment of these tuners, be sure to check these rejection features, following the procedure specified in the service data.

**Alignment Adjustments**

Realignment of the tuner requires the use of the same equipment setup employed during the alignment check. The first step is to set the selector switch on channel 13 and detune the local oscillator by turning the adjustment screw counterclockwise. This step is repeated for all channels re-

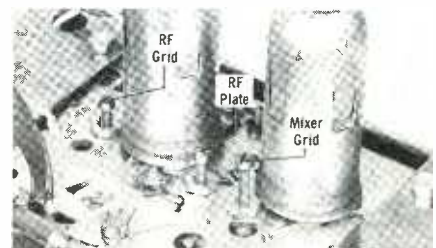

**Fig. 5. Top of turret tuner showing location of trimmer capacitors.**



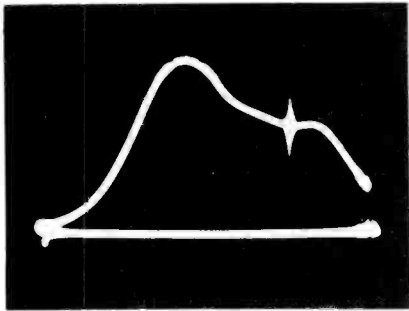

Fig. 6. Response with pix marker at right.

ceived in the area. With the selector back on channel 13, the sweep and marker generators are adjusted for a curve with sound marker positioned on the left side as shown in Fig. 4. The mixer grid and RF plate trimmers (Fig. 5) are then adjusted for maximum gain and symmetry. The selector switch is then set on the lowest channel received, and the sweep and marker generators adjusted for a scope curve with the picture marker on the right side (Fig. 6). The RF grid trimmer is tuned for maximum gain and symmetry in the curve. All in between channels are then checked for excessive tilt. The response on channel 13 must again be viewed since adjustment of the RF grid trimmer on the low band may adversely affect the alignment on channel 13.

Final touch-up adjustments are made by switching back and forth between high and low channels and rocking the trimmers until the tilt between channels is minimized. There is no short cut in this step, and it could take 15 or 20 minutes. The curves on channels 13, 8, 6 and 4 should be similar to those shown in Fig. 7.

The neutrode type turret tuner features an additional adjustment for neutralizing the triode RF amplifier. Instructions for making this adjustment vary for different make sets. Some manufacturers simply say that it is not critical and will not normally require adjustment, while others state that after the alignment has been completed, the neutralization capacitor should be adjusted for minimum response on the scope. The scope can either be connected to the mixer test point or to the 1st video IF grid; however, a demodulator probe must be used at the IF grid. Unless you are in a fringe area, or suspect the neutralization

**The Customer is Always Right!**

you'll find whatever they ask for in  
**RECOTON'S REFERENCE GUIDE!**  
that's why it's easier to sell

# RECOTON REPLACEMENT NEEDLES

*The World's Finest Phoneneedles*

**RECOTON CORPORATION**  
52-35 Barnett Ave., Long Island City 4, N. Y.

In Canada: Quality Records, Ltd., Toronto

Send no Money

## YOURS NOW— The Secrets of Profitable Servicing

Free Inspection

Want to make more money in servicing? Here's the secret in three words—**KNOW YOUR STUFF**—today, tomorrow, and the next day! How?—keep up with new methods and techniques. If you read and absorb the information in these two books, you'll be one of the leading service technicians in your neighborhood today—and hold that spot tomorrow!

**RAPID TV REPAIR** by G. Warren Heath shows you how to lick the toughest servicing problem in minutes! Just look up the symptoms in the index and read how to put your finger on the trouble as easy as ABC. Cut your troubleshooting time way down. Make more money!

**SERVICING COLOR TV**—By Bob Middleton. The best practical book on color TV servicing yet! Fact-packed with the kind of tips you need to master this new branch or servicing! Hundreds of charts, photos, and diagrams show you how to find and fix troubles in any set on the market today.

**HOW TO GET THESE BOOKS *at low cost!***

These two deluxe hard cover books are nationally advertised at \$4.60 each—but through the G/L TECHNICIANS' BOOK CLUB, you can get them—and others like them—for only \$3.35 each—a saving of 27%!

- HOW THE PLAN WORKS**
- To join the club select the book you want on the coupon.
  - SEND NO MONEY NOW**—we'll send you the book postpaid for a **FREE 10-day inspection** in your own home.
  - If you like it send us your remittance—if not send the book back.
  - A new book will be sent to you about every three months on the same **NO-RISK free inspection plan**.
  - You agree to take a minimum of four books during your entire membership period—no time limit. You may cancel any time after that.

**OTHER BOOKS TO BE PUBLISHED SOON**

- TV and Radio Tube Troubles
- Working with the Scope
- Servicing Tape Recorders

**DON'T DELAY—JOIN THIS NO-RISK MONEY-SAVING, MONEY-MAKING CLUB TODAY.** Send in this coupon now.

**NO-RISK COUPON**

Gernsback Library, Inc. Dept. PR-117  
154 West 14th St., New York, N.Y.

Begin my membership with book checked. Send me the book for a Free 10-day trial.

**RAPID TV REPAIR**

**SERVICING COLOR TV**

Send me more information on the G/L TECHNICIANS' BOOK CLUB.

Name ..... please print

Street .....

City ..... State .....

New Automation Punched Card TV Tube Tester

# PROVED!

IN OVER 45-MILLION TUBE TESTS!

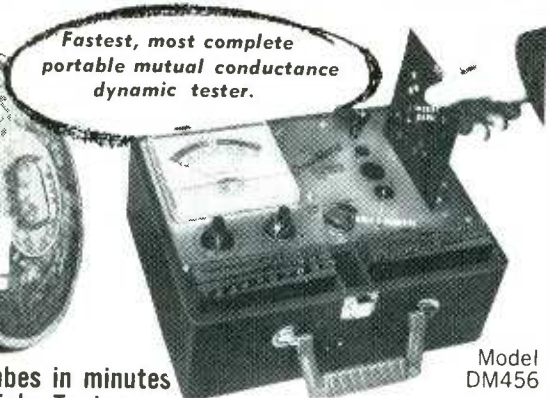

Fastest, most complete portable mutual conductance dynamic tester.

Speed-test complete set of tubes in minutes with the new DynaMatic Tube Tester

- So simple to use—a customer can operate it!
- **LIGHTEST** and **SMALLEST** Gm tester available. Take it on ALL house calls.
- Perforated plastic cards set up socket pin connections and test voltages.
- Permits full-complement tube testing.
- DynaMatic is a dynamic mutual conductance tester—NOT an emission checker.
- Accurately measures mutual conductance in micromhos on 2 ranges. 0-6000, 0-18000.
- Also checks battery tubes.

Model DM456

**THE ORIGINAL Dealer Net 149<sup>95</sup>**

Price Slightly Higher West of Rockies  
**IMMEDIATE DELIVERY!**



136-10 31st Rd., Flushing 54, N. Y.

CANADA: WHITE RADIO, LTD., 41 W. Ave. N, Hamilton, Ont.

EXPORT: ROBURN AGENCIES, 431 Greenwich St., New York

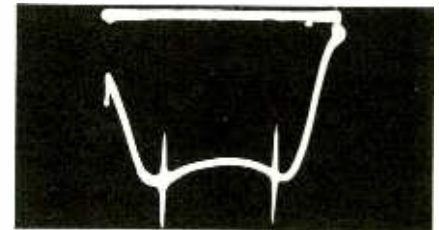

Ch 4

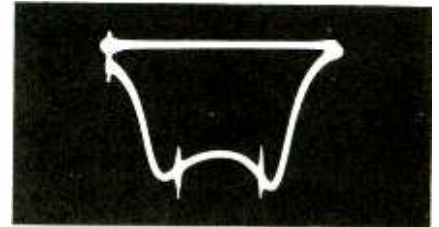

Ch 6

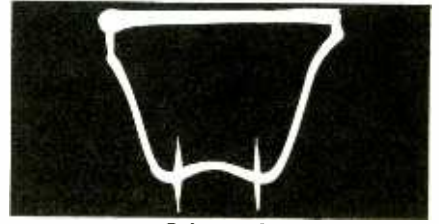

Ch 8



Ch 13

Fig. 7. Comparison of tuner bandpass curves after alignment.

adjustment has been tampered with, it is suggested that you do not adjust the neutralization. Experience has shown that repeated RF tube replacement may be made with no noticeable change in performance, even without neutralization readjustment.

Alignment of the incremental-inductance, switch-type tuner is a little more complex because the coils that tune each channel have to be adjusted in sequence. In the turret tuner, these coils are preset at the time of their manufacture and there are no adjustments.

Since both gain and bandwidth will be affected by adjustment of the individual coils (expanding and compressing), it is essential that alignment instructions be followed to the letter. Because B+ is present on some of the coils, and metal will detune any of the coils, only an insulated tool should be used to adjust the coils. A tuning wand that has both a brass and a powdered iron tip can be very helpful in determining whether to expand or compress a

The **NEW** **YEATS "Shorty"**  
**STATION WAGON & PANEL PICK-UP**  
**appliance dolly**



**YEATS Model No. 5**  
Aluminum alloy  
Height 47"  
Weight 32 lbs.

Only 47" tall, this new YEATS dolly is designed for TV and appliance men who make deliveries by station wagon or panel truck. No need to detach appliance for loading into the "wagon" or pick-up . . . the YEATS "Shorty" will slide into your vehicle with ease. Has aluminum alloy frame with padded felt front, quick fastening (30 second) strap ratchet, and endless, rubber belt step glide. New YEATS folding platform attachment, at left, saves back-breaking work handling TV chassis or table models. Call your YEATS dealer today!



Folding platform is 13 1/2" x 24 1/2" —attaches instantly. (Platform only) \$9.95.

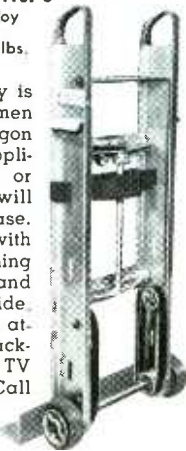

Furniture Pad

**"Everlast" COVERS & PADS**

YEATS semi-fitted covers are made of tough water repellent fabric with adjustable web straps and soft, scratchless white flannel liners. All shapes and sizes—Write.



TV Cover

SEND postcard for full information on our complete line TODAY!

**YEATS** appliance dolly

2103 N. 12th St.

sales co.  
Milwaukee, Wis.



STATEMENT REQUIRED BY THE ACT OF AUGUST 24, 1912, AS AMENDED BY THE ACTS OF MARCH 3, 1933, AND JULY 2, 1946 (Title 39, United States Code, Section 233) SHOWING THE OWNER SHIP, MANAGEMENT AND CIRCULATION OF PF REPORTER, published monthly at Indianapolis, Indiana for October 1, 1957.

1. The names and addresses of the publisher, editor, managing editor, and business managers are:

Publisher: Howard W. Sams, 2201 E. 46th St., Indianapolis, Ind.; Editor: Verne M. Ray, 2201 E. 46th St., Indianapolis, Ind.; Managing Editor: None; Business Manager: Mal Parks, Jr., 2201 E. 46th St., Indianapolis, Ind.

2. The owner is: (If owned by a corporation, its name and address must be stated and also immediately thereunder the names and addresses of stockholders owning or holding 1 percent or more of total amount of stock. If not owned by a corporation, the names and addresses of the individual owners must be given. If owned by a partnership or other unincorporated firm, its name and address, as well as that of each individual member, must be given.)

Howard W. Sams & Co., Inc., 2201 E. 46th St., Indianapolis, Ind.; Mary M. Benham, 215 N. Senate Ave., Indianapolis, Ind.; Alan S. Brengle, 6442 Carthage, San Diego, Calif.; Jean B. Eldred, 184 Morningside Dr., Laconia, N. H.; Paul F. Grubbs, 925 N. Audubon Rd., Indianapolis, Ind.; Edward D. James, 122 E. Michigan St., Indianapolis, Ind.; Harold Knox, Zionsville, Ind.; J. A. Milling, 7905 Morningside Dr., Indianapolis, Ind.; Lucille Overbay, 5768 Washington Blvd., Indianapolis, Ind.; James R. Ronk, 6160 Primrose, Indianapolis, Ind.; Howard W. Sams, 414 Kessler, W. Dr., Indianapolis, Ind.; Donald B. Shaw, 6093 N. Michigan Rd., Indianapolis, Ind.

3. The known bondholders, mortgagees, and other security holders owning or holding 1 percent or more of total amount of bonds, mortgages, or other securities are: (If there are none, so state.)

Armer F. Ahlstrand, 335 Willy Ave., Rockford, Ill.; Ad. Auriema, 89 Broad St., New York, N. Y.; Charles R. Barker, P. O. Box 384, Fredonia, N. Y.; Mary M. Benham, 215 N. Senate Ave., Indianapolis, Ind.; Bertha Bininger, 3510 Watson Rd., Indianapolis, Ind.; Ralph T. Brengle, c/o Potter & Brumfield, Princeton, Ind.; Bruce & Lorraine G. Cumming, 6029 W. Belmont Ave., Chicago, Ill.; Glenn Dial, 812 Truman St., N. E., Albuquerque, N. Mex.; Herbert J. Farr, Jr., 3297 Enderby Rd., Cleveland, O.; Paul F. Grubbs, 925 N. Audubon, Indianapolis, Ind.; Gloria Gustafson, 5768 N. Pennsylvania, Indianapolis, Ind.; Edward G. Hereth (Trustee), Continental Hotel, Apt. 798, Indianapolis, Ind.; Edward G. Hereth (Trustee), Continental Hotel, Apt. 708, Indianapolis, Ind.; Elmer C. Hodges, 1100 Union St., San Francisco, Calif.; M. S. Kiver, 900 Fairview Rd., Highland Park, Ill.; Grace Knox, 505 W. Oak St., Zionsville, Ind.; Harold S. Knox, Zionsville, Ind.; Michelle Fern Koplow, 7035 N. Meridian St., Indianapolis, Ind.; Robert J. Lewis, 5800 Lawrence Dr., Indianapolis, Ind.; Fernanda D. Milling, 7905 Morningside Dr., Indianapolis, Ind.; Jack B. Moore, 128 W. North St., Worthington, O.; Melvin R. Moser, 864 McGill St., Orrville, O.; Lucille Overbay, 5768 Washington Blvd., Indianapolis, Ind.; Edward E. Petri, Guaranty Building, Indianapolis, Ind.; James R. & Phyllis M. Ronk, 6160 Primrose, Indianapolis, Ind.; Walter B. Schulte, 1551 W. Logan St., Freeport, Ill.; O. T. Smith, Culver, Ind.; Eula M. Somers (Estate), c/o Trust Dept., Johnson Co., National Bank & Trust Co., 3911 Prairie Lane, Prairie Village, Kans.; Kenneth Swan, 4243 Broadway, Indianapolis, Ind.; Typographic Service Co., Inc., 215 N. Senate Ave., Indianapolis, Ind.; Chas. W. Vandenberg, P. O. Box 5337, Indianapolis, Ind.; Estate of Lynne Ann Wavering, Continental-Illinois Bank & Trust Co., Chicago, Ill.; Frieda Bininger, 3510 Watson Rd., Indianapolis, Ind.

4. Paragraphs 2 and 3 include, in cases where the stockholder or security holder appears upon the books of the company as trustee or in any other fiduciary relation, the name of the person or corporation for whom such trustee is acting; also the statements in the two paragraphs show the affiant's full knowledge and belief as to the circumstances and conditions under which stockholders and security holders who do not appear upon the books of the company as trustees, hold stock and securities in a capacity other than that of a bona fide owner.

(Signed) HOWARD W. SAMS, Publisher

Sworn to and subscribed before me this 27th day of September, 1957

(Seal) Frances T. Dobbs, Notary Public

(Advertisement)

latest **JACKSON** tube test data

TUBE TYPE	MODEL 648 CIRCUIT				MODEL 49 PLATE TEST				MODEL 115/715/661 FIL. X. PLATE	E.
	FIL. D.	FIL. D.	FIL. D.	FIL. D.	FIL. D.	FIL. D.	FIL. D.	FIL. D.		
4CS6	4.2	237	B1456	30V	4.2	-	26	2LMNS	32	
5DH8	5.0	A126	AC789*	28XZ	5.0	23	35	4JNQ	30	
6CV7	6.3	123	AC46	28XZ	5.0	6	24	3KR	32	
6DQ5	6.3	124	AC34	22Z	6.3	3	10	2S	3	
			A127	A89	6.3	3	38	4NS	10	
			AB579	15W	6.3	234	8	84PS	4	
TUBE TYPE	SEC.	A.	B.	C.	D.	CATH. SHORTS.				
4CS6	H	4.2	3	X	1567	2				
5DH8	P	5.0	4	X	679	8				
6CV7	T	5.0	4	X	12	3				
6DQ5	P	6.3	4	2	13	9				
		6.3	4	2	67	8				
		6.3	2	568	140	3				

Latest Chart Form 848-18, 115/715/661-9, 49-3

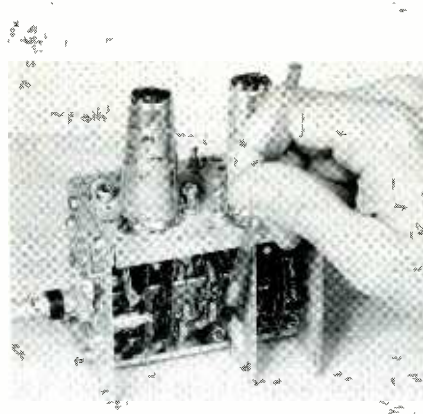

Fig. 8. Using the tuning wand.

coil, and which coil to adjust. By bringing first the brass and then the powdered iron tip close to the coil that tunes a particular channel, you will learn a number of things. (See Fig. 8.) For example, you can tell if adjustment of that coil will affect the curve as desired and if the coil needs expanding or compressing for the desired results. The following information will be helpful in this respect.

1. If the tuning wand affects the curve as desired, the coil needs adjusting.
2. If the brass end tends to correct the fault, the inductance must be reduced which means that the space between coil turns must be increased.
3. If the iron end improves the curve, the inductance is too low and the coil should be compressed.

These simple checks will help speed up the alignment of a switch-type tuner and will also prevent unnecessary coil bending.

### Things to Remember

Possibly the biggest single reason for tuner misalignment is tweaking—someone tweaked the little screws. A good rule to follow is never to tweak any alignment adjustment, tuner or otherwise, unless you are doing it in accordance with a prescribed alignment procedure.

Without the proper bias on the RF stage, the response curve may have almost any shape. Be sure the proper bias voltage is being supplied.

A sweep generator is rated to do a job only if its output cable is properly terminated. Under any other condition, the results obtained are not reliable.

Tuners are designed to conform to rather rigid specifications, and should therefore rarely require realignment. Video IF stages should always be realigned, and set performance rechecked, before performing tuner alignment.

When working in a tuner, never move a part or redress a lead unless you are sure it won't affect alignment, or unless it is necessary to minimize the danger of a short.

Use extreme care in making tuner adjustments. Small changes have very pronounced effects. ▲

**note:**  
Estimated 13/4 million portable TV sets to be sold in '57"!

**Here's Your MARKET...**

for the  
**MOSLEY Flush Mount TV Socket**

**LOW LOSS**  
**NEAT**  
**EFFICIENT**

MODEL F-1PK

● The tremendous demand for portable TV sets opens another BIG market for good set-to-antenna plug-in outlets. MOSLEY Flush Sockets meet this need—supplying attractive, convenient, customer-approved wall outlets for every installation requirement.

Without MOSLEY TV Outlets, portable TV—in most areas—ceases to be portable! Let MOSLEY TV Outlets spark YOUR Portable TV Sales!

For a complete line of up-to-date TV Accessories and Electronic Components send for our "57" catalog.

**Mosley Electronics Inc.**  
8622 ST. CHARLES ROCK ROAD  
ST. LOUIS 14, MISSOURI

the specs are the proof . . .  
the BEST BUYS are **EICO**<sup>®</sup>  
for COLOR & Monochrome TV servicing



• Features DC Amplifiers!

Flat from DC-4.5 mc, usable to 10 mc. VERT. AMPL.: sens. 25 rms mv/in; input Z 3 megs; direct-coupled & push-pull thruout; K-follower coupling bet. stages; 4-step freq-compensated attenuator up to 1000:1. SWEEP: perfectly linear 10 cps-100 kc (ext. cap. for range to 1 cps); pre-set TV V & H positions (30 & 7875 cps); auto. sync. ampl. & lim. PLUS: direct or cap. coupling; bal. or unbal. inputs; edge-lit engraved lucite graph screen; dimmer; filter; bezel fits std photo equipt. High intensity trace CRT. 0.06 use rise time. Push-pull hor. ampl., flat to 400 kc, sens. 0.6 rms mv/in. Built-in volt. calib. Z-axis mod. Sawtooth & 60 cps outputs. Astig. control. Retrace blanking. Phasing control.



Entirely electronic sweep circuit (no mechanical devices) with accurately-biased inductor for excellent linearity. Extremely flat RF output: new AGC circuit automatically adjusts osc. for max. output on each band with min. ampl. variations. Exceptional accuracy: edge-lit hairlines elim. parallax. Swept Osc. Range 3-216 mc in 5 fund. bands. Variable Marker Range 2-75 mc in 3 fund. bands; 60-225 mc on harmonic band. 4.5 mc Xtal Marker Osc., xtal supplied. Ext. Marker provision. Sweep Width 0-3 mc lowest max. deviation to 0-30 mc highest max. dev. 2-way blanking. Narrow range phasing. Attenuators: Marker Size, RF Fine, RF Coarse (4-step decade). Cables: output, 'scope horiz., 'scope vertical.



COMPLETE with steel cover and handle. SPEED, ease, unexcelled accuracy and thoroughness. Tests all receiving tubes (and picture tubes with adapter). Composite indication of Gm, Gp & peak emission. Simultaneous sel of any 1 of 4 combinations of 3 plate voltages, 3 screen voltages, 3 ranges of continuously variable grid voltage (with 5% accurate pot). New series-string voltages: for 600, 450, 300 ma types. Sensitive 200 ua meter. 5 ranges meter sensitivity (1% shunts & 5% pot). 10 SIX-position lever switches: free-point connection of each tube pin, 10 pushbuttons: rapid insert of any tube element in leakage test circuit & speedy sel. of individual sections of multi-section tubes in merit tests. Direct-reading of inter-element leakage in ohms. New gear-driven rollchart. Checks n-p-n & p-n-p transistors: separate meter readings of collector leakage current & Beta using internal dc power supply. CRA Adapter \$4.50

See the 50 EICO models IN STOCK at your neighborhood distributor. Write for FREE Catalog PF-11 Prices 5% higher on West Coast

**EICO**<sup>®</sup> 33-00 Northern Blvd. Long Island City 1, N.Y.

SHOP TALK

(Continued from page 12)

ity adjustment. Finally, a bias control R2 is included to permit adjustment of the bias applied to X2 for replacement transistors. This is needed because the current amplification ( $\beta$ ) among different transistors of the same type may vary considerably.

The yoke itself is located in the collector leg of X2. If we apply a sawtooth wave of the form shown in Fig. 2A to the base of X2, the voltage developed across the yoke will be as shown in Fig. 2B. The sharp voltage spike developed when the transistor is brought to cutoff is due to the inductive reactance of the yoke, and its amplitude is equal to  $\frac{di}{dt}$ . For a yoke

inductance of 40 millihenries, a peak-to-peak yoke current of 450 ma and a retrace interval of 350 microseconds, the pulse generated will have an amplitude of about 52 volts. To this would be added the negative voltage of the collector battery (about 25 volts) for a total of 77 volts. The collector must be capable of withstanding this surge, otherwise it will periodically break down, damping the pulse and increasing the retrace time of the beam.

Since the yoke is directly positioned in the collector arm of the output amplifier, it will have the DC component of the collector

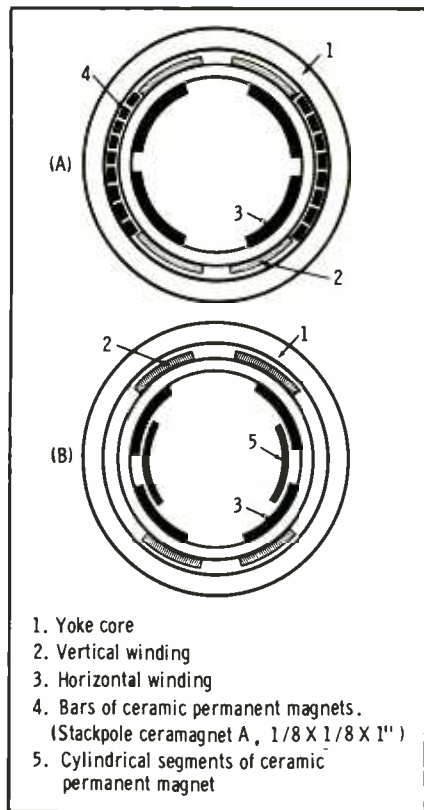

1. Yoke core
2. Vertical winding
3. Horizontal winding
4. Bars of ceramic permanent magnets. (Stackpole ceramagnet A, 1/8 X 1/8 X 1")
5. Cylindrical segments of ceramic permanent magnet

Fig. 3. Magnetic centering used with transformerless deflection amplifier.

current flowing through it (yoke current does not reverse in this circuit). This will cause vertical picture decentering to a considerable extent; so much so, in fact, that conventional centering methods are incapable of bringing the picture back to its proper place on the screen. There are several ways to solve this problem, but

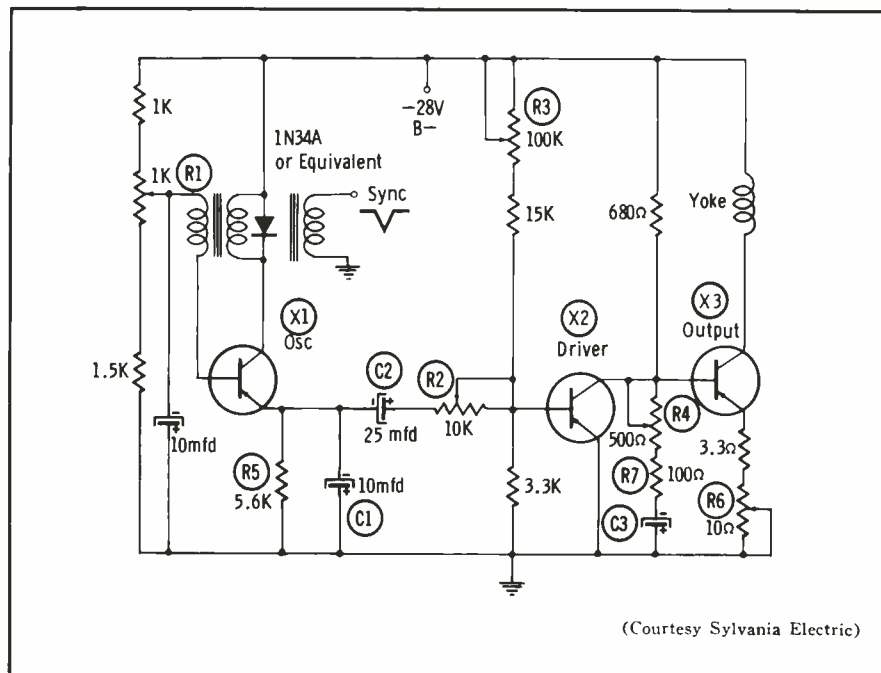

(Courtesy Sylvania Electric)

Fig. 4. A three-stage vertical deflection system.



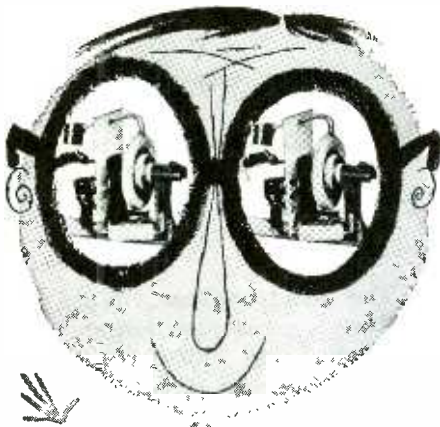

## Seeing Double?

**SURE... THEY LOOK ALIKE  
BECAUSE  
THEY ARE EXACTLY ALIKE**

Each Merit product of the same type is exactly the same as another—both in construction and appearance.

**COMPARE IT WITH  
MERIT**

Take a Merit product off the shelf. Compare it with any other similar product on the market. You'll find Merit is superior!



COMPARE IT WITH

**MERIT**

MERIT COIL & TRANSFORMER CORP.  
4427 N. CLARK ST., CHICAGO 40, ILLINOIS

# INJECTORALL

THE NEEDLE DOES THE JOB!

**TUNER CLEANER**  
with  
**INJECTOR NEEDLE**



**NEW!**  
Wax-Free  
lubricant  
added, keeps  
tuners and  
controls  
cleaned  
longer.

The Injector  
Needle cleans  
and lubri-  
cates where  
you need it...

You can reach hard-to get at  
waxer, without pulling tuners apart or even  
removing chassis from cabinet. DON'T WASTE  
PRECIOUS CHEMICALS! YOU NEVER SPRAY AIR!

**INJECTORALL CO.**

7081 Shore Parkway Brooklyn 14, New York

the most attractive one employs permanent magnets. Small ceramic bar magnets are placed longitudinally in the opening or window formed by the vertical yoke windings. (See Fig. 3A.) An alternative method would be the placement of ring segments of ceramic magnetic material between the yoke and the picture tube neck. (See Fig. 3B.) Both methods provide a strong enough magnetic field to recenter the picture on the screen.

Another vertical deflection system, this one utilizing a driver stage between the oscillator and the output amplifier, is shown in Fig. 4. The oscillator circuit, previously discussed, develops the sawtooth wave in the emitter leg of the transistor. R5 and C1 form the basic timing network although R1 can exert enough influence to function as the hold control.

Pulses from the sync separator section are brought in via a third winding on the blocking oscillator transformer. Another winding in the collector circuit is shunted by a diode, to remove the long narrow voltage spike that is developed by the inductance of the blocking transformer when the oscillator is cut off sharply. By removing the pulse, which serves no useful purpose, the chances for collector breakdown are minimized.

The sawtooth wave developed by the blocking oscillator is transferred via C2 and R2 to a common-emitter driver. R2 is made variable to permit selection of the proper current drive for the low-impedance driver stage (AC input impedance is on the order of 300 ohms). R3 is a bias control for X2 and is incorporated to establish the correct operating conditions for the driver transistor. Adjustment would be most essential if X2 were replaced.

The network comprised of R4, R7 and C3 between the base of X3 and ground is designed to improve the linearity of the signal. The three components function as an integrating network, adding a parabolic waveform of variable amplitude to the base signal of the output stage. The variable feature is provided by R4 which is the linearity control.

The final stage, also a common-

# SAMS "BEST SELLER" BOOKS

FOR THE TECHNICIAN • STUDENT  
EXPERIMENTER • HOBBYIST



USE THIS HANDY ORDER FORM

- Pinpoint TV Troubles in 10 Minutes.** Amazingly practical procedures for solving TV troubles. Includes over 50 time-saving check charts, dozens of diagrams and test Methods, circuit explanations, etc.—a real timesaver for TV repairs. 299 pages; 5½ x 8½"; fully illustrated. Only .....\$3.95
- TV Servicing Guide.** Quick reference guide for Technicians. Trouble symptoms are illustrated by picture tube screen photos and proper repair procedures are clearly described. Covers all sections of the TV circuit. 132 pages; 8½ x 11"; illust. Only .....\$2.00
- Tape Recorders.** Explains recorder theory, tape characteristics, how recorders work; covers motorboard mechanisms, drive motors, volume indicators, bias oscillators, amplifiers, magnetic heads, equalization circuits. 176 pages; 5½ x 8½"; illust. Only .....\$2.75
- Transistor Circuit Handbook.** The authoritative book on transistor types, construction, characteristics, applications, circuitry, techniques for wiring and testing. Covers every phase of the subject. 430 pages; 6 x 9"; illust. Only \$4.95
- Hi-Fi Handbook.** Invaluable data on Hi-Fi design, selection and installation, including fidelity, sound theory, analysis of all components (speakers, enclosures, amplifiers, tuners, etc.), systems design, proper selection and installation. 240 pages; 5½ x 8½"; illust. Only .....\$3.00
- Servicing AGC Systems.** Describes operation and circuit variations of AGC systems; explains applicable servicing techniques. Illustrated by actual case histories and photos of symptoms. 132 pages; 5½ x 8½"; illust. Only .....\$1.75
- Learning Electricity Fundamentals.** The complete, fascinating story of electricity: history, electron theory, static electricity, uses of switches and fuses, resistance, Ohm's Law, magnetism, electro-magnetism, transformers, generators and motors, circuits and controls, practical wiring, etc. 416 pages; 6 x 9"; illust. Only .....\$5.95
- Transistors.** A very practical, complete book on Transistors and their application in TV-Radio-Electronics. Explains theory, circuitry, installation, testing techniques and servicing. 100 pages; 5½ x 8½"; illust. Only .....\$1.50
- Color Television.** An outstanding training course for Technicians. Covers principles of the color TV system; color receiver circuits; installation and servicing of color receivers. Includes color blocks outlining use of color test equipment. 260 pages; 8½ x 11"; profusely illustrated. Only .....\$6.95
- Electronic Metal Locators.** Explains basic types and their operation; tells how to construct your own units; describes applications. Covers interesting uses in industry as well as in prospecting and mine location. 124 pages; 5½ x 8½"; illust. Only .....\$2.50

HOWARD W. SAMS & CO., INC.

Order from your Paris Jobber, or mail to  
Howard W. Sams & Co., Dept. 3 L 7  
2201 E. 46th St., Indianapolis 5, Ind.

Send books checked above. My (check) (money order)  
for \$.....is enclosed.

Name.....

Address.....

City.....Zone.....State.....

(outside U. S. A. priced slightly higher)

emitter arrangement, possesses still another amplitude control, R6. Thus, this system has two such controls, providing a greater flexibility in the selection of replacement transistors. When the  $\beta$  values of the transistor type used can be kept within a fairly narrow range, one of the amplitude controls could probably be dispensed with.

In comparing the two- and the three-transistor deflection systems, the following comments by the designers of these systems may be enlightening:

#### Circuitry.

The two-transistor circuit is simpler in construction, requiring fewer components. This advantage is offset somewhat by the fact that high capacitor values have to be used throughout because of the low impedance level of the circuit. Furthermore, in the two-transistor system, a higher-rated power transistor must be employed in the blocking oscillator stage.

#### Linearity.

In the three-stage circuit, there

is greater leeway in providing linearity compensation such as we found in Fig. 4. Also, with the driver stage and the amplification it provides, degeneration can be employed in the output amplifier.

#### Synchronization.

The two-transistor circuit employing a power transistor in the oscillator was found to require more power for synchronization. This might necessitate the use of higher power transistors in the sync separator stage.

#### Frequency Stability.

Both circuits are comparable in performance.

#### Operational Stability.

It will be noted that the two-stage vertical deflection system utilizes AC coupling throughout, while the three-stage circuit has DC coupling between the driver and the vertical output amplifier. In general, AC coupled systems tend to be more stable than DC systems, particularly in transistor circuits where temperature changes have such a marked effect on operation. Hence, the circuit of Fig. 1 would be more stable than the circuit of Fig. 4.

Several things can be done to increase the stability of Fig. 4. DC feedback, from the emitter of the output stage to the base of the driver stage, would provide some improvement. Another approach would be the use of a reverse-biased diode between driver base and ground. The back resistance of the diode would decrease with temperature and thus reduce the base bias. Still a third solution would be the use of AC coupling between the driver stage and the output stage. This is shown in Fig. 5.

Before we end this discussion on vertical deflection systems, mention should be made of still another circuit. This circuit, shown in Fig. 6, consists of a blocking oscillator, a common-collector driver and a common-emitter output stage.\* The chief difference between this system and that of Fig. 4 is the common-collector driver. A common-collector ampli-

\* "Transistorized Vertical Deflection for Television Receivers," by M. B. Finkelstein. Transistors I, RCA.



**STOP CB\* WITH C-D**

\*STOP CALL BACKS by always using C-D "CUBS"®—the tubular that has proven itself the champ in the service field. They out-perform any other replacement because they're the only molded tubular with built-in extras that insure call-back-free servicing. C-D "CUBS" are made exclusively for the service trade.

SPECIAL! "CUB SERVICE KIT" in all-plastic dispenser. You pay only for the capacitors. Ask your distributor salesman to show you the new C-D "CUB SERVICE KIT" or write for details Cornell-Dubilier Electric Corporation, South Plainfield, N. J. Stop callbacks...insist on



**CORNELL-DUBILIER CAPACITORS**

SOUTH PLAINFIELD, N. J.; NEW BEDFORD, WORCESTER & CAMBRIDGE, MASS.; PROVIDENCE & HOPE VALLEY, R. I.; INDIANAPOLIS, IND.; SANFORD, FUQUAY SPRINGS & VARINA, N. C.; VENICE, CALIF.; & SUB.: THE RADIART CORP. CLEVELAND, O.; CORNELL-DUBILIER ELECTRIC INTERNATIONAL, N. Y.



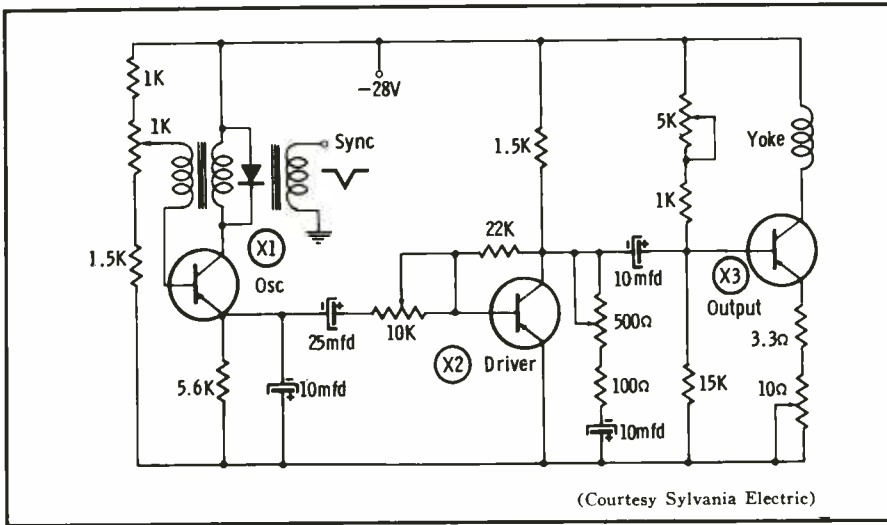

Fig. 5. A variation of Fig. 4, employing AC coupling between all stages.

fier, it will be recalled, possesses a high input impedance and a low output impedance, and these conditions ideally suit the blocking oscillator on one hand and the output amplifier on the other. Note the relative simplicity of the circuit, actually possessing fewer components and controls than any of the other systems.

Probably the principal disadvantage of the circuit of Fig. 6 is the comparatively poor nonlinearity of the over-all system. This stems chiefly from the fact that current gain or  $\beta$  of the output stage decreases as the collector current increases. This situation occurs at the end of the trace when the beam is at the bottom of the raster and the output amplifier is conducting most strongly. The visual result is a squeezing together of the raster lines in this area.

Note that the  $\beta$  decrease with increasing collector current is also

present in the system of Fig. 4, and it affects the input resistance of this stage. However, by using the curvature of the current transfer characteristic ( $I_c$  vs.  $I_b$ ) of the common-emitter transistor driver to correct the nonlinearity of the output stage, considerable improvement can be achieved. Even so, an additional compensating network is still required to bring about the desired linearity of vertical current through the yoke.

The foregoing explanation, while necessarily brief, will explain why the more complicated circuit of Fig. 4 would be used. However, if transistors can be constructed in which the nonlinearity discussed is not encountered, in all probability the simpler deflection circuit of Fig. 6 would be favored. ▲

Ed. NOTE: With this article, Milt Kiver ends the series on transistorized TV circuits. Next month he will begin a study of graphs.

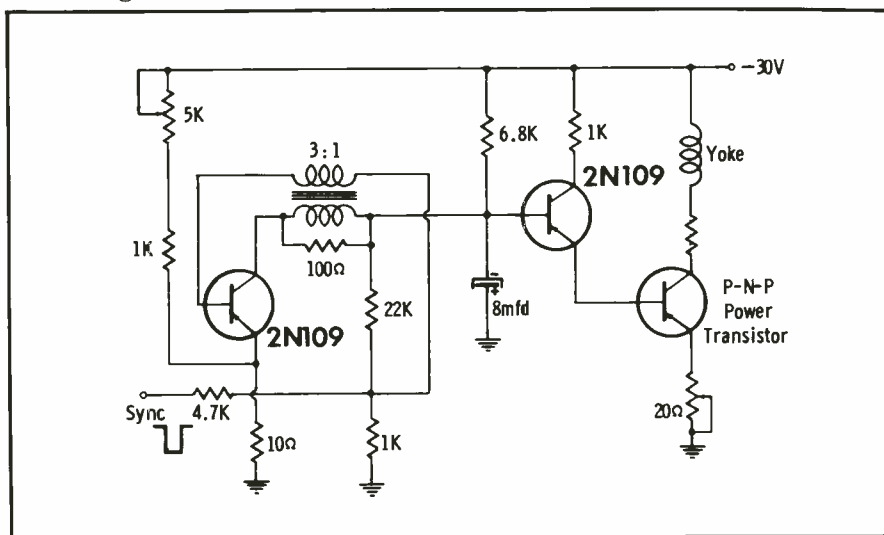

Fig. 6. A vertical deflection system using a common-collector driver.

FOR  
**TOP-O'-CHASSIS  
SERVICING**  
locates defective stage in  
less than 5 minutes for average  
TV receiver.



NEW FROM  
**Wintronix**  
MODEL 850  
**INDUCED WAVEFORM  
ANALYZER**  
complete with  
"Phantom Probe"  
and attachments  
**ONLY \$169<sup>95</sup>**

Localize troubles in TV, radios, amplifiers, etc., right from the top of the chassis . . . and without making a single direct connection to the circuit! The new Wintronix Model 850 does all this by the modern, easy-to-use Induced Waveform method. Helps you quickly spot those often overlooked tube and circuit defects that mean callbacks or extra troubleshooting. Simply connect the output of the Model 850 to any scope, then slip the Phantom Detector Probe successively over each tube in the receiver under test. By viewing the waveform of the received signal (from b'dcast station or generator) at each stage, you quickly localize troubles to the offending stage. Works equally well for RF, IF, video, sync, and audio circuits. A real time and trouble-saver for portable TV. See and try the new Wintronix Induced Waveform Analyzer at your local Wintronix dealer or write for free literature.

**WINSTON  
ELECTRONICS INC.,**  
4312 Main St., Phila. 27, Pa.

**NOW . . . Check Vibrators In ANY Tube Checker**

*Another Sencore Time-Saver*

# "VIBRA-DAPTOR"

MODEL VB-2

**2 ADAPTORS IN**

**Checks Both Three and Four Prong Vibrators**

• Merely plug into any tube checker. Set for 6AX4 (or 6SN7) for 6 Volt Vibrators and 12AX4 (or 12SN7) for 12 Volt Vibrators.  
 • Two lamps viewed through top of adaptor indicate whether or not Vibrator needs replacing. • Rugged — Made of steel.  
 • Replaceable but unbreakable #51 indicating Lamps. • Operates easily with Sencore LC2 Leakage Checker. • Complete instructions screened on front.

**ONLY \$275**  
DEALER NET

At leading distributors everywhere

**POPULAR SENCORE PRODUCTS**

- Transistor Tester
- Leakage Checker
- Filament Tester
- Handy "36"
- Vibra-Daptor

MANUFACTURED BY **SERVICE INSTRUMENTS CORP.**  
171 OFFICIAL RD. ADDISON, ILL.

■ Cut out this ad now for further information. ■

## Servicing Industrial Electronics

(Continued from page 14)

perature. A variety of pyrometers using thermocouples are commercially available for high-temperature sensing.

For most applications requiring high-range pyrometry, photoconductive cells are used. The difference lies in the method of sensing, since thermistors and thermocouples are primarily environmental heat detectors, while the radiation-detecting photocell will be damaged by an increase in its own temperature.

The photoconductive cell varies its resistance when the energy level varies, since imparting of energy to an electron will move it from an inner shell to an outer shell, which then would have a surplus of electrons and would conduct much more readily. The latest photoconductive cells make use of cadmium sulfide, which is "grown" on the lead wires by several dippings in a molten mixture. If the cells are used in this condition, care must be taken when handling them while performing any service work, since skin oils may cause a permanent change in their performance characteristics. For this reason, the cells are usually placed within an evacuated glass envelope.

The range of a photocell pyrometer is from 500°F to about 5,000°F. In Fig. 2, a typical photoconductive cell is connected in the grid of a balanced-bridge amplifier. Radiation falls on the cell, and as the energy per photon

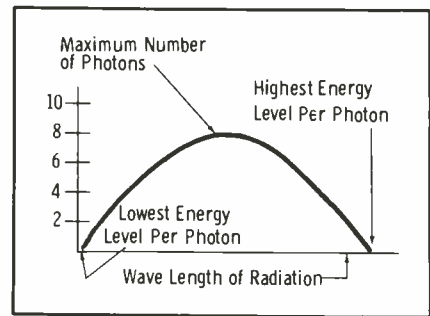

Fig. 1. Number of photons emitted at various wavelengths or energy levels.

increases, current through V1 decreases while current through V2 increases. Changes are indicated by the meter, and after a specific heat increase, relay CR<sub>1</sub> becomes energized, closing CR<sub>1a</sub> and opening CR<sub>1b</sub>.

Another optical pyrometer whose range is similar to the photoconductive cell is the photovoltaic cell. The energy transfer from photon to electron may cause the electron to move out of the atom but not out of the material, thus producing an increase in the number of free electrons in the material. When a pure metal is plated with its oxide, a barrier is formed which allows electrons to pass in only one direction. Due to the metal's loss of free electrons through the barrier, the metal will become negative. The conductor must be transparent to the emitted photons; therefore, very thin slices of gold or silver foil are commonly used. With a circuit completed from negative to positive, as shown in Fig. 3, the electrons can return to the metal. The metal, barrier, and collector will then act as a battery.

The largest single use for the photovoltaic cell is in the form of



"You're sewing with my **JENSEN NEEDLE** again, I see."

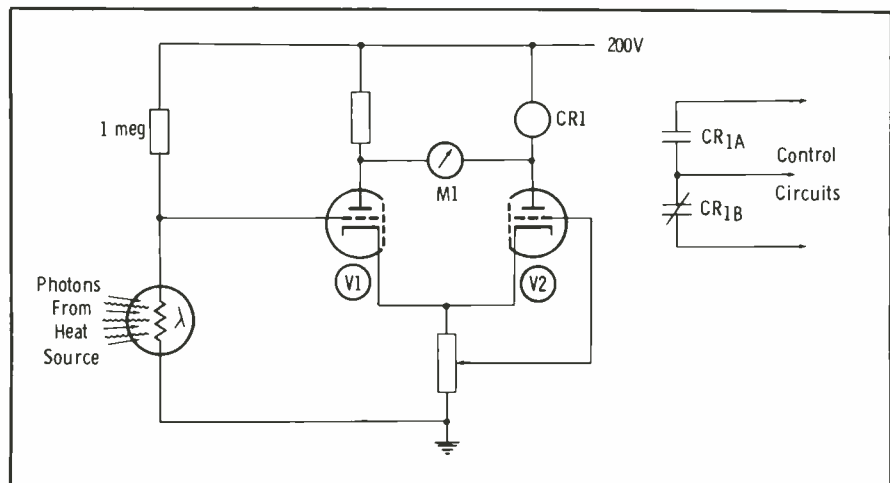

Fig. 2. Photoconductive cell in balanced-bridge relay-controlling circuit.



## Announcing Two New E-Z-HOOK Connectors

**E-Z-HOOK SUB**

New E-Z-Hook SUB is especially designed with two E-Z-Hook connectors

**E-Z-HOOK SUB**

- Makes Substituting Easy
- Eliminates Soldering
- Saves Valuable Test Time

SIX colors (red, blue, green, yellow, orange, black)

No. 71 E-Z-Hook SUB  
69¢ net ea.

**E-Z-HOOK CLIP**

New E-Z-Hook CLIP is especially designed for jumper and test leads.

**E-Z-HOOK CLIP**

- Safe Solder Connection
- Easy Push-on Assembly

SIX colors for easy lead identification.

No. 61-1 E-Z-Hook CLIP Standard 49¢ net ea.  
No. 61-2\*\* Same but gold plated 65¢ net ea.

\*\*For Guided Missile Work and Other Special Applications.

**E-Z-HOOK TEST PRODUCTS**  
SAFE • FAST • SURE

ORDER THROUGH YOUR PARTS DISTRIBUTOR  
**E-Z-HOOK TEST PRODUCTS**  
Dept. F, 1536 Woodburn Ave.  
Covington, Ky.

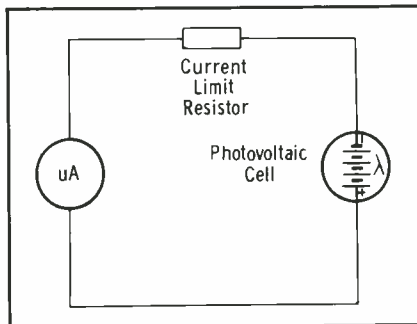

Fig. 3. Oxide-coated metal becomes a photovoltaic cell and acts as battery.

portable light meters used by photographers. The construction of a light meter is shown in Fig. 4. Light enters through the perforated cover, and its energy penetrates the gold leaf conductor. The number of free electrons in the metal increases and current flows through the limiting resistor and the meter. Since the meter reading will increase with the amount of current flow, it can be calibrated to indicate the amount of light energy reaching the perforated cover.

Photoconductive and photovoltaic cells are very inefficient energy converters. Where temperatures are above 2,000°F, and portability is not required, a third type of photosensitive unit is used. The name photoemissive is applied to this third device, since the electron must acquire sufficient energy to escape its own atom and the material as well. Once the electron is emitted from the material, it can be attracted

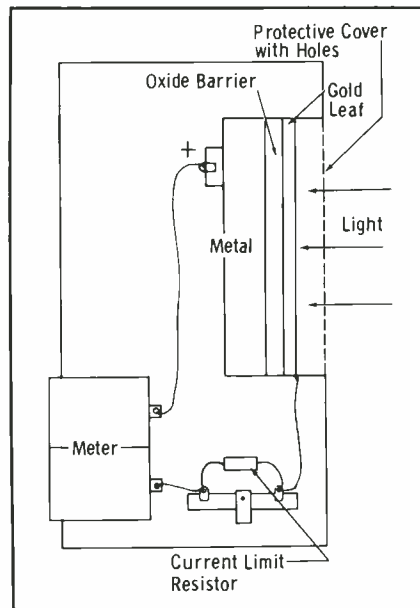
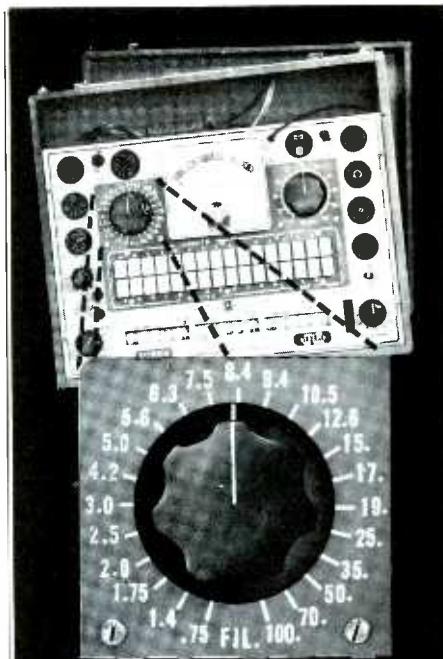

Fig. 4. Basic construction of a photographer's light meter.



## 23 Separate Heater Voltages on the Dynamic® JACKSON 648A Assure Accurate Tests for all Series-String Tubes ...The Correct Voltage for Every Known or Presently Planned Type.

YOU CAN MODERNIZE YOUR PRESENT 648  
New 648 FV Kit provides same heater voltages as the new 648A Tester. Only four wires to solder. Installs in minutes. Available from your distributor now.



"Service Engineered"  
Test Equipment

16-18 S. Patterson Boulevard - Dayton 2, Ohio  
In Canada: The Canadian Marconi Company

**Get More Out of Your Test Equipment!**

Read . . . *Harold W. Sams*

**1958 Test Equipment Annual**

. . . Eight time-saving Editorial Sections covering virtually every phase of test equipment operation—plus an editorial Product Listing of current-model test equipment.

**Reserve Your Copy Today!**  
... only \$1.00





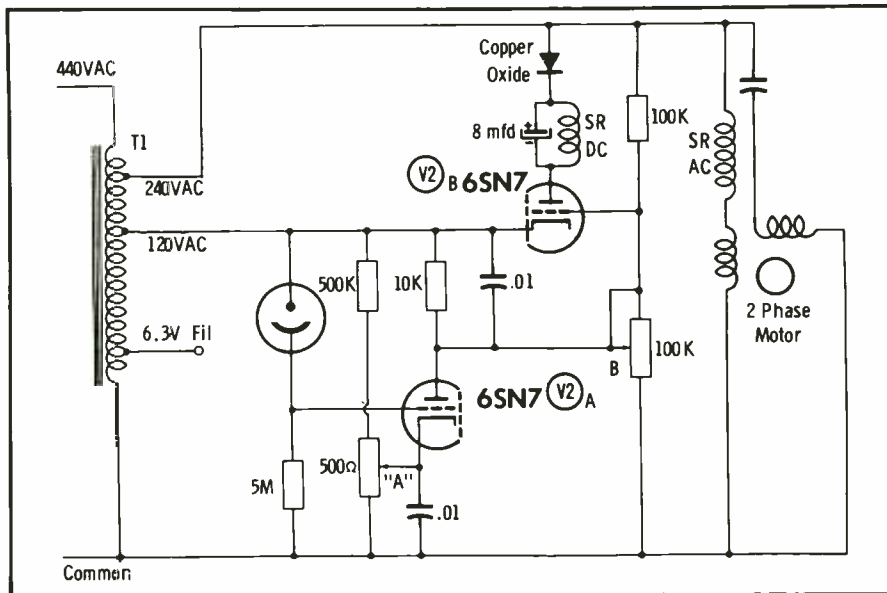

Fig. 7. Circuit for motor-speed control using phototube and dual-triode.

only its intensity is varied. The continuous control method is often referred to as proportional control since the error signal is proportional to the amount and direction of the error. On oil burners, the flame intensity is controlled by the positive displacement oil pump; therefore, proportional control can be used to vary the speed of the oil pump motor.

The unit which is capable of this is shown in Fig. 7. Transformer T1 is tapped to allow the use of several source voltages, and special pains are taken to insure that the voltages applied to the tubes will always be 120 and 240 volts AC. The phototube V1 and a 5-meg resistor are connected in series across the 120-volt source, forming a voltage-divider network which feeds the grid of amplifier V2A. Since V2A grid voltage is obtained from the cathode of V1, increased conduction of V1 allows more voltage to appear across the resistor, and consequently, more current through V2A. Adjustment A is a bias control which must be set to obtain linear operation of V2A.

V2B is connected in series with the DC winding of a saturable reactor which serves to vary the impedance of one AC motor winding in accordance with the degree of saturation of the reactor core. Since the DC winding is shunted by an 8-mfd capacitor, and is connected in series with a copper-oxide rectifier, V2B current pulses produced during positive half-

cycles of the source voltage are rectified so that the current through the winding is essentially DC. Adjustment B can be used to vary the bias of V2B, which is controlled by V2A plate current flowing back to the common side of the line through the 100K resistor.

In following the action of the entire circuit, let's assume that the temperature has risen above the desired level. The increased heat radiation causes more electrons to be emitted from the cathode of the phototube. This lowers the effective resistance of

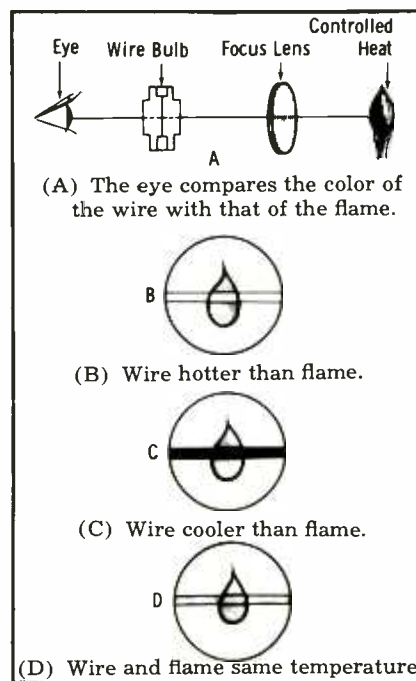

Fig. 8. Optics involved in using a potentiometer-type pyrometer.

another

**B-T LABS**

quality  
engineered  
product

*all channel UHF converter*

Model 99 is your best buy in a UHF converter. Features include tuned input, precise impedance match, UL approval, one-knob tuning and drift-free performance. Largest selling UHF converter in the country at \$22.95 list ...In difficult reception areas use the BTU-2.....only \$39.95

another

**B-T LABS**

quality  
engineered  
product

*2-set coupler*

Model TV-42 a 2-set coupler approved for color, UHF, VHF and FM. Matched resistive circuit with 12db interset isolation and flat response—0-900 megacycles. Another quality TV accessory engineered by B-T Labs.....\$2.95 list

**Sold by electronic parts distributors**  
for further information  
use coupon below

**BLONDER-TONGUE LABS, INC. PF-11**  
9-25 Alling Street, Newark 2, N. J.  
Please send me literature covering  
 B-T TV Accessories  
Name.....  
Address.....  
City..... Zone..... State.....

**DON'T REMOVE  
THAT  
CRT TUBE!**



Snap it back to normal brilliance with new improved Kinecure. INSTANTLY and PERMANENTLY corrects 33 different CRT defects. Saves time, money, and irritation for both servicemen and customers. Thousands of TV servicemen now use new, improved Kinecure. Now time tested and job proven on over 50,000 sets. There is just nothing else like patented Kinecure. It looks different — operates different — works like a charm! Ask your Jobber. Or write for free full information.

**Circuit**

MANUFACTURING CO., INC.  
923 Shadeland Ave., Drexel Hill, Pa.

**Have you ever wished for Aladdin's help in finding your transformer troubles?**

**If so, you can have it in our Model 50-A Inductive Winding Tester . . .**

. . . which QUICKLY and ACCURATELY finds transformer shorts (as little as one turn) in flybacks, yokes, vertical outputs and other iron core transformers, as well as checking the horizontal system in circuit.



**ONLY \$19.95**

SEE YOUR PARTS JOBBER

**B&M ELECTRONIC MFG. CO.**  
2516 Dodge Avenue  
Fort Wayne, Indiana

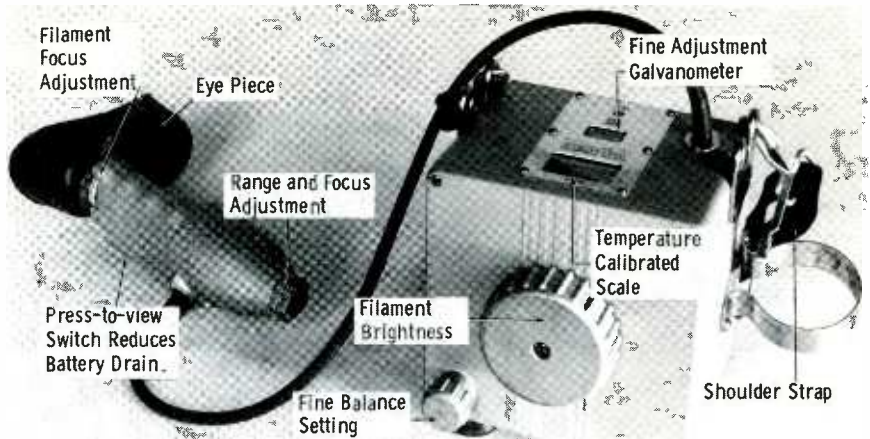

Courtesy Leeds and Northrup Co.

**This potentiometer-type pyrometer operates on the basis of matching the intensity of a fine-wire filament to that of the radiation.**

V1 in the voltage divider, and the increase in voltage across the 5-meg resistor results in increased current through V2A. The additional current down through the bias control for V2B causes its grid to become more negative, and less current flows through this tube. The resultant decrease in saturable reactor current slows the motor speed and allows the temperature to drop.

Thus, continuous control over the temperature can be realized. The 6SN7 tube is capable of a plate current in excess of 10 milliamps, which is sufficient to control the motor speed from one-half rated speed with no DC in the control winding of the saturable reactor, to full-rated speed with a 10-milliamp control current.

Accurate calibration is essential in all heating applications, and one of the most reliable calibrators or portable direct-reading pyrometers is the comparator optic pyrometer. Fig. 8 shows the

optics involved in a potentiometer-type pyrometer. Fig. 8A shows that the light from the heat source passes through the focus lens and thence past the comparator wire to the eye of the instrument user. When the wire is glowing at the same intensity as the flame, the wire and the flame are at the same temperature (Fig. 8D). When the wire is hotter than the flame, it is lighter than the flame in appearance, and when the wire is cooler than the flame, it is darker in appearance.

In Fig. 9, the batteries furnish the power necessary to heat the wire and current is controlled by the setting of P2. P1 and P2 are ganged by a friction clutch so that the pointer and slider of P1 will move when P2 is moved, but not the reverse. When P2 has been adjusted, the final adjustment of P1 will balance the voltage drop across resistor G and a portion of P1 against the voltage of a

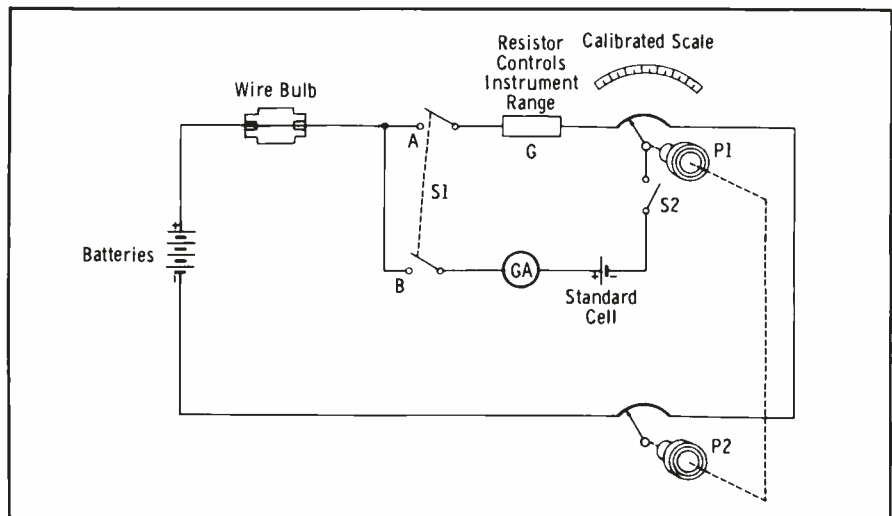

**Fig. 9. Circuit of potentiometer-type pyrometer.**



standard cell. The temperature is read directly from the potentiometer scale. This instrument is fairly accurate but is not suitable for prolonged sensing due to the battery drain.

A highly accurate optical pyrometer is the variable-filter type (Fig. 10). The filament of the lamp is set at a constant intensity, and by a series of filter wedges, the radiation intensity of the heat seen by the eye is varied until the filament blends with the intensity of the filtered radiation. This simple compact unit affords extremely accurate measurement of temperatures.

In last month's article, we described environmental heat sensors and the calibration of a thermocouple. The potentiometer used is quite accurate, but, as was shown by the chart, the thermocouple response to changes in temperature is subject to error. The response of a thermocouple to radiant energy is somewhat different since the temperature being sensed is expressed mathematically; however, the uncontrollable errors are significant and therefore most radiation detectors are calibrated by comparison with an optical pyrometer.

The optical pyrometer is used as a standard because the eye is very sensitive to radiation intensity, and the temperature of the comparison wire can be determined with a high degree of accuracy. The comparison wire is enclosed in a vacuum to reduce temperature loss through convection, and the construction of the optical pyrometer prevents passage of air around the evacuated bulb.

Service will consist mainly of checking calibration and repairing those units which are out of range of the calibrating adjustments. The electronic circuits con-

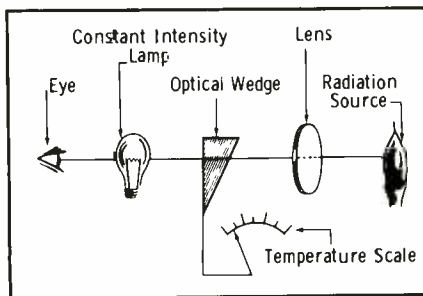

Fig. 10. Principle of the variable-filter optical pyrometer.

sidered so far are serviced in much the same way as radio, television and audio equipment. The industrial units will generally use high-grade components and allow considerable margin in ratings; therefore, when selecting a replacement part, use one with the same rating as the original component.

Industrial electronics is composed of a host of units which convert some physical quantity to a proportional electronic signal. This signal is then used to control

the physical quantity. Heat radiation is only one of the quantities measured in industrial applications. There are flow and pressure sensors, chemical sensors, counters, thickness gages, and vibration detectors. Each of these physical characteristics must be studied in detail before the methods of responding to the electronic signal can be analyzed. The over-all control system will involve the next two installments, "Taking the Industrial Pulse," and "Industrial Muscles." ▲

**SPECIALY PRICED DURING NOVEMBER!**

## THE BEST TOOL DEAL YOU EVER SAW!

NO. 8457

### TV ALIGNMENT TOOL KIT

**CONTAINS 4 BASIC TV TOOLS**

To introduce this new kit that's sure to handle most of your TV set alignment work, G-C has specially priced it for one month only. Roll-type plastic case holds the four tools safely in your pocket or tool box. Buy now and save!

SEE YOUR G-C JOBBER NOW!

FREE G-C CATALOG... send postcard today!

**SPECIAL THIS MONTH ONLY \$1.49**

## GENERAL CEMENT MFG. CO.

Division of Textron Inc.

400 South Wyman Street • Rockford, Illinois

## Troubleshooting with George

### The Solution

George had actually solved the case; but, just for the record, let's help him understand the reason for the puzzling action of the contrast control.

Under normal conditions, the 6BN6 audio stage limits the carrier amplitude, detects the frequency modulation and amplifies the audio signal. Considering the limiting factor, the tube operates between grid cutoff and plate

saturation. The buzz or quieting control in the cathode circuit governs limiting by regulating tube bias for maximum AM rejection. In other words, a variation in signal level at the input or limiter grid will be prevented from appearing as a change in signal amplitude in the plate circuit. Since the stage is designed for the detection of a frequency-modulated signal, only a change of input-signal frequency will produce amplitude variations in the 6BN6 output. Without going

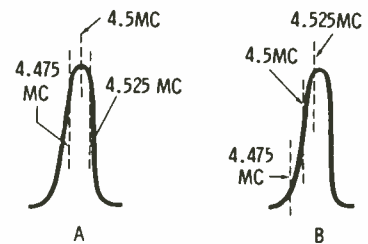

**Fig. 2. Representative response curves of the 6BN6 input circuit.**

(A) Normal curve with 4.5-mc peak.  
(B) Detuned circuit curve.

into further explanation of the gated-beam FM detector (well covered by "TV Sound From the 6DT6," Dec., 1956), we will now attempt to analyze what happened when the quadrature coil was effectively removed from the circuit.

The limiter grid, pin 2 of the 6BN6, connects to chassis ground through the high-Q coil L19, which effectively parallels the input and shunt capacitance of the stage. The resonant frequency of this circuit is, of course, 4.5 mc. Let's assume its response is similar to that represented in Fig. 2A. The 4.5-mc sound carrier never deviates more than  $\pm 25$  kc even with 100% modulation; therefore, frequencies from 4.475 to 4.525 mc make up the sound signal. During normal operation, frequencies within this range will receive relatively equal amplification as evidenced in the curve of Fig. 2A.

But an open quadrature coil changes the shunt capacity of the input grid circuit and the peak resonant frequency of this rather critically tuned circuit. This results in a shift of the curve so that the 4.5-mc marker appears down on the slope as shown in Fig. 2B. The stage now functions as a slope detector in which a slight change in frequency produces a wide variation in signal attenuation. Even without normal action of the quadrature grid, the stage is thus able to detect FM and reproduce an audible signal in its output—that is, it can do so at low settings of the contrast control, when the input signal amplitude varies between cutoff and saturation limits of the tube. As the contrast is advanced, the input signal level increases to the point where all sound carrier frequencies exceed these limits and no variation in tube current is produced. If George had not adjusted the buzz control, chances are he would have never experienced the case of the crazy mixed-up control.

**Time for REPLACEMENT?**

**Specify OXFORD SPEAKERS**

Why gamble when you can be assured of the finest line of replacement speakers . . . OXFORD. Now specified by more manufacturers of original equipment than ever before during our more than twenty-five years of producing the best speakers. Your choice . . . from 2" to 15" with guaranteed faster delivery . . . better service . . . more extensive and complete line.

*TIME for REPLACEMENT . . . specify OXFORD SPEAKERS . . . you'll be glad you did.*

**OXFORD Components, Inc.**

Subsidiary of Oxford Electric Corp.

556 West Monroe Street • Chicago 6, Illinois

In Canada: Atlas Radio Corp., Ltd., Toronto

Export: Roburn Agencies, New York City







### Multi-Set Couplers



Jerrold Electronics Corp., 23rd and Chestnut Sts., Philadelphia, Pa., has introduced a new line of couplers for connection of more than one TV set to a single antenna. A two-set coupler for strong-signal areas is priced at \$3.50, and a low-loss version for fringe areas is \$4.50. A four-set coupler, usable for both strong and weak signals, costs \$5.75. All models may be mounted either indoors or outdoors, and all will handle UHF as well as VHF signals in either monochrome or color.

### Portable Inverters



American Television & Radio Co., 300 E. 4th St., St. Paul, Minn., has introduced a series of lightweight, compact inverters with which DC voltages available in vehicles can be converted into 110-volt, 60-cycle power for operation of various small appliances. The units are equipped with a plug that fits the cigarette-lighter receptacle. Output ratings of the inverters range from 30 to 150 watts.

### Audio Cables

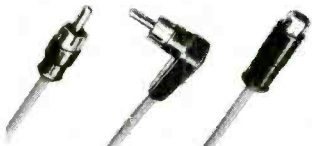

Switchcraft, Inc. 1328 N. Halsted St., Chicago, Ill., has made available a line of cables for interconnection of audio equipment. Standard phono plugs and extension jacks with shielded handles are molded to the ends of the cables in either a straight or a right-angle position.

### New Antennas



Trio Mfg. Co., Griggsville, Ill., has brought out improved models of its "Zephyr-Mite," "Zephyr Pioneer," and "Zephyr Royal" TV antennas. The main driven element has a new "Extended Wing Dipole" configuration, which provides greater sensitivity on all channels.

The fringe-area "Zephyr Royal" (pictured) employs both regular and extended wing dipoles as driven elements and is stagger-tuned for broad bandwidth. List price is \$34.95.

# Columbia **Contro-Roller**

## STOPS TV KNOBS FROM TURNING TOGETHER

- ★ Simple Half Minute Installation  
Any set owner can do-it-himself without tools.
- ★ High Quality Precision Bearings
- ★ Simple to Display
- ★ Easy to Sell

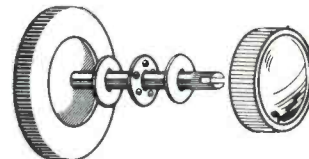

Twenty-five million TV sets in America have two knobs on one shaft (concentric controls). The two knobs usually turn together — in fact it is often impossible to turn one knob without the other knob turning with it. Contro-Roller stops this! Catalog No. 888 DISPLAY CARD OF 24 PACKAGES Every Service Dealer should have a display card of 24 Contro-Roller sets on his counter!

WRITE FOR COMPLETE CATALOG TODAY!

**Columbia WIRE & SUPPLY CO.**  
2850 Irving Park Road Chicago 18, Illinois  
"America's Most Complete Wire Line"

**IT'S NEW! IT'S A BARGAIN! IT'S "IN THE BAG"!**

**VACO®**  
5-PIECE ALL HOLLOW SHAFT Nut Driver Kit  
No. K 505

Only **\$3.68** NET

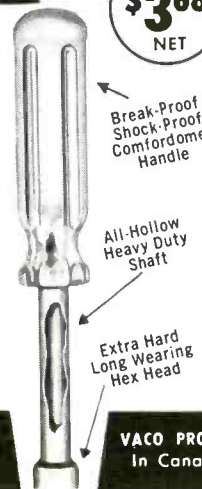

### Convenient! Compact!

Here's a practical, quality built nut driver kit . . . economically priced, too! 5 popular sizes . . .  $\frac{3}{16}$ ",  $\frac{1}{4}$ ",  $\frac{5}{16}$ ",  $1\frac{1}{32}$ ",  $\frac{3}{8}$ " ideal for every service need . . . in one convenient plastic bag with button-down flap to keep drivers in place! Made to VACO professional quality standards throughout backed by our famous unconditional guarantee.

See Your Parts Distributor, Today!

VACO PRODUCTS CO., 317 E. Ontario St., Chicago 11, Ill.  
In Canada: ATLAS RADIO CORP., Toronto 10, Ontario

# BEST BUILT



# YET

The Tung-Sol Magic Mirror Aluminumized Picture Tube captures every tone, every detail brilliantly to bring out the best in every set. It's your best insurance for loyal, satisfied customers. Tell your supplier you'd rather have Tung-Sol tubes.

**ts TUNG-SOL®**  
**Magic Mirror Aluminumized**  
**PICTURE TUBES**

TUNG-SOL ELECTRIC INC., Newark 4, N. J. Sales Offices: Atlanta, Ga.; Columbus, Ohio; Culver City, Calif.; Dallas, Tex.; Denver, Colo.; Detroit, Mich.; Irvington, N. J.; Melrose Park, Ill.; Newark, N. J.; Seattle, Wash.

### Ceramic Capacitor Kits

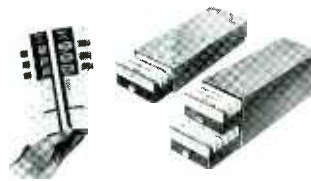

Three popular ceramic capacitor kits are again being supplied through distributors by Sprague Products Co., North Adams, Mass. "Ceramikit" CK-2 (\$38.00) contains 150 assorted disc capacitors with ratings from 5 mmf to .01 mfd. Kit CK-3 (\$19.25) contains 75 capacitors in values from 10 mmf to .01 mfd, neatly stored and indexed in miniature filing cabinets designed to fit into a tool box. "Universal" Kit CK-4 (\$6.00) contains three each of four different "Universal" ceramic capacitors, mounted on a heavy card folder which includes wiring instructions.

### Swivel-Mounted PA Projector

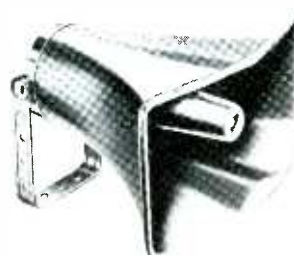

University Loudspeakers, Inc., 80 S. Kensico Ave., White Plains, N.Y., has announced a new wide-angle PA projector, Model CLH, which features a swivel mount allowing 360° rotation of the projector on its axis. This feature enables the user to adjust the projector for the exact sound distribution pattern he desires. Specifications of the CLH are: air-column length, 4½'; horn cutoff, 120 cps; dispersion, 120° × 60°; bell mouth, 21½" × 11½"; and depth (less driver) 20". List price is \$44.50.

### Tape Recorder Microphone

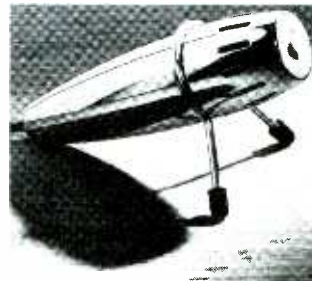

A new omnidirectional microphone designed especially for tape recorder work has been developed by the Electronics Division of Elgin National Watch Co., Elgin, Ill. This rocket-shaped "TRC" mike (shown with snap-on desk stand) has a "push-to-talk" control button in the center of the head, with a slide-lock arrangement for continuous recording. The "TRC" is chrome-finished, measures 4¾" × 1¼" and weighs 7 ounces. List price is \$11.00 for a ceramic version or \$17.85 for the dynamic type.

### Extra Large Tube Caddy



Argos Products Co., Genoa, Ill., has introduced a TC-5 Super Tube Caddy measuring 24" wide × 16½" high × 8½" deep and having a capacity of 3,300 cu. in., or ⅓ more space than the largest previous model, the Argos TC-4 Carry-all. A removable tray is included for storage of tools and accessories needed on home service calls. Price of the TC-5 at parts distributors is \$21.95.



### Color Gun Control



Model T-101 "Color Gun Killer," a new product of Perma-Power Co., 3100 Elston Ave., Chicago, Ill., can be inserted between the base and socket of a three-gun color picture tube for the purpose of providing separate on-off controls for each electron gun. With this

device, any combination of guns can be disabled so that color purity adjustments can be made without the need for cutting or unsoldering any leads. List price is \$4.95.

### Antenna Matching Coils

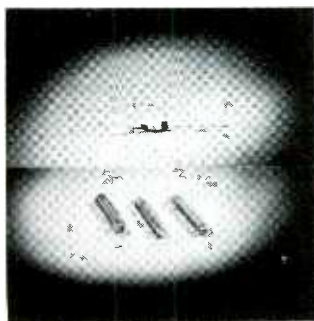

Three new types have been added to the exact replacement line of antenna matching coils produced by Colman Tool & Machine Co., Amarillo, Texas, for installation in TV sets. Nos. 1213 and 1214—the former with an X-shaped cross-section, and the latter with a

hollow core—are for use in late-model RCA Victor sets. No. 1215 is designed to fit recent General Electric sets.

### Bulk Tape Eraser



The Type 710 Heavy Duty Degausser, available from Aerovox Corp., New Bedford, Mass., demagnetizes recording tape without removing it from the reel. A spindle on one corner of the case accommodates the reel,

which is slowly rotated for several turns by hand in order to expose all the tape to the magnetic field of the degausser. Before the power is turned off, the reel should be lifted 6" or 8" off the spindle to prevent the collapsing field from remagnetizing the tape. Net price of the unit is \$49.95.

### Subminiature Resistors

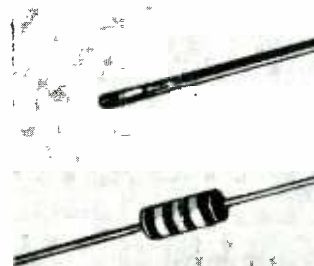

Tiny composition resistors rated at  $\frac{1}{10}$  watt are being made by Ohmite Mfg. Co., 3601 Howard St., Skokie, Ill., for use in miniature transistorized equipment. Although similar in construction to "Little Devil" resistors of  $\frac{1}{2}$ -watt and larger sizes,

the new types are only .067" in diameter and .140" in length. Resistance values available range from 100 ohms to 1 megohm.

November, 1957 • PF REPORTER

# BEST FOR



# EVERY SET

All Tung-Sol radio, TV or Hi Fi tubes are engineered to one standard of quality—Blue Chip Quality. Whether they're for famous set makers or leading service dealers, Tung-Sol Tubes are identical in design and performance. Tell your supplier you'd rather have Tung-Sol!

*Blue Chip Quality*

**ts TUNG-SOL®**  
**RECEIVING TUBES**

TUNG-SOL makes All-Glass Sealed Beam Lamps, Miniature Lamp Signal Flashers, Picture Tubes, Radio, TV and Special Purpose Electron Tubes and Semiconductor Products.

### INDEX TO ADVERTISERS

November, 1957

Advertisers	Page No.
Acme Electric Corp. ....	44
Admiral Corp.— Special Products Div. ....	36
Aerovox Corp. ....	61
Amperex Electronics Corp. ....	47
Amphenol Electronics Corp. ....	46
Argos Products Co. ....	52
Astron Corp. ....	13
B & K Mfg. Co. ....	11
B & M Electronic Mfg. Co. ....	74
Belden Mfg. Co. ....	37
Blonder-Tongue Labs. ....	73
Bussmann Mfg. Co. ....	35
CBS-Hytron ....	29
Centralab, A Div. of Globe-Union, Inc. ....	54, 55
Chicago Standard Transformer Co. .	27
Circuit Mfg. Co., Inc. ....	74
Clarostat Mfg. Co., Inc. ....	33
Columbia Wire & Supply Co. ....	77
Cornell-Dubilier Electric Corp. ....	68
Dynamic Electronics, New York, Inc. ....	40
E-Z-Hook Test Products ....	71
EICO ....	66
Electronic Publishing Co. ....	40
Elgin Nat'l. Watch Co. (Electronics Div.) ....	10
General Cement Mfg. Co. ....	75
General Electric Co. ....	45
Gernsback Library, Inc. ....	63
Good-All Electric Mfg. Co. ....	5
Hickok Electrical Instrument Co. ...	17
Injectoall Co. ....	67
International Resistance Co. (IRC) ....	2nd cover
Jackson Electrical Instrument Co. ....	65, 71
Jensen Industries, Inc. ....	70
Jensen Mfg. Co. ....	15
Littelfuse, Inc. ....	4th cover
Mallory & Co., Inc., P. R. ....	30, 31
Merit Coil & Transformer Corp. ....	67
Mosley Electronics, Inc. ....	65
Oxford Components, Inc. ....	76
Phaotron Instrument & Electronic Co. ....	53
Pyramid Electric Co. ....	41
RCA Components Div. ....	51
RCA Electron Tube Div. ....	3rd cover
Radiart Corp.—Cornell- Dubilier Electric Corp. ....	1
Raytheon Mfg. Co. ....	9, 34
Recoton Corp. ....	63
Sams & Co., Inc., Howard W. ....	43, 49, 67
Sarkes Tarzian, Inc. ....	48
Service Instruments Corp. ....	70
Simpson Electric Co. ....	59
Sprague Products Co. ....	2, 52
Sylvania Electric Products, Inc. ...	6-7
Teletest Instrument Corp. ....	64
Triad Transformer Corp. ....	72
Triplet Electrical Instrument Co. ...	39
Tung-Sol Electric, Inc. ....	78, 79
Utah Radio Products Corp. ....	56
Vaco Products Co. ....	77
Webster Electric Co. ....	57
Weller Electric Corp. ....	42
Wen Products, Inc. ....	4
Winston Electronics, Inc. ....	8, 62, 69
Wright Steel & Wire Co., G. F. ....	58
Xcelite, Inc. ....	58
Yeats Appliance Dolly Sales Co. ....	64

- 1K. ACME**  
Variable Voltage Adjustor Catalog VA312. See ad page 44.
- 2K. ARGOS**  
Complete 6-page Catalog. New—just printed August, 1957. See ad page 52.
- 3K. B & K**  
Bulletin 1050 tells how you can transmit video and audio to any TV set with New Model 1050 Dyna-Scan. Bulletin 650 describes the new Model 650 Dyna-Quik portable dynamic mutual conductance tube and transistor tester. Bulletin 400-C40 describes CRT Cathode Rejuvenator Tester. See ad page 11.
- 4K. B & M**  
One-page Flyer describing the inductive winding tester and its functions. See ad page 74.
- 5K. BUSSMANN**  
Complete TV Fuse Guide, Form TVC. Shows type and ampere size of the fuse to use in various TV sets. See ad page 35.
- 6K. CBS HYTRON**  
"The Independent Service Business and Your Future." Form PA-163. See ad page 29.
- 7K. CHICAGO STANDARD**  
Stancor TV Replacement Guide Catalog Library. See ad page 27.
- 8K. CLAROSTAT**  
"Greenohm" power resistors—fixed & adjustable—5 watts to 200 watts. Form 753393. See ad page 33.
- 9K. CORNELL-DUBILIER**  
Invertors and power supplies. Cat. XTR-INV. See ad page 68.
- 10K. DYNAMIC**  
Newest Hi-Fi accessories and complete Catalog Sheets on Dynamic "Quadnaural" speaker systems & amplifiers. See ad page 40.
- 11K. E-Z-HOOK**  
A convenient reference sheet titled "How to Build the Five Most Useful Scope Probes" with schematic, mechanical component layout, etc. See ad page 71.
- 12K. EICO**  
12-page catalog shows how to save 50% on electronic test instruments and hi-fi equipment in both kit and factory-wired form. See ad page 66.
- 13K. ELGIN**  
Technical data and illustrations of the dynamic, ceramic, and crystal versions of the TRC Series 204 tape recorder microphone. See ad page 10.
- 14K. HICKOK**  
Technical Booklet describing latest method of testing tubes. See ad page 17.
- 15K. IRC**  
Form SO35A-DLR-57—Replacement Parts Catalog. See ad on 2nd cover.
- 16K. JACKSON**  
Folder covering the entire Jackson line of "Service Engineered" test equipment. See ads pages 65, 71.
- 17K. LITTELFUSE**  
Handy Cross-Reference Card showing LC fuses and list prices. See ad on 4th cover.
- 18K. MERIT**  
Form No. 700. Merit's Exact Replacement Wall Chart. See ad page 67.
- 19K. PHAOSTRON**  
Illustrated Catalog lists complete line of custom panel meters. Includes comparison chart of Phaotron instruments vs. other brands, plus dimensions and features. See ad page 53.
- 20K. RCA ELECTRON TUBE DIV.**  
RCA "Profit Builders" catalog of service, business, technical and promotional aids. See ad on 3rd cover.
- 21K. RAYTHEON**  
Information regarding the sales-stimulating "Good-Will Business Builder Program." See ads pages 9, 34.
- 22K. SARKES TARZIAN**  
New "Silicon Rectifier Handbook." See ad page 48.
- 23K. SIMPSON**  
Test Equipment Catalog No. 2058 plus Meter Catalog No. 2057. See ad page 59.
- 24K. SPRAGUE**  
Catalog M-456—Wall-type TV-Radio Service Catalog. See ads pages 2, 52.
- 25K. SONOTONE**  
"Beautiful Sound by Sonotone" (SA-7) catalog of high-fidelity amplifiers and speaker systems. "Phonograph Modernization Manual" (SAC-7) gives data on Sonotone ceramic cartridges and their installation.
- 26K. TACO**  
"Bonanza" Package for Golden Topliner dealers.
- 27K. TOBE DEUTSCHMANN**  
Tobe Service Capacitor Catalog.
- 28K. TRIAD**  
Triad Television Replacement Guide TV-57. See ad page 72.
- 29K. TRIPLETT**  
Catalog on the new 630 PL V-O-M. See ad page 39.
- 30K. TUNG-SOL**  
(1) Semi-Conductor Characteristic and Interchangeability Chart. (2) Industrial Tube Descriptive Brochure. See ads pages 78, 79.
- 31K. UNIVERSITY**  
(1) New Product Catalog describing complete line of public address and hi-fi loudspeakers. (2) KWIKIT Folder covering new do-it-yourself hi-fi enclosure kits.
- 32K. VACO**  
Catalogs on solderless terminals, crimping tools and complete line of service tools. See ad page 77.
- 33K. WELLER**  
New envelope stuffer describing Model 8100K soldering kit. See ad page 42.
- 34K. WEN**  
Illustrated Catalog Sheet No. 808 describes new 2-speed 3/8" power drill. Also folder AL-1 on line of high-grade, low-cost power tools including soldering guns with special-purpose tips. See ad page 4.
- 35K. WINSTON**  
One-page Flyer on full line of equipment. See ads pages 8, 62, 69.
- 36K. WRIGHT**  
Complete details on galvanized TV guy wire strand—various types and sizes. See ad page 58.
- 37K. XCELITE**  
New, illustrated, full-color Catalog featuring complete line plus new products. See ad page 58.
- 38K. YEATS**  
Four-page Catalog describing the Yeats appliance dolly and padded covers for delivering TV sets. See ad page 64.



ORDER YOUR SUBSCRIPTION TODAY TO  
THE INDUSTRY'S LEADING MAGAZINE -

# PF REPORTER

## ★ SUBSCRIPTION ORDER CARD ★

Please enter my subscription to PF REPORTER for:

1 Year \$3.00       2 Years \$5.00       3 Years \$7.00

Bill Me       Remittance Enclosed\*

Add 60¢ per year postage for Canada and Pan-America;  
\$3.00 per year for all other foreign countries.

Give to your parts distributor or mail to  
PF REPORTER, 2201 East 46th Street, Indianapolis, Ind.

Name \_\_\_\_\_

Firm \_\_\_\_\_

Address \_\_\_\_\_

City \_\_\_\_\_ Zone \_\_\_\_\_ State \_\_\_\_\_

Independent Serviceman       Full-Time

Dealer with Service Shop       Part-Time

Service Manager       Student

Other (please explain) \_\_\_\_\_

\* Two extra issues free if remittance accompanies order.

Please send me the following  
literature checked below:

Please indicate number of  
items you have checked.

1	20
K	K
2	21
K	K
3	22
K	K
4	23
K	K
5	24
K	K
6	25
K	K
7	26
K	K
8	27
K	K
9	28
K	K
10	29
K	K
11	30
K	K
12	31
K	K
13	32
K	K
14	33
K	K
15	34
K	K
16	35
K	K
17	36
K	K
18	37
K	K
19	38
K	K

Print plainly or type below

Name \_\_\_\_\_

Firm \_\_\_\_\_

Firm Address \_\_\_\_\_

City \_\_\_\_\_ Zone \_\_\_\_\_ State \_\_\_\_\_

Has your address changed since you last wrote us     No     Yes

To guarantee receipt of literature please check one of boxes below:

Independent Serviceman       Full-Time

Dealer with Service Shop       Part-Time

Service Manager       Student

Other (please explain) \_\_\_\_\_

OFFER GOOD  
ONLY UNTIL  
JAN. 1, 1958

FIRST CLASS  
PERMIT No. 1076  
(Sec. 34.9, P. L. & R.)  
Indianapolis, Ind.



**BUSINESS REPLY CARD**  
No Postage Stamp Necessary If Mailed in the United States

3¢ POSTAGE WILL BE PAID BY

**PF REPORTER**

*Reader's Literature Service Dept.*

2201 EAST 46TH STREET  
INDIANAPOLIS 5, IND.

FIRST CLASS  
PERMIT No. 1076  
(Sec. 34.9, P. L. & R.)  
Indianapolis, Ind.



**BUSINESS REPLY CARD**  
No Postage Stamp Necessary If Mailed in the United States

3¢ POSTAGE WILL BE PAID BY

**PF REPORTER**

2201 EAST 46TH STREET  
INDIANAPOLIS 5, IND.











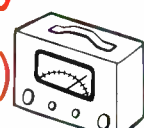

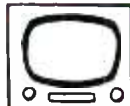

Here's how to make picture tube profits: First, you  
 need your everyday tools  plus good test equipment  
 (RCA) , plus your skill  and knowledge . Then,  
 you need top-quality, dependable RCA Silverama   
 Picture Tubes that rejuvenate nearly any make of set,  
 and make friends of your customers. And, finally,  
 you need the sales "tools", too. And these RCA makes  
 available to you in abundance. See your Authorized RCA  
 Tube distributor for the most powerful merchandising  
 aids available, including these two brand new headliners:



**ILLUMINATED SERVICE SIGN.** This new, compact, TV Service Sign with flasher, tells 'em you handle the best TV tubes on the market, the brand they know best—RCA Silverama.



**SAFE-TV MAT.** This "how-did-I-ever-do-without-it-before" heavy rubber protective mat prevents face plate damage to out-of-chassis picture tubes.

Put these and a world of other new, fresh RCA promotion aids to work for you. With all these aids to help you sell the top picture tube brand in the industry, plus RCA newspaper and magazine ads, TV commercials, booklets, folders, ad mats, seals, and other hard-hitting promotional items, you can't miss making those big ticket, big mark-up, easy-to-make picture tube dollars.



**PICTURE TUBES**  
**RADIO CORPORATION OF AMERICA**

Electron Tube Division, Harrison, N. J.

# LITTELFUSE

Des Plaines, Illinois

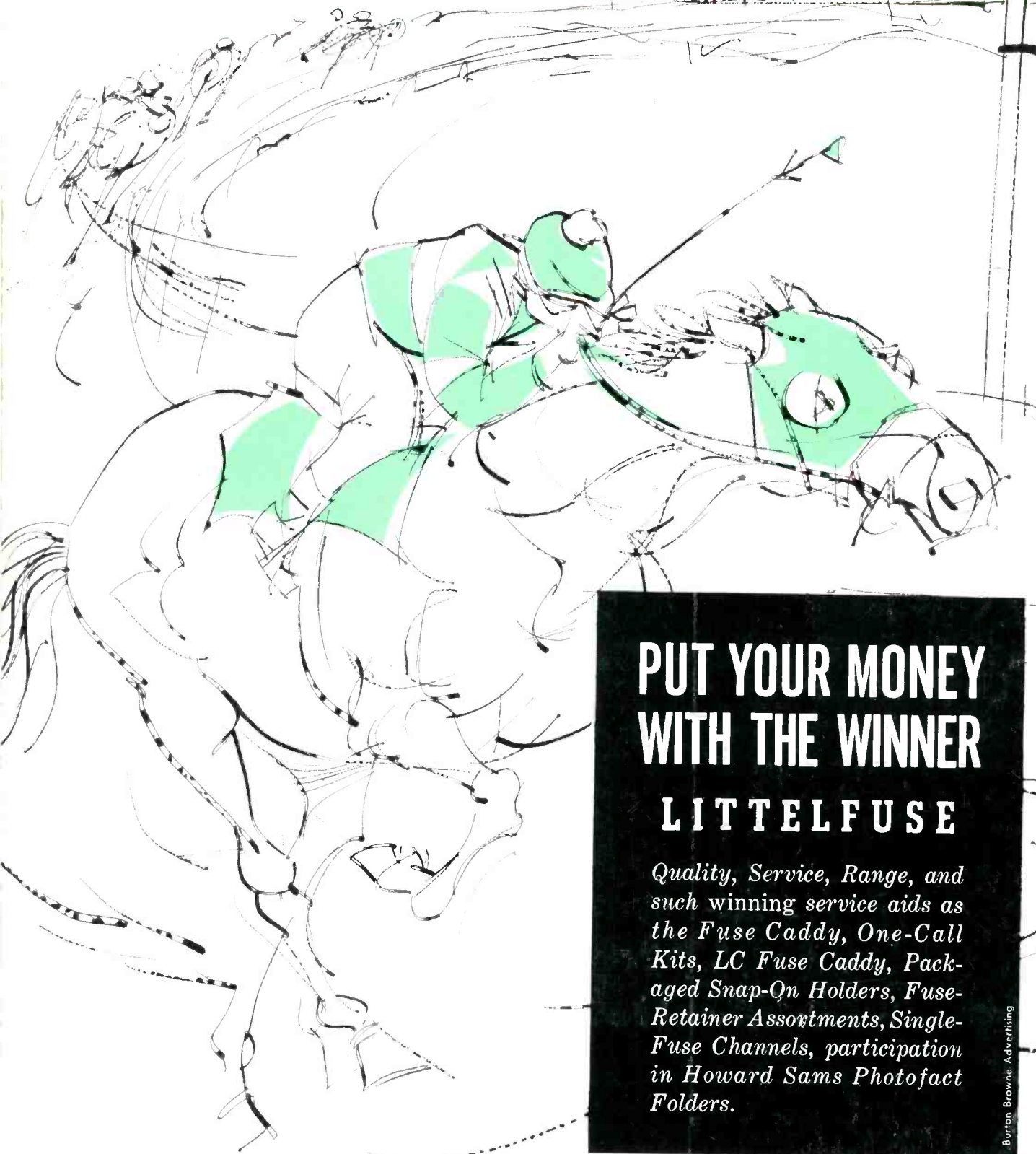

**PUT YOUR MONEY  
WITH THE WINNER**

**LITTELFUSE**

*Quality, Service, Range, and such winning service aids as the Fuse Caddy, One-Call Kits, LC Fuse Caddy, Packaged Snap-On Holders, Fuse-Retainer Assortments, Single-Fuse Channels, participation in Howard Sams Photofact Folders.*

Burton Browne Advertising