



# **ET-3830 User's Guide**



---

# Contents

<b>ET-3830 User's Guide</b> .....	<b>13</b>
<b>Product Basics</b> .....	<b>14</b>
Product Parts Locations .....	14
Product Parts - Front .....	15
Product Parts - Inside .....	16
Product Parts - Back.....	18
Using the Control Panel .....	18
Control Panel Buttons and Lights .....	19
The LCD Screen .....	20
Status Icon Information .....	20
Entering Characters on the LCD Screen .....	22
Changing LCD Screen Language.....	22
Viewing Animations .....	23
Adjusting the Screen Brightness.....	23
Turning Off the Operation Time Out Setting .....	23
Using Power Saving Settings .....	24
Changing the Sleep Timer Settings .....	24
Changing the Power Off Timer Settings .....	24
Using the Epson Smart Panel Mobile App.....	24
Voice-activated Printing .....	25
Epson Connect Solutions for Smartphones, Tablets, and More .....	25
Setting Up Epson Connect Services.....	26
Using Epson Email Print .....	26
Using Epson Remote Print .....	27
Using Epson Scan to Cloud.....	28
Using AirPrint .....	29
Setting Up Printing on a Chromebook .....	29
Android Printing Using the Epson Print Enabler .....	30
Using Fire OS Printing .....	30
Using Windows 10 Mobile Printing .....	31

Using Epson Print and Scan App with Windows Tablets .....	31
Using the Mopria Print Service .....	32
<b>Wi-Fi or Wired Networking</b> .....	<b>33</b>
Network Security Recommendations .....	33
Wi-Fi Infrastructure Mode Setup.....	34
Selecting Wireless Network Settings from the Control Panel .....	35
Setting Up Wireless Printing from a Smartphone or Tablet .....	37
Wi-Fi Direct Mode Setup .....	38
Enabling Wi-Fi Direct (Simple AP) Mode .....	39
Wi-Fi Protected Setup (WPS).....	41
Using WPS to Connect to a Network .....	41
Printing a Network Status Sheet.....	42
Printing a Network Connection Report .....	42
Network Connection Report Codes and Messages .....	43
Changing or Updating Network Connections .....	49
Accessing the Web Config Utility .....	49
Changing a USB Connection to a Wi-Fi Connection.....	50
Changing a Wi-Fi Connection to a Wired Network Connection.....	50
Connecting to a New Wi-Fi Router .....	51
Disabling Wi-Fi Features .....	51
<b>Loading Paper</b> .....	<b>53</b>
Loading Paper in the Cassette .....	53
Paper Loading Capacity .....	58
Double-sided Printing Capacity .....	60
Borderless Paper Type Compatibility .....	61
Compatible Epson Papers.....	62
Selecting the Paper Settings - Control Panel .....	64
Paper or Media Type Settings - Control Panel .....	65
Paper or Media Type Settings - Printing Software.....	66
Selecting the Default Paper Source Settings.....	66
Paper Source Settings Options .....	67
Selecting the Universal Print Settings .....	68
Universal Print Settings Options .....	68

<b>Placing Originals on the Product</b> .....	<b>70</b>
Placing Originals on the Scanner Glass .....	70
<b>Copying</b> .....	<b>73</b>
Copying Documents or Photos .....	73
Copying Options .....	74
<b>Printing from a Computer</b> .....	<b>76</b>
Printing with Windows .....	76
Selecting Basic Print Settings - Windows .....	77
Print Quality Options - Windows .....	79
Multi-Page Printing Options - Windows .....	79
Selecting Double-sided Printing Settings - Windows .....	80
Double-sided Printing Options - Windows .....	83
Print Density Adjustments - Windows .....	83
Selecting Additional Layout and Print Options - Windows .....	84
Custom Color Correction Options - Windows .....	86
Image Options and Additional Settings - Windows .....	87
Header/Footer Settings - Windows .....	88
Selecting a Printing Preset - Windows .....	89
Selecting Extended Settings - Windows .....	90
Extended Settings - Windows .....	92
Printing Your Document or Photo - Windows .....	94
Checking Print Status - Windows .....	95
Locking Printer Settings - Windows .....	96
Locked Setting Options .....	97
Selecting Default Print Settings - Windows .....	99
Changing the Language of the Printer Software Screens .....	100
Changing Automatic Update Options .....	101
Printing with the Built-in Epson Driver - Windows 10 S .....	102
Selecting Print Settings - Windows 10 S .....	102
Printing on a Mac .....	106
Selecting Basic Print Settings - Mac .....	107
Print Quality Options - Mac .....	110
Print Options - Mac .....	111

Selecting Page Setup Settings - Mac .....	111
Selecting Print Layout Options - Mac.....	112
Selecting Double-sided Printing Settings - Mac.....	113
Double-sided Printing Options and Adjustments - Mac.....	114
Managing Color - Mac .....	115
Color Matching and Color Options - Mac .....	116
Selecting Printing Preferences - Mac .....	117
Printing Preferences - Mac.....	118
Printing Your Document or Photo - Mac .....	119
Checking Print Status - Mac.....	120
Printing from a Smartphone or Tablet.....	121
Printing with Epson Photo+ .....	121
Cancelling Printing Using the Product .....	121
<b>Scanning .....</b>	<b>122</b>
Starting a Scan.....	122
Starting a Scan Using the Product Control Panel .....	122
Scanning to a Connected Computer .....	123
Scanning to the Cloud.....	125
Setting Up a WSD Port (Windows 7/Windows Vista) .....	126
Control Panel Scanning Options .....	127
Changing Default Scan Job Settings .....	128
Starting a Scan Using Epson ScanSmart .....	129
Starting a Scan Using the Epson Scan 2 Icon .....	129
Starting a Scan from a Scanning Program.....	132
Starting a Scan from a Smartphone or Tablet.....	134
Scanning a Document in Epson ScanSmart.....	134
Saving a Scan .....	137
Attaching a Scan to Email.....	138
Sending a Scan to a Cloud Service .....	139
Printing a Scan .....	140
Selecting Epson ScanSmart Settings.....	142
Changing the Epson Product.....	142
Changing the Scan Settings .....	143

Changing the File Name Settings .....	145
Changing the Save Settings .....	146
Save Settings.....	148
Customizing Action Icons .....	150
Scanning in Epson Scan 2 .....	151
Additional Scanning Settings - Main Settings Tab .....	154
Additional Scanning Settings - Advanced Settings Tab .....	154
Saving Scanned Documents as a Searchable PDF Using Epson Scan 2 .....	156
Image Format Options .....	157
Scan Resolution Guidelines .....	158
<b>Refilling Ink and Replacing the Maintenance Box .....</b>	<b>160</b>
Ink Safety Precautions .....	160
Checking the Ink and Maintenance Box Levels.....	162
Checking Ink Levels on Your Product.....	163
Checking Maintenance Box Status on the LCD Screen.....	163
Checking Ink and Maintenance Box Levels - Windows .....	164
Checking Ink and Maintenance Box Levels - Mac .....	166
Disabling Special Offers with Windows .....	167
Purchase Epson Ink and Maintenance Box.....	168
Ink Bottle and Maintenance Box Part Numbers .....	169
Refilling the Ink Tanks .....	169
Maintenance Box Replacement .....	175
<b>Adjusting Print Quality.....</b>	<b>177</b>
Print Head Maintenance.....	177
Print Head Nozzle Check.....	177
Checking the Nozzles Using the Product Control Panel .....	178
Checking the Nozzles Using a Computer Utility .....	180
Print Head Cleaning .....	183
Cleaning the Print Head Using the Product Control Panel .....	183
Cleaning the Print Head Using a Computer Utility.....	186
Power Cleaning .....	189
Power Cleaning Using the Product Control Panel.....	189
Power Cleaning Using a Computer Utility .....	190

Print Head Alignment .....	192
Aligning the Print Head Using the Product Control Panel .....	192
Cleaning the Paper Guide .....	194
Cleaning the Print Head Path .....	196
Cleaning the Paper Rollers .....	199
Checking the Number of Sheets Fed.....	202
Checking the Number of Sheets on the LCD Screen.....	202
Checking the Sheet Counter - Windows .....	202
Checking the Sheet Counter - Mac.....	203
<b>Cleaning and Transporting Your Product .....</b>	<b>205</b>
Cleaning Your Product .....	205
Transporting Your Product .....	206
<b>Solving Problems .....</b>	<b>211</b>
Checking for Software Updates.....	211
Viewing the Help Screen .....	212
Product Status Messages .....	212
Message Appears Prompting You to Reset Ink Levels.....	215
Running a Product Check .....	215
Resetting Control Panel Defaults .....	216
Solving Setup Problems .....	217
Product Does Not Turn On or Off.....	217
Noise After Filling the Ink.....	217
Software Installation Problems .....	218
Solving Network Problems .....	218
Product Cannot Connect to a Wireless Router or Access Point .....	219
Network Software Cannot Find Product on a Network.....	220
Product Does Not Appear in Mac Printer Window .....	222
Wireless Network Connection is Unstable on a Mac .....	222
Wired Network Connection Becomes Unstable .....	222
Cannot Print Over a Network.....	223
Cannot Scan Over a Network .....	225
Solving Copying Problems .....	226
Product Makes Noise, But Nothing Copies.....	226



Product Makes Noise When It Sits for a While.....	226
Copies Have Incorrect or Faint Colors.....	227
Position, Size, or Margins of Copies are Incorrect.....	227
Solving Paper Problems.....	227
Paper Feeding Problems.....	228
Paper Jams Inside the Product.....	229
Paper Ejection Problems.....	229
Solving Problems Printing from a Computer.....	230
Nothing Prints.....	230
Product Icon Does Not Appear in Windows Taskbar.....	231
Printing is Slow.....	232
Solving Page Layout and Content Problems.....	234
Inverted Image.....	234
Too Many Copies Print.....	234
Blank Pages Print.....	235
Incorrect Margins on Printout.....	235
Border Appears on Borderless Prints.....	236
Incorrect Characters Print.....	237
Incorrect Image Size or Position.....	237
Slanted Printout.....	238
Solving Print Quality Problems.....	239
White or Dark Lines in Printout.....	239
Blurry or Smearred Printout.....	240
Faint Printout or Printout Has Gaps.....	242
Grainy Printout.....	243
Incorrect Colors.....	245
Solving Scanning Problems.....	246
Scanning Software Does Not Operate Correctly.....	246
Cannot Start Epson Scan 2.....	247
Scanning is Slow.....	248
Cannot Send Scans to a Cloud Service.....	248
Solving Scanned Image Quality Problems.....	248
Image Consists of a Few Dots Only.....	249

Line of Dots Appears in All Scanned Images .....	249
Straight Lines in an Image Appear Crooked .....	250
Scanned Image Quality Problems .....	250
Characters are Not Recognized During Conversion to Editable Text (OCR).....	251
Image Colors are Patchy at the Edges .....	252
Ripple Patterns Appear in an Image .....	252
Scanned Image Edges are Cropped .....	252
Resetting the Epson Scan 2 Settings .....	253
Uninstall Your Product Software.....	253
Uninstalling Product Software - Windows.....	253
Uninstalling Product Software - Mac.....	255
Where to Get Help.....	255
<b>Technical Specifications .....</b>	<b>257</b>
Windows System Requirements .....	257
Mac System Requirements .....	258
Paper Specifications .....	259
Printable Area Specifications .....	260
Scanning Specifications .....	262
Ink Specifications .....	262
Dimension Specifications .....	263
Electrical Specifications .....	263
Environmental Specifications .....	264
Interface Specifications .....	264
Network Interface Specifications .....	264
Safety and Approvals Specifications .....	266
<b>Notices .....</b>	<b>267</b>
Important Safety Instructions.....	267
General Product Safety Instructions .....	267
Wireless Connection Safety Instructions .....	269
LCD Screen Safety Instructions.....	269
FCC Compliance Statement.....	270
Binding Arbitration and Class Waiver .....	271
Trademarks .....	274

Copyright Notice.....	274
libTIFF Software Acknowledgment.....	275
A Note Concerning Responsible Use of Copyrighted Materials.....	276
Default Delay Times for Power Management for Epson Products .....	276
Copyright Attribution .....	276



---

## **ET-3830 User's Guide**

Welcome to the ET-3830 *User's Guide*.

For a printable PDF copy of this guide, [click here](#).

---

## Product Basics

See these sections to learn about the basic features of your product.

[Product Parts Locations](#)

[Using the Control Panel](#)

[Using Power Saving Settings](#)

[Using the Epson Smart Panel Mobile App](#)

[Voice-activated Printing](#)

[Epson Connect Solutions for Smartphones, Tablets, and More](#)

[Using AirPrint](#)

[Setting Up Printing on a Chromebook](#)

[Android Printing Using the Epson Print Enabler](#)

[Using Fire OS Printing](#)

[Using Windows 10 Mobile Printing](#)

[Using Epson Print and Scan App with Windows Tablets](#)

[Using the Mopria Print Service](#)

## Product Parts Locations

See these sections to identify the parts on your product.

[Product Parts - Front](#)

[Product Parts - Inside](#)

[Product Parts - Back](#)

**Parent topic:** [Product Basics](#)

## Product Parts - Front

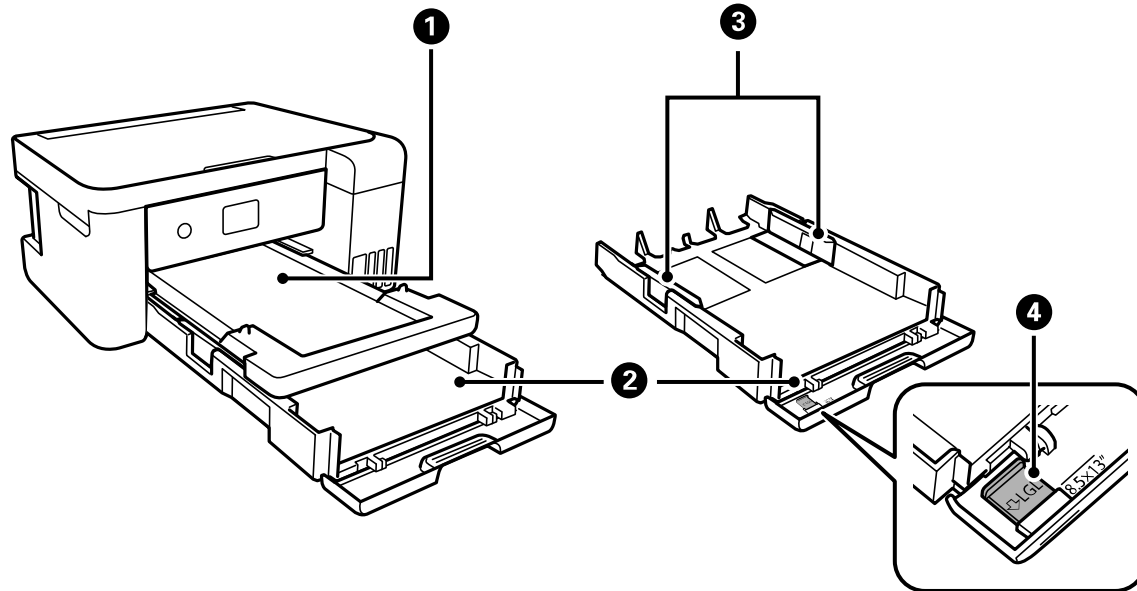

- 1 Output tray
- 2 Paper cassette
- 3 Paper cassette edge guides
- 4 Legal-size paper guide

Parent topic: [Product Parts Locations](#)

## Product Parts - Inside

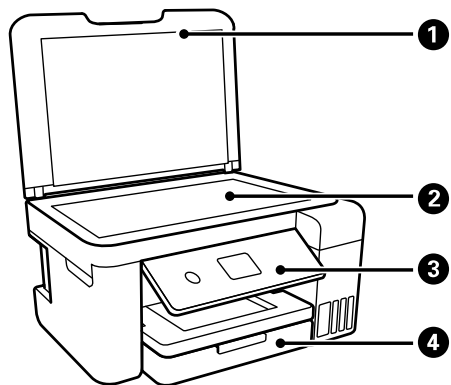

- 1 Document cover
- 2 Scanner glass
- 3 Control panel



4 Front cover

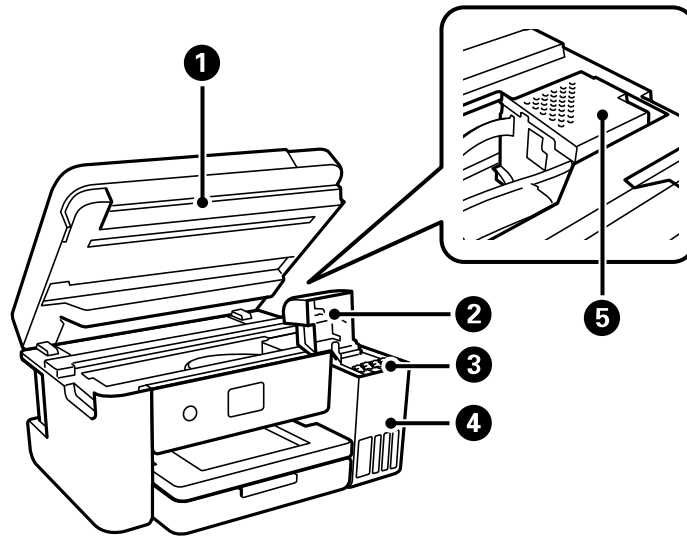

- 1 Scanner unit
- 2 Ink tank cover
- 3 Ink tanks
- 4 Ink tank unit
- 5 Print head

**Parent topic:** [Product Parts Locations](#)

## Product Parts - Back

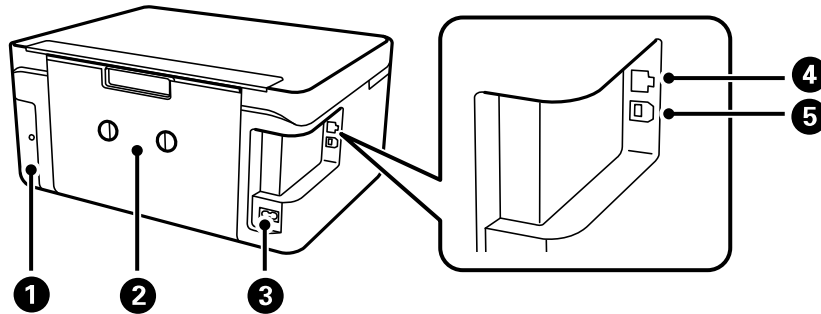

- 1 Maintenance box cover
- 2 Rear cover (duplexer)
- 3 AC inlet
- 4 **LAN** port
- 5 **USB** port

Parent topic: [Product Parts Locations](#)

## Using the Control Panel

See these sections to learn about the control panel and select control panel settings.

[Control Panel Buttons and Lights](#)

[Entering Characters on the LCD Screen](#)

[Changing LCD Screen Language](#)

[Viewing Animations](#)

[Adjusting the Screen Brightness](#)

[Turning Off the Operation Time Out Setting](#)

Parent topic: [Product Basics](#)

## Control Panel Buttons and Lights

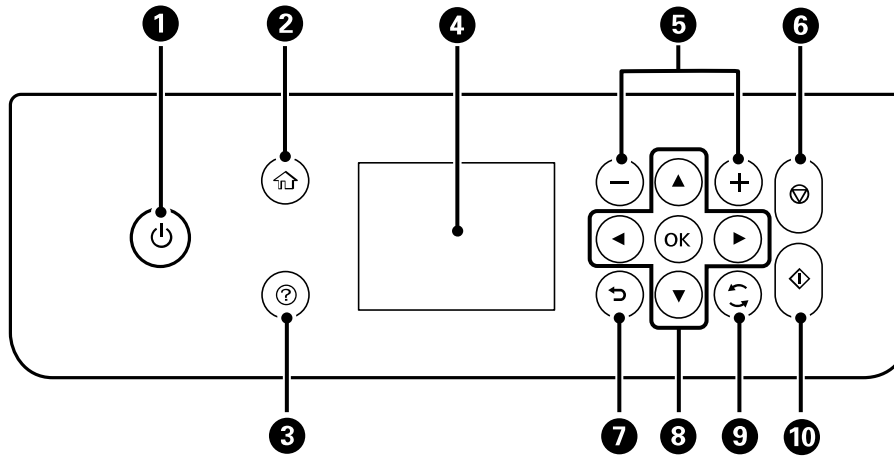

- 1 power button and light
- 2 home button
- 3 help button
- 4 LCD screen
- 5 + and - buttons
- 6 stop button
- 7 back button
- 8 Arrow buttons and **OK** button
- 9 reset button
- 10 start button

[The LCD Screen](#)

[Status Icon Information](#)

**Parent topic:** [Using the Control Panel](#)

## The LCD Screen

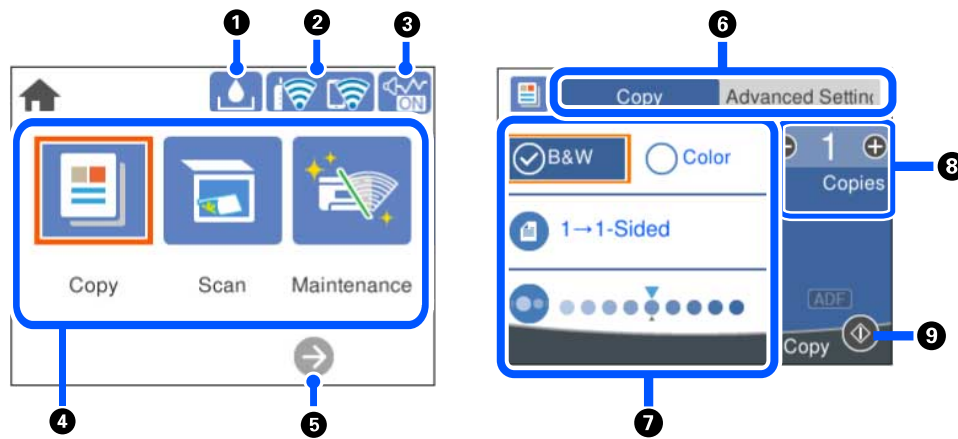













- 1 Displays the maintenance box status
- 2 Displays the network connection status
- 3 Displays the **Quiet Mode** screen
- 4 Menu options
- 5 Scrolls the screen to the right
- 6 Select a tab to view different options and settings
- 7 Settings options
- 8 Displays available options
- 9 Performs the selected action

Parent topic: [Control Panel Buttons and Lights](#)

### Status Icon Information

Your product displays status icons on the LCD screen for certain product status conditions.

Icons	Description
	Displays additional information or instructions, such as loading paper or placing a document.





Icons	Description
	<p>Displays the maintenance box status.</p>
	<p>Displays the network connection status; select the icon to set up or change your network connection.</p> <ul style="list-style-type: none"> <li>•  The product is not connected to a wired (Ethernet) network.</li> <li>•  The product is connected to a wired (Ethernet) network.</li> <li>•  The product is not connected to a wireless network.</li> <li>•  The product is searching for an SSID or experiencing a wireless network connection issue.</li> <li>•  The product is connected to a wireless network; the number of bars indicates the connection's signal strength.</li> <li>•  Wi-Fi Direct is not enabled.</li> <li>•  Wi-Fi Direct is enabled.</li> </ul>
	<p>The <b>Quiet Mode</b> setting is enabled or disabled. Select the icon to change the setting. Depending on the selected paper type and print quality, when this feature is enabled noise is reduced during printing, but print speed may also be reduced.</p>
	<p>There is a problem with the indicated setting. Select the icon to resolve the problem.</p>

Parent topic: [Control Panel Buttons and Lights](#)

## Entering Characters on the LCD Screen

Follow these guidelines to enter characters for passwords and other settings.



- To move the cursor, select the left or right arrows.
- To change the case of letters, select .
- To delete the previous character, select .
- To enter numbers or symbols, select .
- To enter a commonly used domain name, select .
- To enter a space, select .

**Parent topic:** [Using the Control Panel](#)

## Changing LCD Screen Language

You can change the language used on the LCD screen.

1. Press the  home button, if necessary.

2. Select **Settings** > **General Settings** > **Basic Settings** > **Language**.
3. Select a language.

**Parent topic:** [Using the Control Panel](#)

## Viewing Animations

You can view animations on the LCD screen to help guide you with a procedure or to troubleshoot a problem.

1. Press the  help button.
2. Select **Troubleshooting** if you are experiencing a problem or **How To** to view instructions on common procedures.
3. Select a topic from the list of available topics and follow the on-screen instructions.

**Parent topic:** [Using the Control Panel](#)

## Adjusting the Screen Brightness

You can adjust the brightness of the LCD screen.

1. Press the  home button, if necessary.
2. Select **Settings** > **General Settings** > **Basic Settings** > **LCD Brightness**.
3. Press the – or + icons to decrease or increase the brightness.
4. Select **OK** to exit.

**Parent topic:** [Using the Control Panel](#)

## Turning Off the Operation Time Out Setting

The Operation Time Out setting causes the LCD screen to return to the Home screen after a few minutes of inactivity. This feature is enabled by default, but you can turn it off.

1. Press the  home button, if necessary.
2. Select **Settings** > **General Settings** > **Basic Settings**.
3. Scroll down and set **Operation Time Out** to **Off**.

**Parent topic:** [Using the Control Panel](#)

## Using Power Saving Settings

Your product enters sleep mode automatically and turns off the LCD screen if it is not used for a period of time. You can make the time period shorter and select other options to save energy and resources.

[Changing the Sleep Timer Settings](#)

[Changing the Power Off Timer Settings](#)

**Parent topic:** [Product Basics](#)

## Changing the Sleep Timer Settings

You can adjust the time period before your product enters sleep mode and turns off the LCD screen.

1. Press the  home button, if necessary.
2. Select **Settings** > **General Settings** > **Basic Settings** > **Sleep Timer**.
3. Do one of the following:
  - Press the **+** or **-** button to increase or decrease the number of minutes.
  - Press the **OK** button to display the on-screen keypad, select the number of minutes, and select **OK**.
4. Select **Done**.

**Parent topic:** [Using Power Saving Settings](#)

## Changing the Power Off Timer Settings

You can have the product turn off automatically if it is not used for a specified period of time.

1. Press the  home button, if necessary.
2. Select **Settings** > **General Settings** > **Basic Settings**.
3. Select **Power Off Timer**, then select a time period between **30minutes** and **12h** (12 hours).

**Parent topic:** [Using Power Saving Settings](#)

## Using the Epson Smart Panel Mobile App

Use this free Apple and Android app to set up your Epson product and then print, copy, or scan with your networked Epson product. Epson Smart Panel also lets you check ink levels and product status.

1. Visit [epson.com/connect](http://epson.com/connect) (U.S) or [epson.ca/connect](http://epson.ca/connect) (Canada) to learn more about Epson Smart Panel and check the compatibility of your mobile device.
2. Download Epson Smart Panel from the Apple App Store or Google Play.



3. Connect your mobile device to the wireless network that you want to connect your product to or to the same wireless network as your product (if your product is already set up).
4. Do one of the following:
  - If you haven't set up your product, open Epson Smart Panel and follow the instructions to set up your product.
  - If your product is already set up, open Epson Smart Panel and select your Epson product, if necessary.

Now you are ready to print, copy, or scan with your mobile device and your Epson product.

**Parent topic:** [Product Basics](#)

**Related topics**

[Wi-Fi or Wired Networking](#)

## Voice-activated Printing

Take advantage of voice-activated, hands-free printing from your Epson product with Alexa, Siri, and Google Assistant. Depending on which voice assistant you use, you can ask your product to print photos, calendars, recipes, photo props, and more. [Click here](#) for more information.

1. Connect your product to your network. See the link below.
2. Set up your product's email address for use with Epson Connect. See the link below to activate it from the product control panel.
3. [Click here](#) for instructions on how to set up your product and voice assistant to use the voice-activated printing feature.

Now you are ready to print with your voice and your Epson product.

**Parent topic:** [Product Basics](#)

**Related tasks**

[Setting Up Epson Connect Services](#)

**Related topics**

[Wi-Fi or Wired Networking](#)

## Epson Connect Solutions for Smartphones, Tablets, and More

Use your smartphone, tablet, or computer to print and scan documents, photos, emails, and web pages from your home, office, or even across the globe.

**Note:** If you are using your Epson product with the Windows 10 S operating system, you cannot use the software described in this section. You also cannot download and install any Epson product software from the Epson website for use with Windows 10 S; you must obtain software only from the Windows Store.

Print from anywhere with these Epson Connect solutions:

- Epson Email Print
- Epson Remote Print

Scan and send a file as an email or upload it to an online service directly from your Epson product with Epson Scan to Cloud.

[Setting Up Epson Connect Services](#)

[Using Epson Email Print](#)

[Using Epson Remote Print](#)

[Using Epson Scan to Cloud](#)

**Parent topic:** [Product Basics](#)

**Related topics**

[Wi-Fi or Wired Networking](#)

## Setting Up Epson Connect Services

If you did not activate your product's email address for use with Epson Connect when you set up your product, you can activate it using the product control panel.

1. Press the  home button, if necessary.
2. Select **Settings** > **General Settings** > **Web Service Settings** > **Epson Connect Services**.
3. Select **Register**.
4. Follow the instructions on the screen to activate your product's email address.

**Parent topic:** [Epson Connect Solutions for Smartphones, Tablets, and More](#)

**Related topics**

[Wi-Fi or Wired Networking](#)

## Using Epson Email Print

With Epson Email Print, you can print from any device that can send email, such as your smartphone, tablet, or laptop. Just activate your product's unique email address. When you want to print, attach a

PDF, Microsoft Office document, or photo to an email and send it to your product. Both the email and the attachments will print automatically.

1. Connect your product to your network. See the link below.
2. If you did not already set up Email Print when you installed your product software, see the link below to use your product control panel to activate your unique email address. Or visit [epson.com/connect](http://epson.com/connect) (U.S) or [epson.ca/connect](http://epson.ca/connect) (Canada) to learn more about Email Print, create your Epson Connect account, and register your product to the Epson Connect service.
3. Now you are ready to send and print emails to your product's Email Print address.

**Note:** Go to [epsonconnect.com](http://epsonconnect.com) and log into your Epson Connect account to personalize your product's email, adjust print settings, and set up other Epson Connect services.

**Parent topic:** [Epson Connect Solutions for Smartphones, Tablets, and More](#)

**Related tasks**

[Setting Up Epson Connect Services](#)

**Related topics**

[Wi-Fi or Wired Networking](#)

## Using Epson Remote Print

With Epson Remote Print software, you can print from your laptop or desktop computer to an Epson Email-enabled product anywhere in the world.

1. Connect your Epson product to your wireless network. See the link below.
2. If you did not already set up an Epson Connect account when you installed your product software, visit [epsonconnect.com](http://epsonconnect.com) to create your account and register your product to the Epson Connect service.

**Note:** Make a note of your product's email address.

3. Visit [epsonconnect.com](http://epsonconnect.com) to learn more about Remote Print and how to download the Remote Print Driver software.
4. Download and install the Remote Print software.
5. Enter the email address and optional access key of your Epson product during Remote Print setup.
6. Now you are ready to print remotely. Select the print command in your laptop or desktop computer application and choose the Remote Print option for your Epson product.

**Parent topic:** [Epson Connect Solutions for Smartphones, Tablets, and More](#)

**Related tasks**

[Setting Up Epson Connect Services](#)

**Related topics**

[Wi-Fi or Wired Networking](#)

## Using Epson Scan to Cloud

The Epson Scan to Cloud service allows you to scan and send a file as an email or upload it to an online service directly from your Epson product. Register an email address or online services such as Box, DropBox, Evernote, or Google Drive with your Epson Connect account.

1. Connect your Epson product to your network. See the link below.
2. If you did not already set up an Epson Connect account when you installed your product software, visit [epsonconnect.com](http://epsonconnect.com) to create your account and register your product to the Epson Connect service.

**Note:** Make a note of your product's email address and password.

3. Visit [epsonconnect.com](http://epsonconnect.com) to sign into your account with the email address and password you selected.
4. Select your product, select **Scan to Cloud**, and select **Destination List**.
5. Click **Add**, then follow the instructions on the screen to create your destination list.
6. Now you are ready to use Scan to Cloud. Select the setting for scanning to Scan to Cloud on your Epson product control panel.

**Parent topic:** [Epson Connect Solutions for Smartphones, Tablets, and More](#)

**Related tasks**

[Setting Up Epson Connect Services](#)

[Scanning to the Cloud](#)

**Related topics**

[Wi-Fi or Wired Networking](#)

## Using AirPrint

AirPrint enables instant wireless printing from iPhone, iPad, iPod touch, and Mac without the need to install drivers or download software.



**Note:** If you disabled paper configuration messages on your product control panel, you cannot use AirPrint. See the link below to enable the messages, if necessary.

1. Load paper in your product.
2. Set up your product for wireless printing. See the link below.
3. Connect your Apple device to the same wireless network that your product is using.
4. Print from your device to your product.

**Note:** For details, see the AirPrint page on the Apple website.

**Parent topic:** [Product Basics](#)

### Related references

[Paper Source Settings Options](#)

### Related topics

[Wi-Fi or Wired Networking](#)

## Setting Up Printing on a Chromebook

Your Epson printer supports native printing on Chromebook, allowing you to print from a Chromebook without drivers or cables.

For directions on setting up your printer, visit [Setting Up Your Epson Printer on Your Chromebook \(U.S.\)](#) or [Setting Up Your Epson Printer on Your Chromebook \(Canada\)](#).

**Parent topic:** [Product Basics](#)

### Related topics

[Wi-Fi or Wired Networking](#)

## Android Printing Using the Epson Print Enabler

You can wirelessly print your documents, emails, photos, and web pages right from your Android phone or tablet (Android v4.4 or later). With a few taps, your Android device will discover your nearby Epson product and print.

1. Connect your Epson product to your wireless network. See the link below.
2. On your Android device, download the Epson Print Enabler plug-in from Google Play.
3. Go to **Settings** on your Android device, select **Printing**, and enable the Epson plug-in, if necessary.
4. Connect your Android device to the same wireless network as your product.
5. Now you are ready to print. From an Android application such as Chrome or Gmail, tap the menu icon and print whatever is on the screen.

**Note:** If you do not see your product, tap **All Printers** and select your product.

**Parent topic:** [Product Basics](#)

### Related topics

[Wi-Fi or Wired Networking](#)

## Using Fire OS Printing

You can wirelessly print from Amazon Fire tablets and phones to your nearby networked Epson product. There is no software to download, no drivers to install, and no cables to connect. With just a few taps in Email, Calendar, Contacts, and WPS Office, you can send whatever is on the screen to an Epson product.

1. Connect your Epson product to your wireless network. See the link below.
2. Connect your Amazon device to the same wireless network as your product.
3. Now you are ready to print. From your Amazon application, tap the print option and select your product to print whatever is on the screen.

**Note:** If you see a message telling you that a plug-in is required, tap **OK** and tap **Download**. If your Amazon Fire product uses Fire OS 5 and above, your device automatically uses the built-in Mopria Print Service app to print.

**Parent topic:** [Product Basics](#)

### Related topics

[Wi-Fi or Wired Networking](#)

## Using Windows 10 Mobile Printing

You can wirelessly print from Windows 10 Mobile tablets and phones to your nearby networked Epson product. There is no software to download, no drivers to install, and no cables to connect. Look for the print option in your Windows 10 application to send whatever is on the screen to an Epson product.

1. Connect your Epson product to your wireless network. See the link below.
2. Connect your Windows 10 Mobile device to the same wireless network as your product.
3. Now you are ready to print. From your Windows 10 application, tap the print option and select your product to print whatever is on the screen.

**Parent topic:** [Product Basics](#)

### Related topics

[Wi-Fi or Wired Networking](#)

## Using Epson Print and Scan App with Windows Tablets

You can use this free app to print photos and scan from your Windows (Windows 8 or higher) Surface RT or Pro tablet with networked Epson products. The Epson Print and Scan app allows you to scan and capture images right to your tablet or to Microsoft OneDrive.

**Note:** The Epson Print and Scan app does not support Windows 10 Mobile printing and does not supply scanning functions for products without scanners.

1. Connect your Epson product to your wireless network. See the link below.
2. Download the Epson Print and Scan app from the Microsoft Windows Store.
3. Connect your Windows tablet to the same wireless network as your product.
4. Open the Epson Print and Scan app and select your Epson product.

Now you are ready to print photos or scan.

**Parent topic:** [Product Basics](#)

### Related topics

[Wi-Fi or Wired Networking](#)

## Using the Mopria Print Service

You can use the Mopria Print Service to print from your Android phone or tablet (Android v4.4 or later) to your Epson product or any Mopria-certified product from other manufacturers. You can download the Mopria Print Service from Google Play.

**Note:** For details on the Mopria Print Service, [click here](#) (U.S.) or [click here](#) (Canada).

1. Connect your Epson product to your wireless network. See the link below.
2. On your Android device, download the Mopria Print Service app from Google Play.

**Note:** On some Samsung Galaxy devices, Mopria may come preinstalled.

3. Go to **Settings** on your Android device, select **Printing**, and enable the Mopria Print Service, if necessary.
4. Connect your Android device to the same wireless network as your product.
5. Now you are ready to print. From an Android application such as Chrome or Gmail, tap the menu icon and select **Print**. Then select **All printers**, select your Epson product, adjust your print settings, and print.

**Parent topic:** [Product Basics](#)

### **Related topics**

[Wi-Fi or Wired Networking](#)



---

## Wi-Fi or Wired Networking

See these sections to use your product on a Wi-Fi or wired network.

[Network Security Recommendations](#)

[Wi-Fi Infrastructure Mode Setup](#)

[Setting Up Wireless Printing from a Smartphone or Tablet](#)

[Wi-Fi Direct Mode Setup](#)

[Wi-Fi Protected Setup \(WPS\)](#)

[Printing a Network Status Sheet](#)

[Printing a Network Connection Report](#)

[Changing or Updating Network Connections](#)

## Network Security Recommendations

To help deter unauthorized access to your product over a network, you should protect your network environment using appropriate security measures.

Security measures such as these can help deter threats such as loss of user data, use of telephone and fax lines, and other intrusions:

- **Enable security on your wireless LAN**

Enable the appropriate security on the wireless LAN you plan to use with your product. Network security such as a network password can deter interception of traffic over the wireless LAN. Your router may already have a default password enabled by your Internet service provider (ISP). See your ISP and router documentation for instructions on how to change the default password and better secure your network.

- **Connect your product only to a network protected by a firewall**

Connecting your product directly to the Internet may leave it vulnerable to security threats. Instead, connect it to a router or other network connection protected by a firewall. Your router may already have a firewall set up by your Internet service provider; check with your ISP for confirmation. For best results, set up and use a private IP address for your network connection.

- **Change the default administrator password on your product**

If your product has an option to set an administrator password, change the default administrator password to deter access by unauthorized users to personal data stored on your product, such as IDs, passwords, and contact lists.

**Parent topic:** [Wi-Fi or Wired Networking](#)

## Wi-Fi Infrastructure Mode Setup

You can set up your product to communicate with your computer using a wireless router or access point. The wireless router or access point can be connected to your computer over a wireless or wired network.

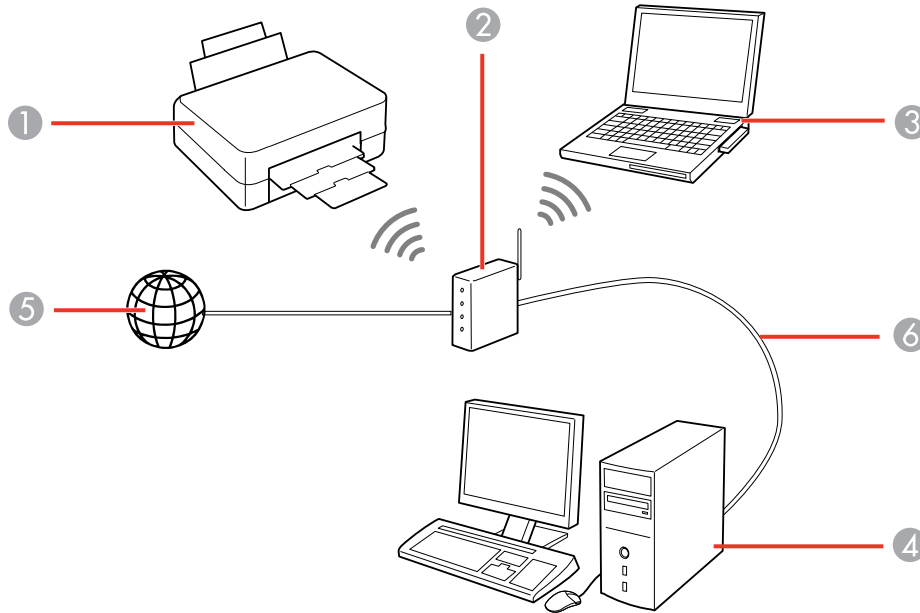

- 1 Epson product
- 2 Wireless router or access point
- 3 Computer with a wireless interface
- 4 Computer
- 5 Internet
- 6 Ethernet cable (used only for wired connection to the wireless router or access point)

[Selecting Wireless Network Settings from the Control Panel](#)



**Parent topic:** [Wi-Fi or Wired Networking](#)

## Selecting Wireless Network Settings from the Control Panel

You can select or change wireless network settings using your product control panel.

To install your product on a wireless network, follow the instructions on the *Start Here* sheet and install the necessary software by downloading it from the Epson website. The installer program guides you through network setup.

**Note:** Breakdown or repair of this product may cause loss of network data and settings. Epson is not responsible for backing up or recovering data and settings during or after the warranty period. We recommend that you make your own backup or print out your network data and settings.

1. Press the  home button, if necessary.
2. Select the  icon and press the **OK** button.

You see a screen like this:

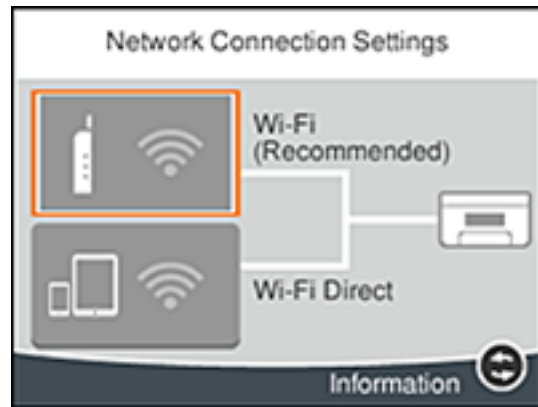





3. Select **Wi-Fi (Recommended)**.
4. Select **Start Setup** or **Change Settings**.
5. Select **Wi-Fi Setup Wizard**.

6. Select the name of your wireless network and press the **OK** button, or press the **+** button and select **Enter Manually** to enter the name manually. Use the displayed keypad to enter your network name, then press the **OK** button.



**Note:** The network name and password are case sensitive. Be sure to correctly enter uppercase and lowercase letters, and numeric or special characters.

- To move the cursor, select the left or right arrows.
  - To change the case of letters, select .
  - To delete the previous character, select .
  - To enter numbers and symbols, select .
  - To enter a space, select .
7. Press the **OK** button to enter your password using the on-screen keypad and select **OK**.
  8. Confirm the displayed network settings and select **Start Setup** to save them.
  9. Do one of the following:
    - If setup was successful, select **Close** to exit.

- If setup was unsuccessful, select **Print Check Report** to print a network setup report or select **Re-enter** to re-enter your network name and password.

10. Press the  home button to exit.

The  Wi-Fi icon displayed on the LCD screen indicates your wireless connection status. If the product is not connected to the network, you may have selected the wrong network name (SSID) or entered the password incorrectly. Repeat these steps to try again.

If you are printing from a computer, make sure you installed the network software as described on the *Start Here* sheet.

**Parent topic:** [Wi-Fi Infrastructure Mode Setup](#)

**Related references**

[Status Icon Information](#)

**Related tasks**

[Entering Characters on the LCD Screen](#)

## Setting Up Wireless Printing from a Smartphone or Tablet

You can use the Epson Smart Panel app to connect your Epson product to a wireless network or connect your device directly to the product. Epson Smart Panel is available on iOS and Android devices.

Make sure you have the following:

- A Bluetooth-enabled device that is connected to a wireless network
- The Epson Smart Panel app installed on the device
- The wireless network name (SSID) and password

**Note:** Your device must be close enough to the product to create and maintain a Bluetooth connection.

1. Make sure the product is turned on and is ready to print.

**Note:** You must perform initial setup and ink installation before setting up wireless printing.

2. Open the Epson Smart Panel app on your device.

3. Do one of the following:

- If the app automatically recognizes the product, follow the on-screen instructions to set up the wireless connection.

- If the app does not automatically recognize the product, select the + icon and continue with the next step.
4. On the next screen, select **Start setting up** and follow the on-screen instructions.

**Note:** If your product is not listed, move closer to the product and try again. If the product is still not shown, connect your printer to the wireless network using the control panel and then select **Connect Smartphone to Product Already Connected to Wi-Fi** in the Epson Smart Panel app and follow the on-screen instructions. See the link below for wireless setup instructions.

Your product is now connected to a wireless network and set up for use with the Epson Smart Panel app.

**Parent topic:** [Wi-Fi or Wired Networking](#)

**Related tasks**

[Using the Epson Smart Panel Mobile App](#)

## Wi-Fi Direct Mode Setup

You can set up your product to communicate directly with your computer or another device without requiring a wireless router or access point. In Wi-Fi Direct Mode, the product itself acts as a network access point for up to 8 devices.

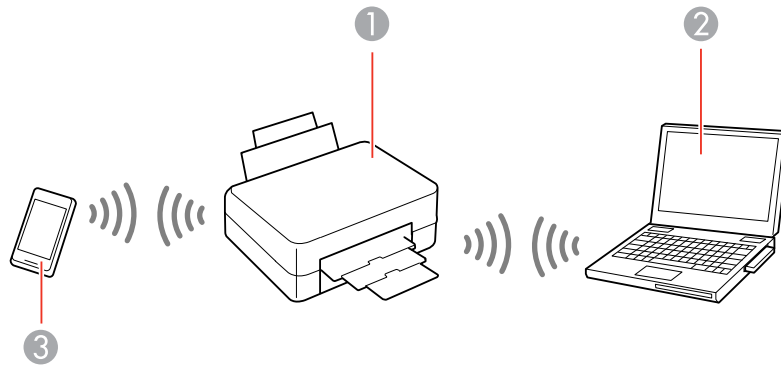

- 1 Epson product
- 2 Computer with a wireless interface
- 3 Other wireless device



## Enabling Wi-Fi Direct (Simple AP) Mode

**Parent topic:** [Wi-Fi or Wired Networking](#)

### Enabling Wi-Fi Direct (Simple AP) Mode

You can enable Wi-Fi Direct mode to allow direct communication between your product and computer, mobile devices, or other devices (up to 8) without a wireless router or access point.

**Note:** Make sure the Epson Smart Panel app or another compatible Epson printing app is installed on your mobile device before connecting to the product.

1. Press the  home button, if necessary.
2. Select the  icon and press the **OK** button.

You see a screen like this:



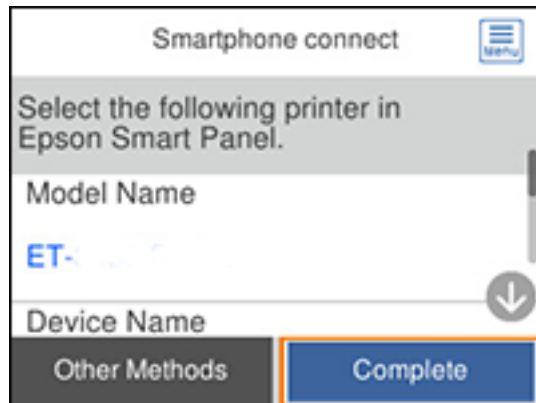

3. Select **Wi-Fi Direct**.
4. Scroll down and select **Start Setup**.

The product information is displayed on the LCD screen like this:



5. Do one of the following:
  - Open the Epson Smart Panel app on your device and use the information on the LCD screen to select your product. Skip to step 7.
  - To connect without using the Epson Smart Panel app, select **Other Methods** and go to the next step.
6. Do one of the following:
  - For iOS devices, select **iOS**. Scan the QR code with the camera app on your device and follow the instructions on your device.
  - For other types of devices, select **Other OS Devices**. Use your device to select the Wi-Fi network name (SSID) displayed on the LCD screen, then enter the password shown.
7. Select **Complete** on the LCD screen.

The blue  Wi-Fi Direct icon is displayed on the LCD screen and indicates if Wi-Fi Direct is enabled on the product.

**Note:** If the  Wi-Fi Direct icon is displayed on the LCD screen, Wi-Fi Direct is not enabled. Repeat these steps to try again.

**Parent topic:** [Wi-Fi Direct Mode Setup](#)



### Related references

[Status Icon Information](#)

### Related tasks

[Using the Epson Smart Panel Mobile App](#)

## Wi-Fi Protected Setup (WPS)

If your network uses a WPS-enabled wireless router or access point, you can quickly connect your product to the network using Wi-Fi Protected Setup (WPS).



**Note:** To check if your router is WPS-enabled, look for a button labeled **WPS** on your router or access point. If there is no hardware button, there may be a virtual WPS button in the software for the device. Check your network product documentation for details.

[Using WPS to Connect to a Network](#)

**Parent topic:** [Wi-Fi or Wired Networking](#)

## Using WPS to Connect to a Network

If you have a WPS-enabled wireless router or access point, you can use Wi-Fi Protected Setup (WPS) to connect your product to the network.

1. Press the  home button, if necessary.
2. Select the  icon and press the **OK** button.

You see a screen like this:

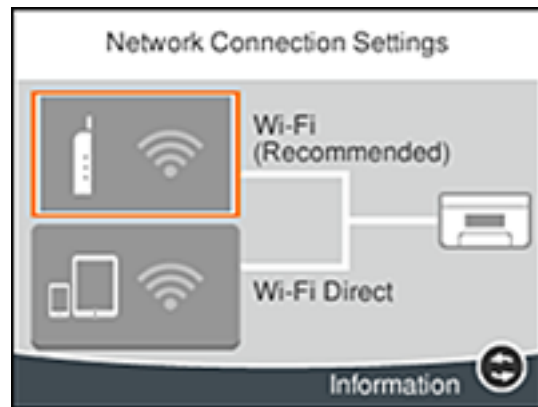

3. Select **Wi-Fi (Recommended)**.
4. Select **Start Setup** or **Change Settings**.
5. Select **Push Button Setup (WPS)**.
6. Follow the instructions on the LCD screen to complete WPS setup.

**Note:** Make sure you select **Start Setup** within two minutes of activating WPS on your router.

7. Press the  home button to exit.



You see the  icon on the LCD screen and should be able to connect to your product directly from your computer or device, and then print. If you are printing from a computer, make sure you installed the network software as described on the *Start Here* sheet.

**Note:** If you don't see the  icon, repeat these steps to try again.

**Parent topic:** [Wi-Fi Protected Setup \(WPS\)](#)

## Printing a Network Status Sheet

You can print a network status sheet to help you determine the causes of any problems you may have using your product on a network.

1. Press the  home button, if necessary.
2. Select **Settings > General Settings > Network Settings > Network Status**.
3. Select **Print Status Sheet**.
4. Press the  start button to print the status sheet.

Examine the settings shown on the network status sheet to diagnose any problems you have.

**Parent topic:** [Wi-Fi or Wired Networking](#)

## Printing a Network Connection Report

You can print a network connection report to view solutions to any problems you may have using your product on a network.

1. Press the  home button, if necessary.
2. Select **Settings > General Settings > Network Settings > Connection Check**.

3. Select **Print Check Report**.
  4. Press the  start button to print the network connection report.
- Examine the error codes and solutions shown on the network connection report.

[Network Connection Report Codes and Messages](#)

**Parent topic:** [Wi-Fi or Wired Networking](#)

## Network Connection Report Codes and Messages

Check the error codes and messages on the network connection report to solve problems you may encounter with network connections. The tables here list solutions to problems based on the error codes and messages that may appear on the top of the report.

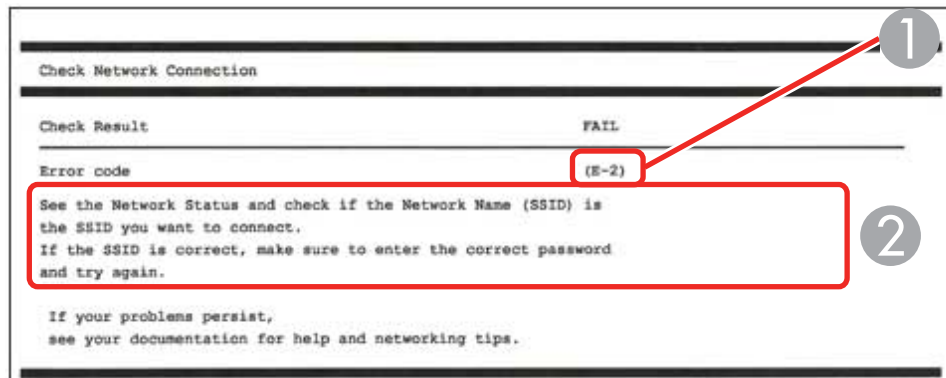

- 1 Error code
- 2 Message

**Note:** Error codes and messages listed here may not all apply to your product.

### Error Codes and Messages

<b>Error code and message</b>	<b>Solution</b>
<b>E-1</b> Confirm that the network cable is connected and network devices such as hub, router, or access point are turned on.	Make sure your router, access point, and/or hub are turned on, and the network cable is securely connected to your device and to your product.  If you are trying to set up Wi-Fi, remove the network cable and set up Wi-Fi again. Ethernet and Wi-Fi cannot be connected at the same time.

Error code and message	Solution
<p><b>E-2, E-3, or E-7</b></p> <p>No wireless network names (SSID) found. Confirm that the router/access point is turned on and the wireless network (SSID) is set up correctly. Contact your network administrator for assistance.</p> <p>No wireless network names (SSID) found. Confirm that the wireless network name (SSID) of the PC you wish to connect is set up correctly. Contact your network administrator for assistance.</p> <p>Entered security key/password does not match the one set for your router/access point. Confirm security key/password. Contact your network administrator for assistance.</p>	<p>Check the following:</p> <ul style="list-style-type: none"> <li>• Make sure your router or access point is turned on, and is correctly connected to your computer or network device.</li> <li>• Turn off the router or access point, wait about 10 seconds, and turn it on again.</li> <li>• Move your product closer to your router or access point, and remove any obstacles between them. Also move your product away from devices such as wireless phones or microwaves.</li> <li>• Confirm that the SSID shown on the network connection report matches the label on your router or access point. Also make sure your SSID uses only ASCII characters and symbols, or your product cannot display the SSID correctly.</li> <li>• If you are trying to connect using the WPS push button method, make sure your router or access point supports it.</li> <li>• If you are using a network password, check the label on your router or access point to confirm that you are using the correct password, or check with your network administrator or router/access point documentation.</li> <li>• If you are connecting to a smart device that generates an SSID, check the device documentation for the SSID and password you should use.</li> <li>• If your wireless connection suddenly disconnects, and another smart device was added to the network using a WPS push button method or your network was set up using a non-WPS push button method, try downloading and installing your product software again.</li> </ul>

Error code and message	Solution
<p><b>E-5</b> Security mode (e.g. WEP, WPA) does not match the current setting of the printer. Confirm security mode. Contact your network administrator for assistance.</p>	<p>If the security on your router or access point is not one of the following types, change the type of security on your router or access point and reset your product's network settings.</p> <ul style="list-style-type: none"> <li>• WEP-64 bit (40 bit)</li> <li>• WEP-128 bit (104 bit)</li> <li>• WPA PSK (TKIP/AES); also known as WPA Personal</li> <li>• WPA2 PSK (TKIP/AES); also known as WPA2 Personal</li> <li>• WPA (TKIP/AES)</li> <li>• WPA2 (TKIP/AES)</li> <li>• WPA3-SAE (AES)</li> </ul> <p>Also make sure you are connecting to the 2.4GHz band on your network and using the password for that band.</p>
<p><b>E-6</b> MAC address of your printer may be filtered. Check whether your router/access point has restrictions such as MAC address filtering. See the documentation of the router/access point or contact your network administrator for assistance.</p>	<p>If your router or access point has MAC address filtering enabled, register your product's MAC address so it is not filtered. Locate the MAC address on the network connection report and check your router or access point documentation for instructions.</p> <p>If your router or access point is using shared authentication with WEP security, confirm that you are using the correct authentication key and index.</p> <p>If your router or access point limits the number of connected devices, raise the connection limit. See your router or access point documentation for instructions.</p>
<p><b>E-8</b> Incorrect IP address is assigned to the printer. Confirm IP address setup of the network device (hub, router, or access point). Contact your network administrator for assistance.</p>	<p>If your product's <b>Obtain IP Address</b> setting is set to <b>Auto</b>, enable DHCP on your router or access point. If it is set to <b>Manual</b>, the IP address may be out of range or on a different network segment; set a valid IP address using your product control panel or the Web Config utility.</p> <p>You can also try turning off your product and the router or access point, waiting about 10 seconds, and turning them on again.</p>

Error code and message	Solution
<p><b>E-9</b></p> <p>Confirm the connection and network setup of the PC or other device. Connection using the EpsonNet Setup is available. Contact your network administrator for assistance.</p>	<p>Make sure your computer or network device are turned on. Also make sure that you can access the Internet and other devices on the same network from the devices you are trying to connect to your product.</p> <p>If you still cannot connect to your product, turn off your router or access point, wait about 10 seconds, and turn it on again. Download and install your product software again to reset your network settings.</p>
<p><b>E-10</b></p> <p>Confirm IP address, subnet mask, and default gateway setup. Connection using the EpsonNet Setup is available. Contact your network administrator for assistance.</p>	<p>Make sure other devices on the network are turned on and do the following:</p> <ul style="list-style-type: none"> <li>• If your product's <b>Obtain IP Address</b> setting is set to <b>Manual</b>, check the IP address, subnet mask, and default gateway addresses on the network connection report to see if they are correct. If not, correct the settings.</li> <li>• If DHCP is enabled, set your product's <b>Obtain IP Address</b> setting to <b>Auto</b>. If you want to use the DHCP-assigned address as a static address, set the <b>Obtain IP Address</b> setting to <b>Manual</b>, enter the product's IP address as listed on the network connection report, and set the subnet mask to 255.255.255.0.</li> </ul> <p>If you still cannot connect to your product, turn off your router or access point, wait about 10 seconds, and turn it on again.</p>
<p><b>E-11</b></p> <p>Setup is incomplete. Confirm default gateway setup. Connection using the EpsonNet Setup is available. Contact your network administrator for assistance.</p>	<p>If you set your product's <b>TCP/IP Setup</b> setting to <b>Manual</b>, check that the default gateway address listed on the network connection report is correct. Also turn on the device that is set as the default gateway.</p>

Error code and message	Solution
<p><b>E-12</b></p> <p>Confirm the following:</p> <ul style="list-style-type: none"> <li>-Entered security key/password is correct</li> <li>-Index of the security key/password is set to the first number</li> <li>-IP address, subnet mask, or default gateway setup is correct</li> </ul> <p>Contact your network administrator for assistance.</p>	<p>Make sure other devices on the network are turned on and do the following:</p> <ul style="list-style-type: none"> <li>• Make sure the IP address, subnet mask, and default gateway addresses are correct, if you are entering them manually.</li> <li>• Confirm that the subnet mask and default gateway addresses for other devices are the same.</li> <li>• Make sure the IP address does not conflict with other devices.</li> </ul> <p>If you still cannot connect to your product, do the following:</p> <ul style="list-style-type: none"> <li>• Turn off your router or access point, wait about 10 seconds, and turn it on again.</li> <li>• Download and install your product software again to reset your network settings.</li> <li>• If your router or access point uses WEP security with several registered passwords, make sure that the first registered password is set on your product.</li> </ul>
<p><b>E-13</b></p> <p>Confirm the following:</p> <ul style="list-style-type: none"> <li>-Entered security key/password is correct</li> <li>-Index of the security key/password is set to the first number</li> <li>-Connection and network setup of the PC or other device is correct</li> </ul> <p>Contact your network administrator for assistance.</p>	<p>Make sure your router, access point, and/or hub are turned on. Also make sure the TCP/IP setup on your router, access point, and/or hub is not set manually; this may cause your product's network settings to differ from the manually set up devices.</p> <p>If you still cannot connect to your product, do the following:</p> <ul style="list-style-type: none"> <li>• Turn off your router or access point, wait about 10 seconds, and turn it on again.</li> <li>• Download and install your product software again to reset your network settings.</li> <li>• If your router or access point uses WEP security with several registered passwords, make sure that the first registered password is set on your product.</li> </ul>



## Network Environment Messages

Message	Solution
The Wi-Fi environment needs to be improved. Turn the wireless router off and then turn it on. If the connection does not improve, see the documentation for the wireless router.	Move your product closer to your router or access point, and remove any obstacles between them. Then turn off your router or access point, wait about 10 seconds, and turn it back on again. If you still cannot connect to your product, check the documentation that came with your router or access point for solutions.
*No more devices can be connected. Disconnect one of the connected devices if you want to add another one.	You can connect up to 8 computers or other devices to your product using a Wi-Fi Direct (Simple AP) connection. If you want to add another device, disconnect an existing connected device first.
The same SSID as Wi-Fi Direct exists in the environment. Change the Wi-Fi Direct SSID if you cannot connect a smart device to the printer.	Change the Wi-Fi Direct SSID.

Parent topic: [Printing a Network Connection Report](#)

## Changing or Updating Network Connections

See these sections to change or update how your product connects to a network.

[Accessing the Web Config Utility](#)

[Changing a USB Connection to a Wi-Fi Connection](#)

[Changing a Wi-Fi Connection to a Wired Network Connection](#)

[Connecting to a New Wi-Fi Router](#)

[Disabling Wi-Fi Features](#)

Parent topic: [Wi-Fi or Wired Networking](#)

## Accessing the Web Config Utility

You can select your product's network settings and confirm its operating status using a web browser. You do this by accessing your product's built-in Web Config utility from a computer or other device that is connected to the same network as your product.

**Note:** You can also access the Web Config utility from the product information area in the Epson Smart Panel app.

1. Check your network status.
2. Note your product's IP address.
3. On a computer or other device connected to the same network as your product, open a web browser.
4. Enter your product's IP address into the address bar.

You see the available Web Config utility options.

**Parent topic:** [Changing or Updating Network Connections](#)

**Related tasks**

[Printing a Network Status Sheet](#)

## Changing a USB Connection to a Wi-Fi Connection

If you have already connected your product to your computer using a USB connection, you can change to a Wi-Fi connection.

1. Disconnect the USB cable from your product.
2. Uninstall your product software.
3. Download and install your product software from the Epson website using the instructions on the *Start Here* sheet.

**Parent topic:** [Changing or Updating Network Connections](#)

**Related concepts**

[Uninstall Your Product Software](#)

## Changing a Wi-Fi Connection to a Wired Network Connection

If you have already connected your product to your computer wirelessly, you can change to a wired network connection if necessary.

1. Disable your product's Wi-Fi features.
2. Connect one end of an Ethernet network cable to the product's **LAN** port.
3. Connect the other end to any available LAN port on your router or access point.
4. Uninstall your product software.

5. Download and install your product software from the Epson website.
6. Follow the on-screen instructions to install the software.
7. When you see the Select Your Connection screen, select **Wired network connection**.
8. If you see a Select Setup Option screen, select **Set up printer for the first time**.
9. Continue following the rest of the on-screen instructions.

**Parent topic:** [Changing or Updating Network Connections](#)

**Related concepts**

[Uninstall Your Product Software](#)

**Related tasks**

[Disabling Wi-Fi Features](#)

## Connecting to a New Wi-Fi Router

If you change the wireless router you have been using on your network, you need to update your product's Wi-Fi connection to the new router.

**Note:** If you switch to a 5 GHz wireless router, set the router to operate in dual band (2.4 GHz and 5 GHz) mode. If your router uses a single network name (SSID) for both the 2.4 GHz and 5 GHz band, give each band its own network name (SSID) instead, such as Home Network 2.4 GHz and Home Network 5 GHz. See your router documentation for instructions.

1. Do one of the following:
  - **Windows:** Uninstall your product software.
  - **Mac:** Go to the next step.
2. Download and install your product software from the Epson website using the instructions on the *Start Here* sheet.

**Parent topic:** [Changing or Updating Network Connections](#)



**Related concepts**

[Uninstall Your Product Software](#)

## Disabling Wi-Fi Features

You may need to disable your product's Wi-Fi features if you change your network connection type or need to solve a problem with your network connection.

**Note:** Before disabling Wi-Fi features, make a note of your product's SSID (network name) and password, and any network settings selected for the Epson Connect services you may use.

1. Press the  home button, if necessary.
2. Select the  icon and press the **OK** button.

You see a screen like this:



3. Select **Wi-Fi (Recommended)**.
4. Select **Change Settings**.
5. Select **Others**.
6. Select **Disable Wi-Fi**.
7. Select **Start Setup** to disable Wi-Fi.

**Parent topic:** [Changing or Updating Network Connections](#)

**Related tasks**

[Printing a Network Status Sheet](#)

---

# Loading Paper

Before you print, load paper for the type of printing you will do.

[Loading Paper in the Cassette](#)

[Paper Loading Capacity](#)

[Double-sided Printing Capacity](#)

[Borderless Paper Type Compatibility](#)

[Compatible Epson Papers](#)

[Selecting the Paper Settings - Control Panel](#)

[Paper or Media Type Settings - Printing Software](#)

[Selecting the Default Paper Source Settings](#)

[Selecting the Universal Print Settings](#)

## Loading Paper in the Cassette

You can load paper up to this size in the paper cassette: Legal (8.5 × 14 inches [216 × 356 mm]).

**Note:** Before loading paper, make sure your product is not currently printing, scanning, or copying.

1. Open the front cover.

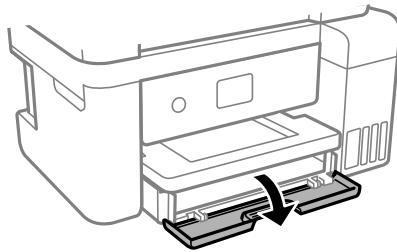

2. Pull out the paper cassette until it stops.

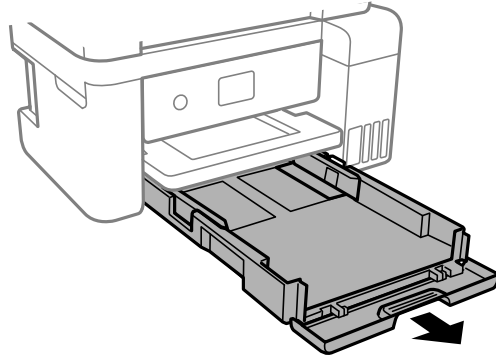

3. Slide the edge guides outward.

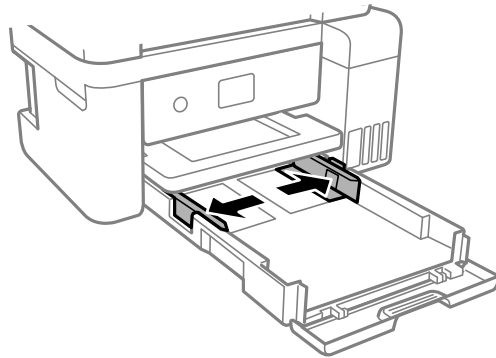

4. Do one of the following:

- Insert paper into the cassette with the glossy or printable side facedown and slide it in until it stops.

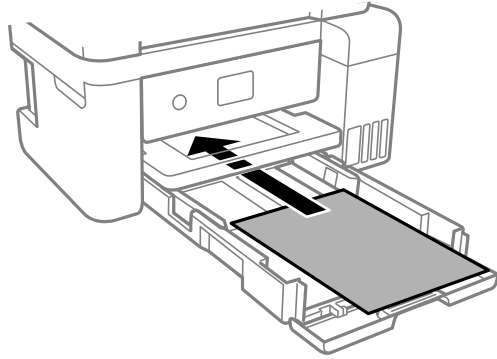

**Note:** Make sure the paper is loaded against the rear of the cassette.

- For legal-size paper, extend the legal paper guide and load paper using the guide line as shown.

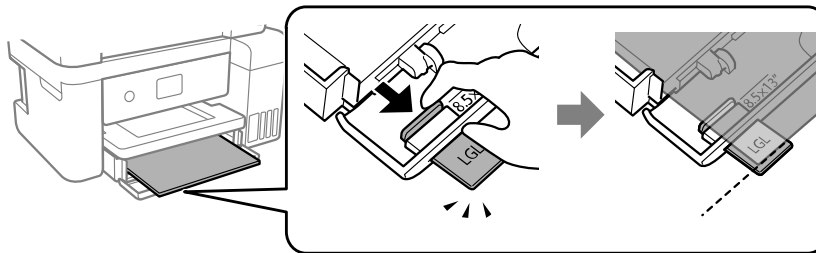

- Insert up to 10 envelopes with the printable side facedown and flap edge left, as shown.

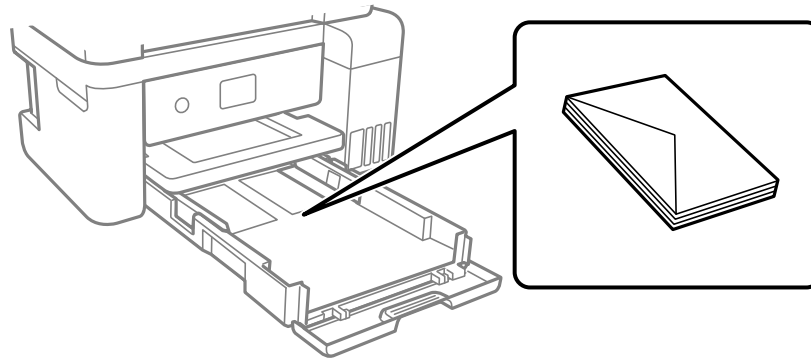

- Load a sheet of loose-leaf or other paper with holes as shown.

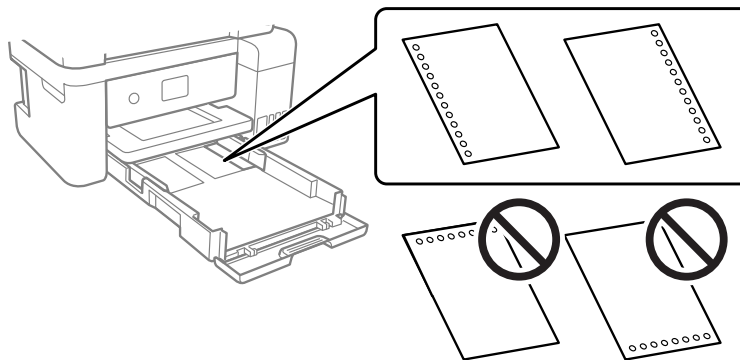



**Note:** Do not select automatic 2-sided printing for this type of paper and do not print over the holes.

5. Slide the edge guides against the paper, but not too tightly.

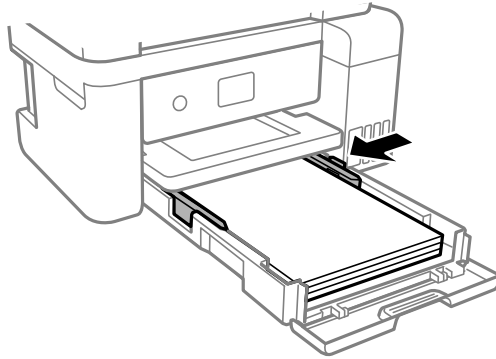

**Note:** Make sure the paper fits under the tabs on the edge guides.

6. Slide the cassette back into the product until it stops and close the front cover.
7. Select the size and type of the paper you loaded on the product LCD screen and select **Close**.

**Note:** If you are printing on letterhead, make sure you select **Letterhead** as the paper type. Make sure you select the correct paper size setting.

8. Extend the output tray.

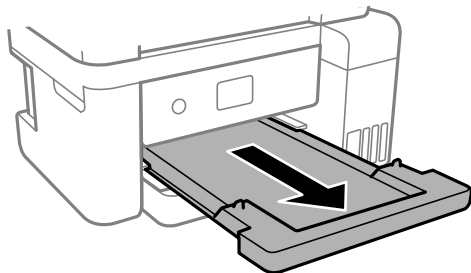

**Note:** Do not remove or insert the paper cassette during printing.

Always follow these paper loading guidelines:

- Load only the recommended number of sheets.
- Load paper short edge first and printable side facedown.
- Make sure the paper is under the tabs on the edge guides and not sticking out from the rear end of the cassette.
- Fan and align the edges of the paper before loading. Do not fan or curl photo paper. Doing so may damage the printable side.
- If the paper is curled, flatten it or curl it slightly in the opposite direction before loading. Printing on curled paper may cause paper jams and smears on the printout.
- Paper feed problems may occur frequently for manual 2-sided printing when printing on one side of pre-printed paper. Reduce the number of sheets to half or less, or load one sheet of paper at a time if paper jams continue.
- Make sure you are using long-grain paper. If you are not sure what type of paper you are using, check the paper packaging or contact the manufacturer to confirm the paper specifications.
- Fan and align the edges of envelopes before loading. If you have trouble loading a stack of envelopes, press each envelope flat before loading it or load one envelope at a time.
- If print quality declines when printing multiple envelopes, try loading one envelope at a time.
- Load letterhead or pre-printed paper top edge first.
- Check the paper package for any additional loading instructions.

**Parent topic:** [Loading Paper](#)

**Related references**

[Double-sided Printing Capacity](#)

[Paper Loading Capacity](#)

**Related tasks**

[Selecting the Paper Settings - Control Panel](#)

## Paper Loading Capacity

See the table here for the loading capacity of the paper cassette.

Paper type	Loading capacity
Plain paper Copy paper Letterhead paper	Letter (8.5 × 11 inches [216 × 279 mm]), Legal (8.5 × 14 inches [216 × 356 mm]), or A4 (8.3 × 11.7 inches [210 × 297 mm]): 250 sheets
	Mexico-Oficio (8.5 × 13.4 inches [216 × 340 mm]), 8.5 × 13 inches (216 × 330 mm), Oficio 9 (8.46 × 12.4 inches [215 × 315 mm]), Executive (7.25 × 10.5 inches [184 × 267 mm]), Half Letter (5.5 × 8.5 inches [140 × 216 mm]), or A6 (4.1 × 5.8 inches [105 × 148 mm]): 50 sheets
	User-defined (7.17 × 10.12 inches to 8.5 × 11.69 inches [182 × 257 mm to 215.9 × 297 mm])* or user-defined (3.5 × 5 inches to 8.5 × 87.24 inches [89 × 127 mm to 215.9 × 1200 mm])* size: 1 sheet
Epson EcoTank Premium Paper Epson Bright White Pro Paper Epson Bright White Premium Paper Epson Multipurpose Plus Paper	200 sheets
Epson Presentation Paper Matte	Letter (8.5 × 11 inches [216 × 279 mm]) or A4 (8.3 × 11.7 inches [210 × 297 mm]): 100 sheets
Epson Premium Presentation Paper Matte Epson Photo Paper Glossy Epson Premium Photo Paper Glossy Epson Ultra Premium Photo Paper Glossy Epson Premium Photo Paper Semi-gloss	20 sheets If paper feeds incorrectly, or printing is uneven or smeared, load 1 sheet at a time.
Epson Premium Presentation Paper Matte Double-sided	1 sheet
Envelopes	10 envelopes

\* Printing from computer only.

**Parent topic:** [Loading Paper](#)

**Related references**[Double-sided Printing Capacity](#)[Paper Specifications](#)**Double-sided Printing Capacity**

You can print double-sided using Auto or Manual mode on the following paper types and sizes.

Paper type	Size	Double-sided printing capacity	
		Auto	Manual
Plain paper Copier paper Letterhead paper	Letter (8.5 × 11 inches [216 × 279 mm]) or A4 (8.3 × 11.7 inches [210 × 297 mm])	250 sheets	30 sheets
	Legal (8.5 × 14 inches [216 × 356 mm]), Mexico-Oficio (8.5 × 13.4 inches [216 × 340 mm]), 8.5 × 13 inches (216 × 330 mm), Oficio 9 (8.46 × 12.4 inches [215 × 315 mm]), Executive (7.25 × 10.5 inches [184 × 267 mm]), Half Letter (5.5 × 8.5 inches [140 × 216 mm]), A6 (4.1 × 5.8 inches [105 × 148 mm])	—	30 sheets
	User-defined (7.17 × 10.12 inches to 8.5 × 11.69 inches [182 × 257 mm to 215.9 × 297 mm])*	1 sheet	1 sheet
	User-defined (3.5 × 5 inches to 8.5 × 87.24 inches [89 × 127 mm to 215.9 × 1200 mm])*	—	1 sheet

Paper type	Size	Double-sided printing capacity	
		Auto	Manual
Epson EcoTank Premium Paper Epson Bright White Pro Paper Epson Bright White Premium Paper Epson Multipurpose Plus Paper	Letter (8.5 × 11 inches [216 × 279 mm])	200 sheets	30 sheets
Epson Premium Presentation Paper Matte Double-sided	Letter (8.5 × 11 inches [216 × 279 mm])	—	1 sheet

\* Printing from computer only.

You cannot print double-sided on the following paper types:

- Epson Presentation Paper Matte
- Epson Photo Paper Glossy
- Epson Premium Photo Paper Glossy
- Epson Premium Photo Paper Semi-gloss
- Epson Ultra Premium Photo Paper Glossy
- Epson Premium Presentation Paper Matte
- Envelopes

**Parent topic:** [Loading Paper](#)

**Related references**

[Paper Loading Capacity](#)

## Borderless Paper Type Compatibility

You can print borderless photos on compatible paper types in compatible sizes:

### Borderless Paper Types

- Epson EcoTank Premium Paper
- Epson Bright White Pro Paper
- Epson Photo Paper Glossy
- Epson Premium Photo Paper Glossy
- Epson Ultra Premium Photo Paper Glossy
- Epson Premium Photo Paper Semi-gloss
- Epson Premium Presentation Paper Matte
- Epson Premium Presentation Paper Matte Double-sided
- Epson Presentation Paper Matte

### Borderless Paper Sizes

- 4 × 6 inches (102 × 152 mm)
- 5 × 7 inches (127 × 178 mm)
- 8 × 10 inches (203 × 254 mm)
- A4 (8.3 × 11.7 inches [210 × 297 mm])
- Letter (8.5 × 11 inches [216 × 279 mm])

**Parent topic:** [Loading Paper](#)

### Related references

[Printable Area Specifications](#)

## Compatible Epson Papers

You can purchase genuine Epson ink, maintenance boxes, and paper at [epson.com](http://epson.com) (U.S. sales) or [epson.ca](http://epson.ca) (Canadian sales). You can also purchase supplies from an Epson authorized reseller. To find the nearest one, call 800-GO-EPSON (800-463-7766) in the U.S. or 800-807-7766 in Canada.

**Note:** Paper/media availability varies by country.

Paper Type	Size	Part number	Sheet count
Epson EcoTank Premium Paper	Letter (8.5 × 11 inches [216 × 279 mm])	S041586-ET	500

<b>Paper Type</b>	<b>Size</b>	<b>Part number</b>	<b>Sheet count</b>
Epson Bright White Pro Paper	Letter (8.5 × 11 inches [216 × 279 mm])	S041586	500
Epson Bright White Premium Paper	Letter (8.5 × 11 inches [216 × 279 mm])	S450218-4	500
Epson Multipurpose Plus Paper	Letter (8.5 × 11 inches [216 × 279 mm])	S450217-4	500
Epson Presentation Paper Matte	Letter (8.5 × 11 inches [216 × 279 mm])	S041062	100
Epson Premium Presentation Paper Matte	8 × 10 inches (203 × 254 mm)	S041467	50
	Letter (8.5 × 11 inches [216 × 279 mm])	S041257 S042180	50 100
Epson Premium Presentation Paper Matte Double-sided	Letter (8.5 × 11 inches [216 × 279 mm])	S041568	50
Epson Photo Paper Glossy	4 × 6 inches (102 × 152 mm)	S041809 S042038	50 100
	Letter (8.5 × 11 inches [216 × 279 mm])	S041141	20
		S041649	50
		S041271	100
A4 (8.3 × 11.7 inches [210 × 297 mm])	S041140	20	
Epson Premium Photo Paper Glossy	4 × 6 inches (102 × 152 mm)	S041727	100
	5 × 7 inches (127 × 178 mm)	S041464	20
	8 × 10 inches (203 × 254 mm)	S041465	20
	Letter (8.5 × 11 inches [216 × 279 mm])	S042183 S041667	25 50

Paper Type	Size	Part number	Sheet count
Epson Ultra Premium Photo Paper Glossy	4 × 6 inches (102 × 152 mm)	S042181	60
	5 × 7 inches (127 × 178 mm)	S042174	100
	8 × 10 inches (203 × 254 mm)	S041945	20
	Letter (8.5 × 11 inches [216 × 279 mm])	S041946	20
Epson Premium Photo Paper Semi-gloss	Letter (8.5 × 11 inches [216 × 279 mm])	S042182	25
	4 × 6 inches (102 × 152 mm)	S042175	50
Epson Premium Photo Paper Semi-gloss	4 × 6 inches (102 × 152 mm)	S041982	40
	Letter (8.5 × 11 inches [216 × 279 mm])	S041331	20

Parent topic: [Loading Paper](#)

## Selecting the Paper Settings - Control Panel

You can change the default paper size and paper type for the cassette using the control panel on the product.

1. Press the  home button, if necessary.
2. Select **Settings** > **General Settings** > **Printer Settings** > **Paper Source Settings** > **Paper Setting**.

You see a screen like this:

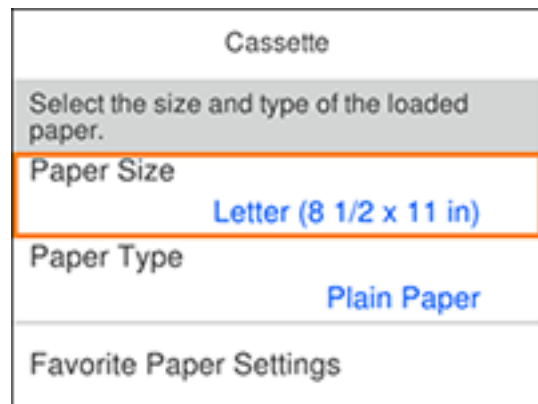



3. Select **Paper Size**.
4. Select the paper size you loaded.
5. Select **Paper Type**.
6. Select the paper type you loaded.
7. Select **Favorite Paper Settings** to choose from a list of commonly used paper settings.
8. Press the  home button to exit.

[Paper or Media Type Settings - Control Panel](#)

**Parent topic:** [Loading Paper](#)

## Paper or Media Type Settings - Control Panel

For this paper	Select this paper Type or Media Type setting
Plain paper Epson EcoTank Premium Paper Epson Bright White Pro Paper Epson Bright White Premium Paper Epson Multipurpose Plus Paper	Plain Paper
Letterhead paper	Letterhead
Envelopes	Envelope
Epson Ultra Premium Photo Paper Glossy	Ultra Glossy
Epson Premium Photo Paper Glossy	Prem. Glossy
Epson Photo Paper Glossy	Glossy
Epson Premium Photo Paper Semi-gloss	Prem. Semi-Gloss
Epson Premium Presentation Paper Matte Epson Premium Presentation Paper Matte Double-sided	Prem. Matte
Epson Presentation Paper Matte	Presentation Matte

**Parent topic:** [Selecting the Paper Settings - Control Panel](#)

## Paper or Media Type Settings - Printing Software

For this paper	Select this paper Type or Media Type setting
Plain paper Epson EcoTank Premium Paper Epson Bright White Pro Paper Epson Bright White Premium Paper Epson Multipurpose Plus Paper	Plain Paper / Bright White Paper
Letterhead paper	Letterhead
Envelopes	Envelope
Epson Ultra Premium Photo Paper Glossy	Ultra Premium Photo Paper Glossy
Epson Premium Photo Paper Glossy	Premium Photo Paper Glossy
Epson Photo Paper Glossy	Photo Paper Glossy
Epson Premium Photo Paper Semi-gloss	Premium Photo Paper Semi-Gloss
Epson Premium Presentation Paper Matte Epson Premium Presentation Paper Matte Double-sided	Premium Presentation Paper Matte
Epson Presentation Paper Matte	Presentation Paper Matte

**Note:** The settings listed here are available only when printing from your computer; they do not apply to your product's control panel settings.

Parent topic: [Loading Paper](#)

## Selecting the Default Paper Source Settings

You can change default paper source settings using the control panel on the product.

1. Press the  home button, if necessary.
2. Select **Settings** > **General Settings** > **Printer Settings**.

You see a screen like this:

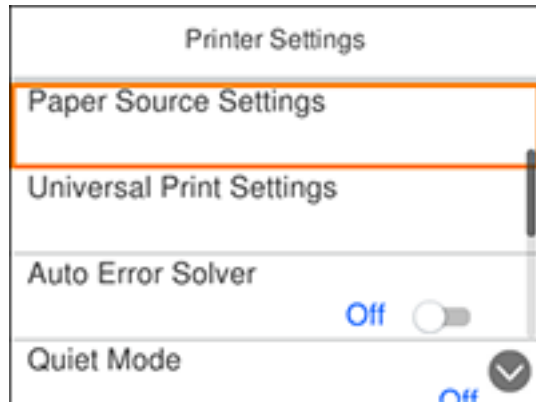

3. Select one of these **Auto Error Solver** options:
  - Turn on this setting to display a warning and print single-sided when a 2-sided printing error occurs, or to print only what the printer could process when a memory full error occurs.
  - Turn off this setting to display an error message and stop printing if an error occurs.
4. Select the **Paper Source Settings** options you want to use.
5. When you are finished, press the  home button to exit.

[Paper Source Settings Options](#)

**Parent topic:** [Loading Paper](#)

## Paper Source Settings Options

Select the paper source options you want to use for your print jobs.



Paper Source Settings option	Available settings	Description
<b>Paper Setting</b>	Various	Select the paper size and type for each paper source
<b>A4/Letter Auto Switching</b>	<b>On</b>	Select <b>On</b> to switch the selected paper size to match the loaded paper (Letter or A4) if the wrong size is selected
	<b>Off</b>	
<b>Error Notice</b>	<b>Paper Size Notice</b>	Select <b>On</b> for either of these settings to display an error message when the selected paper type or size does not match the loaded paper
	<b>Paper Type Notice</b>	

Paper Source Settings option	Available settings	Description
Paper Setup Auto Display	On	Select <b>On</b> to automatically display a menu that lets you select the paper size and type when you load paper in the product  <b>Note:</b> If this setting is disabled, you cannot print using AirPrint.
	Off	

Parent topic: [Selecting the Default Paper Source Settings](#)

## Selecting the Universal Print Settings

You can change the default universal print settings using the control panel on the product.

1. Press the  home button, if necessary.
2. Select **Settings** > **General Settings** > **Printer Settings** > **Universal Print Settings**.
3. Adjust the settings as necessary.
4. When you are finished, press the  home button to exit.

[Universal Print Settings Options](#)

Parent topic: [Loading Paper](#)

## Universal Print Settings Options

Select the universal print setting options you want to use for your print jobs.

Universal Print Settings option	Available settings	Description
Top Offset	—	Adjust the top or left margin
Left Offset		
Top Offset in Back	—	Adjust the top or left margin of the back page when printing double-sided.
Left Offset in Back		

Universal Print Settings option	Available settings	Description
Check Paper Width	On	Select <b>On</b> to check the paper width before printing. This prevents printing beyond the edges of the paper when the paper size settings are incorrect, but may reduce the printing speed.
	Off	
Skip Blank Page	On	Select <b>On</b> to skip printing of blank pages automatically
	Off	

Parent topic: [Selecting the Universal Print Settings](#)

---

## Placing Originals on the Product

Follow the instructions here to place your original documents or photos on the product.

**Caution:** Do not place anything on top of your product or use its cover as a writing surface to avoid damaging it.

**Note:** Your product may differ from the images in this guide, but the instructions are the same unless otherwise noted.

[Placing Originals on the Scanner Glass](#)

## Placing Originals on the Scanner Glass

You can place originals up to this size on the scanner glass: Letter (8.5 × 11 inches [216 × 279 mm]) or A4 (8.3 × 11.7 inches [210 × 297 mm]).

**Note:** To view animated instructions on how to place originals on the scanner glass, press the  help button and select **How To > Place Originals**

1. Open the document cover.

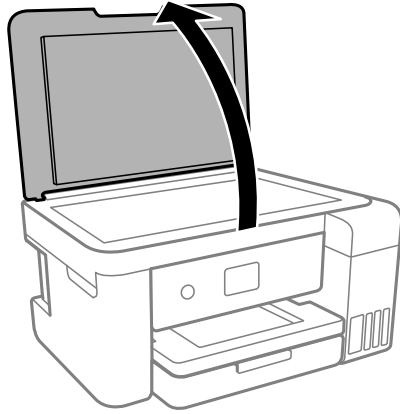

**Note:** If there is any dust or dirt on the scanner glass, the scanning range may expand to include it, so the image of the original may be displaced or reduced. Remove any dust and dirt on the scanner glass before scanning.

2. Place your original facedown on the scanner glass with the top facing into the corner. Slide the original to the edges of the indicated corner.

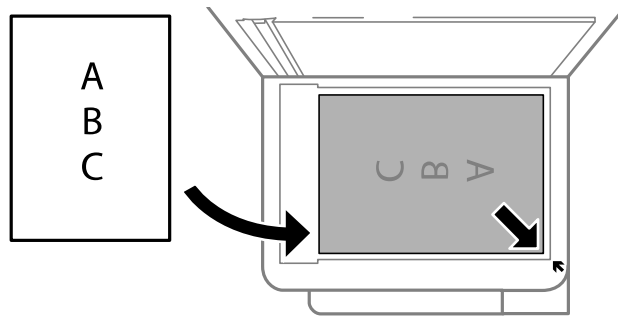

**Note:** If you are using Epson ScanSmart to scan multiple photos at once, just make sure they are at least 0.2 inch (4.5 mm) away from the edge of the scanner glass and at least 0.8 inch (20 mm) away from each other.

**Note:** The edges of your original may be cropped by 0.06 inch (1.5 mm) from the edge of the scanner glass. Manually position your original away from the edges to prevent cropping.

**Note:** When placing bulky originals such as books, prevent exterior light from shining directly onto the scanner glass.

3. Close the document cover gently to keep your original in place.

**Caution:** Do not push down on the document cover or scanner glass or you may damage the product.

Remove your originals after scanning. If you leave the originals on the scanner glass for a long time, they may stick to the glass surface.

**Parent topic:** [Placing Originals on the Product](#)

**Related topics**

[Copying](#)

[Scanning](#)



---

# Copying

See the information here to copy documents or photos using your product.

**Note:** Copies may not be exactly the same size as your originals.

[Copying Documents or Photos](#)

[Copying Options](#)

## Copying Documents or Photos

You can copy documents or photos onto various sizes and types of paper, including Epson special papers.

1. Load the paper you want to print on.
2. Place your original document or photo on the scanner glass.
3. Press the  home button, if necessary.
4. Select **Copy**.

You see a screen like this:



5. To print more than one copy, use the + or - button to increase or decrease the number of copies, or select **Copies**, use the displayed keypad to enter the number of copies, and select **OK**.
6. Change any of the displayed settings as necessary.

7. Select **Advanced Settings** to view and change additional copy settings, if necessary.
8. When you are ready to copy, press the  start button.

**Note:** To cancel printing, press the  stop button.

Parent topic: [Copying](#)

## Copying Options

Select the copying options you want to use for your copies.

**Note:** Not all options or settings may be available, depending on other copying settings.

### Copy

Copying option	Available settings	Description
<b>B&amp;W</b>	—	Copies the document in black and white
<b>Color</b>	—	Copies the document in color
2-Sided	<b>1&gt;1-Sided</b>	Select to make 2-sided copies. When you select <b>1&gt;2-Sided</b> , also select the orientation and binding edge for your originals or copies.
	<b>1&gt;2-Sided</b>	
Density selector	Varying levels	Adjusts the lightness or darkness of copies

### Advanced Settings

Copying option	Available settings	Description
<b>Paper Setting</b>	Various settings	Selects the paper size and paper type
<b>Reduce/Enlarge</b>	<b>100%/Actual Size</b>	Copies the original at its full size
	<b>Auto Fit Page</b>	Automatically sizes the image to fit the paper size you selected
	<b>45%-&gt;195%</b> and other conversions	Automatically converts from one size to another
<b>Original Size</b>	Various sizes	Select the document size of your original

Copying option	Available settings	Description
<b>Multi-Page</b>	<b>Single Page</b>	Copies each page of the original onto an individual sheet
	<b>2-up</b>	Copies two pages onto one sheet. Scroll down and select the document orientation and layout order settings as necessary.
<b>Quality</b>	<b>Standard</b>	Adjusts the quality of your copies
	<b>High</b>	
<b>Original Orientation</b>	<b>Portrait</b>	Specifies the orientation of your originals
	<b>Landscape</b>	
<b>Remove Shadow</b>	<b>Off</b>	Select <b>On</b> to erase the shadows that appear in the center of a document when copying a book or that appear around a document when copying thick paper
	<b>On</b>	
<b>Remove Punch Holes</b>	<b>Off</b>	Select <b>On</b> to erase the binding holes on a document
	<b>On</b>	
<b>ID Card Copy</b>	<b>Off</b>	Select <b>On</b> to copy both sides of an ID card onto one side of a sheet of paper
	<b>On</b>	
<b>Borderless Copy</b>	<b>Off</b>	Adjusts the amount to expand the original photo when printing borderless photos
	<b>On</b>	
	<b>Standard</b>	
	<b>Medium</b>	
	<b>Minimum</b>	

Parent topic: [Copying](#)

---

# Printing from a Computer

Before printing from your computer, make sure you have set up your product and installed its software as described on the *Start Here* sheet.

**Note:** If you have an Internet connection, it is a good idea to check for updates to your product software on Epson's support website. If you see a Software Update screen, select **Enable automatic checking** and click **OK**. The update scans your system to see if you have the latest product software. Follow the on-screen instructions.

[Printing with Windows](#)

[Printing with the Built-in Epson Driver - Windows 10 S](#)

[Printing on a Mac](#)

[Printing from a Smartphone or Tablet](#)

[Printing with Epson Photo+](#)

[Cancelling Printing Using the Product](#)

## Printing with Windows

You can print with your product using any Windows application, as described in these sections.

**Note:** If you are using your Epson product with the Windows 10 S operating system, you cannot use the software described in this section. You also cannot download and install any Epson product software from the Epson website for use with Windows 10 S; you must obtain software only from the Windows Store.

[Selecting Basic Print Settings - Windows](#)

[Selecting Double-sided Printing Settings - Windows](#)

[Selecting Additional Layout and Print Options - Windows](#)

[Selecting a Printing Preset - Windows](#)

[Selecting Extended Settings - Windows](#)

[Printing Your Document or Photo - Windows](#)

[Checking Print Status - Windows](#)

[Locking Printer Settings - Windows](#)

[Selecting Default Print Settings - Windows](#)

[Changing Automatic Update Options](#)

Parent topic: [Printing from a Computer](#)

## Selecting Basic Print Settings - Windows

Select the basic settings for the document or photo you want to print.

1. Open a photo or document for printing.
2. Select the print command in your application.

**Note:** You may need to select a print icon on your screen, the **Print** option in the File menu, or another command. See your application's help utility for details.

3. If necessary, select your product name as the printer you want to use.

**Note:** You may also need to select **Properties** or **Preferences** to view your print settings.

You see the Main tab of your printer settings window:

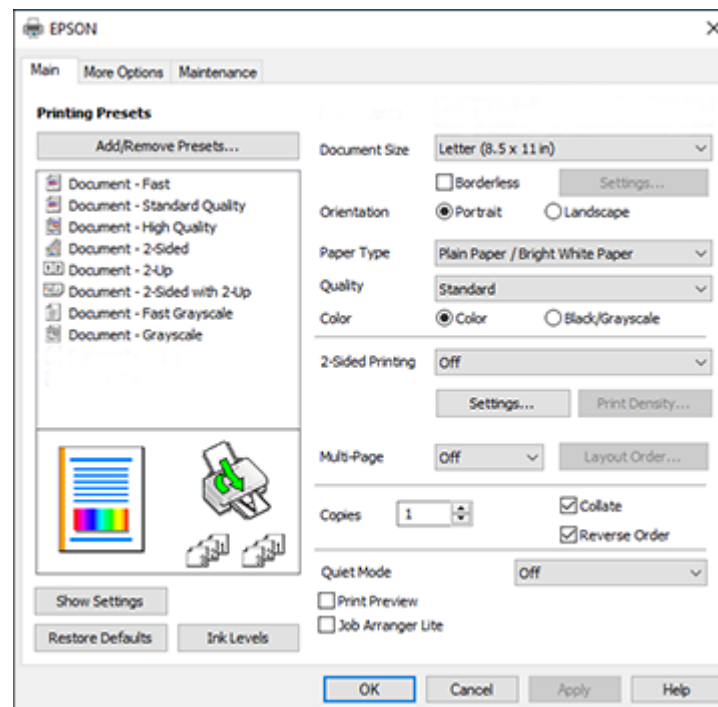

4. Select the size of the paper you loaded as the Document Size setting.

**Note:** You can also select the **User-Defined** setting to create a custom paper size, but you cannot use the **Borderless** setting and the Quality setting will be set to **Standard**.

5. If you are printing a borderless photo, select **Borderless**. You can click **Settings** to access additional options for borderless printing.

**Note:** You must select a compatible borderless paper type and size to print without borders. Check the borderless paper compatibility list for details.

6. Select the orientation of your document.

**Note:** If you are printing an envelope, select **Landscape**.

7. Select the type of paper you loaded as the Paper Type setting.

**Note:** The setting may not exactly match the name of your paper. Check the paper type settings list for details.

8. Select the **Quality** setting that matches the print quality you want to use.

9. Select a Color option:

- To print a color document or photo, select the **Color** setting.
- To print text and graphics in black or shades of gray, select the **Black/Grayscale** setting.

10. To print on both sides of the paper, select the **2-Sided Printing** setting and select the options you want.

11. To print multiple pages on one sheet of paper, or print one image on multiple sheets of paper, select one of the settings in the Multi-Page menu and select the printing options you want.

12. To print multiple copies and arrange their print order, select the **Copies** options.

13. To preview your job before printing, select **Print Preview**.

14. To save your print job as a project that can be modified and combined with other print jobs, select **Job Arranger Lite**.

15. To reduce noise during printing when you select **Plain Paper/Bright White Paper**, select **On** in the Quiet Mode menu.

**Note:** Enabling **Quiet Mode** may reduce printing speed.

[Print Quality Options - Windows](#)

[Multi-Page Printing Options - Windows](#)

**Parent topic:** [Printing with Windows](#)

**Related references**

[Borderless Paper Type Compatibility](#)

[Double-sided Printing Capacity](#)

[Paper or Media Type Settings - Printing Software](#)

**Related tasks**

[Selecting Double-sided Printing Settings - Windows](#)

[Printing Your Document or Photo - Windows](#)

### **Print Quality Options - Windows**

You can select any of the available Quality options to fine-tune the quality of your print. Some settings may be unavailable, depending on the paper type and border setting you have chosen.

**Draft**

For draft printing on plain paper.

**Draft - Vivid**

For draft printing on plain paper with good quality and print speed.

**Standard**

For everyday text and image printing.

**Standard - Vivid**

For text and graphics with good quality and print speed.

**High**

For photos and graphics with high print quality.

**More Settings**

Opens a window that lets you choose among levels of speed and quality.

**Parent topic:** [Selecting Basic Print Settings - Windows](#)

### **Multi-Page Printing Options - Windows**

You can select any of the available options in the Multi-Page menu to set up your multi-page print job.

### **2-Up, 4-Up, 6-Up, 8-Up, 9-Up, and 16-Up**

Prints several pages on one sheet of paper. Click the **Layout Order** button to select page layout and border options.

### **2×1 Poster, 2×2 Poster, 3×3 Poster, 4×4 Poster**

Prints one image on multiple sheets of paper to create a larger poster. Click the **Settings** button to select image layout and guideline options.

**Parent topic:** [Selecting Basic Print Settings - Windows](#)

## **Selecting Double-sided Printing Settings - Windows**

You can print on both sides of the paper by selecting one of the 2-Sided Printing options on the Main tab.

**Note:** Some options may be pre-selected or unavailable, depending on other settings you have chosen or if you are accessing the product over a network.

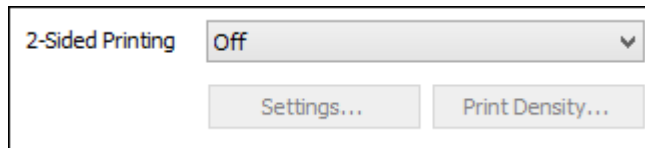

1. Select one of the following options for **2-Sided Printing**:
  - **Auto (Long-edge binding)** to print your double-sided print job by automatically flipping the paper on the long edge.
  - **Auto (Short-edge binding)** to print your double-sided print job by automatically flipping the paper on the short edge.
  - **Manual (Long-edge binding)** to print your double-sided print job by printing one side and prompting you to flip the paper over on the long edge to print the other side (recommended for paper types that do not support automatic duplexing).
  - **Manual (Short-edge binding)** to print your double-sided print job by printing one side and prompting you to flip the paper over on the short edge to print the other side (recommended for paper types that do not support automatic duplexing).
2. Click the **Settings** button.



You see this window:

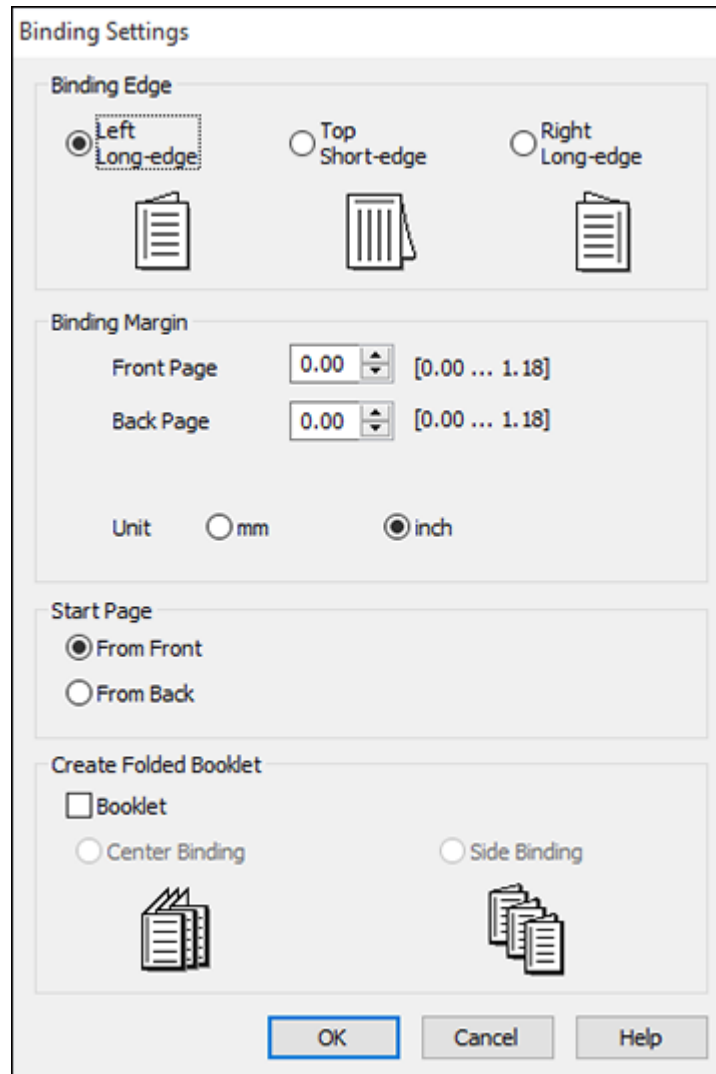

3. Select the double-sided printing options you want to use.
4. Click **OK** to return to the Main tab.

5. Click the **Print Density** button.

You see this window:

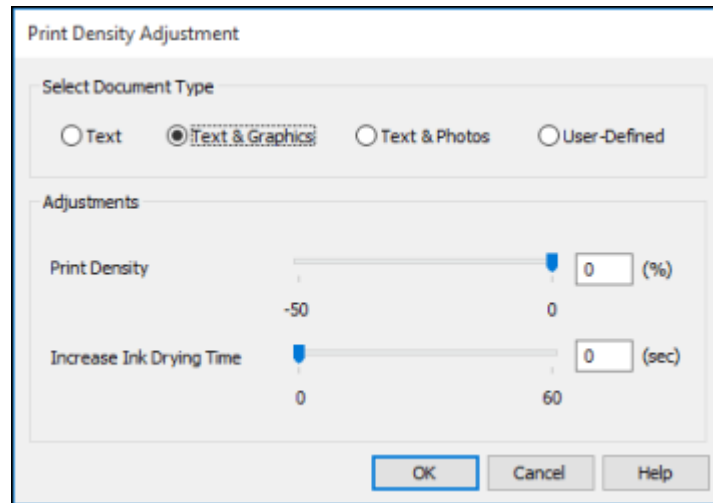

6. Select the type of document you are printing as the Document Type setting. The software automatically sets the Adjustments options for that document type.
7. If necessary, select the Adjustments options you want to use.
8. Click **OK** to return to the Main tab.
9. Print a test copy of your double-sided document to test the selected settings.
10. Follow any instructions displayed on the screen during printing.

[Double-sided Printing Options - Windows](#)

[Print Density Adjustments - Windows](#)

**Parent topic:** [Printing with Windows](#)

#### **Related references**

[Double-sided Printing Capacity](#)

#### **Related tasks**

[Selecting Basic Print Settings - Windows](#)

## **Double-sided Printing Options - Windows**

You can select any of the available options on the Binding Settings window to set up your double-sided print job.

### **Binding Edge Options**

Select a setting that orients double-sided print binding in the desired direction.

### **Binding Margin Options**

Select options that define a wider margin to allow for binding.

### **Start Page**

Selects whether printing starts on the front or back page.

### **Create Folded Booklet Options**

Select the **Booklet** checkbox and a binding option to print double-sided pages as a booklet.

**Parent topic:** [Selecting Double-sided Printing Settings - Windows](#)

## **Print Density Adjustments - Windows**

You can select any of the available options on the Print Density Adjustment window to adjust the print quality of your double-sided print job.

### **Print Density**

Sets the level of ink coverage for double-sided printing.

### **Increase Ink Drying Time**

Sets the amount of time required for drying ink after printing on one side of the paper before printing the other side in double-sided printing to prevent ink smearing.

**Parent topic:** [Selecting Double-sided Printing Settings - Windows](#)

## Selecting Additional Layout and Print Options - Windows

You can select a variety of additional layout and printing options for your document or photo on the **More Options** tab.

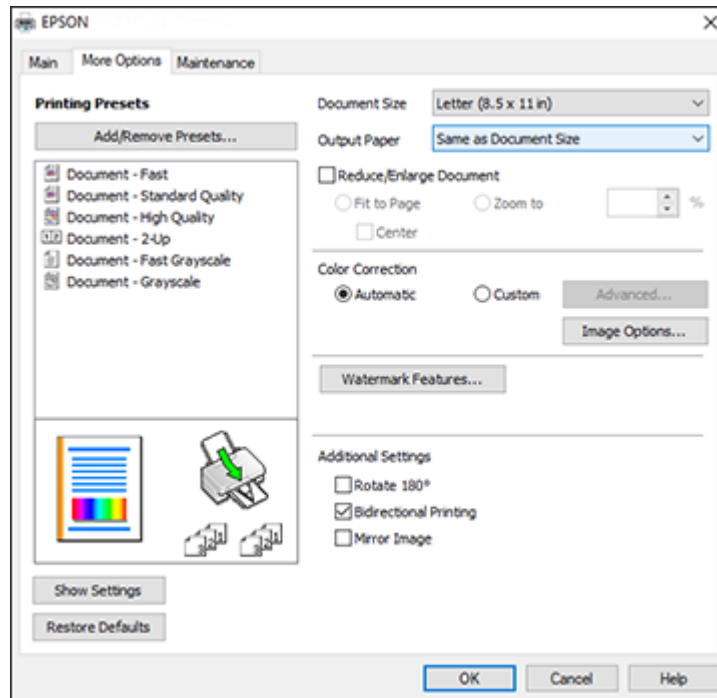

1. To change the size of your printed document or photo, select the **Reduce/Enlarge Document** checkbox and select one of these sizing options:
  - Select the **Fit to Page** option to size your image to fit the paper you loaded. Select the size of your document or photo as the Document Size setting, and the size of your paper as the Output Paper setting. If you want to center your image on the paper, select the **Center** option.
  - Select the **Zoom to** option to reduce or enlarge your document or photo by a specific percentage. Select the percentage in the % menu.
2. Select one of the following Color Correction options:
  - Select **Automatic** to automatically adjust the sharpness, brightness, contrast, and color saturation for your image.

- Select **Custom** and click the **Advanced** button to manually adjust the color correction settings or turn off color management in your printer software.
- Select **Image Options** to access additional settings for improving printed images.

**Note:** You can also select **Color Universal Print** settings.

3. To add the following features, click the **Watermark Features** button:

- **Anti-Copy Pattern:** adds a watermark that only appears when your printout is copied

**Note:** This setting is not available for all types of printing. Click the **Add/Delete** button to create your own pattern, and click the **Settings** button to customize the pattern.

- **Watermark:** adds a visible watermark to your printout

**Note:** Click the **Add/Delete** button to create your own watermark, and click the **Settings** button to customize the watermark.

- **Header/Footer:** adds information such as the date and time to the top or bottom of your printout

**Note:** Click the **Settings** button to customize the text and location of the header or footer.

4. Select any of the Additional Settings options to customize your print.

[Custom Color Correction Options - Windows](#)

[Image Options and Additional Settings - Windows](#)

[Header/Footer Settings - Windows](#)

**Parent topic:** [Printing with Windows](#)

**Related tasks**

[Printing Your Document or Photo - Windows](#)

## Custom Color Correction Options - Windows

You can select any of the available options in the Color Correction window to customize the image colors for your print job.

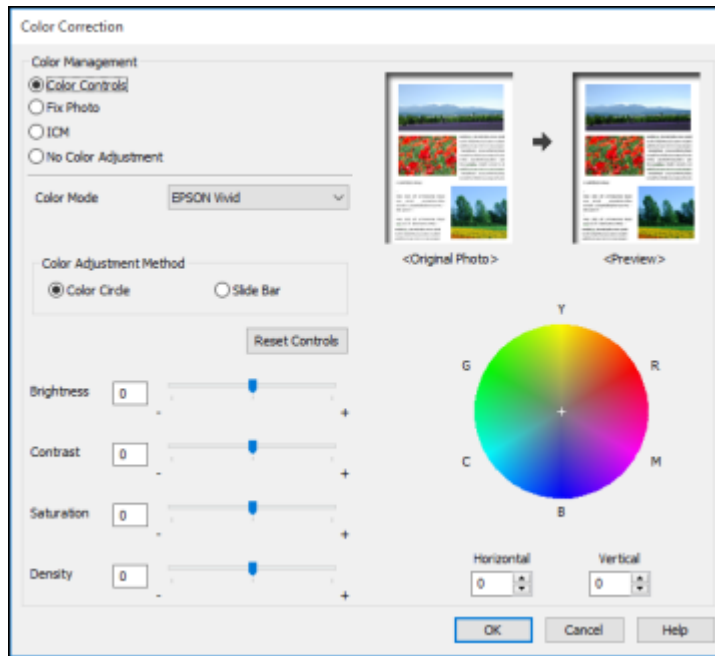

### Color Controls

Lets you select a **Color Mode** setting, individual settings for **Brightness**, **Contrast**, **Saturation**, and **Density**, and individual color tones. Depending on the selected color mode, you can also adjust the midtone density using the **Gamma** setting.

### Fix Photo

Improves the color, contrast, and sharpness of flawed photos.

**Note:** Fix Photo uses a sophisticated face recognition technology to optimize photos that include faces. For this to work, both eyes and the nose must be visible in the subject's face. If your photo includes a face with an intentional color cast, such as a statue, you may want to turn off **Fix Photo** to retain the special color effects.

**ICM**

Lets you manage color using installed color printing profiles.

**No Color Adjustment**

Turns off color management in your printer software so you can manage color using only your application software.

**Parent topic:** [Selecting Additional Layout and Print Options - Windows](#)

**Image Options and Additional Settings - Windows**

You can select any of the Image Options and Additional Settings to customize your print. Some options may be pre-selected or unavailable, depending on other settings you have chosen.

**Image Options****Emphasize Text**

Adjusts the weight of printed text to increase readability.

**Emphasize Thin Lines**

Adjusts the weight of printed lines to increase visibility.

**Edge Smoothing**

Smooths jagged edges in low-resolution images such as screen captures or images from the Web.

**Fix Red-Eye**

Reduces or removes red-eye in photos.

**Print Text in Black**

Prints colored text in black.

**For Color Text**

Prints colored text on a background pattern or underlined.

**For Color Graphs and Images**

Prints colored graphics and images with overlay patterns.

**For Color Text, Graphs, and Images**

Prints colored text, graphics, and images with overlay patterns.

**Enhancement Options**

Specifies Color Universal Print enhancement settings for text, graphics, and images.

**Additional Settings Options****Rotate 180°**

Prints the image rotated 180° from its original orientation.

### Bidirectional Printing

Prints in both directions (right-to-left and left-to-right), speeding up printing, but may reduce print quality.

### Mirror Image

Flips the printed image left to right.

Parent topic: [Selecting Additional Layout and Print Options - Windows](#)

### Header/Footer Settings - Windows

You can select any of the Header/Footer Settings options to add headers or footers when you print. The items are available to print at the top or bottom of your pages, in either the left, right, or center of the page.

**Note:** These settings are not saved with your document.

The screenshot shows the 'Header/Footer Settings' dialog box. It is organized into several sections:

- Positional Settings:** A grid of dropdown menus for 'Top Left', 'Top Center', 'Top Right', 'Bottom Left', 'Bottom Center', and 'Bottom Right'. The 'Top Left' dropdown is set to 'User Name', 'Top Center' to 'None', and 'Top Right' to 'Date/Time'. The bottom row of dropdowns is all set to 'None'.
- Page Settings:** Two spinners for 'Starting number' and 'Start printing on page', both set to '1'.
- Text Input:** A text field labeled 'Text' which is currently empty.
- Formatting Options:**
  - Color:** A dropdown menu set to 'Black'.
  - Font:** A dropdown menu set to 'Arial'.
  - Size:** A spinner set to '11 pt' with a range of '[6 ... 72]'.
  - Style:** A list box containing 'Bold' and 'Italic'.
- Buttons:** 'Reset Defaults', 'OK', 'Cancel', and 'Help' buttons are located at the bottom.



You can select to print the following information:

- User Name
- Computer Name
- Date
- Date/Time
- Document Name
- Collate Number (copy number)
- Page Number
- Text

You can also adjust the text settings for the printed information.

**Note:** The user name, computer name, date, and time come from the Windows Control Panel on your computer.

**Parent topic:** [Selecting Additional Layout and Print Options - Windows](#)

## Selecting a Printing Preset - Windows

For quick access to common groups of print settings, you can select a printing preset on the **Main** or **More Options** tab.

**Note:** You can create your own preset by clicking the **Add/Remove Presets** button.

1. Click the **Main** or **More Options** tab.

You see the available **Printing Presets** on the left:

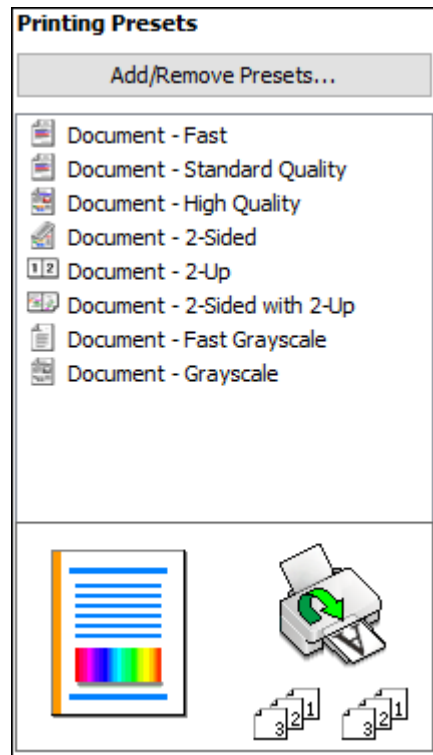



2. Place your cursor over one of the **Printing Presets** to view its list of settings.
3. Click on a preset to change its settings or delete it, or use any of the available options on the screen to control your printing presets.
4. To choose a preset for printing, select it.
5. Click **OK**.

**Parent topic:** [Printing with Windows](#)

## Selecting Extended Settings - Windows

You can select additional settings that apply to all the print jobs you send to your product.

1. Access the Windows Desktop and right-click the  icon for your product in the right side of the Windows taskbar, or click the up arrow and right-click .
2. Select **Printer Settings**.
3. Click the **Maintenance** tab.

You see the maintenance options:

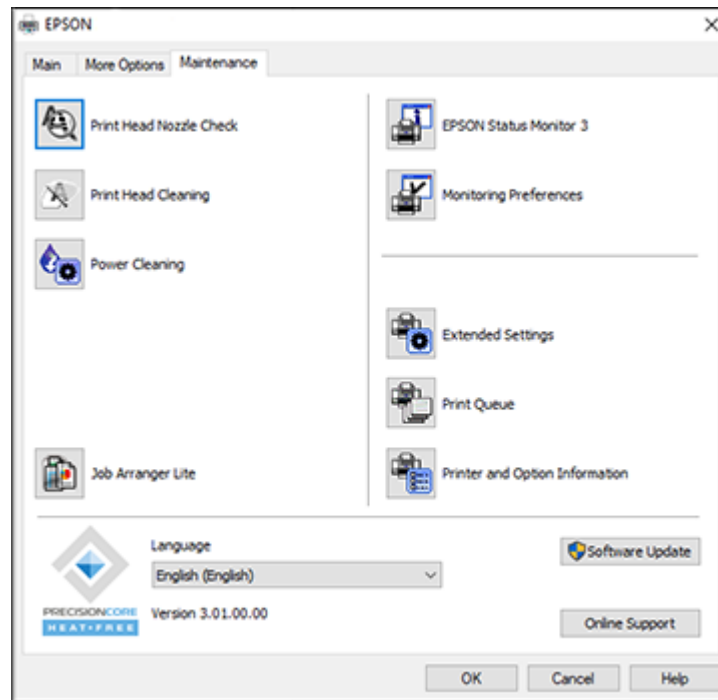

4. Click the **Extended Settings** button.

You see this window:

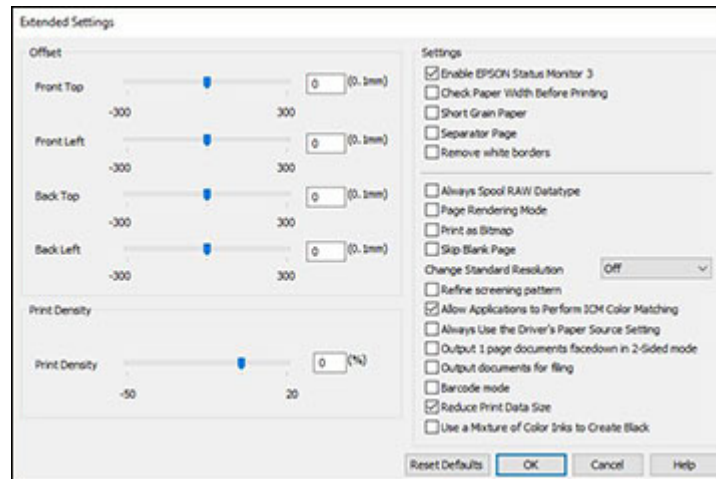

5. Select any of the extended settings to customize your print.
6. Click **OK** to close the Extended Settings window.
7. Click **OK** to close the printer software window.

[Extended Settings - Windows](#)

**Parent topic:** [Printing with Windows](#)

### **Extended Settings - Windows**

You can select these settings on the Extended Settings window.

#### **Enable EPSON Status Monitor 3**

Enables product monitoring for ink and paper supplies and other issues.

#### **Check Paper Width Before Printing**

Prevents printing beyond the edges of the paper if the paper size setting is incorrect; may reduce print speed.

#### **Short Grain Paper**

Prevents ink from smearing when you print on envelopes or other thick paper.

#### **Separator Page**

Before each document, prints a separator page containing the title, user, date, and time.

**Remove white borders**

Removes white margins that may appear when you print borderless photos.

**Always Spool RAW Datatype**

Increases print speed and may solve other printing problems.

**Page Rendering Mode**

Increases print speed when printing is extremely slow or the print head stops during printing.

**Print as Bitmap**

Increases print speed when printing is extremely slow or the print head stops during printing, and other settings do not help.

**Skip Blank Page**

Ensures that your product does not print pages that contain no text or images.

**Change Standard Resolution**

Reduces the resolution of print data to correct printing problems.

**Refine screening pattern**

Prints graphics with a finer screening pattern.

**Allow Applications to Perform ICM Color Matching**

Allows applications to perform ICM color matching.

**Always Use the Driver's Paper Source Setting**

Prints using the paper source setting in the printer driver, rather than the setting in your application.

**Output 1 page documents facedown in 2-Sided mode**

Outputs single-sided pages in a 2-sided print job facedown instead of faceup.

**Output documents for filing**

Outputs all landscape, portrait, 1-sided, and 2-sided documents in the same orientation for easier filing.

**Barcode mode**

Reduces bleeding when printing barcodes on plain paper, letterhead paper, recycled paper, preprinted paper, envelopes, and thick paper.

**Reduce Print Data Size**

Increases print data compression to improve print speed. Not recommended when printing fine patterns.

**Use a Mixture of Color Inks to Create Black**

Mixes color inks to create composite black when printing at standard quality on plain paper or envelopes.

**Parent topic:** [Selecting Extended Settings - Windows](#)

## Printing Your Document or Photo - Windows

Once you have selected your print settings, you are ready to save your settings and print.

1. Click **OK** to save your settings.

You see your application's Print window, such as this one:

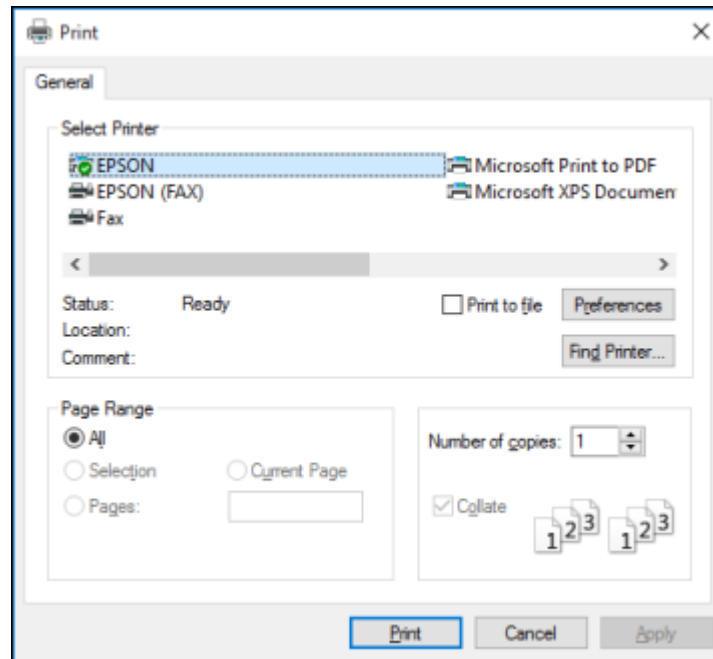

2. Click **OK** or **Print** to start printing.

**Parent topic:** [Printing with Windows](#)

### **Related tasks**

[Selecting Basic Print Settings - Windows](#)

## Checking Print Status - Windows

During printing, you see this window showing the progress of your print job. It allows you to control printing and check ink status.

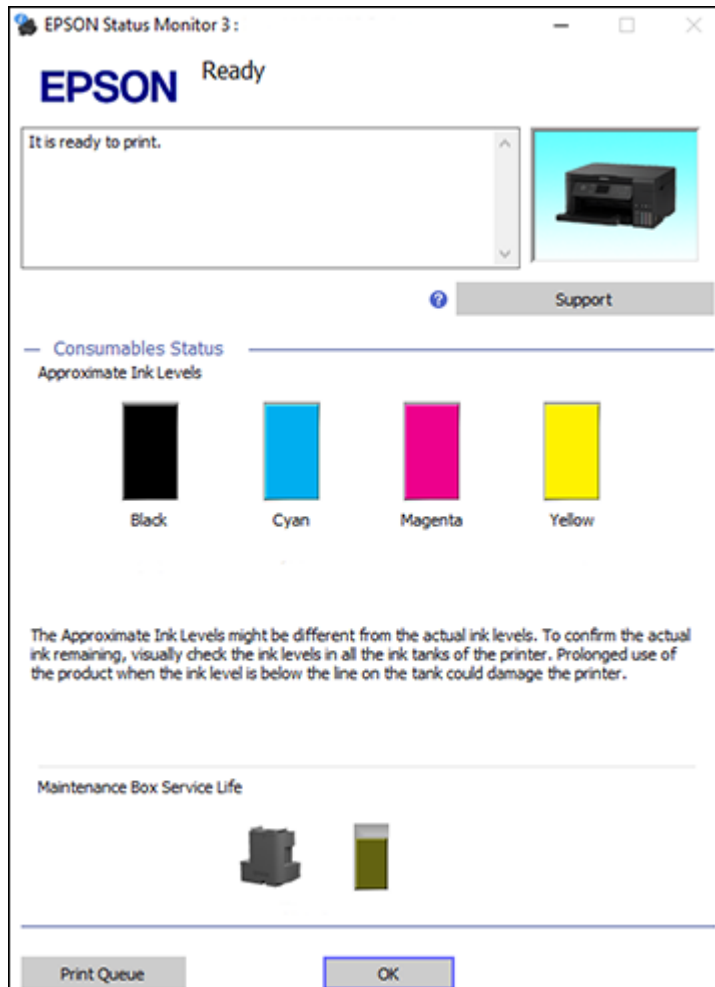





- To cancel printing, click **Cancel**.
- To see print jobs lined up for printing, click **Print Queue**.

Parent topic: [Printing with Windows](#)

## Locking Printer Settings - Windows

Windows administrators can lock access to some printer settings to prevent unauthorized changes.

1. Do one of the following:

- **Windows 10:** Click  and select  (Settings) > **Devices** > **Printers & scanners**. Select your product name and select **Manage** > **Printer properties**.
- **Windows 8.x:** Navigate to the **Apps** screen and select **Control Panel** > **Hardware and Sound** > **Devices and Printers**. Right-click your product and select **Printer properties**.
- **Windows 7:** Click  and select **Devices and Printers**. Right-click your product and select **Printer properties**.
- **Windows Vista:** Click  and select **Control Panel**. Click **Printer** under **Hardware and Sound**, then right-click your product and select **Properties**.

2. Click the **Optional Settings** tab.

**Note:** You can prevent access to the **Optional Settings** tab by changing the user or group permissions in the **Security** tab.

3. Click **Driver Settings**.



You see this window:

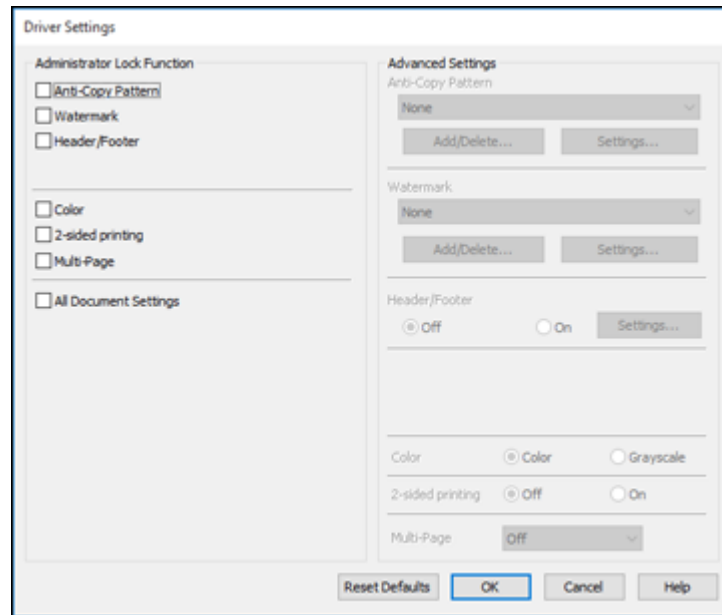

4. Select the checkbox for each setting you want to lock. To lock all print settings, select **All Document Settings**.
5. Under **Advanced Settings**, select the setting option you want to use for each locked setting.
6. Click **OK**.

[Locked Setting Options](#)

**Parent topic:** [Printing with Windows](#)

### **Locked Setting Options**



Select the options you want to use for any locked print settings.

<b>Setting</b>	<b>Options</b>	<b>Description</b>
<b>Anti-Copy Pattern</b>	Various data items	Lets you select the data to use for the pattern or prohibit anti-copy patterns
	<b>Add/Delete</b>	Lets you add or delete a customized anti-copy pattern
	<b>Settings</b>	Lets you select the arrangement, size, and other settings for the custom anti-copy pattern
<b>Watermark</b>	Various text watermarks	Lets you select the text for the watermark or prohibit watermarks
	<b>Add/Delete</b>	Lets you add or delete a customized text or image-based watermark
	<b>Settings</b>	Lets you select the size, position, and other watermark settings
<b>Header/Footer</b>	<b>Off</b>	Prohibits headers or footers
	<b>On</b>	Allows headers and footers
	<b>Settings</b>	Lets you select the text and position for printing headers and footers
<b>Color</b>	<b>Color</b>	Allows color printing
	<b>Grayscale</b>	Allows printing in black or shades of gray only
<b>2-sided printing</b>	<b>Off</b>	Allows printing on one side of the paper only
	<b>On</b>	Allows printing on both sides of the paper
<b>Multi-Page</b>	<b>Off</b>	Prohibits multi-page settings
	<b>2-Up</b>	Allows printing of 2 pages on one sheet of paper
	<b>4-Up</b>	Allows printing of 4 pages on one sheet of paper
	<b>6-Up</b>	Allows printing of 6 pages on one sheet of paper
	<b>8-Up</b>	Allows printing of 8 pages on one sheet of paper
	<b>9-Up</b>	Allows printing of 9 pages on one sheet of paper
	<b>16-Up</b>	Allows printing of 16 pages on one sheet of paper

Parent topic: [Locking Printer Settings - Windows](#)

## Selecting Default Print Settings - Windows

When you change your print settings in a program, the changes apply only while you are printing in that program session. If you want to change the print settings you use in all your Windows programs, you can select new default print settings.

1. Access the Windows Desktop and right-click the  icon for your product in the right side of the Windows taskbar, or click the up arrow and right-click .
2. Select **Printer Settings**.

You see the printer settings window:

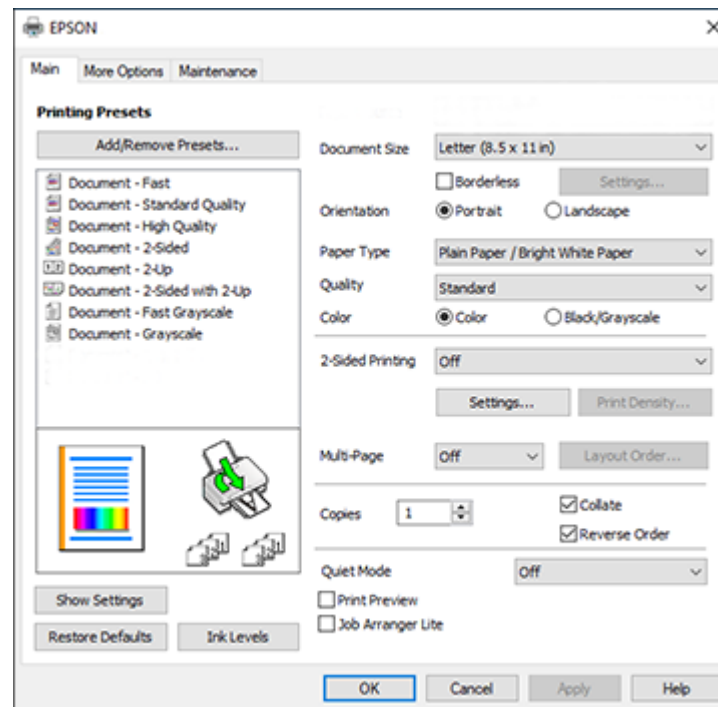

3. Select the print settings you want to use as defaults in all your Windows programs.
4. Click **OK**.



These settings are now the defaults selected for printing. You can still change them as needed for printing in any program session.

## Changing the Language of the Printer Software Screens

**Parent topic:** [Printing with Windows](#)

### Changing the Language of the Printer Software Screens

You can change the language used on the Windows printer software screens.

1. Access the Windows Desktop and right-click the  icon for your product in the right side of the Windows taskbar, or click the up arrow and right-click .

2. Select **Printer Settings**.

You see the printer settings window.

3. Click the **Maintenance** tab.

You see the maintenance options:

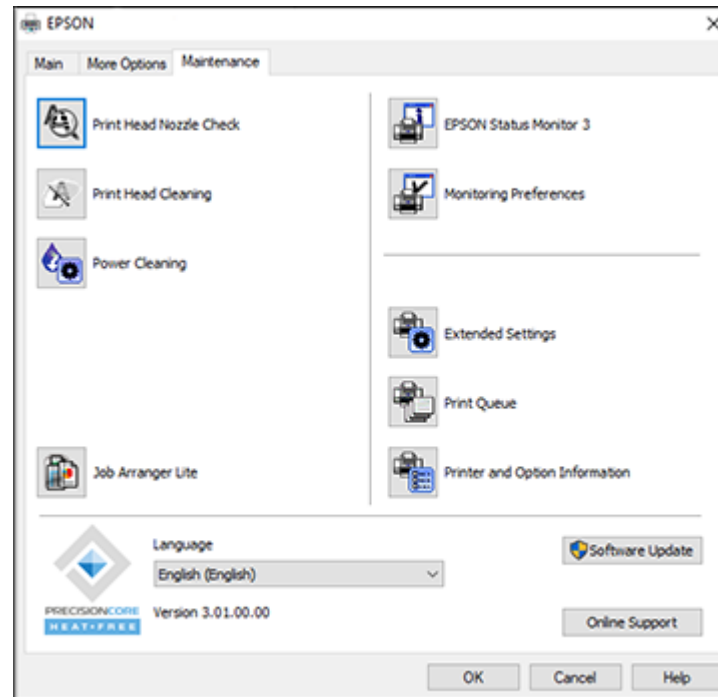

4. Select the language you want to use as the **Language** setting.



5. Click **OK** to close the printer software window.

The printer software screens appear in the language you selected the next time you access them.

**Parent topic:** [Selecting Default Print Settings - Windows](#)

## Changing Automatic Update Options

Your printer software for Windows automatically checks for updates to the product software. You can change how often the software checks for updates or disable this feature.

1. Access the Windows Desktop and right-click the  icon for your product in the right side of the Windows taskbar, or click the up arrow and right-click .
2. Select **Software Update Settings**.

You see this window:

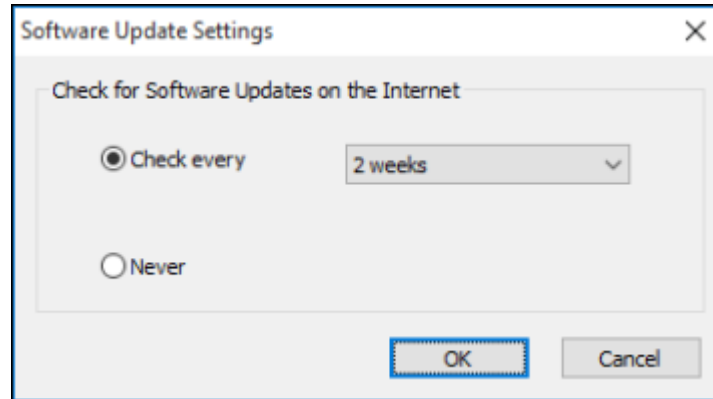

3. Do one of the following:
  - To change how often the software checks for updates, select a setting in the **Check every** menu.
  - To disable the automatic update feature, select the **Never** option.
4. Click **OK** to exit.

**Note:** If you choose to disable the automatic update feature, you can check for updates manually.

**Parent topic:** [Printing with Windows](#)

## Related tasks

[Checking for Software Updates](#)

# Printing with the Built-in Epson Driver - Windows 10 S

You can print with the built-in Epson printer driver using any printing program on Windows 10 S, as described in these sections.

**Note:** The built-in Epson driver in Windows 10 S does not include all the available print settings for your product.

[Selecting Print Settings - Windows 10 S](#)

**Parent topic:** [Printing from a Computer](#)

## Selecting Print Settings - Windows 10 S

Select the settings for your print job in your Windows 10 S application.

1. Open a photo or document for printing.
2. Select the print command in your application.

**Note:** You may need to select a print icon on your screen, the **Print** option in the **File** menu, or another command. See your application's help utility for details.

3. If necessary, select your product name as the printer you want to use.

**Note:** You may also need to select **Properties** or **Preferences** to view your print settings.

You see a window like this:

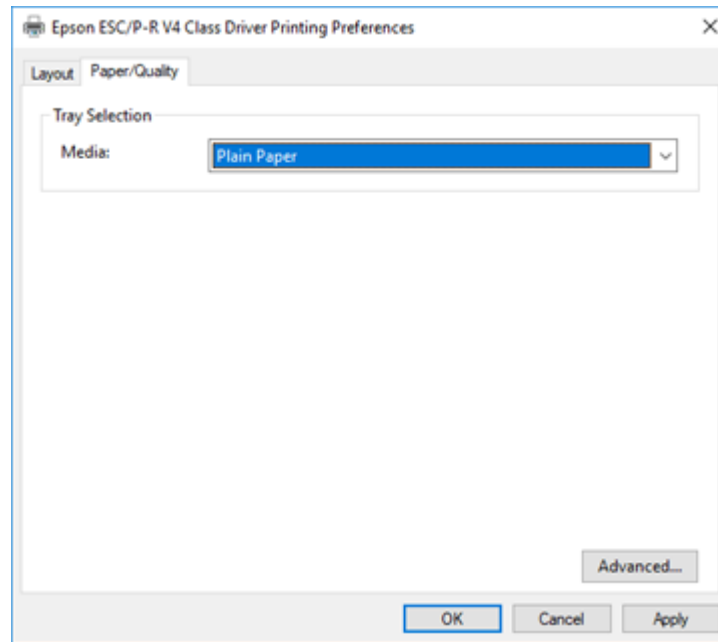

4. Select the type of paper you loaded as the **Media** setting.

**Note:** The setting may not exactly match the name of your paper. Check the paper type settings list for details.

5. Click the **Advanced** button.

You see a window like this:

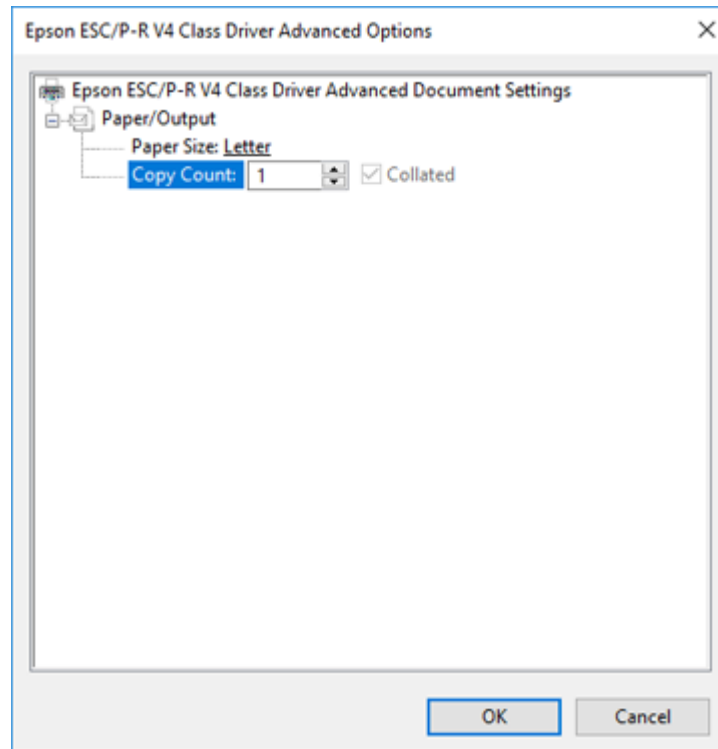

6. Select the size of the paper you loaded as the **Paper Size** setting.
7. To print multiple copies, select or enter the number as the **Copy Count** setting.
8. To print multiple copies of multi-page documents in sets, select the **Collated** checkbox.
9. Click **OK**.

You return to the printing preferences window.



10. Select the **Layout** tab.

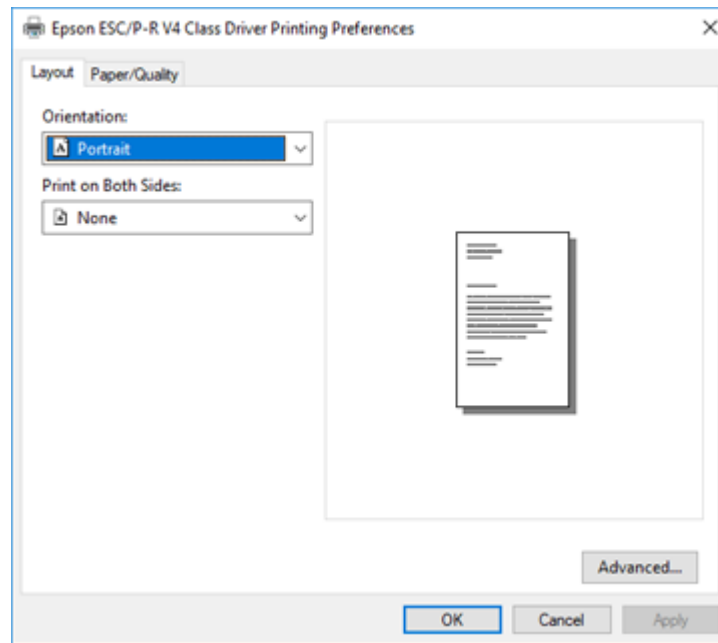

11. Select the orientation of your document as the **Orientation** setting.

- To print double-sided, select one of the **Print on Both Sides** options, depending on how you want to orient the page layout. The icon next to each option shows the layout.

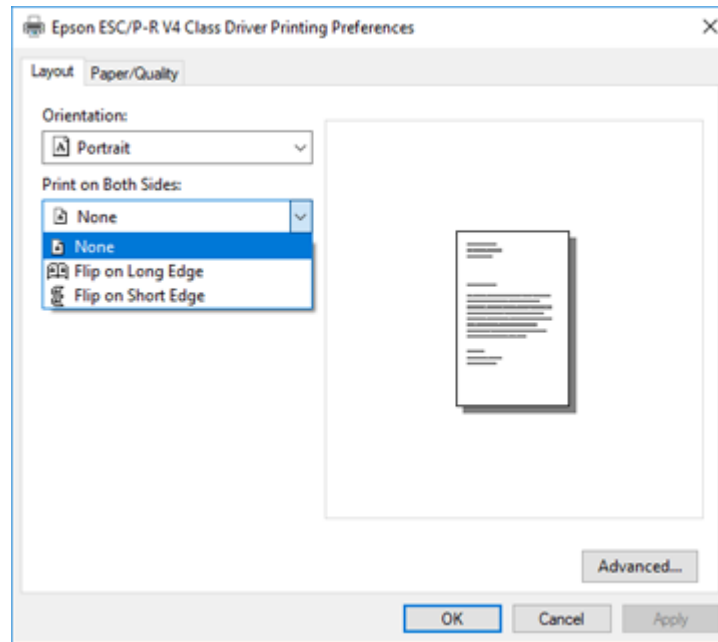

- Click **OK** to save your settings.

You see your application's **Print** window.

- Click **OK** or **Print** to start printing.

**Parent topic:** [Printing with the Built-in Epson Driver - Windows 10 S](#)

## Printing on a Mac

You can print with your product using any Mac printing program, as described in these sections.

**Note:** If you have an Internet connection, it is a good idea to check for updates to your product software on Epson's support website or using Epson Software Updater.

[Selecting Basic Print Settings - Mac](#)

[Selecting Page Setup Settings - Mac](#)

- [Selecting Print Layout Options - Mac](#)
  - [Selecting Double-sided Printing Settings - Mac](#)
  - [Managing Color - Mac](#)
  - [Selecting Printing Preferences - Mac](#)
  - [Printing Your Document or Photo - Mac](#)
- Parent topic:** [Printing from a Computer](#)

## Selecting Basic Print Settings - Mac

Select the basic settings for the document or photo you want to print.

1. Open a photo or document for printing.
2. Select the print command in your application.

**Note:** You may need to select a print icon on your screen, the **Print** option in the File menu, or another command. See your application's help utility for details.

3. Select your product as the **Printer** setting.

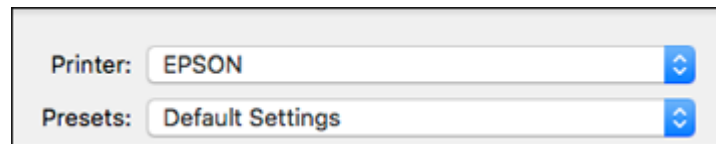

4. If necessary, click the **Show Details** button to expand the print window.

You see the expanded printer settings window for your product:

Printer: EPSON

Presets: Default Settings

Copies: 1

Pages:  All  
 From: 1 to: 1

Paper Size: US Letter 8.50 by 11.00 inches

Orientation:  Portrait  Landscape

Preview

Auto Rotate

Scale: 46%

Scale to Fit:  Print Entire Image  
 Fill Entire Paper

Copies per page: 1

PDF Cancel Print

**Note:** The print window may look different, depending on the Mac OS version and the application you are using.

5. Select the **Copies** and **Pages** settings as necessary.

**Note:** If you do not see these settings in the print window, check for them in your application before printing.

6. Select the page setup options: **Paper Size** and **Orientation**.

**Note:** If you do not see these settings in the print window, check for them in your application before printing. They may be accessible by selecting **Page Setup** from the File menu.

**Note:** Paper sizes may include additional options such as **Borderless**.

7. Select any application-specific settings that appear on the screen, such as those shown in the image above for the Preview application.
8. Select **Print Settings** or **Printer Features** from the pop-up menu.

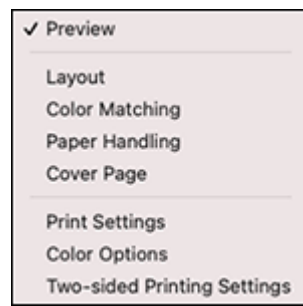

You see these settings:

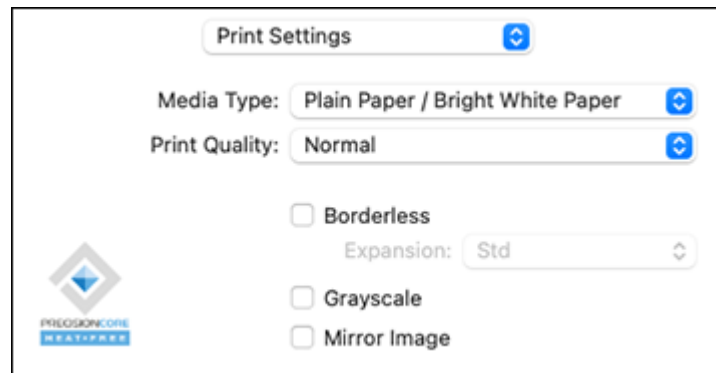

**Note:** The available print settings and appearance of the print window may be different than those covered here, depending on the Mac OS version and the application you are using.

9. Select the type of paper you loaded as the **Media Type** setting.

**Note:** The setting may not exactly match the name of your paper. Check the paper type settings list for details.

10. Select the **Print Quality** setting you want to use.
11. Select the **Borderless** checkbox if you want to print a borderless photo. If the option is grayed out, change the **Media Type** setting to a paper type that supports borderless printing.
12. Select any of the available print options.

[Print Quality Options - Mac](#)

[Print Options - Mac](#)

**Parent topic:** [Printing on a Mac](#)

#### **Related tasks**

[Selecting Page Setup Settings - Mac](#)

[Printing Your Document or Photo - Mac](#)

### **Print Quality Options - Mac**

You can select any of the available Print Quality options to fine-tune the quality of your print. Some settings may be unavailable, depending on the paper type setting you have chosen.

#### **Draft**

For draft printing on plain paper.

#### **Draft-Vivid**

For draft printing on plain paper with good quality and print speed.

#### **Normal**

For everyday text and image printing.

#### **Normal - Vivid**

For everyday text and image printing with good quality and print speed.

#### **Fine**

For text and graphics with good quality and print speed.

#### **Quality**

For text and graphics with increased quality and print speed.

**Parent topic:** [Selecting Basic Print Settings - Mac](#)

## Print Options - Mac

You can select any of the print options to customize your print. Some options may be unavailable, depending on other settings you have chosen.

### Expansion

If you selected a borderless paper size setting, this option adjusts the image expansion settings to control printing at the edges of borderless prints.

### Grayscale

Prints text and graphics in black or shades of gray.

### Mirror Image

Lets you flip the printed image horizontally.

**Note:** If you select the **Min** option for the Expansion setting, you may see white borders on your printed photo.

Parent topic: [Selecting Basic Print Settings - Mac](#)

## Selecting Page Setup Settings - Mac

Depending on your application, you may be able to select the paper size and orientation settings from the print window.

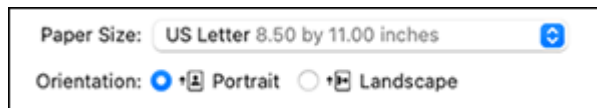

**Note:** If you do not see these settings in the print window, check for them in your application before printing. They may be accessible by selecting **Page Setup** from the File menu.

1. Select the size of the paper you loaded as the **Paper Size** setting. If you are printing a borderless photo, select the **Borderless** checkbox or a paper size with a **Borderless** option. You can also select a custom setting to create a custom paper size, but the Quality setting will be limited to **Normal**.

**Note:** You must select a compatible borderless paper type and size to print without borders. Check the borderless paper compatibility list for details.

2. Select the orientation of your document or photo as shown in the print window.

**Note:** If you are printing an envelope, select the **Landscape** setting.

**Note:** You can reduce or enlarge the size of the printed image by selecting **Paper Handling** from the pop-up menu and selecting a scaling option.

**Parent topic:** [Printing on a Mac](#)

## Selecting Print Layout Options - Mac

You can select a variety of layout options for your document or photo by selecting **Layout** from the pop-up menu on the print window.

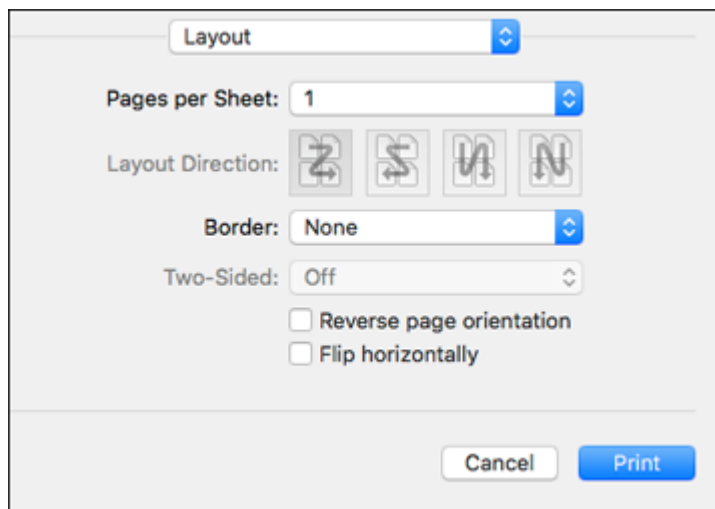

- To print multiple pages on one sheet of paper, select the number of pages in the **Pages per Sheet** pop-up menu. To arrange the print order of the pages, select a **Layout Direction** setting.
- To print borders around each page on the sheet, select a line setting from the **Border** pop-up menu.
- To print on both sides of each page, select a setting from the **Two-Sided** pop-up menu.
- To invert or flip the printed image, select the **Reverse page orientation** or **Flip horizontally** settings.

**Parent topic:** [Printing on a Mac](#)



## Selecting Double-sided Printing Settings - Mac

You can print on both sides of the paper by selecting **Two-sided Printing Settings** from the pop-up menu on the print window.

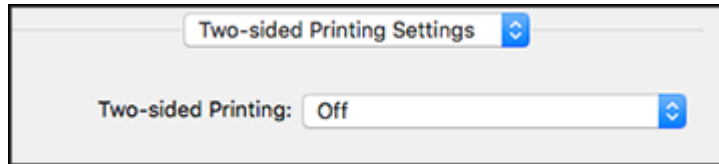

**Note:** Some options may be pre-selected or unavailable, depending on other settings you have chosen or if you are accessing the product over a network. This screen may be different, depending on the Mac OS version you are using.

1. Select one of the **Two-sided Printing** options.

2. Select the type of document you are printing as the **Document Type** setting. The software automatically sets the Adjustments options for that document type.

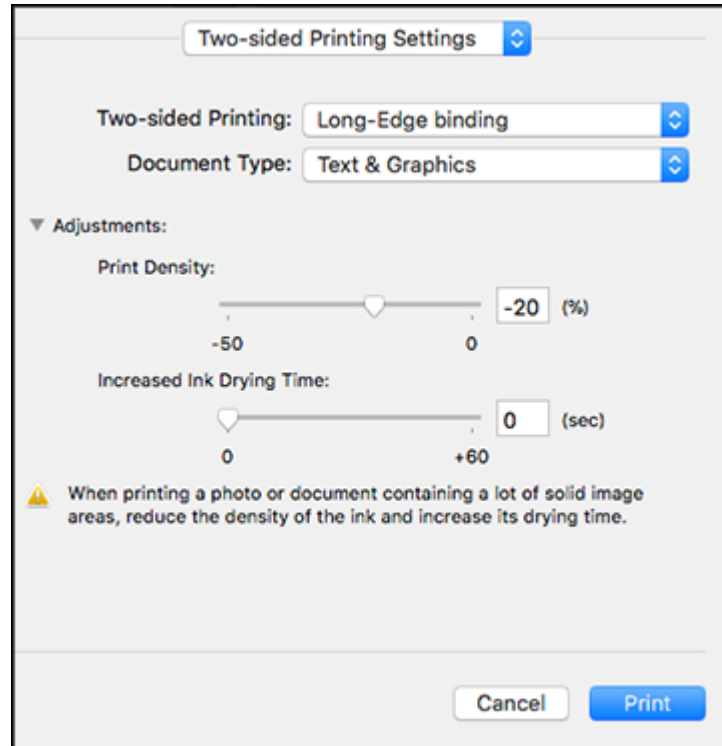

3. If necessary, customize the Adjustments settings as instructed on the screen.
4. Print a test copy of your double-sided document to test the selected settings.
5. Follow any instructions displayed on the screen during printing.

[Double-sided Printing Options and Adjustments - Mac](#)

**Parent topic:** [Printing on a Mac](#)

#### **Related references**

[Double-sided Printing Capacity](#)

### **Double-sided Printing Options and Adjustments - Mac**

You can select any of the available options in the **Two-sided Printing Settings** pop-up menu to set up your double-sided print job.

**Long-Edge binding**

Orients double-sided printed pages to be bound on the long edge of the paper.

**Short-Edge binding**

Orients double-sided printed pages to be bound on the short edge of the paper.

**Print Density**

Sets the level of ink coverage for double-sided printing.

**Increased Ink Drying Time**

Sets the amount of time required for drying ink after printing on one side of the paper before printing the other side in double-sided printing.

Parent topic: [Selecting Double-sided Printing Settings - Mac](#)

## Managing Color - Mac

You can adjust the Color Matching and Color Options settings to fine-tune the colors in your printout or turn off color management in your printer software.

1. Select **Color Matching** from the pop-up menu in the print window.

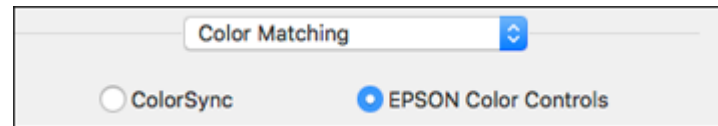

2. Select one of the available options.

3. Select **Color Options** from the pop-up menu in the print window.

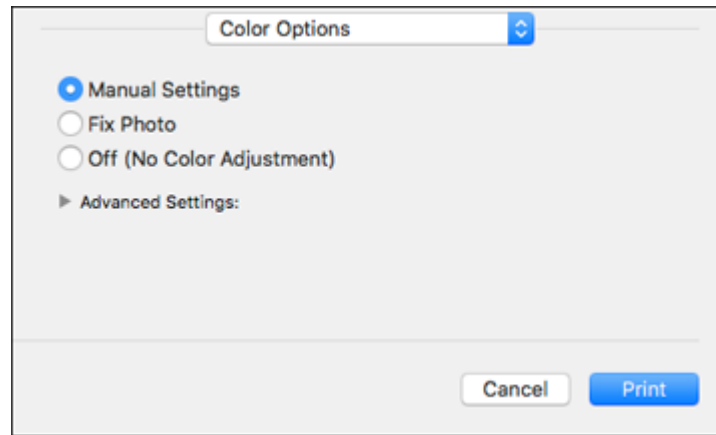

**Note:** The available settings on the Color Options menu depend on the option you selected on the Color Matching menu.

4. Select one of the available options.

[Color Matching and Color Options - Mac](#)

**Parent topic:** [Printing on a Mac](#)

### **Color Matching and Color Options - Mac**

You can select these settings on the **Color Matching** and **Color Options** menus.

#### **Color Matching Settings**

##### **EPSON Color Controls**

Lets you manage color using controls in your printer driver or turn off color management.

##### **ColorSync**

Prints using standard color profiles for your product and paper to help match image colors. You can customize the conversion method and filter settings on the ColorSync pop-up menu in the print window.

## Color Options Settings

### Manual Settings

Lets you select manual color adjustments. Click the arrow next to **Advanced Settings** and select settings for **Brightness**, **Contrast**, **Saturation**, and individual color tones. You can also select a color **Mode** setting for printing photos and graphics and the **Fix Red-Eye** setting to reduce or remove red-eye in photos. Depending on the selected color mode, you can also adjust the midtone density using the **Gamma** setting.

### Fix Photo

Improves the color, contrast, and sharpness of flawed photos. Click the arrow next to **Advanced Settings** and select the **Fix Red-Eye** setting to reduce or remove red-eye in photos.

**Note:** Fix Photo uses a sophisticated face recognition technology to optimize photos that include faces. For this to work, both eyes and the nose must be visible in the subject's face. If your photo includes a face with an intentional color cast, such as a statue, you may want to turn off **Fix Photo** to retain the special color effects.

### Off (No Color Adjustment)

Turns off color management in your printer software so you can manage color using only your application software.

**Note:** An ICC profile is required if color management is turned off.

Parent topic: [Managing Color - Mac](#)

## Selecting Printing Preferences - Mac

You can select printing preferences that apply to all the print jobs you send to your product.

1. In the Apple menu or the Dock, select **System Preferences**.
2. Select **Print & Fax**, **Print & Scan**, or **Printers & Scanners**, select your product, and select **Options & Supplies**.
3. Select **Driver** or **Options**.

You see a screen like this:

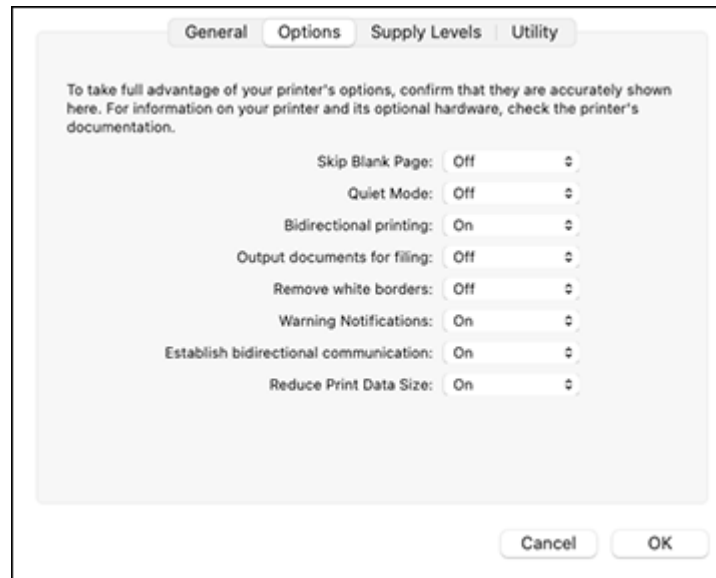

4. Select any of the available printing preferences.
5. Click **OK**.

[Printing Preferences - Mac](#)

**Parent topic:** [Printing on a Mac](#)

### Printing Preferences - Mac

You can select these settings on the **Options** or **Driver** tab.

#### **Skip Blank Page**

Ensures that your product does not print pages that contain no text or images.

#### **Quiet Mode**

Lessens noise during printing but may decrease print speed.

#### **Bidirectional printing**

Prints in both directions (right-to-left and left-to-right), speeding up printing, but may reduce print quality.

**Output documents for filing**

Outputs all landscape, portrait, 1-sided, and 2-sided documents in the same orientation for easier filing.

**Remove white borders**

Removes white margins that may appear when you print borderless photos.

**Warning Notifications**

Lets you choose whether or not to receive warning notifications from the printer software for various operating conditions.

**Establish bidirectional communication**

Allows the product to communicate with the computer. Do not change the default setting unless you experience issues when using a shared printing pool.

**Reduce Print Data Size**

Increases print data compression to improve print speed. Not recommended when printing fine patterns.

Parent topic: [Selecting Printing Preferences - Mac](#)

## Printing Your Document or Photo - Mac

Once you have selected your print settings, you are ready to print.

Click **Print** at the bottom of the print window.

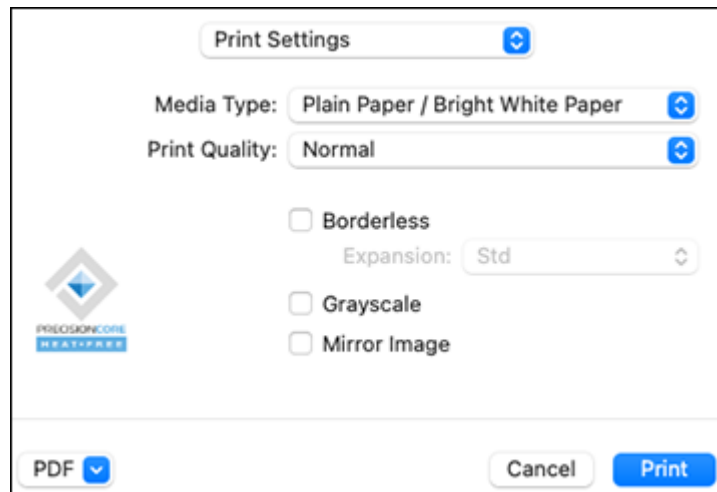

## Checking Print Status - Mac

**Parent topic:** [Printing on a Mac](#)

### Related tasks

[Selecting Basic Print Settings - Mac](#)

[Selecting Page Setup Settings - Mac](#)

[Selecting Print Layout Options - Mac](#)

[Selecting Double-sided Printing Settings - Mac](#)

[Managing Color - Mac](#)

[Selecting Printing Preferences - Mac](#)

## Checking Print Status - Mac



During printing, you can view the progress of your print job, control printing, and check ink status.

1. Click the printer icon when it appears in the Dock.

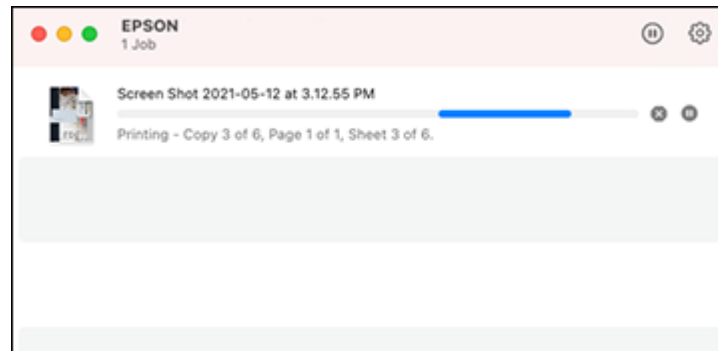
You see the print status window:



2. Select the following options as necessary for your Mac OS version:

- To cancel printing, click the print job and click  or **Delete**.
- To pause a print job, click the print job and click  or **Hold**. To resume a print job, click the paused print job and click  or **Resume**.
- To pause printing for all queued print jobs, click **Pause** or **Pause Printer**.
- To display other printer information, click **Settings** or **Supply Levels**.



**Parent topic:** [Printing Your Document or Photo - Mac](#)

## Printing from a Smartphone or Tablet

You can print from a smartphone or tablet running iOS or Android using the Epson Smart Panel app.

**Note:** Your device must be connected to the same wireless network as your Epson product, and Epson Smart Panel must be configured for use with your product.

1. Download the Epson Smart Panel app from your device's app store or from Epson's website. See the link below.
2. Open the Epson Smart Panel app and select a print menu on the home screen.
3. Follow the on-screen instructions to begin printing.

**Parent topic:** [Printing from a Computer](#)

### Related tasks

[Using the Epson Smart Panel Mobile App](#)

## Printing with Epson Photo+

You can print photos, CD/DVD labels, and more using a variety of layouts and templates with Epson Photo+. Features include image corrections and adjustments, and adding text and stamps to photos. We recommend printing on genuine Epson photo paper for the best results. Make sure you have set up your product as described on the *Start Here* sheet and installed the Epson Photo+ software. See the Epson Photo+ help utility for more information.

**Note:** If you are using your Epson product with the Windows 10 S operating system, you cannot use Epson Photo+. You also cannot download and install any Epson product software from the Epson website for use with Windows 10 S; you must obtain software only from the Windows Store.

**Parent topic:** [Printing from a Computer](#)

## Cancelling Printing Using the Product

If you need to cancel printing, press the  stop button.

**Parent topic:** [Printing from a Computer](#)

---

# Scanning

You can scan your originals and save them as digital files.

[Starting a Scan](#)

[Scanning a Document in Epson ScanSmart](#)

[Selecting Epson ScanSmart Settings](#)

[Scanning in Epson Scan 2](#)

## Starting a Scan

After placing your originals on your product for scanning, start scanning using one of these methods.

[Starting a Scan Using the Product Control Panel](#)

[Starting a Scan Using Epson ScanSmart](#)

[Starting a Scan Using the Epson Scan 2 Icon](#)

[Starting a Scan from a Scanning Program](#)

[Starting a Scan from a Smartphone or Tablet](#)

**Parent topic:** [Scanning](#)

### Related tasks

[Placing Originals on the Scanner Glass](#)

## Starting a Scan Using the Product Control Panel

You can scan an image to a variety of destinations using your product's control panel.

1. Make sure you installed the product software and connected the product to your computer or network.

**Note:** Restart your computer after installing the product software to enable scanning from the control panel.

2. Place your original on the product for scanning.
3. Press the  home button, if necessary.

4. Select **Scan**.

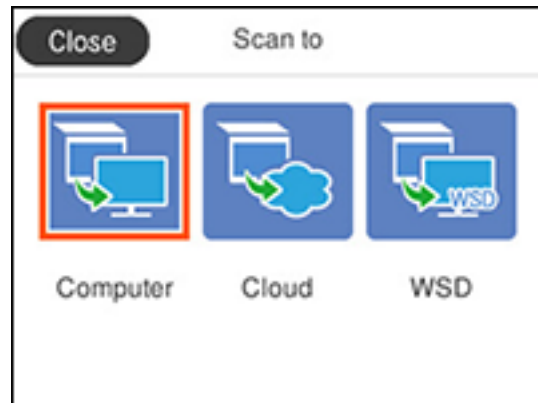

5. Select one of the following **Scan to** options:
  - **Computer** lets you scan to a connected computer using your saved scan settings.
  - **Cloud** sends your scanned files to a destination that you have registered with Epson Connect.
  - **WSD** lets you manage network scanning in Windows 10, Windows 8.x, Windows 7, or Windows Vista (English only). To use this feature, you must first set up a WSD (Web Services for Devices) port on your Windows 7 or Windows Vista computer (the port is set up automatically on Windows 10 and Windows 8.x).
6. Follow the instructions in the links below to complete your scan.

[Scanning to a Connected Computer](#)

[Scanning to the Cloud](#)

[Setting Up a WSD Port \(Windows 7/Windows Vista\)](#)

[Control Panel Scanning Options](#)

[Changing Default Scan Job Settings](#)

**Parent topic:** [Starting a Scan](#)

**Related tasks**

[Placing Originals on the Scanner Glass](#)

### **Scanning to a Connected Computer**

You can scan an original and save it to a connected computer using your product's control panel. The computer must be connected using a USB cable or connected to the same network as your product.

You can save the scanned file as a JPEG or PDF file. You can also set up custom scan settings using Event Manager and automatically scan using those settings on your product control panel.

**Note:** Be sure you have installed Epson ScanSmart, Epson Scan 2, and Event Manager on your computer before scanning to your computer.

1. Place your original on the product for scanning.
2. Press the  home button, if necessary.
3. Select **Scan**.
4. Select **Computer**.

You see a screen like this:

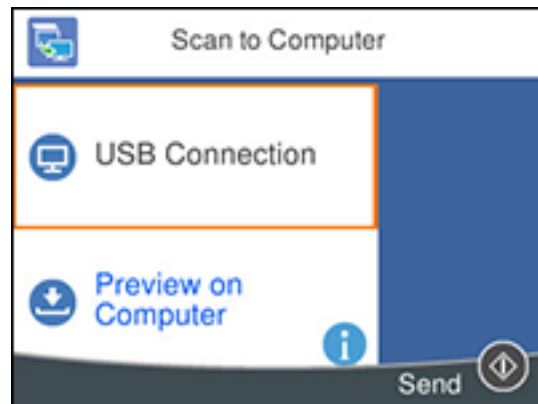

**Note:** Select **Dismiss** on the information screen, if necessary.

5. Select **Select a computer** and choose one of the following options:
  - If your computer is connected to your product over a network, select a connected computer from the displayed list. (If the computer is not listed, select **Search Again**.)
  - If your computer is connected to your product using a USB cable, select **USB Connection**.
6. Select **Preview on Computer** and choose one of the following options:
  - **Preview on Computer** to preview the scanned image on a computer before saving. (Windows 7 or later or OS X 10.11.x or later)

- **Save as JPEG** to save the scanned scanned image as a JPEG file.
- **Save as PDF** to save the scanned document or image as a PDF file.

**Note:** You can customize the settings for each of these options using Event Manager.

7. Select **Send** to start scanning.

**Parent topic:** [Starting a Scan Using the Product Control Panel](#)

**Related tasks**

[Placing Originals on the Scanner Glass](#)

[Changing Default Scan Job Settings](#)

### Scanning to the Cloud

You can use the control panel to send your scanned files to a destination that you have registered with Epson Connect.

**Note:** Make sure to set up your product using Epson Connect before using this feature.

1. Place your original on the product for scanning.
2. Press the  home button, if necessary.
3. Select **Scan**.
4. Select **Cloud**.

You see a screen like this:

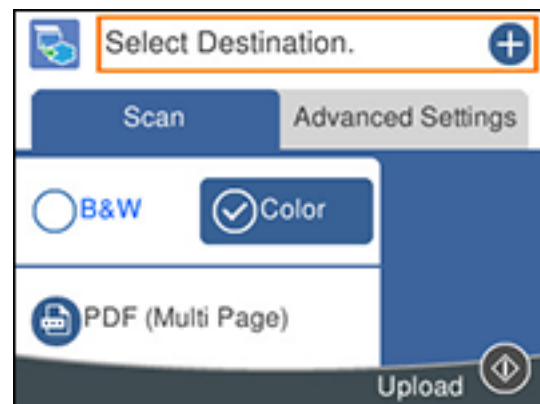

**Note:** You must register your product with Epson Connect to select a destination.

5. Select **Select Destination** to select a destination.
6. Change any of the displayed settings on the **Scan** tab as necessary.
7. Select the **Advanced Settings** tab to view and change additional scan settings, if necessary.
8. Press the  start button to start scanning.

Your product scans your original and saves the scanned file to the selected destination.

**Parent topic:** [Starting a Scan Using the Product Control Panel](#)

#### **Related tasks**

[Setting Up Epson Connect Services](#)

[Placing Originals on the Scanner Glass](#)

#### **Setting Up a WSD Port (Windows 7/Windows Vista)**

You can scan to a networked Windows computer using WSD (Web Services for Devices). You must first set up a WSD port on your Windows 7 or Windows Vista system (the port is set up automatically on Windows 10 and Windows 8.x).

Before you set up a WSD port, make sure you installed your product software, and connected your product and computer to the same network.

1. Turn on your product.
2. Print a network status sheet so you can identify the network name and model name for your product on the network.
3. Click  or **Start** and select **Computer**.
4. On the left side of the window, select **Network**.
5. Locate your product on the Network screen, right-click it, and select **Install**.
6. When you see the User Account Control screen, click **Continue**.

**Note:** If you see an Uninstall screen, click **Uninstall** and repeat these steps as necessary.

7. When you see the message **Your device is ready to use** in the Windows taskbar, click the message.
8. On the Driver Software Installation screen, make sure your product is listed as **Ready to use**. Then click **Close**.

9. Do one of the following:

- **Windows 7:** Click  and select **Devices and Printers**.
- **Windows Vista:** Click **Start** and select **Control Panel > Hardware and Sound > Printers**.

10. Make sure that an icon appears for your product's name on the network.

When you use WSD, select your product name to scan over the network.

**Parent topic:** [Starting a Scan Using the Product Control Panel](#)

#### **Related tasks**

[Printing a Network Status Sheet](#)

### **Control Panel Scanning Options**

Select the options you want to use for scanning.

**Note:** Not all options or settings may be available, depending on the **Scan to** option selected.



<b>Scan to setting</b>	<b>Available options</b>	<b>Description</b>
<b>Color mode</b>	<b>Color</b>	Select whether to scan images in color or black and white
	<b>B&amp;W</b>	
<b>File format</b>	<b>JPEG</b>	Select for photos
	<b>PDF</b>	Select for documents
<b>Scan Area</b>	Various sizes	Select the page size for documents, then select the orientation of the original
	<b>Auto Cropping</b>	Select for photos with dark edges
	<b>Max Area</b>	Select for most photos
<b>Original Type</b>	<b>Text</b>	Specifies the type of original you are scanning
	<b>Text &amp; Image</b>	
	<b>Photo</b>	
<b>Density</b>	<b>-4 to +4</b>	Adjusts the lightness or darkness of scanned images.

Scan to setting	Available options	Description
<b>Remove Shadow</b>	<b>On</b>	Erases the shadows that appear in the center of a document when copying a book or the shadows that appear around a document when copying thick paper
	<b>Off</b>	
<b>Remove Punch Holes</b>	<b>On</b>	Erases the binding holes on a document
	<b>Off</b>	

Parent topic: [Starting a Scan Using the Product Control Panel](#)

### Changing Default Scan Job Settings

You can view or change the default scan job settings your product uses when you scan to your computer. You do this using the Event Manager program.

- Do one of the following to open Event Manager:
  - Windows 10:** Click  and select **Epson Software > Event Manager**.
  - Windows 8.x:** Navigate to the **Apps** screen and select **Event Manager**.
  - Windows (other versions):** Click  or **Start > All Programs** or **Programs > Epson Software > Event Manager**.
  - Mac:** Open the **Applications** folder, click **Epson Software**, and select **Event Manager**.
- Open the **Scanner** (Windows) or **Select Scanner** (Mac) drop-down list and select your product, if necessary.
- Click **Make Job Settings**.
- Open the **Edit Job Settings** drop-down list and select the scan job settings you want to view or change.
- Change the settings as necessary.

**Note:** If you create a new job, you can only assign it to the **Custom Action** setting. You can change the settings of the other assigned jobs, but you cannot rename them or select a different job.



- Click **OK**.
- Click **Close** to close the Event Manager window.

Parent topic: [Starting a Scan Using the Product Control Panel](#)



## Starting a Scan Using Epson ScanSmart

You can start the Epson ScanSmart program to scan originals and easily review and edit scanned images. After that, you can save, print, or share them.

- **Windows 10:** Click  > **Epson Software** > **Epson ScanSmart**.
- **Windows 8.x:** Navigate to the **Apps** screen and select **Epson ScanSmart**.
- **Windows (other versions):** Click  or **Start**, and select **All Programs** or **Programs**. Select **Epson Software** > **Epson ScanSmart**.
- **Mac:** Open the **Applications** folder, open the **Epson Software** folder, and select **Epson ScanSmart**.

You see a screen like this:

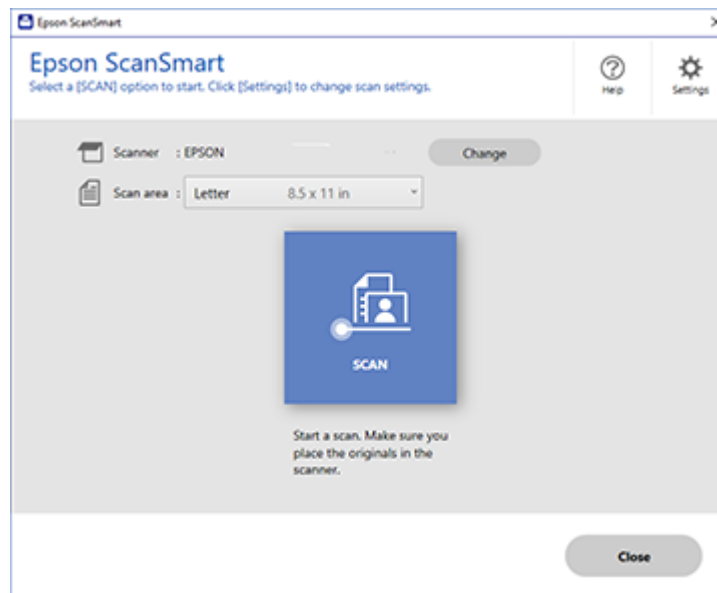



Parent topic: [Starting a Scan](#)

## Starting a Scan Using the Epson Scan 2 Icon

You can start the Epson Scan 2 program to select scan settings, scan, and save the scanned image to a file.

**Note:** If you are using your Epson product with the Windows 10 S operating system, you cannot use the software described in this section. You also cannot download and install any Epson product software from the Epson website for use with Windows 10 S; you must obtain software only from the Windows Store.

- **Windows 10:** Click  and select **EPSON > Epson Scan 2**.
- **Windows 8.x:** Navigate to the **Apps** screen and select **Epson Scan 2**.
- **Windows (other versions):** Click  or **Start**, and select **All Programs** or **Programs**. Select **EPSON > Epson Scan 2 > Epson Scan 2**.
- **Mac:** Open the **Applications** folder, open the **Epson Software** folder, and select **Epson Scan 2**.

You see an Epson Scan 2 window like this:

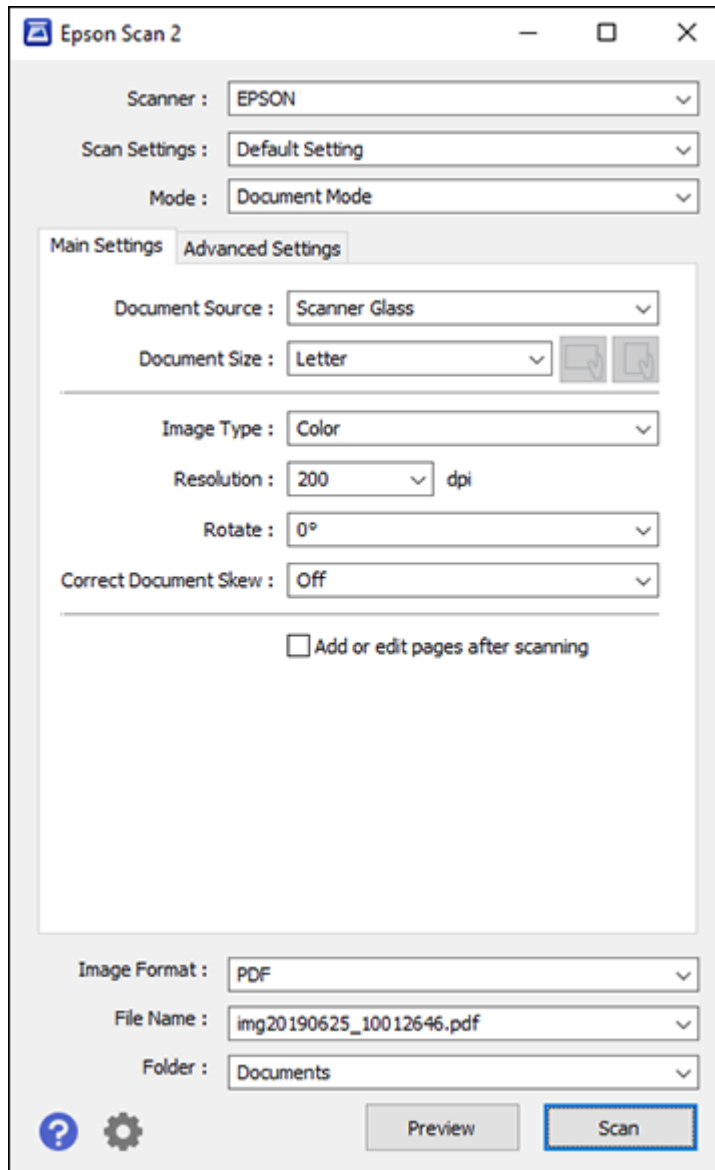

Parent topic: [Starting a Scan](#)

## Starting a Scan from a Scanning Program

You can start Epson Scan 2 from a TWAIN-compliant scanning program to select scan settings, scan, and open the scanned image in the program.

**Note:** If you are using your Epson product with the Windows 10 S operating system, you cannot use the software described in this section. You also cannot download and install any Epson product software from the Epson website for use with Windows 10 S; you must obtain software only from the Windows Store.

1. Open your scanning program and select its scanning option. (See your scanning program help for instructions.)
2. Select your product.

**Note:** In certain programs, you may need to select your product as the "source" first. If you see a **Select Source** option, choose it and select your product. With Windows, do not select a **WIA** option for your product; not all scan functions will be available.

You see an Epson Scan 2 window like this:

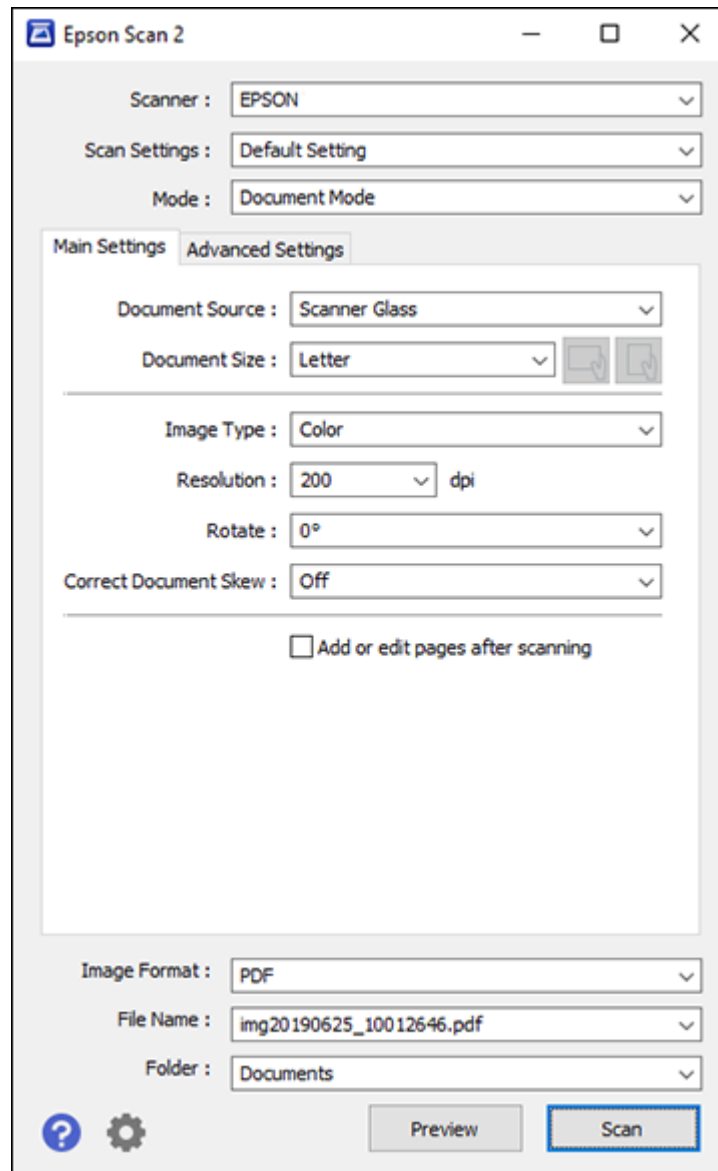

Parent topic: [Starting a Scan](#)

## Starting a Scan from a Smartphone or Tablet

You can use the Epson Smart Panel app to scan from a network scanner to an iOS or Android device over a direct Wi-Fi connection.

1. Download the Epson Smart Panel app from your device's app store or from Epson's website. See the link below.
2. Place your original on the product for scanning.
3. Open the Epson Smart Panel app and select a scan menu on the home screen.
4. Follow the on-screen instructions to scan and save your original.

Parent topic: [Starting a Scan](#)



### Related tasks

[Using the Epson Smart Panel Mobile App](#)

## Scanning a Document in Epson ScanSmart

You can scan and review documents and photos in Epson ScanSmart.

**Note:** The images in this guide show Windows screens. Mac screens may be slightly different. Depending on your product model and software version, not all options may be available.

1. Load your original into the product.
2. Open Epson ScanSmart on your computer. Do one of the following:
  - **Windows 10:** Click  > **Epson Software** > **Epson ScanSmart**.
  - **Windows 8.x:** Navigate to the **Apps** screen and select **Epson ScanSmart**.
  - **Windows (other versions):** Click  or **Start**, and select **All Programs** or **Programs**. Select **Epson Software** > **Epson ScanSmart**.
  - **Mac:** Open the **Applications** folder, open the **Epson Software** folder, and select **Epson ScanSmart**.

You see a screen like this:

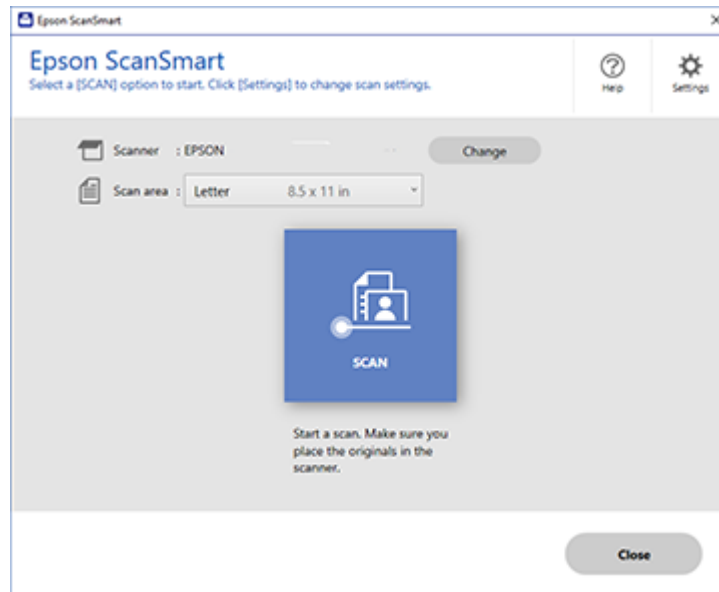

3. Select an option for the **Scan area** setting, if necessary.

**Note:** The **Scan area** setting limits the scan area to a selected size starting at the placement arrow on the scanner bed. It does not scale the image to the selected size.

4. Select **SCAN**.

The original is scanned. When scanning is complete, you see a screen like this:

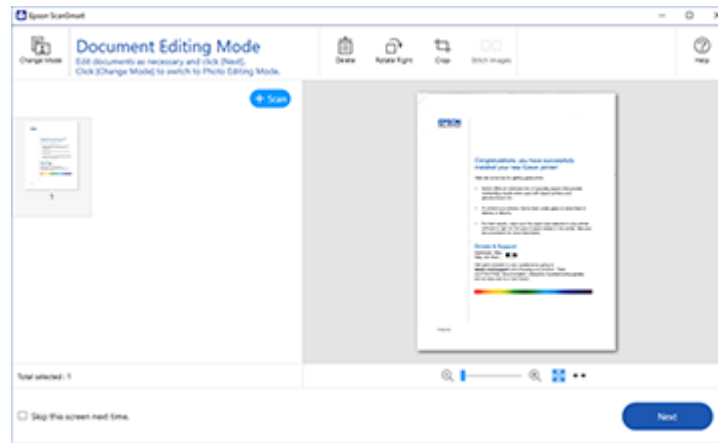

5. You can review, edit, or reorder the scanned images as follows:
  - Select **+ Scan** to scan more originals.
  - Select **Delete** to delete selected scanned images.
  - Select **Rotate Right** to rotate each scanned image.
  - Select **Crop** to crop the selected image.
  - Control-click two images, select **Stitch Images**, and follow the on-screen instructions to combine them into a single image.
6. If Photo Mode is automatically detected, the following enhancement options are available:
  - **Auto Color Enhancement**: automatically adjusts the brightness, contrast, and saturation of your photos
  - **Restore Faded Colors**: restores the colors in faded photos automatically
  - **Remove Red Eye**: automatically removes the red-eye effect from your photos
  - **Auto Cropping**: automatically crops the scanned image edges
7. When you finish reviewing and editing the scanned images, click **Next**.



You see a screen like this:

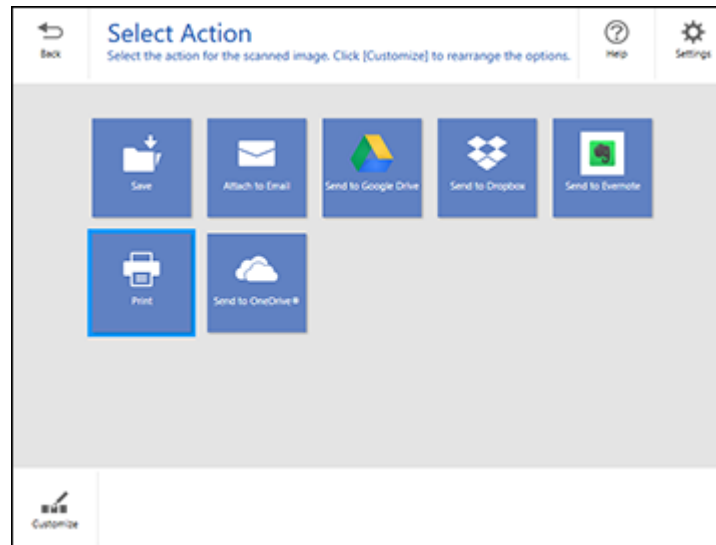

8. Select an option to save, send, or print the scanned images. See the links below.

[Saving a Scan](#)

[Attaching a Scan to Email](#)

[Sending a Scan to a Cloud Service](#)

[Printing a Scan](#)

**Parent topic:** [Scanning](#)

## **Saving a Scan**

You can save a scanned image to your computer in a variety of formats.

1. Make sure your originals are scanned and reviewed. See the link below.
2. In the **Select Action** window, click **Save**.

You see a screen like this:

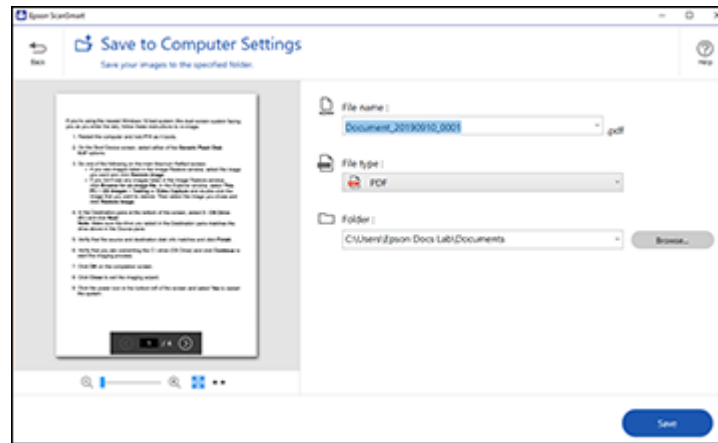

3. Change the settings as follows:
  - The document type and scan date for the file name are automatically detected. You can change them as necessary.
  - You can save the scanned image in a variety of formats. If you select Searchable PDF as the **File type** setting, you can select the OCR (Optical Character Recognition) language.
  - Select the folder on your computer in which to save the file.
4. Click **Save**.

**Parent topic:** [Scanning a Document in Epson ScanSmart](#)

## Attaching a Scan to Email

You can attach a scanned image to an email as a file attachment.

**Note:** Your email app and account settings should be configured before scanning. You must install a MAPI-type email program such as Outlook Express, Windows Live Mail, Entourage, or Mac Mail. Attach to Email only supports 32-bit MAPI-compatible mail apps. Web-based email services such as Gmail are not supported. If you see an error message, your email app may not be compatible and you will need to save the scans and manually attach the file to an email.

1. Make sure your originals are scanned and reviewed. See the link below.

2. In the **Select Action** window, click **Attach to Email**.

You see a screen like this:

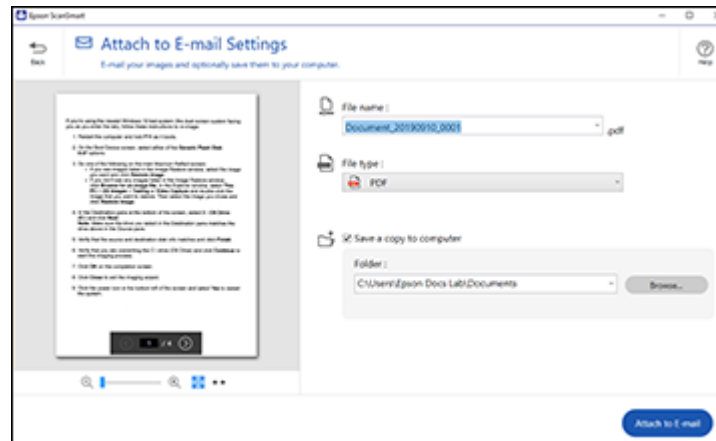

3. Change the settings as follows:
  - The document type and scan date for the file name are automatically detected. You can change them as necessary.
  - You can save the scanned image in a variety of formats. If you select Searchable PDF as the **File type** setting, you can select the OCR (Optical Character Recognition) language.
  - If you also want to save a copy of the scanned image to your computer, make sure the checkbox is selected and select the folder on your computer in which to save the file.
4. Click **Attach to E-mail**.

Your email program opens with the file attached to a new email.

**Parent topic:** [Scanning a Document in Epson ScanSmart](#)

## Sending a Scan to a Cloud Service

You can upload scanned images to a cloud service.

1. Make sure your originals are scanned and reviewed. See the link below.
2. In the **Select Action** window, click one of the cloud service send options.

You see a screen like this:

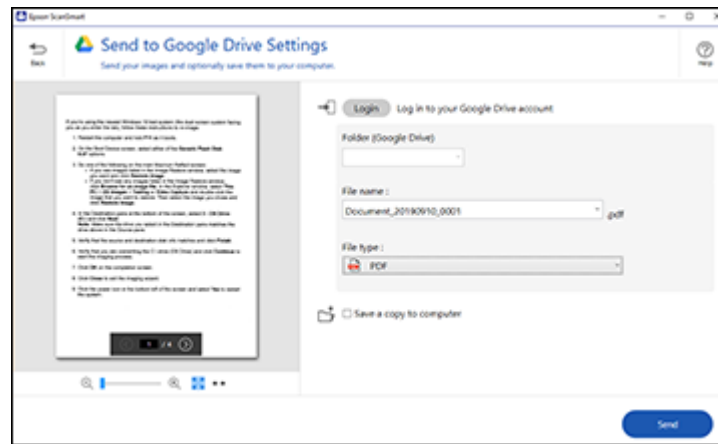

3. Log in to your account.

**Note:** You may need to allow Epson ScanSmart access to your account. The first time you log in, you may be prompted to enter an authentication code.

4. Change the settings as follows:
  - Select the folder in your account where you want to send the document.
  - The document type and scan date for the file name are automatically detected. You can change them as necessary.
  - You can save the scanned image in a variety of formats. If you select Searchable PDF as the **File type** setting, you can select the OCR (Optical Character Recognition) language.
  - If you also want to save a copy of the scanned image to your computer, click the checkbox.
5. Click **Send**.

**Parent topic:** [Scanning a Document in Epson ScanSmart](#)

## Printing a Scan

You can print your scanned image and save the scanned file to your computer.

**Note:** Printing scanned images is available only with Epson printers. If you do not have an Epson printer, save the file and print it from an application that can open the file.

1. Make sure your originals are scanned and reviewed. See the link below.
2. In the **Select Action** window, click **Print**.

You see a screen like this:

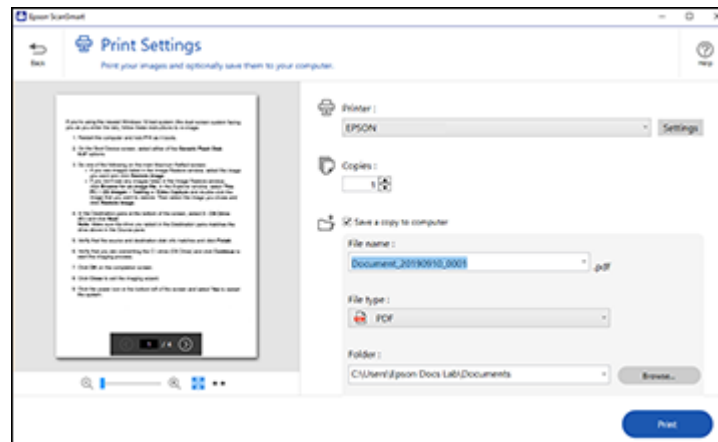

3. Change the settings as follows:
  - Select the Epson printer and change the print settings, if necessary.
  - Select the number of copies you want to print.
  - If you also want to save a copy of the scanned image to your computer, click the checkbox.
  - The document type and scan date for the file name are automatically detected. You can change them as necessary.
  - You can save the scanned image in a variety of formats. If you select Searchable PDF as the **File type** setting, you can select the OCR (Optical Character Recognition) language.
  - Select the folder on your computer in which to save the file.
4. Click **Print**.

**Parent topic:** [Scanning a Document in Epson ScanSmart](#)

## Selecting Epson ScanSmart Settings

After starting Epson ScanSmart, you can change various scanning settings.

[Changing the Epson Product](#)

[Changing the Scan Settings](#)

[Changing the File Name Settings](#)

[Changing the Save Settings](#)

[Customizing Action Icons](#)

**Parent topic:** [Scanning](#)

## Changing the Epson Product

If you are using more than one Epson product with Epson ScanSmart, you can change the product that you are using with your computer.

**Note:** A product connected to your computer via USB takes priority over a product with a Wi-Fi connection.

1. On the main screen, click **Change**.

You see a screen like this:

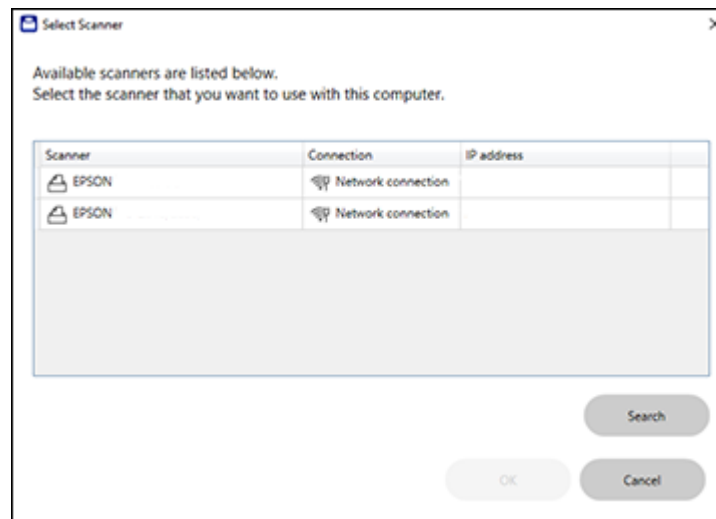

2. Select the Epson product you want to use with your computer and click **OK**.

**Parent topic:** [Selecting Epson ScanSmart Settings](#)

## Changing the Scan Settings

You can change detailed scan settings such as the resolution, document size, and more.

**Note:** If you select **Auto Mode**, you cannot change the scan settings.

1. Click the  **Settings** button.

You see a screen like this:

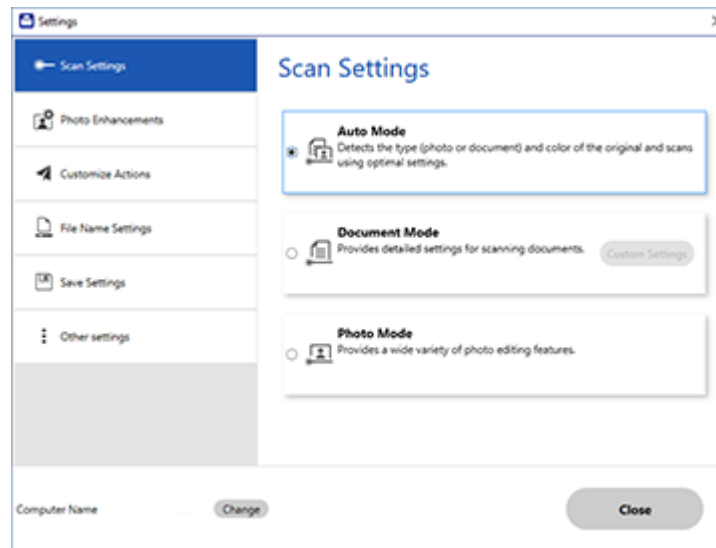

2. Do one of the following:

- To change Document Mode settings, select **Document Mode** > **Custom Settings**.
- To change Photo Mode settings, select **Photo Mode** and click **Close**. When you start a scan, you will be prompted to select scan settings.

You see a screen like this:

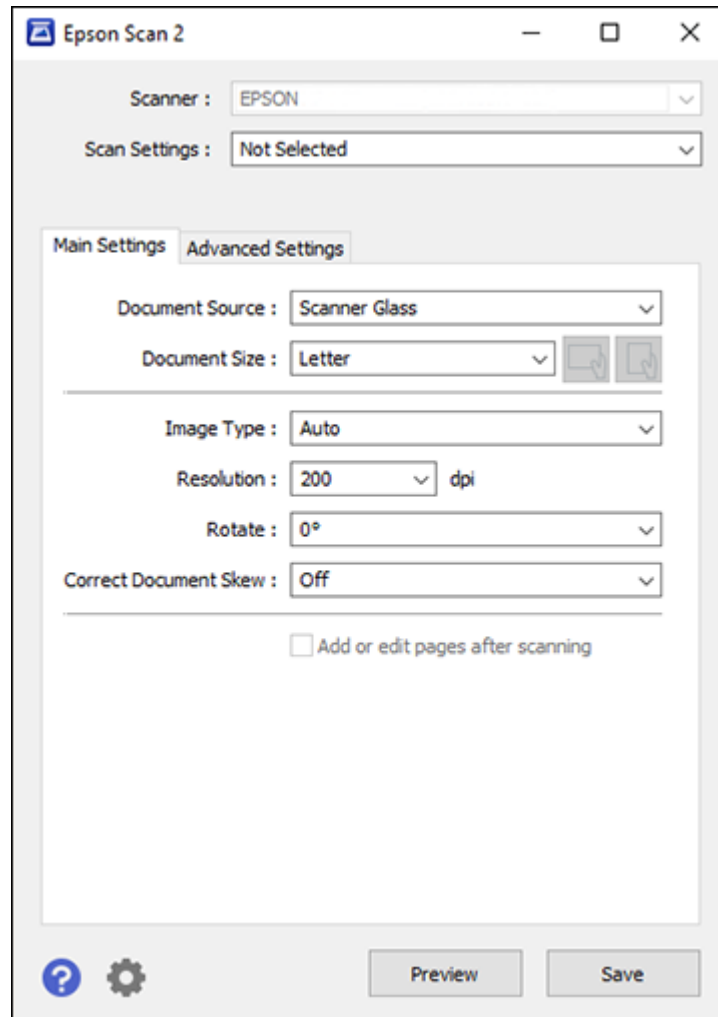

3. Change the settings as necessary and click **Save**.

**Parent topic:** [Selecting Epson ScanSmart Settings](#)



## Changing the File Name Settings

You can change the default file naming method for your scans.

1. Click the  **Settings** button.

You see a screen like this:

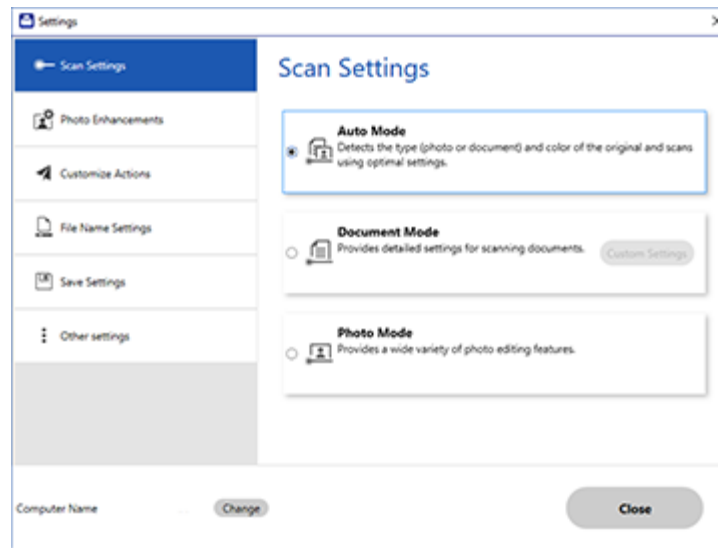

2. Click the **File Name Settings** tab.

You see a screen like this:

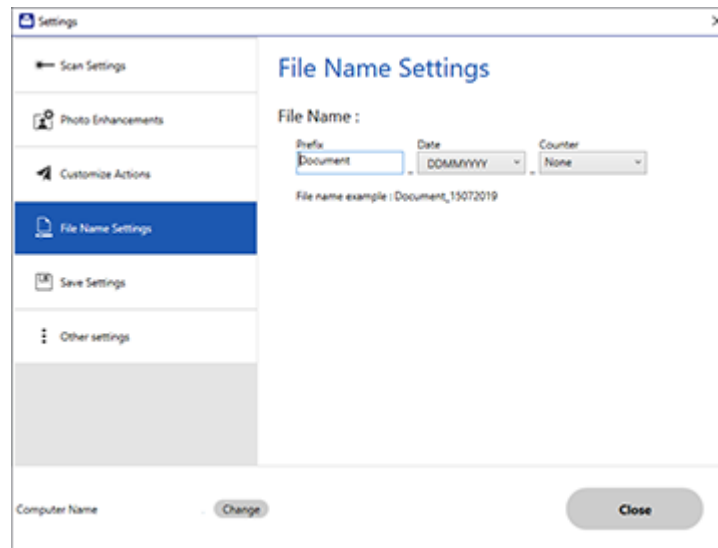

3. Change the settings as necessary:
  - Enter a prefix for the file name.
  - Select the date format.
  - Select a numbering format as the counter format.
4. Click **Close**.

**Parent topic:** [Selecting Epson ScanSmart Settings](#)

## Changing the Save Settings

You can change the file type options for saving your scans.

1. Click the  **Settings** button.

You see a screen like this:

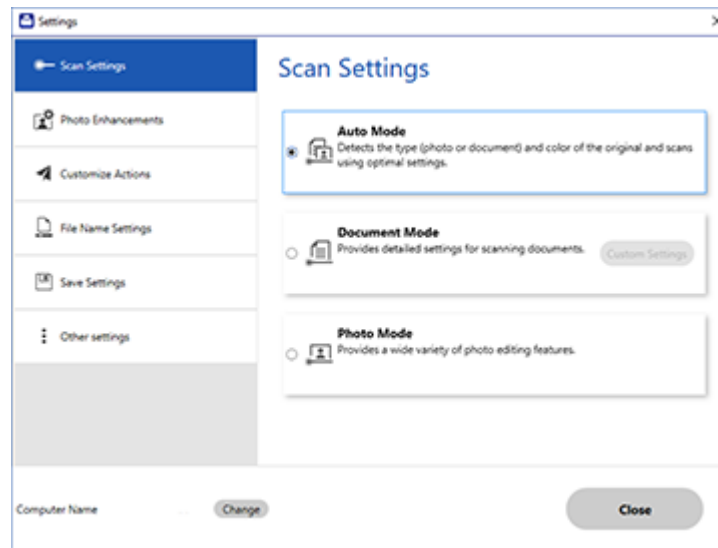

2. Click the **Save Settings** tab.

You see a screen like this:

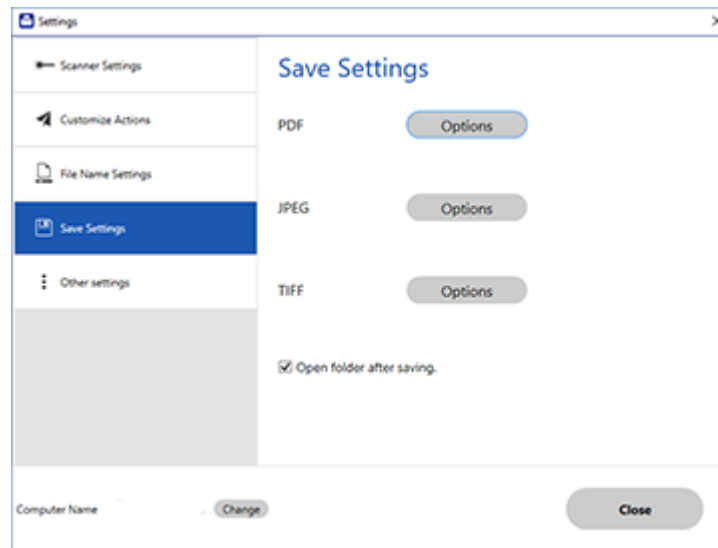

3. Click **Options** for a file format and change the settings as necessary.
4. Click **Open folder after saving** to open the file folder after a file is saved.
5. Click **Close**.

[Save Settings](#)

**Parent topic:** [Selecting Epson ScanSmart Settings](#)

## Save Settings

You can change the settings for how scanned images are saved.

### PDF Options

Setting	Options	Description
<b>General</b>	<b>Generate PDF/A File</b>	Creates a PDF that conforms to PDF/A-1 standards
	<b>Create file with all pages</b>	Saves all pages as one file
	<b>Compression Level</b>	Selects the compression level for color or grayscale images

### JPEG Options

Setting	Options	Description
<b>Image Quality Options</b>	—	Sets a compression level by moving a slider or entering a value. File size increases the higher the resolution is.
<b>Encoding</b> (Windows only)	<b>Standard</b>	Images load from top to bottom in a web browser. It takes longer to load the entire image.
	<b>Progressive</b>	Images first load completely at low resolution and then adjust to high resolution in a web browser
<b>Embed ICC Profile</b> (Windows only)	—	Allows you to add ICC profiles to the image

### TIFF Options

Setting	Options	Description
<b>Byte Order</b>	<b>Windows</b> <b>Macintosh</b>	Specifies the operating system where the scanned image will be used
<b>Compression</b> (Windows only)	—	Specifies the compression format and level for Color/Grayscale and B&W images. File size increases with higher quality.
<b>Embed ICC Profile</b> (Windows only)	—	Allows you to add ICC profiles to the image

Parent topic: [Changing the Save Settings](#)

## Customizing Action Icons

You can customize which scan action icons appear on the **Select Action** screen.

**Note:** You can also customize them by clicking the **Customize** icon on the **Select Action** screen.

1. Click the  **Settings** button.

You see a screen like this:

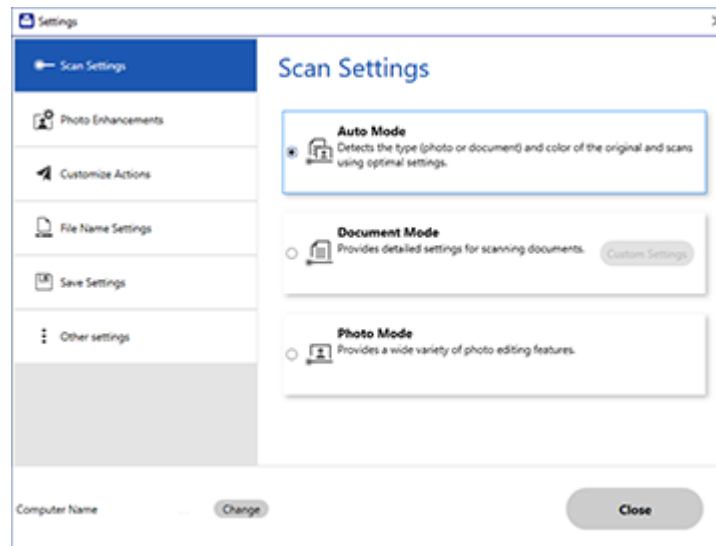

2. Click the **Customize Actions** tab.

You see a screen like this:

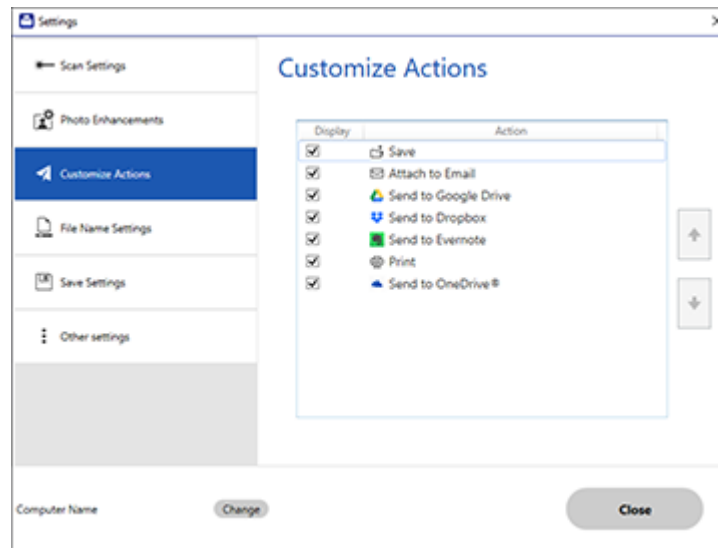

3. Choose which action icons to display by selecting or deselecting each checkbox. Click the arrow icons to move the icons up or down in the display order you want.
4. Click **Close**.

**Parent topic:** [Selecting Epson ScanSmart Settings](#)

## Scanning in Epson Scan 2

Epson Scan 2 gives you access to basic and advanced scanning features. You can scan your document and save the scanned image in various file formats in your operating system's Documents or My Documents folder, or open it in your scanning program. You can preview the scanned image and select or change settings as necessary.

**Note:** If you are using your Epson product with the Windows 10 S operating system, you cannot use the software described in this section. You also cannot download and install any Epson product software from the Epson website for use with Windows 10 S; you must obtain software only from the Windows Store.

1. Start Epson Scan 2.

You see this window:

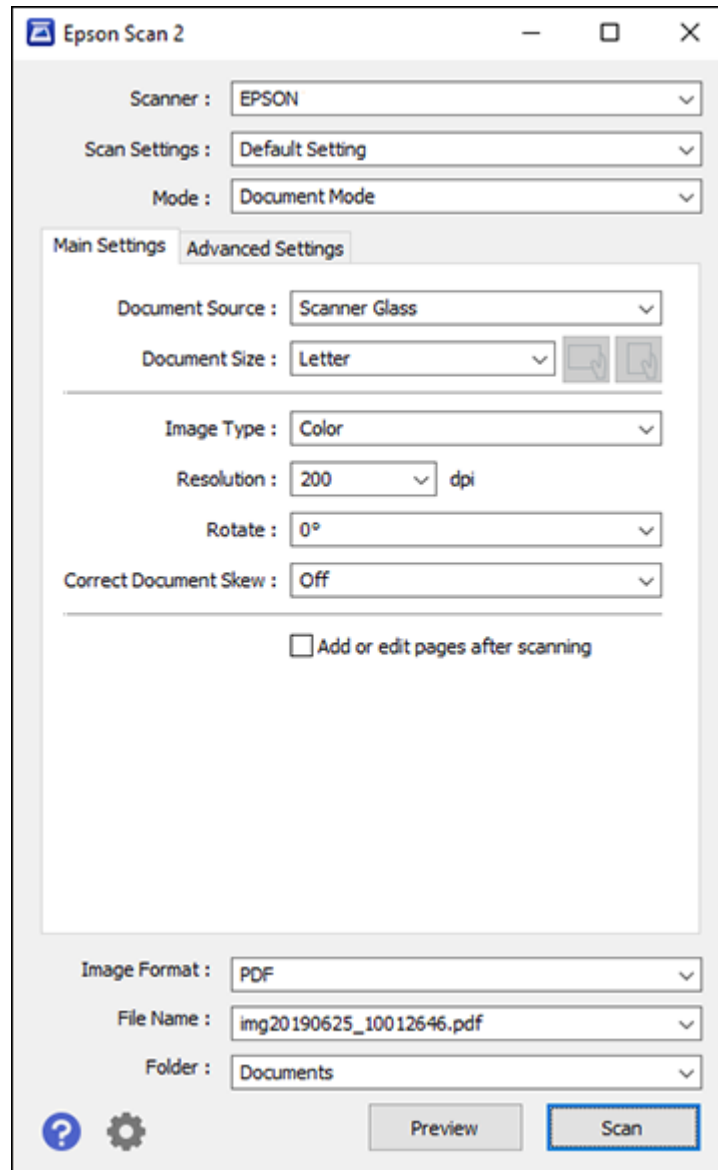



2. Select the **Mode** setting that matches the type of original you are scanning.
3. Select the **Document Source** setting that matches where you placed your original.
4. Select the **Document Size** setting that matches the size of your original. You can select **Customize** to enter a custom size, if necessary.
5. Select the image type of your original and how you want it scanned as the **Image Type** setting.
6. Select the **Resolution** setting you want to use for your scan.
7. Select the **Rotate** setting to rotate the scanned image.
8. Select the **Correct Document Skew** setting to correct skewed originals, image contents, or both.
9. Click the **Preview** button.

Epson Scan 2 previews your original and displays the results in the Epson Scan 2 window.

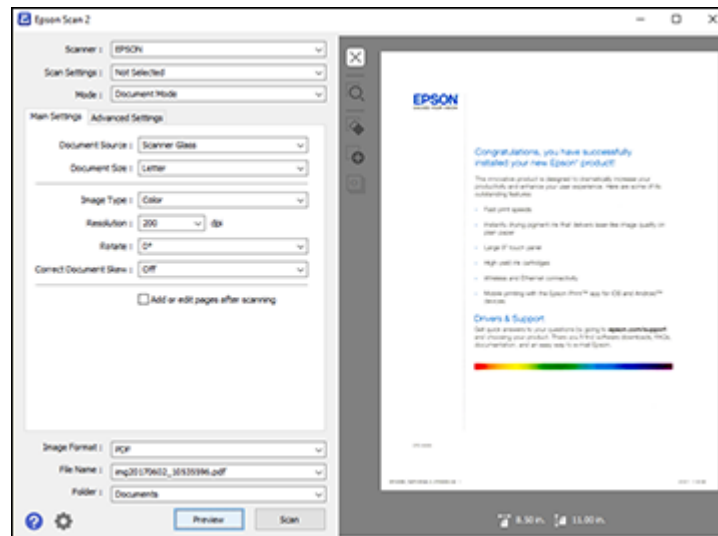

10. Select any of the additional settings that you want to use on the Main Settings tab.
11. Click the **Advanced Settings** tab and select any settings that you want to use.
12. Select the format in which you want to save your scanned file as the **Image Format** setting. If necessary, select **Options** and select any desired format options.
13. Enter the file name for your scanned file in the **File Name** field. If necessary, select **Settings** to modify the file name settings.

14. Select the location in which you want to save your scanned file as the **Folder** setting. If necessary, select **Select** to create a new folder.
15. Click **Scan**.

The product scans your original and saves the scanned file in the location you specified.

[Additional Scanning Settings - Main Settings Tab](#)

[Additional Scanning Settings - Advanced Settings Tab](#)

[Saving Scanned Documents as a Searchable PDF Using Epson Scan 2](#)

[Image Format Options](#)

[Scan Resolution Guidelines](#)

**Parent topic:** [Scanning](#)

## Additional Scanning Settings - Main Settings Tab

You can select these additional scanning settings on the Epson Scan 2 Main Settings tab. Not all adjustment settings may be available, depending on other settings you have chosen.

### **Rotate**

Rotates the original image clockwise to the desired angle before scanning it. Select **Auto** to allow your product to automatically rotate the image based on the orientation of the text (may take longer to scan).

### **Correct Document Skew**

Corrects skewed originals, image contents, or both.

### **Add or edit pages after scanning**

Lets you add, remove, or edit the pages in a scan, including rotating pages and changing the page order.

**Note:** To save multiple pages in a single file, you must select a file format that supports multiple pages such as **PDF** or **Multi-TIFF**. If you select another file format, each scanned image or page is saved as a separate file.

**Parent topic:** [Scanning in Epson Scan 2](#)

## Additional Scanning Settings - Advanced Settings Tab

You can select these additional scanning settings on the Epson Scan 2 Advanced Settings tab. Not all adjustment settings may be available, depending on other settings you have chosen.

### **Remove Background**

Removes the background of the originals.

**Text Enhancement**

Sharpens the appearance of letters in text documents.

**Auto Area Segmentation**

Makes black and white images clearer and text recognition more accurate by separating the text from the graphics.

**Threshold**

Adjusts the level at which black areas in text and line art are delineated, improving text recognition in OCR (Optical Character Recognition) programs.

**Color Enhance**

Enhances the shades of the color you select in the scanned image. This setting is available only if you select **Grayscale** or **Black & White** as the Image Type setting.

**Brightness**

Adjusts the overall lightness and darkness of the scanned image.

**Contrast**

Adjusts the difference between the light and dark areas of the overall scanned image.

**Gamma**

Adjusts the midtone density of the scanned image.

**Unsharp Mask**

Makes the edges of certain image areas clearer. Turn off this option to leave softer edges.

**Descreening**

Removes the ripple pattern that might appear in subtly shaded image areas, such as skin tones. This option improves results when scanning magazines or newspapers. (The results of descreening do not appear in the preview image, only in your scanned image.)

**Color Restoration**

Corrects color in faded images (when scanning in Photo Mode).

**Backlight Correction**

Lightens darkly backlit images (when scanning in Photo Mode).

**Dust Removal**

Removes dust on scanned images (when scanning in Photo Mode).

**Edge Fill**

Corrects shadowing around the edges of the image by filling the shadows with black or white.

**Dual Image Output**

Scans the original image twice using different output settings (Windows only).

**Watermark**

Adds a watermark to a scanned image.

**Parent topic:** [Scanning in Epson Scan 2](#)

## **Saving Scanned Documents as a Searchable PDF Using Epson Scan 2**

You can scan a document and save the text in a searchable PDF. In a searchable PDF, text is recognized using Optical Character Recognition (OCR) and then embedded in the scanned original.

**Note:** The required Epson Scan 2 OCR Component is installed automatically when you install your product software as instructed on the *Start Here* sheet. If you install your scanner software programs individually, be sure to also install this component if you want to perform OCR.

1. Load your original in the product for scanning.
2. Start Epson Scan 2.
3. Select your scan settings.
4. Click **Preview** and adjust the area you want to scan, if necessary.
5. Select **Searchable PDF** as the Image Format setting.
6. Select **Options** from the Image Format list.

You see this window:

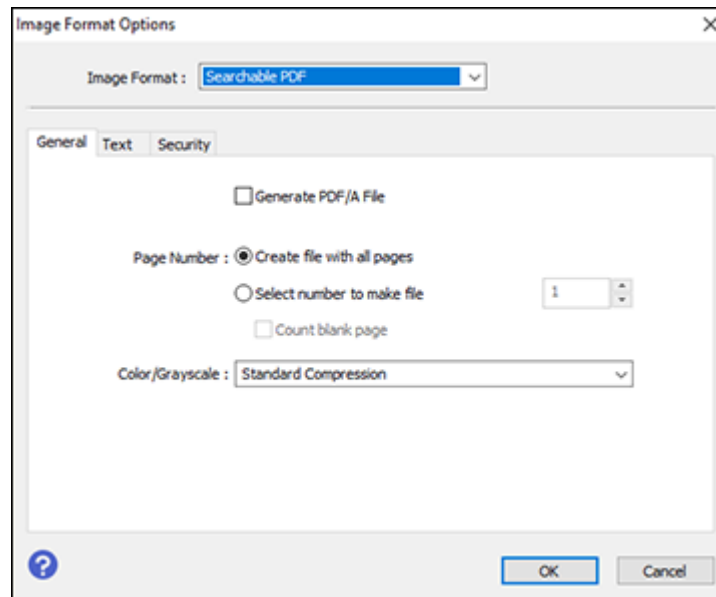

7. Select any of the options on the General tab.
8. Select the **Text** tab.
9. Make sure the language used in the document text is selected as the **Text Language** setting.
10. Select the **Security** tab if you want to add a password to the PDF or protect printing or editing properties.
11. Click **OK**.
12. Confirm the **File Name** setting and select a **Folder** setting for your document.
13. Click **Scan**.

The scanned image is saved as a searchable PDF.

**Parent topic:** [Scanning in Epson Scan 2](#)

## Image Format Options

You can select different image formats and related options. For details on available options, click the ? icon on the Epson Scan 2 Image Format Options window. Not all image formats have options.

**BITMAP (\*.bmp)**

A standard image file format for most Windows programs.

**JPEG (\*.jpg)**

An image format that lets you highly compress image data. However, the higher the compression, the lower the image quality. (The TIFF format is recommended when you need to modify or retouch your scanned image.)

**PNG (\*.png)**

An image format that does not lose quality during editing.

**TIFF (\*.tif)**

A file format created for exchanging data between many programs, such as graphic and DTP software.

**Multi-TIFF (\*.tif)**

A TIFF file format when multiple pages are saved to the same file, allowing you to edit the images using a compatible program.

**PDF (\*.pdf)**

A document format that is readable by Windows and Mac systems using Adobe Reader, Acrobat, or other programs. You can save multi-page documents in one PDF file.

**Searchable PDF (\*.pdf)**

A document format that is readable by Windows and Mac systems using Adobe Reader, Acrobat, or other programs. You can save multi-page documents in one PDF file. Recognized text in the scanned document can be searched.

Parent topic: [Scanning in Epson Scan 2](#)

## Scan Resolution Guidelines

The **Resolution** setting, measured in dpi (dots per inch), controls the amount of detail captured in your scans. Increasing the resolution raises the amount of detail captured but comes with the following disadvantages:

- Larger file sizes
- It takes longer to scan your originals, send/receive your scans by email or fax, and to print your scans
- The image may become too large to fit on your display or print on paper

If you plan to enlarge a scanned image so you can print it at a larger size, you may need to increase the resolution from the default resolution set by Epson Scan 2. Follow these guidelines to determine the resolution setting you need:

- You will scan the image at its original size but enlarge it later in an image-editing program.

Increase the Epson Scan 2 Resolution setting in your scan. Increase the resolution by the same amount you will increase the image size to retain a high image quality. For example, if the resolution is 300 dpi (dots per inch) and you will double the image size later, change the Resolution setting to 600 dpi.

- You will scan the image at 100% or a smaller size.

Select the Epson Scan 2 Resolution setting based on how you will use the scanned image:

- Email/view on a computer screen/post on the web: 96 to 200 dpi
- Print/fax/convert to editable text (OCR)/create searchable PDF: 200 to 300 dpi

**Parent topic:** [Scanning in Epson Scan 2](#)

---

# Refilling Ink and Replacing the Maintenance Box

When the ink level is below the lower line on an ink tank, you need to refill it.

Before checking the ink level or refilling an ink tank as described here, be sure to read the ink safety precautions.

**Caution:** If the ink level is below the lower line on the ink tank, fill it to the upper line on the ink tank. Continued use of the product when the ink level is below the lower line on a tank could damage the product.

[Ink Safety Precautions](#)

[Checking the Ink and Maintenance Box Levels](#)

[Purchase Epson Ink and Maintenance Box](#)

[Refilling the Ink Tanks](#)

[Maintenance Box Replacement](#)

**Related concepts**

[Print Head Maintenance](#)

## Ink Safety Precautions

**Note:** Epson strongly recommends the use of genuine ink to ensure optimal print quality and performance.

**Note:** The product has a low ink alert system. The accuracy of this system depends on the user refilling the ink tanks correctly. The product cannot directly measure the ink levels in the tanks; instead it estimates the amount of ink remaining by internally monitoring ink usage. The low ink alert system may generate inaccurate messages if the ink tanks are not refilled according to these instructions.

As a precaution, perform regular visual inspections of the ink tanks to ensure ink levels do not fall below the lower line. Continued use of the product when the ink level is below the lower line on the tank could damage the product.

### Ink Handling Precautions

- Keep ink bottles and the ink tanks out of the reach of children. Do not allow children to drink from or handle the ink bottles and bottle caps.
- Do not tilt or shake an ink bottle after opening it; otherwise, ink may leak.



- Be careful not to touch any ink when you handle the ink tanks, ink tank caps, and opened ink bottles or ink bottle caps.
- If ink gets on your skin, wash it thoroughly with soap and water. If ink gets into your eyes, flush them immediately with water. If discomfort or problems persist, see a doctor immediately. If ink gets into your mouth, spit it out and see a doctor right away.
- Do not disassemble the maintenance box; otherwise ink may get into your eyes or on your skin.
- Do not shake or squeeze the ink bottles.
- If ink spills, wipe it up immediately. To prevent the ink from spreading, blot the spill with a dry cloth, then wipe it with a damp cloth. The ink will be hard to remove once it has dried.

### **Ink Refilling Precautions**

- Use ink bottles with the correct part number for this product.
- Epson's warranties do not extend to any damage caused by the use of third-party ink or ink not designed for your printer.
- This product requires careful handling of ink. Ink may splatter when the ink tanks are filled or refilled with ink. If ink gets on your clothes or belongings, it may not come off.
- Do not open the ink bottle package until you are ready to fill an ink tank. Ink bottles are vacuum packed to maintain reliability. If you leave an ink bottle unpacked for a long time before using it, print quality may be affected.
- If the ink level is below the lower line on an ink tank, refill the ink. Continued use of the product when the ink level is below the lower line on an ink tank could damage the product.
- Visually check the ink levels in the product's ink tanks to confirm the actual ink levels. Continued use of the product when the ink is expended could damage the product.
- Do not maintain low ink levels for extended periods of time.
- Epson recommends filling an ink tank to the upper line before resetting the ink level.
- For optimum printing results, refill the ink tanks to the upper line at least once a year.
- After bringing an ink bottle inside from a cold storage site, allow it to warm up at room temperature for at least three hours before using it.
- Use the ink bottle before the date printed on the package.
- After opening an ink bottle, Epson recommends using it as soon as possible.
- Store ink bottles in a cool, dark place. Keep them out of direct sunlight.
- Do not store the ink bottles in high or freezing temperatures.

- Store the ink bottles in the same environment as the product. When storing or transporting an opened ink bottle, do not tilt the bottle and do not subject it to impacts or temperature changes. Otherwise, ink may leak even if the cap on the ink bottle is tightened securely. Be sure to keep the ink bottle upright when tightening the cap, and take measures to prevent ink from leaking when you transport the bottle.

#### **Ink Bottle and Ink Tank Information**

- To maintain optimum print head performance, some ink is consumed from all ink tanks during printing and when performing maintenance operations, such as cleaning the print head. Ink may also be consumed when the product is turned on.
- Some ink in the ink bottles supplied with your product is used during initial setup; these ink bottles may print fewer pages compared to subsequent ink bottles.
- The ink bottles may contain recycled materials, but this does not affect product function or performance.
- The specification and appearance of the ink bottles are subject to change without prior notice for improvement.
- If an ink bottle is dented, you can still use the ink. The quality and quantity of ink will not be affected.
- When printing in monochrome or grayscale, color ink may be used instead of black ink, depending on the paper type or print quality settings. This is because a mixture of color inks is used to create black.
- A reserve amount of ink remains in the tank when your product indicates that a refill is necessary. The yields quoted for you do not include this reserve.

**Parent topic:** [Refilling Ink and Replacing the Maintenance Box](#)

## **Checking the Ink and Maintenance Box Levels**

Your product and software will let you know when to refill an ink tank or replace the maintenance box.

[Checking Ink Levels on Your Product](#)

[Checking Maintenance Box Status on the LCD Screen](#)

[Checking Ink and Maintenance Box Levels - Windows](#)

[Checking Ink and Maintenance Box Levels - Mac](#)

[Disabling Special Offers with Windows](#)

**Parent topic:** [Refilling Ink and Replacing the Maintenance Box](#)

## Checking Ink Levels on Your Product

To confirm the actual ink levels, visually check the ink levels in the product's ink tanks. Make sure the ink levels are above the lower lines on the ink tanks.

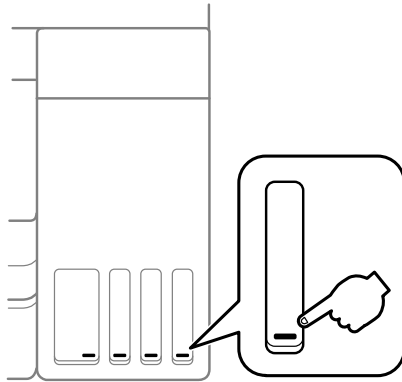

**Note:** The product has a low ink alert system. The accuracy of this system depends on the user refilling the ink tanks correctly. The product cannot directly measure the ink levels in the tanks; instead it estimates the amount of ink remaining by internally monitoring ink usage. The low ink alert system may generate inaccurate messages if the ink tanks are not refilled according to these instructions.

As a precaution, perform regular visual inspections of the ink tanks to ensure ink levels do not fall below the lower line. Continued use of the product when the ink level is below the lower line on the tank could damage the product.

**Parent topic:** [Checking the Ink and Maintenance Box Levels](#)

## Checking Maintenance Box Status on the LCD Screen

You can check the status of your maintenance box using your product's LCD screen.

1. Press the  home button, if necessary.

2. Select the  icon.

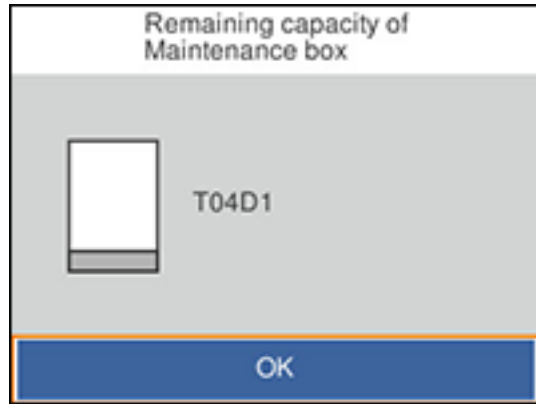

You see the remaining ink capacity of the maintenance box.

3. Select **OK** to exit the screen.



**Parent topic:** [Checking the Ink and Maintenance Box Levels](#)

**Related concepts**

[Maintenance Box Replacement](#)

## Checking Ink and Maintenance Box Levels - Windows

A low ink reminder appears if you try to print when ink is low, and you can check your ink levels at any time using a utility on your Windows computer.

1. To check your ink and maintenance box levels, access the Windows Desktop and double-click the  icon for your product in the right side of the Windows taskbar, or click the up arrow and double-click .

You see a window like this:

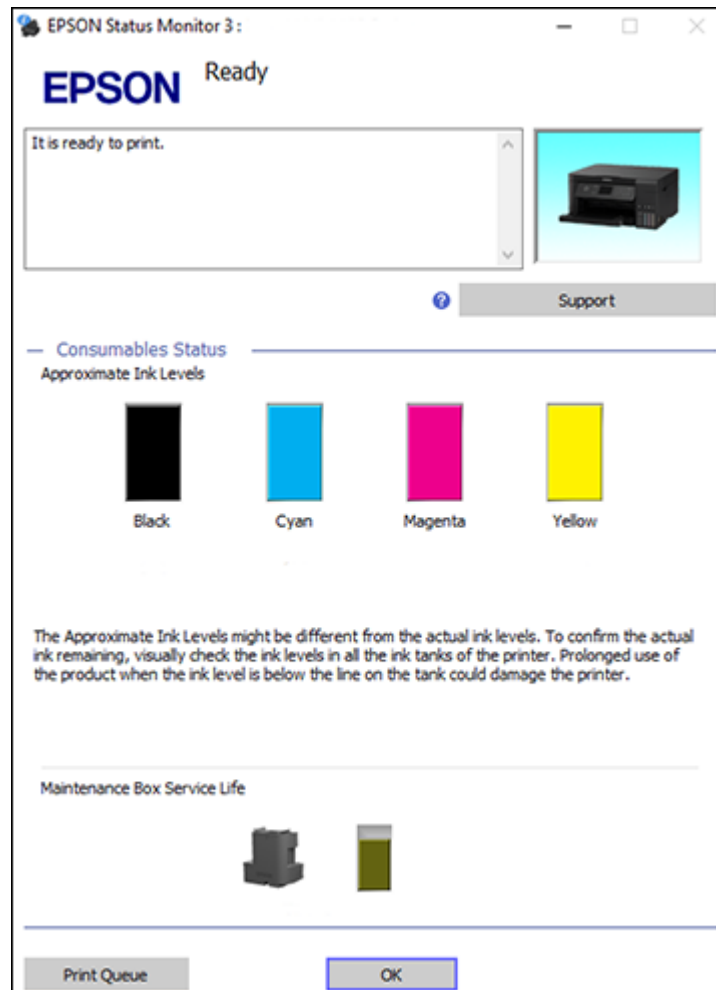

2. Refill any ink tank or replace the maintenance box as needed.

**Note:** The ink levels displayed are an estimate and may differ from the actual ink remaining in the ink tanks. To confirm the actual remaining ink, visually check the ink levels in the ink tanks. Continued use of the product when the ink level is below the lower line on the tank could damage the product.

**Parent topic:** [Checking the Ink and Maintenance Box Levels](#)

**Related concepts**

[Maintenance Box Replacement](#)

**Related tasks**

[Refilling the Ink Tanks](#)

## Checking Ink and Maintenance Box Levels - Mac

You can check your ink levels using a utility on your Mac.

1. In the Apple menu or the Dock, select **System Preferences**. Select **Print & Fax**, **Print & Scan**, or **Printers & Scanners**, select your product, and select **Options & Supplies**. Select **Utility** and select **Open Printer Utility**.
2. Select **EPSON Status Monitor**.

You see a window like this:

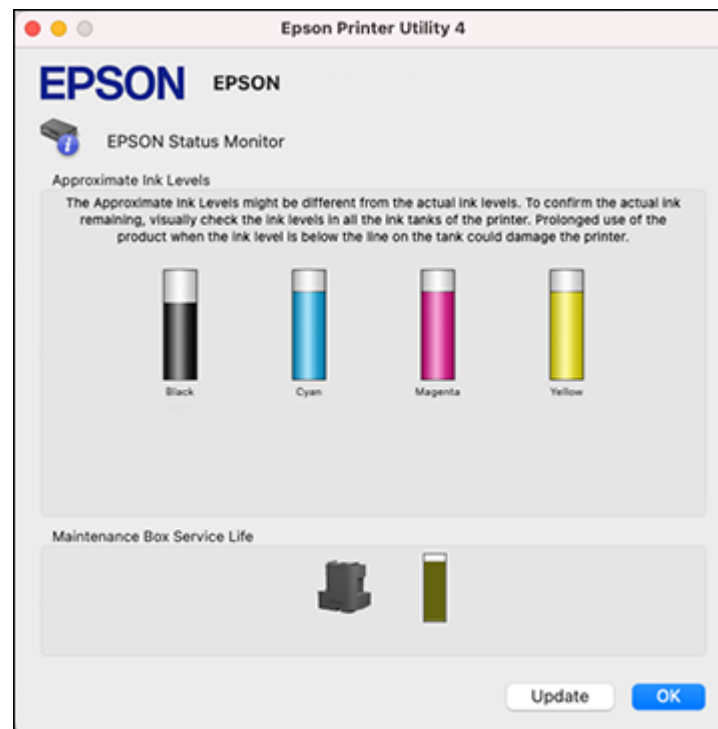

3. Refill any ink tank or replace the maintenance box as needed.

**Note:** To update or refresh the displayed ink levels, click **Update**.

**Note:** The ink levels displayed are an estimate and may differ from the actual ink remaining in the ink tanks. To confirm the actual remaining ink, visually check the ink levels in the ink tanks. Continued use of the product when the ink level is below the lower line on the tank could damage the product.

**Parent topic:** [Checking the Ink and Maintenance Box Levels](#)

**Related concepts**



[Maintenance Box Replacement](#)

**Related tasks**

[Refilling the Ink Tanks](#)

## Disabling Special Offers with Windows

You can disable special offers messages from Epson using a utility on your Windows computer.

1. Access the Windows Desktop and right-click the  icon for your product in the right side of the Windows taskbar, or click the up arrow and right-click . Select **Monitoring Preferences**.

You see this window:

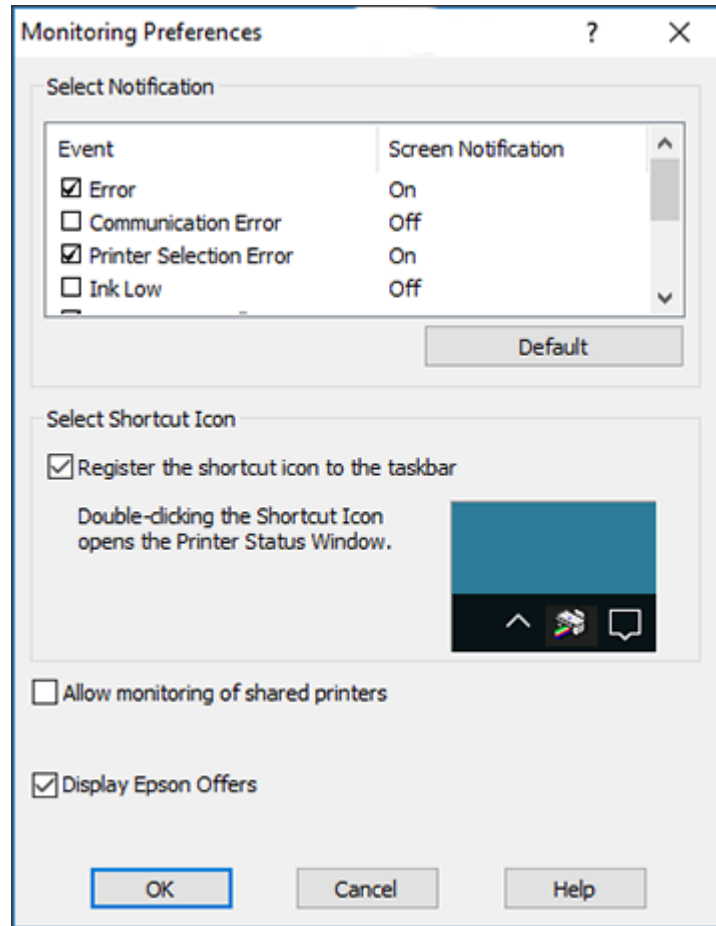

2. To disable promotional offers, deselect the **Display Epson Offers** checkbox.

Parent topic: [Checking the Ink and Maintenance Box Levels](#)

## Purchase Epson Ink and Maintenance Box

You can purchase genuine Epson ink, maintenance boxes, and paper at [epson.com](http://epson.com) (U.S. sales) or [epson.ca](http://epson.ca) (Canadian sales). You can also purchase supplies from an Epson authorized reseller. To find the nearest one, call 800-GO-EPSON (800-463-7766) in the U.S. or 800-807-7766 in Canada.

**Note:** Epson's warranties do not extend to any damage caused by the use of third-party ink or ink not designed for your printer.



The included initial ink bottles must be used for printer setup and are not for resale. The printer ships with full ink bottles and part of the ink from the first bottles is used to charge the print head. Yields vary considerably based on images printed, print settings, paper type, frequency of use and temperature.

#### [Ink Bottle and Maintenance Box Part Numbers](#)

**Parent topic:** [Refilling Ink and Replacing the Maintenance Box](#)

## Ink Bottle and Maintenance Box Part Numbers

Use these part numbers when you order or purchase new ink bottles or a new maintenance box. Use the ink by the date printed on the package.

Ink color	Part number
Black	502120
Cyan	502220
Magenta	502320
Yellow	502420

**Maintenance box part number:** T04D100

**Parent topic:** [Purchase Epson Ink and Maintenance Box](#)

## Refilling the Ink Tanks

Make sure you have new ink bottles handy and have read the ink safety precautions before you begin.

You can continue to use the product even if one or more ink tanks are not filled all the way. However, for the most accurate ink level monitoring, fill all the ink tanks up to the top line.

**Note:** The product has a low ink alert system. The accuracy of this system depends on the user refilling the ink tanks correctly. The product cannot directly measure the ink levels in the tanks; instead it estimates the amount of ink remaining by internally monitoring ink usage. The low ink alert system may generate inaccurate messages if the ink tanks are not refilled according to these instructions.

As a precaution, perform regular visual inspections of the ink tanks to ensure ink levels do not fall below the lower line. Continued use of the product when the ink level is below the lower line on the tank could damage the product.

**Caution:** Wear disposable gloves while refilling the ink tanks to avoid staining your hands. If ink spills, wipe it off immediately with a damp towel to avoid permanent stains. If ink gets on your clothes or belongings, it may not come off.

1. Turn on your product.
2. Close the document cover if it is open.
3. Lift up the scanner unit with both hands until it locks.

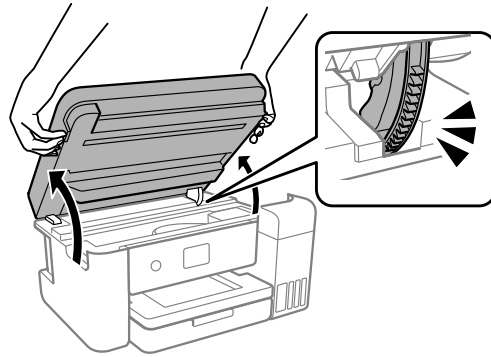

4. Open the ink tank cover.

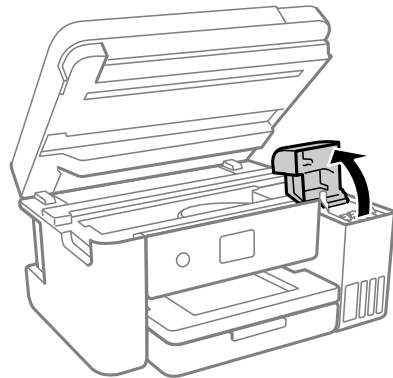

5. Read the precautions on the screen and then proceed to the next screen.
6. Open the cap for the ink tank you are going to fill.

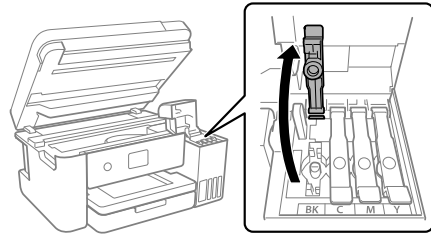

**Note:** Make sure that the color of the ink tank matches the ink color that you want to refill.

7. Hold the ink bottle upright and slowly turn the bottle cap to remove it.



**Caution:** Do not shake or squeeze the bottle. Do not touch the top of the bottle after its cap is removed.

**Warning:** If ink gets on your skin, wash it thoroughly with soap and water. If ink gets into your eyes, flush them immediately with water. If ink gets into your mouth, spit it out immediately. Seek medical advice if problems persist. Keep the ink bottles out of the reach of children and do not drink the ink.

8. Position the top of the ink bottle with the filling port and then insert the bottle straight onto the port. Ink flows into the tank.

**Note:** Refer to the color-coded sticker on the ink tank unit to identify the color of each tank. Do not force the bottles into position; they are keyed for each color.

9. Wait for the ink to fill the tank. Do not squeeze the bottle. Ink flows into the tank and stops automatically when the ink is filled to the upper line.

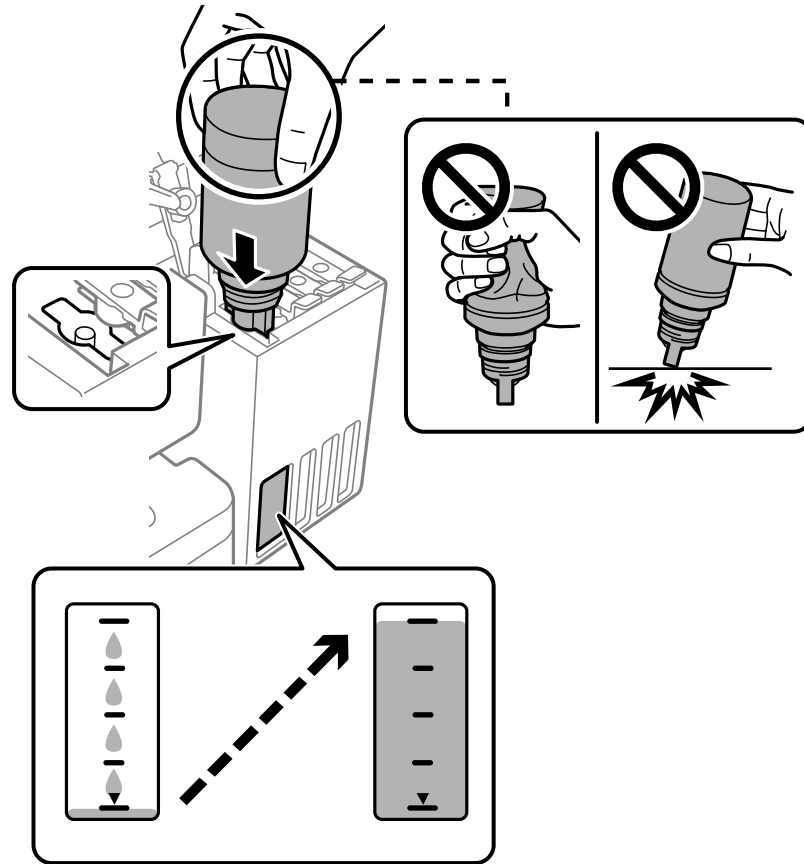

**Note:** If ink does not flow from the bottle, lift and reinsert the bottle. If the ink has reached the upper line of the tank, do not remove and reinsert the bottle or ink may leak.

10. When the ink tank is full, remove the ink bottle and securely close the ink bottle cap.



**Note:** Do not leave the ink bottle inserted. The bottle may be damaged or ink may leak. If any ink remains in the bottle, replace the bottle cap and tighten it. Store the bottle upright for later use.

11. Securely close the ink tank cap.

12. Repeat the previous steps as necessary for each ink tank you need to refill.

13. Close the ink tank cover, then close the scanner unit using both hands.

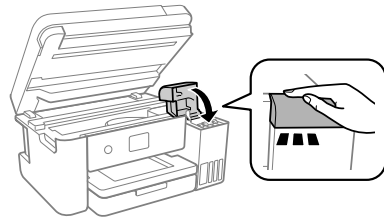

**Note:** The scanner unit is designed to close slowly and resist a little as a precaution against injuring your fingers. Continue to close the scanner unit even if you feel some resistance.

14. Select **Proceed** on the information screen, then select **Proceed** again and follow the on-screen instructions to reset the ink level for the colors you refilled.

Even if you do not refill ink up to the upper line on the ink tank, you can continue using the product. To keep your product operating at its best, however, fill ink tank up to the upper line and reset the ink level immediately.

**Parent topic:** [Refilling Ink and Replacing the Maintenance Box](#)

**Related concepts**

[Purchase Epson Ink and Maintenance Box](#)

**Related tasks**

[Checking Ink Levels on Your Product](#)

## Maintenance Box Replacement

The maintenance box stores surplus ink that gets collected during printing or print head cleaning. When you see a message on the LCD screen, follow the on-screen instructions to replace the maintenance box.

**Note:** When the maintenance box is full, you cannot print or clean the print head until it is replaced. However, you can perform operations that do not require ink, such as scanning.

Note the following precautions when replacing the maintenance box:

- Do not remove the maintenance box or its cover except when replacing the maintenance box; otherwise, ink may leak.
- Do not touch the green chip on the side of the maintenance box.
- Do not tilt the maintenance box after removing it or ink may leak.
- Do not touch the openings in the maintenance box or you may get ink on you.
- Do not drop the maintenance box or subject it to strong shocks.
- If you cannot replace the cover, the maintenance box may not be installed correctly. Remove and reinstall the maintenance box.
- Do not store the maintenance box in high or freezing temperatures.
- Do not replace the maintenance box during printing; otherwise, ink may leak.

- Keep the maintenance box out of direct sunlight.

**Caution:** Do not reuse a maintenance box that has been removed and left uninstalled for a long period. Keep the maintenance box away from direct sunlight.

**Note:** The maintenance box is a user-replaceable part and is not covered by the product warranty.

**Parent topic:** [Refilling Ink and Replacing the Maintenance Box](#)

**Related concepts**

[Purchase Epson Ink and Maintenance Box](#)

**Related tasks**

[Checking Maintenance Box Status on the LCD Screen](#)



---

## Adjusting Print Quality

If your print quality declines, you may need to run a utility to clean or align the print head.

If running these utilities does not solve the problem, you may need to run a Power Cleaning or clean the paper or print head path.

[Print Head Maintenance](#)

[Print Head Alignment](#)

[Cleaning the Paper Guide](#)

[Cleaning the Print Head Path](#)

[Cleaning the Paper Rollers](#)

[Checking the Number of Sheets Fed](#)

### Print Head Maintenance

If your printouts become too light, or you see dark or light bands across them, you may need to clean the print head nozzles. Cleaning uses ink, so clean the nozzles only if print quality declines.

You can check for clogged nozzles before you clean them so you don't clean them unnecessarily.

**Note:** You cannot clean the print head if the ink level has reached the lower line on the ink tank, and may not be able to clean it when the ink level in any of the tanks is low. You must refill the ink tank first.

If you still see white or dark lines or gaps in your printouts, even after cleaning the print head several times, you can run a Power Cleaning.

[Print Head Nozzle Check](#)

[Print Head Cleaning](#)

[Power Cleaning](#)

**Parent topic:** [Adjusting Print Quality](#)

### Print Head Nozzle Check

You can print a nozzle check pattern to check for clogged nozzles.

[Checking the Nozzles Using the Product Control Panel](#)

[Checking the Nozzles Using a Computer Utility](#)

**Parent topic:** [Print Head Maintenance](#)

## Checking the Nozzles Using the Product Control Panel

You can check the print head nozzles using the control panel on your product.

1. Make sure there are no errors on the LCD screen and the output tray is extended.
2. Load a few sheets of plain paper in the product.
3. Press the  home button, if necessary.
4. Select **Maintenance** > **Print Head Nozzle Check**.

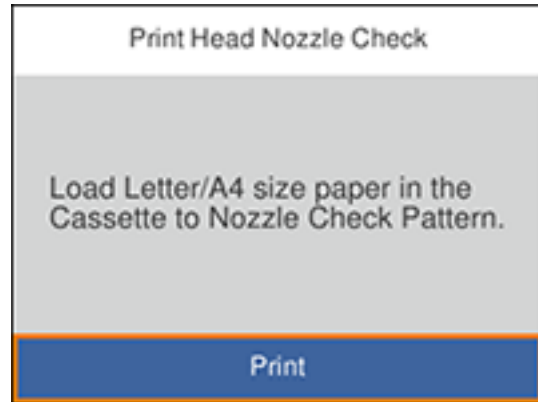

5. Select **Print**.  
The nozzle check pattern is printed.

6. Check the printed pattern to see if there are gaps in the lines.

**Print head is clean**

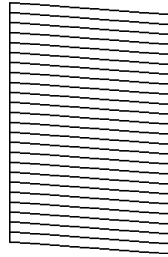

**Print head needs cleaning**

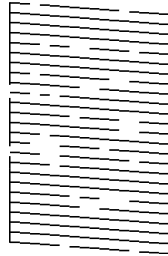

**Print head needs Power Cleaning**

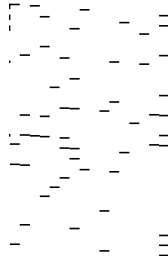

7. Do one of the following:
- If there are no gaps, the print head is clean. Select **O**.

- If there are gaps or the pattern is faint, select **X**. Follow the instructions on the screen to clean the print head.
- If almost the entire pattern is missing, select **O** and perform a Power Cleaning.

If you don't see any improvement after cleaning the print head up to 3 times, turn the product off and wait at least 12 hours. Then run a nozzle check and try cleaning the print head again. If quality still does not improve, run a Power Cleaning.

**Parent topic:** [Print Head Nozzle Check](#)

#### **Related tasks**

[Cleaning the Print Head Using the Product Control Panel](#)



[Power Cleaning Using the Product Control Panel](#)

#### **Related topics**

[Loading Paper](#)

### **Checking the Nozzles Using a Computer Utility**

You can check the print head nozzles using a utility on your Windows or Mac computer.

1. Make sure there are no errors on the LCD screen and the output tray is extended.
2. Load a few sheets of plain paper in the product.
3. Do one of the following:
  - **Windows:** Access the Windows Desktop and right-click the  icon for your product in the right side of the Windows taskbar, or click the up arrow and right-click .
  - **Mac:** In the Apple menu or the Dock, select **System Preferences**. Select **Print & Fax**, **Print & Scan**, or **Printers & Scanners**, select your product, and select **Options & Supplies**. Select **Utility** and select **Open Printer Utility**.
4. Select **Print Head Nozzle Check**.

You see a window like this:

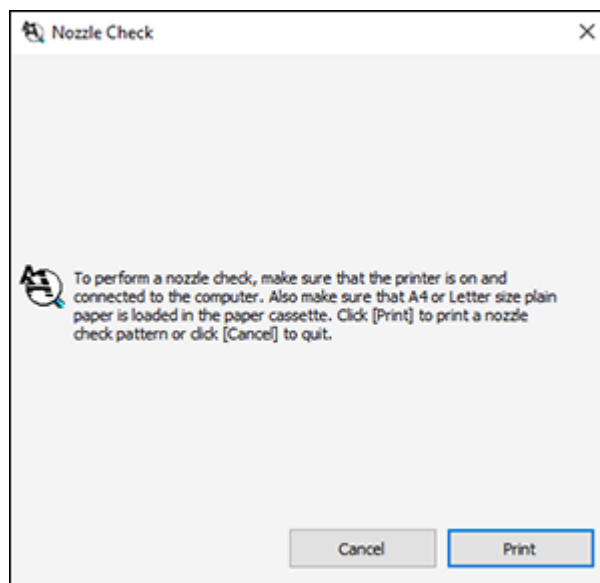

5. Click **Print**.

6. Check the printed pattern to see if there are gaps in the lines.

**Print head is clean**

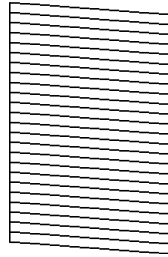

**Print head needs cleaning**

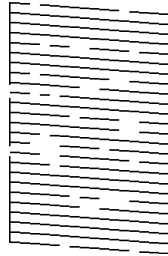

**Print head needs Power Cleaning**

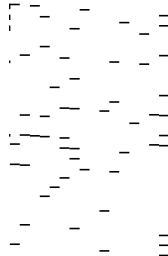

7. Do one of the following:
- If there are no gaps, click **Finish**.

- If there are gaps or the pattern is faint, clean the print head.
- If almost the entire pattern is missing, click **Finish** and perform a Power Cleaning.

If you don't see any improvement after cleaning the print head up to 3 times, turn off the product and wait at least 12 hours. Then run a nozzle check and try cleaning the print head again. If quality still does not improve, run a Power Cleaning.

**Parent topic:** [Print Head Nozzle Check](#)

**Related tasks**

[Cleaning the Print Head Using a Computer Utility](#)

[Power Cleaning Using a Computer Utility](#)

**Related topics**

[Loading Paper](#)

## Print Head Cleaning

If print quality has declined and the nozzle check pattern indicates clogged nozzles, you can clean the print head.

**Note:** You cannot clean the print head if the ink level has reached the lower line on the ink tank, and may not be able to clean it when the ink level in any of the tanks is low. You must refill the ink tank first.

[Cleaning the Print Head Using the Product Control Panel](#)

[Cleaning the Print Head Using a Computer Utility](#)

**Parent topic:** [Print Head Maintenance](#)

**Related topics**

[Refilling Ink and Replacing the Maintenance Box](#)

### Cleaning the Print Head Using the Product Control Panel

You can clean the print head nozzles using the control panel on your product.

1. Make sure there are no errors on the LCD screen and the output tray is extended.
2. Load a few sheets of plain paper in the product.
3. Press the  home button, if necessary.
4. Select **Maintenance > Print Head Cleaning**.
5. Press the **OK** button to clean the print head. You see a message on the LCD screen during the cleaning cycle.

The  power light flashes throughout the cleaning cycle and stays on when the cleaning cycle is finished. When the cleaning cycle is finished, you see a message on the screen and a nozzle pattern prints.

**Caution:** Never turn off the product or open the scanner unit during a cleaning cycle or you may not be able to print.



6. Check the printed pattern to see if there are gaps in the lines.

**Print head is clean**

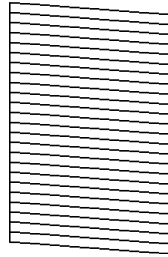

**Print head needs cleaning**

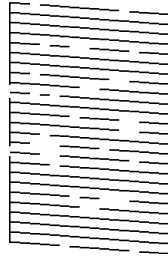

**Print head needs Power Cleaning**

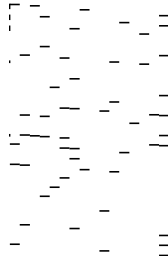

7. Do one of the following:
- If there are no gaps, the print head is clean. Select **O**.

- If there are gaps or the pattern is faint, select **X**. Follow the instructions on the screen to clean the print head.
- If almost the entire pattern is missing, select **O** and run a Power Cleaning.

If you don't see any improvement after cleaning the print head up to 3 times, turn off the product and wait at least 12 hours. Then run a nozzle check and try cleaning the print head again, if necessary. If quality still does not improve, run a Power Cleaning.

**Parent topic:** [Print Head Cleaning](#)

#### **Related tasks**

[Checking the Nozzles Using the Product Control Panel](#)



[Power Cleaning Using the Product Control Panel](#)

#### **Related topics**

[Loading Paper](#)

### **Cleaning the Print Head Using a Computer Utility**

You can clean the print head using a utility on your Windows or Mac computer.

1. Make sure there are no errors on the LCD screen and the output tray is extended.
2. Load a few sheets of plain paper in the product.
3. Do one of the following:
  - **Windows:** Access the Windows Desktop and right-click the  icon for your product in the right side of the Windows taskbar, or click the up arrow and right-click .
  - **Mac:** In the Apple menu or the Dock, select **System Preferences**. Select **Print & Fax**, **Print & Scan**, or **Printers & Scanners**, select your product, and select **Options & Supplies**. Select **Utility** and select **Open Printer Utility**.
4. Select **Print Head Cleaning**.

You see a window like this:

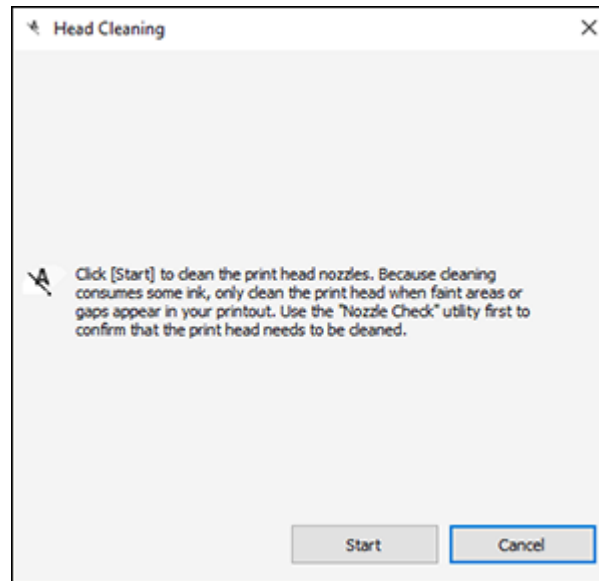

5. Click **Start** to begin the cleaning cycle.

The  power light flashes throughout the cleaning cycle and stays on when the cleaning cycle is finished.

**Caution:** Never turn off the product or open the scanner unit during a cleaning cycle or you may not be able to print.

6. When the cleaning cycle is finished, you can check to see if the nozzles are clean; click **Print Nozzle Check Pattern** and click **Print**.

7. Check the printed pattern to see if there are gaps in the lines.

**Print head is clean**

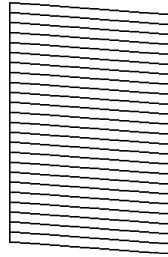

**Print head needs cleaning**

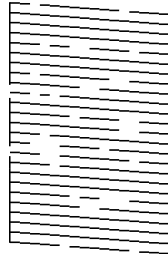

**Print head needs Power Cleaning**

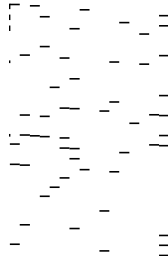

- If there are no gaps, click **Finish**.
- If there are gaps or the pattern is faint, click **Clean** to clean the print head again.

- If almost the entire pattern is missing, click **Finish** and perform a Power Cleaning.

If you don't see any improvement after cleaning the print head up to 3 times, turn off the product and wait at least 12 hours. Then check the print head nozzles and try cleaning the print head again, if necessary. If quality still does not improve, run a Power Cleaning.

**Parent topic:** [Print Head Cleaning](#)

**Related tasks**

[Checking the Nozzles Using a Computer Utility](#)

[Power Cleaning Using a Computer Utility](#)

**Related topics**

[Loading Paper](#)

## Power Cleaning

If you still see white or dark lines or missing nozzles in your printouts, even after cleaning the print head several times, you can run a Power Cleaning.

If you do not see improvement after running a Power Cleaning, turn off the product and wait at least 12 hours before running another Power Cleaning.

**Caution:** Running a Power Cleaning consumes a lot of ink, so you should run it only if necessary. Make sure each ink tank is at least one-third full before running a Power Cleaning, or it may damage the product.

**Caution:** Power Cleaning may cause the maintenance box to reach its capacity sooner. When the maintenance box is full, you need to replace it to continue printing. If the ink levels or the free space in the maintenance box are insufficient for Power Cleaning, you cannot run this feature.

[Power Cleaning Using the Product Control Panel](#)

[Power Cleaning Using a Computer Utility](#)

**Parent topic:** [Print Head Maintenance](#)

**Related concepts**

[Maintenance Box Replacement](#)

**Related tasks**

[Refilling the Ink Tanks](#)

### Power Cleaning Using the Product Control Panel

You can run a Power Cleaning using the control panel on your product.

**Note:** After a Power Cleaning, you must turn off the product and wait at least 12 hours before running another Power Cleaning.

1. Visually check the ink levels and make sure each ink tank is at least one-third full.

**Caution:** If you run a Power Cleaning when the ink levels are low, you may damage the product.

2. Press the  home button, if necessary.
3. Select **Maintenance > Power Cleaning**.
4. Follow the on-screen instructions to run the Power Cleaning.

A confirmation screen is displayed when Power Cleaning is complete.

5. Select **OK** on the confirmation screen and then run a nozzle check.

If the print quality did not improve, turn off the printer and wait at least 12 hours before running another nozzle check. Run Print Head Cleaning or Power Cleaning depending on the printed pattern.

If the print quality does not improve after running the Power Cleaning utility multiple times, contact Epson for support.

**Parent topic:** [Power Cleaning](#)

#### **Related references**

[Where to Get Help](#)

#### **Related tasks**

[Checking the Nozzles Using the Product Control Panel](#)

[Cleaning the Print Head Using the Product Control Panel](#)

#### **Related topics**

[Loading Paper](#)



### **Power Cleaning Using a Computer Utility**

You can run a Power Cleaning using a utility on your Windows or Mac computer.

**Note:** After running a Power Cleaning, you must turn off the product and wait at least 12 hours before running another Power Cleaning.

1. Make sure there are no errors on the LCD screen and the output tray is extended.
2. Load a few sheets of plain paper in the product.

3. Do one of the following:

- **Windows:** Access the Windows Desktop and right-click the  icon for your product in the right side of the Windows taskbar, or click the up arrow and right-click . Select **Printer Settings** and click the **Maintenance** tab.
- **Mac:** In the Apple menu or the Dock, select **System Preferences**. Select **Print & Fax**, **Print & Scan**, or **Printers & Scanners**, select your product, and select **Options & Supplies**. Select **Utility** and select **Open Printer Utility**.

4. Select **Power Cleaning**.

You see a window like this:

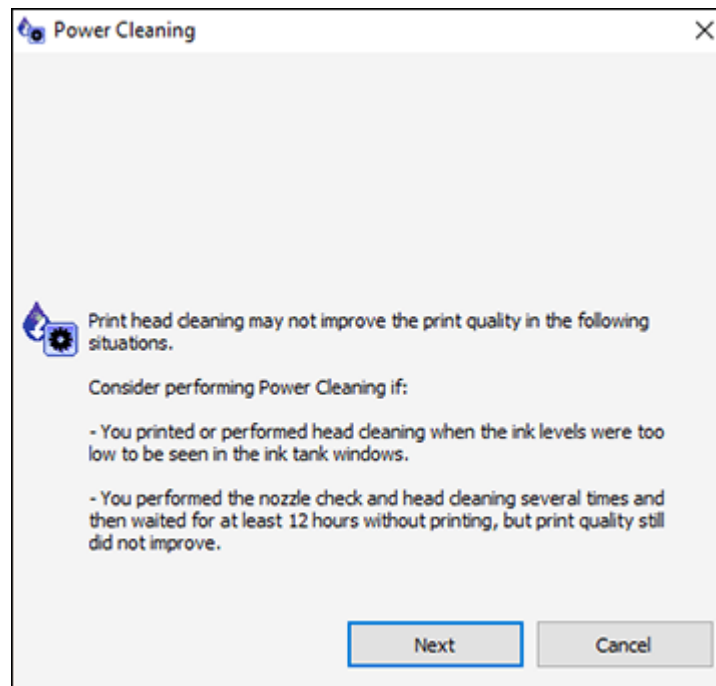

5. Follow the on-screen instructions to run a Power Cleaning.

6. When Power Cleaning is finished, run a nozzle check.

If print quality has not improved after running Power Cleaning, wait for at least 12 hours without printing, and then print the nozzle check pattern again. Run Print Head Cleaning or Power Cleaning again depending on the printed pattern. If quality still does not improve, contact Epson support.

**Parent topic:** [Power Cleaning](#)

**Related references**

[Where to Get Help](#)

**Related tasks**

[Checking the Nozzles Using a Computer Utility](#)

[Cleaning the Print Head Using a Computer Utility](#)

**Related topics**

[Loading Paper](#)

## Print Head Alignment

If your printouts become grainy or blurry, you notice misalignment of vertical lines, or you see dark or light horizontal bands, you may need to align the print head.

**Note:** Banding may also occur if your print head nozzles need cleaning.

[Aligning the Print Head Using the Product Control Panel](#)

**Parent topic:** [Adjusting Print Quality](#)

## Aligning the Print Head Using the Product Control Panel

You can align the print head using the control panel on your product.

1. Make sure there are no errors on the LCD screen and the output tray is extended.
2. Load a few sheets of plain paper in the product.
3. Press the  home button, if necessary.
4. Select **Maintenance** > **Print Head Alignment**.
5. Do one of the following:
  - Select **Vertical Alignment**.
  - Select **Horizontal Alignment**.



6. Press the **OK** button to print an alignment sheet.

**Note:** Do not cancel printing while you are printing a head alignment pattern.

7. Check the printed pattern and select the number representing the most solid printed pattern for each set on the LCD screen.

**Vertical Alignment**

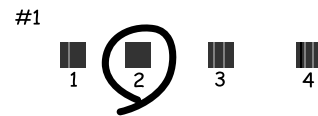
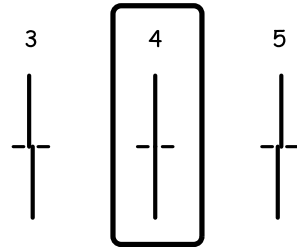

**Horizontal Alignment**



8. Press the **OK** button when you are finished.

**Parent topic:** [Print Head Alignment](#)

### Related concepts

[Print Head Nozzle Check](#)

[Print Head Cleaning](#)

### Related tasks

[Cleaning the Print Head Path](#)

### Related topics

[Loading Paper](#)

## Cleaning the Paper Guide

If you see ink on the back of a printout, you can clean the paper guide rollers to remove any excess ink.

1. If printouts are smeared or scuffed, load plain paper in the cassette in this size: Letter (8.5 × 11 inches [216 × 279 mm]) or A4 (8.3 × 11.7 inches [210 × 297 mm]).
2. Select **Maintenance > Paper Guide Cleaning**.
3. Follow the on-screen instructions to clean the paper guide.
4. Repeat these steps as necessary until the paper comes out clean.
5. If the paper is still smeared with ink, turn off the product and lift up the scanner unit with both hands until it locks.

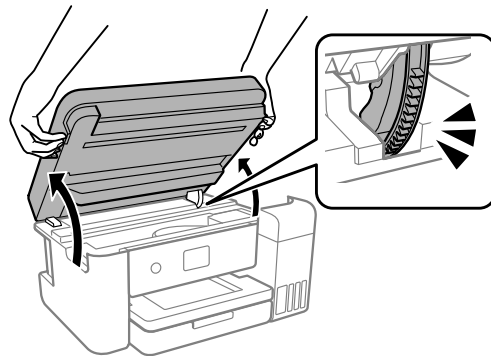

- Using a cotton swab, wipe off any ink smears on the part shown in the illustration below.

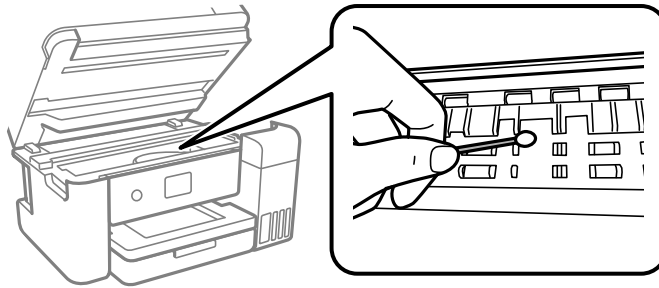

**Caution:** Do not use tissue paper to clean the inside of the product as lint can clog the print head nozzles. Do not touch the flat white cable, the translucent film, or the ink tubes inside the product.

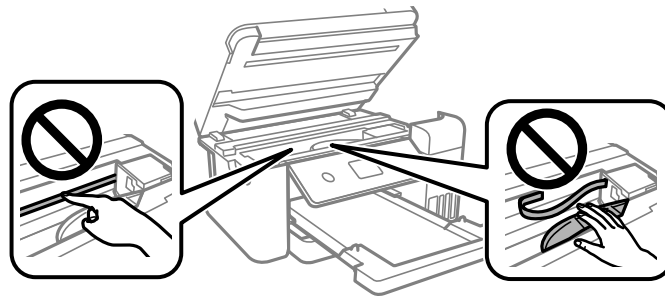

- Close the scanner unit.

**Note:** The scanner unit is designed to close slowly with slight resistance to help prevent injury to your fingers. Continue to close the scanner unit even if you feel some resistance.

**Parent topic:** [Adjusting Print Quality](#)

**Related topics**

[Loading Paper](#)

## Cleaning the Print Head Path

If the print quality has not improved after cleaning and aligning the print head and cleaning the paper path, the print head path inside the printer may be smeared with ink.

To clean the print head path, use the following:

- Several cotton swabs
- ¼ cup (59 ml) water containing 2 to 3 drops of mild dish detergent
- A small flashlight

**Caution:** Do not use any other liquid to clean the print head path or you may damage your product. Do not use tissue paper to clean the inside of the product. The print head nozzles may become clogged with lint.

1. Turn off the product.
2. Unplug the power cable.
3. Disconnect any connected cables.
4. Close the document cover, if necessary.
5. Lift up the scanner unit with both hands until it locks.

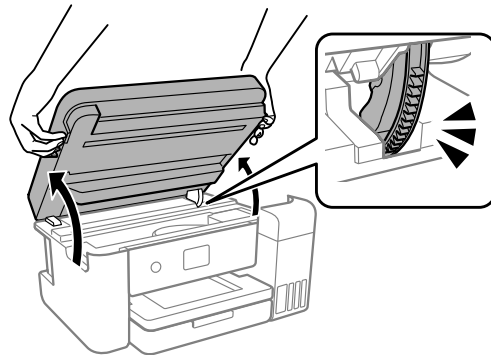

**Caution:** Do not touch the flat white cable, translucent film, or ink tubes inside the product. Doing so may cause a malfunction.

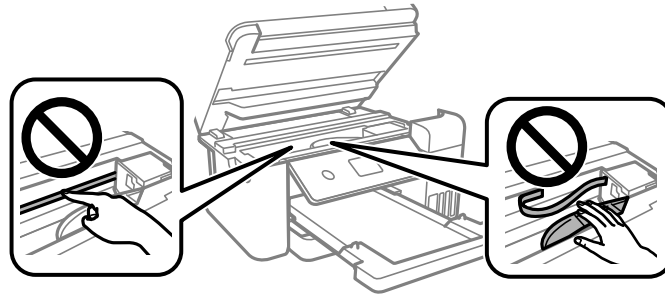

6. Using the flashlight, check the translucent film shown here for ink smears.

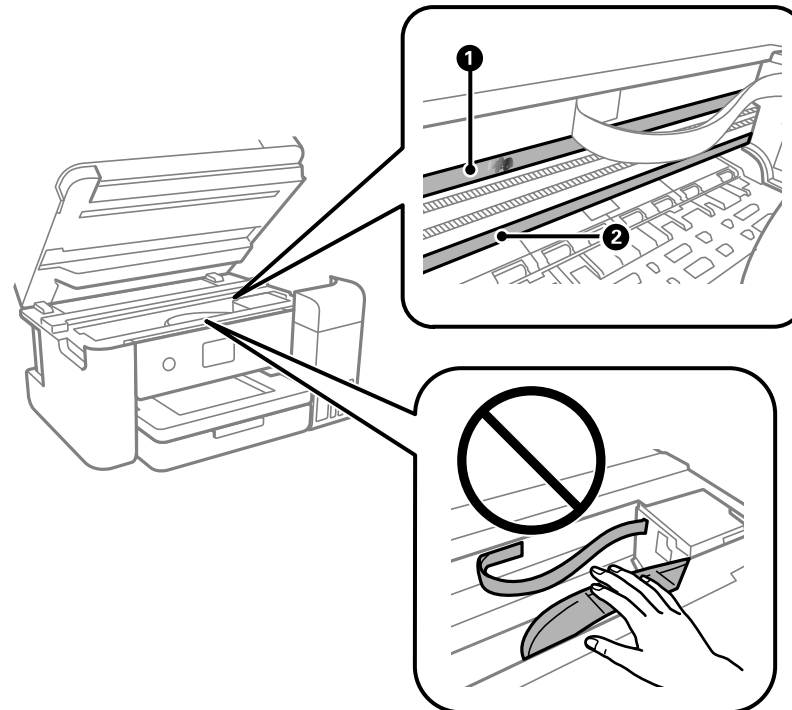

- 1 Translucent film
- 2 Print head rail

**Caution:** Do not touch the print head rail or wipe the grease off of it. You may not be able to print.

7. Moisten a cotton swab with the water and detergent mixture, and squeeze out any excess moisture. Lightly wipe the ink off the translucent film.

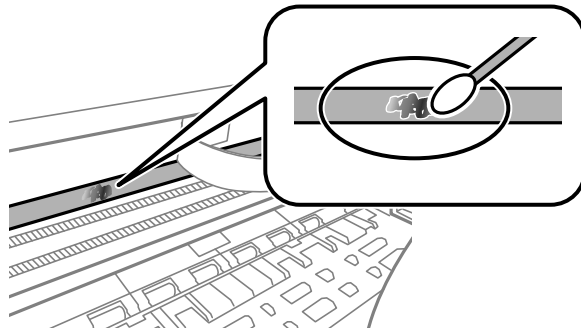

**Caution:** Do not press too hard on the film or you may dislocate the anchor springs and damage your product.

8. Use a new, dry cotton swab to dry the translucent film.
9. Repeat steps 7 and 8 as necessary to clean all ink smears.
10. When the translucent film is dry, close the scanner unit.

**Note:** The scanner unit is designed to close slowly with slight resistance to help prevent injury to your fingers. Continue to close the scanner unit even if you feel some resistance.

11. Reconnect any disconnected cables, plug in the power cord, and turn on the product.

**Parent topic:** [Adjusting Print Quality](#)

**Related concepts**

[Power Cleaning](#)

[Print Head Alignment](#)

## Related tasks

[Cleaning the Paper Guide](#)

# Cleaning the Paper Rollers

If you encounter repeated paper feed issues from the cassette, clean the paper rollers inside the product.

1. Turn off the product.
2. Unplug the power cable.
3. Disconnect any connected cables.
4. Close the document cover, if necessary.
5. Open the scanner unit with both hands until it locks.

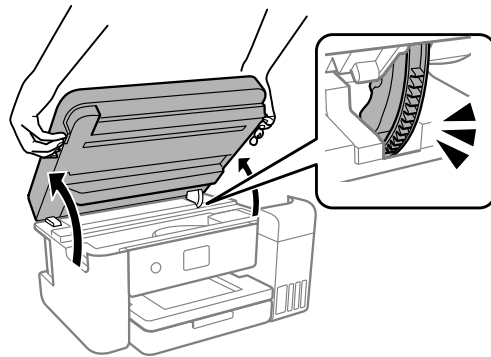

6. Make sure the ink tank caps are securely closed.

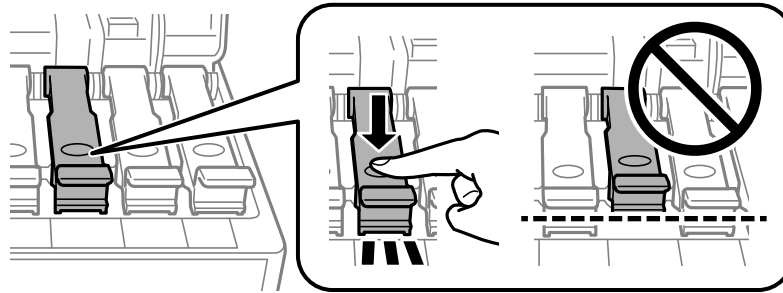

**Note:** If the ink tank caps are not securely closed, ink may leak.

7. Close the scanner unit.

**Note:** The scanner unit is designed to close slowly with slight resistance to help prevent injury to your fingers. Continue to close the scanner unit even if you feel some resistance.

8. Slide out the paper cassette and remove the paper.

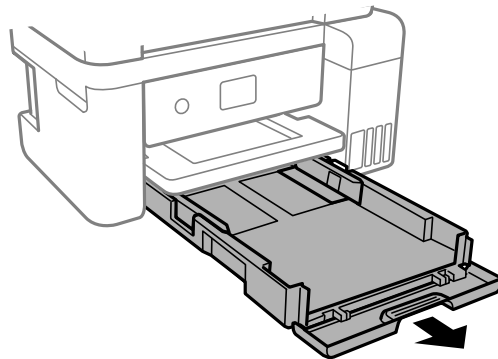



9. Place the product on its side with the ink tank on the bottom.

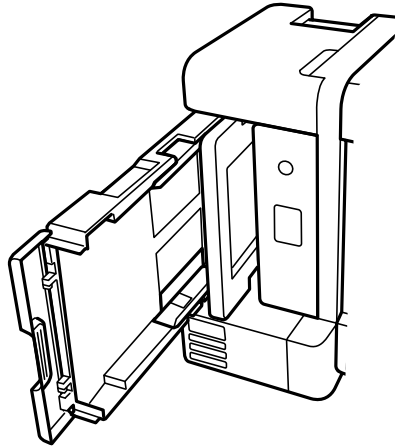

**Warning:** Be careful not to trap your fingers under the product.

10. Use a soft, moist cloth to clean the paper rollers, as shown. Rotate the rollers to clean them thoroughly.

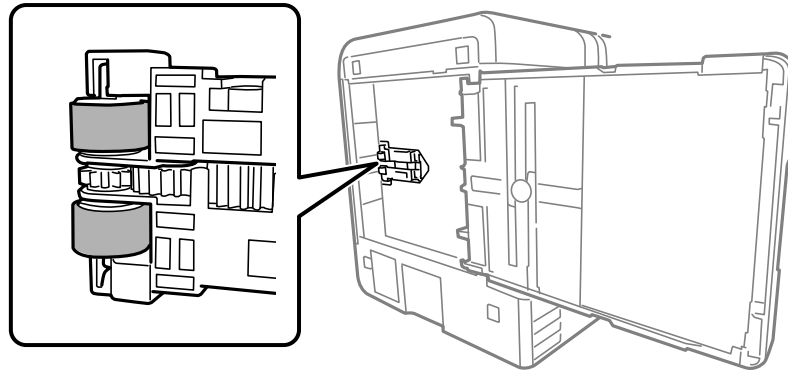

11. Return the product to its normal position.

**Caution:** Do not leave the printer on its side for an extended period of time.

12. Replace the paper, slide in the paper cassette, and connect the power cord.

**Parent topic:** [Adjusting Print Quality](#)

## Checking the Number of Sheets Fed

You can view an option that displays the number of sheets of paper that have fed through the product.

**Note:** You can also view the number of sheets of paper fed through the product by printing a nozzle check.

[Checking the Number of Sheets on the LCD Screen](#)

[Checking the Sheet Counter - Windows](#)

[Checking the Sheet Counter - Mac](#)

**Parent topic:** [Adjusting Print Quality](#)

**Related concepts**

[Print Head Nozzle Check](#)

## Checking the Number of Sheets on the LCD Screen



You can view the total number of prints, black-and-white prints, and color prints that have been printed.

1. Press the  home button, if necessary.
2. Select **Settings** > **Print Counter** to view the number of prints.

**Parent topic:** [Checking the Number of Sheets Fed](#)

## Checking the Sheet Counter - Windows

You can check the number of sheets of paper that have fed through the product by checking the sheet counter.

1. Access the Windows Desktop and right-click the  icon for your product in the right side of the Windows taskbar, or click the up arrow and right-click .
2. Select **Printer Settings**.
3. Click the **Maintenance** tab.
4. Select **Printer and Option Information**.

You see this window:

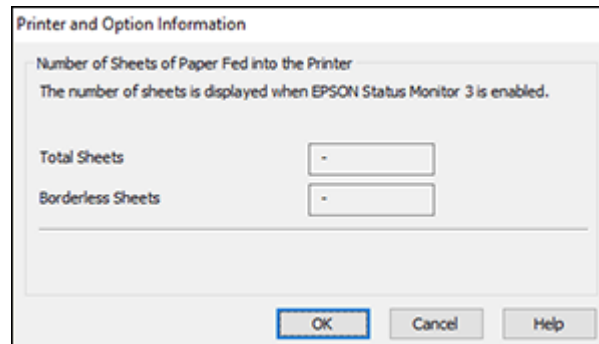

5. After checking the number of sheets fed into the printer, click **OK** to close the window.

**Note:** The number of sheets is displayed only when Epson Status Monitor 3 is enabled.

**Parent topic:** [Checking the Number of Sheets Fed](#)

## Checking the Sheet Counter - Mac

You can check the number of sheets of paper that have fed through the product by checking the sheet counter.

1. In the Apple menu or the Dock, select **System Preferences**. Select **Print & Fax**, **Print & Scan**, or **Printers & Scanners**, select your product, and select **Options & Supplies**. Select **Utility** and select **Open Printer Utility**.
2. Select **Printer and Option Information**.

You see this window:

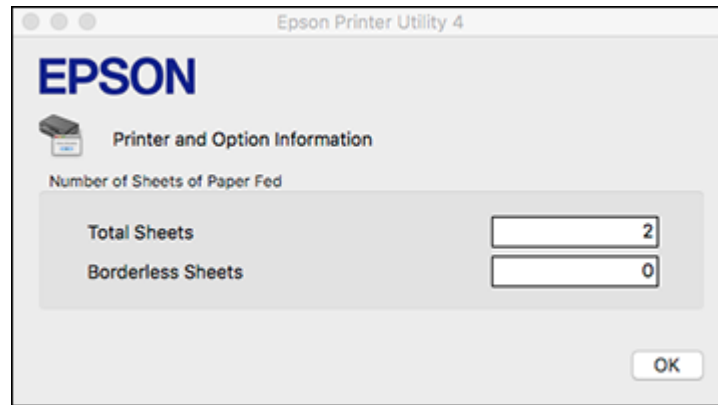

3. After checking the number of sheets fed into the printer, click **OK** to close the window.

**Parent topic:** [Checking the Number of Sheets Fed](#)

---

# Cleaning and Transporting Your Product

See these sections if you need to clean or transport your product.

**Note:** Your product may differ from the images in this guide, but the instructions are the same unless otherwise noted.

[Cleaning Your Product](#)

[Transporting Your Product](#)

## Cleaning Your Product

To keep your product working at its best, you should clean it several times a year.

**Caution:** Do not use a hard brush, alcohol, or paint thinner to clean the product or you may damage it. Do not use oil or other lubricants inside the product or let water get inside it. Do not touch the flat white cable, translucent film, or ink tubes inside the product.

1. Turn off the product.
2. Unplug the power cord.
3. Disconnect any connected cables.
4. Pull out the paper cassette and remove the paper.
5. Clean the outer case and control panel with a soft, clean cloth moistened with a little water. If you cannot remove the dirt, try cleaning with a soft cloth moistened with a mild detergent.

6. Open the document cover.

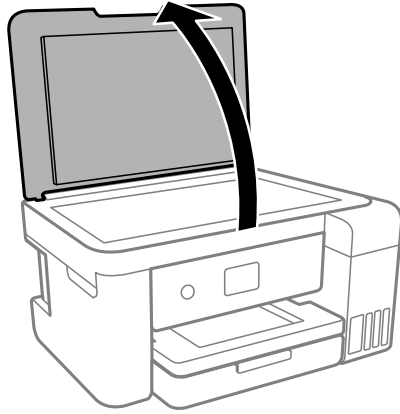

7. Clean the scanner glass with a soft, lint-free cloth (microfiber is recommended) moistened with a little glass cleaner.

**Caution:** Do not spray glass cleaner directly on the glass and do not press the glass surface with any force.

8. Close the document cover.

**Parent topic:** [Cleaning and Transporting Your Product](#)

## Transporting Your Product

If you need to store your product or transport it some distance, prepare it for transportation as described here.

**Caution:** During transportation and storage, follow these guidelines:

- Avoid tilting the product, placing it vertically, or turning it upside down; otherwise ink may leak.

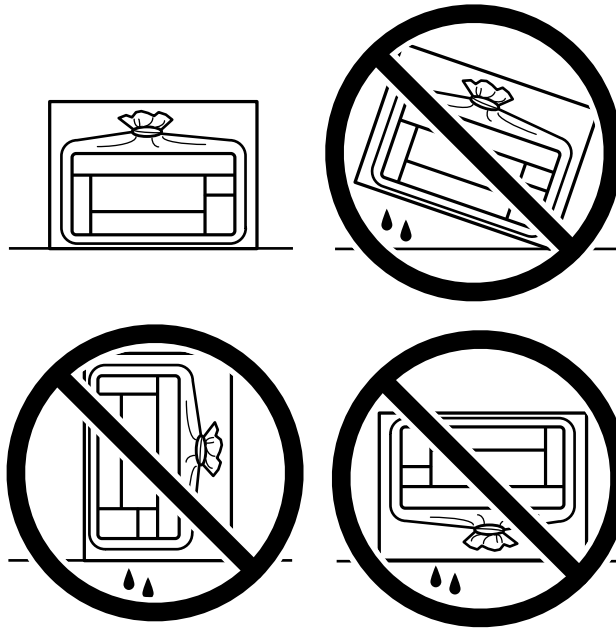

- When storing or transporting an ink bottle after it has been opened, do not tilt the bottle and do not subject it to impacts or temperature changes. Otherwise, ink may leak even if the cap on the ink bottle is tightened securely. Be sure to keep the ink bottle upright when tightening the cap, and take measures to prevent ink from leaking when transporting the ink bottles.
  - Do not put opened ink bottles in the box with the product.
  - Do not carry the product by its control panel; this may damage the product.
1. Turn off the product.
  2. Wait until the power light turns off and then unplug the power cable.

**Caution:** Wait until the power light is off before you unplug the power cable to allow the print head to return to the home position. If the print head does not return to the home position, the ink can dry out and your product can be damaged.

3. Disconnect any connected cables.
4. Remove all the paper from the product.
5. Close the document cover, if necessary.
6. Lift up the scanner unit with both hands until it locks.

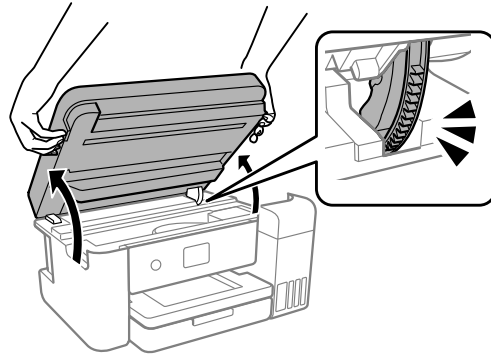

7. Secure the print head to the case with tape.

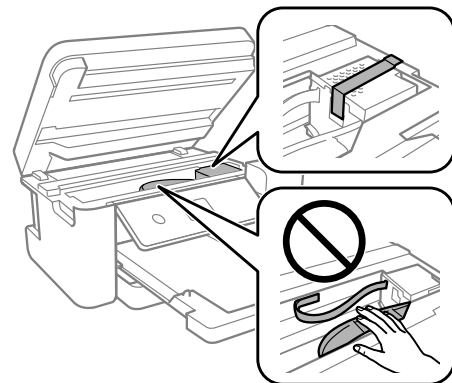



**Caution:** Do not place tape on the white flat cable inside the product; otherwise, you may damage your product.

8. Make sure the ink tank caps are securely closed and close the ink tank cover.

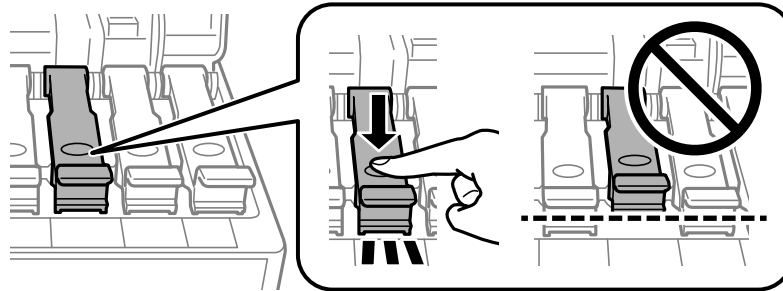

9. Lower the scanner unit using both hands.

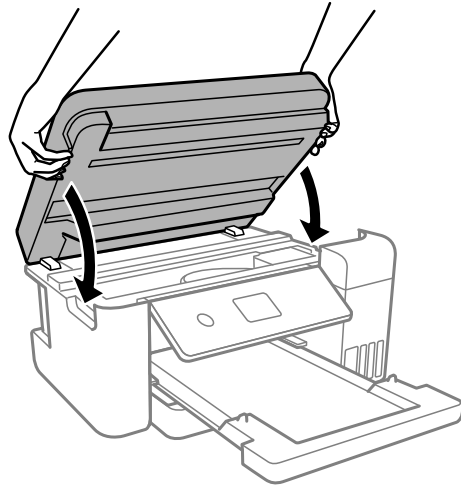

**Note:** The scanner unit is designed to close slowly and resist a little as a precaution against injuring your fingers. Continue to close the scanner unit even if you feel some resistance.

10. Slide in the output tray and close the front cover, then lower the control panel.

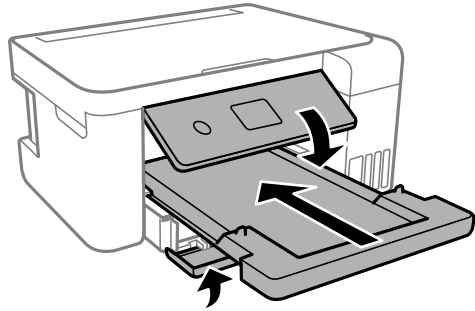

11. Place the product in its original packaging materials, if possible, or use equivalent cushioning around the product.

Be sure to remove the tape from the print head before turning on your product. If print quality has declined when you print again, clean and align the print head.

**Parent topic:** [Cleaning and Transporting Your Product](#)

**Related concepts**

[Print Head Cleaning](#)

[Print Head Alignment](#)

---

# Solving Problems

Check these sections for solutions to problems you may have using your product.

[Checking for Software Updates](#)

[Viewing the Help Screen](#)

[Product Status Messages](#)

[Message Appears Prompting You to Reset Ink Levels](#)

[Running a Product Check](#)

[Resetting Control Panel Defaults](#)

[Solving Setup Problems](#)

[Solving Network Problems](#)

[Solving Copying Problems](#)

[Solving Paper Problems](#)

[Solving Problems Printing from a Computer](#)

[Solving Page Layout and Content Problems](#)

[Solving Print Quality Problems](#)

[Solving Scanning Problems](#)



[Solving Scanned Image Quality Problems](#)

[Uninstall Your Product Software](#)

[Where to Get Help](#)

## Checking for Software Updates

It's a good idea to check Epson's support website occasionally for free updates to your product software. Visit [epson.com/support](http://epson.com/support) (U.S.) or [epson.ca/support](http://epson.ca/support) (Canada) and select your product.

- **Windows:** Your printer software automatically checks for updates. You can also manually update the software by selecting **Software Update** here:
  - Accessing the Windows Desktop and right-clicking the  icon for your product in the right side of the Windows taskbar, or clicking the up arrow and right-clicking .
  - On the **Maintenance** tab in the printer settings window

You can also update the software by selecting **EPSON Software Updater** in the **EPSON** or **Epson Software** program group, accessible by the **Start** button, or on the **Start** or **Apps** screens, depending on your version of Windows.

- **OS X:** You can manually update the software by opening the **Applications > Epson Software** folder and selecting **EPSON Software Updater**.
- **macOS 10.12.x, 10.13.x, 10.14.x, 10.15.x, or 11.x:** You can manually update the software by opening the **App Store**, selecting **Updates**, searching for a software update option for Epson Software, and selecting **Update**.

Parent topic: [Solving Problems](#)

## Viewing the Help Screen

You can view troubleshooting or how-to topics on the LCD screen at any time.

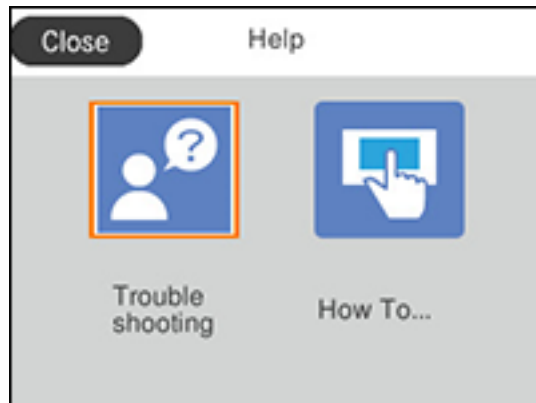

1. Press the  help button.



2. Select an option to view instructional images or animations.

Parent topic: [Solving Problems](#)

## Product Status Messages

You can often diagnose problems with your product by checking the messages on its LCD screen. You can also see help information and how-to instructions on the screen. Press the  home button, if necessary, then press the  help button.

LCD screen message	Condition/solution
Printer error. Turn on the printer again. See your documentation for more details.	Turn the product off and then back on again. If the error continues, check for a paper jam. If there is no paper jam, contact Epson for support.
Paper out in XX.	Load paper in the specified cassette.
Paper Setup Auto Display is set to Off. Some features may not be available. For details, see your documentation.	The <b>Paper Setup Auto Display</b> setting must be turned on to use AirPrint.
The printer's borderless printing ink pad is nearing the end of its service life. It is not a user-replaceable part. Please contact Epson support.	The ink pad is near the end of its service life and the message will be displayed until the ink pad is replaced. Contact Epson for support. (To resume printing, select <b>Dismiss</b> .)
The printer's borderless printing ink pad has reached the end of its service life. It is not a user-replaceable part. Please contact Epson support.	The ink pad is at the end of its service life. Turn off the product and contact Epson for support. You can still perform operations that do not use ink, such as scanning.
To use cloud services, update the root certificate from the Epson Web Config utility.	Access your product's built-in Web Config utility and update the root certificate for your product.
The combination of the IP address and the subnet mask is invalid. See your documentation for more details.	There is a problem with the network connection to your product. Check the solutions in this guide.

LCD screen message	Condition/solution
Check that the printer driver is installed on the computer and that the port settings for the printer are correct.	Click <b>Print Queue</b> on the printer driver's Maintenance tab. Make sure the printer port is selected correctly in Property > Port from the Printer menu as follows:  Select <b>USBXXX</b> for a USB connection or <b>EpsonNet Print Port</b> for a network connection.
Check that the printer driver is installed on the computer and that the USB port settings for the printer are correct.	
Recovery mode Update Firmware	An error has occurred during firmware updating. Connect your product using a USB cable and try updating the firmware again. If you still receive this error message, contact Epson for support.

**Note:** The ink pads in the printer collect, distribute, and contain the ink that is not used on printed pages. During the life of your product it may reach a condition where either satisfactory print quality cannot be maintained or the ink pads have reached the end of their usable life. The Epson Status Monitor, your LCD screen, or lights on the control panel will advise you when these parts need replacing. If this happens during the standard warranty of the product, the exchange of the product or replacement of the pads is covered under the standard warranty. If the product is out of warranty, the pads can be replaced by any Epson authorized service provider. The waste ink pads are not a user-replaceable part.

**Parent topic:** [Solving Problems](#)

**Related concepts**

[Uninstall Your Product Software](#)

[Maintenance Box Replacement](#)

**Related references**

[Where to Get Help](#)

[Paper Source Settings Options](#)

**Related tasks**

[Refilling the Ink Tanks](#)

[Checking for Software Updates](#)

[Using AirPrint](#)

**Related topics**[Wi-Fi or Wired Networking](#)[Solving Paper Problems](#)[Loading Paper](#)[Solving Network Problems](#)[Solving Problems Printing from a Computer](#)

## Message Appears Prompting You to Reset Ink Levels

If you see a message on the LCD screen prompting you to reset the ink levels, do the following:

1. Refill all of the ink tanks or the ink tanks indicated on the LCD screen all the way to the top.

**Note:** Depending on the operating conditions, you may see the ink reset message even when there is still ink in the tanks.

2. Select the colors that you refilled on the LCD screen.
3. Follow the instructions on the LCD screen to reset the ink levels.

**Note:** The product has a low ink alert system. The accuracy of this system depends on the user refilling the ink tanks correctly. The product cannot directly measure the ink levels in the tanks; instead it estimates the amount of ink remaining by internally monitoring ink usage. The low ink alert system may generate inaccurate messages if the ink tanks are not refilled according to these instructions.

As a precaution, perform regular visual inspections of the ink tanks to ensure ink levels do not fall below the lower line. Continued use of the product when the ink level is below the lower line on the tank could damage the product.

**Parent topic:** [Solving Problems](#)

**Related tasks**[Refilling the Ink Tanks](#)

## Running a Product Check

Running a product check helps you determine if your product is operating properly.

1. Disconnect any interface cables connected to your product.
2. Load plain paper in the product.
3. Press the  home button, if necessary.

4. Select **Maintenance > Print Head Nozzle Check**.
5. Select **Print**.  
The nozzle check pattern is printed.
6. Do one of the following, depending on the results of the product check:
  - If the page prints and the nozzle check pattern is complete, the product is operating properly. Any operation problem you may have could be caused by your computer, cable, software, or selected settings. Check other solutions or try uninstalling and reinstalling your printer software.
  - If the page prints but the nozzle check pattern has gaps, clean or align the print head.
  - If the page does not print, the product may have a problem. Check the other solutions in this manual. If they do not work, contact Epson.

**Parent topic:** [Solving Problems](#)

**Related concepts**

[Power Cleaning](#)

[Print Head Cleaning](#)

[Print Head Alignment](#)

[Uninstall Your Product Software](#)

**Related references**

[Where to Get Help](#)

**Related topics**

[Loading Paper](#)

## Resetting Control Panel Defaults

If you have a problem with settings on the product control panel, you can reset them to their factory defaults. You can choose which settings to reset or reset them all.

1. Press the  home button, if necessary.
2. Select **Settings > Restore Default Settings**.
3. Select one of these options:
  - **Network Settings:** Resets all network settings.
  - **Copy Settings:** Resets all copy settings.
  - **Scan Settings:** Resets all scan settings.
  - **Clear All Data and Settings:** Resets all control panel settings and any stored information.



You see a confirmation screen.

4. Select **Yes** to reset the selected settings. (Select **No** if you want to cancel the operation.)

**Parent topic:** [Solving Problems](#)

## Solving Setup Problems

Check these sections if you have problems while setting up your product.

[Product Does Not Turn On or Off](#)

[Noise After Filling the Ink](#)

[Software Installation Problems](#)

**Parent topic:** [Solving Problems](#)

### Product Does Not Turn On or Off

If you cannot turn the product on or off, try these solutions:

- If you cannot turn on your product, make sure the power cord is securely connected and hold down the power button a little longer.
- If you cannot turn off your product, hold down the power button a little longer. If you still cannot turn off your product, unplug the power cord, plug the power cord back in, then turn your product on and off again using the power button.

**Parent topic:** [Solving Setup Problems](#)

### Noise After Filling the Ink

If you hear noises from your product after filling the ink tanks with ink, check these explanations:

- The first time you fill the tanks with ink, the product must charge its print head. Wait until charging finishes before you turn off the product, or it may charge improperly and use excess ink the next time you turn it on. Your product is finished charging the print head when the  power light stops flashing.
- If the product's print head stops moving or making noise, and the charging process has not finished after approximately 20 minutes, turn off your product. Turn it back on and check to see if charging is still in progress. If it is still in progress, contact Epson for help.

**Parent topic:** [Solving Setup Problems](#)

#### Related references

[Where to Get Help](#)

## Software Installation Problems

If you have problems while installing your product software, try these solutions:

- Make sure your product is turned on and any necessary cables are securely connected at both ends. If you still have problems installing software, disconnect the cable and carefully follow the instructions on the *Start Here* sheet. Also make sure your system meets the requirements for your operating system.
- Close any other programs, including screen savers and virus protection software, and install your product software again.
- In Windows, make sure your product is selected as the default printer and the correct port is shown in the printer properties.
- If you see any error message or your software does not install correctly in Windows, you may not have software installation privileges. Contact your system administrator.
- If you are printing over a network, make sure your product is set up properly on the network.
- If the USB cable is not recognized, try using a different USB cable.

**Parent topic:** [Solving Setup Problems](#)

### Related concepts

[Uninstall Your Product Software](#)

### Related references

[Windows System Requirements](#)

[Mac System Requirements](#)

## Solving Network Problems

Check these solutions if you have problems setting up or using your product on a network.

**Note:** Breakdown or repair of this product may cause loss of network data and settings. Epson is not responsible for backing up or recovering data and settings during or after the warranty period. We recommend that you make your own backup or print out your network data and settings.

[Product Cannot Connect to a Wireless Router or Access Point](#)

[Network Software Cannot Find Product on a Network](#)

[Product Does Not Appear in Mac Printer Window](#)

[Wireless Network Connection is Unstable on a Mac](#)

[Wired Network Connection Becomes Unstable](#)

[Cannot Print Over a Network](#)

## Product Cannot Connect to a Wireless Router or Access Point

If your product has trouble finding or connecting to a wireless router or access point, try these solutions:

- If you are connecting the product via Wi-Fi Protected Setup (WPS) and the Wi-Fi icon on your product's LCD screen is not lit or does not appear, make sure you select one of the WPS options from the product control panel within 2 minutes of pressing the WPS button on your router.
- Make sure to place your product within contact range of your 2.4 GHz router or access point. Avoid placing your product near a microwave oven, 2.4 GHz cordless phone, or large metal object, such as a filing cabinet.

**Note:** If you are using a 5 GHz wireless router, set the router to operate in dual band (2.4 GHz and 5 GHz) mode. If your router uses a single network name (SSID) for both the 2.4 GHz and 5 GHz band, give each band its own network name (SSID) instead, such as Home Network 2.4 GHz and Home Network 5 GHz. See your router documentation or contact your internet service provider for instructions.

- Verify that your router or access point is operating correctly by connecting to it from your computer or another device.
- Print a network connection report and check the codes and messages on the report to help determine the cause of the problem.
- You may need to disable the firewall and any anti-virus software on your wireless router or access point.
- Try restarting your router following the instructions in your router documentation.

**Note:** If you are reading these instructions online, you will lose your Internet connection when you restart your router.

- Check to see if access restrictions, such as MAC address filtering, are set on the router or access point. If access restrictions are set, add your product's MAC address to your router's address list. To obtain your product's MAC address, print a network status sheet. Then follow the instructions in your router or access point documentation to add the address to the list.
- If your router or access point does not broadcast its network name (SSID), follow the instructions that came with your product to enter your wireless network name manually.

- If your router or access point has security enabled, determine the kind of security it is using and any required password or passphrase for connection. Then make sure to enter the exact WEP key or WPA passphrase correctly.
- Check if your computer is restricting the available wireless channels. If so, verify that your wireless access point is using one of the usable channels and change to a usable channel, if necessary.
- Turn off the devices you want to connect to the network. Wait for about 10 seconds and then turn on the devices in the following order: wireless router, computer or smart device, and then your product. Move your product and computer or smart device closer to the wireless router to help with radio wave communication, and then try to make network settings again.
- If the IP address assigned to the product is 169.254.XXX.XXX and the subnet mask is 255.255.0.0, the IP address may not be assigned correctly. Check the IP address and the subnet mask assigned to the product. Restart the wireless router or reset the network settings for the product.
- If you are using a Wi-Fi Direct connection that suddenly disconnects, the Wi-Fi direct password on your device may have been changed. If necessary, delete the existing **DIRECT-xxxxxxx** connection settings from your device and enter a new password. See your device documentation for instructions.

**Parent topic:** [Solving Network Problems](#)

**Related concepts**

[Wi-Fi Direct Mode Setup](#)

**Related tasks**

[Printing a Network Status Sheet](#)

[Printing a Network Connection Report](#)

[Selecting Wireless Network Settings from the Control Panel](#)

**Related topics**

[Wi-Fi or Wired Networking](#)

## **Network Software Cannot Find Product on a Network**

If EpsonNet Setup cannot find your product on a network, try these solutions:

- Make sure your product is turned on and connected to your network. Verify the connection using your product control panel.
- Check if your network name (SSID) contains non-ASCII characters. Your product cannot display non-ASCII characters.
- Print a network connection report and check the codes and messages on the report to help determine the cause of the problem.

- Make sure your product is not connected to a guest network.
- If necessary, reinstall your product software and try running EpsonNet Setup again:
  1. Reset your product's network settings to their factory defaults.
  2. **Windows only:** Uninstall your product software.
  3. Restart your router following the instructions in your router documentation.

**Note:** If you are reading these instructions online, you will lose your Internet connection when you restart your router, so note the next step before restarting it.

4. Download your product software from the Epson website using the instructions on the *Start Here* sheet.
- If you have replaced your router, reinstall your product software to connect to the new router.

**Note:** If you are using a 5 GHz wireless router, set the router to operate in dual band (2.4 GHz and 5 GHz) mode. If your router uses a single network name (SSID) for both the 2.4 GHz and 5 GHz band, give each band its own network name (SSID) instead, such as Home Network 2.4 GHz and Home Network 5 GHz. See your router documentation or contact your internet service provider for instructions.

- Check to see if your wireless router or access point has an enabled Privacy Separator function that is preventing detection of your device over the network. See your router or access point documentation for instructions on disabling the Privacy Separator function.
- Try accessing any website from your computer to make sure that your computer's network settings are correct. If you cannot access any website, there is a problem on the computer. Check the network connection of the computer. See the documentation provided with the computer for details.

**Parent topic:** [Solving Network Problems](#)

**Related concepts**

[Uninstall Your Product Software](#)

**Related tasks**

[Printing a Network Connection Report](#)

**Related topics**

[Wi-Fi or Wired Networking](#)

## Product Does Not Appear in Mac Printer Window

If your product does not appear in the Mac printer window, try these solutions:

- Turn your product off, wait 30 seconds, then turn it back on again.
- If you are connecting the product via Wi-Fi Protected Setup (WPS) and the Wi-Fi icon on your product's LCD screen is not lit, make sure you select one of the WPS options from the product control panel within 2 minutes of pressing the WPS button on your router.
- If you are connecting the product wirelessly via EpsonNet Setup and the Wi-Fi icon does not appear lit on your LCD screen, make sure your product software was installed correctly. If necessary, reinstall your software.

**Note:** If you are using a 5 GHz wireless router, set the router to operate in dual band (2.4 GHz and 5 GHz) mode. If your router uses a single network name (SSID) for both the 2.4 GHz and 5 GHz band, give each band its own network name (SSID) instead, such as Home Network 2.4 GHz and Home Network 5 GHz. See your router documentation or contact your internet service provider for instructions.

**Parent topic:** [Solving Network Problems](#)

### Related concepts

[Uninstall Your Product Software](#)

## Wireless Network Connection is Unstable on a Mac

If you connected a device to a USB 3.0 port on your Mac, you may experience wireless network interference between your product and your Mac.

If you cannot connect to your product over the wireless network or the connection becomes unstable, move the device connected to your Mac USB 3.0 port further away from your Mac.

**Parent topic:** [Solving Network Problems](#)

## Wired Network Connection Becomes Unstable

When you connect the product to a wired network using a router or access point that supports IEEE 802.3az (Energy Efficient Ethernet), the connection may become unstable, you may be unable to connect to the product, and the communication speed may become slow. If you experience any of these issues, follow the steps below to disable IEEE 802.3az and then connect your product again.

1. Disconnect the Ethernet cables connected to the computer and your product.
2. Disable IEEE 802.3az for the computer's network adapter if it is enabled (check your operating system's Ethernet connection settings).

3. Connect the computer and your product directly with an Ethernet cable.
4. Print a network connection report from your product.
5. On the computer, open a web browser and enter your product's IP address from the network connection report.
6. Select **Advanced Settings > Network Settings > Wired LAN**.
7. Select **OFF** for IEEE 802.3az. and click **Next**.
8. Click **OK** and remove the Ethernet cable connecting the computer and your product.
9. If you disabled IEEE 802.3az for your computer's network adapter, enable it.
10. Reconnect the Ethernet cables from the router or access point to your computer and product.  
If problems still occur, other devices on the network may be causing them.

**Parent topic:** [Solving Network Problems](#)

**Related tasks**

[Printing a Network Connection Report](#)

## Cannot Print Over a Network

If you cannot print over a network, try these solutions:

- Make sure that your product is turned on.
- Make sure you install your product's network software as described in your product documentation.
- Make sure that the latest version of your product's Epson printer driver is installed. If a genuine Epson printer driver is not installed, the available functions are limited.
- Print a network status sheet and verify that the network settings are correct. If the network status is **Disconnected**, check any cable connections and turn your product off and then on again.
- Print a network connection report and check the codes and messages on the report to help determine the cause of the problem.
- If you are using TCP/IP, make sure the product's IP address is set correctly for your network. If your network does not assign IP addresses using DHCP, set the IP address manually.
- Make sure your computer and product are both using the same wireless network.
- If network printing is slow, print a network status sheet and check the signal strength. If it is poor, place your product closer to your router or access point. Avoid placing your product near a microwave oven, cordless phone, or large metal object, such as a filing cabinet.

**Note:** If you are using a 5 GHz wireless router, set the router to operate in dual band (2.4 GHz and 5 GHz) mode. If your router uses a single network name (SSID) for both the 2.4 GHz and 5 GHz band, give each band its own network name (SSID) instead, such as Home Network 2.4 GHz and Home Network 5 GHz. See your router documentation or contact your internet service provider for instructions.

- Try restarting your router following the instructions in your router documentation.

**Note:** If you are reading these instructions online, you will lose your Internet connection when you restart your router.

- Check to see if your wireless router or access point has an enabled Privacy Separator function that is preventing printing from a device over the network. See your router or access point documentation for instructions on disabling the Privacy Separator function.
- If you are connecting the product wirelessly via EpsonNet Setup and the Wi-Fi connection icon is not lit or does not appear on the product's LCD screen, make sure your product software was installed correctly. If necessary, reinstall your software.
- Check your product's connection status by opening the EPSON Status Monitor 3 (Windows) or EPSON Status Monitor (Mac) on your computer. If the remaining ink levels are displayed, a connection has been successfully established between your computer and your product.
- If you are printing a large data size image, the computer may run out of memory. Print the image at a lower resolution or a smaller size.

**Parent topic:** [Solving Network Problems](#)

**Related concepts**

[Uninstall Your Product Software](#)

**Related references**

[Cannot Scan Over a Network](#)

**Related tasks**

[Printing a Network Status Sheet](#)

[Printing a Network Connection Report](#)

**Related topics**

[Wi-Fi or Wired Networking](#)



## Cannot Scan Over a Network

If you have problems scanning over a network, try these solutions:

- If you cannot scan from your product control panel, make sure you restarted your computer after installing the product software. Make sure the Event Manager program is not being blocked by your firewall or security software.

**Note:** If you are using a 5 GHz wireless router, set the router to operate in dual band (2.4 GHz and 5 GHz) mode. If your router uses a single network name (SSID) for both the 2.4 GHz and 5 GHz band, give each band its own network name (SSID) instead, such as Home Network 2.4 GHz and Home Network 5 GHz. See your router documentation or contact your internet service provider for instructions.

- If you are scanning a large original at a high resolution, a network communication error may occur. Try scanning again at a lower resolution.
- If network communication was interrupted while starting Epson Scan 2, exit Epson Scan 2, wait a few seconds, and restart it. If Epson Scan 2 cannot restart, turn off your product, turn it back on, and try restarting Epson Scan 2 again.
- Check the scanner setting and reset the connection if necessary using Epson Scan 2 Utility:

**Windows 10:** Click  and select **EPSON > Epson Scan 2 Utility**. Make sure your product is selected. If necessary, select the **Other** tab and click **Reset**.

**Windows 8.x:** Navigate to the **Apps** screen, select **EPSON**, and select **Epson Scan 2 Utility**. Make sure your product is selected. If necessary, select the **Other** tab and click **Reset**.

**Windows (other versions):** Click  or **Start > All Programs** or **Programs > EPSON > Epson Scan 2 > Epson Scan 2 Utility**. Make sure your product is selected. If necessary, select the **Other** tab and click **Reset**.

**Mac:** Open the **Applications** folder, click **Epson Software**, and click **Epson Scan 2 Utility**. Make sure your product is selected. If necessary, select the **Other** tab and click **Reset**.

- You may need to disable the firewall and any anti-virus software on your wireless router or access point.

**Parent topic:** [Solving Network Problems](#)

### Related concepts

[Scan Resolution Guidelines](#)

### Related tasks

[Starting a Scan Using Epson ScanSmart](#)

[Starting a Scan from a Scanning Program](#)  
[Starting a Scan from a Smartphone or Tablet](#)  
[Starting a Scan Using the Epson Scan 2 Icon](#)  
[Starting a Scan Using the Product Control Panel](#)

## **Solving Copying Problems**

Check these solutions if you have problems copying with your product.

[Product Makes Noise, But Nothing Copies](#)  
[Product Makes Noise When It Sits for a While](#)  
[Copies Have Incorrect or Faint Colors](#)  
[Position, Size, or Margins of Copies are Incorrect](#)

**Parent topic:** [Solving Problems](#)

### **Product Makes Noise, But Nothing Copies**

If your product makes a noise, but nothing copies, try these solutions:

- Run a nozzle check to see if any of the print head nozzles are clogged. Then clean the print head, if necessary.
- If the nozzle check page does not print, but the product's power is on, make sure your product software is installed correctly.
- Make sure your product is level (not tilted).

**Parent topic:** [Solving Copying Problems](#)

#### **Related concepts**

[Print Head Cleaning](#)  
[Print Head Nozzle Check](#)

### **Product Makes Noise When It Sits for a While**

Your product is performing routine maintenance. This is normal.

**Parent topic:** [Solving Copying Problems](#)

## Copies Have Incorrect or Faint Colors

If your copies have incorrect, uneven, smeared, or faint colors, try these solutions:

- Run a print head nozzle check to see if any of the nozzles are clogged. Then clean the print head, if necessary.
- Do not press too hard on the original when you copy from the scanner glass.
- Clean the scanner glass with a soft, dry, lint-free cloth or use a small amount of glass cleaner on the cloth, if necessary. Paper towels are not recommended.

**Caution:** Do not spray glass cleaner directly on the scanner glass.

- If the colors are smeared, try lowering the copy density setting on the LCD screen.
- Make sure your paper is not curled.
- When vertical banding appears or the paper is smeared, clean the paper path.
- When horizontal banding appears or the top or bottom of the paper is smeared, load paper in the correct direction and slide the edge guides to the edges of the paper.

**Parent topic:** [Solving Copying Problems](#)

## Position, Size, or Margins of Copies are Incorrect

If the position, size, or margins of your copies are incorrect, try these solutions:

- When placing originals on the scanner glass, make sure the original is placed correctly for scanning. Align the corner of the original with the corner indicated by the symbol on the scanner glass. If necessary, move the original away from the edges of the scanner glass slightly.
- Clean the scanner glass.
- Make sure the paper is loaded in the correct direction.
- Select the appropriate **Original Size** in the copy settings on the LCD screen.

**Parent topic:** [Solving Copying Problems](#)

## Solving Paper Problems

Check these sections if you have problems using paper with your product.

[Paper Feeding Problems](#)

[Paper Jams Inside the Product](#)

[Paper Ejection Problems](#)

**Parent topic:** [Solving Problems](#)

## **Paper Feeding Problems**

If you have problems feeding paper, try these solutions:

- Make sure the paper cassette is inserted all the way in the printer.
- Make sure the paper size and type settings match the size and type of paper you loaded.
- If paper does not feed correctly, remove and reload it in the cassette and adjust the edge guides. Make sure the paper stack is not above the tab on the edge guides inside the cassette.
- If multiple pages feed at once, remove the paper, fan the edges to separate the sheets, and reload it.
- Do not load more than the recommended number of sheets.
- Make sure your paper meets the specifications for your product.
- If paper jams when you print on both sides of the paper, try loading fewer sheets.
- For best results, follow these guidelines:
  - Use new, smooth, high-quality paper that is not curled, creased, old, too thin, or too thick.
  - Load paper in the cassette printable side down.
  - Follow any special loading instructions that came with the paper.

**Note:** Your product will not operate properly while tilted at an angle. Place it on a flat, stable surface that extends beyond the base of the product in all directions.

- Clean the paper rollers.
- Operate your product in the recommended environmental conditions.

**Parent topic:** [Solving Paper Problems](#)

### **Related references**

[Paper Jams Inside the Product](#)

[Paper Loading Capacity](#)

[Paper Specifications](#)

### **Related tasks**

[Cleaning the Paper Guide](#)

## Paper Jams Inside the Product

If you see a message that paper has jammed in the product, follow the on-screen instructions to locate and remove the jammed paper.

Take the following precautions when removing jammed paper from the product:

- Remove the jammed paper carefully. Using too much force may damage the product.
- Unless specifically instructed, avoid tilting the product, placing it on its side, or turning it upside down, as ink may spill.

**Warning:** Never touch the buttons on the control panel while your hand is inside the product. If the product starts operating, it may cause an injury. Do not touch any protruding parts inside the product.

**Parent topic:** [Solving Paper Problems](#)

### Related references

[Paper Specifications](#)

### Related tasks

[Cancelling Printing Using the Product](#)

### Related topics

[Loading Paper](#)

## Paper Ejection Problems

If you have problems with paper ejecting properly, try these solutions:

- If paper does not eject fully, you may have set the wrong paper size. Cancel printing to eject the paper. Select the correct paper size when you reprint.
- If paper is wrinkled when it ejects, it may be damp or too thin. Load new paper and be sure to select the correct paper type setting when you reprint.
- If you are using letterhead paper, select the appropriate paper type setting.

**Parent topic:** [Solving Paper Problems](#)

### Related references

[Paper Jams Inside the Product](#)

[Paper Specifications](#)

[Paper or Media Type Settings - Printing Software](#)

**Related tasks**

[Cancelling Printing Using the Product](#)

**Related topics**

[Loading Paper](#)

## Solving Problems Printing from a Computer

Check these sections if you have problems while printing from your computer.

**Note:** When printing using AirPrint, the available print settings are different from those covered in this manual. See the Apple website for details.

[Nothing Prints](#)

[Product Icon Does Not Appear in Windows Taskbar](#)



[Printing is Slow](#)

**Parent topic:** [Solving Problems](#)

### Nothing Prints

If you have sent a print job and nothing prints, try these solutions:

- Make sure your product is turned on and connected to your computer.
- Make sure any interface cables are connected securely at both ends.
- If you connected your product to a USB hub, make sure it is a first-tier hub. If it still does not print, connect your product directly to your computer instead of the hub.
- Make sure the printer status is not offline or pending.
- Make sure you are using the Epson printer driver for your product or the available functions are limited.
- Run a product check to see if a test page prints. If the test page prints, check to see if your product software is installed correctly.
- Make sure your system meets the requirements for your operating system. If you are printing a high-resolution image, you may need more than the minimum requirements. Print the image at a lower resolution or if necessary, increase your system's memory.
- In Windows, make sure your product is selected as the default printer and the printer port setting matches the printer connection port.

- In Windows, delete all jobs from the Windows Spooler. Click **Print Queue** on the Maintenance tab in the printer settings window, and cancel any stalled print jobs.
- In Windows, do one of the following to open the Epson Printer Connection Checker and follow the on-screen instructions to check the connection status:
  - **Windows 10:** Click  and select **Epson Software > Epson Printer Connection Checker**.
  - **Windows 8.x:** Navigate to the **Apps** screen and select the **Epson Printer Connection Checker** icon.
  - **Windows 7:** Click  and select **All Programs > Epson Software > Epson Printer Connection Checker**.
- On a Mac, make sure the printer is added to the printer list and the printer is not paused.

**Parent topic:** [Solving Problems Printing from a Computer](#)

#### **Related references**

[Product Status Messages](#)





#### **Related tasks**

[Running a Product Check](#)

## **Product Icon Does Not Appear in Windows Taskbar**

If you do not see your product icon in the Windows taskbar, first try restarting your computer. If that does not work, try this solution:

1. Do one of the following:

- **Windows 10:** Click  and select  (Settings) > **Devices > Printers & scanners**. Select your product name and select **Manage > Printing preferences**.
- **Windows 8.x:** Navigate to the **Apps** screen and select **Control Panel > Hardware and Sound > Devices and Printers**. Right-click your product name, select **Printing Preferences**, and select your product name again if necessary.
- **Windows 7:** Click  and select **Devices and Printers**. Right-click your product name, select **Printing Preferences**, and select your product name again if necessary.
- **Windows Vista:** Click , select **Control Panel**, and click **Printer** under **Hardware and Sound**. Right-click your product name, select **Printing Preferences**, and select your product name again if necessary.

2. Click the **Maintenance** tab.

3. Click the **Extended Settings** button.
4. Select **Enable EPSON Status Monitor 3** and click **OK**.
5. Click the **Monitoring Preferences** button.
6. Click the checkbox for the option that adds the shortcut icon to the taskbar.
7. Click **OK** to close the open program windows.

**Parent topic:** [Solving Problems Printing from a Computer](#)

## Printing is Slow

If printing becomes slow, try these solutions:

- Make sure your system meets the requirements for your operating system. If you are printing a high-resolution image, you may need more than the minimum requirements. If necessary, increase your system's memory.
- If you are using Windows 7, close the **Devices and Printers** window before you print.
- On a Mac, make sure you download and install the Epson printer driver.
- Make sure **Quiet Mode** is turned off.
- Clear space on your hard drive or run a defragmentation utility to free up existing space.
- Close any programs you are not using when you print.
- If your product is connected to a USB hub, connect it directly to your computer instead.
- If printing becomes slower after printing continuously for a long time, the product may have automatically slowed down to protect the print mechanism from overheating or becoming damaged. Let the product rest with the power on for 30 minutes, then try printing again.
- If you are printing over a wireless network, factors such as interference, network traffic, or weak signal strength may affect your printing speed.

**Note:** If you are using a 5 GHz wireless router, set the router to operate in dual band (2.4 GHz and 5 GHz) mode. If your router uses a single network name (SSID) for both the 2.4 GHz and 5 GHz band, give each band its own network name (SSID) instead, such as Home Network 2.4 GHz and Home Network 5 GHz. See your router documentation or contact your internet service provider for instructions.

For the fastest printing, select the following settings in your product software:

- Turn on any high speed settings in your product software.



- Select a lower print quality setting.
- **Windows:** Click the **Maintenance** or **Utility** tab, select **Extended Settings** or **Speed and Progress**, and select the following settings:
  - **Always Spool RAW Datatype**
  - **Page Rendering Mode**
  - **Print as Bitmap**
- **Windows:** Select **Printing preferences**, click the **More Options** tab, and make sure the **Bidirectional printing** setting is enabled.
- **Mac:** Select **System Preferences**, select **Printers & Scanners**, and select your product. Select **Options & Supplies**, select **Options** (or **Driver**), and enable the **Bidirectional printing** setting.

If printing is still slow and you are using Windows 7 or Windows Vista, try the following:

1. Click  and select **Computer** or **My Computer**. Double-click the **C:** drive and open these folders: **ProgramData > EPSON > PRINTER**.

**Note:** If you do not see the ProgramData folder, open the **Organize** menu and select **Folder and search options**. In the window that appears, click the **View** tab, select **Show hidden files, folders, and drives** in the Advanced settings list, and click **OK**.

2. Right-click the **EPAUDF01.AUD** file and select **Delete**.
3. Restart your computer and try printing again.

**Parent topic:** [Solving Problems Printing from a Computer](#)

#### **Related references**

[Paper or Media Type Settings - Printing Software](#)

[Windows System Requirements](#)

[Mac System Requirements](#)

#### **Related tasks**

[Selecting Basic Print Settings - Windows](#)

[Selecting Extended Settings - Windows](#)

[Selecting Basic Print Settings - Mac](#)

[Selecting Printing Preferences - Mac](#)

## Solving Page Layout and Content Problems

Check these sections if you have problems with the layout or content of your printed pages.

**Note:** When printing using AirPrint, the available print settings are different from those covered in this manual. See the Apple website for details.

[Inverted Image](#)

[Too Many Copies Print](#)

[Blank Pages Print](#)

[Incorrect Margins on Printout](#)

[Border Appears on Borderless Prints](#)

[Incorrect Characters Print](#)

[Incorrect Image Size or Position](#)

[Slanted Printout](#)

**Parent topic:** [Solving Problems](#)

### Inverted Image

If your printed image is inverted unexpectedly, try these solutions:

- Turn off any mirror or inversion settings in your printing application.
- Turn off the **Mirror Image**, **Flip horizontally**, or **Reverse page orientation** settings in your printer software. (This option has different names, depending on your operating system version.)

**Parent topic:** [Solving Page Layout and Content Problems](#)

#### Related tasks

[Selecting Basic Print Settings - Mac](#)

[Selecting Additional Layout and Print Options - Windows](#)

[Selecting Print Layout Options - Mac](#)

### Too Many Copies Print

Make sure that the **Copies** setting in your printing program or printer software is not set for multiple copies.

**Parent topic:** [Solving Page Layout and Content Problems](#)

#### Related tasks

[Selecting Basic Print Settings - Mac](#)

## Blank Pages Print

If blank pages print unexpectedly, try these solutions:

- Make sure you selected the correct paper size settings in your printing program and printer software.
- If a blank page exists in a document you are printing and you want to skip printing it, select the **Skip Blank Page** setting in your printer software, if available.
- Run a print head nozzle check to see if any of the nozzles are clogged. Then clean the print head, if necessary.
- Make sure your product is selected as the printer in your printing program.
- You may need to refill the ink. Visually check the ink levels.

**Parent topic:** [Solving Page Layout and Content Problems](#)

### Related concepts

[Power Cleaning](#)

[Print Head Cleaning](#)

[Print Head Nozzle Check](#)

[Checking the Ink and Maintenance Box Levels](#)

### Related tasks

[Printing Your Document or Photo - Windows](#)

[Selecting Basic Print Settings - Mac](#)

[Selecting Basic Print Settings - Windows](#)

[Selecting Printing Preferences - Mac](#)

[Selecting Extended Settings - Windows](#)

[Printing Your Document or Photo - Mac](#)

### Related topics

[Loading Paper](#)

## Incorrect Margins on Printout

If your printed page has incorrect margins, try these solutions:

- Make sure you selected the correct paper size settings in your printing program and printer software.
- Make sure you selected the correct margins for your paper size in your printing program.

- Make sure your paper is positioned correctly for feeding into the product.
- Load paper in the correct direction and slide the edge guides against the edges of the paper.

You can use the preview option in your printer software to check your margins before you print.

**Parent topic:** [Solving Page Layout and Content Problems](#)

#### **Related tasks**

[Placing Originals on the Scanner Glass](#)

[Selecting Basic Print Settings - Mac](#)

[Selecting Basic Print Settings - Windows](#)

[Selecting Page Setup Settings - Mac](#)

#### **Related topics**

[Loading Paper](#)

## **Border Appears on Borderless Prints**

If you see a border on borderless prints, try these solutions:

- Make sure you are printing on a compatible borderless paper type and size.
- **Windows:** Make sure you selected the **Borderless** setting in your printer software.
- **Mac:** Make sure you selected the **Borderless** checkbox or a paper size with a **Borderless** option in your printer software.
- Adjust the **Expansion** setting to adjust the amount of image expansion on the edges of borderless prints.
- Make sure the image size and the paper size are set correctly; if the image is small, the enlargement may not be enough to cover the paper.

**Parent topic:** [Solving Page Layout and Content Problems](#)

#### **Related references**

[Borderless Paper Type Compatibility](#)

#### **Related tasks**

[Selecting Basic Print Settings - Windows](#)

[Selecting Basic Print Settings - Mac](#)

[Selecting Extended Settings - Windows](#)

[Selecting Page Setup Settings - Mac](#)

[Selecting Print Layout Options - Mac](#)

## **Incorrect Characters Print**

If incorrect characters appear in your prints, try these solutions before reprinting:

- Make sure any cables are securely connected at both ends.
- In Windows, delete all jobs from the Windows Spooler. Click **Print Queue** on the Maintenance tab in the printer settings window, and cancel any stalled print jobs.
- If your product is connected to a USB hub, connect it directly to your computer instead.
- If incorrect characters still appear in your prints, try connecting your product using a different cable.
- If your computer entered sleep mode the last time you printed, the next print job after your computer exits sleep mode may contain garbled characters. Print your document again.
- Make sure you are using the printer software for this product. Check the product name at the top of the driver window.

**Parent topic:** [Solving Page Layout and Content Problems](#)

### **Related tasks**

[Selecting Basic Print Settings - Mac](#)

[Selecting Basic Print Settings - Windows](#)

[Selecting Page Setup Settings - Mac](#)

## **Incorrect Image Size or Position**

If your printed image is the wrong size or in the wrong position, try these solutions:

- Make sure you selected the correct paper size and layout settings in your printing program and printer software.
- Make sure you selected the correct paper size on the control panel.
- Make sure your paper is positioned correctly for feeding into the printer.
- Clean the scanner glass and document cover.
- If the edges of a copy are cropped, slightly move the original away from the edges of the scanner glass.
- Make sure you selected the correct margins for your paper size in your printing program.
- Be sure to select the appropriate original size setting for your original in the copy settings.

- If the image is slightly enlarged and cropped during borderless printing, change the **Expansion** setting.

You can use the preview option in your printer software to check your margins before you print.

**Parent topic:** [Solving Page Layout and Content Problems](#)

**Related tasks**

[Placing Originals on the Scanner Glass](#)

[Cleaning Your Product](#)

[Selecting Basic Print Settings - Mac](#)

[Selecting Basic Print Settings - Windows](#)

[Selecting Page Setup Settings - Mac](#)

**Related topics**

[Loading Paper](#)

## Slanted Printout

If your printouts are slanted, try these solutions:

- Make sure the paper is loaded in the correct direction.
- Make sure your paper meets the specifications for your product.
- Do not load more than the recommended number of sheets.
- Slide the edge guides against the edges of the paper.
- Make sure the paper type setting matches the type of paper you loaded.
- Select a higher print quality setting in your printer software.
- Turn off any high speed settings in your product software.
- Align the print head.
- Make sure the product is not printing while tilted or at an angle.

**Parent topic:** [Solving Page Layout and Content Problems](#)

**Related tasks**

[Selecting Basic Print Settings - Mac](#)

[Selecting Basic Print Settings - Windows](#)

[Aligning the Print Head Using the Product Control Panel](#)

## Related topics

[Loading Paper](#)

# Solving Print Quality Problems

Check these sections if your printouts have problems with print quality, but your image looks fine on your computer screen.

**Note:** When printing using AirPrint, the available print settings are different from those covered in this manual. See the Apple website for details.

[White or Dark Lines in Printout](#)

[Blurry or Smearred Printout](#)

[Faint Printout or Printout Has Gaps](#)

[Grainy Printout](#)

[Incorrect Colors](#)

**Parent topic:** [Solving Problems](#)

## Related topics

[Solving Scanned Image Quality Problems](#)

## White or Dark Lines in Printout

If you notice white or dark lines in your prints (also called banding), try these solutions before you reprint:

- Run a nozzle check to see if any of the print head nozzles are clogged. Then clean the print head, if necessary.
- Make sure the paper type setting matches the type of paper you loaded.
- Make sure you loaded the printable side of the paper correctly for your product.
- Turn off any high speed settings in your product software.
- Align the print head.
- Adjust the print quality in the product software.
- When horizontal banding appears or the top or bottom of the paper is smeared, load paper in the correct direction and slide the edge guides to the edges of the paper.
- When vertical banding appears or the paper is smeared, clean the paper path.
- You may need to refill the ink. Visually check the ink levels.

- If you have not used the product for a long time, run the Power Cleaning utility.

**Note:** Power Cleaning consumes a lot of ink, so run this utility only if you cannot improve print quality by cleaning the print head.

**Parent topic:** [Solving Print Quality Problems](#)

**Related concepts**

[Print Head Cleaning](#)

[Print Head Alignment](#)

[Print Head Nozzle Check](#)

[Power Cleaning](#)

[Checking the Ink and Maintenance Box Levels](#)

**Related references**

[Paper or Media Type Settings - Control Panel](#)

[Paper or Media Type Settings - Printing Software](#)

**Related tasks**

[Refilling the Ink Tanks](#)

[Selecting Basic Print Settings - Mac](#)

[Selecting Basic Print Settings - Windows](#)

[Selecting Additional Layout and Print Options - Windows](#)

[Selecting Printing Preferences - Mac](#)

[Aligning the Print Head Using the Product Control Panel](#)

**Related topics**

[Loading Paper](#)

## **Blurry or Smearred Printout**

If your printouts are blurry or smearred, try these solutions:

- Make sure your paper is not damp, curled, old, or loaded incorrectly in your product.
- Slide the edge guides to the edges of the paper.
- Use a support sheet with special paper, or load special paper one sheet at a time.
- Make sure your paper meets the specifications for your product.
- Use Epson papers to ensure proper saturation and absorption of genuine Epson inks.



- Make sure the paper type setting in your product software matches the type of paper you loaded.
- Make sure you loaded the printable side of the paper correctly for your product.
- If you are printing on thick paper or envelopes, make sure you select the appropriate settings. In Windows, you can also try selecting **Short Grain Paper** in Extended Settings.
- Remove each sheet from the output tray as it is printed.
- Avoid handling printouts on glossy paper right after printing to allow the ink to set.
- Turn off any high speed settings in your product software.
- When vertical banding appears or the paper is smeared, clean the paper path.
- When horizontal banding appears or the top or bottom of the paper is smeared, load paper in the correct direction and slide the edge guides to the edges of the paper.
- If you printed on the wrong side of photo paper, clean the paper path.
- If you print on both sides of a sheet of paper, smudges may appear on the reverse side of heavily saturated or dark images. If one side of a sheet will contain a lighter image or text, print that side first. Make sure the ink has dried before reloading the paper to print on the other side. Adjust the density and/or ink drying time settings.
- Lower the copy density setting on the product control panel.
- The ink levels may be low and you may need to refill the ink. Visually check the ink levels.
- Run a nozzle check to see if any of the print head nozzles are clogged. Then clean the print head, if necessary.
- Align the print head.
- Adjust the print quality in the product software.
- Clean the paper path.
- If you printed when the ink levels were too low to be seen in the ink tank windows, refill the ink tanks to the upper lines and run the Power Cleaning utility. Then run a nozzle check to see if print quality has improved.
- If you have not used the product for a long time, run the Power Cleaning utility.

**Note:** Power Cleaning consumes a lot of ink, so run this utility only if you cannot improve print quality by cleaning the print head.

**Note:** Your product will not operate properly while tilted at an angle. Place it on a flat, stable surface that extends beyond the base of the product in all directions.

**Parent topic:** [Solving Print Quality Problems](#)

**Related concepts**

[Power Cleaning](#)

[Print Head Cleaning](#)

[Print Head Alignment](#)

[Print Head Nozzle Check](#)

[Checking the Ink and Maintenance Box Levels](#)

**Related references**

[Paper Specifications](#)

**Related tasks**

[Cleaning Your Product](#)

[Selecting Additional Layout and Print Options - Windows](#)

[Selecting Basic Print Settings - Windows](#)

[Selecting Basic Print Settings - Mac](#)

[Selecting Double-sided Printing Settings - Mac](#)

[Selecting Double-sided Printing Settings - Windows](#)

[Selecting Printing Preferences - Mac](#)

[Selecting Extended Settings - Windows](#)

[Cleaning the Paper Guide](#)

[Cleaning the Print Head Path](#)

**Related topics**

[Loading Paper](#)

## **Faint Printout or Printout Has Gaps**

If your printouts are faint or have gaps, try these solutions:

- Run a nozzle check to see if any of the print head nozzles are clogged. Then clean the print head, if necessary.
- The ink levels may be low. Visually check the ink levels.
- Make sure the paper type setting matches the type of paper you loaded.
- Make sure your paper is not damp, curled, old, or loaded incorrectly in your product.
- Align the print head.
- Adjust the print quality in the product software.

- Clean the paper path.
- If you have not used the product for a long time, run the Power Cleaning utility.

**Note:** Power Cleaning consumes a lot of ink, so run this utility only if you cannot improve print quality by cleaning the print head.

- If you printed when the ink levels were too low to be seen in the ink tank windows, refill the ink tanks to the upper lines and then run the Power Cleaning utility to replace the ink inside the ink tubes. After running the utility, run a nozzle check to see if print quality has improved.
- If you cannot solve the problem using head cleaning, you can print immediately from a Windows computer with a mixture of color inks to create composite black. Select the **Use a Mixture of Color Inks to Create Black** setting from **Extended Settings** on the printer driver's Maintenance tab. You can print at **Standard** print quality when the **Paper Type** is **Plain Paper / Bright White Paper, Letterhead, or Envelope**.

**Parent topic:** [Solving Print Quality Problems](#)

**Related concepts**

[Power Cleaning](#)

[Print Head Cleaning](#)

[Print Head Alignment](#)

[Print Head Nozzle Check](#)

[Checking the Ink and Maintenance Box Levels](#)

**Related tasks**

[Refilling the Ink Tanks](#)

[Aligning the Print Head Using the Product Control Panel](#)

[Cleaning the Paper Guide](#)

[Cleaning the Print Head Path](#)

**Related topics**

[Loading Paper](#)

## Grainy Printout

If your printouts are grainy, try these solutions:

- Make sure you loaded the printable side of the paper correctly for your product.
- Select a higher print quality setting and turn off any high speed settings in your product software.

- Run a nozzle check to see if any of the print head nozzles are clogged. Then clean the print head, if necessary.
- Align the print head.
- Adjust the print quality in the product software.
- You may need to increase the image resolution or print a smaller size; see your software documentation.

**Note:** Images from the Internet may be low resolution and not result in a high quality printout.

- If you enlarged the image size in an image-editing program, you need to increase the image resolution setting to retain a high image quality. Increase the image resolution by the same amount you increase the image size. For example, if the image resolution is 300 dpi (dots per inch) and you will double the image size for printing, change the resolution setting to 600 dpi.

**Note:** Higher resolution settings result in larger file sizes, which take longer to process and print. Consider the limitations of your computer system when selecting a resolution, and select the lowest possible resolution that produces acceptable quality to keep file sizes manageable.

**Parent topic:** [Solving Print Quality Problems](#)

**Related concepts**

[Power Cleaning](#)

[Print Head Cleaning](#)

[Print Head Nozzle Check](#)

[Print Head Alignment](#)

**Related references**

[Paper or Media Type Settings - Printing Software](#)

**Related tasks**

[Refilling the Ink Tanks](#)

[Selecting Basic Print Settings - Windows](#)

[Selecting Basic Print Settings - Mac](#)

[Selecting Printing Preferences - Mac](#)

[Selecting Additional Layout and Print Options - Windows](#)

[Aligning the Print Head Using the Product Control Panel](#)

## Related topics

[Loading Paper](#)

## Incorrect Colors

If your printouts have incorrect colors, try these solutions:

- Make sure the paper type setting matches the paper you loaded.
- Make sure the **Black/Grayscale** or **Grayscale** setting is not selected in your printer software.
- If you selected **Standard-Vivid** (Windows) or **Normal-Vivid** (Mac) as the quality setting in the printer software, try selecting **Standard** (Windows) or **Normal** (Mac) instead.
- Run a nozzle check to see if any of the print head nozzles are clogged. Then clean the print head, if necessary.
- The ink levels may be low and you may need to refill the ink. Visually check the ink levels.
- If you printed when the ink levels were too low to be seen in the ink tank windows, refill the ink tanks to the upper lines and run the Power Cleaning utility. Then run a nozzle check to see if print quality has improved.
- After you print, the colors in your printout need time to set as the ink dries. During this time, the colors may look different than you expect. To speed up drying time, do not stack your printouts on top of each other.
- Your printed colors can never exactly match your on-screen colors. However, you can use a color management system to get as close as possible. Try using the color management options in your printer software.
- Select **Custom** as the **Color Correction** setting on the More Options tab of the printer software, then click **Advanced**. Try changing the **Scene Correction** setting to something other than **Automatic**. If changing that setting does not work, change the **Color Management** setting to any color correction method other than **PhotoEnhance**.
- For best results, use genuine Epson paper.
- If you have not used the product for a long time, run the Power Cleaning utility.

**Note:** Power Cleaning consumes a lot of ink, so run this utility only if you cannot improve print quality by cleaning the print head.

**Parent topic:** [Solving Print Quality Problems](#)

## Related concepts

[Print Head Nozzle Check](#)

[Print Head Cleaning](#)  
[Power Cleaning](#)  
[Checking the Ink and Maintenance Box Levels](#)

**Related tasks**

[Refilling the Ink Tanks](#)  
[Selecting Basic Print Settings - Windows](#)  
[Selecting Basic Print Settings - Mac](#)  
[Selecting Additional Layout and Print Options - Windows](#)  
[Managing Color - Mac](#)

## Solving Scanning Problems

Check these solutions if you have problems scanning with your product.

[Scanning Software Does Not Operate Correctly](#)  
[Cannot Start Epson Scan 2](#)  
[Scanning is Slow](#)  
[Cannot Send Scans to a Cloud Service](#)

**Parent topic:** [Solving Problems](#)

### Scanning Software Does Not Operate Correctly

If your scanning software does not operate correctly, try these solutions:

- Make sure your computer has adequate memory and meets the system requirements for your operating system.
- Make sure your computer is not running in a power-saving mode, such as sleep or standby. If so, wake your system and restart your scanning software.
- If you upgraded your operating system but did not reinstall your scanning software, try reinstalling it.
- In Windows, make sure your product is listed as a valid device in the **Scanners and Cameras** control panel.
- Try scanning at a lower resolution or increase the free space on the computer's hard disk. Scanning stops if the total data size reaches the limit.
- Use the Epson Scan 2 Utility on your computer to reset the scanner software settings. If resetting the settings does not solve the problem, uninstall and reinstall the scanner software.

**Parent topic:** [Solving Scanning Problems](#)

### Related concepts

[Uninstall Your Product Software](#)

### Related references

[Windows System Requirements](#)

[Mac System Requirements](#)

## Cannot Start Epson Scan 2

If you cannot start Epson Scan 2, try these solutions:

- Make sure your product is turned on and any interface cables are securely connected at both ends.
- Make sure Epson Scan 2 is selected as your scanning program.
- Make sure your computer is not running in a power-saving mode, such as sleep or standby. If so, wake your system and restart Epson Scan 2.
- Check the connection setting and test the connection using Epson Scan 2 Utility:

**Windows 10:** Click  and select **EPSON > Epson Scan 2 Utility**. Make sure the correct product is selected. If necessary, select the **Other** tab and click **Reset**.

**Windows 8.x:** Navigate to the **Apps** screen and select **Epson Scan 2 Utility**. Make sure the correct product is selected. If necessary, select the **Other** tab and click **Reset**.

**Windows (other versions):** Click  or **Start > All Programs** or **Programs > EPSON > Epson Scan 2 > Epson Scan 2 Utility**. Make sure the correct product is selected. If necessary, select the **Other** tab and click **Reset**.

**Mac:** Open the **Applications** folder, click **Epson Software**, and click **Epson Scan 2 Utility**. Make sure the correct product is selected. If necessary, select the **Other** tab and click **Reset**.

- Make sure you do not have multiple versions of Epson Scan 2 installed. If you do, uninstall both versions and install one version.
- If you upgraded your operating system but did not reinstall Epson Scan 2, try reinstalling it.

**Parent topic:** [Solving Scanning Problems](#)

### Related concepts

[Uninstall Your Product Software](#)

[Scan Resolution Guidelines](#)

### Related references

[Additional Scanning Settings - Advanced Settings Tab](#)

**Related tasks**

[Starting a Scan from a Scanning Program](#)  
[Scanning in Epson Scan 2](#)

**Related topics**

[Starting a Scan](#)

## Scanning is Slow

If scanning becomes slow, try these solutions:

- Scan your original at a lower resolution, if possible.
- Make sure your system meets the requirements for your operating system. If you are scanning a high-resolution image, you may need more than the minimum requirements. If necessary, increase your system's memory or reduce the resolution.

**Parent topic:** [Solving Scanning Problems](#)

**Related concepts**

[Scan Resolution Guidelines](#)

## Cannot Send Scans to a Cloud Service

If you cannot send a scan to a cloud service, try these solutions:

- Make sure your computer is connected to the internet.
- Make sure the login information you entered for the cloud service is correct.
- Make sure the cloud service is not down for system maintenance. Check the cloud service website for more information.

**Parent topic:** [Solving Scanning Problems](#)

## Solving Scanned Image Quality Problems

Check these sections if a scanned image on your computer screen has a quality problem.

**Note:** For solutions when using the Epson ScanSmart software, see the Epson ScanSmart help utility.

[Image Consists of a Few Dots Only](#)

[Line of Dots Appears in All Scanned Images](#)

[Straight Lines in an Image Appear Crooked](#)

[Scanned Image Quality Problems](#)



[Characters are Not Recognized During Conversion to Editable Text \(OCR\)](#)  
[Image Colors are Patchy at the Edges](#)  
[Ripple Patterns Appear in an Image](#)  
[Scanned Image Edges are Cropped](#)  
[Resetting the Epson Scan 2 Settings](#)

**Parent topic:** [Solving Problems](#)

## Image Consists of a Few Dots Only

If your scanned image consists only of a few dots, try these solutions:

- Make sure you placed your original for scanning facing the correct way.
- If the **Image Type** setting is **Black & White**, adjust the **Threshold** and scan again.
- Remove any lint or dirt from your original.
- Clean the scanner glass.
- Do not press on the original or the document cover with too much force.

**Parent topic:** [Solving Scanned Image Quality Problems](#)

### Related tasks

[Placing Originals on the Scanner Glass](#)  
[Cleaning Your Product](#)

## Line of Dots Appears in All Scanned Images

If a line of dots appears in all your scanned images, try these solutions:

- Clean the scanner glass with a soft, dry, lint-free cloth or use a small amount of glass cleaner on the cloth, if necessary. Paper towels are not recommended.

**Caution:** Do not spray glass cleaner directly on the scanner glass.

- Make sure any interface cables are securely connected at both ends.
- Remove any dust or dirt that may have adhered to your original.
- Keep the document cover closed to prevent dirt or dust from getting inside.

**Parent topic:** [Solving Scanned Image Quality Problems](#)

### Related tasks

[Cleaning Your Product](#)

## Straight Lines in an Image Appear Crooked

If straight lines in an original appear crooked in a scanned image, make sure to place your original straight when you scan it.

**Parent topic:** [Solving Scanned Image Quality Problems](#)

### Related tasks

[Placing Originals on the Scanner Glass](#)

## Scanned Image Quality Problems

If you encounter quality problems with your scanned image, try these solutions:

### Image is Distorted or Blurry

- Do not move your original or your product during scanning.
- Do not press on the document cover or the original with too much force.
- Your product will not operate properly while tilted at an angle. Place your product on a flat, stable surface that extends beyond its base in all directions.
- Adjust these Epson Scan 2 or Epson ScanSmart settings (if available) and try scanning again:
  - Increase the **Resolution** setting.
  - If the **Image Type** setting is **Black & White**, adjust the **Threshold** setting.
  - If the **Image Type** setting is **Color** or **Grayscale**, select the **Unsharp Mask** setting.
  - If the **Image Type** setting is **Black & White**, select **Text Enhancement**. If the **Image Type** setting is **Color** or **Grayscale**, change the **Text Enhancement** setting to **High**.

### Image is Too Dark

- If the **Image Type** is set to **Color** or **Grayscale**, adjust the **Brightness** setting.
- Check the brightness and contrast settings of your computer monitor.

### Back of Original Image Appears in Scanned Image

- Place a piece of black paper on the back of the original and scan it again.
- Adjust these Epson Scan 2 or Epson ScanSmart settings (if available) and try scanning again:
  - Select the **Advanced Settings** tab and adjust the **Brightness** setting.
  - If the **Image Type** is set to **Black & White**, select **Text Enhancement**. If the **Image Type** is set to **Color** or **Grayscale**, change the **Text Enhancement** setting to **High**.

**Note:** The **Text Enhancement** and **Remove Background** settings depend on the selected **Image Type**.

### **Scanned Image Colors Do Not Match Original Colors**

Printed colors can never exactly match the colors on your computer monitor because printers and monitors use different color systems: monitors use RGB (red, green, and blue) and printers typically use CMYK (cyan, magenta, yellow, and black).

Check the color matching and color management capabilities of your computer, display adapter, and the software you are using to see if they are affecting the palette of colors you see on your screen.

To adjust the colors in your scanned image, adjust these Epson Scan 2 or Epson ScanSmart settings (if available) and try scanning again:

- If the **Image Type** setting is **Color** or **Grayscale**, adjust the **Contrast** setting.
- If the **Image Type** setting is **Black & White** or **Grayscale**, adjust the **Color Enhance** setting.

**Parent topic:** [Solving Scanned Image Quality Problems](#)

#### **Related references**

[Additional Scanning Settings - Main Settings Tab](#)

[Additional Scanning Settings - Advanced Settings Tab](#)

#### **Related tasks**

[Scanning a Document in Epson ScanSmart](#)

[Scanning in Epson Scan 2](#)

## **Characters are Not Recognized During Conversion to Editable Text (OCR)**

If characters in your scanned images are not recognized during OCR conversion, try these solutions:

- Make sure your original is loaded straight on your product.
- Use an original with clear text.
- When saving scanned images as Searchable PDFs, make sure the correct OCR language is selected.
- Adjust the following Epson Scan 2 or Epson ScanSmart settings if available, and try scanning again:
  - On the **Main Settings** tab, make sure you select the correct **Image Type** for your original.
  - On the **Main Settings** tab, set the **Resolution** between 200 and 600 dpi.
  - On the **Advanced Settings** tab, select **Text Enhancement** and choose a setting.

**Note:** The **Text Enhancement** setting depends on the selected **Image Type**.

- If the **Image Type** is set to **Black & White**, adjust the **Threshold** setting on the **Advanced Settings** tab. (The **Image Option** must be set to **None**.)

**Parent topic:** [Solving Scanned Image Quality Problems](#)

**Related references**

[Additional Scanning Settings - Main Settings Tab](#)

[Additional Scanning Settings - Advanced Settings Tab](#)

## Image Colors are Patchy at the Edges

If you are scanning a thick or warped original, cover its edges with paper to block external light as you scan it.

**Parent topic:** [Solving Scanned Image Quality Problems](#)

## Ripple Patterns Appear in an Image

You may see a ripple pattern (called a moiré) in scanned images of printed documents. This is caused by interference from differing pitches in the scanner's screen and your original's halftone screen. To reduce this effect, adjust these Epson Scan 2 settings (if available) and try scanning again:

- Select the **Descreening** setting.
- Select a lower **Resolution** setting.

**Parent topic:** [Solving Scanned Image Quality Problems](#)

**Related references**

[Additional Scanning Settings - Main Settings Tab](#)

[Additional Scanning Settings - Advanced Settings Tab](#)

**Related tasks**

[Scanning a Document in Epson ScanSmart](#)

[Scanning in Epson Scan 2](#)

## Scanned Image Edges are Cropped

If the edges of a scanned image are cropped, make sure your original is placed correctly for scanning. If necessary, move your original away from the edges of the scanner glass slightly.

In the Epson Scan 2 or Epson ScanSmart settings, set the **Edge Fill** setting to **None**.

When scanning using Epson ScanSmart and placing multiple originals on the scanner glass, make sure there is a gap of at least 0.8 in. (20 mm) between the originals.



**Parent topic:** [Solving Scanned Image Quality Problems](#)

#### **Related tasks**

[Placing Originals on the Scanner Glass](#)

## **Resetting the Epson Scan 2 Settings**

If you continue to experience image quality problems after trying all possible solutions, you may need to reset the Epson Scan 2 settings using the Epson Scan 2 Utility.

1. Do one of the following to start the Epson Scan 2 Utility:
  - **Windows 10:** Click  > **EPSON** > **Epson Scan 2 Utility**.
  - **Windows 8.x:** Navigate to the **Apps** screen and select **Epson Scan 2 Utility**.
  - **Windows (other versions):** Click  or **Start**, and select **All Programs** or **Programs**. Select **EPSON** > **Epson Scan 2** > **Epson Scan 2 Utility**.
  - **Mac:** Open the **Applications** folder, open the **Epson Software** folder, and select **Epson Scan 2 Utility**.
2. Click the **Other** tab.
3. Click **Reset** and confirm your choice.

**Note:** If resetting the Epson Scan 2 settings does not solve your problem, uninstall Epson Scan 2 and re-install it.

**Parent topic:** [Solving Scanned Image Quality Problems](#)

## **Uninstall Your Product Software**

If you have a problem that requires you to uninstall and re-install your software, follow the instructions for your operating system.

[Uninstalling Product Software - Windows](#)



[Uninstalling Product Software - Mac](#)

**Parent topic:** [Solving Problems](#)

## **Uninstalling Product Software - Windows**

You can uninstall and then re-install your product software to solve certain problems.

1. Turn off the product.

2. Disconnect any interface cables.
3. Do one of the following:
  - **Windows 10:** Click  and select  (Settings) > **Apps** or **System** > **Apps & features**. Then select the program you want to uninstall and select **Uninstall**.
  - **Windows 8.x:** Navigate to the **Apps** screen and select **Control Panel** > **Programs** > **Programs and Features**. Select the uninstall option for your Epson product, then select **Uninstall/Change**.

**Note:** If you see a **User Account Control** window, click **Yes** or **Continue**.

Select your product again, if necessary, then select **OK**, and click **Yes** to confirm the uninstallation.

- **Windows (other versions):** Click  or **Start**, and select **All Programs** or **Programs**. Select **EPSON**, select your product, then click **EPSON Printer Software Uninstall**.

**Note:** If you see a **User Account Control** window, click **Yes** or **Continue**.

In the next window, select your product and click **OK**. Then follow any on-screen instructions.

4. Do one of the following to uninstall Epson Event Manager, then follow any on-screen instructions:
  - **Windows 10/8.x:** Select **Epson Event Manager** and click **Uninstall**.
  - **Windows 7/Windows Vista:** Open the Windows **Control Panel** utility. Select **Programs and Features**. (In Classic view, select **Programs** and click **Uninstall a program**.) Select **Epson Event Manager** and click **Uninstall/Change**.
5. Do one of the following to uninstall Epson Scan 2, then follow any on-screen instructions:
  - **Windows 10:** Select **Epson Scan 2** and click **Uninstall**.
  - **Windows 8.x/Windows 7/Windows Vista:** Select **Epson Scan 2** and click **Uninstall/Change**.
6. Do one of the following to uninstall Epson ScanSmart, then follow any on-screen instructions:
  - **Windows 10:** Select **Epson ScanSmart** and click **Uninstall**.
  - **Windows 8.x/Windows 7/Windows Vista:** Select **Epson ScanSmart** and click **Uninstall/Change**.
7. Restart your computer, then see the *Start Here* sheet to re-install your software.

**Note:** If you find that re-installing your product software does not solve a problem, contact Epson.

**Parent topic:** [Uninstall Your Product Software](#)

**Related references**

[Where to Get Help](#)

## Uninstalling Product Software - Mac

In most cases, you do not need to uninstall your product software before re-installing it. However, you can download the Uninstaller utility from the Epson support website to uninstall your product software as described here.

**Note:** If you find that re-installing your product software does not solve a problem, contact Epson.

1. To download the Uninstaller utility, visit [epson.com/support](http://epson.com/support) (U.S.) or [epson.ca/support](http://epson.ca/support) (Canada) and select your product.
2. Click **Downloads**.
3. Select your operating system, click **Utilities**, locate the Uninstaller utility, and click **Download**.
4. Run the file you downloaded.
5. Double-click the **Uninstaller** icon.
6. In the Epson Uninstaller screen, select the checkbox for each software program you want to uninstall.
7. Click **Uninstall**.
8. Follow the on-screen instructions to uninstall the software.
9. Reinstall your product software.

**Note:** If you uninstall the printer driver and your product name remains in the **Print & Fax**, **Print & Scan**, or **Printers & Scanners** window, select your product name and click the – (remove) icon to remove it.

**Parent topic:** [Uninstall Your Product Software](#)

**Related references**

[Where to Get Help](#)

## Where to Get Help

If you need to contact Epson for technical support services, use the following support options.

## **Internet Support**

Visit Epson's support website at [epson.com/support](http://epson.com/support) (U.S.) or [epson.ca/support](http://epson.ca/support) (Canada) and select your product for solutions to common problems. You can download drivers and documentation, get FAQs and troubleshooting advice, or e-mail Epson with your questions.

## **Speak to a Support Representative**

Before you call Epson for support, please have the following information ready:

- Product name
- Product serial number (located on a label on the product)
- Proof of purchase (such as a store receipt) and date of purchase
- Computer configuration
- Description of the problem

Then call:

- U.S.: (562) 276-4382, 6 AM to 8 PM, Pacific Time, Monday through Friday, and 7 AM to 4 PM, Pacific Time, Saturday
- Canada: (905) 709-3839, 6 AM to 8 PM, Pacific Time, Monday through Friday, and 7 AM to 4 PM, Pacific Time, Saturday

Days and hours of support are subject to change without notice. Toll or long distance charges may apply.

## **Purchase Supplies and Accessories**

You can purchase genuine Epson ink and paper at [epson.com](http://epson.com) (U.S. sales) or [epson.ca](http://epson.ca) (Canadian sales). You can also purchase supplies from an Epson authorized reseller. To find the nearest one, call 800-GO-EPSON (800-463-7766) in the U.S. or 800-807-7766 in Canada.

**Parent topic:** [Solving Problems](#)



---

# Technical Specifications

These sections list the technical specifications for your product.

**Note:** Epson offers a recycling program for end of life Epson products. Please go to [this site](#) (U.S) or [this site](#) (Canada) for information on how to return your Epson products for proper disposal.

[Windows System Requirements](#)

[Mac System Requirements](#)

[Paper Specifications](#)

[Printable Area Specifications](#)

[Scanning Specifications](#)

[Ink Specifications](#)

[Dimension Specifications](#)

[Electrical Specifications](#)

[Environmental Specifications](#)

[Interface Specifications](#)

[Network Interface Specifications](#)

[Safety and Approvals Specifications](#)

## Windows System Requirements

To use your product and its software, your computer should use one of these Microsoft operating systems:

- Windows 10
- Windows 8.x
- Windows 7
- Windows Vista
- Windows Server 2019
- Windows Server 2016
- Windows Server 2012 R2
- Windows Server 2012
- Windows Server 2008 R2

- Windows Server 2008
- Windows Server 2003 R2
- Windows Server 2003 SP2 or later

Windows Server supports only the printer driver and Epson Scan 2; any additional included software is not supported.

**Note:** For the latest product software available for your operating system, visit the Epson support site at [epson.com/support](http://epson.com/support) (U.S.) or [epson.ca/support](http://epson.ca/support) (Canada), select your product, and select **Downloads**.

**Parent topic:** [Technical Specifications](#)

## Mac System Requirements

To use your product and its software, your Mac should use one of these operating systems:

- macOS 11.x
- macOS 10.15.x
- macOS 10.14.x
- macOS 10.13.x
- macOS 10.12.x
- OS X 10.11.x
- OS X 10.10.x
- OS X 10.9.x
- OS X 10.8.x
- OS X 10.7.x
- OS X 10.6.8

**Note:** For the latest product software available for your operating system, visit the Epson support site at [epson.com/support](http://epson.com/support) (U.S.) or [epson.ca/support](http://epson.ca/support) (Canada), select your product, and select **Downloads**.

**Parent topic:** [Technical Specifications](#)

# Paper Specifications

**Note:** Since the quality of any particular brand or type of paper may be changed by the manufacturer at any time, Epson cannot guarantee the quality of any non-Epson brand or type of paper. Always test a sample of paper stock before purchasing large quantities or printing large jobs.

## Single-sheets

<b>Size</b>	A4 (8.3 × 11.7 inches [210 × 297 mm]) A6 (4.1 × 5.8 inches [105 × 148 mm]) Letter (8.5 × 11 inches [216 × 279 mm]) Legal (8.5 × 14 inches [216 × 356 mm]) 8.5 × 13 inches (216 × 330 mm) 4 × 6 inches (102 × 152 mm) 5 × 7 inches (127 × 178 mm) 8 × 10 inches (203 × 254 mm) Executive (7.25 × 10.5 inches [184 × 267 mm]) Half Letter (5.5 × 8.5 inches [140 × 216 mm]) Mexico-Oficio (8.5 × 13.4 inches [216 × 340 mm]) Oficio 9 (8.46 × 12.4 inches [215 × 315 mm])
-------------	--

## Paper types

Plain paper

**Note:** Your product also supports compatible papers distributed by Epson. Select the link at the end of this topic to view a list of compatible Epson papers.

## Weight\*

Plain paper: 17 lb (64 g/m<sup>2</sup>) to 24 lb (90 g/m<sup>2</sup>)

## Envelopes

### Size

No. 10 (4.1 × 9.5 inches [105 × 241 mm])

### Paper types

Plain bond paper

### Weight\*

20 lb (75 g/m<sup>2</sup>) to 27 lb (100 g/m<sup>2</sup>)

\* Even if the paper thickness is within this range, the paper may not feed in the printer or the print quality may decline depending on the paper properties or quality.

**Parent topic:** [Technical Specifications](#)

**Related references**

[Compatible Epson Papers](#)

## Printable Area Specifications

**Note:** When printing borderless, quality may decline in the expanded printable area.

### Single sheets

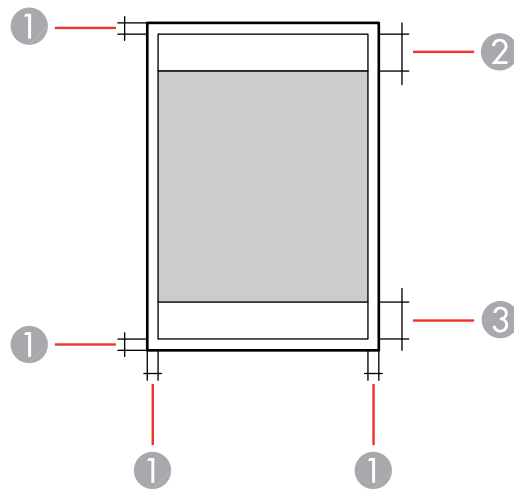

- 1 Top/bottom margins: 0.12 inch (3 mm)
- 2 Reduced print quality area/top: 1.61 inches (41 mm)
- 3 Reduced print quality area/bottom: 1.46 inches (37 mm)

## Borderless

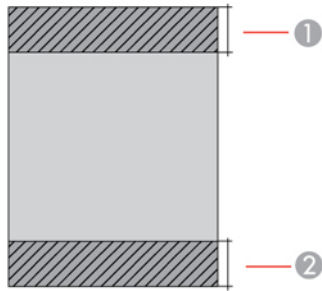

- 1 Reduced print quality area/top: 1.73 inches (44 mm)
- 2 Reduced print quality area/bottom: 1.57 inches (40 mm)

## Envelopes

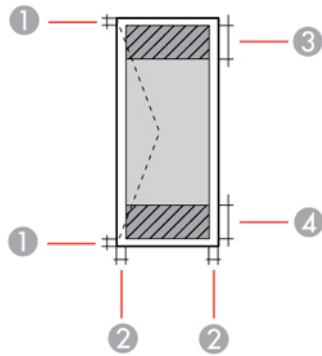

- 1 Left/right margins: 0.12 inch (3 mm)
- 2 Top/bottom: 0.12 inch (3 mm)
- 3 Reduced print quality area/left: 0.71 inch (18 mm)
- 4 Reduced print quality area/right: 1.61 inches (41 mm)

Parent topic: [Technical Specifications](#)

## Scanning Specifications

<b>Scanner type</b>	Flatbed, color
<b>Photoelectric device</b>	CIS
<b>Effective pixels</b>	10200 × 14040 pixels (1200 dpi)
<b>Document size</b>	Maximum: 8.5 × 11.7 inches (216 × 297 mm) Scanner glass: Letter or A4
<b>Scanning resolution</b>	1200 dpi (main scan) 2400 dpi (sub scan)
<b>Output resolution</b>	50 to 9600 in 1 dpi increments
<b>Image data</b>	Color: 48 bits per pixel (16 bits per pixel per color) internal 24 bits per pixel (8 bits per pixel per color) external Grayscale: 16 bits per pixel internal 8 bits per pixel external Black and white: 16 bits per pixel internal 1 bit per pixel external
<b>Light source</b>	LED

Parent topic: [Technical Specifications](#)

## Ink Specifications

**Note:** Epson's warranties do not extend to any damage caused by the use of third-party ink or ink not designed for your printer.

The included initial ink bottles must be used for printer setup and are not for resale. The printer ships with full ink bottles and part of the ink from the first bottles is used to charge the print head. Yields vary considerably based on images printed, print settings, paper type, frequency of use and temperature.

<b>Color</b>	Black, Cyan, Magenta, Yellow
<b>Ink life</b>	Opened package: Use as soon as possible Unopened package: Use before the date on the package has expired
<b>Temperature</b>	Storage: -4 to 104 °F (-20 to 40 °C) 1 month at 104 °F (40 °C) Ink freezes at 5 °F (-15 °C) Ink thaws and is usable after approximately 2 hours at 77 °F (25 °C)

**Parent topic:** [Technical Specifications](#)

**Related references**

[Ink Bottle and Maintenance Box Part Numbers](#)

## Dimension Specifications

<b>Height</b>	Stored: 7.4 inches (187 mm) Printing: 7.4 inches (187 mm)
<b>Width</b>	Stored: 14.8 inches (375 mm) Printing: 14.8 inches (375 mm)
<b>Depth</b>	Stored: 13.7 inches (347 mm) Printing: 19.8 inches (503 mm)
<b>Weight</b> (without ink or power cord)	12.6 lb (5.7 kg)

**Parent topic:** [Technical Specifications](#)

## Electrical Specifications

<b>Power supply rating</b>	100 to 240 V
<b>Input voltage range</b>	90 to 264 V
<b>Rated frequency range</b>	50/60 Hz

<b>Input frequency range</b>	49.5 to 60.5 Hz
<b>Rated current</b>	0.4 to 0.2 A
<b>Power consumption</b> (with USB connection)	Standalone copying: Approximately 12 W (ISO/IEC24712) Ready mode: Approximately 5.3 W Sleep mode: Approximately 0.7 W Power off mode: Approximately 0.2 W

Parent topic: [Technical Specifications](#)

## Environmental Specifications

<b>Temperature</b>	Operating: 50 to 95 °F (10 to 35 °C) Storage: -4 to 104 °F (-20 to 40 °C) 1 month at 104 °F (40 °C)
<b>Humidity</b> (without condensation)	Operating: 20 to 80% RH Storage: 5 to 85% RH

Parent topic: [Technical Specifications](#)

## Interface Specifications

<b>Interface type</b>	Hi-Speed USB (Device Class for computers; USB 3.0 cables are not supported)
-----------------------	---

Parent topic: [Technical Specifications](#)

## Network Interface Specifications

### Wi-Fi

<b>Standard</b>	IEEE802.11 b/g/n; IEEE802.11n available only on the 20 MHz channel
-----------------	--



<b>Security</b>	WEP (64/128 bit) WPA-PSK (TKIP) WPA2-PSK (AES); complies with WPA2 with support for WPA/WPA2 Personal WPA3-SAE (AES)
<b>Frequency band</b>	2.4 GHz
<b>Connection modes</b>	Infrastructure mode Wi-Fi Direct (Simple AP); not supported for IEEE802.11b  <b>Note:</b> Wi-Fi Direct can be used simultaneously with Infrastructure or Ethernet modes.
<b>Maximum radio frequency power transmitted</b>	20 dBm (EIRP)
<b>Ethernet</b>	
<b>Standard</b>	IEEE802.3i (10BASE-T); use a category 5e or higher STP (shielded twisted pair) cable to prevent risk of radio interference IEEE802.3u (100BASE-TX) IEEE802.3az (Energy Efficient Ethernet); connected device should be IEEE802.3az compliant
<b>Communication modes</b>	Auto, 10Mbps Full duplex, 10Mbps Half duplex, 100Mbps Full duplex, 100Mbps Half duplex
<b>Connector</b>	RJ-45
<b>Security</b>	
<b>Security protocol</b>	SSL/TLS; HTTPS Server/Client, IPPS SNMPv3

Parent topic: [Technical Specifications](#)

## Safety and Approvals Specifications

### United States

Safety: UL60950-1

EMC: FCC Part 15 Subpart B Class B

### Canada

Safety: CAN/CSA-C22.2 No.60950-1

EMC: CAN ICES-3 (B)/NMB-3 (B)

This equipment contains the following wireless module:

- Manufacturer: Seiko Epson Corporation
- Type: J26H006

This product conforms to Part 15 of FCC Rules and RSS-210 of the IC Rules. Epson cannot accept responsibility for any failure to satisfy the protection requirements resulting from a non-recommended modification of the product. Operation is subject to the following two conditions: (1) this device may not cause harmful interference, and (2) this device must accept any interference received, including interference that may cause undesired operation of the device.

To prevent radio interference to the licensed service, this device is intended to be operated indoors and away from windows to provide maximum shielding. Equipment (or its transmit antenna) that is installed outdoors is subject to licensing.

This equipment complies with FCC/IC radiation exposure limits set forth for an uncontrolled environment and meets the FCC radio frequency (RF) Exposure Guidelines in Supplement C to OET65 and RSS-102 of the IC radio frequency (RF) Exposure rules. This equipment should be installed and operated so that the radiator is kept at least 7.9 inches (20 cm) or more away from a person's body (excluding extremities: hands, wrists, feet and ankles).

**Parent topic:** [Technical Specifications](#)

---

## Notices

Check these sections for important notices about your product.

**Note:** Epson offers a recycling program for end of life Epson products. Please go to [this site](#) (U.S) or [this site](#) (Canada) for information on how to return your Epson products for proper disposal.

[Important Safety Instructions](#)

[FCC Compliance Statement](#)

[Binding Arbitration and Class Waiver](#)

[Trademarks](#)

[Copyright Notice](#)

## Important Safety Instructions

Before using your Epson product, read and follow these safety instructions.

[General Product Safety Instructions](#)

[Wireless Connection Safety Instructions](#)

[LCD Screen Safety Instructions](#)

**Parent topic:** [Notices](#)

## General Product Safety Instructions

- Be sure to follow all warnings and instructions marked on the product.
- Use only the type of power source indicated on the product's label.
- Use only the power cord that comes with the product. Use of another cord may cause fires or shock. Do not use the cord with any other equipment.
- Make sure the AC power cord meets the relevant local safety standard.
- Place the product near a wall outlet where the plug can be easily unplugged.
- Avoid plugging the product into an outlet on the same circuit as a photo copier or air control system that regularly switches on and off, or on an outlet controlled by a wall switch or timer.
- Do not let the power cord become damaged or frayed. Place it to avoid abrasions, cuts, fraying, crimping, and kinking. Do not place objects on top of it and do not allow it to be stepped on or run over. Be careful to keep the cord straight at each end.

- If you use an extension cord with the product, make sure the total ampere rating of the devices plugged into the extension cord does not exceed the cord's ampere rating. Also, make sure the total ampere rating of all devices plugged into the wall outlet does not exceed the wall outlet's ampere rating.
- Always turn off the product using the power button, and wait until the power light stops flashing before unplugging the product or cutting off power to the electrical outlet.
- If you will not be using the product for a long period, unplug the power cord from the electrical outlet.
- Place the product on a flat, stable surface that extends beyond its base in all directions. It will not operate properly if it is tilted or at an angle.
- Allow space behind the product for the cables, and space above the product so that you can fully raise the document cover.
- Leave enough space in front of the product for the paper to be fully ejected.
- Avoid locations that are subject to rapid changes in heat or humidity, shocks or vibrations, or dust.
- Do not place or store the product outdoors.
- Do not place the product near excessive heat sources or in direct sunlight.
- Leave enough room around the product for sufficient ventilation. Do not block or cover openings in the case or insert objects through the slots.
- Keep the product away from potential sources of electromagnetic interference, such as loudspeakers or the base units of cordless telephones.
- Keep your product at least 8.7 inches (22 cm) away from cardiac pacemakers to prevent your product's radio waves from affecting the operation of the pacemaker.
- When connecting the product to a computer or other device with a cable, ensure the correct orientation of the connectors. Each connector has only one correct orientation. Inserting a connector in the wrong orientation may damage both devices connected by the cable.
- Do not sit or lean on the product. Do not place heavy objects on the product.
- Do not touch the flat white cable, translucent film, or ink tubes inside the product.
- Do not move the print head by hand; this may damage the product.
- Do not put your hand inside the product while it is printing.
- Do not spill liquid on the product or use the product with wet hands.
- Do not use aerosol products that contain flammable gases inside or around the product. Doing so may cause fire.
- Do not press too hard on the scanner glass when placing originals.

- Do not open the scanner section while the product is copying, printing, scanning, or performing any other functions.
- Be careful not to trap your fingers when closing the scanner unit.
- Except as specifically explained in your documentation, do not attempt to service or disassemble the product yourself.
- Unplug the product and refer servicing to qualified service personnel under the following conditions: if the power cord or plug is damaged; if liquid has entered the product; if the product has been dropped or the case damaged; if the product does not operate normally or exhibits a distinct change in performance. Adjust only those controls that are covered by the operating instructions.
- Prolonged use of the product when the ink level is below the lower line could damage the product. Fill the ink tank to the upper line while the product is not operating. To display the correct ink level estimates, reset the ink level after filling the tank.
- Before transporting the product, make sure that the print head is in the home (far right) position.
- When storing or transporting the product, do not tilt it, stand it on its side, or turn it upside down; otherwise, ink may leak.

**Parent topic:** [Important Safety Instructions](#)

## Wireless Connection Safety Instructions

Radio waves from this product may adversely affect the operation of medical equipment or automatically controlled devices, such as pacemakers, automatic doors or fire alarms. When using this product near such devices or inside a medical facility, follow the directions from authorized staff members at the facility, and follow all posted warnings and directions on the device to avoid causing an accident.

**Parent topic:** [Important Safety Instructions](#)

## LCD Screen Safety Instructions

- Use only a dry, soft cloth to clean the LCD screen. Do not use liquid or chemical cleansers.
- If the LCD screen is damaged, contact Epson. If the liquid crystal solution gets on your hands, wash them thoroughly with soap and water. If the liquid crystal solution gets into your eyes, flush them immediately with water. If discomfort or vision problems remain after a thorough flushing, see a doctor immediately.
- Do not press too hard on the LCD screen or subject it to heavy impacts.
- Do not use a pointy or sharp object, such as a pen or your fingernail, to operate the LCD screen.
- If the LCD screen chips or cracks, do not touch or attempt to remove the broken pieces; contact Epson for support.

- The LCD screen may contain a few small bright or dark spots, and may display uneven brightness. These are normal and do not indicate that the screen is damaged in any way.

**Parent topic:** [Important Safety Instructions](#)

## FCC Compliance Statement

### For United States Users

This equipment has been tested and found to comply with the limits for a Class B digital device, pursuant to Part 15 of the FCC Rules. These limits are designed to provide reasonable protection against harmful interference in a residential installation. This equipment generates, uses, and can radiate radio frequency energy and, if not installed and used in accordance with the instructions, may cause harmful interference to radio or television reception. However, there is no guarantee that interference will not occur in a particular installation. If this equipment does cause interference to radio and television reception, which can be determined by turning the equipment off and on, the user is encouraged to try to correct the interference by one or more of the following measures:

- Reorient or relocate the receiving antenna.
- Increase the separation between the equipment and receiver.
- Connect the equipment into an outlet on a circuit different from that to which the receiver is connected.
- Consult the dealer or an experienced radio/TV technician for help.

### WARNING

The connection of a non-shielded equipment interface cable to this equipment will invalidate the FCC Certification or Declaration of this device and may cause interference levels which exceed the limits established by the FCC for this equipment. It is the responsibility of the user to obtain and use a shielded equipment interface cable with this device. If this equipment has more than one interface connector, do not leave cables connected to unused interfaces. Changes or modifications not expressly approved by the manufacturer could void the user's authority to operate the equipment.

### For Canadian Users

CAN ICES-3(B)/NMB-3(B)

**Parent topic:** [Notices](#)

# Binding Arbitration and Class Waiver

## 1. DISPUTES, BINDING INDIVIDUAL ARBITRATION, AND WAIVER OF CLASS ACTIONS AND CLASS ARBITRATIONS

1.1 **Disputes.** The terms of this Section 1 shall apply to all Disputes between you and Epson. The term "Dispute" is meant to have the broadest meaning permissible under law and includes any dispute, claim, controversy or action between you and Epson arising out of or relating to this Agreement, Epson branded products (hardware and including any related software), or other transaction involving you and Epson, whether in contract, warranty, misrepresentation, fraud, tort, intentional tort, statute, regulation, ordinance, or any other legal or equitable basis. "DISPUTE" DOES NOT INCLUDE IP CLAIMS, or more specifically, a claim or cause of action for (a) trademark infringement or dilution, (b) patent infringement, (c) copyright infringement or misuse, or (d) trade secret misappropriation (an "IP Claim"). You and Epson also agree, notwithstanding Section 1.6, that a court, not an arbitrator, may decide if a claim or cause of action is for an IP Claim.

1.2 **Binding Arbitration.** You and Epson agree that all Disputes shall be resolved by binding arbitration according to this Agreement. **ARBITRATION MEANS THAT YOU WAIVE YOUR RIGHT TO A JUDGE OR JURY IN A COURT PROCEEDING AND YOUR GROUNDS FOR APPEAL ARE LIMITED.**

Pursuant to this Agreement, binding arbitration shall be administered by JAMS, a nationally recognized arbitration authority, pursuant to its code of procedures then in effect for consumer related disputes, but excluding any rules that permit joinder or class actions in arbitration (for more detail on procedure, see Section 1.6 below). You and Epson understand and agree that (a) the Federal Arbitration Act (9 U.S.C. §1, et seq.) governs the interpretation and enforcement of this Section 1, (b) this Agreement memorializes a transaction in interstate commerce, and (c) this Section 1 shall survive termination of this Agreement.

1.3 **Pre-Arbitration Steps and Notice.** Before submitting a claim for arbitration, you and Epson agree to try, for sixty (60) days, to resolve any Dispute informally. If Epson and you do not reach an agreement to resolve the Dispute within the sixty (60) days, you or Epson may commence an arbitration. Notice to Epson must be addressed to: Epson America, Inc., ATTN: Legal Department, 3131 Katella Ave., Los Alamitos, CA 90720 (the "Epson Address"). The Dispute Notice to you will be sent to the most recent address Epson has in its records for you. For this reason, it is important to notify us if your address changes by emailing us at [EAILEgal@ea.epson.com](mailto:EAILEgal@ea.epson.com) or writing us at the Epson Address above. Notice of the Dispute shall include the sender's name, address and contact information, the facts giving rise to the Dispute, and the relief requested (the "Dispute Notice"). Following receipt of the Dispute Notice, Epson and you agree to act in good faith to resolve the Dispute before commencing arbitration.

1.4 **Small Claims Court.** Notwithstanding the foregoing, you may bring an individual action in the small claims court of your state or municipality if the action is within that court's jurisdiction and is pending only in that court.

**1.5 WAIVER OF CLASS ACTIONS AND CLASS ARBITRATIONS. YOU AND EPSON AGREE THAT EACH PARTY MAY BRING DISPUTES AGAINST THE OTHER PARTY ONLY IN AN INDIVIDUAL CAPACITY, AND NOT AS A PLAINTIFF OR CLASS MEMBER IN ANY CLASS OR REPRESENTATIVE PROCEEDING, INCLUDING WITHOUT LIMITATION FEDERAL OR STATE CLASS ACTIONS, OR CLASS ARBITRATIONS. CLASS ACTION LAWSUITS, CLASS-WIDE ARBITRATIONS, PRIVATE ATTORNEY-GENERAL ACTIONS, AND ANY OTHER PROCEEDING WHERE SOMEONE ACTS IN A REPRESENTATIVE CAPACITY ARE NOT ALLOWED. ACCORDINGLY, UNDER THE ARBITRATION PROCEDURES OUTLINED IN THIS SECTION, AN ARBITRATOR SHALL NOT COMBINE OR CONSOLIDATE MORE THAN ONE PARTY'S CLAIMS WITHOUT THE WRITTEN CONSENT OF ALL AFFECTED PARTIES TO AN ARBITRATION PROCEEDING.**

**1.6 Arbitration Procedure.** If you or Epson commences arbitration, the arbitration shall be governed by the rules of JAMS that are in effect when the arbitration is filed, excluding any rules that permit arbitration on a class or representative basis (the "JAMS Rules"), available at <http://www.jamsadr.com> or by calling 1-800-352-5267, and under the rules set forth in this Agreement. All Disputes shall be resolved by a single neutral arbitrator, and both parties shall have a reasonable opportunity to participate in the selection of the arbitrator. The arbitrator is bound by the terms of this Agreement. The arbitrator, and not any federal, state or local court or agency, shall have exclusive authority to resolve all disputes arising out of or relating to the interpretation, applicability, enforceability or formation of this Agreement, including any claim that all or any part of this Agreement is void or voidable. Notwithstanding this broad delegation of authority to the arbitrator, a court may determine the limited question of whether a claim or cause of action is for an IP Claim, which is excluded from the definition of "Disputes" in Section 1.1 above. The arbitrator shall be empowered to grant whatever relief would be available in a court under law or in equity. The arbitrator may award you the same damages as a court could, and may award declaratory or injunctive relief only in favor of the individual party seeking relief and only to the extent necessary to provide relief warranted by that party's individual claim. In some instances, the costs of arbitration can exceed the costs of litigation and the right to discovery may be more limited in arbitration than in court. The arbitrator's award is binding and may be entered as a judgment in any court of competent jurisdiction.

You may choose to engage in arbitration hearings by telephone. Arbitration hearings not conducted by telephone shall take place in a location reasonably accessible from your primary residence, or in Orange County, California, at your option.

a) Initiation of Arbitration Proceeding. If either you or Epson decides to arbitrate a Dispute, both parties agree to the following procedure:

(i) Write a Demand for Arbitration. The demand must include a description of the Dispute and the amount of damages sought to be recovered. You can find a copy of a Demand for Arbitration at <http://www.jamsadr.com> ("Demand for Arbitration").

(ii) Send three copies of the Demand for Arbitration, plus the appropriate filing fee, to: JAMS, 500 North State College Blvd., Suite 600 Orange, CA 92868, U.S.A.



(iii) Send one copy of the Demand for Arbitration to the other party (same address as the Dispute Notice), or as otherwise agreed by the parties.

b) Hearing Format. During the arbitration, the amount of any settlement offer made shall not be disclosed to the arbitrator until after the arbitrator determines the amount, if any, to which you or Epson is entitled. The discovery or exchange of non-privileged information relevant to the Dispute may be allowed during the arbitration.

c) Arbitration Fees. Epson shall pay, or (if applicable) reimburse you for, all JAMS filings and arbitrator fees for any arbitration commenced (by you or Epson) pursuant to provisions of this Agreement.

d) Award in Your Favor. For Disputes in which you or Epson seeks \$75,000 or less in damages exclusive of attorney's fees and costs, if the arbitrator's decision results in an award to you in an amount greater than Epson's last written offer, if any, to settle the Dispute, Epson will: (i) pay you \$1,000 or the amount of the award, whichever is greater; (ii) pay you twice the amount of your reasonable attorney's fees, if any; and (iii) reimburse you for any expenses (including expert witness fees and costs) that your attorney reasonably accrues for investigating, preparing, and pursuing the Dispute in arbitration. Except as agreed upon by you and Epson in writing, the arbitrator shall determine the amount of fees, costs, and expenses to be paid by Epson pursuant to this Section 1.6d).

e) Attorney's Fees. Epson will not seek its attorney's fees and expenses for any arbitration commenced involving a Dispute under this Agreement. Your right to attorney's fees and expenses under Section 1.6d) above does not limit your rights to attorney's fees and expenses under applicable law; notwithstanding the foregoing, the arbitrator may not award duplicative awards of attorney's fees and expenses.

**1.7 Opt-out. You may elect to opt-out (exclude yourself) from the final, binding, individual arbitration procedure and waiver of class and representative proceedings specified in this Agreement by sending a written letter to the Epson Address within thirty (30) days of your assent to this Agreement (including without limitation the purchase, download, installation of the Software or other applicable use of Epson Hardware, products and services) that specifies (i) your name, (ii) your mailing address, and (iii) your request to be excluded from the final, binding individual arbitration procedure and waiver of class and representative proceedings specified in this Section 1. In the event that you opt-out consistent with the procedure set forth above, all other terms shall continue to apply, including the requirement to provide notice prior to litigation.**

**1.8 Amendments to Section 1.** Notwithstanding any provision in this Agreement to the contrary, you and Epson agree that if Epson makes any future amendments to the dispute resolution procedure and class action waiver provisions (other than a change to Epson's address) in this Agreement, Epson will obtain your affirmative assent to the applicable amendment. If you do not affirmatively assent to the applicable amendment, you are agreeing that you will arbitrate any Dispute between the parties in accordance with the language of this Section 1 (or resolve disputes as provided for in Section 1.7, if you timely elected to opt-out when you first assented to this Agreement).

**1.9 Severability.** If any provision in this Section 1 is found to be unenforceable, that provision shall be severed with the remainder of this Agreement remaining in full force and effect. **The foregoing shall not apply to the prohibition against class or representative actions as provided in Section 1.5. This means that if Section 1.5 is found to be unenforceable, the entire Section 1 (but only Section 1) shall be null and void.**

Parent topic: [Notices](#)

## Trademarks

EPSON® and Epson Smart Panel® are registered trademarks, EPSON Exceed Your Vision is a registered logomark, and Epson Connect™, and Remote Print™ are trademarks of Seiko Epson Corporation.

Windows is a registered trademark of Microsoft Corporation in the United States and/or other countries.

AirPrint, Apple, iPad, iPhone, iPod touch, ColorSync, Mac, macOS, OS X, and the AirPrint Logo are trademarks of Apple Inc., registered in the U.S. and other countries. App Store is a service mark of Apple Inc., registered in the U.S. and other countries.

Use of the Works with Apple badge means that an accessory has been designed to work specifically with the technology identified in the badge and has been certified by the developer to meet Apple performance standards.

Google® is a registered trademark and Android™, Chromebook™, Gmail™, Google Chrome™, Google Drive™, and Google Play™ are trademarks of Google LLC.

Wi-Fi Direct® is a registered trademark of Wi-Fi Alliance®.

General Notice: Other product names used herein are for identification purposes only and may be trademarks of their respective owners. Epson disclaims any and all rights in those marks.



Parent topic: [Notices](#)

## Copyright Notice

All rights reserved. No part of this publication may be reproduced, stored in a retrieval system, or transmitted in any form or by any means, electronic, mechanical, photocopying, recording, or otherwise, without the prior written permission of Seiko Epson Corporation. The information contained herein is

designed only for use with this Epson product. Epson is not responsible for any use of this information as applied to other products.

Neither Seiko Epson Corporation nor its affiliates shall be liable to the purchaser of this product or third parties for damages, losses, costs, or expenses incurred by purchaser or third parties as a result of: accident, misuse, or abuse of this product or unauthorized modifications, repairs, or alterations to this product, or (excluding the U.S.) failure to strictly comply with Seiko Epson Corporation's operating and maintenance instructions.

Seiko Epson Corporation shall not be liable for any damages or problems arising from the use of any options or any consumable products other than those designated as Original Epson Products or Epson Approved Products by Seiko Epson Corporation.

Seiko Epson Corporation shall not be held liable for any damage resulting from electromagnetic interference that occurs from the use of any interface cables other than those designated as Epson approved Products by Seiko Epson Corporation.

This information is subject to change without notice.

[libTIFF Software Acknowledgment](#)

[A Note Concerning Responsible Use of Copyrighted Materials](#)

[Default Delay Times for Power Management for Epson Products](#)

[Copyright Attribution](#)

**Parent topic:** [Notices](#)

## **libTIFF Software Acknowledgment**

Copyright © 1988-1997 Sam Leffler

Copyright © 1991-1997 Silicon Graphics, Inc.

Permission to use, copy, modify, distribute, and sell this software and its documentation for any purpose is hereby granted without fee, provided that (i) the above copyright notices and this permission notice appear in all copies of the software and related documentation, and (ii) the names of Sam Leffler and Silicon Graphics may not be used in any advertising or publicity relating to the software without the specific, prior written permission of Sam Leffler and Silicon Graphics.

THE SOFTWARE IS PROVIDED "AS-IS" AND WITHOUT WARRANTY OF ANY KIND, EXPRESS, IMPLIED OR OTHERWISE, INCLUDING WITHOUT LIMITATION, ANY WARRANTY OF MERCHANTABILITY OR FITNESS FOR A PARTICULAR PURPOSE.

IN NO EVENT SHALL SAM LEFFLER OR SILICON GRAPHICS BE LIABLE FOR ANY SPECIAL, INCIDENTAL, INDIRECT OR CONSEQUENTIAL DAMAGES OF ANY KIND, OR ANY DAMAGES WHATSOEVER RESULTING FROM LOSS OF USE, DATA OR PROFITS, WHETHER OR NOT

ADVISED OF THE POSSIBILITY OF DAMAGE, AND ON ANY THEORY OF LIABILITY, ARISING OUT OF OR IN CONNECTION WITH THE USE OR PERFORMANCE OF THIS SOFTWARE.

Parent topic: [Copyright Notice](#)

## **A Note Concerning Responsible Use of Copyrighted Materials**

Epson encourages each user to be responsible and respectful of the copyright laws when using any Epson product. While some countries' laws permit limited copying or reuse of copyrighted material in certain circumstances, those circumstances may not be as broad as some people assume. Contact your legal advisor for any questions regarding copyright law.

Parent topic: [Copyright Notice](#)

## **Default Delay Times for Power Management for Epson Products**

This product will enter sleep mode after a period of nonuse. This is to ensure that the product meets Energy Star standards of energy efficiency. More energy savings can be achieved by setting the time to sleep to a shorter interval.

Parent topic: [Copyright Notice](#)

## **Copyright Attribution**

© 2021 Epson America, Inc.

9/21

CPD-60208R1

Parent topic: [Copyright Notice](#)