



ROCKWOOD

TENT CAMPER OWNER'S MANUAL



Dear Rockwood Camper Owner,

We appreciate your purchase of a Rockwood Camping Trailer. To help make your camping experience more enjoyable, we have included the attached Camper Setup Guide to help familiarize you with the setup procedure of your camper.

This DVD provides information to help you properly set up your camper and to allow you to do so more efficiently. The setup instruction for each model is available for selection in the opening menu. In addition, a screen selection feature is available to give you the ability to play specific sections of the setup process individually.

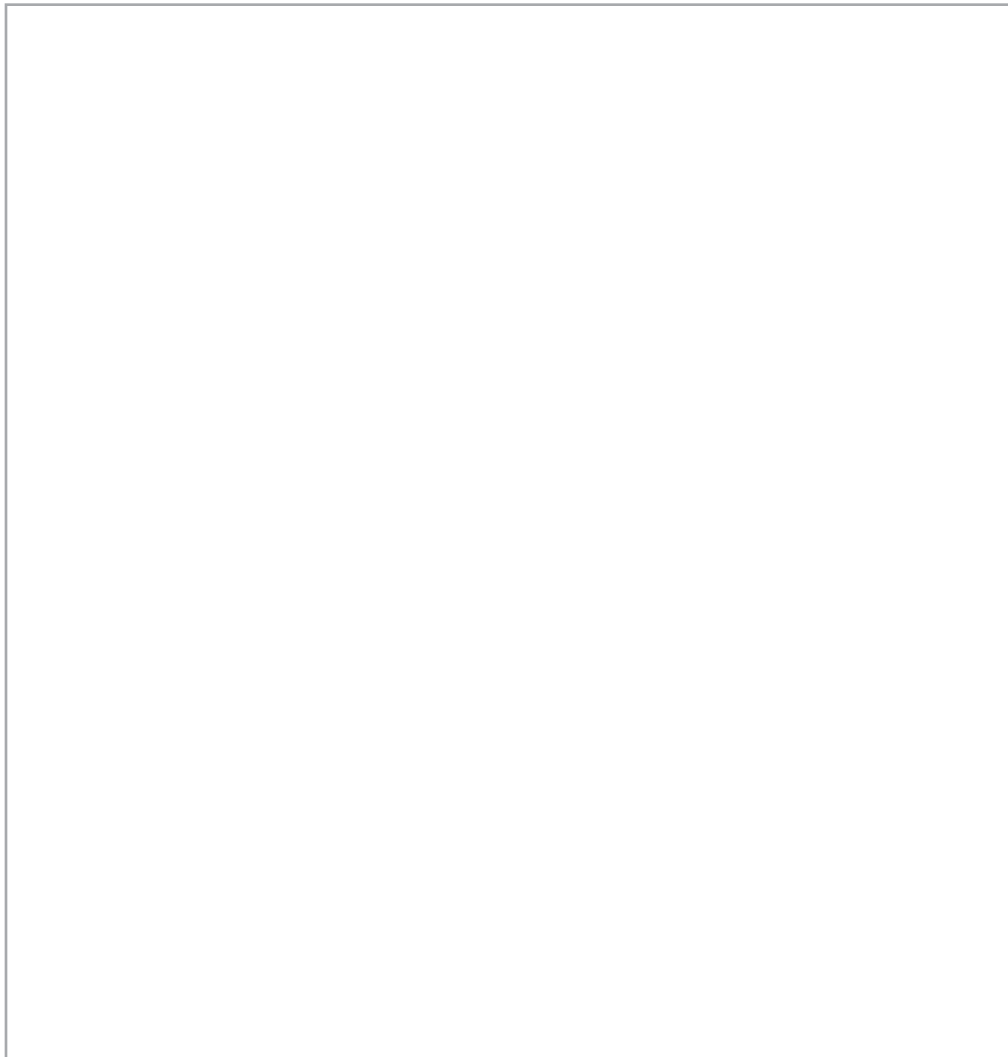



WELCOME HOME!

Thank you for selecting a Forest River tent camper, and welcome to the lifestyle that gives you the freedom to travel and enjoy camping fun whenever you wish.

Your Forest River tent camper complies with the requirements set forth by the Recreational Vehicle Institute Association, as well as various other federal and state agencies.

Items of quality, such as this tent camper, respond best to considerate treatment and care. Therefore, before using it, we suggest that you review the entire contents of this manual. The material within has been prepared in sufficient detail to be of maximum assistance, and the illustrations will be of considerable help when you are getting to know your new camper.

Review this manual with your dealer. They should be able to answer any questions you may have. Read all the literature supplied with your new tent camper, including all warranty and warranty registration information. Remember to validate the warranties by completing and mailing the individual warranty cards for each of the respective manufacturers.

Be sure your dealer has completed and returned your Forest River Tent Camper Warranty Registration Form.

Be sure your dealer has installed the LP gas container bracket, as well as the LP gas container and regulator. Check that the connection has been made between the regulator and the LP gas manifold. Have your dealer explain the operation of filling the LP container as well as how to check the system for leaks.

Keep this owner's manual with the camper, for easy reference, observing and following all instructions and warnings associated with its use. Remember that accidents are usually caused by failure to observe simple and fundamental safety rules or precautions. Accidents can be prevented by recognizing the cause of the accidents and by avoiding the action, or inaction, that may lead to an accident. A careful owner is the best insurance against an accident.

Your tent camper underwent a thorough inspection before it was shipped to the dealer. However, to ensure your complete satisfaction, the dealer will perform an inspection of various components and the operating system of your camper, before you take delivery. Take time to walk through this inspection with your dealer. A walkaround with your dealer will help you become more familiar with your new tent camper and its components, while providing you with the assurance that everything is in proper working order. If you are not familiar with tent camper towing, schedule a test drive with your dealer. Ask any questions you may have at this time.

Your tent camper was designed for short term and recreational use. It was not designed to be used as a permanent dwelling. If you intend to use your camper as a permanent dwelling, it could cause your drapes, upholstery, and interior surfaces to deteriorate prematurely. This premature damage or wear, caused by permanent residency, may, under the terms of Forest River's warranty, be considered abnormal and abusive, and **COULD REDUCE YOUR WARRANTY COVERAGE.**

Should a problem develop for which you need assistance, contact your Forest River Inc. dealer. If you are experiencing an appliance problem, check the appliance manufacturers' information, located in the front of this manual, for information regarding warranty work and/or for the location of an appliance service center.

If you experience a camper problem when traveling, and your camper is under warranty, and you cannot locate an authorized service center, contact your Forest River Inc. dealer BEFORE having repairs performed at an independent service center. Your dealer can advise you what is covered under the terms of your warranty. If a warranty part requires replacement, return the part, along with your invoice, to your local dealer. Doing so enables your dealer to note what has occurred, and ensure that you are properly reimbursed for your expenditures. Modifications made to the tent camper without written authorization from Forest River Inc. Warranty or Service Dept., can result in reduction, or loss of warranty coverage. Please be sure to contact your dealer before making such changes.

SOME PRODUCTS DESCRIBED OR DISPLAYED IN THIS MANUAL MAY BE OPTIONAL EQUIPMENT, AND NOT INCLUDED WITH YOUR CAMPER. ANY SPECIAL EQUIPMENT, MODIFICATIONS, OR ADDITIONS MADE BY, OR AT THE REQUEST OF, THE CUSTOMER, OR ANY SUBSEQUENT OWNER, WHETHER MADE AT THE FACTORY OR IN THE FIELD, ARE NOT COVERED IN THIS MANUAL. WE RESERVE THE RIGHT TO CHANGE THE CONSTRUCTION, OR MATERIAL, OF ANY PART, AT ANY TIME, WITHOUT INCURRING THE OBLIGATION TO INSTALL SUCH CHANGES ON PREVIOUSLY MANUFACTURED TENT CAMPERS.

THIS OWNER'S MANUAL WAS CURRENT AT THE TIME OF PRINTING, HOWEVER, PRODUCTS ARE CONTINUALLY BEING UPGRADED AND IMPROVED, THEREFORE, SOME DIFFERENCES MAY OCCUR, BETWEEN THE DESCRIPTION IN THIS MANUAL, AND THE PRODUCT/S IN YOUR CAMPER. IF DIFFERENCES DO OCCUR, FOLLOW THE COMPONENT MANUFACTURER'S INSTRUCTIONS PROVIDED WITH YOUR FOREST RIVER INC. TENT CAMPER OWNERS' LITERATURE PACKET.

We wish you many happy and adventurous days, as you make great memories with your new Forest River Inc. tent camper.

TRAVEL SAFELY AND...
GO RV'ING!

FOREST RIVER INC. LIMITED WARRANTY FOLD DOWN TENT CAMPER

SUMMARY OF WARRANTY

Forest River Inc., warrants only to the original purchaser, that the tent camper is free from defects in materials and workmanship. Warranty terms include service for 12 months from the original date of purchase, for tent campers used only for non-commercial purposes. Forest River Inc. further warrants, to the original purchaser, that the roof, tent and frame, are free from substantial defect, from the factory, in material and workmanship, for a period of five (5) years for parts, and three (3) years for parts and labor, from the date of purchase, under normal use conditions, effective with 1996 models. This warranty does not apply to any defect in the aesthetics or physical appearance of the unit, nor to normal deterioration of the soft trim and cosmetic items due to wear and exposure.

HOW TO OBTAIN WARRANTY SERVICE

Defects in materials and workmanship of the camper during the first 12 months, will be repaired free of charge, if the unit is returned, with both 'to and from' transportation charges prepaid, to an authorized Forest River Inc. dealer. Defects in material or workmanship of the roof, tent or frame of the camper, during the first three years of the five year warranty period, will be repaired free of charge, if the part is returned, with prepaid 'to and from' transportation charges, to an authorized Forest River Inc. dealer. For the remainder of the five (5) year warranty period, warranty parts will be replaced, but necessary labor will be charged. If an authorized service center is not available in your area refer to the information on the inside back cover, to arrange prompt repairs to your camper.

EXCLUSIONS

- Forest River Inc. assumes no responsibility or liability for defects in workmanship or the operation of, separately warranted products. These products may be warranted by the individual manufacturers and a copy of their warranty has been included in your owner's packet. Separately warranted products will not be serviced, repaired or replaced by Forest River Inc. If service or parts are required for these products, refer to the furnished list of factory authorized service centers. If the list is not available for the particular products, write or call the manufacturer concerned to obtain the location of the nearest service center.
- Forest River Inc. does not warrant components manufactured by others, including, but not limited to tires, appliances, equipment, ranges, ovens, furnaces, batteries, axles, hubs, bearings, power converters, refrigerators, burners, floors, and brake systems. These parts may or may not be warranted by their manufacturers and Forest River Inc., however, assumes no obligations with regard to them.
- This unit was expressly designed for use as a recreational vehicle and is not intended for use as a full-time stationary residence. Forest River Inc. makes no warranty with regard to normal and routine condensation.
- Snow loads must be removed from the roof to avoid damage to the roof.
- This warranty shall not apply to normal maintenance, such as greasing wheel bearings, tightening lug nuts, keeping the areas sealed, where extrusions meet panels, etc., that the tent camper will require, nor to any damages arising from abuse of the failure to have such maintenance performed.
- Fabric items such as canvas, canopies, window screening, vinyl windows, cushion and mattress covers, are not warranted against leakage, tears, punctures, shrinkage, fading or soiling but are warranted only against defective workmanship and materials. Installation of a roof air conditioner must be performed only at the designated area on the roof, by an approved Forest River Inc. dealer, or the roof, lifter system, and related components will not be warranted.

This product is a fold down tent camper, and SHALL NOT be used for COMMERCIAL purposes OR RENTALS. ABUSE, NEGLIGENCE, OR OPERATION OVER UNIMPROVED ROADS WILL VOID THIS WARRANTY. FOREST RIVER INC., MAKES NO WARRANTY WITH REGARD TO ANY PRODUCT NOT REGISTERED AND NORMALLY USED IN THE UNITED STATES OF AMERICA OR CANADA.

DISCLAIMER OR DAMAGES

You and any other user of Forest River Inc. products and any person to whom this unit is transferred, and any person who is an intended or unintended beneficiary of this unit, shall not be entitled to any consequential or incidental damages, including, without limitation, loss of use of the unit, inconvenience, food, lodging, damage to personal property, lost income or earnings.

SOME STATES DO NOT ALLOW THE EXCLUSION OR LIMITATION OF INCIDENTAL OR CONSEQUENTIAL DAMAGES, AND THIS MAY NOT APPLY TO YOU.

DISCLAIMER AND LIMITATIONS OF IMPLIED WARRANTIES

Forest River Inc. limits all implied warranties of fitness for a particular purpose, and merchantability, to the warranty period of one year. No warranties, expressed or implied, extend beyond the one year warranty period. No person has the authority to extend, enlarge, or modify this warranty. No action to enforce this warranty may be commenced more than six months after expiration of the warranty period.

SOME STATES DO NOT ALLOW LIMITATIONS ON HOW LONG AN IMPLIED WARRANTY MAY LAST, SO THE ABOVE LIMITATION MAY NOT APPLY TO YOU. THIS WARRANTY GIVES YOU SPECIFIC LEGAL RIGHTS, AND YOU MAY ALSO HAVE OTHER RIGHTS WHICH VARY FROM STATE TO STATE.

FOREST RIVER'S OBLIGATION

Forest River Inc. will remedy substantial defects in materials and workmanship caused by Forest River Inc. Forest River Inc. shall elect to remedy the defect by either repair, replacement or refund, at Forest River's discretion. Warranty service can only be obtained at Forest River's authorized dealers and service centers. All costs incurred in transporting this tent camper for warranty service shall be borne by you. Forest River Inc. shall remedy the defect within a reasonable time, not to exceed sixty (60) days, after delivery by you. All of Forest River's expenses in remedying the defect shall be borne by Forest River Inc.

YOUR OBLIGATIONS

To validate this Warranty, be sure your dealer completed and returned the owner's registration within (10) days of purchase. The return of this registration form is a condition precedent to warranty coverage. Failure to return the completed form to Forest River Inc. will invalidate this warranty. You shall deliver this fold down tent camper for warranty service within a reasonable time, after discovery of the defect, and in no event after expiration of the Warranty period, as set forth above. All expenses incurred by you in obtaining warranty service, shall be borne by you. You may obtain a list of authorized service centers to perform warranty service, by contacting Forest River Inc. at the address below.

PARTS AND DESIGN CHANGES

Forest River Inc. may make parts and design changes from time to time without notice and repairs or replacements may be made with new or different parts.

WARRANTY REGISTRATIONS

Your warranty registration records should be completed and delivered to the manufacturers of component parts, as they may be a condition of this warranty.

THIS FOREST RIVER INC. WARRANTY IS VOID UNLESS YOUR WARRANTY REGISTRATION IS RETURNED TO FOREST RIVER INC. AT THE ADDRESS LISTED ON THE BACK COVER OF THIS OWNERS MANUAL.

FOREST RIVER, INC. LIMITED LIFETIME WARRANTY FOLD DOWN CAMPER LIFTER SYSTEM

SUMMARY OF WARRANTY

Forest River Inc. extends to the original retail purchaser (You) a limited warranty on its lifter system in Forest River Inc. recreational vehicles against defects in material or workmanship for the lifetime of the recreational vehicle.

COMPANY'S OBLIGATIONS

If the lifter system is determined to be defective during the warranty term, Forest River Inc. will remedy the defect without charge within a reasonable time after receipt of written notice, either by repair or replacement. Warranty service may be obtained from Forest River Inc. or its authorized dealers, or persons designated by Forest River Inc. In the event you have a defective lifter system repaired by an unauthorized service person and said repairs are covered by this Warranty, Forest River Inc. shall be liable only for costs of those repairs up to the amount that Forest River Inc., would have incurred if Forest River Inc. or an authorized dealer had made the repairs.

Warranty performance will commence within a reasonable time after Forest River's receipt of written notice of the defect and will be completed within a reasonable time, subject to availability of parts and scheduling.

ITEMS EXCLUDED FROM WARRANTY

This warranty does not cover defects caused by:

1. Negligence in operation and maintenance.
2. Misuse of lifter system.
3. Damage not resulting from defect or malfunction (act of God).
4. Any damage whatever is caused by or related to any alteration of a Forest River Inc., lifter system.
5. Claims relating to unauthorized repairs, damage or defects.
6. Claims related to power lift system if unit is so equipped.

PURCHASER'S OBLIGATION

You shall give written notice to Forest River Inc. at the address set forth herein within a reasonable time after discovery of the defect. This written notice should contain the following information:

1. Your name and mailing address.
2. Proof of date of purchase.
3. Model, year and serial number of the camper.
4. Name and address of dealer from whom the camper was purchased.
5. Description of the defect.

All costs incurred by you in transporting the Forest River Inc. system for warranty service shall be borne by you. No action to enforce this Warranty shall be commenced later than three (3) months after the expiration of the warranty period.

DISCLAIMER OF CONSEQUENTIAL OR INCIDENTAL DAMAGES

Repair or replacement under this warranty is your exclusive remedy. Forest River Inc. shall not be liable for any incidental or consequential damages resulting from any defect in the lifter system. Some states do not allow the exclusion or limitation of incidental or consequential damages so the above limitation or exclusion may not apply to you.

LIMITATION AND DISCLAIMER OF IMPLIED WARRANTIES

Forest River Inc. expressly limits all implied warranties to the warranty period. Forest River Inc. expressly disclaims, with respect to the Forest River Inc. lifter system, all implied warranties of merchant ability and all implied warranties of fitness for a particular purpose after expiration of the warranty period. There is no warranty of any nature made by Forest River Inc. beyond that contained in this warranty. No person has authority to enlarge, amend, or modify this warranty.

Some states do not allow limitations on how long an implied warranty lasts so the above limitation may not apply to you.

This warranty gives you specific legal rights and you may also have other legal rights which vary from state to state.

PARTS AND DESIGN CHANGES

Forest River Inc. may make parts and design changes from time to time without notice and repairs or replacements may be made with new or different parts.

All inquiries regarding this Warranty should be sent to the address listed on the back cover of this owners manual.

TOC

Welcome Home! 3

Forest River Inc. Limited Warranty Fold Down Tent Camper 4

Forest River, Inc. Limited Lifetime Warranty Fold Down Camper Lifter System 5

Legend 6

Dealer Responsibilities 7

Owner Responsibilities 7

Serial Number, Decals, and Data Plates 9

General Warranty Information 10

Manufacturer's Warranties 10

Forest River Wants Satisfied Customers 10

Care and Maintenance 11

Exterior Maintenance 11

Tent Maintenance 12

Interior Maintenance 14

Forest River Tent Camper Periodic Maintenance Chart 16

Safe Operating Practices 17

Rules for Towing your Camper 18

LP Gas System 32

Electrical System 37

Water and Drainage System 39

Formaldehyde From Building Materials 42

Water-Pur™ 43

Forest River Tent Camper Periodic Maintenance Chart 46

Coach-Net® Emergency Roadside Assistance 47

Set Up Instructions 48

Warranty, Customer Service, Parts Contact 63

LEGEND

The icons shown below are used throughout this manual, to alert you to possible safety or danger issues.



DANGER indicates a hazardous situation which, if not avoided, will result in death or serious injury. This sign is commonly red.



WARNING indicates a hazardous situation which, if not avoided, could result in death or serious injury. This sign is commonly orange.



CAUTION indicates a hazardous situation which could result in vehicle damage or minor to moderate injury. This sign is commonly yellow.

DEALER RESPONSIBILITIES

1. The dealership is responsible for inspecting both factory and dealer installed components for proper operation. This is known as the Pre-Delivery Inspection and Systems Check.
2. Your dealer is required to provide a thorough and complete walk-through demonstration. This demonstration should provide a good understanding of how your new camper operates.
3. The owner's information packet should be presented at this time. This information should include all warranty cards, component information, operation and maintenance instructions relating to your new tent camper.
4. All component warranty registration forms should be discussed and/or completed at this time. Your selling dealer should explain and you should fully understand, the warranty provided on your camper. Be sure you understand the Optional Lifetime Protection Plan offered by Forest River Inc. Ask any questions you may have before leaving the dealership.
5. Your dealer should provide you with information concerning any need for service for your unit, whether in or out of their area. They should also provide you with the contact numbers for the dealership, both during and after hours, along with contact information for Forest River Inc.

OWNER RESPONSIBILITIES

1. Regular and proper maintenance. As the owner, you have the responsibility to properly maintain your tent camper. Be sure you have service performed in a timely manner. Don't ignore a problem; sometimes a phone call is all that's needed. The service technicians will advise you if an appointment needs to be scheduled.
2. Familiarize yourself with your camper. Observe all the component manufacturers instructions regarding the use and service of their products.
3. Complete and return all the warranty cards to each respective manufacturer. Doing so may help you avoid the loss of warranty coverage.

NOTE: A component manufacturer is one whose product, or component part, is installed in or used in, the construction of your camper.

NOTE: MODIFICATIONS TO YOUR CAMPER, WITHOUT WRITTEN AUTHORIZATION FROM FOREST RIVER INC. COULD RESULT IN REDUCTION OR LOSS OF WARRANTY COVERAGE. CONTACT YOUR DEALER BEFORE MAKING SUCH CHANGES.

Coach-Net[®] EMERGENCY ROADSIDE ASSISTANCE
Technical & Roadside Assistance

877-801-0333

When you take delivery of your new Forest River camper, you are provided with an emergency roadside assistance service, free! We've teamed up with the largest RV emergency roadside assistance company in the country to give you immediate access to fast, dependable service when and where you need it. This is a comprehensive emergency roadside service that is available to you around the clock. For further details regarding how to access your Forest River Inc. Emergency Roadside Assistance and Product Support, please call 877-801-0333 or see the brochure information located in the back of this manual.





FOREST RIVER, INC. CUSTOMER DELIVERY AND WARRANTY REGISTRATION FORM **TOWABLES**
 DEALER TO ASSURE THAT THIS FORM IS PROPERLY COMPLETED AND RETURNED TO FOREST RIVER, INC. WITH (10) WORKING DAYS AFTER PDI AND DELIVERY IS PERFORMED.
 SEND FORM TO FOREST RIVER, INC., 1803 CENTURY DRIVE GOSHEN, IN 46828 574-534-3167

OWNERS NAME:		E-MAIL ADDRESS:		DEALERS NAME:		VIN #	
ADDRESS:	Street:	State:	Zip:	ADDRESS:	Street:	City:	State:
DEL DATE:	PHONE #:	FOREST RIVER INC. SERIAL #		BRAND:	MODEL #		ZIP:

PLEASE MARK X IN BOX, LEAVE BLANK IF NOT APPLICABLE. DEALER / LEFT COLUMN, CUSTOMER / RIGHT COLUMN

ELECTRICAL SYSTEM	RUNNING GEAR/FRAME	ALL FITTINGS TIGHT/NO LEAKS
120 VOLT SYSTEM/CIRCUITS, BREAKERS, OPERATION	BRAKE ADJUSTMENTS AND MAINTENANCE IF NECESSARY	P-T-RAP/VENTS TIGHT AND CONNECTED
120 VOLT AUXILIARY GENERATOR OPERATION	BRAKE WIRE CONNECTIONS CHECKED	EXTERIOR
12 VOLT CONVERTOR CIRCUITS, FUSES, OPERATION	COUPLING/UNCOUPLING PROCEDURES AND OPERATION	EXT. DOORS/COMPT. DOORS/LOCK-ALL KEYS
GROUND FAULT CIRCUIT INTERRUPTOR (GFCI)	OPERATE AND LUBE JACKS IF NECESSARY	EXT. STEPS (IF APPLICABLE) LEVEL/SECURE TO FRAME/ALIGNED
ALL INTERIOR LIGHTS, RECEPITS, SWITCHES	TIRE CONDITION AND PRESSURE SET @ _____ PSI (INCL SPARE)	THRESHOLD'S, WINDOWS, ROOF, BODY
ALL EXTERIOR LIGHTS, RECEPITS, SWITCHES	WHEEL LUG TORQUE SET MFG. SPEC. RECHECK @ 250 MI.	WINDOWS, PROPER OPERATION
BATTERY SYSTEM/DISCONNECT TESTED	SPARE TIRE CHECKED FOR SIZE, PRESSURE CONDITION	AWNING DEMONSTRATED/CANVAS CHECKED
MONITOR PANEL OPERATION	LP GAS SYSTEM	FUEL STATION SURV. DEMONSTRATED/OPERATION
PHONE/SATELLITE FUNCTIONS	LOCATION OF LP LINES AND CONNECTIONS SECURED	STABILIZER JACKS DEMONSTRATED
AUDIO/VIDEO ENTERTAINMENT SYSTEM FUNCTIONS	OPERATION OF REG. SET UP AND AUTO-CHANGEOVER	EXTERIOR MAINTENANCE PROCEDURES EXPLAINED
CARBON MONOXIDE DETECTOR	THE LP SYSTEM WAS CHECKED AT _____ IN _____	SLIDE OUT(S) (IF APPLICABLE)
SMOKE DETECTOR	AT _____ (LOCATION) HOLDING _____ IN _____	OPERATION AND MANUAL OVERRIDE DEMONSTRATED
SMOKE CORD INSPECTION AND OPERATION	WC FOR _____ MIN. THE PRESSURE WAS THEN ADJUSTED TO _____ IN WC.	INTERIOR/EXTERIOR SEALS CHECKED
APPLIANCES	WATERPLUMBING SYSTEM	HYDRAULIC OR ELECTRIC PUMPLINES CHECKED
FURNACE AND THERMOSTAT	POTABLE WATER IN/OUT DRAIN LOCATIONS	SLIDE OUT TOPPER(S) CANVAS/OPERATION CHECKED
RANGE/OVEN	CITY WATER FILL CONNECTIONS	GENERAL
WATER HEATER	DEMAND PUMP FUNCTIONS	ALL ACCESSORIES (INCLUDING REMOTES) ARE IN UNIT
REFRIGERATOR	FAULTS OF WASHERS, WASH PRESSURE CHECKED	WARRANTY FORMS COMPLETED AND REVIEWED
AIR CONDITIONER AND THERMOSTAT	WINTERIZING PROCEDURE BY PASS DEMONSTRATED	ALL REQUIRED LITERATURE IS IN UNIT
MICROWAVE	EXTERIOR SHOWER DEMONSTRATED	ALL OWNERS MANUALS IN UNIT AND REVIEWED
TV ANTENNA AND CABLE HOOK UP	BLACK AND GREY HOLDING TANKS/GATE VALVE OPERATIONS	FIRE EXTINGUISHER INSTALLED
ALL OPTIONAL APPLIANCES NOT LISTED	FRESH WATER TANK FILLED/EMPTYED	ALL FURNITURE APPEARANCE/FUNCTION CHECKED
FOLDING CAMPER AND BUNK END UNITS ONLY	TOLLET OPERATION	ALL FLOORING APPEARANCE/FREE OF DEFECTS
COMPLETE SET UP/CLOSING AND AFTER DEMONSTRATION	WATER FILTER OPERATION DEMONSTRATED	HANDLING/TOWING CHECKED, TEST DRIVE
FIT AND FINISH AND CONDITION OF CANVAS		

LIST DEALER INSTALLED OPTIONS (THESE ARE NOT COVERED UNDER THE FOREST RIVER, INC. LIMITED WARRANTY)

OWNER/DEALER INSPECTION REVIEW

- EXTERIOR AND INTERIOR FIT AND FINISH
- OPERATED ALL APPLIANCES, OPTION EQUIPMENT AND ACCESSORIES (REVIEWED MAINTENANCE AND SAFETY OF LP GAS SYSTEM)
- EXPLAINED WEIGHT RATINGS, LIMITATIONS AND PROPER LOAD DISTRIBUTION, TOW VEHICLE CLEAR, WHEEL SET UP, BRAKE CONTROL
- OPERATED ALL FRESH WATER AND PLUMBING COMPONENTS, INCLUDING PROPER WINTERIZATION AND DRAIN LOCATIONS
- COMPLETE REVIEW OF OWNERS MANUALS AND HIGHLIGHT OF SAFETY ISSUES

I have completed the above inspections on the family recreational vehicle to my satisfaction and have been offered a test drive at the time of purchase. I understand that issues regarding damage such as scratches, tears, dents, broken items, etc. will not be warranted except those notes in the space:

I have had the opportunity to review the Forest River, Inc. Limited warranty during the purchase of this unit and I understand that this product is designed to be used for recreational camping and travel. I have been given the opportunity to make notations in the space provided above, have observed or received satisfactory explanation to all questions regarding the items listed during this delivery process.

DATE

PURCHASER'S SIGNATURE

DEALER'S SIGNATURE



FOREST RIVER, INC., DEALER PDI CHECKLIST TOWABLES
 DEALER IS TO ASSURE THAT THIS FORM IS PROPERLY COMPLETED & RETURNED TO FOREST RIVER, INC. WITHIN (10) WORKING DAYS AFTER PDI IS PERFORMED. (SEE BACK OF FORM FOR CORRECT MAILING ADDRESS)

DEALER:	F.R. DLR. #:	BRAND:	MODEL:	F.R. SERIAL #:
<i>PLEASE CHECK EACH ITEM THAT APPLIES TO UNIT WHEN ITEM IS INSPECTED</i>				
RUNNING GEAR/FRAME	SHACKLE/BOLTS TIGHT	CHASSIS BOLTS TIGHT	TIRE CONDITIONS CHECKED/PRESSURE SET @ _____ PSI	SPARE CHECKED FOR SIZE MATCH/PRESSURE
	WHEEL LUG TORQUE SET PER MFG. SPECS.	LUBRICATE/CHECK BEARINGS IF 6 MONTHS SINCE DELIVERY TO THE DEALER/MANUFACTURE	BRAKE WIRE FLUIDS/CONNECTIONS CHECKED	ELECTRICAL WIRE ROUTING/CONNECTIONS CHECKED
	GAS LINE ROUTING SECURED TO FRAME	ALL JACKS OPERATED & CHECKED	STEPS) SECURE TO FRAME/LEVEL/ALIGNED	VISUAL CHECK AXLE CAMBER/WHEEL ALIGNMENT
	IDENTIFICATION TAGS/VIN STAMP CORRECT	WATER SYSTEM/PLUMBING	FRESH WATER TANK LINES CONNECTED	DRAIN LINES THROUGH UNDERBELLY
	DEMAND PUMP FUNCTIONS	AIR PRESSURE TEST PERFORMED ON SYSTEM	GRAVITY WATER FILL/INLET CONNECTED	CITY WATER FILL/INLET CONNECTED
	ALL FAUCETS/FIXTURES - TIGHT/WATER PRESSURE OK	EXTERIOR SHOWER CONNECTED/TESTED	TOLLET OPERATION CHECKED	SEWER & HOLDING TANKS FILLED & DRAINED
	GATE VALVES OPERATED/TESTED/HOLD WATER	SHOWER/TUB/SINKS, DRAINS HOLD WATER	ALL TRAPS & VENTS TIGHT/OPERATE	ALL FITTINGS TIGHT/NO LEAKS
	WATER HEATER BYPASS TIGHT/FUNCTIONS	BLACK TANK CLEANOUT TESTED/NO LEAKS	ALL SEALANTS CHECKED AT DRAINS, SINKS, ETC	WATER FILTER CONNECTIONS TIGHT
	UNIT WINTERIZED, IF NECESSARY	SLIDE ROOMS/ IF APPLICABLE	MOTOR OR PUMP OPERATION/FLUID LEVEL/CHECKED	ROOM SEALS TIGHT OPEN & CLOSED
	ROOM SEALS TIGHT OPEN & CLOSED			

DEALER COMMENTS:

DEALER: I CERTIFY THAT THE TESTS & INSPECTIONS LISTED WERE PERFORMED AS INDICATED ON THE PDI CHECKLIST & DONE IN ACCORDANCE WITH ALL ACCEPTABLE INDUSTRY STANDARDS. THE UNIT DESCRIBED ABOVE HAS NO EVIDENCE OF ACCIDENT, MISUSE OR NEGLIGENCE. I ALSO CERTIFY THAT THE LP GAS & 120 VOLT SYSTEMS, THE OPERATION OF ALL COMPONENTS & APPLIANCES, THE COUPLING & UNCOUPLING PROCEDURES, ROAD TESTS & ALL WARRANTIES HAVE BEEN VERIFIED & PERFORMED PER THE RESPECTIVE MANUFACTURER'S SPECIFICATIONS. UNIT IS NOW READY FOR CUSTOMER WALK THROUGH AND DELIVERY INSTRUCTIONS.

DEALER TECHNICIAN AUTHORIZED SIGNATURE: _____

DATE PDI PERFORMED: _____

F-0900

SERIAL NUMBER, DECALS, AND DATA PLATES

4X4CPR721CD285576		PRD285576																																							
MANUFACTURED BY / FABRIQUE PAR: FOREST RIVER, Inc.		DATE: 1/18/2012																																							
V.I.N./N.I.V.: 4X4CPR721CD285576		TYPE/TYPE: TRA/REM TRA/REM																																							
GVWR/PNBV: 2074 KG (4573 LB)		HW296																																							
Coupler Size:		PRD285576																																							
<table border="1"> <tr> <td>FROM/ AVANT</td> <td>953 KG</td> <td>TIRE SÉRIE</td> <td>RIMS/QUANTÉ</td> <td>COLD INFL. PRESS./PRESS. DE GONFL. À FROID</td> <td>THIS VEHICLE CONFORMS TO ALL APPLICABLE U.S. FEDERAL MOTOR VEHICLE SAFETY STANDARDS IN EFFECT ON THE DATE OF MANUFACTURE SHOWN ABOVE.</td> </tr> <tr> <td>(</td> <td>2100 LBS)</td> <td>ST205/75R14/C</td> <td>14X5.5JJ</td> <td>345 KP SINGLE DUPL</td> <td rowspan="3">THIS VEHICLE CONFORMS TO ALL APPLICABLE STANDARDS PRESCRIBED UNDER THE CANADIAN MOTOR VEHICLE SAFETY REGULATIONS IN EFFECT ON THE DATE OF MANUFACTURE.</td> </tr> <tr> <td></td> <td></td> <td></td> <td></td> <td>50 PSIALP <input checked="" type="checkbox"/> <input type="checkbox"/></td> </tr> <tr> <td>INTÉRMÉDIAIRE</td> <td>0 KG</td> <td></td> <td></td> <td>0 KP SINGLE DUPL</td> </tr> <tr> <td>(</td> <td>0 LBS)</td> <td></td> <td></td> <td>0 PSIALP <input type="checkbox"/> <input type="checkbox"/></td> <td rowspan="3">CE VÉHICULE EST CONFORME À TOUTES LES NORMES QUI LUI SONT APPLICABLES EN VERTU DU RÉGLEMENT SUR LA SÉCURITÉ DES VÉHICULES AUTOMOBILES DU CANADA EN VIGUEUR À LA DATE DE SA FABRICATION.</td> </tr> <tr> <td>REAR/ ARRIÈRE</td> <td>953 KG</td> <td></td> <td></td> <td>345 KP SINGLE DUPL</td> </tr> <tr> <td>(</td> <td>2100 LBS)</td> <td>ST205/75R14/C</td> <td>14X5.5JJ</td> <td>50 PSIALP <input checked="" type="checkbox"/> <input type="checkbox"/></td> </tr> </table>		FROM/ AVANT	953 KG	TIRE SÉRIE	RIMS/QUANTÉ	COLD INFL. PRESS./PRESS. DE GONFL. À FROID	THIS VEHICLE CONFORMS TO ALL APPLICABLE U.S. FEDERAL MOTOR VEHICLE SAFETY STANDARDS IN EFFECT ON THE DATE OF MANUFACTURE SHOWN ABOVE.	(2100 LBS)	ST205/75R14/C	14X5.5JJ	345 KP SINGLE DUPL	THIS VEHICLE CONFORMS TO ALL APPLICABLE STANDARDS PRESCRIBED UNDER THE CANADIAN MOTOR VEHICLE SAFETY REGULATIONS IN EFFECT ON THE DATE OF MANUFACTURE.					50 PSIALP <input checked="" type="checkbox"/> <input type="checkbox"/>	INTÉRMÉDIAIRE	0 KG			0 KP SINGLE DUPL	(0 LBS)			0 PSIALP <input type="checkbox"/> <input type="checkbox"/>	CE VÉHICULE EST CONFORME À TOUTES LES NORMES QUI LUI SONT APPLICABLES EN VERTU DU RÉGLEMENT SUR LA SÉCURITÉ DES VÉHICULES AUTOMOBILES DU CANADA EN VIGUEUR À LA DATE DE SA FABRICATION.	REAR/ ARRIÈRE	953 KG			345 KP SINGLE DUPL	(2100 LBS)	ST205/75R14/C	14X5.5JJ	50 PSIALP <input checked="" type="checkbox"/> <input type="checkbox"/>		
FROM/ AVANT	953 KG	TIRE SÉRIE	RIMS/QUANTÉ	COLD INFL. PRESS./PRESS. DE GONFL. À FROID	THIS VEHICLE CONFORMS TO ALL APPLICABLE U.S. FEDERAL MOTOR VEHICLE SAFETY STANDARDS IN EFFECT ON THE DATE OF MANUFACTURE SHOWN ABOVE.																																				
(2100 LBS)	ST205/75R14/C	14X5.5JJ	345 KP SINGLE DUPL	THIS VEHICLE CONFORMS TO ALL APPLICABLE STANDARDS PRESCRIBED UNDER THE CANADIAN MOTOR VEHICLE SAFETY REGULATIONS IN EFFECT ON THE DATE OF MANUFACTURE.																																				
				50 PSIALP <input checked="" type="checkbox"/> <input type="checkbox"/>																																					
INTÉRMÉDIAIRE	0 KG			0 KP SINGLE DUPL																																					
(0 LBS)			0 PSIALP <input type="checkbox"/> <input type="checkbox"/>	CE VÉHICULE EST CONFORME À TOUTES LES NORMES QUI LUI SONT APPLICABLES EN VERTU DU RÉGLEMENT SUR LA SÉCURITÉ DES VÉHICULES AUTOMOBILES DU CANADA EN VIGUEUR À LA DATE DE SA FABRICATION.																																				
REAR/ ARRIÈRE	953 KG			345 KP SINGLE DUPL																																					
(2100 LBS)	ST205/75R14/C	14X5.5JJ	50 PSIALP <input checked="" type="checkbox"/> <input type="checkbox"/>																																					

RECREATIONAL VEHICLE DATA PLATE

NOTE: THE CAMPER SERIAL NUMBER LABEL IS MOUNTED ON THE FRONT ROAD SIDE OF THE CAMPER.

NOTE: BE PREPARED TO SUPPLY MODEL NUMBER, SERIAL NUMBER AND YEAR, WHEN ORDERING PARTS OR REQUESTING SPECIFIC INFORMATION REGARDING YOUR RV.

Forest River Inc. recommends that you keep a copy of this information separate from the camper, in the event that theft or vandalism requires you to supply a copy to the authorities.

Decals and data plates used throughout the camper, aid in its safe and efficient operation; others give service instructions. Read all decals, data, and instruction plates before using your new camper. If a decal, data, or instruction plate becomes damaged, painted over or removed, it needs to be replaced.

THE FOLLOWING IS ADDED AS A REQUIREMENT OF THE NATIONAL HIGHWAY TRAFFIC SAFETY ADMINISTRATION (NHTSA).

If you believe that your vehicle has a defect which could cause a crash or could cause injury or death, you should immediately inform the national highway traffic safety administration (NHTSA) in addition to notifying the manufacturer.

If NHTSA receives similar complaints, it may open an investigation and if it finds that a safety defect exists in a group of vehicles, it may order a recall and remedy campaign. However, NHTSA cannot become involved in individual problems between you, your dealer, or the manufacturer.

To contact NHTSA, you may either call the auto safety hot line, toll-free at 1-888-327-4236, hearing impaired, 1-800-424-9153, (or 366-0123 in Washington, D.C. 20590.) You can also obtain additional information about vehicle safety from their website, <http://www.safercar.gov>.

GENERAL WARRANTY INFORMATION

The appliances in your tent camper will provide home-like convenience while traveling. They have been designed and tested by their manufacturers for maximum service in a tent camper application. Each appliance in your camper is covered by Forest River's comprehensive warranty as well as being warranted by its respective manufacturer.

It is important that you review all the literature provided in the manufacturer's information packet. Fill out and mail any warranty registration card or forms required by the appliance manufacturer at this time. Failure to do so could void your warranty. Be sure to have your dealer go over the operation of the appliances with you, and note any shortage of literature you may have at that time.

It is important also, that you carefully read all the manufacturer's information provided regarding both operation and maintenance of the appliances. Pay close attention to all safety precautions given and be sure to follow them. Keep all literature, including this manual, with the tent camper for easy reference.

If service on any appliance is required, contact your dealer, or an authorized service representative of the appliance manufacturer. Appliances available in the camper include the range, refrigerator, water heater, and optional furnace. Operating instructions can be found in the literature provided with each appliance in the manufacturer's information packet.

IMPORTANT! Be sure your dealer completes the retail Pre-delivery inspection form and Warranty Registration form (refer to page 8) supplied with your camper, within 10 days of purchase, and that both you and the dealer sign and date them before returning them to Forest River to register your warranty.

MANUFACTURER'S WARRANTIES

For any components with separate warranties on your tent camper, be sure to check the literature supplied by the manufacturer to see if they require you to register your purchase with them to validate their warranty. These warranties generally apply only to the original purchaser of the tent camper. Forest River Inc. recommends that you send the various warranty registration cards or forms, immediately before any time constraints on registration expires, possibly voiding your warranty.

Manufacturer's literature is supplied with the owner's information packet, in newly delivered units. Only those products and options, which are installed on your camper, will be included in this packet. If you have questions regarding this literature, discuss them with your dealer during the pre delivery inspection and report any literature shortage at that time.

FOREST RIVER WANTS SATISFIED CUSTOMERS

Your satisfaction and goodwill are important to both your RV dealer and to Forest River. If you experience a problem and you have exhausted all attempts to rectify the situation with your RV dealership, you may consider contacting the Forest River Warranty/Customer Service representative. Contact information is provided on the back inside cover of the Owner's Manual.

When calling, please have the following information ready:

1. Your I.D. number.
2. Name and location of your selling dealer.
3. The date of your purchase.
4. The nature of the problem.

CARE AND MAINTENANCE

GENERAL INFORMATION

Periodic maintenance of your tent camper is necessary not only to protect your investment, but also to retain the dependability, safety, and appearance that will provide you with many seasons of trouble-free operation. Preventative maintenance will pay for itself many times over by preventing problems before they occur.

Many repair costs are greatly increased by ignoring small problems, which can affect other parts and/or systems of your tent camper.

If a situation arises involving a maintenance or cleaning activity and you are unsure of the proper procedure, contact your dealer. It is our goal to help keep you informed, and help you understand how to keep your tent camper properly maintained.

EXTERIOR

FIBERGLASS AND ALUMINUM SIDING

The care of fiberglass and aluminum siding is essentially the same care as automotive finish.

- Wash your tent camper on a regular basis, using warm water and a mild detergent.
- Take care to avoid spraying water directly into the furnace or refrigerator vents (if so equipped) when washing the tent camper.
- Remove bird droppings, tree sap, insects, and tar, as soon as possible, to avoid staining the camper finish,
- Wash and wax fiberglass and aluminum at least three times a year, with an automotive type liquid or paste wax. Follow the directions for use, as outlined by the product manufacturer. When washing and waxing your camper, do so out of the hot sun and when the exterior surfaces are cool. Storing the tent camper out of the direct sun is an excellent way to help preserve exterior finishes.

Any finish will deteriorate with time. Dulling and fading can be increased by exposure to extreme sunlight, air pollutants, and excessive moisture. Surface weathering of fiberglass does not change the strength of the fiberglass.

Regularly washing the exterior surface is the best insurance against deterioration such as fading, yellowing, or chalking.

If surface deterioration has occurred, check with your dealer for the steps required to restore the finish. In extreme cases, buffing or painting may be necessary.

Small cracks in the fiberglass can usually be repaired by using a fiberglass filler. Allow the filler to harden, sand, then repaint with gelcoat. (Check with your dealer for further instructions and product information.)

To avoid moisture from entering through breaks, physical damage to fiberglass or aluminum should be repaired immediately, before possibly causing problems with interior walls and components. Cover breaks in the sidewall with plastic, sealing the edges with tape until proper repairs can be made.

CAUTION

DO NOT USE RUBBING COMPOUND OR ANY ABRASIVE CLEANER OR CLOTH ON THE CAMPER. IF USING A TAR OR INSECT REMOVER, BE SURE IT IS SAFE FOR USE ON PAINTED SURFACES.

SEALS AND ADHESIVES

It is important to maintain the seals and adhesives on your tent camper. Doing so will help prevent moisture from entering and destroying tent camper components. When washing your tent camper, inspect the seals and body moldings, for signs of drying out and wear. Be aware that weather, sun, and road vibration, will have an effect on seals, causing them to dry, crack, or separate. Check the campers' condition at least twice a year. Clean off all dirt, and check for cracks in the sealant around the vents and extrusions. Use a polyurethane sealant, or a marine type caulk to reseal, if needed.

Note: It is important to frequently check the seals in order to help prevent moisture from entering the camper, causing rot, mold and mildew. This is especially important for campers being stored outside. If you are unsure how to perform the seal maintenance, consult your dealer for the correct method for renewing the seals, or, if you prefer, have your dealer perform the seal maintenance for you.

⚠ WARNING

UNDER THE TERMS OF YOUR TENT CAMPER WARRANTY, FAILURE TO MAINTAIN TENT CAMPER SEALS, THROUGH REGULAR MAINTENANCE, CAN LEAD TO SEVERE DAMAGE OF TENT CAMPER COMPONENTS, AND MAY BE CONSIDERED *NEGLECT OR ABUSIVE TREATMENT*. UNDER THOSE CONDITIONS, DAMAGES OF THIS NATURE ARE NOT WARRANTABLE.

TENT MAINTENANCE

TENT MATERIAL

To help prevent water damage, it is important to seal all stitched areas.

5. Set up the camper as you would when camping. Be sure all windows are zipped closed, and the storm door window is closed and secure.
6. Remove all cushions and drapes, and store them in a dry place.
7. Saturate all seams with water and check inside the camper, for any seam leaks.
8. Allow the tent to dry completely, or wipe seams dry with a smooth white cloth before sealing.
9. Seal all seams with a wax candle or paraffin.
10. After you have sealed all stitching with one of the recommended products, and retested for leaks, then reinstall the cushions and drapes.

CARE OF YOUR VINYL TENT FABRIC

Some tent fabrics are coated with vinyl to allow easier cleaning of the exterior surface. Vinyl coated fabric cannot breathe, and condensation may form on the fabric side. The tent may appear to be leaking. This situation can be corrected by opening the zippered windows slightly, to ventilate the interior of your camper, allowing the condensation to evaporate.

CONDENSATION

Recreational vehicles are built according to government standards which regulate the industry, and according to RVIA standards, which are more severe than government standards.

Follow these tips to help avoid excessive moisture in your camper:

1. Open the roof vent when cooking and/or slightly open the kitchen vinyl window.
2. Use the power vent when bathing or showering. The power vent can also function as an attic fan, to recirculate the air.
3. Never use a humidifier. Vaporizer use should be minimal.
4. Turn on the air conditioner briefly, after cooking or bathing, to help eliminate moisture.

Condensation is a natural occurrence. The amount of condensation will vary with the climactic conditions, particularly, relative humidity. Condensation occurs when water vapor is present in the air. When the temperature reaches the 'dew point', the water vapor in the air condenses, becoming liquid. Properly ventilating your unit helps control condensation. Condensation causes dampness, mildew, staining and, if left unchecked, may cause damage to paneling, ceiling, fabrics, furniture, or personal belongings.

Note: Condensation is not a result of a defect. Damage from condensation remains the responsibility of the owner.

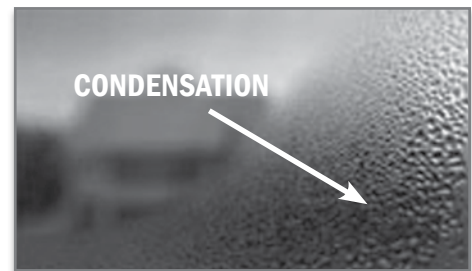

- Note: Always ventilate and dry tent (with bows and braces in place), as soon as possible, after each exposure to moisture. **Mildew is always the result of negligence.**
- Note: To avoid possible damage to the finish, do not use solvents, rubbing compound or abrasive cleaner or cloth, to clean your vinyl tent.
- Note: Do not use hand-held high pressure spray devices such as those at car washes, as they will damage the tape and painted surfaces on the camper.

For heavily soiled spots, a very soft bristled brush can be used. Before using any cleaner or chemical on the camper, test a small area first. After washing, rinse the entire camper thoroughly to remove any soap residue, as it can stain the paint. Use towels or a chamois to dry the camper.

To avoid moisture from entering through breaks, possibly causing problems with interior walls and components, damage to fiberglass or aluminum should be taken care of immediately. Cover breaks in the sidewall with plastic, sealing the edges with tape until proper repairs can be made.

TENT VINYL MAINTENANCE

All vinyl tents need to be dampened with water, one or more times, to seal the needle holes. Your tent may leak the first time it gets wet. This is normal. The tent is sewn with special thread which expands when wet and helps to seal the needle holes.

Seal all seams before the first trip, and each year thereafter to prevent water damage to the interior of your camper. It's a good idea to include a wax candle in your field maintenance kit, to seal small leaks which may develop while you are camping. (If you use a candle for emergency lighting, be sure to observe proper fire safety precaution. Have your camper fire extinguisher nearby, and be sure you and your guests know how to operate it.)

Your plastic windows have a -20° cold crack. Do not crank your tent up to the maximum height in extremely cold weather, (0°). Doing so could shatter your windows.

To avoid damage from mold or mildew, allow a wet tent to dry completely before closing the camper. If you must close the camper with the tent wet, be sure to protect all the cushions and drapes from dampness by storing them in a dry, protected area.

CRANK-UP LIFT SYSTEM

To help protect your Limited Warranty, you must perform general maintenance and regular inspections. Failure to provide proper service maintenance is easily recognized, as it is reflected in the condition of your camper.

POWER-WINCH SYSTEM

Refer to your power winch owners manual for operating and maintenance information.

INSPECT AND SERVICE YEARLY

- Clean and recoat lifter posts externally, with a rust prohibitive, non-drying lubricant.
- Annually grease zerks on front, bottom and top of master tube.
- Lubricate springs annually by raising the roof to the UP position. At each segment of the telescoping post, lubricate with 30 weight oil, taking care to inject the oil into the opening between the posts. To help avoid tent damage, immediately remove any excess oil on the external portion of the post.

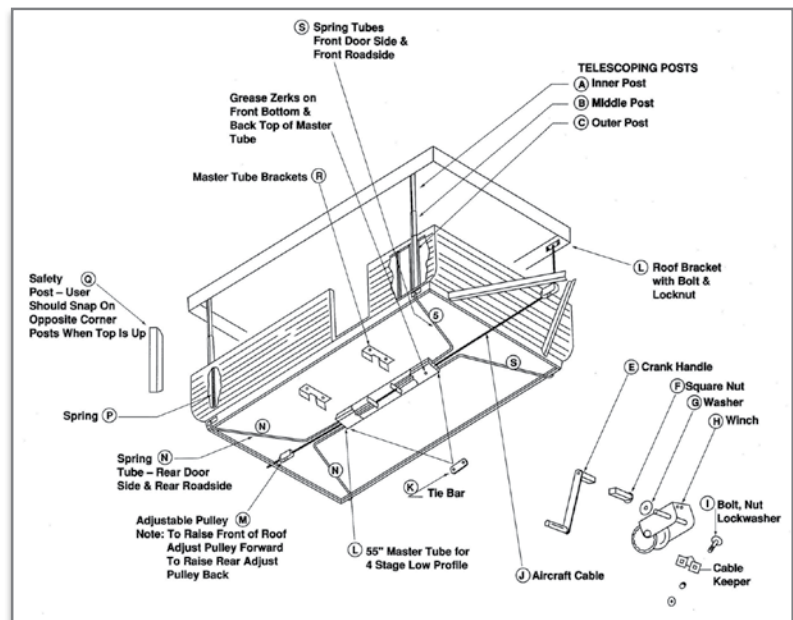

FRAME

Check the condition of the frame regularly. To help avoid rust, keep the frame clean, and repaint as necessary. It is important to keep underbody components clean, especially if you are towing the tent camper in the winter in areas, where road salt is used.

WHEELS AND TIRE

In areas where the camper is subjected to hot sun for prolonged periods, shading the tires by covering them, can reduce tire sidewall cracks from forming. Spraying tire sidewalls with a silicone spray can also help keep them from drying out. Check the condition of the wheels regularly. Keep them clean, and repaint as necessary to avoid rust. Check the tightness and condition of lug bolts regularly.

BRAKES AND WHEEL BEARINGS

Check brake adjustment and lining regularly, and adjust as needed, per the manufacturer's instructions. Also check the wheel bearings regularly and keep lubricated. If needed, repack with grease, and replace the cotter pins.

JACK POST, DOLLY WHEEL, AND COUPLER

Keep threads and moving parts lubricated, and check their condition regularly. Grease the release lever and coupler socket to ensure proper operation and fit.

LP GAS SYSTEM

The LP gas system should be checked regularly for leaks and road damage. Have a qualified LP gas service technician check the entire LP system, including regulator pressure, annually, or sooner, if you suspect a problem, using proper equipment.

INTERIOR

APPLIANCES, SINK AND COUNTERTOP

Clean the sink, countertop, and appliances with hot soapy water, or a good liquid cleaner. Avoid using abrasive cleaners. DO NOT place hot pots or pans directly on countertops, as they can burn or loosen the countertop surface.

Never use steel wool on a stainless steel sink. When cleaning stainless steel, use a mild cleanser, gently scrub the sink in the direction of the grain, and rinse well. Rinse after each use and wipe dry.

After each trip, remove food and ice from the refrigerator. Prop the door open slightly to keep the interior dry and free of mold, mildew, and odors. Read and understand all instructions provided with your appliances, and follow the manufacturer's instructions. Pay particular attention to all cautions or warnings.

CUSHIONS

Fabrics are durable and stain resistant. Use a foam-type upholstery cleaner for general cleaning and stain removal. Fabrics can be further protected by applying a fabric conditioner, at least once a year, such as "Scotchgard."

CURTAINS

For best results, all curtains and drapes should be professionally dry cleaned. You can help avoid accumulation of dirt between cleanings, by vacuuming, or lightly brushing, curtain fabric frequently.

VINYL FLOOR COVERING

Damp mop with water and detergent, rinse thoroughly. DO NOT use abrasive cleaners.

WOOD SURFACES AND PRE-FINISHED PANELS

Keep the wood products in your tent camper looking like new, for the life of the unit, by treating the cabinetry and wood surfaces with a good furniture polish. Clean pre finished panels with a spray-type furniture polish. Avoid constant exposure to direct sunlight, which can cause wood to fade and dry out.

WATER SYSTEM

Regularly check all hoses, fittings, and connections for leaks and signs of wear. Keep the system sanitized, and take care to winterize during cold weather. DO NOT allow water to remain in system for extended periods.

The fresh water inlet line, between the fresh water tank and the galley faucet, is protected by a screen filter. The screen is located where the fresh water access line attaches to the pump. This screen should be removed and cleaned at least once a year, or whenever water flow through the kitchen faucet seems restricted. If debris has clogged the inlet filter, be sure to also clean the fresh water tank, per the instructions outlined in this manual.

ELECTRICAL SYSTEM

Under normal circumstances, the electrical system requires minimal maintenance. If you experience electrical problems with your tent camper, have it checked by a qualified electrician.

BED SLIDES

Lubricate frequently with silicone, to ensure easy operation.

ROOF VENT

Frequently check the roof vent for debris which may block air flow or jam the cranking mechanism. Lubricate the mechanism with light oil.

ABS PLASTIC

Various components of the tent camper are constructed of strong, lightweight ABS plastic. If it becomes necessary to remove a stain, a solution of mild soap and water is generally all that's needed. Tougher stains may require stronger cleaners, but before using an untried product, be sure to read the label to determine if the product is recommended for use on plastics.

Avoid abrasive cleaners (even liquid and cream types), alcohol based products, and solvents such as acetone and MEK, (methyl ethyl ketone). Gasoline and kerosene should not be used for cleaning purposes. They have a damaging effect as well as being a fire hazard.

CAUTION

DAMAGE CAUSED BY SOLVENTS, ALCOHOL, AND OIL-BASED PRODUCTS MAY NOT BE IMMEDIATELY NOTICEABLE. THEY CAN CAUSE THE PLASTIC TO WEAKEN AND BECOME PRONE TO STRESS CRACKING.

WINTERTIME USE**WATER SYSTEM**

Units with above floor water tanks have a dinette storage lid which can be left open to allow warmer air to circulate around the water tank. If the camper has water tanks below the floor, store water in plastic containers in a heated area.

FOOD STORAGE

Since heat rises, canned goods and other foods packed in water should be stored in top cupboards, (only when the camper is in storage, never when traveling). They may also be stored in the refrigerator, as it is insulated against the cold. Store dry foods, and other items that are not damaged by freezing, in the lower storage areas.

LP GAS SYSTEM

It is important to remember that heating with LP consumes gas rapidly, so refill tanks immediately, to avoid running out of fuel.

HEATING**⚠ WARNING**

USE ONLY THE CAMPER FURNACE TO HEAT THE CAMPER, AS IT IS PROPERLY VENTED TO THE OUTSIDE. NEVER USE THE RANGE FOR HEATING. CARBON MONOXIDE POISONING, ASPHYXIATION OR FIRE, COULD OCCUR.

FOREST RIVER TENT CAMPER

PERIODIC MAINTENANCE CHART

ITEM	EACH TRIP	EACH MO.	3 MO.	6 MO.	YEARLY	AS REQ.	PROCEDURE
Fiberglass Exterior		•					Wash with warm water and mild detergent
				•			Wax with liquid or paste wax
				•			Check condition of body moldings and reseal as needed
Tent Material	•						Clean and rinse thoroughly and allow to dry
						•	Remove stains from vinyl with Oxy-Clean
						•	Seal leaks in tent vinyl as required
Roof				•			Inspect and reseal as necessary
					•		Lubricate roof vent mechanism with light oil
Windows and Doors						•	Clean windows with plastic polish used for auto convertible top windows
			•				Lubricate door hinges and step components with WD40
					•		Lubricate door locks and strike pocket, including exterior storage and access doors
Seals and Adhesives		•					Inspect and reseal as necessary
LP Gas System						•	Check for leaks and road damage
Water and Drainage				•			Check hoses, fittings and connections for leaks or signs of wear
						•	Sanitize system and check fresh water inlet line screen
					•		Winterize system, if needed, due to weather conditions
Electrical						•	Perform maintenance on converter per converter manual
						•	Check and service battery (if so equipped)
Appliances	•						Remove food and ice from refrigerator after each trip
		•					Check for obstructions and dirt on exterior appliance vents
Safety Equipment		•					Check fire extinguisher pressure and conditions
Wood Surfaces		•					Clean pre-finished panels and wood
Weight and Distribution	•						Keep unit within specified load limits and proper weight distribution
Lifter System				•			Lubricate
Bunks						•	Lubricate bunk slides with silicone
Axles				•			Mounting bolts should be torqued to specific foot pounds
Wheel Bearings				•		•	Repack wheel bearings
Brakes			•			•	Check operation and for uneven wear

* As conditions and use warrant. (Follow instructions outlined in this manual.)

CONDENSATION

Cooking produces large amounts of moisture in the form of steam and condensation. To allow moisture to escape, open a roof vent or unzip a window.

WINTER STORAGE TIPS

Certain precautions must be taken to protect your camper during winter storage. Consider using the tips listed below. (It's a good idea to consult your dealer regarding any special requirements for storage in your particular geographic location.)

1. Park the camper on a level surface.
2. Clean and dry the camper thoroughly, both inside and out, including the refrigerator, sink and shower.
3. Be sure electrical switches and appliances are turned off.
4. Do not leave a battery in the camper for the winter. It will discharge within 30 to 45 days, and could freeze, if not kept fully charged.
5. Be sure all doors and vents are closed securely. Cover exterior appliance vents to prevent moisture insects, or vermin, from entering during storage.
6. Periodically check the interior of the camper to be sure leaks have not developed which could cause damage to interior components.
7. Keep the tires inflated to the correct pressures.
8. If stored outside, keep the camper free of snow and ice accumulation.
9. Drain the water system. Consult your dealer before using any type of water system antifreeze in your camper. Your tent camper dealer can advise you of the type of nontoxic, antifreeze to use, and how to completely flush and sanitize the water system before using it after winterizing.

 DANGER

AUTOMOTIVE ANTIFREEZE IS TOXIC AND NOT SAFE TO USE IN YOUR DRINKING WATER SYSTEM.

NOTE: IT IS BEST TO STORE YOUR CAMPER INSIDE A PROTECTED AREA; HOWEVER, IF IT IS TO BE STORED OUTSIDE, BE SURE TO CHECK AND RESEAL ALL ROOF JOINTS BEFORE STORING, AND AGAIN IN THE SPRING.

 WARNING

IF YOU CHOOSE TO STORE YOUR CAMPER UNDER A TARP, DAMAGE TO THE ROOF/FIBERGLASS CAN OCCUR IF THE TARP IS TOO DARK IN COLOR AND IS NOT PROPERLY VENTED WHEN STORED IN EXTREME HEAT OR DIRECT SUNLIGHT.

SAFE OPERATING PRACTICES

Now that you have your new tent camper, you're probably anxious to go on your first camping trip. Before doing so however, take time to become familiar with safe operating practices. A few minutes of time spent before a trip can help prevent accidents during a trip.

Throughout this manual, you will find CAUTION, WARNING and DANGER symbols. Cautions are used to highlight information which will assist you, Warnings are used to help prevent you from making a mistake which could cause vehicle damage and/or personal injury, and Danger is used to alert you to a potentially hazardous situation that will, if not avoided, result in death or serious injury.

SAFETY TIPS

- Always put safety first. Follow a definite plan for inspection and safe use. Correct unsafe conditions immediately.
- Never tamper with safety devices.
- Always keep your fire extinguisher on hand and understand its operation. Check regularly to be sure it is in working order.

- LP connections should be checked regularly, and the entire LP system should be checked annually, by qualified personnel.
- Do not overload, or improperly load, the tent camper.
- When traveling, be sure all items stored, inside and outside the camper are secure, and all doors and drawers are firmly closed.
- Keep all surfaces clean and free of hazards. Use only non-flammable solutions for cleaning.
- Be sure your family and guests know what to do in case of fire. Conduct periodic fire drills and designate a meeting place, in the event you need to evacuate the camper.
- Check the condition of your tires often and for proper inflation. Tighten the lug bolts.
- Guard against contaminated water. Sanitize your system periodically.
- Read and follow all precautions and notes listed on labels throughout your camper. Lost, damaged, or stolen should be replaced.
- Be aware of electrical hazards and misuse.
- Keep a first-aid kit in your camper.
- Observe all safe rules of driving associated with towing a camper.
- Read your owner's manual thoroughly.

RULES FOR TOWING YOUR CAMPER

- If this is your first experience with towing a camper, be sure to drive slowly and cautiously while you learn the handling characteristics of your camper and tow vehicle, together. Never allow an inexperienced driver to drive, without your direct supervision.
- Always drive within the posted speed limit. Moderate your speed if driving in traffic or in windy conditions. As your speed increases, your ability to control the camper/tow vehicle combination, is greatly reduced.
- Check bridge load limits, making sure they will support the weight of tow vehicle & camper. Be sure there is clearance for tail swing.
- It's a good idea to have someone guide you from the outside, when backing up. Be sure this person is always in view, and is at a safe distance from the camper.
- Due to the increased weight and length of your tow vehicle/camper combination, allow extra distance to pass or stop. It is also recommended to keep at least twice your normal stopping distance, when towing a camper.
- Reducing speed will help to maintain camper stability when driving downhill, in windy conditions, or when cornering. Frequent braking reduces stability. The weight of the camper puts additional stress on brakes, and can cause them to overheat or fade. Use the tow vehicles' transmission to help control speed and the braking action of the vehicle/camper combination. (See tow vehicle manual.)

SAFETY REGULATIONS FOR LP GAS

SYSTEMS AND APPLIANCES

The following warnings are posted throughout your tent camper to provide information regarding LP gas safety. The warnings are posted not only because of the requirement to do so, but also as a constant reminder to exercise proper caution when using or being around LP gas appliances and equipment. We are listing them here so you can be sure that you, your family, and your guests, understand and follow the instructions and warnings provided.

⚠ WARNING

LP GAS CONTAINERS SHALL NOT BE PLACED OR STORED INSIDE THE VEHICLE.

⚠ WARNING

LP GAS CONTAINERS ARE EQUIPPED WITH SAFETY DEVICES WHICH RELIEVE EXCESSIVE PRESSURE BY DISCHARGING GAS TO THE ATMOSPHERE.

⚠ WARNING

IT IS NOT SAFE TO USE COOKING APPLIANCES FOR COMFORT HEATING, AS FIRE, ASPHYXIATION OR CARBON MONOXIDE POISONING COULD OCCUR.

COOKING APPLIANCES NEED FRESH AIR FOR SAFE OPERATION:

1. Open an overhead vent or turn on exhaust fan, AND . . .
2. Open a window

A warning label has been placed in the cooking area to remind you to provide an adequate supply of fresh air for combustion. Unlike residential homes, the amount of oxygen supply is limited, due to the size of the camper. It is especially important that cooking appliances not be used for comfort heating as THE DANGER OF FIRE, CARBON MONOXIDE POISONING OR ASPHYXIATION, IS GREATER, WHEN THE APPLIANCE IS USED FOR LONG PERIODS OF TIME.

⚠ WARNING

DO NOT STORE LP GAS CONTAINERS, GASOLINE, OR OTHER FLAMMABLE LIQUIDS INSIDE THE VEHICLE AS A FIRE OR EXPLOSION COULD RESULT.

LP CONTAINERS**⚠ WARNING**

A WARNING LABEL HAS BEEN LOCATED NEAR THE LP GAS CONTAINER. THIS LABEL READS: "DO NOT FILL CONTAINER(S) TO MORE THAN 80 PERCENT OF CAPACITY." OVER-FILLING THE LP GAS CONTAINER CAN RESULT IN UNCONTROLLED GAS FLOW WHICH CAN CAUSE FIRE OR EXPLOSION.

A properly filled container will contain approximately 80 percent of its volume as liquid LP gas. An 80 percent automatic shut-off valve has been installed on the LP gas tank which will automatically prevent further filling when the gas volume has reached 80 percent of tank capacity.

THE FOLLOWING LABEL HAS BEEN PLACED IN THE VEHICLE NEAR THE RANGE AREA:

⚠ DANGER**IF YOU SMELL PROPANE**

- Extinguish any open flames, pilot lights and all smoking materials.
- **Do not** touch any electrical switches.
- Shut off the gas supply at the tank valve(s) or gas supply connection.
- Open doors and other ventilating openings.
- Leave the area until the odor clears.
- Have the system checked and leakage source corrected before using again.

LP Gas regulators must always be installed with the diaphragm vent facing downward. Regulators that are not in compartments have been equipped with a protective cover. The regulator vent must face downward and the cover kept in place to minimize vent blockage, which could result in excessive gas pressure, causing fire or explosion.

⚠ WARNING

PORTABLE FUEL BURNING EQUIPMENT INCLUDING WOOD OR CHARCOAL BURNING GRILLS AND STOVES SHALL NOT BE USED INSIDE THE VEHICLE AS THEY MAY CAUSE FIRE, EXPLOSION, CARBON MONOXIDE POISONING OR ASPHYXIATION.

NOTE: FOREST RIVER IS NOT RESPONSIBLE FOR ANY DAMAGE TO PROPERTY, OR PERSONAL INJURY, THAT RESULTS FROM AN IMPROPERLY MAINTAINED APPLIANCE OR LP SYSTEM.

FIRE SAFETY

⚠ WARNING

FIRE SAFETY IS AN IMPORTANT PART OF OWNING A TENT CAMPER. THE FOLLOWING BASIC RULES OF FIRE PROTECTION CAN HELP ELIMINATE THE POSSIBILITY OF A FIRE.

1. Never store flammable liquids in the camper.
2. Never leave cooking food unattended.
3. Never smoke in bed, and always use an ashtray.
4. Never allow children to play with LP gas or electrical equipment.
5. Never use an open flame as a flashlight.
6. Always repair faulty or damaged wiring and electrical components immediately.
7. Never overload the electrical circuit.
8. Locate and repair LP leaks immediately.
9. Keep cooking surfaces clean.
10. Do not allow rubbish to accumulate.
11. Never clean with flammable liquids.
12. Spray fabrics annually with flame retardant.
13. When the range is lit, be sure any curtains near the range are held back with the elastic curtain straps provided in the curtain packets.

IF A FIRE DOES START, FOLLOW THE BASIC RULES OF SAFETY:

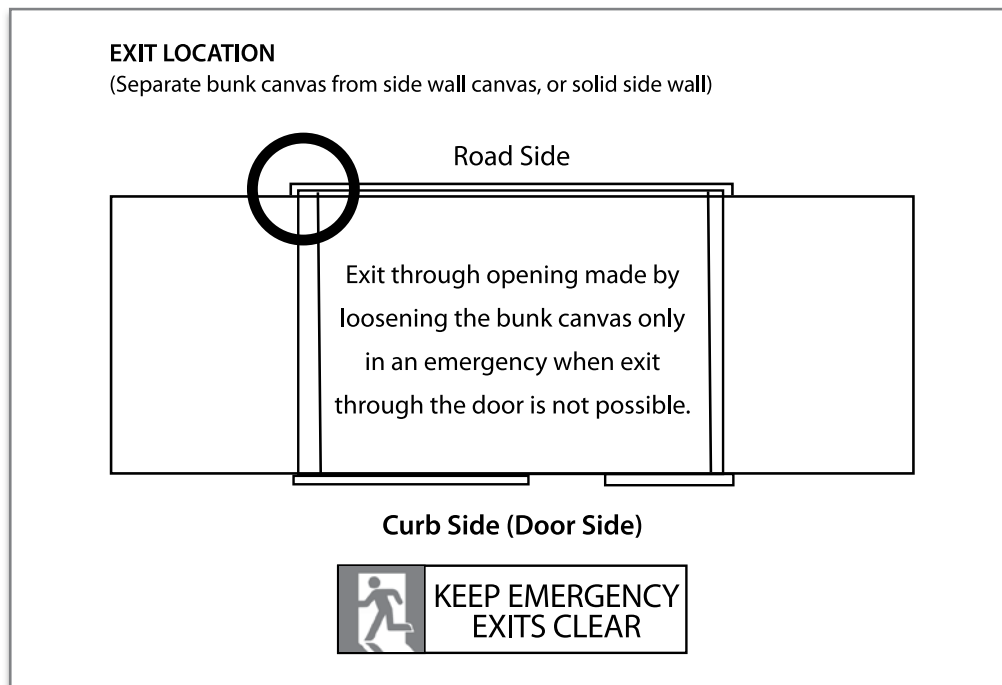

1. Evacuate the camper as quickly as possible.
2. After everyone is clear, check the fire to see if you can attempt to put it out. If you cannot get within 10 feet of the fire without risk of personal injury, or if the fire is fuel-fed, leave the camper immediately, and call the fire department.
3. **DO NOT** attempt to use water to put out the fire. Water can spread some types of fire, and electrocution is possible if the fire has an electrical origin.

FIRE EXTINGUISHER

If you determine that you can attempt to control the fire using the fire extinguisher, make sure you know how to use it. Read the label on the fire extinguisher, and study the information outlined here to become familiar with the safe operation and maintenance of extinguisher.

The fire extinguisher provided with the camper is a chemical type suitable for extinguishing small fires of the class B or C type. Underwriter Laboratories classify fires into three types:

Class A-Fires in wood, paper, fabric, rubber & certain plastics.

Class B-Flammable liquids such as grease, cooking oils, gasoline, or kerosene.

Class C-Electrical fires started from live electrical wires from short-circuited motors or switches.

Extinguishers are designed to put out a fire in its initial stage, *not* if it is blazing out of control. If you decide it is safe to fight a fire with an extinguisher:

- Remove the tamper tape which covers the discharge push button, (do not shake.)
- Hold it upright and stand six to ten feet from the fire, with a clear path to an exit.
- Press the button down completely, aiming at the base of the fire and spray with quick side to side sweeping motion.

TIP: Use the 'PASS' method. Familiarize yourself and all RV occupants with this procedure:

- Pull the pin (some extinguishers may have a cartridge you need to push).
- Aim the nozzle at the base of the fire.
- Squeeze the handle to release the extinguishing agent.
- Spray the base of the fire. (If you aim at the flames, you won't extinguish the fire.)

Avoid inhaling the dry chemicals from the fire extinguisher. Although non-toxic, they could cause temporary irritation. As soon as possible, after the fire is out, clean the area. The dry chemicals may cause surface damage if left too long.

DO NOT ATTEMPT TO USE WATER TO EXTINGUISH A FIRE. Water can spread some types of fire and electrocution is possible. If it is a large fire or a chemical fire, **DO NOT HESITATE!** Leave immediately and call the fire department.

DO NOT STORE LP GAS CONTAINERS, GASOLINE, OR OTHER FLAMMABLE LIQUIDS INSIDE AS A FIRE OR EXPLOSION COULD OCCUR.

COMPUTING YOUR LOAD AND LOAD DISTRIBUTION

GVWR - (Gross Vehicle Weight Rating) the maximum permissible weight of the fully loaded RV.

GAWR - (Gross Axle Weight Rating) the allowable weight, including cargo, that can be safely supported by each axle

GTW - (Gross Tongue Weight) The weight of the tongue as it bears down on the hitch of the towing vehicle.

NOTE: TONGUE WEIGHT SHOULD BE DETERMINED WITH THE CAMPER FULLY LOADED AS IT WOULD BE FOR TRAVEL. (DO NOT ASSUME YOU CAN FILL ALL TANKS AND ALL STORAGE AREAS AND KEEP WITHIN THE GVWR.)

1. Gross Axle Weight

PLUS

2. Tongue Weight

EQUALS

3. Gross Vehicle Weight

NOTE: GROSS AXLE WEIGHT IS DETERMINED WITH ALL TIRES ON THE SCALE. SIDE TO SIDE WEIGHT DISTRIBUTION IS DETERMINED BY WEIGHING EACH SIDE INDEPENDENTLY.

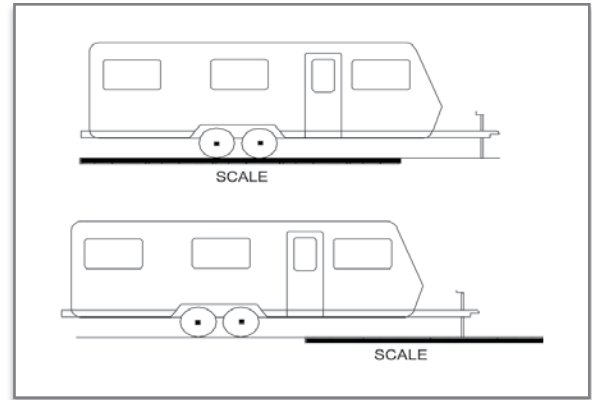

To weigh your camper properly, use the following procedure:

1. Level the trailer and make sure that it remains level throughout the weighing process.
2. To compute gross vehicle weight, pull the trailer onto the scales and weigh with both the axle and front jack resting on the scale. The difference between the weight of the camper fully loaded and empty is the rated personal cargo weight. If for example the GVWR of your camper is listed at 7040 lbs., and empty it weighs 4755 lbs., your personal cargo weight cannot exceed 2285 lbs. The GVWR must not exceed the GVWR found on the certification decal.
3. For tongue weight, rest only the hitch on the scale and weigh with the camper fully loaded for travel. Check the weight against the proper tongue weight as listed on the certification decal.
4. To compute gross axle weight, pull forward so that only the camper axle is resting on the scale. If the weight exceeds the GAWR on the weight distribution information sticker, remove or redistribute the weight to meet the proper specification. The difference between gross vehicle weight and gross axle weight is the tongue weight.

If additional items are added to the camper after it has been weighed, and the loading analysis completed, weigh each additional item using a bathroom scale before placing them in the camper. The total of these items are then added to the GVW originally determined.

Remember that by adding additional weight, you may be affecting the tongue weight of the trailer. The tongue weight is increased by moving cargo forward, and decreased by moving cargo toward the rear. However, too much weight in the rear can cause sway, or handling instability.

Once you become familiar with loading your camper and know how to distribute the weight, make a list and a diagram you can use for future reference. Plan your loading and storage so that emergency items are easily accessed. Place heavier or breakable items on the camper floor for greater load stability. Make sure these items are well packed and secured to prevent movement. Take extra care not to overload the front and rear ends of the camper.

Use packing material around breakable items such as plates and glasses if you will be traveling over rough roads or terrain. It is a good idea to use non-skid materials under heavier items to help prevent breakage or load shifting.

Resist the temptation to carry more supplies than you need. It is important to remember that the weight of items you purchase while traveling, must be added to the camper weight and you may need to rearrange items to maintain correct load distribution.

TOWING VEHICLE REQUIREMENTS

When considering a towing vehicle, keep in mind certain requirements for safe and easy use:

1. Transmission - The transmission can be either manual or automatic, but automatic transmission will control engine loads better.

2. Power - Be sure your tow vehicle has adequate power to tow your camper on the type of roads you will be using. Factors to consider are engine power, cooling capabilities, and axle ratio. Discuss the towing capability of your vehicle with both your recreational vehicle dealer and tow vehicle dealer.
3. Tires & Suspension - It is important to make sure that your tow vehicle tires and suspension have a sufficient rating to handle the additional capacity needed to tow a camper. Check with your tow vehicle dealer and your vehicle owner's manual for the type of tires and tire pressures required. If your tow vehicle is equipped with air shocks, do not use the air shocks as a load leveling device, to level the vehicle/camper combination.
4. Hitch - Your tow vehicle should be equipped with a hitch that has a rating at least equal to the GVWR. Be sure that it is installed per the hitch manufacturer's instructions, and that it meets the tow vehicle's requirements for fit and performance. Also, be sure to install proper hitch wiring to supply 12 volt power to the tent camper, for turn signal and brake light operations.
5. Sway Control - Install a sway control system that is compatible with both your hitch and tow vehicle. Have it installed and properly adjusted per the manufacturer's instruction.
6. Safety Equipment - Install proper safety equipment such as towing mirrors. In most states they are required by law. Most styles available are not permanent and can be easily installed and removed. Check with your dealer for correct types and methods of installation.

⚠ WARNING

SOME MOTORIZED VEHICLES ARE NOT GOOD TOW VEHICLES, AS THEY CANNOT ADEQUATELY CONTROL SWAY IN THE VEHICLE BEING TOWED.

HITCH

To safely tow your new tent camper, you will need to install a Class III weight carrying hitch on units with a 2" ball. Those units with 2 5/16" ball require a class IV weight carrying hitch. It is very important to choose a hitch designed for attachment to your particular tow vehicle, and have it properly installed. Pay particular attention to tongue load limits of your tow vehicle and the hitch you purchase.

Choose a hitch that does not overload the axle on the tow vehicle. Be sure that the hitch ball is not below, or more than, three inches above, the leveled camper tongue.

WEIGHT DISTRIBUTION HITCHES

Hitches can be installed on units with box tube A frames (i.e. not on C-channel A frames), with the following five stipulations:

1. Properly installed by a qualified trained technician.
2. Match system with GVWR of the camper.
3. The camper is loaded per the manufacturer's recommendations.
4. Never exceed 15% of the GVWR on the ball hitch.
5. No weld on weight distributing hitch mounting brackets.

NOTE: FAILING TO FOLLOW ANY OF THE ABOVE 5 STIPULATIONS WILL VOID THE FRAME WARRANTY ON YOUR CAMPER.

WIRING

Along with your hitch, it is also necessary to install proper electrical connection from the tow vehicle to your camper. A car end pigtail is supplied, with leads of adequate length to allow connection to your tow vehicle wiring system. Be sure you use wiring of the correct gauge with sufficient slack between the camper and tow vehicle, to allow for turning without dragging on the ground. Have your tow vehicle dealer, and/or hitch installer, assist you with the installation.

If your tow vehicle has a separate amber turn signal, it will require a special adapter to allow your camper lights to function properly. This adapter may be purchased from your dealer.

WIRING CODE

The wiring color code for connection is as follows:

White - Ground.

Green - Tail, clearance identification, and side marker lights.

Red - Left turn and stop.

Brown - Right turn and stop.

Blue - Optional electric brakes

Black - Interior lights and accessory (Connect directly to the tow vehicle battery using #14 wire and a 15 amp in-line fuse at the battery. Be certain the wire is properly routed away from the exhaust system and moving parts).

Although your tent camper has been checked at the factory, we recommend that you visually check all lights to ensure they are functioning properly before leaving your dealer.

CONNECTING THE HITCH

When attaching the camper coupler to the tow vehicle hitch, use the following steps:

1. Raise the coupler by cranking the jack handle clockwise.
2. Back the tow vehicle up, until the ball on the hitch is directly under the coupler. Have someone assist you, using pre-determined hand signals. Be sure this person is in view at all times and proceed slowly and cautiously.
3. Lift the coupler latching lever.
4. Lower the coupler onto the hitch ball by cranking the jack handle counter-clockwise. Allow the coupler to properly settle onto the hitch ball.
5. Close the coupler latching lever, making sure it is fully locked in place.
6. Raise the jack post as high as needed by cranking counter-clockwise.
7. Fold the cranking handle down against the jack post.

SAFETY CHAINS

After you have the camper coupler properly attached to the hitch ball, the safety chains must be attached. Safety regulations require the safety chain to be crossed under the tongue and hitch to prevent the tongue from dropping to the ground in the event of a hitch or coupler failure.

ATTACHING SAFETY CHAINS

1. Cross the safety chains under the tongue and hitch.
2. Attach the hooks to the chain attachment loops provided on the tow bar portion of the hitch or to the vehicle frame.
3. Be sure the chain slack length is equal on both sides and that it is sufficient to allow the vehicles to turn at their minimum radius without the chains dragging on the pavement.

WARNING

DO NOT ATTACH THE SAFETY CHAINS TO THE VEHICLE BUMPER.

WARNING

DO NOT ATTEMPT TO REPAIR A DAMAGED CHAIN. IF THE SAFETY CHAIN HAS BEEN DAMAGED, IT MUST BE REPLACED.

ELECTRICAL HOOK-UP

Place the camper pigtail into the socket located on the tow vehicle. Be sure to allow enough slack to prevent separation during short turns. Check all lights for proper operation before pulling away.

BRAKES

Your brakes are wired to the tow vehicle through the electrical pigtail, allowing evenly distributed braking power to both the tow vehicle and the tent camper.

Consult your dealer regarding the types of brake controllers available, and proper installation of the controller on your tow vehicle. Have him explain electric brake operation, and their proper use, as well as the importance of the load resistor and safety break-away switch.

Test the brakes and adjust them as necessary, per the instructions of the brake controller manufacturer. Proper adjustment of the brakes can help to avoid dangerous swaying or jack-knifing on slippery pavement, or during an emergency stop.

Before leaving on a trip, check for proper braking action on a short road test, before taking your tent camper on a trip. Apply the brakes several times at different speeds and pressure. If wheel lock-up occurs, the brake shoe adjustment is too tight. If no camper brake action is occurring, brake shoe adjustment is too loose. Do not exceed a speed of 30 mph during this road test. Refer to the Brake/Axle Owner's Manual for adjustment procedures and troubleshooting guide.

⚠ WARNING

THE SAFETY BRAKE-AWAY SWITCH MUST BE IN THE RELEASE POSITION BEFORE TOWING THE CAMPER.

DRIVING AND TOWING TIPS

Now that you are familiar with load limits and weight distribution, as well as hitching your tent camper to the tow vehicle, follow these driving and towing tips, which will make trips with your camper both safer and more enjoyable.

- When learning how to tow your new camper, find a spot that has space to practice accelerating, turning, braking, and backing up.
- A set of RV mirrors on your tow vehicle increases visibility, and is required by law in many states. Most styles are not permanent, and can be easily installed and removed. Keep the mirrors properly adjusted and check them often.
- Before leaving on a trip, inspect your hitch, brakes, and tires. Be sure everything is connected properly and functioning correctly.
- Understand that the camper wheels do not follow in the same track as the tow vehicle wheels. When turning, pull ahead a sufficient distance to allow for the additional tail swing of the camper.
- The additional weight of the tent camper affects accelerating and braking distances. Accelerate slowly and smoothly. When pulling into traffic, be sure there is enough distance to merge safely. Keep a safe distance between yourself and the traffic ahead. When applying the brakes, allow extra time to slow down or stop safely. The heavier your camper, the greater the distance required to bring it to a stop. A panic stop can cause the camper to jack-knife, which can result in damage to both your vehicles, and/or cause an accident.

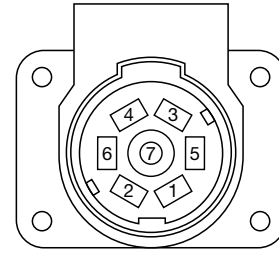

- #1 14 AWG WHITE WIRE: CLEARANCE LIGHTS, TAIL LIGHTS - GROUND**
 - #2 14 AWG BLUE WIRE: BRAKES - NOT USED**
 - #3 14 AWG GREEN WIRE: CLEARANCE LIGHTS, TAIL LIGHTS - POSITIVE**
 - #4 14 AWG BLACK WIRE: CONNECT TO BATTERY - POSITIVE**
 - #5 14 AWG RED WIRE: LEFT TURN SIGNAL, BRAKE LIGHTS - POSITIVE**
 - #6 14 AWG BROWN WIRE: RIGHT TURN SIGNAL, BRAKE LIGHTS - POSITIVE**
 - #7 14 AWG YELLOW WIRE: BACK UP LIGHTS, BOTH LEFT AND RIGHT TAIL LIGHTS - POSITIVE**
- NOTE: ELECTRIC JACKS ARE WIRED DIRECTLY TO BATTERY. DO NOT BACK FEED THROUGH THE CONVERTER.**

- Always drive within the speed limit. Reduce speed if you encounter gusty winds, heavy traffic, or unusual road conditions.
- When backing up, use your mirrors to check for obstructions. If needed, have someone help guide you. Be sure this person is always in view and at a safe distance from the camper.
- Avoid sudden movements when changing lanes. Always check your mirrors and signal your intention before passing.
- When driving on steep grades, select the correct transmission range, and drive at proper speeds. Down-shifting will allow the engine to help control your speed and relieve the extra strain on your brakes. Continuous application of the brakes can cause them to overheat, and could result in a temporary loss of braking. Never exceed the appropriate speed when driving in low gear. Excessive speed in a lower gear can overheat the tow vehicle transmission, which can lead to transmission failure.
- If you encounter driving conditions that put additional strain on the engine, it may be necessary to turn off the tow vehicle air conditioning to improve engine cooling.
- Do not drive with your foot resting on the brake pedal. Doing so will cause abnormally high brake temperatures and lining wear, which will result in increased stopping distance.
- If your tow vehicle is equipped with cruise control, do not use it on wet or icy roads, in congested traffic, or on winding roads.
- If a large truck or a bus passes you, the air from the vehicle may push the rear of the camper to the right, causing the front of the camper to sway. You may compensate for this additional sway by steering slightly toward the passing vehicle until the sway is corrected.
- If the camper should become disconnected from the tow vehicle while driving, the safety chains will keep the camper attached. Slow down and come to a controlled stop at the side of the road. Reattach the safety chains, remembering to cross them under the tongue and hitch.

BACKING UP

Backing up with an attached camper, presents a new set of driving rules. When backing up, it is important to proceed slowly. If the camper turns the wrong direction, stop and consider how to correct the error. The following pointers should help you with your initial attempts at backing up.

- Concentrate on the back of the camper.
- When your tow vehicle and camper are in a straight line, hold the bottom of the steering wheel, and turn it in the direction you want the camper to go.
- Back up, when possible, to the left. You will be able to see the movement of the camper easier.
- Be sure you have a clear line of vision in the mirror.
- When the camper is proceeding in the direction you want it to go, allow the tow vehicle to 'follow'. Turn the steering wheel sharply to bring the camper and tow vehicle back to a straight line. When you have both vehicles in a straight line, straighten the front wheels of the tow vehicle before proceeding.

Practice is the best method of becoming proficient at handling your camper. Take time to practice and become comfortable when towing your camper.

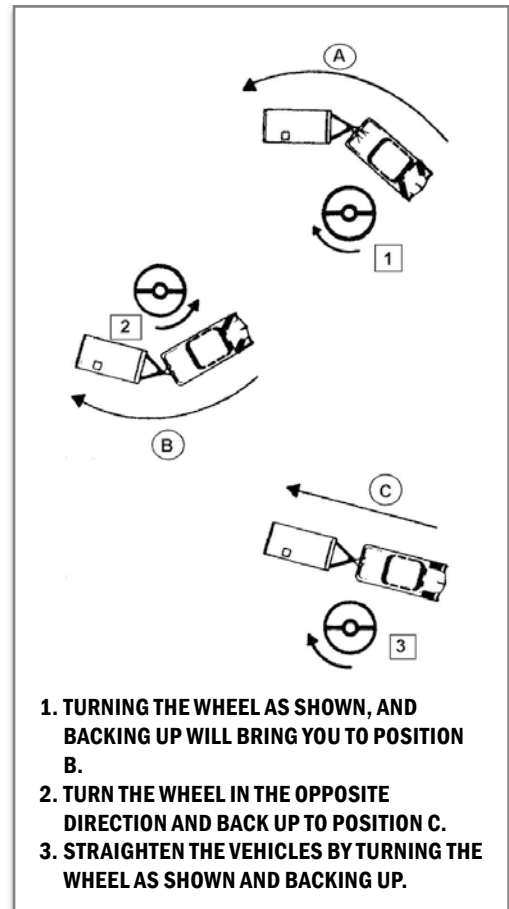

TIRES

Your camper tires play an important role in the load carrying capacity of the vehicle. To ensure good tire life, check your tires often. Inspect the general condition of the tire, as well as the air pressure. Always check the air pressure when the tire is cold. Tires that are hot from traveling will show higher pressure. The correct tire pressure and the load carrying capacity of the tire is imprinted on the side of each tire sidewall. Remember that the air pressure in your camper tires will not be the same as the pressure in your tow vehicle tires. Always inflate camper tires to the correct pressure. Do not over or under inflate. Under inflated tires will run hot, shortening the tire's life, and decreasing the camper's safe load limit.

TIRE SAFETY

Use the following information to make tire safety a regular part of your vehicle maintenance routine.

SAFETY FIRST-BASIC TIRE MAINTENANCE

Properly maintained tires improve steering, stopping, traction, and load-carrying capability of your vehicle. Under inflated tires and overloaded vehicles are a major cause of tire failure. Therefore, to avoid flat tires and other types of tire failures, you should maintain proper tire pressure, observe tire and vehicle load limits, avoid road hazards, and regularly inspect your tires.

FINDING YOUR VEHICLE'S RECOMMENDED TIRE PRESSURE AND LOAD LIMITS

The tire information and vehicle certification label contains information on tires and load limits. These labels indicate the vehicle manufacturer's information including:

- Recommended tire size
- Recommended tire inflation pressure
- Gross Vehicle Weight Rating (GVWR-the maximum occupant and cargo weight a vehicle is designed to carry)
- Front and rear gross axle weight ratings (GAWR-the maximum weight the axle systems are designed to carry)

UNDERSTANDING TIRE PRESSURE AND LOAD LIMITS

Tire inflation pressure is the level of the air in the tire that provides it with load-carrying capacity and affects the overall performance of the vehicle. The tire inflation pressure is a number that indicates the amount of air pressure, measured in pounds per square inch (psi)-a tire requires to be properly inflated. (This number is also expressed in kilopascals (kPa) which is a metric measuring system used internationally).

Vehicle manufacturers determine this number based on the vehicles design load limit which is the greatest amount of weight a vehicle can safely carry and the vehicle's tire size. The proper tire pressure for your vehicle is referred to as the 'recommended cold inflation pressure'.

Tire pressure should always be measured when the tire is 'cold' to get an accurate measurement. A cold tire is one that hasn't been driven on for at least 3 (three) hours. As you drive, your tires get warmer causing the air pressure within the tire to increase. Therefore, you cannot get an accurate measurement of tire pressure unless the tire is cold.

CHECKING TIRE PRESSURE

Because tires are designed to be used on more than one type of vehicle, tire manufacturers list the 'maximum permissible inflation pressure' on the sidewall. The number is the greatest amount of air pressure that should ever be put in the tire under normal driving conditions.

It is important to check your vehicle's tire pressure at least once a month for the following reasons:

- Most tires naturally lose air pressure over time.
- Tires can lose air suddenly if you drive over a pothole or strike the curb when parking.
- With radial tires it is usually not possible to determine under inflation by visual inspection.

For your convenience, purchase a tire pressure gauge to keep in your vehicle.

TIRE SAFETY TIPS

Preventing Tire Damage:

- Slow down if you have to go over a pothole or other object in the road.
- Do not run over foreign objects in the roadway, and try not to strike the curb when parking.

TIRE SAFETY CHECKLIST

- Check tire pressure regularly (at least once a month), including the spare.
- Inspect tires for uneven wear patterns on the tread, cracks, foreign objects, or other signs of wear or trauma.
- Remove bits of glass and any other foreign objects wedged in the tread.
- Make sure your tire valves have valve caps.
- Check tire pressure before going on a long trip.
- Do not overload your vehicle. Check the tire information placard for the maximum recommended load for the vehicle.
- If you are towing a trailer, remember that some of the weight of the loaded trailer is transferred to the towing vehicle.

TIRE FUNDAMENTALS

Federal law requires tire manufacturers to place standardized information on the sidewall of all tires. This information identifies and describes the fundamental characteristics of the tire and also provides a tire identification number for safety standard certification and in case of a recall.

P

Indicates the tire is for passenger vehicles.

NEXT (3 DIGIT) NUMBER

Gives the width in millimeters of the tire from sidewall edge to sidewall edge. In general, the larger the number, the wider the tire.

NEXT (2 DIGIT) NUMBER

Gives the tire's ratio of height to width, (known as the aspect ratio). Numbers of 70 or lower indicate a short sidewall for improved steering response and better overall handling on dry pavement.

R

'R' stands for radial. Radial ply construction of tires has been the industry standard for the past 20 years.

NEXT NUMBER

This two-digit number is the wheel or rim diameter in inches.

If you change your wheel size, you will have to purchase new tires to match the new wheel diameter.

NEXT NUMBER

This two or three digit number is the tire's load index. It is a measurement of how much weight each tire can support. If you are unsure, contact a local tire dealer. Note: You may not find this information on all tires since it is not required by law.

M+S

'M+S' or 'M/S' indicates that the tire has some mud and snow capability. Most radial tires have these markings; hence, they have some mud and snow capability.

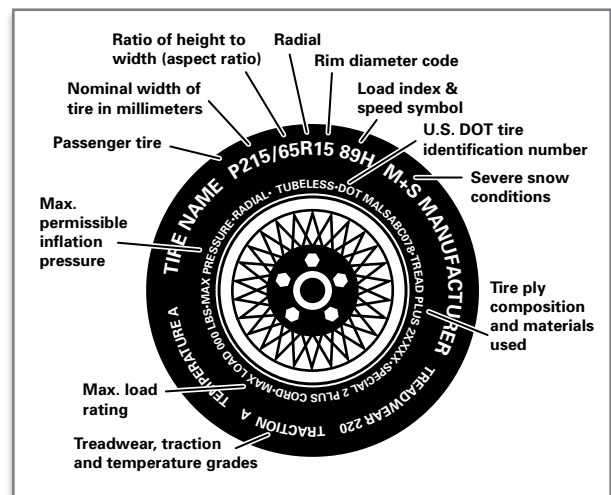

U.S. DOT TIRE IDENTIFICATION NUMBER

This number begins with the letters “DOT” and indicates that the tire meets all federal standards. The next two numbers or letters are the plant code where it was manufactured, and the last four numbers represent the week and year the tire was built. For example, the numbers 3197 means the 31st week of 1997. The other numbers are marketing codes used at the manufacturer’s discretion. This information is used to contact consumers if a tire defect requires a recall.

TIRE PLY COMPOSITION AND MATERIALS USED

The number of plies indicates the number of layers of rubber-coated fabric in the tire. In general, the greater the number of plies, the more weight a tire can support. Tire manufacturers also must indicate the materials in the tire, which include steel, nylon, polyester, and others.

MAXIMUM LOAD RATING

Load rating indicates the maximum load in kilograms and pounds that can be carried by the tire.

MAXIMUM PERMISSIBLE INFLATION PRESSURE

This number is the greatest amount of air pressure that should ever be put in the tire under normal driving conditions.

SPEED RATING

Q – 99 mph	H – 130 mph
R – 106 mph	V – 149 mph
S – 112 mph	W – 168 mph*
T – 118 mph	Y – 186 mph
U – 124 mph	

For tires with a maximum speed capability over 149 mph, tire manufacturers sometimes use the letters ZR. For those with a maximum speed capability over 186 mph, tire manufacturers always use the letters ZR.

Important Note: If it becomes necessary to replace a tire and you feel it is a warranty issue, most tire manufacturers require the D.O.T. number be cut out and returned to them, with the warranty claim, otherwise the warranty could be voided.

Speed rating denotes the speed at which a tire is designed to be driven for extended periods of time. The ratings range from 99 miles per hour (mph) to 186 mph.

Note: This information may not appear on all tires since it is not required by law.

TREADWEAR NUMBER

This number indicates the tire’s wear rate. The higher the treadwear number is, the longer it should take for the tread to wear down. For example, a tire graded 400 should last twice as long as a tire graded 200.

TRACTION LETTER

This letter indicates a tire’s ability to stop on wet pavement. A higher graded tire should allow you to stop your car on wet roads in a shorter distance than a tire with a lower grade. Traction is graded from highest to lowest as ‘AA’, ‘A’, ‘B’, and ‘C’.

TEMPERATURE LETTER

This letter indicates a tire’s resistance to heat. The temperature grade is for a tire that is inflated properly and not overloaded. Excessive speed, under inflation or excessive loading, either separately or in combination, can cause heat build-up and possible tire failure. From highest to lowest, a tire’s resistance to heat is graded as ‘A’, ‘B’, or ‘C’.

TIRE TIPS

- Make sure all of the lug nuts are secure. Use a torque wrench, DO NOT guess.
- Inspect tires for uneven wear patterns on the tread, for cracks, for foreign objects or for other signs of wear or trauma.
- If you are towing a trailer, remember that some of the weight of the loaded trailer is transferred to the towing vehicle.
- Trailers should have the wheel bearings repacked after being in storage for long periods of time.

CAUTION

DO NOT OVERLOAD YOUR VEHICLE. CHECK THE TIRE INFORMATION PLACARD FOR THE MAXIMUM RECOMMENDED LOAD FOR THE VEHICLE.

LUG NUT TIGHTENING

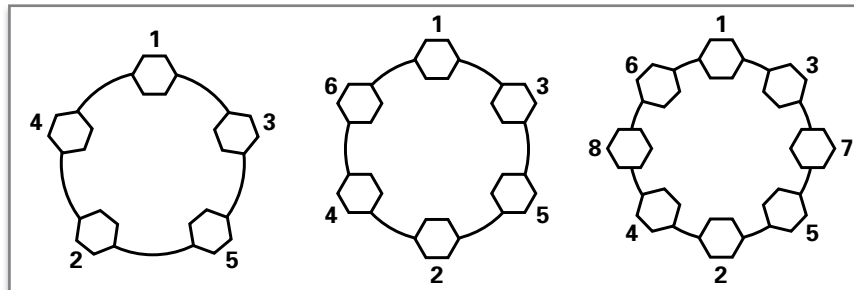

Tighten each lug nut in the order shown in the chart.

To prevent cross threading, start all lug nuts by hand. Requirements for wheel nut torque, vary depending on the size and manufacturer of the wheel. Follow the wheel manufacturers recommendation, but do not exceed 120 ft/lbs on 1/2 in studs. Unless otherwise specified by the wheel manufacturer, use a final torque of 85-95 ft/lbs.

NOTE: IT IS RECOMMENDED THAT WHEEL BEARINGS BE REPACKED YEARLY.

<p>RECREATIONAL VEHICLE TRAILER CARGO CARRYING CAPACITY Dry Weight: -1 VIN: 4X4CPR721CD285576 THE WEIGHT OF CARGO SHOULD NOT EXCEED 2058 kg or 4536 lbs</p> <p>CAUTION: A full load of water equals 75 kg or 167 lbs of cargo @ 1 kg/L (8.33 lb/gal)</p>		<p>TIRE AND LOADING INFORMATION</p> <p>The combined weight of Cargo should Never Exceed: 2058 Kgs or 4536 Lbs</p> <table border="1"> <thead> <tr> <th>TIRE</th> <th>SIZE</th> <th>COLD TIRE PRESSURE</th> <th rowspan="3">SEE OWNER'S MANUAL FOR ADDITIONAL INFORMATION</th> </tr> </thead> <tbody> <tr> <td>FRONT</td> <td>ST205/75R14/C</td> <td>50 PSI / 345 KPA</td> </tr> <tr> <td>REAR</td> <td>ST205/75R14/C</td> <td>50 PSI / 345 KPA</td> </tr> <tr> <td>SPARE</td> <td>ST205/75R14/C</td> <td>50 PSI / 345 KPA</td> <td></td> </tr> </tbody> </table>		TIRE	SIZE	COLD TIRE PRESSURE	SEE OWNER'S MANUAL FOR ADDITIONAL INFORMATION	FRONT	ST205/75R14/C	50 PSI / 345 KPA	REAR	ST205/75R14/C	50 PSI / 345 KPA	SPARE	ST205/75R14/C	50 PSI / 345 KPA	
TIRE	SIZE	COLD TIRE PRESSURE	SEE OWNER'S MANUAL FOR ADDITIONAL INFORMATION														
FRONT	ST205/75R14/C	50 PSI / 345 KPA															
REAR	ST205/75R14/C	50 PSI / 345 KPA															
SPARE	ST205/75R14/C	50 PSI / 345 KPA															
<p>RECREATIONAL VEHICLE TRAILER CARGO CARRYING CAPACITY Dry Weight: -1 VIN: 4X4CPR721CD285576 THE WEIGHT OF CARGO SHOULD NOT EXCEED 2058 kg or 4536 lbs</p> <p>CAUTION: A full load of water equals 75 kg or 167 lbs of cargo @ 1 kg/L (8.33 lb/gal)</p>		<p>RENSEIGNEMENTS SUR LES PNEUS ET LE CHARGEMENT</p> <p>Le poids du chargement ne doit jamais dépasser 2058 Kgs or 4536 Lbs</p> <table border="1"> <thead> <tr> <th>PNEU</th> <th>DIMENSIONS</th> <th>PRESSION DES PNEUS À FROID</th> <th rowspan="3">VOIR LE MANUEL DE L'USAGER POUR PLUS DE RENSEIGNEMENTS</th> </tr> </thead> <tbody> <tr> <td>AVANT</td> <td>ST205/75R14/C</td> <td>50 lb/po2 345 KPA</td> </tr> <tr> <td>ARRIÈRE</td> <td>ST205/75R14/C</td> <td>50 lb/po2 345 KPA</td> </tr> <tr> <td>DE SECOURS</td> <td>ST205/75R14/C</td> <td>50 lb/po2 345 KPA</td> <td></td> </tr> </tbody> </table>		PNEU	DIMENSIONS	PRESSION DES PNEUS À FROID	VOIR LE MANUEL DE L'USAGER POUR PLUS DE RENSEIGNEMENTS	AVANT	ST205/75R14/C	50 lb/po2 345 KPA	ARRIÈRE	ST205/75R14/C	50 lb/po2 345 KPA	DE SECOURS	ST205/75R14/C	50 lb/po2 345 KPA	
PNEU	DIMENSIONS	PRESSION DES PNEUS À FROID	VOIR LE MANUEL DE L'USAGER POUR PLUS DE RENSEIGNEMENTS														
AVANT	ST205/75R14/C	50 lb/po2 345 KPA															
ARRIÈRE	ST205/75R14/C	50 lb/po2 345 KPA															
DE SECOURS	ST205/75R14/C	50 lb/po2 345 KPA															

⚠ WARNING

NEVER EXCEED THE WHEEL MANUFACTURER'S RECOMMENDATIONS.

⚠ WARNING

IT IS IMPORTANT TO MAINTAIN PROPER WHEEL NUT TORQUE TO PROVIDE SAFE AND SECURE ATTACHMENT OF THE WHEEL TO THE HUB/DRUM.

⚠ WARNING

BE SURE TO USE WHEEL NUTS THAT ARE COMPATIBLE WITH THE COIN IN THE WHEEL. IMPROPERLY TORQUED WHEEL NUTS CAN CAUSE THE WHEEL TO SEPARATE FROM THE WHEEL MOUNTING SURFACE DURING OPERATION. THIS COULD RESULT IN PROPERTY DAMAGE, SERIOUS PERSONAL INJURY OR LOSS OF LIFE.

⚠ WARNING

DO NOT PLACE A JACK AGAINST THE CAMPER UNDERBELLY, WHEN CHANGING A TIRE. TO AVOID DAMAGE TO YOUR CAMPER, BE SURE THE JACK IS PLACED FIRMLY AGAINST THE FRAME.

AIR PRESSURE

Remember that the air pressure in your camper tires will not be the same as the pressure in your tow vehicle tires. Always inflate camper tires to the correct pressure. Do not over or under inflate. Under inflated tires will run hot, shortening the tire's life, and decreasing the camper's safe load limit. Over inflated tires will cause a rough and bouncy ride that can damage the camper or the cargo. Cold tire inflation pressure is defined as a tire that has not been used for 3 or more hours, or has been driven less than one mile. Tire inflation pressure of a hot tire may show an increase of as much as 6 psi over a cold tire.

LUG BOLTS

It is also important to check the wheel lug bolts regularly for tightness. Each lug bolt should be torqued according to the following:

TORQUE STAGES		
1st Stage	Aluminum	45 – 50 ft/lbs
	Steel	60 – 65 ft/lbs
2nd Stage	Aluminum	90 – 95 ft/lbs
	Steel	70 - 75 ft/lbs

Check the lug bolts per the following schedule:

1. After the initial test, check again after the first 50 miles.
2. Recheck every 50 miles for the next 200 miles.
3. Thereafter, check before each trip.

Check the lug bolts following periods of excessive braking. Be sure the lug bolts are seated in the counter-sunk holes of the wheel and keep them free of rust. Refer to the axle manufacturer's operation and maintenance manual for additional information concerning the camper's wheels and lug bolts. (If the tire manufacturers information differs from the above instructions, follow the tire manufacturers' directions.)

CHANGING A TIRE

Safety is the first consideration, if it becomes necessary to change a tire while traveling. (If equipped with an optional spare tire, it will be mounted on the outside rear wall of the camper.) Use the following steps when changing a tire:

1. If the flat/damage occurs while driving, bring your tow vehicle and camper to a controlled and gradual stop.
2. Pull off the road as far as safely possible.
3. Turn on hazard warning flashers.
4. If the flat/damage occurs at night, use flares or warning lights also.
5. Use a block to stabilize the opposite wheel.
6. If the wheel has a hub cap, remove it.

7. Raise the camper slightly, with a hydraulic or scissors style jack placed directly under the camper frame. Do not use a bumper style jack, or place any jack under the bumper.
8. Loosen the wheel lug bolts.
9. Use the jack to raise the tire off the road.
10. Remove the lug bolts and keep them together, and store them in an easily accessible place.
11. Remove the wheel and replace with the spare wheel and tire.
12. Replace the lug bolts and tighten by hand.
13. Lower the wheel to the ground and tighten the lug bolts in the sequence previously outlined. (If possible, determine that the bolts are tightened to 90-95 lbs. Recheck the torque at 50 miles, and every 50 miles thereafter, for the next 200 miles.)
14. Replace the hub cap, and store the old tire, jack, and all tools and safety equipment. After changing a flat, have it repaired or replaced as soon as possible. If you find yourself with a flat tire and no spare, and you must leave the camper to find a replacement, be sure to solidly stabilize the camper to prevent it from moving or falling off the jack.

LP GAS SYSTEM

GENERAL INFORMATION

The liquid petroleum (LP) gas system in your tent camper furnishes fuel for cooking, optional heating, and hot water. LP gas can also be used as an alternate energy source for refrigeration. LP gas is a clean, efficient, and safe form of energy when proper handling and safety precautions are observed. It enables you to enjoy a comfortable lifestyle when other forms of energy are not easily utilized.

LP gas is stored as liquid in a special storage tank. The tank is mounted on the frame, at the front of the camper near the hitch. The tank can be enclosed with an optional vinyl gas bottle cover. The cover protects the tank from the elements, and objects which may strike the tank while the camper is being towed. Double gas bottles and cover are also an optional feature.

LP gas is stored in the tank under extreme pressure, leaving space in the tank to allow for expansion into vapor. The vapor is reduced in pressure, by passing through a regulator. This reduction in pressure is a two step process which ensures consistent pressure for use, regardless of outside temperatures, weather, or altitude.

LP GAS CONTAINERS

LP gas containers are tested to withstand pressures in excess of anticipated normal usage. Additionally, every LP gas container has a built-in safety filling feature. The containers are designed to be filled only to 80% of capacity, with liquid LP gas. Filling the container to only 80% naturally allows 20% for vapor space. The extra space allows vapor withdrawal through the QCC1 Acme connection, and also allows expansion space for the liquid. If the tank were completely full, a rise in outside temperature could result in relief valve discharge of LP gas.

ATTACHING THE LP GAS CONTAINER TO THE CAMPER (20 LB. BOTTLE)

1. Attach the LP gas container bracket to the 'A' frame using the two ¼ inch 20 NC hex head bolts provided.
2. Place the LP container into the bracket and tighten the clamp ring. Be sure the container is properly seated.
3. Attach the regulator assembly to the service valve. (It is left-hand threaded).
4. Slowly tighten the QCC1 Acme connection. DO NOT OVER-TIGHTEN. This is a machined, male, brass fitting which seats against a female fitting.



5. Be sure the regulator vent faces downward, and that the regulator cover is kept in place to minimize vent blockage.
6. Before opening the service valve, allowing LP gas to flow into the system, be sure all LP gas appliances are turned off.
7. Open the tank service valve **slowly** and check all connections for leaks, as outlined further, in this section.
8. Follow the manufacturer's instructions carefully, when lighting an LP gas appliance.

⚠ WARNING

VENT BLOCKAGE CAN RESULT IN EXCESSIVE GAS PRESSURE, WHICH CAN CAUSE FIRE OR EXPLOSION. KEEP THE REGULATOR PROTECTIVE COVER IN PLACE TO MINIMIZE THIS DANGER AND PROTECT THE REGULATOR FROM THE ELEMENTS.

⚠ WARNING

NEVER USE AN LP TANK, DIFFERENT THAN THE ONE FURNISHED WITH YOUR CAMPER. IF THE TANK MUST BE REPLACED, CHECK WITH YOUR DEALER FOR CORRECT TANK SPECIFICATIONS AND REPLACEMENT PROCEDURE. KEEP THE TANK SECURELY MOUNTED IN ITS PROPER POSITION. USE ALL THE HARDWARE PROVIDED TO ENSURE PROPER SUPPORT AND POSITION.

⚠ WARNING

KEEP THE TANK SERVICE VALVE ACCESSIBLE AT ALL TIMES. IN AN EMERGENCY, IT MAY BE NECESSARY TO QUICKLY ACCESS THE VALVE TO SHUT OFF THE LP GAS FLOW.

FILLING LP GAS CONTAINERS

Before removing the LP gas container for refilling, or doing any work on the LP system, extinguish all open flames and smoking materials.

PROCEDURE FOR FILLING LP CONTAINERS

1. Turn off all LP appliances and extinguish their pilot light.
2. Close the service valve on the LP tank and remove the QCC1 Acme connection, which has a left-handed thread and must be turned clockwise to remove. Never use a wrench to close the service valve. If leaking occurs when closing by hand, have the valve repaired or replaced.
3. Cap or seal valve inlet to prevent the entrance of dust and dirt.
4. Loosen the clamp ring bolt and remove the container from the camper. Always transport the LP gas bottle in the upright position. Never transport, install, or use a vertical tank in a horizontal or upside down position.
5. Take the container to a qualified LP gas supplier.
6. Have supplier connect the fill nozzle to your tank fill connection.
7. Even though the tank is equipped with an automatic 80% shut-off, which prevents over-filling beyond 80% tank capacity, have the supplier monitor the 20% liquid level gauge, and stop the filling process if liquid does appear.

⚠ WARNING

BE SURE THE TANK IS NOT FILLED BEYOND THE 80% LIQUID LEVEL. IF THE TANK HAS BEEN OVER-FILLED, MAKE SURE THE LP SUPPLIER BLEEDS OUT THE EXCESS. OVER-FILLING THE LP GAS CONTAINER DOES NOT ALLOW FOR THE NECESSARY 20% VAPOR EXPANSION SPACE. THE ABSENCE OF THIS SPACE CAN RESULT IN UNCONTROLLED GAS FLOW WHICH CAN CAUSE FIRE OR EXPLOSION.

TWO STAGE LP GAS REGULATOR

The regulator reduces the pressure of the LP gas vapor from the pressure in the tank to the pressure required for use at the appliances. The regulator seldom requires service. Always protect it from the elements and extreme temperatures.

The regulator has been preset by the manufacturer and adjustment should not be necessary. However, if adjustment is required, do not attempt to adjust it yourself. Adjustment must be made with special equipment and by a qualified LP gas service technician. Have the regulator checked annually, or sooner, if you suspect a problem. The correct line pressure should be 6 to 8 oz., or 10 to 14 inches of water column.

A two-stage regulator performs the pressure reducing function as previously described. This is accomplished in two stages. Two regulators are used in the same body to reduce the pressure of the LP gas in the tanks for use by the appliances in the camper.

The high pressure regulator, (first stage), is used to reduce the pressure to approximately 10 to 13 PSI (ounces per square inch), before sending it along to the low pressure regulator, (second stage). The second stage regulator reduces the pressure further to 11 inches water column, or 6.35 PSI.

The two stage regulator does not have to work as hard since the second stage receives consistent pressure rather than inlet pressure, which varies. The result is a safer and more efficient system and helps to eliminate problems such as freeze up and pilot outages.

⚠ WARNING

NEVER ALTER THE POSITION OF THE REGULATOR. LP GAS REGULATORS MUST ALWAYS BE INSTALLED WITH THE DIAPHRAGM VENT FACING DOWNWARD. KEEP THE REGULATOR COVER IN PLACE, TO MINIMIZE VENT BLOCKAGE, WHICH COULD RESULT IN EXCESSIVE GAS PRESSURE, CAUSING A FIRE OR EXPLOSION.

Because air is required for proper operation of the regulator, it is very important that the regulator vent be kept free of dirt and debris. For this reason, it is necessary to keep the vent facing downward and the regulator covered, to protect it from contamination. A toothbrush can be used to clean the vent if it becomes clogged by foreign matter.

During cold weather, it's important to keep ice from forming in the regulator. Ice can prevent the flow of LP gas to your appliances. Have your LP supplier add anhydrous methanol when filling your tank for use during cold weather. Regulator freeze up can occur in any weather if there is moisture in the tank, or if the tank has been overfilled. Always use moisture-free LP gas. If moisture has entered the tank, have the tank purged, or have anhydrous methanol added by an authorized LP supplier.

REGULATOR FREEZE-UP

The term 'regulator freeze-up' is a misleading one. Regulators and LP gas do not freeze. However, the moisture that can be contained in the gas, can freeze as the gas expands and cools, and it passes through the regulator.

This moisture, in the form of ice, can build up and partially or totally block the passage of the gas through the regulator. Freezing can also occur when outside temperatures are low enough to contribute to the freezing of the moisture in the gas.

The source of the moisture is varied. It can occur at the refinery or gas plant, in the cars used to transport the gas, or even within your own LP tanks. Moisture in an LP tank can also occur when a tank service valve is left open, allowing moist air to enter and become trapped.

A two-stage regulator helps to reduce the possibility of freeze-up due to its larger orifice size and the fact that heat is transferred through the walls of two regulators instead of just one.

There are several steps which can be taken to inhibit or prevent ice from forming inside the LP tank:

- Be sure that your LP tank is free of moisture before refilling.
- DO NOT overfill the LP tank.



- Keep the service valves on an empty tank closed.
- If freezing does occur, have your LP dealer purge the LP tank before refilling.
- Add anhydrous methanol or other approved LP antifreeze or de-icing agent to the LP tank.
- Keep the regulator covered at all times.

If freeze up does occur, NEVER attempt to thaw with an open flame. A small light bulb can sometimes be used to provide heat and aid the thawing process. Once thawed, take proper steps to prevent a reoccurrence. Have the system checked by your LP supplier to determine the source of moisture and correct the problem.

OTHER COLD WEATHER FACTORS:

Since the colder liquid LP in the tank requires heat from the surrounding air to vaporize, remember that as outside temperatures drop, the BTU value of the LP gas is lessened. The lowering of BTU value can significantly affect the performance of the system.

You can help ensure proper performance by keeping your LP tanks as full as possible in cold weather, and reviewing the BTU/hr., rating plates on LP appliances for proper LP management.

LP SYSTEM HOSES AND FITTINGS

The LP hose provided with your camper is designed to withstand pressures far exceeding those of the LP system. However, sunlight and ozone contribute to the deterioration of the hose, creating the need for frequent inspection of the hose for wear.

The average life of an LP hose is approximately 2 to 3 years. Inspect the hose before each camping season, and when having the tank filled. Look for signs of deterioration such as cracks or loss of flexibility. Protect the hose from the direct rays of the sun, if possible, to help slow down the aging process. When the hose is replaced, always replace it with a hose of the same type and rating (check with your dealer).

Fittings are used to connect the various hoses and system components to each other. The QCC1 Acme connection at the end of each LP supply hose is the fitting that you will be disconnecting when removing a tank for refilling. It is made of brass and pipe sealants are not necessary to prevent leaking. It also has a left-handed thread, which means, turn it clockwise to remove, and counter-clockwise to tighten.

If leakage is observed at the QCC1 Acme connection and normal tightening of the fitting does not correct the problem, it will be necessary to replace the entire hose assembly.

The QCC1 Acme connection, was designed to help restrict the flow of LP gas in the event of a regulator failure, or hose malfunction. Due to the flow restricting device inside of the fitting, it can sometimes restrict the flow of fuel to the various appliances within the tent camper.

If it appears that gas flow to your appliances has been restricted, the following procedure should be used to help eliminate the problem:

1. Be sure all the appliances have been turned off (including pilot lights if applicable), and that there is no gas flowing into the system.
2. Be sure that the system is free of leaks .
3. Open the LP tank service valve slowly, (DO NOT SNAP IT OPEN). If opened too quickly, due to the sudden pressure fluctuation, the excess flow control valve may mistakenly sense that the system has been damaged, and shut off the LP.
4. Wait for at least 15 seconds before lighting any pilot light or appliance.

Following this procedure should create a normal flow of LP gas by allowing the excess flow control to settle in slowly. On models equipped with optional double tanks and optional automatic changeover, both hoses from the

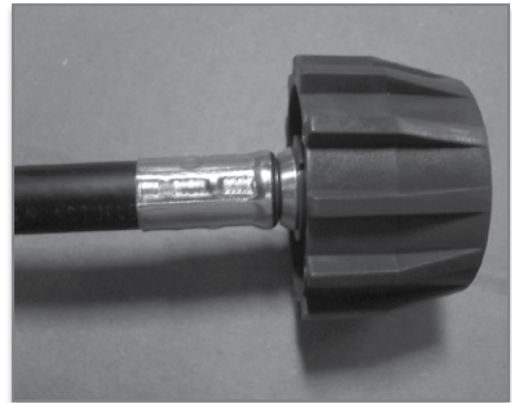

individual LP tanks are connected by a tee, to the regulator. This tee contains a disc check valve that prevents the LP gas from escaping, when an empty tank is disconnected to be refilled.

CHECKING LP SYSTEM FOR LEAKS

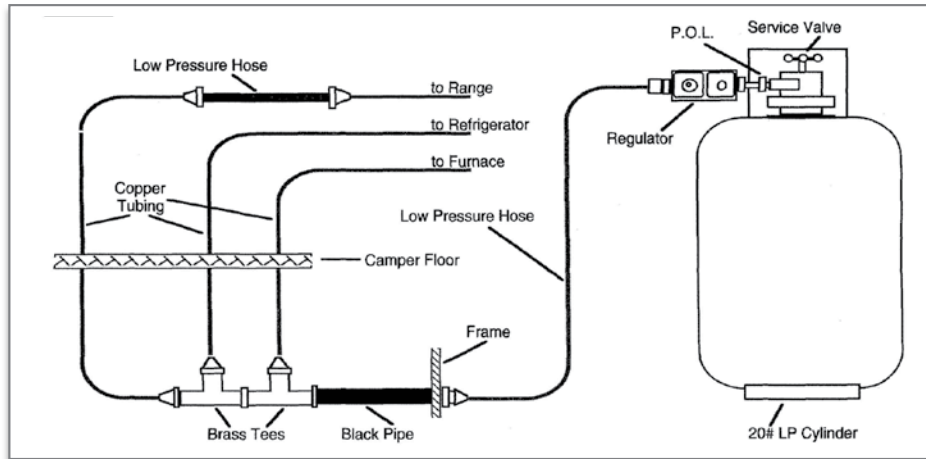

Road vibration can loosen LP gas fittings and connections. It is important to check your LP system for leaks at least every 5,000 towing miles, and whenever the tank is filled.

Making an inspection of LP components a regular part of your campsite set-up can help to identify potential problems before they occur. It's a good idea to have your entire LP gas system checked annually by a qualified LP gas service technician.

Use the following steps when checking the system for leaks:

1. Open all the windows and roof vent.
2. Open the gas tank service valve.
3. Use a non-ammonia, non-chlorinated soap solution, or an approved leak detection solution on all line connections (ammoniated soap solutions can cause cracking on copper or brass lines and fittings). Bubbles are formed by escaping gas, indicating a leak.
4. If a leak is detected, tighten the connection with two open-end wrenches until bubbling stops. Do not over-tighten, or use excessive force. If leak continues, contact your dealer, or a qualified LP gas service representative. DO NOT use tools to tighten tank service valves.
5. Check LP piping where contact with the frame could cause cracking or damage due to vibration or road shocks.

⚠ WARNING

NEVER CHECK FOR LEAKS WITH AN OPEN FLAME. ALSO, NEVER ATTEMPT LP REPAIRS WITHOUT THE PROPER KNOWLEDGE AND TOOLS TO ACCOMPLISH THE JOB.

NOTE: FOREST RIVER DOES NOT RECOMMEND, AND STRONGLY ADVISES AGAINST, ANYONE OTHER THAN A CERTIFIED LP SERVICE TECHNICIAN, PERFORM LP REPAIRS.

NOTE: LP GAS IS NATURALLY ODORLESS. AN ADDITIVE, WHICH CREATES A GARLIC-LIKE ODOR, IS ETHYL MERCAPTAN. THE ADDITION OF THIS CHEMICAL ODOR, ALLOWS THE DETECTION OF THE PRESENCE OF A LEAK.

LP GAS SAFETY PRECAUTIONS

Warning labels and decals used in your camper, are located in areas where the potential for a dangerous situation is present. They have been installed not only because of the requirement to do so, but also as a constant reminder to occupants of the camper to exercise proper caution when using or being around LP gas appliances and equipment.

Be sure that you, your family and all guests who may be using the LP appliances, understand and follow all of the precautions.

⚠ WARNING

DO NOT STORE LP GAS OR ANY OTHER TYPE OF COMBUSTIBLE CONTAINERS INSIDE THE TENT CAMPER. LP GAS CONTAINERS ARE EQUIPPED WITH SAFETY DEVICES WHICH RELIEVE EXCESSIVE PRESSURE BY DISCHARGING GAS TO THE ATMOSPHERE.

⚠ WARNING

USE EXTREME CAUTION WHEN PERFORMING ANY SERVICE WORK IN, OR MAINTENANCE TO, THE CAMPER, THAT A NAIL, SCREW, OR DRILL BIT DOESN'T PUNCTURE A GAS LINE.

NOTE: DO NOT REMOVE THE WARNING LABELS AND DECALS, LOCATED INSIDE YOUR CAMPER. IF ONE SHOULD BE LOST, DAMAGED OR PAINTED OVER, REPLACE IT AS SOON AS POSSIBLE.

ELECTRICAL SYSTEM

12-VOLT SYSTEM

- 12-volt functions of the camper include both the interior and exterior lighting, as well as the optional water pump, furnace, and refrigerator.
- 12-volt power for exterior camper lights is supplied by the tow vehicle, through the pigtail connection. Interior 12-volt lighting can also be supplied by the tow vehicle, but prolonged use will deplete the tow vehicle battery.
- A power converter in the camper, (optional), converts 110-volt electricity from an external source, into 12-volt power for operation of the interior lights, and furnace, if applicable. The refrigerator is wired so it can operate on 12-volt battery power alone.
- While traveling, 12-volt operation of the (optional) refrigerator is possible, through the tow vehicle pigtail connection. (Do not operate the refrigerator using the tow vehicle pigtail connection while camping.) If you will be stopping for more than one hour while operating the refrigerator in 12-volt mode from the tow vehicle, switch operation of the refrigerator, over to LP gas, to prevent draining the tow vehicle battery.

BULBS AND FUSES

There is a fuse panel located at the converter. Be sure to check for the cause of a blown fuse before replacing it. Never replace a fuse with a fuse of a higher amperage.

Note: If your camper is equipped with a shower, an additional fuse is located at the fuse panel.

BULB REPLACEMENT SIZES:

Exterior

- Tail Light #1157
- Clearance Lights #194
- Porch Light #1141

Interior

- Overhead #921

BROWN - PUMP	CIRCUIT 1
GRAY -	CIRCUIT 2
BLUE - PORCH LIGHT FURNACE GAS DETECTOR CASSETTE TOILET	CIRCUIT 3
YELLOW - DOME LIGHT FANTASTIC FAN	CIRCUIT 4
GREEN - REFER	CIRCUIT 5
RED - BATTERY	CIRCUIT 6

MAC/Freedom, LTD,
Off-Road Fuse Panel

BROWN - PUMP	CIRCUIT 1
GRAY - FANTASTIC FAN	CIRCUIT 2
BLUE - PORCH LIGHT FURNACE, RADIO GAS DETECTOR CASSETTE TOILET WATER HEATER	CIRCUIT 3
YELLOW - DOME LIGHT	CIRCUIT 4
GREEN - REFER	CIRCUIT 5
RED - BATTERY	CIRCUIT 6

Classic/Premier, HW
Fuse Panel

⚠ WARNING

TURN OFF ALL INTERIOR LIGHTS WHEN CLOSING THE CAMPER FOR STORAGE OR TOWING. HEAT FROM INTERIOR LIGHT BULBS WHEN THE CAMPER IS CLOSED, IS A FIRE HAZARD.

An electrical short along the line can cause a fuse to blow. Locate the short and take the necessary steps to repair it. If you cannot locate the problem, have a qualified electrician locate it for you.

Exterior 12-volt electrical components such as the brake and tail lights, are fused through the electrical system of the tow vehicle. Check the tow vehicle owner's manual for the location of, and proper method of, replacing 12-volt fuses and components.

TIP:

- Consider keeping a supply of replacement fuses and bulbs handy. Remember that the replacement fuse or bulb must be the same amperage rating, type, or equivalent as the original.
- Replacement fuses and bulbs are available at most campground stores. They may also be available at gas stations, hardware stores, or automotive supply stores.

110-VOLT SYSTEM

The camper can be hooked up to an external 110-volt power source, for operation of the convenience outlets and 110-volt operation of the optional refrigerator. **For models with a power cord storage compartment:** To attach to an outside power source, open the cap on the power cord storage compartment, and pull out to extend the cord. A cutout on the cap allows you to replace the cap over the cord to keep water and dirt from entering the cord storage compartment. The power cord is 25 feet in length and is designed for 30-amp service.

For models with a removable power cord: To attach an outside power source, open the cap on the power cord inlet and attach the removable cord provided. The power cord is 25 feet in length, and designed for 30-amp service.



SHORE LINE CORD

Connecting the power cord to an improperly grounded or non-grounded power source, can result in a dangerous, and possibly fatal electrical shock.

⚠ WARNING

NEVER USE A TWO WIRE EXTENSION CORD AND ADAPTER WITHOUT PROPER GROUNDING, OR PUT AN UNGROUNDED PLUG ON YOUR POWER CORD IN PLACE OF THE MOLDED 30-AMP PLUG.

NOTE: DUE TO THE POTENTIAL DANGER IN FAILING TO HEED THIS WARNING, FOREST RIVER'S WARRANTY OF FITNESS AND MERCHANTABILITY, AS WELL AS ANY OTHER EXPRESSED WARRANTIES MADE IN CONNECTION WITH THIS SALE, SHALL NOT BE EFFECTIVE OR ACTIONABLE, SHOULD DAMAGE, INJURY, OR DEATH RESULT FROM FAILURE TO CONNECT THE POWER CORD TO A PROPERLY GROUNDED POWER SOURCE.

NOTE: SOME ELECTRICAL APPLIANCES MAY HAVE THEIR OWN CIRCUIT BREAKERS. IF THERE IS AN INTERRUPTION IN ELECTRICAL SERVICE INVOLVING AN ELECTRICAL APPLIANCE, CONSULT THE APPLIANCE OWNER'S MANUAL TO DETERMINE WHAT ACTION TO TAKE.

GROUND FAULT CIRCUIT INTERRUPTER

The 110-volt patio outlet is equipped with a protective circuit interrupter. The ground fault circuit interrupter (GFCI), is designed to break the flow of current to the protected outlet when an imbalance of current is detected. Imbalances include electrical leakage in an appliance that has developed a weak spot in electrical insulation.

The possibility of electrocution exists when using a faulty appliance, while at the same time being in contact with an electrical ground such as water or the earth. If an imbalance is detected, the GFCI will trip and shut off power to the outlet. Even with GFCI protection, the electrical shock will still be felt, but to a lesser degree. It also does not protect against short circuits or system overloads. The circuit breaker in the main panel which supplies power to the circuit, will trip if either of these conditions exist. The GFCI receptacle should be tested initially when the camper is purchased, and every month thereafter.

To test the circuit, use the following procedure:

1. Be sure power to the circuit is on.
2. Push the test button.
3. The red reset button should pop out.
4. All power should be interrupted to outlets protected by the GFCI.
5. Verify by plugging in a light at these outlets, and pushing in the reset button.



If the red reset button does not pop out after pushing the test button, or the GFCI circuit continues to trip, immediately turn off the power at the circuit breaker panel and have a qualified electrician check it out.

NOTE: THE GFCI OUTLET IS NOT A SUBSTITUTE FOR GOOD ELECTRICAL SAFETY. IT DOES NOT PROTECT AGAINST CONTACT OF THE HOT AND NEUTRAL WIRE AT THE SAME TIME. THE GFCI DOES NOT PROTECT ANY CIRCUIT OTHER THAN THE ONE TO WHICH IT IS CONNECTED.

WATER AND DRAINAGE SYSTEM

Fresh water can be supplied to your camper in two ways. You can utilize water from an internal supply that you carry with you, in the campers fresh water tank, or from an external pressurized source.

Access the exterior pressurized water source by connecting to the source with a clean garden hose, used ONLY for conducting fresh water into the camper.

Components of the camper's water system, consist of strong, light-weight, corrosion resistant materials, which provide long life, and easy cleaning. By following the instructions for water system use as outlined in this manual, you can expect efficient operation with a minimum of maintenance.

FRESH WATER TANK

Your internal water supply tank is filled through a gravity fill spout located on the side of the camper. Two styles of fill spouts are used. To fill the style equipped with a hinged lid, slide the locking lever to the side to release and lift the protective cover.

The other style has a cap that screws off for access. In either case, water can be added to the tank by use of a bucket or hose. It is a good idea to use a different color hose for filling the fresh water tank than the one used for drainage, so that you will know at a glance which one is safe to use. If using a container such as a bucket to fill the tank, be sure it is clean and safe, and label it so it will be used only for this purpose.

NOTE: ALWAYS FILL THE TANK WITH CLEAN, DRINKABLE WATER FROM A KNOWN SAFE SOURCE.

NOTE: BE SURE TO CLOSE THE LID ON THE GRAVITY FILL SPOUT TO MAINTAIN SYSTEM SECURITY.

NOTE: WATER CAN BE DRAWN FROM THE ONBOARD SUPPLY TANK BY TURNING ON THE FAUCET.

NOTE: WHEN THE SYSTEM IS FILLED, CHECK FOR ANY LEAKAGE.

DRAINING THE WATER TANK

Water in the supply tank can be drained by opening the drain cock located beside the water tank. Lift the drain cock handle to drain the tank. Push the handle back down to close the valve. The drain valve for campers with tanks below the floor, is located under the camper, beside the gravity fill spout.



PRESSURIZED WATER SUPPLY

To utilize water from an external pressurized source (city water), proceed as follows:

1. Be sure the galley (kitchen) faucet is in the OFF position.
2. Remove the cap from the city water connection, located on outside wall near the sink.
3. Connect a good quality hose to both the camper connection, and the connection at the city water supply. Remember to use hoses of different colors for obtaining water and draining lines, to avoid possible contamination of your water system.
4. Turn the city water supply on. Open the kitchen faucet. Be sure there are no kinks in your hose which could restrict the water flow.

NOTE: A CHECK VALVE IN THE SYSTEM PREVENTS THE WATER FROM FILLING THE INTERNAL WATER STORAGE TANK.

WATER PUMP

When using water from the fresh water tank, the system must be pressurized. A self-priming 12V DC pump is provided to handle this function. A pump ON/OFF switch is located on the backside of the dinette next to the converter. When the switch is in the ON position, an indicator light on the switch illuminates to let you know the pump has been activated. Once activated, the pump will turn itself on automatically whenever a faucet or valve is opened, creating a demand for water. Once the water flow is shut off, the pump will also shut off.

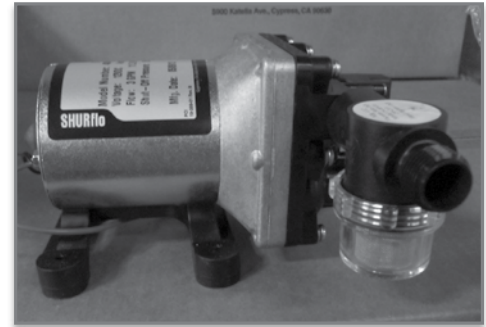

Sometimes, when using the pump for the first time after filling the fresh water tank, the water flowing from the faucet will sputter until all the air has been cleared from the water line. This is normal, and does not indicate a problem with the pump. When using the internal water supply, the pump should be left on, since it only runs when there is a demand for water from the system. The water pump is equipped with a screen to trap debris and should be cleaned out periodically.



DO NOT TURN THE WATER PUMP ON WHEN USING WATER FROM AN OUTSIDE PRESSURIZED SOURCE.

FILLING THE SYSTEM

If your camper is equipped with a shower, allow the entire system (water tank, water heater, and water lines) to fill with water, before using the water heater. When using water from either an internal or external source, open the faucets to allow water to flow through the system. When the flow becomes steady and free of air, turn the faucets off. Be sure that the water heater has been filled before lighting the pilot.

NOTE: WHEN USING THE INTERNAL WATER SUPPLY, YOU MAY WANT TO ADD WATER TO THE TANK TO REPLACE THE WATER USED DURING THE INITIAL START UP PROCESS OF ALLOWING ALL COMPONENTS OF THE SYSTEM TO FILL. THIS PROCESS WILL USE A SUBSTANTIAL AMOUNT OF WATER FROM YOUR WATER STORAGE TANK.

DRAINAGE

The sink drain is a direct connection to the drain fitting on the side of the camper. As water is used, it should be drained through a hose directly into the campsite septic system, or if not available, into a bucket for proper disposal.

NOTE: BE A RESPONSIBLE CAMPER. DO NOT ALLOW WATER YOU HAVE USED, (WATER FROM YOUR GRAY OR BLACK HOLDING TANKS), TO DRAIN DIRECTLY ONTO THE GROUND.

CASSETTE PORTA POTTI

A cassette Porta Potti is available on some camper models. The type of porta potti varies, but commonly, it is constructed of high quality plastic for durability and easy cleaning and maintenance. It consists of two sections, a permanently installed toilet system and a slide out waste holding tank (cassette). The toilet section includes a seat and cover, flush and valve blade opener, toilet tissue compartment and holder, waste level indicator, built-in toilet fluid storage compartment, a drip tray, a drain tube assembly and level indicator for the fresh water tank, and a fresh water tank.

The cassette section is located underneath the toilet and is removable for cleaning from outside the camper through an access door. A rotating pour spout, automatic holding tank vent, air release valve, blade, carrying handles and hand grips are incorporated into the cassette.

Other features include a safety sensor switch which guards against adding water to the bowl without the cassette in proper position.

The Porta Potti you have may look and operate differently from the one shown and described in this manual. For complete operating, cleaning, maintenance, and winterizing/storage instructions, refer to the instructions supplied with the Porta Potti that came with your camper. Pay particular attention to any notes or cautions associated with its use. Also be sure to complete and return warranty registration information to the manufacturer.



SANITIZING PORTABLE WATER SYSTEM

Sanitize the system before initial use, after extended periods of non-use, and anytime there is a suspicion that the system has been contaminated.

To sanitize the system, use the following procedure:

1. Place one ounce of liquid household bleach (5% sodium hypochlorite solution) in your RV's fresh water tank, for each ten gallons of capacity. (If your tank holds 30 gallons, put 3 ounces of bleach in the tank.)
2. With the tank empty and all faucets and drains closed, pour the solution into the fresh water tank.
3. Complete filling the tank with fresh water.
4. Operate the galley (kitchen) pump faucet until water flows freely.
5. Again add fresh water to the tank until the water level reaches the fill spout.
6. Allow the system to stand undisturbed for at least three hours.
7. Drain the system by opening the galley faucet and the supply tank drain cock, while flushing the system with water of drinking quality.
8. Continue flushing the system, allowing water to flow for several minutes.
9. Close the tank drain valve and the faucet. Refill the system with water of known drinking quality.

NOTE: IF THE TASTE OR ODOR OF THE CHLORINE SOLUTION USED TO SANITIZE THE SYSTEM LINGERS, POUR A SOLUTION OF 5 GALLONS OF WATER MIXED WITH A QUART OF VINEGAR INTO THE TANK. AGITATE THE SOLUTION IN THE TANK BY TOWING THE CAMPER, THEN ALLOW IT TO SIT IN TANK FOR ANOTHER DAY OR TWO. DRAIN THE TANK, FILL AND FLUSH WITH FRESH WATER, AND REFILL WITH FRESH WATER OF DRINKING QUALITY.

If you are unsure of the quality of the drinking water you are adding to your system, you can disinfect it by using 8 drops of household bleach for each gallon of water added.

DRAINING THE SYSTEM

The water system should be drained when not in use. To drain, proceed as follows:

1. Open the galley faucet and the supply tank drain valve.
2. When the tank is drained, pump the galley faucet several times to expel any water in the faucet and supply line.

For models with a shower, additional draining requirements will include the water pump and the water heater. There are also additional low point drain valves on the water lines of some models. Check the water lines on your camper for any low point drains that may need to be opened to completely drain the system. In addition, ask your dealer about drainage requirements for your particular camper model. Refer to winter storage instructions for additional information on draining the system.

WATER SYSTEM MAINTENANCE AND TROUBLESHOOTING

Most problems can be greatly reduced, if not altogether eliminated, by following a schedule of planned inspections and maintenance. Neglecting proper maintenance procedures is the usual cause of most water system problems, and is easily recognized as such.

In addition to neglect, road vibrations and shocks, as well as excessive pressure from some city water sources are the other main causes of most water system damage. It is important to inspect all plumbing joints and fillings, often, for cracks and leaks. Water leaking from a plumbing joint can cause considerable damage if left unchecked.

A leak in the fresh water system should be suspected any time the pump is running and all faucets and valves are closed. When the leaking fitting has been identified, attempt to stop the leak by tightening. DO NOT over tighten. Plastic fittings rarely need to be tightened with a wrench. If these fittings leak after tightening by hand, disconnect the fitting and check for dirt, scale, or other foreign substances which may be preventing proper connection, and may be causing the leak. Clean the fitting thoroughly and reinstall. If leaking persists, shut off the water supply until the fitting can be properly replaced. Check with your dealer for correct method of replacement, and replacement parts.

Proper winterization procedures of the plumbing system will normally, be all that is necessary to prevent damage caused by freezing. Freezing damage can harm any component of the system, including the water tank, pump, water heater, and all piping. Be sure to follow the winterization procedures outlined in this manual. Also discuss with your dealer, any additional precautions that should be taken to winterize your camper's plumbing system. Due to the differences in climates, your winter maintenance needs may change as you travel.

Read the literature supplied with plumbing components, such as the pump, for troubleshooting tips. Also remember that it is possible for an electrical problem to cause water system problems. Lack of power to the pump can be caused by a variety of reasons. If you are unsure of how to locate and/or repair a plumbing problem, it is best to have your dealer or a qualified plumber handle the job.

FORMALDEHYDE FROM BUILDING MATERIALS

Certain building products such as particleboard, fiberboard, and hardwood plywood are manufactured with an adhesive containing urea-formaldehyde. These products emit a small quantity of formaldehyde into the air. In reference to building materials; Forest River, Inc. is CARB 93120 Compliant with applicable Phase 2 emission.

Other products containing formaldehyde or urea-formaldehyde resins are some carpets, draperies, upholstery, fabrics, deodorizers, cosmetics, and permanent press fabrics. Formaldehyde is also a by-product of combustion and is produced by cigarettes and gas appliances.

The concentration of formaldehyde in the indoor air depends upon the quantity and emission rates of all emission rates of all emitting products in the structure compared to the volume of indoor air and the fresh air ventilation rate. As with other indoor pollutants, ventilation should reduce formaldehyde levels.



WARNING

FORMALDEHYDE LEVELS IN THE INDOOR AIR CAN CAUSE TEMPORARY EYE AND RESPIRATORY IRRITATION AND MAY AGGRAVATE RESPIRATORY CONDITIONS OR ALLERGIES.

WATER-PUR™

To help you choose quality water treatment products, the Water Quality Association develops its Gold Seal program. WQA tests water treatment equipment and awards the Gold Seal only to those systems that meet or exceed industry standards for performance, capacity, and integrity in removing a variety of drinking water contaminants. **WQA Gold Seal** testing and validation is available for drinking water treatment units. It provides the following assurances:

1. **Performance Testing** - measures contaminant reduction capabilities over the life and capacity of the unit.
2. **Structural Integrity** - measures durability under pressurization beyond the usual demands of home water systems, simulating 10 years of normal use.
3. **Materials Safety** - confirms a product does not add anything harmful to the water being treated.
4. **Literature Review** - verifies clarity and accuracy of product literature sales and advertising copy, installation and maintenance instructions, and product labeling. Gold Seal labeled products must meet the Water Quality Association's Code of Ethics standards. Only the Water Quality Association can award the Gold Seal, and only products meeting comprehensive industry standards can earn it.

The **Water-Pur™** system filters all water going into your RV, not just drinking water, thereby protecting your complete plumbing system from contaminants, providing filtered cold **and** hot water, and providing filtered water to your bathroom. It also:

- removes over 99% of chlorine, taste and odor
- removes over 99% of turbidity
- removes over 99% of Giardia & Cryptosporidium
- does not channel, fluidize, or bypass like a granular activated carbon filter
- does not permit the passage of cultivated bacteria like a granular activated carbon filter
- does not contain silver nitrate or any other pesticide or harmful chemical
- is constructed from all NSF listed materials
- is rated for 10,000 gallons or one year
- has a flow rate of 2.5 gallons per minute

The **Water-Pur™** cartridge is made of activated carbon particles fused into a uniform block, providing micron filtration. Service life is greatly extended by a 15 micron polypropylene prefiltration medium and a layer of 5 micron polypropylene melt blown intermediate filtration medium.

The replaceable cartridge, which is the heart of the **Water-Pur™** system has been tested to meet the material requirements of NSF Standards 42, 53 and 58. It has been tested to meet the performance requirements of NSF Standard 42 for Class 1 Chlorine reduction and Standard 53 for Class 1 Turbidity and Cyst reduction.

The **Water-Pur™** Models CCI10CLW12 & CCI-5CLW12 have been tested and awarded the WQA Gold Seal, certifying these systems meet or exceed RV/Marine industry standards for performance, capacity and integrity, under WQA S-200 for Household and Commercial Water Filters.



Look for the Gold Seal and buy with confidence.

For more information, write:

Water Quality Association

4151 Naperville Rd.

Lisle, IL. 60532-1088

(a not-for-profit organization) or visit our website at www.wqa.org

MODEL CCI-10CLW12 OPERATING INSTRUCTIONS

Prior to using your RV's fresh water system with the **Water-Pur™** CCI-10CLW12 installed, the entire system should be sanitized and rinsed. Make certain that the **Water-Pur™** filter cartridge is not in the filter housing.

Place one ounce of liquid household bleach (5% sodium hypochlorite solution) in your fresh water tank, for each ten gallon of capacity. (If your tank holds 30 gallons, put 3 ounces of bleach in the tank.) Fill your RV's fresh water tank with potable water. SLOWLY open the faucets in the RV and allow water to flow until you smell chlorine at each faucet, then close the faucet.

DO NOT PERMIT THE CHLORINATED WATER TO SPLASH ONTO CLOTHES, WALLS, COUNTERS, OR FLOORS. Allow the system to sit overnight. Drain the fresh water tank and fill with potable water. Run the faucets until the chlorine smell is gone. Repeat as necessary.

Shut off the fresh water pump or disconnect from your city water supply. Open the kitchen faucets to remove pressure. Place a shallow pan beneath the **Water-Pur™** filter. Remove the sump from the **Water-Pur™** housing by turning counterclockwise being careful not to spill the water in the housing. Empty the water from the housing. Unwrap the **Water-Pur™** cartridge and place it in the housing. (Either side up). Make certain that the 'O' ring is properly seated, and reattach the housing to the filter cap by turning clockwise. Tighten the housing firmly by hand. DO NOT overtighten.

Close the kitchen faucets and either turn on your fresh water pump or your city water supply. Check for leaks at the filter housing. Tighten if necessary. Open the kitchen faucet and allow water to flow for ten minutes. Your **Water-Pur™** system is now ready to deliver fresh tasting filtered water to all of the faucets in your RV!

To winterize your RV's water system, remove the **Water-Pur™** cartridge from the housing and follow the manufacturer's directions for de-winterizing, then replace the **Water-Pur™** cartridge. The cartridge should be replaced every 12 months or 10,000 gallons, whichever comes first.

An easy way to remember to do this is to replace the cartridge when you de-winterize in the spring. Replace the **Water-Pur™** cartridge only with a genuine **Water-Pur™** cartridge available from your dealer.

OPERATIONAL NOTE

The **Water-Pur™** cartridge is not to be autoclaved or steam sterilized. Use the **Water-Pur™** cartridge with micro-biologically safe water. Activated carbon filters are not designed to kill or remove bacteria or viruses. Actual results obtained will vary with various combinations of organic contaminants, changes in pH or other conditions encountered in actual use. All information presented is based on data believed to be reliable. It is offered for evaluation and verification, but is not to be considered a warranty of any kind. The contaminants removed by the **Water-Pur™** cartridge are not necessarily in your water. Some jurisdictions tax, regulate or restrict devices making health related or aesthetic claims. **Water-Pur™** makes no claims in those jurisdictions.

WARRANTY

The **Water-Pur™** system is warranted against defects in material and workmanship for a period on one year from date of purchase. Warranty does not cover damage due to abuse, neglect, improper installation, exposure to pressure or temperature above or below stated operating parameters, or improper winterizing. The Seller makes no other warranties of any kind, expressed or implied concerning this product, including warranties of merchantability or fitness for a particular purpose, except that this product should be capable of performing as described in this manual. Seller's obligation for this product's performance below specifications shall be limited solely to the replacement of product proven defective, at the Seller's sole discretion. Determination of suitability of product for uses contemplated by Buyer, shall be the sole responsibility of Buyer. Use of this product constitutes Buyer's acceptance of this limited liability. If warranty card is not received by the **Water-Pur™** Company, proof of purchase will be established by the Buyer presenting the original dated receipt for purchase.

DESCRIPTION

The **Water-Pur™** Model CCI-10CLW12 is a Household Class, Group 2, water filtration device designed for installation in recreational vehicles. It has a micron rating of 1 micron, a capacity of 10,000 gallons of chlorine removal at 2.5 gallons per minute. This capacity was determined under WQA Standard S-200 Test Conditions, and may vary with local water characteristics. The cartridge consists of activated carbon particles fused into a uniform block with enhanced absorptive capacity and efficiency. The cartridge flows in a radial outside-to-inside direction providing increased dirt capacity and low pressure drop (8 psid @ 1 gpm service flow, maximum differential pressure of 100 psid and a collapse pressure of 200 psid). Unlike granular activated carbon (GAC) filters, the extruded carbon will not channel or bypass, due to the extreme uniformity of its extruded prefiltration medium and a second layer of 5 micron polypropylene melt blown filter medium. Maximum cartridge operating pressure is 125 psid and maximum operating temperature is 0° F. Minimum operating temperature is 40° F. The housing and cartridge are constructed of 100% NSF listed materials.

FOREST RIVER TENT CAMPER

PERIODIC MAINTENANCE CHART

ITEM	EACH TRIP	EACH MO.	3 MO.	6 MO.	YEARLY	AS REQ.	PROCEDURE
Fiberglass Exterior		•					Wash with warm water and mild detergent
				•			Wax with liquid or paste wax
				•			Check condition of body moldings and reseal as needed
Tent Material	•						Clean and rinse thoroughly and allow to dry
						•	Remove stains from vinyl with Oxy-Clean
						•	Seal leaks in tent vinyl as required
Roof				•			Inspect and reseal as necessary
					•		Lubricate roof vent mechanism with light oil
Windows and Doors						•	Clean windows with plastic polish used for auto convertible top windows
			•				Lubricate door hinges and step components with WD40
					•		Lubricate door locks and strike pocket, including exterior storage and access doors
Seals and Adhesives		•					Inspect and reseal as necessary
LP Gas System						•	Check for leaks and road damage
Water and Drainage				•			Check hoses, fittings and connections for leaks or signs of wear
						•	Sanitize system and check fresh water inlet line screen
					•		Winterize system, if needed, due to weather conditions
Electrical						•	Perform maintenance on converter per converter manual
						•	Check and service battery (if so equipped)
Appliances	•						Remove food and ice from refrigerator after each trip
		•					Check for obstructions and dirt on exterior appliance vents
Safety Equipment		•					Check fire extinguisher pressure and conditions
Wood Surfaces		•					Clean pre-finished panels and wood
Weight and Distribution	•						Keep unit within specified load limits and proper weight distribution
Lifter System				•			Lubricate
Bunks						•	Lubricate bunk slides with silicone
Axles				•			Mounting bolts should be torqued to specific foot pounds
Wheel Bearings				•		•	Repack wheel bearings
Brakes			•			•	Check operation and for uneven wear

* As conditions and use warrant. (Follow instructions outlined in this manual.)

Coach-Net[®] EMERGENCY ROADSIDE ASSISTANCE

Technical & Roadside Assistance 877-801-0333

When you take delivery of your new Forest River camper, you are provided with an emergency roadside assistance service, free! We've teamed up with the largest RV emergency roadside assistance company in the country to give you immediate access to fast, dependable service when and where you need it. This is a comprehensive emergency roadside service that is available to you around the clock. For further details regarding how to access your Forest River Inc. Emergency Roadside Assistance and Product Support, please call 877-801-0333.

EXCLUSIVE BENEFITS

EMERGENCY ROADSIDE ASSISTANCE

Simply show your Forest River Roadside Assistance card for payment of covered benefits with no out-of-pocket expense throughout the U.S. and Canada. (Includes one additional family car!) Free jump-starts, tire changes, fuel delivery and lock-out service.

SERVICE ASSISTANCE

We offer over 6,800 qualified service agencies throughout North America. A simple phone call gives you expert direction on where the closest qualified service agency is located.

NATIONWIDE SERVICE APPOINTMENT ASSISTANCE

Here's a "no-hassle" way of arranging a service appointment when and where you travel. We make an appointment for you, give you directions and a time that fits your schedule. We're a toll-free call away!

MOBILE MECHANIC

We will dispatch a mechanic to the site of your mechanically disabled vehicle.* Labor charges and parts are not covered.

\$2000 TRIP INTERRUPTION REIMBURSEMENT

Getting in an accident while traveling in your RV means you're stuck. We take care of you by paying for a car rental, meals and lodging. Even helping with a plane ticket home.

24-HOUR TOLL-FREE EMERGENCY MESSAGE SERVICE

Stay in touch with family and friends with no cost emergency message service.

CUSTOM TRIP ROUTING AND FULL COLOR MAPS

Make your next trip more enjoyable with these easy to follow maps, travel tips, places to see and much more.

This information and service is provided by:

Coach-Net[®]
Technical & Roadside Assistance

900 N. Lake Havasu Avenue
Lake Havasu City, AZ 86403
877-801-0333

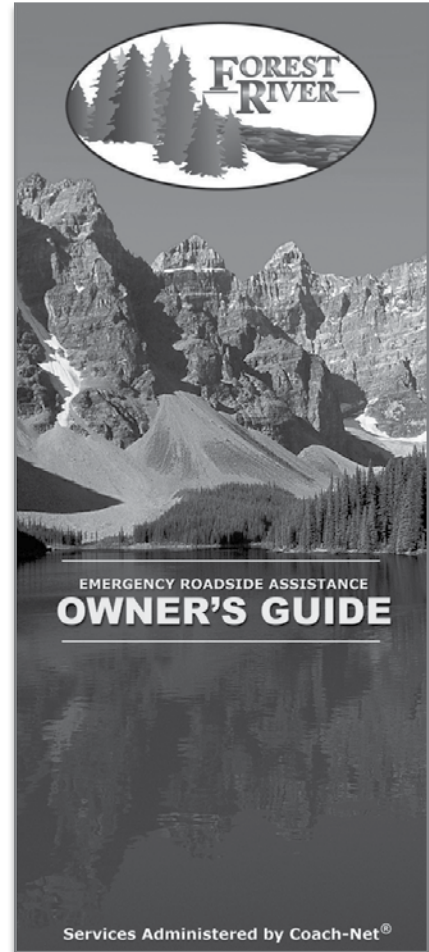

* Except where prohibited by warranty

SET UP INSTRUCTIONS

CAMPSITE SELECTION AND SET-UP

After taking delivery of your new tent camper, take a short trip to a local campground. Practice pulling into a space and backing up. Take time to learn how to connect to the campground water and sewer, and how to operate the various elements of your camper.

Learn all you can about your new camper before taking it on an extended trip. Becoming familiar with all facets of your new camper will make your first camping experience more enjoyable.

SET-UP TIPS AND PRECAUTIONS

Before setting up your new camper, always keep the following tips and guidelines in mind:

1. Choose a campsite that is as level as possible from side to side. An uneven campsite can cause binding of the lifting system.
2. Be sure there are no low hanging branches or other obstructions that could interfere with moving the camper onto the site, raising the roof, or extending the bunks.
3. Check the placement of campsite electric utility outlets, keeping in mind the length of the camper's power cord.
4. Be sure to release all four roof latches before attempting to raise the roof.
5. To prevent movement, place blocks in front of or behind, the camper wheels.
6. Remove all items you may have stored on the roof, before attempting to raise it.
7. Be sure the awning, (if equipped), is attached to the camper before raising the roof.

ROCKWOOD TENT CAMPERS - LTD, FREEDOM, FREEDOM OFF ROAD, PREMIER, HIGH WALL

1. Once you have selected your campsite, make sure you position your camping trailer on level ground. Before starting the set up procedure, be sure that the battery is properly connected to power the unit if you plan on operating an elec-

tric lifter system or optional power tongue jack. (High Wall models only).



2. **FREEDOM Off Road only** To access the Off-Road front storage deck and install the loading ramp, remove the (6) locking safety pins from the steel deck rails. Remove the steel deck rails, and mount them on the side of the deck by inserting the bolts on the ramp end into the openings in the steel mesh deck. You are now ready to load your ATV.



When disassembling, remove the ramps; and return them to the "rail" position on the trailer. Then, insert the locking safety pins into all (6) locations.



INITIAL EXTERIOR SET-UP

3. Begin with inserting the dolly wheel onto the jack post (if desired) and locking into place. Disconnect the safety chains from the tow vehicle and unplug the electrical connection. Now crank the handle on the dolly jack and lower the jack post to the ground. A small wood block can be used to prevent the jack post or dolly wheel from sinking into the ground. Now release the coupler latching lever and raise the coupler free of the hitch ball with the dolly jack.

Move the tow vehicle away from the camper. Level the camper from front to rear by raising or lowering the dolly jack as required.

Next, set the stabilizer jacks with sand pads on all four corners of the camper. Simply crank down each jack to stabilize the camper.



Note: Keep hands and fingers away from the pinch points on the stabilizing jacks when extending or retracting. Be sure to return the jack handle to the storage compartment to ensure it will not be lost. After all stabilizers are set, release the four latches that hold the roof secure.



WARNING: The stabilizing jacks are for support only and are not intended as a means of leveling the camper. Attempting to use the jacks as leveling tools may result in damage to the lifter system.

4. If you plan to utilize the awning, unzip and roll out the awning at this point. Release the awning legs located on the front of the awning rail and place them on the ground. Now, extend both support arms located on the back of the awning rail, and place into the sockets on the roof sidewall. Continue to extend the support arms until the fabric is taut, and

twist to lock. Next, extend the legs to the top pin position on the pole.



5. It is now time to raise the roof. **For electric lift systems:** Once the roof latches are released, simply push the switch on the power winch to the "up" position to raise the roof. Keep an eye on the extender cable for indication that the roof is fully raised. To lower the roof, push the lever on the power winch to the "down" position. If necessary, the power winch is equipped with a manual override feature. To access the mount for the crank handle, remove the round plastic cap on the motor cover. Then insert the supplied jack handle and crank the handle to raise and lower the roof.



For manual lift systems: Once the roof latches are released insert the lifter crank handle in the crank shaft, and turn it clockwise to raise the roof. The Rockwood lifter system has an automatic brake. If the handle is released at any time...cranking up or down...the roof will hold its position. . Keep an eye on the extender cable for indication that the roof is fully raised.



1. The guide wire will tell you when the roof is extended to full height. Set the safety supports on the opposing corner lifter arms.



2. At this time, adjust the awning legs to the desired height. If you prefer, you can attach the awning legs to the sockets located on the sidewall. During periods of high precipitation, adjust the awning pitch to allow water to run off. It is recommended during heavy winds that the awning be closed.



3. **LTD models only:** Now, slide the bunk end out until it is fully extended. Then, remove the support poles from under the mattress. Inserting the round end into the frame, and using your shoulder for leverage, raise the bunk and insert the flattened end into the clip. Locking the bunk into position.



FREEDOM, FREEDOM Off Road, PREMIER and High Wall models: Now, remove the 'double' pole bed supports from under the mattress. The poles with the black cap are installed in the back of the camper, and the poles with the white cap are installed in the front. Install the poles by inserting the clip into the bracket at the top of the tent camper wall and into the bracket on the tent camper frame. Place the bottom pole into the appropriate slot to

ensure the top pole is level. Then slide the bunk end out until it is fully extended.



If there appears to be an obstruction preventing the bunks from sliding out, **DO NOT** proceed until the source of the interference has been found and corrected. Keep bed slides well lubricated with a type of clear Silicone spray.

4. Adjust the side bunk tent assembly by securing the fitted corners and extending the tent sides below the bunk. Repeat the bunk-end set up procedure on the other bunk end.



Rockwood uses water resistant, a 5 piece sectionalized tent with down facing interlock seams and is double stitched at all tension points. **See the Tent maintenance section of your owner's manual for more information on how to clean and maintain your tent for years of enjoyment.**

5. **FREEDOM, FREEDOM Off Road, PREMIER and High Wall models:** at this point, if your tent camper is equipped with Rockwood's E-Z Glide slide out dinette, there are a few additional steps you will need to do. Release the slide room by lifting the "lift and turn" latch, then turning to release the lock.



Take hold of the handle and pull out the slide room. Attach the cotter pins to the steel pins extruding from the sidewall at the seal. Similar to the bed ends, Rockwood attaches the tent material to the slide out, so simply attach the Velcro strips to both sides of the slide out.



INTERIOR SET-UP PROCEDURES

6. Before entering the camper, you may want to set-up the step(s) stored under the door opening by pulling it down into place.
7. If you have a “flip-over galley”, set the galley into position by flipping it up onto the cabinet (LTD and select models).



If you have a “swing level galley”, lift the galley into place by grabbing the handle and using an even swing motion.



8. Now, zip the tent corners and slide the locking pin into the bed rail to secure the bunk. To complete the bunk end setup, put the overhead support pole into the bed bow and push into place. Next, adjust the length of the pole until the bunk material

is stretched tight. Set the other bunk end pole into place and the bed ends are ready to use.



9. **FREEDOM, FREEDOM Off Road, PREMIER and High Wall models:** now, complete the slide out setup by attaching the slide out dinette rafter pole to the tent bow, and stretch the tent into position. Insert the end of the rafter pole in the metal clip, and adjust the tension.
10. **High Wall models only:** If your Rockwood High Wall Series is equipped with a “hard wall” shower, some additional set up is required. Lift the top shower wall section up and slide in into place. Lock the safety latch. Next, lift the bottom shower wall section up and slide out into place. Lock the safety latch.



To complete the setup, install the shower door by inserting the bottom lip into the locking brackets and the top tabs into the locks. Install the interior shower curtain and exterior privacy curtain. The “black and gray water” dump valves are located on the “off-door” side for waste removal.



Next, install the faucet spout stored inside the sink by screwing into place on the top of the sink. **Note:**

Remember to remove the faucet spout and store it back inside the sink when tearing down.

1. Remove the dinette cushions from the bed position, and place the table on its side or on the bed. If your camper has a free standing table, simply unfold the table legs, and lock into place. If your table is a pedestal table, install the leg(s) into the floor base and set the table into place. Now, position the seat cushions and supported back cushions on the bases.



2. **FREEDOM, FREEDOM Off Road, PREMIER and High Wall models:** Most Rockwood models feature the Fantastic Vent. This 12 volt, 3 speed fan is quiet, dissipates condensation, and exchanges the air in your tent camper allowing you to breathe natural ambient outside air.
3. **LTD models only:** To set the screen door, release the door by turning the two twist locks. As the door swings down, lift it up and align the tabs into the slots on top of the side-wall. (Picture) Then twist the retainers to secure the top of the door. Attach the two door sections together and release the retainer clip on the side of the door. Now, simply attach the tent to the screen door with the Velcro strip.



FREEDOM, FREEDOM Off Road, PREMIER and High Wall models: Before installing the door, you should first remove the travel door by lifting the door to release the hinge pins. Then, stow the door beneath the rear bunk, and secure it with the attached shock cord. Be sure to reinstall this

door before attempting to slide in the bunk during teardown.



To set the screen door, simply push the one piece door up and release the snaps on the side of the door. Allow the guide wires to support the door. Next, twist the retainer clip at the bottom of the door to release it from the travel position. Position yourself in the middle of the door. Lift it out of the travel position and guide the door outside the opening setting it onto the threshold. Twist the 6 retainer clips to hold the door secure. Then, attach the tenting to both sides of the door with the Velcro strips.



4. To provide power to your heated mattresses, simply plug in the power cord and controller provided into the outlet sewn into the side of the mattress and plug into a 110 volt outlet located on the walls near the bed ends.



5. **High Wall models only:** if you have the model HW296, you have a 20" LCD TV Monitor as stan-

ard equipment. To position the TV for viewing, release the lock and turn it into position.



6. For models with a ceiling mounted folding clothes hanger: to use, release the catch and rotate the bar down.
7. For models with a Gaucho (a sofa-like seating space): It can be converted to a bed by releasing the snap on the locking strap located on the gaucho base under the seat cushion next to the door and pulling the gaucho seat bottom forward, using the back cushions to complete the mattress.
8. Since the appliances in your Rockwood camper may vary according to floor plans and options, we suggest that you consult your dealer or owner's manuals included with your camper for operating and maintenance information.

RETURN TO THE OUTSIDE FOR FINAL SET-UP

9. Fasten the corner flap to the snap at the end of the Velcro strip on the underside of the bunk and attach the tent to the Velcro along the length of the bunk. A shock cord is also added for safety. Next, Velcro the lifter post covers in place for added protection against the elements and insects.



10. **LTD models only:** if you desire, you can remove the two-burner stove from inside the camper and install it onto the mounting bracket located on the side of the camper. To attach the stove to the exterior wall, be sure that the lip on the extrusion across the back of the stove fully locks into place on the extrusion mounted to the camper sidewall. Then, attach the LP gas line provided from the opening on the side of the camper to the stove. A quick

disconnect fitting on the stove is provided for this purpose. When connecting the stove to the LP gas supply, the LP valve on the disconnect fitting must be in the OFF position (valve handle at a right angle to the gas line). To attach the quick disconnect, hold the gas line, pull back on the outer connecting collar and insert over the stove connection. When connected, turn the gas valve to the ON position (valve handle in line with the gas line). Don't forget to remove the stove before closing up the camper.



FREEDOM, FREEDOM Off Road, PREMIER and High Wall models: To attach the grill, remove it from the box and assemble according to the manufacturer's instructions. Begin by installing the grill base on to the mounting bracket located on the side of the tent camper. To attach the grill base to the exterior wall, be sure that the lip on the extrusion across the back of the base fully locks into place on the extrusion mounted to the camper sidewall. Place the grill on the base and attach the LP gas line provided from the opening on the side of the camper to the grill. A quick disconnect fitting on the grill is provided for this purpose. When connecting the grill to the LP gas supply, the LP valve on the disconnect fitting must be in the OFF position (valve handle at a right angle to the gas line). To attach the quick disconnect, hold the gas line, pull back on the outer connecting collar and insert over the grill connection. When connected, turn the gas valve to the ON position (valve handle in line with the gas line.)



TENT CAMPER TAKE DOWN PROCEDURE

Taking down your camper is basically the reverse process you used to set it up. However, it is important to ensure that various systems and features are shut off and stored properly. In addition, it is critical to make sure that moisture and debris is not left to damage the camper's components while it is stored. To take down the camper, proceed as follows:

1. Don't forget to remove and store the stove top or grill before closing up the camper.
2. Unplug the power cord from the outside supply and store.
3. Disconnect the water hookups and store the hose.
4. **LTD, FEEDOM, FREEDOM Off Road:** Your camper is equipped with dome lights that have individual switches. It is important to always turn off all lights, the furnace and pilot lights prior to closing the trailer.
PREMIER, High Wall only: Your camper is equipped with a dome light main power switch. This switch must be in the "off" position before the camper is closed. It is also important to always turn off the furnace and any pilot lights prior to closing the trailer.
5. Check that all appliance switches are in the OFF position, heated mattresses are unplugged with controller stored, stove top covers are closed and the main LP valve is in the CLOSED position.
6. If your camper has a refrigerator, and contents require it, switch to 12 volt operation.
7. **High Wall models only:** if you have the model HW29SC, you have a 20" LCD TV Monitor as standard equipment. Remember to turn, lower and lock the TV for storage.
8. **LTD models only:** store the inside/outside stove top in the storage position provided on the dinette seat base.
9. Place the dinette table and cushions (and any other table, gaucho cushion, etc.) in their stored position.
10. **High Wall models only:** If your Rockwood High Wall Series is equipped with a "hard wall" shower, uninstall the interior shower curtain and exterior privacy curtain. Remove the shower door by releasing the top tabs from the locks and by lifting the bottom lip from the locking brackets. Store the shower door on the dinette. Next, unlock the safety latches connecting the upper walls to the lower

walls of the shower. Now, slide in and lower the right wall and then the left wall.

11. Unzip the tent at each corner and slide the locking pin from the bed rail to release the bunk.
12. Close the roof vent or fan. Make sure no debris is lodged under the cap that could damage the screen or mechanism. If your camper is equipped with the Fantastic Vent, it is important to always secure the vent cover with the lock on the inside.
13. For models with a ceiling mounted folding clothes hanger: Remove clothing and hangers from the bar and fold the bar back into its flush mounted ceiling position.
14. Unfasten the tent from the Velcro at the door and remove the tent from around the door frame.
15. **LTD models only:** Lock the combination storm/screen door to the door frame, lift the entire door off the lower door and swing it up to the stored position. Fasten it to the roof with the two retaining locks.
FREEDOM, FREEDOM Off Road, PREMIER and High Wall models: lock the combination storm/screen door to the one piece door frame, release the six retainer clips to release the door, position yourself in the middle of the door and lift the entire door swinging it to the stored position using the guide wires for support. Place the bottom of the door in the storage bracket above the door opening, twist the retainer clip and then fasten the snaps on the side of the door at the top.
16. Then, retrieve the travel door from beneath the rear bunk and reinstall it in the entry door opening.
17. Be sure that all interior cabinets, wardrobe, pantry, etc., have been lowered or placed in their travel positions.
18. Be sure all windows are zipped and curtains are closed as required to avoid damage when closing the bunks.
19. Remove the center support poles from both bunks roof bows and store them under the mattresses. Then, lower the roof bows onto the mattresses.
20. Next, remove the center support poles from the dinette slide roof bow and store it under the seat cushion. Then, lower the roof bow onto the dinette cushions.
21. If you have a "flip-over galley", lower the galley by flipping it over from the cabinet into storage position (LTD and select models). If you have a "swing

level galley”, lower the galley into the storage position by grabbing the handle and using an even swing motion.

22. **Remove the faucet spout and store it back inside the sink.**
23. **FREEDOM, FREEDOM Off Road, PREMIER and High Wall models:** if your tent camper is equipped with Rockwood’s E-Z Glide slide out dinette, detach the tent material from the Velcro strips on both sides of the slide out. Remove the cotter pins from the steel pins extruding from the sidewall at the seal. Take hold of the handle and push in the slide room. **Note: make sure the path is clear inside the camper. Secure the slide room by turning and closing the “lift and turn” latch to engage the lock.**



⚠ WARNING

WARNING: WHEN CLOSING UP THE DINETTE OR CAMPER IN GENERAL, BE SURE TO PULL OUT THE TENT FABRIC AND CLEAR OUT OF THE SLIDE RAIL PATH BEFORE PUSHING IN THE BED.

24. Close the entry door step into its stored position.
25. Release the Velcro strips securing the tent material around the roof support poles.
26. Remove both lifter pole safety supports.
27. Detach the shock cord, tent flap Velcro and snap under the bunk and lift the tent up onto the bunks.
28. Be sure the tent is pushed back and away from the edge of the bunks.
29. **LTD models only:** Raise each bunk a few inches with your legs and shoulder, and then remove the bed support poles from the support sockets. Store the support poles in a convenient location such as under the bunk mattresses. Next, push both bunks into their travel positions.

30. **FREEDOM, FREEDOM Off Road, PREMIER and High Wall models:** push both bunks into their travel positions. Next remove the “double” pole bed supports from the brackets. Store the support poles in a convenient location such as under the bunk mattresses.

NOTE: BE SURE THAT THE TENT DOES NOT CATCH OR BIND WHEN PUSHING IN THE BUNKS.

31. Release the stabilizer jacks and raise them into their storage position.
32. **LTD and FREEDOM models:** insert the lifting mechanism cranking lever into the winch adapter and lower the roof by turning counter clockwise until the roof stops. **DO NOT OVER CRANK.** The roof can be fully retracted and still be 1 to 2 inches above the side walls. Do not continue to turn the cranking lever or damage to the lifter system will result.
33. For electric lift systems: to lower the roof, simply push the lever on the power winch to the “down” position. **DO NOT OVER CRANK.** The roof can be fully retracted and still be 1 to 2 inches above the side walls. Do not continue to push the lever or damage to the lifter system will result.
Note: When lowering the roof, make sure that the tent is kept clear of the lifter posts when the roof is lowered.
34. Store the awning when the roof is fully lowered.
35. Fasten the roof latches at each corner. It may be necessary to push down slightly on the roof at each corner to completely close the roof section and allow the latches to close.
36. Hitch the camper to your tow vehicle.

ROCKWOOD FOLDING CAMPER - HARD SIDE

1. Once you have selected your campsite, make sure you position your camping trailer on level ground. Before starting the set up procedure, be sure that the battery is properly connected to power the unit if you plan on operating the optional power tongue jack.



INITIAL EXTERIOR SET UP:

1. Begin with inserting the dolly wheel onto the jack post (if desired) and locking into place. Disconnect the safety chains from the tow vehicle and unplug the electrical connection. Now crank the handle on the dolly jack and lower the jack post to the ground. A small wood block can be used to prevent the jack post or dolly wheel from sinking into the ground. Now release the coupler latching lever and raise the coupler free of the hitch ball with the dolly jack. Move the tow vehicle away from the camper. Level the camper from front to rear by raising or lowering the dolly jack as required.

Next, set the stabilizer jacks with sand pads on all four corners of the camper. Simply crank down each jack to stabilize the camper.



Note: Keep hands and fingers away from the pinch points on the stabilizing jacks when extending or retracting. Be sure to return the jack handle to the storage compartment to ensure it will not be lost. After all stabilizers are set, release the two latches that hold the roof secure.



⚠ WARNING

WARNING: THE STABILIZING JACKS ARE FOR SUPPORT ONLY AND ARE NOT INTENDED AS A MEANS OF LEVELING THE CAMPER. ATTEMPTING TO USE THE JACKS AS LEVELING TOOLS MAY RESULT IN DAMAGE TO THE LIFTER SYSTEM.

2. **AT THIS TIME, REFER TO THE OPTIONAL A-FRAME AWNING/SCREEN ROOM SET UP INSTRUCTIONS AT THE END OF THIS SECTION, IF YOU PURCHASED THIS OPTION.**
3. It's now time to raise the roof. Lift the handle on the left roof section with a smooth firm action to raise both roof sections. Lift until the left roof section locks securely into the groove at the top of the right roof section.

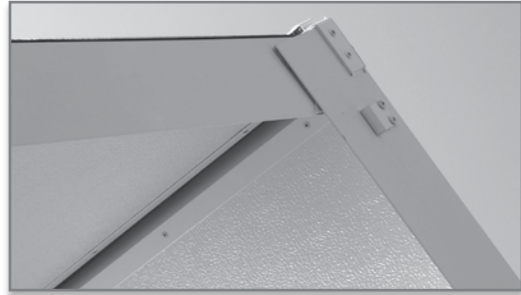

INTERIOR SET-UP PROCEDURES

4. Open the lower section of the door. Enter into the camper while opening and holding the upper section of the door. Close the lower door section.



5. Raise the door side wall by lifting at the top of the upper door opening. Continuing to hold the upper door section open, until the wall is upright.



While applying outward pressure on the wall directly below, secure the left side latch at the top of the wall into the plate mounted on the ceiling.



6. Lift to set the off door side wall until up right.



7. Secure both the latches as done previously. Then, secure the other door side latch using the same procedure.



8. Attach the door sections by securing the latch mounted to the lower door section to the catch mounted to the upper section.



9. Remove the dinette cushions from the bed position, and place the table on its side or on the bed. In most models, Rockwood uses a free standing table so it

can be utilized both inside and outside the camper. Simply unfold the table legs and lock into place.



If your model has a floor mounted table base, install the pedestal legs into the floor pedestal, and set the table into place.

10. Next, position the seat cushions and supported back cushions on the bases.



11. Most Rockwood models feature the Fantastic Vent. This 12 volt, 3 speed fan is quiet, dissipates condensation, and exchanges the air in your tent camper allowing you to breathe natural ambient outside air. **Note: It is important to always secure the vent cover with the lock on the inside before closing for travel.**

12. **If you have the Model A122 or A122BH**, your Rockwood has been equipped with standard heated mattresses that generate a warm, gentle, soothing heat for those chilly nights. To provide power to your heated mattresses, simply plug in the power cord and controller provided into the outlet sewn into the side of the mattress and plug into a 110 volt outlet located on the walls near the bed ends.



13. Since the appliances in your Rockwood camper may vary according to floor plans and options, we

suggest that you consult your dealer / or owner's manuals included with your camper for operating and maintenance information.

RETURN TO THE OUTSIDE FOR FINAL SET-UP

1. To attach the grill, remove it from the box and assemble according to the manufacturer's instructions. Begin by installing the grill base on to the mounting bracket located on the side of the tent camper. To attach the grill base to the exterior wall, be sure that the lip on the extrusion across the back of the base fully locks into place on the extrusion mounted to the camper sidewall. Place the grill on the base and attach the LP gas line provided from the opening on the side of the camper to the grill. A quick disconnect fitting on the grill is provided for this purpose. When connecting the grill to the LP gas supply, the LP valve on the disconnect fitting must be in the OFF position (valve handle at a right angle to the gas line). To attach the quick disconnect, hold the gas line, pull back on the outer connecting collar and insert over the grill connection. When connected, turn the gas valve to the ON position (valve handle in line with the gas line). Don't forget to remove the grill before closing up the camper.

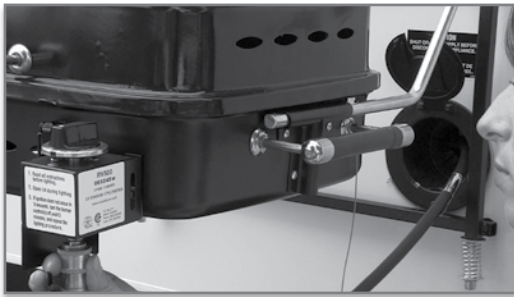

CLOSING INSTRUCTIONS

2. At this time, refer to the optional A-frame Awning/Screen Room closing instructions at the end of this section, for disassembly instructions if you purchased this option.

⚠ WARNING

THE ROCKWOOD HARD SIDE CAMPING TRAILER MUST BE IN THE CLOSED POSITION TO TOW.



3. Begin closing the camper. Start with disconnecting the door sections by releasing the latch mounted to the lower door section from the catch mounted to the upper section.
4. Next, release the latch on the right at the top of the door side wall from the plate mounted on the ceiling. Then release the two latches at the top of the off door side wall from the plates mounted on the ceiling. Lower the off door side wall until down flat.
5. Now, release the latch on the left at the top of the door side wall from the plates mounted on the ceiling. With the upper section of the door open, step into the door opening of the wall. While holding the upper section of the door, lower the door side wall gently until down flat.
6. Open the lower door section, and exit the camper. Close the upper section of the door and then close the lower section.
7. Lift the handle on the right roof section up with firm action, holding it up until the left roof section disengages from the groove on the right roof section.
8. Now, fasten the safety latches on both sides to the top roof section and raise the (4) stabilizer jacks up to the closed position.

A-FRAME AWNING/SCREEN ROOM INSTRUCTIONS

Note: For complete detailed installation and operating instruction, refer to the Dometic A-Frame Awning & Screen Room Manual provided.

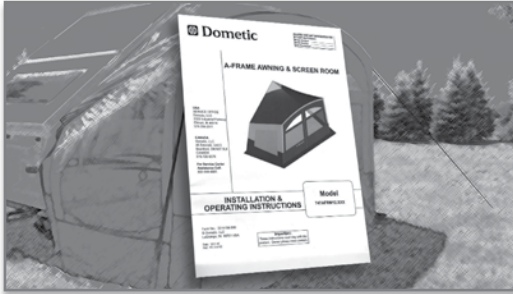

QUICK SET UP INSTRUCTIONS

1. If you have purchased the optional A-Frame Awning and Screen Room and plan to utilize it at this time, remove it from the storage bag to begin installation.



2. Separate the fabric from the aluminum support poles and stakes.



3. Before beginning the installation of the fabric, remove the front panel of the awning/screen room.



4. Open the lower section of the door and enter. Raise the door side wall by lifting at the top of the upper door opening while continuing to hold the upper door section open, until the wall is upright.



While applying outward pressure on the wall directly below, secure the left side latch at the top of the wall into the plate mounted on the ceiling.

Lift to set the off door side wall until up right.



Secure both the latches.



5. Now, release the door side latch and lower the door side wall while you position yourself near the off door wall to the side of the closed wall.

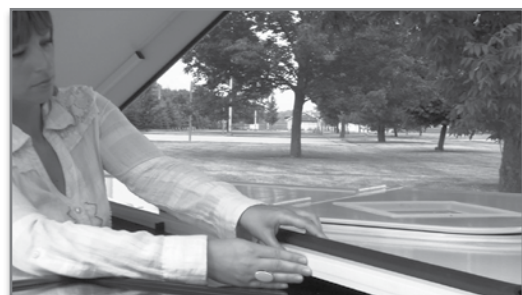

On the door sidewall, install the Velcro tape along the top inside edge of the wall,

1. Install the A-Frame Awning Screen Room fabric to the Velcro tape along the top inside edge of the door side wall. **These initial steps will only be completed during the first time set up.**

Return outside the camper to complete the remaining steps of the awning and screen room set up.

2. Install Velcro to the outside edge of the front and rear wall and along the bottom outside edge of the lower wall to attach the skirting later.



3. When raising the door side wall, be sure the A-Frame Awning Screen Room fabric is positioned outside the wall and properly positioned under the roof edge.



4. Assemble the aluminum poles and insert them into proper position through the sleeves sewn into the fabric. Be sure that the poles are properly secured into the mounting brackets attached to the fabric.



5. Now, attach the mesh skirting to the Velcro tape installed previously along the bottom outside edge of the lower wall.



6. Complete by securing the fabric to the ground with the stakes provided.



7. To convert the A-Frame Awning as a Screen Room, simply zip on the front panel.



QUICK DISASSEMBLY PROCEDURE

8. When closing your camper, you must first complete the disassembly procedure. Begin by pulling up all stakes, and disassembling the support poles and removing the front screen room panel, if attached.
9. Once the sidewalls are lowered, it is important to position the attached material on to the off door side wall to allow the roof to close properly.



10. Return all other awning/screen room parts to the storage bag to ensure all are available for use during the next camping trip.

CAUTION

CAUTION: IT IS IMPORTANT TO ALLOW A WET TENT TO DRY COMPLETELY BEFORE BREAKING CAMP. IF YOU MUST LEAVE SOON AFTER A RAIN STORM, OR JUST AFTER DAWN, PROTECT ALL CUSHIONS AND DRAPES FROM DAMPNESS, MOLD AND MILDEW THAT CAN FORM INSIDE THE CAMPER, WHEN FABRICS OR SURFACES ARE STORED DAMP. IF DAMPNESS DOES OCCUR, SET THE CAMPER UP AS SOON AS POSSIBLE, AND ALLOW IT TO DRY THOROUGHLY.

Rockwood Warranty, Customer Service and Parts

CONTACT INFORMATION

Mailing Address:

Rockwood
Warranty/Customer Service
P.O. Box 333
Millersburg, IN 46543

Phone Number:

To reach a Rockwood Warranty/Customer Service Representative:

574-642-2640

To reach a Rockwood Parts Representative:

574-642-2640

FACTORY SERVICE CENTER

The Rockwood factory service center is located in Millersburg, IN and is available for major service work that may be required. Service work is performed on an appointment basis only. It is best to schedule appointments for service well in advance. To schedule a unit for service, please contact a Rockwood Warranty/Customer Service Representative at the phone number listed above.



ROCKWOOD TENT CAMPERS
FOREST RIVER, INC
P.O. BOX 333
MILLERSBURG, IN 46543
www.forestriverinc.com/rockwood



Learn More
Scan this barcode using
a QR Reader on your
smart phone to learn
more about Forest River.



A Berkshire Hathaway company.

Forest River, Inc.
Corporate Office
PO Box 3030
Elkhart, IN 46515-3030
Phone (574) 389-4600