

# Owner's Manual



## IMPORTANT!

This manual contains operating, care, and maintenance instructions. To assure safe operation, any user of this firearm must read and understand this manual before using the firearm. Failure to follow the instructions and heed the warnings in this manual can cause property damage, personal injury, and/or death.

This manual should always accompany this firearm, and be transferred with it upon change of ownership.

**WARNING!** Keep this firearm out of the reach of children, unauthorized individuals, and others unfamiliar with safe handling of firearms.



Page 2	.....The Ten Commandments of Firearm Safety
Page 7	.... Important Parts of the Firearm
Page 10	.... Safe Firearm Handling
Page 12	.... To Load the Firearm
Page 14	.... To Unload the Firearm
Page 16	.... Lubrication and Maintenance
Page 20	.... To Function Test the Firearm
Page 25	.... Parts List
Page 28	.... How to Obtain Parts and Service

## A Tradition of Performance and Safety.

Your rifle has been made to Marlin's strict standards of safety and reliability. It has been proof tested with a high pressure load, function fired, and checked for accuracy at the factory. Built with tradition and engineered to last, your rifle is the product of over 135 years of Marlin technology.

## Before You Use This Firearm.

It is very important that you read and understand this manual before using your new rifle. Warnings should be read and heeded carefully. Always follow the "Ten Commandments of Firearm Safety," listed in this manual. Failure to follow these rules, warnings, and other instructions in this manual, can result in personal injury, property damage or death.

## Safety is Critical to Performance.

A superbly crafted firearm is only as good as the hands that hold it. You can never be too careful. Shooting accidents are often caused by careless oversights such as failing to control the direction of the muzzle, failing to engage the safety fully, leaving ammunition in the chamber or using improper loads. These oversights can result in the destruction of life, limb or property. There's no calling back a bullet once it's been fired, so it's critical that you know the principles of safe firearm handling and storage before you ever take your new Marlin firearm out of the box.

The proper use and performance of your firearm depends on correct assembly and maintenance, so it's critical that you familiarize yourself with the information in this instruction book. Even if you're a veteran shooter with a collection of Marlin firearms, take the time to read this manual. Not all firearms are the same. That means the first step in safe handling is to learn the features and requirements of your new Marlin.

## THE TEN COMMANDMENTS OF FIREARM SAFETY

The Ten Commandments of Firearm Safety should be etched in your memory forever. Let them govern your action wherever and whenever you're involved with firearms. In the field. On the range. Or in your home. Please take the time to review and understand these rules.



### 1st C O M M A N D M E N T

#### ALWAYS KEEP THE MUZZLE POINTED IN A SAFE DIRECTION.

*This is the most important firearm safety rule.* A safe direction is one in which an accidental discharge will not cause injury to yourself or others. Never allow your firearm to point at anything you don't intend to shoot. Be especially careful when you're loading or unloading. Treat every firearm as if it were loaded. Make it a habit to know where the muzzle is pointed at all times, even when your firearm is unloaded. No one will be injured by an accidental discharge if you keep your firearm pointed in a safe direction. It's as simple as that.

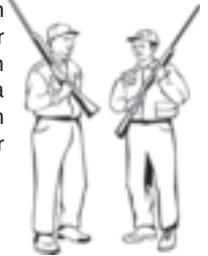

### 2nd C O M M A N D M E N T

#### FIREARMS SHOULD BE UNLOADED WHEN NOT ACTUALLY IN USE.

*Load your firearm only* when you're in the field or on the target range and ready to fire. Never let a loaded firearm out of your sight or out of your hands. Unload it as soon as you're finished shooting - before you bring it into your car, camp or home. Remember, unloading your firearm means unloading it completely, so there is no ammunition in the chamber or in the magazine. Before handling a firearm or passing it to someone else, visually check the chamber, receiver and magazine to be certain they do not contain ammunition. Always keep the firearm's action open when not in use. Never assume a firearm is unloaded even if you were the last person to use it. Always check for yourself.

- *Let common sense rule* when you carry a loaded firearm. If you're in a situation that could risk accidental discharge - such as crossing a fence, wading through a stream or climbing a tree - always unload your firearm. Never pull or push a loaded firearm toward yourself or another person. Never carry a loaded firearm in a scabbard, detached holster or gun case.

- *Certain firearms* are equipped with internal security devices to prevent unauthorized use. In addition, some firearms owners use external devices, such as cable locks and trigger blocks, for the same purpose. Even if you use such a device, you should still keep your firearm unloaded when stored or not in use. Using internal or external devices cannot substitute, securing your firearms and ammunition in a separate, locked location.

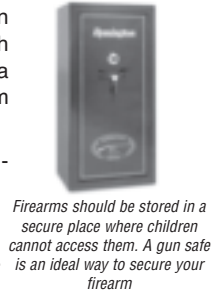

- *Safe storage* of firearms is just as critical as safe handling. Never store firearms loaded. Be sure to keep your firearms in a secure place where unauthorized persons cannot get their hands on them without your knowledge.

- *Take special care* if there are children around. Children are fascinated by firearms. It's a natural curiosity that can have tragic consequences when children are not properly supervised. Store your firearms in a locked gun safe or some other location that physically bars a child from gaining access.

- *Ammunition* should be stored and locked in a location separate from your firearm. Never leave an unsecured firearm or ammunition in a closet, dresser drawer or under the bed. Remember, it is your responsibility to make sure that children and others unfamiliar with firearms cannot get access to your firearm and ammunition.



## 3rd C O M M A N D M E N T

### DON'T RELY ON YOUR FIREARM'S SAFETY

*Treat every Firearm* as if it can fire at any time, whether or not there's pressure on the trigger. Your firearm has been carefully designed to maximize performance and safety. However, like any mechanical device, a firearm's safety could fail.

*Human error* is a more likely reason for a firearm safety to "fail". By mistake, you may think the safety is on when it really isn't. Or the safety may have been disengaged without your knowledge. Or you could think your firearm is unloaded when there's actually a cartridge or shell in it. A mechanical safety is not a substitute for common sense. It's merely a supplement to your proper handling of a firearm.

*Never touch* the trigger on a firearm until you are ready to shoot. Keep your fingers away from the trigger when you're loading or unloading. And don't pull the trigger when the safety is engaged or positioned between safe and fire.

*Before using your firearm*, read this instruction book to understand the exact location and operation of your firearm's safety. Even when the safety is on, maintain control of your loaded firearm and control the direction of the muzzle. In other words, don't rely on your safety to justify careless handling. If your firearm's internal mechanisms are broken or have been altered, your firearm may fire even when the safety is on. Remember, you and your safe firearm handling practices are your firearm's best safety.



## 4th C O M M A N D M E N T

### BE SURE OF YOUR TARGET AND WHAT'S BEYOND IT.



You can't stop a shot in mid-air, so never fire unless you know exactly where your shot is going and what it will strike. Never fire at a sound, a movement or a patch of color. A hunter in camouflage can easily be mistaken for a target by an impulsive shooter. Before you pull the trigger, be absolutely sure of your target and what's behind it. Make sure the shot has a backstop such as a hillside or dense material like sand. Remember, bullets can travel great distances with tremendous velocity. Know how far your shot will go if you miss your target or the bullet ricochets.



# 5th C O M M A N D M E N T

## USE PROPER AMMUNITION

*Every firearm is designed* to use a certain caliber or gauge of ammunition. Using the wrong ammunition, mixing ammunition or using improperly reloaded ammunition can cause serious personal injury or death. And it only takes one cartridge or shotshell of the incorrect caliber or gauge, or which has been improperly reloaded, to destroy your firearm. It's your responsibility to make sure the ammunition you use exactly matches the caliber or gauge of your firearm. Refer to this instruction book to find out the specific requirements of your firearm. Always read and heed the instructions on ammunition boxes.

*Confusing shells* or cartridges can cause serious personal injury or death and destroy your firearm. Examine your shells or cartridges closely and use only the precise caliber or gauge for your specific firearm. For example, suppose you accidentally loaded a 20 ga. shell into a 12 ga. shotgun. Because the 20 ga. shell is too small for the chamber, the 20 ga. shell could travel down the barrel and get lodged in the bore. If you then loaded a standard 12 ga. shell behind it and fired, the 12 ga. shot will slam into the lodged 20 ga. shell and may cause the barrel to explode right in your hand. This is commonly called a 12/20 burst, and it can kill you.

*Check all ammunition* before you load it to make sure it matches your firearm's requirements. Every cartridge and shell is head-stamped with its caliber or gauge for easy identification. Likewise, you'll find the caliber or gauge of your new Marlin firearm imprinted on the barrel.

### Reloading Requires Extra Diligence.

*If you're an ammunition reloader*, you are responsible for personally assuring that the loads and components of your reloaded ammunition meet your firearm's factory-tested standards. Never use ammunition, which has been reloaded by someone else!

*Many shooters handload* as a hobby or to save money on commercial, factory-made ammunition. However, it requires a thorough knowledge of reloading procedures and a deep respect for the explosive potential of gunpowder.

*Firearms are designed*, manufactured and proof-tested to standards based on factory-loaded ammunition. Handloaded or reloaded ammunition that deviates, either intentionally or accidentally, from load or component recommendations can be very dangerous.

Reloaders must observe all possible safety precautions and practices related to the proper handling of explosives. Whether you're a seasoned reloader or just starting out, you should study the subject, watch reloading demonstrations and talk to experienced reloaders.

*The first rule of reloading* is to always follow the manufacturer's instructions for the components you're using. They'll tell you to follow certain guidelines. Namely:

1. Don't mix or substitute powders or primers.
2. Don't use unknown or substandard components.
3. Use only suitable components that have been factory-tested by reputable ammunition, powder and bullet manufacturers.
4. Always be sure to use the manufacturer's recommended recipe when reloading.

*Not following these guidelines* could result in severe injury or death to yourself or severe damage to your firearm. Dangerously high pressure and explosions can result from an overcharge of powder or other deviations from established reloading guidelines. Be very careful. The process of reloading exposes you to environmentally hazardous material. Lead, which is known to cause cancer and birth defects, is the most common substance in bullets and shot. It is important to handle lead bullets and shot with extreme care. Work only in a well-ventilated area and always wash your hands after exposure and before eating. Never smoke while reloading.

*Primers and powders* are also highly toxic and flammable. So after reloading be sure to clean up all materials from your work area. Don't leave primer or powder spills anywhere on the floor or bench top. Dispose of all waste material in accordance with the manufacturer's recommendations.

*Finally, when reloading* or handloading concentrate on what you're doing at all times. Do not be distracted by talking to others, listening to the radio or watching TV while reloading. Never reload after consuming alcoholic beverages or drugs of any kind. You are working with extremely hazardous materials and you can't risk even a few seconds of distraction. Remember, if you reload, you are the ammunition manufacturer and you are responsible for the performance and safety of your reloaded ammunition.

## 6th C O M M A N D M E N T

### IF YOUR FIREARM FAILS TO FIRE WHEN THE TRIGGER IS PULLED, HANDLE WITH CARE.

If for some reason the ammunition doesn't fire when you pull the trigger, stop and remember the 1st Commandment of Firearm Safety - always keep the muzzle pointed in a safe direction. Keep your face away from the breech, then put the safety on, carefully open the action, unload the firearm and dispose of the cartridge safely. Remember that anytime there's a shell in the chamber, your firearm is loaded and ready to use. Even if you tried to shoot and your firearm didn't fire, treat your firearm as if it could still discharge.

## 7th C O M M A N D M E N T

### ALWAYS WEAR EYE AND EAR PROTECTION WHEN SHOOTING.

Your sight and hearing risk injury from shooting and should be protected at all times. Wear protective shooting glasses to guard against falling shot, clay target chips, powder residue, ruptured cartridge cases and even twigs and branches in the field. Also be sure to wear eye protection when you're disassembling or cleaning a firearm so that tensioned parts (like springs) and cleaning solvents don't come in contact with your eyes. Continued exposure to shooting noise can permanently damage your hearing. On the range, where shooting volume is the loudest, be sure to use the maximum protection of a headset. Learn to use ear protection at all times.



## 8th C O M M A N D M E N T

### BE SURE THE BARREL IS CLEAR OF OBSTRUCTIONS BEFORE SHOOTING.

Before loading your firearm, open the action and make sure there's no ammunition in the chamber or magazine. Check the barrel for any obstructions or debris. Even a small amount of snow, mud, excess lubricant or grease in the bore can dangerously increase pressure and cause the barrel to bulge or burst when firing. Use a cleaning rod and patch to wipe away anti-rust compounds or any other residues or obstructions in the barrel. Never try to shoot out an obstruction by loading another shell and firing!

When firing, rely on your instincts. If the noise or recoil of your firearm seems weak, stop everything, unload your firearm and be sure nothing is lodged in the barrel. Remember the 12/20 burst? That's what can happen when the barrel is obstructed. Always be sure you're using the correct ammunition in your firearm and that it's free of obstructions.

## 9th C O M M A N D M E N T

### DON'T ALTER OR MODIFY YOUR FIREARM AND HAVE IT SERVICED REGULARLY.

Your firearm has been designed to operate according to certain factory specifications. You'll jeopardize your safety and that of others around you by attempting to alter its trigger, mechanical safety or other mechanisms. So never alter or modify your firearm in any way.



Like any mechanical device, a firearm is subject to wear. It must be maintained and periodically serviced to assure optimum safety and performance. Only a qualified service facility should service, repair or modify your Marlin firearm. Consult your instruction book for instructions on how to send your firearm to the factory or for the location of the nearest Marlin authorized repair station.

Proper cleaning and lubrication are also important to firearm maintenance and are necessary to assure accuracy, safety and reliability. Before cleaning, always make sure that your firearm is completely unloaded.

And always clean the barrel from the chamber end to the muzzle when possible.

Make it a practice to clean your bore every time you're going to shoot. Be sure to clean your entire firearm before and after long-term storage and no less than once a year. It's also important to clean your firearm whenever it's been exposed to adverse conditions such as rain, dirt, mud, snow, sleet or saltwater.

For safe and dependable operation of your firearm, all parts of your firearm must be properly cleaned and lubricated. Periodically inspect the internal workings of your firearm to be sure they're clean and free of rust, unwanted dirt and debris.

Use recommended lubricants on your firearm and do not over-lubricate. Excessive use of a non-recommended lubricant could adversely affect the function and safe operation of your firearm. Remember, you are responsible for the proper care and maintenance of your firearm. Failure to properly maintain your firearm cannot only damage or ruin your firearm, it can expose you and others to unnecessary risks of personal injury or death.

Remington® has a wide range of firearm care products and resources for best results when cleaning your firearm. Everything from solvents and lubricants to rods and patches. They're all available from your Marlin dealer.



## 10th C O M M A N D M E N T

### LEARN THE MECHANICS AND HANDLING CHARACTERISTICS OF YOUR FIREARM.

Not all firearms are alike. They have different mechanical characteristics that dictate how you should carry and handle them. Anyone who plans to use a firearm should first become totally familiar with the type of firearm it is and the safe handling procedures for loading, unloading, carrying, shooting and storing it.

Before you even unpack your new Marlin firearm, read this instruction book from cover to cover and familiarize yourself with the different component parts of the firearm. Then read, understand and follow the Ten Commandments of Firearm Safety in this manual.

**WARNING!** Discharging firearms in poorly ventilated areas, cleaning firearms or handling ammunition may result in exposure to lead, a substance known to cause birth defects, reproductive harm, cancer and other serious physical injury. Have adequate ventilation at all times. Wash hands thoroughly after exposure.



### SHOOT SOBER!!

There's one other rule that must be followed when handling firearms. In fact, respect for this rule is necessary in order to effectively practice the Ten Commandments of Firearm Safety. The rule is: SHOOT SOBER! Firearms and alcohol or drugs make a deadly combination. Never consume anything that would mildly impair your judgment or physical coordination when you're using a firearm. A staggering percentage of the shooting accidents that occur every year involve alcohol or drugs. Be smart. Always shoot sober and stay alive.

**WARNING!** Failure to follow any of these safety rules may cause personal injury or death to the shooter or bystander and damage to property. Do not use a firearm until you fully understand and practice the Ten Commandments of Firearm Safety. If you have any questions about the safe use of a Marlin firearm, write to us at Marlin Firearms, Consumer Service, P.O. Box 130, Madison, NC 27025-0120, or call us at 1-800-544-8892.

### DON'T KEEP THIS TO YOURSELF.

Now that you're a firearm owner you have the obligation to help ensure that shooting sports are safe for everyone - participants and bystanders alike. You can do that by practicing these principles of firearm safety and passing them on to others - especially new shooters. Set an example for beginners. Be a guide to their safe entry into the exciting world of shooting sports. Invest your time and patience for the love of the sport and for its future. After all, it's your love of the sport that led you to buy a new Marlin.

Firearm ownership is a right and privilege. It's a right guaranteed in this nation's Constitution. It's a privilege, which carries with it a personal responsibility to use your firearm in a way which will ensure your safety and the safety of others. The preservation of this right and privilege depends on the personal commitment of you and your fellow shooters to the safe and responsible use of firearms. Let the Ten Commandments of Firearm Safety outlined in the book guide you at all times. Teach and promote these rules whenever you can. Remember, firearm safety depends on you! That's the only way to really enjoy your new Marlin firearm and to preserve sport shooting as we know it today.



## Marlin® Lever Action Centerfire Rifles

*Congratulations on your choice of a Marlin®. With proper care, it should give you many years of dependable use and enjoyment. For best results, we recommend that you use Remington Ammunition - the ammunition used in factory testing your firearm against our rigorous function and performance standards.*

*These pictures shows the main parts of a Marlin Centerfire Lever Action Rifles. The pictures will aid in understanding the instructions.*

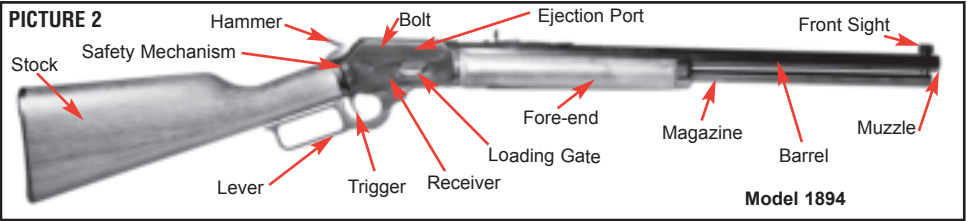
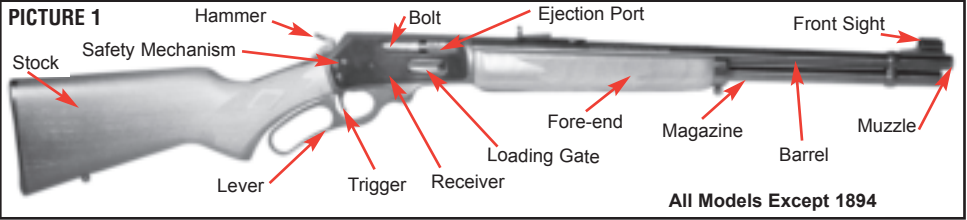

### General Operation

Your lever action centerfire rifle is capable of firing multiple shots by cycling the action and pulling the trigger. The start of the cycling sequence is when the safety mechanism is engaged in the “Safe” position, the lever is fully rearward and the bolt is fully closed. Rotating the lever downward retracts the bolt, disengages the trigger and disconnects the firing pins. As the bolt moves rearward, any cartridge in the chamber is extracted from the chamber and ejected from the firearm. A new cartridge is released from the magazine onto the carrier and the hammer is cocked as the lever completes its rotation forward. Rotating the lever rearward lifts the carrier, allowing the new cartridge to be loaded into the chamber as the bolt is closing. The cycle sequence is completed when the lever is fully rotated rearward and upward, locking the bolt forward, engaging the trigger and connecting the firing pins. Manually moving the safety mechanism to the “Fire” position and pulling the trigger will discharge the rifle.

### Important Parts of the Firearm

#### Serial Number and Cartridge Designation:

Serial numbers are located on the shooter’s left side of the receiver.

Specifications for the correct cartridges intended for use in your firearm are located on the shooter’s left side of the barrel. See Picture 3.

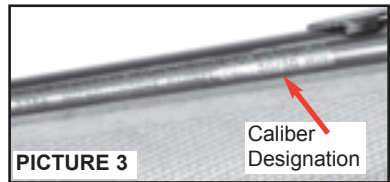

**WARNING!** Use only the specified cartridge type and caliber of ammunition specified for your firearm as designated on the barrel. See “To Load Your Firearm,” page 12.

## The Safety Mechanism

The manual safety mechanism of your centerfire lever action firearm is a hammer-block type, providing protection against accidental or unintentional discharge under normal usage when properly engaged and in good working order. The safety mechanism blocks the hammer, preventing the hammer from striking the firing pin when fully engaged in the "SAFE" position. This safety mechanism is not a substitute for following the rules of safe firearm handling.

The safety mechanism is located towards the rear of the receiver, above the trigger. To engage the safety mechanism, push the safety button fully to the shooter's right until the safety button stops. The red band will not be visible. See Picture 4.

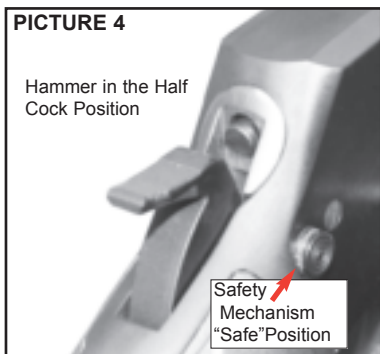

*Always engage the safety mechanism by moving the safety button fully to the shooter's right before handling, loading or unloading the firearm.*

**NOTE:** The hammer must Not be "At Rest" (See: "The Hammer", on page 8) or resting on the firing pin to activate the Safety Mechanism. If the hammer is "At Rest" without touching the trigger, move the hammer with your thumb to the first stageable position, known as the "half cock" position. Then push the safety button fully to the shooter's right. When you are ready to discharge the firearm, disengage the safety mechanism by pushing the safety button to the

shooter's left. This is the "FIRE" position. The safety button's red band will be visible. You have now disengaged the safety mechanism. If the hammer is fully cocked and the lever is fully closed, the firearm is ready to FIRE. See Picture 5.

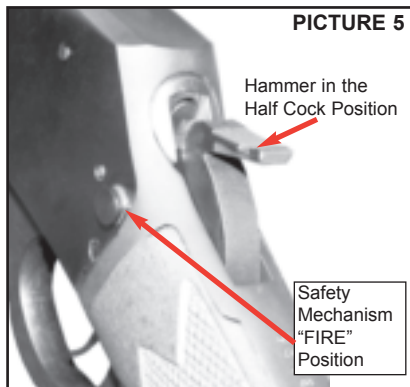

*Do not touch the trigger while moving the safety mechanism. Your fingers and all other objects should be kept outside of the trigger guard and away from the trigger until you are actually ready to FIRE.*

*Never attempt to pull the trigger when the Safety Mechanism is activated in the "SAFE" position.*

**WARNING!** The firearm will discharge when the hammer is cocked, the trigger is pulled and the *safety mechanism* is disengaged or in the "FIRE" position.

*Even when the safety is engaged in the "SAFE" position, careless handling can cause the firearm to discharge. See the "Ten Commandments of Firearm Safety," on page 2.*

## The Hammer

Lever action centerfire firearms have an exposed hammer with three (3) positions.





**AT REST** - the hammer is fully forward, resting on the firing pin.

**HALF COCK** - the hammer is located rearward at the first stageable position. Traditionally, this position is referred to as the half cock safety.

**FULL COCK** - the hammer is located fully rearward at the second stageable position.

**WARNING!** Lowering the hammer from the full cock to another position (decocking) should not be attempted unless the safety mechanism is engaged. Always keep the firearm pointed in a safe direction. See “To Unload the Firearm,” on page 14.

## Additional Features

Besides the manual safety mechanism and traditional hammer half cock, these lever actions centerfire firearms incorporate passive features providing additional protection against accidental or unintentional discharge under normal usage and when kept in good working order. These passive features, such as the two-piece firing pin system, steel alloys and/or their metallurgical treatments, the sear, trigger, and hammer engagements, the lock-up system, head space, disconnecting trigger, and the lever, all work without direct input from the user as long as your firearm is kept clean and in good working order.

**WARNING!** Do not alter, modify, bypass, or render these safety features inoperative.

## The Locking Device

This firearm was originally sold with a key-operated locking device to assist the owner in protecting against unauthorized use. These are storage locking devices, which should be used when the firearm is stored or not in use. Never store a firearm loaded.

PICTURE 6

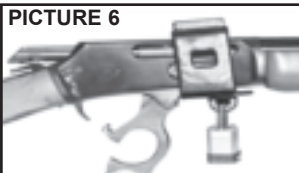

**WARNING!** These locking devices do NOT eliminate the need for safe firearm handling and storage, including keeping this and every firearm unloaded and locked in a secure place when not in use. Read and follow these and other safety rules in this instruction manual. Failure to read, understand, and obey these rules can result in serious personal injury or death. See the “Ten Commandments of Firearm Safety,” on page 2.

Keep your locking device engaged when your firearm is not in use. Keep the keys in a secure place, inaccessible to others. DO NOT leave your keys or any ammunition with your firearm, which should be kept unloaded and locked in a safe place.

To secure your firearm with an external locking device, see instructions provided in the packaging.

## The Lever and Bolt Assembly:

The lever is used to open and close the action (bolt assembly) and is the interface to connect the trigger and engage the locking block when fully rotated rearward in the closed position. See Picture 7. The bolt is opened by rotating the lever down and forward.

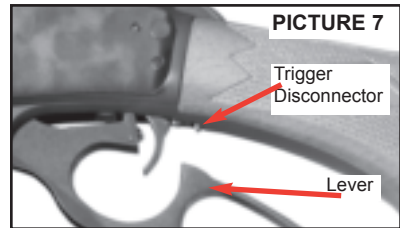

When the locking block is fully engaged in the bolt assembly, it connects the front and rear firing pins and pushes the bolt assembly against the breech, locking the cartridge into the chamber, containing the discharged pressure of the ammunition within the chamber. The bolt assembly is a one-piece system, manufactured specifically for your firearm to maintain proper head space (distance between the cartridge and the bolt face). The bolt assemblies are not interchangeable between rifles. To help ensure the bolt assembly and receivers stay paired-up, the bolt assemblies are marked with the last three digits of the receiver's serial number. For your safety, keep your bolt assembly paired with its respective receiver.

Ensure the last three (3) digits of the serial number match the numbers stamped on the bolt. See Pictures 8 and 8a.

There are two basic types of bolt assemblies for the Marlin lever action centerfire firearms. Both bolts assemblies function the same and carry the same features. All Models except the 1894 use the same style bolt, which are round in appearance. See Picture 8. The Model 1894 has a bolt assembly which is rectangle in appearance. See Picture 8a.

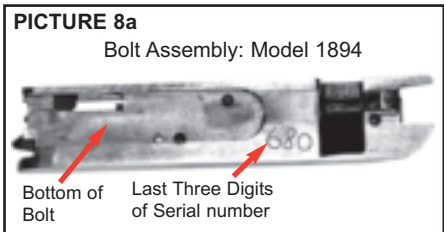
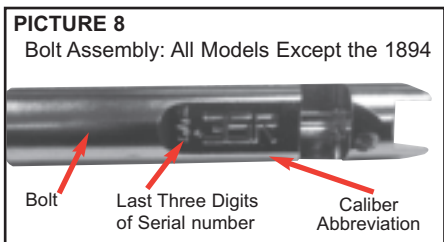

**WARNING!** Use only the original bolt with in your firearm. Do Not attempt to insert or use a bolt on any firearm which was not purchased with the firearm. Damage to the firearm, serious personal injury and/or death may result from an improperly matched bolt and receiver combination.

## The Trigger Assembly

***Pulling the trigger DISCHARGES the firearm.***

The lever action centerfire firearms are equipped with Marlin's custom designed trigger assembly. The trigger assembly is a single action system which has been designed for optimal trigger pull weight. The trigger assembly provides a crisp, clean trigger pull for superior out-of-the-box accuracy. The trigger assembly is not adjustable. All repairs to the trigger assembly must be made by the factory or a Marlin Authorized Repair Center.

**WARNING!** Never place your finger on the trigger unless the safety mechanism is engaged or you are ready to discharge the firearm.

**WARNING!** Never manipulate, adjust or change any of the internal components of your firearm unless specifically directed to do so in this instruction manual. Improper manipulation of any internal component may affect the safety and reliability of your firearm and may cause serious injury or death.

## Safe Firearm Handling

1. Always keep the firearm pointed in a safe direction.
2. If the hammer is in the "At Rest" position, without touching the trigger move the hammer with your thumb to the first stageable position. See "The Hammer," on page 8.
3. Engage the safety mechanism by moving the safety button fully to the shooter's right. The red band will not be visible.
4. Open the action by rotating the lever down and forward until the bolt is fully rearward.
5. Look into the ejection port and visually check the chamber, loading port, and magazine for cartridges and ensure the firearm is completely unloaded.
6. Look into the ejection port, ensure the firing pin tip is NOT protruding from the bolt face as shown in picture 9a. Picture 9b shows the correct firing pin tip position; the firing pin tip is not protruding from the bolt face.

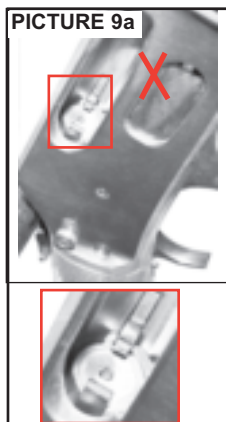

**WARNING!** If the firing pin is protruding from the bolt face, as in Picture 9a, your firearm is not safe. Send the firearm to a Marlin Authorized Repair Center. See “How to Obtain parts and Service from the Marlin Firearms Company” on page 28. The use of a firearm that is not in a safe operating condition may result in serious personal injury, injury to by-standers and/or death and damage to property.

7. Close the bolt by rotating the lever fully rearward.
8. With the safety mechanism engaged, place your thumb on the hammer and apply enough thumb pressure to keep the hammer from moving when it is released.
9. While maintaining control of the hammer, pull the trigger until the trigger releases.
10. While maintaining control of the hammer with your thumb; allow the hammer to partially move forward. Do not release the hammer.
11. While maintaining control of the hammer; remove finger from the trigger.
12. Lower the hammer to the first stageable position or the half cock position. See the “Half Cock” Picture on page 8.

**NOTE:** Marlin recommends practicing moving the hammer from cock to the half cock position with an unloaded firearm until you are confident you can uncock the firearm without losing control of the hammer.

## The Barrel

**WARNING!** The inside of the barrel must be clean and free of any obstructions. See the “Ten Commandments of Firearm Safety,” on page 2. The chamber and bore should be cleaned before discharging the firearm the first time.

### To Check the Barrel for Obstructions:

1. Always keep the firearm pointed in a safe direction.
2. If the hammer is in the “At Rest” position, without touching the trigger move the hammer with your thumb to the first stageable position or “Half Cock” position. See “The Hammer,” on page 8.

3. Engage the safety mechanism by moving the safety button fully to the shooter’s right. The red band will not be visible.
4. Open the action by rotating the lever down and forward until the bolt is fully rearward.
5. Look into the ejection port, visually check the chamber, loading port, and magazine to make sure the firearm is completely unloaded. If the firearm is not unloaded, see “To Unload the Firearm,” on page 14.
6. Insert a cleaning rod of the correct bore size into the muzzle.
7. Push the cleaning rod completely through the barrel until the rod can be seen at the ejection port.

### To Remove a Bore Obstruction:

**WARNING! NEVER** try to remove an object from the barrel by loading another cartridge and firing. This may cause serious personal injury or death.

1. Always keep the firearm pointed in a safe direction.
2. If the hammer is in the “At Rest” position, without touching the trigger move the hammer with your thumb to the first stageable position. See “The Hammer,” on page 8.
3. Engage the safety mechanism by moving the safety button fully to the shooter’s right. The red band will not be visible.
4. Open the action by rotating the lever downward until the bolt is fully rearward.
5. Look into the ejection port and visually check the chamber, loading port, and magazine to make sure the firearm is completely unloaded. If the firearm is not unloaded, see “To Unload the Firearm” on page 14.
6. Insert a cleaning rod of the correct bore size into the muzzle.
7. Lightly tap the cleaning rod against the obstruction to free the object from the barrel.
8. Push the rod completely through the barrel until the rod can be seen at the ejection port.
9. If an object cannot be easily pushed out of the barrel with a cleaning rod, return the firearm to a Marlin Authorized Repair Center.

## Loading of the Firearm:

**Note:** For instructions on how to clean the barrel see “To Clean the Barrel,” on page 18.

**WARNING!** Before loading the firearm, make sure the inside of the barrel is free of dirt, oil, or other obstructions.

**WARNING!** Lever action centerfire firearms are manufactured in different centerfire calibers. The specific caliber of centerfire ammunition suitable for use in your firearm is marked on the barrel of your firearm. Use only the specific caliber of centerfire ammunition designated on the barrel of your firearm. Different calibers of centerfire ammunition are not interchangeable. Do not use any ammunition other than what is designated for your firearm. Using incorrect ammunition in your firearm can result in a severe malfunction of your firearm and/or ammunition leading to personal injury or death. See the “Ten Commandments of Firearm Safety,” on page 2.

## Ammunition:

Always check the cartridge for the correct designation before loading the firearm. If the caliber is not marked on the cartridge refer to the ammunition packaging. To find additional ammunition information, see the Remington Arms catalog or visit the Remington website at [www.remington.com](http://www.remington.com).

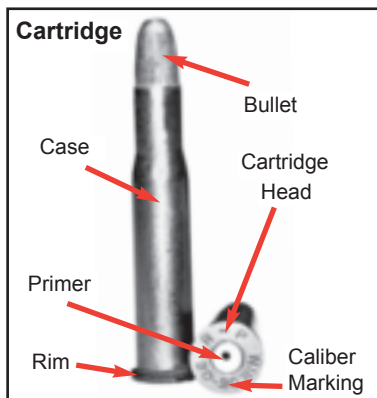

**WARNING!** Do not apply oil, grease or any lubricants to cartridges.

**WARNING!** Some pointed and full metal jacket round nose bullets can chain-fire other cartridges in a tubular magazine during recoil, causing damage to firearm and potentially serious injury or death. All soft-nose bullets, including pointed polymer tips, can be used safely in a Marlin lever action firearms. If you are uncertain about the safety of using a particular cartridge in your Marlin firearm, contact the ammunition manufacturer.

**WARNING!** Marlin does not recommend using aluminum cased ammunition in Marlin lever action firearms.

**WARNING!** Do not use Blazer brand ammunition. This cartridge design is not compatible with the lever action's feeding system. If used, live cartridges may inadvertently remain in the magazine.

**WARNING!** Always wash hands after handling ammunition. See the “Ten Commandments of Firearm Safety,” on page 2.

## To Load the Firearm:

**WARNING!** Always check the cartridge for the correct designation before loading the firearm.

**WARNING!** The use of improperly reloaded or hand-loaded ammunition can lead to barrel obstructions, excessive pressure and/or inadvertent discharge of a firearm, resulting in property damage, personal injury and/or death.

**Caution:** The bore should be cleaned before loading the firearm the first time. Follow the cleaning instructions shown on page 18, “To Clean the Barrel.”

1. Always keep the firearm pointed in a safe direction.
2. If the hammer is in the “At Rest” position, without touching the trigger move the hammer with your thumb to the first stageable or Half cock position. See “Safe Firearm Handling,” on page 10.
3. Engage the safety mechanism by moving the safety button fully to the shooter's right. The red band will not be visible.
4. Open the action by rotating the lever down and forward until the bolt is fully rearward.

5. Look into the ejection port, visually check the chamber, loading port and magazine for cartridges, ensuring the firearm is completely unloaded. If the firearm is not empty, see "To Unload the Firearm" on page 14.
6. Make sure the barrel is free of obstructions. See "To Check the Barrel for Obstructions" on page 11.

### I. To Load the Chamber:

7. With an empty magazine, place one cartridge of the correct caliber through the ejection port onto the feed ramp with the bullet pointed toward the muzzle. See Picture 10.
8. Close the bolt by rotating the lever fully rearward, locking the cartridge in the chamber.

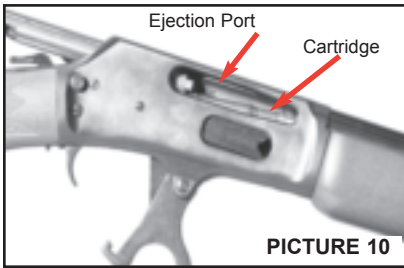

**WARNING!** The firearm is now loaded with a cartridge in the chamber.

### II. To Load the Magazine:

**WARNING!** Always check the cartridge for the correct designation before loading the firearm.

9. With the chamber empty, close the bolt by rotating the lever fully rearward.
10. Lower the hammer from the cock position to the first stagable or half cock position. See "Safe Firearm Handling" on page 10.
11. Insert a cartridge, bullet end first, by pushing the loading gate with the nose of the cartridge. See Picture 11.

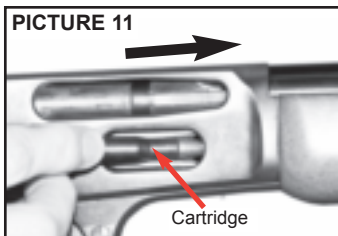

12. Push the cartridge forward into the magazine until it is captured behind the loading gate. See Picture 12.

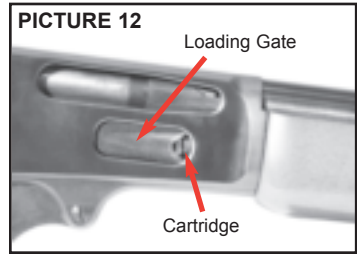

13. Insert an additional cartridge, bullet end first, by pushing the loading gate with the nose of the cartridge.
14. With the nose of the additional cartridge, push the preceding cartridge deeper into the magazine, until the cartridges are captured behind the loading gate.
15. Repeat steps 12 and 13 until the magazine is full. Ensure the last cartridge is completely inside the loading port or gate.

### III. To Load the Chamber from the Magazine:

16. With a cartridge in the magazine, open the bolt by rotating the lever fully down and forward.
17. Close the bolt by rotating the lever fully rearward.

**Both the chamber and magazine are now fully loaded!**

**WARNING!** The firearm is now cocked and fully loaded. Make sure the safety mechanism is still engaged in the "SAFE" position. Always keep the firearm pointed in a safe direction.

18. Ensure the safety mechanism is engaged.
19. To lower the hammer from the cocked position. See "Safe Firearm Handling," on page 10.

## To Discharge the Firearm:

**WARNING!** Always wear eye and hearing protection when discharging your firearm. See “*The Ten Commandments of Firearm Safety*,” on page 2.



1. Point the muzzle at your intended target.
2. Move the hammer to the second stageable position or the cocked position with your thumb.
3. Disengage the safety mechanism by moving the safety button fully to the shooter’s left to the “FIRE” position. The red band will be visible.
4. With the target acquired and the butt of the firearm mounted firmly against your shoulder, pull the trigger. The firearm will discharge each time the trigger is pulled after the action is cycled until the magazine and chamber are empty.

**WARNING!** If a cartridge does not discharge when the trigger is pulled (misfire), keep the firearm pointed in a safe direction and wait one minute before opening the bolt or the action. See “To Unload the Firearm,” on page 14.

**WARNING!** If the “report” of the discharged cartridge is noticeably softer or louder or any way irregular, keep the firearm pointed in a safe direction; unload the firearm and check for bore obstructions. See “To Check the Barrel for Obstructions,” on page 11.

5. Without touching the trigger move the hammer with your thumb to the first stageable or “Half Cock” position. See “Safe Firearm Handling,” on page 10.
6. Engage the safety mechanism by moving the safety button fully to the shooter’s right. The red band will not be visible.
7. Open the action by rotating the lever down and forward until the bolt is fully rearward.

8. Look into the ejection port and visually check the chamber, loading port and magazine for cartridges, ensuring the firearm is completely un-loaded. If the firearm is not empty, see “To Unload the Firearm” on page 14.
9. Make sure the barrel is free of obstructions, see “To Check the Barrel for Obstructions” on page 11.

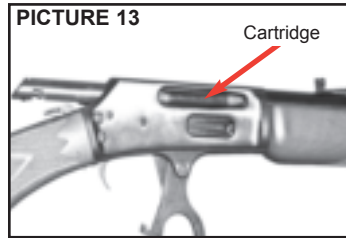

## To Unload the Firearm:

**WARNING!** NEVER assume your firearm is unloaded to justify careless handling. Always control the direction of the muzzle of your firearm, even if you think it is completely unloaded.

1. Always keep the firearm pointed in a safe direction.
2. If the hammer is in the “At Rest” position, without touching the trigger move the hammer with your thumb to the first stageable position. See “Safe Firearm Handling,” on page 10.
3. Engage the safety mechanism by moving the safety button fully to the shooter’s right. The red band will not be visible.
4. Open the action by rotating the lever down and forward until the bolt is fully rearward.
5. Close the action by rotating the lever rearward until the bolt is fully forward.
6. Repeat steps 4 and 5 until all cartridges are ejected from the firearm (both the magazine and the chamber.) See Picture 13.
7. With the bolt open, look into the ejection port and visually check the chamber, loading port and magazine for cartridges, ensuring the firearm is completely unloaded.
8. Make sure the barrel is free of obstructions. See page 11, “To Check the Barrel for Obstructions.”



## Sights:

**WARNING!** Before adjusting the sights or mounting any optic sights, make sure the firearm is completely unloaded and the safety mechanism is engaged by placing the safety in the “ON” or “SAFE” position.

### Rear Sight Adjustment Rule:

To make a Point-On-Target (POT) adjustments, move the rear sight in the direction you wish the group to move on target. For reference, see the Sight Adjust-ment Chart, to adjust rear sights.



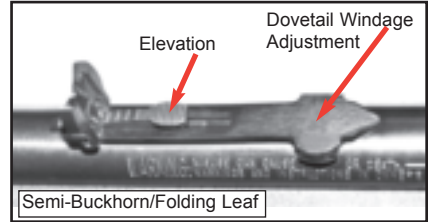
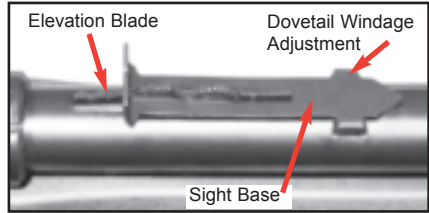
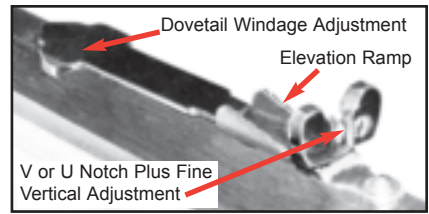

### Receiver Mounted Optics:

The top of the lever action receivers may be drilled and tapped for an optic sight mount (not provided). For optic mounting and adjustment, see the instructions provided with your optic sight system.

**NOTE:** For ballistics and trajectory information, see the Remington catalog or visit the Remington website at [www.remington.com](http://www.remington.com).



**WARNING!** Improper mounting or use of a scope may result in personal injury. Always allow sufficient space between the scope and eye to avoid contact during recoil. Follow the scope manufacturer’s instructions to mount and use the optic correctly.

Position on Target (POT)	Sight Adjustment Chart
 POT is above the center	<p><b>Sights with elevation screw:</b> a. Turn elevation screw counter clockwise.</p> <p><b>Sights with elevation blade:</b> a. Move elevation blade lower.</p>
 POT is below the center	<p><b>Sights with elevation screw:</b> a. Turn elevation screw clockwise.</p> <p><b>Sights with elevation blade:</b> a. Move elevation blade to higher notch.</p>
 POT is to the left	<p><b>Sights with Windage screw:</b> a. Loosen the windage screw. b. Slide the sight leaf to the right. c. Tighten the windage screw.</p> <p><b>Windage Dovetail Adj.:</b> a. Tap sight base to the right.</p>
 POT is to the right	<p><b>Sights with Windage screw:</b> a. Loosen the windage screw. b. Slide the sight leaf to the left. c. Tighten the retaining screw.</p> <p><b>Windage Dovetail Adj.:</b> a. Tap sight base to the left.</p>

### Offset Hammer Spur:

The offset hammer spur is provided along with a mounting wrench to ensure the best hammer control possible when an optic is mounted on a lever action receiver as there may not be enough space between the optic and the hammer to adequately place a thumb on and control the hammer.

**Caution:** Always use an Offset Hammer Spur when an Optic (scope) is mounted on a lever action firearm.

**Note:** The offset hammer spur can be mounted on either side of the hammer for left or right-handed shooters.

**WARNING!** Do not use the rifle with an optic unless the Marlin Offset Hammer Spur is securely attached in the proper position. Make periodic checks to ensure the offset hammer spur is securely attached to the hammer.

## To Mount a Hammer Spur:

**WARNING!** Unload your firearm before installing an Offset Hammer Spur. See “To Unload the Firearm” on page 14.

1. Always keep the firearm pointed in a safe direction.
2. If the hammer is in the “At Rest” position, without touching the trigger move the hammer with your thumb to the first stageable position. See “Safe Firearm Handling,” on page 10.
3. Engage the safety mechanism by moving the safety button fully to the shooter’s right. The red band will not be visible.
4. Open the action by rotating the lever down and forward until the bolt is fully rearward.
5. Look into the ejection port, visually check the chamber, loading port and magazine for cartridges, ensuring the firearm is completely unloaded. If the firearm is not empty, see “To Unload the Firearm” on page 14.
6. Make sure the barrel is free of obstructions, see “To Check the Barrel for Obstructions” on page 11.
8. Secure the Offset Hammer Spur to the hammer by inserting and tightening the set screw with the hex wrench provided in packaging. The Offset Hammer Spur may be mounted on either the right or left side of the hammer. Picture 14.

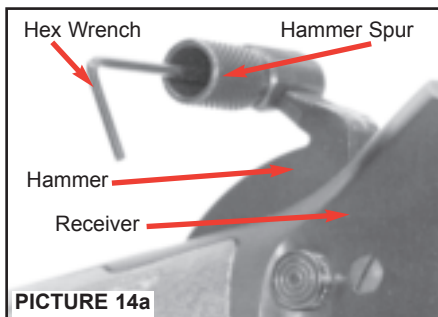

## Cleaning, Lubrication and Maintenance

**WARNING!** Before cleaning your firearm make sure it is completely unloaded (both the chamber and the magazine) and engage the safety mechanism by placing the safety button in the “SAFE” position.

**WARNING!** After each use, follow the lubrication and maintenance directions in this Owner’s Manual. If the firearm is immersed in water, it must be thoroughly cleaned and lubricated as soon as possible. In case of saltwater immersion, first flush all parts with fresh water, then dry, clean and lubricate the firearm. If the firearm does not function properly, have it checked and corrected by a Marlin Authorized Repair Center before further use. Failure to follow these instructions may lead to firearm malfunctions which could result in serious personal injuries or death.

**Caution:** The chamber and bore should be cleaned before loading and firing the firearm the first time.

### Lubrication:

**Over-lubrication should be avoided at all times. A light application of Rem™ Oil helps to prevent rusting.**

**WARNING! Excessive use of a lubricant could adversely affect the function and safe operation of your firearm. Failure to properly maintain your firearm**



**can not only damage your firearm; it can expose you and others to risks of personal injury or death.**

**When the firearm is to be stored, it should be carefully cleaned and adequately oiled. Outside metal surfaces should be wiped with Rem™ Oil occasionally. When the firearm is to be reused, all excess lubrication must be removed. The chamber and bore must be thoroughly wiped dry.**

**For safe and dependable operation of your firearm, the barrel and action must be cleaned periodically.**

**Marlin recommends using Remington cleaning products and lubricants or their equivalents.**

**WARNING!** The use of non-recommended lubricants or cleaners could adversely affect the function and safe operation of your firearm. Do not use congealing lubricants. The use of non-congealing lubricants such as Rem™ Oil is strongly recommended.

### To Disassemble the Firearm for Cleaning:

**CAUTION:** Lever action centerfire firearms should **NOT** be disassembled beyond what is described in this manual, except by the factory or a Marlin Authorized Repair Center.

**WARNING!** Unload the firearm before cleaning. Look into the ejection port and visually check the chamber and magazine to make sure there are no cartridges in the firearm. Always wear eye protection when handling, disassembling and assembling the firearm.

1. Always keep the firearm pointed in a safe direction.
2. If the hammer is in the "At Rest" position, without touching the trigger move the hammer with your thumb to the first stageable position. See "Safe Firearm Handling," on page 10.
3. Engage the safety mechanism by moving the safety button fully to the shooter's right. The red band will not be visible.
4. Open the action by rotating the lever down and forward until the bolt is fully rearward.
5. Look into the ejection port, visually check the chamber, loading port and magazine for cartridges, ensuring the firearm is completely unloaded. If the firearm is not empty, see "To Unload the Firearm" on page 14.
6. Remove the lever from the receiver by moving the bolt forward (1/4 closed).

7. Remove the lever mounting screw by turning the screw counterclockwise. See Picture 15.

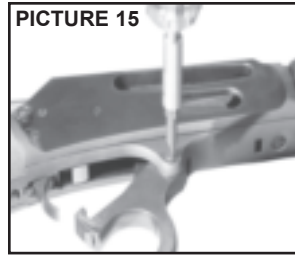

8. Pull the lever down and remove from the bolt assembly and receiver.

### To Remove the Bolt Assembly:

9. With the lever removed, pull the bolt assembly rearward from the receiver. See Picture 16.

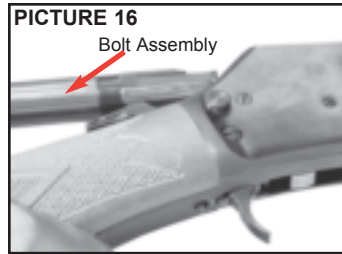

10. With a pair of pliers, remove the ejector from the receiver by lifting it out through the ejection port. See Picture 17.

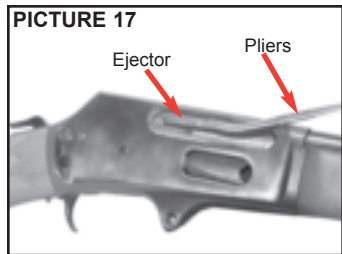

## To Disassemble the Magazine:

**WARNING!** Use extreme care when disassembling the magazine, as the magazine spring is under compression. Always wear eye protection to avoid serious personal injury.

11. With one hand, hold the magazine plug while unscrewing the magazine tube plug screw by turning it counterclockwise. See Picture 18.

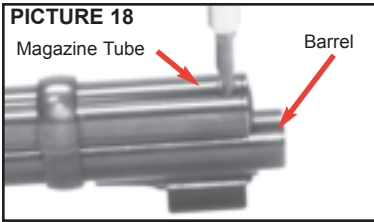

12. With the magazine tube plug screw removed, pull the magazine tube plug and the magazine spring slowly outward from the magazine tube.
13. Remove the magazine tube follower by rotating the firearm with the muzzle down and forward. The magazine follower should slide out the magazine tube.

## To Remove the Butt Stock:

14. Remove the butt stock mounting screw located on the tang behind the hammer (sometimes called the tang screw) by turn it counterclockwise.
15. With a firm grip on the receiver and butt stock, pull the butt stock from the receiver.

## To Clean the Barrel:

1. Use the instructions and equipment provided in a quality cleaning kit such as a Remington Cleaning Kit. For recommendations, see your dealer or a Marlin Authorized Service Center.
2. Saturate a cleaning patch with Brite Bore™ or equivalent.
3. Attach the patch to a cleaning rod tip.
4. Pass the patch through the bore from the chamber end to the muzzle several times removing loose residue and fouling.
5. Select the correct caliber cleaning brush and attach a brush to the cleaning rod.

6. Spray the bore brush with Brite Bore.
7. Push the cleaning rod through the barrel several times.
8. Remove the brush from the rod and attach a tip with a cleaning patch.
9. Push the cleaning patch through the bore.
10. Repeat several times using a new cleaning patch each time until the patch is removed from the barrel without fouling residue.
11. Push a clean patch saturated with Rem™ Oil through the barrel.
12. Push a clean dry patch through the barrel to remove excess lubricant.
13. Apply a light application of Rem™ Oil to the outside of the barrel with a soft clean cloth.

**WARNING!** After cleaning, Make sure the barrel is free of obstructions, see “To Check the Barrel for Obstructions,” on page 11.

## To Clean the Bolt Assembly:

1. Thoroughly spray and brush the bolt body using Rem™ Action Cleaner.
2. Spray around the front and rear firing pins with Rem™ Action Cleaner.
3. Air dry or use compressed air to thoroughly dry the bolt body and firing pins.
4. Apply a light application of Rem™ Oil to the inside and outside of the bolt assembly, the firing pins and the firing pin spring.
5. Ensure the firing pin spring is present and the rear firing pin moves freely by pushing on the rear firing pin.
6. If the rear firing pin does not move freely, repeat steps 1 thru 5. See Picture 19.

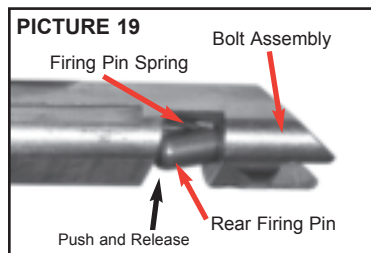

**WARNING!** If the rear firing pin does not return fully when depress, then your firearm is **NOT** in a safe operating condition and it must **NOT** be used until you have it inspected and the problem corrected by a Marlin Authorized Repair Center.

## To Clean the Receiver & Ejector:

1. Thoroughly spray and then brush all components inside the receiver using Rem™ Action Cleaner.
2. Thoroughly spray and then if required, brush the ejector using Rem™ Action Cleaner.
3. Air dry or use compressed air to thoroughly dry the receiver assembly and the ejector.
4. Apply a light application of Rem™ Oil to the inside and outside of the receiver and the ejector.

## To Clean and Lubricate the Trigger and Hammer:

**NOTE:** Clean and lubricate the trigger and hammer assemblies as a unit. Do not remove the hammer or the trigger assembly from the receiver.

1. With the bolt removed and the hammer in the second stageable position (cocked), thoroughly spray inside the receiver as specified in Picture 20 and Picture 21 with Rem™ Action Cleaner. For better spray control use a spray straw.

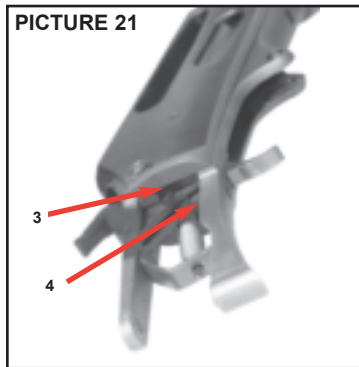
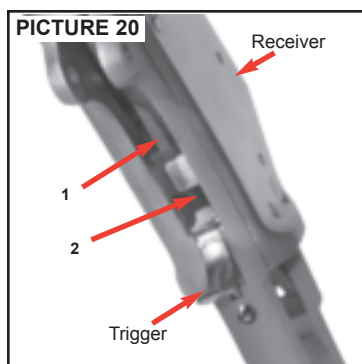

2. Move the safety mechanism from the “safe” to “fire” position multiple times.
3. Air dry or use compressed air to thoroughly dry the receiver assembly.
4. Ensure the bolt block moves freely by pushing the bolt block from the bottom of the receiver. See Picture 22.

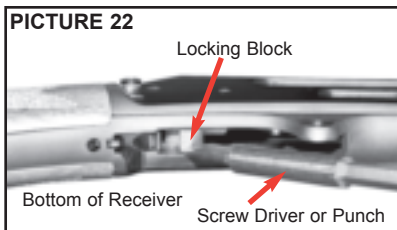

5. If the bolt block does not move freely, repeat step 1 thru 4.
6. Lightly spray Rem™ Oil in each of the four (4) points in specified in picture 20 and picture 21.

**NOTE:** While your lever action firearm has been designed and manufactured to provide improved corrosion protection, only proper care will keep your firearm in good operating condition and maintain its appearance. After extensive use, the protective coating on plated parts may be worn sufficiently, reducing the corrosion protection. Such worn parts should be replaced to assure the integrity of the corrosion protection.

## To Reassemble after Cleaning and Lubrication

**WARNING!** Always wear eye protection when handling, disassembling and assembling the firearm.

### To Assemble the Firearm:

**WARNING!** Before replacing the bolt assembly, make sure the barrel is free from obstructions and the chamber is empty. See "To Check for Barrel Obstructions," on page 11.

1. With the closed end of the ejector to the rear, insert the ejector into the ejector slot of the receiver. See Picture 23.

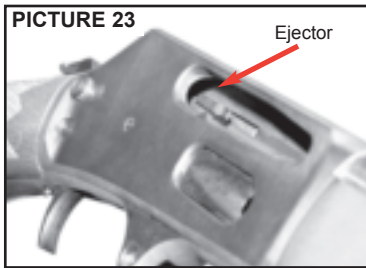

2. Ensure the bolt block is in the down or unlocked position. If the bolt lock is in the up position as shown in Picture 24, from the rear of the receiver push down on the locking lock with a small screw driver.

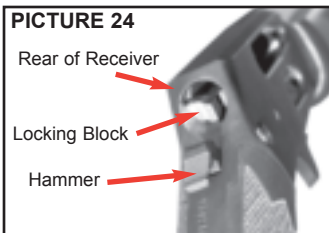

3. Insert the bolt assembly into the rear of the receiver. Orient the bolt with the extractor to the shooter's right.
4. Hold down the ejector in the receiver as the bolt is pushed forward.
5. Push the bolt forward approximately half way to the fully closed position.
6. From the bottom of the receiver, insert the lever through the lever slot in the bolt assembly until the lever mounting holes are aligned with the corresponding receiver mounting hole. See Picture 25.

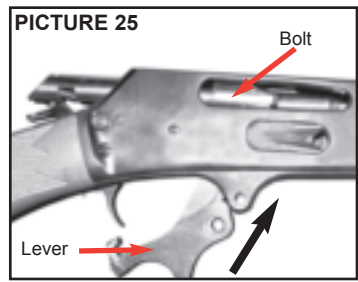

7. Attach the lever to the receiver by inserting and tightening the lever mounting screw from the shooter's right. Tighten the lever mounting screw hand tight. Do not over tighten. See Picture 26.

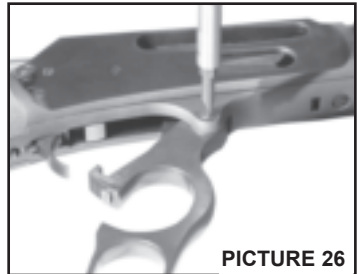

8. Insert the butt stock onto the rear of the receiver.
9. Insert and tighten the butt stock mounting screw. Do not over tighten.
10. Tighten all receiver screws. There are three (3) screws on the shooter's right and one (1) screw on the shooter's left. Do not over tighten. See Pictures 27 and 28.

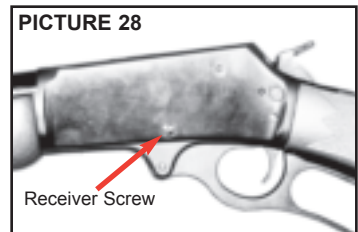
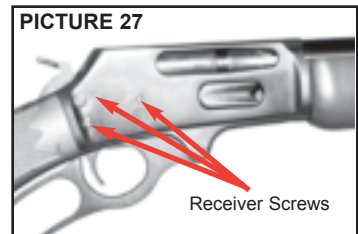



11. If a scope is mounted ensure the scope is secure and the offset hammer spur is securely mounted. See "To Install a Offset Hammer Spur" on page 15.
12. Ensure the safety mechanism is engaged or in the "Safe" position. The read band will not be visible.

\*\*\*\*\*

## To Function Test the Firearm:

When the firearm is fully reassembled, a short function test should be conducted to ensure proper operation before loading or discharging the firearm. If the firearm does not function as described in any part of the Function Test procedure, then the firearm should be reassembled and function tested again. **DO NOT** discharge the firearm. If the firearm fails the Function Test again, **DO NOT** discharge the firearm. The firearm should be sent to a Marlin Authorized Repair Center or call: 1-800-544-8892, Mon - Fri., 9:00AM-5:00PM Eastern Time.

**WARNING!** Completely unload the firearm before Function Testing the firearm. Look into the ejection port and visually check the chamber, loading port, and magazine to make sure there are no cartridges in the firearm. Always wear eye protection when handling the firearm.

1. Always keep the firearm pointed in a safe direction.
2. If the hammer is in the "At Rest" position, without touching the trigger move the hammer with your thumb to the first stageable position or the "Half Cock" position. See "The Hammer," on page 8.
3. Engage the safety mechanism by moving the safety button fully to the shooter's right. The red band will not be visible.
4. Open the action by rotating the lever down and forward until the bolt is fully rearward.
5. Look into the ejection port and visually check the chamber, loading port and magazine for cartridges, ensuring the firearm is completely unloaded.

6. Ensure the rear firing pin is disconnected and the firing pin spring is present and pliable. Push on the rear firing pin from the bottom of the bolt, then release. The rear firing pin should return to the downward position without hesitation. See Picture 29.

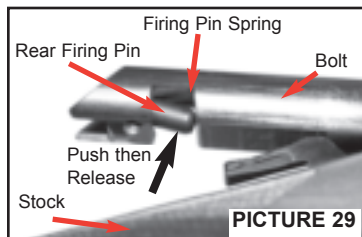

**WARNING!** If the rear firing pin does not move freely or return to the downward position (disconnected) without hesitation when pushed and released, your firearm is not safe. Send the firearm to a Marlin Authorized Repair Center to have the problem corrected. See "How to Obtain parts and Service from the Marlin Firearms Company" on page 28. The use of a firearm that is not in a safe operating condition may result in serious personal injury, and damage to property.

7. Look into the ejection port and ensure the firing pin tip is NOT protruding from the breech block (bolt face). Picture 30a shows the firing pin improperly protruding from the bolt face. Picture 30b shows the correct firing pin tip position; the firing pin tip is not protruding from the bolt face.

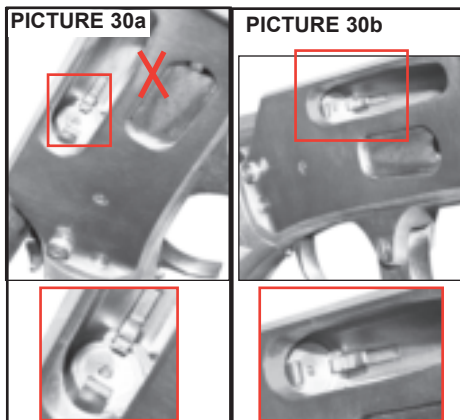

**WARNING!** If the firing pin is protruding from the breech block (bolt face), as in Picture 30a, your firearm is not safe and must not be used until the problem is corrected by a Marlin Authorized Repair Center. The use of a firearm that is not in a safe operating condition may result in serious personal injury, death and damage to property.

8. With the safety mechanism engaged, cycle the action and fully close the lever by rotating it rearward.
9. Pull the trigger fully rearward and then remove your finger from trigger. The hammer should release.
10. Ensure the trigger returns completely to the forward position each time the trigger is pulled.
11. Cycle the action and repeat steps 8 and 10 multiple times.

**WARNING!** If the trigger does not fully return to the forward position each time it is released, then your firearm is **NOT** in a safe operating condition and it must **NOT** be used until you have it inspected and the problem corrected by a Marlin Authorized Repair Center.

12. With the safety mechanism engaged, move the lever fully downward and then rotate the lever rearward until it is between 1/8th & 1/4" from the fully rearward or the closed position. See Picture 31.

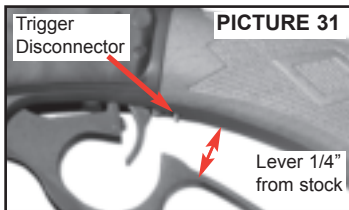

13. Pull the trigger. The hammer should Not release.
14. Repeat steps 12 and 13 multiple times.

**WARNING!** If the hammer releases when the lever is not fully rotated rearward, then your firearm is **NOT** in a safe operating condition and it must **NOT** be used until you have it inspected and the problem corrected by a Marlin Authorized

Repair Center. The use of a firearm that is not in a safe operating condition may result in serious personal injury, death and damage to property.

15. Cycle the action and fully rotate the lever rearward into the closed position.
16. Ensure the lever remains in the fully rearward or the closed position. When the lever is fully closed, there should not be a gap between the trigger disconnector and the lever. For the location of the trigger disconnector see Picture 31.

**WARNING!** If the lever does not remain in the fully closed position, then your firearm is **NOT** in a safe operating condition and it must **NOT** be used until you have it inspected and the problem corrected by a Marlin Authorized Repair Center. The use of a firearm that is not in a safe operating condition may result in serious personal injury, death and damage to property.

17. Fully cycle the action. Ensure the lever is rotated fully rearward.
18. With the safety mechanism engaged, move the hammer to the "Half Cock" position or the first stageable position.
19. Pull the trigger. The hammer should Not release.

**WARNING!** If the hammer releases when the hammer is in the "Half Cock" or first stageable position, then your firearm is **NOT** in a safe operating condition and it must **NOT** be used until you have it inspected and the problem corrected by a Marlin Authorized Repair Center. The use of a firearm that is not in a safe operating condition may result in serious personal injury, death and damage to property.

20. Cycle the action and ensure the lever is fully rearward or in the closed position.
21. With the hammer in the second stageable position or "cocked" position, operate the safety from the "Fire" to the "Safe" position multiple times. The safety mechanism must operate freely when the safety button is moved from the "Safe" to "Fire" position. It must NOT stop between the two positions.
22. Repeat steps 18 and 19 multiple times.

**WARNING!** If the safety does **NOT** freely return to the full “Safe” or full “Fire” position after repeating steps 20 thru 22 multiple times, then your firearm is **NOT** in a safe operating condition and it must **NOT** be used until you have had it inspected and corrected by a Marlin Authorized Repair Center. The use of a firearm that is not in a safe operating condition may result in serious personal injury, death and damage to property.

- 23. Ensure the safety mechanism is engaged by moving the safety button fully to the shooter’s right.
  - 24. With the safety mechanism engaged, lower the hammer to the “Half Cock” or first stageable position. See “Safe Firearm Handling” on page 10.
- 

**WARNING!** Incorrectly assembling the firearm or the use of modified parts can result in damage to your firearm and personal injury or death to you or others. Marlin recommends all service and replacement of components be performed by a Marlin Authorized Repair Center. If a repair or component replacement was not completed by a Marlin Authorized Repair Center, we recommend that you have your firearm checked by an Authorized Repair Center. See page 28 for a Marlin Authorized Repair Center nearest you.

**The firearm owner and user must accept full responsibility for the correct reassembly and functioning of the firearm after disassembly or replacement of parts.**

All rights to this instruction manual are reserved. The information in this document is subject to change without notice. Remington reserves the right to change the content herein without the obligation to notify any person or organization of such changes.

Marlin® is a registered trademark of the Remington Arms Company, LLC and may not be used in any way without the express written consent of Remington. All other trademarks used herein remain the exclusive property of their respective owners. Nothing contained in this manual should be construed as granting, by implication or trademarks displayed herein. Misuse of any trademarks or any content of this manual is strictly prohibited. Remington shall aggressively enforce its intellectual property rights to the fullest extent of the law.

### Firearm Maintenance Record

DATE	Service	Performed By

# MODEL 308, 336, 338, 444, & 1895

## Lever Action Centerfire Rifles

### Exploded View

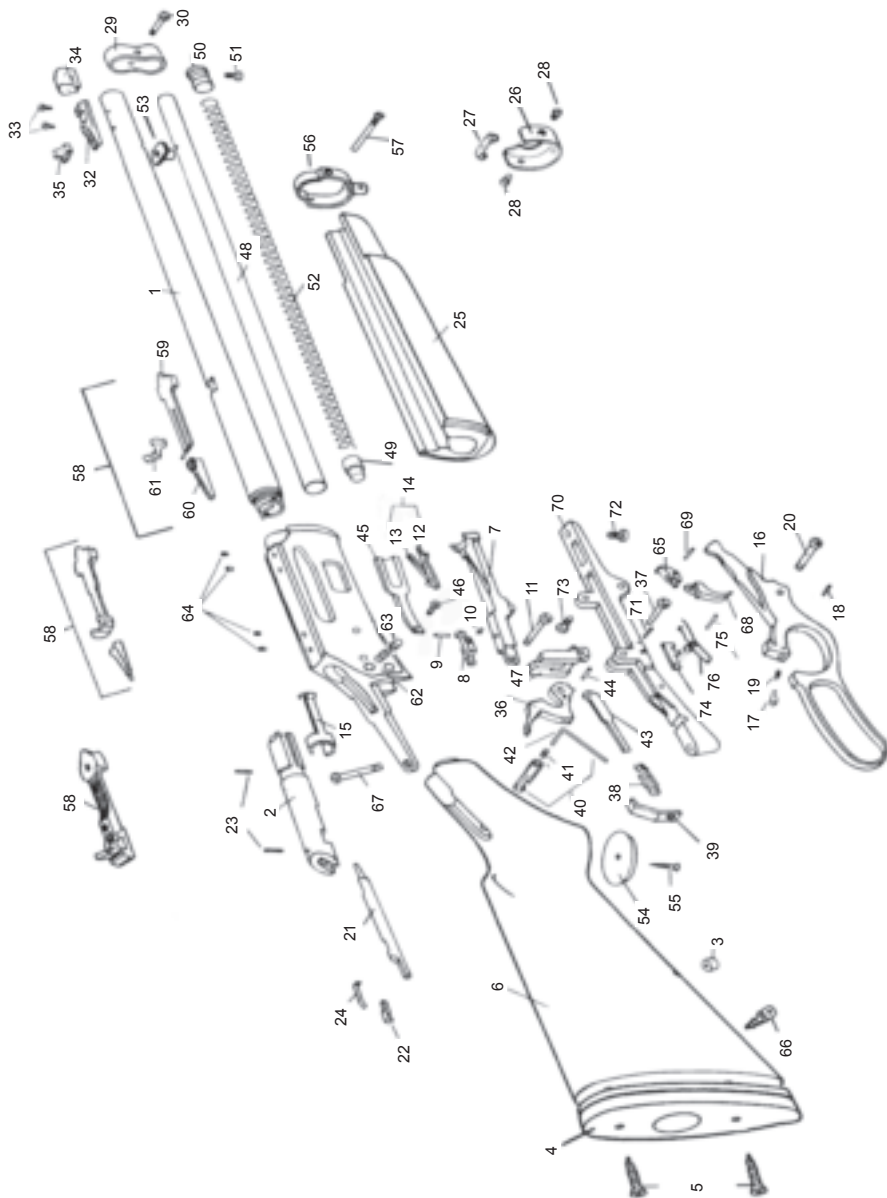

\*\*\* Restricted - Part installed by an Marlin Authorized Repair Center.  
\*\*\*\* Not-Restricted - Part may require some final fitting, sanding or filing.

Drawing is provided for part identification only and should not be used as a guide to assemble the firearm.

# MODEL 308, 336, 338, 444, & 1895

## Lever Action Centerfire Rifles

### Parts List

ITEM NO.	PART NAME	ITEM NO.	PART NAME
1**	Barrel	39	Hammer Spring Adjusting Plate
2**	Breech Bolt	40	Hammer Spur Complete
3***	Bullseye	41	Hammer Spur Screw
4***	Buttplate/Butt pad	42	Hammer Spur Wrench
5	Buttplate screw (2)	43	Hammer Strut
6***	Buttstock	44	Hammer Strut Pin
7**	Carrier	45	Loading Spring
8	Carrier Rocker	46	Loading Spring Screw
9	Carrier Rocker Pin	47**	Locking Block
10	Carrier Rocker Spring	48	Magazine Tube
**	Carrier Assembly (Not Shown)	49	Magazine Tube Follower
11	Carrier Screw	50	Magazine Tube Plug
12	Ejector	51	Magazine Tube Plug Screw
13	Ejector Spring	52	Magazine Tube Spring
14	Ejector w/Spring	53	Magazine Tube Stud
15***	Extractor	54***	Pistol Grip Cap
16**	Finger Lever	55	Pistol Grip cap Screw
17***	Finger Lever Plunger	56	Rear Band
18	Finger Lever Plunger Pin	57	Rear Band Screw
19	Finger Lever Plunger Spring	58	Rear Sight Assembly
20	Finger Lever Screw	59	Rear Sight Base
21	Firing Pin, Front	60	Rear Sight Elevator
22	Firing Pin, Rear	61	Rear Sight Folding Leaf
23	Firing Pin Retaining Pin (2)	62**	Receiver
24	Firing Pin Spring	63**	Safety Button Assembly
25	Forearm	64	Scope Mount Dummy Screw (4)
26	Forearm Tip	65**	Sear
27	Forearm Tip Tenon	66	Swivel Stud, Rear
28	Forearm Tip Tenon Screw (2)	67	Tang Screw
29	Front Band	68**	Trigger
30	Front Band Screw	69	Trigger and Sear Pin
31	Front Sight (Not Shown)	70**	Trigger Guard Plate
32	Front Sight Base	71	Trigger Guard Plate Latch Pin
33	Front Sight Base Screw (2)	72	Trigger Guard Plate Screw
34	Front Sight Hood	73	Trigger Guard Plate Support
35	Front Sight Insert	Screw	
36**	Hammer	74**	Trigger Safety Block
37	Hammer Screw	75	Trigger Safety Block Pin
38	Hammer Spring (Mainspring) Mount Bracket	76	Trigger Safety Block Spring

**Note: Parts are subject to change without notice.**

Some components may be restricted from sale. For details on how to order parts see "How to Obtain Parts and Service from the Marlin Firearms Company," on page 28.

Have your firearm's serial number available when ordering parts to ensure the correct components are obtained for your particular firearm configuration.

# MODEL 1894

## Lever Action Centerfire Rifle

### Exploded View

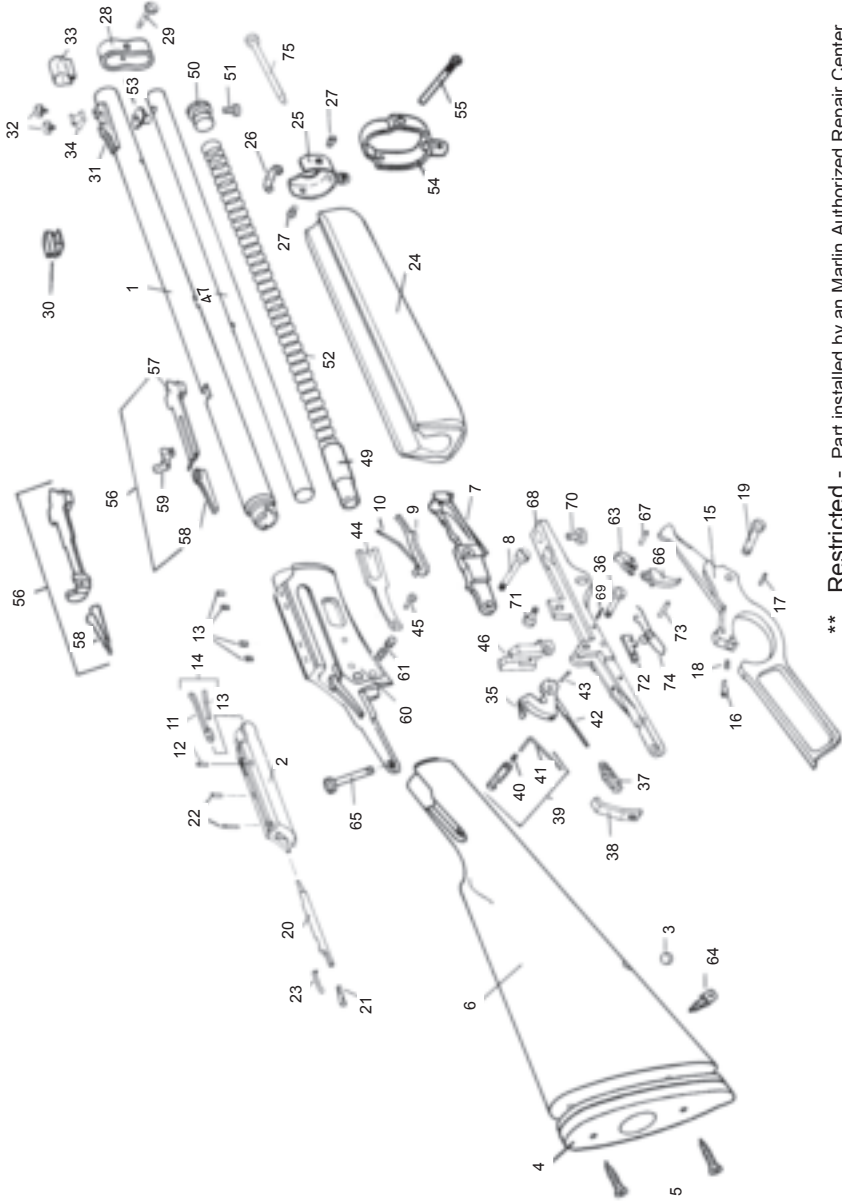

\*\*\* Restricted - Part installed by an Marlin Authorized Repair Center.  
 \*\*\*\* Not-Restricted - Part may require some final fitting, sanding or filing.

Drawing is provided for part identification only and should not be used as a guide to assemble the firearm.



# MODEL 1894

## Lever Action Centerfire Rifle

### Parts List

ITEM NO.	PART NAME	ITEM NO.	PART NAME
1**	Barrel	39	Hammer Spur Complete
2**	Breech Bolt	40	Hammer Spur Screw
3***	Bullseye	41	Hammer Spur Wrench
4***	Buttplate/Butt pad	42	Hammer Strut
5	Buttplate screw (2)	43	Hammer Strut Pin
6***	Buttstock	44	Loading Spring
7**	Carrier Assembly	45	Loading Spring Screw
8	Carrier Screw	46**	Locking Block
9	Ejector w/Spring	47	Magazine Tube
10	Ejector Spring	48	Magazine Tube Assembly
11***	Extractor	49	Magazine Tube Follower
12	Extractor Retaining Pin	50	Magazine Tube Plug
13	Extractor Spring	51	Magazine Tube Plug Screw
14***	Extractor w/Spring	52	Magazine Tube Spring
15**	Finger Lever	53	Magazine Tube Stud
16***	Finger Lever Plunger	54	Rear Band
17	Finger Lever Plunger Pin	55	Rear Band Screw
18	Finger Lever Plunger Spring	56	Rear Sight Assembly
19	Finger Lever Screw	57	Rear Sight Base
20	Firing Pin, Front	58	Rear Sight Elevator
21	Firing Pin, Rear	59	Rear Sight Folding Leaf
22	Firing Pin Retaining Pin (2)	60**	Receiver
23	Firing Pin Spring	61**	Safety Button Assembly
24	Forearm	62	Scope Mount Dummy Screw (4)
25	Forearm Tip	63**	Sear
26	Forearm Tip Tenon	64	Swivel Stud, Rear
27	Forearm Tip Tenon Screw (2)	65	Tang Screw
28	Front Band	66**	Trigger
29	Front Band Screw	67	Trigger and Sear Pin
30	Front Sight	68**	Trigger Guard Plate
31	Front Sight Base	69	Trigger Guard Plate Latch Pin
32	Front Sight Base Screw (2)	70	Trigger Guard Plate Screw
33	Front Sight Hood	71	Trigger Guard Plate Support
34	Front Sight Insert	Screw	
35**	Hammer	72	Trigger Safety Block
36	Hammer Screw	73	Trigger Safety Block Pin
37	Hammer Spring (Mainspring)	74	Trigger Safety Block Spring
38	Hammer Spring Plate	75	10 Shot Plug

**Note:** Parts are subject to change without notice.

Some components may be restricted from sale. For details on how to order parts see "How to Obtain Parts and Service from the Marlin Firearms Company," on page 28.

Have your firearm's serial number available when ordering parts to ensure the correct components are obtained for your particular firearm configuration.

# How to Obtain Parts and Service From the Marlin Firearms Company

## To Order Parts:

To order parts please visit [www.marlin-firearms.com](http://www.marlin-firearms.com) or call 1-800-544-8892. For additional information on service enhancements, upgrades, repair, additional barrels, and specialty parts, visit [www.marlin-firearms.com](http://www.marlin-firearms.com).

To place an order or for additional information on service enhancements, up grades, and additional barrels, please call our toll free consumer service number, 1-800-544-8892, Mon.-Fri., 9:00 AM-5:00 PM Eastern time.

1. Fax completed order form (from the web site) to 1-336-548-7801.
2. To order by phone without the order form, call 1-800-544-8892.

### **Please have the following information ready before you call.**

- Firearm model and serial number.
- Part description and quantity. Part descriptions can be found on the parts listing page 25 and 27 in this manual.
- Your complete mailing address (P.O. Box and Street Address) including zip code, telephone number and e-mail address.
- Method of payment: MasterCard, Visa, Amex or Discover card number and expiration date. A quote may be made to you over the phone. (Sorry, no C.O.D.s.)

**WARNING!** Use only Marlin parts in Marlin's firearms.

**NOTE:** Some parts may be restricted. Owner's manuals/ instruction books may be requested via our web site at [www.marlinfirearms.com](http://www.marlinfirearms.com) or by calling 1-800-544-8892.

## Repair Services:

If there is a defect with your Marlin firearm that (i) you believe is, or should be, covered by the Warranty, (ii) you would like Marlin to address at your cost and expense, or (iii) you would otherwise like to discuss with Marlin, please contact Marlin Consumer Services at 1-800-544-8892, Mon.-Fri 9:00AM – 5:00PM. Please do not send your firearm or other item to Marlin without first (a) calling this number, (b) receiving instructions from the Marlin representative, and (c) obtaining a Service Request document containing your Service Repair Number. With regards to the Service Request document, Marlin will either e-mail this document to you or, if you do not have an e-mail address, Marlin will mail it to you. Please be sure to store your Service Request document in your records so that it is both safe and accessible. Finally, to the extent you seek Warranty coverage, please review the Warranty for your Marlin firearm and note that you may void your Warranty by taking action without first contacting Marlin.

**WARNING!** Do not send live or spent shells in your firearm or in the same box with the firearm. This is a violation of federal law. If you feel you must send spent shells, please send them in a separate package and include name, address (with zip code), telephone number, model and serial number of your firearm.

# Firearm Owner's Record

Model: \_\_\_\_\_

Serial # \_\_\_\_\_

Date Purchased: \_\_\_\_\_

Purchased From: \_\_\_\_\_

Price Paid: \_\_\_\_\_

Remember to complete and return the Firearm Warranty Registration Card in order to obtain full benefit of your Limited Five Year Firearm Warranty.

## **A WORD ON THE MAINTENANCE AND CARE OF YOUR MARLIN FIREARM** **Don't Alter or Modify Your Firearm and Have it Serviced Regularly.**

*Your firearm* has been designed to operate according to certain factory specifications. You'll jeopardize your safety and that of others around you by attempting to alter its trigger, mechanical safety or other mechanisms. Never alter or modify your firearm in any way.

*Like any mechanical device*, a firearm is subject to wear. It must be maintained and periodically serviced to assure optimum safety and performance. Only a qualified service facility should service, repair or modify your Marlin firearm. Consult your instruction manual for location of the nearest Authorized Marlin Repair Center.

Marlin recommends that you have your firearm professionally serviced annually. You should also have your firearm professionally serviced after prolonged storage or if there is ever any question pertaining to the proper functioning characteristics of your firearm.

*Proper cleaning and lubrication* are also important to firearm maintenance and are necessary to assure accuracy, safety, and reliability. Before cleaning, always make sure that your firearm is completely unloaded. And always clean the barrel from the chamber end to the muzzle when possible.

### **Firearm Sale or Transfer:**

If your firearm has been adjusted or changed in any way and you intend to sell or otherwise transfer possession of your firearm, you must: 1) provide a complete service record, (2) warn the purchaser or recipient of your firearm that it has been adjusted or modified, and (3) give the purchaser or recipient this owner's manual for review and reference. If you do not wish to sell or transfer your firearm in an adjusted condition (recommended), return it to a Marlin Authorized Repair Center for restoration of your firearm to the original factory conditions. Do Not attempt to restore the firearm to factory conditions yourself.

**WARNING!** NEVER alter or modify any part of the firearm. Improper alterations can make the firearm unsafe and result in personal injury or death to you or others.

This firearm should not be sold where prohibited by federal, state or local laws.

# Firearm Maintenance Record

---

DATE	SERVICE PERFORMED	PERFORMED BY



**MODEL 308, 336, 338, 444, 1894, and 1895  
Lever Action Centerfire Rifles**

*Marlin*®

Marlin is a Trademark Registered in the United States Patent and Trademark Office

Printed in the U.S.A.

407320 REV. 01.16





**LIMITED WARRANTY**  
The Marlin Firearms Company  
**FIVE YEAR LIMITED WARRANTY AGAINST  
DEFECTS IN MATERIAL & WORKMANSHIP**

This firearm warranty is good only to the ORIGINAL OWNER who has registered his ownership with The Marlin Firearms Company.

**WARRANTY and CERTIFICATE OF OWNERSHIP card must be completed and mailed to The Firearm Warranty Registration address shown on the mailing panel on the reverse side of this card WITHIN TEN (10) DAYS of purchase to insure the protection of the warranty. NOTICE of defect in materials and/or workmanship must be received by the company WITHIN FIVE (5) YEARS from the date of purchase.**

**Normal wear, or damage resulting from neglect, abuse, alteration, or repairs not made or authorized by The Marlin Firearms Company or use of non-Marlin parts are not covered by the warranty.**

**THIS WARRANTY GIVES YOU SPECIFIC LEGAL RIGHTS, AND YOU MAY ALSO HAVE OTHER RIGHTS WHICH VARY FROM STATE TO STATE.**

PLEASE DETACH AND SAVE THIS PANEL BEFORE MAILING

This card registers your product and helps us get to know our consumers.  
However, failure to complete and return this card does not diminish your warranty rights.

4176613367



**VERY IMPORTANT:**

Model      -       
   
Please write in the last 5 digits of UPC bar code located on product carton  
or affix owner registration sticker here

First Name           I. Last Name

Address (street number)     (Street name)            Apartment Number

City         State   Zip Code      Phone Number   -   -

Email Address (Example: yourname@yourhost.com)

Yes! I want to receive offers or communications that may interest me from other companies via e-mail. I understand this e-mail address may be shared with and/or combined with information from other sources

Yes! I want to receive offers or communications from Marlin via e-mail

Date of Purchase   /   /   Store Name

Serial Number             Purchase Price \$     .

8. **Where do you hunt?**  
 Public  Own  
 Private  Hunting Club  
 Lease  Don't Hunt

9. **How many days do you spend hunting & shooting?**  
 a. 1 - 5  
 b. 6 - 10  
 c. 10 - 20  
 d. 20 +

10. **What are the outdoor interests in your household?**  
**(1) Hunting**  
 a. Waterfowl  (2) **Shooting**  
 b. Upland Birds  a. Trap/Skeet  
 c. Turkey  b. Sporting Clays  
 d. Big Game  c. Target  
 e. Small Game  d. Plinking  
 e. Silhouettes  
 f. Archery  
 g. Crossbows

11. **A. This Marlin just purchased will be used for:**  
 01. Waterfowl  07. Trap  
 02. Big Game  08. Skeet  
 03. Small Game  09. Sporting Clays  
 04. Varmints  10. Targets/Plinking  
 05. Upland Birds  11. Gun Collection  
 06. Turkey  12. Home Defense
- B. Using the above options, please list the number that corresponds with the primary use:**

12. **How many other Marlin Firearms do you own?**  
 None  1-2  3-4  More

13. **Which do you use the internet for? (check all that apply)**  
 1. Finding info about products  3. Purchasing products  
 2. Locating parts, service or company contacts  4. Have not used

14. **Your Gender:**  Male  Female  
15. **Your Marital Status:**  Married  Single

16. **Date of Birth:**   /   /    
Month / Day / Year

17. **Including yourself, how many people live in your household? (Examples: 01, 02, etc.)**  
Children (18 and younger)   Adults

18. **Date of Birth of children in your household 18 years of age and younger:**  
 Male  Female   /   /    
Month / Day / Year  
 Male  Female   /   /    
Month / Day / Year

19. **For you primary residence, do you:**  
 1. Own  2. Rent

20. **Education:** (Please check which category applies to you)  
 1. Some High School  3. College Degree  
 2. Completed High School  4. Graduate Degree

21. **Which best describes your family income?**  
 Under \$15,000  \$100,000-\$124,999  
 \$15,000-\$24,999  \$125,000-\$149,999  
 \$25,000-\$34,999  \$150,000-\$174,999  
 \$35,000-\$49,999  \$175,000-\$199,999  
 \$50,000-\$74,999  \$200,000-\$249,999  
 \$75,000-\$99,999  \$250,000 or Over

22. **Why did you purchase a Marlin Firearm?**  
 1. Previous Experience  4. Internet  
 2. Friends Recommend  5. Ads  
 3. Salesperson  6. Reputation

23. **Do you own a dog?**  
 1. Family  2. Hunting

24. **What type of vehicle do you drive most often?**  
 1. Truck  4. Mid Size Car  
 2. SUV  5. Compact Car  
 3. Full Size Car  6. Van/Mini Van

Thank You! We appreciate your responses to this questionnaire. The information you choose to share with us will be used by us and our marketing partners to offer you product information and other communications that may interest you. If you prefer not to be contacted about these special offers (direct mail), please check here:

PLEASE FOLD AND SEAL WITH TAPE BEFORE MAILING. DO NOT STAPLE

PLEASE DETACH AND SAVE THIS PANEL BEFORE MAILING

PLEASE DETACH WARRANTY CARD THEN FOLD AND SEAL WITH TAPE BEFORE MAILING. DO NOT STAPLE

**REGISTER ONLINE AND QUALIFY FOR MONTHLY PRIZES**  
(All fields must be completed in order to qualify for monthly drawings.)

**WWW.MARLINFIREARMS.COM/WARRANTY**

PLEASE DETACH AND SAVE THIS PANEL BEFORE MAILING

**MARLIN'S PERFORMANCE UNDER THE WARRANTY ON THE REVERSE SIDE OF THIS CARD**

1. After notice of defect in material and/or workmanship is received by The Marlin Firearms Company, Marlin shall send instructions for shipment of the firearm; and repairs will be made and the firearm returned within a reasonable time after the firearm is received. Cost of shipping, insurance charges, etc. involved in returning the firearm to the company shall be prepaid by the original owner.
2. Cost of parts and labor performed shall be provided without charge by The Marlin Firearms Company.
3. If The Marlin Firearms Company, after receipt of the firearm, determines that the defects in material and/or workmanship were the result of abuse and/or neglect, or otherwise not covered by the warranty set forth above, Marlin shall notify such owner to that effect and give an estimate for repair. In such cases, repair, return shipping and insurance charges, etc. shall be paid by such owner.
4. In the event that The Marlin Firearms Company is unable to make warranty repairs to the firearm, it shall, within a reasonable time after its receipt, notify the owner to that effect and give him the option either to receive a replacement of the same model, if then available in its inventory, or to receive a refund, either of which, if feasible, will be made through the store of purchase.

**The Marlin Firearms Company**  
www.marlinfirearms.com

PLEASE DETACH AND SAVE THIS PANEL BEFORE MAILING

Please do not send products or other correspondence to the address below.

048 E

PLACE  
FIRST-CLASS  
STAMP  
HERE

PLEASE DETACH WARRANTY CARD THEN FOLD AND SEAL WITH TAPE BEFORE MAILING. DO NOT STAPLE



**FIREARM WARRANTY REGISTRATION**  
PO BOX 1871  
MADISON, NC 27025-1871

PLEASE DETACH THIS PANEL THEN FOLD AND SEAL WITH TAPE BEFORE MAILING. DO NOT STAPLE

**REGISTER ONLINE AT:**  
[WWW.MARLINFIREARMS.COM/WARRANTY](http://WWW.MARLINFIREARMS.COM/WARRANTY)

Please take a moment right now to fill it out or:  
better meet your future needs.  
Completion of this questionnaire will enable us to  
Thank you for choosing a Marlin Firearm.  
This is your Marlin Firearm Warranty Registration Card.

**FIREARM WARRANTY REGISTRATION CARD**

**REGISTER ONLINE AT:**  
[WWW.MARLINFIREARMS.COM/WARRANTY](http://WWW.MARLINFIREARMS.COM/WARRANTY)