

.003Hz TO 30MHz

**LIN/LOG SWEEP GENERATOR**

MODEL 2200

SERIAL NO.

~~308~~

**OPERATING AND MAINTENANCE  
MANUAL**

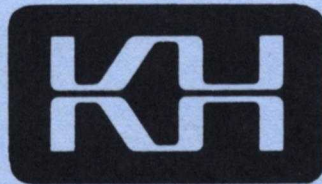

**KROHN-HITE CORPORATION**

Avon Industrial Park/Bodwell St., Avon Massachusetts 02322 U.S.A.



If You Didn't Get This From My Site,  
Then It Was Stolen From...

[www.SteamPoweredRadio.Com](http://www.SteamPoweredRadio.Com)



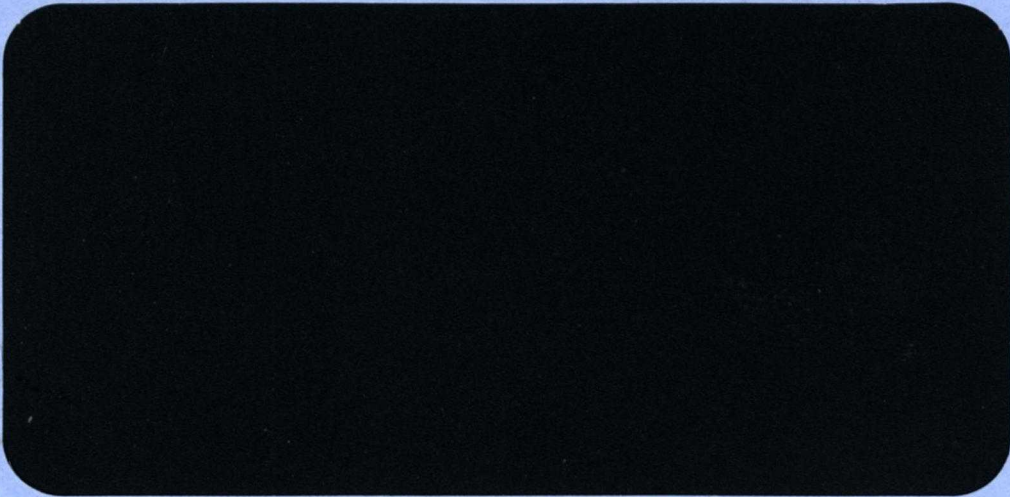

## SERVICE AND WARRANTY

*KROHN-HITE Instruments are designed and manufactured in accordance with sound engineering practices and should give long trouble-free service under normal operating conditions. If your Instrument fails to provide satisfactory service and you are unable to locate the source of trouble, contact our Representative if there is one in your area or write to our Service Department giving all the information available concerning the failure.*

*Do not return the instrument without our written authorization for, in most cases, we will be able to supply you with the information necessary to repair the instrument and thus avoid the transportation problems and costs. When it becomes necessary to return the instrument to our Factory, kindly pack it carefully and ship it to us prepaid.*

*All KROHN-HITE products are warranted against defective materials and workmanship. This warranty applies for a period of one year from the date of delivery to the original purchaser. Any instrument that is found within the one year period not to meet these standards, will be repaired or replaced. All instruments returned for repair and/or recalibration are insured by Krohn-Hite while on the premises. This warranty does not apply to electron tubes, fuses, or batteries. No other warranty is expressed or implied.*

*KROHN-HITE CORPORATION reserves the right to make design changes at any time without incurring any obligation to incorporate these changes in instruments previously purchased.*

*Modifications to this instrument must not be made without the written consent of an authorized employee of KROHN-HITE CORPORATION.*



**NEW!**

0.003Hz to 30MHz  
**LIN/LOG SWEEP GENERATOR**  
 model 2200



model 2200

*1295 weeks*

- Waveforms: Sine, Triangle, Square, Ramps and Pulses
- LIN/LOG Sweep, Up and Down
- Frequency Marker
- 9 Modes of Operation: Continuous, Gate, Trigger, Burst, Pulse, Sweep, Trig Sweep, Trig Sweep Burst, External VC
- Calibrated Sweep Start and Stop Controls
- Main Output: 30 Volts P-P
- Calibrated Attenuator
- Dual DC Offset Controls
- Variable Symmetry and Start Phase

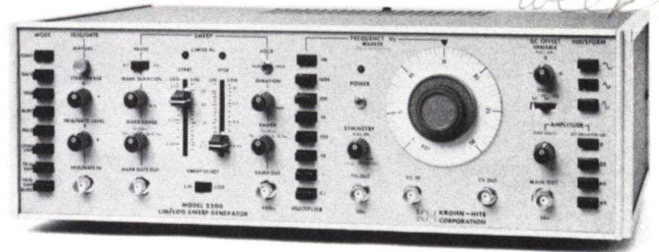

The KROHN-HITE Model 2200 features multi-functions never before offered in a single function generator! A unique Frequency Marker feature and 9 other modes of operation combine to make this 30MHz Lin/Log Sweeper a standout.

The model 2200 is actually 2 generators in 1. The main generator provides sine, triangle, square, pulse and sawtooth waveforms and covers a frequency range of 0.003Hz to 30MHz. The ramp generator provides linear and exponential (log) ramps over a range of 0.01Hz to 10kHz. These 2 generators are operated independently, or interconnected to provide a wide variety of operational modes, including: Triggered (single cycle) or gated waveforms; tone bursts, with variable rates and durations; variable width pulses, with independently adjustable rep-rates; continuous or triggered sweeps, either linear or logarithmic, with independent slide controls for start and stop frequencies.

An exclusive feature of the Model 2200 is the Frequency Marker. This allows the user to selectively pause during a frequency sweep, for any duration between 0.1ms and infinity. Connecting the RAMP output to a scope horizontal input provides intensification of the scope trace for the pause period. The dial indicates the frequency of the pause in this mode of operation to provide accurate frequency marking during response tests. Multiple pauses and

staircase ramps may be initiated with the MARK TRIG input. A marker pulse is also simultaneously generated during the pause, and may be used to gate or trigger other external circuits.

The unique SYMMETRY control provides additional pulse and sawtooth waveforms. Haversine and havertriangle waveforms are set with the START PHASE control.

The main output of the 2200 is adjustable from 2 millivolts to 30 volts p-p, by the calibrated dB attenuator and vernier. Two DC offset controls are also provided. The VARIABLE offset allows all waveforms to be positioned about zero to a maximum of  $\pm 15$  volts. The FIXED offset automatically halves the amplitude and fixes the baseline at zero. Both offsets may be used simultaneously to position a fixed baseline about zero.

Several auxiliary outputs are also provided on the 2200. The linear and logarithmic ramps are simultaneously available. The PEN LIFT output is provided for use with an x-y plotter. The TTL output is coincident with the main generator frequency, and may be used for gating, blanking, etc. The CV (control voltage) output may be monitored with a digital voltmeter for more precise frequency adjustment. The MARK GATE output is coincident with the pause duration and provides gating and timing signals.

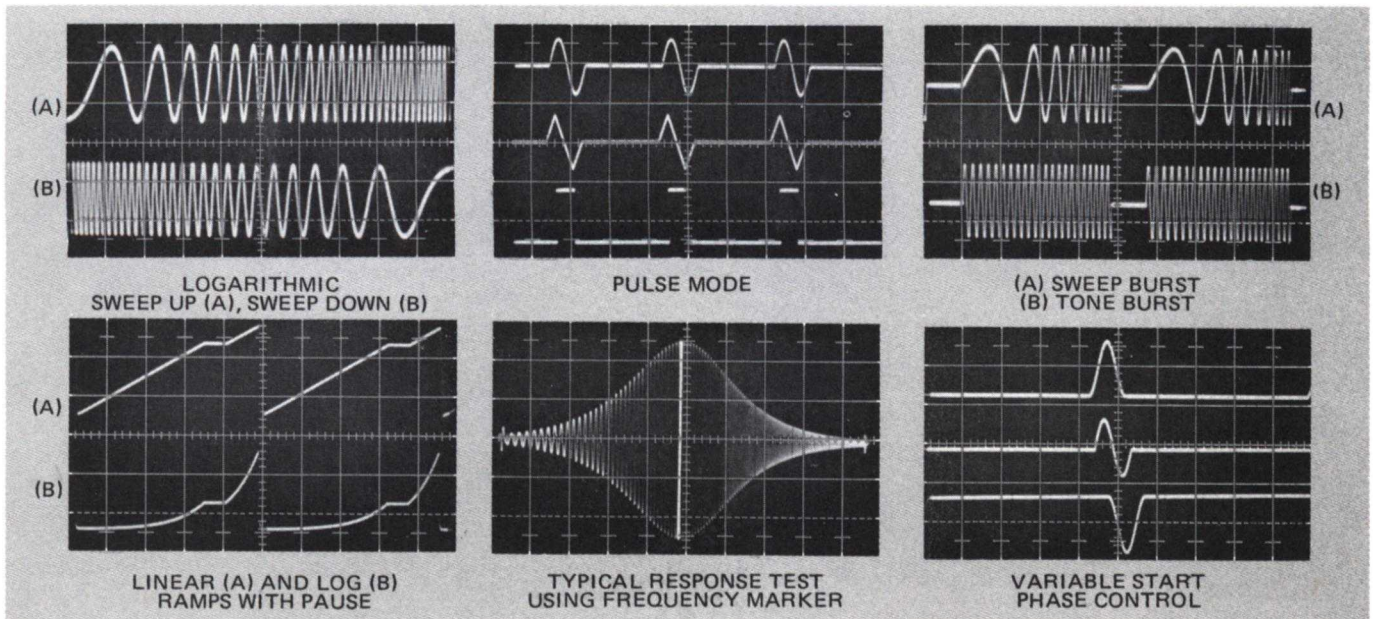



## SPECIFICATIONS

### MAIN OUTPUT

**Waveforms:** Sine, square, triangle, pos. and neg. pulses and ramps.

**Frequency Range:** 0.003Hz to 30MHz in 8 ranges.

**Frequency Control:** Dial calibrated linearly from 1 to 30, and an 8 position pushbutton multiplier switch.

BAND	MULTIPLIER	FREQUENCY RANGE
1	.1	0.003Hz-3Hz
2	1	0.03Hz-30Hz
3	10	0.3Hz-300Hz
4	100	3Hz-3kHz
5	1K	30Hz-30kHz
6	10K	300Hz-300kHz
7	100K	3kHz-3MHz
8	1M	30kHz-30MHz

**Frequency Accuracy:** 2% of full scale on bands 1-7, 3.5% of full scale on band 8.

**Frequency Stability:**

10 minutes	0.05% bands 1-7
24 hours	0.25% bands 1-6, 1% bands 7-8
vs line	0.01% for 10% line change
jitter (cycle to cycle)	0.025%

**Maximum Output:** 30V p-p (15V p-p into 50 ohms).

**Impedance:** Constant 50 ohms,  $\pm 2\%$ .

**Amplitude Control:** Pushbutton attenuator calibrated in 20dB steps to 60dB and vernier. dB attenuator accuracy  $\pm 0.2$ dB. Minimum output less than 2mV.

**DC Component:** Zero  $\pm 100$ mV,  $\pm 4$ mV/ $^{\circ}$ C, reduced in proportion to dB attenuator setting.

**Frequency Response:** Sinewave; 0.1dB to 300kHz, 0.2dB to 3MHz, 1dB to 30MHz. Triangle, 0.1dB to 300kHz, 1dB to 3MHz, 3.5dB to 30MHz.

**Sinewave Distortion:** Less than 0.5% 0.1Hz to 300kHz, 2% to 3MHz. All harmonics at least 22dB down to 30MHz.

**Squarewaves and Pulses:** Rise and fall time less than 10ns, total aberrations less than 5% with 50 ohm matching load.

**Triangle Linearity:** 99% 0.1Hz to 300kHz, 98% to 3MHz, 90% to 30MHz.

**Time Symmetry:** 99% on bands 1-7, 90% on band 8.

**VARIABLE SYMMETRY:** Potentiometer for adjusting negative duration of pulses and positive slope of ramps. Main tuning dial controls positive duration of pulses and negative slope of ramps. Symmetry ratio adjustable 100:1.

**VC (external voltage control):** Frequency controlled about the dial setting with zero to  $\pm 3$  volts. Range 1000:1. Slew rate 0.2V/us. Impedance 6k ohms. Upper frequency limited to maximum of selected band.

**DC OFFSETS:** Fixed offset reduces the waveform to one half its amplitude and sets the plus or minus peak to zero. Variable offset allows setting about ground to  $\pm 15$  volts peak. Fixed and variable offsets may be used simultaneously. Peak AC plus DC offset limited to  $\pm 15$  volts.

**EXTERNAL SYNCHRONIZATION (rear panel):** A 2 volt p-p external signal will lock generator over a range of 3% with a slight change in distortion.

### OPERATIONAL MODES (MAIN OUTPUT)

**CONT:** Continuous Output, frequency determined by dial and multiplier.

**GATE:** Continuous output for duration of external or manual gate.

**TRIG:** Single cycle output when externally or manually triggered.

**BURST:** Repetitive tone burst, rate variable from 0.01Hz to 10kHz.

**PULSE:** Pulse output adjustable between 16ns and 100s or single cycle of selected waveform. Rep rate from 0.01Hz to 10kHz.

**CONT SWP:** Continuous sweeping between frequencies determined by START and STOP controls. Range: 100:1 linear, 1000:1 log.

**TRIG SWP:** Holds at START frequency, single sweep when externally or manually triggered.

**TRIG SWP BURST:** Single swept burst when externally or manually triggered.

**TRIG/GATE:** Manual or external. Waveform start/stop point adjustable  $\pm 90^{\circ}$  to 300kHz,  $\pm 70^{\circ}$  to 3MHz. Above 3MHz, generator may free run, unless START PHASE is near zero. Input level variable -5V to +5V. Triggers on positive slope. Maximum trigger frequency, 10MHz. Impedance, 10k ohms.

### SWEEP CHARACTERISTICS

Linear or logarithmic. Start and stop frequencies independently selected. Typical accuracy: Linear scale 10% f.s., Log scale 20%. Frequencies may sweep up or down. Sweep may be stopped with sweep hold control. Hold drift: Linear, (0.01Hz/sec) x MULTIPLIER; logarithmic, 0.2% of frequency/sec.

**Range:** Linear 100:1; Logarithmic 1000:1.

**Duration:** Variable, 0.1ms to 100s.

### MARKER CHARACTERISTICS (positive ramp, sweep up only)

Marker frequency set by MARKER dial and MULTIPLIER. Swept frequency pauses at selected marker frequency. Pause variable from 0.1ms to infinity.

**Marker accuracy:** 2% of full scale, bands 1-7, 3.5% of full scale band 8.

**Pause frequency drift:** Linear (0.05 Hz/sec) x MULTIPLIER; Log 1% of frequency/sec.

**MARK TRIG input (rear panel):** Pause-mark start triggered by falling edge of TTL pulse. Any connection disables front panel MARKER dial control.

### AUXILIARY OUTPUTS

**RAMP OUT:** Linear 3V. Impedance 600 ohms.

**SWP (log) OUTPUT (rear panel):** Amplitude and offset controlled by sweep START and STOP controls.

**PEN LIFT (rear panel):** TTL pulse, "high" during sweep and marking.

**TTL OUT:** Frequency and symmetry same as Main Output. Drives up to 10 TTL loads. Rise and fall time less than 6ns. Total aberrations less than 10%.  $180^{\circ}$  out of phase with main squarewave output. Impedance 50 ohms.

**CV (control voltage) OUT:** 2mV to 3 volts, proportional to generator frequency. Accuracy 1% on bands 1-7. Impedance 2.4k ohms.

**MARK GATE OUT:** TTL pulse, variable with MARK DURATION control.

**SWEEP STATUS INDICATORS:** In sweep modes, indicates Ramp Generator condition. If ramp is held at start or stop, corresponding LED is on. Both LEDs off indicate a Ramp pause or hold. Both LEDs on indicate sweeping period.

**OPERATING TEMPERATURE RANGE:** 0  $^{\circ}$ C to 50  $^{\circ}$ C.

**POWER REQUIREMENTS:** Switch selectable, 90-110, 108-132, 180-220, or 216-264 volts, single phase, 50-400 Hz, 60 watts.

### DIMENSIONS AND WEIGHTS

Cabinet Size/Weight	H	W	D	Net	Gross
U.S.	5 1/4"	16 5/8"	11 1/2"	10 lb.	12 lb.
Metric	13.3 cm	42.2 cm	29.2 cm	4.6 kg	5.5 kg

Specifications apply at 25  $^{\circ}$ C,  $\pm 5^{\circ}$  C, with maximum output voltage, dial set between 1 and 30, and SYMMETRY control off.

### OPTIONAL RACK-MOUNTING KIT:

Part No. RK-519: Permits installation of the Model 2200 into a standard 19" rack spacing.



*Specifications subject to change without notice.*

# KROHN-HITE CORPORATION

Avon Industrial Park/Bodwell Street, Avon, Massachusetts 02322  
Telephone 617-580-1660 - TWX 710-345-0831



.003Hz TO 30MHz  
**LIN/LOG SWEEP GENERATOR**

MODEL 2200 SERIAL NO. ~~308~~

**OPERATING AND MAINTENANCE  
MANUAL**



**KROHN-HITE CORPORATION**

AVON INDUSTRIAL PARK/255 BODWELL STREET/AVON, MASS. 02322 USA



© KROHN-HITE CORPORATION 1979



## CONTENTS

Section		Page
1	GENERAL DESCRIPTION .....	1
2	OPERATION .....	7
3	INCOMING INSPECTION AND CHECKOUT .....	17
4	CIRCUIT DESCRIPTION .....	22
5	MAINTENANCE .....	33
6	CALIBRATION .....	46
Appendix	LIST OF TEST EQUIPMENT .....	51

## ILLUSTRATIONS

Figure		Page
1	Model 2200 Lin/Log Sweep Generator .....	ii
2	Optional Rack Mounting Kit .....	5
3	Operating Controls, Connectors and Displays .....	6
4	Main Output MODE Waveforms .....	13
5	Test Set Up for Frequency Pause Marker .....	15
6	Simplified Block Diagram .....	23
7	Test Circuit for FIXED OFFSET Adjustment .....	49

## TABLES

Number		Page
5. 1	Troubleshooting Chart .....	35
5. 2	FET Switching Logic Chart .....	45



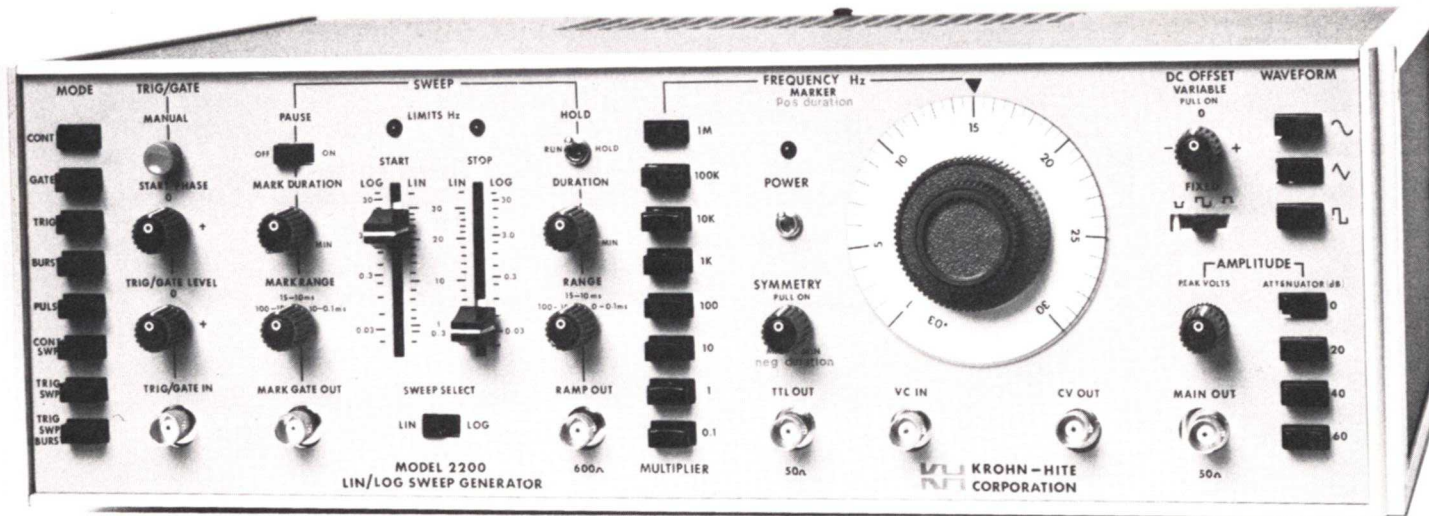

Figure 1. Model 2200 Lin/Log Sweep Generator



# SECTION 1

## GENERAL DESCRIPTION

### 1.1 INTRODUCTION

The Krohn-Hite Model 2200, shown in Figure 1, is a versatile lin/log sweep generator designed for applications in the sub-audio (0.003 Hz) to high frequency (30 MHz) range. It provides 9 different modes of operation, including up or down linear or log sweeps, gated, burst and pulse-type signals. An exclusive feature of the Model 2200 is the Frequency Pause-Marker. This feature allows the user to stop the up-frequency sweep at any point during the sweep duration, for any period between 0.1 ms and infinity. The added convenience of this feature is that it produces a visible marker when the sweep is viewed with an oscilloscope, by driving the scope horizontal axis with the generator's RAMP OUTPUT. The frequency at which the pause-marker occurs can be varied anywhere between the frequency sweep limits, and is accurately indicated by the FREQUENCY Hz MARKER dial.

The Model 2200 provides an output voltage of 30V p-p, open-circuit, controlled by a calibrated push-button dB attenuator and vernier. The dual DC offset controls provide fixed and/or variable offset capability. The variable SYMMETRY control provides a 100:1 adjustment of the MAIN OUTPUT waveform symmetry ratio, for generating sawtooth or pulse waveforms. (A separate PULSE mode is also provided.)

In addition to the above features, several auxiliary outputs are also provided. The TTL output, coincident with the main generator frequency, may be used for gating, blanking, etc. The MARK GATE output is a TTL compatible pulse coincident with the duration of the Frequency Pause-Marker. The PEN LIFT output provides a stylus control when plotting response with an X-Y or strip-chart recorder. The RAMP OUTPUT is a 3 volt ramp coincident with the sweep, and can be used to drive the horizontal axis of an oscilloscope or X-Y plotter. The ramp output can also be used independent of the main generator in non-sweep modes. Finally, the CV output provides a DC voltage proportional to the generator frequency, accurate within 1% to provide more precise measurement or setting of frequency.

The generator has been carefully inspected, tested, aged and readjusted before shipment to insure that it is working properly. If for some reason the generator is not working properly or appears to have been damaged in shipment, inform the freight carrier of the damage, and notify KROHN-HITE or its nearest sales office immediately.

### 1.2 SPECIFICATIONS

#### MAIN OUTPUT

WAVEFORMS: Sine, square, triangle, positive and negative pulses and ramps.

FREQUENCY RANGE: 0.003 Hz to 30 MHz in 8 ranges.

FREQUENCY CONTROL:

Dial calibrated linearly from 1 to 30, and an 8 position pushbutton MULTIPLIER switch.

<u>Band</u>	<u>Multiplier</u>	<u>Frequency Range</u>
1	. 1	0.003 Hz-3 Hz
2	1	0.03 Hz-30 Hz
3	10	0.3 Hz-300 Hz
4	100	3 Hz-3 kHz
5	1K	30 Hz-30 kHz
6	10K	300 Hz-300 kHz
7	100K	3 kHz-3 MHz
8	1M	30 kHz-30 MHz

FREQUENCY ACCURACY: 2% of full scale on bands 1-7, 3.5% of full scale on band 8.

FREQUENCY STABILITY:

10 minutes	0.05% bands 1-7
24 hours	0.25% bands 1-6, 1% bands 7-8
vs line	0.01% for 10% line change
jitter (cycle to cycle)	0.025%

MAXIMUM OUTPUT: 30V p-p (15V p-p into 50 ohms).

IMPEDANCE: Constant 50 ohms,  $\pm 2\%$ .

AMPLITUDE CONTROL:

Pushbutton attenuator calibrated in 20 dB steps to 60 dB and vernier. dB attenuator accuracy  $\pm 0.2$  dB. Minimum output less than 2 mV.

DC COMPONENT: Zero  $\pm 100$  mV,  $\pm 4$  mV/ $^{\circ}$ C, reduced in proportion to dB attenuator setting.

FREQUENCY RESPONSE: Sinewave; 0.1 dB to 300 kHz, 0.2 dB to 3 MHz, 1 dB to 30 MHz. Triangle, 0.1 dB to 300 kHz, 1 dB to 3 MHz, 3.5 dB to 30 MHz.

SINEWAVE DISTORTION: Less than 0.5% 0.1 Hz to 300 kHz, 2% to 3 MHz. All harmonics at least 22 dB down to 30 MHz.

SQUAREWAVES AND PULSES: Rise and fall time less than 10 ns, total aberrations less than 5% with 50 ohm matching load.

TRIANGLE LINEARITY: 99% 0.1 Hz to 300 kHz, 98% to 3 MHz, 90% to 30 MHz.

TIME SYMMETRY: 99% on bands 1-7, 90% on band 8.

VARIABLE SYMMETRY

Potentiometer for adjusting negative duration of pulses and positive slope of ramps. Main tuning dial controls positive duration of pulses and negative slope of ramps. Symmetry ratio adjustable 100:1.



**VC (EXTERNAL VOLTAGE CONTROL)**

Frequency controlled about the dial setting with zero to  $\pm 3$  volts. Range 1000:1. Slew rate 0.2V/us. Impedance 6k ohms. Upper frequency limited to maximum of selected band.

**DC OFFSETS**

Fixed offset reduces the waveform to one half its amplitude and sets the plus or minus peak to zero. Variable offset allows setting about ground to  $\pm 15$  volts peak. Fixed and variable offsets may be used simultaneously. Peak AC plus DC offset limited to  $\pm 15$  volts.

**EXTERNAL SYNCHRONIZATION (REAR PANEL)**

A 2 volt p-p external signal will lock generator over a range of 3% with a slight change in distortion.

**OPERATIONAL MODES (MAIN OUTPUT)**

CONT: Continuous output, frequency determined by dial and multiplier.

GATE: Continuous output for duration of external or manual gate.

TRIG: Single cycle output when externally or manually triggered.

BURST: Repetitive tone burst, rate variable from 0.01 Hz to 10 kHz.

PULSE: Pulse output adjustable between 16 ns and 100 s or single cycle of selected waveform. Rep rate from 0.01 Hz to 10 kHz.

CONT SWP: Continuous sweeping between frequencies determined by START and STOP controls. Range: 100:1 linear, 1000:1 log.

TRIG SWP: Holds at START frequency, single sweep when externally or manually triggered.

TRIG SWP BURST: Single swept burst when externally or manually triggered.

**TRIG/GATE**

Manual or external. Waveform start/stop point adjustable  $\pm 90^\circ$  to 300 kHz,  $\pm 70^\circ$  to 3 MHz. Above 3 MHz, generator may free run, unless START PHASE is near zero. Input level variable -5V to +5V. Triggers on positive slope. Maximum trigger frequency, 10 MHz. Impedance, 10k ohms.

**SWEEP CHARACTERISTICS**

Linear or logarithmic. Start and stop frequencies independently selected. Typical accuracy: Linear scale 10% f. s., Log scale 20%. Frequencies may sweep up or down. Sweep may be stopped with sweep hold control. Hold drift: Linear, (0.01 Hz/sec) x MULTIPLIER; logarithmic, 0.2% of frequency/sec.

Range: Linear 100:1; Logarithmic 1000:1.

Duration: Variable, 0.1 ms to 100 s.

**MARKER CHARACTERISTICS** (positive ramp, sweep up only)

Marker frequency set by MARKER dial and MULTIPLIER. Swept frequency pauses at selected marker frequency. Pause variable from 0.1 ms to infinity.

Marker accuracy: 2% of full scale, bands 1-7, 3.5% of full scale band 8.

Pause frequency drift: Linear (0.05 Hz/sec) × MULTIPLIER; Log 1% of frequency/sec.

MARK TRIG input (rear panel): Pause-mark start triggered by falling edge of TTL pulse. Any connection disables front panel MARKER dial control.

**AUXILIARY OUTPUTS**

RAMP OUT: Linear 3V. Impedance 600 ohms.

LOG OUTPUT (REAR PANEL): Amplitude and offset controlled by sweep START and STOP controls.

PEN LIFT (REAR PANEL): TTL compatible pulse, "high" during sweep and marking.

TTL OUT: Frequency and symmetry same as Main Output. Drives up to 10 TTL loads. Rise and fall time less than 6 ns. Total aberrations less than 10%. 180° out of phase with main squarewave output. Impedance 50 ohms.

CV (CONTROL VOLTAGE) OUT: 2 mV to 3 volts, proportional to generator frequency. Accuracy 1% on bands 1-7. Impedance 2.4K ohms.

MARK GATE OUT: TTL compatible pulse, variable with MARK DURATION control.

**SWEEP STATUS INDICATORS**

In sweep modes, indicates Ramp Generator condition. If ramp is held at start or stop, corresponding LED is on. Both LEDs off indicate a Ramp pause or hold. Both LEDs on indicate sweeping period.

**GENERAL**

OPERATING TEMPERATURE RANGE: 0°C to 50°C.

POWER REQUIREMENTS: Switch selectable, 90-110, 108-132, 180-220, or 216-264 volts, single phase, 50-400 Hz, 60 watts.

DIMENSIONS AND WEIGHTS:

Cabinet Size/Weight	H	W	D	Net	Gross
US	5 1/4"	16 5/8"	11 1/2"	16 lb.	18 lb.
Metric	13.3 cm	42.2 cm	29.2 cm	7 kg.	8 kg.

Specifications apply at 25°C, ±5°C with maximum output voltage, dial set between 1 and 30, and SYMMETRY control off.



OPTIONAL RACK-MOUNTING KIT: Part No. RK-519: Permits installation of the Model 2200 into a standard 19" rack spacing.

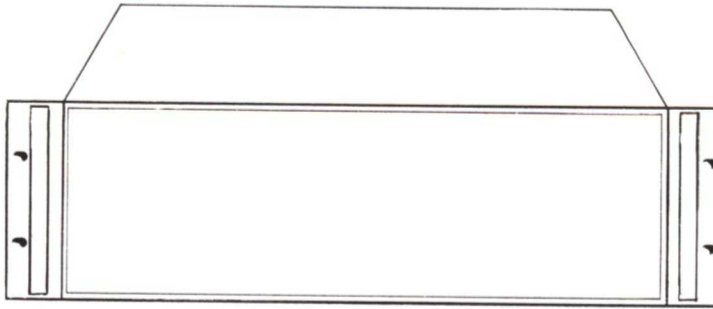

Figure 2. Optional Rack Mounting Kit.

Specifications subject to change without notice.

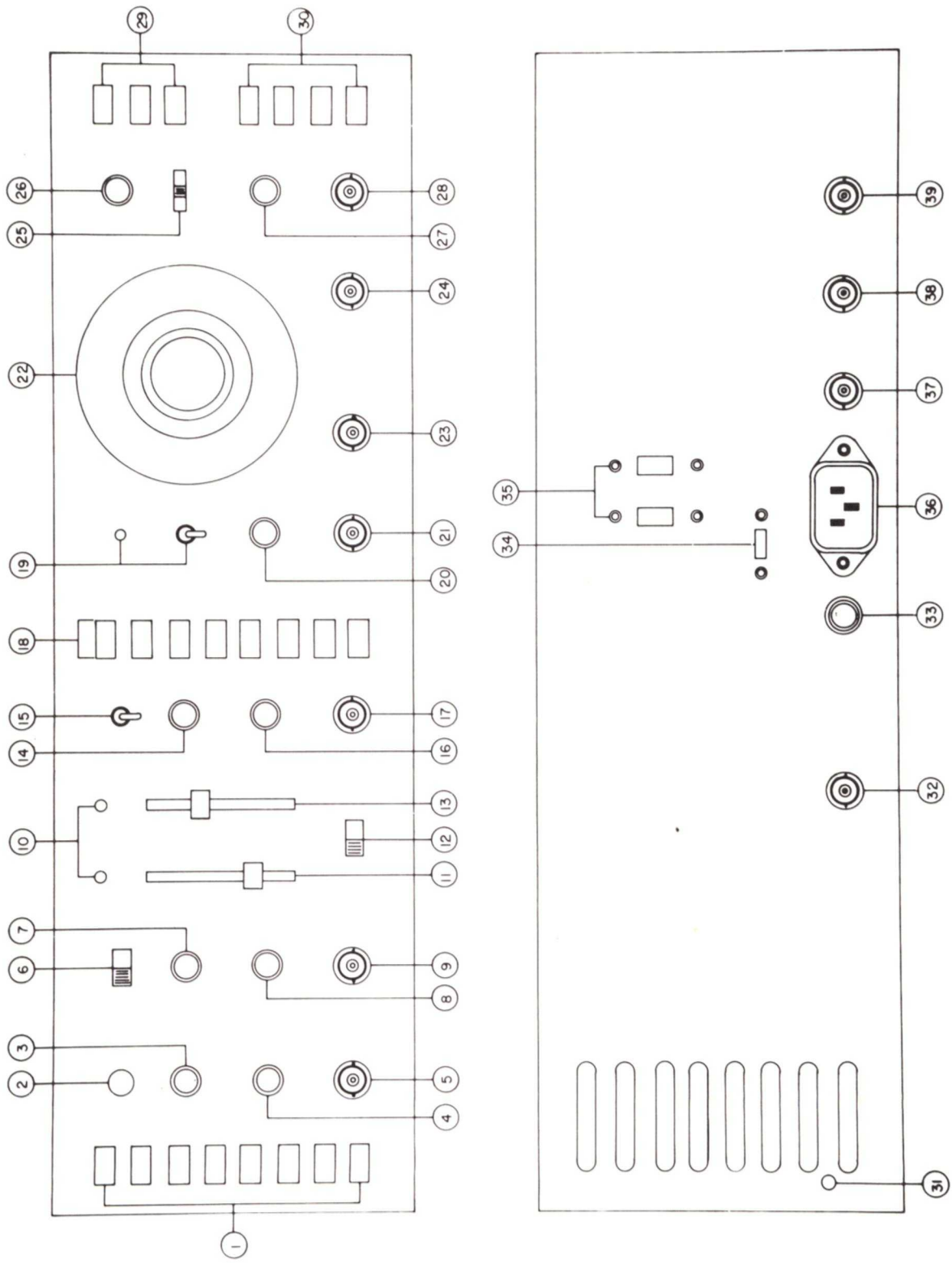

Figure 3. Operating Controls, Connectors and Displays



## SECTION 2

# OPERATION

### 2.1 POWER REQUIREMENTS

The Model 2200 Lin/Log Sweep Generator may be powered from a single phase, 50-400 Hz AC line voltage of either 90-110/108-132 volts, or 180-220/216-264 volts. The LINE selector switches on the rear panel select the proper mode of operation. All units are shipped with the LINE switches set to 120V and NORM, respectively, and a fuse bag attached to the line cord. The fuse bag contains a 3/8 ampere fuse. For 180V-264V operation, remove the 3/4 ampere fuse located in the fuse receptacle, replace it with the 3/8 ampere fuse from the fuse bag and switch the 120V/240V LINE switch to the 240V position. The NORM (normal)/LO (low) LINE switch is provided for operating with low AC line voltages (90-110 volts or 180-220 volts). A chart is provided on the rear panel showing the correct switch positions required for each line voltage.

#### CAUTION!

The covers of this instrument should not be removed when the instrument is connected to an AC power source, because of the potentially dangerous voltages that exist within the unit.

### 2.2 OPERATING CONTROLS, CONNECTORS AND DISPLAYS (See Figure 3)

#### 2.2.1 Front Panel

- ① **MODE:** 8-station pushbutton control for selecting the generator mode of operation. The ninth mode of operation is the External VC control. See Section 2.3.2.
- ② **MANUAL TRIG/GATE:** Pushbutton control to manually trigger or gate the generator frequency in TRIG, GATE, TRIG SWP and TRIG SWP BURST modes.
- ③ **START PHASE:** Single turn control adjusts the phase angle at which the sine or triangle waveform start in the TRIG, GATE, PULSE, BURST and TRIG SWP BURST modes. Start-stop points adjustable  $\pm 90^\circ$  to 300 kHz,  $\pm 70^\circ$  to 3 MHz. Produces haversine or havertriangle waveforms in TRIG and PULSE modes.
- ④ **TRIG/GATE LEVEL:** Single turn control, varies the threshold level of the TRIG/GATE input, for a positive slope between -5V and +5V. Hysteresis, 0.5V. In BURST mode, adjusts burst duration between 5% - 80% of burst period, as determined by SWEEP DURATION control.

- ⑤ TRIG/GATE IN: Input for external trigger or gate signal. Input impedance, 10K ohms. Maximum trigger frequency, 10 MHz. Will withstand  $\pm 50$  volts peak without damage.
- ⑥ PAUSE: Slide switch that activates FREQUENCY PAUSE-MARKER. See Section 2. 3. 3.
- ⑦ MARK DURATION: Single turn control adjusts duration of RAMP pause and MARK GATE OUTPUT within range determined by MARK RANGE selector. Rotating MARK DURATION to maximum CCW position provides infinite pause in any position of MARK RANGE selector. See Section 2. 3. 3.
- ⑧ MARK RANGE: 3 position switch selects range of MARK DURATION: 100 s-10 s, 1 s-10 ms, and 10 ms-0. 1 ms. See Section 2. 3. 3.
- ⑨ MARK GATE OUT: TTL compatible pulse occurs at pause/marker frequency, width coincident with MARK DURATION setting. See Section 2. 3. 3.
- ⑩ LIMITS Hz: Complimentary LEDs that indicate RAMP (sweep) status in CONT SWP, TRIG SWP or TRIG SWP BURST modes. If the RAMP (sweep) is holding at its START or STOP point, the corresponding LED will be lit. If the RAMP is holding (sweep pause) both LEDs will be off. If the generator is sweeping, both LEDs will be on.
- ⑪ START: Slide control calibrated in Hertz with linear scale from 0. 3 to 30 and log scale from 0. 03 to 30, adjusts sweep start frequency in CONT SWP, TRIG SWP and TRIG SWP BURST modes. Also sets start voltage of LOG OUTPUT ramp. See Section 2. 3. 6.
- ⑫ SWEEP SELECT: Slide switch to select linear (Lin) or logarithmic (Log) sweep.
- ⑬ STOP: Slide control calibrated with same scales as START control, adjusts sweep stop frequency. Also sets stop voltage of LOG OUTPUT ramp. See Section 2. 3. 6.
- ⑭ (SWEEP) DURATION: Single turn control adjusts sweep duration in CONT SWP, TRIG SWP, and TRIG SWP BURST modes; adjusts burst and pulse rate in BURST and PULSE modes; adjusts RAMP OUT duration in nonsweep modes.
- ⑮ HOLD: Toggle switch to manually stop the frequency sweep. Sweep resumes when HOLD switch is returned to RUN mode.
- ⑯ (SWEEP) RANGE: 3 position control selects range of ramp or sweep duration: 100 s-10 s, 1 s-10 ms and 10 ms-0. 1 ms.
- ⑰ RAMP OUT: Linear, 0 to 3 volt ramp, duration adjusted with SWEEP DURATION control. Provides auxiliary output independent of main generator frequency in CONT, TRIG or GATE modes. See Section 2. 3. 6. Used to drive scope horizontal axis to observe FREQUENCY MARKER. See Section 2. 3. 3.
- ⑱ MULTIPLIER: 8 station control, calibrated in decade steps from x. 1 to x1M, multiplies FREQUENCY Hz/MARKER dial setting and START and STOP scales.
- ⑲ POWER: On-off toggle switch with power-on indicator.
- ⑳ SYMMETRY: Pull-on variable control. See Section 2. 3. 4.



- ②① TTL OUT: TTL compatible pulse coincident with main generator frequency, inverted with respect to MAIN OUTPUT squarewave. Rise and fall less than 6ns. Output impedance, 50 ohms.
- ②② FREQUENCY Hz/MARKER (pos duration): See Section 2.3.1.
- ②③ VC IN: Input for external voltage control of frequency. Zero to  $\pm 3$  volts gives 1000:1 frequency control, within dial range. Input impedance, 6k ohms.
- ②④ CV OUT: DC voltage, proportional to main generator frequency, 2mV to 3 volts, 1% accuracy over calibrated portion of FREQUENCY Hz/MARKER dial. Output impedance, 2.4k ohms.
- ②⑤ FIXED DC OFFSET: 3 position slide switch selects zero, or fixed positive or negative offset. See Section 2.3.5.
- ②⑥ VARIABLE DC OFFSET: Single turn, pull-on control provides variable adjustment of Main Output offset. See Section 2.3.5.
- ②⑦ PEAK VOLTS: Single turn potentiometer for controlling the Main Output voltage in each position of the AMPLITUDE ATTENUATOR.
- ②⑧ MAIN OUT: The selected waveforms appear at this output; impedance 50 ohms.
- ②⑨ WAVEFORM: 3 station pushbutton control selects sine, triangle, or square waveforms. The selected waveform appears at the MAIN OUTPUT.
- ③⑩ ATTENUATOR (dB): 4 position pushbutton attenuator, calibrated in dB steps from 0 dB to -60 dB. Attenuator accuracy,  $\pm 0.2$  dB. Minimum output, less than 2 millivolts.
- ③⑪ DC LEVEL ADJ: Single turn screwdriver adjust for adjusting MAIN OUT DC level.
- ③⑫ SYNC INPUT: A 2 volt p-p signal applied to this input will lock the generator frequency to the SYNC frequency within a 3% locking range.
- ③⑬ FUSE RECEPTACLE: 3/4A slow blow fuse for 120V operation, 3/8A slow blow fuse for 240V operation.
- ③⑭ CHASSIS/FLOATING: 2 position slide switch that disconnects signal ground ( $\frac{1}{\text{---}}$ ) from chassis ground ( $\frac{1}{\text{///}}$ ) when in the FLOATING position.
- ③⑮ LINE: Complimentary slide switches for selecting 120 or 240 volt operation, and NORMAL or LOW line conditions. The 120/240V LINE switch determines the proper voltage range (90-132V or 180-264V), while the NORM/LO LINE switch selects normal (108-132V, 216-264V) or low (90-110V, 180-220V) line voltage.
- ③⑯ AC POWER RECEPTACLE: Standard 3-prong connector. A detachable 3-wire line cord is included.
- ③⑰ LOG OUTPUT: Exponential ramp, frequency coincident with SWEEP DURATION, start and stop voltage levels controlled by sweep START and STOP controls, respectively.
- ③⑱ PEN LIFT: TTL compatible pulse, "high" during sweep and marking.

③ MARKER TRIG INPUT: The start of the pause-marker will be initiated by the falling edge of a TTL pulse applied to the MARKER TRIG input. Multiple pulses applied to this input during each ramp duration will provide a staircase ramp at the RAMP OUTPUT (see Section 2.3.6). Any connection made to this input will deactivate the front panel MARKER dial control.

## 2.3 OPERATION

### 2.3.1 FREQUENCY Hz/MARKER (pos duration) and MULTIPLIER

The FREQUENCY dial is a single turn dial, with a concentric 5:1 vernier drive, and is calibrated in Hertz with a linear scale from 1 to 30 (0.03 to 1 uncalibrated). The effective dial range is 1000:1. The MULTIPLIER is an 8-position, pushbutton control calibrated in decade steps from 0.1 to 1M ( $10^6$ ).

The dial determines the frequency or period of the Main Output in the CONT, TRIG, GATE, PULSE and BURST modes. In the CONT SWP, TRIG SWP and TRIG SWP BURST modes, the dial determines the frequency of the pause-marker.

The dial also controls the positive duration (width) of the squarewave and the negative slope of the sinewave and triangle, when the SYMMETRY control is on, in all modes except CONT SWP, TRIG SWP, and TRIG SWP BURST. The SYMMETRY control (Section 2.3.4), independently controls the squarewave negative duration (rep-rate) and sinewave and triangle positive slopes.

When the FREQUENCY dial and SYMMETRY control are used together, they provide additional sawtooth and pulse waveforms at the MAIN OUTPUT.

If an external voltage is applied to the VC IN connector it will vary the frequency of the generator about the dial setting and within the dial range. If the SYMMETRY control is on, the external voltage will vary the squarewave positive duration or the sinewave and triangle negative slope about the dial setting.

### 2.3.2 Modes of Operation

The Model 2200 provides a selection of 9 different modes of operation. Eight of these modes are selected by the pushbutton MODE switch; the ninth mode of operation is the External Frequency control (VC IN) which is functional in all positions of the MODE switch.

Each position of the MODE switch corresponds to a specific interconnection between the 2200's main generator circuit and its internal ramp generator and gate-trigger circuit to produce the desired function.

The frequency or period of the output waveform is controlled by the FREQUENCY Hz/MARKER dial and MULTIPLIER in the CONT, GATE, TRIG, BURST and PULSE modes. In the CONT SWP, TRIG SWP and TRIG SWP BURST modes, the frequency sweep range is controlled by the sweep START and STOP controls.

The waveform rep-rate or frequency duration is controlled by an external signal at the TRIG/GATE IN connector, in the TRIG and GATE modes, respectively. In the BURST, PULSE, CONT SWP, TRIG SWP and TRIG SWP BURST modes, the internal Ramp Generator controls the MODE rep-rate and/or duration.

The SYMMETRY control may be used in all modes. When a squarewave output is selected in the PULSE mode of operation, the SYMMETRY control sets a minimum negative duration. The pulse negative duration is then controlled by the internal



SWEEP DURATION, down to the minimum duration set by the SYMMETRY control. The SYMMETRY control will, however, control the sinewave and triangle positive slope in the PULSE mode.

In the CONT SWP, TRIG SWP and TRIG SWP BURST modes, the SYMMETRY control provides a fixed negative squarewave duration, while the START and STOP controls and the RAMP DURATION determine the limits of the modulated pulse width and pulse-width modulation rate, respectively, of the squarewave positive duration. Conversely, the Main Output sinewave and triangle negative slopes will be modulated.

All parameters of the main generator (AMPLITUDE, WAVEFORM and DC OFFSETS) are adjustable in all modes of operation.

The following is a detailed explanation of the various modes. Figure 4 shows the Main Output waveform for each mode of operation.

#### 2.3.2.1 Continuous and/or External VC Mode

Operates as conventional generator. Ramp generator is entirely independent and may be used simultaneously.

- a) Depress CONT.
- b) Select frequency with DIAL and MULTIPLIER.
- c) Frequency may also be controlled within the DIAL range, by an external voltage of zero to  $\pm 3$  volts.

#### 2.3.2.2 Gate Mode

Continuous output for duration of external or manual gate.

- a) Depress GATE.
- b) Select frequency with DIAL and MULTIPLIER.
- c) Adjust TRIG/GATE LEVEL, if required.
- d) Adjust START PHASE for desired setting.
- e) Apply external gate or depress manual TRIG/GATE.

#### 2.3.2.3 Triggered Mode

Single cycle output when externally or manually triggered.

- a) Depress TRIG.
- b) Select single cycle period with DIAL and MULTIPLIER.
- c) Adjust TRIG/GATE LEVEL.
- d) Adjust START PHASE for desired setting.
- e) Initiate with external or manual trigger.

#### 2.3.2.4 Tone Burst Mode

Repetitive tone-burst with variable rep-rate.

- a) Depress BURST.
- b) Set burst frequency with DIAL and MULTIPLIER.
- c) Set burst rate with sweep DURATION control (100 s-0.1 ms).
- d) Set on/off ratio of burst with TRIG/GATE LEVEL control (5% - 80% of burst period rate).
- e) Set base line with START PHASE control.

#### 2.3.2.5 PULSE Mode

Repetitive pulse or single-cycle output, with variable rep-rate and width.

- a) Depress PULSE.
- b) Adjust rep-rate with sweep DURATION control (0.01 Hz-10 kHz).
- c) Adjust pulse width with DIAL and MULTIPLIER (100 s-16 ns).
- d) Set base line with START PHASE control.

#### 2.3.2.6 Continuous Sweep Mode

Continuous frequency sweep, up or down, linear or log.

- a) Depress CONT SWP.
- b) Select LIN or LOG.
- c) Set sweep frequency limits with sweep START and STOP controls and frequency MULTIPLIER.
- d) Set sweep time with sweep RANGE and DURATION controls.

#### 2.3.2.7 Triggered Sweep Mode

Output holds at START frequency, single sweeps when externally or manually triggered, then resets to start frequency.

- a) Depress TRIG SWP.
- b) Select LIN or LOG.
- c) Set sweep frequency limits with sweep START and STOP controls, and frequency MULTIPLIER.
- d) Set sweep time with sweep RANGE and DURATION controls.
- e) Adjust TRIG/GATE LEVEL.
- f) Initiate with external or manual trigger.

#### 2.3.2.8 Triggered Sweep Burst Mode

Single swept burst when externally or manually triggered.

- a) Depress TRIG SWP BURST.
- b) Select LIN or LOG.
- c) Set sweep frequency limits with sweep START and STOP controls and frequency MULTIPLIER.
- d) Set sweep time with sweep DURATION control.
- e) Adjust TRIG/GATE LEVEL.
- f) Set baseline with START PHASE control.
- g) Initiate with external or manual trigger.

#### 2.3.3 FREQUENCY PAUSE-MARKER

An exclusive feature of the Model 2200 is the Frequency Pause-Marker. This feature allows the user to selectively pause during each up-frequency sweep, in the CONT SWP, TRIG SWP or TRIG SWP BURST mode, for any period from 0.1 ms to infinity. The PAUSE-MARKER also produces a visible marker or intensification at the pause if the swept output is viewed on an oscilloscope and the RAMP OUT used to drive the scope horizontal axis.



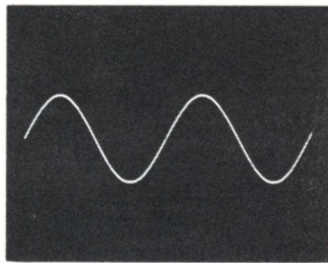

(a) Continuous

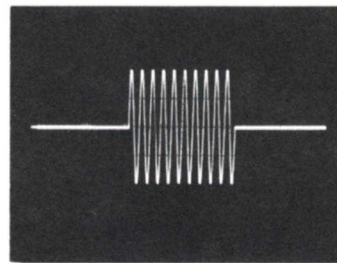

(b) Gate

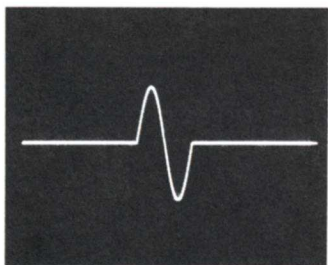

(c) Triggered

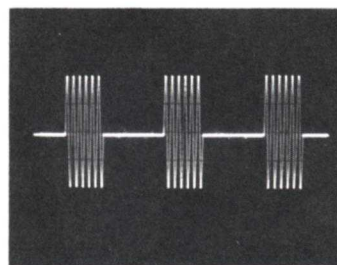

(d) Tone Burst

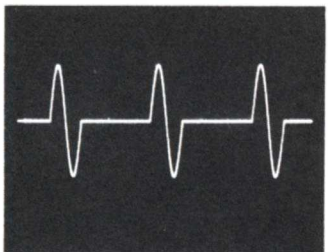

(e) Pulse

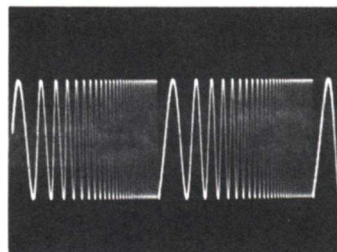

(f) Continuous Sweep

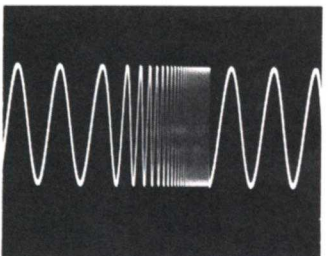

(g) Triggered Sweep

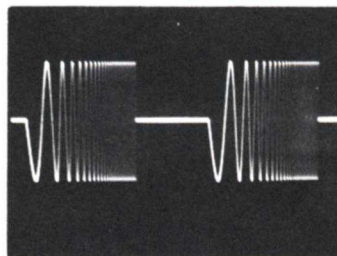

(h) Triggered Sweep Burst

Figure 4. Main Output Mode Waveforms

To use the PAUSE-MARKER, first select the frequency sweep START and STOP points, and adjust the SWEEP DURATION to the desired rate. Switch the PAUSE to ON; connect the swept output of the circuit being tested to the scope vertical input. Connect the RAMP OUTPUT to the scope horizontal input. The RAMP is used to control the horizontal sweep.

When the PAUSE switch is "ON", the pause will be visible at the RAMP OUT and LOG OUTPUT connectors, in all modes.

The frequency of the pause is controlled by the FREQUENCY Hz/MARKER dial. The duration of the pause is controlled by a 3-position MARK RANGE selector, that provides pause ranges of 100 s-1 s, 1 s-10 ms, and 10 ms-0.1 ms. The MARK DURATION control provides a variable adjustment of each MARK RANGE position. When the MARK DURATION is set to its maximum CCW position, the pause period will be infinite, for any MARK RANGE position.

The MARK GATE OUT is a TTL compatible pulse that goes "high" when the sweep (ramp) pauses, and remains high for the duration of the pause, as set by the MARK DURATION control.

The pause-marker may also be initiated by a TTL pulse applied to the rear panel MARKER TRIG INPUT. When a connection is made to this input it automatically disengages the FREQUENCY Hz/MARKER dial. The start of the pause-marker is triggered by the falling edge of the external pulse.

Figure 5 shows a typical set-up using the PAUSE-MARKER.

#### 2.3.4 SYMMETRY (neg duration) Control

The SYMMETRY control of the 2200 controls the negative squarewave duration (re-rate) and positive sinewave or triangle slope, independent of the positive duration (width) and negative slope, respectively, which are controlled by the FREQUENCY Hz/MARKER dial and MULTIPLIER. The symmetry ratio is adjustable to 100:1 on each MULTIPLIER range.

The SYMMETRY control is functional in all modes. Note: In the PULSE mode of operation, the negative duration of the squarewave is controlled by the SWEEP DURATION. The SYMMETRY control will set a minimum negative duration; the SWEEP DURATION control will have no effect below this minimum setting.

#### 2.3.5 DC Offsets

The Model 2200 provides a selection of fixed offset, variable offset or both. A 3-position slide switch selects fixed positive, zero, or fixed negative offset. In the FIXED OFFSET mode, the amplitude of the waveform is halved and the negative peak of the waveform is set at zero for positive offset; the positive peak is set for zero with negative offset.

The VARIABLE offset control is a pull-on potentiometer that varies the output DC level  $\pm 15V$ . The maximum combined AC plus DC should not exceed  $\pm 15V$  peak, otherwise clipping of the waveform will occur. When both the FIXED and VARIABLE offset controls are used the waveform amplitude will be halved, and its positive or negative peak may be set between zero and  $\pm 15$  volts with the VARIABLE offset control. A particular application for this would be to generate ECL or TTL compatible pulses.



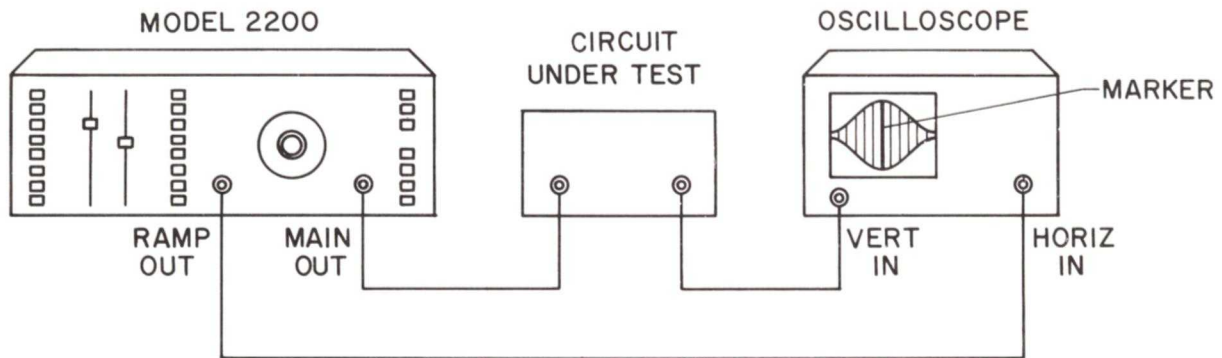

2200:

- 1) PAUSE "ON"
- 2) Sweep Mode
- 3) Sweep Limits set with START and STOP slide control
- 4) Mark duration controls vary Marker intensity
- 5) Frequency dial varies Marker position

Oscilloscope:

- 1) Time base set for External Sweep Input, DC Coupled.

Figure 5. Test Set-Up for Frequency Pause-Marker

### 2.3.6 Ramp Generator Output

The internal Ramp Generator may be used independent of the Main Generator in the CONT, TRIG or GATE modes of operation. Both the linear and exponential ramps are made available. The linear ramp is a fixed, 3 volt ramp available at the front panel RAMP OUT connector. The exponential ramp is available at the rear panel LOG OUTPUT connector. The beginning and ending voltages of the exponential ramp are controlled by the sweep START and STOP controls. For a positive going exponential ramp (0V to +3V) the sweep START control is set to its low frequency end. For a negative-going ramp (+3V to 0V) the STOP control is set to its low end while the START control is set to its high end.

Both the linear and exponential ramps are coincident in frequency, their duration being controlled by the SWEEP DURATION and SWEEP RANGE controls.

If the PAUSE-MARKER feature is used, both the linear and log ramps will pause at the frequency of the FREQUENCY Hz/MARKER dial, for a pause period determined by the MARK DURATION and MARK RANGE controls. The RAMP OUT is normally used to drive the scope horizontal axis when the PAUSE-MARKER feature is used with the CONT SWP, TRIG SWP or TRIG SWP BURST modes. (Applies to up-sweeping ramps, only).

The Ramp Generator will also produce multiple pauses or a staircase ramp by applying a series of TTL pulses to the MARKER TRIG input. The number of pulses occurring during each RAMP duration will determine the number of steps to the staircase, provided the pause duration is shorter than the pulse rep-rate. The MARK DURATION and MARK RANGE will determine the length of the pause (tread). Each pause of the ramp will be initiated on the falling edge of each TTL pulse applied to the MARK TRIG input. If the generator is operated in the TRIG SWP or

TRIG SWP BURST modes, and the pulses applied to the MARKER TRIG INPUT are also applied to the TRIG/GATE IN, the staircase ramp will then synchronize to the TTL pulses at the MARKER TRIG INPUT. The rising edge of the first pulse into the TRIG/GATE IN will trigger the Ramp; the first pause will then always occur one TTL pulse period later.



## SECTION 3

### INCOMING INSPECTION AND CHECKOUT

#### 3.1 INTRODUCTION



The following procedure should be used to verify that the generator is operating within specifications, both for incoming inspection and for routine servicing. Tests should be made with all covers in place, and the procedure given below should be followed in sequence. Familiarize yourself with the initial set-up and operating procedures outlined in Section 2, Operation.

#### 3.2 EQUIPMENT REQUIRED

Refer to the Appendix on page 51.

#### 3.3 PROCEDURE

After allowing the instrument to warm up for at least 30 minutes, set the controls initially to the following positions:

FREQUENCY Hz/MARKER	30
MULTIPLIER	X100
WAVEFORM	
AMPLITUDE	Attenuator set for 0 dB, PEAK VOLTS control Max CW.
MODE	CONT
FIXED DC OFFSET	 (Off)
VARIABLE DC OFFSET	Off
SYMMETRY	Off
CHASSIS/FLOATING	Chassis

#### CAUTION!

The covers of this instrument should not be removed when the instrument is connected to an AC power source, because of the potentially dangerous voltages that exist within the unit.

### 3.3.1 Waveforms

Connect the oscilloscope to the generator's MAIN OUT. Operate the WAVEFORM switch in each of its positions; the waveforms should be undistorted and at least 30 volts peak to peak.

### 3.3.2 Amplitude Controls

Vary the PEAK VOLTS control from maximum to minimum; the waveform amplitude should diminish by more than 30 dB. Return the PEAK VOLTS control to its Maximum CW position. Check the operation of the attenuator in each of its positions; the waveform amplitude should diminish in 20 dB steps. The ACVM may be used to further verify the accuracy of the attenuator ( $\pm 0.1$  dB). Return the attenuator to the 0 dB position.

### 3.3.3 DC Offsets

Turn the PEAK VOLTS control down to its minimum position. Pull the VARIABLE OFFSET control "ON"; you should be able to vary the main output DC level by  $\pm 15$  volts. Return the VARIABLE OFFSET control to "OFF".

Turn the PEAK VOLTS control up to maximum and set the FIXED OFFSET control to the  $\sqcup$  (+) position; the output waveform's amplitude should be reduced to one-half its p-p value, and its negative peak should start at zero volts. Repeat this for the  $\sqcap$  (-) position of the FIXED OFFSET control; the waveform amplitude should be reduced to one-half, while its positive peak should be set for zero volts. Return the FIXED OFFSET control to the  $\square$  (off) position.

### 3.3.4 Symmetry Control

Set the WAVEFORM switch to  $\square$ ; pull the SYMMETRY control ON; you should be able to adjust the output squarewave negative duration with respect to the positive duration by a ratio of 100:1. Return the SYMMETRY control to the "OFF" position.

### 3.3.5 Frequency Controls and Accuracy

Connect the frequency counter to the MAIN OUT (WAVEFORM switch on  $\square$ ) and check the accuracy of the frequency dial in each position of the MULTIPLIER. Frequency accuracy is specified as 2% of full scale on bands 1-7 (X, 1-X100K) and 3.5% on band 8 (X1M).

### 3.3.6 External Voltage Control (VC)

Connect the DC source to the VC input. Vary the DC source and observe the change in the generator's frequency.

Disconnect the DC voltage source from the VC input.

### 3.3.7 CV (Control Voltage) Output

The CV output is a DC voltage proportional to the generator frequency. Connect the DCVM to the CV output and check to see that its value is within 1% of the frequency reading observed on the frequency counter (1 to 30 on the dial, bands 1-7 only). Disconnect the frequency counter and DCVM.



### 3.3.8 Frequency Response

The frequency response specifications apply to sinewave and triangle output, only.

Connect the ACVM to the generator's main output. Set the WAVEFORM switch  $\sim$ . Vary the generator frequency up to 300 kHz; the variations in output amplitude should be less than 0.1 dB (approximately 1%). Increase the generator to 3 MHz; variations in amplitude should be less than 0.2 dB. Repeat this with the WAVEFORM switch in the  $\wedge$  mode; variations in the triangle amplitude should be less than 0.1 dB to 300 kHz, and less than 1 dB to 3 MHz.

For frequencies between 3-30 MHz, the response of the generator may be checked with the oscilloscope. Set the generator initially to 30 kHz (30 x 10k) and adjust the scope vertical gain for a reference display. Switch to the x1M multiplier position; and tune the generator frequency from 3 MHz-30 MHz; peak to peak variations should be less than 1 dB for the sinewave, and less than 3.5 dB for the triangle wave.

### 3.3.9 Sinewave Distortion

Connect the distortion analyzer to the generator's MAIN OUT. Set the WAVEFORM switch to  $\sim$ . Check the distortion of the output sinewave at various frequencies. Distortion should be less than 0.5%, from 0.1 Hz to 300 kHz.

The use of a wave or spectrum analyzer may prove more feasible for higher frequency distortion measurements. Total harmonic distortion between 300 kHz-3 MHz should be less than 2% of the fundamental. At generator frequencies above 3 MHz, all harmonics should be down by at least -22 dB. Disconnect the analyzer from the main output.

### 3.3.10 TTL Output

Connect the oscilloscope to the TTL output, and set the generator frequency to between 1-10 kHz. Check to see that the waveform amplitude is at least zero to +3V peak.

### 3.3.11 Sweep Ramp Duration and Manual Hold

Connect the oscilloscope to the RAMP OUT connector and check for a 3 volt peak, linear ramp.

The Ramp duration may be measured by using either the oscilloscope or a frequency counter set for period operation. Vary the SWEEP DURATION control in each position of the SWEEP RANGE switch; the Ramp duration should cover the ranges indicated; some overrange is normal.

Set the SWEEP DURATION to a slow period (approximately 1s) and observe the RAMP OUT on the oscilloscope. Switch the manual HOLD switch to the HOLD mode; the ramp voltage should hold at a DC level. Return the HOLD switch to the RUN mode, the ramp will resume its positive excursion.

### 3.3.12 GATE Mode

Set the TRIG/GATE LEVEL to its maximum CW (+) position. Set the mode switch to GATE; the generator should produce a continuous output as long as the MANUAL TRIG/GATE button is depressed. Note: Generator may free run unless TRIG/GATE level is set near (+), and START PHASE near (0).

### 3.3.13 TRIG Mode

Set the MODE switch to TRIG, and the FREQUENCY Hz/MARKER dial and MULTIPLIER to  $10 \times 100$ . The generator should produce one cycle of dial frequency or one pulse of one-half the dial period each time the MANUAL TRIG/GATE button is depressed. Set the MULTIPLIER switch to X100 and feed a  $10 \text{ Hz} \pm 5\text{V}$  p-p square wave into the TRIG/GATE IN. The Generator should produce one cycle of dial frequency at a 10 Hz rep-rate. Disconnect the external trigger source.

### 3.3.14 BURST Mode

Set the MODE switch to BURST. The burst frequency is controlled by the FREQUENCY Hz/MARKER dial and MULTIPLIER. The burst duration and rep-rate are controlled by the TRIG/GATE LEVEL and SWEEP DURATION controls, respectively.

### 3.3.15 PULSE Mode

Set the MODE switch to PULSE. You should be able to vary the pulse width and rep-rate by the FREQUENCY dial and SWEEP DURATION controls, respectively.

### 3.3.16 CONT SWP Mode

Set the mode switch to CONT SWP. The output frequency should sweep between the limits set by the sweep START and STOP controls, at a rate set by SWEEP DURATION controls.

### 3.3.17 TRIG SWP Mode

Set the MODE switch to TRIG SWP. The generator should be holding at the START frequency setting. Depress the MANUAL TRIG/GATE button; the generator should produce a single sweep to the STOP frequency setting, at a rate controlled by the SWEEP DURATION control, then should reset to the START frequency setting.

### 3.3.18 TRIG SWP BURST Mode

Set the MODE switch to TRIG SWP BURST. Depress the MANUAL TRIG/GATE button; the generator should produce a single swept burst between the START and STOP frequency settings, at a rate controlled by the SWEEP DURATION controls.

### 3.3.19 START PHASE Control

Set the MODE switch to PULSE and the WAVEFORM switch to  $\sim$ . Adjust the SWEEP DURATION control to obtain one or two single cycles on the oscilloscope. Vary the START PHASE control from max CCW to max CW; the start of the sine-wave should vary from approximately  $-90^\circ$  to approximately  $+90^\circ$ .

NOTE: In PULSE or BURST modes, Generator may free-run if the START PHASE is set for greater than  $+90^\circ$ .

### 3.3.20 Frequency Pause-Marker and MARK GATE OUT

The FREQUENCY PAUSE-MARKER is functional in all modes, but only during an up-frequency sweep. To check the PAUSE feature, set the MODE switch to any MODE except TRIG SWP and TRIG SWP BURST and set the START and STOP frequency controls to 0.3 and 30 respectively, on the linear scale. Set the FREQUENCY Hz MARKER dial and MULTIPLIER TO  $10 \times 1\text{K}$ .

Connect the RAMP OUT to the oscilloscope. Set the SWEEP RANGE control to 1 s-10 ms SWEEP DURATION to max CW. Set the MARK RANGE control to the 10 ms-0.1 ms position and switch the PAUSE switch to ON.

Observe the ramp voltage on the oscilloscope. Check that the duration of the ramp pause can be varied by the MARK DURATION control. Rotate the MARK DURATION control to its CCW position. Rotate the FREQUENCY Hz/MARKER dial; you should be able to vary the level of the pause over the Ramp duration.

Connect the MARK GATE OUT to the alternate input channel of the oscilloscope. The MARK GATE OUT should produce a TTL compatible pulse whose width is coincident with the MARK DURATION setting.

### 3.3.21 Marker Trig Input

The MARKER TRIG INPUT provides an external control of the start of the pause-marker. Any connection made to this input disables the FREQUENCY Hz/MARKER dial control. The start of the pause will be triggered by the falling edge of a TTL pulse.

### 3.3.22 PEN LIFT Output

The PEN LIFT output is a TTL compatible pulse that goes "high" (approximately +4V) during a frequency sweep or pause. The output may be checked with the oscilloscope or a DC voltmeter. Set the MODE switch to TRIG SWP; the PEN LIFT output should be "low" (approximately zero volts). Depress the MANUAL TRIG/GATE button; the PEN LIFT output should go "high" during the duration of the sweep.

### 3.3.23 LOG Output

Connect the oscilloscope to the LOG output connector. The LOG OUTPUT is an exponential ramp voltage, frequency coincident with the RAMP OUT and with its beginning and ending voltages adjusted by the SWEEP START and STOP controls.



## SECTION 4

### CIRCUIT DESCRIPTION

#### 4.1 SYSTEM OPERATION

A simplified block diagram of the Model 2200 is shown in Figure 6.

The Model 2200 consists of a main generator, a sweep ramp generator, a trigger/gate circuit and a pause-marker circuit. The main generator performs a voltage to frequency conversion, and generates the main output sine, square and triangle waveforms. The oscillating loop within the main generator consists of the integrating capacitor, triangle buffer, hysteresis flip-flop and current switch. To describe a cycle of the loop, first assume the current switch to be off. The current from the negative current source through Q214 charges the integrating capacitor in the negative direction and produces a negative going slope on the output of the triangle buffer. When the amplitude reaches -1.5 volts it triggers the hysteresis flip-flop, which then turns on the current switch. A current from the positive current source is now fed to the integrating capacitor via Q211, charging the capacitor in the positive direction and producing the positive going slope on the output of the triangle buffer. When the amplitude reaches +1.5 volts it again triggers the hysteresis flip-flop which turns off the current switch, shutting off the current from the positive current source and allowing the negative current to charge the integrating capacitor in the negative direction again. This cycle will continue at a rate determined by the value of the charging currents from the positive and negative current sources and the value of the integrating capacitor. The current generated by the positive and negative current sources are determined by the values of R, 2R and the outputs of the VC amplifiers. Since only the positive current is switched to the capacitor every half cycle, its value must be twice that of the negative current, hence the R:2R relationship. R and 2R are switched in decade steps by the MULTIPLIER, S101.

The VC amplifiers are driven by a frequency control voltage from the main tuning dial, in the CONT, TRIG, GATE, BURST, and PULSE modes; in the CONT SWP, TRIG SWP and TRIG SWP BURST modes, this control voltage is provided by the sweep ramp generator. The triangle and square waveforms are produced by the oscillating loop. The hysteresis flip-flop drives the square wave generator to produce both the TTL output and a square wave suitable for driving the waveform buffer amplifier. The signal developed in the output of the triangle buffer is fed directly to the WAVEFORM switch, and is also used as the input to the sine shaper and hysteresis flip-flop.

The triangle signal is processed by the sine shaper into a piecewise, linear approximation sinewave, with typically 0.25% distortion. The sine buffer provides a suitable drive signal for the waveform buffer amplifier.

The selected output waveform is fed to a unity gain buffer which drives the amplitude (PEAK VOLTS) control. The FIXED OFFSET operates by halving the amplitude of the input waveform, and adding in a DC offset. The amplitude and variable offset controls feed the output amplifier. The output amplifier provides a 30V p-p source to drive the generator's 50 ohm output attenuator.

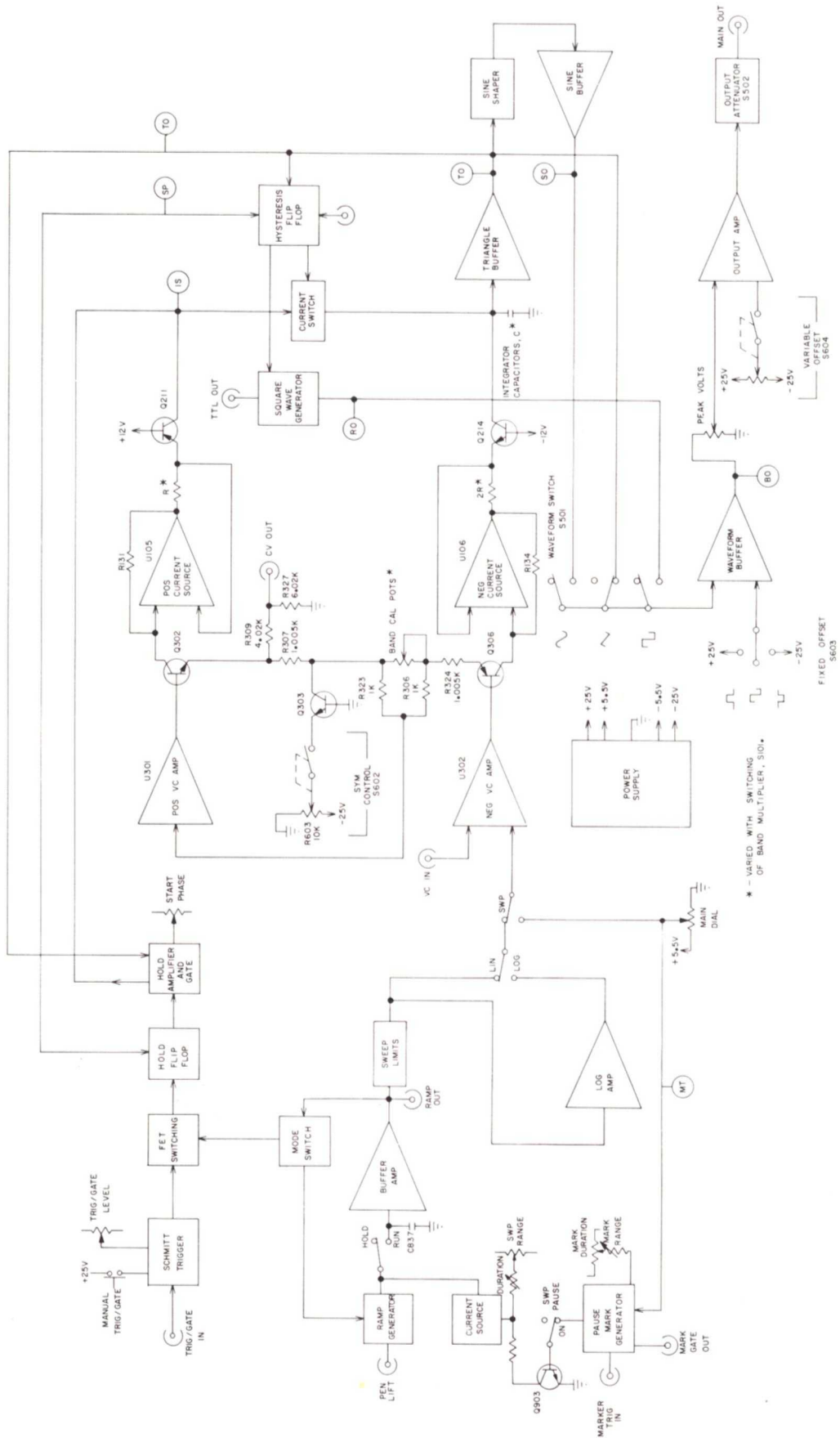

Figure 6. Simplified Block Diagram



The sweep ramp generator is independent of the main generator frequency. It consists of an integrating capacitor, C837, with a buffer stage, a variable current source, a current discharge switch and a sense amplifier. The sweep ramp operates similar to the main generator hysteresis flip-flop, current switch and integrating capacitor. The output of the ramp generator is a 5 volt, fixed linear ramp. The ramp provides a continuous output in all modes except TRIG SWP and TRIG SWP BURST; in these two modes, the ramp is triggered by the trigger/gate circuit.

This ramp is processed through a sweep limit control circuit which produces a ramp with independently variable minimum and maximum levels. These levels correspond to the START and STOP frequency sweep limits. The output of the sweep limit control circuit is tied to one contact of the SWEEP SELECT switch and also to the input of a log amplifier, producing a simultaneous logarithmic or exponential ramp with the same variable minimum and maximum levels. The log ramp is tied to the other contact of the SWEEP SELECT switch.

The linear or log ramp drives the main generator VC amplifiers in the CONT SWP, TRIG SWP and TRIG SWP BURST modes. In the PULSE and BURST modes the ramp output is tied to the trigger/gate circuit through the MODE switch and provides a repetitive gate or trigger signal for controlling the burst on-time and pulse re-rate, respectively.

The trigger/gate circuit consists of a Schmitt trigger, a hold flip-flop, and a hold amplifier and gate. A FET switching network controlled by the MODE switch determines the correct reset signal for the flip-flop in each mode of operation. The circuit effectively turns the main generator on and off in the TRIG, GATE, BURST and PULSE modes by controlling the +I current applied to the main generator integrating capacitor. In the TRIG SWP and TRIG SWP BURST modes, the Schmitt Trigger provides the trigger for the Sweep Ramp circuit.

The pause-mark circuit produces the PAUSE feature offered by the 2200. The circuit consists of a buffer amplifier, a sense amplifier and a 555 timer. The circuit acts to stop and hold the sweep ramp output voltage during an up-frequency sweep (if the PAUSE switch is on), for a period determined by the timer, whose timing resistors are selected by the MARK DURATION controls.

#### 4.2 POWER SUPPLY

The +25 volt supply consists of an IC amplifier first stage (U101) and second stage (Q102) driving the pass transistor (Q101). The reference voltage is provided by CR107 and applied to pin 3 of U101. The +25 volts is fed to pin 2 of U101 through the voltage divider R107, R108 and R109, with R107 being the +25 volt adjustment. For improved high frequency performance, C104 bypasses the amplifier stage and drives the emitter of the second stage. If the supply is shorted, the amplifier and second stage are shut off, turning off the pass transistor resulting in current being supplied only by the shunt resistor, R101.

The -25 volt supply is identical to the +25 volt supply except for polarity and the use of the +25 volts as its reference through summing resistors R119 and R121. This makes the -25 volts slave to the +25 volts and any deviation in the +25 volts will create a similar deviation in the -25 volts.

To prevent a condition where the -25 volts does not come on during turn on, R110, CR106 and CR107 have been added to prevent the +25 volts from reaching full voltage before the -25 volts starts on.



The +5.5 volts and -5.5 volts each consist of an IC amplifier driving a series pass transistor, (Q106, Q107). Diodes from the base of the series transistors to current-sensing emitter resistors provide current limiting. The +5.5 volts uses the +25 volts as a reference through divider R124 and R125. The -5.5 volts uses the -25 volts as a reference through R128 and R129.

#### 4.3 VC AMPLIFIERS

The -VC Amplifiers are inverting buffer amplifiers that supply the current sources with a current proportional to the main frequency dial, ext VC input, SYMMETRY control and sweep ramp voltage.

The -VC Amplifier is a unity gain inverting amplifier consisting of U302 driving a Darlington emitter follower, Q305 and Q306. The input to the -VC Amplifier is from the main tuning pot, the EXT VC, or the sweep ramp generator. The main tuning dial center arm varies from 0 to +5 volts, and the EXT VC operates from 0 to +3 volts. The output from the -VC Amplifier, taken from the emitter of Q306, is fed to the +VC Amplifier, a second unity gain, inverting amplifier consisting of U301 driving a Darlington emitter follower Q301 and Q302. The voltages at the output of the -VC and +VC Amplifiers vary from 0 to 5 volts, depending on the input, and are of opposite polarity to each other. The resistance between the output of the +VC and -VC Amplifiers is adjusted by calibration pots switched in on each multiplier range. The current developed in the collectors of Q302 and Q306 control the positive and negative current sources and are proportional to the voltage applied to the input of the -VC Amplifier.

Q303 unbalances the positive and negative VC Amplifiers when the SYMMETRY control is engaged. Q304 switches in R314 to the center arm of the main tuning dial to improve calibration when the X1M band is used.

#### 4.4 CURRENT SOURCES

The positive and negative current sources provide a current to the integrating capacitor, proportional to the VC voltage and scaling resistor.

The negative current source consists of an inverting differential amplifier U106 with the feedback resistor, R134, also being the collector resistor of the -VC output follower. The reference input to U106 is determined by followers Q214 and Q215. The scaling resistor is inserted between the output of U106 and the emitter of Q214.

The inverting input is connected to the collector of the -VC output follower Q306, and must be equal to the reference input voltage; the feedback resistor R134 is also the collector resistor of Q306, and must have a current determined by the emitter resistor and emitter voltage of Q306. To satisfy both conditions, the output of the inverting amplifier must be at a voltage equal to the reference input voltage plus the VC voltage, if the feedback resistor is made equal to the emitter resistor, as is the case. This circuit arrangement forces the voltage across the scaling resistor to be equal to the VC voltage.

The positive current source is identical in operation with the exception of a follower added at the output of the amplifier to handle twice the current. When the SYMMETRY control is switched on, the positive current is cut in half to equal the negative current. This does not permit control by the dial during the positive slope. The SYMMETRY control affects the +VC voltage only. This results in independent control of the negative slope by the dial and positive slope by the SYMMETRY control.

#### 4.5 TRIANGLE BUFFER

The triangle buffer has a high input impedance to prevent loading of the integrating capacitor and provides a low output impedance for driving the sine shaper, hysteresis flip-flop, hold amplifier and gate and waveform buffer amplifier. The triangle buffer consists of a FET follower Q218, a unity gain amplifier U202 and an output emitter follower Q223. At high frequencies additional signal is fed to the hysteresis flip-flop from the emitter follower Q219, through capacitor C222. The integrating capacitors are switched into the circuit by FET's and the multiplier switch.

In the 0.1 to 1K multiplier positions C123 and C122 are switched in by Q220 and Q222 through the multiplier switch. C226 is the integrating capacitor for the 10K multiplier position and is connected in all positions except the 100K and 1M multiplier positions. C218 is the integrating capacitor for the 100K and 1M position and remains in the circuit in all positions. In the 100K and 1M position C218 is the only integrating capacitor left in the circuit by turning off FET's Q220, Q222, and turning on FET's Q227 and Q221.

#### 4.6 HYSTERESIS FLIP-FLOP AND CURRENT SWITCH

The purpose of the hysteresis flip-flop is to develop the square wave and control the current to the integrator capacitors by driving the current switch.

The hysteresis flip-flop consists of a sense amplifier, transistor array U201, transistor Q208 and a differential switch Q206, Q207. The current switch consists of a differential switch Q209, Q210.

The triangle output is fed to one input of the sense amplifier. When this input reaches the level of the reference input the sense amplifier changes level or flips, driving Q208 and the differential switch Q206, Q207. The new state developed at the collector of Q206 resents the reference input of the sense amplifier. The sense amplifier also drives the differential current switch Q209, Q210, reversing the current flow to the integrating capacitor, and the direction of the triangle output. The collector of Q208 provides a stop pulse to the trigger/gate hold flip-flop.

#### 4.7 SQUARE WAVE GENERATOR

The square wave generator develops the square wave drive to the Waveform Buffer Amplifier and the TTL output.

It consists of a differential current mode switch Q202, Q203 and a common base amplifier Q201.

The output from the collector of Q207 of the hysteresis flip-flop drives the differential current mode switch Q202, Q203. The output at the collector of Q202 feeds the Waveform Buffer Amplifier while the collector of Q203 drives the emitter of the common base amplifier Q201. The TTL output is taken from the collector of Q201. The amplitude of the square wave is adjusted with R211 and the DC level is adjusted with R202.

#### 4.8 SINE SHAPER

The sine shaper is used to shape the triangle from the integrator into a sine wave.



The sine shaper consists of five segments, each segment containing a differential amplifier and a current source. The current from the current source is less than required for linear operation of the amplifier over the entire voltage swing, therefore, the amplifier limits at the level determined by the current source.

Each of the five segments is connected in parallel and have their current limited at different predetermined levels. The slope of each segment is determined by the emitter resistors of each differential amplifier. The input DC level and amplitude are optimized for lowest distortion with R401 and R404. One of the transistors in U401 is used for temperature compensation. R407 sets the sine wave output amplitude.

#### 4.9 SINE BUFFER

The sine buffer is an amplifier used to provide the required drive signal at zero DC level from the sine shaper to the waveform buffer amplifier. The sine buffer consists of a differential amplifier, Q405 and Q406 driving an emitter follower Q407. Feedback from the output through R447 sets the gain at approximately 1.25 and R444 adjusts the output DC level to zero. C409 is adjusted for optimum high frequency response.

#### 4.10 WAVEFORM BUFFER AMPLIFIER

The Waveform Buffer Amplifier isolates the WAVEFORM selector switch from the output amplifier and provides the source for the FIXED DC offset control. It consists of a differential amplifier transistor array U105, emitter follower and an associated offset control switching network. The selected waveform is fed to the input of the differential amplifier. The output drives the emitter follower Q505 through Q504 (used as a zener diode). The output of the emitter follower provides the waveform to the amplitude PEAK VOLTS Control. The FIXED DC OFFSET Control (S603) switches FETs Q501 and Q502 to halve the input amplitude to U501 when offset is selected. In addition it provides positive or negative voltage pulling of the feedback input of U501 setting the waveform above or below zero.

#### 4.11 OUTPUT AMPLIFIER

The Output Amplifier is a wide band amplifier with a gain of 10 and is designed to provide 30 volts peak to peak into the output attenuator.

The Output Amplifier consists of a differential first stage, transistor array U502, a complementary second stage, Q506, Q508, Q509, Q512 with Q507, Q510, Q511, Q513 as a current source for this stage, and a complementary push-pull emitter follower output Q514, Q515, Q516, Q517.

The input to the first stage is to pin 2 of U503. The output of the first stage is fed differentially from pins 1 and 14 to the second stage. At higher frequencies, pin 1 is bypassed to ground and the drive to the second stage is coupled to the current source. This allows the second stage and its current source to operate push-pull, doubling its drive capabilities. The output of the second stage feeds the emitter follower output stage which drive the broadband 50 ohm output attenuator. The VARIABLE DC OFFSET Control, R606, is connected to the feedback input of the first stage, pin 13.



#### 4.12 SWEEP RAMP GENERATOR

The sweep ramp generator produces a zero to +5V linear ramp. The ramp drives the main generator VC circuit, via the sweep limit controls, in all sweep modes. The circuit consists of a sense amplifier, Q802-Q803, Q806-Q807 and Q808, transistor switch Q820, current discharge switch Q831, variable current source U830 and Q830, integrating capacitor C837 and buffers Q837-Q838.

The output of the ramp generator is from the emitter of Q838. The ramp is fed back to the input of the sense amplifier (base of Q802) via R815.

To describe a cycle of the loop, assume the ramp voltage is at zero, and the discharge switch Q831 is off. Negative current from R811 and CR806 pulls the base of Q802, shutting off Q802 and turning on Q803. Q803 pulls the emitter of Q807 down, which in turn holds Q808 off. When Q808 is off, Q820 will also be off. When Q820 is off, the base of Q831 will be pulled negative, holding Q831 off, allowing the current source to charge capacitor C837.

When the ramp voltage is initially zero volts, the base of Q802 will be approximately -4 volts. As the ramp voltage increases, positive current will be supplied to Q802, via R815, forcing the base of Q802 towards zero. When the ramp voltage reaches +5 volts, the net current supplied by R811 and R815 will be zero; with zero volts on its base, Q802 will turn on, shutting off Q803. The emitter of Q807 will go positive, turning on Q808, and reverse biasing CR806, shutting off the negative current through R811. At the same time Q820 will be turned on which will turn on Q831.

The capacitor will discharge its current through Q831. The ramp will collapse to zero, effectively shutting off the positive current through R815. When the ramp voltage reaches zero volts (retrace) the sense amplifier will again switch; Q802 will turn off, turning on Q803, pulling the emitter of Q807 down. Q808 and Q820 will turn off.

With Q808 off, the base of Q802 will again be pulled by the negative current through CR806 and R811. With Q820 turned off, Q831 will turn off, allowing the capacitor to recharge, thereby completing the cycle.

The ramp generator runs continuously in all modes except triggered sweep and triggered sweep burst. In the TRIG SWP mode, the base of Q820 is pulled slightly more positive by the MODE switch. During the ramp retrace, Q820 will start to go off before Q808 can switch. A degenerative loop, consisting of the sense amp, Q820 and Q831 will be formed and will hold the ramp voltage low until the ramp is triggered. When an external or manual trigger is applied to the Generator, a trigger pulse from the trig/gate circuit is directed to the base of Q802 via CR801 and CR804-CR805. This pulse will momentarily turn off Q802, allowing Q808 to turn off, and producing one ramp cycle before the loop again locks.

In the TRIG SWP BURST mode, the base of Q820 is pulled negative. When the ramp voltage reaches +5 volts, Q802 will turn on and Q803 will turn off, driving the emitter of Q807 positive. Q820 will start to go on before Q808 can switch; the feedback loop consisting of Q820, Q831 and the sense amp will hold the ramp voltage at +5 volts. When the Generator is externally or manually triggered, the trigger pulse from the trig/gate circuit is directed to the base of Q803, turning Q803 off and Q808 on, allowing one ramp cycle to be produced.

In the TRIG SWP BURST mode, the main generator must be gated on and off. A differential amplifier (Q825-Q826) driven from the collector of Q820 develops a gate control signal for the hold flip-flop in the trigger/gate circuit (Section 4.13). This signal also drives the LED (Limits Hz) and PEN LIFT driver stages.

Switch S906 provides a manual interrupt of the ramp voltage; in the HOLD mode, the current path to the integrating capacitor is opened, and the capacitor holds the ramp voltage level until the switch is returned to the RUN mode.

#### 4.13 TRIGGER/GATE CIRCUIT

The trigger/gate circuit turns the main generator on and off in the TRIG, GATE, BURST and PULSE modes. The circuit consists of a Schmitt trigger (Q705, Q711-Q713), FET switches (Q721 through Q724), a hold flip-flop (U735), and a hold amplifier and gate (U745, Q754). The operation of the circuit is as follows:

The hold amplifier and gate perform the actual on-off function. The amplifier consists of a differential transistor array, U745 connected as a differential amplifier with a current switch (gate) in series with the collector of one of the transistors. The output of the integrator drives the base of the collector-gated transistor, (Pin 2) while the base of the other transistor (Pin 10) is tied to the center arm of the START PHASE potentiometer. The potentiometer sets a reference voltage on Pin 10 between -1.5 volts and +1.5 volts which correspond to the negative and positive peaks, respectively, of the integrator output. When the current switch (gate) is turned on, (Pin 13) the +I current will be drawn off by the differential amplifier through the current switch. As the integrator output level approaches the reference level set by the START PHASE potentiometer, the amount of +I current to the integrating capacitor will be reduced until the voltages on Pins 2 and 10 of U745 are equal. At this point the differential amplifier will be in balance, and will lock and hold the integrator output. Under these conditions, the +I current will be reduced to one-half its value, resulting in a net current of zero to the integrating capacitor. With no further charging current, the capacitor will hold the output of the integrator at the reference level set by the START PHASE potentiometer. The level set by the START PHASE potentiometer coincides with the start/stop point of the integrator output, and varies from  $-90^{\circ}$  (-1.5V) to  $+90^{\circ}$  (+1.5V).

The hold amplifier gate (Pin 1, U745) is turned on and off by the hold flip-flop, which consists of transistor array U735. When the reset input (Pin 2) of the hold flip-flop is "low" the hold gate will be turned off, and the main generator will run.

The main generator provides a set pulse that occurs at the negative peak of the integrator output. The set pulse is applied to Pin 9 of U735. When the flip-flop is set the hold gate will be turned on, and the main generator will be held off.

The FET switching network Q721-Q724 is controlled by the MODE switch, and directs the proper reset signal to the hold flip-flop, for each mode of operation.

The Schmitt trigger (Q711-Q713) is triggered by an external level at the TRIG/GATE IN, by the MANUAL TRIG/GATE button, or by an output of the ramp generator. The Schmitt squares up its input waveform and feed the FET switching network. The level at which the Schmitt will trigger is determined by the TRIG/GATE LEVEL. The MANUAL TRIG/GATE contains a "debounce" reset circuit (Q705) that insures the reset of the Schmitt, regardless of the setting of the TRIG/GATE LEVEL.

In the CONT, CONT SWP and TRIG SWP modes, the reset input of the hold flip-flop is held low by a 1.5K resistor to -5.5V via FET Q724. This turns off the hold amplifier, allowing the generator to free run.

In the TRIG mode, an external or manual trigger fires the Schmitt circuit; FET Q723 feeds a derivative of the Schmitt output to the reset input of the hold flip-flop, which in turn shuts off the hold amplifier, allowing the main generator to free run.



At the next negative peak of the integrator, however, the set pulse sets the hold flip-flop, turning on the hold amplifier which locks and holds the integrator output.

In the GATE mode the output of the Schmitt is level shifted and direct coupled to the reset input via FET Q722. The reset input will remain low for the duration of the external or manual gate, allowing the main generator to run. When the external or manual gate is removed, the next set pulse to the hold flip-flop will turn on the hold amplifier.

In the PULSE mode, the Schmitt is triggered by the ramp generator; the TRIG/GATE LEVEL determines the point on the ramp at which the Schmitt fires. As in the TRIG mode, a derivative of the Schmitt output drives the hold flip-flop reset input, via FET Q723. The Schmitt is triggered once during each duration of the ramp.

In the BURST mode, the Schmitt is again triggered by the ramp; the output of the Schmitt is level shifted and direct coupled to the hold flip-flop reset input, via FET Q722. As in the GATE mode, the main generator will free run for the duration of the gate; in this case the gate on-time occurs between the level on the ramp at which the Schmitt is triggered, and the retrace of the ramp. Varying the TRIG/GATE LEVEL varies the BURST on-time.

In the TRIG SWP and TRIG SWP BURST modes, the Schmitt is triggered by a manual or external signal, and in turn triggers the ramp generator.

In the TRIG SWP mode, the hold flip-flop reset input is held "low" allowing the main generator to free run at the START frequency setting. When the Schmitt is triggered, it in turn triggers the ramp generator via the MODE switch (Test point TS) to produce a single sweep.

In the TRIG SWP BURST mode, the reset input of the flip-flop is held "high" by a gate signal from the ramp generator via FET Q721 shutting off the main generator. When the ramp is triggered by the Schmitt, this gate signal at the reset input goes "low", allowing the main generator to produce a single frequency sweep. At the end of the sweep, the gate pulls the rest "high" again shutting off the main generator.

#### 4.14 PAUSE-MARK GENERATOR

The pause-mark generator provides the control signal that momentarily stops and holds the sweep ramp output level during each sweep cycle, creating a "pause" in the frequency sweep. (Up sweep, only).

The circuit consists of: a buffer amp, U761, a sense amp, U765, Q765, a 555 timer, U755, a variable current source, U904, Q776 and a transistor switch, Q903. The circuit operates as follows:

The main tuning dial voltage determines the pause frequency. The dial voltage is first buffered by U761, then fed to the sense amp, which compares the dial voltage to the sweep ramp voltage. The output of the sense amp will remain high (approx. +3V) and the timer will be shut off as long as the dial voltage exceeds the ramp voltage. As the ramp voltage increases, it will approach the tuning dial voltage. When both voltages are equal the output of the sense amplifier will change state (approx. -0.4V), and turn on the timer. The timer's interval is determined by the time constant produced by integrating capacitor C776, and variable current source U904, Q776, S904 (MARK RANGE) and R907 (MARK DURATION). The current source charges C776, developing a ramp voltage across C776. When the ramp voltage reaches +4 volts, the timer will shut off.



The output of the timer (Pin 3, U775) is a TTL pulse that goes "high" for the duration of the ramp voltage across C776. This pulse drives a transistor switch Q903, when the PAUSE switch is "on". Q903 is tied into the current source of the sweep ramp generator. When Q903 is turned on by the timer; the current from the ramp generator current source will be rerouted through Q903; with no further current the ramp integrating capacitor C837 will hold its voltage at a level determined by the start of the TTL timing pulse. Since the ramp has been stopped and held, the frequency sweep will be stopped also. As mentioned earlier, the tuning dial determines the frequency of the pause.

When the timer shuts off, the ramp will resume sweeping from the point at which it was held.

The timer output is also tied directly to the MARK GATE OUT. The TTL pulse also drives transistor Q780, which in turn powers the LIMITS Hz LED indicators. The PEN LIFT drive is taken from the gate signal used to control the hold flip-flop in the TRIG SWP BURST mode and applied to Q790.

#### 4.15 SWEEP LIMIT CONTROLS

The sweep limit control provides the means for independently adjusting the minimum and maximum linear ramp voltages. The output of the sweep ramp generator is simultaneously fed to a unity gain inverting amplifier (U844) and a non-inverting follower amplifier (U843) with level shifting. U843 offsets the linear ramp from (zero to +5V) to (-5V to zero), and feeds the START FREQUENCY control, R915. U844 produces an inverted offset ramp from zero to -5V, and feeds the STOP FREQUENCY control R913. The ramp voltages on the center arms of R913 and R915 are fed to a summing amplifier U848; the output of U848 is a linear ramp with variable min and max voltage levels, determined by the respective ramp amplitudes on the center arms of R913 and R915.

Switch S907 switches tie point SV (input of the Main Generator VC Loop) between the output of the sweep limit control circuit (linear ramp) and the output of the log sweep ramp generator.

#### 4.16 LOG SWEEP RAMP GENERATOR

The log sweep ramp generator converts the +5V linear sweep ramp (Pin 6 U848) to a +5V exponential ramp. Inverting amplifier U853 scales down the linear ramp voltage; transistor Q858 provides temperature compensation. Transistor Q859, connected as a common base amplifier, converts its input voltage (base-emitter junction) to an exponential current. U860 converts the exponential current input from the collector of Q859 to an exponential voltage output from approximately zero to +5V. The minimum and maximum voltages of the exponential ramp (which correspond to the min and max frequencies) are adjusted by R860 and R855, respectively.

#### 4.17 OUTPUT PROTECTION CIRCUIT (OPTIONAL)

The optional output protection circuit when installed is designed to protect the generator's output amplifier stage from damage if an excessive voltage is accidentally applied to the generator's output terminals. The circuit will be activated if the external voltage exceeds  $\pm 15$  volts.

The circuit consists of a triac, Q521, transistor Q520 that drives the triac gate, and transistors Q518 and Q519 that act as current sensing elements.

The generator's output current determines the voltage drop across the output stage collector resistors, R567 and R576. When the IR drop across either R567 or R576 exceeds 5 volts, it will turn on Q518 or Q519, which will then turn on Q520. Q520 will, in turn, fire the triac; the triac clamps the generator's output to ground, preventing any excess current from the external source from flowing back into the generator's output stage. A fast blow fuse, F503 is inserted in series with the generator's output BNC to prevent the triac from exceeding its maximum continuous rating. The fuse will blow if the external source current exceeds the fuse rating.

## SECTION 5

# MAINTENANCE

### 5.1 INTRODUCTION

If the generator is not functioning properly and requires service, the following procedure may facilitate locating the source of trouble. Access to the interior of the generator is accomplished by removing the four screws centered at the rear of each cover. Sliding off the side covers will unlock the top and bottom covers.

#### WARNING!

This maintenance procedure should be performed by qualified personnel, only. If the covers must be removed during the troubleshooting procedure, it is strongly recommended that extra precautions be taken in working with exposed circuitry, and that insulated probes and/or tools be used.

SHUT THE POWER SWITCH OFF AND DISCONNECT  
THE LINE CORD FROM THE POWER SOURCE BE-  
FORE REPAIRING OR REPLACING COMPONENTS.

When a malfunction is detected, first check the line voltage and fuses, and then make an inspection for broken wires, burned or loose components, poor solder joints, or similar conditions which could cause trouble. Before troubleshooting, it should be determined if the normal adjustments mentioned in Section 6, Calibration, will correct the trouble. The troubleshooting of the generator will be greatly simplified if there is an understanding of the operation of the circuit. Reference should be made to Section 4, Circuit Description.

### 5.2 EQUIPMENT REQUIRED



Refer to the Appendix on page 51.

### 5.3 PRELIMINARY SET-UP

Before troubleshooting, set the controls to the following initial positions:

DURATION	Range 10 ms-0.1 ms, vernier Max Cw
MODE	CONT
PAUSE	Off



HOLD	RUN
MULTIPLIER	1K
FREQUENCY Hz/MARKER dial	15
SYMMETRY	Push-Off
VARIABLE DC OFFSET	Push-Off
FIXED DC OFFSET	
WAVEFORM	
AMPLITUDE	Attenuator, 0 dB Peak Volts, Max CW

The simplest way to locate a fault in the system is to first localize the fault to one of the generator's major sections listed below, and then to trace the signal through the particular section until the defective component or components are found. Table 5.1 lists several symptoms that may occur due to a fault; reference is then made to a specific paragraph. Once the fault is isolated the signal may be traced through the section, using the AC and DC reference voltages provided on the circuit schematics at the rear of this manual. Any great deviation from the normal voltages listed will help locate the fault.

A review of Section 4, Circuit Description will help simplify the understanding of the generator's major circuit sections, and the interfacing between sections, in each mode of operation.

The 2200 basically consists of the following major sections with reference to the mode(s) of operation in which the circuit is tied/switched in.

<u>Section</u>	<u>Associated Mode</u>
5.4 Power Supply	All
5.5 Main Generator	All
5.6 Sweep Ramp Generator	Burst, Pulse, Cont Swp, Trig Swp, Trig Swp Burst
Sweep Limit Control, Log Sweep Ramp Generator	Cont Swp, Trig Swp, Trig Swp Burst
5.7 Trigger/Gate Circuit	Trig, Gate, Burst, Pulse, Trig Swp Burst
5.8 Pause-Marker Circuit	Cont Swp, Trig Swp, Trig Swp Burst with PAUSE control on.

Malfunctions that would be limited to the Main Generator are, for example,

- 1) Inoperative or defective frequency dial tuning
- 2) Defective symmetry control
- 3) Defective fixed or variable DC offset control
- 4) Defective attenuator operation

In addition to the Troubleshooting Chart (Table 5. 1) a Logic Chart is provided which gives the gate voltages of the MODE switching FETS Q721-Q724 in each position of the MODE switch. The Logic Chart can be extremely useful in locating a problem when two or more MODES are inoperative; if Q721, Q722, Q723 or Q724 is defective, the Main Generator may not operate properly, even if the Main Generator circuit itself is OK. For example, if the Generator does not work in the GATE and BURST modes, Q722 may be at fault.

TABLE 5. 1. TROUBLESHOOTING CHART

<u>SYMPTOM</u>	<u>PROCEDURE</u>	<u>REFER TO SECTION #</u>	
1. No signal at MAIN OUT, in any MODE	1a. Is POWER indicator lamp on?		
	YES	NO →	go to step 1d
	↓		
	1b. Check for zero to ~3.5V signal at TTL OUT		
	NO	YES →	go to step 1l
	↓		
	1c. Check for ~5V signal at RAMP OUT		
	NO	YES →	go to step 1g
	↓		
	1d. Check for proper AC line voltage and correct setting of 120V/240V LINE switches		
	YES	NO →	2. 1
	↓		
	1e. With POWER switch off and line cord removed from AC source, check fuse receptacle. If fuse OK, go to step 1f. If blown or missing, replace with properly rated fuse. If fuse blows again, go directly to paragraph 5. 4.		



TABLE 5. 1. TROUBLESHOOTING CHART (Continued)

<u>SYMPTOM</u>	<u>PROCEDURE</u>	<u>REFER TO SECTION #</u>
	Replacing fuse corrects fault	
	NO                      YES →	—
	↓	
	1f. Check for correct regulated supply voltages of +25V and -25V.	
	YES                      NO →	5. 4
	↓	
	1g. Check for $\geq +6$ VDC at cathode of CR201 (point IS, PC590)	
	YES                      NO →	5. 7
	↓	
	1h. Check for $\sim 2.5$ V on center arm of FREQUENCY dial, R602 (point MT, PC590)	
	YES                      NO →	Check continuity between center arm of R602 and point MT.
	↓	
	1i. Check for $\sim +13.3$ V and $-13.3$ V at points +C (collectors of Q301-Q302) and -C (collectors of Q305-Q306), respectively. Also check for continuity between +C, PC590 and +C PC591, and between -C, PC590 and -C, PC591	
	YES                      NO →	5. 5. 1
	↓	

TABLE 5. 1. TROUBLESHOOTING CHART (Continued)

<u>SYMPTOM</u>	<u>PROCEDURE</u>	<u>REFER TO SECTION #</u>
	1j. Check for $\sim +16V$ and $-16V$ at emitter of Q108 and pin 6 of U106, respectively.	
	YES      NO → ↓	5. 5. 2
	1k. Check for $\sim \pm 1.5V$ p-p triangle at test point TO, PC590. Also check for continuity at respective point on PC592	
	NO      YES → ↓	go to step 1m
	1l. TO $\geq \pm 1.5VDC$ , and TI is of opposite polarity	
	YES → NO →	5. 5. 3 5. 5. 4
	1m. Check for $\sim \pm 1.5V$ p-p triangle at test point BO, PC592	
	YES      NO → ↓	5. 5. 6
	1n. Check for $+15V$ p-p triangle at junction of R571, R574 and R577-R578 (output of Output Amplifier)	
	YES      NO → ↓	5. 5. 7
	1o. Check continuity of Output Attenuator switch, S502. Check for defective protection circuit (if applicable) 5. 5. 8. Also check for a blown or missing fuse F503.	

TABLE 5. 1. TROUBLESHOOTING CHART (Continued)

<u>SYMPTOM</u>	<u>PROCEDURE</u>	<u>REFER TO SECTION #</u>
2. No sinewave at MAIN OUT	2a. Check for $\sim\pm 1.8V$ p-p sinewave at test point SO. Also, check continuity of SO PC590 to respective point on SO, PC592.	5. 5. 5
	<p style="text-align: center;">YES      NO → ↓</p>	
	2b. Check continuity of Waveform Selector, S501.	
3. No TTL OUT	3a. Check for $\sim\pm 1.6V$ p-p square wave at test point RO.	5. 5. 3
	<p style="text-align: center;">YES      NO → ↓</p> <p style="text-align: center;">Check Q201.</p>	
4. No output in GATE, TRIG, BURST and PULSE modes	4a. Set MODE switch to GATE position. Measure DC voltage on emitter of Q713 (Schmitt Trigger); should be +2V with MAN TRIG button depressed and +5V with MAN TRIG button released.	5. 7
5. No output in BURST and PULSE modes	5a. In BURST or PULSE mode, check for +5V ramp at point "ST" PC593: check continuity from "ST" PC593 to "ST" PC594 to "TG" PC594 to "TG" PC593.	
6. No frequency sweep in CONT SWP, TRIG SWP and TRIG SWP BURST modes.	6a. Check for zero to +3V ramp at RAMP OUT BNC.	5. 6 paragraph (1)
	<p style="text-align: center;">YES      NO → ↓</p>	



TABLE 5. 1. TROUBLESHOOTING CHART (Continued)

<u>SYMPTOM</u>	<u>PROCEDURE</u>	<u>REFER TO SECTION #</u>
	6b. Check for zero to +5V ramp at output of sweep Limit Controls (pin 6 of U848).	
	YES      NO →	5. 6 paragraph (2)
	↓	
	6c. With LIN/LOG switch in LIN position, check for zero to +5V ramp at "SV" PC593; also check for same signal at "SV" PC594	
	YES      NO →	5. 6 paragraph (3)
	↓	
	6d. Check for zero to +5V ramp at "VT", PC594; also check continuity from "VT" PC594 to "VT" PC593 to "VT" PC591.	
7. No TRIG SWP mode	7a. Check for +9V at point "SC" PC593; also check continuity to "SC" PC594.	
8. No TRIG SWP BURST mode	8a. Check for -8V at "SC" PC593; check continuity to "SC" PC594.	
9. No CONT, CONT SWP and TRIG SWP modes.	9a. Check Q724	
10. No TRIG and PULSE modes	10a. Check Q723	
11. No GATE and BURST modes	11a. Check Q722	
12. No TRIG SWP BURST modes	12a. Check Q721	

TABLE 5. 1. TROUBLESHOOTING CHART (Continued)

<u>SYMPTOM</u>	<u>PROCEDURE</u>	<u>REFER TO SECTION #</u>
13. Pause-Marker not working	13a. With SWEEP PAUSE switch on, check for 4. 2V peak pulse at MARK GATE out.	5. 8
	YES      NO → ↓	
	13b. Check continuity of MKR pulse from "MG" PC593 to "MG" PC595. Check for + 1. 2V peak pulse at + 5V baseline at "SD" PC595 (collector of Q903). If OK, check continuity from "SD" PC595 to "SD" PC593.	
14. SWEEP status Indicators not working.	14a. Referring to the schematic diagram check logic levels on Q786, Q788 and Q792.	—
15. No PEN LIFT output.	15a. Check Q790	

5.4 POWER SUPPLY

The power supply for the generator consists of four supplies, +25 volt, -25 volt, +5. 5 volt and -5. 5 volt. The +25 volt supply is used as the reference for the -25 volt and +5. 5 volt supplies and should be evaluated first if the voltages are found to be incorrect.

If any supply voltage is low, it may be due to excessive load current. The +25 volt and -25 volt supplies are designed to shut down if shorted, with current only being supplied through shunt resistors R101 and R115. The +5. 5 volt and -5. 5 volt supplies are designed with current limiting for protection against excessive current being drawn by other parts of the circuit.

If the +25 volt supply is incorrect check zener reference (VR119) voltage. If the zener reference voltage is correct and the +25 volts is low, pin 2 of U101 should be lower than pin 3. If pin 2 is not lower than pin 3 it is likely that the trouble is located in the -25 volt supply due to the interaction caused by the anti lock-up circuit CR106, CR107, and R110. If pin 2 is lower than pin 3, the output of U101, pin 6, will be higher than normal. This in turn, through zener VR105, will turn on Q102 making its collector more negative, turning on series pass transistor, Q101, restoring the +25 volt supply to its normal value. In the same manner, if the -25 volt supply is low the error correcting voltage may be traced through U102 and Q104 to the series pass transistor Q105.

The +5.5 volt supply uses the +25 volts as a reference. If the +5.5 volt supply is low, pin 2 of U103 will be lower than pin 3 making pin 6 more positive than normal, turning on series pass transistor Q106, restoring the +5.5 volts to its normal value. The -5.5 volt supply uses the -25 volts as its reference and the error signal may be traced in the same manner through U104 to series pass transistor Q107.

## 5.5 MAIN GENERATOR

### 5.5.1 VC Amplifiers

If the voltage at the center arm of R602 (MT) is correct and the emitter of Q306 is more negative than normal, pin 2 of U302 will be negative which should make pin 6 of U302 more positive than normal making the emitter of Q305 more positive, in turn correcting the voltage at the emitter of Q306.

If the emitter of Q306 is correct and emitter of Q302 is more positive than normal, pin 2 of U301 will be positive which should make pin 6 of U301 more negative than normal making the emitter of Q301 more negative, in turn correcting the voltage at the emitter of Q302.

### 5.5.2 Positive and Negative Current Sources

Measure the voltages at the emitters of Q211 and Q214. If these are incorrect the most likely source of trouble is Q211, Q212 or Q214, Q215.

If the -VC amplifier is correct and pin 6 of U106 is more negative than normal, pin 2 of U102 should be more negative than pin 3, trying to correct the voltage at pin 6. If it cannot, the most likely source of trouble is U106. If pin 2 is equal to pin 3, and Pin 6 of U106 is not normal the most likely source of trouble is Q306.

If the +VC amplifier output is correct and the emitter of Q108 is more positive than normal, pin 2 of U105 should be more positive than pin 3. This should make pin 6 more negative correcting the emitter of Q108. If pin 2 is equal to pin 3 and the emitter of Q108 is not normal, the most likely source of trouble is Q302.

### 5.5.3 Hysteresis Flip-Flop and Current Switch

If no signal appears at the output of the Triangle Buffer TO, one-half of the DC voltage at TO should appear at the input of the Hysteresis Flip-Flop, (U201, Pin 1). If this voltage is +0.75 volts or more, pin 14 of U201 should be less than 5.5 volts. This should turn on Q207 and Q209, the current switch, and turn off Q206. Turning off Q206 will result in a voltage at pin 4 of U201 of -0.75 volts. Turning on Q209 will shunt the current from the Positive Current Sources, (Q211, Q212), to ground making the input to the Triangle Buffer (gate of Q218) more negative than normal.

The collector of Q207 drives the input to the square wave generators, Q201, Q202 and Q203. If Q207 is turned on the base of Q203 will be more positive than the base of Q202 (-5.5 volts) turning on Q203 and turning off Q202 resulting in Q202 output, RO, sitting positive. Q203 being turned on will turn on transistor Q201, making the TTL output sit in its low state.

### 5.5.4 Triangle Buffer

If the triangle output (TO) has no signal and the input of U202 (pin 13) is of opposite polarity as TO, the most likely source of trouble is either transistor array U202 or follower Q223.



If the triangle output, TO, has a DC voltage of 1.5 volts or greater, and the triangle amplifier input, U202, pin 13, has an equal voltage of the same polarity as TO, the trouble may be located in the FET input follower Q218 or emitter follower Q219, the FET switches Q217, Q220, Q221, Q222, the Current Switch Q209, Q210, Q213, Q216 or the Hysteresis Flip-Flop.

If the FET input follower Q218 is operating correctly, the gate will be a few tenths of a volt more negative than its output, which feeds U202 pin 13.

In all but the highest two bands, 100k and 1M, FET switches Q220, Q222 are on and Q217, Q221 are off. In the 100k and 1M multiplier position, Q220, Q222 are off and Q217, Q221 are on.

#### 5.5.5 Sine Shaper and Sine Buffer

If the triangle at TO is linear and 3 volts peak to peak, an undistorted sine wave should appear at SN. If the sine wave appears distorted, the problem can be localized in the shaping stage by measuring the drop across the emitter resistors of U401, U402 and U403.

The voltage drops across R411 and R412 should be equal and approximately 1.2 volts. If not, U401 is probably defective.

The voltage drops across R417 and R418 should be equal and approximately 0.53 volts. If not equal, U402 is probably defective. If not 0.53 volts, Q401 is probably bad.

The voltage drops across R419 and R420 should be equal and approximately 0.6 volts. If not equal, U402 is bad. If not 0.6 volts, Q402 is probably defective.

The voltage drops across R429 and R430 should be equal and approximately 0.28 volts. If not equal, U403 is probably defective. If not 0.28 volts, Q403 is bad.

The voltage drops across R431 and R432 should be equal and approximately 0.69 volts. If not equal, U403 is probably defective. If not 0.69 volts, Q404 is probably bad.

If the DC level at SN is 5.5 volts and the DC level at SO is not 0 volts the most likely source of trouble is Q405, Q406 or Q407.

#### 5.5.6 Output Buffer

If the correct signal appears at TO, and the WAVEFORM selector switch is making its proper connections, a 3 volt peak to peak triangle with 0V DC offset should appear at BO.

If the triangle is less than 3 volts peak to peak, or it does not drop to 1.5 volts peak to peak when the FIXED OFFSET Control is switched, the most likely source of trouble is Q501, Q502 or Q503.

If a clipped signal or DC offset appears at BO, and the FIXED OFFSET Control is in the  (off) position the most likely source of trouble is U501, Q504 or Q505.

### 5.5.7 Output Amplifier

If no signal appears on the MAIN OUTPUT, check to see if fuse F503 is blown; also check that the ATTENUATOR switch is in the 0 dB position. If the signal is present, but clipped or distorted, the Output Amplifier or the Protection Circuit (if installed) may be at fault. Check for a 30 volt peak to peak triangle waveform on the output of the Output Amplifier (junction of R571 and R574). If the signal is correct at this point, the trouble will most likely be in the Protection Circuit; if so, see paragraph 5.11. If the signal at the junction of R571 and R574 is incorrect, then the Output Amplifier is not working properly; if so, continue with the procedure that follows.

With the PEAK VOLTS Control set at minimum output (CCW), the MAIN OUTPUT DC LEVEL Control on the rear panel should adjust the output level through zero. If the output level cannot be adjusted through zero, check the internal fuses F501, F502 and F503.

If the fuses are not blown, tracing the error signal will localize the trouble area, i. e., if the output is positive, pin 13 of U502 should be positive making pin 1 more positive than pin 14. Through followers Q506 and Q508, driver transistors Q509 and Q512 will be turned off and Q510 and Q513 will be on. Turning off Q509 and Q512 will turn off output followers Q514 and Q516 while Q510 and Q513 will turn on output followers Q515 and Q517. This action should restore the output to normal.

If fuse F503 is blown, the cause was external to the generator and may have also blown F501 and F502. If either F501 or F502 is blown, additional damage may have occurred to drivers Q509, Q510, Q512, Q513 or output followers Q514, Q515, Q516, Q517 and should be checked by replacing fuses F501 and F502 with (2) 470 $\Omega$ , 1/2W resistors and by connecting TP1 to TP2 (the base of Q514 to the base of Q515) and connecting TP3 to TP4 (the base of Q510 to the base of Q511).

ALL CONNECTIONS OR DISCONNECTIONS SHOULD BE MADE WITH THE POWER OFF TO PREVENT ACCIDENTAL DAMAGE.

These connections have been made to shut off output followers Q514, Q515, Q516, Q517, and driver transistors (used as current sources at dc) Q510 and Q513.

With the fuse F503 replaced and the connections made as outlined, turn the power on and measure the dc output level. A bad transistor will give a dc level in the output corresponding to a negative output if the faulty transistor is one of the negative stages and a positive output if one of the positive stages. In most instances, ohms measurements will locate the defective transistor.

### 5.5.8 Output Protection Circuit (If Applicable)

If the output protection circuit appears at fault, first check to see if momentarily shutting off the power or turning down the amplitude restores the output. If not, check the following:

- 1) Transistors Q518, Q519 and Q520 should be turned off. If one or more are defective, the triac, Q521 will be turned on in error.
- 2) If Q518, Q519 and Q520 are off but the output is still incorrect, Q521 is probably bad.
- 3) If only a half-cycle of the output signal appears, the trouble may be zener VR511 or VR512.



## 5.6 SWEEP GENERATOR, SWEEP LIMIT CONTROL AND LOG SWEEP RAMP GENERATOR

### (1) Sweep Ramp Generator

The Sweep Ramp Generator runs continuously in all modes except TRIG SWP and TRIG SWP BURST. If the ramp circuit is inoperative, the RAMP OUT will have either a zero or +3V DC level. First check that the SWEEP HOLD switch is in the RUN position. Next check for +6.2V DC on the emitter of Q830. If the voltage is incorrect, the current source consisting of U830, and DURATION controls R912 and S905 may be at fault. Also check Q903. Next check the common collectors of Q830-Q831. If the ramp voltage is present, the followers (Q837-Q838) may be defective. If the ramp signal is not present on the collectors of Q830-Q831, trace the voltage switching sequence through the circuit as follows:

Measure the voltage at the base of Q802; it should be either more positive than +0.3V or more negative than -0.3V. If more positive, emitter of Q807 and collector of Q808 should be +3.5V. The base of Q831 should be -2V, which should turn Q831 on, pulling its collector down below zero volts, which is the discharge state for capacitor C837.

If Q802 base is more negative, Q807 emitter should be +0.2V, and the collector of Q808 should be more negative than -1V. The base of Q831 should be -6V, which should turn off Q831 and allow C837 to change to +5V from the current source via Q830.

The defective component will be found where the switching action is blocked.

### (2) Sweep Limit Control

The Sweep Limit Control converts the zero to +5V ramp signal to a signal with variable minimum and maximum peak levels. There should be a zero to -5V ramp on the output (pin 6) of U844. The output of U843 (pin 6) should have a zero to -4.5V ramp. If either voltage is incorrect, U843 or U844 is bad. Next check the output of summing amplifier U848 (pin 6) for a zero to +5V ramp signal with the START slide control at the low (0.03) end and the STOP slide control at the high (30) end. If incorrect, U848 is probably bad.

### (3) Log Sweep Ramp Generator

The Log Sweep Ramp Generator converts the linear ramp output from the Sweep Limit Control to an exponential (log) ramp signal. Referring to the schematic diagram, check the output of U860 (pin 6) for a zero to +5V exponential ramp with the START and STOP slide controls set to min and max positions, respectively. If the signal is not correct, the problem may be due to U853, Q858-Q859 or U853.

## 5.7 GATE/TRIGGER CIRCUIT

A malfunction in the Gate/Trigger Circuit may affect all or some of the Main Generator's modes of operation. The problem area may be localized as follows:

(1) If the Main Generator runs continuously in all modes, or not at all, the Hold Amplifier (U745), Gate (Q754) or the Hold Flip-Flop (U735) may be defective. If the Main Generator runs continuously in all modes, set the MODE switch to GATE and check the reset input of U735 (junction of CR732-CR733), it should be +0.5V. If OK, Pin 7 of U735 should be +3V and pin 13 of U745 should be less than +6V.



If the Main Generator does not run in any mode, set the MODE switch to CONT and check for -1.2V at the junction of CR732-CR733. If OK, pin 7 of U735 should be +4.5V and pin 13 of U745 should be greater than +6V.

Any voltage not in agreement should point to the defective component.

(2) If the GATE, TRIG, BURST and PULSE modes are not working, the Schmitt Trigger (Q711-Q713, CR710-CR711, CR717-CR718) may be defective. Set the MODE switch to GATE and the TRIG/GATE LEVEL CONTROL maximum CW, and measure the voltage at the emitter of Q713; it should be +2V with the MAN TRIG button depressed and +5V when the MAN TRIG button is released. If the voltage is incorrect, trace the error through the circuit using the voltage levels provided on the schematic.

Also, if the Main Generator gates on, but does not gate off when the GATE signal is removed, the set pulse may not be getting to pin 9 of U735.

(3) If only the BURST and PULSE modes are not working, make sure the Ramp signal is getting to the Schmitt Trigger input. The Ramp signal should be present at point "TG" PC593; if not trace the circuit path back through the MODE switch to the Sweep Ramp Generator output.

(4) If a combination of two or more modes not previously mentioned are not working, one of the FET switches (Q721-Q724) may be bad. Use the Logic Chart (Table 5.2) to determine which FET is turned on in each mode of operation. For example, if the CONT, CONT SWP and TRIG SWP modes are not working, Q724 may be bad.

(5) Double triggering or improper triggering may be due to a defective Q705 in the manual trigger reset circuit.

#### 5.8 PAUSE-MARKER CIRCUIT

If the PAUSE-MARKER does not work, set the Generator controls as specified on the schematic (PC593, PC594, PC595) and trace the waveforms and DC levels through the circuit until the defective component is found.

TABLE 5.2. FET SWITCHING LOGIC CHART

MODE	Gate voltages:			
	<u>+24.5V = "1"</u>	<u>-24.5V = "0"</u>		
	Q721	Q722	Q723	Q724
CONT	0	0	0	1
GATE	0	1	0	0
TRIG	0	0	1	0
BURST	0	1	0	0
PULSE	0	0	1	0
CONT SWP	0	0	0	1
TRIG SWP	0	0	0	1
TRIG SWP BURST	1	0	0	0

## SECTION 6

### CALIBRATION

#### 6.1 INTRODUCTION



The following procedure is provided for the calibration and adjustment of the generator in the field, and adherence to this procedure should restore the generator to its original performance specifications. If the generator cannot be calibrated by the procedure given, refer to Maintenance, Section 5, or consult our Factory Service Department. The location of all test points and adjustable components may be found in the circuit layout drawings at the rear of this manual.

#### 6.2 EQUIPMENT REQUIRED

Refer to the Appendix on page 51.

#### 6.3 TEST PROCEDURE

After turning the generator on, allow it to warm up for at least 30 minutes, then set the Main Generator controls to the following positions:

MODE	CONT
FREQUENCY Hz/MARKER	30
MULTIPLIER	X1K
WAVEFORM	
AMPLITUDE	Attenuator set for 0 dB, PEAK VOLTS control Max CCW
FIXED DC OFFSET	 (Off)
VARIABLE DC OFFSET	Off
SYMMETRY	Off
CHASSIS/FLOATING	Chassis

#### WARNING!

This calibration procedure should be performed by qualified personnel only. Remove the covers before connecting the instrument to the AC source and use only insulated probes and/or tools.

### 6.3.1 Power Supply Adjust

Set the DMM to DC mode. Connect the HI end of the DMM to the +25 volt test point; connect the LO end of the DMM to the -25 volt test point on PC591. Adjust R107 for a reading of +50 volts, exactly.

Connect the LO end of the DMM to signal ground ( $\frac{\perp}{\text{---}}$ ) and check the following voltages on PC591:

<u>Test Point</u>	<u>Tolerance</u>
+25V	+25.00V, $\pm 0.25V$
-25V	-25.00V, $\pm 0.25V$
+5.5V	+5.50V, $\pm 0.16V$
-5.5V	-5.50V, $\pm 0.16V$

### 6.3.2 DC Quiescent Voltage Levels

Connect the DMM to test point +20V on PC592 and adjust R541 for +20.0V,  $\pm 0.2V$ .

Connect the DMM across either R567 or R576 (18 ohm, 1W collector resistors) on PC592; adjust R566 for a voltage drop of 0.8 volts,  $\pm 0.03$  volts.

Connect the DMM to the MAIN OUT; adjust R536 for zero,  $\pm 10$  millivolts.

DUE TO INTERACTION, REPEAT ADJUSTMENT OF R541, R566 and R536.

Set the FREQUENCY Hz dial for 30; connect the DMM to test point TO on PC590 and adjust R223 for zero,  $\pm 1$  millivolt.

Connect DMM to MAIN OUT; readjust R536 for zero volts, if necessary. Turn PEAK VOLTS control to Max CW and adjust R528 for a DMM reading of zero,  $\pm 20$  millivolts. Set the PEAK VOLTS control for mid-range; adjust R532 for a DMM reading of zero,  $\pm 20$  millivolts. Return PEAK VOLTS to Max CW.

Set the FREQUENCY Hz dial to its low end stop. Connect the scope to the MAIN OUT, and release all the MULTIPLIER buttons; this will inhibit the generator's oscillating loop. Observe the DC level on the scope and adjust R241 for a DC level of approximately zero. The level may slowly drift off after adjustment. This is normal.

Set the MULTIPLIER for X10K and connect the DMM to the CV output. Adjust R319 for plus (+) 2 millivolts.

### 6.3.3 Minimum Frequency and Symmetry Adjust

Connect the scope to the MAIN OUT; connect the frequency counter to the TTL output. Adjust R331 for a frequency reading of 200 Hz, while adjusting R326 for a symmetrical triangle.

### 6.3.4 Band Calibration (Part I)

Connect the DMM to the CV output and adjust the dial for a CV voltage of +3.00 volts,  $\pm 0.01$  volts. Adjust the generator frequency on each band as follows:



<u>Band</u>	<u>Adjustment</u>	<u>Tolerance</u>
X10K	R144	299.7 kHz-300.3 kHz
X1K	R148	29.97 kHz-30.03 kHz
X100	R149	2.997 kHz-3.003 kHz
X10	R154	299.7 Hz -300.3 Hz

### 6.3.5 Dial Calibration

Set the MULTIPLIER for X10K. Adjust the dial for a CV voltage of +0.3 volts  $\pm 0.001$  volts. The generator frequency should be between 29.9 kHz-30.1 kHz. Adjust the dial for exactly 30 kHz; loosen the dial set screws and set dial so that the 3.0 dial mark lines up with the dial indicator arrow. Tighten dial set screws and recheck frequency reading.

Set the frequency dial to 30; adjust R312 for a CV voltage of +3.00 volts,  $\pm 0.01$  volts. Frequency reading should be between 299.4 kHz-300.6 kHz.

### 6.3.6 Band Calibration (Part II)

Set MULTIPLIER for X100K. Adjust the FREQUENCY dial for a CV voltage of +0.300 volts,  $\pm 0.001$  volts. Adjust R141 for a frequency reading of 299.7 kHz-300.3 kHz.

Set dial for a CV voltage of +3.00 volts,  $\pm 0.01$  volts. Adjust C221 for a reading of 2.997 MHz-3.003 MHz.

Reset the dial for a CV voltage of +0.300 volts,  $\pm 0.001$  volts. Switch MULTIPLIER to X1M and adjust R140 for a frequency reading of 2.99 MHz-3.01 MHz.

Set FREQUENCY dial for 30. Adjust C208 for a frequency reading of 29.9 MHz-30.1 MHz.

DUE TO INTERACTION, REPEAT STEP 6.3.6.

### 6.3.7 Sine Shaper Adjustment

Set the WAVEFORM switch to  and set the generator frequency to 3.0 x 1K. (3 kHz) Connect the distortion analyzer to the MAIN OUT. Connect the DMM to test point TO on PC590 and readjust R223 for zero  $\pm 1$  millivolt. Adjust R401 and R404 for a distortion reading of less than 0.25%.

### 6.3.8 Main Output Level Readjust

Disconnect the distortion analyzer and set the WAVEFORM switch to . Set the PEAK VOLTS control to Max CCW. Set the generator frequency to 5 x 100 (500 Hz), and connect the DMM to the MAIN OUT. Readjust for zero,  $\pm 20$  millivolts.

Set the PEAK VOLTS control to Max CW and readjust R528 for zero,  $\pm 20$  millivolts.

### 6.3.9 Waveform Amplitude and DC Level Adjustments

Switch the DMM to the AC mode of operation. With the WAVEFORM switch still on , adjust R548 for a triangle amplitude of 8.33 volts to 8.50 volts.

Set the WAVEFORM switch to  $\square$ . Adjust R211 for a squarewave amplitude of 16.66 volts to 17.00 volts. Switch the DMM to DC operation; adjust R202 for a reading of zero,  $\pm 2$  millivolts. Due to interaction, R211 and R202 may have to be readjusted.

Switch the DMM to AC operation, and set the WAVEFORM switch to adjust R407 for a sinewave amplitude of 10.6 volts to 10.8 volts. Switch the DMM to DC operation; adjust R444 for a reading of zero,  $\pm 20$  millivolts. Due to interaction, R407 and R444 may have to be readjusted.

### 6.3.10 Fixed DC Offset Adjust

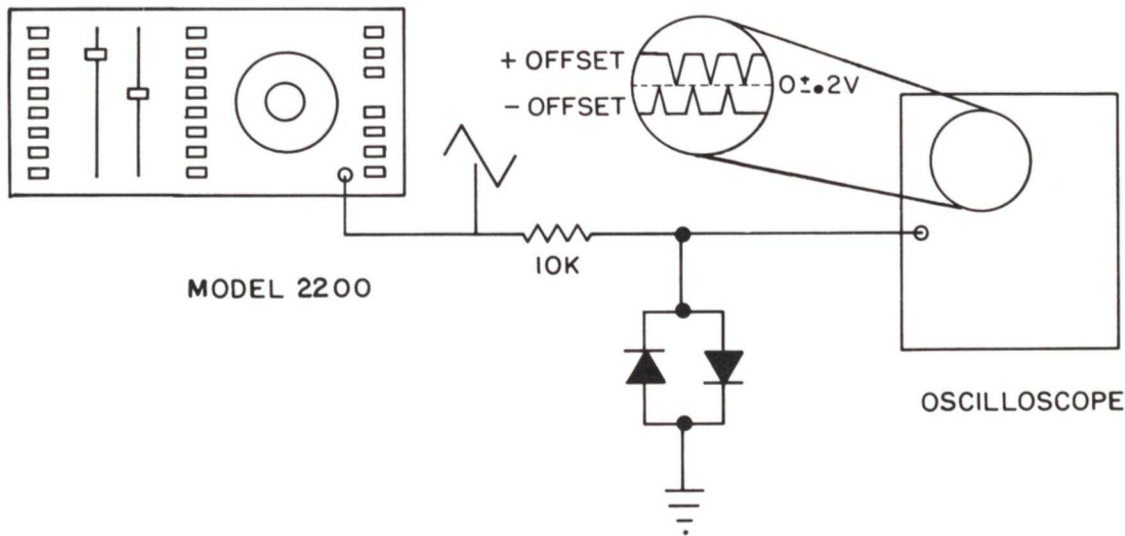

Figure 7. Test Circuit for FIXED OFFSET Adjust

Set the WAVEFORM switch to  $\wedge$  frequency to 500 Hz. Switch the DMM to AC operation, and switch the FIXED OFFSET control to the  $\square$  (+) position; adjust R509 for an AC reading of 4.16 volts to 4.25 volts. Return the FIXED OFFSET to the  $\square$  (off) position. Switch the DMM to DC operation and readjust R528 for a reading of zero,  $\pm 20$  millivolts. Disconnect the DMM and connect the generator MAIN OUT to the scope through the clipping circuit shown in Figure 7. The circuit consists of a 10k ohm resistor (carbon or film) in series with the MAIN OUT and the scope input, plus two (2) back-to-back diodes across the scope input terminals. Return the FIXED OFFSET control to the  $\square$  (+) position; set the scope vertical input sensitivity to 0.2V/cm, DC coupled, horizontal to 1 ms/cm cal.

Initially adjust R513 so that the negative peak of the triangle is at zero volts DC. Switch the FIXED OFFSET control between  $\square$  (+) and  $\square$  (-) and readjust R513 so that the positive and negative peaks fall on the same line; the line itself should be within  $\pm 1$  cm. ( $\pm 0.2$ V) of zero. Remove the clipping circuit.

### 6.3.11 Main Output Squarewave Adjust

Connect the scope to the MAIN OUT, using a 50 $\Omega$  terminator and cable (terminator at scope end). Set the WAVEFORM selector to  $\square$  PEAK VOLTS control to Max CW, FREQUENCY Hz controls to 3 MHz (3X1M). Adjust both R550 and C517 for optimum squarewave shape.

### 6.3.12 Amplitude Flatness vs Frequency

Set the frequency MULTIPLIER to 1K, WAVEFORM switch to  $\sim$ . Set the MODE switch to CONT SWP, the SWEEP START control to 30 and the SWEEP STOP control to 0.3. Set the SWEEP SELECT switch to LOG sweep.

Connect the MAIN OUTPUT to the scope vertical (y-axis) input through a  $50\Omega$  terminator and the CV OUT to the scope horizontal (x-axis) input. Set the scope for external horizontal sweep, and adjust the 2200 SWEEP DURATION controls for a 1ms sweep time. Adjust the scope vertical sensitivity for a 6 cm display. Note the amplitude of the swept display. Switch the MULTIPLIER to 1M and adjust C409 for optimum sinewave response. Peak to peak amplitude should not vary more than 0.5 cm (1 volt). Disconnect the CV OUT and return the scope horizontal control to normal sweep mode.

### 6.3.13 Sweep Limit Adjustments

Set the following controls as indicated:

MODE	TRIG SWP
START	Set to minimum end stop (down)
STOP	Set to minimum end stop (down)
SWEEP SELECT	LIN
PAUSE	OFF
SWEEP RANGE	1 s-10 ms
SWEEP DURATION	Max CW
HOLD	Run

- 1) Connect a DCVM to the CV output and adjust R850 for +2 millivolts.
- 2) Set the SWEEP SELECT to LOG and adjust R860 for a CV output of +2 millivolts. Reset SWEEP SELECT to LIN.
- 3) Set the STOP control to its maximum end (up). Adjust R803 for a CV output of +2 millivolts. Allow voltage to settle, then make a final adjustment of R803.
- 4) Return the STOP control to its minimum end (down). Switch the MODE switch to TRIG SWP BURST. Adjust R851 for +2 millivolts on the CV output.
- 5) Set the START control to its maximum end (up) and adjust R843 for +2 millivolts on the CV output.
- 6) Set the START control to its low end, and the STOP control to its high end. Measure the CV output, it should be +3.1 to +3.2 volts.
- 7) Set the SWEEP SELECT to LOG. Adjust R855 for a CV output of +3.15 volts,  $\pm 0.05$  volts.



## APPENDIX

### Test Equipment Required

The following is a list of recommended test equipment for Incoming Inspection, Maintenance and Calibration of the 2200:

<u>Description</u>	Applicable to		
	<u>Section 3</u>	<u>Section 5</u>	<u>Section 6</u>
a) Oscilloscope, bandwidth from DC to 100-150 MHz, vertical sensitivity 5 mV/cm, AC/DC coupled, plus vertical amplifier plug-in (Tektronix type 7704A Mainframe with 7A13 Differential Comparator Amplifier and 7B50A Time Base, or equivalents).	X	X	X
b) Frequency Counter, capable of frequency measurements between 0.003 Hz and 30 MHz, 0.1% accuracy (General Radio 1192-B or equivalent).	X		X
c) AC Differential Voltmeter (ACVM), 3 MHz bandwidth or greater, for voltage measurements up to 20 volts, and voltage variations less than 0.1 dB (1%). (Fluke Model 931A or equivalent).	X		X
d) Digital Multimeter (DMM) for DC voltage measurements between zero and ±50 volts and resistance measurements. (Fluke Model 8000A or equivalent).	X	X	X
e) Distortion Analyzer, bandwidth at least 100 kHz, to measure distortion down to 0.1% (Krohn-Hite Model 6800 or equivalent).	X		X
f) Spectrum Analyzer, bandwidth at least 100 MHz, to measure harmonic distortion of frequencies between 300 kHz and 30 MHz. (Hewlett Packard Model 141T Display CRT, with Model 8553B Spectrum Analyzer, or equivalent).	X		
g) (1) 10K ohm resistor			X
h) (2) silicon diodes			X
i) (1) 50 ohm terminator	X		X



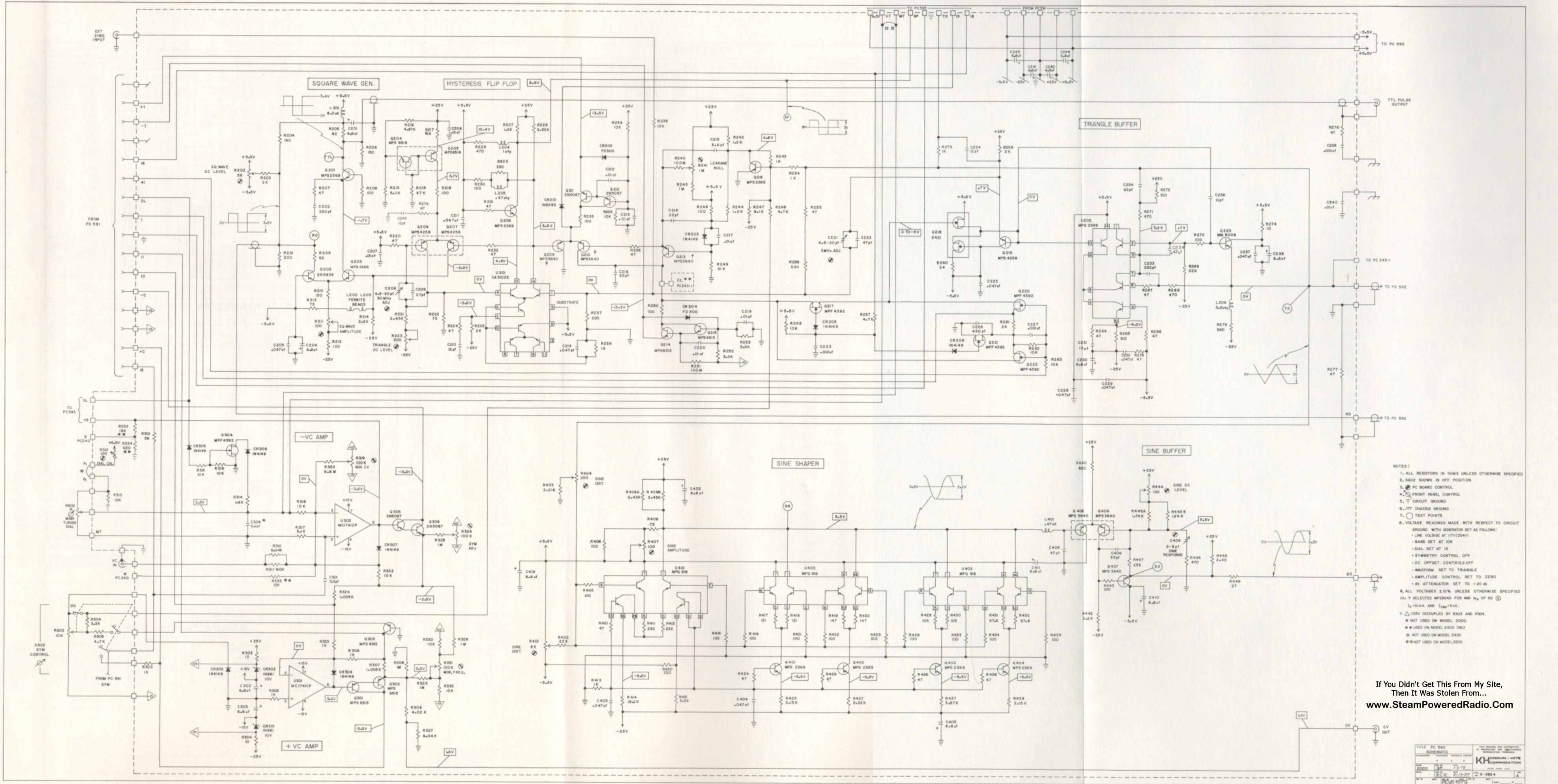

- NOTES:
1. ALL RESISTORS IN OHMS UNLESS OTHERWISE SPECIFIED
  2. S602 SHOWN IN OFF POSITION
  3. PC BOARD CONTROL
  4. FRONT PANEL CONTROL
  5.  $\nabla$  CIRCUIT GROUND
  6.  $\nabla$  CHASSIS GROUND
  7.  $\odot$  TEST POINTS
  8. VOLTAGE READINGS MADE WITH RESPECT TO CIRCUIT GROUND WITH GENERATOR SET AS FOLLOWS:
    - LINE VOLTAGE AT 117V(254V)
    - BAND SET AT 10K
    - DIAL SET AT 15
    - SYMMETRY CONTROL OFF
    - DC OFFSET CONTROL OFF
    - WAVEFORM SET TO TRIANGLE
    - AMPLITUDE CONTROL SET TO ZERO
    - $\mu$ S ATTENUATOR SET TO  $\times 20$
  9. ALL VOLTAGES  $\pm 10\%$  UNLESS OTHERWISE SPECIFIED
  10.  $\nabla$  SELECTED MPS3640 FOR MIN  $I_{DS}$  OF 50  $\mu$ A
    - $I_{DS} = 10$ mA AND  $I_{DM} = 5$ mA.
  11.  $\Delta$  125V DECOUPLED BY R305 AND R304
  12.  $\nabla$  NOT USED ON MODEL 2000
  13.  $\nabla$  NOT USED ON MODEL 2400 ONLY
  14.  $\nabla$  NOT USED ON MODEL 2400
  15.  $\nabla$  NOT USED ON MODEL 2200

If You Didn't Get This From My Site,  
Then It Was Stolen From...  
[www.SteamPoweredRadio.Com](http://www.SteamPoweredRadio.Com)

TITLE	PC 590	SCHEMATIC
DATE	10-10-77	
DESIGNER	PC 590	
CHECKED	PC 590	
APPROVED	PC 590	
SCALE	1:1	
SHEET	1	OF 1



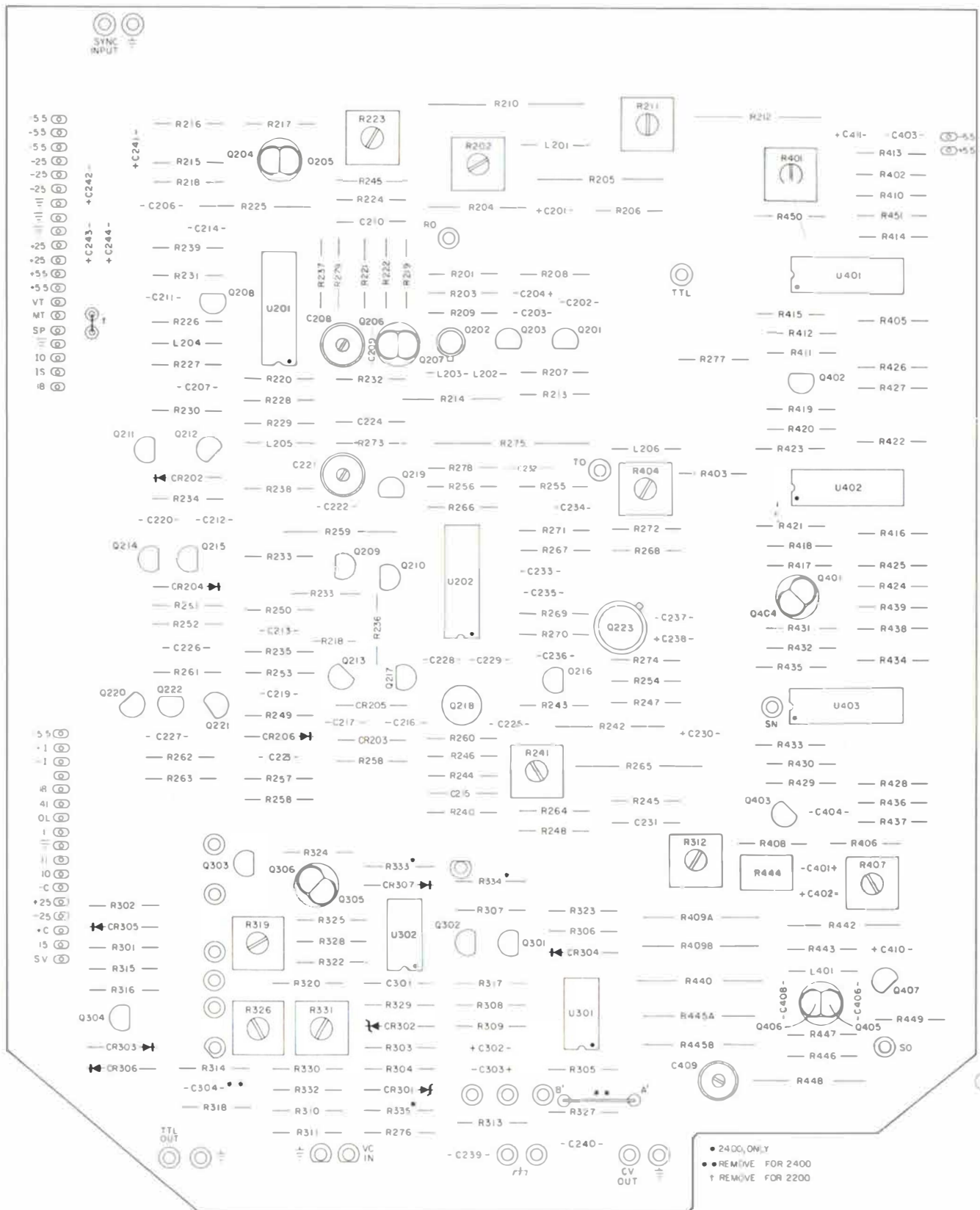

PC 590



## RESISTORS

Symbol	Description	Mfr.	Part No.	Symbol	Description	Mfr.	Part No.
R201	200	5%	1/4W	AB	CB2011		
R202	5K	POT		BKM	72PM		
R203	2K	10%	1/4W	AB	CB2021		
R204	160	5%	1/2W	AB	EB1615		
R205	82	5%	1W	AB	GB8205		
R206	150	5%	1/4W	AB	CB1515		
R207	47	10%	1/4W	AB	CB4701		
R208	100	10%	1/4W	AB	CB1011		
R209	62	5%	1/4W	AB	CB6205		
R210	150	10%	2W	AB	HB1511		
R211	100	POT		BKM	72PM		
R212	100	10%	1/4W	AB	CB1011		
R213	75	10%	1/4W	AB	CB7501		
R214	2.2K	5%	1/2W	AB	EB2225		
R215	5.11K	1%	1/4W	AB	CC5111F		
R216	4.87K	1%	1/4W	AB	CC4871F		
R217	619	1%	1/4W	AB	CC6190F		
R218	47K	10%	1/4W	AB	CB4731		
R219	100	10%	1/4W	AB	CB1011		
R220	47	10%	1/4W	AB	CB4701		
R221	2.43K	1%	1/4W	AB	CC2431F		
R222	75	1%	1/4W	AB	CC75R0F		
R223	200	POT		BKM	72PM		
R224	47	10%	1/4W	AB	CB4701		
R225	2K	1%	1/2W	AB	CC2001F		
R226	470	10%	1/4W	AB	CB4711		
R227	1.2K	5%	1/4W	AB	CB1225		
R228	3.92K	1%	1/4W	AB	CC3921F		
R229	330	10%	1/4W	AB	CB3311		
R230	100	10%	1/4W	AB	CB1011		
R231	47	10%	1/4W	AB	CB4701		
R232	47	10%	1/4W	AB	CB4701		
R233	100	10%	1/4W	AB	CB1011		
R234	10K	10%	1/4W	AB	CB1031		
R235	10K	10%	1/4W	AB	CB1031		
R236	47	10%	1/4W	AB	CB4701		
R237	200	1%	1/4W	AB	CC2000F		
R238	10K	10%	1/4W	AB	CB1031		
R239	1K	10%	1/4W	AB	CB1021		
R240	100M	10%	1/4W	AB	CB1071		
R241	1M	POT		BKM	72PM		
R242	1.2K	10%	1/2W	AB	EB1221		
R243	1K	5%	1/4W	AB	CB1025		
R244	1.2K	5%	1/4W	AB	CB1225		
R245	1M	10%	1/4W	AB	CB1051		
R246	100	10%	1/4W	AB	CB1011		
R247	9.1K	5%	1/4W	AB	CB9125		
R248	4.7K	10%	1/4W	AB	CB4721		
R249	51K	10%	1/4W	AB	CB5131		
R250	100	10%	1/4W	AB	CB1011		
R251	100M	10%	1/4W	AB	CB1071		
R252	3.3K	10%	1/4W	AB	CB3321		
R253	3.3K	10%	1/4W	AB	CB3321		
R254	1K	5%	1/4W	AB	CB1021		
R255	47	5%	1/4W	AB	CB4705		
R256	200	1%	1/4W	AB	CC2000F		
R257	4.7K	10%	1/4W	AB	CB4721		
R258	10K	10%	1/4W	AB	CB1031		
R259	2K	10%	1/2W	AB	EB2021		
R260	24	10%	1/4W	AB	CB2401		
R261	24	10%	1/4W	AB	CB2401		
R262	10K	10%	1/4W	AB	CB1031		
R263	10K	10%	1/4W	AB	CB1031		
R264	47	10%	1/4W	AB	CB4701		
R265	510	5%	1W	AB	GB5115		
R266	47	10%	1/4W	AB	CB4701		
R267	47	10%	1/4W	AB	CB4701		
R268	470	10%	1/4W	AB	CB4711		
R269	22K	10%	1/4W	AB	CB2231		
R270	100	10%	1/4W	AB	CB1011		
R271	470	10%	1/4W	AB	CB4711		
R272	510	5%	1/4W	AB	CB5115		
R273	1K	10%	1/4W	AB	CB1021		
R274	10	10%	1/4W	AB	CB1001		
R275	560	10%	2W	AB	HB5611		
R276	47	10%	1/4W	AB	CB4701		
R277	47	10%	1/4W	AB	CB4701		
R278	47	10%	1/4W	AB	CB4701		
R301	56	10%	1/4W	AB	CB5601		
R302	1K	0.1%	1/4W	KID	M4-T1-1K		
R303	10	10%	1/4W	AB	CB1001		
R304	10	10%	1/4W	AB	CB1001		
R305	1K	10%	1/4W	AB	CB1021		
R306	1K	5%	1/4W	AB	CB1025		
R307	1.005K	0.1%	1/8W	KID	M3-T1-1.005K		
R308	1M	10%	1/4W	AB	CB1051		
R309	4.02K	0.1%	1/8W	KID	M3-T1-4.02K		
R310	6.04K	0.1%	1/8W	KID	M3-T1-6.04K		
R311	910K	10%	1/4W	AB	CB9141		
R312	100	POT		BKM	72PM		
R313	10K	5%	1/4W	AB	CB1035		
R314	1.6K	5%	1/4W	AB	CB1625		
R315	10K	10%	1/4W	AB	CB1031		
R316	10K	10%	1/4W	AB	CB1031		
R317	5.1K	10%	1/4W	AB	CB5121		
R318	10K	0.1%	1/8W	KID	M3-T1-10K		
R319	100K	POT		BKM	72PM		
R320	6.8M	5%	1/4W	AB	CB6855		
R322	10K	0.1%	1/8W	KID	M3-T1-10K		
R323	1K	5%	1/4W	AB	CB1025		
R324	1.005K	0.1%	1/8W	KID	M3-T1-1.005K		
R325	1M	10%	1/4W	AB	CB1051		
R326	100K	POT		BKM	72PM		
R327	6.04K	0.1%	1/8W	KID	M3-T1-6.04K		
R328	1M	10%	1/4W	AB	CB1051		
R329	1M	10%	1/4W	AB	CB1051		
R330	10K	5%	1/4W	AB	CB1035		
R331	100K	POT		BKM	72PM		
R332	10K	5%	1/4W	AB	CB1035		
R333*	18K	10%	1/4W	AB	CB1831		
R334*	620	5%	1/4W	AB	CB6215		
R335*	10K	1%	1/4W	AB	CC1002F		
R401	5K	POT		BKM	72PM		
R402	22K	10%	1/4W	AB	CB2231		
R403	2.21K	1%	1/4W	AB	CC2211F		
R404	200	POT		BKM	72PM		
R405	100	10%	1/4W	AB	CB1011		
R406	100	5%	1/4W	AB	CB1015		
R407	100	POT		BKM	72PM		
R408	75	5%	1/4W	AB	CB7505		
R409A	2.43K	1%	1/4W	AB	CC2431F		
R409B	2.43K	1%	1/4W	AB	CC2431F		
R410	47	10%	1/4W	AB	CB4701		
R411	232	1%	1/4W	AB	CC2320F		
R412	232	1%	1/4W	AB	CC2320F		
R413	1K	10%	1/4W	AB	CB1021		
R414	18.2K	1%	1/4W	AB	CB1822F		
R415	100	10%	1/4W	AB	CB1011		
R416	100	10%	1/4W	AB	CB1011		
R417	121	1%	1/4W	AB	CC1211F		
R418	121	1%	1/4W	AB	CC1211F		
R419	147	1%	1/4W	AB	CC1471F		
R420	147	1%	1/4W	AB	CC1471F		
R421	100	10%	1/4W	AB	CB1011		
R422	100	10%	1/4W	AB	CB1011		
R423	100	10%	1/4W	AB	CB1011		
R424	47	10%	1/4W	AB	CB4701		
R425	2.15K	1%	1/4W	AB	CC2151F		
R426	47	10%	1/4W	AB	CB4701		
R427	2.32K	1%	1/4W	AB	CC2321F		
R428	100	10%	1/4W	AB	CB1011		
R429	105	1%	1/4W	AB	CC1050F		
R430	105	1%	1/4W	AB	CC1050F		
R431	97.6	1%	1/4W	AB	CC97R6F		
R432	97.6	1%	1/4W	AB	CC97R6F		
R433	100	10%	1/4W	AB	CB1011		
R434	100	10%	1/4W	AB	CB1011		
R435	100	10%	1/4W	AB	CB1011		
R436	47	10%	1/4W	AB	CB4701		
R437	3.57K	1%	1/4W	AB	CC3571F		
R438	47	10%	1/4W	AB	CB4701		
R439	2.15K	1%	1/4W	AB	CC2151F		
R440	820	1%	1/4W	AB	GB8215		
R442	2.2K	5%	1/2W	AB	CB1011		
R443	100	10%	1/4W	AB	CB1011		
R444	100,(25 TURN)	POT		BN	3299W-1-101		
R445A	1.74K	1%	1/4W	AB	CC1741F		
R445B	1.74K	1%	1/4W	AB	CC1741F		
R446	470	10%	1/4W	AB	CB4711		
R447	255	1%	1/4W	AB	CC2550F		
R448	2.4K	5%	1/2W	AB	EB2425		
R449	27	10%	1/4W	AB	CB2701		
R450	220	10%	1/4W	AB	CB2211		
R451	3.3K	5%	1/4W	AB	CB3321		
R602	1K	POT		KH	83759		
R603	10K	POT		AB	{Part of Switch 5602}		
R604	3.3K	10%	1/4W	AB	CB3321		
R605	4.7K	10%	1/4W	AB	CB4721		

\*Model 2400, only.

## CAPACITORS

Symbol	Description	Mfr.	Part No.	Symbol	Description	Mfr.	Part No.
C201	6.8uf 20% 35V	SP	196D685X0035FB	C232	0.047uf 20% 50V	ELM	8131-50-651-473M
C202	330uf 5% 500V	ELM	DM15C331J	C233	220pf 10% 500V	ELM	DM15C221K
C203	0.047uf 20% 50V	ERT	8131-50-651-473M	C234	62pf 10% 500V	ELM	DM15C620K
C204	6.8uf 20% 35V	SP	196D685X0035FB	C235	0.47uf 20% 50V	ELM	8131-50-651-473M
C206	0.01uf 20% 500V	SP	C023B501G103M	C236	10pf 5% 500V	ELM	DM15C100J
C207	0.047uf 20% 50V	ERT	8131-50-651-473M	C237	0.047uf 20% 50V	ELM	8131-50-651-473M
C208	4.5-20pf TRIMMER	STT	75-TR1K0-02-4.5/20pf	C238	6.8uf 20% 35V	SP	196D685X0035FB
C209	27pf 10% 500V	ELM	DM15C270K	C239	0.001uf 20% 500V	SP	C023B501E102M
C210	12pf 10% 500V	ASP	9213-12110	C240	0.01uf 20% 500V	SP	C023B501G103M
C211	0.047uf 20% 50V	ERT	8131-50-651-473M	C241	6.8uf 20% 35V	SP	196D685X0035FB
C212	0.01uf 20% 500V	SP	C023B501G103M	C242	6.8uf 20% 35V	SP	196D685X0035FB
C213	0.01uf 20% 500V	SP	C023B501G103M	C243	6.8uf 20% 35V	SP	196D685X0035FB
C214	0.047uf 20% 50V	ERT	8131-50-651-473M	C244	6.8uf 20% 35V	SP	196D685X0035FB
C215	5.6pf 10% 500V	ASP	9210-56910	C301	7.5pf 10% 500V	ASP	9212-75910
C216	22pf 10% 500V	ELM	DM15C220K	C302	6.8uf 20% 35V	SP	196D685X0035FB
C217	0.01uf 20% 500V	SP	C023B501G103M	C303	6.8uf 20% 35V	SP	196D685X0035FB
C218	22pf 10% 500V	ELM	DM15C220K	C304	0.1uf * 20% 100V	ERT	8131-100-651-104M
C219	0.01uf 20% 500V	SP	C023B501G103M	C401	6.8uf 20% 35V	SP	196D685X0035FB
C220	0.01uf 20% 500V	SP	C023B501G103M	C402	6.8uf 20% 35V	SP	196D685X0035FB
C221	4.5-20pf TRIMMER	STT	75-TR1K0-02-4.5/20pf	C403	0.047uf 20% 50V	ERT	8131-50-651-473M
C222	47pf 10% 500V	ELM	DM15C470K	C404	0.047uf 20% 50V	ERT	8131-50-651-473M
C223	0.001uf 20% 500V	SP	C023B501E102M	C405	6.8uf 20% 35V	SP	196D685X0035FB
C224	12pf 10% 500V	ASP	9213-12110	C406	47pf 10% 500V	ELM	DM15C470K
C225	0.047uf 20% 50V	ERT	8131-50-651-473M	C408	33pf 5% 500V	ELM	DM15C470K
C226	430pf 10% 500V	ELM	DM15C431K	C409	3-9pf TRIMMER	STT	75-TR1K0-02-3/9pf
C227	0.001uf 20% 500V	SP	C023B501E102M	C410	6.8uf 20% 35V	SP	196D685X0035F13
C228	0.047uf 20% 50V	ERT	8131-50-651-473M	C411	6.8uf 20% 35V	SP	196D685X0035F13
C229	0.047uf 20% 50V	ERT	8131-50-651-473M				
C230	6.8uf 20% 35V	SP	196D685X0035FB				
C231	12pf 10% 500V	ASP	9213-12110				

\*Not Used on Model 2400.

## TRANSISTORS, DIODES & MISC.

Symbol	Description	Mfr.	Part No.	Symbol	Description	Mfr.	Part No.
Q201	MPS2369	MOT	MPS2369	U201	CA3102E	RCA	CA3102E
Q202	2N5836	MOT	2N5836	U202	MPQ2369	MOT	MPQ2369
Q203	MPS2369	MOT	MPS2369	U301	MC1741CP	MOT	MC1741CP
Q204	MPS6518	MOT	MPS6518	U302	MC1741CP	MOT	MC1741CP
Q205	MPS6518	MOT	MPS6518	U401	MPQ918	MOT	MPQ918
Q206	MPS4258	MOT	MPS4258	U402	MPQ918	MOT	MPQ918
Q207	MPS4258	MOT	MPS4258	U403	MPQ918	MOT	MPQ918
Q208	MPS2369	MOT	MPS2369	CR202	FD300	FR	FD300
Q209*	MPS3640	MOT	MPS3640	CR203	1N4149	APD	1N4149
Q210*	MPS3640	MOT	MPS3640	CR204	FD300	FR	FD300
Q211	2N5087	MOT	2N5087	CR205	1N4149	APD	1N4149
Q212	2N5087	MOT	2N5087	CR206	1N4149	APD	1N4149
Q213*	MPS3640	MOT	MPS3640	CR301	1N961	APD	1N961
Q214	MPS6515	MOT	MPS6515	CR302	1N961	APD	1N961
Q215	MPS6515	MOT	MPS6515	CR303	1N4149	APD	1N4149
Q216	MPS2369	MOT	MPS2369	CR304	1N4149	APD	1N4149
Q217	MPF4392	MOT	MPF4392	CR305	1N4149	APD	1N4149
Q218	E421	SIL	E421	CR306	1N4149	APD	1N4149
Q219	MPS4258	MOT	MPS4258	CR307	1N4149	APD	1N4149
Q220	MPF4392	MOT	MPF4392	L201	8.2uhy	DLV	1537-34
Q221	MPF4392	MOT	MPF4392	L202	BEAD, FERRITE	STK	57-0181
Q222	MPF4392	MOT	MPF4392	L203	BEAD, FERRITE	STK	57-0181
Q223	MM8009	MOT	MM8009	L204	1uhy	DLV	1537-12
Q301	MPS6515	MOT	MPS6515	L205	.47uhy	DLV	1537-06
Q302	MPS6515	MOT	MPS6515	L206	5.6uhy	DLV	1537-30
Q303	MPS6515	MOT	MPS6515	L401	.47uhy	DLV	1537-06
Q304	MPF4392	MOT	MPF4392	S602	SWITCH, PUSH-PULL W/GANGED POTENTIOMETER, SYMMETRY CONTROL	KH	A3732
Q305	2N5087	MOT	2N5087				
Q306	2N5087	MOT	2N5087				
Q401	MPS2369	MOT	MPS2369				
Q402	MPS2369	MOT	MPS2369				
Q403	MPS2369	MOT	MPS2369				
Q404	MPS2369	MOT	MPS2369				
Q405	MPS3640	MOT	MPS3640				
Q406	MPS3640	MOT	MPS3640				
Q407	MPS3640	MOT	MPS3640				

\*Q209, Q210 and Q213 are type MPS3640 selected for  $h_{fe} \geq \beta I_C = 10mA$  and  $I_{CBO} < 5nA$ .

## MANUFACTURERS CODE

AB (01121) Allen Bradley Co.	Milwaukee, Wisc.	KH (88865) Krohn-Hite Corp.	Avon, Mass.
APD (50273) American Power Devices	Andover, Mass.	K10 (12126) Kidco Inc.	Medford, N.J.
ASP (82142) Aircro Speer	Dubois, Pa.	MOT (04713) Motorola Semiconductor	Phoenix, Ariz.
BKM (30646) Beckman Instrument Inc.	Cedar Grove, N.J.	RCA (49671) Radio Corp. of America	Harrison, N.J.
DLV (99800) Delevan Electronics	East Aurora, N.Y.	SIL (17856) Siliconix	Sunnyvale, Calif.
ELM (72136) Electromotive Mfg.	Willimantic, Conn.	SP (56289) Sprague Electric Co.	North Adams, Mass.
ERT (72982) Erie Technological	Erie, Pa.	STK (78488) Stackpole Carbon Co.	St. Mary's, Pa.
FR (07263) Fairchild Semiconductor	San Rafael, Calif.	STT	Cazanovia, N.Y.



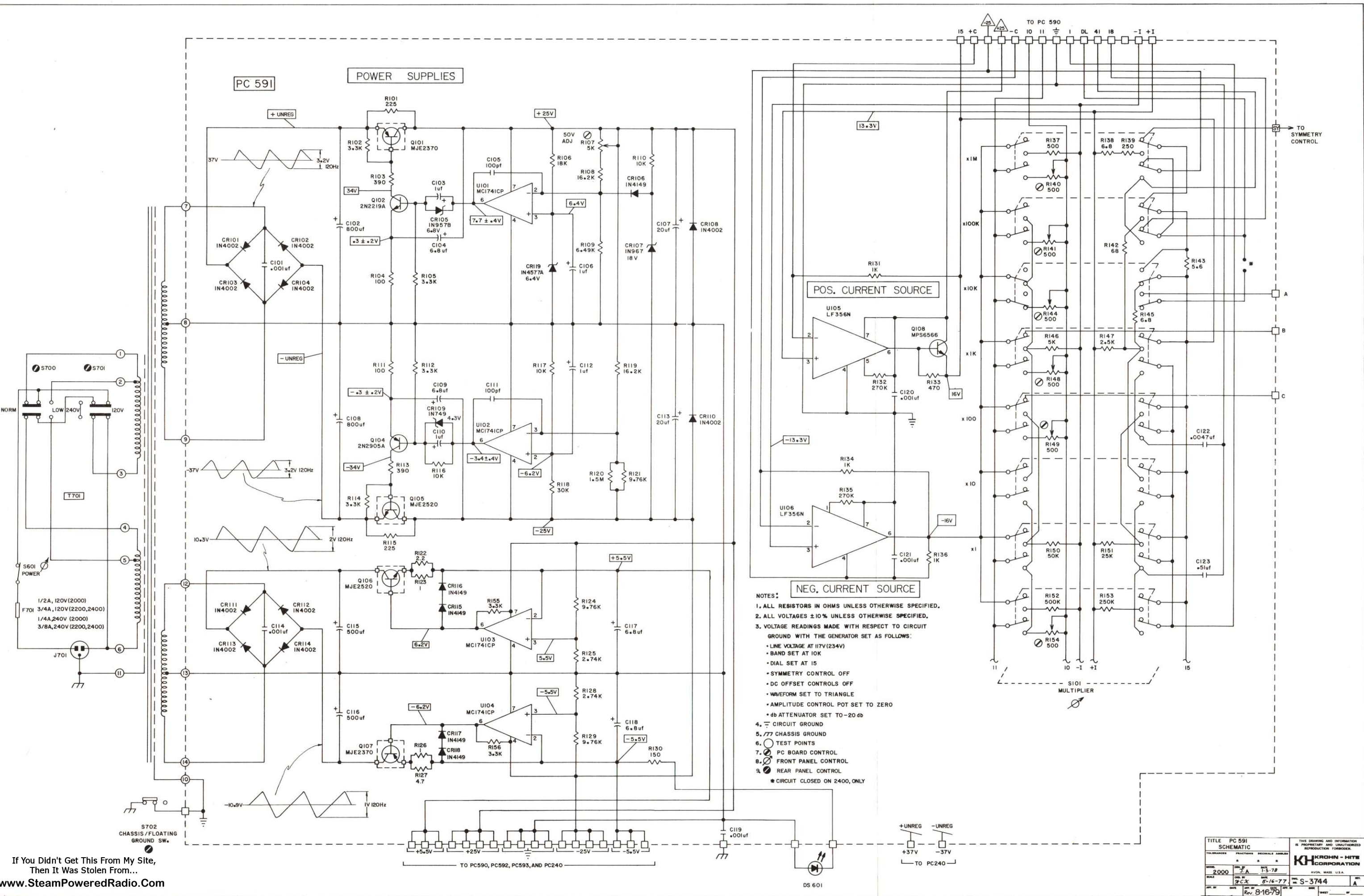

PC 591

POWER SUPPLIES

POS. CURRENT SOURCE

NEG. CURRENT SOURCE

- NOTES:
1. ALL RESISTORS IN OHMS UNLESS OTHERWISE SPECIFIED.
  2. ALL VOLTAGES  $\pm 10\%$  UNLESS OTHERWISE SPECIFIED.
  3. VOLTAGE READINGS MADE WITH RESPECT TO CIRCUIT GROUND WITH THE GENERATOR SET AS FOLLOWS:
    - LINE VOLTAGE AT 117V (234V)
    - BAND SET AT 10K
    - DIAL SET AT 15
    - SYMMETRY CONTROL OFF
    - DC OFFSET CONTROLS OFF
    - WAVEFORM SET TO TRIANGLE
    - AMPLITUDE CONTROL POT SET TO ZERO
    - db ATTENUATOR SET TO -20 db
  4.  $\square$  CIRCUIT GROUND
  5.  $\text{---}$  CHASSIS GROUND
  6.  $\circ$  TEST POINTS
  7.  $\text{---}$  PC BOARD CONTROL
  8.  $\text{---}$  FRONT PANEL CONTROL
  9.  $\text{---}$  REAR PANEL CONTROL
- \*CIRCUIT CLOSED ON 2400, ONLY

TITLE PC 591		SCHEMATIC		THIS DRAWING AND INFORMATION IS PROPRIETARY AND UNAUTHORIZED REPRODUCTION IS PROHIBITED.	
REV. 2000	REV. 3-A	DATE 1-3-78	DESIGNER J.A.	AVON, MASS. U.S.A.	
SCALE	DATE 5-16-77	REV. S-3744	APP. BY	REV. A	
APP. BY	DATE	APP. BY	DATE	REV.	

If You Didn't Get This From My Site,  
Then It Was Stolen From...  
www.SteamPoweredRadio.Com



## RESISTORS

Symbol	Description			Mfr.	Part No.	Symbol	Description			Mfr.	Part No.
R101	225	5%	5W	TL	EL-3	R129	9.76K	1%	1/4W	AB	CC9761F
R102	3.3K	10%	1/4W	AB	CB3321	R130	150	10%	1/2W	AB	EB1511
R103	390	10%	1/2W	AB	EB3911	R131	1K	0.1%	1/4W	KID	M4-T1-1K
R104	100	10%	1/4W	AB	CB1011	R132	270K	10%	1/4W	AB	CB2741
R105	3.3K	10%	1/4W	AB	CB3321	R133	470	10%	1/4W	AB	CB4711
R106	18K	10%	1/4W	AB	CB1831	R134	1K	0.1%	1/4W	KID	M4-T1-1K
R107	5K	POT		BKM	72PM	R135	270K	10%	1/4W	AB	CB2741
R108	16.2K	1%	1/4W	AB	CC1622F	R136	1K	10%	1/4W	AB	CB1021
R109	6.49K	1%	1/4W	AB	CC6491F	R137	500	0.1%	1/2W	KID	M5-T1-500
R110	10K	10%	1/4W	AB	CB1031	R138	6.8	10%	1/4W	AB	CB68G1
R111	100	10%	1/4W	AB	CB3321	R139	250	0.1%	1/4W	KID	M4-T1-250
R112	3.3K	10%	1/4W	AB	EB3911	R140	500	POT		BKM	72PM
R113	390	10%	1/2W	AB	EB3911	R141	500	POT		BKM	72PM
R114	3.3K	10%	1/4W	AB	CB3321	R142	68	10%	1/4W	AB	CB6801
R115	225	5%	5W	TL	EL-3	R143	5.6	10%	1/4W	AB	CB56G1
R116	10K	10%	1/4W	AB	CB1031	R144	500	POT		BKM	72PM
R117	10K	0.1%	1/8W	KID	M3-T1-10K	R145	6.8	10%	1/4W	AB	CB68G1
R118	30K	0.1%	1/4W	KID	M4-T1-30K	R146	5K	0.1%	1/8W	KID	M3-T1-5K
R119	16.2K	1%	1/4W	AB	CC1622F	R147	2.5K	0.1%	1/4W	KID	M4-T1-2.5K
R120	1.5M	10%	1/4W	AB	CB1551	R148	500	POT		BKM	72PM
R121	9.76K	1%	1/4W	AB	CC9761F	R149	500	POT		BKM	72PM
R122	2.2	10%	1/2W	AB	EB22G1	R150	50K	0.1%	1/8W	KID	M3-T1-50K
R123	1	10%	1/4W	AB	CB1061	R151	25K	0.1%	1/4W	KID	M4-T1-25K
R124	9.76K	1%	1/4W	AB	CC9761F	R152	500K	0.1%	1/4W	KID	M4-T1-500K
R125	2.74K	1%	1/4W	AB	CC2741F	R153	250K	0.1%	1/4W	KID	M4-T1-250K
R126	1	10%	1/2W	AB	EB1061	R154	500	POT		BKM	72PM
R127	4.7	10%	1/4W	AB	CB47G1	R155	3.3K	10%	1/4W	AB	CB3321
R128	2.74K	1%	1/4W	AB	CC2741F	R156	3.3K	10%	1/4W	AB	CB3321

## CAPACITORS

Symbol	Description			Mfr.	Part No.	Symbol	Description			Mfr.	Part No.
C101	.001uf	20%	500V	SP	C023B501E102M	C113	20uf		50V	SP	30D2066050CC4
C102	800uf		50V	MAL	TCW81H050L2B1P	C114	.001uf	20%	500V	SP	C023B501E102M
C103	1uf	20%	35V	SP	196D105X0035HA1	C115	500uf		25V	MAL	TT501N025G1A1P
C104	6.8uf	20%	35V	SP	196D685X0035FB	C116	500uf		25V	MAL	TT501N025G1A1P
C105	100pf	10%	500V	ELM	DM15C101K	C117	6.8uf	20%	35V	SP	196D685X0035FB
C106	1uf	20%	35V	SP	196D105X0035HA1	C118	6.8uf	20%	35V	SP	196D685X0035FB
C107	20uf		50V	SP	30D2066050CC4	C119	.001uf	20%	500V	SP	C023B501E102M
C108	800uf		50V	MAL	TCW81H050L2B1P	C120	.001uf	20%	500V	SP	C023B501E102M
C109	6.8uf		35V	SP	196D685X0035FB	C121	.001uf	20%	500V	SP	C023B501E102M
C110	1uf	20%	35V	SP	196D105X0035HA1	C122	.0047uf	5%	1000V	TRW	X463UW
C111	100pf	10%	500V	ELM	DM15C101K	C123	0.51uf	5%	1000V	TRW	X463UW
C112	1uf	20%	35V	SP	196D105X0035HA1						

## TRANSISTORS, DIODES & MISC.

Symbol	Description		Mfr.	Part No.	Symbol	Description		Mfr.	Part No.
Q101	TIP32A		TI	TIP32A	U104	MC1741CP		MOT	MC1741CP
Q102	2N2219A		MOT	2N2219A	U105	LF356N		NS	LF356N
Q103	2N2905A		MOT	2N2905A	U106	LF356N		NS	LF356N
Q105	TIP31A		TI	TIP31A	CR101	1N4002		ITT	1N4002
Q106	TIP31A		TI	TIP31A	CR102	1N4002		ITT	1N4002
Q107	TIP32A		TI	TIP32A	CR103	1N4002		ITT	1N4002
Q108	MPS6566		MOT	MPS6566	CR104	1N4002		ITT	1N4002
U101	MC1741CP		MOT	MC1741CP	CR105	1N957B, 6.8V		APD	1N957
U102	MC1741CP		MOT	MC1741CP	CR106	1N4149		APD	1N4149
U103	MC1741CP		MOT	MC1741CP	CR107	1N967, 18V		APD	1N967B
					CR108	1N4002		ITT	1N4002



### TRANSISTORS, DIODES & MISC. (CONT.)

Symbol	Description	Mfr.	Part No.	Symbol	Description	Mfr.	Part No.
CR109	1N749, 4.3V	APD	1N749	J701	RECEPTACLE, POWER	SWC	EAC-301
CR110	1N4002	ITT	1N4002	S101	SWITCH, PUSHBUTTON, MULTIPLIER	KH	B3674
CR111	1N4002	ITT	1N4002	S601	SWITCH, TOGGLE, POWER	CK	U11
CR112	1N4002	ITT	1N4002	S700	SWITCH, SLIDE, NORM/LOW	SWC	46256LFR
CR113	1N4002	ITT	1N4002	S701	SWITCH, SLIDE, 120V/240V	SWC	46256LFR
CR114	1N4002	ITT	1N4002	S702	SWITCH, SLIDE, GROUND	SWC	GF-123
CR115	1N4149	APD	1N4149	T701	TRANSFORMER, POWER	KH	C3691-A
CR116	1N4149	APD	1N4149		LINFCORD	BEL	17250B
CR117	1N4149	APD	1N4149				
CR118	1N4149	APD	1N4149				
CR119	1N4577A, 6.4V	NS	1N4577A				
DS601	LED, INDICATOR, POWER	DIA	559-0101-003				
F701	FUSE, SLOW BLOW, 120V (2000)	BUS	MDL-5A				
	FUSE, SLOW BLOW, 120V (2200, 2400)	BUS	MDL-3/4A				
	FUSE, SLOW BLOW, 240V (2000)	BUS	MDL-.25A				
	FUSE, SLOW BLOW, 240V (2200, 2400)	BUS	MDL-3/8A				

### MANUFACTURERS CODE

AB	(01121)	Allen Bradley Co.	Milwaukee, Wisc.	KID	(12126)	Kidco Inc.	Medford, N.J.
APD	(50273)	American Power Devices	Andover, Mass.	MAL	(37942)	P. R. Mallory & Co.	Indianapolis, Inc.
BKM	(30646)	Beckman Instrument Inc.	Cedar Grove, N.J.	MOT	(04713)	Motorola Semiconductor	Phoenix, Ariz.
BUS	(71400)	Bussman Mfg. Div.	St. Louis, Mo.	NS	(36462)	National Semiconductor Ltd.	Plattsburgh, N.Y.
CK	(09353)	C&K Components Inc.	Watertown, Mass.	SP	(56289)	Sprague Electric Co.	North Adams, Mass.
DLV	(99800)	Delevan Electronics	East Aurora, N.Y.	SWC	(82389)	Switchcraft Inc.	Chicago, Ill.
ELM	(72136)	Electromotive Mfg.	Willimantic, Conn.	TL	(94322)	TeI-Labs Inc.	Needham, Mass.
ITT		ITT Semiconductor	Woburn, Mass.	TRW	(84411)	TRW Capacitor Div.	Ogallala, Neb.
KH	(88865)	Krohn-Hite Corp.	Avon, Mass.	UID		UID Electronics Div., AMF Inc.	Hollywood, Fla.



PC 592

OUTPUT AMPLIFIER

OUTPUT BUFFER

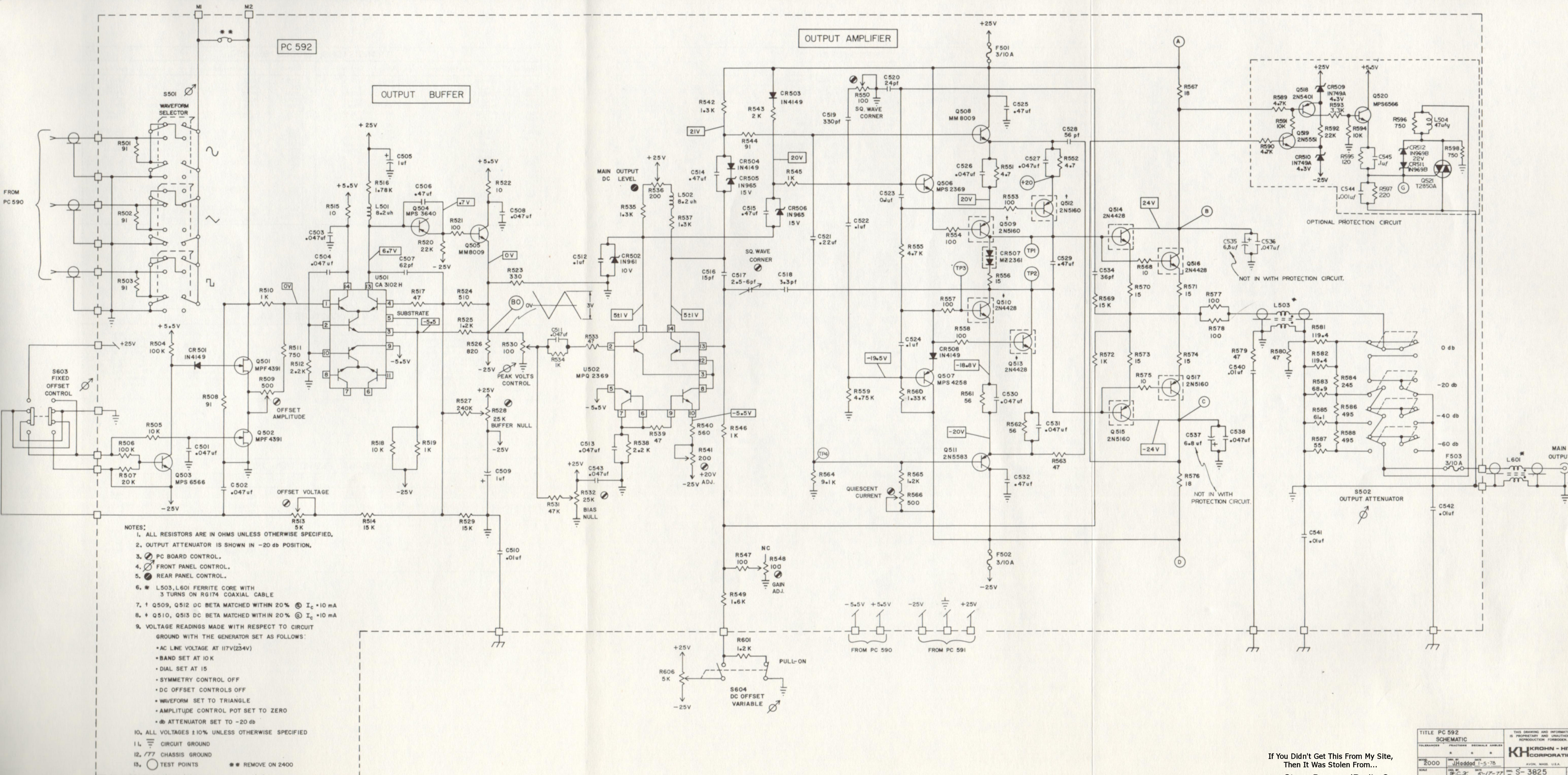

- NOTES:
1. ALL RESISTORS ARE IN OHMS UNLESS OTHERWISE SPECIFIED.
  2. OUTPUT ATTENUATOR IS SHOWN IN -20 db POSITION.
  3. PC BOARD CONTROL.
  4. FRONT PANEL CONTROL.
  5. REAR PANEL CONTROL.
  6. \* L503, L601 FERRITE CORE WITH 3 TURNS ON RG174 COAXIAL CABLE
  7. † Q509, Q512 DC BETA MATCHED WITHIN 20% @  $I_c = 10 \text{ mA}$
  8. † Q510, Q513 DC BETA MATCHED WITHIN 20% @  $I_c = 10 \text{ mA}$
  9. VOLTAGE READINGS MADE WITH RESPECT TO CIRCUIT GROUND WITH THE GENERATOR SET AS FOLLOWS:
    - AC LINE VOLTAGE AT 117V(234V)
    - BAND SET AT 10 K
    - DIAL SET AT 15
    - SYMMETRY CONTROL OFF
    - DC OFFSET CONTROLS OFF
    - WAVEFORM SET TO TRIANGLE
    - AMPLITUDE CONTROL POT SET TO ZERO
    - db ATTENUATOR SET TO -20 db
  10. ALL VOLTAGES  $\pm 10\%$  UNLESS OTHERWISE SPECIFIED
  11. CIRCUIT GROUND
  12. CHASSIS GROUND
  13. TEST POINTS \*\* REMOVE ON 2400

TITLE PC 592		SCHEMATIC		THIS DRAWING AND INFORMATION IS PROPRIETARY AND UNAUTHORIZED REPRODUCTION FORBIDDEN.	
DESIGNED BY	DATE	APPROVED BY	DATE	KROHN-HITE CORPORATION AVON, MASS. U.S.A.	
2000	JHaddad 1-5-76			S-3825	
SCALE	REV	DATE	BY	REV 8-16-79	

If You Didn't Get This From My Site,  
Then It Was Stolen From...  
www.SteamPoweredRadio.Com







## RESISTORS

Symbol	Description			Mfr.	Part No.	Symbol	Description			Mfr.	Part No.
R501	91	5%	1/4W	AB	CB9105	R547	100	1%	1/4W	AB	CC1000F
R502	91	5%	1/4W	AB	CB9105	R548	100	POT		BKM	72PM
R503	91	5%	1/4W	AB	CB9105	R549	1.6K	5%	1/4W	AB	CB1625
R504	100K	10%	1/4W	AB	CB1041	R550	100	POT		BKM	72PM
R505	10K	10%	1/4W	AB	CB1031	R551	4.7	10%	1/4W	AB	CB47G1
R506	100K	10%	1/4W	AB	CB1041	R552	4.7	10%	1/4W	AB	CB47G1
R507	20K	5%	1/4W	AB	CB2035	R553	100	10%	1/4W	AB	CB1011
R508	91	5%	1/4W	AB	CB9105	R554	100	10%	1/4W	AB	CB1011
R509	500	POT		BKM	72PM	R555	4.7K	10%	1/4W	AB	CB4721
R510	1K	5%	1/4W	AB	CB1535	R556	15	10%	1/4W	AB	CB1501
R511	750	5%	1/4W	AB	CB7515	R557	100	10%	1/4W	AB	CB1011
R512	2.2K	10%	1/4W	AB	CB2221	R558	100	10%	1/4W	AB	CB1011
R513	5K	POT		BKM	72PM	R559	4.75K	1%	1/4W	AB	CC4751F
R514	15K	10%	1/4W	AB	CB1535	R560	1.33K	1%	1/4W	AB	CC1331F
R515	10	10%	1/4W	AB	CB1001	R561	56	10%	1/4W	AB	CB5601
R516	1.78K	1%	1/4W	AB	CC1781F	R562	56	10%	1/4W	AB	CB5601
R517	47	10%	1/4W	AB	CB4701	R563	47	10%	1/4W	AB	CB4701
R518	10K	10%	1/4W	AB	CB1031	R564	9.1K	5%	1/4W	AB	CB9125
R519	1K	1%	1W	KEL	KM-100	R565	1.2K	5%	1/4W	AB	CB1225
R520	22K	10%	1/4W	AB	CB2231	R566	500	POT		BKM	72PM
R521	100	10%	1/4W	AB	CB1011	R567	18	10%	1W	AB	GB1801
R522	10	10%	1/4W	AB	CB1001	R568	10	10%	1/4W	AB	CB1001
R523	330	10%	1/4W	AB	CB3311	R569	15K	5%	1/4W	AB	CB1535
R524	510	5%	1/4W	AB	CB5115	R570	15	10%	1/4W	AB	CB1501
R525	1.2K	10%	1/4W	AB	CB1221	R571	15	10%	1/4W	AB	CB1501
R526	820	10%	2W	AB	MB8211	R572	1K	1%	1/4W	AB	CC1001F
R527	240K	5%	1/4W	AB	CB2445	R573	15	10%	1/4W	AB	CB1501
R528	25K	POT		BKM	72PM	R574	15	10%	1/4W	AB	CB1501
R529	15K	5%	1/4W	AB	CB1535	R575	10	10%	1/4W	AB	CB1001
R530	100	POT		KH	A-3707	R576	18	10%	1W	AB	GB1801
R531	47K	10%	1/4W	AB	CB4731	R577	100	1%	3/4W	KID	M6-T1-100
R532	25K	POT		BKM	72PM	R578	100	1%	3/4W	KID	M6-T1-100
R533	47	10%	1/4W	AB	CB4701	R579	47	10%	1/4W	AB	CB4701
R534	1K	5%	1/4W	AB	CB1025	R580	47	10%	1/4W	AB	CB4701
R535	1.3K	5%	1/2W	AB	EB1325	R581	119.4	1%	3/4W	KID	M6-T1-119.4
R536	200	POT		BKM	72XW	R582	119.4	1%	3/4W	KID	M6-T1-119.4
R537	1.3K	5%	1/2W	AB	EB1325	R583	68.9	1%	1/2W	KID	M5-T1-68.9
R538	2.2K	10%	1/4W	AB	CB2221	R584	245	1%	1/4W	KID	M4-T1-245
R539	47	10%	1/4W	AB	CB4701	R585	61.1	1%	1/2W	KID	M5-T1-61.1
R540	560	10%	1W	AB	GB5611	R586	495	1%	1/4W	KID	M4-T1-495
R541	200	POT		BKM	72PM	R587	55	1%	1/2W	KID	M5-T1-55
R542	1.3K	5%	1/4W	AB	CB1325	R588	495	1%	1/4W	KID	M4-T1-495
R543	2K	5%	1/4W	AB	CB2025						
R544	91	5%	1/4W	AB	CB9105	R601	1.2K	5%	1/4W	AB	CB1225
R545	1K	5%	1/4W	AB	CB1025						
R546	1K	5%	1/4W	AB	CB1025	R606	5K	POT			PART OF 5604 ASSY

## CAPACITORS

Symbol	Description			Mfr.	Part No.	Symbol	Description			Mfr.	Part No.
C501	0.047uf	20%	50V	ERT	8131-50-651-473M	C523	0.1uf	20%	100V	ERT	8131-100-651-104M
C502	0.047uf	20%	50V	ERT	8131-50-651-473M	C524	0.1uf	20%	100V	ERT	8131-100-651-104M
C503	0.047uf	20%	50V	ERT	8131-50-651-473M	C525	0.47uf	20%	100V	ERT	8131-100-651-474M
C504	0.047uf	20%	50V	ERT	8131-50-651-473M	C526	0.047uf	20%	50V	ERT	8131-50-651-473M
C505	1uf	20%	35V	MAL	TDC105M035AL	C527	0.047uf	20%	50V	ERT	8131-50-651-473M
C506	0.47uf	20%	100V	ERT	8131-50-651-474M	C528	56pf	10%	500V	ELM	DM15C560K
C507	62pf	10%	500V	ELM	DM15C620K	C529	0.47uf	20%	100V	ERT	8131-100-651-474M
C508	0.047uf	20%	50V	ERT	8131-50-651-473M	C530	0.047uf	20%	50V	ERT	8131-50-651-473M
C509	1uf	20%	35V	MAL	TDC105M035AL	C531	0.047uf	20%	50V	ERT	8131-50-651-473M
C510	0.01uf	20%	500V	SP	C023B501G103M	C532	0.47uf	20%	100V	ERT	8131-100-651-474M
C511	0.047uf	20%	50V	ERT	8131-50-651-473M						
C512	0.1uf	20%	100V	ERT	8131-100-651-104M	C534	36pf	5%	500V	ELM	DM15C360J
C513	0.047uf	20%	50V	ERT	8131-50-651-473M	C535 *	6.8uf	20%	35V	SP	196D685X0035FB
C514	0.47uf	20%	100V	ERT	8131-100-651-474M	C536	0.047uf	20%	50V	ERT	8131-50-651-473M
C515	0.47uf	20%	100V	ERT	8131-100-651-474M	C537 *	6.8uf	20%	35V	SP	196D685X0035FB
C516	15pf	5%	500V	ELM	DM15C150J	C538	0.047uf	20%	50V	ERT	8131-50-651-473M
C517	2.5-6pf	TRIMMER		STT	75-TR1K0-02-2.5/6pf						
C518	3.3pf	10%	500V	ASP	9209-33910	C540	0.01uf	20%	500V	SP	C023B501G103M
C519	330pf	10%	500V	ELM	DM15C331J	C541	0.01uf	20%	500V	SP	C023B501G103M
C520	24pf	10%	500V	ELM	DM15C240K	C542	0.01uf	20%	500V	SP	C023B501G103M
C521	0.22uf	20%	50V	ERT	8131-50-651-224M	C543	0.047uf	20%	50V	ERT	8131-50-651-473M
C522	0.1uf	20%	100V	ERT	8131-100-651-104M						

\*Not used with optional protection circuit.

### TRANSISTORS, DIODES & MISC.

Symbol	Description	Mfr.	Part No.	Symbol	Description	Mfr.	Part No.
Q501	MPF4391	MOT	MPF4391	CR502	1N961	APD	1N961
Q502	MPF4391	MOT	MPF4391	CR503	1N4149	APD	1N4149
Q503	MPS6566	MOT	MPS6566	CR504	1N4149	APD	1N4149
Q504	MPS3640	MOT	MPS3640	CR505	1N965	APD	1N965
Q505	MM8009	MOT	MM8009	CR506	1N965	APD	1N965
Q506	MPS2369	MOT	MPS2369	CR507	MZ2361	MOT	MZ2361
Q507	MPS4258	MOT	MPS4258	CR508	1N4149	APD	1N4149
Q508	MM8009	MOT	MM8009				
Q509*	2N5160	MOT	2N5160	F501	FUSE,FAST BLOW,3/10A	BUS	GFA-3/10A
Q510**	2N4428	MOT	2N4428	F502	FUSE,FAST BLOW,3/10A	BUS	GFA-3/10A
Q511	2N5583	RCA	2N5583	F503	FUSE,FAST BLOW,3/10A	BUS	GFA-3/10A
Q512*	2N5160	MOT	2N5160	L501	8.2uhy	DLV	1537-34
Q513**	2N4428	MOT	2N4428	L502	8.2uhy	DLV	1537-34
Q514	2N4428	MOT	2N4428	L503	CORE,FERRITE	STK	768-T-188/3E2A
Q515	2N5160	MOT	2N5160				
Q516	2N4428	MOT	2N4428	L601	CORE,FERRITE	STK	768-T-188/3E2A
Q517	2N5160	MOT	2N5160				
U501	CA3102H	RCA	CA3102H	S501 & S502	SWITCH PUSH-BUTTON,7 STATION	KH	B-3675
U502	MPQ2369	MOT	MPQ2369				
CR501	1N4149	APD	1N4149	S603	SWITCH,SLIDE,FIXED OFFSET	SWC	SS-93-10
				S604	SWITCH,PUSH-PULL W/GANGED POTENTIOMETER,VARIABLE OFFSET	KH	A3714

\*Q509, Q512 DC Beta Matched within 20% @ I<sub>c</sub> = 10mA  
 \*\*Q510, Q513 DC Beta Matched within 20% @ I<sub>c</sub> = 10mA

### MANUFACTURERS CODE

AB (01121) Allen Bradley Co.	Milwaukee, Wisc.	KH (88865) Krohn-Hite Corp.	Avon, Mass.
APD (50273) American Power Devices	Andover, Mass.	KID (12126) Kidco Inc.	Medford, N.J.
ASP (82142) Airco Speer	Dubois, Pa.	MAL (37942) P. R. Mallory & Co.	Indianapolis, Ind.
BKM (30646) Beckman Instrument Inc.	Cedar Grove, N.J.	MOT (04713) Motorola Semiconductor	Phoenix, Ariz.
BUS (71400) Bussman Mfg. Div.	St. Louis, Mo.	RCA (49671) Radio Corp. of America	Harrison, N.J.
DLV (99800) Delevan Electronics	East Aurora, N.Y.	SP (56289) Sprague Electric Co.	North Adams, Mass.
ELM (72136) Electromotive Mfg.	Willimantic, Conn.	STK (78488) Stackpole Carbon Co.	St. Mary's, Pa.
ERT (72982) Erie Technological	Erie, Pa.	STT	Cazanovia, N.Y.
KEL (07088) Kelvin Resistors	Van Nuys, Calif.	SWC (82389) Switchcraft Inc.	Chicago, Ill.

### OPTIONAL PROTECTION CIRCUIT

Symbol	Description	Mfr.	Part No.	Symbol	Description	Mfr.	Part No.
R589	4.7K 10% 1/4W	AB	CB4721	Q518	2N5401	MOT	2N5401
R590	4.7K 10% 1/4W	AB	CB4721	Q519	2N5551	MOT	2N5555
R591	10K 10% 1/4W	AB	CB1031	Q520	MPS6566	MOT	MPS6566
R592	22K 10% 1/4W	AB	CB2231	Q521	T2850A	RCA	T2850A
R593	3.3K 10% 1/4W	AB	CB3321				
R594	10K 10% 1/4W	AB	CB1031				
R595	120 10% 1/2W	AB	EB1211	CR509	1N749A,4.3V	APD	1N749A
R596	750 5% 1/4W	AB	CB7515	CR510	1N749A,4.3V	APD	1N749A
R597	220 10% 1/4W	AB	CB2211	CR511	1N969B,22V	APD	1N969B
R598	750 5% 1/4W	AB	CB7515	CR512	1N969B,22V	APD	1N969B
C544	.001uf 20% 500V	SP	C0238501E102M				
C545	0.1uf 20% 100V	ERT	8131-100-651-104M	L504	47uhy	DLV	2890-26





**KROHN-HITE**  
CORPORATION