

Preparation

**Part Number: PT758-35170-02**

**Kit Contents**

Item #	Quantity Req.	Description
1	1	Ø16 x 7 et13 Alloy Wheel

**Hardware Bag Contents**

Item #	Quantity Req.	Description
1		
2		
3		

**Additional Items Required For Installation**

Item #	Quantity Req.	Description
1	1	Center Cap <b>PT280-35170-02</b>
2	As needed	Low-Profile, Lead-Free Stick-on Type Balance Weights <b>3M TN-4023</b> (or equivalent)
3	As needed	Balance Weights, Clip-on Type
4	As needed	Valve Grommet Fitting Kit P/N <b>04423-0E010</b>

**Conflicts**

None
------

**General Applicability**

2017 and newer Tacoma TRD PRO
-------------------------------

**Recommended Sequence of Application**

Item #	Accessory
1	16" Alloy Wheel
2	Optional Wheel Locks

**Vehicle Service Parts** (May be required for reassembly)

Item #	Quantity Req.	Description
1	0-4 as needed	Valve Stem Fit Kit (if required) Consult EPC or MicroCAT for correct TPMS P/N for corresponding model and year.
2	0 - 4 as needed	TPMS 20 degree (if required) Consult EPC or MicroCAT for correct TPMS P/N for corresponding model and year.

**Recommended Tools**

<b>Personal &amp; Vehicle Protection</b>	Notes
Safety Glasses	
Seat Protection	Blanket
<b>Special Tools</b>	Notes
Tire Mounting Machine	Hunter TC3250 or equiv.
Wheel Balancing Machine	Hunter DSP9700 or equiv.
Centering Cone	Hunter <b>192-51-2</b> or equiv.
Foot Brake Application Tool	Snap-on B240A Pedal Jack or equivalent.
<b>Installation Tools</b>	Notes
Lug Nut Wrench	21 mm wrench flat
Torque Wrench	20-150 ft-lbf (27-204 N-m)
Torque Wrench	30-150 in-lbf (3.3-17 N-m)
Sockets	10mm, 11mm, 12mm, and 21 mm Deep Well, Thin Wall
Extension	4-inch (as needed)
Rubber Mallet	
Clean Lint-free Cloth	
Nylon Panel Removal Tool	e.g. Toyota Pry Tool #1 Toyota SST # 00002-06001-01 or equiv.
Valve Stem Removal Tool	Schraeder Valve Type
Valve Stem Torque Tool	Snap-On QDTPMS or equiv.
Wire Brush	Hand held size
<b>Special Chemicals</b>	Notes
Tire Lube / Paste	Myers or equivalent
Cleaner (for rework of stick on weights if needed)	Locally approved cleaner

**Legend**

 **STOP:** Damage to the vehicle may occur. Do not proceed until process has been complied with.

 **OPERATOR SAFETY:** Use caution to avoid risk of injury.

 **CAUTION:** A process that must be carefully observed in order to reduce the risk of damage to the accessory/vehicle and to ensure a quality installation.

 **TOOLS & EQUIPMENT:** Used in Figures calls out the specific tools and equipment recommended for this process.

 **REVISION MARK:** This mark highlights a change in installation with respect to previous issue.

 **SAFETY TORQUE:** This mark indicates that torque is related to safety.

Procedure

Care must be taken when installing this accessory to ensure damage does not occur to the vehicle. The installation of this accessory should follow approved guidelines to ensure a quality installation.

These guidelines can be found in the "Accessory Installation Practices" document.

This document covers such items as:-

- Vehicle Protection (use of covers and blankets, cleaning chemicals, etc.).
- Safety (eye protection, rechecking torque procedure, etc.).
- Vehicle Disassembly/Reassembly (panel removal, part storage, etc.).
- Electrical Component Disassembly/Reassembly (battery disconnection, connector removal, etc.).

Please see your Toyota dealer for a copy of this document.

**1. Prepare the Vehicle.**

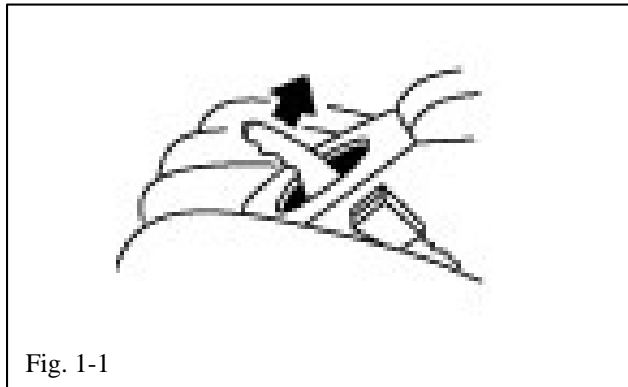

**STOP** (a) Firmly apply the parking brake (Fig. 1-1).

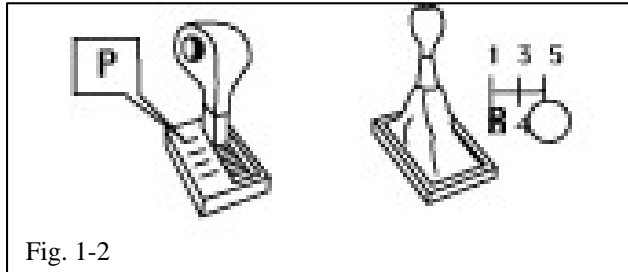

**STOP** (b) Put automatic transmission in "P". Put manual transmission in "R" (Fig. 1-2).

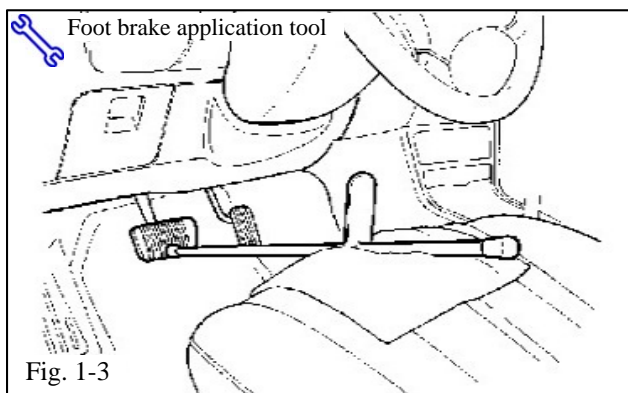

(c) Add seat protection (blanket) and apply the foot brake using a foot brake application tool (Fig. 1-3).

(d) Lift the vehicle.

**STOP CAUTION:** Place a safety stand under the front of the vehicle or under the front pinch seam, "jack position," while the vehicle is off the ground for additional vehicle support.

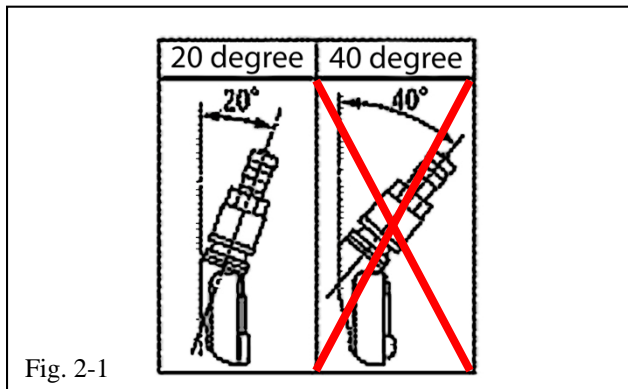
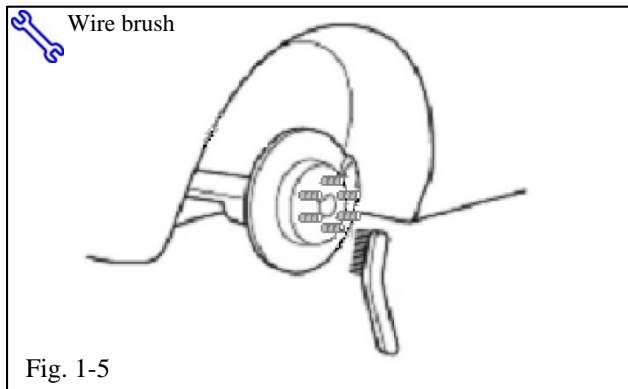
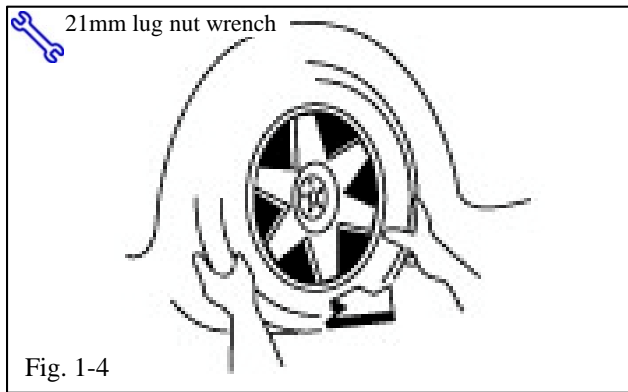

- ⚠ (e) Mark the tire installation position on the inward facing tire sidewall i.e. Front Right = FR, Front Left = FL, Rear Right = RR, Rear Left = RL.
- ✚ (f) Remove the OE wheel and tire assembly from the vehicle (Fig. 1-4). Wear safety glasses while removing wheels.

- ✚ (g) If required, remove any corrosion on the mounting surface of the vehicle with a wire brush (Fig. 1-5). Wear safety glasses to protect against any debris.

⚠ **NOTE: If pre-balanced tire and wheel assemblies are to be installed, skip to Step 6; otherwise continue to Step 2.**

## 2. Remove the Tire Pressure Monitor Valve Sub-assembly.

⚠ **NOTE: If reusing the TPMS sensors they must be 20-degree Tire Pressure Sensors (Fig. 2-1)!**

- (a) Remove & retain the valve cores and release the air from all four tires.
- (b) Remove & retain the nuts and washers and let the pressure sensors drop inside the tires.

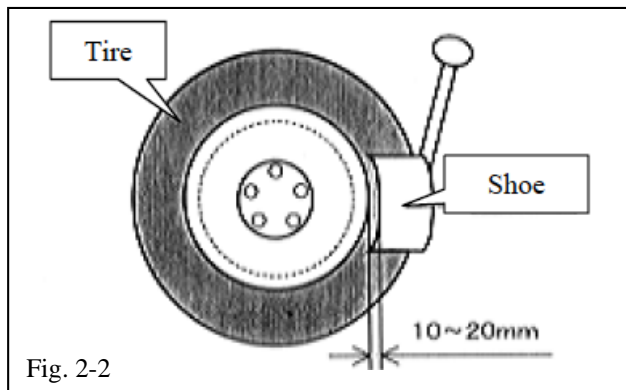

(c) Carefully separate the outer tire bead from the wheel rim (Fig. 2-2).

**STOP NOTE:** Be careful not to damage the tire pressure monitor due to interference between the sensor and tire bead.

(d) Remove the sensor from the tire and remove the bead on the lower/inner side as in the usual tire removal operation.

(e) Dismount the OE tire from the OE wheel.

(f) Repeat for all four tires.

### 3. Install the Tire Pressure Monitor Sensor (TPMS) Sub-assembly into the Accessory Wheels.

(a) Check that the wheel valve hole is clean and free of sharp edges or burrs.

(b) Check that the rim is clean.

(c) Visually check that no deformation or damage exists on the tire pressure monitor valve sub-assembly.

(d) Check that the grommet, washer and nut are all clean and in good condition.

**STOP NOTE:** Replace the grommet ONLY IF the grommet is old or was damaged. A damaged grommet is NOT reusable.

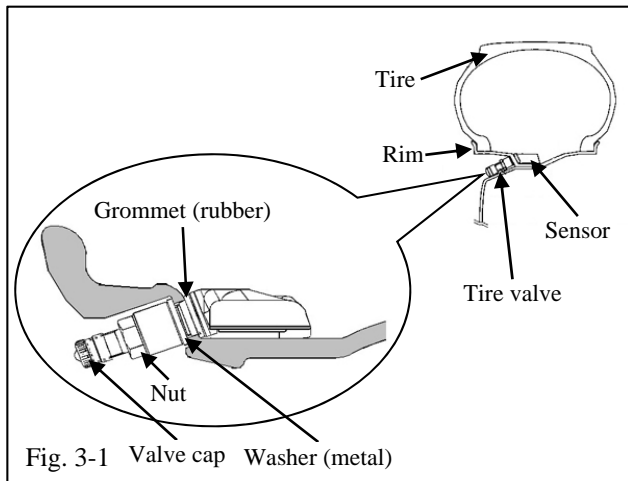

Fig. 3-1 Valve cap Washer (metal)

- (e) Insert the tire pressure monitor valve sub-assembly into the wheel valve hole from the inside of the rim and bring the valve stem to the outside (Fig. 3-1).
- (f) Insert the tire pressure monitor valve sub-assembly so that the "Manufacturer's" mark is visible.

**STOP NOTE:** Incorrect orientation of the pressure monitor sub-assembly may cause damage and prevent signal transmission during high-speed driving.

- !** (g) Install the washer on the outside of the wheel and secure it with the nut.

**S Torque: 36 in-lbf (4.0 N-m)**

**4. Mount the Tires.**

- (a) Mount the dismantled OE **265/70R16 112T** tires on the alloy wheels. Ensure the marked side is facing inward.

**STOP NOTE:** Align the red dot on the tire to the valve stem location on the wheel.

- (b) Use tire lube on the tire beads and bead locations on the wheel prior to mounting the tire.
- (c) Position the wheel on the mounting machine with the sensor at ~ 7 o'clock position (shaded area in Fig. 4-1). The mount/dismount head is considered as 12 o'clock.

- (d) Mount the lower tire bead.

**STOP NOTE:** If the sensor is positioned outside this area, it generates interference with the tire bead, causing possible damage to the sensor.

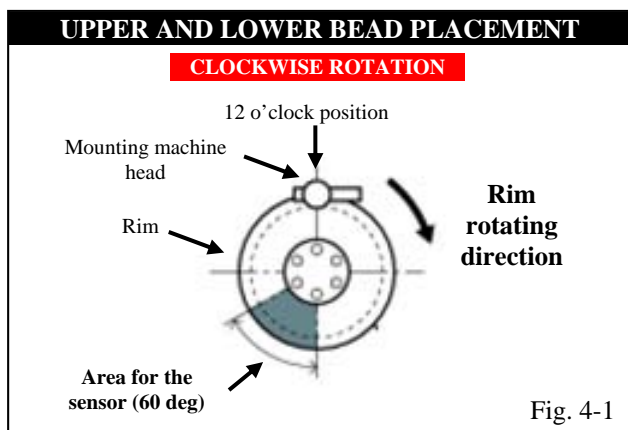
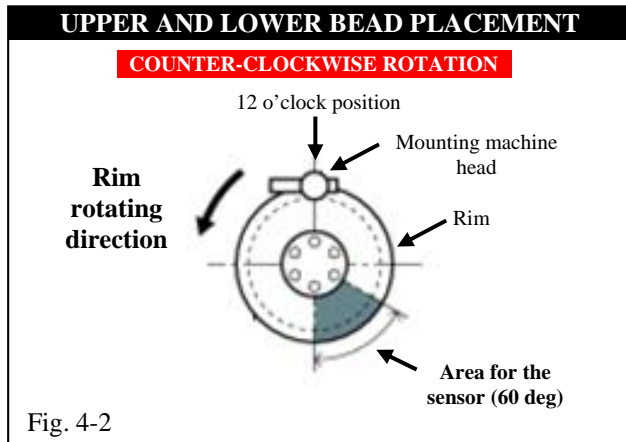

Fig. 4-1



(e) Reposition the wheel on the mounting machine with the sensor at ~ 7 o'clock position (shaded area in Fig. 4-1).

(f) Mount the upper tire bead.

**STOP** NOTE: If the mounting machine rotates in the counterclockwise direction, refer to Fig. 4-2 for sensor placement.

**STOP** NOTE: Make sure that the tire bead and tool does not interfere with the main body of the sensor and the bead does not clamp sensor.

**+** (g) To seat the tire beads, inflate the tire beyond 30 PSI (210 kPa) but not more than the maximum tire bead seat pressure indicated on the tire sidewall. If it is not indicated, use 40 PSI (275 kPa) as a limit. If both tire beads are not seated when the pressure registers 40 PSI (275 kPa), deflate the tire and re-inflate it to seat the beads.

(h) Install and torque the valve stem cores with the valve stem torque tool.

(i) Regulate the tire pressures to the OE tire pressure specified on the OE tire pressure label found on the driver side door jamb.

(j) Be sure to **recheck the torque** on the TPMS nuts.

**S** Torque: 36 in-lbf (4.0 N-m)

(k) Install the valve stem caps by hand.

**5. Balance the Wheels.**

 **NOTE:** Application temperature for stick-on type weight is above 50°F (10°C). It is good practice to apply the stick-on type in sections comprised of no more than 5 or 6 individual weight segments. This wheel requires stick-on weight on the outer rim and clip-on weight on the inner rim for correct balancing.

- (a) If new tires are being used, remove the tire labels from the tire tread.
- (b) Prior to mounting stick-on weight, use VDC-approved cleaner as needed to clean the weight mounting location on the wheel, then wipe down with a clean, dry, lint-free cloth. Ensure that the location is clean and dry.

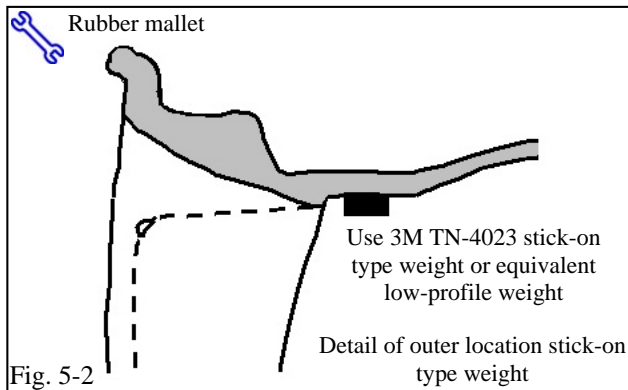
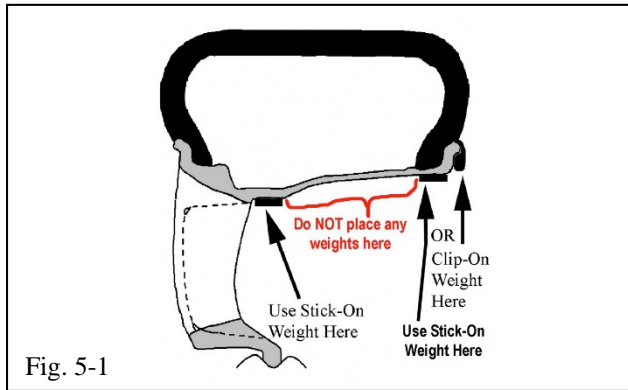

(c) Mount the wheel/tire on the wheel balance machine and balance in DYNAMIC MODE. Enable the LOAD ROLLER, if applicable, to ensure proper bead seating. Use clip-type balance weights on the inner rim lip and stick-on type weights at outer location (Fig. 5-1 & Fig. 5-2). Use a rubber mallet, if required, to achieve complete adhesion of stick-on type weight(s).

**⚠ NOTE:** Weights should be no taller than 4 ~ 5 mm in height.

**⚠ NOTE:** The maximum allowable amount of clip-on type weight on the inner and outer rim is **200 g** (7.0 oz.). If weight required exceeds this, place machine in STATIC mode and proceed. If weight required still exceeds limit, rotate tire 180 degrees relative to wheel and repeat Step 5(c). If removal and replacement of stick-on type weight is necessary, remove the weight using a nylon removal tool. Clean the surface with a clean cloth using a locally approved cleaning solution. Wipe the surface dry before re-applying new weight(s). **DO NOT RE-USE STICK-ON WEIGHTS.**

(d) Re-spin the wheel on the machine with the LOAD ROLLER DISABLED (if applicable) and note the indicated remaining unbalance. The maximum permitted unbalance is 8 g (0.28 oz.) at the inner location and 8 g (0.28 oz.) at the outer location. If the indicated unbalance is not within the permissible limit, add required additional balance weights, within specification, and re-spin the tire/wheel assembly.



**6. Install the Wheels / Tires on the Vehicle.**

-  (a) Install the wheel/tire assemblies onto the vehicle in the marked positions (FR, FL, RR, RL). Hand start the lug nuts.

 **NOTE:** If wheel locks are being added, install one wheel lock per wheel at the 12 o'clock position with the valve stem at the 6 o'clock position (Fig. 6-1).

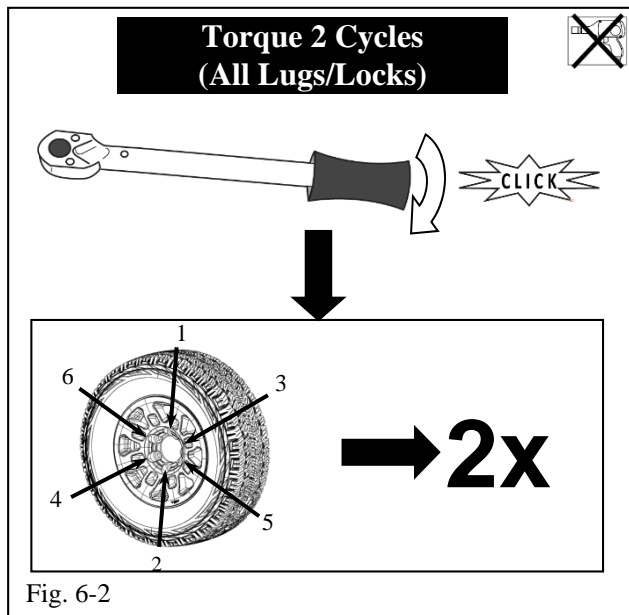
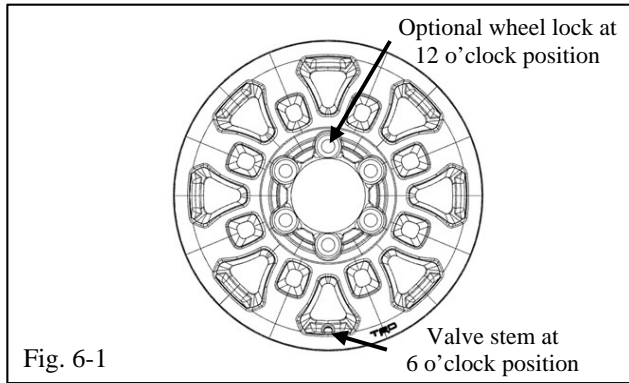

- (b) Tighten the lug nuts in sequence 1 through 6 or equivalent star pattern (Fig. 6-2). Ensure that the socket does not scuff the wheels. Tighten to 83 ft-lbf (112 N-m) using a torque wrench.

 **Torque: 83 ft-lbf (112 N-m)**

 **CAUTION: DO NOT USE AN IMPACT WRENCH TO INSTALL OR REMOVE WHEEL LOCKS.**

- (c) Re-torque all lug nuts in the same 1-6 sequence (Fig. 6-2).

 **Torque: 83 ft-lbf (112 N-m)**

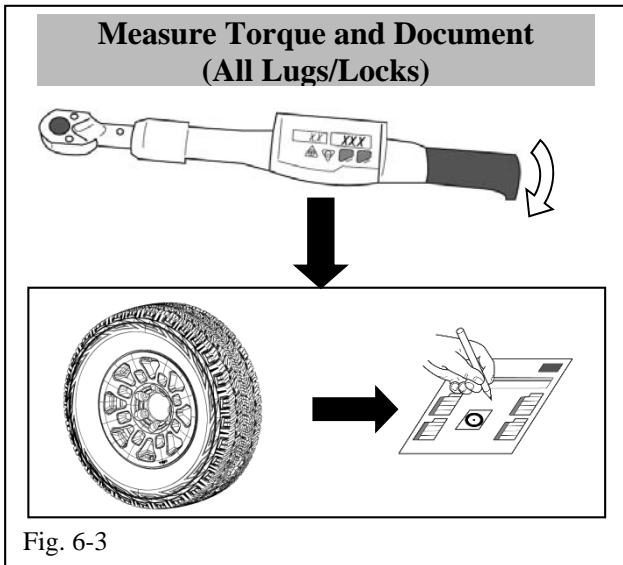

- (d) With the vehicle still on the lift, use a digital torque wrench to measure the torque of each lug nut/lock, and TPMS nut. Record the values on the Torque Audit Sheet (Fig. 6-3) (PPO installation only, does not apply to DIO installation).
- (e) Lower the vehicle.
- (f) Check tire inflation pressure value recommended in the owner's manual or the B-pillar label located on the driver's side for this vehicle ( $\pm 2$  PSI). Verify during this process only.
- (g) Install the valve stem caps.

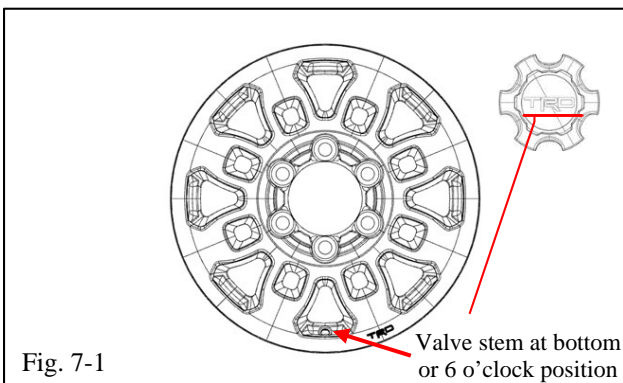

**7. Install the Center Caps.**

-  (a) Install the center caps into the wheels. Be sure to orient the TRD logo right side up and level in relationship to the valve stem when it is in the 6 o'clock position. Gently push the center cap into the wheel until the cap snaps into place (Fig. 7-1).

### 8. TPMS Transmitter ID Registration Using Techstream.

- (a) Connect the Techstream to DLC3 (Fig. 8-1).
- (b) Turn the ignition switch to the ON position (do not start the vehicle) then turn the Techstream ON.
- (c) Start the Techstream application by clicking on the shortcut located on the Desktop.

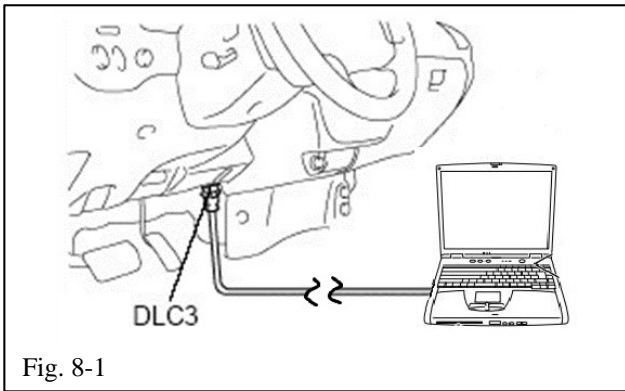

Fig. 8-1

- (d) Click “Connect to Vehicle” button (Fig. 8-2).

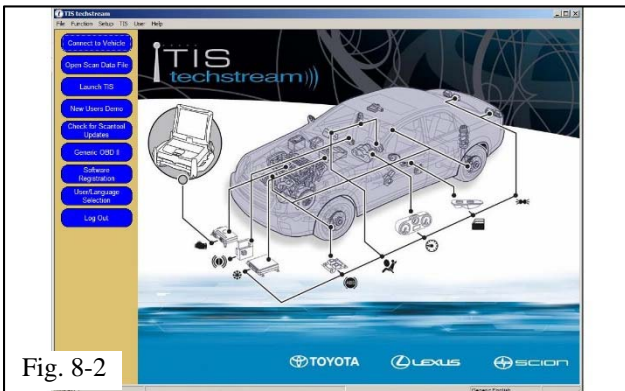

Fig. 8-2

- (e) Confirm that the information displayed on the Vehicle Connection Wizard is correct. If not, make the appropriate selections from the drop down menus, then click “Next” (Fig. 8-3).

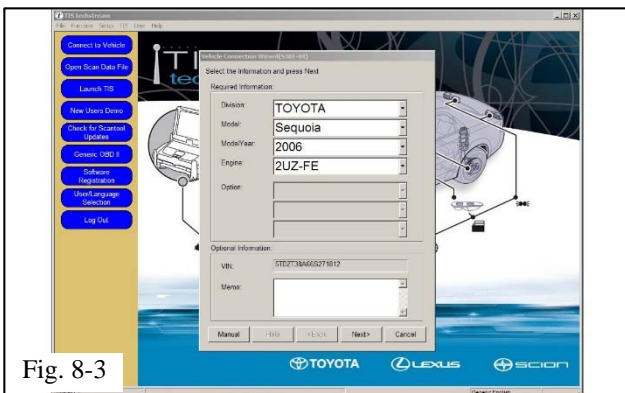

Fig. 8-3

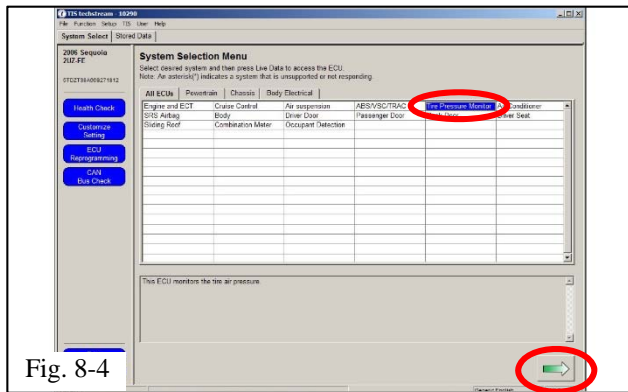

Fig. 8-4

(f) Select “**Tire Pressure Monitor**” then click the green arrow located on the bottom right (Fig. 8-4).



Fig. 8-5

(g) Select “**UTILITY**” to begin input of new TPMS ID codes (Fig. 8-5).

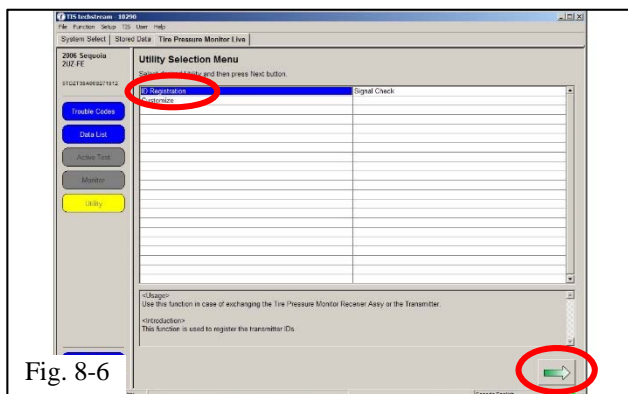

Fig. 8-6

(h) Select “**ID Registration**” then click the green arrow located at the bottom right corner (Fig. 8-6).

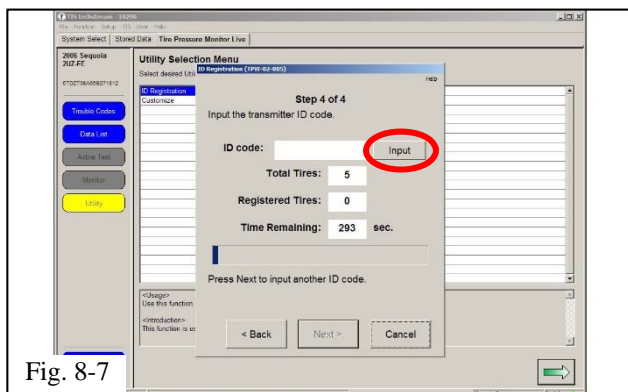

Fig. 8-7

(i) Select “**Next**” for Steps 1 through 3. Select “**Input**” in Step 4 to begin TPMS ID registration (Fig. 8-7).

**⚠ NOTE: PPO Only!** Read the TPMS ID off the label attached to the tire near the air valve.

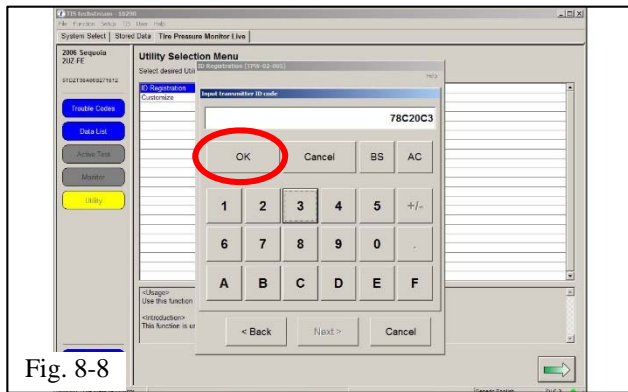

Fig. 8-8

- (j) Input the TPMS ID code then click “OK”  
Repeat the same procedure for all other TPMS ID codes (Fig. 8-8).

**NOTE:** If this process is not completed within 5 minutes, the transmitter will return to normal operation mode and process will need to be started over at Step 11(g).

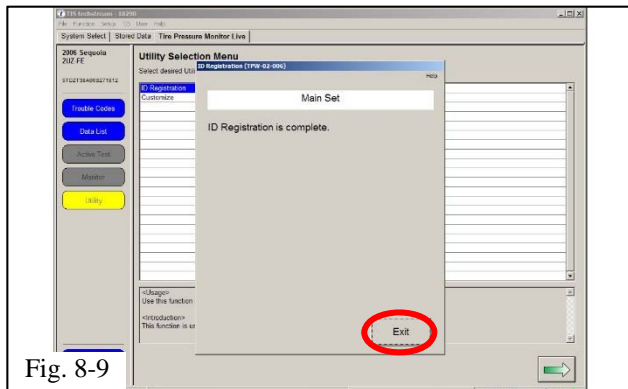

Fig. 8-9

- (k) After all TPMS ID numbers have been registered, “ID Registration is complete” text should be displayed. Click “Exit” to finish the registration process (Fig. 8-9).

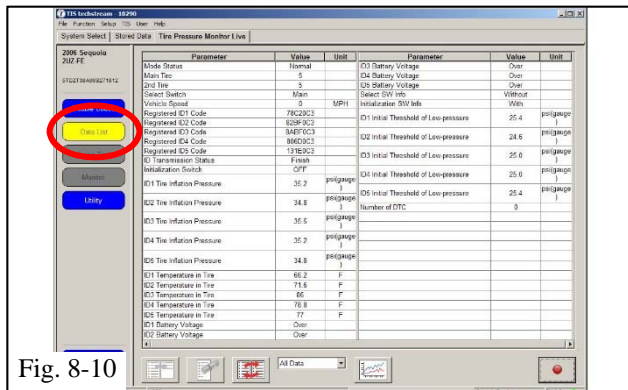

Fig. 8-10

- (l) Select “DATA LIST” to view and confirm the TPMS ID numbers have been correctly registered (Fig. 8-10).

Checklist - these points **MUST** be checked to ensure a quality installation.

Check:

Look For:



Inspect Lug Nuts & Torque

Verify that five lug nuts/locks are installed on each wheel and the optional wheel lock is in the correct position. Torque must be **83 ft-lbf (112 N-m)**.



TPMS Torque

TPMS nut must be torqued to **36 in-lbf (4.0 N-m)**.

Record Lug & Lock Torque

Measure the torque of each lug/lock on all wheels and record it on the Torque Audit Sheet (PPO installation only, does not apply to DIO installation).

Register TPMS sensors

Make sure to register all TPMS sensors to the vehicle using the Techstream tool.

Record TIN

Record Tire ID # (TIN).

Center Caps

Verify center caps are securely in place on all four wheels & oriented correctly.

Correct Tire Pressure

Verify tire pressure is set to the value specified on the OE Tire Pressure Label.

Driver Instrument Panel

Verify "TPMS warning light" is not ON.

Optional Wheel Lock Placement

Verify the Wheel Lock Key is in the appropriate location in the vehicle and the associated paperwork is placed into the vehicle glove compartment.

Vehicle Appearance Check

After accessory installation and removal of protective cover(s), perform a visual inspection.

Ensure no damage (including scuffs and scratches) was caused during the installation process.  
(For PPO installations, refer to TMS Accessory Quality Shipping Standard.)