

# Radio Electronics®

JANUARY 1992

TECHNOLOGY - VIDEO - STEREO - COMPUTERS - SERVICE

## BUILD THIS SWEEP/FUNCTION GENERATOR AND FREQUENCY COUNTER

Square, triangle and sine waves to 2.5 MHz, and a 150-MHz frequency counter!



## CABLE TV's MAGIC BULLET

Find out how it works

## BUILD A MONITOR EXERCISER

A convenient troubleshooting tool for computer monitors



## TURN ANY PHONE INTO A HIGH-QUALITY SPEAKERPHONE

Build R-E's Speaker Mate!

## ANALOG-TO-DIGITAL CONVERSION

Experimenting with the IBM PC



\$2.95 U.S.  
\$3.75 CAN

A  
GERNSBACK  
PUBLICATION

\*\*\*\*\* CAR-RT SORT \*\* CR27  
303092DRK6450M091

01 49

MAY 92

LLOYD DARKNELL  
6450 MYRTLEWOOD DR  
CUPERTINO, CA

RB

95014



**FLUKE**®



**PHILIPS**

# Introducing SCOPEMETER™

There's More Than One Reason to Reach for It.

In fact, there's *every* reason to reach for ScopeMeter™. Because only ScopeMeter combines the expertise of Fluke and Philips to bring you a dual-channel digital scope along with everything you've come to expect from Fluke digital multimeters.

The result: an integrated scope-and-multimeter that lets you see a waveform and digital meter display at the same time from the same input. Or switch between dedicated high-performance Scope and Meter functions with the touch of a key. That makes it faster and easier than ever to capture, store and analyze precisely what you're looking for. At a price that looks good, too.

To get your hands on a ScopeMeter, contact your Fluke sales office or your nearest Fluke distributor. For more product information, call 1-800-44-FLUKE.

SCOPEMETER. Now there's only one to reach for.



## Built to Take It.

- Completely sealed against water, dust and contaminants.
- EMI protected and measures up to 600 volts rms.
- Rugged construction with shock-resistant holster.
- Three-year warranty from Fluke.



## Simply Easy.

- Intuitive front panel layout for simple, straightforward operation.
- Pop-up menus and five function keys for easy control.
- Autoset automatically sets voltage, time and trigger functions.
- Safety-designed BNC connectors and probes simplify floating measurements.

## Double Duty.

- 50 MHz digital storage scope and 3000-count digital multimeter in one handheld package.
- Precision Min Max Record and 40 ns Glitch Capture make it easy to troubleshoot intermittent failures.
- Simultaneous waveform and digital display on a backlit screen you can read across the room.

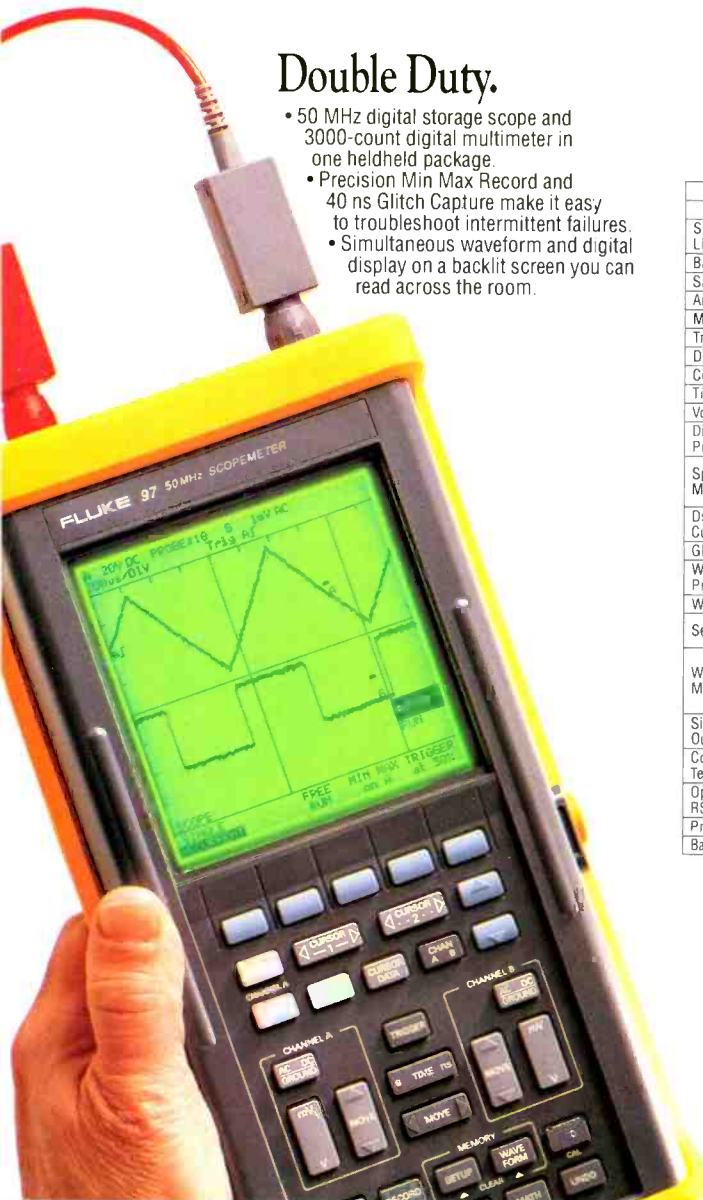

FLUKE 90 SERIES SCOPEMETER SELECTION GUIDE			
	FLUKE 97	FLUKE 95	FLUKE 93
Suggested List Price	\$1795	\$1495	\$1195
Bandwidth	50 MHz Dual Channel		
Sample Rate	25 Megasamples/second		
Autoset	Automatically sets Voltage, Time and Trigger		
Multimeter Display	3 1/3 digits (>3000 Counts)		
True RMS Volts	AC or AC+DC up to 600V (1700V Pk-Pk)		
Diode Test	Up to 2.8V		
Continuity Beeper	Yes		
Time/Division	10 ns/div to 60 sec/civ		
Volts/Division	1 mV/div to 100V/div	5 mV/div to 100V/div	
Digital Delay or Pre-Trigger	By Number of Cycles, Events, Time, or Zoom Mode		By Time
Special Multimeter Modes	Min Max Average Record, Relative (zero), dBm, dBV, dBW, Audio Watts, % Scale, Frequency, Smoothing, Change Alert™		Frequency, Smoothing, Change Alert™
Oscilloscope Cursors	12 Measurements, Display 5 Simultaneously		
Glitch Capture	≥40 ns		
Waveform Processing	Average, Variable Persistence, Min Max Record		
Waveform Memory	Store and Recall 8 Waveforms		
Set-Up Memory	Store and Recall 10 Front Panel Set-Ups		
Waveform Mathematics	Add, Subtract, Multiply, Invert, Filter or Integrate Waveforms		
Signal Generator Output	Sinewave or Squarewave		
Component Tester Output	Voltage or Current Ramp		
Optically Isolated RS-232-C Interface	Full Operation by Remote Control		
Printer Output	Serial		
Backlit Display	Electroluminescent		

## Goes Wherever You Go.

- Runs on rechargeable NiCad Batteries, standard C-cells or the included line voltage adapter/battery charger.
- Adjustable tilt-stand comes in handy as a hanger, too.
- Compatible with a wide range of Fluke multimeter accessories.

©1991 John Fluke Mfg. Co., Inc. Ad No 00075

**FLUKE**®

CIRCLE 121 ON FREE INFORMATION CARD

# January 1992 *Radio Electronics*®

Vol. 63 No. 1

## BUILD THIS

- 35 SWEEP/FUNCTION GENERATOR**  
Generate square, triangle, and sine waves with this inexpensive benchtop instrument.  
**Michael A. Lashansky**
- 43 SPEAKER MATE**  
Turn any regular telephone into a high-quality speakerphone!  
**David Plant**
- 47 MONITOR TESTER**  
Troubleshoot computer monitors without hooking them up to a computer.  
**Garth Price**
- 59 EXPERIMENTING WITH ADC FOR YOUR PC**  
Build a low-cost automatic data-capture system.  
**James J. Barbarello**

## TECHNOLOGY

- 33 CABLE TV'S INFAMOUS BULLET**  
How a New York cable company zapped signal pirates.  
**Ken Foley**
- 50 WORKING WITH LED'S**  
A close look at a variety of LED circuits.  
**Ray Marston**

## DEPARTMENTS

- 6 VIDEO NEWS**  
What's new in this fast-changing field.  
**David Lachenbruch**
- 22 EQUIPMENT REPORTS**  
McGraw-Hill Science & Technical CD-ROM.
- 69 HARDWARE HACKER**  
VGA adapter for the Mac LC, computer monitors, and more.  
**Don Lancaster**
- 73 AUDIO UPDATE**  
Reader questions.  
**Larry Klein**
- 75 DRAWING BOARD**  
More on automotive voltage regulators.  
**Robert Grossblatt**
- 84 COMPUTER CONNECTIONS**  
The future of multimedia mayhem.  
**Jeff Holtzman**

1991 ANNUAL INDEX	
<i>Electronics</i> Volume 62	
Advertising	1-12
Articles	13-100
Columns	101-105
Classified	106-110
Index	111-115
Letters	116-120
Market Center	121-125
New Products	126-130
What's News	131-135

**PAGE 63**

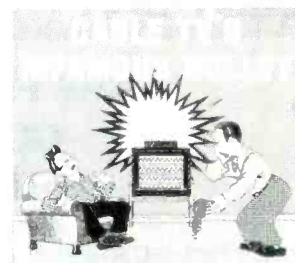

How American Cablevision's "bullet" zapped signal pirates.

**KEN FOLEY**  
The New York City-based cable company, American Cablevision, has a unique way of dealing with signal pirates. Instead of suing them, the company sends them a "bullet" — a signal that cuts off their access to the network. This method has been successful in reducing piracy and has become a model for other cable companies.

**PAGE 33**

## AND MORE

- 96 Advertising and Sales Offices**
- 96 Advertising Index**
- 12 Ask R-E**
- 14 Letters**
- 86 Market Center**
- 30 New Lit**
- 24 New Products**
- 63 1991 Annual Index**
- 4 What's News**



## ON THE COVER



Even though a dependable function generator and frequency counter are invaluable pieces of test equipment—ones that are a necessity on a professional test bench—they're often simply beyond the means of the hobbyist. Until now, that is. Our sweep/function generator and frequency counter produces up to a 2.5-MHz square, triangle, or sine-wave output with a 1- to 20-volt peak-to-peak amplitude, and it costs just \$300 to build. In addition, the instrument features a TTL or CMOS 0.5- to 15-volt peak output, and can be used as a 150 MHz frequency counter. For all the details, turn to page 35.

## COMING NEXT MONTH

### THE FEBRUARY ISSUE GOES ON SALE JANUARY 7.

#### BUILD THIS SCANNER CONVERTER

It allows unrestricted coverage of the 800-MHz band.

#### CIRCUIT COOKBOOK

Our in-depth survey of LED's continues with practical chaser and bargraph circuits.

#### SWEEP/FUNCTION GENERATOR AND FREQUENCY COUNTER

Part II provides all the construction details.

#### NEW LIFE FOR AM RADIO?

Will AMAX receivers breathe new life into the AM band?

As a service to readers, RADIO-ELECTRONICS publishes available plans or information relating to newsworthy products, techniques and scientific and technological developments. Because of possible variances in the quality and condition of materials and workmanship used by readers, RADIO-ELECTRONICS disclaims any responsibility for the safe and proper functioning of reader-built projects based upon or from plans or information published in this magazine.

Since some of the equipment and circuitry described in RADIO-ELECTRONICS may relate to or be covered by U.S. patents, RADIO-ELECTRONICS disclaims any liability for the infringement of such patents by the making, using, or selling of any such equipment or circuitry, and suggests that anyone interested in such projects consult a patent attorney.

RADIO-ELECTRONICS, (ISSN 0033-7862) January 1992. Published monthly by Gernsback Publications, Inc., 500-B Bi-County Boulevard, Farmingdale, NY 11735 Second-Class Postage paid at Farmingdale, NY and additional mailing offices. Second-Class mail registration No. R125166280, authorized at Toronto, Canada. One-year subscription rate U.S.A. and possessions \$17.97, Canada \$25.65 (includes G.S.T. Canadian Goods and Services Tax Registration No. R125166280), all other countries \$26.97. All subscription orders payable in U.S.A. funds only, via international postal money order or check drawn on a U.S.A. bank. Single copies \$2.95. © 1992 by Gernsback Publications, Inc. All rights reserved. Printed in U.S.A.

**POSTMASTER:** Please send address changes to RADIO-ELECTRONICS, Subscription Dept., Box 55115, Boulder, CO 80321-5115.

A stamped self-addressed envelope must accompany all submitted manuscripts and/or artwork or photographs if their return is desired should they be rejected. We disclaim any responsibility for the loss or damage of manuscripts and/or artwork or photographs while in our possession or otherwise.

# Radio Electronics®

Hugo Gernsback (1884-1967) founder

Larry Steckler, EHF, CET,  
editor-in-chief and publisher

#### EDITORIAL DEPARTMENT

Brian C. Fenton, editor

Marc Spiwak, associate editor

Kim Dunleavy,  
assistant technical editor

Teri Scaduto, assistant editor

Jeffrey K. Holtzman  
computer editor

Robert Grossblatt, circuits editor

Larry Klein, audio editor

David Lachenbruch  
contributing editor

Don Lancaster  
contributing editor

Kathy Terenzi, editorial assistant

#### ART DEPARTMENT

Andre Duzant, art director

Injae Lee, illustrator

Russell C. Truelson, illustrator

#### PRODUCTION DEPARTMENT

Ruby M. Yee, production director

Janice Box,  
editorial production

Karen S. Brown  
advertising production

Marcella Amoroso  
production assistant

#### CIRCULATION DEPARTMENT

Jacqueline P. Cheeseboro  
circulation director

Wendy Alanko  
circulation analyst

Theresa Lombardo  
circulation assistant

Michele Torrillo, reprint bookstore

Typography by Mates Graphics

Cover photo by Diversified Photo  
Services

Radio-Electronics is indexed in  
*Applied Science & Technology Index*  
and *Readers Guide to Periodical Literature*.

Microfilm & microfiche editions are  
available. Contact circulation department  
for details.

#### Advertising Sales Offices listed on page 96.

Radio-Electronics Executive and

Administrative Offices

1-516-293-3000.

Subscriber Customer Service:

1-800-288-0652.

Order Entry for New Subscribers:

1-800-999-7139.

The  
Audit  
Bureau  
of Circulation





# HASTA LA VISTA BABY!

Terminate your Search for a Handi-Counter™. We're going to blow you away with this offer! \*\$100. off our full range Model 2810.

\*Limited time only, no discounts and no trade ins. Made in the U.S.A.

# \$159.

**Don't Wait,  
This Offer Can't Last!  
Reg. Price, \$259**



- Full range -10Hz to 3GHz.
- LCD display (daylight visibility).
- True state-of-the-art technology with the high speed ASIC.
- NiCads & Charger included.
- Ultra-high sensitivity.
- Extruded metal case.
- 4 gate times.
- Compatible with MFJ207.

### Suggested options

TA100S:	Telescoping Whip Antenna.....	\$ 12.
CC30	Vinyl Carry Case.....	\$ 14.
BL10:	LED Backlight.....	\$ 15.
BL28:	EI Backlight for use in roomlight and low light.....	\$ 45.
BG28:	Bargraph Signal Level Indicator.....	\$100.
TCXO 30:	Precision ±0.2ppm 20 to 40°C temp. compensated time base.....	\$100.

Universal Handi-Counter™ Model 3000, \$375. and Bench Model 8030, \$579. Both offer frequency, period, ratio and time interval.



## OPTOELECTRONICS

Call for free catalog - Factory Direct Order Line:

# 1-800-327-5912

FL (305)771-2050 • FAX (305)771-2052

CIRCLE 139 ON FREE INFORMATION CARD

5821 NE 14th Ave. • Ft. Lauderdale, FL 33334  
5% Ship/Handling (Max. \$10) U.S. & Canada.  
15% outside continental U.S.A.  
Visa and Master Card accepted.

# WHAT'S NEWS

*A review of the latest happenings in electronics.*

## Wireless data communication for mobile workers

Incorporating Motorola's RPM400i radio packet modem, a notebook-size, battery-operated computer from IBM (White Plains, NY) will allow users to access and input information to a mainframe computer from remote locations. Service technicians, for instance, could use the 9075 PCradio Model 002 to obtain technical information or order emergency parts without leaving the job site. The modem incorporates the smallest and lightest data radio currently available, according to Motorola. The PCradio operates over the ARDIS network, a partnership of IBM and Motorola that was formed last year to provide nationwide wireless communications to Fortune 1000 companies, and the Mobidata network in Canada. The unit uses an 80C186 microprocessor and operates at either 5 or 10 MHz. The model 002, whose wireless modem operates at up to 4800 bps, can also be used with telephone communications networks (at 2400 bps). PCradio can send or receive fax copies over cellular networks at up to 9600 bps and over



**INCORPORATING MOTOROLA'S** radio packet modem, IBM'S PCradio can provide a wireless link to larger IBM computers via radio or cellular-based communications—ideal for police officers checking license-plate numbers, sales reps requiring immediate information on product inventories, or service technicians ordering emergency parts.

landlines at 2400 bps. On cellular networks, with an optional handset, PCradio can be used as a telephone. Two other PCradio models will also be available: The model 001 is a basic unit for conventional telephone communications; the model 003 is designed for cellular-based communications, includes a cellular modem, and can also be used with standard telephone networks. As we go to press, FCC approval has just been granted.

## Highly sensitive moisture sensors

Researchers at Sandia National Laboratories (Albuquerque, NM) have fabricated from silicon extremely sensitive moisture sensors capable of making accurate humidity measurement inside IC's.

Besides their excellent sensitivity and quick response time, the sensors offer several other advantages, including consistent performance at temperatures higher than 100°C. But their primary advantage lies in the fact that because they are made of silicon—the same basic material used to manufacture IC's—the sensors can be made by manufacturing methods that are compatible with the standard techniques used to make IC's. That "complete compatibility" of equipment and procedures holds the promise of the future manufacture of so-called "smart sensors" that combine the sensor and micro-electronic logic elements on the IC chip. That opens the door to such applications as environmental control in buildings by integrating a smart humidity sensor within heating, ventilation, and air-conditioning (HVAC) systems.

The capacitor-type sensors use a material known as oxidized porous silicon (OPS) as the moisture-adsorbing dielectric between the two electrodes in the capacitor. When water vapor contacts the sensor, it permeates through the porous volume between the electrodes, causing a net change in the dielectric

constant of the porous volume, which is then monitored by measuring the capacitance of the device.

## Law-enforcement aircraft

A light utility aircraft has been specially modified by the British company Pilatus Britten Norman to accommodate state-of-the-art surveillance and anti-narcotic detection equipment manufactured by Westinghouse Electronic Systems Group (Baltimore, MD). The modified plane, known as the Multi-Sensor Surveillance Aircraft, or MSSA, features



**THE WESTINGHOUSE** Multi-System Surveillance Aircraft (MSSA), a specially modified light plane fitted with advanced detection and interdiction technologies, is designed for law-enforcement and anti-narcotic surveillance missions.

a unique, bulbous nose that provides enough room for the installation of sensors and avionics systems, including the radar and infrared imaging system that form the heart of the MSSA's ability to detect and track unusual activity on the ground or in the air, night or day.

In addition to the radar (a version of the one supplied by Westinghouse for the USAF's F-16 fighter) and the infrared system (similar to that used by the U.S. Coast Guard), the MSSA has a high-tech operations console and an advanced communications system that put the plane's capabilities at the fingertips of an onboard operator and link them to support personnel in the air or on the ground. The aircraft, which is intended for use in drug interdiction, law-enforcement surveillance, border and fisheries patrol, airspace control, etc., was scheduled to be available by the end of 1991.

**R-E**



# TEST FOR LESS WITH FORDHAM

**Model DVM-636**

**Now Only \$59<sup>95</sup>**

*Rugged & Reliable!*  
• 8 Functions  
• 37 Ranges

**SCOPE Hand Held Digital Multimeters**

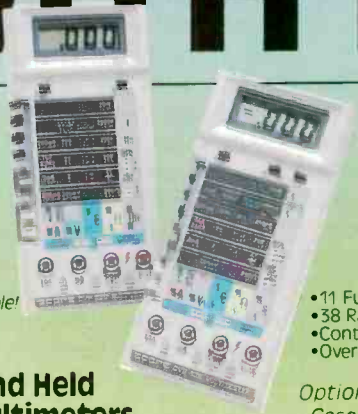

**Model DVM-638**

**Now Only \$69<sup>95</sup>**

• 11 Functions  
• 58 Ranges  
• Continuity Beeper  
• Overload Protection

*Optional Carrying Case CA-92 \$9.95*



**NEW! GLOBAL<sup>®</sup> SPECIALTIES Digital Multimeter**

• 3½ Digit LCD  
• Full Overload protection  
• Diode & Continuity Checks With Audible Alarm  
• 10MΩ Input Impedance  
• Auto Ranging: AC/DC Voltage  
• AC/DC Current Resistance  
• Accuracy 0.5%

**Model 735 Our Price \$49<sup>95</sup>**

*Optional Carrying Case CA-92 \$9.95*



**SCOPE 3½ Digit LCR Meter**

*Ideal for field applications!*  
• Light weight • Portable • Hand Held  
• Overload Protection • Test Leads

**Model LCR-680 SALE \$119<sup>95</sup>**

*Optional Carrying Case CA-92 \$9.95*

**SCOPE 3½ Digit LCD Meter**

• 0.5% Accuracy • DC/AC Voltage, DC Current  
• Diode & Battery Test • Overload Protection  
DC 500V, AC 350V, Ohms 250V DC/AC

**Model DVM-630 SALE \$32<sup>50</sup>**

*Reg. \$50.00  
Optional Deluxe Carrying Case CC-30 \$4.50*



**Sweep Function Generator**

**Sale! Now \$198<sup>00</sup>**

*Reg. \$319.95*

**Model FG-801**

• Selectable Wave & TTL Pulse  
• 7 Freq. Ranges (0.2 Hz to 2MHz)  
• Sweep Ratio 100:1



**SCOPE Analog Lab**

**Sale! Now \$198<sup>00</sup>**

*Reg. \$225.00*

**Model SC-6000**

• 5 Freq. Ranges  
• Variable Positive Power  
• Potentiometer



**Proto-Board Station**

**Special! \$298<sup>00</sup>**

**Model SC-9000A**

• 3 Wire AC Line Input  
• Function Generator  
• Triple Power Supply  
• 8 Logic LED's



**Feature Packed! HITACHI Oscilloscope**

**Now \$425<sup>00</sup> Save \$190<sup>00</sup>**

*Reg. \$615.00*

**Model V-212 Dual Trace**

• DC to 20 MHz, 1mV/div  
• 6" Rectangular Screen  
**PROBES INCLUDED!**



**HITACHI Dual Trace Oscilloscope**

**Now \$598<sup>00</sup>**

**Best Value!**

**Model V-355**

• 19 Calibrated Sweeps  
• 6" CRT • Auto Focus  
**PROBES INCLUDED!**



# Fordham

260 Motor Parkway, Hauppauge, New York 11788

ASK FOR YOUR FREE CATALOG

**TOLL FREE 800-695-4848**

Service & Shipping Charge Schedule  
Continental U.S.A.

FOR ORDERS	ADD	FOR ORDERS	ADD
\$0-25	\$4.50	\$501-750	\$16.00
\$26-50	\$6.00	\$751-1,000	\$18.00
\$51-100	\$7.50	\$1,001-1,250	\$20.00
\$101-200	\$9.00	\$1,251-1,500	\$22.00
\$201-300	\$10.00	\$1,501-2,000	\$27.50
\$301-400	\$12.00	\$2,001 and up	\$35.00
\$401-500	\$14.00		

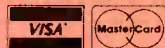

# VIDEO NEWS

What's new in the fast-changing video industry.

DAVID LACHENBRUCH

● **"Flat" tubes.** The catch-phrase for next year's color TV sets will be "flat tubes." Panasonic was the first in this latest flat-tube wave, introducing the "SuperFlat" under its premium Prism brand name. The SuperFlat scored a big success in Japan under the name "Gao," which means "king of pictures." The tube has a computer-designed faceplate which isn't really flat but has considerably less curvature than a conventional tube. In addition, the faceplate is extremely dark, providing more contrast, and new electronics supply the power and focus to realize the contrast without a loss of brightness and detail.

Not to be outdone, most other Japanese companies are now preparing their flatter tube versions. Sony will field a "Super Trinitron" in the United States in 1992, and Hitachi, Mitsubishi, and Toshiba are also flattening out their faceplates in Japan. All of this raises the question: What is "flat"? In a previous go-round, Toshiba developed the "FST," which originally stood for the "flat square tube." However, the tube wasn't either flat or square, so Toshiba changed the phrase to "flatter square tube," still preserving the acronym "FST."

Thomson Consumer Electronics, whose European tube operation has been selling a tube with a computer-designed faceplate—not quite flat, but with a flat appearance—took a poke at Panasonic's SuperFlat at a recent trade show with the slogan, "Super Planar, world's first super flat tube—4 million sold to date." Then along came Zenith, which is developing a truly flat-faced tube, the FTM (for "flat tension mask") tube that uses a piece of plate glass for a face. Zenith filed a complaint with the Better Business Bureau's National Advertising Division urging it to stop manufacturers from advertising "reduced curvature" tubes as "flat." But, somehow, "SuperReducedCurvature" doesn't have that special ring

to it. How about going back to "Gao?"

● **Digital sound for VHS.** First there was a longitudinal monophonic audio track on VHS, then longitudinal stereo, then hi-fi helical stereo. Now, finally, digital stereo is here. In Japan, JVC, Panasonic, Mitsubishi, Hitachi, and Sharp have introduced Super VHS recorders with digital audio tracks. The digital sound will be available only with S-VHS because the layout of the standard VHS signal doesn't have enough space for digital audio. The digital-sound recorders, having analog longitudinal and helical tracks as well, are compatible with previous recorders. The digital-audio system can record two channels at 48-kHz sampling frequency, 16 bits, or four channels at 32 kHz, 12 bits. Principal use of the recorders in Japan will be the tape satellite broadcasts that have digital audio. There's no word on whether the digital-sound recorders will be exported.

● **Public electronics show.** The latest advances in TV's, VCR's, camcorders, and home multimedia products will be on display to the public as the Consumer Electronics Show (CES) in Chicago opens its doors to actual "consumers" for the first time in its 25-year history. It's expected to attract as many as 100,000 visitors from the Chicago area and beyond. In the past, CES has been for the trade only, but this year's show, which will run from May 28 through May 31, will have two public days. May 28 and 29 will be trade-only days, as will the morning of Saturday, May 30, but the show will be open to all visitors from noon Saturday through 6 PM Sunday at the McCormick Convention Center and the Hilton Hotel. The nominal admission price will be \$10, but it's expected that dealers and exhibitors will distribute cut-rate tickets. The show's sponsor is the Electronic Industries Association's Consumer Electronics Group (EIA/CEG).

● **Camcorder format war.** The 8mm format was the clear winner in 1991 in the battle of the camcorder formats, with the VHS-C (compact) and full-size VHS models trailing with about equal shares. The EIA tallies sales of "compact" VCR's and full-size VHS. The "compact" category includes both 8mm and VHS-C. For the six months from April through September 1991, compacts outsold full-size units by 70% to 30% (but for the nine months through September, full-size models represented 33.2% of the total). The EIA doesn't break down compacts between VHS-C and 8mm, but the U.S. Commerce Department keeps track of imports of 8mm as a separate category, without breaking down between VHS and VHS-C model imports. In the latest available figures, for 1991's first seven months, 8mm constituted 42% of imported camcorders. Applying these figures to the EIA's data, this indicates that the ratio in 1991 worked out to roughly 40% 8mm and 30% each VHS-C and full-size VHS.

But don't count VHS-C out. The VHS-C proponents, led by Panasonic and JVC, are mounting a major campaign stressing compatibility of VHS-C with VHS home VCR decks by means of the VHS adaptor that comes with all VHS-C camcorders—not to mention a forthcoming generation of VCR's that can accept both VHS and VHS-C cassettes without adaptors.

The latest trends in camcorders include "digital zoom," an electronic extension of optical zoom to provide as much as 100:1 zoom ratio, at least theoretically. At that magnification, however, so much detail is lost that the picture isn't very viewable. Other trends are color LCD viewfinders; internal titles, including pre-selected on-screen messages such as "Birthday Party," "Wedding," "Our Vacation," etc.; and remote controls to permit the user to operate the tripod-mounted camcorder while he or she is in the picture.

R-E



**48 HOUR SHIPPING**

# ELENCO & HITACHI PRODUCTS AT DISCOUNT PRICES

TO ORDER  
CALL TOLL FREE  
**1-800-292-7711**

## Hitachi RSO Series

- (Portable Real-time Digital Storage Oscilloscopes)
- VC-6023 - 20MHz, 20MS/s \_\_\_\_\_ \$1,695
  - VC-6024 - 50MHz, 20MS/s \_\_\_\_\_ \$1,995
  - VC-6025 - 50MHz, 20MS/s \_\_\_\_\_ \$2,195
  - VC-6045 - 100MHz, 40MS/s \_\_\_\_\_ \$2,995
  - VC-6145 - 100MHz, 100MS/s \_\_\_\_\_ \$4,495

RSO's from Hitachi feature roll mode, averaging, save memory, smoothing, interpolation, pretriggering, cursor measurements. These scopes enable more accurate, simpler observation of complex waveforms, in addition to such functions as hardcopy via a plotter interface and waveform transfer via the RS-232C interface. Enjoy the comfort of analog and the power to digital.

## 25MHz Elenco Oscilloscope

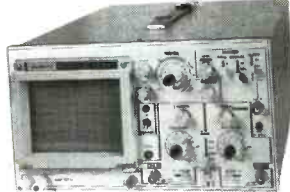

**\$349**  
**S-1325**

- Dual Trace
- 1mV Sensitivity
- 6" CRT
- X-Y Operation
- TV Sync

• (2) 1x, 10x Probes included

## SPECIAL BUY

**V-212 - 20MHz Scope \$425**

### Hitachi Portable Scopes

**DC to 50MHz, 2-Channel, DC offset function, Alternate magnifier function**

- V-525 - CRT Readout, Cursor Meas. \$995
- V-523 - Delayed Sweep \$975
- V-522 - Basic Model \$875
- V-422 - 40MHz \$775
- V-223 - 20MHz delayed sweep \$695
- V-222 - 20MHz deluxe \$625

## PRICE BREAKTHRU

### 20MHz Digital Storage Oscilloscope

- Analog/Digital Scope **DS203**
- 2K word per channel memory **\$795**
- 10MS/s sampling rate
- State-of-art technology
- Includes probes

## HITACHI COMPACT SERIES SCOPES

This series provides many new functions such as CRT Readout, Cursor measurements (V-1085/1065A/665A), Frequency Ctr. (V-1085), Sweeptime Autoranging, Delayed sweep and Trigger Lock using a 6-inch CRT. You don't feel the compactness in terms of performance and operation.

- V-660 - 60MHz, Dual Trace \_\_\_\_\_ \$1,149
- V-665A - 60MHz, DT, w/cursor \_\_\_\_\_ \$1,345
- V-1060 - 100MHz, Dual Trace \_\_\_\_\_ \$1,395
- V-1065A - 100MHz, DT, w/cursor \_\_\_\_\_ \$1,649
- V-1085 - 100MHz, QT, w/cursor \_\_\_\_\_ \$1,995
- V-1100A - 100MHz, Quad Trace \_\_\_\_\_ \$2,195
- V-1150 - 150MHz, Quad Trace \_\_\_\_\_ \$2,695

## Elenco 40MHz Dual Trace

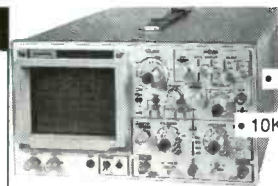

Good to 50MHz  
**\$495**  
**S-1340**

- High luminance 6" CRT
- 1mV Sensitivity
- 10KV Acceleration Voltage
- 17ns Rise Time
- X-Y Operation
- Includes (2) 1x, 10x Probes

All scopes include probes, schematics, operators manual and 3 year (2 yrs for Elenco scopes) world wide warranty on parts & labor. Many accessories available for all Hitachi scopes. Call or write for complete specifications on these and many other fine oscilloscopes. **1x, 10x Scope Probes: P-1 65MHz \$19.95, P-2 100MHz \$26.95**

**B + K TEST EQUIPMENT**  
All Models Available  
Call for special price

### Digital Capacitance Meter



**CM-1550B**  
**\$58.95**  
9 Ranges  
.1pf-20,000ufd  
.5% basic accy.  
Zero control w/ Case  
Big 1" Display

### Digital LCR Meter



**LC-1801**  
**\$125**  
Measures:  
Coils 1uH-200H  
Caps .1pf-200uf  
Res .01-20M

### Multimeter with Capacitance & Transistor Tester



**\$55 CM-1500B**  
Reads Volts, Ohms  
Current, Capacitors,  
Transistors and  
Diodes / with case

Big 1" Display

## FLUKE

### MULTIMETERS

All Models Available  
Fluke 70-II \_\_\_\_\_ \$65  
Fluke 77-II \_\_\_\_\_ \$145  
Fluke 79-II \_\_\_\_\_ \$169  
Fluke 87 \_\_\_\_\_ \$269  
Call for special price

### Quad Power Supply



**XP-580**  
**\$59.95**  
2-20V @ 2A  
12V @ 1A  
5V @ 3A  
-5V @ .5A

Fully regulated and short circuit protected

### Digital Triple Power Supply



**XP-765**  
**\$269**  
0-20V @ 1A  
0-20V @ 1A  
5V @ 5A

Fully regulated, Short circuit protected with 2 limit control, 3 separate supplies  
**XP-660 with Analog Meters \$195**

### AM/FM Transistor Radio Kit with Training Course

Model AM/FM 108  
**\$26.95**

14 Transistors • 5 Diodes  
Makes a great school project

### True RMS 4 1/2 Digit Multimeter



**M-7000**  
**\$135**  
.05% DC Accuracy  
.1% Resistance  
with Freq. Counter and Deluxe Case

### GF-8016 Function Generator with Freq. Counter



**\$249**

Sine, Square, Triangle  
Pulse, Ramp, .2 to 2MHz  
Freq Counter .1 - 10MHz  
Int/Ext operation

GF-8015 without Freq. Meter \$179

### Function Generator Blox



**#9600**  
**\$28.95**

Provides sine, triangle, square wave from 1Hz to 1MHz  
AM or FM capability

### Color Convergence Generator



**SG-250**  
**\$79.95**

Kit \$59.95

Finest in the industry  
10 rock steady patterns  
RF & Video output

## STANDARD AMATEUR RADIOS

Now available - The worlds finest amateur radios. Unsurpassed quality and features make STANDARD the worlds most popular line of amateur radios.

### Mini Deluxe HTs:

C168A 2 meter **CALL**  
C468A 450MHz

Twin Band HTs  
C228A 2M/220MHz **CALL**  
C528A 2M/440MHz

Twin Band Mobile  
C5608DA 2M/440MHz **CALL**

We also have many accessories for these radios and most heath radios. Call for details.

### Learn to Build and Program Computers with this Kit

Includes: All Parts, Assembly and Lesson Manual



Model  
**MM-8000**  
**\$129.00**

Starting from scratch you build a complete system. Our Micro-Master trainer teaches you to write into RAMs, ROMs and run a 8085 microprocessor, which uses similar machine language as IBM PC.

**WE WILL NOT BE UNDERSOLD!**

UPS Shipping: 48 States 5%  
(\$3 Min \$10 Max) Shipping  
IL Res., 7.5% Tax FAX: 708-520-0085

### Wide Band Signal Generators



**SG-9000 \$129**  
RF Freq 100K-450MHz AM Modulation of 1KHz Variable RF output  
**SG-9500 w/ Digital Display & 150 MHz built-in Counter \$249**

### High Current Power Supply



**XP-800**  
**\$295**

Digital

Volt/Amp Meters

Fully regulated, 0-122VAC @ 2A, 0-40VAC @ 10A or 0-30VDC @ 10A. Fully variable, Short circuit protected.

## C & S SALES INC.

1245 Rosewood, Deerfield, IL 60015  
(800) 292-7711 (708) 541-0710



**15 Day Money Back Guarantee**  
**2 Year Warranty** Prices Subject to Change

**WRITE FOR FREE CATALOG**

CIRCLE 109 ON FREE INFORMATION CARD

# If You're Serious About a Future in Electronics, Ensure that Future with the Best Educational Training Available.

**FREE!**

SEND FOR YOUR CIE HOME STUDY COURSE CATALOG AND RECEIVE A FREE 24 PAGE CIE ELECTRONICS SYMBOL HANDBOOK!

Includes hundreds of the most frequently used electronic symbols. Published by CIE exclusively for our students and alumni. Yours free when you request a CIE Course Catalog.

## Procedure

Figure 16 shows the circuit diagram for this experiment. You'll need the pin numbers for the IC aren't included on the diagram. For those, you'll have to refer to Fig. 17, which shows pertinent 74151A data. For the data inputs, you'll use an eight-pole DIP switch in conjunction with 10 k $\Omega$  pull-up resistors. For the Select and Strobe lines, finally, you'll use the trainer data switches.

1. With the power off, mount the 74151A IC and the DIP switch on the breadboard.
2. Connect the eight 10 k $\Omega$  resistors to the DIP switch as shown in Fig. 16. Connect the opposite end of each resistor to the +5V supply. The second terminal of each switch is to be connected to trainer ground.
3. Connect the IC V<sub>CC</sub> (pin 16) to +5V, connect the GND to trainer ground.
4. Next, connect the trainer data switches to the Select and Strobe inputs on the IC using Fig. 17 as a guide. Initially, set SW1 through SW4 to 0.
5. Connect the trainer Y LED to the Y output, and connect the W LED to the W output.
6. Set all eight poles of the DIP switch to 0. The high-level will be 1.

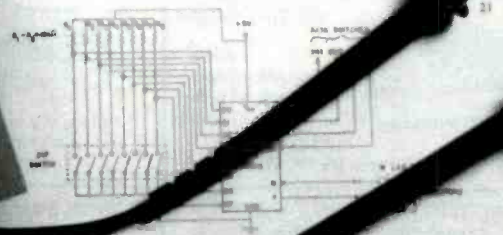

Fig. 16. Circuit for Experiment 2.

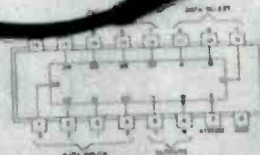

Fig. 17. Pin diagram for 74151A.

7. Turn the power on. The Y LED on your trainer should be off, and the W LED should be on. If you don't observe these conditions, turn off the power and check your connections.
8. From the present input conditions on the inputs, you can see that the input will be enabled.
9. Set the appropriate DIP switch HI (up), and verify your predictions. Record your results in terms of the selected input D, where D is the number of the selected data line in the appropriate space in the truth table in Fig. 18.



If you want to learn about electronics, and earn a good income with that knowledge then CIE is your best educational value.

CIE's reputation as the world leader in home study electronics is based solely on the success of our graduates. And we've earned that reputation with an unconditional commitment to provide our students with the very best electronics training.

Just ask any of the 150,000-plus graduates of the Cleveland Institute of Electronics who are working in high-paying positions with aerospace, computer, medical, automotive and communication firms throughout the world.



## CIE PROVIDES YOU WITH A LEARNING METHOD SO GOOD, IT'S PATENTED.

CIE's Auto-programmed lessons are a proven learning method for building valuable electronics career skills. Each lesson is designed to take you step-by-step and principle-by-principle. And while all CIE lessons are designed for independent study, CIE's instructors are personally available to assist you with just a toll-free call. The result is practical training... the kind of experience you can put to work in today's marketplace.

## LEARN BY DOING...WITH STATE-OF-THE-ART FACILITIES AND EQUIPMENT.

In 1969, CIE pioneered the first Electronics Laboratory course and in 1984, the first Microprocessor Laboratory course. Today, no other home study school can match CIE's state-of-the-art equipment and training. And all your laboratory equipment, books, and lessons are included in your tuition. It's all yours to use while you study at home and for on-the-job after graduation.

## PERSONALIZED TRAINING...TO MATCH YOUR BACKGROUND.

While some of our students have a working knowledge of electronics others are just starting out. That's why we've developed twelve career courses and an A.A.S. Degree program to choose from. So, even if you're not sure which electronics career is best for you, CIE can get you started with

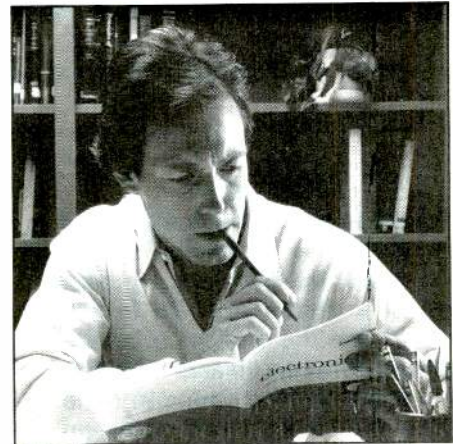

core lessons applicable to all areas of electronics. And every CIE course you take earns you credit towards completion of your Associate in Applied Science Degree. So you can work toward your degree in stages or as fast as you wish. In fact, CIE is the only school that actually rewards you for fast study, which can save you thousands of dollars.

SEND TODAY FOR YOUR CIE COURSE CATALOG AND WE'LL SEND YOU A FREE 24 PAGE CIE ELECTRONICS SYMBOL HANDBOOK!

FINANCIAL AID AVAILABLE TO QUALIFIED INDIVIDUALS.

## CIE'S COMMITTED TO BEING THE BEST...IN ONE AREA...ELECTRONICS.

CIE isn't another be-everything-to-everybody school. We teach only one subject and we believe we're the best at what we do. Also, CIE is accredited by the National Home Study Council. And with more than a 1,000 graduates each year, we're the largest home study school specializing exclusively in electronics. CIE has been training career-minded students like yourself for nearly 60 years and we're the best at our subject ..... **ELECTRONICS ... BECAUSE IT'S THE ONLY SUBJECT WE TEACH!**

### WHY CHOOSE CIE FOR YOUR TRAINING?

- 150,000 successful graduates from every country around the world.
- Only CIE rewards you for fast study. CIE offers an Associate Degree program based on actual study time used. The faster you complete your degree the less your overall tuition.
- State-of-the-art laboratory equipment is yours to keep and it comes assembled, ready for hands-on experiments.
- Approved for educational benefits under the G.I. Bill for veterans and other eligible persons.
- Upon graduation, CIE offers free preparation to pass the Certified Electronics Technician Exams.

**YES!** I want to get started. Send me my CIE school catalog including details about the Associate Degree Program. (For your convenience, CIE will have a representative contact you - there is no obligation.) AE34

Name: \_\_\_\_\_

Address: \_\_\_\_\_

City: \_\_\_\_\_ State: \_\_\_\_\_

Zip: \_\_\_\_\_ Age: \_\_\_\_\_

Phone No. ( \_\_\_\_\_ ) \_\_\_\_\_

Check box for G.I. Bulletin Benefits

Veteran  Active Duty



**CLEVELAND INSTITUTE OF ELECTRONICS**

1776 East 17th Street  
Cleveland, Ohio 44114  
(216) 781-9400



A school of thousands  
A class of one  
Since 1934

# ASK R-E

Write to Ask R-E, Radio-Electronics, 500-B Bi-County Blvd., Farmingdale, NY 11735

## AUDIO LIGHT

I'd like to build a device that will turn on a light if the decibel sound level of a band exceeds a preset level at a distance of 75 to 100 feet. I'd like the device to be adjustable between 60 and 120 decibels, and when the sound hits the preset level a light will come on and stay on until the sound drops again. Do you have something that can help me?—C. Jones, Broken Arrow, OK

Every time I go to a wedding or other large family affair I think about building something like that. It seems that I always wind up sitting right in front of the band's speakers.

Seriously though, this isn't a difficult thing to design but you can get yourself terribly confused by thinking about things like the distance in feet or the sound level in decibels. What you're really talking about is building yourself an amp to drive a simple VU meter that can be scaled for really high sound levels. Calibrating it to detect a particular sound level at a particular distance should be just a matter of tweaking a potentiometer.

The easiest way to put together a circuit like this is to build it around one of National Semiconductor's LM3915's. That chip will take an analog signal, do all the voltage scaling for you, and give you ten logarithmic outputs that are just what you want for a VU meter. While it's a really simple chip to use, I would suggest very strongly that you get a data sheet for it before you start using it.

The circuit in Fig. 1 is a good beginning for the project you have in mind. It will take four mike inputs, amplify them, and use the outputs to drive an LM3915 set up as a VU meter. One of the nice things about the LM3915 is that simply switching one connection will give you either a bar or dot output. The schematic has the chip arranged for a dot output since you're interested in having a light trigger from only one of the outputs. When you build the circuit, you can hang up to four mikes around the room and use

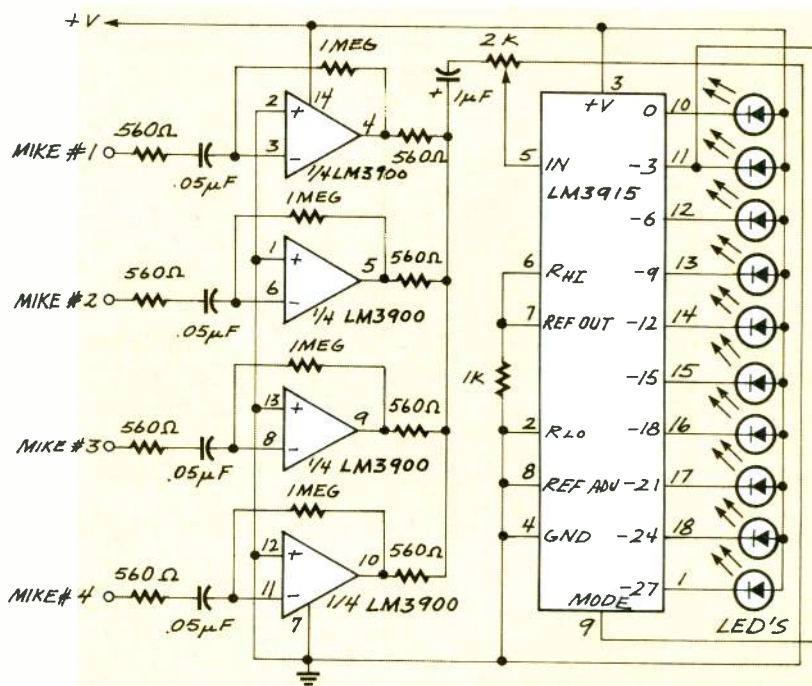

FIG. 1—TO TURN ON A LIGHT whenever the sound level in a room exceeds a preset level, you can use one of National Semiconductor's LM3915's (see text).

the potentiometer shown in the schematic to calibrate the LM3915 outputs any way you want.

Even though I've shown the LED's connected to the chip's outputs, you'll probably want to use one of the outputs to trigger the light you referred to in your letter. I have no idea how bright a light you want to use, but it's a safe bet that you won't be able to connect the bulb directly to any of the outputs of the LM3915. You just won't be able to get the drive current you need.

You can, however, use any of the

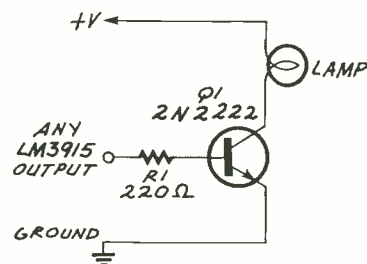

FIG. 2—TO DRIVE HEAVY current loads with an LM3915 output, you must add a transistor as shown here.

LM3915 outputs to drive a transistor as shown in Fig. 2, without having to disconnect the LED. Even a small-signal transistor such as a 2N2222 is chunky enough to light a bright nine-volt bulb as shown. If you want a larger bulb—something like an AC line powered 100-watt bulb—use the transistor's output to power a relay whose contacts can handle the current required by the bulb. A relay with contacts rated at two amps would certainly be more than adequate.

## COMMERCIAL LIMITER

I've reached my limit as far as television commercials are concerned since some of them are so loud I'm afraid they're going to destroy the speaker in my television set. I've been looking for a circuit that would detect a rise in volume and reduce the level going to the speaker. I found a circuit called the "Commercial Zapper" in an old issue of Radio-Electronics (Feb., 1983), but it blanks out the audio and all I want



**to do is reduce it. Do you have anything that will help solve my problem or at least point me in the right direction?—D. Alford Jr., Libuse, LA**

I'm fully aware of the problem you're talking about. I don't know how it's possible for people to fall asleep in front of the TV any more since every time I try it, the commercials keep waking me up. Nothing is more annoying than just being on the verge of flaking out during some mindless pap on the tube and being jolted awake by some voice screaming out the virtues of four wheel drive, gourmet dog food or the dirt-eating power of an old detergent in a new box. Maybe we should all stick to public television, pledge drives and all.

The FCC sets strict limits on the audio level that can be sent over the publicly owned (that includes you and me) airwaves and, believe it or not, the people whose grand mission in life is to say as little as they can in as many words as possible always manage to stay within the FCC limits. I've read studies about this and even did some of my own spot measurements to verify it. I'm sorry to report that we can't get them for a violation of the FCC guidelines.

Most of the program audio on the tube has a dynamic range that goes from dead silence to the maximum allowed. The people responsible for the commercials you're complaining about keep the audio level up near the top most of the time and, as far as silence goes, hey, they're paying for thirty seconds and unfortunately they can do anything they want with that time—however obnoxious it might be.

The "Commercial Zapper" you saw in **Radio-Electronics** was designed to put VCR's in pause during commercials so you could automatically eliminate them while you were taping black-and-white movies. The theory behind it was that the colorburst reference signal would be absent during the movie and present only during the commercials. By detecting burst, you could tell when a commercial was coming on and output a signal that would put your VCR in pause.

Most broadcasters leave the burst signal active all the time now, even during black-and-white transmis-

sions, so the Commercial Zapper, while great back then, wouldn't do a lot for you now. And, since you want to reduce only the level of the sound, there are much better ways to get the job done.

Before we start talking about schematics and circuits, there's one big thing you should keep in mind. Modifying any of the stuff inside your TV, even just the audio circuits, can be an extremely dangerous undertaking. Owning a TV set is kind of like being married—it can give you a lot of pleasure if you sit back and enjoy it but you can be in for a lot of trouble if you open it up and fool around with the way it works. There are lots of hazardous components in a TV and they're operating at voltages that can kill you if you're not careful about what you're doing.

If you don't have a good deal of electronic experience under your belt, you should stop reading this right now and switch most of your viewing to public television. Be warned about the hazards involved.

In order to automatically cut the level of the audio from your TV when it reaches a preset level, you're going to have to modify the audio circuitry in the TV—or at least be able to identify it so you can add to it. You shouldn't do anything to your TV unless you have the paperwork and service manuals so you can locate and identify the circuitry that deals with the audio.

If you don't have or can't get the paperwork but are still determined to modify it, the safest places to get the audio are either at the volume control or the speaker. Unplug the TV from the wall and VERY CAREFULLY discharge the second anode and high-voltage capacitors to avoid a possible shock hazard. Modern TV's use very low leak components and they can hold a charge for a long time.

The circuit you're looking for is an audio limiter—one that will turn the volume down for you whenever the sound gets too loud. Since it's difficult to modify the TV's existing audio circuitry, the best way to do it is to run the audio through a small add-on board. There are lots of limiter circuits but I've been using the limiter circuit shown in Fig. 3 for several years in several applications.

All the current that is drawn by the  
*continued on page 82*

# Safety, Security, Convenience, Entertainment and Energy Management

## Home Automation from Heath, the catalog that has it all...

Enter the world of Home Automation. Remote lighting and appliance controls. Security alarms and lighting. Automated thermostats. Video monitoring systems. Whole-house security systems. They're all yours in the Heath Home Automation Catalog. To receive your FREE copy, call today toll-free.

**1-800-44-HEATH**  
**(1-800-444-3284)**

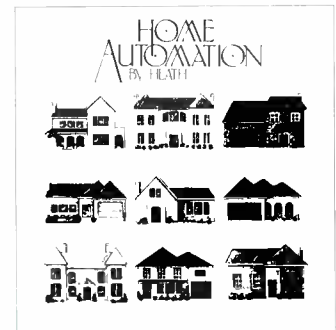

**Heath Company**

Marketing Dept. 020-130  
Benton Harbor, MI 49022

CL-807R1

CIRCLE 86 ON FREE INFORMATION CARD

# LETTERS

Write to Letters, *Radio-Electronics*, 500-B Bi-County Blvd., Farmingdale, NY 11735

## DIGITAL SINEWAVE GENERATOR

I enjoyed the article "Digital Sine-wave Synthesizer" by Steven D. Swift (*Radio-Electronics*, October 1991). About three years ago, I designed an almost identical circuit for work. I needed a precisely controlled sinewave generator that produced six specific frequencies. Based on my experience, I have some comments for the more advanced and creative hobbyists who are building this project.

I have not looked at the contents of the author's EPROM, but Fig. 2-c on page 44 led me to believe that his sine-lookup table contains the zero-crossing values of 80 H at 0° and 180° on the waveform. Harmonic distortion can be slightly reduced if the table is offset slightly from these values (by adding 0.5 degrees to the calculation, for example). I can prove this mathematically, but the reasoning might be clearer if you think of the zero crossings as crossover notch distortion. The rate of change of amplitude of the sinewave should be maximum at the zero crossings. It should not dwell there. The theoretical limit of the THD is 0.7% (for 256 steps in an 8-bit EPROM) if this suggestion is followed.

The author's circuit shows a discrete implementation that should work perfectly. Large programmable logic devices, such as the EP1800 series, have architectures ideally suited to the adders and registers that form the heart of the circuit. That is how I implemented my circuit. If only a few output frequencies are required, a second programmable logic device or an array of gates can be used to generate the "A" inputs to the adders. That reduces the flexibility of the circuit, but also eliminates the hassle of looking up binary codes.

If dual outputs are required, two circuits that are clocked by the same clock generator can be constructed. Those outputs can be locked together in phase, or varied in phase if

an offset generator is placed between the "S" outputs and the second sine-lookup table EPROM. That then makes possible 26 discrete phases.

The author's circuit has no adjustment for amplitude or phase. Those can easily be added in one more op-amp stage. When I constructed my circuit, I had to back off from 8 bits of resolution at higher frequencies. That caused no problems because higher frequencies were nearer the corner frequency of the low-pass filter, and, therefore, harmonics caused by larger steps were attenuated anyway.

BRUCE CARTER  
Port Orange, FL

## AUDIO SWEEP/MARKER GENERATOR UPDATE

Anyone building my "Audio Sweep/Marker Generator" (*Radio-Electronics*, February and March 1991) might encounter a problem that we cannot explain. It concerns IC11, an 8-input NAND gate. Two sources of information on the pinout arrangement show that there is no internal connection to pin 1. In the PC layout, pin 1 is connected to pin 2 to make the foil pattern layout a little simpler. That arrangement worked well with my prototype. However, I am indebted to Mr. Gordon La Grange of Baytown, TX, for pointing out that he had to snip off pin 1 before he could get a proper output from the NAND gate. That output is not shown properly in Fig. 13-e on page 59 in the March issue. The correct output is properly described in the paragraph almost directly below Fig. 13-k. If you invert the pulses in Fig. 13-e and make them no wider than a single line width, you'll have a correct picture.

JOHN WANNAMAKER

## TRUE TESLA COIL?

In the article entitled "Solid-State Tesla Coil" (*Radio-Electronics*, September 1991), the circuit is described as an end-fed Tesla coil.

I would like to point out that, in

actuality, this is not a true Tesla coil, in that Tesla dealt with separately tuned circuits (the primary and the secondary). While it is true that Tesla did use an end-fed resonator in his Colorado Springs "Magnifying Transmitter," an actual RF-coupled coil was used as the signal generator.

The basic idea for an end-fed resonator was devised by a French inventor named Dr. Paul Oudin, who based his work on the experiments of another Frenchman, D'Arsonval. D'Arsonval's work centered around what is known as the D'Arsonval Solenoid. Its purpose was to create, via an inductive/capacitive tank circuit, therapeutic RF currents to treat various bodily dysfunctions. Oudin reasoned that high voltages could be produced if one were to attach a second coil to D'Arsonval's tank circuit.

If one examines Tesla's patents related to his work in early radio, it becomes quite evident that the true definition of the Tesla coil must include separate circuits.

I would also like to comment on the size of the secondary coil in the project. In the case of Tesla's Magnifying Transmitter, the extra (or free-resonant) coil's inductance was actually very low in comparison to the secondary winding that was driving it. The main problem is one of adjusting the frequencies so that the resonant coil runs in the current-fed mode, rather than becoming a simple extension of the driving primary. In the case of the *Radio-Electronics* project, that would imply that the external secondary winding could behave simply as additional windings of the high-frequency ferrite transformer, T2.

If any readers wish further clarification on this, I would suggest the manuscript entitled "Tesla Coils—An RF Power Processing Tutorial for Engineers," by Kenneth & James Corum, Ph.D's. It's available from Corum & Associates, 8551 State Route 534, Windsor, OH 44099.

BRENT C. TURNER  
Villa Park, CA



## TUBE AMPLIFIERS REVISITED

At this late date, I would like to add my two cents' worth to the ongoing discussion on tube audio amplifiers. I must first admit that I like tube amplifiers and have built several of them myself.

I believe that correctly designed tube and solid-state amplifiers probably do sound the same, as long as you don't drive either one into clipping. However, to never drive an amplifier into clipping at any point in its circuit requires that sufficient voltage and current be available from each stage, so as to always meet the demands made by the next device. In most tube audio amps, everything up to the final stage is run in Class A1, where the tube is a pure transconductance device, whereas a transistor requires current.

Another advantage to tube amps is the fact that they operate at low currents and high voltages. It is much easier to make such a supply smoother and "stiffer." Modern high-end amplifiers and home-built ones made by knowledgeable "audio amateurs" use very large values of filter capacitance in their power supplies to provide a high level of reserve input voltage.

Finally, tube amps are simpler and use fewer active devices. The classic Dynaco uses one voltage-amplifier tube and one phase-inverter triode—both in one envelope as a 7199—to drive its output tubes; the notorious Carver Silver Seven uses essentially the same basic circuit. A solid-state amplifier comparable to the Dynaco, using only discrete parts, would use two dozen transistors.

So, while I must admit that there are some great solid-state amplifiers, I am going to stick with the tube ones. The tubes are still available, the transformers can be found, and the electrical power to run the heaters doesn't cost much. The added benefit to my home-built tube gear is that I had a lot of fun building it and spent very little money.

CHRIS L. DONALDSON  
*Blue Springs, MO*

## COMPUTER CLASHES CONTINUED

I really do think that Mr. Cheng's comments in the April "Letters" column went a bit far—and so did Mr.

Holtzman's reply. The entire exchange brings to mind the old tale about the blind man and the elephant; it really is tough to discern the big picture through all the fog. As one who has programmed extensively for 80X86 PC's, Amigas, and other computers, I have more comments than I can fit in a reasonably sized letter. A few will have to do.

First, on standardization: As Mr. Holtzman pointed out, the desirable part about standardization is that it facilitates communication. There are two flip sides. One is that many software (as well as hardware) suppliers don't want communication. Suppliers of programs for CAD and music scoring are especially notorious—they want you locked in tight. The second is that standards are often ages out of date—witness the NTSC television standard—to the point of stifling innovation.

The niche machines are a paradox. They owe their existence to the fact that in one important sense they are *more* standardized than PC's. No two PC's are alike, even in such fundamentals as memory organization, video graphics layout, and interrupt organization. As we all know, that causes no end of problems. Within the CPU itself, the instruction set is an unstandardized chaos, having on the order of a thousand individual quirks. Even the largest, best-capitalized organizations have been able to cope with that, so that compiled code tends to be a wretchedly sub-optimal joke. The lessons of the old mainframes have yet to be learned.

The upshot is that things that aren't done often enough to support multi-billion-dollar software companies are often best done on niche machines, especially if speed, large memory, or a GUI is desired, or interrupts are needed. Sure, a Lotus or a Microsoft can handle the problems caused by dozens of graphics drivers, dozens of extended memory drivers, more than 500 printer drivers, dozens of slightly different serial and parallel ports, hundreds of quirky BIOS variants, and hundreds or maybe thousands of hard-disk variants. The person who writes a specialized program for filter analysis and sells a few hundred copies probably can't make it multi-compatible, except by resorting to lowest-common-denominator user

## Earn Your B.S. Degree in ELECTRONICS or COMPUTERS



### By Studying at Home

Grantham College of Engineering, now in our 41st year, is highly experienced in "distance education"—teaching by correspondence—through printed materials, computer materials, fax, and phone.

No commuting to class. Study at your own pace, while continuing on your present job. Learn from easy-to-understand but complete and thorough lesson materials, with additional help from our instructors.

Our Computer B.S. Degree Program includes courses in BASIC, PASCAL and C languages — as well as Assembly Language, MS DOS, CADD, Robotics, and much more.

Our Electronics B.S. Degree Program includes courses in Solid-State Circuit Analysis and Design, Control Systems, Analog/Digital Communications, Microwave Engr, and much more.

An important part of being prepared to *move up* is holding the right college degree, and the absolutely necessary part is knowing your field. Grantham can help you both ways—to learn more and to earn your degree in the process.

Write or phone for our free catalog. Toll free, 1-800-955-2527, or see mailing address below.

Accredited by  
the Accrediting Commission of the  
National Home Study Council

**GRANTHAM**  
**College of Engineering**  
Grantham College Road  
Slidell, LA 70460

# Electronics Paperback Books

GREAT PAPERBACKS AT SPECIAL PRICES

**BP248—TEST EQUIPMENT CONSTRUCTION** ..... \$5.95. Details construction of simple, inexpensive, but extremely useful test equipment. AF Gen, Test Bench Ampl, Audio Millivoltmeter, Transistor Tester and six more.

Test Equipment Construction

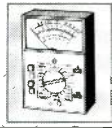

How to Use Oscilloscope and Other Test Equipment

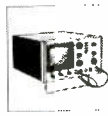

**BP267—HOW TO USE OSCILLOSCOPES AND OTHER TEST EQUIPMENT** ..... \$6.95. Mastering the oscilloscope is not really too difficult. This book explains all the standard controls and functions. Other equipment is also described.

**BP265—MORE ADVANCED USES OF THE MULTIMETER** ..... \$5.95. Use these techniques to test and analyze the performance of a variety of components. Also see how to build add-ons to extend multimeter capabilities.

More Advanced Uses of the Multimeter



An Introduction to Loudspeakers and Enclosure Design

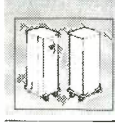

**BP256—INTRO TO LOUDSPEAKERS AND ENCLOSURE DESIGN** ..... \$5.95. We explore the variety of enclosure and speaker designs in use today so the reader can understand the principles involved.

**BP263—A CONCISE INTRO TO dBASE** ..... \$6.95. The dBASE series of programs are probably the best known database programs for microcomputers. This book is designed to help you get started working with them.

A Concise Introduction to dBASE

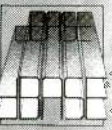

**BP260—CONCISE INTRO TO OS/2** ..... \$5.95. If you are a multitasking PC user and want to get the most out of your computer, then you must learn its OS/2 operating system. This book shows you just how to do that, quickly and easily.

A Concise Introduction to OS/2



**BP249—MORE ADVANCED TEST EQUIPMENT CONSTRUCTION** ..... \$6.95. Eleven more test equipment construction projects. They include a digital voltmeter, capacitance meter, current tracer and more.

More Advanced Test Equipment Construction



Digital Audio Projects



**BP245—DIGITAL AUDIO PROJECTS** ..... \$5.95. Practical circuits to build and experiment with. Includes A/D converter, input amplifier, digital delay line, compander, echo effect and more.

**BP247—MORE ADVANCED MIDI PROJECTS** ..... \$5.95. Circuits included are a MIDI indicator, THRU box, merge unit, code generator, pedal, programmer, channelizer, and analyzer.

More Advanced MIDI Projects



An Introduction to Amateur Radio



**BP257—INTRO TO AMATEUR RADIO** ..... \$6.95. Amateur is a unique and fascinating hobby. This book gives the newcomer a comprehensive and easy to understand guide to the subject.



**PCP102—INTRODUCING DIGITAL AUDIO** ..... \$9.95. Covers all kinds of digital recording methods—CD, DAT and Sampling. Bridges the gap between the technician and the enthusiast. Principles and methods are explained.

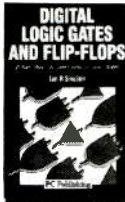

**PCP107—DIGITAL LOGIC GATES AND FLIP-FLOPS** ..... \$10.00. Thorough treatment of gates and flip-flops for enthusiasts, student and technicians. Only a basic knowledge of electronics is needed.

**BP251—COMPUTER HOBBYISTS HANDBOOK** ..... \$8.95. A wrapup of everything the computer hobbyist needs to know in one easy to use volume. Provides a range of useful reference material in a single source.



**PCP108—COMPUTERS AND MUSIC** ..... \$9.95. Explains the basics of computers and music with no previous knowledge of computers needed. Covers types of music software and explains how to set up your own computer music studio.

- BP195—INTRODUCTION TO SATELLITE TV**..... \$9.95. A definitive introduction to the subject written for the professional engineer, electronics enthusiast, or others who want to know more before they buy. 8 x 10 in.
- BP190—ADVANCED ELECTRONIC SECURITY PROJECTS**.....\$5.95. Includes a passive infra-red detector, a fiber-optic loop alarm, computer-based alarms and an unusual form of ultrasonic intruder detector.
- BP235—POWER SELECTOR GUIDE**.....\$10.00. Complete guide to semiconductor power devices. More than 1000 power handling devices are included. They are tabulated in alpha-numeric sequence, by technical specs. Includes power diodes, Thyristors, Triacs, Power Transistors and FETs.
- BP234—TRANSISTOR SELECTOR GUIDE**.....\$10.00. Companion volume to BP235. Book covers more than 1400 JEDEC, JIS, and brand-specific devices. Also contains listing by case type, and electronic parameters. Includes Darlingtons transistors, high-voltage devices, high-current devices, high power devices.
- BP99—MINI-MATRIX BOARD PROJECTS**.....\$5.50. Here are 20 useful circuits that can be built on a mini-matrix board that is just 24 holes by ten copper-foil strips.
- BP117—PRACTICAL ELECTRONIC BUILDING BLOCKS—Book 1**.....\$5.75. Oscillators, Timers, Noise Generators, Rectifiers, Comparators, Triggers and more.
- BP184—INTRO TO 68000 ASSEMBLY LANGUAGE**.....\$6.95. The 68000 is a great new breed of microprocessor. Programming in assembly language increases the running speed of your programs. Here's what you need to know.

**BP179—ELECTRONIC CIRCUITS FOR THE COMPUTER CONTROL OF ROBOTS** ..... \$7.50. Data and circuits for interfacing the computer to the robot's motors and sensors.

- BP239—GETTING THE MOST FROM YOUR MULTIMETER**..... \$5.95. Covers basics of analog and digital meters. Methods of component testing includes transistors, thyristors, resistors, capacitors and other active and passive devices.
- BP97—IC PROJECTS FOR BEGINNERS**.....\$5.50. Power supplies, radio and audio circuits, oscillators, timers, switches, and more. If you can use a soldering iron you can build these devices.
- BP37—50 PROJECTS USING RELAYS, SCR'S & TRIACS**.....\$5.50. Build priority indicators, light modulators, warning devices, light dimmers and more.
- RADIO—100 RADIO HOOKUPS**.....\$3.00. Reprint of 1924 booklet presents radio circuits of the era including regenerative, neutrodyne, reflex & more.
- BP42—SIMPLE LED CIRCUITS**..... \$5.50. A large selection of simple applications for this simple electronic component.
- BP127—HOW TO DESIGN ELECTRONIC PROJECTS**.....\$5.75. Helps the reader to put projects together from standard circuit blocks with a minimum of trial and error.
- BP122—AUDIO AMPLIFIER CONSTRUCTION**.....\$5.75. Construction details for preamps and power amplifiers up through a 100-watt DC-coupled FED amplifier.
- BP92—CRYSTAL SET CONSTRUCTION**..... \$5.50. Everything you need to know about building crystal radio receivers.
- BP45—PROJECTS IN OPTOELECTRONICS**..... \$5.50. Includes infra-red detectors, transmitters, modulated light transmission and photographic applications.

**BP185—ELECTRONIC SYNTHESIZER CONSTRUCTION** ..... \$5.95. Use this book to learn how to build a reasonably low cost yet worthwhile monophonic synthesizer. You'll learn a lot about electronic music synthesis in the process.

CHECK OFF THE BOOKS YOU WANT

**ELECTRONIC TECHNOLOGY TODAY INC.**  
P.O. Box 240, Massapequa Park, NY 11762-0240

SHIPPING CHARGES IN USA AND CANADA

\$0.01 to \$5.00	..... \$1.50
\$5.01 to \$10.00	..... \$2.50
\$10.01 to \$20.00	..... \$3.50
\$20.01 to \$30.00	..... \$4.50
\$30.01 to \$40.00	..... \$5.50
\$40.01 to \$50.00	..... \$6.50
\$50.01 and above	... \$8.00

**SORRY** No orders accepted outside of USA & Canada

Number of books ordered

Name \_\_\_\_\_  
Address \_\_\_\_\_  
City \_\_\_\_\_ State \_\_\_\_\_ Zip \_\_\_\_\_

Total price of merchandise ..... \$ \_\_\_\_\_  
Sales Tax (New York State Residents only) ..... \$ \_\_\_\_\_  
Shipping (see chart) ..... \$ \_\_\_\_\_

All payments must be in U.S. funds

Total Enclosed \$ \_\_\_\_\_



interfaces and sticking by a 640K memory model. Even then, it's never really certain that the program that runs on my PC will run on the PC next door—and getting it to print properly on the system next door is well nigh out of the question.

So, what will become of those 60 million PC's, plus the Macs, Amigas, Ataris, and so on? It's sad, but humanity has been down this road before, and we find that horse parts, though they were once as abundant proportionally, simply aren't permitted on the freeway. Those computers aren't going to make it either, though some, notably the DOS PC, may well hang on for a long while as windows in some POSIX-OS/2 Windows DOS Sparc-Mac-PC-Amiga machine of the future. (After all, if it were worth the trouble, it wouldn't be all that hard to *simulate* an Apple or Commodore 64 of seven years ago on a 486 PC, high-end Mac, or high-end Amiga *faster than real time!*)

And that raises what should be the hottest issue of all, something far more important than ranting and rav-

ing over doomed PC's versus doomed Macs versus doomed Amigas. The issue is our own data, which we must somehow get out of the DOS window and onto that machine of the future—to say nothing of moving it from one application to another, or to a supercomputer. We have allowed much of our data, entered laboriously and at tremendous expense, to become embodied in files that are formatted in obtuse, secret, and non-standardized ways.

It is high time that the software manufacturers who practice this are forced to change. They are in effect thieves who have stolen from us what is rightfully our property. It is time to insist that all software that we buy have the capability to disgorge our data in full, including such things as the coordinates of graphical objects, in an open, published-data-interchange format. As a symbolic discouragement to theft and extortion by software manufacturers, and to allow third parties to assist in retrieving the stolen property without fear of litigation, it is time to amend the

copyright law to explicitly permit reverse engineering in any program that stores output but won't provide it in an open format, irrespective of any and all language to the contrary in the licensing "agreement."

We have been down this road before. Compiler suppliers once swore that royalty-free function libraries would end the world. Much the same was said of ANSI-standard C, and of spreadsheet DIF files, and so on. Oddly enough, the world is still here. So to any manufacturer who feels this proposal is unreasonable, I say this: Maybe your problem is that you are making money by holding your customers up for ransom, rather than by providing a good product. If so, the sooner you are out of business, the better—preferably on terms that are as punitive as possible to you, your investors, and your bankers. You are not indispensable, regardless of who you think you are or how big you are. There are hungry hordes waiting in the wings to replace you.

PAUL SCHICK  
Madison, WI

R-E

## LEARN to CLEAN/MAINTAIN/REPAIR CAMCORDERS



EARN \$85  
AN  
HOUR!

HUGE EXPANDING MARKET!

Work from your home—part time or full time! No prior experience needed! Average monthly availability only requirement for your success! Over 1.4 million camcorders in use! Over 4 million expected to be sold in 1991 alone!

It is a fact that the vast majority of camcorder malfunctions, just like VCR's are due to simple mechanical failure. We can show you how to fix these breakdowns and earn an average of \$1,000.00 while working at home!

**Get In Now**—Soon camcorders will be like VCR's—found in almost every home.

For an immediate cleaning job you can earn \$100.00 in less than 30 minutes work.

For an immediate repair job you can earn over \$100.00!

FREE INFORMATION PACKAGE call or write:  
Toll-Free 1-800-537-0589  
Viejo Foundations, Inc.  
5329 Fountain Ave., Dept. REC  
Los Angeles, CA 90029

CIRCLE 188 ON FREE INFORMATION CARD

## Discover the Pattern for Success.

Work Smarter for Less  
with a B+K PRECISION  
Video Generator.



**Portable IC Color Pattern Generator**

- Battery operated, compact portable unit
- 13 patterns including gated rainbow
- CH 3/CH 4 output crystal controlled
- Composite video output to 1 Vp-p
- Progressive scan

**Model 1211C \$229**

**NTSC Signal Generator**

- NTSC color bars, with or without IWQ
- Linear staircase with high or low chroma
- Multiburst
- External video, external audio
- Interlaced scan

**Model 1251 \$1,195**

**NTSC Generator with RGB**

- NTSC color bar pattern
- 1 Vp-p or variable composite video output
- RGB outputs on BNC or 9-pin D-type subminiature connector
- Composite sync, vertical sync, and horizontal sync outputs
- Interlaced or progressive scan

**Model 1249A \$558**

**Deluxe NTSC Video Signal Generator**

- High accuracy NTSC color bars
- TCXO master oscillator
- RGB, Gen Lock, Circle, and Black Burst
- Multiburst to 8 MHz, 100%/50% level
- Interlaced or progressive scan

**Model 1260 \$1,995**

Start working smarter! For details on the complete line of B+K PRECISION video generators or for immediate delivery, contact your local distributor or:



BK PRECISION®

MAXTEC INTERNATIONAL CORP.

Domestic and International Sales  
6470 W. Cortland St., Chicago, IL 60635  
312-889-1448 • FAX: 312-794-9740

For information only  
circle 77 on free information card.

For sales assistance  
circle 182 on free information card.

# No other training to troubleshoot computers

Only NRI walks you through the step-by-step assembly of a powerful 386sx computer system you train with and keep—giving you the hands-on experience you need to work with, troubleshoot, and service today's most widely used computer systems. Only NRI gives you everything you need to start a money-making career, even a business of your own, in computer service.

No doubt about it: The best way to learn to service computers is to actually build a state-of-the-art computer from the keyboard on up. Only NRI, the leader in career-building at-home electronics training for more than 75 years, gives you that kind of practical, real-world computer servicing experience.

Indeed, no other training—in school, on the job, *anywhere*—shows you how to troubleshoot and service computers like NRI.

**Get inside the West Coast 386sx computer system... and experience all the power and speed of today's computer technology!**

With NRI's exclusive hands-on training, you actually build and keep the powerful new West Coast 386sx/20 MHz mini tower computer system.

You start by assembling and testing your computer's 101-key "intelligent" keyboard, move on to test the circuitry of the main logic board, install the power supply and 1.2 meg high-density floppy disk drive, then interface your high-resolution monitor.

What's more, you now go on to install and test a powerful 40 meg IDE hard disk drive—today's most-wanted computer peripheral—included in your course to

**NEW!**  
**386sx/20 MHz**  
**Mini Tower**  
**Computer!**

#### DIAGNOSTIC HARDWARE AND SOFTWARE

R.A.C.E.R. plug-in diagnostic card and QuickTech menu-driven software, both from Ultra-X, give you hands-on experience with today's professional diagnostic tools

#### MONITOR

High-resolution, nonglare, 14" TTL monochrome monitor with tilt and swivel base

#### DIGITAL LOGIC FROBE

Simplifies analyzing digital circuit operation

#### DIGITAL MULTIMETER

Professional test instrument for quick and easy measurements

#### SOFTWARE

Train with MS-DOS, GW-BASIC, and popular Microsoft Works applications software

#### DISCOVERY LAB

Complete breadboarding system lets you design and modify circuits, diagnose and repair faults

#### LESSONS

Clear, illustrated texts build your understanding of computers step by step

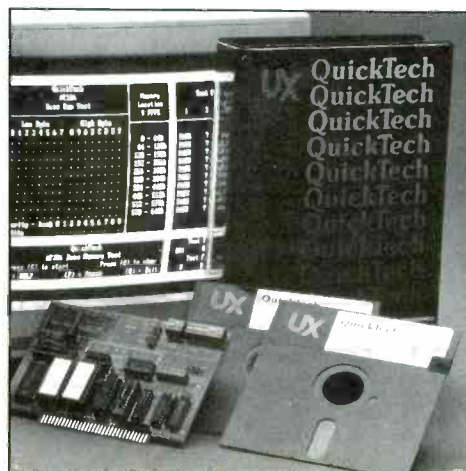
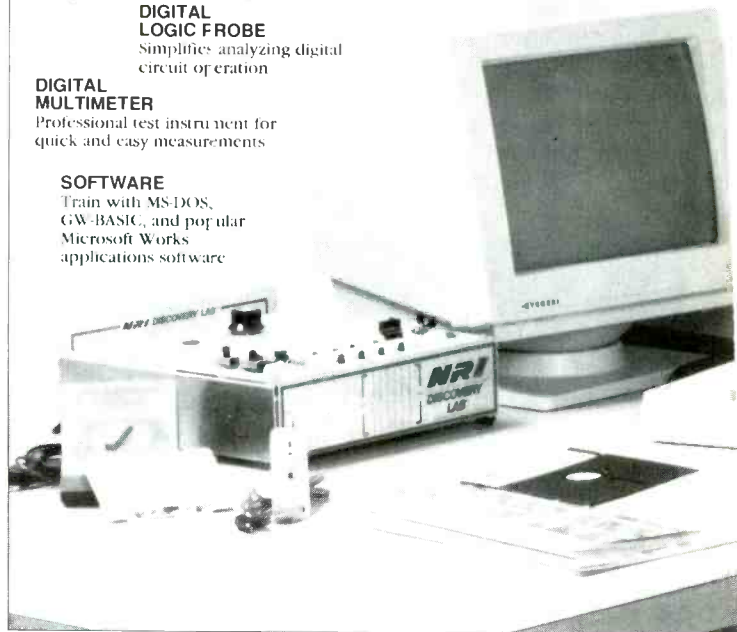

dramatically increase your computer's data storage capacity while giving you lightning-quick data access. But that's not all!

**Professional diagnostic hardware and software makes troubleshooting fast and accurate**

Your NRI training now includes a remarkable diagnostic package that allows you to quickly locate and correct defects in IBM XT, AT 80286/80386, and



# shows you how and service like NRI!

## NEW! 40 MEG HARD DISK DRIVE!

You install this 40 meg IDE hard disk drive internally, for greater data storage capacity and data access speed

## NEW! 386sx/20 MHz MINI TOWER COMPUTER!

Features 32-bit 80386sx CPU, 1 meg RAM, 64K ROM, 1.2 meg high-density floppy disk drive

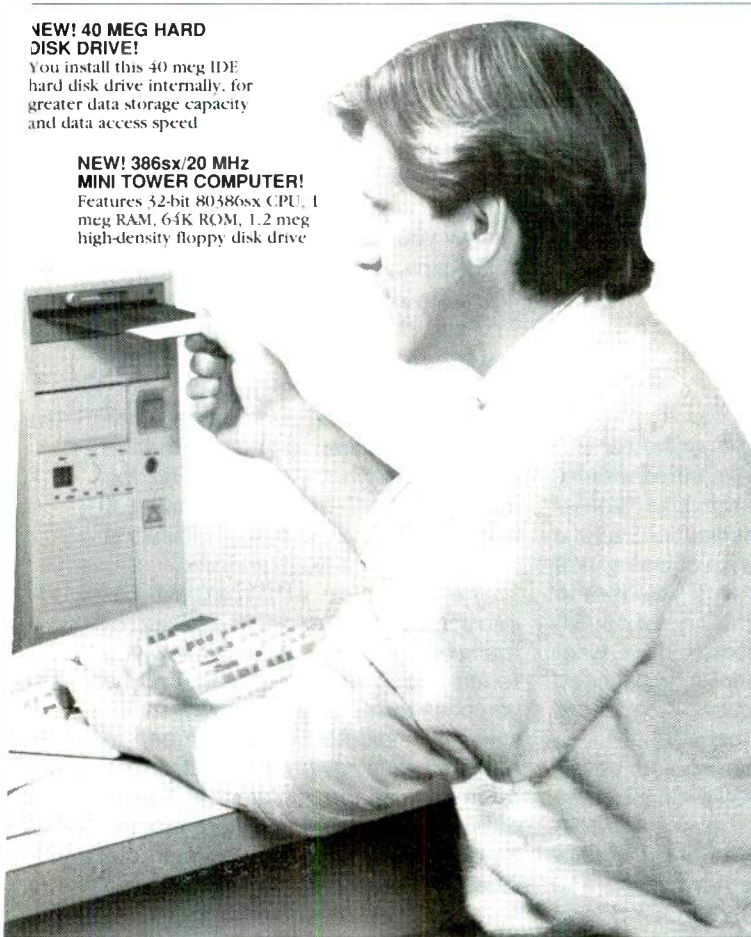

NRI gives you the confidence and the know-how to step into a full-time, money-making career as an industry technician, even start a computer service business of your own!

## No experience necessary... NRI builds it in

With NRI, you learn at your own pace in your own home. No classroom pressures, no night school, no need to quit your present job until you're ready to make your move. And all throughout your training, you have the full support of your personal NRI instructor and the NRI technical staff, always ready to answer your questions and give you help whenever you need it.

## FREE catalog tells more. Send today!

Send today for NRI's big, free catalog that describes every aspect of NRI's innovative computer training, as well as hands-on training in TV/video/audio servicing, telecommunications, industrial electronics, and other high-growth, high-tech career fields.

If the coupon is missing, write to NRI School of Electronics, McGraw-Hill Continuing Education Center, 4401 Connecticut Avenue, NW, Washington, DC 20008.

IBM is a registered trademark of International Business Machines Corp. QuickTech and R.A.C.E.R. are registered trademarks of Ultra-X, Inc. West Coast is a member of the 'yntax Group.

compatible computers.

You'll use your Ultra-X QuickTech diagnostic software to test the system RAM and such peripheral adapters as parallel printer ports, serial communications ports, video adapters, and floppy and hard disk drives. You'll go on to use your R.A.C.E.R. diagnostic card, also from Ultra-X, to identify individual defective RAM chips, locate interfacing problems, and pinpoint defective support chips.

This ingenious diagnostic package is just one more way

## **NRI** School of Electronics

McGraw-Hill Continuing Education Center  
4401 Connecticut Avenue, NW  
Washington, DC 20008



For career courses approved  
under GI Bill

check for details

### ✓ Check one FREE catalog only

- MICROCOMPUTER SERVICING
- TV/Video/Audio Servicing
- Industrial Electronics & Robotics
- Telecommunications
- Basic Electronics

- Computer Programming
- Security Electronics
- Electronic Music Technology
- Desktop Publishing
- PC Software Engineering Using C

Name \_\_\_\_\_ (Please print) \_\_\_\_\_ Age \_\_\_\_\_

Address \_\_\_\_\_

City/State/Zip \_\_\_\_\_ Accredited Member, National Home Study Council 3-012

# EQUIPMENT REPORTS

## McGraw-Hill CD-ROM Science and Technical Reference Set

Everything you ever  
wanted to know  
... on a disc.



CIRCLE 10 ON FREE INFORMATION CARD

What would you say if we told you that you could have easy access to all of the *McGraw-Hill Concise Encyclopedia of Science and Technology* and the *McGraw-Hill Dictionary of Scientific and Technical Terms* without having to give up any room on your already crowded bookshelf of reference and data books? Thanks to the CD-ROM format, all of that fits on a disc that looks just like a standard audio CD.

The *Concise Encyclopedia*, which contains some 7700 articles and 1700 photos and line drawings, is a condensed version of McGraw-Hill's 20-volume encyclopedia. It has been one of our favorite desk references for the past several years because of its broad coverage of more than 75 major science and engineering disciplines. Unfortunately, the book is a bit unwieldy—it has more than 2000 pages, is 3½ inches thick, and weighs several pounds. The *Dictionary of Scientific and Technical Terms* is another impressive reference, with 117,000 terms and definitions.

Unlike a book, you need the right computer equipment to read a CD-ROM. First, of course, you need a CD-ROM drive with the Microsoft CD-ROM extensions that allow DOS to access it. (The extensions are supplied when you purchase a drive.) You

also need an IBM AT or better PC with 1 megabyte of expanded memory compatible with the LIM (Lotus-Intel-Microsoft) specification, and a minimum of 1 megabyte of free space on your hard disk drive. If you want to view the graphics, you'll need a VGA graphics card and monitor. If you want to output text to a printer, you'll need a LaserJet or compatible. A mouse is supported, but not required.

As long as you have enough space on your hard disk, you'll run into little problem installing the software. A setup program on the CD-ROM copies files onto your hard disk, and modifies your CONFIG.SYS and AUTOEXEC.BAT files.

### Using the database

Once the installation is finished, you're ready to jump into the database. The retrieval software, Discover, is your interface to the reference set. There are several ways to get to the information you want: graphic access, alphabetical access, link-phrases/terms, and complete text search.

Graphic access is the way to go if you don't know the precise term or phrase you want to find information on. A color graphic, "Mirror of the Cosmos" appears on the screen, reflecting the major disciplines of the

encyclopedia. You could click on "Engineering," for example, and then be presented with another graphic—this time it's a laboratory bench with notebooks and textbooks scattered around and on shelves, with titles such as "Electrical Power," "Telecommunications," "Physical Electronics," and "Electronic Circuits." When you click on one of those, you're brought to another, non-graphic menu, which allows you to further narrow your choice.

For alphabetic access, you display the table of contents. But since all 7700 articles can't fit on the screen, you have to "expand" it alphabetically to get to the choice you want.

Accessing a "link phrase" is, however, the best way to find information if you know what you're looking for. It's the fastest method, because it works by finding the *hypertext* links in each article and illustration.

The provision of hypertext capabilities is an important feature of the reference set. The links allow you to jump from one article to another as you pass terms of interest. Any major links are indicated on the screen in color. You can navigate the data in the reference via the "links" that tie the data together. So if you were reading an article on electronic listening devices, you might see links to "Amplifiers" or "Radio Transmitter."

It is also possible to do a word search on the entire database, but that inefficient searching takes an awful long time.

We found the data base to be relatively easy to use, although we would have preferred to have an on-disc tutorial. After all, there's certainly enough room on the disc for a multi-megabyte tutorial.

We think that the *McGraw-Hill CD-ROM Science and Technical Reference Set* is a very strong product. Before you buy, however, consider that the paper versions are available for a total of just over \$200. The CD-ROM, which has much lower production costs, sells for \$495. **R-E**





**CABLE TV CONVERTERS AND DE-SCRAMBLERS** SB-3 \$79.00 TRI-BI \$95.00 MLD-\$79.00 M35B \$69.00 DRZ-DIC \$149.00. Special combos available. We ship COD. Quantity discounts. Call for pricing on other products. Dealers wanted. FREE CATALOG. We stand behind our products where others fail. One year warranty. **ACE PRODUCTS**, P.O. Box 582, Saco, ME 04072 1 (800) 234-0726.

CIRCLE 75 ON FREE INFORMATION CARD



**APPLIANCE REPAIR HANDBOOKS**—13 volumes by service experts: easy-to-understand diagrams, illustrations. For major appliances (air conditioners, refrigerators, washers, dryers, microwaves, etc.), elec. housewares, personal-care appliances. Basics of solid state, setting up shop, test instruments. \$2.65 to \$5.90 each. Free brochure. **APPLIANCE SERVICE**, PO Box 789, Lombard, IL 60148. 1-(312) 932-9550.

CIRCLE 84 ON FREE INFORMATION CARD



**THE MODEL WTT-20 IS ONLY THE SIZE OF A DIME**, yet transmits both sides of a telephone conversation to any FM radio with crystal clarity. Telephone line powered - never needs a battery! Up to ¼ mile range. Adjustable from 70-130 MHz. Complete kit \$29.95 + \$1.50 S + H. Free Shipping on 2 or more! COD add \$4. Call or send VISA, MC, MO. **DECO INDUSTRIES**, Box 607, Bedford Hills, NY 10507. (914) 232-3878.

CIRCLE 127 ON FREE INFORMATION CARD

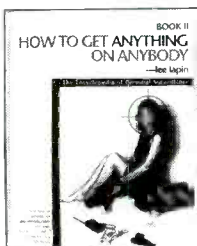

**COMPUTER CRACKING, INFORMATION TRACKING**, cutting edge audio/video surveillance, electronic trailing, night vision, surveillance photography, intelligence kits, cellular, pager, fax interception, recorders, scrambling and sources. ALL NEW—BOOK II HOW TO GET ANYTHING ON ANYBODY—Lee Lapin. "Really scary stuff"—Charles Jaco, CNN. \$38.50. **ISECO**, 2228 El Camino, No. 349-R, San Mateo, CA 94103.

CIRCLE 194 ON FREE INFORMATION CARD

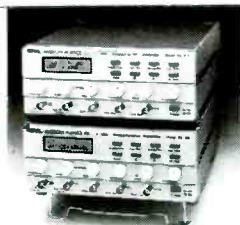

**FUNCTION GENERATORS WITH INTELLIGENT 100MHz FREQUENCY COUNTER**. Sine, square, triangle, ramp, DC & Sync. TTL outputs. Seven frequency ranges: 2Hz to 6MHz (FG-506), 2Hz to 13MHz (FG-513). Intelligent 100MHz frequency counter with period mode. Continuous, trigger, gate, clock, sweep and external frequency modes. Lin/Log sweep. Adjustable duty cycle/symmetry. Voltage controlled frequency functions. TCXO with 1ppm/yr. aging rate (optional). FG-506 \$695.00; FG-513 \$1295.00. Call: 800-664-9838. **AMERICAN RELIANCE INC.**, 9952 E. Baldwin Pl., El Monte, CA. 91731.

CIRCLE 176 ON FREE INFORMATION CARD

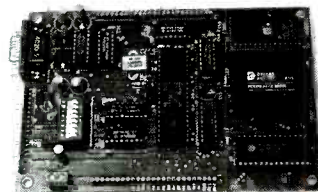

**CREATE INTELLIGENT PROJECTS WITH THE VERSATILE Z8 PROGRAMMABLE MICROCOMPUTER**. This powerful computer was designed for flexibility and can be used for various electronic projects. I/O Intensive. Up to 20MHz operation. Download programs or run EPROM code. Special hardware features included. Prices from \$125.00. Battery-backed RAM, X-assembler, and other options available. CALL FOR FREE BROCHURE. **MJS DESIGNS, INC.**, 1438 W. Broadway Rd., Suite B185, Tempe, AZ 85282. (602) 966-8618.

CIRCLE 179 ON FREE INFORMATION CARD

## CALL NOW AND RESERVE YOUR SPACE

- 6 x rate \$940.00 per each insertion.
- Fast reader service cycle.
- Short lead time for the placement of ads.
- We typeset and layout the ad at no additional charge.

Call 516-293-3000 to reserve space. Ask for Arline Fishman. Limited number of pages available. Mail materials to: mini-ADS, RADIO-ELECTRONICS, 500-B Bi-County Blvd., Farmingdale, NY 11735.

FAX: 516-293-3315



**5 MINUTE ASSEMBLY! MONEYBACK GUARANTEE!** Attach the VT-75 chip to any 3V-12V battery and you have the most powerful miniature transmitter you can buy *anywhere*. Tiny Law Enforcement grade device allows you to hear every sound—even footsteps—over 1 mile away on any FM radio or wideband scanner. 80-130MHz. 100mW output! VT-75 microtransmitter complete \$49.95 + \$1.50 S & H. Visa, MC, MO. COD's add \$4.00. **DECO INDUSTRIES**, Box 607, Bedford Hills, NY 10507. 1-800-759-5553.

CIRCLE 127 ON FREE INFORMATION CARD

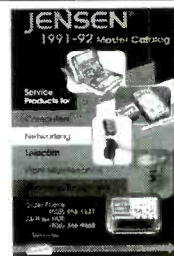

**FREE CATALOG! ELECTRONIC TOOLS & TEST EQUIPMENT**—Jensen's new Master Catalog, available free, presents major brand name electronics tools, tool kits, and test instruments, plus unique, hard-to-find products for assembly and repair and custom field service kits available only from Jensen. All fully described and illustrated. Enjoy free technical support and rapid, post-paid delivery anywhere in the Continental USA. **JENSEN TOOLS, INC.**, 7815 S. 46th St., Phoenix, AZ 85044. Phone: 602-968-6231; FAX 1-800-366-9662.

CIRCLE 115 ON FREE INFORMATION CARD

# NEW PRODUCTS

Use the Free Information Card for more details on these products.

## MULTIFUNCTION COUNTER.

Especially well-suited for the communications industry, *B&K Precision's 1856 multifunction counter* can be used to make highly accurate and repeatable measurements of radio transmitter frequency right up to the microwave range. It exceeds the requirements for adjusting transmitter frequency to FCC standards, as required for radio stations or land mobile, radio telephone receivers. Because the 1856 extends to 1.3 GHz, it even covers cellular channels.

The counter has a 5-Hz to 1.3-GHz bandwidth and a TCXO (temperature-compensated crystal oscillator) timebase with 0.5-ppm stability at  $23 \pm 5^\circ\text{C}$  and 1-ppm stability from 0 to  $50^\circ\text{C}$ . The model 1856's functions include frequency, period, period average, and totalize. The period-measurement function, used for very low-frequency measurements, makes

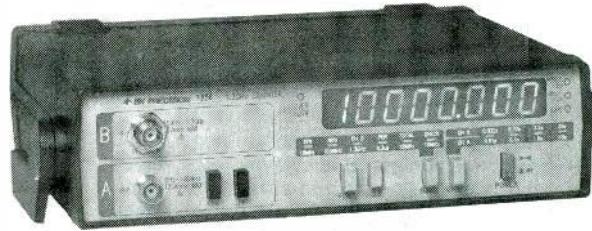

CIRCLE 16 ON FREE INFORMATION CARD

it easy to measure tone-encoding functions used in many types of communications systems. In the totalize mode, useful in counting the number of operations performed by production machines or in quality-control tests, pulses from 5 Hz to 10 MHz are counted up to 99,999,999. Reset and hold can be performed using a switch, or using a remote start/stop input.

The compact model 1856 measures  $2.5 \times 9.4 \times 7.5$  inches and weighs 3.3 pounds. It's large, high-intensity, 8-digit

LED readout provides kHz/ $\mu\text{s}$ , MHz/ms, gate, and overflow indicators. A detachable power cord, a schematic, parts list, spare fuses, and an instruction manual are included. Optional accessories include an antenna for conveniently checking transmitter frequency and a 10:1/direct probe.

The model 1856 multifunction counter has a suggested list price of \$495.—**B&K Precision**, 6470 West Cortland Street, Chicago, IL 60635; Phone: 312-889-1448.

LED readout provides kHz/ $\mu\text{s}$ , MHz/ms, gate, and overflow indicators. A detachable power cord, a schematic, parts list, spare fuses, and an instruction manual are included. Optional accessories include an antenna for conveniently checking transmitter frequency and a 10:1/direct probe.

The ADXL-50 accelerometer costs \$23.00 (100's) and \$5.00 in automotive OEM quantities.—**Analog Devices**, Literature Center, 70 Shawmut Road, Canton, MA 02021.

**DMM ACCESSORIES.** A new line of modular test accessories from *Fieldpiece* is designed to solve such on-site servicing problems as not having the right test lead for the job, alligator clips that pop off of test points, and too-short probe tips. The solution is simple but innovative: All the accessory connectors, including the connection between the probe tip and the probe handle, are standard banana plugs or jacks. A female banana jack, built into the "handle" of the deluxe test lead, fits a sleeved male banana plug. The line includes a variety of probe tips, alligator clips with pig-tails, and a current clamp head, all of which plug onto the end of the deluxe test lead. One test lead end can be plugged into another to double the length of the test lead; with the addition of an alligator clip, it's possible to build an 8-foot

## ACCELERATION SENSOR.

According to *Analog Devices*, their *ADXL-50* is the industry's first surface-machined acceleration sensor (accelerometer) and the only one to offer complete signal-conditioning and self-test circuitry on-chip. Designed primarily for automotive applications such as collision detection, active suspension, and anti-skid braking systems, the device measures acceleration in a single plane of sensitivity over the  $\pm 50\text{-g}$  range to an accuracy of 5%. Self-test cir-

cuitry is activated by a digital command and guarantees operation of both the sensor and associated signal conditioning to stated specifications. That

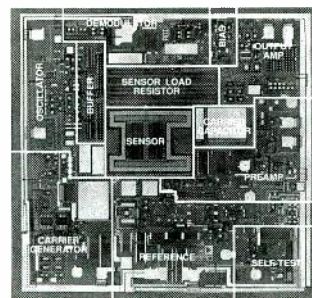

CIRCLE 17 ON FREE INFORMATION CARD

is a vital feature in applications such as air-bag systems. The ADXL-50 measures only  $500\mu\text{m} \times 625\mu\text{m}$ , much smaller than other types of micro-machined sensors. Unlike other accelerometers that monitor the resistance change of stressed piezoresistors to detect acceleration, the ADXL-50 measures the changes in capacitance, and is therefore insensitive to temperature changes.

The sensor operates in a force/balance mode. Voltage is applied to the sen-



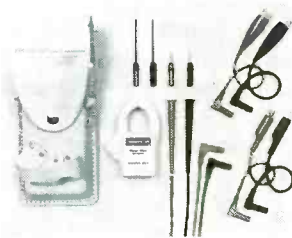

**CIRCLE 18 ON FREE INFORMATION CARD**

ground lead that is unlikely to come apart. The accessory kit, model *ADK10* includes a pair (red and black) of each of the following: 42-inch test leads, small and large alligator clips, and short (1/2-inch) and long (3-inch) probe tips, packed in a plastic box.

The box has room for the model *ACH current clamp head*, which can be used with Fieldpiece "Stick"-style DMM's as well as any multimeter with 1mVDC resolution (most meters).

The small-head clamp fits into tight spaces and measures current up to 300 amps. Also available is the *ALC1 leather case*, which holds a DMM and accessories. It has a belt loop on the back and leather loops on the front hold two extra probe tips or the *ACH current clamp head*. The leather case can accommodate a "Stick," Fluke 70 Series (without the boot), or Beckman 220/150 Series (without the tilt stand) multimeter. It is available with the accessories and current clamp head as model *ALCK8*.

The *ADK10* accessory kit, *ACH* current clamp head, *ALC1* leather case, and *ALC8* leather case with accessories and current clamp head cost \$26.95, \$24.95, \$24.95, and \$59.95, respectively.—**Fieldpiece Instru-**

**ments, Inc.**, 8322B Artesia Blvd., Buena Park, CA 90621; Phone: 714-992-1239; Fax: 714-992-1239.

**UV-LIGHT-BLOCKING EPROM LABEL.** When used on EPROM packages, a UV-opaque write-on label

from *DATAK (Cat# EP-1)* gives added assurance that the burned program will not be accidentally erased by stray light from fluorescent lamps or other ultra-violet sources. The label consists of a white polyurethane layer for writing, a black opaque-vinyl layer, and a layer of pressure-sensitive adhesive. The flexible film construction conforms to EPROM packages having raised windows. The label can be removed without leaving an adhesive residue on the EPROM package. Sized to fit on top of a 24-pin wide DIP, the 1.1 x 0.46-inch label will accommodate three lines of standard type. It can be written on with a typewriter, ball-point pen, soft pencil, or any platen feed computer printer.

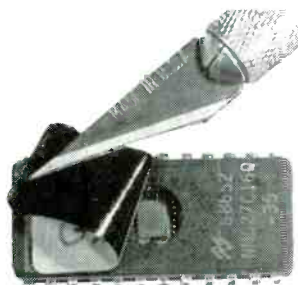

**CIRCLE 19 ON FREE INFORMATION CARD**

Cat# EP-1, containing

# Train at HOME to be an Electronics Technician!

As the demand for computers and microprocessors in business, manufacturing and communications continues to grow, so does the need for qualified technicians. It's not unusual for experienced technicians to earn from \$30,000 to more than \$40,000 a year.\* Now through Peoples College of Independent Studies you can train for this exciting field without interrupting your job or home life.

## Choose From Five Programs of Study

- Electronics & Microprocessor Technology
- Industrial Electronics & Microprocessor Technology
- Communications Electronics with Microprocessor Technology
- Computer Servicing & Electronics Technology
- Specialized Associate Degree In Electronics Technology

## Professional Equipment Is Included

Depending on the program you select, you'll perfect your skills using this advanced equipment, included in the price of tuition:

- IBM-Compatible Personal Computer
- Digital Multimeter
- Digital Logic Probe
- Elenco Oscilloscope
- Portable Cellular Telephone

(\* Source: U.S. Bureau of Labor Statistics)

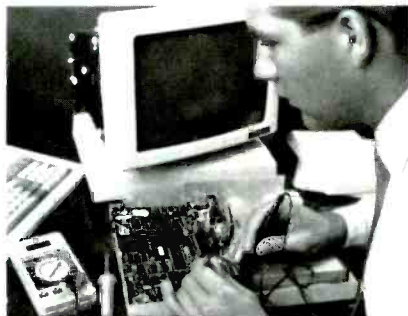

## Exclusive Extras That Enhance Your Training

Peoples College introduces some training firsts to make your learning experience more complete:

- Accelerated Learning System — a scientifically proven study system that helps you learn faster and easier than ever before.
- Video Tutor Training Tapes — give you a permanent, visual record of informative lectures and close-up demonstrations.
- Experience Labs — professionally designed experiments that give you hands-on "bench" experience.
- Industry Certification Training Guide — provided with four of our programs. Prepares you for examinations you may take for your professional license or certification.

## Easy Payment Plans — No Finance Charges

To help you get started on your education, Peoples College has reduced tuition rates and offers low monthly payment plans with no finance fees. So don't delay, call or write for more information today!

**For COLOR CATALOG Mail Coupon or Call TOLL FREE 1-800-765-7247**

*Programs offered only in United States, Canada, Puerto Rico and Virgin Islands. No Obligation. No sales per-son will call.*

Our programs are accredited by the Accrediting Commission of the National Home Study Council

**YES! I would like to know more about your training programs. Send a catalog to:**

Name \_\_\_\_\_  
 Address \_\_\_\_\_  
 City \_\_\_\_\_  
 State \_\_\_\_\_ Zip \_\_\_\_\_

Phone # \_\_\_\_\_  
**PEOPLES COLLEGE**  
 OF INDEPENDENT STUDIES  
 233 Academy Drive • P.O. Box 421768  
 Kissimmee, FL 34742-1768  
 Member, D.I. Peoples Group RO192

**CIRCLE 190 ON FREE INFORMATION CARD**

147 UV-opaque EPROM labels on three sheets, costs \$4.00.—**DATAK Corporation**, 55 Freeport Blvd., #23, Sparks, NV 89431; Phone: 702-359-7474; Fax: 702-359-7494.

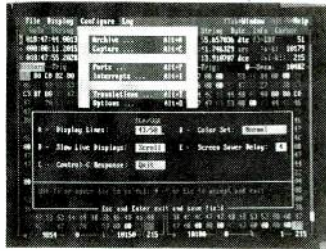

CIRCLE 20 ON FREE INFORMATION CARD

**SERIAL LINE MONITOR/PROTOCOL ANALYZER SOFTWARE.** *DataScope Version 2.0* transforms a PC into a passive or active RS-232 data and signal-line monitor that can eliminate guesswork while dealing with serial transmissions. The upgraded version of *Paladin Software's* program is still capable of collecting 8 megabytes of data and signal information with microsecond time-stamp resolution, but has been enhanced with tiled concurrent window displays and a pull-down menu interface. Up to four unique

and simultaneous displays can be active at the same time, providing passive, interactive, and historic monitoring in any user-selected combination. Display tiles can be combined to create larger windows, and one of four presentation filters (mixed, alternating, COM1, or COM2) can be applied to every window. *DataScope* can operate at all possible rates up to 115,200 baud, while matching user-specified trigger strings against incoming

data. It offers full archive-parameter control combined with pre-, center-, and post-trigger positioning. Character translation sets can be replaced or altered by the user to modify the translation strings and/or attributes for each source separately. Version 2.0 runs on all IBM-PC-compatible machines with MS-DOS 2.1 or above, 256K of available RAM, and at least one serial port.

*DataScope Version 2.0*, with connector shells, cables, and a comprehensive manual, costs \$249.—**Paladin Software, Inc.**, 3945 Kenosha Avenue, San Diego, CA 92117; Phone: 619-490-0368.

**CEBUS-NETWORK DEVELOPMENT PRODUCTS.**

An integrated circuit, a modem subsystem, and an evaluation system from

*Intellon Corporation* will enable manufacturers and application developers to implement carrier sense/multiple access (CSMA) networks over standard AC electrical wiring. The products are based on Intellon's patented "Spread Spectrum Carrier" technology, which is being considered by the Electronic Industries Association as the power-line signalling standard for its Consumer Electronics Bus (CEBus). The CEBus power line standard offers more than 100 times the speed of the power line signalling method most widely used today, and will enable communication and control among electrical devices, sensors, and control systems in homes and commercial buildings.

The *Spread Spectrum Power Line Modem*

# PUSH BUTTON TECHNOLOGY

AT PRICES THAT WON'T PUSH YOU OVER THE EDGE

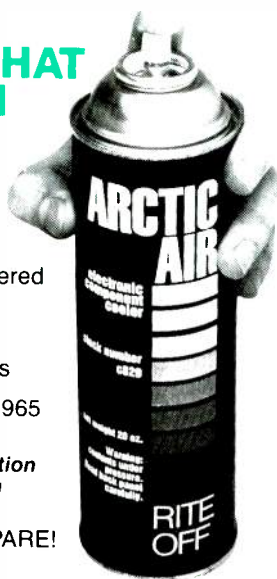

- Environmentally Engineered Formulations
- Chemicals For All Your Repair/Production Needs
- Quality Products Since 1965

Call Today For More Information  
Manufacturers Reps Wanted

WE DARE YOU TO COMPARE!



**RITE OFF**

1545 5TH INDUSTRIAL COURT  
BAY SHORE, NEW YORK 11706  
(800) 645-5853  
IN NY (516) 665-6868

Yesterday's Values, Tomorrow's Technology

CIRCLE 195 ON FREE INFORMATION CARD

# CABLE - TV

## TUNABLE NOTCH FILTERS

- FOR ELIMINATION OF SEVERE INTERFERENCE
- FOR "CENSORING" OF ADULT BROADCASTS

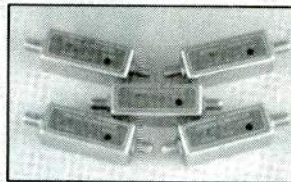

- 45 dB AT CENTER FREQUENCY
- 5 dB AT 2 MHZ FROM CENTER
- 2 dB INSERTION LOSS

MODEL	TUNES TO CHANNEL	PRICE	SHIPPING
23H	2 or 3 (or 6 meter ham)	\$30	NO
46FM	4, 5, or 6 (or any FM station)	\$30	SHIPPING
713	7, 8, 9, 10, 11, 12, or 13	\$30	OR
1417	14(A), 15(B), 16(C), or 17(D)	\$30	C.O.D.
1822	18(E), 19(F), 20(G), 21(H), or 22(I)	\$30	CHARGES

**3 for \$75 - 10 for \$200 - Mix or Match**  
**30 DAY MONEY BACK GUARANTEE (3 FILTER LIMIT)**

FAST DELIVERY  
CALL TOLL FREE FOR C.O.D. OR SEND CHECK TO ORDER

## STAR CIRCUITS

P.O. BOX 94917  
LAS VEGAS, NV 89193  
**1-800-535-7827**



(SSPM), built around the SSPM IC, is said by Intelon to be the first integrated circuit to implement the EIA's proposed CEBus power line physical layer standard. The 28-pin chip operates at the CEBus standard rate of 10,000 "1" bits per second. It generates and receives all the required signalling information, handles the CEBus physical layer protocol, and assists the higher-layer protocols. The modem board, which can be attached to a power supply and a host microprocessor that supports CEBus protocols, helps speed application development by freeing engineers from developing and testing the power line network hardware.

The evaluation system allows developers to evaluate CEBus and Spread

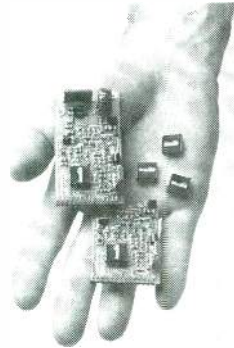

CIRCLE 21 ON FREE INFORMATION CARD

Spectrum Carrier technology and to implement a demonstration CEBus CSMA network that communicates over AC power wiring, which can be used to model and analyze network characteristics by creating and running various traffic-loading scenarios. The system includes software that runs on any IBM or compatible PC and three complete CEBus network nodes. It

features an electronic mail system to demonstrate the network and its capabilities.

The evaluation system costs \$3,495; the SSPM chip and the modem board (pictured) cost less than \$5 plus a one-time, \$2500 license fee in OEM quantities and \$105 in quantities of ten, respectively.—**Intellon Corporation**, 5150 West Highway 40, Ocala, FL 32675; Phone: 914-237-7416; Fax: 914-237-7616.

**BEZEL SELECTION.** Designed for use in the electronics industry as a frame for LCD displays, *Ill's Bezel*



CIRCLE 22 ON FREE INFORMATION CARD

*Beautiful* comes in four popular sizes that fit most LCD small-character displays. Available in colors (red, yellow, and blue) as well as black and white, Bezel Beautiful is molded in UL-listed, machinable, engineering-grade plastic. Molded with a slightly concave, outward curve from mounting edge to mounting edge, the bezel automatically adjusts itself to align without any gaps or spaces against any panel. Once mounted, it will remain flat on the face of the product to which it has been bonded for the life of the unit. It can be attached using the heat-seal method, sheet-metal screws, or a glue gun. The bezels come in four sizes, with measurements in inches for the viewing area of 1 x 2.5, 0.7 x 1.8, 0.7 x 2.5, and 0.7 x 3.5.

**CHRISTMAS SALE!**

Save on cable rental fees!

**CABLE TV  
DESCRAMBLERS  
WE'LL BEAT  
ANY PRICE**

**JERROLD—TOCOM—ZENITH  
HAMLIN—OAK—PIONEER  
SCIENTIFIC ATLANTA**

- 24 HOUR SHIPMENTS!
- MONEY BACK GUARANTEE!
- QUANTITY DISCOUNTS!

MASTER CARD / AMEX / VISA / C.O.D.

Have make and model number of equipment used in you area ready.

**CALL TOLL-FREE  
1-800-284-8432**

**CABLE WAREHOUSE**  
10117 West Oakland Park Blvd.,  
Suite 515, Sunrise, FL 33351  
NO FLORIDA SALES

CIRCLE 186 ON FREE INFORMATION CARD

NO COMPLICATED ELECTRONICS, NO EXPENSIVE INSTRUMENTS:

## Home study course shows you how to make good money in VCR repair.

An amazing fact: you can do more than four out of five VCR repairs with ordinary tools and basic fix-it procedures. Our home study program shows you how.

Learn all of the systems, mechanisms, and parts of almost all brands of VCRs. With *no* expensive instruments. *No* complicated electronics. *No* fancy workshop. The step-by-step texts and close personal attention from your instructor make learning easy.

Texts, course materials, and tool kit are sent to your home. Graduate ready to make up to \$50.00 or more per hour in your own spare-time or full-time business.

**Send today for your free career booklet. Or call 800-223-4542**

Name \_\_\_\_\_

Address \_\_\_\_\_

City \_\_\_\_\_ State \_\_\_\_\_ Zip \_\_\_\_\_

### The School of VCR Repair

2245 Perimeter Park, Dept. VA342, Atlanta, Georgia 30341

Bezel Beautiful is priced at less than a dollar each in OEM quantities.—**International Instrumentation Incorporated (III)**, Box 3751, Thousand Oaks, CA 91359; Phone: 805-495-7673.

**TRI-FIELD METER.** The *Tri-Field Meter* from *AlphaLab* independently reads AC electric fields, AC magnetic fields, and radio/microwaves with multi-directional sensors that read field strengths in all directions simultaneously. It reads all three types of fields numerically and with a safe/borderline/high scale, weighted proportionally to the fields' effect on the body. Thresholds are based on epidemiological and laboratory studies. Although no absolute hazard thresholds have been established, re-

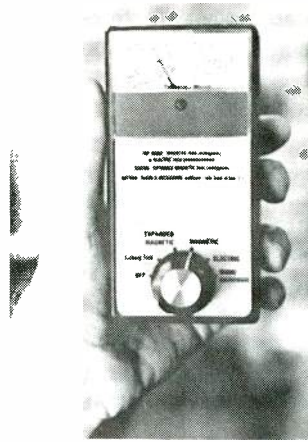

CIRCLE 23 ON FREE INFORMATION CARD

duction of relative exposure is advised. The meter comes with batteries, instructions, and a one-year limited warranty. The Tri-Field Meter costs \$100 postpaid.—**AlphaLab**, 1272 East Alameda Ave., Salt Lake City, UT 84102; Phone: 503-621-9701.

**32-SWITCH CONTROL CARD.** An eight-bit computer board from *AccuSys*, dubbed the *32 Switch Reed Relay Card* gives any PC the ability to select and control 32 analog or digital signals with ease. Any signal up to 100 volts and 10 watts can be controlled by the computer. Because there is no address limit to the number of boards that can co-reside in a single PC, one computer can control the connection of hundreds of signals by plugging in as many switch cards as there are available slots. The *32 Switch*

*Card's* ability to route multiple analog signals through a single interface eliminates the need for redundant modems. When combined with higher capacity external relays, the card is capable of more active functions. For instance, when combined with an application that senses energies, it can switch off water heaters and household appliances when they aren't needed and automatically close ventilation systems or call the police or fire department when sensing a fire or break-in.

The *32 Switch Reed Relay Card*, including software interface examples with source code in Assembler, BASIC, C, Fortran, Cobol, and dBASE, costs \$395.—**AccuSys, Inc.**, 3695 Kings Row, Reno, NV 89503; Phone 702-746-1111. **R-E**



CIRCLE 24 ON FREE INFORMATION CARD

## The World's Most Popular Probe



Model SP100  
100 MHz Switchable 1x-10x .... **\$45**

**Free**

Free probe guide shows economical replacements for Tektronix, H-P, Philips and all others.

**More SP100 Probes Have Been Sold Worldwide Than Any Other Probe Ever Made**

- **Universal**  
For Tektronix, Hewlett Packard, Philips, Leader, B&K, Kikusui, Hitachi, Beckman and other oscilloscopes
- **Economical**  
Substantial savings compared to OEM probes
- **10 day return policy**  
Guaranteed performance and quality

**TEST PROBES, INC. TPI**

9178 Brown Deer Road, San Diego, CA 92121  
Toll Free 1-800-368-5719

CIRCLE 123 ON FREE INFORMATION CARD

Try the

**Radio Electronics®**

bulletin board system

(RE-BBS)  
516-293-2283

The more you use it the more useful it becomes.

We support 1200 and 2400 baud operation.

Parameters: 8N1 (8 data bits, no parity, 1 stop bit) or 7E1 (7 data bits, even parity, 1 stop bit).

Add yourself to our user files to increase your access.

Communicate with other R-E readers.

Leave your comments on R-E with the SYSOP.

RE-BBS  
516-293-2283



# GET THE LATEST ADVANCES IN ELECTRONICS

WITH A SUBSCRIPTION TO

# Radio Electronics®



ENJOY THE WORLD OF ELECTRONICS EACH MONTH!

Now you can subscribe to the best electronics magazine. The only one that brings you articles on—electronics projects, technology, circuit design, communications, new products and much more.

Radio-Electronics looks to the future and shows you what new video, audio and computer products are on the horizon. What's more you'll find helpful, monthly departments such as Video News, Equipment Reports, Hardware Hacker, Audio Update, Drawing Board, Communications Corner. All designed to give you instruction, tips, and fun.

## Radio-Electronics gives you exciting articles like:

- ISDN: The Telephone Network of Tomorrow
- The Facts on FAX
- A Digital Phone Lock
- How To Design Switching Circuits
- EIA-232 A real standard for serial interfacing?
- Build a synergy card for your PC
- '386 Power at a '286 price
- Build a biofeedback monitor
- More on Multiplexing



FOR FASTER SERVICE CALL TODAY  
1-800-999-7139

# DON'T DELAY SUBSCRIBE TODAY!

Just fill out the order card in this magazine and mail it in today.

# NEW LIT

Use The Free Information Card for fast response.

## HOW TO SERVICE YOUR OWN TUBE AMP; by Tom Mitchell. Media Concepts, P.O. Box 1408, Norwalk, CT 90651-1408; 213-594-4717; \$69.95.

This "how-to" course is a complete multi-media package that consists of a 247-page guidebook and a 68-minute videotape, stored in a plastic binder. Designed to save musicians money, the program instructs guitarists on the care, service, and modification of their tube-based guitar amplifiers. The author claims that, by following the instructions in the course, users can diagnose and repair more than 95% of all tube amplifier breakdowns and problems.



CIRCLE 28 ON FREE INFORMATION CARD

In a nontechnical, informal, and entertaining style, the program introduces guitarists to electronics, explaining how to recognize components, exploring basic amplifier circuits, describing tools and test equipment, and providing in-depth coverage of tubes, transformers, speakers, and enclosures. It discusses how to read schematic diagrams, how to troubleshoot with voltage charts, biasing, and the correct ways to use an amplifier. Included are voltage charts for most common amplifiers, ten troubleshooting flowcharts, a maintenance checklist, and

useful reference information. Several do-it-yourself amplifier modifications are also described.

## HMC FULL LINE CATALOG; from Hub Material Company, 33 Springfield Avenue, Canton, MA 02021; Phone: 617-821-1870; Fax: 617-821-4133; free.

Containing a broad selection of products for electronics professionals and hobbyists, this 142-page catalog features a full index, a table of contents, and color-coded pages to help readers find specific items. The fully-illustrated guide to electronic tools, test equipment, and supplies for the manufacture, assembly, and repair of electronics contains a variety of brand-name, competitively priced products.



CIRCLE 25 ON FREE INFORMATION CARD

Included are test instruments (DMM's, oscilloscopes, and datacommunications and telecommunications test sets), tool kits and precision hand tools, soldering and desoldering systems and supplies (fluxes, solder, tips, wick, and sponges), lamps and magnifiers, and anti-static devices (bags, wrist straps, mats, runners, meters, and ionizers. Prod-

uct descriptions are accompanied by photographs and prices, as well as "Tech Tips" and comparison tables to make selection easier.

## HOLIDAY 1991 HOME AUTOMATION BY HEATH; from Heath Company, Dept. 350-058, Benton Harbor, MI 49022; Phone: 1-800-44-HEATH; free.

Consumer products designed for safety, security, convenience, entertainment, and energy management are featured in this 40-page, full-color catalog.

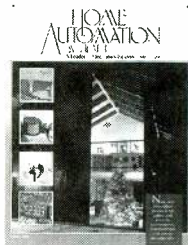

CIRCLE 26 ON FREE INFORMATION CARD

Aimed at do-it-yourselfers and electronics hobbyists, the catalog introduces several new products, including an electronic drape controller that allows drapes to be controlled by a handheld remote or be programmed to open or close at set times throughout the day, three air cleaners that electronically deep-clean the air, a gas detector that sounds a loud alarm in the event of a poisonous or explosive gas leak, and a wireless add-on light switch for installation in staircases or long hallways that need a light switch at each end. Also featured in the catalog are whole-house automation and se-

curity systems, motion-sensing indoor and outdoor lighting controls, security cameras, wireless video broadcasters, and energy-saving thermostats. The catalog provides technical information on the products, and explains how the products work. Such topics as passive-infrared technology, X-10 technology, and how time is measured are also discussed.

## AUDIO FLYER; from Parts Express, 340 East First St., Dayton, OH 45402-1257; Phone: 513-222-0173; Fax: 513-222-4644; free.

Audiophiles and electronics enthusiasts alike will appreciate the selection of goods offered in this 44-page, full-color catalog.



CIRCLE 27 ON FREE INFORMATION CARD

The catalog is filled with audio sound components and accessories; cables and wires; audio accessories; cables, speaker enclosures, woofers, mid-ranges, tweeters, and full speaker systems; P.A. equipment; and cross-overs. Highlights of this issue include decorative wall plates and accessories for in-wall installed audio systems; 12-gauge neon wire; in-wall speakers; several woofers; and an iso-tip butane soldering iron. R-E



# A Shocking Offer!

Now for the first time in CIE's 56 year history you do not have to be enrolled at CIE to receive our Electronics and Electricity Lesson Modules. Available for a limited time to non-students for the shockingly low introductory price of only \$99.50.

With CIE's patented AUTO-PROGRAMMED method of learning you'll quickly learn and then master the basics of electronics and electricity and then move on to ... soldering techniques, applications of Kirchhoff's law, voltage and power, printed circuit boards ... and much, much, more.

Your commitment to CIE ends with your payment, but CIE's commitment to your success just begins when you receive your lessons, exams, binder and equipment. This special price includes the benefits CIE normally extends to its students and graduates.

You'll receive CIE Bookstore privileges, a patented learning method, access to CIE's student, faculty and alumni electronic bulletin board and a free issue of CIE's school newspaper "The Electron". 24-Hour grading and unlimited access to CIE's faculty is available on an optional basis.

And best of all, when you decide to continue your electronics education in any of CIE's programs, you'll receive a \$100.00 CIE tuition credit certificate.

All this knowledge and support will put you on the road to understanding digital electronics, microprocessing principles, computer systems, telecommunications, and much, much, more.

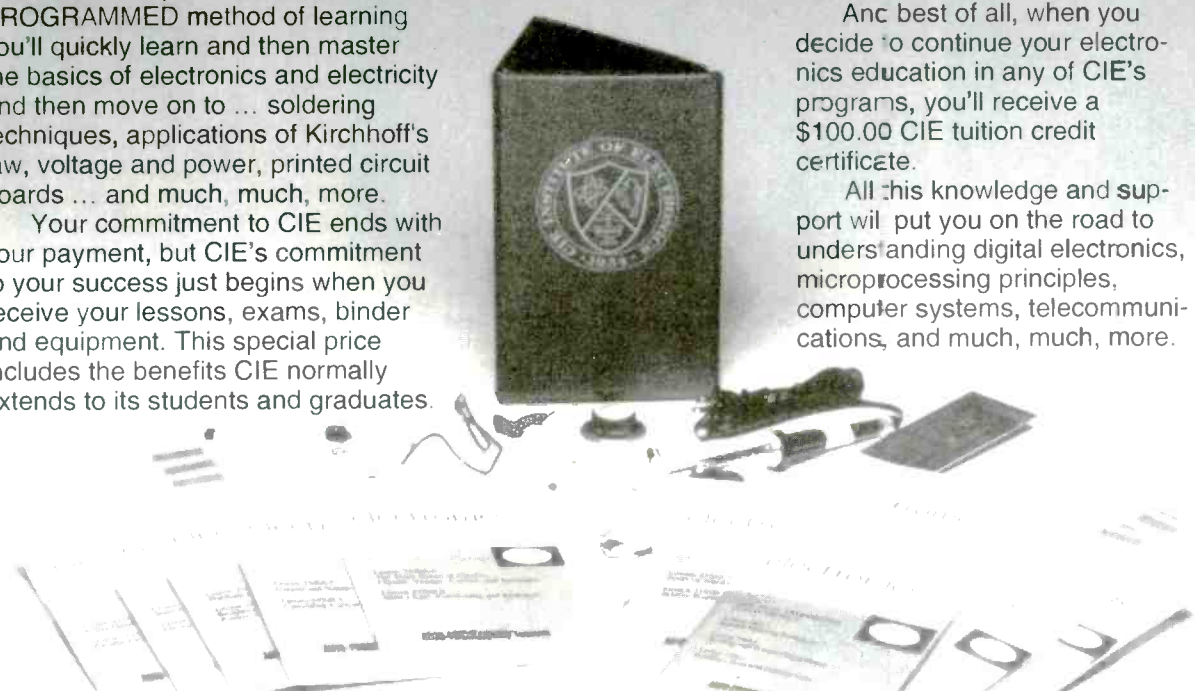

All This For Only!

**\$99.50**

- Free Issue of "The Electron"
- Build your personal burglar alarm
- Theory and hands-on training lessons and exams covering "current and voltage" through "printed circuit boards"
- CIE Bookstore privileges
- Patent learning method
- Electronic Bulletin Board privileges

**• A \$100.00 CIE TUITION CREDIT CERTIFICATE**

**Yes, send me CIE's Introductory Electronic and Electricity Lessons and Equipment.**

A7301

Name: \_\_\_\_\_

Street: \_\_\_\_\_ Apt. #: \_\_\_\_\_

City: \_\_\_\_\_

State: \_\_\_\_\_ Zip: \_\_\_\_\_

Age: \_\_\_\_\_ Phone (\_\_\_\_) \_\_\_\_\_

Total Merchandise: \_\_\_\_\_ \$99.50

Ohio Residents add 7% Sales Tax: \_\_\_\_\_

California Residents add 6 1/2% Sales Tax: \_\_\_\_\_

Total this order: \_\_\_\_\_

Shipping and Handling Charges: \_\_\_\_\_ \$5.00

Method of Payment: Amount Enclosed: \_\_\_\_\_ \$

Personal Check or Money Order

Master Card  Visa

Card Expiration Date: \_\_\_\_\_

Signature: \_\_\_\_\_



**BOOKSTORE**

1776 East 17th Street  
Cleveland, Ohio 44114



**CHARGE BY PHONE!**



9 AM to 4:30 PM Eastern Time;

1-800-321-2155 ext. 7301; In Ohio 1-800-523-9109 ext. 7301

## THE PARTS PLACE<sup>SM</sup>



**NEW! Now You're Talking!**  
This book will help you earn your first Amateur Radio license and get on the air. It includes all the questions on the new codeless Technician class exam and the Novice written exam. The book also provides helpful tips on equipment and antennas. Illustrated. Over 300 pages. #62-2414 . . . **16.95**

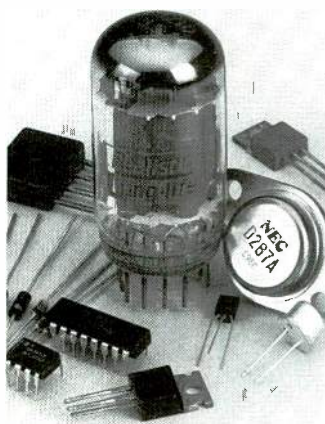

**Special-Order Hotline.** Your local Radio Shack stocks over 1000 popular electronic components. Plus, we can special-order over 10,000 items from our main warehouse—ICs, semiconductors, tubes, crystals, even SAMS<sup>®</sup> manuals. No postage charges or minimum requirements for this service. Come in for details!



**NEW! PC/XT Experimenter's Circuit Card.** This premium-quality prototyping board fits a computer's XT expansion bus connector. Features durable epoxy glass construction and plated-through holes on standard 0.100" centers. Accepts D-sub connector shown at right. 3<sup>7</sup>/<sub>8</sub> x 10<sup>1</sup>/<sub>16</sub> x 1<sup>1</sup>/<sub>16</sub>". #276-1598 . . . . . **29.95**

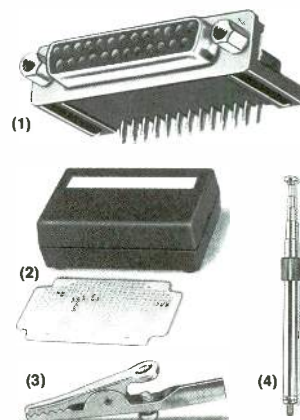

(1) **NEW! Right-Angle D-Sub 25 Female Connector.** Ideal for use with PC/XT circuit card at left. #276-1504, **2.49**  
(2) **Box/Board Combination.** Molded box and 2 x 3<sup>1</sup>/<sub>8</sub>" circuit board. #270-291 . . . **4.99**  
(3) **2" Slim Alligator Clips.** #270-346 . . . **Pkg. of 8/2.19**  
(4) **Cordless Phone Handset Antenna.** #270-1411 . . . **2.99**



**Mercury Bulb Switch.** Just the thing for motion detectors, alarms, experiments and school science projects. Rated 2 amps at 12VDC. Compact T-1<sup>1</sup>/<sub>2</sub> size envelope. #275-040 . . . . . **1.29**



(1) **Two-Tone Piezo Buzzer.** Extra-loud. Operates from 8 to 16VDC. #273-070 . . . . . **10.95**  
(2) **Electromechanical Buzzer.** Loud 12VDC buzzer in a sturdy metal case is great for alarms. #273-051 . . . . . **2.49**



(1) **Stackable Banana Plugs.** Jack permits "chain" hook-ups. #274-734, **Set of 2/1.59**  
(2) **Nylon Binding Posts.** #274-662 . . . . . **Set of 2/1.59**  
(3) **Micro-Clip Jumpers.** 20" long. #278-017 . . . **Pair/3.49**

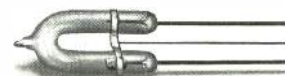

**Super-Bright Strobe Tube.** Perfect for photo replacement, hobby projects and experiments. Trigger: 4 kV. Anode: 200V min. Bulb is about 1<sup>1</sup>/<sub>2</sub>" long and has 1<sup>3</sup>/<sub>4</sub>" leads. #272-1145 . . . . . **3.29**

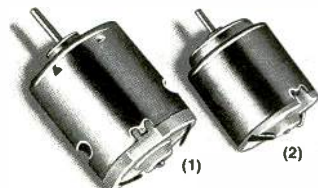

(1) **High-Speed 12VDC Motor.** Up to 15,200 RPM! About 2" long. #273-255 . . . . . **2.99**  
(2) **Low-Voltage Motor.** For science projects and solar power demos. Requires 1<sup>1</sup>/<sub>2</sub> to 3VDC. #273-223 . . . . . **99¢**



(1) **Lead-Free Solder.** 96% tin, 4% silver. 0.032" size. 0.25 oz. #64-025 . . . . . **1.99**  
(2) **Rosin Soldering Paste Flux.** 1 oz. #64-021 . . . . . **1.79**  
Over 100 soldering items and tools for electronics are in stock now at Radio Shack!



(1) **Hi-Precision Thermistor.** Resistance changes in proportion to temperature. #271-110 . . . . . **1.99**  
(2) **500-Piece Resistor Set.** 1/4-watt, 5% tolerance. Includes 54 popular values. #271-312 . . . . . **Set 7.95**



**Car Electrical System Tester.** Spot problems before you're stranded! Plug this analyzer into your vehicle's lighter socket. Color-coded LEDs pinpoint problems in your battery, alternator and regulator. #22-1635 . . . . . **5.95**

Since 1921 Radio Shack has been the place to obtain up-to-date electronic parts as well as quality tools, test equipment and accessories at low prices. Our nearly 7000 locations are ready to serve you—NOBODY COMPARES

Prices apply at participating Radio Shack stores and dealers. Radio Shack is a division of Tandy Corporation

**Radio Shack<sup>®</sup>** SINCE 1921  
**AMERICA'S TECHNOLOGY STORE<sup>SM</sup>**

CIRCLE 78 ON FREE INFORMATION CARD



# CABLE TV'S INFAMOUS BULLET

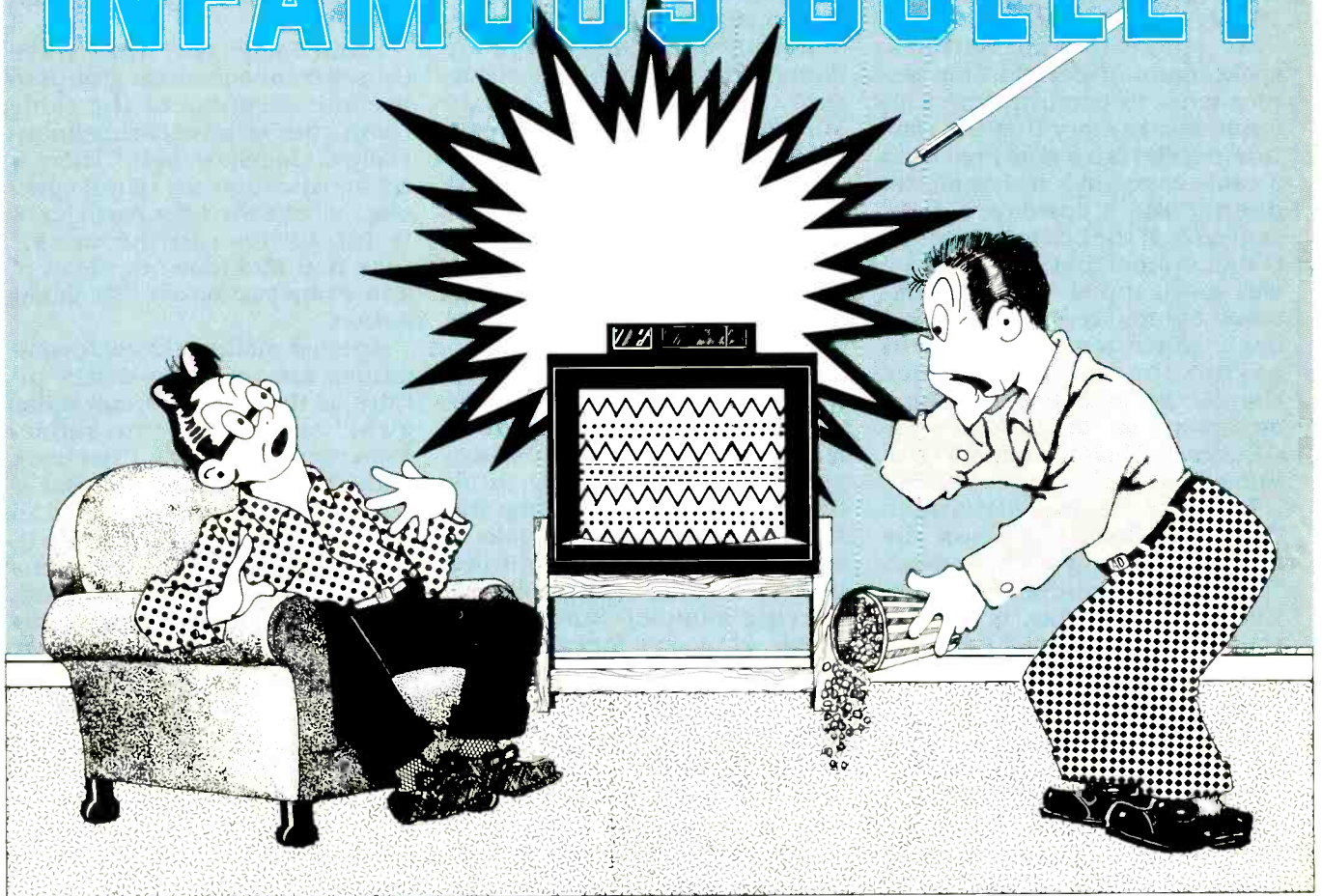

**How American Cablevision's "bullet" zapped signal pirates.**

KEN FOLEY

ON WEDNESDAY, MARCH 13, 1991, American Cablevision of Queens fired their first infamous electronic "bullet." According to American Cablevision, they fired a direct hit. Within minutes their switchboard was overloaded with calls from subscribers whose television sets had gone black. American Cablevision was elated—the victims had unsuspectingly taken the bait.

The next morning, American Cablevision sent armies of technicians to service the homes of the complaining customers. They replaced the cable converter

boxes, and took the dead boxes back to the electronic coroner's laboratory, performing hundreds of autopsies. According to official American Cablevision records of the mass epidemic, the "Certificates of Death" were identical—illegal chip "zaps".

On Wednesday April 24, 1991, American Cablevision filed a civil suit in New York City federal court against three hundred and seventeen alleged cable pirates. That was the first time such a large number of cable crooks had been arraigned together. American Cablevision offered the de-

fendants a deal: Pay five hundred dollars within twenty days, or face prosecution and fines from one thousand, to one hundred and ten thousand dollars.

"I think this is something that everybody's going to have to start doing," said American Cable President Barry Rosenblum. American Cablevision has approximately three hundred and thirty thousand paid subscribers in Queens and Brooklyn, and estimates it forfeits hundreds of thousands of dollars each year to video marauders, and plans to fire more bullets. The electronic

bullet is the brainchild of Jerrold Communications of Hatboro, Pennsylvania. It was first fired in 1990, by Greater Media Cable of Philadelphia.

In three separate assaults, Greater Media Cable blasted away, netting three hundred and sixty eight illegal converters, which garnered a bounty close to twenty thousand dollars.

We spoke to Jim Bathold, spokesman for Jerrold Communications, to confirm American Cablevision's story that the electronic bullet is a signal fired from a cable company's headquarters directly into a customer's cable converter. If the box is legitimate, the customer never knows he was just zapped. But if black-market chips were installed in a basic converter to circumvent paying the monthly service charge, the bullet uses the chips' own programs to neutralize the decoder and halt the cable service immediately.

Mr. Bathold then elaborated "Yes, that is basically how the bullet works," he confirmed. "But it would not be in our best interest to elaborate, or explain the operational procedure in detail. Otherwise it tells subscribers, 'Here we come.' We have not put one word out there in writing of how it works—no press packages or news releases. We especially wouldn't go into detail with electronic hobbyists," he choked out laughing.

Hoping to fare better in Jerrold's engineering division, we were fortunate to reach an engineer that was also a reader of **Radio-Electronics**. His boss' boss, technical engineering supervisor, Stan Dori, said: One of the approaches pirates have been taking for years to defeat scrambling is to physically use a decoder box to unscramble the scrambling method. That is, to reverse engineer the legitimate descrambler's software.

The bullet came into being because one of Jerrold's customers (a cable company) told them of rumors that pirates were defeating Jerrold's scrambling technology. And the cable company wanted to aggressively pursue them. So Jerrold acquired a number of the pirate devices

through various methodologies, and reverse engineered them so that a counter measure could be developed. That counter measure was the bullet, an offensive signal that Jerrold can send down the data stream to neutralize what the pirates reverse engineered. That's the bullet—double-reverse engineering.

Dori continued, "So by understanding what the pirates are doing and not doing to defeat current technology, we're able to launch a counter-offensive signal, the bullet, to defeat them."

In the hopes of discouraging customers from buying illegitimate descramblers, information regarding the bullet is being leaked from the cable industry, which claims they are losing up to three billion annually from piracy.

According to Jodi Hooper of the National Cable Television Association, "People think cheating on cable services is like a school prank. They don't really think they are committing a crime and stealing. They just don't take it seriously." Hooper also indicated that some cable companies are offering complete amnesty to people who come forward before their systems are audited and the bullet is released. She says if the culprits wait until they are discovered, they will chance the possibility of criminal prosecution and heavy fines.

Richard Aurelio, president of Time Warner's New York City Cable Group, compares cable piracy to shoplifting. "Now that we have the technology, we're going to use it to rope them in." But it's a migraine for the cable industry. Most of the cable companies began scrambling their satellites in 1986, and are now concentrating on detecting people with decoders and illegal hookups.

The National Cable Television Association says about eight million homes nationwide are linked illegally to basic cable signals. And an additional three million homes illegally tap into pay services such as Cinemax and HBO.

But from 1975 through last year, the number of basic service subscribers nationwide grew from nine million to fifty-five million. The U.S. Telephone Association reports that the average

basic cable rate nationwide jumped sixty-eight percent between 1986 and 1989.

So even though the cable companies are reporting that losses from theft have tripled during the same period, cable industry revenue has jumped about seventy percent from over ten billion in 1986 to almost eighteen billion last year.

Such large revenues have caused some consumer groups to become skeptical of the cable companies' claims of being financially wounded by theft. "There is no justification for using speculative high-theft figures to justify outrageous rate increases," says Ken McEldowney, head of San Francisco-based Consumer Action.

Another method the cable companies are using to detect pirates, is the "closed circuit radar gun," or time-domain reflectometer. The major drawback with the reflectometer is that it has to be physically attached to the cable entering each home to detect unauthorized connections or decoders. Other than that, sleuthing is still done primarily by inspectors who spend their days eyeballing exterior cables for tampering.

So naturally if the cable industry succeeds in scaring thousands into confessing, it will score a two-headed victory. First by recovering millions in lost revenue having people sign up—as was the case for Utah's TCI Cablevision in 1989 where they ran a blitz advertising campaign showing guilt-ridden signal pirates imprisoned—and second by having the option of keeping the bullet in reserve as a secret weapon and not necessarily having to pay the hefty zapper fee to Jerrold Communications.

Now Time Warner, the second largest cable company with over six million subscribers in thirty six states, is threatening to start firing bullets nationwide. Are they bluffing?

If they are not bluffing, they will undoubtedly catch more cable thieves who are foolish enough to run to their cable company to complain that their pirated cable box is not working properly.

R-E



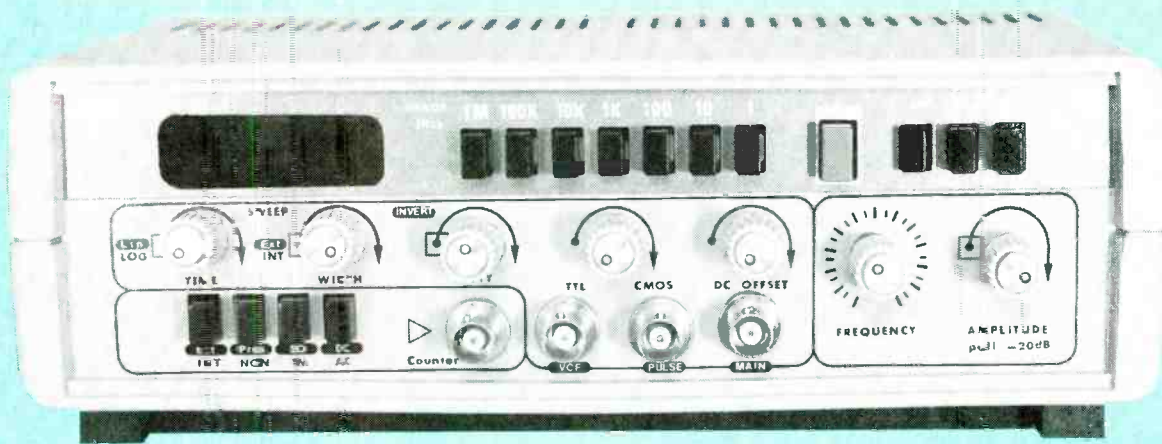

**Build this sweep/function generator  
and frequency counter and add to your  
bench-top instrument collection.**

MICHAEL A. LASHANSKY

IF YOU'RE AN ELECTRONIC PROFESSIONAL or advanced hobbyist, you know the value of a well-equipped workbench. An important piece of basic equipment is a function generator and frequency counter. Although few professionals are missing one from their bench, many hobbyists can't justify the expense of quality commercial units. If you're one of those who has put off buying such an instrument, we can show you how to build one that produces up to a 2.5-MHz square, triangle, or sine-wave output with a 1 to 20-volt peak-to-peak amplitude and a 20-dB attenuator. This instrument also has a TTL or CMOS 0.5- to 15-volt peak output as well as a sweep generator and frequency counter that can read up to 150 MHz. All of these features are combined in a single bench-top unit, for a price of \$300.

**Overview**

Our function generator and counter produces a square, triangle, or sine-wave output with a continuously variable amplitude of one volt to 20 volts peak-to-peak. A 20-dB attenuator allows smaller amplitude signals to be generated. A variable 0.5 to 15-volt peak TTL or CMOS pulse out-

put is also available. You can vary the DC-level content, duty cycle, or invert any of those signals.

The output frequency covers seven decades, ranging from 0.1 Hz up to 2.5 MHz. (A higher frequency limit can be attained by making some potentiometer adjustments, but at the expense of a degraded amplitude and waveform shape, which we will discuss in our next article.) Fine adjusting is achieved through a linear dial. A six-digit LED indicates the output frequency of the generator, or it can be used to display the frequencies of external signals.

Using the sweep generator, any of the output waveforms can be swept linearly or logarithmically by selecting the sweep width and/or speed with the front panel controls. You can also sweep the selected waveform under the control of an external voltage, which is useful for frequency modulation generation techniques.

The frequency-counter section can either give a readout of the frequency being generated or it can measure external signals. The counter's range is from DC to 150 MHz with an input sensitivity of 20 millivolts. Input signals can be DC or AC coupled and

the input impedance is switchable between 50 ohms and 1 megohm. A prescale/non-prescale function is provided to make maximum use of the six-digit LED to display high-frequency counts. The gate time of the counter is controlled by the frequency decade switches and offers gate times of 10, 1, 0.1, and 0.01 seconds.

### Theory of operation

All low- to mid-end function generators—including this one—use a similar technique for generating a waveform. A basic triangle wave is first generated, then massaged into a sine wave and a square wave. The block diagram of Fig. 1 shows the basic workings of the main board. A frequency-controlled multivibrator drives two current switches, which alternately charge and discharge a capacitor through a resistor. The resulting triangle wave is fed either through a sine-shaper circuit, a square-wave amplifier, or

straight out to the output amplifier section.

The output of the square-wave amplifier controls the polarity of the charging voltage of the capacitor. The capacitor will charge to positive, then to negative and back again to positive, thereby creating a triangle wave with an amplitude of 2 volts peak-to-peak. The waveform frequency is controlled by the RC time constant and the amount of negative voltage applied to the multivibrator. We will explore that in more detail later.

The output of the square-wave amplifier is also used to drive a TTL gate and CMOS level-shifter gate combination, which allows both TTL- and CMOS-level pulse outputs.

The sweep-generator section is made up of a voltage controlled multivibrator with a long time constant. That produces a DC voltage that varies according to the voltage applied. The output can be routed to a logarithmic amplifier to create both linear

and log outputs. The signal is then fed to a buffer/level control amplifier which is then coupled to the voltage-control input of the function generator's main multivibrator.

The frequency-counter section is made up of an input-amplifier signal-conditioning circuit, a divide-by-100 prescaler, an Intersil 7216B frequency-counter chip, and a six-digit LED. Signals are routed through the front panel for measuring. Prescaling decreases the resolution of the display but allows 150 MHz to be displayed with six digits. The decimal point on the LED indicates that the display is read in kHz.

### Triangle-wave generation

Figure 2 shows the schematic of the current switch and the triangle/square-wave generator. The combination of IC1-IC4 and Q1-Q4 makes up the main voltage-controlled multivibrator. A negative voltage is applied to the inverting input of IC1, which

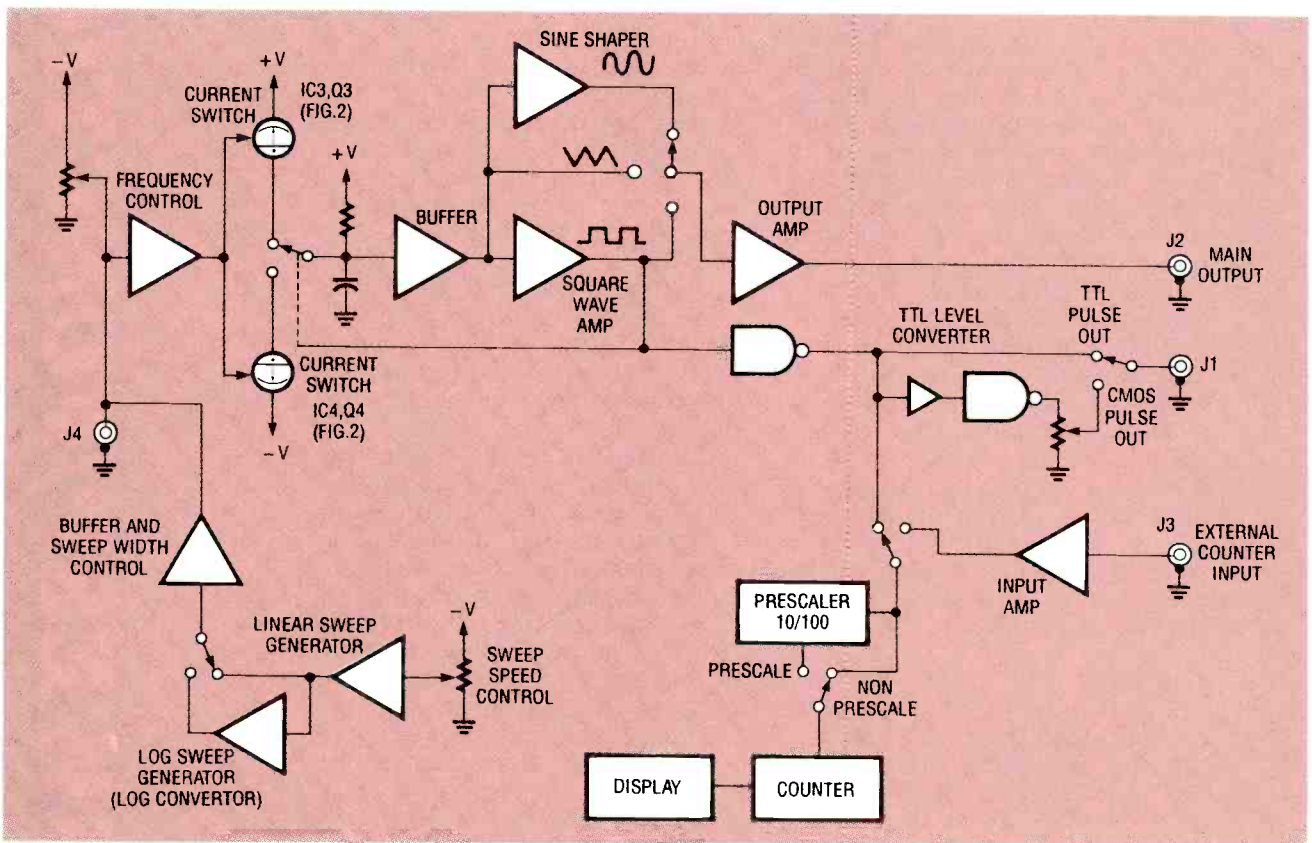

FIG. 1—BLOCK DIAGRAM OF THE FUNCTION GENERATOR. Note how the square-wave output is continuously fed back into the current-switch input. That is done to precisely align the triangle and square wave output through the hysteresis loop to prevent crossover distortion.



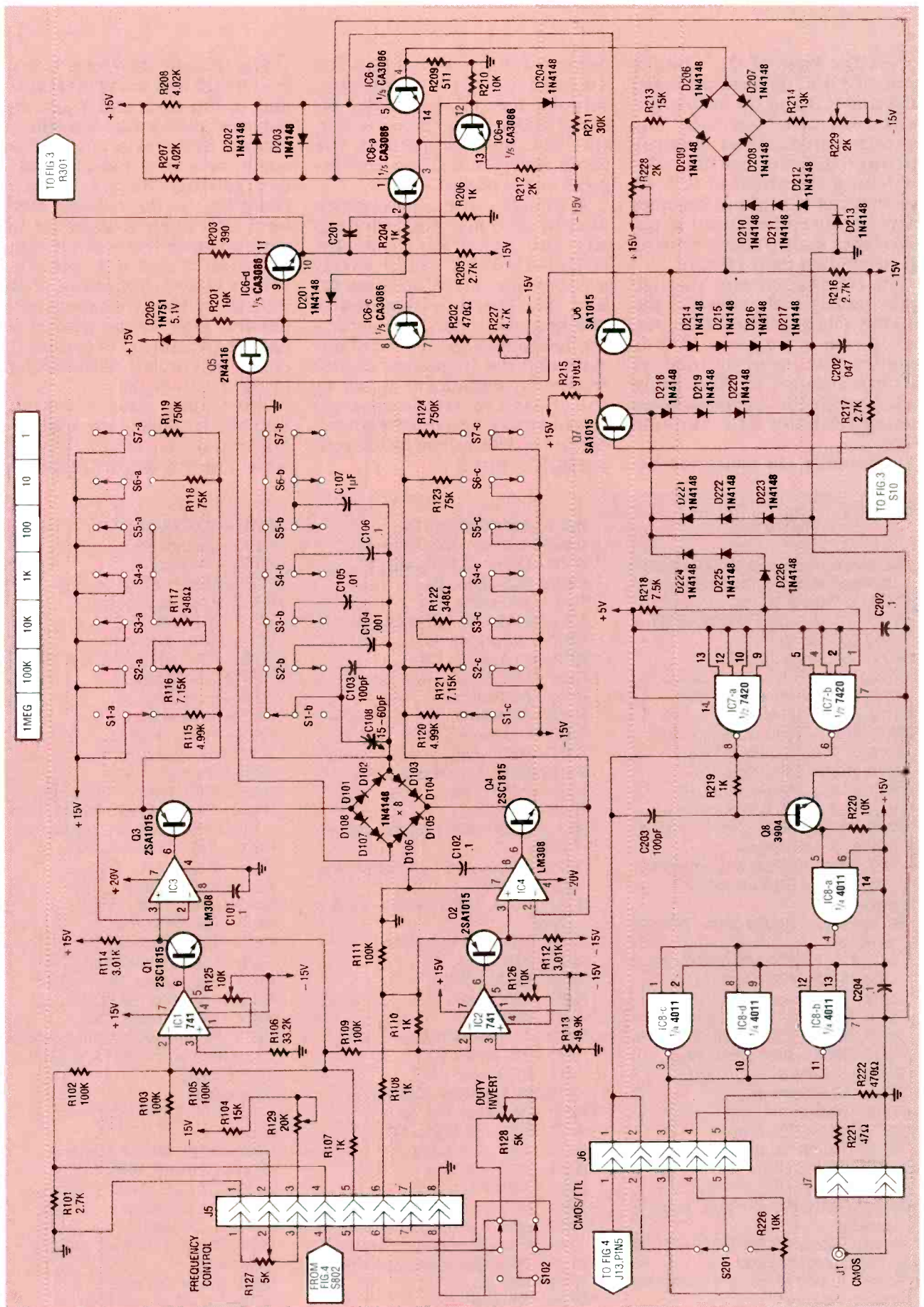

FIG. 2—CURRENT SWITCH, TRIANGLE/SQUARE-WAVE GENERATOR schematic. The triangle waveform is generated by alternately switching current sources Q3 and Q4, thereby charging and discharging C103-C107. As the triangle wave crosses the upper and lower levels of IC3's input, a square wave is generated at the output of hysteresis comparator IC6.

drives the base of Q1. Components IC1 and Q1 form a current sink and IC3 and Q3 form a current-controlled switch. The amount of current flowing through Q1 determines the switching threshold of IC3. As the input of IC1 (pin 2) becomes more negative, the output at pin 6 becomes more positive causing Q1 to conduct more current.

The collector current through Q1 generates a voltage at IC3, pin 3. That voltage causes IC3's output to switch from one state to another. The inverting input of IC3 is connected to the positive rail through the switch-selected timing resistors R115 through R119.

Transistor Q3 switches be-

tween on and off based on the amount of current flowing through the timing resistor selected and Q1. Components IC2, Q2, IC4, and Q4 perform the same function but are 180 degrees out of phase.

A triangle waveform is generated by charging and discharging the selected capacitor (C103-C107) by alternately switching current sources Q3 and Q4. The time required to charge and discharge the capacitor determines the period of one cycle and the frequency. Course frequency adjustment is set by the chosen resistor-capacitor combination, and fine frequency control is determined by the voltage at IC1, pin 2.

The triangle waveform is buffered by Q5 and transistors IC6-c and -d. IC6-a, -b, and -e acts as a balanced differential amplifier to form a hysteresis comparator which acts as a two-state latch controlling the direction of charging. As the triangle waveform alternately crosses the upper and lower levels of the input (IC3, pin 2 and IC4, pin 2), a square wave is generated at the output of the hysteresis comparator. That square wave is fed back to Q3 and Q4 to control the charging current path through bridge D101-D108.

The square wave is fed back into the triangle wave input for alignment with the triangle wave. The importance of the hys-

## PARTS LIST

**All resistors are ¼-watt, 5% unless otherwise indicated.**

R101—2700 ohms, 1%  
 R102, R104, R105, R109, R111—100,000 ohms, 1%  
 R106—33,200 ohms, 1%  
 R107, R108, R110—1000 ohms, 1%  
 R112, R114—3010 ohms, 1%  
 R113—49,900 ohms, 1%  
 R115, R120—4990 ohms, 1%  
 R116, R121—7150 ohms, 1%  
 R117, R122—348 ohms, 1%  
 R118, R123—75,000 ohms, 1%  
 R119, R124—750,000 ohms, 1%  
 R125, R126, R826, R827—10,000 ohms, potentiometer  
 R127, R128—5000 ohms, potentiometer (part of S101 and S102, respectively)  
 R129, R825—20,000 ohms, potentiometer  
 R201, R210, R220—10,000 ohms  
 R202, R222—470 ohms  
 R203—390 ohms  
 R204, R206, R219—1000 ohms  
 R205, R216, R217—2700 ohms, 1%  
 R207, R208—4020 ohms, 1%  
 R209—511 ohms  
 R211—30,000 ohms  
 R212—2000 ohms  
 R213, R214—13,000 ohms  
 R215—910 ohms, 1%  
 R218—7500 ohms  
 R221—47 ohms  
 R223, R828—5000 ohms, potentiometer  
 R224, R225, R228, R229—2000 ohms, potentiometer  
 R226—10,000 ohms, potentiometer (part of S201)  
 R227—4700 ohms, potentiometer

R301—49,900 ohms, 1%  
 R302, R303—11,300 ohms, 1%  
 R304, R306—12,100 ohms, 1%  
 R305—309 ohms, 1%  
 R307—200 ohms, 1%  
 R308, R309—24,900 ohms, 1%  
 R310—127 ohms, 1%  
 R311—63.4 ohms, 1%  
 R312, R313, R320—1000 ohms  
 R314—5100 ohms  
 R315—680 ohms  
 R316—150 ohms  
 R317—6800 ohms  
 R318, R319—10,500 ohms, 1%  
 R321—2000 ohms  
 R322—12 ohms  
 R323, R324—1000 ohms, potentiometer  
 R325—5000 ohms, potentiometer (part of S301)  
 R401, R402, R503, R504—10,000 ohms  
 R403, R404—22,000 ohms  
 R405—170 ohms, 1%  
 R406—12,000 ohms  
 R407—1200 ohms  
 R408—2000  
 R409—18,200 ohms 1%  
 R410—270 ohms, 1%  
 R411—100 ohms, 1%  
 R412, R414, R502—3000 ohms  
 R413—24,300 ohms, 1%  
 R415, R418—47 ohms, 1W  
 R416, R417—7.5 ohms  
 R419—50 ohms, ½W  
 R420—499 ohms, ½W  
 R421—56.2 ohms, 1%  
 R422, R424—10,000 ohms, potentiometer (R424 is part of S401)  
 R423—200 ohms, potentiometer  
 R501—100,000  
 R505—10 megohms  
 R701—10,000 ohms

R702—100,000 ohms  
 R703—1 megohm  
 R704—50 ohms  
 R705, R718—150 ohms  
 R706, R712—220 ohms  
 R707—470 ohms  
 R708, R715—51 ohms  
 R709—R711, R713, R714, R716, R717—510 ohms  
 R719—36 ohms  
 R720—1000 ohms  
 R801—7500 ohms, 1%  
 R802—33,000 ohms, 1%  
 R803—33 ohms, 1%  
 R804, R805, R807—5100 ohms, 1%  
 R806, R810, R816, R817, R819, R820, R822—10,000 ohms, 1%  
 R808—510,000 ohms, 1%  
 R809—2200 ohms, 1%  
 R811—22,000 ohms, 1%  
 R812—2400 ohms, 1%  
 R813—100 ohms, 1%  
 R815—150,000 ohms, 1%  
 R818—15,500 ohms, 1%  
 R821—2000 ohms, 1%  
 R823—15,000 ohms, 1%  
 R824—18,000 ohms, 1%  
 R830, R831—5000 ohms, potentiometer (part of S801 and S802, respectively)

## Capacitors

C101, C102, C204, C205—0.1 µf ceramic  
 C103, C203—100 pF, ceramic  
 C104—0.001 µF, Mylar  
 C105—0.01 µF, Mylar  
 C106—0.1 µF, Mylar  
 C107—1 µF, Mylar  
 C108, C504—15–60 pF, variable capacitor  
 C201—68 pF, ceramic  
 C202—0.047 µF, ceramic  
 C301, C303—0.1 µF, ceramic



teresis loop (IC6 pin 4) is to ensure that the triangle and square wave are perfectly timed to avoid any crossover distortion.

The collector of Q7 is clipped to approximately 3 volts by D218–D226 and fed to IC7, pins 1 and 9. IC7 is a dual four-input AND gate, which logically AND's the input square wave with a logic high to produce a TTL-level square wave output. The outputs of the two gates are tied together for increased current drive, and fed to the pulse-output control circuitry. The TTL square wave is level shifted by Q8 to 15-volt CMOS levels, where it is NANDed with 15 volts in IC8-a. The output of the gate is fed in parallel to IC8-b, -c, and -d, where they are also

NANDed with 15 volts.

The outputs of IC8-b, -c, and -d are connected in parallel for greater drive capability and routed through S201, a 10K potentiometer with a SPDT switch, which controls the pulse output mode. With the potentiometer in the OFF position, a TTL-level output is available. Turning the potentiometer throws the switch, which routes the CMOS output to the BNC connector J1. The 10K potentiometer controls the amount of signal available to J1 and will vary the amplitude of the signal from 0.5 volts to 15 volts.

Figure 3 shows the schematic of the sine shaper and output amplifier. Sine-wave generation is accomplished by taking the tri-

angle wave from IC6-d and feeding it through the nonlinear network made up of D301–D312 and resistors R301–R310. The circuit attenuates the input triangle wave according to its level, producing a sine-wave equivalent. The output of the sine shaper is fed through a high-pass filter to the input of IC9, a CA3030 op-amp. Zener diodes D313 and D314 drop the 15-volt supply voltage to  $\pm 11.3$  volts to accommodate the  $\pm 12$ -volt requirements of the IC. The gain of IC9 is about 10, and can be adjusted by potentiometer R323. The CA3030 is an inexpensive wide-band op-amp but requires some frequency compensation to work over its entire bandwidth.

C302, C304, C502—39 pF, ceramic  
 C305, C401—4.7 pF, ceramic  
 C307—15 pF, ceramic  
 C308, C408—5–35 pF, variable capacitor  
 C402—120 pF, ceramic  
 C403—2.2 pF, ceramic  
 C404, C406—6.8  $\mu$ F, tantalum, 20 volts  
 C405, C407—0.047  $\mu$ F, ceramic  
 C501—33 pF, ceramic  
 C503—10 pF, ceramic  
 C601, C602—1000  $\mu$ F, electrolytic, 50 volts  
 C603, C604—100  $\mu$ F, electrolytic, 50 volts  
 C605—1  $\mu$ F, tantalum, 20 volts  
 C701, C704–C706—0.1  $\mu$ F, ceramic  
 C702, C707—100 pF, ceramic  
 C703 10u tantalum 16 volts  
 C801—22  $\mu$ F, tantalum, 16 volts  
 C802, C803—220 pF, ceramic  
 C804, C805—100 pF, ceramic  
 C806—500 pF, ceramic

#### Semiconductors

D101–D108, D201–D204, D206–D226, D301–D312, D315–D318, D401, D402, D701, D702, D801—1N4148 diode  
 D205—1N751, 5.1-volt Zener diode  
 D313, D314—1N746, 3.3-volt Zener diode  
 BR1—W02M bridge diode  
 Q1, Q4, Q12, Q13, Q21—2SC1815 or MPSA05 NPN transistor  
 Q2, Q3, Q6, Q7, Q11, Q19, Q20—2SA1015 or 2N4403 PNP transistor  
 Q5, Q17—2N4416, N-channel FET  
 Q8—2N3904, NPN transistor  
 Q9, Q10, Q14—2SC1923 or MPSH34, NPN transistor  
 Q15—2N2219, NPN transistor  
 Q16—2N2905, PNP transistor

Q18—PN5139, PNP transistor  
 IC1, IC2—LM741, op-amp  
 IC3, IC4—LM308, op-amp  
 IC5, IC6, IC20—CA3086, NPN five-transistor IC (Harris)  
 IC7—7420, dual 4-input AND gate  
 IC8—4011, quad NAND gate  
 IC9—CA3030, op-amp  
 IC10—4066, CMOS quad bilateral switch  
 IC11—7216B, frequency counter and LED driver (Intersil)  
 IC12—7815, +15-volt voltage regulator  
 IC13—7805, +5-volt voltage regulator  
 IC14—7915, –15-volt voltage regulator  
 IC15—MC10116, ECL triple-line receiver with Schmitt trigger (Motorola)  
 IC16—SP8629, prescaler (Plessey)  
 IC17—LM324, quad op-amp  
 IC18—MC1458, dual op-amp  
 IC19—CA3140, op-amp (Harris)  
 SR801—1000 ohms, thermistor  
 DISP1–DISP6—common-cathode LED (FND357)

#### Other components

S1–S7—4PDT-D switch  
 S8—DPDT switch  
 S9–S1—DPDT-D switch  
 S12–S14—DPDT-I switch  
 S15—DPDT on/off switch  
 S101—DTDP switch used with R127 (5K potentiometer)  
 S102—DTDP switch used with R128 (5K potentiometer)  
 S201—SPDT switch used with R226 (10K potentiometer)  
 S301—DPDT switch used with R325 (5K potentiometer)  
 S401—SPDT switch used with R424

(10K potentiometer)  
 S801—DPDT switch used with R830 (5K potentiometer)  
 S802—DPDT switch used with R831 (5K potentiometer)  
 J1–J4—BNC panel mount connector  
 J5, J14—8-position female/male, 0.1-inch centers  
 J6—5-position female/male, 0.1-inch centers  
 J7, J12—2-position female/male, 0.1-inch centers  
 J8, J13—6-position female/male, 0.1-inch centers  
 J9–J11, J15, J16—4-position female/male, 0.1-inch centers  
 XTAL1—10-MHz AT/CUT crystal  
 T1—115/40 volts AC, 0.5-amp transformer  
 F1—0.5-amp fuse

**Miscellaneous:** Case (CTP-1 by Global Specialties), three 1.75-inch standoffs, two T0-5 heatsinks, three T0-220 heatsinks, three PC boards, internal wiring, fuseholder, 3-conductor 18-gauge power-supply cord and strain relief.

**Note:** The following items are available from Tristat Electronics, Inc., 66A Brockington Cres., Nepean, Ontario, Canada, K2G 5L1, (613) 228-7223:

- A set of three etched, drilled and plated-through PC boards—\$76.
- All components without the PC board and case—\$250.
- Complete kit of all parts (unfinished front panel)—\$300.
- Cut and silk-screened front panel—\$10.

Add \$17 for shipping and handling. Send check or M.O.

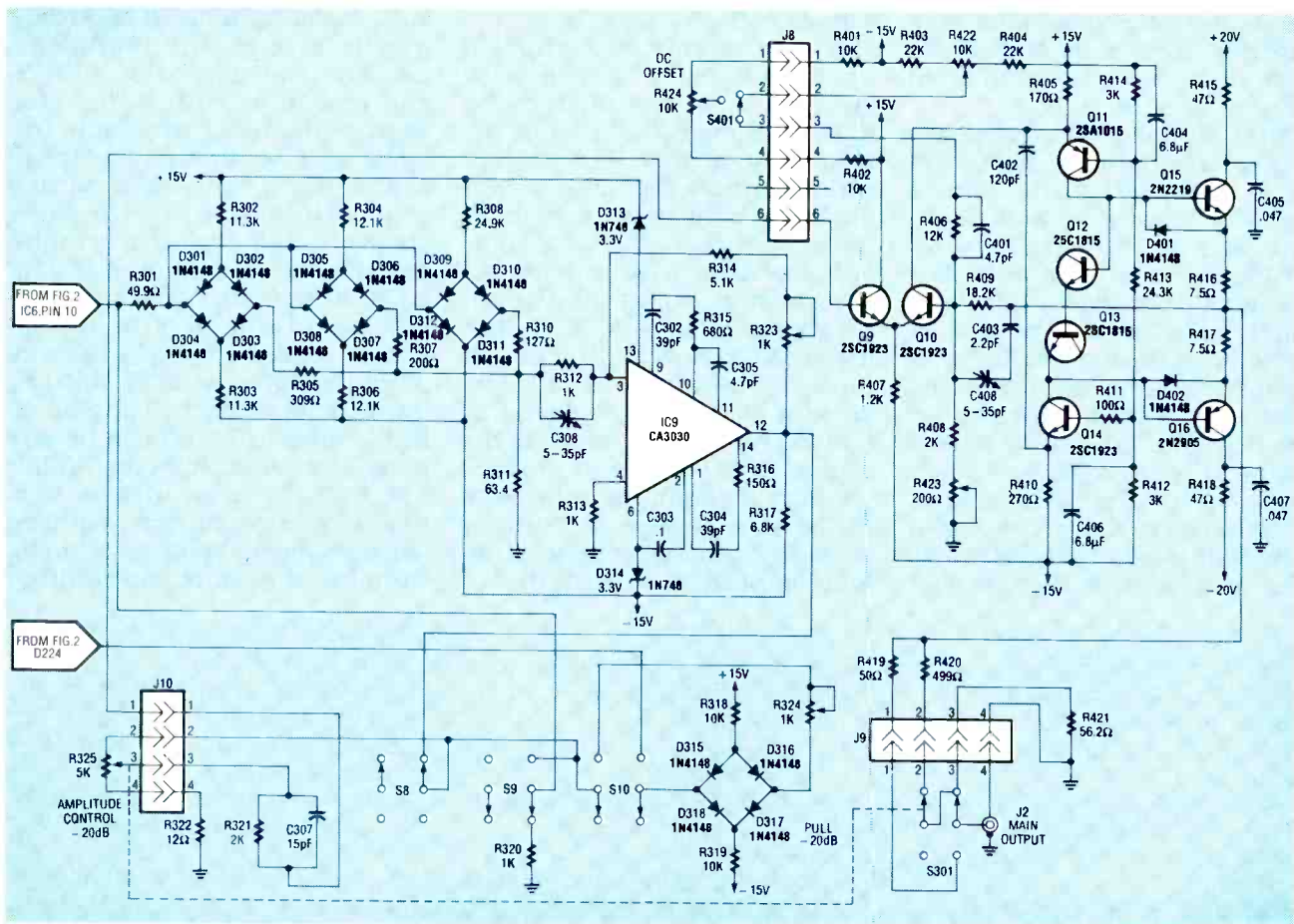

FIG. 3—SINE SHAPER AND OUTPUT AMPLIFIER schematic. The triangle wave from IC6-d is fed to a nonlinear network made up of D301–D312 and R301–R310. The triangle wave is attenuated according to its level, producing a sine-wave equivalent.

The main output amplifier consists of Q9 and Q10 configured as an unbalanced differential pair and transistors Q11–Q16 configured as a complementary symmetry push-pull amplifier. A differential amplifier amplifies the difference between the signals present at the base of each transistor. The input signal is fed into the base of Q9 and the output of the push-pull amplifier is fed back through the attenuating circuit of R409, C403, and C408 and coupled to the base of Q10. The output of the differential pair, Q9 and Q10, is taken from the collector of Q10 with the gain of that signal controlled by R408 and R423, which shunts the input signal to ground.

The DC content of the output signal is determined by the DC bias voltage at the base of Q10 (that value is set by potentiometer R422 and should be adjusted to give a 0-volt DC level). Panel-mounted switch/potentiometer

S401 allows the user to adjust the DC base bias of Q10, which causes the output signal to ride on a DC voltage from –10 volts to +10 volts depending on the potentiometer setting.

The output of Q10 is connected to the emitters of Q11 and Q14 through DC blocking capacitor C402. Transistors Q11 and Q14 are used in the common-base mode with the input signal fed into the emitters and the outputs taken from the collectors. Transistors Q12 and Q13 are used as diodes to connect the collectors of Q11 and Q14. The output of Q11 is fed to the base of Q15, which amplifies the positive half of the signal. The output of Q14 is fed into the base of Q16 which amplifies the negative excursion of the signal. Switch S301 controls the amount of signal entering the amplifier section through the use of a potentiometer. When the ganged DPDT switch is left in its normal IN position, the output

will swing 20 volts peak-to-peak (open circuit). Pulling the switch attenuates the signal by 20 dB. Output impedance is approximately 600 ohms in the normal switch position and 50 ohms in the 20-dB position.

The frequency-counter and sweep-generator circuits are shown in Fig. 4. The sweep generator consists of IC17–IC20. The potentiometer section of S801 applies a negative voltage to the inverting input of integrator IC17-a. The input signal is inverted and charges C801 until it reaches the switching threshold of comparator IC17-b. When the switching threshold is reached the output will go high, forward biasing Q21 which discharges C801 to ground through R806. The output at IC17-a pin 7 is a positive-going ramp and is routed through the linear/log selection switch S801 to either the output buffer amp or the log-arithmetic ramp generator.



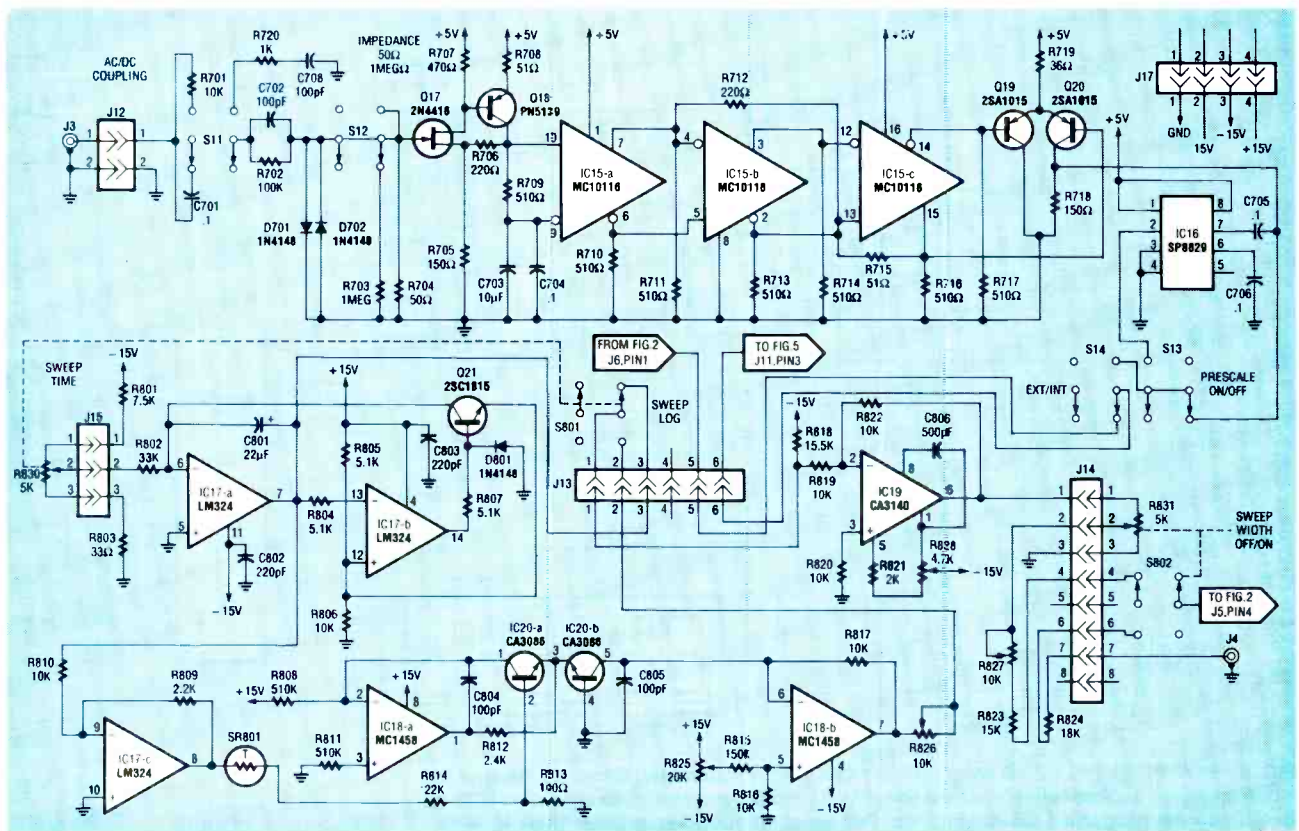

**FIG. 4—SWEEP GENERATOR AND SIGNAL ROUTING** Potentiometer R830 applies a negative voltage to IC17-a; C801 charges until it reaches the switching threshold of IC17-b, which then forward biases Q1. The output at IC17, pin 7 is a positive-going ramp which is routed through the linear/log selection switch S801 to the output buffer amp or log ramp generator. IC16 is a prescaler chip used to downscale frequencies greater than 10 MHz.

An anti-log generator circuit is made up of IC17-c, IC18-a, -b, IC20-a, and -b, which performs an  $X^2$  function. IC17-c acts as an input buffer and attenuator. IC18-a and IC20-a drives the emitter of IC20-b in proportion to the input voltage at the base of IC20-a. The collector current of IC20-b varies exponentially with the emitter-base voltage. The current is then converted to a voltage by amplifier IC18-b. Potentiometer R825 sets the balance of IC18-b's output between a linear and exponential function while potentiometer R826 controls the output signal level. Thermistor SR801 is necessary to compensate for temperature drift because the output of the circuit is directly proportional to the anti-log of the input voltage, and the coefficient of the log term is directly proportional to absolute temperature. Without compensation, the scale factor would also vary directly with temperature. Constant gain is achieved by making the voltage at the base of

IC20-a directly proportional to temperature.

The linear and logarithmic positive-going ramps are buffered by IC19, a CA3140 op-amp, and are converted to a negative-going ramp. That signal is then fed into IC1 pin 2 through R102. Switch-potentiometer S802-R831 controls the negative voltage that is coupled to IC1 pin 2 when it is in the normal IN position. IC1 is controlled by the main frequency-adjust potentiometer S101, which consists of R127 unconnected to S101.

With S802 in the OUT position, the output of IC19 will be present at IC1. Potentiometer S802 sets the level of the ramp and controls the sweep width. It should be noted that IC1 pin 2 is a summing point and the voltage present from the main frequency control and the sweep generator adds together. The sweep generator starts its sweep at the point determined by the initial voltage at pin 2. For maximum sweep control, the main frequency ad-

just potentiometer should be turned to its minimum level.

### Frequency counter

The power supply and frequency counter circuit is shown in Fig. 5. The frequency counter can count either signals generated internally or measure external signals. The external signal is switch coupled through S11 directly through R701, or capacitively coupled through C701, as shown in Fig. 4. When the input signal is directly coupled, the low-pass filter of C708 and R720 is present. Capacitively-coupled signals by-pass the low-pass filter and pass through a high-pass filter. Diodes D701 and D702 clamp the input to protect Q17. Switch S12 selects the gate resistor and sets the input impedance of the circuit. Transistors Q17 and Q18 provide amplification and impedance matching for IC15, an MC10116 ECL triple-line receiver with Schmitt trigger. Differential amplifier Q19 and Q20 provide a single-ended output from the dif-

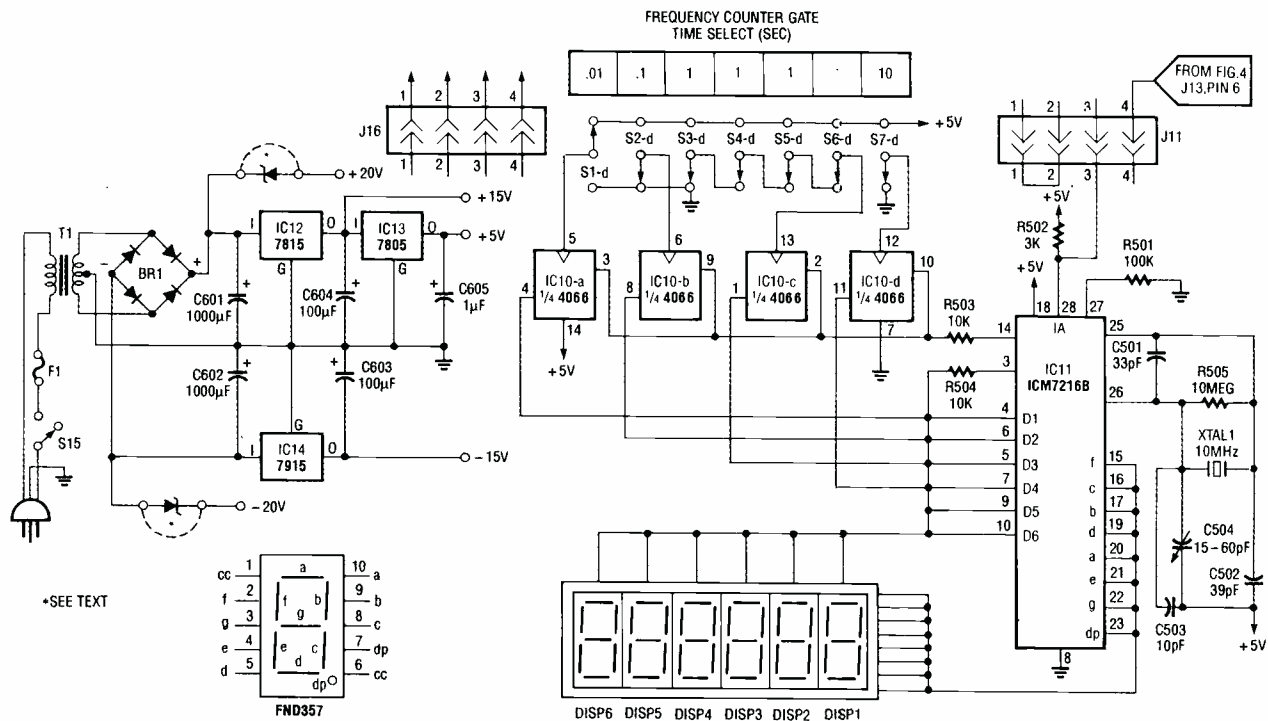

**FIG. 5—POWER SUPPLY AND FREQUENCY COUNTER schematic.** Either an internal or external signal source is selected via S14 (Fig. 4). Both signal sources are fed to IC11, a frequency counter and LED driver chip. For input frequencies greater than 10 MHz, prescaling is needed.

ferential outputs of IC15. Switch S13 controls whether the input signal is fed directly from the input amplifier or from the divide-by-100 prescaler to the counter section.

The counter section can take its input from the internal source or from an external source via S14. The internal signal represents the output frequency of the frequency generator and is taken from the junction of D221 and D224. Both signal sources are pulled up to CMOS levels by R502 and fed into IC11, an Intersil frequency counter and LED driver chip. The chip combines a high-frequency oscillator, decade time-base counter, an 8-decade data counter and latches, 7-segment decoder, digit multiplexes, and 8-segment and 8-digit drivers, which directly drive multiplexed LED's. The input frequency of the chip is limited to 10 MHz, so prescaling of the input is required to measure higher frequency signals. The 7216B is a multifunctional chip, performing many useful measuring tasks.

A 10-MHz crystal, XTAL1 with components C501-C504 and R505 set the internal timebase to

10 MHz. That configuration works well with our divide-by-100 prescaler because the timebase can remain the same, only the decimal point takes on a different meaning. In non-prescaled operation, the decimal point on the LED indicates the reading is in kHz, when the input is prescaled, the decimal point indicates the display is read as  $\times 10$  kHz. We'll discuss more about that later.

Gate-time selection is controlled by the main frequency selection switches S1-d through S7-d. They are configured to give gate times of 0.01 seconds in the 1-MHz range, 0.1 seconds in the 100-kHz range, 1 second in the 10-kHz through 10-Hz ranges, and 10 seconds in the 0.1-Hz range. The gate time select (IC11 pin 14) must be connected to the appropriate digit driver to select the required time.

Gate-time selection is achieved by applying 5 volts DC from one of the switches S1-d through S7-d to the control input of one of the quad-bilateral switches of IC10. Each of the bilateral switches of IC10 controls the digit driver that is connected to the gate-select in-

put. Because switches S1-d through S7-d are dependent (only one can be engaged at any one time) only one of the bilateral switches will have 5 volts on its control input, all the others will be at ground. Resistor R504 hardwires the function select to implement the frequency measuring mode only. Both R504 and R503 are required to reduce ringing at the input, which could result in false selections.

The power supply is fairly straightforward. AC line current is switch-connected through S15 to fuse F1 to the primary of T1. The transformer is center tapped with a secondary voltage of 40 volts and full load current of 0.5 amps. Diode bridge BR1 rectifies the AC secondary voltage and it is filtered by capacitors C601 and C602. Voltage regulators, IC12-IC14, provide +15, +5, and -15 volts DC. The  $\pm 20$  volts DC is taken right from the bridge circuit. If a 40-volt AC secondary transformer cannot be found, Zener diodes can be used to drop a high secondary voltage down to the  $\pm 20$ -volt range. Next time we'll discuss how to build and test the function generator. **R-E**



# SPEAKER MATE

*This easy-to-build project will turn any regular telephone into a high-quality speakerphone!*



SPEAKERPHONES HAVE COME A LONG way since the two-piece units we used to see on the 1958 TV series, *The FBI*. There, an agent, played by Ephrim Zimbalist Jr., sat on his chief's desk as they "conferenced" around the country, planning the capture of the villain. In those days the units were available only by a rather expensive lease from Ma Bell, and the talk unit and receive section had to be located on opposite sides of the desk to avoid acoustic feedback—the same sort of sound that a public address system generates when the speakers are located too close to the microphone.

Today, thanks to some sophisticated electronics, the speaker and the microphone can now be used in a single enclosure. However, as we will discuss later, there are still acoustic considerations

to contend with. We've all heard what the typical speakerphone sounds like, and that's probably why most of us don't already own one. Speakerphones have also had a history of being expensive—until now.

The Speaker-Mate speakerphone is inexpensive, compact, easy to build, and powered from the phone line. You'll still need a regular phone because you can't dial out on the Speaker-Mate, and it doesn't have a ringer. But its sound quality is excellent.

A quality speakerphone relies on a balanced combination of electronic design and acoustic physics. With the Speaker-Mate, once an enclosure was chosen, the microphone and speaker were moved to different positions to achieve the best possible sound before making the final design.

## Operation

Modern speakerphones work on a switching principle to minimize audio feedback. Neither the talk path nor the receive path are totally off, but each are attenuated by a factor of 52 dB, and both sit in an idling mode until one person talks. It's similar to voice-controlled transmissions (VOX) used by ham operators, where both station transmitters are off until one operator talks; when they are through the other station can talk. The comparison ends here because with a speakerphone, the receiving station can interrupt simply by talking louder.

Figure 1 is a block diagram of the Speaker-Mate. The talk path goes left to right on the upper half of the drawing, and the receive path goes from right to left. Both paths go through their respective

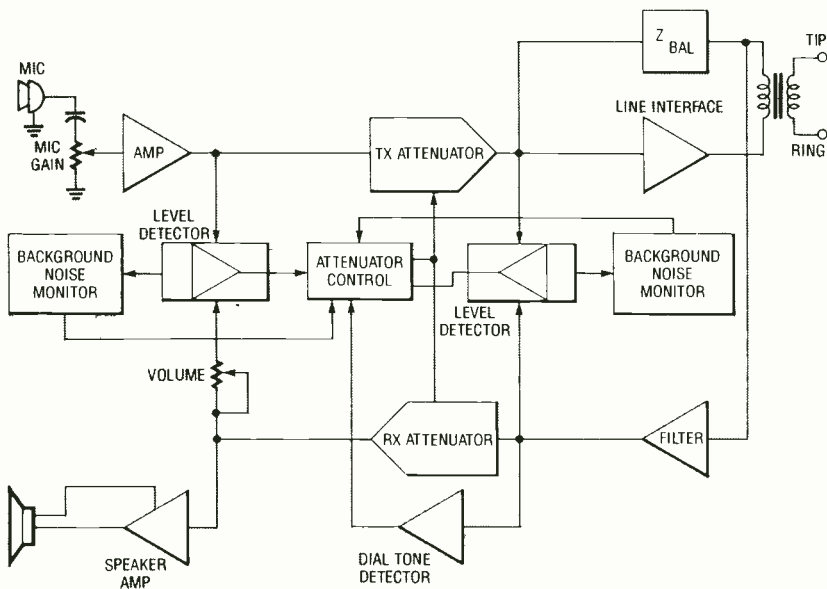

FIG. 1—BLOCK DIAGRAM OF THE SPEAKER-MATE. The talk path goes left to right on the upper half of the drawing, and the receive path goes from right to left.

attenuators which are controlled by the attenuator control block. That section gets its data from level detectors on both circuit paths. The detectors are interconnected with background-noise monitors.

One of the requirements of the speaker-phone design is to differentiate between speech, which constantly varies in amplitude, and constant background noise. When constant and unvarying noise is heard, the attenuator control mutes both paths until speech is read. A separate detector is provided to attenuate the dial tone; it is not a single tone and does not qualify as noise. The Z balance network matches both paths to the phone line.

### Circuitry

Referring to the schematic in Fig. 2, the 600-ohm balanced telephone line is coupled to the

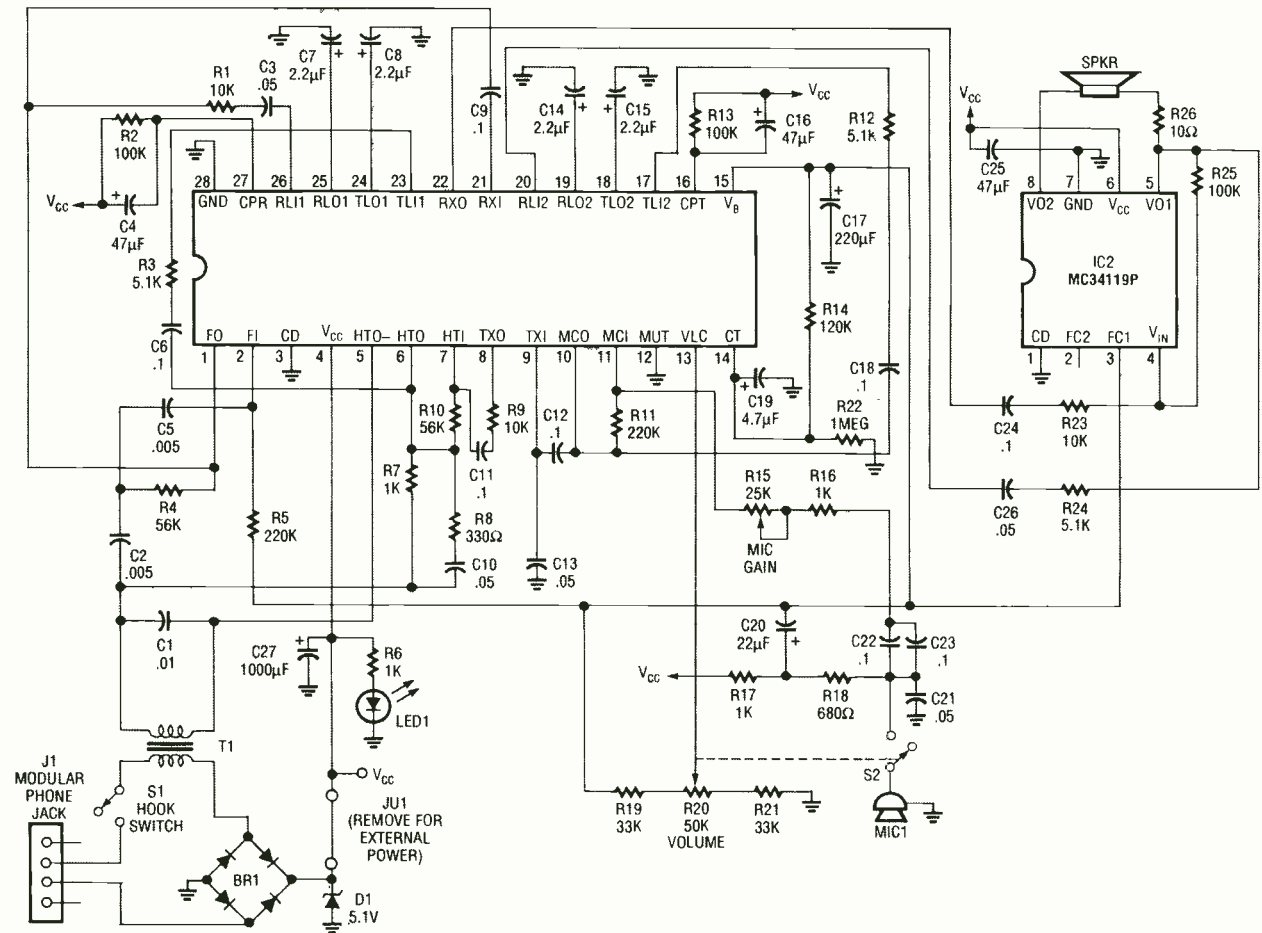

FIG. 2—SPEAKER-MATE SCHEMATIC. The 600-ohm balanced telephone line is coupled to the device through T1, a 600-to-600 ohm transformer. A Zener diode limits transient spikes and regulates the supply to 5.1 volts.



## PARTS LIST

### All resistors are ¼-watt, 5%

R1, R9, R23—10,000 ohms  
 R2, R13, R25—100,000 ohms  
 R3, R12, R24—5100 ohms  
 R4, R10—56,000 ohms  
 R5, R11—220,000 ohms  
 R6, R7, R16, R17—1000 ohms  
 R8—330 ohms  
 R14—120,000 ohms  
 R15—25,000 ohms, PC-mount vertical potentiometer  
 R18—680 ohms  
 R19, R21—33,000 ohms  
 R20—50,000 ohms, potentiometer with switch (S2)  
 R22—1 megohm  
 R26—10 ohms

### Capacitors

C1—0.01  $\mu$ F, ceramic disk  
 C2, C5—0.005  $\mu$ F, ceramic disk  
 C3, C10, C13, C21, C26—0.05  $\mu$ F ceramic disk  
 C4, C16, C25—47  $\mu$ F, 16 volts, radial electrolytic  
 C6, C9, C11, C12, C18, C22, C23, C24—0.1  $\mu$ F, ceramic disk

C7, C8, C14, C15, C19—2.2  $\mu$ F, 16 volts, radial electrolytic  
 C17—220  $\mu$ F, 16 volts, radial electrolytic  
 C20—22  $\mu$ F, 16 volts, radial electrolytic  
 C27—1000  $\mu$ F, 16 volts, radial electrolytic

### Semiconductors

IC1—MC34118P voice-switched speakerphone, Motorola  
 IC2—MC34119P low-power audio amplifier, Motorola  
 D1—1N4733 5.1-volt Zener diode, or equivalent  
 LED1—high efficiency red light-emitting diode, GI MV5774 cr equivalent  
 BR1—50-volt bridge rectifier, RB115 or equivalent

### Other components

MIC1—electret microphone element  
 T1—600-to-600 ohm PC-mount transformer, 0.75-inch mounting center  
 J1—modular PC-mount phone jack  
 S1—SPST toggle switch

S2—SPST switch (mounted on potentiometer R20)

**Miscellaneous:** Cabinet, PC board, ⅜-inch I.D. rubber grommet, 3-inch 8-ohm speaker, knob, modular phone cord, wire, solder, RTV silicon glue, etc.

**Note:** The following items are available from Project-Mate, 2727 W. Manor Pl., Seattle, WA 98199 (206) 283-4700:

- A kit containing a PC board and all listed parts except the cabinet, speaker, and modular phone cord—\$46.00.
  - Pac-Tec cabinet with silk-screened front panel—\$18.50
  - 3-inch speaker—\$3.75.
  - Drilled and plated PC board—\$11.50
  - IC1 and IC2—\$18.50
  - Ring detector kit including piezo transducer—\$9.50
- Include \$3.50 shipping and handling and allow 2 weeks for delivery. 15% discount on orders of 2 or more similar items.

Speaker-Mate through T1, a 600-to-600 ohm transformer. Switch S1 in series with T1 provides the answer function, and when the circuit is closed (off-hook), current flows through BR1 which produces a DC voltage of 6–8 volts. A Zener diode across the output limits transient spikes and regulates the supply to 5.1 volts which powers the circuit and optional LED1. The LED, if used, should be of the high-efficiency variety, because R6 limits its current to 2 mA to minimize telephone-loop current drain. The secondary of T1 is fed to IC1, a Motorola MC34118P voice-switched speakerphone chip, which controls all functions except driving the speaker. That is

done by IC2, a Motorola MC34119P low-power audio amplifier IC. Both IC's can operate from less than 3 volts.

Potentiometer R20 controls the volume and is limited in range by R19 which sets the high level, and R21 which sets the low

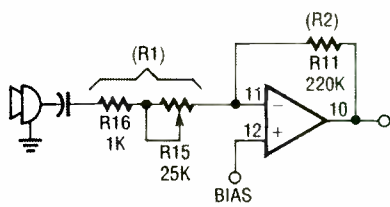

**FIG. 3—YOU CAN ADD** a microphone gain adjustment to allow for different environments and applications. The gain is the ratio of R2/R1. With R1 at 1K, the gain is 220, and with R1 at 26K, the gain is 8.5.

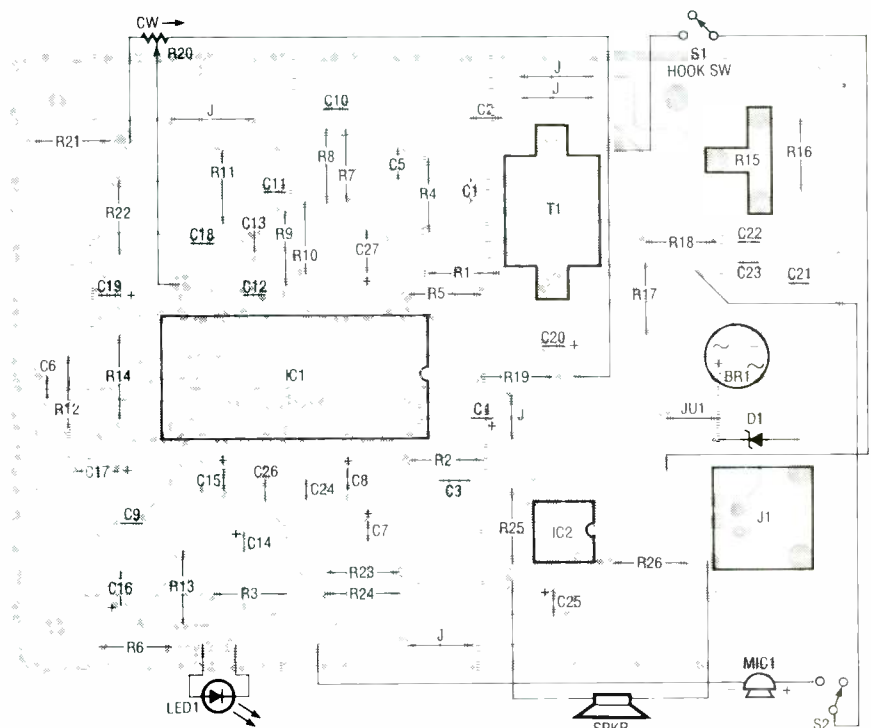

**FIG. 4—PARTS-PLACEMENT DIAGRAM.** Mount the two IC's first to provide a good reference for the rest of the components. Use sockets for both IC's, especially for the 28-pin chip.

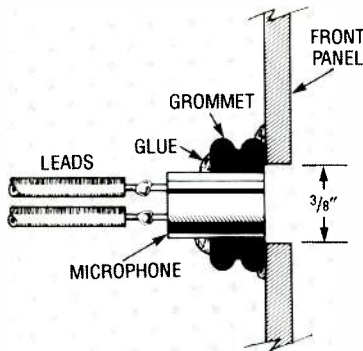

**FIG. 5—MICROPHONE MOUNTING** scheme. A rubber grommet is glued to the inside of the front panel behind the microphone opening. The microphone should not touch the front panel, but if it's too far recessed it will give an echo sound.

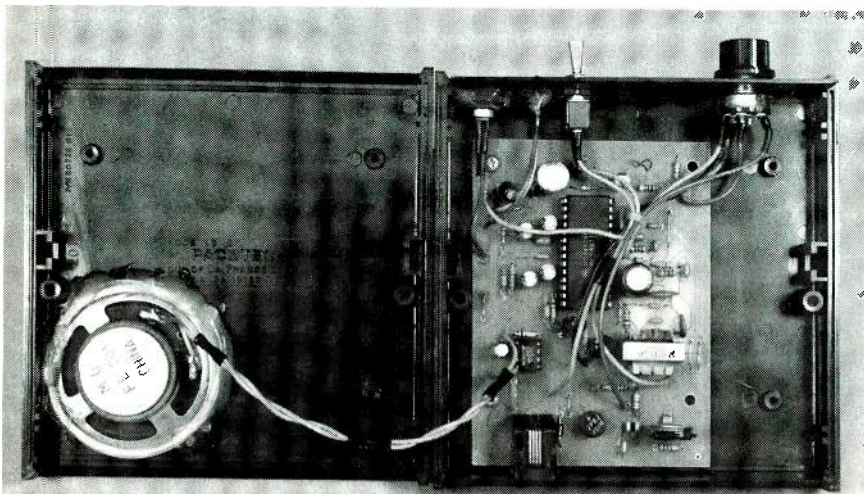

**FIG. 6—THE COMPLETED PROTOTYPE.** The front panel included with the kit makes for a nice finishing touch.

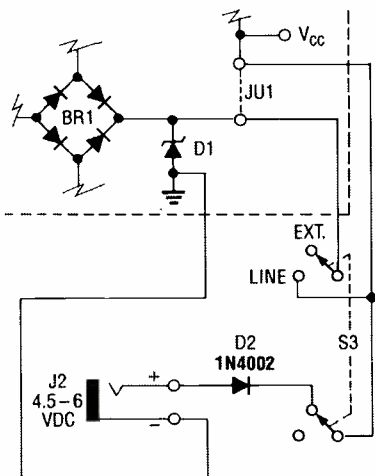

**FIG. 7—EXTERNAL POWER ADDITION.** The parts can be mounted on the rear panel and wired into the board. S3 will switch the unit between being line-powered and powered from an external source.

level. The low end is set to not completely turn off the audio and the high end limits the current required by the power amplifier to within the parameters allowed by the telephone loop current. Excessive audio would create a pumping sound due to the voltage dropping on audio peaks. Potentiometer R20 can be either linear or audio taper with very little effect on the sound, due to the limiting resistors.

We found it desirable to add a microphone gain adjustment to allow for different environments and applications. That was done by adding a 25K potentiometer (R15) in series with a 1K limiting

With R20 connected to  $V_{CC}$ , the calling station will have the slight capture advantage, and of the three options, we found that R22 to ground worked best.

### Construction

Because the Speaker-Mate is designed with some tight time constants, it is highly recommended that suggested part values be followed for optimum performance. And, although a variety of project cases can be used, the electronics and the physical layout were tuned for the enclosure used with the prototype; it is available from many different distributors as well as from the source mentioned in the parts list. The project case comes with a professionally screened front panel when purchased from that source.

With the exception of the front-panel mounted components and the speaker, all parts fit on the PC board; a foil pattern is provided if you want to etch your own board. A pre-etched board is available separately, as is a kit that includes the PC board and all other parts to completely build the Speaker-Mate project.

A parts-placement diagram is shown in Fig. 4. Mounting the two IC's first gives a good reference for the rest of the component mounting. Double check the polarity of each IC before soldering, and note that pin 1 goes on the square pad on the PC board. (Incidentally, the other square pads indicate jumpers or external leads.) It is suggested that you use IC sockets for both IC's, especially for the 28-pin chip.

The resistors can be mounted next, their clipped leads can be used as jumpers (J) where necessary. However, don't install the jumpers at this time. Diode D1, bridge rectifier BR1, and the electrolytic capacitors are polarized and should be checked carefully before mounting. The phone jack, J1, has plastic "feet" on the bottom of it. After positioning the jack on the PC board, the feet should be melted apart on the underside of the board with the tip of your soldering iron to provide mechanical strength. Be

*continued on page 66*



# MONITOR TESTER

SERVICING COMPUTER monitors isn't all too different from servicing composite-video monitors and television sets. There are some very important differences, however, the most obvious of which is that most computer monitors don't operate on the NTSC horizontal frequency of 15.734 kHz and vertical frequency of 59.94 Hz. Since your standard video test gear can't be used, you need a new troubleshooting tool—a computer-video sync generator.

We'll show you how to build a "sync generator" that provides horizontal sync, vertical sync, and RGB video for three popular styles of monitors: CGA, EGA, and VGA. Without connecting the monitor to a computer, you'll be able to verify video, deflection, and DC supply generation. Once repairs are made, fine tuning adjustments can be done with the monitor connected to a computer using appropriate software. However, using the sync generator first prevents tying up a computer that could be used more productively elsewhere.

## Circuit description

The sync generator is a complex frequency-divider circuit. The starting point is two TTL clock oscillators—one is 5.0688-MHz (OSC1) and the other is 4.9152-MHz (OSC2). Depending upon two switch settings, one of the clock signals gets routed to various divider stages, ultimately leading to the final stage, a 4-bit binary counter.

***Our sync generator lets you test computer monitors without having to connect them to a computer.***

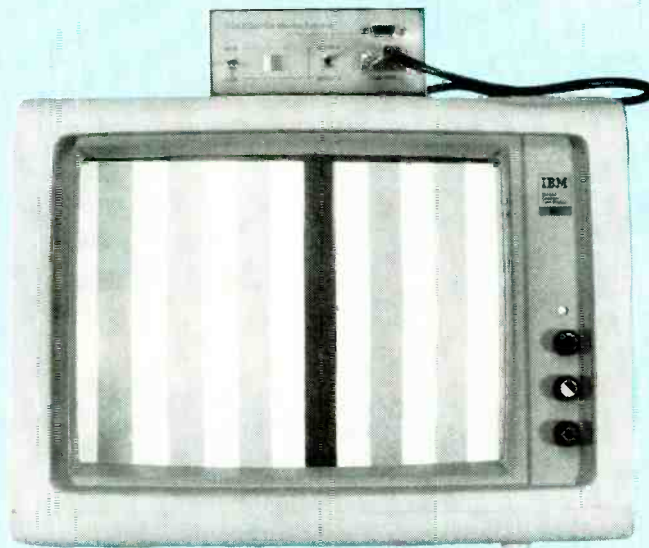

GARTH PRICE, CET

## VGA operation

Referring to the schematic in Fig. 1, switch S2, when closed, places a logic "0" (a low) on pin 1 of IC6, a 74HC158 quad 2-line to 1-line selector, so all "A" inputs will be passed to the "Y" outputs. The output of OSC1, a TTL clock oscillator, is then passed from pin 14 of IC6 (A4) to pin 12 (Y4) and then to the CLK input (pin 8) of IC3, a 74LS164 shift register. (NOTE: It is important that the EGA/VGA switch S2 is in the proper position for the type of monitor in use. An improper horizontal sync frequency can easily cause damage to deflection circuits!)

At the same time, the OE output of IC3 (pin 10) is fed

through a 74HC14 Schmitt inverter (IC2-d) into the A3 input of IC6 (pin 11). That signal is then passed to the Y3 output (pin 9), through R10, to the base of Q1, and to IC3's CLR input (pin 9). As a result, the clock signal is divided by five and used as a reset, so every fifth clock pulse causes a clear to occur.

As just mentioned, shift register IC3 divides its CLK input (OSC1's output) by five ( $5.0688/5 = 1.01376$ ). In other words, all of the "Q" outputs have a frequency of  $1/5$  the clock input, but only when the chip is reset by its own OE output. The QC output (which is also  $1/5$  the clock input when the chip is reset by OE) of IC3 (pin 5) sends the 1.01376-MHz signal to IC4's (a 74LS74 D-type flip-flop) CLK input (pin 3) where it is further divided by 2, so the net division is ten.

With that division by ten, a 506.88-kHz signal is sent to pin 2 of IC6 (A1), passed through to pin 4 (Y1), and on to binary counter IC5's (a 74LS163) CLK input (pin 2). Counter IC5 divides the signal by 16 to produce a horizontal sync of 31.68 kHz with a pulse width of 2 microseconds. Counter IC5 also divides the CLK input by two for generating blue (QA, pin 14), by four for red (QB, pin 13), and by eight for green (QC, pin 12). In other words, blue video is gated eight times the horizontal sync, red video four times, and green twice. The monitor thus lights up with yellow, cyan, green, magenta, red, blue, black, and white bars, and then repeats. (Note that the CGA/EGA

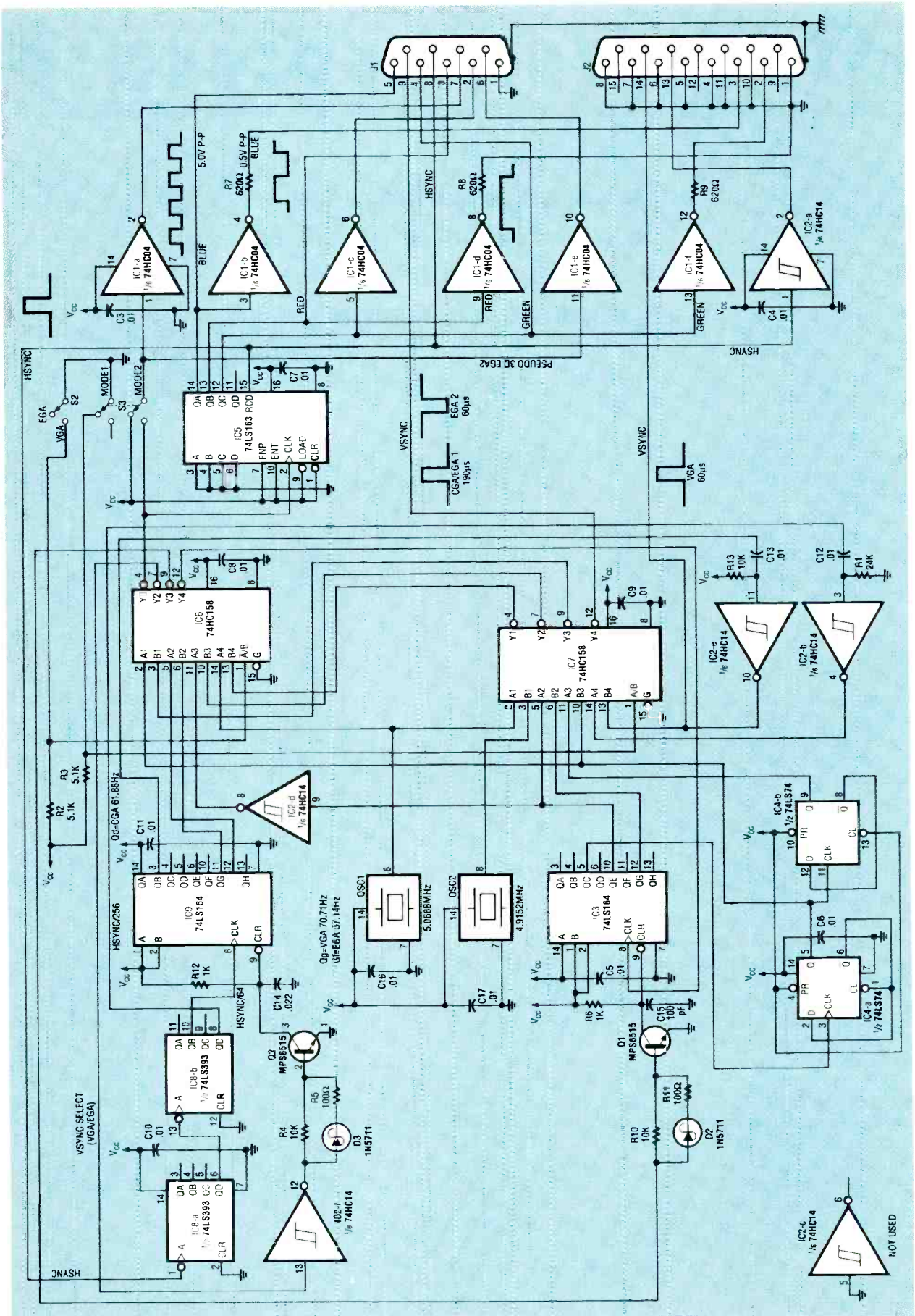

FIG. 1—MONITOR EXERCISER SCHEMATIC. When operating the unit, make sure that EGA/VGA switch S2 is in the proper position for the type of monitor in use. An improper horizontal sync frequency can cause damage to deflection circuits.



# SHOPPER™

This Is An Advertisement

## DATABOOKS\*

### INTEL

#### Memory

Over 1000 pages of data sheets, application notes and article reprints on Intel's Dynamic and Static RAMS, EPROMS and Flash Memories.

Order # **210830** 19.95 Memory.....Weight: 2 lbs.

#### Microprocessors

Over 1400 pages of data sheets on Intel's Microprocessors such as the 8086 and 8088. Also all of Intel's Math Coprocessors (8087, 80287 and 80387A) and CPUs (286, 386 and 486).

Order # **230843** 23.95 Microprocessors .....Weight: 2.5 lbs.

#### Microcommunications

Over 1300 pages containing data sheets, design and applications information for Intel's entire line of microcommunications products. A few examples listed are Intel's first 32-bit LAN coprocessor (the 82596), 82050, 82504, 82510, 8251A, 82530, 82586, 8273, 8274, 8291A, 8292, 2910A, 2911A, etc. Also included is the twisted pair Ethernet\* products, modem chips for desktop and laptop PCs and technical information on Intel's communications boards and supercomponents.

\*Ethernet is a registered trademark of Xerox Corp.

Order # **231658** 27.95 Microcommunications.....Weight: 2.25 lbs.

#### 8-Bit Embedded Controllers

Over 1100 pages of data sheets, detailed specifications and architectural descriptions of Intel's 8-Bit Embedded Controller families - the MCS8-48, MCS8-51, MCS8-80/85 and RUP1™. Includes the following part numbers: 8031, 8032, 8035, 8039, 8040, 8044, 8048, 8049, 8050, 8051, 8052, 8080A, 8085A, 8155, 8156, 8185, 8224, 8228, 8243, 8344, 8744, 8748, 8749, 8751, 8752, 8755, 80C31, 80C32, 80C51, 80C52, 80C54, 80C58, 83C51, 87C51, 87C54, 87C58, 80C452, 83C152, 83C452 and 88F51.

Order # **270645** 19.95 8-Bit Embedded Controllers.....Weight: 2 lbs.

#### Peripherals

Over 1400 pages on Intel's popular peripheral components such as the 8237, 8253, 8255, 8256, 8259, 8272, 8279, 8741, 8742 and more. Also included are Intel's complete line of 32-Bit Bus Chip Sets, Application Notes and Technical Briefs.

Order # **296467** 23.95 Peripherals.....Weight: 2.5 lbs.

### NATIONAL

#### Data Communications/Local Area Networks/UARTs

Over 700 pages of data sheets, technical information and application notes on National's Local Area Networks (DP8390, 8391, 8392, etc.), High Speed Serial/IBM Data Communications (DP8340, 8341, NS32440, etc.), ISDN Components (TP3401, HPC16083, etc.), UARTs (INS8250, 16450, 16550, 16C451, etc.), Modems (74HC942 & 74HC943), and many Transmission Line Drivers/Receivers (DS1488, 1489, 26LS31, etc.).

Order # **400011** 14.95 Data Communications/LANs/UARTs..Weight: 1.5 lbs.

\*Books are not returnable. We carry the newest versions available.

# EASYTECH

THE ELECTRONICS SOURCE

2917 Bayview Drive-Fremont, CA 94538

\*Shipping: Include 5% of total order (\$3.00 min.)

\*COD: \$5.00 Additional Charge



### MOTOROLA

#### MECL Device Data

Over 500 pages of data sheets and technical data for Motorola's broad line of MECL integrated circuits. This book includes the families MECL 10KH, MECL 10K, MECL III, MECL memories and Phase-Locked Loop products (such as the MC4024P and MC4044P). Also included is a technical introduction to MECL and a detailed discussion of system design considerations.

Order # **DL122** 9.95 MECL Device Data .....Weight: 1.5 lbs.

#### High-Speed CMOS Logic Data

Over 600 pages on Motorola's entire line of 74HC and 74HCT series.

Order # **DL129** 9.95 High-Speed CMOS Logic Data ....Weight: 1.5 lbs.

#### Thyristor Device Data

Over 500 pages of data sheets, theory and applications information on Motorola's broad range of Thyristor devices. Also included is a comprehensive Selector Guide and industry Cross Reference on Motorola's Thyristor families, including SCRs, Triacs, GTOs and trigger devices.

Order # **DL137** 11.95 Thyristor Device Data.....Weight: 1.5 lbs.

#### Linear/Switchmode Voltage Regulator Handbooks

This 600 page handbook describes Motorola's voltage regulator products and provides information on applying these products. Basic Linear regulator theory and switching regulator topologies has been included along with practical design examples. Other relevant topics include: trade-offs of Linear versus switching regulators, series pass elements for Linear regulators, switching regulator component design considerations, heatsinking, construction and layout, power supply supervision and protection, and reliability. A Motorola regulator Selector Guide along with data sheets and an industry Cross-Reference are also contained in this handbook.

Order # **HB206** 9.95 Linear/Switchmode Volt. Reg. Handbook .....Weight: 2 lbs.

#### MC68000 Family Reference

Over 700 pages of data sheets and technical information on Motorola's entire MC68000 family. Just a few examples are the MC68000, 68008, 68010, 68020, 68302, 68881, 68681, 68184, etc.

Order # **M68000FR** 12.95 MC68000 Family Reference .....Weight: 2 lbs.

#### MC68000 Family Programmer's Reference Manual

Over 500 pages of detailed information, in an instruction-per-page format, on each of the instructions used by the MPUs and coprocessors in the MC68000 family. Includes MPUs from the MC68000 to the MC68040, the MC68851 PMMU, the MC68881 and MC68882 Floating-Point Coprocessors, and the CPU32 processor core used in the M68300 family. The manual is divided into Integer Instruction, Floating-Point Instructions, Supervisor (Privileged) Instructions, and CPU32 Instructions and Addressing Modes. A Format Summary lists all the instructions in binary format, and a processor/instruction Cross Reference is included.

Order # **M68000PM** 11.95 Programmer's Reference Manual....Weight: 2 lbs.

#### MC68000 8-/16-/32-Bit Microprocessors User's Manual

This 210 page manual provides hardware details and programming information for the MC68000, MC68008, MC68010 and MC68HC000 microprocessors. The MC68008 has an 8-Bit Data Bus and smaller addressing range. The MC68010 introduced virtual memory to the family and has a few different instructions. The MC68HC000 uses about 10% of the power of the MC68000; otherwise the devices are very similar. The manual fully describes their electrical and operating characteristics, noting any differences. Includes a summary of the instruction set. Refer to M68000PM Programmer's Reference Manual for complete detail in instruction set.

Order # **M68000UM** 6.95 Microprocessors User's Manual....Weight: .75 lbs.

EASY ORDER: 1-800-582-4044

EASY FAX: 1-800-582-1255

CUSTOMER SERVICE: 1-510-770-2345

Monday-Friday, 7AM-5PM (PST)/10AM-8PM (EST)

CIRCLE 254 ON FREE INFORMATION CARD

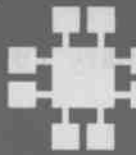

# JDR Microdevices

ORDER TOLL-FREE 800-538-5000

Serving you since 1979

BUY WITH CONFIDENCE FROM JDR!

• 30-DAY MONEY BACK GUARANTEE

• 1 YEAR WARRANTY

• TOLL-FREE TECH SUPPORT



## MOTHERBOARDS

## MODULAR CIRCUIT TECHNOLOGY

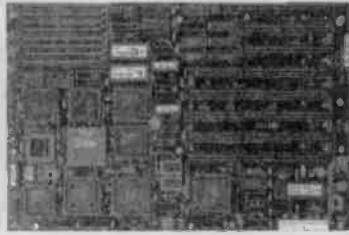

NEW LOWER PRICES

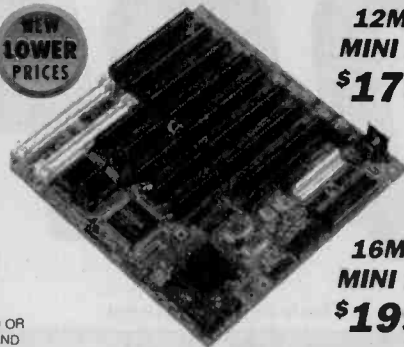

12MHz  
MINI 286  
\$179<sup>95</sup>

16MHz  
MINI 286  
\$199<sup>95</sup>

### 16MHz MINI 386-SX \$349<sup>95</sup>

- NORTON SI 15.3 • LANDMARK AT SPEED 20.8
- EXPANDABLE TO 8MB ON-BOARD • AMI BIOS • CHOOSE 0 OR 1 WAIT STATE FOR USE WITH SLOWER RAM • FIVE 16-BIT AND THREE 8-BIT SLOTS • CHIPS & TECHNOLOGY "NEAT" CHIPSET
- SOCKET FOR 80387 CO-PROCESSOR • 8.5" X 13" SIZE FITS MINI-286 & FULL-SIZE CASES

MCT-386SX 16 MHz 386SX	\$349.95
MCT-386SX-20 20 MHz VERSION	\$399.95
MCT-M386-25 25 MHz MINI 386	\$699.00
MCT-386MBC-33 FULL SIZE 33MHz CACHE 386	\$949.00
MCT-386MBC-25 25 MHz CACHE 386	\$899.00
MCT-486MBC33 33 MHz (LANDMARK = 151.0)	\$1,895.00
MCT-486MB25 25 MHz VERSION	\$1,495.00

### • NORTON SI 14.0 • LANDMARK AT SPEED 15.9

- 6/12MHz KEYBOARD SELECTABLE SPEEDS • EXPANDABLE TO 4MB ON-BOARD USING 80NS 256K OR 1MB SIMMS(O.K. INSTALLED) • FIVE 16-BIT AND THREE 8-BIT SLOTS • AMI BIOS • SOCKETED FOR 80287 CO-PROCESSOR • 8.5" X 8.75" SIZE FITS MINI-286 AND FULL-SIZE 286 CASES

MCT-M286-12	\$179.95
MCT-M286-16 16MHz VERSION	\$199.95
MCT-TURBO-10 10 MHz 8088	\$99.95

## UPRIGHT CASE

\$249<sup>95</sup>

- FOR STANDARD, FULL SIZE AND MINI-MOTHERBOARDS
- 250 WATT POWER SUPPLY (110/220V)
- MOUNTS FOR 3 FLOPPY AND 4 HARD DRIVES
- TURBO AND RESET SWITCHES
- SPEED DISPLAY, POWER, DISK LEDS
- INCL. MOUNTING HARDWARE, FACEPLATES AND SPEAKER

CASE-100 ..... \$249.95

### MORE CASES...

CASE-200 UPRIGHT HOLDS 11 DRIVES	\$499.95
CASE-120 MINI-UPRIGHT W/200 WATT PS	\$199.95
CASE-70 FULL-SIZE 286-STYLE CASE	\$89.95
CASE-50 MINI-SIZE 286-STYLE CASE	\$39.95
CASE-FLIP FLIP-TOP 8088-STYLE CASE	\$39.95
CASE-JR MINI-SIZE CASE WITH 200W PS	\$149.95

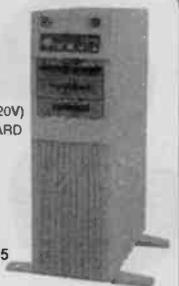

## POWER SUPPLIES

• 110/220V • UL APPROVED

PS-135 8088 135 WATT	\$59.95
PS-150 8088 150 WATT	\$69.95
PS-200X 8088 200 WATT	\$89.95
PS-200 286/386/486 200 WATT	\$89.95
PS-250 286/386/486 250 WATT	\$129.95



## SYSTEM DIAGNOSTICS CARD

\$49<sup>95</sup>

- WORKS WHEN SOFTWARE CANNOT
- 286/386/486 COMPATIBLE
- PLUG INTO SLOT, READ LED DISPLAY AND CHECK YOUR BIOS MANUAL FOR ERROR CODE
- VIEW LEDS ON-BOARD OR ON BACK-PANEL

PCODE	\$49.95
PCODE+ INCLUDES O.A. VERSION 3.12	\$69.95
GATEKEEPER 8-BIT PASSWORD SECURITY CARD	\$49.95

### MEMORY CARDS

MCT-EEMS 16-BIT EEMS CARD	\$149.95
MCT-AEMS 16-BIT EMS CARD(USES 1MB DRAMS)	\$129.95
MCT-EEMS 8-BIT EMS CARD 2MB CAPACITY	\$129.95
MCT-RAM 8-BIT 576K RAM CARD	\$49.95

### DISPLAY CARDS

MCT-VGA 8/16-BIT, 640 X 480 VGA CARD	\$149.95
MCT-VGA-1024 1024 X 768 VGA CARD	\$169.95
MCT-VGA-1024+ 1024 X 768 IN 256 COLORS	\$199.95
MCT-MGP MONOGRAPHS/PRINTER CARD	\$49.95



## IDE FLOPPY/HARD CONTROLLER

\$29<sup>95</sup>

- SUPPORTS 2 IDE HARD & 2 FLOPPY (360K, 720K, 1.2MB & 1.44MB) DRIVES
- HARD DISK ACTIVITY LED SUPPORTED

MCT-IDEFH ..... \$29.95

## 1.44MB FLOPPY CONTROLLER

\$49<sup>95</sup>

- SUPPORTS 2 FLOPPY (360K, 720K, 1.2MB & 1.44MB) DRIVES
- SELECTABLE AS PRIMARY OR SECONDARY DRIVE CONTROLLER

MCT-FDC-HD	\$49.95
MCT-FDC-HD4 4 FLOPPY VERSION	\$59.95
MCT-HDC HARD DRIVE CONTROLLER	\$79.95
MCT-RLL RLL HARD DRIVE CONTROLLER	\$89.95
MCT-FAFH 16-BIT 1:1 F/H CONTROLLER	\$149.95
MCT-AFH-RLL 16-BIT F/H RLL CONTROLLER	\$199.95

### MULTI I/O CARDS

MCT-VGAEIO MONO MULTI I/O, IDE F/H CARD	\$299.95
MCT-IDEIO 16-BIT IDE MULTI I/O CARD	\$69.95
MCT-AIO 8-BIT 286/386 MULTI I/O CARD	\$59.95
MCT-IO 8-BIT 8088 MULTI I/O CARD	\$59.95



101-KEY  
\$49<sup>95</sup>

- 101-KEY WITH 12 FUNCTION KEYS - 286/386/486 COMPATIBLE
- BTC-5339 ..... \$69.95
- FC-3001 101-KEY, 12 F-KEYS & CALCULATOR ..... \$74.95
- BTC-5060 84-KEY WITH 10 FUNCTION KEYS ..... \$59.95

## DYNAMIC RAM

PART#	SIZE	SPEED	PINS	PRICE
TMS4464-12	65536x4	120ns	18	3.40
41256-100	262144x1	100ns	16	1.99
41256-80	262144x1	80ns	16	2.19
414256-100	262144x4	100ns	20	6.95
414256-80	262144x4	80ns	20	7.95
1MB-100	1048576x1	100ns	18	6.95
1MB-80	1048576x1	80ns	18	7.95
1MB-60	1048576x1	60ns	18	9.95

## MEMORY MODULES

PART#	SIZE	SPEED	FOR	PRICE
41256A9B-80	256K x 8	80ns	SIMM/PC	21.95
421000A8B-10	1MB x 8	100ns	SIMM/MAC	64.95
421000A9B-10	1MB x 9	100ns	SIMM/PC	64.95
421000A9B-80	1MB x 9	80ns	SIMM/PC	69.95
421000A9B-60	1MB x 9	60ns	SIMM/PC	89.95
256KX9SIP-80	256K x 9	80ns	SIP/PC	21.95
1MBX9SIP-10	1MB x 9	100ns	SIP/PC	64.95
1MBX9SIP-80	1MB x 9	80ns	SIP/PC	69.95

## MATH CO-PROCESSORS

MANUAL, SOFTWARE GUIDE & MANUFACTURERS 5 YEAR WARRANTY

	PART #	SPEED	PRICE	PART #	SPEED	PRICE
INTEL	8087	5 MHz	89.95	80387-20	20 MHz	209.95
	8087-2	8 MHz	129.95	80387-25	25 MHz	219.95
	8087-1	10 MHz	169.95	80387-33	33 MHz	229.95
	80287-XL	12 MHz	94.95	80387-SX	16 MHz	129.95
	80387-16	16 MHz	109.95	80387-SX20	20 MHz	149.95
CYRIX	83D87-16	16 MHz	299.95	83D87-40	40 MHz	649.00
	83D87-20	20 MHz	319.95	83S87-16(SX)	16 MHz	269.95
	83D87-25	25 MHz	419.95	83S87-20(SX)	20 MHz	329.95
	83D87-33	33 MHz	549.00	83S87-25(SX)	25 MHz	399.95
INT	2C87-8	8 MHz	79.95	2C87-12	12 MHz	99.95
	2C87-10	10 MHz	89.95	2C87-20	20 MHz	139.95

## MAXIMIZE CO-PROCESSOR SPEED

- OUR "2ND STAGE" ALLOWS 20MHz CO-PROCESSORS TO RUN AT FULL SPEED IN THE SLOWEST 286 SYSTEMS
- 2ND-STAGE FOR 1020 MHz 80287S ..... \$49.95
- 2ND-STAGE-8 FOR 8/16 MHz 80287S ..... \$49.95
- 2ND-STAGE-12 FOR 12 MHz 80287S ..... \$49.95

## Seagate HARD DRIVES 42MB \$219

FORM	MODEL	SIZE	FORMAT	AVG. SPEED	PRICE
3-1/2"	ST-125A	21.4MB	IDE	28MS	\$199
5-1/4"	ST-225	21.4MB	MFM	65MS	\$199
3-1/2"	ST-138A	32.1MB	IDE	28MS	\$209
3-1/2"	ST-138B	32.2MB	SCSI	28MS	\$259
3-1/2"	ST-138R	32.7MB	RLL	29MS	\$249
5-1/4"	ST-238	32.7MB	RLL	65MS	\$219
5-1/4"	ST-251-1	42.8MB	MFM	28MS	\$249
3-1/2"	ST-157A	44.7MB	IDE	28MS	\$219
3-1/2"	ST-157N	48.6MB	SCSI	28MS	\$299
5-1/4"	ST-277-1	65.5MB	RLL	28MS	\$289
5-1/4"	ST-4096	80.2MB	MFM	28MS	\$569
5-1/4"	ST-296N	84.9MB	SCSI	28MS	\$369
3-1/2"	ST-1102A	89.1MB	IDE	19MS	\$399
3-1/2"	ST-1144A	131MB	IDE	19MS	\$499
3-1/2"	ST-1201A	177MB	IDE	15MS	\$749

5-1/4" MOUNTING KIT FOR 3-1/2" DRIVES  
ST-MHW ..... \$9.95

## FLOPPY DRIVES

FDD-1.44X 1.44MB HD BLACK FACEPLATE	\$79.95
FDD-1.44A 1.44MB HD BEIGE FACEPLATE	\$79.95
FDD-360 5-1/4" DOUBLE-SIDED DD 360K	\$69.95
FDD-1.2 5-1/4" DOUBLE-SIDED HD 1.2M	\$89.95
FD-55GFV TEAC 5-1/4" DOUBLE-SIDED HD 1.2M	\$99.95

## 1024 x 768 VGA PACKAGE \$499<sup>95</sup>

- 8088 & 286/386/486 COMPATIBLE CARD & 1024 X 768 INTERLACED MONITOR
- 1:1 ASPECT RATIO
- 0.28 DOT PITCH
- 256 COLORS FROM 262,000
- 8/16-BIT CARD HAS 512K VIDEO RAM EXPANDABLE TO 1MB

VGA-PKG-1024+ ..... \$499.95  
VGA-PKG 640 X 480 VGA PACKAGE ..... \$399.95

## MORE MONITORS...

NEC-MULTI-3D 14" MULTISYNCH MONITOR	\$649.00
VGA-MONITOR VGA MONITOR	\$379.95
MONO-VGA PAPERWHITE VGA MONITOR	\$139.95
JDR-AMBER 12" MONO-AMBER SCREEN	\$89.95

## 2400 BAUD MODEM \$79<sup>95</sup>

- 2400/1200/300 BPS INTERNAL DATA MODEM • FULL HAYES AT COMPATIBILITY • INCLUDES PROCOMM SOFTWARE

MCT-24M	\$79.95
MCT-FAXM AS ABOVE W/4800 BPS FAX SEND	\$89.95
PCEM7296 INTEL 9600 BPS EXTERNAL	\$549.00
PCCB6201 INTEL SATISFACTION FAX/MODEM	\$449.95
VIVA-24MNP 2400 BPS EXT MODEM W/MNP	\$149.95



TERMS For shipping & handling include \$5.00 for ground and \$7.50 for air. Orders over 1 lb. and foreign orders may require additional shipping charges - contact our Sales Dept. for the amount. CA residents must include applicable sales tax. Prices subject to change without notice. We are not responsible for typographical errors. We reserve the right to limit quantities and to substitute manufacturer. All merchandise subject to prior sales. A full copy of our terms and conditions of sale is available upon request. Items pictured may only be representative. JDR Microdevices, JDR, the JDR logo and the MCT logo are registered trademarks of JDR MICRODEVICES, INC. Modular Circuit Technology is a trademark of JDR MICRODEVICES, INC. Copyright 1991 JDR MICRODEVICES.



KEY CODE 1204

CIRCLE 257 ON FREE INFORMATION CARD



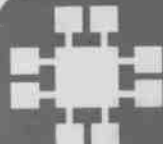

Serving you since 1979

# JDR Microdevices®

2233 SAMARITAN DRIVE, SAN JOSE CA 95124

BUY WITH CONFIDENCE FROM JDR!

- 30-DAY MONEY BACK GUARANTEE
- 1 YEAR WARRANTY
- TOLL-FREE TECH SUPPORT



## MCT'S MODULAR PROGRAMMING SYSTEM

USE 1 SLOT TO PROGRAM EPROMS, PROMS, PALS & MORE!

### HOST ADAPTOR CARD/CABLE

- UNIVERSAL INTERFACE FOR THE PROGRAMMING MODULES
- SELECTABLE ADDRESSES PREVENT CONFLICTS

MOD-MAC ..... \$299.95

### UNIVERSAL MODULE

- PROGRAMS EPROMS, EEPROMS, PALS, BI-POLAR PROMS, 874E & 8751 SERIES DEVICES, 16V8 AND 20V8 GALs (GENERIC ARRAY LOGIC) FROM LATTICE, NS, SGS - TESTS TTL & CMOS IC'S, DYNAMIC AND STATIC RAM - LOAD DISK, SAVE DISK, EDIT, BLANK CHECK, PROGRAM, AUTO, READ MASTER, VERIFY & COMPARE - TEXT TOOL SOCKET FOR .3"-6" WIDE ICs (8 - 40 PINS)

MOD-MUP ..... \$499.95

MOD-MUP-EA 4-UNIT ADAPTOR ..... \$99.95

### EPROM MODULE

- PROGRAMS 24-32 PIN EPROMS, CMOS EPROMS & 16K TO 1024K EEPROMS - HEX TO OBJ CONVERTER - AUTO, BLANK CHECK/PROGRAM/VERIFY - VPP 5, 12.5, 12.75, 13, 21 & 25 VOLTS - NORMAL, INTELLIGENT, INTERACTIVE & QUICK PULSE PROGRAMMING ALGORITHMS

MOD-MEP ..... \$119.95

MOD-MEP-4 4-EPROM PROGRAMMER ..... \$169.95

MOD-MEP-8 8-EPROM PROGRAMMER ..... \$259.95

### OTHER PROGRAMMING MODULES...

MOD-MPL PAL PROGRAMMING MODULE ..... 249.95

MOD-MMP MICROPROCESSOR PROGRAMMER ..... 179.95

MOD-MIC DIGITAL IC & MEMORY TESTER ..... 129.95

MOD-MBP BI-POLAR PROM PROGRAMMER ..... 259.95

### PAL DEVELOPMENT SOFTWARE

ENTRY LEVEL CUPL PAL DEVELOPMENT KIT.

MOD-MPL-SOFT ..... \$99.95

## PC LABS INTERFACE CARDS

### DIGITAL I/O & COUNTER CARD

\$169<sup>95</sup>

- CONTROL UP TO 84 DIGITAL DEVICES WITH 32 INPUTS/OUTPUTS
- LOW LOADING: 0.2MA AT 0.4V INPUT
- HIGH OUTPUT CAPACITY: SINK 24MA, SOURCE 15MA
- 3 CHANNELS FOR TIMER/COUNTER

PCL-720 ..... \$169.95

### REAL WORLD INTERFACE CARD

\$295<sup>95</sup>

- 16 DIGITAL INPUTS/OUTPUTS; 8 ANALOG INPUTS & 1 ANALOG OUTPUT
- 12-BIT RESOLUTION A TO D & D TO A
- 25KHZ MAX A TO D SAMPLE RATE
- LABTECH ACQUIRE SOFTWARE INCLUDED

PCL-711S ..... \$295.95

PCL-848 IEEE-488 INTERFACE CARD W/CABLE ..... \$345.95

**FREE 100 PAGE CATALOG!**

Call Toll-Free to request our latest full color catalog with over 5000 products for the developer, hobbyist and PC enthusiast

## DATARASE II EPROM ERASER \$39<sup>95</sup>

- CONVENIENT POCKET-SIZE!
- ERASES ALL SIZES OF EPROM UP TO 4 AT A TIME
- WALL PLUG POWER SUPPLY

## D-SUBMINIATURE CONNECTORS

TYPE	ORDER BY	CONTACTS				
		09	15	25	37	50
SOLDER CUP	MALE DBxxP	.45	.59	.69	1.35	1.85
	FEMALE DBxxS	.49	.69	.75	1.39	2.29
R/A PC SOLDER	MALE DExxPR	.49	.69	.79	2.27	---
	FEMALE DExxSR	.55	.75	.86	2.49	---
W/W TYPE	MALE DExxPW	1.69	2.55	3.89	5.69	---
	FEMALE DExxSW	2.76	4.27	6.84	9.95	---
IDS TYPE	MALE IDBxxP	1.39	1.99	2.25	4.25	---
	FEMALE IDBxxS	1.45	2.05	2.35	4.45	---
HOODS	METAL MF-00Dxx	1.05	1.15	1.25	---	---
	PLASTIC MC00Dxx	.39	.39	.39	.69	.75

## IC SOCKETS

### DIP CONNECTORS

TYPE	ORDER BY	CONTACTS						
		08	14	16	20	24	28	40
SOLDERTAIL	xx PIN ST	.11	.11	.12	.18	.20	.22	.30
	WIREWRAP	xx PIN WW	.50	.69	.89	1.09	1.49	1.69
ZIF	ZIF-xx	---	6.95	6.95	9.95	10.95	11.95	4.95
TOOLED	AUGATxx	.55	.69	.89	.85	.99	1.09	1.29
TOOLED WW	AUGATxxWW	1.30	1.80	2.10	2.60	3.15	3.70	5.40

## IDC CONNECTORS AND CABLE

DESCRIPTION	ORDER BY	CONTACTS				
		20	26	34	40	50
SOLDER HEADER	IDHxxS	1.29	1.68	2.20	2.58	3.24
R/A HEADER	IDHxxSR	1.35	1.76	2.31	2.72	3.39
W/W HEADER	IDHxxW	2.98	3.84	4.50	5.28	6.63
R/A W/W HEADER	IDHxxWR	3.28	4.22	4.45	4.80	7.30
HEADER SOCKET	IDScxx	.65	.75	.75	1.19	1.19
RIBBON HEADER	IDMxx	5.50	6.25	7.00	7.50	8.50
IDC EDGE CARD	IDExx	.55	.75	.89	1.29	1.69
RIBBON CABLE	RCxx	.30	.39	.51	.60	.75

ORDERING INSTRUCTIONS: INSERT THE NUMBER OF CONTACTS IN THE POSITION MARKED "xx" OF THE "ORDER BY" PART NUMBER LISTED. EXAMPLE: A 15-PIN RIGHT ANGLE MALE PC SOLDER PART NUMBER WOULD BE DB15PR.

## JDR INSTRUMENTS®

### TEST EQUIPMENT

ALL JDR INSTRUMENTS CARRY A 2 YEAR WARRANTY

#### 35MHZ OSCILLOSCOPE

- EXCEPTIONALLY BRIGHT CRT
- TV SYNC FILTER
- DELAYED & SINGLE SWEEP MODES
- FAST 10NS RISE TIME

MODEL-3500 ..... \$499.95

MODEL-2000 20MHZ VERSION ..... \$389.95

#### 100MHZ MULTIFUNCTION COUNTER

- RANGE: 10HZ TO 100MHZ DIRECT, 10MHZ TO 100MHZ PRESCALED BY 10
- PERIOD MEASUREMENTS: 10HZ TO 2.5MHZ ±1 COUNT ACCURACY
- TIME BASE: 10MHZ
- 8 DIGIT LED DISPLAY W/DECIMAL POINT

DFC-100 ..... \$179.95

DFC-1000 1 GHZ VERSION ..... \$199.95

DFG-600 SWEEP FUNCTION GENERATOR ..... \$189.95

DOS-600 AUDIO OSCILLATOR/COUNTER ..... \$189.95

#### 3.5 DIGIT DMM \$29<sup>95</sup>

- BASIC DC ACCURACY ±0.5%
- DC VOLTAGE: 20V-1000V; AC VOLTAGE: 200V-750V; DC CURRENT: 2MA - 2A
- RESISTANCE: 2KΩ - 2MΩ
- 14 RANGES

DMM-150 ..... \$29.95

DMM-200 3.5 DIGIT DMM 22 RANGES ..... \$49.95

DMM-300 3.5 DIGIT 19 RANGES W/CAP & TEMP ..... \$79.95

DPM-1500 PROBE DMM AUTORANGING ..... \$49.95

#### LOGIC PROBE

LP-100 ..... \$17.95

LP-200 PULSER-PROBE ..... \$19.95

## PROTOTYPE CARDS

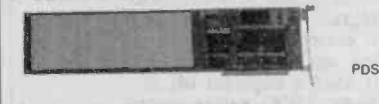

### 8-BIT SOLDERLESS 8088 BREADBOARD WITH DECODE \$79<sup>95</sup>

- ADDRESS DECODING LOGIC, DATA BUFFERING, 2 LSI CIRCUITS FOR PROGRAMMABLE DIGITAL I/O & COUNTER-TIMER FUNCTIONS - LOGICALLY GROUPED - ACCESSES ALL I/O SIGNAL CONNECTIONS - CLEARLY LABELLED BUS LINES
- ACCEPTS UP TO 24 FOURTEEN-PIN ICs - ACCEPTS 9, 15, 25 OR 37-PIN D-SUB CONNECTORS

PDS-601 ..... \$79.95

PDS-600 ABOVE CARD WITHOUT DECODE ..... \$49.95

PDS-611 16-BIT BUS BREADBOARD WITH DECODE, \$69.95

PDS-610 ABOVE CARD WITHOUT DECODE ..... \$59.95



## PC PROTOTYPING CARDS

- 8-BIT CARD - GOLD-PLATED EDGE - CARD FINGERS
- BUFFERING & DECODE LAYOUT - FR-4 EPOXY LAMINATE

JDR-PR2 ..... \$29.95

JDR-PR1 AS ABOVE, W/O I/O DECODING LAYOUT ..... \$27.95

JDR-PR10 16-BIT WITH I/O DECODING LAYOUT ..... \$34.95

EXT-80286 286-COMPATIBLE EXTENDER CARD ..... \$39.95

EXT-8088 8088-COMPATIBLE EXTENDER CARD ..... \$29.95

### SOLDERLESS BREADBOARDS

PART #	SIZE	DIST. STRIPS	TIE PTS	TERM STRIPS	TIE PTS	BNDG POSTS	PRICE
PDS-100	3.9" X 6.5"	1	100	2	1260	2	12.95
PDS-200	5.1" X 8.5"	4	400	2	1260	3	19.95
PDS-300	6.9" X 9.1"	5	500	3	1890	4	24.95
PDS-400	8.2" X 9.3"	7	700	4	2520	4	34.95

## EPROMS

PART#	SIZE	SPEED	Vpp	PINS	PRICE
2716-4	2048x8	350ns	25V	24	4.95
2732A	4096x8	250ns	25V	24	3.95
2764	8192x8	450ns	12.5V	28	3.95
2764-250	8192x8	250ns	12.5V	28	3.95
2764-200	8192x8	200ns	12.5V	28	4.49
27128A-200	16384x8	200ns	12.5V	28	4.95
27256	32768x8	250ns	12.5V	28	4.95
27C24	32768x8	250ns	12.5V	28	5.95
27512	65536x8	250ns	12.5V	28	5.95
27C121-20	131072x8	200ns	12.5V	32	17.95

## STATIC RAM

PART#	SIZE	SPEED	PINS	CMOS	LP	PRICE
HM61-6-2	2048x8	120ns	24	Y	N	2.95
HM61-6L-P-4	2048x8	200ns	24	Y	Y	2.95
HM61-6L-P-3	2048x8	150ns	24	Y	Y	3.25
HM61-6L-P-2	2048x8	120ns	24	Y	Y	3.95
HM6264LP-15	8192x8	150ns	28	Y	Y	3.95
HM6264LP-12	8192x8	120ns	28	Y	Y	4.95
HM6264LP-10	8192x8	100ns	28	Y	Y	5.95
HM43256LP-15	32768x8	150ns	28	Y	Y	4.95
HM43256LP-12	32768x8	120ns	28	Y	Y	5.95
HM43256LP-10	32768x8	100ns	28	Y	Y	6.95

## PALS

PART#	SPEED	PINS	IN	OUT#	FUNCTIONS	PRICE
16L8	35ns	20	10	2	AND-OR INV	2.95
16R4	35ns	20	8	4	AND-OR INV	2.95
16R6	35ns	20	8	2	AND-OR INV	2.95
20L8	40ns	24	14	2	AND-OR INV	2.95
20R4A	25ns	24	12	4	AND-OR INV	3.49
20R6	40ns	24	12	2	AND-OR INV	2.95
20R8	40ns	24	12	8	AND-OR INV	2.88
20XB	50ns	24	10	8	AND-OR XOR INV	2.95

## GALS

PART#	SPEED	PINS	REPLACES	IN	OUT	PRICE
16VB	35ns	20	10L8 TO 16RPE	8	8	2.49
16VB-15	15ns	20	10L8 TO 16RPE	8	8	2.95
20VB	35ns	24	14L8 TO 16RPE	20	8	3.49
20VB-15	15ns	24	14L8 TO 16RPE	20	8	4.95
22V10	35ns	24	PGM OUTPUT	22	10	6.95
22V10-15	15ns	24	PGM OUTPUT	22	10	15.95

CUSTOMER SERVICE 800-538-5001  
 TECHNICAL SUPPORT 800-538-5002  
 TOLL-FREE FAX ORDERS 800-559-5003

LOCAL/INTERNATIONAL 408-559-1200  
 LOCAL/INT'L FAX 408-559-0250  
 BBS (9600/2400/1200) 408-559-0253

ORDER TOLL-FREE  
**800-538-5000**  
 MON.-FRI. 7 A.M. TO 5 P.M., SAT. 9 A.M. TO 3 P.M.

KEY CODE 1204

# Official 1934 SHORT WAVE RADIO MANUAL



## Build

simple, high-performance old-time shortwave radios!

All of the secrets are here: the circuit diagrams, parts layout, coil specifications, construction details, operation hints, and much more!

This is a compilation of shortwave construction articles from "Short Wave Craft" magazines published in the 20's & 30's. It's wall-to-wall "how-to."

Included are circuit diagrams, photographs, and design secrets of all shortwave receivers being manufactured in 1934 including some of the most famous: SW-58, the SW-5 "Thrill Box", the deForest KR-1, the Hammarlund "Comet Pro", and many more.

Also included is a new chapter showing how you can use transistors to replace hard-to-find vacuum tubes. You'll even see the circuit that was lashed together on a table top one night using junk box parts, a hair curler and alligator clips. Attached to an antenna strung across the basement ceiling and a 9 volt battery, signals started popping in like crazy. In a couple of minutes an urgent message from a ship's captain off Seattle over 1500 miles away was heard asking for a navigator to help him through shallow water!

These small regenerative receivers are extremely simple, but do they ever perform! This is a must book for the experimenter, the survivalist who is concerned about basic communication, shortwave listeners, ham radio operators who collect old receivers, and just about anyone interested in old-time radio.

Great book! Fun to read! One of the best old-time radio books to turn up in years. Heavily illustrated! Order a copy today! 8 1/2 x 11 paperback 260 pages only \$15.70 postpaid!

## Lindsay Publications

Box 538-YA1, Bradley IL 60915

Send a copy of *Short Wave Radio Manual*. Enclosed is \$15.70. Chk, MC, Visa. Send a free catalog of other books.

Name \_\_\_\_\_

Address \_\_\_\_\_

City \_\_\_\_\_ St \_\_\_\_\_ Zip \_\_\_\_\_

# ADVERTISERS INDEX

RS #		Page	RS #	Page	
290	A & T Labs	48BL	—	J P Video	48AN
247	Accord Elect. Systems	48AX	279	Kelvin Electronics	48AA
268	Ace	48AH, AI	—	Lake Sylvan Sales, Inc.	48CD
291	Action Electronics	48BQ	—	L-Com, Tech.	48BW
220	Advanced Computer	48X, Y	273	Less Buster's Electronics	48BN
224	Alfa Electronics	48BY	—	Lindsay	48D
250	All Electronics Corp.	48BJ, BK	—	L J M, Inc.	48BP
225	Alltronics	48CI	—	Matrix North (U.S.A.)	48BW
251	Alpha Labs	48BN	267	M C M	48BS
288	American Design	48BG	239	Mendelson Electronics, Inc.	48CG
—	AndraTech	48AT	—	Mental Automation, Inc.	48BH
—	Applied Elect. Research	48CA	259	Meredith Instruments	48AZ
271	K.E. Ayers Associates	48BP	—	MicroThinc	48BZ
226	Battery Tech	48AV	211	Midwest Laser	48BM
292	B C M	48CD	212	Ming Engineering Prod. Inc.	48CJ
233	B.G. Micro	48AJ	260	Mondo-tronics, Inc.	48CD
285	Blue Earth Research	48I	—	Motron Electronics Co.	48BZ
242	B & S Sales	48J	—	Movie View	48W
—	BVC	48BF	213	MWK Industries	48BA
227	Cable Plus	48R	249	National Amateur Radio	48AB
282	Cable View Electronics	48E	214	Needham's Electronics	48AP
—	Chenesco Products, Inc.	48AN	215	New Sensor Corp.	48BO
228	Circuit Specialists	48Q	—	Nexsys-4 Company	48BZ
—	City Wide Ent., Inc.	48BF	287	Optoelectronics	48BI
284	Colby Instruments	48BL	216	Ocean State Electronics	48BE
252	Command Productions	48AT	217	Pak Rat Electronic Parts	48BB
—	C N C Concepts, Inc.	48BZ	270	Parts Express	48AD, AE
229	Computer Business Mart	48AV	278	P.C. Boards	48BH
230	Consumertronics	48AN	—	PMC Electronics	48BN
274	Cool Amp	48BT	280	Print Products Int'l	48BH
231	Crestwood Products Inc.	48AX	261	Prizm Resources, Inc.	48AY
234	d b Computer Products	48L	—	Rockford	48BZ
283	D B S Satellite TV	48AO	248	Roger's Specialists	48Z
235	D & C Electronics	48P	—	S & M Electronics	48BS
236	Dalbani	48S	218	Sescom, Inc.	48BD
243	Danbar Sales	48H	269	Simpson	48CA
253, 254	Easy Tech	48A, FG	219	Skyvision, Inc.	48BC
—	E D E	48CA	—	Startek	48M
255	E K I	48CD	275	Surplus Traders	48AK
236	Electrified Discounters	48T, U	—	Tannerelectronics	48BB
256	Electronic Goldmine	48BW	220	TechServ Corp.	48BD
272	Electronic Rainbow, Inc.	48AG	281	TECI	48BR
237	Electronic Surplus	48CA	244	Timeline	48K
—	Fair Radio	48BR	223	Toronto Surplus & Scientific	48BU
241	Gateway Electronics, Inc.	48BP	276	T S W Electronics	48AR, AS
—	GAV	48AT	286	Tucker Surplus	48AQ
—	Hallbar	48BS	221	Ucando Videos	48AP
245	Halted	48V	240	United Electronics Supply	48CE
238	Haltek	48N, O	—	University of Arizona	48CD
289	Hosfelt Electronics	48AU	—	U.S. Electronics	48CA
—	Information Unlimited	48AM	262-263	Viejo	48AF
—	Innotek, Inc.	48CA	264	Viejo	48BM
—	INT'L Micropower Inc.	48BR	277	VRS Electronics	48BF
246	Interactive Image Tech.	48CB, CC	—	Willabee & Ward	48AC
257, 258	JDR	48B, C	265	WPT	48AW
—	Joseph Electronics	48AL	266	Xandi	48AZ



# SUN COAST OR CABLE VIEW

CABLE-TV EQUIPMENT

OF SILVER SPRINGS FLORIDA

ELECTRONICS

AN ILLINOIS COMPANY

\*\*\*\*\* JERROLD \*\*\*\*\*

ANY QUANTITY

NEW FAST TRI-BI COMBO-----125.00  
 NEW FAST TRI-BI (PAN ONLY)---75.00  
 NEW SUPER TRI-BI COMBO-----135.00  
 NEW SUPER TRI-BI (PAN ONLY)- 85.00  
 ALL TRI-BI COMBOS COME WITH A BRAND  
 NEW 83 CHANNEL REGAL CONVERTER W\R

"LOOK" "LOOK" "LOOK"  
 ALL PRODUCTS COME WITH A  
 FULL ONE YEAR WARRANTY ON  
 PARTS AND LABOR WITH THE  
 EXCEPTION OF ZEINTH WHICH  
 IS REFURBISHED AND COMES  
 WITH A 90 DAY WARRANTY.

\*\*\*\*\* LOOK LOOK \*\*\*\*\*

WE WILL MATCH OR BEAT ANYONES  
 PRICES WHO IS ADVERTISING IN  
 NUTS & VOLTS MAGAZINE WITH THE  
 SAME WARRANTY ON ITEMS LISTED  
 IN THIS AD.

\*\*\*\*\* SCIENTIFIC ATLANTA \*\*\*\*\*

ANY QUANTITY

NEW SUPER SA-3 COMBO-----135.00  
 NEW SUPER SA-3 (PAN ONLY)---85.00  
 ALL SA-3 COMBOS COME WITH A BRAND  
 NEW 83 CHANNEL REGAL CONVERTER.

\*\*\*\*\* PIONEER \*\*\*\*\*

ANY QUANTITY

NEW SUPER PIONEER COMBO-----140.00  
 NEW SUPER PIONEER (PAN ONLY)--85.00

DOES YOUR TV HAVE A SNOWY  
 PICTURE? MAYBE AN AMPLIFIER  
 IS WHAT YOU NEED TO CLEAR UP  
 THE SIGNAL. BRAND NEW 25db  
 AMPLIFIERS - SPECIAL - \$15.00

REGAL CONVERTERS

BRAND NEW 83 CH WITH REMOTE  
 SPECIFY HRC OR STD FREQUENCY  
 WITH A FULL ONE YEAR WARRANTY  
 \$85.00

\*\*\*\*\* HAMLIN \*\*\*\*\*

ANY QUANTITY

HAMLIN COMBO-----110.00  
 MLD1200 (PAN ONLY)----- 55.00

\*\*\*\*\* TOCOM \*\*\*\*\*

ANY QUANTITY

NEW TOCOM COMBO-----175.00  
 NEW TOCOM (PAN ONLY)--120.00

\*\*\*\*\* OAK \*\*\*\*\*

ANY QUANTITY

NEW OAK KN-12 COMBO-----110.00  
 KN-12 (PAN ONLY)-----55.00

\*\*\* SPECIAL OF THE MONTH \*\*\*

ZENITH Z-TAC 1-4 -- 175.00  
 5 OR MORE -- 155.00  
 ADD \$10. PER UNIT FOR REMOTE

ORDERS RECEIVED BY 2:00 PM WILL BE  
 SHIPPED SAME DAY IN MOST CASES.  
 WE SHIP UPS AND FEDERAL EXPRESS COD.  
 CASH OR MONEY ORDER ONLY - SORRY NO  
 CHECKS. NO REFUND ON SHIPPING--15%  
 RESTOCKING CHARGE ON ALL RETURNS.

SUN COAST HOURS: MON - SAT 11-7  
 ORDER LINE ONLY -- 800-367-0429  
 TECH INFO ----- 904-625-9545

CABLE VIEW HOURS: MON - SAT 10 - 8  
 ORDER LINE ONLY ----- 800-338-2857  
 TECH INFO ----- 904-625-9545

IT IS NOT THE INTENT OF SUN COAST DIST OR CABLE VIEW ELEC TO DEFAUD  
 ANY PAY TV OPERATOR AND WE WILL NOT ASSIST ANY COMPANY OR INDIVIDUAL  
 IN DOING THE SAME.

ABSOLUTELY NO FLORIDA OR ILLINOIS SALES

CIRCLE 282 ON FREE INFORMATION CARD

ONE FULL YEAR WARRANTY ON PARTS AND LABOR

ONE FULL YEAR WARRANTY ON PARTS AND LABOR

**EASY ORDER**  
1-800-582-4044



**EASY FAX**  
1-800-582-1255

**COMMODORE COMPUTER CHIPS**

Order #	Price	Description	Pins
6502	2.95	MPU with Internal Clock	40
6510	13.95	CPU (906107-01)	40
6520A	3.75	Peripheral Interface Adapter 2Mhz	40
6522	2.95	Versatile Interface Adapter	40
6526A	13.95	Complex Interface Adapter 2Mhz (906108-02)	40
6532	3.95	128x8 RAM, I/O and Timer Array	40
6545-1	3.75	CRT Controller	40
6551A	3.75	Asynchronous Comm. Interface Adapter 2Mhz	28
6567	22.95	Video Interface Chip (906109-01) VIC-II (For C64)	40
6581	11.95	Sound Interface Device (906112-02) 12V	28
8701	6.75	Clock Chip (251527-01)	16
82S100PLA	15.95	For C64 (U17) and C128 (906114-01) No data available	28

**EEPROMS (Electrically Erasable)**

Order #	Price	Organization	Pins
9346	2.75	1024 Bit Serial, 5V Read/Write	8
2816A35	3.45	2048x8 350ns, 5V Read/Write	24
2817A25	6.75	2048x8 250ns, 5V Read/Write (Pin 1 - Ready/Busy)	28
2864A25	8.95	8192x8 250ns, 5V Read/Write (Pin 1 - N/C)	28
28C64-25	9.95	8192x8 250ns, 5V Read/Write CMOS (Pin 1 - N/C)	28
28C256-25	26.95	32,768x8 250ns, 5V Read/Write CMOS	28

**EPROMS (UV Erasable)**

Order #	Price	Organization	Speed	Prog. Volt.	Pins
MMS203Q	2.25	256x8	2K	1000ns	25V 24
TMS2516	4.25	2048x8	16K	450ns	25V 24
TMS2532	6.95	4096x8	32K	450ns	25V 24
TMS2532-30	8.95	4096x8	32K	300ns	25V 24
TMS2532A45	7.95	4096x8	32K	450ns	21V 24
TMS2564	5.95	8192x8	64K	450ns	25V 28
TMS2564-50	4.75	8192x8	64K	500ns	25V 28
TMS2716	5.95	2048x8	16K	450ns (±5V, +12V)	25V 24
2708	4.75	1024x8	8K	450ns (±5V, +12V)	25V 24
2716	3.45	2048x8	16K	450ns	25V 24
2716-1	3.95	2048x8	16K	350ns	25V 24
27C16	4.25	2048x8	16K	450ns CMOS	25V 24
2732	3.95	4096x8	32K	450ns	25V 24
2732A20	4.75	4096x8	32K	200ns	21V 24
2732A25	3.45	4096x8	32K	250ns	21V 24
2732A45	2.95	4096x8	32K	450ns	21V 24
2732B45	4.25	4096x8	32K	450ns	12.5V 24
27C32	4.75	4096x8	32K	450ns CMOS	25V 24
2764-20	3.95	8192x8	64K	200ns	21V 28
2764-25	3.75	8192x8	64K	250ns	21V 28
2764A15	4.45	8192x8	64K	150ns	12.5V 28
2764A20	3.95	8192x8	64K	200ns	12.5V 28
2764A25	3.25	8192x8	64K	250ns	12.5V 28
2764A45	2.95	8192x8	64K	450ns	12.5V 28
2764AOTP	2.25	8192x8	64K	250ns One Time Prog.	12.5V 28
27C64A15	3.95	8192x8	64K	150ns CMOS	12.5V 28
27C64FP25*	3.95	8192x8	64K	250ns One Time Prog.	12.5V PLCC 32
27128-20	6.75	16,384x8	128K	200ns	21V 28
27128-25	5.95	16,384x8	128K	250ns	21V 28
27128A15	5.75	16,384x8	128K	150ns	12.5V 28
27128A20	4.95	16,384x8	128K	200ns	12.5V 28
27128A25	3.95	16,384x8	128K	250ns	12.5V 28
27128A30	3.25	16,384x8	128K	300ns	12.5V 28
27128AOTP	2.95	16,384x8	128K	250ns One Time Prog.	12.5V 28
27C128-15	5.95	16,384x8	128K	150ns CMOS	12.5V 28
27C128-25	5.25	16,384x8	128K	250ns CMOS	12.5V 28
27CP128-20	5.75	16,384x8	128K	200ns CMOS	12.5V 28
27256-15	5.75	32,768x8	256K	150ns	12.5V 28
27256-20	5.25	32,768x8	256K	200ns	12.5V 28
27256-25	4.75	32,768x8	256K	250ns	12.5V 28
27256-30	3.45	32,768x8	256K	300ns	12.5V 28
27C256-15	5.95	32,768x8	256K	150ns CMOS	12.5V 28
27C256-25	4.25	32,768x8	256K	250ns CMOS	12.5V 28
27C256FP25*	4.95	32,768x8	256K	250ns One Time Prog.	12.5V PLCC 32
27512-20	6.95	65,536x8	512K	200ns	12.5V 28
27C512-12	8.95	65,536x8	512K	120ns CMOS	12.5V 28
27C512-15	6.95	65,536x8	512K	150ns CMOS	12.5V 28
27C512-25	5.95	65,536x8	512K	250ns CMOS	12.5V 28
27C010-15	9.95	131,072x8	1MB	150ns CMOS	12.5V 32
27C020-15	24.95	262,144x8	2MB	150ns CMOS	12.5V 32

\*Surface Mount

**8000**

Order #	Price	Description	Pins
8031	3.55		
80C31	7.25		
8035	1.75		
8039	1.75		
80C39	3.75		
8080A	2.75		
8085A	2.95		
8085A2	3.55		
8086	4.45		
8088	4.25		
8088-1	7.25		
8088-2	6.25		
8155	2.45		
8155-2	3.75		
82C11	5.95		
8212	2.45		
8214	3.85		
8216	1.35		
8224	2.45		
8237A5	4.15		
8243	1.95		
8250	5.75		
8251A	2.25		
8253	1.95		
8253-5	2.25		
8254	4.55		
8254-2	5.95		
8255A5	2.75		
8256	10.75		
8257	2.25		
8259-5	2.25		
8272	3.75		
8274	6.55		
8275	18.95		
8279-5	3.45		
8284A	2.25		
8286	2.95		
8288	3.75		
A80286-10	19.95		
N80286-12	21.95		
N80L286-8	11.95		
R80286-12	26.95		
R80286-6	9.95		
80C287A12	49.95		
82C284-8	4.95		
82C284-12	19.95		
82288-8	4.95		
82288-12	19.95		
83D87-33	199.95		
8741	9.95		
8742	14.25		
8748H	8.95		
8749	9.95		
8751	24.95		
8755	11.95		

\*For Laptops Only

**DYNAMIC RAMS**

Order #	Price	Organization	Speed	Pins
4116-12	1.45	16,384x1	120ns	16
4116-20	.85	16,384x1	200ns	16
4816A4	.55	16,384x1	Single +5V 250ns	16
4416-12	2.25	16,384x4	120ns	18
4416-15	1.95	16,384x4	150ns	18
4161-15	4.95	65,536x1	Video RAM 150ns	20
4164-10	1.95	65,536x1	100ns	16
4164-15	1.55	65,536x1	150ns	16
4164-20	1.25	65,536x1	200ns	16
41264-12	6.95	65,536x4	Video RAM 120ns	Skinny Dip 24
41464-80	3.25	65,536x4	80ns	18
41464-12	2.75	65,536x4	120ns	18
41256-10	1.95	262,144x1	100ns	16
41256-12	1.85	262,144x1	120ns	16
41256-15	1.75	262,144x1	150ns	16
41257-12	3.25	262,144x1	Nibble 120ns	16
51258-80	4.95	262,144x1	Static Column 80ns	16
514256-80	7.25	262,144x4	80ns	20
514256-10	6.95	262,144x4	100ns	20
514258-80	9.95	262,144x4	Static Column 80ns	20
524256VZ80	16.95	262,144x4	Video RAM 80ns	ZIP 28
511000-80	7.25	1,048,576x1	80ns	18
511000-10	6.95	1,048,576x1	100ns	18
511000-12	6.55	1,048,576x1	120ns	18
511001-80	8.25	1,048,576x1	Nibble 80ns	18

**STATIC RAMS**

Order #	Price	Organization	Speed	Pins
2101	1.65	256x4	450ns	22
2111	1.75	256x4	450ns	18
2112	2.45	256x4	450ns	16
5101	3.95	256x4 CMOS	450ns	22
2114L20	1.49	1024x4 Low Power	200ns	18
2114-45	1.05	1024x4	450ns	18
2148-3	1.95	1024x4	55ns	18
2149-35	3.75	1024x4	35ns	18
2147-3	3.75	4096x1	55ns	18
20C71-25	6.75	4096x4 CMOS	25ns	Skinny Dip 24
6168-45	3.25	4096x4 CMOS	45ns	20
6116LP1	2.95	2048x8 CMOS Low Power	100ns	24
6116LP3	2.75	2048x8 CMOS Low Power	150ns	24
6116-1	2.75	2048x8 CMOS	100ns	24
6116-3	2.25	2048x8 CMOS	150ns	24
6516-45	4.25	2048x8 CMOS	45ns	Skinny Dip 24
7C128-55	3.95	2048x8 CMOS	55ns	Skinny Dip 24
8128-15	2.15	2048x8	150ns	28
6264LP10	4.95	8192x8 CMOS Low Power	100ns	28
6264LP15	3.95	8192x8 CMOS Low Power	150ns	28
6264-10	4.75	8192x8 CMOS	100ns	28
8167-55	3.45	16,384x1	55ns	20
62256LP10	6.75	32,768x8 CMOS Low Power	100ns	28
62256LP15	6.25	32,768x8 CMOS Low Power	150ns	28
62256SLP12	7.95	32,768x8 CMOS Low Power	120ns	Skinny Dip 28
628128LP8	34.95	131,072x8 CMOS Low Power	85ns	32
628128LP10	32.95	131,072x8 CMOS Low Power	100ns	32

**Z80A, Z80B, Z80-8MHZ, Z8000**

Order #	Price	Description	Pins
Z0803008PSD	9.50	Serial Communications Controller 8Mhz	40
Z80A	1.25	CPU (MK3880-4) (780C-1) 4Mhz	40
Z80A-CTC	1.55	Counter Timer Circuit (MK3882-4) 4Mhz	28
Z80A-DART	3.95	Dual Asynchronous Receiver/Transmitter 4Mhz	40
Z80A-PIO	1.85	Parallel I/O Interface Controller (MK3881-4) 4Mhz	40
Z80A-SIO/0	3.95	Serial I/O (Tx/CB & Rx/CB Bonded) (MK3884-4) 4Mhz	40
Z80A-SIO/2	3.95	Serial I/O (Lacks SYNCB) (MK3887-4) 4Mhz	40
Z80B	2.45	CPU (MK3880-6) 6Mhz	40
Z84C0008	5.95	CPU 8Mhz (CMOS)	40
Z84C1008	10.95	DMA (Direct Memory Access) 8Mhz (CMOS)	40
Z84C2008	5.95	PIO (Parallel I/O Interface Cont.) 8Mhz (CMOS)	40
Z84C3008	5.95	CTC (Counter Timer Circuit) 8Mhz (CMOS)	28
Z84C4008	8.95	SIO/0 8Mhz (CMOS)	40
Z84C4108	8.95	SIO/1 8Mhz (CMOS)	40
Z84C4208	8.95	SIO/2 8Mhz (CMOS)	40
Z8530	4.55	Serial Communications Controller	40



**EASY FAX**  
1-800-582-1255

# EASYTECH

THE ELECTRONICS SOURCE

**EASY ORDER**  
1-800-582-4044

## METEX 4 1/2 DIGIT LCD DMM

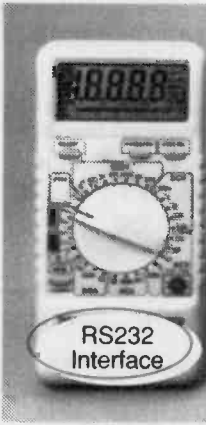

M4650CR

FUNCTION	RANGE	ACCURACY	RESOLUTION
DC VOLTAGE	200mV	±0.05% of rdg+3dgts	10µV
	2V		100µV
	20V		1mV
	200V		10mV
AC VOLTAGE	200mV	±0.5% of rdg+10dgts	10µV
	2V		100µV
	20V		1mV
	200V		10mV
DC CURRENT	2mA	±0.5% of rdg+3dgts	100nA
	20mA		10µA
	200mA		1mA
	2A		10mA
AC CURRENT	2mA	±0.8% of rdg+10dgts	100nA
	20mA		10µA
	200mA		1mA
	2A		10mA
RESISTANCE	200Ω	±0.2% of rdg+5dgts	0.01Ω
	2KΩ		0.1Ω
	20KΩ		1Ω
	200KΩ		10Ω
	2MΩ		100Ω
	20MΩ		1KΩ
CAPACITANCE	2000pF	±2.0% of rdg+20dgts	0.1pF
	200nF		10pF
FREQUENCY	20KHz	±3.0% of rdg+30dgts	1Hz
	200KHz		10Hz

**GENERAL CHARACTERISTICS:**

**Max. Display:** 19999 counts with automatic polarity indication • **Max. Input Current of AC and DC:** 20A (max. of 15 minutes) • **Overrange Indication:** "OL" and "Bar graph flashing" figure on display • **Max. Common Mode Voltage:** 500VDC/AC RMS • **Reading Rate Time:** Approx. 1-2 readings per sec. • **Temp. for Guaranteed Accuracy:** 23°C ±5°C • **Temperature Ranges:** Operating 0°C to 40°C, 32°F to 104°F, Storage -10°C to 50°C, 14°F to 122°F • **Power Supply:** One 9V battery (Included) • **Size:** 3.4"W x 7.4"D x 1.3"H • **Unit Weight (Excluding carrying case):** 0.8 lbs. • **Accessories:** Operating manual, 9V battery, test leads, spare fuse, and carrying case. RS-232C Cable, Floppy Disk (Optional)

Order #	Price	Description	Weight
M4650CR	109.95	4 1/2 Digit LCD Multimeter .....	1.50 lbs.
RS232C	9.95	RS-232 Interface (Cable and Floppy Disk) .....	3.5 oz.

## SOLDERING STATIONS

**Features - 168-3CK**

•The AUTOTEMP 168-3CK soldering station offers the ultimate in controlled temperature hand soldering • The soldering tip is grounded through the power unit to ensure less than 0.4mV or 0.03mA leakage • The cartridge element wire is precision wound at the end of the stainless steel shaft to ensure max. temperature as close to the working surface of the tip as possible. This results in both rapid heating and instant recovery •AutoTemp is constructed with a lock-out feature to allow supervisors the ability to set and lock the stations at a specific temperature • Ideal for hobbyists, service technicians or production lines.



**Features - XY9-60DK**

•SUPERTEMP XY9-60DK solder station offers a unique electronic control circuit that maintains tip temperature to within ±3°C (6°F) of idling. This is accomplished by embedding the thermocouple sensing unit in the top of the heating element shaft so that the tip actually sits against it • Revolutionary electronic "Zero Voltage" thyristor switching protects voltage and current sensitive components (CMOS devices) against transient voltage spikes caused in stations using mechanical switching action • Heat-up time to working temperature approx. 60 seconds • SuperTemp units exceed all soldering equipment military specifications regarding electro-static sensitive devices due to zero voltage switching and fully grounded tip.



Order #	Price	Description	Weight
168-3CK	69.95	60 Watt Soldering Station .....	2.38 lbs.
XY9-60DK	109.95	60 Watt Soldering Station (Digital Readout) .....	4.68 lbs.

## TOOL KITS



E8305

Both units feature: DMM's, pliers, utility knife, screw driver sets, hex key sets, wrenches, soldering iron, solder, desoldering pump, solder stand and much more!



E8900

The best collection of fix-it and put-it-together tools. Ideal for do-it-yourself, handyman and professional craftsman. Designed for most maintenance and repair jobs around the house, workshop, etc. Compact vinyl covered carry-along suitcase with combination lock and sturdy removable pallets. Provides safe storage and keeps all tools clean and organized. Case Size: 17.5" x 12.5" x 3.5"

The most popular tools come packed in this large and complete kit. Use it for building, repairing and general maintenance of most electronic equipment. The heavy duty, molded poly case is built to hold 2 pallets, and has a bottom center partition. The case comes with 2 surface type locks, a durable handle, side buckles and strap. Case Size: 18" x 14" x 7"

Order #	Price	Description	Weight
E8305	119.95	51 Piece Professional Tool Kit .....	12 lbs.
E8900	199.95	92 Piece Electrician's Tool Kit .....	17 lbs.

## 2.25" SPEAKER

**"STAR"**

**Model SF575D**

- Output: 0.2 Watt
- Impedance: 32Ω
- Diameter: 2.25"
- Terminals: Solder Lugs



Order #	Price	Description	Diam.
SP232	.95	32Ω Speaker .....	2.25"

## HEAT SINK

**"THERMALLOY"**

**Model THM6010**

- Suit 14 & 16 Pin Dip ICs
- Can be added after assy
- Dimensions: 0.75" x 0.604"



Order #	Price	Description	Style
THM6010	.35	Heat Sink .....	DIP

## WALL TRANSFORMER

**"BPC"**

**Model BA-920**

- Input: 115 VAC @ 60 Hz
- Output: 9 Vdc @ 200mA
- UL Listed: 31J9/E8257



Order #	Price	Description	Weight
BA920	1.95	Wall Transformer .....	8 oz

## WALL TRANSFORMER

**"ELECTRONICS CORPORATION"**

**Model AD135-700**

- UL Listed: 74BI
- Input: 120 VAC @ 60 Hz
- Output: 13.5 VAC @ 700mA



Order #	Price	Description	Weight
AD135	2.95	Wall Transformer .....	11.4 oz

## TERMINAL BLOCK

**"KULKA"**

**Model 599**

- Connection: Spade Tabs
- Mounting Holes: 5/32"

Order #	Price	Description	Pos.
TB5	.75	Terminal Block .....	5

## IC MASTER

**New Updated 3 Volume Set**

- Convenient •Affordable •Easy To Use •Indispensable
- 80,000 Different ICs (Including 12,000 new ICs on the market)
- 1,000 Manufacturers' Data Pages (100% new and updated)
- 180,000 Pin-for-Pin Replacement Devices
- Military •Digital •Microprocessor •Interface •Linear •Memory •PLDs •ASICs •MPU Development Systems



Order #	Price	Description
Order # 91MASTER .....	134.95	

# EASYTECH

THE ELECTRONICS SOURCE

2917 Bayview Drive  
Fremont, CA 94538



**Easy Order: 1-800-582-4044**  
**Easy Fax: 1-800-582-1255**  
**International Fax: 1-510-770-2346**  
**Customer Service: 1-510-770-2345**

Monday-Friday, 7am - 5pm (PST) / 10am-8pm (EST)

- COD-No personal checks, US funds (\$5.00 Surcharge)
- USPS
- UPS
- Federal Express
- Airborne

Add 5% of total for shipping UPS Ground (\$3.00 min.).  
Actual shipping charges based on weight.

Call or write today for your free copy of our catalog.

(California residents, add appropriate sales tax. 12 month warranty on all EasyTech products. 30 day money back guarantee. We reserve the right to substitute manufacturers. Prices subject to change without notice.)

CIRCLE 253 ON FREE INFORMATION CARD

January 1992, Radio-Electronics

# DANBAR SALES CO.

870 W. CIENEGA AVE., UNIT 1, SAN DIMAS, CA 91773

**(714) 592-2940 FAX (714) 592-9518**

<p><b>HEWLETT-PACKARD 853A/ HP 8558B</b></p> <p>Spectrum Analyzer Display with spectrum analyzer plug-in. Goes from 0.1 to 1500 MHz, 1 KHz resolution, -117 to + 30 dBm amplitude range, calibrated.</p> <p><b>\$6500.00</b></p>	<p><b>HEWLETT-PACKARD 8640B</b></p>  <p>AM/FM Signal Generator, .5 to 512 MHz, + 19 to -145dBm RF output, counter, phase lock.</p> <p><b>\$2650.00</b></p>	<p><b>HEWLETT-PACKARD 3586B</b></p> <p>Selective Level Meter</p> <p>Makes carrier frequency measurements to 32.5 and voice channel measurements from 50 Hz to 100 KHz. Works with HP3336.</p> <p><b>\$3250.00</b></p>
<p><b>HEWLETT-PACKARD 3325A</b></p> <p>Automatic Synthesizer, .1uHz to 21MHz, 1uHz resolution, 1mV to 10Vp-p, sine, square, triangle, +/- ramp, dc offset to 5V, full sweep.</p> <p><b>\$5000.00</b></p>	<p><b>FLUKE 8520A</b></p> <p>Digital multimeter, 5.5 digit, AC/DC Volts, 2 &amp; 4 wire ohms, 20ppm DC accuracy.</p> <p><b>\$795.00</b></p>	<p><b>HEWLETT-PACKARD 3336B</b></p> <p>Synthesizer/ Level Generator</p> <p>Bell standard, 10 Hz to 21 MHz, 4 output Z, AM, PM modulation .01-99.99 sec.</p> <p><b>\$1250.00</b></p>
<p><b>HEWLETT-PACKARD 8620C W/ HP 86290B *NEW*</b></p> <p>Sweep Oscillator Mainframe, with Sweep Oscillator plug-in. 2 to 18.6 GHz, +10dBm, +/- 30MHz accuracy up to 18.6 GHz. Both pieces are new and come with manuals.</p> <p><b>\$7500.00</b></p>	<p><b>TEKTRONIX PLUG-INS</b></p> <p><b>TEK 7A13</b> \$750.00 Differential amplifier</p> <p><b>TEK 7A26</b> \$350.00 Dual trace amplifier</p> <p><b>PG501</b> \$850.00 Pulse generator</p> <p><b>SC504</b> \$700.00 Time mark generator</p>	<p><b>TEKTRONIX 576 CURVE TRACER</b></p>  <p>Accept 3 different test fixtures, delivers up to 220 watts, 2 or 3 lead devices.</p> <p><b>\$3250.00</b></p>
<p><b>CLAROSTAT 240C</b></p> <p>Resistance decade box provides at the flip of a switch any resistance from 1 to 999,999 ohms for working circuits in 1 ohm steps.</p> <p><b>\$150.00</b></p>	<p><b>TEKTRONIX 7633</b></p> <p>Storage oscilloscope, 100 MHz multimode storage, comes with (2) 7A18 dual trace amplifier, DC to 75 MHz. (1) 7B53A, dual time base.</p> <p><b>\$1150.00</b></p>	<p><b>WAVETEK 1067</b></p> <p>Sweep generator, 1 to 400 MHz, primarily for CATV use. + 10 to - 55dBm calibrated output, RF output 75 ohm, includes manual.</p> <p><b>\$795.00</b></p>
<p><b>TEKTRONIX 466</b></p> <p>100MHz Storage oscilloscope, 5 mV/div to 5V/div variable persistence, 3000 div/uS stored writing speed. Comes with 2 new Probe Master probes and a operators manual.</p> <p><b>\$1225.00</b></p>	<p><b>TEKTRONIX 7904</b></p> <p>500 MHz oscilloscope with the following plug ins: 7A24, dual trace amplifier. 7A26, dual trace amplifier. 7B80, delayed time base. 7B85, delaying time base.</p> <p><b>\$2000.00</b></p>	<p><b>HEWLETT-PACKARD 435B</b></p>  <p>Power Meter, comes with HP 8481A power sensor &amp; cable. Power range -25 dBm to + 20 dBm with 8481 A.</p> <p><b>\$ 1150.00</b></p>

**WANTED: ELECTRONIC  
TEST EQUIPMENT**  
Call or fax us your list.

All test equipment has  
been tested and is  
guaranteed to be in good  
working condition.

**WE ACCEPT VISA  
AND MASTERCARD.**



# Put Real World Control In Your Grasp

**Micro-440 Combines the Features  
and Value You Need for Fast,  
Economical Project Designs.**

**Everything You Need  
in One Compact Package!**



The Blue Earth Micro-440 is a versatile programmable controller designed for the demands of today's fast-paced development environment. The standard features of the Micro-440 provide you with everything needed for a quick, cost-effective solution to your project design requirements. In applications from automation to data logging, embedded control to hobby projects, see what the Micro-440 can do for you!

## Standard Features:

- **83C51FB CPU** - High integration member of the popular 8051 family includes a PCA (Programmable Counter Array) with 5 high speed I/O channels and a watchdog timer.
- **Built-In BASIC and MONITOR-51** - The CPU ROM contains a floating point BASIC interpreter and an assembly language debug monitor for fast and easy program development.
- **32K RAM** - On-board memory can be used for program or data storage and includes a 10+ year lithium backup battery. A write protectable block is available for permanent program storage (no EPROM needed).
- **Dual RS-232C Ports** - Includes a primary communication channel plus a printer port and features a hardware or software selectable low power shutdown mode.
- **14 Digital I/O** - All I/O lines are TTL/CMOS compatible for easy interfacing to application circuitry.
- **Clock/Calendar Module** - Includes year, month, day, and time registers plus a programmable interrupt output.
- **Precision 5 Volt Regulator** - Allows operation from almost any filtered 6-16 volt D.C. source.
- **A/D Converter** - An 8-bit 8 channel analog-to-digital converter features single or differential inputs and 40µS conversion time.
- **Expansion Connector** - Contains all CPU bus signals plus power - enabling user to add Blue Earth or custom expansion modules.
- **Sturdy ABS Plastic Case** - Provides protection for electronic components and looks good, too!
- **6 Layer Board Uses SMT** - High tech manufacturing enhances performance and reliability while reducing overall size.

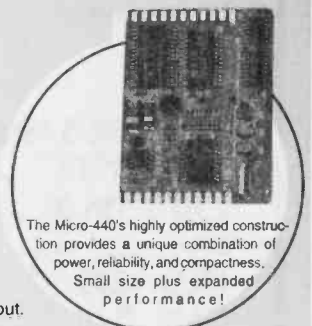

The Micro-440's highly optimized construction provides a unique combination of power, reliability, and compactness. Small size plus expanded performance!

## Expansion Modules

For fast implementation of expanded hardware requirements, Blue Earth Research has developed several ready to use add-on modules, all in their own attractive plastic case.

- Application Module** - For testing and demonstration. Includes 7-segment LED, beeper, potentiometer, and power MOSFETS.
- 12-Bit A/D Module** - Four channels of high speed (8.5 µS) precision analog inputs.
- I/O Expander** - Adds 24 configurable I/O channels for LCD and keypad, general purpose I/O, or high current outputs.
- Memory Expander** - Plug in 8K to 128K bytes of RAM, EPROM, or EEPROM.



APPLICATION MODULE

## Software

The Micro-440 can be purchased with a wide range of program development and support software. All software packages run on any PC or compatible and include complete documentation.

- Macro Assembler** - Full featured 8051 assembler with powerful macro capabilities and comprehensive error processing.
- C51 Compiler** - Optimizing C Compiler for the 8051 family by Franklin Software, Inc. Supports re-entrant functions and implements the ANSI standard for the C language.
- PL/M-51 Compiler** - Powerful yet easy to learn language. Genuine Intel Compiler.
- TASM** - Table driven cross assembler. Supports 10 different processor families. Includes "C" source code on disk.

## Our Programming Power is Affordable!!

Blue Earth Research is breaking traditional cost barriers by including all the necessary features that are either expensive options or not available with other controllers. To realize even more power and potential from your Micro-440, we offer packages that combine the Micro-440 with powerful development software and applicable hardware - all at reasonable prices.

- Micro-440 Programmable Controller Only - Stand Alone Unit** .....\$199.00
  - Hardware Package - Micro-440 with Power Supply, Application Module, RS-232 Cable, User's Manual, and Pocket Reference** .....\$299.00
  - As above, with MCS@-51 Reference Manual** .....\$319.00
  - Assembler Package - Includes complete hardware package, with professional grade Macro Assembler, Symbolic Debugger, and Hex File Converter** .....\$399.00
- Prices subject to change without notice and do not include shipping or MN sales tax



**BLUE EARTH™  
RESEARCH**

310 Belle Avenue • Mankato, MN 56001  
507 387-4001 VOICE  
507 387-4008 FAX  
507 387-4007 BBS

Call for complete details and specifications and a full product/price list. We offer complete technical support.

NO MICHIGAN  
CALLS ACCEPTED

# B & S SALES

## CONVERTERS

	<b>5</b>	<b>10</b>	<b>20</b>
JERROLD-Volume-DONV.....	\$85	\$80	\$75
Descrambler Compatible 99 Channel Capacity Parental Lock Audio/Video Outputs			
JERROLD-400—60 Channels.....	40	35	30
DRX-3-105			
JERROLD-450—68 Channels.....	42	38	32
DRZ-3-105			
JERROLD DRZ-3-A&B.....	69	65	58
For Dual Cable Systems			
EASTERN 550—86 Channels.....	70	65	60
EASTERN 550—86 Channels.....	74	69	65
With Parental*			

## ADD-ON SCRAMBLERS

	<b>5</b>	<b>10</b>	<b>20</b>
PIONEER-3 (Super Combo).....	\$75	\$70	\$65
TVT-3 Tri BL.....	65	60	55
FTB-3 TRI BL.....	60	46	42
SA-3.....	55	45	42
MLD-1200—2 or 3.....	34	29	24
OAK—2 or 3.....	45	39	35
SUPER PIONEER UNIT.....	145	140	135
Compatible w/all Pioneer Systems			

## ALL IN ONE—CONVERTERS/DESCRAMBLERS

**Note: Call for Availability**

CRX6600-3-M.....	Hamlin Systems
DRZ-3-DIC.....	Jerrold Systems
DRX-3-DIC.....	Jerrold Systems
SAB536.....	Scientific Atlanta
SAB580.....	Scientific Atlanta
STARCOM VI & VII.....	Jerrold Systems
Z-TAC (all but PM Model).....	Zenith Systems

## MISCELLANEOUS

Jumper Cables, Remote Control for most Cable Converters; Interference Filters or any channel.

**HOURS: MONDAY THROUGH FRIDAY 8 A.M. TO 8 P.M. EST**

90 DAY GUARANTEE — in order for the 90-day guarantee to be in effect, this form must be signed and returned.

**FOR VCR, SECOND, THIRD, ETC. HOOK UPS**

YES, I agree — all units are to be used or resold in compliance with Federal and State laws.  
Signature \_\_\_\_\_ Date \_\_\_\_\_

Name \_\_\_\_\_  
Address \_\_\_\_\_  
City \_\_\_\_\_ State \_\_\_\_\_  
Zip \_\_\_\_\_ Phone No. \_\_\_\_\_

IT IS NOT THE INTENTION OF B & S SALES TO DEFRAUD ANY PAY TELEVISION OPERATOR AND WE WILL NOT ASSIST ANY COMPANY OR INDIVIDUAL IN DOING THE SAME.  
46518 Van Dyke #101, Utica, MI 48317 (313) 790-7896 • FAX (24 hours) (313) 739-6047

CIRCLE 242 ON FREE INFORMATION CARD



# TIMELINE INC.

## Liquid Crystal Displays

16 Characters x 1 line 3 for \$25.<sup>00</sup>  
 40 Characters x 2 line 2 for \$25.<sup>00</sup>  
 16 x 2 \$12.<sup>00</sup> ..... 32 x 4 \$20.<sup>00</sup>  
 20 x 2 \$12.<sup>00</sup> ..... 4 x 2 - \$5.<sup>00</sup>  
 24 Characters x 2 line LCD 12.<sup>00</sup>  
 5V power required • Built In C-MOS LCD driver & controller • Easy "Microprocessor" interface • 98 ASCII character generator

**ADAPTEC 4070A (RLL) or 4000A (MFM)**  
 SCSI Controller, your choice \$60.<sup>00</sup>

## SHARP-LASER DIODE

Part#: LT022MC \$5.<sup>00</sup>  
 5mW at 780 nm, single transverse mode

**8 bit IRMA BOARD \$99.<sup>00</sup>**  
 Links 3270 mainframe systems to IBM PC

## MAGNETIC CARD READER \$25.<sup>00</sup>

Includes: • 20 character dot matrix display with full alpha-numeric capability • keypad with full alpha-numeric entry • separate 7.5 VDC/0.5 Amp power supply • standard telephone interface extension cord • lithium battery and flat-cone speaker.

## FLOPPY DRIVES

360 K \$45.<sup>00</sup> 1.2 Mb \$55.<sup>00</sup>  
 720 K \$40.<sup>00</sup> 1.44 Mb \$60.<sup>00</sup>  
 5.25" bracket for 720K or 1.44Mb drives \$7 extra

## 640 x 200 LCD \$29.<sup>00</sup>

The unit is the display for the Toshiba T1100+ laptop computer. Driver board to generate text and graphics not included. This is a serial interface LCD. You should be very familiar with wiring when attempting to use this unit.

640 x 400 LCD \$50.<sup>00</sup> Seiko part #:F642F

## 380 WATT POWER SUPPLY \$29.00

Non-enclosed • Output: +5V @ 50 A, +12V @ 6 A, -12V @ 1.5 A, Dimensions: 12" L x 5" W x 4"H

**73 WATT SWITCHING POWER SUPPLY \$19.00 or 2 for \$30.00**  
 (2) 4 pin power connectors attached • 115/230 Volt  
 Dimensions: 8.5" L x 4.5" W x 2" H • Output: • +5V @ 2-9.75 A • +12V @ 0-1.5 A • -5V @ 0-0.4 A • -12V @ 0-0.5 A

40 WATT NON-ENCLOSED POWER SUPPLY 2 for \$25.00  
 50 WATT NON-ENCLOSED POWER SUPPLY 2 for \$25.00  
 60 WATT ENCLOSED POWER SUPPLY 2 for \$25.00

## NEC-ARGON LASER \$399.<sup>00</sup>

30 Mw. (avg). Blue Beam only, Model 3030. Fully tested. Power supply available for \$500.

**HeNe Laser Tube 10Mw (max. output) \$99.<sup>00</sup>**

**Optical Laser Array \$499.<sup>00</sup>**  
 Call for free information package

## Magnavox EGA color monitor \$150.00

.39 dot pitch. Model #:9CM053. EGA card available.

## HARD DRIVES

**10Mb Drive \$50.<sup>00</sup>**  
 (Half Height, ST506 Compatible 612 Cylinders, 2 heads)  
**20Mb Hard Drive \$120.<sup>00</sup>**  
**CDC 94166-141 \$449.<sup>00</sup>**  
 (115Mb, Full Height, ESDI Interface)

## Non-Enclosed TTL Monitors

Comes with pinout. 12V at 1.4 Amp Input. Horizontal frequency 15 KHz. Ability to do 40 and 80 column.  
 5" Black & White....\$49.00  
 7 inch.....\$29.95  
 9 inch (Amber).....\$29.95

## (80 x 16 line) Graphic & Alphanumeric

480 Dot x 128 Dot LIQUID CRYSTAL DISPLAY  
**15.<sup>00</sup> each, or 2 for 20.<sup>00</sup>**  
 Driver board available 60.<sup>00</sup>

**101 Key XT Keyboard \$24.00**  
**85Key XT/AT Switchable Keybd \$24.00**

## CONTROLLER CARD BLOWOUT!

**XT hard drive controller**  
 Controls 2 hard drives .....\$39.00  
 MFM controller-1/2 card-8 bit with cables \$44.00  
**AT Hard Drive controller 16 bit**  
 Part #WD1003-WAH - runs up to 12 Mhz only. \$29.00

## 80387-s

These are - 16DX Mhz co-processors. Fully tested and guaranteed to work at the desired speeds below.

16Mhz — 115.<sup>00</sup> 20Mhz — 120.<sup>00</sup>  
 25Mhz — 125.<sup>00</sup> 33Mhz — 135.<sup>00</sup>

## Proteon ProNet-4 Model p1347 Token Ring Board \$129.<sup>00</sup>

16 bit • 4 Mbps • IEEE 802.2 and 802.5 compatible • twisted pair • interoperable with IBM Token Ring network

## AMPRO LITTLE BOARD PC \$79.<sup>00</sup>

256K RAM included, expandable to 768K on board (256x9 SIMMS) • Floppy Controller 360K/720K/1.2Mb/1.44Mb • 2 serial ports and 1 parallel port • Keyboard input & Speaker Output • Has SCSI controller socket • (requires optional pal & controller) • Board is the size of a 5.25" floppy drive

## THE SPY IN THE SKY

1728 element CCD \$19.00  
 4096 element CCD \$29.00

1490 W. ARTESIA BLVD, GARDENA, CA 90247

Order desk only: USA: (800) 872-8878 CA: (800) 223-9977

L.A. & Technical Info: (213) 217-8912 • OEM INQUIRIES WELCOME

Fax: (213) 532-6304 • 20% Restocking fee for returned orders.

Minimum Order: \$20.00 Minimum shipping handling charge \$5.00. We accept cashiers checks, MC or VISA. No personal checks or COD's. CA residents add 8.25% sales tax. We are not responsible for typographical errors. All merchandise subject to prior sale. Phone orders welcome. foreign orders require special handling. Prices subject to change without notice.





**TWO NEW MODELS  
ULTRA HIGH SENSITIVITY  
FIND FREQUENCIES FAST  
LOCATE RF SOURCES  
CALIBRATE EQUIPMENT,  
ANTENNAS, CIRCUITS**

- 2 INCH LED BAR GRAPH  
BRIGHT RED DISPLAY SHOWS  
THE RELATIVE RF SIGNAL  
STRENGTH OF INPUT SIGNAL  
(NO BACK LIGHT REQUIRED)
- SWITCH SELECTABLE  
DOT OR BAR GRAPH
- ALL MODELS COMPATIBLE  
WITH MFJ ANT ANALYZER
- 9-12 VDC AUTO-POLARITY  
POWER INPUT - WILL  
ACCEPT DC POWER PLUG  
CENTER NEG. OR POS.
- WHILE CHARGING NI-CAD  
BATTERIES- COUNTER  
CAN BE USED OR  
SWITCHED OFF
- StarCab™  
ALUMINUM CABINET

**ALL PRICES  
INCLUDE FACTORY  
INSTALLED NI-CADs &  
110VAC ADP/CHARGER**

# STARTEK

## BAR GRAPH - COUNTERS



**TWO NEW MODELS  
1-1500 MHZ &  
1-3200 MHZ**

- 3-5 HOUR PORTABLE  
OPERATION WITH  
STANDARD FACTORY  
INSTALLED NI-CAD's
- 3 GATE TIMES
- 1PPM TCXO TIMEBASE
- DISPLAY HOLD SWITCH  
WITH INDICATOR
- FULL YEAR  
LIMITED WARRANTY
- BRIGHT RED LED DIGITS  
(NO BACK LIGHT REQ'D)
- DESIGNED & 100%  
ASSEMBLED IN USA

**MODEL 15-BG**  
1 MHZ - 1.5 GHZ. . . \$220.

**MODEL 35-BG**  
1 MHZ - 3.2 GHZ. . . \$265.

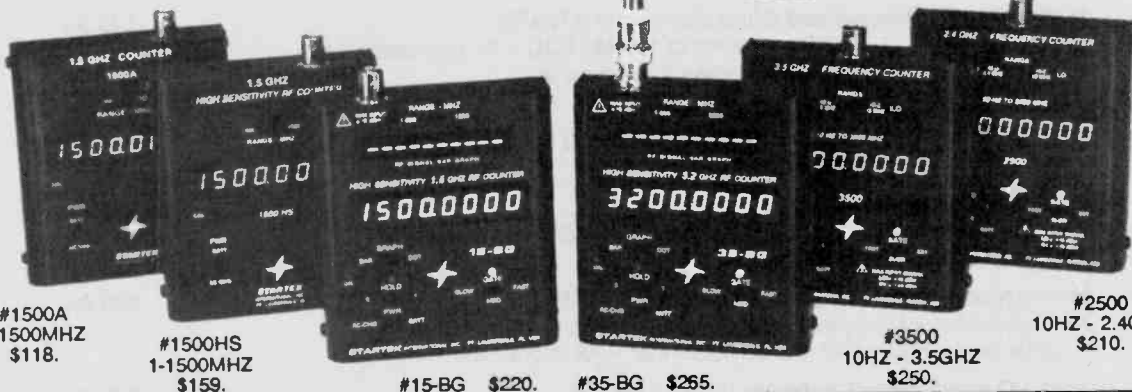

#1500A  
1-1500MHZ  
\$118.

#1500HS  
1-1500MHZ  
\$159.

#15-BG \$220.

#35-BG \$265.

#3500  
10HZ - 3.5GHZ  
\$250.

#2500  
10HZ - 2.4GHZ  
\$210.

**FREE CARRYING CASE & TELESCOPING ANTENNA WITH PURCHASE OF MODEL 35-BG, 15-BG OR 3500  
FREE CARRYING CASE WITH PURCHASE OF MODEL 1500HS OR 2500  
LIMITED TIME OFFER - YOU MUST MENTION THIS AD WHEN ORDER IS PLACED**

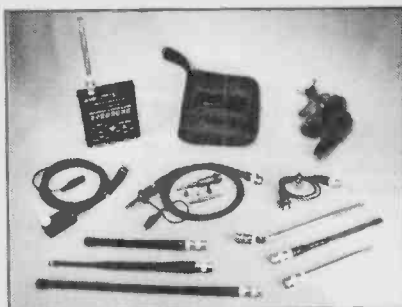

**■ ANTENNAS**

- #TA-90 Telescoping BNC antenna . . . 12.00
- #TA-90-L Telescoping-elbow BNC . . . 15.00
- #RD-150 150 MHZ Rubber Duck BNC . . . 16.00
- #RD-2760 27 & 50 MHZ 11" RD-BNC . . . 28.00
- #RD-460 450 MHZ Rubber Duck-BNC . . . 18.00
- #RD-800 800 MHZ Rubber Duck-BNC . . . 29.00
- MISC
- #CC-90 Black vinyl zipper carry case . . 12.00
- #DC-690 12VDC Auto adaptor/charger . . 9.00

**■ PROBES**

- #LP-22 Probe, Low Pass/Audio. \$22.00  
use with 2500 & 3500.  
Attenuates RF noise.
- #P-110 Probe, freq counter or. . . 39.00  
scope use, 1X, 10X.  
200 MHZ scope use.
- BNC INTERFACE CABLE
- #BNC-18 18" 50 Ohm cable. . . . . 6.50  
male BNC ea. end
- #BNC-PCA Adaptor, . . . . . 2.00  
F-BNC to M-PHONE



**ORDERS & INFORMATION  
305-561-2211**

**ORDERS ONLY - TOLL FREE  
800-638-8050**



**STARTEK INTERNATIONAL INC**  
398 NE 38th ST., FT. LAUDERDALE, FL 33334  
PHONE (305) 561-2211 FAX (305) 561-9133

TERMS: Shipping-handling charges for Florida add \$4 + tax, US & Canada add 5% (\$4 min, \$10 max), all others add 15% of total. COD fee \$4. Payment by VISA, MC, DISCOVER, COD for CASH or M.O. Prices & specifications subject to change without notice or obligation.

# A COMPLETE ELECTRONICS SUPERMARKET!

- Multi-Scan Super VGA Color Monitor** ..... \$269.00  
 Casper TM-5414 ★ MDA, CGA, EGA, VGA, & SVGA Compat. ★ 1024 × 768  
 ★ 14" ★ NEW ★ .31 mm dot pitch ★ 1 Yr. Warranty ★ IBM Compatible ★
- IBM Keyboard** (IBM P/N 645-0200) ..... \$49.95  
 Genuine IBM ★ Tactile Touch! ★ 84 key ★ 5 pin Din  
 ★ AT 286 & 386 Compatible ★
- 84 Key Keyboard** ..... \$19.95  
 AT/XT Compatible ★ Autosense ★ NEW ★
- XT Turbo Motherboard** (order # R/TURBO-10) ..... \$39.95  
 XT Compatible ★ 10 MHz ★ 8 Slot ★ w/Bios & CPU ★ 256k × 4 DRAM ★  
 0 K inst. ★ 2.1x faster than XT ★ 8088-1 CPU ★
- XT Motherboard** (order# R/XMB) ..... \$29.95  
 XT Compatible ★ 4.77 MHz ★ up to 640K using 256K × 1 & 64K × 1 DRAM  
 ★ w/BIOS & CPU ★ 8 Slot ★ 0 K installed ★
- 286-12 Motherboard** (order# R/XMB) ..... \$79.95  
 AT Compatible ★ 12 MHz ★ Mini Footprint ★ w/Bios & CPU ★
- 386-33 Motherboard w/CACHE!** (order# R/386CMBC-33) ..... \$449.00  
 33 MHz ★ 8 MB SIMM ★ 0 K inst. ★ w/Bios & CPU ★ 64K Cache ★
- 16 Bit 286/386 Floppy/Hard Controller** (order #R/AFH) ..... \$49.95  
 Supports 2 FDD's & 2 HDD's ★ 360kb to 1.44Mb FDD ★ AT Compatible ★  
 supports MFM Hard Drives ★ w/cables & manuals ★
- 8 Bit I/O Interface Card** (order #R/IO) ..... \$29.95  
 XT Compatible ★ PIO ★ SIO ★ Com 1-4 ★ 2nd SIO opt.  
 ★ Clock/Calendar ★ Game ★
- 0-384K Multifunction Card** (order #R/MF) ..... \$29.95  
 XT Compatible ★ 384K opt, 0K installed ★ PIO ★ SIO ★ Game Port  
 ★ Clock/Calendar ★ 2nd SIO opt. ★
- Monochrome Graphics Multi I/O** (order #R/MGMIO) ..... \$39.95  
 XT Compatible ★ Hercules Compatible ★ supports 2 360K FDD's  
 ★ Game port ★ PIO ★ SIO ★ Clock/Calendar ★ All in one slot! ★
- Multi I/O and Floppy Controller** (order #R/MIO) ..... \$29.95  
 XT Compatible ★ Supports 2 360K FDD's ★ PIO ★ SIO ★ Game Port  
 ★ 2nd SIO opt. ★ Clock/Calendar ★
- Eprom Programmer-Ten Gang** (order #R/EPROM-10)..... **SALE!** ..... \$149.95  
 w/Software ★ IBM Compatible ★ 2716 to 27512 ★
- IDE Hard Drive Controllers**
- with High Density Floppy controller ..... \$24.95
  - with High Density Floppy Controller and 2 SIO/1 PIO/game ports ..... \$29.95

Haltek Electronics is a 15,000 sq. ft. retail store in the heart of silicon valley. We offer one of the most diversified selections of high-tech goods from the oldest to state of the art. We are exceptionally strong with computer products, IC's passive components, electro mechanical, optics, wire & cable and probably one of the biggest inventories of Lambda power supplies around. We do not have a catalog or a product listing, due to the ever changing supply.

So give us a call and we will be happy to check stock for any and all your electronics needs.

# HALTEK

ELECTRONICS



1062 LINDA VISTA AVENUE • MOUNTAIN VIEW, CA 94043 • 408-744-1333 / 415-969-0510

CIRCLE 238 ON FREE INFORMATION CARD



# A COMPLETE ELECTRONICS SUPERMARKET!

- Printer Cables** (order #prntr cbl) ..... \$4.95  
Parallel ★ IBM compatible ★ 6' ★ NEW ★
- 182 MB ESDI Hard Drive** (order # R/1654) ..... \$495.00  
Micropolis 16545.25" H.H. ★ Refurb ★ 1 Yr. Warranty ★
- 40 MB MFM Hard Drive** (order # R/ST 251) ..... \$195.00  
Seagate ST 251-1 ★ 5.25" H.H. ★ Refurb ★ 1 Yr. Warranty ★ 28 ms
- 80 MB SCSI Hard Disk Drive** (order # R/ST-296N) ..... \$295.00  
Seagate ST-296N ★ 5.25" H.H. ★ Refurb ★ 1 Yr Warranty ★ 28 ms ★
- Hard Disk Cable Set** (IDS34 × IDE34 × IDE34) ..... \$2.95  
Extra 20 pin data cable ..... \$1.49
- Visible Laser Diode** ..... \$49.95  
Toshiba TOLD 9211 ★ w/docs ★ 670nm ★ Pulls ★
- Helium Neon Laser Tube** ..... \$14.95  
Approximately 1mW ★ w/mount & connector ★ w/o power supply ★
- 8" Digital Calipers** ..... **NEW!** ..... \$150.00  
Mitutoyo CD-8"/mm ★ Data Hold ★ data output ★ Plastic carrying case ★  
LCD High Visibility Display ★
- Mini HeNe Laser System** ..... **Tube & Power Supply** ..... \$79.95  
12 VDC input ★ Great for low recoil rifle sights ★ portable applications  
★ P/S 1" × 1" × 2.5" ★ Tube .75" × 3" ★
- Lens/Mirror Unit** ..... \$4.95  
Fuji Optical ★ 190mm lens ★ 1 1/8" front surface mirror ★ F1.5 ★
- S.C.S.I. Cable** ..... \$9.95  
DB25 male to 50 pin Blue Ribbon male ★ 3' ★ NEW ★
- 5 Volt Power Supply** ..... \$195.00  
Lambda #LYS-K-5-OV ★ 70 Amps ★ NEW ★ w/manual ★
- 12 Volt Power Supply** ..... \$39.95  
Lambda #LM-B-12 ★ 3 Amps ★ with O.V.P. ★
- Hand Held IC Tester** ..... \$185.00  
Tests TTL 74, CMOS 40/45 DRAM 4164-411000, 4416-44256 ★Auto power down  
★ 3.5"W × 7"L × 2"H ★ 9VDC battery or adapter (incl.) ★ New ★  
Identifies unknown TTL 74 and CMOS 40/45 ★ **compare price anywhere!** ★
- Keyboard Adapter** ..... \$3.50  
AT/5 pin DIN to PS/2 Microdin ★ use your AT Keyboard on a PS/2  
★ Great with our real IBM keyboards ★
- AT-IO Boards** (order #DIO-500) ..... \$18.95  
2 serial ports ★ 1 parallel printer port ★ game port ★ AT compatible  
★ short card ★ NEW ★

• • • ABOUT OUR REFURBS • • •

Our refurbished inventory contains items that fall into one or more of the following categories: 1) failed primary testing, 2) was sold and returned as failed, 3) cosmetically imperfect. In any case, the item was returned to the O.E.M. (original equipment manufacturer) and was reconditioned or fixed to original manufacturers specifications. HALTEK guarantees all refurbished products for 90 days from the date of purchase. Any item may be exchanged within that period. The management of Haltek Electronics requires that any returns be in the original packaging and be complete, including any and all manuals, cables, software, etc. and must be accompanied by the original sales receipt. Prices subject to change without notice • Quantities limited to stock on hand • All items are refurbished unless indicated as "new"

BRS# (415) 969-6321

# HALTEK

E L E C T R O N I C S



1062 LINDA VISTA AVENUE • MOUNTAIN VIEW, CA 94043 • 408-744-1333 / 415-969-0510

CIRCLE 238 ON FREE INFORMATION CARD

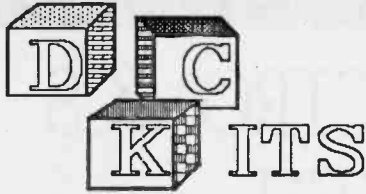

TOLL FREE ORDER  
HOT LINE  
1-800-423-0070

### KIT CORNER

#### WIRELESS FM STEREO BROADCASTER KIT

CAT. NO. SFM-II \$19.95

DC'S all new FM Stereo Transmitter Kit is based upon the unique BA1404 Stereo Broadcaster Integrated Circuit that includes all the complex circuitry to generate the stereo signal. The kit includes the new special IC, a 38 KHz crystal, circuit board, and all the small components. This fascinating project will provide many hours of enjoyment as you re-broadcast your CD/VCR/Cassette or stereo broadcasts from your satellite system thru your high-quality FM home or auto stereo system.



#### FUNCTION GENERATOR KIT ORDER FG2 KIT

\$19.95

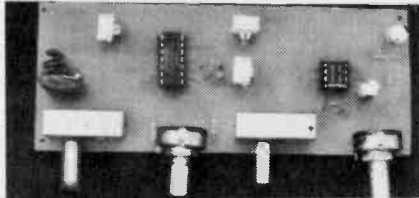

A great project to enhance your bench. This handy little function generator has a built-in buffer amplifier, a 3-decade range selector switch that covers 15 Hz to 25 kHz, output level control and function switch to select sine, square, or triangle.

#### ICL7106 EV KIT LCD DIGITAL PANEL METER NOW \$24.95

The ICL7106 EV Kit is based upon a 3-1/2 digit A/D converter that includes all the circuitry to build a digital panel meter. Operates from a 9-v battery. Includes LCD, 7106 IC, circuit board and small parts. Builder must add resistors to expand to multi-meter

#### POWER SUPPLY KIT PS-1 \$16.99

Output of this power supply is continuously adjustable from 1.2 to 25V DC. The LM317T voltage regulator provides excellent regulation and ripple rejection. Includes a 1 A transformer, PC board, LM317T, 2 binding posts, and all small parts.

#### 70-WATT STEREO POWER AMP 35 WATTS PER CHANNEL

Now you can boost your low power car stereo with the new PM-35 module kit. Each module can provide up to 35 watts per channel while operating from the vehicle's battery into a 4 ohm speaker system. New hi-tech power op-amps are used in a unique circuit to increase voltage swings, thus more power. Additional modules can be used to increase power to 100 or 200 watts/channel. ORDER PM-35 KIT \$19.95

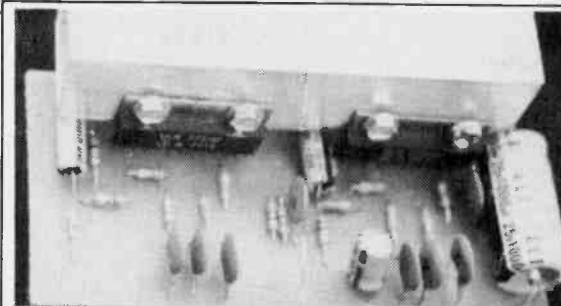

### PC BOARD HACKERS CORNER

#### MAKE CIRCUIT BOARDS THE NEW, EASY WAY



WITH TEC-200 FILM  
JUST 3 EASY STEPS

1. Copy circuit pattern on TEC-200 film using any plain paper copier.
  2. Iron film onto copper clad board.
  3. Peel off film and etch.
- ORDER TEC-200-10 FOR TEN

#### PC BOARD SUPPLIES

Copper clad boards for use with TEC-200

22-250 3 X 6	\$1.62
P1-36 3 X 6	2.03
22-260 4 X 6	2.27
22-261 6 X 6	2.88
22-263 6 X 9	4.08

#### POSITIVE PRESENTIZED PC BOARDS

22-330 2 X 4	\$3.83
22-332 3 X 4	4.40
22-334 4 X 6	5.78
22-336 6 X 6	7.60
22-338 6 X 9	9.63

### DC'S PARTS WAREHOUSE

#### UNIVERSAL DECODER (RE MAY 1990) ICs

CD22402E	7.95	CA3126E	1.95	NE564	2.29
LM733	.99	74C00N	.29	CD4053	.50
LM7805	.50	LM7812	.50	LM7905	.50
18 Uh CHOKE	.39	3.58 MHz	1.00		

ORDER ABOVE ITEMS DIRECT FROM THIS PAGE

#### MORE KITS

3 DIGIT LED DVM ONLY 3" X 3" READS 0 TO 100 V DC ORDER DVM3 \$19.95  
FM WIRELESS BROADCASTER FMI \$ 9.95  
8038 FUNCTION GEN. KIT FGI \$ 9.50  
SEQUENCER PROJECT SEQKIT \$ 9.50

#### CHRISTMAS TREE PROJECT

Build this unique seasonal project and have an unusual conversation piece. Powered by two D cells, 17 LEDs flash in a seemingly random fashion. Kit includes everything except batteries. ORDER XMASKIT \$16.95

#### UNIQUE IC's

NE602	\$2.00
UGN3013	.98
ULN2429	1.75
ZN414	2.00
XR2206CP	4.75
XR2212CP	4.75
MAX232	5.40
ULN3330	1.50
ICL8038	3.85
ICM7226BIPL	23.50

## DC ELECTRONICS

TO ORDER FROM THIS PAGE CALL: 1-800-423-0070  
SEND MAIL ORDERS TO:  
PO BOX 3203 SCOTTSDALE, AZ 85271



# BACK TO SCHOOL SPECIALS!

from

**CIRCUIT**

**SPECIALISTS**



**DIGITAL MULTI METER \$24.95**

**Order Stock #REDT-3800**

- 30 ranges
- 3 1/2 digit D.M.M.
- LCD display
- Measures: DC & AC current, resistance diode check audible continuity & transistor HFE

**LOGIC PROBE \$8.49**

**Order Stock #REL P-1**

- TTL/CMOS/DTL
- Hi/Low/Pulse/Hi impedance
- 20 MHz max input frequency
- Reverse power polarity protection
- 3 - 18 VDC
- Completely assembled, ready to use! Not a kit!!

**DIGITAL PULSAR \$9.95**

**Order Stock #RESJ-1**

- Accurate time base generator
- Output: open collector [interfacable with any logic circuits]
- 4.5 - 18 VDC
- 9 selectable output frequencies [16 MHz, 8 MHz, 1 MHz, 100 KHZ, 1 KHZ, 100 HZ, 10 HZ & 1 HZ]

## LOWEST COSTS ON BREADBOARDS!



> > > **OUR BREADBOARDS INCLUDE JUMPER WIRES!!**

Stock #	Bus Strips	Terminal Strips	Binding Posts	Total Contact Points	Special Back to School Prices
REWB-102+J	2	1	0	830	\$ 5.96
REWB-104-3+J	1	1	2	1360	\$11.37
REWB-104-1+J	3	2	3	1560	\$14.28
REWB-106+J	5	3	4	2390	\$19.98
REWB-108+J	7	4	4	3220	\$26.40

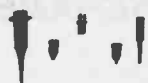

## > > > POMONA OSCILLOSCOPE PROBES

Stock #	Attn.	Length	Price
RE 5621	X10	4.92'	\$23.80
RE 4550	X1 & X10	4.92'	\$26.00



## > > > COMPUTER PARTS

Stock #	Function	Price
REMG P	Mono/graphics/printer card	\$ 14.50
REZCombo	Dual display card [CGA + MGP]+ CGA emulation	\$ 15.50
REATIO	2 Serial, 1 parallel, 1 game card	\$ 14.00
REParadiseVGA	16 Bit VGA card with 256K & Paradise chip [expands to 512K]	\$ 74.00
REG6300	16 Bit VGA card with 256K Genoa G6300 [expands to 512K]	\$109.00
RERVGA2	16 Bit VGA card with 256K Renaissance RVGA 2 [expands to 512K]	\$ 79.00
REET4000	16 Bit SVGA card with 1 meg installed, Tseng Labs ET 4000 chip	\$129.00
REB23	286 Motherboard 12 MHZ, AMI BIOS	\$ 79.00
REB16	286 Motherboard 16 MHZ, AMI BIOS	\$ 99.00
RESV1482	14" Color monitor super VGA [1024 X 768, .28 DP]	\$319.00
RENOV386-25	386 Motherboard 25 MHZ, AMI BIOS	\$390.00
RENOV386-33Cache	386 Motherboard 33 MHZ, 64K Cache, AMI BIOS	\$590.00

## THINKING ABOUT A COMPUTER SYSTEM?

Call us TOLL FREE for the latest prices on our HIGH QUALITY computer systems.

Circuit Specialists manufactures systems from low cost XT and 286 systems to the latest 486 EISA & ISA power systems!

For more information: Call TOLL FREE 1-800-528-1417 or FAX 1-602-464-5824

Visit our Warehouse/Showroom at 220 South Country Club in beautiful Mesa, Arizona - Home of the Red Hot Deals!!!

This offer expires November 30, 1991.



Visa, MasterCard & Discover Gladly Accepted

CIRCLE 228 ON FREE INFORMATION CARD

# Cable TV Equipment

**We Have The Best Quality Control on Zenith Equipment. Give Us A Try.**

	Quantity			
	1	5	10	20
<b>NEW PRODUCT</b> <b>Zenith Z TAC</b> All in one Anti-Flash Converter Descrambler Remote Control Audio Video RCA Jack, Dual Cable Capable, Volume Control. Loaded with features.	249.	199.	169.	
<b>Tocom 5503</b> All in one Converter Descrambler, Remote Control, Volume Control.	249.	209.	189.	
<b>Scientific Atlanta 8500 Series</b> All in one Converter Descrambler & Remote	189.	159.	149.	
<b>Scientific Atlanta 8535</b> All in one Converter Descrambler & Remote	229.	189.	179.	
<b>Hamlin CR6600M</b> All in one Converter Descrambler & Remote	139.	99.	89.	
<b>RTC 56</b> All in one Converter Descrambler & Remote	129.	89.	79.	
<b>Oak M35B</b> All in one Converter Descrambler Manual Pile.	59.	39.	35.	
<b>Jerrold 400 DRX-3DIC</b> All in one Converter Descrambler & Remote	109.	89.	79.	69.
<b>Jerrold 450 DRZ-3DIC</b> All in one Converter Descrambler & Remote	119.	99.	89.	

## TRY OUR NEW PIONEER DESCRAMBLER

REMOTE CONVERTERS				
Stargate 2000	89.	75.	65.	60.
Panasonic PZ PC1453G2	89.	76.	71.	66.
Jerrold 450 DRZ-3A	65.	55.	49.	45.

## ADD ON DESCRABLERS

TB-3	79.	55.	48.	45.
FTB-3	79.	55.	48.	45.
TVT-3 New Digital Trimode	99.	75.	68.	63.
SB-3	69.	49.	43.	39.
SA-3 B	79.	75.	48.	45.
MLD-1200	69.	49.	39.	35.
Pioneer Add On	139.	109.	89.	79.

All Orders Shipped U.P.S.

**(800) 822-9955**

**CABLE PLUS**

14417 CHASE ST., SUITE 481  
PANORAMA CITY, CA 91402

**Customer Service**

HOURS: M-F 10:30 AM-5:30 PM Pacific Stan. Time

NO CA SALES

**(818) 785-5104**





# CD-ROM RIOT

Retail Value Over \$5400 **MAGNAVOX** Retail Value Over \$5400

## Headstart 300CD COMPUTER w/CD-ROM

- 80286 Compatible with Dual Processor Speeds (12.5 and 8 MHz)
- 1 Megabyte RAM/Socket for 80287
- One 3-1/2" (1.44 Mb) Floppy Disk Drive
- One CD-ROM (680 Mb) Drive with Full Audio Capability
- Internal 40 Mb 28ms Hard Disk Drive
- 16-Bit VGA with 256K Video RAM
- Internal 2400 Baud Modem
- 3-Available 16 Bit Expansion Slots
- Battery-Backed Clock/Calendar
- Parallel Port, Serial Port, Mouse Port, Game Port
- 9-Pin and 15-Pin Video Ports, Stereo RCA Jacks
- 101-Key Keyboard • Headphones
- 3 Button Logitech Compatible Mouse
- 52 Software Programs (22 Programs Plus 30 Games Including Manhole)

### Software Included with Headstart 300CD

Headstart Environment, Pop-UPS, MS-DOS 4.01, GW-BASIC, Quattro 1.0, Q&A 3.0, Publish-It!, Deluxe Paint II, Mavis Beacon Teaches Typing, Backup Pro, Twist & Shout, Word For Word Professional, DS OPTIMIZE, DS RECOVER Prodigy, FLASHlink

Retail Value Over \$5400

6-Month On-Site Service

**\$995**

Like New Condition Magnavox Renewed

Year Parts and Labor Warranty

W/300 CD Purchase-Buy A Magnavox 14" VGA Color Monitor for ONLY \$100 External 5 1/4" - 1.2 MB Floppy Available! Additional CD-ROM Software Titles and Bundles are Available!!! Call for Pricing on the Magnavox 300CD 386-SX-16MHz CD-ROM System

CD ROM Software

- The Grolier Electronic Encyclopedia • Microsoft Bookshelf • Hot Line Two (National Directory of Addresses and Telephone Numbers) • PC Globe
- CD Guide Optical Edition • Audio CD Music Sampler • The Manhole

**PLUS 30 GAMES**

## HITACHI - CDR-1503S External CD-ROM System

- Second Generation Drive • Outstanding Performance and Reliability
- Slim Design and Reinforced Body - 15"x13"x3" • Allows For Stacking Between Computer and Monitor • Headphone Jack With Volume Control
- Drawer Style CD Holder - NO CADDY NEEDED • Access Indicator
- Open Indicator • Audio Output • Interface Card for IBM FC/XT/AT
- Daisychain Connection for up to Four Drives

- Includes MS-DOS Extensions Version 2.10
- Like New Condition • Refurbished
- 6 Month Warranty

WOW!!!

**\$379**

## We Currently Have The Following CD ROM Bundle Available

ONLY **\$169**

**ENCYCLOPEDIA** - From Grolier - All 21 volumes of the Academic American Encyclopedia with 33,000 entries, over 1,000 pictures and more than 9 million words. **REFERENCE LIBRARY** - Includes Webster's New World Dictionary, Dictionary of Quotable Definitions, Dictionary of 20th Century History, New World Guide to Concise Writing, National Directory, and J.K. Lasser's Legal Forms for Smaller Businesses. **WORLD ATLAS** - Over 240 Detailed EGA/VGA color maps and thousands of facts on government, economy, communications, and over 70 other topics. **US ATLAS** - Maps and Information on more than 200 US regions. **GAME PACK** - Includes the 5 following games: Beyond The Black Hole, Life & Death, Gin King, Bruce Lee Lives, and Chessmaster 2000. The Software Bundle is Sold at \$169 With CD-ROM Hardware Purchase. CD-ROM Bundle Without Hardware is \$299. Software Bundles Are IBM Compatible. Additional Titles Available CALL!

### PRINTER POWER

## SEIKOSHA-SL-80AI PRINTER

24-PIN Narrow Carriage - W/Tractor List \$499

135 CPS - 54 NLO  
- Parallel Interface  
Epson/IBM Emulation  
2 Year Warranty

AMAZING Brand New

**\$169**

Financing Available!

HOURS: Mon-Thurs 9AM-7PM  
Fri-Sat: 10AM-6PM  
1066 Sherman Avenue  
Hamden, CT 06514  
FAX 203-248-8680  
FAX ORDERS AND BIDS ACCEPTED!

# Electrified Discounters

Orders Only

(800) 678-8585

Customer Service & Technical Support (203) 287-1976  
Mon-Fri 9:00 am - 5 pm EST

30-DAY MONEY

BACK GUARANTEE!

Full Refund of HARDWARE

Price on all Advertised Products

Catalog Sent With All Orders

MasterCard

VISA

AMERICAN EXPRESS

Dealer Inquiries Invited

All Prices listed are Cash Discounted. Add 2-3% for MasterCard, VISA, or AMEX. Not responsible for typographical errors. Prices are subject to change without notice. Comm. residents add 6% sales tax. Quantities are limited! Prices do not include freight. Allow 3 weeks for personal/company check clearance. Compatibility is not guaranteed. IBM is a registered trademark of International Business Machines, Inc.

# Electrified

WE WILL TRY TO BEAT ANY PRICE ON ANYTHING FROM ANYWHERE !!!  
A TRULY PROFESSIONAL STAFF WITH A COMMITMENT TO SERVICE !!!

## SCANNING SCANNERS

### MICROTEK TELESCAN II

Intelligent Full Page Scanner/FAX Package  
Sheet Feed Design • 300 x 300 DPI Resolution

INCLUDES: **FREE** - Microtek Fax Board - 9600

- Full Utility Software • Up to 64 Shades of Gray
- Scanning Area - Max = 8-1/2" x 14", Min = 3" x 3"
- 4 Scaling Settings - Line Art Mode & Halftone Mode

Read Right OCR Software V.201 **\$199**

- One Step Direct Fax Scanning
- Feed up to 50 Pages
- Supports Both PCX and TIFF Formats
- Dual Voltage • Full Warranty

\*W/Microtek Telescan II Purchase

Quantity Discounts Available

**\$449**

## CHINON FULL PAGE SCANNER FLAT BED CAMERA TYPE

Includes: Utility Software  
Serial Scanner Cable  
(Hooks Up To Your Serial Port)

No Kit Required  
Resolution: 200, 150, 120, 100 DPI  
PCX and TIF Format-Zoom In Image  
Character Mode or Graphics Mode/Contrast Control

READRIGHT - OCR Software Only **\$199\***

Macintosh Interface Option Available

Parallel Interface Option Available

FAX Boards Are Available - ONLY **\$69\***

Full Manufacturers Warranty To The End User

\*W/Chinon DS-2000 Purchase List \$595 Quantity Discounts Available

**FREE\***  
OCR Compatible Software

Model DS-2000

**\$349**

## AT&T FULL-PAGE SCANNER

SAVE OVER 75%

MODEL SC-60 **BRAND NEW**

Sheet Feed Series

- Includes - IBM Compatible Interface Card Not Micro Channel Compatible
- Includes - AT&T PAGE POWER SOFTWARE (Draw, Scan and Fax Package)
- Includes - Microsoft Runtime Windows - Resolution 200 DPI Full-Page/400 DPI Half-Page - OCR Compatible OCR Software Now Avail. ONLY **\$169**

List \$1190

1 Year Warranty List \$1190

AMAZING ONLY

**\$299**



**FREE** Microsoft Windows 3.0 Upgrade

DIABLO-D80F	\$ 499	80 CPS-Ltr. Oily-w/Sheet Feeder, Refurbished
IBM 5182 - Color	New \$ 399	200 CPS, 35 NLO, Wide Car., Black or 8 colors.
PANASONIC KXP-1695	Renewed \$ 349	330 CPS - 66 NLO - Wide Carriage, 2-yr. warranty
PANASONIC KXP-1624	Renewed \$ 319	24-Pin, Wide Carriage, 192 CPS, 63 NLO, 2-yr. wty.
CENTRONICS-136B	New \$ 299	180 CPS - 34 NLO - Wide - Heavy Duty
CITIZEN MSP-50	New \$ 249	300 CPS-50 NLO - Narrow - Color Optional
PANASONIC KXP-1124	Renewed \$ 219	24-Pin, 192 CPS, 63 NLO - 2 Year Warranty
PANASONIC KXP-1123	Renewed \$ 189	24-Pin, 240 CPS, 53 NLO, 2-Year Warranty
TOSHIBA 301(Below Cost)	New \$ 199	Laptop Printer - 24 Pin - 180 CPS
SEIKOSHA SL-1600AI	New \$ 129	160 CPS - 40 NLO - Narrow - 2 Year Warranty
RITEMAN by C.ITOH	New \$ 119	120 CPS - 60 CPS Exp. - Narrow Carriage

# Electrified

WE WILL TRY TO BEAT ANY PRICE ON ANYTHING FROM ANYWHERE!!!  
A TRULY PROFESSIONAL STAFF WITH A COMMITMENT TO SERVICE!!!

## LAPTOP LAND

### BONDWELL LAPTOP SPECIALS

#### Model B-310-40-Plus Laptop

- 80C286-12MHz CPU - Zero Wait State • 40 MB Hard Drive (25ms) • 1.44MB Floppy Drive • 1MB of RAM
- Expandable to 2MB • 640x200 Resolution
- 10.5" Backlit Supertwist LCD Nonglare Display
- 31 Key Keyboard • Parallel Port • 2 Serial Ports
- CGA Video Port • Realtime Clock/Calendar with Lithium Battery Backup • MS-DOS 3.3/Basic
- 7.6 lbs • AC Power Adapter • 13"x12.2"x2.2"
- Rechargeable and Removeable Nicad Batteries

List \$2295

Your Cost

**\$995**

#### B-310 VGA-40

- 80C286-16MHz • 1MB Expands to 5MB
- 40MB Hard Drive • 1.44MB Floppy
- VGA Backlit Nonglare Triple Supertwist LCD
- PC Alarm System • Printer Port
- 2-Serial Ports • VGA Port
- Clock/Calendar w/Lithium Battery Backup
- MS DOS 4.01 • 7.5 lbs • 13"x12.5"x2.1"

**B-310-VGA-40 BUNDLE**  
Includes: Carrying Case  
• Extra Batteries  
• DAC Software  
(Word, Checkbook & Rolodex)  
Only \$100 More!

A Super Bargain!!

**\$1,079**



All Bondwell Products  
BRAND NEW  
Manufacturer's Warranty

#### Bondwell B-310SX VGA-80

- 80386SX • 16MHz • Zero Wait State
- 80MB Hard Drive (19ms) • 1.4MB Floppy
- 2MB of Ram Expandable to 5MB
- Shadow RAM Support • EMS 4.0 Drivers
- PC ALARM SYS. • Password Protected
- VGA Nonglare Triple Supertwist LCD
- Resolution 640 x 480 • VGA Port
- 81 Key Keyboard Parallel Port
- 2 Serial Ports • Real Time Clock/Calendar with Lithium Battery Backup
- MS-DOS 4.01 • 7.5 lbs. • AC Power Adapter
- Nicad Batteries Included • 13"x12.5"x2.1"

**ONLY \$1779**

#### B-310SX-VGA-40

Same as above w/40MB and 1MB of RAM

**ONLY \$1,479**

#### Model B-200 Laptop Special

- Fast - 80C88-8MHz • 640K-RAM-(2) 3.5" • 720K Drives
- High Definition Supertwist LCD Nonglare Display
- 640x200 CGA Resolution • Only 6.9 lbs.
- Parallel/Serial/RGB Video Port • 13"x12"x2.2"
- Rechargeable/Removable Nicad Battery Pack
- AC to DC Power Adapter • 81 Key Keyboard
- Full One Year Warranty From BONDWELL List \$1,079
- Includes DR DOS 3.41 by Digital Research **\$499**

New Models Coming from Bondwell  
B-330-SX-60 & B-310SL-120 CALL FOR INFO!!!

### MONITOR MANIA

#### MAGNAVOX CM9043 - EGA-COLOR

- 14" - EGA • 640 x 350 • Green Amber Text Mode • Hi-Resolution • CGA Compatible
- 64 Color Capability • Like New Condition - Renewed • 1-Year Warranty
- ITT-EGA Card w/Parallel/Serial — ONLY \$19

**\$179**

### MONITOR MANIA

#### MAGNAVOX 9CM082 - VGA

- 14" - Color Hi-Res - VGA Monitor
- 800x600 • Dot Pitch .31 • 31.5 KHz Horizontal Scanning Frequency
- Tilt & Swivel • 2-Year Warranty
- Like New Condition • Renewed

**ONLY \$279**

### MONITOR MANIA

#### PANASONIC C-1381

- 14" - Multisync Color Monitor • 1024 x 768 • Dot Pitch .28mm
- Non-interlaced or Interlaced Modes • Tilt & Swivel Stand
- Full 1-Year Warranty from Panasonic
- Like New Condition • Renewed

**\$309**

#### AT&T CRT-327-12" TTL

- HI-Res • 800x480 • Tilt & Swivel
- Black & White Monitor • INCLUDES AT&T 1024HP Card

List BRAND  
\$1390 NEW

Works on all IBM AT/XT's & Compatibles

**\$119**

6-\$115, 12-\$109, 24-\$105, Over 24-CALL 90 Day Warranty

#### NCR - 15" - Green - TTL

- with NCR - Monitor Card 640x400
- Save over 75%
- 1 YEAR Warranty BRAND NEW

List \$438

**\$99**

#### AMSTRAD COLOR VGA

- ULTRA HI-Res-12" VGA - Model 12HR • Tilt & Swivel
- 720x480-Anti-Glare Screen
- ONLY \$99
- STB-VGA Extra Card
- BRAND NEW 1 YEAR WARRANTY

.28  
DOT PITCH

**\$299**

### HARD DRIVE DEALS

- AT&T 40 MB Tape Backup Kit- Internal \$199
- MICROSCIENCE HH-1120 -122MB Formatted
- RLL 5 1/4" - 1/2 HL - 28 MS - 1-Year Warranty \$449
- MICROSCIENCE MODEL 4090 -
- 111MB (Unformatted), 93MB (Formatted)
- Access Speed - 18MS - 3-1/2" w/5-1/4" Frame-RLL
- 4 MB Access Track to Track • VOICE COIL DRIVE
- 1 Year Warranty \$399
- MICROSCIENCE 4070-62MB-MFM-18MS
- 3-1/2"-w/5-1/4" Frame - 1 Year Warranty-NEW \$349
- SEAGATE-ST-138R-32MB-RLL-3 1/2" \$189
- SEAGATE-ST-238-30MB-RLL-5 1/4"-1/2HT \$179
- SEAGATE-ST-225-20MB-MFM-5 1/4"-1/2HT \$149
- WESTERN DIGITAL-MFM-XT Cont. w/Cables \$ 49
- RLL Controllers for XT and AT's Available CALL

Seagate Warranty - 90 Days - OEM Pulls  
QUANTITY PRICING AVAILABLE - CALL

#### SEAGATE SWIFT ST-1100/94355-100

- 100MB Unformatted - 84 MB - Formatted
- Access Speed 15 MS MFM
- 3.5" Drive - BRAND NEW
- 6 Month Warranty
- Quantity Discounts Available!

AMAZING

**\$449**

#### PRIAM/VERTEX V-170

- 90MB -Formatted RLL • 60MB- Formatted MFM
- 28 MS Access Speed/Made in USA
- Full Ht., Voice Coil Technology
- Brand New • Pulls • 6 Month Warranty

**\$299**

#### SEAGATE ST-4051

- 40MB - Full Ht. - 40 MS - Seagate Pulls
- 15 Month Warranty Brand New Condition

**\$169**

### COMPUTER PRODUCTS

#### — Computers —

- Acer • Altos • Apple • Citizen • Compaq • Goldstar • JCC • Leading Edge • Quadrant • Mitsubishi • NEC • Packard Bell • Panasonic • Samsong • Sharp • Toshiba • Trinity • Unisys • WYSE

#### — Laptops —

- Bondwell • Compaq • Goldstar • Leading Edge • Mitsubishi • NEC • Packard Bell • Panasonic • Samsong • Sharp • Texas Instruments • Zenith

#### — Monitors —

- Amdc • Apple • AT&T • Goldstar • Hitachi • IBM • Magnavox • Mitsubishi • NCR • NEC • Packard Bell • Panasonic • Princeton Graphics • Samsong • Seiko • Sony • Tatung • Zenith

#### — Printers —

- ALPS • Apple • Brother • Canon • Citizen • C-ITOH • Diablo • Diconix (Kodak) • Epson • Fujitsu • Genicom • Hewlett Packard • IBM • Mar. • Messman • Tally • NEC • Okidata • Panasonic • Printronics • Seikosha • Televideo • Texas Instruments • Toshiba

Financing Available!

### Electrified Discounters

HOURS: Mon-Thurs 9AM-7PM  
Fri-Sat: 10AM-6PM  
1066 Sherman Avenue  
Hamden, CT 06514  
FAX 203-248-8680  
FAX ORDERS AND BIDS ACCEPTED!

Orders Only

**(800) 678-8585**

Customer Service & Technical Support (203) 287-1976  
Mon-Fri 9:00 am - 5 pm EST

30-DAY MONEY  
BACK GUARANTEE!  
Full Refund of HARDWARE  
Price on all Advertised Products  
Catalog Sent With All Orders



#### Dealer Inquiries Invited

All Prices listed are Cash Discounts. Add 2.12% for MasterCard, VISA, or AMEX. Not responsible for typographical errors. Prices are subject to change without notice. Conn. residents add 6% sales tax. Quantities are limited! Prices do not include freight. Allow 3 weeks for personal/company check clearance. Competitibility is not guaranteed. IBM is a registered trademark of International Business Machines, Inc.



Check into HSC's selection,  
then make your selection!

## Tiny 12 MHz AT Motherboard at a Tiny Price!

"Mini"-sized 7-slot AT-type motherboard (8.6" x 9.6") fits in standard cases or your custom application. Seven expansion slots (Five 16-Bit and Two 8-Bit). Room for up to 4 MB RAM on Motherboard (Uses 256K, 1M SIP or 1MB DIP). Chips & Technology Chip Set, 12 MHz 0-Wait 80286, built-in EMS 4.0 Hardware support for multitasking.

Competitive computing power...Performance benchmark within 10% of 386SX!

HSC# MBE12M7 **\$89.00**

Get your computer going with these add-ons:

HSC# HCFIDE Controller for two IDE Hard Drives & 2 MFM Floppies \$29.00

HSC# VKVG512 VGA Card 1024x768, 16 Color, 800x600, 256 Color \$75.00

### Noisy AC Power?

## AC Line Filter

15 Amps, 115VAC  
Provides Excellent RFI Noise Protection  
Grounded Cord & Receptacle Included

HSC# 12343 **\$12.50**

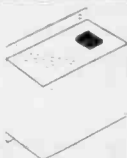

## Hard & Floppy Drive Hardware

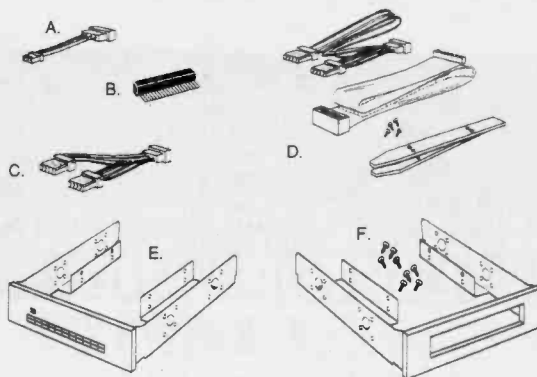
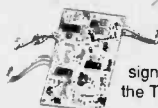

Fig.	Description	HSC#	Price
A	3.5" Floppy Power Adaptor Cable	11718	.99
B	3.5" Floppy Pins-to-Edge Data Cable Adaptor	ADT21080	2.49
C	Floppy or Hard Disk Power "Y" Cable (4')	FDDY	1.95
D	Cable & Rail Kit for 2nd Hard Disk Drive contains: Rails for AT Chassis, 4 screws, 20-pin Data Cable (21"), Power "Y" Cable with 14" long branch	12692	3.95
E	3.5" to 5.25" Hard Disk Drive Bracket, Used	12693	4.95
E	3.5" to 5.25" Hard Disk Drive Bracket, New	HDK325S	9.95
F	3.5" to 5.25" Floppy Drive Kit (incl. A & B above)	FDK325	9.95

## Return of the Amazing Hobbyist Project Boards!



You may remember these items from over a year ago...well, we found a few more! The board at left is a MTS Stereo decoder board from a television accessory device. We provide a pinout diagram for the connectors, but the rest is up to you! The item shown at right is a digital audio switch from the same television accessory unit. It will divert audio signals from five different (stereo) inputs to two different sets of output jacks. We provide a schematic and truth-table for the TTL inputs to control direction of the output. Your choice of project board, \$9.95 each while they last!

**\$9.95** each



## AC Adaptors

Fig.	Output	Plug	HSC#	Price
A	5VDC @ 500mA, ±12VDC @ 130mA	5p. DIN	12634	\$4.95
C	5VDC @ 1A, ±12VDC @ 250mA	5p. DIN	12245	\$14.95
A	5.8VDC @ 125mA <b>Special!</b>	2-pin	0286	\$1.25
B	9VDC @ 225mA	2.5mm	8735	\$2.95
B	9VDC @ 500mA	3mm Coax	10853	\$3.95
A	12VDC @ 500mA	3p. DIN	6814	\$4.95
A	14VDC @ 200mA	None	7976	\$2.95
D	Selectable Output & Polarity, 110/220 3.4, 5.6, 7.5, 9, 12VDC @ 300mA	Multiple	12406	\$3.95
B	17VAC C.T. @ 750mA	None	12424	\$3.95
B	24VAC @ 825mA	3mm Coax	12586	\$3.95



## Cable Madness!

HSC# 10816	HPIB Cable, .5 Meter	\$25.00
HSC# 12381	BNC Cable, 6 foot, RG58 (Pomona)	\$ 7.95
HSC# 12363	AC 3-Wire extension, 15 ft. 16-3 (black)	\$ 5.95
HSC# 12362	AC 3-Wire extension, 25 ft. 14-3 (orange)	\$ 7.95
HSC# 12029	SCSI Interconnect, 18 inch, 50p. to 50p.	\$ 7.95

## Ramsey Kits for the DIY'er...

HSC is proud to feature Ramsey Electronics Kits for the electronics hobbyist and "do-it-yourself" crowd...and they make more than just LED blinkers and sound-effects generators! Look at some of these exciting Amateur Radio projects! Send a SASE for complete list of kits available at HSC!

**AR-1** Aircraft Receiver kit: Listen to airlines, corporate and private pilots, control towers, approach and departure radar control and many other FAA services. Sensitive, smooth varactor tuning, speaker audio output. Detailed instruction manual makes assembly a snap! \$24.95, Case and knob kit \$12.95

**QRP-20, 30, 40, or 80** Ham Transmitter kits for 20, 30, 40 or 80 Meters: One-watt crystal controlled rigs with front panel switch for choosing between two VCO-controlled crystals, giving frequency range of up to 20 KHz. Pi-network antenna coupling to diode protected receiver T-R antenna jack. VSWR protection, VCO frequency tuning, 12-14 VDC operation. Each kit, \$29.95 Case and knob kit \$12.95

**HR-20, 30, 40, or 80** Ham Receiver kits for 20, 30, 40 or 80 Meters: Companion receivers to above transmitters. Better than 2 uV sensitivity, front panel RF Gain control, Audio Gain control, smooth varactor tuning, no toroids to wind! Uses popular NE602 IC and LM386 for audio output stage. Runs off a regular 9 V battery (not included). Each kit, \$27.95 Case and knob kit, \$12.95

**ETR-146** 2-Meter Synthesized Transceiver kit: No crystals needed! True frequency synthesis for 144 - 148 MHz. Front panel selection of favorite frequency pairs, and you can set up more if needed. 5 Watts RF Output. Accepts ICOM or equivalent speaker/mics. \$129.95, Case and knob kit \$24.95

**ER-146** or **FR-220** 2 Meter or 1.25 Meter (220MHz) Ham Receiver kit: Either one is a lot of receiver for the money! Dual conversion FM receivers designed around a sophisticated receiver-on-a-chip feature a microwave transistor RF amp., NE602 Mixer, Ceramic IF filters (10.7MHz & 455KHz), smooth, stable varactor tuning. Uses 9V battery (not included). \$29.95 each, Case and knob kit \$12.95

**FM-10** FM Stereo Transmitter kit: That's right, STEREO! Supply a music source to the line-level inputs, find a clear frequency and you are on the air with a school, home, camp or neighborhood FM station, operating per revised FCC Part 15 Rules. Easy assembly and operating instructions with FCC rules information. Tunes 88 - 108 MHz, very stable RF output, operates off one 9V battery (not included). Adjustable stereo balance and subcarrier, great stereo separation. \$29.95, Case and knob kit \$12.95

## dbx Noise Reduction Unit for your personal stereo

Uses two AAA batteries (not included). For dbx (or type "B" Dolby) encoded tapes. Features separate volume controls. Measures 4 3/8" x 1 1/4" x 1 3/16", with belt clip. Reduces annoying tape hiss, increases enjoyment!

HSC #12414

**\$4.95**



**HALTED** specialties co. **HSC Electronic Supply**

Toll Free (Orders Only) 1-800-4 HALTED (1-800-442-5833)

Retail Stores:

3500 Ryder St., Santa Clara, CA 95051

(408) 732-1573

4837 Amber Ln., Sacramento, CA 95841

(916) 338-2545

6819 Redwood Dr., Cotati, CA 94931

(707) 792-2277

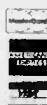

Terms: Some quantities are limited; all items subject to prior sale. Minimum order: \$10.00 plus shipping. Orders under \$20.00 subject to \$2.00 handling fee. All orders shipped FOB Santa Clara, CA (this means you pay freight) by UPS Surface (no P.O. Boxes) unless otherwise specified, in which case prevailing carrier rate plus \$5.00 handling fee applies. Prepaid orders for merchandise amounts only will be shipped through COD. If you have questions about your order, call Customer Service at (408) 732-1854 M-F 9AM to 5PM PST.

CIRCLE 245 ON FREE INFORMATION CARD

# MIKE NELSON'S MOVIE VIEW SALES, INC.

WHERE YOU'RE TREATED POLITE AND GIVEN INDIVIDUALIZED ATTENTION!

INFO (708) 766-5222/FAX (708) 766-5269

P.O. BOX 26 • WOOD DALE, IL 60191

Call C.S.T. Monday thru Friday 9:00 - 6:00 • Sat. 10:00 - 2:00

Friendly Courteous Service • 10 Yrs. Experience • 6 Mo. Warranty

JERROLD	1-3	4 or more
NEW TRI/BI COMBO (FTB)	130.00	125.00
NEW TRI/BI PAN	89.00	80.00
NEW SB-3 COMBO	115.00	110.00
NEW SB-3 PAN	60.00	55.00
DPV-7212	CALL	
<b>BASE BAND</b>		
DPBB-7212	CALL	
DRZ-3105	53.00	50.00
FTB-2	89.00	80.00
SB-2	60.00	55.00
<b>HAMLIN</b>	<b>1-3</b>	<b>4 or more</b>
NEW HAMLIN COMBO (CH 2 or 3)	115.00	110.00
NEW HAMLIN MLD-1200	60.00	55.00
MLD-1200-2	60.00	55.00

PIONEER	1-3	4 or more
NEW SA-PIO-COMBO	160.00	155.00
NEW SA-PIO-PAN	95.00	90.00
<b>SCIENTIFIC ATLANTA</b>		
NEW SA-3 COMBO (SA-3B)	130.00	125.00
NEW SA-3 PAN	89.00	80.00
<b>OAK</b>		
NEW OAK N-12 COMBO (Vari Sync)	115.00	110.00
NEW OAK N-12 PAN (Vari Sync)	60.00	55.00
M-35-B	50.00	45.00
<b>PANASONIC CONVERTERS</b>		
	20 LOT	100 LOT
	65.00	58.00
<b>ZENITH: CALL</b>		
8580:		250.00
8536:		190.00

## MOST ORDERS SHIPPED SAME DAY!

QTY.	ITEM	PRICE EA.	TOTAL PRICE

SUB TOTAL

SHIPPING Add \$4.00 per unit

COD & CREDIT CARDS Add 5%

TOTAL

**ABSOLUTELY NO ILLINOIS SALES —**

VISA-MASTER

C.O.D.

CASHIER'S CHECK

MONEY ORDER

**ORDERS ONLY: 1-800-735-5912**

Card # \_\_\_\_\_ Exp. Date \_\_\_\_\_

Name \_\_\_\_\_

Address \_\_\_\_\_

City \_\_\_\_\_ State \_\_\_\_\_ Zip \_\_\_\_\_

Phone ( ) \_\_\_\_\_

## (WAIVER) - MUST BE SIGNED FOR OUR RECORD

Yes, I am paying for full service. This is only to be used as a second unit.

**DECLARATION OF AUTHORIZED USE** - I, the undersigned, do hereby declare under penalties of perjury that all products purchased, now and in the future, will only be used on cable TV systems with proper authorization from local officials or cable company officials in accordance with all applicable federal and state laws. FEDERAL AND VARIOUS STATE LAWS PROVIDE FOR SUBSTANTIAL CRIMINAL AND CIVIL PENALTIES FOR UNAUTHORIZED USE.

SIGNATURE X \_\_\_\_\_

It is not the intent of MOVIE VIEW to defraud any television operator and we will not assist any company or individual in doing the same.

# COMPONENTS TO COMPUTERS

**Ray-O-Vac**  
Replacement  
Battery for AT



ACPP/N 844

ACP Only ..... \$9.95



## LED's

T-1 3/4 Infrared LED  
Qty 10 Only ..... \$1.49

T-1 3/4 Red LED  
Qty 10 Only ..... 79¢

T-1 3/4 Yellow LED  
Qty 10 Only ..... 99¢



## XELTEK

**E(E)PROM Programmers**

Single socket version ..... \$129.

4 socket version ..... \$199.

8 socket version ..... \$269.

16 socket ..... \$479.

### UNIVERSAL

Programs E(E)PROM, PROM,  
PAL, GAL, EPLD, FPLD, tests  
TTL, CMOS, RAM etc.,

UniPro ..... \$549.

### SUPER UNIVERSAL

Programs E(E)PROM, Flash  
EPROM, PROM, PAL, GAL,  
EPLD, FPLD (to 68 pins  
PLCC), tests TTL, CMOS,  
RAM etc. (to 40 pin),  
SuperPro ..... \$699.

### MICRO CONTROLLER PROGRAMMER

E(E)PROM, Controllers \$359.

### PLD PROGRAMMER

PAL, GAL, EPLD, FPLD \$129.

### NEW! "4-in-1" Test

### Measurement System

Frequency Counter(100MHz),  
function Generator (2 MHz),  
3-1/2 digit Multimeter and  
Power Supply all in chassis  
MFI-"4-in-1" Tester ..... \$799.

## 3.5" and 5.25" Bulk Diskettes Sale

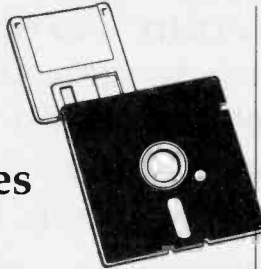

Disks certified to ANSI stan-  
dards with ACP's 100% Money-  
Back Guarantee, sleeves and tabs  
included. Labels available...

### 5.25" Diskettes DS/DD (360K)

Qty. 1000 DS/DD ..... 20¢ each

Qty. 500 DS/DD ..... 23¢ each

Qty. 100 DS/DD ..... 25¢ each

Qty. 25 DS/DD ..... 27¢ each

### 5.25" Diskettes DS/HD (1.2Mb)

Qty. 1000 DS/HD ..... 38¢ each

Qty. 100 DS/HD ..... 39¢ each

Qty. 25 DS/HD ..... 39¢ each

### 3.5" Diskettes DS/DD (720K)

Qty. 500 DS/DD ..... 38¢ each

Qty. 100 DS/DD ..... 39¢ each

Qty. 25 DS/DD ..... 39¢ each

### 3.5" Diskettes DS/HD (1.44Mb)

Qty. 500 DS/HD ..... 76¢ each

Qty. 100 DS/HD ..... 78¢ each

Qty. 25 DS/HD ..... 79¢ each

## MASS STORAGE

Hard Disk  
Specials  
All New

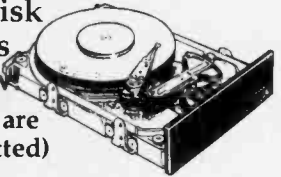

(all sizes are  
as formatted)

### AT Embedded Drives (IDE)

21.4Mb, 23ms, 2.5" drive,

#CP2024, list \$699, ..... sale \$399

42.8Mb, 28ms, 3.5" drive, 1" high

#CP3000, list \$549, ..... sale \$239

42.8Mb, 25ms, 3.5" drive, 1" high

#CP3044, list \$575, ..... sale \$289

84Mb, 25ms, 3.5" drive,

#CP3184, list \$845, ..... sale \$479

120Mb, 18ms, 3.5" drive, 1" high

#CP30104, list \$999, ..... sale \$549

104.9Mb, 25ms, 3.5" drive,

#CP3104, list \$930, ..... sale \$449

209.7Mb, 19ms, 3.5" drive,

#CP3204, list \$1555, ..... sale \$799

### SCSI Drives

42.8Mb, 25ms, 3.5" drive, 1" high

#CP3040, list \$575, ..... sale \$289

104.9Mb, 25ms, 3.5" drive,

#CP3100, list \$930, ..... sale \$489

21.4Mb, 19ms, 3.5" drive,

#CP3200, list \$1555, ..... sale \$849

## ASTEC Switching Power Supplies

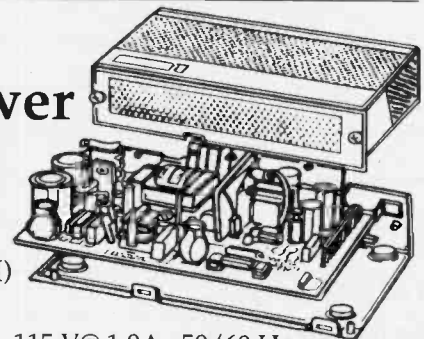

115 V @ 2.2A,

230V @ 1.2A

50/60 Hz (10 1/2 x 5x2 1/2" H)

### Output 1 128W

+5V @ 10A

+12V @ 2.5A

+12V @ 3.5A

-12V @ 0.5A

ACP Only ..... \$29.

### Output 2 86W

+5V @ 10A

+12V @ 1.0A

+12V @ 1.5A

-12V @ 0.5A

115 V @ 1.0A 50/60 Hz

230V @ 0.6A (7 3/4 x 4x2 1/2" H)

-5V @ 0.14A +24V @ 1.7A

+5V @ 2.2A

ACP Only open frame . \$24.

ACP since 1976 has in stock the largest and broadest selection of components and computers in Southern California. We are both wholesale and retail. Our retail facility is 14,000 sq. ft., located near the Orange County Airport. If you don't see the part you need, please give us a call. If you are a reseller or dealer we suggest you call our wholesale division at 714-558-8822. Thank you for considering ACP. Prices subject to change without notice. Quantities limited to stock on hand. Minimum order is \$10.00. All items new unless indicated. Product may be returned within 10 days from ship date with prior authorization from ACP. Returns must have RMA# and returned with copy of original packing slip and complete with original packaging, manuals, diskettes, etc.. Shipping charges added. Yes we accept VISA, Mastercharge, and AMEX.

# Advanced Computer Products

SINCE 1976 • 1310 E. EDINGER • SANTA ANA CA 92705 • 800-FONE-ACP • 714-558-8813 • FAX 714-558-1603





# PC-based Industrial & Lab Solutions



**PCL-718**  
**High Performance Data Acquisition Card**  
 The high-performance card, has A/D, D/A, D/I, D/O and counter/timer functions. Top specs, lot's of supporting software available  
 ACP Price ..... **\$649.**



**PCL-711S**  
**Your-PC Multi-Lab Package**  
 Low-cost fully-integrated package for general lab and industrial automation. 8 single-ended A/D inputs, one analog output (D/A), 16 digital inputs, 16 outputs, PCLD-7115 wiring terminal board and utility software.  
 ACP Price ..... **\$249.**



**PCL-755A/755C**  
**Slot Extension Card/Kit**  
 Compatible with IBM PC/XT and AT slots, plug in and raise the slot to top with straight pin-to-pin extension.  
**PCL-755A** ..... **\$49.**  
 The PCL 755C includes the PCL-755A plus a flat extension cable and external module to move four slots outside your PC making the slots more accessible for working with PC add-on cards.  
**PCL-755C** ..... **\$79.**



**PCL-812**  
**Enhanced MultiLab Card**  
 Enhanced version of the MultiLab card offers high performance as well as low cost. 16 single-ended A/D inputs, 2 analog outputs (D/A), 16 digital inputs, 16 outputs, counter/timer (INTEL 8253), DMA and interrupt capability.  
 ACP Price ..... **\$319.**

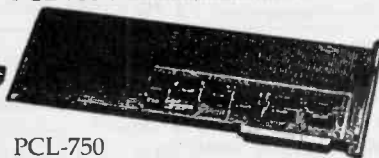

**PCL-750**  
**Prototype Development Card**  
 Excellent alternative to a pure breadboard card for prototype developing of PC add-on cards. Built-in basic circuits, 3290 holes, independent memory and I/O decoders, sizes jumper selectable, all bus signals buffered, marked and ready for use.  
 ACP Price ..... **\$79.**

**FG-8002**  
**Function Generator**  

- Wide frequency range: 0.02 Hz to 2 MHz
- Versatile Waveforms: Sine Triangle, Square, Ramp and Pulse, Screwed Sine
- TTL leveled square wave output
- Variable symmetry to generate sawtooth and pulse waveforms
- Applied 0 to 10V to VCF input implements external sweep and output freq.
- DC Offset voltage from 0 to ±10V can be superimposed to output waveform
- Maximum Attenuation of 40db can be obtained

 ACP Price ..... **Call**

## GoldStar®

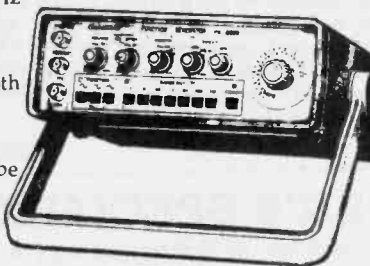

## Beckman Industrial™

Credit Card Size!



**Model DM78**  
**Digital Multimeter**  

- Slim-line design
- DC Volts, AC Volts, Ohms, Continuity, Diode test Functions
- Auto-Ranging
- Carry Case Included

 ACP Price ..... **\$29.95**

**Model 222F**  
**Digital Multimeter**  

- 3-1/2 Digits, Auto-Ranging
- Accuracy 0.50% rdg
- DC Volts, AC Volts, Ohms, Continuity, Diode test Functions

 ACP Price ..... **\$119.**

**Model 223F**  
**Digital Multimeter**  

- 3-1/2 Digits, Auto-Ranging
- Audible Bar-Graph
- Accuracy 0.25% rdg
- DC Volts, AC Volts, Ohms, Continuity, Diode test Functions

 ACP Price ..... **\$139.**

*Home of Orange County's Oldest and Largest Computer Swap Meet!*

Don't Miss It!  
**Sunday 8am-3pm**  
**Jan. 26**  
 Free Admission and Parking

# Advanced Computer Products

SINCE 1976 • 1310 E. EDINGER • SANTA ANA CA 92705 • 800-FONE-ACP • 714-558-8813 • FAX 714-558-1603

# "WE HAVE GREAT CONNECTIONS"

## #SPL-25

6 foot IBM/Clone parallel printer cable assembly type-biege w/thumb screws

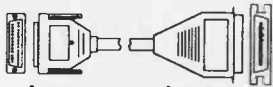

\$3 ea 10 up \$2.50 ea

## #SPL-29

DB25/F to DB9/M "AT" Mouse Adapter



\$2 each

## #SPL-31

Mini 6/M to DB9/M PS/2 Serial Adapter

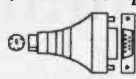

\$2 each

## #VC-6FF

6 foot TV Cable "F" male to "F" male

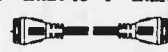

6 ft \$1 Ea 12/ \$10  
12 ft \$2 Ea 6/ \$10

## #CN-433

5 Pin DIN Female cable mount-black



25¢ ea 100/ \$20

## #VA-154 Copyguard Corrector

Enjoy videotapes without flashing and tearing

Macrovision methods often make it impossible to enjoy a clear, stable picture from prerecorded video cassettes. Picture roll, jitter, snow, tearing and flashing are the annoying side effects cured by the Copyguard Corrector. Sophisticated digital circuitry inside this compact unit (no larger than two 8mm tapes!), descrambles any copy-protection scheme and delivers a stable, whistle-clean signal. Connects easily between two VCR's, or your VCR and a video monitor, with its single video in and video out jacks. Recently, copy protection developers have successfully sued to keep descramblers such as the Copyguard Corrector off the market. We cannot predict for how long this unit will be available, and suggest you order early to be safe!



Reg. \$69.00 Now \$49 each or 2/ \$90 Special!

Unauthorized duplication of Copyrighted videotapes is prohibited by Federal Copyright Law!

## Serial/Parallel or Parallel/Serial Converter

This Serial/Parallel Converter allows serial to parallel interface conversion. Examples of applications are: Computer with RS-232C output to printer with Centronics input, etc. The converter provides the following interfaces to facilitate solving your interface problems properly: TTL or CMOS compatible Centronics input interface connector, RS232C compatible output interface of DB25S type connector, baud rate selectable from 150 all the way up to 19200, and DCE/DTE selectable features, etc. Also available in Parallel/Serial version.

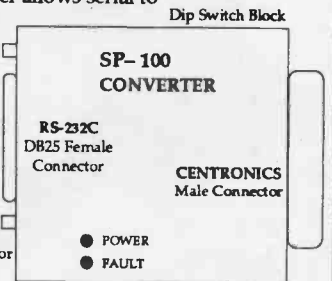

#CA-100SP Serial/Parallel Converter \$35 each 2/ \$60

#CA-100PS Parallel/Serial Converter \$35 each 2/ \$60

## #CC-737

Adapter for:

- Mac 512 to Mac Plus or better.
- Mac 512 to Apple IIGS.

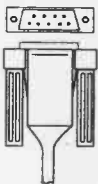

\$1.50 20 up \$1 ea

## #TM-319 DOUBLE DISK™ The original patented disk converter.

HOW IS THIS POSSIBLE? Have you ever tried to format a regular, double density 3.5" disk to 1.44 MB? Of course you have. It doesn't work. The computer gives you an invalid media error. So there must be a difference in the disk media. Right? Wrong! Surprisingly, manufacturers find it less expensive to use THE SAME MAGNETIC MEDIA for both HD and DD disks. THE ONLY DIFFERENCE IS THE EXTRA SENSE HOLE IN THE HD CASE. That hole tells the drive to operate in high density mode. So, how can you take advantage of the fact that the media is the same?

TWO YEARS OF TESTING. We've conducted an intensive testing program. We have converted over 159,800 disks and tested each one for data integrity. In two years NOT ONE CONVERTED DISK HAS LOST ANY DATA! SUCCESS! "The Double Disk Converter" is a true product success story. From the moment we put it on the market the order lines have been ringing non stop! Nearly every major corporation, school, university and government agency is now using the device. In fact, over one hundred thousand satisfied purchasers are converting millions of disks and SAVING SERIOUS MONEY with the Double Disk Converter™.

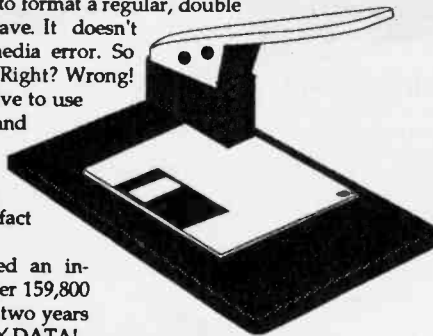

### STILL THE BEST

Made of heavy gauge, deep drawn steel! For all IBM/clones and Macintosh systems! Don't trust your data with anything less than The Original Double Disk Converter™!

\$26.95 4 up \$25 ea

## #CC-1001

100 ft RS-232 cable assembly, shielded 25 pin M/F. Gold plated pins. Fully shielded to stand shocks and misuse. Metal hoods.



\$30 4 up \$25 ea

Free 32 Page Catalog w/Order

## ROGER'S SPECIALIST

27712 Pinehills Avenue, Santa Clarita CA, 91351

Credit cards - Order 24 hours a day 7 days a week by FAX

Company Check or Money Order - Include \$3.50 for shipping and your phone number

Voice or FAX  
805-251-2520



Voice or FAX  
800-366-0579



Voice  
805-251-3085

Fast Service FAX Orders

**KELVIN DIGITAL MULTIMETERS**

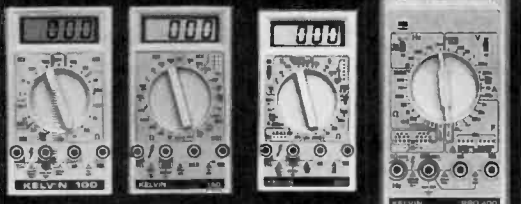

100 Basic	150 Basic+	200 Advanced	PRO 400 with 20MHz Freq Counter
DC VOLTAGE AC VOLTAGE DC CURRENT RESISTANCE CONTINUITY Test Buzzer DIODE TEST TRANSISTOR HFE 3 1/2 Digit LCD LOW BATTERY ACCURACY +/- 0.5% RDG IMPEDANCE-1 Meg	DC VOLTAGE AC VOLTAGE DC CURRENT RESISTANCE CONTINUITY Test Buzzer DIODE TEST TRANSISTOR HFE 3 1/2 Digit LCD LOW BATTERY ACCURACY +/- 0.5% RDG IMPEDANCE-1 Meg	DC VOLTAGE AC VOLTAGE DC CURRENT AC CURRENT RESISTANCE CAPACITANCE CONTINUITY Test Buzzer DIODE TEST TRANSISTOR HFE 3 1/2 Digit LCD LOW BATTERY ACCURACY +/- 0.5% RDG IMPEDANCE-1 Meg	FREQUENCY COUNTER TO 20MHz IDEAL FOR TROUBLE SHOOTING AC/DC VOLTAGE RANGES AC/DC CURRENT RANGES 5 FREQUENCY RANGES 5 CAPACITANCE RANGES LOGIC TEST CONTINUITY TESTER BUZZER DIODE CHECK TRANSISTOR HFE TEST LED TEST VERIFY GOOD/BAD DISPLAY - 3 1/2 Digit LCD ACCURACY - 0.5% IMPEDANCE - 10 Mega Ohm
<b>\$19.95</b>	<b>\$29.95</b>	<b>\$39.95</b>	<b>\$69.95</b>

**Protective Cases**  
For Models 100, 150, 200 ..... \$4.95 Case For Model Pro 400 ..... \$9.95

**DIGITAL TRAINER**

Trainer Manual (100 Pgs) gives detailed instructions. An excellent training tool covering topics for High School (Beginner/Advanced), Trade School (Beginner/Intermediate) & College.

A PERFECT FIT WITHIN ANY DIGITAL CURRICULUM & YOUR CLASSROOM TEXTBOOK

**THE KELVIN LDT™ Laptop Digital Trainer**

ONLY **\$99.95**

Stock No. 840460

FREE COMPREHENSIVE TEACHER/STUDENT LAB MANUAL

FEATURES:  
 ■ ONE DIGIT TRUE HEXADECIMAL DISPLAY WITH BUILT IN LOGIC MEMORY, DECODER, DRIVERS FULL ALPHA CHARACTER  
 ■ TWO INDEPENDENT CLOCKS - USER ADJUSTABLE FREQUENCY & DUTY CYCLES  
 ■ BREACBOARD-500 PT PROTO-TYPE AREA  
 ■ TWO POWER DISTRIBUTION SWITCHES (GND, VCC)  
 ■ 4 8 BIT BIT SWITCHES  
 ■ MOMENTARY PUSH BUTTON SWITCH (SPDT)  
 ■ 4 LED DISPLAYS w/IC DRIVERS  
 ■ POW'ER SUPPLY: WALL PLUG-IN TYPE, U.L. LISTED  
 ■ VOLTAGE REG-±5 VOLTS, SHORT CIR. OVERLOAD PROTECT  
 ■ HOOK-UP WIRES  
 ■ COMPACT CARRYING CASE  
 ■ INSTRUCTION MANUAL FOR BEGINNER TO ADVANCED USERS  
 MADE WITH PRIDE IN THE USA

**WALL TRANSFORMERS**

**WALL TRANSFORMER**

STOCK NO. TYPE - Female  
 220069 1V DC/500 mA ..... \$3.95 ea  
 220068 2V DC/500 mA ..... \$4.25 ea

**MALE JACK**

STOCK NO. TYPE  
 370044 2.1 mm Male  
 \$ .49 ea ..... \$ .39 /10.

**BREADBOARDS**

680093  
 680097

**COMPONENTS**

Stock No.	TYPE	YOUR COST
600021	555 TIMER	\$.20 EA
600029	556 DUAL TIMER	\$.40 EA
600039	LM566 PLL FUNCTION GENERATOR	\$.60 EA
600018	741C OP-AMP INTERNALLY COMPENSATED	\$.30 EA
600026	1458 OP-AMP DUAL 741C OP-AMP DIP	\$.35 EA
630041	2N2222	\$.18 EA
630383	PN2222	\$.08 EA
600023	7805 VOLTAGE REG.	\$.36 EA
600014	SILICON CONTROLLED RECTIFIER (Similar to GE C106C1) 4.0 AMP, 100 PIV	\$.89 EA

**WIRE JUMPER KIT**  
 Pre-cut, Pre-Stripped  
 330289 140 Piece Set ... \$ 4.75  
 330290 350 Piece Set ... \$ 7.75

**FLUKE 87**

**FLUKE 70 Series II**  
 FLUKE 3 YEAR WARRANTY

**DISCOUNTED PRICES!**

**BEST BUY - NEW Series II**

FLUKE 70 Series II	\$ 63
FLUKE 73 Series II	\$ 89
FLUKE 75 Series II	\$127
FLUKE 77 Series II	\$149
FLUKE 79 Series II	\$169
FLUKE 83	\$199
FLUKE 85	\$229
FLUKE 87 True RMS	\$269
FLUKE 86 AUTOMOTIVE	\$367
FLUKE 88 AUTOMOTIVE	\$423
FLUKE 45	\$579

**FLUKE 97 SCOPEMETER**

**NEW! SCOPEMETER™ SERIES**  
 HAND HELD, 50 MHz, DUAL CHANNEL

FLUKE 93 ..... \$1095  
 FLUKE 95 ..... \$1395  
 FLUKE 97 FULLY LOADED ... \$1695

**SCOPES**

**20 MHz SCOPE** ..... \$345  
 Dual Trace 2 Yr Warranty-Parts & Labor  
 Stock No. 740085

**SCOPE PROBES**

60 MHz, X1 & X10 SPECIAL  
 700072 ..... \$18.95  
 150 MHz, X10  
 700073 ..... \$39.95

**BATTERIES**

Duracell / Eveready  
**9V Alkaline Battery**  
 \$1.95 ea  
 \$1.75 ea/10+

**9V Battery SNAP & HOLDER**  
 Snap \$ .15 ea \$ .10 ea/100+  
 Holder \$2.20 ea \$ .10 ea/100+

**LED CENTER**

**SPECIAL SPECIAL SPECIAL**

**RED LED**  
 As Low As **5¢** ea/1000+ Qty

**JUMBO LED**

TYPE - T 1 3/4, 5mm  
 STOCK NO. YOUR COST 1000+ Qty  
 260020 Red \$.06 ea/100+ \$.05 ea  
 260027 Green \$.08 ea/100+ \$.07 ea  
 260026 Yellow \$.08 ea/100+ \$.07 ea

**LED HOLDER**  
 for T 1 3/4 SIZE, BLACK  
 Stock No. 250019  
 \$.10 ea/100+ Qty

**LED DISPLAY**

**Bar Graph**

STOCK NO. COLOR YOUR COST 10+ Qty 20 Pin  
 260058 Red \$1.99 ea \$1.79 ea  
 260088 Green \$1.99 ea \$1.79 ea  
 260089 Yellow \$1.99 ea \$1.79 ea

**MOVING SIGN DISPLAY**  
 for Fabricating Your Own Moving Sign Display

50 mm  
 STOCK NO. 280091  
 \$5.95 ea  
 \$5.45 ea/20+

**TEST ACCESSORIES**

**IC CLIPS**  
 SOLDER TYPE SPRING LOADED  
 STOCK NO. COLOR COST 25+ Qty  
 990104 BLACK \$.65 ea \$.50 ea  
 990105 RED \$.65 ea \$.50 ea

**IC TEST LEAD SET**  
 5 COLOR CODED 18" LEADS WITH MINATURE HOOK-ON PROD. AT BOTH ENDS  
 Stock No. YOUR COST 3+ Qty  
 990108 \$8.95 ea \$8.25 ea

**DOUBLE BANANA JACK**

Stock No. YOUR COST 3+ Qty  
 500056 \$2.30 ea \$2.07 ea

**FEMALE BNC TO DUAL BANANA PLUG**

Stock No. YOUR COST 3+ Qty  
 990103 \$2.95 ea \$2.75 ea

**DUAL BANANA BINDING POST TO MALE BNC PLUG**

Stock No. YOUR COST 3+ Qty  
 600058 \$5.95 ea \$4.95 ea

**BNC TEST CABLES 3 FT.**

**MALE TO MALE**

Stock No. YOUR COST 3+ Qty  
 990101 \$3.45 ea \$2.95 ea

**PROJECT PARTS**

**Soldering IRON**  
 with STAND, BLUE LONG LIFE TIP  
 Stock No. 990098  
 \$4.50 ea

**Project Speaker**  
 2", 8 Ohm, .1 Watt  
 Stock No. 350009  
**59¢**

**Project BUZZER**  
 3-9 Volt DC, 80 db  
 Stock No. 680089  
**\$1.59 ea**  
 \$1.39 ea/10+ Qty

**HORN ALARM**  
 Loud Penetrating Sound  
 Stock No. 640001  
**\$.75 ea**  
 9V DC  
**\$.69 ea/10+ Qty**

**DC MOTOR**  
 for SOLAR/ROBOTIC  
 Stock No. 852211  
**\$.50 ea**  
 1.5 to 6VDC  
**\$.45 ea/20+ Qty**

**XENON STROBE TUBE**

Stock No. 260050  
**\$2.95 ea**  
**\$2.50 ea/20+ Qty**

**TRIGGER COIL**  
 for XenonStrobe Tube  
 Stock No. 320037  
**\$1.25 ea**  
**\$.89 ea/20+ Qty**

**INFRARED LED**  
 IR Pair, LED infrared transmitter and receiver  
 Stock No. 260061  
**\$2.79 ea**

**NEON LAMP**  
 NE2, Long Leads  
 Stock No. 260003  
**\$.15 ea**  
**\$.12 ea/100+ Qty**

**PHOTO CELL**  
 CADMIUM SELENIDE  
 Stock No. 260017  
**\$.99 ea**

**PHOTO CELL**  
 SULPHIDE  
 Stock No. 260018  
**\$.99 ea**

**PUSH-BUTTON SWITCH**  
 PUSH-ON, PUSH-OFF  
 Stock No. 270021  
**\$.55 ea**  
**\$.49 ea/100+ Qty**

**SUB-MINIATURE MOMENTARY SWITCH**

Stock No. 990002  
**\$.35 ea**  
**\$.28 ea/100+ Qty**

**MINIATURE TOGGLE SWITCH**

Stock No. 270034  
**\$.90 ea**  
 Type - SPST  
**\$.79 ea/50+ Qty**

**KELVIN ELECTRONICS**

CIRCLE RESPONSE CARD or WRITE for our CATALOG full of WHOLESALE PRICED ITEMS.

**OVER 10,000 ITEMS IN STOCK**

ELECTRONIC COMPONENTS & TECHNOLOGY ACTIVITIES

VISA & MASTERCARD ACCEPTED  
 \$20 MINIMUM ORDER  
 MINIMUM FREIGHT \$5



# ARE YOU INTERESTED IN AMATEUR RADIO? *NARA Can Help You!*

## NARA Educational Package



Everyone in the family can get their Ham Radio license with the help of the NARA Educational Package.

Includes:

- \* IBM Compatible Software for Novice and Technician class licenses.
- \* *The Ham Radio Handbook* (see right for description)
- \* FCC Rules and Regulations
- \* Complete list of Contact Volunteer Examiners
- \* Amateur Radio - KING OF HOBBIES. A special written introduction to Amateur Radio.

\$29.95 (\$3.00 S&H)

## The Ham Radio Handbook

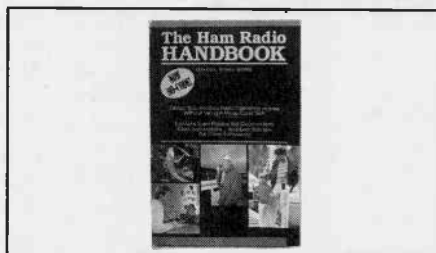

Everything you need to know to pass the exam for the Codeless Technician license is in *The Ham Radio Handbook*.

Includes:

- \* All possible questions and all correct answers
- \* Simple and easy theory explanations along with photos and drawings
- \* Chapters devoted to each subelement to eliminate confusion

\$9.95 (\$2.00 S&H)

## Part 97 FCC Rules and Regulations

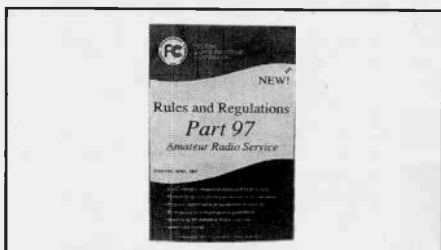

An important guide for everyone interested in the Amateur Radio Service.

Includes:

- \* All rules and regulations governing the Amateur Radio Service
- \* Amateur Radio technical and equipment standards
- \* Emergency communications guidelines
- \* Frequencies and privileges available to all licensees

\$4.95 (\$1.00 S&H)

## NARA Membership



Get involved in the Amateur Radio community join NARA today! NARA is a non-profit organization dedicated to encouraging others to become involved in the Amateur Radio Service.

Membership includes:

- \* One year subscription to NARA *Communicator* magazine
- \* Latest facts on whats happening in Amateur Radio

\$10.00 1yr., \$18.00 2 yr., \$25.00 3yr.

**TO PLACE YOUR ORDER CALL NARA AT 1-800-GOT 2 HAM (1-800-468-2426)  
OR CONTACT YOUR LOCAL AMATEUR RADIO DEALER**



**NARA**

NATIONAL AMATEUR RADIO ASSOCIATION

16541 Redmond Way, Suite 232-H  
Redmond, WA 98052

CIRCLE 249 ON FREE INFORMATION CARD

The world's smallest 12-band receiver.

Includes digital clock, travel alarm, headphones, deluxe travel pouch, and Grundig guide book. Measures approximately 3 1/2" x 5 5/8" x 1 1/4" and weighs a mere 14 ounces!



The world is at your fingertips with...

# The Grundig World Band Receiver

Announcing a revolutionary breakthrough in world-band radios...from Grundig, the leader in German short-wave electronics. This miracle of miniaturization is not sold in U.S. stores or catalogs—only Willabee & Ward has it!

**Tune in to events around the globe.** The RK-709 is the world's smallest 12-band receiver—AM, FM, FM Stereo (with headphones, included), and all 9 major shortwave bands. Small enough to fit into a pocket, briefcase, or purse, yet big on features. Telescoping antenna pulls signals from anywhere in the world. Listen to legendary BBC newscasts—the best in the world. Hear what Radio Moscow is saying about Gorbachev, Yeltsin, and President Bush. Listen to the Voice of America when you travel abroad. Follow a crisis or breaking story wherever you are and no matter where it's happening: Baghdad, Panama, Beijing or Tokyo.

You don't have to pack a travel alarm, either.

You won't need it—this is better. The RK-709 wakes you with the radio or its ingenious "Humane Wake System"—the tone begins softly and gathers volume until you wake up! The digital alarm clock features a sleep timer that turns off the radio 10 to 60 minutes after you turn in!

**Only \$159!**

**Payable in monthly installments.**

The Grundig RK-709 is only \$159 (plus \$7.50 shipping/handling), payable in convenient monthly credit card installments. Includes deluxe carrying pouch and stereo headphones. One year warranty, 30 day money back guarantee. Order today.

Don't be confused by other 4, 5, 7, or 9 band radios. Grundig's RK-709 is today's best buy on a real 12 band receiver.

**CALL TOLL-FREE: 1-800-367-4534 Ext. 623-166**

Willabee & Ward  
47 Richards Avenue  
Norwalk, Conn. 06857



Satisfaction guaranteed.

**CALL TOLL-FREE: 1-800-367-4534**  
Ext. 623-166

Please send me \_\_\_\_\_ Grundig RK-709 World Band Receiver(s). For each receiver, charge 4 installments of \$41.63\* to my credit card:

- MasterCard     VISA  
 Discover         Am. Ex.

Credit Card # \_\_\_\_\_ Exp. Date \_\_\_\_\_

Name \_\_\_\_\_  
PLEASE PRINT CLEARLY

Address \_\_\_\_\_

City/State/Zip \_\_\_\_\_

Signature \_\_\_\_\_  
(All orders subject to acceptance.)

I prefer not to pay by credit card and will pay by check. Enclosed is my check for \$159\*\* plus \$7.50 shipping/handling, a total of \$166.50 for each receiver.

\*Any applicable sales tax will be billed with shipment.

Phone orders normally shipped next business day.

**Zener Diode Kit**

5 pieces each of the following 1 watt zeners: 5.1V, 5.6V, 6.2V, 6.8V, 7.5V, 8.2V, 9.1V, 10V, 12V, 13V, 15V, 16V, 18V and 24V. This is a comprehensive assortment of popular voltages. Each value is individually packaged and labeled. 70 pieces



#RN-320-190 **\$12<sup>50</sup>** Each

**Electrolytic Capacitor Kit**

A good assortment of useable electrolytic capacitors. Assorted capacitance and voltage values. 50 pieces total.



#RN-020-910 **\$2<sup>95</sup>** Each

**Ceramic Capacitor Kit**

A good assortment of values and working voltages. Popular sizes. 100 pieces total.



#RN-020-900 **\$1<sup>95</sup>** Each

**300 Piece Capacitor Kit**

One of our most popular kits. 300 piece assortment consisting of electrolytics, ceramics, mylars, and more. Many different values and voltages. Well worth many times the cost.



#RN-020-920 **\$4<sup>95</sup>** Each

**Value Kit**

A comprehensive assortment of motors, switches, capacitors, connectors, lamps, transformers and more. A guaranteed wholesale value of at least \$25.00.



#RN-320-145 **\$4<sup>95</sup>** Each

**Heat Shrink Tubing Kit**

Kit contains 4 ft. each of the following sizes: 1/16", 1/8", 1/4", 1/2" and 3/4" sizes before heating. Assorted colors. Shrinks to 50% of original size.



#RN-320-170 **\$6<sup>95</sup>** Each

**3 Lb. Hardware Assortment**

A good assortment of small wood, sheet metal and machine screws, machine bolts, nuts, washers, and other hardware. Hundreds of fasteners in different styles, sizes and finishes.



#RN-081-005 **\$3<sup>95</sup>** Each

**Matching Transformer**

Adapts 75 ohm coax to 300 ohm twin lead (or visa-versa) at antenna or television. 5-90 MHz UHF/VHF. 3 capacitor PC board type.

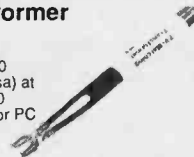

#RN-180-010 **49¢** (1-49) **35¢** (50-up)

**F-59 Connector**

Popular connector for cable TV systems. Full ferrule for hex crimp. Securely holds RG-59 cable.



#RN-090-355 **22¢** (1-49) **16¢** (50-up)

**Push-On "F" Adaptor**



#RN-090-357 **50¢** (1-49) **38¢** (50-up)

**F-81 Connector**  
(With nut and washer)

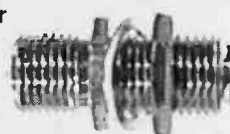

#RN-090-360 **40¢** (1-49) **30¢** (50-up)

**"F" Type Grounding Block**



#RN-090-338 **50¢** (1-49) **38¢** (50-up)

**"F" Right Angle**



#RN-090-337 **90¢** (1-49) **70¢** (50-up)

**Deluxe Push-On "F"**  
(Full attached ferrule)



#RN-090-356 **60¢** (1-49) **48¢** (50-up)

**3.5 Amp DC Power Supply**

A quality, compact 12 VDC power supply. Perfect for testing car stereos, CB equipment, radar detectors and other 12 VDC items. Regulated 13.8 VDC, 3.5 amp continuous, 6 amp surge. LED power indicator. Binding post outputs. Net weight: 4 lbs.



#RN-120-500 **\$79<sup>50</sup>** List **\$23<sup>80</sup>** Your Cost

**Quality 30 Watt Iron**

Economical 30 watt iron with replaceable tip. Blue plastic handle. 120VAC. A quality iron at a reasonable price. Display packaged.



#RN-370-010 **\$4<sup>90</sup>** (1-9) **\$4<sup>70</sup>** (10-up)

**Soldering Stand**

Convenient weighted soldering iron stand with cleaning sponge. Display boxed.

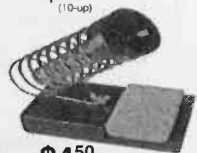

#RN-370-020 **\$4<sup>95</sup>** (1-9) **\$4<sup>50</sup>** (10-up)

**Mini Diagonal Plier**

4-1/2" side cutters. Drop forged steel. Dipped plastic, insulated handles.



#RN-360-010 **\$4<sup>25</sup>** (1-9) **\$3<sup>80</sup>** (10-up)

**4-1/2" Long Nose Plier**

Quality drop forged steel. 4-1/2 inch overall length. Insulated, rubber dipped handles.



#RN-360-030 **\$3<sup>75</sup>** (1-9) **\$3<sup>35</sup>** (10-up)

**Alligator Clip Set**

10 piece set contains two of each: Black, red, white, green, and yellow. 24 gauge, 12" length.



#RN-360-150 **\$3<sup>25</sup>** (1-9) **\$2<sup>75</sup>** (10-up)

**Cleaning Brushes**

Perfect for cleaning PC boards and other electronic assemblies. 8" overall length. Available with brass or nylon bristles.



#RN-360-400 (Nylon) **95¢** (1-9) **79¢** (10-up)  
#RN-360-405 (Brass)

Quantity pricing applies per part number only.

**Thruster Woofers**

Designed to take a beating! Specially manufactured with the automobile environment in mind. Humidity resistant polymerized paper cones. Gives them the sound quality of paper and the durability of polypropylene. Heavy duty oversized magnets. Two color printed polymerized dust caps. Red foam anti-fungal surrounds, and structurally superior stamped frame baskets.



Order#	Size	Magnet	V.C.	Z	Freq. Resp.	Power Cap.	SPL 1W/1M	QTS	fs	VAS	List	Your Cost
#293-040	8"	25 oz.	1.5"	4	35-4KHz	150W Max	95 dB	.14	39	1.94	\$59.95	\$24.95
#293-090	10"	30 oz.	2"	4	30-2KHz	175W Max	96.23 dB	.12	32	3.78	69.95	29.95
#293-125	12"	40 oz.	2"	4	25-2KHz	200W Max	96.1 dB	.16	28	7.38	85.95	39.95
#293-150	15"	50 oz.	2"	4	23-2KHz	250W Max	97.85 dB	.20	25	19.04	99.95	59.95



## Car Stereo Patch Cables

Special extra long patch cable for connecting low level car stereo output (RCA) directly to a power amplifier. 17 foot length with ground strap to cut down on interference. Gold plated connectors.



#RN-240-140 \$4<sup>25</sup> \$3<sup>95</sup>  
(1-9) (10-up)

## 12" Subwoofer Box



The perfect high volume cabinet for dual voice coil subwoofers. Cabinet volume: 2 cu. ft. with dual ports. This cabinet really performs (and it fits in most autos). It even works well behind the back seat, in the trunk of your car. Box comes with a pre-cut 11" hole for a woofer and port holes. Charcoal carpet covered with carry handles and input terminals. Dimensions: 13" (H) x 13" (D) x 30" (W). Net weight: 29 lbs.

#RN-260-495 \$59<sup>90</sup>  
Each

## 12" Pioneer Subwoofer



12" super duty, dual voice coil subwoofer. 30 oz. magnet, 2" voice coil. 100 watts RMS. 145 watts max power handling capability. 25 Hz resonant frequency. 6 ohm impedance (4 and 8 ohm compatible). Sensitivity: 89 dB/1W/1M. Response: 25-700 Hz. QTS=.31, VAS=10.3 cu ft. Dimensions: A= 12", B= 4-3/4", C= 3-3/4", D= 1-1/2". Hole: 11-1/4". Net weight: 6 lbs. Pioneer #A30GU30-55D.

#RN-290-145 \$39<sup>80</sup> \$36<sup>80</sup>  
(1-3) (4-up)

## Subwoofer Crossover Network



Super duty, 200 watt RMS power handling capability. Designed specially for dual voice coil subwoofer systems. 12 dB per octave roll-off at 150 Hz into 8 ohms. Crossover also features a set of outputs for use with your existing speaker system. Network is totally passive, requiring no power source of its own.

#RN-260-220 \$28<sup>80</sup> \$24<sup>40</sup>  
(1-5) (6-up)

## Subwoofer Input/Output Terminal

This recessed terminal panel has inputs for right and left channels as well as outputs for right and left channels to route to your satellite speakers. Greatly simplifies subwoofer hook-up. Outside dimensions: 3-7/8" x 5-3/8".



#RN-260-308 \$3<sup>95</sup> \$3<sup>50</sup>  
(1-9) (10-up)

## 12 Gauge Neon Wire

The competition in today's auto sound contests is so fierce that good sound alone is not enough to win. More and more installers are striving to make their installation more pleasing to the eye. Parts Express now stocks 12 gauge speaker wire in vibrant neon colors. This wire is the same high quality, made in the U.S. wire you have used before, but now it has flashy, neon colored insulating jackets. Available in neon pink, neon green, and neon orange. Sold by the foot.



#RN-100-162 (Neon pink)  
#RN-100-166 (Neon orange) 49¢ /Ft.  
#RN-100-170 (Neon green)

## 4 Ga. DC Power Cable

Large gauge cable for running power and ground to amplifiers in car stereo installations. Sold by the foot.



#RN-100-194 (Red 4 ga.) \$1<sup>20</sup> /Ft.  
#RN-100-195 (Black 4 ga.)

## 8 Ga. DC Power Cable

Large gauge cable for running power and ground to amplifiers in car stereo installations. Sold by the foot.



#RN-100-174 (Black)  
#RN-100-173 (Red)  
#RN-100-182 (Neon Pink) 49¢ /Ft.  
#RN-100-186 (Neon Orange)  
#RN-100-190 (Neon Green)

## High Power Speaker Cable

Extra large gauge speaker wire for use with very high power stereo systems and for use in extremely long cable runs. Rope lay construction consists of over 250 strands of 36 ga. wire. 21 picofarads per foot capacitance for use with all amplifiers. Extra thick, clear PVC insulation. Polarity is indicated by a black stripe on one conductor. Available by the foot or in 50 and 100 foot spools. Please order in multiples of 5 feet.



#RN-100-151 (per foot) 39¢ /Ft.  
#RN-100-150 (50 ft.)  
#RN-100-155 (100 ft.)

## AGU High Current Fuses

Part #	Amp	(1-9)	Price (10-up)
#RN-070-810	25A	1.40	1.26
#RN-070-815	30A	1.40	1.26
#RN-070-820	40A	1.40	1.26
#RN-070-825	50A	1.40	1.26
#RN-070-930	60A	1.40	1.26



## 8 Ga. In-Line Fuse Holder

Super heavy-duty fuse holder for high current car stereo installations. Screw together Bakelite fuse holder with 8 ga. wire. For use with AGU type fuses or regular AGC fuses when spring spacer is used.



#RN-070-800 \$3<sup>20</sup> \$2<sup>75</sup>  
(1-9) (10-up)

## 4-Way Fuse Block

Fuse block with 4 sets of gold plated fuse clips for use with fuses. Four LEDs indicate when a fuse is good by glowing red. A bridge bar is included for common connection of the input side. Clear plastic cover allows for visual inspection of fuse status. Uses heavy duty fuses.



#RN-070-810 \$23<sup>50</sup> \$21<sup>90</sup>  
(1-5) (6-up)

## 4 Ga.-8 Ga. Distribution Block

Solid brass block with connections for 1-4 ga. wire input from battery and 4-8 ga. wire outputs for power to the amplifiers. Resecset set screws hold the wire in place. Brass block is completely insulated with clear plastic to prevent accidental shorting. Rubber plugs are included to seal set screw holes.



#RN-265-800 \$12<sup>90</sup> \$11<sup>50</sup>  
(1-5) (6-up)

## High To Low Level Adaptor

Converts speaker level outputs from your head unit to pre-amp level. Utilizes Op amp circuit design for high power handling and to reduce or eliminate in-line noise problems. Low level output is adjustable from 1 volt to 100 mV. For use with head units rated up to 50 watts per channel.

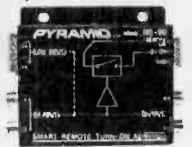

#RN-265-023 \$11<sup>50</sup> \$10<sup>95</sup>  
(1-3) (4-up)

## High To Low Level Adaptor With Remote Turn-On

Automatically turns your amp On or Off with your car's head unit. Converts high level to low level pre-amp output. Also features low level inputs. Utilizes operational amplifier circuit design for high power capability and to reduce or eliminate in-line noise problems. For use with head units rated up to 50 watts per channel.



#RN-265-027 \$12<sup>50</sup> \$11<sup>95</sup>  
(1-3) (4-up)

## Ultimate Woofers

Manufactured in the U.S.A. Ultimate's Polymer Laminate series of woofers are dollar for dollar the best you can buy. Featuring polymer laminate cones to maintain rigidity, extra long throat baskets, extended bump plates, vented pole pieces, double-fold reinforced baskets and more. If you are looking for a woofer that performs flawlessly and looks good too, look no further. Ultimate polymer laminate woofers are here at Parts Express.



Order#	Size	Magnet	V.C.	Z	Freq. Resp.	Power Cap.	SPL 1W/1M	QTS	fs	VAS	(1-3)	(4-up)
#292-510	8"	35 oz.	2"	4	30-3KHz	220W Max	94 dB	.39	40	.89	\$46.50	\$44.00
#292-515	10"	35 oz.	2"	4	25-3KHz	225W Max	95 dB	.33	29	2.89	56.90	53.50
#292-520	12"	50 oz.	2"	4	20-3KHz	250W Max	96 dB	.31	25	6.27	69.90	65.50
#292-525	15"	50 oz.	2"	4	20-25KHz	250W Max	97 dB	.39	20	14.35	88.50	84.90

Parts Express  
340 E. First St.  
Dayton, Ohio 45402  
Local: 513-222-0173  
FAX: 513-222-4644

## ORDERING INFORMATION

• 15 day money back guarantee • \$15.00 minimum order • We accept Mastercard, Visa, Discover, and C. O. D. orders. • 24 hour shipping • Shipping charge = UPS chart rate + \$1.00 (\$3.00 minimum charge) • Hours 8:30 am - 7:00 pm EST, Monday - Friday • Mail order customers, please call for shipping estimate on orders exceeding 5 lbs. • Foreign destination customers please send \$5.00 U.S. funds for postage to receive catalog •

# LEARN VCR

## CLEANING/MAINTENANCE/REPAIR

EARN UP TO \$1000 A WEEK, WORKING PART TIME FROM YOUR OWN HOME!

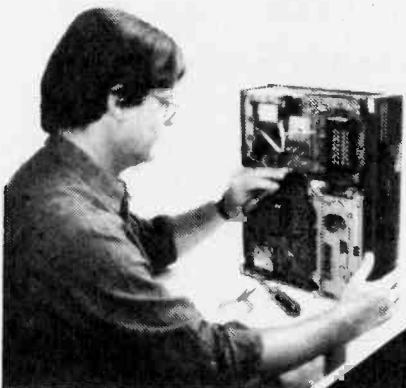

Secrets Revealed!

NO Special Tools or Equipment Needed.

EARN UP TO \$60 AN HOUR AND MORE!

### THE MONEY MAKING OPPORTUNITY OF THE 1990'S

IF you are able to work with common small hand tools, and are familiar with basic electronics (i.e. able to use voltmeter, understand DC electronics) . . .

IF you possess average mechanical ability, and have a VCR on which to practice and learn. . . . then we can teach **YOU** VCR maintenance and repair!

**FACT:** up to 90% of ALL VCR malfunctions are due to simple MECHANICAL or ELECTRO-MECHANICAL breakdowns!

**FACT:** over 77 million VCRs in use today nationwide! Average VCR needs service or repair every 12 to 18 months!

Viejo's **400 PAGE TRAINING MANUAL** (over 500 photos and illustrations) and **AWARD-WINNING VIDEO TRAINING TAPE** reveals the **SECRETS** of VCR maintenance and repair—"real world" information that is **NOT** available elsewhere!

Also includes all the info you'll need regarding the **BUSINESS-SIDE** of running a successful service operation!

**FREE INFORMATION**  
CALL TOLL-FREE 1-800-537-0589

Or write to: Viejo Publications Inc.  
5329 Fountain Ave. Dept. RES 1  
Los Angeles, CA 90029

CIRCLE 262 ON FREE INFORMATION CARD

# LEARN TO CLEAN/MAINTAIN/REPAIR FAX MACHINES

HUGE NEW UNTAPPED MARKET!

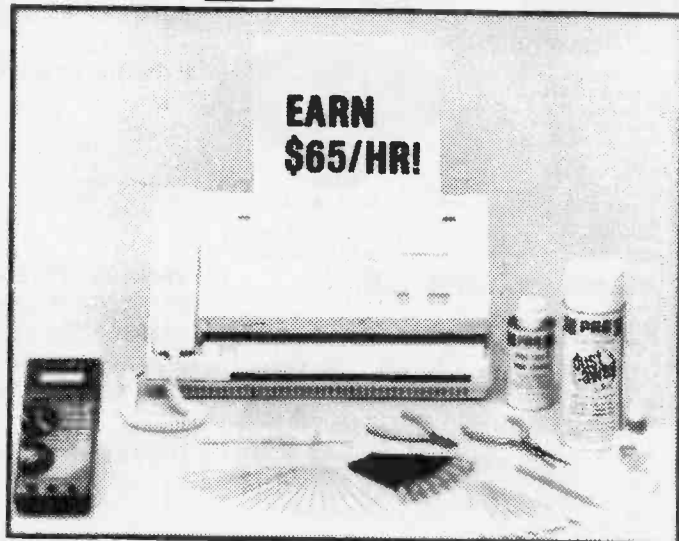

EARN \$65/HR!

**Over 8 million Fax machines in homes/offices - predictions are for over 25 million by 1992!**

- Work from your home/van
- Home study program gets you started servicing fax machines in 2 weeks!
- No special tools/equipment needed
- Earn additional profits selling fax supplies!
- Fax machines are not cheap - therefore, you can get good \$\$ for the repair.
- Average Fax machine requires professional service every 18 months.
- Home study training program includes full instructions on EVERY ASPECT of Fax maintenance/repair. FULL COVERAGE of how to set up your home-based service business.

**FREE DETAILS**  
CALL 1-800-537-0589

Or write to: Viejo Publications, Inc.  
5329 Fountain Avenue  
Dept. RES2 Los Angeles, CA 90029

CIRCLE 263 ON FREE INFORMATION CARD

# RAINBOW KITS

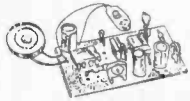

## RADAR SIGNAL DETECTOR

If you think that a sensitive radar detector is a complicated piece of equipment, take a look at this new kit. This simple, yet effective, detector circuit can be built in less than an hour and can be tuned to respond to signals between 50MHz to 500GHz. It's a fun kit to build and play with. A cigarette lighter plug is included. Size 1"x3/4" operates on 9 to 15v DC.

**KIT RSD-1 \$12.95**

## STROBE LIGHT

If you need an attention getter, or warning light, you need the strobe light kit. Use it for emergency light for autos, for model planes or radio towers. Even use it on your bicycle. Operates on 6 or 12v DC and has a variable strobe rate.

**KIT ST-1 \$8.95**

## DIGITAL THERMOMETER

Have you ever wanted to tell temperature changes fast & accurately? The DT-1 kit will turn your digital volt meter into an accurate digital thermometer with .1 degree resolution. It gives you a 250 degree window with a range from -40F to 300F degrees. It has a remote sensor .25" sq. that can be mounted many feet from the meter if need be.

**KIT DT-1 \$8.95**

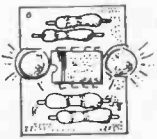

## BLINKY LIGHTS

Want to attract attention? These kits are perfect for decorating name tags, lighting up your hat, or flashing lights for your model trains. Some people use them to simulate a burglar alarm for autos. Put it in a box, set it on your dash and it looks like the real thing. Each kit contains two LEDs that alternates flashing. Operates on a 9v battery. Size 5"x5"

**KIT RB-2 \$3.45**

## CAPACITANCE METER

This easy to build kit will turn your digital volt meter into a CAPACITOR METER. Turn that junk box of unmarked capacitors into a fortune. Measures capacitors from (2pF to 2.2uF. Operates on a 9v battery. Size 1.75"x2"

**KIT CA-2 \$12.95**

## WIRELESS FM MIKE

Small but mighty 8"x1" PCB, will really stomp out a signal well over 400 yds. This is a buffered wireless mike that operates on 80 to 120 MHz FM. Comes complete with a microphone, and 9V battery connector. Operates on 6 to 12v DC.

**KIT WM-1 \$12.95**

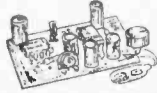

## SUPER SNOOPER-BIG EAR

Use this BIG EAR amplifier to listen through walls, hear conversations across the room. Beef up the sensitivity with a parabolic reflector and hear blocks away. Due to the size, the BIG EAR can be hidden about anywhere. Use the earphones from a pocket transistor radio to listen. Makes an ultra-sensitive intercom. Can also be used as a general purpose 1.5W amp. We supply a mini-microphone in the kit. You can also use any 8 to 45 ohm speaker. Operates on 6 to 12v DC. Size 1"x1.75"

**KIT AA-1 \$10.95**



## AC LINE MONITOR

This is something every computer user, photographer, or anyone that must maintain a safe usable AC line voltage should have handy. Monitor the voltage of your motor home's 110v AC generator inside the motor home. Every technician's bench needs this item. The AC line monitor will indicate, with multi-color LEDs, what voltage is being distributed to your equipment at that particular outlet.

**KIT LM-110 \$10.95**

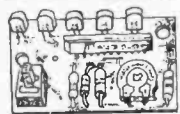

## 12V BATTERY MONITOR

Have you ever been in your car, boat, or camper — you try to start your motor but the battery is dead? The BATTERY MONITOR kit uses the cigarette lighter plug outlet to monitor the true battery voltage. Multi-color LEDs indicate the voltage in 1v steps from 11v to 15v, green means great, yellow is good, and red — call the tow truck or get out the oars. Size 1.2"x1.75"

**KIT LM-12 \$5.95**



## PHONE BUG

Small but mighty, so small it fits anywhere. Telephone line powered, never needs batteries. Transmits both sides of a phone conversation loud and clear, wireless, to any FM radio at great distances away. Variable tunes 70MHz to 130MHz. It can also be used to make any phone a speaker phone. Size 55"x1"

**KIT TEL-B1 \$10.95**



## PHONE RECORDING SWITCH

This telephone line powered switch is small enough to install anywhere only .9"x.6". Every time someone picks up the phone the tape recorder will record both sides of the conversation automatically. Use it in your office to record all phone conversations so you don't lose that important address you wrote on the back of an envelope.

**KIT TEL-SW 1\$10.95**

## BUSY PHONE LIGHT

Add this little kit to any or all of your phones. When any extensions are in use the LED will light. Uses a 9v battery, P.C. Board 1"x1/2". Complete with etched & drilled PCB, all parts and schematics.

**KIT TEL-LIT-1\$9.95**

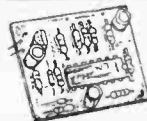

## VOICE ACTIVATED SWITCH

This vox can be used to operate a tape recorder, ham radio, CB radio. Use it to turn on an alarm. The output can operate a load up to 100ma. It will operate a relay, lights, motor, or LEDs. What could you do with a sound activated switch? Size 1.5"x1.25"

**KIT VOX-1 \$6.95**

## LIE DETECTOR

This kit can be great fun at parties. Lie and an audible tone will change, the more you lie the more the tone changes. When you lie your palms & forehead sweat. This kit allows you to measure these changes. Only a very slight amount of change will cause the tone to increase in frequency. Operates on 6 to 12v DC. Size

**KIT LD-1 \$9.95**

# LASER KITS

Laser Switching Power Supply Kit, input 12V DC .75-1.25A. Output 2 to 3 KV at 3-4.5 MA, trigger voltage of approx. 8-10 KV. Complete with 6.25" x 2.25" printed circuit board, schematic and all the parts.

**LPS-1 \$59.95**

1MW Laser Tube, NEW Mini He-Ne 1.125" dia. x 5.75" long, perfect for experimenters and laser projects. Works great with above power supply LPS-1.

**LIMW-1 \$39.95**

Mirror and Motor Kit—This unique kit allows you to project Lissajous patterns on walls and ceiling. Change the pattern by changing the speed of the motors. Comes complete with 2 motors, front surface mirrors, motor brackets, rheostat control to control #1 motor, and high power resistors to use on #2 motor.

**MM-2 \$19.95**

★ **SPECIAL** ★  
**Laser Power Supply Kit LSP-1**  
**1MW Laser Tube LIMW-1**  
**Mirror and Motor Kit MM-2**  
**ALL 3 FOR \$99.95**

9V 100MA rechargeable Ni-cad batteries. This 9V Ni-cad is truly a 9V not the standard 7.2V you're accustomed to. Use ever and over.

**NEW \$4.00 ea.**  
**10/\$29.95**

9V battery charger kit. This kit is a must when you buy 9V Ni-cads, charges 2 batteries at once. Use on 110V AC or with a 12V DC cigarette lighter plug which is included. Comes complete with parts, P.C. board, housing and schematic.

**CH-9V \$19.95**



THIS MANUAL CONTAINS ALL SCHEMATICS, PARTS & P.C. BOARD LAYOUTS FOR ALL OF THE RAINBOW KITS. USE YOUR OWN PARTS TO CONSTRUCT ANY OF OUR KITS.

**KIT BOOK \$14.95**

**\$5.00 OFF IF YOU BUY ANY KIT.**



# TV NOTCH FILTERS

OUR TV FILTERS ELIMINATE UNWANTED TV CHANNELS OR ANY INTERFERENCE THAT ALTERS BOTH THE SOUND AND VIDEO.

Channels available 2 thru 6 & 14 thru 22  
 Specify a specific channel when ordering

CHOICE  
**14.95**  
 EACH

NOTE: All TV Filter Kits are sold for educational purposes only. You must obtain permission from your local cable company before using these filters on your cable system.



Please add sufficient postage

We will accept telephone orders for Visa & Mastercard

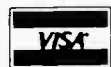

To Order Call  
**317-291-7262**



# ELECTRONIC RAINBOW INC

6254 LaPas Trail • Indianapolis, IN 46268



# AOR Scanners.

Great Performance. Great Service. Great Value.

Free Freight  
25-Day Money-Back Guarantee  
Toll-Free Service and Support  
No Credit Card Surcharge  
One Year Warranty



**AR950**

**\$239**

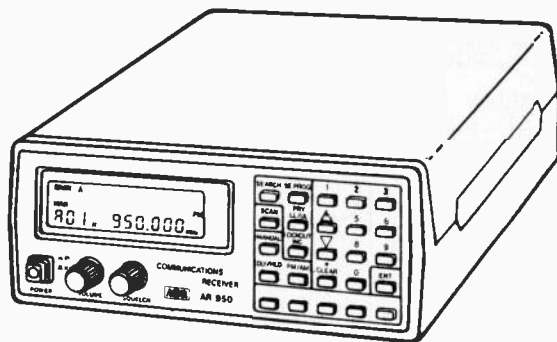

**AR1000**

**\$429**

**1000 Channels. 8-600MHz, 805-1300MHz**

**Standard Features:**

- Extremely compact size.
- Continuous coverage (except UHF TV 600-805)
- Antenna attenuator switch, 10db.
- Manual tuning knob.
- Earphone jack, 3.5mm.
- AM, FM and wide band FM tuning modes.
- Backlighted LCD display.
- 10 Scan Banks, 10 Search Banks.
- Selectable Priority Channel.
- Delay, Hold Features.
- Selectable Search Increments, 5-955KHz.
- Permanent memory backup.
- 4 AA Ni Cad batteries included.
- AC adaptor/charger.
- Carry Case.
- Cigarette Lighter Charger.
- Belt Clip.
- Earphone.

**Options:**

- External Speaker. Mobile Mount. MS190 \$19.50
- Extended Warranty. 2/3 yrs \$45/\$55

**Specifications:**

- Coverage: 8-600, 805,1300MHz
- Sensitivity: .35uV NFM, 1.0uV WFM, 1.0AM
- Speed: 20 ch/sec. scan. 40 ch/sec. search
- IF: 561.225, 58.075, 455KHz or 10.7MHz
- Increments: 5 to 955KHz selectable/ 5 or 12.5 steps.
- Audio: .4 Watts
- Power: Input 9 - 13.8 V. DC
- Antenna: BNC
- Display: LCD
- Dimensions: 6 7/8H x 1 3/4D x 2 1/2W. 12oz wt.

**100 Channels. Low, Air, High, UHF & 800MHz.**

**Standard Features:**

- Extremely compact size.
- Unrestricted 800MHz coverage.
- 100 channels permanent memory
- Earphone Jack & Attenuator.
- Delay, Hold features.
- Channel 1 Priority.
- 5 Scan Banks, 5 Search Banks.
- Telescopic and Flexible Antennas w/ BNC connector.
- AC & DC Power cords w/ mtng hardware.
- One Year Limited Warranty.

**Options:**

- Base type antenna 25 to 1000MHz w 50' coax. AS300 \$59.95
- Mag Mnt Mobile Antenna. 15' coax. MA100 \$25.00
- Cigarette Lighter power adaptor. CP100 \$4.00
- External Speaker with mobile mount. MS100 \$19.50
- Extended Warranty. 2/3 yrs \$40/\$55

**Specifications:**

- Coverage: 27-54, 108-174, 406-512, 830-950MHz
- Sensitivity: .4uV Lo,Hi. .8uV Air. .5uV UHF. 1.0uV 800
- Scan Speed: 15 ch/sec.
- IF: 21.4MHz, 455KHz
- Increments: 10,12.5,25,30
- Audio: 1W
- Power: 12.8VDC, 200MA
- Antenna: BNC
- Display: LCD w/backlight
- Dimensions: 2 1/4H x 5 5/8W x 6 1/2D. 14oz wt.

**We offer 100's of communications products.**

**AR3000**

**\$995**

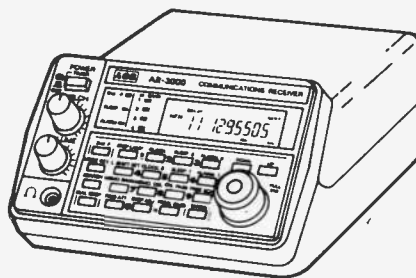

**400 Channels. 100KHz to 2036MHz.**

**Standard Features:**

- Extremely compact size.
- Continuous coverage
- Attenuation Programmable by Channel.
- Manual tuning knob.
- Tuning increments down to 50Hz.
- AM, FM, wide band FM, LSB, USB, CW modes.
- Backlighted LCD display.
- 4 Scan and Search Banks, Lockout in Search.
- 4 Priority Channels.
- RS232 control through DB25 connector.
- Delay, Hold Features.
- 15 band pass filters, GaAsFET RF amp.
- Sleep and Alarm Features.
- AC adaptor/charger. DC power cord.
- Telescopic Antenna.

**Options:**

Earphone.	EP200	\$2.00
External Speaker. Mobile Mount.	MS190	\$19.50
Extended Warranty. 2/3 yrs.		\$65/75
Mobile Mounting Bracket.	MM1	\$14.90
RS232 Control Package	SCS3	\$295.00
(software & cable) offers spectrum display and database.		

**Specifications:**

Coverage:	100KHz - 2036MHz
Sensitivity:	.35uV NFM, 1.0uV WFM, 1.0AM/SSB/CW
Speed:	20 ch/sec. scan. 20ch/sec. search
IF:	736.23, (352.23) (198.63) 45.0275, 455KHz
Increments:	50Hz and greater
Selectivity:	2.4KHz/-6db (SSB) 12KHz/-6db (NFM/AM)
Audio:	1.2 Watts at 4 ohms
Power:	Input 13.8 V. DC 500mA
Antenna:	BNC
Display:	LCD
Dimensions:	3 1/7H x 5 2/5W x 7 7/8D Wt. 2lb 10oz.

**AR2500**

**\$499**



**2016 Channels. 1 MHz to 1500 MHz**

**Standard Features**

- Continuous coverage
- AM, FM, wide band FM, & BFO for SSB, CW.
- 64 Scan Banks.
- 16 Search Banks.
- RS232 port built in.
- Includes AC/DC pwr crd. Antenna, Mntng Brckt.
- One Year Limited Warranty.

**Options:**

Earphone.	EP200	\$2.00
External Speaker. Mobile Mount.	MS190	\$19.50
Extended Warranty. 2/3 yrs.		\$65/75
Mobile Mounting Bracket.	MM1	\$14.90
RS232 Control Package	SCS2	\$295.00
(software & cable) offers spectrum display and database.		

**Specifications:**

Coverage:	1 MHz - 1500MHz
Sensitivity:	.35uV NFM, 1.0uV WFM, 1.0AM/SSB/CW
Speed:	38 ch/sec. scan. 38 ch/sec. search
IF:	750.00, 45.0275, 5.5MHz 455KHz
Increments:	5,12,5,25 KHz
Audio:	1.2 Watts at 4 ohms
Power:	Input 13.8 V. DC 300mA
Antenna:	BNC
Display:	LCD, backlighted.
Dimensions:	2 1/4H x 5 5/8W x 6 1/2D Wt. 1lb.

## To Order Call 1•800•445•7717

In All 50 States and Canada. 24 Hours a Day. Fax Orders: 1-800-448-1084, 24 Hours a Day.  
**ACE Communications Monitor Division 10707 E. 106th Street, Fishers, IN 46038**  
 Int'l Voice# 317-842-7115. Int'l Fax# 317-849-8794.  
 Service and Support Lines: Mon-Fri 9a.m. to 9p.m., Saturday 10-4. EST  
 MasterCard, Visa, American Express, Checks, Approved P.O.'s. & C.O.D. (add 5.00)  
 Prices and specifications subject to change.

# B. G. MICRO

P. O. Box 280298 Dallas, Texas 75228

(214) 271-5546

FAX (214) 271-2462



## FAN

Brand New from McLean Eng.  
A Division of Zero Corp.  
Square 4-11/16" by 1.5"  
Thick 10" Wire Leads  
120V - 60hz - .12 amps - 110CFM  
Metal Housing - 5 Plastic Blades  
UL and CSA Approved  
\$5.95 ea.

## SPECIALS

MAX232	2.30
1488	.45
1489	.45
DB25-(Solder Cup) M/F	2/1.00
DB25-Rt. Angle PC BD. F	.55
DB9-Rt. Angle PC BD. M/F	.35

## DISPLAY DEVICES

4MT07 By Futaba  
Vacuum Fluorescent Clock  
And Timer - 4 Digt Display  
Easy to Read - Easy to Use.  
.3" Character Height  
With Data 79¢

LTP 1157AE  
1.2" 5x7 Matrix Displays  
5x7 Array with x,y select.  
This Red Orange Matrix Can Be  
Stacked Horizontally. Choice of  
Two Matrix Orientation-Cathode  
Column, Anode Row. Great For  
"Moving Message" Signs.  
\$1.19 Ea., 8/\$6.95, 100/\$75.00

## 74LS

LS00	.14	LS114	.25	LS241	.60
LS01	.14	LS122	.35	LS242	.65
LS02	.14	LS123	.45	LS243	.50
LS03	.14	LS124	1.35	LS244	.55
LS04	.14	LS125	.30	LS245	.55
LS05	.14	LS126	.35	LS251	.45
LS08	.14	LS132	.35	LS253	.40
LS09	.14	LS133	.25	LS257	.35
LS10	.14	LS136	.28	LS258	.45
LS11	.14	LS138	.35	LS259	1.00
LS12	.20	LS139	.35	LS260	.40
LS13	.25	LS145	.75	LS266	.30
LS14	.30	LS148	.35	LS273	.75
LS15	.20	LS151	.35	LS279	.30
LS20	.14	LS153	.35	LS280	.80
LS21	.16	LS154	.85	LS283	.35
LS22	.16	LS155	.50	LS290	.70
LS26	.14	LS156	.42	LS293	.50
LS27	.20	LS157	.30	LS298	.65
LS28	.15	LS158	.25	LS299	1.00
LS30	.14	LS160	.25	LS322	1.30
LS32	.16	LS161	.35	LS323	2.25
LS33	.25	LS162	.45	LS348	.75
LS37	.24	LS163	.36	LS353	1.00
LS38	.24	LS164	.45	LS357	.80
LS42	.35	LS165	.60	LS363	.75
LS51	.15	LS166	.75	LS364	.75
LS54	.20	LS169	.90	LS365	.30
LS55	.20	LS170	.45	LS366	.28
LS73	.33	LS173	.60	LS367	.35
LS74	.22	LS174	.35	LS368	.30
LS75	.25	LS175	.35	LS373	.50
LS83	.30	LS181	1.25	LS374	.45
LS85	.45	LS191	.45	LS375	.35
LS86	.20	LS192	.65	LS377	.75
LS90	.35	LS193	.65	LS378	.80
LS92	.30	LS194	.40	LS390	.80
LS93	.25	LS195	.52	LS393	.75
LS95	.30	LS196	.55	LS399	1.00
LS96	.33	LS197	.75	LS541	1.20
LS107	.28	LS221	.50	LS645	.75
LS109	.20	LS240	.50	LS646	.75
LS112	.25			LS670	.80
LS113	.25	25LS2569	1.50		

## THE S25 NETWORK

Try The 1st Truly Low Cost LAN

- Connect 2 or 3 PCs, XTs, ATs
- Uses serial ports and 5 wire cable
- Runs at 115 K baud
- Runs in background, totally transparent
- Share any device, any file, any time
- Needs only 14K of ram

Skeptical: We make believers!

## SUPER BUYS

### DTMF

SSI-202 Decoder	2.25
8870 Decoder	2.25
5087 Generator	2.00
5089 Generator	2.10

### 2N4401

Super 2N3904 NPN	
Switching Transistor	
40V-TO-92 - P.C. Leads	
15/1.00	1000/20.00

### 80C32

C-MOS By Matra - 12MHZ	
3.95	

LM350T	2.65
LM338K	4.95
16L8-15 TI-B-PAL	1.25
8088-2	3.25
8742	7.00

## WIRE WRAP

Dual Wipe - 2 Level		
14 Pin	10/2.50	100/20.00
16 Pin	10/2.50	100/20.00
20 Pin	10/3.50	100/30.00

## SOCKETS

Low Profile SOLDER TAIL	
6 Pin	14/1.00
8 Pin	13/1.00
14 Pin	13/1.00
16 Pin	13/1.00
18 Pin	13/1.00
20 Pin	13/1.00
22 Pin	13/1.00
24 Pin	8/1.00
28 Pin	7/1.00
40 Pin	7/1.00

BUY \$10

GET \$1.00 - FREE CHOICE	
68 Pin PLCC	.79
84 Pin PLCC	.89

## 6500/6800

6502	2.00	6821	1.00
6520	1.25	6845P	2.20
6522	2.70	6845S	2.20
6530	3.00	6850	1.75
6532	4.25	6852	3.50
6545	2.10	6860	3.95
6551	2.40	68681	3.00
6800	1.40	68A09EP	1.29
6802	2.50	68A40	4.00
6803	3.00	68A54	3.00
6805	2.95	68B09	4.00
6809EP	2.75	68B10	2.00
6809P	2.50	68B45	4.95
6810	1.25	68B54	4.00

## TEXT TO SPEECH BOARD

PC/XT COMPATIBLE. MAKE YOUR COMPUTER TALK!

PRICE CUT \$69<sup>95</sup>

ASSEMBLED & TESTED  
ADD \$3.50 SHIPPING  
& HANDLING



A VERY POWERFUL AND AMAZING SPEECH CARD. USES THE GENERAL INSTRUMENTS SP0256-AL2 SPEECH CHIP AND THE CTS256A-AL2 TEXT TO SPEECH CONVERTER.

THIS BOARD USES ONE SLOT ON THE MOTHERBOARD AND REQUIRES A COM SERIAL PORT. BOARD MAY ALSO BE USED IN A STAND ALONE ENVIRONMENT (EXTERNAL POWER SUPPLY) WITH ALMOST ANY COMPUTER THAT HAS A RS232 SERIAL PORT. TO USE THE BOARD IT IS ONLY NECESSARY TO SEND ENGLISH TEXT TO THE RS232 INPUT ON THE BOARD. THE BOARD INCLUDES A 1500 BYTE TEXT BUFFER AND HANDSHAKE LINE TO ALLOW YOU TO SEND DATA TO THE BOARD; THE SAME AS YOU WOULD SEND DATA TO AN RS232 SERIAL PRINTER. YOU CAN SET UP BATCH FILES THAT WILL MAKE YOUR COMPUTER GREET YOU WITH "GOOD MORNING MASTER," ETC. EVERY TIME YOU TURN IT ON. DEMONSTRATION SOFTWARE AND A LIBRARY BUILDING PROGRAM ARE INCLUDED ON A 5 1/4 INCH PC/XT DISKETTE. FULL DOCUMENTATION AND SCHEMATICS ARE ALSO INCLUDED. FOR INFORMATION ON A LOW COST SPEECH SYNTHESIZER SYSTEM FOR THE VISUALLY IMPAIRED, PLEASE SEND FOR FREE PACKET T.M.1.

STAND ALONE POWER SUPPLY  
FOR ABOVE  
ADD \$2.50 SHIPPING & HANDLING

\$19<sup>99</sup>

## STATIC RAM

2016-2KX8 200 n.s.	1.00
2101-1 - 256X4 500 n.s.	.75
21L02-1 350 n.s.	.65
2102AL-4 L.P. 450 n.s.	.49
2111-1 256X4 500 n.s.	1.00
2112A-2	2.50
2114L-3 1KX4 300 n.s.	.45
2125A-2 1KX1 70 n.s.	1.70
2147 4KX1	1.95
6116P-4	1.00
6117	1.20
6264-15	1.40
62256 32KX8	5.75

## EPROM SPECIAL

We bought a large quantity of 2708s, 2716s, 2532s, 2732s, 2764s, 27128s, 27512s and 27256s from a computer manufacturer who redesigned their boards. We removed them from sockets, erased and verified them, and now we offer the savings to you. Complete satisfaction guaranteed.

Your Choice		
2708	1.20	10/8.00
2716	1.75	10/15.00
2532	2.00	10/17.50
2732	2.00	10/17.50
2764	2.25	10/20.00
27128	3.20	10/27.50
27256	3.85	10/32.50
27512	5.10	10/45.00

## DYNAMIC RAM

2108-4 8KX1	1.50
2118-4 16KX1-5Volt	.70
4027-4KX1-250 n.s.	.80
4116-16KX1-250 n.s.	.40
4116-16KX1-200 n.s.	.75
4116 16KX1-150 n.s.	.90
4164 150 n.s.	.49 or 9/3.50
4164 120 n.s.	1.10
4164-100 n.s.	1.40
TMS4416-16KX4-150 n.s.	2.75
4464-150 n.s.	1.40
4464-120 n.s.	1.45
4464-100 n.s.	1.45
4464-80 n.s.	1.45
41256 150 n.s.	1.25 or 9/9.95
41256 120 n.s.	1.30 or 9/10.99
41256 100 n.s.	1.30 or 9/10.99
41256-80 n.s.	1.30 or 9/10.99
41256-60 n.s.	1.85
1 Meg - 100 n.s.	4.40
1 Meg - 80 n.s.	4.40
414256-80 n.s. 256 x 4	4.60

SIPPS & SIMMS AVAILABLE

## THREE CHIP SET

B.G. SPECIAL	
16450, 1488, 1489	— \$6.95
16550, 1488, 1489	— \$13.50

## 8000/80000

8031	2.95	8251	1.10
80C32	3.95	8253-5	1.75
8035	1.00	8254	1.80
8039	1.00	8255	1.50
8085	1.55	8255-5	1.75
8086	1.55	8257	1.50
8087	87.50	8259A	1.85
8087-1	167.50	8259C-5	2.10
8087-2	127.50	8275	10.95
8088	2.20	8279	2.25
8088-2	3.25	8284	1.49
8155	2.25	8286	3.50
8156	2.25	8287	2.49
8202A	8.00	8288	3.50
8212	1.25	8530	3.00
8214	2.00	8741	7.00
8216	1.25	8742	7.00
8224	1.25	8748	7.00
8228	1.75	8749	7.00
8237-5	2.80	8755	7.00
8243	1.75	8755	7.00
8250	2.95	80286-8 PLCC	8.50
(16450)	6.50	80287-8	125.00
(16550)	13.00	80287-10	135.00
		V-20-10MHZ	6.50

TERMS: (Unless specified elsewhere) Add \$3.25 postage, we pay balance. Orders over \$50.00 add 85¢ for insurance. No C.O.D. Texas Res. add 8 1/2% Tax. 90 Day Money Back Guarantee on all items. All items subject to prior sale. Prices subject to change without notice. Foreign order - US funds only. We cannot ship to Mexico or Puerto Rico. Countries other than Canada, add \$9.00 shipping and handling.

CIRCLE 233 ON FREE INFORMATION CARD

SEND FOR FREE CATALOG! OVER 150 NEW ITEMS!

SEND FOR FREE CATALOG! OVER 150 NEW ITEMS!



# SURPLUS SALE

WE HAVE AVAILABLE OVER 125,000 SURPLUS PLUG-IN WALL ADAPTERS. THESE ARE ALL BRAND NEW IN A WIDE RANGE OF VOLTAGES AND CURRENTS IN BOTH AC AND DC OUTPUTS. WE ALSO HAVE 220/240VAC ADAPTERS AND DUAL OUTPUT VOLTAGE POWER SUPPLIES. PHONE OR FAX US FOR OUR LATEST ADAPTER CATALOG OR CALL FOR AVAILABILITY AND PRICE QUOTE ON YOUR NEEDS. WE ARE ALSO INTERESTED IN PURCHASING YOUR EXCESS ADAPTER INVENTORY. CONTACT US TODAY!

## SPECIAL PURCHASE!

### 12VDC/100ma WALL ADAPTERS

12,000 IN STOCK  
AT PRESS TIME!!

### Panasonic<sup>®</sup>

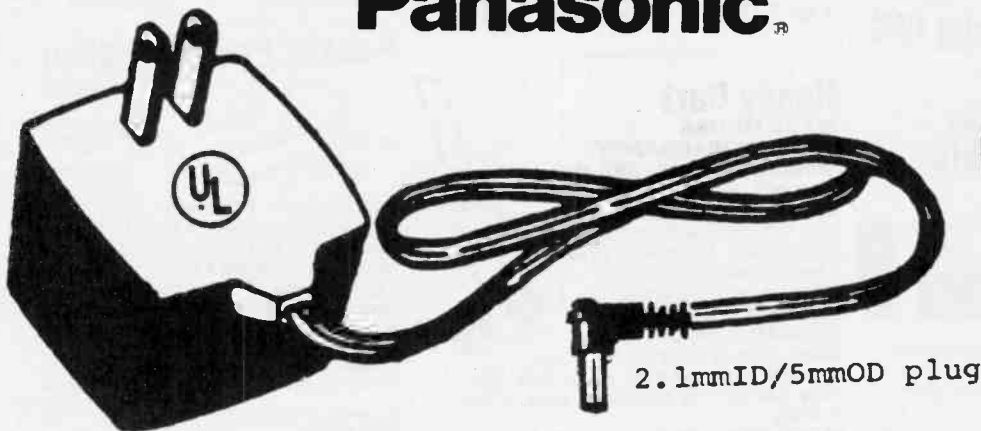

NOW  
ONLY  
**99¢**

EA/5000

\$1.10 EA/1000

\$1.20 EA/ 100

\$1.35 EA/ 50

2.1mmID/5mmOD plug

SURPLUS TRADERS specializes in the distribution of surplus parts and equipment to the electronic, computer and hi-tech industry. We publish a wholesale surplus catalog which is available to the trade at no charge. Please make your request on your company letterhead or accompanied by your business card. If you indicate your areas of interest or specialization - we will key our computer to target special offers in your field of interest. Hobbyists and those not in the trade may obtain our catalog for a handling charge of \$2.

**SURPLUS  
TRADERS**  
P.O. Box 276  
Winters Lane  
Alburg, Vermont 05440  
**514-739-9328**  
(Fax 514-345-8303)

# \$\$\$ SAVINGS on SPECIALS at JOSEPH ELECTRONICS \$\$\$

• Test Instruments • Tools • Chemicals • Soldering Equipment • Custom Cases

## "Mr. Test Volt" 3 1/2 Digit Multimeter

PROTEK

Designed for fast accurate tests of appliances, automotive, marine, HVAC and electrical circuits. Single rotary knob with just 7 positions for fast sure set-up. Safety probes, installed battery supplied. Built-in goof proof overload protection for AC/DC volts and ohms. Model D-906



List \$49.95

**Special \$19<sup>43</sup>**

## Weller WST2 Pyropen® Jr.

Mini iron soldering that goes everywhere with temperature control. Recharged in seconds, with butane gas, the easy-to-handle WST2 requires no power cord or batteries. Temperature control. Soldering iron: 392°F-842°F (200°C-450°C); hotblow feature: 806°F (430°C) maximum; torch feature: 2372°F (1300°C) maximum. "Longlife" soldering tips deliver quick heat-up-time



Cat. No. WST2

List \$64.96

**Special \$38.43**

## Kenwood CS 4025 20MHz 2-Channel Oscilloscope

The CS 4025 is a high quality oscilloscope that use a large number of custom IC's to achieve superior performance in an economical 20MHz package. 3 year warranty.



KENWOOD

**List \$495.00 Special \$343<sup>00</sup>**

## Portable Speaker System

This pair of speakers with a DXBB amplifier circuit provides sensational sound when used with, portable CD players stereo cassette players or AM/FM radios. Additional features include volume control, an LED indicator, 3" high quality speakers and treble control. The amplifier can be powered by a DC adaptor or 4 "C" batteries (not included).



**SPECIFICATIONS**  
 Frequency Response: 50-15,000 Hz  
 Impedance: 8 ohms  
 Power Supply: 6V DC adaptor or 4 "C" batteries 7 watts

Output Rating: New Cat. No. 90-630

List \$41.59

**Special \$24<sup>43</sup>**

## Universal Printer Stand

The two-piece design of this printer stand universally adapts to any size desktop printer. The stand is designed to tilt the printer at an angle, allowing the user to easily see the printout.

**NEW Cat. No. 44-510**

List \$14.59

**Special \$7<sup>43</sup>**

## Pocket Power Inverter



Applications: • TVs and VCRs • Sound and video equipment • Standard and fluorescent lights • Electronic test and maintenance equipment • Small appliances e.g. fans, shavers and mixers • Recharging battery powered devices • Most other electronic products.

**SPECIFICATIONS**  
 Voltage In: 10.0-15.0 volts DC  
 Voltage Out: 115 volts AC RMS (with true RMS measuring meter)

Continuous Power: 100 watts  
 Peak Output: 200 watts

Model 3

List \$129.95

**Special \$99<sup>43</sup>**

## Compact Disc Cleaning System

Kit contains all the necessary tools for ensuring peak performance of your compact disc system. Contents: 3 oz. can specially formulated cleaning solution, cleaning brush, chamois applicator and disc holder. (Kit) Cat. No. 30-700

List \$21.59

**Special \$9<sup>43</sup>**

## New "Trouble-Shooter" Tool Case

Compact, convenient and handy tool case for servicemen and technicians. This maintenance tool case is only 9" x 7" x 2-1/4", yet holds as many as 17 tools, meters, and test instruments. Small enough to easily carry, or will fit in your desk drawer or standardized tool carrying case.



Manufactured of the finest quality black Cordura, many features. Holds tools and meters firmly. Has great "on-the-job" utility. Ideal when servicing personal computers, printers, terminals, and the cables that link them. Made in U.S.A. (Tools not included)

Model CD-1

List \$37.95

**Special \$19<sup>43</sup>**

## Portable Handheld Vacuum

This vacuum is designed for easy cleaning of computer keyboards and delicate camera equipment of dirt and dust. Also included with the vacuum is a reusable dust bag, brush, and detail nozzle.

NEW Cat. No. 44-275

List \$15.00



**Special \$7<sup>43</sup>**

## 75 Channel Wireless Volume Control Cable Converter

Converts any television set to receive 75 cable channels or standard TV channels between 2 and 13 to a fixed output on channel 2 or 3. Remote control features include volume control, sleep timer, last channel recall, favorite channel memory. UL listed. FCC registered.

Cat. No. 32-3590

List \$152.30 **Special \$119<sup>43</sup>**

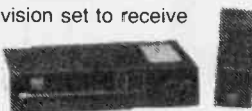

## Handy Cart

MADE IN USA  
 10 YEAR WARRANTY  
 Weight Capacity 350 lbs.

Specially designed base (ground level) to accommodate heavy duty industrial and commercial applications. Extra wide wheel base to prevent cart from tilting while going down curbs and stairs. Unique stepslider glides cart up and down stairs and curbs easily and provides extra balance. Extra large and wide ball bearing wheels for easy rolling stability.

Model 1000

List \$69.95

**Special \$49<sup>43</sup>**



A WOMAN OWNED SMALL BUSINESS

8830 N. Milwaukee Av. Niles, IL 60648  
 708-297-4200 FAX: 708-297-6923

Call or write for our NEW Catalog—FREE with order.  
**CALL TOLL-FREE • SAME-DAY SHIPPING**  
**1-800-323-5925**

ADD only \$7.50 Shipping and Handling for each order. IL Residents add Sales Tax



# AMAZING ELECTRONIC PRODUCTS and KITS

## NEW CONCEPT! Mystery Levitating Device



Remember *War of the Worlds*? Objects float in air and move to the touch. Defies gravity, amazing gift, conversation piece, magic trick or great science project.  
ANT1K Easy to Assemble Kit / Plans ..... \$19.50

## Combination Solid State Tesla Coil & Variable 100,000VDC Generator

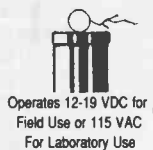

Operates 12-19 VDC for Field Use or 115 VAC For Laboratory Use

### Experiments Using Tesla Coil:

- Plasma in a Jar/Tornado, Furnace
- Kirlian Photography
- Wireless Energy Transmission
- Induction Fields • Pyrotechnic Effects
- Corona and Brush Discharge
- Energizer for Neon Plasma Tubes

### Experiments Using Hi Volts DC:

- Plasma Blaster Driller/Cutter
- Anti-Gravity/Force Fields
- Ion Reaction Motors
- Lightning Generation
- High Ion Source
- Ozone For Air Purification
- Electrification of People & Objects
- Particle Accelerators/Atom Smashing
- High Energy Capacity Charging

- HVM7 Plans Complete System ..... \$10.00  
HVM7K Complete System Kit/Plans ..... \$149.50  
TCL4K Tesla Coil Only Kit/Plans ..... \$79.50  
115/19AC Wall Adapter for 115AC ..... \$9.50

## Solar Power! All New!

Free, Clean, Safe and Plenty for All



- SOL1 4" Dia., .5V, 2A Silicon Cell & Plans ... \$8.50  
SOL2 6x12", 14V, .2A Amorphous Cell & Plans \$7.50

### Solar Energy Kits / Build The Following:

- SOLM1 Motor Kit For Science Fair ..... \$14.50  
SOLIT1 12" Multi-color Neon Outside Lite Kit \$34.50  
SOLCH1 Charger Kit With 6V 9A Battery .. \$24.50  
SOLSHK1 Shocker Kit For Objects, Fence, Bug Zapper ..... \$29.50

## Solar Furnace

Use the power of the sun to build a device that can melt metal! Easy to build, excellent science fair project.  
SOLFUR1+ Data Sheets, w/Big Fresnel Lens \$14.50

## Plasma Fire Saber

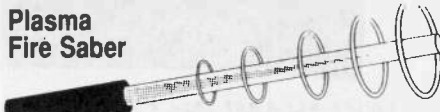

Produces the spectacular effect that captured the fantasy of millions of movie fans. Visible plasma field is controlled by grip pressure and adjusts saber length. Active energy field produces weird & bizarre effects. Excellent for special effects. Specify photon blue, neon red, phasor green, or starfire purple.  
PFS2 Plans ..... \$8.00 PFS2K Kit/Plans \$49.50  
Special Offer PFS20 Assembled reg \$89.50, \$59.50

## Poster Neon

At Last! Put *NEON* in your favorite poster! Ready to use, safe and simple. Includes 26" red neon tube and special energizer.  
PLUS20X, With Neon Tube ..... \$39.50

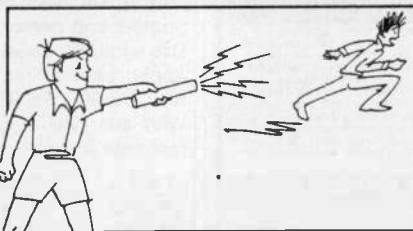

## Shocker Force Field / Vehicle

**Electrifier** - Neat little device allows you to make hand and shock balls, shock wands and electrify objects, charge capacitors. Great pay back for those wise guys who have wronged you!  
SHK1KM Easy To Assemble Electronic Kit . \$24.50

## 100,000V Intimidator / Shock Wand

**Module** Build an electrical device that is affective up to 20 feet. May be enclosed for handheld, portable field or laboratory applications.  
ITM2KM Easy to Assemble Electronic Kit ... \$49.50  
ITM2 Plans Only; Credit-able to Kit ..... \$10.00

**Ion Ray Gun** - Projects charged ions that induce shocks in people & objects without any connection! Great science project as well as a high tech party prank.  
IOG3 Plans ..... \$10.00 IOG3K Kit/Plans \$69.50

## Invisible Pain Field Generator

Shirt pocket size electronic device produces time variant complex shock waves of intense directional acoustic energy capable of warding off aggressive animals, etc.  
IPG7 Plans .... \$8.00 IPG7K Kit / Plans \$49.50  
IPG70 Assembled ..... \$74.50

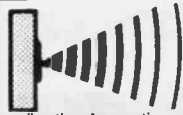

## Homing / Tracking Transmitter

Beeper device, 3 mile range.  
HOD1 Plans .... \$10.00 HOD1K Kit/Plans \$49.50

## Listen Thru Walls, Floors

Highly sensitive stethoscope mike.  
STETH1 Plans ... \$6.00 STETH1K Kit/Plans \$49.50

## 3 Mile FM Wireless

**Mike** - *Subminiature!* Crystal clear, ultra-sensitive pickup transmits voices and sounds to FM radio. Excellent security system, warns of intrusion. Become your neighborhood disk jockey! Monitor children and invalids.  
FMV1 Plans ..... \$7.00 FMV1K Kit/Plans . \$39.50



## Telephone Transmitter - 3 Miles!

Automatically transmits both sides of a telephone conversation to an FM radio. • Tunable Frequency • Undetectable on Phone • Easy to Build & Use • Up to 3 Mile Range • Only transmits during phone use  
VWPM7 Plans .... \$6.00 VWPM7K Kit/Plans \$39.50

## Automatic Telephone Recording Device

Connects between telephone and recorder • No power needed • Undetectable • Crystal Clear • Extends Tape Time  
SPECIAL OFFER! Complete system including extended play recorder. TAXP2Z . \$99.50



## Sunglasses/FM Radio!

This high tech, all new device is a full range, tune-able FM radio built in to a pair of sunglasses. Great for covert listening of wireless devices and regular entertainment.  
SUGL1 Ready to Use, with batteries ..... \$24.50

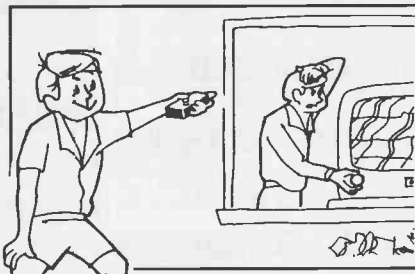

**TV & FM Jocker / Jammer** - Shirt pocket device allows you to totally control and remotely disrupt TV or radio reception. Great gag to play on family or friends. Discretion required.  
EJK1KM Easy to Assemble Electronic Kit . \$19.50

## Visible Beam Laser

High brightness red HeNe laser visible for miles. Produce your own light show! Projects a beam of red lite clearly visible under most circumstances. Can be used to intimidate by projection of a red dot on target subject. Also may be used to "listen in" utilizing our laser window bounce method #LLIS1 below. Easy to Build Modules Produce A Working Visible Laser:  
LAS1KM Kit w/1mw Laser Tube, Class II . \$69.50  
LAS3KM Kit w/2.5mw Laser Tube, Class IIIA \$99.50

## SALE! SALE! SALE! SALE!

**Low Power 0.5mw HeNe Laser Tube** with plans to build a low cost visible red laser system. Great for low budget science fair project!  
LATO5 .. \$24.50

**Laser Pen** - Great for movies, drive-ins, even science' projects. LAPN1 Ready to Use ..... \$149.50

## "Laser Bounce" Listener System

allows you to hear sounds from an area via a lite beam reflected from a window or other similar object. System uses our ready-to-use LATR1 Laser Terminator gun site as the transmitter. The receiver section is supplied as an easy-to-build kit, including our cushioned HS10 headsets. Order # LLIST20 System, includes our LATR1 Ready-to-Use Laser Gun Site, LLR1K Special Receiver Kit, and HS10 Headset, all for only \$299.50

## Visible Red Laser Diodes

670NM Toshiba. All new, full spec, with plans to build a system. VRD1 3mw Laser Diode / Plans .. \$49.50  
VRD3 5mw Laser Diode / Plans ... \$69.50

## See In The Dark Viewing

Device uses invisible infrared illumination for seeing in total darkness. Excellent for low cost night vision, along with observing lasers and other IR sources. Functional unit, many useful applications.  
SD5 Plans ..... \$10.00  
SD5K Kit / Tube / Plans ..... \$299.50  
GPV10 Ready to Use Viewer ..... \$499.50  
6032A Tube / Plans to build your own ... \$99.50



## INFORMATION UNLIMITED

Dept RES-12, Box 716, Amherst, NH 03031  
Phone: 603-673-4730 FAX 603-672-5406  
MC, VISA, COD, Checks Accepted. Please Add \$5.00 Shipping & Handling

## Catalog

with many more items  
FREE with Order,  
Or Send \$1 P&H



Order by Mail,  
or by 24 Hour  
Orders-Only Phone:  
**800-221-1705**



# TOP SECRET MANUALS



## OFF-THE-SHELF HARDWARE

Van Eck System, Shirk Module, Voice Disguiser, Hearing Assistant, Diabetes Alarm, 6th Sense Communicator, The Levitator, Resonant Coils, TENS Devices, Long Range Eavesdropper, Bumper Beeper, PC A/D Interface, Radar Emitter, Subliminal Mixer, Neurophone, EM Weapons Countermeasures, Payphone Autodialer - more! Assembled and tested (no kits) \$1 for descriptions.

## PHONE COLOR BOXES

Designed by Phone Phreaks! 15 phone color boxes described. Dozens circuits, programs. Plus call forwarding, conferencing, prehook history. Plus 50 useful and legal phone circuit plans. More Manuals \$29.

## VOICE MAIL BOX HACKING

How Voice Mail Box (VMB) systems are used and the specific ways they are hacked. Includes ASPEN, MESSAGE CENTER, BIX, EZ, SYDNEY, PHONE MAIL, AUDIX, etc. Absolutely required for all sysops, users! \$29.

## CELLULAR PHONE MANUAL

How cellular phones are designed, operated and programmed. How cellular systems are vulnerable to hack attacks and countermeasures. \$29.

## HIGH VOLTAGE DEVICES

HV devices plans: Stun Gun, Laser, Prod, Cane, Umbrella, Zapper, RF Radar/Audio Jammer, Fishers, Blaster, Jacob's Ladder, Plasma and Van de Graaff Guns, Fence Charger, Geiger Counter, Ozone Gen, Fish Stunner, Pest Killer, Plant Stimulator, Kirlian, Magnetizer, etc. \$100KICI \$29.

## EM BRAINBLASTER

Tutorial and plans for powerful ELECTROMAGNETIC WEAPONS and LAB DEVICES. Optimum circuits, freqs., waveforms, intensities. Comprehensive, MIND BOGGLING! \$29.

## RADIONICS MANUAL

Exciting electronic and electromagnetic therapeutic and diagnostic devices (mostly experimental). History, descriptions, plans (dozens), availabilities of Radionics Devices from early to modern. \$29.

## SECRET & SURVIVAL RADIO

Optimum survival and security radio equipment, methods, frequency allocations and voice/data scrambling/encoding. Includes small receivers/xmitters, telemetry, antenna optimizations, remote monitoring and control, security, surveillance and ultrasonic, fiberoptic and infrared commo. More! 70+ circuit plans, tables \$29.

## TV DECODERS/CONVERTERS

Tutorial and plans for several TV decoders and converters. use tips \$14.

## STEALTH TECHNOLOGY

Police radar is fascinating! It also has error rates of 10%-20%! Every known. Error mode - Method and material to minimize radar reflections - Strategy and tactic to fight unjust radar tickets (that cost you a fortune in insurance) - Method to detect and jam signals - fully described! \$19.

## NEW CIRCUIT

DESIGN CONCEPT  
Describes new circuit design "MAGIC POLYHEDRON" concept. Soldering typically less than 20% of PC and perf board designs - much less risks of toxic chemicals, burns, bad solders, cooked parts, etc. Compact, efficient, versatile, low-noise, reliable shape, size, layout. Easy to troubleshoot and make design changes. Relatively inexpensive. Easy to integrate with chasses, controls, connectors, displays, power supplies, etc. Assemble circuits just about anywhere. \$19.

## KW-HR METERS

How wattour meters work, calibration, error modes (many), ANSI Standards, etc. Demand, Pole and Polyphase Meters. Experimental results \$19.

## STOPPING POWER METERS

As reported on CBS 60 MINUTES! How certain electrical loads (simply plugs into an outlet) can slow down wattour meters - even stop them - while drawing full loads! Also describes meter creep, overload droop. \$19.

## THE I.G. MANUAL

External magnetic ways to slow down and stop wattour meters while drawing full loads. \$19.

## GAS FO' ALL!

Every known vulnerability of gasoline and diesel fuel pumps and dispensers. \$19.

## LIBERATE GAS & WATER

How gas and water meters can be reversed using simple household equipment. \$19.

## SURVIVAL GUNS & AMMO

THE ULTIMATE FIREARMS SURVIVAL MANUAL!  
Describes optimum guns and ammo, conversions, silencers, explosive devices, improvised weapons, End Times scenarios, retreats, etc. \$19.

## ROCKET'S RED GLARE

How to design and build solid-propellant amateur and survival rockets. Special emphasis on the formulation, manufacture and installation of propellants, motors, igniters, etc. Includes list of commonly available materials. And the design of launch pads and electronics. \$19.

## VOICE DISGUISER

Plans for neat devices to change voice pitches. Effective against snoops using voice analyzers; to conceal gender for women living alone, for anti-intrusion systems; for music accompaniment, for gags. Voice sounds natural. \$19.

## SECRET & ALTERNATE IDS

Privacy is virtually gone! With the huge databases now maintained by credit bureaus and governments, your sanity and future survival are at great risk - unless you can escape under a secret and alternate ID. Legal methods detailed. Not a rehash of the Paper Trip books \$14.

## CONSUMERTRONICS

2011 CRESCENT DR., P.O. DRAWER 537  
ALAMOGORDO, NM 88310  
1-505-434-0234

FAX 1-505-434-0234 (Orders Only) Mon.-Sat. 8am-8pm MST Voice & Manual FAX, 9pm-8am Auto. FAX, Add \$4 ship. (USA, Canada). All items are in stock COD (UPS cash only), VISA and MasterCard OK. 100+ More Computer and Electronic Offers!! Catalog is \$2 in business since 1971. As seen on TV.

## ROBOFONE AUTODIALER

Powerful, versatile, menu-driven program allows you to dial any number (up to 10K) or mix of local and long distance numbers in any order, over any length of time, whether busy or answered (your choice) and log the times, commands and results to monitor, printer and/or disk. Quick-dial directory of up to 600 numbers! BUSY redial options. Direct modem command and control. All result codes, including Voice and Ringing. Optional shell to terminal program upon Connect. Exit to menu or DOS (for batching). Ideal "Wargames" power dialer, phone call logger and telemarketing dialer. Manual + Disk\* \$29.

## HARD DRIVE MANUAL

Relates to all hard drive and controller implementations (emphasis on PCs). How to select, interface, initialize, set up, maintain, troubleshoot and repair them. How to protect them from mistakes, sabotage, prying eyes, sticky fingers. How to recover damaged and lost files. Includes software reviews. Loaded with info, advice and tips. \$29.

## DISK SERVICE MANUAL

Maintain, troubleshoot, repair, adjust, align floppy drives without special equipment or software - 5.25"/3.5"/8", PC/XT/AT/386/486, Apple, Commodore, Raypro, Tandy, Epson, Atari, TI, HP, DEC, etc. systems. All floppies need regular upkeep. \$29.

## DISK DRIVE TUTORIAL

Theory and practical facts on floppy drives, disks, FDCs, formatting, software protection. Systems described above. Invaluable advice and tips on how to best select, interface and use drives and disks. \$19.

## COMPUTER PHREAKING

TRUJANHORSES, VIRUSES, WORMS, etc. and countermeasures. Includes disk with 250K+ of hacker text files and utilities, and legendary FLUSHOUT\* protection system (Ed. Choice, PC Magazine). Dozens of computer crime and abuse methods and countermeasures. How systems are penetrated, BBS advice, password defeats, glossary, much more! Manuals + 2 Disks\* \$39.

## BRAIN VIRUS ANTIDOTE

The PAKISTANI BRAIN VIRUS plagued dozens of institutions, businesses. The mildly destructive original version has been hacked into highly virulent strains. BVA consists of the antidote, source code and write-up. Disk\* (NOT injected) \$19.

## BEYOND VAN ECK PHREAKING

Eavesdropping on VDT and TV video signals using an ordinary TV! Ranges up to 1 KM. Plans, countermeasures. Includes legal Van Eck Ecs, and original Top Secret Van Eck design! \$29.

## ATMS

ATM crimes, abuses, security, vulnerabilities 100+ methods described - from Reg. E to ciphers. Case histories, law, countermeasures, detailed security checklist. Internal photos, figures! Still unsolved! One crook stole \$237,000 from one bank's ATM's! \$39.

## ABSOLUTE SECURITY

Dozens of simple, versatile, secure computer security methods and tips. Plus our invulnerable Cipher Program (in .COM and its .BAS Source). Plus \$1,000 CIPHER CONTEST rules with Ciphertext Manual + Disk\* \$24.

## CRYPTANALYSIS TECH.

Five powerful menu-driven crypto programs (in .COM and their .BAS sources) to analyze, decrypt "secure" ciphertexts. Worked-out examples. Recommended in the prestigious COMPUTERS & SECURITY. Manual + Disk\* \$29.

## STOCKPRO

Unique, powerful, shrewd, unconventional common stock investment strategy. Created for NMSU, and basis of expensive consulting system. Manual + Disk\* \$29.

## PRINTER/PLOTTER MANUAL

Types, descriptions, specs and 100+ interfaces (parallel, serial). Detailed plans for X-switchers, buffers, and serial-to-parallel and parallel-to-serial interfaces, breakout devices. Many buy, use, service, repair tips. \$14.

## SOFTWARE PROTECTION

Unique system that highly discourages costly software piracy while not interfering with legal archival copies. No known way to defeat. No special equipment required. Easy, automatic to install on your disks. Can be used with any other protection system. Manual + Disk\* \$59.

## CONS & SCAMS

Cons and scams fleece Americans of at \$50+ Billion per year! The most comprehensive manual on cons and scams of all kinds from the classic to the high tech. Details on hundreds of cons and scams and their many variations and countermeasures. Fraud is rampant - protect yourself! \$29.

## SPECIAL PROJECTS

We design, build, repair, modify, maintain and consult on any device, system or project - computerized, electronic, electrical, mechanical, optical. Many invention prototypes. Confidentiality guaranteed. Describe and include \$25 fee (does not obligate you). We then provide you cost, time estimates.

## TECH. RESEARCH SERVICES

Unique 51+K electronic and computer design articles in database accessed by title and subject. Digital, uP, uC, analog, hybrid, nonprogrammer software. Provides keys, we return list. \$25 search fee (1-20 keywords/phrases, you may combine unrelated topics). Saves you R&D \$\$\$ Powerful RES-SNAP program will allow your own searches thru popular electronic books, magazines and your files. Disk\* \$95.

\*All software supports all IBM-PC and compatible systems ('86-'88).  
SOLE FOR EDUCATIONAL PURPOSES ONLY.

# Toner Cartridge Recharge

## Kits—Supplies—Service

Everything you need to recharge toner cartridges used with Canon based laser printers and personal copiers.  
Use with HP: LaserJet, LaserJet II, IID, IIP, III, IIIP  
Apple: LaserWriter, LaserWriter IINT, IINTX, QMS:  
Kiss, PS-800, PS-810, Canon: LB-P8A1, A2, II, OKI, NEC, Ricoh, etc.  
With our Kits—Supplies—Service you can start your own profitable recharge business or just recharge your own cartridges.

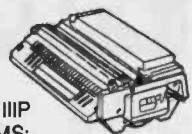

Model	Recharge Kits/Supplies	Dealers Please Call	Retail
TR-300	Recharge Kit for CX type laser printer engines.		\$21.95
TR-302	Recharge Kit for SX type laser printer engines.		\$26.30
TR-304	Recharge Kit for HP IIP (LPB-4) laser printer.		\$21.95
TR-325	Recharge Kit for PC-10/12/14/20/24/25 copier.		\$25.50
TR-370	Recharge Kit for Sharp Z-50/55/70 copier.		\$34.95
4080	Replacement Toner Kit for Ricoh 4080 laser.		\$35.95ea/6
6000	Replacement Toner Kit for Ricoh 6000 laser.		\$14.25ea/6
9710	200 grms of high quality black toner for CX.		\$9.95ea/12
9730	250 grms of high quality black toner for SX.		\$12.50ea/12
8011-Blue/Br	200 grms of Blue/Brown toner for CX & SX.		\$22.95ea/12
8057	150 grms of high quality black toner for PC.		\$10.95ea/12
Felt-CX, SX	replacement treated felt for all models.		\$0.90ea/12
SS-CX, SX	seal strips for sealing in toner for reshipping.		\$0.85ea/12
DPP	Drum Padding Powder (pixie dust)		\$12.95
EverDrum™	OPC drum life extender agent. 40+ applications.		\$41.95
C2094	3M Toner Vacuum with attachments.		\$199.95

Instructions Available Free to Customers!  
Call 800-221-3516 ask for our catalog.



Chenesko Products, Inc.  
2221 Fifth Ave., S4, Ronkonkoma, NY 11779  
Call: 516-467-3205, Fax: 516-467-3223

# CABLE TV DESCRAMBLERS!

## CABLE KINGDOM!



\*JEROLD\* \*OAK\* \*HAMLIN\* \*ZENITH\*  
\*PIONEER\* \*SCIENTIFIC ATLANTA\*

IN STOCK

6 MONTH WARRANTY! WE SHIP COD!  
ABSOLUTELY LOWEST WHOLESALE/RETAIL PRICES!

\*\*\*\*\*FREE CATALOG\*\*\*\*\*

## J.P. VIDEO

1470 OLD COUNTRY RD., SUITE 315  
PLAINVIEW, NY 11803  
NO N.Y. SALES

CALL NOW! 1(800) 950-9145



## Where the Educated Satellite Television Consumer Shops!

**Doing Business with DBS...What's in it For YOU!**

**Buy Smart - Not Just for less! Read the fine print. DBS puts it in writing!!**

**Satisfaction Guaranteed:** If within 30 days you are not completely satisfied with your purchase, just call for a RA (return authorization) and send it back to DBS in new, undamaged condition, original box with instructions, warranty cards, etc. and we will cheerfully exchange the product or refund your money.

**Fresh Packed Factory Sealed:** Unless the customer requests a change in VC2 module or requests a burn-in all units are factory fresh. Used, Demo or Returned items are also available at reduced prices.

**Lowest Price Guarantee:** If within 30 days you find the same quality product and service for less. Simply send the retail advertisement with a copy of your invoice and DBS will refund you the difference. Price protection applies only to new merchandise.

**DBS Loaner Program:** If during the warranty period the product purchased fails, DBS will loan you a component to get your system up and running until the item is repaired or replaced under warranty.

**800 Number for Technical Support:** All DBS Customers are welcomed to call 800-350-0256 for technical support. If you need assistance with hooking-up or installing your equipment from DBS, or if you have questions regarding the compatibility of your existing equipment with new models, you will find the answers through our tech Line. We pride ourselves on our expert technical assistance.

**Trade-in Program:** DBS offers Trade-in Values on all receivers and decoders. If you are planning to upgrade an existing system then call DBS for the trade-in value on your receiver.

**5 Year Warranty:** All New IRD's, Receiver & Decoders are offered with a 5 year Warranty for an additional cost of just 99.00

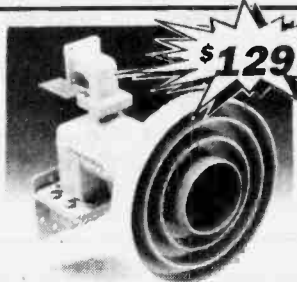

**\$129**

### Chaparral Corotor II

- Co-boresight C/Ku feedhorn. • Easy to mount.
- Fits more dishes, accepts an optional Corotor II Golden Ring to illuminate deeper dishes.

**Price Buster System!!**



### EchoStar 4000

**Receiver \$699 Complete System \$1199**

- Parental Lockout by Satellite & Channwl. • Full Function IR Remote. • Last Channel Recall. • Built in Motor Drive.



**Limited Time Offer**

**Receiver HTS VIII Plus Complete System \$1099 \$1649**

- Custom name your favorite programs • 2 remotes-full function & simplified. • Autopeaking. • Built-in C/Ku switching. • Matrix, discrete, Videocipher II digital audio w/extended Frequency Response. • 100 favorite video & audio programmable.

**Built-In Videocipher II Plus-Legal Decoder**

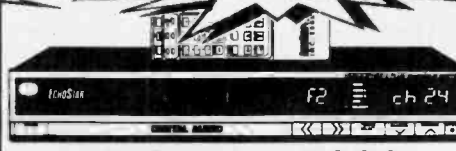

### EchoStar 5000

**Receiver \$829 Complete System \$1349**

- 20 Favorite Channels. • PLL Synthesized Video/Audio Tuning. • Video Noise Reduction Filters. • 90 Programmable Satellite Positions. • Multi-Mode Front Panel LED Display. • Full Feature On Screen

## C Band LNBS - SALE PRICED! - Ku Band LNBS

LNB 25 k HEMT	\$199
LNB 30 k HEMT	\$149
LNB 35 k HEMT	\$129
LNB 40 k HEMT	\$99
LNB 50 k HEMT	\$79

**2 Year Warranty**  
Featuring LNBS from Cal Amp, EchoStar, Drake & Norsat.  
**Save an Additional \$20**  
if purchased with an IRD (integrated Receiver Decoder)

LNB 0.8 HEMT	\$239
LNB 0.9 HEMT	\$209
LNB 1.0 HEMT	\$169
LNB 1.1 HEMT	\$149
LNB 1.2 HEMT	\$129

## IRD's Integrated Receiver/Decoder (Videocipher)

Chaparral Monterey 30	1,199
Chaparral Monterey 50	1,399
Chaparral Monterey 90	1,649
Chaparral Monterey 100 w/PC interface	1,759
Drake 1224 w/APS	1,049
Drake 1424	1,349
Drake 1524	1,499
EchoStar 510	1,029
EchoStar 710	1,179
EchoStar SRD-3000	699
EchoStar SRD-4000	729
EchoStar SRD-5000	849
EchoStar SRD-6000	950
General Instruments 2710	1,039
General Instruments 2730	1,099
General Instruments 2770	1,499
Houston Tracker 4	899
Houston Tracker 5	999
Houston Tracker 8 Plus	1,099
Houston Tracker 10	1,349
Panasonic PS-700 EX	1,349
Panasonic CRD 4500	999
STS SR 300	1,249
Toshiba 80	1,049
Toshiba 120	1,149
Toshiba 1800	1,389
Toshiba 2000	1,449
Toshiba 2200	1,549
Uniden President 900	849
Uniden President 1000	849
Uniden 4200	729
Uniden 4400	849
Uniden 4800	1,299
Zenith 7000	1,299

**COMPLETE base systems included:** Orbitron C-10 or Unimesh 10' ASI, 45 LNB, Feedhorn, 18" Jack & Motor. C/Ku Band system also includes a Dual C/Ku Feedhorn, 1.3 Ku LNB and necessary switches for automatic switching between C/Ku.. For the complete base system add \$550 to the receiver of your choice. For C/Ku band add an additional \$200.

### Antenna's

Ajak H-180/Winegard 10' Perf. H/H	899
EchoStar X-10*	499
EchoStar X-12*	729
Orbitron 7.5 w/LNA Cover*	249
Orbitron 8.5 w/LNA Cover*	299
Orbitron C 10 w/LNA Cover*	349
Orbitron Super SX-10* w/LNA Cover*	429
Orbitron O-12* w/LNA Cover*	629
Orbitron O-16* w/LNA Cover	2,399
Orbitron O-16' H/H w/motor	2,979
Paralipse 12' (\$175 for paint)	999
Paralipse 12' CD H/H (\$150 for paint)	1,249
Paralipse 14.5' H/H (\$175 for paint)	1,899
Paralipse 16' H/H (\$175 for paint)	5,100
Tru Focus (Patio Mount) 6'	279
Tru Focus (Polar Mount) 6'	325
Unimesh 10' ASI Quad	379
Unimesh 10'	429
Unimesh II 10' w/Quad & Unimount H/H	699
Winegard 7'	399
Winegard 10' Quad Star	399
Winegard 10' Pinnacle Perf.	725

Shipping on IRDs is \$15 (with some exceptions) systems is \$85 in 48 states. Call for quote on any upgraded antenna that is not (shown without \*) UPS shippable.

**Order Toll Free!**

**1-800-327-0046 • 1-800-350-0256**  
**in California: 1-800-734-4SAT**  
**Office: 805-652-0255 Fax: 805-652-2190**



**Hours:**  
**8 to 6 • Mon-Fri**  
**9 to 1 • Saturday**  
Pacific Standard Time

# Learning Electronics has never been Easier!

These Computer Animated VHS Videos Vividly Illustrate Important Electronic Concepts

Part 1 DC	\$34.95	Part 6 Oscillators	\$34.95
Part 2 AC	\$34.95	Digital 1	\$34.95
Part 3 Semiconductor	\$34.95	Digital 2	\$34.95
Part 4 Power Supplies	\$34.95	VCR Maint&Rep.	\$34.95
Part 5 Amplifiers	\$34.95	Intro to VCR Rep.	\$34.95

You Deserve  
the UCANDO  
Advantage.  
Order yours  
today!



Each Video is app. 55 Min. long



For PAL videos Contact:  
Electronic Assembly Co.  
P.O. Box 21191, Edgeware 8030,  
Christchurch, New Zealand

Visa & Master Card Accepted

Mail Check or Money Order to:  
**UCANDO Videos**  
P.O. Box 928  
Greenville, OH 45331

Call Toll Free  
**1-800-678-6113**

Copyright © 1987 UCANDO VCR Educational Prod. Co.

CIRCLE 221 ON FREE INFORMATION CARD

## Internal Programmer for PC

**\$139<sup>95</sup>**

New Intelligent Averaging Algorithm. Programs 64A in 10 sec., 256 in 1 min., 1 Meg (27010, 011) in 2 min. 45 sec., 2 Meg (27C2001) in 5 min. Internal card with external 40 pin ZIF.

- Reads, Verifies, and programs 2716, 32, 32A, 64, 64A, 128, 128A 256, 512, 513, 010, 011, 301, 27C2001, MCM 68764, 2532, 4 Megabits
- **Automatically sets programming voltage**
- Load and save buffer to disk
- Binary, Intel Hex, and Motorola S formats
- **No personality modules required**
- 1 Year warranty
- 10 days money back guarantee
- Adapters available for 8748, 49, 51, 751, 52, 55, TMS 7742, 27210, 57C1024, and memory cards
- Made in U.S.A.

2 ft. Cable      40 pin ZIF

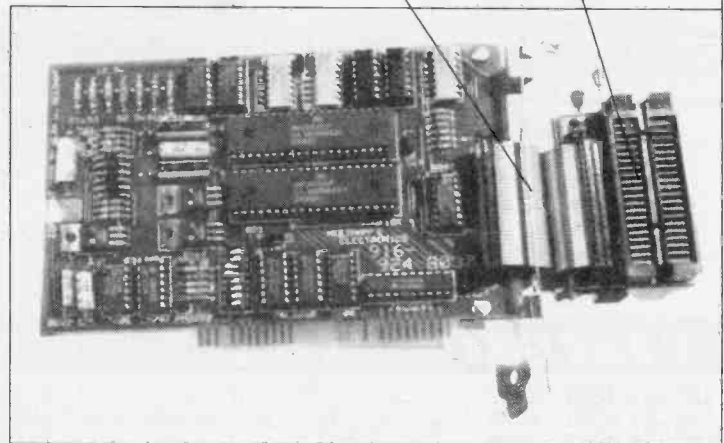

EMPDemo.EXE available **BBS** (916) 972-8042

4539 Orange Grove Ave.  
Sacramento, CA 95841  
(Monday-Friday, 8 am-5 pm PST)

**NEEDHAM'S ELECTRONICS**

Call for more information  
**(916) 924-8037**  
FAX (916) 972-9960



C.O.D.





**PHONE HOURS:**  
Mon.-Fri. 9:00 AM-6:00 PM  
Sat. 8:30 AM-1 PM

**STORE HOURS:**  
Tues.- Fri. Noon-6:00 PM  
Sat. 8:30 AM-1 PM

1717 RESERVE ST.  
GARLAND, TX 75042

\* MILITARY UNITS CANNOT BE SHIPPED OUTSIDE U.S.A.  
ALL UNITS GUARANTEED OPERATIONAL WITH MANUAL  
ALL EQUIPMENT F.O.B. GARLAND, TX  
VISA & MASTERCARD OK - NO C.O.D.s

In TX: 800-749-4642

Ask for Ext. 134

In Dallas: (214)340-0631

### HICKOK 1605M ELECTRONIC MULTIMETER \$119.00



**EQUIVALENT  
TO HP 410C!**

- Measures a wide range of AC voltage, DC voltage, current and resistance
- DC voltmeter range is from 0 to  $\pm 1,500$  volts
- DC current range is from 0 to  $\pm 150$  mA with special ranges of  $\pm 1.5$ , 5 and 15 nA using the DC voltmeter probe
- Resistance measurements can be made from under 1  $\Omega$  to over 500 M $\Omega$
- AC voltage can be measured from 0.5 to 300 V (rms) from 20 Hz to 700 MHz

### HP 403B AC VOLTMETER \$299.00

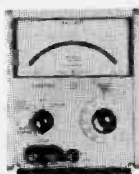

- Transistorized, battery-operated average responding AC voltmeter
- Voltage range from 0.001 to 300 V in 12 ranges
- Frequency range from 5 Hz to 2 MHz
- Accuracy of  $\pm 2\%$  from 10 Hz to 1 MHz and  $\pm 5\%$  from 1 to 2 MHz
- Fuse protected overload

**\*NEW\*NEW\*NEW\*NEW\*NEW\*NEW\***

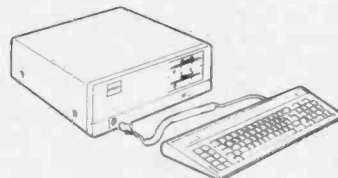

### NEW UNISYS PC CLONE!

New in Box Unisys PC Clone with:  
Keytronics 101 keyboard, 256 K memory, clock, serial port, one 360 K floppy drive, manuals, DOS, etc. **\$175.00**

Memory expansion card for above, bringing total memory to 640 K **+ \$65.00**

Unisys computer at top with used monochrome monitor, printer port and monochrome card **\$250.00**

Same as above but with two 360 K floppy drives **\$200.00**

30 meg flash card **\$149.00**

640 K, 2 floppy disk drives, 30 meg Hard drive, and monochrome system **\$489.00**

### HP 204C/002 OSCILLATOR \$299.00

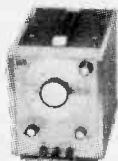

- Rechargeable batteries
- Wide ranged oscillator, solid state and highly portable
- Frequency range from 5 Hz to 1.2 MHz
- Output is 5 V into an open circuit and 2.5 V into 600  $\Omega$
- Output impedance is 600  $\Omega$
- The output is variable with greater than 40 dB attenuation for an open circuit output of less than 50 mV RMS

### SUPER DEAL ON HARD DRIVES AND CONTROLLERS!

Old, but works fine! 10 megabyte Seagate ST412 and new surplus IBM (XEBEC) controller with cables, formatted, ready to plug in and go.

**ONLY \$69.95!**

### TEKTRONIX MODEL 851 DIGITAL TESTER \$79.95



**\$2995.00  
NEW PRICE!**

- The 851 is an easy-to-operate portable unit containing a DMM, a counter and input signal conditioning circuits and is used for servicing digital equipment
- The DMM is an auto ranging 4 1/2 digit multimeter with floating inputs and a 500 VDC maximum input and 350 VAC maximum input
- The counter is an auto ranging 6 digit, 36 MHz universal counter with three inputs and an accuracy of  $\pm 0.005\%$
- The unit also has a calibrated gated square wave output at 5 KHz which is suitable for probe compensation
- All three channels feature -30 to +30 V threshold adjustments

### HIGH FREQUENCY OSCILLOSCOPE PROBE \$23.95



**NEW!**

- Switchable X1, X10; Rugged probe
  - Bandwidth of 10 MHz (X1); 100 MHz (X10)
- Includes sprung hook, 6" ground lead, BNC adaptor, IC test tip, trimmer tool, and storage pouch.

### TEK 453 DUAL TRACE SCOPE ~~\$595.00~~ \$395.00

**JUST REDUCED!**

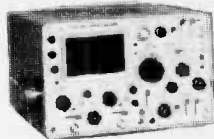

- 5 mV/div TO 10 V/div calibrated deflection factors
- DC to 50 MHz bandwidth at 20 mV/div
- Calibrated time base 0.1  $\mu$ sec/div to 5 sec/div
- Calibrated X-Y operation 5 mV/div to 10 V/div in 11 steps
- Calibrated mixed a sweep and sweep delay
- 8X10 div CRT

### TEKTRONIX 500-SERIES PLUG-INS!

#### TEK 1L10 SPECTRUM ANALYZER

For use with 530-, 540-, 550-, and 580-series scopes.  
Dial accuracy is  $\pm (100\text{kHz} + 1\% \text{ of dial reading})$   
RF attenuation of 51 dB

**\$ 395.00**

#### TEK 3A6 DUAL TRACE PLUG-IN

Designed for Tek 560, 561, 564, and 565 scopes  
DC to 10 MHz  
10 mV DIV to 10 V DIV in 10 steps  
Dual Trace

**\$ 39.00**

#### TEK 3B4 TIME BASE PLUG-IN UNIT

Designed for use with the Type 561A, 564 and 567 Oscilloscopes  
Provides calibrated sweep rates from 0.05  $\mu$ sec/div to 5 sec/div in 25 calibrated steps  
Provides 5 steps of deflection sensitivity from 0.2 volts/div to 5 volts/div

**\$ 50.00**

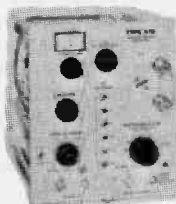

### LAVOIE LABS LA800D WWW COMPARATOR \$79.00

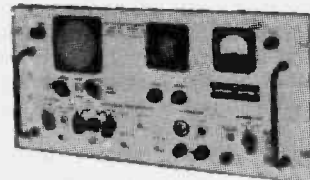

Receives WWW on 5 MHz or 15 MHz and compares the accuracy of your signal. Frequency deviation are monitored as an audio beat or on small CRT. A must for checking the accuracy of your radio!

### FLASH CARD-30 \$149.00



New-in-box 30 meg hard drive on a card with 65 msec access time. Easy installation in your PC.

# REVOLUTIONARY PC BASED TEST EQUIPMENT

## I1000

## OUR BEST DATA INTERFACE



The I1000 Data Interface Card is a 100% IBM PC/XT/AT compatible half card. The I1000 is the heart of the TSW system, and is required to drive any or all of the T1000 series peripherals. With the TSW system, you will use only one I1000 card and one expansion slot, while having the capability of running many pieces of external test equipment. One I1000 card is capable of addressing up to 256 external pieces of test equipment. In other words, the T1001, T1002, T1003, and T1004 can all be driven simultaneously by just one I1000. Additional (I1000 compatible) members of the T1000 series are under development and will appear in future advertisements. The I1000 connects to the first peripheral using a 6 foot DB-25

male to female cable. Additional T1000 series units are simply stacked and paralleled with the first. The peripheral test equipment is powered by the computers +12 and -12 volt power lines. The current load on the +12 volt line is between 100 and 300 milliamperes per unit. The current load on the -12 volt line is between 0 and 20 milliamperes per unit. We have been running our entire product line (connected simultaneously) for 18 months. The I1000 uses a bidirectional parallel format. The maximum data output rate is one 8 bit byte per 3us or 2.6 Mega bits per second. The I1000 is addressable, or may be left at the factory preset prototype address (HEX 300).

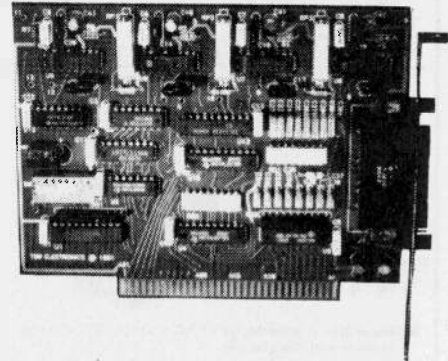

ORDER#	1-9	10-49
I1000	\$77.00 ea.	\$72.00 ea.



## T1000 SERIES OVERVIEW



The T1000 family of products are each housed in a 10"x7.5"x3.1" ABS plastic instrument case. All of the front panel functions are clearly silk screened. The T1000 series units stack to create a lightweight, compact, modular component system. When

combined, an elegant test block is formed, eliminating the need for bulky, old fashioned equipment. We provide all of the ready to run executable software needed for each piece of T1000 series equipment. We also provide a simple BASIC tutorial and

(remarked) source code for those who would like to develop personalized T1000 series applications. In this way, our products are especially suited for custom projects and industrial applications where flexibility is a must.

## T1001

## CAPACITANCE • FREQUENCY • EVENT/PERIOD

## ALL IN ONE



The T1001 contains a precision autoranging capacitance meter, a 100MHz frequency counter, and an event/period measurement system. Within the T1001, all measurements are governed by an on board 60MHz crystal oscillator.

### CAPACITANCE

This is no ordinary capacitance meter. It is accurate and autoranging from 0pF to 1uF, and from 1uF to 10,000uF. It has a maximum step resolution of .3pF and performs approx. two conversions per second for values below 1uF. This meter works beautifully between 0 and 10pF where many other units are found lacking. Our cap meter is able to learn. If you wish a particular range to be more precise, you simply insert your reference components and ask the unit to learn the new values. We use the full power of the PC to perform matrix and curve fitting techniques. This allows us to achieve amazing accuracy. Our capacitance meter also features a "zero and read" function. Insert a reference capacitor and press "Z". Remove it and insert a different capacitor. The screen displays the difference in capacitance as well as the capacitor tolerance. If you would rather directly enter a theoretical value (for comparison), just

press "D" and enter the reference value. These two features are most useful when matching or sorting. If you zero on a capacitor and leave it in place, you will easily observe component stability. Another time saving feature is our Ultra Fast Connect System. This allows the component under test to be inserted rapidly. Additionally, several capacitors may be inserted simultaneously in parallel. This is useful when trying to construct an exact value. The displayed units may be moved through pF, nF, uF, or mF at any time by pressing "U". The T1001 can be adapted to perform industrial functions such as moisture sensing. We are always available to help you implement your custom industrial applications.

### FREQUENCY

This is a high stability digital frequency counter capable of >100MHz without frequency division. It is ideal for digital (logic) circuit designing. It accepts any standard TTL level input. To use a prescaled frequency just press "D" and then type in a division factor between 1 and 100. The screen will then display the frequency being fed into the prescaler. We have used the AP-90-T prescaler manufactured by Startek International and found it to work quite well. Many frequency counters offer 2 or 3 timebase settings. Ours provides you with eight. To completely calibrate all 8 timebases, you would perform the following steps: attach a frequency to the BNC input,

press "C" to initiate calibration, enter the frequency used. In a minute or so, the computer will finish its analysis and your counter will have been fully calibrated. The displayed units may be moved through GHz, MHz, kHz, or Hz at any time by pressing "U".

### PERIOD

The third and final device contained within the T1001 is a complete pulse measurement system. It can be set to measure a positive or negative pulse. It has a noise immunity circuit which screens off all but the first pulse received. This device also provides a TTL compatible start pulse to the user. This start pulse (handshake) is provided to let the user's circuit know when to send the test pulse. One application which we have used many times is to use the start pulse to continuously fire a one-shot (monostable multivibrator) circuit. Displayed on the screen and continuously updating is the precise pulse width. Establishing RC timing values has never been easier. This period meter features a 16.6ns resolution and accurately measures pulses ranging from 80ns to 71.3 seconds + or - one step. The displayed units may be moved through ns, us, ms, or seconds at any time by pressing "U".

ORDER#	1-9	10-49
T1001	\$179.00 ea.	\$169.00 ea.

**T1002**

**DIGITAL CLOCK SYNTHESIZER**

**4.29 BILLION FREQ's**

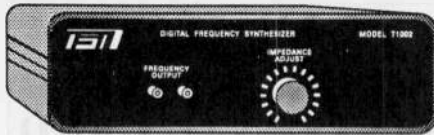

The T1002 is a digital clock synthesizer which produces a TTL compatible, 50% duty cycle square wave. This device will synthesize 4.29 billion different frequencies between 6MHz and .0055Hz. It uses a 48MHz crystal oscillator as a master reference.

This unit also features an output impedance compensation control which allows you to use regular wire instead of an expensive injection probe. To select a frequency, just press "D" and type in the frequency desired. If your frequency is not available, the closest available frequency will be displayed and synthesized. Pressing the up or down arrows will increase or decrease the frequency. The T1002 can be used to generate clocks, popular baud rates, sync pulses, and period calibration

waveforms. Displayed units may be moved through MHz, KHz, Hz, us, ms, seconds, or minutes simply by pressing "U". Custom osc. frequencies, multiple osc. frequencies, and other variations are available upon request.

Frequency output formula:  
 $f_o(\text{Hz}) = 48\text{MHz}/(2^n)$  where n is an integer between 4 and 2<sup>32</sup>

OR JER#	1-9	10-49
T1002	\$179.00 ea.	\$169.00 ea.

**T1003**

**12 BIT A TO D • 8 BIT D TO A • 24 BIT DIG. I/O**

**ALL IN ONE**

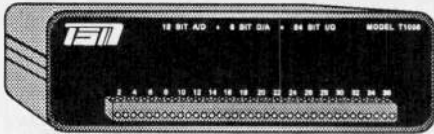

The T1003 consists of an 8 channel 12 bit analog to digital converter, a single 8 bit digital to analog converter, and 24 configurable digital I/O lines. This device will allow you to interface your computer to the real world quickly and easily. If you have ever successfully breadboarded a circuit, you will find this device simple to operate.

simultaneously. Any of these channels may be activated or deactivated with the press of a key.

**D TO A**

Next, we have an 8 bit digital to analog converter which produces 0 to 5V in 20mV steps. To produce a DC voltage, you would simply press "V" and then enter the desired voltage. This device is great for linear op-amp projects.

**24 BIT DIGITAL I/O**

Finally, we have a 24 bit digital I/O section which can be set up as three 8 bit ports, or two 8 and two 4 bit ports. Each port may be set up as input or output with the press of a key. This section has an infinite number of uses. Create your own alarm system. Generate 1's and 0's needed for digital gate control. Why build a display for a prototype circuit? Just feed the raw

binary into your T1003 and see the count displayed on the screen. Your breadboard or digital trainer becomes much more powerful when you connect it to the T1003. Large corporations have been using their computers to process tedious information for years. Now the same technology is available to you at a great price. The T1003 is easily accessed through a 36 position European style terminal block mounted on the unit face. When using the included software, all of the functions which have just been described appear on the display simultaneously.

Industrial Applications:

- Count product flow
- Continuity on finished circuitry
- Monitor voltage parameters
- Automatic test equipment

ORDER#	1-9	10-49
T1003	\$189.00 ea.	\$179.00 ea.

**T1004**

**LOGIC IC TESTER / IDENTIFIER**

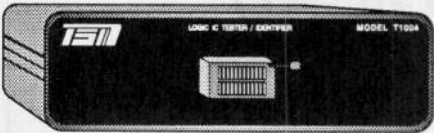

The T1004 is an advanced digital logic (ic) tester and identifier. This unit is capable of testing a vast number of

logic packages including 7400,4000, custom pals, and more. This package includes a tutorial on how to add components to the existing database. The T1004 goes beyond simply running a truth table. This unit has the ability to analyze an unknown IC, and if it is within the database, identify it. Additionally, it measures the input low to

high and high to low thresholds, as well as the output voltage levels. From this, the T1004 often has enough information to assist you in determining the exact logic family of the IC under test.

ORDER#	1-9	10-49
T1004	\$249.00 ea.	\$239.00 ea.

**DB-25-6**

**6 FOOT INTERFACE CABLE**



This cable is required in order to connect the I1000 to any peripheral unit. If you elect to construct your own, it must be fully populated, wired 1:1, and

contain 24 awg (or larger) wire. Pin 20 of the male end of this cable must be removed in order to mate with the DB-25 female on the I1000.

ORDER#	1-9	10-49
DB-25-6	\$12.95 ea.	\$10.95 ea.

**DB-RIB-(num)**

**INTERCONNECTS (num) PERIPHERAL UNITS**



This cable is required (in addition to the DB-25-6) in order to use more than one peripheral unit (T1001-T1004) simultaneously. If you elect to construct your own, it must be made using 28

awg, 25 conductor ribbon cable and contain 1 DB-25 IDC male, and (num) DB-25 IDC female connectors. Connectors must be placed at 5" intervals.

ORDER#	1-9
DB-RIB-2	\$15.95 ea.
DB-RIB-3	\$23.95 ea.
DB-RIB-4	\$28.95 ea.



Make check or M.O. payable to:  
**TSW ELECTRONICS**  
 Address:  
 2756 N. University Drive, Suite 168  
 Sunrise, FL 33322

Add \$5.00 S&H for ea. T1001-T1004  
 Add \$2.00 S&H for ea. I1000, or cable  
 Florida Residents add 6% sales tax  
 Allow 4 weeks for delivery  
 For technical info call (305) 748-3387

**TSW ELECTRONICS**

CIRCLE 276 ON FREE INFORMATION CARD

All prices are in U.S. Dollars  
 Prices and unit availability subject to change without notice

January 1992, Radio-Electronics



# Be an FCC LICENSED ELECTRONIC TECHNICIAN!



Earn up to \$30 an hour and more!

Learn at home in spare time. No previous experience needed!

No costly school. No commuting to class. The Original Home-Study course prepares you for the "FCC Commercial Radio-telephone License." This valuable license is your professional "ticket" to thousands of exciting jobs in Communications, Radio-TV, Microwave, Maritime, Radar, Avionics and more...even start your own business! You don't need a college degree to qualify, but you do need an FCC License.

**No Need to Quit Your Job or Go To School**  
This proven course is easy, fast and low cost! **GUARANTEED PASS**—You get your FCC License or money refunded. **Send for FREE facts now. MAIL COUPON TODAY!**

## COMMAND PRODUCTIONS

FCC LICENSE TRAINING, Dept. 210  
P.O. Box 2824, San Francisco, CA 94126  
Please rush FREE details immediately!

NAME \_\_\_\_\_  
ADDRESS \_\_\_\_\_  
CITY \_\_\_\_\_ STATE \_\_\_\_\_ ZIP \_\_\_\_\_

# MS-DOS EPROM PROGRAMMING SYSTEM NEEDS NO INTERNAL CARD

**EPROMS** (24, 28, 32 and 40\* pins)  
2708, 2758, TMS2716\*, 2716  
27C16, 2516, 2532\*, 2564\*  
68764\*, 68766\*, 2732, 2732A  
27C32, 2764, 2764A, 27C64  
27128, 27128A, 27C128  
27256, 27C256, 27512  
27C512, 27513\*  
27011\*, 27C011\* (1 MEG)  
27010, 27C010  
27C1000, 27C1001  
27C020, 27C2001 (2 MEG)  
27C040, 27C4001 (4 MEG)

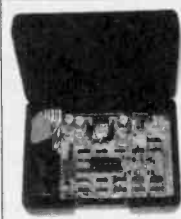

shown with power-pak & cable stored in case

**EPROMS**  
2804, 2816A, 28C16  
2817A\*, 2864A, 28C64  
28256, 28C256, 52B13\*  
52B33\*

**MicroControllers**  
8741A\*, 8742\*, 8748(H)\*  
8749(H)\* 8751\*, 87C51\*  
8752\* 8753\*, 8744\*  
68705 \*, TMS7742\*

\*ADAPTER REQUIRED

Diagrams included with manual  
Assembled adapters are available

CONNECTS TO YOUR SYSTEM'S

## PARALLEL PRINTER PORT

•A FAST, EASY-TO-USE SYSTEM WORKS WITH ANY DESKTOP OR LAPTOP MACHINE  
•EXPANDABLE, FLEXIBLE DESIGN SUPPORTS CURRENT AND FUTURE DEVICES  
•SUPPORTS 8, 16 & 32 BIT DATA FORMATS INCLUDING WORD SPLIT & DOUBLE WORD  
•READS AND CONVERTS INTEL HEX, MOTOROLA S-RECORD AND BINARY FILES  
•HARDWARE PROTECTED AGAINST DEFECTIVE AND INCORRECTLY INSERTED DEVICES  
•NO SOFTWARE INSTALLATION NECESSARY - PROGRAM TOTALLY SELF CONFIGURING

## SYSTEM SOFTWARE COMMANDS

•PROGRAM EPROM(S) FROM DISK FILE	•SAVE EPROM(S) OR BUFFER TO DISK	•COPY EPROM(S)
•READ DISK FILE INTO BUFFER	•PROGRAM EPROM(S) FROM BUFFER	•VERIFY EPROM ERASED
•READ EPROM(S) INTO BUFFER	•COMPARE EPROM(S) WITH BUFFER	•SELECT BUFFER EDITOR
		•SELECT DEVICE TYPE
		•DEVICE CHECKSUM
		•SET BUFFER (0, 1, 2, 3)

PLUS AN INTEGRATED BUFFER EDITOR WITH 18 BYTE LEVEL COMMANDS

SYSTEM INCLUDES: PROGRAMMING UNIT, POWER PACK \$289  
CONNECTING CABLE, OPERATION MANUAL & SOFTWARE

SOFTWARE AVAILABLE ON 3 1/2" OR 5 1/4" DISK (PLEASE SPECIFY)  
CALL ABOUT OPTIONAL ADAPTERS - A SOFT TRAVEL CASE IS AVAILABLE FOR \$19.00

TO ORDER SEND CHECK, MONEY ORDER, WRITE OR CALL:

VISA

ANDRATECH  
P.O. BOX 222  
MILFORD, OHIO 45150  
(513) 831-9708  
FAX (513) 831-7562

MASTER CARD

ADD \$5.00 FOR SHIPPING

ADD \$4.00 FOR C.O.D.

WRITE FOR MORE INFORMATION OR CALL AND LISTEN TO OUR "TALKING" DATA SHEET

## PROFESSIONAL CIRCUIT DESIGN

# QICAD

Save time and money!

QICAD is a full-featured printed circuit layout package that gives you everything you need to design circuit boards quickly.

- ON-LINE HELP
- AUTOROUTER
- POWERFUL EDITING
- HPGL/DMPL PLOTS
- GERBER
- POSTSCRIPT
- EXCELLON (DRILL)
- EGA / VGA compatible

**\$195.00** complete price

345 W. Williams Avenue  
Fallon, NV 89406  
(702) 423-1653 (702)423-1654 FAX

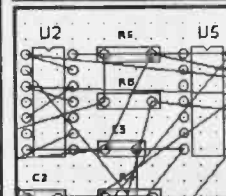
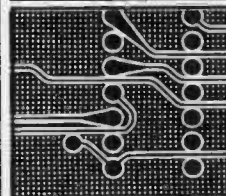
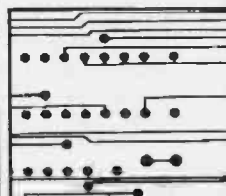

**gav**

# HOSFELT ELECTRONICS, INC.



## POWER RELAY

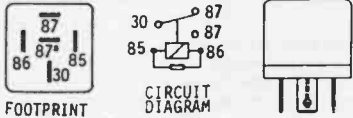

1" Sq x 1" H

12 VDC, 35 amp, SPDT, 86 ohm coil.  
Hook-up via standard 1/4" quick tab or plug in.

No. 45-246 **\$2.95**

## PLASTIC CALIPERS



Measures up to 6" in 1/16" increments, and 150mm in 1mm increments. Includes depth guide. Large numbers make it easy to read.

No. 54-115 **\$1.95**

## ROSIN CORE SOLDER



Meets Fed Spec QQ-S-571E  
.031 - 21 Gauge  
60% tin - 40% lead  
One Pound

No. SOLDER **\$6.95**

## I.E.C. LINE CORD

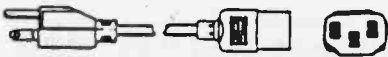

6 ft long, beige w/ molded plugs  
18/3 wire - Shielded

No. 60-131 **\$3.25**

## VOLTAGE REGULATORS

PART#	CASE	PRICE
78L05	T0-92	\$ .35
78M05	T0-220	\$ .39
7805	T0-220	\$ .49
7806	T0-220	\$ .59
7808	T0-220	\$ .49
7809	T0-220	\$ .69
78C12	T0-202	\$ .49
7812	T0-220	\$ .49
78L15	T0-92	\$ .49
7815	T0-220	\$ .59
7824	T0-220	\$ .49
7905	T0-220	\$ .59
7912	T0-220	\$ .59
7915	T0-220	\$ .59
LM317K	T0-3	\$2.99
LM317T	T0-220	\$ .65
LM323K	T0-3	\$3.25
LM350K	T0-3	\$3.49
LM350T	T0-220	\$2.75
LM723H	T0-5	\$ .99
LM723N	14 PIN DIP	\$ .49
TL783C	T0-220	\$1.49

## 4 AMP @ 200V BRIDGE RECTIFIERS

Mfg - General Instruments

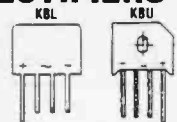

No. KBL02 **\$ .75**  
No. KBU4D **\$ .75**

## HIGH SPEED 12 VDC FAN



Mfg - Elina  
Mfg # - DA121238M  
4.7" x 4.7" x 1.5"  
Operating Voltage: 10.2-13.8  
Rated Current: 400 mA  
4.8 watt, 2700 RPM  
85 CFM, Noise level 41 dB  
Hook-up via 12" color coded wires

No. 26-194 **\$8.95**

## 12 PIECE NEEDLE FILE SET

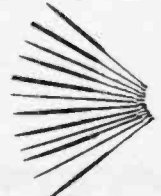

This miniature file set has 12 different 5/8" long files that can be used by hand or locked in a pin vise. Precision made for use on wood, metal or plastic.

No. 54-104 **\$3.95**

## FACTORY AUTHORIZED DISTRIBUTOR FOR:

**FREE**  
112 PAGE CATALOG  
CIRCLE RESPONSE  
CARD

**TO PLACE YOUR ORDER  
CALL TOLL FREE  
1 800 524 6464  
or Fax 614-264-5414**



2700 SUNSET BOULEVARD  
STUEBENVILLE, OH 43952  
MAIL ORDERS ALLOW \$3.75 SHIPPING

CIRCLE 269 ON FREE INFORMATION CARD

**FREE!**  
COMPUTER TOOL KIT  
WITH EACH PURCHASE

Question: Who needs a Zenith Personal Information Terminal?  
Answer: With all these features and the low price, everyone!

**Know a pilot?**  
Use to access the new DUAT service to file flight plans, check the weather, and more!

**Worried about security?**  
Choose from 10,000 codes to allow only authorized users to communicate.

**Need 24 hour communications?**  
Attach a printer and use as a dedicated auto receiver terminal for unattended reception.

**Want to dial your regular phone automatically?**  
Stores up to 26 numbers for voice, data, or auto-logon dialing.

**Want high speed communications?**  
Attach a high speed modem and communicate with other users or devices at up to 9600 baud! (Model ZTX-11-Z only).

**Need to access multiuser computer systems?**  
Talk to mainframes and more with the ASCII and DEC VT52 terminal emulation modes.

- ASCII, DEC VT52 emulation
- Parallel printer port
- Changeable security access code
- RS-232 port (ZTX-11-Z only)
- Composite video output
- New in original box with manual
- Built-in 300 baud auto answer modem
- Phone #. dialing sequence storage
- Switch for single or multi-line phone
- Two phone jacks: line and phone
- Program in Basic by external computer

**ZTX-11-Z with RS-232 \$75**

**ZTX-1-UZ without RS-232 \$50**

**COMPUTER BUSINESS MART**

10215 Buena Vista Avenue, Suite A • Santee, CA 92071  
**(619) 449-9040 • FAX (619) 449-7929**

VISA — MasterCard — AMEX — Discover — COD — PO

CIRCLE 229 ON FREE INFORMATION CARD

**BATTERIES REPLACEMENT BATTERIES**  
(ALL NEW - MADE IN USA)

<p><b>ICOM</b></p> <p>7S 13.2v 1200 mah \$59.00 8S 9.6v 1200 mah \$59.00 BP7 13.2v 600 mah \$59.00 BP8 8.4v 1000 mah \$59.00 SA/SAT BP82, BP83 BP83A 7.2v 750 mah BP84 7.2v 1000 mah BP85A 9.6v 600 mah BP85B 12v 600 mah</p>	<p><b>KENWOOD</b></p> <p>PB1 12v 1000 mah \$59.00 KNB4 7.2v 2200 mah \$59.00 PB6 7.2v 750 mah \$46.00 PB7 7.2v 1500 mah \$55.00 PB8 12v 750 mah \$55.00</p>	<p><b>MOTOROLA</b></p> <p>HT300 7.2v 1600 mah \$45.00 HT90 12v 600 mah \$34.00 HT440 12v 600 mah \$39.00 MT500 15v 500 mah \$39.00</p> <p><b>RADIUS</b> P-10 500 mah \$28.00</p> <p><b>SABER</b> 7.2v 1100 mah \$59.00</p>	<p><b>CAMCORDER</b></p> <p>JVC PANASONIC PV/BP80/88 12v 2.3 amps RCA/HITACHI Full size VHS-C SONY NP22 NP55/77 ALL BRANDS AVAILABLE</p>
<p><b>YAESU</b></p> <p>FNB-2 v 500 mah \$21.00 FNB-2 v 600 mah \$23.00 FNB-4A FNB-10 FNB-10S 7.2v 1000 mah \$43.00 FNB-12 FNB-12S 12v 600 mah \$45.00</p>	<p><b>SPECIALS</b></p> <p><b>ICOM-SA/SAT</b></p> <p>ICOM-72A CHARGER WITH BP-84 (Equiv.)—3" High 7.2v @ 1000 MAH \$135.00</p> <p>or</p> <p>BP-85B (Equiv.) 3" High 12v @ 600 MAH \$164.00</p>	<p><b>INSERTS</b></p> <p><b>KENWOOD</b> BP-21 \$13.00, BP-25, 26- \$20.00</p> <p><b>ICOM</b> BP-3 \$17.00, BP-5 \$22.00 BP-7, BP-8</p>	<p><b>CELLULAR</b></p> <p>MITSUBISHI \$60.00 NEC \$45.00 NOVATEL \$45.00 PANASONIC \$45.00 Bag Phone Kits \$55.00 MOTOROLA "FLIP" \$60.00</p>

\* ALL BATTERY PACKS - GUARANTEED TO HAVE THE ADVERTISED CAPACITY

SEND FOR  
FREE CATALOG  
DEALER INQUIRIES  
WELCOME

**BATTERY-TECH, INC.**  
28-25 215 PLACE, BAYSIDE, N.Y. 11360 • FAX 718-461-1978  
**800-442-4275 - N.Y.S. 718-631-4275**



MASTER CARD



# COMPLETE FCC LICENSE PREPARATION

- \* General Radiotelephone Operator's License
- \* Radar Endorsement

- \* Second Class Radiotelegraph
- \* All Amateur Radio Licenses

- \* MORE MONEY?
- \* A BETTER POSITION?
- \* EXCITING CAREER OPPORTUNITIES?

**AN FCC LICENSE  
MAY BE YOUR ANSWER**



The FCC License Specialists

We offer Home Study Courses for  
ALL TYPES of FCC Licenses.  
Formats include:

- \* TEXTS
- \* AUDIO CASSETTE COURSES
- \* VIDEO CASSETTE COURSES
- \* REGIONAL SEMINARS

## GENERAL RADIOTELEPHONE OPERATOR LICENSE

Your Job Opportunity "Ticket"

For years, the Commercial FCC license has been highly sought-after by many technicians and required by numerous employers. The General Radiotelephone Operator License has come to be known as the most HIGHLY RESPECTED "ticket" in the field of electronics. For many, it has been the KEY to job advancement and higher pay. Many companies offer immediate pay raises by simply passing the license exam. Other companies require the license for employment. When an employer sees the FCC license on a resume, he understands that the job applicant has a firm grasp of radio communications...a firm foundation that can be built upon to meet the demands of any job situation.

## SECOND CLASS RADIOTELEGRAPH LICENSE

**BECOME A SHIP RADIO OFFICER:** At present, there is a tremendous shortage of ship radio officers. This means lots of job and advancement possibilities. After a six-month training period, you may earn \$45,000 to \$55,000 for an eight-month year. If you are really sharp in electronics, you can take a test that qualifies you to become a RADIO ELECTRONICS OFFICER. If you need a review, some radio unions offer a short training program that can help you to pass that test. Radio Electronics Officers can earn as much as \$60,000 to \$70,000 for a six-month year. Does this sound good? All you need to get started, is the SECOND CLASS RADIOTELEGRAPH LICENSE. To assist you in reaching that goal, we have produced, "The Radiotelegraph Package".

## WHAT OUR SATISFIED CUSTOMERS ARE SAYING

"Your STUDY QUESTIONS WERE NOTHING SHORT OF OUTSTANDING...Thank you for writing such a complete course." - E.J., Lemon Grove, CA

"I was so well prepared that I ACTUALLY ENJOYED TAKING THE TESTS, while others I saw around me were clearly floundering." - M.A.E., Waldorf, MD

"The day I took the test, EVERYONE WHO PASSED HAD YOUR MATERIALS." - J.D., Puerto Rico



### WPT Publications

7015 NE 61st Ave.  
Vancouver, WA 98661  
(800) 800-7588 or (206) 750-9933



The FCC License Specialists

Please rush me a Free Catalog.

Name \_\_\_\_\_

Address \_\_\_\_\_

City \_\_\_\_\_

State \_\_\_\_\_ Zip \_\_\_\_\_

# CRESTWOOD PRODUCTS

40994 GIBBEL RD. HEMET CA. 92544  
 ORIGINATOR, MANUFACTURER & DISTRIBUTOR

UNITED STATES PATENT NO. 5,055,960

A USEFUL AND WORTHWHILE TOOL for the  
 \*\*PROFESSIONAL \*\*STUDENT \*\*EXPERIMENTOR

## VU-THRU VCR DIAGNOSTIC TOOL

1-800-544-8583

A PRECISION MOLDED HIGH IMPACT CLEAR PLASTIC SHELL THE SAME SIZE AND SHAPE AS A STANDARD VHS VIDEO CASSETTE. THE VU-THRU TOOL HAS NO TAPE, REELS OR OTHER INTERNAL PARTS BUT WILL FOOL A VCR TO OPERATE IN ALL MODES AS THOUGH A STANDARD VIDEO CASSETTE WERE IN PLACE. IT LETS YOU SEE WHAT IS HAPPENING INSIDE, WHILE THE MACHINE IS RUNNING

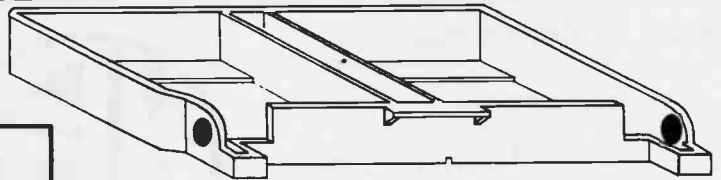

The 9 page ILLUSTRATED INSTRUCTION MANUAL details FIVE ways to use the VU-THRU TOOL to simplify and speed-up many common repair jobs PLUS MANY HELPFUL HINTS ON TROUBLESHOOTING VCR's

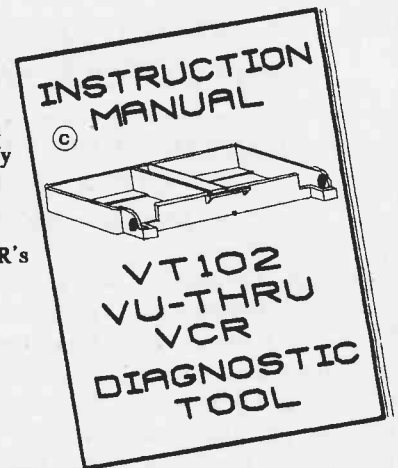

\$ 9.95 each  
 \$ 3.50 S&H  
 \$ 13.45 total

SPECIAL ORDER TWO  
 FOR \$ 19.90  
 WE PAY S&H

COD add \$ 3.50  
 CA. orders add 7%  
 sales tax

CANADA - MEXICO MAIL ORDER ONLY---- ADD \$ 5.00 U.S. FUNDS

WANTED!! DEALERS OUTSIDE OF THE USA--WRITE FOR FULL DETAILS--EXCLUSIVE TERRITORIES STILL AVAILABLE

CIRCLE 231 ON FREE INFORMATION CARD

# ACCORD

# ELECTRONIC SYSTEMS, INC.

1001 N.W. 62nd Street  
 Suite 306-F  
 FORT LAUDERDALE, FL 33309

Phone: (305) 772-2242  
 Fax: (305) 772-2568

<p><b>WHAT?</b>          5¢ ea. / 50 pcs.          4¢ ea. / 100+ pcs.</p>	<p>3 pcs. for \$1.00          28¢ ea. for 50+ pcs.</p>	<p><b>TIMERS</b>          555: 20¢ ea. / 10 pcs          556: 25¢ ea. / 10 pcs</p>	<p><b>SUPER SPECIAL</b></p> <p>LM311 - \$0.15          LM741 - \$0.15          7416 - \$0.15          74LS04 - \$0.15          74LS244 - \$0.15</p>																																				
<p>3mm or 5mm          DIFFUSED LEDs          RED, GREEN or YELLOW          8¢ ea. for 10pcs.          6¢ for 100+pcs.</p>	<p><b>LM317T</b>          55¢ ea. / 10 pcs.          50¢ ea. / 50 pcs.</p>	<p><b>OP-AMPS</b>          LM 324, LM358          3pcs. for \$1.00</p>	<p><b>DIODES</b></p> <p>10 pcs. 50 pcs. 100+</p>																																				
<p><b>LED HOLDER</b>          5¢ ea. for 10pcs.          4¢ ea. for 100+pcs.</p>	<p><b>2N2222A</b>          18¢ ea. / 10 pcs.          17¢ ea. / 100+pcs.</p>	<p><b>CABLE TIES</b>          (Bags of 100)          4 inches - \$1.57 / BAG          5.6 inches - \$2.17 / BAG</p>	<p><b>KESTER SOLDER</b>          SN60/40 .031 DIA.          1lb. roll \$7.00</p>																																				
<p><b>IC SOCKETS</b></p> <table border="1"> <tr> <td></td> <td>10 pcs.</td> <td>50 pcs.</td> <td>100+ pcs.</td> </tr> <tr> <td>6 PIN</td> <td>.06</td> <td>.05</td> <td>.03</td> </tr> <tr> <td>8 PIN</td> <td>.08</td> <td>.06</td> <td>.04</td> </tr> <tr> <td>14 PIN</td> <td>.14</td> <td>.11</td> <td>.07</td> </tr> <tr> <td>16 PIN</td> <td>.16</td> <td>.12</td> <td>.08</td> </tr> <tr> <td>20 PIN</td> <td>.20</td> <td>.15</td> <td>.10</td> </tr> <tr> <td>24 PIN</td> <td>.24</td> <td>.18</td> <td>.12</td> </tr> <tr> <td>28 PIN</td> <td>.28</td> <td>.21</td> <td>.14</td> </tr> <tr> <td>40 PIN</td> <td>.40</td> <td>.30</td> <td>.20</td> </tr> </table>		10 pcs.	50 pcs.	100+ pcs.	6 PIN	.06	.05	.03	8 PIN	.08	.06	.04	14 PIN	.14	.11	.07	16 PIN	.16	.12	.08	20 PIN	.20	.15	.10	24 PIN	.24	.18	.12	28 PIN	.28	.21	.14	40 PIN	.40	.30	.20	<p><b>MINI PUSH-BUTTON MOMENTARY - N.O.</b>          30¢ ea./10pcs. - 25¢ ea. / 100 pcs.</p>	<p><b>3.579 MHz CRYSTAL</b>          75¢ ea./10pcs - 70¢ ea./50+pcs.</p>	<p><b>HARDLINK</b></p> <p><b>NEVER COPY FILES AGAIN!</b>          DON'T USE A FLOPPY DISK TO TRANSFER FILES BETWEEN COMPUTERS. CONNECT HARDLINK TO YOUR PARALLEL OR SERIAL PORT AND LET THE PROGRAM DO IT FOR YOU. INTRODUCTORY OFFER.....\$89.95</p>
	10 pcs.	50 pcs.	100+ pcs.																																				
6 PIN	.06	.05	.03																																				
8 PIN	.08	.06	.04																																				
14 PIN	.14	.11	.07																																				
16 PIN	.16	.12	.08																																				
20 PIN	.20	.15	.10																																				
24 PIN	.24	.18	.12																																				
28 PIN	.28	.21	.14																																				
40 PIN	.40	.30	.20																																				

Radio-Electronics, January 1992

CIRCLE 247 ON FREE INFORMATION CARD

# Amazing Pocket Reference!

480 pages of tables, maps, formulas, constants & conversions  
and it fits in your shirt pocket! (3.2" x 5.4" x 0.6")

*The Greatest pocket reference of all time!*

**\$9.95**

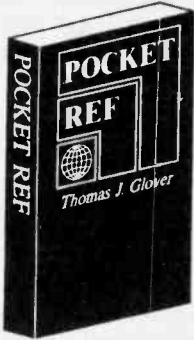

*The perfect  
Christmas stocking stuffer!*

- **Electrical**  
Electric Wire Size vs Load  
Wire Classes & Insulation  
NEMA Motor Frames  
Wire & Sheet Gauges  
Electric HP vs Torque  
Resistor Color Codes  
Capacitor Color Codes  
Pilot Lamp Specs  
Fuse & Battery Specs  
RF Coil Winding Data  
Wire Size vs Turns/Inch  
Decibel Tables
- **Air**
- **Automotive**
- **Carpentry & Construction**
- **Chemistry & Physics**
- **Math**
- **Mining & Milling**
- **Money & Currency**
- **Physical Constants**
- **Plumbing & Pipe**
- **Rope, Cable, & Chain**
- **Steel & Metals**
- **Geology**
- **Glues, Solvents, Paints and Finishes**
- **Hardware**
- **Surveying & Mapping**
- **Tools**
- **Water**
- **Weights of Materials**
- **Welding**
- **Computers & Printers**  
Computer ASCII Codes  
IBM® PC Error Codes  
IBM® Interrupts-IO Map  
IBM® Memory Map
- **3200 Conversion Factors**
- **General Information**  
US & State Holidays  
Signs of the Zodiac  
Flowers of the Months  
Anniversary Names  
Radio Alphabet  
Morse & TEN Radio Codes  
Paper Sizes (Int'l)  
Military Rank & Grade  
State Information  
Climate Data of the US  
Time Zones of the US  
Time Zones of the World  
Telephone Area Codes  
World Airport Elevations  
Lost Credit Card Phone #'s  
Airline 1-800 Phone #'s  
Temperature Conversion  
Sound Intensities  
Body Weight vs Height  
Wind Strength Scale  
Wind Chill Factors  
Firewood Comparisons  
Frequency Spectrum  
Sun & Planet Data
- **Detailed Index**

## LATEST INTELLIGENCE

Now, for the first time, the meanings of more than 35,000 terms, phrases, abbreviations, and acronyms used in the international intelligence, law enforcement, military, and aeronautics communities have been compiled into one convenient, well-indexed volume. If you have a scanner or shortwave receiver, LATEST INTELLIGENCE, by James E. Tunnell will unlock a world of listening possibilities!

- Callsign Country Prefix
- Secret Service
- Frequencies Red Cross Network
- US Military Bases / Frequencies
- Cellular Telephone Frequencies
- Goodyear Blimp Frequencies
- TV, Audio, CB Frequencies
- Aircraft / Country Codes
- Police 10 and 12 Codes
- Fire Codes / Frequencies
- Border Patrol Frequencies
- Repeater Frequencies
- Civil Aircraft Markings
- Road Condition Codes
- Mystic Star Frequencies
- Pro Words
- Security Clearance Basics
- Country Codes

**\$16.95**

*Season's  
Greetings*

## HOT OFF THE PRESS - IT'S HERE!

### Pocket PC Ref

An incredible shirt pocket size reference book on IBM® PC's and compatibles. If you're a PC service man, hacker, hobbyist, or general user, **BUY THIS BOOK !!!** It contains a wealth of hard to find information that took 1000's of hours to collect. By Thomas J. Glover and Millie M. Young. **GREAT STOCKING STUFFER!**

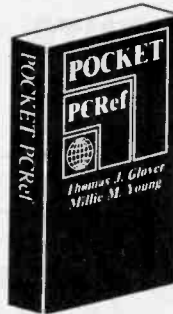

**\$14.95**

- MS-DOS® 5.0 Reference (142 pages)
- PC Industry Phone Book with over 2000 main and tech support numbers!
- Specs and configuration information for over 1200 Hard Drives !!
- ASCII Codes, PC Error Codes
- Interrupts-IO Map-Memory Map
- 80286 Hard Disk Types
- Printer Control Codes
- Cable Wiring, Modem Commands
- And MUCH, MUCH MORE

Description	Quantity	Price Each	Total

Order \$ USA Shipping & Handling  
 \$0 to \$15.00 ..... \$2.00  
 \$15.01 to \$30.00 ..... \$4.25  
 \$30.01 to \$100 ..... \$6.00  
 Canada orders add \$1 to above S&H

Sub Total  
 Shipping & Handling (see table at left)  
 Sales tax (CO residents only), add 4.7% of Sub total+S&H  
 All payments must be in U.S. funds. **ORDER TOTAL**

Name: \_\_\_\_\_ Company: \_\_\_\_\_  
 Address: \_\_\_\_\_  
 City/State/Zip: \_\_\_\_\_ Phone: (\_\_\_\_) \_\_\_\_\_  
 Payment (circle one): Check Money Order Visa MasterCard Discover Prices subject to change without notice.  
 Card #: \_\_\_\_\_ Exp. Date: \_\_\_\_\_ Signature: \_\_\_\_\_

**PRIZM Resources, Inc., Dept 962, P.O.Box 557, Morrison, CO 80465**  
**(303) 979-6054 Toll Free Order Line (800) 873-7157**

CIRCLE 261 ON FREE INFORMATION CARD

January 1992, Radio-Electronics



## Complete Helium Neon Laser

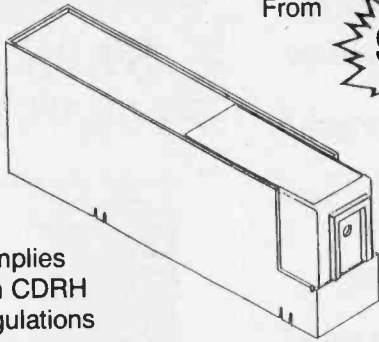

From **\$5900**

Complies with CDRH Regulations

This Module contains a He-Ne tube and matching power supply, all in one housing! Comes with instructions and a 1 year warranty. Makes an ideal Science Fair Project. Operates on 12 VDC @ 600 mA. Output: Visible Red 633nm Continuous.

0.5 mW Power Output **Cat. #HNKD-10 \$5900**

1.5 mW Power Output. 3 times the power as above!  
**Cat. #HNKD-15 \$7500**

## Visible Laser Diode Module

Size only  
1.6" long  
.63" dia.

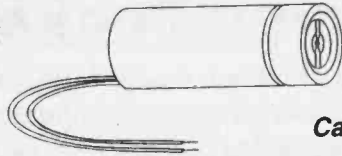

**\$7500**

**Cat. # VDM-1**

This Module contains a visible red, 670nm, Toshiba TOLD-9200, Laser Diode with Drive Circuit and Collimating Lens, all in a compact housing. Operates on 4.5 VDC or 3 AAA cells.

## Yes, We Have Them, Too!

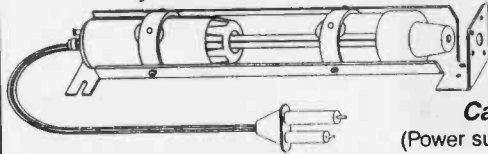

**\$1000**

**Cat. # 20X**  
(Power supplies available)

This is the same used 2-3 mW He Ne Tube that others sell for \$20-\$40. They require 1.3 to 1.5 KV @ 5.0 mA to operate and an 8KV Trigger to start. **YES**, we have matching power supplies as well. These are commercially made switchers with matching HV connectors. Specify 12VDC or 110VAC **\$50.00**

## MEREDITH INSTRUMENTS

5035 N. 55th AVE., #5 / P. O. BOX 1724  
GLENDALE, AZ 85301

TOLL FREE ORDER # **1-800-722-0392**

FAX Line:  
**602-934-9482**

**FREE CATALOG**

on these and other related items.

Technical Service Line:  
**602-934-9387**

CIRCLE 259 ON FREE INFORMATION CARD

# XANDI Electronics

**SATISFACTION GUARANTEED!**

The use of surface mount technology makes this the smallest FM transmitter you can buy! This is not a toy, it out performs most units on the market today. Our semi-kit has all the surface mount parts pre-assembled to the circuit board.



XST500(S) Semi-Kit ..... \$39.95



The XTR100 Tracking Transmitter transmits a continuous series of beep-beep tones that can be received by any FM receiver. Can be used for games, contests, or as an anti-theft device.

XTR100(C) Kit ..... \$35.95



The XFM100 FM transmitter has a range of up to 1 mile. It works with any standard FM receiver. It contains a built in high gain two stage audio amplifier for maximum sensitivity.

XFM100(C) Kit ..... \$32.95



The XPB1 is a telephone transmitter capable of transmitting to any FM receiver up to a 1/4 mile away. Powered by the telephone line it requires no batteries.

XPB1(C) Kit ..... \$26.95

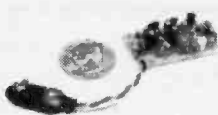

The XTT100 is a battery powered phone transmitter with a range of up to one mile. It only transmits when the phone is being used in order to conserve battery life.

XTT100(C) Kit ..... \$32.95

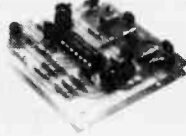

The XBD200 quickly locates hidden transmitters in the frequency range of 1 to 2000 MHz by emitting an audio output proportional to the transmit level.

XBD200(C) Kit ..... \$39.95

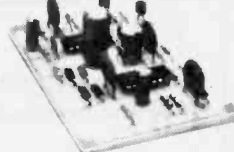

Use the XPS100 to call your home from any other phone and listen in using the built in microphone and amplifier.

XPS100(C) Kit ..... \$43.95



Use the XV200 to disguise your voice, and make it unrecognizable but understandable. Changes the pitch of your voice higher or lower than normal. The results are amazing!

XV200(C) Kit ..... \$61.95

WE ACCEPT VISA, MC, CK, MO  
COD PLEASE ADD \$6.00  
CALL 1-602-829-8152 OR  
WRITE FOR A CATALOG

**TOLL FREE  
PHONE ORDERS  
1-800-336-7389**

**MAIL ORDERS TO:  
XANDI ELECTRONICS  
BOX 25647  
TEMPE, AZ 85285-5647**

CIRCLE 266 ON FREE INFORMATION CARD

# LASERS

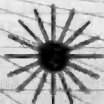

*Surplus Division*  
*Save \$\$\$*

## He-Ne's

**WE HAVE THOUSANDS OF He-Ne TUBES AND HEADS FROM .5 mW TO 35 mW STARTING AT \$25.00**



### 5-6 mW He-Ne LASER HEAD

For holography, light shows, leveling and experiments. New, 12mo warranty.

list \$450.00 **OUR PRICE \$100.00**

### LASER POWER SUPPLY FOR ABOVE

110 V.A.C. input 3" x 4' x 1". New, 12mo. warranty.

list \$150.00 **OUR PRICE \$95.00**

## ARGONS

### ITEM 33BR6 OMNICHROME OR AMERICAN HEADS

(Completely rebuilt with new parts: Cathode, Anode, New Brewsters, Etc.) For medium power applications, these heads are a great bargain. They are air cooled and produce an output in the 20-150 mW range, depending on wavelength and mode desired. 6 Month warranty. (blue-green)

List price \$4200.00 **OUR PRICE.....\$2600.00**



**GLOSSARY:** *mW* = Milliwatts (light power output)  
*He-Ne* = Helium Neon (red light)  
*ARGON* = laser that emits a blue/green light  
*nM* = Nano Meter (wavelength of light) (color)

ALL LASER PARTS ARE SOLD AS COMPONENTS ONLY WHEN ASSEMBLED THIS LASER MUST INCORPORATE THE SAFETY REQUIREMENTS OF THE CENTER FOR DEVICES AND RADIOLOGICAL HEALTH OF THE FOOD AND DRUG ADMINISTRATION.

## New Products Division

### 5 mW 670 NM TOSHIBA 9211

With single element glass collimator, heat sink and 4.5 to 10 VDC P.S. All contained in 1 1/4" x 1/2" enclosed cylindrical case. NEW, with 12 month warranty. Excellent for alarms, sights and leveling.

**OUR PRICE.....\$190.00**



### HAND-HELD LASER POINTER

1mW He-Ne laser & power supply in one package. 16" x 1.75". Projects beam up to 1 mile, great for visual effects use. Includes 8 AA batteries. 5 times brighter than diode laser pointers!

**OUR PRICE.....\$85.00**

## LASER PLANS

### ITEM 63A LASER PLANS

Laser modulation and de-modulation using He-Ne. Transmit voice or data over free space. Uses commonly available components. 6 pages.

**PLANS.....\$5.00**

### ITEM 64A LASER EXPERIMENTS

Demonstrate coherence, collimation, divergence, focusing, light show effects, rifle alignment, pipe laying, trench cutting, optical alignment of sophisticated laser systems, light sculpture. 9 pages.

**PLANS.....\$5.00**

### ITEM LC7 CO2 LASER SYSTEM

Burning or cutting. 20-40 watt continuous duty, cost saving.

**PLANS.....\$20.00**

### ITEM RUB4 RUBY, YAG, ND: GLASS SYSTEM

These high powered devices produce an intense pulse of optical energy capable of blasting a hole through the hardest of materials. This is the device that started "it all" and still finds a valuable niche in many of today's laser applications. Theory of operation lends itself to becoming a viable approach to the inevitable space age "Buck Rogers Ray Gun". Lasers produce a pulse of light capable of being seen from the moon. A color temperature equivalent to many million degrees Kelvin is obtainable from this device.

**PLANS.....\$20.00**

### ITEM LSD3 HIGH SPEED OPTICAL DETECTOR

Is compatible with above laser systems, battery operated with basic receiving optics. Ultrasensitive circuitry detects nanosecond pulses. Facsimile and expanded outputs.

**PLANS.....\$10.00**

**\*YAG**  
**\*COLLIMATORS**  
**\*SHUTTERS**  
**\*FIBEROPTICS**  
**\*670-780 NM DIODES**  
**\*IR VIEWERS**  
**\*SCANNERS**  
**\*AO MODULATORS**  
**\*LIGHT SHOWS**

# MWK INDUSTRIES

TOLL FREE **1-800-356-7714**

198 LEWIS COURT  
CORONA, CA 91720

(714) 278-0563  
FAX (714) 278-4887

**WE ACCEPT: VISA, MASTERCARD, C.O.D. AND PURCHASE ORDERS**

**CALL OR FAX FOR OUR CURRENT CATALOG!**

**WANTED: WE BUY EXCESS LASERS, OPTICS AND RELATED PRODUCTS**

We are constantly expanding our product line to include more NEW products and are always looking for new sources of laser, optics and associated hardware. If you are a manufacturer of any such equipment, we are extremely interested in marketing your particular line of products through MWK INDUSTRIES.

CIRCLE 213 ON FREE INFORMATION CARD

"AT" CMOS SETUP RAM. MC146818 (GDP6818) \$1.95 ea.  
This device also includes the clock calendar and alarm functions.

**AC FANS** 115 VAC 4 11/16 In. Sq. X 1.5 In. Thick. NEW. High CFM.  
By McLean Eng. UL Approved. \$5.95

**ALPHA-NUMERIC LED ARRAY**  
7x5 LED Matrix. For Moving Message Signs, Etc. By IEE. # 2057 - c/c rows. Your Choice: # 2058 - c/a rows. **\$2.49 ea.**  
With Hook-Up (SIZE: 2 X 1.5 in) (8 For \$14.95) **RARE SURPLUS FIND! NEW!**

**CRYSTALS** --- \$0.99  
1.843 4.000 14.318  
2.000 4.915 20.000  
2.457 5.068 (ALL IN MHZ)  
3.120 8.000 CALL FOR  
3.579 10.000 OTHER  
3.680 11.059 FREQUENCIES

**STEPPER MOTOR \$3.95**  
IBM Surplus. 8 wire. 4 windings. 7V @ 350 mA 1.8° (200 steps per rev.) DC. res. 20 ohm ea. 25 oz. in. torque. Works great on 5vdc. W/Data FOR ROBOTICS

**TRIAC: BT139-500 16AMP 500 PRV. TO-220 3/52**  
**TRIAC DRIVERS**  
MOC3040 MOC3011 MOC3041 **\$0.99**

**LINEARS**  
OP07 (DIP).....\$1.19  
TL062 (house #).....\$0.49  
TL072 (DIP).....\$0.59  
LM324 (DIP).....\$0.39  
LM358 (DIP).....\$0.49  
LM348 (DIP).....\$0.49  
MC4741 (DIP).....\$0.49  
LM318 (DIP).....\$0.99  
LF356 (can).....\$0.89  
5532 (DIP).....\$0.99  
5534 (DIP).....\$0.99  
MC3403 (DIP).....\$0.49  
TLO84 (DIP).....\$0.99  
RC4558 (DIP).....\$0.49  
4136 (DIP).....\$0.69  
LM339 (DIP).....\$0.39  
75491 (DIP).....\$0.49  
75492 (DIP).....\$0.49  
ULN2003 (DIP).....\$0.59  
LM3900 (DIP).....\$0.59  
LM2900 (DIP).....\$0.79  
XR2240 (DIP).....\$0.99

**DIP TTL OSC.**  
4.0 16.0 32 40  
12.0 20.0 48 50  
(ALL IN MHZ) **\$1.49**

**SIEMENS SMART LED ARRAY!**  
5x7 Red. Built in logic! #DLO-7135  
Requires only a chip select and an ASCII input. Operates on 5 VDC. 1 inch tall. With Data. New Units. Displays entire 128 char. set!  
**\$2.95 each or 8 for \$17.95**

**CMOS 8032 MICROPROCESSOR**  
80C32 By Matra. 40 pin DIP 12 MHZ. Very low power. **\$4.95**

**PLASTIC TRANSISTORS: 8 FOR \$1**  
2N3904 PN2222 2N4124 2N3415 6116LP15.....\$1.49  
2N3906 PN2907 2N5401 2N3417 6264P15.....\$2.49  
2N4401 2N3565 2N5172 2N5089 62256LP10.....\$4.95  
2N4403 2N5086 2N6517 2N3392 2114.....\$0.89  
2N4125 2N5551 MP5A06 MP5A56 7198S45P.....\$1.99

**STATIC RAMS**  
6116LP15.....\$1.49  
6264P15.....\$2.49  
62256LP10.....\$4.95  
2114.....\$0.89  
7198S45P.....\$1.99

**WIRE WRAP SOCKETS**  
14 OR 16 PIN \$0.49 ea.  
(TWO LEVEL) 10 FOR \$3.50

**MACHINE PIN SOCKETS**  
By Augat or Gerry. Highest Quality  
20 pin \$ .49 40 pin \$ .79

**VOLT. REG. ICs**  
7805.....\$0.49  
7812.....\$0.49  
7815.....\$0.49  
7824.....\$0.49  
7905.....\$0.49  
7912.....\$0.49  
7915.....\$0.49  
7924.....\$0.49

**LM350T.....\$2.95**  
**LM317T.....\$0.69**  
**LM337T.....\$0.69**  
**LAS6350.....\$1.49**  
**78H05.....\$3.95**  
**723C.....\$0.49**  
**TL494.....\$1.19**  
**TL495.....\$1.19**  
**TL497.....\$1.49**

**LM338K.....\$3.95**  
**SG3524.....\$1.25**  
**SG3526.....\$1.25**  
**LM309K.....\$0.99**  
**LM350K.....\$3.95**

**CMOS EPROMS**  
27C32HQ (house#).....\$1.49  
27C64.....\$2.49  
27C256-25(TI).....\$2.95  
27C512-15.....\$4.95

**TO-3 POWER TRANSISTORS**  
2N4398.....\$1.49 MJ2955.....\$0.99  
2N3055.....\$0.89 2N6056.....\$1.49 2N6254.....\$1.49  
2N3771.....\$1.95 2N5038.....\$1.95 2N5881.....\$0.99  
2N3772.....\$1.95 2N6308.....\$2.49 2N5879.....\$0.99

**DIODES !!**  
1N4006  
1 AMP 800 PIV Full Leads  
**20 for \$1**

**DUAL DIGIT LED READOUT**  
.60 In. Char. Common Anode. Red. LTD6910  
VERY High Efficiency  
79 cents 6/ \$3.95

**MAX 232 RS232 DRIVER \$2.49**

**TANNER ELECTRONICS** 214-242-8702 FAX: 214-709-5041  
1301 W. Beltline Rd. #105 Carrollton, Tx 75006 (Store prices vary)

**TERMS:** Send check, or use, Visa, MC. NO COD. USA, Canada Only. Add \$3.85 min. for UPS. Texas add sales tax. 90 Day limited warranty on all items. \$15/min

**SIMPLEX REPEATER**  
PR-50 SIMPLEX VOICE REPEATER WILL WORK AS A VEHICULAR REPEATER OR A STAND-ALONE SIMPLEX REPEATER. SIMPLY CONNECT THIS UNIT TO YOUR EXISTING MOBILE RADIO OR BASE UNIT. GREAT FOR HILLTOP OR FIELD APPLICATIONS.  
DRAWS ONLY 50mA OF CURRENT.  
**149.00**

**HOOKUP IS SIMPLE:**

**STUN GUNS**  
49.00 |  
STUN GUN EMITS 65KV CHARGE INTO POTENTIAL ATTACKER, A MUST FOR STUDENTS, NIGHT WORKERS, MAIL CARRIERS, SECURITY GUARDS.

**PAK RAT ELECTRONICS**  
P.O. BOX 690073  
HOUSTON, TEXAS  
ZIP 77269  
PH-713-893-0313  
ASK FOR A FREE CATALOG  
PH • 713-893-0313  
FAX • 713-583-1446

**HOURS: NOON TO 6:00 MON-FRI 9:00-1:00 SAT.**

**WINDSEEKER WIND GENERATOR**  
AIRCRAFT QUALITY MOTOR  
DIRECT DRIVE HIGH EFF. ALTERNATOR  
CONTROL ELECTRONICS  
WELDED STEEL CONSTRUCTION  
WINDSEEKER  
HIGH CURRENT SLIP RINGS  
WIND FORCE REGULATOR  
VS12-300-850.00 300 WATTS  
VS24-400-950.00 400 WATTS

**STATPOVER 250**  
FITS IN THE PALM OF YOUR HAND!  
**190.00!**  
WITH CIGARETTE LIGHTER ATTACHMENT

**SINE WAVE INVERTERS**

MODEL	POWER	PRICE
PROVATT 250	250 WATTS	190.00
PROVATT 600	600 WATTS	500.00
TRACE 2012	2000 WATT	1090.
2012 WITH STANDBY	2000 WATT	1310

**CHARGE CONTROLLERS**

MODEL	CURRENT	PRICE
M-8 8-AMP	8 AMP	42.00
M-16 16-AMP	16 AMP	54.00

**MINI CHARGING PANEL**  
125 mA AT 14V.  
GREAT FOR BATTERY CHARGING.  
**8.0011**  
COMES WITH WIRES AND DIODES!!!

**TERMS**  
SHIPPING AND HANDLING COST VARY AS TO THE ITEM YOU ARE ORDERING. ALL EQUIPMENT WARRANTIED FOR 90-DAYS. CERTIFIED CHECK, PERSONAL CHECK OR MONEY ORDER. PERSONAL CHECKS HELD FOR 1-WEEK BEFORE SHIPMENT.

**GIANT SOLAR PANEL**  
3/4 AMP  
14.4V  
12x36 IN.  
**44.00 EA!**

Radio-Electronics, January 1992

488B

CIRCLE 217 ON FREE INFORMATION CARD



# Order Your FREE '48 page Skyvision Catalog Today

It's Loaded With Factory Fresh Satellite TV Products, "All At Discount Prices"

Call Toll Free 800-334-6455 International call 1-218-739-5231 Fax line 218-739-4879



## Satellite TV Anywhere

- Complete Systems
- Upgrades
- 2ft to 24ft Dishes
- Parts
- Accessories
- Major Brands
- Factory Fresh
- USA Warranty
- Fast Delivery



### WORLD SATELLITE TV AND SCRAMBLING METHODS

#### "The Technicians' Handbook"

This thorough text is a must-buy for technicians, satellite professionals and curious do-it-yourselfers. The design, operation and repair of satellite antennas, feeds, LNBS, receivers and modulators are examined in detail. An in-depth study of scrambling methods and broadcast formats including the VideoCipher II, Oak Orion, FilmNet, Sky Channel, EuroCypher, D2 MAC, BSB and Teleclub Payview III. Circuit and block diagrams of all components are presented and clearly examined throughout the handbook. This information is a prelude to the chapters on troubleshooting and setting up a test bench. This expert guidance on testing, servicing and tuning is complimented by a wealth of detailed illustrations.

340 pages, 8 1/2 x 10 3/8 over 200 photos, diagrams, wiring schematics and 16 tables / appendices / index  
S&H \$5 (U.S.) \$39.95



### THE SKYVISION DO-IT-YOURSELF INSTALLATION VIDEO

"Now You Can Watch It Being Done"  
Installing or "Tuning up" your satellite system made simple.  
VHS or Beta... S&H \$3 (U.S.) ..... \$33.95

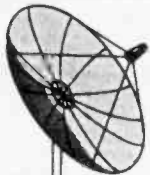

### ORBITRON Mesh Dishes

"Quality Demonstrated by Performance"

7ft	dish & polar tracking mount	\$239
8.5ft	"	299
10ft	"	349
10ft H.D.	"	439
12ft	"	699

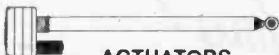

### ACTUATORS

18"	Superjack II	S&H \$14	\$89
24"	Superjack XL ball	" 15	139
24"	Venture acme	" 15	129
51"	JGS acme	" 22	219

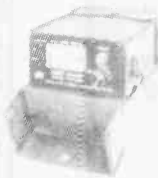

### TUNE YOUR DISH TO ITS MAXIMUM!

"With The Pico" Signal Meter

A must for the serious dealer or satellite system owner. Saves time, frustration and money. Use when installing a new system, moving your dish, re-alignment of a dish that has been moved by wind, frost heaves etc., gets you right on the satellite belt for the best possible pictures!  
Pico signal meter S&H \$6 \$89.95



### LNBS/LNAs LOW TEMP "Hemt Technology" "Commercial Grade"

45° LNB C-band 4GHz	S&H \$6	\$99
40° LNB	"	109
30° LNB	"	149
<30° LNB (25°-29°)	"	199
1.3db LNB Ku 12GHz	S&H \$6	\$109
1.2db LNB	"	119
1.1db LNB	"	129
1.0db LNB	"	139
0.9db LNB	"	199
0.8db LNB	"	249
50° LNA (70MHz & block)	S&H \$6	\$129
45° LNA	"	139
40° LNA	"	149
35° LNA	"	159
30° LNA	"	179

### Ku Band System

ONLY \$488

Includes: 3' solid aluminum dish with ring mount & quad feed support, slide jack, Uniden 2200 receiver, 1.3 dB LNB & feed

### C Band System

ONLY \$888

Includes: 7' mesh dish with polar mount & quad feed support, slide jack, Echostar 3000 IRD 40° LNB & feed. (VCII+ module optional)

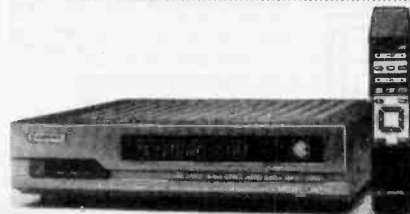

### IRDs / RECEIVERS / SYSTEMS

"Save \$\$\$ on Packages"

System package includes: ORBITRON 7 foot mesh dish, 40 degree LNB, 18" Motor Arm, Feedhorn and Receiver/IRD, VC II+ decoder module, plus a FREE detailed installation Video.

	IRD/Receiver	System
UNIDEN UST2200 (Receiver)	\$219	
UNIDEN UST9000 (Receiver)	\$459	\$899
UNIDEN UST9900 (IRD)	\$919	\$1349
UNIDEN UST4200 (slave recv.)	\$709	
UNIDEN UST4400 (IRD)	\$877	\$1309
HTS V (IRD)	\$1099	\$1539
HTS VIII Plus (IRD)	\$1255	\$1698
HTS X (IRD)	\$1449	\$1889
MONTEREY 90 (IRD)	\$1869	\$2299
MON.T.100C (Commer.) (IRD)	\$1439	\$1859
DRAKE ESR924i (Receiver)	\$599	\$1049
DRAKE ESR1024 (IRD)	\$1037	\$1487
DRAKE ESR1224 (IRD)	\$1165	\$1599
DRAKE ESR1424 (IRD)	\$1369	\$1799
ECHOSTAR 410 (IRD)	\$899	\$1349

For 10 ft Orbitron Antenna — Add \$100  
Just a partial listing of hundreds of products in the Skyvision catalog. Ask for your's today!

Send in coupon, call or circle the reader card.

All Major Credit Cards Accepted

## Skyvision Inc.®

1046 Frontier Drive, Fergus Falls, MN 56537 - Toll Free 800-334-6455

Mail in coupon or call Toll FREE today for the SKYVISION Satellite TV Product Catalog.

Delivered free to your mail box in U.S. and its possessions.

\* International requests add \$8.00 to cover shipping and handling.

Send Skyvision Satellite TV Products Catalog

Name \_\_\_\_\_ Phone ( ) \_\_\_\_\_

Address \_\_\_\_\_

City \_\_\_\_\_ State \_\_\_\_\_ Zip \_\_\_\_\_



YOU CAN

Install A System, Upgrade & Repair Yourself And Save \$\$\$

**NEW** PROFESSIONAL LOOKING EQUIPMENT REQUIRES FINISHED HARDWARE  
**HARDWARE KITS FOR CONSTRUCTORS:**

These hardware kits contain three sizes of electronic type hardware: in quantities of up to 50 pieces of each 2-56, 4-40, and 6-32, with both pan head Phillips and flat head Phillips for a professional look. The hardware kits are available in nickel or black nickel finish. The lengths available are 1/8", 1/4", 3/8", 1/2", 5/8", 3/4", and 1", with flat washers, nuts and KEPS nuts supplied in a multi-compartment plastic box. There is also a metric version available with ISO 2mm, 3mm, and 4mm with lengths of 2mm, 3mm, 6mm, 8mm, 10mm, 12mm, 20mm, and 25mm, with flat washers, nuts and KEPS nuts.

**GRAND ASSORTMENTS:**  
 GA-1 USA Standard 2-56, 4-40, and 6-32 Nickel Plated ..... \$49.95  
 GA-2 USA Standard 2-56, 4-40, and 6-32 Black Nickel Plated ..... \$49.95  
 GA-3 ISO Standard 2mm, 3mm, and 4mm Nickel Plated ..... \$49.95  
 GA-4 ISO Standard 2mm, 3mm, and 4mm Black Nickel Plated ..... \$49.95  
 Twelve other assortments available and 100 lot replacements of all hardware. Write for catalog.

SESCOM INC. 2100 WARD DRIVE  
 HENDERSON, NV 89015-4249 U.S.A.  
 800-834-3457 (ORDERS) 702-565-3400  
 (FAX) 702-565-4828 PREPAID ORDERS  
 SHIPPED UPS GROUND NO CHARGE  
 2ND DAY AIR \$10.00 NEXT DAY AIR \$20.00

**VISA** **MasterCard**  
 WE ALSO ACCEPT VISA AND MASTERCARD. CALL FOR COMPLETE CATALOG AND ENGINEERING DIMENSIONS. WE ALSO STOCK PUNCHES AND INSTANT LETTERING.

**MINIATURE POWER TRANSFORMERS**

Miniature printed circuit type transformers for small projects requiring less than 1/3 of a watt of power. These transformers have dual primaries, 110/220 VAC, 50/60 Hz. Wiring details are included. A small foot print requiring a little more than one square inch of board space and about one inch tall. Perfect for one or two op-amp circuits or small digital projects. Perfect for the all-in-one type projects.

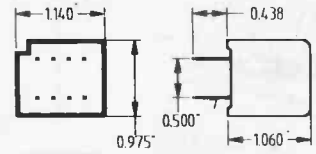

TWO ROWS ARE 500 APART. PINS ARE 200 FROM CENTER TO CENTER. PLACED IN THE CENTER OF THE UNIT.

MODEL	SECONDARY VOLTAGE	AC (ma) CURRENT	1-9	10-24	25-49	50-99
MPT-5	5	24	\$10.00	\$8.33	\$7.34	\$6.90
MPT-12	12	10	10.50	8.42	7.71	7.25
MPT-24	24	5	10.75	8.95	7.89	7.42
MPT-D6	6-0-6	10	10.50	8.42	7.71	7.25
MPT-D9	9-0-9	6.7	10.75	8.95	7.89	7.42
MPT-D12	12-0-12	5	10.75	8.95	7.89	7.42
MPT-D15	15-0-15	4	11.00	9.16	8.07	7.59

**ALUMINUM RACK AND CHASSIS BOXES**

QUANTITY DISCOUNT  
 10-99 10%  
 100-UP 20%

**FEATURES:**  
 DESIGNED FOR SMALL LOT PRODUCTION  
 EASY TO FABRICATE (DRILL OR PUNCH HOLES)  
 SHIPPED UNASSEMBLED (FLAT)  
 ALL MAIN PANELS ARE FLAT  
 FRONT AND REAR ARE CLEAR BRUSHED  
 ANODIZED, TOP AND BOTTOM PANELS ARE BLACK  
 BRUSHED ANODIZED, END PANELS ARE BLACK ANODIZED



**BLANK PANELS**

MODEL	DESCRIPTION	PRICE
1 RP B	1.75 x 19	\$8.95
2 RP B	3.50 x 19	13.15
3 RP B	5.25 x 19	17.35
4 RP B	7.00 x 19	21.50

1/8" Aluminum black anodized. Dimensions shown in inches.



**CHASSIS BOXES**

MODEL	W	D	H	PRICE
MC-1A	4	3	2	\$15.75
MC-2A	6	3	2	17.85
MC-3A	8	3	2	19.95
MC-4A	4	4	3	17.85
MC-5A	6	4	3	19.95
MC-6A	8	4	3	22.05
MC-7A	4	7	4	19.95
MC-8A	6	7	4	22.05
MC-9A	8	7	4	24.15

Dimensions shown in inches. W=Width, D=Depth, H=Height

**RACK BOXES**

MODEL	H	D	PRICE
1RU5	1.75	5	\$29.40
1RU7	1.75	7	31.50
1RU10	1.75	10	33.60
2RU5	3.50	5	31.50
2RU7	3.50	7	33.60
2RU10	3.50	10	35.70
3RU5	5.25	5	39.90
3RU7	5.25	7	42.00
3RU10	5.25	10	44.10

Dimensions shown in inches. H=Height, D=Depth

CIRCLE 218 ON FREE INFORMATION CARD

**DOUBLE YOUR INCOME!**  
**Computer maintenance/service**  
**- \$10 billion industry.**

If you are presently servicing electronic equipment computer repair can double your income.

National research results indicate that computer technicians bill out at double the hourly rate of office machine technicians. Tech-Serv can put you into computer repair quickly, economically and efficiently and with a complete support program including a proven marketing plan. We provide:

**RECOGNITION**  
 Nationally recognized trademarks and logos give you immediate recognition as a professional computer repair specialist by being a Tech-Serv Authorized Computer Repair Center.

**TRAINING**  
 Hands on Training: IBM, Compaq, Apple and compatibles at 3 separate levels:  
 Level 1: 8086-8088 Based Machines  
 DOS System Configuration and upgrades  
 Level 2: 80286/80386 Machines, Letter Quality and Laser Printers  
 Level 3: System Networks Configuration, Installation and Repair

**PARTS AND BOARD REPAIR**  
 Single source for parts and board repair. 24-hour express turnaround.

**DOCUMENTATION**  
 We provide manuals, schematics, documentation and advanced diagnostic software.

**NEW HARDWARE**  
 CPU's: IBM, Apple, Compaq, and others.  
 Printers: Okidata, Epson, HP Lasers and others at huge discounts.

**FINANCING**  
 Available for aqualified businesses  
**OVER 250 DEALERS WORLDWIDE.**  
 Find out why more and more electronic professionals are adding computer repair to their businesses or starting their own computer repair businesses.

**techserv** AUTHORIZED DEALER  
 SERVING THE WORLD OF MICROS  
 253 West 28th Street, New York, NY 10001

*Act Now!*  
*(212) 967-1865*

Radio-Electronics, January 1992

©1991 Tech-Serv Corp.

CIRCLE 220 ON FREE INFORMATION CARD

# OCEAN STATE ELECTRONICS

PROFESSIONAL, AMATEUR, OR COMMERCIAL — WE'RE YOUR ONE STOP ELECTRONIC SOURCE  
CALL OR WRITE FOR OUR FREE 96 PAGE CATALOG 1-401-596-3080

**SIGNETICS NE602N**  
Balanced Mixer/Osc. Popular IC among experimenters for building DC and super-het receivers.  
**\$2.25 ..... BUY 3 OR MORE ... \$1.99**



**CD22402E**  
CMOS LSI Sync Generator  
**\$9.95**



**PN2222A**  
The World's Most Popular Transistor. Gen. Purpose AMP/Switch. TO-92  
**\$.05 EACH (10 PIECE MIN. REQUIRED)**



**200 WATT INVERTER**  
Plugs into your lighter and runs:  
• Ham Equipment  
• Lights  
• Soldering Iron  
• Computer  
• Power Tools  
• Shaver  
• 13" TV with VCR  
• MUCH MORE



Model: POW 200  
Input: 10 to 15 volts DC  
Output: **115 volts AC true RMS**  
Power: 400 Watts peak  
200 Watts for 2 minutes  
140 Watts continuously  
5" x 2.6" x 1.7"

Weight: 15 ounces  
Warranty: 1 year

Regularly **\$149.95**  
**FALL SPECIAL \$139.95**

DEALER INQUIRIES INVITED

**ANTENNA INSULATOR**  
Light-weight, durable molded tenite plastic. Dielectric strength is comparable to its ceramic predecessor without susceptibility to cracking or breakage under impact or severe temperature change. Weatherproof.  
**\$2.00/PAIR**



**FILAMENT TRANSFORMER**  
6.3VCT AT 3 AMPS  
2 1/4"L x 1 7/8"D x 1 7/8"H  
**\$5.95**



**DELUX CODE KEY**  
Adjustable, heavy duty brass base with ball bearing pivots. Designed for hard usage. 3/16" plated contacts.  
**\$10.75**



**BUZZER**  
Produces steady high frequency signal. Excellent for code practice. Screw control for adjusting pitch. Uses standard 1 1/2V battery.  
**\$4.99**



**RECTIFIER DIODES**

1N4001	1 AMP 50 PRV	.09
1N4002	1 AMP 100 PRV	.09
1N4003	1 AMP 200 PRV	.10
1N4004	1 AMP 400 PRV	.10
1N4005	1 AMP 600 PRV	.12
1N4006	1 AMP 800 PRV	.15
1N4007	1 AMP 1000 PRV	.17
1N5400	3 AMP 50 PRV	.20
1N5401	3 AMP 100 PRV	.20
1N5402	3 AMP 200 PRV	.20
1N5404	3 AMP 400 PRV	.25
1N5406	3 AMP 600 PRV	.25
1N5407	3 AMP 800 PRV	.25
1N5408	3 AMP 1000 PRV	.25

**MAGNET WIRE**  
Plain enamel. Solid bare copper. For winding coils, transformers and toroids. Prices for 1/4 lb. spools

#14	3.25	#24	3.75	#34	4.80
#16	3.30	#26	3.75	#36	4.90
#18	3.35	#28	3.85	#38	4.95
#20	3.55	#30	4.00	#40	5.10
#22	3.65	#32	4.40		

**TOROIDS**

IRON		FERRITE	
T-25-2	.40	FT37-43	.60
T-25-6	.40	FT37-61	.60
T-37-6	.45	FT37-77	.60
T-37-12	.45	FT50-43	.75
T-50-2	.55	FT50-61	.75
T-50-3	.55	FT50-77	.75
T50-6	.55	FT82-43	1.00
T68-0	.75	FT82-67	1.00
T68-2	.75	FT82-68	1.00
T68-6	.75	FT114-61	2.15
T80-2	.85	FT140-43	4.10
T200-2	4.00	FT240-61	8.00

**AFFORDABLE DIGITAL MULTIMETER**  
19 RANGES  
3 1/2 DIGIT LCD DISPLAY  
DVC - 1000  
ACV - 750  
DCA - 10A  
RES - 2 MEG  
DIODE CHECK  
**\$24.95**



TRANSISTORS		LINEAR IC'S	
2N2222A	.35	NE555	.25
2N3055	.69	NE564	1.75
2N3553	2.75	LM733N	.65
2N3563	.35	LM741	.30
2N3666	1.00	UA7805	.39
2N3904	.10	UA7812	.39
2N3906	.10	UA7820	.49
2N4401	.15	UA7824	1.49
2N4403	.15	CA3126E	4.60
MPF102	.29	LM317T	.69

**IN34A**  
HARD TO FIND  
Germanium Diode,  
100V PRV 200MA  
1-9 ... \$2.5 10+ ... \$2.0



**WE STOCK A COMPLETE LINE OF TOROIDS AND BEADS.**

**EDGEWISE MOUNT S-METER/SWR**  
200uA movement. Scale reads signal 0-60dB. Has two ear flanges with holes for mounting. Measures approx. 1 1/2"W x 1 1/4"D x 3/8"H.  
**\$4.00**



200uA movement. Scale reads both signal (0-30dB) and SWR. Same mounting as above. Measures 1 3/8"W x 1 1/4"D x 3/4"H.  
**\$4.00**

**Q-DOPE**  
Solution of pure polystyrene in solvents. Dries fast and leaves a clear, protective coating on toroids, coils and transformers, with no or minimal effect on inductive values. May also be used as a cement for molded or fabricated items made of polystyrene.  
(Bottle with Brush 2 fl. oz. 59 ml) **\$3.75**



**MAKE CIRCUIT BOARDS THE NEW, EASY WAY WITH TEC-200 FILM**

JUST 3 EASY STEPS:  
• Copy circuit pattern on TEC-200 film using any plain paper copier.  
• Iron film on to copper clad board.  
• Peel off film and etch.  
Convenient 8 1/2 x 11 size. With Complete Instructions

5 SHEETS	<b>\$6.25</b>
10 SHEETS	<b>\$10.75</b>
20 SHEETS	<b>\$16.25</b>



**IC SOCKETS - LOW PROFILE**

8 PIN	.10	22 PIN	.23
14 PIN	.11	24 PIN	.25
16 PIN	.12	28 PIN	.30
18 PIN	.17	40 PIN	.43
20 PIN	.21	64 PIN	.68

**REGULATED POWER SUPPLIES 13.8 VDC**  
Perfect for ham equipment, CB's, car stereos and other 13.8 VDC items. LED on indicator, short circuit protection. Binding post output.

3 AMP	<b>\$31.50</b>
4 AMP	<b>\$39.50</b>
6 AMP	<b>\$46.50</b>
10 AMP	<b>\$79.50</b>
20 AMP	<b>\$119.50</b>



**HEAT SINK COMPOUND**  
Used for heat transfer from semiconductor devices to mounting points.  
TUBE, 21 GRAMS **\$2.50**



**MINIATURE TOGGLE SWITCHES**  
3A 125V Solder Terminals

SPDT	ON-ON	<b>\$1.25</b>
DPDT	ON-ON	<b>\$1.50</b>



**TEST LEAD WIRE**  
18 GA. Flexible Rubber Insulation (Not Plastic). Rated 5000 VOLTS  
5-999FT **\$2.00/FT** 1000 FT **\$110.00**  
Specify Color: Red or Black



**INSULATED BANANA PLUGS**

BLACK	<b>\$.89</b>	RED	<b>\$.89</b>
-------	--------------	-----	--------------



**SOLDERLESS TEST PRODS**  
4 INCHES LONG

BLACK	<b>\$1.00</b>	RED	<b>\$1.00</b>
-------	---------------	-----	---------------



**INSULATED ALLIGATOR CLIPS 2"**

BLACK	<b>\$.22</b>	RED	<b>\$.22</b>
-------	--------------	-----	--------------



## TO ORDER

**KITS**  
Complete with PC Board and Instructions. Educational, Fun to Build, and Practical.

**MEDUSA (Sound Sensor)**  
A walking robot with an electronic brain. Registering your command, the robot starts to hobble on its 4 legs and stops automatically after a preset time. Movement: 2 legs on each side of crank shaft. Control: Sound sensor including condenser microphone/transistor. Powered by two 1.5V batteries. N size (not included).  
**\$41.95**



**SPIDER (Infra-red)**  
An intelligent robot which knows how to avoid interference. Robot emits an infra-red beam which detects an obstacle in front and automatically turns left and continues on. Powered by one 9V and 2 AA batteries (not included).  
**\$62.95**



**3" EQUIPMENT FAN**  
New, not a pull. MFG ETRI, Mod#126LJ, 115VAC. Measures 3 1/8" x 3 1/8" x 1 1/2". This is a top quality fan.  
**\$9.95 Buy 2 or more ..... \$8.95**



**TRIMMER CAPACITOR ASSORTMENT**  
Top Quality. May contain some two and three gang as well.  
10 pcs. **\$1.50**



**COPPER CLAD PC BOARDS**

4" x 6"	DOUBLE SIDED	<b>\$.99</b>
3 1/4 x 6 3/4	DOUBLE SIDED	<b>.89</b>
6 1/2 x 6	SINGLE SIDED	<b>1.25</b>
7 x 5	SINGLE SIDED	<b>1.50</b>
8 x 7	SINGLE SIDED	<b>2.00</b>

Call 1-800-866-6626 **ORDERS ONLY**  
(Catalog requests can not be taken on toll free number.)  
8 a.m. - 9 p.m. EST  
Monday through Saturday

OR WRITE TO:  
Ocean State Electronics,  
P.O. Box 1458, Westerly, R.I. 02891

OR FAX TO: **LOCAL CALLS USE**  
(401) 596-3590 596-3080

If paying by **CREDIT CARD** include Card No. and Expiration Date  
Mail in orders please include \$4.00 shipping  
Minimum order \$10.00  
R. I. Residents add 7% Sales Tax

**ORDERS RECEIVED BY 1:00 PM EST—SHIP SAME DAY!**  
**FREE SHIPPING ON ALL MAIL IN ORDERS OVER \$25.00.**  
Applies to UPS Ground in Continental U.S. Only.



**0-15V POWER SUPPLY**  
The 0-15V Power Supply is one of the most useful, low-cost power supplies you can build. It will supply voltage to transistors, radios, tape recorders, and electronic games.  
**\$12.95**

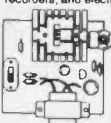

**FISH CALLER**  
The Fish Caller, when completed, makes a cicking sound that should attract hungry fish in the vicinity.  
**\$7.95**



**PANAVERSE**  
INTERCHANGEABLE VERSATILITY

#303	STANDARD HEAD	<b>\$20.99</b>
#300	STANDARD BASE	<b>\$17.99</b>
#315	CIRCUIT BOARD HOLDER	<b>\$23.99</b>



**SIGNAL INJECTOR/TRACER**  
This handy tester is both a signal generator and receiver. As a generator use it to check out an amplifier, stage by stage. Also tests AM radio IF and RF stages. As a receiver you can pin point where a defective part exists. Will transmit and receive simultaneously.  
**\$18.95**



**LOGIC PROBE**  
Hand held Digital Logic Probe provides convenient and precise use in the measurement of logic circuits. It displays logic levels (high or low), pulses and voltage transients down to 300 nanoseconds. High intensity LED readouts provide instant response to the logic state.  
**\$18.95**





## LEARN THE SECRETS OF HOW TO FIX ELECTRONIC EQUIPMENT FASTER ON OUR REPAIR TECHNIQUES ON VIDEOTAPE

YOUR SATISFACTION GUARANTEED

Learn our techniques and make more money repairing electronic equipment. These tapes are packed with much practical information that will save enough of your valuable time to quickly pay for the tapes.

Learn from an expert what fails, why it fails, how to find it faster, and how to fix it faster.

Much of this information is available nowhere else.

These tapes start at the beginning for beginners, but cover each subject so thoroughly that even old pros will learn valuable new techniques and skills.

The material in these video tapes is the same material that we have presented in classes that have been taught for the local college, businesses, and industrial maintenance departments. You will find very little of the information presented on most of these tapes in textbooks or in any courses that you have taken elsewhere. Most of the material is original. We show what fails, all of the ways that the various components fail, how to recognize the failures, and how to test and locate the failures. We also show how to repair and make improvements where appropriate to give a reliable repair.

Send payment with order and we will pay shipping. Order any five tapes or more and get 5% discount, order any 10 or more tapes and get a 10% discount, order any 15 tapes or more and get a 15% discount. ORDER NOW!

How to use a Voltmeter (1 hr. 51 min.)	\$39.95
How to use a logic probe and logic pulser	\$39.95
All about resistors and their failure modes (1 hr.)	\$39.95
All about capacitors and their failure modes (1 hr. 28 min.)	\$39.95
All about inductors and their failure modes, Part I. Includes Inductors, transformers, flybacks, pinball coils, solenoids.	\$39.95
All about inductors and their failure modes, Part II. Includes magnetic clutches, relays of all types, other devices (58 min.)	\$39.95
All about diodes and their failure modes. Includes rectifiers, SCR's, Zeners, triacs, LED's (55 min.)	\$39.95
All about transistor failure modes (56 min.)	\$39.95
How to solder like a pro — with lots of time saving circuit board repair techniques, including some of the fastest ways to change IC's you ever saw (1 hr. 30 min.)	\$39.95
All about electrical contacts, connectors, connections and their failure modes, common and uncommon problems, symptoms, good cures	\$39.95
How to use the oscilloscope (to track down digital failures)	\$39.95
How to read schematics and use them for troubleshooting, Part I. Covers monitors, how to find monitor problems with wiring diagrams, gives symptoms, where to look, covers both raster scan and X-Y monitors (56 min.)	\$39.95
How to troubleshoot digital integrated circuits — includes micro-processors, what goes wrong and how to find it, how to use the best literature on IC's and where to get it (1 hr. 45 min.)	\$39.95
How to select and hire the best electronic technician. It takes one to know one, and believe us, they are not all created equally excellent. This tape will save management and you a lot of grief if it keeps them from hiring a dud	\$39.95
The best money making ideas I know. (For anyone contemplating getting into the amusement or arcade business — Shows how to do it right the first time.) (56 min.)	\$39.95
Videogame Repairs (for arcade games). (36 min.)	\$39.95
Pinball Repairs (for arcade games). (44 min.)	\$39.95
Videogame monitor repairs and adjustments (for arcade games). (31 min.)	\$39.95

### OUR NEWEST TAPES

Job opportunities and money making opportunities in electronics. (45 min.)	\$39.95
Pinball Theory (for arcade games). (1 hr. 29 min.)	\$39.95
Videogame Theory (for arcade games). (1 hr. 12 min.)	\$39.95
Troubleshooting and locating component failures. (1 hr. 10 min.)	\$39.95
Power Supplies — Linear and Switching. (42 min.)	\$39.95

## VIDEO REPAIR SCHOOL

P. O. BOX 813 - RE  
SELMER, TN 38375

(601) 287-1594

## MILLENNIUM SPECTRUM THE LEADING EDGE IN VGA

### EDSUN CEG & SIERRA HICOLOR

COLOR IMAGE CAPTURE AND SCANNER USERS:

HICOLOR eliminates guesswork. See accurate colors of your scanned image instead of crude posterized approximations. Spectacular!

AUTOCAD USERS: You will be amazed at the difference in speed and clarity when you install our CEG equipped board.

WINDOWS USERS: Don't settle for viewing 1/3 of a page. See 300% more with dazzling speed!

**HIGH PERFORMANCE WITHOUT HIGH PRICES**

**FAST** We use the fastest VGA chip set made.

**SHARP** Our cards all run at up to 1024 x 768 true pixels. CEG cards offer apparent resolution of 2048 x 1536.

**COLOR** Our HICOLOR cards have 32,768 individually selectable colors. CEG cards offer unlimited color blending capability. All our cards can display 256 colors at 1024 x 768.

**MILLENNIUM SPECTRUM** works with any IBM compatible computer. All our cards support Windows 3.0.

**72hz refresh** **VESA compatible**

CEG card with 1 meg	\$250
HICOLOR card with 1 meg	\$225
ET-4000 1meg super VGA	\$150
Upgrade to CEG	\$110
CEG + HICOLOR package	\$300
runs CEG or HICOLOR graphics	(save \$175)

**30 DAY MONEY BACK GUARANTEE**

**BVC Inc. 916-482-6251 8:00am-5:00pm PST**

## CABLE TV NOBODY BEATS US!!!

JERROLD 450	39.95
REMOTES (All)	9.95
DQN-5	69.95
TRI-BI (TVT)	64.95
PIONEER (Super Combo)	69.95
BA-5135 or BA-6110	269.95
SA-8580	269.95
ZENITH (All)	269.95
STARCOM 7 (Baseband)	299.95

### TEST AIDS BULLET PROOF

TOCOM SUPER CHIPS	29.95
STARCOM 6 or 7	59.95
SA-8580	49.95
ZENITH	59.95
PIONEER S10	Call

**818-713-8575  
800-626-1919**

# Discover the Treasures of ADC's Electronics and Computer Components...



## Network ready

### Diskless Workstation/PC

Everything you could want in a personal computer and a terminal... all in one unit!

- Arcnet LAN Interface
- VT100-compatible terminal
- Novell Netware diskless boot

Drastically cuts the costs of networking, ready to boot itself onto your Novell network, runs most popular PC programs!

Processor: 8MHz, V40 (8086 compatible)

Memory: 768Kb RM; Display: 14" paper white monochrome

Keyboard: All-in-one, 108-key, enhanced AT style

(added legends for VT100/220 commands)

Also includes: 1 serial/1 parallel port, on-board real-time clock, calendar, calculator and auto dial.

Menu driven setup.

Lanterm Model A Item #36949 NEW **\$229<sup>00</sup>**

## 12" Composite Monitor



12" anti-glare, green screen. Has audio and video input which makes this ideal for Atari/Commodore & Apple II computers. Operates on 110VAC. •Brightness/Contrast/Volume controls. Has convenient fold-out tilt base. Manuals included. Major Mfr's Close Outs Item #34216 (Get one while they last!) **\$59<sup>00</sup> NEW**

## 84 Key, XT/AT, Auto Switchable Keyboard

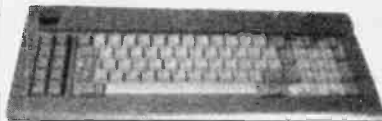

Number, caps, & scroll lock. Separate function-key keypad. 1" twist-down kick stand tilts keyboard for easier operation. Item #33024 **\$29<sup>95</sup> NEW**

## 12V @ 6.5 Ah Lead Acid Battery



Dim.: 5 7/8" W x 3 5/8" H x 2 1/2" Panasonic #LCR12V6.5P Item #35248 NEW **\$14<sup>95</sup>**

## 300 Watt Line Stabilizer/Conditioner

Perfect for protecting your PC and other electronic equipment (TVs, stereos, etc.) Lightweight and portable, 110/220V Switchable

Corrects and protects valuable equipment from any irregularities caused by high or low voltage interference.

• 300 Watt, 2.5 Amp, 5-Outlet Protection • Small in size and lightweight (12 lbs.), this unit is a perfect portable. Has a 6-ft. (detachable power cord with 3-prong plug. Input Range, 190-240VAC or 96-138VAC, 50/60Hz. Sine wave output. Max. current: 2.5A. Dim.: 6" x 9" x 4.5"

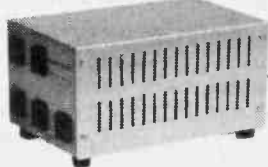

Item #34955 NEW **\$59<sup>95</sup>**

## Disk Drive



### A. Floppy/Hard Card

• Supports up to four floppies & two hard drives • Run 2 internal & 2 external floppies, or 1 external floppy & 1 tape back up • Supports 3 1/2" and 5 1/4" drives. 360K, 720K, and 1.2Mb formats • Cables sold separately

#34946 **\$49<sup>95</sup>**

## Controller Cards



### B. XT Controller Cards

For 10 or 20 Mb Drives Full card size, this MFM controller is compatible with 10Mb TM252 & 20Mb ST225 drives. Original IBM card.

Item #36008 **\$29<sup>95</sup>**

## Helium-Neon Laser Tube

.6 - 1.3mW

Build your own professional-grade laser!



Overall length: 9-1/2".

Output: .6-1.3mW.

Wavelength: 632.8nm. Operate

this unit with a high-voltage power

supply (can be used with ADC #29248, shown

below). Great for science projects and experiments.

Generates an easy-to-read beam of light. Siemens mode

LGR-7631A, Mounted in bracket with plug.

Item #36835 **\$39<sup>95</sup> NEW**

## 12 Volt, Rechargeable NiCad Packs

Perfect portable power sources! For all those electronic gadgets that operate on 12VDC.

### 12V @ 1.65Ah, 'C' Cells

Consists of 10 'C' cells, connected in series and wrapped in a cardboard case. Dim.: 9 5/8" x 1 3/4"

Item #34948

NEW

**\$15<sup>95</sup> ea.**



12V

@ 2.5Ah

'Sub D' Cells

Consists of 10 Sub-D

cells connected in

series & plastic shrink

wrapped. Dimensions: 7 1/2" x 2"

Item #36262 **\$19<sup>95</sup> NEW**

## 300 Watt Line Stabilizer/Conditioner

Perfect for protecting your PC and other electronic equipment (TVs, stereos, etc.) Lightweight and portable, 110/220V Switchable

Corrects and protects valuable equipment from any irregularities caused by high or low voltage interference.

• 300 Watt, 2.5 Amp, 5-Outlet Protection • Small in size and lightweight (12 lbs.), this unit is a perfect portable. Has a 6-ft. (detachable power cord with 3-prong plug. Input Range, 190-240VAC or 96-138VAC, 50/60Hz. Sine wave output. Max. current: 2.5A. Dim.: 6" x 9" x 4.5"

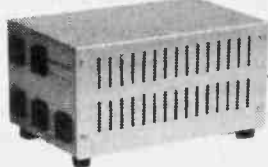

Item #34955 NEW **\$59<sup>95</sup>**

## Order Toll Free! 1-(800) 776-3700 today!

AMERICAN DESIGN COMPONENTS, PO Box 2601, Secaucus, NJ 07096-2601

MINIMUM ORDER \$15. RE192

YES! Please send me the following items —

Item No.	How Many?	Description	Price	Total

FREE 1991 Catalog with every order!

Shipping & handling: we ship UPS unless otherwise specified. Add 10% of total plus \$3. Canadian: \$3 plus P.O. cost. Charge only. Sales Tax (NJ residents only, please add 6% of total)

ORDER TOTAL

- My check or money order is enclosed.  
 Charge my credit card.  
 Visa  MasterCard  Amex  Discover

Card No. \_\_\_\_\_  
 Exp. Date \_\_\_\_\_  
 Signature \_\_\_\_\_  
 Telephone: Area Code \_\_\_\_\_ Number \_\_\_\_\_  
 Name \_\_\_\_\_  
 Address \_\_\_\_\_  
 City \_\_\_\_\_  
 State \_\_\_\_\_ Zip \_\_\_\_\_

All inquiries and free catalog requests — call (201) 941-5000.

For all phone orders, call TOLL FREE 800-776-3700. In New Jersey call (201) 601-8999.

# HITACHI

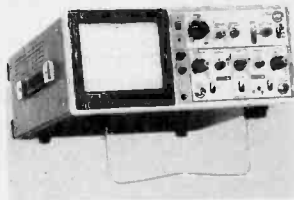

V-212  
REG. \$525.00  
SALE  
**\$419.95**

MODEL	DESCRIPTION	REGULAR	SALE
<b>Analog Oscilloscopes</b>			
V-212	20 MHz, Dual Channel	525.00	419.95
V-660	60 MHz, Dual Channel, Delayed Sweep, CRT Readout	1345.00	1045.95
V-665A	60 MHz, Dual Channel, Delayed Sweep, CRT Readout, Cursor Measurement, Counter	1545.00	1285.95
V-1060	100 MHz, Dual Channel, Delayed Sweep, CRT Readout	1645.00	1365.95
V-1065A	100 MHz, Dual Channel, Delayed Sweep, CRT Readout, Cursor Measurement, Counter	1895.00	1645.95
<b>Digital Storage Oscilloscopes</b>			
VC-6023	20 MHz, 2 Ch, 20 MS/s, 2 KM/Ch, RS-232	1995.00	1689.95
VC-6024	50 MHz, 2 Ch, 20 MS/s, 2 KM/Ch, RS-232	2295.00	1989.95
VC-6025	50 MHz, 2 CH, 20 MS/s, 2 KM/Ch, Sweep Autorange, RS-232	2595.00	2189.95
VC-6045	100 MHz, 2 Ch, 40 MS/s, 4K Mem, Sweep Autorange, RS-232	3395.00	2989.95
VC-6145	100 MHz, 4 Ch, 100 MS/s, 4K Mem, Sweep Autorange, RS-232	5295.00	4489.95

# PRINT™

Products International

8931 Brookville Rd, Silver Spring MD 20910  
800-638-2020 \* 301-587-7824 \* FAX 800-545-0058



**BK PRECISION®**  
MAXTEC INTERNATIONAL CORP.

## Winter Specials



**\$99.95**

MODEL 2120  
Oscilloscope, 20 MHz,  
Dual Trace.  
REG. \$549.00  
SALE \$Call For Quote!

MODEL 1541A  
Oscilloscope, 40 MHz,  
Dual Trace.  
REG. \$845.00  
SALE \$Call For Quote!

MODEL 2160  
Oscilloscope, 60 MHz, Dual  
Trace w/Delayed Sweep.  
REG. \$1099.00  
SALE \$Call For Quote!

MODEL 2501  
Digital Storage Adapter  
Converts Your Analog Scope  
To Digital Storage!  
REG. \$357.00  
SALE \$299.95

MODEL 2522  
DSO, 20 MHz, 10 MS/s,  
2K Memory/Channel  
REG. \$995.00  
SALE \$836.95

MODEL 388-HD  
Test Bench, 41  
Range DMM.  
REG. \$129.00  
SALE \$99.95



ORDER LINE (800)638-2020  
FAX LINE (800)545-0058  
WE MAKE ORDERING SIMPLE!



CIRCLE 280 ON FREE INFORMATION CARD

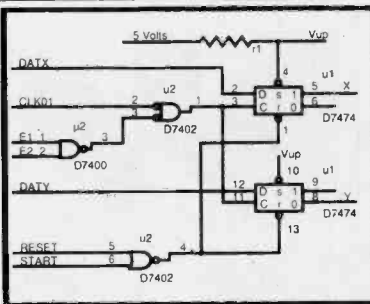

**SuperCAD™**  
Schematic  
Entry Software  
for the IBM PC  
& Compatibles  
**\$99.00**

ONLY COMPLETE PACKAGE

- ★ Easy-to-use schematic entry program for circuit diagrams
- ★ Visible on-screen and pull down menus
- ★ Supports popular graphic standards, mice and printers
- ★ Powerful editing and drawing commands
- ★ Extensive digital, analog and discrete part libraries
- ★ In-depth, readable instruction manual
- ★ Over 100 screens of on-line help information
- ★ Software includes part building and netlisting
- ★ Add P.C. board layout software and routing software for only \$99.00 each

Write or call for FREE demo disk:

**MENTAL AUTOMATION, INC.**

ORDERS/INFORMATION:

Send check or money orders to:  
Mental Automation, Inc.,  
5415 - 136th Place S.E.  
Bellevue, WA 98006

Or Call

**(206) 641-2141**

MasterCard Visa & MasterCard orders accepted!

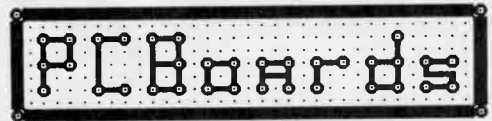

P-C-B ARTWORK MADE EASY!  
Create and Revise PCB's in a Flash

- \* HERC, CGA, EGA, VGA, SUPER-VGA
- \* HELP SCREENS
- \* EXTREMELY USER FRIENDLY
- \* AUTO GROUND PLANES
- \* DOT- MATRIX, LASER and PLOTTER ART
- \* GERBER and EXCELLON OUTPUT
- \* CREATE YOUR OWN FILMS with 1X ART
- \* LIBRARIES
- \* DOWNLOAD DEMOS from 24 hr. BBS!

REQUIREMENTS: IBM PC or Compatible, 384 K RAM  
DOS 3.0 or later. IBM compatible printers, HP Laser

PCBoards - layout program 99.00

(PCBoards HP or HI PEN PLOTTER DRIVER 49.00)

PCRoute - auto-router 99.00

SuperCAD - schematic pgm. 99.00

Demo Pkg. - (includes all 3 programs) 10.00

Call or write for more information

PCBoards

2110 14th Ave. South, Birmingham, AL 35205

1-800-473-PCBS / (205)933-1122

BBS / FAX (205)933-2954



# MAXIMUM RANGE MAXIMIZED SENSITIVITY

We've Carefully balanced the amount of gain used in our input amplifiers - too much or too little results in poor performance. **OPTOELECTRONICS' HANDI-COUNTERS™** with maximized sensitivity give you the maximum range for antenna pick-up.

Made in the USA



**MODEL 3000**  
Multi-function Counter  
10Hz-3GHz, 10 Digit LCD with  
frequency, period, ratio, interval  
& signal level bargraph....\$375.



**Maximum  
Security  
Device.**  
Increase your  
frequency  
finding™ by 10  
times the distance  
or more.  
**Tunable  
Preselector  
APS-104**  
\$995.

Counter Sold  
separately



**MODEL 8030**  
With all the features of the  
3000 plus enhanced input  
signal conditioning and  
enhanced TCXO time base  
\$579.

# OPTOELECTRONICS

\$199.



The Original Pocket-Sized LED  
Handi-Counter™

All of **OPTOELECTRONICS'** LED  
Handi-Counters™ will:

- Count frequencies above 2.4GHz.
- Have display saving Power Switch  
(avoids premature LED burn-out, leading cause of  
counter failure.)

Accept no substitutes -  
Look for the **OPTOELECTRONICS**  
name on the label!

Only **OPTOELECTRONICS**  
offers you **MAXIMIZED SENSITIVITY.**

Factory Direct Order Line **1-800-327-5912**

**FL(305)771-2050 • FAX(305)771-2052**

5821 NE 14th Ave. • Ft. Lauderdale, FL33334 • 5% Ship/Handling (Max. \$10)  
U.S. & Canada. 15% outside continental U.S.A.  
Visa and Master Card accepted.

**Model 2210A**  
10Hz-2.4GHz Full range  
counter. Price includes  
Nicads & AC charger/adaptor.

\$99.



**Model 2300 - 1MHz-2.4GHz**  
Available with NiCads and AC  
Charger Adapter. Complete  
Package only....\$128.

We Sell **QUALITY PARTS** • We Have **DISCOUNT PRICES** • We Ship **FAST**

# ALL ELECTRONICS CORP.

## "MAX" The Remote VCR Controller

"MAX" allows you to watch and control a single VCR from other locations in the house. Transmits audio, video and IR signals up to 100 feet through mini-cable. Works on up to 4 televisions at a time, but a separate "MAX" receiver is required for each TV. Can also be used with other infrared controller devices such as CD players or stereos. Because it is hardwired, signal transmission is clearer than more expensive non-hardwired units. Includes transmitter, receiver, 100' cable, hook-up cables and wall transformer. These new units originally sold for over \$100.00.

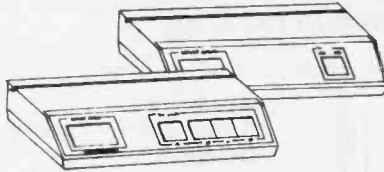

CAT# MAX \$40.00 each 4 or more \$35.00 each

## FLASH UNIT

New compact flash assembly from a U.S. manufacturer of cameras. Operates on 3 Vdc and measures 2 1/2" x 1 1/4". Ideal for use as a strobe, warning light or attention getter.

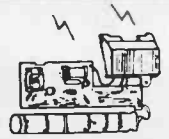

Includes hook-up diagram.

CAT# FSH-1 \$3.75 each  
10 for \$35.00 • 100 for \$325.00

## BATTERY PACK (USED)

Four AA nickel cadmium batteries connected in series to make a 4.8 volt pack. Batteries are in a 2 X 2 configuration with a 2 pin connector attached. The four batteries can be separated into single AA size solder tab nickel cadmium batteries or resoldered into other configurations.



CAT# NCB-41AAU  
\$3.00 per pack • 10 for \$25.00

## CABLE TIES & CRIMP CONNECTORS

CAT#	APPROX. LENGTH	MIN. TENSIL STRENGTH	COLOR	MAX. BUNDLE DIA.	10	100	1000
TR-400	4"	18 lbs	neutral	15/16"	30	\$2.50	\$15.00
TR-400B	4"	18 lbs	black	15/16"	35	\$3.00	\$17.50
TR-600	6"	30 lbs	neutral	1 1/2"	50	\$4.00	\$30.00
TR-600B	6"	30 lbs	black	1 1/2"	50	\$4.00	\$30.00
TR-800	8"	50 lbs	neutral	1 3/4"	60	\$5.00	\$40.00
TR-800B	8"	50 lbs	black	1 3/4"	70	\$6.00	\$50.00
TR-1100	11"	50 lbs	neutral	3"	70	\$6.00	\$50.00
TR-1100B	11"	50 lbs	black	3"	80	\$7.00	\$60.00
TR-1500	15"	50 lbs	neutral	4"	\$1.00	\$8.00	\$70.00
Heavy-duty 15" cable tie.							
TR-1500HD	15"	120 lbs	neutral	4 1/4"	\$1.50	\$12.00	\$100.00

## INSULATED CRIMP TERMINALS

### QUICK DISCONNECT MALE 1/4"



CAT#	WIRE SIZE	COLOR	50 PCS	100 PCS	500 PCS	1,000 PCS
2125	22-18	RED	2.50	4.50	20.00	32.00
2225	16-14	BLUE	2.50	4.50	20.00	32.00
2325	12-10	YELLOW	3.00	5.50	26.00	50.00

### QUICK DISCONNECT FEMALE 1/4"



CAT#	WIRE SIZE	COLOR	50 PCS	100 PCS	500 PCS	1,000 PCS
1125	22-18	RED	2.50	4.50	20.00	32.00
1225	16-14	BLUE	2.50	4.50	20.00	32.00
1325	12-10	YELLOW	3.25	6.00	27.50	52.00

### SPADE TERMINALS



CAT#	WIRE SIZE	COLOR	STUD SIZE	50 PCS	100 PCS	500 PCS	1,000 PCS
9106	22-18	RED	6	2.50	4.50	20.00	32.00
9108	22-18	RED	8	2.50	4.50	20.00	32.00
9110	22-18	RED	10	2.50	4.50	20.00	32.00
9206	16-14	BLUE	6	2.50	4.50	20.00	32.00
9208	16-14	BLUE	8	2.50	4.50	20.00	32.00
9210	16-14	BLUE	10	2.50	4.50	20.00	32.00
9308	12-10	YELLOW	8	3.25	6.00	27.50	52.00
9310	12-10	YELLOW	10	3.25	6.00	27.50	52.00

We have a wide selection of butt connectors, ring terminals, end caps, quick splice connectors, and piggy-back 1/4" connectors.

CALL for a quote on larger quantities or other styles.

## 200 ASSORTED PARTS

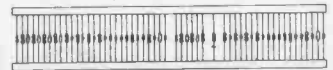

Strips of assorted parts. Each strip contains an assortment of resistors, capacitors and diodes. Each strip contains at least 200 parts.

CAT# GRABTR \$2.00 per assortment

## FLASH TUBE



2" long X 0.15" diameter. 2" long wire attached to one end. CAT# FLT-6 75¢ each

## KEYPAD

12 button telephone keypad. Ivory finish. 2.83" x 2.2" x 0.58" thick. Matrix encoded. Ideal for telephone or security keypad.

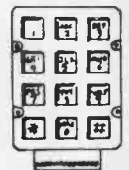

CAT # KPT-1  
\$1.00 each  
10 for \$9.00

# TOLL FREE ORDER LINES 1-800-826-5432

FAX (818) 781-2653 • INFORMATION (818) 904-0524

Minimum Order \$10.00 • All Orders Can Be Charged To Visa, Mastercard Or Discovercard • Quantities Limited • California, Add Sales Tax • Shipping And Handling \$3.50 For the 48 Continental United States - All Others Including Alaska, Hawaii, P.R. And Canada Must Pay Full Shipping • No C.O.D. • Prices Subject to change without notice.

# ITEMS of SPECIAL INTEREST

## HIGHEST QUALITY METAL CASSETTES (Erased)

Premium quality metal tape in C-60 cassettes (30 or more per side). One of the finest "brand-name" tapes on the market, in durable, clear plastic transport mechanisms. Recorded and bulk erased, the record-protect tabs have been removed and therefore, need to be taped over to re-record. Audiophiles will appreciate the wide dynamic range of this tape. If your cassette deck has a "metal" setting you will hear the difference. A real bargain!

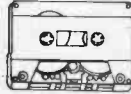

**CAT# C-600M \$1.25 Each 10 for \$10.00**

## CASSETTE STORAGE CASE

Black, unbreakable plastic audio cassette storage case.

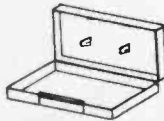

**CAT# CBOX 5 for \$1.00 • 100 for \$15.00**

## WIRELESS REMOTE CONTROL For Nintendo™ Video System

CAMERICA "Freedom Connection"™ Turns your wired Nintendo™ control paddle into a remote control unit. Infrared remote like those used on TV's and VCR's eliminates messy wires. Allows players more mobility. Two players can use one remote unit except on games where they play simultaneously. In those games two "Freedom Connections" units are required. A well-known national discount toy chain sells these for more than twice our price. Operates on 4 AAA batteries (not included).

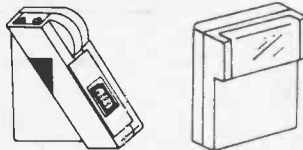

**CAT# IR-1 \$9.95 each**

Set of 4 AAA batteries **CAT# BAT-4AAA \$2.40 / set**

## INFRARED SECURITY LIGHT (AS-IS)

Elektriko # SIL-101 - Experiment with infrared sensors with these outdoor security lights. Lots of interesting components, IR detector, photoresistor, relay, transformer, IC's, voltage regulator, and other goodies. Returned to the distributor for variety of reasons. We don't want to test them and would prefer to sell them "as-is." Infrared sensor detects movement up to 65 feet and turns on lights. Sensor can be adjusted for sensitivity and duration of lighting. Will handle two 150 watt PAR 38 lamps. Bulbs not included. **CAT# IL-101 \$7.50 each**

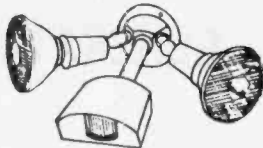

## EXPERIMENTER'S DELIGHT ATARI 5200 VIDEO GAME (AS-IS)

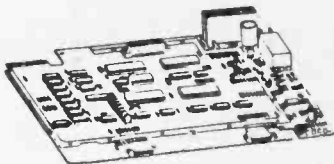

These Atari video game controllers were returned to the dealer because of various defects. None of them work properly, but they have lots of great parts which could be used in other projects. They include a RF video modulator, eight 16K dynamic RAMs in sockets, microprocessors and D-A converters in sockets, two voltage regulators on

a heavy-duty heatsink and lots of other IC's, capacitors, resistors, connectors and other components all in the original chassis. Does not include the power transformer or controls (joysticks). The video modulator or the RAMs alone are worth the price.

**CAT# A-5200 WERE \$7.50 each - 2 for \$13.50  
REDUCED TO \$5.00 each • 2 for \$9.00**

## 48 Key Keyboard



NEW Texas Instrument keyboards. **IDEAL FOR THE EXPERIMENTOR.** Unencoded 48 S.P.S.T. mechanical switches. Terminates to 15 pin connector. Can be used for any hobby applications. Size 4" X 9".

**New CLEARANCE PRICE**

**CAT# KP-48S \$2.00 ea. • 10 for \$19.00**

## Solderless Breadboard

Inexpensive model. Large enough to design most experimental circuits. Contains main board and two power buss strips. 2 1/2" X 6 3/4"

**CAT# PB-101**

were \$9.00 each

Reduced to \$7.50 each



## CIRCUIT BOARD PEN

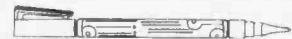

Circuit Works # 2200

Make and fix circuit board lines instantly. Valved pen with a specially formulated silver bearing thermoplastic polymer allows you to draw conductive silver traces. Can be soldered after 15 or 20 minutes with 350 degree iron. Each pen contains enough silver conductor for 100 feet of shielding, traces and connections.

Traces are narrow as 1/16" in width.

**CAT# CW-2200 \$10.95 each**

## LOW PRICED 12 VDC HORN-TYPE RELAY

JL2A-12V.  
12 Vdc, SPDT,  
32 ohm coil.  
5 amp contacts.

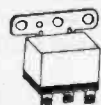

Three terminal relay. Energizing coil transfers voltage to third contact. Metal dustcover with mounting bulkhead mounting flange. 1.25" X 2" X 2.5".

Large quantity available. Priced to move.

**CAT# RLY-JL2 3 for \$1.00  
10 for \$3.00 • 100 for \$25.00**

**CALL OR WRITE FOR OUR  
FREE 60 PAGE CATALOG  
WITH OVER 4000 PARTS!  
OUTSIDE THE U.S.A. PLEASE SEND  
\$2.00 POSTAGE FOR A CATALOG**

**TOLL FREE  
PHONE ORDERS  
1-800-826-5432**

**MAIL ORDERS TO:  
ALL ELECTRONICS  
P.O. BOX 567  
VAN NUYS, CA 91408**

CIRCLE 250 ON FREE INFORMATION CARD



# A & T Labs, Inc.

## Magnetic Field Meter

Determine Your Exposure to Line Frequency Magnetic Fields!

- Quickly measure radiated fields of electrical and electronic equipment
- Digital display
- Hand size
- Easy to use
- Battery operated
- .02 - 20,000 u Tesla Sensitivity
- As featured in Radio Electronics, April, 1991

### To Order:

- Model ELFM-1 Magnetic Field Meter \$109.00  
Assembled, less battery
- Easy to build kit of all parts, less battery \$85.00
- Shipping & Handling- 5% US, 10% Canada
- Check or Money Order

**ATL, Inc., Box 4884, Wheaton, IL 60187**

CIRCLE 290 ON FREE INFORMATION CARD

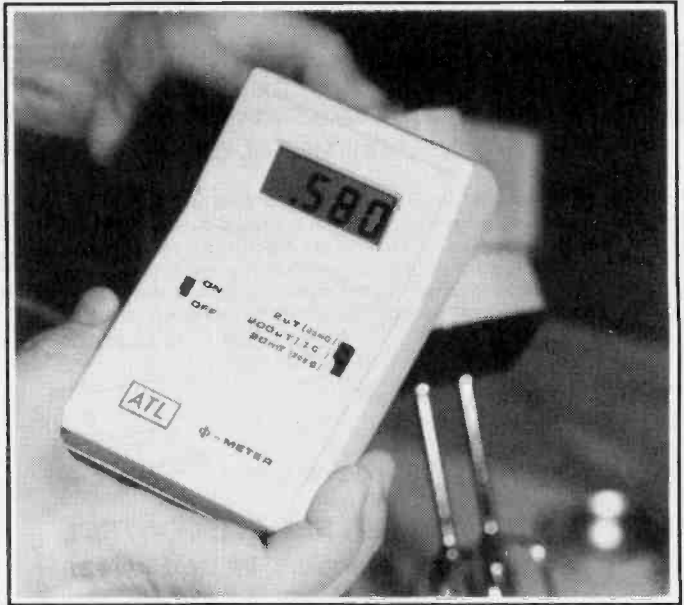

Also: Send for free information on other ATL "Hi-Per" Kits, Featured in Radio-Electronics Including: 500 Watt FET Amplifier; Dual 5A, 50V Lab Power Supply

## 1000 MHz SIGNAL GENERATOR FOR \$995

### KEY PERFORMANCE FEATURES:

- TWELVE FUNDAMENTAL OSCILLATOR RANGES FROM 100 kHz TO 1000 MHz OPTIMIZED FOR LOW PHASE NOISE AND STABLE OUTPUT FREQUENCY
- DIGITAL READOUT OF OUTPUT FREQUENCY WITH 0.002 % ACCURACY AND 4 1/2 DIGITS OF RESOLUTION
- LOW HARMONIC DISTORTION < -30 dBc
- DIGITAL READOUT OF OUTPUT POWER TO +10 dBm WITH A RESOLUTION OF 0.1 dBm



- CALIBRATED OUTPUT ATTENUATOR IN 10 dB STEPS WITH A RANGE OF 50 dB.
- SOLID METAL HOUSING FOR HIGH STABILITY AND LOW RF LEAKAGE

We have studied the market carefully, and what is really missing is a low-cost signal source. Our model SG 1000A signal generator does not compromise on key essential features such as: very low phase noise, stable output frequencies directly counted, internally levelled output power to +10 dBm with calibrated attenuator. AM/FM modulation is supported over the entire 100 kHz to 1000 MHz range. Option 1: phase-coherent sub-harmonic trigger output for super-stable timebase triggering. This option also allows the use of the instrument as a sensitive frequency counter: \$195. Option 2: 2 each 30dB fixed attenuators to extend the output power range to -110 dBm: \$45. Option 3: Bias-T from 20 kHz to 8000 MHz: \$65.



**Colby Instruments, Inc.** Electronic Research & Development

1810 14th St., Santa Monica, CA 90404

**Phone: (213)450-0261 FAX: (213)452-0027**

CIRCLE 284 ON FREE INFORMATION CARD

# LEARN to CLEAN/ MAINTAIN/ REPAIR CAMCORDERS



**EARN \$85  
AN  
HOUR!**

## HUGE EXPANDING MARKET!

Work from your home – part-time or full-time!  
No prior experience needed – Average mechanical  
ability only requirement for your success! Over 15  
million camcorders in use – Over 5 million expected  
to be sold in 1991 alone!

It is a fact that the vast majority of camcorder  
malfunctions (just like VCRs!) are due to simple me-  
chanical failure... We can show you how to easily fix  
those breakdowns and earn an average of \$85.00/Hr.  
while working at home!

**Get In Now** – Soon camcorders will be like VCRs,  
i.e., one in almost every home.

For a camcorder cleaning job you can earn \$65.00 for  
less than 30 minutes work.

For a camcorder repair job you can earn over \$100.00.

**FREE INFORMATION PACKAGE** call or write:

Toll-Free 1-800-537-0589

Viejo Publications, Inc.

5329 Fountain Ave., Dept. RESC  
Los Angeles, CA 90029

CIRCLE 264 ON FREE INFORMATION CARD

Midwest Laser Products  
Proudly Presents...



## Laser Show Designer

Make your own professional laser light shows for fun  
and profit! Our Laser Show Designer uses the latest  
most sophisticated technology to bring to you the best  
computer controlled light show ever! Create animated  
objects, 3D effects, text, lumia effects, abstracts that  
flow to the music, beam targeting, anything your im-  
agination desires! Our system uses powerful on screen  
editing, icons, and slider bars to create any effect you  
want. Laser Show Designer comes with all necessary  
scanning equipment and software designed specifically  
for the Amiga computer and is upgradable beyond any  
other system.

\$2900

VHS Video \$7.00 (tape+shipping cost)

## Visible Laser Diode Module Special

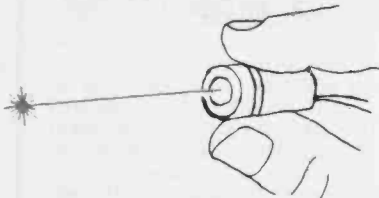

Cat. # DM1  
\$99<sup>00</sup>

Thanks to technological breakthroughs in laser mini-  
aturization and increasing demand for such components  
we now have available the smallest most economical  
laser diode system ever!

### WIDE RANGE OF APPLICATIONS

- \*Pointer/Gun Sight
- \*Alignment Systems
- \*Light Shows
- \*Medical Equipment
- \*Detection Beams
- \*Project Building
- \*Surveying Systems
- \*Educational Equipment
- \*Holography

### SPECIFICATIONS:

- \*Requires only 3 penlight batteries.
- \*Size: 1.6 inches by 0.625 inch diameter.
- \*3mW Laser Diode ; 670nm wavelength (Red)
- \*Beam Size: 2mm at apature ; 0.6 inch diam. at 40ft.

## 2-3mW He-Ne Laser Tube

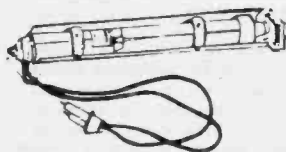

Power Requirements:  
1700vdc @ 4.5mA

Inventory Reduction Sale  
\$28 each  
10 for \$200

### FREE CATALOG

## Midwest Laser Products

P.O. Box 2187 Bridgeview, IL 60455 (708)460-9595

Please include \$7.00 for shipping and handling. Il. Res. include 7% sales tax.  
All products come with a 10 day satisfaction guarantee and 90 day warranty.  
C.O.D. orders welcome (\$3.00 fee)

CIRCLE 211 ON FREE INFORMATION CARD

# LESS BUSTER'S ELECTRONICS®

UNIQUE ELECTRONIC PRODUCTS

**UNIVERSAL REGULATED, POWER ADAPTER** **INTRODUCTORY OFFER \$19.95**  
**SELECTABLE & VARIABLE DC VOLTAGES!**

- IDEAL FOR DIGITAL & ANALOG ELECTRONICS
- 7 PRESET, CALIBRATED, REGULATED VOLTAGES (1.5, 3.0, 4.5, 6.0, 7.5, 9.0 & 12.0V DC) (BATTERY ELIMINATOR AA, AAA, C, D, & 006P'S)
- VARIABLE REGULATED VOLTAGE 1.25-12.5DC.
- 6 DIFFERENT STYLE POWER PLUGS
- POLARITY REVERSAL SWITCH.
- AC OPERATED, SEL. 120 OR 240 AC 50/60Hz
- REGULATION .3% 800MA., OR BETTER.
- AC OUTPUT RIPPLE 5MV. P.P. OR LESS.
- PROTECTION: OUTPUT, AUTOMATIC RESET LM-317T REGULATOR. INPUT .5AMP FUSE.
- MODEL LG-711VPRPA ASSEMBLED.....\$29.95

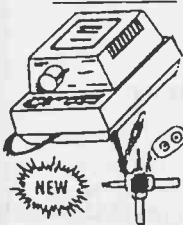

Offer expires 2-2-92

## COLOR TV-VCR ANTENNA

COMPACT SIZE (75 Ohms)

UHF-VHF-FM

- QUALITY VCR RECORDINGS
- HIGH DEFINITION VIEWING

Ideal antenna, for confined areas, such as attics, patios, lofts, (Meet your CC&R requirements) etc! Range 90-110 miles. (Varies with installation & height). Adjustable offset Boom axis compensator & high front to back ratio, reduces VHF-UHF ghosts. Lightweight & compact size. Boom length 44" & Rear element width 74". 18 element UHF corner reflector & 5 element VHF-FM yagi. Antenna price, includes 35' fabricated 75Ω RG-59 coax cable. Dr. CHAN'S Model 2023A. \$21.95

AMPLIFIED-INDOOR, VHF-UHF-FM!

## COLOR TV-VCR ANTENNA

\$39.95  
 1.1. BUSTER'S PRICE

The Aristocrat LG-1 indoor amplified antenna, is designed specifically for the apartment dweller who is not allowed to install an outdoor antenna (VIZ Landlord, CC&R's or a limited budget, with no cable TV fees). Amplifier, permits antenna to be located (up to 30

ft., from TV-VCR), wherever the incoming TV signals are the strongest. 14dB gain VHF-FM, UHF amplifiers, will operate 2 or 3 TV-VCRS. Output is 75 ohm 15' coax line with male F connector. Accessories included, (depicted below). 1ea. #1 separator, #6 3X splitter, #9 Balun, #7 cable extender & 15', extra coax cable. Antenna operation 117VAC, for any VCR-TV-FM receivers. Model LG-1..\$44.95

- ACCESSORIES**
- VCR-TV-MATV-ANTENNAS**
- #1: Separator: UHF-VHF/FM 54-890MHZ. 75ΩFJ to 3X 300ΩLT.....\$1.50ea.
  - #2: Quick Twist on, F Plug to RG 59U coax. 5ea.\$2.00
  - #3: Push on F plug to F screw on Jack. 5ea.\$2.50
  - #4: Transformer: UHF-VHF/FM 75ΩFJ to 300ΩLT.... 75ca.
  - #5: Splitter/Combiners, Hybrid Reversible, Video UHF-VHF/FM 75ΩFJ X2 75ΩFJ. \$1.50ea.
  - #6: F Grounding block. 75ca.
  - #7: Coupling FJ2X 2ea\$1.00.
  - #8: Switch A/B DC-900MHZ. High isolation, FCC approved. 75ΩFJ X2 75ΩFJ. \$4.50ea.
  - #9: Transformer: UHF-VHF/FM 75ΩFJ to 300ΩT.....75ca.

- QUICK TWIST® COAX CABLE ASSEMBLIES**
- TV-FM-ANT-VCRS-MATV**
- Re-usable-Adjustable: to a shorter length, RG-59/U 75Ω, double shielded, low loss, assembled coax cable, with 2 each re-usable screw on, Quick Twist, male F connectors. (as depicted, No crimping).
- 3.75ft. \$1.50ea.
  - 7.50ft. \$2.00ea.
  - 15.00ft. \$3.00ea.
  - 30.00ft. \$4.00ea.
  - 45.00ft. \$5.50ea.

**HOW TO KEEP YOUR VCR ALIVE!**  
**ALIAS**  
 (THE NITTY GRITTY OF VCR REPAIR)  
 Bible of VCR Mechanical & Electro-mechanical THEORY -REPAIRS-DATA 409 Pages, over 700 Illustrations. VIZ: Special Section Illustrates & describes over 60 mechanisms of 45 Manufacturers. Save on service manual costs! A must nitty gritty manual for the DO-IT YOURSELFERS & PROFESSIONAL TECHNICIANS. BOOK: 2nd Edition, 1990. Free S&H VIA UPS. Your cost..\$24.95

**LESS BUSTER'S ELECTRONICS®** \*Send Money order or Check.  
 2039 CIVIC CENTER DRIVE, STE. #176 \*Minimum order \$10.00.  
 NORTH LAS VEGAS, NEVADA 89030 \*Shipping & Handling +\$3.50 UPS.  
 TEL: 1-702-842-0325 Continental 48 States, others extra.  
 Orders processed Immediately, Notification sent in case of unforeseeable delay.  
 LESS BUSTER'S ELECTRONICS® and QUICK TWIST® 1891 LEG

Phonvu:

# CAMERA PHONE®

VISUAL TELEPHONE COMMUNICATION SYSTEM

Sends TV pictures over  
 The phone line in Twelve Seconds

Captures any TV Camera, Camcorder  
 VCR, NTSC Video output and holds  
 the display and sends on command

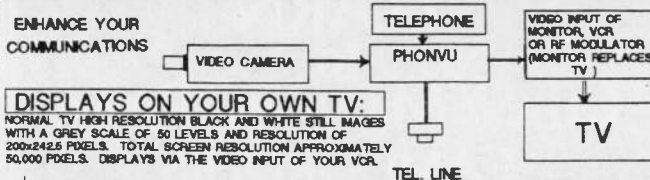

**DISPLAYS ON YOUR OWN TV:**  
 NORMAL TV HIGH RESOLUTION BLACK AND WHITE STILL IMAGES WITH A GREY SCALE OF 50 LEVELS AND RESOLUTION OF 200x242.5 PIXELS. TOTAL SCREEN RESOLUTION APPROXIMATELY 50,000 PIXELS. DISPLAYS VIA THE VIDEO INPUT OF YOUR VCR.



SHOWN AS AN INTEGRATED SYSTEM: TV, CAMERA, AND TELEPHONE NOT INCLUDED  
 CAMERA PHONE: MODEL: BW1  
 Retail: \$249.95  
 EACH \$480.00 Per Pair  
 PAL SYSTEMS ADD \$10.00

ALSO AVAILABLE IN KIT FORM

PHONE and FAX Order (213) 827-1852  
**PMC Electronics** Box 1148  
 Marina Del Rey, CA 90292

## NOW YOU CAN "SEE" INVISIBLE FIELDS AND AVOID THEM

Most homes and offices have hot spots with strong artificial electro-magnetic fields, where chronic exposure may cause mental or physical problems. Even the EPA names these fields as suspected carcinogens. You can reduce your risk by avoiding these high-field areas.

The **TriField™** meter detects far more of these fields than any other electromagnetic pollution meter. It's the only one that independently reads AC electric fields, AC magnetic fields, and radio/microwaves. It also reads field strengths in all directions simultaneously. Every other meter that sells for under \$100 reads only magnetic and only in one direction — they can entirely miss a magnetic field unless pointed correctly and are blind to radio/microwaves and electric fields, both of which cause biological effects.

The **TriField™** meter reads all three types of fields numerically and with a SAFE/BORDERLINE/HIGH SCALE, weighted proportional to effect on the body. Thresholds are based on epidemiological and laboratory studies. (While no absolute hazard thresholds have been established, reduction of relative exposure is prudent.)

The **TriField™** meter comes ready-to-use with battery, instructions, and one-year limited warranty. The cost is \$100 postpaid.

AlphaLab / 1272 E. Alameda Avenue / SLC, UT 84102  
 For literature and information, call (503) 621-9701



# VACUUM TUBE DEALER PRICE LIST Nov. '91



			SOVTEK, USSR		
5U4G	\$4.30 each	12 at \$3.90 each	25 at \$3.50 each		
12AX7WA/7025	4.35	3.75	3.60		
6922 (military 6DJ8)	5.75	5.20	4.75		
EL84/6BQ5	2.60	2.25	1.75		
EL84M/6BQ5WA	5.20	4.50	3.50		
6V6GT	3.90	3.35	2.95		
6L6GC	3.50	2.95	2.60		
5881/6L6WGC	6.75	6.20	5.75		

The 5881 is Russia's selected military 6L6WGC and is regarded as the very best 6L6 type in the world. Eric Clapton recently replaced the Philips/Sylvania 6L6 STR's in the custom Soldano amp which he uses live, with SOVTEK 5881's because of their milky smooth sound. Discriminating musicians thruout the world are retubing with the SOVTEK 5881/6L6WGC.

50 CALL FOR SPOT QUOTE  
100 CALL FOR SPOT QUOTE

			SINO, CHINA		
5U4G	\$4.60 each	10 at \$4.15 each	25 at 3.75 each		100 CALL FOR SPOT QUOTE
EL34	4.90	4.30	3.90		" " " " "
6L6GC	4.70	3.95	3.70		" " " " "
12AX7a	3.85	3.25	3.10		" " " " "
12AT7	3.90	3.40	3.25		" " " " "
6146B	11.50	10.60	9.80		" " " " "
6550	9.40	8.95	8.35		" " " " "
KT88	11.60	10.50	9.95		" " " " "

			EI, YUGOSLAVIA		
EL34/6CA7	\$5.10 each	10 at \$4.65 each	25 at \$4.10 each		100 CALL FOR SPOT QUOTE
6DJ8	3.15	2.75	2.35		" " " " "
12AU7/ECC82	3.15	2.75	2.35		" " " " "
12AX7/ECC83	3.15	2.75	2.35		" " " " "

			SIEMENS, GERMANY		
EL34	\$7.25 each	10 at \$6.75 each	25 at \$6.20 each		100 CALL FOR SPOT QUOTE

			TESLA, CZECHOSLOVAKIA		
EL34	\$6.75 each	10 at \$6.25 each	25 at \$5.70 each		100 CALL FOR SPOT QUOTE

			GE, USA		
5U4GB	\$11.85 each	10 at \$11.25 each	6550a	\$17.95 each	10 at \$16.50 each
6CA7	14.95	13.50	7025	14.75	13.25
6L6GC	14.95	13.50	7027a	16.95	16.25
6LF6	18.50	16.95	7591a	14.75	13.50
12BH7	9.95	9.50	7868	16.95	16.25
12AT7	6.85	6.40	8417	15.75	14.25

### SOLID STATE RECTIFIER

Built into tube socket. Direct plug-in replacement for all 5Y3, 5U4 and 5AR4 types. \$6.25 each 10 at \$5.90

ODD BALL TUBES (MOSTLY USA STOCK)							
4CX350A \$79.00 each	6AV6 \$1.95 each	6GW8 \$6.90 each	6X4 \$3.90 each	6189W \$4.15 each			
5AR4 7.95	6AX5 4.90	6J5 4.50	6X5 3.90	(12AU7W industrial)			
5BC3/9 1.95	6BA6 1.95	6J7 5.50	6X8 2.25	6267 2.80			
5V4GT 5.50	6BK11 6.90	6K11 6.90	12AY7 5.95	6973 11.90			
5Y3GT 3.95	6C4 2.80	6SC7 6.90	12AZ7 2.90	7189 5.90			
6AL5 2.40	6C5GT 2.75	6SG7 3.50	12DT8 4.95	7199 17.80			
6AN8 4.95	6C10 4.90	6SJ7 4.45	12DW7 13.95	7247 13.95			
6AQ5A 4.25	6CA4 3.50	6SK7 2.90	12FQ8 4.75	OA2 3.75			
6AS7 3.90	6CG7 6.90	6SL7 4.35	5749 3.90	OA3 1.95			
6AT6 3.25	6EU7 11.80	6SN7 3.95	(6BA6W industrial)	OB2 1.95			
6AU6 2.25	6FH8 9.25	6U10 4.90	5879 6.50	OC3 3.75			

GIVE US A CALL ON ANY TOUGH-TO-GET TUBE. WE'LL FIND IT FOR YOU!  
ALL TUBES GUARANTEED! QUANTITY DISCOUNTS AVAILABLE!

MATCHING AVAILABLE ON ALL OCTAL POWER TUBES \$1.00 extra per tube.  
"PLATINUM" MATCHING ALSO AVAILABLE WITH 24 HOUR  
TEST AND BURN-IN, ENSURING PREMIUM MATCH. PAIRS OR QUADS \$2.00 extra per tube.

MINIMUM ORDER \$50.00  
ADD \$5.00 SHIPPING (\$10.00 OUTSIDE UNITED STATES)  
SEND CHECK OR MONEY ORDER TO:

## NEW SENSOR CORPORATION

133 FIFTH AVENUE, NEW YORK, NY 10011

CONTACT: MIKE MATTHEWS TELEPHONE: (212) 529-0466 TOLL FREE: 1-800-633-5477 FAX: (212) 529-0486

CIRCLE 215 ON FREE INFORMATION CARD

January 1992, Radio-Electronics

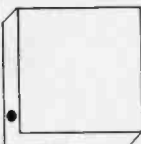

**VOICE UNIT**  
**\$15.00**

This amazing box does everything but dance! The EPROM currently installed gives 3 different messages in English, French, or Spanish. You can chose from two musical melody selections to accompany the message. The unit is approximately 6-5/8" X 7-3/8" X 2-7/8", self-contained, runs on 110 VAC (or can be modified to run on 12 VDC) and comes in a metal enclosure. It features a 2732 EPROM (expandable to a 27128 EPROM) and a dual amplifier with separate volume controls for voice and music. We include instructions for power and selection hook-up, so you can have your sound'n'song module up and talking without much fuss. We don't have programming information, but those truly adventurous enthusiasts may be able to figure out how to program the EPROM with their own messages!



**8123 PAGE BLVD \* ST. LOUIS, MO 63130**  
**(314)427-6116**  
9222 CHESAPEAKE DR. \* SAN DIEGO, CA 92123  
**(619)279-6802**  
2525 FEDERAL BLVD. \* DENVER, CO 80211  
**(303)458-5444**  
**MAIL ORDERS CALL TOLL-FREE**  
**1-800-669-5810**

**ELECTRONICALLY SPEAKING,**  
**GATEWAYS GOT IT!**

**12 VOLT 3.3 AMP**  
**SWITCHING POWER SUPPLY**  
**\$19.95**

Made by Sierra Power Systems, this power supply is approximately 5" X 4-3/4" X 2"



**POCKET PC REF**  
**\$14.95**

**NEW !! Over 300 pages of Information !!**

Small in size, BIG in content ! This little book contains a 142 page MS-DOS 5.0 Reference section, a PC Industry phone book with over 2000 main and tech support numbers, Specs and configuration information for over 1200 hard drives, ASCII Codes, PC Error Codes, 80286 Hard Disk Types, Interrupts - IO Map - Memory Map, Printer Control Codes, Cable Wiring, Modem Commands, and much more !

**TRUE 9V NICAD BATTERIES**  
**4 FOR \$10.00**



9 volt rechargeable nicad batteries manufactured by VARTA. Normally 9 volt nickel cadmium batteries have an output of 7.2 volts DC. These are true 9 volt DC nickel cadmium batteries.

**THE FINE PRINT :**

PRICES SUBJECT TO CHANGE WITHOUT NOTICE  
GATEWAY IS NOT RESPONSIBLE FOR PRINTING ERRORS  
MASTERCARD AND VISA ACCEPTED

\$10 MERCHANDISE MINIMUM ON MAIL ORDERS  
FAX ORDERS TO (314)427-3147 ATTN: MAILORDER DEPT  
(INCLUDE PHONE NUMBER)



SUPPLY OF SOME ITEMS IS LIMITED  
PRICES DO NOT INCLUDE SHIPPING



**STEPPER MOTOR KIT \$16.95**

This is your chance to learn about stepper motor operation without spending a fortune. Experiment with stepper motor control, speed, and direction. Features include variable speed, step, range, direction, and on/off controls as well as led indicators. Kit includes stepper motor, circuit board, and components. Requires 12vdc power source.

**CIRCLE 241 ON FREE INFORMATION CARD**

**LogicLab™ Explorer**

The **Soft** Logic Bench

**New Release**

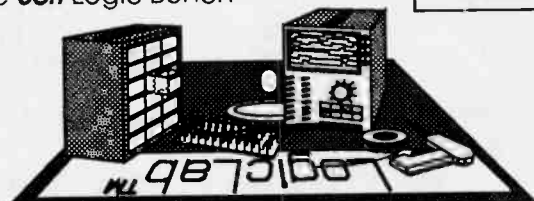

An **affordable** logic simulator for students/hobbyists

- Easy-to-use graphical user interface
- Point-and-click wire wrap operations
- Thorough users manual — easy-to-follow tutorial

**LogicLab™** gives you the equivalent of:

- A parts cabinet stocked with more than thirty types of common 74LS series ICs
- A 16-channel, 1-nanosecond logic analyzer
- A wire wrap board that holds up to forty ICs
- LED and seven-segment indicators
- Pushbutton switches
- Signal sources
- **NEW • Hardcopy output**
- and much more

**ONLY \$49<sup>95</sup>**

Send check or money order to:  
**K.E. Ayers & Associates**  
7825 Larchwood St.  
Dublin, OH 43017

30 day money-back guarantee  
Requires IBM-PC/XT or AT (or compatible), 512K,  
DOS 3.2 (or higher), EGA or VGA display, and a mouse.

**CIRCLE 271 ON FREE INFORMATION CARD**

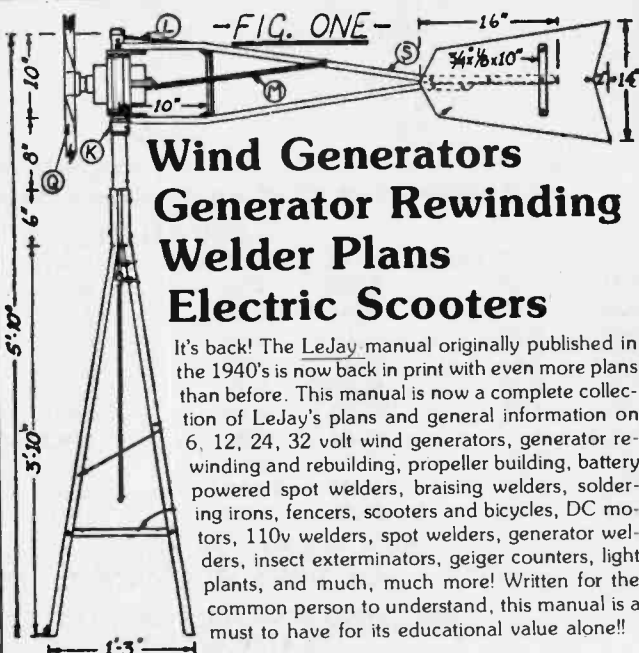

**Wind Generators**  
**Generator Rewinding**  
**Welder Plans**  
**Electric Scooters**

It's back! The LeJay manual originally published in the 1940's is now back in print with even more plans than before. This manual is now a complete collection of LeJay's plans and general information on 6, 12, 24, 32 volt wind generators, generator rewinding and rebuilding, propeller building, battery powered spot welders, braising welders, soldering irons, fencers, scooters and bicycles, DC motors, 110v welders, spot welders, generator welders, insect exterminators, geiger counters, light plants, and much, much more! Written for the common person to understand, this manual is a must to have for its educational value alone!!



To order send check or money order for \$14.95 plus \$2 shipping and handling  
(\$4 shipping and handling outside USA and Canada) to:  
**LJM Inc., P.O. Box 174, Dept. R, Lake City, MN 55041**



# BK PRECISION / ACTION ELECTRONICS PRICE BUSTERS!

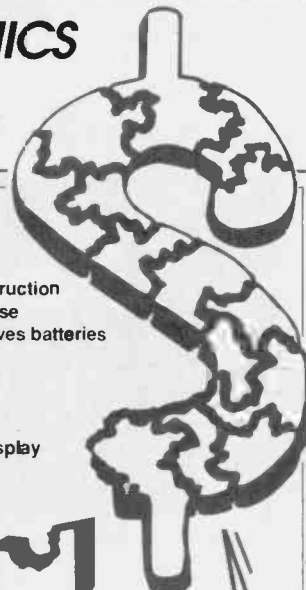

## AC CLAMP METER

Model 340A



- Measures ACV, ACA ohms
- Measures ACA to 300A
- Audible continuity check
- Data hold
- 3½ digit LCD readout

**\$107**

## THE SURVIVOR™

Model 2860



- Ruggedized construction
- Water resistant case
- Auto power off saves batteries
- Probe holder
- Audible continuity
- 20-amp range
- High-energy fuse
- Large 0.8" LCD display

**\$89**

## 2 MHz FUNCTION GENERATOR

Model 3011B



- 4-digit LED display
- Generates sine, triangle, square, pulse and ramp waveforms
- TTL pulse and CMOS pulse outputs
- Coarse and fine frequency controls
- Variable DC offset, with on-off switch
- Variable duty cycle; CAL position for 50% duty cycle

**\$220**

## 40 MHz DUAL-TRACE

Model 1541B

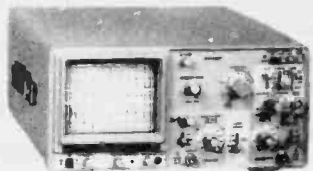

- 1 mV/div sensitivity
- Video sync separators
- Z axis input
- Single sweep
- V mode-displays two signals unrelated in frequency

**\$599**

## 20 MHz DUAL-TRACE

Model 2120

Model 2125 (with delayed sweep)

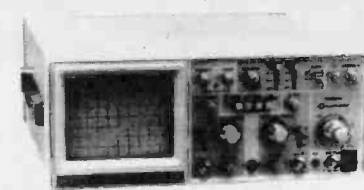

- 1 mV/div sensitivity
- AUTO/NORM triggered sweep operation
- AC, TVH, TVV and line coupling
- Calibrated 18 step time-base with x10 magnifier
- Compact low-profile design

**\$399**

## PARTS TESTER

Model 815



- Tests capacitors (0.1 pF to 20 mF)
- Tests resistors (0.1Ω to 20MΩ)
- Tests transistors, SCRs, diodes, and LEDs
- Tests batteries under load
- Heavy duty drop resistant case

**\$89**

## PORTABLE TEST BENCH® DMM SERIES

Models 388-HD/377



- 0.5% DCV accuracy
- Resistance, 0.1Ω to 2000MΩ
- Frequency, 20Hz to 200kHz
- Capacitance to 20μF
- Logic level measure (TTL)
- Transistor gain measure (hFE)
- Safety yellow case
- Model 388-HD
- 41 Ranges
- DC and AC current to 20A
- Drop resistant to 4 feet
- Model 377
- DC and AC current 200μA to 10 A
- 39 ranges

Model 388-HD **\$109** Model 377 **\$89**

## ¾ DIGIT ANALOG DMM BAR GRAPH

Models 2912/2911

- 41 segment analog bar graph
- Auto/Manual ranging
- 4,000 count digital display
- Continuity diode check
- 10-amp range
- Model 2912
- 40 ranges
- 0.3% DCV accuracy
- High-energy fuse
- Data hold and peak hold
- Capacitance measurement
- Frequency measurement
- Min-Max memory
- Model 2911
- 20 ranges
- 0.5% DCV accuracy

Model 2912 **\$129** Model 2911 **\$79**



Buy with Confidence from:

## ACTION ELECTRONICS

1300 E. Edinger Ave.  
Santa Ana, Ca 92705

(714) 547-5169 • FAX: (714) 547-3291

➤ Action saves you more! Pay our low sale price plus UPS chart rate —no hidden service charges.

➤ MasterCard, Visa, American Express, check or C.O.D.

➤ We ship within 24 hours!

➤ CA residents add 7.75% sales tax.

➤ Ask for your FREE 68-page B+K PRECISION catalog





Big Plans . . .  
Small  
Budget ? ?

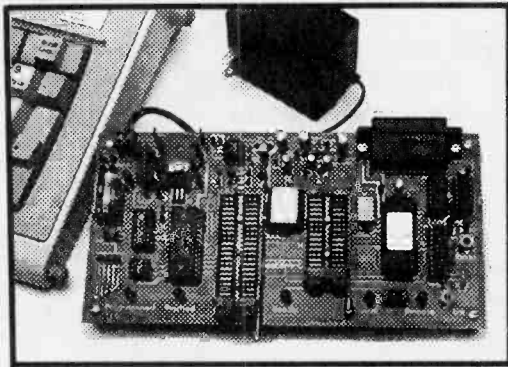

## 6805 Microcomputer Development System

TECI's MCPM-1 system allows your IBM PC and Compatibles to be used as a complete development system for the Motorola 6805 family of single chip microcomputers. Many time saving features at an affordable price.

**MCPM-1 Programmer for Motorola MC68705P3, P5, U3, U5, R3, R5**  
MCPM-1 w/ driver, assembler, simulator/debugger . . . . . \$449  
MCPM-1 w/ driver program only . . . . . \$349

Also available - Programmer for 68HC05, in-circuit emulators, "How-to" Primer, and many software tools to help you.

Call Toll Free  
1-800-336-8321



The Engineers Collaborative, Inc.  
Rt. #3 Box 8C Barton, VT 05822 USA  
TEL: (802) 525-3458 FAX: (802) 525-3451  
Call Toll Free (800) 336-8321

CIRCLE 281 ON FREE INFORMATION CARD

## DC TO 50 MHZ O-SCOPE

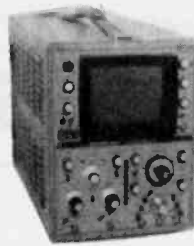

**OS-189/USM-281A SCOPE**, militarized Hewlett-Packard 180 with dual-trace and time-base sweep delay plug-ins and 8x10 cm CM CRT. Sensitivity: 5 mv to 20 v/div in 12 calibrated steps; vernier to 50 V. Sweep: 0.1 us to 2 s/div in 23 steps. Delay: 0.1 us to 50 ms/div in 18 steps. 11.4x7.9x21.3; 44 lbs sh.

**USED**-reparable with CRT trace . . . . . \$150  
**CHECKED** . . . . . \$275  
**MANUAL** for USM-281A, partial reproduction, add . . . . . \$25

## SOUND PROTECTOR

Avoid hearing damage from loud machine noise, firearms, explosions. 4"H x 3"W x 3"D foam-lined plastic cups with padded cushions and headband. Made for military; 3#. **ASTROCOM #10232**



**Unused** . . . . . \$16.95



**GROUNDING 6-OUTLET AC STRIP** with lighted ON-OFF, RESET, and long 15' cord. 13x1.8x2.5, 3 lbs. #ST-6AC,

**Used** . . . . . \$5.95 ... 2/\$10  
**Unused** . . . . . \$9.95

**ENERGY STORAGE CAPACITOR 88 MFD 1200 VDC**, non-PCB for high voltage projects; 10"Hx4.5"x3.8", 9 lbs. sh wt. #LPC-271, **Used** ... \$12.50

**TORROIDAL TRANSFORMER** with two 20 V 5 AMP secondaries; 115 VAC 60 Hz primary. Nice specs for audio amps, etc.! No hardware; 4.5" dia. x 1.6"H, 4 lbs. #4365-P1S2 . . . . . \$11.95

**MATCHED DC METER SET**, consisting of 0-30 VDC and 0-30 amp DC 2.5" dia sealed meters with 50 MV shunt; 3 lbs. #M30V-30A, **used** ... \$19.95

Prices F.O.B. Lima, O. • VISA, MASTERCARD Accepted.  
Allow for Shipping • Write for latest Catalog  
Address Dept. ES • Phone 419/227-6573

## FAIR RADIO SALES

1016 E. EUREKA • Box 1105 • LIMA, OHIO • 45802

IMMEDIATE SHIPMENT  
UNIQUE  
EASIER TO USE

## International MicroPower Corp.

We put the DESIGN back into kit design.

SCHEMATICS AVAILABLE  
SURFACE MOUNT COMPONENTS  
PRE-ASSEMBLED TO BOARD

### ALL NEW DESIGNS



World's FIRST hobby kit for CALLER I.D.  
See WHO IS CALLING before answering the phone.  
Simple to use:

- Plug into standard wall jack
- RS-232 to PC or serial printer

**IMC-CID-1K kit \$38.00**  
**IMC-CID-1A assembled & tested \$45.50**

Optional Software diskette to display calls on PC and record to disk file.  
**IMC-CIDSW-1 \$6.50**

(Caller I.D. not yet available everywhere. Check with your local phone company.)

#### ULTRA HIGH FIDELITY

Wireless Microphone Transmitter

These FM transmitter devices are superior to other kits. You get much more for your money with the following features: (compare to others!)  
• True Varactor tuning 88-108 MHz; • Precision voltage regulator; • Multi-turn tunng for ease of use; • Stable frequency regardless of temperature or loading

Wireless Microphone Transmitter  
**IMC-WM-1 \$39.50**

#### UNDETECTABLE

Wireless Telephone Transmitter with automatic battery saver

Wireless Telephone Transmitter  
**IMC-WTT-1 \$39.50**

ATTENTION: COMPLETE SCHEMATICS ONLY \$4.50 ORDER BEFORE 21, 1991 AND RECEIVE EITHER A FREE SCHEMATIC OR FREE SHIPPING & HANDLING.

**1-800-992-3511**  
ORDERS ONLY  
(SORRY, NO CATALOGS)

International MicroPower Corporation  
3305 W. Spring Mountain Road, Suite 60  
Las Vegas, NV 89102  
VISA/MC (COD add \$5, All others add \$2.50 SH)

# MCM ELECTRONICS HAS... BLOCKBUSTER BUYS!



SAVE  
**44%**

**6 1/2" Heavy-Duty Poly Woofer**  
Heart thumping sound you'd expect from a much larger speaker and now at an unheard of price!

#55-057  
Reg. \$18.00 (ea.) ... Sale **\$10.95** (ea.)



**Ultimate Test CD**  
Ultimate CD at an ultimate price!!  
Test your auto or home CD players today.

#80-505  
Reg. \$9.99 (ea.) ... Sale **\$7.95** (ea.)

SAVE  
**46%**



**NEW!**  
**Nintendo Type Replacement Pads**  
Replaces worn directional pad, A&B response pad and select/start pad in Nintendo controls. Two sets of replacement pads for two joysticks.

#83-1340  
Reg. \$1.79 (1-9 bags) ... Sale **\$1.49** (10 bags-up)



**NEW!**

**TENMA™**  
**Economy Pocket DMM**  
Looking for a quality, value-packed Pocket DMM? Call MCM today for this new Tenma Pocket DMM!

#72-825 ... Sale **\$19.95** (ea.)

For a FREE subscription to the MCM Electronics catalog, call the toll free number below.

SAVE  
**OVER 50%**

**VCR Idler Tire Kit**  
Popular Idler Tire Kit slashed more than 50% off list prices! Contains 150 of the most popular tires used today.

#102-001  
Reg. \$2.25 (kit) ... Sale **\$39.95** (kit)

**Superwash (24 oz. Can)**  
Super savings on Super Wash! This cleaner is a must for most service applications!

#20-290  
Reg. \$11.99 (ea.) ... Sale **\$6.99** (ea.)

SAVE  
**40%**



CALL TOLL FREE 1-800-543-4330 • FAX (513) 434-6959



**MCM ELECTRONICS**  
650 CONGRESS PARK DR.  
CENTERVILLE, OH 45459-4072  
A PREMIER Company

**HURRY, SPECIAL PRICING ENDS  
JANUARY 31, 1992.**

RES-01

CIRCLE 267 ON FREE INFORMATION CARD

## AUTOMOTIVE ELECTRONICS



Learn about this exiting new field  
We have kits, plans, and books.  
**FREE CATALOG CALL 1-800-535-3091**  
**S&M ELECTRO-TECH INC.**  
P.O. Box 34334 Blaine MN. 55434

## HALLBAR ELECTRONIC KITS

### SOUND ACTIVATED CHRISTMAS TREE

Twenty-five red, green and yellow LEDs flash with any sound (voice, music or ambient room noise). Runs on a 9V battery. Complete with parts kit, PC Board, hardware, oak stand and instructions.

Size 8 1/2" x 4 1/2"

HK-706  
\$ 23.95

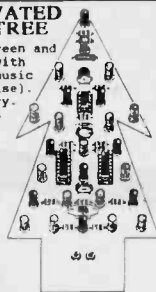

### VOLT AMP MONITOR

Features a 0-15 vdc voltmeter and a 0-1 amp ammeter mounted on a blue lucite stand, complete with parts kit, hardware, stand and instructions.

Size 4" x 4" x 3"

HK-718  
\$ 14.95



### EMERGENCY STROBE LIGHT

Features variable flash rate from 15 to 30 flashes per minute. Plugs into your cigarette lighter or runs from a 9V alkaline battery (not included). Complete with parts kit, PC board, hardware, plastic case and instructions.

Size 3 1/2" x 2 1/2"

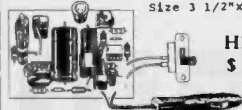

HK-762  
\$ 16.95

### WIRELESS MIC/ROOM BUG

Features a very sensitive condenser microphone which picks up sound from up to 15 feet away and transmits up to 400 feet to your FM radio. Runs on a 9V battery. Complete with parts kit, PC Board, hardware, plastic case and instructions.

Size 3 1/2" x 2 1/2"

HK-736  
\$ 12.95



### TELEPHONE HOLD BUTTON W/MUSIC

Features adjustable volume for music and modular telephone cord and jack. Connects to your radio. Complete with parts kit, PC Board, hardware, plastic case and instructions.

Size 3 1/2" x 2 1/2"

HK-746  
\$ 8.95



We accept VISA, M/C and MONEY ORDERS in US funds. No CODs. Calif. add sales tax. Shipping in continental US add \$3.50. Alaska, Hawaii and Canada add \$5.00.

Catalog \$1.50 or free with order.  
Send orders to: **HALLBAR**  
31320 VIA COLINAS #105, WESTLAKE VILLAGE, CA 91362

**TOLL FREE ORDER LINE 1-800-892-8000**  
CA 1-818-889-2209 FAX 1-818-706-0825

**We have received many inquiries from this news report. So we're pleased to run it again:**

## **Silver Plating Ploy**

**by Jim Wenstrom, CE KFLS/KKRB**

**Klamath Falls OR.** OK, your edge connectors don't connect. Or you want to plate your own PC creations but don't want to bother with electro-plate solutions. The plating on the socket for that 4CX15000 has worn off and no longer makes reliable contact. Your budget was shot months ago. What are you going to do now?

"Give the people at Cool-Amp Company a call. They have a silver plating compound I have used for the past couple of years that solves all of the above problems and more.

"This white powder has an indefinite shelf-life, is inexpensive, and easy to use ... It will actually put a silver plate on copper or brass ... There are no messy or dangerous chemicals.

"Application couldn't be easier. Use a cotton swab or ball and a little bit of water and just rub it on. In minutes you can silver-plate a circuit board or replate a power amp tube or socket.

It has saved me time, money and my sanity."

9/26/90

Thanks Jim Wenstrom for the original report and for permission to run it again. Call us at the factory for information—or to order direct. We'll also send you a brochure on our other product, Conducto-Lube—the silver-based conductive lubricant.

# **COOL-AMP**

**Cool-Amp Conducto-Lube Company**

15834 Upper Boones Ferry Road • Lake Oswego, Oregon 97035  
(503) 624-6426 • Fax (503) 624-6436



# Toronto Surplus & Scientific

596 Gordon Baker Rd.  
Willowdale, Ontario  
Canada M2H 3B4

TEL: (416) 490-8865 FAX/PHONE: (416) 785-7955

VISA

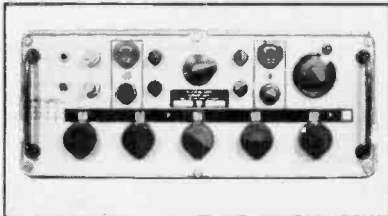

### R1051B RECEIVER

Covers 2Mhz - 30 Mhz LSB, USB, ISB, AM, CW & FSK Navy Shipboard Design. Direct Frequency readout, Accurate High Stability Time Base. Requires 115VAC 60 Hz for operation.  
Price: \$475.00

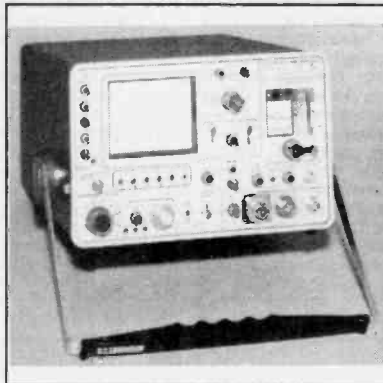

### INDUSTRY STANDARD TEKTRONIX 491 SPECTRUM ANALYZER

Covers 10 Mhz - 40 Ghz. Solid state portable unit features internal phase lock, minimum sensitivity is - 100 dBm. A 12.4 Ghz mixer is included with each unit. External mixer kit, cables and attenuators are available with purchase of each 491 for \$200.00 extra per set.  
Price: \$1,200.00 ea.

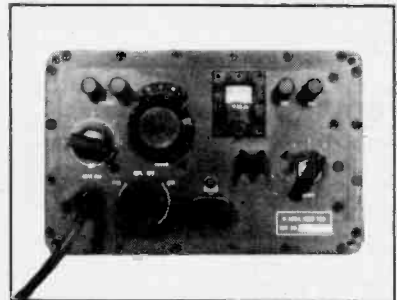

### R-1004/GRC-109 RECEIVER

3-24 Mhz/AM-CW Rugged field. Receiver used by the Special Forces and the CIA. A great gift for the new young Ham. New batteries are available for \$5.00 each  
Used Repairable \$45.00

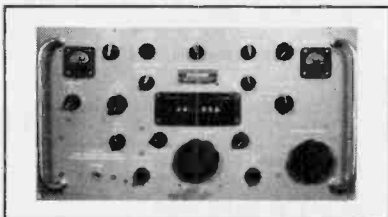

### R390A RECEIVER

"The classic radio receiver that is still a great investment". - These units are complete with meters and cover the frequency range of 0.5 - 32 Mhz in AM, CW, MCW with direct frequency readout via mechanical digital display - checked complete, less covers.  
Price: \$295.00

### PHOTOGRAPHIC EXPOSURE TIMER



"Brand New" Top Quality W. German made. 60 minutes with easy to set time. Many uses for this.  
Price: \$19.95



### 467 SIMPSON DIGITAL VOLTMETER

Top quality American made 3 1/2 digit DVM with many features including; Digilog™ Scale, +/- Peak Hold, Diode Test and True RMS. Comes complete with carrying case, external current shunt and 5000 volt probe. Requires 9V battery.

Price: Like New \$195.00  
Used Checked \$125.00



### FIELD MICROSCOPE

Manufactured by American Optical. New up to 1000X magnification. Portable field microscope. Complete with stage, fold away feet, 10X eyepiece, 3 position turret, storage case. Requires objectives.  
Price: \$325.00!!!

Partial or full reprints of manuals are available at extra cost.



### 8 DAY AIRCRAFT CLOCK

Precision Swiss made Wakmann Aircraft Clock. "New In The Box" fits 2 1/4" hole.  
Price: \$145.00 ea.

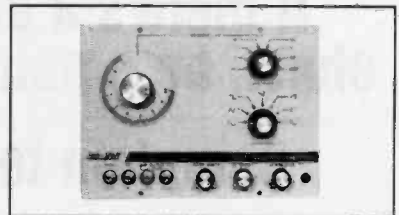

### FUNCTION GENERATOR

Features rugged design. .01 Hz - 1Mhz, DC Offset, Pulse Width, Sine Square Triangle & Ramp Output and much more - an excellent value at  
Price: \$125.00 Requires case

# R-E SHOPPER CLASSIFIED

## COMPUTER HARDWARE

**IBM PC VIDEO DIGITIZER** connects through the printer port, capturing up to 640 by 480 with 256 gray levels in 20 seconds. Includes software for CGA, EGA, and VGA. Grabs can export pictures for DTP. Only \$89.98. More information send \$3.00 for sample disk. **COLORBURST**, PO Box 3091, Nashua, NH 03061.

**XT BIOS ROM** with 16550 initialization. \$19.95 postpaid. Micromethods, Box 909, Warrenton, OR 97146. (503) 861-1765.

## COMPUTER SOFTWARE

**COMMODORE 64** Ham programs, 8 disk sides, over 200 amateur programs \$16.95. 29 cent stamp gets unusual software catalog of utilities, games, adult and British disks. Home-Spun Software, Box 1064-R, Estero, FL 33928.

**VIRUSFREE SHAREWARE**. 25 MEGABYTES \$39.00, add \$40.00/25MB increment up to 450 MEGABYTES. Include \$3.00 shipping per 25MB: 1 (800) 876-8496, Visa-MC, **SHARE-NET**, POB 12368, Oklahoma City, OK 73157.

**LEARN ELECTRONICS** Why spend thousands of dollars on an electronic course when you can learn electronics on your MSDOS-PC compatible computer? We offer modern Computer Aided Instruction programs to help you achieve your goal. Lessons are shipped every other month until you complete the course. Each lesson costs only \$29.95 plus \$3.00 S&H. Order lesson one today and receive a **FREE** safety program. Specify disk size. Satisfaction guaranteed. **EES-RES03**, POB 1391, Lubbock, TX, 79408.

**DESIGN CIRCUITS** with our user friendly electronic engineering software. IBM and compatibles. Commodore 64 and 128. Eleven different programs from \$19.95 to \$24.95 each. Complete sets \$197.50. Catalog \$2.00. Visa/Mastercard. Order today! WeaselGraphics, PO Box 647, Sun City, CA 92586-0647. Phone 1 (800) 356-8113.

**\$.25 SOFTWARE**. 100 PROGRAMS OF THE BEST GAMES, UTILITIES, DATABASE, WORD PROCESSING, AND MORE. Send \$24.95 plus \$3.00 S/H to D.T.S., PO Box 34879, Houston, TX 77234-4879.

**UNIVERSAL MICROPROCESSOR SIMULATOR/DEBUGGER 1.2** each set \$55.00. Simulates the 6811, 8051, Z80, 8085, 6809, 6800, 6502 and 65C02. Features line assembler, disassembler, and debugging utilities. The **ROMY-8 EPROM EMULATOR** (32K, 8 bit) works with simulator \$150.00 only. Emulates EPROMs 2716-27256. J&M Software Hardware Design, Inc., 83 Seaman Road, West Orange, NJ 07052. Tel: (201) 325-1892.

**ASSEMBLERS FOR** Synertek's/MOS Technology's 6500/6502 family, Motorola's 6800, 6801 and 6805 families (6800, 6801, 6802, 6803, 6805, 68HC05, 6808, 68701, 68705), Intel's 8051 family and Texas Instruments' TMS7000 family (includes General Instruments' PIC7041/CTS256A-AL2 **SPEECH PROCESSOR**). All assemblers run on IBM PCs or compatibles with DOS 2.0 or higher, accept DOS text source files with lines up to 99 characters (no specific columns required), and use standard mnemonics and operand syntax. Numerical values may be specified in binary, octal, decimal or hexadecimal. Configurable parameters set through easy to use text files or command line options. Symbols may be predefined from separate files (for use in defining symbols specific to microprocessor or system used in, for example SFR names used in 8051 family). Files produced for listing, object code, symbol table and cross reference table. Object file may be stored in one of seven common formats for use with EPROM programmers (additional formats available on request). Any one for \$29.00, any two for \$45.00. Includes free updates for 12 months. Indicate disk size. **Microware Engineering**, 620 Park Ave., Suite 180B, Rochester, NY 14607-2994.

## CB-SCANNERS

**THE SCANNER HACKERS BIBLE**. 112 modifications. Covering: Pro-2004/5, Yaesu, Kenwood, Bearcat, Icom. Frequency fixes, modifications (scan rates, interfaces, programmable channels, improving operation), antennas, laws, cellular telephone operation and frequencies and more!!! \$33.45. **CODs** (602) 782-2316. **TELECODE**, Box 6426-SH, Yuma, AZ 85366-6426.

**THE ALC100A** Automatic Volume Controller keeps the volume of transceivers and scanners nearly constant whether the received signal is a whisper or a shout. Size 3/4" X 3/4" X 1/4". Price \$24.95. C&S Electronics, Box 2142, Norwalk, CT 06852-2142. Phone (203) 866-3208.

## EDUCATION

**GET YOUR "FCC Commercial General Radiotelephone License."** Electronics home study. Fast, inexpensive! **Free details.** Command Productions, D-225, Box 2824, San Francisco, CA 94126-2824.

**THE CATALYST** is a newsletter/catalog featuring a selection of science books, kits and curiosities, plus information and experiments by the **SATURDAY SCIENTIST**. Send \$1.00 (REFUNDABLE) for the latest issue. Santa Barbara Science, PO Box 41960, Santa Barbara, CA 93140.

## REPAIRS-SERVICES

**HEATH/HEATHKIT** I can repair your audio, instruments, general and weather products no longer serviced by Heath. Factory trained: **CALL (219) 287-9373**.

**RESEARCH AND DEVELOPMENT TEAM** will take your product ideas and create it. Confidentiality assured. Call B & R Electronics, Atlanta, GA (404) 631-4689.

## TEST EQUIPMENT

**MLA: HEWLETT PACKARD MICROWAVE LINK ANALYZER** HP3702B HP3705A HP3710A HP3716A. Meets spec. \$1,000.00 (214) 530-0077 Evenings.

**MARCONI NOISE GEAR. TF2090 SYSTEM.** YOUR CHOICE OF FILTERS. **CONFIGURED AND TESTED**, \$1,000.00 (214) 530-0077 Evenings.

**SENCORE EQUIPMENT, LESS than 200 HOURS USE. BUSINESS FAILED**, equipment deserves good home. SC61, VA62, VC63, NT64, ST66 and MORE. Will take \$3,500.00. Call **FRED (E.D.T.)** 8AM-4PM (606) 234-5286 after 4PM (606) 234-8685.

## MUSIC & ACCESSORIES

**WANTED: PLANS**, kits, books for building electronic music effects and equipment. Greg Mein, 218 Sunset Lane, Hiawatha, IA 52233. (619) 378-1907.

## BUSINESS OPPORTUNITIES

**EASY WORK!** Excellent pay! Assemble products at home. Call toll free 1 (800) 467-5566 ext. 11068.

**EARN \$\$\$ WITH YOUR COMPUTER AT HOME** Exciting new part-time opportunities working with an established software marketing company. Will teach. For info send \$1.00 (refundable) to: Computer, PO Box 1442-RE, Orange Park, FL 32067.

## SURVEILLANCE

**COUNTERSURVEILLANCE** Electronic Devices Catalog...\$5.00  
Miniature Surveillance Transmitter Kits...\$39.95  
Voice Changers, Scramblers, Vehicle Tracking, Bug & Phone Tap Detectors. Books, Videos, & much more!

**CALL IDENTIFIER** displays callers phone number, stores phone number with date & time of call...\$69.95

**F D I** P.O. Box 337, Buffalo, NY 14226 (716) 691-3476

If there's a pain in your chest, be a pain in the neck.

Complain to a doctor.

Chest pain could be a sign of heart disease. The sooner you see your doctor, the better your chances for life.



American Heart Association

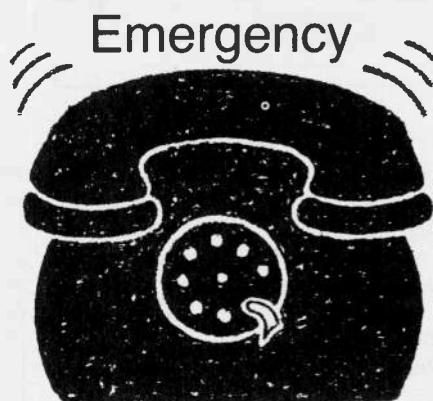

# MICE & MODEMS

## INTERNAL MODEMS & FAX CARDS

2400 BPS Modem	\$69.00
2400 Modem/4800 Send Fax	\$81.00
2400 Modem/9600 Send Fax	\$85.00
2400 Modem V.42 bis MNP5	\$111.95
9600 Send Receive Fax	\$110.91
2400 Modem/9600 Send Receive Fax	\$132.40

## EXTERNAL MODEMS & FAX CARDS

2400 BPS Modem	\$89.00
2400 Modem/4800 Send Fax	\$94.90
2400 Modem/9600 Send Fax	\$99.99
2400 Modem V.42 bis MNP5	\$151.00

**ALL MODEMS ARE HAYES COMPATIBLE**  
**MNP 2-7 & COMMS SOFTWARE INCLUDED**  
**FREE PRODIGY TRIAL! 5 YEAR WARRANTY**

## MICE AND TRACKBALLS

NAKAI: Serial Mouse, 2 button, optional graphics software (\$5.00)	\$16.00
Z-NIX SUPERMOUSE II & MICROSOFT WINDOWS v.3. Serial Mouse with software	\$75.00
GENIUS F302: Serial Mouse, Pad & Pocket, Graphics & Menu software, 1050 dpi	\$42.00
GENIUS F303: PS/2 Mouse, Pad & Pocket, Graphics & Menu software, 1050 dpi	\$46.00
LYNX Trackball: Serial, 2 button, mouse alternative - takes up less desk space	\$39.00
MOUSE PADS: Help your mouse run smoothly, high quality, red or grey	\$2.90

## SCANNERS AND OCR

LOGITECH SCANMAN: 400 dpi, 4" width, Paintshow Plus software, for all D/TP packages	\$79.00
CAT READER OCR: Logitech Scanman & CAT Reader combo	\$99.00



**MATRIX NORTH (USA)**  
**4154 NORSE WAY**  
**LONG BEACH, CA 90808**

**TEL: (800) 800 MICE**  
**FAX: (213) 429 6369**

## THE ELECTRONIC GOLDMINE



The Electronic Goldmine has one of the greatest selections of unique electronic kits available in the world! We have over 65 kits and over 1,400 unique, bargain priced, components in our catalog!



### AMAZING ARROW KIT

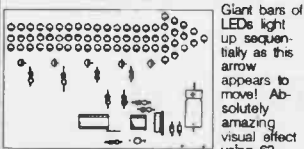

LEDs and a variable speed control. Kit comes with 9V battery snap (battery not included), but will also operate on any voltage between 5V and 12V AC or DC. Size of board: 5 1/2" x 4".  
**C6398 \$21.95**

### PRECISION MICROPHONOGRAPHER



**Sale!**

**THIS MONTH ONLY!**  
**G513 99¢**

### KEY LOCK SWITCHES

These are high quality units with round type keys (each unique). They were removed from new equipment and we didn't get the mounting nut, so we're selling them cheap! Key can be removed in off position only.  
**G2302 99¢**

### BOX OF MAGNETS

Box full of small ceramic magnets. Rectangular shape, a little smaller than 1" long by 1/8" square. These are not powerful, in fact they are rather weak. However, they're fun to play with. Polarity marked with red paint on one end.  
**G2330 Box of 77 \$2.00**

### ZIP WIRE

Attractive clear insulated flexible 18 ga wire is perfect for replacement use on lamps, stereos, radios, TV or speakers. Standard pair wire rated No. 18 sp1-1. Maximum 300 volts. Made in U.S.A. Handy 30ft. spool.  
**G2350 \$2.00**

### AUTOMATIC SENSOR-LITE

Completely automatic night light features attractive Jewelite display, solid state circuitry and variable intensity light. Night light lights up at night only to conserve electricity. These are brand new on blister pack retail cards.  
**G2349 \$2.00**  
**10 FOR \$16.00**

### 12VAC ADAPTER



Puts out 12.5 VAC at up to 265 ma. Brand new, has small 2 prong female connector and long flexible cord. For standard 120VAC.  
**G950 \$1.39 EACH 10 / \$12.00**

### 20W + 20W STEREO AMP KIT

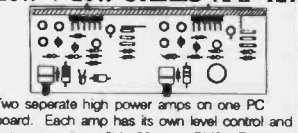

Two separate high power amps on one PC board. Each amp has its own level control and puts out an incredible 20 watts RMS. Features red LED "on" indicator and low distortion circuitry. Great stereo booster amp for your car sound system. Use with any speakers capable of handling at least 20 watts. Operates on 12VDC. Size of board: 6" x 2.5".  
**C6442 \$19.95**

## TECHNICAL SCHOOL CLOSED!

Selling hundreds of HEATH Co. test and training equipment at up to 70% off their catalog prices. Use Heath catalog for description. Condition: new to slightly used, many without manuals. All professionally wired & tested, or in kit form if noted. First come, first served. Check or major credit cards. Sorry, no COD or open accounts. Add \$4.50 Mailing & Handling, any quantity.

### HEATH TEST EQUIPMENT

IM5217 Battery Operated V.O.M. - Wired	27.60	SOLD
ITW2250 Auto Range Capacitor Meter, Wired	57.50	
IT2250K Auto Range Capacitor Meter Kit	46.50	
PKW3129 Semiconductor Checker, Wired	49.60	SOLD
PKW105 Deluxe 10:1 Combo Probe, Wired	8.95	
SPECIAL 10 @ 7.95, 25 @ 6.50		
SK101 12 VDC-3A Power Supply	29.50	
SM2926 3-6 Digit DMM, Assem. w/Case	37.60	SOLD
SM2206 Clamp-On Ammeter	36.50	
SM2420 Deluxe Universal Counter	185.00	
2717A Reg. H.V. Power Supply	165.00	
2718 Tri-Reg. Power Supply	158.50	
4225(equal) Dual Trace 25 MHz Oscilloscope	355.00	

### GENUINE KESTER 44 RESIN CORE SOLDER

Size	Qty	Price	Code	
5/8"	58	5.95		
3/4"	58	6.95		
1"	66	4.50		
1 1/4"	66	4.25		
1 3/4"	57	6.45		
2"	66	14.50		
2 1/2"	66	3.85		

### Dual Banana Adaptors

2710 BNC Female to Banana  
 2720 BNC Male to Binding Posts  
 2730 BNC Female to Posts  
**3.95 ea. 10 @ 3.45 ea.**



### 2" Project Speaker

Experimenter's Deight, 8 ohm, 1 Watt  
**2" Spk 3 for 2.00 10 for 5.45**



### HEATH EDUCATIONAL SYSTEMS

ET100 Microcomputer Trainer	395.00	
EWD100 Dual 5.5" Disk Drive (for Above)	95.00	
ZVM133 Terminal for ET100 Above	149.00	
ET100SET All 3 listed above	595.00	
ET4000 960 Hole Breadboard Block	6.95	SOLD
ET500 350 Hole Breadboard Block	2.95	
ET250 170 Hole Breadboard Block	1.95	
ETB3000 Bread Board/Experiment Module	24.50	
ETA3660 Extra 660 hole Breadboard Block	7.95	
ETB6201 Dig. Experiment Circuit Bld Module	49.50	
EEA3104A Electronic Kits Guide & 2 Audio Tapes	18.50	
HCA3000 RF Connector Adaptor Kit	55.00	

### MISCELLANEOUS

DSA654 DX Aut Satellite Receiver		
I.F. 950-1458 MHz	585.00	
HP-15C H-P Scientific Calculator & 360 pg. Book	49.50	
RS232-V24 Datacom NVR Breakout Box, RS232		
24 line I/O 14 LED Test Set	29.50	
U93 Oki-Data Microline Printer	95.00	
700-T T-1 Silent 700 Data Terminal w/Acoust.	54.50	
DB2525-2V RS232 AE Sw. Box, Metal	14.50	
CN3625-2V Centronic AB Sw. Box, Metal	18.50	
B1060 500 Insul. Lug Asst. AWG12-22 w/Case	12.50	
HT301 Deluxe Ratcliff Close Lug Crimp Tool	11.50	
548A H-P Logic Clip	99.00	

### Stainless Pliers Set

Designed for precision electronic work. Stainless, rustproof, washable and won't contaminate. Furthermore, they're non-magnetic. Features: box joint, precision ground cutting edge and plastic grips. Fits palm. Limited quantity available.  
**H104A 5-1/4" Offset Needlenose 4.85**  
**H104B 4-1/4" Diagonal Cutter 4.85**  
**H104D 5" Long Needlenose 4.85**  
**H104E 4-3/4" Short Needlenose 4.85**  
**One Set of 4 12.85, 10 sets ea. 9.95**



Note: The small kits of component parts usually supplied with manuals are not available and prices reflect this omission. All courses are new, and with exam.

EE404 Operational Amplifiers	SOLD 18.60
EE402 Active Filters Course	SOLD 47.60
EE105 Opto Electronics Course	24.50
EE4004 Passive Circuit Design Course	SOLD 28.60
EE3140 Concepts of Electronics, 2 Vol.	36.50
EE3201A Digital Techniques Course, 2 vol. SPEC.	36.50
EE4201 Fiber Optics Learning Course, SPECIAL	19.50
EE5201 Lab Experiments Digital Tech w/Guide	18.50
EH4762 TTL CMOS Circuits	SOLD 29.60
Easy Course Programming HP-11C & 15C 250 pg.	9.50

### EDUCATIONAL BOOKS

These books are brand new & represent a saving over publishers list prices. All hard bound except (soft) as noted.

Micro Computer Experimentation w/Intel SDK-85	7.50
TTL Cook Book, Lancaster (soft), Sams	4.95
Assembly Language Program (soft), Intel	4.95
Decision Making Under Uncertainty, Hull, P-Hall	8.95
In-Circuit Testing, J. Baleston	12.50
Industrial Ventilation, 19th Edition, American Conf.	14.95

### BOOKS BY MC GRAW HILL

Software Reliability, Musa Iamino	9.50
Introducing The Unix System, McGilton & Morgan	8.95
Digital Electronics, Tokheim & Activities Man., 2 Vol.	5.95
A Reference Guide to Practical Electronics (soft)	3.95
Strategies for Electronic Test, Pynn	4.95

### BOOKS BY MERRILL

Electronic Devices, Floyd, 2nd Ed.	19.50
Experiments in Electronic Dev., Accompanys above	6.50
Digital Experiments-Trouble shoot, Cox (soft)	6.95
Experiments in Electric Circuits, Stanley, 2nd	8.50
Principles of Electronic Circuits, Floyd, 2nd Ed.	9.95
Principles of Electronic Circuits, Floyd, 3rd Ed.	12.95

### Quick Guard Motion Alarm

Instant attachment to car computer etc. by magnets. Emits 80db pulsated alarm signal if disturbed. Simple arm & disarm w/serial key. 20 sec. entry & exit delay. Auto reset after 30 sec. of alarm. 9V battery operation.  
**ST23 SPECIAL 12.85 ea. 10 @ 10.50**



### NEW DATA CABLES-FULLY POPULATED-MOLDED

CM10MM10 D-Sub 9 Cond., Male/Male, 10ft	SOLD 6.95
CM15MM10 D-Sub 15 Cond., Male/Male, 10ft.	6.95
CM15MM15 D-Sub 15 Cond., Male/Male, 15ft.	6.95
SPECIAL Buy 10 @ 5.95, 25 @ 4.95	

ASK FOR BETTER PRICE ON AVAILABLE QUANTITIES



**1755 Osgood St., N. Andover, MA 01845**  
**CALL: 508/682-6936 FAX: 508/689-9484**  
**ORDER TOLL FREE: 800/343-1455 RES**

January 1992, Radio-Electronics



# R-E SHOPPER CLASSIFIED

## COMPONENTS

**PLD DESIGN** sales and programming service; A complete PLD service at affordable prices. New AMPALI6R6PC \$ .99 each, other types available. CALL 1 (800) TED-HEXS.

**FREE PARTS FLYER. 1N4001 DIODE** 1000/\$12.00, **MOV** 130V 38J 15/\$5.00, .01µF **50V** disc cap 500/\$9.00, **LED MV-50** red 100/\$6.50, **12 VOLT** red LED 3/\$1.00/ Add \$3.00 s&h. **NETWORK SALES**, 90 Turner, Elk Grove, IL 60007. (708) 952-1115.

## AUDIO-VIDEO-LASERS

**LASER ITEMS** list. Send SASE Mike's Laser Factory, 132 1/2 East 3rd Street, Dayton, Ohio 45402.

**FREE HOLOGRAM** with \$2.00 shipping. Any **LASER PROJECTS** patterns for: Lightshows. Optics. Measurement. Alignment; and **ANIMATION!** HOLOVISION, 2536 Alki Ave. S.W., #203, Seattle, WA 98116.

## CABLE TV

**CABLE HACKERS BIBLE**. Volume 2. Covering all aspects of most cable systems. Schematics — fixes — theory. \$44.95. **TOCOM** 5503/5507 "SUPER TEST CHIPS" — \$29.95. **JERROLD** 400 manual — \$14.95. Catalog — \$3.00. **CODs** (602) 782-2316 **TELECODE**, Box 6426-SH, Yuma, AZ 85366-6426.

**TV NOTCH FILTERS**. BROCHURE \$1.00 MICRO THinc., BOX 63/6025, MARGATE, FL 33063. (305) 752-9202.

**Z-TAC REPAIRS** got you biting the bullet? Then let us help with a full line of Zenith replacement parts and complete repair facility. CALL 1 (800) TED-HEXS.

## MISCELLANEOUS ELECTRONICS WANTED

**QUASAR VR1000** VCR parts or whole units. Bay's TV Service, (304) 744-8431, ask for Steve.

**SURPLUS PHOTOFACTS WANTED**. Many numbers, all quantities. Loeb, 414 Chestnut Lane, East Meadow, NY 11554. (516) 481-4380.

## SATELLITE EQUIPMENT

**SATELLITE HACKERS BIBLE**. Covering: Satellite data communications — RTTY — SCPC — WEFAX — Russian satellite television demodulator plans — frequency listings — schematics for: RTTY/CW/FAX demodulators — BMAC receiver — stock market quote receivers — SuperGuide. Includes 144 IBM-PC software files. \$53.45 **CODs** (602) 782-2316 **TELECODE**, Box 6426-SH, Yuma, AZ 85366-6426.

**SATELLITE RECEIVERS** repaired (most units). Send \$120.00 plus \$10.00 S&H. Include brief description of problem. **Sunset Electronics**, 12145 Alta Carmel Court, Suite 250-139, San Diego, CA 92128.

## TELEPHONE

**BUILD TOUCH-TONE** display. Connects to printer port. Decode dialed telephone number digits, time, date on your PC. With autologging and printout. Complete schematics and basic software. Free information. **VRM SYSTEMS**, 164 Donhead Village Blvd., Richmond Hill, Ontario L4C 7R6 Canada.

**KNOW WHO'S CALLING!** Call identifier displays incoming caller's phone number \$79.95 ppd. **SURVEILLANCE COUNTERSURVEILLANCE** catalog \$5.00. Eavesdropping, POB 337, Buffalo, NY 14226 (716) 691-3476.

## MISCELLANEOUS ELECTRONICS FOR SALE

**TUBES**. OLD stock from radio-TV stores. Extensive listings \$1.00 (refundable). Diers, 4276-SC2 North 50th Street, Milwaukee, WI 53216-1313.

**BATTERIES GALORE** for all your electronics and household projects. Every type available. Free catalog 1 (800) 657-5929 or write PO Box 9932, Maplewood, MN 55109.

**TV NOTCH FILTERS**. BROCHURE \$1.00, MICRO THinc., BOX 63/6025, MARGATE, FL 33063 (305) 752-9202.

**MARCONI NOISE GEAR. TF2090 SYSTEM**. Your choice of filters. **CONFIGURED** and **TESTED**, \$1,000.00 (214) 530-0077 Evenings.

**HEWLETT PACKARD 5245L FREQUENCY COUNTER. READY FOR USE** in YOUR LAB, \$100.00. **PRE-TESTED REPAIR PARTS**: XTAL oven assy, \$45.00. Readout with Nixie or any card assy, \$20.00. Nixie, \$5.00. Knobs, \$3.00. \$25.00 minimum. Add \$25.00 shipping for counter, \$5.00 for parts. Check/M.O. plus part number/description to Turcotronix, 1000 E. 14th, Suite 429, Plano, TX 75074.

**INVITATION TO BID**: 2500 ea. specialty #28AR102-2 BNC 90 deg. M-F. Amphenol equiv. #31-70037 \*\* 7900 ea. Specialty #28J169-4 BNC F-Crimp. Amphenol equiv. #31-70064 \*\* 500 ea. Specialty #28AS112-1 BNC F-Bulkhead. Amphenol equiv. #31-70041 300 ea. OSM #2054-5239 SMA F-flange. Individually packaged by manufacturer. Line item bids to: Connectors, 2930 Holycross Lane, Garland, TX 75044.

**ELECTRONIC PARTS**, kits. Security devices. Free information. No minimum order. Welsh Electronics, 620 Olive Lane, Ambridge, PA 15003-2458.

**MLA: HEWLETT PACKARD MICROWAVE LINK ANALYZER** HP3702B HP3705A HP3710A HP3716A. Meets spec. \$1,000.00 (214) 530-0077 Evenings.

## HAM GEAR FOR SALE

**DIGITAL VOICE recorder**. 60 seconds record/play-back time, user expandable to 4 minutes, \$84.95. DVR chip with data sheets, \$12.95. VHF FM crystal controlled transmitter chip, 3 for \$10.00. Add \$3.00 for S&H. C&S Electronics, PO Box 2142, Norwalk, CT 06852-2142 Phone (203) 866-3208.

## PLANS-KITS-SCHEMATICS

**DESCRAMBLER KITS**. Complete cable kit \$44.95. Complete satellite kit \$49.95. Add \$5.00 shipping. Free brochure. No New York sales. Summit RS, Box 489, Bronx, NY 10465.

**BUILD OR buy assembled**, four digit SWR & power meter, with alarm & set points. Plans available. **Free information**, **Rupp Electronics**, 5403 West-breeze, Fort Wayne, IN 46804. (219) 432-3049.

**BLACK BOX BIBLE**. Collection of 16+ cable, satellite and video stabilizers schematics covering: VideoCiphers, Oak, Cable (Sinewave, Jerrold, Tri-Mode, Universal, SSAVI) and Macrovision. \$33.45. **CODs** (602) 782-2316 **TELECODE**, Box 6426-SH, Yuma, AZ 85366-6426.

**NI-CAD ZAPPER** can rejuvenate those un-rechargeable NI-CAD batteries. For complete schematic and parts list to construct the NI-CAD Zapper, send \$5.00 check or money order to: Tentronix, 3605 Broken Arrow, Coeur d'Alene, ID 83814.

**FM STEREO BROADCASTER** kit. This kit outperforms the competition. Transmitter will broadcast any audio signal from a CD player, VCR, or cassette player to FM stereo radios throughout your home and yard. All the complex circuitry is in the unique BA1404 integrated circuit. Tunable across the FM band, runs on 1.5 to 12 volts DC. Complete kit of PC board and components for \$22.00 postpaid. **Tentronix**, 3605 Broken Arrow, Coeur d'Alene, ID 83814.

**DETER AUTO THEFT**. 3 simple extremely hard to defeat diagrams, variations, time delays. \$8.00 — \$18.00 Radio Shack parts. Stops joyriding, child accidents, plans \$5.00. Chory Electronics, 1285 Bart James Road, Elizabeth City, NC 27909. Information SASE.

**TOUCH-TONE DECODER**. Decode those tones you've heard on your telephone or scanner! The HB-16 Decoder decodes, stores, and displays touch-tone (DTMF) digits directly from your telephone line, scanner, tape recorder, or virtually any audio source. Decode dialed numbers received on cordless, cellular! Kit including plans, all ICs, and PC board for only \$29.95. Send SASE for more information. **HB Technologies**, POB 2771-N, Spring Valley, CA 91979.

**FM TRANSMITTERS!** Tune from 88-108 MHz. Just like expensive kits only assembled/tested. Only \$19.95. To order or get more info, write Jim Dawson, PO Box 483, Lansing, IL 60438.

**BUILD 6** simple low cost circuits to extend the functions and ranges of your meters and scope. Easy to build, useful! Send now for complete instructions. \$5.00 **Blue Bell Design, Inc.**, Dept RSM, 524 White Oak Rd., Blue Bell, PA 19422.

**BUILD A digital clock** that plays one of twelve melodies on the quarter hour. Six large digit displays with 12/24 hour mode, date, alarm and accessory outlet. Also available completely assembled and tested. Send \$2.00 for complete assembly plans and pricing to **KERBER KLOCK KO.**, 36117 Hillcrest Dr., Eastlake, OH 44095.

**BUILD YOUR** own neighborhood radio station with our high quality FM stereo transmitter kit, with case \$49.95. Also available, two meter RF power amplifier kit 10X power gain \$35.95. Add \$3.50 S&H. Send SASE for complete list of kits. **Sunset Electronics**, 12145 Alta Carmel Ct., Suite 250-139, San Diego, CA 92128.

## PUBLICATIONS

**OVERSEAS JOBS**. Kuwait and Saudi Arabia. \$35.00/hr and up! Technicians and engineers needed now! For information and company listings, send \$5.00 to: Jobs, PO Box 1271, Greenwood, SC 29648.

Death is forever.  
Heart disease  
doesn't have to be.

THE AMERICAN HEART  
ASSOCIATION  
MEMORIAL PROGRAM.



American Heart Association

This space provided as a public service.

Radio  
**Electronics**  
**SHOPPER**

# ALFA ELECTRONICS

QUALITY TEST EQUIPMENT  
AFFORDABLE PRICE



**DMM 2360**  
**\$129.95**  
**DMM + LCR Meter**  
**Most Versatile DMM**  
Inductance: 1 $\mu$ H-40H  
Capacitance: 1pF-40 $\mu$ F  
Frequency: 1Hz - 4MHz  
Temperature: -40 - 302°F  
Logic Test: 20MHz  
Diode, Continuity  
Volt, Amp, Ohm  
3999 count display  
Peak Hold  
Auto power off

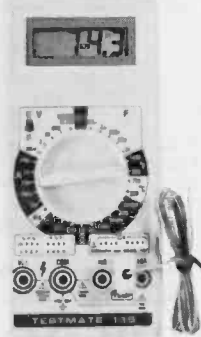

**DMM 135**  
**\$69.95**  
**DMM measures**  
**Temperature**  
0° - 1400°F, -20°-750°C,  
0.1°, 1° resolution  
Capacitance: 1pF-20 $\mu$ F  
Resistance: 0.1 $\Omega$ -200M $\Omega$   
Volt, Current, Continuity  
Diode, hFE tests  
Type K thermocouple included



**Clamp Meter**  
**3012 \$79.95**  
**AC current**  
**10mA-1000Amp**  
AC current range 20, 200 1000A,  
good for both high and low current  
ACV: 200V, 750V. DCV: 1000V  
Resistance: 200 $\Omega$ , 20k $\Omega$ , Continuity,  
diode check  
Line frequency test: 0-2000Hz, with  
1Hz resolution  
Peak Hold, Data Hold  
Comes with leads, hard carrying  
case



**LCR Meter 814**  
**\$199.95**  
**The Best Handheld**  
**LCR**  
Inductance: 0.1 $\mu$ H-200H  
Capacitance: 0.1pF-20,000 $\mu$ F  
Resistance: 1m $\Omega$ -20M $\Omega$   
1% basic accuracy  
Dissipation factor indicates leakage  
in capacitor and Q factor in inductor  
Zero adjustment to reduce  
parasitics from test fixture  
Very good for high frequency RF  
and surface mount components.

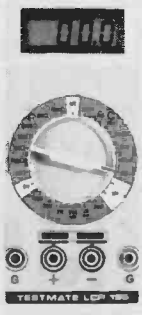

**LCR Meter 195**  
**\$119.95**  
**Very popular LCR**  
Inductance: 1 $\mu$ H-200H  
Capacitance: 0.1pF-200  $\mu$ F  
Resistance: 0.01 $\Omega$ -20M $\Omega$   
Basic accuracy: R:1%, C:2%,  
L:3%  
Test frequency 1 kHz



**Capacitance Meter**  
**7705 \$57.95**  
0.1 pF-20,000 $\mu$ F in 9 ranges  
0.5% basic accuracy  
Zero adjustment  $\pm$  20pF to  
compensate parasitics from test  
fixture

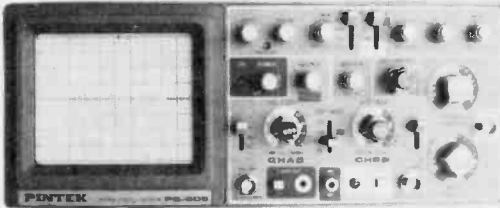

**20 MHz Oscilloscope with Delay**  
**Sweep PS-205 \$419.95**  
Dual Trace, Component test, 6" CRT, X-Y Operation, TV  
Sync, Z Modulation, CH2 Output, Graticule Illum, 2 probes  
x1, x10  
**PS-200 20MHz BASIC \$339.95**  
**PS-405 40MHz DELAY \$559.95**  
**PS-605 60MHz DELAY \$749.95**

**20 MHz Digital Storage**  
**Oscilloscope DS-203 \$749.95**  
Switchable between digital and analog  
2 K word per channel storage  
Sampling rate: 10 M sample /sec  
8 bit vertical resolution (25 Levels/div)  
Expanded Timebase 10ms/div - 0.5 s/div  
Refresh, Roll, Save all, Save CH2, Pre-Trig  
Plotter Control

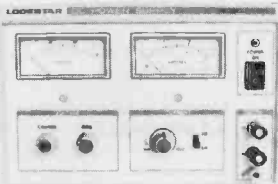

**Power Supply**  
**PS-303 \$169.95**  
**0-30 VDC, 0-3A output**  
0.02% + 2mV line regulation  
0.02% + 3mV load regulation  
1 mVrms noise and ripple  
Short circuit and overload protected

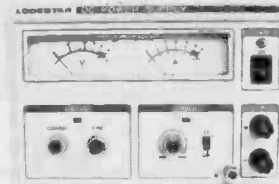

**Power Supply**  
**PS-1610 \$299.95**  
**0-16 VDC, 0-10A output**  
Constant voltage & constant current mode  
0.2%+2mV line regulation  
0.04% +2mV load regulation  
1mVrms noise and ripple  
Short circuit and overload protected

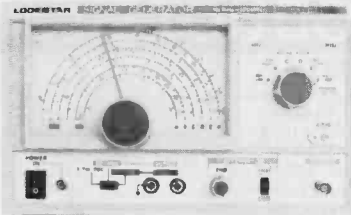

**RF SIGNAL**  
**GENERATOR**  
**SG-4160B \$124.95**  
100 kHz-150MHz sinewave in 6 ranges  
Output 100mVrms to 35 MHz  
Internal 1kHz, External 50Hz-20kHz  
modulation  
Audio output 1 kHz at 1 Vrms

**AUDIO GENERATOR**  
**AG-2601A \$124.95**  
10Hz - 1MHz in 5 ranges  
Output: 8Vrms sine, 10Vp-p squarewave  
Synchronization:  $\pm$ 3% of oscillation  
frequency per Vrms  
Output distortion: 0.05% 500Hz - 50kHz  
0.5% 50Hz - 500kHz  
Output impedance: 600 ohm

**FUNCTION**  
**GENERATOR**  
**FG-2100A \$169.95**  
0.2 Hz - 2 MHz in 7 ranges  
Sine, square, triangle, pulse and ramp  
Output: 5mV-20Vp-p  
1% distortion  
DC offset  $\pm$  10V  
VCF: 0-10V control frequency to 1000:1



**RF SIGNAL**  
**GEN./COUNTER**  
**SG-4162AD \$239.95**  
Generates RF signal same as SG-4160B  
Frequency counter 1Hz - 150MHz  
Sensitivity <50mV  
For internal and external sources

**AUDIO GEN./COUNTER**  
**AG-2603AD \$239.95**  
Generates audio signal same as AG-2601A  
Frequency counter 1Hz-150MHz  
Sensitivity <50mV  
For internal and external sources

**FUNCTION**  
**GEN./COUNTER**  
**FG-2102AD \$239.95**  
Generates signal same as FG-2100A  
Frequency counter 4 digits  
Feature TTL and CMOS output

**ALFA ELECTRONICS**  
P.O. BOX 8089 Princeton, NJ 08543

**(800) 526-ALFA**  
**(609) 275-0220**  
15 DAY MONEY BACK GUARANTEE  
1 YEAR WARRANTY  
Visa, Master Card, American Express, COD, Purchase Order Welcome

CIRCLE 224 ON FREE INFORMATION CARD

## Tunable Notch Filters and Telephone Recording Equipment

### Eliminates...

- Beeping and Buzzing
- Severe Interference

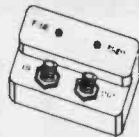

Assembled and Tested Filters

as low as \$16 each  
in quantities of 10 or more

Kit Filters

as low as \$8 each  
in quantities of 21 or more

Micro Thinc.

P.O. Box 63-6025

Margate, Fl 33063

Brochure \$1

(305)-752-9202

# CABLE T.V. GREAT GIFT IDEA DESCRAMBLERS WINTER SALE

QUANTITY	1	5	10	20
SB-3	68	48	43	39
TB-3	77	54	47	45
FTB-3	78	55	48	46
SA-3	78	69	48	46
SA8580	CALL	CALL	CALL	CALL
PANASONIC	88	76	70	
ZENITH	CALL	CALL	CALL	CALL

2 Piece Jerrold and Scientific Atlanta units ON SALE FOR \$139

## Dealers Wanted

Please have MAKE and MODEL used in your area when calling. Anyone Implying Theft of Service Will be Denied Assistance.

We Have The Best SERVICE AFTER THE SALE

CNC Concepts Inc. **9-5**  
P.O. Box 34503 **Mon-Fri**  
MPLS., MN 55434 **NO MN. SALES**  
**1-800-535-1843**

## HEAR THE TONES...SEE THE NUMBERS! TOUCH-TONE DECODER/DISPLAY AND ASCII CONVERSION BOARD



- \*EIGHT DIGIT DISPLAY
- \*32 CHARACTER BUFFER
- \*ASCII SERIAL OUTPUT

Model TDD-8 decodes and displays all 16 DTMF digits and provides an ASCII serial output. Digits are displayed on eight LED's. 32 character memory can be scrolled. It will accept almost any audio source such as a tape recorder, telephone answering machine, scanner, etc. Perfect for remote computer data entry using a telephone keypad. Serial output can be connected to your computer. IBM compatible software included for displaying, storing/printing time, date and number for automatic logging. Ideal for automatically logging your auto-patch traffic!

TDD-8 DTMF DECODER/DISPLAY/ASCII \$99.00 MoTron Electronics  
CAB-1 AUDIO & COMPUTER CABLES \$20.00 310 Garfield St., #4  
PS-12 110VAC TO 12VDC POWER PACK \$10.00 Eugene, OR 97402  
add \$5 S/H - VISA/MC ACCEPTED

TEL: 800-338-9058 503-687-2118 FAX: 503-687-2492

(Touch-Tone is a trademark of AT&T)

## BUY BONDS



### ASSEMBLY KITS

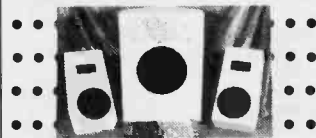

BMR-10 Speaker Kit \$82.95  
BMR-20 Amplifier Kit \$99.95  
BMR-30 Subwoofer Kit \$82.95

Developed by Rockford Corporation. Made In USA

Educational & Organizational Discounts Available

To order call toll-free  
**1-800-366-2349 ext. 3010**  
or send check or money order.  
Rockford Corporation Educational Services  
613 S. Rockford Drive Tempe, Arizona 85281  
Include \$3.00 per unit Shipping & Handling

Try the

**Radio Electronics.**

bulletin board system

(RE-BBS)  
516-293-2283

The more you use it the more useful it becomes.

We support 300 and 1200 baud operation.

Parameters: 8N1 (8 data bits, no parity, 1 stop bit) or 7E1 (7 data bits, even parity, 1 stop bit).

Add yourself to our user files to increase your access.

Communicate with other R-E readers.

Leave your comments on R-E with the SYSOP.

# QUALITY NEW & USED P.C. PRODUCTS!!

15 DAY DOA MONEY BACK 90 DAY WARRANTY

LIMITED QUANTITIES	N = NEW	R = REFURBISHED	P = PULLS
MAXISWITCH 101 KEYBOARD (R).....\$29	TRIDENT VGA 1024X768 256K (N).....\$55	256K X 4 80ns (P/N).....\$4.50	
101 ENH KEYBOARD (N).....\$27	OAK VGA 800X600 256K (N).....\$39	256K or 64K 150ns DRAM (P).....\$59	
MFM 1:1 FLOP/HARD CTRL (N).....\$29	14" MONO MONITOR WT or AM (N).....\$89	256K or 64K 120ns DRAM (P).....\$65	
10MHz XT MOTHERBOARD (R).....\$39	CUTIE 3 BUTTON MOUSE W/SW (N).....\$15	256K 100ns DRAM (P).....\$75	
286-12MHz MOTHERBOARD (N).....\$60	TEAC or SONY 1.44 MMB FL DR (R).....\$53	INTEL MATH CHIP 80287-8.....\$9.00	
150W XT PWR SUPPLY (R).....\$30	PC XT/AT GAME CARD (N).....\$8	INTEL MATH CHIP 8087-2.....\$49.00	
200W AT PWR SUPPLY (R).....\$33	MONOCHROME VIDEO CARD (R/N).....\$12	EPROM 2764-250ns (P).....\$8.99	
IDE F/H/2 SER 1 PAR GAME (N).....\$24	AT I/O 2 SER 1 PAR 1 GAME (N).....\$12	EPROM 27128-250ns (P).....\$9.95	

PERSTOR PS180-16FN 16 BIT ARLL FLOPPY/HARD CONTROLLER, INCREASES MP/M DR CAPACITY BY 90% (N).....\$189

286-12MHz SYSTEM, DT or MINI/T, 1MB, 101KB, IDE F/H CTRL, 2 SER, 1 PARA, 1 GAME, 1.2 FLOP.DR, ATB (N).....\$299
286-20MHz SYSTEM, DT or MINI/T, 1MB, 101KB, IDE F/H CTRL, 2 SER, 1 PARA, 1 GAME, 1.2 FLOP.DR, ATB (N).....\$349
386SX-16MHz SYSTEM, DT or MINI/T, 1MB, 101KB, IDE F/H CTRL, 2 SER, 1 PARA, 1 GAME, 1.2 FLOP.DR, ATB (N).....\$459
386-25 N/CACHE SYS, DT or MINI/T, 1MB, 101KB, IDE F/H CTRL, 2 SER, 1 PARA, 1 GAME, 1.2 FLOP.DR, ATB (N).....\$579
486-25 64KC SYSTEM, DT or MINI/T, 1MB, 101KB, IDE F/H CTRL, 2 SER, 1 PARA, 1 GAME, 1.2 FLOP.DR, ATB (N).....\$998



VISA

Prepaid  
+\$3 Handling  
COD + \$7 CertCk

(RMA#  
Req. for  
Returns)

# NEXSYS-4

CALL NOW

**408-944-9318**

Prices subject to change without notice.

2115 OLD OAKLAND ROAD, SAN JOSE, CA 95131 FAX: 408-473-0826



# Simpson

# mercer mercer mercer

DIVISION ■

**9800**  
WAS \$267.95  
NOW \$154.95

**9810**  
WAS \$489.95  
NOW \$249.95

**MODEL 9800/9810**  
Multifunction  
Frequency Counter

**MODEL 9702**  
Clamp-Type  
AC Digital  
Volt-Ohm-Ammeter

**MODEL 9670**  
Digital  
Capacitance Meter

**MODEL 9120**  
Volt-Ohm-  
Milliammeter

**MODEL 9340**  
Digital  
Multimeter

**NOW!**

Order Direct  
from **mercer** DIVISION  
FOR **SUPER SAVINGS**

VISA    Mastercard

CALL 708-697-2265

CIRCLE 269 ON FREE INFORMATION CARD

## HOLIDAY SALE

486-33 M/64K cache 6 x 16, 2 x 8, 1 x 32, up to 32 MB	999
386-33 M/64K cache 6 x 16, 2 x 8, 1 x 32, up to 32 MB	499
386-25 6 x 16 bit, 2 x 8 bit, 1 x 32 bit, up to 32 MB	399
3685X-20 6 x 16 bit, 2 x 8 bit, 1 x 32 bit, up to 32 MB	279
386SX-16 6 x 16 bit, 2 x 8 bit, 1 x 32 bit, up to 32 MB	239
286-20 6 x 16 bit, 2 x 8 bit, up to 4 MB	119
286-16 6 x 16 bit, 2 x 8 bit, up to 4 MB	99
286-12 6 x 16 bit, 2 x 8 bit, up to 4 MB	79
57157A IDE 45MB 28MS	199
571102A IDE 89MB 19MS	329
1.44 or 1.2 floppy drives	59
tower case 8 bays 220W	139
Mini tower 4 bays 200W	89
SVGA 14" 1024 x 768 28 DPI	369
VGA 14" 640 x 480 31 DPI	319
SVGA card 16 bit 1024 x 768 M/1MB	129
VGA card 16 bit 640 x 480 M/256K	59
IDE cbl M/ZS/P/G	33
IDE cbl	17
AT S/P/G	17

APPLIED ELECTRONIC RESEARCH, INC.

4701 SW 45TH ST

FORT LAUDERDALE FL 33314

(305) 987-9785 Fax (305) 987-5996

VISA FREE CATALOG MC



### X-BAND TRANSMITTER

Miniature (2 1/4 x 3 1/4 x 1 1/2) GaAs microstrip transmitter provides 10 dBm centered at 10.525 GHz. Integrated microstrip patch antenna eliminates the need for an external antenna. Advanced matching techniques secured good temperature stability with low frequency pulling. Great for long-range testing of radar detectors, calibration of radar receiving equipment, and point-to-point communication links.

Complete Assembled System ..... \$39.00

Parts & Instruction Kit ..... \$29.00

Plus \$2.00 Shipping and Handling

**INNOTEK Inc.**

P.O. Box 80096, Fort Wayne, IN 46898

(219) 489-1711

Visa - MasterCard - Check - Money Order - COD  
Money-Back Guarantee



\$48.75

**PORTASOL—Cordless, Refillable,  
Butane Gas Power'd Soldering Tool Kit.**

**U.S. ELECTRONICS, INC.**

3308 Commercial Ave.

Northbrook, IL 60062-1909

(708) 559-1033 • Fax (708) 559-1037

FREE CATALOG With Order, VISA/MC Ill. Add Tax.

### PRINTED CIRCUIT KITS

ER-4-KIT lets you copy art from this magazine onto your circuit board. Complete kit includes everything but exposure bulb. Shipped UPS to your street address (no PO Boxes) for \$39.95.

Full Catalog of other PC sets and supplies, dry transfer Titles, Patterns, Symbols, Wire-markers, etc. sent FREE. Just call or write to: DATAK, 55 Freeport Blvd., Sparks, NV 89431; 702-359-7660.

### CB RADIO OWNERS!

We specialize in a wide variety of technical information, parts and services for CB radios. 10-Meter and FM conversion kits, repair books, plans, high-performance accessories. Thousands of satisfied customers since 1976! Catalog \$2.

**CBC INTERNATIONAL, INC.**

P.O. BOX 31500RS, PHOENIX, AZ 85046

### SURVEILLANCE

COUNTERSURVEILLANCE Electronic Device Catalog...\$5.00

Miniature Surveillance Transmitter Kits... \$39.95 each  
Voice Changers, Scramblers, Vehicle Tracking, Bug & Phone Tap Detectors, Books, Videos, & much more!

CALL IDENTIFIER displays callers phone number, stores phone number with date & time of call...\$49.95 each

CALL IDENTIFIER, P.O. Box 337, Buffalo, NY 14226 (716) 691-3476

**Cable Test**  
Orders only **Aids** Information  
1-800-452-7090 (213) 967-0081

Test chips for JERROLD, TOCOM, ZENITH, SA. & more. Fully activates units in just minutes. Easy installation. Zenith only \$39.95ea. Most others only \$39.95ea.

Ph. Co. orders. Not for use in cable-co. owned equip. For use-ups test and equip.

January 1992, Radio-Electronics

# The Electronics Lab in a Computer!

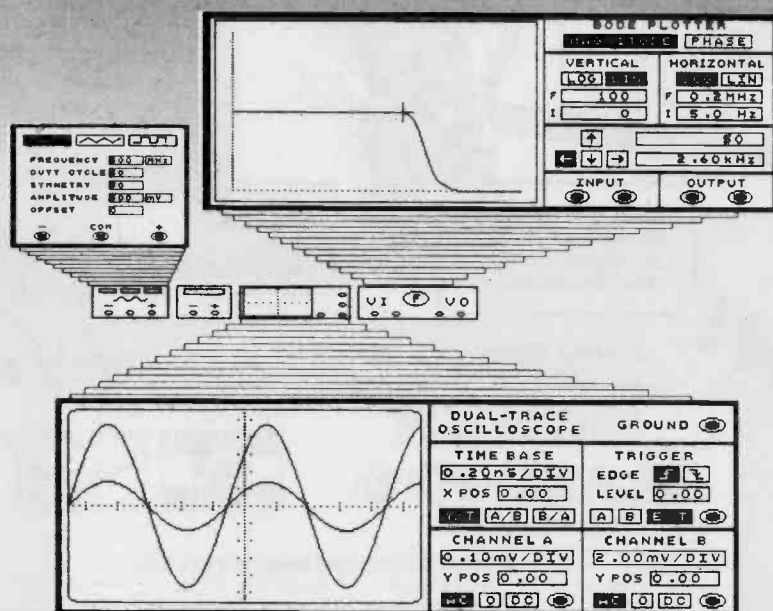

## Electronics Workbench<sup>®</sup>

“Electronics Workbench is pretty amazing. The program is really useful. It’s also a lot of fun to play with....and I’m glad to recommend it to anyone interested in electronics.”

Jerry Pournelle, Ph.D., InfoWorld

“...a marvelous learning and teaching tool....”

Art Salsberg, Editor-in-Chief, Modern Electronics Magazine

“Building a circuit is simple and intuitive.”

Jeff Holtzman, Computer Editor, Radio-Electronics Magazine

# Electronics Workbench<sup>®</sup>

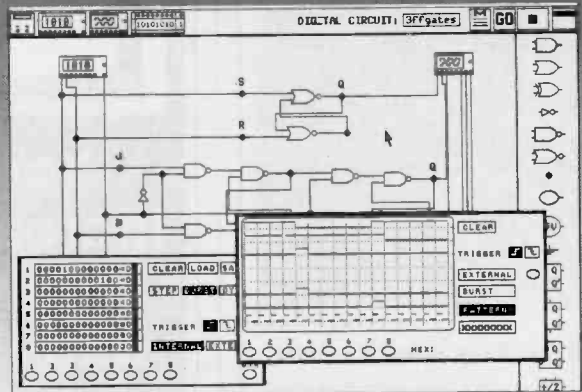
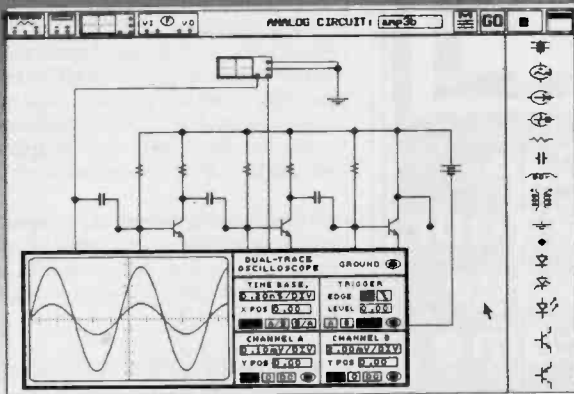

Build and simulate both Analog and Digital circuits.

Complete with simulated instruments.

## The Electronics Lab in a Computer!

### Feature Summary

- digital and analog modules included
- dual-trace oscilloscope
- function generator
- multimeter
- spectrum analyzer (Bode plotter)
- word generator
- logic analyzer
- logic conversion—truth table to Boolean formula to logic gates
- complete control over component values
- Ebers-Moll bjunction transistor modelling—all parameters under user control
- Quine-McCluskey logic simplification
- print circuit schematic, parts list, instrument readings, macros
- grid snap
- optional grid display
- optional display of component labels and values
- user-defined models for all components
- global component models referenced by name
- block commands—move, copy, cut
- supports over 150 printers—user can define new printers
- pan the workspace
- rotate or mirror parts
- rubberbanding orthogonal autorouting wires
- direct manipulation of components and instruments (click and drag)
- zoom instruments for adjustment and reading
- user defined IC macros for parts bin
- customizable parts bins
- customizable hypertext help system

### Three Versions

- **Professional Version:** uses color coding for circuit tracing with an unlimited\* number of components; EGA/VGA support.
- **Personal Plus Version:** builds circuits containing an unlimited\* number of components.
- **Personal Version:** builds circuits containing 20 components or less. \*limited only by the amount of memory available

### Requirements

- **Professional:** IBM AT or PS/2 or true compatible with 640 kB RAM; Microsoft-compatible mouse; EGA/VGA graphics; hard disk; MS-DOS 3.0 or later.
- **Personal/Personal Plus:** IBM PC/XT/AT or PS/2 or true compatible with 512 kB RAM; Microsoft-compatible mouse; graphics display; two floppy drives or hard disk; MS-DOS 2.1 or later.

Yes, I want Electronics Workbench<sup>®</sup> in my computer!

Return to:

Check the version you want:

<input type="checkbox"/> MS-DOS 5.25"	<input type="checkbox"/> MS-DOS 3.5"	
Professional		\$299.00
Personal Plus		\$199.00
Personal		\$ 99.00

Name: \_\_\_\_\_

Address: \_\_\_\_\_

City: \_\_\_\_\_ State: \_\_\_\_\_ Zip: \_\_\_\_\_

Tel: ( ) \_\_\_\_\_ Fax: ( ) \_\_\_\_\_

MC/VISA/AMEX# \_\_\_\_\_

Signature: \_\_\_\_\_ Exp. \_\_\_\_\_



INTERACTIVE IMAGE TECHNOLOGIES LTD.

Radio-Electronics Offer

908 Niagara Falls Boulevard, North Tonawanda, NY 14120-2060 Tel: (416) 361-0333 Fax: (416) 368-5799

ORDER INFORMATION: Canadian residents please add 7% GST (Ontario residents add 8% PST plus 7% GST). All orders please add \$15.00 shipping and handling.



THE  
PORTABLE  
RADIO  
IN AMERICAN  
LIFE

MICHAEL BRIAN SCHIFFER

**Americans love radios,** and anyone who's ever owned one will love this new book. It traces radio history from the 1890s through the golden age and the transistor revolution, and shows how it reflects trends in our culture and industry. More than 450 illustrations depict all kinds of models, old-time ads too. This 8½ x 11, hardcover volume makes a great gift, \$45.00 (+\$3 p&h).

The University of Arizona Press  
1230 N. Park Ave., Tucson AZ 85719  
Visa/MC, call 1-800-426-3797



Connect Muscle Wires to a battery or other power source and watch them *contract in length!* Remove power, and they relax and are ready for millions more cycles.

Muscle Wires let you create direct *linear action* without heavy gears, coils, or motors. Use them in robots, models, planes, railroads - anywhere you need small, strong *motion*.

Get our new 96 page Book and Muscle Wire Sample Kit - it has everything you need to *get moving today!* Toll free:

**800-374-5764**

Visa, MC, check, MO

**Mondo-tronics**

2476 Verna Court  
San Leandro, CA 94577

Phone: 510-351-5930  
Fax: 510-351-6955

**Book and  
Sample Kit  
only  
\$29.90**  
Plus \$4.00 P&H  
CA orders add tax

CIRCLE 260 ON FREE INFORMATION CARD



## You Can Increase Your Knowledge and Income

by becoming an  
EKI Certified Electronic  
Technician—whether you are  
starting or experienced.

If you are looking to:

- Obtain certification as an electronics technician
- Enhance your current knowledge
- Change your career or advancement
- Have more hands-on training in conjunction with your current study

### Features:

- Excellent home-study program
- Immediate results
- A great value
- NO CONTRACT to sign
- Study at a pace that's right for you
- 2-week trial/evaluation is available to qualified applicants

**FREE  
FREE  
FREE**  
FULL COLOR  
**CATALOG**

CALL TODAY:

**1-800-453-1708**



16631 NOYES AVE  
IRVINE CA 92714

CIRCLE 255 ON FREE INFORMATION CARD

Building a new computer,  
or upgrading an old one?

Start with  
an AMI motherboard.

AMI, the leading manufacturer of BIOS, has developed a full line of motherboards. Since these are built with AMI BIOS, compatibility is never a problem. And neither is performance — AMI motherboards are made with the same quality discipline that has made AMI a respected industry leader.

So whether you have an old computer that needs upgrading, or you just like building computers, the way to begin is with an AMI motherboard. We stock a variety of them:

ISA 386SX (AT or XT footprint)  
ISA 386/486 (AT or XT footprint)  
EISA (AT footprint)

Send for catalog and price list.



BCM, Dept 26  
49 Sherwood Terrace, Suite R  
Lake Bluff, Illinois 60044



TEL: 708-234-5576  
FAX: 708-234-2522

CIRCLE 292 ON FREE INFORMATION CARD

**CABLE TV "BOXES"  
WHOLESALE PRICES!**

CONVERTERS • DESCRAMBLERS  
REMOTE CONTROLS • ACCESSORIES

FROM \$9.95!! CALL NOW!!

—GUARANTEED BEST PRICES—  
—BEST WARRANTIES—COD'S  
—IMMEDIATE SHIPPING—

**LAKE SYLVAN  
SALES, INC.**

**1-800-800-4582** PHONE

**1-612-895-9454** FAX

Public transportation  
is for everyone.



# SPECIALS

LIMITED QUANTITIES

## CABLE CONVERTERS

*SIGMA*

**SIGMA 550—86 CHANNEL \$99.95 EACH**

TOP CHANNEL ROLLOVER,  
LAST CHANNEL MEMORY,  
PARENTAL LOCKOUT,  
FAVORITE CHANNEL, SURGE  
PROTECTION, 4 db AMP,  
DECODER COMPATIBLE,  
1 YEAR WARRANTY.

**\$79.95** EACH 5 LOT

**\$75.00** EACH 10 LOT

**\$67.50** EACH 20 LOT

**\$65.00** EACH 50 LOT

### VIEWSTAR IS HERE

MXC-2520-525 MHZ remote volume  
remote volume control

Audio/video Baseband **\$129.95** ea.

Output, decoder loop **\$95.00** 5 lot

Parental Lockout **\$90.00** 10 lot

Favorite channel **\$80.00** ea. 20 lot

Remote Fine tuning

### NEW "North Coast"

'Excel' 66 channel remote **\$109.95** ea.

Fine tune remote,  
60 min. Sleep timer **\$85.00** 5 lot

Display dimmer.  
Favorite channel **\$79.95** 10 lot

Parental Lockout,  
HRC/STD Remote **\$75.00** 20 lot

Selectable Twinline A/B Select Optional

## UNITED ELECTRONIC SUPPLY

P.O. BOX 1206, ELGIN, IL 60121

**(708) 697-0600**



# THE GAME MACHINE®

## RANDOM NUMBER GENERATOR WITH PRINTER!

INTERNAL COMPUTER GENERATES AND DISPLAYS HUNDREDS OF FIVE DIGIT NUMBERS EVERY SECOND - STOP MOMENTARILY WHEN A 2 1/4" PAPER "TICKET" IS INSERTED IN THE FRONT PANEL AND THE DISPLAYED NUMBER IS STAMPED ON THE TICKET.

ONCE THE TICKET IS REMOVED THE MACHINE RESUMES RANDOM SELECTION.

AN EXCITING ADDITION TO YOUR RECREATION ROOM, YOUR CHURCH'S OR CIVIC GROUP'S FUN-D RAISING EVENTS, ETC.

Very crisp, bright numerals from the plasma display make it easy to read from across a well lighted room. Computer, display board, printer and 6-digit counter are all securely mounted in a sturdy steel box measuring 17"W x 10"H x 11"D and weighing 27 pounds. Access to components via the rear cover with a round key (included).

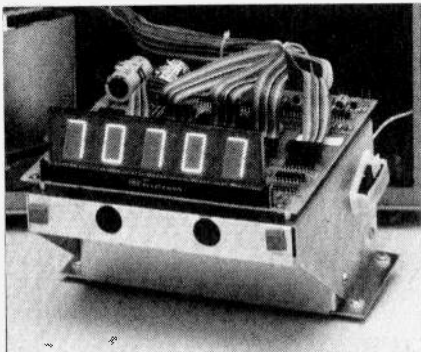
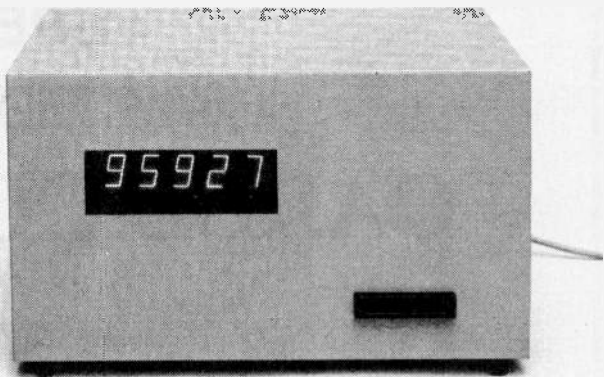

**#157 RANDOM NUMBER GENERATOR \$39.95 PLUS \$10.00 SHIPPING**

AN OPTIONAL SOUND EFFECTS GENERATOR BOARD PLUG INTO 120VAC AND THE BACK OF THE SYSTEM MAKES VERY UNIQUE NOISES THAT CHANGE WHEN A TICKET IS PUNCHED.

**SOUND EFFECTS BOARD \$10.00 PLUS \$4.50 SHIPPING**

**52 PAGE AUTUMN '91 CATALOG #18 NOW AVAILABLE**

**CREDIT CARD ORDER LINE: 800-642-1123**

**INFORMATION PHONE: 216-621-1121**

R & D ELECTRONICS 1224 PROSPECT AVENUE, CLEVELAND, OHIO 44115  
CIRCLE 237 ON FREE INFORMATION CARD

**Strong yet sensitive, teddy bear type. Brown hair, big brown eyes. Prefers blue jeans and plaid shirts. Seeking careful, responsible, nature lover who enjoys the forest. All others need not respond. Send replies to Smokey Bear Headquarters, Washington, D.C. 20252.**



Only you can prevent forest fires.





# 1-800-344-4465 "THE NUMBER THAT SAVES YOU MONEY!"

## FIELD SERVICE KIT

The Legge Field Service Kit permits repair technicians to perform field repair on a staticfree surface. Complete with 2' x 2' work surface, wrist-band, 15' ground with 1-meg ohm resistor and clip.



Part No. 570-0001F

**\$29.95** ea.

## 9600 BAUD FAX CARD

Microtek MFAX96P  
Auto dial & receive  
Background Operation  
Multi-page/Destination  
Polling. Operates any Microtek 300 dpi.  
Scanner. Includes Fax Software. IBM PC, XT, AT Compatible  
Part No. 220-3109

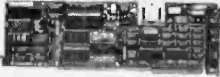

**\$99** ea.

## TEMPEST LETTER QUALITY PRINTER

120/240VAC 49/63HZ  
RS 232C/MIL-STD-188  
Serial Interface. Letter  
Quality Daisy  
Printwheel. Mfg. for Inteq by Qume  
FACTORY REFURBISHED Model LQP-5100B  
(AFP-7-T). 55 CPS Print Speed Wide Carriage



Part No. 220-3702

**\$149** ea.

## 45MB SCSI HARD DRIVE

RODIME RO3057S  
3 1/2" DRIVE  
SCSI Interface, 28ms  
APPLE & IBM compatible



Part No. 220-3412

**\$129** ea.

## IBM PC/AT CASE

Genuine IBM Case  
Full Size AT Case  
Accepts Mini or  
Full Size Motherboards  
Slide-off Top. 8 Slot Frame  
Made in U.S.A.



Part No. 220-2759

**\$49** ea.

## 3" MINI FAN

115V, .11A mini fan  
with 12" wire leads.  
Dimensions: 3-1/8" x  
3-1/8" x 1-1/2". Ball bearing motor.  
Part No. 290-0070F

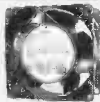

**\$5.95** ea.

## ALARM BOARD

Great experimenting board.  
24 lug and 6 lug terminal  
strips, 8 relays, 8 slide  
switches, over 30 ICs, 4  
heatsinks, 2ft. four conductor telephone  
line cord and many other parts.  
Part No. 100-0657F

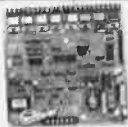

**\$5.95** ea.

## ESCORT RADAR DETECTOR

The popular Escort radar detector. XK Band. Signal strength meter. Highway/City switch and alert lamp. (Factory Demo's)



Part No. 660-0020F

**\$49.95** ea.

## REGENCY TRAVEL SCANNER

The INFORMANT. Great for the travelers. Programmed with frequencies for each state. Includes DC power cord and AC adapter included.



Part No. 660-0018F

**\$79.95** ea.

## ROBOTIC EDUCATIONAL KIT

A comprehensive introductory course on intelligent machines which encompasses robotics, All computers and sensor systems. The course has five units of text, a sixth with experiments and a final exam kit.



Part No. 370-0006

**\$9.95** ea.

## 3 1/2" DISK DRIVE

360K Disk Drive  
MFG. By: Mitsumi  
Model No. M57BCL-1  
Complete with mounting bracket and two S&K switches. Great for hobbyist and computer buffs. 34 pin data connection and 4 pin power connection.

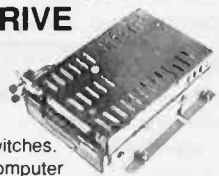

Part No. 220-3415F

**\$9.95** ea.

## YAMAHA CARRYING CASE

Universal carrying case for long flat objects like tennis rackets or musical instruments. Fits objects up to 3 5/8"(H)x11"(W)x26"(L) in size.



Part No. 650-0093F

**\$9.95** ea.

## NYLON CD CARRYING CASE

Padded nylon CD carrying case. Includes hand and shoulder straps.



Part No. 650-6401F

**\$5.95** ea.

## PLASTIC PARTS BOX

15"x14"x5"  
Great for under counter storage.



Part No. 580-9998F

**\$5.00** ea.

## PUSH ON F ADAPTOR

Part No. 240-1230F  
55¢ (ea) **35¢** (25+)



## BNC FEMALE TO F MALE

Part No. 240-1082F  
\$1.35 (ea) **\$1.15** (25+)



## BNC FEMALE TO TNC FEMALE

Part No. 240-1015F  
\$1.55 (ea) **\$1.25** (25+)

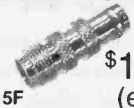

## BNC FEMALE TO TNC MALE

Part No. 240-1258  
\$1.75 (ea) **\$1.45** (25+)



## UHF FEMALE TO RCA MALE

Part No. 240-1104F  
95¢ (ea) **75¢** (25+)



## DOUBLE MALE F

Part No. 240-1229F  
75¢ (ea) **45¢** (25+)



## PL-259

Part No. 240-1253F  
95¢ (ea) **75¢** (25+)



## SO-239

Part No. 240-1301F  
85¢ (ea) **65¢** (25+)



## UHF T ADAPTOR

Part No. 240-1076F  
\$2.25 (ea) **\$1.85** (25+)



## UG-175U

Part No. 240-1220F  
45¢ (ea) **25¢** (25+)



# MECI

**Mendelson Electronics Co., Inc.**  
340 East First Street • Dayton, Ohio 45402  
800/422-3525 • 513/461-3525 • Fax 513/461-3391



# 1-800-344-4465

STORE HOURS: 9:30-5:00 (Eastern Time) Monday thru Saturday  
IBM PC/XT is a registered trademark of IBM Corp.  
TERMS: MASTERCARD/VISA/DISCOVER, CHECK, or MONEY ORDER  
(Checks allow 100 weeks for clearance)  
Ohio residents add 6.5% State tax  
Shipping/handling: UPS Chart Rate + \$2.00 (Min \$3.90) (add \$3.75 if ordering COO)  
Prices subject to change without notice  
**\$20.00 Minimum Order**  
Returns after 10 days subject to a 20% restocking fee (All returns must have RA#)  
All sales subject to prior sale  
Call or write for a free catalog.

CIRCLE 239 ON FREE INFORMATION CARD

# USE R-E SHOPPER CLASSIFIEDS

**READ BY MORE THAN 100,000 ELECTRONICS BUYERS AND SELLERS AND TRADERS**

## INSTRUCTION FOR PLACING YOUR AD!

### HOW TO WRITE YOUR AD

**TYPE** or **PRINT** your classified ad copy **CLEARLY** (not in all capitals) using the form below. If you wish to place more than one ad, use a separate sheet for the additional ads (a photocopy of this form works well). Choose a category from the list below and write that category number into the space at the top of the order form. If you do not specify a category, we will place your ad under Miscellaneous or whatever section we deem most appropriate.

We cannot bill for classified ads. Payment in full must accompany your order. We do permit repeat ad or multiple ads in the same issue, but in all cases, full payment must accompany your order.

### WHAT WE DO

The first two words of each ad are set in bold caps at no extra charge. No special positioning, centering, dots, extra space, etc. can be accommodated.

### RATES

Our classified ad rate is 40¢ per word. Minimum charge is \$6.00

per ad per insertion (15 words). Any words that you want set in bold or caps are 10¢ each extra. Bold caps are 20¢ each extra. Indicate bold words by underlining. Words normally written in all caps and accepted abbreviations are not charged as all-caps words. State abbreviations must be Post Office 2-letter abbreviations. A phone number is one word.

### CONTENT

All classified advertising in the **R-E Shopper** is limited to electronics items only. All ads are subject to the publisher's approval. We reserve the right to reject or edit all ads.

### DEADLINES

Ads received by our closing date will run in the next issue. For example, ads received by April 5 will appear in the July, 1991 issue that is on sale June 4. Shopper ads will appear Jan., Mar., May etc. No cancellations permitted after the closing date. No copy changes can be made after we have typeset your ad. **NO REFUNDS**, advertising credit only. No phone orders.

**AD RATES: 40¢ per word, Minimum \$6.00.**

Send your ads with payment to:

**Radio-Electronics SHOPPER, 500-B Bi-County Blvd. Farmingdale, NY 11735**

## CATEGORIES

- |                              |                                 |  |                           |
|------------------------------|---------------------------------|--|---------------------------|
| 100 — Antique Electronics    | 270 — Computer Equipment Wanted | 450 — Ham Gear Wanted                    | 630 — Repairs-Services    |
| 130 — Audio-Video-Lasers     | 300 — Computer Hardware         | 480 — Miscellaneous Electronics For Sale | 660 — Satellite Equipment |
| 160 — Business Opportunities | 330 — Computer Software         | 510 — Miscellaneous Electronics Wanted   | 690 — Security            |
| 190 — Cable TV               | 360 — Education                 | 540 — Music & Accessories                | 710 — Telephone           |
| 210 — CB-Scanners            | 390 — FAX                       | 570 — Plans-Kits-Schematics              | 720 — Test Equipment      |
| 240 — Components             | 420 — Ham Gear For Sale         | 600 — Publications                       |                           |

## CLASSIFIED AD COPY ORDER FORM

Ad No. 1—Place this ad in Category # \_\_\_\_\_

1 - \$6.00	2 - \$6.00	3 - \$6.00	4 - \$6.00
5 - \$6.00	6 - \$6.00	7 - \$6.00	8 - \$6.00
9 - \$6.00	10 - \$6.00	11 - \$6.00	12 - \$6.00
13 - \$6.00	14 - \$6.00	15 - \$6.00	16 - \$6.40
17 - \$6.80	18 - \$7.20	19 - \$7.60	20 - \$8.00
21 - \$8.40	22 - \$8.80	23 - \$9.20	24 - \$9.60
25 - \$10.00	26 - \$10.40	27 - \$10.80	28 - \$11.20

29 - \$11.60	30 - \$12.00	31 - \$12.40	32 - \$12.80
33 - \$13.20	34 - \$13.60	35 - \$14.00	36 - \$14.40
37 - \$14.80	38 - \$15.20	39 - \$15.60	40 - \$16.00

Ad No 1—Total words \_\_\_\_\_ x .40 per word = \$ \_\_\_\_\_  
 All Caps words \_\_\_\_\_ x .10 per word = \$ \_\_\_\_\_  
 Bold words \_\_\_\_\_ x .10 per word = \$ \_\_\_\_\_  
 Bold Cap words \_\_\_\_\_ x .20 per word = \$ \_\_\_\_\_

**TOTAL COST OF AD No. 1 \$ \_\_\_\_\_**

Card # \_\_\_\_\_

Expiration Date \_\_\_\_ / \_\_\_\_ / \_\_\_\_

Signature \_\_\_\_\_

Total classified ad Payment \$ \_\_\_\_\_ enclosed.

Check  MasterCharge  Visa (\$15.00 minimum credit card order)

Name \_\_\_\_\_ Phone \_\_\_\_\_

Address \_\_\_\_\_ City State Zip \_\_\_\_\_

### FAX/PHONE SWITCH™

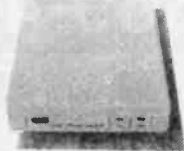

Unbelievable! Fully Automatic! Easy Installation! No switches or buttons to push!

- Connects a phone and FAX or modem to a single phone line.
- Eliminates the need for an expensive dedicated phone line.
- Works with an answering machine.
- Electronically senses if the outgoing phone call is being made from Fax/Modem/Phone.
- On incoming calls, tells the caller to remain silent if they want to Fax.
- To reach the phone, it tells the caller to say "Telephone" at a tone.
- New in sealed factory carton. Warranted.

**Closeout Price \$79.95**

### MAN3840



7 segment LED display. This hard to find device is available in quantity.

**\$1.79 each**

**100 for \$150.00**

### PHOTORESISTOR

Great for security system projects, robotic applications, model railroads, etc. Metal TO-18 package, clear lens, >90KΩdark. <500Ω under room light.

**Special Deal! 12 for \$9.95**

### ULTRALINEAR 10.7MHz BAND PASS FILTER

Very high quality complex L-C filter. List price over \$45.00. Limited Quantities

**Now only \$11.95 each**

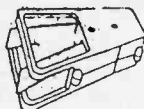

### PIEZO FAN

A very unique item. Made up of two piezo electric strips mounted in a plastic case. When AC voltage is applied the strips vibrate causing a fanning action. Optimum output at 110 VAC. Will work down to 20 VAC at decreasing output. 3/4" x 2" x 1/8" with 8" leads. With specs.

**2 for \$9.95**

### 80386 MOTHERBOARD

Grab bag. BRAND NEW 20MHz 386 motherboards. (No CPU, RAM, or ROMS)

**2 for \$100.00**

### 2 MEGABYTE RAM CARD

(1 MEG on card) For motherboard listed above.

**\$67.50 each or 2 for \$100.00**

### TELEVIDEO COMPUTER CABINET ('386?)

Includes power supply, dual half high disk drive bays, internal speaker, much more. Not a cheap "tin" clone box. Remove two screws and spacers and the '386 motherboard drops right in!

**Were over \$190.00 NOW ONLY \$49.95**



### BOOM MIKE

Electret condenser type. This versatile microphone may be wired for Handy Talkie, telephone, base station, aircraft radio, CB radio, motorcycle intercom, etc. A transistor radio type earphone may be installed in either or both muffs. The microphone unit can be easily removed and installed on another headset or helmet.

**\$4.95**



### MINIATURE SPEAKER

This 1" diameter speaker is an ideal companion for installation in our boom mike featured above.

**\$1.49**



### POWER PINCHER

Now there's an easy, inexpensive way to save \$5, \$10 ... \$20 a month or even more on your home energy bills. Power Pincher reduces the energy used by your refrigerator, freezer, washer, or any other major AC electric motor-driven appliance in your home by as much as 60%. (Licensed from NASA under US Patent No. 4,052,648.)

**\$19.95 ea. or 4 for \$76.00**

### PLUG PARADISE

Molex, Amp, Cannon, Viking, etc. 5 Lb. for \$5.00

### 'MAC' TORX DRIVER

This 13-inch long torx driver is the only tool which will open up an Apple Macintosh.

**\$4.95**



### HP 5082-2830

### QUAD HOT CARRIER DIODE RING

Use as image reject mixer in microwave downconverter. Applications.

**5 for \$4.95**

### SILICON VALLEY "GOLD"

Over 50 pounds of printed circuit boards from computers, monitors, modems, test, RF and microwave equipment, all stuffed with goodies such as toroids, IC's, switches, sockets, connectors, oscillators, crystals, transistors, diodes, varactors, varistors, etc. A gold mine of usable parts.

**50 Lbs. for \$49.95**

### 6 POLE CRYSTAL FILTER MODULE

(Granger P/N 259-0031-00) Set for about 4 MHz easily modified for other frequencies.

**2 for \$12.95**

**HC1E 6MHz XTAL for above, \$1.00**



### CIRCULAR POLARIZER

SummaTech 58mm circular polarizer, excellent for Leica, Pentax, Canon, etc.

**Our Price**

**COMPARE AT \$75 \$9.95**

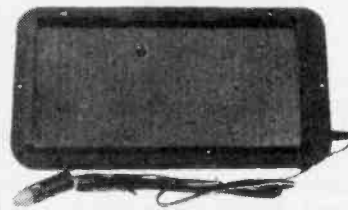

### 12 VDC, 1W SOLAR PANEL

With cord and plug measures 7" x 13". New — factory sealed package.

**\$27.49 each**

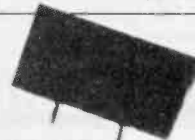

### VARO H407 HV DIODE

750 mA 6KV diode. Great for laser supply.

**\$1.99 or 10 for \$15.00**

### MATCHED N CHANNEL JFETs

2N3958 — A pair of matched N channel JFET's in one package for low noise. Very stable. Differential amplifier applications.

**\$1.99 ea. or 10 for \$17.95**

### FENWAL ELECTRONICS GD13J1

Ultra-fast "mustard seed" thermistor.

**\$3.95 ea. or 10 for \$25.00**



### SCANNER RF AMPLIFIER

5 MHz to 900 MHz installs at antenna and serves as a preamplifier to increase signal to noise ratio. Increase the sensitivity of your scanner or shortwave receiver over 6 times (10 db gain). Easy hookup, power supply and coupler included.

**Special NOW \$19.95**

### SWITCH BONANZA

Assorted switches, may include rotary, toggle, slide, "micro", breaker and weird.

**50 pcs. for \$5.95**

# ALLTRONICS

2300 ZANKER ROAD • SAN JOSE, CA 95131

VISA — MC — AM EX cards accepted. Minimum order \$12.00. California residents add 8 1/4% sales tax.

Phone (408) 943-9773 • FAX (408) 943-9776

A74 N/V.11.91

CIRCLE 225 ON FREE INFORMATION CARD



# ELECTRONICS

1

2

3

A DIVISION OF MING E&P, INC.

ORDER TOLL FREE  
1-800-669-4406



## RF TRANSMITTER & RECEIVER

#TX-88 \$10.95

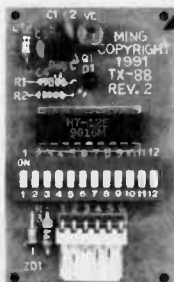

#RE-99 \$21.95

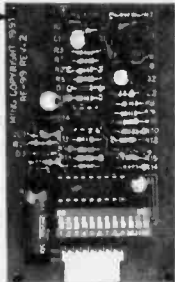

Tiny PCB level transmitter powered by 12VDC with a range of 100'-200' within line-of-sight. Capable of multi-channel signals and 4096 possible code combinations. SIZE: 1.5" x 2.38" x 0.38"

Small PCB level receiver powered by 12VDC with IC's included for both single or multi-channel decoding. 8 bit address codes and 4 bit data codes.

SIZE: 2.25" x 3.75" x 0.5"

#RC-99 Combination of TX-88 & RE-99 \$29.95

## DIGITAL VOICE MODULE

#DVM-58C \$89.95

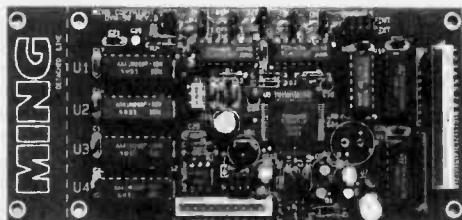

- Record and playback up to 2 minutes of your message on optional 4Mb of DRAM (32K bps). **1 Meg DRAM included.**
- Up to 16 variable-length messages -each w/direct trigger.
- Very low standby current, only **8 mA** w/4 Mega DRAM.
- "ENDLESS RECORDING MODE" for continuous recording.
- "REPEAT MODE" and "VOX" can be enabled.
- Selectable bit sampling rates of 16K or 32K bps
- "EOS" (end of sentence) output lets you control other devices at the end of a message in the playback mode.
- PCB dimensions- 5.75" x 2.75" x 0.5".

## IC TESTER / IDENTIFIER

HT-21 HANDY TESTER \$195.00

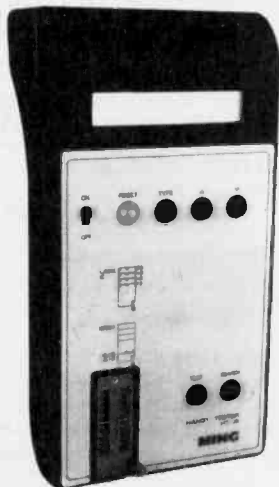

- Tests TTL 74, CMOS 40/45 and DRAM 4164-411000, 4416-4425 series IC's.
- Identifies any unknown IC number on TTL 74 and CMOS 40/45 series.
- 1 x 16 LCD dot matrix display.
- Automatic power shut-off to conserve battery life.
- Up to 500 hours of operation on a single 9V alkaline battery.
- 9V AC adapter included.
- Lightweight at only 9 oz.
- Dimensions 3.5" x 7" x 2".

Stop guessing with your IC's, the HT-21 Handy Tester is a complete stand alone system which is portable, powerful and a very affordable device for IC testing and identifying either in-house or in the field.

## DIGITAL VOICE RECORDER

#DVR-120M \$149.95

Incorporating the #DVM-58C Digital Voice Module within an ABS enclosure and including the following:

- 4 Mega DRAM
- Internal playback speaker
- Record/playback pushbuttons
- Reset pushbutton
- MIC and LINE OUT jacks
- 12V AC adapter
- Microphone
- Terminal strip connector

## DIGITAL VOICE MODULE

#DVM-2804 \$49.95  
(EPROM not included)

A compact digital voice module designed for playback of pre-recorded message(s) from an EPROM IC:

- Up to 5 separate messages from direct trigger inputs
- Dual socket design accepts a 256K EPROM for a total of 8 seconds or a 1 Meg EPROM for a total of 32 seconds of message(s) playback.
- Built-in 0.5W amplifier.
- SMT design, SIZE: 2.75" x 1.75" x 0.875"

## DIGITAL VOICE PROGRAMMING TOOL

#DVMP \$495.00

This programming tool is designed to be used with your existing EPROM programmer for the purpose of programming voice data onto EPROM IC's for digital voice modules such as the #DVM-2804.

MAIL ORDERS:  
17921 Rowland St.  
City of Industry, CA 91748

FAX ORDERS:  
(818) 912-9598

TECHNICAL SUPPORT  
(818) 912-9469

ALL PRICES SUBJECT TO  
CHANGE WITHOUT NOTICE

VISA, MC & DISCOVER CREDIT CARDS ACCEPTED

FREIGHT CHARGES ADD:  
UPS - Ground \$ 5.00  
Second day (blue) \$ 8.00  
Next Day (red) \$15.00  
C.O.D. ADD: \$ 4.00

CALIF. RESIDENTS ADD: 8.25% Sales Tax

CANADIAN ORDERS:  
All orders must be PREPAID by check or credit card (VISA, MC).  
Add a flat rate of US\$15.00 for shipping and handling by U.S. POST OFFICE (air).

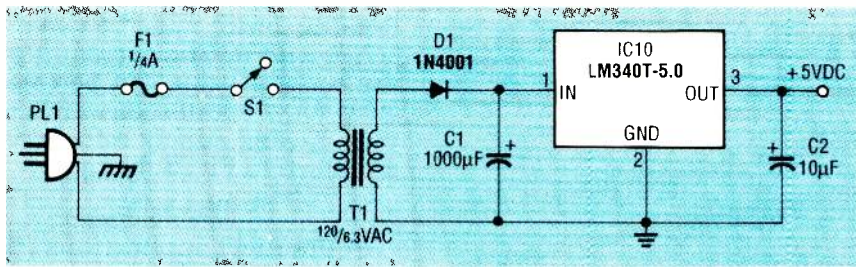

FIG. 2—POWER SUPPLY. If you don't have a suitable 5-volt DC power supply available, you can build this one.

color sequence is the reverse of VGA.)

Vertical sync is generated by sending horizontal sync to pin 1 of IC8-a, a 74LS393 binary coun-

### PARTS LIST

All resistors are 1/4-watt, 5%.

- R1—24,000 ohms
- R2, R3—5100 ohms
- R4, R10, R13—10,000 ohms
- R5, R11—100 ohms
- R6, R12—1000 ohms
- R7—R9—620 ohms
- R14—56 ohms

#### Capacitors

- C1—1000 µF, 50 volts, electrolytic
- C2—10 µF, 10 volts, electrolytic
- C3—C13, C16, C17—0.01 µF, 50 volts, ceramic
- C14—0.022 µF, 50 volts, ceramic
- C15—100 pF, 50 volts, ceramic

#### Semiconductors

- IC1—74HC04 hex inverter
- IC2—74HC14 hex Schmitt trigger inverter
- IC3, IC9—74LS164 shift register
- IC4—74LS74 D flip-flop
- IC5—74LS163 4-bit binary counter
- IC6, IC7—74HC158 2-line to 1-line selector
- IC8—74LS393 dual 4-bit binary counter
- IC10—LM340T-5.0 5-volt regulator

- OSC1—5.0688-MHz TTL clock oscillator
  - OSC2—4.9152-MHz TTL clock oscillator
  - D1—1N4001 diode
  - D2, D3—1N5711 Schottky diode
  - Q1, Q2—MPS6515 NPN transistor
- Other components**
- F1—0.25-amp AGC fast-blow fuse
  - J1—DE9S 9-pin female connector
  - J2—HD DB15S 15-pin high-density female connector
  - S1, S2—SPST switch
  - S3—DPDT switch
  - T1—120/6.3VAC transformer

**Miscellaneous:** AC linecord, wire-wrap IC sockets, metal enclosure, wire, solder, etc.

ter, where it ends up divided by 64 at pin 10 of IC8-b and fed into the CLK input (pin 8) of IC9, another 74LS164 shift register. The CLK input to IC9 (pin 9) ultimately comes from its own QC output via IC6's A2 input (pin 5), its Y2 output (pin 7), Schmitt inverter IC2-f, and transistor Q2. Using IC9's QC output to reset itself causes a division of its clock input by 7. Therefore, the horizontal sync is first divided by 64 by IC8, then divided by seven by IC9, making a total division of 448. Therefore, a 70.71-Hz signal (31.68 kHz divided by 448) with a 60-µs pulse width is sent from IC9 pin 3 to pin 14 of J2, a 15-pin high-density VGA connector, via IC13, R13, and Schmitt inverter IC2-e.

### CGA/EGA1 operation

When switch S2 is set to "EGA," it places a logic "1" (a high) on pin 1 of IC6, which then connects its "B" inputs to the "Y" outputs. When S3 is set to "Mode 1," it places a logic "0" (a low) on pin 1 of IC7, another 74HC158 selector, which connects its "A" inputs to the "Y" outputs. Now

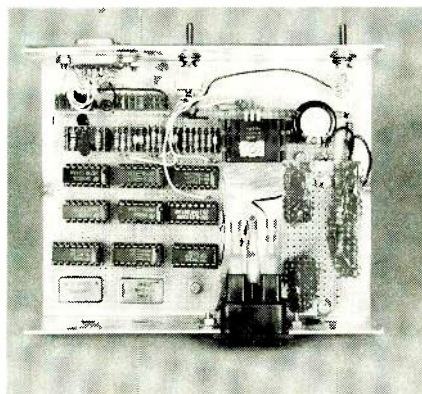

FIG. 3—THE AUTHOR'S PROTOTYPE. Perforated construction board and wire-wrap techniques were used to assemble the project.

IC7 uses OSC1 as its timing source which is input at pin 2 and output at pin 4. That, in turn, is input to pin 13 of IC6 and output at pin 12. From pin 12 of IC6, OSC1 is to IC3's CLK input (pin 8). Because IC3's QC output (pin 10) is tied back to its CLR input (pin 9) via IC7 pins 5 and 7, IC6 pins 10 and 9, R1, and Q1, IC3 divides OSC1 by five.

Output QC of IC3, which is also OSC1/5 because QC is used as the clear signal, routes 1.014 MHz (5.0688/5) to pin 3 of IC4-a, causing further division by four at pin 9 of IC4-b for a total division of 20 (253.44 kHz). The 253.44-kHz output from IC4 pin 9 is connected to pin 3 of IC6 via IC7 pins 11 and 9. The input to pin 3 of IC6 is output at pin 4, and from there it goes to S3 and the CLK input of IC5 (pin 2). After IC5 divides the 253.44 kHz by sixteen, the horizontal sync measures 15.84 kHz.

Vertical sync is generated by dividing horizontal sync (15.84 kHz) by 256 at pin 8 of IC8. That output connects to C12, R1, IC2-b, and pin 14 of IC7. The 61.88 Hz vertical sync signal with a 190 µs positive pulse width is then sent to pin 9 of output jack J1 via IC7 pin 12.

### EGA2 operation

When S2 is set to "EGA," it places a high on pin 1 of IC6, which then selects its "B" inputs. With S3 set to "Mode 2," it places a high on pin 1 of IC7 so it also selects "B" inputs. With the "B" inputs selected, IC7 uses OSC2 as its timing source and 4.9152 MHz passes from pin 4 of IC7 to pin 13 of IC6. The signal then connects to IC3's CLK input (pin 8) from pin 12 of IC6. The QC output from IC3 is connected to IC6 pin 10 via IC7 pins 6 and 7. The signal is then output at pin 9 of IC6, and connects back to the CLR input (pin 8) of IC3. The OSC2 signal is divided by seven by IC3 producing 702.17 kHz at IC3's QC output. The QC output from IC3 ties to IC4-a, which causes an additional division by 2, for a net of 14. The 351.08 kHz from IC4-a pin 5 is connected to IC5's CLK input (pin 2) via IC7 pins 10 and 9, and IC6 pins 3 and 4. The signal is further divided by

continued on page 94 49



# WORKING WITH LEDs

**We begin our in-depth survey of optoelectronic systems by taking a close look at a wide variety of LED circuits.**

**RAY MARSTON**

OPTICAL ELECTRONIC DEVICES ARE so widely used in today's consumer-electronics that it's hard to come across a product that doesn't use light-emitting diodes (LED's) in one way or another. If you've ever had a need to use LED's or specialized flashing devices in your circuit design, we might be of some help to you. We'll start by presenting some basic information on LED's, then we'll take a look at some multi-LED packages. Finally, we'll round-off with a discussion of different types of flasher circuits used for controlling LED's.

**LED basics**

LED's are commonly used as visual indicators because of their fast response time and high efficiency. When compared to tungsten-filament lamps, their typical energy conversion efficiency is ten to fifty times greater and their response time is one hundred to one thousand times faster. LED's are widely available in red, orange, yellow and green colors.

Figure 1 shows the standard LED symbol and typical forward voltages of different colored LED's. The device is a genuine diode, and a voltage of approximately 2 volts is produced across it when it is passing a forward current of 20 milliamps. If an LED is reverse biased, it will avalanche or "Zener" at a fairly low voltage value, as shown in Fig. 2. Most LED's have maximum reverse voltage ratings in the range of 3 to 5 volts.

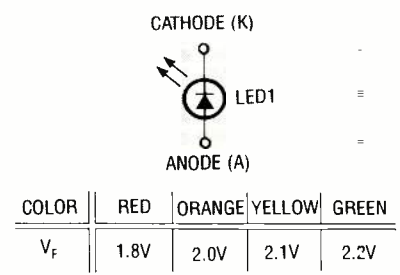

**FIG. 1—LED SYMBOL AND TYPICAL forward voltages of standard LED's at  $I_f = 20$  milliamps.**

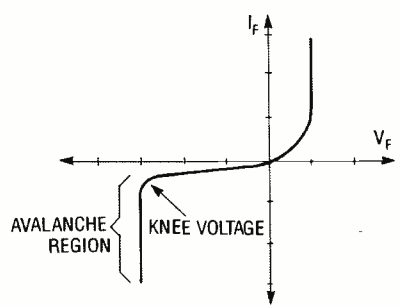

**FIG. 2—GRAPH SHOWING REVERSE biased LED responding as a Zener diode.**

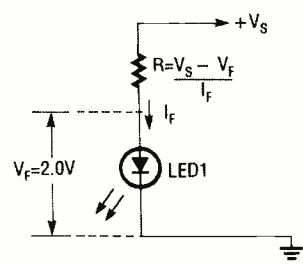

**FIG. 3—METHOD OF FINDING the current-limiting resistance value for a given  $V_S$  and  $I_f$ .**

When an LED is used, a resistor or other suitable current-

limiting device must be wired in series with it. The current-limiting resistor value can be calculated for a specific forward current,  $I_f$ , and supply voltage,  $V_S$ , as shown in Fig. 3, being,

$$R = (V_S - V_f) / I_f$$

In practical applications, the series resistor can be connected to either the anode or the cathode of the LED. The LED brightness is proportional to the LED current; most LED's will operate safely up to absolute maximum currents of 30 to 40 milliamps. With a DC supply voltage and a suitable line dropping resistor, the current through the LED should be maintained at a constant value of approximately 20 milliamps.

An LED can be used as an indicator in an AC circuit by wiring a diode in inverse parallel with it, as shown in Fig. 4. The diode prevents the LED from becoming reverse biased on the negative half of the sine wave cycle. For a given brightness, the line dropping resistance value in an AC circuit should be one half that used in a DC circuit. When an LED is used in an AC circuit, the forward current conducts through the LED only during the positive half of the sine wave cycle, after the LED has reached its threshold voltage of about 1.5 volts. Therefore, the LED conducts current less than one half the time in an AC circuit as it does in a DC circuit. In order to achieve the same average current through the LED with an AC supply, approximately twice as much current must flow so the resistance value must be reduced by one half.

One of the first problems you will encounter when using an LED is identifying its polarity. The cathode on most LED's is identified by a notch or flat surface on the component, or by a short lead. That practice is not universal, however, so the only accurate way to identify the polarity of an LED is to test it in the basic circuit of Fig 3; try the LED in both positions, when it glows, the cathode is the most negative of the two terminals. It is always a good practice to test an LED before soldering it onto the PC board.



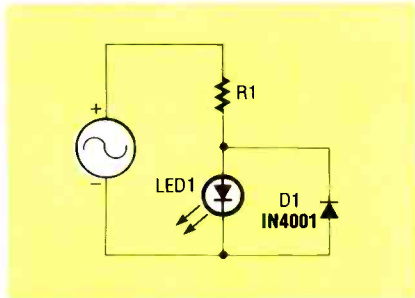

FIG. 4—AN LED USED IN AN AC circuit; D1 is wired in inverse parallel to prevent the LED from being reverse biased.

Special mounting kits are available for securing LED's onto PC boards and front panels. Those kits consist of a special mounting grommet and grooved ring shown in Fig. 5-a. If mounting hardware is not available, you can drill panel holes and either epoxy the LED into place or solder its leads into a PC board, which can support the LED. That method is shown in Fig. 5-b.

### LED packages

LED's can be purchased as single components, as shown in Fig. 1, or in a multi-LED package. The most common type of multi-LED package is the 7-segment display, comprising seven or eight LED's packaged for displaying alphanumeric characters. Another

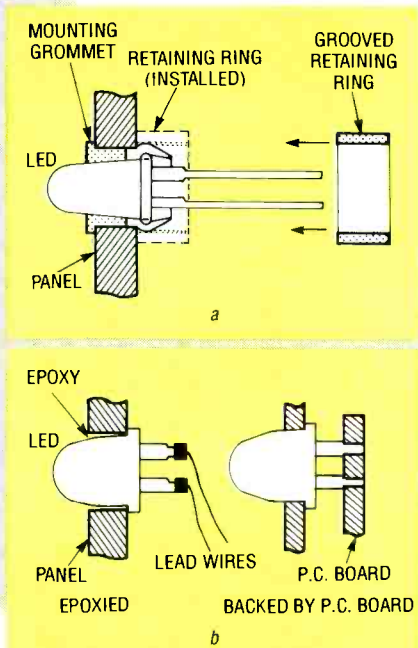

FIG. 5—LED MOUNTING METHODS; (a) shows an LED mounting kit consisting of a grommet and retaining ring, and (b) shows an LED mounted in a drilled hole with epoxy or soldered leads.

well-known type of multi-LED package is the bar-graph display, which is made up of ten to thirty linearly-mounted LED's. An example of a ten-element LED package is shown in Fig. 6-a.

Most LED's provide only a single output color. There are, however, a few specialized LED packages that provide multi-color outputs. Those devices actually consist of two LED's contained in one package. Figure 6-b shows a bi-color LED which is comprised of a pair of LED's connected in inverse parallel. The color green is emitted when the device is biased in one direction,

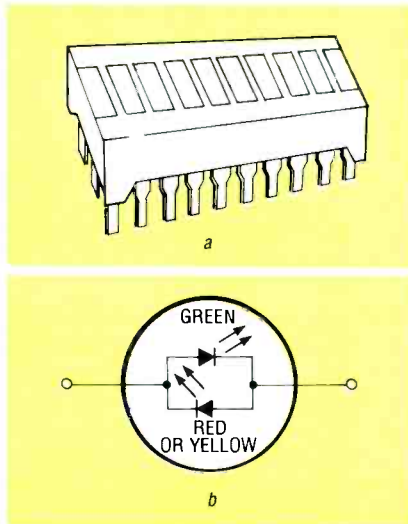

FIG. 6—MULTI-LED PACKAGES; (a) is a 10-element LED, and (b) is a 2-color LED which contains two LED's connected in inverse parallel.

and red or yellow is emitted when it is biased in the reverse direction. The bi-color LED is useful for giving polarity indication and null detection.

Another type of multi-color LED is shown in Fig. 7. This four color LED is made by mounting a green and red LED in a 3-pin common-cathode package. That device can generate green or red colors by turning on only one LED at a time, or it can generate orange and yellow by turning on the two LED's in the current ratios shown in the table.

A very important practical point concerns the use of "second-grade" or "out-of-spec" devices advertised as bargain packages. Those devices often have forward voltage drops in the range of three to ten volts. Al-

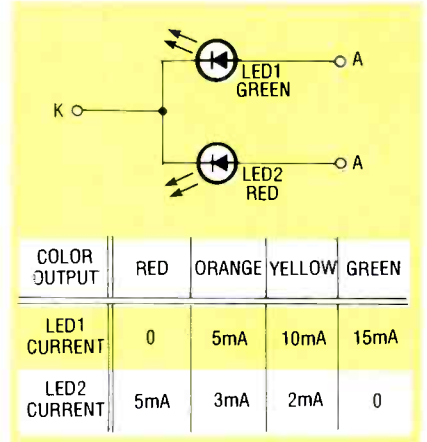

FIG. 7—MULTI-COLOR LED; this LED gives four colors from two junctions as shown in the current ratios given in the table.

though "second grade" LED's may be suitable for many applications, it's always a good idea to test those devices before using them in your circuit, as we said earlier.

### Multi-LED circuits

A number of LED's can be driven from a single source by wiring all LED's in series as shown in Fig. 8. The supply voltage used in that circuit is equal to the sum of the individual LED forward voltages and the voltage drop across the line-dropping resistor. The line-dropping resistance value can be calculated by using the equation

$$R = (V_S - V_{FT}) / I_F$$

The total forward voltage,  $V_{FT}$ , is the sum of the forward voltage drop of each LED.

The circuit shown in Fig. 8 draws minimal total current, but is limited in the number of LED's that it can drive. A number of those series LED circuits can,

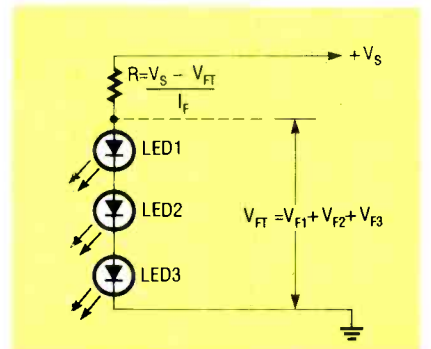

FIG. 8—LED'S WIRED IN SERIES and driven by a single current-limiting resistor.

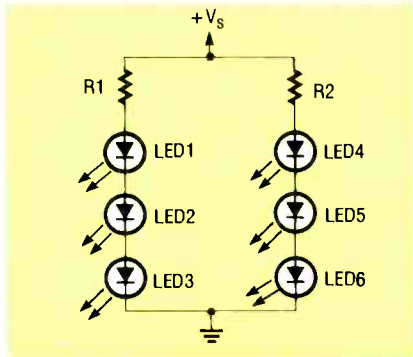

FIG. 9—A NUMBER OF SERIES LED circuits can be wired in parallel, to drive multiple LED's.

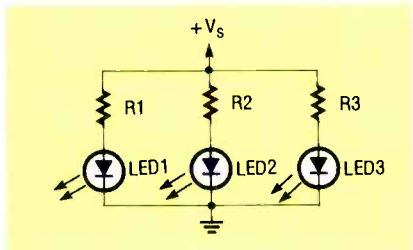

FIG.10—THIS CIRCUIT CAN DRIVE a large number of LED's, but at the expense of high current.

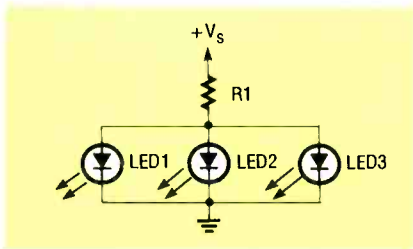

FIG. 11—NEVER USE THIS LED driving circuit. One LED will draw all of the current.

however, be wired in parallel, so that almost any number of LED's can be driven from a single source, as shown in the 6-LED circuit of Fig. 9.

An alternate but less efficient method of driving multiple LED's is to simply wire a number of dropping resistors and LED's in parallel, as shown in Fig. 10. That type of circuit will work, but it draws a significant total current, which is equal to the sum of the individual LED currents.

Since we're on the subject of how to connect multiple LED's, let's discuss what *not* to do. Never hook-up multiple LED's as shown in Fig. 11. That circuit will not work properly because of inevitable differences in the forward-voltage characteristics of the LED's, one LED will usually draw most of the available cur-

rent, leaving little or none left for the remaining LED's.

Three widely used types of visible-output LED-control circuits are those used for LED flashing, LED sequencing, and LED dot or bar analog-value indication. LED flasher circuits are designed to turn an LED alternately on and off, to give an eye-catching display action. Those circuits may control a single LED, or they may be designed to control two LED's in such a way that one turns on as the other turns off.

A special LED-flasher IC is available, the LM3909, which can be used to flash an LED from a low voltage DC supply, and does so at a very low average current level. Some practical LED flasher circuits using the LM3909 IC are shown later in this article.

LED sequencer circuits are designed to drive a chain of LED's so that each LED in the chain is switched on and off in a time-controlled sequence, so that a ripple of light seems to run along the chain.

LED analog-value indicator circuits are designed to visually appear and respond as an analog meter. An analog-value LED circuit drives a chain of linearly-spaced LED's in such a way that the length of the chain that is illuminated is proportional to the analog value of a voltage applied to the input of the driver circuit.

### LED-flasher circuits

One of the simplest types of LED display circuits is the LED flasher, in which a single LED repeatedly switches alternately on and off, usually at a rate of one or two flashes per second. A 2-LED flasher is a simple modification of this circuit, but is arranged so that one LED switches on when the other switches off. A 2-LED transistor flashing circuit is shown in Fig. 12.

In the flashing circuit shown in Fig. 12, Q1 and Q2 are wired as astable multivibrators, with their switching speeds determined by time constants  $R3 \times C1$  and  $R4 \times C2$ . The circuit operates at about 1 flash per second using the component values shown. The 2-LED flashing circuit can be converted to single-LED operation by replacing the unwanted

LED with a short circuit.

An IC version of the 2-LED flasher is shown in Fig. 13. That design is based on the dependable 555 timer chip, or its more modern CMOS counterpart, the 7555. The IC is wired in the astable mode, with its time constant determined by R4 and C1. The output at pin 3 of the IC alternately switches between the ground and the positive supply voltage, alternately shorting out

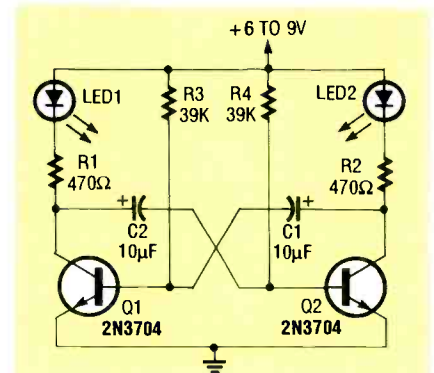

FIG. 12—TWO-LED FLASHER circuit operates at 1 Hz; Q1 and Q2 respond as astable multivibrators while LED1 and LED2 alternately flash on and off.

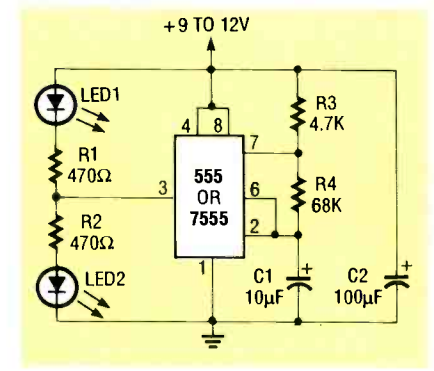

FIG. 13—TWO-LED FLASHER circuit operates at 1 Hz using a 555 or 7555 timer IC.

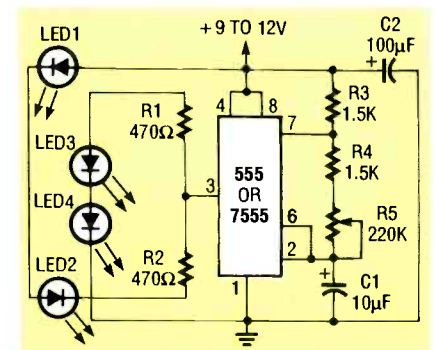

FIG. 14—FOUR-LED DOUBLE-BAR flasher in a "cross" configuration; the flashing rate is variable from 15 to 2000 flashes per minute.



and disabling LED1 or LED2. The flashing circuit can be converted to single-LED operation by shorting out the unwanted LED and its associated current-limiting resistor.

A visually interesting display can be produced with a useful modification of the above circuit, shown in Fig. 14. Two pairs of series-connected LED's are connected in the form of a cross so that the visual display alternately switches between a horizontal bar (LED1 and LED2 on) and a vertical bar (LED3 and LED4 on). The flash rate is made variable via potentiometer R5 and can range between 15 and 2000 flashes per second.

### Flasher IC LM3909

A seemingly trivial task that sometimes faces the design engineer is that of providing illuminated power indication of the ON state of an electronic unit or the location of a passive device such as a fire extinguisher or emergency switch in a darkened room. LED's operate reliably when main power is available, but a serious problem arises when battery-powered equipment is involved.

LED indicators typically draw about 12 milliamps when illuminated and can therefore place a fairly heavy strain on small supply batteries. Since LED's drop two or more volts under the ON condition, they can not readily be powered from battery voltages below about 3 volts.

National Semiconductor provides an ingenious solution to the problem of LED power drain and operation from weak batteries with the 8-pin LM3909 LED flasher/oscillator IC. The LM3909 IC is a low-duty-cycle (brief ON period, long OFF period) oscillator that provides a voltage-doubled, high-current pulse to an external LED. High pulse currents of up to 100 milliamps are produced from the IC, while still drawing very low average currents of about 0.3 to 1.5 milliamps. Because of the voltage-doubling capability, the LM3909 can flash an LED even when powered from battery voltages as low as 1.1 volts, and can provide months, or even years, of continuous flashing operation from a

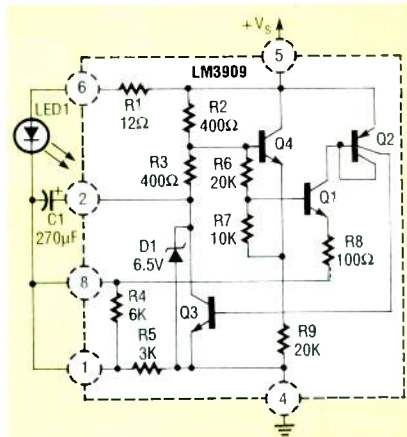
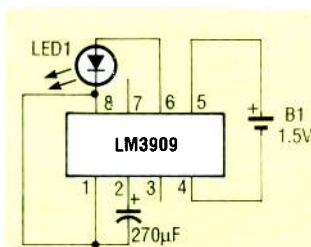

FIG. 15—INTERNAL CIRCUIT AND external connections of the LM3909 low-voltage LED flasher IC.



CELL SIZE	ESTIMATED BATTERY LIFE UNDER CONTINUOUS 1.5V OF FLASHER OPERATION	
	STANDARD CELL	ALKALINE CELL
AA	3 MONTHS	6 MONTHS
C	7 MONTHS	15 MONTHS
D	15 MONTHS	30 MONTHS

FIG. 16—LED FLASHER USING 1.5 VOLT SUPPLY. TABLE shows estimated battery life under continuous 1.5-volt LED flashing operation.

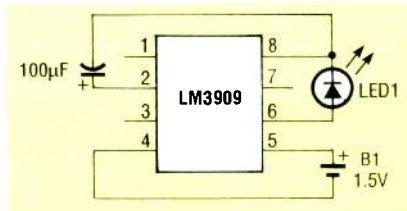

FIG. 17—MINIMUM POWER, longer life, 1.1-Hz flasher. Average drain current is 0.32 milliamps.

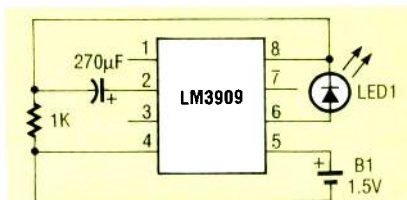

FIG. 18—FAST 1.5-VOLT BLINKER; flash rate is 2.6 Hz and drain current is 1.2 milliamps.

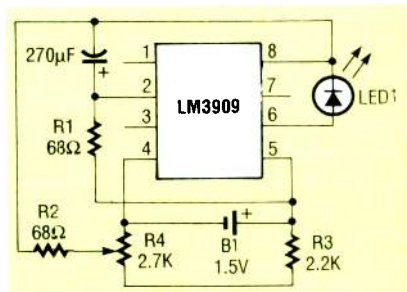

FIG. 19—VARIABLE-RATE FLASHER.

single 1.5-volt cell.

The LM3909 requires the addition of only a battery and a timing capacitor to function as an LED flasher. The internal circuit of this IC, together with typical external connections for 1.5-volt flasher operation, are shown in Fig. 15. In that particular application, the LED receives current via the 270- $\mu$ F timing capacitor C1, R1, and Q3 for only about 1% of the time. All transistors except Q4 are off for the remaining part of each operating cycle. Resistor R9 draws only about 50  $\mu$ A. The timing capacitor C1 is charged through R2 and

R3 and through R5 connected between pins 1 and 4 of the IC.

Transistors Q1 through Q3 remain off until C1 becomes charged to about 1 volt. That voltage is determined by the junction drop of Q4, its base-emitter voltage divider, consisting of R6-R7, and the junction drop of Q1. When the voltage at pin 1 becomes a volt more negative than that at pin 5 (+V<sub>S</sub>), Q1 begins to conduct and turns Q2 and Q3 on. The IC then supplies a pulse of high current to the LED. The current gain of Q2-Q3 is approximately 500. Transistor Q3 can handle over 100 milliamps of collector current, and rapidly pulls pin 2 close to ground, pin 4. Since C1 is charged at that time, it forces the pin 1 terminal below the ground potential value. As a result of the pin 1 terminal being less than the ground potential, the one-volt drop across the LED is greater than the supply voltage value—R1 then limits the LED current to a safe value.

Capacitor C1 alternately charges via the timing resistor R5 and discharges via the LED and R1 in this application. In some other applications, the



short between pins 1 and 8 can be removed, enabling the capacitor to charge through a total of 9 kilohms, increasing the duty cycle and reducing the average current drawn. If voltage boosting is not needed, loads can be wired directly between pins 2 and 6 or pins 2 and 5 of the IC.

The LM3909 IC is thus a fairly versatile device. A variety of useful applications are shown in the remaining part of this article.

### Practical LM3909 circuits

The LM3909 circuits shown in Figs. 16 and 17 can be used as locator beacons for fire extinguishers, emergency switches, and boat-mooring floats because of their low voltage operation and low current drain. The circuit shown in Fig. 16 gives a brief flash once every second or so, and typically draws an average current of only 0.63 milliamps. As shown in the table, that circuit will continually operate for three to thirty months from a battery, depending on the size and type of cell that is used.

An even longer life can be obtained from the minimum-power flasher circuit shown in Fig. 17. That circuit is similar to the one described above, except that the short is removed from between pins 1 and 8, causing the capacitor to charge via 9 kilohms of internal IC resistance ( $R4 + R5$ ). The IC then operates with an increased duty cycle, and reduced average current is drawn. That circuit has a typical current drain of 0.32 milliamps.

A circuit similar to that of Fig. 17 can be designed for use with a 3-volt power supply. For 3-volt operation, the timing capacitor value should be increased to 270  $\mu\text{F}$  for approximately the same flash

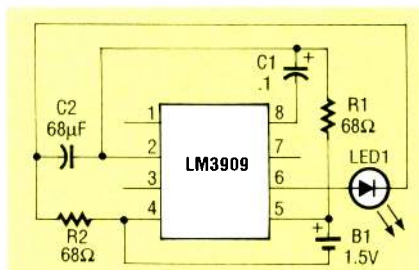
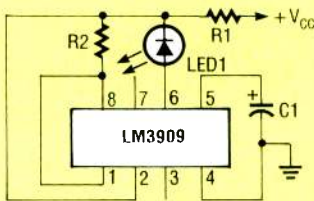

FIG. 20—HIGH EFFICIENCY LED indicator gives seemingly "continuous" operation from 1.5 volts. The current drain is 4 milliamps.



$V_{CC}$	FLASHING FREQUENCY, Hz	C1	R1	R2	$V_{CC}$ RANGE
6V	2.0	400 $\mu\text{F}$	1K	1.5K	5–25V
15V	2.0	180 $\mu\text{F}$	3.9K	1K	13–50V
100V	1.7	180 $\mu\text{F}$	43K 1W	1K	85–200V

FIG. 21—THIS WARNING FLASHER CAN OPERATE within a voltage range of 5 to 200 volts according to capacitor and resistor values specified in the table.

rate of 1 Hz. The average drain current for that circuit is 0.77 milliamps, which is more than twice the drain current of the 1.5-volt flashing circuit.

Another variation of the 1.5-volt flasher shown in Fig. 18 operates at a frequency of 2.6 Hz. In that circuit, the internal timing resistors are shunted by an external 1-kilohm resistor; the charging time constant is reduced, the duty cycle is decreased and the average current drain rises to 1.2 milliamps. The circuit gives a far more noticeable flasher indication than the three previous circuits, but at the expense of a much higher current drain.

If you enjoy experimenting with circuits, you can build the variable-rate flasher shown in Fig. 19. The flashing rate is varia-

lumination and has a rather modest battery drain of about 4 milliamps.

All of the LED flasher circuits we have discussed in Figures 16 through 20 are intended for operation from 1.5- or 3-volt supplies. The LM3909 can also be used with much higher supply voltages, ranging from 5–200 volts DC. The internal 6.5-volt Zener diode, wired between pins 2 and 4 of the IC, regulates the voltage between the LED cathode and ground. Those circuit configurations can be made with a minimum number of external components, as shown in the schematic of Fig. 21.

As a final circuit suggestion, you can build a useful flashlight-finder shown in Fig. 22. The LM3909, 200- $\mu\text{F}$  timing capaci-

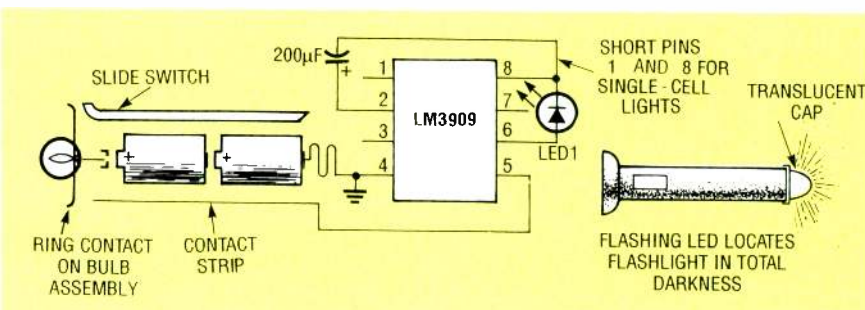

FIG. 22—A SIMPLE FLASHLIGHT FINDER; THE LM3909, capacitor and LED are installed inside a translucent cap mounted on the end of the battery.

ble from zero to 20 Hz via potentiometer  $R4$ . Resistors  $R1$  and  $R2$  are used to stabilize the duty cycle of the circuit and maintain a fairly steady apparent brightness level as the flashing rate is varied.

The Fig. 20 circuit is designed to give apparently continuous illumination of the LED when powered from a 1.5-volt cell. The circuit operates as a 2-kHz square-wave generator; resistors  $R1$  and  $R2$  are used to approximately equalize the ON and OFF times of the generator. The circuit gives a fairly dim LED il-

tor and LED are installed inside a translucent cap mounted on the end of the flashlight. An insulated contact strip connects to the positive terminal of the battery and passes through the case for connection to pin 5 of the IC. The negative terminal of the battery connects to pin 4 (ground) of the IC. If a single-cell light is used, short pins 1 and 8. Drawing current through the lamp filament simplifies wiring and causes negligible power loss since the resistance of a cold bulb is less than 2 ohms.



# Plug a Friend into **Radio Electronics**<sup>®</sup> this Christmas ... and Save \$19.43!

*This Christmas give an electrifying gift ... plug a friend into Radio-Electronics and brighten his whole new year! Whether electronics is his livelihood or his hobby, your gift will sharpen his focus and illuminate the whole spectrum of electronics throughout the coming year.*

Radio-Electronics will keep him informed and up-to-date with new ideas and innovations in all areas of electronic technology ... computers, video, radio, stereo, solid state technology, satellite TV, industrial and medical electronics, communications, robotics, and much, much more.

He'll get great plans and printed circuit patterns for great electronic projects. In just the last year, Radio-Electronics has presented voice scramblers, video switchers, frequency standards, wireless audio links, radiation monitors, function generators, and much more.

In coming issues, Radio-Electronics will present practical, educational, and money-saving projects like: a helium-neon laser ... a lighting controller ... a video timebase corrector ... a video noise processor ... a light-beam communicator ... an antenna amplifier ... and many others!

PLUS ... equipment troubleshooting techniques ... circuit design ... reports on new technology and new products ... equipment test reports ... in-depth coverage on computers, video, audio, shortwave radio ... and lots more exciting features and articles.

SAVE \$19.43\* ... OR EVEN \$38.86\* ... For each gift of Radio-Electronics you give this Christmas, you save a full \$19.43\* off the newsstand price. And as an R-E gift donor, you're entitled to start or extend your own subscription at the same Special Holiday Gift Rate —you save an additional \$19.43\*!

No need to send money ... if you prefer, we'll hold the bill till January, 1992. But you must rush the attached Gift Certificate to us to allow time to process your order and send a handsome gift announcement card, signed with your name, in time for Christmas.

So do it now ... take just a moment to fill in the names of a friend or two and mail the Gift Certificate to us in its attached, postage-paid reply envelope. That's all it takes to plug your friends into a whole year of exciting projects and new ideas in Radio-Electronics!

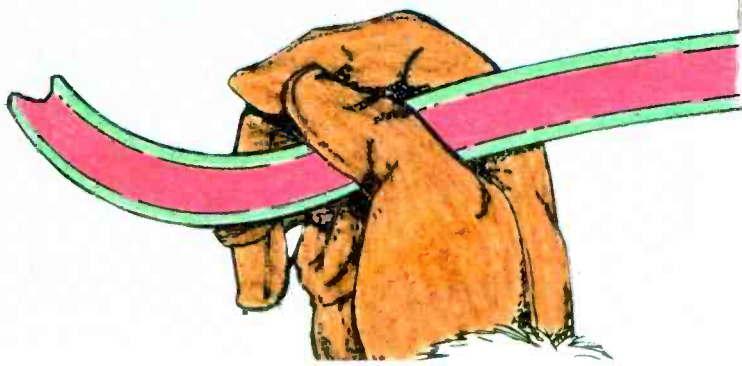

\*Basic sub rate — 1 yr/\$17.97 2 yrs/\$34.97



# Enter A World Of Excitement with a Subscription to Popular Electronics®

Get the latest electronic technology and information monthly!

Now you can subscribe to the magazine that plugs you into the exciting world of electronics. With every issue of Popular Electronics you'll find a wide variety of electronics projects you can build and enjoy.

Popular Electronics brings you informative new product and literature listings, feature articles on test equipment and tools—all designed to keep you tuned in to the latest developments in electronics. So if you love to build fascinating electronics, just fill out the subscription form below to subscribe to Popular Electronics... It's a power-house of fun for the electronics enthusiast.

## EXCITING MONTHLY FEATURES LIKE:

- CONSTRUCTION**—Building projects from crystal sets to electronic roulette
- FEATURES**—Educational training on digital electronics, Ohm's Law, Antennas, Communications, Antique Radio, Simplified Theory
- HANDS-ON-REPORTS**—User test comments on new and unusual consumer products
- SPECIAL COLUMNS**—Think Tank, Circuit Circus, Computer Bits, DX Listening, Antique Radio, Amateur, Scanner Scene

## PLUS: ALL OUR GREAT DEPARTMENTS!

You'll get 12 exciting and informative issues of Popular Electronics for only \$18.95. That's a savings of \$16.45 off the regular single copy price. Subscribe to Popular Electronics today! Just fill out the subscription order form below.

**HOW RADIO GOT ITS VOICE**  
**Popular Electronics**  
 OCTOBER 1991  
 A Buyer's Guide to DMM's  
 Explore the digital-multimeter marketplace at a glance in our handy round up  
**Does Your Meter Lie To You?**  
 Even the best meter can lead you astray if you don't fully understand what you are measuring  
**Build a Precision Dual-Output Power Supply**  
 An inexpensive, adjustable, dual-output supply that's packed with features  
**The Light-Beam Communicator**  
 Talk on a beam of light with this just-for-fun project  
**Product Reviews**  
 Canon L1 Camcorder, Yamaha AM/FM Stereo Tuner, Heath Analyzer, Neo-Geo Video System, and more  
**Save 46% Off The Regular NEWSSTAND Rate**  
 Also: • Think Tank • Ham Radio • Antique Radio • Scanner Scene  
 \$2.95 U.S. \$3.75 CANADA  
 3 NEW FactCards IN THIS ISSUE

FOR FASTER SERVICE CALL TODAY  
**1-800-827-0383**

(7:30AM-8:30PM)  
 EASTERN STANDARD TIME

## Popular Electronics® SUBSCRIPTION ORDER FORM

P.O. Box 338, Mt. Morris IL. 61054

AREA2

**YES!** I want to subscribe to Popular Electronics for 1 Full year (12 Issues) for only \$18.95. That's a savings of \$16.45 off the newstand price.

- Payment Enclosed  Bill me later  
 Please charge my:  Visa  Mastercard

Acct. #

Signature  Exp. Date

PLEASE PRINT BELOW:

NAME

ADDRESS

CITY  STATE  ZIP

Allow 6 to 8 weeks for delivery of first issue. U.S. Funds only.  
 In Canada add \$6.98 Postage (Includes G.S.T.) All Other Foreign add \$7.50 Postage.



# EXPERIMENTING WITH ADC FOR YOUR PC

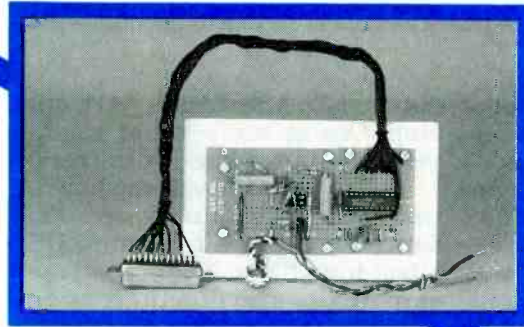
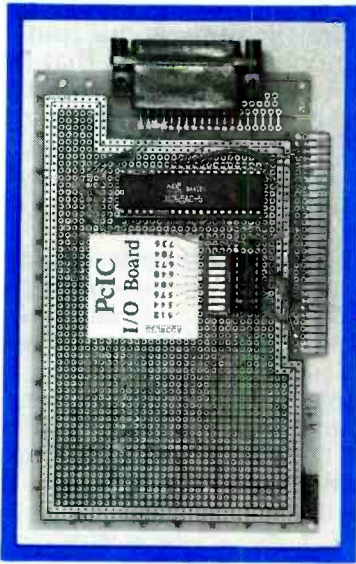

JAMES J. BARBARELLO

**Build our low-cost data-capture system and let your PC measure temperature, displacement, and other quantities.**

IN PREVIOUS ARTICLES, WE INTRODUCED several general-purpose analog and digital I/O systems for the PC. (See "Experimenting With PC-Based Test Equipment" in May, June, and July of 1991.) The first installment described a test instrument for measuring capacitance; the second described a digital R/C meter. Both devices interfaced to the PC via a standard parallel port. The third installment described a simple PC expansion card, the PC IO, that adds 24 digital I/O lines by means of an 8255 Parallel Input/Output (PIO) device, the standard in the PC architecture.

In this article, we'll build a very low cost analog-to-digital converter (ADC) interface that allows you to measure temperature, displacement, audio signals, and any other 0–5 volt analog signal. Our ADC builds off the PC IO: By adding an amplifier and ADC circuit, and some simple BASIC software, you can capture and display data and log it to your PC at a rate of 1000 (or more, de-

pending on the speed of your PC) data points per second.

This article shows you how to use the ADC to build an accurate temperature sensor, but it's easy to modify the circuit to accept other types of analog input devices.

## Circuit theory

As shown in the block diagram of Fig. 1, the circuit consists of two functional blocks: a signal conditioner and an A/D converter. The signal conditioner is a variable-gain amplifier with an adjustable DC offset that allows you to calibrate the circuit for a variety of sensors. To understand why calibration is necessary, let's look at the IC that does the actual analog-to-digital conversion, a standard eight-bit device called the ADC0804. Unlike a traditional voltmeter, the ADC0804 responds to AC voltage changes very quickly, in fact at a rate greater than 1000 per second. The ADC0804 converts each sample to digital form, after

which a computer may read the digital outputs for display or subsequent analysis.

The ADC0804 accepts an analog input of 0–5 volts DC and converts it to a binary number between 0 and 255. With a maximum range of 5 volts, and 256 steps between 0 and 5, resolution is  $5/256 = 0.0195$  volts, or almost 20 millivolts. So for any analog input voltage between 0.0000 and 0.0195, the ADC0804 will produce a binary 0 (00000000); for any voltage between 0.0195 and 0.0390, a binary 1 (00000001), and so on.

Twenty millivolts may seem like more than enough resolution, but what if you wanted to measure a signal with a maximum value of 40 millivolts? You'd only be able to distinguish two values in the given range. That's where the signal-conditioning portion



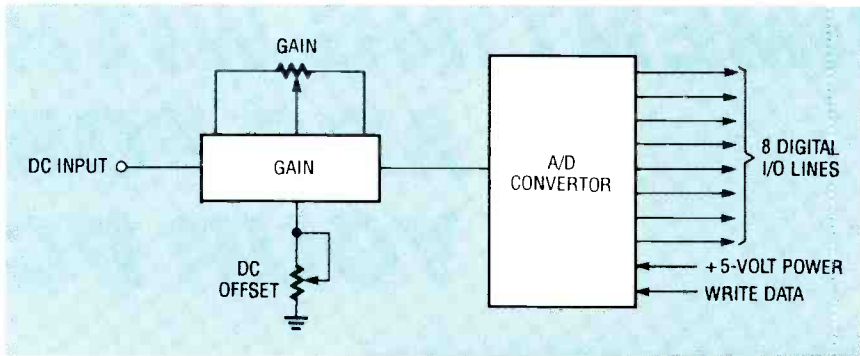

FIG. 1—BLOCK DIAGRAM shows the two major sections of the circuit, an amplifier and the ADC proper.

of the circuit comes in. By amplifying the signal so that it has an effective range close to the maximum range of the IC, we can break it down into much finer increments, and then let software scale it back to the appropriate value.

The DC offset portion of the signal conditioner lets us cancel any steady-state DC voltage and measure only the change in the DC voltage. That's required for the temperature sensor probe, which is built around the base-collector junction of a standard 2N2222 transistor. More on that in a moment.

### The circuit

Referring to the schematic diagram shown in Fig. 2, IC1 is a

standard 1458 (dual 741) op-amp. One op-amp (IC1-a) amplifies the input voltage by the ratio  $-R3/R6$ . With the values shown, that's a voltage gain of  $-10$ . Resistor R8 ensures minimum DC offset from IC1-a. The second op-amp (IC1-b) also functions as an amplifier, but in this case, voltage gain is  $-(R5 + R11)/R7$ , where R11 is a 15-turn, 10K potentiometer that allows the gain to be adjusted between values of  $-1$  and  $-2$ . Like R8, R9 ensures minimum DC offset from IC1-b. The two inversions in the op-amps result in a non-inverted output signal.

The voltage divider consisting of R2 and R12 allows insertion of a DC offset voltage of  $0-+2.5$  volts DC. This can offset any

positive quiescent DC voltage from an input device.

The ADC is IC2; it is configured for a free-running mode that samples the input signal (pin 6) continuously. To ensure that the A/D is initialized properly, the software drives pins 3 ( $\overline{WR}$ ) and 5 ( $\overline{INTR}$ ) low momentarily on startup. The eight digital outputs (IC2 pins 12-18) drive the PIO directly, by way of P1.

A pair of 9-volt batteries supplies power for the op-amps; the host PC supplies +5-volt power for the voltage-divider circuit and IC2 via pin 25 of P1. Doing so ensures a more stable reference voltage than if the batteries were used. Of course, you're free to use a dual-polarity power supply in place of the batteries.

### Temperature sensing

A standard 2N2222 transistor can readily serve as a \$0.20 temperature sensor. Referring to Fig. 3-a, note that the emitter and base of Q1 are shorted together. That connection provides a diode—the base/collector junction. When power is applied across the junction, we would expect a constant drop of about 0.7 volts across it. The term *about* is important here, because the actual drop depends on the temperature of the junction.

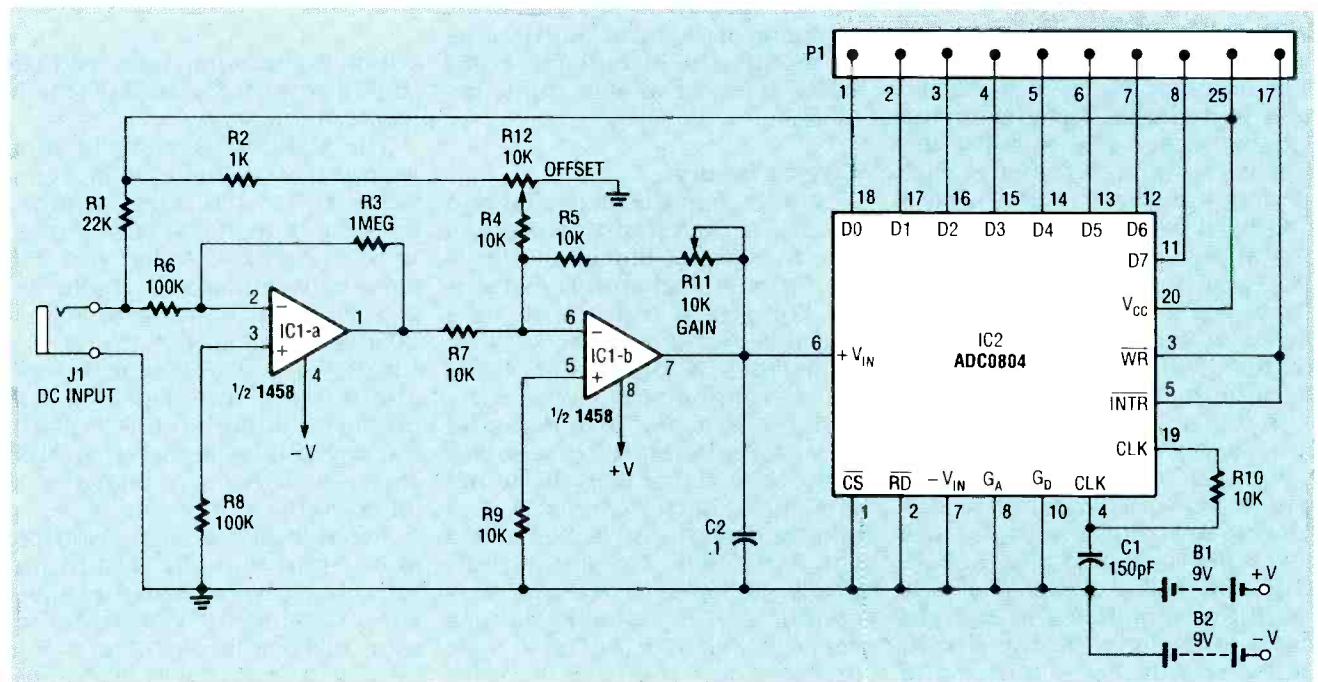

FIG. 2—COMPLETE SCHEMATIC shows the two gain stages (IC1-a, IC1-b) and the A/D converter (IC2).



## PARTS LIST

All resistors are ¼-watt, 5%, unless otherwise noted.

R1—22,000 ohms

R2—1000 ohms

R3—1 megohm

R4, R5, R7, R9, R10—10,000 ohms

R6, R8—100,000 ohms

R11—R13—10,000 ohms, 15-turn potentiometer

### Capacitors

C1—150 pF, ceramic disk (any value between 150–330 pF OK)

C2—0.1 µF, ceramic disk

### Semiconductors

IC1—5558 or 1458 dual op-amp, 8-pin DIP

IC2—ADC0804 or ADC0803 8-bit A/D converter

Q1—2N2222 or PN2222 general purpose transistor

### Other components

B1, B2—9-volt battery

J1—miniature (½-inch) phono jack

P1—DB-25 male connector

**Miscellaneous:** 24-gauge stranded wire, perforated construction board, 9-volt battery clips, housing for probe, shielded cable.

**Note:** The complete PC IO Board (with PC board, and all components) is available for \$39.95 (part #PCIO). The ADC0804 and a calibrated PN2222A temperature sensor transistor are available for \$8.00 (part #ADC). Software, including compiled and source code versions with continuous and interval sampling and data logging/listing is available for \$8.00 (part #ADC-S). Specify part numbers and send check or Money Order to JJ Barbarello, 817 Tennent Road, Manalapan, NJ 07726. The author will be glad to answer any questions, but they must be accompanied by a self-addressed stamped return envelope.

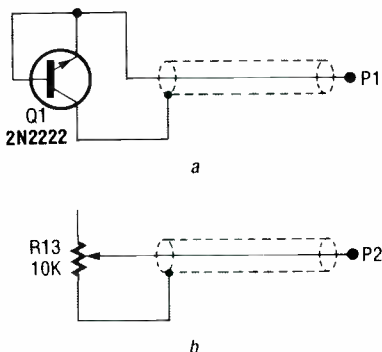

FIG. 3—DRIVE THE ADC with a temperature-sensing transistor (a) or a calibration potentiometer (b).

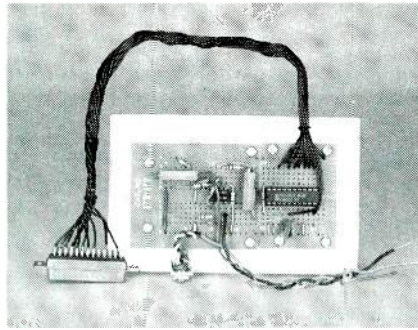

FIG. 4—THE AUTHOR'S PROTOTYPE was built on several pieces of scrap perforated construction board.

Silicon transistors used in this way have a temperature coefficient of about  $-2\text{mV}/^\circ\text{C}$ . That is, at  $0^\circ\text{C}$ , the drop would be about 0.6 volt. As the temperature increases, the drop decreases. At  $100^\circ\text{C}$  the drop will be about 0.4 volt. Although every transistor has a slightly different temperature coefficient, all transistors vary linearly with temperature. So by calibrating for the particular transistor used, it's possible to obtain an accurate yet low-cost temperature sensor.

### Construction

Assembly is not critical; you can build the circuit on perforated construction board as shown in Fig. 4. We recommend using sockets for the IC's.

To connect to the PC IO board, connect eleven one-foot lengths of wire to the appropriate points on IC2, and the other ends to the corresponding pins of P1, a standard DB-25 male connector.

Next, build the temperature probe. Use either a 2N2222A (metal case) or PN2222A (plastic case) and a length of shielded cable. Twist the base and emitter leads together, and solder them to the center conductor of the cable. To avoid shorts, cover the leads near the transistor with heat-shrink tubing. Mount the transistor in a cylindrical case (a hollowed-out ballpoint pen body, for example), making sure the case can withstand the temperature range you will be measuring. Fill the probe with silicone or epoxy. Then attach a miniature phono plug to the free end of the cable, making sure that the center conductor goes to the tip and the shield to the ring.

### The software

The QuickBASIC program that reads the voltage output of the circuit and converts it to a temperature is shown in Listing 1; note that line numbers are included for reference only. (The software is also available on the RE-BBS, 516-293-2283, 1200/2400, 8N1, as a file called PCADMATE.LST.) The program requires several constants to work. Rather than store that information in the QB file, which would require recompiling every time we recalibrate, we store it in a sequential data file, TEMP.DAT, which contains the values we need, each separated by a comma. First comes the decimal I/O port address of the PC I/O card (described in July), followed by the voltage at the low temperature, the low temperature, the voltage at the high temperature, and the high temperature. (Voltages should be specified in volts and temperatures in  $^\circ\text{C}$ .)

For example, if those values were 640, 4.1, 0, 0, and 100, TEST.DAT would contain

640, 4.1, 0, 0, 100

followed by a carriage return and line feed. The file can be created with any word processor; just remember to save it in ASCII or text format, not the word processor's native format.

Lines 2–4 of the program open TEMP.DAT, read the values, close the file, and then set up the 8255 on the PC IO card so that lines 1–16 are inputs, and 17–22 are outputs.

Lines 5–8 format the screen for a pleasing look.

Lines 9–17 are the real meat of the program, the measuring and display loop. Line 10 pulses the  $\overline{\text{WRITE}}$  line low to obtain a reading. Line 11 then retrieves that reading into variable X. The program converts that number into a voltage (V) between 0 and 5.0. Next, line 12 calculates the Centigrade (cent) and Fahrenheit (faren) temperature values. Then lines 13–15 format and display the values. Line 16 pauses before the next sample is taken, and line 17 checks whether the Escape key has been pressed. If so, the program ends; otherwise, execution loops back to line 10.



## Calibration

First create the data file (TEMP.DAT) with nominal values for port address, voltages, and temperatures (640, 4.1, 0, 0, 100); we'll fine-tune those values momentarily. Then run the program to initialize the PC IO card.

Next, connect the ADC circuit to the PC IO card, plug the probe into J1, and place the tip of the probe against a piece of ice. Using a digital voltmeter on a low range, measure the voltage across the tip and ring of the plug. Record the temperature (0°C) and the resultant voltage.

Pour some boiling water in a styrofoam cup, place the probe in the water, and repeat the process, recording both temperature (100°C) and voltage. Use the two voltage values to determine the temperature coefficient of your probe. For instance, if the 0°C reading were 552 mV and the 100°C reading were 342 mV, the temperature coefficient would be  $(0.342 - 0.552)/(100) = -2.1\text{mV}/^\circ\text{C}$ .

Prepare a 10K potentiometer as shown in Fig. 3-b. At this point, the ADC board should be connected to the PC IO, the 9-volt batteries (or other power source) should be connected, and the BASIC program should be running. Connect a DVM across J1, set the calibration potentiometer so the value on the DVM equals the high value taken earlier, and adjust R12 for 0.000 volts, as shown on the PC's screen. Then set the calibration potentiometer so the value on the DVM equals the low value, and adjust R11 for a value (as shown on the screen) between 4.0 and 4.5 volts. The actual value doesn't matter, just the difference between the high and low values.

Check the high reading setting again to make sure it is still 0.0 volts, and recalibrate if necessary. Go back and forth between the two readings several times.

Now enter the correct values into TEMP.DAT. Make sure the file is stored in the same sub-directory as the program.

Now you're ready to use the probe. Just place it against the item to be measured, and hold it there until you get a steady temperature reading.

## LISTING 1

```
REM*****
REM** ADCTEMP.BAS - V910629 *
REM** ADC0804 A/D IC & 2N2222 Temp Probe *
REM*****
1 CLS : DEFINT A, X: DEF SEG = 64
2 OPEN "TEMP.DAT" FOR INPUT AS 1
3 INPUT #1, add, lowvolt, lowval, hivolt, hival
4 CLOSE #1: OUT ADD + 3, 146
REM***** SET UP SCREEN *****
5 LOCATE 1, 23: PRINT "PcTEMP TEMPERATURE MEASURING SYSTEM"
6 LOCATE 2, 1: PRINT STRINGS(79, 220): LOCATE 8, 32: PRINT
STRINGS(16, 220)
7 FOR i = 9 TO 16: LOCATE i, 32: PRINT CHR$(219); SPACES(14);
CHR$(219): NEXT
8 LOCATE 12, 33: PRINT STRINGS(14, 220): LOCATE 16, 33: PRINT
STRINGS(14, 220)
REM***** SAMPLING LOOP *****
9 again:
10 OUT add + 2, 0: OUT add + 2, 1: REM: Take A Sample
11 x = INP(add): v = x * 5 / 255
12 cent=hival - (v * (hival - lowval) / lowvolt):faren = 1.8 *
INT cent / 32
13 LOCATE 4, 33: PRINT USING "Output = ### v"; v
14 LOCATE 10, 37: PRINT USING "###"; cent; : PRINT CHR$(248); "C"
15 LOCATE 14, 37: PRINT USING "###.#"; faren; : PRINT CHR$(248);
"F"
16 FOR i = 1 TO 500: NEXT
17 IF INKEY$ = CHR$(27) THEN END ELSE GOTO again
```

## LISTING 2

```
IF CENT < 10.5 THEN OUT ADD+1, 1
IF CENT > 10.5 THEN OUT ADD+1, 0
```

where  $V_Z$  is the voltage drop at 0°C,  $T$  is the temperature in °C, and  $TC$  is the temperature coefficient.

## LISTING 3

```
4 CLOSE #1: OUT ADD + 3, 146: OFEN "READING.DAT" FOR OUTPUT AS 1
16 FOR i = 1 TO 500: NEXT: OUTPUT #1, V
17 IF INKEY$ = CHR$(27) THEN CLOSE: END ELSE GOTO again
```

## LISTING 4

```
OPEN "READING.DAT" FOR INPUT AS 1
DO WHILE NOT EOF(1)
INPUT #1, V: PRINT V
LOOP
CLOSE: END
```

## Alternate ranging

It is possible to adjust the circuitry and the computer program to any temperature range you desire. Just recalibrate the circuit and adjust the constants in TEMP.DAT. For example, assume you want to measure temperatures between -35°F and +104°F.

First, determine the temperature coefficient as described above. Next, convert the desired temperature range from °F to °C using the formula  $C = 5/9 \times (F - 32)$ . In our example, +104°F is 40°C, and -35°F is -37.2°C. Then calculate the drop at those two temperatures using the following formula.

$$V_D = V_Z + (T \times TC)$$

At 40°C,  $V_D = 600\text{mV} + (40^\circ\text{C} \times -2.1\text{mV}/^\circ\text{C}) = 600\text{mV} - 84\text{mV} = 516\text{mV}$ .

At -37.2°C,  $V_D = 600\text{mV} + (-35^\circ\text{C} \times -2.1\text{mV}/^\circ\text{C}) = 600\text{mV} + 78.17\text{mV} = 678.17\text{mV}$ .

Now plug in the calibration potentiometer (shown in Fig. 3-b), set it to the high-temperature drop (516 mV), and adjust R12 until the output is 0.000. Then set the potentiometer to the low-temperature drop (678 mV), and adjust R11 for a value between four and five volts. Last, insert the temperature values and the high-temperature output voltage into the data file. Now the circuit is fully calibrated for the new temperature range.

## Software modifications

You could use the probe as a low-temperature detector. Connect a sensitive 5-volt relay to pins 9 (+) and 23 (gnd) of P1. If the temperature goes below a

*continued on page 82*

# 1991 ANNUAL INDEX

## *Radio Electronics*® Volume 62

1991 Annual Index Radio-Electronics Volume 62

Abbreviations: (ARE) Ask R-E; (AUD) Audio Update; (C) Construction;  
(CC) Computer Connections; (CD) Computer Digest; (D) Department;  
(DB) Drawing Board; (ER) Equipment Reports; (HH) Hardware Hacker;  
(LTR) Letters; (VN) Video News; (WN) What's News

<p>1991 Retrospective (Holtzman)(CC) <b>Dec 84</b></p> <p>360-Degree Potentiometer (ARE) Nov 12</p> <p>874X Programmer (Eady)(C) <b>Nov 71</b></p>	<p>Past, Present, and Future of Tape Cartridges, The Reader Letters: Some Bouquets and Brickbats Transfer Functions Part II: Answering a Letter of Protest <b>Aug 80</b></p> <p>Automotive Charging Systems (Grossblatt)(DB) <b>Oct 82</b></p>	<p>Turn Your PC Into a Universal Frequency Counter (Grasty &amp; Schulz)(C) <b>Feb 37, Mar 43</b></p> <p>Video Capture on the Cheap! (Toner)(C) <b>Dec 37</b></p>
<b>A</b>	<b>B</b>	<b>C</b>
<p><b>Adobe</b></p> <p>PostScript Cartridge (Holtzman)(CC) <b>Mar 84</b></p> <p>Type Manager (Holtzman)(CC) <b>Feb 78</b></p> <p><b>Alternators as Stepper Motors</b> (Lancaster)(HH) <b>Sep 67, Dec 69</b></p> <p><b>Amateur Radio License</b></p> <p>FCC Approves No-Code (Stone) <b>Apr 27</b></p> <p><b>American Heritage Electronic Dictionary</b>, Houghton Mifflin's (Holtzman)(CC) <b>Jul 77</b></p> <p>Amiga, The Friendly (Holtzman)(CC) <b>Aug 81</b></p> <p>Amplifier Design, Efficiency and (Klein)(AU) <b>Dec 78</b></p> <p>Analog Scopes (O'Neal) <b>Nov 43</b></p> <p>Analog-to-Digital and Digital-to-Analog Converters (Bigelow) <b>Jul 58</b></p> <p>Analyst 2 Data Line Monitor, Data Controls' (ER) <b>Feb 20</b></p> <p>Analyzer, THD (Keidel)(C) <b>Dec 47</b></p> <p>Answering a Letter of Protest: Transfer Functions Part II (Klein)(AUD) <b>Mar 74</b></p> <p>Apple Disk (ARE) <b>Feb 12</b></p> <p>Arisoft's LANtastic Two-Station AE-2 Ethernet Starter Kit (Holtzman)(CC) <b>Mar 84</b></p> <p><b>ASK R-E (D)</b> <b>Feb 12, Mar 12, Apr 12, May 12, (LET) Aug 14, Jun 8 Aug 8, Sep 12, Oct 8 Nov 12, Dec 12</b></p> <p>Association Book Resources (Lancaster)(HH) <b>Jun 65</b></p> <p>Asymetrix Corp.'s ToolBook 1.0 (Holtzman)(CC) <b>Feb 78</b></p> <p>Audible Loblic Probe PC Board for (Grossblatt)(DB) <b>Aug 77</b></p> <p><b>AUDIO (See also AUDIO UPDATE)</b></p> <p>Amplifiers: Do They Sound Different? (Klein)(AUD) <b>Apr 80, (LET) Oct 14</b></p> <p>Binaural Basics (Sunier) <b>Oct 51</b></p> <p>Format Confusion (Fenton) <b>Sep 63</b></p> <p>-Level Meters (Lancaster)(HH) <b>Jan 68</b></p> <p>New World of DSP, The (Bernard) <b>Jun 43</b></p> <p>R. L. Drake R-8 World Band Shortwave Receiver (ER) <b>Sep 18</b></p> <p>Simple FM Transmitter (Melton)(C) <b>Nov 84</b></p> <p>Speaker Protector (Vaught)(C) <b>Aug 55</b></p> <p>Sweep/Marker Generator (Wannamaker)(C) <b>Feb 43, Mar 55</b></p> <p>THD Analyzer (Keidel)(C) <b>Dec 47</b></p> <p>Tune In the World With R-E's EZ Shortwave Receiver (Kreuter)(C) <b>Jan 56</b></p> <p>Vocal Effects/Mixer (Weeder)(C) <b>Oct 39</b></p> <p>Will "Beastie" Speaker Cables Improve Your Audio? (Honeycutt) <b>Feb 50</b></p> <p><b>AUDIO UPDATE (Klein)(D)</b> <b>Jan 80, Mar 74, Apr 80 (LET) Oct 14, May 72, Jun 72 Jul 74, Aug 80, Sep 74 Oct 82, Nov 86, Dec 78</b></p> <p>Audio Amplifiers: Do They Sound Different? <b>Apr 80, (LET) Oct 14</b></p> <p>Boston Sound, The: Part I <b>Jan 80</b></p> <p>Part II <b>Feb 81</b></p> <p>Distortion Primer, A: Part I <b>Jun 72</b></p> <p>Part 2 <b>Jul 74</b></p> <p>Efficiency and Amplifier Design <b>Dec 78</b></p> <p>Future Products <b>Sep 74</b></p> <p>Japan: The Evolution of an Audio Colossus <b>May 72</b></p> <p>OEM, Custom Models, and Private Labels <b>Nov 86</b></p>	<p>Bakerizing and Laminating (Lancaster)(HH) <b>Sep 67</b></p> <p><b>Battery</b></p> <p>Safe Charging (ARE) <b>Jun 8, Oct 14</b></p> <p>Technology (Dewey) <b>Jan 45</b></p> <p>Tool, Build the (Eady)(C) <b>Dec 53</b></p> <p>Binaural Basics (Sunier) <b>Oct 51, (LET) Dec 14</b></p> <p>Blinking Blocks (ARE) <b>Nov 12</b></p> <p><b>Boston Sound, The:</b> Part I (Klein)(AUD) <b>Jan 80</b></p> <p>Part II (Klein)(AUD) <b>Feb 81</b></p> <p>Buckyballs and C60 (Lancaster)(HH) <b>Aug 69</b></p> <p><b>BUILD (See also CONSTRUCTION)</b> the Battery Tool (Eady)(C) <b>Dec 53</b></p> <p>the Microanalyzer (Miga)(C) <b>Sep 47</b></p> <p>a Negative Ion Generator (Caristi)(C) <b>Jan 41, Feb 55</b></p> <p>R-E's Call-Alert (Kreuter &amp; Plant)(C) <b>Oct 60</b></p> <p>Your Own Electrocardiograph (Roberts) <b>Jul 31, Aug 44</b></p> <p>Your Own Macintosh-Compatible Computer (Colby)(C) <b>Jan 31, (LET) May 14 (LET) Apr 13, (LET) Aug 14</b></p> <p>Buyer's Guide to Digital Storage Oscilloscopes (Prentiss) <b>Nov 31</b></p>	<p>1991 Retrospective Evolution of Standards, The Friendly Amiga, The History in the Making Making Connections MS-DOS 5.0 New Beginning for this Column, A New Wave in the Computer Industry, A Some Predictions for PC's to Come During the Next Decade <b>Jan 84, (LET) Apr 13</b></p> <p>Video Standards <b>May 77</b></p> <p>Windows Pains (and Pleasures) (Holtzman)(CC) <b>Feb 78</b></p> <p>Watch <b>Jun 80</b></p> <p><b>CONSTRUCTION 874X Programmer (Eady)</b> <b>Nov 71</b></p> <p>Audio Sweep/Marker Generator (Wannamaker) <b>Feb 43, Mar 55</b></p> <p><b>Build</b> the Battery Tool (Eady) <b>Dec 53</b></p> <p>the Microanalyzer (Miga) <b>Sep 47</b></p> <p>a Negative Ion Generator (Caristi) <b>Jan 41</b></p> <p>R-E's Call-Alert (Kreuter &amp; Plant) <b>Oct 60</b></p> <p>Your Own Electrocardiograph (Roberts) <b>Jul 31, Aug 44</b></p> <p>Your Own Macintosh-Compatible Computer (Colby) <b>Jan 31, (LET) May 14 (LET) Apr 13, (LET) Aug 14</b></p> <p>Color Bar Generator (Gould) <b>Jul 41</b></p> <p>Digital Sinewave Synthesizer (Swift) <b>Oct 43</b></p> <p>Doppler-Ultrasonic Heart Monitor (Jaffe) <b>Nov 49</b></p> <p>DRAM Tester (Hufft) <b>May 33</b></p> <p><b>Electronic</b> Compass (Caristi) <b>Jun 39</b></p> <p>Fuse (Petruszellis) <b>Dec 63</b></p> <p>Energy Consumption Monitor (Brule) <b>Dec 31</b></p> <p>Experimenting With PC-Based Test Equipment (Barbarelo) <b>May 57, Jun 48, Jul 53</b></p> <p>Experiments in Voice Recognition (Cooper) <b>Apr 49</b></p> <p>Line Power From 12 Volts (Cuthbert) <b>Apr 43</b></p> <p>Logic Analyzer (Robidoux &amp; Dmitroca) <b>Jun 31, Jul 47</b></p> <p>Magnetic Field Meter (Metz) <b>Apr 33</b></p> <p>Micro Monitor (Cooke) <b>Oct 67, Nov 67</b></p> <p>Music on Hold (Hausman) <b>Nov 58</b></p> <p>PC-to-TV Converter (Stevens) <b>Oct 33</b></p> <p>Phone Sentry, The (Cooper) <b>Sep 60</b></p> <p>Poor Man's Laser Printer (Renton) <b>Apr 17</b></p> <p>Pulse Mate (Plant) <b>May 41</b></p> <p>RS-232 Terminal/Monitor (Avritch) <b>Aug 50</b></p> <p>Simple FM Transmitter (Melton) <b>Nov 84</b></p> <p>Solid State Tesla Coil (Bylund) <b>Sep 33</b></p> <p>Speaker Protector (Vaught) <b>Aug 55</b></p> <p>Spectrum Analyzer (Doberstein &amp; Cardone) <b>Aug 33, Sep 40</b></p> <p>Stepper-Motor Robot (Eady) <b>Apr 63</b></p> <p>THD Analyzer (Keidel) <b>Dec 47</b></p> <p>Tune In the World With R-E's EZ Shortwave Receiver (Kreuter) <b>Jan 56</b></p> <p>Turn Your PC Into a Universal Frequency Counter (Grasty &amp; Schulz) <b>Feb 37, Mar 43</b></p> <p>Use Your Telephones as a Home Intercom System (Polimene) <b>May 44</b></p> <p><b>Video</b> Capture on the Cheap! (Toner) <b>Dec 37</b></p> <p>Telephone (Colby) <b>Apr 45, Mar 33</b></p> <p>Vocal Effects/Mixer (Weeder) <b>Oct 39</b></p> <p>Voltage Doubler (Hubscher) <b>Aug 61</b></p> <p>Continuous-Pulse Generator (Plant)(C) <b>May 41</b></p> <p>Converters, V/F (Trietley) <b>Jun 54</b></p>

Corel Draw (Holtzman)(CC)	Feb 78	Ferroelectric IC's: Chips That Remember (Byers)	Mar 63	Laser Printer, Poor Man's (Renton)(C)	Apr 17
Current-Transformer Ideas (Lancaster)(HH)	Dec 69	FirstApps, hDC Computer Corp. (Holtzman)(CC)	Feb 78	LED Troubles (ARE)	Sep 12
Curve Fitting Fuzzy Data (Lancaster)(HH)	Oct 72	Flashlight Battery Supplies (Lancaster)(HH)	Oct 72	<b>Let's</b> Add an Audible Indicator to Our Logic Probe (Grossblatt)(DB)	Jun 74
<b>D</b>					
Data Controls' Analyst 2 Data Line Monitor (ER)	Feb 20	<b>Fluke</b> Model 12 Digital Multimeter (ER)	Dec 22	Build an Oscilloscope! (Grossblatt)(DB)	Oct 85
DC-to-AC Inverter Line Power From 12 Volts (Cuthbert)(C)	Apr 43	Model 45 Dual Display Multimeter (ER)	Mar 22	Look at Electronic Tuning Diodes (Lancaster)(HH)	Jun 65
<b>Digital Multimeter</b>		Model 79 DMM (ER)	Jul 20	<b>LETTERS (D)</b> Jan 9, Feb 17, Mar 16 Apr 13, May 14, Jun 74 Jul 8, Aug 14, Sep 16 Oct 14, Nov 16, Dec 14	
<b>Fluke</b> Model 12	Dec 22	Flyback Squeal (ARE)	Apr 12	Line Power From 12 Volts (Cuthbert)(C)	Apr 43
Model 45 Dual Display Multimeter	Mar 22	<b>FM</b> Stereo Standards (Lancaster)(HH)	Dec 69	<b>Logic Analyzer</b> (Robidoux & Dmitroca)(C)	Jun 31, Jul 47
Model 79	Jul 20	Transmitter, Simple (Melton)(C)	Nov 84	The Micro Monitor (Cooke)(C)	Oct 67, Nov 67
Global Specialties PCI-DMM PC-Based Multimeter	Nov 22	Focused X-Ray Breakthrough, and More (Lancaster)(HH)	Aug 69	<b>Logic Probe</b> A Simple, Inexpensive (Grossblatt)(HH)	May 75
<b>Digital</b> Signal Processing		Fractals and Chaos Update (Lancaster)(HH)	Dec 69	Audible PC Board For Our (Grossblatt)(DB)	Aug 77
New World of DSP, The (Bernard)	Jun 43	Frequency Counter, Universal, Turn Your PC into a (Grasty & Schutz)(C)	Feb 37	Let's Add an Audible Indicator to (Grossblatt)(DB)	Jun 74
Sinewave Synthesizer (Swift)(C)	Oct 43	Friendly Amiga, The (Holtzman)(CC)	Aug 81	Long-Playing Recorder, A (ARE)	Mar 12
Storage Oscilloscopes, A Buyer's Guide to (Prentiss)	Nov 31	Frugalvision Image Capture Board Video Capture on the Cheap! (Toner)(C)	Dec 37		
Tachometer (ARE)	Jun 8	Fuel Cells (Hubscher)	Jun 61, (LET) Dec 14		
-to-Analog and Analog-to-Digital Converters (Bigelow)	Jul 58	Future Products (Klein)(AUD)	Sep 74		
Distortion Primer, A: Part I (Klein)(AUD)	Jun 72	<b>G</b>			
Part II (Klein)(AUD)	Jul 74	<b>Global Specialties</b> PCI-DMM PC-Based Multimeter (ER)	Nov 22	Machine-Shop Resources (Lancaster)(HH)	Apr 71
Doppler-Ultrasound Heart Monitor (Jaffe)(C)	Nov 49	Protolab (ER)	Jan 12	Macintosh-Compatible Computer, Build Your Own (Colby)(C)	Jan 31, (LET) May 14 (LET) Apr 13, (LET) Aug 14
DRAM Drawing (Huff)(C)	May 33	<b>H</b>			
<b>DRAWING BOARD (Grossblatt)(D)</b>	Mar 77, Apr 78 Jun 74, Aug 77, Oct 85, Dec 75	<b>Ham Radio</b> Call-Alert, Build R-E's (Kreuter & Plant)(C)	Oct 60	Magnetic Field Meter (Metz)(C)	Apr 33, (LET) Jul 8, (LET) Sep 16
Automotive Charging Systems Every Test Bench Needs a Good Power Supply	Mar 77	HARDWARE HACKER (Lancaster)(D)	Jan 68, Feb 71 Apr 71, May 65, Jun 65 Jul 68, Aug 69, Sep 67 Oct 72, Nov 78, Dec 69	Making Connections (Holtzman)(CC)	Mar 84
Let's Add an Audible Indicator to Our Logic Probe	Jun 74	Cheap Visible Lasers, and More Cold Fusion Update, and More Curve Fitting Fuzzy Data	Feb 71 Jan 68 Oct 72	Micro Monitor (Cooke)(C)	Oct 67, Nov 67
Let's Build an Oscilloscope! PC Board For Our Audible Logic Probe	Oct 85 Aug 77	Driving Inductive Loads, and More Electric Dog Tag Contest, and More Focused X-Ray Breakthrough, and More Let's Look at Electronic Tuning Diodes New Hackable Project Ideas, and More	Feb 71 Jan 68 Sep 67 Nov 78 Aug 69 Jun 65 Apr 71, (LET) Jul 8 Dec 69	Microanalyzer, Build the (Miga)(C)	Sep 47
Simple but Effective Test Equipment	Apr 78	More On	May 65, (LET) Aug 14	Micrograf Designer 2.0 (Holtzman)(CC)	Jul 77
Driving Inductive Loads, and More (Lancaster)(HH)	Sep 67	Standards Resource Information, and More Toner Cartridge Reloading, More On	Jul 8 Dec 69 May 65, (LET) Aug 14	<b>Microsoft</b> MS-DOS 5.0 (Holtzman)(CC)	Sep 75
DSP, The New World of (Bernard)	Jun 43	Understanding Transforms, and More	Jul 14	Windows 3.0 (Holtzman)(CC)	Jan 84, Feb 78
Dual-Digital Potentiometer (Lancaster)(HH)	Feb 71	Heart Monitor, Doppler-Ultrasound (Jaffe)(C)	Nov 49	Windows 3.1 (Holtzman)(CC)	Jun 80
Dual Display Multimeter, Fluke Model 45 (ER)	Mar 22	Hercules Graphics Station Card (Holtzman)(CC)	May 77	Microwave-Oven Tester Build the Microanalyzer (Miga)(C)	Sep 47
<b>E</b>					
E-Field Machines (Lancaster)(HH)	Oct 72	Hewlett Packard 54601A Portable Digital Oscilloscope (ER)	Apr 18	Microwave Resources (Lancaster)(HH)	May 65
Efficiency and Amplifier Design (Klein)(AUD)	Dec 78	High-Energy Resources (Lancaster)(HH)	Oct 72	More On AM Radio (Dec 1990)	(LET) Feb 17
<b>Electric</b> Dog Tag Contest, and More (Lancaster)(HH)	Nov 78	History in the Making (Holtzman)(CC)	Oct 94	MoreFonts, MicroLogic (Holtzman)(CC)	Feb 78
Motor Resources (Lancaster)(HH)	Feb 71	Home Intercom System, Use Your Telephones as a (Polimene)(C)	May 44	Motorcycle Rebuild (ARE)	Aug 8
Electrical Quantities One Volt = ?	Feb 63	Home-Energy Monitoring (Lancaster)(HH)	Dec 69	MS-DOS 5.0 (Holtzman)(CC)	Sep 75
Electrocardiograph, Build Your Own (Roberts)(C)	Jul 31, Aug 44	Hot Troubleshooting Tips (Phelps)	Feb 61	Multilayer Keyboard (ARE)	Jun 8, (LET) Sep 16
Electromagnetic Theory, An Intuitive Look at (Rice)	Aug 65, Sep 57 Oct 53, Nov 64, Dec 60	Houghton Mifflin's American Heritage Dictionary (Holtzman)(CC)	Jul 77	Multimeter, Fieldpiece HS25 "Stick" Style (ER)	Jun 22
<b>Electronic</b> (Caristi)(C)	Jun 39, (LET) Sep 16	HS25 Heavy Duty "Stick" Style Multimeter (ER)	Jun 22	Music on Hold (Hausman)(C)	Nov 58
Compass (Petruzellis)(C)	Dec 63	<b>I</b>			
Tuning Diodes, Let's Look at (Lancaster)(HH)	Jun 65	<b>IBM</b> Compatibility (ARE)	Dec 12	Negative Ion Generator, Build a (Caristi)(C)	Jan 41, Feb 55
Electronics Workbench, Interactive Image Technologies' (Holtzman)(CC)	Jul 77	XGA Adapter (Holtzman)(CC)	Jun 80	New Beginning for this Column, A (Holtzman)(CC)	Jul 77
ELF Gaussmeter Magnetic Field Meter (Metz)(C)	Apr 33	Induction Motor Speed Controls (Lancaster)(HH)	Feb 71	New Hackable Project Ideas, and More (Lancaster)(HH)	Apr 71
Energy Consumption Monitor (Brule)(C)	Dec 31	Infrared People Detectors (Lancaster)(HH)	Apr 71	<b>NEW LIT (D)</b> May 28, Jun 28, Jul 29, Aug 31 Sep 26, Oct 27, Nov 28, Dec 29	
<b>EQUIPMENT REPORTS (D)</b>	Jan 12, Feb 20, Mar 22 Apr 18, Jun 22, Jul 20 Aug 22, Sep 18, Oct 22 Nov 22, Dec 22	"In-Package" Battery Testers (Lancaster)(HH)	Apr 71	<b>NEW PRODUCTS (D)</b> Jan 18, Feb 22, Mar 24 Apr 22, May 22, Jun 24 Jul 22, Aug 24, Sep 22 Oct 24, Nov 24, Dec 24	
Data Controls' Analyst 2 Data Line Monitor	Feb 20	<b>Inside</b> Marketing Information for the Audio Consumer (Klein)(AUD)	Nov 86	New Wave in the Computer Industry, A (Holtzman)(CC)	Nov 92
<b>Fluke</b> Model 12 Digital Multimeter	Dec 22	Switching Power Supplies (Trietley)	Apr 57, May 49	New World of DSP, The (Bernard)	Jun 43
Model 45 Dual Display Multimeter	Mar 22	Intel 8052 (ARE)	Oct 8	No Color Titles (ARE)	Mar 12
Model 79 DMM	Jul 20	Interactive Image Technologies' Electronics Workbench (Holtzman)(CC)	Jul 77	NTSC-To-RGB Converter (Oct 1990)	(LET) Feb 17
Global Specialties PCI-DMM PC-Based Multimeter	Nov 22	Intercom, Home System Use Your Telephones as a (Polimene)(C)	May 44	OEM, Custom Models, and Private Labels (Klein)(AUD)	Nov 86
Protolab	Jan 12	Intuitive Look At Electromagnetic Theory, An (Rice)	Aug 65, Sep 57, Oct 53, Nov 64, Dec 60	One Volt = ? (Nasser)	Feb 63
Hewlett Packard 54601A Portable Digital Oscilloscope	Apr 18	<b>J</b>			
HS25 Heavy Duty "Stick" Style Multimeter	Jun 22	Japan: The Evolution of an Audio Colossus (Klein)(AUD)	May 72	<b>Oscilloscope</b> Hewlett Packard 54601A Portable Digital (ER)	Apr 18
R.L. Drake R-8 World Band Shortwave Receiver	Sep 18	<b>K</b>			
Sharp Model PC-E500 Pocket Computer	Aug 22	Keyboard Tracer (ARE)	May 12	Let's Build an (Grossblatt)(DB)	Oct 85
Units + Conversion Factors Unit Conversion Software	Oct 22	<b>L</b>			
Every Test Bench Needs a Good Power Supply (Grossblatt)(DB)	Mar 77	LANtastic Two-Station AE-2 Ethernet Starter Kit, Artisoft's (Holtzman)(CC)	Mar 84	Analog (O'Neal)	Nov 43
Evolution of Standards, The (Holtzman)(CC)	Apr 85			Putting a New Scope to Work (Ramirez)	Jan 50
Experimenting With PC-Based Test Equipment (Barbarelo)(C)	May 57, Jun 48, Jul 53	<b>P</b>			
Experiments in Voice Recognition (Cooper)(C)	Apr 49	Parametric Amplification (Lancaster)(HH)	Jun 65	Past, Present, and Future of Tape Cartridges, The (Klein)(AUD)	Aug 80
<b>F</b>					
<b>FCC</b> Approves No-Code (Stone)	Apr 27	Patent Alternatives (Lancaster)(HH)	Jan 68	PC Board For Our Audible Logic Probe (Grossblatt)(DB)	Aug 77
Regulations (Lancaster)(HH)	Oct 72	<b>O</b>			
		PC-Based Multimeter, Global Specialties' PCI-DMM (ER)	Nov 22	Personal Communications Networks (Newell)	May 61
		Test Equipment, Experimenting With (Barbarelo)(C)	May 57, Jun 48, Jul 53	Photovoltaic Panel Bargains (Lancaster)(HH)	Nov 78
		PC-to-TV Converter (Stevens)(C)	Oct 33		



**Phone (See also TELEPHONE)**  
 Caller ID (Lancaster)(HH) **Sep 67**  
 Sentry, The (Cooper)(C) **Sep 60**

Pizazz Plus,  
 Application Techniques (Holtzman)(CC) **Feb 78**

Pocket Computer, Sharp Model PC-E500 (ER) **Aug 22**

Poor Man's Laser  
 Printer (Renton)(C) **Apr 17,(LET)Jun 74,Jul 8**

**Power**  
 Electronic Resources (Lancaster)(HH) **Jul 68**  
 Inverter, DC-to-AC  
 Line Power From 12 Volts (Cuthbert)(C) **Apr 43**  
 Supply, Every Test Bench  
 Needs a Good (Grossblatt)(DB) **Mar 77**

Preventing Modern Dropouts (Lancaster)(HH) **Jun 65**

Print-Screen Indicator (ARE) **May 12, Sep 12,(LET)Dec 14**

Programmable Logic Resources (Lancaster)(HH) **Sep 67**

Programmer, 874X (Eady)(C) **Nov 71**

Protolab, Global Specialties' (ER) **Jan 12**

Pulse Mate (Plant)(C) **May 41**

Putting a New Scope to Work (Ramirez) **Jan 50**

## R

**RADIO**  
 Call-Alert, Build R-E's (Kreuter & Plant)(C) **Oct 60**

R.L. Drake R-8 World Band  
 Shortwave Receiver (ER) **Sep 18**

R-E's EZ Shortwave Receiver,  
 Tune in the World With (Kreuter)(C) **Jan 56**

R.L. Drake R-8 World Band Shortwave Receiver (ER) **Sep 18**

Reader Letters: Some  
 Bouquets and Brickbats (Klein)(AUD) **Oct 82**

Robot, Stepper-Motor (Eady)(C) **Apr 63**

RS-232 Terminal/Monitor (Avritch)(C) **Aug 50**

## S

Safe Charging (ARE) **Jun 8, Oct 14**

Santa Claus Machines (Lancaster)(HH) **May 65**

Scope, Putting a New One to Work (Ramirez) **Jan 50**

Semiconductor Memories (Bigelow) **Mar 68**

Serial-Bus Analyzer  
 RS-232 Terminal/Monitor (Avritch)(C) **Aug 50**

**Servicing**  
 Hot Troubleshooting Tips (Phelps) **Feb 61**  
 Putting a New Scope to Work (Ramirez) **Jan 50**

Sharp Model PC-E500 Pocket Computer (ER) **Aug 22**

**Shortwave Receiver**  
 R-E's EZ, Tune In the World With (Kreuter)(C) **Jan 56**  
 R.L. Drake R-8 World Band (ER) **Sep 18**

**Simple**  
 but Effective Test Equipment (Grossblatt)(DB) **Apr 78**  
 FM Transmitter (Melton)(C) **Nov 84**  
 Inexpensive Logic Probe, A (Grossblatt)(HH) **May 75**

**Sinewave**  
 Generator (ARE) **Oct 8**  
 Synthesizer, Digital (Swift)(C) **Oct 43**

Single-Channel Filter (ARE) **Aug 8**

Slower Recording (ARE) **Oct 8**

SMPTE Time Code Standards (Lancaster)(HH) **Nov 78**

**SOFTWARE**  
 874X Programmer (Eady)(C) **Nov 71**

Adobe  
 PostScript Cartridge (Holtzman)(CC) **Mar 84**  
 Type Manager (Holtzman)(CC) **Feb 78**

American Heritage Electronic Dictionary,  
 Houghton Mifflin's (Holtzman)(CC) **Jul 77**

CrossTalk for Windows, DCA (Holtzman)(CC) **Feb 78**

Corel Draw (Holtzman)(CC) **Feb 78**

Electronics Workbench,  
 Interactive Image Technologies' (Holtzman)(CC) **Jul 77**

FirstApps, hDC Computer Corp. (Holtzman)(CC) **Feb 78**

Micrografix Designer 2.0 (Holtzman)(CC) **Jul 77**

Microsoft  
 MS-DOS 5.0 (Holtzman)(CC) **Sep 75**  
 Windows 3.0 (Holtzman)(CC) **Jan 84, Feb 78**  
 Windows 3.1 (Holtzman)(CC) **Jun 80**

MoreFonts, MicroLogic (Holtzman)(CC) **Feb 78**

Pizazz Plus,  
 Application Techniques (Holtzman)(CC) **Feb 78**  
 Software Solution (ARE) **Sep 12**

ToolBook 1.0, Asymetrix Corp.'s (Holtzman)(CC) **Feb 78**

Ventura Publisher  
 Windows Edition (Holtzman)(CC) **Feb 78**

**Windows, Microsoft**  
 Pains (and Pleasures) (Holtzman)(CC) **Feb 78**  
 3.0, Microsoft (Holtzman)(CC) **Jan 84, Feb 78**  
 3.1 (Holtzman)(CC) **Jun 80**  
 Watch (Holtzman)(CC) **Jun 80**

Units + Conversion Factors  
 Unit Conversion Software (ER) **Oct 22**

Solar Energy Breakthrough (Lancaster)(HH) **Nov 78**

Solid State Tesla Coil (Bylund)(C) **Sep 33**

Some Predictions for PC's to Come  
 During the Next Decade (Holtzman)(CC) **Jan 84**

Speaker Cables,  
 Will "Beastie" Improve Your Audio? (Honeycutt) **Feb 50**

Speaker Protector (Vaught)(C) **Aug 55,(LET)Dec 14**

Spectrum Analyzer  
 (Doberstein & Cardone)(C) **Aug 33, Sep 40**

**Standards**  
 Resource Information,  
 and More (Lancaster)(HH) **Dec 69**  
 The Evolution of (Holtzman)(CC) **Apr 85**  
 Video (Holtzman)(CC) **May 77**

Stepper-Motor Robot (Eady)(C) **Apr 63**

Switching Power Supplies, Inside (Trietley) **May 49, Apr 57**

## T

Tape Cartridges, The Past,  
 Present, and Future of (Klein)(AUD) **Aug 80**

Technical Literature (Lancaster)(HH) **Jan 68, Feb 71**  
**Apr 71, Aug 69, Oct 71**

Telecommunications  
 Personal Communications Networks (Newell) **May 61**

**TELEPHONE**  
 Build R-E's Call-Alert (Kreuter & Plant)(C) **Oct 60**  
 Caller ID (Lancaster)(HH) **Aug 69**  
 Music on Hold (Hausman)(C) **Nov 58**  
 Phone Sentry, The (Cooper)(C) **Sep 60**  
 Telephone Information (Lancaster)(HH) **Aug 69**  
 Use Your Telephones as a  
 Home Intercom System (Polimene)(C) **May 44**  
 Video Telephone (Colby)(C) **Mar 33, Apr 45**

Terminal/Monitor, RS-232 (Avritch)(C) **Aug 50**

**Tesla**  
 Coil, Solid State (Bylund)(C) **Sep 33**  
 Coils (Lancaster)(HH) **Oct 72**

**TEST EQUIPMENT**  
 Analog Scopes (O'Neal) **Nov 43**  
 Audio Sweep/Marker  
 Generator (Wannamaker)(C) **Feb 43, Mar 55**  
 Build the Microanalyzer (Miga)(C) **Sep 47**  
 Color Bar Generator (Gould)(C) **Jul 41**  
 Data Controls' Analyst 2  
 Data Line Monitor (ER) **Feb 20**  
 Digital Sinewave Synthesizer (Swift)(C) **Oct 43**  
 Digital Storage Oscilloscopes,  
 A Buyer's Guide to (Prentiss) **Nov 31**  
 DRAM Tester (Huff)(C) **May 33**  
 Electronic Fuse (Petruszellis)(C) **Dec 63**  
 Experimenting With PC-Based  
 Test Equipment (Barbarelo)(C) **May 57, Jun 48, Jul 53**

Fluke  
 Model 12 Digital Multimeter (ER) **Dec 22**  
 Model 45 Dual Display Multimeter (ER) **Mar 22**  
 Model 79 DMM (ER) **Jul 20**

Global Specialties  
 PCI-DMM PC-Based Multimeter (ER) **Nov 22**  
 Protolab (ER) **Jan 12**

Hewlett Packard 54601A  
 Portable Digital Oscilloscope (ER) **Apr 18**  
 Hot Troubleshooting Tips (Phelps) **Feb 61**  
 Let's Build an Oscilloscope! (Grossblatt)(DB) **Oct 85**  
 Logic Analyzer (Roubidoux & Dmitroca)(C) **Jun 31, Jul 47**  
 Micro Monitor (Cooke)(C) **Oct 67, Nov 67**  
 Pulse Mate (Plant)(C) **May 41**  
 Putting a New Scope to Work (Ramirez) **Jan 50**

Simple but Effective  
 Test Equipment (Grossblatt)(DB) **Apr 78**

Spectrum Analyzer  
 (Doberstein & Cardone)(C) **Aug 33, Sep 40**  
 THD Analyzer (Keidel)(C) **Dec 47**

Turn Your PC Into a Universal Frequency  
 Counter (Grasty & Schulz)(C) **Feb 37, Mar 43**

THD Analyzer (Keidel)(C) **Dec 47**

Toner Cartridge Reloading,  
 More On (Lancaster)(HH) **May 65**

ToolBook 1.0, Asymetrix Corp.'s (Holtzman)(CC) **Feb 78**

Total Harmonic Distortion (ARE) **Dec 12**

Transfer Functions Part II:  
 Answering a Letter of Protest (Klein)(AUD) **Mar 74**

Transmitter, Simple FM (Melton)(C) **Nov 84**

Troubleshooting Tips, Hot (Phelps) **Feb 61**

Tune In the World With R-E's EZ  
 Shortwave Receiver (Kreuter)(C) **Jan 56,(LET)Oct 14**

Turn Your PC Into a Universal  
 Frequency Counter (Grasty & Schulz)(C) **Feb 37, Mar 43**

## U

**Understanding**  
 Decibels (Lancaster)(HH) **Jan 68**  
 Transforms, and More (Lancaster)(HH) **Jul 68**

Units + Conversion Factors  
 Unit Conversion Software (ER) **Oct 22**

Universal Frequency Counter,  
 Turn Your PC Into a (Grasty & Schulz)(C) **Feb 37, Mar 43**

Unusual Newsletters (Lancaster)(HH) **Jun 65**

Use Your Telephones as a Home  
 Intercom System (Polimene)(C) **May 44,(LET)Nov 16**

## V

V/F Converters (Trietley) **Jun 54**

Ventura Publisher  
 Windows Edition (Holtzman)(CC) **Feb 78**

VHF Resources (Lancaster)(HH) **May 65**

**VIDEO (See also VIDEO NEWS)**  
 Color Bar Generator (Gould)(C) **Jul 41**  
 PC-to-TV Converter (Stevens)(C) **Oct 33**  
 Capture on the Cheap! (Toner)(C) **Dec 37**  
 Compression Secrets (Lancaster)(HH) **Jul 68**  
 Crosshatch Generator (Lancaster)(HH) **Jul 68**  
 Standards (Holtzman)(CC) **May 77**  
 Sync (ARE) **Feb 12**  
 Telephone (Colby)(C) **Mar 33, Apr 45**  
 Time Codes (Lancaster)(HH) **Dec 69**

**VIDEO NEWS (Lachenbruch)(D)** **Jan 8, Feb 6, Mar 6**  
**Apr 6, May 6, Jun 6**  
**Jul 6, Aug 6, Sep 6**  
**Oct 6, Nov 6, Dec 6**

Vocal Effects/Mixer (Weeder)(C) **Oct 39**

Voice Recognition,  
 Experiments in (Cooper)(C) **Apr 49**

**Voltage**  
 Doubler (Hubscher)(C) **Aug 61**  
 -to-Frequency Converters (Trietley) **Jun 54**

## W

**WHAT'S NEWS (D)** **Jan 4, Feb 4, Mar 4**  
**Apr 4, May 4, Jun 4**  
**Jul 4, Aug 4, Sep 4**  
**Oct 4, Nov 5, Dec 4**

Wavelet Breakthroughs (Lancaster)(HH) **Jul 68**

Wholesale Surplus Sources (Lancaster)(HH) **Jan 68**

Wig-Wag Circuit? (ARE) **Nov 12**

Will "Beastie" Speaker Cables  
 Improve Your Audio? (Honeycutt) **Feb 50**

Wind-Speed Read (ARE) **Apr 12 (ARE)** **Apr 12**

**Windows**  
 Pains (and Pleasures) (Holtzman)(CC) **Feb 78**  
 3.0, Microsoft (Holtzman)(CC) **Jan 84, Feb 78**  
 3.1 (Holtzman)(CC) **Jun 80**  
 Watch (Holtzman)(CC) **Jun 80**



He's listening to a radio station in China.



It's a microphone.



64K! And you call yourself a man...

## SPEAKER MATE

continued from page 46

sure to wipe off the tip of your iron on a wet sponge immediately after melting the plastic. Transformer T1 should be mounted with its marker, if any, toward the input jack side.

The last step is installing all jumpers (J) and JU1; the JU1 jumper is installed for phone-line powered applications, and left out for use with an external power source. So install JU1 for now, and we'll go into greater detail on it later. If a jumper runs close to existing circuitry, you might place some shrink tubing on the bare lead. The kit mentioned in the parts list includes some shrink tubing.

There are some options for the front-panel configuration. In the prototype, SPST toggle switch S1 is used as the ANSWER switch and is mounted next to LED1, the "power on" indicator. Cut the leads long enough to reach the front panel without too much excess. Volume control R20 has its attached switch, S2, wired in series with the microphone element to provide a "mute" function. The mute setup works well because the low-impedance microphone circuit doesn't pick up interference when open. If the mute function is not needed, R20's switch can become the ANSWER switch and you can eliminate toggle switch S1. However, the complete kit does include the toggle switch.

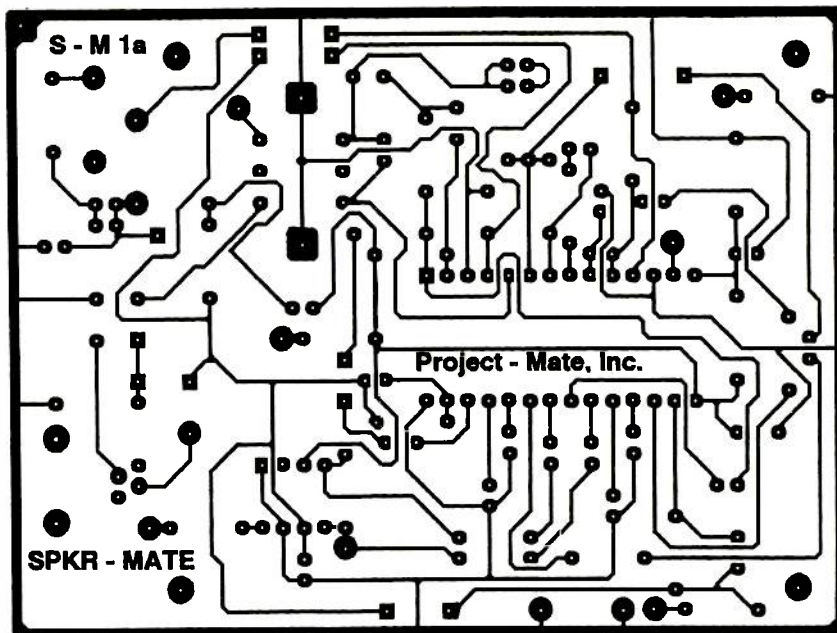

FOIL PATTERN for the Speaker-Mate.

In preparing the circuit board for the cabinet, leave the speaker leads long enough to attach the speaker on the top half of cabinet. We have found that a spare piece of perforated construction board makes an excellent drilling guide for making a neat speaker grille on top of the cabinet. Cutting out a notch on the cabinet rear for the modular telephone jack (J1) and drilling a 1/2-inch hole for access to the microphone gain potentiometer completes the cabinet back.

Completion of the front panel is next. Figure 5 shows how we mounted the microphone. A 3/8-inch inside-diameter rubber grommet was glued to the inside of the front panel behind the 3/8-inch microphone opening. You can use either hot-melt glue or

RTV silicone. Insert the microphone element (with leads attached) into the grommet so that it sits back just enough to not touch the front panel, but no more; a recessed element will give an echo sound we want to avoid. This step acoustically and mechanically decouples the microphone from the speaker output, yet gives some directional effect. It will be glued in such a position in the grommet in just a minute. Note that an electret microphone is polarity-sensitive; the pin that connects to the case of the microphone is ground.

Finish up by wiring R20 and its switch S2, LED1, and S1. We found that prewiring these components first makes assembly easier. The final step is to fit the panel into the enclosure and glue LED1, the microphone, and the speaker in place with RTV silicon, making sure that the electret element is positioned as mentioned before. Set the microphone gain potentiometer, R15, to about half way. Figure 6 shows the completed Speaker-Mate prototype.

### Testing and use

For acoustical reasons, the proven approach to testing the unit is with the board mounted in a closed case. At an extreme setting of microphone gain, the microphone may pick up the speaker output. This extreme

continued on page 83

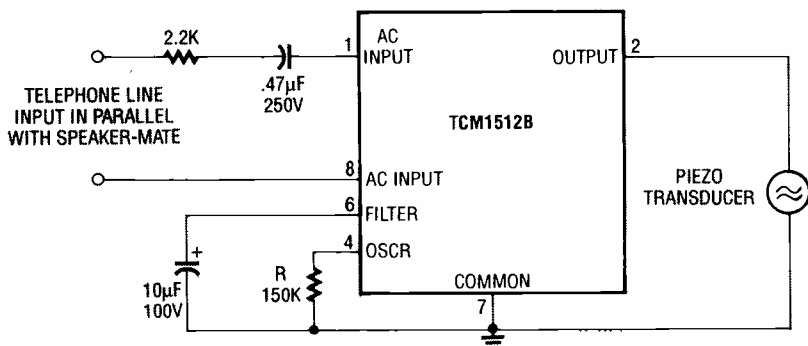

FIG. 8—YOU MAY WANT TO ADD a ringer to the Speaker-Mate. The tone ringer chip (IC3) monitors the telephone line for a ring signal of 15 to 68 Hz, 40 to 150 volts AC. Resistor R sets the warble and center frequency; with R at 150K, the warble is approximately 10 Hz and the center frequency is 1250 Hz.



# HARDWARE HACKER

VGA adapter for the Mac LC, computer monitors, flyback, shielding, and GPS navigation resources.

DON LANCASTER

It seems I did miss an obvious source in our recent *Tesla and High Energy Resources* sidebar. This is the *Tesla Society* up in Colorado, who runs a great museum and now offers annual Tesla and nontraditional energy conferences. Their *High Energy Enterprises* division has lots of books and videotapes.

These range the gamut from hard-to-find and genuinely useful research materials on down (way on down) through bunches of "Boy-a-whole-flock-of-them-flew-over-that-time!" pseudoscience titles.

On the other hand, if you are into antigravity, the 1000 miles per gallon carburetors, Russian weather control conspiracies, *Reed* motors, all those pangalactic happy faces on Mars, or zero point scalar energy, these books and videos are definitely for you. This is *most* fascinating reading and watching, either way.

Actually, I'll freely admit that I firmly now believe in one trilateral conspiracy. That's the one involving the first, second, and third laws of thermodynamics. But that's just me. And if you want to prove me wrong, just show to me any simple and independently verifiable experiment that anyone can reliably duplicate.

Some more info on wavelets: The *Wavelets* book offered by *Jones and Bartlett* is at long last in print. And a major new tutorial just came out in the October 1991 IEEE-SP *Signal Processing* magazine on pages 14-38.

## Shields and shielding

These have been popular topics lately on our helpline, so perhaps it is time to go over some fundamentals. You can *shield* something electronic either to keep objectionable signals from getting out or getting in. For instance, on any light dimmer, you might want to suppress the horrible AM radio interference caused by a triac suddenly turning on. On a low-

level audio circuit, you might want to prevent power-line hum and noise from getting to you.

If you do know ahead of time that you're going to have interfering noise or signals present, one very powerful technique is to change over to fully *balanced* circuits. They sense only the *differences* between their inputs, rather than any absolute values with respect to ground. Thus, any *common mode* interfering signals that bounce both inputs up and down together will automatically be rejected. Or at least suppressed. Several fancy audio studios have even gone to totally balanced power lines to dramatically reduce their hum and noise problems.

There are usually two paths that interference can travel. One is with *radiated* energy, which can propagate directly through space to emit from or interact with your circuit. The other is *conducted* energy, which enters along your power connectors and input or output cables.

Since separate tricks are needed to deal with any radiated or conducted energy, step one is finding out *which* path is the one you will want to deal with first.

The radiated energy interference will usually have two components. They are that "E" or *electric* field, which largely concerns itself with induced *voltages* and that "H" or *magnetic* field, which creates induced *currents*. Once again, you have to

know *which* field component you are going to suppress before you pick a proper method.

Any old conductor should usually block an E field. One obvious hacker choice that works well are boxes built up out of double-sided printed-circuit board. See Fig. 1.

But there are gotchas. At lower frequencies, there is the lack of a well-developed *skin effect*, which causes an E field to penetrate *deeper* into a conductor. Thus, *thicker* shields are needed to suppress *lower* frequencies. Say 20 mils for an AM broadcast band use or 80 mils for the high ultrasonic frequencies.

A shield can also act as a shorted turn to any nearby inductor, possibly lowering the Q and detuning. A slot or other continuity break can sometimes help this problem.

While some small shield holes are often tolerable, any poor contacts are definitely not. A continuous solder bead or else lots and lots of individual screws may be needed for really high shielding effectiveness.

It's very important that unintended currents don't ever run through any shields. Unwanted signal drops can often end up in *series* with your input signals, making things much worse rather than better. Which is also why you should keep all your digital and analog grounds separate.

The H fields can be blocked by use of any strongly magnetic materials. These materials are said to have a very high *permeability*. The simplest magnetic shield is a piece of scrap sheet steel from the air conditioning shop or trailer hitch works. But things get messy in a hurry if you need lots of magnetic attenuation.

Those special and fancy shielding materials are optimum only in certain thicknesses and over a specific frequency range. Worse yet, some of these cannot be cut or drilled without a complex reannealing process. And

## NEED HELP?

Phone or write your **Hardware Hacker** questions directly to:  
Don Lancaster  
**Synergetics**  
Box 809  
Thatcher, AZ 85552  
(602) 428-4073



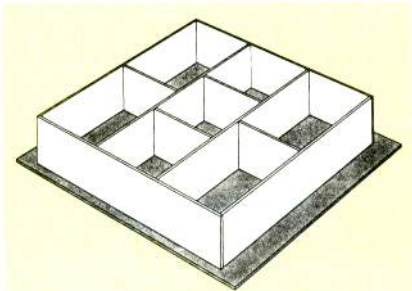

FIG. 1—SIMPLE E-FIELD SHIELDS for radio-frequency hacker projects are easily built up from pieces of double-sided printed circuit board stock.

too strong of a magnetic field could saturate a shield, making it useless.

To be effective, a magnetic shield should completely surround the volume it is protecting.

A good free booklet on all of the fundamentals of magnetic shielding is available from *Amuneal*, while other sources of custom shield materials now include *Advance Magnetics* and *Magnetic Shield Corp.*

Conducted interference can be best eliminated by some blocking filter. These filters should freely pass

## GPS RESOURCES

### Ashtech

390 Potrero Avenue  
Sunnyvale, CA 94086  
(800) 229-2400  
CIRCLE 301 ON FREE INFORMATION CARD

### Bancomm

6541 Via del Oro  
San Jose, CA 95119  
(408) 578-4161  
CIRCLE 302 ON FREE INFORMATION CARD

### GPS World

P.O. Box 10460  
Eugene, OR 97440  
(503) 343-1200  
CIRCLE 303 ON FREE INFORMATION CARD

### Magellan Systems Corp.

960 Overland Court  
San Dimas, CA 91773  
(818) 358-2363  
CIRCLE 304 ON FREE INFORMATION CARD

### Magnavox

2829 Maricopa Street  
Torrance, CA 90503  
(800) 421-5864  
CIRCLE 305 ON FREE INFORMATION CARD

### NASA Tech Briefs

41 East 42nd Street Ste. 921  
New York, NY 10017  
(212) 490-3999  
CIRCLE 306 ON FREE INFORMATION CARD

### Rockwell Commercial GPS

P.O. Box 568842  
Dallas, TX 75356  
(214) 996-5863  
CIRCLE 307 ON FREE INFORMATION CARD

### Speleonics

P.O. Box 5283  
Bloomington, IN 47407  
(812) 339-7305  
CIRCLE 308 ON FREE INFORMATION CARD

### Ti/GPS Products

P.O. Box 869305, M/S 8449  
Plano, TX 75086  
(214) 575-4057  
CIRCLE 309 ON FREE INFORMATION CARD

### Trimble Navigation

585 North Mary Avenue  
Sunnyvale, CA 94086  
(800) TRI-MBLE  
CIRCLE 310 ON FREE INFORMATION CARD

the signals of interest, but present a high series impedance and a low shunt impedance to all others. *Murata-Erie* is one good source.

The ferrite bead is a remarkably cheap and super effective inter-

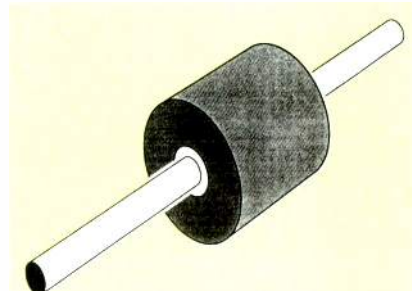

FIG. 2—FERRITE BEAD interference suppressors are simply slipped onto any conductor. The ferrite beads behave as lossy and broadband high-frequency transformers. Multiple turns can also be used.

ference suppressor. As Fig. 2 shows us, you simply hang them on a wire or else run a turn or two through them. Ferrite beads act as a broadband high-frequency lossy transformer. There are various materials and sizes, again depending on frequency. Sources of ferrite beads include *Fair-Rite*, *FerriShield*, *Ferroxcube*, *Intermark*, and *Siemens*.

One very little known ferrite bead gotcha: Do not ever cast a ferrite bead in epoxy or otherwise constrain it so it cannot move. The beads must be able to physically change their size slightly, or else the performance will sharply degrade.

Two trade journals that involve themselves with shields and shielding are *Electronics Test* and *Compliance Engineering*.

## Monitor fundamentals

We sure do get a lot of computer-monitor and TV compatibility calls. Let's start off with the obvious: The performance and bandwidth of an ordinary TV or VCR using composite NTSC video is severely limited. That is why all the computer folks went to special RGB monitors in the first place. And that is why nearly all the computers are totally incompatible with ordinary television gear.

Yes, there now are all sorts of ways you can use your computer for real video editing or to record computer screens on a VCR. But note that there is no way I know of that you can record plain old 80-column text as composite video on your VCR. Or display it on any unmodified TV set.

How does a monitor work? Inside is a cathode ray "picture tube" with one or more guns that squirt lots of electrons at a phosphor screen. At

## NEW FROM DON LANCASTER

### HARDWARE HACKER STUFF

Hardware Hacker Reprints II or III	24.50
Midnight Engineering Reprints	16.50
Incredible Secret Money Machine	16.50
CMOS Cookbook	24.50
TTL Cookbook	24.50
Active Filter Cookbook	19.50
Micro Cookbook vol I or II	19.50
Lancaster Classics Library	109.50
AppleWriter Cookbook	19.50

### POSTSCRIPT STUFF

Ask The Guru Reprints I, II or III	24.50
LaserWriter Secrets (Ile/Mac/PC)	29.50
PostScript Show & Tell	39.50
Intro to PostScript VHS Video	39.50
PostScript Beginner Stuff	39.50
PostScript Cookbook (Adobe)	16.50
PostScript Ref. Manual II (Adobe)	28.50
PostScript Program Design (Adobe)	22.50
Type I Font Format (Adobe)	15.50
LaserWriter Reference (Apple)	19.50
Real World Postscript (Roth)	22.50
PostScript Visual Approach (Smith)	22.50
Thinking in PostScript (Reid)	22.50
Undst PS Pgrmmg (Holtzgang)	26.50
The Whole Works (all PostScript)	299.50

### BOOK-ON-DEMAND STUFF

Book-on-demand resource kit	39.50
Bakerizing film package	16.50

FREE VOICE HELPLINE

VISA/MC

## SYNERGETICS

Box 809-RE  
Thatcher, AZ 85552  
(602) 428-4073

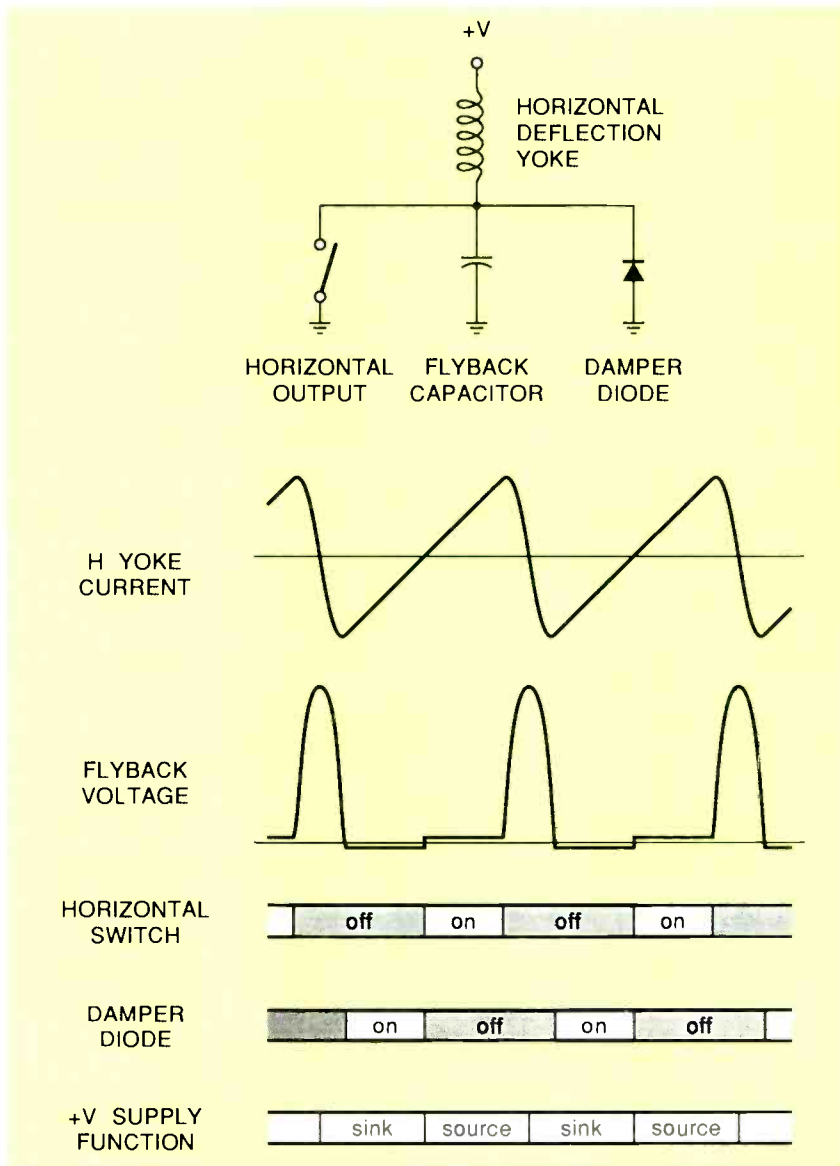

FIG. 3—THE RECURRENT FLYBACK SWEEP on television sets and computer monitor displays is extremely energy efficient, but will only work over a VERY limited range of horizontal scan rates.

any instant, *only one single dot* appears on the screen. That dot gets moved around by the scanning process, and will get brightened and dimmed by rapidly setting its intensity at a video modulation rate.

To build up the *illusion* of a full picture, that scanned dot is moved rapidly and *horizontally* from left to right and more slowly *vertically* from the top to bottom. The decay characteristics of the phosphors selected and your human persistence of vision combine to create the *illusion* of a total picture.

Television uses what is known as an *interlaced* scan. To build up a TV frame, the dot starts at the upper left

and rapidly scans to the right and slowly on downward, painting every *second* scan line. When it gets to the bottom of this *field*, it goes back to the top and picks up what it missed, painting a second field. The normal field rate is usually 60 hertz for black and white or 59.94 hertz for color.

The NTSC (National Television Standards Committee) standard uses 512 lines per frame, or 262.5 lines per field. That leads to standard horizontal scan rates of 15750 Hertz for black and white or 15735 Hertz for color. The two numbers end up slightly different to get all the rest of those color magic numbers to properly drop in place.

## DIGITAL VIDEO STABILIZER

ELIMINATES ALL VIDEO COPYGUARDS

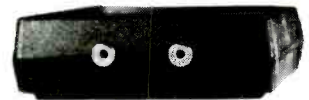

While watching rental movies, you will notice annoying periodic color darkening, color shift, flashing or jagged edges. This is caused by the copy protection jamming signals embedded in the video tape, such as Macrovision copy protection. THE DIGITAL VIDEO STABILIZER: RXII COMPLETELY ELIMINATES ALL COPY PROTECTIONS AND JAMMING SIGNALS AND BRINGS YOU CRYSTAL CLEAR PICTURES.

### WARNING

THE DIGITAL VIDEO STABILIZER IS INTENDED FOR PRIVATE HOME USE ONLY. IT IS NOT INTENDED TO COPY RENTAL MOVIES OR COPYRIGHTED VIDEO TAPES THAT MAY CONSTITUTE COPYRIGHT INFRINGEMENT.

### FEATURES

- Easy to use and a snap to install
- State-of-the-art Microchip technology
- 100% automatic
- Compatible to all types of VCRs and TVs
- The best and most exciting Video Stabilizer in the market
- Light weight (8 ounces) and compact (1x3.5x5")
- Uses a standard 9 Volt battery (last 1-2 years)
- Fast UPS delivery
- Air shipping available
- UNCONDITIONAL 30 day money back guarantee
- 1 year warranty

(Dealers Welcome)  
**FREE 20P Catalog**

To Order: \$59.95 ea + \$4 for p & h  
Visa, M/C, COD Mon-Fri: 9-6 EST

**1-800-445-9285 ext. 63801**  
SCO Electronics Inc. Dept. 63801  
581 W. MERRICK RD. VALLEY STREAM, NY 11580

CIRCLE 191 ON FREE INFORMATION CARD

## CABLE TV DESCRAMBLERS

How You Can Save Money on Cable Rental Fees

### Bullet Proof

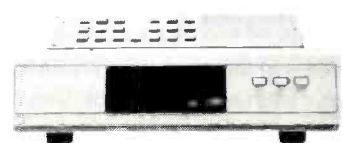

1 Unit 5+

BEST Super Tri-Bi Auto/ Var. Gain Adjustment \$119.95...\$85  
Jerold Super Tri-Bi... \$109.95...\$79  
Scientific Atlanta... \$109...\$79  
Pioneer... \$109...\$79  
Panasonic TZPC145... \$99.95...\$79  
Stargate Converter... \$95...\$69  
Digital Video Stabilizer: \$59.95...\$29  
Wireless Video Sender: \$59.95...\$49.95

**US Cable'll Beat  
Anyone's Price  
advertised in  
this Magazine!**

**30 Day Money Back Guarantee**  
**FREE 20 page Catalog**

Visa, M/C, COD or send money order to:

**U.S. Cable TV Inc.** Dept. 53801  
4100 N. Powerline Rd., Bldg. F-4  
Pompano Beach, FL 33073

**1-800-772-6244 ext. 53801**

**For Our Record**

I, the undersigned, do hereby declare under penalty of perjury that all products purchased, now and in the future, will only be used on Cable TV systems with proper authorization from local officials or cable company officials in accordance with all applicable federal and state laws. FEDERAL AND VARIOUS STATE LAWS PROVIDE FOR SUBSTANTIAL CRIMINAL AND CIVIL PENALTIES FOR UNAUTHORIZED USE.

Date: \_\_\_\_\_

Signed: \_\_\_\_\_

**No Florida Sales!**

CIRCLE 192 ON FREE INFORMATION CARD

## NAMES AND NUMBERS

### Actel

955 East Arques Avenue  
Sunnyvale, CA 94086  
(408) 739-1010  
CIRCLE 311 ON FREE INFORMATION CARD

### AD-Vance Magnetics

625 Monroe Street  
Rochester, IN 46975  
(219) 223-3158  
CIRCLE 312 ON FREE INFORMATION CARD

### American Colloid Co

1500 West Shore Drive  
Arlington Heights, IL 60004  
(708) 392-4600  
CIRCLE 313 ON FREE INFORMATION CARD

### Amuneal

4737 Darrah Street  
Philadelphia, PA 19124  
(215) 535-3000  
CIRCLE 314 ON FREE INFORMATION CARD

### Aremco

PO Box 429  
Ossining, NY 10562  
(914) 762-0685  
CIRCLE 315 ON FREE INFORMATION CARD

### Fair-Rite

PO Box J  
Walkill, NY 12589  
(914) 895-2055  
CIRCLE 316 ON FREE INFORMATION CARD

### FerriShield

350 Fifth Avenue, Ste 7505  
New York, NY 10118  
(212) 268-4020  
CIRCLE 317 ON FREE INFORMATION CARD

### Ferroxcube

2001 West Blue Heron Blvd  
Riviera Beach, FL 33404  
(407) 881-3200  
CIRCLE 318 ON FREE INFORMATION CARD

### Steve Hansen

35 Windsor Drive  
Amherst, NH 03031  
(603) 429-0948  
CIRCLE 319 ON FREE INFORMATION CARD

### Intermark

One Pen Plaza, Ste 4526  
New York, NY 10119  
(212) 629-3620  
CIRCLE 320 ON FREE INFORMATION CARD

### Jones & Bartlett

20 Park Plaza  
Boston, MA 02116  
(617) 482-3900  
CIRCLE 321 ON FREE INFORMATION CARD

### Magnetic Shield Corp

740 North Thomas Drive  
Bensenville, IL 60106  
(708) 766-7800  
CIRCLE 322 ON FREE INFORMATION CARD

### Management Roundtable

1050 Commonwealth Ave, Ste 301  
Boston, MA 02215  
(800) 338-2223  
CIRCLE 323 ON FREE INFORMATION CARD

### Mini-Circuits

PO Box 350166  
Brooklyn, NY 11235  
(718) 934-4500  
CIRCLE 324 ON FREE INFORMATION CARD

### Murata-Erie

2200 Lake Park Drive  
Smyrna, GA 30080  
(404) 436-1300  
CIRCLE 325 ON FREE INFORMATION CARD

### Siemens

2191 Laurelwood Road  
Santa Clara, CA 95054  
(408) 980-4500  
CIRCLE 326 ON FREE INFORMATION CARD

### Synergetics

Box 809-RE  
Thatcher, AZ 85552  
(602) 428-4073  
CIRCLE 327 ON FREE INFORMATION CARD

### Tesla Society/HE Enterprises

PO Box 5636  
Security, CO 80931  
(719) 475-0918  
CIRCLE 328 ON FREE INFORMATION CARD

Interlaced scan is used by NTSC to minimize flicker. But *interlaced scan is totally unsuitable for data displays, especially small text!* The reason is that interlace works only if successive lines are more or less the same. This is clearly *not* the case between dot lines of finer text. Thus, most computer screens *demand* a *noninterlaced* display where each field is complete and identical.

Most computer monitors also will use a 59.94- or a 60-hertz vertical scan rate. Less than that and you'll end up with too much flicker. If you try to lengthen the phosphor persistence you may end up with "comets" for traveling balls.

The horizontal scan rate is decided by how many horizontal lines you are using per field. As you increase the number of lines in a display, the horizontal scan rate goes up. Scan rates from 22 to 45 kilohertz are typical, with some exotic displays going much higher.

Now for the kicker: *Most monitors*

*will work only over a VERY limited range of horizontal scan frequencies!* Unless you go to some very fancy multi-sync techniques.

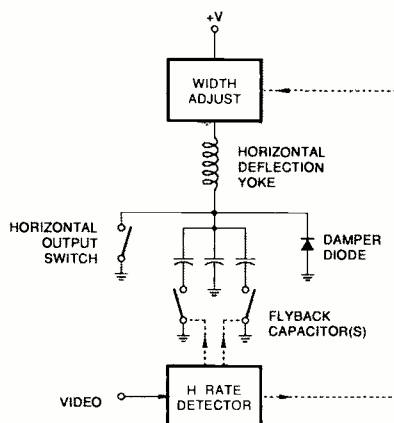

**FIG. 4—MULTI-SYNCING MONITORS change their sweep values to try and match an input horizontal scanning rate. But once selected, they still operate only over a very limited frequency range.**

### Flyback deflection

Why can't someone just build a monitor that accepts an ultra-wide range of horizontal scan frequencies and be done with it? The answer to that has much to do with both energy conservation and the way things have been done in the past.

A set of coils known as a *deflection yoke* normally goes on the neck of the display tube. These are plain old coils that will move your electron beam to wherever you want it to go. Normally, the horizontal yoke is where all the action is, since it does things several hundred times faster than the vertical one.

Since several kilowatts or more of deflection power are involved in the horizontal deflection of a larger color display, sneaky tricks will have to be played to reuse and recycle all of the energy involved. These sneaky tricks go by the name of *recurrent flyback deflection*, and are shown to you in Fig. 3

The basic rule of any inductor is



that...

$$e = L\Delta i/\Delta t$$

Let's rearrange things a tad...

$$\Delta i/\Delta t = e/L$$

Now  $\Delta i$  is the change in current and  $\Delta t$  is the change in time, so  $\Delta i/\Delta t$  will be a *linear current ramp* whose rate of change should equal your supply voltage divided by the inductance of your horizontal yoke.

Say that the switch in Fig. 3 is now open and has been that way for a long time. There is no current in the yoke, and no deflection. The spot will still be in the middle of the line.

Now, close the switch, but just for around *one-half* of the live scan time. What happens? We now apply a positive voltage to an inductor, and start building a linear current ramp. That current ramp in the deflection yoke creates one linearly increasing magnetic field, and the spot moves to the right. When you get to the right side of the screen, you'll have bunches of energy stored in the horizontal yoke's magnetic field.

What are you going to do with it? If you just burn it up as heat, you'll end up with bad reliability and high power consumption. Besides needing *far* tougher electronics. Instead, let's work smarter instead of harder.

Open your switch. Your equivalent circuit now consists of a yoke coil in series with the *flyback* capacitor. A standard and high-Q series-resonant circuit. But one that started out with zero volts on your capacitor and a strong current through the coil.

At this time, all of the energy is in the coil and none is in the capacitor. Let the circuit resonate for a while, exactly like any other series-resonant circuit. In one quarter of a cycle, the capacitor will be charged up to a large positive voltage, often in the 800-1200 volt range. At the peak, the current will be zero, and the inductor will be "empty" and field-free.

*You have now transferred all of the magnetic energy that was in the yoke into electrical energy stored in the flyback capacitor! And done so with very little loss.*

Let the circuit continue to resonate. The current will *reverse* in direction, and energy will start transferring back *into* the inductor. Note that the current is now going in the *opposite direction*.

Let the circuit resonance continue

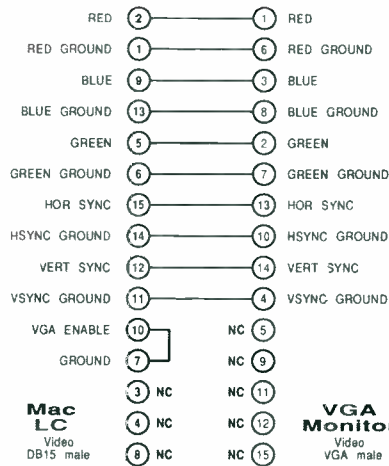

**FIG. 5—THE MACINTOSH LC definitely can NOT be used with a NTSC monitor. But this simple cable and jumpering lets you use it with most VGA color monitors. The configuration jumper from pin 7 to pin 10 selects VGA scan rates and standards.**

until the capacitor gets to zero volts. You will now have placed all of the original magnetic energy right back into the deflection yoke, with one very important difference: Since the current is going in the opposite direction, you're now at the *maximum left*

spot position, compared to the maximum right that you were half a resonance cycle ago. And, again, you have done this with very little loss.

This process is known as a *flyback*, and the retrace interval is called the *flyback time*. The beam is turned off during the flyback time so the retrace is invisible.

Let the circuit resonance try and continue. The flyback capacitor will try and go negative but, at that time, a *dampener diode* will turn itself on. Your circuit now consists once again of a coil connected between a positive voltage and ground. It will once again start generating a positive current ramp. Only this time, it starts from a *negative* initial current. Thus, your sweep starts linearly moving from the left to the center. As you move on towards the center of your scan line, the yoke energy gets sent back *into* the positive supply.

When you get to the center of the screen, you once again close your switch to repeat everything for the next cycle. The dampener diode shuts down just as soon as you cross cen-

**LEARN VCR**  
**CLEANING/MAINTENANCE/REPAIR**  
**EARN UP TO \$1000 A WEEK, WORKING**  
**PART TIME FROM YOUR OWN HOME!**

Secrets Revealed!  
 NO Special Tools or Equipment Needed.  
**EARN UP TO \$60 AN HOUR AND MORE!**

**THE MONEY MAKING OPPORTUNITY OF THE 1990'S**

IF you are able to work with common small hand tools, and are familiar with basic electronics (i.e. able to use voltmeter, understand DC electronics)...  
 IF you possess average mechanical ability, and have a VCR on which to practice and learn... then we can teach **YOU** VCR maintenance and repair

**FACT:** up to 90% of ALL VCR malfunctions are due to simple MECHANICAL or ELECTRO-MECHANICAL breakdowns!  
**FACT:** over 77 million VCRs in use today nationwide! Average VCR needs service or repair every 12 to 18 months!  
**Viejo's 400 PAGE TRAINING MANUAL** (over 500 photos and illustrations) and **AWARD-WINNING VIDEO TRAINING TAPE** reveals the **SECRETS** of VCR maintenance and repair—"real world" information that is **NOT** available elsewhere!  
 Also includes all the info you'll need regarding the **BUSINESS-SIDE** of running a successful service operation!

**FREE INFORMATION**  
**CALL TOLL-FREE 1-800-537-0589**  
 Or write to: Viejo Publications Inc.  
 5329 Fountain Ave.  
 Los Angeles, CA 90029 Dept. RE

**CIRCLE 187 ON FREE INFORMATION CARD**

**Be an FCC LICENSED ELECTRONIC TECHNICIAN!**

**Earn up to \$30 an hour and more!**  
 Learn at home in spare time. No previous experience needed!

No costly school. No commuting to class. The Original Home-Study course prepares you for the "FCC Commercial Radiotelephone License." This valuable license is your professional "ticket" to thousands of exciting jobs in Communications, Radio-TV, Microwave, Maritime, Radar, Avionics and more...even start your own business! You don't need a college degree to qualify, but you do need an FCC License.

**No Need to Quit Your Job or Go To School**  
 This proven course is easy, fast and low cost! **GUARANTEED PASS**—You get your FCC License or money refunded. **Send for FREE facts now. MAIL COUPON TODAY!**

**COMMAND PRODUCTIONS**  
 FCC LICENSE TRAINING, Dept. 90  
 P.O. Box 2824, San Francisco, CA 94126  
 Please rush FREE details immediately!

NAME \_\_\_\_\_  
 ADDRESS \_\_\_\_\_  
 CITY \_\_\_\_\_ STATE \_\_\_\_\_ ZIP \_\_\_\_\_

**January 1992 Radio-Electronics**

ter screen. Automatically.

Once again: Close your switch to move from center to right. Transfer the coil energy to a flyback capacitor. Resonate half a cycle and transfer the flyback capacitor energy back to the coil *inverting its sign* and putting you far left. Turn on the damping diode to move from left to center. And repeat the process once each scan line.

Several details I've omitted: That flyback pulse also gets sensed and routed to a current step-up transformer called a *flyback transformer*. The flyback transformer steals a minor part of the energy and uses it to create the high voltage DC supply that is needed by the display tube. Other windings can be used for blanking, horizontal phase comparison, and boosted supply voltages elsewhere in the TV or monitor. And games have to be played to keep any uncenter DC bias out of the horizontal yoke. But regardless of these details, the basic concept of recycling your deflection energy remains.

This very elegant, highly tested, and ultra conservative flyback scheme inherently works best only at *one* horizontal scan frequency. And that is why you can't normally get a monitor that can accept any old horizontal rate.

Yes, there are multi-sync monitors. These usually work by measuring the intended input scan frequency and then switching in one or more flyback capacitors and adjusting the supply voltage accordingly. Figure 4 shows one multisync scheme. Once switched, a multisync monitor is a narrow-band system just like any other flyback-driven circuit.

### VGA for the Mac LC

The Macintosh LC computer was designed for use with the Mac color monitors to the Mac color standards. Since these can be expensive, lots of hackers are often on the lookout for lower-cost substitutes. But note that you definitely can *not* use an NTSC color monitor because of the higher scan rates on the LC.

And also do note that you should *never* buy a substitute monitor without making certain it works and is good enough for your uses.

Happily, there is a hidden "secret" provision on the Mac LC that lets you change your LC output so it is VGA-

compatible. Quality VGA monitors are often available much cheaper in far wider selections than are "real" Mac monitors.

The secret jumper that changes the LC scan rates for VGA compatibility is shown in Fig. 5.

### GPS Nav resources

From time to time we've looked at the *Navicube* concept right here in *Hardware Hacker*. The *Navicube* is a magic \$5 cube 3 inches on a side which always knows where it is and which way it is pointing. Several recent developments that should ultimately make the *Navicube* possible include low-cost accelerometers, advances in fiber-optic gyros, and the ongoing GPS navigation system.

GPS is short for *Global Positioning Satellites*, a military navigation system that has recently seen several dramatic improvements in price, reliability, and availability. I've tried to gather together some GPS info for you as this month's resource sidebar.

The system consists of a flock of roving satellites, any five or six of which should be overhead at any given time. The satellites broadcast a series of low microwave-frequency radio signals. By intercepting and comparing the signals from several overhead satellites, you can extract your current absolute position and do so to around a fifty-foot accuracy. Your speed, acceleration, and current time can also be determined to surprisingly high accuracies. Within two inches per second even.

And by shifting to a *differential* scheme from any one known and fixed point, you can improve your accuracy to a fraction of an inch.

Amazingly, the antennas needed are no big deal. They can easily fit inside a small shoebox. Unlike video satellites, the GPS antennas need a wide beamwidth, a narrow-frequency bandwidth, plus a pseudorandom modulation which works acceptably well with lower signal-to-noise ratios. The antennas do require line-of-sight operation, so they have to be used outdoors, on a rooftop, or on the top of a vehicle or boat.

Since the reception electronics are incredibly complex, it is unlikely that you would want to try and build up your own GPS receivers by using discrete components.

Thankfully, sophisticated chip sets are now becoming readily available from *Rockwell*, *Magellan*, and others. Their initial pricing is in the \$500 range. But it is reasonable to expect Japanese GPS chips within a year or two for under \$35. So now is the time to start on your GPS hacks.

The leading trade journal in the field is called, of all things, *GPS World*. It is free to qualified subscribers. An interesting hacker newsletter that deals with navigation and communications of interest to cavers is Frank Reid's great *Speleonics*. Some other GPS info appears from time to time in *NASA Tech Briefs*. Several other sources of GPS gear include *Ashtech*, *Bancomm*, *Texas Instruments*, and *Trimble Navigation*. Trimble has a nice GPS intro book available. It's called *GPS—A guide to the next utility*.

### New tech lit

From *Actel*, a new databook on *Field Programmable Gate Arrays*. And from *Mini-Circuits* a new *RF/IF Signal Processing Guide* on higher frequency mixers, splitters, amplifiers, transformers, and such. Their broadband amplifiers cost around a dollar or so each.

A free update on our Santa Claus machine technology is now titled an *Insiders Guide to Rapid Prototyping*, and is available from *Management Roundtable*. These folks also put on annual conferences.

A new quarterly hacker newsletter on lower-cost vacuum projects and techniques is now available through *Steve Hansen*. It's called *The Bell Jar*.

Free samples of *Liquisorb*, a low-cost cornstarch colloidal absorbent, are available from *American Colloid Company*. Since these sample packets dramatically swell up in the presence of liquid water, one obvious use is as a low-cost flood alarm.

And through *Aremco*, a *Materials Catalog M12* that includes a wide variety of high-temperature ceramic materials, including machinable and pourable versions.

For the fundamentals of digital integrated circuits, be sure to check out my classic *CMOS Cookbook* and *TTL Cookbook*. You can also reach me via *GENIE PSRT* (800) 638-9636, where you'll find lots of resource stuff not available elsewhere.

R-E



# AUDIO UPDATE

## Reader questions: Real and imagined, serious and silly

LARRY KLEIN

**A**fter several decades of answering readers' hi-fi questions for various electronics and audio publications, one can get a little nostalgic. I look back with fondness to the days when I had all the answers—or at least thought I did—and was pleased to provide them to curious readers. Today I certainly don't have all the answers, and occasionally I don't even understand the questions. In any case, herewith is a selection of updated Q's and A's that, if not my greatest hits, at least reflect some of the interesting concerns of the audio public in the last decade.

### Subliminal Satanism

*I keep hearing that some heavy-metal rock bands put subliminal Satanic messages on their albums. The messages are supposedly in the form of words recorded in reverse at the ends of certain cuts. What effect do these messages have on listeners?*  
L.B.  
Everetts, N.C.

Mostly it causes them to write silly questions to magazine columnists. The term "subliminal" is usually applied to stimuli that are outside the range of conscious perception but are nevertheless said to reach the brain and affect thinking. The purported danger in such a technique is that the messages bypass conscious evaluation and cause their hearers (or viewers) to uncritically buy products, vote for certain candidates... or worship Satan. Since there appears to be no legitimate research indicating any effect at all from subliminal motivational messages, good or bad, I wouldn't worry about it... unless, of course, you experience sudden inexplicable urges to buy large quantities of toothpaste, to vote for Jesse Helms, or join your local coven after a long evening of heavy-metal head banging.

My comments also apply to "subliminal" self-help tapes. A recent study by the National Academy of

Sciences concluded that such tapes "have no proven value." That seems logical, considering that any messages recorded below the threshold of hearing would necessarily be buried in normal tape noise.

### Record and tape wear

*I hope you can settle a bet for me. I maintain that, unlike LP records, cassettes don't wear out. My friend insists that they both wear with use. And what's the situation with CD longevity? I've read some troubling reports lately.*

J.S.

Evanston, IL

They both wear, but the effects are different for tapes and discs. When vinyl discs begin to wear, noise and distortion are *added* to the signal. Worn tapes, on the other hand, tend to suffer signal losses. There are momentary "dropouts" that reflect damage to the tape's oxide coating caused by friction against the player's heads, capstan, and guides. There may also be a partial erasure of the high frequencies brought about by an accumulation of residual magnetism in those same metal parts. Periodic cleaning and demagnetizing of the player help minimize the damage.

Over time, there may be a marked increase in cassette wow and flutter. Assuming that the player is okay, and that the tape or the cassette shell mechanism has not been damaged through overheating on a car's dashboard, the fault is probably caused by an overly tight winding inside the cassette. The tape pack can be restored to its normal looseness by repeatedly, but gently, slapping the cassette face down against a semi-hard surface such as a magazine or book. Squeal can sometimes be helped by a very small amount of silicone lubricant applied in the areas where the tape hubs meet the shell, but most of the time it reflects a problem (sometimes brought about by aging) in the composition of the tape coating.

Recently questions have been raised about CD longevity, with claims that CD's suffer from "laser rot" over time. The reasons given for the self-destructive tendencies of CD's have been varied, but the claim is that today's CD's have, at best, a very limited life span.

I think that such predictions should be taken with a sack of salt, considering their original sources are the same "underground" audio publications that disparaged CD's from the outset.

I spoke to a gentleman in charge of preservation research at the Library of Congress, and he says he knows of no evidence that supports the view that normal, properly manufactured CD's will spontaneously "fail" over time. All of which is not to say that some CD's haven't had playback problems because of mishandling or manufacturing defects.

### Undriven drivers

*There's a hi-fi dealer in my area who features what he calls "Single Speaker Demonstrations." He claims that it was discovered in England that the presence of other non-playing speaker systems in a listening room can affect the sound produced by the playing speakers. Does the removal of non-playing speakers really help a listener evaluate different systems more accurately?*

J.S.

Los Angeles, CA

I don't think so, particularly since it would certainly prevent a fast A/B comparison between systems. It's probable that there is a slight measurable acoustic effect in a show-room produced by stacks of unconnected speaker systems. Theoretically, acoustic-suspension speakers would function as Helmholtz absorbers at the frequency of their system resonances, and vented systems would do the same at their port resonances. In either case, the suck-outs would occur in the same low-frequency areas where



most standing-wave problems occur and conceivably might moderate the effects. But given the very large (10-20 dB) bass-response irregularities found in most rooms—including dealer demo rooms—it seems unlikely that even the most golden of ears could isolate a positive or negative effect produced by the presence of a dozen or so undriven speaker systems.

Incidentally, I understand that some lunatic fringe audiophiles even advocate removing telephones, clocks, and watches from listening rooms in the belief that they somehow resonate destructively with the music. As with so many other superstitious beliefs, this one also has in it a small—very small—grain of truth.

If you were to feed an audio oscillator through your system and sweep it slowly at high volume from, say, 40 to 200 Hz, you would find that small and large objects in the room vibrate slightly at their specific resonant frequencies. But with music there is usually not enough sustained

acoustic energy at any one frequency to produce audible resonances. However, it is not a good idea to place small art objects on top of your speakers as there might be enough coupled vibration to cause them to dance sympathetically to whatever tune is playing.

### Sonic shatter

*I'm curious about the old Memorex wine glass shattering commercials. Exactly what technology was involved? Was it anything like Caruso's vocal trick?*

M.H.

Mendenhall, MS

Like all good wine glasses, the goblets used in the commercial were both rigid and relatively fragile. To calibrate the goblets, each was placed directly in front of a loudspeaker driven by an audio oscillator. The oscillator was swept slowly through the range of approximately 700 to 850 Hz, which covered the resonant frequencies of the glasses used by Memorex. During the frequency

sweep, a finger resting lightly on the rim of the goblet could easily detect the increase in vibration at the goblet's specific resonant frequency. That was marked on the crystal goblet for future reference.

At glass-breaking time, a tape recording (on a Memorex cassette) was made of the celebrity singer producing a sustained note at the previously determined critical frequency. When the cassette tape was played back very loudly through a speaker, the wine glass—which had an approximately 140-dB sound field impinging on it—would react by flexing itself to pieces.

Given the above, it should be clear that shattering a glass by an unamplified voice is no easy trick. Not only does the singer have to produce an enormous sound pressure level, but also the frequency has to be within a hertz or so of the wine glass's specific—and unknown—resonant frequency. Perhaps in Caruso's day voices were stronger and crystal more fragile.

R-E

U.S. Postal Service STATEMENT OF OWNERSHIP, MANAGEMENT AND CIRCULATION <small>Required by 39 U.S.C. 3685</small>		
1A TITLE OF PUBLICATION RADIO-ELECTRONICS	1B PUBLICATION NO. 0 0 3 3 7 8 6 2	2 DATE OF FILING 10/9/91
3 FREQUENCY OF ISSUE MONTHLY	3A NO. OF ISSUES PUBLISHED ANNUALLY 12	3B ANNUAL SUBSCRIPTION PRICE \$17.97
4 COMPLETE MAILING ADDRESS OF KNOWN OFFICE OF PUBLICATION (Street, City, County, State and ZIP+4 Code) (Not printer)		
500-B B1-COUNTY BLVD. FARMINGDALE, NY 11735		
5 COMPLETE MAILING ADDRESS OF THE HEADQUARTERS OF GENERAL BUSINESS OFFICES OF THE PUBLISHER (Not printer)		
500-B B1-COUNTY BLVD. FARMINGDALE, NY 11735		
6 FULL NAMES AND COMPLETE MAILING ADDRESS OF PUBLISHER, EDITOR, AND MANAGING EDITOR (This item MUST NOT be blank)		
PUBLISHER (Name and Complete Mailing Address)		
LARRY STECKLER 500-B B1-COUNTY BLVD. FARMINGDALE, NY 11735		
EDITOR (Name and Complete Mailing Address)		
BRIAN FENTON 500-B B1-COUNTY BLVD. FARMINGDALE, NY 11735		
MANAGING EDITOR (Name and Complete Mailing Address)		
7 OWNER (If owned by a corporation, its name and address must be stated and also immediately thereunder the names and addresses of stockholders owning or holding 1 percent or more of total amount of stock. If not owned by a corporation, the names and addresses of the individual owners must be given. If owned by a partnership or other unincorporated firm, its name and address, as well as that of each individual must be given. If the publication is published by a nonprofit organization, its name and address must be stated.) (Items must be completed)		
FULL NAME COMPLETE MAILING ADDRESS		
GERNSBACH PUBLICATIONS INC. 500-B B1-COUNTY BLVD FARMINGDALE, NY 11735		
LAWRENCE STECKLER 500-B B1-COUNTY BLVD FARMINGDALE, NY 11735		
8 KNOWN BONDHOLDERS, MORTGAGEES, AND OTHER SECURITY HOLDERS OWNING OR HOLDING 1 PERCENT OR MORE OF TOTAL AMOUNT OF BONDS, MORTGAGES OR OTHER SECURITIES (If there are none, so state)		
FULL NAME COMPLETE MAILING ADDRESS		
9 FOR COMPLETION BY NONPROFIT ORGANIZATIONS AUTHORIZED TO MAIL AT SPECIAL RATES (Section 423 12 DMF only) The purpose, function, and nonprofit status of this organization and the exempt status for Federal income tax purposes (Check one)		
<input type="checkbox"/> HAS NOT CHANGED DURING PRECEDING 12 MONTHS <input type="checkbox"/> HAS CHANGED DURING PRECEDING 12 MONTHS (If changed, publisher must submit explanation of change with this statement)		
10 EXTENT AND NATURE OF CIRCULATION (See instructions on reverse side)	AVERAGE NO. COPIES EACH ISSUE DURING PRECEDING 12 MONTHS	ACTUAL NO. COPIES OF SINGLE ISSUE PUBLISHED NEAREST TO FILING DATE
A TOTAL NO. COPIES (Net Press Run)	280,140	277,350
B PAID AND/OR REQUESTED CIRCULATION 1 Sales through dealers and carriers, street vendors and counter sales 2 Mail Subscriptions (If paid and/or requested)	54,898 124,791	58,298 120,784
C TOTAL PAID AND/OR REQUESTED CIRCULATION (Sum of B1 and B2)	179,689	179,082
D FREE DISTRIBUTION BY MAIL, CARRIER OR OTHER MEANS SAMPLES, COMPLIMENTARY, AND OTHER FREE COPIES	7,003	7,642
E TOTAL DISTRIBUTION (Sum of C and D)	186,692	186,724
F COPIES NOT DISTRIBUTED 1 Office use, left over, unaccounted, spoiled after printing 2 Return from News Agents	8,201 85,247	397 90,229
G TOTAL (Sum of E, F1 and F2—should equal net press run shown in A)	280,140	277,350
11 I certify that the statements made by me above are correct and complete	SIGNATURE AND TITLE OF EDITOR, PUBLISHER, BUSINESS MANAGER, OR OWNER EDITOR	

PS Form 3526, Dec 1985

(See instruction on reverse)



One tree can make 3,000,000 matches.



One match can burn 3,000,000 trees.

A Public Service of This Magazine & The Advertising Council





# DRAWING BOARD

## More on automotive voltage regulators.

ROBERT GROSSBLATT

Once again I have to apologize to everyone out there who's waiting for us to get back to the design of a digital scope. We won't be doing that until next time because I need this space to finish going through our discussion of generators, alternators, voltage regulators, and all the rest of the stuff you meet when you take a trip to the always amazing world of charging systems.

As I mentioned last time, I was amazed by the amount of interest in this and, as a certified member in good standing of the old car and bike freak club (with a particular emphasis on British stuff), my duty is clear.

We've already gone through the basics of the charging system and seen that there are really only two ways an alternator can be wired into a bike or car. One side of the field winding is tied to either the hot side of the battery (a pulled-up field), or to ground (a grounded field). Most British cars and bikes use a pulled-up field and you'll find a lot of American cars using a grounded field. I said this last time but it's really important so let me repeat it. Before you can build your own voltage regulator, you **HAVE** to know how your alternator is wired. Using the wrong regulator will destroy the regulator and probably trash the alternator as well.

The easiest way to tell what system is used in your car or bike is to use a multimeter. With the ignition turned on, but the engine not running, measure the voltage from the hot side of the battery to the terminal marked "F" on your existing regulator. If you get a reading between 12 and 13 volts (the battery voltage), your car is using a pulled-up field.

If you get a zero, or near-zero reading, you're probably looking at a grounded field. You can make sure by reading the voltage from the regulator's "F" terminal to ground. You should see the 12- to 13-volt battery

voltage there. If you don't see the battery voltage anywhere you either have a bad connection or you're measuring from the wrong terminals. Check the multimeter leads and, if that doesn't cure the problem, get out a flashlight and trace the wires. You absolutely have to know what you're dealing with before you add a voltage regulator!

Anyone who finds that they have a pulled-up field can stop reading right now and skip ahead a bit because the regulator we designed last month is exactly the one needed. If you've got a grounded-field alternator, there's still some work to do. The regulator we designed has to be modified before you can use it.

The easiest way to see the changes is to compare the original pulled-up field circuit (last month's Fig. 3) to the modified design for a grounded-field regulator shown in Fig. 1. One of the first things you should notice is that R7 and R8 are now in parallel. Electrically, there's no real reason for having those two resistors in parallel. The only reason I left them both there is to help make the similarity between the two circuits more evident. You can leave them wired in parallel or simply do the

arithmetic necessary to come up with an equivalent single-resistor replacement.

The major change to the circuit is that the alternator field connection is now made off the emitter of Q3 rather than the collector. All the changes in the circuit are aimed at varying the voltage at Q3's emitter. The Darlington pair made from Q2 and Q3 is still controlled by the voltage at the collector of Q1 in exactly the same way as it is for the pulled-up field regulator. The positive feedback (supplied by C3 and R8) that speeds up the switching of the circuit from fully on to fully off now comes from Q3's emitter rather than its collector.

The reasons for the changes in the circuit are all based around the idea of being able to vary the output voltage. Since, in the case of a grounded field, the given is that one side of the field is tied to ground, the job of the regulator is to increase the output voltage at the "F" terminal when the control voltage at the base of Q1 falls below the point set by R10. The LED has been moved so it will monitor the field voltage and D1 has been moved so it can soak up any back-voltage generated when the alternator field collapses. You'll also see that the value of R7

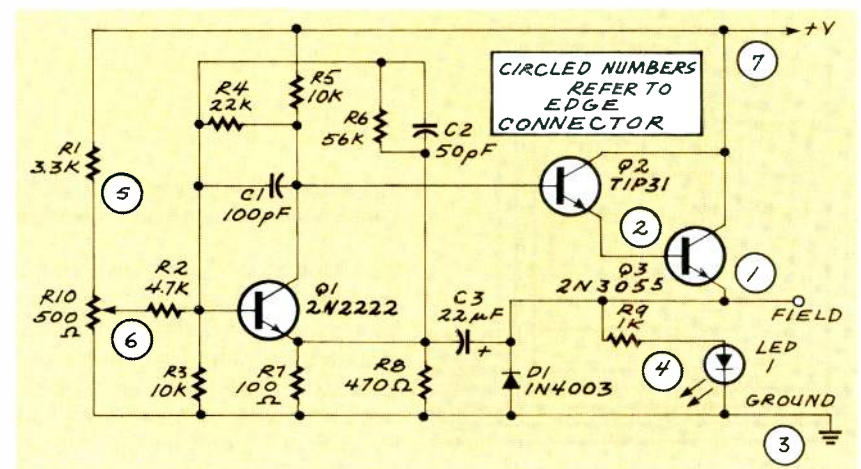

FIG. 1—COMPARE THE ORIGINAL pulled-up field circuit (last month's Fig. 3) to the modified design for a grounded-field regulator shown here.

# R-E Engineering Admart

Rates: Ads are 2 1/4" x 2 7/8". One insertion \$995 each. Six insertions \$950 each. Twelve insertions \$925 each. Closing date same as regular rate card. Send order with remittance to Engineering Admart, Radio-Electronics Magazine, 500-B Bi-County Blvd., Farmingdale, NY 11735. Direct telephone inquiries to Arline Fishman, area code-1-516-293-3000. FAX 1-516-293-3115. Only 100% Engineering ads are accepted for this Admart.

## FCC LICENSE PREPARATION

The FCC has revised and updated the commercial license exam. The NEW EXAM covers updated marine and aviation rules and regulations, transistor and digital circuitry. THE GENERAL RADIOTELEPHONE OPERATOR LICENSE - STUDY GUIDE contains vital information. VIDEO SEMINAR KITS ARE NOW AVAILABLE.

WPT PUBLICATIONS  
979 Young Street, Suite E  
Woodburn, Oregon 97071  
Phone (503) 981-5159 Dept. 50

CIRCLE 181 ON FREE INFORMATION CARD

## HIGH POWER AUDIO AMPLIFIER CONSTRUCTION



BP277—Here's background and practical design information on high power audio amplifiers capable of 300 ± 400 watts r.m.s. You'll find MOSFET and bipolar output transistors in inverting and non-inverting circuits. To order your copy send \$6.25 plus \$2.50 for shipping in the U.S. to Electronic Technology Today Inc., P.O. Box 240, Massapequa Park, NY 11762-0240.

## MIDI PROJECTS



BP182—MIDI interfacing enables any so equipped instruments, regardless of the manufacturer, to be easily connected together and used as a system with easy computer control of these music systems. Combine a computer and some MIDI instruments and you can have what is virtually a programmable orchestra. To order your copy send \$6.95 plus \$2.50 for shipping in the U.S. to Electronic Technology Today Inc., P.O. Box 240, Massapequa Park, NY 11762-0240.

has been dropped to 100 ohms but, as I said earlier, you can replace it and R8 with a single resistor.

Before we take this any further, a word or two has to be said about C3. When the voltage on the output side of the regulator changes, some voltage is bled off through C3 and used to help speed up the action of the regulator. That is true both when the regulator is supplying current to the alternator field and when it's shutting the field current down as well. So, when the regulator is working, current will flow back and forth through C3.

Whenever you have that situation with an electrolytic, the right component to use is a non-polarized capacitor.

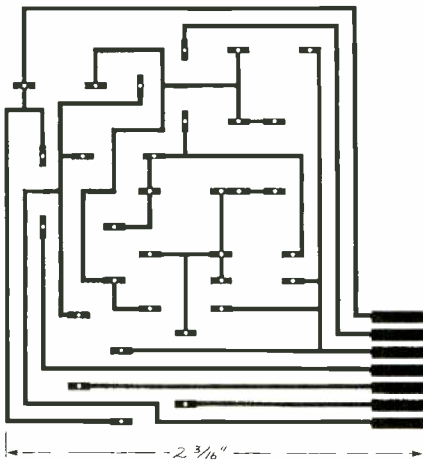

FIG. 2—FOIL PATTERN for the grounded-field regulator.

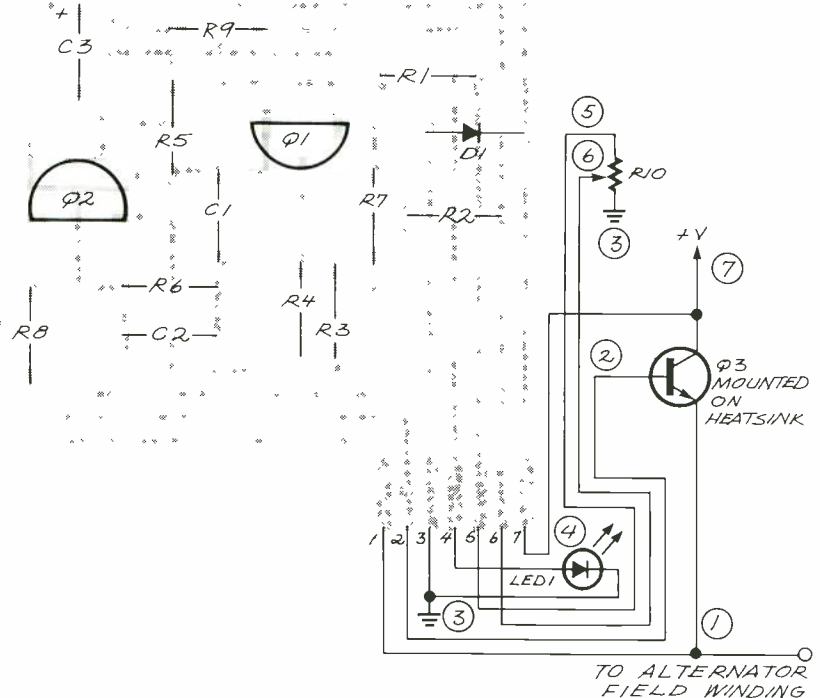

FIG. 3—PARTS-PLACEMENT/WIRING DIAGRAM. Use at least 14-gauge wire for the three connections to the vehicle's electrical system.

tor. Telephone circuits use them all the time. If you can't find a non-polarized electrolytic of the proper value, a standard substitute is to use a pair of polarized capacitors wired front-to-back in parallel. When I was building the circuit, I didn't have a non-polarized 22 µF capacitor around so, since I was in a hurry to get the circuit in my car, I just used a regular polarized

capacitor instead. Once the car was back on the road, I figured I'd be able to drive to the parts supplier, get the right component, and make the correct substitution.

That was several years ago and, even though I've made many trips to Capacitors-R-Us since then, I've never replaced the original polarized capacitor. I know it's the right thing to do



but I've never gotten around to it. The choice is yours.

The foil pattern for the grounded-field regulator is in Fig. 2, and the parts-placement/wiring diagram is shown in Fig. 3. If you have last month's column around, you'll see that the new pattern is not very different from the pattern for the previous regulator.

Once you have the regulator ready to install in your car, use at least 14-gauge wire for the three connections to the vehicle's electrical system. Remember that the field windings in the alternator have an impedance of only about four ohms so, with a minimum of twelve volts from the battery, the wire has to carry at least four amps. If you have any doubts about the gauge of the wire, use the same stuff that was there originally.

The only other precaution to take when you're using either one of the two regulators is to realize that, since they're designed to be adjustable, they're capable of making the alternator put out a lot of power. While that isn't so bad for short periods of time, having the electrical system run at a constant level of sixteen or seventeen volts is a good way to blow stuff up.

As soon as you have the circuit connected and you're sure that the whole charging system is working, spend a little bit of time with your multimeter to calibrate the potentiometer (R10). Adjusting the potentiometer will change the trip point of the regulator and you should have those voltages marked wherever you have the potentiometer mounted. Red-line the settings at sixteen volts—you never, NEVER want the system voltage to get beyond that point.

If you're one of those unfortunate people who have a generator as your system's electrical engine, none of the circuits we've developed are suitable. As we discussed last month, since the amount of current you get from a generator is solely dependent on how fast it's turning, the only way to control the current being fed to the electrical system is to have a make-and-break type switch between the generator's output and the rest of the electrical system.

You can always use an alternator/regulator combination in place of a

generator. The only problems you'll have are mechanical ones, since you'll more than likely have to fabricate your own mounting brackets and you may be forced to do a bit of surgery to make everything fit in securely. While doing a substitution like this is simple in theory, in practice there are a couple of nasty things that can screw you up if you're not careful.

The two big hassles are the substitute alternator's maximum current output for a given RPM and the size of the alternator pulley. As your starting point, you want the alternator to be able to generate enough current when the engine is idling. I can't give you exact figures since they'll depend on your vehicle. You might be able to get them from the paperwork covering your existing generator.

Once you have a ballpark current figure, you're ready to start the search for a suitable alternator. Most alternator pulleys are about half the diameter of the main one driven by the engine. That means the alternator generally turns twice as fast as the

engine and the alternator you need should have a high enough maximum current output at about twice your engine idle speed. The voltage regulator will take care of determining how much below that maximum current is right for your system. All you'll have to do is put a multimeter across the battery and adjust R10.

What makes everything complicated is the fan belt. You want to be absolutely sure that, once you have the new alternator mounted next to the engine, you can use a standard-size fan belt. This is such a big deal that I'd remake the alternator mounts to change the circumference of the needed fan belt. Nothing is worse than not being able to get replacement fan belts from any auto supplier in the universe.

I wish I had a simpler answer to the problem of generators but all I've ever done is replace them with alternators. I'll admit that it's a lot more work than building a replacement regulator but the ultimate outcome is a lot better.

R-E

# JAN Crystals

*your reliable source for a world of crystal clear communication*



- Commercial Two-Way
- MicroProcessors
- Amateur/Experimental
- Scanners/Monitors/Pagers
- Satellite-Telemetry
- Plus custom applications

**EXPEDITED ORDER SERVICE!**  
FOR FREE CATALOG,  
CALL OR WRITE:

**JAN CRYSTALS**  
P.O. Box 06017  
Ft. Myers, FL 33906  
(813) 936-2397

**TOLL FREE 1-800-526-9825**  
**FAX ORDERS: 1-813-936-3750**

## SUPER LONG PLAY TAPE RECORDERS

**12 Hour Model — USES 120 TAPE \$119.00\***



Modified Panasonic Slimline, high quality AC-DC provide 6 continuous hours of quality recording & playback on each side of cassette for 12 hours total. Includes • Voice level control • Digital counter, etc. TDK - 120 Cassette Furnished.

---

**PHONE RECORDING ADAPTER**

Records calls automatically. All Solid state connects to your telephone jack and tape recorder. Starts recording when phone is lifted. Stops when you hang up. **\$28.50\*** FCC APPROVED

---

**VOX VOICE ACTIVATED CONTROL SWITCH**

Solid state. Self contained. Adjustable sensitivity. Voices or other sounds automatically activate and control recorder. Uses either recorder or remote mike. **\$28.50\***

\* Add for ship. & handling Phone Adapter & Vox \$2.00 each. Recorders \$5.00 each. Calif. Res. add tax. Mail order, VISA, M/C, COD's OK. Money Back Guarantee. Free data available Dealer Inquiries invited.

**AMC SALES INC.** Dept. A-9335 Lubec Street  
Box 928, Downey, CA 90241  
1-800-926-2488  
Phones (213) 869-8519 FAX (213) 923-1478  
Mon-Fri 8-5 PAC TIME

# SELECT 5 BOOKS for only \$4<sup>95</sup>

(values to \$152.75)

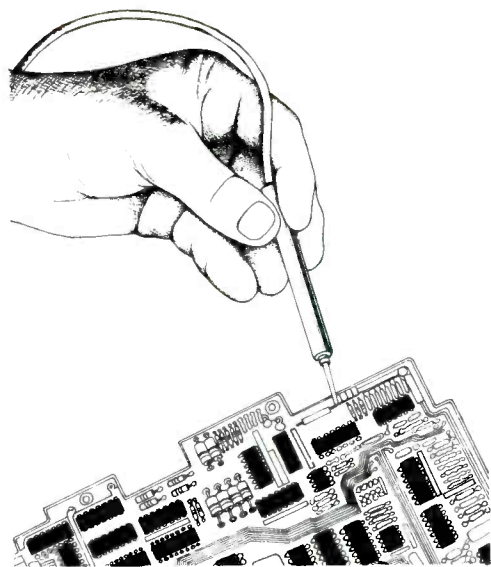

3414 \$39.95  
Counts as 2

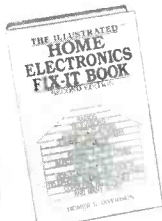

2883P \$18.95



585120-2 \$12.95

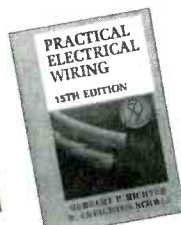

10024 \$32.95  
Counts as 2



2613P \$17.95



3107P \$18.95



2980P \$19.95

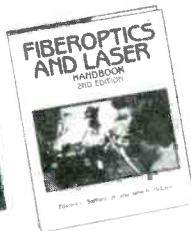

2981P \$18.95



3550 \$34.95  
Counts as 2



1367P \$24.95



3031P \$17.95



3321P \$16.95

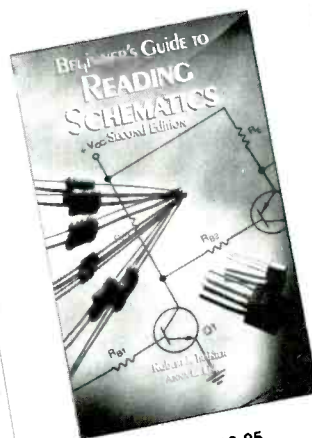

3632 \$18.95



3672 \$28.95

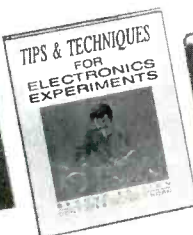

3145P \$12.95

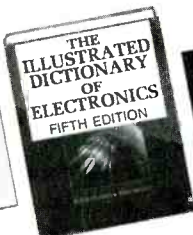

3345 \$39.95

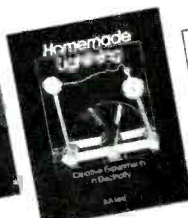

3576P \$14.95



3270 \$32.95  
Counts as 2

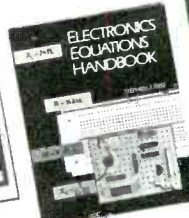

3241P \$16.95



9372P \$21.95

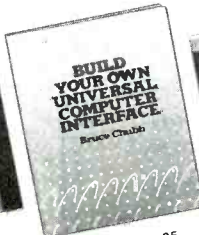

3122P \$21.95

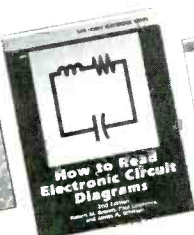

2880P \$14.95



3804P \$19.95



3205 \$24.95



3778 \$26.95



# Your most complete source for electronics books for over 25 years.

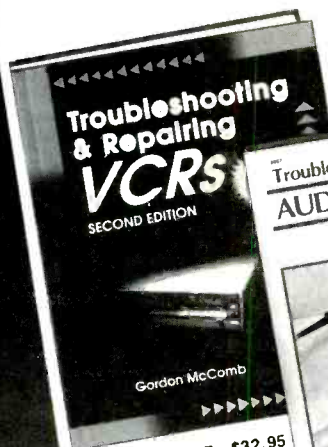

3777 \$32.95  
Counts as 2

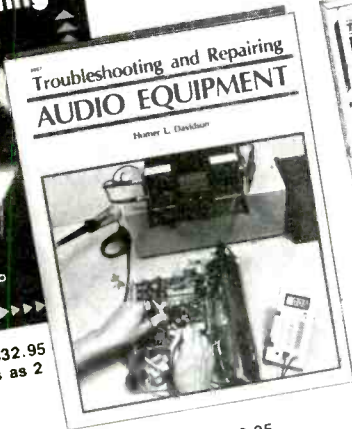

2867P \$18.95

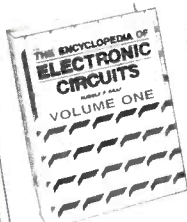

1938 \$60.00  
Counts as 3

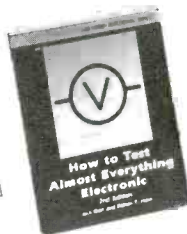

2925P \$9.95



3557 \$29.95  
Counts as 2



2941P \$16.95



3374P \$16.95



9370 \$38.60  
Counts as 2



3279 \$36.95  
Counts as 2



2995 \$25.95

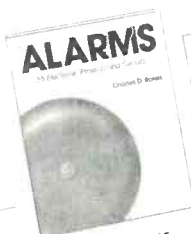

2996P \$14.95



3660 \$32.95  
Counts as 2



3627 \$29.95  
Counts as 2

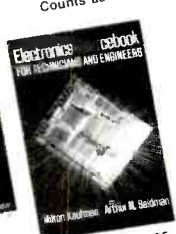

033559-1 \$29.95  
Counts as 2

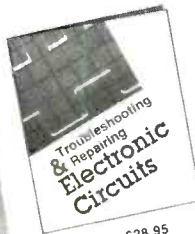

3258 \$28.95

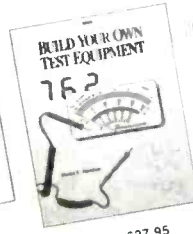

3475 \$27.95

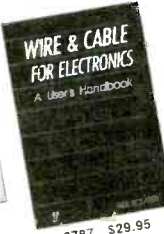

3787 \$29.95  
Counts as 2



1604P \$17.95

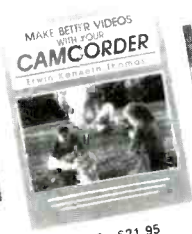

3659 \$21.95

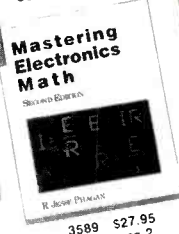

3589 \$27.95  
Counts as 2

**Membership Benefits • Big Savings.** In addition to this introductory offer, you keep saving substantially with members' prices of up to 50% off the publishers' prices. • **Bonus Books.** Starting immediately, you will be eligible for our Bonus Book Plan, with savings of up to 80% off publishers' prices. • **Club News Bulletins.** 15 times per year you will receive the Book Club News, describing all the current selections—mains, alternates, extras—plus bonus offers and special sales, with scores of titles to choose from. • **Automatic Order.** If you want the Main Selection, do nothing and it will be sent to you automatically. If you prefer another selection, or no book at all, simply indicate your choice on the reply form provided. You will have at least 10 days to decide. As a member, you agree to purchase at least 3 books within the next 12 months and may resign at any time thereafter. • **Ironclad No-Risk Guarantee.** If not satisfied with your books, return them within 10 days without obligation! • **Exceptional Quality.** All books are quality publishers' editions especially selected by our Editorial Board. (Publishers' Prices Shown)

All books are hardcover unless number is followed by a "P" for paperback.  
©1992 ELECTRONICS BOOK CLUB, Blue Ridge Summit, PA 17294-0810



## ELECTRONICS BOOK CLUB

Blue Ridge Summit, PA 17294-0810

YES! Please accept my membership in the Electronics Book Club and send the 5 volumes listed below, billing me \$4.95. If not satisfied, I may return the books within ten days without obligation and have my membership cancelled. I agree to purchase at least 3 books at regular Club prices during the next 12 months and may resign any time thereafter. A shipping/handling charge and sales tax will be added to all orders.

--	--	--	--

Name \_\_\_\_\_

Address \_\_\_\_\_

City \_\_\_\_\_

State \_\_\_\_\_ Zip \_\_\_\_\_ Phone \_\_\_\_\_

Signature \_\_\_\_\_

Valid for new members only. Foreign applicants will receive special ordering instructions. Canada must remit in U.S. currency. This order subject to acceptance by the Electronics Book Club.

RE192



## PC-BASED TEST EQUIPMENT

continued from page 62

specified value, the relay will be energized. When the temperature rises again, the relay will be de-energized. For example, to trip at 10.5°C, add the lines shown in Listing 2 between lines 16 and 17 of the original program.

You can also change the value in the FOR-NEXT loop to alter the time between samples. For instance, on the author's system, changing the value to 5000 causes samples to be collected once every 10 seconds. The exact time depends on your PC's speed, so you'll have to experiment.

With a longer time between samples, you can log data samples to disk. To do so, change lines 4, 16 and 17 as shown in Listing 3.

To read and display the resultant data, run the program shown in Listing 4.

### Other inputs

The signal conditioner circuit can accept other input sources, including linear-displacement potentiometers (LDP's), piezoelectric transducers, and microphones. An LDP is a specialized potentiometer whose wiper moves linearly instead of in the normal circular fashion. Usually these extremely accurate devices, which can be purchased from surplus electronics suppliers, are mechanically connected to a moving mechanism. They convert linear motion into a corresponding resistance. If a DC voltage is placed across the LDR, the output at the wiper is a voltage proportional to the amount of displacement of the slider.

Piezoelectric devices can be attached directly to a surface to measure tension and stress. Unlike an LDP, a piezoelectric device produces a voltage directly, hence doesn't need a DC voltage source. A microphone can also be used to measure sound-related phenomenon.

In fact, any device that can provide a voltage that varies between zero and a few hundred millivolts can be connected to the circuit described in this article. R-E

## ASK R-E

continued from page 13

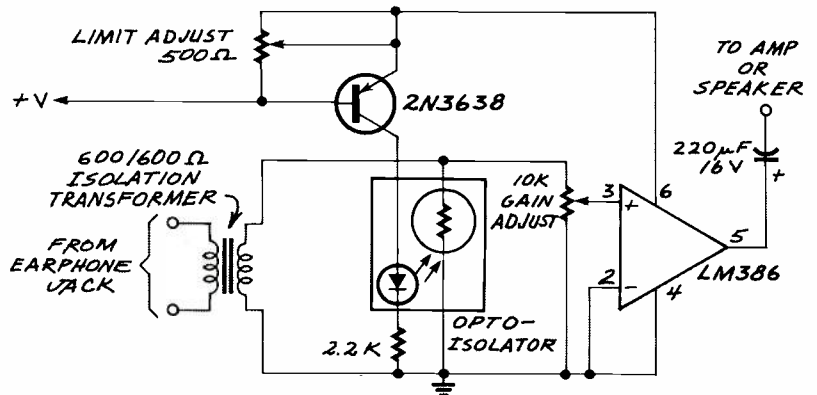

FIG. 3—AN AUDIO LIMITER will turn the volume down for you whenever the sound gets too loud.

amplifier has to pass through the resistor on the +V line. The amount of current drawn by the amp will vary in direct proportion to the amount of work the amplifier has to do. As the input signal increases, so does the amount of current the amplifier needs to handle it.

The voltage created across the resistor is a DC analog of the AC audio voltage at the amplifier's inputs. The DC voltage controls the transistor and, when it's high enough, the transistor will turn on and energize the LED in the optoisolator. That will change the resistance of the photoresistor wired into the amplifier's feedback loop and, as a result, cause a change in the gain of the amplifier. All the parts used in the limiter are easy to find with the possible exception of the optoisolator. That isn't a big deal since you can make one of your own by using a standard LED and photoresistor. Just put them next to each other in a small tube and seal up the tube ends to make it light-tight.

Building the circuit is a lot easier than getting it into your TV set. If you have any doubts at all about doing it, you're much better off forgetting the whole idea. You really don't want to blow up the TV or yourself in the process of modifying the audio.

If your TV has an earphone jack, you can build the circuit in a small box and run the audio from the jack, through a small isolation transformer, through the limiter, and finally connect it to a separate amplifier and speaker.

### POWER-SUPPLY REPAIR

I have an IBM-compatible computer and the power supply died on me. I took it out of the case and, after some investigation, I'm pretty sure that one of the transformers is shorted. It seems like a shame to buy a new supply since all it would take to repair my old one is replacing one component. Do you have any sources of supply for the transformer I need?—G. Benfisch, New York, NY

All of the IBM-type power supplies are regulated switchers and they all use at least two transformers—one for the AC line voltage and the other for the switcher. You didn't specify which one was shorted but remember that both of them have to fit exactly on the printed circuit board. You can probably find a replacement transformer that has the same specs as the one you need but you also have to make sure it fits on the board.

If you are willing to devote a lot of time to catalogs, ads, and the telephone, you might come up with something suitable, but since a whole replacement supply costs only about forty or fifty bucks from just about every supplier in the universe, I can't see any reason to screw around with fixing your old one.

Your time has to be worth something, and even if you found a replacement transformer I wouldn't be surprised if it costs as much as a whole new power supply. But then again, the education just might be worth the expense. R-E

## SPEAKER MATE

continued from page 66

gain is built into the unit to allow for different electret microphones, but it can be set very high before any feedback occurs. You can actually set the gain to the point where you can be heard on the speakerphone in an adjacent room.

With the unit plugged into your phone line, turn the ANSWER switch on and you should hear a dial tone. (You may need a "Y" adaptor to put the Speaker-Mate in parallel with an existing telephone.) The dial tone will not be very loud because the device is designed to limit the volume of the dial output, but you will hear it. The LEVEL control will respond only a little bit due to the limiting action of the dial-tone detector within IC1.

The next step is to get a friend to help you set up the microphone gain. The mid setting will probably be close, but you may want more gain depending on the environment and if you want to be able to use the device at some distance. Remember, though, that at higher settings background noise will also come through and the speech may have an echo. For desk use, a setting can be found that allows talking in a normal voice with the unit placed about 15 to 20 inches from the user. Remember that the person you are talking to is the judge of the microphone setting, and the VOLUME control affects only your received listening level.

Once set up, you must call someone on a conventional phone, turn on the Speaker-Mate, and then hang up the regular phone. To receive calls, simply answer with the Speaker-Mate and speak in a normal voice. The sound quality is so good that the calling party will probably not even know you are using a speakerphone.

### User add-ons

In a rural installation, the added distance from the central phone office can cause a reduction in loop current to the point

where line-powered operation of the project may become marginal. Performance in the talk path is normal, but the received audio may have a pumping sound due to the lack of available current to reproduce the audio peaks.

While the project would still be usable, Fig. 7 shows a simple external power addition which consists of adding a 1/8-inch miniature jack (J2), a DPDT slide switch (S3), and a diode (D2). The parts can be mounted on the rear panel of the project case and wired into the printed-circuit board. The PC board is prepared by removing jumper JU1 and connecting the two wires from S3 in place of JU1; the ground connection can be made to a spare hole in the board provided for this purpose.

As shown in Fig. 7, S3 will switch the unit between being line-powered and powered from an external source. If you're using the external-power modification, a 4.5- or 6-volt DC wall adaptor is perfect. Do not exceed 6 volts, as the Zener diode is not in the circuit when using external power.

The Speaker-Mate is not a stand alone telephone because a ringer is needed to hear incoming calls and a dialer is required to make outgoing calls. You may want to add the ringer to the Speaker-Mate, as shown in Fig. 8. The tone ringer chip (IC3), manufactured by Texas Instruments, monitors the telephone line for a ring signal of 15 to 68 Hz, 40 to 150 volts AC. The ring signal powers a two-tone warble signal generated by IC3. The output of the device drives a solid-state piezoelectric transducer. The circuit can be installed within the Speaker-Mate's enclosure and the transducer can be mounted on the front or rear panel, with a small hole drilled as an audio port.

There is also a dialer circuit you can build using Motorola's MC145412 IC and a handful of other miscellaneous parts. The schematic for the dialer circuit is available from Project-Mate (see the parts list) if you send a self-addressed stamped envelope (SASE).

R-E

## ELECTRONICS PAPERBACKS



**BP282—UNDERSTANDING PC SPECIFICATIONS...\$7.25.** Explains difference between types (XT, AT, 80386, etc.), math co-processors, input devices, memory, RAM discs, floppy drives, hard discs, displays and more. Everything you need to know if you can't tell your E.M.S. from your E.G.A.!

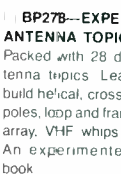

**BP278—EXPERIMENTAL ANTENNA TOPICS...\$5.95.** Packed with 28 different antenna topics. Learn how to build helical, crossed field, dipoles, loop and frame, phased array, VHF whips and more. An experimenter's dream book.



**BP276—SHORT WAVE SUPERHIT RECEIVER CONSTRUCTION...\$5.95.** Everything you need to know to build your own receiver plus a variety of enhancement you can add later—input filter, rf amplifier, product detector, S meter, and more.



**BP271—HOW TO EXPAND, MODERNIZE AND REPAIR PCs AND COMPATIBLES...\$7.75.** Includes PC overview, memory upgrades, adding a hard disc, adding floppy drives, display adapters and monitors, installing a co-processor, preventive maintenance, repairs, do it yourself PCs and more.



**BP266—ELECTRONIC MODULES AND SYSTEMS FOR BEGINNERS...\$7.25.** Describes more than 60 modular electronics circuits—how they work, how to build them, and how to use them. A wonderful book for the experimenter.



**BP255—INTERNATIONAL RADIO STATIONS GUIDE...\$7.95.** Provides the casual listener, amateur radio DXer and the professional radio monitor with an essential reference work designed to guide him or her around than ever more complex radio bands.



MAIL TO Electronic Technology Today, Inc.  
P.O. Box 240  
Massapequa Park, NY 11762-0240

### SHIPPING CHARGES IN USA AND CANADA

\$0.01 to \$5.00	\$1.50	\$30.01 to 40.00	\$5.50
\$5.01 to \$10.00	\$2.50	\$40.01 to 50.00	\$6.50
\$10.01 to 20.00	\$3.50	\$50.01 and above	\$8.00
\$20.01 to 30.00	\$4.50		

**SORRY, No orders accepted outside of USA and Canada**

Total price of merchandise	\$	_____
Shipping (see chart)	\$	_____
Subtotal	\$	_____
Sales Tax (NYS only)	\$	_____
Total Enclosed	\$	_____

Name \_\_\_\_\_  
Address \_\_\_\_\_  
City \_\_\_\_\_ State \_\_\_\_\_ Zip \_\_\_\_\_



## Multimedia mayhem

JEFF HOLTZMAN

**M**ultimedia. It may be the first overhyped buzzword of the 90's. Or it may be the beginning of Gutenberg II. Gutenberg I occurred around the year 1440, when Johannes Gutenberg invented movable type, thus clearing the way for high-volume printing. High-volume printing did two things: it vastly increased the variety of literature available, and it vastly increased the audience for that literature. Sixty years later, millions of books had been printed, and Europe was home to thousands of what we today might call "QwikPrint" shops. Five hundred and fifty one years later, we're on the threshold of another revolution in publication technology. Gutenberg I brought to the masses media for the efficient transmission of language; Gutenberg II will bring to the masses media for the efficient transmission of all aural and visual information.

That's a grandiose claim. However, the confluence of several social and technological factors makes it a likely one.

Socially, traditional forms are losing out to other media. Literacy is dropping; mixed-media forms of education and entertainment are becoming increasingly popular. People depend more on CNN than the New York Times to keep abreast of current events. Computer-generated graphics receive frequent showings in major art centers. Electronic music has received the attention of serious composers. Live drama is now minuscule compared to film. Traditional print publishers are dabbling in new forms—books on tape, encyclopedias on CD-ROM. And video games are preparing an entire generation for a lifetime of interaction with electronic media. High schools are graduating illiterate, innumerate people; to compensate, corporations are spending billions educating, re-educating, and preeducating this increasingly unqualified work force.

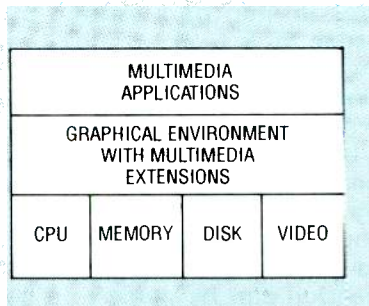

**FIG. 1—MULTIMEDIA ARCHITECTURE provides a standard interface for multimedia applications to build on.**

You may bemoan the loss of traditional modes of communication—and I would join you. Nonetheless, it's happening. So you can either throw up your hands or find a way of preserving the old while embracing the new. And that's where multimedia fits in.

### Gutenberg II

In addition to those social factors, there's a whole lot of technology coming together to set the stage for Gutenberg II. The basic architecture is shown in Fig. 1.

Multimedia demands computing power, including a fast CPU, lots of memory (RAM) and permanent storage (disk), and high resolution video. Now this base technology level is here, at affordable prices.

On top of the base technology layer is a user-friendly graphical environment, with special extensions to

handle new media (sound cards, CD-ROM drives, MIDI interfaces, laser disc and other motion video sources, etc.). The graphical environment is a highly contentious area right now, but recent events lead me to the conclusion that when all the smoke clears, there's going to be much less different among the competing systems than there is in common. Windows, OS/2, and the Mac environment are all headed toward standards. Architectural layering will hide underlying technologies, so it won't matter whether you're running the Mac Finder, Windows' Program Manager, or the OS/2 Desktop. It'll matter even less whether it's an Intel or Motorola CPU under the hood. When you plug in the latest multimedia extravaganza, it'll just run.

At the highest level are the applications. There are some 2500 CD-ROM titles in "print" right now. Few of these are multimedia based; the vast majority consist of pretty boring text/numeric databases. However, several dozen full multimedia titles will be released between the time this is written and the time you read it; 1992 promises the release of hundreds of new titles. Such as? How about: Compton's Multimedia Encyclopedia, the Guinness Multimedia Disk of Records, Just Grandma and Me: A Broderbund Living Book, Countries of the World, Composer Quest, The Electronic Library of Art, Berlitz language lessons (Spanish, French, German, Italian), Great Cities of the World, Battle Chess, SimCity, The Macmillan Dictionary for Children, Multimedia Beethoven, Introductory Games in French and Spanish, World Atlas, Desert Storm.

There are other factors contributing to this revolution in publishing. Hypertext research initiated by Ted Nelson in the early 60's plays a prominent role. Advances in cognitive and instructional psychology also contribute significantly.

### VENDOR INFORMATION

SideBar (\$99.99), Paper Software, P.O. Box 567, New Paltz, NY 12561. (800) 551-5187, (914) 255-0056.

**CIRCLE 41 ON FREE INFORMATION CARD**

*High-Tech Ventures, The Guide for Entrepreneurial Success, (\$29.25) C. Gordon Bell and John E. McNamara, by Addison-Wesley, April 1991.*

**CIRCLE 42 ON FREE INFORMATION CARD**



**TABLE 1—MULTIMEDIA HARDWARE LEVELS**

Component	Base Level	Power User	Developer
CPU	80286/10 MHz	80386/25 MHz	80486/33 MHz
RAM	2 MB	4 MB	16 MB
Hard disk	30 MB	80 MB	0.5–1.0 GB
Video	VGA (16 color)	VGA (256 color)	1024 × 768 × 256 color, non-interlaced, video overlay
Optical storage*	CD-ROM with audio output		
Audio*	8-bit DAC, 8-bit ADC, 11 and 22 kHz sampling rates. 16-bit DAC and ADC preferred. Multi-voice synthesizer. MIDI		
*Note: Required for upgrade kit			

**Getting in step**

Chances are you don't own a multimedia-compatible PC right now. But as those titles are released, you're going to start thinking strongly about buying one, or about buying an upgrade kit for your existing PC (or buying separate components for an upgrade.)

Microsoft has defined a basic multimedia PC as shown in Column 2 of Table 1; performance-conscious users will want a system like that in Column 3; developers will opt for something like Column 4. An upgrade kit consists of a CD-ROM drive, along with an audio board that provides ADC, DAC, and MIDI support.

NCR, CompuAdd, Tandy, NEC, Olivetti, Zenith, Fujitsu, and Philips have all announced or begun shipping multimedia PC's; prices start around \$2500. Upgrade kits starting around \$700 are available from CompuAdd, Creative Labs, Headland, Media Vision, and Tandy.

It's only a matter of time before all major hardware vendors provide similar offerings.

**Standards and competition**

Microsoft initiated formation of a trade group, the Multimedia PC Marketing Council (MPMC). Since its formation, however, the MPMC has attached itself to the Software Publishers Association, thereby guaranteeing that no one vendor's interests will be served at the expense of others—or the consumer's.

Nonetheless, there is IBM, which has been strangely silent about the

MPMC. The IBM/Microsoft battle is one thing, but bear in mind that IBM is heavily involved in multimedia technologies. A few years ago Big Blue introduced a touch-screen system that is widely used in training applications. The company has an entire division dedicated to educational systems; it has funded or sponsored projects that we'll soon be hearing lots about, including one on the voyage of Columbus. Other IBM titles include Ulysses, the Declaration of Independence, and Hamlet. Expect a strong showing—when IBM is ready.

There are some other technologies that have been hanging around for years, waiting to become economical and adopted by large numbers of users. DVI (Digital Video Interactive) is one; CD-I (Compact Disc Interactive) is another. It's too soon to tell whether the Microsoft/MPMC standards will really take hold. It's likely that they will, however. These standards are comprehensive, are built on general-purpose computing platforms, and are supported by a fairly broad spectrum of vendors. Why would the average consumer buy a CD-I player when he or she can get the same effect on a PC that also allows word processing, checkbook balancing, etc? DVI, CDI, and similar technologies will either become compliant with emerging standards, remain as they are and carve out niche markets, or simply die.

**Conclusions**

Above I said that Gutenberg II would support all sound and visual information. Want to guess what

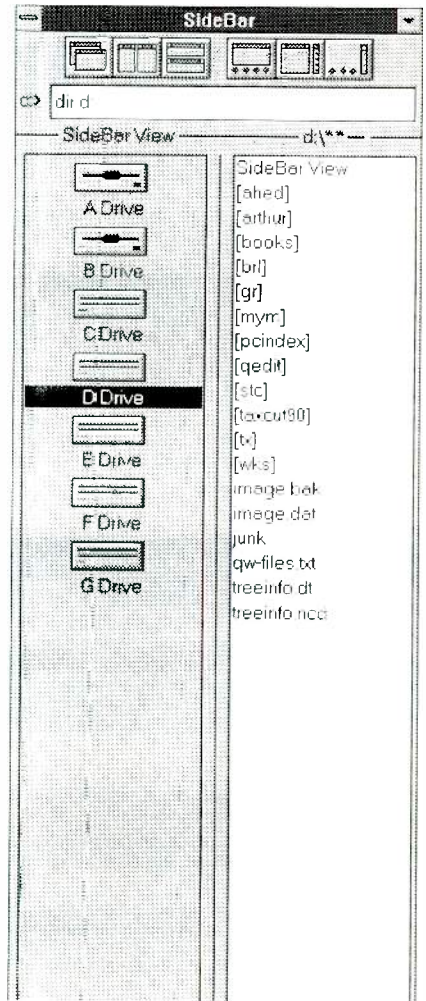

**FIG. 2—SIDEBAR is the most elegant Windows shell on the market. It won't overload you with features; rather it adheres to a small-is-beautiful philosophy. Nice work.**

Gutenberg III will support? Even better, when it'll happen?

**News bits**

Intel's microprocessor line is coming under increasing pressure. **Chips & Technologies**, which has suffered financial hardships in recent years, has bet the farm on two new chip lines that the company hopes will restore it to the glory of former days. One line comprises a set of 386DX and 386SX CPU's; the other is a complete PC-on-a-chip. The latter combines fully compatible versions of the major system components (8086 CPU, 8254 timer, 8259 interrupt controller, DMA emulator, XT bus controller, CGA graphics controller, and 16C450 UART) in a single package called the F8680. Building a system with the F8680 amounts to

*continued on page 92*

# BUYER'S MART

## FOR SALE

**TUBES:** "oldest," "latest." Parts and schematics. SASE for lists. **STEINMETZ**, 7519 Maplewood Ave., R.E., Hammond, IN 46324.

**RESTRICTED** technical information: Electronic surveillance, schematics, locksmithing, covert sciences, hacking, etc. **Huge selection. Free brochures.** **MENTOR-Z**, Drawer 1549, Asbury Park, NJ 07712.

**CABLE TV** converters: Jerrold, Oak, Scientific Atlantic, Zenith & many others. "New MTS" stereo add-on: mute & volume. Ideal for 400 and 450 owners! 1 (800) 826-7623, Amex, Visa, M/C accepted. **B & B INC.**, 4030 Beau-D-Rue Drive, Eagan, MN 55122.

## FREE CATALOG

**FAMOUS "FIRESTIK" BRAND CB ANTENNAS AND ACCESSORIES. QUALITY PRODUCTS FOR THE SERIOUS CB'er. SINCE 1962**  
**FIRESTIK ANTENNA COMPANY**  
 2614 EAST ADAMS  
 PHOENIX, ARIZONA 85034

**TUBES**, new, up to 90% off, SASE. **KIRBY**, 298 West Carmel Drive, Carmel, IN 46032.

**T.V.** notch filters, phone recording equipment, brochure \$1.00. **MICRO THinc**, Box 63/6025, Margate, FL 33063. (305) 752-9202.

**CIRCUIT Boards** — Complete printed circuit fabrication from single sided to production multilayers. Twenty-four hour turnaround available. **CIRCUIT CENTER**, PO Box 128, Addison, IL 60101. (708) 543-0671.

**PREVENT** descrambler detection & damage! Order Tech-Block today! Simple in-line connection. Only \$19.95 P.P.D. **THE STAGE DOOR VIDEO**, PO Box 518, Belleview, FL 32620. For C.O.D.'s 1 (800) 395-4557.



### Quality Microwave TV Antennas

**WIRELESS CABLE - IFTS - MMDS - Amateur TV Ultra High Gain 50db(+)** • Tuneable 1.9 to 2.7 Ghz.  
 • 36-Channel System Complete \$149.95  
 • 12-Channel System Complete \$114.95  
 • Call or write (SASE) for "FREE" Catalog

**PHILLIPS-TECH ELECTRONICS**  
 P.O. Box 8533 • Scottsdale, AZ 85252  
 (602) 947-7700 (\$3.00 Credit all phone orders)  
**LIFETIME WARRANTY** MasterCard • Visa • COD's • Quantity Pricing

**ELECTRONIC** supermarket surplus prices! Transformer specials, railroaders, builders, engineers, experimenters, LSASE, **FERTIK'S**, 5400 Ella, Phila., PA 19120.

**OUR** monthly picture flyer lists quality surplus parts at low prices. Single and quantity prices. **STARTRONICS**, Box 683, McMinnville, OR 97128.

**PHOTOFACT** folders under #1400 \$5.00. Others \$7.00. Postpaid. **LOEB**, 414 Chestnut Lane, East Meadow, NY 11554. (516) 481-4380.

## CB RADIO OWNERS!

We specialize in a wide variety of technical information, parts and services for CB radios. 10-Meter and FM conversion kits, repair books, plans, high-performance accessories. Thousands of satisfied customers since 1976! Catalog \$2.

**CBC INTERNATIONAL**  
 P.O. BOX 31500RE, PHOENIX, AZ 85046

**DESCRAMBLERS** cable TV converters, lowest prices, guaranteed, best quality, all types available, **CNC CONCEPTS, INC.**, Box 34503, Minneapolis, MN 55434. 1 (800) 535-1843.

**TOCOM and Zenith "test" chips. Fully activates unit. \$50.00. Cable descramblers from \$40.00. Orders 1 (800) 452-7090. Information (213) 867-0081.**

**SPEAKER** repair. All makes — models. Stereo & professional. Kits available. Refoaming \$18.00. **AT-LANTA AUDIO LABS**, 1 (800) 568-6971.

**REMOVE** tamper resistant torx screws. Set includes seven 1/4" bits. \$29.95 plus \$3.50 S&H. **SUN-SET ELECTRONICS**, 12145 Alta Carmel Court, Suite 250-139, San Diego, CA 92128.

## CLASSIFIED AD ORDER FORM

To run your own classified ad, put one word on each of the lines below and send this form along with your check to:

**Radio-Electronics Classified Ads**, 500-B Bi-County Boulevard, Farmingdale, NY 11735

**PLEASE INDICATE** in which category of classified advertising you wish your ad to appear. For special headings, there is a surcharge of **\$25.00**.

( ) Plans/Kits ( ) Business Opportunities ( ) For Sale  
 ( ) Education/Instruction ( ) Wanted ( ) Satellite Television  
 ( )

Special Category: \$25.00

### PLEASE PRINT EACH WORD SEPARATELY, IN BLOCK LETTERS.

(No refunds or credits for typesetting errors can be made unless you clearly print or type your copy.) Rates indicated are for standard style classified ads only. See below for additional charges for special ads. **Minimum: 15 words.**

1	2	3	4	5
6	7	8	9	10
11	12	13	14	15 (\$46.50)
16 (\$49.60)	17 (\$52.70)	18 (\$55.80)	19 (\$58.90)	20 (\$62.00)
21 (\$65.10)	22 (\$68.20)	23 (\$71.30)	24 (\$74.40)	25 (\$77.50)
26 (\$80.60)	27 (\$83.70)	28 (\$86.80)	29 (\$89.90)	30 (\$93.00)
31 (\$96.10)	32 (\$99.20)	33 (\$102.30)	34 (\$105.40)	35 (\$108.50)

We accept MasterCard and Visa for payment of orders. If you wish to use your credit card to pay for your ad fill in the following additional information (Sorry, no telephone orders can be accepted.):

Card Number

Expiration Date

Please Print Name

Signature

**IF YOU USE A BOX NUMBER YOU MUST INCLUDE YOUR PERMANENT ADDRESS AND PHONE NUMBER FOR OUR FILES. ADS SUBMITTED WITHOUT THIS INFORMATION WILL NOT BE ACCEPTED.**

**CLASSIFIED COMMERCIAL RATE:** (for firms or individuals offering commercial products or services) \$3.10 per word prepaid (no charge for zip code). **MINIMUM 15 WORDS.** 5% discount for same ad in 6 issues; 10% discount for same ad in 12 issues within one year; if prepaid. **NON-COMMERCIAL RATE:** (for individuals who want to buy or sell a personal item) \$2.50 per word, prepaid...no minimum. **ONLY FIRST WORD AND NAME** set in bold caps at no extra charge. Additional bold face (not available as all caps) **55c per word additional.** Entire ad in boldface, \$3.70 per word. **TINT SCREEN BEHIND ENTIRE AD: \$3.85 per word. TINT SCREEN BEHIND ENTIRE AD PLUS ALL BOLD FACE AD: \$4.50 per word. EXPANDED TYPE AD: \$4.70 per word prepaid.** Entire ad in boldface, \$5.60 per word. **TINT SCREEN BEHIND ENTIRE EXPANDED TYPE AD: \$5.90 per word. TINT SCREEN BEHIND ENTIRE EXPANDED TYPE AD PLUS ALL BOLD FACE AD: \$6.80 per word. DISPLAY ADS:** 1" x 2 1/4"—\$410.00; 2" x 2 1/4"—\$820.00; 3" x 2 1/4"—\$1230.00. **General Information:** Frequency rates and prepayment discounts are available. **ALL COPY SUBJECT TO PUBLISHERS APPROVAL. ADVERTISEMENTS USING P.O. BOX ADDRESS WILL NOT BE ACCEPTED UNTIL ADVERTISER SUPPLIES PUBLISHER WITH PERMANENT ADDRESS AND PHONE NUMBER.** Copy to be in our hands on the 5th of the third month preceding the date of the issue. (i.e., Aug. issue copy must be received by May 5th). When normal closing date falls on Saturday, Sunday or Holiday, issue closes on preceding working day. Send for the classified brochure. Circle Number 49 on the Free Information Card.



**TEST equipment** pre-owned now at affordable prices. Signal generators from \$50.00, oscilloscopes from \$50.00, other equipment, including manuals available. Send \$2.00 U.S. for catalog, refunded on 1st order. **J.B. ELECTRONICS**, 3446 Dempster, Skokie, IL 60076. (708) 982-1973.

**DESCRAMBLERS:** Oak Sigma, Varisync, Hamlin, Scientific Atlanta, Jerrold, Pioneer, Sylvania. Catalog \$5.00 money order (credited first order), service manuals, schematics, **SURPLUS ELECTRONICS**, PO Box 10009, Colorado Springs, CO 80932.

**WIRELESS CABLE RECEIVERS 1.9 TO 2.7 GHz**

30 CH PARABOLIC DISH SYSTEM \$173.90  
 30 CH ROD ANTENNA SYSTEM \$193.90  
 30 CH CRYSTAL CONTROLLED SYSTEM \$294.95

SUN MICROWAVE INT'L. INC. SEND \$1.00 FOR P.O. BOX #34522 CATALOG ON THESE PHOENIX, AZ 85067 AND OTHER FINE (602) 230-1245 VIDEO PRODUCTS QUANTITY DISCOUNTS

ORDERS ONLY 1-800-484-4190 CODE 9793



**YO! Like to go exploring?** New computer maze game — **Dungeon Thief**. Simple, fun, for all ages/abilities. Full game \$15.00, demo \$3.00. PC's/compatibles, color or mono. Specify disk (5.25," 3.5") Check/m.o. to: **SENTE SYSTEMS, INC.**, Dept. 67, Box 9439, Anaheim, CA 92812.

**MASTERCARD AND VISA** are now accepted for payment of your advertising. Simply complete the form on the first page of the Market Center and we will bill.

**ELECTRONIC** test equipment and parts. Free catalog. **EF ELECTRONICS**, Box 326, Aurora, IL 60506.

**DESCRAMBLERS**, all brands, examples Tocom VIP w/r \$275.00, Oak RTC-56 w/r 10 @ \$89.00, M-3 5-B \$35.00 — 10 @ \$29.00, F.T.B. 10 @ \$59.00, SA3-B 10 @ \$59.00, Hamlin CRX-6600 w/r 10 @ \$79.00, Sylvania 4040 DIC replaces Jerrold 400 DIC w/r 10 @ \$69.00, full warranty C.O.D. orders **OK MOUNT HOOD ELECTRONICS**, (206) 260-0107.

**Advanced solid-state LASER**

This incredible unit weighs less than 1/2 ounce. Only 1.125" long and 0.580" wide. With a range of more than 1000 yards, you are limited only by your imagination!

This is not a breakable glass tube but a state-of-the-art advanced solid-state laser with literally hundreds of applications!

3mW only \$149.00  
 5mW only \$175.00

**SPECIAL DEAL** save 10% on two or more!

Low power, self-contained unit which will produce a visible red beam from a 5 - 10 volt power supply.

**POLARIS Industries**  
 141 W. Wieuca Rd., Suite 300-B  
 Atlanta, GA. 30342  
 Call Our Toll Free 24-Hour Order Line  
**1-800-222-5620**



**TEST TURN-ONS** SA 8580 SA 8550 SA 8500 SA 8570/90 Zenith all Jerrold Starcom 6/7 Tocom-VIP \$44.95 each 1 pc boxes SA 8580 Starcom 7B/B Pioneer 6110 Tocom VIP \$279.95 each. 1 (800) 74-CABLE.

**CB TV** Jerrold 450-DIC \$45.00, JSX-DIC M35B or SB-3 \$19.00, RTC-56 \$79.00. Other brands in stock. For dealers only (405) 685-2048.

**TUBES.** Thousands. \$.85. None higher. SASE for list. **CHUCK ADAMSON**, 3410 Sands, El Paso, TX 79904. (915) 757-8609.

**DESCRAMBLERS**  
**CABLE TV EQUIPMENT**

CALL TOLL FREE  
**1-800-228-7404**

30 DAY MONEY BACK GUARANTEE

OUR PRODUCTS ARE BULLET PROOF

YOU WON'T FIND ANY HOLES IN OUR WARRANTIES

WE CARRY ALL MAJOR BRANDS  
 BEST PRICE BEST SERVICE

MAKE THE CONNECTION

**NU-TEK ELECTRONICS**

FOR MORE INFORMATION CALL OR WRITE

**1-512-250-5031**

NU-TEK ELECTRONICS  
 8114 MALCONB WOOD DR.  
 #307 DEP. 290 AUBURN TEXAS 76769



**CABLE TV**  
**DESCRAMBLER LIQUIDATION!**

**FREE CATALOG!**

Hamlin Combos \$44, Oak M35B \$60 (min. 5), etc.

**WEST COAST ELECTRONICS**

For Information: 818-709-1758  
 Catalogs & Orders: 800-628-9656

**Ferro Fluid**

Pro-Tech ferro fluid is commonly used on voice coils to substantially improve frequency response, increase transient and continuous power handling capabilities and reduce second and third order harmonic distortion. It reduces the Q and lowers the impedance peak at resonance without a significant reduction in SPL. Ferro fluid can effectively increase power handling capability of a driver by 200-300%. General purpose fluid for tweeters and midranges only. 10cc bottle (enough for 75-100 tweeters).



#RM-340-430 **\$19.95** Each

**Light Oak Speaker Cabinet**

Premium ported speaker cabinet made of acoustical grade particle board and covered with a light oak vinyl laminate. Pre-cut with an 11-1/4" hole for use with most 12" woofers. The baffle board has no tweeter or midrange holes for design flexibility. The 3/4" thick particle board ensures low panel resonance. Dimensions: 11" x 15" x 27". Volume: 2.5 cu ft. Grill and terminal included. Sold individually.

#RM-262-100 **\$49.00** Each **\$45.50** (2-up)

**12 Gauge Neon Wire**

The competition in today's auto sound contests is so fierce that good sound alone is not enough to win. More and more installers are striving to make their installation more pleasing to the eye.



Parts Express now stocks 12 gauge speaker wire in vibrant neon colors. This wire is the same high quality, made in the U.S. wire you have used before, but now it has flashy, neon colored insulating jackets. Available in neon pink, neon green, and neon orange. Sold by the foot on or 50 ft. spools.

#RM-100-162 (Neon pink)  
 #RM-100-166 (Neon orange) **49¢/Ft.**  
 #RM-100-170 (Neon green)

**Tuned Port Tubes**

These attractive, preformed tuned ports allow the back pressure radiated from the rear of the woofer to reinforce the sound level in front. Made of black plastic.



Part #	Length	Dia.	(1-9)	(10-up)
#RM-260-320	2"	1-7/8"	1.40	.95
#RM-260-321	4"	1-7/8"	1.60	1.20
#RM-260-322	5"	2"	1.65	1.30
#RM-260-323	1"	2-7/8"	1.40	.95
#RM-260-324	5"	2-7/8"	1.85	1.50
#RM-260-326	3"	2-7/8"	1.65	1.30
#RM-260-327	2-1/2"	3-7/8"	1.85	1.50
#RM-260-328	5"	3-7/8"	1.95	1.60

No mixing for quantity pricing.

**Famous Maker 3-1/2" Speaker Pair**

Dual cone 3-1/2" speaker pair for upgrading stock dash speakers. Graphite fiber composite woofer cone provides a smooth extended response at all power levels. The high frequency radiator (whizzer) takes over from the woofer at 6,000 Hz and greatly extends the response past 20 KHz. Strontium ferrite magnet. 3/4" high temperature voice coil. Impedance: 4 ohm. Power handling capability: 25 watts continuous, 70 watts peak. Frequency response: 120-21,000 Hz. Equipped with dust screen. Made in the U.S. by a company with over 40 years experience in the auto sound market.



#RM-265-275 **\$29.95** Pair

**Subwoofer Input/Output Terminal**

This recessed terminal panel has inputs for right and left channels as well as outputs for right and left channels to route to your satellite speakers. Greatly simplifies subwoofer hook-up. Outside dimensions: 3-7/8" x 5-3/8".

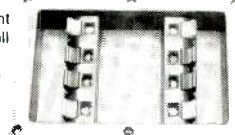

#RM-260-308  
**\$3.95** (1-9) **\$3.50** (10-up)



**Parts Express**  
 International, Inc.  
 340 E. First St., Dayton, Ohio 45402  
 Local: 1-513-222-0173  
 FAX: 513-222-4644

• 15 day money back guarantee • \$15.00 minimum order • We accept Mastercard, Visa, Discover, and C.O.D. orders. • 24 hour shipping • Shipping charge = UPS chart rate + \$1.00 (\$3.00 minimum charge) • Hours 8:30 am - 7:00 pm EST, Monday - Friday • 9:00 am - 2:00 pm Saturday. Mail order customers, please call for shipping estimate on orders exceeding 5 lbs. Foreign destination customers please send \$5.00 U.S. funds for catalog postage.

CALL TOLL FREE  
**1-800-338-0531**

**FREE CATALOG**



\*\*\*\*\*PRESENTING\*\*\*\*\*  
**CABLE TV  
DESCRAMBLERS**

\*\*\*\*\* STARRING \*\*\*\*\*  
**JERROLD, HAMLIN, OAK**  
AND OTHER FAMOUS MANUFACTURERS

- FINEST WARRANTY PROGRAM AVAILABLE
- LOWEST RETAIL / WHOLESALER PRICES IN U.S.
- ORDERS SHIPPED FROM STOCK WITHIN 24 HRS.
- ALL MAJOR CREDIT CARDS ACCEPTED

FOR FREE CATALOG ONLY **1-800-345-8927**  
FOR ALL INFORMATION **1-818-709-9937**

**PACIFIC CABLE CO., INC.**  
7325 1/2 Reseda Blvd., Dept. 2110  
Reseda, CA 91335

**EDITOR** with source \$49.00 modify and sell all you like. No royalties. Written in QuickBasic version 4.5. Manual on disk included. **TARBELL ELECTRONICS**, 5881 John Avenue., Long Beach, CA 90805. (213) 423-2792.

**PLANS AND KITS**

**FASCINATING** electronic devices! Dazers! Lasers! FM/AM/phone transmitters! Detectors! Kits/assembled! Catalog \$2.00. **QUANTUM RESEARCH**, 16645-113 Avenue, Edmonton, AB. T5M 2X2.

**HOBBY**/broadcasting/HAM/CB/surveillance transmitters, amplifiers, cable TV, science, bugs, other great projects! Catalog \$1.00. **PANAXIS**, Box 130-F1, Paradise, CA 95967.

**DIGITAL recorder**. Digitally record any audio source with special effects. Microprocessor controlled device. Detailed plans, \$9.75: **T. ZURAW**, Box 341, Dearborn Hts, MI 48127.

**BUILD** our picture only, satellite TV descrambler for most channels. Uses 6 transistors and 4 chips. Most parts from Radio Shack. For educational purposes only, not to be used illegally. Circuit board and plans \$30.00 U.S. funds. Circuit board, plans, and parts kit \$89.00 U.S. funds. Build a super high economy carburetor, to make eight cylinder engines run on less than one gallon of gasoline per hour. Plans for 5 types \$20.00 U.S. funds. Cheque, money order or Visa welcome. Order from **VALLEY MICROWAVE**, Bear River, Nova Scotia, Canada B0S 1B0. Tel. (902) 467-3577 8 to 4 eastern time. Fax: (902) 467-3937 anytime.

**INVESTIGATORS**, experimenters — Quality new plans. Micro and restricted devices. Free catalog. Self addressed stamped envelope required. **KELLEY SECURITY, INC.** Suite 90, 2531 Sawtelle Blvd., Los Angeles, CA 90064.

**REMOTE CONTROL KEYCHAIN**

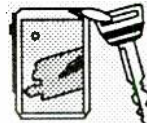

Complete w/mini-transmitter and +5 vdc RF receiver Fully assembled including plans to build your own auto alarm Quantity discounts available

**\$24.95** Check, Visa or M/C Add \$ 3 shipping

**VISITECT INC.** Box 14156, Fremont, Ca. 94539  
(510) 531-8425 Fax (510) 531-8442

**PCB** and schematic CAD. \$195.00 IBM EGA CGA Multilayer, rubberband, autovia, NC drill, laser, dot matrix, plotter, library, Gerber. **AUTOSCENE**, 10565 Bluebird St., Minneapolis, MN 55433. (612) 757-8584 free demo disk.

**GREAT** value. **Precision** fully-regulated supply (2 + x0-50V +/-0.01%5A0.5%) and (1 + x5V-3A). Tested parts as specified Radio El. Mar/90. No case U.S. \$560.00 + \$20.00 shipping (U.S./Can) cheque or M.O. to: **BCH**, 150 Clark Blvd., Dept. 299, Bramalea, Ontario Canada L6T-4Y8.

**REMOVE  
LEAD  
VOCALS**

Build this kit for under \$60 which removes lead vocals from standard stereo records, CDs, tapes or FM broadcasts. Easily connects to any home component stereo. Perform live with the backgrounds. You can be the lead singer of your favorite band. Detailed Plans. \$4.95

**Weeder Technologies**  
14773 Lindsey Rd.  
Mt. Orab, Ohio 45154

**REMOVE** VCR copy protection, PCB PAL instructions \$16.50 w/P&H, **LOGICAL CHOICE**, 955 NW Ogden, Bend OR 97701.

**BUG**, telephone, FM, plans. Convert RadioShack device, easy. \$12.95 **ALLAN LABS**, PO Box 14302, 101 Allan Lane, Research Triangle Park, NC 27709.

**PRINTED** circuit art work. Low cost, for free information write **NEGRON ENGINEERING**, 159 Garfield Place, Brooklyn, NY 11215. Fax or call (718) 768-4028.

**VIDEOCIPHER II**/scanner/cable/satellite modifications books. Catalog — \$3.00. **TELECODE**, PO Box 6426-RE, Yuma, AZ 85366-6426.

**DESCRAMBLER** kits. Complete cable kit \$44.95. Complete satellite kit \$49.95. Add \$5.00 shipping. Free brochure. No New York sales. **SUMMIT RE**, Box 489, Bronx, NY 10465.

**CABLE T.V. EQUIPMENT**

**OAK RTC-56 99.00 M35-B 29.00**  
**TOCOM BULLET PROOF TEST CHIP 59.00 EA**  
**TOCOM 5503 VIP 250.00 5503 A 200.00**  
**HAMLIN, JERROLD, ZENITH, S.A. LOW AS 19.00**  
**M-F 6A-3P PST. 1-800-622-3799**  
**SAME DAY SHIPPING. FULL WARRANTY**

**CABLE  
DESCRAMBLERS**

Converters, Remote Controls, Descramblers, more

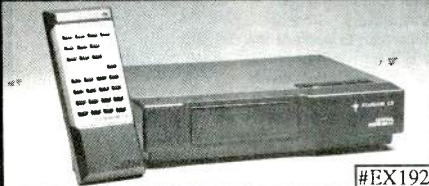

#EX192

All major brands carried

- \*JERROLD, \*TOCOM, \*ZENITH
- \*GENERAL INSTRUMENTS
- \*SCIENTIFIC ATLANTA, \*OAK
- \*HAMLIN, \*EAGLE, \*PIONEER

7th Year in business. Thank You  
Member of Omaha Chamber of Commerce  
1 Year warranty on new equipment  
30 Day money back guarantee  
Orders shipped from stock within 24 hours

CALL TODAY FOR A FREE CATALOG  
**1-800-624-1150**



**C.O.D.**

**M.D. ELECTRONICS**  
875 SO. 72nd St.  
Omaha, NE 68114

**Cable TV  
Descrambler Kits**

**Universal Kit.....\$55.00**

Includes all parts and PC Board. Not included is the ac adaptor or enclosure.

**Tri-Mode Kit.....\$39.00**

Includes all parts PC Board and AC Adaptor Not included is the enclosure.

**SB-3 Kit.....\$29.00**

Includes all parts. PC Board and AC Adaptor. Not included is the enclosure.

**Universal Tutorial.....\$9.95**

Includes an in depth study of the technology used and has troubleshooting hints.

**Tri-Mode Tutorial.....\$9.95**

Includes a gate by gate study of the circuit and has troubleshooting hints.

Call Toll Free 1-800-258-1134

**COD Only**

**M & G Electronics, Inc.**  
72 Orange St., Suite 216  
Providence, RI. 02903

**SECURITY system** plans for eight zone, entry/exit delay, prealarm controller with independent tamper/fire zones. Build it yourself for under \$50.00! Introductory offer also includes plans to modify a readily available product into an inexpensive alarm system motion detector. \$15.00 ppd. **V-TRONICS**, PO Box 177, Ruby, NY 12475.

**PLANS:** New 150 watts audio amplifier SC compensated with power supply. Send SASE and \$10.00 to **IOVATION**, 21 Tennyson, Dover, NH 03820.

**ELECTRONIC projects** — Complete plans/projects list. Audio/automotive/infrared/magnetic/power/photographic/custom designs/computer programs. Catalog \$3.00 credit 1st order. **ULRICH ELECTRONICS**, 11625 Jefferson St. NE, Blaine, MN 55434.

**BUILD** 6 simple low cost circuits to extend the functions and ranges of your meters and scope. Easy to build, useful! Send now for complete instructions. \$5.00 **BLUE BELL DESIGN, INC.**, Dept REM, 524 White Oak Rd., Blue Bell, PA 19422.

**INVENTORS**

**INVENTORS!** Can you patent and profit from your idea? Call **AMERICAN INVENTORS CORP.** for free information. Serving inventors since 1975. 1 (800) 338-5656.

**SPECIALIZED SECURITY**

**SURVEILLANCE** — Audio/video/infrared, personal protection equipment. Public, private, corporate uses. Extensive book; \$9.00. Was "Security Systems" catalog. **TRI-TRON OF ATLANTA**, 1857G Fox Hollow, Lilburn, GA 30247-3363.

**SATELLITE TV**

**FREE** catalog — Lowest prices worldwide. **SKYVISION**, 1012 Frontier, Fergus Falls, MN 56537. 1 (800) 334-6455. (See full page ad the Shopper section)

**SATELLITE TV** — Do it yourself — systems. Upgrades. Parts. Major brands discounted 40% — 60%. We'll beat everyone's price. **L.J.H. INC.**, call Larry (609) 596-0656.

# FREE CATALOG!

## 1-800-648-7938

### JERROLD HAMLIN OAK ETC

# CABLE TV DESCRAMBLERS

- Special Dealer Prices!
- Compare our Low Retail Prices!
- Guaranteed Prices & Warranties!
- Orders Shipped Immediately!

**REPUBLIC CABLE PRODUCTS, INC.**  
4080 Paradise Rd. #15, Dept RE192  
Las Vegas, NV 89109

VISA MasterCard

For all other information (702) 362-9026

## BUSINESS OPPORTUNITIES

**YOUR** own radio station! Licensed/unlicensed AM, FM, TV, cable. Information \$1.00. **BROADCASTING**, Box 130-F1, Paradise, CA 95967.

LET the government finance your small business. Grants/loans to \$500,000. Free recorded message: (707) 449-8600. (KSI).

EASY work! Excellent pay! Assemble products at home. Call toll free 1 (800) 467-5566 Ext. 5192.

## FREE CATALOG

- CABLE T.V. BOXES - ALL TYPES •
- LOW PRICES - DEALER PRICES •

## ACE PRODUCTS

1-800-234-0726

HOME assembly work available! Guaranteed easy money! Free details! **HOMEWORK-R**, Box 520, Danville, NH 03819.

WHAT snow? For sale: thriving, fully equipped, audio-video repair shop. Proven 40%+ increase in net last three years. \$70,000.00 cash. **AUDIOTECH**, 256-B North Highway 101, Encinitas, CA 92024. FAX (619) 944-0345, Phone (619) 944-9048.

# CABLE TV "BOXES"

## Converters-Descramblers Remote Controls-Accessories

- ★ Guaranteed Best Prices ★
- ★ 1 Year Warranty - C.O.D.'s ★
- ★ Immediate Shipping ★
- ★ FREE CATALOG ★

Call or Write  
**NAS/TRANS-WORLD CABLE CO.**  
3958 North Lake Blvd. • Suite 255  
Lake Park, Florida 33403  
1-800-442-9333  
1-800-848-3997

CABLE TV Secrets — the outlaw publication the cable companies tried to ban. HBO, Movie Channel, Showtime, descramblers, converters, etc. Suppliers list included. \$9.95. **CABLE FACTS**, Box 7111, Pataskala, OH 43062.

SECRET cable descrambler. Build your own descrambler for less than \$11.00, in seven easy steps. Radio Shack parts list included. Also free descrambling methods that cost nothing to try! Send \$10.00 to: **LOUIE WHITE**, 2 Marlin, Baytown, TX 77520.

MAKE \$\$\$! Become an American electronics dealer! Profit opportunities since 1965. Call **SCOTT PRUETT**, 1 (800) 872-1373.

**MONEYMAKERS!** Easy! One man CRT rebuilding machinery \$6,900.00 rebuilt \$15,900.00 new. CRT, 1909 Louise, Crystalake, IL 60014. (815) 459-0666. Fax (815) 477-7013.

## CABLE DESCRAMBLERS OAK M35B COMBO \$39.95

Jerrold, Zenith, Hamlin, Sci. Atlanta, Pioneer & MORE! OUR PRICES ARE BELOW WHOLESALE!

### CABLE+PLUS

14417 Chase St. #481-A Panorama City, CA 91402  
1-800-822-9955 • Other Info. 1-818-785-4500  
NO CALIF. SALES — DEALERS WANTED

## BIG PROFITS ELECTRONIC ASSEMBLY BUSINESS

Start home spare time investment knowledge or experience unnecessary. **BIG DEMAND** assembling electronic devices. Sales handled by professionals. Unusual business opportunity.

FREE Complete illustrated literature  
BARTARE 00 Bux 248  
Walnut Creek Calif. 94597

## ANTIQUE RADIO CLASSIFIED

Free Sample!  
Antique Radio's  
Largest Circulation Monthly.  
Articles, Ads & Classifieds.

6-Month Trial: \$15. 1-Yr: \$27 (\$40-1st Class).  
A.R.C., P.O. Box 802-L9, Carlisle, MA 01741

# MARK V ELECTRONICS, INC.

## Competitive Pricing \* Fast Shipping Since 1985

▲ indicates the level of difficulty in the assembling of our Products. ▲ Beginner ▲▲ Intermediate ▲▲▲ Advanced ★ Fully Assembled

**SPECIAL OFFER**

Special offer will be given to the purchase of Amplifier + Metal Cabinet + Power Transformer: TA 3600, SM 720, SM 100

AMPLIFIERS		KIT ASSEMB.	
1A 28MK2	Digital Voice Memo ▲	\$ 30.00	
1A 50A B	Multi Purpose Melody Generator ▲	12.84	17.20
1A 50C	Multi Purpose Melody (Happy Birthday, Wedding March, etc.) Generator ▲	13.65	18.71
1A 120MK2	35W Class A Main Power Mono Amp ▲	31.50	42.80
1A 300	30W Multi-Purpose Single Channel Amp ▲	20.00	29.00
SM 302	60W • 60W Stereo Power Amplifier (with Mic. inputs) ▲▲	73.00	85.00
TA 323A	30W X 2 Stereo Pre-main Amp ▲	31.50	42.80
TA 377A	State of the Art Fully Complementary Symmetrical FEI Pre-Amp ▲▲▲	59.95	75.00
TA 400	40W Solid State Mono Amp ▲	28.00	34.93
TA 477	120W Mostel Power Mono Amp ▲▲	68.00	85.00
SM 720	120W • 120W AC DC Stereo Hi-Fi & Pre-Main Amp ▲▲	75.00	89.00
TA 800MK2	120W • 120W Low Imp. Pre-Main Stereo Power Amp ▲▲	63.92	
TA 802	80W • 80W Pure DC Stereo Main Power Amp ▲▲	45.94	59.72
TA 1000A	100W Dynamic Class A Main Power Mono Amp ▲▲	50.00	65.00
TA 1500	100W X 2 Class A DC Stereo Pre-Main Amp ▲▲▲	73.70	95.81
TA 2200	DC Fet Super Class A DC Pre-Amp ▲▲▲	47.70	58.24
TA 2500	Hi Pre-Amp w/10 band graphic equalizer ★		78.00
TA 2800	Hi FEI IC Pre-Amp w/3 way tone control ★	48.90	63.57
TA 3000	Stereo Simulator (For Mono TV or Any Mono Source) ▲▲	27.00	38.50
TA 3600	300W HQ Hi-Fi Power Mono Amp ▲▲▲	85.00	110.00
SM-222	7 Band Hi-Fi Graphic Equalizer ▲	26.80	38.80
SM 333	Audio/Video Surround Sound Processor ▲▲▲	65.00	75.00
SM 666	Dynamic Noise Reduction ▲	26.00	34.00
SM 888	Universal Audio/Video KARAOKE Mixer Pre-Amp ★		155.00

MISCELLANEOUS		KIT ASSEMB.	
TV 25B	3 Channel Color Light Controller ★	\$	\$ 65.00
TV 25	Stereo Loudspeaker Protector ▲	14.85	20.85
TV 35	FM Wireless Microphone ▲	11.25	
TV 36	AC/DC Quartz Digital Clock ▲	19.00	26.20
TV 38	Sound Touch Control Switch ▲	12.00	
TV 41MK V	Infrared Remote Control Unit (w/Case) ▲▲▲	22.00	35.00
TV 42	Bar Dot Level Meter ▲▲	24.15	33.81
TV 43	3" Digital Panel Meter ▲	29.00	38.00
TV 45	20 Steps Bar Dot Audio Level Display ▲▲	38.45	46.14
TV-47	Superior Electronic Roulette ▲	19.46	27.24
016	10,000 Ohm 80V DC Capacitor (TA-3600 TA-477 TA-1000A TA-302)		23.50
017	8,200 Ohm 50V DC Capacitor (TA 802 TA-120MK2)		13.00
021	Nobel Resistor Single Vol. Control (TA-3600 TA-477 TA-1000A TA-120MK2)		12.00
022	Alps Resistor Dual Vol. Control (TA-377A TA-802 TA-2200)		22.00

REGULATORS		PRICE	
TR 355A	0 15V 5A Regulated DC Power Supply (no case & x former) ▲	\$15.65	\$ 21.76
TR 355B	0 30V 3A Regulated DC Power Supply (no case & x former) ▲	15.65	21.76
TR 503	0 50V 3A Regulated DC Power Supply (no case & x former) ▲	16.75	23.65

METAL CABINETS WITH ALUMINUM PANEL			PRICE
MODEL	H" x W" x D" MATCHING		
LG-1273	3" 12" 7" TA 2800 TA 377A TA 2200		\$ 23.85
LG-1684	4" 16" 8" TA 323A TA 377A TA 2200		28.50
LG-1924	4" 19" 11" TA 802 TA-1500 TA-120MK2 A 800 MK2 TA-1000A		34.50
LG-1925	5" 19" 11" TA 477 TA 800 MK2 TA 1500 TA-1000A TA-3600		38.00
LG-1983	2 1/2" 19" 8" TA 377A TA-2800 TA-2200 TA-120MK2		30.50

POWER TRANSFORMERS		PRICE	
MODEL	DESCRIPTION		
001	28V x 2.6A to 30V x 2.6A TA 800 MK2 TA 802 TA-1000A TA 1500		\$ 28.00
002	36V x 2.3A TR-503 TA-323A TA-400 TA-300 TA-377A		23.00
003	40V x 2.6A TA-477		30.00
004	24V x 2.6A TA-120 MK 2		23.00
005	26V x 2.3A TR-355B		17.00
006	18V x 2.5A TR 355A		17.00
007	53V x 2.8A TA-3600		45.00

We accept major Credit Cards, Money Orders, Checks and C.O.D. Orders. C.O.D. fee is \$6.50. Minimum order is \$20.00. We ship by UPS ground inside US (min. \$4.00) and ship by US mail outside US. Please call our sales department for orders over 2 lbs. or foreign orders. All assembled units have a 30 days warranty. Quality or Volume discount available upon request. Residents of CA please add sales tax 8.25%. Prepaid Order for faster shipment. Prices are subject to change without prior notice. We are not responsible for typographical errors.

**MARK V ELECTRONICS, INC. - 8019 E. Slauson Ave, Montebello, CA 90640**

Business & Showroom hours: (Pacific Time)  
Mon. thru Fri. 9:30 am to 5:00 pm  
Sat. 10:00 am to 5:00 pm



# Your Natural Resource for Wide

## Test/Measurement and Prototype Equipment

### Jameco Solderless Breadboards

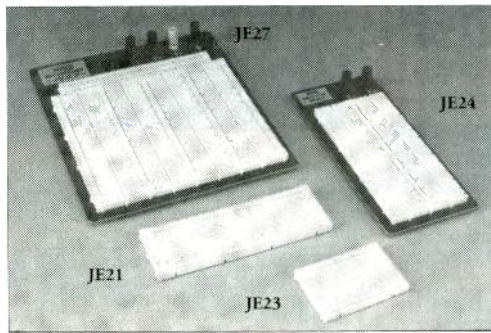

Jameco's long-lasting breadboards feature screen-printed color coordinates and are suitable for many kinds of prototyping and circuit design. Larger models feature a heavy-duty aluminum backing with voltage and grounding posts.

Part No.	Dim. L" x W"	Contact Points	Binding Posts	Price	Part No.	Dim. L" x W"	Contact Points	Binding Posts	Price
JE21	3.25 x 2.125	400	0	\$4.95	JE25	6.500 x 4.25	1,660	3	17.95
JE23	6.50 x 2.125	830	0	6.95	JE26	6.875 x 5.75	2,390	4	22.95
JE24	6.50 x 3.125	1,360	2	12.95	JE27	7.250 x 7.50	3,220	4	31.95

### GoldStar 20MHz Dual Trace Oscilloscope



The perfect unit for today's testing and measurement needs! Features include a 6" CRT display, and bandwidth from DC to 20 MHz. The GoldStar Oscilloscope comes with two 40MHz probes, two fuses, power cord, operation manual, schematics and block and wiring diagram. It's lightweight and portable with a two-year warranty.

GS7020.....\$399.95

### BNC Cable Assemblies for GS7020

BNC1	BNC(M) to BNC(M) RG58 A/U (39" L).....	\$3.95
BNC2	BNC(M) to Micro Hook RG174 (39" L).....	3.95
BNC3	BNC(M) to Macro Hook RG174 (39" L).....	3.95

### Weller Soldering and Desoldering Stations

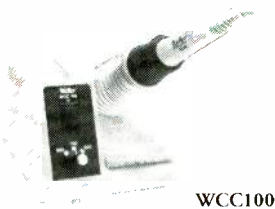

- Temperature adjustable from 350° to 850°F
- Zero voltage circuit protects sensitive components from damage
- Lighted on/off switch

WCC100 Soldering Station.....\$89.95

- 50 Watt Temperature Controlled Desoldering Station
- Desoldering head is temperature controlled to 800°F
- Low maintenance vacuum system

DS600 Desoldering Station ..\$549.95

### Metex Digital Multimeters

- Handheld, high accuracy • AC/DC voltage, AC/DC current, resistance, diodes, continuity, transistor hFE.
  - Manual ranging w/ overload protection
  - Comes with probes, batteries, case and manual
- M3650 & M4650 only:
- Also measures frequency and capacitance

M3800 3.5 Digit Multimeter .....\$39.95

M3610 3.5 Digit Multimeter .....\$59.95

M3650 3.5 Digit Multimeter w/Frequency & Capacitance .....\$74.95

M4650 4.5 Digit w/Frequency & Capacitance & Data Hold Switch.....\$99.95



24 Hour Toll-Free Order Hotline!  
1-800-831-4242

### Jameco Logic Pulser

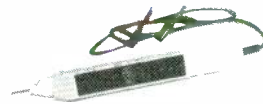

- Compatible with TTL, DTL, RTL, HTL, HNLT, MOS and CMOS IC's
- 1MΩ Sync input impedance • Pulser mode output current: 10mA • Square wave current output: 5mA • Audible tone

LP540.....\$16.95

### Jameco Logic Probe



- Max Frequency 80MHz • Minimum detectable pulse: 10ns • 120KΩ input impedance • Max. supply voltage: ±25V
- TTL threshold: (Lo)+0.8V ±0.1V, (Hi) +2.3V ±0.2V • CMOS threshold: (Lo) 30% VCC ±10%, (Hi) 70% VCC ±10%

MS104.....\$24.95

### A.R.T. EPROM Programmer



- Programs all current EPROMs in the 2716 to 27512 range plus the X2864 EEPROM
- RS232 port • Software included

EPP.....\$199.95

### UVP EPROM Eraser

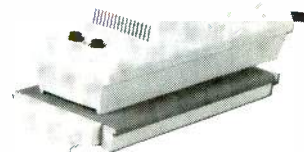

- Erases all EPROM's • Erases 1 chip in 15 minutes and 8 chips in 21 min
- UV intensity: 6800 UW/CM<sup>2</sup>

DE4.....\$89.95

### EPROMs - for your programming needs

Part No.	Price	Part No.	Price	Part No.	Price
TMS2516.....	\$4.25	2764-20.....	\$3.95	27256OTP.....	\$3.75
TMS2532-35.....	8.95	2764-25.....	3.75	27256-15.....	5.49
TMS2532A.....	6.95	2764A-20.....	3.75	27256-20.....	4.95
TMS2564.....	5.95	2764A-25.....	3.19	27256-25.....	4.49
TMS2716.....	5.95	27C64-15.....	3.95	27C256-15.....	5.95
1702A.....	3.95	27C64-25.....	3.25	27C256-20.....	4.95
2708.....	4.75	27128OTP.....	3.49	27C256-25.....	4.25
2716.....	3.39	27128-20.....	7.95	27512OTP.....	4.95
2716-1.....	3.75	27128-25.....	7.75	27512-20.....	6.75
27C16.....	4.25	27128A-15.....	4.95	27512-25.....	5.95
2732.....	4.95	27128A-20.....	4.49	27C512-15.....	6.75
2732A-20.....	4.49	27128A-25.....	3.75	27C512-20.....	6.49
2732A-25.....	3.49	27C128-15.....	5.75	27C512-25.....	5.95
2732A-45.....	2.95	27C128-25.....	7.95	27C010-15.....	9.95
27C32.....	4.75			68766-35.....	6.95

• Partial Listing • Over 4000 Electronic and Computer Components in Stock!



24 Hour Toll-Free Order Hotline  
1-800-831-4242



Please refer to Mail Key 2 when ordering





# Selection & Competitive Prices

## Computer Products and Electronic Components

### Assemble Your Own Computer Kit!

#### Jameco 16MHz 80286 Computer Kit

- Building your own computer provides you with a better understanding of components and their functions
- In-depth assembly instructions included
- Have your new computer assembled and running in an evening, using common tools
- Software included
- Purchase computer kits configured by Jameco or design your own

#### Includes:

- 80286-16 Motherboard with 2MB RAM (expandable to 8MB)
- 101-key enhanced keyboard
- Multi I/O Card w/ controller
- Toshiba 1.44MB, 3.5" floppy disk drive
- Baby sized desktop case
- 200 Watt power supply
- DR DOS 5.0
- AMI diagnostic software

JE2816.....\$599.95

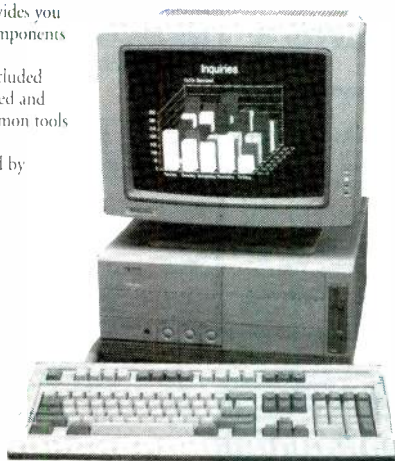

monitor and adapter extra

#### Jameco 4-Channel Switching Power Supply

- +5VDC @ 5.0A
- 5VDC @ 1.0A
- +12VDC @ 1.0A
- 12VDC @ 1.0A

- Microprocessor mini-computer, terminal and process control applications
- Input: 90-130VAC @ 47-440Hz
- Size: 6.25"L x 3.88"W x 1.5"H
- Weight: 1.25 lbs.
- Data included

FCS604A.....\$44.95 Additional Power Supplies available!

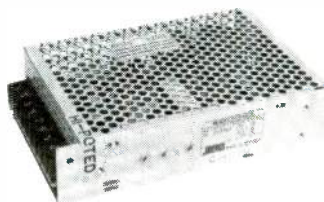

#### Zaison 56 Watt Switching Power Supply

- +5VDC @ 4.5A
- +12VDC @ 1.4A
- 12VDC @ 0.3A
- +12VDC @ 1.2A

Limited Quantity

- Input: 115VAC @ 47-440Hz
- Two 4 pin molex style connectors for voltage output
- Size: 6"L x 4.5"W x 2"H
- Weight 1.5 lbs.

PS6141.....\$24.95



#### Integrated Circuits\*

Part No.	1-9	10+
7400	\$.29	\$.19
7402	.29	.19
7404	.29	.19
7406	.35	.25
7407	.35	.25
7408	.35	.25
7410	.29	.19
7417	.35	.25
7420	.29	.19
7432	.35	.25
7433	.35	.25
7447	.89	.79
7474	.39	.29
7476	.45	.35
7486	.45	.35
7489	2.95	2.75
7490	.59	.49
74121	.49	.39
74192	.79	.69
74193	.79	.69

#### Linear ICs\*

Part No.	1-9	10+
TL082CP	\$.59	\$.49
LM317T	.65	.55
LM324N	.35	.29
LM336Z	1.05	.95
LM339N	.39	.35
NE555V	.29	.25
LM556N	.49	.39
LM723CN	.49	.39
LM741CN	.29	.25
LM1458N	.35	.29
LM1488N	.45	.39
LM1489N	.45	.39
ULN2003A	.69	.59
LM3914N	1.95	1.75
NE5532	1.19	1.09
7805T	.45	.41
7812T	.45	.41

\* Call for a complete listing of ICs

#### Dynamic RAMs

Part No.	Description	Price
4164-100	100ns, 64K x 1	\$1.89
4164-120	120ns, 64K x 1	1.69
4164-150	150ns, 64K x 1	1.49
41256-60	60ns, 256K x 1	2.49
41256-80	80ns, 256K x 1	2.19
41256-100	100ns, 256K x 1	1.95
41256-120	120ns, 256K x 1	1.79
41256-150	150ns, 256K x 1	1.69
511000P-80	80ns, 1MB x 1	7.25
511000P-10	100ns, 1MB x 1	6.75

#### Miscellaneous Components\*

##### Potentiometers

Values available (insert ohms into space marked "XX"):  
 500Ω, 1K, 5K, 10K, 20K, 50K, 100K, 1MΩ  
 43PXX 3/4 Watt, 15 Turn ..... \$ .99  
 63PXX 1/2 Watt, 1 Turn ..... .89

##### Transistors And Diodes

PN2222	\$.12	1N751	\$.15
PN2907	.12	C106B1	.65
1N4004	.10	2N4401	.15
2N2222A	.25	1N4148	.07
1N4735	.25	2N3055	.69
2N3904	.12	1N270	.25

##### Switches

JMT123	SPDT, On-On (Toggle)	\$.15
206-8	SPST, 16-pin (DIP)	1.09
MPC121	SPDT, On-Off-On (Toggle)	1.19
MS102	SPST, Momentary (Push-Button)	.39

\*Additional components available

#### Connectors

Part No.	Description	Price
DB25P	Male, 25-pin	\$.65
DB25S	Female, 25-pin	.75
DB25H	Hood	.39
DB25MH	Metal Hood	1.35
<b>LEDs</b>		
XC209R	T1, (Red)	\$.14
XC556G	T1 3/4, (Green)	.16
XC556R	T1 3/4, (Red)	.12
XC556Y	T1 3/4, (Yellow)	.16

#### IC Sockets

Low Profile	Wire Wrap(Gold)	Level #2	
8LP	\$.10	8WW	\$.49
14LP	.11	14WW	.69
16LP	.12	16WW	.79
24LP	.19	24WW	1.15
28LP	.22	28WW	1.39
40LP	.28	40WW	1.89

Soldertail Standard and Header Plug Sockets Also Available

24-Hour Toll-Free Order Hotline:

# 1-800-831-4242

Call or Write for a

## FREE 90-Page 1992 Catalog!

\$30.00 Minimum Order • Data Sheets - 50¢ each

# JAMECO®

ELECTRONIC COMPONENTS  
COMPUTER PRODUCTS

1355 Shoreway Road  
Belmont, CA 94002  
FAX: 1-800-237-6948  
BBS Support: 415-637-9025

International Sales • Customer Service • Technical Assistance  
• Credit Department • All Other Inquiries: 415-592-8097 • 7AM - 5PM P.S.T.

© 1992 Jameco, Inc.  
CA Residents Add 7.25%, 7.75% or 8.25% Sales Tax  
Shipping, handling and insurance are additional.  
**EXPRESS**

Terms: Prices subject to change without notice  
Items subject to availability and prior sale.  
Complete list of terms/conditions is available upon request.

**CABLE TV DESCRAMBLERS!**

**CABLE KINGDOM!**

- \*JEROLD\* \*OAK\* \*HAMLIN\*
- \*ZENITH\* \*PIONEER\*
- \*SCIENTIFIC ATLANTA\*

IN STOCK

6 MONTH WARRANTY! WE SHIP COD!  
ABSOLUTLEY LOWEST  
WHOLESALE/RETAIL PRICES!  
\*\*\*\*\*FREE CATALOG\*\*\*\*\*

J.P. VIDEO  
1470 OLD COUNTRY RD  
SUITE 315  
PLAINVIEW, NY 11803  
NO N.Y. SALES  
CALL NOW! 1 (800) 950-9145

**WANTED**

**INVENTIONS/** new products/ideas wanted: call TICI for free information/inventors newsletter. 1 (800) 468-7200 24 hours/day - USA/Canada.

**INVENTORS:** We submit ideas to industry. Find out what we can do for you. 1 (800) 288-IDEA.

**INVENTORS!** Your first step is important. For free advice, call **ADVANCED PATENT SERVICES**, Washington, DC, 1 (800) 458-0352.

**INVENTORS!** Confused? Need help? Call **IMPAC** for free information kit. USA/CANADA: 1 (800) 225-5800 (24 hours).

**EDUCATION & INSTRUCTION**

**F.C.C. Commercial General Radiotelephone License.** Electronics home study. Fast, inexpensive! "Free" details. **COMMAND**, D-176, Box 2824, San Francisco, CA 94126.

**COMPLETE** course in electronic engineering. Eight volumes. Includes all necessary math and physics. Free brochure. **BANNER TECHNICAL BOOKS**, 1203 Grant Avenue, Rockford, IL 61103.

**CABLE TV DESCRAMBLERS  
★ CONVERTERS ★  
and ACCESSORIES.**

**SAVE MONEY.  
DON'T RENT!**

PANASONIC, JERROLD, OAK,  
PIONEER, SCIENTIFIC ATLANTA  
AND MORE. LOWEST PRICES. FREE CATALOG.  
**CABLE READY COMPANY (800) 234-1006**

**CABLE TV  
DESCRAMBLERS  
ALL TYPES 800-582-1114  
FREE CATALOG  
M.K. ELECTRONICS • 7958 Pines Blvd  
Suite 276 • Pembroke Pines, FL 33024**

**BE a recording engineer;** Train at home for high paying — exciting careers. Free information. **AUDIO INSTITUTE**, 2258-A Union St., Suite K, San Francisco, CA 94123.

**VCR** tapes by college instructor covering electronic topics. Send for free demo \$3.50 P&H O.C.S., PO 292, Fort Mill, SC 29715.

**ELECTECH**  
**CABLE T.V. DESCRAMBLERS**

- All quality brand names •
  - All fully guaranteed • All the time •
- Knowledgeable Sales Service Department  
**FOR FREE CATALOG 800-253-0099**

**BEST BY MAIL**

Rates: Write National, Box 5, Sarasota, FL 34230

**OF INTEREST TO ALL**

**50% CASH DISCOUNT** at over 1,000 select Holiday Inns, Hilton Hotels, Best Western & More! Information \$1.00. **DISCOUNT TRAVEL SERVICE**, 662 Franklin Ave., Garden City, NY 11530, Suite 421.

**MONEYMAKING OPPORTUNITIES**

**WE PAY UP TO \$300.00 weekly** Woodburning Picture Frames. Everything supplied. No experience or selling. Bay Frame, PO Box 1588-RE, Jackson, TN 38302.

**PERSONAL-MISCELLANEOUS**

**SINGLES! MEET OTHER Fun Exciting People** Call INTRODUCTION 1-900-776-4225. \$2/Min.

**PAY TV AND SATELLITE DESCRAMBLING  
ALL NEW 1992 EDITION ALL NEW**

It's up to the minute! All new update on cable, wireless and satellite. Turn-ons, bypasses, circuits, chipping, bullets, bags, Geotac, Liberty One ECM's, Data Readers, programming, and lots more. Our best yet Only \$15.95. Other (all different) editions 1991, 1989, Volume One (Basics) \$15.95 each. **MDS Handbook** \$9.95. Satellite systems under \$600 \$12.95. Any 3/\$29.95 or 6/\$49.95. Video \$29.95. Scrambling News Monthly \$24.95/yr. Sample \$3. All new catalog \$1. Shipping costs included.

Scrambling News, 1552 Hertel Ave.,  
Buffalo, NY, 14216. Voice/Fax (716) 874-2088  
COD'S ARE OK. ADD \$6

**COMPUTER CONNECTIONS**

*continued from page 85*

adding some SRAM or DRAM—that's it. Who wants it? In the era of \$2000 386 boxes and \$3000 486 boxes, who cares about a CGA-level 8086? Makers of laptop and hand-held devices like HP's 95LX. That's the theory, anyway. It may be that we're about to witness an explosion of PC Gadgets, miniature DOS-like devices that surpass calculators and the Sharp Wizard type of device. The other line consists of 386 clones that provide 10–15% better performance. Both lines incorporate a new technology called SuperState that provides an interrupt level higher than all normal IRQ's and the NMI, and which when entered gives a totally new address space for executing code. SuperState could be used to implement power management functions, to emulate missing instructions (e.g., 286

*continued on page 96*

**THE ELECTRONIC GOLDMINE**

The Electronic Goldmine has one of the greatest selections of unique electronic kits available in the world! We have over 65 kits and over 1,400 unique bargain priced components in our catalog.

**FREE CATALOG**  
With OVER 1400 DIFFERENT ITEMS INCLUDING 65 KITS! REQUEST YOUR COPY TODAY!

**SURFACE MOUNT TECHNOLOGY KIT**

This kit contains 2 bright tiny LEDs (one red and one green) that alternately flash. The two transistor multivibrator circuit uses the same tiny surface mount devices (SMD) as used in almost all late model sophisticated electronic products. Size only 1.56" x .34". Complete with all parts, PC board and instructions.

**C6465 \$5.00**



**INFRARED DETECTOR KIT**

Great for testing and verification of infrared output. Uses sensitive sensor and electronic circuitry to respond to all types of infrared TV VCR etc. remote controllers and LEDs producing sound and lighting a bright red LED. 9V battery (not included). Size of board 2.5" x 1.4". Complete with all parts, PC board and instructions.

**C6441 \$5.95**

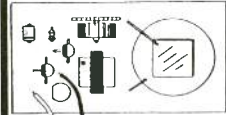

**INEXPENSIVE GEIGER COUNTER**

Probably the lowest priced Geiger Counter kit available in the world today! Features sensitive thin window Geiger Muller tube and speaker that emits clicks in proportion to the radiation level. Detects Beta and Gamma rays. Operates from one 9V battery (not included). Only 3" x 1.88".

**C6447 \$39.95**

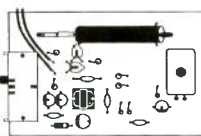

**BATTERY POWERED ULTRAVIOLET MINERAL LAMP**

**UVG-4 SHORT WAVE TYPE**  
Useful for detecting fluorescent minerals. 4 watt uses 4 "AA" (not included). Size 6.5" x 1.25" x 1.75"

**G812 \$31.95**

**MINIMUM ORDER: \$10.00** plus \$3.50 shipping and handling. We accept MC, Visa and Money Orders.  
**SEND ORDERS TO:** The Electronic Goldmine  
P.O. Box 5408 Scottsdale, AZ 85261  
**PHONE ORDERS (602) 451-7454 FAX ORDERS (602) 451-9495**

**CIRCLE 178 ON FREE INFORMATION CARD**

**Worldwide Cable**

**CABLE TV  
DESCRAMBLERS**

THE MOST ADVANCED  
TECHNOLOGY IN CABLE EQUIPMENT:

- BASE BAND
- PIONEER
- HAMLIN
- SCIENTIFIC ATLANTA
- JERROLD
- TOCOM
- ZENITH
- OAK

For out of this world prices call  
**WORLDWIDE CABLE**  
**1 800-772-3233**  
**FREE CATALOG AVAILABLE**

7491 C-5 N. FEDERAL HWY., SUITE 142  
BOCA RATON, FL 33487

MC / COD / VISA NO FLORIDA SALES

**CIRCLE 193 ON FREE INFORMATION CARD**



**EASY ORDER**  
1-800-582-4044



**EASY FAX**  
1-800-582-1255

**TRIPP LITE – PRECISION REGULATED DC POWER SUPPLIES**

Complete Line of DC Power Supplies to Convert 120VAC to 13.8VDC ±0.5VDC.

**Standard Features Include:**

- Solid state integrated circuit provides excellent regulation
- Output voltage maintained up to 95% of no load value
- High quality filtering for low noise operation
- Heavy duty power transformer for complete line isolation
- On/Off indicator light and rugged on/off switch on faceplate
- 3 conductor grounded cord on 10 Amp and larger models
- Current limiting electronic foldback for auto overcurrent protection

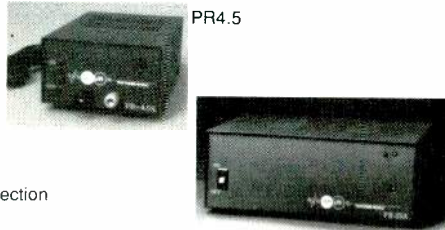

Tripp Lite DC Power Supplies Are Designed For Reliability and Superior Performance.

Order #	Price	ICS* (amps)	Continuous Duty (amps)	Fusing	Ripple Voltage	HxWxD (Inches)	Weight
PR4.5	32.95	4.5	3	Internal	0.1 Volt Max	3.125 x 4.75 x 8.25	5 lbs.
PR7	44.95	7	5	Chassis Mount	0.15 Volt Max	3.75 x 6.5 x 7.5	7 lbs.
PR10	64.95	10	7.5	Chassis Mount	0.15 Volt Max	4.5 x 6.625 x 7.625	10 lbs.
PR15	89.95	15	12	Chassis Mount	0.15 Volt Max	4.75 x 7.5 x 8.25	13 lbs.
PR25	126.95	25	20	Chassis Mount	0.15 Volt Max	5.125 x 12.5 x 10.5	20 lbs.
PR40	179.95	40	32	Chassis Mount	0.15 Volt Max	7.25 x 12.5 x 10	26 lbs.
PR60	249.95	60	48	Chassis Mount	0.15 Volt Max	8.5 x 12.5 x 10	29 lbs.

Intermittent Communications Duty (50% Duty Cycle)

**SOLDERLESS PROTOTYPING BOARDS**

**Features**

- \*Color coordinates for easy recognition
- Insertion wire: 20-29 AWG (0.3 – 0.8 mm)
- Over 10,000 insertion cycles
- \*Accepts all standard components

Order #	Price	Price 10+	Dimensions (in.) L x W x H	Dist. Strips	Dist. Points	Terminal Strips	Terminal Points	Binding Posts
SB200	2.99	2.49	6.5 x 0.37 x 0.4	2	100 x 2	0	0	0
SB400	4.89	4.39	3.3 x 2.2 x 0.4	2	100	1	300	0
SB630	5.45	4.95	6.5 x 1.4 x 0.4	0	0	1	630	0
SB830	6.49	5.99	6.5 x 2.2 x 0.4	2	200	1	630	0
SB1360	12.49	11.99	8.5 x 3.9 x 1.2	1	100	2	1,260	2
SB1660	17.45	16.95	8.5 x 5.1 x 1.2	4	400	2	1,260	3
SB2390	22.49	21.49	9.1 x 6.9 x 1.2	5	500	3	1,890	4
SB3220	31.49	30.49	9.5 x 8.3 x 1.2	7	700	4	2,520	4

**ZILOG DATABOOKS\***

**Z80 CPU Technical Manual**

This 338 page manual contains the architecture, pin description, timing, instruction set, instruction description, interrupt response and hardware/software implementation examples of the Z80 CPU.

Order # Z29 9.95 Z80 CPU Technical Manual .....Weight: 1 lb.

**Intelligent Peripheral Controllers**

Over 700 pages of data sheets, application notes and technical information on Zilog's intelligent peripheral controllers. The part numbers contained in this book are Z840, Z840C, Z84C01, Z8410/C10, Z8420/C20, Z8430/C30, Z8440/1/2/4, Z84C40/1/2/3/4, Z84C50, Z8470, Z84C90, Z84011/C11, Z84013/15, Z84C13/C15, Z80180, Z80181 and Z280.

Order # Z2480 13.95 Intelligent Peripheral Controllers .....Weight: 2 lbs.

**Datcom ICs**

Over 700 pages of data sheets and other technical information on Zilog's Data Communications ICs. Part numbers contained in this book are the Z16C30/31/33/35/50, Z5380, Z85230, Z80C30, Z85C30, Z8030, Z8530, Z80181, Z84013, Z84015, Z84C13, Z84C15, Z8440, Z84C40 and Z85C80. Also included are application notes.

Order # Z2503 13.95 Datcom ICs .....Weight: 2 lbs.

**Microcontrollers**

Over 1300 pages of data sheets, application notes and technical information on Zilog's microcontrollers. The part numbers contained in this book are Z8600/01/02/03/04/11/12/13/71/81/82/91, Z8800/01/20/22, Z86C00/C06/C08/C09/C10/C12/C19/C20/C21/C27/C30/C40/C50/C61-C62/C89/C90/C91/C93/C94/C96/C97, Z86E08/E19/E21/E30/E40, Z88C00, Z86127, Z86128, Z765A, Z5380 and Z53C80.

Order # Z8275 16.95 Microcontrollers .....Weight: 3 lbs.

\*Books are not returnable. We carry the newest versions available.

**ACTIVE COMPONENTS**

MICROS		DRAMS	
Order #	Price	Order #	Price Desc.
6242	8.95	MK4027N2	.75 .....4x1
6502	2.95	4116-20	.85 .....16x1
6522A	3.75	4416-12	2.95 .....16x4
6821	1.75	4164-10	1.95 .....64x1
6845	2.45	4164-15	1.55 .....64x1
8080A	2.75	4164-20	1.25 .....64x1
8085A	2.95	41464-12	2.75 .....64x4
8086	4.45	41256-80	2.75 .....256x1
8088	4.25	41256-12	2.15 .....256x1
8237A5	4.15	51258-80	4.95 .....256x1
8250	5.75	514256-10	6.95 .....256x4
8251A	2.25	514258-80	9.95 .....256x4
8253-5	2.25	511000-80	7.25 .....1Mx1
8255A5	2.75	511000-10	6.95 .....1Mx1
8275	18.95	511001-80	8.25 .....1Mx1

STATIC RAMS		EPROMS	
Order #	Price	Order #	Price Prog.
2101	1.65	2708	4.75 .....25V
2114L25	1.39	2716	3.45 .....25V
2147-3	3.75	2732	3.95 .....25V
6116LP3	2.25	2732A25	3.45 .....21V
6116-3	2.25	2732B45	4.25 .....12.5V
6264LP10	4.95	2764-25	3.75 .....21V
6264LP15	3.95	2764A25	3.25 .....12.5V
6264-10	4.75	27C64A15	3.95 .....12.5V
6264-15	3.75	27128A25	3.95 .....12.5V
62256LP10	6.75	27256-25	4.75 .....12.5V
62256LP15	6.25	27C512-15	6.95 .....12.5V
628128LPB	34.95	27C010-15	9.95 .....12.5V
628128LP10	32.95	27C020-15	24.95 .....12.5V

LINEAR		LINEAR		Description
Order #	Price	Order #	Price	Description
MAX232CPE	4.55	CA3161E	1.95	Decoder Driver
LM311N	.49	CA3162E	6.25	Converter
LM324N	.35	78L05	.35	.5V Pos. Reg. TO-92
LM339N	.39	7805K	1.25	.5V Pos. Reg. TO-3
LM555CN	.29	7805T	.45	5V Pos. Reg. TO-220
LM741CN	.29	7812T	.45	5V Pos. Reg. TO-220
LM1488N	.45	79L05	.29	.5V Neg. Reg. TO-92
LM1489N	.45	7905T	.49	5V Neg. Reg. TO-220

**MEMORY MODULES—SIMMS**

Order #	Price	Organization	Speed
256x9-80	19.95	262,144x9	80ns
1x9-80	57.00	1,048,576x9	80ns
4x9-80	210.00	4,194,304x9	80ns



2917 Bayview Drive  
Fremont, CA 94538

**Easy Order: 1-800-582-4044**  
**Easy Fax: 1-800-582-1255**  
**International Fax: 1-510-770-2346**  
**Customer Service: 1-510-770-2345**  
Monday-Friday, 7am - 5pm (PST)/10am-8pm (EST)

- COD-No personal checks, US funds (\$5.00 Surcharge)
- USPS  UPS  Federal Express  Airborne

Add 5% of total for shipping UPS Ground (\$3.00 min.).  
Actual shipping charges based on weight.

Call or write today for your free copy of our catalog.

California: residents, add appropriate sales tax.  
12 month warranty on all EasyTech products.  
30 day money back guarantee.  
We reserve the right to substitute manufacturers.  
Prices subject to change without notice.



Courteous Service • Discount Prices • Fast Shipping

# ALL ELECTRONICS

P.O. Box 567 • Van Nuys, CA 91408

## 20 AMP RFI/EMI FILTER

Corcom# 20B6

20 amp RFI/EMI general purpose common-mode filter. Controls line-to-ground noise. Small size, low leakage. 3.46" X 1.16" X 2.81". UL and CSA listed. CAT# RFI-201 \$8.50 each



## 4PDT - 24 Vdc RELAY

24 Vdc, 650 ohm coil - 3 amp contacts Standard 14 pin (ICE CUBE) style. Plastic dust cover. Size: 1 1/4" X 1 3/4" X 7/8" CAT# 4PRLY-24N \$4.00 each



## HIGHEST QUALITY METAL CASSETTES (ERASED)

Premium quality metal tape in C-60 cassettes (30 min. or more per side). One of the finest "brand-name" tapes on the market, in durable, clear plastic transport mechanisms. Recorded and bulk erased, the record-protect tabs have been removed and therefore, need to be taped over to re-record. Audiophiles will appreciate the wide dynamic range of this tape. If your cassette deck has a "metal" setting you will hear the difference. A real bargain! 60 min. tape - CAT# C-600M \$1.25 each • 10 for \$10.00

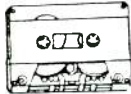

## CASSETTE STORAGE CASE

Black, unbreakable plastic audio cassette storage case. CAT# CBOX 5 for \$1.00 100 for \$15.00



## HEAT SINK COMPOUND

G.C. Electronics # 10-8109 For effective transfer of heat between components and heat sinks. Z9 silicone heat sink compound. CAT# HSC-1 \$2.00 per 1 oz tube



## OPTO SENSOR

TRW/Optron # OPB5447-2 IR emitter/sensor pair in Rectangular package with 28" color coded leads. CAT# OSR-4 2 for \$1.00



## WALL TRANSFORMER

12 Vdc 500 ma.

2.1mm D.C. power plug with center negative. White case. CAT# DCTX-125W \$4.50 each

12 Vdc, 200 ma.

2.1 mm D.C. power plug with center negative. CAT# DCTX-122 \$3.00 each



## PHOTORESISTOR

1,000 ohms bright light. 16K ohms dark. 0.182" dia. X .08" high. 0.18" long leads.

CAT# PRE-7 2 for \$1.00 100 for \$45.00 • 1000 for \$400.00



## TOLL FREE ORDER LINES

1-800-826-5432

CHARGE ORDERS to Visa, MasterCard or Discover

TERMS: Minimum order \$10.00. Shipping and handling for the 48 continental U.S.A. \$3.50 per order. All others including AK, HI, PR or Canada must pay full shipping. All orders delivered in CALIFORNIA must include state sales tax (7 1/4%, 7 1/2%, 7 3/4%, 8 1/4%). Quantities Limited. NO C.O.D. Prices subject to change w/out notice.

Call or Write For Our

FREE 64 Page Catalog

(Outside The U.S.A. Send \$2.00 Postage)

ALL ELECTRONICS CORP.

P.O. Box 567 • Van Nuys, CA • 91408

# Shortwave Listening Guidebook

by Harry Helms

The world is talking on shortwave radio, and here's the book that tells you how to listen in! In direct, nontechnical language, Harry explains how to get the most from your shortwave radio. Its 320 heavily illustrated pages are filled with practical advice on:

- antennas
- when and where to tune
- selecting the right radio for you
- accessories
- reception techniques



Learn how to hear the BBC, Radio Moscow, ham radio operators, ships at sea, even Air Force One! Includes hundreds of frequencies for stations around the world and the times you can hear them.

Only \$16.95 plus \$3.00 shipping (CA residents please include sales tax).

HighText Publications, Inc.

7128 Miramar Road Suite 15L, San Diego, CA 92121

## MONITOR TESTER

continued from page 49

16 by IC5 to produce a horizontal sync of 21.94 kHz.

Vertical sync is generated by dividing the horizontal sync by 64 at IC8's  $\text{Q}_B$  output (pin 10). The  $\text{Q}_F$  output of IC9 connects back to its own CLR input via IC6 pins 6 and 7 causing IC9 to divide by 6, for a net division of 384. That gives us a vertical sync of 57.14 Hz at IC9's  $\text{Q}_A$  output. That  $\text{Q}_A$  output is connected to IC2-e pin 11, which is configured as a one-shot, and outputs a 60-microsecond negative pulse to IC7 pin 13. The pulse is output at pin 12 of IC7 which is connected to pin 9 of connector J1. Switch S3 routes 351.08 kHz to the low-byte RGB inputs of an EGA monitor. That causes the monitor to display a pseudo three-dimensional pattern to display on the monitor.

As a few final notes, VGA RGB inputs are 75-ohm impedance. Resistors R7-R9 reduce the amplitude of the color signals to 0.5-volt p-p. 400-line operation is produced by making horizontal sync negative polarity and vertical sync positive. EGA monitors switch from Mode 2 (enhanced) to Mode 1 by changing the polarity of vertical sync; in Mode 1 it's positive, in Mode 2, it's negative.

## Construction

The use of perforated construction board and wire-wrap is recommended for this project. Try to keep the TTL clock oscillators (OSC1 and OSC2) as close to IC6 and IC7 as possible. Also, decouple all IC's and the oscillators with the 0.01  $\mu\text{F}$  ceramic disc capacitors as shown in the schematic in Fig. 1. (You can solder them directly to the  $V_{CC}$  and ground wire-wrap pins).

This project requires +5-volts to operate. If you've already got a suitable power supply you can use it. Otherwise, Fig. 2 shows a suitable one for the project.

Once the circuitry is completed, you should put the assembled boards in a metal project box and tie earth ground to the case. Figure 3 shows the author's completed prototype.

R-E

**ANNOUNCING:**  
AN END  
TO  
HIGH MONTHLY  
CABLE FEES!



All Jerrold, Oak, Hamlin, Zenith, Scientific Atlanta, Magnavox and all specialized cable equipment available for shipment within 24 hours. For fast service MC/VISA or C.O.D. telephone orders accepted. 60 Day Guarantee (Quantity Discounts). Send self-addressed Stamped envelope.

1-800-232-5017



C.O.D. ORDERS ACCEPTED



**CABLE-TRONICS, INC.**

1304 E. Algonquin Road Suite 501 Algonquin, Illinois 60102

# EXERCISE

Does Your Heart Good.



American Heart Association



# UNICORN ELECTRONICS

10010 Canoga Ave., Unit B-8  
Chatsworth, CA 91311

**SINCE 1983 — YOUR I.C. SOURCE — AND MUCH MORE!!**  
**NO SHIPPING CHARGES ON PRE-PAID ORDERS!\***  
**NO CREDIT CARD SURCHARGE!**  
**SCHOOL P.O.'s WELCOME!**

## LASER DIODES

STOCK #	MFG.	WAVE-LENGTH	OUTPUT POWER	OPER. CURR.	OPER. VOLT.	PRICE
LS9220	TOSHIBA	660 nm	3 mW	85 mA	2.5v	129.99
LS9200	TOSHIBA	670 nm	3 mW	85 mA	2.3v	49.99
LS9201	TOSHIBA	670 nm	5 mW	80 mA	2.4v	59.99
LS9211	TOSHIBA	670 nm	5 mW	50 mA	2.3v	69.99
LS9215	TOSHIBA	670 nm	10 mW	45 mA	2.4v	109.99
LS3200	NEC	670 nm	3 mW	85 mA	2.2v	79.99
LS022	SHARP	780 nm	5 mW	65 mA	1.75v	19.99

## LASER TUBES

STOCK #	WAVELENGTH	OUTPUT POWER (MIN.)	OUTPUT POWER (MAX.)	BEAM DIAM.	BEAM DIVERG.	POLARIZATION	OPERATING VOLTAGE	OPER. CURR.	FIRING VOLT.	MIN. SERIES RES.	SIZE C X L (IN MM)	WT. (GM.)	BRH CL.	PRICE 1-9	10+
LT7770	543nm (Green)	0.5mW	1.0mW	0.71mm	≤ 1.2 mrad	random	1750v ± 110v	6.5 mA	≤ 8 kV	81k Ω	37 x 350	200	II	799.99	749.99
LT7650	632.8nm (Red)	0.5mW	2.0mW	0.49mm	≤ 1.7 mrad	>100 1	1000v ± 100v	3.5 mA	< 7 kV	68k Ω	25 x 146	70	IIIA	529.99	479.99
LT7656	632.8nm (Red)	0.5mW	2.0mW	0.34mm	≤ 2.4 mrad	random	1050v ± 100v	2.8 mA	≤ 8 kV	82k Ω	22.5 x 118	60	IIIA	134.99	124.99
LT7655	632.8nm (Red)	0.5mW	2.0mW	0.49mm	≤ 1.7 mrad	random	1000v ± 100v	3.5 mA	≤ 7 kV	68k Ω	25 x 150	70	IIIA	144.99	134.99
LT7655S	632.8nm (Red)	1.0mW	2.0mW	0.49mm	≤ 1.7 mrad	random	1000v ± 100v	3.5 mA	≤ 7 kV	68k Ω	25 x 150	70	IIIA	159.99	144.99
LT7632	632.8nm (Red)	1.2mW	3.0mW	0.61mm	≤ 3.0 mrad	random	1300v ± 100v	3.5 mA	≤ 7 kV	81k Ω	20 x 210	70	IIIA	249.99	229.99
LT7621S	632.8nm (Red)	2.0mW	5.0mW	0.75mm	≤ 1.2 mrad	random	1300v ± 100v	5.0 mA	≤ 7 kV	68k Ω	30 x 255	140	IIIA	204.99	191.99
LT7634	632.8nm (Red)	2.0mW	5.0mW	0.75mm	≤ 1.2 mrad	random	1300v ± 100v	5.0 mA	≤ 7 kV	68k Ω	30 x 255	140	IIIA	209.99	194.99
LT7621MM	632.8nm (Red)	5.0mW	15mW	1.0mm	≤ 2.5 mrad	random	1250v ± 100v	6.5 mA	≤ 7 kV	68k Ω	30 x 255	140	IIIB	359.99	334.99
LT7627	632.8nm (Red)	5.0mW	15mW	0.80mm	≤ 1.1 mrad	random	1900v ± 100v	6.5 mA	≤ 8 kV	81k Ω	37 x 350	200	IIIB	369.99	344.99
LT7628	632.8nm (Red)	5.0mW	15mW	0.80mm	≤ 1.1 mrad	>500 1	1900v ± 100v	6.5 mA	≤ 8 kV	81k Ω	37 x 350	200	IIIB	389.99	364.99
LT7627MM	632.8nm (Red)	10mW	30mW	1.2mm	≤ 4.0 mrad	random	1750v ± 100v	6.5 mA	≤ 8 kV	81k Ω	37 x 350	200	IIIB	479.99	444.99

## Dynamic RAMS

STOCK #	DESC.	SPEED	1-24	25-99	100+
41256-60	256K x 1	60 ns	2.59	2.46	2.21
41256-80	256K x 1	80 ns	2.19	2.08	1.87
41256-100	256K x 1	100 ns	1.99	1.89	1.70
41256-120	256K x 1	120 ns	1.89	1.80	1.62
41256-150	256K x 1	150 ns	1.79	1.70	1.53
511000-70	1 meg x 1	70 ns	5.49	5.22	4.70
511000-80	1 meg x 1	80 ns	5.29	5.03	4.53
511000-10	1 meg x 1	100 ns	5.09	4.84	4.36
514256-70	256K x 4	70 ns	6.49	6.17	5.55
514256-80	256K x 4	80 ns	6.09	5.79	5.21
514256-10	256K x 4	100 ns	5.69	5.41	4.87
541000-80	4 meg x 1	80 ns	26.99	25.64	23.08
544256-80	1 meg x 4	80 ns	31.99	30.39	27.35

## EPROMS

STOCK #	SPEED	1-24	25-99	100+
2716	450 ns	3.29	3.13	2.82
2732	450 ns	4.19	3.98	3.58
2732A	250 ns	3.29	3.13	2.82
2764	250 ns	3.49	3.32	2.99
2764A	250 ns	3.09	2.94	2.65
27128	250 ns	4.79	4.55	4.10
27C128	250 ns	4.79	4.55	4.10
27256	250 ns	4.59	4.36	3.92
27C256	250 ns	4.29	4.08	3.67
27512	250 ns	5.49	5.22	4.70
27C512	250 ns	5.49	5.22	4.70
27C1024	200 ns	10.99	10.44	9.40
27C2048	200 ns	21.99	20.89	18.80

### Laser Pointer



- Output: 3.5 mW
  - Wavelength: 670NM
  - Power Supply: 2xAAA Batteries (included)
  - Beam: Approx. 3" @ 100 yards
- Quantity Discounts Available

STOCK #	PRICE
LSPOINT	\$199.99

### Power Supply



- Input: 115/230V
- Output: +5v @ 3.75A  
+12v @ 1.5A  
-12v @ .4A
- Size: 7" L x 5 1/4" W x 2 1/2" H

STOCK #	PRICE
PS1003	\$19.99

### Collimator Pen



- Output: 2.5 mW (max.)
- Current: 90-150 mA
- Op. Volt.: 2.2-2.5V
- Wavelength: 820NM
- Data Sheet inc.

STOCK #	PRICE
SB1052	\$39.99

### Disc Drive & Computer Cleaning Kit



Not just a drive cleaner-but a complete computer cleaning kit. Includes swabs, head cleaning fluid, anti-static cleaner, screen wipes and cleaning diskette.

STOCK #	PRICE
SB1099 3 1/2" Kit	\$6.99
SB1100 5 1/4" Kit	\$6.99

### Disc Drive Head-Cleaning Kit



Includes cleaning fluid and head-cleaning diskette

STOCK #	PRICE
SB1105 3 1/2" Drive Kit	\$1.99
SB1106 5 1/4" Drive Kit	\$1.99

### Anti-Static Screen Wipes



For static-sensitive applications  
Dispenser packs, individually wrapped

STOCK #	PRICE
SB1104 Dispenser pack of 25 wipes	\$1.99
SB1107 Dispenser pack of 100 wipes	\$4.99

### Robotic Arm Kit



Robots were once confined to science fiction movies. Today, whether they're performing dangerous tasks or putting together complex products, robotics are finding their way into more and more industries. The Robotic Arm Kit is an educational kit that teaches basic robotic arm fundamentals as well as testing your own motor skills. Command it to perform simple tasks.

STOCK #	PRICE
YO1	\$49.99

### Avoider Robot Kit



An intelligent robot that knows how to avoid hitting walls. This robot emits an infra-red beam which detects an obstacle in front and then automatically turns left and continues on.

STOCK #	PRICE
MV912	\$49.99

ORDER LINE — (800) 824-3432

INTERNATIONAL ORDERS — (818) 341-8833

FAX ORDERS — (818) 998-7975

TECHNICAL SUPPORT — (818) 341-8833



- 15.00 MINIMUM ORDER
- UPS BLUE, RED & FEDERAL EXPRESS SHIPPING AVAILABLE
- OPEN MCN-FRI 9:00 AM - 6:00 PM, SAT 10:00 AM - 3:00 PM PDT
- CA RESIDENTS ADD 7% SALES TAX
- CALL FOR QUANTITY DISCOUNTS
- CALL FOR FREE CATALOG (FOR 1ST CLASS DELIVERY OR CATALOGS DELIVERED OUTSIDE THE U.S. — SEND \$2.00)
- WE CARRY A COMPLETE LINE OF ELECTRONIC COMPONENTS



\*NO SHIPPING CHARGES ON PRE-PAID ORDERS DELIVERED IN THE CONTINENTAL U.S.

CIRCLE 196 ON FREE INFORMATION CARD

## COMPUTER CONNECTIONS

continued from page 92

or even 386 op codes), to perform multitasking, and all sorts of other things creative designers will enjoy thinking up.

### Product Watch

If you've bitten the Windows bug, you've probably heard about Norton's Desktop for Windows (NDW), an everything-including-the-kitchen-sink collection of Win3 utilities. If that sort of overblown approach turns you off, check out SideBar (Fig. 2). This is quite simply the most elegant Windows program I've seen in four or five years of Windows watching. As the name suggests, SideBar places a bar along the side of your screen; this bar gives you the best of both DOS and Windows. At the top, the bar contains several pushbuttons for arranging icons on your desktop. Beneath the buttons is a text box for entering DOS commands (dir, cd, md, etc.). SideBar interprets your commands itself; it does not run a copy of COMMAND.COM. The remainder of the space is occupied by a set of drive icons, file/directory listings, or both. The dual display can locate two file windows horizontally or vertically. You can select one or more files from one window and drag them to the other. The same approach works for copying, moving, deleting, renaming, changing attributes, associating (documents to applications), and placing icons on SideBar to execute directly.

SideBar can replace Windows' Program Manager, File Manager, or both. It provides a text-menu approach to launching applications, that while not as visual as NDW, is really elegant and easy to use.

SideBar is extremely resource aware and efficient. You can force it to unload itself and thereby save memory when running applications; just double-click on the background to bring SideBar back. The documentation is quite well done; all product packaging is made from recycled materials.

I really like some of NDW's utilities. But for the time being, I'm going to use SideBar as my main Windows interface.

R-E

## ADVERTISING INDEX

RADIO-ELECTRONICS does not assume any responsibility for errors that may appear in the index below.

Free Information Number	Page	191	
			SCO Electronics ..... 69
108	AMC Sales ..... 77	—	Science Probe ..... CV3
75	Ace Products ..... 23, 89	—	Scope Electronics ..... 5
107	All Electronics ..... 94	—	Star Circuits ..... 26
176	American Reliance Inc. .... 23	92	Tektronix ..... CV4
84	Appliance Service ..... 23	123	Test Probes ..... 28
77,182	B&K Precision ..... 17	—	The School Of VCR Repair ..... 27
109	C & S Sales ..... 7	196	Unicorn ..... 95
—	CIE ..... 8, 31	192	U.S. Cable ..... 69
186	Cable Warehouse ..... 27	187,188	Viejo Publications ..... 17, 71
—	Command Productions ..... 71	181	WPT Publications ..... 76
127	Deco Industries ..... 23	193	Worldwide Cable ..... 92
177	EasyTech ..... 93		
178	Electronic Goldmine ..... 92		
—	Electronic Tech. Today ... 16, 82, 83		
—	Electronics Book Club ..... 79		
121	Fluke Manufacturing ..... CV2		
—	Grantham College ..... 15		
86	Heathkit ..... 13		
—	HighText Publications, Inc. .... 94		
—	ISCET ..... 28		
194	ISECO, Inc. .... 23		
114	Jameco ..... 90, 91		
104	Jan Crystals ..... 77		
115	Jensen Tools ..... 23		
197	M&G Electronics ..... 88		
53	MD Electronics ..... 88		
179	MJS Design ..... 23		
93	Mark V. Electronics ..... 89		
—	NRI Schools ..... 18		
189	Optoelectronics ..... 3		
56	Parts Express ..... 87		
190	People's College ..... 25		
78	Radio Shack ..... 32		
195	Rite-Off ..... 26		

### ADVERTISING SALES OFFICE

**Gernsback Publications, Inc.**  
500-B Bi-County Blvd.  
Farmingdale, NY 11735  
1-(516) 293-3000  
President: Larry Steckler

**For Advertising ONLY**  
516-293-3000  
Fax 1-516-293-3115  
Larry Steckler  
publisher

**Christina Estrada**  
assistant to the President  
**Arline Fishman**  
advertising director

**Denise Haven**  
advertising assistant  
**Kelly McQuade**  
credit manager

**Subscriber Customer Service**  
1-800-288-0652

**Order Entry for New Subscribers**  
1-800-999-7139  
7:00 AM - 6:00 PM M-F MST

### SALES OFFICES

#### EAST/SOUTHEAST

**Stanley Levitan**, Eastern Sales Manager  
Radio-Electronics  
1 Overlook Ave.  
Great Neck, NY 11021  
1-516-487-9357, 1-516-293-3000  
Fax 1-516-487-8402

#### MIDWEST/Texas/Arkansas/Okla.

**Ralph Bergen**, Midwest Sales Manager  
Radio-Electronics  
One Northfield Plaza, Suite 300  
Northfield, IL 60093-1214  
1-708-446-1444  
Fax 1-708-559-0562

#### PACIFIC COAST/Mountain States

**Marvin Green**, Pacific Sales Manager  
Radio-Electronics  
5430 Van Nuys Blvd, Suite 316  
Sherman Oaks, CA 91401  
1-818-986-2001  
Fax 1-818-986-2009

#### RE Shopper

**Joe Shere**, National Representative  
P.O. Box 169  
Idyllwild, CA 92549  
1-714-659-9743  
Fax 1-714-659-2469





Welcome to . . .

# SCIENCE PROBE!®

The Amateur Scientist's Journal

Embark on an irresistible new journey into the realm of mystery, challenge, and exploration! The perfect magazine for the budding scientist, the serious amateur, the professional who would like to relax, and those who simply want to gaze at the stars.

**Science PROBE!** — the *only* magazine devoted entirely to Amateur Scientists! If you are fascinated by science in all its many forms . . . if you can't stay away from a microscope, telescope, calipers, or test tube — we invite you to share the wonders in every issue of **Science PROBE!** You will join a community of Amateur and Student Scientists who enthusiastically seek scientific knowledge or follow scientific pursuits for their own sakes and not merely as a profession.

Obtain your next issue of **Science PROBE!** by visiting a quality Newsstand, Convenience Store, or Supermarket or by reserving your personal copy through the mail by completing the coupon below.

From your very first issue of **Science PROBE!** you will be involved in a world of scientific facts, experiments, and studies pursued by amateur scientists who are university students, investors, academicians, engineers, or office workers, salesmen, farmers—whose *quest* is to probe into the mysteries of science and reveal them to all.

Plan to become a **Science PROBE!** reader!

Articles to appear in upcoming issues of **Science PROBE!** are:

**How an Amateur Mapped the Milky Way**  
**Make your own Seismometer**  
**Operate a Solar-powered Weather Station**  
**Grow Crystals Automatically**  
**Experiment with a Saltwater Aquarium**  
**How to Keep a Science Notebook**

If you're fascinated by science in all its many forms, if you are compelled to experiment and explore, then **Science PROBE!** is your kind of magazine!

**Science PROBE!**  
 500-B Bi-County Boulevard  
 Farmingdale, NY 11735

7RA29

Please forward my copy of **Science PROBE!** as soon as it comes off the press. I am enclosing \$3.50-U.S.A. (\$4.23-Canada-includes G.S.T.) plus \$1.00 for shipping and handling. Better still, please enroll me as a subscriber and send the next four (4) quarterly issues of **Science Probe**. I am enclosing \$9.95-U.S.A. (Canada: \$16.00—includes G.S.T.)

Next Issue Only       Next Four Issues (1 Year)

Offers valid in the U.S.A. and Canada only. No foreign orders.

Name \_\_\_\_\_

Address \_\_\_\_\_

City \_\_\_\_\_ State \_\_\_\_\_ ZIP \_\_\_\_\_

All Orders payable in U.S.A. Funds only.

**ON SALE AT QUALITY NEWSSTANDS, CONVENIENCE STORES AND SUPERMARKETS**  
**GET YOUR COPY TODAY—\$3.50-U.S.A.—\$3.95-Canada**

# WHAT YOUR TOOLS SAY ABOUT YOU.

## "ULTIMATE PROFESSIONAL"

Here's the newest family member: the 60 MHz Tek 224. It's as rugged, reliable and easy to use as the rest of the 220 Series—and extended bandwidth makes it the logical choice for computer service professionals.



## "ACE TROUBLESHOOTER"

The Tek 222 is everything a service scope ought to be. Lightweight. Rugged. Fully programmable. Floatable to  $\pm 400$  V. Two channels, 10 MHz, Auto Setup and Auto Trigger make it easy finding trouble—fast.

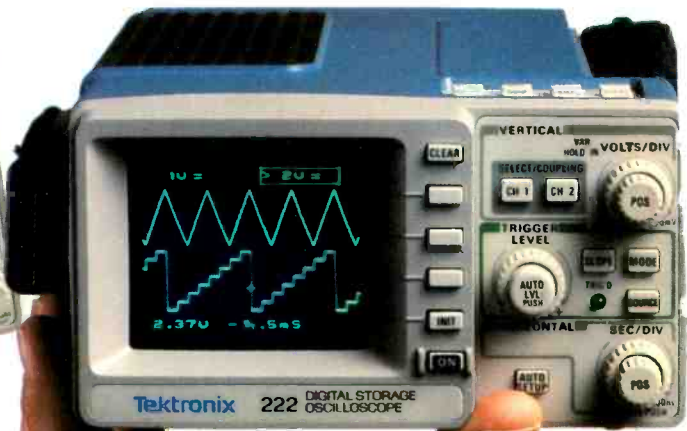

## "RUGGED SURVIVALIST"

Tek's 222PS Power Scout™ offers the field-proven performance of the 222, plus it's rated 600 VAC, 850 VDC and 6 kV peak surge. Perfect for circuit measurements requiring extra protection—and a few added guts.



They're just 4½ pounds. U.L. certified. And start at \$2450. 220 Series handheld oscilloscopes—all with Tek's exclusive IsolatedChannel™ architecture—are the service tools the professionals use. There's one with you written all over it. To order, contact your Tek representative or distributor. Or just call Tek direct: 1-800-426-2200

**Tektronix**  
COMMITTED TO EXCELLENCE