



Liebert®

NXL™ Power-tie Controls

Installation Manual

The information contained in this document is subject to change without notice and may not be suitable for all applications. While every precaution has been taken to ensure the accuracy and completeness of this document, Vertiv assumes no responsibility and disclaims all liability for damages resulting from use of this information or for any errors or omissions. Refer to other local practices or building codes as applicable for the correct methods, tools, and materials to be used in performing procedures not specifically described in this document.

The products covered by this instruction manual are manufactured and/or sold by Vertiv. This document is the property of Vertiv and contains confidential and proprietary information owned by Vertiv. Any copying, use or disclosure of it without the written permission of Vertiv is strictly prohibited.

Names of companies and products are trademarks or registered trademarks of the respective companies. Any questions regarding usage of trademark names should be directed to the original manufacturer.

Technical Support Site

If you encounter any installation or operational issues with your product, check the pertinent section of this manual to see if the issue can be resolved by following outlined procedures. Visit <https://www.VertivCo.com/en-us/support/> for additional assistance.

TABLE OF CONTENTS

IMPORTANT SAFETY INSTRUCTIONS	1
1.0 MECHANICAL INSTALLATION	3
1.1 Introduction.....	3
1.2 Preliminary Checks	3
2.0 CONTROL CONNECTIONS AND COMMUNICATION	4
2.1 Control Cable and Communication	4
2.1.1 Programmable Relay Board	7
2.2 Inter-Module Control Wiring.....	9
3.0 INSTALLATION DRAWINGS	14
4.0 SPECIFICATIONS	18

FIGURES

Figure 1 External Interface Board connections layout.....	3
Figure 2 Breaker Interface Board	3
Figure 3 Voltage and Current Sensing Terminal.....	4
Figure 4 Control wiring, Programmable Relay Board	5
Figure 5 Programmable relay board dialog box.....	6
Figure 6 Control wiring layout for Liebert NXL Power-Tie.....	11
Figure 7 Liebert NXL Power-Tie System #1 layout	12
Figure 8 Liebert NXL Power-Tie System #2 or #3 layout	13
Figure 9 Liebert NXL Power-Tie control wiring for single system	14

TABLES

Table 1 Programmable Relay Board pinout	5
Table 2 Cable group #22A - from SIB breaker interface board (BIB) to SIB breaker	7
Table 3 Cable group #22B - from SIB breaker interface board (BIB) to breaker motor operator (optional).....	7
Table 4 Cable group #23A - from tie breaker interface board (BIB) to tie breaker.....	7
Table 5 Cable group #23B - from tie breaker interface board (BIB) to breaker motor operator (optional).....	7
Table 6 Cable group #24A - from MBB breaker interface board (BIB) to MBB breaker	7
Table 7 Cable group #24B - from MBB breaker interface board (BIB) to breaker motor operator (optional).....	8
Table 8 Cable group #25A - from MIB breaker interface board (BIB) to MIB breaker.....	8
Table 9 Cable group #25B - from MIB breaker interface board (BIB) to breaker motor operator (optional).....	8
Table 10 Cable group #26A - from LBB breaker interface board (BIB) to LBB breaker	8
Table 11 Cable group #27A - parallel from SCC/UPS inter-module communication board to Liebert NXL Power-Tie inter-module communication board	8
Table 12 Cable group #27B - redundant parallel from SCC/UPS inter-module communication board to Liebert NXL Power-Tie inter-module communication board	9

Table 13 Cable group #28A - parallel from Liebert NXL Power-Tie inter-module communication board to next Liebert NXL Power-Tie inter-module communication board9

Table 14 Cable group #28B - redundant parallel Liebert NXL Power-Tie inter-module communication board to next Liebert NXL Power-Tie inter-module communication board9

Table 15 Cable group #29A - from MBB breaker interface board to SKRU interface9

Table 16 Cable group #29B - from MBB breaker interface board to SKRU interface.....9

Table 17 Cable group #32 - from Liebert NXL Power-Tie control terminal block to voltage and current sense points10

Table 18 Liebert NXL Power-Tie Control specifications 15

IMPORTANT SAFETY INSTRUCTIONS

SAVE THESE INSTRUCTIONS

This manual contains important instructions that should be followed during installation of your Liebert NXL Power-Tie Controls. Read this manual thoroughly, paying special attention to the sections that apply to your installation, before working with the unit. Retain this manual for use by installing personnel.

WARNING

Risk of electrical shock. Can cause personal injury or death.

Only properly trained and qualified personnel wearing appropriate safety headgear, gloves, shoes and glasses should be involved in installing the modules or preparing the modules for installation. When performing maintenance with any part of the equipment under power, service personnel and test equipment should be standing on rubber mats.

In case of fire involving electrical equipment, use only carbon dioxide fire extinguishers or those approved for use in fighting electrical fires.

Extreme caution is required when performing installation and maintenance.

Special safety precautions are required for procedures involving handling, installation and maintenance of the UPS system. Observe all safety precautions in this manual before handling or installing the module. Observe all precautions in the Operation and Maintenance Manual before as well as during performance of all maintenance procedures.

WARNING

Risk of electrical shock and fire. Can cause equipment damage, personal injury or death.

Under typical operation and with all doors closed, only normal safety precautions are necessary. The area around the system should be kept free of puddles of water, excess moisture and debris.

Only test equipment designed for troubleshooting should be used. This is particularly true for oscilloscopes. Always check with an AC voltmeter to ensure safety before making contact or using tools. Even when the power is turned Off, dangerously high potential electric charges may exist at the capacitor banks.

All wiring must be installed by a properly trained and qualified electrician. All power and control wiring must comply with all applicable national, state and local codes.

One person should never work alone, even if all power is disconnected from the equipment. A second person should be standing by to assist and to summon help in case of an accident.

NOTE

Materials sold hereunder cannot be used in the patient vicinity (e.g., use where UL, cUL or IEC 60601-1 is required). Medical applications, such as invasive procedures and electrical life-support equipment, are subject to additional terms and conditions.

NOTICE

This unit complies with the limits for a Class A digital device, pursuant to Part 15 Subpart J of the FCC rules. These limits provide reasonable protection against harmful interference in a commercial environment. This unit generates, uses and radiates radio frequency energy and, if not installed and used in accordance with this instruction manual, may cause harmful interference to radio communications.

Operation of this unit in a residential area may cause harmful interference that the user must correct at his own expense.

1.0 MECHANICAL INSTALLATION

1.1 Introduction

The Liebert NXL Switchgear provides continuous, high-quality AC power to your business-critical equipment, such as telecommunication and data processing equipment. Liebert NXL UPS's will supply power that is free of the disturbances and variations in voltage and frequency common to utility power, which is subject to brownouts, blackouts, surges and sags.

The Liebert NXL Power-Tie system provides manually initiated, uninterrupted transfers of a critical load bus between the two UPS systems.

This topology permits one UPS and its associated distribution system to be shut down for maintenance while the load continues to be supplied by another UPS, without the necessity of transferring the load to bypass during shutdown or restart of the UPS being maintained.

1.2 Preliminary Checks

This chapter is a guide to general procedures and practices that should be observed by the installing personnel. The particular conditions of each site will determine the applicability of such procedures.

Before installing the Liebert NXL Power-Tie, make these preliminary checks:

- Examine the Liebert NXL Power-Tie for transit damage, both internally and externally. Report any damage to the shipper immediately.
- Verify that the correct equipment is being installed. The Liebert NXL Power-Tie cabinet has an identification tag on the interior doors listing the type, size and main calibration parameters of the UPS.
- Verify that the UPS room satisfies the environmental conditions stipulated in the equipment specification, paying particular attention to the ambient temperature and air exchange system.

2.0 CONTROL CONNECTIONS AND COMMUNICATION

2.1 Control Cable and Communication

Figure 1 External Interface Board connections layout

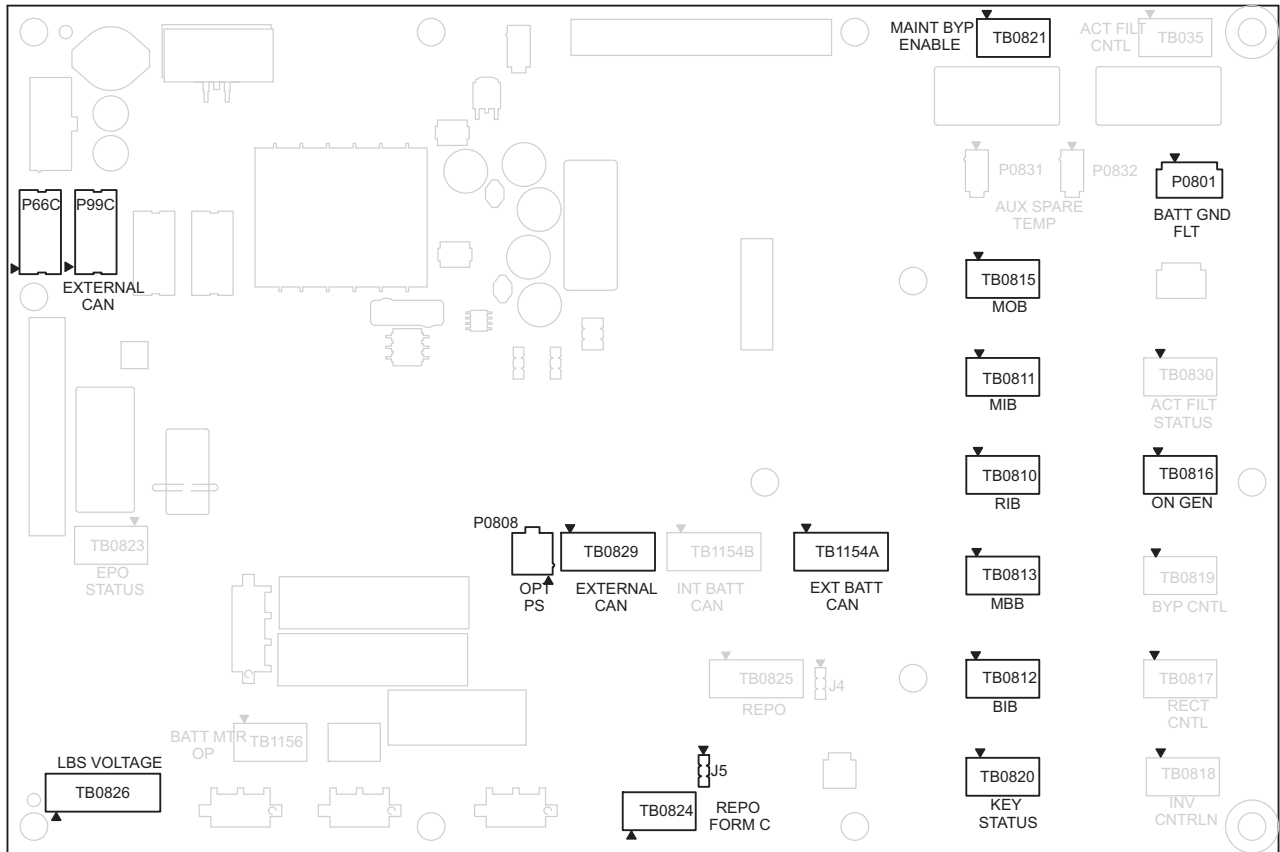

Figure 2 Breaker Interface Board

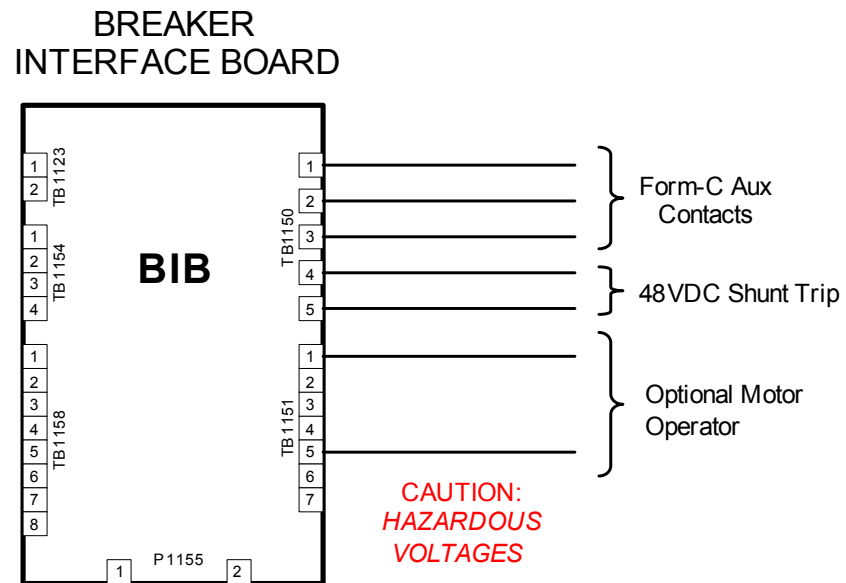
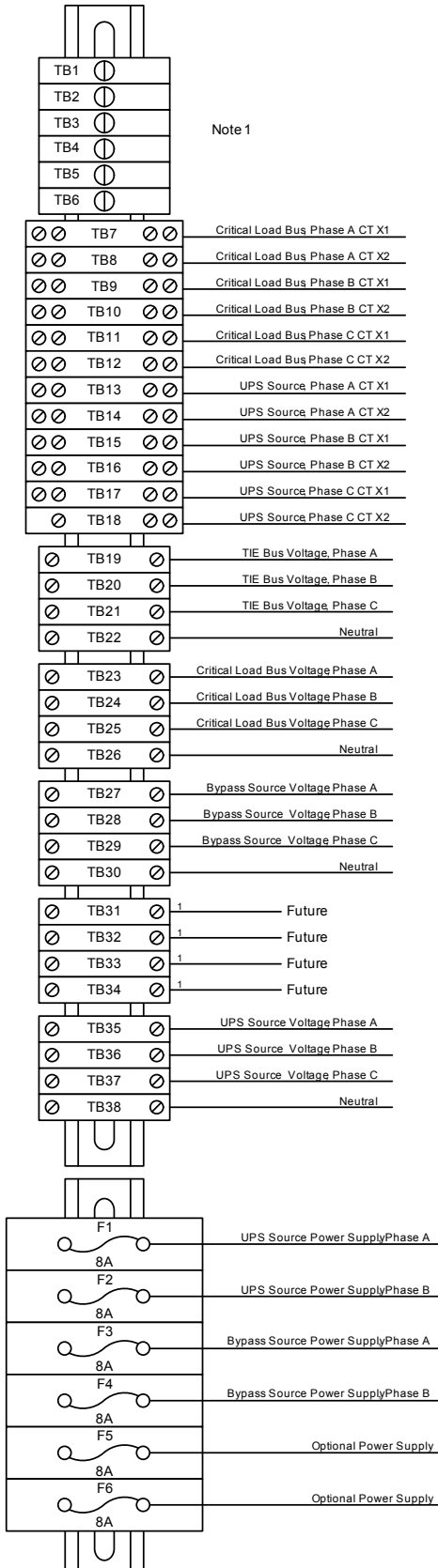

Figure 3 Voltage and Current Sensing Terminal



Note 1

CT SHORTING TABLE	
TB#	SHORTS CT
TB1	LOAD I PHA
TB2	LOAD I PHB
TB3	LOAD I PHC
TB4	UPS I PHA
TB5	UPS I PHB
TB6	UPS I PHC

CAUTION:
TB19-TB38 and F1-F6 connected to
HAZARDOUS VOLTAGES

NOTES:

1. TB1-TB6 are shorting switches. During normal operation, these devices are open. When button is depressed and turned 90° (locked position) the associated CT is shorted. Reference Table "CT SHORTING TABLE" on this sheet.
2. TB19-TB38 are disconnect devices. During normal operation these devices are closed. All external wiring into TB 19-TB38 must be fused at the source.

2.1.1 Programmable Relay Board

The Programmable Relay Board (PRB) provides a means to trigger an external device when an event occurs in the Liebert NXL. Each PRB has eight channels. Each channel has Form-C dry contacts rated at 1A @ 30VDC or 125VAC @ 0.45A.

Any alarm/event can be programmed to any channel or channels. Up to four (4) events can be programmed to a relay. If multiple events are grouped to one relay, any of the events becoming active will activate the channel. The same alarm/event can be programmed to more than one channel. Up to two Programmable Relay Boards can be installed in the Liebert NXL for a total of 16 channels. Programming is performed through the HMI touchscreen display.



NOTE

Up to two PRB's can be installed in a Liebert NXL.

Figure 4 Control wiring, Programmable Relay Board

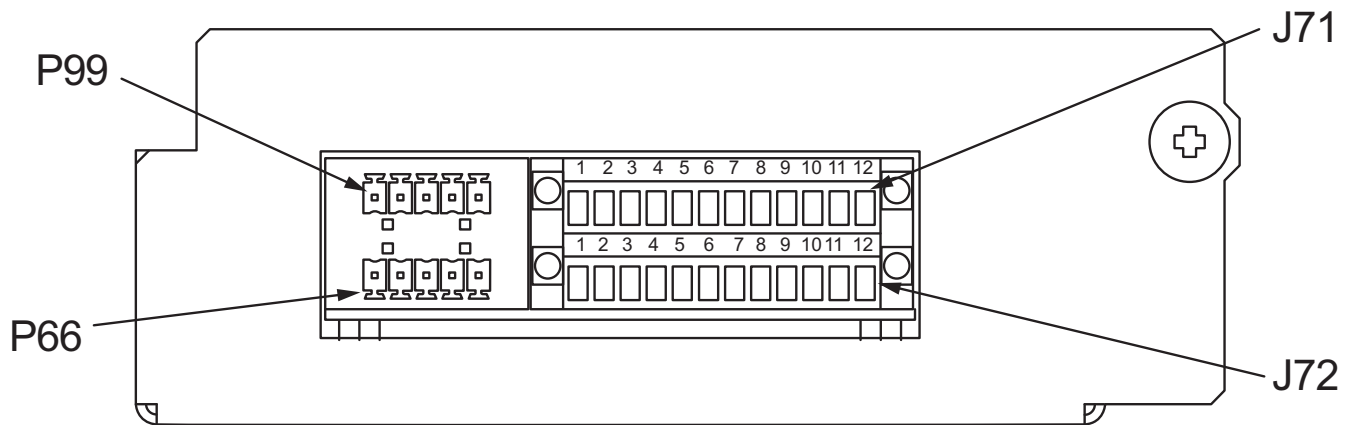

Table 1 Programmable Relay Board pinout

Terminal Block	Channel	Pin No.	Common	Normally Closed	Normally Open
J71	CH1	1-3	1	2	3
	CH2	4-6	4	5	6
	CH3	7-9	7	8	9
	CH4	10-12	10	11	12
J72	CH5	1-3	1	2	3
	CH6	4-6	4	5	6
	CH7	7-9	7	8	9
	CH8	10-12	10	11	12

Configuring the Programmable Relay Board Settings

1. Press Internal Option Settings from the Config menu.
2. Press which Programmable Relay Board will be configured. The Programmable Relay Board dialog box is displayed.
3. Press the Relay channel
4. Press up to four events. Selected events will show up under Relay 1 Assignment.



NOTE

To deselect an event, click on the event.

5. Repeat **Steps 3** and **4** for each relay.
6. Press SAVE to keep the settings.

Figure 5 Programmable relay board dialog box

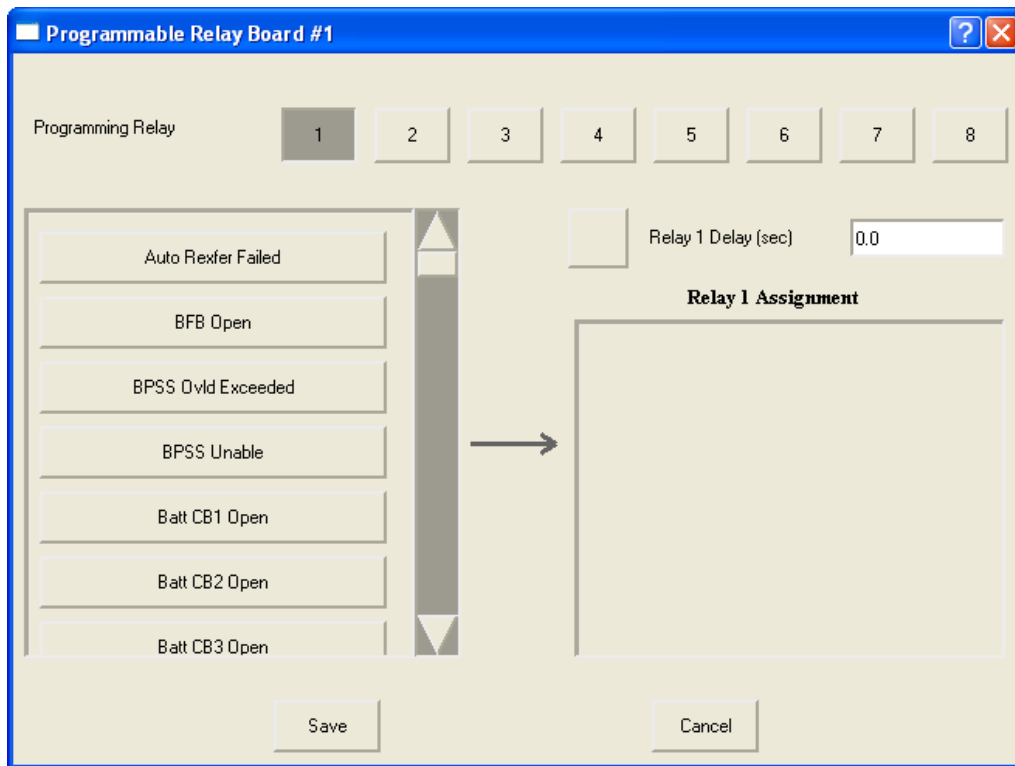

- Assignment—0 to 4 event (default: 0)
- Delay, sec—0 to 99.9 (default: 0)

2.2 Inter-Module Control Wiring



NOTE

Unless otherwise noted, use copper or aluminum conductors suitable for at least 75°C.

Table 2 Cable group #22A - from SIB breaker interface board (BIB) to SIB breaker

Terminal Designation		Signal Name	Maximum Length
From	To		
TB1150-1	Remote Breaker Contacts	SIB AUX CONTACT COMMON	#14-22AWG 500FT (150m)
TB1150-2		SIB AUX CONTACT, CLOSED = CB IS OPEN	
TB1150-3		SIB AUX CONTACT, CLOSED = CB IS CLOSED	
TB1150-4		SIB 48VDC TRIP COIL (-)	
TB1150-5		SIB 48VDC TRIP COIL (+)	

Table 3 Cable group #22B - from SIB breaker interface board (BIB) to breaker motor operator (optional)

Terminal Designation		Signal Name	Maximum Length
From	To		
TB1151-1	Remote Breaker Motor Operator Contacts	AC LINE	#14-22AWG 500FT (150m)
TB1151-5		MOTOR OPERATOR CLOSE	

Table 4 Cable group #23A - from tie breaker interface board (BIB) to tie breaker

Terminal Designation		Signal Name	Maximum Length
From	To		
TB1150-1	Remote Breaker Contacts	TIE AUX CONTACT COMMON	#14-22AWG 500FT (150m)
TB1150-2		TIE AUX CONTACT, CLOSED = CB IS OPEN	
TB1150-3		TIE AUX CONTACT, CLOSED = CB IS CLOSED	
TB1150-4		TIE 48VDC TRIP COIL (-)	
TB1150-5		TIE 48VDC TRIP COIL (+)	

Table 5 Cable group #23B - from tie breaker interface board (BIB) to breaker motor operator (optional)

Terminal Designation		Signal Name	Maximum Length
From	To		
TB1151-1	Remote Breaker Motor Operator Contacts	AC LINE	#14-22AWG 500FT (150m)
TB1151-5		MOTOR OPERATOR CLOSE	

Table 6 Cable group #24A - from MBB breaker interface board (BIB) to MBB breaker

Terminal Designation		Signal Name	Maximum Length
From	To		
TB1150-1	Remote Breaker Contacts	MBB AUX CONTACT COMMON	#14-22AWG 500FT (150m)
TB1150-2		MBB AUX CONTACT, CLOSED = CB IS OPEN	
TB1150-3		MBB AUX CONTACT, CLOSED = CB IS CLOSED	
TB1150-4		MBB 48VDC TRIP COIL (-)	
TB1150-5		MBB 48VDC TRIP COIL (+)	

Table 7 Cable group #24B - from MBB breaker interface board (BIB) to breaker motor operator (optional)

Terminal Designation		Signal Name	Maximum Length
From	To		
TB1151-1	Remote Breaker Motor Operator Contacts	AC LINE	#14-22AWG 500FT (150m)
TB1151-5		MOTOR OPERATOR CLOSE	

Table 8 Cable group #25A - from MIB breaker interface board (BIB) to MIB breaker

Terminal Designation		Signal Name	Maximum Length
From	To		
TB1150-1	Remote Breaker Contacts	MIB AUX CONTACT COMMON	#14-22AWG 500FT (150m)
TB1150-2		MIB AUX CONTACT, CLOSED = CB IS OPEN	
TB1150-3		MIB AUX CONTACT, CLOSED = CB IS CLOSED	
TB1150-4		MIB 48VDC TRIP COIL (-)	
TB1150-5		MIB 48VDC TRIP COIL (+)	

Table 9 Cable group #25B - from MIB breaker interface board (BIB) to breaker motor operator (optional)

Terminal Designation		Signal Name	Maximum Length
From	To		
TB1151-1	Remote Breaker Motor Operator Contacts	AC LINE	#14-22AWG 500FT (150m)
TB1151-5		MOTOR OPERATOR CLOSE	

Table 10 Cable group #26A - from LBB breaker interface board (BIB) to LBB breaker

Terminal Designation		Signal Name	Maximum Length
From	To		
TB1150-1	Remote Breaker Contacts	LBB AUX CONTACT COMMON	#14-22AWG 500FT (150m)
TB1150-2		LBB AUX CONTACT, CLOSED = CB IS OPEN	
TB1150-3		LBB AUX CONTACT, CLOSED = CB IS CLOSED	

Table 11 Cable group #27A - parallel from SCC/UPS inter-module communication board to Liebert NXL Power-Tie inter-module communication board

Terminal Designation		Signal Name	Maximum Length
From	To		
P3101-3	P3101-3	SYSTEM CAN +24V	#18AWG 1000FT (300m)
P3101-4	P3101-4	SYSTEM CAN COMMON	
P3101-7	P3101-7	GROUND	
P3101-14	P3101-14	GROUND	
P3101-12	P3101-12	LBS SYNCH CAN +24V	
P3101-13	P3101-13	LBS SYNCH CAN COMMON	

Note: Must use Belden 8106 or (3) Belden 8102; outer shield drain wire must be connected to pins 7 and 14 at each connector.

Table 12 Cable group #27B - redundant parallel from SCC/UPS inter-module communication board to Liebert NXL Power-Tie inter-module communication board

Terminal Designation		Signal Name	Maximum Length
From	To		
P3103-3	P3103-3	REDUNDANT SYSTEM CAN +24V	#18AWG 1000FT (300m)
P3103-4	P3103-4	REDUNDANT SYSTEM CAN COMMON	
P3103-7	P3103-7	GROUND	
P3103-14	P3103-14	GROUND	
P3103-12	P3103-12	REDUNDANT LBS SYNCH CAN +24V	
P3103-13	P3103-13	REDUNDANT LBS SYNCH CAN COMMON	

Note: Must use Belden 8106 or (3) Belden 8102; outer shield drain wire must be connected to pins 7 and 14 at each connector.

Table 13 Cable group #28A - parallel from Liebert NXL Power-Tie inter-module communication board to next Liebert NXL Power-Tie inter-module communication board

Terminal Designation		Signal Name	Maximum Length
From	To		
P3101-1	P3101-1	SHARE CAN +24V	#18AWG 1000FT (300m)
P3101-2	P3101-2	SHARE CAN COMMON	
P3101-7	P3101-7	GROUND	
P3101-14	P3101-14	GROUND	
P3101-8	P3101-8	PWM SYNCH CAN +24V	
P3101-9	P3101-9	PWM SYNCH CAN COMMON	

Note: Must use Belden 8106 or (3) Belden 8102; outer shield drain wire must be connected to pins 7 and 14 at each connector.

Table 14 Cable group #28B - redundant parallel Liebert NXL Power-Tie inter-module communication board to next Liebert NXL Power-Tie inter-module communication board

Terminal Designation		Signal Name	Maximum Length
From	To		
P3103-3	P3103-3	SHARE CAN +24V	#18AWG 1000FT (300m)
P3103-4	P3103-4	SHARE CAN COMMON	
P3103-7	P3103-7	GROUND	
P3103-14	P3103-14	GROUND	
P3103-12	P3103-12	PWM SYNCH CAN +24V	
P3103-13	P3103-13	PWM SYNCH CAN COMMON	

Note: Must use Belden 8106 or (3) Belden 8102; outer shield drain wire must be connected to pins 7 and 14 at each connector.

Table 15 Cable group #29A - from MBB breaker interface board to SKRU interface

Terminal Designation		Signal Name	Maximum Length
From	To		
TB1158-6	SKRU CONTACTS	KEY STATUS SWITCH, CLOSED = KEY RELEASED	#14-22AWG 500FT (150m)
TB1158-4		KEY STATUS SWITCH, COMMON	
TB1158-5		KEY STATUS SWITCH, CLOSED = KEY CAPTIVE	

Table 16 Cable group #29B - from MBB breaker interface board to SKRU interface

Terminal Designation		Signal Name	Maximum Length
From	To		
TB1151-1	SKRU CONTACTS	CLOSED = ENABLE SKRU	#14-22AWG 164FT (50m)
TB1151-5		MAINTENANCE BYPASS CABINET, COMMON	

Table 17 Cable group #32 - from Liebert NXL Power-Tie control terminal block to voltage and current sense points

Terminal Designation		Signal Name	Maximum Length
From	To		
TB7	VOLTAGE & CURRENT SENSE POINTS	Critical Load Bus, Phase A CT X1	22-12AWG/ 500FT (150m)
TB8		Critical Load Bus, Phase A CT X2	
TB9		Critical Load Bus, Phase B CT X1	
TB10		Critical Load Bus, Phase B CT X2	
TB11		Critical Load Bus, Phase C CT X1	
TB12		Critical Load Bus, Phase C CT X2	
TB13		UPS SOURCE, Phase A CT X1	
TB14		UPS SOURCE, Phase A CT X2	
TB15		UPS SOURCE, Phase B CT X1	
TB16		UPS SOURCE, Phase B CT X2	
TB17		UPS SOURCE, Phase C CT X1	
TB18		UPS SOURCE, Phase C CT X2	
TB19		TIE BUS VOLTAGE, PHASE A	
TB20		TIE BUS VOLTAGE, PHASE B	
TB21		TIE BUS VOLTAGE, PHASE C	
TB22		NEUTRAL	
TB23		CRITICAL LOAD BUS VOLTAGE, PHASE A	
TB24		CRITICAL LOAD BUS VOLTAGE, PHASE B	
TB25		CRITICAL LOAD BUS VOLTAGE, PHASE C	
TB26		NEUTRAL	
TB27		BYPASS SOURCE VOLTAGE, PHASE A	
TB28		BYPASS SOURCE VOLTAGE, PHASE B	
TB29		BYPASS SOURCE VOLTAGE, PHASE C	
TB30		NEUTRAL	
TB31		FUTURE	
TB32		FUTURE	
TB33		FUTURE	
TB34		FUTURE	
TB35		UPS SOURCE VOLTAGE, PHASE A	
TB36		UPS SOURCE VOLTAGE, PHASE B	
TB37		UPS SOURCE VOLTAGE, PHASE C	
TB38		NEUTRAL	
F1		UPS Source Power Supply, Phase A	
F2		UPS Source Power Supply, Phase B	
F3		Bypass Source Power Supply, Phase A	
F4		Bypass Source Power Supply, Phase B	
F5		Optional Power Supply	
F6		Optional Power Supply	

3.0 INSTALLATION DRAWINGS

Figure 6 Control wiring layout for Liebert NXL Power-Tie

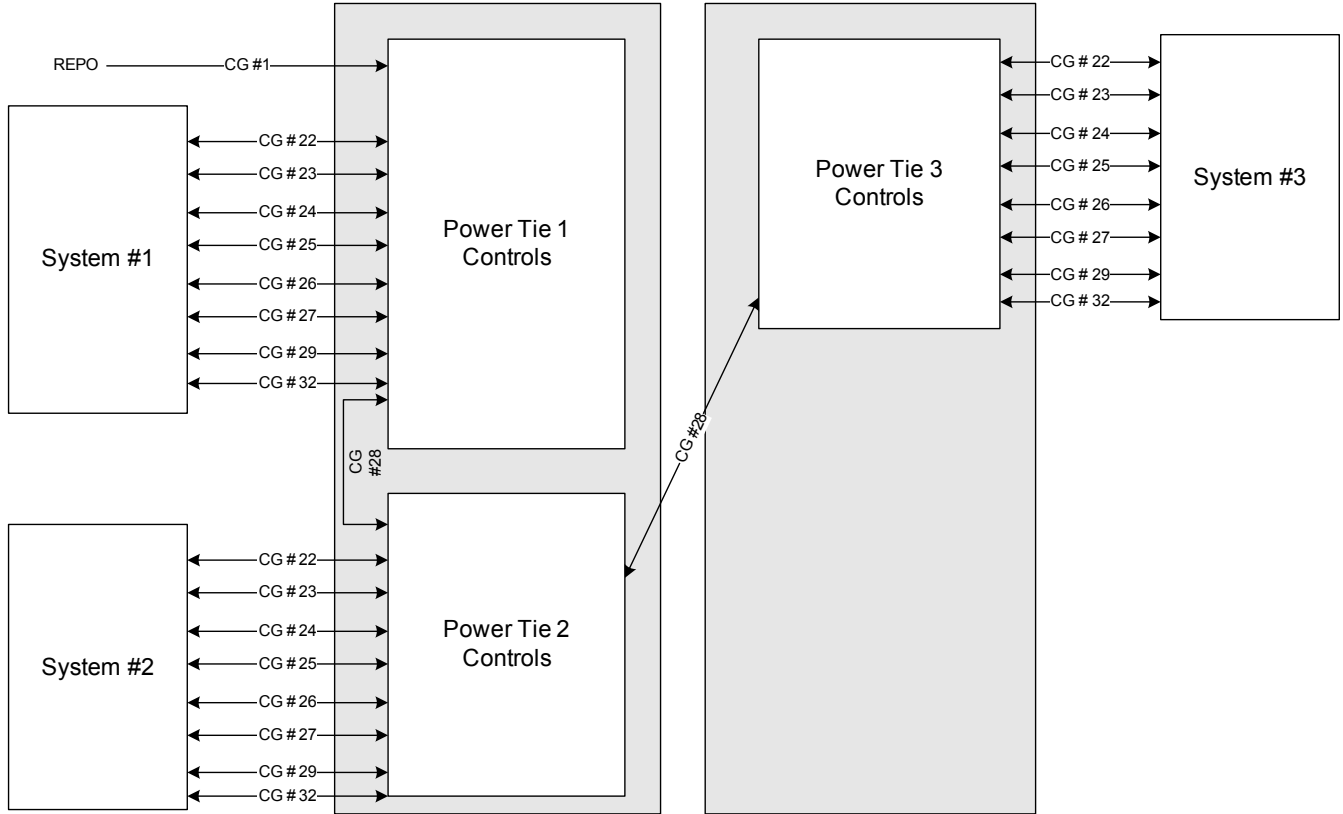
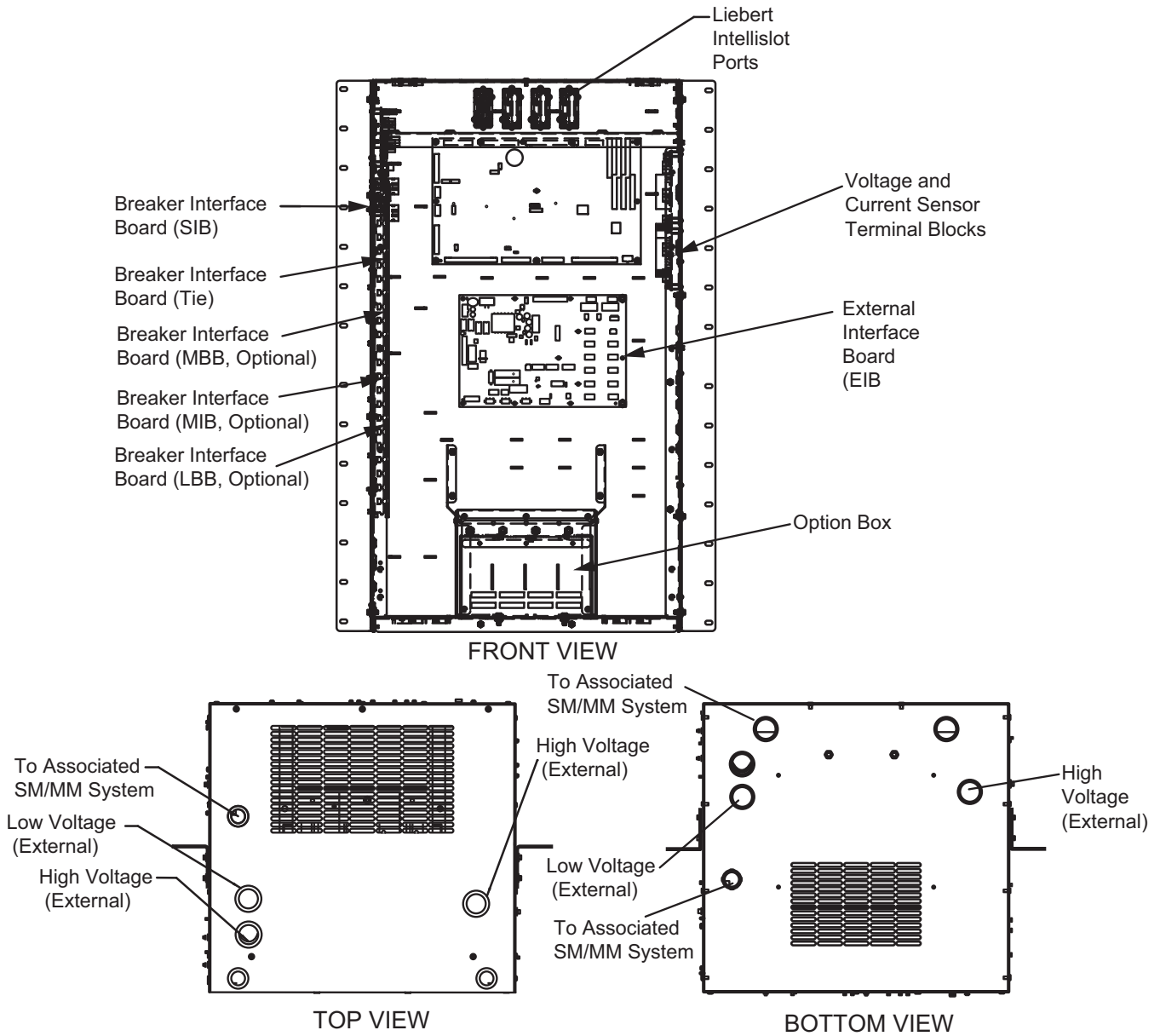
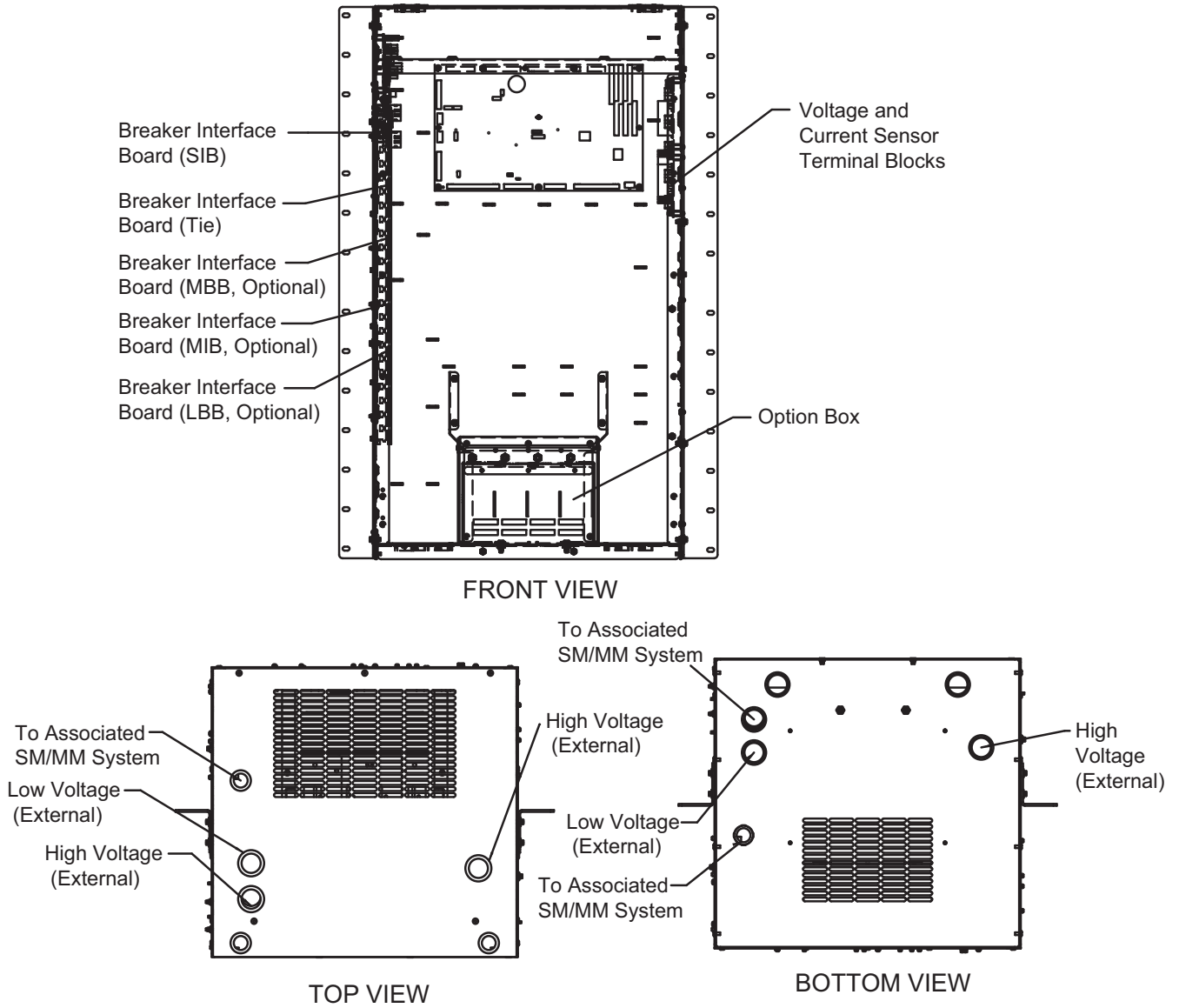

Figure 7 Liebert NXL Power-Tie System #1 layout



539652
Page 1, Rev. 3

Figure 8 Liebert NXL Power-Tie System #2 or #3 layout



539652
Pg. 02, Rev. 03

Figure 9 Liebert NXL Power-Tie control wiring for single system

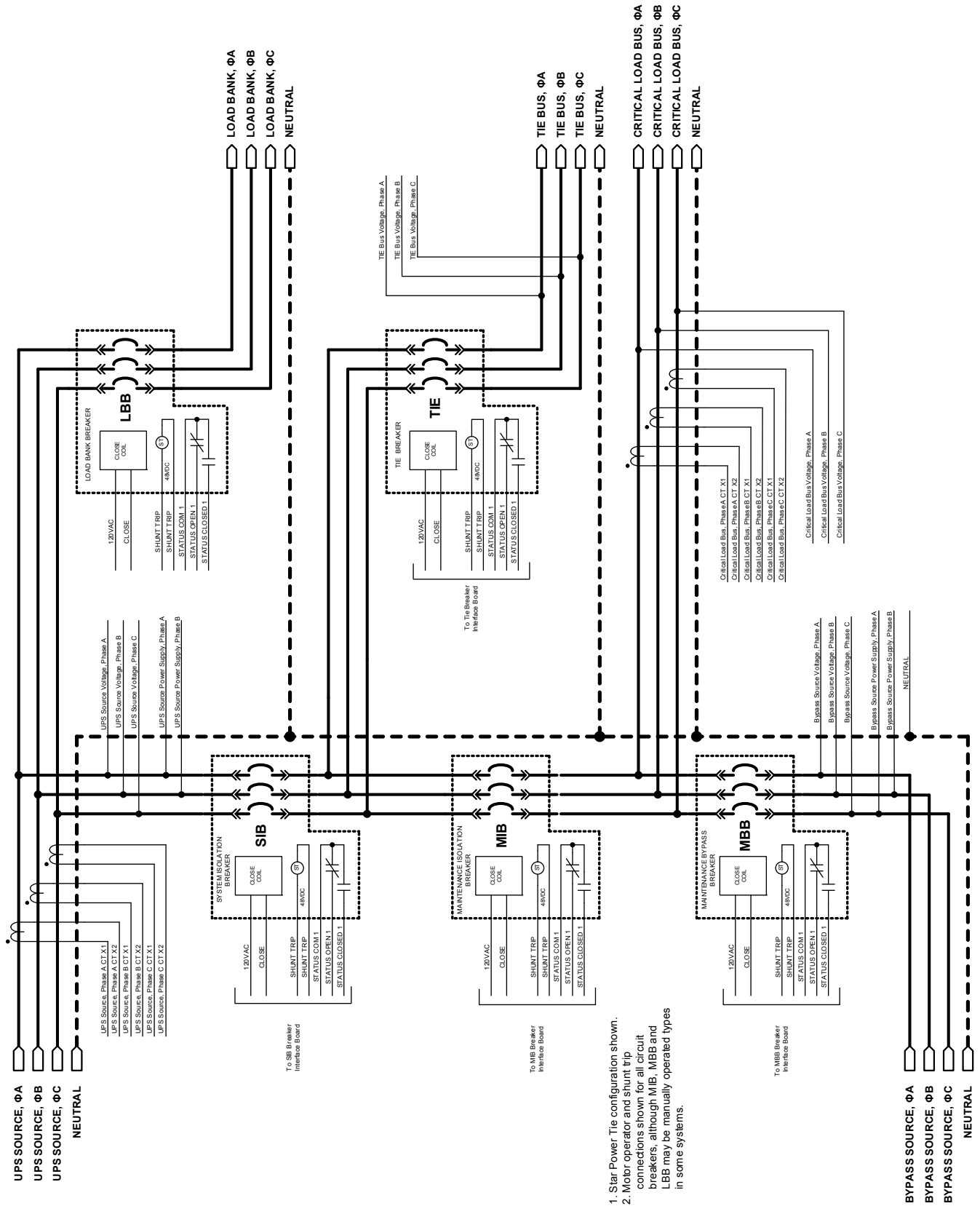

4.0 SPECIFICATIONS

Table 18 Liebert NXL Power-Tie Control specifications

Environmental Parameters	
Storage Temperature Range, °F (°C)	-13 to 158 (-25 to 70)
Operating Temperature Range, °F (°C)	32 to 104 (0 to 40) (UPS)
Relative Humidity	95% or less Non-Condensing (Operating and Non-Operating)
Maximum Altitude Above mean sea level, ft (m)	4920 (1500) (as per IEC 62040/3) - 1% Max kW derate / 328 rise between 4921-9842 (100m rise between 1500-3000m)

NOTES



