

WILDEN®

EOM
Engineering
Operation &
Maintenance

PS Stallion
Original™ Metal Pump

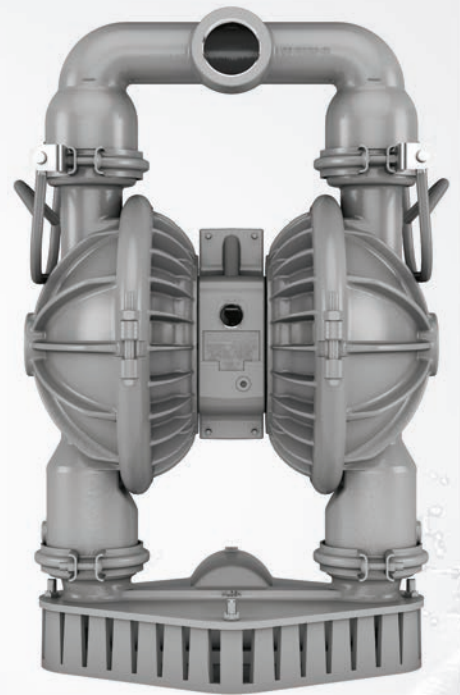

Where Innovation Flows

wildenpump.com

PSG
a **DOVER** company

TABLE OF CONTENTS

SECTION 1 CAUTIONS—READ FIRST! 1

SECTION 2 WILDEN PUMP DESIGNATION SYSTEM 2

SECTION 3 HOW IT WORKS—PUMP & AIR DISTRIBUTION SYSTEM 3

SECTION 4 DIMENSIONAL DRAWINGS 4

SECTION 5 PERFORMANCE
 PS Stallion Performance
 Performance Curves
 PS4 - EZ-Install TPE-Fitted 6
 PS8 - EZ-Install TPE-Fitted 6
 PS15 - EZ-Install TPE-Fitted 7
 Suction-Lift Curves 8

SECTION 6 SUGGESTED INSTALLATION, OPERATION & TROUBLESHOOTING 11

SECTION 7 DISASSEMBLY / REASSEMBLY 14
 Air Valve/Center Section Disassembly 17
 Reassembly Hints & Tips 21

















SECTION 8 EXPLODED VIEW & PARTS LISTING
 PS4 Stallion Metal 22
 PS8 Stallion Metal 24
 PS15 Stallion Metal 26

SECTION 9 ELASTOMER OPTIONS 28





CAUTIONS—READ FIRST!

-  **CAUTION:** Do not apply compressed air to the exhaust port — pump will not function.
-  **CAUTION:** Do not over-lubricate air supply — excess lubrication will reduce pump performance. Pump is pre-lubed.
-  **TEMPERATURE LIMITS:**
- | | | |
|---|----------------|----------------|
| Polypropylene | 0°C to 79°C | 32°F to 175°F |
| PVDF | -12°C to 107°C | 10°F to 225°F |
| PFA | 7°C to 107°C | 45°F to 225°F |
| Neoprene | -18°C to 93°C | 0°F to 200°F |
| Buna-N | -12°C to 82°C | 10°F to 180°F |
| EPDM | -51°C to 138°C | -60°F to 280°F |
| Viton® FKM | -40°C to 177°C | -40°F to 350°F |
| Wil-Flex™ | -40°C to 107°C | -40°F to 225°F |
| Saniflex™ | -29°C to 104°C | -20°F to 220°F |
| Polyurethane | -12°C to 66°C | 10°F to 150°F |
| Polytetrafluoroethylene (PTFE) ¹ | 4°C to 104°C | 40°F to 220°F |
| Nordel® EPDM | -51°C to 138°C | 60°F to 280°F |
| Nylon | -18°C to 93°C | 0°F to 200°F |
| Acetal | -29°C to 82°C | -20°F to 180°F |
| SIPD PTFE with Neoprene-backed | -18°C to 93°C | 0°F to 200°F |
| SIPD PTFE with EPDM-backed | 4°C to 138°C | 40°F to 280°F |
| Geolast® | -40°C to 82°C | -40°F to 180°F |
- ¹4°C to 149°C (40°F to 300°F) - 13 mm (1/2") and 25 mm (1") models only.
- NOTE: Not all materials are available for all models. Refer to Section 2 for the material options available for your pump.
-  **CAUTION:** When choosing pump materials, be sure to check the temperature limits for all wetted components. Example: Viton® has a maximum limit of 177°C (350°F), but polypropylene has a maximum limit of only 79°C (175°F).
-  **CAUTION:** Maximum temperature limits are based upon mechanical stress only. Certain chemicals will significantly reduce maximum safe operating temperatures. Consult Chemical Resistance Guide for chemical compatibility and temperature limits.
-  **WARNING:** Prevent static sparking — If static sparking occurs, fire or explosion could result. Pump, valves and containers must be grounded to a proper grounding point when handling flammable fluids and whenever discharge of static electricity is a hazard.
-  **CAUTION:** Do not exceed 8.6 bar (125 psig) air supply pressure.
-  **CAUTION:** The process fluid and cleaning fluids must be chemically compatible with all wetted pump components. Consult Chemical Resistance Guide.
-  **CAUTION:** Do not exceed 82°C (180°F) air inlet temperature for Pro-Flo® SHIFT models.
-  **CAUTION:** Pumps should be thoroughly flushed before installing into process lines. FDA- and USDA-approved pumps should be cleaned and/or sanitized before being used.
-  **CAUTION:** Always wear safety glasses when operating pump. If diaphragm rupture occurs, material being pumped may be forced out air exhaust.
-  **CAUTION:** Before any maintenance or repair is attempted, the compressed air line to the pump should be disconnected and all air pressure allowed to bleed from pump. Disconnect all intake, discharge and air lines. Drain the pump by turning it upside down and allowing any fluid to flow into a suitable container.
-  **CAUTION:** Blow out air line for 10 to 20 seconds before attaching to pump to make sure all pipeline debris is clear. Use an in-line air filter. A 5µ (micron) air filter is recommended.
-  **NOTE:** Before starting disassembly, mark a line from each liquid chamber to its corresponding air chamber. This line will assist in proper alignment during reassembly.
-  **CAUTION:** Pro-Flo® pumps cannot be used in submersible applications. Pro-Flo® SHIFT is available in both submersible and non-submersible options. Do not use non-submersible Pro-Flo® SHIFT models in submersible applications. Turbo-Flo® pumps can also be used in submersible applications.
-  **CAUTION:** Tighten all hardware prior to installation.



WILDEN PUMP DESIGNATION SYSTEM

PS STALLION

LEGEND

XXX / XXXXX / XXX / XX / XX / XXXX

MODEL

WETTED PARTS & OUTER PISTON

AIR VALVE
CENTER BLOCK
AIR CHAMBERS

DIAPHRAGMS

VALVE BALLS

VALVE SEAT

SPECIALTY CODE
(if applicable)

MATERIAL CODES

MODEL

PS4 = 38 mm (1-1/2")
PS8 = 51 mm (2")
PS15 = 76 mm (3")

WETTED PARTS & OUTER PISTON

AA = ALUMINUM / ALUMINUM
WW = DUCTILE IRON / DUCTILE IRON (PS4 & PS8 Only)

AIR CHAMBERS

A = ALUMINUM

CENTER BLOCK

A = ALUMINUM

AIR VALVE

R = ANODIZED ALUMINUM

DIAPHRAGMS

FWS = SANITARY WIL-FLEX™, EZ-INSTALL [Santoprene® (Two Orange Dots)]
ZGS = GEOLAST®, EZ-INSTALL
ZPS = POLYURETHANE, EZ-INSTALL (Clear)
ZSS = SANIFLEX™, EZ-INSTALL (Cream)
ZWS = WIL-FLEX™, EZ-INSTALL (Orange Dot)

VALVE BALL

BN = BUNA-N (Red Dot)
EP = NORDEL® (Blue Dot)
FS = SANIFLEX™ [Hytrel® (Cream)]
FW = SANITARY WIL-FLEX™ [Santoprene® (Two Orange Dots)]
NE = NEOPRENE (Green Dot)
PU = Polyurethane (Brown)
VT = VITON® (Silver or White Dot)
WF = WIL-FLEX™ [Santoprene® (Orange Dot)]

VALVE SEAT

BN = BUNA-N (Red Dot)
EP = NORDEL® (Blue Dot)
FS = SANIFLEX™ [Hytrel® (Cream)]
NE = NEOPRENE (Green Dot)
PU = Polyurethane (Clear)
VT = VITON® (Silver or White Dot)
WF = WIL-FLEX™ [Santoprene® (Orange Dot)]

SPECIALTY CODES

- 0046 Stallion internals, BSPT
- 0048 Stallion Internals
- 0050 Stallion**
- 0051 Stallion, BSPT**
- 0076 Food Processing, Stallion Internals

NOTE: Bold specialty codes indicate the standard product offering.



HOW IT WORKS—PUMP

The Wilden diaphragm pump is an air-operated, positive displacement, self-priming pump. These drawings show flow pattern through the pump upon its initial stroke. It is assumed the pump has no fluid in it prior to its initial stroke.

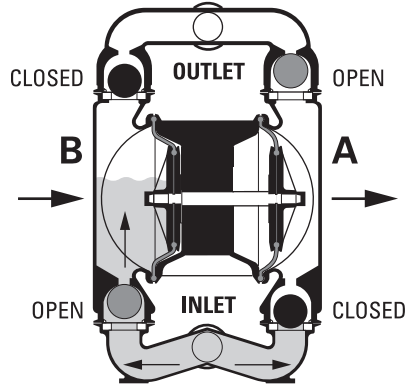

FIGURE 1 The air valve directs pressurized air to the back side of diaphragm A. The compressed air is applied directly to the liquid column separated by elastomeric diaphragms. The diaphragm acts as a separation membrane between the compressed air and liquid; a balanced load removes mechanical stress from the diaphragm. The compressed air moves the diaphragm away from the center of the pump. The opposite diaphragm is pulled in by the shaft connected to the pressurized diaphragm. Diaphragm B is on its suction stroke; air behind the diaphragm has been forced out to the atmosphere through the exhaust port of the pump. The movement of diaphragm B toward the center of the pump creates a vacuum within chamber B. Atmospheric pressure forces fluid into the inlet manifold forcing the inlet valve ball off its seat. Liquid is free to move past the inlet valve ball and fill the liquid chamber (see shaded area).

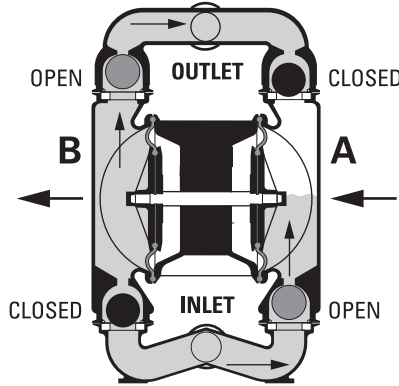

FIGURE 2 When the pressurized diaphragm, diaphragm A, reaches the limit of its discharge stroke, the air valve redirects pressurized air to the back side of diaphragm B. The pressurized air forces diaphragm B away from the center while pulling diaphragm A to the center. Diaphragm B is now on its discharge stroke. Diaphragm B forces the inlet valve ball onto its seat due to the hydraulic forces developed in the liquid chamber and manifold of the pump. These same hydraulic forces lift the discharge valve ball off its seat, forcing fluid to flow through the pump discharge. The movement of diaphragm A toward the center of the pump creates a vacuum within liquid chamber A. Atmospheric pressure forces fluid into the inlet manifold of the pump. The inlet valve ball is forced off its seat allowing the fluid being pumped to fill the liquid chamber.

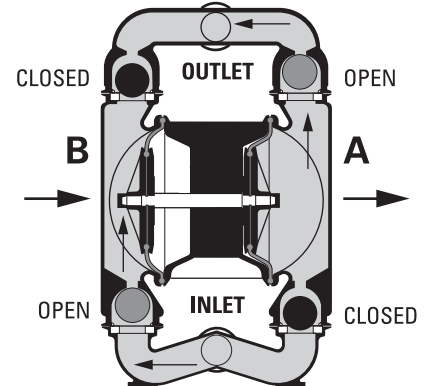
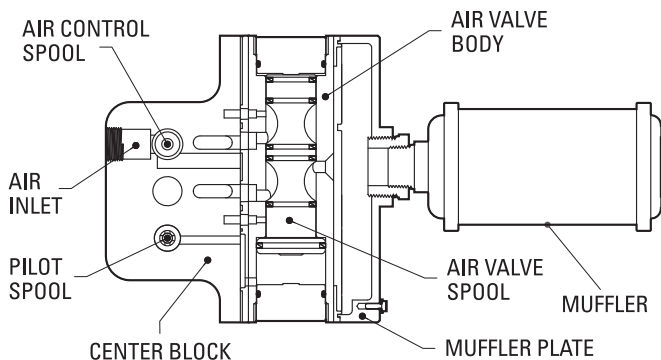

FIGURE 3 At completion of the stroke, the air valve again redirects air to the back side of diaphragm A, which starts diaphragm B on its exhaust stroke. As the pump reaches its original starting point, each diaphragm has gone through one exhaust and one discharge stroke. This constitutes one complete pumping cycle. The pump may take several cycles to completely prime depending on the conditions of the application.



HOW IT WORKS—AIR DISTRIBUTION SYSTEM



The heart of the patented Pro-Flo® SHIFT Air Distribution System (ADS) is the air valve assembly. The air valve design incorporates an unbalanced spool with the small end of the spool being pressurized continuously while the large end of the spool is alternately pressurized, then exhausted to move the spool. The air valve spool directs pressurized air to one chamber while exhausting the other. The air forces the main shaft/diaphragm assembly to move to one side – discharging liquid on that side and pulling liquid in on the other side. When the shaft reaches the end of the stroke, the inner piston actuates the pilot spool, which controls the air to the large end of the air valve spool. The repositioning of the air valve spool routes the air to the other air chamber. The air control spool allows air to flow freely into the air chamber for the majority of each pump stroke, but it significantly restricts the flow of air into the air chamber when activated by the inner piston near the end of the each stroke.



DIMENSIONAL DRAWINGS

PS4 Stallion

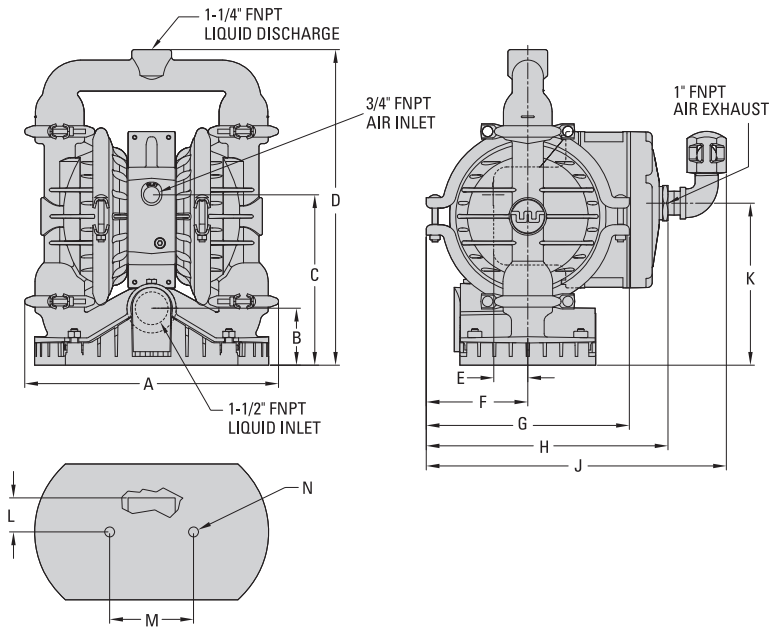

DIMENSIONS

ITEM	METRIC (mm)	STANDARD (inch)
A	366	14.4
B	81	3.2
C	245	9.6
D	455	17.9
E	48	1.9
F	147	5.8
G	292	11.5
H	348	13.7
J	432	17.0
K	233	9.2
L	48	1.0
M	122	4.8
N	15 DIA.	0.6 DIA.

LW0261 REV. B

PS8 Stallion

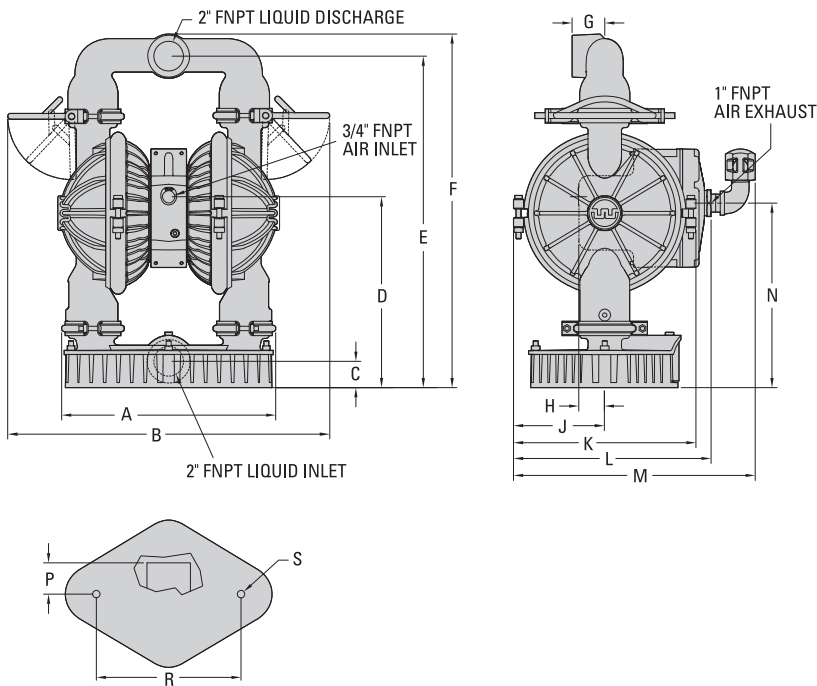

DIMENSIONS

ITEM	METRIC (mm)	STANDARD (inch)
A	406	16.0
B	612	24.1
C	51	2.0
D	362	14.3
E	630	24.8
F	671	26.4
G	61	2.4
H	48	1.9
J	173	6.8
K	345	13.6
L	375	14.8
M	459	18.1
N	350	13.8
P	58	2.3
R	274	10.8
S	15 DIA.	0.6 DIA.

LW0262 REV. C

PS15 Stallion

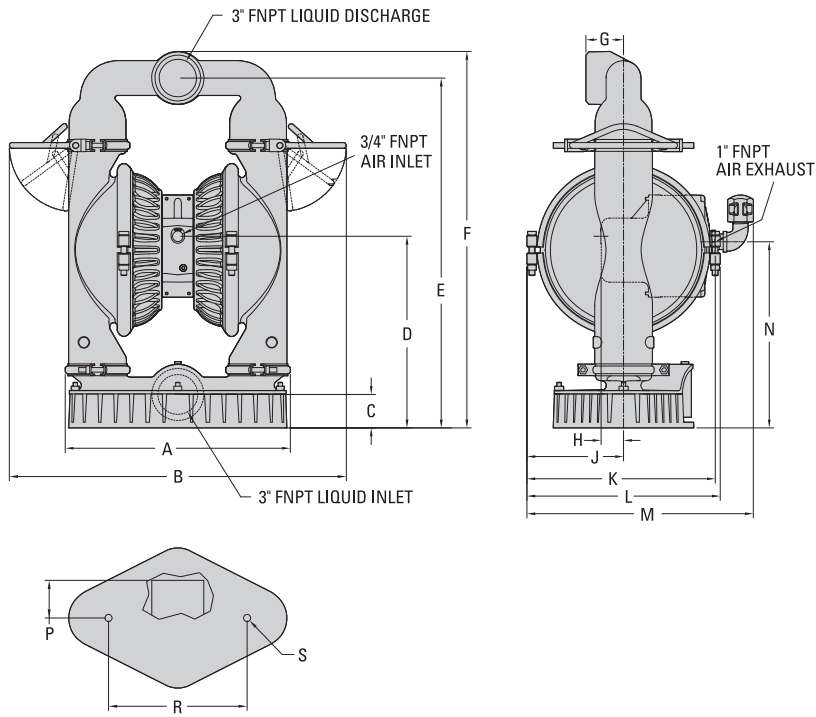

DIMENSIONS

ITEM	METRIC (mm)	STANDARD (inch)
A	495	19.5
B	742	29.2
C	74	2.9
D	422	16.6
E	770	30.3
F	828	32.6
G	84	3.3
H	48	1.9
J	213	8.4
K	414	16.3
L	424	16.7
M	498	19.6
N	409	16.1
P	84	3.3
R	305	12.0
S	15 DIA.	0.6 DIA.

LW0263 REV. B

SUCTION-LIFT CURVES

**PS4 Stallion
METAL SUCTION-
LIFT CAPABILITY**

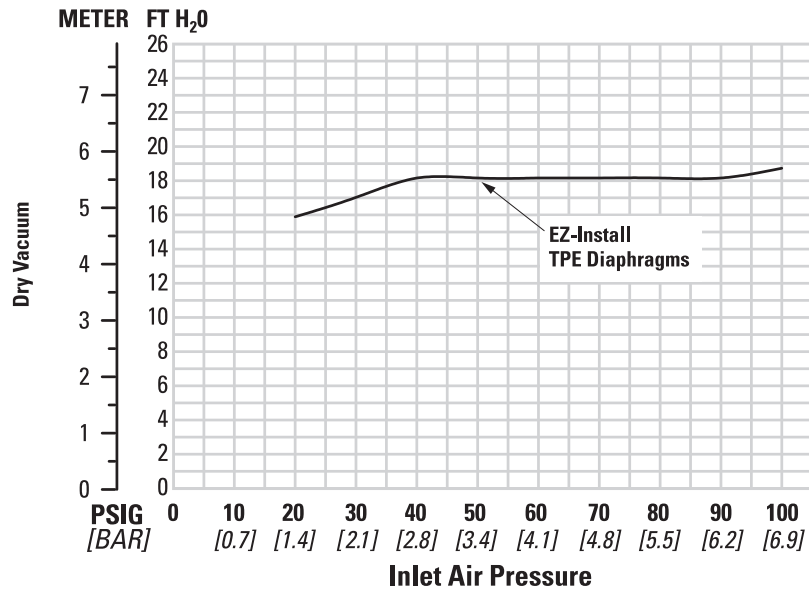

**PS8 Stallion
METAL SUCTION-
LIFT CAPABILITY**

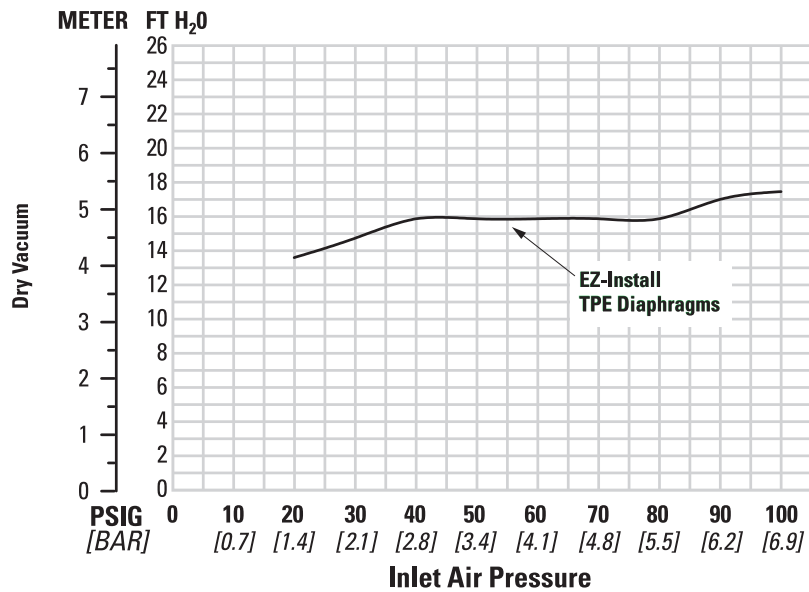

Suction lift curves are calibrated for pumps operating at 305 m (1,000') above sea level. This chart is meant to be a guide only. There are many variables which can affect your pump's operating characteristics. The

number of intake and discharge elbows, viscosity of pumping fluid, elevation (atmospheric pressure) and pipe friction loss all affect the amount of suction lift your pump will attain.

SUCTION-LIFT CURVES

**PS15 Stallion
METAL SUCTION-
LIFT CAPABILITY**

Suction lift curves are calibrated for pumps operating at 305 m (1,000') above sea level. This chart is meant to be a guide only. There are many variables which can affect your pump's operating characteristics. The number of intake and discharge elbows, viscosity of pumping fluid, elevation (atmospheric pressure) and pipe friction loss all affect the amount of suction lift your pump will attain.

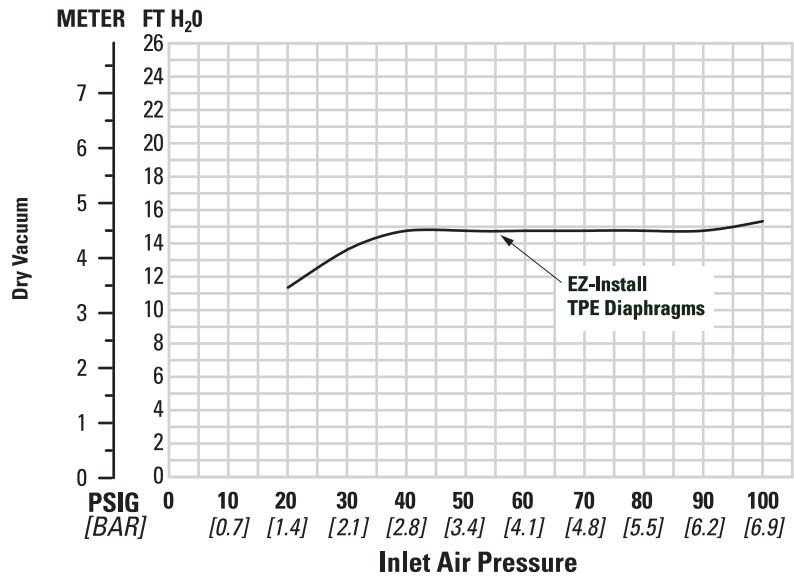

NOTES

Wilden pumps are designed to meet the performance requirements of even the most demanding pumping applications. They have been designed and manufactured to the highest standards and are available in a variety of liquid-path materials to meet your chemical-resistance needs. Refer to the performance section of this manual for an in-depth analysis of the performance characteristics of your pump. Wilden offers the widest variety of elastomer options in the industry to satisfy temperature, chemical-compatibility, abrasion-resistance and flex concerns.

The suction pipe size should be at least the equivalent or larger than the diameter size of the suction inlet on your Wilden pump. The suction hose must be non-collapsible, reinforced type as these pumps are capable of pulling a high vacuum. Discharge piping should also be the equivalent or larger than the diameter of the pump discharge which will help reduce friction losses. It is critical that all fittings and connections are airtight or a reduction or loss of pump suction capability will result.

INSTALLATION: Months of careful planning, study, and selection efforts can result in unsatisfactory pump performance if installation details are left to chance.

Premature failure and long term dissatisfaction can be avoided if reasonable care is exercised throughout the installation process.

LOCATION: Noise, safety, and other logistical factors usually dictate where equipment will be situated on the production floor. Multiple installations with conflicting requirements can result in congestion of utility areas, leaving few choices for additional pumps.

Within the framework of these and other existing conditions, every pump should be located in such a way that six key factors are balanced against each other to maximum advantage.

ACCESS: First of all, the location should be accessible. If it is easy to reach the pump, maintenance personnel will have an easier time carrying out routine inspections and adjustments. Should major repairs become necessary, ease of access can play a key role in speeding the repair process and reducing total downtime.

AIR SUPPLY: Every pump location should have an air line large enough to supply the volume of air necessary to achieve the desired pumping rate. Use air pressure up to a maximum of 8.6 bar (125 psig) depending on pumping requirements.

For best results, the pumps should use a 5µ (micron) air filter, needle valve and regulator. The use of an air filter before the pump will ensure that the majority of any pipeline contaminants will be eliminated.

SOLENOID OPERATION: When operation is controlled by a solenoid valve in the air line, three-way valves should be used. This valve allows trapped air between the valve and the pump to bleed off which improves pump performance. Pumping volume can be estimated by counting the number of strokes per minute and then multiplying the figure by the displacement per stroke.

MUFFLER: Sound levels are reduced below OSHA specifications using the standard Wilden muffler. Other

mufflers can be used to further reduce sound levels, but they usually reduce pump performance.

ELEVATION: Selecting a site that is well within the pump's dynamic lift capability will ensure that loss-of-prime issues will be eliminated. In addition, pump efficiency can be adversely affected if proper attention is not given to site location.

PIPING: Final determination of the pump site should not be made until the piping challenges of each possible location have been evaluated. The impact of current and future installations should be considered ahead of time to make sure that inadvertent restrictions are not created for any remaining sites.

The best choice possible will be a site involving the shortest and straightest hookup of suction and discharge piping. Unnecessary elbows, bends, and fittings should be avoided. Pipe sizes should be selected to keep friction losses within practical limits. All piping should be supported independently of the pump. In addition, the piping should be aligned to avoid placing stress on the pump fittings.

Flexible hose can be installed to aid in absorbing the forces created by the natural reciprocating action of the pump. If the pump is to be bolted down to a solid location, a mounting pad placed between the pump and the foundation will assist in minimizing pump vibration. Flexible connections between the pump and rigid piping will also assist in minimizing pump vibration. If quick-closing valves are installed at any point in the discharge system, or if pulsation within a system becomes a problem, a surge suppressor (SD Equalizer®) should be installed to protect the pump, piping and gauges from surges and water hammer.

If the pump is to be used in a self-priming application, make sure that all connections are airtight and that the suction lift is within the model's ability. **NOTE:** Materials of construction and elastomer material have an effect on suction lift parameters. Please refer to the performance section for specifics.

When pumps are installed in applications involving flooded suction or suction head pressures, a gate valve should be installed in the suction line to permit closing of the line for pump service.

Pumps in service with a positive suction head are most efficient when inlet pressure is limited to 0.5–0.7 bar (7–10 psig). Premature diaphragm failure may occur if positive suction is 0.7 bar (10 psig) and higher.

SUBMERSIBLE APPLICATIONS: Pro-Flo® SHIFT pumps can be used for submersible applications, when using the Pro-Flo® SHIFT submersible option. Turbo-Flo™ pumps can also be used for submersible applications.

NOTE: Pro-Flo® and Accu-Flo™ pumps are not submersible.

ALL WILDEN PUMPS ARE CAPABLE OF PASSING SOLIDS. A STRAINER SHOULD BE USED ON THE PUMP INTAKE TO ENSURE THAT THE PUMP'S RATED SOLIDS CAPACITY IS NOT EXCEEDED.

CAUTION: DO NOT EXCEED 8.6 BAR (125 PSIG) AIR SUPPLY PRESSURE.

SUGGESTED INSTALLATION

This illustration is a generic representation of an air-operated double-diaphragm pump.

EXAMPLE 1

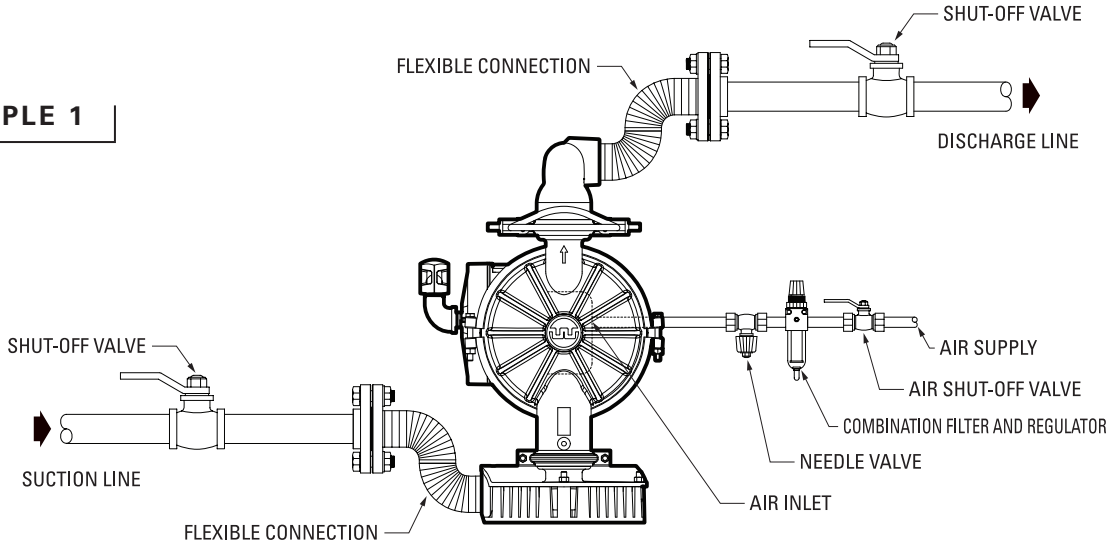

EXAMPLE 2

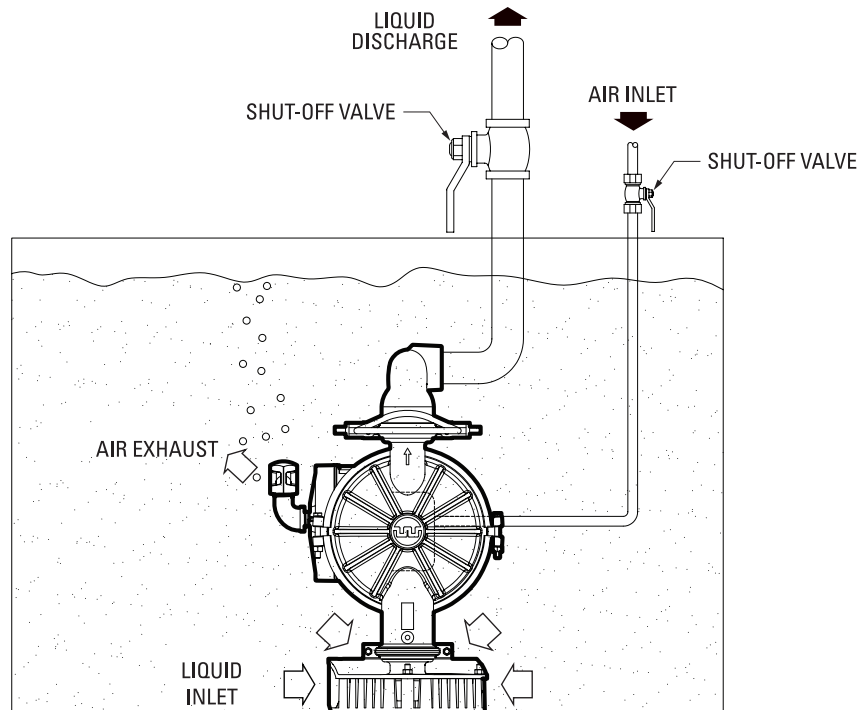

NOTE: In the event of a power failure, the shut-off valve should be closed, if restarting of pump is not desirable once power is regained.

AIR OPERATED PUMPS: To stop the pump from operating in an emergency situation, simply close the

shut-off valve (user-supplied) installed in the air supply line. A properly functioning valve will stop the air supply to the pump, therefore stopping output. This shut-off valve should be located far enough away from the pumping equipment such that it can be reached safely in an emergency situation.

SUGGESTED OPERATION & MAINTENANCE

OPERATION: PS Stallion pumps are pre-lubricated, and do not require in-line lubrication. Additional lubrication will not damage the pump, however if the pump is heavily lubricated by an external source, the pump's internal lubrication may be washed away. If the pump is then moved to a non-lubricated location, it may need to be disassembled and re-lubricated as described in the DISASSEMBLY/REASSEMBLY.

Pump discharge rate can be controlled by limiting the volume and/or pressure of the air supply to the pump. An air regulator is used to regulate air pressure. A needle valve is used to regulate volume. Pump discharge rate can also be controlled by throttling the pump discharge by partially closing a valve in the discharge line of the pump. This action increases friction loss which reduces flow rate. (See Section 5.) This is useful when the need exists to control the pump from a remote location. When the pump discharge pressure equals or exceeds the air supply pressure, the pump will stop; no bypass or pressure relief valve is needed, and pump damage will not occur. The pump has reached a "deadhead" situation and can be

restarted by reducing the fluid discharge pressure or increasing the air inlet pressure. PS Stallion pumps run solely on compressed air and do not generate heat, therefore your process fluid temperature will not be affected.

MAINTENANCE AND INSPECTIONS: Since each application is unique, maintenance schedules may be different for every pump. Frequency of use, line pressure, viscosity and abrasiveness of process fluid all affect the parts life of a Wilden pump. Periodic inspections have been found to offer the best means for preventing unscheduled pump downtime. Personnel familiar with the pump's construction and service should be informed of any abnormalities that are detected during operation.

RECORDS: When service is required, a record should be made of all necessary repairs and replacements. Over a period of time, such records can become a valuable tool for predicting and preventing future maintenance problems and unscheduled downtime. In addition, accurate records make it possible to identify pumps that are poorly suited to their applications.

TROUBLESHOOTING

Pump will not run or runs slowly.

1. Ensure that the air inlet pressure is at least 0.4 bar (5 psig) above startup pressure and that the differential pressure (the difference between air inlet and liquid discharge pressures) is not less than 0.7 bar (10 psig).
2. Check air inlet filter for debris (see SUGGESTED INSTALLATION).
3. Check for extreme air leakage (blow by) which would indicate worn seals/bores in the air valve, pilot spool and main shaft.
4. Disassemble pump and check for obstructions in the air passageways or objects which would obstruct the movement of internal parts.
5. Check for sticking ball check valves. If material being pumped is not compatible with pump elastomers, swelling may occur. Replace ball check valves and seals with proper elastomers. Also, as the check valve balls wear out, they become smaller and can become stuck in the seats. In this case, replace balls and seats.
6. Check for broken inner pistons which will cause the air valve spool to be unable to shift.
7. Remove plug from pilot spool exhaust.

Pump runs, but little or no product flows.

1. Check for pump cavitation; slow pump speed down to allow thick material to flow into liquid chambers.

2. Verify that vacuum required to lift liquid is not greater than the vapor pressure of the material being pumped (cavitation).
3. Check for sticking ball check valves. If material being pumped is not compatible with pump elastomers, swelling may occur. Replace ball check valves and seats with proper elastomers. Also, as the check valve balls wear out, they become smaller and can become stuck in the seats. In this case, replace balls and seats.

Pump air valve freezes.

1. Check for excessive moisture in compressed air. Either install a dryer or hot air generator for compressed air. Alternatively, a coalescing filter may be used to remove the water from the compressed air in some applications.

Air bubbles in pump discharge.

1. Check for ruptured diaphragm.
2. Check tightness of outer pistons (refer to Section 7).
3. Check tightness of fasteners and integrity of O-rings and seals, especially at intake manifold.
4. Ensure pipe connections are airtight.

Product comes out air exhaust.

1. Check for diaphragm rupture.
2. Check tightness of outer pistons to shaft.



PUMP DISASSEMBLY

Tools Required:

- Appropriate-sized wrenches

CAUTION: Before any maintenance or repair is attempted, the compressed air line to the pump must be disconnected and all stored air pressure allowed to bleed from the pump and system. Drain the pump by turning it upside down and allowing any fluid to flow into a suitable container. Be aware of any hazardous effects of contact with your process fluid.

NOTE: Your pump and the tools needed for disassembly may differ from the model shown in this example.

**Step 1**

Before starting disassembly, mark a line from each liquid chamber to its corresponding air chamber to note alignment. This will assist in proper alignment during reassembly.

**Step 2**

Using an appropriate-sized wrench, remove the four nuts that fasten the handles, handle brackets, handles (if equipped) and the two small clamp bands that fasten the discharge manifold to the liquid chambers.

**Step 3**

Remove the discharge manifold to expose the valve balls and seats. Inspect the ball cage area of the manifold for excessive wear or damage.



Step 4

Remove the discharge valve balls and seats from the liquid chambers and inspect for nicks, chemical attack or abrasive wear. Replace worn parts with genuine Wilden parts for reliable performance.

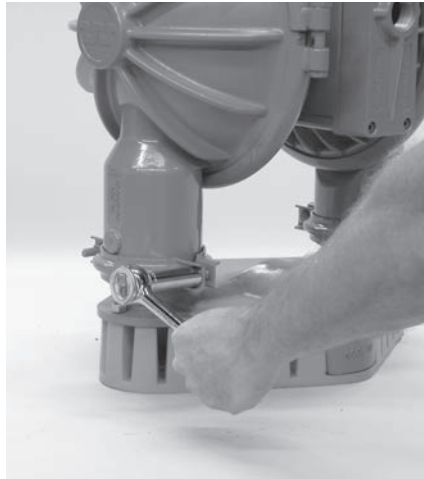

Step 5

Using appropriate-sized wrench, remove the two small clamp bands which fasten the inlet manifold to the liquid chambers.

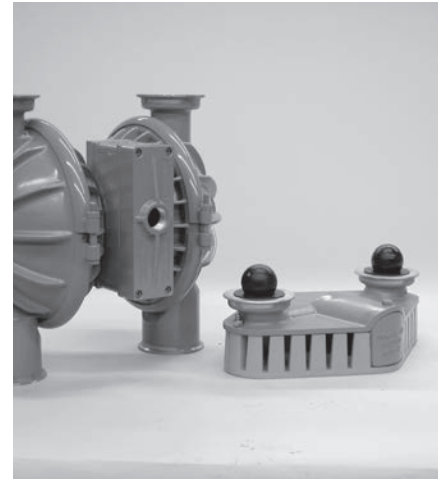

Step 6

Lift the liquid chambers and center section assembly from the inlet manifold to expose the inlet valve balls and seats. Inspect the ball cage area of the liquid chambers for excessive wear or damage.

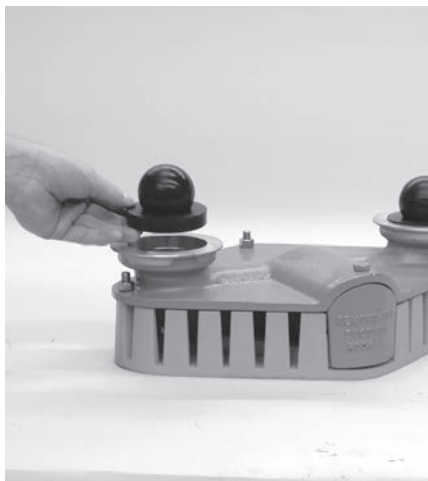

Step 7

Remove the inlet valve balls and seats from the inlet manifold and inspect for nicks, chemical attack or abrasive wear. Replace worn parts with genuine Wilden parts for reliable performance.



Step 8

Using an appropriate-sized wrench remove the screen base from the inlet manifold. Using an appropriate-sized wrench, remove the suction hook up cover from the inlet manifold. Inspect the inlet manifold for cracks or lodged solids in the suction path which may impair performance.



Step 9

Using an appropriate-sized wrench, remove one of the large clamp bands which secure the liquid chamber to the air chamber and center section assembly.



Step 10

Lift the liquid chamber from the center section assembly exposing the diaphragm and outer piston.



Step 11

By rotating the diaphragm by hand or by using an adjustable wrench remove the diaphragm assembly.

NOTE: Due to varying torque values, one of the following two situations will occur:

- 1) The outer piston, diaphragm, and inner piston remain attached to the shaft and the entire assembly can be removed from the center section assembly.
- 2) The outer piston, diaphragm, and inner piston separate from the shaft which remains fastened to the opposing side. Repeat the disassembly instructions for the remaining side of the pump.



Step 12

Inspect the diaphragm assembly and shaft for wear, damage, or chemical attack. Replace any damaged components with genuine Wilden parts for reliable performance.

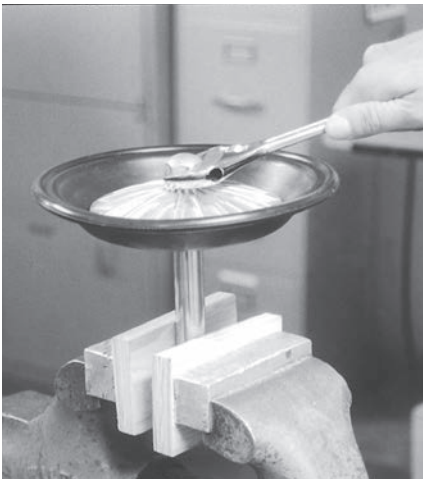

Step 13

To remove diaphragm assembly from shaft, secure shaft with soft jaws (aluminum, plastic, or plywood) to ensure the shaft is not damaged. Using an adjustable wrench, remove the diaphragm assembly from the shaft.

AIR VALVE / CENTER SECTION DISASSEMBLY

Tools Required:

- Appropriate-sized Wrenches
- Snap-Ring Pliers
- O-Ring Pick

CAUTION: Before any maintenance or repair is attempted, the compressed air line to the pump should be disconnected and all air pressure allowed to bleed from the pump. Disconnect all intake, discharge and air lines. Drain the pump by turning it upside down and allowing any fluid to flow into a suitable container. Be aware of hazardous effects of contact with your process fluid.

The Wilden Pro-Flo® SHIFT metal pumps utilize a revolutionary Pro-Flo® SHIFT air distribution system. Proprietary composite seals reduce the coefficient of friction and allow the Pro-Flo® SHIFT to run lube-free. The Pro-Flo® SHIFT air distribution system is designed to perform in on/off, non-freezing, non-stalling, tough duty applications.



Step 1

Using a pair of snap-ring pliers, remove the snap ring from pilot sleeve.



Step 2

Using an O-ring pick, remove O-ring from modulator spool.



Step 3

Using the appropriate-sized wrench, loosen and remove the fasteners that attach the air chamber to center section.

AIR VALVE / CENTER SECTION DISASSEMBLY

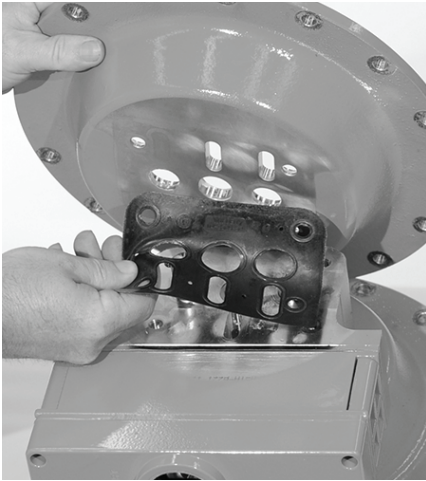

Step 4

Lift away air chamber from center section and remove center block gasket. Replace gasket if necessary.



Step 5

Turn assembly over and remove the pilot spool sleeve from the center section.



Step 6

Using an O-ring pick, gently remove the O-ring from the opposite side of the dimpled end of the pilot spool.



Step 7

Gently remove the pilot spool from the sleeve and inspect for nicks, wear or damage. Replace the pilot spool assembly or sleeve O-rings if necessary. During reassembly, never insert the dimpled end of the pilot spool first, this will damage the single urethane O-ring by passing it over the ports in the pilot sleeve.

NOTE: Seals should not be removed from the assembly. Seals are not sold separately.



Step 8

Remove modulator spool from center section. Check for wear to spool or O-rings and replace if necessary.



Step 9

Using the appropriate-sized wrench, loosen the fasteners and lift away remaining air chamber and center block gasket from center section. Replace gasket if necessary.

AIR VALVE / CENTER SECTION DISASSEMBLY

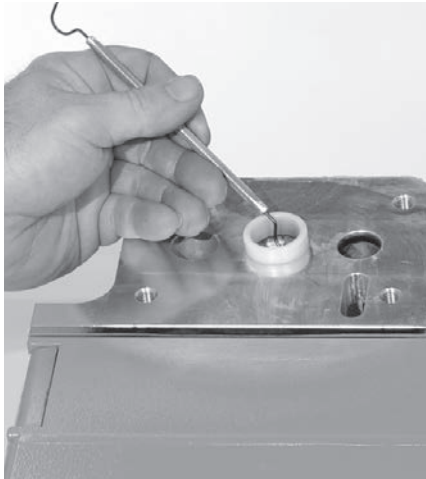

Step 10

Using an O-ring pick, remove the two (2) shaft bushings from center block. Inspect and replace if necessary. Using an O-ring pick, gently remove the two (2) Glyd™ rings from the center block. Inspect and replace if necessary.

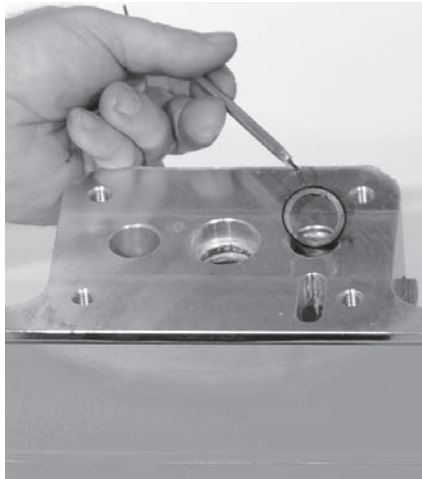

Step 11

Using an O-ring pick, remove the two (2) Glyd™ rings from modulator spool bore. Inspect and replace if necessary.



Step 12

Using an appropriate-sized wrench, remove the pilot exhaust muffler. Inspect for damage or contamination and replace if necessary.



Step 13

Using an appropriate-sized hex wrench, loosen and remove the four (4) air valve bolts from center section assembly.

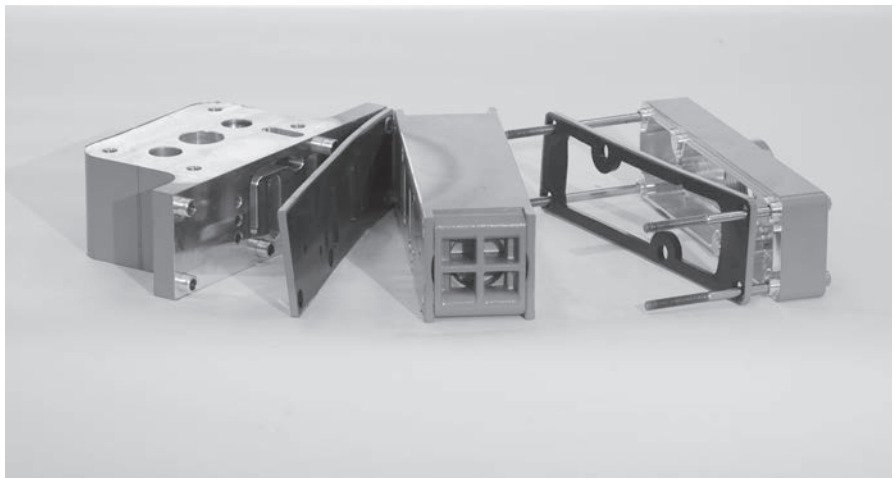

Step 14

Lift away muffer plate and muffer plate gasket from center block. Inspect for wear and replace if necessary. Lift away the air valve assembly and remove air valve gasket. Inspect the gasket and replace if necessary.

AIR VALVE / CENTER SECTION DISASSEMBLY

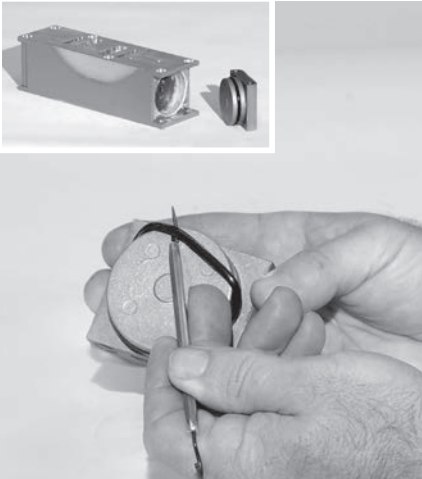

Step 15

Remove air valve end cap to expose air valve spool by lifting up on end cap. Inspect O-ring on end cap using an O-ring pick. Replace O-ring(s) if necessary. **NOTE:** The Pro-Flo® SHIFT air valve incorporates an end cap at both ends of the air valve.

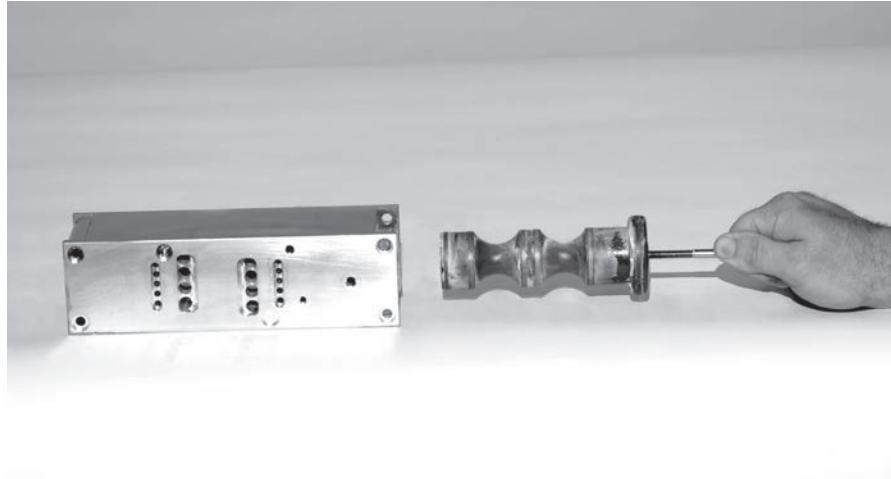

Step 16

Remove the air valve spool from the air valve body by threading one air valve bolt into the end of the air valve spool and gently sliding the spool out of the air valve body. Inspect seals for signs of wear and replace the entire air valve assembly if necessary. Re-insert the spool immediately into air valve body after inspection as the seals expand and cannot be reinserted after a length of time.

NOTE: Seals should not be removed from the assembly. Seals are not sold separately.

SINGLE-POINT EXHAUST PRO-FLO® SHIFT

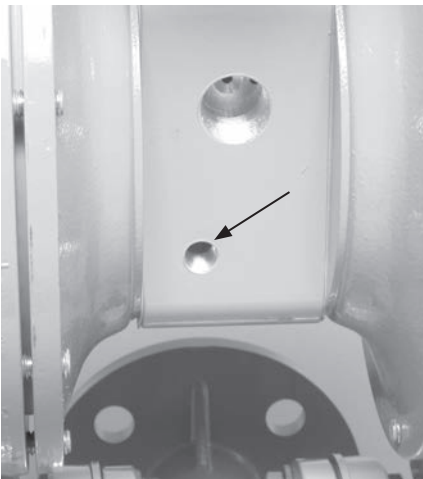

Step 1

Remove pilot exhaust muffler in pilot bleed port located at the front of the center block. Install 1/4" NPT pipe plug (00-7010-08) into bleed port.



Step 2

Next, install an optional single-point exhaust gasket (04-2638-52). The single-point air valve gasket can be purchased as a spare part or included with the purchase of a new Pro-Flo® SHIFT pump.

REASSEMBLY HINTS & TIPS

ASSEMBLY:

Upon performing applicable maintenance to the air distribution system, the pump can now be reassembled. Please refer to the disassembly instructions for photos and parts placement. To reassemble the pump, follow the disassembly instructions in reverse order. The air distribution system needs to be assembled first, then the diaphragms and finally the wetted path. Please find the applicable torque specifications on this page. The following tips will assist in the assembly process.

- Lubricate air valve bore, center section shaft and pilot spool bore with NLGI grade 2 white EP bearing grease or equivalent.
- Clean the inside of the center section shaft bore to ensure no damage is done to new shaft seals.
- A small amount of NLGI grade 2 white EP bearing grease can be applied to the muffler and air valve gaskets to lubricate gaskets during assembly.
- Make sure that the exhaust port on the muffler plate is centered between the two exhaust ports on the center section.
- Stainless bolts should be lubed to reduce the possibility of seizing during tightening.
- Use a mallet to tamp lightly on the large clamp bands to seat the diaphragm before tightening.

PS4 STALLION MAXIMUM TORQUE SPECIFICATIONS

Description of Part	Torque
Air Valve	13.6 N•m (120 in-lb)
Air Chamber/Center Block	27 N•m (20 ft-lb)
Outer Pistons	54 N•m (40 ft-lb)
Small Clamp Bands	3.4 N•m (30 in-lb)
Large Clamp Bands	10.7 N•m (95 in-lb)

PS8 STALLION MAXIMUM TORQUE SPECIFICATIONS

Description of Part	Torque
Air Valve	13.6 N•m (120 in-lb)
Air Chamber/Center Block	27 N•m (20 ft-lb)
Outer Pistons	108 N•m (80 ft-lb)
Small Clamp Bands	6.6 N•m (58 in-lb)
Large Clamp Bands	48 N•m (35 ft-lb)

PS15 STALLION MAXIMUM TORQUE SPECIFICATIONS

Description of Part	Torque
Air Valve	13.6 N•m (120 in-lb)
Air Chamber/Center Block	27 N•m (20 ft-lb)
Inner Piston Ring	19 N•m (15 ft-lb)
Outer Piston	108 N•m (80 ft-lb)
Small Clamp Bands	15.5 N•m (137 in-lb)
Large Clamp Bands	61 N•m (45 ft-lb)

Figure A

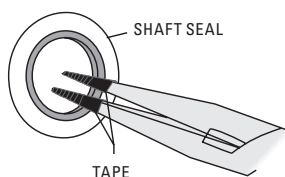

SHAFT SEAL INSTALLATION:

PRE-INSTALLATION

- Once all of the old seals have been removed, the inside of the bushing should be cleaned to ensure no debris is left that may cause premature damage to the new seals.

INSTALLATION

The following tools can be used to aid in the installation of the new seals:

Needle-Nose Pliers
Phillips Screwdriver
Electrical Tape

- Wrap electrical tape around each leg of the needle-nose pliers (heat shrink tubing may also be used). This is done to prevent damaging the inside surface of the new seal.
- With a new seal in hand, place the two legs of the needle-nose pliers inside the seal ring. (See Figure A.)
- Open the pliers as wide as the seal diameter will allow, then with two fingers pull down on the top portion of the seal to form a kidney shape. (See Figure B.)
- Lightly clamp the pliers together to hold the seal into the kidney shape. Be sure to pull the seal into as tight of a kidney shape as possible, this will allow the seal to travel down the bushing bore easier.
- With the seal clamped in the pliers, insert the seal into the bushing bore and position the bottom of the seal into the correct groove. Once the bottom of the seal is seated in the groove, release the clamp pressure on the pliers. This will allow the seal to partially snap back to its original shape.
- After the pliers are removed, you will notice a slight bump in the seal shape. Before the seal can be properly resized, the bump in the seal should be removed as much as possible. This can be done with either the Phillips screwdriver or your finger. With either the side of the screwdriver or your finger, apply light pressure to the peak of the bump. This pressure will cause the bump to be almost completely eliminated.
- Lubricate the edge of the shaft with NLGI grade 2 white EP bearing grease.
- Slowly insert the center shaft with a rotating motion. This will complete the resizing of the seal.
- Perform these steps for the remaining seals.

Figure B

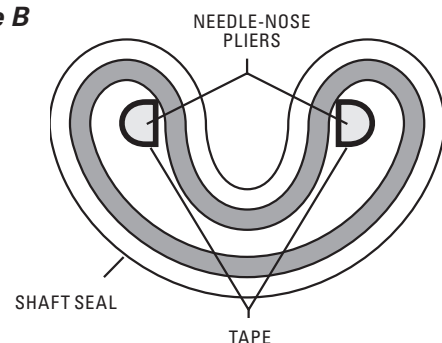



EXPLODED VIEW & PARTS LISTING

PS4 STALLION

EXPLODED VIEW

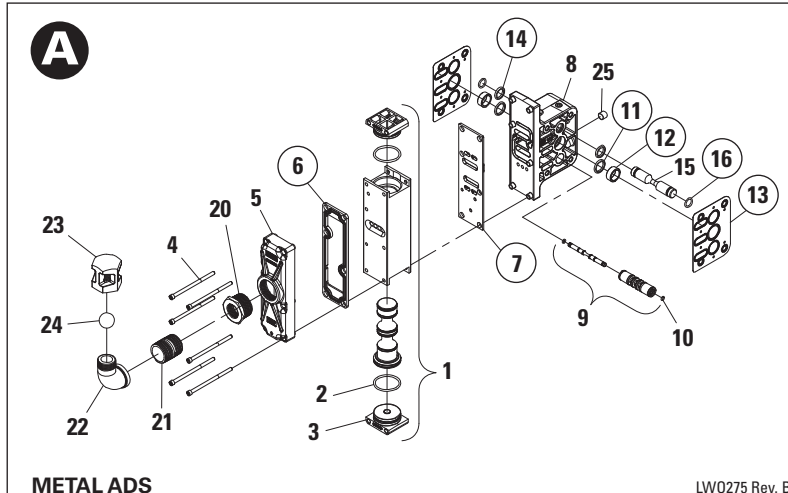
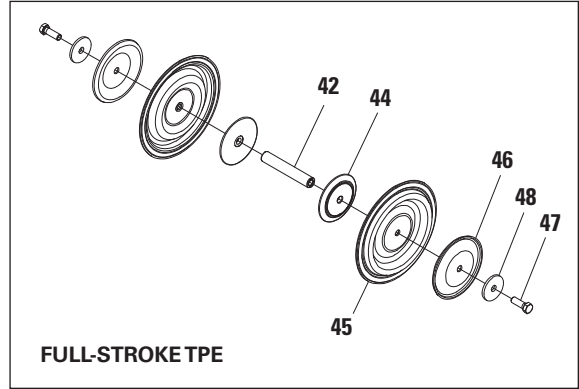
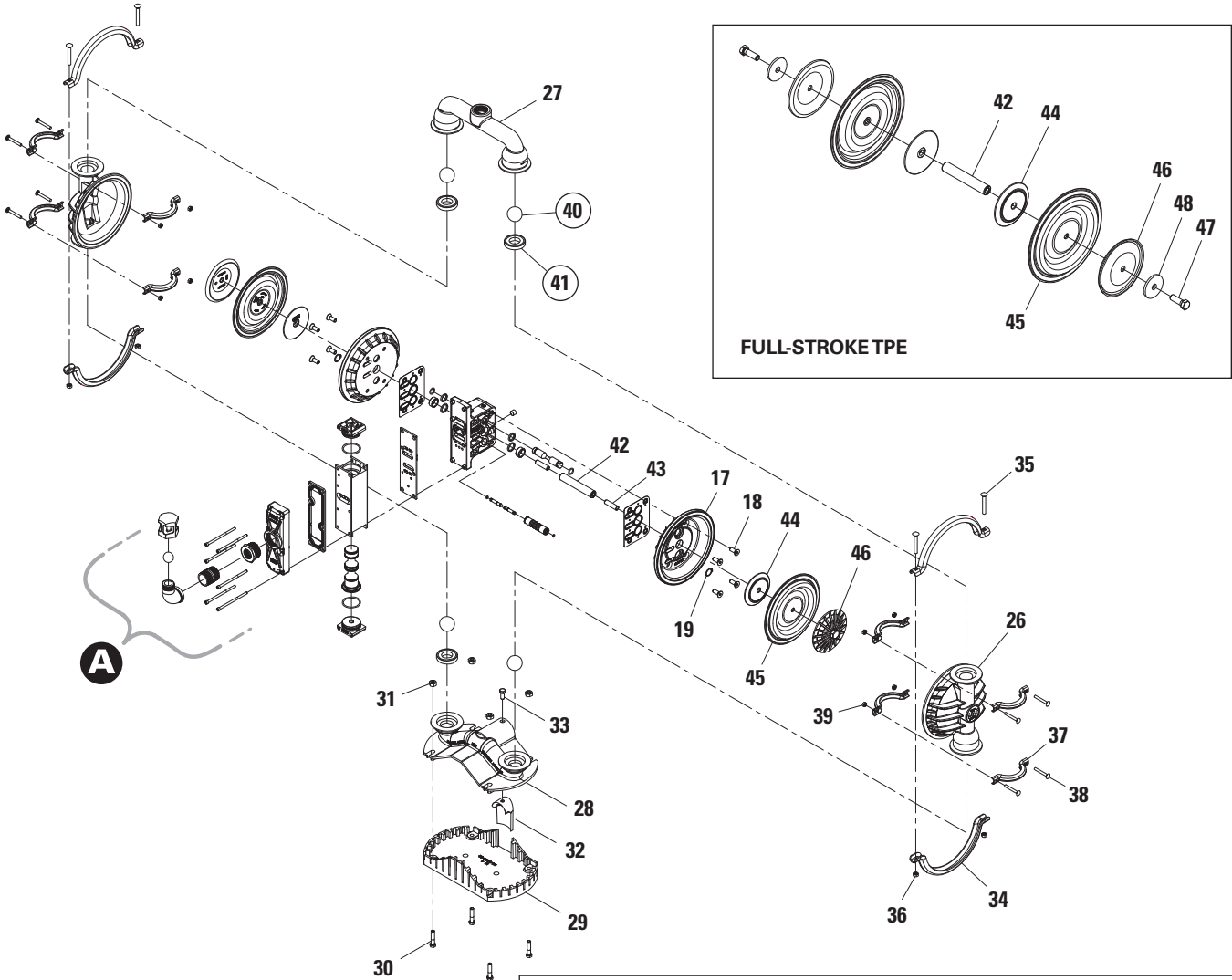

ALL CIRCLED PART IDENTIFIERS ARE INCLUDED IN REPAIR KITS (see section 9).



EXPLODED VIEW & PARTS LISTING

WILDEN

PS4 STALLION

PARTS LISTING

Item	Description	Qty.	PS4/AAAAR/0050 P/N	PS4/WMAAR/0050 P/N
AIR DISTRIBUTION COMPONENTS				
1	Air Valve Assembly ,Pro-Flo® SHIFT ¹	1	04-2039-11	04-2039-11
2	O-Ring, End Cap (-225, Ø1.859" x Ø.139")	2	04-2390-52-700	04-2390-52-700
3	End Cap	2	04-2340-01	04-2340-01
4	Screw, SHC, Air Valve (1/4"-20 x 4 1/2")	6	01-6000-03	01-6000-03
5	Muffler Plate, Pro-Flo® SHIFT	1	04-3189-01	04-3189-01
6	Gasket, Muffler Plate, Pro-Flo® SHIFT	1	04-3509-52	04-3509-52
7	Gasket, Air Valve, Pro-Flo® SHIFT	1	04-2638-52	04-2638-52
8	Center Block Assembly, Pro-Flo® SHIFT ²	1	04-3129-01	04-3129-01
9	Pilot Sleeve Assembly	1	04-3880-99	04-3880-99
10	Pilot Spool Retaining O-Ring (-009, Ø.208" x Ø.070")	2	04-2650-49-700	04-2650-49-700
11	Seal, Shaft	2	08-3210-55-225	08-3210-55-225
12	Bushing, Shaft	2	08-3306-13	08-3306-13
13	Gasket, Center Block Pro-Flo V™	2	04-3529-52	04-3529-52
14	O-Ring, (-210, Ø.734" x Ø.139")	2	04-3209-49	04-3209-49
15	Air Control Spool	1	04-3859-03	04-3859-03
16	Air Control Spool Retaining O-Ring (-114, Ø.612" x Ø.103")	2	04-3879-50	04-3879-50
17	Air Chamber, Pro-Flo V™	2	04-3660-01	04-3660-01
18	Screw, HSFHS (3/8"-16 x 1")	8	71-6250-08	71-6250-08
19	Retaining Ring	2	04-3890-03	04-3890-03
20	Bushing, Reducer, 1-1/2" MNPT to 1" FNPT	1	04-6959-08	04-6959-08
21	Pipe Nipple	1	15-7420-08	15-7420-08
22	Elbow, 1" NPT x 90°	1	15-3252-08	15-3252-08
23	Check Body	1	15-3550-01	15-3550-01
24	Check Ball	1	15-1450-51	15-1450-51
25	Plug, Pipe, 1/4" NPT	1	00-7010-08	00-7010-08
WETTED PATH COMPONENTS				
26	Liquid Chamber	2	04-5000-01	04-5000-02
27	Manifold, Discharge NPT	1	04-5020-01	04-5020-02
	Manifold, Discharge BSPT	1	04-5020-01-14	04-5020-02-14
28	Manifold, Footed Inlet NPT	1	04-5080-01	04-5080-02
	Manifold, Footed Inlet BSPT	1	04-5080-01-14	04-5080-02-14
29	Screen, Stallion	1	04-5620-62	04-5620-62
30	Screw, HHC (3/8"-16 x 1-3/4")	4	04-6181-03	04-6181-03
31	Hex Nut (3/8"-16)	4	08-6450-03	08-6450-03
32	Suction Cover	1	04-5660-01	04-5660-01
33	Screw, HHC (3/8"-16 x 7/8")	1	08-6140-03	08-6140-03
34	Large Clamp Band Assembly	2	04-7330-08	04-7330-08
35	Bolt, RHSN Large Clamp Band (5/16"-18 x 2-1/2")	4	04-6070-08	04-6070-08
36	Hex Nut, Large Clamp Band (5/16"-18)	4	04-6420-08	04-6420-08
37	Small Clamp Band Assembly	4	04-7100-08	04-7100-08
38	Bolt, RHSN Small Clamp Band (1/4"-20 x 2")	8	04-6050-08	04-6050-08
39	Hex Nut, Small Clamp Band (1/4"-20)	8	04-6400-08	04-6400-08
VALVE BALLS/VALVE SEATS/VALVE O-RINGS				
40	Ball, Valve	4	*	*
41	Seat, Valve	4	*	*
EZ-INSTALL RUBBER COMPONENTS				
42	Shaft, Stallion	1	04-3848-03	04-3848-03
43	Stud, Shaft	2	08-6150-08	N/A
44	Piston, Inner	2	04-3700-01-700	04-3700-01-700
45	Diaphragm	2	*	*
46	Piston, Outer	2	04-4552-01	04-4550-08
47	Screw, HHC, (1/2"-20 X 1-1/2")	2	N/A	04-6091-08
48	Washer (.513 X 2.188 X .194)	2	N/A	04-6800-08

¹Refer to Elastomer Chart - see Section 9.

¹Air Valve Assembly includes items 2 and 3.

²Metal Center Block Assembly includes items 11, 12 and 14.

Note: Aluminum pumps are available with an aluminum screen. Requires (1) 04-5620-01 (Screen), (4) 04-6140-08 (Bolt) and (4) 15-6740-08-50 (Washer).

All boldface items are primary wear parts.

LW0276 Rev. D

PS8 STALLION

PARTS LISTING

Item	Description	Qty.	PS8/AAAAR/0050 P/N	PS8/WMAAR/0050 P/N
AIR DISTRIBUTION COMPONENTS				
1	Air Valve Assembly, Pro-Flo® SHIFT¹	1	04-2039-11	04-2039-11
2	O-Ring, End Cap (-225, Ø1.859" x Ø.139")	2	04-2390-52-700	04-2390-52-700
3	End Cap	2	04-2340-01	04-2340-01
4	Screw, SHC, Air Valve (1/4"-20 x 4 1/2")	6	01-6000-03	01-6000-03
5	Muffler Plate, Pro-Flo® SHIFT	1	04-3189-01	04-3189-01
6	Gasket, Muffler Plate, Pro-Flo® SHIFT	1	04-3509-52	04-3509-52
7	Gasket, Air Valve, Pro-Flo® SHIFT	1	04-2638-52	04-2638-52
8	Center Block Assembly, Pro-Flo® SHIFT ²	1	04-3129-01	04-3129-01
9	Pilot Sleeve Assembly	1	04-3880-99	04-3880-99
10	Pilot Spool Retaining O-Ring (-009, Ø.208" x Ø.070")	2	04-2650-49-700	04-2650-49-700
11	Seal, Shaft	2	08-3210-55-225	08-3210-55-225
12	Bushing, Shaft	2	08-3306-13	08-3306-13
13	Gasket, Center Block Pro-Flo V™	2	04-3529-52	04-3529-52
14	O-Ring, (-210, Ø.734" x Ø.139")	2	04-3209-49	04-3209-49
15	Air Control Spool	1	04-3859-03	04-3859-03
16	Air Control Spool Retaining O-Ring (-114, Ø.612" x Ø.103")	2	04-3879-50	04-3879-50
17	Air Chamber, Pro-Flo V™	2	08-3660-01	08-3660-01
18	Screw, HSFHS (3/8"-16 x 1")	8	71-6250-08	71-6250-08
19	Retaining Ring	2	04-3890-03	04-3890-03
20	Bushing, Reducer, 1-1/2" MNPT to 1" FNPT	1	04-6959-08	04-6959-08
21	Pipe Nipple	1	15-7420-08	15-7420-08
22	Elbow, 1" NPT x 90°	1	15-3252-08	15-3252-08
23	Check Body	1	15-3550-01	15-3550-01
24	Check Ball	1	15-1450-51	15-1450-51
25	Plug, Pipe, 1/4" NPT	1	00-7010-08	00-7010-08
WETTED PATH COMPONENTS				
26	Liquid Chamber	2	08-5000-01	08-5000-02
27	Manifold, Discharge NPT	1	08-5020-01	08-5020-02
	Manifold, Discharge BSPT	1	08-5020-01-14	08-5020-02-14
28	Manifold, Footed Inlet NPT	1	08-5080-01-30	08-5080-02-30
	Manifold, Footed Inlet BSPT	1	08-5080-01-36	08-5080-02-36
29	Screen, Stallion	1	08-5620-62	08-5620-62
30	Screw, HHC (3/8"-16 x 3")	3	08-6146-03	08-6146-03
31	Hex Nut (3/8"-16)	3	02-6430-03	02-6430-03
32	Suction Cover	1	08-5660-01	08-5660-01
33	Screw, HHC (3/8"-16 x 7/8")	1	08-6140-03	08-6140-03
34	Large Clamp Band Assembly	2	08-7300-08	08-7300-08
35	Screw HHC, Large Clamp Band (3/8"-16 x 3")	4	08-6120-08	08-6120-08
36	Hex Nut, Large Clamp Band (3/8"-16)	4	08-6450-08	08-6450-08
37	Small Clamp Band Assembly	4	08-7100-08	08-7100-08
38	Bolt, RHSN, Small Clamp Band (5/16"-18 x 1-1/2")	4	08-6050-08	08-6050-08
39	Hex Nut (5/16"-18)	12	04-6420-08	04-6420-08
40	Bolt, RHSN, Small Clamp Band (5/16"-18 x 2")	4	08-6050-08-50	08-6050-08-50
41	Bracket, Handle	4	08-7410-08	08-7410-08
42	Handle	2	08-7250-08	08-7250-08
VALVE BALLS/VALVE SEATS/VALVE O-RINGS				
43	Ball, Valve	4	*	*
44	Seat, Valve	4	*	*
EZ-INSTALL RUBBER COMPONENTS				
45	Shaft, Stallion	1	08-3848-03	08-3848-03
46	Piston, Inner	2	08-3700-01	08-3700-01
47	Diaphragm	2	*	*
48	Piston, Outer	2	08-4550-01	08-4550-02

*Refer to Elastomer Chart - see Section 9.

²Metal Center Block Assembly includes items 11, 12 and 14.

LW0278 Rev. C

¹Air Valve Assembly includes items 2 and 3. **All boldface items are primary wear parts.**

EXPLODED VIEW & PARTS LISTING

PS15 STALLION

EXPLODED VIEW

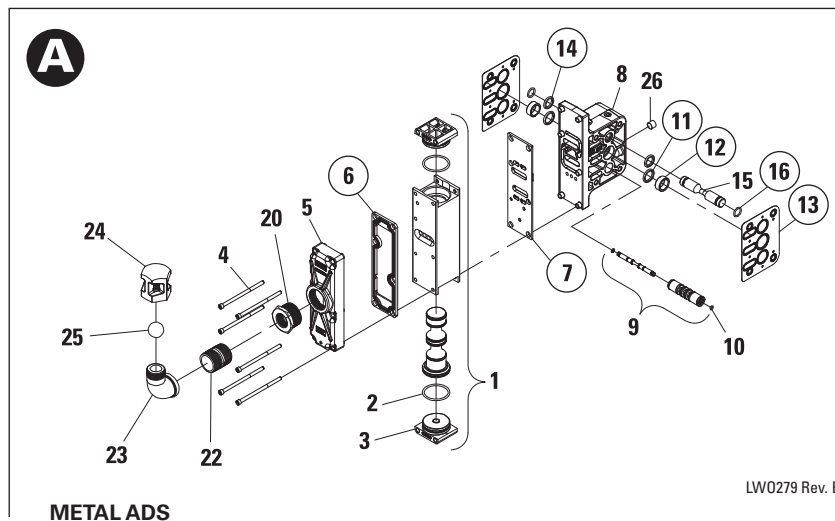
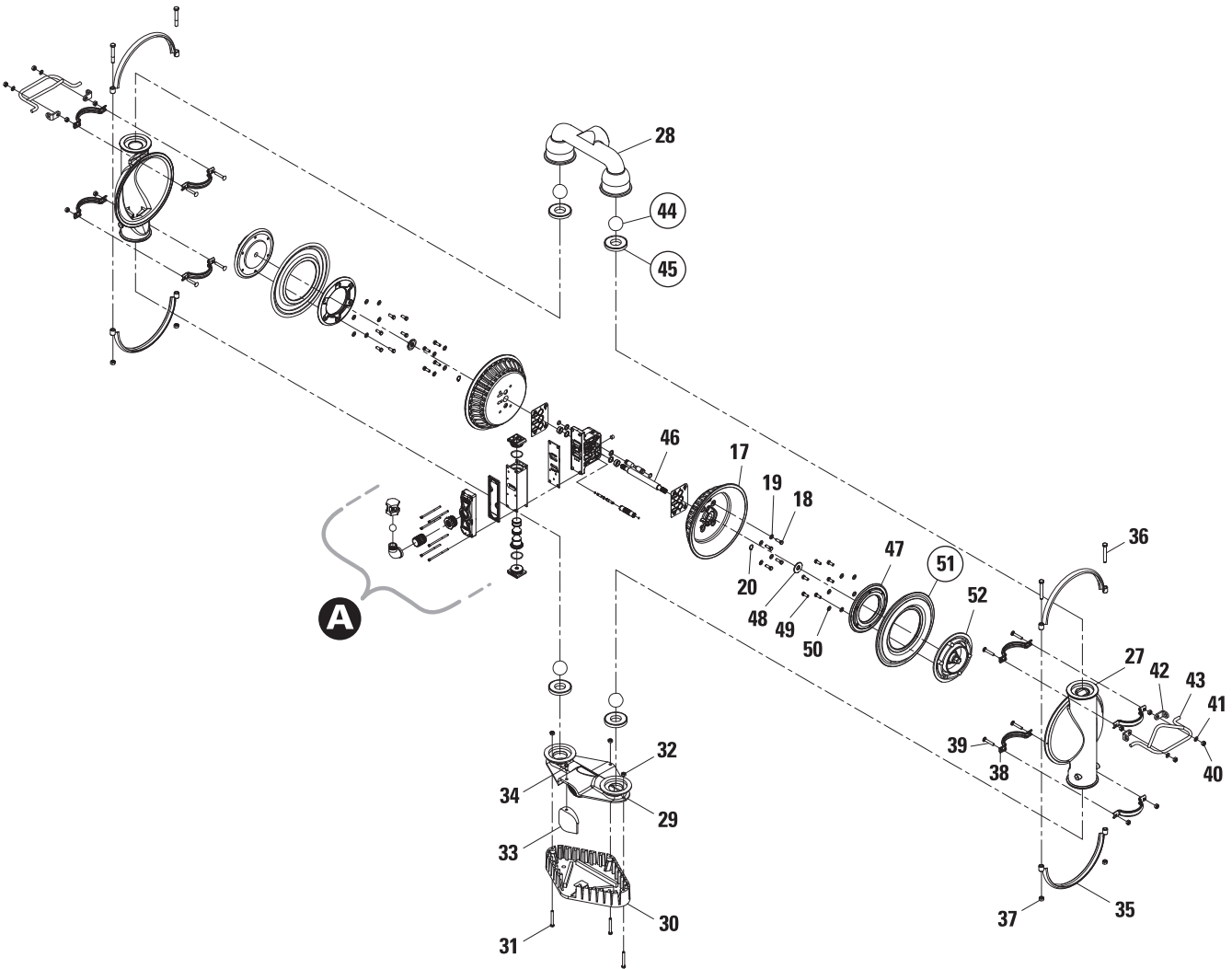

LW0279 Rev. B

ALL CIRCLED PART IDENTIFIERS ARE INCLUDED IN REPAIR KITS (see section 9).

EXPLODED VIEW & PARTS LISTING
PS15 STALLION
PARTS LISTING

Item	Description	Qty.	PS15/AAAAR/0050 P/N
AIR DISTRIBUTION COMPONENTS			
1	Air Valve Assembly, Pro-Flo® SHIFT ¹	1	04-2039-11
2	O-Ring, End Cap (-225, Ø1.859" x Ø.139")	2	04-2390-52-700
3	End Cap	2	04-2340-01
4	Screw, SHC, Air Valve (1/4"-20 x 4-1/2")	6	01-6000-03
5	Muffler Plate, Pro-Flo® SHIFT	1	04-3189-01
6	Gasket, Muffler Plate, Pro-Flo® SHIFT	1	04-3509-52
7	Gasket, Air Valve, Pro-Flo® SHIFT	1	04-2638-52
8	Center Block Assembly, Pro-Flo® SHIFT ²	1	15-3129-01
9	Pilot Sleeve Assembly	1	15-3884-99
10	O-Ring, Pilot Spool Retaining (-009, Ø.208" x Ø.070")	2	04-2650-49-700
11	Seal, Shaft	2	15-3210-55-225
12	Bushing, Shaft	2	15-3306-13
13	Gasket, Center Block Pro-Flo V™	2	04-3529-52
14	O-Ring, (-210, Ø.734" x Ø.139")	2	04-3209-49
15	Air Control Spool	1	15-3859-03
16	O-Ring, Air Control Spool Retaining (-114, Ø.612" x Ø.103")	2	04-3879-50
17	Air Chamber, Pro-Flo V™	2	15-3660-01
18	Screw, HHC (3/8"-16 x 1-1/8")	8	15-6130-08
19	Washer, Flat (Ø.406" x Ø.812" x .065")	8	15-6740-08-50
20	Retaining Ring	2	04-3890-03
21	Bushing, Reducer 1-1/2" MNPT to 1" FNPT	1	04-6959-08
22	Pipe Nipple	1	15-7420-08
23	Elbow, 1" NPT x 90°	1	15-3252-08
24	Check Body	1	15-3550-01
25	Check Ball	1	15-1450-51
26	Plug, Pipe, 1/4" NPT	1	00-7010-08
WETTED PATH COMPONENTS			
27	Liquid Chamber	2	15-5000-01
28	Manifold, Discharge NPT	1	15-5020-01
	Manifold, Discharge BSPT	1	15-5020-01-14
29	Manifold, Footed Inlet NPT	1	15-5080-01-30
	Manifold, Footed Inlet BSPT	1	15-5080-01-36
30	Screen, Stallion	1	15-5620-62
31	Screw, HHC (3/8"-16 x 3")	3	08-6146-03
32	Hex Nut (3/8"-16)	3	08-6450-03
33	Suction Cover	1	15-5660-01
34	Screw, HHC (3/8"-16 x 7/8")	1	08-6140-03
35	Large Clamp Band Assembly	2	15-7300-08
36	Screw, HHC Large (1/2"-13 x 3-1/2")	4	15-6120-08
37	Large Hex Nut (1/2"-13)	4	15-6420-08
38	Small Clamp Band Assembly	4	15-7100-08
39	Bolt, RHSN Small (3/8"-16 x 2-1/4")	8	15-6050-08
40	Hex Nut (3/8"-16)	12	08-6450-08
41	Washer, Flat (Ø.406" x Ø.812" x .065")	4	15-6740-08-50
42	Bracket, Handle	4	15-7410-08
43	Handle	2	15-7250-08
GASKETS/VALVE BALLS/VALVE SEATS/VALVE O-RINGS			
44	Ball, Valve	4	*
45	Seat, Valve	4	*
EZ-INSTALL RUBBER COMPONENTS			
46	Shaft, Stallion	1	15-3848-03
47	Piston, Inner	2	15-3700-01
48	Washer, Inner Piston Back-up	2	15-6850-08
49	Screw, HHC (3/8"-16 x 1-1/8")	12	15-6130-08
50	Washer (Ø.406" x Ø.812" x .065")	12	15-6740-08-50
51	Diaphragm, Primary	2	*
52	Piston, Outer	2	15-4550-01

*Refer to Elastomer Chart - see Section 9.

¹Air Valve Assembly includes items 2 and 3.

²Metal Center Block Assembly includes items 11, 12 and 14.

All boldface items are primary wear parts.



ELASTOMER OPTIONS

PS4 STALLION

MATERIAL	EZ-INSTALL DIAPHRAGMS (2)	VALVE BALLS (4)	VALVE SEATS (4)
Polyurethane	04-1022-50	N/A	N/A
Neoprene	N/A	04-1080-51-50	04-1120-51-50
Buna-N®	N/A	04-1080-52-50	04-1120-52-50
Geolast®	04-1022-15	N/A	N/A
EPDM	N/A	04-1080-54-50	04-1120-54-50
Viton®	N/A	04-1080-53-50	04-1120-53-50
Saniflex™	04-1022-56	N/A	N/A
FDA Wil-Flex™	04-1022-57	N/A	N/A
Wil-Flex™	04-1022-58	N/A	N/A

LW0276 Rev. D

PS8 STALLION

MATERIAL	EZ-INSTALL DIAPHRAGMS (2)	VALVE BALLS (4)	VALVE SEATS (4)
Polyurethane	08-1022-50	08-1080-62-50	08-1120-62-50
Neoprene	N/A	08-1080-51-50	08-1120-51-50
Buna-N®	N/A	08-1080-52-50	08-1120-52-50
Geolast®	08-1022-15	N/A	N/A
EPDM	N/A	08-1080-54-50	08-1120-54-50
Viton®	N/A	08-1080-53-50	08-1120-53-50
Saniflex™	08-1022-56	08-1080-56-50	08-1120-56-50
FDA Wil-Flex™	08-1022-57	N/A	N/A
Wil-Flex™	08-1022-58	08-1080-58-50	08-1120-58-50

LW0278 Rev. C

PS15 STALLION

MATERIAL	EZ-INSTALL DIAPHRAGMS (2)	VALVE BALLS (4)	VALVE SEATS (4)
Polyurethane	15-1022-50	15-1080-50	N/A
Neoprene	N/A	08-1080-51	15-1120-51-50
Buna-N®	N/A	08-1080-52	15-1120-52-50
Geolast®	15-1022-15	N/A	N/A
EPDM	N/A	08-1080-54	15-1120-54-50
Viton®	N/A	08-1080-53	15-1120-53-50
Saniflex™	15-1022-56	15-1080-56	N/A
FDA Wil-Flex™	15-1022-57	15-1080-57	N/A
Wil-Flex™	15-1022-58	15-1080-58	N/A

LW0280 Rev. C

WARRANTY

Each and every product manufactured by Wilden Pump and Engineering, LLC is built to meet the highest standards of quality. Every pump is functionally tested to insure integrity of operation.

Wilden Pump and Engineering, LLC warrants that pumps, accessories and parts manufactured or supplied by it to be free from defects in material and workmanship for a period of five (5) years from date of installation or six (6) years from date of manufacture, whichever comes first. Failure due to normal wear, misapplication, or abuse is, of course, excluded from this warranty.

Since the use of Wilden pumps and parts is beyond our control, we cannot guarantee the suitability of any pump or part for a particular application and Wilden Pump and Engineering, LLC shall not be liable for any consequential damage or expense arising from the use or misuse of its products on any application. Responsibility is limited solely to replacement or repair of defective Wilden pumps and parts.

All decisions as to the cause of failure are the sole determination of Wilden Pump and Engineering, LLC.

Prior approval must be obtained from Wilden for return of any items for warranty consideration and must be accompanied by the appropriate MSDS for the product(s) involved. A Return Goods Tag, obtained from an authorized Wilden distributor, must be included with the items which must be shipped freight prepaid.

The foregoing warranty is exclusive and in lieu of all other warranties expressed or implied (whether written or oral) including all implied warranties of merchantability and fitness for any particular purpose. No distributor or other person is authorized to assume any liability or obligation for Wilden Pump and Engineering, LLC other than expressly provided herein.

PLEASE PRINT OR TYPE AND FAX TO WILDEN

PUMP INFORMATION			
Item # _____		Serial # _____	
Company Where Purchased _____			
YOUR INFORMATION			
Company Name _____			
Industry _____			
Name _____		Title _____	
Street Address _____			
City _____	State _____	Postal Code _____	Country _____
Telephone _____	Fax _____	E-mail _____	Web Address _____
Number of pumps in facility? _____		Number of Wilden pumps? _____	
Types of pumps in facility (check all that apply): <input type="checkbox"/> Diaphragm <input type="checkbox"/> Centrifugal <input type="checkbox"/> Gear <input type="checkbox"/> Submersible <input type="checkbox"/> Lobe			
<input type="checkbox"/> Other _____			
Media being pumped? _____			
How did you hear of Wilden Pump? <input type="checkbox"/> Trade Journal <input type="checkbox"/> Trade Show <input type="checkbox"/> Internet/E-mail <input type="checkbox"/> Distributor		<input type="checkbox"/> Other _____	

ONCE COMPLETE, FAX TO (909) 783-3440

NOTE: WARRANTY VOID IF PAGE IS NOT FAXED TO WILDEN

WILDEN PUMP & ENGINEERING, LLC

Where Innovation Flows



WILDEN[®]

PSG

22069 Van Buren St., Grand Terrace, CA 92313-5607

P: +1 (909) 422-1731 • F: +1 (909) 783-3440

wildenpump.com

PSG reserves the right to modify the information and illustrations contained in this document without prior notice. This is a non-contractual document. 04-2015

Authorized PSG Representative:

Copyright ©2015, PSG, A Dover Company