

Printer Settings

You can change most printer settings from your software program or printer driver. If your printer is attached to the network, you can change settings from the **Dell Printer Configuration Web Tool**. To launch the **Dell Printer Configuration Web Tool**, type the printer IP address in your Web browser. Print a Printer Settings page to find your printer's IP address (see "[Printing a Printer Settings Page](#)").

Settings you change from the software or printer driver apply only to the job you are preparing to send to the printer.

Changes made to printer settings from an software program override changes made from the printer operator panel.

If you cannot change a setting from your software program, use the printer operator panel or the **Dell Printer Configuration Web Tool**. Changing a printer setting from the printer operator panel or from the **Dell Printer Configuration Web Tool** makes that setting the user default.

Printing a Printer Settings Page

The Printer Settings page lists all the options you purchased or installed. If a feature or an option is not listed, you need to check your installation.

1. Press **Menu**.
2. Press ▼ until **Configure** appears, and then press ► or ⏴.
3. Press ▼ until **Reports** appears, and then press ► or ⏴.
4. **Printer Settings** is displayed. Press ⏴.
The Printer Settings page is printed.
5. Verify that the options you installed are correctly listed under **Printer Options**.
6. If an option you installed is not listed, turn off the printer, unplug the power cord, and reinstall the option.
7. Verify the amount of memory installed is correctly listed under **General**.

Using the Operator Panel to Change Printer Settings

You can select menu items and corresponding values from the operator panel.

When you first enter the printer menus from the operator panel, you see an asterisk (*) next to a value in the menus.

This asterisk indicates the factory default menu setting. These settings are the original printer settings. (Factory defaults may vary for different countries.)

When you select a new setting from the operator panel, an asterisk appears next to the setting to identify it as the current user default menu setting.

These settings are active until new ones are selected or the factory defaults are restored.

To select a new value as a setting:

1. Press **Menu**.
2. Press ▼ ▲ until the required menu appears, and press ► or ⏴.
3. Press ▼ ▲ until the desired menu or menu item appears, and press ► or ⏴.
 - 1 If the selection is a menu, the menu is opened and the first printer setting in the menu appears.
 - 1 If the selection is a menu item, the default menu setting for the menu item appears. (The current user default menu setting has an asterisk (*) beside it.)

Each menu item has a list of values for the menu item. A value can be:

- 1 A phrase or word to describe a setting
- 1 A numerical value that can be changed
- 1 An On or Off setting
- 1 Press ▼ ▲ at the same time. This will recover the factory default menu settings.

4. Press ▼ ▲ to scroll until the desired value appears.
5. Press ↵.
This enables the setting value, which is indicated by an asterisk (*) next to the setting value.
6. Press **Cancel** or ◀ to return to the previous menu.
To continue setting other items, select the desired menu. To quit setting new values, press **Cancel**.

User default menu settings remain in effect until you save new settings or restore the factory defaults. Settings you choose from your software program can also change or override the user default menu settings you select from the operator panel.

 **NOTE:** Settings you choose from your software program may override the settings you select from the operator panel.

Using the Dell Printer Configuration Web Tool to Change Printer Settings

If your printer is connected to the network, you can change the operator panel settings from your Web browser. If you are a network administrator, you can clone the printer settings of one printer to one or all printers on the network.

Type your network printer IP address in your Web browser. Choose **Printer Settings** from the topics list, and then select the printer settings you want to change.

To copy your printer settings to another printer on the network, choose **Copy Printer Settings** from the topics list, and then type the other printer's IP address.

If you do not know your printer IP address, it is specified on the Printer Settings page. To print a Printer Settings page:

1. Press **Menu**.
2. Press ▼ until **Configure** appears, and then press ▶ or ↵.
3. Press ▼ until **Reports** appears, and then press ▶ or ↵.
4. **Printer Settings** is displayed. Press ↵.
The Printer Settings page is printed.

Initializing NVRAM

You can restore the original factory default menu settings by initializing NVRAM.

1. Press **Menu**.
2. Press ▼ until **Configure** appears, and then press ▶ or ↵.
3. Press ▼ until **Maintenance** appears, and then press ▶ or ↵.
4. Press ▼ until **Init NVRAM** appears, and then press ▶ or ↵.
5. The **Init NVRAM Are you sure?** message appears on the operator panel. Press ↵.
6. Turn off the printer, and then on again.

Deleting NVRAM from Network settings

You can initialize IP Address by deleting NVRAM from Network settings.

1. Press **Menu**.
2. Press ▼ until **Configure** appears, and then press ▶ or ↵.

3. Press ▼ until Network appears, and then press ► or ↵.
4. Press ▼ until Init NVRAM appears, and then press ► or ↵.
5. The Init NVRAM Are you sure? message appears on the operator panel. Press ↵.
6. Turn off the printer, and then on again.

Installing the Optional Tray Module

⚠ CAUTION: If you are adding an optional 250-sheet tray module or 500-sheet tray module after setting up the printer, be sure to turn off the printer, unplug the power cable, and disconnect all cables from the back of the printer before completing these tasks.

1. Optional tray modules attach under the standard 250-sheet tray module and only one additional tray can be added.

Some instructions may vary depending on the tray module configuration in your printer.

🔍 NOTE: Some tray module configurations differ from those described in this manual.

1. Unpack the tray and remove all packing material and tape.

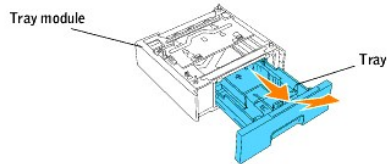

2. Place the tray module in the location that you would like the printer to be located.

🔍 NOTE: You will place the printer on the tray in a later step.

3. Turn off the printer.
4. If there are any trays already attached to the printer, unlock the tray from the printer by removing the tray from the tray module and turning the locking mechanism, inside the printer, as shown in the graphic.

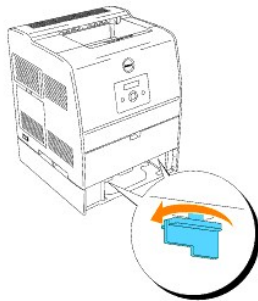

5. Remove the printer from the tray.

⚠ CAUTION: Lift the printer with two people, one facing the front of the printer (operator panel side) and the other facing the back. Never try to lift the printer while facing its right and left side.

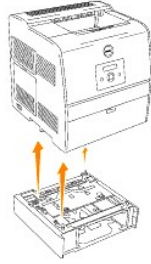

6. Attach the trays together by installing the standard tray you just removed on top and inserting the two screws provided. Tighten the screws with a coin until they are secure.

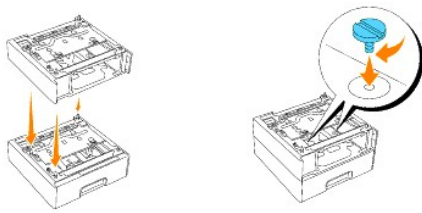

7. Place the printer on top of the tray modules.

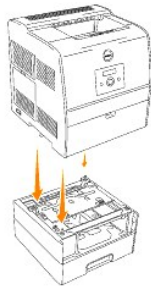

8. Lock the trays into place by removing the top tray from the tray module and rotating the locking mechanism as shown in the graphic.

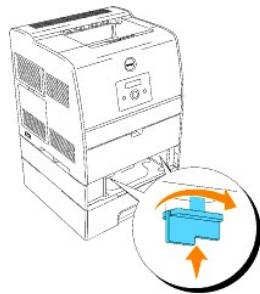

9. Replace all trays and load the paper.

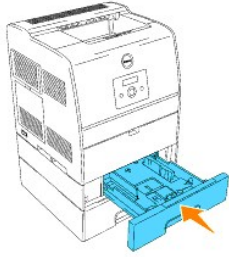

10. Turn on the printer.

NOTE: The printer will automatically detect the attached trays but will not detect the paper type.

11. Print a Printer Settings page to verify the optional 250-sheet tray module or 500-sheet tray module is installed correctly.
 - a. Press **Menu**.
 - b. Press **▼** until **Configure** appears, and then press **▶** or **⏴**.
 - c. Press **▼** until **Reports** appears, and then press **▶** or **⏴**.
 - d. **Printer Settings** is displayed. Press **⏴**.
The **Printer Settings** page is printed.
 - e. Verify that **250 Sheet Tray Module** or **500 Sheet Tray Module** is listed in the printer settings under **Printer Options**.

If the tray modules are not listed, turn off the printer, unplug the power cable, and reinstall the optional 250-sheet tray module or 500-sheet tray module.
12. After loading paper in the optional tray, specify the paper type and size from the printer operator panel.
 - a. Press **▼** until the paper size for the installed tray appears, and then press **⏴**.
 - b. Press **▼** until the paper type for the installed tray appears, and then press **⏴**.
13. Update your driver by following the instructions for each operating system. If the printer is on a network, update the driver for each client.

When Using PCL Driver

Windows XP/Server 2003

1. Click **Start** → **Printers and Faxes**.
2. Right-click this printer icon and select **Properties**.
3. Click the **Options** tab, and then select **Get Information from Printer**.
4. Click **Apply**, and then click **OK**.
5. Close the **Printers and Faxes** folder.

Windows 2000/NT4.0

1. Click **Start** → **Settings** → **Printers**.
2. Right-click this printer icon and select **Properties**.
3. Click the **Options** tab, and then select **Get Information from Printer**.
4. Click **Apply**, and then click **OK**.
5. Close the **Printers** folder.

Windows Me/95/98

1. Click **Start** → **Settings** → **Printers**.
2. Right-click this printer icon and select **Properties**.
3. Click the **Options** tab, and then select **Get Information from Printer**.

4. Click **Apply**, and then click **OK**.
5. Close the **Printers** folder.

If **Get Information from Printer** is unavailable, follow these steps:

1. In the **Items** list box of the **Options** tab, find **Option Tray Module**.
2. Change the setting from **Not Available** to **250 Sheet Tray Module (A4/Letter Cassette)**, **250 Sheet Tray Module (Legal Cassette)** or **500 Sheet Tray Module**.
3. Click **Apply**, and then click **OK**.
4. Close the **Printers and Faxes** (or **Printers**) folder.

When Using PS Driver

Windows XP/Server 2003

1. Click **Start** → **Printers and Faxes**.
2. Right-click this printer icon and select **Properties**.
3. Select the **Device Settings** tab, and then select the option manually.
4. Click **Apply**, and then click **OK**.

Windows 2000/NT4.0

1. Click **Start** → **Settings** → **Printers**.
2. Right-click this printer icon and select **Properties**.
3. Select the **Device Settings** tab, and then select the option manually.
4. Click **Apply**, and then click **OK**.

Windows Me/95/98

1. Click **Start** → **Settings** → **Printers**.
2. Right-click this printer icon and select **Properties**.
3. Select the **Options** tab, and then select the option manually.
4. Click **Apply**, and then click **OK**.

Mac OS 9.x

When using Chooser:

1. Select the printer using the **Chooser** and click **Setup**.
2. Click **Configure**.
3. Set the option menu item in **Installable Options**, and click **OK**.

When using a desktop printer:

1. Click the icon of the desktop printer you created.
2. Click **Printing** on the menu bar, and select **Change Setup**.
3. Set the option menu item in **Installable Options**, and then click **OK**.

Mac OS X

1. Select the printer from the **Printer List** screen in **Print Center** (or **Printer Setup Utility**).
2. Click **Printers** on the **Print Center** (or **Printer Setup Utility**) menu bar, and select **Show Info**.
3. Select **Installable Options**, and select the options that have been installed on the printer, and then click **Apply Changes**.

Safety and Regulatory Information

- [Safety Information](#)
 - [Regulatory Information](#)
 - [Noise Emissions Levels](#)
 - [Laser Notice](#)
 - [Energy Star](#)
-

Safety Information

 **CAUTION:** Read and follow all safety instructions in your *Owner's Manual* prior to setting up and operating your printer.

Regulatory Information

Federal Communications Commission (FCC) Compliance Information Statement (US Only)

The Dell Laser Printer 3100cn has been tested and found to comply with the limits for a Class B digital device, pursuant to Part 15 of the FCC Rules. Operation is subject to the following two conditions: (1) this device may not cause harmful interference, and (2) this device must accept any interference received, including interference that may cause undesired operation.

The FCC Class B limits are designed to provide reasonable protection against harmful interference in a residential installation. This equipment generates, uses and can radiate radio frequency energy and, if not installed and used in accordance with the instructions, may cause harmful interference to radio communications. However, there is no guarantee that interference will not occur in a particular installation. If this equipment does cause harmful interference to radio or television reception, which can be determined by turning the equipment off and on, the user is encouraged to try to correct the interference by one or more of the following measures:

- 1 Reorient or relocate the receiving antenna.
- 1 Increase the separation between the equipment and receiver.
- 1 Connect the equipment into an outlet on a circuit different from that to which the receiver is connected.
- 1 Consult your point of purchase or service representative for additional suggestions.

The manufacturer is not responsible for any radio or television interference caused by using other than recommended cables or by unauthorized changes or modifications to this equipment. Unauthorized changes or modifications could void the user's authority to operate this equipment.

 **NOTE:** To assure compliance with FCC regulations on electromagnetic interference for a Class A computing device, use a properly shielded and grounded cable. Use of a substitute cable not properly shielded and grounded may result in a violation of FCC regulations.

FCC Identification Information

The following information is provided on the device or devices covered in this document in compliance with FCC regulations:

- 1 Model number: Dell Laser Printer 3100cn
- 1 Company name:

Dell Inc.
One Dell Way
Round Rock, Texas 78682 USA
512-338-4400

Industry Canada Compliance Statement

This Class B digital apparatus meets all requirements of the Canadian Interference-Causing Equipment Regulations.

Avis de Conformité aux Normes de l'industrie du Canada

Cet appareil numérique de la classe B respecte toutes les exigences du Règlement sur le matériel brouilleur du Canada.

European Community (EC) Directives Conformity

With a Network Cable Attached

This product is in conformity with the protection requirements of EC Council directives 89/336/EEC and 73/23/EEC on the approximation and harmonization of the laws of the Member States relating to electromagnetic compatibility and safety of electrical equipment

This product satisfies the Class B limits of EN 55022 and safety requirements of EN 60950.

Without a Network Cable Attached

This product is in conformity with the protection requirements of EC Council directives 89/336/EEC and 73/23/EEC on the approximation and harmonization of the laws of the Member States relating to electromagnetic compatibility and safety of electrical equipment designed for use within certain voltage limits.

This product satisfies the Class B limits of EN 55022 and safety requirements of EN 60950.



NOTICE: When a print server is installed, this is a Class A product. In a domestic environment, this product may cause radio interference, in which case, the user may be required to take adequate measures.

CE Notice (European Union)

Marking by the symbol **CE** indicates compliance of this Dell printer to the EMC Directive and the Low Voltage Directive of the European Union. Such marking is indicative that this Dell system meets the following technical standards:

- 1 EN 55022 — *Information Technology Equipment — Radio Disturbance Characteristics — Limits and Methods of Measurement.*
- 1 EN 55024 — *Information Technology Equipment - Immunity Characteristics - Limits and Methods of Measurement.*
- 1 EN 61000-3-2 — *Electromagnetic Compatibility (EMC) - Part 3: Limits - Section 2: Limits for Harmonic Current Emissions (Equipment Input Current Up to and Including 16 A Per Phase).*
- 1 EN 61000-3-3 — *Electromagnetic Compatibility (EMC) - Part 3: Limits - Section 3: Limitation of Voltage Fluctuations and Flicker in Low-Voltage Supply Systems for Equipment With Rated Current Up to and Including 16 A.*
- 1 EN 60950 — *Safety of Information Technology Equipment.*



NOTE: EN 55022 emissions requirements provide for two classifications:

- 1 Class B is for typical domestic areas.

This Dell device is classified for use in a typical Class B domestic environment.

A *Declaration of Conformity* in accordance with the preceding directives and standards has been made and is on file at Dell Inc. Products Europe BV, Limerick, Ireland.

CE Mark Notice

This equipment complies with the essential requirements of the European Union Directive 1999/5/EC.

Cet équipement est conforme aux principales caractéristiques définies dans la Directive européenne RTTE 1999/5/CE.

Die Geräte erfüllen die grundlegenden Anforderungen der RTTE-Richtlinie (1999/5/EG).

Questa apparecchiatura è conforme ai requisiti essenziali della Direttiva Europea R&TTE 1999/5/CE.

Este equipo cumple los requisitos principales de la Directiva 1999/5/CE de la UE, "Equipos de Terminales de Radio y Telecomunicaciones".

Este equipamento cumpre os requisitos essenciais da Directiva 1999/5/CE do Parlamento Europeo e do Conselho (Directiva RTT).

Ο εξοπλισμός αυτός πληροί τις βασικές απαιτήσεις της κοινοτικής οδηγίας EU R&TTE 1999/5/EK.

Deze apparatuur voldoet aan de noodzakelijke vereisten van EU-richtlijn betreffende radioapparatuur en telecommunicatie-eindapparatuur 1999/5/EG.

Deette udstyr oppfyller de Væsentlige krav i EU's direktiv 1999/5/EC om Radio- og teleterminaludstyr.

Dette utstyret er i overensstemmelse med hovedkravene i R&TTE-direktivet (1999/5/EC) fra EU.

Utrustningen uppfyller kraven för EU-direktivet 1999/5/EC om ansluten teleutrustning och ömsesidigt erkännande av utrustningens överensstämmelse (R&TTE).

Tämä laite vastaa EU:n radio- ja telepääteläitedirektiivin (EU R&TTE Directive 1999/5/EC) vaatimuksia.

NOM Information (Mexico Only)

The following information is provided on the device(s) described in this document in compliance with the requirements of the official Mexican standards (NOM):

Exporter:	Dell Inc. One Dell Way Round Rock, TX 78682
Importer:	Dell Computer de México, S.A. de C.V. Paseo de la Reforma 2620 - 11º Piso Col. Lomas Altas 11950 México, D.F.
Ship to:	Dell Computer de México, S.A. de C.V. al Cuidado de Kuhne & Nagel de México S. de R.L. Avenida Soles No. 55 Col. Peñon de los Baños 15520 México, D.F.
Model number:	Dell Laser Printer 3100cn
Supply voltage:	110-127 VAC
Frequency:	50/60 Hz
Current consumption:	7.0 A

Noise Emissions Levels

The following measurements were made in accordance with ISO 7779 and reported in conformance with ISO 9296.

Average sound power	
Printing	6.5 B
Idling	Background level

Laser Notice

The printer is certified in the U.S. to conform to the requirements of DHHS 21 CFR Subchapter J for Class I (1) laser products, and elsewhere is certified as a Class I laser product conforming to the requirements of IEC 60825-1.

Class I laser products are not considered to be hazardous. The printer contains internally a Class IIIb (3b) laser that is nominally a 5 milliwatt gallium arsenide laser operating in the wavelength region of 770-795 nanometers. The laser system and printer are designed so there is never any human access to laser

radiation above a Class I level during normal operation, user maintenance, or prescribed service condition.

Energy Star

ENERGY STAR® Compliance

Certain configurations of Dell printers comply with the requirements set forth by the Environmental Protection Agency (EPA) for energy-efficient printers. If the front panel of your printer bears the ENERGY STAR® Emblem, your original configuration complies with these requirements and all ENERGY STAR® power management features of the printer are enabled.

Any Dell printer bearing the ENERGY STAR® Emblem is certified to comply with EPA ENERGY STAR® requirements as configured when shipped by Dell. Any changes you make to this configuration (such as installing additional expansion cards or drives) may increase the printer's power consumption beyond the limits set by the EPA's ENERGY STAR® Computers program.

ENERGY STAR® Emblem



The EPA's ENERGY STAR® Office Equipment program is a joint effort between the EPA and computer manufacturers to reduce air pollution by promoting energy-efficient computer products. The EPA estimates that use of ENERGY STAR® computer products can save computer users up to two billion dollars annually in electricity costs. In turn, this reduction in electricity usage can reduce emissions of carbon dioxide, the gas primarily responsible for the greenhouse effect, and sulfur dioxide and nitrogen oxides, the primary causes of acid rain.

You can also help reduce electricity usage and its side effects by turning off your computer when it is not in use for extended periods of time, particularly at night and on weekends.

Printing With CUPS (Linux)

This section provides information for printing or setting up the printer driver with CUPS (Common UNIX Printing System) on Red Hat 8/9 and SuSE 8.2/9.

• [Operation on Red Hat 8/9](#)

• [Operation on SuSE 8.2/9](#)

Operation on Red Hat 8/9

Setting Overview

If you use Red Hat 8, you need to first confirm that the printing system is set to CUPS on your workstation. But if you use Red Hat 9, you do not need to do this because the CUPS is preinstalled as the default printing system.

Red Hat 8:

1. Confirm that the printing system is set to CUPS.
2. Install CUPS if necessary.
3. Install the printer driver.
4. Set up the print queue.
5. Specify the default queue.
6. Specify the printing options.

Red Hat 9:

1. Install the printer driver.
2. Set up the print queue.
3. Specify the default queue.
4. Specify the printing options.

Confirming the Printing System (For Red Hat 8)

 **NOTE:** If you use Red Hat 9, skip this section and go to "[Installing the Printer Driver](#)."

Make sure that the default printing system is set to CUPS on your operating system.

1. Select **GNOME Menu** → **System Settings** → **Printer System Switcher**.
2. Type the administrator's password.
3. When **CUPS** is selected as **Available Printing System**, click **OK**. Go to "[Installing the Printer Driver](#)."
When **LPRng** is selected as **Available Printing System**, select **CUPS** and click **OK**. If **CUPS** is not displayed, **CUPS** is not installed on your workstation. Go to "[Installing CUPS \(For Red Hat 8\)](#)."
4. If you change the printing system in step 3, select **GNOME Menu** → **System Tools** → **Terminal** to activate the terminal window. Type as follows.

```
su
(Type the administrator's password)
/etc/init.d/cups start
/etc/init.d/lpd stop
```

Installing CUPS (For Red Hat 8)

 **NOTE:** If you use Red Hat 9, skip this section and go to "[Installing the Printer Driver](#)."

1. Select **GNOME Menu** → **System Settings** → **Packages**.
2. Type the administrator's password.
3. Scroll down to the bottom of the **Add or Remove Packages** window.
4. Click **Details** in **Printing Support**.

The **Printing Support Package Details** window appears.

5. Select the **CUPS** check box in **Extra Packages**, and then click **Close**.
6. Click **Update** in the **Add or Remove Packages** window.
7. Click **Continue** in the **Completed System Preparation** window.
Installation starts. When you are requested to insert the *Red Hat 8* CD during installation, insert it into the CD-ROM disk drive.
8. The message **Update Complete** appears, and the installation is complete. Click **OK**.
9. Click **Quit** in the **Add or Remove Packages** window.

The installation is complete. Return to "[Confirming the Printing System \(For Red Hat 8\)](#)."

Installing the Printer Driver

1. Double-click **Dell-Laser-Printer-3100cn-x.x.x.noarch.rpm** in the *Drivers and Utilities* CD.
2. Type the administrator's password.
3. Click **Continue** in the **Completed System Preparation** window.
Installation starts. When the installation is complete, the window is automatically closed.

Setting Up the Queue

To execute printing, you must set up the print queue on your workstation.

1. Select **Main Menu** → **Run Program**. Type `cupsconfig` and click **Run** in the **Run Program** window.
The browser is activated and the **CUPS** window appears.

 **NOTE:** For Red Hat 8, select **GNOME Menu** → **System Tools** → **CUPS Printer Configuration**.

2. Click **Manage Printers**.
3. Click **Add Printer** at the bottom of the window.
4. Type `root` as the user name, and type the administrator's password.
5. Type the printer's name in the **Name** box in the **Add New Printer** window, and then click **Continue**.
The **Location** and **Description** do not have to be specified.
6. Select **LPD/LPR Host or Printer** from **Device** menu, and then click **Continue**.
7. Type the printer's IP address in **Device URI**.
Format: `lpd://xxx.xxx.xxx.xxx` (printer's IP address)
8. Select **Dell** from the **Make** menu, and then click **Continue**.
9. Select **Dell Laser Printer 3100cn...** from the **Model** menu, and then click **Continue**.
The message **Printer xxx has been added successfully** appears.

The set up is complete.

When you have finished setting up the queue you can print jobs from the software program. Start the print job from the software program, and then specify the queue in the print dialog box.

However, sometimes you can only print from the default queue depending on the software program (for example Mozilla). In these cases, before you start printing, set queue you want to print to as the default queue. For information on specifying the default queue, see "[Setting the Default Queue](#)."

Setting the Default Queue

1. Select **Main Menu** → **System Tools** → **Terminal**.
2. Type the following command in the terminal window.

```
su
(Type the administrator's password)
lpadmin -d (The queue name)
```

Specifying the Printing Options

You can specify the printing options such as color mode or double-sided printing.

1. Select **Main Menu** → **Run Program**. Type `cupsconfig` and click **Run** in the **Run Program** window.

The browser is activated and the **CUPS** window appears.

 **NOTE:** For Red Hat 8, select **GNOME Menu** → **System Tools** → **CUPS Printer Configuration**.

2. Click **Manage Printers**.
3. Click **Configure Printer** of the queue for which you want to specify the printing options.
4. Type `root` as the user name, and type the administrator's password.
5. Specify the required settings, and then click **Continue**.
The message **Printer xxx has been configured successfully**, appears.

The setting is complete. Execute printing from the software program.

Uninstalling the Printer Driver

1. Select **Main Menu** → **System Tools** → **Terminal**.
2. Type the following command in the terminal window.

```
su
(Type the administrator's password)
rpm -e Dell-Laser-Printer-3100cn
```

The printer driver is uninstalled.

Operation on SuSE 8.2/9

Installing the Printer Driver

1. Double-click **Dell-Laser-Printer-3100cn-x.x-x.noarch.rpm** in the *Drivers and Utilities* CD.
2. Click **Install package with YaST**.
3. Type the administrator's password.
Installation starts. When the installation is complete, the window is automatically closed.

Setting Up the Queue

To execute printing, you must set up the print queue on your workstation.

Setting Up the Queue on SuSE 8.2

1. Select **SuSE work menu** → **Administration** → **YaST2 modules** → **Hardware** → **Printer**.
or select **SuSE work menu** → **System** → **YaST2** and then type the password, and select **Hardware** → **Printer**.
2. Type the administrator's password.
3. **Printer setup: Autodetected printers** is activated.
For USB connections:
 - a. Select **Dell Inc. Dell Laser Printer 3100cn on USB (/Dell/Laser%20Printer%203100cn?serial=xxxxxxxxx)** as **Available are**, and then click **Configure**.
For parallel connections:
 - a. Select **Other (not detected)** as **Available are** in **Printers to configure**, and then click **Configure**.
 - b. Select **Parallel printer** as **Connection for printer**, and then click **Next**.
 - c. Click **Next**.
For network connections:
 - a. Select **Other (not detected)** as **Available are** in **Printers to configure**, and then click **Configure**.
 - b. Select **Show more connection types** as **Connection for printer**, and then click **Next**.
 - c. Select **LPD filtering and forwarding queue**, and then click **Next**.
 - d. Type the printer's IP address in **Host name of the printer server**, and type the name of the printer queue in **Name of the remote queue** (for example, `lp`). Click **Next**.
4. Select **DELL** in **Select manufacturer**. Select **Laser Printer 3100cn** as **Select Model**, and then click **Next**.

5. Confirm the settings in **Printer overview**, and then click **OK**.
6. Click **Finish**.
7. Click **Continue**.

Setting Up the Queue on SuSE 9

1. Select **Start Applications** → **System** → **YaST**.
2. Type the administrator's password.
YaST Control Center is activated.
3. Select **Hardware** from **Printer**.
4. **Printer setup: Autodetected printers** is activated.
For USB connections:
 - a. Select **Dell Inc. Dell Laser Printer 3100cn on USB (/Dell/Laser%20Printer%203100cn?serial=xxxxxxxx)** as **Available are**, and then click **Configure**.
 - b. Confirm the settings in **Edit configuration**, and then click **OK**.

For parallel connections:

- a. Select **Other (not detected)** as **Available are** in **Printers to configure**, and then click **Configure**.
- b. Select **Parallel printer** as **Printer Type**, and then click **Next**.
- c. Click **Next**.
- d. Set the name of the printer queue in **Queue name**, and type the queue name for printing in **Name for printing**. The **Description of Printer** and **Location of Printer** do not have to be specified.
- e. Select the **Do Local Filtering** check box, and then click **Next**.
- f. Select **DELL** in **Select manufacturer**. Select **Laser Printer 3100cn** in **Select Model**, and then click **Next**.
- g. Confirm the settings in **Edit configuration**, and then click **OK**.

For network connections:

- a. Select **Other (not detected)** as **Available are** in **Printers to configure**, and then click **Configure**.
- b. Select the **Print via LPD-Style Network Server** as **Printer Type**, and then click **Next**.
- c. Type the printer's IP address in **Host name of the printer server**. And type the name of the printer queue in **Name of the remote queue**, and then click **Next**.
- d. Set the name of the printer queue in **Queue name**, and type the queue name for printing in **Name for printing**. The **Description of Printer** and **Location of Printer** do not have to be specified.
- e. Select the **Do Local Filtering** check box, and then click **Next**.
- f. Select **DELL** as **Select manufacturer**. Select **Laser Printer 3100cn** as **Select Model**, and then click **Next**.
- g. Confirm the settings in **Edit configuration**, and then click **OK**.

5. Click **Finish**.

Printing From the Application Program

When you have finished setting up the queue you can print jobs from the application program. Start the print job from the application program, and then specify the queue in the print dialog box.

However, sometimes you can only print from the default queue depending on the application program (for example Mozilla). In these cases, before you start printing, set queue you want to print to as the default queue. For information on specifying the default queue, see "[Setting the Default Queue](#)."

Setting the Default Queue

1. To activate the **Printer setup: Autodetected printers**, do the following.

For SuSE 9:

- a. Select **Start Applications** → **System** → **YaST**.
- b. Type the administrator's password.
YaST Control Center is activated.
- c. Select **Hardware** from **Printer**.

For SuSE 8.2:

- a. Select **SuSE work menu** → **Administration** → **YaST2 modules** → **Hardware** → **Printer**.
- b. Type the administrator's password.

2. **Printer setup: Autodetected printers** is activated.
3. Click **Change**.
4. Select the printer you want to set to default, and then click **Set as default**.
5. Click **Finish**.

 **NOTE:** For SuSE 8.2, also click **Continue**.

Specifying the Printing Options

You can specify the printing options such as color mode or double-sided printing.

1. Select **Start Applications** → **Internet** → **Web Browser**.
The browser is activated.

 **NOTE:** For SuSE 8.2, select **Start Applications** → **Internet** → **WWW** → **Konqueror Web Browser**.

2. Type `http://localhost:631/admin` in **Location**, and then press the <Enter> key.
3. Type `root` as the user name, and type the administrator's password.
The **CUPS** window appears.

 **NOTE:** If you use SuSE 9, set the password for authority as the printer administrator before setting the printer queue. If you have not set it, go to "[Setting the Password for Authority as the Printer Administrator \(For SuSE 9\)](#)."

4. Click **Manage Printers**.
5. Specify the required settings, and then click **Continue**.
The message **Printer xxx has been configured successfully** appears.

The setting is complete. Execute printing from the application program.

Setting the Password for Authority as the Printer Administrator (For SuSE 9)

If you use SuSE 9, you must set the password for authority as the printer administrator to do operations as the printer administrator. If you use SuSE 8.2, you do not need to do this.

1. Select **Start Applications** → **System** → **Terminal** → **Konsole**.
2. Type the following command on the terminal window.

```
su
(Type the administrator's password.)
lppasswd -g sys -a root
(Type the password for authority as the printer administrator after the Enter password prompt.)
(Retyping the password for authority as the printer administrator after the Enter password again prompt.)
```

Uninstalling the Printer Driver

1. Select **Start Applications** → **System** → **Terminal** → **Konsole**.
2. Type the following command on the terminal window.

```
su
(Type the administrator's password)
rpm -e Dell-Laser-Printer-3100cn
```

The printer driver is uninstalled.

Installing the Optional Duplex Module

- [To Make Duplexing the Default for All Print Jobs](#)

- [Installing Cards](#)

☑ **NOTE:** If you are adding an optional duplex module after setting up the printer, be sure to turn off the printer, unplug the power cable, and disconnect all the cables from the back of the printer before completing these tasks.

☑ **NOTE:** The 64 MB memory card comes with the optional duplex module. Before you use the optional duplex module, you need to install the 64 MB memory card on the printer. If you already have an existing memory card installed on the printer, you do not have to use the 64 MB memory card provided with your duplex module.

The optional duplex module attaches to the back side of the printer.

When installing the supplied 64MB memory card, see "[Installing a Memory Card](#)".



1. Turn off the printer.
2. Open the rear cover, and then pull it downward while holding the release catches on both sides of the inner rear cover. Pull the rear cover out to remove it from the printer, while pushing the round blue buttons at both sides of the rear cover. Close the inner rear cover.

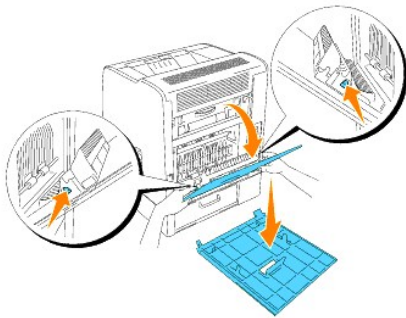

3. To remove the paper cover, push in on the paper cover while pulling out on the right side of the printer cover.

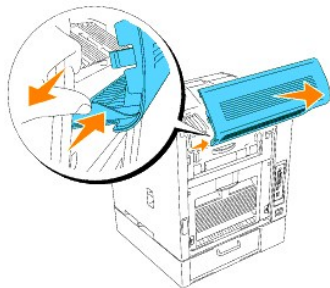

➡ **NOTICE:** In steps 4 through 5, the duplex module must be supported until the support straps have been fastened.

4. Insert the hooks on the optional duplex module into the grooves on the back side of the printer.

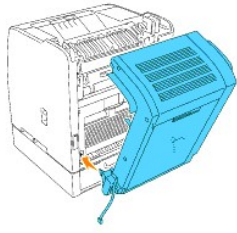

5. Attach the straps to the left and right side of the printer, and then close the optional duplex module.

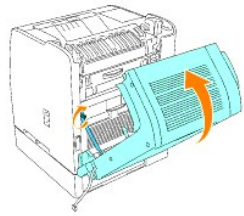

6. Tighten the screws on the bottom left and right while firmly holding the optional duplex module in a closed position.



7. Open the optional duplex module. Remove the connector cover, and then attach the connector on the bottom left of the optional duplex module to the printer. Keep the original cover somewhere safe.

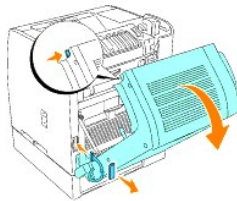

8. Close the optional duplex module.

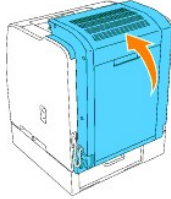

9. Attach the new connector cover supplied with the duplex module.

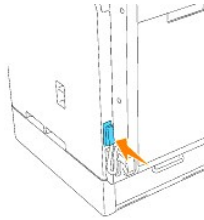

When installing the supplied 64MB memory card, see "[Installing a Memory Card](#)".

10. Turn on the printer.
11. Make sure the optional duplex module is properly installed.
 - a. Press **Menu**.
 - b. Press **▼** until **Configure** appears, and then press **▶** or **⏴**.
 - c. Press **▼** until **Reports** appears, and then press **▶** or **⏴**.
 - d. **Printer Settings** is displayed. Press **⏴**.
The **Printer Settings** page is printed.
 - e. Verify that the optional duplex module is listed under **Printer Options** in the **Printer Settings** page.
If the optional duplex module is not listed, turn off the printer, unplug the power cable, and reinstall the optional duplex module.
 - f. Verify the **Memory Capacity** on the **Options** tab in the printer driver.
12. Update your driver by following the instructions. If the printer is on a network, update the driver for each client.

When Using PCL Driver

Windows XP/Server 2003

1. Click **Start** → **Printers and Faxes**.
2. Right-click this printer icon and select **Properties**.
3. Click the **Options** tab, and then select **Get Information from Printer**.
4. Click **Apply**, and then click **OK**.
5. Close the **Printers and Faxes** folder.

Windows 2000/NT4.0

1. Click **Start** → **Settings** → **Printers**.
2. Right-click this printer icon and select **Properties**.
3. Click the **Options** tab, and then select **Get Information from Printer**.
4. Click **Apply**, and then click **OK**.
5. Close the **Printers** folder.

Windows Me/95/98

1. Click **Start** → **Settings** → **Printers**.
2. Right-click this printer icon and select **Properties**.
3. Click the **Options** tab, and then select **Get Information from Printer**.
4. Click **Apply**, and then click **OK**.

5. Close the **Printers** folder.

If **Get Information from Printer** is unavailable, follow these steps:

1. In the **Items** list box of the **Options** tab, find **Duplex Module**.
2. Change the setting from **Not Available** to **Available**.
3. Click **Memory Capacity**, and then select an appropriate numerical value.

 **NOTE:** Select 128 MB if the 64 MB memory provided with this option has been added to the standard 64 MB memory.

4. Click **Apply**, and then click **OK**.
5. Close the **Printers and Faxes** (or **Printers**) folder.

When Using PS Driver

Windows XP/Server 2003

1. Click **Start** → **Printers and Faxes**.
2. Right-click this printer icon and select **Properties**.
3. Select the **Device Settings** tab, and then select the option manually.
4. Click **Apply**, and then click **OK**.

Windows 2000/NT4.0

1. Click **Start** → **Settings** → **Printers**.
2. Right-click this printer icon and select **Properties**.
3. Select the **Device Settings** tab, and then select the option manually.
4. Click **Apply**, and then click **OK**.

Windows Me/95/98

1. Click **Start** → **Settings** → **Printers**.
2. Right-click this printer icon and select **Properties**.
3. Select the **Options** tab, and then select the option manually.
4. Click **Apply**, and then click **OK**.

Mac OS 9.x

When using Chooser:

1. Select the printer using the **Chooser** and click **Setup**.
2. Click **Configure**.
3. Set the option item in **Installable Options**, and click **OK**.

When using a desktop printer:

1. Click the icon of the desktop printer you created.
2. Click **Printing** on the menu bar, and select **Change Setup**.
3. Set the option menu item in **Installable Options**, and then click **OK**.

Mac OS X

1. Select the printer from the **Printer List** screen in **Print Center** (or **Printer Setup Utility**).
2. Click **Printers** on the **Print Center** (or **Printer Setup Utility**) menu bar, and select **Show Info**.
3. Select **Installable Options**, and select the options that have been installed on the printer, and then click **Apply Changes**.

To Make Duplexing the Default for All Print Jobs

You can set up your driver to use duplexing on all print jobs. If you do not want duplexing for a specific print job, you can override this feature.

1. In Windows Server 2003 and Windows XP, click **Start** → **Printers and Faxes**.
In all other operating systems, click **Start** → **Settings** → **Printers**.
2. Right-click this printer icon.
3. In Windows Server 2003, Windows XP and Windows 2000, click **Printing Preferences**.
In Windows NT 4.0, click **Document Defaults**.
In Windows Me and Windows 95/98, click **Properties**.
4. Click **Paper** (or **Layout**) tab.
5. In the **Duplex** combo box, select either **Flip on Long Edge** or **Flip on Short Edge**, and then click **Apply**.
6. Click **OK**, and then close the **Printers and Faxes** (or **Printers**) folder.

Installing Cards

Installing a Memory Card

Your printer supports 64, 128, 256, and 512 MB additional memory cards.

 **NOTE:** The 64 MB memory card comes with the optional duplex module. Before you use the optional duplex module, you need to install the 64 MB memory card on the printer. If you already have an existing memory card installed on the printer, you do not have to use the 64 MB memory card provided with your duplex module.

1. Make sure that the printer is turned off.
2. Remove the control board cover on the left side of the printer by pulling the notch.

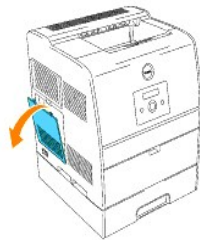

3. Hold the memory card so the notch is aligned with the projection on the slot.

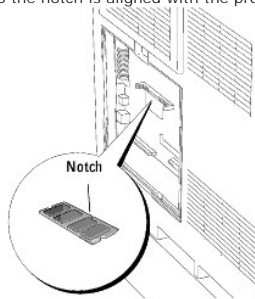

4. Push the memory card into the slot firmly.

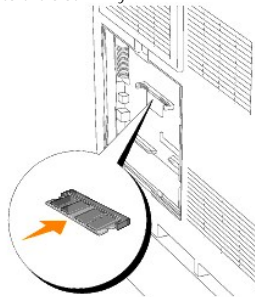

5. Reattach the control board cover to the printer.



Installing a Multi Protocol Card

A multi protocol card allows you to use the following network protocols.

Network protocol	Supported OSes
IPP	Windows Me/2000/XP/Server 2003
SMB	Windows 95/98/Me/NT 4.0/2000/XP/Server 2003
NetWare (IPX/SPX)	NetWare3.12/3.2/4.1/4.11/4.2/5/6/6.5*
AppleTalk	Mac OS 9/Mac OS X

* Supports only Support Pack 1.1 or later.

To Install the Multi Protocol Card

1. Make sure that the printer is turned off.
2. Remove the control board cover on the left side of the printer by pulling the notch.

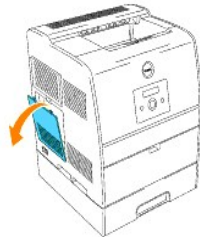

3. Hold the multi protocol card so its connector is toward the printer, and push the connector into the slot on the control board.

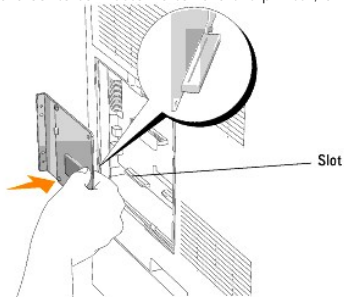

4. Tighten the two screws supplied with the multi protocol card on the back side of the printer.

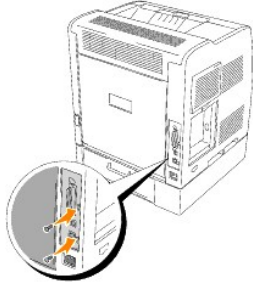

5. Reattach the control board cover to the printer.



Understanding Printer Menus

When your printer is configured as a network printer available to a number of users, the access to the `Configure` menus can be limited. This prevents other users from using the operator panel to inadvertently change a printer user default that has been set by the administrator. In this case, you can access the `Stored Print`, `Tray Settings`, and `Replace Toner` menus only.

However, you can use your printer driver to override printer user defaults and select settings for individual print jobs.

- [Using the Printer Menus](#)
 - [Setting of Panel Lock](#)
-

Using the Printer Menus

Stored Print

This menu provides applicable printing services such as `Secure Print` and `Proof Print`.

Secure Print

Purpose:

To print confidential jobs. The printer can hold the job in memory until you arrive at the printer and type the password on the operator panel. This requires 320 MB or more of RAM to be enabled. In addition, set the `RAM Disk` setting to `on`.

Values:

Del after Print	Prints the job, and then deletes it from printer memory.
Save afterPrint	Prints the job, and then saves it in printer memory.
Delete	Deletes the job from printer memory.

Proof Print

Purpose:

To print only one copy and check the print result before printing all of the copies. This prevents a large number of misprinted copies from being printed at one time. This requires 320 MB or more of RAM to be enabled. In addition, set the `RAM Disk` setting to `on`.

Values:

Del after Print	Prints the job, and then deletes it from printer memory.
Save afterPrint	Prints the job, and then saves it in printer memory.
Delete	Deletes the job from printer memory.

Tray Settings

Use the Tray Settings menu to define the print media loaded in each tray.

 **NOTE:** Values marked by an asterisk (*) are the factory default menu settings.

Paper Type

Purpose:

To specify the type of paper loaded in each tray.

Values:

Tray 1	Plain 1
	Plain 2
Tray 2 ^{*1}	Plain 1
	Plain 2
MPF	Plain 1
	Plain 2
	Transparency
	Covers 1
	Covers 2
	Label
	Coated 1
	Coated 2
	Envelope
	Plain 1 S2
	Plain 2 S2
	Covers 1 S2
	Covers 2 S2
	Coated 1 S2
Coated 2 S2	

^{*1} Only displayed when an optional 250-sheet tray module or 500-sheet tray module is installed on the printer.

Paper Size

Purpose:

To specify the paper size for each tray.

Values:

Tray 1	Letter ^{*1}
	B5
	A5
	A4 ^{*1}
	Executive
	Legal ^{*3}

	8.5 x 13" ^{*3}
Tray 2 ^{*4}	Letter ^{*1}
	B5 ^{*2}
	A5 ^{*2}
	A4 ^{*1}
	Executive ^{*2}
	Legal ^{*2, 3}
	8.5 x 13" ^{*2, 3}
MPF	Letter
	B5
	A5
	A4
	Executive
	Legal
	8.5 x 13"
	Envelope #10
	Monarch
	DL
	C5
	Free Size [*]
	Monarch LEF
DL LEF	

*1 Denotes country-specific factory default values.

*2 Available for the optional 250-sheet tray module only.

*3 Available for the optional 250-sheet tray module (Legal cassette) only.

*4 Only displayed when an optional 250-sheet tray module or 500-sheet tray module is installed on the printer.

Use this menu item to:

- 1 Optimize print quality for the specified paper.
- 1 Select paper source through your software program by selecting type and size.
- 1 Automatically link trays. The printer automatically links any trays containing the same type and size of paper, if you have set the Paper Type and Paper Size to the correct values.

Replace Toner

Use the Replace Toner menu to select the color of the toner cartridge that you need to replace.

Values:

Cyan Toner(C)	Magenta Toner(M)
Yellow Toner(Y)	Black Toner(K)

Configure

Use the Configure menu to configure a variety of printer features.

Basic Settings

Use the **Basic Settings** menu to configure the basic printer settings.

 **NOTE:** Values marked by an asterisk (*) are the factory default menu settings.

Power Saver Time

Purpose:

To specify the amount of time the printer waits after a job is printed before it goes into the power saver mode.

Values:

1-60 min	Specifies the amount of time before the printer enters power saver mode after it finishes a print job.
15 min*	

Enter 1 to put the printer in power saver mode one minute after it finishes a print job. This uses much less energy, but requires more warm-up time for the printer. Enter 1 if your printer shares an electrical circuit with room lighting and you notice lights flickering.

Select a high value if your printer is in constant use. Under most circumstances, this keeps the printer ready to print with minimum warm-up time. Select a value between 1 and 60 minutes for power save mode if you want a balance between energy consumption and a shorter warm-up period.

The printer automatically returns to the print mode from the power saver mode when it receives data from the computer. You can also return the printer to the print mode by pressing any button on the operator panel.

Error Alarm

Purpose:

To establish whether the printer sounds an alarm when an error occurs.

Values:

Off*	Does not sound an alarm when an error occurs.
On	Sounds an alarm when an error occurs.

Job Timeout

Purpose:

To specify the amount of time the printer waits to receive additional bytes of data from the computer. When this timeout expires, the print job is canceled.

Values:

Off	Disables the job timeout.
-----	---------------------------

5-300 sec	Specifies the amount of time the printer waits for additional data before it cancels the job.
30 sec*	

Panel Language

Purpose:

To determine the language of the text on the operator panel screen.

Values:

English*	French
Italian	German
Spanish	

Auto Log Print

Purpose:

To specify whether the printer outputs logs automatically.

Values:

Off*	Does not print the logs.
On	Prints the logs.

Print logs can also be printed using the Reports menu.

See also:

["Reports"](#)

ID Print

Purpose:

To specify a location where the user ID is printed. This feature is available for the PCL driver and unavailable for the PS driver.

Values:

Off*	Does not print the user ID.
Top Left	Prints the user ID on the top left of the page.

Top Right	Prints the user ID on the top right of the page.
Bottom Left	Prints the user ID on the bottom left of the page.
Bottom Right	Prints the user ID on the bottom right of the page.

 **NOTE:** When printing on DL size paper, a part of the user ID may not be printed correctly.

Text Print

Purpose:

To specify whether the printer outputs PDL data, which is not supported by the printer, as text when the printer receives it. Text data is printed on A4 or Letter size paper.

Values:

Off	Does not print the received data.
On*	Prints the received data as text data.

Banner Sheet

Purpose:

To specify the position of banner sheet, and also specify the tray in which the banner sheet is loaded.

Values:

Position	Off*	Does not print the banner sheet.
	Top	Prints on the beginning of document.
	Bottom	Prints on the end of document.
	Top & Bottom	Prints on both beginning and end of document.
Input Tray	Tray 1*	The banner sheet is loaded in tray 1.
	Tray 2* ¹	The banner sheet is loaded in tray 2.
	MPF	The banner sheet is loaded in multipurpose feeder.

*1 Only displayed when an optional 250-sheet tray module or 500-sheet tray module is installed on the printer.

RAM Disk

Purpose:

To allocate memory to the RAM Disk file system for the Secure Print and Proof Print features.

The change becomes effective after the printer is turned off and then on again.

Values:

Off*	Does not allocate memory to the RAM Disk file system. Proof Print jobs will abort and be recorded to the job log.
On	Allocates memory to the RAM Disk file system automatically.

 **NOTE:** The RAM Disk menu is only displayed when 320 MB or more of additional RAM is installed on the printer.

Substitute Tray

Purpose:

Specifies whether or not to use another size paper when the paper that is loaded in the specified tray does not match the paper size settings for the current job.

Values:

Off*	No tray size substitute accepted.
Larger Size	Substitutes paper of next largest size. When there is no larger paper size, the printer substitutes paper of nearest size.
Nearest Size	Substitutes paper of nearest size.
MPF Feed	Substitutes paper from the multipurpose feeder.

Maintenance

Use the Maintenance menu to initialize the NV (non-volatile) memory, configure the plain paper quality adjustment settings, and configure the security settings.

Paper Density

Purpose:

To specify the paper density.

Values:

Plain 1	Light
	Normal*
Label	Label 1
	Label 2*

BTR Adj

Purpose:

To specify the value of the reference voltage for the transfer roller.

Values:

Plain 1	0-15
	5*
Plain 2	0-15
	5*
Transparency	0-15
	5*
Covers 1	0-15
	5*
Covers 2	0-15
	5*
Label	0-15
	5*
Coated 1	0-15
	5*
Coated 2	0-15
	5*
Envelope	0-15
	5*

Init NVRAM

Purpose:

To initialize the NV (non-volatile) memory. After executing this function and rebooting the printer, all the menu parameters are reset to their default values.

Clear Storage

Purpose:

To clear all files that are stored as Secure and Proof Print in the RAM Disk.

 **NOTE:** The Clear Storage menu is only displayed when the RAM Disk is set to Auto.

Non-Dell Toner

Purpose:

To specify whether to use a refilled Toner Cartridge or not. When this setting is on, you can use Toner Cartridges provided by other companies.

Values:

Off*	Disables the use of refilled toner cartridges.
On	Enables the use of refilled toner cartridges.

Parallel

The Parallel menu can be adjusted to configure the parallel interface.

 **NOTE:** Values marked by an asterisk (*) are the factory default menu settings.

ECP

Purpose:

To specify the ECP communication mode of the parallel interface.

The change becomes effective after the printer is turned off and then on again.

Values:

On*	The ECP communication mode is enabled.
Off	The ECP communication mode is disabled.

Adobe Protocol

Purpose:

To specify PostScript communication protocol for the parallel interface.

The change becomes effective after the printer is turned off and then on again.

Values:

Auto	Used when auto-detecting the PostScript communication protocol.
RAW	Used when no special processing is required for data.
Standard	Used when the communication protocol is in ASCII format.
BCP	Used when the communication protocol is in binary format.
TBCP*	Used when the communication protocol supports both ASCII and binary data to switch between them according to the specified control code.

Reports

Use the Reports menu to print various types of reports and lists.

Printer Settings

Purpose:

To print a list of the current user default values, the installed options, the amount of installed printer memory, and the status of printer supplies.

Panel Settings

Purpose:

To print a detailed list of all the settings on the operator panel menus.

PCL Fonts List

Purpose:

To print a sample of the available PCL fonts.

See also:

["Understanding Fonts,"](#) ["Printing a Font Sample List"](#)

Job History

Purpose:

To print a detailed list of the processed print jobs. This list contains the latest 20 print jobs.

Error Log

Purpose:

To print an error history.

PS Fonts List

Purpose:

To print a sample of the available PostScript fonts.

See also:

["Understanding Fonts,"](#) ["Printing a Font Sample List"](#)

Stored Documents

Purpose:

To print a list of all files that are stored as Secure and Proof Print in the RAM Disk.

Network

Use the Network menu to change printer settings affecting jobs sent to the printer through a network port.

Ethernet

Purpose:

To specify the communication speed and the duplex settings of Ethernet.

The change becomes effective after the printer is turned off and then on again.

Values:

Auto*	Detects the Ethernet settings automatically.
10Base Half	Uses 10base-T half-duplex.
10Base Full	Uses 10base-T full-duplex.
100Base Half	Uses 100base-TX half-duplex.
100Base Full	Uses 100base-TX full-duplex.

TCP/IP

Purpose:

To specify the TCP/IP settings.

The change becomes effective after the printer is turned off and then on again.

Values:

IP AddressSetup	AutoIP*	Automatically sets the IP address.
	BOOTP	Uses BOOTP to set the IP address.
	RARP	Uses RARP to set the IP address.
	DHCP	Uses DHCP to set the IP address.
	Panel	Enables the IP address entered on the operator panel.
IP Address		Displays the IP address allocated to the printer by using the keys on the operator panel.
Subnet Mask		Displays the subnet mask.
Gateway Address		Displays the gateway address.

Protocol

Purpose:

To enable or disable each item.

The change becomes effective after the printer is turned off and then on again.

Values:

LPD	On*	Enables the LPD port.	
	Off	Disables the LPD port.	
Port9100	On*	Enables the Port9100 port.	
	Off	Disables the Port9100 port.	
IPP* ¹	On*	Enables the IPP port.	
	Off	Disables the IPP port.	
SMB TCP/IP* ¹	On*	Uses TCP/IP for SMB.	
	Off	Does not use TCP/IP for SSB.	
SMB NetBEUI* ¹	On*	Uses NetBEUI for SMB.	
	Off	Does not use Net BEUI for SMB.	
FTP	On*	Enables the FTP port.	
	Off	Disables the FTP port.	
Netware* ¹	On*	Enables the NetWare port.	
	Off	Disables the NetWare port.	
SNMP	UDP	On*	Enables the UDP.
		Off	Disables the UDP.
	IPX* ¹	On*	Enables the IPX.
		Off	Disables the IPX.
E-Mail Alert	On*	Enables the E-Mail Alert feature.	
	Off	Disables the E-Mail Alert feature.	
EWS	On*	Enables an access to Dell Printer Configuration Web Tool embedded in the printer.	
	Off	Disables an access to Dell Printer Configuration Web Tool embedded in the printer.	
AppleTalk* ¹	On*	Enables the AppleTalk port.	
	Off	Disables the AppleTalk port.	

*1 Only displayed when an optional multiprotocol card is installed.

IPX/SPX

Purpose:

To configure the IPX/SPX settings.

The change becomes effective after the printer is turned off and then on again.

Values:

Auto*	Automatically sets the frame type.
Ethernet II	Uses the Ethernet frame type.
Ethernet 802.3	Uses the IEEE802.3 frame type.
Ethernet 802.2	Uses the IEEE802.3/IEEE802.2 frame type.
Ethernet SNAP	Use the IEEE802.3/IEEE802.2/SNAP frame type.

 **NOTE:** The IPX/SPX menu is only displayed when an optional multi protocol card is installed on the printer.

IP Filter

Purpose:

To specify the reception of data from certain IP addresses for blocking. You can set up to five IP addresses.

The change becomes effective after the printer is turned off and then on again.

Values:

Filter <i>n</i> (<i>n</i> is 1 to 5.)	Address	Sets the IP address for Filter <i>n</i> .	
	Mask	Sets the mask for Filter <i>n</i> .	
	Mode	Off*	Disable the IP Filter feature for Filter <i>n</i> .
		Accept	Accepts an access from specified IP address.
		Reject	Rejects an access from specified IP address.

Init NVRAM

Purpose:

To initialize network data stored in NVRAM.

Adobe Protocol

Purpose:

To specify PostScript communication protocol for each interface. You can configure **Adobe Protocol** settings for **Network**.

The change becomes effective after the printer is turned off and then on again.

Values:

Auto*	Used when auto-detecting the PostScript communication protocol.
RAW	Used when no special processing is required for data.
Standard	Used when the communication protocol is in ASCII interface.
BCP	Used when the communication protocol is in binary format.
TBCP	Used when the communication protocol supports both ASCII and binary data to switch between them according to the specified control code.

USB

Use the **usb** menu to change printer settings affecting a USB port.

Adobe Protocol

Purpose:

To specify PostScript communication protocol for USB interface.

The change becomes effective after the printer is turned off and then on again.

Values:

Auto*	Used when auto-detecting the PostScript communication protocol.
RAW	Used when no special processing is required for data.
Standard	Used when the communication protocol is in ASCII interface.
BCP	Used when the communication protocol is in binary format.
TBCP	Used when the communication protocol supports both ASCII and binary data to switch between them according to the specified control code.

PCL

Use the **pcl** to change printer settings that only affect jobs using the PCL emulation printer language.

 **NOTE:** Values marked by an asterisk (*) are the factory default menu settings.

Input Tray

Purpose:

To specify the input tray.

Values:

Auto*	Automatically selects a tray according to the paper size and type settings of the job being printed except for the multipurpose feeder.
Tray 1	The paper is fed from the standard 250-sheet tray module.
Tray 2*1	The paper is fed from the optional 250-sheet tray module or 500-sheet tray module.
MPF	The paper is fed from the multipurpose feeder.

*1 Only displayed when an optional 250-sheet tray module or 500-sheet tray module installed on your printer.

Paper Size

Purpose:

To specify the default paper size.

Values:

Letter*1	B5
A5	A4*1
Executive	8.5 x 13"
Legal	Envelope #10
Monarch	DL
C5	

*1 Denotes country-specific factory default values.

Orientation

Purpose:

To specify how text and graphics are oriented on the page.

Values:

Portrait*	Prints text and graphics parallel to the short edge of the paper.
Landscape	Prints text and graphics parallel to the long edge of the paper.

Duplex

Purpose:

To set duplexing as the default for all print jobs. (Select Duplex from the printer driver to duplex only specific jobs.)

Values:

Duplex Print	Off*	Prints on one side of the paper.
	On	Prints on both sides of the paper.
Binding	Long Edge*	Assumes binding along the long edge of the page. (Left edge for portrait orientation and top edge for landscape orientation)
	Short Edge	Assumes binding along the short edge of the page. (Top edge for portrait orientation and left edge for landscape orientation)

 **NOTE:** The Duplex menu is only available when an optional duplex module has been installed on the printer.

Font

Purpose:

To specify the default font from the registered fonts in the printer.

Values:

CG Times	CG Times It	CG Times Bd
CG Times BdIt	Univers Md	Univers MdIt
Univers Bd	Univers BdIt	Univers MdCd
Univers MdCdIt	Univers BdCd	Univers BdCdIt
AntiqueOlv	AntiqueOlv It	AntiqueOlv Bd
CG Omega	CG Omega It	CG Omega Bd
CG Omega BdIt	GaramondAntiqua	Garamond Krsv
Garamond Hlb	GaramondKrsvHlb	Courier*
Courier It	Courier Bd	Courier BdIt
LetterGothic	LetterGothic It	LetterGothic Bd
Albertus Md	Albertus XBd	Clarendon Cd
Coronet	Marigold	Arial
Arial It	Arial Bd	Arial BdIt
Times New	Times New It	Times New Bd
Times New BdIt	Symbol	Wingdings
Line Printer	Times Roman	Times It
Times Bd	Times BdIt	Helvetica
Helvetica Ob	Helvetica Bd	Helvetica BdOb
CourierPS	CourierPS Ob	CourierPS Bd

CourierPS BdOb	SymbolPS	Palatino Roman
Palatino It	Palatino Bd	Palatino BdIt
ITCBookman Lt	ITCBookman LtIt	ITCBookmanDm
ITCBookmanDm It	HelveticaNr	HelveticaNr Ob
HelveticaNr Bd	HelveticaNrBdOb	N C Schbk Roman
N C Schbk It	N C Schbk Bd	N C Schbk BdIt
ITC A G Go Bk	ITC A G Go BkOb	ITC A G Go Dm
ITC A G Go DmOb	ZapfC MdIt	ZapfDingbats

Symbol Set

Purpose:

To specify a symbol set for a specified font.

Values:

ROMAN-8*	ISO L1	ISO L2
ISO L5	ISO L6	PC-8
PC-8 DN	PC-775	PC-850
PC-852	PC-1004	PC-8 TK
WIN L1	WIN L2	WIN L5
DESKTOP	PS TEXT	MC TEXT
MS PUB	MATH-8	PS MATH
PI FONT	LEGAL	ISO-4
ISO-6	ISO-11	ISO-15
ISO-17	ISO-21	ISO-60
ISO-69	WIN 3.0	WINBALT
SYMBOL	WINGDINGS	DNGBTSMS

Font Size

Purpose:

To specify the font size for scalable typographic fonts.

Values:

4.00 – 50.00	The values are in steps of 0.25.
--------------	----------------------------------

12.00*	
--------	--

Font size refers to the height of the characters in the font. One point equals approximately 1/72 of an inch.

 **NOTE:** The `Font Size` menu is only displayed for typographic fonts.

See also:

["Pitch and Point Size"](#)

Font Pitch

Purpose:

To specify the font pitch for scalable monospaced fonts.

Values:

6.00 – 24.00	The values are in steps of 0.01.
10.00*	

Font pitch refers to the number of fixed-space characters in a horizontal inch of type. For nonscalable monospaced fonts, the pitch is displayed, but cannot be changed.

 **NOTE:** The `Font Pitch` menu is only displayed for fixed, or monospaced, fonts.

See also:

["Pitch and Point Size"](#)

Form Line

Purpose:

To set the number of lines in a page.

Values:

5 – 128	The values are in steps of 1.
64*	

The printer sets the amount of space between each line (vertical line spacing) based on the `Form Line` and `Orientation` menu items. Select the correct `Form Line` and `Orientation` before changing `Form Line`.

See also:

"[Orientation](#)," "[Paper Size](#)"

Quantity

Purpose:

To set the number of copies you want for the printer default value. (Set the number of copies required for a specific job from the printer driver. Values selected from the printer driver always override values selected from the operator panel.)

Values:

1-999	The values are in steps of 1.
1*	

Image Enhance

Purpose:

To specify whether to perform the image enhancement feature. Image enhancement is a feature that makes the boundary line between black and white smoother to decrease jagged edges and enhance the visual appearance.

Values:

On*	Enables to perform the image enhancement feature.
Off	Disables to perform the image enhancement feature.

Hex Dump

Purpose:

To help isolate the source of a print job problem. With Hex Dump selected, all data sent to the printer is printed in hexadecimal and character representation. Control codes are not executed.

Values:

Off*	Disables the Hex Dump feature.
On	Enables the Hex Dump feature.

Draft Mode

Purpose:

To save toner by printing in the draft mode. The print quality is reduced when printing in the draft mode.

Values:

Off*	Does not print in the draft mode.
On	Prints in the draft mode.

Line Termination

Purpose:

To add the line termination commands.

Values:

Off*	The line termination command is not added. CR=CR, LF=LF, FF=FF
Add-LF	The LF command is added. CR=CR-LF, LF=LF, FF=FF
Add-CR	The CR command is added. CR=CR, LF=CR-LF, FF=CR-FF
CR - XX	The CR and LF commands are added. CR=CR-LF, LF=CR-LF, FF=CR-FF

Color Mode

Purpose:

To specify the color mode to Color or Black. This setting is used when the color printing mode setting is not specified for the print job that is sent to the printer.

Value:

Black*	Prints in the black and white mode.
Color	Prints in the color mode.

PostScript

Use the `PostScript` menu to change printer settings that only affect jobs using the PostScript emulation printer language.

 **NOTE:** Values marked by an asterisk (*) are the factory default menu settings.

PS Error Report

Purpose:

To specify whether the printer outputs error contents for a PostScript error.

Values:

On*	Discards the print job without printing an error message.
Off	Prints an error message before it discards the job.

 **NOTE:** This instructions from the PS driver override the settings specified on the operator panel.

PS Job Timeout

Purpose:

To specify the execution time for one PostScript job.

Values:

Off*	Job timeout does not occur.
1-900min.	A PostScript error occurs if processing is not completed after the specified time.

PaperSelectMode

Purpose:

To specify the way to select the tray for PostScript mode.

The change becomes effective after the printer is turned off and then on again.

Value:

Auto*	The tray is selected as the same setting as in the PCL mode.
Select fromTray	The tray is selected in a method compatible with regular Post Script printers.

Security

Use the security menu to set a password to limit access to the menus. This prevents items from being change accidentally.

 **NOTE:** Values marked by an asterisk (*) are the factory default menu settings.

See also:

["Setting of Panel Lock"](#)

Panel Lock

Purpose:

To limit access to the menus.

Values:

Off*	Does not limit access to the menus.
On	Limits access to the menus.

Change Password

Purpose:

To set a password to limit access to the menus.

Values:

0000-9999
0000*

Setting of Panel Lock

This feature prevents unauthorized personnel from changing settings made by the printer administrator. For regular printing, items can be selected from the menu and printer settings remain unchanged. For regular printing, items can be configured using the printer driver.

 **NOTE:** Disabling the operator panel menus does not prevent access to the stored Print, Tray Settings, and Replace Toner menus.

1. Press **Menu**.
2. Press **▼** until **Configure** appears, and then press **▶** or **↵**.
3. Press **▼** until **Security** appears, and then press **▶** or **↵**.
4. **Panel Lock** is displayed. Press **▶** or **↵**.
5. Press **▼** until **On** appears, and then press **↵**.
6. Press **◀**.
7. Press **▼** until **Change Password** appears, and then press **▶** or **↵**.
8. Enter the old password (when you enter it for the first time after doing the settings, enter 0000), and then press **↵**.
9. Enter the new password, and then press **↵**.
10. Reenter the password to confirm the password that you entered, and then press **↵**.
The password has been changed.

 **NOTE:** If you forget your password, turn off the printer. Then, while holding **Menu**, turn on the printer. Continue to hold **Menu** until the display indicates **Ready to Init**. Release **Menu** and press **↵**. Press **◀** to select **Yes**, then press **↵**. The display will briefly indicate **Password has been initialized**. This will recover the factory default panel password.

 **NOTE:** If panel lock is **On**, the factory-default panel password is 0000.

See also:

["Change Password"](#)

Enabling Menus

1. Press **Menu**.
2. Press **▼** until **Configure** appears, and then press **▶** or **↵**.

3. Press ▼ until Security appears, and then press ► or ↵.
4. Panel Lock is displayed. Press ► or ↵.
5. Press ▼ until off appears, and then press ↵.

Printing

This chapter covers tips for printing, how to print certain lists of information from your printer, and how to cancel a job.

- [Tips for Successful Printing](#)
 - [Sending a Job to Print](#)
 - [Cancelling a Print Job](#)
 - [Printing a Printer Settings Page](#)
 - [Printing a Font Sample List](#)
 - [Using the Print and Hold Function](#)
-

Tips for Successful Printing

Tips on Storing Print Media

Store your print media properly. For more information, see "[Storing Print Media](#)."

Avoiding Jams

 **NOTE:** Dell recommends that you try a limited sample of any print media you are considering using with the printer before purchasing large quantities.

By selecting appropriate print media and loading it properly, you are able to avoid most jams. See the following for instructions on loading print media:

- 1 "[Loading Print Media in Standard and Optional Trays](#)" (which includes the standard 250-sheet tray module, and the optional 250-sheet tray module and 500-sheet tray module)
- 1 "[Loading the Multipurpose Feeder](#)"
- 1 "[Avoiding Jams](#)"

If you experience a jam, see "[Clearing Jams](#)" for instructions.

Sending a Job to Print

To support all of the printer features, use the printer driver. When you choose **Print** from a software program, a window representing the printer driver opens. Select the appropriate settings for the specific job you are sending to print. Print settings selected from the driver override the default menu settings selected from the printer operator panel.

You may need to click **Properties** or **Setup** from the initial Print box to see all of the available printer settings you can change. If you are not familiar with a feature in the printer driver window, open the online Help for more information.

To print a job from a typical Windows application:

1. Open the file you want to print.
 2. From the **File** menu, select **Print**.
 3. Verify that the correct printer is selected in the dialog box. Modify the printer settings as appropriate (such as the pages you want to print or the number of copies).
 4. Click **Properties** or **Setup** to adjust printer settings not available from the first screen, and then click **OK**.
 5. Click **OK** or **Print** to send the job to the selected printer.
-

Canceling a Print Job

There are several methods for canceling a print job.

Canceling From the Printer Operator Panel

To cancel a print job after it has started printing:

1. Press **Cancel**.
Printing is canceled.

Canceling a Job From the Computer Running Windows

Canceling a Job From the Taskbar

When you send a job to print, a small printer icon appears in the right corner of the taskbar.

1. Double-click the printer icon.
A list of print jobs appears in the printer window.
2. Select the job you want to cancel.
3. Press <Delete> on the keyboard.

Canceling a Job From the Desktop

1. Minimize all programs to reveal the desktop.
 2. Click **Start** → **Printers and Faxes**.
A list of available printers appears.
 3. Double-click the printer you selected when you sent the job.
A list of print jobs appears in the printer window.
 4. Select the job you want to cancel.
 5. Press <Delete> on the keyboard.
-

Printing a Printer Settings Page

To verify detailed printer settings, print a Printer Settings page. A printed Printer Settings page also allows you to verify whether or not options have been installed properly.

See "[Understanding Printer Menus](#)" to identify the display and operator panel buttons if you need help.

1. Press **Menu**.
2. Press ▼ until **Configure** appears, and then press ► or ⏴.
3. Press ▼ until **Reports** appears, and then press ► or ⏴.
4. **Printer Settings** is displayed, and then press ⏴.
The Printer Settings page is printed.

The message **Printer Settings Printing** appears while the page prints. The printer returns to the **Ready to Print** message after the Printer Settings page prints.

If any other message appears when you print this page, see "[Understanding Printer Messages](#)" for more information.

Printing a Font Sample List

To print samples of all the fonts currently available for your printer:

1. Press **Menu**.
2. Press ▼ until **Configure** appears, and then press ► or ⏴.
3. Press ▼ until **Reports** appears, and then press ► or ⏴.
4. Press ▼ until either **PCL Fonts List** or **PS Fonts List** appears.
 - 1 Select **PCL Fonts List** to print a listing of the fonts available to the PCL emulator.
 - 1 Select **PS Fonts List** to print a listing of the fonts available to the PostScript® 3™.
5. Press ⏴.

The message **PCL Fonts List Printing** or **PS Fonts List Printing** appears and remains on the operator panel until the page prints. The printer returns to the **Ready to Print** state after the font sample list prints.

Using the Print and Hold Function

When you send a job to the printer, you can specify in the driver that you want the printer to hold the job in memory. When you are ready to print the job, you must go to the printer and use the operator panel menus to identify which job in the memory you want to print. You can use this function to print a confidential job (**Secure Print**), or verify one copy before printing additional copies (**Proof Print**).

 **NOTE:** The printer holds the job until you delete it by using the operator panel or you turn off the printer.

 **NOTE:** Print and Hold functions require a minimum of 320 MB available printer memory. Also, you need to configure the RAM disk settings on either the operator panel or the printer driver.

 **NOTE:** Depending on the documents, its job may be too big for the available memory. In this case, an error occurs.

Printing and Deleting Held Jobs

Once held jobs are stored in printer memory, you can use the printer operator panel to specify what you want to do with one or more of the jobs. You can select either **Secure Print** and **Proof Print** from the "**Stored Print**." Then, you select your user name from a list. If you select **Secure Print**, you must type the password you specified in the driver when you sent the job. See "**Secure Print**" for more information.

From either the **Secure Print** and **Proof Stored Print** items, you have three choices:

- 1 Del after Print
- 1 Save after Print
- 1 Delete

Accessing Held Jobs From the Operator Panel

1. Press **Menu**.
2. **Stored Print** is displayed. Press ► or ⏴.
3. **Secure Print** is displayed. Press ► or ⏴.
4. Press ▼ until your user name appears, and then press ► or ⏴.
5. If you print confidential jobs (**Secure Print** jobs), enter the password you have specified on the printer driver, and then press ⏴.
6. Press ▼ until the job you want to print appears, and then press ► or ⏴.
7. Press ▼ until the way you want to print appears, and then press ⏴.
8. Enter the print quantity, and then press ⏴.
When you select **Select All** in step 6 and the print quantity has been set on the computer, select **Default** in **Doc**, and then press ⏴. When you select a document in step 6, the number of copies that is specified in the printer driver appears.

Accessing the Proof Print Jobs



1. Press **Menu**.
2. **Stored Print** is displayed. Press ► or ⏴.
3. Press ▼ until **Proof Print** appears, and then press ► or ⏴.

4. Press ▼ until your user name appears, and then press ► or ↵.
5. Press ▼ until the job you want to print appears, and then press ► or ↵.
6. Press ▼ until the way you want to print appears, and then press ►.
7. Enter the print quantity, and then press ↵.
When you select `Select All` in step 5 and the print quantity has been set on the computer, select `Default` in `Doc`, and then press ↵. When you select a document in step 5, the number of copies that is specified in the printer driver appears.

Proof Print

If you send a Proof Print job, the printer prints one copy and holds the remaining copies you requested from the driver in printer memory. Use Proof Print function to examine the first copy to see if it is satisfactory before printing the remaining copies.

See "[Printing and Deleting Held Jobs](#)" if you need help printing the additional copies stored in memory.

-  **NOTE:** The printer holds the job until you delete it by using the operator panel or you turn off the printer.
-  **NOTE:** When you select `Del` after `Print`, the held job is automatically deleted after printing.
-  **NOTE:** If you use Windows 9x, make sure to disable `Collate` in your application when doing Proof Print with `Post Script`.

Secure Print

When you send a job to the printer, you can specify a password from the driver. The password must be 0 to 12 digits using the numbers 0 to 9. If you do not enter the password from the printer driver, it is not required at the operation panel. This function is called "Store Print". The job is then held in printer memory until you enter the same 12-digit password from the printer operator panel and choose to print or delete the job. This ensures that the job does not print until you are there to retrieve it, and no one else using the printer can print the job.



When you select `Secure Print` from `Stored Print` after selecting your user name, the following prompt is displayed:

```
Enter Password  
[xxxxxxxxxxxx]
```

Use the buttons on the operator panel to enter the 12-digit password associated with your confidential job. As you enter the password, the password you entered is displayed to ensure confidentiality.

If you enter an invalid password, the message `Incorrect Password` appears. Wait three seconds, or Press ↵ or **Cancel** to return to the screen for user selection.

When you enter a valid password, you have access to all print jobs matching the user name and password you entered. The print jobs matching the password you entered appear on the screen. You can then choose to print or delete jobs matching the password you entered. (See "[Printing and Deleting Held Jobs](#)" for more information.)

-  **NOTE:** The printer holds the job until you delete it by using the operator panel or you turn off the printer.
-  **NOTE:** When you select `Del` after `Print`, the held job is automatically deleted after printing.

Print Media Guidelines

Print media is paper, transparencies, labels, envelopes, coated paper among others. Your printer provides high-quality printing on a variety of print media. Selecting the appropriate print media for your printer helps avoid printing troubles. This section describes how to select print media, how to care for print media, and how to load the print media in the standard and optional 250-sheet tray module or 500-sheet tray module.

- [Paper](#)
 - [Transparencies](#)
 - [Envelopes](#)
 - [Labels](#)
 - [Storing Print Media](#)
 - [Identifying Print Media Sources and Specifications](#)
-

Paper

For the best print quality in color, use 75 g/m² (20 lb) xerographic, grain long paper. For the best print quality in black and white, use 90 g/m² (24 lb) xerographic, grain long paper. Before buying large quantities of any print media, Dell recommends trying a sample first.

When loading paper, identify the recommended print side on the paper package, and load the paper accordingly. See "[Loading Print Media in Standard and Optional Trays](#)" and "[Loading the Multipurpose Feeder](#)" for detailed loading instructions.

Paper Characteristics

The following paper characteristics affect print quality and reliability. Dell recommends that you follow these guidelines when evaluating new paper stock.

Weight

The tray automatically feeds paper weights from 60 to 105 g/m² (16 to 28 lb bond) grain long. The multipurpose feeder automatically feeds paper weights from 60 to 216 g/m² (16 to 56 lb bond) grain long. Paper lighter than 60 g/m² (16 lb) might not be stiff enough to feed properly, and could cause paper jams. For best performance, use 75 g/m² (20 lb bond) grain long paper.

Curl

Curl is the tendency of print media to curve at its edges. Excessive curl can cause paper feeding problems. Curl usually occurs after the paper passes through the printer, where it is exposed to high temperatures. Storing paper unwrapped in humid conditions, even in the paper tray, can contribute to paper curling prior to printing and cause feeding problems.

Smoothness

The degree of paper smoothness directly affects print quality. If the paper is too rough, the toner does not fuse to the paper properly, resulting in poor print quality. If the paper is too smooth, it can cause paper feeding problems. Smoothness between 150 and 250 Sheffield points produces the best print quality.

Moisture Content

The amount of moisture in the paper affects both print quality and the ability of the printer to feed the paper properly. Leave the paper in its original packaging until you are ready to use it. This limits the exposure of the paper to moisture changes that can degrade its performance.

Grain Direction

Grain refers to the alignment of the paper fibers in a sheet of paper. Grain is either grain long, running the length of the paper, or grain short, running the width of the paper. For 60 to 135 g/m² (16 to 36 lb bond) paper, grain long fibers are recommended. For papers heavier than 135 g/m² (36 lb bond), grain short is preferred.

Fiber Content

Most high-quality xerographic paper is made from 100% chemically pulped wood. Paper containing fibers such as cotton possess characteristics that can result in degraded paper handling.

Recommended Paper

To ensure the best print quality and feed reliability, use 75 g/m² (20 lb) xerographic paper. Business papers designed for general business use also provide acceptable print quality.

Always print several samples before buying large quantities of any type of print media. When choosing any print media, you should consider the weight, fiber content, and color.

The laser printing process heats paper to high temperatures of 225°C (437°F) for Magnetic Ink Character Recognition (MICR) applications, and 205°C (401°F) for non-MICR applications. Only use paper able to withstand these temperatures without discoloring, bleeding, or releasing hazardous emissions. Check with the manufacturer or vendor to determine whether the paper you have chosen is acceptable for laser printers.

Unacceptable Paper

The following paper types are not recommended for use with the printer:

- 1 Chemically treated papers used to make copies without carbon paper, also known as carbonless papers, carbonless copy paper (CCP), or no carbon required (NCR) paper
- 1 Preprinted papers with chemicals that may contaminate the printer
- 1 Preprinted papers that can be affected by the temperature in the printer fuser
- 1 Preprinted papers that require a registration (the precise print location on the page) greater than ±0.09 in., such as optical character recognition (OCR) forms

In some cases, you can adjust registration with your software program to successfully print on these forms.

- 1 Coated papers (erasable bond), synthetic papers, thermal papers
- 1 Rough-edged, rough or heavily textured surface papers or curled papers
- 1 Recycled papers containing more than 25% post-consumer waste that do not meet DIN 19 309
- 1 Multiple-part forms or documents
- 1 Label paper with Cut

Selecting Paper

Proper paper selection helps prevent jams and ensures trouble-free printing.

To help avoid jams or poor print quality:

- 1 Always use new, undamaged paper.
- 1 Before loading the paper, identify the recommended print side of the paper. This information is usually indicated on the paper package.
- 1 Do not use paper that you have cut or trimmed yourself.
- 1 Do not mix print media sizes, weights, or types in the same source. This may result in a paper jam.
- 1 Do not remove trays while a job is printing or `Printing` is displayed on the operator panel.
- 1 Make sure the `Paper Type` and `Paper Size` settings are correct. (See "[Tray Settings](#)" for detailed information about these settings.)
- 1 Make sure the paper is properly loaded in the tray.

- 1 Flex paper back and forth, and then fan them. Straighten the edges of the stack on a level surface.

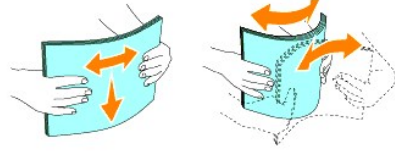

- 1 When curl is excessive, with plain paper, turn it over and reset it.

Selecting Preprinted Forms and Letterhead

When selecting preprinted forms and letterhead paper for the printer:

- 1 Use long grain paper for best results.
- 1 Use only forms and letterhead printed using an offset lithographic or engraved printing process.
- 1 Select papers that absorb ink, but do not bleed.
- 1 Avoid papers with rough or heavily textured surfaces.
- 1 Use papers printed with heat-resistant inks designed for use in xerographic copiers. The ink must withstand temperatures of 225°C (437°F) without melting or releasing hazardous emissions.
- 1 Use inks that are not affected by the resin in toner or the silicone in the fuser. Inks that are oxidation-set or oil-based should meet these requirements; latex inks might not. If you are in doubt, contact your paper supplier.

Printing on Letterhead

Check with the manufacturer or vendor to determine whether the preprinted letterhead you have selected is acceptable for laser printers.

Page orientation is important when printing on letterhead. Use the following table for help when loading letterhead in the print media sources.

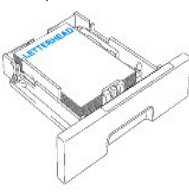
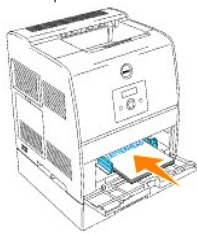
Print media source	Print side	Page orientation
Standard 250-sheet tray module Optional 250-sheet tray module or 500-sheet tray module	Face up 	Back of tray
Multipurpose feeder	Face up 	Logo enters the printer first

Selecting Pre-punched Paper

Pre-punched paper brands can differ in the number and placement of holes and in manufacturing techniques.

To select and use pre-punched paper:

- 1 Test paper from several manufacturers before ordering and using large quantities of pre-punched paper.
 - 1 Paper should be punched at the paper manufacturer and not drilled into paper already packaged in a ream. Drilled paper can cause jams when multiple sheets feed through the printer. This may result in a paper jam.
 - 1 Pre-punched paper can include more paper dust than standard paper. Your printer may require more frequent cleaning and feed reliability may not be as good as standard paper.
 - 1 Weight guidelines for pre-punched paper are the same as non-punched paper.
-

Transparencies

Before buying large quantities of any print media, Dell recommends trying a sample first.

When printing on transparencies:

- 1 Set the **Paper Type** to **Transparency** from the printer driver to avoid damaging your printer.
- 1 Use transparencies designed specifically for laser printers. Do not use regular transparencies. Transparencies must be able to withstand temperatures of 205°C (401°F) without melting, discoloring, offsetting or releasing hazardous emissions.
- 1 Avoid getting fingerprints on the transparencies. This may result in poor print quality.
- 1 Before loading transparencies, fan the stack to prevent sheets from sticking together.

Selecting Transparencies

The printer can print directly on transparencies designed for use in laser printers. Print quality and durability depend on the transparency used. Before buying large quantities of any print media, Dell recommends trying a sample first.

The Paper Type setting should be set to Transparency to help prevent jams. (See "[Paper Type](#)" for detailed information about this setting.) Check with the manufacturer or vendor to determine whether your transparencies are compatible with laser printers that reach temperatures as high as 205°C (401°F). Only use transparencies that are able to withstand these temperatures without melting, discoloring, offsetting, or releasing hazardous emissions.

Envelopes

You can load envelopes in the multipurpose feeder for a single print job. Before buying large quantities of any print media, Dell recommends trying a sample first. See "[Loading the Multipurpose Feeder](#)" for instructions on loading an envelope.

When printing on envelopes:

- 1 Use only high-quality envelopes that are designed for use in laser printers.
- 1 Set the print media source to **MPF**. Set the **Paper Type** to **Envelope**, and select the correct size of envelope from the printer driver.
- 1 For best performance, use envelopes made from 75 g/m² (20 lb bond) paper. You can use up to 105 g/m² (28 lb bond) weight for the envelope feeder as long as the cotton content is 25% or less. Envelopes with 100% cotton content must not exceed 90 g/m² (24 lb bond) weight.
- 1 Use only new, undamaged envelopes.
- 1 For best performance, do not use envelopes that:
 - 1 Have excessive curl or twist
 - 1 Are stuck together or damaged in any way

- 1 Contain windows, holes, perforations, cutouts, embossing
 - 1 Use metal clasps, string ties, or metal folding bars
 - 1 Have an interlocking design
 - 1 Have postage stamps attached
 - 1 Have any exposed adhesive when the flap is in the sealed or closed position
 - 1 Have nicked edges or bent corners
 - 1 Have rough, cockle, or laid finishes
- 1 Use envelopes that can withstand temperatures of 205°C (401°F) without sealing, excessive curling, wrinkling, or releasing hazardous emissions. If you have any doubts about the envelopes you are considering, check with the envelope supplier.
- 1 Adjust the width guide to fit the width of the envelopes.
- 1 To load envelopes in the multipurpose feeder, insert the envelopes either with the flaps open and toward the front of the printer, or with the flaps closed and the short-edge of the envelopes facing into the printer.
- 1 See "[Loading the Multipurpose Feeder](#)" for instructions on loading an envelope.
- 1 Use one envelope size during a print job.
- 1 Make sure the humidity is low because high humidity (more than 60%) and the high printing temperatures may seal the envelopes.
-

Labels

Your printer can print on many labels designed for use with laser printers. Label adhesives, face sheet (printable stock), and topcoats must be able to withstand temperatures of 205°C (401°F) and pressure of 25 pounds per square inch (psi).

Before buying large quantities of any print media, Dell recommends trying a sample first.

When printing on labels:

- 1 Do not load labels together with paper or transparencies at the same time. This may result in a jam.
 - 1 Do not use label sheets with a slick backing material.
 - 1 Do not print within 1 mm (0.04 in.) of the die cut.
 - 1 Use full label sheets. Partial sheets may cause labels to peel off during printing, resulting in a jam. Partial sheets also contaminate your printer and your cartridge with adhesive, and could void your printer and cartridge warranties.
 - 1 Use labels that can withstand temperatures of 205°C (401°F) without sealing, excessive curling, wrinkling, or releasing hazardous emissions.
 - 1 Do not print within 1 mm (0.04 in.) of the edge of the label, of the perforations, or between die-cuts of the label.
 - 1 Do not use label sheets that have adhesive to the edge of the sheet. Dell recommends zone coating of the adhesive at least 1 mm (0.04 in.) away from edges. Adhesive material contaminates your printer and could void your warranty.
 - 1 If zone coating of the adhesive is not possible, a 3 mm (0.125 in.) strip should be removed on the leading edge, and a non-oozing adhesive should be used.
 - 1 Remove a 3 mm (0.125 in.) strip from the leading edge to prevent labels from peeling inside the printer.
 - 1 Portrait orientation is preferred, especially when printing bar codes.
 - 1 Do not use labels that have exposed adhesive.
-

Storing Print Media

For proper print media storage, the following guidelines help avoid media feeding problems and uneven print quality.

- 1 For best results, store print media in an environment where the temperature is approximately 21°C (70°F) and the relative humidity is 40%.
- 1 Store cartons of print media on a pallet or shelf, rather than directly on the floor.
- 1 If you store individual packages of print media out of the original carton, make sure they rest on a flat surface so that the edges do not buckle or curl.
- 1 Do not place anything on top of the print media packages.

Identifying Print Media Sources and Specifications

The following tables provide information on standard and optional print media sources.

Print Media Sizes and Support

	Multipurpose feeder	Standard 250-sheet tray module		Optional 250-sheet tray module		Optional 500-sheet tray module	Optional duplex module
		A4/Letter cassette	Legal cassette	A4/Letter cassette	Legal cassette		
A4	Y	Y	Y	Y	Y	Y	Y
A5	Y	Y	Y	Y	Y	N	N
B5	Y	Y	Y	Y	Y	N	Y
Letter	Y	Y	Y	Y	Y	Y	Y
Folio (8.5 x 13 in.)	Y	N	Y	N	Y	N	Y
Legal (8.5 x 14 in.)	Y	N	Y	N	Y	N	Y
Executive	Y	Y	Y	Y	Y	N	Y
COM-10 envelope	Y	N	N	N	N	N	N
Monarch	Y	N	N	N	N	N	N
C5	Y	N	N	N	N	N	N
DL	Y	N	N	N	N	N	N
User-specified print media	Y	N	N	N	N	N	N

Print Media Supported

	Multipurpose feeder	Standard 250-sheet tray module	Optional 250-sheet tray module	Optional 500-sheet tray module	Optional duplex module
Plain Paper 1 (60–80 gsm)	Y	Y	Y	Y	Y
Plain Paper 1-Side2 (60–80 gsm)	Y	N	N	N	N
Plain Paper 2 (81–105 gsm)	Y	Y	Y	Y	Y
Plain Paper 2-Side2 (81–105gsm)	Y	N	N	N	N
Covers 1 (106–163 gsm)	Y	N	N	N	N
Covers 1-Side2 (106–163 gsm)	Y	N	N	N	N
Covers 2 (164–216 gsm)	Y	N	N	N	N
Covers 2-Side2 (164–216 gsm)	Y	N	N	N	N
Transparency	Y	N	N	N	N
Labels	Y	N	N	N	N
Coated 1 (106–163 gsm)	Y	N	N	N	N
Coated 1-Side2 (106 –163 gsm)	Y	N	N	N	N
Coated 2 (164–216 gsm)	Y	N	N	N	N
Coated 2-Side2 (164 –216 gsm)	Y	N	N	N	N
Envelope	Y	N	N	N	N

Setup Paper Type

Paper type	Weight (gsm)	Remarks
Plain1	60-80	-
Plain2	81-105	-
Covers1	106-163	-
Covers2	164-216	-
Coated1	106-163	BJP (Bubble Jet Printer) paper cannot be used.
Coated2	164-216	BJP (Bubble Jet Printer) paper cannot be used.
Transparency	-	BJP (Bubble Jet Printer) paper cannot be used.
Label	-	BJP (Bubble Jet Printer) paper cannot be used.
Envelopes	-	-

Setting Up for Shared Printing

● [Point and Print](#)

● [Peer-to-Peer](#)

You can share your new printer on the network using the *Drivers and Utilities* CD that shipped with your printer, or using Microsoft's point and print or peer-to-peer method. However, if you use one of the Microsoft methods, you will not have all of the features, such as the status monitor and other printer utilities, that are installed with the *Drivers and Utilities* CD.

To share a locally-attached printer on the network, you need to share the printer, and then install the shared printer on network clients:

1. Click **Start** → **Settings** → **Printers**.
2. Right-click this printer icon and select **Properties**.
3. From the **Sharing** tab, check the **Shared** check box, and then type a name in the **Shared as** text box.
4. Click **Additional Drivers** and select the operating systems of all network clients printing to this printer.
5. Click **OK**.
If you are missing files, you are prompted to insert the server operating system CD.

To check that the printer was successfully shared:

1. Make sure the printer object in the **Printers** folder shows it is shared. For example, in Windows 2000, a hand is shown underneath the printer icon.
1. Browse **Network Neighborhood**. Find the host name of the server and look for the shared name you assigned to the printer.

Now that the printer is shared, you can install the printer on network clients using the point and print method or the peer-to-peer method.

Point and Print

This method is usually the best use of system resources. The server handles driver modifications and print job processing. This lets network clients return to their programs much faster.

If you use the point and print method, a subset of driver information is copied from the server to the client computer. This is just enough information to send a print job to the printer.

1. On the Windows desktop of the client computer, double-click **Network Neighborhood**.
2. Locate the host name of the server computer, and then double-click the host name.
3. Right-click the shared printer name, and then click **Install**.

Wait for the driver information to copy from the server computer to the client computer, and for a new printer object to be added to the **Printers** folder. The time this takes varies, based on network traffic and other factors.
Close **Network Neighborhood**.

4. Print a test page to verify print installation.
5. Click **Start** → **Settings** → **Printers**.
6. Select the printer you just created.
7. Click **File** → **Properties**.
8. From the **General** tab, click **Print a Test Page**.

When a test page prints successfully, printer installation is complete.

Peer-to-Peer

If you use the peer-to-peer method, the printer driver is fully installed on each client computer. Network clients retain control of driver modifications. The client computer handles the print job processing.

1. Click **Start** → **Settings** → **Printers**.
2. Click **Add Printer** to launch the **Add Printer** wizard.
3. Click **Network Print Server**.
4. Select the network printer from the **Shared printers** list. If the printer is not listed, type in the path of the printer in the text box.
For example: \\<server host name>\<shared printer name>
The server host name is the name of the server computer that identifies it to the network. The shared printer name is the name assigned during the server installation process.
5. Click **OK**.
If this is a new printer, you may be prompted to install a printer driver. If no system driver is available, then you will need to provide a path to available drivers.
6. Select whether you want this printer to be the default printer for the client, and then click **Finish**.
7. Print a test page to verify printer installation:
 - a. Click **Start** → **Settings** → **Printers**.
 - b. Select the printer you just created.
 - c. Click **File** → **Properties**.
 - d. From the **General** tab, click **Print a Test Page**.
When a test page prints successfully, printer installation is complete.

Removing Options

If the printer location needs to change or the printer and print media handling options need to be shipped to a new location, all print media handling options must be removed from the printer. For shipping, pack the printer and print media handling options securely to avoid damage.

- [Removing the Optional Duplex Module](#)
 - [Removing Optional Tray Modules](#)
 - [Removing the Optional Memory Card](#)
 - [Removing the Optional Multi Protocol Card](#)
-

Removing the Optional Duplex Module

1. Remove the connector cover supplied with the duplex module.

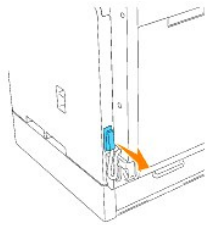

2. Disconnect the connector at the bottom left of the module. Then, attach the original connector cover into the connector.

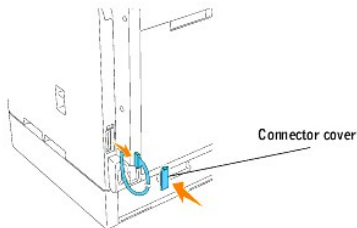

3. Turn off the printer and unplug the printer power cable.
4. Remove the screws on the left and right at the bottom of the duplex module while firmly holding the optional duplex module in a closed state.



5. Grab the optional duplex module and pull down.

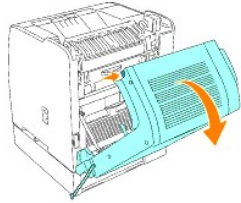

6. Remove the screws of the straps on the left and right of the module from the optional duplex module.

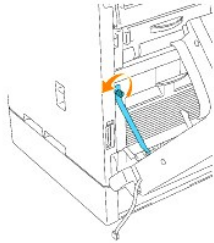

7. Remove the optional duplex module from the printer.

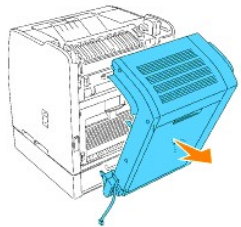

8. Gently push both sides of the bottom of the paper cover to install it.

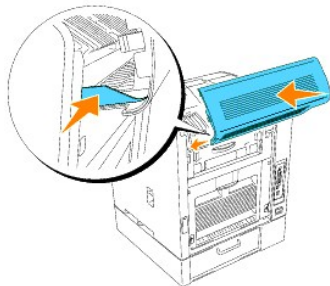

9. Open the inner rear cover. Attach the cover, which you have kept since installing the duplex module, until it clicks, and then close the rear cover.

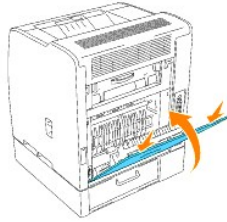

Removing Optional Tray Modules

⚠ CAUTION: To lift the printer safely and replace the optional 250-sheet tray module or 500-sheet tray module requires two people to stand in front (operator panel side) and behind the printer and to lift at the same time. Do not try to lift the printer from the sides.

⚠ CAUTION: Make sure your fingers are not under the printer when you set it down.

📌 NOTE: You can use a maximum of two trays with your printer (the standard 250-sheet tray module and one additional 250-sheet tray module or 500-sheet tray module).

1. Turn off the printer and unplug the printer power cable.
2. Unlock the tray from the printer by removing the tray from the tray module and turning the locking mechanism, inside the printer, as shown in the graphic.



3. Remove the printer from the tray.

⚠ CAUTION: Lift the printer with two people, one facing the front of the printer (operator panel side) and the other facing the back. Never try to lift the printer while facing its right and left sides.

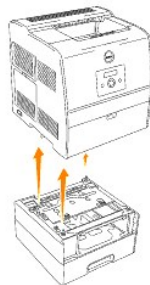

4. To unlock the trays, loosen the screws with a coin and remove them from the inside of the tray.

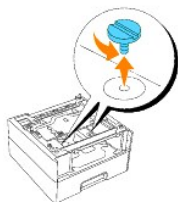

5. Remove the optional 250-sheet tray module or 500-sheet tray module.

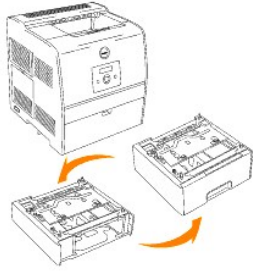

6. Place the printer on top of the standard 250-sheet tray module.



7. Lock the standard 250-sheet tray module into place by removing the tray from the tray module and rotating the locking mechanism as shown in the graphic.

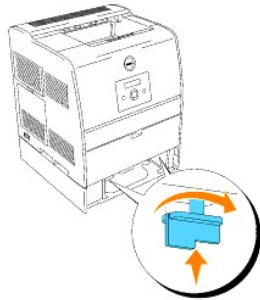

8. Replace all trays.

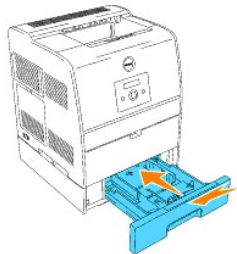

Removing the Optional Memory Card

1. Make sure that the printer is turned off.
2. Remove the control board cover on the left side of the printer by pulling the notch.

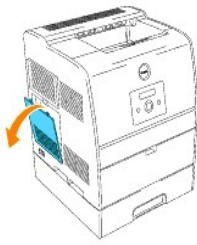

3. Push the knobs on both sides of the slot outward. Remove the memory card from the slot.

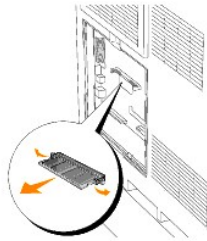

4. Reattach the control board cover to the printer.



For more information, see "[Installing Cards](#)".

Removing the Optional Multi Protocol Card

1. Make sure that the printer is turned off.
2. Remove the control board cover on the left side of the printer by pulling the notch.

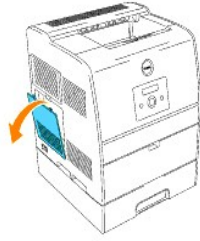

3. Loosen the two screws from the back side of the printer.

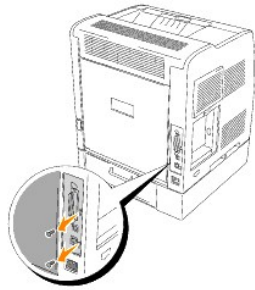

4. Hold the bottom of the multi protocol card and remove it from the control board.

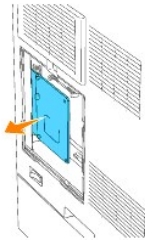

5. Reattach the control board cover to the printer.



For more information, see "[Installing Cards](#)".

Troubleshooting

Troubleshooting Guide

This section consists of the following instructions.

[Configuration of your printer instructions](#)

User Settings

- | [Menu Map](#)
- | [Setup printing Letter Plain 1 from Multipurpose Feeder](#)
- | [Setup printing Letter Plain 1 from Tray 1](#)
- | [Setup printing Letter Plain 1 from Tray 2](#)
- | [Setup printing Transparency from Multipurpose Feeder](#)
- | [Setup printing Envelope from Multipurpose Feeder](#)
- | [Setup Paper Size](#)
- | [Setup Paper Type](#)

Configuration

- | [Parallel Printing](#)
- | [USB Printing](#)
- | [Setup Network](#)
- | [Setup Security](#)

[Trouble Shooting Instructions](#)

- | [Diagnostic Menu Map \(Customer Mode\)](#)
- | [Testing "Print Quality"](#)
- | [Testing "Toner Pallets Check" or "Contamination Check"](#)
- | [Clear NVRAM](#)

[Others](#)

- | [How to replace the Drum Cartridge](#)
- | [How to install the Toner Cartridge](#)
- | [Basic toner cleaning instructions](#)

The section will help you solve problems with the printer, options, or print quality.

-
- [Basic Printer Problems](#)
 - [Display Problems](#)
 - [Printing Problems](#)
 - [Print Quality Problems](#)
 - [Option Problems](#)
 - [Other Problems](#)
 - [Contacting Service](#)
-

Basic Printer Problems

Some printer problems can be easy to resolve. If a problem occurs with your printer, check each the following:

- 1 If a message displays on the operator panel, see "[Understanding Printer Messages.](#)"
- 1 The printer power cable is plugged into the printer and a properly grounded electrical outlet.
- 1 The printer power is on.
- 1 The electrical outlet is not turned off at any switch or breaker.
- 1 Other electrical equipment plugged into the outlet is working.
- 1 All options are properly installed.
- 1 If you have checked all of the above and still have a problem, turn off the printer, wait for 10 seconds, and then turn on the printer. This often fixes the problem.

 **NOTICE:** If an error message appears, see "[Understanding Printer Messages.](#)"

Display Problems



Problem	Action
Operator panel displays only diamonds or is blank.	<ul style="list-style-type: none"> · Turn off the printer, wait for 10 seconds, and turn on the printer. · Self Test Message appears on the operator panel. When the test is completed, Ready to Print is displayed.
Menu settings changed from the operator panel have no effect.	<ul style="list-style-type: none"> · Settings in the software program, the printer driver, or the printer utilities are overriding the settings made on the operator panel. · Change the menu settings from the printer driver, the printer utilities, or the software program instead of the operator panel. · Disable the settings in the printer driver, the printer utilities, or the software program so you can change settings on the operator panel.



Printing Problems

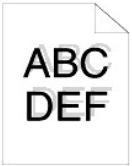

Problem	Action
Job did not print correct or incorrect characters printed.	Make sure Ready to Print appears on the operator panel before you send a job to print. Press Menu to return to Ready to Print .
	Make sure print media is loaded in the printer. Press Menu to return to Ready to Print .
	Verify the printer is using the correct page-description language (PDL).
	Verify that you are using the correct printer driver.
	Make sure you are using the correct Ethernet, USB, or IEEE cable and it is securely connected at the back of the printer.
	Verify that the correct print media size is selected.
	If using a print spooler, verify that the spooler has not stalled.
	Check the printer interface from the Configure menu. Determine the host interface you are using. Print a Panel Settings page to verify that the current interface settings are correct.
Secure print is not available or not printing	Minimum 256 MB is required.
	RAM Disk must be enabled using the operator panel.
	The number of secure print jobs your printer can store is dependent on the job size including number of pages, graphics, color attributes, and the amount of memory installed. To increase this number, add additional memory.

Print media misfeeds or multiple feeds occur.	Make sure the print media you are using meets the specifications for your printer. See " Print Media Supported " for more information.
	Flex print media before loading it in any of the sources.
	Make sure the print media is loaded correctly.
	Make sure the width and length guides on the print media sources are adjusted correctly.
	Do not overfill the print media sources.
	Do not force print media into the multipurpose feeder when you load it; otherwise, it may skew or buckle.
	Remove any curled print media from sources.
	Load the recommended print side correctly for the type of print media you are using. See " Loading Print Media in Standard and Optional Trays " for more information.
	Turn the print media over or around and try printing again to see if feeding improves.
	Do not mix print media types.
	Do not mix reams of print media.
Remove the top and bottom sheets of a ream before loading the print media.	
Load a print media source only when it is empty.	
Envelope misfeeds or multiple feeds occur.	Remove the stack of envelopes from the multipurpose feeder.
Page breaks in unexpected places.	Check the Job Timeout in the Basic Settings menu. Increase the setting.
Job prints from the wrong source or on the wrong print media.	Check the Paper Size and Paper Type in the Tray Settings menu on the printer operator panel and in the printer driver.
Print media does not stack neatly in the output bin.	Turn the print media stack over in the tray or multipurpose feeder.
Printer does not duplex pages.	Make sure Duplex is selected in both the PCL (Printer Control Language) menu on the printer operator panel and in the printer driver.
	Make sure you have enough printer memory installed.

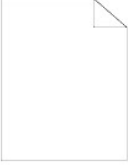
Print Quality Problems

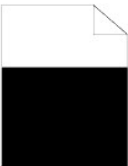
Problem	Action
Color is out of alignment. 	<ul style="list-style-type: none"> The inside of printer is dirty. If you install a new black cartridge and a ROS cleaning has not been done, this problem will happen. See "Cleaning Inside the Printer".
Print is too light. 	<ul style="list-style-type: none"> The toner may be low. Confirm the amount of the toner and change the toner cartridges if necessary. Set the Draft Mode check box to off in the Advanced in the printer driver. If you are printing on an uneven print surface, change the Paper Type settings in the Tray Settings menu. See "Paper Type." Verify that the correct print media is being used. The drum cartridge may need to be replaced. Change the drum cartridge.
Toner smears or print comes off page.	<ul style="list-style-type: none"> If you are printing on an uneven print surface, change the Paper Type settings in the Tray Settings menu. See

	<p>"Paper Type."</p> <ul style="list-style-type: none"> Verify that the print media is within the printer specifications. See "Print Media Supported."
<p>Toner spots appear on the page/printing is blurred.</p> 	<ul style="list-style-type: none"> Check the toner cartridge to make sure it is installed correctly. Change the toner cartridge. See "Replacing the Toner Cartridge."
<p>Entire page is white.</p> 	<ul style="list-style-type: none"> Make sure the packaging material is removed from the toner cartridge. Check the toner cartridge to make sure it is installed correctly. The toner may be low. Change the toner cartridge. See "Replacing the Toner Cartridge."
<p>Streaks appear on the page.</p> 	<ul style="list-style-type: none"> The toner may be low. Change the toner cartridge. See "Replacing the Toner Cartridge." If you are using preprinted forms, make sure the toner can withstand temperatures of 0 °C to 35 °C.
<p>Characters have jagged or uneven edges.</p> 	<ul style="list-style-type: none"> Change the Print Mode in the Graphics tab (or Advanced dialog box) to Standard in the printer driver. If you are using downloaded fonts, verify that the fonts are supported by the printer, the host computer, and the software program.
<p>Part or all of the page prints in black.</p> 	<ul style="list-style-type: none"> Check the toner cartridge to make sure it is installed correctly.

<p>The job prints, but the top and side margins are incorrect.</p> 	<ul style="list-style-type: none"> • Make sure the Paper Size setting in the Tray Settings is correct. • Make sure the margins are set correctly in your software program.
<p>Printing on both ends of the transparencies is faded.</p> 	<ul style="list-style-type: none"> • This occurs when the printer is operating in a location where relative humidity reaches 85% or more. Adjust the humidity or relocate the printer to an appropriate environment.

Option Problems

If an option does not operate correctly following installation or stops working:

- 1 Turn off the printer, wait for 10 seconds, and then turn on the printer. If this does not fix the problem, unplug the printer, and check the connection between the option and the printer.
- 1 Print the Printer Settings page to see if the option is listed in the Installed Options list. If the option is not listed, reinstall it. See "[Printing a Printer Settings Page](#)."
- 1 Make sure the option is selected in the printer driver you are using.

The following table lists printer options and corrective actions for related problems. If the suggested corrective action does not correct the problem, call customer service.

Problem	Action
Optional tray	<ul style="list-style-type: none"> • Make sure a secure connection exists between trays (250-sheet tray module or 500-sheet tray module). • Make sure the print media is loaded correctly. See "Loading Print Media in Standard and Optional Trays" for more information.
Optional duplex module	<ul style="list-style-type: none"> • If the duplex module is listed on the Printer Settings page, and the print media jams when it enters or exits the duplex module, the printer and duplex module may not be properly aligned. • If the duplex module is not available, verify the duplex module cable is connected to the printer and that your printer has the minimum 128 MB memory required.
Printer memory	<ul style="list-style-type: none"> • Make sure the printer memory is securely connected to the printer system board.
Multiprotocol card	<ul style="list-style-type: none"> • Make sure the card is securely inserted to the correct slot. • Make sure you are using the correct card.

Other Problems

Condensation has occurred inside the printer.

- 1 Using the operator panel, set the time the printer is in the power saver mode to 60 minutes, and then leave the printer turned on. The inside of the printer warms up and the condensation evaporates. When the condensation has evaporated you can use the printer normally.

11. Now press **MENU** to get back to Tray Settings/Paper Size.
12. Press ▼ to get to Paper Type.
13. Press ► to select Paper Type.
14. Press ▼ to get to MPF.
15. Press ▼ to select MPF.
16. Using ▲ and ▼ , select the appropriate paper type (Plain 1).
17. Press **SELECT**, once Plain 1 is displayed on the lower line.
18. Now we have the MPF Type set to Plain 1.
19. Now press **MENU** to get back to Ready to Print
20. Now insert the Letter-sized stack of paper into the MPF.
21. On the screen MPF/Letter will appear. (ONLY ON 3x00cn)
22. Press **SELECT** to confirm this. (ONLY ON 3x00cn)
23. Now on the screen MPF/Plain 1 will appear.
24. Press **SELECT** to confirm this.
25. We now have all the hardware settings on the printer correct

Now, all software settings screen shots are from WORD, this was done in Word. However if in any application, you go **File → Print** and then click the **Properties** button, you will get this same driver properties window.

26. Open up Word and create a new document.
27. Go to **File → Print**.
28. Select the Dell Color Laser Printer from the printers list
29. Click the **Properties** button to the right.
30. This brings up Driver Properties.
31. Click on the Paper Tray Tab.
32. Change the Paper Source to MPF.
33. Click the Paper Tab.
34. Select in paper size, Letter.
35. Select for Output Size, Same as Paper Size.
36. Click **OK**.
37. Click **Close**.
38. Now the printer driver is setup correctly.
39. Now go to **File → Page Setup**.
40. Click the Paper Tab.
41. Change Paper Size to Legal.
42. Change the Paper source settings BOTH to "DEFAULT TRAY AS PER PRINTER".
43. Click **OK**.
44. Type in some gibberish in the body of the document and click Print!

Setup printing Letter Plain 1 from Tray 1

1. On the printer operator panel press **MENU**.
2. Press ▼ to get to Tray Settings.
3. Press ► to select Tray Settings.
4. Press ▼ to get to Paper Size. (ONLY ON 3x00cn)
5. Press ► to select Paper Size. (ONLY ON 3x00cn)
6. Press ▼ to get to Tray 1. (ONLY ON 3x00cn)
7. Press ► to select Tray 1. (ONLY ON 3x00cn)
8. Using ▲ and ▼ , select the appropriate paper size (Letter). (ONLY ON 3x00cn)
9. Press the middle button, **SELECT**, once Letter is displayed on the lower line, this puts a * by it. (ONLY ON 3x00cn)
10. Now we have the Tray 1 Size set to Letter. (ONLY ON 3x00cn)

11. Now press **MENU** to get back to Tray Settings/Paper Size.
12. Press ▼ to get to Paper Type.
13. Press ► to select Paper Type.
14. Press ▼ to get to Tray 1.
15. Press ► to select Tray 1.
16. Using ▲ and ▼ , select the appropriate paper type (Plain 1).
17. Press **SELECT**, once Plain 1 is displayed on the lower line.
18. Now we have the Tray 1 Type set to Plain 1.
19. Now press **MENU** to get back to Ready to Print.
20. Now insert the Letter-sized stack of paper into the Tray 1.
21. On the screen Tray 1/Letter will appear. (ONLY ON 3x00cn)
22. Press **SELECT** to confirm this. (ONLY ON 3x00cn)
23. Now on the screen Tray 1/Plain 1 will appear.
24. Press **SELECT** to confirm this.
25. We now have all the hardware settings on the printer correct.

Now, all software settings screen shots are from WORD, this was done in Word. However if in any application, you go **File → Print** and then click the **Properties** button, you will get this same driver properties window.

26. Open up Word and create a new document.
27. Go to **File → Print**.
28. Select the Dell Color Laser Printer from the printers list.
29. Click the **Properties** button to the right.
30. This brings up Driver Properties.
31. Click on the Paper Tray Tab.
32. Change the Paper Source to Tray 1.
33. Click the Paper Tab.
34. Select in paper size, Letter.
35. Select for Output Size, Same as Paper Size.
36. Click **OK**.
37. Click **Close**.
38. Now the printer driver is setup correctly.
39. Now go to **File → Page Setup**.
40. Click the Paper Tab.
41. Change Paper Size to Legal.
42. Change the Paper source settings BOTH to "DEFAULT TRAY AS PER PRINTER".
43. Click **OK**.
44. Type in some gibberish in the body of the document and click Print!

Setup printing Letter Plain 1 from Tray 2

1. On the printer operator panel press **MENU**.
2. Press ▼ to get to Tray Settings.
3. Press ► to select Tray Settings.
4. Press ▼ to get to Paper Size. (ONLY ON 3x00cn)
5. Press ► to select Paper Size. (ONLY ON 3x00cn)
6. Press ▼ to get to Tray 2. (ONLY ON 3x00cn)
7. Press ► to select Tray 2. (ONLY ON 3x00cn)
8. Using ▲ and ▼ , select the appropriate paper size (Letter). (ONLY ON 3x00cn)
9. Press the middle button, **SELECT**, once Letter is displayed on the lower line, this puts a * by it. (ONLY ON 3x00cn)
10. Now we have the Tray 2 Size set to Letter. (ONLY ON 3x00cn)

11. Now press **MENU** to get back to Tray Settings/Paper Size.
12. Press ▼ to get to Paper Type.
13. Press ► to select Paper Type.
14. Press ▼ to get to Tray 2.
15. Press ▼ to select Tray 2.
16. Using ▲ and ▼ , select the appropriate paper type (Plain 1).
17. Press **SELECT**, once Plain 1 is displayed on the lower line.
18. Now we have the Tray 2 Type set to Plain 1.
19. Now press **MENU** to get back to Ready to Print
20. Now insert the Letter-sized stack of paper into the Tray 2.
21. On the screen Tray 2/Letter will appear. (ONLY ON 3x00cn)
22. Press **SELECT** to confirm this. (ONLY ON 3x00cn)
23. Now on the screen Tray 2/Plain 1 will appear.
24. Press **SELECT** to confirm this.
25. We now have all the hardware settings on the printer correct

Now, all software settings screen shots are from WORD, this was done in Word. However if in any application, you go **File → Print** and then click the **Properties** button, you will get this same driver properties window.

26. Open up Word and create a new document.
27. Go to **File → Print**.
28. Select the Dell Color Laser Printer from the printers list
29. Click the **Properties** button to the right.
30. This brings up Driver Properties.
31. Click on the Paper Tray Tab.
32. Change the Paper Source to Tray 2.
33. Click the Paper Tab.
34. Select in paper size, Letter.
35. Select for Output Size, Same as Paper Size.
36. Click **OK**.
37. Click **Close**.
38. Now the printer driver is setup correctly.
39. Now go to **File → Page Setup**.
40. Click the Paper Tab.
41. Change Paper Size to Legal.
42. Change the Paper source settings BOTH to "DEFAULT TRAY AS PER PRINTER".
43. Click **OK**.
44. Type in some gibberish in the body of the document and click Print!

Setup printing Transparency from Multipurpose Feeder

1. On the printer operator panel press **MENU**.
2. Press ▼ to get to Tray Settings.
3. Press ► to select Tray Settings.
4. Press ▼ to get to Paper Size. (ONLY ON 3x00cn)
5. Press ► to select Paper Size. (ONLY ON 3x00cn)
6. Press ▼ to get to MPF. (ONLY ON 3x00cn)
7. Press ► to select MPF. (ONLY ON 3x00cn)
8. Using ▲ and ▼ , select the appropriate paper size (Transparency). (ONLY ON 3x00cn)
9. Press the middle button, **SELECT**, once Transparency is displayed on the lower line, this puts a * by it. (ONLY ON 3x00cn)
10. Now we have the MPF Size set to Transparency. (ONLY ON 3x00cn)

11. Now press **MENU** to get back to Tray Settings/Paper Size.
12. Press ▼ to get to Paper Type.
13. Press ► to select Paper Type.
14. Press ▼ to get to MPF.
15. Press ▼ to select MPF.
16. Using ▲ and ▼, select the appropriate paper type (Plain 1).
17. Press **SELECT**, once Plain 1 is displayed on the lower line.
18. Now we have the MPF Type set to Plain 1.
19. Now press **MENU** to get back to Ready to Print
20. Now insert the Transparency-sized stack of paper into the MPF.
21. On the screen MPF/Transparency will appear. (ONLY ON 3x00cn)
22. Press **SELECT** to confirm this. (ONLY ON 3x00cn)
23. Now on the screen MPF/Plain 1 will appear.
24. Press **SELECT** to confirm this.
25. We now have all the hardware settings on the printer correct

Now, all software settings screen shots are from WORD, this was done in Word. However if in any application, you go **File → Print** and then click the **Properties** button, you will get this same driver properties window.

26. Open up Word and create a new document.
27. Go to **File → Print**.
28. Select the Dell Color Laser Printer from the printers list
29. Click the **Properties** button to the right.
30. This brings up Driver Properties.
31. Click on the Paper Tray Tab.
32. Change the Paper Source to MPF.
33. Click the Paper Tab.
34. Select in paper size, Transparency.
35. Select for Output Size, Same as Paper Size.
36. Click **OK**.
37. Click **Close**.
38. Now the printer driver is setup correctly.
39. Now go to **File → Page Setup**.
40. Click the Paper Tab.
41. Change Paper Size to Legal.
42. Change the Paper source settings BOTH to "DEFAULT TRAY AS PER PRINTER".
43. Click **OK**.
44. Type in some gibberish in the body of the document and click Print!

Setup printing Envelope from Multipurpose Feeder

1. On the printer operator panel press **MENU**.
2. Press ▼ to get to Tray Settings.
3. Press ► to select Tray Settings.
4. Press ▼ to get to Paper Size. (ONLY ON 3x00cn)
5. Press ► to select Paper Size. (ONLY ON 3x00cn)
6. Press ▼ to get to MPF. (ONLY ON 3x00cn)
7. Press ► to select MPF. (ONLY ON 3x00cn)
8. Using ▲ and ▼, select the appropriate paper size (Envelope). (ONLY ON 3x00cn)
9. Press the middle button, **SELECT**, once Envelope is displayed on the lower line, this puts a * by it. (ONLY ON 3x00cn)
10. Now we have the MPF Size set to Envelope. (ONLY ON 3x00cn)

11. Now press **MENU** to get back to Tray Settings/Paper Size.
12. Press ▼ to get to Paper Type.
13. Press ► to select Paper Type.
14. Press ▼ to get to MPF.
15. Press ▼ to select MPF.
16. Using ▲ and ▼ , select the appropriate paper type (Plain 1).
17. Press **SELECT**, once Plain 1 is displayed on the lower line.
18. Now we have the MPF Type set to Plain 1.
19. Now press **MENU** to get back to Ready to Print
20. Now insert the Envelope-sized stack of paper into the MPF.
21. On the screen MPF/Envelope will appear. (ONLY ON 3x00cn)
22. Press **SELECT** to confirm this. (ONLY ON 3x00cn)
23. Now on the screen MPF/Plain 1 will appear.
24. Press **SELECT** to confirm this.
25. We now have all the hardware settings on the printer correct

Now, all software settings screen shots are from WORD, this was done in Word. However if in any application, you go **File → Print** and then click the **Properties** button, you will get this same driver properties window.

26. Open up Word and create a new document.
27. Go to **File → Print**.
28. Select the Dell Color Laser Printer from the printers list
29. Click the **Properties** button to the right.
30. This brings up Driver Properties.
31. Click on the Paper Tray Tab.
32. Change the Paper Source to MPF.
33. Click the Paper Tab.
34. Select in paper size, Transparency.
35. Select for Output Size, Same as Paper Size.
36. Click **OK**.
37. Click **Close**.
38. Now the printer driver is setup correctly.
39. Now go to **File → Page Setup**.
40. Click the Paper Tab.
41. Change Paper Size to Legal.
42. Change the Paper source settings BOTH to "DEFAULT TRAY AS PER PRINTER".
43. Click **OK**.
44. Type in some gibberish in the body of the document and click Print!

Setup Paper Size

1. Start Here
2. On the printer press **MENU**.
3. Press ▼ to get to Tray Settings.
4. Press ► to select Tray Settings.
5. Press ▼ to get to Paper Size.
6. Press ► to select Paper Size.
7. Press ▼ to get to MPF.
8. Press ► to select MPF.
9. Using ▲ and ▼ , select the appropriate paper size (Letter).
10. Press the middle button, **SELECT**, once Letter is displayed on the lower line, this puts a * by it.

11. Now we have the MPF Size set to Letter.
12. Now press **MENU** to get back to Tray Settings/Paper Size.
13. Press ▼ to get to Paper Type.
14. Press ► to select Paper Type.
15. Press ▼ to get to MPF.
16. Press ▼ to select MPF.
17. Using ▲ and ▼ , select the appropriate paper type (Plain 1).
18. Press **SELECT**, once Plain 1 is displayed on the lower line.
19. Now we have the MPF Type set to Plain 1.
20. Now press **MENU** to get back to Ready to Print
21. Now insert the Letter-sized stack of paper into the MPF.
22. On the screen MPF/Letter will appear.
23. Press **SELECT** to confirm this.
24. Now on the screen MPF/Plain 1 will appear.
25. Press **SELECT** to confirm this.
26. We now have all the hardware settings on the printer correct

Now, all software settings screen shots are from WORD, this was done in Word. However if in any application, you go **File → Print** and then click the **Properties** button, you will get this same driver properties window.

27. Open up Word and create a new document.
28. Go to **File → Print**.
29. Select the Dell Color Laser Printer from the printers list
30. Click the **Properties** button to the right.
31. This brings up Driver Properties.
32. Click on the Paper Tray Tab.
33. Change the Paper Source to MPF.
34. Click the **MPF Settings** button.
35. Select Plain 1 from the list of paper types.
36. Click **OK**.
37. Now click the Paper Tab.
38. Select in paper size, Letter.
39. Select for Output Size, Same as Paper Size.
40. Click **OK**.
41. Click **Close**.

Setup Paper Type

Paper type	Weight (gsm)	Remarks
Plain1	60-80	-
Plain2	81-105	-
Covers1	106-163	-
Covers2	164-216	-
Coated1	106-163	BJP (Bubble Jet Printer) paper cannot be used.
Coated2	164-216	BJP (Bubble Jet Printer) paper cannot be used.
Transparency	-	BJP (Bubble Jet Printer) paper cannot be used.
Label	-	BJP (Bubble Jet Printer) paper cannot be used.
Envelopes	-	-

Configuration

Parallel Printing

A local printer is a printer attached to your computer or a print server using a USB or parallel cable.

Installing Printer Drivers

Connecting the Printer to the Computer Before Inserting the Drivers and Utilities CD

Windows 98, Me, 2000, XP, and Server 2003

1. Connect your printer to your computer.
2. When the **Found New Hardware Wizard** appears, click **Cancel**.
3. Insert the *Drivers and Utilities* CD into your computer.
4. Click **Personal Installation**.
5. Click **Install**. The **Found New Hardware Wizard** appears.
6. Click **Next**. The wizard automatically finds and installs the corresponding printer driver.
7. When the **Complete the Found New Hardware Wizard** screen appears, click **Finish**.
8. Select either the **Typical Installation** or **Custom Installation** checkbox, and then click **Next**. If you select **Custom Installation**, you can select the specific software you want to install.
9. When using Windows 98 or Me, the Adobe License Agreement appears, click to accept the agreement and then click **Install**.
10. When the **Congratulations!** screen appears, in Windows 2000, Windows XP, and Server 2003, click **Printer Test Page** if necessary. Click **Finish**.
11. Click **Cancel**.

Windows 95 and NT 4.0

1. Connect your printer to your computer.
2. Insert the *Drivers and Utilities* CD into your computer.
3. Click **Personal Installation**.
4. On the **Add Printer** screen, select the port name from the **Port Name** combo box, and then set the printer's options under **Printer Configuration**. Click **Next**.
5. Select either the **Typical Installation** or **Custom Installation** checkbox, and then click **Next**. If you select **Custom Installation**, you can select the specific software you want to install.
6. The Adobe License Agreement appears, click to accept the agreement and then click **Install**.
7. When the **Congratulations!** screen appears, click **Finish**.
8. Click **Cancel**.

USB Printing

A local printer is a printer attached to your computer or a print server using a USB or parallel cable.

Installing Printer Drivers

Connecting the Printer to the Computer Before Inserting the Drivers and Utilities CD

Windows 98, Me, 2000, XP, and Server 2003

1. Connect your printer to your computer.
2. When the **Found New Hardware Wizard** appears, click **Cancel**.
3. Insert the *Drivers and Utilities* CD into your computer.
4. Click **Personal Installation**.
5. Click **Install**. The **Found New Hardware Wizard** appears.
6. Click **Next**. The wizard automatically finds and installs the corresponding printer driver.
7. When the **Complete the Found New Hardware Wizard** screen appears, click **Finish**.

8. Select either the **Typical Installation** or **Custom Installation** checkbox, and then click **Next**. If you select **Custom Installation**, you can select the specific software you want to install.
9. When using Windows 98 or Me, the Adobe License Agreement appears, click to accept the agreement and then click **Install**.
10. When the **Congratulations!** screen appears, in Windows 2000, Windows XP, and Server 2003, click **Printer Test Page** if necessary. Click **Finish**.
11. Click **Cancel**.

Windows 95 and NT 4.0

1. Connect your printer to your computer.
2. Insert the *Drivers and Utilities* CD into your computer.
3. Click **Personal Installation**.
4. On the **Add Printer** screen, select the port name from the **Port Name** combo box, and then set the printer's options under **Printer Configuration**. Click **Next**.
5. Select either the **Typical Installation** or **Custom Installation** checkbox, and then click **Next**. If you select **Custom Installation**, you can select the specific software you want to install.
6. The Adobe License Agreement appears, click to accept the agreement and then click **Install**.
7. When the **Congratulations!** screen appears, click **Finish**.
8. Click **Cancel**.

Setup Network

 **NOTE:** To use this printer in a UNIX or Linux environment, you need to install a UX Filter or Linux Driver. For more information on how to install and use these, refer to your User's Guide.

 **NOTE:** When using a CD drive in a Linux environment, you need to mount the CD according to your system environment. The command strings are mount/media/cdrom.

Print and Check the Printer Settings Page

1. Print the Printer Settings page.
 - a. When **Ready to Print** appears in the LCD, press **Menu**.
 - b. Press **▼** until **Configure** appears, and then press **▶** or **⏴**.
 - c. Press **▼** until **Reports** appears, and then press **▶** or **⏴**.
 - d. **Printer Settings** is displayed. Press **⏴**.

The Printer Settings page is printed.

2. Under the TCP/IP heading, verify the IP address.

If the IP address is 0.0.0.0, wait for a few minutes to resolve the IP address automatically, and then print the Printer Settings page again.

Run the Installation Software

1. Insert the *Drivers and Utilities* CD into your computer.
2. The *Drivers and Utilities* CD should launch the installation software automatically.

If the CD does not automatically launch, click **Start** → **Run**, type `D:\CDFB.exe` (where D is the drive letter of your CD), and then click **OK**.

3. When the *Drivers and Utilities* CD screen appears, click **Network Installation - Install the printer for use on a network**. If using Windows XP, Windows 2000, Windows NT 4.0, or Windows 2003 Server, go to step 4. For all other operating systems, go to step 5.
4. For local installation, select **Local Installation - Install printer on this computer**, and then click **Next**.

For remote installation:

- a. Select **Remote Installation - Install printer on one or more remote computers**, and then click **Next**.
 - b. Enter your Administrator user name, password, and clients or servers and then click **Add**.
 - c. Click **Next**.
5. Select the network printer you would like to install. If you do not see your printer listed, click **Update** to refresh the list or click **Add Printer** to add a printer to the network. You may update the IP address and port name at this point. Click **Next**.
6. Select your printer from the list. If you would like to change the printer name listed, enter a new name in the Printer Name field.
7. If you want other users on the network to access this printer, select **Share this printer with other computers on the network**, and then enter a share name that users will easily identify.
8. If you want to set a printer as the default, select the printer and then click the **Set this printer as default** check box.

9. If you want to restrict color printing, select the appropriate Color Track option. Enter the password.
10. If the PostScript (PS) Driver is available and you want to install it, click on the check box.
11. Click **Next**.
12. Select the software and documentation you want to install. You can specify the destination folder to install the Dell software and documentation. To change the destination folder, click **Browse...**
13. Click Next.
14. For PostScript Driver Installation Only- If the Adobe License Agreement appears, click to accept the agreement and then click **Install**.
15. When the Congratulations! screen appears, select whether or not to restart your computer, and then click **Finish**.

Use the Dell Printer Configuration Web Tool to monitor the status of your network printer without leaving your desk. You can view and/or change the printer configuration settings, monitor toner level, and when it is time to order replacement toner cartridges, just click the Dell supplies link right from your Web browser.

 **NOTE:** The **Dell Printer Configuration Web Tool** is not available when the printer is locally attached to a computer or a print server.

To launch the Dell Printer Configuration Web Tool, type the network printer IP address in your Web browser, and the printer configuration appears on the screen. Refer to your *User's Guide* for more information.

You can set up the Dell Printer Configuration Web Tool to send you an email when the printer needs supplies or intervention.

To set up email alerts:

1. Launch the Dell Printer Configuration Web Tool.
2. Click **E-Mail Alert** link.
3. Under **Setup E-Mail Lists and Alerts**, enter the Primary SMTP Gateway, the Reply Address, and enter your email address or the key operator's email address in the email list box.
4. Click **Apply New Settings**.

Setup Security

1. Press **Menu**.
2. Press **▼** until **Printer Settings** appears, and then press **▶** or **⏪**.
3. Press **▼** until **Printer Settings** appears, and then press **▶** or **⏪**.
4. Press **▼** until **Security Settings** appears, and then press **▶** or **⏪**. **Security Settings** is displayed.

Purpose:

To set or change the password to limit access to the menus from the operator panel.

Set the password of the **Dell Printer Configuration Web Tool** from **Set Password** in **Print Server Settings**.

Values:

Panel Lock	Specifies whether to limit access to the menus.
Change Password	Sets a password to limit access to the menus.
Re-enter Password	Type the new password again to confirm.

 **NOTE:** This menu sets a password to lock the operator panel. When changing the password for the **Dell Printer Configuration Web Tool**, click **Set Password** on the left frame and set the password.

Trouble Shooting Instructions

Use the Customer Mode to locate the unit in the printer that causes a problem.

Diagnostic Menu Map (Customer Mode)

1. Turn off the printer.
2. Turn on the printer while holding down ▲ and ▼ .
The Customer Mode menu appears.

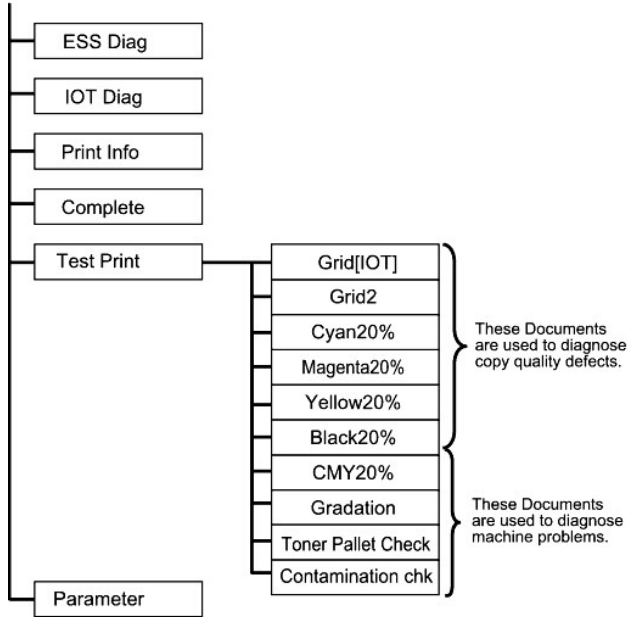

Testing "Print Quality"

"Print Quality" is used to diagnose print quality defects.

1. On the Customer Mode menu, go down to Cyan20%, Magenta20%, Yellow20%, or Black20% and press ↵ .

Cyan20%	Outputs cyan toner at 20% density on the whole area of the paper.
Magenta20%	Outputs magenta toner at 20% density on the whole area of the paper.
Yellow20%	Outputs yellow toner at 20% density on the whole area of the paper.
Black20%	Outputs black toner at 20% density on the whole area of the paper.

After you output the test results, contact Dell.

Testing "Toner Pallets Check" or "Contamination Check"

"Toner Pallet Check" and "Contamination Chk" are used to diagnose machine problems.

1. On the Customer Mode menu, go down to TonerPalletCheck or ContaminationChk, and press ↵ .

Toner Pallet Check	Allows you to identify the problem with the toner when print quality problems occur while printing pictures or photos.
Contamination Check	Allows you to check for any regular lines or spots when printing if print quality problems are occurring.

After you output the test results, contact Dell.

Clear NVRAM

You can restore the original factory default menu settings by initializing NVRAM.

1. Press **Menu**.
2. Press **▼** until *Configure* appears, and then press **▶** or **⏴**.
3. Press **▼** until *Maintenance* appears, and then press **▶** or **⏴**.
4. Press **▼** until *Init NVRAM* appears, and then press **▶** or **⏴**.
5. The *Init NVRAM Are you sure?* message appears on the operator panel. Press **⏴**.
6. Turn off the printer, and then on again.

Others

How to replace the Drum Cartridge

⚠ CAUTION: Before performing any of the following procedures, read and follow the safety instructions in your *Owner's Manual*.

Dell cartridges are available only through Dell. You can order more online at <http://www.dell.com/supplies> or by phone. To order by phone, see your *Owner's Manual*.

Dell recommends Dell drum cartridges for your printer. Dell does not provide warranty coverage for problems caused by using accessories, parts, or components not supplied by Dell.

🔍 NOTE: Remove any print jobs from the center output tray and close the multipurpose feeder cover before opening the top cover or front door.

🔍 NOTE: First pull the optional duplex module back if it is installed.

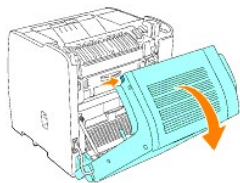

1. To open both covers on the printer, grab the notch in the front door and pull forward. Lift the top cover and push back.

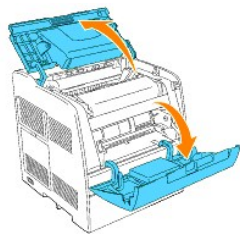

2. To remove the used drum cartridge, push up the lever on the right side of the printer.

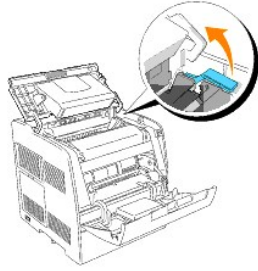

3. Grab the drum cartridge by the handle, and pull it up and out.

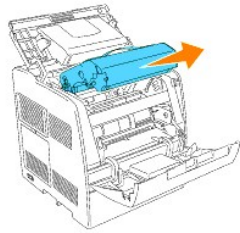

⚠ CAUTION: Do not touch inside the printer with your hands. Some parts may be hot. Allow time for the printer to cool before attempting to remove parts in this area.

4. Remove the protective sheet from the drum cartridge.

⚠ CAUTION: Do not touch the drum at the bottom of the drum cartridge.

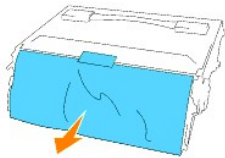

5. To insert the drum cartridge, push up the lever on the right side of the printer. With the lever in the upright position, hold the drum cartridge by the handle, align the arrows on the drum cartridge with the corresponding arrows on the printer and guide the cartridge in until it snaps into place.

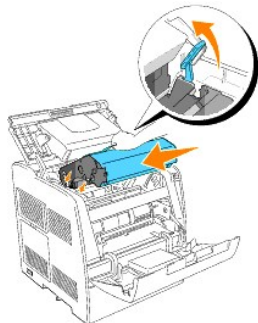

6. Pull down the lever on the right to lock the drum cartridge in place.

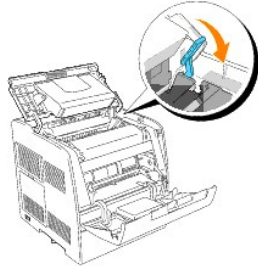

7. Close the top cover.

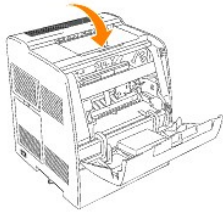

How to install the Toner Cartridge

⚠ CAUTION: Before performing any of the following procedures, read and follow the safety instructions in your *Owner's Manual*.

In addition to the toner level indicator that appears each time you send a job to print, a message appears on the operator panel to alert you when it's time to order a new toner cartridge.

Dell toner cartridges are available only through Dell. You can order more toner online at <http://www.dell.com/supplies> or by phone. To order by phone, see "Ordering Toner Cartridges" in your *Owner's Manual*.

Dell recommends Dell toner cartridges for your printer. Dell does not provide warranty coverage for problems caused by using accessories, parts, or components not supplied by Dell.

Selecting a Replacement Toner Cartridge

1. Press **Menu**.
2. Press **▼** until **Replace Toner** appears, and then press **▶** or **↵**.
3. Press **▲▼** until the desired toner to replace appears, and press **↵**.

🔧 NOTE: Each time you replace a black cartridge, you should use the cleaning rod. See "[Cleaning Inside the Printer](#)."

Replacing the Used Toner Cartridge

🔧 NOTE: Remove any print jobs from the center output tray and close the multipurpose feeder cover before opening the front door.

1. Grab the notch in the front door and pull forward.

The toner cartridge that must be replaced has moved to the front of the printer.

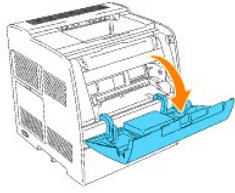

2. Push up the handhold on the right to unlock the cartridge.

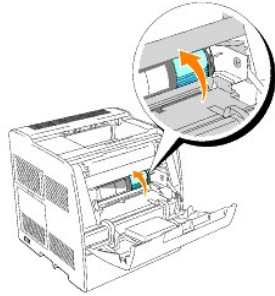

3. Hold the toner cartridge and pull out the cartridge.

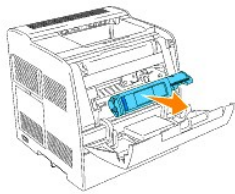

⚠ CAUTION: Do not touch inside the printer with your hands. Some parts may be hot.

4. Make sure the color of the toner cartridge matches the slot on the toner cartridge carrier. Gently shake the cartridge to distribute the toner evenly.

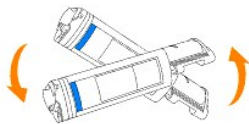

5. Lift the tab up 90 degrees and pull the toner seal straight off, keeping it parallel with the toner cartridge.

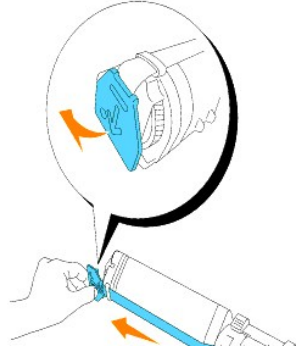

6. To insert the toner cartridge, align the arrows on the cartridge with the corresponding arrows on the printer. Guide the cartridge in until it snaps into place, and then push down the handhold to lock the cartridge in place.

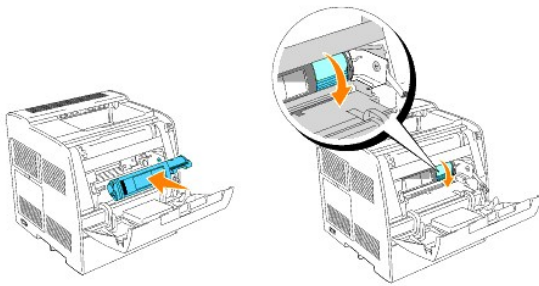

7. If replacing just one toner cartridge, close the front door and you are finished.

 **NOTE:** Make sure the toner cartridge is installed correctly. Otherwise, the front door cannot close firmly.

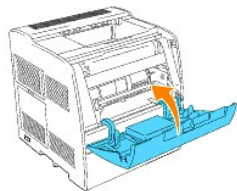

8. Repeat steps 4 through 7 when inserting the remaining cartridges.

Basic toner cleaning instructions

A cleaning rod for cleaning inside the printer is installed on your printer.

1. Open the front door.

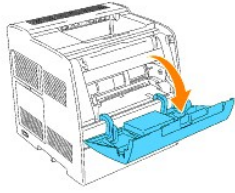

2. Pull out the slide bar that is inside the printer on the right side until it stops. The access window cover slides open.

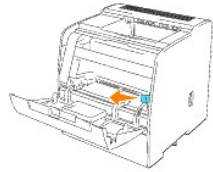

3. Hold the cleaning rod and push the rod in and pull out once to clean inside the printer.

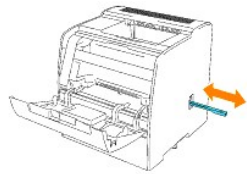

4. Push the slide bar back to its original position.
5. Close the front door.

Enterprise Console Management Modules

The following enterprise console management modules and user's manuals are available on your *Drivers and Utilities* CD under \Utilities\SnapIns:

- 1 IBM Tivoli® NetView®
- 1 CA Unicenter®
- 1 HP OpenView®

To use the modules, go to the following directory on your CD and run each **.exe** file or **.chm** file.

IBM Tivoli: \Utilities\SnapIns\IBM Tivoli

CA Unicenter: \Utilities\SnapIns\CA Unicenter

HP OpenView: \Utilities\SnapIns\HP OpenView

Printing With UX Filter (UNIX/Linux)

- [Overview](#)
 - [Installing the UX Filter](#)
 - [Uninstalling the UX Filter](#)
 - [Printing and Using the Utilities](#)
 - [Precautions and Limitations](#)
-

Overview

The UX Filter

This section describes the features of the UX filter and its operating environment.

Features

The UX filter is a utility software which converts files created by the UNIX workstation into a format which conforms to the PostScript language loaded in the printer. The utility provides software that converts text files, SunRaster image files (for Sun/Solaris only), TIFF image files and XWD image files into the PostScript language program. Also, it makes use of the printer features to output in the following manner.

- 1 Input paper selection
- 1 Double-sided printing
- 1 Output paper selection

➡ **NOTICE:** Depending on the configurations of the printers, some may not be able to use the UX filter.

Operating Environment

Text files, SunRaster image files (for Solaris only), TIFF image files and XWD image files received from a workstation connected to a printer by a USB cable or parallel cable (hereinafter referred to as the local workstation), or from one located on the network (hereinafter referred to as the remote workstation), can be converted into the PostScript language program and output to the printer.

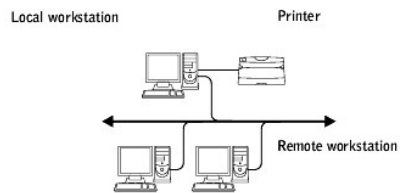

In addition, it can also be used in an environment where a printer, installed with an interface board, is connected directly to the network.

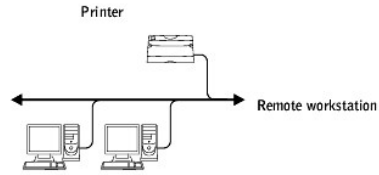

Before Using UX Filter

Check the following items before using the UX filter.
Before setting up the workstation, set up the printer as follows.

1. Make sure the lpd port is working or not when using the network environment. If the lpd port is not working, set LPP to ON on the operator panel. (Mandatory) See "[Protocol](#)" for more information.

When a parallel or USB port is to be used, make sure these are working. (Mandatory)
2. Set up IP address and subnet mask when the printer is used in the network environment. (Mandatory)
3. Make TBCPFilter function available if TBCPFilter function is installed on the printer. See "[Adobe Protocol](#)" for more information.

Installing the UX Filter

Before Installation

The following are required for the installation.

- 1 Supported operating system is described in "[Page-description Language \(PDL\)/Emulation, Operating System, and Interface.](#)"

Disk capacity: 20 MB of free disk space required, including temporary working space for installation.
- 1 Log on as a root account to perform the operation here. If you have no root privilege, contact your system administrator.
- 1 Output printer must be registered in the workstation before using UX filter. (HP-UX)
Use `sam` command for registration of output printer.
For more information, see the HP-UX related manual.

Files Added by the Installation

The following files will be added when the UX filter is installed.

Solaris

Directory	File name	Contents
/usr/local/dellbin3100cn	txt2ps2	Text conversion utility
	sunras2ps2	SunRaster conversion utility
	tiff2ps2	TIFF conversion utility
	xwd2ps2	XWD conversion utility
	dellpsif	Input filter
/usr/lib/lp/postscript	dellposttxt	Symbolic link file to txt2ps2
	dellpostps	Symbolic link file to dellpsif
	dellbinpath3100cn	Directory description file for the UX filter print tool
/usr/lib/lp/model	Model interface program	Source file of the model interface program (stored as the printer name during registration)
/etc/lp/interfaces	Model interface program	Interface program for PRINTER (stored as the printer name during registration)
/etc/lp/fd	dellposttxt.fd	Filter description file for txt2ps2

	dell3100cn.fd	dell3100cn filter description file for Dell Laser Printer 3100cn
	dellpostio.fd	dellpostio Filter description file
	delldownload.fd	delldownload Filter description file
/usr/share/man/man1	dellpsif.1	man file for dellpsif
	sunras2ps2.1	man file for sunras2ps2
	txt2ps2.1	man file for txt2ps2
	tiff2ps2.1	man file for tiff2ps2
	xwd2ps2.1	man file for xwd2ps2

 **NOTE:** The directories listed are default directories.

Linux

Directory	File name	Contents
/usr/local/dellbin3100cn	txt2ps2	Text conversion utility
	tiff2ps2	TIFF conversion utility
	xwd2ps2	XWD conversion utility
	printcap.sample	Printcap file sample
	dellpsif	Input Filter
	.dellpsdefault3100cn	Default command option file
/usr/share/man/man1	dellpsif.1	man file for dellpsif
	txt2ps2.1	man file for txt2ps2
	tiff2ps2.1	man file for tiff2ps2
	xwd2ps2.1	man file for xwd2ps2

 **NOTE:** The directories listed are default directories.

HP-UX

Directory	File name	Contents
/usr/local/dellbin3100cn	txt2ps2	Text conversion utility
	xwd2ps2	XWD conversion utility
	tiff2ps2	TIFF conversion utility
/usr/lib/lp/postscript	dellbinpath3100cn	Directory description file for the UX filter print tool
/usr/spool/lp/interface	Model interface program	Interface program for PRINTER (stored as the printer name during registration)
/usr/share/man/man1	txt2ps2.1	man file for txt2ps2
	tiff2ps2.1	man file for tiff2ps2
	xwd2ps2.1	man file for xwd2ps2

 **NOTE:** The directories listed are default directories.

Installation Procedure Overview

This section provides information on the installation of the UX filter using the UNIX workstation.

Linux

1. Setup the printer and network.
2. Insert the *Drivers and Utilities* CD into the local workstation.
3. Run the installer and begin the installation.
4. Edit `/etc/printcap` and print for testing the printer.

Solaris

1. Setup the printer and network.
2. Insert the *Drivers and Utilities* CD into the local workstation.
3. Run the installer and begin the installation.
4. Print for testing the printer.

HP-UX

1. Setup the printer and network.
2. Insert the *Drivers and Utilities* CD into the local workstation.
3. Run the installer and begin the installation.
4. Print for testing the printer.

Operation on Linux

Installation of Software

1. Insert the *Drivers and Utilities* CD in the CD-ROM drive of the local workstation.
If CD-ROM drive is not mounted on your workstation, extract files by using another workstation that has a CD-ROM drive to transfer those files to your workstation.
2. Log on as a root account and extract the installation script from the *Drivers and Utilities* CD.

 **NOTICE:** If you have no root privilege, contact your system administrator.

```
# mount /dev/cdrom /mnt/cdrom
# cd /tmp
# cp /mnt/cdrom/UNIXFilter/Linux/UXFILTER.tar /tmp
# tar xvf ./UXFILTER.tar
```

 **NOTE:** CD-ROM is sometimes mounted automatically.

3. Type `./install.sh` and run the installer.

```
#!/install.sh
```

4. Select the printer model to install.

```
Printer Model?
  1. Dell Laser Printer 3100cn
  2. Exit
Enter Process No(1/2)? : 1
```

5. It asks whether you want to install the filter. Type `<y>`.

```
Install Filter? (y/n) [y] : y
```

 **NOTE:** If [] appears in a message, the default value will appear inside the []. It will be selected when you press the <Enter> key.

The disk status on the workstation appears. 20 MB of free disk space is required for the installation of the filter.

6. Specify the directory to install the filter. To install into `/usr/local/dellbin3100cn`, press the <Enter> key. To change the directory, specify one. Change the directory to.

```
Enter Library directory name [/usr/local/dellbin3100cn]
```

7. Confirm the directory to be installed.

```
directory is '/usr/local/dellbin3100cn' (y/n)[n] : y
```

The software installation is complete.

Setting the Printer

Write printer setting in `/etc/printcap` or `/etc/printcap.local` referencing `/usr/local/dellbin3100cn/printcap.sample`.

Linux (LPRng):

/etc/printcap.local Or /etc/printcap

```
lp:\
:bk:\
:bkf:\
:lpd_bounce=true:\
:sd=/var/spool/lpd/lp:\
:af=/var/spool/lpd/lp/lp.acct:\
:lf=/var/spool/lpd/lp/log:\
:rm=PrinterHostName:\
:rp=ps:\
:if=/usr/local/dellbin3100cn/dellpsif:
```

- ➔ **NOTICE:** The directory to spool can be created in the partition with sufficient disk space. If there is no spooling directory, it is not possible to print large files.
- ➔ **NOTICE:** The account files or logging files can be created with the file name specified in the directory path specified.

Operation on Solaris

Installation/Printer Setting

1. Insert the *Drivers and Utilities* CD in the CD-ROM drive of the local workstation.
If CD-ROM drive is not mounted on your workstation, extract files by using another workstation that has a CD-ROM drive to transfer those files to your workstation.
2. Log on as a root account and extract the installation script from the *Drivers and Utilities* CD.

- ➔ **NOTICE:** If you have no root privilege, contact your system administrator.

```
# cd /tmp
# cp /cdrom/cdrom0/UNIXFilter/Solaris/UXFILTER.tar /tmp
# tar xvf ./UXFILTER.tar
```

3. Type `./install.sh` and run the installer.

```
# ./install.sh
```

4. Select the printer model to install.

```
Printer Model ?
 1. Dell Laser Printer 3100cn
 2. Exit
Enter Process No (1/2)? : 1
```

5. The following menu appears. Select `<1>` and set up the local printer.

```
Solaris Installation for Dell Laser Printer 3100cn Type Printer
 1. Set Local Printer
 2. Set Remote Printer
Enter Process No (1/2)? : 1
```

6. Type the device name of the connection port.

```
Enter port-device-name? [/dev/ecpp0] : /dev/bpp0
```

- ➔ **NOTICE:** Specify the device file in the communication port available.

7. When `Set Remote Printer` is selected, type the host name of the server or the host name of the printer.

```
Enter server-hostname? : server
server-hostname is 'server' (y/n)[y] : y
```

- ➔ **NOTICE:** The host name of the server must be pre-registered with DNS, NIS, NIS+ or /etc/hosts.

8. When `Set Remote Printer` is selected, type the remote printer name.

```
Enter server-printer-name? : ps
server-printer-name is 'ps' (y/n)[y] : y
```

- ➔ **NOTICE:** Type `ps` when the printer is a network connection printer.

9. Type the printer name to be registered with the system.

```
Enter printer-name? [dell3100cn] : dell3100cn
Printer-name is 'dell3100cn' (y/n)[y] : y
```

10. Specify the directory to install the utility. To install into `/usr/local/dellbin3100cn`, press the `<Enter>` key. To change the directory, specify one.

```
Enter Binary directory name? [/usr/local/dellbin3100cn] :
```

11. If this utility has been installed earlier, the user will be prompted whether to overwrite the earlier version.

```
directory is '/usr/local/dellbin3100cn' (y/n)[n] : y
```

12. If the server input at step 5 the printer connected by the network, type `<y>`. If the server and the printer are connected locally, type `<n>`.

```
'dell3100cn' is network printer?: (y/n)[y] : y
```

13. When the other filters have been registered in your workstation, the following message appears. Type `<y>`.

```
Do you want remove 'XXXXXX' filter and re-install (y/n) [y]
```

The software installation is complete.

 **NOTICE:** When the printing settings are modified or changed by the Administration Tool (admintool) after the installation, printing may not work.

Operation on HP-UX

Installation Procedure

 **NOTE:** The host name of the output printer which you want to specify in step 6 must be pre-registered with a `sam` command.

1. Insert the *Drivers and Utilities* CD into the CD-ROM drive of the local workstation.
2. Log on as a root account and extract the installation script from the *Drivers and Utilities* CD.

 **NOTICE:** If you have no root privilege, contact your system administrator.

```
# mount -F cdfs -o cdcase /dev/dsk/c1t2d0 /cdrom
# cd /tmp
# cp /cdrom/UNIXFilter/HP-UX/UXFILTER.tar /tmp
# tar xvf UXFILTER.tar
```

 **NOTE:** `/dev/ds/c1t2d0` is an example. Specify the CD-ROM device file for all workstations.

3. Type `./install.sh` and run the installer.

```
# ./install.sh
```

4. Select the printer model to install.

```
Printer Model ?
 1. Dell Laser Printer 3100cn
 2. Exit
Enter Process No (1/2)? : 1
```

5. Specify the directory to install the utility.

```
Enter install directory name /usr/local/dellbin3100cn :
directory is '/usr/local/dellbin3100cn' (y/n)[n]: y
```

6. Type the name of the output printer. Type `dell1p3100cn`. Type the printer name to be registered with the system.

```
Enter output-printer-name? : dell1p3100cn
output-printer-name is 'dell1p3100cn' (y/n)[y]: y
```

 **NOTE:** The registered printer name can be verified by executing `lpstat -v`.

7. Type the logical printer name. Register `dell3100cn`. Type a printer name that has not already been registered with the system.

```
Enter logical-printer-name? : dell3100cn
Printer-name is 'dell3100cn' (y/n)[y]: y
```

8. The utility will be installed in the directory specified at step 5. Registration will be executed here so that the logical printer registered at step 7 can

access the utility. As this process is automatically executed, no input is required. With the above steps, the installation is complete.

Uninstalling the UX Filter

About Uninstalling

The UX filter does not come with an uninstaller. To uninstall the UX filter, follow the following procedure.

➔ **NOTICE:** Log on as a root account to perform the operation here. If you have no root privilege, contact your system administrator.

Linux

1. Delete the descriptions for each printer from `/etc/printcap`.
2. Delete the added spool directory.
3. Restart `lpd`.
4. Delete all the directories that contain the UX filters and the files in these directories created during the installation. The following directories must be deleted.

```
/usr/local/dellbin3100cn
```

The above directories are standard directories created during the installation. If you had specified other directories for the installation, delete those directories.

Solaris

1. Delete the printer that was registered with the system. Use the printer name created during the installation and the `lpadmin` command.

```
# lpadmin -x printername
```

2. Delete the filters registered with the system. Delete the filters registered during the installation using the `lpfilter` command.

```
# lpfilter -f dell3100cn -x (for Dell Laser Printer 3100cn)
# lpfilter -f delldownload -x
# lpfilter -f dellpostio -x
# lpfilter -f dellposttxt -x
```

3. Delete the symbolic files required to call up the filter. Delete the following files from `/usr/lib/lp/postscript`.

```
dellposttxt
dellpostps
dellbinpath3100cn
```

4. Delete the interface program files of *Selected printer type name* from `/usr/lib/lp/model`. Please also delete the interface program files of *Selected printer name* from `/etc/lp/interfaces`.
5. Delete all the directories that contain the UX filters and the files in these directories created during the installation. The following directories must be deleted.

```
/usr/local/dellbin3100cn
```

6. Delete the filter description files. Delete the following files from `/etc/lp/fd`. Filter description files for various printers.

```
dell3100cn.fd (for Dell Laser Printer 3100cn)
delldownload.fd
dellpostio.fd
dellposttxt.fd
```

HP-UX

1. Delete the printer that was registered with the system. Use the `sam` command to delete the printer set up during the installation.

```
# sam
```

2. Delete all the directories that contain the UX filters and the files in these directories created during the installation. The following directories must be deleted.

```
/usr/local/dellbin3100cn (directory specified during the installation)
```

Printing and Using the Utilities

Printing (Linux)

This section provides information on printing with the filter.
To print, specify the printer registered with `/etc/printcap` as the output destination.

Printing From Linux

To print to the default printer:

If the printer is registered as the default printer, the name of the printer can be shortened and specified as shown in the following example.

```
% lpr filename
```

To print to other printers:

To print to a printer named `dell3100cn`, type as follows.

```
% lpr -Pdell3100cn filename
```

To select a paper tray for printing:

To select a paper tray, you need to define a printer which uses the desired tray by using a `.dellpsdefault3100cn` file in your home directory. After setting the `.dellpsdefault3100cn` file, you can print using the command.

```
% lpr -Ptray2 filename
```

About `/usr/local/dellbin3100cn/.dellpsdefault3100cn`:

This is the file for system default settings when using various utilities via `/etc/printcap`. Hereinafter, it is referred to as the *default command option setting file*.

Method:

To define a printer named `a4d` which prints on A4 with the long-edge binding feature turned on, follow the following steps.

Procedure:

1. Register the printer `a4d` with `/etc/printcap`.

Linux (LPRng):

`/etc/printcap.local` or `/etc/printcap`

```
a4d:\
:bk:\
:bkf:\
:lpd_bounce=true:\
:sd=/var/spool/lpd/a4d:\
:af=/var/spool/lpd/a4d/a4d.acct:\
:lf=/var/spool/lpd/a4d/log:\
:rm=PrinterHostName:\
:rp=ps:\
:if=/usr/local/dellbin3100cn/dellpsif_a4d:
```

2. Log on as the root account and create the symbolic links for `dellpsif_a4d` of IF Filter for printing on A4 with the long-edge binding feature turned on.

```
# ln -s /usr/local/dellbin3100cn/dellpsif /usr/local/dellbin3100cn/dellpsif_a4d
```

3. Add the following descriptions to the default command option setting file that specifies the user defined commands of the `dellpsif_a4d` of IF Filter.

```
dellpsif_a4d -IA4 -D
```

4. When the printer name `a4d` is specified, printing can be done on A4 with the long-edge binding feature turned on.

```
% lpr -Pa4d filename
```

Printing (Solaris)

This section provides information on printing that makes use of the filter. To print from Solaris, specify the printer registered during the installation of filters as the output destination.

- 🔔 **NOTICE:** To use the `lp` command, make sure the operating environment of the spooler has been set up correctly (enabled, available) using the `lpstat` command (`lpstat -p all`). For details on the options of the `lp` command and the `lpstat` command or how to make use of them, see the related manuals of Solaris.

Printing From Solaris

To print to the default printer:

If the printer is registered as the default printer, the name of the printer can be shortened and specified as shown in the following example.

```
% lp filename
```

To print to other printers:

To print to a printer named `dell3100cn`, type as follows.

```
% lp -d dell3100cn filename
```

- 🔔 **NOTE:** The name of the printer can be confirmed by executing `lpstat -v`.

To change the default printer temporarily for printing:

To change the default printer, set the printer name in the environment variable `LPDEST`.
To set a printer named `dell3100cn` as the default printer for printing, type as follows.

```
% setenv LPDEST dell3100cn  
% lp filename
```

- 🔔 **NOTE:** Using this method, a default printer can be set up for each user.
- 🔔 **NOTE:** The above example describes the setup method executed when `csh` is used.

To select a paper tray for printing:

To select a paper tray for printing, specify the paper tray after the `-y` option of the `lp` command.

- 🔔 **NOTE:** Depending on installed options, the available paper trays are different.

To select and print to a letter size paper of the printer named `dell3100cn` with landscape, specify as follows.

```
% lp -d dell3100cn -y landscape -y letter filename
```

The following options can be specified by the `lp` command.
To print text files:

- 🔔 **NOTE:** It prints according to the length and width specified by the `lpadmin` command.

`-y double`

Sets printing to 2-column printing.

`-y landscape`

Rotates the image by 90° and uses the paper in the landscape orientation.

`-y size=n`

Sets the font size to `n` point.

`-y outcolumn=n`

This option converts text to single-byte text and sets printing to start from the *n*th column.

`-y outline=n`

Sets printing to start from the *n*th line.

`-y font=font`

Sets the font for printing single-byte alphanumeric characters. If the font specified is not available for the printer, the default fonts are used.

 **NOTE:** To specify a font, type the font name as-is after the `-y font=` option.
`% lp -y font=Courier-Oblique filename`

 **NOTE:** For information on the available fonts, see the PS Fonts List.

`-y margin=u:b:r:l`

Specifies the margin of a page in inches. The *u* (upper margin), *b* (bottom margin), *r* (right margin), and *l* (left margin) are positive real numbers (up to two decimal points). The default is 0.

To print text/PostScript files:

`-y DuplexBook`

Enables the long-edge binding feature. When it is specified, the printing direction or position will be adjusted and both sides of the paper printed so that the longer edge of the pages can be bound.

`-y DuplexList`

Enables the short-edge binding feature. When it is specified, the printing direction or position will be adjusted and both sides of the paper printed so that the shorter edge of the pages can be bound.

`-y tray=input`

The paper tray-related parameters that can be specified by the `lp` command are as follows.

 **NOTE:** When you specify `com 10`, `MxNmm` or `MxNin` and so on, also specify the `-y msi` option.

`tray1`
Feed paper from tray 1 (standard 250-sheet tray module).

`tray2`
Feed paper from tray 2 (optional 250-sheet tray module or 500-sheet tray module).

`a4`
Feed paper from the tray loaded with A4 (210 x 297 mm).

`a5`
Feed paper from the tray loaded with A5 (148 x 210 mm).

`b5`
Feed paper from the tray loaded with B5 (182 x 257 mm).

`letter`
Feed paper from the tray loaded with Letter (8.5 x 11 inches).

`folio`
Feed paper from the tray loaded with Folio (8.5 x 13 inches).

`legal`
Feed paper from the tray loaded with Legal (8.5 x 14 inches).

`executive`
Feed paper from the tray loaded with Executive (7.25 x 10.5 inches).

`monarch`
Feed paper from the tray loaded with Monarch (3.875 x 7.5 inches).

`com10`
Feed paper from the tray loaded with Envelope #10 (4.125 x 9.5 inches).

`d1`
Feed paper from the tray loaded with DL (110 x 220 mm).

`c5`
Feed paper from the tray loaded with C5 (162 x 229 mm).

`MxNmm`
Feed paper from the tray loaded with MxNmm defined by users.
Possible range specified:
Width: 90.0 to 215.9 mm
Length: 139.7 to 355.6 mm

`MxNin`

Feed paper from the tray loaded with MxNinches defined by users.
Possible range specified:
Width: 3.54 to 8.50 inches
Length: 5.50 to 14.0 inches
If this option is not specified or the tray specified tray is not available, feed paper from the default tray.

`-y toner_save`
Turns on the *save toner* mode for printing. The print result will be fainter than that of normal printing.

`-y nc=n`
Specifies the number of output copies (the value of copies must be a positive integer). If this option is not specified, 1 will be selected.

`-y ps`
The input file will be processed as the PostScript file. If the file does not begin with `%!`, `%!` will be output to the beginning line. If a file contains `%!`, this option will be ignored.

`-y msi`
Specifies Multipurpose Feeder.

`-y m=type`
Specifies Multipurpose Feeder Paper Type.

Available Multipurpose Feeder Paper Types are as follows.

B
FinePaper/Bond/Plain Paper 2

BB
FinePaperBack/Bond/Plain Paper 2 - Side 2

P
Stationary/Plain/Plain Paper 1

PB
StationaryBack/Plain/Plain Paper 1 - Side 2

H1
ThickPaper/Heavyweight 1/Covers 1

H1B
ThickPaperBack/Heavyweight 1/Covers 1 - Side 2

H2
ThickPaper2/Heavyweight 2/Covers 2

H2B
ThickPaper2Back/Heavyweight 2/Covers 2 - Side 2

OHP
Transparency

L
LabelPaper/Labels

C1
CoatingPaper1/Coated 1/Coated Paper 1

C1B
CoatingPaper1Back/Coated 1/Coated Paper 1 - Side 2

C2
CoatingPaper2/Coated 2/Coated Paper 2

C2B
CoatingPaper2Back/Coated 2/Coated Paper 2 - Side 2

E
Envelope

If this option is not specified, Multipurpose Feeder Paper Type for the printer can be used.

`-y mfo=mode`

Specifies orientation for Multipurpose Feeder.

Available orientations for Multipurpose Feeder are as follows.

le
Landscape

ler
Landscape (Rotated)

se
Portrait

ser

Portrait (Rotated)

-y po=n

Specifies Alternate Tray.

Available Alternate Trays are as follows.

0

Use Printer Settings

1

Display Message

2

Feed from Multipurpose Feeder

3

Use Nearest Size (Adjust to Fit)

4

Use Larger Size (Adjust to Fit)

5

Use Nearest Size (No Zoom)

6

Use Larger Size (No Zoom)

-y st=mode

Specifies Feed Separators from.

Available Feed Separators from the following.

auto

AutoTray/Auto

1

1stTray/Tray 1 (standard 250-sheet tray module)

2

2ndTray/Tray 2 (optional 250-sheet tray module or 500-sheet tray module)

off

Off

-y sp

Specifies Printed Separators

-y sb

Specifies Skip Blank Pages.

-y cm=mode

Specifies Output Color.

Available Output Colors are as follows.

c

Color (CMYK)

k

Black

-y pr=mode

Specifies Print Mode.

Available Print Modes are as follows.

hs

High Speed

hq

High Quality

-y cc=mode

Specifies RGB Color Correction.

Available RGB Color Corrections are as follows.

0

Off

1
Photo

2
sRGB

3
Standard/ Normal

4
Presentation

This option is available only for color printing.

`-y gc=mode`

Specifies RGB Gamma Correction.

Available RGB Gamma Corrections are as follows.

1.0
1.0

1.4
1.4

1.8
1.8

2.2
2.2

2.6
2.6

off
Off

`-y sc=mode`

Specifies Screen.

Available Screens are as follows.

0
Fineness

1
Gradation

2
Auto

3
For Transparency

`-y gg=mode`

Specifies Gray Guaranteed.

Available Gray Guaranteed modes are as follows.

on
On

off
Off

This option is available only for color printing.

`-y ct`

Specifies Color Transformation.

This option is available only for color printing.

Printing (HP-UX)

This section provides information on printing from the registered logical printer during the installation.

Printing From HP-UX

To print to the default printer:

If the printer is registered as the default printer, the name of the printer can be shortened and specified as shown in the following example.

```
% lp filename
```

To print to other printers:

To print to a printer named dell3100cn, type as follows.

```
% lp -d dell3100cn filename
```

To change the default printer temporarily for printing:

To change the default printer, set the printer name in the environment variable PRINTER.
To set a printer named dell3100cn as the default printer for printing, type as follows.

```
% setenv PRINTER dell3100cn  
% lp filename
```

To print with added options:

To print with the options, specify the option of the lp command using -o as follows.

The available options are the same as txt2ps2/tiff2ps/xwd2ps2.

Depending on installed options, the available paper trays are different.

```
%lp -d dell3100cn -o r -o ILT filename
```

To print using file format:

To print text files:

```
% lp -d dell3100cn filename
```

To print XWD files:

```
% lp -d dell3100cn -o XWD filename
```

To print TIFF format files:

```
% lp -d dell3100cn -o TIF filename
```

To print PostScript files:

```
% lp -d dell3100cn filename
```

To print PostScript files as text files:

```
% lp -d dell3100cn -o TX filename
```

However, for PostScript files with options set up, such as paper selection, etc., when the same option is specified, it will be ignored.

txt2ps2 (Linux/Solaris/HP-UX)

Format

```
/usr/local/dellbin3100cn/txt2ps2 [-d] [-D] [-Itray-input] [-t] [-2] [-r] [-F] [-l|lines] [-w|columns] [-o|outcolumns] [-L|outlines] [-en] [-ssize] [-E] [-ffont] [-Nc=copies] [-ps] [-mg=up:bottom:right:left] [-Hd=position:format:page] [-Hffont] [-MSI] [-M=type] [-Mfo=mode] [-Pon] [-St=mode] [-Sp] [-Sb] [-Cm=mode] [-Pr=mode] [-Cc=mode] [-Gc=mode] [-Sc=mode] [-Gg=mode] [-Ct] {filename...}
```

Function

Reads text, converts it to the PostScript language program, and writes to standard output. If the filename is not specified, the standard input will be taken as the command input.

By typing character strings in the environmental variable TXT2PS2OPTION, the input of option at the command line can be omitted.

At the environmental variable TXT2PS2OPTION and the command line, if no option is specified, the printer will output in 10-point font size in the portrait orientation.

At the environmental variable TXT2PS2OPTION and the command line, if the same option is specified, the one specified at the command line will prevail.

txt2ps2 outputs the PostScript language program that adjusts the line/column according to the paper size. For this reason, the user need not be aware of the paper size. If there is an option to specify the line/column, automatic line feed according to the paper size will not be executed. Printing will be output

according to the line/column specified.
txt2ps2 interprets the following control codes. Other control codes/undefined codes will be converted to octal numbers and output as-is.

LF

Line feed

FF

Form feed (modifiable by option)

TAB

8-column tab stop (modifiable by option)

BS

Backspace 1 character

Option

-d

Enables the short-edge binding feature. When it is specified, the printing direction or position will be adjusted and both sides of the paper printed so that the shorter edge of the pages can be bound. This option is available only when optional duplex module is installed on the printer.

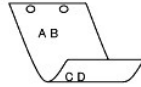

-D

Enables the long-edge binding feature. When it is specified, the printing direction or position will be adjusted and both sides of the paper printed so that the longer edge of the pages can be bound. This option is available only when optional duplex module is installed on the printer.



-Itray-input

Specifies the paper tray. A paper tray can be selected by directly specifying a tray or by specifying a paper size. When a paper size is specified, the tray loaded with paper of the specified size will be found and selected automatically. The parameters for selecting a paper tray are as follows.

1

Feed paper from tray 1 (standard 250-sheet tray module).

2

Feed paper from tray 2 (optional 250-sheet tray module or 500-sheet tray module).

A4

Feed paper from the tray loaded with A4 (210 x 297 mm).

A5

Feed paper from the tray loaded with A5 (148 x 210 mm).

B5

Feed paper from the tray loaded with B5 (182 x 257 mm).

LT

Feed paper from the tray loaded with Letter (8.5 x 11 inches).

FL

Feed paper from the tray loaded with Folio (8.5 x 13 inches).

LG

Feed paper from the tray loaded with Legal (8.5 x 14 inches).

EX

Feed paper from the tray loaded with Executive (7.25 x 10.5 inches).

MO

Feed paper from the tray loaded with Monarch (3.875 x 7.5 inches).

COM10

Feed paper from the tray loaded with Envelope #10 (4.125 x 9.5 inches).

DL

Feed paper from the tray loaded with DL (110 x 220 mm).

C5

Feed paper from the tray loaded with C5 (162 x 229 mm).

MxNmm

Feed paper from the tray loaded with MxNmm defined by users.
Possible range specified:
Width: 90.0 to 215.9 mm
Length: 139.7 to 355.6 mm

MxNin

Feed paper from the tray loaded with MxNinches defined by users.
Possible range specified:
Width: 3.54 to 8.50 inches
Length: 5.50 to 14.0 inches

If this option is not specified or the tray specified is not available, feed paper from the default tray.

-t

Turns on the *save toner* mode for printing. The print result will be fainter than that of normal printing. In some cases, this option will be ignored.

-2

Sets printing to 2-column printing.

-r

Rotates the image by 90° and uses the paper in the landscape orientation.

-F

Ignores the form feed code (FF).

-l*lines*

Specifies the number of lines per page.

-w*columns*

Specifies the number of columns per line.

-o*outcolumns*

Converts print data to single-byte text and sets printing to start from outcolumns.

`-Loutline`

Prints text from the outline columns.

`-en`

Expands horizontal tabs to *n* columns (space). The default is 8.

`-ssize`

Specifies the font size as point size. The default is 10.

`-E`

This function turns on the image enhancement function. In some cases, this option will be ignored.

`-ffont`

Sets the font.



NOTE: The available fonts are limited to the font in the printer. For more information, see "[Understanding Fonts](#)."

`-Nc=copies`

Specifies the number of output copies (the value of copies must be a positive integer).

`-ps`

The input file will be processed as the PostScript file. If the file does not begin with `%!`, `%!` will be output to the beginning line. If a file contains `%!`, it will be processed in the same way as `dellpsif`.

`-mg=up:bottom:right:left`

Specifies the margin of a page in inches. The upper margin, bottom margin, right margin, and left margin are positive real numbers (up to two decimal points). The default is 0.

`-mg=0:0:0:3`

Sets the left margin to 3 inches.

`-mg=3:3:0:5`

Sets the upper margin to 3 inches; bottom margin, 3 inches; and left margin, 5 inches. If the margin is 0, it can be omitted.

`-mg:::3`

Sets the left margin to 3 inches.

`-Hd=position:format:page`

Specifies the position that the user information of the header or footer is output at. *position* specifies output position. But this option is available only for converting text files.

`ul`

Output on the upper left corner of the paper.

`ur`

Output on the upper right corner of the paper.

`dl`

Output on the lower left corner of the paper.

`dr`

Output on the lower right corner of the paper.

format specifies the contents and the order to output. This option is omissible.
If this option is omitted, *uh* is specified as the default value.

u

User name

h

Host name

t

Date and time

If the output contents are specified as *tuh*, it is output as follows.
Date and Time User: *username* Host: *hostname*

page specifies the page to output. This option is omissible.

f

Output the top page only.

(default in case of PostScriptfiles conversion)

a

Output all pages.

(default in case of Text files conversion)

Specify these options as follows.

In the case that convert text file, output the host name following the user name on the upper right corner of the paper, output all pages.
(User name, Host name, all page output are default)

-Hd=ur
-Hd=ur:uh
-Hd=ur:uh:a

In the case that convert PostScript file, output the host name following the date and time on the lower left corner of the paper, output all pages (a option value is necessary because *output the top page only* is default when PostScript file is converted.)

-Hd=dI:th:a

➡ **NOTICE:** If the paper size is not specified, it outputs the header and footer at the position of A4 size by default. If the paper size is specified by *1p* command, the output position of the header or footer is not changed from the position of the paper size specified by *txt2ps2*. Specify the paper size at the same time when the header and footer option is used. Sometimes all pages are not printed despite specifying all page output when PostScript file conversion is specified. In such cases, specify *output the top page only*. By using TZ environmental variable, specify time zone (GMT etc.).

-Hf font

Specify the font to print the header and footer. European fonts the same as half size alphanumeric fonts can be specified. Helvetica is specified as default. If the wrong font is specified, the default European font of the printer can be used. If the header/footer output option is specified, the font specification for the header/footer is ignored.

-MSI

Specifies Multipurpose Feeder.

-M= type

Specifies Multipurpose Feeder Paper Type.
Available Multipurpose Feeder Paper Types are as follows.

B

FinePaper/Bond/Plain Paper 2

BB

FinePaperBack/Bond/Plain Paper 2- Side 2

P

Stationary/Plain/Plain Paper 1

PB

StationaryBack/Plain/Plain Paper 1 - Side 2

H1

ThickPaper/Heavyweight 1/Covers 1

H1B

ThickPaperBack/Heavyweight 1/Covers 1 - Side 2

H2

ThickPaper2/Heavyweight 2/Covers 2

H2B

ThickPaper2Back/Heavyweight 2/Covers 2 - Side 2

OHP

Transparency

L

LabelPaper/Labels

C1

CoatingPaper1/Coated 1/Coated Paper 1

C1B

CoatingPaper1Back/Coated 1/Coated Paper 1 - Side 2

C2

CoatingPaper2/Coated 2/Coated Paper 2

C2B

CoatingPaper2Back/Coated 2/Coated Paper 2 - Side 2

E

Envelope

If this option is not specified, Multipurpose Feeder Paper Type of the printer can be used.

`-Mfo=mode`

Specifies orientation for Multipurpose Feeder.
Available orientations for Multipurpose Feeder are as follows.

le

Landscape

ler

Landscape (Rotated)

se

Portrait

ser

Portrait (Rotated)

`-Pon`

Specifies Alternate Tray.
Available Alternate Trays are as follows.

0

Use Printer Settings

1

Display Message

2

Feed from Multipurpose Feeder

3

Use Nearest Size (Adjust to Fit)

4

Use Larger Size (Adjust to Fit)

5

Use Nearest Size (No Zoom)

6

Use Larger Size (No Zoom)

-St=mode

Specifies Feed Separators from.
Available Feed Separators froms are as follows.

auto

AutoTray/Auto

1

1stTray/Tray 1 (standard 250-sheet tray module)

2

2ndTray/Tray 2 (optional 250-sheet tray module or 500-sheet tray module)

off

Off

-Sp

Specifies Printed Separators

-Sb

Specifies Skip Blank Pages.

-Cm=mode

Specifies Output Color.
Available Output Colors are as follows.

c

Color (CMYK)

k

Black

-Pr=mode

Specifies Print Mode.
Available Print Modes are as follows.

hs

High Speed

hq

High Quality

`-Cc=mode`

Specifies RGB Color Correction.
Available RGB Color Corrections are as follows.

0

Off

1

Photo

2

sRGB

3

Standard/ Normal

4

Presentation

This option is available only for color printing.

`-Gc=mode`

Specifies RGB Gamma Correction.
Available RGB Gamma Corrections are as follows.

1.0

1.0

1.4

1.4

1.8

1.8

2.2

2.2

2.6

2.6

off

Off

`-Sc=mode`

Specifies Screen.
Available Screens are as follows.

0

Fineness

1

Gradation

2

Auto

3

For Transparency

-Gg=mode

Specifies Gray Guaranteed.
Available Gray Guaranteed options are as follows.

on

On

off

Off

This option is available only for color printing.

-ct

Specifies Color Transformation.
This option is available only for color printing.

Example

To convert the program list of the `file.txt` file into the PostScript language program that sets the paper to the landscape orientation and prints in the 2-column mode, type as follows:

```
% txt2ps2 -r -2 file.txt | lpr (for Linux)
% txt2ps2 -r -2 file.txt | lp (for Solaris/HP-UX)
```

To convert `file.txt` to the PostScript language program and output it to the `file.ps` file, type as follows:

```
% txt2ps2 file.txt > file.ps
% lpr file.ps (for Linux)
% lp file.ps (for Solaris/HP-UX)
```

To convert the output result of the command into the PostScript language program using `txt2ps2` and print it to the printer, type as follows:

```
% ls -alF | txt2ps2 | lpr (for Linux)
% ls -alF | txt2ps2 | lp (for Solaris/HP-UX)
```

Environmental Variable

TXT2PS2OPTION

Optional settings based on the environmental variable. To output in the 2-column mode, 8 points and the landscape orientation, type as follows:

```
% setenv TXT2PS2OPTION "-2 -s8 -r"
```

To use the same options as those of the `dellpsif` filter specified by `printcap`, type as follows:

```
% setenv TXT2PS2OPTION "<dellpsif>"
```

File

`/usr/local/dellbin3100cn/.dellpsdefault3100cn`

This is the default command option setting file for individual users.

Important

- 1 When the same option is specified twice, the later setting will prevail. As `TXT2PS2OPTION` is analyzed before the option of the command line, it is possible to temporarily modify the options already set in `TXT2PS2OPTION` by typing at the command line.
- 1 The comment description (`%page:m n`) of the page number cannot be output to the PostScript program file which is output by the default option of `txt2ps2`. Thus, when the output of `txt2ps2` is to be taken as the output of another application (`psrev` of `TRANSCRIPT`, etc.), add the page number description by inserting the line command (`-l1ines`).
- 1 If a BS code is found at the beginning of a line, the print position of the next character will be located at the left of the beginning of the line.

- 1 When there are multiple tab codes in one line, the tab position may be off as a result of automatic line feed. In such case, use the `-I` or `-w` option.
- 1 The number of columns specified by the `-w` option is not the actual number of printed characters. The actual number of single-byte characters to be printed is derived by deducting the output column position (outcolumns) specified by the `o` option from the number of columns specified by the `-w` option. The `-mg` option cannot be specified when `-w`, `-l`, `-o`, and `-L` option are specified. The start positions of margin of the margin command (`-mg=u:b:r:l`) are not set against the edge of the paper. The margins are set against the printable area of the paper allowed by the printer. Use the `-ps` option only when a PostScript file that contains no `%!` at the beginning of the file is used as the PostScript file. If a normal text file is input, it will not function correctly.
- 1 In HP-UX, `txt2ps2` considers files written by PostScript that contain `%!` at the beginning of the file as the PostScript files. To print PostScript files as text files, specify the `tx` option. With this option, PostScript files will be processed as text files.

sunras2ps2 (Solaris)

Format

```
/usr/local/dellbin3100cn/sunras2ps2 [-d] [-D] [-Itray-input] [-t] [-r] [-n] [-l=left,bottom] [-s=width,height] [-S=width] [-E] [-Nc=copies] [-Hd=position: format] [-Hffont] [-MSI] [-M=type] [-Mfo=mode] [-Pon] [-St=mode] [-Sp] [-Sb] [-Cm=mode] [-Pr=mode] [-Cc=mode] [-Gc=mode] [-Sc=mode] [-Gg=mode] [-Ct] [filename...]
```

Function

Reads SunRaster data, converts it to the PostScript language program and writes to standard output. If the filename is not specified, the standard input will be taken as the command input. SunRaster files with a pixel depth of 1, 8, 24, and 32 bits can be specified. `sunran2ps2` takes filename as having been created in 72dpi and calculates the output size. Thus, to convert SunRaster files created in other resolutions, specify the size option (`-s`, `-S`) explicitly.

Option

`-d`

Enables the short-edge binding feature. When it is specified, the printing direction or position will be adjusted and both sides of the paper printed so that the shorter edge of the pages can be bound. This option is available only when the optional duplex module is installed on the printer.

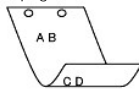

`-D`

Enables the long-edge binding feature. When it is specified, the printing direction or position will be adjusted and both sides of the paper printed so that the longer edge of the pages can be bound. This option is available only when the optional duplex module is installed on the printer.



`-Itray-input`

Specifies the paper tray.

A paper tray can be selected by directly specifying a tray or by specifying a paper size.

When a paper size is specified, the tray loaded with paper of the specified size will be found and selected automatically. The parameters for selecting a paper tray are as follows.

1

Feed paper from tray 1 (standard 250-sheet tray module).

2

Feed paper from tray 2 (optional 250-sheet tray module or 500-sheet tray module).

A4

Feed paper from the tray loaded with A4 (210 x 297 mm).

A5

Feed paper from the tray loaded with A5 (148 x 210 mm).

A6

Feed paper from the tray loaded with A6 (105 x 148 mm).

B5

Feed paper from the tray loaded with B5 (182 x 257 mm).

LT

Feed paper from the tray loaded with Letter (8.5 x 11 inches).

FL

Feed paper from the tray loaded with Folio (8.5 x 13 inches).

LG

Feed paper from the tray loaded with Legal (8.5 x 14 inches).

EX

Feed paper from the tray loaded with Executive (7.25 x 10.5 inches).

MO

Feed paper from the tray loaded with Monarch (3.875 x 7.5 inches).

COM10

Feed paper from the tray loaded with Envelope #10 (4.125 x 9.5 inches).

DL

Feed paper from the tray loaded with DL (110 x 220 mm).

C5

Feed paper from the tray loaded with C5 (162 x 229 mm).

LP 210x900

Feed paper from the tray loaded with LP210x900 (210 x 900 mm).

MxNmm

Feed paper from the tray loaded with MxNmm defined by users.

Possible range specified:
Width: 90.0 to 215.9 mm
Length: 139.7 to 355.6 mm

MxNin

Feed paper from the tray loaded with MxN inches defined by users.

Possible range specified:
Width: 3.54 to 8.50 inches
Length: 5.50 to 14.0 inches

If this option is not specified or the tray specified is not available, feed paper from the default tray.

-t

Turns on the *save toner* mode for printing. The print result will be fainter than that of normal printing. In some cases, this option will be ignored.

-r

Rotates the image by 90o and uses the paper in the landscape orientation.

-n

Disables the addition of the showpage. It is used when files converted to the PostScript language program are merged with files created with other

applications.

-l=left,bottom

Specifies the print position. Printing will be executed from the left and bottom of the page. The default is 0.25 inches for both left and bottom.

-s=width,height

Specifies the output size. Printing will be executed with the width and height in inches.

-S=width

Sets the width of the output size in inches. The height will be calculated automatically according to the width.

-E

This function turns on the image enhancement function. In some cases, this option will be ignored.

-Nc=copies

Specifies the number of output copies (the value of copies must be a positive integer).

-Hd=position:format

Specifies the position to be output the user information as the header or footer. *position* specifies output position. But this option is available only for converting text files.

ul

Output on the upper left corner of the paper.

ur

Output on the upper right corner of the paper.

dl

Output on the lower left corner of the paper.

dr

Output on the lower right corner of the paper.

format specifies the contents and the order to output. This option is omissible. If this option is omitted, **uh** is specified as the default value.

u

User name

h

Host name

t

Date and time

If the output contents are specified as **tuh**, it is output as follows.

Date and Time User: *username* Host: *hostname*.

Specify these options as follows.

In the case that convert text file, output the host name following the user name on the upper right corner of the paper, output all pages. (User name, Host name, all page output are default)

-Hd=ur

-Hd=ur:uh

-Hf font

Specify the font to print the header and footer. European fonts the same as half size alphanumeric fonts can be specified. Helvetica is specified as default.

If the wrong font is specified, default European font of the printer can be used.
If header/footer output option is specified, the font specification of header/footer is ignored.

-MSI

Specifies Multipurpose Feeder.

-M=type

Specifies Multipurpose Feeder Paper Type.
Available Multipurpose Feeder Paper Types are as follows.

B

FinePaper/Bond/Plain Paper 2

BB

FinePaperBack/Bond/Plain Paper 2 - Side 2

P

Stationary/Plain/Plain Paper 1

PB

StationaryBack/Plain/Plain Paper 1 - Side 2

H1

ThickPaper/Heavyweight 1/Covers 1

H1B

ThickPaperBack/Heavyweight 1/Covers 1 - Side 2

H2

ThickPaper2/Heavyweight 2/Covers 2

H2B

ThickPaper2Back/Heavyweight 2/Covers 2 - Side 2

OHP

Transparency

L

LabelPaper/Labels

C1

CoatingPaper1/Coated 1/Coated Paper 1

C1B

CoatingPaper1Back/Coated 1/Coated Paper 1 - Side 2

C2

CoatingPaper2/Coated 2/Coated Paper 2

C2B

CoatingPaper2Back/Coated 2/Coated Paper 2 - Side 2

E

Envelope

If this option is not specified, Multipurpose Feeder Paper Type of the printer can be used.

-Mfo=mode

Specifies orientation for Multipurpose Feeder.
Available orientations for Multipurpose Feeder are as follows.

le

Landscape

ler

Landscape (Rotated)

se

Portrait

ser

Portrait (Rotated)

-Pon

Specifies Alternate Tray.
Available Alternate Trays are as follows.

0

Use Printer Settings

1

Display Message

2

Feed from Multipurpose Feeder

3

Use Nearest Size (Adjust to Fit)

4

Use Larger Size (Adjust to Fit)

5

Use Nearest Size (No Zoom)

6

Use Larger Size (No Zoom)

-St=mode

Specifies Feed Separators from.
Available Feed Separators from the following.

auto

AutoTray/Auto

1

1stTray/Tray 1 (standard 250-sheet tray module)

2

2ndTray/Tray 2 (optional 250-sheet tray module or 500-sheet tray module)

off

Off

-Sp

Specifies Printed Separators

-Sb

Specifies Skip Blank Pages.

-Cm=mode

Specifies Output Color.
Available Output Colors are as follows.

c

Color (CMYK)

k

Black

-Pr=mode

Specifies Print Mode.
Available Print Modes are as follows.

hs

High Speed

hq

High Quality

-Cc=mode

Specifies RGB Color Correction.
Available RGB Color Corrections are as follows.

0

Off

1

Photo

2

sRGB

3

Standard/ Normal

4

Presentation

This option is available only for color printing.

-Gc=mode

Specifies RGB Gamma Correction.
Available RGB Gamma Corrections are as follows.

1.0

1.0

1.4

1.4

1.8

1.8

2.2

2.2

2.6

2.6

off

Off

-Sc=mode

Specifies Screen.
Available Screens are as follows.

0

Fineness

1

Gradation

2

Auto

3

For Transparency

-Gg=mode

Specifies Gray Guaranteed.
Available Gray Guaranteed options are as follows.

on

On

off

Off

This option is available only for color printing.

-ct

Specifies Color Transformation.

This option is available only for color printing.

Example

To output the displayed screen image to a file using the snapshot command and convert the file into the PostScript language program using the `sunras2ps2` command, type as follows.

```
% sunras2ps2 file.rs > file.ps
```

To output the displayed screen image to a file using the snapshot command, convert the file into the PostScript language program using the `sunras2ps2` command and output it to a printer, type as follows.

```
% sunras2ps2 file.rs | lp
```

Important

- 1 When `-s` and `-S` are specified at the same time or when the same option is specified twice, the later setting will prevail.
- 1 If the output size option (`-s`, `-S`) is not specified, scaling will be executed taking one pixel of the raster data as one pixel of the printer.
- 1 If the print position option specifies a point beyond the printable area of the printer, data beyond the printable area will not be printed.

tiff2ps2 (Linux/Solaris/HP-UX)

Format

```
/usr/local/dellbin3100cn/tiff2ps2 [-d] [-D] [-Itray-input] [-t] [-r] [-n] [-l=left,bottom] [-s=width,height] [-S=width] [-E] [-Nc=copies] [-Hd=position:format] [-Hffont] [-MSI] [-M=type] [-Mfo=mode] [-Pon] [-St=mode] [-Sp] [-Sb] [-Cm=mode] [-Pr=mode] [-Cc=mode] [-Gc=mode] [-Sc=mode] [-Gg=mode] [-Ct] [filename...]
```

Function

Reads TIFF data, converts it to the PostScript language program and writes to standard output. If the filename is not specified, the standard input will be taken as the command input. TIFF files with a pixel depth of 1, 4, 8, 24, and 32 bits can be specified.

There are four types of supported compression formats.

Huffman compression (CCITT Group 3 transformed Huffman run length encoding)

Fax-CCITT3 compression (facsimile-compatible CCITT Group 3)

PackBits compression

Non-compression

Even in the above compression format, the TIFF file that has multiple images in one file is not supported.

tiff2ps2 takes filename as having been created in 72 dpi and calculates the output size. Thus, to convert TIFF files created in other resolutions, specify the size option (-s, -S) explicitly for conversion.

Option

-d

Enables the short-edge binding feature. When it is specified, the printing direction or position will be adjusted and both sides of the paper printed so that the shorter edge of the pages can be bound. This option is available only when the optional duplex module is installed on the printer.

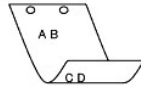

-D

Enables the long-edge binding feature. When it is specified, the printing direction or position will be adjusted and both sides of the paper printed so that the longer edge of the pages can be bound. This option is available only when the optional duplex module is installed on the printer.



-Itray-input

Specifies the paper tray.

A paper tray can be selected by directly specifying a tray or by specifying a paper size.

When a paper size is specified, the tray loaded with paper of the specified size will be found and selected automatically.

The parameters for selecting a paper tray are as follows.

1

Feed paper from tray 1 (standard 250-sheet tray module).

2

Feed paper from tray 2 (optional 250-sheet tray module or 500-sheet tray module).

A4

Feed paper from the tray loaded with A4 (210 x 297 mm).

A5

Feed paper from the tray loaded with A5 (148 x 210 mm).

A6

Feed paper from the tray loaded with A6 (105 x 148 mm).

B5

Feed paper from the tray loaded with B5 (182 x 257 mm).

LT

Feed paper from the tray loaded with Letter (8.5 x 11 inches).

FL

Feed paper from the tray loaded with Folio (8.5 × 13 inches).

LG

Feed paper from the tray loaded with Legal (8.5 × 14 inches).

EX

Feed paper from the tray loaded with Executive (7.25 × 10.5 inches).

MO

Feed paper from the tray loaded with Monarch (3.875 × 7.5 inches).

COM10

Feed paper from the tray loaded with Envelope #10 (4.125 × 9.5 inches).

DL

Feed paper from the tray loaded with DL (110 × 220 mm).

C5

Feed paper from the tray loaded with C5 (162 × 229 mm).

LP 210x900

Feed paper from the tray loaded with LP210x900 (210 × 900 mm).

MxNmm

Feed paper from the tray loaded with MxNmm defined by users
Possible range specified:
Width: 90.0 to 215.9 mm
Length: 139.7 to 355.6 mm

MxNin

Feed paper from the tray loaded with MxNinches defined by users
Possible range specified:
Width: 3.54 to 8.50 inches
Length: 5.50 to 14.0 inches

If this option is not specified or the tray specified is not available, feed paper from the default tray.

-t

Turns on the *save toner* mode for printing. The print result will be fainter than that of normal printing. In some cases, this option will be ignored.

-r

Rotates the image by 90° and uses the paper in the landscape orientation.

-n

Disables the addition of the showpage. It is used when files converted to the PostScript language program are merged with files created with other applications.

-l=*left,bottom*

Specifies the print position. Printing will be executed from the left and bottom of the page. The default is 0.25 inches for both left and bottom.

-s=*width,height*

Specifies the output size. Printing will be executed with the width and height in inches.

-S=*width*

Sets the width of the output size in inches. The height will be calculated automatically according to the width.

-E

This function turns on the image enhancement function. In some cases, this option will be ignored.

-Nc=*copies*

Specifies the number of output copies (the value of copies must be a positive integer).

-Hd=*position:format*

Specifies the position to be output the user information as the header or footer.
position specifies output position. But this option is available only for converting text files.

ul

Output on the upper left corner of the paper.

ur

Output on the upper right corner of the paper.

dl

Output on the lower left corner of the paper.

dr

Output on the lower right corner of the paper.

format specifies the contents and the order to output. This option is omissible.
If this option is omitted, *uh* is specified as the default value.

u

User name

h

Host name

t

Date and time
If the output contents are specified as *tuh*, it is output as follows.
Date and Time User: *username* Host: *hostname*.

Specify these options as follows.

In the case that convert text file, output the host name following the user name on the upper right corner of the paper, output all pages.
(User name, Host name, all page output are default)

-Hd=ur

-Hd=ur:uh

-Hf*font*

Specify the font to print header and footer. European fonts the same as half size alphanumeric fonts can be specified. Helvetica is specified as default.
If the wrong font is specified, default European font of the printer can be used.
If header/footer output option is specified, the font specification of header/footer is ignored.

-MSI

Specifies Multipurpose Feeder.

-M=*type*

Specifies Multipurpose Feeder Paper Type.
Available Multipurpose Feeder Paper Types are as follows.

B

FinePaper/Bond/Plain Paper 2

BB

FinePaperBack/Bond/Plain Paper 2 - Side 2

P

Stationary/Plain/Plain Paper 1

PB

StationaryBack/Plain/Plain Paper 1 - Side 2

H1

ThickPaper/Heavyweight 1/Covers 1

H1B

ThickPaperBack/Heavyweight 1/Covers 1 - Side 2

H2

ThickPaper2/Heavyweight 2/Covers 2

H2B

ThickPaper2Back/Heavyweight 2/Covers 2 - Side 2

OHP

Transparency

L

LabelPaper/Labels

C1

CoatingPaper1/Coated 1/Coated Paper 1

C1B

CoatingPaper1Back/Coated 1/Coated Paper 1 - Side 2

C2

CoatingPaper2/Coated 2/Coated Paper 2

C2B

CoatingPaper2Back/Coated 2/Coated Paper 2 - Side 2

E

Envelope

If this option is not specified, Multipurpose Feeder Paper Type of the printer can be used.

-MFeo=mode

Specifies orientation for Multipurpose Feeder.
Available orientations for Multipurpose Feeder are as follows.

le

Landscape

ler

Landscape (Rotated)

se

Portrait

ser

Portrait (Rotated)

-Por

Specifies Alternate Tray.
Available Alternate Trays are follows.

0

Use Printer Settings

1

Display Message

2

Feed from Multipurpose Feeder

3

Use Nearest Size (Adjust to Fit)

4

Use Larger Size (Adjust to Fit)

5

Use Nearest Size (No Zoom)

6

Use Larger Size (No Zoom)

`-St=mode`

Specifies Feed Separators from.
Available Feed Separators from the following.

auto

AutoTray/Auto

1

1stTray/Tray 1 (standard 250-sheet tray module)

2

2ndTray/Tray 2 (optional 250-sheet tray module or 500-sheet tray module)

off

Off

`-Sp`

Specifies Printed Separators

`-Sb`

Specifies Skip Blank Pages.

`-Cm=mode`

Specifies Output Color.
Available Output Colors are as follows.

c

Color (CMYK)

k

Black

`-Pr=mode`

Specifies Print Mode.
Available Print Modes are as follows.

hs

High Speed

hq

High Quality

`-Cc=mode`

Specifies RGB Color Correction.
Available RGB Color Corrections are as follows.

0

Off

1

Photo

2

sRGB

3

Standard/ Normal

4

Presentation

This option is available only for color printing.

`-Gc=mode`

Specifies RGB Gamma Correction.
Available RGB Gamma Corrections are as follows.

1.0

1.0

1.4

1.4

1.8

1.8

2.2

2.2

2.6

2.6

off

Off

`-Sc=mode`

Specifies Screen.
Available Screens are as follows.

0

Fineness

1

Gradation

2

Auto

3

For Transparency

`-Gg=mode`

Specifies Gray Guaranteed.
Available Gray Guaranteed options are as follows.

`on`

On

`off`

Off

This option is available only for color printing.

`-Ct`

Specifies Color Transformation.
This option is available only for color printing.

Example

To convert the TIFF image into the PostScript language program and output it to a file, type as follows.

```
% tiff2ps2 file.tiff > file1.ps
```

To output the TIFF image to a printer, type as follows.

```
% tiff2ps2 file.tiff | lpr (for Linux)
% tiff2ps2 file.tiff | lp (for Solaris/HP-UX)
```

Important

- 1 When `-s` and `-S` are specified at the same time or when the same option is specified twice, the later setting will prevail.
- 1 When the output size option (`-s`, `-S`) is not specified, scaling will be executed taking one pixel of the TIFF data as one pixel of the printer.
- 1 If the print position option (`-lleft bottom`) specifies a point beyond the printable area of the printer, data beyond the printable area will not be printed.

xwd2ps2 (Linux/Solaris/HP-UX)

Format

```
/usr/local/dellbin3100cn/xwd2ps2 [-d] [-D] [-Itray-input] [-t] [-r] [-n] [-l=left,bottom] [-s=width,height] [-S=width] [-E] [-Nc=copies] [-Hd=position:format] [-Hfont] [-MSI] [-M=type] [-Mfo=mode] [-Pon] [-St=mode] [-Sp] [-Sb] [-Cm=mode] [-Pr=mode] [-Cc=mode] [-Gc=mode] [-Sc=mode] [-Gg=mode] [-Ct] [filename...]
```

Function

Reads XWD data, converts it to the PostScript language program and writes to standard output. If the filename is not specified, the standard input will be taken as the command input. XWD files with a pixel depth of 1, 4, 8, 24, and 32 bits can be specified.

There are three types of supported compression formats.

The visual class is Static Gray and the pixel is 1 bit.

The visual class is Pseudo Color and the pixel is 4 bits or 8 bit. The image format is Zpixmap.

The visual class is True Color and the pixel is 24 bits or 32 bit. The image format is Zpixmap.

xwd2ps2 takes filename as having been created in 72dpi and calculates the output size. Thus, to convert XWD files created in other resolutions, specify the size option (`-s`, `-S`) explicitly for conversion.

Option

`-d`

Enables the short-edge binding feature. When it is specified, the printing direction or position will be adjusted and both sides of the paper printed so that the shorter edge of the pages can be bound. This option is available only when the optional duplex module is installed on the printer.

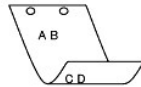

-D

Enables the long-edge binding feature. When it is specified, the printing direction or position will be adjusted and both sides of the paper printed so that the longer edge of the pages can be bound. This option is available only when the optional duplex module is installed on the printer.



-Itray-input

Specifies the paper tray.

A paper tray can be selected by directly specifying a tray or by specifying a paper size.

When a paper size is specified, the tray loaded with paper of the specified size will be found and selected automatically.

The parameters for selecting a paper tray are as follows.

1

Feed paper from tray 1 (standard 250-sheet tray module).

2

Feed paper from tray 2 (optional 250-sheet tray module or 500-sheet tray module).

A4

Feed paper from the tray loaded with A4 (210 x 297 mm).

A5

Feed paper from the tray loaded with A5 (148 x 210 mm).

A6

Feed paper from the tray loaded with A6 (105 x 148 mm).

B5

Feed paper from the tray loaded with B5 (182 x 257 mm).

LT

Feed paper from the tray loaded with Letter (8.5 x 11 inches).

FL

Feed paper from the tray loaded with Folio (8.5 x 13 inches).

LG

Feed paper from the tray loaded with Legal (8.5 x 14 inches).

EX

Feed paper from the tray loaded with Executive (7.25 x 10.5 inches).

MO

Feed paper from the tray loaded with Monarch (3.875 x 7.5 inches).

COM10

Feed paper from the tray loaded with Envelope #10 (4.125 x 9.5 inches).

DL

Feed paper from the tray loaded with DL (110 x 220 mm).

C5

Feed paper from the tray loaded with C5 (162 x 229 mm).

LP 210x900

Feed paper from the tray loaded with LP210x900 (210 x 900 mm).

MxNmm

Feed paper from the tray loaded with MxN mm defined by users.
Possible range specified:
Width: 90.0 to 215.9 mm
Length: 139.7 to 355.6 mm

MxNin

Feed paper from the tray loaded with MxNinches defined by users
Possible range specified:
Width: 3.54 to 8.50 inches
Length: 5.50 to 14.0 inches

If this option is not specified or the tray specified is not available, feed paper from the default tray.

-t

Turns on the *save toner* mode for printing. The print result will be fainter than that of normal printing. In some cases, this option will be ignored.

-r

Rotates the image by 90o and uses the paper in the landscape orientation

-n

Disables the addition of the showpage. It is used when files converted to the PostScript language program are merged with files created with other applications.

-l=*left, bottom*

Specifies the print position. Printing will be executed from the left and bottom of the page. The default is 0.25 inches for both left and bottom.

-s=*width, height*

Specifies the output size. Printing will be executed with the width and height in inches.

-S=*width*

Sets the width of the output size in inches. The height will be calculated automatically according to the width.

-E

This function turns on the image enhancement function. In some cases, this option will be ignored.

-Nc=*copies*

Specifies the number of output copies (the value of copies must be a positive integer).

-Hd=*position:format*

Specifies the position to be output the user information as the header or footer.
position specifies output position. But this option is available only for converting text files.

ul

Output on the upper left corner of the paper.

ur

Output on the upper right corner of the paper.

dl

Output on the lower left corner of the paper.

dr

Output on the lower right corner of the paper.

format specifies the contents and the order to output. This option is omissible.
If this option is omitted, *uh* is specified as the default value.

u

User name

h

Host name

t

Date and time
If the output contents are specified as *tuh*, it is output as follows.
Date and Time User: *username* Host: *hostname*.

-Hfont

Specify the font to print header and footer. European fonts the same as half size alphanumeric fonts can be specified. Helvetica is specified as default.
If the wrong font is specified, default European font of the printer can be used.
If header/footer output option is specified, the font specification of header/footer is ignored.

-MSI

Specifies Multipurpose Feeder.

-M=type

Specifies Multipurpose Feeder Paper Type.
Available Multipurpose Feeder Paper Types are as follows.

B

FinePaper/Bond/Plain Paper 2

BB

FinePaperBack/Bond/Plain Paper 2 - Side 2

P

Stationary/Plain/Plain Paper 1

PB

StationaryBack/Plain/Plain Paper 1 - Side 2

H1

ThickPaper/Heavyweight 1/Covers 1

H1B

ThickPaperBack/Heavyweight 1/Covers 1 - Side 2

H2

ThickPaper2/Heavyweight 2/Covers 2

H2B

ThickPaper2Back/Heavyweight 2/Covers 2 - Side 2

OHP

Transparency

L

LabelPaper/Labels

C1

CoatingPaper1/Coated 1/Coated Paper 1

C1B

CoatingPaper1Back/Coated 1/Coated Paper 1 - Side 2

C2

CoatingPaper2/Coated 2/Coated Paper 2

C2B

CoatingPaper2Back/Coated 2/Coated Paper 2 - Side 2

E

Envelope

If this option is not specified, Multipurpose Feeder Paper Type of the printer can be used.

-Mfo=mode

Specifies orientation for Multipurpose Feeder.
Available orientations for Multipurpose Feeder are as follows.

le

Landscape

ler

Landscape (Rotated)

se

Portrait

ser

Portrait (Rotated)

-Pon

Specifies Alternate Tray.
Available Alternate Trays are as follows.

0

Use Printer Settings

1

Display Message

2

Feed from Multipurpose Feeder

3

Use Nearest Size (Adjust to Fit)

4

Use Larger Size (Adjust to Fit)

5

Use Nearest Size (No Zoom)

6

Use Larger Size (No Zoom)

-St=mode

Specifies Feed Separators from.
Available Feed Separators from the following.

auto

AutoTray/Auto

1

1stTray/Tray 1 (standard 250-sheet tray module)

2

2ndTray/Tray 2 (optional 250-sheet tray module or 500-sheet tray module)

off

Off

-Sp

Specifies Printed Separators

-Sb

Specifies Skip Blank Pages.

-Cm=mode

Specifies Output Color.
Available Output Colors are as follows.

c

Color (CMYK)

k

Black

-Pr=mode

Specifies Print Mode.
Available Print Modes are as follows.

hs

High Speed

hq

High Quality

-Cc=mode

Specifies RGB Color Correction.
Available RGB Color Corrections are as follows.

0

Off

1

Photo

2

sRGB

3

Standard/ Normal

4

Presentation

This option is available only for color printing.

`-Gc=mode`

Specifies RGB Gamma Correction.
Available RGB Gamma Corrections are as follows.

1.0

1.0

1.4

1.4

1.8

1.8

2.2

2.2

2.6

2.6

`off`

Off

`-Sc=mode`

Specifies Screen.
Available Screens are as follows.

0

Fineness

1

Gradation

2

Auto

3

For Transparency

`-Gg=mode`

Specifies Gray Guaranteed.
Available Gray Guaranteed options are as follows.

`on`

On

`off`

Off

This option is available only for color printing.

`-Ct`

Specifies Color Transformation.
This option is available only for color printing.

Example

To convert the XWD image into the PostScript language program and output it to a file, type as follows.

```
% xwd2ps2 file.xwd > file.ps
```

To output the XWD image to a printer, type as follows.

```
% xwd2ps2 file.xwd | lpr (for Linux)
% xwd2ps2 file.xwd | lp (for Solaris/HP-UX)
```

Important

- 1 When `-s` and `-S` are specified at the same time or when the same option is specified twice, the later setting will prevail.
- 1 When the output size option (`-s`, `-S`) is not specified, scaling will be executed taking one pixel of the TIFF data as one pixel of the printer.
- 1 If the print position option (`-l`*left bottom*) specifies a point beyond the printable area of the printer, data beyond the printable area will not be printed.

dellpsif (Linux)

Format

```
/usr/local/dellbin3100cn/dellpsif -w width -l length -i indent -n login -h host accountfile
```

Function

If the first two characters of the input data are not `%!`, the dellpsif filter will convert it to the PostScript language program that can be output according to the paper size. If the first two characters of the input data are `%!`, it will be considered the PostScript language program and no data conversion will be executed. The following control codes are interpreted for the conversion of input data.

LF

Line feed

FF

Form feed

TAB

8-column tab stop

BS

Backspace 1 character

The dellpsif is the hard link file of txt2ps2.
The dellpsif filter will be used as the IF filter specified by `/etc/printcap`.
The lpd daemon will specify the following command options and start up the dellpsif filter.

```
dellpsif -w width -l length -i indent -n login -h host accountfile
```

In addition, options useable by txt2ps2 can be specified by the `/usr/local/dellbin3100cn/.dellpsdefault3100cn` file. With this option, detailed control can be achieved. However, if the input data are PostScript files, only the following options of txt2ps2 will become valid.

-d

Enables the short-edge binding feature. When it is specified, the printing direction or position will be adjusted and both sides of the paper printed so

that the shorter edge of the pages can be bound. This option is available only when the optional duplex module is installed on the printer.

-D

Enables the long-edge binding feature. When it is specified, the printing direction or position will be adjusted and both sides of the paper printed so that the longer edge of the pages can be bound. This option is available only when the optional duplex module is installed on the printer.

-Itray=input

Specifies the paper tray.
The parameters to be able to specify are the same as txt2ps2.

-t

Turns on the *save toner* mode for printing. The print result will be fainter than that of normal printing. In some cases, this option will be ignored.

-E

This function turns on the image enhancement function. In some cases, this option will be ignored.

-Nc=copies

Specifies the number of output copies (the value of copies must be a positive integer).

-ps

The input file will be processed as the PostScript file. If the file does not begin with `%!`, `%!` will be output to the beginning line. For files with `%!`, this option will be ignored.

-M=type

Specifies Multipurpose Feeder Paper Type.
If this option is not specified, Multipurpose Feeder Paper Type of the printer can be used.

-MEo=mode

Specifies orientation for Multipurpose Feeder.

-Pon

Specifies Alternate Tray.

-St=mode

Specifies Feed Separators from.

-Sp

Specifies Printed Separators

-Sb

Specifies Skip Blank Pages.

-Cm=mode

Specifies Output Color.

`-Pr=mode`

Specifies Print Mode.

`-Cc=mode`

Specifies RGB Color Correction.
This option is available only for color printing.

`-Gc=mode`

Specifies RGB Gamma Correction.

`-Sc=mode`

Specifies Screen.

`-Gg=mode`

Specifies Gray Guaranteed.
This option is available only for color printing.

`-Ct`

Specifies Color Transformation.
This option is available only for color printing.

File

`/usr/local/dellbin3100cn/.dellpsdefault3100cn`
This is the default command option setting.

Important

- 1 The `dellpsif` filter ignores the `pw` and `pl` entries of `/etc/printcap`. Thus, the `pw` and `pl` entries cannot be used to change the option of each paper size.
- 1 If the same option is specified for PostScript files which already have added options, such as paper selection, it will be ignored.
- 1 Use the `-ps` option only when a PostScript file that contains no `%!` at the beginning of the file is processed as the PostScript file. If a normal text file is input, it will not function correctly.

Precautions and Limitations

During Installation

Pay attention to the following points during the installation.

Solaris

- 1 Use `lpadmin` command to register the default printer.

```
# lpadmin -d Printer Name
```
- 1 To inhibit the banner sheets output, change the value of `nobanner=no` to `nobanner=yes` that includes in the file corresponding to the printer name in `/etc/lp/interfaces/`.
- 1 The printer registered by UX filter must not be changed by `admintool`.
- 1 When Content types: `postscript` is displayed by typing `lpstat -p printername -l`, it's necessary to delete the printer and reinstall.

- 1 To install UX filter into the default directory (/usr/local/dellbin3100cn), it's necessary to create /usr/local directory in advance.

HP-UX

- 1 The printer to specify as an output printer must be registered in your system. To register an output printer, use sam command and so on. See the HP-UX related manual for details.
- 1 To install UX filter into the default directory (/usr/local/dellbin3100cn), it's necessary to create /usr/local directory in advance.

Linux

- 1 To install UX filter into the default directory (/usr/local/dellbin3100cn), it's necessary to create /usr/local directory in advance.

During Printing

Pay attention to the following points during printing.

Using lp/lpr Command (Linux/Solaris/HP-UX)

- 1 If an option is specified incorrectly, no error message will be output. If printing is not executed after the lp command is executed, activate each utility individually and error messages will be output. (Using Solaris, the error message is displayed on the screen. Using Linux, the error message is written into the error log file specified by printcap.)
- 1 In text printing, the environmental variable TXT2PS2OPTION will be ignored.
- 1 In text printing, if a BS code is found at the beginning of a line, the print position of the next character will be on the left of the beginning of the line.
- 1 In text printing, when there are multiple tab codes in one line, the positions of tab may be off due to automatic line feed. If this happens, specify l or w option.
- 1 In text printing, the number of columns specified by the w option does not reflect the number of characters actually printed. The actual number of single-byte characters to be printed is derived by deducting the output column position (out columns) specified by the o option from the number of columns specified by the w option.
- 1 If the same option is specified, or if s, s are both specified, the one specified later will prevail.
- 1 In printing images, If the print position option (1) specifies an area beyond the printable area of the printer, data beyond the printable area will not be printed. (Using Solaris, It's impossible to output images by lp command.)

Using txt2ps2 (Linux/Solaris/HP-UX)

- 1 When the same option is specified twice, the later setting will prevail. As TXT2PS2OPTION is analyzed before the option of the command line, it is possible to temporarily modify the options already set in TXT2PS2OPTION by inputting at the command line
- 1 The default output of txt2ps2 cannot output the comment description (%page:m n) of the page number. This is because the converted PostScript language program controls line feed and form feed. Thus, when the output of txt2ps2 is to be taken as the output of another application (psrev of TRANSCRIPT, etc.), add the page number description by inserting the line command (-lines).
- 1 If a BS code is found at the beginning of a line, the print position of the next character will be on the left of the beginning of a line.
- 1 When there are multiple tab codes in one line, the positions of tab may be off due to automatic line feed. If this happens, specify the -l or -w option.
- 1 The number of columns specified by the -w option does not reflect the number of characters actually printed. The actual number of single-byte characters to be printed is derived by deducting the output column position (out columns) specified by the o option from the number of columns specified by the w option.
- 1 The -mg option cannot be specified when -w, -l, -o, and -L option are specified.
- 1 The start positions of margins of the margin command (-mg=u:b:r:l) are not set against the edge of paper. The margins are set against the printable area for paper allowed by the printer.
- 1 Use the -ps option only when a PostScript file that contains no %! at the beginning of the file is used as the PostScript file. If a normal text file is input, it will not function correctly.
- 1 To use the same options as those of the dellpsif filter by TXT2PS2OPTION, set the user's home directory in the environmental variable HOME. If the environmental variable HOME is not set up, the same options as those of the dellpsif filter cannot be used. (Linux)

Using sunras2ps2/tiff2ps2/xwd2ps2 (sunras2ps2 apply to Solaris only)

- 1 If the same option is specified, or if *s*, *s* are both specified, the one specified later will prevail.
- 1 If the size option (*s*, *s*) is not specified, scaling will be executed taking one pixel of the image data as one pixel of the printer.
- 1 If the print position option (-1 left bottom) specifies a point beyond the printable area of the printer, data beyond the printable area will not be printed.

Using tiff2ps2 (Linux/Solaris/HP-UX)

- 1 There are four types of supported compression formats.
 - Huffman compression (CCITT Group 3 transformed Huffman run length encoding)
 - Fax-CCITT3 compression (facsimile-compatible CCITT Group 3)
 - PackBits compression
 - Non-compression

Even if the format is a supported format, the tiff that has multiple images in one file is not supported.

Using xwd2ps2 (Linux/Solaris/ HP-UX)

- 1 There are three types of supported compression formats.
 - The visual class is Static Gray and the pixel is 1 bit.
 - The visual class is Pseudo Color and the pixel is 4 bits or 8 bit. The image format is Zpixmap.
 - The visual class is True Color and the pixel is 24 bits. The image format is Zpixmap.

Using dellpsif (Linux)

- 1 Use the `-ps` option only when a PostScript file that contains no `%!` at the beginning of the file is used as the PostScript file. If a normal text file is input, it will not function correctly.
- 1 `-w`, `-1` option usually correspond to `pw`, `p1` entry of `/etc/printcap`. However, this UX filter ignore `pw`, `p1` entry of `/etc/printcap`. So, the option cannot be changed by each page size using `pw`, `p1` entry.

Printing PostScript Files (Linux/Solaris/ HP-UX)

- 1 If same options for the PostScript file that contains options, such as paper size, are specified using `dellpsif` (Linux) or the `lp` command (Solaris/HP-UX), the specified option will be ignored.

Printing Image Files (Solaris)

- 1 To print image files from Solaris the user cannot specify the image file directly with the `lp` command for printing. Make use of `sunras2ps2`, `tiff2ps2`, `xwd2ps2` and convert the file to a PostScript file. Output it using the `lp` command after the conversion.

```
% xwd2ps2 file.xwd | lp
```

Double-sided Printing (Linux/Solaris/HP-UX)

- 1 The printer without a optional duplex module is unable to do double-sided printing.

Header/footer Option (-Hd=position:format:page, -Hfheaderfont) (txt2ps2,sunras2ps2,tiff2ps2,xwd2ps2)

- 1 If the paper size is not specified when using options, it outputs the header/footer at the position of A4-size paper. To specify the paper size at the same time to use header/footer option. (If the paper size for the PostScript file converted by using the option is specified by the option of `lp` command for example, the position of the header and footer cannot be changed.)

- 1 The margin is specified automatically when the option is used. When the option to specify the margin is used at the same time, the value that is smaller than the value specified automatically as follows is ignored. In case of text files

```
Upper margin: 0.23 inch
Lower margin: 0.06 inch
Right margin: 0.03 inch
Left margin: 0.09 inch
```

In case of images

```
Lower margin: 0.3 inch
```

- 1 When using the option, the number of lines and the number of columns specified are ignored. Also, it is impossible to specify landscape and 2-column.
- 1 In case of the PostScript file, it happens that the printer doesn't output all pages despite that *output all page* is specified. In such a case, specify *print the only top page*.
- 1 It's impossible to use `lp` command in Solaris.

TBCPFilter (Solaris/Linux/HP-UX)

- 1 Make sure the TBCPFilter is available so the printer can specify the availability of the TBCPFilter.

As for libtiff

Copyright ©1988-1997 Sam Leffler

Copyright © 1991-1997 Silicon Graphics, Inc.

THE SOFTWARE IS PROVIDED "AS-IS" AND WITHOUT WARRANTY OF ANY KIND, EXPRESS, IMPLIED OR OTHERWISE, INCLUDING WITHOUT LIMITATION, ANY WARRANTY OF MERCHANTABILITY OR FITNESS FOR A PARTICULAR PURPOSE.

IN NO EVENT SHALL SAM LEFFLER OR SILICON GRAGHICS BE LIABLE FOR ANY SPECIAL, INCIDENTAL, INDIRECT OR CONSEQUENTIAL DAMAGES OF ANY KIND, OR ANY DAMAGES WHATSOEVER RESULTING FROM LOSS OF USE, DATA OR PROFITS, WHETHER OR NOT ADVISED OF THE POSSIBILITY OF DAMAGE, AND ON ANY THEORY OF LIABILITY, ARISING OUT OF OR IN CONNECTION WITH THE USE OR PERFORMANCE OF THIS SOFTWARE.

Operator Panel

• [Using the Operator Panel Buttons](#)

• [Printing a Panel Settings Page](#)

Using the Operator Panel Buttons

The printer operator panel has a 2-line by 16-character liquid crystal display (LCD), seven buttons, and two indicators that flash when the printer is ready to print, and when an error occurs.

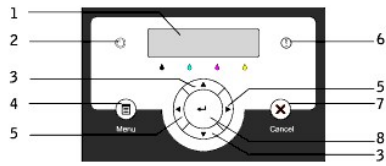

1. LCD display
 2. Ready indicator
 - | Displays green when the printer is ready. Blinks when data is being received.
 3. ▼ ▲ buttons
 - | In the Menu mode, displays menus or items in order.
 4. Menu button
 - | Toggles between the Menu mode and the Print mode.
 5. ◀ ▶ buttons
 - | In the Menu mode, selects different submenus. Also selects setting values.
 6. Error indicator
 - | Displays red when an error has occurred. Blinks when an irrecoverable error has occurred.
 7. Cancel button
 - | In the Menu mode, exits to the Print mode.
 - | Cancels current print job.
 8. 🖨️ button
 - | In the Menu mode, selects the currently displayed menu or item.
 - | In the Print mode, outputs data in the printer.
-

Printing a Panel Settings Page

The Panel Settings page shows current settings for the operator panel menus.

1. Press **Menu**.
2. Press ▼ until **Configure** appears, and then press ▶ or 🖨️.
3. Press ▼ until **Reports** appears, and then press ▶ or 🖨️.
4. Press ▼ until **Panel Settings** appears, and then press 🖨️.
The Panel Settings page is printed.
5. Verify that any optional 250-sheet tray module or 500-sheet tray module you installed are configured for the sizes and types of print media you loaded.

Printer Specifications

- [OS Compatibility](#)
- [Dimensions](#)
- [Memory](#)
- [Page-description Language \(PDL\)/Emulation, Operating System, and Interface](#)
- [Cartridge and Printer Life](#)
- [Environmental](#)
- [Cables](#)

OS Compatibility

Compatible with Windows® (XP/Me, 2000, Server 2003, NT 4.0/9x); Novell® (3.x, 4.x, 5.x, 6.x) but not supported 1; Red Hat Linux® (7.3, AS2.1) but not supported 2;

1 Dell networked Printers are compatible with Microsoft, Novell and Linux operating systems, but Dell telephone support only supports factory-installed operating systems (Microsoft) for the first 30 days for free. See <http://www1.us.dell.com/content/products/compare.aspx?laser?c=us&cs=555&l=en&s=biz> for more details. The customer will have to purchase technical support from the manufacturer of the operating system in order to get technical assistance beyond 30 days.

2 If the customer has other operating systems, such as Novell or Linux, and has purchased Gold Technical Support (for more information on Gold Technical Support, see http://www.dell.com/us/en/gen/services/service_gts.htm), the telephone support will be a "best effort" attempt to resolve the operating system issue. If the manufacturer needs to be contacted, the customer must pay an additional fee for that support. The only time that Dell pays for the third party support is when Dell is responsible for the issue. In the case of getting the printers installed and working, this is configuration and the customer would be responsible for paying.

Dimensions

Height: 536 mm (21 in.) Width: 425 mm (16.7 in.) Depth: 420 mm (16.5 in.)
Weight (not including cartridge): 31 kg (68.4 lb)

Memory

Base memory	64 MB
Maximum memory	576 MB
Connector	144PIN SO-DIMM Non-ECC
DIMM Size	64 MB*, 128 MB, 256 MB, 512 MB
Speed	PC133, CL=2 or 3

* Only the one supplied with optional duplex module is available.

Page-description Language (PDL)/Emulation, Operating System, and Interface

PDL/Emulations	PostScript 3, PCL 6, PCL5e
OSes	Windows 95/98/Me/2000/NT4.0/XP, Windows Server 2003, UNIX (Solaris 9, HP-UX 11-i), Linux (Red Hat 8/9, Red Hat Enterprise Linux AS 2.1, SuSE 8.2/9), Mac OS 9/X

Interfaces	Standard local:	USB, IEEE 1284
	Standard network:	10/100Base-Tx Ethernet

MIB Compatibility

A Management Information Base (MIB) is a database containing information about network devices (such as adapters, bridges, routers, or computers). This information helps network administrators manage the network (analyze performance, traffic, errors, and so on). The 3100cn complies with standard industry MIB specifications, allowing the printer to be recognized and managed by various printer and network management software systems, such as IBM Tivoli, Hewlett-Packard OpenView, CA Unicenter, Hewlett-Packard Web JetAdmin, and so on.

Cartridge and Printer Life

Toner cartridge yield at approximately 5% coverage	2,000 pages, 4,000 pages
Drum cartridge	24,000 pages
Duty cycle (maximum)	45,000 pages/month (25% coverage color) 60,000 pages/month (black and white only) (Reference)
Printer life	100,000 pages or 5 years, whichever comes first

Environmental

Humidity

Temperature	5°C to 32°C
Relative humidity (non-condensing)	15% to 85%

Storage

Temperature range	0 °F to 104 °F (-20°C to 40°C)
Storage humidity range	5% RH to 95% RH (non-condensing)

Altitude

Operating	Up to 3,100 m (10,000 feet)
Storage	70.9275 Kpa



Chemical Emission

Concentration of ozone	0.019 mg/m ³
------------------------	-------------------------

Cables

Your interconnection cable must meet the following requirements:

Connection	Cable certification
------------	---------------------

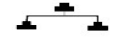
1	Parallel (IEEE 1284)	 <p>(Computer side) (Printer side)</p>
2	USB	USB2.0 
3	10/100Base-Tx Ethernet	CAT-5E 

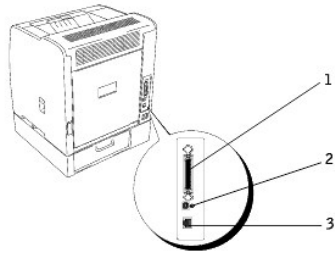

Understanding Printer Messages



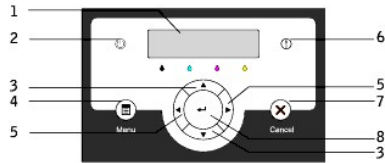

The printer operator panel displays messages describing the current state of the printer and indicates possible printer problems you must resolve. This topic provides a list of all printer messages, explains what they mean, and tells you how to clear the messages.



1	LCD display	5	◀ ▶ buttons
2	Ready indicator	6	Error indicator
3	▼ ▲ buttons	7	Cancel button
4	Menu button	8	⏴ button

Message	What this message means	What you can do
(The first and second lines are displayed together. The third and fourth lines blink every three seconds.)		
<i>NNN-NNN</i> Restart Printer Contact Support IfMessageReturns	Error <i>NNN-NNN</i> relates to printer problems.	Turn off the printer, and then on. If this does not solve the problem, contact Dell. See "Contacting Dell" in the <i>Owner's Manual</i> .
<i>NNN-NNN</i> Restart Printer Reseat Fuser Contact Support	The outer levers on both sides of the fuser unit are not securely locked. Error <i>NNN-NNN</i> relates to printer problems.	Confirm that the outer levers on both sides of the fuser unit are securely locked. If this does not solve the problem, contact Dell. See "Contacting Dell" in the <i>Owner's Manual</i> .
016-316 Restart Printer Reseat Memory Contact Support	The printer detected an unsupported additional memory module in the memory slot.	Remove the additional memory module. If this does not solve the problem, contact Dell. See "Contacting Dell" in the <i>Owner's Manual</i> .
016-318 Restart Printer Reseat Memory Contact Support	The additional memory module is not fully inserted into the slot.	Remove the additional memory module from the slot, and then reattach it firmly. If this does not solve the problem, contact Dell. See "Contacting Dell" in the <i>Owner's Manual</i> .
<i>NNN-NNN</i> Restart Printer Reseat <i>XXX</i> Contact Support	<i>XXX</i> is not fully inserted. Error <i>NNN-NNN</i> relates to printer problems.	Confirm that the unit is securely inserted. If this does not solve the problem, contact Dell. See "Contacting Dell" in the <i>Owner's Manual</i> .
Paper Jam <i>XXX</i> <i>NNN-NNN</i> Open <i>YYY</i> Remove Paper	The printer detects a paper jam in <i>XXX</i> . <i>XXX</i> indicates a position in which a paper jam occurs.	Clear the paper path. When "Reg Cover" appears in <i>YYY</i> , the procedure to remove print media is different depending on whether the Duplex Module is attached or not. See " Clearing Jams ".
Paper Jam <i>XXX</i> <i>NNN-NNN</i> Open <i>YYY</i> and <i>ZZZ</i>	<i>YYY</i> indicates a position that you open. Error <i>NNN-NNN</i> relates to printer problems.	
Paper Jam <i>XXX</i> <i>NNN-NNN</i> Open <i>YYY</i> Open <i>ZZZ</i>		
Paper Jam Tray 1 071-101 Open Feed1 Cover Pull out Tray 1	The printer detects a paper jam in <i>XXX</i> . <i>XXX</i> indicates a position in which a paper jam occurs.	Pull out the specified tray and clear the paper path. See " Clearing Jams ".

Paper Jam Tray 2 072-101 Open Feed2 Cover Pull out Tray 2		
004-312 TRAY1 must be 250 sheet tray Contact Support	The printer detects an incorrect configuration of the trays.	Turn off the printer. Set the trays in the proper configuration again. See " Installing the Optional Tray Module "
Transparency 077-131 Open Reg Cover Remove Paper	The printer detects jammed transparencies.	Clear the paper path. Then load the transparencies again. See " Clearing Jams "
Transparency 077-132 Open Duplex Mod Open Reg Cover Remove Paper		
Remove Drum Cart 091-940 Install Toner Cartridge First	The drum cartridge must be removed.	Remove the drum cartridge from the printer. See " Replacing the Drum Cartridges "
Insert TonerCart NNN-NNN Insert XXX	The specified toner cartridge is either missing or not fully inserted into the printer. XXX is one of the following: • Yellow Toner • Cyan Toner • Magenta Toner • Black Toner Error NNN-NNN relates to printer problems.	Reinsert the specified toner cartridge. See " Replacing the Toner Cartridge "
Insert Drum Cart 091-972 Drum Cartridge Not Installed	The drum cartridge is either missing or not fully inserted into the printer.	Reinsert the drum cartridge. See " Replacing the Drum Cartridges "
Reinsert Drum 091-911 Printer Unable to Detect Drum		
Replace Toner NNN-NNN Replace XXX	The toner cartridge is low on toner. XXX is one of the following: • Yellow Toner • Cyan Toner • Magenta Toner • Black Toner Error NNN-NNN relates to printer problems.	Remove the specified toner cartridge and install a new one. See " Replacing the Toner Cartridge "
Replace DrumCart 091-935 Drum Full of Waste Toner	The drum cartridge needs to be replaced.	Replace the drum cartridge. See " Replacing the Drum Cartridges "
Toner Verify NNN-NNN Remove/Reinsert XXX	An unsupported toner cartridge is installed. XXX is one of the following: • Yellow Toner • Cyan Toner • Magenta Toner • Black Toner Error NNN-NNN relates to printer problems.	Replace the specified toner cartridge. See " Replacing the Toner Cartridge "
Drum Recognition 091-916 Remove and Reinsert Drum	An unsupported drum cartridge is installed.	Replace the drum cartridge. See " Replacing the Drum Cartridges "
TonerRecognition NNN-NNN Remove/Reinsert XXX	An unsupported toner cartridge is installed. XXX is one of the following: • Yellow Toner • Cyan Toner • Magenta Toner • Black Toner Error NNN-NNN relates to printer problems.	Replace the specified toner cartridge. See " Replacing the Toner Cartridge "
Wrong Cartridge NNN-NNN XXX Unsupported	A toner cartridge which has a volume that is not supported has been installed. XXX is one of the following: • Yellow Toner • Cyan Toner • Magenta Toner • Black Toner Error NNN-NNN relates to printer problems.	Replace the specified toner cartridge. See " Replacing the Toner Cartridge "
Close FrontCover	Printer cover is open.	Close the specified cover.

077-300 Front or Top Cover Is Open	XXX is one of the following: <ul style="list-style-type: none"> • Reg Cover • BTR Cover • Paper Cover • Feeder 1 • Feeder 2 • Duplex Cover 	
Close XXX NNN-NNN YYY Is Open	YYY is one of the following: <ul style="list-style-type: none"> • Reg Cover • BTR Cover • Paper Cover • Feeder 1 Cover • Feeder 2 Cover • Duplex Cover Error NNN-NNN relates to printer problems.	
Close Duplex Mod 077-308 Duplex Module Is Open	Optional duplex module is open.	Close the optional duplex module.
CarrierAlignment 093-310 Reinsert Toner Cartridge	The toner cartridge does not rotate properly during replacement.	<ul style="list-style-type: none"> • Open the front door. • Confirm that toner cartridges are securely installed.
Load XXX NNN-NNN Load XXX YYY Load XXX YYY	Incorrect paper size is loaded in the specified tray. XXX indicates the number of the tray or multipurpose feeder. YYY indicates a paper size. yyy indicates paper quality. Error NNN-NNN relates to printer problems.	Load the specified paper in the specified trays. See " Loading Print Media in Standard and Optional Trays "
Load Tray 024-964 Load XXX YYY Load XXX YYY	Incorrect paper sizes are loaded in all trays. YYY indicates a paper size. yyy indicates paper quality.	Load the specified paper in all the trays. See " Loading Print Media in Standard and Optional Trays "
Out of Memory 016-700 Job too Large Press Set	The printer memory is full and cannot continue processing the current print job. Error NNN-NNN relates to printer problems.	<ul style="list-style-type: none"> • Press  to clear the message, cancel the current print job, and conduct the next print job, if any. • Press Cancel to cancel the current print job. • Press Menu to open the Stored Print and delete the holding job. • To avoid this error in the future, do the following: <ul style="list-style-type: none"> • Delete unnecessary fonts, macros, and other data in printer memory. • Install additional printer memory. See " Accessing Held Jobs From the Operator Panel "
Disk Full 016-980 Job too Large Press Set	RAM disk memory is full and cannot continue processing the current print job.	<ul style="list-style-type: none"> • Press  to clear the message, cancel the current print job, and conduct the next print job, if any. • Press Cancel to cancel the current print job. • Press Menu to open the Stored Print and delete the current job. • To avoid this error in the future, do the following: <ul style="list-style-type: none"> • Reduce the number of print pages such as splitting the print data. • Increase free memory space by deleting unnecessary data in the RAM disk. See " Accessing Held Jobs From the Operator Panel "
PCL Request 016-720 Invalid PCL file Press Set	Error relating to PCL emulation problems occurs.	<ul style="list-style-type: none"> • Press  to clear the message, cancel the current print job, and conduct the next print job, if any. • Press Cancel to cancel the print job.
Invalid Job 016-799 Data Violation Press Set	When the configuration of the printer on the printer driver does not conform to the printer you are using, this message appears.	<ul style="list-style-type: none"> • Press Cancel to cancel the print job. • Press  to clear the message, cancel the current print job, and conduct the next print job, if any. • Make sure that the configuration of the printer on the printer driver conforms to the printer you are using.
Insert TonerCart NNN-NNN Insert XXX	The specified toner cartridge is either missing or not fully inserted into the printer. XXX is one of the following: <ul style="list-style-type: none"> • Yellow Toner • Cyan Toner • Magenta Toner • Black Toner Error NNN-NNN relates to printer problems.	Prepare the specified toner cartridge. See " Replacing the Toner Cartridge "
Ready to Print NNN-NNN XXX Is Low	Toner cartridge is nearly empty. XXX is one of the following: <ul style="list-style-type: none"> • Yellow Toner • Cyan Toner 	Replace the specified toner cartridge. See " Replacing the Toner Cartridge "

	<ul style="list-style-type: none"> · Magenta Toner · Black Toner Error <i>NNN-NNN</i> relates to printer problems.	
Ready to Print 091-402 Drum Cartridge Replace Soon	Drum life warning. The drum cartridge needs to be replaced.	Replace the drum cartridge. See " Replacing the Drum Cartridges "
Ready to Print 193-700 non-DELL Toner Installed	The printer is in the custom toner mode.	When some of the toner cartridges reach the end of their lives, you cannot continue printing.

Connecting Your Printer

- [Choosing the Right Cable](#)
- [Connecting the Printer Locally](#)
- [Connecting the Printer to the Network](#)

Choosing the Right Cable

Your Dell Laser Printer 3100cn interconnection cable must meet the following requirements:

Connection	Cable certification
Parallel	Parallel IEEE 1284
USB	USB 2.0
10/100Base-TX Ethernet	CAT-5E

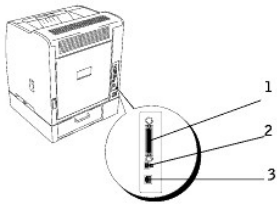

1	Parallel port	<p>(Computer side) (Printer side)</p>
2	USB port	
3	Ethernet port	

Connecting the Printer Locally

A local printer is a printer attached to your computer using a USB or parallel cable. If your printer is attached to a network instead of your computer, skip this step and go on to ["Connecting the Printer to the Network."](#)

Microsoft® Windows® 98 SE, Windows Me, Windows 2000, Windows XP, Windows Server 2003, and Mac OS 9 or later operating systems support USB connections. Some UNIX® and Linux® computers also support USB connections. See your computer operating system documentation to see if your system supports USB.

To attach the printer to a computer:

1. Make sure the printer, computer, and any other attached devices are turned off and unplugged.
2. Connect the printer to the computer using a USB or parallel cable.

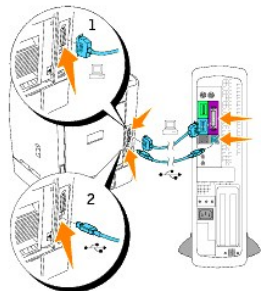

1	Parallel port
2	USB port

A USB port requires a USB cable. A parallel port requires a parallel cable. Be sure to match the USB cable with the USB port on your printer or the parallel cable with the parallel port on your printer.

Plug the other end of the cable into a USB or parallel port on the back of the computer. For a USB cable, do not plug it into the USB keyboard.

Turn On the Printer

1. Plug one end of the printer power cable into the socket at the back of the printer and the other end into a properly grounded outlet.

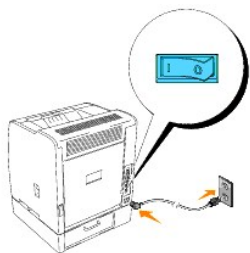

2. Turn on the computer and the printer.

Connecting the Printer to the Network

To attach the printer to a network:

1. Make sure the printer, computer, and any other attached devices are turned off and unplugged.
2. Plug one end of a standard category 5 cable into a LAN drop or hub, and the other end into the Ethernet port on the back of the printer. The printer automatically adjusts for the network speed.

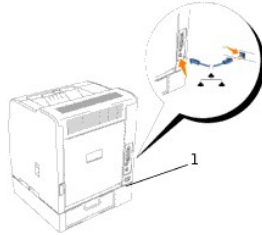

1 Ethernet port

Turn On the Printer

1. Plug one end of the printer power cable into the socket at the back of the printer and the other end into a properly grounded outlet.
2. Turn on the computer and the printer.

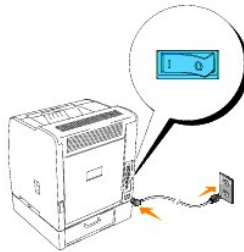

Print and Check the Printer Settings Page

Print a Printer Settings page to verify the network connection. This page also provides important information that helps you configure for network printing.

1. Press **Menu**.
2. Press **▼** until **Configure** appears, and then press **▶** or **↵**.
3. Press **▼** until **Reports** appears, and then press **▶** or **↵**.
4. **Printer Settings** is displayed. Press **↵**.

The Printer Settings page is printed.

5. If the IP address shows anything other than 0.0.0.0 (the factory default) or 169.254.xx.xx, the printer has an IP address assigned and stored. Go to "[Verify the IP Settings](#)."

Assign an IP Address

An IP address is a unique number that consists of four sections that are delimited by a period and can include up to three digits in each section, for example, 111.222.33.44.

Assigning an IP address already in use can cause network performance issues.

 **NOTE:** Assigning an IP address is considered as an advanced function and is normally done by a system administrator.

-  **NOTE:** Do not continue with this procedure until you have the following three addresses:
- IP Address
 - Subnet Mask Address
 - Gateway Address

For more information on using your operator panel, see "[Operator Panel](#)."

1. Turn on the printer.

The **Ready to Print** appears.

2. Press **Menu**.

3. Press **▼** until **Configure** appears, and then press **▶** or **↵**.

4. Press **▼** until **Network** appears, and then press **▶** or **↵**.

5. Press **▼** until **TCP/IP** appears, and then press **▶** or **↵**.

6. Press **▼** until **IP AddressSetup** appears, and then press **▶** or **↵**.

7. Press **▼** until **Panel** appears, and then press **↵**.

8. Press **◀**.

9. Press **▼** until **IP Address** appears, and then press **▶** or **↵**.

10. The cursor is located at the first digit of the IP address. Press **▲▼** to enter the numbers for the IP address.

11. Press **▶**.

The cursor moves to the next digit.

12. Repeat steps 10 and 11 to enter all of the digits in the IP address, and then press **↵**.

13. Press **◀**.

14. Press **▼** until **Subnet Mask** appears, and then press **▶** or **↵**.

15. Repeat steps 10 to 11 to set **Subnet Mask**, and then press **↵**.

16. Press **◀**.

17. Press **▼** until **Gateway Address** appears, and then press **▶** or **↵**.

18. Repeat steps 10 to 11 to set **Gateway Address**, and then press **↵**.

19. Turn off the printer, and then turn it on again.

The IP address is assigned to your printer. You can verify the setting by opening the web browser on any computer on the network and enter the IP address into the URL line. If the IP address is set up correctly, the **Dell Printer Configuration Web Tool** displays in your browser.

You can also assign the IP address to the printer when installing the printer drivers with installer. When you use the **Network Installation** feature, and the **IP AddressSetup** is set to **AutoIP** on the operator panel menu, you can set the IP address from 0.0.0.0 to the desired IP address on the printer selection window.

Verify the IP Settings

1. Print another **Printer Settings** page.
2. Look under the **TCP/IP** heading on the **Printer Settings** page to make sure the IP address, netmask, and gateway are what you expected.

or

Ping the printer and verify that it responds. For example, at a command prompt on a network computer, type ping followed by the new printer IP address (for example, 192.168.0.11):

```
ping 192.168.0.11
```

If the printer is active on the network, you will receive a reply.

Maintaining Your Printer

Periodically your printer requires you to complete certain tasks to maintain optimum print quality. If several people are using the printer, you may want to designate a key operator to maintain your printer. Refer printing problems and maintenance tasks to this key operator.

- [Determining the Status of Supplies](#)
- [Conserving Supplies](#)
- [Ordering Supplies](#)
- [Storing Print Media](#)
- [Storing the Drum and Toner Cartridges](#)
- [Replacing the Drum Cartridges](#)
- [Replacing the Toner Cartridge](#)
- [Cleaning Inside the Printer](#)

Determining the Status of Supplies

If your printer is connected to the network, the **Dell Printer Configuration Web Tool** can provide instant feedback on remaining toner levels. Type the printer IP address in your Web browser to view this information. To use the E-Mail Alert Setup feature that notifies you when the printer requires new supplies, type your name or the name of the key operator in the e-mail list box.

On the operator panel, you can also confirm the following:

- 1 Any supply or maintenance items that require attention replacing (However, the printer can only display information about one item at a time.)
- 1 Remains of each toner cartridges

Conserving Supplies

You can change several settings in your software program or on the operator panel to conserve toner and paper.

Supply	Setting	Function	For more information
Toner	Draft Mode in the Advanced	This check box allows the users to select a print mode that uses less toner. When this feature is used, the image quality will be lower than when it is not used.	
Print media	Multiple Up	The printer prints two or more pages on one side of a sheet. Values for Multiple Up are 2 Up, 4 Up, 8 Up, 16 Up, or 32 Up. Combined with the duplex setting, Multiple Up allows you to print up to 64 pages on one sheet of paper. (32 images on the front and 32 on the back)	
	Duplex	Double-sided printing is available when you attach the optional duplex module. This allows you to print on both sides of a sheet of paper.	" Duplex "

Ordering Supplies

You can order toner from Dell on the Internet when using a networked printer. Type the IP address of your printer in your Web browser, launch the **Dell Printer Configuration Web Tool**, and click the **Order Supplies at**: to order toner for your printer.

You can also order toner by the following method.

1. Click **Start** → **All Programs** → **Dell Printers** → **Dell Laser Printer 3100cn** → **Dell Supplies Management System**.

The **Dell Supplies Management System** window appears.

2. If ordering from the Web:
 - a. When you cannot get information from the printer automatically by two-way communication, a window that prompts you to type the Service Tag number appears. Type your Dell printer Service Tag number in the field provided. Your Service Tag number is located inside the front door of your printer.
 - b. Click **Visit Dell printer supplies ordering web site**.
 3. If ordering by phone, call the number that appears under the **By Telephone** heading.
-

Storing Print Media

To avoid potential paper feeding problems and uneven print quality, there are several things you can do.

- 1 To achieve the best possible print quality, store print media in an environment where the temperature is approximately 21°C (70°F) and the relative humidity is 40%.
 - 1 Store cartons of print media on a pallet or shelf, rather than directly on the floor.
 - 1 If you store individual packages of print media out of the original carton, make sure they rest on a flat surface so the edges do not buckle or curl.
 - 1 Do not place anything on top of the print media packages.
-

Storing the Drum and Toner Cartridges

Store the drum and toner cartridges in their original packaging until you need to use them. Do not store the cartridges in:

- 1 Temperatures greater than 40°C (104°F).
 - 1 An environment with extreme changes in humidity or temperature.
 - 1 Direct sunlight.
 - 1 Dusty places.
 - 1 A car for a long period of time.
 - 1 An environment where corrosive gases are present.
 - 1 An environment with salty air.
-

Replacing the Drum Cartridges

 **CAUTION:** Before performing any of the following procedures, read and follow the safety instructions in your *Owner's Manual*.

Dell cartridges are available only through Dell. You can order more online at <http://www.dell.com/supplies> or by phone. To order by phone, see your *Owner's Manual*.

Dell recommends Dell drum cartridges for your printer. Dell does not provide warranty coverage for problems caused by using accessories, parts, or components not supplied by Dell.

Removing the Used Drum Cartridge

 **NOTE:** Remove any print jobs from the center output tray and close the multipurpose feeder cover before opening the top cover or front door.

 **NOTE:** First pull the optional duplex module back if it is installed.

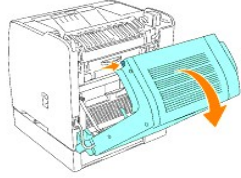

1. To open both covers on the printer, grab the notch in the front door and pull forward. Lift the top cover and push back.

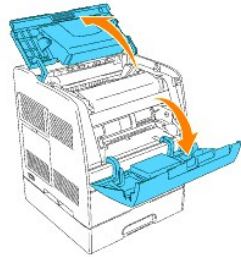

2. To remove the used drum cartridge, push up the lever on the right side of the printer.

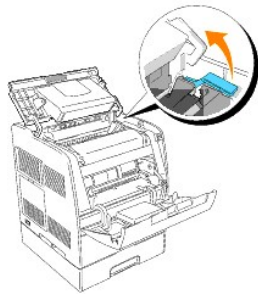

3. Grab the drum cartridge by the handle, and pull it up and out.

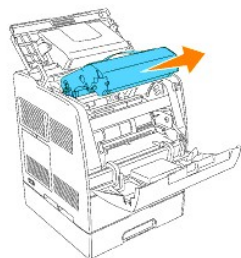

CAUTION: Do not touch inside the printer with your hands. Some parts may be hot. Allow time for the printer to cool before attempting to remove parts in this area.

Installing the New Drum Cartridge

1. Remove the protective sheet from the drum cartridge.

CAUTION: Do not touch the drum at the bottom of the drum cartridge.

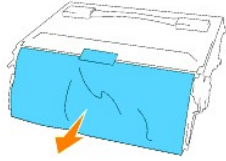

2. To insert the drum cartridge, push up the lever on the right side of the printer. With the lever in the upright position, hold the drum cartridge by the handle, align the arrows on the drum cartridge with the corresponding arrows on the printer and guide the cartridge in until it snaps into place.

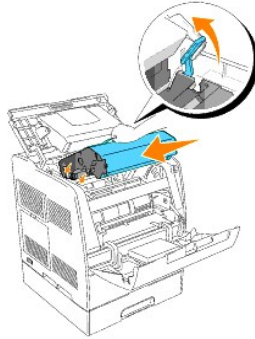

3. Pull down the lever on the right to lock the drum cartridge in place.

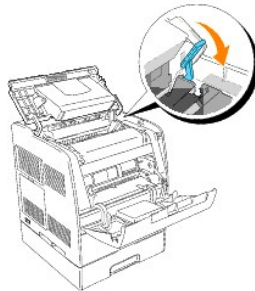

4. Close the top cover.

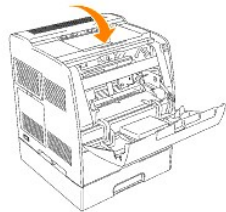

Replacing the Cleaning Pad

1. Pull out the slide bar that is inside the printer on the right side until it stops. The access window cover slides open.



2. Pull the cleaning rod until the cleaning pad comes out of the printer.

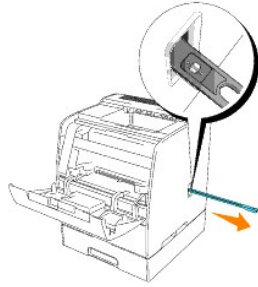

3. Push the two tabs on the cleaning pad inward to remove the pad.

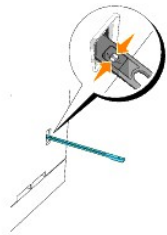

4. Hold the new cleaning pad under the cleaning rod and push it in until it clicks.

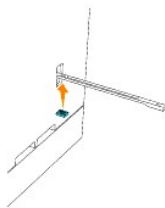

5. Push the cleaning rod back to its original position until it stops.

6. Push the slide bar back to its original position.



7. Close the front door.

 **NOTE:** When the optional duplex module has been opened, close it. Gently pull open the multipurpose feeder cover if necessary.

Replacing the Toner Cartridge

 **CAUTION:** Before performing any of the following procedures, read and follow the safety instructions in your *Owner's Manual*.

In addition to the toner level indicator that appears each time you send a job to print, a message appears on the operator panel to alert you when it's time to order a new toner cartridge.

Dell toner cartridges are available only through Dell. You can order more toner online at <http://www.dell.com/supplies> or by phone. To order by phone, see "Ordering Toner Cartridges" in your *Owner's Manual*.

Dell recommends Dell toner cartridges for your printer. Dell does not provide warranty coverage for problems caused by using accessories, parts, or components not supplied by Dell.

Selecting a Replacement Toner Cartridge

1. Press **Menu**.
2. Press **▼** until **Replace Toner** appears, and then press **▶** or **↵**.
3. Press **▲▼** until the desired toner to replace appears, and press **↵**.

 **NOTE:** Each time you replace a black cartridge, you should use the cleaning rod. See "[Cleaning Inside the Printer](#)."

Removing the Used Toner Cartridge

 **NOTE:** Remove any print jobs from the center output tray and close the multipurpose feeder cover before opening the front door.

1. Grab the notch in the front door and pull forward.

The toner cartridge that must be replaced has moved to the front of the printer.

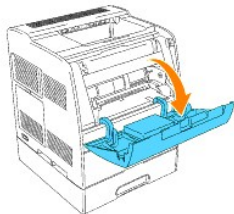

2. Push up the handhold on the right to unlock the cartridge.

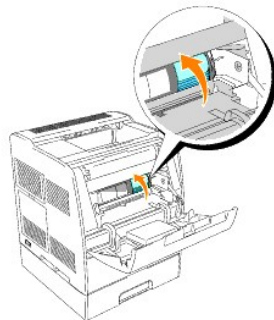

3. Hold the toner cartridge and pull out the cartridge.

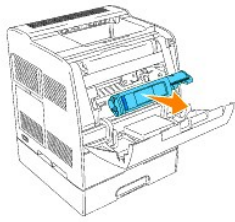

⚠ CAUTION: Do not touch inside the printer with your hands. Some parts may be hot.

Installing the New Toner Cartridge

1. Make sure the color of the toner cartridge matches the slot on the toner cartridge carrier. Gently shake the cartridge to distribute the toner evenly.

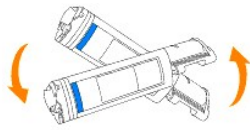

2. Lift the tab up 90 degrees and pull the toner seal straight off, keeping it parallel with the toner cartridge.

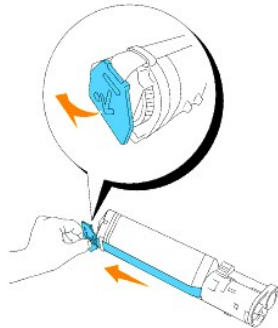

3. To insert the toner cartridge, align the arrows on the cartridge with the corresponding arrows on the printer. Guide the cartridge in until it snaps into place, and then push down the handhold to lock the cartridge in place.

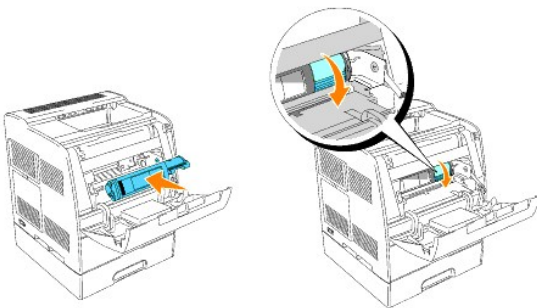

4. If replacing just one toner cartridge, close the front door and you are finished.

🔍 NOTE: Make sure the toner cartridge is installed correctly. Otherwise, the front door cannot close firmly.

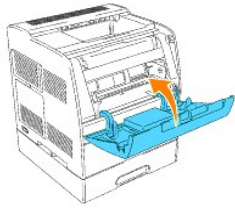

5. Repeat steps 1 through 4 when inserting the remaining cartridges.
-

Cleaning Inside the Printer

A cleaning rod for cleaning inside the printer is installed on your printer.

1. Open the front door.

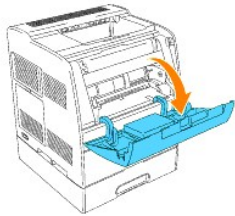

2. Pull out the slide bar that is inside the printer on the right side until it stops. The access window cover slides open.



3. Hold the cleaning rod and push the rod in and pull out once to clean inside the printer.



4. Push the slide bar back to its original position.
5. Close the front door.

Dell Laser Printer 3100cn User's Guide

• [Notes, Notices, and Cautions](#)

Click the links to the left for information on the features, options, and operation of your printer. For information on other documentation included with your printer, see "[Finding Information](#)."

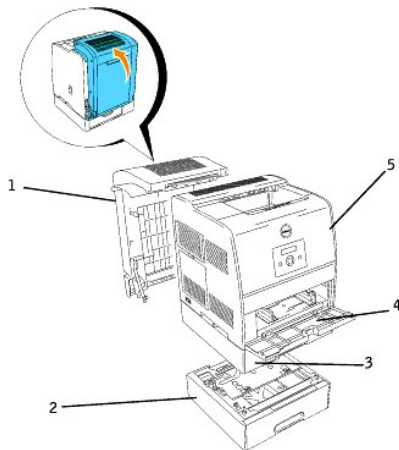

1	Optional duplex module
2	Optional 250-sheet tray module (A4/Letter cassette) Optional 250-sheet tray module (Legal cassette) Optional 500-sheet tray module NOTE: Your printer allows for a maximum of two trays (the standard 250-sheet tray module and either the optional 250-sheet tray module or 500-sheet tray module).
3	Standard 250-sheet tray module (A4/Letter cassette)
4	Multipurpose feeder
5	Printer

To order replacement toner cartridges or supplies from Dell:

1. Double-click the icon on your desktop.





2. Visit Dell's website, or order Dell printer supplies by phone.

www.dell.com/supplies

For best service, have your Dell printer Service Tag available.

For help locating your Service Tag number, see "[Express Service Code and Service Tag number](#)."

Notes, Notices, and Cautions

-  **NOTE:** A NOTE indicates important information that helps you make better use of your printer.
-  **NOTICE:** A NOTICE indicates either potential damage to hardware or loss of data and tells you how to avoid the problem.
-  **CAUTION:** A CAUTION indicates a potential for property damage, personal injury, or death.

Information in this document is subject to change without notice.

© 2005 Dell Inc.. All rights reserved.

Reproduction in any manner whatsoever without the written permission of Dell Inc. is strictly forbidden.

Trademarks used in this text: *Dell* and the *DELL* logo are trademarks of Dell Inc.; *Microsoft*, *Windows*, and are registered trademarks of Microsoft Corporation; *Macintosh*, *MacOS*, *AppleTalk*, *EtherTalk* and *TrueType* are trademarks of Apple Computer, Inc., registered in the U.S. and other countries; *UNIX* is a registered trademark of The Open Group in the United States and other countries; *Red Hat* and *RPM* are trademarks or registered trademarks of Red Hat Inc. in the United States and other countries; *Linux* is a trademark or registered trademark of Linus Torvalds in the United States and other countries; *The Common UNIX Printing System*, *CUPS*, and the *CUPS* logo are the trademarks of Easy Software Products; *ENERGY STAR* is a registered trademark of the U.S. Environmental Protection Agency. As an ENERGY STAR Partner, Dell Inc. has determined that this product meets the ENERGY STAR guidelines for energy efficiency.

As for libtiff

Copyright ©1988-1997 Sam Leffler

Copyright © 1991-1997 Silicon Graphics, Inc.

THE SOFTWARE IS PROVIDED "AS-IS" AND WITHOUT WARRANTY OF ANY KIND, EXPRESS, IMPLIED OR OTHERWISE, INCLUDING WITHOUT LIMITATION, ANY WARRANTY OF MERCHANTABILITY OR FITNESS FOR A PARTICULAR PURPOSE.

IN NO EVENT SHALL SAM LEFFLER OR SILICON GRAGHICS BE LIABLE FOR ANY SPECIAL, INCIDENTAL, INDIRECT OR CONSEQUENTIAL DAMAGES OF ANY KIND, OR ANY DAMAGES WHATSOEVER RESULTING FROM LOSS OF USE, DATA OR PROFITS, WHETHER OR NOT ADVISED OF THE POSSIBILITY OF DAMAGE, AND ON ANY THEORY OF LIABILITY, ARISING OUT OF OR IN CONNECTION WITH THE USE OR PERFORMANCE OF THIS SOFTWARE.

Other trademarks and trade names may be used in this document to refer to either the entities claiming the marks and names or their products. Dell Inc. disclaims any proprietary interest in trademarks and trade names other than its own.



UNITED STATES GOVERNMENT RESTRICTED RIGHTS

This software and documentation are provided with RESTRICTED RIGHTS. Use, duplication or disclosure by the Government is subject to restrictions as set forth in subparagraph (c)(1)(ii) of the Rights in Technical Data and Computer Software clause at DFARS 252.227-7013 and in applicable FAR provisions: Dell Inc., One Dell Way, Round Rock, Texas, 78682, USA.

This equipment has been tested and found to comply with the limits for a Class B digital device, pursuant to Part 15 of the FCC rules.

March 2005 Rev. A01

Finding Information

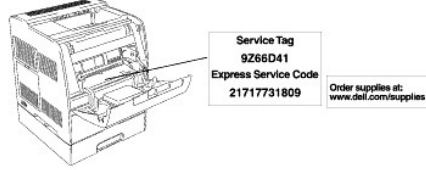
What are you looking for?	Find it here
<ul style="list-style-type: none"> · Drivers for my printer · My <i>User's Guide</i> 	<p><i>Drivers and Utilities CD</i></p>  <p>The <i>Drivers and Utilities CD</i> contains documentation and drivers for your printer. You can use the CD to uninstall/reinstall drivers or access your documentation.</p> <p>Readme files may be included on your CD to provide last-minute updates about technical changes to your printer or advanced technical reference material for experienced users or technicians.</p>
<ul style="list-style-type: none"> · Safety information · How to use my printer · Warranty information 	<p><i>Owner's Manual</i></p>  <p>⚠ CAUTION: Read and follow all safety instructions in your <i>Owner's Manual</i> prior to setting up and operating your printer.</p>
<p>How to set up my printer</p>	<p><i>Setup diagram</i></p> 
<p>Troubleshooting Guide</p>	<p>Troubleshooting Guide</p> <ul style="list-style-type: none"> - User Settings - Configuration - Trouble Shooting Instructions - Others
<p>Express Service Code and Service Tag number</p>	<p>Express Service Code and Service Tag number.</p>  <p>The Express Service Code and Service Tag numbers are located inside the front door of your printer.</p>
<ul style="list-style-type: none"> · Latest drivers for my printer · Answers to technical service and support questions · Documentation for my printer 	<p>Dell Support Website</p> <p>The Dell Support Website provides several online tools, including:</p> <ul style="list-style-type: none"> · Solutions — Troubleshooting hints and tips, articles from technicians, and online courses · Upgrades — Upgrade information for components, such as memory · Customer Care — Contact information, order status, warranty, and repair information · Downloads — Drivers · Reference — Printer documentation and product specifications <p>You can access Dell Support at support.dell.com. Select your region on the WELCOME TO DELL SUPPORT page, and fill in the requested details to access help tools and information.</p>

Dell Printer Configuration Web Tool

Using the Dell Printer Configuration Web Tool

One of the features of the **Dell Printer Configuration Web Tool** is the E-Mail Alert Setup, which sends you, or the key operator, an email when the printer needs supplies or intervention.

If you fill out printer inventory reports requiring the asset tag number of all of the printers in your area, use the Printer Information feature in the **Dell Printer Configuration Web Tool**. Just type the IP address of each printer on the network to display the asset tag number.

The screenshot displays the Dell Printer Configuration Web Tool interface for a Dell Laser Printer 3100cn. The page includes a navigation menu on the left with options like Printer Status, Printer Jobs, Printer Settings, and Printer Information. The main content area shows the printer's status, including IP Address (192.168.1.100), Location, and Contact Person. A 'Printer Status' section displays toner levels for Cyan (71%), Magenta (94%), Yellow (90%), and Black (97%). A warning message indicates that the toner cartridge needs to be replaced soon. Below this, a 'Consumables' table shows the Drum Cartridge status as OK. A 'Paper Tray' table shows the status of the MFF and Tray 1, both OK, with capacities of 150 sheets and 230 sheets, respectively, and a size of A4 (210 x 297 mm).

The **Dell Printer Configuration Web Tool** feature also lets you change printer settings and keep track of printing trends. If you are a network administrator, you can easily copy the printer's settings to one or all printers on the network – right from your Web browser.

To launch the **Dell Printer Configuration Web Tool**, just type your network printer's IP address in your Web browser.

If you do not know what your printer's IP address is, print a Printer Settings page, which lists the IP address:

1. Press **Menu**.
2. Press **▼** until **Configure** appears, and then press **▶** or **↵**.
3. Press **▼** until **Reports** appears, and then press **▶** or **↵**.
4. **Printer Settings** is displayed. Press **↵**.

The Printer Settings page is printed.

If the IP address shows 0.0.0.0 (the factory default), an IP address has not been assigned. To assign one for your printer, see "[Assign an IP Address](#)."

Use the **Dell Printer Configuration Web Tool** for:

Printer Status

Get immediate feedback on printer supply status. When toner is running low, click the **Order Supplies at** link in the lower left area of the first screen to order additional toner cartridges.

Printer Jobs

The **Printer Jobs** menu contains information on **Job List** page and **Completed Jobs** page. These pages show the details of the status regarding each protocol or the print jobs.

Printer Settings

Change printer settings, view the operator panel remotely.

Print Server Settings

Use the **Print Server Settings** menu to set the type of printer interface and necessary conditions for communications.

Copy Printer Settings

Quickly copy the printer's settings to another printer or printers on the network just by typing each printer's IP address.

 **NOTE:** You must be a network administrator to use this feature.

Print Volume

Keep track of printing trends, such as paper usage and types of jobs being printed.

Printer Information

Get the information you need for service calls, inventory reports, or the status of current memory and engine code levels.

Tray Settings

Get the information about the paper type and size for each tray.

E-Mail Alert

Receive an email when the printer needs supplies or intervention. Type your name or the key operator's name in the email list box to be notified.

Set Password

Lock the operator panel with a password so that other users don't inadvertently change the printer settings you selected.

 **NOTE:** You must be a network administrator to use this feature.

Online Help

Click **Help** to visit the *User's Guide* on the Dell website to verify configured settings.

Order Supplies at:

www.dell.com/supplies

Contact Dell Support at:

support.dell.com

Using the Dell Printer Configuration Web Tool

Environment Settings for Web Browser

Dell recommends configuring the environment settings for your Web browser, before using the **Dell Printer Configuration Web Tool**, for the following reasons.

For Netscape Communicator 7.1

Setting Up the Display Language

1. Select **Preferences** from **Edit** on the menu bar.
2. Select **Languages** under the **Navigator** group.
3. Specify the display language in order of preference in the **Language in order of preference** list.

For example:
English [en] or **English/United States [en-us]**
German [de]
French [fr]
Italian [it]
Spanish [es]

Setting the Printer's IP Address to Non-proxy

1. Select **Preferences** from **Edit** on the menu bar.
2. Select **Proxies** under **Advanced** of the **Navigator** group.
3. Select either **Direct connection to the Internet** or **Manual proxy configuration**.
When you select **Manual proxy configuration**, specify the printer's IP address in the **No Proxy for:** box.

When you have finished setting the language and proxy, type `http://nnn.nnn.nnn.nnn/` (the printer's IP address) in the URL entry field of the browser to activate the **Dell Printer Configuration Web Tool**.

For Internet Explorer 6.0

Setting Up the Display Language

1. Select **Internet Options** from **Tools** on the menu bar.
2. Select **Languages** in the **General** tab.
3. Specify the display language in order of preference in the **Language in order of preference** list.

For example:
Italian (Italy) [it]
Spanish (Traditional Sort) [es]
German (Germany) [de]
French (France) [fr]
English [en] or **English (United States) [en-us]**

Setting the Printer's IP Address to Non-proxy

1. Select **Internet Options** from **Tools** on the menu bar.
2. Select **Proxy server** under **LAN Settings** in the **Connections** tab.
3. Do either of the following.
 1. Clear the **Direct connection to the Internet** check box.
 1. Click **Advanced**, and then specify the printer's IP address in the **Do not use proxy server for addresses beginning with** field under **Exceptions**.

When you have finished setting the language and proxy, type `http://nnn.nnn.nnn.nnn/` (the printer's IP address) in the URL entry field of the browser to activate the **Dell Printer Configuration Web Tool**. For information on the printer's IP address, see "[Print and Check the Printer Settings Page.](#)"

Page Display Format

The layout of the page is divided into three sections.

Top Frame

Located at the top of all pages is the Top Frame. When **Dell Printer Configuration Web Tool** is activated, the current status and specifications of the printer are displayed in the Top Frame on every page.

The following items are displayed in the Top Frame.

Dell Laser Printer 3100cn	Displays the printer product name.
IP Address:	Displays the printer's IP address.
Location:	Displays the printer's location. The location can be changed in Basic Information on the Print Server Settings page.
Contact Person:	Displays the printer's administrator's name. The name can be changed in the Basic Information on the Print Server Settings page.
Printer Console	Displays the status of the printer operator panel display and indicators. This is automatically refreshed at the set interval. The interval can be changed in the Basic Information on Print Server Settings page.
Help	Links to the <i>User's Guide</i> on the Dell web page.
Printer Bitmap	Shows the printer bitmap. The Printer Status menu appears in the Right Frame by clicking this image.

Left Frame

Located at the left side of all pages is the Left Frame. The titles of menus displayed in the Left Frame are linked to corresponding menus and pages. You can go to the corresponding page by clicking their characters.

The following menus are displayed in the Left Frame.

Printer Status	Links to the Printer Status menu.
Printer Jobs	Links to the Printer Jobs menu.
Printer Settings	Links to the Printer Settings Report menu.
Print Server Settings	Links to the Print Server Reports menu.
Copy Printer Settings	Links to the Copy Printer Settings page.
Print Volume	Links to the Print Volume page.
Printer Information	Links to the Printer Information page.
Tray Settings	Links to the Tray Settings page.
E-Mail Alert	Links to the E-Mail Alert page.
Set Password	Links to the Set Password page.
Online Help	Links to the <i>User's Guide</i> on the Dell web page.
Order Supplies at:	Links to the Dell web page. Web address: www.dell.com/supplies
Contact Dell Support at:	Links to the Dell support page. Web address: support.dell.com

Right Frame

Located at the right side of all pages is the Right Frame. The contents of the Right Frame correspond to the menu that you select in the Left Frame. For details on the items displayed in the Right Frame, see "[Details of Menu Items.](#)"

Buttons on the Right Frame

Refresh Button

Receives the current printer configuration and updates the latest information in the Right Frame.

Apply New Settings Button

Submits new settings made on the **Dell Printer Configuration Web Tool** to the printer. The old printer settings will be replaced by the new settings.

Restart printer to apply new settings. Button

Submits new settings made on the **Dell Printer Configuration Web Tool** to the printer and reboots the printer. The old printer settings will be replaced by the new settings.

Restore Settings Button

Restores the old settings from before changes made. New settings will not be submitted to the printer.

Changing the Settings of Menu Items

Some menus allow you to change the printer settings through the **Dell Printer Configuration Web Tool**. When you are accessing these menus, the authentication dialog appears on the screen. Type a user name and password for the printer's administrator by following the prompts displayed in the dialog box.

The default user name is **admin**, and the default password is **password**. You can change only the password in the **Set Password** page in the **Print Server Settings** menu. The user name cannot be changed. See "[Set Password](#)" for more information.

Details of Menu Items

"Printer Status"		"Printer Status"	
		"Printer Events"	
		"Print Volume"	
		"Printer Information"	
"Printer Jobs"		"Job List"	
		"Completed Jobs"	
"Printer Settings"	"Printer Settings Report"	"Menu Settings"	
		"Reports"	
	"Printer Settings"		"Basic Settings"
			"Parallel Settings"
			"Network Settings"
			"USB Settings"
			"PCL Settings"
			"PS Settings"
			"Security Settings"
	"Printer Maintenance"		"Paper Density Settings"
			"BTR Adjustments"
			"Init NVRAM"
			"Clear Storage"*
			"Non-Dell Toner"
	"Print Server Settings"	"Print Server Reports"	"Print Server Setup Page"
"NetWare Setup Page"			
"E-Mail Alert Setup Page"			
"Print Server Settings"		"Basic Information"	
		"Port Settings"	
		"TCP/IP"	
		"NetWare"	
		"SMB"	
		"AppleTalk"	

		"E-Mail Alert"
		"SNMP"
	"Other Features"	"Set Password"
		"Reset Print Server"
"Copy Printer Settings"		"Copy Printer Settings"
		"Copy Printer Settings Report"
"Tray Settings"		

* This item is only available when the optional memory card is installed.

Printer Status

Use the **Printer Status** menu to check the status of consumables, hardware, and specifications of the printer.

The following pages are displayed in the **Printer Status** menu.

Printer Status

Purpose:

To check the status of remaining consumables and trays.

Values:

Toner Level		Displays the percent of toner remaining. When the printer runs out of toner, the message appears. The text <i>Order Toner</i> is linked to the Dell Printer Supplies website.	
Consumables	Status	OK	Indicates that consumables are available.
		Empty	Indicates that consumables are used up.
Paper Trays	Status	OK	Indicates that there is some paper in the tray but the quantity is unknown.
		Add Paper	Indicates that there is no paper in the tray.
	Capacity	Displays the maximum capacity status of the paper tray.	
	Size	Displays the size of paper in the tray.	
Output Tray	Status	OK	Indicates that the tray is available.
		Full	Indicates that the tray is not available.
	Capacity	Displays the maximum capacity status of the paper tray.	
Covers	Status	Closed	Indicates that the cover is closed.
		Open	Indicates that the cover is open.
Printer Type		Displays the type of printing for your printer. Color Laser is displayed normally.	
Printing Speed		Displays the printing speed for your printer.	

Printer Events

Purpose:

When printer faults occur such as *running out of paper* or *running out of toner*, the details of all alerts or indications of faults are displayed in the **Printer Events** page.

Values:

Location	Displays the location where the printer fault occurred.
Details	Displays the details of the printer fault.

Print Volume

Purpose:

To verify the number of printed pages. This page can also be displayed by clicking **Print Volume** in the Left Frame.

Values:

Printer Page Count	Displays the total number of pages printed since the printer was shipped from the factory.
Paper Used	Displays the number of pages for each paper size.

Printer Information

Purpose:

To verify the printer details such as hardware configuration and software version. This page can also be displayed by clicking **Printer Information** in the Left Frame.

Values:

Dell Service Tag Number	Displays Dell's service tag number.	
Asset Tag Number	Displays the printer's asset tag number.	
Printer Serial Number	Displays the printer's serial number.	
Memory Capacity	Displays the memory capacity.	
Processor Speed	Displays the processing speed.	
Printer Revision Levels	Firmware Version	Displays the revision date (revision level).
	Network Firmware Version	Displays the revision date (revision level).

Printer Jobs

The **Printer Jobs** menu contains information on **Job List** page and **Completed Jobs** page. These pages show the details of the status regarding each protocol or the print jobs.

Job List

Purpose:

To confirm the print jobs that are being processed.

To update the screen, click the **Refresh** button.

Values:

ID	Displays the job id.
Job Name	Displays the file name of the job being printed.
Owner	Displays the job owner's name.
Host Name	Displays the name of the host computer.
Job Status	Displays the status of the job being printed.
Host I/F	Displays the status of the host interface.
Job Submitted Time	Displays the date the print job was submitted.

Completed Jobs

Purpose:

To check the completed print jobs.

To update the screen, click the **Refresh** button.

Values:

ID	Displays the job id.
Job Name	Displays the file name of the completed print job.
Owner	Displays the job owner's name.
Host Name	Displays the name of the host computer.
Output Result	Displays the status of completed print jobs.
Impression Number	Displays the impression number.
No. of Sheets	Displays the number of pages in the job.
Host I/F	Displays the status of the host interface.
Job Submitted Time	Displays the date the print job was submitted.

Printer Settings

Use the **Printer Settings** menu to display the printer settings report and to configure printer settings.

The following tabbed pages are displayed at the top of the Right Frame.

Printer Settings Report

The **Printer Settings Report** tab includes the **Menu Settings** page.

Menu Settings

Purpose:

To display the current settings of the operator panel menus.

Values:

--	--	--

Basic Settings	Power Saver Time	Displays the amount of time before the printer enters power saver mode after it finishes a print job.
	Error Alarm	Displays whether the printer sounds an alarm when an error occurs.
	Job Timeout	Displays specify the amount of time the printer waits to receive additional bytes of data from the computer.
	Panel Language	Displays the language of the text on the operator panel screen.
	Auto Log Print	Displays whether the printer outputs logs automatically.
	ID Print	Displays a location where the user ID is printed.
	Text Print	Displays whether the printer outputs PDL data, which is not supported by the printer, as text when the printer receives it.
	Banner Sheet Position	Displays the position of banner sheet.
	Banner Sheet Input Tray	Displays the tray in which the banner sheet is loaded.
	RAM Disk	Displays whether to allocate memory to the RAM Disk file system for the Secure Print and Proof Print features. This item is only available when the optional memory card is installed.
	Substitute Tray	Displays whether or not to use another size paper when the paper that is loaded in the specified tray does not match the paper size settings for the current job.
Parallel Settings	ECP	Displays the ECP communication mode of the parallel interface.
	Adobe Protocol	Displays PostScript communication protocol for each interface.
Network Settings	Adobe Protocol	Displays PostScript communication protocol for each interface.
USB Settings	Adobe Protocol	Displays PostScript communication protocol for each interface.
PCL Settings	Input Tray	Displays the input tray.
	Paper Size	Displays the default paper size.
	Orientation	Displays how text and graphics are oriented on the page.
	Duplex Print	Displays whether to do duplexing as the default for all print jobs. This item is only available when the optional duplex module is installed.
	Font	Displays the default font from the registered fonts in the printer.
	Symbol Set	Displays a symbol set for a specified font.
	Font Size	Displays the font size for scalable typographic fonts.
	Font Pitch	Displays the font pitch for scalable monospaced fonts.
	Form Line	Displays the number of characters in a line.
	Quantity	Displays the number of copies you want for the printer default value.
	Image Enhancement	Displays whether to perform the image enhancement feature.
	Hex Dump	Displays whether the Hex Dump feature is on or off.
	Draft Mode	Displays whether to print in the draft mode.
	Line Termination	Displays whether to set the line termination.
Color Mode	Displays the color mode setting.	
PS Settings	PS Error Report	Displays whether the printer outputs error contents for a PostScript error.
	PS Job Timeout	Displays the execution time for one PostScript job.
	Paper Select Mode	Displays the tray that is selected in the PostScript printing.
Security Settings		Displays whether the panel is locked by a password.
Paper Density Settings	Plain 1	Displays the paper density for the plain paper.
	Label	Displays the paper density for the label.
BTR Adjustments	Plain 1	Displays the voltage of the second Bias Transfer Roll (BTR) unit for plain paper 1.
	Plain 2	Displays the voltage of the second BTR unit for plain paper 2.
	Transparency	Displays the voltage of the second BTR unit for transparencies.
	Covers 1	Displays the voltage of the second BTR unit for covers 1.
	Covers 2	Displays the voltage of the second BTR unit for covers 2.
	Label	Displays the voltage of the second BTR unit for labels.
	Coated 1	Displays the voltage of the second BTR unit for coated paper 1.
	Coated 2	Displays the voltage of the second BTR unit for coated paper 2.
Envelope	Displays the voltage of the second BTR unit for envelopes.	
Non-Dell Toner	Non-Dell Toner	Displays whether to use a refilled toner cartridge.

Tray Settings	Tray 1 Paper Type	Displays the type of paper loaded in the standard 250-sheet tray.
	Tray 1 Paper Size	Displays the size of paper loaded in the standard 250-sheet tray.
	Tray 2 Paper Type	Displays the type of paper loaded in the optional 250-sheet tray or 500-sheet tray module.
	Tray 2 Paper Size	Displays the size of paper loaded in the optional 250-sheet tray or 500-sheet tray module.
	MPF Paper Type	Displays the type of paper loaded in the multipurpose feeder.
	MPF Paper Size	Displays the size of paper loaded in the multipurpose feeder.

Reports

Purpose:

To print various types of reports and lists.

Values:

Printer Settings	Click Start button to print the Printer Settings page.
Panel Settings	Click Start button to print the Panel Settings page.
PCL Fonts List	Click Start button to print the PCL Fonts List.
Job History	Click Start button to print the Job History page.
Error Log	Click Start button to print the Error Log page.
PS Fonts List	Click Start button to print the PS Fonts List.
Stored Documents	Click Start button to print the Documents page. This item is only available when the optional memory card is installed. RAM Disk ON.

Printer Settings

The **Printer Settings** tab includes **Basic Settings**, **Parallel Settings**, **Network Settings**, **USB Settings**, **PCL Settings**, **PS Settings**, and **Security Settings** pages.

Basic Settings

Purpose:

To configure the basic printer settings.

Values:

Power Saver Time	Sets the amount of time the printer waits after a job is printed before it goes into the power saver mode.
Error Alarm	Specifies whether the printer sounds an alarm when an error occurs.
Job Timeout	Specifies the amount of time the printer waits to receive additional bytes of data from the computer. When this timeout expires, the print job is canceled.
Panel Language	Determine the language of the text on the operator panel screen.
Auto Log Print	Specifies whether the printer outputs logs automatically.
ID Print	Specifies a location where the user ID is printed.
Text Print	Specifies whether the printer outputs PDL data, which is not supported by the printer, as text when the printer receives it.
Banner Sheet Position	Specifies the position of banner sheet.
Banner Sheet Input	Specifies the tray in which the banner sheet is loaded.

Tray	
RAM Disk	Specifies whether to allocate memory to the RAM Disk file system for the Secure Print and Store Print features. This item is only available when the optional memory card is installed.
Substitute Tray	Specifies whether or not to use another size paper when the paper that is loaded in the specified tray does not match the paper size settings for the current job.

Parallel Settings

Purpose:

To configure the parallel interface.

Values:

ECP	Specifies the ECP communication mode of the parallel interface.
Adobe Protocol	Specifies PostScript communication protocol for each interface.

Network Settings

Purpose:

To Specify the PostScript communication protocol for this printer.

Values:

Adobe Protocol	Specifies PostScript communication protocol for each interface.
----------------	---

USB Settings

Purpose:

To change printer settings affecting a USB port.

Values:

Adobe Protocol	Specifies PostScript communication protocol for each interface.
----------------	---

PCL Settings

Purpose:

To change printer settings that only affect jobs using the PCL emulation printer language.

Values:

Input Tray	Specifies the input tray.
Paper Size	Specifies the default paper size.
Orientation	Specifies how text and graphics are oriented on the page.
Duplex Print	Sets duplexing as the default for all print jobs. This item is only available when the optional duplex module is installed.
Font	Specifies the default font from the registered fonts in the printer.
Symbol Set	Specifies a symbol set for a specified font.
Font Size	Specifies the font size for scalable typographic fonts.
Font Pitch	Specifies the font pitch for scalable monospaced fonts.
Form Line	Specifies the number of characters in a line.
Quantity	Sets the number of copies you want for the printer default value.
Image Enhancement	Specifies whether to perform the image enhancement feature.
Hex Dump	Specifies whether to help isolate the source of a print job problem. With Hex Dump selected, all data sent to the printer is printed in hexadecimal and character representation. Control codes are not executed.
Draft Mode	Specifies whether to print in the draft mode.
Line Termination	Sets the line termination.
Color Mode	Specifies the color mode to Color or Black . This setting is used when the color printing mode setting is not specified for the print job that is sent to the printer.

PS Settings

Purpose:

To change printer settings that only affect jobs using the PostScript emulation printer language.

Values:

PS Error Report	Specifies whether the printer outputs error contents for a PostScript error.
PS Job Timeout	Specifies the execution time for one PostScript job.
Paper Select Mode	Specifies the way to select the tray for the PostScript mode.

Security Settings

Purpose:

To set or change the password to limit access to the menus from the operator panel.

Set the password of the **Dell Printer Configuration Web Tool** from **Set Password** in **Print Server Settings**.

Values:

Panel Lock	Specifies whether to limit access to the menus.
Change Password	Sets a password to limit access to the menus.

Re-enter Password | Type the new password again to confirm.

 **NOTE:** This menu sets a password to lock the operator panel. When changing the password for the **Dell Printer Configuration Web Tool**, click **Set Password** on the left frame and set the password.

Printer Maintenance

Printer Maintenance tab includes **Paper Density Settings**, **BTR Adjustments**, **Registration Adjustments**, **Init NVRAM**, **Clear Storage**, and **Custom Toner** pages.

Paper Density Settings

Purpose:

To specify the paper density.

Values:

Plain 1	Light
	Normal
Label	Label 1
	Label 2

BTR Adjustments

Purpose:

To specify the value of the reference voltage for the transfer roller.

Values:

Plain 1	Sets the value of the reference voltage to the transfer roller for Plain 1.
Plain 2	Sets the value of the reference voltage to the transfer roller for Plain 2.
Transparency	Sets the value of the reference voltage to the transfer roller for Transparency.
Covers 1	Sets the value of the reference voltage to the transfer roller for Covers 1.
Covers 2	Sets the value of the reference voltage to the transfer roller for Covers 2.
Label	Sets the value of the reference voltage to the transfer roller for Label.
Coated 1	Sets the value of the reference voltage to the transfer roller for Coated 1.
Coated 2	Sets the value of the reference voltage to the transfer roller for Coated 2.
Envelope	Sets the value of the reference voltage to the transfer roller for Envelopes.

Init NVRAM

Purpose:

To initialize the NV (non-volatile) memory. After executing this function and rebooting the printer, all the menu parameters are reset to their default values.

The NVRAM for the network feature cannot be initialized.

Values:

Initialize NVRAM and restart printer.	Click Start to initialize the NVRAM.
---------------------------------------	---

Clear Storage

Purpose:

To clear all files that are stored as Secure and Proof Print in the RAM Disk.
This item is only available when the optional memory card is installed. RAM Disk ON.

Values:

Clear Storage	Click Start to clear all files stored in the RAM Disk.
---------------	---

Non-Dell Toner

Purpose:

Specifies whether to use the refilled toner cartridge or not. When this setting is on, you can use toner cartridges provided by other companies.

Values:

Non-Dell Toner	Overrides factory toner cartridge setting. Non-Dell-brand toner cartridges may disable some printer features, reduce print quality and reduce the reliability of your printer. Dell recommends only new Dell-brand toner cartridges for your printer. Dell does not provide warranty coverage for problems caused by using accessories, parts, or components not supplied by Dell.
-----------------------	---

Copy Printer Settings

The **Copy Printer Settings** menu includes the **Copy Printer Settings** and **Copy Printer Settings Report** pages.

Copy Printer Settings

Purpose:

To copy the printer settings to one or more of the same model of printer.

To copy the settings to another printer, specify the IP address and password of the printer to which the settings are copied in the **IP Address** text box and **Password** text box. When you leave the **Password** text box blank, your own password is submitted. Then, click the **Copy the settings to the Host in the above list.** button. Copying the settings is complete. The connection time-out period is 60 seconds. After that, you can check whether settings were copied or not on this page. And you need to check the **Copy the settings to the Host in the above list and reboot the machine.** menu of the **Dell Printer Configuration Web Tool** in the destination printer to verify if settings were actually copied or not.

If the settings can be copied but printer configuration is different, the settings of only the same items are copied. Printer settings are simultaneously copied to printers of up to 10 IP addresses.

Copy Printer Settings Report

Purpose:

To verify the histories of copying after turning on the printer.

Print Server Settings

Use the **Print Server Settings** menu to set the type of printer interface and necessary conditions for communications.

The following tabbed pages are displayed in the top of the Right Frame.

Print Server Reports

The **Print Server Reports** tab includes **Print Server Setup Page**, **NetWare Setup Page**, and **E-Mail Alert Setup Page**.

Print Server Setup Page

Purpose:

To verify the current settings of TCP/IP protocol and printing ports. On this page, you can only verify the settings of items. If you want to change the settings, go to the pages in the **Print Server Settings** tab.

Values:

Ethernet	Ethernet Settings	Displays the current settings of Ethernet transmission rate and the duplex settings.
	Current Ethernet Settings	Displays the current Ethernet settings.
	MAC Address	Displays the printer's MAC address.
TCP/IP Settings	Host Name	Displays the host name.
	IP Address Mode	Displays the settings for the IP address.
	IP Address	Displays the printer's IP address.
	Subnet Mask	Displays the subnet mask.
	Gateway Address	Displays the gateway address.
DNS	Current DNS Server Address	Displays the DNS server address.
WINS* ¹	WINS Mode	Displays the settings for the WINS Address Mode .
	WINS Primary Server	Displays the primary WINS server address.
	WINS Secondary Server	Displays the secondary WINS server address.
LPD	Port Status	Displays the port status.
	Connection Time-Out	Displays the connection timeout period.
Port9100	Port Status	Displays the port status.
	Port Number	Displays the port number.
	Connection Time-Out	Displays the connection timeout period.
IPP* ¹	Port Status	Displays the port status.
	Printer URI	Displays the printer URI.
	Connection Time-Out	Displays the connection timeout period.
	Port Number	Displays the port number.
	Maximum Sessions	Displays the maximum number of connections received simultaneously by the client.
HTTP	Port Status	Displays the port status.

	Port Number	Displays the port number.
	Simultaneous Connections	Displays the number of connections received simultaneously by the client.
	Connection Time-Out	Displays the connection timeout period.
FTP	Port Status	Displays the port status.
	Connection Time-Out	Displays the connection timeout period.
SMB*¹	Port Status	Displays the port status.
	Host Name	Displays the host name.
	Workgroup	Displays the workgroup name.
	Maximum Sessions	Displays the maximum sessions.
	Unicode Support	Displays the status of the Unicode Support feature.
	Auto Master Mode	Displays the status of the Auto Master Mode feature.
	Encrypt Password	Displays the status of the Encrypt Password feature.
	Job Time-Out	Displays the timeout period.
	Connection Time-Out	Displays the connection timeout period.
AppleTalk*¹	Port Status	Displays the port status.
	Printer	Displays the printer name used in AppleTalk.
	AppleTalk Zone	Displays the AppleTalk zone name.
	AppleTalk Type	Displays the AppleTalk type.
SNMP Agent	Port Status	Displays the port status.
	Trap Notification (IP)	Displays the status of the Trap Notification (IP) feature and IP address.
	Trap Notification (IPX)*¹	Displays the status of the Trap Notification (IPX) feature and IP address.
	Authenticate Error Trap	Displays the status of the Authenticate Error Trap .
IP Filter	Access List	Displays the list of IP addresses that are permitted or denied access to the printer.

*1 An optional multi protocol card is required to use.

NetWare Setup Page

Purpose:

To verify the current settings of IPX/SPX and Netware. In this page, you can only verify the settings of items. If you want to change the settings, go to the pages in the **Print Server Settings** tab.

Values:

IPX/SPX Settings	Frame Type	Displays the active frame type.
	Current Frame Type	Displays the current frame type.
	Network Address	Displays the IPX network address.
NetWare	Port Status	Displays the port status.
	Device Name	Displays the printer name.
	Active Mode	Displays the current mode for Active Mode.
	Tree Name	Displays the tree name.
	Context Name	Displays the context name of the Print Server Object.
	File Server Name	Displays the file server name.
	Print Server Name	Displays the print server name.
	Polling Interval	Displays the time interval.
	Receive Time-Out	Displays the timeout period to confirm data has been received.
	NCP Packet Burst	Displays the status, and whether to use NCP packet burst.

	Status Information	Displays messages according to the conditions of the printer.
	Logical Printer Number	Displays the printer number during RPrinter Mode.

 **NOTE:** An optional multi protocol card is required to display the **NetWare Setup Page**.

E-Mail Alert Setup Page

Purpose:

To verify the current settings of SMTP/POP used for the e-mail feature and E-Mail Alerts feature. In this page, you can only verify the settings of items. If you want to change the settings, go to the pages in the **Print Server Settings** tab.

Values:

Port Status		Displays the port status.
Primary SMTP Gateway		Displays the primary SMTP gateway.
Reply Address		Displays the IP address of servers connected with SMTP protocol when data is incoming.
SMTP Server Connection		Displays the status of the SMTP server connection.
E-Mail List 1		Displays the acceptable e-mail addresses for the E-Mail Alert feature specified in E-mail List 1.
E-Mail List 2		Displays the acceptable e-mail addresses for the E-Mail Alert feature specified in E-mail List 2.
Select Alerts for List 1	Supplies Alerts	Displays the status, and whether to receive an E-Mail Alert for consumables.
	Paper Handling Alerts	Displays the status, and whether to receive an E-Mail Alert for paper handling.
	Service Call	Displays the status, and whether to receive an E-Mail Alert for Service Calls.
Select Alerts for List 2	Supplies Alerts	Displays the status, and whether to receive an E-Mail Alert for consumables.
	Paper Handling Alerts	Displays the status, and whether to receive an E-Mail Alert for paper handling.
	Service Call	Displays the status, and whether to receive an E-Mail Alert for Service Calls.

Print Server Settings

The **Print Server Settings** tab includes **Basic Information**, **Port Settings**, **TCP/IP**, **NetWare**, **SMB**, **AppleTalk**, **E-Mail Alert**, and **SNMP** pages.

Basic Information

Purpose:

To configure the printer's basic information.

Values:

System Settings	Printer Name	Specifies the name of the printer up to 31 alphanumeric characters.	
	Location	Specifies the location of the printer up to 63 alphanumeric characters.	
	Contact Person	Specifies the contact name, number, and other information of the printer administrator and service center up to 63 alphanumeric characters.	
	Administrator E-mail Address	Specifies the contact address of the printer administrator and service center up to 63 alphanumeric characters.	
	Asset Tag Number	Specifies the asset tag number.	
EWS Settings	Auto Refresh	On	Refreshes the contents of the status display pages automatically.
		Off	Does not refresh the status display pages automatically.

	Auto Refresh Interval	Sets the time interval for refreshing the contents of the status display pages automatically from 15 to 600 seconds.
--	------------------------------	--

 **NOTE:** The auto refresh feature is effective for the contents of the Top Frame, **Printer Status** page, **Job List** page, and **Completed Jobs** page.

Port Settings

Purpose:

To specify whether to enable or disable printing ports and management protocol features.

Values:

Ethernet	Ethernet Settings	Auto	Detects Ethernet transmission rate and the duplex settings automatically.
		10BASE-T Half-Duplex	Selects 10Base-T Half-Duplex as the default value.
		10BASE-T Full-Duplex	Selects 10Base-T Full-Duplex as the default value.
		100BASE-TX Half-Duplex	Selects 100Base-T Half-Duplex as the default value.
		100BASE-TX Full-Duplex	Selects 100Base-T Full-Duplex as the default value.
	Current Ethernet Settings	Displays the current settings of Ethernet.	
	MAC Address	Displays the printer's MAC address.	
Port Settings	LPD	Select the check box to enable the LPD.	
	Port9100	Select the check box to enable the Port9100.	
	IPP* ¹	Select the check box to enable the IPP port.	
	FTP	Select the check box to enable the FTP port.	
	SMB* ¹	Select the check box to enable the SMB. You can also configure the transport protocol to be used. TCP/IP and NetBEUI can be selected simultaneously as the transport protocol.	
	NetWare* ¹	Select the check box to enable the NetWare port.	
	AppleTalk* ¹	Select the check box to enable the AppleTalk port.	
	E-Mail Alert	Select the check box to enable the E-Mail Alert feature.	
	SNMP Agent	Select the check box to enable the SNMP. You can also configure the transport protocol to be used. UDP and IPX can be selected simultaneously as the transport protocol. IPX is only available when the multiprotocol card is installed.	

*1 An optional multi protocol card is required to use.

 **NOTE:** The settings in the **Port Settings** item will be valid only when the printer is rebooted. When you change or set this item, click the **Restart printer to apply new settings.** button to apply new settings.

TCP/IP

Purpose:

To configure the IP address, subnet mask, and gateway address of the printer.

Values:

TCP/IP Settings	Host Name	Specifies the host name up to 15 alphanumeric characters. The default name will remain valid if no entry is made.

	IP Address Mode	AutoIP	Automatically sets the IP address.
		DHCP	Uses DHCP to set the IP address.
		BOOTP	Uses BOOTP to set the IP address.
		RARP	Uses RARP to set the IP address.
		Manually Set	Enables the IP address set in IP Address .
	IP Address	Sets the IP address allocated to the printer in the <i>nnn.nnn.nnn.nnn</i> format. Each section of <i>nnn.nnn.nnn.nnn</i> is a value between 0 and 254. Note that values 127 and 224 to 254 are not valid for the first three-digits.	
	Subnet Mask	Sets the subnet mask in the <i>nnn.nnn.nnn.nnn</i> format. Each section of <i>nnn.nnn.nnn.nnn</i> is a value between 0 and 255. Note that 255.255.255.255 is invalid.	
	Gateway Address	Sets the gateway address in the <i>nnn.nnn.nnn.nnn</i> format. Each section of <i>nnn.nnn.nnn.nnn</i> is a value between 0 and 254. Note that values 127 and 224 to 254 are not valid for the first three-digits.	
DNS	DNS Mode	Select the check box to get the DNS server address automatically from the DHCP server.	
	DNS Server ADDR	Sets the DNS server address.	
WINS*1	WINS Mode	Select the check box to get the WINS server address automatically from the DHCP server.	
	WINS Primary Server	Sets WINS server address in the <i>nnn.nnn.nnn.nnn</i> format. Each section of <i>nnn.nnn.nnn.nnn</i> is a value between 0 and 254. Note that values 127 and 224 to 254 are not valid for the first three-digits.	
	WINS Secondary Server	Sets a back up WINS server address in the <i>nnn.nnn.nnn.nnn</i> format. Each section of <i>nnn.nnn.nnn.nnn</i> is a value between 0 and 254. Note that values 127 and 224 to 254 are not valid for the first three-digits.	
LPD	Connection Time-Out	Sets the connection timeout period from 1 to 1000 seconds.	
	IP Filter	To set the IP Filter settings, click IP Filter . The " IP Filter " page is displayed.	
Port9100	Port Number	Sets the port number from 9000 to 9999.	
	Connection Time-Out	Sets the connection timeout period between 1 and 1000 seconds.	
	IP Filter	To set the IP Filter settings, click IP Filter . The " IP Filter " page is displayed.	
IPP*1	Printer URI	Displays the printer URI.	
	Connection Time-Out	Sets the connection timeout period from 1 to 1000 seconds.	
	Port Number	Displays the port number for receiving requests from the client.	
	Maximum Sessions	Displays the maximum number of connections received simultaneously by the client.	
HTTP	Port Number	Sets the port number to 80 and 9000 to 9999.	
	Simultaneous Connections	Displays the maximum number of connections received simultaneously by the client.	
	Connection Time-Out	Sets the connection timeout period from 1 to 255 seconds.	
FTP	Password	Sets whether to enable or disable the password. And also specifies the password value up to seven characters.	
	Connection Time-Out	Sets the connection timeout period from 1 to 1000 seconds.	

*1 An optional multi protocol card is required to use.

NetWare

Purpose:

To configure detailed settings for IPX/SPX and NetWare.

Values:

IPX/SPX	Frame Type	Auto	Specifies the active frame type automatically.
		Ethernet II	Selects Ethernet II frame type.
		Ethernet 802.3	Selects IEEE802.3 frame type.
		Ethernet 802.2	Selects IEEE802.2 frame type.
		Ethernet SNAP	Selects SNAP frame type.
	Current Frame Type	Displays the current frame type.	

	Network Address	Displays the IPX network address.	
NetWare	Device Name* ¹	Specifies the printer name up to 47 alphanumeric characters. For PServer Mode, set the Print Server Name (Print Server Object Name). For RPrinter Mode, set the Remote Printer Name (Printer Name in Bindery and Printer Object Name in Directory). The original setting remains valid if no input is made.	
	Active Mode	Bindery: PServer Mode	Selects this option when using Directory: PServer Mode in Bindery: PServer Mode .
		Bindery: RPrinter Mode	Selects this option when using Directory: RPrinter Mode in Bindery: PServer Mode .
		Directory: PServer Mode	Selects this option when using Directory: PServer Mode in Bindery: RPrinter Mode .
		Directory: RPrinter Mode	Selects this option when using Directory: RPrinter Mode in Bindery: RPrinter Mode .
	Tree Name* ¹	Specifies the tree name up to 32 alphanumeric characters. Configure this item only when Directory: PServer Mode or Directory: RPrinter Mode is selected.	
	Context Name	Specifies the context name of the Print Server Object up to 255 alphanumeric characters. Configure this item only when Directory: PServer Mode or Directory: RPrinter Mode is selected.	
	File Server Name* ¹	Specifies the file server name up to 47 alphanumeric characters. Configure this item only when Bindery: PServer Mode or Bindery: RPrinter Mode is selected.	
	Print Server Name* ¹	Specifies the print server name up to 47 alphanumeric characters. Configure this item only when Bindery: RPrinter Mode or Directory: RPrinter Mode is selected.	
	Polling Interval	Sets the time interval from when print data enters the print queue until printing starts. The setting range is from 1 to 1000 seconds. The original setting remains valid if no input is made. Configure this item only when Bindery: PServer Mode or Directory: PServer Mode is selected.	
	Receive Time-Out	Sets the timeout period that confirms data has been received. The setting range is from 1 to 1000 seconds.	
	NCP Packet Burst	On	Uses NCP packet burst.
		Off	Does not use NCP packet burst.
	Password	Sets the print server password up to 32 alphanumeric characters. Configure this item only when Bindery: PServer Mode or Directory: PServer Mode is selected.	
Confirm Password	Allows you to confirm the configured password by re-entering the same password.		
Status Information	Displays the messages according to the conditions of the printer.		
Logical Printer Number	Displays the printer number during Bindery: RPrinter Mode or Directory: RPrinter Mode .		

1 The following are illegal characters: semicolon (;), colon (:), asterisk (), question mark (?), period (.), comma (,), yen mark (¥), back slash (\), double quotation ("), comparison symbols (< >), brackets ([]), operation symbols (+, =, or ~), pipe (|), slash (/), and space ().

 **NOTE:** The settings in the **NetWare** page will be valid only when NetWare or the printer is rebooted. Click the **Restart printer to apply new settings.** button to apply new settings.

 **NOTE:** An optional multi protocol card is required to display the **NetWare** page.

SMB

Purpose:

To configure detailed settings for SMB.

Values:

Host Name	Specifies the host name up to 15 alphanumeric characters. The original setting will remain valid if no input is made.	
Workgroup	Specifies the workgroup name up to 15 alphanumeric characters. The original setting will remain valid if no input is made.	
Administrator Name	Specifies the administrator name up to 20 alphanumeric characters. The original setting will remain valid if no input is made. The default name is <i>admin</i> .	
Administrator Password	Specifies the administrator password up to 14 alphanumeric characters. The original setting will remain valid if no input is made. The default password is <i>password</i> .	
Confirm Administrator Password	Allows you to confirm the configured administrator password by re-entering the same password.	
Maximum Sessions	Displays the maximum sessions.	
Unicode Support	On	Notifies the host name and workgroup name in Unicode characters.
	Off	Does not notify the host name and workgroup name in Unicode characters.

Auto Master Mode	On	Enable the Auto Master Mode.
	Off	Disable the Auto Master Mode.
Encrypt Password	On	Encrypts the password.
	Off	Does not encrypt the password.
Job Time-Out	Sets the timeout period from 60 to 3600 seconds.	
Connection Time-Out	Sets the connection timeout period from 60 to 3600 seconds.	

 **NOTE:** The settings in the **SMB** page will be valid only when the printer is rebooted. Click the **Restart printer to apply new settings.** button to apply new settings.

 **NOTE:** An optional multi protocol card is required to display the **SMB** page.

AppleTalk

Purpose:

To configure the detailed settings for AppleTalk.

Values:

AppleTalk	Printer	Specifies the printer name in the AppleTalk network up to 32 alphanumeric characters and symbol sets.
	AppleTalk Zone	Specifies the AppleTalk zone name up to 32 alphanumeric characters and symbol sets.
	AppleTalk Type	Displays the AppleTalk type.

 **NOTE:** An optional multi protocol card is required to display the **AppleTalk** page.

E-Mail Alert

Purpose:

To configure detailed settings for E-Mail Alert. This page can also be displayed by clicking **E-Mail Alert** in the Left Frame.

Values:

Primary SMTP Gateway		Sets the primary SMTP gateway.
Reply Address		Sets the IP address of the incoming server connected with SMTP protocol.
SMTP Server Connection		Displays the status of the SMTP server connection.
E-Mail List 1		Sets acceptable e-mail addresses for the E-Mail Alert feature up to 255 alphanumeric characters.
E-Mail List 2		Sets acceptable e-mail addresses for the E-Mail Alert feature up to 255 alphanumeric characters.
Select Alerts for List 1	Supplies Alerts	Select the check box to receive an E-Mail Alert for consumables.
	Paper Handling Alerts	Select the check box to receive an E-Mail Alert for paper handling.
	Service Call	Select the check box to receive an E-Mail AlertE-Mail Alert for Service Calls.
Select Alerts for List 2	Supplies Alerts	Select the check box to receive an E-Mail Alert for consumables.
	Paper Handling Alerts	Select the check box to receive an E-Mail Alert for paper handling.
	Service Call	Select the check box to receive an E-Mail Alert for Service Calls.

SNMP

Purpose:

To configure the detailed settings of SNMP.

Values:

Community Name (Read only)^{*1}	Specifies the community name to access (read only) the data up to 31 alphanumeric characters. The original setting will remain valid if no input is made. Characters entered for community Name in previous settings will not be displayed on the screen. The default Read/Write Community is Private.
Community Name (Read/Write)^{*1}	Specifies the community name to access (read and write) the data up to 31 alphanumeric characters. The original setting will remain valid if no input is made. Characters entered for community Name in previous settings will not be displayed on the screen. The default Read/Write Community is Public.
Community Name (Trap)^{*1}	Specifies the community name used for trap up to 31 alphanumeric characters. The original settings will remain valid if no input is made. Characters entered for Community Name (Trap) in previous settings will not be displayed on the screen. The default Trap Community is " " (NULL).
Trap Notification (IP)	Select the check box to notify trap occurrence. In this case, specify the IP address and IP socket in the <i>nnn.nnn.nnn.nnn:mmmmm</i> format. Each section of <i>nnn.nnn.nnn.nnn</i> is a value between 0 and 255. Note that values 127 and 224 to 254 are not valid for the first three-digits only. IP socket <i>mmmmm</i> is a value between 0 and 65535.
Trap Notification (IPX)^{*2}	Select the check box to notify trap occurrence. In this case, specify the IPX address in the <i>nnnnnnnn.mmmmmmmmmmm.iiii</i> format. IP network <i>nnnnnnnn</i> is a hexadecimal value between 0 and fffffff, IPX node <i>mmmmmmmmmmmm</i> is a hexadecimal value between 0 and ffffffff and IPX socket <i>iiii</i> is a hexadecimal value between 0 and ffff.
Authenticate Error Trap	Select the check box to notify Authenticate Error Trap.

*1 The default value of each items can be changed by using Dell Printer Configuration Web Tool.

*2 An optional multi protocol card is required to use.

IP Filter

Purpose:

To configure the detailed settings for the IP Filter used for LPD and Port9100. This page can be linked from LPD and Port9100 settings on the TCP/IP page.

Values:

Address	Sets the address in the address field. Enter a numeric value between 0 and 255 in each field of "aaa.bbb.ccc.ddd." However, 127 and 224 to 254 cannot be used to "aaa."	
Address Mask	Sets the Address Mask in the Mask field. Enter a numeric value between 0 and 255 in each field.	
Active Mode	Permit	Permits printing from specified network address.
	Disabled	Disables the IP Filter feature for the specified IP address.
	Reject	Rejects printing from specified network address.

When you make the settings for the filter, enter the IP address of the IP Filter in the **Address** field and the Subnet Mask in the **Address Mask** field. Enter a numeric value between 0 and 255 in each field. "*" is appended to the current value.

Setup Procedure

You can set up to a maximum of five items and the first item takes priority. Enter the shortest address first before proceeding to the next longer address when setting multiple filters.

The following section explains how the **IP Filter** operates.

IP Filter Procedure

- 1 Enabling Printing From a Specified User

The following describes the procedure to enable printing only from the "192.168.100.10" IP address.

Procedures:

1. Click the first column of **Access List** row **1**.
2. Enter "192.168.100.10" in the **Address** field and "255.255.255.255" in the **Address Mask** field.
3. Select **Permit**.
4. Click **Apply New Settings**.

- 1 Disabling Printing From a Specified User

The following describes the procedure to disable printing only from the "192.168.100.10" IP address.

Procedures:

1. Click the first column of **Access List** row **1**.
2. Enter "192.168.100.10" in the **Address** field and "255.255.255.255" in the **Address Mask** field.
3. Select **Reject**.
4. Click the first column of **Access List** row **2**.
5. Enter "0.0.0.0" in the **Address** field and "0.0.0.0" in the **Address Mask** field.
6. Select **Permit**.
7. Click **Apply New Settings**.

- 1 Enabling and Disabling Printing from Network Addresses

You can enable printing from the "192.168" network address and disable printing from the "192.168.200" network address. However, the example below describes how to enable printing from the "192.168.200.10" IP address.

Procedures:

1. Click the first column of the **Access List** row **1**.
2. Enter "192.168.200.10" in the **Address** field and "255.255.255.255" in the **Address Mask** field.
3. Select **Permit**.
4. Click the first column of the **Access List** row **2**.
5. Enter "192.168.200.0" in the **Address** field and "255.255.255.0" in the **Address Mask** field.
6. Select **Reject**.
7. Click the first column of the **Access List** row **3**.
8. Enter "192.168.0.0" in the **Address** field and "255.255.0.0" in the **Address Mask** field.
9. Select **Permit**.
10. Click **Apply New Settings**.

Other Features

The **Other Features** tab includes **Set Password** page and **Reset Print Server** page.

Set Password

Purpose:

To set or change the password that is required to access the printer setup parameters from the **Dell Printer Configuration Web Tool**.

Set the password of the operator panel from **Security Settings** in the **Printer Settings**.

This page can also be displayed by clicking **Set Password** in the Left Frame.

Values:

Administrator Password	Sets the password up to 8 alphanumeric characters. The password will appear as asterisks (*) in the field when it is entered.
Confirm Administrator Password	

Reset Print Server

Purpose:

To initialize NVRAM for the network feature and reboot the printer.

Initialize the printer's NVRAM from the **InitNVRAM** in the **Printer Settings**.

Values:

Initialize NIC NVRAM and restart printer	Click the Start button to initialize NVRAM. Network settings will revert to the factory default settings and reboot the network capability.
Restart Printer	Click the Start button to reboot printer.

Tray Settings

Use the **Tray Settings** menu to set the printer media types and sizes for trays respectively.

Values:

Tray 1 Paper Type	Sets the type of paper loaded in the standard 250-sheet tray module.
Tray 1 Paper Size	Sets the size of paper loaded in the standard 250-sheet tray module.
Tray 2 Paper Type	Sets the type of paper loaded in the optional 250-sheet tray or 500-sheet tray module.
Tray 2 Paper Size	Sets the size of paper loaded in the optional 250-sheet tray or 500-sheet tray module.
MPF Paper Type	Sets the type of paper loaded in the multipurpose feeder.
MPF Paper Size	Sets the size of paper loaded in the multipurpose feeder.

About Your Printer

The following illustrations show the standard Dell Laser Printer 3100cn, with optional duplex module, and an optional 250-sheet tray module or 500-sheet tray module.

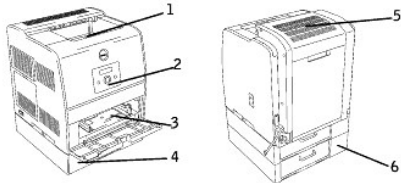

Standard printer		Printer with options	
1	Center output tray	5	Optional duplex module
2	Operator panel	6	Optional 250-sheet tray module (A4/Letter cassette)
3	Multipurpose feeder		Optional 250-sheet tray module (Legal cassette)
4	Standard 250-sheet tray module (A4/Letter cassette)		Optional 500-sheet tray module
		The optional 250-sheet tray module and 500-sheet tray module cannot be installed together.	

NOTE: When you use the printer with the multipurpose feeder opened, do not locate the printer in direct sunlight. Doing so may cause a malfunction or unnatural screen image.

Understanding Fonts

- [Typefaces and fonts](#)
- [Bitmapped and Scalable Fonts](#)
- [Resident Fonts](#)
- [Symbol Sets](#)

Typefaces and fonts

A font is a set of characters and symbols created with a distinct design. The distinct design is called a typeface. The typefaces you select add personality to a document. Well-chosen typefaces make a document easier to read.

The printer has numerous resident fonts in PCL 6 and PostScript 3. See "[Resident Fonts](#)" for a listing of all resident fonts.

Weight and style

Typefaces are often available in different weights and styles. These variations modify the original typeface so you can, for example, emphasize important words in text or highlight book titles. The different weights and styles are designed to complement the original typeface.

Weight refers to the thickness of the lines that form the characters. Thicker lines result in darker characters. Some words commonly used to describe the weight of a typeface are bold, medium, light, black, and heavy.

Style refers to other typeface modifications, such as tilt or character width. Italic and oblique are styles where the characters are tilted. Narrow, condensed, and extended are three common styles that modify the character widths.

Some fonts combine several weight and style modifications: for example, Helvetica Narrow Bold Oblique. A group of several weight and style variations of a single typeface is called a typeface family. Most typeface families have four variations: regular, italic (oblique), bold, and bold italic (bold oblique). Some families have more variations, as the following illustration for the Helvetica typeface family shows:

Helvetica	ABCDEFGHIJKLMNOabcdefghijklmnopqrstuvwxyz1234567890
Helvetica Oblique	ABCDEFGHIJKLMNOabcdefghijklmnopqrstuvwxyz1234567890
Helvetica Bold	ABCDEFGHIJKLMNOabcdefghijklmnopqrstuvwxyz1234567890
Helvetica Bold Oblique	ABCDEFGHIJKLMNOabcdefghijklmnopqrstuvwxyz1234567890
Helvetica Narrow	ABCDEFGHIJKLMNOabcdefghijklmnopqrstuvwxyz1234567890
Helvetica Narrow Oblique	ABCDEFGHIJKLMNOabcdefghijklmnopqrstuvwxyz1234567890
Helvetica Narrow Bold	ABCDEFGHIJKLMNOabcdefghijklmnopqrstuvwxyz1234567890
Helvetica Narrow Bold Oblique	ABCDEFGHIJKLMNOabcdefghijklmnopqrstuvwxyz1234567890

Pitch and Point Size

The size of a font is specified as either a pitch or point size, depending on whether the font is fixed space or proportional.

In fixed space fonts, each character has the same width. Pitch is used to specify the size of fixed space fonts. It is a measure of the number of characters that will print in one horizontal inch of type. For example, all 10-pitch fonts print 10 characters per inch (cpi) and all 12-pitch fonts print 12 cpi:

Courier	10 Pitch	1234567890
Courier-Bold	10 Pitch	1234567890
Courier	12 Pitch	123456789012
Courier-Bold	12 Pitch	123456789012
← 1 inch →		

In proportional (or typographic) fonts, every character can have a different width. Since proportional fonts have characters with different widths, the font size is specified in point size, not pitch. Point size refers to the height of the characters in the font. A point is defined as 1/72 inch. The characters in a font printed at 24 point will be twice as large as the characters in the same font printed at 12 point.

The following illustration shows samples of a font printed in different point sizes:

48 point 36 point
24 point 18 point 12 point 10 point

The point size of a font is defined as the distance from the top of the tallest character in the font to the bottom of the lowest character in the font. Due to the definition of point size, different fonts printed at the same point size may appear quite different in size. This is because there are other font parameters that affect how the font looks. However, the point size of a font is an excellent specification of the relative size of a font. The following examples illustrate two very different proportional fonts at 14 point:

ITC Avant Garde
abcdefghABCDEFGH
ITC Zapf Chancery
abcdefghABCDEFGH

Bitmapped and Scalable Fonts

The printer uses both bitmapped and scalable fonts.

Bitmapped fonts are stored in printer memory as predefined patterns of bits that represent a typeface at a specific size, style, and resolution. The following illustration shows an example of a character from a bitmapped font.

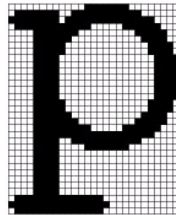

Bitmapped fonts are available in different type styles and point sizes as downloadable fonts. Contact the place where you bought your printer for more information about downloadable fonts.

Scalable fonts (also called outline fonts) are stored as computer programs that define the outlines of the characters in the font. Each time you print characters from a scalable font, the printer creates a bitmap of the characters at the point size you choose and saves it temporarily in printer memory.



These temporary bitmapped fonts are deleted when you turn off or reset the printer. Scalable fonts provide the flexibility of printing in many different point sizes.

Your printer uses different scalable font formats for downloading fonts to the printer. PCL 6 uses Intellifont and TrueType scalable fonts. PostScript 3 uses Type 1 and TrueType scalable fonts. There are thousands of different scalable fonts available in these different font formats from numerous font suppliers.

If you plan to use many downloadable bitmapped or scalable fonts or if you plan to use many different sizes of scalable fonts, you may need to purchase additional memory for your printer.

Resident Fonts

Your printer is equipped with resident fonts stored permanently in printer memory. Different fonts are available in PCL 6 and PostScript 3. Some of the most popular typefaces, like Courier and TimesNew (PCL 6)/Times New Roman (PostScript 3), are available for all printer languages.

The following table lists all the fonts resident in your printer. See "[Printing a Font Sample List](#)" for instructions on how to print samples of the fonts. You can select the resident fonts from your software program, or from the operator panel if you are using PCL 6.

Resident scalable fonts	
PCL 6	PostScript 3
Albertus Medium	AlbertusMT
	AlbertusMT-Italic
	AlbertusMT-Light
Albertus Extra Bold	
Antique Olive	AntiqueOlive-Roman
Antique Olive Italic	AntiqueOlive-Italic
Antique Olive Bold	AntiqueOlive-Bold
	AntiqueOlive-Compact
Arial	ArialMT
Arial Italic	Arial-ItalicMT
Arial Bold	Arial-BoldMT
Arial Bold Italic	Arial-BoldItalicMT
ITC Avant Garde Gothic Book	AvantGarde-Book
ITC Avant Garde Gothic Book Oblique	AvantGarde-BookOblique
ITC Avant Garde Gothic Demi	AvantGarde-Demi
ITC Avant Garde Gothic Demi Oblique	AvantGarde-DemiOblique
ITC Bookman Light	Bookman-Light
ITC Bookman Light Italic	Bookman-LightItalic
ITC Bookman Demi	Bookman-Demi
ITC Bookman Demi Italic	Bookman-DemiItalic
Clarendon Condensed	
Coronet	Coronet-Regular
CourierPS	Courier
CourierPS Oblique	Courier-Oblique
CourierPS Bold	Courier-Bold
CourierPS Bold Italic	Courier-BoldOblique
CG Omega	

CG Omega Bold	
CG Omega Italic	
CG Omega Bold Italic	
Garamond Antiqua	
Garamond Halbfett	
Garamond Kursiv	
Garamond Kursiv Halbfett	
Helvetica	Helvetica
Helvetica oblique	Helvetica-Oblique
Helvetica Bold	Helvetica-Bold
Helvetica Bold oblique	Helvetica-BoldOblique
Helvetica Narrow	Helvetica-Narrow
Helvetica Narrow oblique	Helvetica-Narrow-Oblique
Helvetica Narrow Bold	Helvetica-Narrow-Bold
Helvetica Narrow Bold oblique	Helvetica-Narrow-BoldOblique
CG Times	
CG Times Italic	
CG Times Bold	
CG Times Bold Italic	
Univers Medium	
Univers Medium Italic	
Univers Bold	
Univers Bold Italic	
Courier	
Courier Italic	
Courier Bold	
Courier Bold Italic	
Letter Gothic	LetterGothic
Letter Gothic Italic	LetterGothic-Slanted
Letter Gothic Bold	LetterGothic-Bold
	LetterGothic-BoldSlanted
Marigold	Marigold
New Century Schoolbook Roman	NewCenturySchlBk-Roman
New Century Schoolbook Italic	NewCenturySchlBk-Italic
New Century Schoolbook Bold	NewCenturySchlBk-Bold
New Century Schoolbook Bold Italic	NewCenturySchlBk-BoldItalic
	Optima
	Optima-Bold
	Optima-BoldItalic
	Optima-Italic
Palatino Roman	Palatino-Roman
Palatino Italic	Palatino-Italic
Palatino Bold	Palatino-Bold

Palatino Bold Italic	Palatino-BoldItalic
SymbolPS	Symbol
Symbol	
Times Roman	Times-Roman
Times Italic	Times-Italic
Times Bold	Times-Bold
Times Bold Italic	Times-BoldItalic
Times New	TimesNewRomanPSMT
Times New Italic	TimesNewRomanPS-ItalicMT
Times New Bold	TimesNewRomanPS-BoldMT
Times New Bold Italic	TimesNewRomanPS-BoldItalicMT
	Univers
	Univers-Oblique
	Univers-Bold
	Univers-BoldOblique
Univers Medium Condensed	Univers-Condensed
Univers Medium Condensed Italic	Univers-CondensedOblique
Univers Bold Condensed	Univers-CondensedBold
Univers Bold Condensed Italic	Univers-CondensedBoldOblique
Wingdings	Wingdings-Regular
ITC Zapf Chancery Medium Italic	ZapfChancery-MediumItalic
ITC Zapf Dingbats	ZapfDingbats
	Univers-Extended
	Univers-ExtendedObl
	Univers-BoldExt
	Univers-BoldExtObl
	Univers-Light
	Univers-LightOblique
	Clarendon
	Clarendon-Light
	Clarendon-Bold
	Helvetica-Condensed
	Helvetica-Condensed-Bold
	Helvetica-Condensed-BoldObl
	Helvetica-Condensed-Oblique
	StempelGaramond-Bold
	StempelGaramond-BoldItalic
	StempelGaramond-Italic
	StempelGaramond-Roman
	Apple-Chancery
	Chicago
	Geneva

	Monaco
	NewYork
	Oxford
	Taffy
	MonaLisa-Recut
	Candid
	Bodoni
	Bodoni-Italic
	Bodoni-Bold
	Bodoni-BoldItalic
	Bodoni-Poster
	Bodoni-PosterCompressed
	CooperBlack
	CooperBlack-Italic
	Copperplate-ThirtyTwoBC
	Copperplate-ThirtyThreeBC
	Eurostile
	Eurostile-Bold
	Eurostile-ExtendedTwo
	Eurostile-BoldExtendedTwo
	GillSans
	GillSans-Italic
	GillSans-Bold
	GillSans-BoldItalic
	GillSans-Condensed
	GillSans-BoldCondensed
	GillSans-Light
	GillSans-LightItalic
	GillSans-ExtraBold
	Goudy
	Goudy-Italic
	Goudy-Bold
	Goudy-BoldItalic
	Goudy-ExtraBold
	HoeflerText-Regular
	HoeflerText-Italic
	HoeflerText-Black
	HoeflerText-BlackItalic
	HoeflerText-Ornaments

	JoannaMT
	JoannaMT-Italic
	JoannaMT-Bold
	JoannaMT-BoldItalic
	LubalinGraph-Book
	LubalinGraph-BookOblique
	LubalinGraph-Demi
	LubalinGraph-DemiOblique
Line Printer	

Symbol Sets

A symbol set is the collection of alphabetic and numeric characters, punctuation, and special characters available in the font you select. Symbol sets support the requirements for different languages or specific applications, such as math symbols used for scientific text.

In PCL 6, a symbol set also defines which character will print for each key on the keyboard (or more specifically, for each *code point*). Some applications require different characters at some code points. To support multiple applications and languages, your printer has 36 symbol sets for the resident PCL 6 fonts.

Symbol Sets for PCL 6

Not all font names support all of the symbol sets listed.

Roman 8 (Default)	ISO 8859-1 Latin 1	ISO 8859-2 Latin 2
ISO 8859-9 Latin 5	ISO 8859-10 Latin 6	PC-8
PC-8 DN	PC-775 Baltic	PC-850 Multilingual
PC-852 Latin 2	PC-1004 OS/2	PC Turkish
Windows 3.1 Latin 1	Windows 3.1 Latin 2	Windows 3.1 Latin 5
DeskTop	PS Text	MC Text
Microsoft Publishing	Math 8	PS Math
Pi Font	Legal	ISO 4 United Kingdom
ISO 6 ASCII	ISO 11 Swedish:names	ISO 15 Italian
ISO 17 Spanish	ISO 21 German	ISO 60 Norwegian v1
ISO 69 French	Windows 3.0 Latin 1	Windows Baltic
Symbol	Wingdings	ITC ZapfDingbats MS

Understanding Your Printer Software

Use the *Drivers and Utilities* CD that came with your printer to install a combination of software programs, depending on your operating system.

The following software programs can only operate on Windows. They cannot operate on Macintosh, UNIX, or Linux.

Printing Status Window

The **Printing Status Window** alerts you when an error or warning occurs, for example, when the top cover is open or toner is running low.

The **Printing Status Window** always launches when printing. When an error occurs, the error message appears on the **Printing Status Window**.

Status Window

On the **Status Window**, you can check how much toner and paper are remaining or the configuration of options for the local printer.

Status Monitor Console

Use the **Status Monitor Console** to manage multiple **Status Window**.

1. Select a printer from the list view (or **Printer Selection**) by clicking its name to open a **Status Window** or **Dell Printer Configuration Web Tool** for a particular printer.
1. Select **Help** to read the online help.
1. The **Status Monitor Console** displays the **Status Window** for local connections, or the **Dell Printer Configuration Web Tool** for network connections.

Dell Supplies Management System

You can launch the **Dell Supplies Management System** dialog box from the **Printing Status** window, the **All Programs** menu, or the desktop icon. You can also launch it from the **Status Window** when a toner error occurs.

You can order consumables by phone or from the web.

1. Click **Start** → **All Programs** → **Dell Printers** → **Dell Laser Printer 3100cn** → **Dell Supplies Management System**.

The **Dell Supplies Management System** window appears.

2. If ordering from the Web:
 - a. When you cannot get information from the printer automatically by two-way communication, a window that prompts you to type the Service Tag number appears. Type your Dell printer Service Tag number in the field provided. Your Service Tag number is located inside the front door of your printer.
 - b. Click **Visit Dell printer supplies ordering web site**.
3. If ordering by phone, call the number that appears under the **By Telephone** heading.

User Setup Disk Creating Tool

The **User Setup Disk Creating Tool** program located in the **MakeDisk** folder of the **Utilities** folder on the *Drivers and Utilities* CD and the printer drivers located on the *Drivers and Utilities* CD are used to create driver installation packages that contain custom driver settings. A driver installation package can contain a group of saved printer driver settings and other data for things such as:

- 1 Print orientation and Multiple Up (document settings)

- 1 Watermarks

- 1 Font references

If you want to install the printer driver with the same settings to multiple computers running the same operating system, create a setup disk in a floppy disk or in a server on the network. Using the setup disk that you have created will reduce the amount of work required when installing the printer driver.

- 1 Install in advance the Dell Laser Printer 3100cn printer driver in the computer on which the setup disk is to be created.

- 1 The setup disk can only be used on the operating system on which the disk was created or computers running the same operating system. Create a separate setup disk for different types of operating systems.

Software Update

The firmware and/or driver updates can be downloaded from <http://support.dell.com/>.

Installing the Toner and Drum Cartridges

● [Installing the Toner Cartridge](#)

● [Installing the Drum Cartridge](#)

 **CAUTION:** Before performing any of the following procedures, read and follow the safety instructions in your *Owner's Manual*.

Installing the Toner Cartridge

Install or replace the toner cartridge while the printer is on (if the power is not on, the cartridge carrier will not rotate).

1. After confirming the Insert Yellow Toner (Y) message, open the front door.

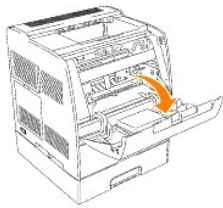

2. Hold the tape on the protective cover and pull it forward to remove the cover from each cartridge slot.

 **NOTE:** You need to remove the protective cover only the first time that you install the toner.

 **NOTE:** Dispose of the protective cover after you remove it.

 **NOTE:** The protective cover is attached to each toner cartridge mount.

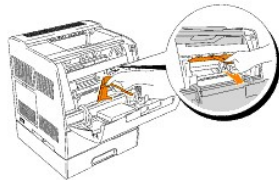

3. Make sure the color of the toner cartridge matches the slot on the toner cartridge carrier. The order is Y, M, C, K. Gently shake the cartridge to distribute the toner evenly.

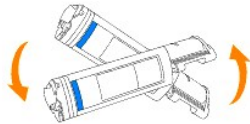

4. Lift the tab up 90 degrees and pull the toner seal straight off, keeping it parallel with the toner cartridge.

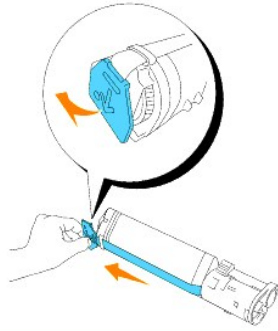

5. To insert the toner cartridges, align the arrows on the cartridge with the corresponding arrows on the printer. Guide the cartridge in until it snaps into place and then push down the handhold to lock the cartridge in place.

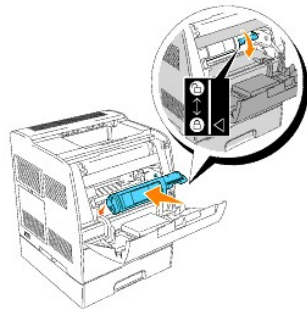

6. Close the front door.

 **NOTE:** Make sure the toner cartridge is installed correctly. Otherwise, the front door cannot close firmly.

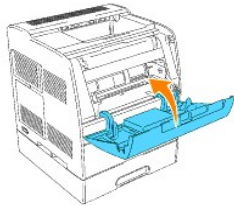

7. The toner cartridge carrier rotates to the next empty slot. When the color of the newly inserted cartridge appears on the display, followed by the **Insert** message, insert the next toner cartridge.
8. Repeat steps 1 through 7 when inserting the remaining cartridges.

Installing the Drum Cartridge

1. When the **Insert Drum** or **Insert Drum Cart** message appears, open the front door, then lift and push back the top cover.

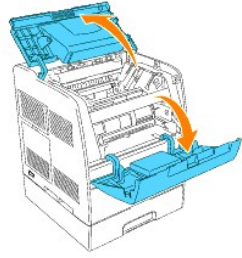

2. Remove the protective sheet from the drum cartridge.

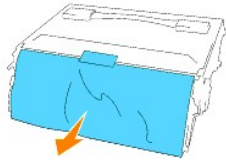

3. To insert the drum cartridge, push up the lever on the right side of the printer. With the lever in the upright position, hold the drum cartridge by the handle, align the arrows on the drum cartridge with the corresponding arrows on the printer and guide the cartridge in until it snaps into place.

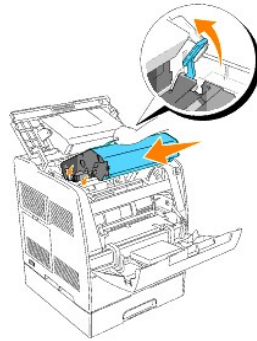

4. Pull down the lever on the right to lock the drum cartridge in place.

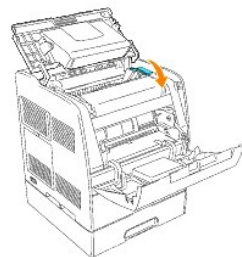

5. Close the top cover, then the front door.

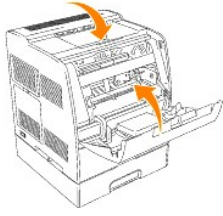

 **NOTE:** After installing the drum cartridge, the printer makes an adjustment for about one to two minutes. Do not turn off the printer during this time.

Loading Print Media

Proper print media loading helps prevent jams and ensures trouble-free printing.

Before loading print media, identify the recommended print side of the print media. This information is usually on the print media package.

- [Loading Print Media in Standard and Optional Trays](#)
 - [Multipurpose Feeder](#)
 - [Loading the Multipurpose Feeder](#)
 - [Using the Multipurpose Feeder](#)
 - [Linking Trays](#)
 - [Using the Duplex Function](#)
 - [Using the Center Output Tray](#)
 - [Using the Support Extension](#)
-

Loading Print Media in Standard and Optional Trays

 **NOTE:** To avoid paper jams, do not remove trays while a job prints.

All trays are loaded the same way.

1. Remove the tray.

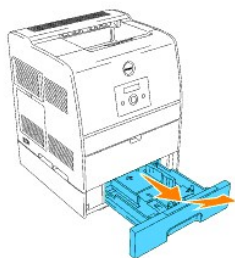

2. Slide the width guides to the edge of the tray. The width guides should be fully extended.

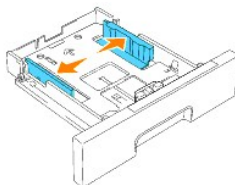

3. Squeeze the length guide and slide it to the edge of the tray.

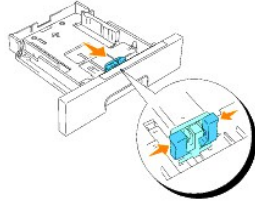

4. Before loading the print media, flex the sheets back and forth, and then fan them. Straighten the edges of the stack on a level surface.

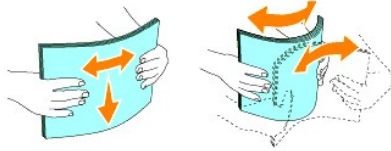

5. Place the print media into the tray with the recommended print side face up.

NOTE: Do not exceed the maximum fill line in the tray. Overfilling the tray may cause paper jams.

6. Slide the width guides and length guide until they rest lightly against the edge of the print media stack.

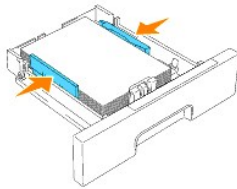

7. Insert the tray.

8. If you load any print media into the tray, configure the **Paper Type** and **Paper Size** settings for that tray according to the message.

Loading Letterhead

Place the printed side face up.

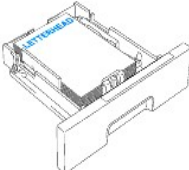
Print media source	Print side	Page orientation
Standard 250-sheet tray module Optional 250-sheet tray module or 500-sheet tray module	Face up 	Back of tray
Multipurpose feeder	Face up	Logo enters the printer first

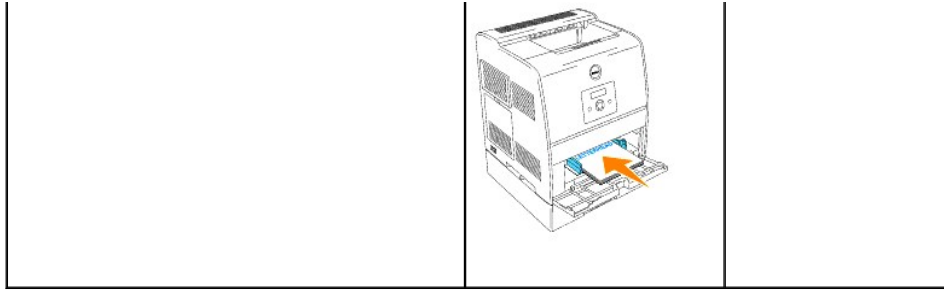

Multipurpose Feeder

Capacity

The maximum stack height is 16 mm (0.6 in.). The multipurpose feeder can hold approximately:

- 1 150 sheets of 75 g/m² (20 lb) paper

Print Media Dimensions

The multipurpose feeder accepts print media within the following dimensions:

- 1 Width -- 90 mm to 215.9 mm (3.5 in. to 8.5 in.)
- 1 Length -- 139.7 mm to 355.6 mm (5.5 in. to 14 in.)

Loading the Multipurpose Feeder

In addition to plain paper, the multipurpose feeder can use various other sizes and types of print media such as envelopes, and transparencies.

1. Gently pull open the multipurpose feeder cover.

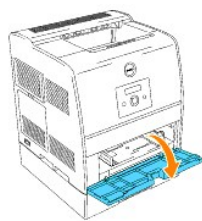

2. Slide the width guides to the edge of the tray. The width guides should be fully extended.

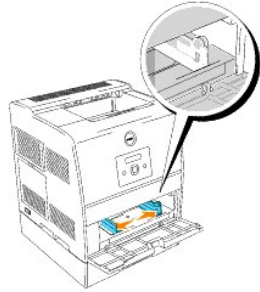

3. Insert the print media into the feeder with the recommended print side face up.

 **NOTE:** Do not force the print media.



4. Slide the width guides until they rest lightly against the edge of the print media stack.

 **NOTE:** Be careful not to bend the print media.

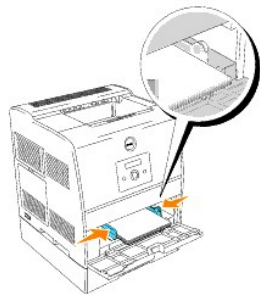

5. Make sure the size and type settings for the multipurpose feeder are set to the correct value for the print media you have loaded.
6. Select print media source, size, and type in your software program and select the print media size and type on the printer operator panel.

Loading Envelopes



To load envelopes that are under 8.66 inches (220 mm) in width, insert the envelopes with the flaps open and toward the front of the printer, with the recommended print side face up.

To load envelopes that are over 8.66 inches (220 mm) in width, insert the envelopes with the flaps closed and the short-edge of the envelopes facing into the printer, with the recommended print side face up.

You can load envelopes up to the maximum fill line in the tray at one time.

 **NOTE:** Make sure set the envelope flaps are completely unfolded.

 **NOTICE:** Never use envelopes with windows, coated linings, or self-stick adhesives. These lead to paper jams and damage to the printer.

Using the Multipurpose Feeder

- 1 Load only one size and type of print media during a single print job.
- 1 To achieve the best possible print quality, use only high-quality print media that is designed for use in laser printers. For more guidelines on print media, see "[Print Media Guidelines](#)."
- 1 Do not add or remove print media when there is still print media in the multipurpose feeder or when the printer is printing from the multipurpose feeder. This may result in a paper jam.
- 1 Print media should be loaded with the recommended print side up and the top of the print media going into the multipurpose feeder first.
- 1 Do not place objects on the multipurpose feeder. Also, avoid pressing down or applying excessive force on it.
- 1 Do not remove any tray while a job is printing from the multipurpose feeder or `Printing` is displayed on the operator panel. This may result in a paper jam.

The icons on the multipurpose feeder identify how to load the multipurpose feeder with paper, and how to turn an envelope for printing.



Linking Trays

Tray linking allows you to load the same size and type of print media in multiple sources. The printer automatically links the source/trays and will use the first tray until it runs out, then switch to the linked tray.

If you load the same size print media in each tray, make sure the print media is the same type in order to link the trays.

When the selected trays are loaded with the same size and type of print media, select the `Paper Size` and `Paper Type` settings in the `Tray Settings` for each source.

To disable tray linking, set the **Paper Size** and **Paper Type** to a unique value in each one of the trays. If all trays do not have the same type of print media when linked, you could mistakenly print a job on the wrong paper type.

Using the Duplex Function

Duplex printing (or two-sided printing) allows you to print on both sides of a sheet of paper. For sizes that are acceptable for duplex printing, see "[Print Media Sizes and Support](#)."

Using Duplex Bind

When using duplex bind printing in the printer driver, you must select either **Flip on Short Edge** or **Flip on Long Edge**. **Binding** in the Duplex menu item defines the way duplexed pages are bound, and how the printing on the back of the sheet (even-numbered pages) is oriented in relation to the printing on the front (odd-numbered pages).

The two values for **Binding** are:

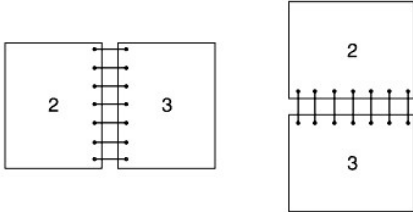
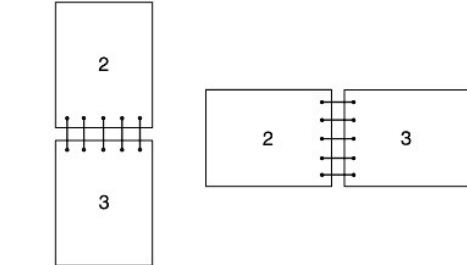
Long Edge	<p>Assumes binding along the long edge of the page (left edge for portrait orientation and top edge for landscape orientation). The following illustration shows long-edge binding for portrait and landscape pages:</p> 
Short Edge	<p>Assumes binding along the short edge of the page (top edge for portrait orientation and left edge for landscape orientation). The following illustration shows short-edge binding for portrait and landscape pages:</p> 

 **NOTE:** When you print on both sides of postcard-size paper, make sure the paper is not curled.

Using the Center Output Tray

The center output tray holds up to:

- 1 250 sheets (20 lb (75 g/m²)) of plain paper: or
- 1 20 sheets of transparency: or

1 20 sheets of label: or

1 10 sheets of envelope

Using the Support Extension

The support extension is designed to prevent print media from falling from the printer after the print job is complete. Before printing a document, make sure the paper extender is fully extended.

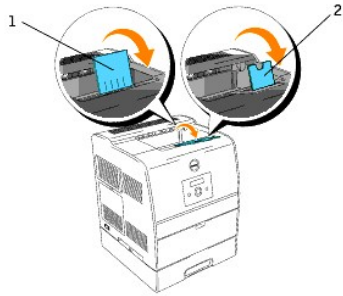

Clearing Jams

Careful selection of appropriate print media and proper loading allow you to avoid most jams. See "[Print Media Guidelines](#)" for more information.

- [Avoiding Jams](#)
- [Identifying the Location of Paper Jams](#)
- [Removing Print Jams Near the Fuser Unit](#)
- [Removing Print Jams Near the Center Output Tray](#)
- [Removing Print Jams From the Print Media Pickup Area](#)
- [Removing Print Jams From the Optional Duplex Module](#)
- [Removing Print Jams From the Print Media Source](#)
- [Removing Print Jams From the Multipurpose Feeder](#)

 **NOTE:** Before buying large quantities of any print media, Dell recommends trying a sample first.

Avoiding Jams

- 1 Use only recommended print media. See "[Print Media Guidelines](#)" for more information.
 - 1 See "[Loading Print Media in Standard and Optional Trays](#)" and "[Loading the Multipurpose Feeder](#)" to load printer media properly.
 - 1 Do not overload the print media sources. Make sure the stack print media height does not exceed the maximum height indicated by the load line labels in the trays.
 - 1 Do not load wrinkled, creased, damp, or curled print media.
 - 1 Flex, fan, and straighten print media before you load it. If a jam occurs with print media, try feeding one sheet at a time through the multipurpose feeder.
 - 1 Do not use print media that you have cut or trimmed yourself.
 - 1 Do not mix print media sizes, weights, or types in the same print media source.
 - 1 Make sure the recommended print side is face up.
 - 1 Keep print media stored in an acceptable environment. For more information, see "[Storing Print Media](#)" for more information.
 - 1 Do not remove the feeding tray during a print job.
 - 1 Push all trays in firmly after loading them.
 - 1 Make sure all cables that connect to the printer are correctly attached.
 - 1 Overtightening the guides may cause jams.
-

Identifying the Location of Paper Jams

The following illustration shows where paper jams may occur along the print media path.

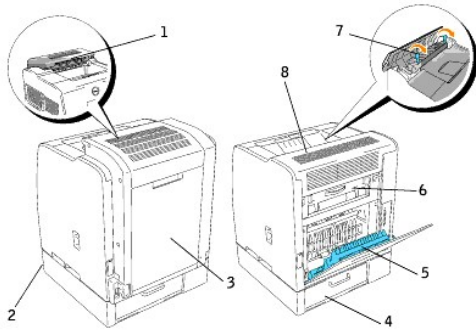

⚠ CAUTION: Do not attempt to clear any jams using tools or instruments. This may permanently damage the printer.

1	Duplex module
2	Print media source
3	Duplex cover
4	Feeder cover
5	Inner rear cover (displayed Reg Cover on message)
6	Bias Transfer Roll (BTR) cover
7	Fuser cover
8	Paper cover (not present when duplex module has been installed)

Removing Print Jams Near the Fuser Unit

🔧 NOTE: To resolve the message displayed on the operator panel, you must clear all print media from the print media path.

When Using the Optional Duplex Module

1. Open the duplex module.

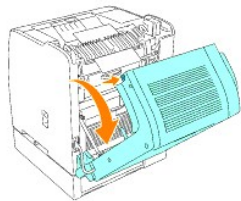

2. Open the BTR cover.

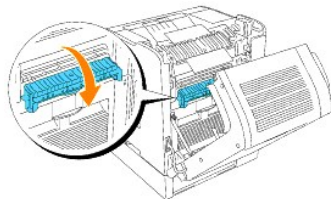

⚠ CAUTION: The inside of the printer on the back side is hot.

3. Press the levers on both sides and remove any jammed print media.

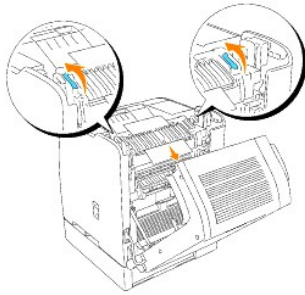

🔍 NOTE: Never touch the outer levers located on both sides of the fuser unit, which are used to remove or install the fuser unit.

4. Return the levers to their original positions.
5. Close the BTR cover.
6. Close the duplex module.

When Not Using the Optional Duplex Module

1. Open the rear cover.

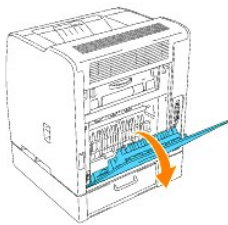

2. Open the BTR cover.

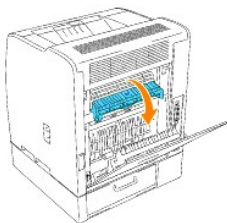

⚠ CAUTION: The inside of the printer on the back side is hot.

3. Open the paper cover.

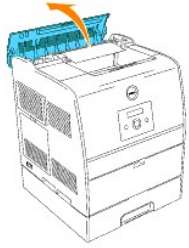

4. Press the levers on both sides and remove any jammed print media.

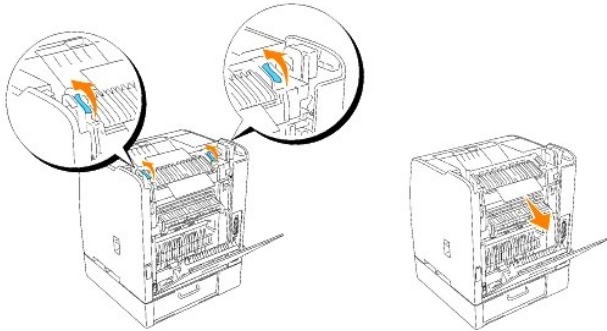

NOTE: Never touch the outer levers located on both sides of the fuser unit, which are used to remove or install the fuser unit.

5. Return the levers to their original positions.
6. Close the paper cover.
7. Close the BTR cover.
8. Close the rear cover.

Removing Print Jams Near the Center Output Tray

NOTE: To resolve the message displayed on the operator panel, you must clear all print media from the print media path.

1. Open the paper cover or the optional duplex module (if the duplex module is installed).

CAUTION: The inside of the printer is hot.

2. Lift up the levers on both sides.



NOTE: Never touch the outer levers located on both sides of the fuser unit, which are used to remove or install the fuser unit.

3. Open the fuser cover and remove any jammed print media.

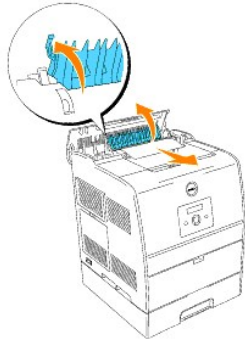

4. Push down the levers on the both sides.
5. Close the paper cover or the optional duplex module (if the duplex module is installed).

Removing Print Jams From the Print Media Pickup Area

NOTE: To resolve the message displayed on the operator panel, you must clear all print media from the print media path.

When Using the Optional Duplex Module

1. Open the duplex module.

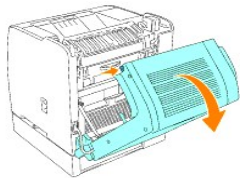

2. Open the inner rear cover.

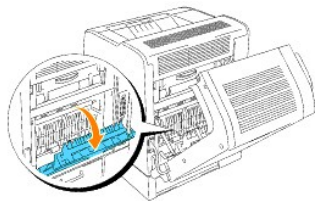

3. Remove the print media from the back of the printer. The accessible portion of the print media determines how it should be removed. If the print media is not accessible, go to 4.

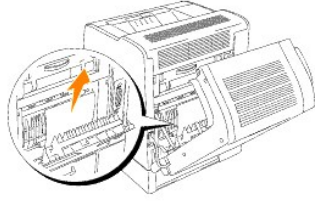

4. Close the inner rear cover.
5. Close the duplex module.
6. Grab the feeder cover on the back of the printer and pull down.

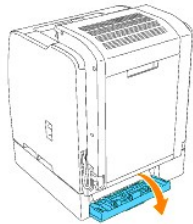

7. Remove any accessible print media.



8. Close the cover.

When Not Using the Optional Duplex Module

1. Open the rear cover. The inner rear cover opens at the same time.

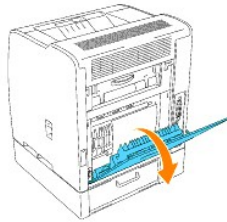

2. Remove the print media from the back of the printer. The accessible portion of the print media determines how it should be removed. If the print media is not accessible, go to step 3.

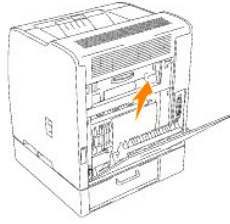

3. Close the rear cover.
4. Grab the feeder cover on the back of the printer and pull down.



5. Remove any accessible print media.



6. Close the cover.

Removing Print Jams From the Optional Duplex Module

 **NOTE:** To resolve the message displayed on the operator panel, you must clear all print media from the print media path.

1. Grab the duplex cover and pull down.

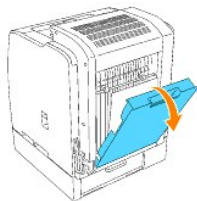

2. Remove any accessible print media. The accessible portion of the print media determines how it should be removed. If only a small portion of the print media is accessible, do not remove the print media. Go to step 3.

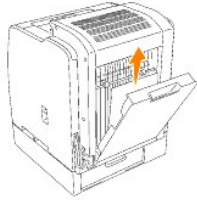

3. Close the duplex cover.
4. Grab the optional duplex module and pull back.

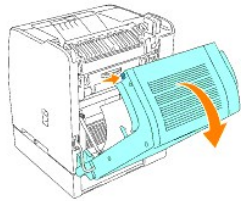

5. Remove any accessible print media.
6. Close the optional duplex module.

Removing Print Jams From the Print Media Source

 **NOTE:** To resolve the message displayed on the operator panel, you must clear all print media from the print media path.

1. Pull the tray halfway out.

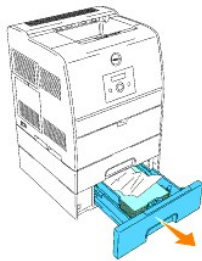

2. Remove the print media depending on how it has jammed.
 - 1 If print media is located on a tilted surface or a wall at the front of the tray, pull the print media straight out.
 - 1 If the print media is in the pass-through area across two trays, pull the print media straight up and out.



3. Return the tray to its original position.

Removing Print Jams From the Multipurpose Feeder

Pull the jammed print media straight out of the multipurpose feeder as shown below.

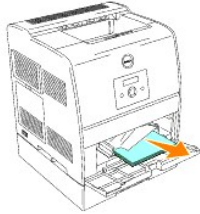

 **NOTE:** To resolve the message displayed on the operator panel, you must clear all print media from the print media path.

Appendix

- [Dell Technical Support Policy](#)
 - [Contacting Dell](#)
 - [Warranty and Return Policy](#)
-

Dell Technical Support Policy

Technician-assisted technical support requires the cooperation and participation of the customer in the troubleshooting process and provides for restoration of the operating system, software program and hardware drivers to the original default configuration as shipped from Dell, as well as the verification of appropriate functionality of the printer and all Dell-installed hardware. In addition to this technician assisted technical support, online technical support is available at Dell Support. Additional technical support options may be available for purchase.

Dell provides limited technical support for the printer and any Dell-installed software and peripherals. Support for third-party software and peripherals is provided by the original manufacturer, including those purchased and/or installed through Software & Peripherals (DellWare), ReadyWare, and Custom Factory Integration (CFI/DellPlus).

Contacting Dell

You can access Dell Support at support.dell.com. Select your region on the WELCOME TO DELL SUPPORT page, and fill in the requested details to access help tools and information.

You can contact Dell electronically using the following addresses:

- 1 **World Wide Web**
www.dell.com/
www.dell.com/ap/ (for Asian/Pacific countries only)
www.euro.dell.com (for Europe only)
www.dell.com/la/ (for Latin American countries)
 - 1 **Anonymous file transfer protocol (FTP)**
[ftp.dell.com/](ftp://ftp.dell.com/)
Log in as user: anonymous, and use your email address as your password.
 - 1 **Electronic Support Service**
mobile_support@us.dell.com
support@us.dell.com
apsupport@dell.com (for Asian/Pacific countries only)
support.euro.dell.com (for Europe only)
 - 1 **Electronic Quote Service**
sales@dell.com
apmarketing@dell.com (for Asian/Pacific countries only)
 - 1 **Electronic Information Service**
info@dell.com
-

Warranty and Return Policy

Dell Computer Corporation ("Dell") manufactures its hardware products from parts and components that are new or equivalent to new in accordance with industry-standard practices. For information about the Dell warranty for your printer, see the *Owner's Manual*.

[Dell Laser Printer 3100cn User's Guide](#)

[Finding Information](#)

[Dell Printer Configuration Web Tool](#)

[About Your Printer](#)

[Installing the Toner and Drum Cartridges](#)

[Connecting Your Printer](#)

[Enterprise Console Management Modules](#)

[Installing the Optional Tray Module](#)

[Installing the Optional Duplex Module](#)

[Print Media Guidelines](#)

[Loading Print Media](#)

[Operator Panel](#)

[Printer Settings](#)

[Understanding Printer Menus](#)

[Understanding Your Printer Software](#)

[Printing](#)

[Setting Up for Shared Printing](#)

[Understanding Fonts](#)

[Understanding Printer Messages](#)

[Clearing Jams](#)

[Troubleshooting](#)

[Maintaining Your Printer](#)

[Removing Options](#)

[Printer Specifications](#)

[Printing With UX Filter \(UNIX/Linux\)](#)

[Printing With CUPS \(Linux\)](#)

[Safety and Regulatory Information](#)

[Appendix](#)

|
|
|
|
|
|
|
|
|
|

