

Panasonic[®]

Operating Instructions

Network Camera

Model No. WV-X8570N
WV-S8530N

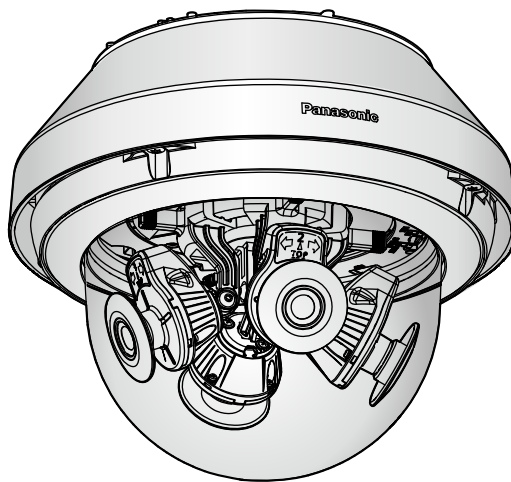

WV-X8570N

Before attempting to connect or operate this product, please read these instructions carefully and save this manual for future use.

The model number is abbreviated in some descriptions in this manual.



Preface

About the user manuals

There are 3 sets of operating instructions as follows.

- Operating Instructions (this document): Explains how to perform the settings and how to operate this camera.
- Important Information: Provides information about the cautions required for safely using and installing this camera.
- Installation Guide: Explains how to install and connect devices.

The screens used in these operating instructions show the case of WV-X8570N. Depending on the model used, the screens shown in the explanations may differ to the actual camera screens.

Note

- “Control No.:C****” used in this document should be used to search for information on the Panasonic support website and will guide you to the right information.

About notations

The following notations are used when describing the functions limited for specified models.

The functions without the notations are supported by all models.

X8570N: The functions with this notation are available when using the model WV-X8570N.

S8530N: The functions with this notation are available when using the model WV-S8530N.

Abbreviations

The following abbreviations are used in these operating instructions.

Microsoft Windows 10 is described as Windows 10.

Microsoft Windows 8.1 is described as Windows 8.1.

Microsoft Windows 7 is described as Windows 7.

Windows Internet Explorer 11 is described as Internet Explorer.

SDXC/SDHC/SD memory card is described as SD card or SD memory card.

Universal Plug and Play is described as UPnP™ or UPnP.

For administrator registration

At the time of first access to the camera (or at the time of initialization), the registration screen will be displayed.

Define the user name and the password for the administrator, and enter them correctly. Hereafter, they can be used for login.

Administrator registration

Enter the user name and password of the administrator.

User name (1 to 32 characters)	<input style="width: 90%; height: 20px;" type="text"/>
Password (8 to 32 characters)	<input style="width: 90%; height: 20px;" type="password"/>
Retype password	<input style="width: 90%; height: 20px;" type="password"/>

Note:

- (1) Distinguish between upper- and lower cases.
- (2) Entry of the following is not allowed as a user name: 2-byte characters, and 1-byte symbols " & ; \
- (3) Entry of the following is not allowed as a password: 2-byte characters, and 1-byte symbols " &
- (4) For the password, use three or more types of characters from upper- and lowercase alphabetic characters, numbers, and symbols.
- (5) Keep the user name and password at hand so as not to lose.
- (6) It is recommended to change the password periodically.
- (7) Set the password which does not include the user name.

[User name (1 to 32 characters)]

Enter the user name of the administrator.

Available number of characters: 1 - 32 characters

Unavailable characters: 2-byte characters, and 1-byte symbols " & ; \

[Password (8 to 32 characters)]/[Retype password]

Enter the administrator password.

Available number of characters: 8 - 32 characters

Unavailable characters: 2-byte characters, and 1-byte symbols " &

Note

- Distinguish between upper- and lower cases.
- For the password, use three or more types of characters from upper- and lowercase alphabetic characters, numeric characters, and symbols.
- Set the password which does not include the user name.

IMPORTANT

- If you forgot or do not know the password or user name, the camera must be initialized. Because all settings other than preset position settings are deleted when the camera is initialized, make sure to keep the information secure from third parties. Refer to "Parts and functions" section in the Important Information in the supplied CD-ROM for more information about initializing the camera.
- It is recommended to change the password periodically.

The registration completion screen will be displayed after registering a user name and password of the administrator. After 10 seconds, the camera will be reconnected automatically. Please click "here" if it is not displayed automatically.

When the camera is reconnected to, an authentication window is displayed. Enter the registered user name and password to start operation.

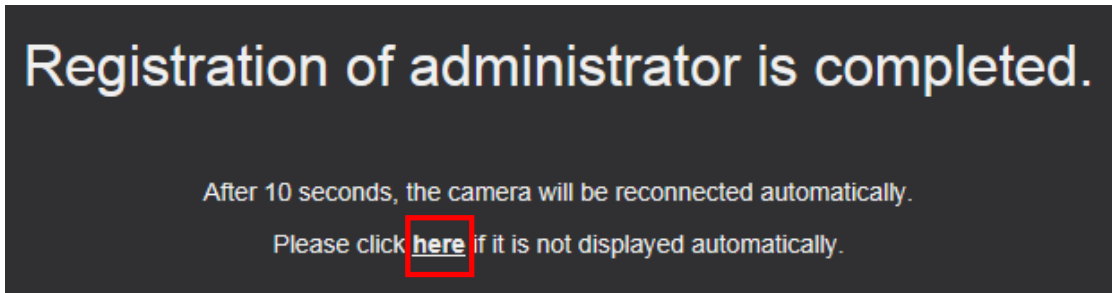

Viewer software

In order to display H.265 (or H.264) images, receive audio from the camera (X8570N), and play images saved on the SD memory card, the “Network Camera View 4S” (ActiveX®) viewer software must be installed. This software can be installed directly from the camera or by selecting the [Install] button next to [Viewer Software] on the menu of the CD-ROM provided, and then following the on-screen instructions.

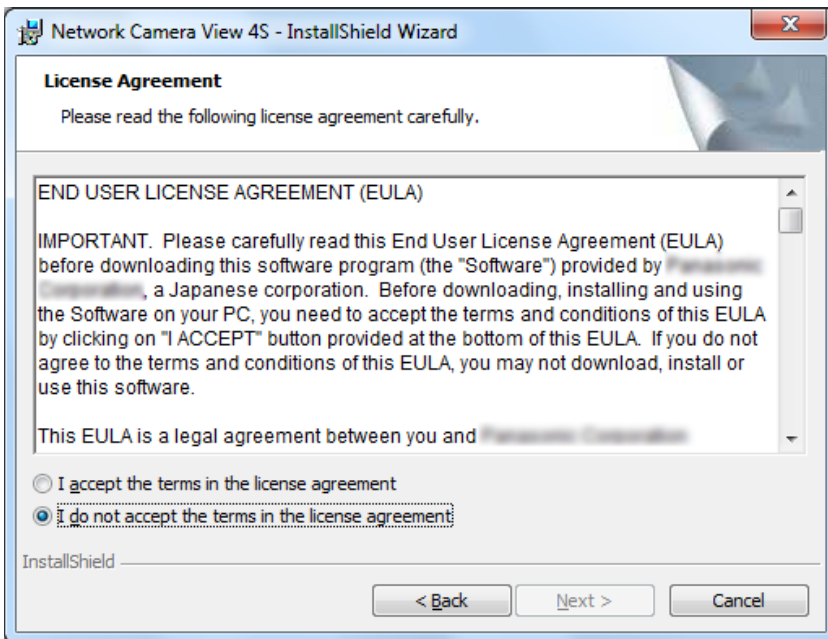

IMPORTANT

- The default setting of “Automatic installation” is “On”. Follow the instructions on page 209 when the message is displayed on the information bar of the browser.
- Depending on the software environment of your PC, it may take time for the message to be displayed on the information bar of the browser.
- If you display the “Live” page on a PC and click the [Viewer Software] button, the installation screen for ActiveX, which is required for viewing camera images, is displayed. Follow the on-screen instructions and install the software. When displayed JPEG images (still images), there is no need to install ActiveX.
- When the install wizard is displayed again even after completing the installation of the ActiveX, restart the PC.

- The viewer software used on each PC should be licensed individually. The number of installations of the viewer software from the camera can be checked on the [Upgrade] tab of the “Maintenance” page (→page 183). Refer to your dealer for the software licensing.

Table of Contents

- 1 Operations9**
- 1.1 **Monitor images on a PC9**
 - 1.1.1 Monitor camera images9
 - 1.1.2 About the “Live” page12
- 1.2 **Monitor images on a mobile terminal or tablet device16**
 - 1.2.1 Monitor images on a mobile terminal (including smartphones)16
 - 1.2.2 Monitor images on a tablet device20
- 1.3 **Record images on the SD memory card manually24**
- 1.4 **Action at an alarm occurrence26**
 - 1.4.1 Alarm type26
 - 1.4.2 Action at an alarm occurrence26
- 1.5 **Display the log list28**
- 1.6 **Playback of images on the SD memory card32**
 - 1.6.1 Playback “Stream(1)”/“Stream(2)” images saved to the SD memory card33
- 2 Settings36**
- 2.1 **About the network security36**
 - 2.1.1 Equipped security functions36
- 2.2 **Display the setup menu from a PC37**
 - 2.2.1 How to display the setup menu37
 - 2.2.2 How to operate the setup menu38
 - 2.2.3 About the setup menu window39
- 2.3 **Use Easy Setup [Easy Setup]41**
 - 2.3.1 Configure Easy installation [Easy installation]41
 - 2.3.2 Configure the Internet settings [Internet]42
 - 2.3.3 Configure an event action [Event action]44
 - 2.3.3.1 Configure the schedule/alarm (event function type setup menu)45
 - 2.3.3.2 Alarm: Configure the terminal (X8570N) and VMD (alarm setup menu)46
 - 2.3.3.3 Alarm: Sets the recording stream (recording stream setup menu).48
 - 2.3.3.4 Alarm: Configure the details for recording conditions49
 - 2.3.3.5 Alarm: Configure the output terminal (X8570N)50
 - 2.3.3.6 Alarm: configure the mail notifications and mail server50
 - 2.3.3.7 Schedule: Configure SD recording (Recording format setup menu)52
 - 2.3.3.8 Schedule: Set SD memory recording (video recording setup menu)52
- 2.4 **Configure the basic settings of the camera [Basic]55**
 - 2.4.1 Configure the basic settings [Basic]55
 - 2.4.2 Configure the settings relating to the SD memory card [SD memory card]62
 - 2.4.3 Configure the settings relating to alteration detection [Alteration detection]68
 - 2.4.4 How to configure alteration detection settings70
 - 2.4.4.1 Generation of the CRT key (encryption key)70
 - 2.4.4.2 Generation of CSR (Certificate Signing Request)71
 - 2.4.4.3 Installation of the certificate issued by CA73
 - 2.4.4.4 Configuration of alteration detection74
 - 2.4.5 Access copy images saved on the SD memory card onto the PC [SD memory card images]75
 - 2.4.6 Configure the directory of the PC that images will be downloaded to [Log]76
- 2.5 **Configure the settings relating to images and audio (X8570N) [Image/Audio (X8570N), Image (S8530N)]77**
 - 2.5.1 Configure the settings relating to the image capture mode [Image] (S8530N)77
 - 2.5.2 Configure the settings relating to JPEG images [Image]78
 - 2.5.3 Configure the settings relating to Stream [Image]80

2.5.4	Configure the settings relating to image adjust, privacy zone, and VIQS [Image quality]	87
2.5.4.1	Configure the settings relating to image quality (“Image adjust” setup menu)	87
2.5.4.2	Set mask areas	97
2.5.4.3	Configure the settings relating to the privacy zone (“Privacy zone” setup menu)	100
2.5.4.4	Configure the VIQS setting	102
2.5.4.5	Configure the VIQS area	104
2.5.5	Configure the settings relating to audio [Audio] X8570N	106
2.6	Configure the alarm settings [Alarm]	108
2.6.1	Configure the settings relating to the alarm action [Alarm]	108
2.6.2	Configure the settings relating to the output terminal [Alarm] X8570N	110
2.6.3	Change the AUX name [Alarm] X8570N	112
2.6.4	Configure the settings relating to the camera action on alarm occurrence [Alarm]	113
2.6.4.1	Configure settings relating to alarm E-mail notifications	114
2.6.4.2	Configure settings relating to recording to an SD memory card when an alarm occurs	115
2.6.4.3	Configure settings relating to Panasonic alarm protocol notification when an alarm occurs	116
2.6.4.4	Configure settings relating to HTTP alarm notification when an alarm occurs	117
2.6.5	Configure the VMD settings [VMD area]	117
2.6.6	Set the VMD areas [VMD area]	119
2.6.7	Configuration of the settings relating to alarm notification [Notification]	121
2.6.7.1	Configure the settings relating to Panasonic alarm protocol	122
2.6.7.2	Configure the settings relating to HTTP alarm notification	124
2.7	Configure the settings relating to the authentication [User mng.]	126
2.7.1	Configure the settings relating to the user authentication [User auth.]	126
2.7.2	Configure the settings relating to the host authentication [Host auth.]	129
2.7.3	Configure the settings relating to the priority stream [System]	130
2.7.4	Configure IEEE 802.1X [IEEE 802.1X]	131
2.7.5	Configure the data encryption settings [Data encryption]	132
2.8	Configuring the network settings [Network]	134
2.8.1	Configure the network settings [Network]	134
2.8.2	Configure advanced network settings [Advanced]	138
2.8.2.1	Configure the settings related to sending E-mails	139
2.8.2.2	Configure the settings relating to the NTP server	143
2.8.2.3	Configure the UPnP settings	144
2.8.2.4	Configure the HTTPS settings	146
2.8.2.5	Configure the settings relating to DDNS	147
2.8.2.6	Configure the settings relating to SNMP	149
2.8.2.7	Configure the QoS settings	150
2.8.3	How to configure HTTPS settings	152
2.8.3.1	Select the certificate to use when accessing with HTTPS	153
2.8.3.2	Obtaining the root certificate	153
2.8.3.3	Configuration of HTTPS connections	159
2.8.3.4	Generation of the CRT key (SSL encryption key)	160
2.8.3.5	Generation of CSR (Certificate Signing Request)	161
2.8.3.6	Installation of the CA certificate	162
2.8.4	Access the camera using the HTTPS protocol (for pre-installed certificate)	163
2.8.4.1	Configuration of the host file	163
2.8.5	Access the camera using the HTTPS protocol (for CA Certification)	168
2.8.6	How to configure the settings relating to DDNS	169

2.8.6.1	Configuration of the DDNS service (Example of the “Viewnetcam.com” service)	170
2.8.6.2	When using “Dynamic DNS Update”	173
2.8.6.3	When using “Dynamic DNS Update(DHCP)”	174
2.9	Configure the settings relating to the schedules [Schedule]	175
2.9.1	How to set the schedules	178
2.9.2	How to delete the set schedule	180
2.10	Maintenance of the camera [Maintenance]	182
2.10.1	Check the system log [System log]	182
2.10.2	Upgrade the firmware [Upgrade]	183
2.10.3	Check the status [Status]	184
2.10.4	Reset the settings/Reboot the camera [Default reset]	187
2.10.5	Settings data/backing up or restoring logs [Data]	188
2.11	Display the Panasonic support website [Support]	190
3	Others	191
3.1	Using the CD-ROM	191
3.1.1	About the CD launcher	191
3.1.2	Installing Panasonic “IP Setting Software”	192
3.1.3	Installing the manuals	193
3.1.4	Installing the Viewer software	193
3.1.5	Configure the network settings of the camera using the Panasonic “IP Setting Software”	194
3.2	About the displayed system log	197
3.3	Troubleshooting	201
3.4	Directory structure of drive B	211

1 Operations

1.1 Monitor images on a PC

The following are descriptions of how to monitor images from the camera on a PC.

1.1.1 Monitor camera images

1. Start up the web browser.
2. Enter the IP address designated using the Panasonic “IP Setting Software” in the address box of the browser.
 - **Example when entering an IPv4 address:** http://URL registered using IPv4 address
http://192.168.0.10/
 - **Example when entering an IPv6 address:** http://[URL registered using IPv6 address]
http://[2001:db8::10]/

<Example of IPv4 access>

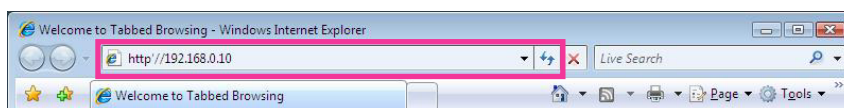

<Example of IPv6 access>



IMPORTANT

- When the HTTP port number is changed from “80”, enter “http://IP address of the camera + : (colon) + port number” in the address box of the browser. (Example: http://192.168.0.11:8080)
- When the PC is in a local network, configure the proxy server setting of the web browser (under [Internet Options...] under [Tools] of the menu bar) to bypass the proxy server for the local address.

Note

- Refer to page 163 and page 168 for further information about the case in which “HTTPS” is selected for “HTTPS” - “Connection” on the [Advanced] tab of the “Network” page (→page 134).

3. Press the [Enter] key on the keyboard.

→ The “Live” page will be displayed. Refer to page 12 for further information about the “Live” page.

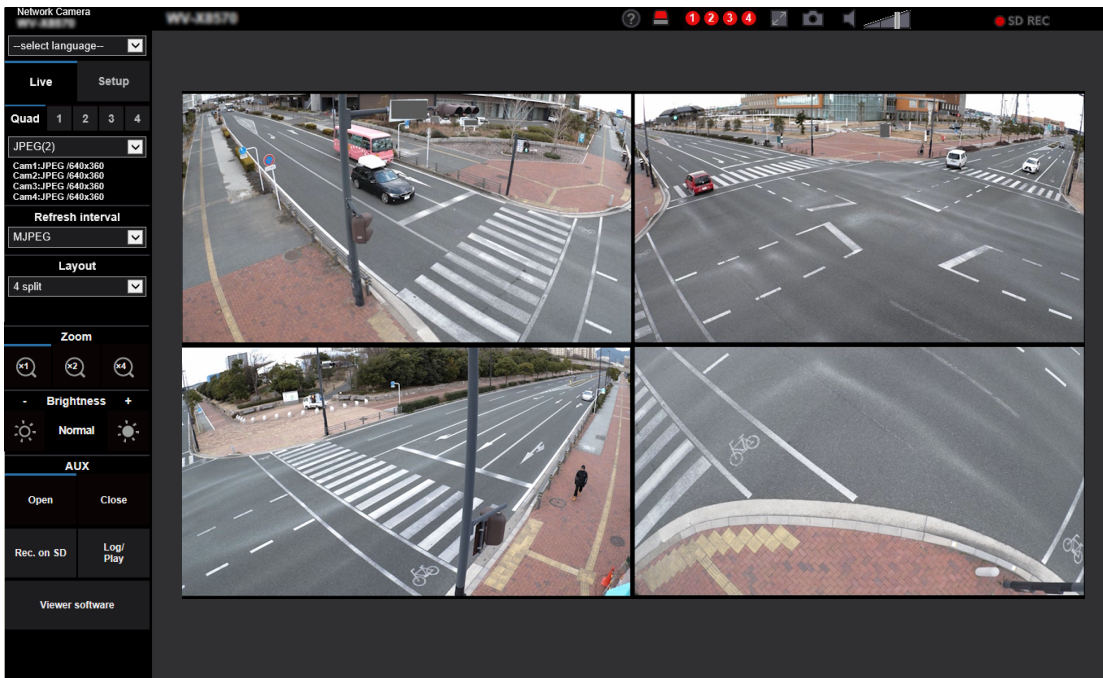

When “On” is selected for “User auth.”, the authentication window will be displayed before displaying live images for the user name and password entries.

IMPORTANT

- It is recommended to change the password periodically.
- When displaying multiple H.265 (or H.264) images on a PC, images may not be displayed depending on the performance of the PC.

Note

- The maximum number of concurrent access user is 24 including users who is receiving H.265 (or H.264) images and users who are receiving JPEG images. Depending on the set values for “Bandwidth control(bit rate)” and “Max bit rate (per client)*”, the maximum concurrent access number may be 24 or less users. When 24 users are concurrently accessing, the access limit message will be displayed for users who subsequently attempt to access. When “Multicast” is selected for “Transmission type” of “Stream”, only the first user who accessed to monitor H.265 (or H.264) images will be included in the maximum number. The second and subsequent users who are monitoring H.265 (or H.264) images will not be included in the maximum number.
- If you set the “Stream transmission” (→page 80) to “On”, an H.265 (or H.264) image will be displayed based on the settings of the “Stream encoding format”. If you set the “Stream transmission” (→page 80) to “Off”, a JPEG image will be displayed. A JPEG image can be displayed even if the “Stream transmission” is set to “On”, but in that case, the transmission interval of the JPEG image will be restricted.
- The refresh interval may become longer depending on a network environment, PC performance, photographic subject, access traffic, etc.

<Refresh interval of JPEG images>

When “On” is selected for “Stream transmission”

max. 1 fps (at 3840×2160), max. 2 fps (at 2560×1440), max. 5 fps (at 1280×720, 640×360, 320×180)

X8570N

max. 5fps **S8530N**

When “Off” is selected for “Stream transmission”

max. 15fps ~~X8570N~~

max. 30fps ~~S8530N~~

1.1.2 About the “Live” page

Note

- The buttons and setting items displayed on the “Live” page can be changed depending on the user rights of the accessing user. You can set the user right settings from “User auth.” under “User mng.”. (→page 126)

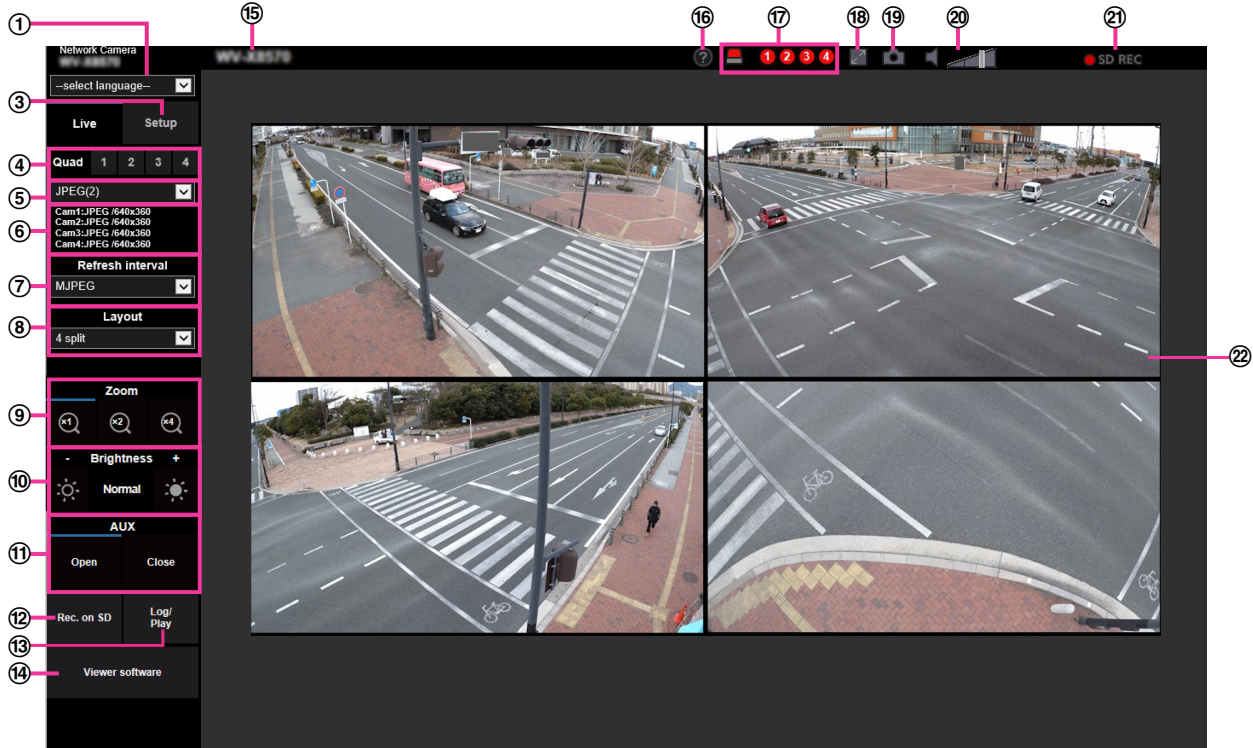

① **[select language] pull-down-menu**

The camera’s display language can be selected. The default language can be set in the [Menu language] in the [Basic] settings. (→page 55)

② **[Login] button**

This button is displayed when “User auth.” is “On” and a person other than the administrator logs in, or when “User auth.” is “Off” and “Guest User” is set to “Use”. (→page 126)

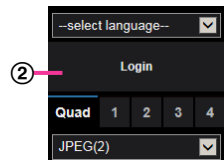

If login fails, close all the browsers, open the “Live” page and login once again.

③ **[Setup] button¹**

Displays the setup menu.

④ **Select camera to be displayed**

Select the camera to be displayed in the main area.

Quad: Displays images of Cam. 1, 2, 3, and 4 in 4-split screen.

1: Displays images from Cam. 1.

2: Displays images from Cam. 2.

3: Displays images from Cam. 3.

4: Displays images from Cam. 4.

⑤ **[Live view] pull-down menu**

You can select and switch to the image to be displayed in the main area from the following:

When “Quad” is selected: Stream(2)/JPEG(2)

When “1”, “2”, “3”, or “4” is selected: Stream(1)/ Stream(2)/ JPEG(1)

The image in the main area is displayed based on the contents set in Stream(1) – (2) (→page 80) or JPEG(1) – (2) (→page 79).

Also the first stream displayed when you accessed the camera can be set from “Initial display stream” of the [Image] tab.

Note

- When “1”, “2”, “3”, or “4” is selected and the image capture size is one of “3840×2160”, “2560×1440”, “1600×1200”, “1920×1080”, “1280×960” or “1280×720”, the image may become smaller than the actual size depending on the window size of the web browser. When “Quad” is selected, it may become smaller than the actual size depending on the window size of the web browser.

⑥ **Stream information display**

Displays the setup for stream encoding format, image capture size, bit rate, and frame rate for the live view of a stream.

Note

- Displays the values set in the stream. The actual bit rate and frame rate vary depending on the network environment and the used PC.

⑦ **[Refresh interval] pull-down menu**

This pull-down menu will be displayed only when a JPEG image is displayed. Use it to select the display method of the JPEG image.

- **MJPEG:** Uses viewer software to display JPEG images successively as MJPEG (Motion JPEG). Not available if the viewer software is not installed.
- **Refresh interval : 1s/Refresh interval : 3s/Refresh interval : 5s/Refresh interval : 10s/Refresh interval : 30s/Refresh interval : 60s:** Refreshes JPEG format (still images) images at the specified interval.

Note

- Depending on the network environment or the PC used, JPEG format (still images) images may not be refreshed at the specified interval.
- When “JPEG(2)” is selected for “Quad”, “Refresh interval: 1s” and “Refresh interval: 3s” are not available.

⑧ **[Layout] pull-down menu**

This pull-down menu will be displayed only when the images are displayed in “Quad”.



Select the layout of the camera images to be displayed in the main area from “4 split”, “360 deg.”, or “270 deg. + right below”.

⑨ **[Zoom] buttons**

Images will be zoomed in on with the electronic zoom by the viewer software “Network Camera View 4S”. When selecting “Quad”, this button will not be displayed.

- **[x1] button:** The images in the main area will be displayed at x1.
- **[x2] button:** The images in the main area will be displayed at x2.
- **[x4] button:** The images in the main area will be displayed at x4.

⑩ **[Brightness] buttons²**

The brightness is adjustable from 0 to 255. Click the  button to make the image brighter, or click the  button to make the image darker. If you click the [Normal] button, the display will be reset to default. When selecting “Quad”, this button will not be displayed.

⑪ **[AUX] button** **X8570N**

These buttons will be displayed only when “Terminal 3” of “Alarm” is set to “AUX output” on the setup menu. (→page 46)

- **[Open] button:** The status of the AUX connector will be open.
- **[Close] button:** The status of the AUX connector will be closed.

Note

- The names of “AUX”, “Open” and “Close” can be changed. (→page 112)

⑫ **[Rec. on SD] button**²

The [Rec. on SD] button will be displayed only when “Manual” is selected for “Save trigger” on the [SD memory card] tab. (→page 66)

Click this button to manually record images on the SD memory card. Refer to page 24 for descriptions of how to manually record images on the SD memory card.

⑬ **[Log] button**

When the [Log] button is clicked, the log list will be displayed and images saved on the SD memory card can be played.

Refer to page 28 for further information about the log list and for how to play images on the SD memory card.

⑭ **[Viewer Software] button**

Starts installation of the viewer software for display. This button will not be available if the viewer software is already installed on the PC, or if the “Automatic installation” of the [Viewer software (nwc4Ssetup.exe)] in the [Basic] tab is set to “Off”. (→Page 59)

⑮ **Camera title**

The camera title entered for “Camera title” on the [Basic] tab will be displayed. (→page 56)

⑯ **Support button**

When this button is clicked, the support site below will be displayed in a newly opened window. This website contains technical information, FAQ, and other information.

<https://security.panasonic.com/support/>

⑰ **Alarm occurrence indication button**²

This button will blink at an alarm occurrence, and the camera of alarm occurrence (one of (1) to (4) buttons) will light. When this button is clicked, all the alarm output terminal will be reset **X8570N** and this button will disappear. (→page 26)

Note

- Since the blinking of the alarm occurrence indication button is not coupled to recording images to the SD memory card, forwarding E-mails, or other operations, check the settings of each operation separately.

⑱ **Full screen button**

Images will be displayed on a full screen. If the full screen button is clicked once when the image displayed in the main area is smaller than the main area, the image is displayed corresponding to its image capture size. If the full screen button is clicked once when images are displayed corresponding to their image capture sizes, images are displayed in full screen. To return to the “Live” page when displaying an image in full screen, press the [Esc] key. When selecting “Quad”, this button will not be displayed.

⑲ **Snap shot button**

Click this button to take a picture (a still picture). The picture will be displayed on a newly opened window. When right-clicking on the displayed image, the pop-up menu will be displayed. It is possible to save the image on the PC by selecting “Save” from the displayed pop-up menu.

When “Print” is selected, printer output is enabled. When selecting “Quad”, this button will not be displayed.

Note

- The pop-up menu [Save] and [Print] will not be displayed if the viewer software is not installed.
- The following settings may be required.

Open Internet Explorer, click [Tools] → [Internet Options] → [Security] → [Trusted Sites] → [Sites]. Register the camera address on [Website] of the displayed trusted windows. After registration, close the web browser, and then access the camera again.

- When it takes longer than the specified period to obtain the snap shot picture due to the network environment, the snap shot picture may not be displayed.
- If the image capture size specified for JPEG cannot be obtained, JPEG images are displayed with the image capture size that could be obtained.
Therefore, when JPEG images obtained with snap shot are displayed on a PC, the displayed image size may differ from the captured sized.

⑳ **Mic input button**

Turns on/off the audio reception (hear audio from the camera on a PC). This button will be displayed only when "Mic input" is selected for "Audio transmission mode" in the setup menu. (→page 106)

When the audio reception is turned off, the button will turn into the  button and audio from the camera will not be heard.

Audio volume can be adjusted (Low/ Middle/ High) by moving the volume cursor .

Note

- When "Adjust Mic input" is set to "Audio volume control mode" in the setup menu, the volume cursor is not displayed when using "Audio recording".
- When the camera is restarted, the adjusted volume level (for the reception) will return to the level that had been set on the [Audio] tab on the setup menu. (→page 106)
- Actual volume level will change in three steps even though the volume cursor can be adjusted minutely.
- If multiple camera browsers are open at the same time on the same computer, audio cannot be heard from the camera browsers that were opened later. Please only access 1 camera at a time.

㉑ **SD recording status indicator**

The status of the SD recording can be checked with this indicator.

When the SD recording starts, the SD recording status indicator will light red. It will go off when the SD recording stops.

This indicator will be displayed when "Manual" or "Schedule" is selected for "Save trigger" on the setup menu. (→page 62)

㉒ **Main area**

Images from the camera will be displayed in this area.

The current time and date will be displayed according to the settings configured for "Time display format" and "Date/time display format". (→page 55)

In addition, when being adjusted, the status of brightness (→Page 58) will be displayed as well as the characters configured for "Camera title on screen" (→Page 57).

A zoom operation can be performed using the mouse wheel. (except "Quad")

When clicking a desired point while displaying live images at x2 or x4 in the main area, the camera will move to locate the clicked point at the center of the main area.

Note

- When the camera is operated by a user with a low access level, images displayed on the screen may be changed temporarily. This does not affect operation of the camera.
- Depending on the PC in use, screen tearing* may occur when the shooting scene drastically changes due to the GDI restrictions of the OS.

*A phenomenon in which portions of the screen are displayed out of alignment.

¹ Only operable by users whose access level is "1. Administrator".

² Only operable by users whose access level is "1. Administrator" or "2. Camera control" when "On" is selected for "User auth." (→page 126)

1.2 Monitor images on a mobile terminal or tablet device

1.2.1 Monitor images on a mobile terminal (including smartphones)

It is possible to connect to the camera using a mobile terminal via the Internet and monitor images (MJPEG or JPEG) from the camera on the screen of the mobile terminal. It is also possible to refresh images to display the latest image.

The compatible mobile terminals are shown as follows. (As of March, 2018)

- iPad, iPhone (iOS 4.2.1 or later)
- Android™ mobile terminals

When an Android terminal is used, an MJPEG format image is displayed by the Firefox® browser, and a JPEG format image is displayed by the standard browser.

For further information about compatible devices, refer to our website.

(<https://security.panasonic.com/support/info/> <Control No.: C0108>)

IMPORTANT

- When the authentication window is displayed, enter the user name and password.
To enhance the security, it is recommended to change the password periodically. (→page 126)

Note

- It is necessary to configure the network settings of the mobile terminal in advance to connect to the Internet and monitor images from the camera. (→page 134)

1. Access to “http://IP address/cam”¹ or “http://Host name registered in the DDNS server/cam”² using a mobile terminal.

→ Images from the camera will be displayed.

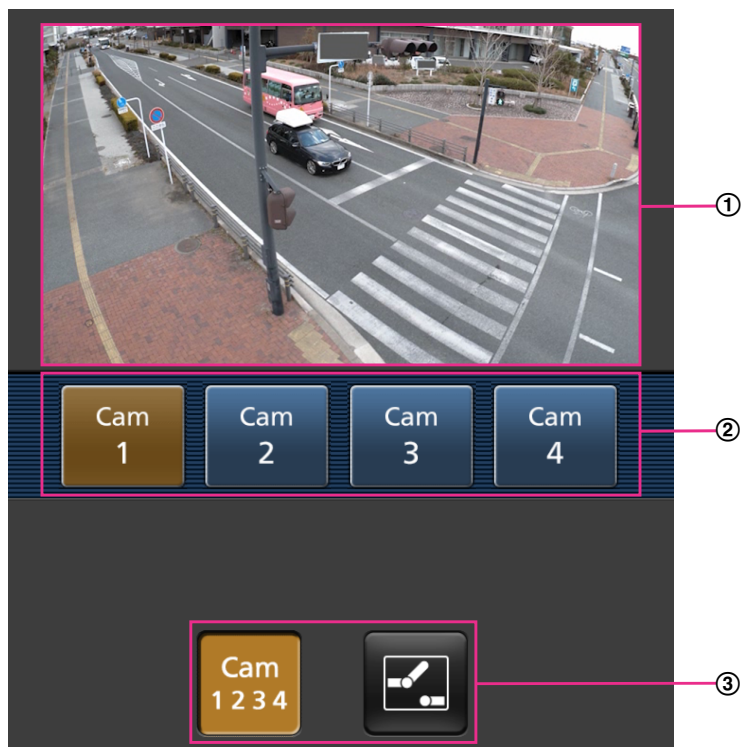

- ① Live images area
Displays images from the camera.
- ② Operation buttons area
When functions are selected in the function selection area ③, buttons to operate those functions are displayed.
- ③ Function selection area
When functions that can be operated are selected, operation buttons are displayed in the operation buttons area ②.

Note

- The operations button displayed on the mobile terminal screen may not be available depending on the user rights and access level of the accessing user. To display the operations button, it is necessary to set the user rights and access level (“User auth.” in “User mng.”). (→page 126)

2. Click the button of the function that you want to operate.

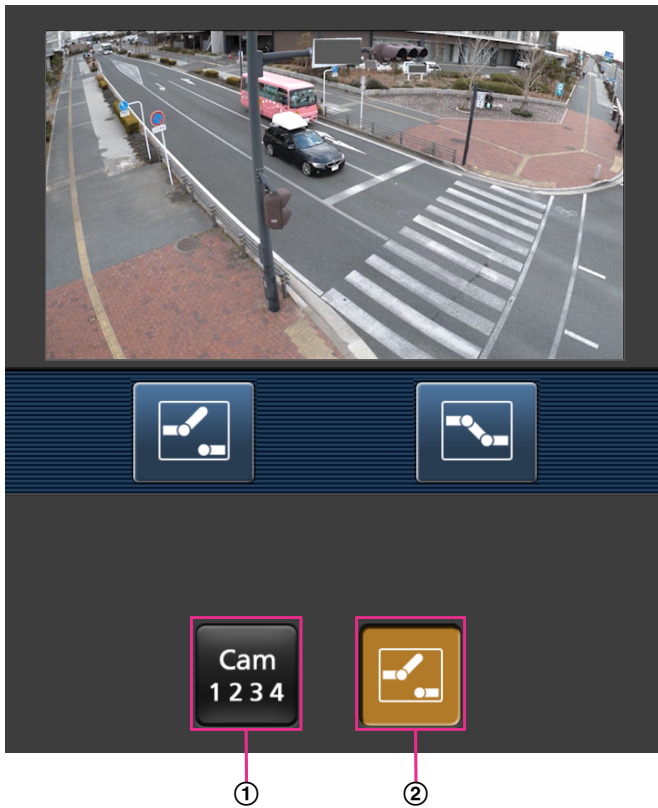

- ① Switch camera
- ② AUX control **X8570N**

Each function is explained below.

- ① Switch camera

Press this button to display the buttons used to select the camera on the screen.

The camera to be displayed can be switched by selecting one of the displayed buttons.

The images from Cam. 1, 2, 3, or 4 are displayed in 640x360 or JPEG of VGA.

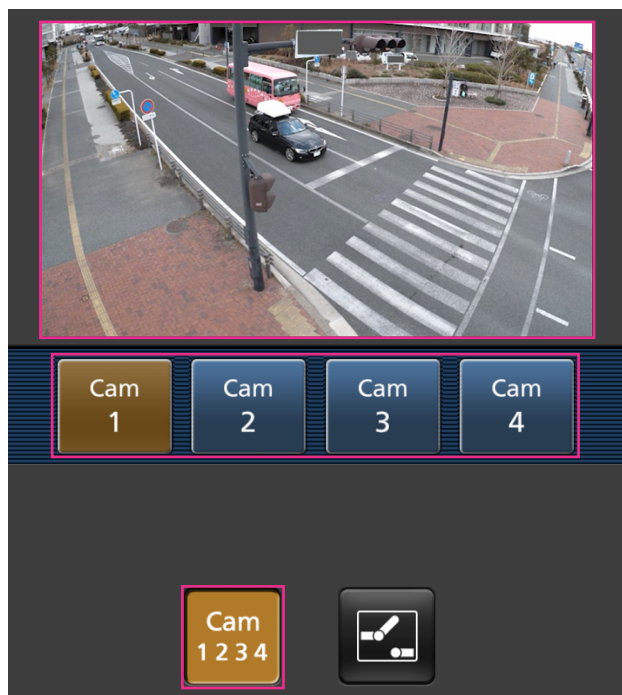

② AUX control **X8570N**

Press the  button to display the buttons used to operate the AUX output on the screen.

The AUX output terminals can be controlled with the  and  buttons.

This function is only displayed when [Terminal 3] is set to [AUX output] on the settings menu.
(→page 46)



Note

- When the HTTP port number is changed from “80”, enter “http://IP address: (colon) + port number/cam”¹ in the address box of the browser. When using the DDNS function, access to “http://Host name registered in the DDNS server: (colon) + port number/cam”².
- When “HTTPS” is selected for “HTTPS” - “Connection” on the [Advanced] tab of the “Network” page, enter as follows.
“https://IP address: (colon) + port number/cam” or “https://Host name registered in the DDNS server: (colon) + port number/cam”
- When the authentication window is displayed, enter the user name of an administrator or user and password. Depending on the mobile terminal in use, password entry may be required each time the screen is switched.
- It is impossible to receive audio using a mobile terminal. (X8570N)
- Depending on the mobile terminal in use, larger size images may not be displayed. In this case, selecting a setting close to the lowest quality setting for “Image quality setting” of “JPEG” (→page 78) may sometimes solve this problem.
- Depending on the mobile terminal in use or its contract plan, it may be impossible to access.

¹ IP address is the global WAN IP address of the router that can be accessed via the Internet. However, when accessing the same LAN as the camera with a wireless compatible mobile terminal, the IP address is the local IP address.

² Only when accessing the camera via the Internet.

1.2.2 Monitor images on a tablet device

It is possible to connect to the camera using a tablet device via the Internet and monitor images (MJPEG or JPEG) from the camera on the screen of the tablet device. It is also possible to refresh images to display the latest image.

The compatible mobile terminals are shown as follows. (As of March, 2018)

- iPad, iPhone (iOS 4.2.1 or later)
- Android™ mobile terminals

When an Android terminal is used, an MJPEG format image is displayed by the Firefox® browser, and a JPEG format image is displayed by the standard browser.

For further information about compatible devices, refer to our website (<https://security.panasonic.com/support/info/> <Control No.: C0108>).

IMPORTANT

- When the authentication window is displayed, enter the user name and password.
To enhance the security, it is recommended to change the password periodically. (→page 126)

Note

- It is necessary to configure the network settings of the tablet device in advance to connect to the Internet and monitor images from the camera. (→page 134)
 - Depending on the device model, the same screen as the PC may be displayed. In that case, access to “http://IP address/live/tab.html” or “http://Host name registered in the DDNS server/live/tab.html”.
 - A mobile terminal can be connected. However, it is recommended to use a tablet device since the screen is optimized for the tablet devices.
1. Access to “http://IP address/” or “http://Host name registered in the DDNS server/” using a tablet device.
→ Images from the camera will be displayed.

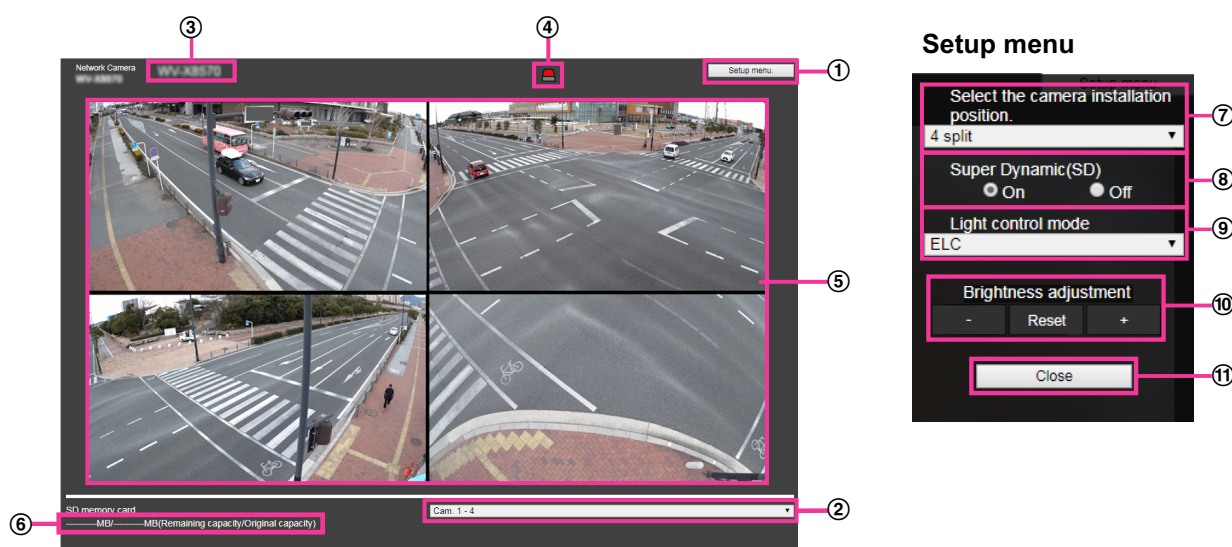

① [Setup menu] button

Displays the setup menu.

② Display camera switching pull-down menu

Selects the camera image to be displayed in the display area ⑤.

Cam. 1-4: Displays camera images of Cam. 1, 2, 3, and 4 simultaneously. The display is subject to the settings of “⑦ Layout setup pull-down menu”.

Cam. 1: Displays live images from Cam. 1 on a 1-split screen.

Cam. 2: Displays live images from Cam. 2 on a 1-split screen.

Cam. 3: Displays live images from Cam. 3 on a 1-split screen.

Cam. 4: Displays live images from Cam. 4 on a 1-split screen.

Default: Cam. 1-4

③ **Camera title**

The camera title entered for “Camera title” on the [Basic] tab will be displayed. (→page 56)

④ **Alarm occurrence indication button²**

When an alarm occurs, the display flashes. When this button is clicked, the output terminal will be reset and this button will disappear. (→page 26)

Note

- Since the blinking of the alarm occurrence indication button is not coupled to recording images to the SD memory card, forwarding E-mails, or other operations, check the settings of each operation separately.

⑤ **Main area**

The live images from the camera will be displayed in this area.

⑥ **Remaining capacity**

Displays the remaining capacity and total capacity of the SD memory card.

⑦ **Layout setup pull-down menu**

Select the layout of the camera images to be displayed in the area ⑤ from “4 split”, “360 deg.”, or “270 deg. + right below”. The layout setting pull-down menu is displayed when “Cam. 1-4” is selected in the display camera switching pull-down menu.

360 deg.: Displays the images of Cam. 1, 2, 3, and 4 in “360 deg.”. Select when installing the camera 4 horizontally in order to shoot the surroundings widely. When it is selected, the setting of “Upside-down” of the camera 4 will be changed to “Off”.

270 deg. + right below: Displays the images of Cam. 1, 2, 3, and 4 in “270 deg. + right below”. Select when installing the camera 4 facing downward in order to shoot the surrounding and right below. When it is selected, the setting of “Upside-down” of the camera 4 will be changed to “On”.

4 split: Displays the images of Cam. 1, 2, 3, and 4 in the 4 Screens. The “Upside-down” setting of Cam. 4 is maintained.

Default: 360 deg.

⑧ **Super Dynamic setting**

Select “On” or “Off” to determine whether or not to activate the super dynamic function. Refer to the description “Super Dynamic function” (→page 89) about the super dynamic function.

On: The super dynamic function will work.

Off: The super dynamic function will not work.

Default: On

Note

- When the following are observed depending on the light condition, select “Off” for “Super Dynamic(SD)”.
 - When flickering appears or the color changes on the screen
 - When noise appears in the brighter area on the screen

⑨ **[Light control mode] pull-down menu**

Select the light control mode from the following.

Indoor scene (50 Hz)/Indoor scene (60 Hz): The shutter speed will automatically be adjusted to prevent flicker caused by fluorescent light. Select 50 Hz or 60 Hz corresponding to the location where the camera is in use.

ELC: Uses shutter speed adjustment to control light.

Default: ELC

⑩ **[Brightness adjustment] button**

Adjust the brightness. The [Brightness adjustment] button is not displayed when Cam. 1-4 is selected with the display camera switching pull-down menu.

Click the [+] button to make the image brighter.

Click the [-] button to make the image darker.

Click the [Reset] button to reset to the default brightness setting.

⑪ **[Close] button**

Close the setup menu.

Note

- When the HTTP port number is changed from “80”, enter “http://IP address: (colon) + port number”^{*1} in the address box of the browser. When using the DDNS function, access to “http://Host name registered in the DDNS server: (colon) + port number”^{*3}.
- When “HTTPS” is selected for “HTTPS” - “Connection” on the [Advanced] tab of the “Network” page, enter as follows.
“https://IP address: (colon) + port number” or “https://Host name registered in the DDNS server: (colon) + port number”
- When the authentication window is displayed, enter the user name of an administrator or user and password. Depending on the mobile terminal in use, password entry may be required each time the screen is switched.
- It is impossible to receive audio using a tablet device. **X8570N**
- Depending on the tablet device in use, larger size images may not be displayed. In this case, selecting a setting close to the lowest quality setting for “Image quality setting” of “JPEG” (→page 78) may sometimes solve this problem.
- Depending on the tablet device in use or its contract plan, it may be impossible to access.

^{*1} Only operable by users whose access level is “1. Administrator”.

^{*2} Only operable by users whose access level is “1. Administrator” or “2. Camera control” when “On” is selected for “User auth.” (→page 127)

^{*3} Only when accessing the camera via the Internet.

1.3 Record images on the SD memory card manually

Images displayed on the “Live” page can be recorded on the SD memory card manually. This button is operable only when “Manual” is selected for “Save trigger” on the [SD memory card] tab on the “Basic” page of the setup menu. (→page 66)

It is possible to select the stream to record from “Stream(1) Cam. 1” to “Stream(1) Cam. 4” or “Stream(2) Cam. 1” to “Stream(2) Cam. 4” on “Recording format” of the setup menu (→page 65). When “Manual” is selected, Cam. 1, 2, 3, and 4 are simultaneously recorded.

Images recorded on the SD memory card can be copied onto the PC. (→page 75)

1. Display the “Live” page. (→page 9)

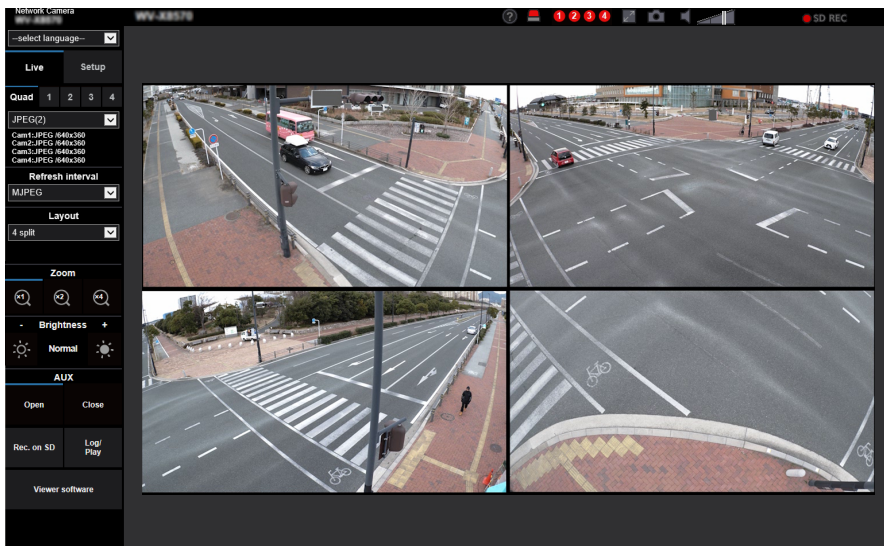

2. Click the [Rec. on SD] button.
→ The SD recording window will open.

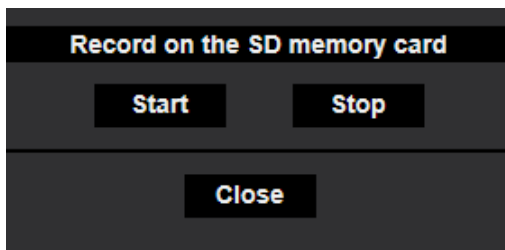

3. Click the [Start] button to start recording images on the SD memory card. The SD recording status indicator will light red (→page 12) while images are being recorded on the SD memory card. The image saving interval can be configured on the [SD memory card] tab of the “Basic” page. (→page 62)
4. Click the [Stop] button to stop saving images on the SD memory card.
→ The SD recording status indicator will turn off.
5. Click the [Close] button to close the window.

Note

- Image data saved on Drive B can be obtained by executing “Access img.” on the [SD memory card] tab and logging in from the user authentication window (→page 75). The destination to save image data is a fixed directory on Drive B (→page 211).

- When the [Start] button is clicked immediately after the [Stop] button is clicked, saving of images may not start. In this case, click the [Start] button again.

1.4 Action at an alarm occurrence

The alarm action (camera action at an alarm occurrence) will be performed when the following alarms occur.

1.4.1 Alarm type

- **Terminal alarm:** When connecting an alarm device such as a sensor to the alarm input terminal of the camera, the alarm action will be performed when the connected alarm device is activated. **X8570N**
- **VMD alarm:** When motion is detected in the set VMD area, the alarm action will be performed.
*VMD stands for “Video Motion Detection”.
- **Command alarm:** When a Panasonic alarm protocol is received from the connected device via a network, the alarm action will be performed.

1.4.2 Action at an alarm occurrence

Display the alarm occurrence indication button on the “Live” page

The alarm occurrence indication button will be displayed on the “Live” page at an alarm occurrence.
(→page 12)

IMPORTANT

- When “Polling(30s)” is selected for “Status update mode” (→page 55), the Alarm occurrence indication button will be refreshed in 30-second intervals. For this reason, it may take a maximum of 30 seconds until the alarm occurrence indication button is displayed on the “Live” page at an alarm occurrence.

Notify of alarm occurrences to the device connected to the output terminal

X8570N

It is possible to output signals from the output terminal of the camera and sound the buzzer when an alarm occurs. The settings for the alarm output can be configured in the [Alarm] tab of the “Alarm” page.
(→page 110)

Save images on the SD memory card

When an alarm occurs, images (H.265/H.264) will be saved on the SD memory card. The settings to save images on the SD memory card can be configured on the [SD memory card] tab (→page 62) of the “Basic” page and the [Alarm] tab of the “Alarm” page. (→page 113)

Notify of alarm occurrences by E-mail

Alarm E-mail (alarm occurrence notification) can be sent at an alarm occurrence to the E-mail addresses registered in advance. Up to 4 addresses can be registered as recipients of the alarm E-mail. An alarm image (still picture) can be sent with the alarm E-mail as an attached file. The settings for alarm E-mail can be configured in the “Alarm E-mail notification” section on the [Alarm] tab of the “Alarm” page (→page 113) and the [Advanced] tab of the “Network” page (→page 139).

Notify of alarm occurrences to the designated addresses (Panasonic alarm protocol notification)

This function is available only when a Panasonic device, such as the network disk recorder, is connected to the system. When “On” is selected for “Panasonic alarm protocol”, the connected Panasonic device will be notified that the camera is in the alarm state. The settings for Panasonic alarm protocol can be configured in the “Panasonic alarm protocol notification” section of the [Notification] tab of the “Alarm” page. (→page 122)

Notify of alarm occurrences to the designated HTTP server (HTTP alarm notification)

Alarm occurrence notifications can be sent at an alarm occurrence to the HTTP servers registered in advance. Up to 5 HTTP servers can be registered as recipients of alarm notifications. The URL sent to HTTP servers with alarm notifications can be specified. The settings for HTTP alarm notification can be configured on the [Notification] tab of the “Alarm” page. (→page 124)

1.5 Display the log list

The history of various logs will be displayed in list form.

- **Alarm log:** Logs of the alarm occurrences such as time and date of the alarm occurrences, the image recording period and the alarm type will be displayed.
- **Manual/Schedule log:** Logs filed when images have been recorded manually or during the period of the schedule, and the image recording period will be displayed.

1. Display the “Live” page.

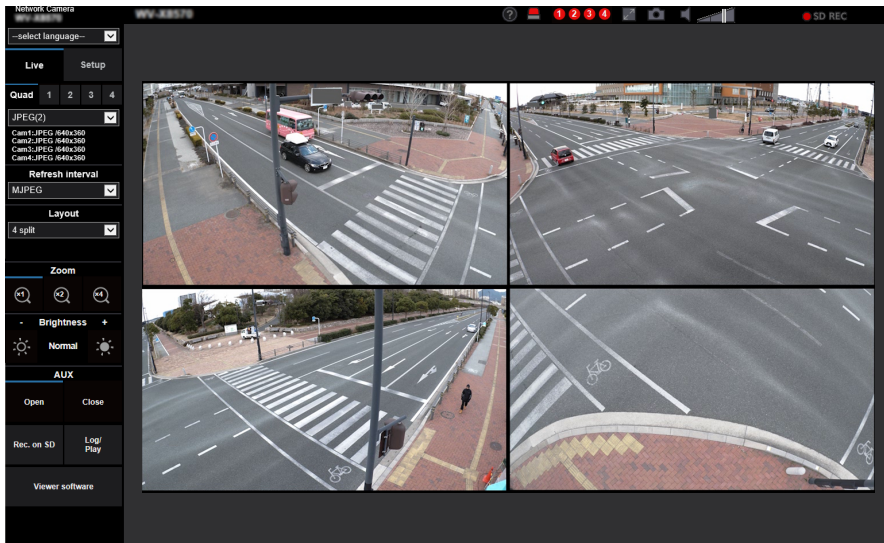

2. Click the [Log] button.

→ The log list will be displayed in a newly opened window (log list window).

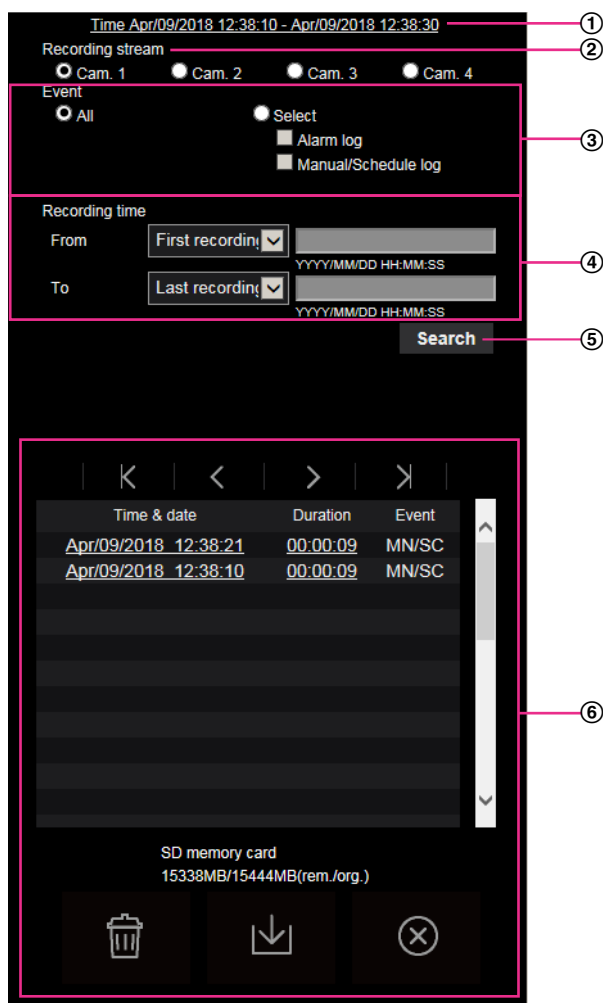
**IMPORTANT**

- Only a single user can operate the log list window. Other users cannot access the log list window.

① **Time**

Displays the time period of the data recorded on the SD memory card.

② **Recording stream**

Select the recording stream that you want to display logs for.

- **Cam. 1:** The logs recorded by “Recording stream” of Cam. 1 will be displayed.
- **Cam. 2:** The logs recorded by “Recording stream” of Cam. 2 will be displayed.
- **Cam. 3:** The logs recorded by “Recording stream” of Cam. 3 will be displayed.
- **Cam. 4:** The logs recorded by “Recording stream” of Cam. 4 will be displayed.

③ **Event**

Select a log type to display on the log list.

- **All:** All logs will be displayed.
- **Select:** Only the logs of the selected log type will be displayed.
 - **Alarm log:** The log when an alarm is detected will be displayed.
 - **Manual/Schedule log:** Manual and Schedule logs will be displayed.
- **Default:** All

④ **Recording time**

Configure the time period of logs displayed on the log list.

- **From:** Configure the starting period of logs displayed on the log list.
 - **First recording:** Displays from the first log recorded on the SD memory card.
 - **Today:** Displays the logs recorded today.
 - **Yesterday:** Displays the logs recorded from yesterday to the present day.
 - **Last 7 days:** Displays the logs recorded from 6 days ago to the present day.
 - **Last 30 days:** Displays the logs recorded from 29 days ago to the present day.
 - **Date/time:** Displays the logs recorded from the entered date and time on “Date/time” box.
- **To:** Configure the ending period of logs displayed on the log list when “First recording” or “Date/time” is selected for “From”.
 - **Last recording:** Displays until the last log recorded on the SD memory card.
 - **Date/time:** Displays the logs recorded until the entered date and time on “Date/time” box.

⑤ **[Search] button**





Searches for logs according to the conditions specified in “Event” and “Recording time”.

The search result will be displayed on the log list.

⑥ **Log list**

Displays the log search results.



You can play back recorded data by clicking on the time or duration of the recorded data displayed under [Time & date] and [Duration].

-  **(Top) button:** Click this button to display the log listed at the top.
-  **(Prev. page) button:** Click this button to display the previous page of the log list.
-  **(Next page) button:** Click this button to display the next page of the log list.
-  **(Last) button:** Click this button to display the log listed at the bottom.
- **[Time & date]:** Time and date when each log has been recorded will be displayed.

Note



- When “Off” is selected for “Time display format”, the alarm occurrence times are displayed in 24 hour time format.
- The recording timing of logs is as follows.
 - **Alarm log:** Alarm occurrence time and date will be filed as a log.
 - **Manual/Schedule log:** Time and date when recording of images onto the SD memory card started manually or during the period of the schedule will be filed as a log. In sequential recording, the logs will be filed every hour from the time when recording is started. The timing of log recording may differ among Camera 1 to 4.
- **[Duration]:** Displays the period of time that the data has been recorded on the SD memory card.

Note

- The difference between the recording end time and recording start time of the image is calculated by rounding off to the nearest tenth of a second.
- **[Event]:** The event type will be displayed.
 - **MN/SC:** Log by “Manual/Schedule”
 - **TRM1** : Alarm by alarm input to Terminal 1
 - **TRM2** : Alarm by alarm input to Terminal 2
 - **TRM3** : Alarm by alarm input to Terminal 3
 - **VMD:** Alarm by VMD alarm
 - **COM:** Alarm by command alarm

- **[SD memory card]:** Available capacity and the original capacity of the SD memory card will be displayed.
-  **(Delete) button:** Deletes log lists from all pages. When logs are searched for, only the searched logs are deleted. Images associated with deleted logs will also be deleted.

IMPORTANT

- If there are many recorded data files on the SD memory card, it may take time to delete all of them. (For example, when the total size is 1 GB, it may take about 1 hour to delete the files.) In this case, format the SD memory card. However, please note that formatting will delete all of the files on the SD memory card.
 - In the process of the deletion, “Alarm” and “Manual/Schedule” cannot be operated.
 - Do not turn off the power of the camera until the deletion is complete. When the power of the camera is turned off in the process of the deletion, some images may remain on the SD memory card. In this case, click the  button on the same log list window used to delete the logs.
-  **(Download) button:** Click this button to download all logs of the selected log list onto the PC.

Note

- The following settings may be required.
Open Internet Explorer, click [Tools] → [Internet Options] → [Security] → [Trusted Sites] → [Sites]. Register the camera address on [Website] of the displayed trusted windows.
After registration, close the web browser, and then access the camera again.
 - Up to 50,000 logs per camera can be downloaded to the SD memory card. When more than 50,000 logs are filed, the older logs will be overwritten by the newer logs. In this case, the oldest log is the first to be overwritten.
If there are many logs, it may take time to download the logs.
-  **(Close) button:** Click this button to close the log list window.

1.6 Playback of images on the SD memory card

When clicking a time and date listed on the log list window, the “Live” page will turn to the “Playback” page. When images associated with the clicked time and date are on the SD memory card, the first image of them will be displayed.

IMPORTANT

- Refresh interval of images may become slow during playback or download.
- When many images are saved on the SD memory card, it may take time to display images on the “Playback” page.
- When the aspect ratio is “4:3”, images will be displayed in VGA size on the “Playback” page regardless of the image capture size of the images saved on the SD memory card. When the aspect ratio is “16:9”, images will be displayed in “640x360” on the “Playback” page regardless of the image capture size of the images saved on the SD memory card. Therefore, images may look coarse on the “Playback” page.
- The playback refresh interval may become slower when recording data to the SD memory card.

Note

- The streams of Cam. 1, 2, 3, and 4 cannot be played back simultaneously. The playback can be performed by single camera.

1.6.1 Playback “Stream(1)”/“Stream(2)” images saved to the SD memory card

IMPORTANT

- Depending on the network environment, download of video data may fail. If downloading failed while playing images, you may be able to download images after stopping the currently played images and starting the download again.
- Depending on the network environment and status of the camera, you may not be able to operate each operation on this screen consecutively.



① Slider bar

By operating the slider bar, you can select where to start playing images from. The slider bar can only be used before playing images, or when playing is paused or stopped.

⏸ (PAUSE) button

Playback will be paused when this button is clicked during playback.

▶ (PLAY) button

When this button is clicked, recorded data will be played.

Note

X8570N

- If audio is recorded, it can be played back, but the image and audio will not be synchronized. Therefore, images and audio may not always match. When data is being recorded to the SD memory card, audio may sound as if it is cutting out and the audio quality may be reduced.
- When recorded audio is played back, the refresh interval of live images and playback may become slow.

- Recorded audio is not played back when “Off” is selected for “Audio transmission mode” on the [Audio] tab of the “Image/Audio” page.

(FF) button

Each time this button is clicked, the playback speed will change. When the  button is clicked during fast playback, playback speed will return to the normal playback speed.

Note

- The maximum speed of the fast playback varies depending on the setting of “Bit rate” - “Stream recording” of the SD memory card.
- Recorded audio will not be played back during fast playback. 

(5s backward) button

Each time this button is clicked, the recorded data goes back by 5 seconds and starts playing.

(5s forward) button

Each time this button is clicked, the recorded data goes forward by 5 seconds and starts playing.

(STOP) button

Playback will stop and the “Playback” window will turn to the “Live” page.

[Time & date]



Time and date when each log has been recorded will be displayed.

[Duration]

Displays the period of time that the data has been recorded on the SD memory card.

[Event]

The event type will be displayed.

- MN/SC:** Log by “Manual/Schedule”
- TRM1** : Alarm by alarm input to Terminal 1
- TRM2** : Alarm by alarm input to Terminal 2
- TRM3** : Alarm by alarm input to Terminal 3
- VMD:** Alarm by VMD alarm
- COM:** Alarm by command alarm

(Start) button

The selected image will be downloaded onto the PC.

Before downloading images, designate the destination directory in advance. (→page 76)

The message window will be displayed to ask if it is OK to start download when the  button is clicked. Click the [OK] button.

Note

- The image playing screen cannot be operated while downloading. Perform operations after the downloading is completed.
- When the [Cancel] button is clicked in the process of the download, the download will be canceled. In this case, video data already downloaded before clicking the [Cancel] button will be saved on the PC.
- Video data are saved in the files of approx. 20 MB. When the file size of video data is more than 20 MB, two or more files will be downloaded.

- It is possible to play back H.264 video data saved on the PC using such applications as Windows Media® Player. However, we are not liable for performance relating to these applications.
- Depending on the status of the SD memory card or Windows Media Player, H.264 video data cannot be played back.
- For information on playing back H.265 video data, refer to the following Panasonic website below.
<https://security.panasonic.com/support/info/> <Control No.: C0303>

2 Settings

2.1 About the network security

2.1.1 Equipped security functions

The following security functions are featured in this camera.

- ① Access restrictions by the host authentication and the user authentication
It is possible to restrict users from accessing the camera by setting the host authentication and/or the user authentication to "On". (→page 126, page 129)
- ② Access restrictions by changing the HTTP port
It is possible to prevent illegal access such as port scanning, etc. by changing the HTTP port number. (→page 136)
- ③ Access encryption by the HTTPS function
It is possible to enhance the network security by encrypting the access to cameras using the HTTPS function. (→page 152)

IMPORTANT

- Design and enhance security countermeasures to prevent leakage of information such as image data, authentication information (user name and password), alarm E-mail information, DDNS server information, etc. Perform the countermeasure such as access restriction (using the user authentication) or access encryption (using the HTTPS function).
- After the camera is accessed by the administrator, make sure to close the browser for added security.
- Change the administrator password periodically for added security.

Note

- When user authentication (authentication error) has failed to pass 8 times within 30 seconds using the same IP address (PC), access to the camera will be denied for a while.

2.2 Display the setup menu from a PC

The settings of the camera can be configured on the setup menu.

IMPORTANT

- The setup menu is only operable by users whose access level is “1. Administrator”. Refer to page 126 for how to configure the access level.

2.2.1 How to display the setup menu

1. Display the “Live” page. (→page 9)
2. Click the [Setup] button on the “Live” page.
→ The setup menu will be displayed. Refer to page 39 for further information about this menu.

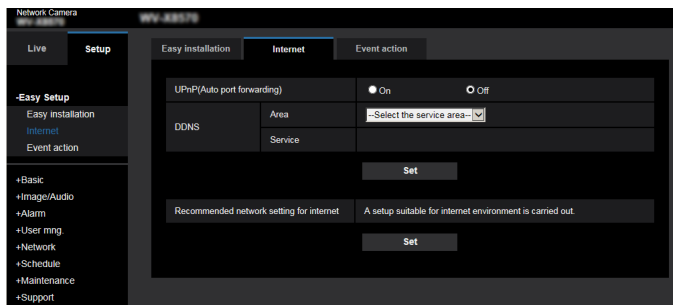

2.2.2 How to operate the setup menu

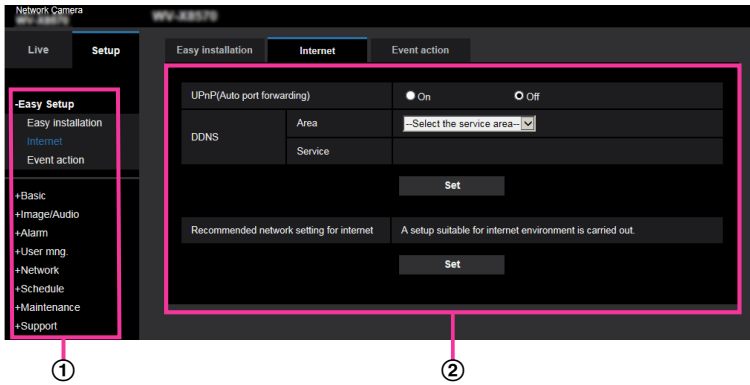

- ① Menu buttons
- ② Setup page

1. Click the desired button in the frame on the left of the window to display the respective setup menu. When there are tabs at the top of the “Setup” page displayed in the frame on the right of the window, click the desired tab to display and configure the setting items relating to the name of the tab.
2. Complete each setting item displayed in the frame on the right of the window.
3. After completing each setting item, click the [Set] button to apply them.

IMPORTANT

- When there are two or more [Set], [Register], and [Execute] buttons on the page, click the respective button to the edited setting item.

<Example>

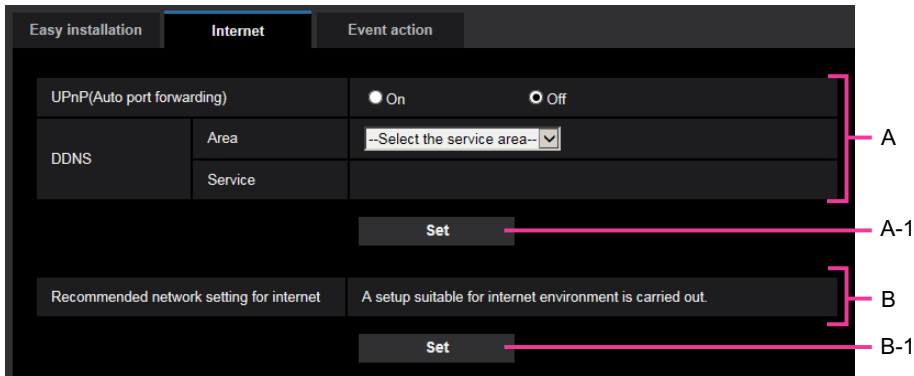

When completing the setting items in field ①, click the [Set] button ② below field ①. The edited settings in field ① will not be applied unless the [Set] button ② below field ① is clicked. In the same manner as above, click the [Set] button ④ below field ③ when completing the setting items in field ③.

2.2.3 About the setup menu window

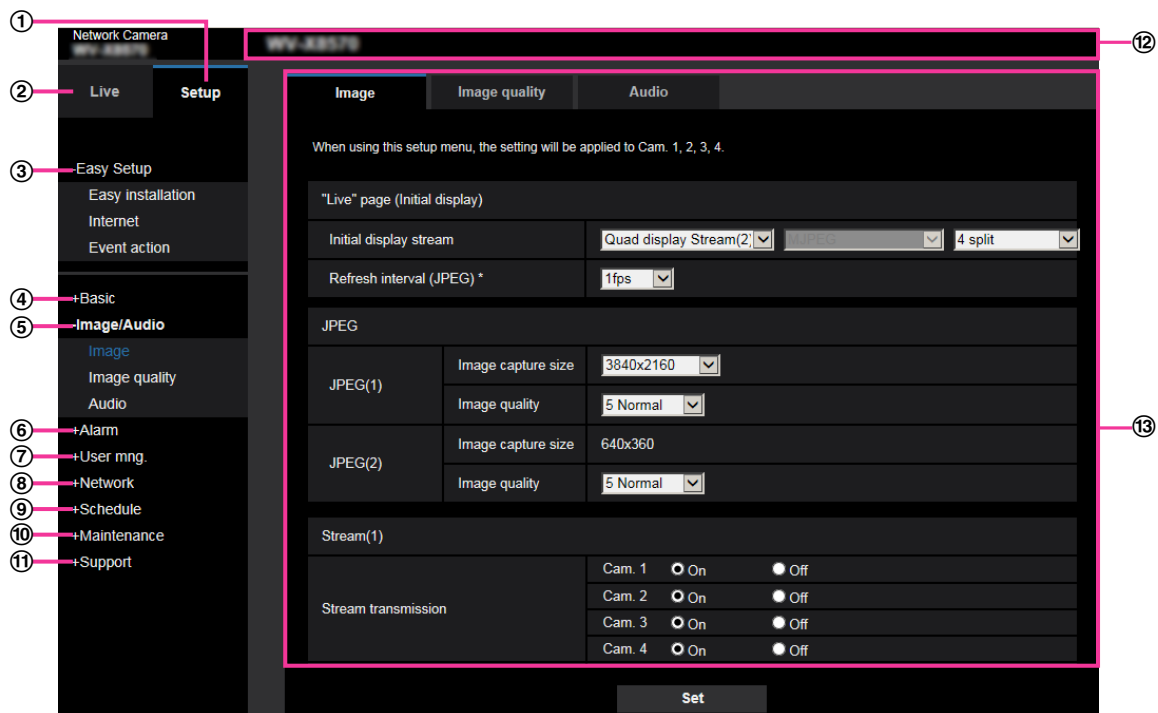

- ① **[Setup] button**
Display the "Setup" page.
- ② **[Live] button**
Display the "Live" page.
- ③ **[Easy Setup] button**
Displays the "Easy Setup" page. The "Easy Setup" page is used to set up Easy installation, the connectivity to the Internet, as well as event actions such as alarm settings and camera action on alarm. (→page 41)
- ④ **[Basic] button**
Displays the "Basic" page. The basic settings such as time and date and camera title, and the settings relating to the SD memory card can be configured on the "Basic" page. (→page 55)
- ⑤ **[Image/Audio] button** (X8570N) **[Image] button** (S8530N)
Displays the "Image/Audio" page (X8570N), "Image" page (S8530N). The settings relating to the camera such as image quality, image capture size, etc. of JPEG, H.265, and H.264 can be configured on the "Image/Audio" page (X8570N) or "Image" page (S8530N). (→page 77)
- ⑥ **[Alarm] button**
Displays the "Alarm" page. The settings relating to alarm occurrences such as settings for the alarm action at an alarm occurrence, the alarm occurrence notification, and the VMD area settings can be configured on the "Alarm" page. (→page 108)
- ⑦ **[User mng.] button**
Displays the "User mng." page. The settings relating to the authentication such as users and PCs restrictions for accessing the camera can be configured on the "User mng." page. (→page 126)
- ⑧ **[Network] button**
Displays the "Network" page. The network settings and the settings relating to DDNS (Dynamic DNS), SNMP (Simple Network Management Protocol), the NTP server, and QoS can be configured on the "Network" page. (→page 134)

- ⑨ **[Schedule] button**
Displays the “Schedule” page. On the “Schedule” page, it is possible to designate time zones to allow to activate the VMD detection function. (→page 175)
- ⑩ **[Maintenance] button**
Displays the “Maintenance” page. System log check, firmware upgrade, status check and initialization of the setup menu can be carried out on the “Maintenance” page. (→page 182)
- ⑪ **[Support] button**
Displays the support page. In the support page, how to access to the Panasonic support web site is described. (→page 190)
- ⑫ **Camera title**
The title of the camera whose settings are currently being configured will be displayed.
- ⑬ **Setup page**
Pages of each setup menu will be displayed. There are tabs for some setup menus.
The bottom of the settings page has been omitted.

2.3 Use Easy Setup [Easy Setup]

The “Easy Setup” page uses simple operations to set the following:

- Configure the installation settings.
- Make the camera image available on the Internet
- Set event actions such as recording of a schedule/alarm to the SD memory card

The “Easy Setup” page consists of the [Easy installation] tab, the [Internet] tab and [Event action] tab.

2.3.1 Configure Easy installation [Easy installation]

Click the [Easy installation] tab on the “Basic” page. (→page 37, page 38)

The layout selection menu will be displayed.

The items relating to the adjustment of angular field of view at the camera installation can be set.

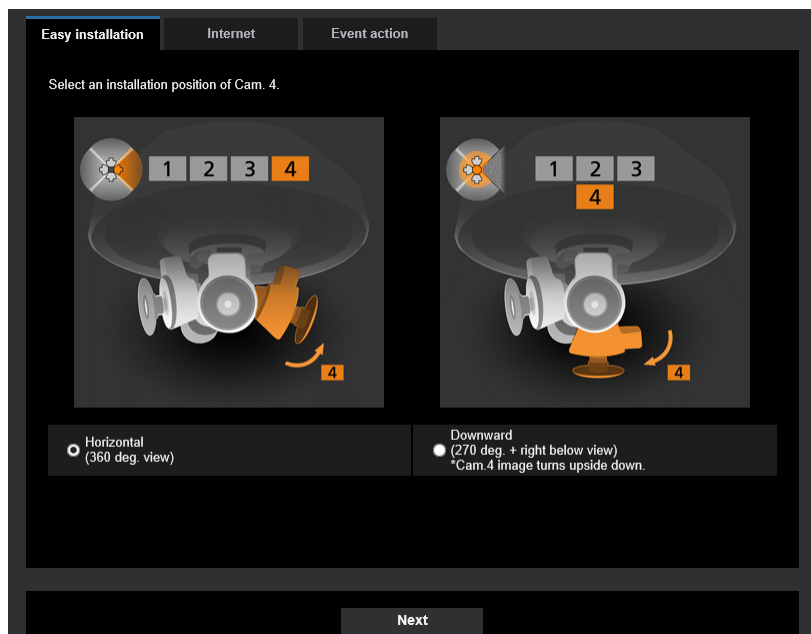

- **Horizontal (360 deg. view):** Select when installing the camera 4 horizontally in order to shoot the surrounding widely.
- **Downward (270 deg. + right below view):** Select when installing the camera 4 facing downward in order to shoot the surrounding and right below.

Note

- When “Downward (270 deg. + right below view)” is selected, only the image of camera 4 will turn upside-down.

[Next] button

Click the [Next] button to display the camera image.

When selecting “Horizontal (360 deg. view)”



When selecting “Downward (270 deg. + right below view)”

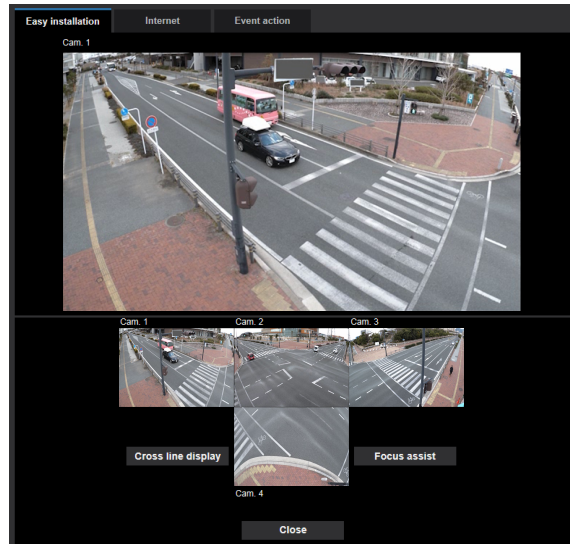

① **Main area**

The live images from the camera will be displayed in this area.

② **Layout**

The images of Cam. 1, 2, 3, and 4 are zoomed out according to the selected layout (“Horizontal (360 deg. view)” or “Downward (270 deg. + right below view)”) for each camera.

To select the camera image to be displayed in the area ①, click the camera image (Cam. 1, 2, 3, or 4). The displayed image is refreshed periodically.

③ **[Cross line display] button**

When the [Cross line display] button is clicked, the auxiliary line (a cross dotted line) will be displayed on the display ①. It helps to check the horizontality and verticality of the displayed image. To turn off the auxiliary line, click the [Cross line display] button while it is displayed.

④ **[Focus assist] button** **S8530N**

Clicking the [Focus assist] button displays the focus assist on the camera image shown in ①. For how to use the focus assist function, refer to the supplied “Installation Guide”.

The focus assist can be turned off if the [Focus assist] button is clicked while it is displayed.

⑤ **[Close] button**

The display returns to the layout selection menu.

2.3.2 Configure the Internet settings [Internet]

Click the [Internet] tab of the “Basic” page. (→page 37, page 38)

The settings relating to UPnP (Auto port forwarding), DDNS (Viewnetcam.com), and network settings for the Internet can be configured on this page.

[UPnP (Auto port forwarding)]

Select “On” or “Off” to determine whether or not to use the port forwarding function of the router.

To use the auto port forwarding function, the router in use must support UPnP and the UPnP must be enabled.

- **Default:** Off

Note

- Due to auto port forwarding, the port number may sometimes be changed. When the number is changed, it is necessary to change the port numbers registered in the PC and recorders, etc.
- The UPnP function is available when the camera is connected to the IPv4 network. IPv6 is not supported.
- To check if auto port forwarding is properly configured, click the [Status] tab on the “Maintenance” page, and check that the “Enable” is displayed for “Status” of “UPnP”. (→page 184)
When “Enable” is not displayed, refer to “Cannot access the camera via the Internet.” in 3.3 Troubleshooting.
- When the “UPnP (Auto port forwarding)” setting is changed, the “Auto port forwarding” setting under “UPnP” on the [Advanced] tab of the “Network” page also changes to the same setting.

[Area]

Select the region where the camera is installed.

Global/Japan

Note

- If the camera is used in Japan, select “Japan”. If the camera is used outside of Japan, select “Global”. The “Viewnetcam.com” service that is displayed when “Global” is selected cannot be used in Japan.

[Service]

Select “Viewnetcam.com” or “Off” to determine whether or not to use “Viewnetcam.com”.

By selecting “Viewnetcam.com” and clicking the [Set] button, the registration window for “Viewnetcam.com” will be displayed in a newly opened window.

Follow the on-screen instructions to register with “Viewnetcam.com”.

Refer to page 171 or the “Viewnetcam.com” website (<http://www.viewnetcam.com/>) for further information.

- **Default:** Off

Note

- When the “DDNS” setting is changed, the “DDNS” setting on the [Advanced] tab of the “Network” page also changes to the same setting.

[Recommended network setting for internet]

The recommended settings for connecting to the Internet are performed here.

By clicking the [Set] button, a dialog displaying how the following settings will change is displayed.

Click the [OK] button after checking the settings to change the settings to the displayed values.

- [Image] tab on the “Image/Audio” page (X8570N) “Image” page (S8530N)
 - [JPEG(1)]**
[Image capture size]: QVGA/320x180
 - [Stream(1)]/[Stream(2)]**
[Internet mode (over HTTP)]: On
[Transmission priority]: Best effort
[Max bit rate (per client)*]: 1024 kbps
 - [Stream(1)]**
[Image capture size]: 2560x1440 (X8570N) 1280x960/1280x720 (S8530N)
 - [Stream(2)]**
[Image capture size]: VGA/640x360
- [Network] tab on the “Network” page
 - [Common]**
[Max RTP packet size]: Limited(1280byte)
[HTTP max segment size(MSS)]: Limited(1280byte)

2.3.3 Configure an event action [Event action]

Click the [Event action] tab in the “Easy Setup” page. (→page 37, page 38)

The current settings are displayed here.

Alarm	
Alarm condition	Off
Alarm	Off
Output terminal	Off
E-mail notification	Off

Schedule	
Schedule	Off

The event actions for SD schedule recording and alarm detection can be set in the [Event action] tab. Once the settings are completed in each setup menu, click the [Next] button to proceed. The setup flow is as follows.

Note

- If you click the [Next] button, the settings in the screen will be saved.

Flow of event action setup

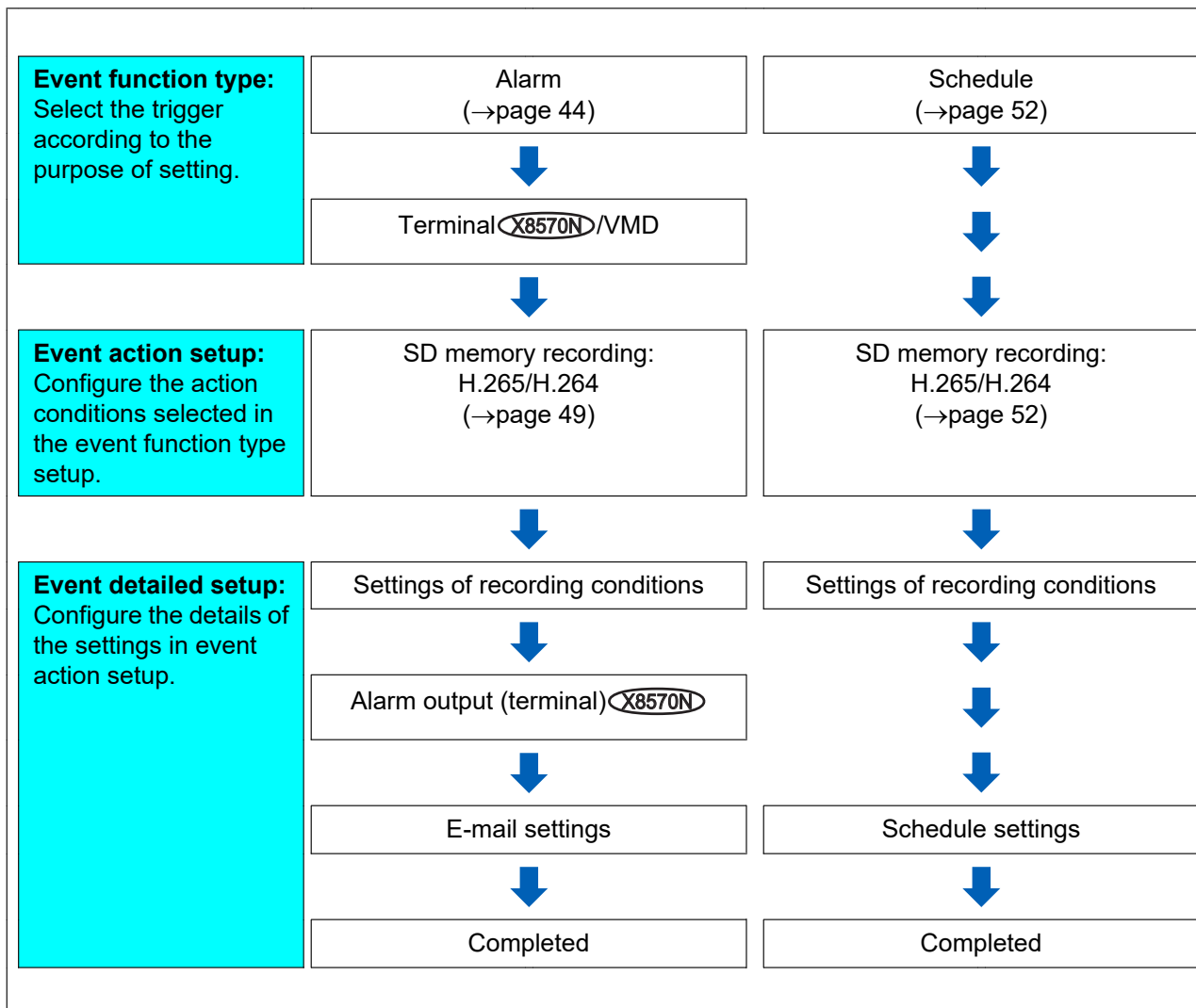

2.3.3.1 Configure the schedule/alarm (event function type setup menu)

Here, select the function type of the event.

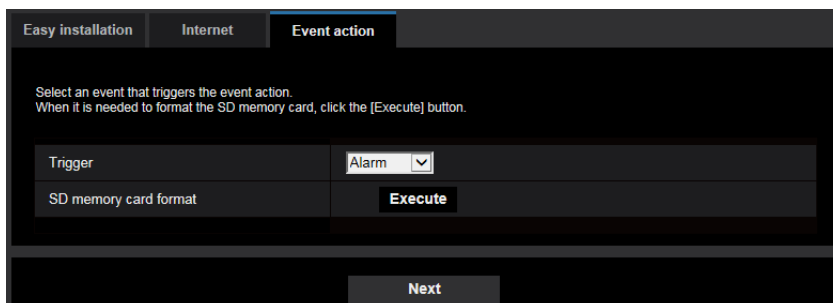

[Trigger]

- **Alarm:** Select when setting the alarm detection settings.
- **Schedule:** Select during “SD memory recording”

- **Default:** Alarm

[SD memory card format]

To format the SD memory card, click the [Execute] button.

Once you click the [Execute] button, the “Format” confirmation screen will be displayed.

If you click the [OK] button, the formatting will start.

Once the “Format” completion screen is displayed, press the  button.

IMPORTANT

- All data saved on the SD memory card will be deleted when the SD memory card is formatted.
- Do not turn off the power of the camera during formatting.

[Next] button



If you select “Alarm”, and click the [Next] button, the alarm setup menu will be displayed. (→page 46)

If you select “Schedule”, and click the [Next] button, the schedule function type setup menu will be displayed.

(→page 52)

2.3.3.2 Alarm: Configure the terminal and VMD (alarm setup menu)

The settings relating to actions when an alarm is detected can be configured in this section.

Alarm	
Terminal 1	Off 
Terminal 2	Off 
Terminal 3	Off 
VMD alarm	<input checked="" type="radio"/> On <input type="radio"/> Off
Alarm deactivation time	5 s (5-600s)

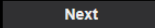
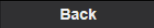
Alarm

[Terminal 1]

Determine how to use terminal 1.

- **Off:** Not used.
- **Alarm input(TRM1):** Receives terminal alarm input.
 - **Close:** An alarm is detected when the terminal status is changed to “On”.
 - **Open:** An alarm is detected when the terminal status is changed to “Off”.Also, the pull-down menu for selecting the camera number will be displayed when “Alarm input(TRM1)” is selected.
 - **Cam. 1:** Functions as an alarm input of Cam. 1.
 - **Cam. 2:** Functions as an alarm input of Cam. 2.
 - **Cam. 3:** Functions as an alarm input of Cam. 3.
 - **Cam. 4:** Functions as an alarm input of Cam. 4.
- **Black & white input:** Receives the black & white input. (When the input is set to “On”, the black & white mode is activated)

- **Auto time adjustment:** Receives time setting through terminal input. When the signal is entered, if the time difference from the hour (every hour) is less than 29 minutes, the time is adjusted to 00 minutes 00 seconds. The time is not changed in operations which reset the time under 5 seconds. If you select auto time adjustment, the pull-down menu to select close or open is displayed.
 - **Close:** Performs auto time adjustment when the terminal status is changed to “Close”.
 - **Open:** Performs auto time adjustment when the terminal status is changed to “Open”.
- **Default:** Off

[Terminal 2] X8570N

Determine how to use terminal 2.

- **Off:** Not used.
- **Alarm input(TRM2):** Receives terminal alarm input.
 - **Close:** An alarm is detected when the terminal status is changed to “On”.
 - **Open:** An alarm is detected when the terminal status is changed to “Off”.
 Also, the pull-down menu for selecting the camera number will be displayed when “Alarm input(TRM2)” is selected.
 - **Cam. 1:** Functions as an alarm input of Cam. 1.
 - **Cam. 2:** Functions as an alarm input of Cam. 2.
 - **Cam. 3:** Functions as an alarm input of Cam. 3.
 - **Cam. 4:** Functions as an alarm input of Cam. 4.
- **Alarm output:** Alarm output will be carried out according to the settings for “Output terminal” (→page 110).
Also, the pull-down menu for selecting the camera number will be displayed when the “Alarm output” is selected.
 - **Cam. 1:** Outputs when an alarm is detected with Cam. 1.
 - **Cam. 2:** Outputs when an alarm is detected with Cam. 2.
 - **Cam. 3:** Outputs when an alarm is detected with Cam. 3.
 - **Cam. 4:** Outputs when an alarm is detected with Cam. 4.
- **Default:** Off

[Terminal 3] X8570N

Determine how to use terminal 3.

- **Off:** Not used.
- **Alarm input(TRM3):** Receives terminal alarm input.
 - **Close:** An alarm is detected when the terminal status is changed to “On”.
 - **Open:** An alarm is detected when the terminal status is changed to “Off”.
 Also, the pull-down menu for selecting the camera number will be displayed when “Alarm input(TRM3)” is selected.
 - **Cam. 1:** Functions as an alarm input of Cam. 1.
 - **Cam. 2:** Functions as an alarm input of Cam. 2.
 - **Cam. 3:** Functions as an alarm input of Cam. 3.
 - **Cam. 4:** Functions as an alarm input of Cam. 4.
- **Alarm output:** Alarm output will be carried out according to the settings for “Output terminal” (→page 110).
Also, the pull-down menu for selecting the camera number will be displayed when the “Alarm output” is selected.
 - **Cam. 1:** Outputs when an alarm is detected with Cam. 1.
 - **Cam. 2:** Outputs when an alarm is detected with Cam. 2.
 - **Cam. 3:** Outputs when an alarm is detected with Cam. 3.
 - **Cam. 4:** Outputs when an alarm is detected with Cam. 4.
- **AUX output:** AUX output is carried out. The [AUX] button will be displayed on the “Live” page.
- **Default:** Off

VMD alarm

- **On:** If the VMD area is not configured, the entire region is configured. To configure the VMD area, use the [VMD area] tab on the “Alarm” page. (→page 119)
- **Off:** Disables all VMD states.
- **Default:** Off

[Alarm deactivation time]

Set the duration for which detection is not to be performed after an alarm has been detected. For example, by using this function you can prevent mail from being sent too often when the E-mail notifications are configured to be sent to cellular phones when an alarm is detected.

5 – 600 seconds

- **Default:** 5s

Note

- The duration of the alarm deactivation time can be specified for each type of alarm. For example, during the time when detections for “Terminal alarm 1” are not made, detections for “VMD alarm” can be made.

[Next] button

Click the [Next] button to display the recording stream setup menu (→page 48)

Note

- If you click the [Next] button, the setting items in the screen are saved.

[Back] button

If you click the [Back] button, the event function type setup menu will be displayed. (→page 45)

2.3.3.3 Alarm: Sets the recording stream (recording stream setup menu).

Select the type of stream to record on the SD memory card.

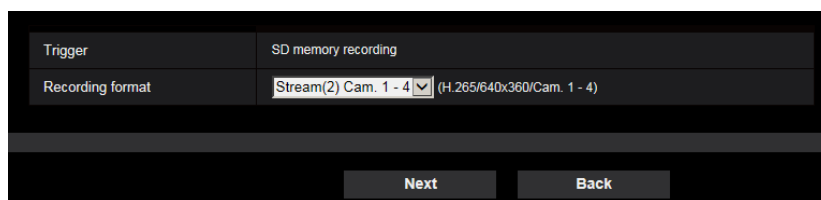

[Recording format]

Select the stream encoding format for the images to be recorded from Stream(1) or Stream(2).

[Next] button

Click the [Next] button to display the video recording setup menu.

Note

- If you click the [Next] button, the setting items in the screen are saved.

[Back] button

If you click the [Back] button the alarm setup menu will be displayed. (→page 46)

2.3.3.4 Alarm: Configure the details for recording conditions

① Configure SD memory recording (H.265 or H.264) (video recording setup menu)

The SD memory recording (H.265 or H.264) when an alarm is detected is configured in this section.

Stream recording(Alarm)	
Audio recording	<input checked="" type="radio"/> On <input type="radio"/> Off
Frame rate*	30fps * ▾
Pre alarm (recording) duration	Off ▾
Post alarm (recording) duration	30s ▾
<input type="button" value="Next"/> <input type="button" value="Back"/>	

[Audio recording] X8570N

Select On/Off to determine whether or not to record audio data.

- **On:** Saves audio data to videos (MP4 format).
- **Off:** Does not save audio data to videos (MP4 format).

[Frame rate]

Select a frame rate for the H.265 (or H.264) to be recorded.

Note

- Refer to [Frame rate*] in “2.3.3.8 Schedule: Set SD memory recording (video recording setup menu)” for information about available frame rates and the bit rates that are set according to the frame rate.

[Pre alarm (recording) duration]

Determine whether or not to perform the pre alarm recording. Set the duration to save image data on the SD memory card.

Off/ 1s/ 2s/ 3s/ 4s/ 5s/ 8s/ 10s/ 15s/ 20s/ 25s/ 30s/ 40s/ 50s/ 60s/ 90s/ 120s

- **Default:** Off

Note

- The values change depending on the bit rate and the image capture size of the recorded stream. As the selected bit rate increases, the available maximum value for the pre alarm duration decreases.

[Post alarm (recording) duration]

Set the duration to save image data on the SD memory card after an alarm occurrence.

10s/ 20s/ 30s/ 40s/ 50s/ 60s/ 120s/ 180s/ 240s/ 300s

- **Default:** 30s

* The actual recording time may sometimes be longer than the duration selected for this setting.

[Next] button

If you select “Alarm output” in the alarm setup menu and click the [Next] button, the alarm output setup menu will be displayed. (→page 50)

If you click the [Next] button in the alarm setup menu without selecting “Alarm output”, the mail setup menu will be displayed. (→page 50)

Note

- If you click the [Next] button, the setting items in the screen are saved.

[Back] button

If you click the [Back] button, the recording stream setup menu will be displayed. (→page 48)

2.3.3.5 Alarm: Configure the output terminal X8570N

Alarm output is configured in this section.

- To configure settings relating to the output terminal:

Output terminal	
Terminal output upon alarm detection	<input checked="" type="radio"/> On <input type="radio"/> Off
SD memory card error	<input checked="" type="radio"/> On <input type="radio"/> Off
Terminal state upon alarm detection	<input type="radio"/> Latch <input checked="" type="radio"/> Pulse
Terminal action upon alarm detection	<input type="radio"/> Open <input checked="" type="radio"/> Close
Pulse output width	<input type="text" value=""/> s (1-120s)

Refer to page 110 for information about how to configure the above screen.

[Next] button

If you click the [Next] button, the mail setup menu will be displayed. (→page 50)

Note

- If you click the [Next] button, the setting items in the screen are saved.

[Back] button

If you click the [Back] button, the video recording setup menu (→page 49) will be displayed.

2.3.3.6 Alarm: configure the mail notifications and mail server

The settings relating to e-mail can be configured in this section.

- To configure e-mail related settings:

SMTP(E-mail)	
E-mail notification	<input type="radio"/> On <input type="radio"/> Off
Alarm image attachment	<input type="radio"/> On <input type="radio"/> Off
Image capture size	640x360
SMTP server address	<input type="text"/> Example of entry: 192.168.0.10
SMTP port	<input type="text"/> 25 (1-65535)
POP server address	<input type="text"/> Example of entry: 192.168.0.10
Authentication	Type <input type="radio"/> None <input type="radio"/> POP before SMTP <input type="radio"/> SMTP
	User name <input type="text"/>
	Password <input type="text"/>
Sender's E-mail address	<input type="text"/>
SSL	<input type="radio"/> On <input type="radio"/> Off
Destination of notification	
Destination E-mail address	
Address 1	<input type="text"/> <input type="button" value="Delete"/> <input type="checkbox"/> Terminal 1 <input type="checkbox"/> Terminal 2 <input type="checkbox"/> Terminal 3 <input type="checkbox"/> VMD <input type="checkbox"/> Command alarm <input type="checkbox"/> Diag.
Address 2	<input type="text"/> <input type="button" value="Delete"/> <input type="checkbox"/> Terminal 1 <input type="checkbox"/> Terminal 2 <input type="checkbox"/> Terminal 3 <input type="checkbox"/> VMD <input type="checkbox"/> Command alarm <input type="checkbox"/> Diag.
Address 3	<input type="text"/> <input type="button" value="Delete"/> <input type="checkbox"/> Terminal 1 <input type="checkbox"/> Terminal 2 <input type="checkbox"/> Terminal 3 <input type="checkbox"/> VMD <input type="checkbox"/> Command alarm <input type="checkbox"/> Diag.
Address 4	<input type="text"/> <input type="button" value="Delete"/> <input type="checkbox"/> Terminal 1 <input type="checkbox"/> Terminal 2 <input type="checkbox"/> Terminal 3 <input type="checkbox"/> VMD <input type="checkbox"/> Command alarm <input type="checkbox"/> Diag.
E-mail subject	<input type="checkbox"/> Use the camera title <input type="checkbox"/> Cause of alarm <input type="text"/>
E-mail body	<input checked="" type="checkbox"/> Cause of alarm <input checked="" type="checkbox"/> Occurrence time The %p% alarm was occurred at %t% <input type="text"/>
Terminal name	
Terminal 1 (Up to 10 characters)	<input type="text"/> Terminal1
Terminal 2 (Up to 10 characters)	<input type="text"/> Terminal2
Terminal 3 (Up to 10 characters)	<input type="text"/> Terminal3
<input type="button" value="Set"/>	

Refer to page 139 for information about how to configure the above screen.

[Set] button

If you click the [Set] button, setup will be completed.

[Back] button

If you click the [Back] button, the video recording setup menu (→Page 52) or the alarm output setup menu (→page 50) will be displayed.

2.3.3.7 Schedule: Configure SD recording (Recording format setup menu)

Select the type of stream to record on the SD memory card.

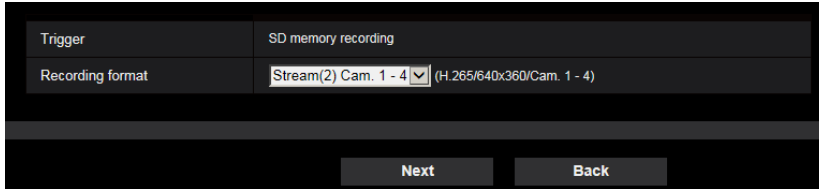

[Recording format]

Select the stream to be recorded from Stream(1) or Stream(2).

[Next] button

Click the [Next] button to display the video recording setup menu. (→page 52)

Note

- If you click the [Next] button, the setting items in the screen are saved.

[Back] button

If you click the [Back] button, the event function type setup menu will be displayed. (→page 45)

2.3.3.8 Schedule: Set SD memory recording (video recording setup menu)

Here, SD memory recording (H.265 or H.264) is configured according to the schedule.

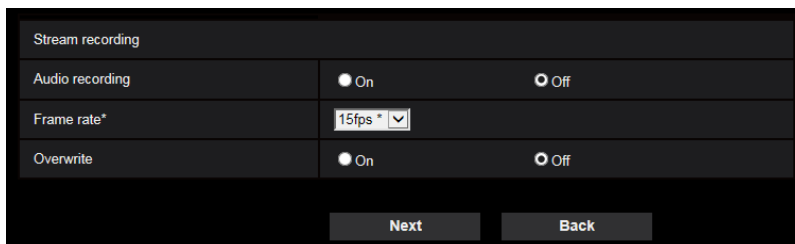

[Audio recording] (X8570N)

Determine whether or not to perform audio recording.

- **On:** Saves audio data to videos (MP4 format).
- **Off:** Does not save audio data to videos (MP4 format).
- **Default:** Off

IMPORTANT

- When the [Overwrite] setting is changed from “Off” to “On”, if the remaining capacity of the SD memory card is low, old images may be deleted in order to prepare to save new images.

[Frame rate*]

Select a frame rate for the H.265 or H.264 to be recorded from the following.

(X8570N)

1fps/ 3fps/ 5fps*/ 7.5fps*/ 10fps*/ 12fps*/ 15fps*

S8530N

1fps/ 3fps/ 5fps*/ 7.5fps*/ 10fps*/ 12fps*/ 15fps*/ 20fps*/ 30fps*

- **Default:** 15fps* **X8570N** 30fps* **S8530N**

Note

- If you click the [Next] button, the “Transmission priority” will be set to “Frame rate”. (→page 82)

The bit rate is set as follows depending on the selected image capture size and frame rate.

Unit: kbps

Image capture size	Frame rate (fps)								
	1	3	5	7.5	10	12	15	20	30
320×180	128	256	256	256	256	256	256	256	384
QVGA	128	256	256	256	256	256	256	256	384
640×360	256	384	384	384	384	384	384	512	512
VGA	256	384	384	384	384	384	384	512	512
1280×720	384	512	512	512	768	768	768	768	1024
1280×960	512	768	768	768	768	1024	1024	1024	1024
1600×1200 S8530N	768	1024	1024	1024	1536	1536	1536	2048	2048
1920×1080 S8530N	768	1024	1024	1024	1536	1536	1536	2048	2048
2560×1440 X8570N	1536	2048	2048	2048	2048	2048	2048	–	–
3840×2160 X8570N	3072	4096	4096	4096	4096	4096	4096	–	–

[Overwrite]

Determine whether or not to overwrite images when the remaining capacity of the SD memory card becomes insufficient.

- **On:** Overwrites when the remaining capacity of the SD memory card becomes insufficient. (The oldest image is the first to be overwritten.)
- **Off:** Stops saving images on the SD memory card when the SD memory card becomes full.
- **Default:** Off

IMPORTANT

- When the [Overwrite] setting is changed from “Off” to “On”, if the remaining capacity of the SD memory card is low, old images may be deleted in order to prepare to save new images.

[Next] button

If you click the [Next] button, the setup menu to set the schedule for recording into the SD memory card will be displayed. (→page 54)

[Back] button

If you click the [Back] button, the schedule function type setup menu will be displayed. (→page 52)

2 Settings

- To configure the schedule settings:

Schedules		
Schedule 1 (White) ■	Schedule mode	VMD permission
	Time range	<input checked="" type="checkbox"/> Mon <input checked="" type="checkbox"/> Tue <input checked="" type="checkbox"/> Wed <input checked="" type="checkbox"/> Thu <input checked="" type="checkbox"/> Fri <input checked="" type="checkbox"/> Sat <input checked="" type="checkbox"/> Sun 24h 09:00 - 17:30
Schedule 2 (Blue) ■	Schedule mode	VMD permission
	Time range	<input checked="" type="checkbox"/> Mon <input checked="" type="checkbox"/> Tue <input checked="" type="checkbox"/> Wed <input checked="" type="checkbox"/> Thu <input checked="" type="checkbox"/> Fri <input checked="" type="checkbox"/> Sat <input checked="" type="checkbox"/> Sun 24h 23:00 - 07:00
Schedule 3 (Green) ■	Schedule mode	Recording to SD (Recording stream)
	Time range	<input type="checkbox"/> Mon <input type="checkbox"/> Tue <input type="checkbox"/> Wed <input type="checkbox"/> Thu <input type="checkbox"/> Fri <input checked="" type="checkbox"/> Sat <input type="checkbox"/> Sun <input checked="" type="checkbox"/> 24h
Schedule 4 (Red) ■	Schedule mode	Off
	Time range	<input type="checkbox"/> Mon <input type="checkbox"/> Tue <input type="checkbox"/> Wed <input type="checkbox"/> Thu <input type="checkbox"/> Fri <input type="checkbox"/> Sat <input type="checkbox"/> Sun 24h
Schedule 5 (Black) ■	Schedule mode	Off
	Time range	<input type="checkbox"/> Mon <input type="checkbox"/> Tue <input type="checkbox"/> Wed <input type="checkbox"/> Thu <input type="checkbox"/> Fri <input type="checkbox"/> Sat <input type="checkbox"/> Sun 24h

Set Back

Refer to page 175 for information about how to set the above screen.

[Set] button

If you click the [Set] button, setup will be completed.

[Back] button

If you click the [Back] button, the (video recording setup menu will be displayed. (→page 52)

Note

- Video recording is not performed if “SD memory recording” is not selected in the “Schedule mode”.

2.4 Configure the basic settings of the camera [Basic]

The basic settings such as camera title, time and date, SD memory card and the logs can be configured on the “Basic” page. The “Basic” page has the [Basic] tab, the [SD memory card] tab, and the [Log] tab.

2.4.1 Configure the basic settings [Basic]

Click the [Basic] tab on the “Basic” page. (→page 37, page 38)

The settings such as the camera title, time and date, etc. can be configured on this page.

Basic		SD memory card	Log
Menu language		Auto	
Camera title		WV-X9570	
Time & date	Date/time	Jan 01 2018 00:00:00	
	Time display format	24h	
	Date/time display format	Mmm/DD/YYYY	
	NTP	NTP>>	
	Time zone	(GMT+09:00) Osaka, Sapporo, Tokyo	
	Summer time (daylight saving)	Out	
	Start time & date	Month Day Time	
End time & date	Month Day Time		
Display on screen	Cam. 1	Cam. 2	Cam. 3 Cam. 4 Apply the settig of Cam. 1 to Cam. 2, 3, 4
Date/time display	<input type="radio"/> On <input type="radio"/> Off		<input checked="" type="checkbox"/>
Date/time position	Upper left		<input checked="" type="checkbox"/>
Camera title on screen display	<input type="radio"/> On <input type="radio"/> Off		<input checked="" type="checkbox"/>
Camera title position	Upper left		<input checked="" type="checkbox"/>
Camera title on screen	Cam. 1	Cam1	
	Cam. 2	Cam2	
	Cam. 3	Cam3	
	Cam. 4	Cam4	
Character size	100%		
Brightness status display	<input type="radio"/> On <input type="radio"/> Off		
Upside-down	Cam. 1	<input type="radio"/> On <input type="radio"/> Off	
	Cam. 2	<input type="radio"/> On <input type="radio"/> Off	
	Cam. 3	<input type="radio"/> On <input type="radio"/> Off	
	Cam. 4	<input type="radio"/> On <input type="radio"/> Off	
Indicator	<input type="radio"/> On <input type="radio"/> Off		
Status update mode	<input type="radio"/> Polling(30s) <input type="radio"/> Real time		
Status reception port	31004 (1-65535)		
Viewer software (nvcv4Ssetup.exe)	Automatic installation	<input type="radio"/> On <input type="radio"/> Off	
	Drawing method	<input type="radio"/> GDI <input type="radio"/> Direct2D	
	Decoding Options	<input type="radio"/> Software <input type="radio"/> Hardware <input type="button" value="Confirm"/>	
	Smoother live video display on the browser (buffering)	<input type="radio"/> On <input type="radio"/> Off	
	Frame Skip Options (When PC is Heavy Processing Load)	<input type="radio"/> Auto <input type="radio"/> Manual	
	Contrast enhancement (RGB.0 to 255)	<input type="radio"/> On <input type="radio"/> Off	
<input type="button" value="Set"/>			

[Menu language]

Select the language to initially display when the camera is accessed from the following.
Auto/English/Japanese/Italian/French/German/Spanish/Chinese/Russian/Portuguese

- **Auto:** The language used by the browser is automatically selected. If the language used by the browser is not supported by the camera, English is selected.
- **Default:** Auto

The language displayed on the “Live” page can also be changed. (→page 12)

Note

- When Japanese is selected, diagnostic e-mails and the tablet screen are displayed in Japanese.
When Chinese is selected, the tablet screen is displayed in Chinese.
When any other language is selected, diagnostic e-mails and the tablet screen are displayed in English.

[Camera title]

Enter the title of the camera. Click the [Set] button after entering the title of the camera. The entered title will be displayed in the “Camera title” field.

- **Available number of characters:** 0 - 20 characters
- **Unavailable characters:** " &
- **Default:** The model No. is displayed.

[Date/time]

Enter the current time and date. When “12h” is selected for “Time display format”, “AM” or “PM” can be selected.

- **Available range:** Jan/01/2013 00:00:00 - Dec/31/2035 23:59:59

IMPORTANT

- Use an NTP server when the more accurate time & date setting is required for the system operation.
(→page 143)

[Time display format]

Select the time display format from “24h” and “12h”. Enter the current hour reflecting this setting when entering the current time and date for “Date/time”.

- **Default:** 24h

[Date/time display format]

Select a date/time display format. When “2018/04/01 13:10:00” is set for “Date/time” after selecting “24h” for “Time display format”, time & date will be respectively displayed as follows.

- **DD/MM/YYYY:** 01/04/2018 13:10:00
- **MM/DD/YYYY:** 04/01/2018 13:10:00
- **DD/Mmm/YYYY:** 01/Apr/2018 13:10:00
- **YYYY/MM/DD:** 2018/04/01 13:10:00
- **Mmm/DD/YYYY:** Apr/01/2018 13:10:00
- **Default:** Mmm/DD/YYYY

[NTP]

When “NTP >>” is clicked, the [Advanced] tab of the “Network” page will be displayed. (→page 143)

[Time zone]

Select a time zone corresponding to the location where the camera is in use.

- **Default:** (GMT +09:00) Osaka, Sapporo, Tokyo

[Summer time (daylight saving)]

Select “In”, “Out” or “Auto” to determine whether or not to apply daylight saving time. Configure this setting if the summer time (daylight saving time) is applied in the location where the camera is in use.

- **In:** Applies summer time. An asterisk (*) will be displayed on the left side of the displayed time and date.
- **Out:** Does not apply summer time.
- **Auto:** Applies summer time in accordance with the settings for “Start time & date” and “End time & date” (month, week, day of the week, time).
- **Default:** Out

[Start time & date] [End time & date]

When “Auto” is selected for “Summer time (daylight saving)”, select the time & date for the start time and the end time (month, week, day of the week, time).

[Display on screen]

Cam. 1/ Cam. 2/ Cam. 3/ Cam. 4: Select each camera and set up.

- **[Date/time display]**
Select On/Off to determine whether or not to display the date and time on an image. To hide the date and time, select “Off”. Checking the “Apply the setting of Cam. 1 to Cam. 2, 3, 4” check box reflects the setting changed with Cam. 1 in other cameras, Cam. 2, 3, and 4.
 - **Default:** On
- **[Date/time position]**
Select the position to display the time and date in an image. Checking the “Apply the setting of Cam. 1 to Cam. 2, 3, 4” check box reflects the setting changed with Cam. 1 in other cameras, Cam. 2, 3, and 4.
 - **Upper left:** The information will be displayed at the upper left corner of the screen.
 - **Lower left:** The information will be displayed at the lower left corner of the screen.
 - **Upper center:** The information will be displayed at the upper center of the screen.
 - **Lower center:** The information will be displayed at the lower center of the screen.
 - **Upper right:** The information will be displayed at the upper right corner of the screen.
 - **Lower right:** The information will be displayed at the lower right corner of the screen.
 - **Default:** Upper left

Note

- Only upper left or lower left can be configured for the OSD display position when “90 °” or “270 °” is selected for “Image rotation”.
- **[Camera title on screen display]**
Select “On” or “Off” to determine whether or not to display the camera title on the screen. When “On” is selected, the character string entered for “Camera title on screen” will be displayed at the position selected for “Camera title position”. Checking the “Apply the setting of Cam. 1 to Cam. 2, 3, 4” check box reflects the setting changed with Cam. 1 in other cameras, Cam. 2, 3, and 4.
 - **Default:** On
- **[Camera title position]**
Select the position where the character string is displayed on the screen. Checking the “Apply the setting of Cam. 1 to Cam. 2, 3, 4” check box reflects the setting changed with Cam. 1 in other cameras, Cam. 2, 3, and 4.
 - **Upper left:** The character string will be displayed in the upper left part of the screen.
 - **Lower left:** The character string will be displayed in the lower left part of the screen.
 - **Upper center:** The character string will be displayed in the upper center part of the screen.
 - **Lower center:** The character string will be displayed in the lower center part of the screen.
 - **Upper right:** The character string will be displayed in the upper right part of the screen.
 - **Lower right:** The character string will be displayed in the lower right part of the screen.
 - **Default:** Upper left
- **[Camera title on screen]**
Enter a character string to be displayed on the image. The character string set for each Cam. 1, Cam. 2, Cam. 3, and Cam. 4 is displayed in the stream image of the camera.
 - **Available number of characters:** 0 - 20 characters

- **Available characters:** 0-9, A-Z, a-z and the following marks.
! " # \$ % & ' () * + , - . / : ; = ?
- **Default:**
 - Camera 1: Cam. 1
 - Camera 2: Cam. 2
 - Camera 3: Cam. 3
 - Camera 4: Cam. 4

[Character size]

Select the character size of the date and time as well as text displayed in the image.

- **100%:** Displays in the standard size.
- **150%:** Displays in 150% of the standard size.
- **200%:** Displays in 200% of the standard size.
- **Default:** 100%

IMPORTANT

- If the settings for [Date/time position] and [Camera title position] are different, the frame rate may be lower than the specified value.
- If the settings for [Date/time position] and [Camera title position] are different, characters may be displayed incorrectly or overlapped depending on the [Character size] setting and the number of characters used. After completing the settings, confirm the result on the “Live” page.
- If “150%” or “200%” is selected for [Character size], the frame rate may be lower than the specified value.
- Depending on the setting and the numbers of characters used for [Character size] and the image capture size, characters displayed on the screen may be cut off. After completing the settings, confirm the result on the “Live” page.

[Brightness status display]

Select “On” or “Off” to determine whether or not to display the status of brightness on images displayed on the “Live” page when adjusting brightness.

- **Default:** On

[Upside-down]

Set whether or not to turn the image (JPEG, H.265, or H.264) upside-down. On/Off can be set per Cam. 1, Cam. 2, Cam. 3, Cam. 4.

- **Default:**
 - Cam. 1: Off
 - Cam. 2: Off
 - Cam. 3: Off
 - Cam. 4: Off

IMPORTANT

- If the settings for “Upside-down” are changed while the following area settings are set, the areas need to be checked and reset.
 - Mask area (→page 97)
 - Privacy zone (→page 100)
 - VMD area (→page 117)
 - VIQS area (→page 102)

[Indicator]

Determine whether or not to use the following indicators. Select “On” to use the following indicators to check the operational status by lighting them.

- Link indicator (LINK)
- Access indicator (ACT)
- SD memory card error indicator (SD ERROR)
- SD MOUNT lamp (SD MOUNT)
- **Default:** On

Note

- **Link indicator (LINK) (orange):** This indicator will light when communication with the connected device is available.
- **Access indicator (ACT) (green):** This indicator will blink when accessing a network.
- **SD memory card error indicator (SD ERROR) (red):** Lights when data cannot be saved to the SD memory card.
- **SD MOUNT lamp (SD MOUNT) (green):** Lights when data can be saved to the SD memory card. It blinks or is off when data cannot be saved to the SD memory card.
 - Indicator is off: Indicates “Not use” is selected for SD memory card, or an error occurred for the SD memory card.
 - Indicator blinks: Indicates the SD memory card is being recognized or is performing the necessary processing for the SD memory card to be removed.
 - Indicator lights: Indicates data can be saved to the SD memory card.

[Status update mode]

Select an interval of the camera status notification from the following.

When the status of the camera changes, the alarm occurrence indication button, [AUX] button **X8570N**, or the “SD recording status indicator” will be displayed in the “Live” page to notify of the camera status.

- **Polling(30s):** Updates the status each 30 seconds and provide notification of the camera status.
- **Real time:** Provide notification of the camera status when the status has changed.
- **Default:** Real time

Note

- Depending on the network environment, notification may not be provided in real time.
- When multiple cameras are using the same “Status reception port”, even if “Real time” is selected for “Status update mode”, status notification is not provided in real time. In this case, change the “Status reception port” settings.

[Status reception port]

When selecting “Real time” for “Status update mode”, designate a port number to which the status change notification is to be sent.

- **Available port number:** 1 - 65535
- **Default:** 31004

The following port numbers are unavailable since they are already in use.

20, 21, 23, 25, 42, 53, 67, 68, 69, 80, 110, 123, 161, 162, 443, 995, 10669, 10670

[Viewer software (nwcV4Ssetup.exe)] - [Automatic installation]

Determine whether or not to install the viewer software from this camera.

- **On:** Installs the viewer software from the camera automatically.
- **Off:** The viewer software cannot be installed from the camera.
- **Default:** On

IMPORTANT

- For PCs that do not have the viewer software “Network Camera View 4S” installed, JPEG images are displayed. Displaying H.265 (or H.264) images or receiving audio **X8570N** from the camera is not

possible. In order to display H.265 (or H.264) images or receive audio **X8570N** from the camera, installation of the viewer software is required. Click "Viewer Software" on the "Live" page

- The number of the viewer software installations can be checked on the [Upgrade] tab of the "Maintenance" page.

[Viewer software (nwcV4Ssetup.exe)- [Drawing method]

Perform image display settings when displaying camera images with the viewer software.

- **GDI:** The drawing method generally used in Windows.
- **Direct2D:** Can reduce choppy drawing of images.
- **Default:** GDI

IMPORTANT

- Use "Direct2D" with a computer that has the latest graphic driver version installed to it.
- When using "Direct2D", set "Smoother live video display on the browser (buffering)" to "On". If "Off" is selected for "H.264 Smoother live video display on the browser (buffering)", "Direct2D" may not be very effective.

Note

- If your computer's operating system is Windows 7 and the Aero function is disabled, "Direct2D" may not be very effective.
- When "Direct2D" is selected for "Drawing method", video may not be displayed or the displayed image may be seen as it is partially corrupted depending on the PC in use.
- Refer to the Panasonic support website for information of PCs for which "Direct2D" is selectable. Panasonic website (<https://security.panasonic.com/support/info/> <Control No.: C0313>)

[Viewer software (nwcV4Ssetup.exe)] - [Decoding Options]

Select the decoding method for H.265/H.264 images on the "Live" page.

- **Software:** Decoding is performed by software.
- **Hardware:** Uses the Hardware Acceleration (QSV/DXVA) function that performs fast decoding.
- **Default:** Software

IMPORTANT

- "Hardware" may not be able to be used depending on the computer used. One of the following messages is displayed when the [Confirm] button is clicked.
 - The hardware decode is available for both H.265 and H.264 on your PC.
 - Depending on your PC environment, images may not be able to be outputted. In this case, select "Software" for "Decoding Options".
 - The hardware decode is available for H.264 on your PC, but unavailable for H.265 on your PC.
 - Depending on your PC environment, images may not be able to be outputted. In this case, select "Software" for "Decoding Options".
 - "The hardware decode is not available on your PC."
 - Select "Software" for "Decoding Options".

Note

- When "Hardware" is selected for "Decoding Options", video may not be displayed or the displayed image may be seen as it is partially corrupted depending on the PC in use.
- Refer to the Panasonic support website below for information of PCs for which "Hardware" is selectable. Panasonic website (<https://security.panasonic.com/support/info/> <Control No.: C0313>)

[Viewer software (nwcV4Ssetup.exe)] - [Smoother live video display on the browser (buffering)]

Perform settings to display camera images on the viewer software.

- **On:** Images are temporarily stored on the computer and are displayed smoother.
- **Off:** Images are displayed in real-time and are not stored on the computer.
- **Default:** On

[Viewer software (nwcV4Ssetup.exe)] - [Frame Skip Options (When PC is Heavy Processing Load)]

Perform settings to display camera images on the viewer software.

- **Auto:** If there is a delay in displaying images from the camera, the delay can be resolved by automatically skipping frames.
- **Manual:** If there is a delay in displaying images from the camera, frames are not skipped automatically.
- **Default:** Auto

Note

- When "Manual" is selected, "Off", "1 Frame Skip", "2 Frames Skip", "4 Frames Skip", "6 Frames Skip", or "8 Frames Skip" can be selected for frame skip by right-clicking on the "Live" page. The value selected here will revert to "Off" when the browser is closed.

[Viewer software (nwcV4Ssetup.exe)] - [Contrast enhancement(RGB:0 to 255)]

Select "On" or "Off" to determine whether or not to enhance the contrast of H.265 images or H.264 images on the "Live" page.

If "On" is selected, the range of RGB signal on display is extended from 16-235 to 0-255.

When there is a bright part in an image, the intensity may be overexposed. Select a setting suitable to your usage environment.

- **Default:** Off

Note

- This setting is only available when viewing images on the "Live" page with Internet Explorer.
- Even if this setting is changed, transmitted image data and data saved on the SD memory card are not changed.

2.4.2 Configure the settings relating to the SD memory card [SD memory card]

Click the [SD memory card] tab on the “Basic” page. (→page 37, page 38)
 The settings relating to the SD memory card can be configured on this page.

Operating mode

[SD memory card]

Select “Use” or “Not use” to determine whether or not to use the SD memory card.

- **Default:** Use

[Audio recording] X8570N

Select whether or not to save audio data when saving video data in MP4 format.

- **Off:** Does not save audio data to videos (MP4 format).
- **On:** Saves audio data to videos (MP4 format).
- **Default:** Off

[Remaining capacity notification]

When the E-mail notification function or the Panasonic alarm protocol function is used to provide notification of the remaining capacity of the SD memory card, select a level to be notified at from the following.

50%/ 20%/ 10%/ 5%/ 2%

- **Default:** 50%

Note

- Notification will be provided each time the remaining capacity goes below each of the specified values. For example, notification will be provided each time the remaining capacity reaches 50%, 20%, 10%, 5% and 2% when “50%” is selected. Notification may not always be made at the very moment when the remaining capacity of the SD memory card has reached each value.

[Overwrite]

Determine whether or not to overwrite when the remaining capacity of the SD memory card becomes insufficient.

- **On:** Overwrites when the remaining capacity of the SD memory card becomes insufficient. (The oldest image is the first to be overwritten.)
- **Off:** Stops saving images on the SD memory card when the SD memory card becomes full.
- **Default:** Off

IMPORTANT

- Select “Not use” when operating without an SD memory card.
- When an SD memory card is inserted when “Use” is selected, data will be saved in accordance with the setting of “Save trigger”.
- After inserting the SD memory card, it is necessary to select “Use” to use the SD memory card.
- When the image refresh interval is short, notification/recording timing or interval may become incorrect. Notification/recording may also not be performed correctly as configured when multiple users are receiving images. In this case, set the refresh interval longer.
- There are limited times to overwrite on an SD memory card. When having a high frequency of overwriting, the lifetime of the SD memory card may become shorter.
- A lifetime of an SD memory card should be influenced by the number of the image files stored and log savings on the SD memory card. Selecting smaller value for “Max bit rate (per client)*” of the stream to be recorded can reduce the number of files that can be stored on the SD memory card.
- If the data writing speed goes down after data is repeatedly written on an SD memory card, we recommend replacing the SD memory card.
- When the setting is changed from “Off” to “On”, if the remaining capacity of the SD memory card is low, old images may be deleted in order to prepare to save new images.

SD memory card security**[Additional info for detecting alteration]**

Select whether or not to add information to enable detection when the data in the SD memory card is altered. Alteration detection supports video data (MP4 format) only and can be checked using exclusive software. For further information about exclusive software for alteration detection and how to use it, refer to our website below.

<https://security.panasonic.com/support/info/> <Control No.: C0304>

Click the [Setup>>] button to display the setup menu that can configure the settings relating to additional info for detecting alteration. The setup menu will be displayed in a newly opened window. (→page 68)

[SD memory card password lock]

Configure a password for the SD memory card. When configuring a password, devices other than the camera will be unable to write to or read the SD memory card. If the SD memory card is stolen or lost, the risk of recorded data being leaked can be reduced.

[Set]

When an SD memory card with no configured password is inserted, a password can be configured using the [Set] button.

SD memory card password lock(Set)	
Password	<input type="password"/>
Retype password	<input type="password"/>
<input type="button" value="Set"/>	

[Password]/[Retype password]

Enter the password.

Available number of characters: 4 - 16 characters

Unavailable characters: " &

Default: None (blank)

[Remove]

When an SD memory card with a configured password is inserted, the password can be removed using the [Remove] button.

SD memory card password lock(Remove)	
Password	<input type="password"/>
<input type="button" value="Set"/>	

[Password]

Enter the password.

Available number of characters: 4 - 16 characters

Unavailable characters: " &

[Change]

When an SD memory card with a configured password is inserted, the password can be changed using the [Change] button.

SD memory card password lock(Change)	
Old password	<input type="password"/>
New password	<input type="password"/>
Retype new password	<input type="password"/>
<input type="button" value="Set"/>	

[Old password]/[New password]/[Retype new password]

Enter the password.

Available number of characters: 4 - 16 characters

Unavailable characters: " &

[Status]

Display the configuration status of the password lock.

- **Lock:** A password is configured on the SD memory card, and the lock function is enabled.
- **Unlock:** The lock function is disabled.

Also display the password configuration status of SD memory card respectively.

- **Password is set.:** The password is configured correctly.
- **Error(Unsupported SD memory card):** A card that does not support password lock is inserted. Check that an SDHC memory card or SDXC memory card is inserted.
- **Error(Password mismatch):** The SD memory card cannot be used because the password configured for the SD memory card and the password configured for the camera do not match. Check that the passwords are correct.
- **Error(Undefined error):** Displayed when the SD memory card is formatting, locked (write-protected), or when an error occurs in the SD memory card. Check the SD memory card.

Note

- The password lock function supports only SDHC memory cards and SDXC memory cards.
- If you will use the SD memory card on a device other than the camera with password lock configured, remove the password using the password lock remove button before removing the SD memory card. The password cannot be removed on devices (such as PCs) other than the camera.
- When the “Status” of “SD memory card password lock” is “Lock”, if an SD memory card with noconfigured password is inserted, the password is automatically configured to the SD memory card.

IMPORTANT

- If you forget the configured password, the password cannot be removed. The SD memory card with the configured password will become unusable, so manage passwords with great care.
- If you forget the configured password and you want to replace the SD memory card with a new one, perform one of the following step to set the “Status” of “SD memory card password lock” to “Unlock” before replacing the SD memory card.
- Use the password lock remove button to enter a password and then press the [Set] button. In this case, even if you enter an incorrect password, the “Status” will change to “Unlock”.
 - Initialize settings from the “Maintenance” page.

Recording stream 1**[Recording format]**

Select the type of image data to be recorded on the SD memory card.

- **Off:** Does not record data.
- **Stream(1) Cam. 1 to Cam. 4:** Records video data (Stream(1)) in the MP4 video encoding format. The data is recorded in accordance with the settings of “Stream(1)” on the [Image] tab of the “Image/Audio” page **X8570N** or “Image” page **S8530N**.
- **Stream(2) Cam. 1 to Cam. 4:** Records video data (Stream(2)) in the MP4 video encoding format. The data is recorded in accordance with the settings of “Stream(2)” on the [Image] tab of the “Image/Audio” page **X8570N** or “Image” page **S8530N**.
- **Default:** Off

IMPORTANT

- If using an SD memory card whose speed is other than the SD Speed Class 10, set the maximum bit rate of “Stream(1)” and “Stream(2)” selected in “Recording format” to 1536 Mbps.
- If using an SD memory card whose speed is SD Speed Class 10, set the maximum bit rate of “Stream(1)” and “Stream(2)” selected in “Recording format” to 4096 Mbps.
- For SD memory cards with an SD Speed Class 10, use a card that supports UHS-I.

2 Settings

(Ultra High Speed-I)

- When recording the stream of 3840×2160 image capture size, other than the SD Speed Class 10 cannot be used.

Note

- When “Stream(1)” is selected, the settings for “Stream(1)” on the [Image] tab of the “Image/Audio” page (X8570N) or “Image” page (S8530N) will be changed to the settings for “Stream(1) & recording”. When “Stream(2)” is selected, the settings for “Stream(2)” on the [Image] tab of the “Image/Audio” page (X8570N) or “Image” page (S8530N) will be changed to the settings for “Stream(2) & recording”.
- When “Stream(1)” or “Stream(2)” is selected for “Recording format”, the settings of the following functions may be corrected.
 - When “VBR” is selected for “Transmission priority”, “Frame rate” is set.
 - When “2s”, “3s”, “4s” or “5s” is selected for “Refresh interval”, “1s” is set.
- The name of the saved file will be given automatically.
- When “Stream(1)” or “Stream(2)” is selected for “Recording format”, the number of users that can access the camera may be reduced.
- When “On” is selected for “Additional info for detecting alteration”, the maximum value of the available bit rate for “Stream” will be limited.

[Save trigger]

Select a trigger to save images on the SD memory card from the following.

- **Alarm input:** Saves images at an alarm occurrence.
- **Manual:** Saves images manually.
- **Schedule:** Saves images in accordance with the settings for “Schedule” (→page 175).
- **Default:** Manual

If you have selected “Alarm input” in the [Save trigger], you can select the alarm type from the following:

- **Terminal 1 (X8570N):** Save the image when an alarm occurs in Terminal 1.
- **Terminal 2 (X8570N):** Save the image when an alarm occurs in Terminal 2.
- **Terminal 3 (X8570N):** Save the image when an alarm occurs in Terminal 3.
- **VMD:** Save the image when motion detection occurs.
- **Command alarm:** Save the image when a command alarm is entered.

Note

- To enable alarms to occur, alarm settings must be configured in advance on the [Alarm] tab.

Stream recording(Alarm)

Stream recording(Alarm)	
Pre alarm (recording) duration	Off ▼
Post alarm (recording) duration	30s ▼

This setting is only available when “Stream(1)” or “Stream(2)”, is selected for “Recording format” of the SD memory card, and “Alarm input” is selected for “Save trigger”.

[Pre alarm (recording) duration]

Determine whether or not to perform the pre alarm recording. Set the duration to save image data on the SD memory card.

Off/ 1s/ 2s/ 3s/ 4s/ 5s/ 8s/ 10s/ 15s/ 20s/ 25s/ 30s/ 40s/ 50s/ 60s/ 90s/ 120s

- **Default:** Off

Note

- The available values change depending on the bit rate and image capture size for “Stream” selected for recording. As the selected bit rate increases, the available maximum value for the pre alarm duration decreases.

[Post alarm (recording) duration]

Set the duration to save image data on the SD memory card after an alarm occurrence.

10s/ 20s/ 30s/ 40s/ 50s/ 60s/ 120s/ 180s/ 240s/ 300s

- Default:** 30s
 - * The actual recording time may sometimes be longer than the duration selected for this setting.

SD memory card information**[Remaining capacity]**

Total capacity and remaining capacity of the SD memory card will be displayed.

Depending on the status of the SD memory card, the size indications will differ as follows.

Indication	Description
-----MB/-----MB	No SD memory card is inserted. Failed to obtain available capacity due to error, etc.
*****MB/*****MB	The SD memory card is unformatted, or locked (write-protected).
#####MB/ #####MB	The SD memory card password lock cannot be unlocked.

Note

- When “Off” is selected for “Overwrite” and the available size of the SD memory card is “0 MB”, images will not be saved on the SD memory card. When the notification function is on, a notification will be sent to the registered addresses and destinations of the Panasonic alarm protocol when the SD memory card becomes full. (→page 114, page 121)

[Format]

To format the SD memory card, click the [Execute] button.

IMPORTANT

- Before formatting the SD memory card, it is necessary to select “Use” for “SD memory card” on the [SD memory card] tab of the “Basic” page (→page 62).
- Use the SD memory card after formatting it using the [SD memory card] tab. If using the SD memory card that has not been formatted on the [SD memory card] tab, the following functions may not work correctly.
 - Save/obtain alarm images
 - Save/obtain images saved manually
 - Save/obtain images in accordance with the schedule settings
 - Save/obtain the alarm logs, the manual/schedule logs, and the system logs
 - Play/download images on the SD memory card
- When an SD memory card is formatted while another user is in operation, the operation will be canceled.
- It is impossible to access the SD memory card during the process of formatting.
- All data saved on the SD memory card will be deleted when the SD memory card is formatted.
- Do not turn off the power of the camera during the process of formatting.

2 Settings

- After formatting the SD memory card, available size may be smaller than the total size since the default directory is automatically created in the SD memory card.
- For information on compatible SD memory cards (option), refer to the Important Information in the supplied CD-ROM.
- Refer to our website (<https://security.panasonic.com/support/info/> <Control No.:C0107>) for latest information about the compatible SD memory cards.
- When repeatedly recording images on an SD memory card using the auto overwrite function, make sure to use an SD memory card with high reliability and durability.
- Use the SD memory card that complies with UHS-1(Ultra High Speed-1) in the case of SD Speed Class10.

SD memory card images

[Access img.]

Images on the SD memory card can be obtained. Click the [Execute] button. Refer to page 75 for how to access images.

2.4.3 Configure the settings relating to alteration detection

[Alteration detection]

Selecting alteration detection enables detection using exclusive software when the data on the SD memory card is altered.

Alteration detection supports video files (MP4 format) only.

Refer to page 70 for information on how to configure alteration detection.

For further information about exclusive software for alteration detection and how to use it, refer to our website below.

<https://security.panasonic.com/support/info/> <Control No.: C0304>

Alteration detection	
Select certificate	Pre-installed ▾
Additional info for detecting alteration	<input checked="" type="radio"/> On <input type="radio"/> Off
Set	
Pre-installed certificate	
Certificate download	Execute
CA Certificate	
CRT key generate	Execute
Generate Certificate Signing Request	Execute
CA Certificate install	<input type="text" value="Browse..."/> Execute
Information	Invalid Confirm Delete
Certificate download	Execute
Close	

[Select certificate]

Select the certificate to be used with HTTPS.

Pre-installed: Selects a pre-installed certificate.

CA: Selects a "CA Certificate". Only displayed when the "CA Certificate" is installed.

Default: Pre-installed

[Additional info for detecting alteration]

Select whether or not to give information for alteration detection to video files (MP4 format) to be saved on the SD memory card.

Note

- When the certificate (CA certificate) issued by CA (Certificate Authority) is not valid, "On" cannot be selected.

[Pre-installed certificate - Certificate download]

Click the [Execute] button and download the root certificate for the pre-installed certificate. By installing the root certificate to your PC, you can get signature verification for the pre-installed certificate.

Note

- Refer to the Panasonic website (<https://security.panasonic.com/support/info/<Control No.:C0305>>) for further information about how to install certificates on your PC.

[CA Certificate - CRT key generate]

CRT key (encryption key) used for alteration detection is generated. To generate the CRT key, click the [Execute] button to display "CRT key generate" dialog box.

[CA Certificate - Generate Certificate Signing Request]

When using the CA certificate issued by CA as the CA certificate used for alteration detection, the CSR (Certificate Signing Request) will be generated.

To generate the CSR, click the [Execute] button to display the "CA Certificate - Generate Certificate Signing Request" dialog window.

[CA Certificate - Certificate install]

Installs the certificate (CA certificate) issued by CA and displays the information of the installed certificate (CA certificate).

To install the certificate (CA certificate), click the [Browse...] button to display the [Open] dialog box, and select the file of the certificate (CA certificate) issued by CA, and click the [Execute] button.

If the certificate (CA certificate) is already installed, the file name of the installed certificate will be displayed.

[CA Certificate - Information]

Displays the information of the certificate (CA certificate) issued by CA.

When the [Confirm] button is clicked, the registered information of the installed certificate (CA certificate) will be displayed in the "CA Certificate - Confirm" dialog box. If the certificate (CA certificate) is not installed, the content of the generated CSR file will be displayed.

When the [Delete] button is clicked, the installed certificate (CA certificate) will be deleted.

[CA Certificate - Certificate download]

Downloads the certificate (CA certificate) issued by CA from the camera.

When implementing alteration detection of video data (MP4 files) on the SD memory card using exclusive software, the downloaded certificate is used.

IMPORTANT

- Before deleting the valid certificate (CA certificate), confirm that there is a backup file of the certificate (CA certificate) on the PC or another media. The backup file will be required when installing the certificate (CA certificate) again.

2.4.4 How to configure alteration detection settings

The settings relating to alteration detection that detects when data in the SD memory card is altered or edited can be configured on this page.

The alteration detection settings will be configured in the following procedure.

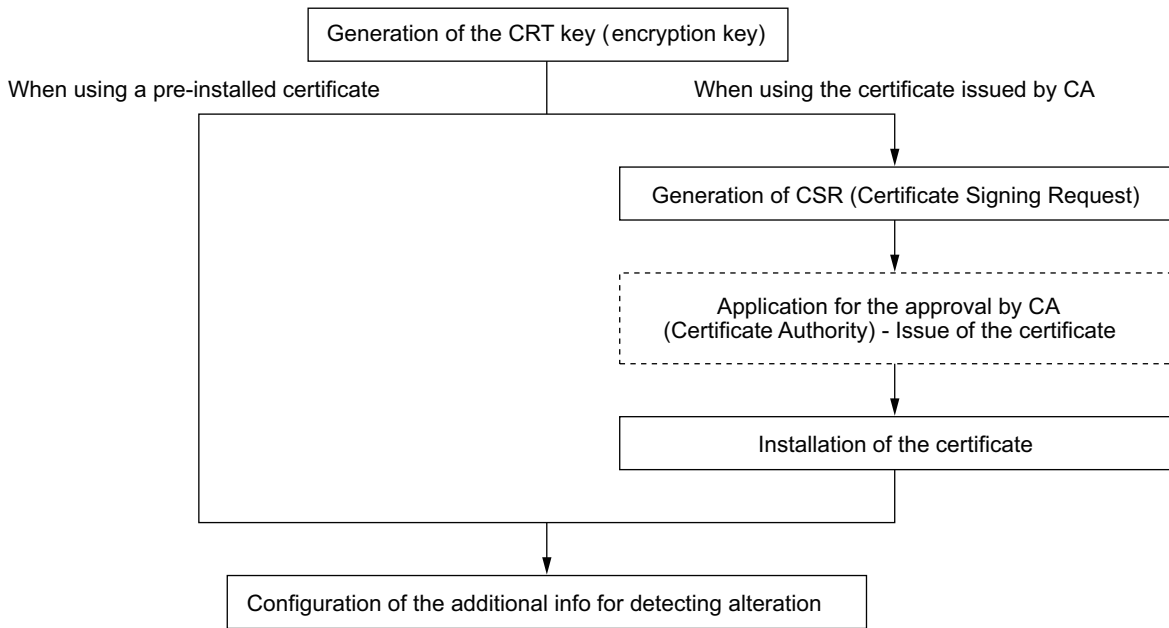

2.4.4.1 Generation of the CRT key (encryption key)

IMPORTANT

- When the certificate (CA certificate) issued by CA is valid, it is impossible to generate the CRT key.
- When the certificate (CA certificate) issued by CA is used, the available key size varies depending on the CA. Check the available key size in advance.
- To generate the CRT key, it may take about 2 minutes. Do not operate the web browser until the generation of CRT key is complete. While the CRT key is being generated, the refresh interval and line speed may be lower.

1. Click the [Execute] button of “CRT key generate”.
→ The “CRT key generate” dialog box will be displayed.

Current CRT key			
CRT key	RSA key size		
	Last modified	Not generated	History
CRT key generate			Execute
*Generating a CRT key takes around 2 minutes.			
Close			

2. Click the [Execute] button.
→ The generation of CRT key will be started. When the generation is finished, the key size and generation time & date of the generated key will be displayed on “Current CRT key”.

Note

- To change (or update) the generated CRT key, perform step 1 to 2. The CRT key and certificate issued by CA are valid in a set. When the CRT key is changed, it is necessary to re-apply for the certificate issued by CA.
- When the CRT key is updated, the log of the previous CRT key is saved. When the [History] button of “Current CRT key” on the “CRT key generate” dialog box is clicked, the “Previous CRT key” dialog box will be displayed, and it is possible to check the key size and generation time & date of the previous key. When the [Apply] button is clicked on the “Previous CRT key” dialog box, it is possible to replace the current CRT key with the previous one.

Previous CRT key			
History	RSA key size	2048bit	
	Last modified		Apply
Close			

2.4.4.2 Generation of CSR (Certificate Signing Request)

IMPORTANT

- If the CRT key is not generated, it is impossible to generate the CSR.
- Before generating the CSR file, configure the following settings on [Internet Options] of the web browser in advance. Click [Internet Options...] under [Tools] of the menu bar of Internet Explorer, and then click the [Security] tab.
 - Register the camera for [Trusted Sites].
 - Click the [Custom level...] button to open the [Security Settings] window, and check the [Enable] radio button of [File Download] under [Downloads].
 - Click the [Custom level...] button to open the [Security Settings] window, and check the [Enable] radio button of [Automatic prompting for file downloads] under [Downloads].

2 Settings

1. Click the [Execute] button of “CA Certificate - Generate Certificate Signing Request”.
→ The “CA Certificate - Generate Certificate Signing Request” dialog box will be displayed.

2. Enter the information of the certificate to be generated.

Item	Description	Available number of characters
[Common Name]	Enter the camera address or host name.	64 characters
[Country]	Enter the country name.	2 characters (Country code)
[State]	Enter the state name.	128 characters
[Locality]	Enter the locality name.	128 characters
[Organization]	Enter the organization name.	64 characters
[Organizational Unit]	Enter the unit name of the organization.	64 characters
[CRT key]	Displays the key size and generation time & date of the current key.	—

3. Click the [OK] button after entering the items.
→ The [Save As] dialog box will be displayed.
4. Enter a file name for the CSR in the [Save As] dialog box to save on the PC.
→ The saved CSR file will be applied to the CA.

IMPORTANT

- The certificate will be issued for the set of the generated CSR and CRT key. If the CRT key is re-generated or updated after applying to the CA, the issued certificate will be invalidated.

Note

- This camera generates the CSR file in the PEM format.

2.4.4.3 Installation of the certificate issued by CA

IMPORTANT

- If the CSR file is not generated, it is impossible to install the certificate (CA certificate) issued by CA.
 - For the installation of the certificate issued by CA, the CA certificate issued by CA is required.
1. Click the [Browse...] button of “CA Certificate - Certificate install”.
→ The [Open] dialog box will be displayed.
 2. Select the certification file and click the [Open] button. Then, click the [Execute] button.
→ The certification will be installed.

Note

- The host name registered in the installed certificate will be displayed on “CA Certificate - Information”. Depending on the status of the certificate, the following are displayed.

Indication	Description
Invalid	The CA certificate is not installed.
[Host name of the certificate]	The certificate has already been installed and validated.
Expired	The certification has already expired.

- When the [Confirm] button is clicked, the registered information of the installed certificate (CA certificate) will be displayed in the “CA Certificate - Confirm” dialog box. (Only “Organizational Unit” will be displayed with an asterisk (*).)

CA Certificate - Confirm		
Common Name	NWCAM	
Country	JP	
State	Fukuoka	
Locality	Fukuoka	
Organization	Panasonic	
Organizational Unit	Software	
CRT key	RSA key size	2048bit
	Last modified	2014/01/09 17:27:36
Close		

- When the [Delete] button is clicked, the installed certificate (CA certificate) will be deleted.
- When “On” is selected for “Additional info for detecting alteration”, it is impossible to delete the certificate (CA certificate) issued by CA.
- To change (or update) the certificate issued by CA, perform step 1 and 2.

IMPORTANT

- Before deleting the valid certificate (CA certificate), confirm that there is a backup file of the certificate (CA certificate) on the PC or another media. The backup file will be required when installing the certificate (CA certificate) again.
- The expiration date of the certificate issued by CA can be checked by double-clicking the server certification file issued by CA.

2.4.4.4 Configuration of alteration detection

1. Select “On” for “Additional info for detecting alteration”, and click the [Set] button.
2. Extensive information for alteration detection will be added to video files (MP4 format) recorded after changing the setting.

IMPORTANT

- When the “Additional info for detecting alteration” setting is changed, manual recording on the SD memory card will stop. Start manual saving again as necessary.

Note

- Alteration detection can be performed on video files (MP4 format) recorded when “On” is selected for “Additional info for detecting alteration” using exclusive software.
For further information about exclusive software and how to use it, refer to our website below.
<https://security.panasonic.com/support/info/> <Control No.: C0304>

2.4.5 Access copy images saved on the SD memory card onto the PC [SD memory card images]

Click the [SD memory card] tab on the “Basic” page. (→page 37, page 38)

The following are descriptions of how to copy images saved on the SD memory card onto the PC. It is necessary in advance to select “Allow” for “FTP access to camera” on the [Network] tab of the “Network” page. (→page 134)

IMPORTANT

- It may sometimes be impossible to operate when another user is accessing images on the SD memory card. In this case, retry later.
 - Depending on the settings of a proxy server or a firewall, images may not be obtained via a network. In this case, refer to the network administrator.
1. Click the [Execute] button of “SD memory card images”.
→ The user authentication window will be displayed.

2. Click the [OK] button after entering the user name and password of the camera administrator.
→ The folder in which images are to be saved will be displayed.

Note

- When the FTP server of the camera is logged to access images, the SD memory card is assigned to Drive B. Images are saved in different directories according to “Save trigger”. Move to the directory corresponding to the desired images and copy them. Refer to page 211 for further information about the directory structure.

Possible duration of stream images (H.265 or H.264) that can be saved on the SD memory card (as indications)

For possible duration of stream images (H.265 or H.264) that can be saved on the SD memory card, refer to our website below.

<https://security.panasonic.com/support/info/> <Control No.: C0307>

2.4.6 Configure the directory of the PC that images will be downloaded to [Log]

Click the [Log] tab on the “Basic” page. (→page 37, page 38)

The directory of the PC that images recorded on the SD memory card will be downloaded to can be configured in this section.

SD memory card		
		Name of the destination directory for downloaded images
Alarm	Cam. 1	C:\nwcam
	Cam. 2	C:\nwcam2
	Cam. 3	C:\nwcam3
	Cam. 4	C:\nwcam4
Manual/Schedule	Cam. 1	C:\nwcam
	Cam. 2	C:\nwcam2
	Cam. 3	C:\nwcam3
	Cam. 4	C:\nwcam4

Alarm

The settings related to the directory of the PC that recorded images of when alarms occur will be downloaded to can be performed.

[Cam. 1]

Enter the name of the directory of the PC to which the recorded images of Cam. 1 are to be downloaded. For example, enter “C:\alarm” to designate the folder “alarm” under drive C.

- **Available number of characters:** 3 - 128 characters
- **Available characters:** Alphanumeric characters, the slash (/), the backslash (\), the colon (:), and the underscore (_).

[Cam. 2]

Enter the name of the directory of the PC to which the recorded images of Cam. 2 are to be downloaded.

[Cam. 3]

Enter the name of the directory of the PC to which the recorded images of Cam. 3 are to be downloaded.

[Cam. 4]

Enter the name of the directory of the PC to which the recorded images of Cam. 4 are to be downloaded.

Manual/Schedule

The settings related to the directory name of the PC that images recorded by manual saving or schedule saving will be downloaded to can be performed.

Designate the destination folder in the same manner as for “Alarm”.

2.5 Configure the settings relating to images and audio X8570N [Image/Audio X8570N, Image S8530N]

The settings relating to the camera such as image quality and audio X8570N of JPEG, H.265, and H.264 can be configured on the “Image/Audio” page X8570N or “Image” page S8530N.

The “Image/Audio” page X8570N or the “Image” page S8530N has the [Image] tab, the [Image quality] tab, and the [Audio] tab X8570N.

2.5.1 Configure the settings relating to the image capture mode [Image] S8530N

Click the [Image] tab on the “Image” page. (→page 37, page 38)

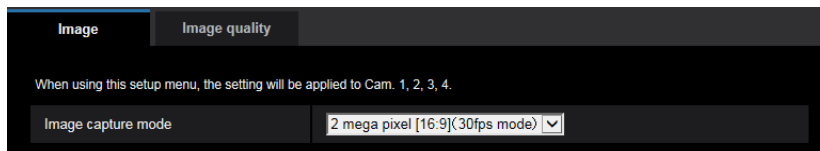

[Image capture mode]

- 2 mega pixel [16:9](30fps mode)/2 mega pixel [4:3](30fps mode)
 - **Default:** 2 mega pixel [16:9](30fps mode)

IMPORTANT

- The positions of areas may move out of alignment when the “Image capture mode” setting is changed when the following area settings are configured. Therefore we recommend that you configure each area setting after configuring the “Image capture mode”.
 - mask area (→page 97)
 - privacy zone (→page 100)
 - VMD area (→page 117)
 - VIQS area (→page 102)

2.5.2 Configure the settings relating to JPEG images [Image]

Click the [Image] tab on the “Image/Audio” page **X8570N** or “Image” page **S8530N**. (→page 37, page 38)

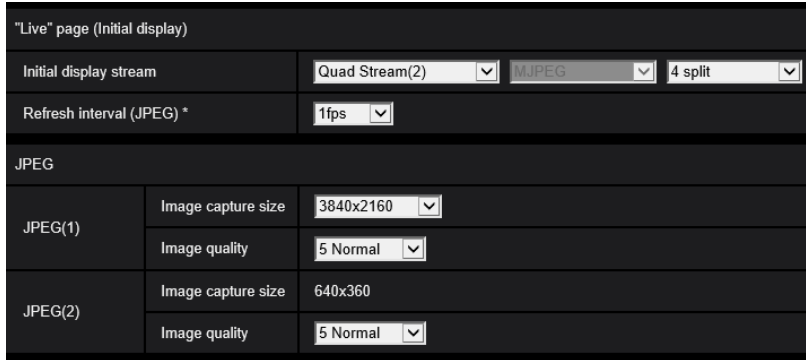

“Live” page (Initial display)

Configure the settings relating to the initial images displayed on the “Live” page.

[Initial display stream]

Select the image to display on the “Live” page from the following.

Quad display Stream(2)/ Quad display JPEG(2)/ Cam.1 Stream(1)/ Cam.1 Stream(2)/ Cam.1 JPEG(1)/ Cam.2 Stream(1)/ Cam.2 Stream(2)/ Cam.2 JPEG(1)/ Cam.3 Stream(1)/ Cam.3 Stream(2)/ Cam.3 JPEG(1)/ Cam.4 Stream(1)/ Cam.4 Stream(2)/ Cam.4 JPEG(1)

- **Default:** Quad display Stream(2)

Note

- When “Quad display JPEG(2)”, “Cam.1 JPEG(1)”, “Cam.2 JPEG(1)”, “Cam.3 JPEG(1)”, or “Cam.4 JPEG(1)” is selected, the refresh interval can be selected.
MJPEG/Refresh interval: 1s/ Refresh interval: 3s/ Refresh interval: 5s/ Refresh interval: 10s/ Refresh interval: 30s/ Refresh interval: 60s
When “Quad display JPEG(2)” is selected for “Initial display stream”, “Refresh interval: 1s” and “Refresh interval: 3s” are not available.
- When “Quad display Stream(2)” or “Quad display JPEG(2)” is selected, the display method for 4-screen display can be selected.
360 deg./ 270 deg. + right below/ 4 split
Default: 4 split

[Refresh interval (JPEG)*]

Select an interval to refresh the displayed JPEG image from the following.

X8570N

0.1fps/0.2fps/0.33fps/0.5fps/1fps/2fps*/3fps*/5fps*/6fps*/10fps*/12fps*/15fps*

S8530N

0.1fps/0.2fps/0.33fps/0.5fps/1fps/2fps/3fps/5fps/6fps*/10fps*/12fps*/15fps*/30fps*

- **Default:** 1fps **X8570N**, 5fps **S8530N**

Note

- When “On” is selected for “Stream transmission”, the refresh interval may be longer than the set value when any value with an asterisk (*) on the right is selected.

- Depending on factors such as the network environment, the resolution, the image quality, or the number of computers concurrently accessing the camera, the transmission interval may be longer than the set value.
- If images are not delivered in the specified transmission interval, you can make the images be delivered closer to the specified time by lowering the resolution or image quality.

JPEG

Configure the settings such as “Image capture size”, “Image quality” of “JPEG(1)” and “Image quality” of “JPEG(2)” on this section. Refer to page 80 for further information about the settings relating to H.265 (or H.264) images.

[Image capture size]

Select the image capture size to display the JPEG image.

Product No./Image capture mode	JPEG(1)	JPEG(2)
WV-X8570N	3840×2160 2560×1440 1280×720 640×360 320×180	640×360
WV-S8530N 2 mega pixel [16:9](30fps mode)	1920×1080 1280×720 640×360 320×180	640×360
WV-S8530N 2 mega pixel [4:3](30fps mode)	1600×1200 1280×960 VGA QVGA	VGA

- **Default:**
 - **X8570N**
 - JPEG(1): 3840×2160, JPEG(2): 640×360
 - **S8530N**
 - JPEG(1): 1920×1080, JPEG(2): 640×360

Note

- This setting is common among Cam. 1, 2, 3, and 4.

[Image quality]

Select the image quality of JPEG images for each image capture size.

0 Super fine/ 1 Fine/ 2/ 3/ 4/ 5 Normal/ 6/ 7/ 8/ 9 Low

- **Default:** 5 Normal

Note

- This setting is common among Cam. 1, 2, 3, and 4.

2.5.3 Configure the settings relating to Stream [Image]

Click the [Image] tab on the “Image/Audio” page (X8570N) or “Image” page (S8530N). (→page 37, page 38)
 Configure the settings relating to H.265 (or H.264) image such as “Max bit rate (per client)”, “Image capture size”, “Image quality”, etc. in this section. Refer to page 78 for the settings relating to JPEG images.

Stream(1)	
Stream transmission	Cam. 1 <input checked="" type="radio"/> On <input type="radio"/> Off
	Cam. 2 <input checked="" type="radio"/> On <input type="radio"/> Off
	Cam. 3 <input checked="" type="radio"/> On <input type="radio"/> Off
	Cam. 4 <input checked="" type="radio"/> On <input type="radio"/> Off
Stream encoding format	<input checked="" type="radio"/> H.265 <input type="radio"/> H.264
Internet mode (over HTTP)	<input checked="" type="radio"/> On <input type="radio"/> Off
Image capture size	3840x2160
Transmission priority	Frame rate
Frame rate*	15fps *
Max bit rate (per client) *	8192kbps * <input type="text" value=""/> kbps
Image quality	Normal
Smart Coding	GOP control <input type="text" value="Off"/>
	Auto VIQS <input checked="" type="radio"/> On <input type="radio"/> Off
Refresh interval	1s
Transmission type	Unicast port (AUTO)
Unicast port1(Image)	Cam. 1 <input type="text" value="32000"/> (1024-50000)
	Cam. 2 <input type="text" value="32000"/> (1024-50000)
	Cam. 3 <input type="text" value="32000"/> (1024-50000)
	Cam. 4 <input type="text" value="32010"/> (1024-50000)
Unicast port2(Audio)	Cam. 1 <input type="text" value="33004"/> (1024-50000)
	Cam. 2 <input type="text" value="33006"/> (1024-50000)
	Cam. 3 <input type="text" value="33008"/> (1024-50000)
	Cam. 4 <input type="text" value="33010"/> (1024-50000)
Multicast address	Cam. 1 <input type="text" value="239.192.0.20"/>
	Cam. 2 <input type="text" value="239.192.0.22"/>
	Cam. 3 <input type="text" value="239.192.0.24"/>
	Cam. 4 <input type="text" value="239.192.0.26"/>
Multicast port	Cam. 1 <input type="text" value="37004"/> (1024-50000)
	Cam. 2 <input type="text" value="37006"/> (1024-50000)
	Cam. 3 <input type="text" value="37008"/> (1024-50000)
	Cam. 4 <input type="text" value="37010"/> (1024-50000)
Multicast TTL/HOPLimit	<input type="text" value="16"/> (1-254)

Stream(1)/Stream(2)

[Stream transmission]

- **[Cam. 1]:** Select “On” or “Off” to determine whether or not to transmit H.265 (or H.264) images of Cam. 1.
- **[Cam. 2]:** Select “On” or “Off” to determine whether or not to transmit H.265 (or H.264) images of Cam. 2.
- **[Cam. 3]:** Select “On” or “Off” to determine whether or not to transmit H.265 (or H.264) images of Cam. 3.
- **[Cam. 4]:** Select “On” or “Off” to determine whether or not to transmit H.265 (or H.264) images of Cam. 4.
- **On:** Transmits H.265 (or H.264) images.
- **Off:** Does not transmit H.265 (or H.264) images.
- **Default:** On

Note

- When “On” is selected for “Stream transmission” in “Stream(1)” or “Stream(2)” displaying of H.265 (or H.264) images or JPEG images on the “Live” page will become available.

- When “On” is selected for one of “Cam. 1”, “Cam. 2”, “Cam. 3”, and “Cam. 4” of “Stream transmission” for “Stream(1)” or “Stream(2)”, the refresh interval of JPEG images is limited to a maximum of 5 fps.

[Stream encoding format]

Select the stream encoding format for transmission.

- **H.265:** Transmits H.265 images.
- **H.264:** Transmits H.264 images.
- **Default:** H.265

Note

- This setting is common among Cam. 1, 2, 3, and 4.

[Internet mode (over HTTP)]

Select “On” when transmitting H.265 (or H.264) images via the Internet. It is possible to transmit stream without changing the broadband router settings configured for JPEG image transmission.

- **On:** H.265 (or H.264) images and audio will be transmitted using the HTTP port. Refer to page 136 for further information about the HTTP port number settings.
- **Off:** H.265 (or H.264) images and audio will be transmitted using the UDP port.
- **Default:** Off

Note

- When “On” is selected, only “Unicast port (AUTO)” will be available for “Transmission type”.
- When “On” is selected, it may take time to start displaying stream images.
- When “On” is selected, stream images may not be displayed depending on the number of the concurrent access user and audio data availability, etc.
- When “On” is selected, only IPv4 access is available.
- This setting is common among Cam. 1, 2, 3, and 4.

[Image capture size]

Select the image capture size from the following. What can be selected may be limited depending on the image capture size already selected.

Product No./Image capture mode	Stream(1)	Stream(2)
WV-X8570N	3840×2160 2560×1440	1280×720 640×360 320×180
WV-S8530N 2 mega pixel [16:9](30fps mode)	1920×1080 1280×720	1280×720 640×360 320×180
WV-S8530N 2 mega pixel [4:3](30fps mode)	1600×1200 1280×960	1280×960 VGA QVGA

This setting is common among Cam. 1, 2, 3, and 4.

- **Default:**
 - **X8570N**
 - Stream(1): 3860×2160
 - Stream(2): 640×360
 - **S8530N**

2 Settings

- Stream(1): 1920×1080
- Stream(2): 640x360

[Transmission priority]

Select a transmission priority for “Stream” from the following.

- **Constant bit rate:** H.265 (or H.264) images will be transmitted with the bit rate selected for “Max bit rate (per client)*”.
- **VBR:** H.265 (or H.264) images will be transmitted with the frame rate selected for “Frame rate*” while maintaining the image quality level selected in “Image quality”. In this case, images will be transmitted with the bit rate kept within the maximum bit rate that is set for “Max bit rate (per client)*”. The image quality is fixed, and the recording capacity changes according to the “Image quality” setting and conditions of the subject.
- **Frame rate:** H.265 (or H.264) images will be transmitted with the frame rate selected for “Frame rate*”.
- **Best effort:** In accordance with the network bandwidth, H.265 (or H.264) images will be transmitted with the maximum bit rates that are set for “Max bit rate (per client)*”.
- **Default:** Frame rate

Note

- When “Frame rate” is set for “Transmission priority”, number of users who can access the camera may be limited.
- This setting is common among Cam. 1, 2, 3, and 4.

[Frame rate*]

Select a frame rate from the following.

X8570N

1fps/ 3fps/ 5fps*/ 7.5fps*/ 10fps*/ 12fps*/ 15fps*

S8530N

1fps/ 3fps/ 5fps*/ 7.5fps*/ 10fps*/ 12fps*/ 15fps*/ 20fps*/ 30fps*

- **Default:** 15fps* **X8570N**, 30fps* **S8530N**

Note

- “Frame rate*” is restricted by “Max bit rate (per client)*”. For this reason, the frame rate may be lower than the specified value when any value marked with an asterisk (*) is selected. When “VBR” is selected for “Transmission priority”, depending on the settings of “Max bit rate (per client)*” and “Image quality”, transmission of images may periodically be paused. Check the transmission of images after changing settings.
- This setting is common among Cam. 1, 2, 3, and 4.
- Depending on the number users connecting at the same time or the combination of features used, the frame rate may be lower than the configured value. Check the transmission of images after changing settings.

[Max bit rate (per client)*]

Select an H.265 (or H.264) bit rate per a client from the following.

64kbps/ 128kbps*/ 256kbps*/ 384kbps*/ 512kbps*/ 768kbps*/ 1024kbps*/ 1536kbps*/ 2048kbps*/ 3072kbps*/ 4096kbps*/ 6144kbps*/ 8192kbps*/ 10240kbps*/ 12288kbps*/ 14336kbps*/ 16384kbps*/ 20480kbps*/ 24576kbps*/--FREE ENTRY--

When “--FREE ENTRY--” is selected, the bit rate can be freely entered .

- **Default:**

X8570N

- Stream(1): 8192kbps*
- Stream(2): 1536kbps*

S8530N

- Stream(1): 3072kbps*
- Stream(2): 1536kbps*

* The range of bit rates that can be configured for H.265 (or H.264) bit rates differs depending on the “Transmission priority” and “Image capture size”.

When “Constant bit rate”, “Frame rate”, or “Best effort” is selected for “Transmission priority”

- QVGA (S8530N), VGA (S8530N), 320x180, and 640x360: 64kbps - 4096kbps*
- 1280x960 (S8530N) and 1280x720: 128kbps* - 8192kbps*
- 1920x1080 (S8530N): 256kbps* - 12288kbps*
- 2560x1440 (X8570N): 768kbps* - 24576kbps*
- 3840x2160 (X8570N): 2048kbps* - 24576kbps*

When “VBR” is selected for “Transmission priority”

- QVGA (S8530N), VGA (S8530N), 320x180, and 640x360: 64kbps - 12288kbps*
- 1280x960 (S8530N) and 1280x720: 128kbps* - 12288kbps*
- 1920x1080 (S8530N): 256kbps* - 24576kbps*
- 2560x1440 (X8570N): 768kbps* - 24576kbps*
- 3840x2160 (X8570N): 2048kbps* - 24576kbps*

Note

- The bit rate for “Stream” is restricted by “Bandwidth control(bit rate)” on the [Network] tab on the “Network” page (→page 134). When a value with “*” attached is set, images may not be streamed.
- This setting is common among Cam. 1, 2, 3, and 4.
- Depending on the number users connecting at the same time or the combination of features used, the bit rate may be lower than the configured value. Check the transmission of images after changing settings.

[Image quality]

Select the image quality of H.265 (or H.264) images from the following.

- **For “Constant bit rate”, “Frame rate”, and “Best effort”:** Motion priority/Normal/Quality priority
- **“VBR”:** 0 Super fine/ 1 Fine/ 2/ 3/ 4/ 5 Normal/ 6/ 7/ 8/ 9 Low
- **Default:** 5 Normal

This setting is common among Cam. 1, 2, 3, and 4.

[Smart Coding] - [GOP control]

By using “GOP control”, the transmission data volume can be reduced when there is little motion in the image.

- **When “H.265” is selected as the “Stream encoding format”:** Off/On(Low)/On(Mid)/On(Advanced)/On(Frame rate control)
- **When “H.264” is selected as the “Stream encoding format”:** Off/On(Low)/On(Mid)
- **Default:** Off

IMPORTANT

- When “On(Low)”, “On(Mid)”, “On(Advanced)”, or “On(Frame rate control)” is selected, recording to an SD memory card cannot be performed.

Note

- When using “GOP control”, the refresh interval is increased when streaming H.265 (or H.264) images. For this reason, do not use it when the network environment has frequent errors.
- “On(Low)”, “On(Mid)”, “On(Frame rate control)” are available only when “VBR” is selected for “Transmission priority”. “On(Advanced)” can be set regardless of the “Transmission priority” setting.

- When “On(Frame rate control)” is selected, the frame rate ranges from 1fps to the value set in [Frame rate*] depending on the size of image changes.
- When “On(Frame rate control)” is selected, the display may temporarily become slower or faster when changing frame rates.
- This setting is common among Cam. 1, 2, 3, and 4.

[Smart Coding] - [Auto VIQS]

Maintains high image quality in the areas of the image containing moving objects and reduces the transmission data volume in other areas of the image.

- **Off:** Does not use “Auto VIQS”.
- **On:** Maintains high image quality in the areas of the image containing moving objects, and reduces the transmission data volume in other areas of the image.
- **Default:** Off

Note

- If “Auto VIQS” is “On”, the VIQS setting set from the [Image/Position] tab is disabled.
- This setting is common among Cam. 1, 2, 3, and 4.

[Refresh interval]

Select an interval (I-frame interval; 0.2 - 5 seconds) to refresh the displayed H.265 (or H.264) images from the following.

If using under a network environment with frequent error occurrences, shorten the refresh interval for H.265 (or H.264) to diminish image distortions. However, the refresh interval may be longer than the set value.

0.2s/ 0.25s/ 0.33s/ 0.5s/ 1s/ 2s/ 3s/ 4s/ 5s

- **Default:** 1s

Note

- When “On(Low)” is selected for “GOP control”, the refresh interval is set to Max. 8s.
- When “On(Mid)” is selected for “GOP control”, the refresh interval is set to Max. 16s.
- When “On(Advanced)” is selected for “GOP control”, the refresh interval is set to 60s.
- If “GOP control” is set to “On(Frame rate control)”, the frame rate ranges from 1fps to the value set in [Frame rate*] depending on the size of image changes. The smaller the frame rate value, the longer the refresh interval. When the frame rate is the value set in [Frame rate*], the refresh interval is at Max. 16s.
- This setting is common among Cam. 1, 2, 3, and 4.

[Transmission type]

Select the transmission type of H.265 (or H.264) images from the following.

- **Unicast port (AUTO):** Up to 24 users can access the camera concurrently. “Unicast port1(Image)” and “Unicast port2(Audio)” **X8570N** will automatically be selected when transmitting images and audio **X8570N** from the camera. When it is unnecessary to fix the port number for stream transmission such as when using in a particular LAN environment, it is recommended to select “Unicast port (AUTO)”.
- **Unicast port (MANUAL):** Up to 24 users can access the camera concurrently. It is necessary to select “Unicast port1(Image)” and “Unicast port2(Audio)” **X8570N** manually to transmit images and audio **X8570N** from the camera.

It is possible to fix the port number of the router used for stream transmission via the Internet by setting “Unicast port (MANUAL)” (→page 134). Refer to the operating instructions of the router in use.

- **Multicast:** Unlimited number of users can access the camera concurrently. Complete the entry field of “Multicast address”, “Multicast port” and “Multicast TTL/HOPLimit” when transmitting stream with multicast. Refer to page 9 for further information about the maximum concurrent access number.
- **Default:** Unicast port (AUTO)

Note

- This setting is common among Cam. 1, 2, 3, and 4.

[Unicast port1(Image)]^{*1}

Enter the unicast port number (used to transmit images from the camera).

- **Available port number:** 1024 - 50000 (Only even numbers are available.)
- **Default:**
 - **[Cam. 1]:**
 - Stream(1): 32004
 - Stream(2): 32014
 - **[Cam. 2]:**
 - Stream(1): 32006
 - Stream(2): 32016
 - **[Cam. 3]:**
 - Stream(1): 32008
 - Stream(2): 32018
 - **[Cam. 4]:**
 - Stream(1): 32010
 - Stream(2): 32020

[Unicast port2(Audio)]^{*1}

Enter the unicast port number (used to transmit audio from the camera).

- **Available port number:** 1024 - 50000 (Only even numbers are available.)
- **Default:**
 - **[Cam. 1]:**
 - Stream(1): 33004
 - Stream(2): 33014
 - **[Cam. 2]:**
 - Stream(1): 33006
 - Stream(2): 33016
 - **[Cam. 3]:**
 - Stream(1): 33008
 - Stream(2): 33018
 - **[Cam. 4]:**
 - Stream(1): 33010
 - Stream(2): 33020

[Multicast address]^{*2}

Enter the multicast IP address. Images and audio will be transmitted to the designated IP address.

- **Available IPv4 address:** 224.0.0.0 - 239.255.255.255
- **Available IPv6 address:** Multicast address starting with "FF"
- **Default:**
 - **[Cam. 1]:**
 - Stream(1): 239.192.0.20
 - Stream(2): 239.192.0.21
 - **[Cam. 2]:**
 - Stream(1): 239.192.0.22
 - Stream(2): 239.192.0.23
 - **[Cam. 3]:**
 - Stream(1): 239.192.0.24
 - Stream(2): 239.192.0.25

2 Settings

- **[Cam. 4]:**
 - Stream(1): 239.192.0.26
 - Stream(2): 239.192.0.27

Note

- Enter a multicast IP address after checking available multicast address.

[Multicast port]²

Enter the multicast port number (used to transmit images from the camera).

- **Available port number:** 1024 - 50000 (Only even numbers are available.)
- **Default:**
 - [Cam. 1]: 37004
 - [Cam. 2]: 37006
 - [Cam. 3]: 37008
 - [Cam. 4]: 37010

Note

- When audio is transmitted from the unit, the port number to be used will be the multicast port number plus "1000". ~~X8570N~~

[Multicast TTL/HOPLimit]²

Enter a value for "Multicast TTL/HOPLimit".

- **Available value:** 1-254
- **Default:** 16

Note

- This setting is common among Cam. 1, 2, 3, and 4.

IMPORTANT

- When transmitting stream images via the internet, the transmitted image sometimes may not be displayed depending on the settings of a proxy server or a firewall. In this case, refer to the network administrator.
- When two or more network interface cards are installed on the PC in use, the network interface card(s) not used for receiving images should be invalidated when displaying images using the multicast port.

¹ It is necessary to designate the unicast port number when "Unicast port (MANUAL)" is selected for "Transmission type".

² It is necessary to designate the multicast IP address when "Multicast" is selected for "Transmission type".

2.5.4 Configure the settings relating to image adjust, privacy zone, and VIQS [Image quality]

Click the [Image quality] tab on the “Image/Audio” page **X8570N** or “Image” page **S8530N**. (→page 37, page 38)

When the [Setup>>] button of each setting item is clicked, the detailed settings menu will be displayed in a newly opened window. The detailed settings can be configured while monitoring images displayed on the [Image quality] tab.

The settings relating to the image adjust, privacy zone, and VIQS can be configured on this page.

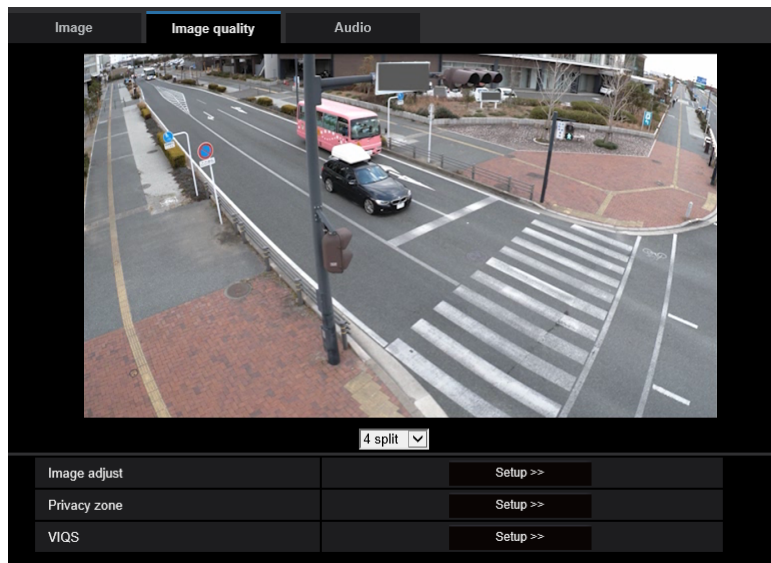

[Image adjust]

Click the [Setup>>] button to display the setup menu that can configure the settings relating to image quality. The setup menu will be displayed in a newly opened window. (→page 87)

[Privacy zone]

Click the [Setup>>] button to display the setup menu that can configure the settings relating to the privacy zone. The setup menu will be displayed. (→page 100)

[VIQS]

Click the [Setup>>] button to display the setup menu relating to VIQS. (→ page 102)

2.5.4.1 Configure the settings relating to image quality (“Image adjust” setup menu)

Click the [Setup>>] button of “Image adjust” on the [Image quality] tab of the “Image/Audio” page **X8570N** or “Image” page **S8530N**. (→page 87)

The settings relating to image quality can be configured with the setup menu displayed in a newly displayed window. When the values are changed, the changed values will be applied to the currently displayed image on the [Image quality] tab.

Click the “+” mark on the left of each item in the setup menu to expand the respective item, and enable detailed settings.

Click the “-” mark on the left of an expanded item to return to the screen displayed before the item was expanded.

2 Settings

<Example: Super dynamic (SD)>

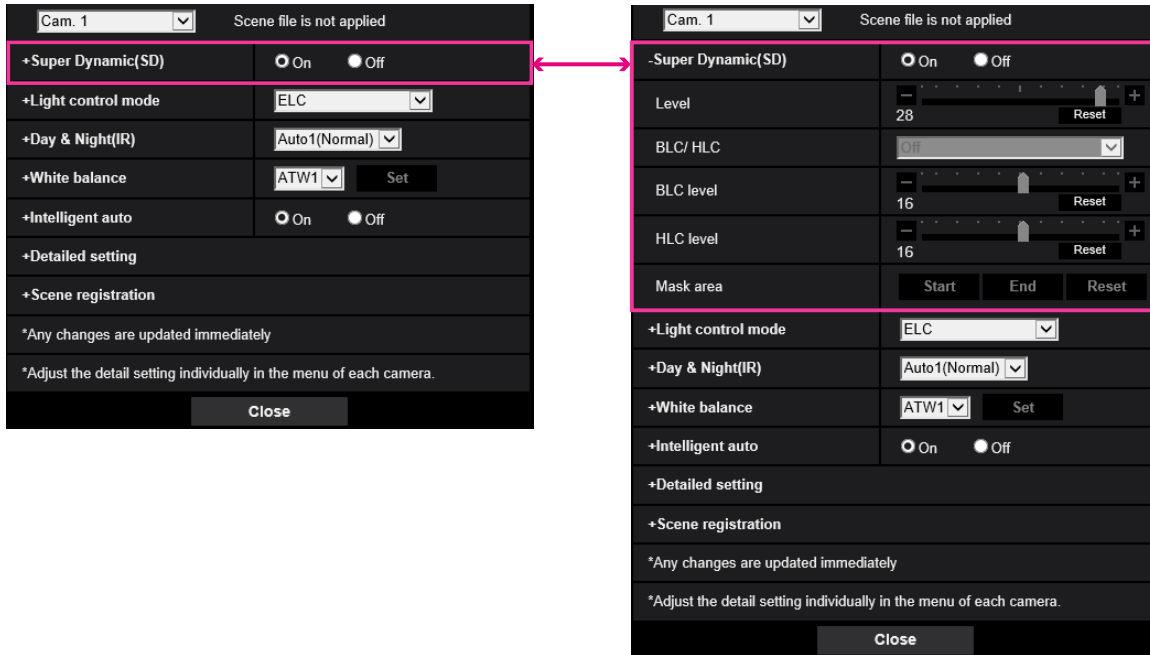

[Camera selection]

Select the camera to reflect the image quality setting.

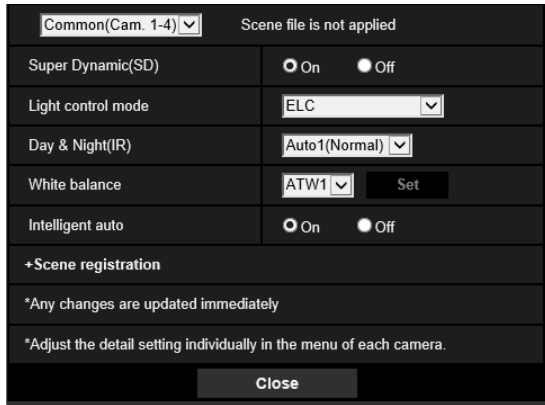

- **Common(Cam. 1-4):** Configures the Cam. 1, 2, 3, and 4 simultaneously. The image displayed in the [Image quality] tab is divided into 4-split display of Cam. 1, 2, 3, and 4.
- **Cam. 1:** Sets image quality of camera 1. The image displayed in the [Image quality] tab is image of Cam. 1.
- **Cam. 2:** Sets image quality of camera 1. The image displayed in the [Image quality] tab is image of Cam. 2.
- **Cam. 3:** Sets image quality of camera 1. The image displayed in the [Image quality] tab is image of Cam. 3.
- **Cam. 4:** Sets image quality of camera 1. The image displayed in the [Image quality] tab is image of Cam. 4.
- **Default:** Common(Cam. 1-4)

Note

- When “Common(Cam. 1-4)” is set, the setting is available only the ones before the advanced setting is expanded (“Super Dynamic”, “Light control mode”, “Day & Night(IR)”, “White balance”, “Intelligent Auto”, and “Scene registration”). To perform advanced settings, select “Cam. 1”, “Cam. 2”, “Cam. 3”, or “Cam. 4”.

Super Dynamic(SD)**[Super Dynamic(SD)]**

Select “On” or “Off” to determine whether or not to activate the super dynamic function.

Refer to the description “Super Dynamic function” (→page 89) about the super dynamic function.

- On:** The super dynamic function will work.
- Off:** The super dynamic function will not work.
- Default:** On

Note

- When the following are observed depending on the light condition, select “Off” for “Super Dynamic(SD)”.
 - When flickering appears or the color changes on the screen
 - When noise appears in the brighter area on the screen

[Level]

Adjust the super dynamic (SD) level.

If you move the slider in the “+” direction, a subject with high contrast can be captured without over exposure or under exposure.

If you move the slider in the “-” direction, the parts with medium brightness can be captured with rich gradation.

Click the [Reset] button to reset to the default setting.

- Default:** 28

Note

- When the following are observed depending on the light condition, select “Off” for “Super Dynamic(SD)”.
 - When flickering appears or the color changes on the screen
 - When noise appears in the brighter area on the screen

Super Dynamic function

When there is wide variation between the illumination of light and dark areas of the location being monitored, the camera adjusts the lens iris in accordance with the brighter areas. This causes loss of detail in darker areas. Conversely, adjusting the lens brightness for the darker areas causes the brighter areas to become washed out.

2 Settings

Super Dynamic digitally combines an image that is set up for a clear view of the brighter areas with an image that is set up for a clear view of the darker areas, creating a final image that preserves overall detail.

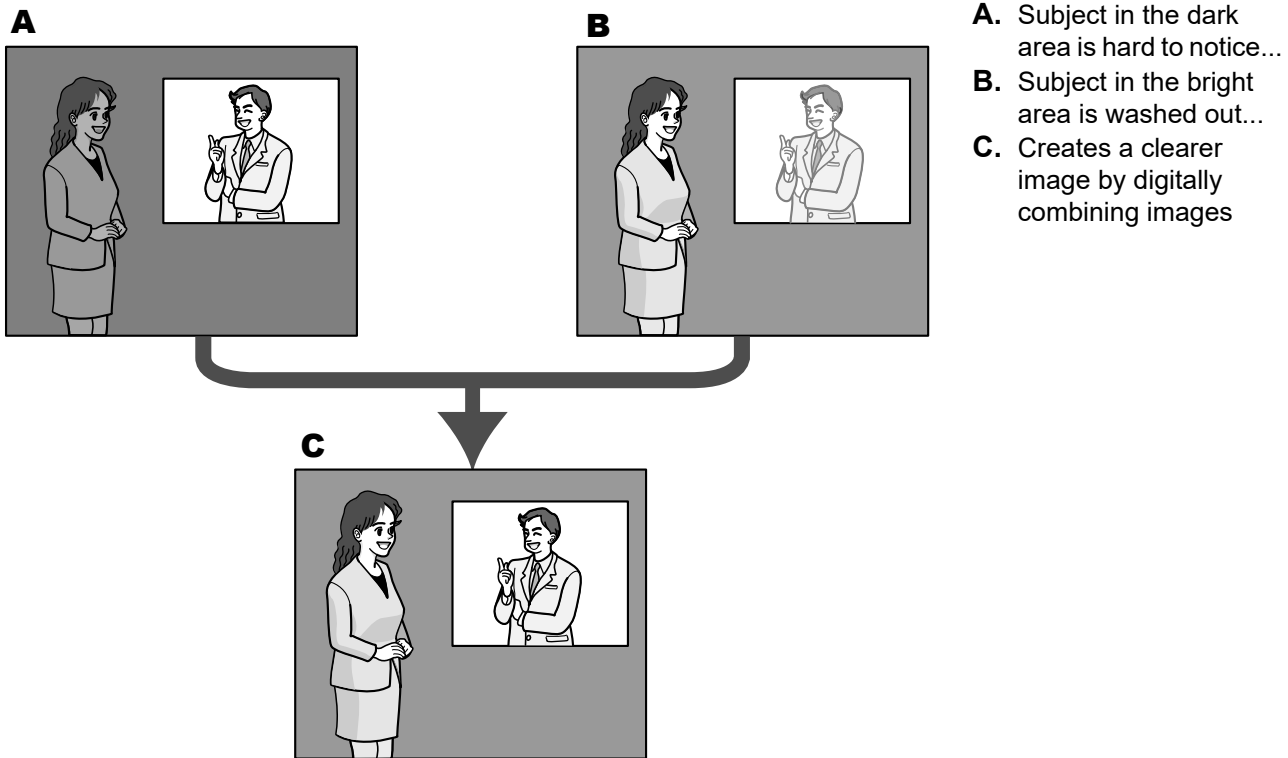

[BLC/ HLC]

Select from the following. When “On” is selected for “Super Dynamic(SD)” or when “On” is selected for “Intelligent Auto”, this setting is not available.

- **Back light compensation (BLC):** Activates the back light compensation (BLC) function.
- **High light compensation(HLC):** Activates the high light compensation (HLC) function. The high light compensation function limits the over exposure of subjects caused bright light (such as light from headlights of cars) at night.
- **Off:** Deactivates the back light compensation function and high light compensation function.
- **Default:** Off

[BLC level]

Adjust the BLC level.

If you move the slider in the “+” direction, the effect of back light compensation will increase.

If you move the slider in the “-” direction, the effect of back light compensation will decrease.

Click the [Reset] button to reset to the default setting.

- **Default:** 16

[HLC level]

Adjust the high light compensation level.

If you move the slider in the “+” direction, the effect of high light compensation (HLC) will increase.

If you move the slider in the “-” direction, the effect of high light compensation (HLC) will decrease.

Click the [Reset] button to reset to the default setting.

- **Default:** 16

[Mask area]

When mask area is set, the selected area is masked and you can adjust brightness. When “On” is selected for “Super Dynamic(SD)”, this setting is not available. When “Common(Cam. 1-4)” is selected, this setting is not available. Set the mask area of the camera respectively.

Refer to page 97 for information on how to set the mask area.

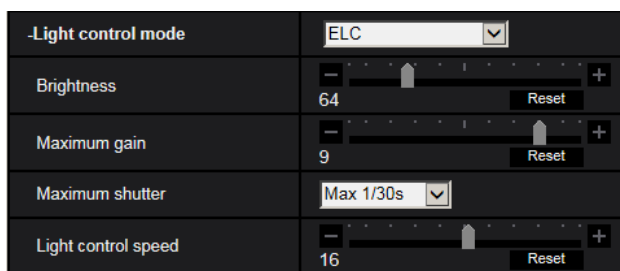
Light control mode**[Light control mode]**

Select the light control mode from the following.

- **Indoor scene (50 Hz) / Indoor scene (60 Hz):** The shutter speed will automatically be adjusted to prevent flicker caused by fluorescent light. Select 50 Hz or 60 Hz corresponding to the location where the camera is in use.
- **ELC:** Uses shutter speed adjustment to control light.
- **Default:** ELC

[Brightness]

Adjust the brightness.

If you move the slider in the “+” direction, the image will become brighter.

If you move the slider in the “-” direction, the image will become darker.

Click the [Reset] button to reset to the default brightness setting.

- **Default:** 64

[Maximum gain]

Adjusts the maximum gain. When the luminance of the subject becomes darker, gain will be automatically increased and screen will become brighter. If you increase the gain, the noise may also increase.

If you move the slider in the “+” direction, the maximum gain will increase.

If you move the slider in the “-” direction, the maximum gain will decrease.

Click the [Reset] button to reset to the default setting.

- **Default:** 9

[Maximum shutter]

The maximum shutter time adjusts the storage time of the sensor. The following are available for the recording duration.

Max.1/10000s, Max.1/4000s, Max.1/2000s, Max.1/1000s, Max.1/500s, Max.1/250s, Max.1/120s, Max.1/100s, Max.2/120s, Max.2/100s, Max.3/120s, Max.1/30s, Max.2/30s, Max.4/30s, Max.6/30s, Max.10/30s, Max.16/30s

- **Default:** Max.1/30s

IMPORTANT

- If the following value is set for “Maximum shutter”, the frame rate may drop when the subject is dark.
 - A value longer than “Max. 1/30s” (Max.2/30s/ Max.4/30s/ Max.6/30s/ Max.10/30s/ Max.16/30s)

Note

- When “0” is selected for “Maximum gain”, “Max. 2/30s” or higher is not available.

[Light control speed]

Adjust the light control speed.

If you move the slider in the “+” direction, the light control speed will increase.

If you move the slider in the “-” direction, the light control speed will decrease.

Click the [Reset] button to reset to the default setting.

- **Default:** 16

Day & Night(IR)

Day & Night(IR)	Auto1(Normal) ▼
Level	<input type="radio"/> High <input checked="" type="radio"/> Low
Dwell time	10s ▼

[Day & Night(IR)]

Select switching between the color mode and the black & white mode from the following.

- **Off:** The color mode is selected.
- **On:** Always captured as black & white images.
- **Auto1(Normal):** The camera automatically switches between the color mode and the black & white mode in accordance with the picture brightness (luminance).
- **Auto2(IR Light):** The camera automatically switches between the color mode and the black & white mode in accordance with the picture brightness (luminance). Suitable when using near-infrared lighting at night.
- **Auto3(SCC):** Suitable to keep the color mode even under darker light condition. The Super Chroma Compensation (SCC) function retains the color mode even with dim lighting.
- **Default:**Auto1(Normal)

Super Chrome Compensation (SCC) function

This function achieves faithful color images using the proprietary color compensation technology that reproduce images even under low illumination where it is usually difficult to capture objects faithfully.

Note

- Since the color compensation technology is used for “Auto3(Super Chrome Compensation(SCC))”, some colors may look different from the actual objects depending on the light condition (such as when infrared lights are used).
- The operating sound might be heard when changing to black-and-white mode, however it does not indicate any malfunction.
- The color mode and the black white mode may not be switched automatically depending on the environment. In such a case, use the schedule function to switch the color and the black white mode. For how to set up, refer to the following Panasonic support website.
<https://security.panasonic.com/support/info/> <Control No.: C0314>

[Level]

Select the threshold illuminance level (brightness) to switch between the color mode and the black & white mode. The descriptions about the following threshold illuminance levels are given when “Off” is selected for “Super Dynamic(SD)”.

- **High:** Switches from the color mode to the black & white mode when the ambient brightness (illuminance) of the camera is approx. 2 lx or less.

- **Low:** Switches from the color mode to the black & white mode when the ambient brightness (illuminance) of the camera is approx. 1 lx or less.
- **Default:** High

Note

- When a low value is selected for “Maximum gain”, it may be difficult to switch modes depending on the environment.

[Dwell time]

Select a wait time for switching between the color mode and the black & white mode from the following.
2s/ 10s/ 30s/ 1min

- **Default:** 10s

White balance

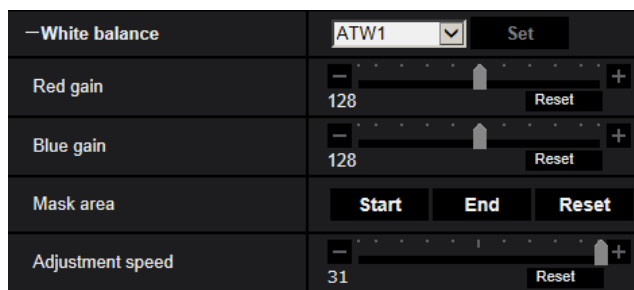

[White balance]

Select a method of white balance adjustment from the following.

White color can be adjusted by “Red gain” and “Blue gain”.

- **ATW1:** Selects the automatic tracing white balance mode. The camera will constantly check the color temperature of the light source and adjust the white balance automatically. Operating color temperature range is approx. 2,700 K to 6,000 K.
- **ATW2:** Selects the automatic tracing white balance mode under a sodium lamp. The camera will adjust the white balance automatically under a sodium lamp. Operating color temperature range is approx. 2,000 K to 6,000 K.
- **AWC:** Selects the automatic white balance control mode. This adjustment is suitable for a location where a light source is stable. Operating color temperature range is approx. 2,000 K to 10,000 K.
- **Default:** ATW1

Note

- Under the following conditions, color may not be faithfully processed. In these cases, select “AWC”.
 - When shooting a subject whose major part is a thick color
 - When shooting blue sky or sun at sunset
 - When shooting a subject whose luminance is too low
- When “AWC” is selected, click the [Set] button.

[Red gain]

Adjust the red color of images.

When the slider is moved in the “+” direction, the red color will become thicker. When the slider is moved in the “-” direction, the red color will be thinner. Click the [Reset] button to reset the color to the default.

- **Default:** 128

[Blue gain]

Adjust the blue color of images.

When the slider is moved in the “+” direction, the blue color will become thicker. When the slider is moved in the “-” direction, the blue color will be thinner. Click the [Reset] button to reset the color to the default.

- **Default:** 128

[Mask area]

If you set the mask area, you can adjust the white balance after masking the set area. When “Common(Cam. 1-4)” is selected, this setting is not available. Set the mask area of the camera respectively.

Refer to page 97 for information about how to configure the mask area.

[Adjustment speed]

Adjust the white balance adjustment speed.

If you move the slider in the “+” direction, the white balance adjustment speed will increase. If you move the slider in the “-” direction, the white balance adjustment speed will decrease. If you click the [Reset] button, the slider position and white balance adjustment speed will be reset to default.

- **Default:** 16

Intelligent Auto

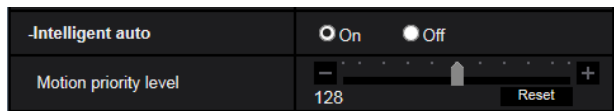

[Intelligent Auto]

Select On/Off to determine whether or not to activate the “Intelligent Auto” function.

“Intelligent Auto” can detect conditions (back lighting, outdoor, night time, etc.) and moving objects, and then automatically adjust the camera’s aperture, gain, shutter speed, and contrast in order to display the moving objects more clearly.

- **Default:** On

[Motion priority level]

Adjusts the motion priority level when “Intelligent Auto” is activated.

If you move the slider in the “+” direction, it becomes difficult for the moving subjects to blur, but the noise of dark subjects increases.

If you move the slider in the “-” direction, it becomes easier for the moving subjects to blur, but the noise of dark subjects decreases.

Click the [Reset] button to reset to the default setting.

- **Default:** 128

Detailed setting

-Detailed setting	
Auto contrast adjust	<input type="radio"/> On <input checked="" type="radio"/> Off(Manual)
Contrast level	128  +
Adaptive black stretch	128  +
Adaptive highlight stretch	128  +
Fog compensation	<input checked="" type="radio"/> On <input type="radio"/> Off
Level	4  +
Chroma gain level	128  +
Hue level	128  +
Aperture level	16  +
Pedestal level	128  +
DNR	128  +

[Auto contrast adjust]

Select On/Off(Manual) to determine whether or not to activate the auto contrast adjust function.

On: Activates the auto contrast adjust function.

Off: Stops the auto contrast adjust function.

- **Default:** On

Note

- When “On” is selected for “Intelligent Auto”, this setting is not available.

[Contrast level]

Adjust the contrast level.

If you move the slider in the “+” direction, the contrast of the image will increase.

If you move the slider in the “-” direction, the contrast of the image will decrease.

Click the [Reset] button to reset to the default setting.

- **Default:** 128

[Adaptive black stretch]

Adjust the brightness of the dark parts of the image.

If you move the slider in the “+” direction, the dark parts of the image will become brighter.

If you move the slider in the “-” direction, the dark parts of the image will become darker.

Click the [Reset] button to reset to the default setting.

- **Default:** 128

IMPORTANT

- The “adaptive black stretch” settings may cause the noise in the darker parts to increase, and the parts around borders between the darker parts and the brighter parts may become darker/brighter than the other darker/brighter parts.

[Adaptive highlight stretch]

Adjust the brightness of the bright parts of the image.

If you move the slider in the “+” direction, the dark parts of the image will become brighter.

If you move the slider in the “-” direction, the bright parts of the image will become darker.

Click the [Reset] button to reset to the default setting.

- **Default:** 128

[Fog compensation]

Select “On” or “Off” to determine whether or not to activate the fog compensation function. When “On” is selected for “Auto contrast adjust”, or when “On” is selected for “Intelligent Auto”, this setting is not available. The fog compensation function can make dim images that have been affected by fog or other conditions clearer using digital image processing.

- **On:** Activates the fog compensation function.
- **Off:** Stops the fog compensation function.
- **Default:** Off

[Level]

Adjust the fog compensation level.

The level of fog compensation will increase when the slider is moved in the “+” direction, and decrease when the slider is moved in the “-” direction. Click the [Reset] button to reset to the default setting.

- **Default:** 4

[Chroma gain level]

Adjusts the chroma level (color density).

If you move the slider in the “+” direction, the colors will become loud and vivid. If you move the slider in the “-” direction, the colors will become subdued. Click the [Reset] button to reset the color to the default.

- **Default:** 128

[Hue level]

Adjust the hue level of images.

If you move the slider in the “+” direction, the redness of skin color will increase, and the blueness of sky color will decrease.

If you move the slider in the “-” direction, the redness of skin color will decrease, and the blueness of sky color will increase.

Click the [Reset] button to reset to the default setting.

- **Default:** 128

[Aperture level]

Adjust the aperture level (outline compensation).

If you move the slider in the “+” direction, the outline of the image will become sharper, and if you move it in the “-” direction, the outline of the image will become softer. Click the [Reset] button to reset the color to the default.

- **Default:** 16

[Pedestal level]

Adjust the black level of images by moving the slider.

When the slider is moved to the “+” direction, images will become brighter. When the slider is moved to the “-” direction, images will be darker. Click the [Reset] button to reset the color to the default.

- **Default:** 128

[DNR]

The digital noise reduction function reduces noise automatically under the condition of low illuminance.

If you move the slider in the “+” direction, the noise reduction effect is strengthened. There may be many afterimages.

If you move the slider in the “-” direction, the noise reduction effect is weakened. There are fewer afterimages. Click the [Reset] button to reset to the default setting.

- **Default:** 128

Scene registration

[Scene file]

The combination of settings used to adjust image quality can be saved as a scene file. The scene file can be selected here.

Registered scene files can be configured in the “Schedule” page (→page 175). If the timing of when images are viewed greatly affects the area where images are viewed, registering scene files to the schedule can let you match a combination of settings to different times of day in order to view images in the best conditions.

[Scene file title]

The scene file name (up to 10 characters) displayed in “Scene file” can be changed. Only file names displayed in “1:”, “2:”, “3:”, and “4:” can be changed.

- **Unavailable characters:** " &

[Load] button

Loads the setting data selected in “Scene file” and changes the current image accordingly.

[Register] button

The title of the scene file can be registered to the scene file.

2.5.4.2 Set mask areas

This explains how to mask an area of the image and adjust brightness.

When setting the mask area, set “Super Dynamic(SD)” to “Off”.

2 Settings

1. Display the “Image adjust” setup menu. (→page 87)

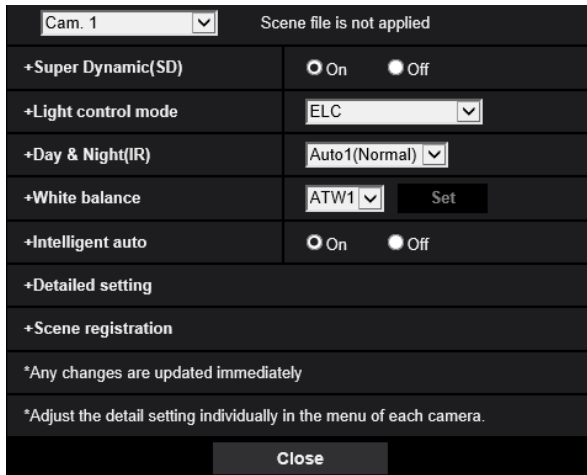

2. Click “+” on the left of “Super Dynamic(SD)” to display the detailed SD menu.



3. Click the [Start] button of “Mask area”.
→ Borders will appear and the image displayed on the [Image quality] tab will be divided into 48 (6×8).

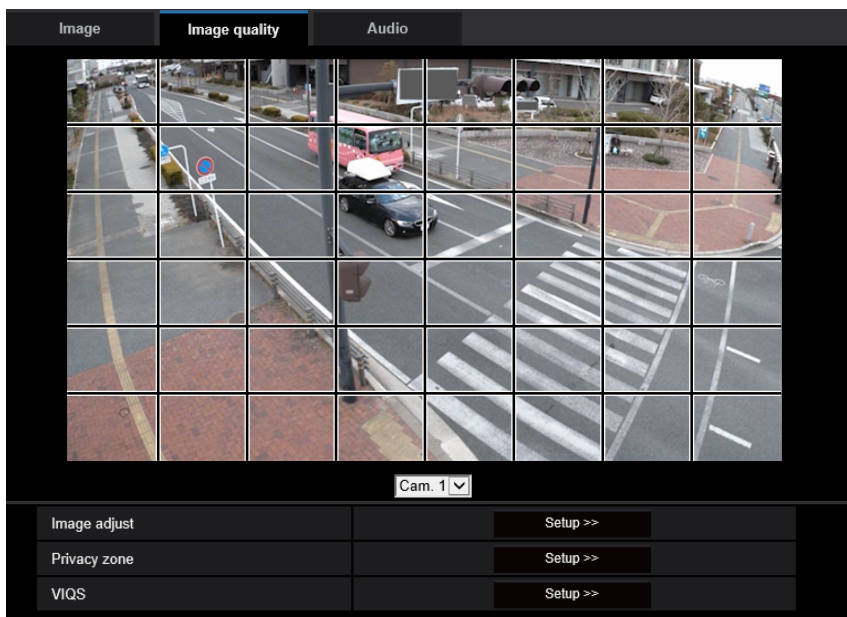

4. Click the divided areas to be masked.

→ The clicked areas will be masked and will become white. To cancel masking, click the area again.

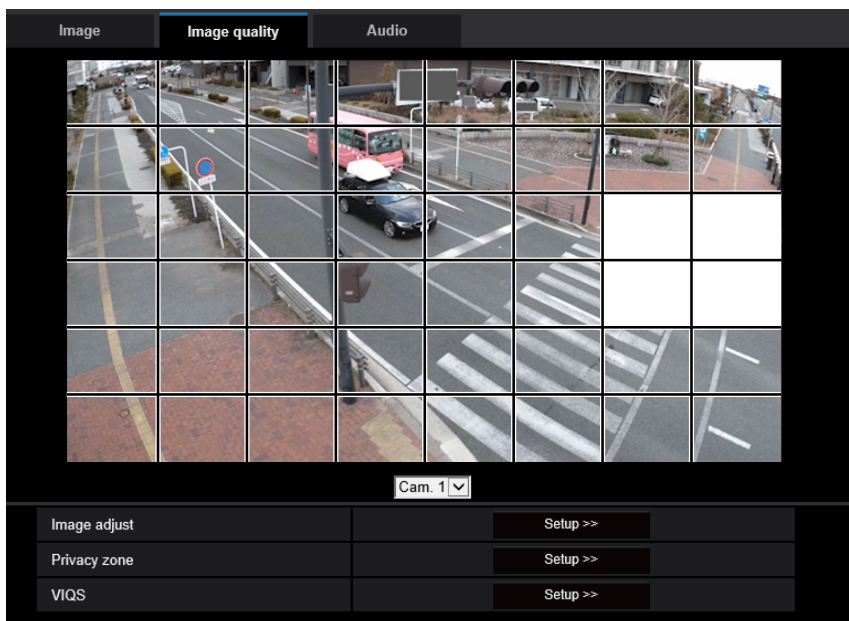

5. Click the [End] button after completing masking areas.

→ The borders on the image displayed on the [Image quality] tab will disappear.

IMPORTANT

- The mask area may move out of alignment when “Image capture mode” of the [Image] tab is changed. Make sure to check the mask area after changing the “Image capture mode” setting.

Note

- When the [Reset] button is clicked, masking for all the masked areas will be canceled.

2.5.4.3 Configure the settings relating to the privacy zone (“Privacy zone” setup menu)

Click the [Setup>>] button of “Privacy zone” on the [Image quality] tab of the “Image/Audio” page (X8570N) or “Image” page (S8530N). (→page 87)

When there is a zone that you do not want to display, set the zone as a privacy zone not to be displayed. Up to 8 privacy zones can be set.



[Camera selection]

Select a camera to set the privacy zone from Cam. 1, Cam. 2, Cam. 3, or Cam. 4.

[Area]

The privacy zone will be set when an area is designated by dragging the mouse. Each zone can be overlapped. The zones are numbered sequentially from area 1.

[Note]

- Set the privacy zone larger than the size of an object to be hidden.

[Status]

Select “On” or “Off” to determine whether or not to display the privacy zone.

- **On:** The privacy zone will be displayed.
- **Off:** The privacy zone will not be displayed.
- **Default:** Off

[Delete] button

Click the [Delete] button corresponding to the zone to be deleted.

[Close] button

Click this button to close the “Privacy zone” setup menu.

IMPORTANT

- After configuring the privacy zone, the privacy zone may move out of alignment if the setting for “Image capture mode” of the [Image] tab or “Upside-down” of the [Basic] tab is changed. Make sure to check the privacy zone after changing the setting.

2.5.4.4 Configure the VIQS setting

Click the [Setup>>] button of “VIQS” on the [Image] tab of the “Image/Audio” page (X8570N) “Image” page . (S8530N) (→page 87)

VIQS is an abbreviation of Variable Image Quality on Specified area and is a feature that enables you to change the images of a specified area.

It is possible to enhance the image quality of the specified range within a shooting area (image).

It is also possible to moderate the image data size by lowering the image quality of other areas.

The VIQS setting is available only for H.265 (or H.264) images.

Up to 8 VIQS areas can be set.

To check the image after configuring VIQS, when H.265 (or H.264) images are selected under “Stream”, you can check the image by pressing the [Confirm] button. You can also check by displaying an H.265 (or H.264) image on the “Live” page.



[Area]

When selecting a VIQS area in the screen, it will be numbered as area 1. (Subsequent areas will be numbered in the order of selection.)

[Status]

Select “On” or “Off” to determine whether or not to use the VIQS area.

- **On:** The VIQS area will be set.
- **Off:** Does not set the VIQS area.
- **Default:** Off

[Delete] button

Deletes the VIQS area. Click the button to delete the VIQS area.

[Level]

Configure the difference level in the image quality between specified areas and non-specified areas. The greater the difference level, the more the image quality of the non-specified area is reduced. This makes it possible to moderate the image data size.

0 Min./ 1/ 2/ 3/ 4/ 5 Normal/ 6/ 7/ 8/ 9 Max.

- **Default:** 5 Normal

Stream

[Stream(1)]

Select “On” or “Off” to determine whether or not to activate the VIQS function for the transmitted (Stream(1)) images.

The VIQS (Stream(1)) images can be confirmed with the [Confirm] button.

- **Default:** Off

[Stream(2)]

Select “On” or “Off” to determine whether or not to activate the VIQS function for the transmitted (Stream(2)) images.

The VIQS (Stream(2)) images can be confirmed with the [Confirm] button.

- **Default:** Off

IMPORTANT

- After the VIQS setting is set to “On”, the VIQS area may move out of alignment when the “Image capture mode” setting on the [Image] tab of the “Image/Audio” page **X8570N** or “Image” page **S8530N** is changed. Make sure to check the VIQS setting after changing the “Image capture mode” setting.

Note

- Refer to page 104 for setting procedure of the VIQS area.
- When “Off” is selected for “Stream transmission” of the applicable stream, the stream selection cannot be changed.

2.5.4.5 Configure the VIQS area

The VIQS area is specified by following the steps below.

1. Drag the mouse on the screen to specify the area (up to 8 areas).
 - The specified area is set to area “1(White)”, and the outline is displayed.
 - The areas are set in the area number order from number 1. The color next to the area number show the color of the corresponding outline.



2. Configure the difference level in the image quality between specified areas and non-specified areas. The greater the difference level, the more the image quality of the non-specified area is reduced. This makes it possible to moderate the image data size.
3. Select On/Off to activate/deactivate a distributed image of “Stream(1)” or “Stream(2)”.
4. Click the [Set] button.
 - This unit is updated with the setting contents. Click the [Delete] button corresponding to the area to be deleted.
5. Click the [Confirm] button.
 - The image (“Stream(1)” or “Stream(2)”) that the [Confirm] button was pressed for is displayed. When a window is newly opened and about 3 seconds pass, the currently outputted bit rate can be confirmed with the configured VIQS.

IMPORTANT

- No setting contents are determined unless the [Set] button is clicked.
- To check the image after configuring VIQS, display an H.265 (or H.264) image on the “Live” page, or press the [Confirm] button under “Stream”.
- The outputted bit rate changes depending on the subject. Confirm the bit rates with actual subjects used when operating the camera.
- If the larger range is specified, the output bit rate increases. Check the current output bit rate to decide the area size.

2.5.5 Configure the settings relating to audio [Audio] X8570N

Click the [Audio] tab on the “Image/Audio” page. (→page 37, page 38)
The settings relating to audio can be configured on this page.

Note

- Images and audio will not be synchronized. Therefore, images and audio may not always match.
- Audio may be interrupted depending on the network environment.

Mic input

[Mic input volume]

Set the audio volume for input into the camera. This setting is reflected in the volume when listening to audio on a PC (mic input to PC), and in the volume during “Audio recording”.

- **Mic High/Mic Middle/Mic Low:** Set the volume when audio is input to the camera using a microphone.
- **Line High/Line Middle/Line Low:** Set the volume when audio is input to the camera using line input.
- **Default:** Mic Middle

[AGC (audio)]

Automatically adjusts the audio reception to a suitable volume. The degree to which the volume is adjusted can be selected from High/Middle/Low.

When “High” is selected, it is easier to hear quiet sounds, but sounds may be heard as noise. If you do not want to hear noise, select “Middle” or “Low”. These settings are linked with the volume settings of the “Audio recording”.

- **Default:** High

[Audio bit rate]

Set the audio compression bit rate.

[G.726(Live)]: 16kbps/32kbps

[G.711(Live)]: 64kbps (cannot be changed)
 [AAC-LC(Live/Recording)]: 64kbps/96kbps/128kbps

- **Default:**
 - [G.726(Live)]: 32kbps
 - [AAC-LC(Live/Recording)]: 128kbps

Audio transmission/reception

[Audio transmission mode]

Select the communication mode used for audio data reception between the camera and the PC from the following:

- **Off:** Does not receive audio between the camera and the PC.
- **Mic Input (To PC):** PC receives the audio data from the camera. On the PC, the image can be viewed together with the accompanying audio. The image and audio are not synchronized.
- **Default:** Off

[Mic input interval (Camera to PC)]

Select an interval for audio reception from the following.

80ms/ 160ms

- **Default:** 80ms

Note

- When a shorter interval is selected, the delay time will be shorter. When a longer interval is selected, audio interruption may be diminished even though the delay time will be longer. Select the interval according to the network environment.
- “Mic input interval (Camera to PC)” is unavailable when “AAC-LC” is selected for “Audio input encoding format”.

Live page

[Audio input encoding format]

Select the audio input encoding format to be used in the “Live” page from G.726, G.711, or AAC-LC.

- **Default:** G.726

[Audio volume control mode]

Select the operation method using the volume cursor of the Mic input button on the “Live” page.

- **Adjust PC speaker:** Change the volume of the PC in which the “Live” page is opened.
- **Adjust Mic input:** Change the mic input volume of the camera.
- **Default:** Adjust Mic input

2.6 Configure the alarm settings [Alarm]

The settings relating to alarm occurrences such as settings for the alarm action at an alarm occurrence or alarm images, the VMD area settings, and the alarm occurrence notification can be configured on this page. The “Alarm” page has the [Alarm] tab, the [VMD area] tab, and the [Notification] tab.

2.6.1 Configure the settings relating to the alarm action [Alarm]

Click the [Alarm] tab on the “Alarm” page. (→page 37, page 38)

The settings relating to the alarm can be configured in this section. Refer to page 113 and page 110 for further information about the settings relating to the alarm images and the alarm output terminal **X8570N**.

Alarm		VMD area	Notification
Alarm			
Terminal 1	Off		
Terminal 2	Off		
Terminal 3	Off		
VMD alarm	VMD >>		
Command alarm	Command alarm	<input checked="" type="radio"/> On <input type="radio"/> Off	
	Reception port	8181 (1-65535)	
Alarm deactivation time	5 s (5-600s)		

Alarm

[Terminal 1] **X8570N**

Determine how to use terminal 1.

- **Off:** Not used.
- **Alarm input(TRM1):** Receives alarms. When “Alarm input” is selected, a pull-down menu for “Close” and “Open” is displayed.
 - **Close:** An alarm is detected when the terminal status is changed to “Close”.
 - **Open:** An alarm is detected when the terminal status is changed to “Open”.
 Also, the pull-down menu for selecting the camera number will be displayed when “Alarm input” is selected.
 - **Cam. 1:** Functions as an alarm input of Cam. 1.
 - **Cam. 2:** Functions as an alarm input of Cam. 2.
 - **Cam. 3:** Functions as an alarm input of Cam. 3.
 - **Cam. 4:** Functions as an alarm input of Cam. 4.
- **Black & white input:** Receives the black & white switchover input. (When the input is set to On, the black & white mode is activated.)
- **Auto time adjustment:** Receives the time adjustment input. When the signal is received and if the clock is within 29 minutes ± the hour, the time will be adjusted to 00 minutes 00 seconds. When the time setting is moved back by less than 5 seconds, the time is not changed. When “Auto time adjustment” is selected, a pull-down menu for “Close” and “Open” is displayed.
 - **Close:** The time is adjusted when the terminal status is changed to “Close”.
 - **Open:** The time is adjusted when the terminal status is changed to “Open”.
- **Default:** Off

[Terminal 2] **X8570N**

Determine how to use terminal 2.

- **Off:** Not used.
- **Alarm input(TRM2):** Receives alarms. When “Alarm input” is selected, a pull-down menu for “Close” and “Open” is displayed.
 - **Close:** An alarm is detected when the terminal status is changed to “Close”.
 - **Open:** An alarm is detected when the terminal status is changed to “Open”.
 Also, the pull-down menu for selecting the camera number will be displayed when the “Alarm input” is selected.
 - **Cam. 1:** Functions as an alarm input of Cam. 1.
 - **Cam. 2:** Functions as an alarm input of Cam. 2.
 - **Cam. 3:** Functions as an alarm input of Cam. 3.
 - **Cam. 4:** Functions as an alarm input of Cam. 4.
- **Alarm output:** Alarm output will be carried out according to the settings for “Output terminal” (→page 110). Also, the pull-down menu for selecting the camera number will be displayed when the “Alarm output” is selected.
 - **Cam. 1:** Outputs when an alarm is detected with Cam. 1.
 - **Cam. 2:** Outputs when an alarm is detected with Cam. 2.
 - **Cam. 3:** Outputs when an alarm is detected with Cam. 3.
 - **Cam. 4:** Outputs when an alarm is detected with Cam. 4.
- **Default:** Off

[Terminal 3] **X8570N**

Determine how to use terminal 3.

- **Off:** Not used.
- **Alarm input(TRM3):** Receives alarms. When “Alarm input” is selected, a pull-down menu for “Close” and “Open” is displayed.
 - **Close:** An alarm is detected when the terminal status is changed to “Close”.
 - **Open:** An alarm is detected when the terminal status is changed to “Open”.
 Also, the pull-down menu for selecting the camera number will be displayed when the “Alarm input” is selected.
 - **Cam. 1:** Functions as an alarm input of Cam. 1.
 - **Cam. 2:** Functions as an alarm input of Cam. 2.
 - **Cam. 3:** Functions as an alarm input of Cam. 3.
 - **Cam. 4:** Functions as an alarm input of Cam. 4.
- **Alarm output:** Alarm output will be carried out according to the settings for “Output terminal” (→page 129). Also, the pull-down menu for selecting the camera number will be displayed when the “Alarm output” is selected.
 - **Cam. 1:** Outputs when an alarm is detected with Cam. 1.
 - **Cam. 2:** Outputs when an alarm is detected with Cam. 2.
 - **Cam. 3:** Outputs when an alarm is detected with Cam. 3.
 - **Cam. 4:** Outputs when an alarm is detected with Cam. 4.
- **AUX output:** AUX output will be supplied. The [AUX] buttons will be displayed on the “Live” page.
- **Default:** Off

IMPORTANT

- In order for the EXT I/O terminals to detect alarm inputs when the terminal status is changed from Open to Close (On) or from Close to Open (Off), about 100 ms or more is needed. Because alarms cannot be detected for about 5 seconds after a detection is made, alarm inputs received within about 5 seconds after an alarm is detected are not detected.

Note

- AUX is a camera terminal that allows users to operate (Open/Close) arbitrarily from the “Live” page. For example, an operator can remotely control lights in a place where the camera is installed by connecting the terminal to the light controller.
- Refer to the Important Information on the provided CD-ROM for further information about input/output rating of each terminal.

[VMD alarm]

When clicking “VMD >>”, the [VMD area] tab of the “Alarm” page will be displayed. (→page 119)

[Command alarm]

Select “On” or “Off” to determine whether or not to receive the command alarm.

The command alarm is the function that provides notification of a Panasonic protocol alarm from the other cameras. When “On” is selected, alarm actions will be performed between multiple cameras.

- **Default:** Off

[Reception port]

Select a port number to be used to receive the command alarm.

- **Available range:** 1-65535
- **Default:** 8181

The following port numbers are unavailable since they are already in use.

20, 21, 23, 25, 42, 53, 67, 68, 69, 80, 110, 123, 161, 162, 443, 554, 995, 10669, 10670, 32768-49151, 59000-61000

[Alarm deactivation time]

Configure the duration that detections won't be made after an alarm is detected. For example, by using this function you can prevent E-mail from being sent too often when E-mail notifications are configured to be sent to cellular phones when an alarm is detected.

5-600s

- **Default:** 5s

Note

- The duration that alarm detections are not made can be managed for each type of alarm. For example, during the time when detections for command alarms are not made, detections for VMD alarm can be made.

2.6.2 Configure the settings relating to the output terminal

[Alarm] X8570N

Click the [Alarm] tab on the “Alarm” page. (→page 37, page 38)

The settings relating to the output terminal can be configured in this section.

Output terminal	
Terminal output upon alarm detection	<input checked="" type="radio"/> On <input type="radio"/> Off
SD memory card error	<input checked="" type="radio"/> On <input type="radio"/> Off
Terminal state upon alarm detection	<input type="radio"/> Latch <input checked="" type="radio"/> Pulse
Terminal action upon alarm detection	<input checked="" type="radio"/> Open <input type="radio"/> Close
Pulse output width	<input type="text" value=""/> s (1-120s)

Output terminal

In order to be able to configure “Output terminal”, “Alarm output” must be selected for [Terminal 2] and [Terminal 3] of the [Alarm] setting.

[Terminal output upon alarm detection]

Select “On” or “Off” to determine whether or not to output the alarm signals to the output terminal when an alarm is detected.

- **Default:** Off

[SD memory card error]

Select “On” or “Off” to determine whether or not to output signals from the output terminal when an error is detected for the SD memory card. The output of SD memory card error is only available for [Terminal 2].

SD memory card error condition: SD memory card error (write error, read error, etc), Total use time over 6 years, and number of overwrites over 2000 times

- **On:** When an error status is detected, the signals from an output terminal is outputted and the [Alarm occurrence indication] button on the “Live” page blinks.
- **Off:** Deactivates the warning status detection.
- **Default:** Off

IMPORTANT

- In order to be able to correctly use this function, format the SD memory card with the camera before using it.

Note

- The “Total use time: 6 years” is the total power-on time from the SD card being inserted. “Number of overwrite times: 2000 cycles” are the upper limit overwrite counts of the industrial SD memory card (MLC type). These are typical values and not a guarantee of the SD card lifetime.
- A signal is outputted to the output terminal when either an alarm or SD memory card error (only “Terminal 2”) occurs.
- When an SD memory card error is detected, the [Alarm occurrence indication] button on the “Live” page blinks. If you click on the [Alarm occurrence indication] button, the button will be hidden.
- Output signals from the output terminal for [SD memory card error] differ depending on the settings of [Terminal state upon alarm detection].
 - When “Latch” is selected: Even after you click the [Alarm occurrence indication] button and it disappears, output signals from the output terminal will continue as long as the cause of the [SD memory card error] is not resolved.
 - When “Pulse” is selected: Even after you click the [Alarm occurrence indication] button and it disappears, output signals from the output terminal will continue as long as the cause of the [SD memory card error] is not resolved. However, if the time period specified for [Pulse output width] is exceeded, output signals from the output terminal will be stopped.

[Terminal state upon alarm detection]

Select “Latch” or “Pulse” for the output terminal at an alarm occurrence.

- **Latch:** When an alarm is detected, the output terminal will be in the state selected for “Terminal action upon alarm detection” until the alarm occurrence indication button is clicked.
- **Pulse:** When an alarm is detected, the output terminal will be in the state to the “Terminal action upon alarm detection” setting for the period set for “Pulse output width”. When the alarm occurrence indication button is clicked, the output terminal will return to the normal state.
- **Default:** Latch

[Terminal action upon alarm detection]

Select “Open” or “Close” to determine whether to open or close the output terminal when outputting the alarm signals.

2 Settings

- **Open:** The output terminal will open when outputting the alarm signals. (Normally close)
- **Close:** The output terminal will close when outputting the alarm signals. (Normally open)
- **Default:** Close

Note

- When “Open” is selected, the alarm signal will be output for about 20 seconds when the power of the unit is turned on.

[Pulse output width]

When “Pulse” is selected for “Terminal state upon alarm detection”, select an output terminal duration from the following.

- **Available range:** 1-120s
- **Default:** 1s

2.6.3 Change the AUX name [Alarm] X8570N

Click the [Alarm] tab on the “Alarm” page. (→page 37, page 38)

The names of “AUX”, “Open” and “Close” on the “Live” page can be changed.

AUX title	
AUX (Up to 10 characters)	<input type="text" value="AUX"/>
Open (Up to 5 characters)	<input type="text" value="Open"/>
Close (Up to 5 characters)	<input type="text" value="Close"/>

AUX title

[AUX (Up to 10 characters)]

Enter the name for “AUX” on the “Live” page.

- **Unavailable characters:** " &
- **Default:** AUX

[Open (Up to 5 characters)]

Enter the name for “Open” of “AUX” on the “Live” page.

- **Unavailable characters:** " &
- **Default:** Open

[Close (Up to 5 characters)]

Enter the name for “Close” of “AUX” on the “Live” page.

- **Unavailable characters:** " &
- **Default:** Close

Note

- When AUX setting is not available, AUX name cannot be changed.
- AUX is a camera terminal that allows users to operate (Open/Close) arbitrarily from the “Live” page. For example, an operator can remotely control lights in a place where the camera is installed by connecting the terminal to the light controller.

2.6.4 Configure the settings relating to the camera action on alarm occurrence [Alarm]

Click the [Alarm] tab on the “Alarm” page. (→page 37, page 38)

The settings related to the camera action on alarm can be configured in this section.

Camera action on alarm	
Alarm E-mail notification	E-mail server >>
Alarm image recording(SD memory card)	SD memory card setup >>
Panasonic alarm protocol	Panasonic alarm protocol notification >>
HTTP alarm notification	HTTP alarm notification setup >>

[Alarm E-mail notification]

Click “E-mail server >>” to display the setup menu that can configure the settings relating to E-mail notification when an alarm occurs. The setup menu will be displayed in a newly opened window. (→page 114)

[Alarm image recording(SD memory card)]

Click “SD memory card setup >>” to display the setup menu that can configure the settings relating to recording images on an SD memory card when an alarm occurs. The setup menu will be displayed in a newly opened window. (→page 115)

[Panasonic alarm protocol]

Click “Panasonic alarm protocol notification >>” to display the setup menu that can configure the settings relating to transmitting Panasonic alarm protocol notifications when an alarm occurs. The setup menu will be displayed in a newly opened window. (→page 116)

[HTTP alarm notification]

Click “HTTP alarm notification setup >>” to display the setup menu that can configure the settings relating to transmitting HTTP alarm notifications when an alarm occurs. The setup menu will be displayed in a newly opened window. (→page 117)

2.6.4.1 Configure settings relating to alarm E-mail notifications

Click “E-mail server >>” of “Camera action on alarm” on the [Alarm] tab of the “Alarm” page. (→page 113)

E-mail notification	
E-mail notification	<input checked="" type="radio"/> On <input type="radio"/> Off
Alarm image attachment	<input checked="" type="radio"/> On <input type="radio"/> Off
Image capture size	640x360
SMTP server address	<input type="text"/> Example of entry: 192.168.0.10
SMTP port	<input type="text"/> 25 (1-65535)
POP server address	<input type="text"/> Example of entry: 192.168.0.10
Authentication	Type <input checked="" type="radio"/> None <input type="radio"/> POP before SMTP <input type="radio"/> SMTP
	User name <input type="text"/>
	Password <input type="text"/>
Sender's E-mail address	<input type="text"/>
SSL	<input checked="" type="radio"/> On <input type="radio"/> Off
Destination of notification	Destination E-mail address
Address 1	<input type="text"/> Delete <input type="checkbox"/> Terminal 1 <input type="checkbox"/> Terminal 2 <input type="checkbox"/> Terminal 3 <input type="checkbox"/> VMD <input type="checkbox"/> Command alarm <input type="checkbox"/> Diag.
Address 2	<input type="text"/> Delete <input type="checkbox"/> Terminal 1 <input type="checkbox"/> Terminal 2 <input type="checkbox"/> Terminal 3 <input type="checkbox"/> VMD <input type="checkbox"/> Command alarm <input type="checkbox"/> Diag.
Address 3	<input type="text"/> Delete <input type="checkbox"/> Terminal 1 <input type="checkbox"/> Terminal 2 <input type="checkbox"/> Terminal 3 <input type="checkbox"/> VMD <input type="checkbox"/> Command alarm <input type="checkbox"/> Diag.
Address 4	<input type="text"/> Delete <input type="checkbox"/> Terminal 1 <input type="checkbox"/> Terminal 2 <input type="checkbox"/> Terminal 3 <input type="checkbox"/> VMD <input type="checkbox"/> Command alarm <input type="checkbox"/> Diag.
E-mail subject	<input type="checkbox"/> Use the camera title <input type="checkbox"/> Cause of alarm <input type="text"/>
E-mail body	<input checked="" type="checkbox"/> Cause of alarm <input checked="" type="checkbox"/> Occurrence time The %p% alarm was occurred at %t%
Terminal name	
Terminal 1 (Up to 10 characters)	<input type="text"/> Terminal1
Terminal 2 (Up to 10 characters)	<input type="text"/> Terminal2
Terminal 3 (Up to 10 characters)	<input type="text"/> Terminal3
<input type="button" value="Set"/> <input type="button" value="Close"/>	

Refer to page 139 for information on configuration for these settings.

2.6.4.2 Configure settings relating to recording to an SD memory card when an alarm occurs

Click “SD memory card setup >>” of “Camera action on alarm” on the [Alarm] tab of the “Alarm” page.
(→page 113)

Operating mode	
SD memory card	<input type="radio"/> Use <input checked="" type="radio"/> Not use
Audio recording	<input checked="" type="radio"/> On <input type="radio"/> Off
Remaining capacity notification	50% <input type="text"/>
Overwrite	<input checked="" type="radio"/> On <input type="radio"/> Off
SD memory card security	
Additional info for detecting alteration	Setup >>
SD memory card password lock	Password Set Remove Change
	Status Unlock
Recording stream	
Recording format	Stream(2) Cam. 1 - 4 <input type="text"/> (H.265/640x360/Cam. 1 - 4)
Save trigger	Alarm input <input type="text"/> <input checked="" type="checkbox"/> Terminal 1 <input checked="" type="checkbox"/> Terminal 2 <input checked="" type="checkbox"/> Terminal 3 <input checked="" type="checkbox"/> VMD <input checked="" type="checkbox"/> Command alarm
Stream recording(Alarm)	
Pre alarm (recording) duration	Off <input type="text"/>
Post alarm (recording) duration	30s <input type="text"/>
Set Close	

Refer to page 62 for information on configuration for these settings.

2.6.4.3 Configure settings relating to Panasonic alarm protocol notification when an alarm occurs

Click “Panasonic alarm protocol notification >>” of “Camera action on alarm” on the [Alarm] tab of the “Alarm” page. (→page 113)

Panasonic alarm protocol notification			
Panasonic alarm protocol	<input checked="" type="radio"/> On	<input type="radio"/> Off	
Additional alarm data	<input checked="" type="radio"/> On	<input type="radio"/> Off	
Destination port	1818 (1-65535)		
Retry times	▼		
Destination of notification			
	Alarm	Diag.	Destination server address
Address 1	<input type="checkbox"/>	<input type="checkbox"/>	<input type="text"/> Delete
Notification per Camera	<input checked="" type="radio"/> On	<input type="radio"/> Off	Camera No. ▼
Notification per VMD area	<input checked="" type="radio"/> On	<input type="radio"/> Off	Alarm area No. ▼
Address 2	<input type="checkbox"/>	<input type="checkbox"/>	<input type="text"/> Delete
Notification per Camera	<input checked="" type="radio"/> On	<input type="radio"/> Off	Camera No. ▼
Notification per VMD area	<input checked="" type="radio"/> On	<input type="radio"/> Off	Alarm area No. ▼
Address 3	<input type="checkbox"/>	<input type="checkbox"/>	<input type="text"/> Delete
Notification per Camera	<input checked="" type="radio"/> On	<input type="radio"/> Off	Camera No. ▼
Notification per VMD area	<input checked="" type="radio"/> On	<input type="radio"/> Off	Alarm area No. ▼
Address 4	<input type="checkbox"/>	<input type="checkbox"/>	<input type="text"/> Delete
Notification per Camera	<input checked="" type="radio"/> On	<input type="radio"/> Off	Camera No. ▼
Notification per VMD area	<input checked="" type="radio"/> On	<input type="radio"/> Off	Alarm area No. ▼
Address 5	<input type="checkbox"/>	<input type="checkbox"/>	<input type="text"/> Delete
Notification per Camera	<input checked="" type="radio"/> On	<input type="radio"/> Off	Camera No. ▼
Notification per VMD area	<input checked="" type="radio"/> On	<input type="radio"/> Off	Alarm area No. ▼
Address 6	<input type="checkbox"/>	<input type="checkbox"/>	<input type="text"/> Delete
Notification per Camera	<input checked="" type="radio"/> On	<input type="radio"/> Off	Camera No. ▼
Notification per VMD area	<input checked="" type="radio"/> On	<input type="radio"/> Off	Alarm area No. ▼
Address 7	<input type="checkbox"/>	<input type="checkbox"/>	<input type="text"/> Delete
Notification per Camera	<input checked="" type="radio"/> On	<input type="radio"/> Off	Camera No. ▼
Notification per VMD area	<input checked="" type="radio"/> On	<input type="radio"/> Off	Alarm area No. ▼
Address 8	<input type="checkbox"/>	<input type="checkbox"/>	<input type="text"/> Delete
Notification per Camera	<input checked="" type="radio"/> On	<input type="radio"/> Off	Camera No. ▼
Notification per VMD area	<input checked="" type="radio"/> On	<input type="radio"/> Off	Alarm area No. ▼
Example of entry: 192.168.0.10			
Set		Close	

Refer to page 122 for information on configuration for these settings.

2.6.4.4 Configure settings relating to HTTP alarm notification when an alarm occurs

Click “HTTP alarm notification setup >>” of “Camera action on alarm” on the [Alarm] tab of the “Alarm” page. (→page 113)

HTTP alarm notification		Alarm	
Address 1	<input type="checkbox"/>	<input type="text" value="http://"/>	<input type="button" value="Delete"/>
User name		<input type="text"/>	
Password		<input type="text"/>	
Notification data		<input type="text" value="/cgi-bin/comalarm.cgi?CMD=01"/>	
Address 2	<input type="checkbox"/>	<input type="text" value="http://"/>	<input type="button" value="Delete"/>
User name		<input type="text"/>	
Password		<input type="text"/>	
Notification data		<input type="text" value="/cgi-bin/comalarm.cgi?CMD=01"/>	
Address 3	<input type="checkbox"/>	<input type="text" value="http://"/>	<input type="button" value="Delete"/>
User name		<input type="text"/>	
Password		<input type="text"/>	
Notification data		<input type="text" value="/cgi-bin/comalarm.cgi?CMD=01"/>	
Address 4	<input type="checkbox"/>	<input type="text" value="http://"/>	<input type="button" value="Delete"/>
User name		<input type="text"/>	
Password		<input type="text"/>	
Notification data		<input type="text" value="/cgi-bin/comalarm.cgi?CMD=01"/>	
Address 5	<input type="checkbox"/>	<input type="text" value="http://"/>	<input type="button" value="Delete"/>
User name		<input type="text"/>	
Password		<input type="text"/>	
Notification data		<input type="text" value="/cgi-bin/comalarm.cgi?CMD=01"/>	
		<input type="button" value="Set"/>	<input type="button" value="Close"/>

Refer to page 124 for information on configuration for these settings.

2.6.5 Configure the VMD settings [VMD area]

Click the [VMD area] tab on the “Alarm” page. (→page 37, page 38)

The video motion detection areas can be set on this page.

Up to 4 areas per camera can be set. When motion is detected in the set area, it will be regarded as an alarm.

IMPORTANT

- The alarm occurrence indication button (→page 12) will be displayed when motion is detected by the VMD function.
- The alarm occurrence indication button will be displayed when receiving an alarm input of a terminal alarm or a command alarm.
- Depending on the network environment, notification may be delayed even when “Real time” is selected for “Status update mode” on the [Basic] tab of the “Basic” page (→page 55).
- After configuring the VMD area, the VMD area may move out of alignment when “Image capture mode” of the [Image] tab is changed. Make sure to check the VMD area after changing the “Image capture mode” setting.

2 Settings

- The motion detection function is not the dedicated function to prevent thefts, fires, etc. We are not responsible for any accidents or damages that may occur.



[Camera selection]

Select a camera to set the area from Cam. 1, Cam. 2, Cam. 3, or Cam. 4.

[Area]

When selecting a VMD area in the screen, it will be numbered as area 1. (Subsequent areas will be numbered in the order of selection.)

[Status]

Select "On" or "Off" to determine whether or not to perform video motion detection.

- **On:** Performs video motion detection.
- **Off:** Does not perform video motion detection.
- **Default:** Off

[Detection area]

Adjust the size of the VMD area using the slider. The smaller the selected value is, the higher the sensitivity of VMD area becomes. The current value (1-10) will be displayed on the right of the slider.

- **Default:** 1

[Detection sensitivity]

Adjust the sensitivity of motion detection in the VMD area using the slider. The settings can be configured for each area individually. The larger the value is set, the higher the sensitivity level becomes. The current value (1 (low) - 15 (high)) will be displayed below the slider.

- **Default:** 8

[Delete] button

Click the [Delete] button corresponding to the area to be deleted. The outline of the selected area will be deleted.

[Light detection control]

Select “On” or “Off” to determine whether or not to suspend video motion detection affected by brightness change such by a dimming level control.

- **Default:** Off

IMPORTANT

- “Light detection control” may not work when brightness change is too small.
- When “On” is selected for “Light detection control”, the video motion detection may not be performed even when detecting a subject moving over the whole screen.

[Area No. notification]

When “Panasonic alarm protocol notification >>” is clicked, the [Notification] tab of the “Alarm” page will be displayed. (→page 121)

VMD information addition**[Information addition]**

Select “On” or “Off” to determine whether or not to add VMD information to superimposed image data. The VMD information can be searched by some of Panasonic network disk recorders. Refer to the operating instructions of the connected devices for further information about the functions and settings.

- **Default:** Off

2.6.6 Set the VMD areas [VMD area]

Set the areas to activate the VMD function.

IMPORTANT

- While the items in the setup menu are being changed, no alarm will be detected. After completing the setup, close the setup menu.

2 Settings

1. Set the video motion detection area by dragging the mouse on the screen.
→ The designated area will become the VMD area “1(White)” and the outline will be displayed. When 2 - 4 VMD areas are set, each area will be numbered in order. The areas will be identified by the respective outline colors. The “Status” of the outline to be set for the area will become “On”.



2. Adjust “Detection area” and “Detection sensitivity” using the slider.
Refer to page 117 for further information about the “Detection sensitivity” and “Detection area”.
The currently displayed area and its detection sensitivity will be displayed in the “Detection area” section.
Change areas and the settings of “Detection area” and “Detection sensitivity” as necessary.
3. Click the [Set] button after completing the settings.

IMPORTANT

- The setting will not be applied unless the [Set] button is clicked.
4. To invalidate the VMD area, click the [Set] button after selecting “Off” for “Status” of the VMD area to be invalidated.
→ The outline of the invalidated VMD area will turn to a dotted line. When the VMD area is invalidated, no alarm will occur even when a motion can be recognized in the area.
 5. To delete the VMD area, click the [Delete] button corresponding to the area to be deleted.
→ The outline of the respective VMD area will disappear.

6. Click the [Set] button.
→ The edited settings will be applied.

2.6.7 Configuration of the settings relating to alarm notification [Notification]

Click the [Notification] tab on the “Alarm” page. (→page 37, page 38)

The settings relating to Panasonic alarm protocol and HTTP alarm notification can be configured in this section.

2.6.7.1 Configure the settings relating to Panasonic alarm protocol

Panasonic alarm protocol notification | [HTTP alarm notification](#)

Panasonic alarm protocol notification

Panasonic alarm protocol On Off

Additional alarm data On Off

Destination port (1-65535)

Retry times

Destination of notification	Alarm	Diag.	Destination server address	
Address 1	<input type="checkbox"/>	<input type="checkbox"/>	<input type="text"/>	Delete
Notification per Camera	<input type="radio"/> On	<input type="radio"/> Off	Camera No. <input type="text"/>	
Notification per VMD area	<input type="radio"/> On	<input type="radio"/> Off	Alarm area No. <input type="text"/>	
Address 2	<input type="checkbox"/>	<input type="checkbox"/>	<input type="text"/>	Delete
Notification per Camera	<input type="radio"/> On	<input type="radio"/> Off	Camera No. <input type="text"/>	
Notification per VMD area	<input type="radio"/> On	<input type="radio"/> Off	Alarm area No. <input type="text"/>	
Address 3	<input type="checkbox"/>	<input type="checkbox"/>	<input type="text"/>	Delete
Notification per Camera	<input type="radio"/> On	<input type="radio"/> Off	Camera No. <input type="text"/>	
Notification per VMD area	<input type="radio"/> On	<input type="radio"/> Off	Alarm area No. <input type="text"/>	
Address 4	<input type="checkbox"/>	<input type="checkbox"/>	<input type="text"/>	Delete
Notification per Camera	<input type="radio"/> On	<input type="radio"/> Off	Camera No. <input type="text"/>	
Notification per VMD area	<input type="radio"/> On	<input type="radio"/> Off	Alarm area No. <input type="text"/>	
Address 5	<input type="checkbox"/>	<input type="checkbox"/>	<input type="text"/>	Delete
Notification per Camera	<input type="radio"/> On	<input type="radio"/> Off	Camera No. <input type="text"/>	
Notification per VMD area	<input type="radio"/> On	<input type="radio"/> Off	Alarm area No. <input type="text"/>	
Address 6	<input type="checkbox"/>	<input type="checkbox"/>	<input type="text"/>	Delete
Notification per Camera	<input type="radio"/> On	<input type="radio"/> Off	Camera No. <input type="text"/>	
Notification per VMD area	<input type="radio"/> On	<input type="radio"/> Off	Alarm area No. <input type="text"/>	
Address 7	<input type="checkbox"/>	<input type="checkbox"/>	<input type="text"/>	Delete
Notification per Camera	<input type="radio"/> On	<input type="radio"/> Off	Camera No. <input type="text"/>	
Notification per VMD area	<input type="radio"/> On	<input type="radio"/> Off	Alarm area No. <input type="text"/>	
Address 8	<input type="checkbox"/>	<input type="checkbox"/>	<input type="text"/>	Delete
Notification per Camera	<input type="radio"/> On	<input type="radio"/> Off	Camera No. <input type="text"/>	
Notification per VMD area	<input type="radio"/> On	<input type="radio"/> Off	Alarm area No. <input type="text"/>	

Example of entry: 192.168.0.10

Set

Panasonic alarm protocol notification

[Panasonic alarm protocol]

Select “On” or “Off” to determine whether or not to provide notification by Panasonic alarm protocol according to the settings for the “Alarm” and “Diag.” checkboxes of “Destination of notification” below.

- When an alarm is detected (“Alarm”)
- When a notification of the remaining capacity of the SD memory card has been provided (“Diag.”)
- When the SD memory card has become full (“Diag.”)
- When the SD memory card cannot be recognized (“Diag.”)
- **Default:** Off

Note

- When “On” is selected, notification of the alarm occurrence will be provided to the registered destination server addresses in order (to IP address 1 first, to IP address 8 last).

[Additional alarm data]

Determine whether or not to send notifications for VMD alarm detection area numbers with the Panasonic alarm protocol by selecting On/Off.

- **Default:** Off

[Destination port]

Select a destination port for the Panasonic alarm protocol from the following.

- **Available range:** 1 - 65535
- **Default:** 1818

The following port numbers are unavailable since they are already in use.

20, 21, 23, 25, 42, 53, 67, 68, 69, 80, 110, 123, 161, 162, 443, 995, 10669, 10670

[Retry times]

Select a retry time for the Panasonic alarm protocol.

- **Available range:** 0-30
- **Default:** 2

Destination of notification

[Address 1] - [Address 8]

Enter the destination IP address or host name of the Panasonic alarm protocol from the following. Up to 8 destination server addresses can be registered.

- **[Alarm] checkbox:** When the checkbox is checked, the Panasonic alarm notification will be provided upon an alarm occurrence.
- **[Diag.] checkbox:** When the checkbox is checked, notification using Panasonic alarm protocol will be provided in the following cases.
 - When notification of the remaining capacity of the SD memory card has been provided
 - When the SD memory card has become full
 - When the SD memory card cannot be recognized
- **[Destination server address]:** Enter the destination server address or host name.
 - **Available characters:** Alphanumeric characters, the colon (:), the period (.), the underscore (_), and the hyphen (-).

To delete the registered destination server address, click the [Delete] button respective to the desired destination server address.

[Notification per Camera]

Select whether to perform the transmission setup per camera by selecting On/Off.

If “On” is selected for “Notification per Camera”, an alarm is notified only when “Camera No.” matches the number of the camera with which VMD alarm is detected.

Alarm notifications other than “VMD alarm” are not implemented.

- **Default:** Off

[Camera No.]

- Available range: 1-4
- Default: 1

[Notification per VMD area]

Select “On” or “Off” to determine whether or not to set “Notification per VMD area”.

If “Notification per VMD area” is turned “On”, an alarm is notified only when “Alarm area No.” matches “Alarm area” configured by “VMD alarm”. Alarm notifications other than “VMD alarm” are not implemented. When using “Notification per VMD area”, select “On” for “Status” of the alarm area in VMD.

- Default: Off

[Alarm area No.]

- Available range: 1-4
- Default: 1

IMPORTANT

- When entering the host name of the “Destination server address”, the DNS settings on the [Network] tab of the “Network” page must be configured. (→page 134)
- Confirm that the destination IP addresses are registered correctly. When a registered destination does not exist, notification may be delayed.

2.6.7.2 Configure the settings relating to HTTP alarm notification

HTTP alarm notification		Alarm	
Address 1	<input type="checkbox"/>	<input type="text" value="http://"/>	<input type="button" value="Delete"/>
User name		<input type="text"/>	
Password		<input type="text"/>	
Notification data		<input type="text" value="/cgi-bin/comalarm.cgi?CMD=01"/>	
Address 2	<input type="checkbox"/>	<input type="text" value="http://"/>	<input type="button" value="Delete"/>
User name		<input type="text"/>	
Password		<input type="text"/>	
Notification data		<input type="text" value="/cgi-bin/comalarm.cgi?CMD=01"/>	
Address 3	<input type="checkbox"/>	<input type="text" value="http://"/>	<input type="button" value="Delete"/>
User name		<input type="text"/>	
Password		<input type="text"/>	
Notification data		<input type="text" value="/cgi-bin/comalarm.cgi?CMD=01"/>	
Address 4	<input type="checkbox"/>	<input type="text" value="http://"/>	<input type="button" value="Delete"/>
User name		<input type="text"/>	
Password		<input type="text"/>	
Notification data		<input type="text" value="/cgi-bin/comalarm.cgi?CMD=01"/>	
Address 5	<input type="checkbox"/>	<input type="text" value="http://"/>	<input type="button" value="Delete"/>
User name		<input type="text"/>	
Password		<input type="text"/>	
Notification data		<input type="text" value="/cgi-bin/comalarm.cgi?CMD=01"/>	

HTTP alarm notification

[Address 1] - [Address 5]

Enter the destination IP address or host name of the HTTP alarm notification. Up to 5 destination server addresses can be registered.

- **Available characters:** Alphanumeric characters, the colon (:), the period (.), the underscore (_), and the hyphen (-).
- **Default:** http://

Example of entry: “http://IP address of the HTTP server + : (colon) + port number” or “http://Host name: (colon) + port number”

[Alarm] checkbox

When the checkbox is checked, the HTTP alarm notification will be provided upon an alarm occurrence.

[Delete] button

When this button is clicked, all configured information, including the address, user name, password, and notification data, will be deleted.

[User name]

Enter the user name (login name) to access the HTTP server.

- **Available number of characters:** 0 - 63 characters
- **Unavailable characters:** " & ; ; \

[Password]

Enter the password to access the HTTP server.

- **Available number of characters:** 0 - 63 characters
- **Unavailable characters:** " &

[Notification data]

Enter the notification data to add after the destination HTTP server addresses set in [Address 1] - [Address 5].

- **Available characters:** Alphanumeric characters
- **Default:** /cgi-bin/comalarm.cgi?CMD=01

Note

- For “Address 1” to “Address 5”, a total of 256 characters can be entered for the address (including “http://”) and “Notification data”.
- Make sure to enter a slash (/) as the first character for “Notification data”.
- If the HTTP alarm notification fails, information about the failure will be added to the system log.
- Even if the [Set] button is clicked after deleting the contents of “Notification data”, “/cgi-bin/comalarm.cgi?CMD=01” will be set.
- HTTPS cannot be used.

<Example>

When http://192.168.0.100 is set for the address and /cgi-bin/comalarm.cgi?CMD=01 is set for “Notification data”, an HTTP alarm notification such as http://192.168.0.100/cgi-bin/comalarm.cgi?CMD=01 will be executed.

2.7 Configure the settings relating to the authentication [User mng.]

The settings relating to the authentication such as users and PCs restrictions for accessing the camera with a PC, mobile terminal or tablet device can be configured on the “User mng.” page.
The “User mng.” page has 2 tabs; the [User auth.] tab, the [Host auth.] tab.

2.7.1 Configure the settings relating to the user authentication [User auth.]

Click the [User auth.] tab on the “User mng.” page. (→page 37, page 38)

The settings relating to the authentication of users who can access this camera from the PC, mobile terminal or tablet device can be configured on this page. Up to 24 users can be registered.

Note

- When user authentication has failed to pass (authentication error) 8 times within 30 seconds using the same IP address (PC), access to the unit will be denied for a while.

User auth. Host auth. System IEEE 802.1X Data encryption

User auth. On Off

Guest User Use Not use

Authentication Digest

Set

User name registration --New registration-- Change Delete

User name (1 to 32 characters)

Password (8 to 32 characters)

Retype password

Access level 3. Live only

Set

Note:

(1) Distinguish between upper- and lower cases.
(2) Entry of the following is not allowed as a user name: 2-byte characters, and 1-byte symbols " & ; \\
(3) Entry of the following is not allowed as a password: 2-byte characters, and 1-byte symbols " &
(4) For the password, use three or more types of characters from upper- and lowercase alphabetic characters, numbers, and symbols.
(5) Keep the user name and password at hand so as not to lose.
(6) It is recommended to change the password periodically.
(7) Set the password which does not include the user name.

Access level	Camera control	Live only	Guest User
Live view selectable	<input checked="" type="checkbox"/>	<input type="checkbox"/>	<input type="checkbox"/>
Listen	<input checked="" type="checkbox"/>	<input type="checkbox"/>	<input type="checkbox"/>
Refresh Rate	<input checked="" type="checkbox"/>	<input type="checkbox"/>	<input type="checkbox"/>
Snap shot	<input checked="" type="checkbox"/>	<input type="checkbox"/>	<input type="checkbox"/>
Playback of recording (Log disp.)	<input checked="" type="checkbox"/>	<input type="checkbox"/>	<input type="checkbox"/>
Manual rec./Delete rec.	<input checked="" type="checkbox"/>	<input type="checkbox"/>	<input type="checkbox"/>
Brightness	<input checked="" type="checkbox"/>	<input type="checkbox"/>	<input type="checkbox"/>
AUX	<input checked="" type="checkbox"/>	<input type="checkbox"/>	<input type="checkbox"/>

Set

[User auth.]

Select "On" or "Off" to determine whether or not to authenticate the users.

- Default:** On

[Guest User]

Select whether or not to set Guest User. If you select "Use", you can set which functions are available or unavailable for guest users for whom user authentication has not been performed.

- Default:** Not use

[Authentication]

Set the user authentication method.

- **Digest or Basic:** Uses “Digest or Basic” authentication.
- **Digest:** Uses “Digest” authentication.
- **Basic:** Uses “Basic” authentication.
- **Default:** Digest

Note

- When the [Authentication] setting has been changed, close the web browser, and then access the camera again.
- For other devices such as network disk recorders, unless otherwise stated, digest authentication is not supported. (As of March, 2018)

[User name registration]

At the time of new registration, register a new user name in [User name]. Click [▼] in “User name registration” to view registered users. Registered users are displayed as “Registered user name [Access level]”. (Example: admin [1])

If you click the [Change] button on the right, the selected user will be displayed in [User name], and you can change the password. By clicking the [Delete] button on the right, you can delete the selected user.

[User name]

Enter a user name.

- **Available number of characters:** 1 - 32 characters
- **Unavailable characters:** " & ; ; \
- **Default:** None (blank)

Note

- When the user name already in use is entered and the [Set] button is clicked, the respective user information will be overwritten.

[Password (8 to 32 characters)] [Retype password]

Enter a password.

- **Available number of characters:** 8 - 32 characters
- **Unavailable characters:** " &
- **Default:** None (blank)

Note

- Distinguish between upper- and lower cases.
- For the password, use three or more types of characters from upper- and lowercase alphabetic characters, numeric characters, and symbols.
- Set the password which does not include the user name.

[Access Level]

Select the access level of the user from the following.

- **1. Administrator:** Allowed all available operations of the camera.
- **2. Camera control:** Allowed to control the camera. Functions selected for “Access level” can be operated.
- **3. Live only:** Allowed to display live view. Functions selected for “Access level” can be operated.
- **Default:** 3. Live only

[Access level]

Select the available functions based on the user access level (camera control, live view, guest user).

- **Default:**
 - Camera control: All are checked
 - Live only: All are not checked
 - Guest User: All are not checked

Note

- **If you have set “User authentication” to “Off”, and “Guest User” to “Not use”:**
The “Access Level” item cannot be set. And, while all the live operation buttons are displayed, the [Setup] buttons require authentication.
- **If you have set “User authentication” to “Off”, and “Guest User” to “Use”:**
You can set the items for “Guest User”.
- **If you have set “User authentication” to “On”:**
You cannot set the items for “Guest User”.

You can set the following functions.

Live view selectable	Selecting an image displayed in the live view setting permissions
Listen X8570N	Mic Input (To PC) (when listening on a PC) setting permissions (→page 15)
Refresh Rate	JPEG format image refresh interval setting permissions (→page 13)
Snap shot	Snap shot operation permissions (→page 14)
Playback of recording (Log disp.)	Log operation permissions (→page 14)
Manual rec./Delete rec.	SD memory card save/delete permissions (→page 14)
Brightness	Brightness setting permissions (→page 13)
AUX X8570N	AUX setting permissions (→page 14)

2.7.2 Configure the settings relating to the host authentication [Host auth.]

Click the [Host auth.] tab on the “User mng.” page. (→page 37, page 38)

The restriction settings of PCs (IP address) from accessing the camera can be configured on this page.

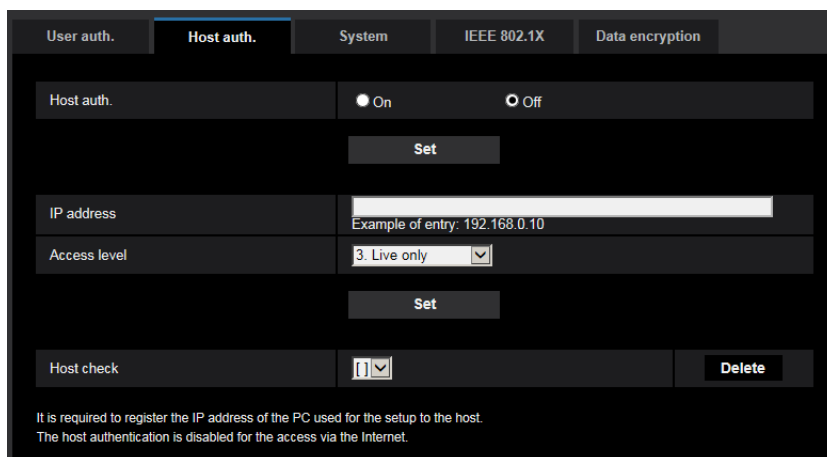

The screenshot shows the 'Host auth.' configuration page. At the top, there are navigation tabs: 'User auth.', 'Host auth.', 'System', 'IEEE 802.1X', and 'Data encryption'. The 'Host auth.' tab is selected. The main content area includes:

- A 'Host auth.' section with a radio button for 'On' (selected) and 'Off'.
- A 'Set' button below the radio buttons.
- An 'IP address' field with a text input and an example entry: '192.168.0.10'.
- An 'Access level' dropdown menu currently showing '3. Live only'.
- Another 'Set' button below the IP address and access level fields.
- A 'Host check' field with a dropdown menu showing a list icon.
- A 'Delete' button to the right of the 'Host check' field.

At the bottom of the page, there is a note: "It is required to register the IP address of the PC used for the setup to the host. The host authentication is disabled for the access via the Internet."

[Host auth.]

Select “On” or “Off” to determine whether or not to authenticate the host.

- **Default:** Off

IMPORTANT

- Set “Host auth.” to “On” after registering the IP address of the PC.

[IP address]

Enter the IP address of the PC to be allowed to access the camera. Host name cannot be entered for the IP address.

Note

- When “IP address/subnet mask” is entered, it is possible to restrict PCs in each subnet. For example, when “192.168.0.1/24” is entered and “2. Camera control” is selected for the access level, the PCs whose IP address is between “192.168.0.1” - “192.168.0.254” can access the camera with the access level “2. Camera control”.
- When the IP address already in use is entered and the [Set] button is clicked, the respective host information will be overwritten.
- When an error message “After registering the “IP address” of the PC used for the setup, set “On” for “Host auth.”.” is displayed, the IP address of the PC used for setup may be incorrect. Check if the IP address of the PC is configured correctly.

[Access level]

Select the access level of the host from the following.

1. Administrator/ 2. Camera control/ 3. Live only

Refer to page 126 for further information about the access level.

- **Default:** 3. Live only

[Host check]

From the pull-down menu of “Host check”, the registered host can be selected and the selected host’s IP address can be checked.

The registered IP address will be displayed with the access level.

(Example: 192.168.0.21 [1])

To delete the registered host, click the [Delete] button after selecting the IP address to be deleted.

2.7.3 Configure the settings relating to the priority stream

[System]

Click the [System] tab on the “User mng.” page. (→page 37, page 38)

The description below is the configuration of the priority stream that can transmit images without deteriorating the image quality and refresh interval even when multiple users access concurrently.

The screenshot shows a web interface with several tabs: "User auth.", "Host auth.", "System" (selected), "IEEE 802.1X", and "Data encryption". The "System" tab is active, displaying the "Priority stream" settings. The settings are as follows:

Priority stream	
Activation	<input checked="" type="radio"/> On <input type="radio"/> Off
Destination IP address(1)	<input type="text"/>
Destination IP address(2)	<input type="text"/>
Stream type	<input type="text"/> (H.265/3840x2160)

Priority stream

[Activation]

Select “On” or “Off” to determine whether or not to use the priority stream.

- **Default:** Off

Note

- When “On” is selected for “Activation” of “Priority stream”, number of users who can access the camera may be limited.

[Destination IP address(1)]

Enter the first destination IP address.

[Destination IP address(2)]

Enter the second destination IP address.

[Stream type]

Select “Stream(1)” or “Stream(2)”.

- **Stream(1):** Stream(1) images will be transmitted.
- **Stream(2):** Stream(2) images will be transmitted.
- **Default:** Stream(1)

2.7.4 Configure IEEE 802.1X [IEEE 802.1X]

Click the [IEEE 802.1X] tab on the “User mng.” page. (→For menu display and how to operate, refer to page 37, page 38)

The settings relating to IEEE 802.1X can be configured on this page.

[IEEE 802.1X]

Select “On” or “Off” to determine whether or not to perform port authentication using IEEE 802.1X.

- **Default:** Off

[User name]

Enter the user name to access the authentication LAN switch.

- **Available number of characters:** 1 - 32 characters
- **Unavailable characters:** " & ; \

[Password]

[Retype password]

Enter the password to access the authentication LAN switch.

- **Available number of characters:** 4 - 32 characters
- **Unavailable characters:** " &

[EAP method]

Select the authentication method from EAP-MD5 or EAP-PEAP.

2.7.5 Configure the data encryption settings [Data encryption]

Click [Data encryption] on the "User mng." page. (→For menu display and how to operate, refer to page 37, page 38)

The settings relating to the data encryption can be configured in this section.

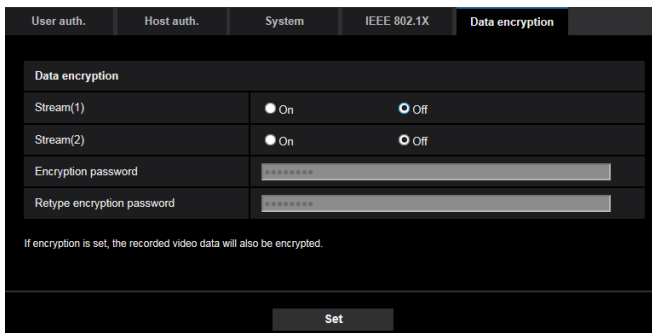

[Stream 1], [Stream 2]

Select "On" or "Off" for Stream(1) and Stream(2) to determine whether or not to activate data encryption.

- **Default:** Off

[Encryption password], [Retype encryption password]

Set the password for data encryption.

- **Available number of characters:** 4 - 16 characters
- **Unavailable characters:** " &

IMPORTANT

- Data encryption is not available for JPEG(1) and JPEG(2).
- The initial password is displayed in "MAC address" on the [Upgrade] screen of the [Maintenance] tab. When using data encryption, make sure to change the password.
- The encrypted MP4 files cannot be viewed on the image playing screen in the browser (→1.6 Playback of images on the SD memory card). Download it to a PC and use the decryption tool to confirm it. For information about the decryption tool, refer to the "readme.txt" file in the supplied CD-ROM or our website (<https://security.panasonic.com/support/info/> <Control No.: C0310>).

Note

- In order to view streams with data encryption set to "On", you must install the viewer software.
- If you confirm streams with data encryption set to "On" on the "Live" page, password entry for decryption is displayed. If you correctly enter the "Encryption password" that was set, you will be able to view images.
- When "Mic input" is selected for "Audio transmission mode", only audio may be played until the password is entered. **X8570N**

- Streams that have data encryption enabled for them are wrapped in < > in the [Live view] pull-down menu. Additionally, streams that have data encryption enabled for them are enclosed within < > in the setup menu pull-down menu.

Example: When Stream 1 and JPEG are data encrypted

- [Live view] pull-down menu on the “Live” page

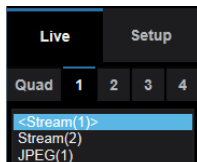

- Pull-down menu in the setup menu

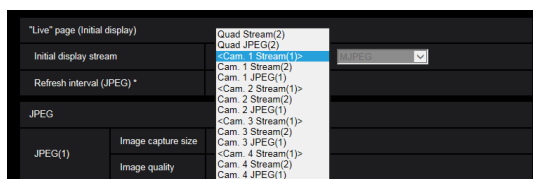

- The AAC-LC audio data will be encrypted when “On” is selected for “Data encryption” of both Stream(1) and Stream(2). (“G.726” and “G.711” will not be encrypted.) When “AAC-LC” is selected for “Audio input encoding format”, the audio will not be played while JPEG image is displayed in the “Live” page. **X8570N**
- For encrypted MP4 files, you can use the decryption tool to confirm the images.
- If “On” is selected for data encryption, the maximum number of cameras that can be connected simultaneously will be reduced.

2.8 Configuring the network settings [Network]

The network settings can be configured on the “Network” page.
The “Network” page has the [Network] tab and the [Advanced] tab.

2.8.1 Configure the network settings [Network]

Click the [Network] tab on the “Network” page. (→page 37, page 38)

The following information is required to configure the network settings. Contact the network administrator or your Internet service provider.

- IP address
- Subnet mask
- Default gateway (when using the gateway server/router)
- HTTP port
- Primary DNS address, Secondary DNS address (when using DNS)

Network		Advanced
IPv4 network		
Network Settings	Auto(Advanced) ▾	
IP address(IPv4)	192 . 168 . 1 . 199	
Subnet mask	255 . 255 . 255 . 0	
Default gateway	192 . 168 . 1 . 1	
DNS	<input type="radio"/> Auto <input checked="" type="radio"/> Manual	
Primary server address	0 . 0 . 0 . 0	
Secondary server address	0 . 0 . 0 . 0	
IPv6 network		
Manual	<input checked="" type="radio"/> On <input type="radio"/> Off	
IP address(IPv6)		
Default gateway		
DHCPv6	<input checked="" type="radio"/> On <input type="radio"/> Off	
Primary DNS server address		
Secondary DNS server address		
Common		
HTTP port	80 (1-65535)	
Line speed	Auto ▾	
Max RTP packet size	<input type="radio"/> Unlimited(1500byte) <input checked="" type="radio"/> Limited(1280byte)	
HTTP max segment size(MSS)	Unlimited(1460byte) ▾	
Bandwidth control(bit rate)	81920kbps ▾	
Easy IP Setup accommodate period	<input type="radio"/> 20min <input checked="" type="radio"/> Unlimited	
FTP access to camera	<input checked="" type="radio"/> Allow <input type="radio"/> Forbid	
Set		

IPv4 network

[Network Settings]

Select the method of how to configure the IP address from the following.

- **Static:** The IP address is configured by entering manually on “IP address(IPv4)”.
- **DHCP:** The IP address is configured using the DHCP function.
- **Auto(AutoIP):** The IP address is configured using the DHCP function. When the DHCP server is not found, the IP address is automatically configured.
- **Auto(Advanced):** Using the DHCP function, network address information is referred to, and an unused IP address is configured to the camera as a static IP address. The configured IP address is automatically determined within the subnet mask range by the camera. When the DHCP server is not found, the IP address is set to 192.168.0.10.
- **Default:** Auto(Advanced)

Note

- When “Auto(AutoIP)” is selected and the IP address cannot be obtained from the DHCP server, an IP address not used in the same network will be searched within 169.254.1.0 - 169.254.254.255.

[IP address(IPv4)]

When not using the DHCP function, enter the IP address of the camera. Do not enter an IP address already in use (for the PCs and the other network cameras).

- **Default:** 192.168.0.10

Note

- Multiple IP addresses are unavailable even when using the DHCP function. Refer to the network administrator for further information about the settings of the DHCP server.

[Subnet mask]

When not using the DHCP function, enter the subnet mask of the camera.

- **Default:** 255.255.255.0

[Default gateway]

When not using the DHCP function, enter the default gateway of the camera.

- **Default:** 192.168.0.1

Note

- Multiple IP addresses for the default gateway are unavailable even when using the DHCP function. Refer to the network administrator for further information about the settings of the DHCP server.

[DNS]

Determine how to set the address of the DNS server by selecting “Auto” (obtain the address automatically) or “Manual” (enter the address of the DNS server). When “Manual” is selected, it is necessary to configure the settings for the DNS.

When using the DHCP function, it is possible to obtain the DNS address automatically by selecting “Auto”.

Refer to the network administrator for further information about the settings.

- **Default:** Auto

[Primary server address], [Secondary server address]

When “Manual” is selected for “DNS”, enter the IP address of the DNS server.

Refer to the network administrator about the IP address of the DNS server.

IPv6 network

[Manual]

Select “On” or “Off” to determine whether or not to manually configure the IP address for IPv6 network (IPv6 address).

- **On:** Enter an IPv6 address manually.
- **Off:** Manual entry of an IPv6 address will become unavailable.
- **Default:** Off

[IP address(IPv6)]

When “On” is selected for “Manual”, manual entry of the IPv6 address is required. Do not enter an address already in use.

Note

- When connecting to the manually configured IPv6 address beyond the router, use an IPv6 compatible router and turn on the automatic IPv6 address assignment function. In this case, it is necessary to configure IPv6 address including prefix information provided from the IPv6 compatible router. Refer to the manuals provided with the router for further information.

[Default gateway]

When “On” is selected for “Manual” of IPv6 network, enter the default gateway of IPv6 network of the camera.

- **Default:** None (blank)

[DHCPv6]

Select “On” or “Off” to determine whether or not to use the IPv6 DHCP function.

Configure the DHCP server not to assign the same IP addresses used for the other network cameras and PCs whose IP address is unique. Refer to the network administrator for further information about the settings of the server.

- **Default:** Off

[Primary DNS server address], [Secondary DNS server address]

Enter the IPv6 address of the DNS server. Refer to the network administrator about the IPv6 address of the DNS server.

Common

[HTTP port]

Assign the port numbers independently.

- **Available port number:** 1 - 65535
- **Default:** 80

The following port numbers are unavailable since they are already in use.

20, 21, 23, 25, 42, 53, 67, 68, 69, 110, 123, 161, 162, 443, 554, 995, 10669, 10670, 32768-49151, 59000-61000

[Line speed]

Select the line speed for data transmission from the following. It is recommended to use with the default “Auto”.

- **Auto:** Line speed will be applied automatically.
- **100M-Full:** 100 Mbps full-duplex
- **100M-Half:** 100 Mbps half-duplex
- **10M-Full:** 10 Mbps full-duplex
- **10M-Half:** 10 Mbps half-duplex
- **Default:** Auto

[Max RTP packet size]

Select “Unlimited(1500byte)” or “Limited(1280byte)” to determine whether or not to restrict the RTP packet size when viewing images from the camera using the RTP protocol. It is recommended to use with the default “Unlimited(1500byte)”.

When the RTP packet size is restricted in the network line in use, select “Limited(1280byte)”. Refer to the network administrator for further information about the maximum packet size in the network line.

- **Default:** Unlimited(1500byte)

[HTTP max segment size(MSS)]

Select “Unlimited(1460byte)”, “Limited(1280byte)”, or “Limited(1024byte)” to determine whether or not to restrict the maximum segment size (MSS) when viewing images from the camera using the HTTP protocol. We recommended that you use this feature with the default setting.

When the MSS is restricted in the network line in use, select “Limited(1024byte)” or “Limited(1280byte)”. Refer to the network administrator for further information about the MSS in the network line.

- **Default:** Unlimited(1460byte)

[Bandwidth control(bit rate)]

Select the total bit rate for data transmission from the following.

X8570N

Unlimited/ 4096 kbps/ 6144 kbps/ 8192 kbps/ 10240 kbps/ 12288kbps/ 15360 kbps/ 20480 kbps/ 25600 kbps/ 30720 kbps/ 35840kbps/ 40960 kbps/ 51200 kbps/ 61440 kbps/ 81920 kbps/ 102400 kbps/ 153600 kbps

S8530N

Unlimited/ 256kbps/ 384kbps/ 512kbps/ 768kbps/ 1024kbps/ 2048kbps/ 4096kbps/ 6144kbps/ 8192kbps/ 10240 kbps/ 12288kbps/ 15360 kbps/ 20480 kbps/ 25600 kbps/ 30720kbps/ 35840kbps/ 40960 kbps/ 51200kbps/ 61440 kbps/ 81920kbps/ 102400 kbps/ 153600 kbps

- **Default:** 81920kbps **X8570N**, 51200kbps **S8530N**

Note

- When “Bandwidth control(bit rate)” is set low, taking a picture using the snap shot button may not function depending on the usage environment. In this case, select “JPEG” on the “Live” page and take a picture with the snap shot button using the lowest possible image capture size.
- In order to play back the images saved in the SD memory card, it is required to set “Unlimited” or “51200kbps” or more for “Bandwidth control(bit rate)”.

[Easy IP Setup accommodate period]

Select “20min” or “Unlimited” to determine how long the network setting operation using the Panasonic “IP Setting Software” can be allowed.

- **20min:** The network setting operation using the Panasonic “IP Setting Software” are allowed for 20 minutes since the camera starts up.
- **Unlimited:** The network setting operation using the Panasonic “IP Setting Software” are allowed without time limitation.
- **Default:** 20min

Note

- The camera information display using the Panasonic “IP Setting Software” is allowed without time limitation, and camera images can be opened.
- Refer to the network administrator for the addresses of each server.
- The port forwarding function changes a global IP address to a private IP address, and “Static IP masquerade” and “Network Address Translation (NAT)” have this function. This function is to be set in a router.

2 Settings

- To access the camera via the Internet by connecting the camera to a router, it is necessary to assign a respective HTTP port number for each camera and address translation by using the port forwarding function of the router. For further information, refer to the operating instructions of the router in use.

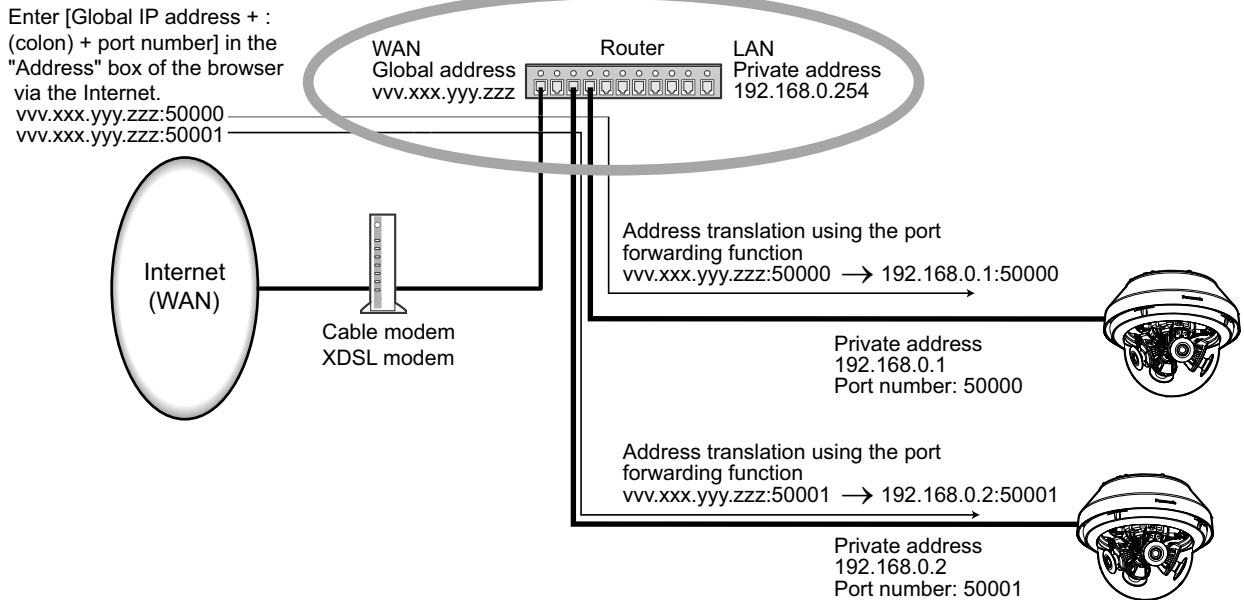

[FTP access to camera]

Select "Allow" or "Forbid" to determine whether to allow or forbid the FTP access to camera.

- Default:** Forbid

IMPORTANT

- If you allow FTP access to the camera, there is a possibility that authentication information (user names, passwords, etc.) will be leaked when accessing the camera from a PC.

2.8.2 Configure advanced network settings [Advanced]

Click the [Advanced] tab on the "Network" page. (→page 37, page 38)

The settings related to SMTP (E-mail), NTP, UPnP, HTTPS, DDNS, SNMP, QoS can be configured in this section.

You can move to the setting page of a setting item by clicking the corresponding link for that setting item.

2.8.2.1 Configure the settings related to sending E-mails

Network		Advanced
SMTP(E-mail) NTP UPnP HTTPS DDNS SNMP QoS		
SMTP(E-mail)		
E-mail notification	<input checked="" type="radio"/> On <input type="radio"/> Off	
Alarm image attachment	<input checked="" type="radio"/> On <input type="radio"/> Off	
Image capture size	640x360	
SMTP server address	<input type="text" value="Example of entry: 192.168.0.10"/>	
SMTP port	<input type="text" value="25"/> (1-65535)	
POP server address	<input type="text" value="Example of entry: 192.168.0.10"/>	
Authentication	Type	<input checked="" type="radio"/> None <input type="radio"/> POP before SMTP <input type="radio"/> SMTP
	User name	<input type="text"/>
	Password	<input type="text"/>
Sender's E-mail address	<input type="text"/>	
SSL	<input type="radio"/> On <input type="radio"/> Off	
Destination of notification		Destination E-mail address
Address 1	<input type="text"/>	Delete
	<input type="checkbox"/> Terminal 1 <input type="checkbox"/> Terminal 2 <input type="checkbox"/> Terminal 3 <input type="checkbox"/> VMD <input type="checkbox"/> Command alarm <input type="checkbox"/> Diag.	
Address 2	<input type="text"/>	Delete
	<input type="checkbox"/> Terminal 1 <input type="checkbox"/> Terminal 2 <input type="checkbox"/> Terminal 3 <input type="checkbox"/> VMD <input type="checkbox"/> Command alarm <input type="checkbox"/> Diag.	
Address 3	<input type="text"/>	Delete
	<input type="checkbox"/> Terminal 1 <input type="checkbox"/> Terminal 2 <input type="checkbox"/> Terminal 3 <input type="checkbox"/> VMD <input type="checkbox"/> Command alarm <input type="checkbox"/> Diag.	
Address 4	<input type="text"/>	Delete
	<input type="checkbox"/> Terminal 1 <input type="checkbox"/> Terminal 2 <input type="checkbox"/> Terminal 3 <input type="checkbox"/> VMD <input type="checkbox"/> Command alarm <input type="checkbox"/> Diag.	
E-mail subject	<input type="checkbox"/> Use the camera title <input type="checkbox"/> Cause of alarm <input type="text"/>	
E-mail body	<input checked="" type="checkbox"/> Cause of alarm <input checked="" type="checkbox"/> Occurrence time The %p% alarm was occurred at %%.	
Terminal name		
Terminal 1 (Up to 10 characters)	<input type="text" value="Terminal1"/>	
Terminal 2 (Up to 10 characters)	<input type="text" value="Terminal2"/>	
Terminal 3 (Up to 10 characters)	<input type="text" value="Terminal3"/>	
Set		

[E-mail notification]

Select “On” or “Off” to determine whether or not to provide notification by E-mail according to the settings for the “Alarm” and “Diag.” checkboxes of “Destination of notification” below.

- When an alarm is detected (“Alarm”)
- When a notification of the remaining capacity of the SD memory card has been provided (“Diag.”)
- When the SD memory card has become full (“Diag.”)
- When the SD memory card cannot be recognized (“Diag.”)
- **Default:** Off

[Alarm image attachment]

Select “On” or “Off” to determine whether or not to attach an image to the E-mail to be sent when an alarm is detected.

- **Default:** Off

[Image capture size]

The image capture size of the image to be attached to an alarm E-mail is 640x360 or VGA.

[SMTP server address]

Enter the IP address or the host name of the SMTP server used to send E-mails.

- **Available number of characters:** 1 - 128 characters
- **Available characters:** Alphanumeric characters, the colon (:), the period (.), the underscore (_), and the hyphen (-).

[SMTP port]

Enter the port number to which E-mails are sent.

- **Available port number:** 1-65535
- **Default:** 25

The following port numbers are unavailable since they are already in use.

20, 21, 23, 42, 53, 67, 68, 69, 80, 110, 123, 161, 162, 443, 995, 10669, 10670

[POP server address]

When “POP before SMTP” is selected for “Type”, enter the IP address or the host name of the POP server.

- **Available number of characters:** 1 - 128 characters
- **Available characters:** Alphanumeric characters, the colon (:), the period (.), the underscore (_), and the hyphen (-).

IMPORTANT

- When entering the host name for “SMTP server address” or “POP server address”, it is necessary to configure the DNS settings on the [Network] tab of the “Network” page. (→page 134)

[Authentication]

- **Type**

Select the authentication method to send E-mails from the following.

- **None:** It is not necessary to clear any authentication to send E-mails.
- **POP before SMTP:** It is necessary to first clear the POP server authentication to use the SMTP server to send E-mails.
- **SMTP:** It is necessary to clear the SMTP server authentication to send E-mails.
- **Default:** None

Note

- When you don’t know the authentication method to send E-mails, refer to the network administrator.
- **User name**

Enter the user name to access the server.

- **Available number of characters:** 0 - 32 characters
- **Unavailable characters:** " & ; ; \

- **Password**

Enter the password to access the server.

- **Available number of characters:** 0 - 32 characters
- **Unavailable characters:** " &

[Sender's E-mail address]

Enter the E-mail address of a sender.

The entered E-mail address will be displayed in the "From" (sender) line of the sent E-mails.

- **Available number of characters:** 3 - 128 characters
- **Available characters:** Alphanumeric characters, the at sign (@), the period (.), the underscore (_), and the hyphen (-).

[SSL]

Select "On" if you want to use SSL encryption when sending E-mail notifications for alarm occurrences or the "Diag." function. When you select "On", the authentication method will be set to "SMTP". Set the user name and the password used for authentication.

- **Default:** Off

Note

- Some SMTP servers may not support SSL.
- SSL supports SMTP over SSL, but STARTTLS is not supported.
- When "On" is selected, the SMTP port number may need to be set to 465. Ask your Internet service provider for the appropriate settings.

[Address 1] - [Address 4]

Enter the destination E-mail address. Up to 4 destination E-mail addresses can be registered.

- **Available number of characters:** 3 - 128 characters
- **Available characters:** Alphanumeric characters, the at sign (@), the period (.), the underscore (_), and the hyphen (-).

To delete the registered address, click the [Delete] button respective to the desired address.

- **Terminal 1** (X8570N): Notify by e-mail when an alarm occurs in Terminal 1.
- **Terminal 2** (X8570N): Notify by e-mail when an alarm occurs in Terminal 2.
- **Terminal 3** (X8570N): Notify by e-mail when an alarm occurs in Terminal 3.
- **VMD:** Notify by e-mail when motion is detected.
- **Command alarm:** Notify by e-mail when a command alarm is entered.
- **Diag.:**
 - When a notification of the remaining capacity of SD memory card has been provided
 - When the SD memory card has become full
 - When the SD memory card cannot be recognized

Note

- In the diagnostic e-mail notification sent when you have checked the destination of notification [Diag.] field, the contents of the [E-mail subject] and [E-mail body] which are set later are not changed.

[E-mail subject]

Enter the E-mail subject.

- **Available number of characters:** 0 - 50 characters
- **Use the camera title:** The camera title will be displayed in the e-mail subject.
- **Cause of alarm:** Adds the cause of alarm to the E-mail subject.

[E-mail body]

Enter the E-mail body.

- **Available number of characters:** 0 - 200 characters
- **Cause of alarm:** The cause of alarm %p% is added in the e-mail body. %p% is replaced by the cause of alarm and sent.
 - For VMD alarm of Camera 1: "VMD(CH1)"
For VMD alarm of Camera 2: "VMD(CH2)"
For VMD alarm of Camera 3: "VMD(CH3)"
For VMD alarm of Camera 4: "VMD(CH4)"
 - For terminal alarm: Terminal name set in "Terminal 1", "Terminal 2", and "Terminal 3" of "Terminal name". (Example: If the name of Terminal 1 is "Terminal1", it is "Terminal1") **X8570N**
 - For command alarm: "CMD"
- **Occurrence time:** The time of occurrence %t% will be added to the e-mail body. %t% will be replaced by the time of occurrence of the alarm (HH:MM:SS) and sent.
- **Default:**
 - Cause of alarm: Checked
 - Occurrence time: Checked
 - E-mail body: The %p% alarm was occurred at %t%.

Note

- Notification E-mail will be sent with the message "The capacity of the SD memory card is full." when the SD memory card has become full, or "The SD memory card cannot be detected." when mounting of the SD memory card failed.
- Entering alternative text into the E-mail body automatically adds the event or time when an alarm occurs.
Alternative text cause of alarm: %p%, occurrence time: %t%
(Examples of use)
After setting the following characters in the E-mail body, there is a Camera 1 VMD alarm occurrence at the time 19:13:24.
E-mail body settings: %p% alarm occurred at %t%.
Sent E-mail body: "A "VMD(CH1)" alarm occurred at 19:13:24."
When the body of the email is empty, the language that the email is sent in is determined by "Menu language" of "Basic". If "Japanese" is specified, email is sent in Japanese. If another language is specified, email is sent in English.

[Terminal 1 (Up to 10 characters)] **X8570N**

Enter the name of Terminal 1 used in the cause of alarm in the e-mail body.

- **Unavailable characters:** " &
- **Default:** Terminal1

[Terminal 2 (Up to 10 characters)] **X8570N**

Enter the name of Terminal 2 used in the cause of alarm in the e-mail body.

- **Unavailable characters:** " &
- **Default:** Terminal2

[Terminal 3 (Up to 10 characters)] **X8570N**

Enter the name of Terminal 3 used in the cause of alarm in the e-mail body.

- **Unavailable characters:** " &
- **Default:** Terminal3

Example of e-mail notification

An e-mail format in which the camera title check box is specified in the e-mail subject and the cause of alarm/occurrence time are specified in the e-mail body

Example e-mail:

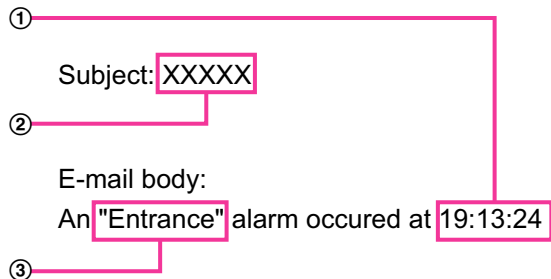

- ① The alarm occurrence time is assigned.
- ② The camera title is used as the e-mail subject.
- ③ The name set for Terminal names 1 to 3, which is the cause of alarm, is assigned to the name.

2.8.2.2 Configure the settings relating to the NTP server

The settings relating to the NTP server such as the NTP server address, port number, etc. can be configured on this page.

IMPORTANT

- Use an NTP server when the more accurate time & date setting is required for the system operation.

[Time adjustment]

Select the time adjustment method from the following. Time adjusted by the selected method will be used as the standard time of the camera.

- Manual:** Time set on the [Basic] tab on the “Basic” page will be used as the standard time of the camera.
- Synchronization with NTP server:** Time automatically adjusted by synchronizing with the NTP server will be used as the standard time of the camera.
- Default:** Manual

[NTP server address setting]

When “Synchronization with NTP server” is selected for “Time adjustment”, select the method of how to obtain the NTP server address from the following.

- **Auto:** Obtains the NTP server address from the DHCP server.
- **Manual:** The NTP server address will be entered manually on “NTP server address”.
- **Default:** Manual

IMPORTANT

- When obtaining the NTP server address from the DHCP server, it is necessary to select “DHCP”, “Auto(AutoIP)”, or “Auto(Advanced)” for “Network Settings” on the [Network] tab of the “Network” page. (→page 134)

[NTP server address]

When “Manual” is selected for “NTP server address setting”, enter the IP address or the host name of the NTP server.

- **Available number of characters:** 1 - 128 characters
- **Available characters:** Alphanumeric characters, the colon (:), the period (.), the underscore (_), and the hyphen (-).
- **Default:** None (blank)

IMPORTANT

- When entering the host name for “NTP server address”, it is necessary to configure the DNS settings on the [Network] tab of the “Network” page. (→page 134)

[NTP port]

Enter a port number of the NTP server.

- **Available port number:** 1 - 65535
- **Default:** 123

The following port numbers are unavailable since they are already in use.

20, 21, 23, 25, 42, 53, 67, 68, 69, 80, 110, 161, 162, 443, 995, 10669, 10670

[Time adjustment interval]

Select an interval (1 - 24 hours: in 1 hour intervals) of synchronization with the NTP server.

- **Default:** 1h

2.8.2.3 Configure the UPnP settings

This camera support UPnP (Universal Plug and Play). By using the UPnP function, it becomes possible to configure the following automatically.

- Configuration of the port forwarding function of the router (However, a router supporting UPnP is required.) This configuration is useful when accessing the camera via the Internet, or from a mobile terminal or tablet device.

- Automatic refreshment of the shortcut to the camera that is created on the [Network] folder of the PC even when the IP address of the camera changes.

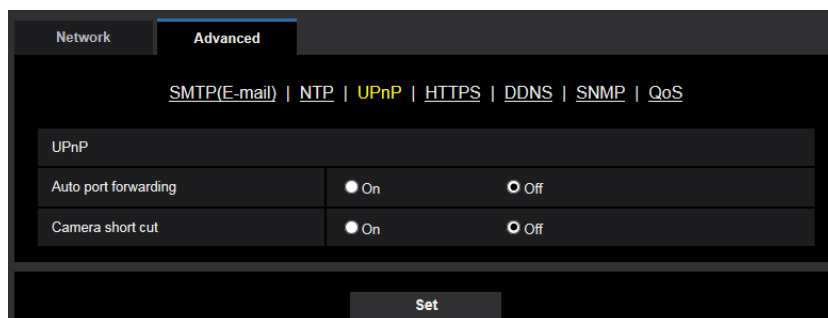

[Auto port forwarding]

Select “On” or “Off” to determine whether or not to use the port forwarding function of the router.

To use the port forwarding function, the router in use must support UPnP and the UPnP must be enabled.

- **Default:** Off

Note

- Due to port forwarding, the port number may sometimes be changed. When the number is changed, it is necessary to change the port numbers registered in the PC and recorders, etc.
- The UPnP function is available when the camera is connected to the IPv4 network. IPv6 is not supported.
- To check if auto port forwarding is properly configured, click the [Status] tab on the “Maintenance” page, and check that the “Enable” is displayed for “Status” of “UPnP”. (→page 184)
When “Enable” is not displayed, refer to “Cannot access the camera via the Internet.” in the “3.3 Troubleshooting” section. (→page 201)

[Camera short cut]

Select whether or not to create the shortcut to the camera on the [Network] folder of the PC. When creating the shortcut, select “On”.

To use the shortcut function to the camera, enable the UPnP function on the PC in advance.

- **Default:** Off

Note

- To display the shortcut to the camera on the [Network] folder of the PC, it is necessary to add the Windows component. Refer to the following to enable the UPnP function.

For Windows 7

[Start] → [Control Panel] → [Network and Internet] → [Network and Sharing Center] → select [Turn on network discovery] of [Network discovery] of [Change advanced sharing settings] → click [Save changes] → Complete

For Windows 8.1

Right-click [Start] → select [Control Panel] → [Network and Internet] → [Network and Sharing Center] → select [Turn on network discovery] of [Network discovery] of [Change advanced sharing settings] → click [Save changes] → Complete

For Windows 10

[Start] → [Settings] → [NETWORK & INTERNET] → [Ethernet] → [Network and Sharing Center] → select [Turn on network discovery] of [Network discovery] of [Change advanced sharing settings] → click [Save changes] → Complete

2.8.2.4 Configure the HTTPS settings

It is possible to enhance the network security by encrypting the access to cameras using the HTTPS function. Refer to page 152 for how to configure the HTTPS settings.

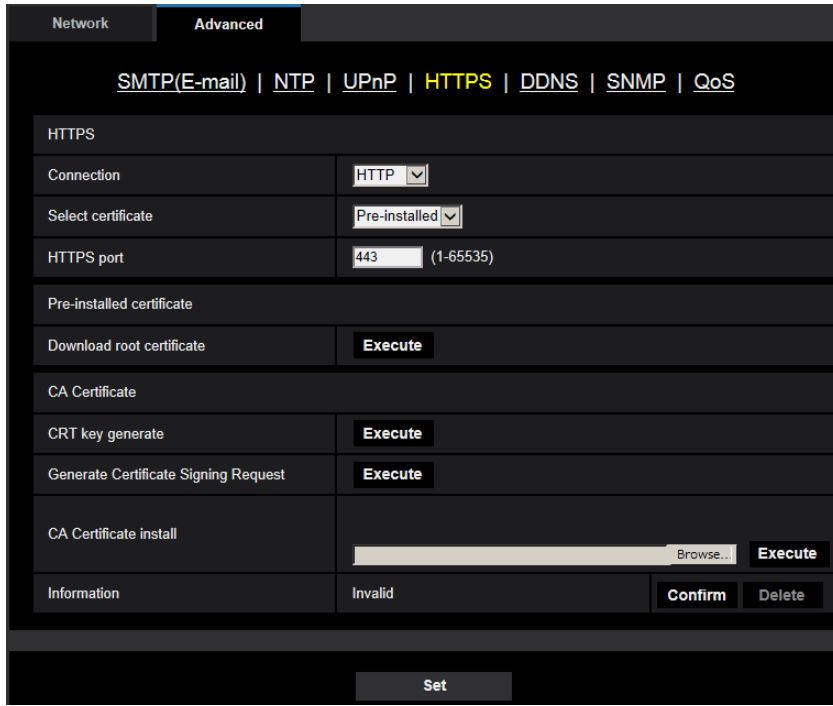

[HTTPS - Connection]

Select the protocol used to connect the camera.

- **HTTP:** Only the HTTP connection is available.
- **HTTPS:** Only the HTTPS connection is available.
- **Default:** HTTP

Note

- To change to an HTTPS connection when HTTP is selected, perform HTTPS connection settings first. The HTTPS connection will be available even if the setting is changed to HTTP afterwards.

[HTTPS - Select certificate]

Select the certificate to be used with HTTPS.

- **Pre-installed:** Select a pre-installed certificate.
- **CA:** Select a CA certificate. Only displayed when the CA Certificate is installed.
- **Default:** Pre-installed

[HTTPS - HTTPS port]

Designate the HTTPS port number to be used.

- **Available port number:** 1 - 65535
- **Default:** 443

The following port numbers are unavailable since they are already in use.

20, 21, 23, 25, 42, 53, 67, 68, 69, 80, 110, 123, 161, 162, 554, 995, 10669, 10670, 32768-49151, 59000-61000

[Pre-installed certificate - Download root certificate]

Click the [Execute] button to download the root certificate for the pre-installed certificate. By installing the root certificate to your PC, you can get signature verification for the pre-installed certificate.

[CRT key generate]

CRT key (SSL encryption key) used for the HTTPS protocol is generated. To generate the CRT key, click the [Execute] button to display "CRT key generate" dialog box.

[CA Certificate - Generate Certificate Signing Request]

When using the CA certificate issued by CA (Certificate Authority) as the CA certificate used for the HTTPS protocol, the CSR (Certificate Signing Request) will be generated.

To generate the CSR, click the [Execute] button to display the "CA Certificate - Generate Certificate Signing Request" dialog window.

[CA Certificate - CA Certificate install]

Installs the CA certificate issued by CA (Certificate Authority) and displays the information of the installed CA certificate.

To install the CA certificate, click the [Browse...] button to display the [Open] dialog box, and select the file of the CA certificate issued by CA, and click the [Execute] button.

If the CA certificate is already installed, the file name of the installed CA certificate will be displayed.

[CA Certificate - Information]

Displays the information of the CA certificate.

When the [Confirm] button is clicked, the registered information of the installed CA certificate will be displayed in the "CA Certificate - Confirm" dialog box. If the CA certificate is not installed, the content of the generated CSR file will be displayed.

When the [Delete] button is clicked, the installed CA certificate will be deleted.

IMPORTANT

- Before deleting the valid CA certificate, confirm that there is a backup file of the CA certificate on the PC or another media. The backup file of the CA certificate will be required when installing the CA certificate again.

Note

- After changing the connection setting, access the camera again by after waiting a while according to the changed setting ("http://IP address of the camera" or "https://IP address of the camera").
- When the camera is accessed using the HTTPS protocol, the refresh interval and frame rate of images may be lower.
- When the camera is accessed using the HTTPS protocol, it may take time to display images.
- When the camera is accessed using the HTTPS protocol, the images may be distorted or audio may be interrupted.
- When accessing to the camera via HTTPS, the maximum number of cameras that can be connected simultaneously will be reduced.
- The maximum number of concurrent access user varies depending on the maximum image size and transmission format.

2.8.2.5 Configure the settings relating to DDNS

To access this camera via the Internet, it is necessary to configure the settings for the DDNS function.

2 Settings

Refer to page 169 for how to configure the settings relating to DDNS.

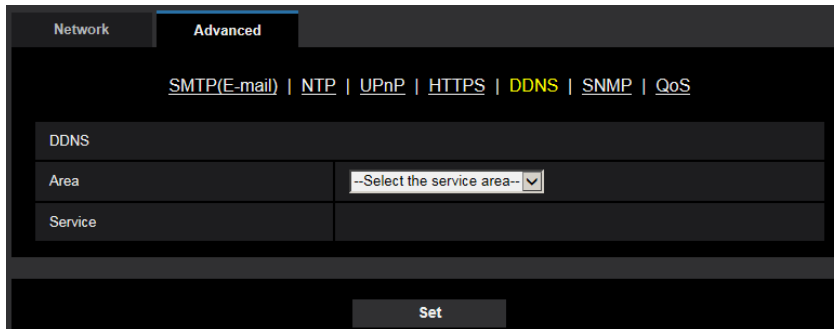

The screenshot shows the 'Advanced' settings page for DDNS. At the top, there are navigation links: SMTP(E-mail), NTP, UPnP, HTTPS, DDNS (highlighted), SNMP, and QoS. Below these, the 'DDNS' section is visible. It contains a table with two rows: 'Area' and 'Service'. The 'Area' row has a dropdown menu with the text '--Select the service area--'. The 'Service' row is currently empty. At the bottom of the form is a 'Set' button.

[Area]

Select the region where the camera is installed.
Japan/Global

Note

- If the camera is used in Japan, select “Japan”. If the camera is used outside of Japan, select “Global”. The “Viewnetcam.com” service that is displayed when “Global” is selected cannot be used in Japan.

[Service]

Select the DDNS service to determine whether or not to use DDNS.

- **Off:** Does not use the DDNS function.
- **Viewnetcam.com:** Uses the “Viewnetcam.com” service.
- **Dynamic DNS Update:** Uses Dynamic DNS Update (RFC2136 compliant) without the DHCP cooperation.
- **Dynamic DNS Update(DHCP):** Uses Dynamic DNS Update (RFC2136 compliant) with the DHCP cooperation.
- **Default:** Off

Note

- When using Dynamic DNS Update (RFC2136 compliant), refer to the network administrator for whether or not to cooperate with the DHCP.

2.8.2.6 Configure the settings relating to SNMP

The settings relating to SNMP can be configured on this page. It is possible to check the status of the camera by connecting to the SNMP manager. When using the SNMP function, contact the network administrator.

[SNMP version]

Select the SNMP version to be used.

- **SNMPv1/v2:** SNMPv1/v2 is activated.
- **SNMPv3:** SNMPv3 is activated.
- **SNMPv1/v2/v3:** SNMPv1/v2/v3 is activated.
- **Default:** SNMPv1/v2

[SNMPv1/v2] - [Community]

Enter the community name to be monitored.

- **Available number of characters:** 0 - 32 characters
- **Default:** None (blank)

IMPORTANT

- When using the SNMP function, it is necessary to enter the community name. When no community name is entered, the SNMP function will not work.

[SNMPv3] - [User name]

Set the SNMPv3 user name.

- **Available number of characters:** Empty field or 1 - 32 characters
- **Unavailable characters:** " & ; \

[SNMPv3] - [Authentication]

Select the SNMPv3 authentication method from MD5 or SHA1.

- **Default:** MD5

[SNMPv3] - [Encryption method]

Select the SNMPv3 encryption method from DES or AES.

- **Default:** DES

[SNMPv3] - [Password]

Set the SNMPv3 password.

- **Available number of characters:**
 - If the authentication method is MD5: Empty field or 8-16 characters
 - If the authentication method is SHA1: Empty field or 8-20 characters
- **Unavailable characters:** " &

[System name]

Enter a system name to be used to manage the camera with the SNMP function.

- **Available number of characters:** 0 - 32 characters
- **Default:** None (blank)

[Location]

Enter the name of the location where the camera is installed.

- **Available number of characters:** 0 - 32 characters
- **Default:** None (blank)

[Contact]

Enter the E-mail address or the phone number of the SNMP manager.

- **Available number of characters:** 0 - 255 characters
- **Default:** None (blank)

2.8.2.7 Configure the QoS settings

The settings relating to the Diffserv function and shaping of stream are configured in this section.

Diffserv

The Diffserv function can be used to set the priority of image/audio data sent from routers. The priority set to this function must match the DSCP value configured to the router. When using the Diffserv function, contact the network administrator.

The screenshot shows a configuration page for Diffserv. At the top, there are navigation links: [SMTP\(E-mail\)](#), [NTP](#), [UPnP](#), [HTTPS](#), [DDNS](#), [SNMP](#), and [QoS](#). The 'Diffserv' section contains the following fields:

Image DSCP(0-63)	<input type="text" value="0"/>
Audio DSCP(0-63)	<input type="text" value="0"/>
Panasonic alarm protocol notification DSCP (0-63)	<input type="text" value="0"/>

Below the fields is the 'Shaping of stream' section with two radio buttons: On and Off. A 'Set' button is located at the bottom of the configuration area.

[Image DSCP(0-63)]

Enter the packet priority for video data.

- **Available values:** 0 - 63
- **Default:** 0

[Audio DSCP(0-63)] X8570N

Enter the packet priority for audio transmission/reception.

- **Available values:** 0 - 63
- **Default:** 0

[Panasonic alarm protocol notification DSCP(0-63)]

Enter the packet priority for Panasonic alarm protocol notification.

- **Available values:** 0 - 63
- **Default:** 0

Shaping of stream

[Shaping of stream]

Select On/Off to determine whether or not to control the H.265 (or H.264) image data so that it does not burst. It is effective in situations such as when a network device loses video data from the camera, but the video display may be delayed.

- **Off:** Disables the shaping of stream function.
- **On:** Enables the shaping of stream function.
- **Default:** Off

2.8.3 How to configure HTTPS settings

The settings relating to the HTTPS protocol that can enhance the network security by encrypting the access to cameras on this page.

HTTPS settings can be configured by either using the certificate pre-installed to the camera, or using a CA certificate that you obtained by yourself from the CA (CA: Certification Authority). The settings will be configured in the following procedure.

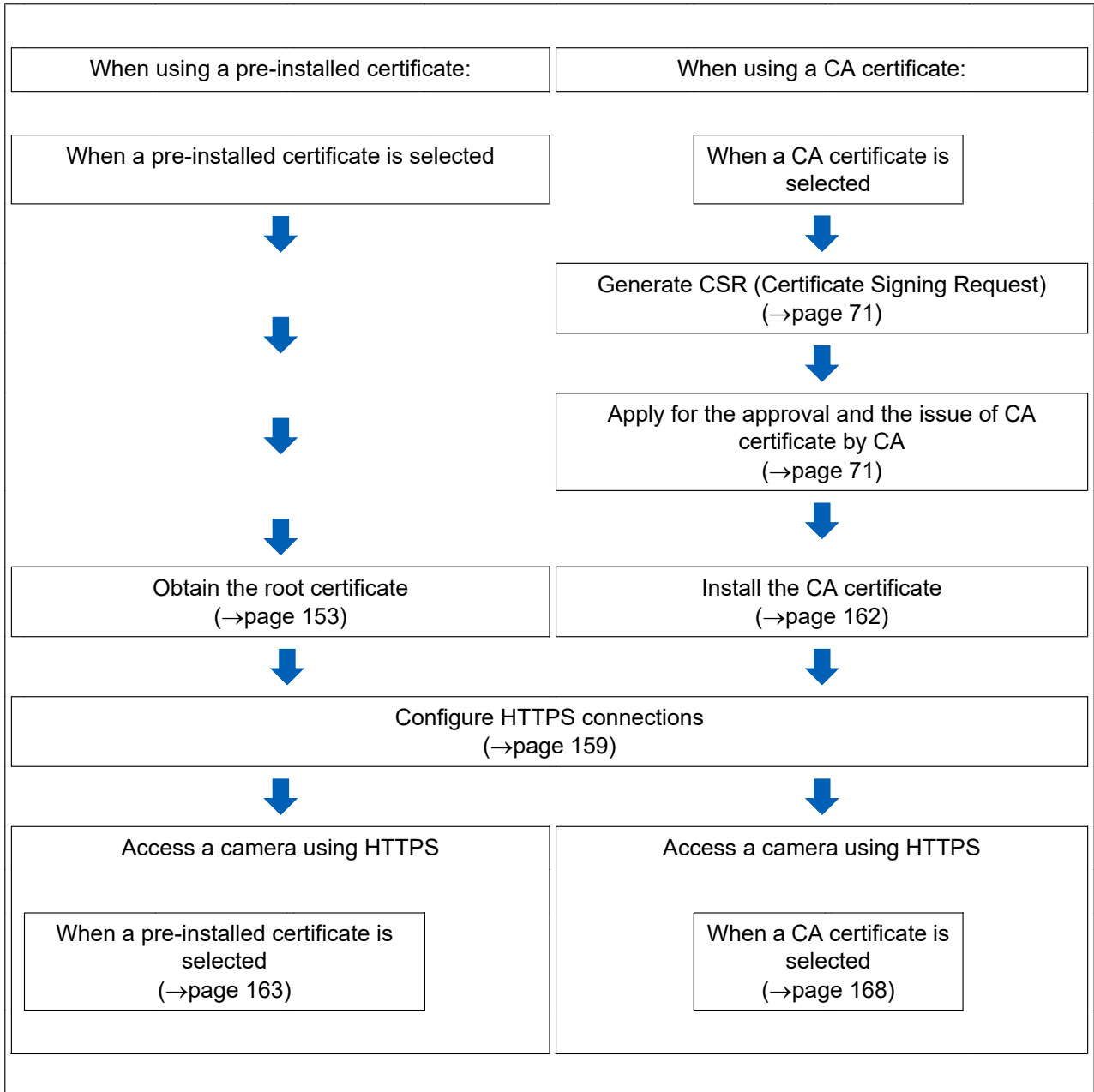

HTTPS	
Connection	HTTP <input type="button" value="v"/>
Select certificate	Pre-installed <input type="button" value="v"/>
HTTPS port	443 (1-65535)
Pre-installed certificate	
Download root certificate	<input type="button" value="Execute"/>
CA Certificate	
CRT key generate	<input type="button" value="Execute"/>
Generate Certificate Signing Request	<input type="button" value="Execute"/>
CA Certificate install	<input type="text" value=""/> <input type="button" value="Browse..."/> <input type="button" value="Execute"/>
Information	Invalid <input type="button" value="Confirm"/> <input type="button" value="Delete"/>

- ① Configuring the HTTPS connection (→page 159)
- ② Select the certificate (→page 153)
- ③ Obtain the root certificate (→page 153)
- ④ Generation of the CRT key (SSL encryption key) (→page 160)
- ⑤ Generation of CSR (Certificate Signing Request) (→page 161)
- ⑥ Install the CA certificate (→page 162)

Note

- To use the CA certificate, you need to apply for the approval and the issue of CA certificate by CA.

2.8.3.1 Select the certificate to use when accessing with HTTPS

Select the certificate to be used with HTTPS with [HTTPS – Select certificate].

- **When using a pre-installed certificate:** Select “Pre-installed”.
When “Pre-installed” is selected, a root certificate (page 153) must be obtained.
- **When using a CA certificate:** Select “CA”.

Note

- “CA” can only be selected when a CA certificate has been added. Refer to page 152 for information on how to add a CA certificate.

2.8.3.2 Obtaining the root certificate

This procedure only needs to be done once for each PC that accesses the camera.

2 Settings

1. Access the camera, and click the [Execute] button for “Pre-installed certificate - Download root certificate” under “HTTPS” in the [Advanced] tab in the settings menu of the “Network” page. Click “Open” displayed on the bottom of the browser.

The screenshot displays the web interface of a Network Camera. The left sidebar contains a menu with categories: Live, Setup, -Easy Setup, -Basic, -Image/Audio, -Alarm, +User mng., -Network, +Schedule, +Maintenance, and +Support. The 'Setup' category is expanded, and the 'Network' sub-category is selected, with the 'Advanced' sub-tab active. The main content area shows the 'HTTPS' configuration page, with sub-tabs for SMTP(E-mail), NTP, UPnP, HTTPS, DDNS, SNMP, and QoS. The 'HTTPS' sub-tab is selected. The configuration table includes the following rows:

HTTPS	
Connection	HTTP
Select certificate	Pre-installed
HTTPS port	443 (1-65535)
Pre-installed certificate	
Download root certificate	Execute
CA Certificate	
CRT key generate	Execute
Generate Certificate Signing Request	Execute
CA Certificate install	Browse... Execute
Information	Invalid Confirm Delete

At the bottom of the browser window, a download bar is visible with the text: "Do you want to open or save rootca.cer (1.03 KB) from 192.168.0.10?". The 'Open' button is highlighted with a red box.

2. Click “Install Certificate...”.

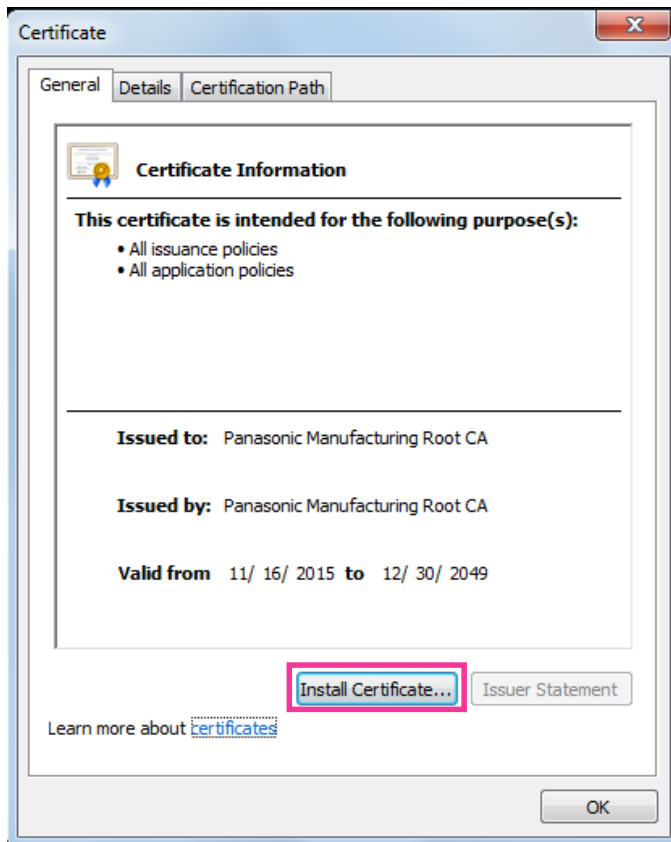

3. Click “Next” displayed in “Certificate Import Wizard”.

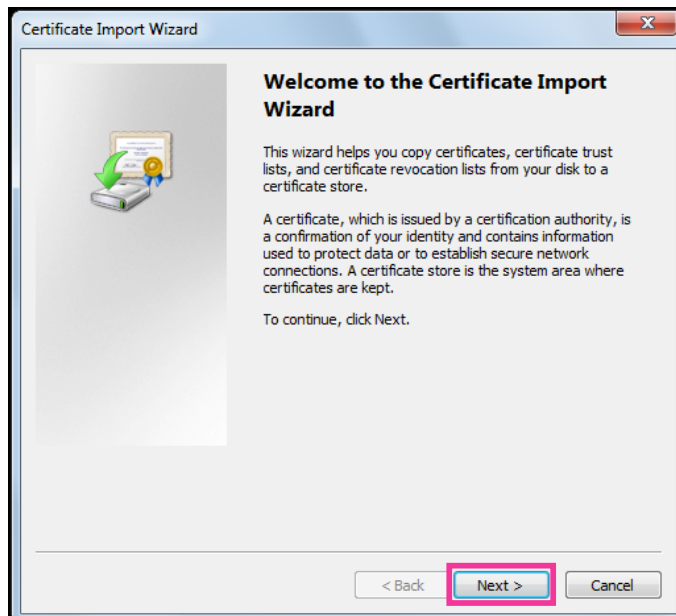

4. Select “Place all certificates in the following store”, and click “Browse...”.

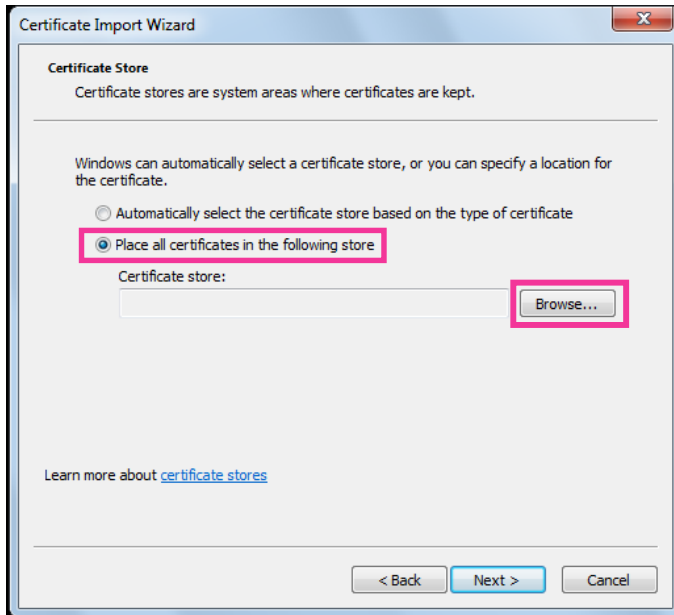

5. Select “Trusted Root Certificate Authorities”, and click “OK”.

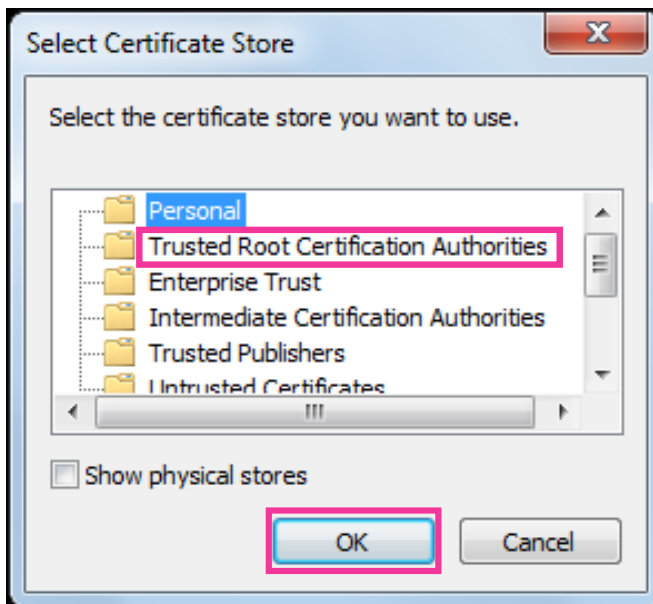

6. Click “Next”.

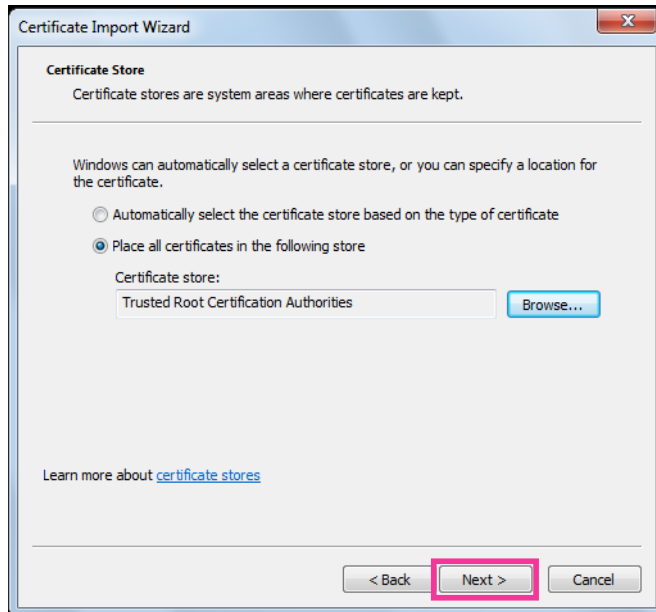

7. Click “Finish”.

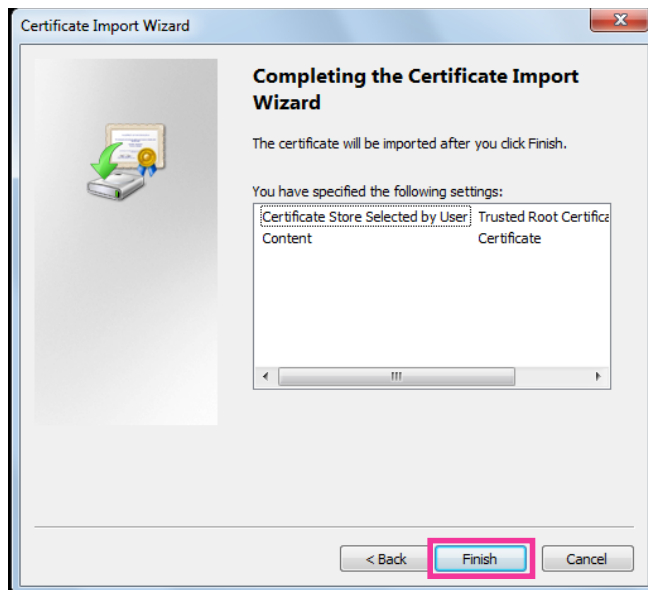

8. Confirm that the content shown next to “Thumbprint” in the “Security warning” window is as follows and then click “Yes”.
- Thumbprint (sha1): 0B886A3C E7F2DBA8 1035DDFA 2B21F80B 06778932

Note

- Other parties cannot create another thumbprint with the same values. You can confirm that you have retrieved the correct root certificate from the specified camera by confirming the values of the thumbprint.

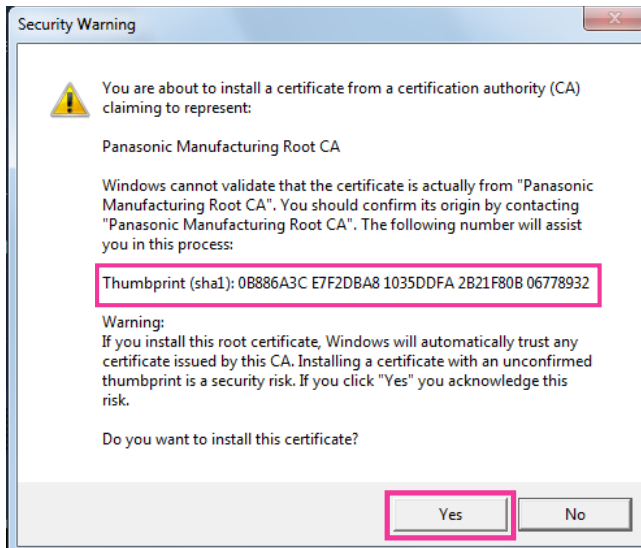

→ When the import is successfully completed, the screen "The import was successful." will be displayed.

9. Click the [OK] button.

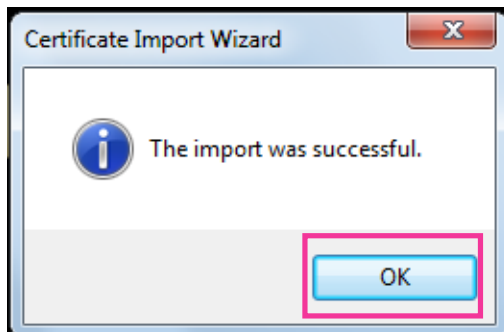

10. Click the [OK] button in the “Certificate” window to close the window.

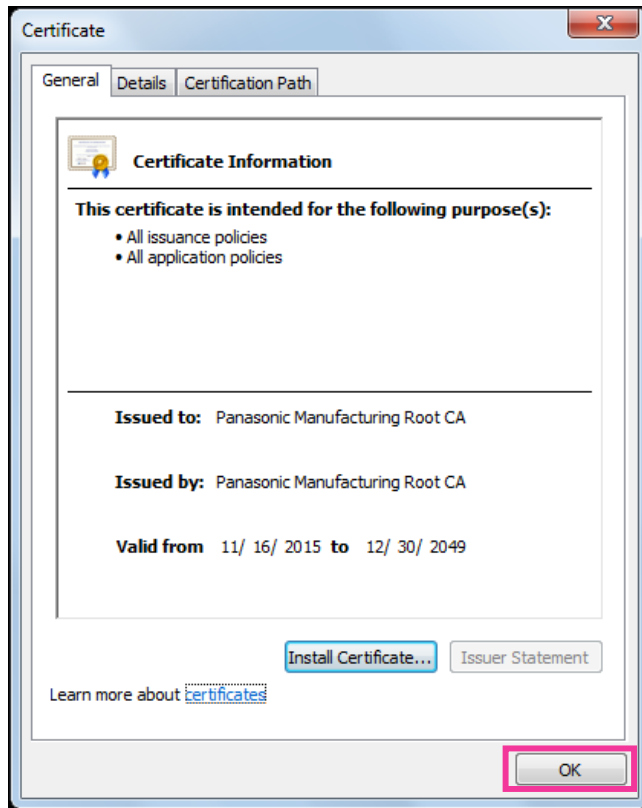

2.8.3.3 Configuration of HTTPS connections

1. Select “HTTPS” to access the camera in [HTTPS – Connection].
2. Designate the HTTPS port number to be used for [HTTPS – HTTPS port].
 - **Available port number:** 1 - 65535
 - **Default:** 443

The following port numbers are unavailable since they are already in use.
20, 21, 23, 25, 42, 53, 67, 68, 69, 80, 110, 123, 161, 162, 554, 995, 10669, 10670, 32768-49151, 59000-61000
3. Click the [Set] button.
 - It will become possible to access to the cameras using the HTTPS protocol.
Restart the browser and access again.
Refer to the following for information on methods to access cameras using HTTPS.
 - **Monitor images on a PC:** page 9
 - **Monitor images on a mobile terminal:** page 16
 - **Monitor images on a tablet device:** page 20
4. If “Certificate error” is displayed, refer to the following.
 - **When using a pre-installed certificate:** page 153
 - **When using a CA certificate:** page 168

Note

- When the connection setting is changed, after waiting for a while, access the camera again with either “http://IP address of the camera” or “https://IP address of the camera” depending on the changed setting.
- **When using the pre-installed certificate:**
In advance, install the root certificate of the Pre-installed certificate on the PC in use. Refer to page 153 for information on the setting procedure.
- When the camera is accessed using the HTTPS protocol, the refresh interval and frame rate of images may be lower.
- When the camera is accessed using the HTTPS protocol, it may take time to display images.
- When the camera is accessed using the HTTPS protocol, the images may be distorted or audio may be interrupted.
- The maximum number of concurrent access user varies depending on the maximum image size and transmission format.

2.8.3.4 Generation of the CRT key (SSL encryption key)

IMPORTANT

- When the CA certificate is valid, it is impossible to generate the CRT key.
- When the CA certificate is used, the available key size varies depending on the CA. Confirm the available key size in advance.
- To generate the CRT key, it may take about 2 minutes. Do not operate the web browser until the generation of CRT key is complete. While the CRT key is being generated, the refresh interval and line speed may be lower.

1. Click the [Execute] button of “CRT key generate”.
→ The “CRT key generate” dialog box will be displayed.

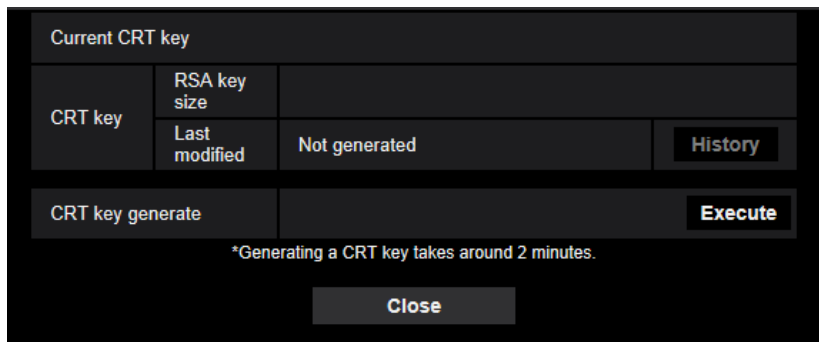

2. Click the [Execute] button.
→ The generation of CRT key will be started. When the generation is finished, the key size and generation time & date of the generated key will be displayed on “Current CRT key”.

Note

- To change (or update) the generated CRT key, perform step 1 to 2. The CRT key and CA certificate are valid in a set. When the CRT key is changed, it is necessary to re-apply for the CA certificate.
- When the CRT key is updated, the log of the previous CRT key is saved. When the [History] button of “Current CRT key” on the “CRT key generate” dialog box is clicked, the “Previous CRT key” dialog box will be displayed, and it is possible to check the key size and generation time & date of the previous

key. When the [Apply] button is clicked on the “Previous CRT key” dialog box, it is possible to replace the current CRT key with the previous one.

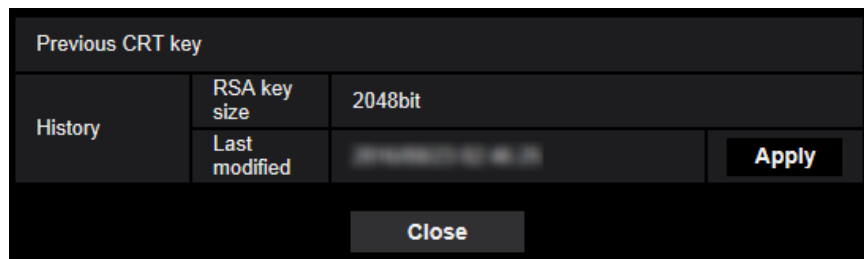

2.8.3.5 Generation of CSR (Certificate Signing Request)

IMPORTANT

- If the CRT key is not generated, it is impossible to generate the CSR.
 - Before generating the CSR file, configure the following settings on [Internet Options] of the web browser in advance. Click [Internet Options...] under [Tools] of the menu bar of Internet Explorer, and then click the [Security] tab.
 - Register the camera for [Trusted Sites].
 - Click the [Custom level...] button to open the [Security Settings] window, and check the [Enable] radio button of [File Download] under [Downloads].
 - Click the [Custom level...] button to open the [Security Settings] window, and check the [Enable] radio button of [Automatic prompting for file downloads] under [Downloads].
1. Click the [Execute] button of “CA Certificate - Generate Certificate Signing Request”.
 - The “CA Certificate - Generate Certificate Signing Request” dialog box will be displayed.

2. Enter the information of the certificate to be generated.

Item	Description	Available number of characters
[Common Name]	Enter the camera address or host name.	64 characters
[Country]	Enter the country name.	2 characters (Country code)

2 Settings

Item	Description	Available number of characters
[State]	Enter the state name.	128 characters
[Locality]	Enter the locality name.	128 characters
[Organization]	Enter the organization name.	64 characters
[Organizational Unit]	Enter the unit name of the organization.	64 characters
[CRT key]	Displays the key size and generation time & date of the current key.	—

Note

- To use the CA certificate, follow the requests from the CA about the information to be entered.
 - The available characters for [Common Name], [State], [Locality], [Organization], [Organizational Unit] are 0-9, A-Z, a-z and the following marks.
- . _ , + / ()
3. Click the [OK] button after entering the items.
→ The [Save As] dialog box will be displayed.
 4. Enter a file name for the CSR in the [Save As] dialog box to save on the PC.
→ The saved CSR file will be applied to the CA.

IMPORTANT

- The CA certificate will be issued for the set of the generated CSR and CRT key. If the CRT key is re-generated or updated after applying to the CA, the issued CA certificate will be invalidated.

Note

- This camera generates the CSR file in the PEM format.

2.8.3.6 Installation of the CA certificate

IMPORTANT

- If the CSR file is not generated, it is impossible to install the CA certificate.
 - For the installation of the CA certificate, the CA certificate issued by CA is required.
1. Click the [Browse...] button of "CA Certificate - CA Certificate install".
→ The [Open] dialog box will be displayed.
 2. Select the CA certificate file and click the [Open] button. Then, click the [Execute] button.
→ The CA certificate will be installed.

Note

- The host name registered in the installed CA certificate will be displayed on "CA Certificate - Information". Depending on the status of the CA certificate, the following are displayed.

Indication	Description
Invalid	The CA certificate is not installed.
[CA certificate Host name]	The CA certificate has already been installed and validated.

Indication	Description
Expired	The CA certificate has already expired.

- When the [Confirm] button is clicked, the registered information of the CA certificate will be displayed in the “CA Certificate - Confirm” dialog box. (Only “Organizational Unit” will be displayed with an asterisk (*).)

CA Certificate - Confirm		
Common Name	NWCAM	
Country	JP	
State	Fukuoka	
Locality	Fukuoka	
Organization	Panasonic	
Organizational Unit	Software	
CRT key	RSA key size	2048bit
	Last modified	2016/08/25 10:27:38
Close		

- When the [Delete] button is clicked, the installed CA certificate will be deleted.
- When “HTTPS” is selected for “Connection”, it is impossible to delete the CA certificate.
- To update the CA certificate, perform step 1 and 2.

IMPORTANT

- Before deleting the valid CA certificate, confirm that there is a backup file of the CA certificate on the PC or another media. The backup file of the CA certificate will be required when installing the CA certificate again.
- When the CA certificate has expired, the HTTPS function will become unavailable. When the camera is restarted, the connection protocol will be changed to HTTP. Update the CA certificate before it expires.
- The expiration date of the CA certificate can be checked by double-clicking the CA certificate file issued by CA.

2.8.4 Access the camera using the HTTPS protocol (for pre-installed certificate)

When accessing the camera with HTTPS from a browser using the pre-installed certificate, in order to stop a warning message from being played, you must configure your PC by following the steps below. Explanations are based on procedures for Windows 7 using Internet Explorer 11. Procedures for other operating systems or browsers may differ.

2.8.4.1 Configuration of the host file

This procedure must be done on each PC for all the camera that are accessed.

Note

- The following procedure cannot be used if you are using DDNS.
1. Start the browser and then access the camera using the HTTPS protocol.

2 Settings

2. When the security alert window is displayed, click “Continue to this website (not recommended).”

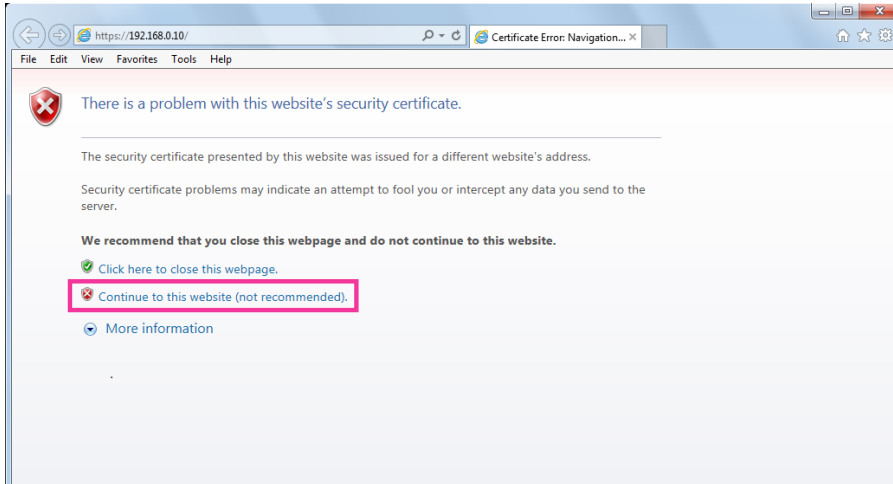

→The “Live” page will be displayed. If an authentication window is displayed, enter the user name and password.

Note

- This warning is displayed because the text entered in the address box does not match the text displayed in the subject of the certificate. This type of warning is displayed because when the certificate for the pre-installed certificate is created, the IP address or domain name assigned to the camera has not been determined yet. However, because the certificate configured in “2.8.3.2 Obtaining the root certificate” (→page 153) is only issued for Panasonic products, this is not a problem.
3. Click “Certificate error” over the URL, and click “View certificates” on the bottom of the “Mismatched Address” window.

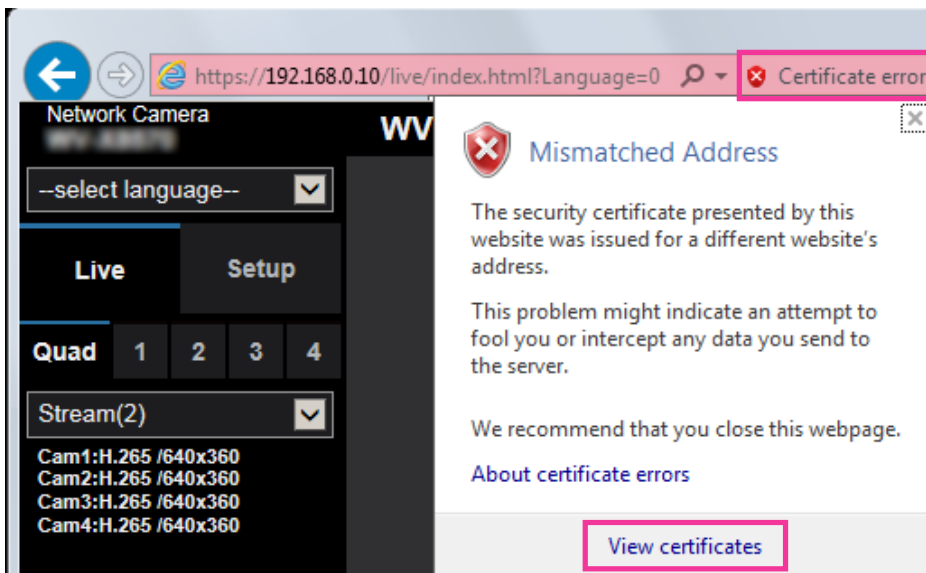

Note

- If “Certificate Invalid” is displayed as shown below even though you have installed the root certificate (→page 153), end the connection, and check that no suspicious devices are connected.

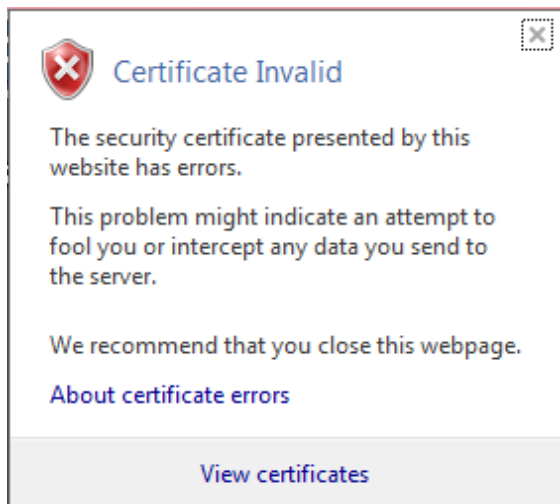

4. The “Certificate” window is displayed. Select the “Details” tab.

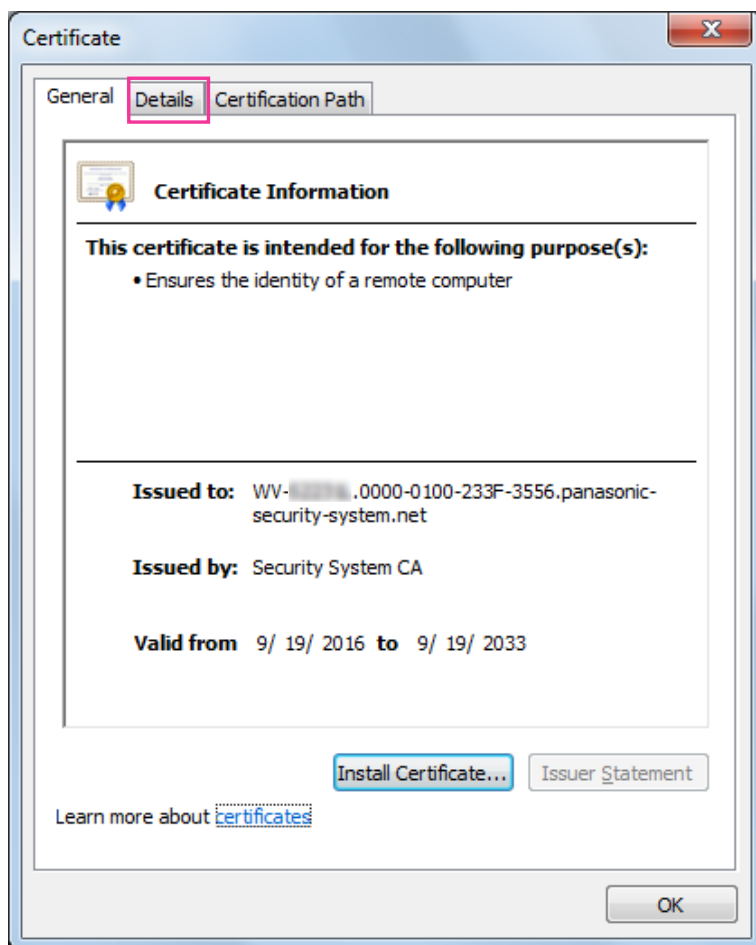

2 Settings

5. Confirm <All> that is displayed for “Show” and then click “Subject” in the field. Copy the text shown after “CN=” in the lower box.

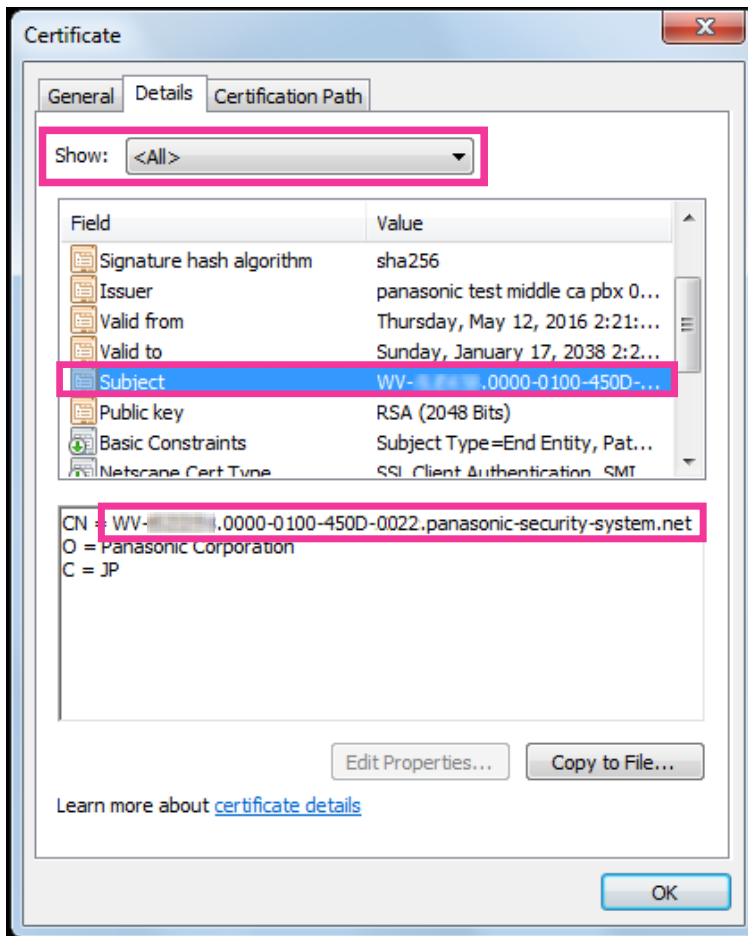

6. From the Start menu enter the following text in the “Search programs and files” text box and then press [Ctrl], [Shift], and [Enter] at the same time.
notepad C:\Windows\System32\drivers\etc\hosts

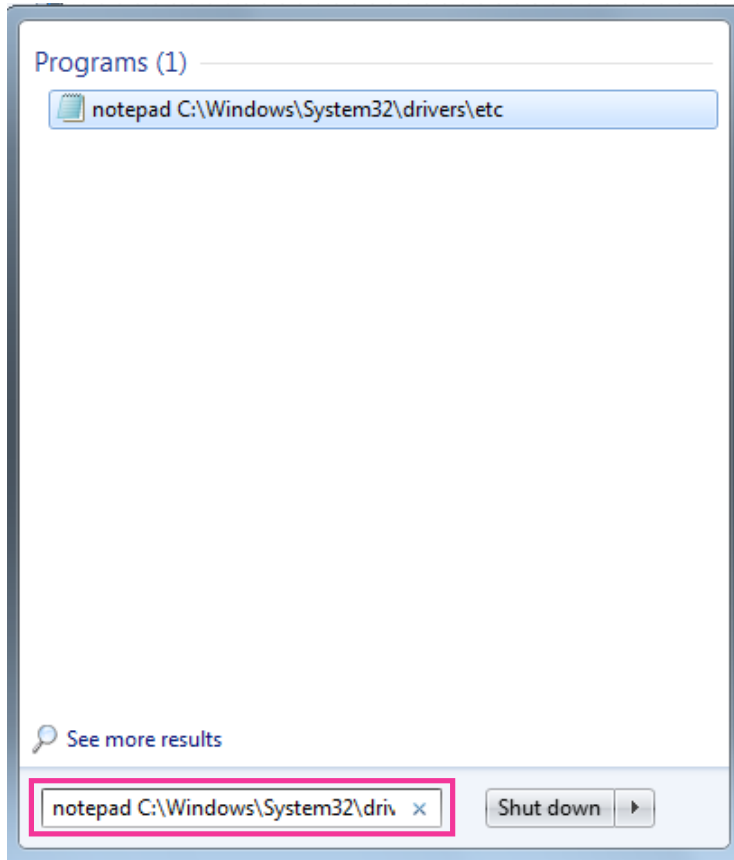

7. If the “User Account Control” window is displayed, select “Yes”.
8. The “hosts - Notepad” window is opened. Add the following text to the end of the file.
(camera IP address) (copied text from step 5)
The example is when the IP address is “192.168.0.10” and the CN of the camera is “WV-xxxxxx.0000-0100-450D-0022.panasonic-security-system.net”.

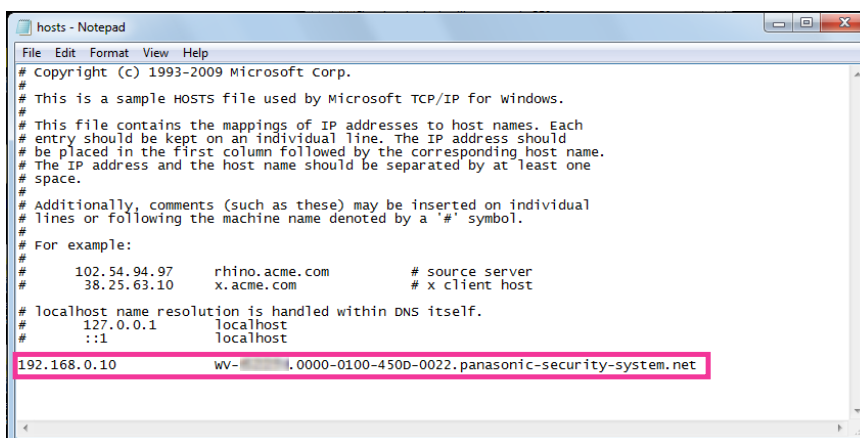

9. Select “File” → “Save” to save the file and then close the file.

10. When accessing with a browser, add the following text for the CN after entering “https://” in the “address” box.

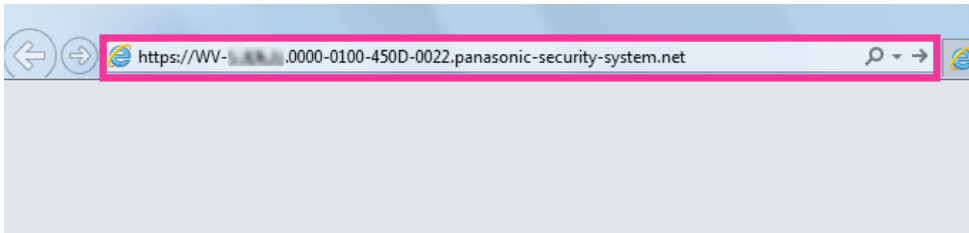

IMPORTANT

- When the HTTPS port number is changed from “443”, enter “the following text for CN + : (colon) + port number” in the address box of the browser.
Example of when the port number is "61443":
`https://WV-xxxxx.0000-0100-450D-0022.panasonic-security-system.net:61443`
- We recommend adding the camera's URL to your browser's bookmark. If you forget the camera's URL, refer to the hosts file.

11. When the settings are completed, the color of the background of the address box changes to white. Confirm that “Website Identification” is displayed after clicking the key mark on the right side of the address bar.

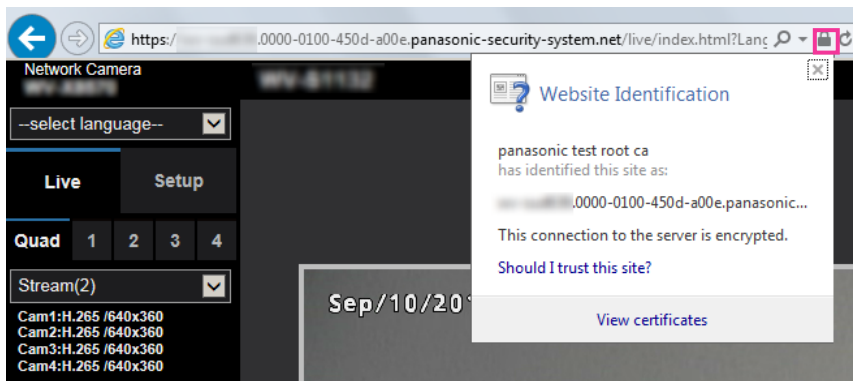

Note

- If you cannot access with this method it may be because of proxy server settings. Ask the network administrator.

IMPORTANT

- When the camera is accessed using the HTTPS protocol, the refresh interval and frame rate of images may be lower.

2.8.5 Access the camera using the HTTPS protocol (for CA Certification)

1. Start up the web browser.
2. Enter the IP address of the camera in the address box of the browser.
 - **Example of entry:** `https://192.168.0.10/`

IMPORTANT

- When the HTTPS port number is changed from “443”, enter “https://IP address of the camera + : (colon) + port number” in the address box of the browser.
(**Example:** https://192.168.0.11:61443)
 - When the camera is in a local network, configure the proxy server setting of the web browser (under [Internet Options...] under [Tools] of the menu bar) to bypass the proxy server for the local address.
3. Press the [Enter] key on the keyboard.
→ The “Live” page will be displayed.

IMPORTANT

- When the camera is accessed using the HTTPS protocol, the refresh interval and frame rate of images may be lower.

2.8.6 How to configure the settings relating to DDNS

When activating the DDNS function using the camera, either of the following DDNS services is available.

- “Viewnetcam.com” service
- Dynamic DNS Update (RFC2136 compliant)

IMPORTANT

- Before using the DDNS service, it is necessary to perform the port forwarding setting for the router.
- **About Dynamic DNS Update (RFC2136 compliant)**
Operation using DDNS services other than the “Viewnetcam.com” service is not guaranteed. We are not responsible for any troubles or accidents on the circumstances where the camera is used arising out of such services.
Refer to the DDNS service providers for the selection and configuration of the DDNS services other than the “Viewnetcam.com” service.

Note

- “Viewnetcam.com” is a Dynamic DNS service designed for use with Panasonic Network Cameras. Refer to the “Viewnetcam.com” website (<http://www.viewnetcam.com/>) for further information about the service.

About DDNS services (IPv4/IPv6)

By using a DDNS service, it becomes possible to view camera images via the Internet.

The DDNS service associates dynamic global addresses and domain names.

It is possible to configure the settings for the “Viewnetcam.com” or Dynamic DNS Update (RFC2136 compliant). In most of the DNS services offered by providers, global addresses are not static but dynamic. Therefore, access to the camera via an old global address may be invalidated after a certain period of time. Either of the following services is required when accessing a camera whose global address is not static via the Internet.

- **DDNS service (such as “Viewnetcam.com”)**
It is possible to access via a registered and static domain name (example: *****.viewnetcam.com) even after the global address is changed. Enrollment in a domain name service is required even when using the IPv6 connection.
Refer to the “Viewnetcam.com” website (<http://www.viewnetcam.com/>) for further information about the service.
- **Static IP address service (such as a service offered by a contracted provider)**
In this service, global addresses are static (not changed).

2.8.6.1 Configuration of the DDNS service (Example of the “Viewnetcam.com” service)

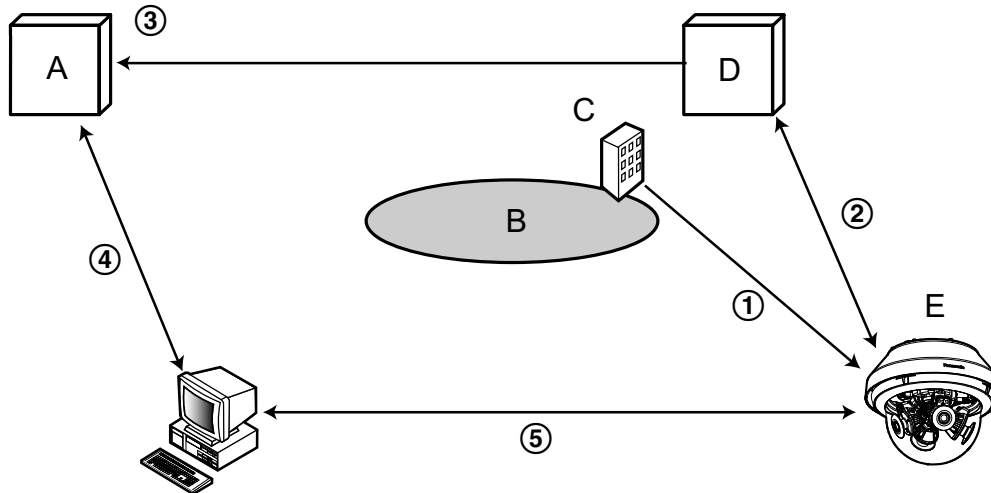

- A. DNS server
- B. Internet
- C. Provider
- D. “Viewnetcam.com” service server
- E. Camera installed in the remote locations

- ① **Global address is changed.**
The contracted provider allocates a global address to the router (or the camera). The global address is not static but dynamic.
- ② **“*****.viewnetcam.com” and the current global address is automatically registered.**
If you are enrolled in “Viewnetcam.com”, the unique “domain name” (example: *****.viewnetcam.com) will be allocated. The “Viewnetcam.com” service server automatically manages the domain name of camera and the global address of router (or camera) when a camera automatically notifies the service server of the global address.
- ③ **Current global address is automatically registered via “*****.viewnetcam.com”.**
The “Viewnetcam.com” service server registers the global address and the domain name of router (or camera) in the DNS server.
- ④ **Global address is obtained via the URL (domain name).**
By entering the URL (including the domain name) on the web browser when accessing the camera via the Internet, the DNS server identifies the registered global address of router (or camera).
- ⑤ **Access using the current global address**
The identified global address is used for accessing the router (or camera) to monitor images.

Note

- Refer to the contracted provider whether the current IP address is static or not.
- Depending on the provider, local addresses may be allocated. In this case, the DDNS service is unavailable. Refer to the contract provider for further information.

When using the “Viewnetcam.com” service

The screenshot shows the DDNS configuration interface. At the top, there are tabs for 'Network' and 'Advanced', with 'Advanced' selected. Below the tabs, there are links for 'SMTP(E-mail)', 'NTP', 'UPnP', 'HTTPS', 'DDNS' (highlighted in yellow), 'SNMP', and 'QoS'. The main configuration area is titled 'DDNS' and contains the following fields:

Area	Global
Service	Viewnetcam.com
Personal(Camera) URL	
Your Account Link	
Access interval	1h
Global IP Address Notification Method	<input checked="" type="radio"/> Normal <input type="radio"/> Advanced

At the bottom of the form, there is a 'Set' button.

[Personal(Camera) URL]

The URL of the camera registered for “Viewnetcam.com”.

[Your Account Link]

When the displayed URL is clicked, the registration window for the “Viewnetcam.com” service will be displayed in a newly opened window.

Register the information in the registration window to enroll in the “Viewnetcam.com” service.

[Access interval]

Select the interval to access the “Viewnetcam.com” service server to check the IP address and the host name from the following.

10min/ 20min/ 30min/ 40min/ 50min/ 1h

- **Default:** 1h

[Global IP Address Notification Method]

Typically [Global IP Address Notification Method] should be set to “Normal”.

If you cannot access the camera using the registered URL 30 minutes after registering with “Viewnetcam.com”, select “Advanced”.

In this case, UPnP (→page 144) must be enabled for the camera and for the router.

- **Default:** Normal

Procedure to register information for the “Viewnetcam.com” service

1. Select [Viewnetcam.com] for [Service] and click the [Set] button.
 - A URL is displayed in [Your Account Link].
 - If a URL is not displayed in [Your Account Link], confirm the camera's network settings and Internet connection, then click [Set] again.
2. Register the information for “Viewnetcam.com” by following the instructions of the wizard.
 - The registration window for “Viewnetcam.com” will be displayed in a newly opened window.

2 Settings

When the registration window is not displayed, check that the PC is being connected to the Internet, and click the reload button of the browser.

DDNS	
Area	Global
Service	Viewnetcam.com
Personal(Camera) URL	
Your Account Link	http://*****
Access interval	1h
Global IP Address Notification Method	<input type="radio"/> Normal <input checked="" type="radio"/> Advanced

3. Register the information for “Viewnetcam.com” by following the instructions of the wizard.
 - When the message “The new camera is successfully registered to Viewnetcam.com” is displayed, close the registration window.The URL set at the time of registration can be used for camera access. However, this URL is unavailable when accessing the camera from the PC connected to the same network (LAN).

DDNS	
Area	Global
Service	Viewnetcam.com
Personal(Camera) URL	****.****.***
Your Account Link	http://*****
Access interval	1h
Global IP Address Notification Method	<input type="radio"/> Normal <input checked="" type="radio"/> Advanced

Note

- When the registration for the “Viewnetcam.com” service is completed, the URL registered for “Personal(Camera) URL” is displayed. It may take up to about 30 minutes until the URL of the registered camera is validated.
- To cancel the enrollment in the “Viewnetcam.com” service, access the “Viewnetcam.com” website (<http://www.viewnetcam.com/>) later.
- When “Expired” is displayed in the URL of “Viewnetcam.com” in the viewnetcam settings page or the status page, restart the camera after registering the “Viewnetcam.com” service. After restarting the camera, check that the registered URL is displayed in the URL of “Viewnetcam.com” of [Status] - [Viewnetcam.com] on the “Maintenance” page.
- It is possible to check the information registered for the “Viewnetcam.com” service by accessing the URL displayed beside “Your Account Link”. When the URL is not displayed, check that the PC is being connected to the Internet, and click the [Set] button.

- If access often fails due to the change in the global address of router, set a smaller value for “Access interval”.

Checking the information registered for the “Viewnetcam.com” service

It is possible to check if the camera has been registered for the “Viewnetcam.com” service. (→page 184)

2.8.6.2 When using “Dynamic DNS Update”

The screenshot shows the DDNS configuration interface. At the top, there are navigation links: SMTP(E-mail), NTP, UPnP, HTTPS, DDNS (highlighted), SNMP, and QoS. Below these, the 'DDNS' section is expanded. It contains four rows of configuration options:

Area	Japan
Service	Dynamic DNS Update
Host name	
Access interval	24h

A 'Set' button is located at the bottom center of the configuration area.

[Host name]

Enter the host name to be used for the Dynamic DNS Update service.

- **Available number of characters:** 3 - 250 characters
Enter in the form of “(host name). (domain name)”.
- **Available characters:** Alphanumeric characters, the colon (:), the period (.), the underscore (_), and the hyphen (-).
- **Default:** None (blank)

Note

- Refer to the network administrator for further information about the available host names.

[Access interval]

Select the interval to access the Dynamic DNS Update service server to check the IP address and the host name from the following.

10min/ 20min/ 30min/ 40min/ 50min/ 1h/ 6h/ 24h

- **Default:** 24h

2.8.6.3 When using “Dynamic DNS Update(DHCP)”

The screenshot shows a web-based configuration interface for Dynamic DNS Update (DHCP). At the top, there are tabs for 'Network' and 'Advanced', with 'Advanced' selected. Below the tabs, there are links for 'SMTP(E-mail)', 'NTP', 'UPnP', 'HTTPS', 'DDNS', 'SNMP', and 'QoS'. The 'DDNS' section is expanded, showing a table with the following fields:

DDNS	
Area	Japan
Service	Dynamic DNS Update(DHCP)
Host name	

At the bottom of the form, there is a 'Set' button.

[Host name]

Enter the host name to be used for the Dynamic DNS Update service.

- **Available number of characters:** 3 - 250 characters
Enter in the form of “(host name). (domain name)”.
- **Available characters:** Alphanumeric characters, the colon (:), the period (.), the underscore (_), and the hyphen (-).
- **Default:** None (blank)

Note

- Refer to the network administrator for further information about the available host names.

2.9 Configure the settings relating to the schedules [Schedule]

On the “Schedule” page, it is possible to configure the settings relating to schedules as follows.

- Alarm permission (Terminal alarm 1, 2, 3) **X8570N**
- Alarm permission(Terminal alarm 1) **X8570N**
- Alarm permission(Terminal alarm 2) **X8570N**
- Alarm permission(Terminal alarm 3) **X8570N**
- VMD permission
- Access permission
- SD memory recording
- Scene file
- Allow e-mail transmission
- Reboot (Schedule 5 only)

The “Schedule” page has only the [Schedule] tab.

2 Settings

Up to 5 schedules can be set.

The screenshot displays the 'Schedule' configuration screen. It features five schedule entries, each with a color-coded icon and a 'Schedule mode' dropdown menu set to 'Off'. Below each mode dropdown is a 'Time range' section with a '24h' button and a grid of time slots for each day of the week (Mon-Sun). The grid shows time markers at 0:00, 6:00, 12:00, 18:00, and 24:00. A 'Set' button is located at the bottom of the screen.

1. Select an action to be assigned to the schedule from "Schedule mode".
"Off" is selected at the default.
 - **Off:** No action will be taken for the respective schedule.
 - **Alarm permission (Terminal alarm 1, 2, 3):** Alarm input (terminal alarm) will be allowed during the period of the schedule. (X8570N)
 - **Alarm permission (Terminal alarm 1):** Terminal 1 alarm input will be allowed during the period of the schedule. (X8570N)
 - **Alarm permission (Terminal alarm 2):** Terminal 2 alarm input will be allowed during the period of the schedule. (X8570N)

- **Alarm permission(Terminal alarm 3):** Terminal 3 alarm input will be allowed during the period of the schedule. (X8570N)
- **VMD permission:** The video motion detection (VMD) function will be active during the period of the schedule.
- **Access permission:** Users whose access level is set to “2. Camera control” and “3. Live only” on the [User auth.] tab (→page 126) can access the camera only in the period of schedule.
- **Recording to SD(Recording stream1):** The SD recording specified with “Recording stream” will be performed at the designated time in the schedule.
- **Image adjust 1: Scene 1:** Images are set to the image settings of “Scene file 1” at the designated time in the schedule. When the designated time for the schedule finishes, images are set to the image settings of “Scene file is not applied”.
- **Image adjust 1: Scene 2:** Images are set to the image settings of “Scene file 2” at the designated time in the schedule. When the designated time for the schedule finishes, images are set to the image settings of “Scene file is not applied”.
- **Image adjust 1: Scene 3:** Images are set to the image quality settings of “Scene file 3” at the designated time in the schedule. Once designated time in the schedule is over, the image quality setting is set to “Scene file is not applied”.
- **Image adjust 1: Scene 4:** Images are set to the image quality settings of “Scene file 4” at the designated time in the schedule. Once designated time in the schedule is over, the image quality setting is set to “Scene file is not applied”.
- **E-mail permission:** While the schedule is set, e-mail notification is sent when alarm is input.
- **Reboot:** The camera reboots at the scheduled time. Can only be selected with Schedule 5.

Note

- Select “On” for “User auth.” on the [User auth.] tab of “User mng.” page (→page 126) and “Off” for “Host auth.” on the “Host auth.” page (→page 129) to validate “Access permission”.
 - When “SD memory recording” is selected, select “Schedule” for “Save trigger” on the [SD memory card] tab. (→page 52)
2. Select days of a week by checking the respective checkboxes.
 3. From the pull-down menu, select the start time and the end time of the schedule.
When not designating time, check the checkbox of “24h”.
 4. Click the [Set] button after completing the settings.
→ The result will be displayed at the bottom of the window.

Note

- The schedules displayed at the bottom of the window can be identified by colors assigned to each schedule.

2.9.1 How to set the schedules

The screenshot displays the 'Schedule' configuration screen. It features five schedule entries, each with a unique color and name: Schedule 1 (White), Schedule 2 (Blue), Schedule 3 (Green), Schedule 4 (Red), and Schedule 5 (Black). For each entry, the 'Schedule mode' is set to 'Off'. The 'Time range' section includes checkboxes for each day of the week (Mon, Tue, Wed, Thu, Fri, Sat, Sun) and a '24h' checkbox. Below the settings is a 24-hour grid for each day of the week, with time markers at 0:00, 6:00, 12:00, 18:00, and 24:00. At the bottom of the screen are 'Set' and 'Back' buttons.

1. Check the check box of the desired day of the week of "FTP image transmission schedule".
→ The selected day of the week will be validated for the schedule.
2. To designate time, select the desired "hour" and "minute" from the pull-down menu.
When not designating time, check the checkbox of "24h".

- Click the [Set] button after completing the settings.
→ The result will be displayed at the bottom of the window.

The screenshot shows a 'Schedule' configuration window with the following sections:

- Schedules Table:**

Schedule Name	Schedule Mode	Time Range
Schedule 1 (White)	VMD permission	Mon-Sun, 09:00 - 17:30
Schedule 2 (Blue)	VMD permission	Mon-Sun, 23:00 - 07:00
Schedule 3 (Green)	FTP periodic image transmission	Sat-Sun, 24h
Schedule 4 (Red)	Off	None
Schedule 5 (Black)	Off	None
- Gantt Chart:** A 24-hour timeline from 0:00 to 24:00. Blue bars indicate VMD permission (09:00-17:30 Mon-Sun, 23:00-07:00 Mon-Sun). Green bars indicate FTP periodic image transmission (24h Sat-Sun). A white bar indicates 'Off' (12:00-18:00 Mon-Sun).
- Buttons:** A 'Set' button is located at the bottom center of the window.

2.9.2 How to delete the set schedule

The screenshot displays the 'Schedule' configuration page. It features a table of five schedules, each with a unique color and name:

Schedule Name	Schedule Mode	Time Range
Schedule 1 (White)	VMD permission	Mon-Sun, 24h 09:00 - 17:30
Schedule 2 (Blue)	VMD permission	Mon-Sun, 24h 23:00 - 07:00
Schedule 3 (Green)	Access permission	Mon-Sun, 24h (all days)
Schedule 4 (Red)	Off	Mon-Sun, 24h (all days)
Schedule 5 (Black)	Off	Mon-Sun, 24h (all days)

Below the table is a Gantt chart showing the active periods for each day of the week (Mon-Sun) from 0:00 to 24:00. The chart uses colored bars to represent the active periods: blue for VMD permission, white for Access permission, and green for Off. A 'Set' button is located at the bottom of the interface.

The color of each schedule is not linked with the area color of VMD area.
When [VMD permission] is set, the VMD functions in all the areas set with [VMD area].

1. Uncheck the check box of the set day of the week.

- Click the [Set] button after completing the settings.
→ The schedule of the selected day of the week is deleted.

Schedule

Schedules

Schedule 1 (White)	Schedule mode	Off
	Time range	<input type="checkbox"/> Mon <input type="checkbox"/> Tue <input type="checkbox"/> Wed <input type="checkbox"/> Thu <input type="checkbox"/> Fri <input type="checkbox"/> Sat <input type="checkbox"/> Sun 24h <input type="text"/> : <input type="text"/> : - <input type="text"/> : <input type="text"/> :
Schedule 2 (Blue)	Schedule mode	Off
	Time range	<input type="checkbox"/> Mon <input type="checkbox"/> Tue <input type="checkbox"/> Wed <input type="checkbox"/> Thu <input type="checkbox"/> Fri <input type="checkbox"/> Sat <input type="checkbox"/> Sun 24h <input type="text"/> : <input type="text"/> : - <input type="text"/> : <input type="text"/> :
Schedule 3 (Green)	Schedule mode	Off
	Time range	<input type="checkbox"/> Mon <input type="checkbox"/> Tue <input type="checkbox"/> Wed <input type="checkbox"/> Thu <input type="checkbox"/> Fri <input type="checkbox"/> Sat <input type="checkbox"/> Sun 24h <input type="text"/> : <input type="text"/> : - <input type="text"/> : <input type="text"/> :
Schedule 4 (Red)	Schedule mode	Off
	Time range	<input type="checkbox"/> Mon <input type="checkbox"/> Tue <input type="checkbox"/> Wed <input type="checkbox"/> Thu <input type="checkbox"/> Fri <input type="checkbox"/> Sat <input type="checkbox"/> Sun 24h <input type="text"/> : <input type="text"/> : - <input type="text"/> : <input type="text"/> :
Schedule 5 (Black)	Schedule mode	Off
	Time range	<input type="checkbox"/> Mon <input type="checkbox"/> Tue <input type="checkbox"/> Wed <input type="checkbox"/> Thu <input type="checkbox"/> Fri <input type="checkbox"/> Sat <input type="checkbox"/> Sun 24h <input type="text"/> : <input type="text"/> : - <input type="text"/> : <input type="text"/> :

	0:00	6:00	12:00	18:00	24:00
Mon					
Tue					
Wed					
Thu					
Fri					
Sat					
Sun					

Set

2.10 Maintenance of the camera [Maintenance]

System log check, firmware upgrade, status check and initialization of the setup menu can be performed on this page.

The “Maintenance” page has the [System log] tab, the [Upgrade] tab, [Status] tab, the [Default reset] tab, and the [Data] tab.

2.10.1 Check the system log [System log]

Click the [System log] tab of the “Maintenance” page. (→page 37, page 38)

Up to 4,000 system logs can be saved on the SD memory card when the SD memory card is inserted after selecting “Use” for “SD memory card” on the [SD memory card] tab (→page 62)

When “Not use” is selected for “SD memory card”, up to 100 system logs can be saved on the built-in memory of the camera.

When the saved system logs have reached the maximum number, the newer logs will overwrite the older system logs. In this case, the oldest log is the first to be overwritten.

The system logs will be displayed in group of 100 logs each, and the logs will be saved even when the power of the camera is turned off.

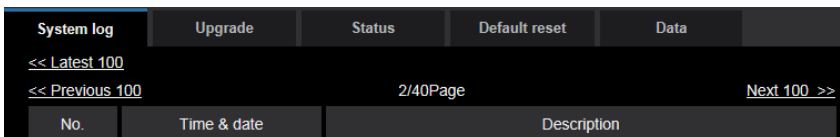

[<< Latest 100]

When clicking “<< Latest 100”, the latest 100 system logs will be displayed.

[Next 100 >>]

When clicking “Next 100 >>”, the next 100 system logs will be displayed.

[Number of pages display]

The currently opened page will be displayed in the “page/total page” format.

[<< Previous 100]

When clicking “<< Previous 100”, the previous 100 system logs will be displayed.

[No.]

The serial number of the system log will be displayed.

[Time & date]

Time and date at the error occurrence will be displayed.

Note

- When “Off” is selected for “Time display format” on the [Basic] tab (→page 55), time & date of logs will be displayed in 24-hour format.

[Description]

The descriptions about the system log will be displayed. Refer to page 197 for further information about the system logs.

2.10.2 Upgrade the firmware [Upgrade]

Click the [Upgrade] tab of the “Maintenance” page. (→page 37, page 38)

The current firmware can be checked and upgraded to the latest version on this page. Contact the dealer for further information about the firmware upgrade.

System log		Upgrade	Status	Default reset	Data
Model no.		[Model no.]			
MAC address		[MAC address]			
Serial no.		[Serial no.]			
Firmware version		[Firmware version]			
IP address(IPv6)	Linklocal	[Linklocal]			
	Static	[Static]			
	RA	[RA]			
	DHCPv6	[DHCPv6]			
Viewer software installation counter		[Viewer software installation counter]			
Time past from the date of manufacture		[Time past from the date of manufacture]			

Browse...

Reset the settings to the default after completing the upgrade.
 (Except the network settings)

Do not reset the settings to the default after the upgrade.

Execute

Resets to default HTML data after completing the upgrade.

Download the latest firmware from the following our website.
 Note: Internet connection required to view this page.
 - In case of using outside of Japan.
<http://security.panasonic.com/support/>
 - In case of using in Japan.
<http://sol.panasonic.biz/security/support/index.html>

It will take around 8 minutes to complete the upgrade.
 Please wait and do not operate the browser during this process.

[Model no.], [MAC address], [Serial no.], [Firmware version], [IP address(IPv6)], [Viewer software installation counter], [Time past from the date of manufacture]

Information of each item will be displayed.

1. Contact the dealer and download the latest firmware onto a PC.

IMPORTANT

- A blank (space) cannot be used for the name of the directory where the downloaded firmware to be saved.
2. Click the [Browse...] button and designate the downloaded firmware.

Note

- The latest firmware upgrade is posted on our website.
 - When using the camera in Japan
<https://sol.panasonic.biz/security/support/index.html>

- When using the camera outside of Japan
<https://security.panasonic.com/support/>
 - To view the website, it is necessary to be connected to the internet.
3. Click the radio button respective to the desired option to determine whether or not to initialize the settings after completing the firmware upgrade.
Default: Do not reset the settings to the default after the upgrade.
- Note**
- Note that the settings cannot be restored after an initialization is operated.
4. Click the [Execute] button.
→ The confirmation window will be displayed.

IMPORTANT

- After upgrading, make sure to check the version on this page.
- After completing the upgrade, delete temporary internet files. (→page 201)
- Upgrade the firmware using a PC in the same subnet as the unit.
- Follow the instructions from the dealer when upgrading the firmware.
- When upgrading the application software, use the designated file (extension: img) for the firmware upgrade.
The name of the firmware to be used for the upgrade should be “model name (Use small letters. “WV-” is not required.)_xxxxx.img”.
* (“xxxxx” indicates the version of the firmware.)
- Do not turn off the power of the camera during the upgrade process.
- Do not perform any operation during upgrading and wait until it completes.
- The following network settings will not be reset when upgrading the firmware after selecting “Reset the settings to the default after completing the upgrade. (Except the network settings)”.
Primary server address and secondary server address DNS settings for IPv4, primary DNS server address and secondary DNS server address settings for IPv6, On/Off for DHCP, IP address, subnet mask, default gateway, HTTP port, HTTPS port, connection protocol (HTTP/HTTPS), CRT key, CA certificate, UPnP setting, line speed, bandwidth control (bit rate), time & date
- The viewer software used on each PC should be licensed individually. Refer to your dealer for the software licensing.

2.10.3 Check the status [Status]

Click the [Status] tab of the “Maintenance” page. (→page 37, page 38)

The status of this camera can be checked on this page.

System log	Upgrade	Status	Default reset	Data
Viewnetcam.com				
Server	www.viewnetcam.com			
Status	Enabled			
Personal(Camera) URL				
UPnP				
Port number(HTTP)	-			
Status	Failed to find the router, or can't be setting			
Port number(HTTPS)	-			
Status	Disable			
Router global address				
Self check				
Hardware1	0000 0000 0000 0000 0000 0000 0000 00			
Hardware2	0000 0000 0000 0000 0000 0000 0000 00			
USB interface				
Status	Not use			
Disable	Execute			
SD memory card				
Model no.	Not use			
Serial no.	Unknown			
Remaining capacity	#####(Remaining capacity)/(Total capacity)			
Total use time	Unknown			
Number of overwrite times	Unknown			
No.	Time & date	Description		
1	2020/08/16 16:21	[SD] Write protect (No Locked card)		

Viewnetcam.com

[Server]

The URL of the "Viewnetcam.com" service server will be displayed.

[Status]

The registration status for the "Viewnetcam.com" will be displayed.

[Personal(Camera) URL]

The URL of the camera registered for "Viewnetcam.com" will be displayed.

UPnP

[Port number(HTTP), Port number(HTTPS)]

The port number that is set for UPnP port forwarding will be displayed.

[Status]

The port forwarding status will be displayed.

[Router global address]

The global address of router will be displayed.

Self check

The self check result of the hardware will be displayed.

Note

- Refer to our website (<https://security.panasonic.com/support/info/<Control No.:C0111>>) for further information about the contents of the displayed statuses (relating to the “Viewnetcam.com” service, the UPnP function, or the self check).

USB interface

[Status]

When a connection between the Wi-Fi USB adapter for setup and the USB terminal is recognized, the model number of the Wi-Fi USB adapter and others will be displayed. If not recognized, “Not use” will be displayed.

[Disable]

To disable the Wi-Fi USB adapter for setup, click the [Execute] button.

To enable the Wi-Fi USB adapter for setup again, initialize with the [INITIAL SET] button. (For how to initialize with the [INITIAL SET] button, refer to the Important Information in the supplied CD-ROM.)

SD memory card

[Model no.]

Displays the model number of the SD memory card.

If model number information could not be obtained, “Read error” is displayed. If the SD memory card is not used, “Not use” is displayed. In other cases “Unknown” is displayed.

[Serial no.]

Displays the serial number of the SD memory card.

If the serial number information could not be obtained, “Unknown” is displayed.

[Remaining capacity]

Displays the remaining capacity and total capacity of the SD memory card.

This is the same information that is displayed in [Remaining capacity] of the SD memory card information on the [SD memory card] tab of the “Basic” page.

[Total use time]

Displays the length of time that SD memory card has been inserted into and used with the camera.

If the length of time that the SD memory card has been used for cannot be obtained, “Unknown” is displayed. “Total use time” is updated once per hour.

[Number of overwrite times]

Displays the number of overwrite times as calculated from the total capacity of the SD memory card, the number of times the camera has written files to the SD memory card, and the file sizes.

If the number of overwrite times cannot be calculated, “Unknown” is displayed.

Note

- Because the overwrite time values are just estimates calculated by the camera, they may differ to the actual number of overwrite times.
- The above information will not be displayed if “SD memory card password lock” is set and the password is not matched.

[No.] / [Time & date] / [Description] of the log

Displays the log related to the SD memory card.

Category	Indication	Description
SD memory card	<SD> Format	Successfully formatted the SD memory card.
	<SD> Format error	Error occurred when formatting the SD memory card.
	<SD> Write-protect ON (Locked card)	A write-protected SD memory card is inserted.
	<SD> Detection error	The SD memory card could not be correctly recognized.
	<SD> Write error	An error occurred when writing to the SD memory card.
	<SD> Read error	An error occurred when reading from the SD memory card.
	<SD> Delete error	An error occurred when deleting data from the SD memory card.
	<SD> File system error	An error occurred in File system of the SD memory card.
	<SD> Undefined error	An error other than the ones above has occurred for the SD memory card.

IMPORTANT

- In order to be able to correctly use this function, format the SD memory card with the camera before using it.
- When using SD memory cards that have been used on other devices such as PCs, the correct information may not be able to be displayed.
- Up to 30 SD memory card logs can be saved to the built-in memory of the camera. When the saved system logs have reached the maximum number, the newer logs will overwrite the older system logs.

Note

- Refer to our website (<https://security.panasonic.com/support/info/>) for further information about the contents of the displayed statuses (relating to the “Viewnetcam.com” service, the UPnP function, or the self check).

2.10.4 Reset the settings/Reboot the camera [Default reset]

Click the [Default reset] tab of the “Maintenance” page. (→page 37, page 38)

2 Settings

The settings and the HTML data of the camera can be initialized and reboot of the camera can be performed on this page.

System log	Upgrade	Status	Default reset	Data
Reset to the default (Except the network settings)		Execute		
Load the default HTML files (setup menu).		Execute		
Reset to the default and load the default HTML files.		Execute		
Reboot		Execute		

[Reset to the default (Except the network settings)]

Click the [Execute] button to reset the settings to the default. Note that the network settings will not be reset. It is impossible to operate the camera for about 3 minutes after the initialization.

[Load the default HTML files (setup menu).]

Click the [Execute] button to reset the HTML files to the default. It is impossible to operate the camera for about 3 minutes after the initialization.

[Reset to the default and load the default HTML files.]

Click the [Execute] button to reset the settings of the camera and the HTML files to the default. Note that the network settings will not be reset. It is impossible to operate the camera for about 3 minutes after the initialization.

[Reboot]

Click the [Execute] button to reboot the camera. It is impossible to operate the camera for about 2 minutes after rebooting the camera.

Note

- For how to initialize the network settings (→page 134), refer to the Important Information in the supplied CD-ROM.
- If “Diag.” of the alarm/e-mail notification function is selected, it allows users to provide the notification of the error to the specified E-mail address or an original alarm destination when an error such as no SD memory card insertion after the reboot or a locked SD memory card insertion occurs. (→page 139, page 121)

2.10.5 Settings data/backing up or restoring logs [Data]

Click the [Data] tab of the “Maintenance” page. (→page 37, page 38)

The settings related to backing up or restoring settings data, and saving logs can be configured in this section.

The screenshot shows the 'Data' settings page with the following sections:

- Backup:**
 - Setup data: [Execute]
 - Scene file: [Execute]
 - Logs: [Execute]
- Restore:**
 - Setup data: [Browse...]
 - Restore all settings.
 - Restore all settings except the network settings.
 - Scene file: [Browse...] [Execute]

A warning message at the bottom states: "It will take around 2 minutes to complete restoring data. Please wait and do not operate the browser during this process."

Backup

[Setup data]

Click the [Execute] button to backup the setup data of the camera to a PC.

[Scene file]

Click the [Execute] button to backup the scene files of the camera to a PC.

[Logs]

Click the [Execute] button to backup the log data of the camera to a PC.

IMPORTANT

- When backing up settings or logs, creating the backup files takes time.
- When the backup operation takes 10 minutes or more, a communication timeout may occur. In this case all of the backup data may not be obtained. Therefore, we recommend completing backup operations within 10 minutes. It is also possible to check whether or not the correct data was obtained by restoring the obtained data (excluding log data).

Restore

[Setup data]

Press the [Browse...] button and select the setup data files to restore.

Click the radio button respective to the desired option to determine whether or not to also restore network related setting contents.

Click the [Execute] button to start restoring. Do not perform operations until the restoration is complete. (The camera will be rebooted when the restoration is complete.)

Make sure to set the file name of setup data files used when restoring to "model name.dat". (The model name must be written in lower case letters and "WV-" is not needed.)

IMPORTANT

- When 5 minutes or more is required to restore setup data files, there is a possibility that the restore has failed because of reasons such as transmission disconnections. In this case, restore setup data files again.

Note

- Restore operations for setup data are not applied to HTTPS related settings.

[Scene file]

Press the [Browse...] button and select the scene files to restore.

Click the [Execute] button to start restoring. Do not perform operations until the restoration is complete.

Make sure to set the file name of scene file data used when restoring to "model name.txt". (The model name must be written in lower case letters and "WV-" is not needed.)

2.11 Display the Panasonic support website [Support]

Methods for accessing the Panasonic support website are explained on the "Support" page.



To access the Panasonic support website from a web browser, click the link for the support page.

To access from a mobile terminal, scan the "Data Matrix" or "QR Code" with your mobile terminal to display the Panasonic support website.

If you cannot display the website, access the Panasonic website (https://security.panasonic.com/support/qr_sp_select/).

3 Others

3.1 Using the CD-ROM

3.1.1 About the CD launcher

By inserting the provided CD-ROM into the CD-ROM drive of your PC, the CD launcher is automatically started and the license agreement is displayed. Read the agreement and select “I accept the terms in the license agreement”, and then click “OK”.

The CD launcher window is displayed.

- If the launcher window is not displayed, double click the “CDLauncher.exe” file on the CD-ROM.

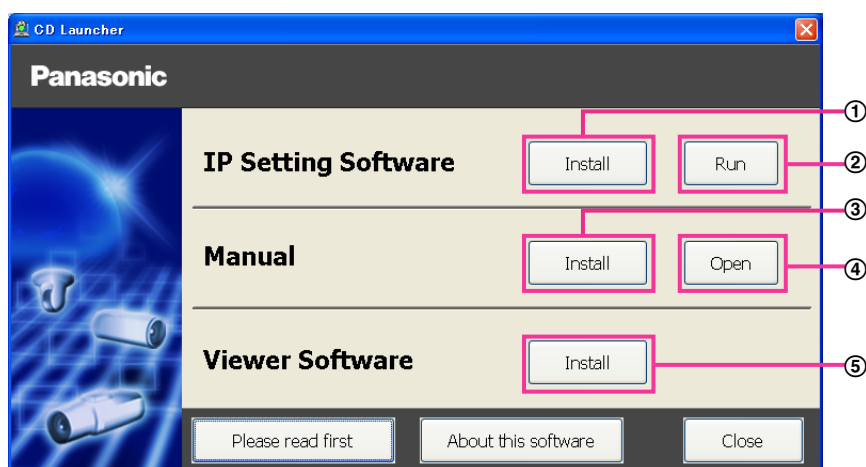

Using the supplied CD-ROM, the following actions can be performed.

- ① The Panasonic “IP Setting Software” can be installed on the PC. (→page 192)
- ② Settings related to the camera’s network can be set from the Panasonic “IP Setting Software”. (→page 194)
- ③ The manuals can be installed on the PC. (→page 193)
- ④ You can also view the manuals without installing them to the PC by clicking the [Open] button.
- ⑤ The Viewer software can be installed on the PC. (→page 193)

3.1.2 Installing Panasonic “IP Setting Software”

On the CD launcher window, click the [Install] button next to [IP Setting Software] to display the Panasonic “IP Setting Software” installation window. Confirm the following settings before starting the installation.

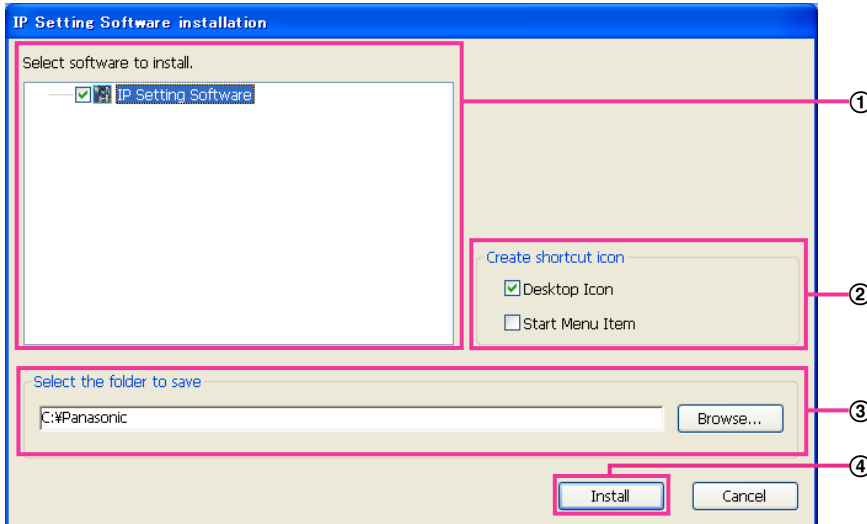

- ① Select the Panasonic “IP Setting Software” to install.
- ② Select where to create the Panasonic IP setting shortcut icon when the Panasonic “IP Setting Software” is installed.
- ③ Specify which folder on the PC to install the Panasonic “IP Setting Software” to.
- ④ Click the [Install] button to start the installation.

Note

- To uninstall the Panasonic “IP Setting Software” delete the shortcut icon from where you specified it to be installed (the default is on the desktop) during installation and the [EasyIPConfig] folder from the folder (the default is C:\Panasonic) you specified during installation.

3.1.3 Installing the manuals

On the CD launcher window, click the [Install] button next to [Manual] to display the Manual installation window. Confirm the following settings before starting the installation.

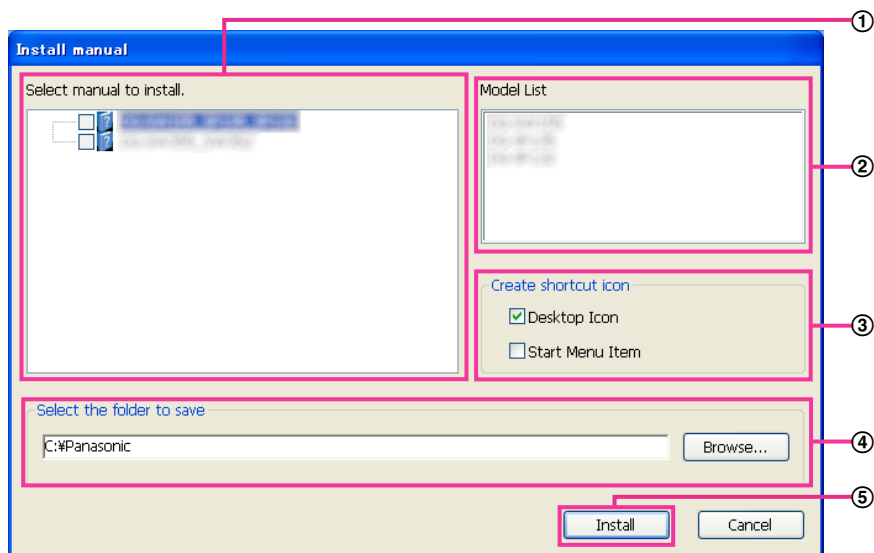

- ① Select which manuals to install. The camera models that the manuals support are displayed in ② “Model List”.
- ② The camera models that are supported by the manuals selected in ① are displayed here.
- ③ Select where to create the manuals shortcut icon when the manuals are installed.
- ④ Specify which folder on the PC to install the manuals to.
- ⑤ Click the [Install] button to start the installation.

Note

- To uninstall the manuals delete the shortcut icon from where you specified it to be installed (the default is on the desktop) during installation and the [Manual] folder from the folder (the default is C: \Panasonic) you specified during installation.

3.1.4 Installing the Viewer software

In order to display H.265 (or H.264) images, receive audio from the camera, and display logs or play images saved on the SD memory card, the “Network Camera View 4S” (ActiveX®) viewer software must be installed. On the CD launcher window, click the [Install] button next to [Viewer Software], and follow the instructions displayed on the window to install the software. A message is displayed if a PC that does not have the Viewer software installed tries to access the camera. Install the software by following the instructions displayed on the window. Refer to page 4 for further information.

Note

- To uninstall the Viewer software, follow the steps below depending on the OS used on your PC. Delete [Network Camera View 4S] from [Control Panel] - [Programs] - [Uninstall a program].

3.1.5 Configure the network settings of the camera using the Panasonic “IP Setting Software”

It is possible to perform the network settings of the camera using the “IP Setting Software” on the provided CD-ROM. When using multiple cameras, it is necessary to configure the network settings of each camera independently. If the Panasonic “IP Setting Software” does not work, access the “Network” page from the setup menu of the camera in the browser and perform settings separately. (→page 134)

IMPORTANT

- The “Windows Security Alert” window may be displayed when starting the “IP Setting Software”. In this case, disable “User Account Control” from the control panel.
 - Panasonic “IP Setting Software” is inoperable in other subnets via the same router.
 - This camera cannot be displayed or set with an older version of the “IP Setting Software” (version 2.xx).
 - Due to security enhancements in “IP Setting Software”, “Network Settings” of the camera to be configured cannot be changed when around 20 minutes have passed after turning on the power of the camera. (When the effective period is set to “20min” in the “Easy IP Setup accommodate period”.) However, settings can be changed after 20 minutes for cameras in the initial set mode.
1. To start the Panasonic “IP Setting Software”, click the [Run] button next to [IP Setting Software] from the CD launcher menu window, or double-click on the shortcut icon created after installing the software on the PC.
 - The License Agreement will be displayed. Read the Agreement and choose “I accept the terms in the license agreement”, and click [OK].
 - The “IP Setting Software” screen is displayed. If a camera is found, information about it, such as the MAC address and IP address, is displayed.
 2. Click the [Access Camera] button after selecting the MAC address/IP address of the camera to be configured.

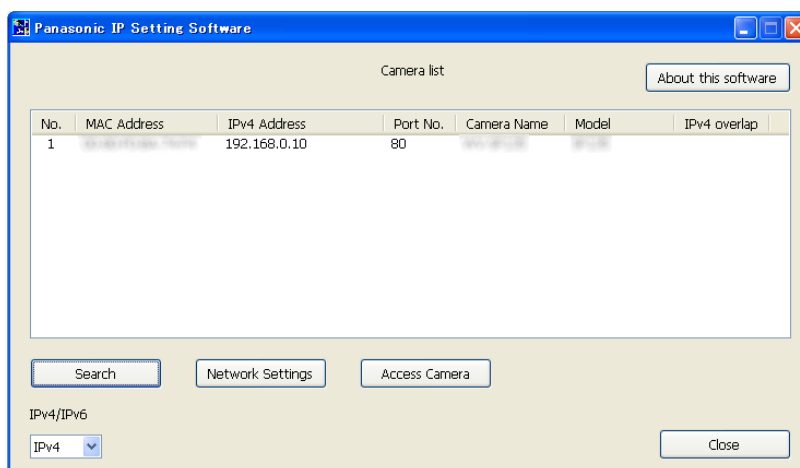

Note

- When using a DHCP server, the IP address assigned to the camera can be displayed by clicking the [Search] button of the “IP Setting Software”.
- When duplicate IP addresses are used, the number of the camera with the duplicate address is displayed in overlap.
- The displayed camera information is not automatically updated. Click the [Search] button to update the information.
- It is possible to change the “Camera list” display between IPv4 addresses and IPv6 addresses in accordance with the protocol in use.

- The information displayed can be sorted by clicking the title of each displayed item.
 - When the [Network Settings] button is clicked, the “Network Settings” screen is displayed and network settings can be changed. For further information, refer to page 195.
3. When the viewer software “Network Camera View 4S” installation screen is displayed, follow the on-screen instructions to install the software. (The viewer software “Network Camera View 4S” is installed from the camera.)
- The “Live” page of the camera is displayed.
 - If the viewer software “Network Camera View 4S” cannot be installed or images are not displayed, click the [Install] button next to [Viewer Software] from the CD launcher window to install the software.

Changing Network Settings

When changing settings related to the network settings, such as connection mode, IP address, and subnet mask, click the [Network Settings] button in [IP Setting Software] screen.

The “Network Settings” screen is displayed. Enter each item and then click the [Save] button.

The screenshot shows a "Network Settings" dialog box with the following fields and options:

- Network Settings:** Radio buttons for StaticIP, DHCP, Auto(AutoIP), and Auto(Advanced) (selected).
- Port No.:** Text box containing 80.
- IPv4 Address:** Text box containing 192 . 168 . 0 . 10.
- Subnet Mask:** Text box containing 255 . 255 . 255 . 0.
- Default Gateway:** Text box containing 192 . 168 . 0 . 1.
- DNS:** Radio buttons for Auto (selected) and Manual.
- Primary DNS:** Text box containing 0 . 0 . 0 . 0.
- Secondary DNS:** Text box containing 0 . 0 . 0 . 0.
- Wait for camera restarting.:** Checked checkbox.
- Buttons:** Save and Back.

Note

- By unchecking the “Wait for camera restarting.” checkbox, multiple cameras can be continuously configured.
- For further information about each setting of the “Network Settings” page, refer to page 134.

IMPORTANT

- It may take for around 2 minutes to complete to upload the settings to the camera after clicking the [Save] button. The settings may be invalidated when the LAN cable is disconnected before completing the upload. In this case, perform the settings again.

3 Others

- When using a firewall (including software), allow access to all UDP ports.

3.2 About the displayed system log

Error indications relating to SMTP

Category	Indication	Description
POP3 server error	Authentication error.	<ul style="list-style-type: none"> Entered user name or password may be incorrect. Check if the E-mail settings are configured correctly.
	Failed to find the POP3 server.	<ul style="list-style-type: none"> The IP address of the server may be incorrect. Check if the IP address of the server is configured correctly. The POP3 server may be down. Ask the network administrator.
SMTP server error	Authentication error.	<ul style="list-style-type: none"> Entered user name or password may be incorrect. Check if the E-mail settings are configured correctly.
	Failed to resolve the E-mail server address from DNS.	<ul style="list-style-type: none"> The designated IP address of the DNS may be incorrect. Check if the DNS settings are configured correctly. The DNS server may be down. Ask the network administrator.
	Failed to find the SMTP server.	<ul style="list-style-type: none"> The IP address of the server may be incorrect. Check if the IP address of the server is configured correctly. The SMTP server may be down. Ask the network administrator.
Internal error	Undefined error.	<ul style="list-style-type: none"> An error occurred in the E-mail function. Check if the E-mail settings are configured correctly.

Error indications relating to “Viewnetcam.com”

Category	Indication	Description
Access test error	Access test failed	<ul style="list-style-type: none"> Port forwarding may not be configured for the router. Refer to the manuals provided with the router in use to enable the UPnP setting.
Viewnetcam.com server error	Failed to resolve the Viewnetcam.com server address from DNS.	<ul style="list-style-type: none"> The designated IP address of the DNS may be incorrect. Check if the DNS settings are configured correctly. The DNS server may be down. Ask the network administrator.
Connection error	No response from the Viewnetcam.com server.	<ul style="list-style-type: none"> The “Viewnetcam.com” server may be down. Ask the network administrator.
	File transfer error.	

3 Others

Category	Indication	Description
Internal error	Undefined error.	<ul style="list-style-type: none">An error relating to the "Viewnetcam.com" function occurred. Check if the "Viewnetcam.com" settings are configured correctly.

Error indications relating to Dynamic DNS Update

Category	Indication	Description
DDNS server error	Failed to resolve the DDNS server address from DNS.	<ul style="list-style-type: none">The designated IP address of the DNS may be incorrect. Check if the DNS settings are configured correctly.The DNS server may be down. Ask the network administrator.
Connection error	No response from the DDNS server.	<ul style="list-style-type: none">The DDNS server may be down. Ask the network administrator.
	Same host name has registered.	<ul style="list-style-type: none">The same host name has already been registered in the DDNS server. Check if the DDNS Update settings are configured correctly.
Internal error	Undefined error.	<ul style="list-style-type: none">An error occurred in the DDNS function. Check if the DDNS Update settings are configured correctly.

Error indications relating to NTP

Category	Indication	Description
Connection error	No response from the NTP server.	<ul style="list-style-type: none">The IP address of the server may be incorrect. Check if the IP address of the server is configured correctly.The NTP server may be down. Ask the network administrator.
Internal error	Undefined error.	<ul style="list-style-type: none">An error occurred in the NTP function. Check if the NTP settings are configured correctly.
Synchronizing with NTP succeeded.	NTP update succeeded.	<ul style="list-style-type: none">Time correction succeeded.

Log indications relating to HTTPS

Category	Indication	Description
HTTPS	Certificate Signing Request - Generated	<ul style="list-style-type: none"> Generation of the CSR (Certificate Signing Request) is complete.
	CA Certificate - Installed	<ul style="list-style-type: none"> Installation of the CA certificate is complete.
	CA Certificate - Deleted	<ul style="list-style-type: none"> Deletion of the CA certificate is complete.
	Previous CRT key - Applied	<ul style="list-style-type: none"> Previous CRT key is applied.
	CRT key - Generated	<ul style="list-style-type: none"> Generation of the CRT key is complete.

Log indications relating to login

Category	Indication	Description
Login	User name or IP address	<ul style="list-style-type: none"> The login user name will be displayed when "On" is selected for "User auth." The IP address of the PC currently accessing to the camera will be displayed when "On" is selected for "Host auth."

Error indications relating to login error

Category	Indication	Description
Login failure	User name	<ul style="list-style-type: none"> The user name that has failed in login will be displayed when "On" is selected for "User auth.". If no user is registered, "Guest User" will be displayed.

Error indications relating to Panasonic alarm protocol notification

Category	Indication	Description
Panasonic alarm protocol notification error	Failed to find destination of notification.	<ul style="list-style-type: none"> The IP address of the destination of notification may be incorrect. Check if the IP address of the destination of notification is configured correctly. The destination of notification may be down. Ask the network administrator.
	Failed to resolve destination addr. from DNS.	<ul style="list-style-type: none"> The DNS server settings may be incorrect. Check if the DNS settings are configured correctly. The DNS server may be down. Ask the network administrator.

Error indications relating to HTTP alarm notification

Category	Indication	Description
HTTP alarm notification error	Failed to find destination of notification.	<ul style="list-style-type: none"> The IP address of the destination of notification may be incorrect. Check if the IP address of the destination of notification is configured correctly. The destination of notification may be down. Ask the network administrator.
	Failed to resolve destination addr. from DNS.	<ul style="list-style-type: none"> The DNS server settings may be incorrect. Check if the DNS settings are configured correctly. The DNS server may be down. Ask the network administrator.

Error indications relating to SD memory card security settings

Category	Indication	Description
SD memory card	Certificate Signing Request - Generated	<ul style="list-style-type: none"> Generation of the CSR (Certificate Signing Request) is complete.
	CA Certificate - Installed	<ul style="list-style-type: none"> Installation of the CA certificate is complete.
	CA Certificate - Deleted	<ul style="list-style-type: none"> Deletion of the CA certificate is complete.
	Previous CRT key - Applied	<ul style="list-style-type: none"> Previous CRT key is applied.
	CRT key - Generated	<ul style="list-style-type: none"> Generation of the CRT key is complete.

3.3 Troubleshooting

Before asking for repairs, check the symptoms with the following table.

Contact your dealer if a problem cannot be solved even after checking and trying the solution in the table or a problem is not described below.

Symptom	Cause/solution	Reference pages
Cannot access from the web browser.	<ul style="list-style-type: none"> Is the LAN cable (category 5e or better) firmly connected to the network connector of the camera? 	Important Information
	<ul style="list-style-type: none"> Is the link indicator (LINK) lit? When it is not lit, connection to a LAN may not be established or a network may not be working correctly. Check if the cables have any contact failure or if the wiring is correct or not. 	Important Information
	<ul style="list-style-type: none"> Is the power of the camera on? Check if the power of the camera is turned on. 	Important Information
	<ul style="list-style-type: none"> Are the set IP addresses valid? 	134
	<ul style="list-style-type: none"> Are you accessing the wrong IP address? Check the connection as follows. With the Windows command prompt, > ping "IP address of the camera". If there is reply from the camera, the connection is normal. If there is no reply, check the connection with the following methods using a computer connected to the same network as the camera. If the firewall settings on the PC are enabled, temporarily disable them before performing settings on the camera. <ul style="list-style-type: none"> Start the Panasonic "IP Setting Software", confirm the camera's IP address, and then access that IP address. If the network settings (IP address, subnet mask, and default gateway) are incorrect, reboot the camera and change the network settings by using the Panasonic "IP Setting Software" within 20 minutes after the restart. In networks that do not have a DHCP server, the IP address of the camera will be configured to "192.168.0.10" when the camera is rebooted by holding the INITIAL SET button on the camera. After the camera is initialized, access the camera and set the IP address again. (When the camera is initialized, all the settings of the camera previously configured on the setup menu will be initialized.) 	194

Symptom	Cause/solution	Reference pages
	<ul style="list-style-type: none"> Is “554” selected for the HTTP port number? For the HTTP port number, select a port number other than the following port numbers used by the camera. The number used by the camera: 20, 21, 23, 25, 42, 53, 67, 68, 69, 110, 123, 161, 162, 443, 554, 995, 10669, 10670, 32768-49151, 59000-61000 	136
	<ul style="list-style-type: none"> Is the same IP address provided to other devices? Are there contradictions between the address and the network subnet to be accessed? When the camera and the PC are connected in the same subnet: Are the IP addresses of the camera and the PC set in a common subnet? Or is “Use Proxy Server” for the settings of the web browser checked? When accessing the camera in the same subnet, it is recommended to enter the address of the camera in the “Don’t Use Proxy For These Addresses” box. When the camera and the PC are connected in the different subnet: Is the IP address of the default gateway set for the camera correct? 	-
	<ul style="list-style-type: none"> Is the name currently used to access the camera different from the name registered for the “Viewnetcam.com” service? Access the camera again with the registered name. 	171
	<ul style="list-style-type: none"> Did you access “http://” while using the HTTPS function? To use the HTTPS function, access “https://”. It is also necessary to enter the port number. 	163 168
	Cannot access the camera via the Internet.	<ul style="list-style-type: none"> Are the network settings of the camera correct? Set the default gateway or DNS server address correctly. To use the DDNS service, check that the settings are correct. Is the setting for “Default gateway” on the “Network” page configured? Or is the setting correct? When communicating using IPv4: Configure the setting for “Default gateway” of “IPv4 network” on the [Network] tab of the setup menu.

Symptom	Cause/solution	Reference pages
	<ul style="list-style-type: none"> • Is the setting of port forwarding configured for the router? To enable the access to the camera via the Internet, it is necessary to perform the port forwarding setting when the router in use does not support the UPnP function. Refer to the manuals provided with the router for further information. • Is UPnP function of the router disabled? Refer to the manuals provided with the router in use to enable the UPnP function. • Is packet filtering set for the router to forbid the access via the Internet? Configure the settings of the router in use to enable the access via the Internet. Refer to the manuals provided with the router for further information about the settings. 	144
	<ul style="list-style-type: none"> • Are you accessing the camera using the local address (the IP address used in a local network)? When accessing the camera, use the global address (or the URL registered in the DDNS service) and the port number of the camera as the IP address to be used in the Internet. 	135 136 169
Cannot access the camera via the URL of the "Viewnetcam.com" service.	<ul style="list-style-type: none"> • Is the global address of camera (or router) notified to the "Viewnetcam.com" service server? Log into the "My Account" page of "Viewnetcam.com" website (http://www.viewnetcam.com/) to check the information of the registered camera. If the global address is not displayed for the IP address, access the camera, and register the user information for the "Viewnetcam.com" service on the [Advanced] tab on the "Network" page of the setup menu. In addition, check the "Status" of "Viewnetcam.com" (on the [Status] tab) and the system log (on the [System log] tab) of the "Maintenance" page of the setup menu. 	171 184
Authentication window is displayed repeatedly.	<ul style="list-style-type: none"> • Is the user name and password changed? While accessing the camera, when changing the user name and password of another user logging into the camera on another web browser, the authentication window will be displayed each time the screen is changed or refreshed. Close the browser and access the camera again. • Have you changed the [Authentication] setting? When the [Authentication] setting has been changed, close the web browser, and then access the camera again. 	-

3 Others

Symptom	Cause/solution	Reference pages
It takes time to display the screen.	<ul style="list-style-type: none"> Are you accessing the camera in the HTTPS mode? In this mode, the refresh interval becomes slower due to decode procession. 	-
	<ul style="list-style-type: none"> Are you accessing another camera in the same local network via a proxy server? Configure the web browser to not use the proxy server. 	-
	<ul style="list-style-type: none"> Are two or more users browsing the camera images simultaneously? It may take time to display the screen or refresh interval may become slower when two or more users browse the camera images simultaneously. 	-
Cannot access the camera from a tablet device.	<ul style="list-style-type: none"> Is the URL correct? Or is "/mobile" missing at the end of the URL? Check if the URL is entered correctly. When accessing the camera from a tablet device, it is necessary to enter "/mobile" at the end of the URL that is used for the camera access from a PC. 	20
	<ul style="list-style-type: none"> Is the SSL encryption method different from that of the camera? Select "HTTP" (Do not select "HTTPS") for "HTTPS" - "Connection" on the "Network" page - the [Advanced] tab, and access the camera again. 	146
	<ul style="list-style-type: none"> Did you access "http://" while using the HTTPS function? To use the HTTPS function, access "https://". It is also necessary to enter the port number. 	163
Cannot access the camera from a mobile terminal.	<ul style="list-style-type: none"> If access to the camera using a tablet fails, try again with the URL used by PC adding <code>"/live/tab.html"</code> at the end. 	20
	<ul style="list-style-type: none"> Is the SSL encryption method different from that of the tablet device? Select "HTTP" (Do not select "HTTPS") for "HTTPS" - "Connection" on the "Network" page - the [Advanced] tab, and access the camera again. 	146
	<ul style="list-style-type: none"> Did you access "http://" while using the HTTPS function? To use the HTTPS function, access "https://". It is also necessary to enter the port number. 	163
A cookie error was displayed when performing user registration for "Viewnetcam.com".	<ul style="list-style-type: none"> Is the web browser configured to allow cookies? Configure the web browser to allow cookies. In Internet Explorer, from [Tools] select [Internet Options] and configure the cookies setting in the [Privacy] tab. 	-

Symptom	Cause/solution	Reference pages
User registration for the "Viewnetcam.com" service fails.	<ul style="list-style-type: none"> Is the registered E-mail address correct? When an E-mail with the "Viewnetcam.com" website link is not received, the registered E-mail address may be incorrect. Visit the "Viewnetcam.com" website (http://www.viewnetcam.com/) to register the correct E-mail address. 	-
Cannot obtain images on the SD memory card.	<ul style="list-style-type: none"> Is "Allow" selected for "FTP access to camera" on the [Network] tab of "Network" page? It is necessary in advance to select "Allow" for "FTP access to camera" on the [Network] tab of the "Network" page. 	138
	<ul style="list-style-type: none"> Is the entered password correct? Restart the web browser and enter the password again. 	75
	<ul style="list-style-type: none"> Access to the SD memory card may be failed. Restart the web browser and retry to obtain images. 	-
No image is displayed.	<ul style="list-style-type: none"> Is the viewer software installed on the PC? Install the viewer software on a PC. 	4
Live image or recorded image in the SD memory is not displayed.	<ul style="list-style-type: none"> When required memory space for displaying video is not ensured, the live image of the camera or the recorded image in the SD memory will not be displayed. Once exiting Internet Explorer, wait for 3 minutes and retry to access the camera or restart the PC. After troubleshooting, if this problem still occurs frequently, it may be solved by trying the above after selecting 1 screen for the live image display, or setting a smaller image capture size or bit rate for the camera image to minimize the required memory space. 	-
No image is displayed. / Older images or logs are displayed.	<ul style="list-style-type: none"> When [Every time I visit the webpage] is not selected for [Check for newer versions of stored pages:] in the [Temporary Internet Files] section, images sometimes may not be displayed on the "Live" page. In this case, do the following. <ol style="list-style-type: none"> Select [Internet Options...] from [Tools] on the menu bar of Internet Explorer. The [Internet Options] window will be displayed. Click the [Settings] button in the [Browsing history] section on the [General] tab, and then select [Every time I visit the webpage] for [Check for newer versions of stored pages:] in the [Temporary Internet Files] tab on the [Website Data Settings] window. 	-
Images are displayed blurry.	<ul style="list-style-type: none"> Is the focus adjusted correctly? Check if the focus is adjusted correctly. 	Installation Guide

3 Others

Symptom	Cause/solution	Reference pages
The image is not being refreshed.	<ul style="list-style-type: none"> Depending on the version of your browser, there might be difficulties refreshing the picture, etc. 	Important Information
	<ul style="list-style-type: none"> Depending on the traffic of the network or the concentration of access to the camera, there might be difficulties displaying the camera picture. Request the camera picture using the web browser such as by pressing the [F5] key, etc. 	-
No image is displayed (or too dark).	<ul style="list-style-type: none"> Is the brightness setting set at an appropriate level? Click the [Normal] button of [Brightness]. 	12
Images are displayed washed out.	<ul style="list-style-type: none"> Is the brightness setting set at an appropriate level? Click the [Normal] button of [Brightness]. 	12
Flicker appears on the screen.	<ul style="list-style-type: none"> When flicker occurs frequently, select “Indoor scene” for “Light control mode”. 	87
Images cannot be saved on the SD memory card. Failed to write/read data on the SD memory card.	<ul style="list-style-type: none"> Is the SD memory card inserted correctly? Check if the SD memory card is inserted correctly. 	Important Information
	<ul style="list-style-type: none"> Is the SD memory card formatted? Format the SD memory card. 	67
	<ul style="list-style-type: none"> Isn't the write protect switch set to “LOCK”? When the write protect switch is set to “LOCK”, available size/total size indication of the SD memory card to be displayed on “Remaining capacity” of the [SD memory card] tab will be “*****MB/*****MB”. 	-
	<ul style="list-style-type: none"> Is “-----MB/-----MB” displayed on “Remaining capacity” of the [SD memory card] tab? Format the SD memory card. 	67
	<ul style="list-style-type: none"> Is “#####MB/#####MB” displayed on “Remaining capacity” of the [SD memory card] tab? Check the setting of “SD memory card password lock”. 	64
	<ul style="list-style-type: none"> Is any recognition error received when the “Diag.” of “E-mail notification” or “Panasonic alarm protocol” is used? Format the SD memory card. 	67 139 121
	<ul style="list-style-type: none"> Isn't the SD memory card out of order? There are limited times to overwrite on an SD memory card. When frequently overwritten, it may be at the end of product life. It is recommended to replace the SD memory card. 	-
Audio is not output from other products such as a network disk recorder or PC software package. X8570N	<ul style="list-style-type: none"> Some of the products such as a network disk recorder or PC software package may not support “G.711” or “AAC-LC”. Set “Audio input encoding format” of the products to “G.726 (32 kbps).” 	106

Symptom	Cause/solution	Reference pages
The alarm occurrence indication button and the SD recording status indicator on the "Live" page do not display the current status in real time.	<ul style="list-style-type: none"> Is the viewer software installed on the PC? Confirm that the viewer software "Network Camera View 4S" is installed. 	4
	<ul style="list-style-type: none"> Is "Real time" selected for "Alarm status update mode"? 	55
No image is displayed on the "Live" page.	<ul style="list-style-type: none"> Press the [F5] key on the keyboard of the PC or click the [Live] button. 	12
Shortcut icon of the camera is not displayed on "Network" of the PC.	<ul style="list-style-type: none"> Is the Windows component of UPnP added? Add the component to the PC in use. 	144
Cannot download the log list.	<ul style="list-style-type: none"> Download of files using Internet Explorer may be disabled. Enable "File Download" in the "Security Settings" window ([Internet Options] - [Security]). After changing the settings, close the web browser, and then access the camera again. 	-
Images are not displayed or not refreshed smoothly.	<ul style="list-style-type: none"> Delete temporary internet files as follows. <ol style="list-style-type: none"> Select "Internet Options..." under "Tools" on the menu bar of Internet Explorer. The "Internet Options" window will be displayed. Click the [Delete Files...] button in the "Temporary Internet Files" section on the [General] tab. 	-
	<ul style="list-style-type: none"> The firewall function of the anti-virus software may be filtering the port of the camera. Exclude the port number of the camera from the list of the port numbers to be filtered by the anti-virus software. 	-
No indicator lights.	<ul style="list-style-type: none"> Is "Off" selected for "Indicator" on the "Basic" page? Select "On" for "Indicator". 	55
H.265 (or H.264) images are not displayed.	<ul style="list-style-type: none"> When "Network Camera View 4S" is deleted from a PC on which the viewer software "Network Camera View 3" is installed, H.265 (and H.264) images will not be displayed. In this case, install "Network Camera View 4S" after deleting "Network Camera View 3". 	4

3 Others

Symptom	Cause/solution	Reference pages
<p>When displaying H.265 (or H.264) images on two or more web browser windows, images from two or more cameras are displayed in sequence on a single browser window.</p>	<ul style="list-style-type: none"> • This may occur due to the display adapter and driver combination. When this has occurred, first update the driver of the display adapter to the latest version. If updating the driver does not solve the problem, adjust the hardware acceleration as follows. The following are descriptions for when Windows 7 is installed on the PC in use. This setting may not be changed depending on the network environment. <ol style="list-style-type: none"> 1. Right-click on the desktop and select "Screen resolution" from the displayed pop-up menu. 2. Click "Advanced settings". 3. Select the [Troubleshoot] tab and then click "Change settings". 4. If the [User Account Control] dialog box is displayed, click "Yes". When logged in as a user other than the administrator, enter the password and click "Yes". Enter a user name as required. 5. Move the slider for "Hardware acceleration" to the extreme left towards "None", and then click "OK". 	<p style="text-align: center;">-</p>
<p>Failed to download recorded data from the image playing screen in the browser.</p>	<ul style="list-style-type: none"> • You may not be using Internet Explorer with administrator rights. After shutting down all of the open Internet Explorer windows and tabs, restart Internet Explorer by right-clicking the Internet Explorer icon in the Start menu and selecting "Run as Administrator". • In the "Name of the destination directory for downloaded images" settings, specify a directory that general users can write to. 	<p style="text-align: center;">76</p>
<p>When clicking the back button of the web browser, the screen is not displayed correctly.</p>	<ul style="list-style-type: none"> • Press the [F5] key on the keyboard to refresh the display. 	<p style="text-align: center;">-</p>

Information Bar

The “Information Bar” (①) expressed in the following symptom and solutions will be displayed just below the address bar only when there is information to communicate.

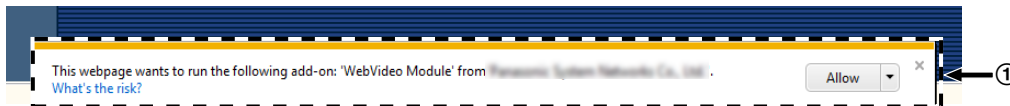

Depending on the OS installed on the PC, the following may occur. Follow the instructions below when the following has occurred. By performing the following solutions, other applications may not be affected.

Symptom	Cause/solution	Reference pages
The following message is displayed on the information bar. “Internet Explorer blocked a pop-up from ***.***.***.*** (IP address).”	<ul style="list-style-type: none"> Select “Options for this site” → “Always allow”. 	-
The following message is displayed on the information bar. “This webpage wants to run the following add-on: `WebVideo Module' from `Panasonic Corporation`.”	<ul style="list-style-type: none"> Select [Allow]. 	-
The following message is displayed on the information bar. “This webpage wants to install the following add-on: `nwc4Ssetup.exe' from `Panasonic Corporation`.”	<ul style="list-style-type: none"> Select [Install]. The “Security Warning” window will be displayed. Click the [Install] button on the displayed “Security Warning” window. 	-
An unnecessary status bar or scroll bar is displayed on the pop-up window.	<ul style="list-style-type: none"> Click “Internet Options...” under “Tools” of the menu bar of Internet Explorer, and then click the [Security] tab. Click “Internet” in the “Select a Web content zone to specify its security settings.” section. Then, click the [Custom level...] button to open the “Security Settings” window. Under “Miscellaneous”, select “Enable” for “Allow script-initiated windows without size or position constraints”. Click the [OK] button. When the warning window is displayed, click the [Yes] button. 	-

3 Others

Symptom	Cause/solution	Reference pages
Images are not fit in the frames.	<ul style="list-style-type: none">When “120 DPI” or higher is selected for “DPI setting”, they may not be displayed correctly. When using Windows 10: Right-click on the desktop, click “Display settings”, and then move the slider of “Change the size of text, apps, and other items” to “100% (Recommended)”. Select “Landscape” of “Orientation”. When using Windows 8.1: Right-click on the desktop, click “Screen resolution” → “Make text and other items larger or smaller”, and then move the slider of “Change the size of all items” to “Smaller” so that the screen becomes the recommended size. When using Windows 7: Right-click on the desktop, click “Screen resolution” → “Make text and other items larger or smaller”, and then select “Smaller - 100% (default)”.	-

3.4 Directory structure of drive B

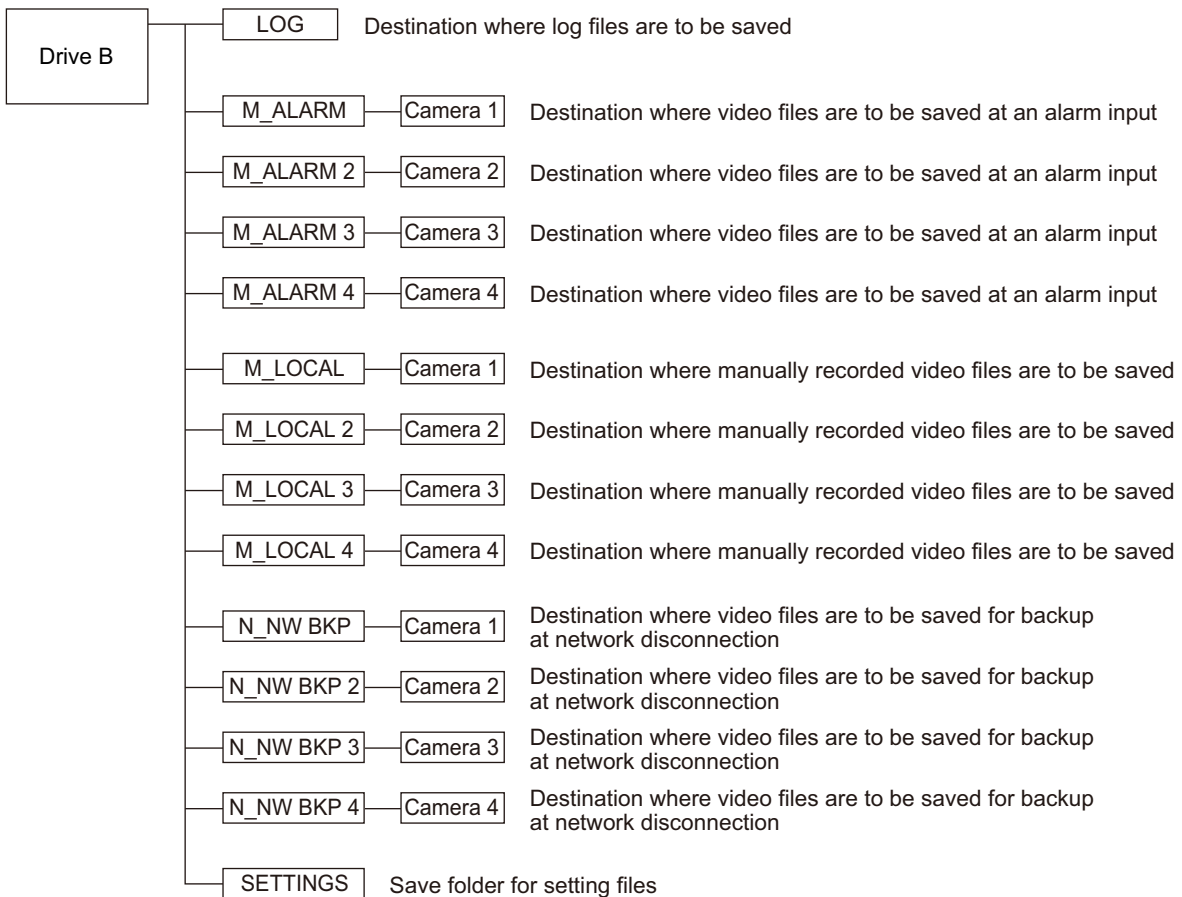

For U.S. and Canada:

Panasonic i-PRO Sensing Solutions Corporation of America

800 Gessner Rd, Suite 700 Houston, TX 77024
<https://www.security.us.panasonic.com/>

Panasonic Canada Inc.

5770 Ambler Drive, Mississauga, Ontario, L4W 2T3 Canada
1-877-495-0580
<https://www.panasonic.com/ca/>

For Europe and other countries:

Panasonic Corporation

<http://www.panasonic.com>

Panasonic i-PRO Sensing Solutions Co., Ltd.
Fukuoka, Japan

Authorised Representative in EU:

Panasonic Testing Centre
Panasonic Marketing Europe GmbH
Winsbergring 15, 22525 Hamburg, Germany

© Panasonic i-PRO Sensing Solutions Co., Ltd. 2019

PGQP2617XA N0618-2109