

FOREST

DRAPERY HARDWARE

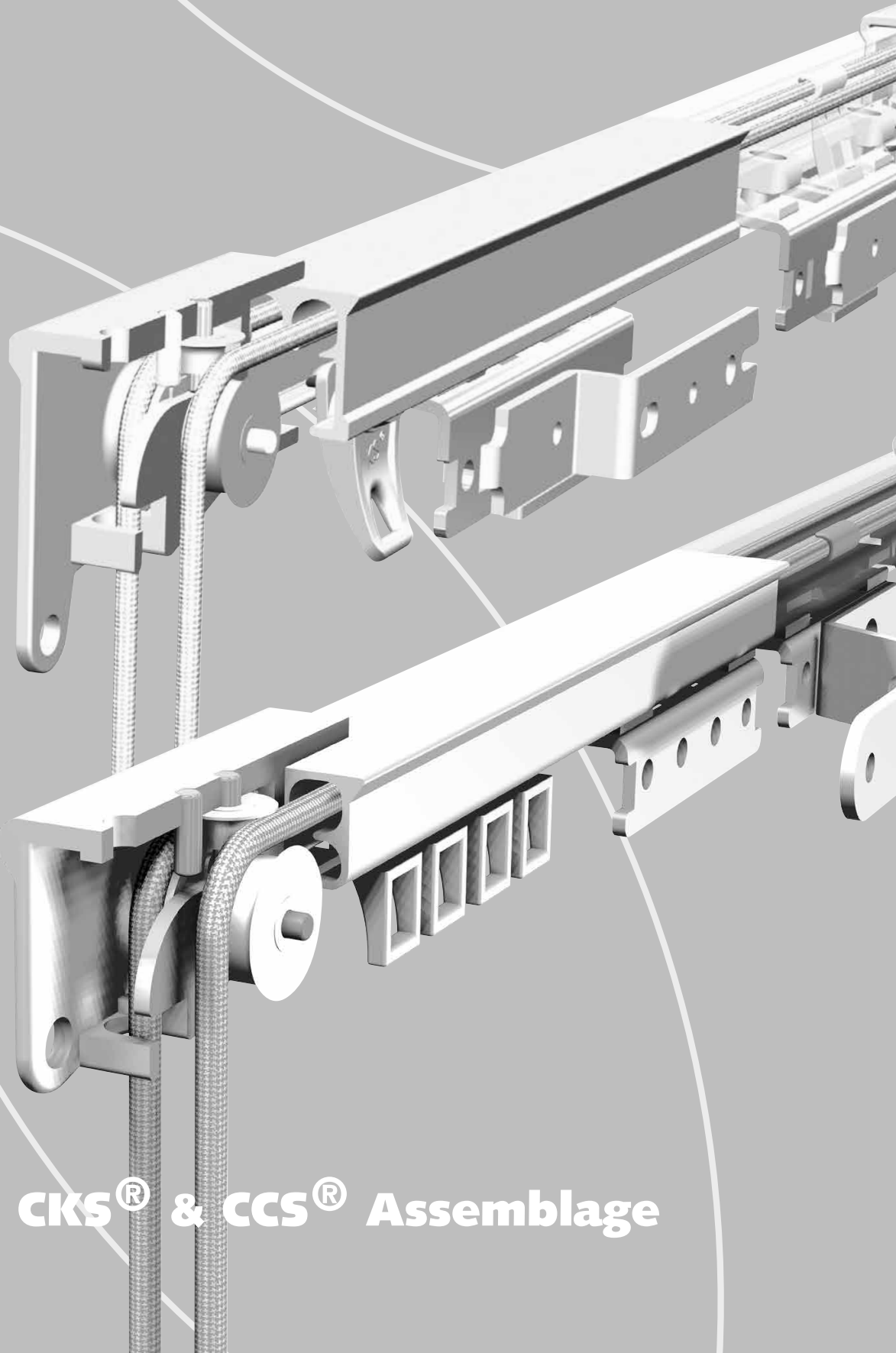
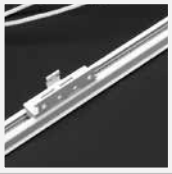
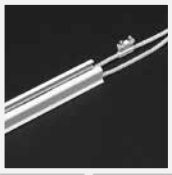

CKS[®] & CCS[®] Assemblage

CCS® & CKS® - Assemblage - cord

Instructions for assembling CCS® & CKS® center- and one-way draw, with cord.

Necessary items:

CCS-track	30010... ..
Nylon cord	1030401000
CCS Master Carrier Overlap R/L	30157...000
CCS Master Carrier Underlap R/L	30156...000
CCS End Pulley	30301...000
CCS End Pulley Small	30302...000
CKS Cord Connector	3030301000
Drill with bit 1	
Lighter (for heathen the nylon cord)	

Necessary items:

CKS-track	1501001.....
Nylon cord	1030401000
CKS Master Carrier Overlap R/L	1515701000
CKS Master Carrier Underlap R/L	1515601000
CKS Pulley	1530101000
CKS Cord Connector	1530301000
Drill with bit 1	
Lighter (for heathen the nylon cord)	



① Determining track-length: CKS® minus 8 cm (3,2" for center closing and one-way draw), CCS® minus 8 cm (center closing) and minus 6,5 cm (one-way draw). Determining cord-length: 2 times track length + 2 times the desired drop height of the cord. Cut the nylon cord by heating it with the lighter.

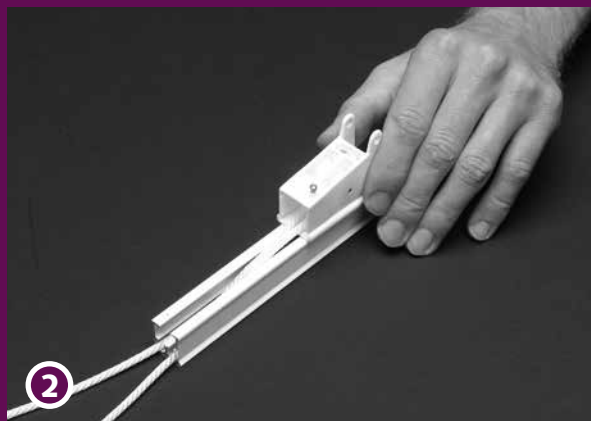

② Pull one end of the cord through the holes of the first pulley and slide the pulley over the track, like picture shows. With one way draw of CCS®, the Small Pulley has to be used. Fix the pulley onto the track and continue next steps on the other side of the track.

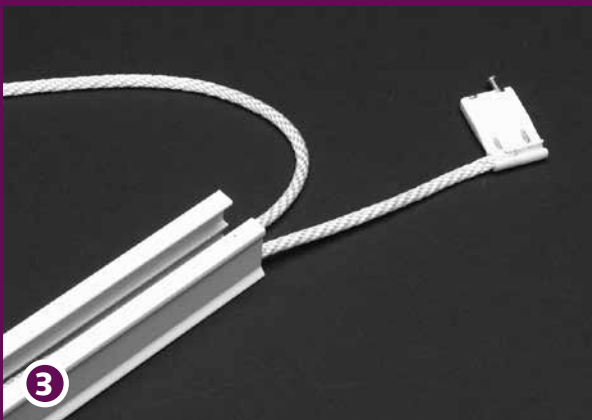

③ Fix the cord half into the cord connector. Ensure, with CCS® that the gap of the cord connector is facing outwards the track and with CKS®, the gap is facing towards the middle of the track. The fixing is easy by making a slide movement of the cord trough the gap of the cord connector.

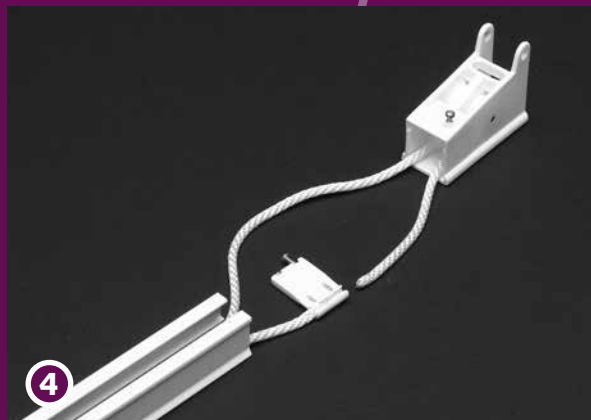

④ Pull the other end of the cord through the second pulley and connect it into the other side of the first cord connector.

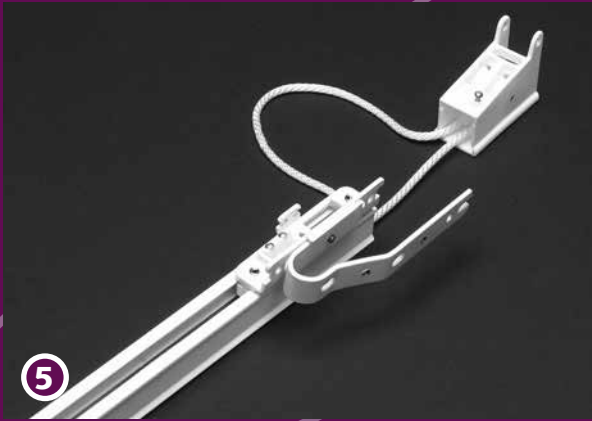

5 Slide the master carrier overlap, together with the cord connector into the cord channel of the track.

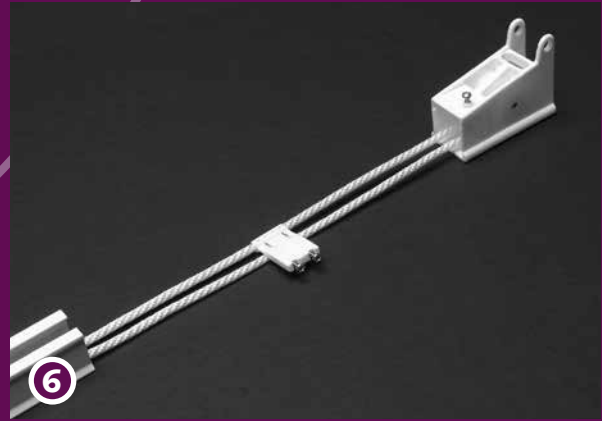

6 Fix the second cord connector on the opposite cord, (CCS[®] facing outside, CKS[®] to the middle of the track).

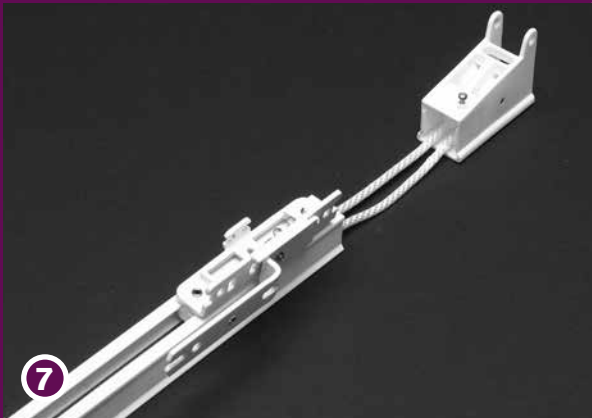

7 Slide the master carrier underlap, together with the second cord connector into the cord channel of the track and fix the second pulley onto the track. Use the screwdriver.



8 By pulling the cord, the side of operation can be determined. Slide the master carriers wide from each other and screw the cord connectors tight. Now, the system is balanced.



9 Ensure that the cord runs behind the metal pin in the pulley. This avoids slack in the mechanism during operation.



10 By pulling the cord through the big gap of the pulley, it will hang straight down the curtain and a good operation is guaranteed.

CCS® & CKS® Assembly – cord adjustability.

Instructions for assembling CCS® & CKS®, with cord adjustability.

This application can be made for CCS®, as well for CKS®. The advantage is that the requested drop height can be determined at a later stage. This feature makes the system very suitable for pre-assembling. This application is also possible for one-way draw. Start, repeating the first two steps of the instructions with cord and continue with the steps below.

Necessary items:

CCS-track	30010..
Nylon cord	1030401000
CCS Master Carrier Overlap R/L	30157...000
CCS Master Carrier Underlap R/L	30156...000
CCS End Pulley	30301...000
CCS End Pulley Small	30302...000
CKS Cord Connector	3030301000
Drill with bit 1	
Lighter (for heathen the nylon cord)	

Necessary items:

CKS-track	1501001.....
Nylon cord	1030401000
CKS Master Carrier Overlap R/L	1515701000
CKS Master Carrier Underlap R/L	1515601000
CKS Pulley	1530101000
CKS Cord Connector	1530301000
CKS Cord Connector (half)	1530311000
Drill with bit 1	
Lighter (for heathen the nylon cord)	



Fix one cord connector onto the end of the cord (CCS® facing outside, CKS® to the middle of the track). Slide the half cord connector on the other end of the cord (with CCS®, use a normal CCS cord connector), but do not screw it.

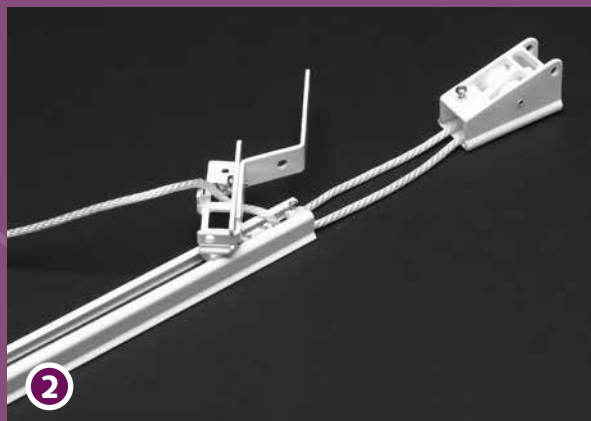

Slide the master carrier, together with the two cord connectors into the cord channel of the track. The cord is lifting out of the track, through the first gap of the master carrier overlap.

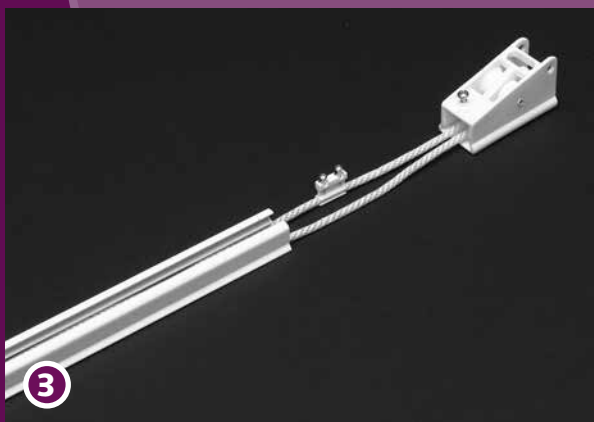

Fix the second cord connector on the opposite cord, (CCS® facing outside, CKS® towards the middle of the track).

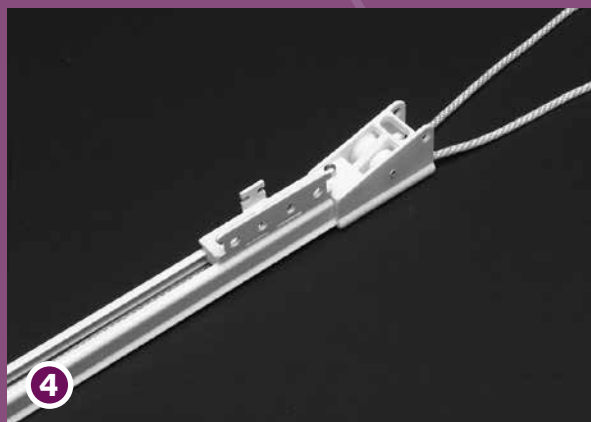

Slide the master carrier underlap, together with the cord connector into the cord channel of the track and fix the second pulley onto the track.

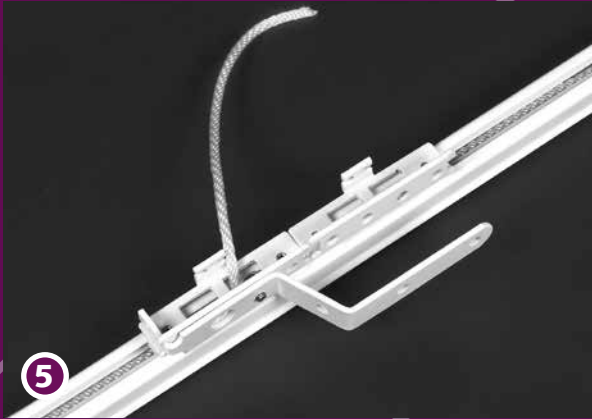

Determine the cord length by pulling the cord. Pull at the end to reduce the drop height, pull at the loop to increase the drop height. Screw the half cord connector tight to position the cord drop height (with CCS®: the second cord connector in the double construction).

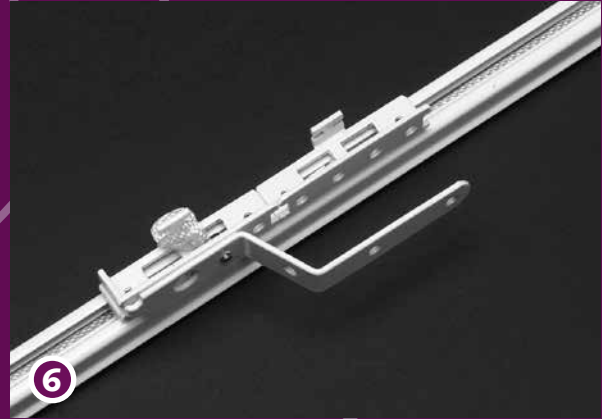

If necessary, cut the cord by heating it and make a knot at the end of the cord. Tight this on the extension in the middle of the master carrier overlap. This creates a strong construction.



Ensure that the cord runs behind the metal pin in the pulley. This avoids slack in the mechanism during operation.



By pulling the cord through the big gap of the pulley, it will hang straight down the curtain and a good operation is guaranteed.

Tips & Suggestions:

- The maximum length for cording / chaining CCS® is as follow: 6,10 mtr (20 Ft.) and for CKS® is 6 mtr (19.7 Ft.).
- The above sizes are without the pulleys! With pulleys, the sizes are as follow:

	centredraw	one-way draw
CCS®	6,18 mtr (20.27')	6,17 mtr (20.24')
CKS®	6,08 mtr (20')	6,08 mtr. (20')



FOREST
— DRAPERY HARDWARE —