



SIEMENS

Ingenuity for life

High-Voltage Products

Reliable products for all
customer requirements

[siemens.com/energy-management](https://www.siemens.com/energy-management)



Coil Products



Bushings



Surge Arresters



Instrument Transformers



Circuit Breakers



Disconnectors



Gas-Insulated Switchgear



Content

Foreword	5
Circuit-Breakers	6 – 23
Disconnectors	24 – 35
Surge Arresters	36 – 43
Instrument Transformers	48 – 67
Coil Products	68 – 75
Bushings	76 – 83
Gas-Insulated Switchgear.....	84 – 97
Silicone Long Rod Insulators	98 – 107
Service.....	108 – 111





Foreword

Energy! The elixir of life on our globe. Energy demand will increase by over 30% by 2040. Our global society depends on a safe, clean and sustainable energy supply. Generating electrical power and its transmission and distribution will be the key to achieving this ambitious task. The huge power demand in cities and industries requires effective power plants, as well as an efficient transmission of electrical power at high-voltage levels. High-voltage products are the physical backbone for reliable, safe, environmentally-friendly and economical power transmission.

This brochure showcases our comprehensive portfolio of high-voltage products: circuit-breakers, disconnectors and earthing switches, surge arresters, instrument transformers, coil products, bushings, and gas-insulated switchgear. Based on your requirements, Siemens high-voltage products create value through their high availability, low environmental impact, and low lifecycle costs. And the services we offer for high-voltage products ensure efficient long-term operation of your equipment.

What makes Siemens high-voltage products truly unique, however, is our dedication to creating additional benefits for our customers:

Proven reliability

The reliability of Siemens high-voltage products is recognized worldwide and far exceeds that of standard high-voltage products.

Global customer partnerships

Our technical experts are always close to our customers and we have references in almost every country of the world. The number of installations of our high-voltage products is one of the highest globally.

Continuous innovation for more than 100 years

We work with our customers to tackle their challenges and provide sustainable solutions. With our passion for and expertise in technology, we set standards and create long-term value – for our customers, for society, and for each individual.

Circuit-Breakers

Customer partnership around the globe

More than 136,000* circuit-breakers delivered to 150 countries with over 100 years of operational experience.



* counted by unit

Proven reliability

The probability of a major fault is one in 5,520 years (CIGRE average value is one major fault in 333 years).

MTBF* (Years)

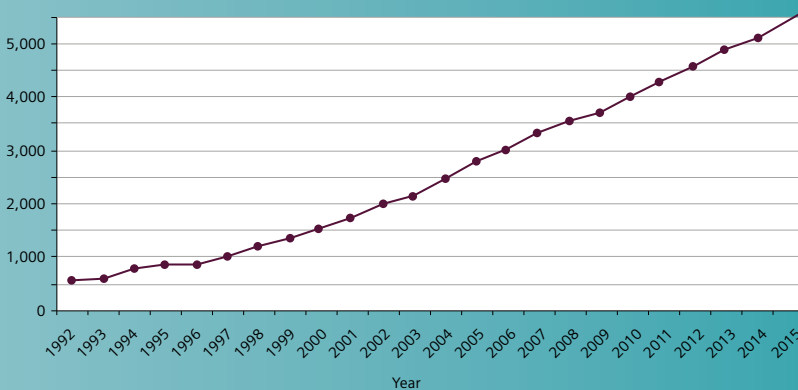

*Mean time between failures

- Siemens circuit-breakers are certified in accordance with the latest international standards, e.g., ISO/EN, IEC, ANSI, GOST, etc.
- A strong platform concept for interrupter unit and drives, which is also used for LT, DT, DTC and GIS, minimizes the risk of failure
- This ensures a failsafe product lifecycle of up to 50 years, including special applications, e.g., in high and low ambient temperatures or in earthquake-risk zones

Continuous innovation
since 1910

1910

Manufacturing of circuit-breakers starts in Berlin, Germany



1964

Delivery of the first SF₆ high-voltage circuit-breaker for 245 kV



1973

Development of the self-compression principle

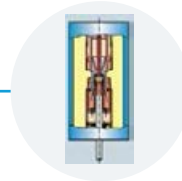

1982

Delivery of the first 800 kV CB



1996

Delivery of the first circuit-breaker with self-compression arcing chamber



2007

Delivery of the first 3AP1 DTC 145 kV compact switchgear



2009

Delivery of the first 3AP DCB disconnecting circuit-breaker



2010

Pilot installation of first vacuum circuit-breaker prototypes 3AV 72.5 kV



2012

2 cycle dead-tank circuit-breakers for 245 kV and 362 kV



2013

Pilot installation of ultra high-voltage circuit-breaker 3AP5 DT 1,200 kV



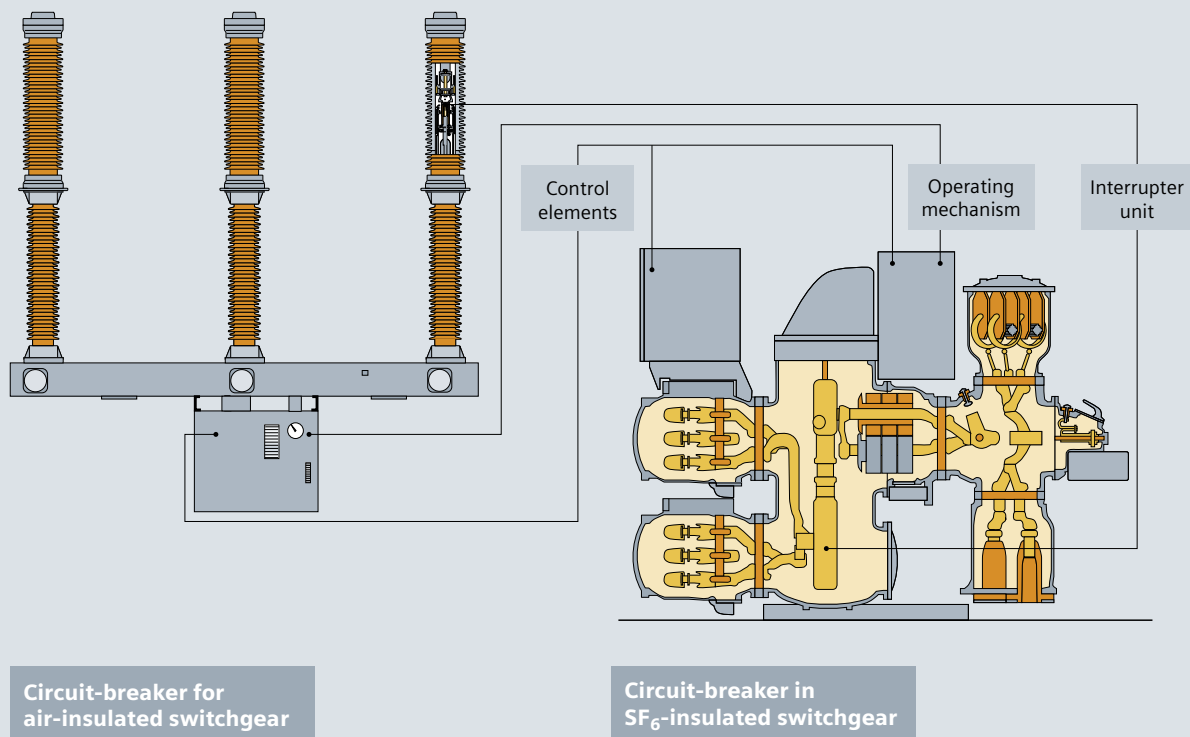

Fig. 1: Circuit-breaker parts: circuit-breaker for air-insulated switchgear (left), circuit-breaker in SF₆-insulated switchgear (right)

Circuit-Breakers for 72.5 kV up to 800 kV

Circuit-breakers are the central part of AIS and GIS switchgear. They have to fulfill demanding requirements such as:

- Reliable opening and closing
- Consistently high quenching performance with rated and short-circuit currents even after many switching operations
- High-performance, reliable, maintenance-free operating mechanisms.

State-of-the-art technology combined with years of operating experience is put to use in the further development and optimization of Siemens circuit-breakers. This ensures Siemens circuit-breakers meet the demands placed on high-voltage switchgear.

The comprehensive quality system is certified in accordance with DIN EN ISO 9001. It covers development, manufacturing, sales, commissioning, and after-sales service. Test laboratories are accredited by EN 45001 and PEHLA/STL.

The modular design

Circuit-breakers for air-insulated switchgear are individual components and are assembled on site with the individual electrical and mechanical components of an AIS installation.

Thanks to the consistent application of a modular design, all Siemens circuit-breaker types, whether air-insulated or gas-insulated, are made up of the same range of components based on a well-proven platform design (fig. 1):

- Interrupter unit
- Operating mechanism
- Sealing system
- Operating rod
- Control elements.

Interrupter unit – self-compression arc-quenching principle

The Siemens product range from 72.5 kV up to 800 kV includes high-voltage circuit-breakers with self-compression interrupter units – for optimum switching performance under every operating condition and for every voltage level.

Self-compression circuit-breakers

3AP high-voltage circuit-breakers for the complete voltage range ensure optimum use of the thermal energy of the arc in the contact cylinder. This is achieved by the self-compression interrupter unit.

Siemens patented this method for arc quenching in 1973. Since then, Siemens has continued to develop the self-compression interrupter unit technology.

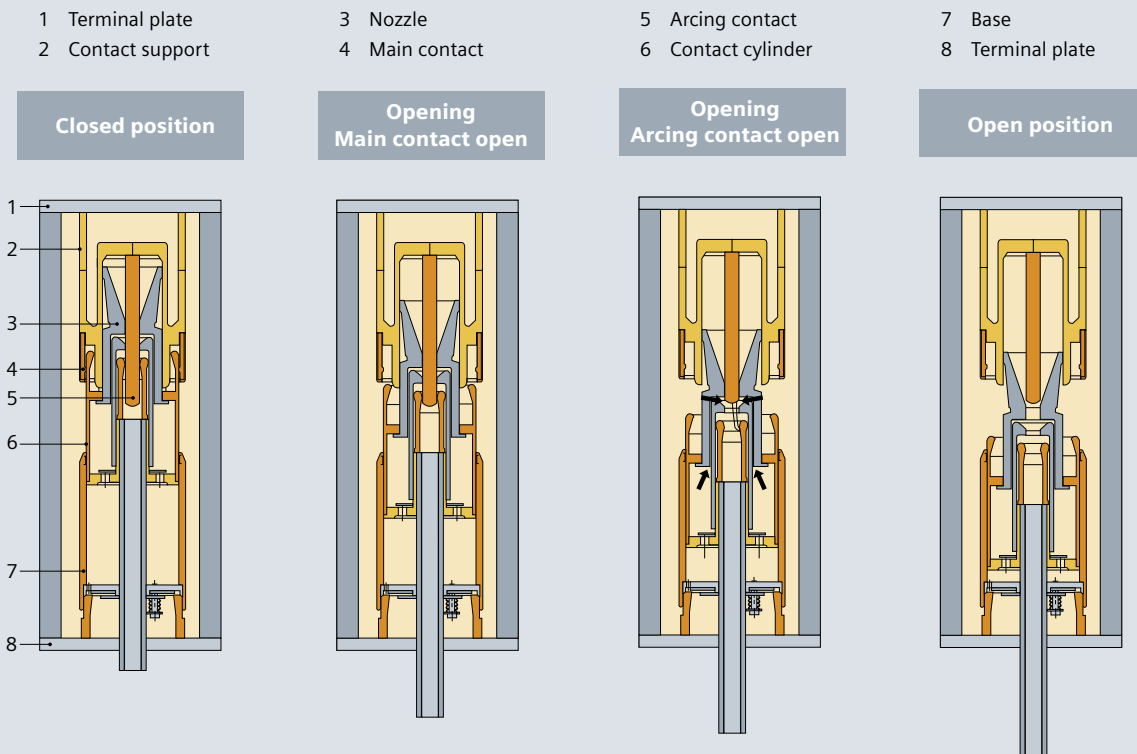

Fig. 2: The interrupter unit

One of its technical innovations is the increasing use of arc energy to extinguish the arc. In short-circuit breaking operations, the actuating energy required is reduced to the energy needed for mechanical contact movement.

This means that the operating energy is significantly minimized. The self-compression interrupter unit allows the use of a compact stored-energy spring mechanism that provides unrestricted high dependability.

Stored-energy spring mechanism – for the complete product range

The operating mechanism is a central part of the high-voltage circuit-breakers. The drive concept of the 3AP high-voltage circuit-breakers is based on the stored-energy spring principle. The use of such an operating mechanism for voltage ranges of up to 800 kV was needed as a result of the development of a self-compression interrupter unit requiring minimal actuating energy.

Advantages of the stored-energy spring mechanism are:

- Highest degree of operational safety: It is a simple and sturdy design and uses the same principle for rated voltages from 72.5 kV up to 800 kV with just a few moving parts. Due to the self-compression design of the interrupter unit, only low actuating forces are required.

- Availability and long service life: Minimal stressing of the latch mechanisms and rolling-contact bearings in the operating mechanism ensure reliable and wear-free transmission of forces.
- Maintenance-free design: The spring charging gear is fitted with wear-free spur gears, enabling load-free decoupling.

Siemens circuit-breakers for rated voltage levels from 72.5 kV up to 800 kV are equipped with self-compression interrupter units and stored-energy spring mechanisms.

For special technical requirements such as rated short-circuit breaking currents of 80 kA, Siemens can offer twin-nozzle circuit-breaker series 3AQ or 3AT with an electrohydraulic mechanism.

The interrupter unit: self-compression system

The conducting path

The current conducting path of the interrupter unit consists of the contact support (2), the base (7), and the movable contact cylinder (6). In the closed position, the current flows via the main contact (4) and the contact cylinder (6) (fig. 2).

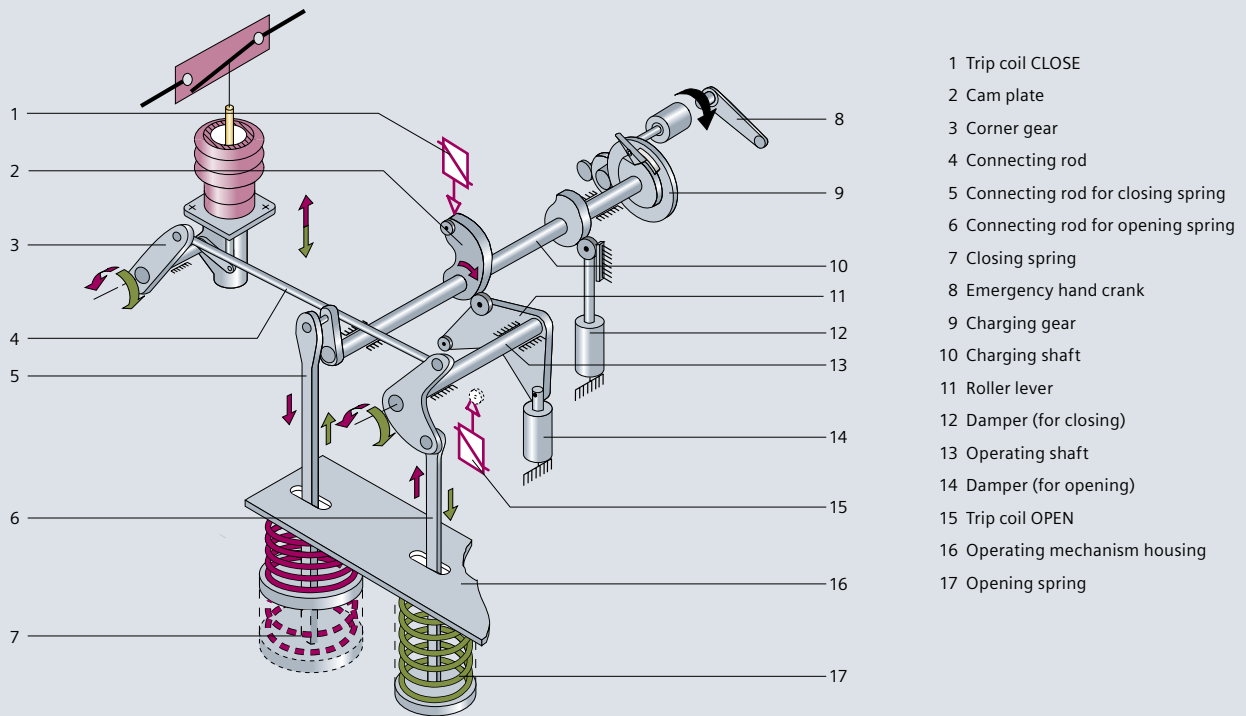

Fig. 3: Operating mechanism

Breaking operating currents

During the opening operation, the main contact (4) opens first and the current commutates to the closed arcing contact. During the further course of opening, the arcing contact (5) opens and an arc is drawn between the contacts. At the same time, the contact cylinder (6) moves into the base (7) and compresses the SF₆ gas located there. This gas compression creates a gas flow through the contact cylinder (6) and the nozzle (3) to the arcing contact, extinguishing the arc.

Breaking fault currents

In the event of interrupting high short-circuit breaking currents, the SF₆ gas is heated up considerably at the arcing contact due to the energy of the arc. This leads to a pressure increase in the contact cylinder. During the further course of opening, this increased pressure initiates a gas flow through the nozzle (3), thus extinguishing the arc. In this case, the arc energy is used to interrupt the fault current. This energy does not need to be provided by the operating mechanism.

Major features:

- Self-compression interrupter unit
- Use of the thermal energy of the arc
- Minimized energy consumption
- High reliability over the long term.

The operating mechanism

Stored-energy spring mechanism

Siemens circuit-breakers for voltages up to 800 kV are equipped with stored-energy spring mechanisms. These operating mechanisms are based on the same principle that has continued to prove its worth in Siemens low-voltage and medium-voltage circuit-breakers for decades. The design is simple and robust, with few moving parts and a highly-reliable vibration-isolated latch system. All components of the operating mechanism, the control and monitoring equipment, and all terminal blocks are arranged in a compact and convenient way in one cabinet.

Depending on the design of the operating mechanism, the energy required for switching is provided by individual compression springs (one per pole), or by springs that function jointly on a three-pole basis.



Fig. 5: 3AP4 FI 800 kV pole

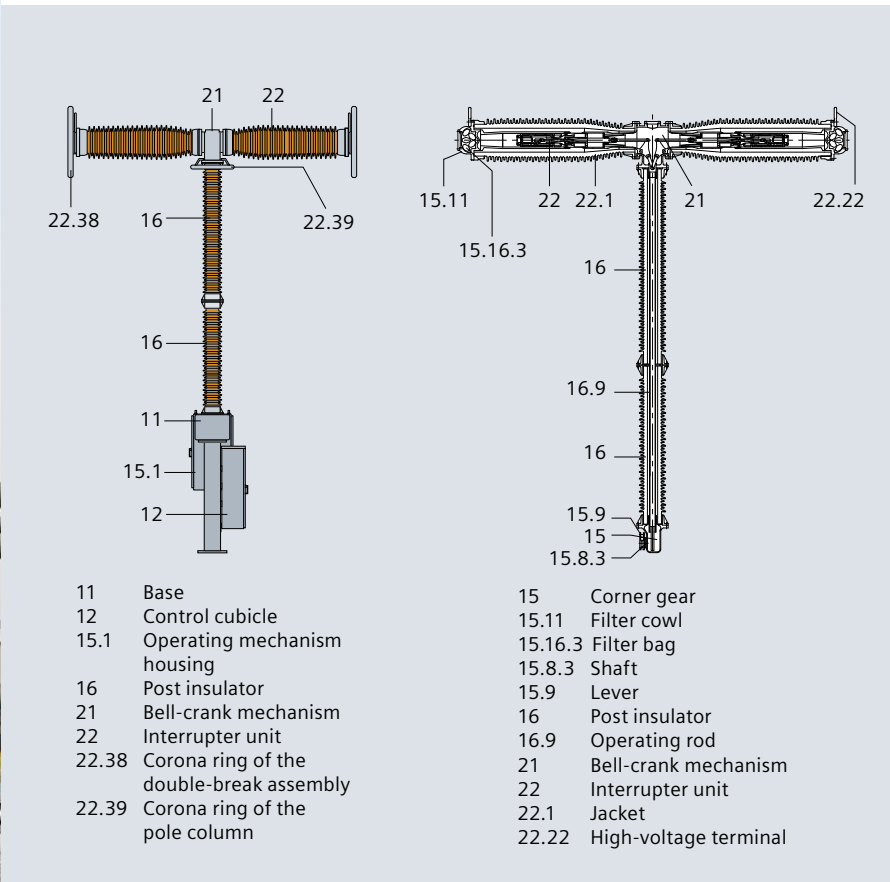

Fig. 6: 3AP2 FI 550 kV pole

Fig. 7: Sectional view of pole column



Fig. 4: Control cubicle

The principle of the operating mechanism with charging gear and latching is identical on all types (fig. 3). Differences between mechanism types are in the number, size and arrangement of the opening and closing springs.

Main features at a glance:

- Uncomplicated, robust construction with few moving parts
- Maintenance-free
- Vibration-isolated latches
- Load-free uncoupling of charging mechanism
- Easy access
- 10,000 operating cycles.

The control unit includes all necessary devices for circuit-breaker control and monitoring such as (fig. 4):

- Pressure / SF₆ density monitors
- Relays for alarms and lockout
- Operation counters (upon request)
- Local circuit-breaker control (upon request)
- Anti-condensation heaters.

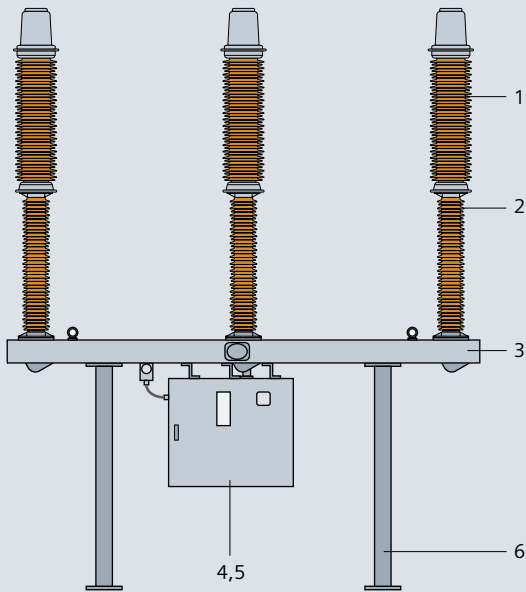

- | | |
|------------------------|-------------------------------|
| 1 Interrupter unit | 4 Control cubicle |
| 2 Post insulator | 5 Operating mechanism housing |
| 3 Circuit-breaker base | 6 Pillar |



Fig. 9: 3AP1 FG 145 kV

Fig. 8: 3AP1 FG 145 kV with three-pole stored-energy spring mechanism

Live-Tank Circuit-Breakers for 72.5 kV up to 800 kV

Live-tank circuit-breakers for air-insulated switchgear

The interrupter unit in live-tank circuit-breakers is not earthed during operation; it is exposed to high-voltage potential. These circuit-breakers are therefore called live tanks.

The live-tank circuit-breaker family is available for rated voltages from 72.5 kV up to 800 kV (fig. 5).

They consist of the following main components based on a well-established platform concept (fig. 6, fig. 7, fig. 8):

- Self-compression interrupter unit
- Stored-energy spring mechanism
- Insulator column (AIS)
- Operating rod
- Circuit-breaker base
- Control unit.

3AP1 circuit-breakers up to 300 kV are equipped with one interrupter unit per pole, and 3AP2 circuit-breakers up to

550 kV include two interrupter units. For applications from 362 kV to 550 kV, the circuit-breakers can be equipped with optional closing resistors (3AP3). The 3AP4 includes four interrupter units per pole and can also be delivered with closing resistors on request (3AP5). Moreover, the Siemens high-voltage live-tank circuit-breakers are available for three-pole operation with a common base (FG) (fig. 9), for single-pole operation with a common base (FE), or for single-pole operation with separate bases (FI).

Siemens high-voltage circuit-breakers operate safely, and are capable of withstanding high mechanical loads. Particularly strong porcelain insulators and a circuit-breaker design optimized by using the latest mathematical techniques give them very high seismic stability while in operation, enabling them to perform to their full potential during the entire service life of up to 50 years (table 1). The uncomplicated design of the circuit-breakers and the use of many similar components ensure high reliability. The experience Siemens has gained from the many circuit-breakers in service has been applied to improving the design. The self-compression interrupter unit, for example, has proven its reliability in more than 100,000 installations all over the world.



Efficiency

- Maintenance-free for 25 years
- Service-free even with frequent breaking operations

Performance

- Two-cycle current interruption
- High number of short-circuit interruptions

Sustainability

- Vacuum interruption
- Nitrogen insulation
- Beneficial CO₂ footprint

Reliability

- 40 years of experience in vacuum switching technology
- Perfect for low temperature applications

Fig. 10: 3AV1 FG vacuum circuit-breaker 72.5 kV

Live-tank circuit-breakers with vacuum technology

Following 40 years of experience producing medium-voltage vacuum interrupters and more than three million delivered units, Siemens has now introduced this proven technology into high-voltage power networks.

The new member of the Siemens circuit-breaker family meets the same high quality standards as the SF₆ portfolio for high performance and reliability throughout its long service life, and is also designed according to the well-established modular platform concept.

The new 3AV1 vacuum circuit-breaker has clear technical advantages: It features reliable switching capacity, requires no maintenance even when subjected to frequent breaking operations, and is also environmentally friendly – thanks to switching operations performed in a vacuum, with nitrogen as the insulating medium.

These circuit-breakers are the right choice for future projects across a wide range of applications.

A complete set of type tests in accordance with the latest edition of IEC 62271-100 has proven the suitability of the 72.5 kV live-tank vacuum circuit-breaker.

Field experience

Prototypes of the new Siemens high-voltage vacuum circuit-breakers have already been installed in European power networks. A number of Energy customers are operating the 3AV1 prototypes in their systems, and are sharing their operating and field experience with us. In fact, several thousand switching operations have already been performed successfully in the field and documented (fig. 10).

Type		3AP1						3AP2/3		3AP4/5
Rated voltage	[kV]	72.5	123	145	170	245	300	420	550	800
Number of interrupter units per pole		1						2		4
Rated short-duration power-frequency withstand voltage	[kV]	140	230	275	325	460	460	610	800	830
Rated lightning impulse withstand voltage/min	[kV]	325	550	650	750	1,050	1,050	1,425	1,550	2,100
Rated switching impulse withstand voltage	[kV]	–	–	–	–	–	850	1,050	1,175	1,425
Rated normal current, up to	[A]	2,500	4,000	4,000	4,000	4,000	4,000	5,000	5,000	5,000
Rated short-time withstand current (1 s–3 s), up to	[kA _(ms)]	31.5	40	40	40	50	40	63	63	63
Rated short-circuit breaking current, up to	[kA]	31.5	40	40	40	50	40	80	63	63
Temperature range	[°C]	–60 up to +55*								
Rated operating sequence		0-0.3 s-CO-3 min-CO or CO-15 s-CO								
Rated break time		3 cycles						2 cycles		
Rated frequency	[Hz]	50/60								
Maintenance after		25 years								
Type		3AV1								
Rated voltage	[kV]	72.5								
Number of interrupter units per pole		1								
Rated normal current, up to	[A]	2,500								
Rated short-time withstand current, up to	[kA]	31.5								
Rated short-circuit breaking current, up to	[kA]	31.5								
Rated frequency	[Hz]	50								
Rated power-frequency withstand voltage	[kV]	140								
Rated lightning impulse withstand voltage	[kV]	325								
Rated duration of short circuit	[s]	3								
Rated peak withstand current (2.7 p.u.)	[kA]	85								
First-pole-to-clear-factor	[p.u.]	1.5/1.3								
Capacitive voltage factor	[p.u.]	1.4								
Temperature range	[°C]	–55 up to +40								
Maintenance after		25 years								
Insulating medium		N ₂								
All values in accordance with IEC; other values on request										

Table 1: Technical data of live-tank circuit-breaker portfolio

* Limited normal current ratings at more than +40°C



Fig. 11: SPS2/3AP1 DT 72.5 kV



Fig. 12: SPS2/3AP1 DT 145 kV

Dead-Tank Circuit-Breakers for 72.5 kV up to 550 kV

Circuit-breakers in dead-tank design

In contrast to live-tank circuit-breakers, dead tanks have a metal-enclosed interrupter unit and the housing is always earthed. They are therefore called dead-tank circuit-breakers. For certain substation designs, dead-tank circuit-breakers might be required instead of the standard live-tank circuit-breakers. The dead-tank circuit-breaker offers particular advantages if the protection design requires the use of several current transformers per pole assembly. For this purpose, Siemens can offer dead-tank circuit-breaker types suitable for different voltage levels (*fig. 11, fig. 12, fig. 13*).

Most important characteristics of a dead-tank circuit-breaker:

- A compact construction due to toroidal-core current transformers on bushings
- High short-circuit breaking currents (up to 63 kA with one interrupter unit)
- Low impulse load of the bases
- Higher seismic withstand capability due to low center of gravity of the bases
- Gas mixture or heating system for lowest temperature applications
- Gas-insulated components ensure highest availability with minimum maintenance effort
- Metal-enclosed interrupter unit (earthed housing).



Fig. 13: SPS2/3AP1 DT 362 kV (two cycles)

Current transformers (CT)

The dead-tank circuit-breakers can be equipped with bushing current transformers for measurement or protection purposes, fulfilling the requirements of international standards such as IEC, ANSI, etc. The current transformers are mounted in weatherproof housings onto both sides of each circuit-breaker pole, and are located at the base of the bushings. The current transformer leads terminate in the control cubicle at short-circuiting-type terminal blocks. A standard housing provides space for up to three current transformers per bushing.

The 3AP DT high-voltage circuit-breaker operates safely and is capable of bearing high loads. Extra-strong porcelain bushings and an optimized circuit-breaker design give it very high seismic stability while in operation. The circuit-breaker covers the whole temperature range from -60 °C up to 55 °C with pure SF₆, which makes it suitable for all climate zones.

Like the other circuit-breakers, the Siemens dead tanks are based on a proven modular design using a patented self-compression arc-quenching system and the stored-energy spring drive mechanism. They ensure a consistent quenching performance with rated and short-circuit currents – even after many switching operations.

Dead-tank circuit-breaker

Type SPS2 and 3AP DT

The type SPS2 power circuit-breakers are used for the US and ANSI markets, and the 3AP DT circuit-breaker types are offered in IEC markets. Both types are designed as general, definite-purpose circuit-breakers for use at maximum rated voltages from 72.5 kV up to 550 kV (table 2). In 2012, two new DT breakers with two-cycles interruption for 245 kV and 362 kV complemented the Siemens DT portfolio, and have been established on the market with great success (fig. 13).

Technical data

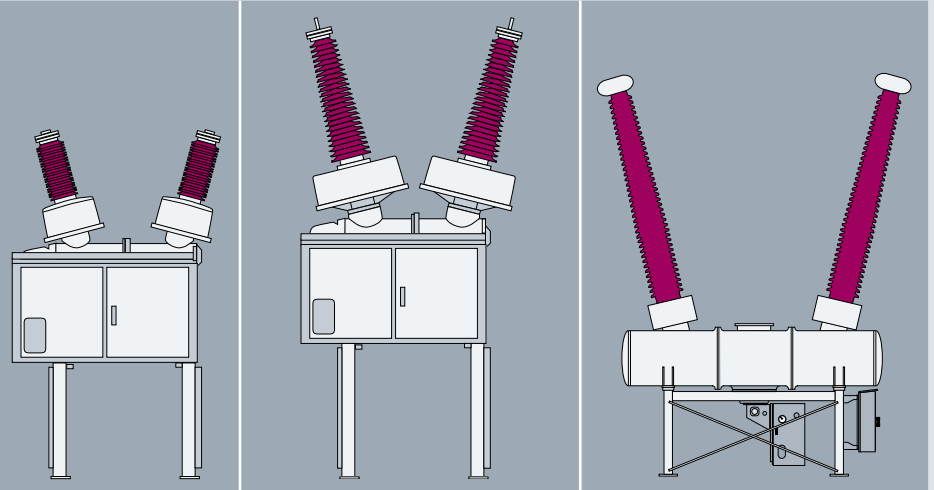

Type	3AP1 DT / SPS2					3AP2/3 DT / SPS2	
Rated voltage [kV]	72.5	123	145	245	362	362	550
Rated power-frequency withstand voltage [kV]	140 / 160	230 / 260	275 / 310	460	520	520	800 / 860
Rated lighting impulse withstand voltage [kV]	325 / 350	550	650	1,050	1,380	1,380	1,865 / 1,800
Rated switching impulse withstand voltage [kV]	–	–	–	–	950	950	1,175
Rated nominal current up to [A]	3,150	3,150	3,150	3,150	5,000	4,000	4,000 / 5,000
Rated breaking current up to [kA]	40	40	63	90	63	80	63
Operating mechanism type	Stored-energy spring mechanism						

Table 2: Technical data of dead-tank circuit-breaker

The design

Dead-tank circuit-breakers (except for the 550 kV version) consist of three identical pole units mounted onto a common support frame. The opening and closing spring of the FA-type operating mechanism is transferred to the moving contacts of the interrupter unit through a system of connecting rods and a rotating seal at the side of each phase.

The connection to the overhead lines and busbars is established by SF₆-insulated air bushings. The insulators are available in either porcelain or composite (epoxy-impregnated fiberglass tube with silicone rubber sheds) materials.

The tanks and the bushings are charged with SF₆ at a rated pressure of 6.0 bar. The SF₆ is used for insulation and arc-quenching purposes.

The 3AP2/3 DT for 550 kV (fig. 14, fig. 15) consists of two interrupter units in a series that features a simple design. The proven Siemens arc-quenching system ensures faultless

operation, a consistently high arc-quenching capacity, and a long service life, even at high switching frequencies.

Thanks to ongoing further development, optimization, and consistent quality assurance, Siemens self-compression arc-quenching systems meet all the demands placed on modern high-voltage technology.

A control cubicle mounted at one end of the circuit-breaker houses the spring operating mechanism and circuit-breaker control components. The interrupter units are located in the aluminum housing of each pole unit. The interrupters use the latest Siemens self-compression arc-quenching system.

The stored-energy spring mechanism is the same design as used for the Siemens 3AP live-tank circuit-breakers, GIS, and compact switchgear. This design has been in service for more than ten years, and has a well-documented reliability record.

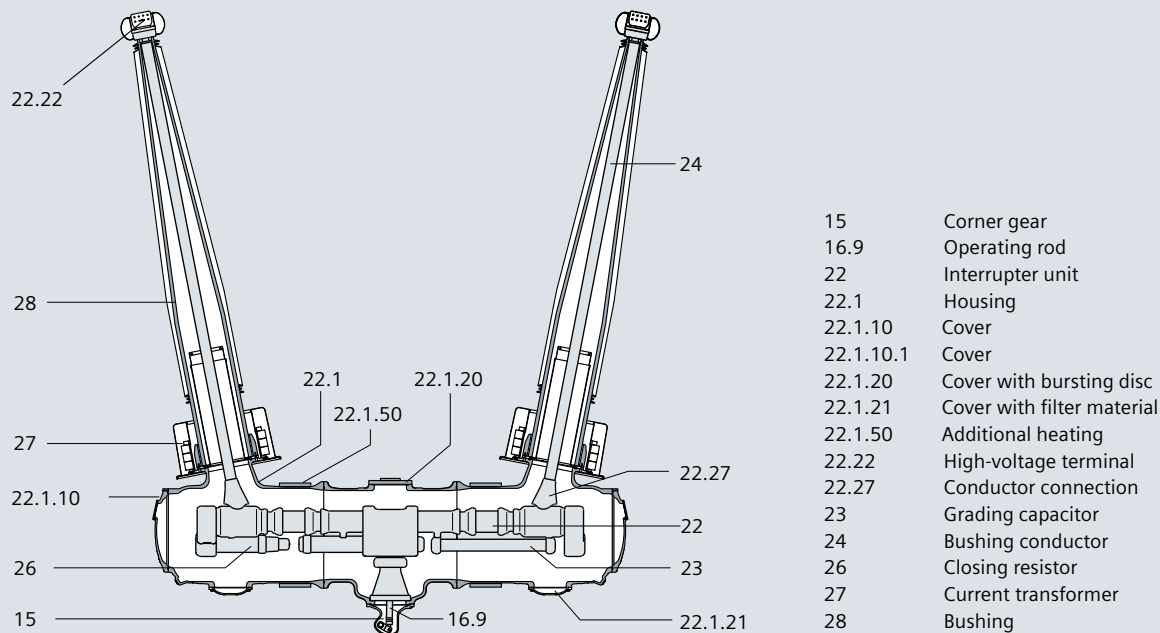

Fig. 14: Sectional view of a 3AP2/3-DT circuit-breaker pole

Operators can specify up to four (in some cases, up to six) bushing-type current transformers (CT) per phase. These CTs, mounted externally on the aluminum housings, can be removed without dismantling the bushings.

Operating mechanism

The mechanically and electrically trip-free spring mechanism type FA is used on type SPS2 and 3AP1/2 DT circuit-breakers. The closing and opening springs are loaded for "O-C-O" operations.

A weatherproof control cubicle (degree of protection IP55) has a large door sealed with rubber gaskets for easy access during inspection and maintenance. Condensation is prevented by heaters that maintain a difference between inside/outside temperature, and by ventilation.

The control system includes all the secondary technical components required for operating the circuit-breaker, which are typically installed in the control cubicle. The current transformer connections are also located in the control cubicle.

There is a wide selection of control, tripping, motor and heating power supplies. Depending on customer requirements, two standard control versions are available.

Basic version

The basic variant includes all control and monitoring elements that are needed for operation of the circuit-breaker. In addition to the elementary actuation functions, it features:

- 19 auxiliary switch contacts (nine normally open, nine normally closed, one passing contact)
- Operations counter
- Local actuator.



Fig. 15: 3AP2 DT 550 kV

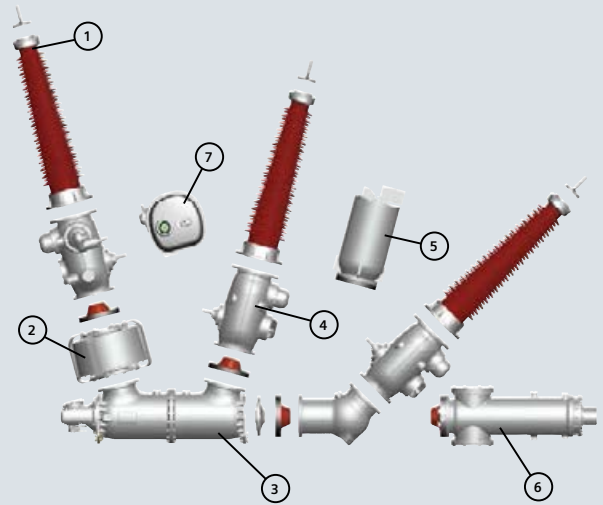

1. Bushing
2. Current transformer
3. Circuit-breaker with self-compression principle
4. Three-position disconnector and earthing switch
5. Voltage transformer
6. Cable connection assembly
7. High-speed earthing switch

Fig. 16: Possible components for the 3AP1 DTC

Compact version

In addition to the basic version, this type includes:

- Spring monitoring by motor runtime monitoring
- Heating monitoring (current measuring relay)
- Luminaire and socket attachment with a common circuit-breaker to facilitate servicing and maintenance work
- Overvoltage attenuation
- Circuit-breaker motor
- Circuit-breaker heating.

The 3AP1 DTC – Dead-Tank Compact – a Compact Switchgear up to 245 kV

The hybrid concept

The hybrid concept combines SF₆-encapsulated components and air-insulated devices. The application of gas-insulated components increases availability of switchgear. According to CIGRE analyses, gas-insulated components are

four times more reliable than air-insulated components. The level of encapsulation can be defined in accordance with the requirements of the individual substation layout and the system operator's project budget. This leads to optimized investments and can be combined with further air-insulated devices.

The modular design

Based on the well-proven modular design, the core components of the main units apply the same technology that is used in the well-established high-voltage circuit-breakers, disconnectors, and GIS product family from Siemens.

These components are (fig. 16):

- Self-compression arc-quenching interrupter unit of the AIS 3AP circuit-breaker
- Stored-energy spring mechanism
- SF₆-insulated disconnector/earthing switch from the GIS type 8DN8
- Outdoor earthing switch from the disconnector product range.



Fig. 17: 3AP1 DTC 145 kV



Fig. 18: 3AP1 DTC 245 kV

This enables flexible solutions according to different substation configurations (*fig. 17, fig. 18, fig. 20*):

- Circuit-breaker with single-pole or three-pole operating mechanism
- Disconnecter, earthing switch, high-speed earthing switch
- Current transformer, voltage transformer, and voltage detecting system
- Cable connections possible at various positions
- Bushings available as porcelain or composite insulators
- Additional separations of gas compartment, with SF₆ density monitor on request
- Double-breaker modules for ultra-compact substation designs
- Option to combine with stand-alone components, e.g., disconnecter module with voltage transformer.

Highlights and characteristics

- Simple SF₆ filling and monitoring, one gas compartment possible (separation optional)
- Flexibility in confined spaces and extreme environmental conditions, e.g., low temperature applications to -55 °C

- Single-pole encapsulation: no three-phase fault possible, and fast replacement of one pole (spare part: one pole)
- Safety can be enhanced by separated gas compartments, e.g., between circuit-breaker and disconnecter
- Complete module can be moved with a fork-lift truck
- Fast installation and commissioning: easy assembly of fully manufactured and tested modular units
- Less maintenance effort: first major inspection after 25 years
- Service life minimum 50 years
- Single-pole and three-pole operated drive system for 145 kV and 245 kV (*fig. 19*).

Standard

The international IEC 62271-205 standard treats compact switchgear assemblies for rated voltages above 52 kV. The used terminology for the hybrid concept is the so-called mixed technology switchgear (MTS).

The Siemens compact switchgear is fully type-tested in accordance with this standard (*table 3*).

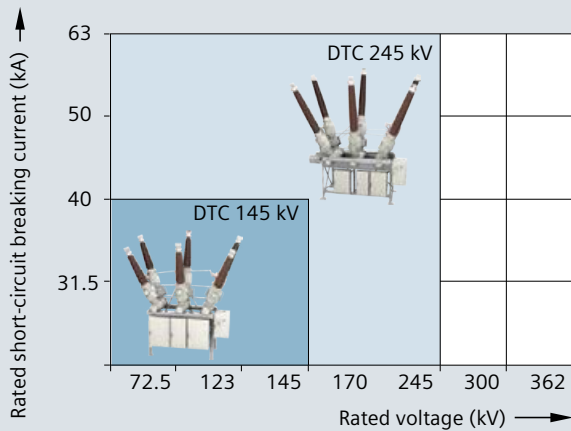

Fig. 19: DTC product range, one-pole or three-pole operation



Fig. 20: 3AP1 DTC 145 kV with voltage transformer and cable connection

Siemens has one of the most modern testing laboratories available, which is certified and part of the European network of independent testing organizations (PEHLA). Additional international testing laboratories (KEMA, CESI) also certify the high quality standards of the Siemens circuit-breakers.

Accessories for 3AP1 DTC

To enhance the possibility of circuit-breaker monitoring, the Siemens voltage detecting system (VDS) or SIVIS camera systems can be used.

The VDS is an economic alternative to a voltage transformer if the measurement of voltage values is not required. Up to three VDS systems can be integrated into the outgoing units to monitor the voltage. The system is attached directly to the disconnecter and earthing switch component of the DTC, and enables the voltage condition of the compact switchgear to be checked.

High-voltage compact switchgear		3AP1 DTC	
Rated voltage	[kV]	145	245
Rated normal current	[A]	3,150	4,000
Rated frequency	[Hz]	50/60	50/60
Rated lightning impulse withstand voltage	[kV]	650	1050
Rated power-frequency withstand voltage	[kV]	275	460
Rated short-time withstand current (3 s)	[kA]	40	63
Rated peak withstand current	[kA]	108	170

Table 3: Technical data of 3AP1 DTC



Fig. 21: 3AP1 DCB 145 kV



Fig. 22: 3AP2 DCB interlock indicator

SIVIS camera systems for the 3AP1 DTC make it possible to quickly and easily check the disconnecting earthing switch module positions. The systems are a complementary solution for preexisting position indicators on earthing switch operating mechanisms. With these camera systems, Siemens has made it easy for maintenance and service personnel to monitor the disconnecter, earthing switch, and high-speed rating positions during maintenance, which further improves the safety standards of the switchgear. Depending on individual requirements, the customer can choose between a stationary and a mobile camera system.

The DCB – Disconnecting Circuit-Breaker

ONE device – TWO functions

In switchgear, isolating distances in air combined with circuit-breakers are used to protect the circuit state in the grid.

Siemens developed a combined device in which the isolating distance was integrated into the SF₆ gas compartment on the basis of an SF₆-insulated circuit-breaker to reduce environmental effects. The combined device (DCB – disconnecting circuit-breaker) is used as a circuit-breaker and additionally as a disconnecter – two functions combined in one device (*fig. 21, fig. 23*).

The DCB was developed on the basis of a higher-rated standard 3AP circuit-breaker to provide the higher dielectric properties required, and was type-tested in accordance with IEC 62271-108 for disconnecting circuit-breakers. Due to the SF₆-insulated disconnecter function, there is no visible opening distance anymore. The proper function of the kinematic chain has been thoroughly verified. The

		3AP1 DCB	3AP2 DCB
Rated voltage	[kV]	145	420
Number of interrupter units per pole		1	2
Rated power-frequency withstand voltage	[kV]	275/315	520/610
Rated lightning impulse withstand voltage	[kV]	650/750	1,425/1,665
Rated switching impulse withstand voltage	[kV]	n.a.	1,050/1,245
Rated normal current up to	[A]	3,150	4,000
Rated short-circuit breaking current	[kArms]	31.5	40
Ambient air temperature *)	[°C]	-40 ... +40	-40 ... +40
Insulating medium		SF ₆	SF ₆
Classification CB		M2, C2	M2, C2
Classification DS		M2	M2
Insulators		Composite **)	Composite
Attached earthing switch (optional)		Yes	No
*) Other ambient temperature values on request			
**) Or porcelain			

Table 4: Technical data of 3AP DCB



Fig. 23: 3AP2 DCB 420 kV

closest attention was paid to developing a mechanical interlock, which guarantees that the circuit-breaker remains in open position when used as a disconnecter. When this mechanical interlock is activated, it is impossible to close the breaker (fig. 22). The current status of the DCB can also be controlled electrically, and is shown by highly-visible position indicators.

In addition, an air-insulated earthing switch can be mounted onto the supporting structure. Its earthing function is implemented by a well-established earthing switch with a Ruhrtal-designed maintenance-free contact system.

The disconnecting circuit-breakers are type-tested in accordance with class M2 and C2 of IEC 62271-108, a specific standard for combined switching devices (table 4).

Combining the strengths of a well-proven product portfolio, Siemens can provide a new type of device that fulfills the system operator's needs for highest reliability and safety, while saving space and costs at the same time.

Highlights and characteristics

- Maximum reliability by applying well-proven and established components from Siemens circuit-breakers and Ruhrtal-designed earthing switches
- Maximum availability due to longer maintenance intervals
- Economical, space-saving solution by combining the circuit-breaker and the disconnecter into one device
- Minimized costs for transportation, maintenance, installation and commissioning, as well as civil works (foundation, steel, cable ducts, etc.)
- Compact and intelligent interlocking and position indicating device
- Also available without earthing switch
- Porcelain or composite insulators available.

Circuit-breakers

➔ [siemens.com/energy/hv-circuit-breaker](https://www.siemens.com/energy/hv-circuit-breaker)

Disconnectors

Customer partnership around the globe

Siemens delivered more than 121,000 disconnectors to over 110 countries worldwide.

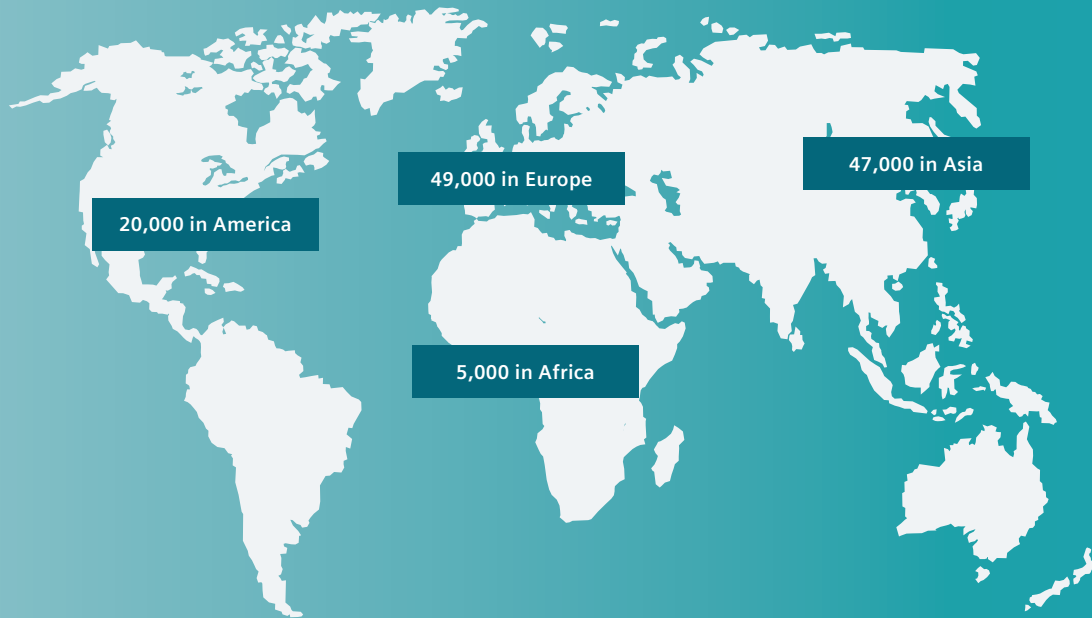

Proven reliability

- Delivery of pre-assembled and pre-adjusted disconnector poles and main components
- Easy erection and final adjustment according to operating instructions
- No special tools necessary, only standard tools are to be used
- Use of maintenance-free components, joints, and rotating units (greased for life, protected against wash out)
- Dry-lubricated contact systems



Continuous innovation since 1908

1908

Delivery of a mobile disconnector construction for 70 kV (three-pole)



1922/23

1922: Air-insulated disconnector for 80 kV
1923: Double-side break disconnector for 110 kV



1951

Introduction of new V-type disconnector for 110 kV

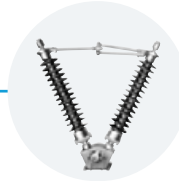

1955/58

1955: Introduction of pantograph disconnector for 380 kV
1958: Delivery of pantograph disconnectors for first 380 kV substation in Germany



1972

Introduction of new 3DS series for 220 kV and 380 kV



1992

Disconnector business sold to Ruhrtal (founded in Germany in 1922)



2001

Ruhrtal acquired by Siemens



2007

Production of first 3DN1 center-break disconnector for 72.5 kV up to 245 kV



2008

First 800 kV DC double-side break disconnector



2014

First disconnector for 1200 kV AC systems developed, successfully tested, and erected at Bina Experimental Substation in India





Fig. 24: Center-break disconnector



Fig. 25: Block and finger contact system

High-Voltage Disconnectors and Earthing Switches

General

Disconnectors are an essential part of electrical power substations. They indicate a visible isolating distance in an air isolated gap.

Modern production technologies and investments in the Siemens production sites worldwide ensure sustained product and process quality in accordance with Siemens' high standards.

Siemens disconnectors fulfill the system operator's requirements of low lifecycle costs with maximum availability and a cost-effective operation by:

- Delivery of entirely routine-tested and pre-adjusted assembly groups
- Easy erection and commissioning
- Maintenance-free bearings and contact systems
- Lifetime technical support
- Proven reliability of contact systems over decades of service.

The most important features are:

- Self-resilient contact fingers – no further spring elements are necessary to generate the contact force
- Silver-plated contact surface provides maximum conductivity without regular greasing lubrication
- Factory set contact forces; no readjustments required during service life
- Ice layers up to 20 mm can be broken without difficulty
- Maintenance-free contact system for up to 25 years.

The reliability of Siemens disconnectors and earthing switches over many decades has been ensured by a comprehensive testing and quality assurance system certified in accordance with DIN EN ISO 9001.

Center-break disconnectors

The center-break disconnector is the most frequently used disconnector type. The disconnector base supports the operating mechanism and two rotating porcelain support insulators. The current path arms that are fixed to the insulators open in the center. Each rotating unit comprises two high-quality ball bearings and is designed for high mechanical loads. They are lubricated and maintenance-free for the entire service life (fig. 24).

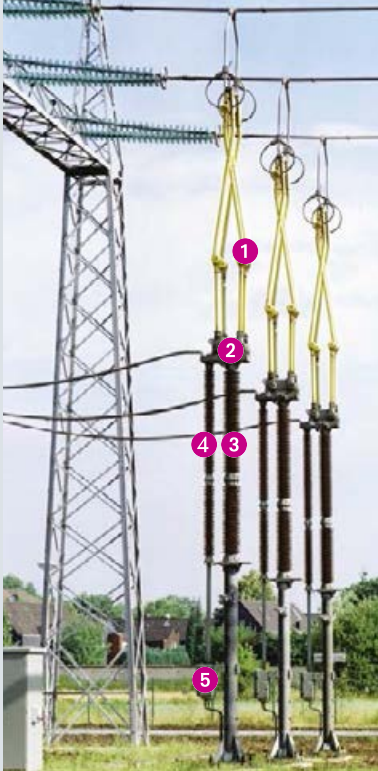

1. Scissor arms
2. Bearing frame
3. Support insulator
4. Rotating insulator
5. Motor operating mechanism

Fig. 26: Components of the pantograph disconnector

The current path of the center-break disconnector consists of only a few components, thus reducing the number of contact resistances is reduced to a minimum. The main contact system of block-contact and spread-contact fingers assures a steady contact force even after decades of operation (fig. 25).

Pantograph disconnectors

This type of disconnector has a vertical isolating distance and is generally used in busbar systems to connect two busbars, a busbar to a line, or a busbar to a power transformer.

The main components of a pantograph disconnector are shown in fig. 26.

The geometry of the pantograph ensures optimum operational behavior. Rotary contact systems inside the joints that have thermal and dynamic current-carrying capacity are used for current transfer.

Ice loads of up to 20 mm can be broken without difficulty. The specific contact force is adjusted at the factory and remains unchanged during service life.



Fig. 27: Vertical-break disconnector

The rigidity of the scissor arms prevents opening during a short circuit. The switch position cannot be changed by external forces. In both end positions of the disconnector, the rotary arm in the bearing frame is switched beyond the dead center point.

Pantograph disconnectors with rated voltages from 123 kV up to 362 kV can be equipped with group-operating mechanisms or one-pole operating mechanisms. All pantograph disconnectors for higher rated voltages are equipped with one-pole operating mechanisms.

Vertical-break disconnectors

This type of disconnector is suitable for small phase distances. The current path of the vertical-break disconnector opens vertically and requires a minimum phase distance (fig. 27).

The current path performs two movements:

- A vertical swinging movement
- A rotary movement around its own longitudinal axis.

The rotary movement generates the contact force and breaks possible ice layers.



Fig. 28: Double-side break disconnector with integrated surge arrester

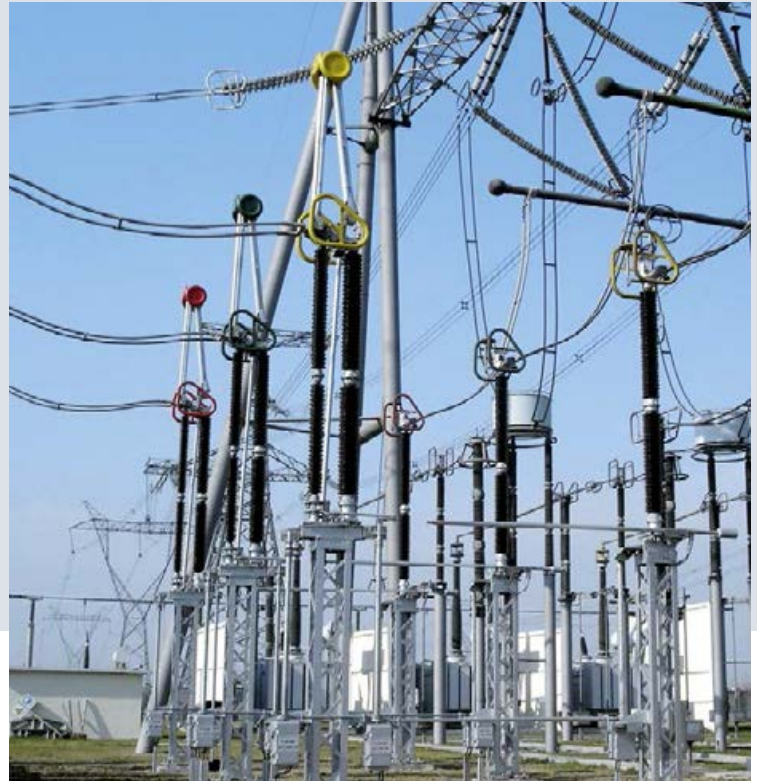

Fig. 29: Knee-type disconnector

In both end positions, the rotary arm is switched beyond the dead center point. This locks the current path in the short-circuit-proof CLOSED position, and prevents the current path from switching to the OPEN position under external forces.

The ample distance between support insulator and rotating insulator ensures dielectric strength of the parallel insulation even in saline fog conditions.

The installation and commissioning on site is quick and easy, as the movable part of the current path is one single subassembly that is pre-adjusted and routine-tested at the factory.

Double-side break disconnectors

The double-side break disconnector features three support insulators. The support insulator in the center is mounted on a rotating unit and carries the current path. Both end support insulators are fixed.

The main application of double-side break disconnectors are substations with limited phase distances and where vertical opening of the current path is not possible. High mechanical terminal loads are possible due to the compact and stable design. The disconnector can also be combined with an integrated surge arrester (fig. 28).

For voltage levels up to 245 kV, the contact fingers of the double-side break disconnectors are integrated into the current path tube, and the fixed contacts consist of contact blocks. The current path performs a horizontal swinging movement, and the contact force is generated by spreading the contact fingers while sliding on the contact blocks.

For voltage levels higher than 245 kV, contact strips are attached to the ends of the current path tubes. The contact fingers are part of the fixed contacts. In this design, the current path performs a combined swinging and rotary movement. After completion of the swinging movement,



Fig. 30: Free-standing earthing switch

the contact force is generated by rotating the current path around its own axis.

Knee-type disconnectors

This disconnector type has the smallest horizontal and vertical space requirements. The knee-type disconnector has two fixed and one rotating insulator. Thanks to its folding-arm design, only limited overhead clearance is required, which results in lower investment costs (*fig. 29*).

The very compact design has advantages for indoor applications as well as mounting onto walls or ceilings. This type of disconnector is also available up to 800 kV.

Earthing switches

The use of earthing switches (*fig. 30*) ensures absolute de-energization of high-voltage components in a circuit or switchgear.

Free-standing earthing switches are available for all voltage levels up to 800 kV.

Suitable built-on earthing switches are available for all disconnector types from the Siemens scope of supply.

According to the system operator's requirements, built-on earthing switches can be arranged laterally or in an integrated arrangement depending on the position of the main current path of the disconnector.

If required, all earthing switches can be designed for switching-induced inductive and capacitive currents in accordance with IEC 62271-102, Class A or Class B.

3DV8

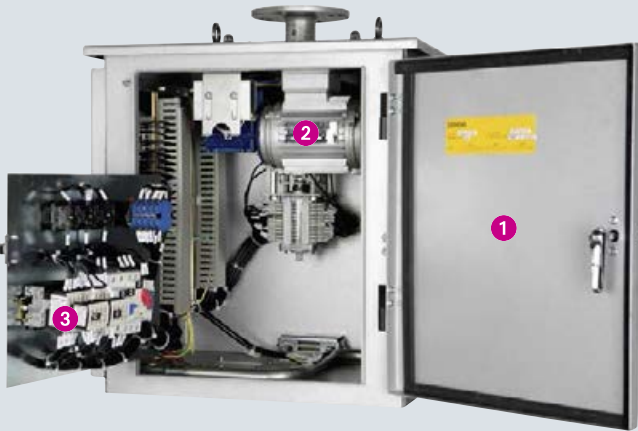

Steel, spray-zinc and painted (3DV8) / cast-aluminum housing (MA6/7) with door (1) – degree of protection IP55; gear unit (2) with motor; electrical equipment with auxiliary switch (3)

MA6/7

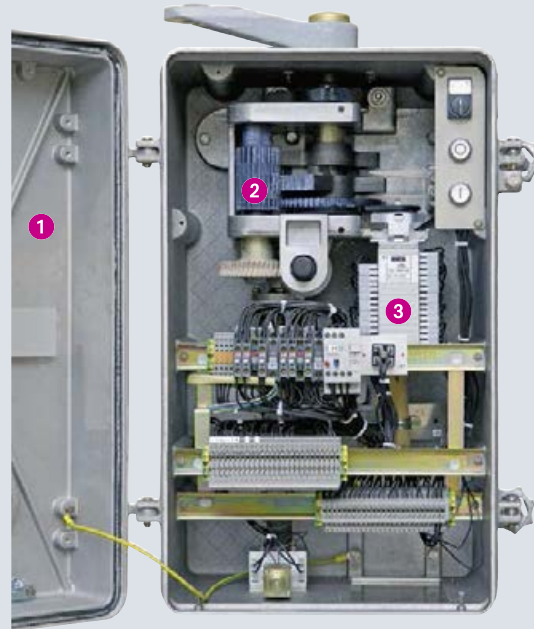

Fig. 31: Motor operating mechanism

3DV8 and MA6/7 motor operating mechanisms

The 3DV8 type is the standard design. The MA6/7 types can be provided as an alternative option, offering the following additional advantages:

- Motor operating mechanism is mechanically decoupled in the end positions to prevent damage to the disconnector in the event of operational errors
- Aluminum casting housing is very robust.

The motor operating mechanism can also be operated manually by a hand crank, which can be inserted into the cubicle. The insertion of the hand crank automatically isolates the motor circuit for safety purposes. Heaters are provided to prevent condensation (fig. 31).

The auxiliary switch is customized to the gear unit and signals the switch position with total reliability. This ensures safe substation operation.

After the motor starts, the auxiliary switch moves and the switch position signal is cancelled. The disconnecter subsequently operates until the end position is reached.

The auxiliary switch then moves again and issues the switch position signal.

This sequence ensures that the CLOSED position is indicated only after the disconnecter is locked and short-circuit proof, and the rated current can be carried. The OPEN position is indicated only after the opened current path has reached the nominal dielectric strength.

An overview of Siemens disconnectors is shown in table 5 to table 9.

Disconnectors

[siemens.com/energy/disconnector](https://www.siemens.com/energy/disconnector)

Technical data										
Design		Center break								
Rated voltage		72.5	123	145	170	245	300	362	420	550
Rated power-frequency withstand voltage 50 Hz/1 min										
To earth and between phases	[kV]	140	230	275	325	460	380	450	520	620
Across the isolating distance	[kV]	160	265	315	375	530	435	520	610	800
Rated lightning impulse withstand voltage 1.2/50 μ s										
To earth and between phases	[kV]	325	550	650	750	1,050	1,050	1,175	1,425	1,550
Across the isolating distance	[kV]	375	630	750	860	1,200	1,050 (+170)	1,175 (+205)	1,425 (+240)	1,550 (+315)
Rated switching impulse withstand voltage 250/2,500 μ s										
To earth and between phases	[kV]	–	–	–	–	–	850	950	1,050	1,175
Across the isolating distance	[kV]	–	–	–	–	–	700 (+245)	800 (+295)	900 (+345)	900 (+450)
Rated normal current up to	[A]	4,000								
Rated peak withstand current up to	[kA]	160								
Rated short-time withstand current up to	[kA]	63								
Rated duration of short circuit	[s]	1/3								
Icing class		10/20								
Temperature range	[°C]	–60/+55								
Operating mechanism type		Motor operation/Manual operation								
Control voltage	[V, DC] [V, AC]	60/110/125/220 220...230, 1~, 50/60 Hz								
Motor voltage	[V, DC] [V, AC]	60/110/125/220 110/125/220, 1~, 50/60 Hz 220/380/415, 3~, 50/60 Hz								
Maintenance		25 years								
All values in accordance with IEC; other values on request										

Table 5: Center-break disconnect

Technical data									
Design		Pantograph							
Rated voltage		123	145	170	245	300	362	420	550
Rated power-frequency withstand voltage 50 Hz/1 min									
To earth and between phases	[kV]	230	275	325	460	380	450	520	620
Across the isolating distance	[kV]	265	315	375	530	435	520	610	800
Rated lightning impulse withstand voltage 1.2/50 μ s									
To earth and between phases	[kV]	550	650	750	1,050	1,050	1,175	1,425	1,550
Across the isolating distance	[kV]	630	750	860	1,200	1,050 (+170)	1,175 (+205)	1,425 (+240)	1,550 (+315)
Rated switching impulse withstand voltage 250/2,500 μ s									
To earth and between phases	[kV]	–	–	–	–	850	950	1,050	1,175
Across the isolating distance	[kV]	–	–	–	–	700 (+245)	800 (+295)	900 (+345)	900 (+450)
Rated normal current up to	[A]	5,000							
Rated peak withstand current up to	[kA]	200							
Rated short-time withstand current up to	[kA]	80							
Rated duration of short circuit	[s]	1/3							
Icing class		10/20							
Temperature range	[°C]	–60/+50							
Operating mechanism type		Motor operation/Manual operation							
Control voltage	[V, DC] [V, AC]	60/110/125/220							
		220...230, 1~, 50/60 Hz							
Motor voltage	[V, DC] [V, AC]	60/110/125/220							
		110/125/220, 1~, 50/60 Hz							
		220/380/415, 3~, 50/60 Hz							
Maintenance		25 years							
All values in accordance with IEC; other values on request									

Table 6: Pantograph disconnector

Technical data									
Design		Vertical break							
Rated voltage		123	145	170	245	300	362	420	550
Rated power-frequency withstand voltage 50 Hz/1 min									
To earth and between phases	[kV]	230	275	325	460	380	450	520	620
Across the isolating distance	[kV]	265	315	375	530	435	520	610	800
Rated lightning impulse withstand voltage 1.2/50 μ s									
To earth and between phases	[kV]	550	650	750	1,050	1,050	1,175	1,425	1,550
Across the isolating distance	[kV]	630	750	860	1,200	1,050 (+170)	1,175 (+205)	1,425 (+240)	1,550 (+315)
Rated switching impulse withstand voltage 250/2,500 μ s									
To earth and between phases	[kV]	–	–	–	–	850	950	1,050	1175
Across the isolating distance	[kV]	–	–	–	–	700 (+245)	800 (+295)	900 (+345)	900 (+450)
Rated normal current up to	[A]	5,000							
Rated peak withstand current up to	[kA]	160							
Rated short-time withstand current up to	[kA]	63							
Rated duration of short circuit	[s]	1/3							
Icing class		10/20							
Temperature range	[°C]	–60/+50							
Operating mechanism type		Motor operation/Manual operation							
Control voltage	[V, DC] [V, AC]	60/110/125/220 220...230, 1~, 50/60 Hz							
Motor voltage	[V, DC] [V, AC]	60/110/125/220 110/125/230, 1~, 50/60 Hz 220/380/415, 3~, 50/60 Hz							
Maintenance		25 years							
All values in accordance with IEC; other values on request									

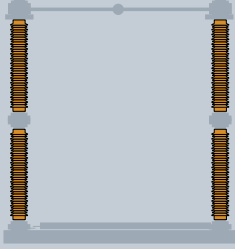
Table 7: Vertical-break disconnector

Technical data				
Design		Knee-type		
Rated voltage		123	550	800
Rated power-frequency withstand voltage 50 Hz/1 min				
To earth and between phases	[kV]	230	620	830
Across the isolating distance	[kV]	265	800	1,150
Rated lightning impulse withstand voltage 1.2/50 μ s				
To earth and between phases	[kV]	550	1,550	2,100
Across the isolating distance	[kV]	630	1,550 (+315)	2,100 (+455)
Rated switching impulse withstand voltage 250/2,500 μ s				
To earth and between phases	[kV]	–	1,175	1,550
Across the isolating distance	[kV]	–	900 (+450)	1,200 (+650)
Rated normal current up to	[A]	4,000		
Rated peak withstand current up to	[kA]	100	160	160
Rated short-time withstand current up to	[kA]	40	63	63
Rated duration of short circuit	[s]	1/3		
Icing class		10/20		
Temperature range	[°C]	–60/+50		
Operating mechanism type		Motor operation/Manual operation		
Control voltage	[V, DC] [V, AC]	60/110/125/220 220...230, 1~, 50/60 Hz		
Motor voltage	[V, DC] [V, AC]	60/110/125/220 110/125/230, 1~, 50/60 Hz 220/380/415, 3~, 50/60 Hz		
Maintenance		25 years		
All values in accordance with IEC; other values on request				

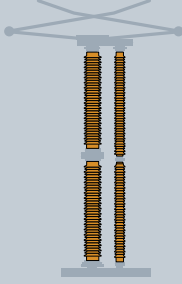
Table 8: Knee-type disconnector

Technical data									
Design		Double-side break							
Rated voltage		123	145	170	245	300	420	550	800
Rated power-frequency withstand voltage 50 Hz/1 min									
To earth and between phases	[kV]	230	275	325	460	380	520	450	830
Across the isolating distance	[kV]	265	315	375	530	435	610	520	1,150
Rated lightning impulse withstand voltage 1.2/50 μ s									
To earth and between phases	[kV]	550	650	750	1,050	1,050	1,425	1,550	2,100
Across the isolating distance	[kV]	630	750	860	120	1,050 (+170)	1,425 (+240)	1,550 (+315)	2,100 (+455)
Rated switching impulse withstand voltage 250/2,500 μ s									
To earth and between phases	[kV]	–	–	–	–	850	1,050	1,175	1,550
Across the isolating distance	[kV]	–	–	–	–	700 (+245)	900 (+345)	900 (+450)	1,200 (+650)
Rated normal current up to	[A]	5,000							
Rated peak withstand current up to	[kA]	160							
Rated short-time withstand current up to	[kA]	63							
Rated duration of short circuit	[s]	1/3							
Icing class		10/20							
Temperature range	[°C]	–60/+50							
Operating mechanism type		Motor operation/Manual operation							
Control voltage	[V, DC] [V, AC]	60/110/125/220 220...230, 1~, 50/60 Hz							
Motor voltage	[V, DC] [V, AC]	60/110/125/220 110/125/230, 1~, 50/60 Hz 220/380/415, 3~, 50/60 Hz							
Maintenance		25 years							
All values in accordance with IEC; other values on request									

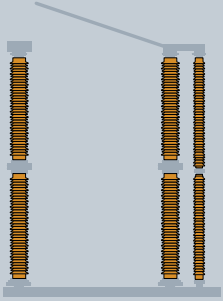
Table 9: Double-side break

Surge Arresters

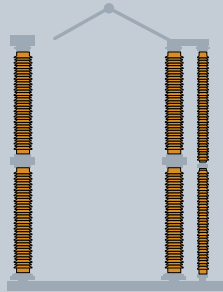
Customer partnership around the globe

More than 226,500 HV and 1,870,000 MV arresters are in service worldwide.

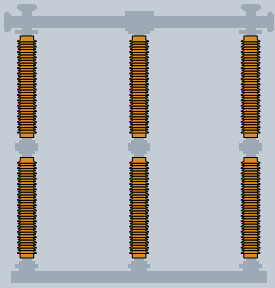
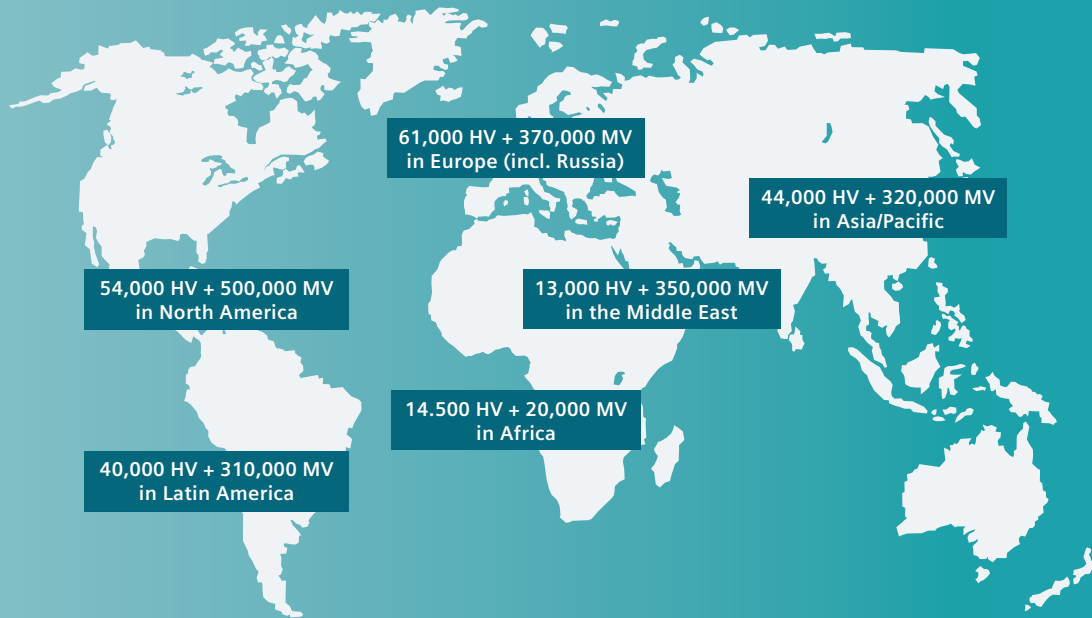

Proven reliability

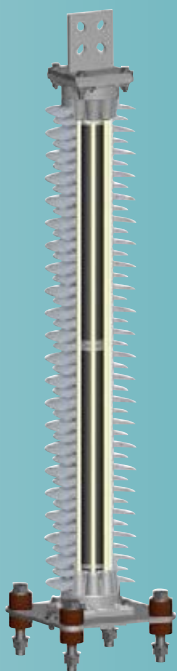

Silicone HTV rubber directly molded onto MOV blocks and end fittings

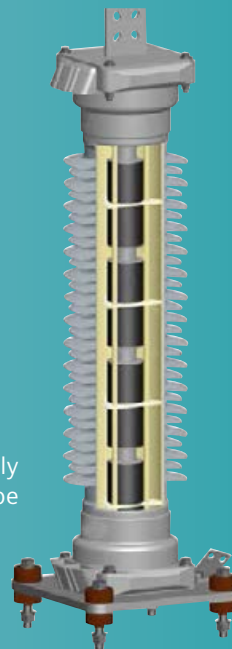

Silicone rubber directly molded onto FRP tube

Customer benefits

- No moisture ingress, no failures
- No air bubbles = no partial discharges
- No aging effects on MOVs
- Maintains characteristics throughout lifetime

Continuous innovation since 1925

1925

Siemens develops its first surge arresters. The first devices are the so-called cathode-drop types

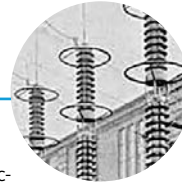

1963

The first surge arrester for systems of up to 550 kV is launched. The pulley wheel electrodes are replaced by ceramic-bonded shunt resistors and a series spark gap. The surge arrester comprises three columns in parallel and has a ohmic-capacitive control

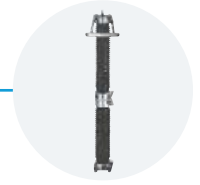

1971

Development of the first gas-insulated and metal-encapsulated surge arrester for gas-insulated switchgear (GIS)



1989

The 3EQ2 surge arrester for systems of up to 550 kV is one of the first high-voltage surge arresters with composite polymer hollow core housing



1998

Introduction of the polymer-housed medium-voltage/distribution class arresters of the 3EK family, which feature Cage Design™, a unique solution with direct silicone molding on the metal oxide varistors



2000

Development of the first GIS arrester for systems up to 800 kV

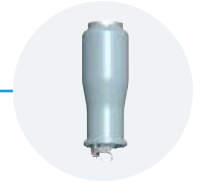

2003

3EL silicone-rubber-housed arresters in Cage Design™ for applications up to 550 kV

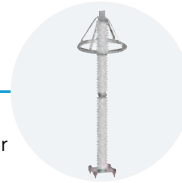

2008

The first externally gapped line arrester (EGLA), which increases the reliability of a 144 kV overhead line, is supplied to the South Korean power provider KEPCO



2010

Siemens launches the arrester condition monitor, an innovative monitoring solution with unique features



2012

Market introduction of the 3FL long rod insulators, suspension & tension insulators for overhead power lines up to 550 kV



2013

3EQ5: Siemens first surge arresters for 1,200 kV AC systems are developed, successfully tested, and erected at Bina Experimental Substation in India



2016

Launch of silicone-rubber-housed medium-voltage arresters of the 3EJ family with high energy discharge capability

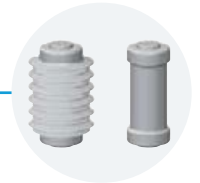



Fig. 33: Surge arrester in traditional porcelain housing; available for system voltages up to 800 kV



Fig. 34: 400 kV line in Bulgaria, NGLA solution realized with 3EL2



Fig. 35: 550 kV line in Colombia, NGLA solution realized with 3EL2

Introduction

The main task of an arrester is to protect equipment from the effects of overvoltages. During normal operation, an arrester should not have any negative effects on the power system. The arrester must also be able to withstand typical surges without incurring any damage. Non-linear resistors fulfill these requirements thanks to their properties:

- Low resistance during surges to limit overvoltages
- High resistance during normal operation to avoid negative effects on the power system
- Sufficient energy absorption capability for stable operation.

With this type of non-linear resistor, there is only a small flow of current when continuous operating voltage is applied. In the event of surges, however, excess energy can be quickly removed from the power system by a high discharge current.

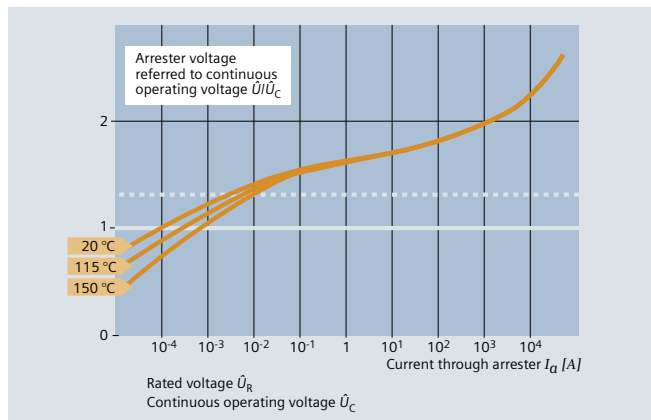

Fig. 32: Current/voltage characteristics of a non-linear MO arrester

High-Voltage Surge Arresters

Non-linear resistors

Non-linear resistors made of metal oxide (MO) have proved particularly suitable for this use. The non-linearity of MO resistors is considerably high, which is why MO arresters do not need series gaps (fig. 32).

Siemens has many years of experience with arresters – the previous gapped SiC arresters and the new gapless MO arresters – in low-voltage systems, distribution systems, and transmission systems. They are usually used for protecting transformers, generators, motors, capacitors, traction vehicles, cables and substations.

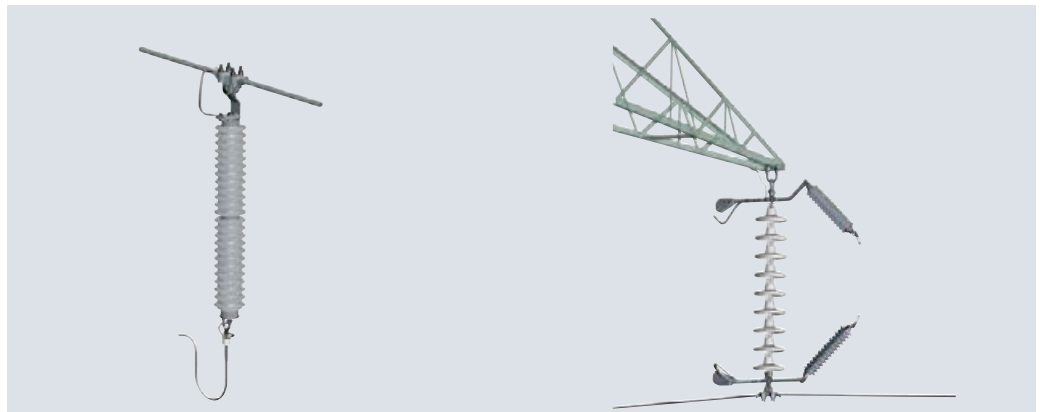

Siemens provides two solutions for line surge arresters:

Non-gapped line arresters (NGLA)

Non-gapped line surge arresters offer a high degree of mounting flexibility and operational reliability. Depending on the tower design and the arrangement of insulators and lines, these arresters can either be installed directly on the insulators or on the tower. Thanks to their high energy absorption capacity, non-gapped line arresters ensure a very high level of protection against overvoltages caused by lightning and network-generated switching impulse currents.

Siemens 3EL1, 3EL2, 3EL3, 3EL5 surge arresters are available as NGLA types.

Externally gapped line arresters (EGLA)

Siemens EGLA line surge arresters of the 3EV1, 3EV2, and 3EV5 series have an external spark gap placed in series that galvanically isolates the active part of the line surge arrester from the line voltage under normal conditions. In case of lightning, the spark gap is ignited and the dangerous overvoltage is safely discharged through the resulting arc. The active component limits the subsequent current to ensure that the arc is extinguished within the first half-cycle of the operating current frequency.

The series varistor units (SVU) of the EGLA 3EV1, 3EV2 and 3EV5 product lines are based on the respective 3EL1, 3EL2 and 3EL5 product lines.

There are special applications such as the protection of:

- Equipment in areas at risk of earthquakes or heavy pollution
- Surge-sensitive motors and dry-type transformers
- Generators in power stations with arresters that possess a high degree of short-circuit current strength
- Gas-insulated high-voltage metal-enclosed switchgear (GIS)
- Valves in HVDC transmission installations
- Static compensators
- Airport lighting systems
- Electric smelting furnaces in the glass and metals industries
- High-voltage cable sheaths
- Test laboratory apparatus.

MO arresters are used in medium-, high-, and extra high-voltage power systems. Here, the very low protection level and the high energy absorption capability provided during switching surges are especially important. For high-voltage levels, the simple construction of MO arresters is always an advantage. Another very important feature of MO arresters is their high degree of reliability when used in areas with a problematic climate, for example in coastal and desert areas, or in regions affected by heavy industrial air pollution. Furthermore, certain special applications have only been made possible thanks to the introduction of MO arresters. One example is the protection of capacitor banks

in series reactive-power compensation equipment, which requires extremely high energy absorption capabilities.

Tradition and innovation

Fig. 33 shows a Siemens MO arrester in a traditional porcelain housing, a well-proven technology representing decades of Siemens experience. Siemens also offers surge arresters with polymer housings for all system voltages and mechanical requirements.

Applications as line surge arresters

The use of surge arresters on hazardous stretches of a power line helps improve network protection and increases the reliability of the entire transmission system (fig. 34, fig. 35).

Offering a highly efficient combination of low weight, outstanding strength, and safety features, Siemens 3EL surge arresters are ideally suited for this purpose.

These arresters are divided into two subgroups:

- Cage Design™ arresters
- Composite hollow core design arresters.

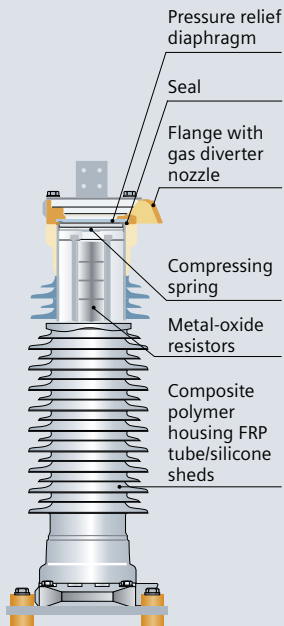

Fig. 36: Cross section of a polymer-housed arrester in tube design

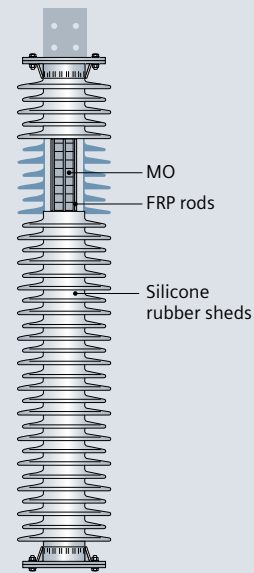

Fig. 37: 3EL-range surge arrester in Cage Design™

Fig. 36 shows a cross section of a composite hollow core design arrester. The housing consists of a fiberglass-reinforced plastic tube with insulating sheds made of silicone rubber. The advantages of this design, which has the same pressure relief device as an arrester with porcelain housing, include completely safe and reliable pressure relief, high mechanical strength even after pressure relief, and excellent pollution-resistant properties. The advanced mechanical features mean that Siemens arresters with a polymer housing (type 3EQ) can also serve as post insulators. The pollution-resistant properties are the result of the water-repellent effect (hydrophobicity) of the silicone rubber, which can even be transferred to pollution layers.

The newest types of polymer surge arresters also feature the cage design. They use the same MO resistors as the 3EP and 3EQ types, resulting in the same excellent electrical performance. The difference is that the 3EL (fig. 37) types achieve their mechanical strength from a cage built up by fiber-reinforced plastic rods. Furthermore, the whole active part is directly and entirely molded with silicone rubber to prevent moisture ingress and partial discharges. The poly-

mer-housed high-voltage arrester design chosen by Siemens and the high-quality materials Siemens used offer many advantages, including a long service life and suitability for outdoor use, high mechanical stability, and ease of disposal.

Another important design is the gas-insulated metal-enclosed surge arrester (*GIS arresters*, fig. 38). Siemens has been making these arresters for more than 25 years. When GIS arresters are used with gas-insulated switchgear, they usually offer a higher protective safety margin compared to when used with outdoor-type arresters. This is for two reasons: Firstly, they can be installed closer to the item that needs protection, so that traveling wave effects can be limited more effectively. Secondly, compared with the outdoor type, inductance of the installation is lower (both that of the connecting conductors and that of the arrester itself). This means that the protection offered by GIS arresters is superior to that offered by any other method, especially in the case of surges with a very steep rate of rise or high frequency, which gas-insulated switchgear is exceptionally sensitive to.

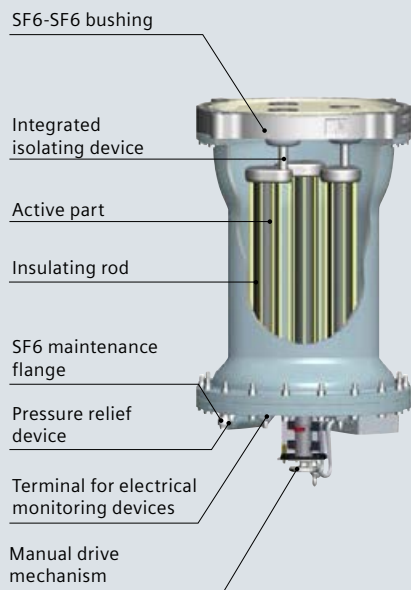

Fig. 38: Gas-insulated metal-enclosed arrester (GIS arrester)

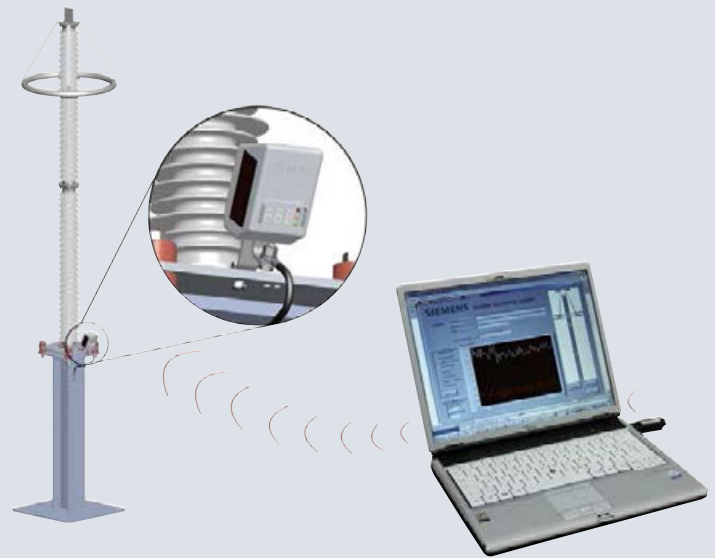

Fig. 39: Wireless arrester condition monitor (ACM) data download

Monitoring

Siemens also offers a wide range of products for diagnosis and monitoring of surge arresters. The innovative arrester condition monitor (*fig. 40*) is the heart of the future-proof (IEC 61850) monitoring product line.

Early detection of relevant changes through efficient equipment monitoring

Due to continuously growing worldwide power demand, more and more power networks are required to transmit higher loads – sometimes up to the limits of their capacity. This makes reliable, responsible network operation an increasingly difficult challenge. In many of today's markets, transmission and distribution system operators are also liable for compensation in the case of power failures. And natural events like lightning can cripple entire networks. As a result, many network operators are seeking solutions to increase the reliability of their transmission systems. Equipment monitoring is a proven method for the recording of operating states and remaining service life, providing the operator with important asset management data and enabling the immediate assessment of a network's overall

state. Surge arresters are highly reliable components in power transmission and distribution systems. When operated in accordance with their specifications, their service life can reach up to 30 years without any maintenance. Nevertheless, overloads that can cause arrester failure and even endanger the safety of the network may sometimes occur. Equipment monitoring helps detect changes and faults at the earliest possible stage, and supports security of supply on a whole new level. Siemens provides a complete line of monitoring devices with a variety of innovative functionalities, including wireless download of monitoring arrester data (*fig. 39*), that can be perfectly matched to the customer requirements, ensuring that impending faults will be detected as early as possible and before security of supply is compromised.



Fig. 40: Medium-voltage MO arrester for special applications



Fig. 41: Arrester condition monitor (ACM)

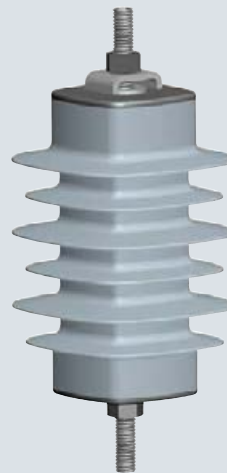

Fig. 42: Medium-voltage arrester 3EK4 for distribution systems



Fig. 43: Medium-voltage arrester 3EK7 for distribution systems

Low-Voltage and Medium-Voltage Surge Arresters and Limiters

Surge arresters and limiters protect operational equipment both from external overvoltages caused by lightning strikes in overhead lines and from internal overvoltages produced by switching operations or earth faults. The arrester is normally installed between phase and earth. The built-in stack of non-linear, voltage-dependent resistors (varistors) made of metal oxide (MO) or zinc oxide (ZnO) becomes conductive from a defined overvoltage limit value, so that the load can be discharged to earth. When the power-frequency voltage underflows this limit value (the discharge voltage), the varistors return to their original resistance value, so that only a so-called leakage current of a few mA flows at operating voltage. Because this leakage current heats up the resistors, and thus the arrester, the device must be designed according to the neutral-point treatment of the system to prevent impermissible heating of the arrester.

In contrast to the normal surge arrester, the surge limiter contains a series gap in addition to the MO resistor stack. If the load generated by the overvoltage is large enough, the series gap ignites and the overvoltage can be discharged to earth until the series gap extinguishes and the varistors return to their non-conductive state. This process is

repeated throughout the entire duration of the fault. This makes it possible to design the device with a considerably lower discharge voltage as a conventional surge arrester, and is particularly useful for the protection of motors that normally have a poor dielectric strength. To guarantee a sufficient protective function, the discharge voltage value of the arresters or limiters must not exceed the dielectric strength of the operational equipment requiring protection.

The medium-voltage product range includes:

- The 3EB and 3EC surge arresters for railway DC, as well as AC applications (fig. 40)
- The 3EF group of surge arresters and limiters for the protection of motors, dry-type transformers, airfield lighting systems, and cable sheaths, as well as for the protection of converters for drives (fig. 40)
- The 3EK silicone-housed surge arrester for distribution systems, medium-voltage switchgear up to 72.5 kV, and line surge arresters for outdoor use (fig. 42 and fig. 43).

An overview of the complete range of Siemens arresters appears in table 10 to table 12.







	Special applications	Railway applications				Medium-voltage distribution class	
	3EF1; 3EF3; 3EF4; 3EF5	3EB2	3EB3	3EC3	3EB4	3EK4	3EK7
							
Applications	Motors, dry-tape transformers, airfield lighting systems, sheath voltage limiters, protection of converters for drivers	DC overhead contact lines	DC systems (locomotives, overhead contact lines)	DC systems (locomotives, overhead contact lines)	AC and DC systems (locomotives, overhead contact lines)	Distribution systems and medium-voltage switchgear	Distribution systems and medium-voltage switchgear
Highest voltage for equipment (U_m)	12	2	4	4	30	45	72.5
Maximum rated voltage (U_r)	15	2	4	4	45/4	36	60
Maximum nominal discharge current (I_n)	1 (3EF1/3) 10 (3EF4/5)	20	20	20	20	10	10
Maximum thermal energy rating (W_{th})	13.0	10.0	26.0	10.0	10.0	n.a.	n.a.
Maximum thermal charge transfer rating (Q_{th})	n.a.	n.a.	n.a.	n.a.	n.a.	1.1	1.1
Maximum repetitive charge transfer rating (Q_{rs})	2.8	2.5	7.5	2.5	2.8/2.5	0.4	0.4
Rated short-circuit current (I_g)	40	40	40	40	50	20	20
Classification according to EN 50526-1	n.a.	DC-B	DC-C	DC-B	DC-B	n.a.	n.a.
Housing material	Polyethylene	Silicone	Silicone	Porcelain	Silicone	Silicone	Silicone
Design principle	Polyethylene directly molded onto MOV (3EF1); hollow insulator (3EF3/4/5)	Directly molded		Hollow insulator	Hollow insulator, silicone directly molded onto FRP tube	Cage design, silicone directly molded onto MOV	
Installation	Indoor	Outdoor	Outdoor	Outdoor	Outdoor	Outdoor	Outdoor/ Indoor

Table 10: Medium-voltage metal-oxide surge arresters and limiters (300 V to 72.5 kV)













	3EP5	3EP4	3EP6	3EP3	3EL5	3EL1	3EL2	3EL3	3EQ1	3EQ4	3EQ3	3EQ5
												
Applications	Medium- and high-voltage systems	Medium- and high-voltage systems	High-voltage systems	High-voltage systems, HVDC, SC&SVC applications	Medium- and high-voltage systems, station and line surge arrester	Medium- and high-voltage systems, station and line surge arrester	Medium- and high-voltage systems, station and line surge arrester	High-voltage systems, station and line surge arrester	Medium- and high-voltage systems	High-voltage systems	High-voltage systems, HVDC, SC&SVC applications	High-voltage systems, HVDC applications
Highest voltage of the system (U_s) kV	123	362	800	800	145	252	550	800	362	800	800	1200
Maximum rated voltage (U_r) kV	96	288	588	624	126	288	468	588	288	588	624	850
Maximum nominal discharge current (I_n) kA	10	10	20	20	10	10	20	20	10	20	20	20
Maximum thermal energy rating (W_{th}) kJ/kV _r	7.0	7.0	14.0	42.0	4.5	6.0	9.0	14.0	7.0	18.0	42.0	48.0
Maximum repetitive charge transfer rating (Q_{rs}) C	2	2	3.6	12.0	1	1.6	2.4	3.6	2	6	12.0	16.0
Rated short-circuit current (I_s) kA	50	65	65	65	20	65	65	65	50	80	80	80
Bending moment dynamic SSL kNm	2.0	4.5	30.0	34.0	0.5	1.2	4.0	10.0	6.0	38.0	72.0	225.0
Housing material	Porcelain	Porcelain	Porcelain	Porcelain	Silicone	Silicone	Silicone	Silicone	Silicone	Silicone	Silicone	Silicone
Design principle	Hollow insulator				Cage design, silicone directly molded onto MOV				Hollow insulator, silicone molded onto FRP tube			
Installation	Outdoor											
Standard	IEC 60099-4, Ed. 3.0 (2014) and IEEE C62.11 (2012)											

Table 11: High-voltage metal-oxide surge arresters (72.5 to 1,200 kV)





	3ES5-M/N 3-phase	3ES2-E 1-phase	3ES6-L/X 1-phase	3ES5-H 1-phase	3ES6-J	3ES5-C/D with oil-SF ₆ 1-phase	
							
Applications	High-voltage systems, protection of metal-enclosed, gas-insulated switchgear and transformers						
Highest voltage of the system (U_s)	kV	170	170	420	550	800	550
Maximum rated voltage (U_r)	kV	156	156	396	444	612	444
Maximum nominal discharge current (I_n)	kA	20	20	20	20	20	20
Maximum thermal energy rating (W_{th})	kJ/kV _r	10.0	10.0	14.0	14.0	14.0	14.0
Maximum repetitive charge transfer rating (Q_{rs})	C	2.4	2.4	3.2	3.2	3.2	3.6
Rated short-circuit current (I_s)	kA	50/65	50	65/80	65	65	65
Bushing type		M/N	E	L/X	H	J	C/D
Bushing		SF ₆ -SF ₆	SF ₆ -SF ₆	SF ₆ -SF ₆	SF ₆ -SF ₆	SF ₆ -SF ₆	Oil-SF ₆
Number of phases		1	1	1	1	1	1

Table 12: Metal-oxide surge arresters for GIS (72.5 to 800 kV)



	ACM advanced	ACM basic	Surge counter	
				
Concept	Electronic	Electronic	Electromechanic	
Measured variables	Analyzes surge current impulses (time stamp, peak value, pulse width, energy content) Total leakage current 3 rd harmonic of leakage current with temperature correction and harmonic compensation (3 LEDs) Arrester energy absorption	Number of surge current impulses Total leakage current 3 rd harmonic of leakage current with temperature correction and harmonic compensation (3 LEDs)	Number of surge current impulses	
Power supply	Solar	Solar	None	
Remote indication	Wireless	No	Special model AC: wired via aux. contact	
Installation	Integrated into ground wire	Integrated into ground wire	Integrated into ground wire	
Order no.	3EX5 080-1 3EX5 085 (USB wireless module)	3EX5 080-0	3EX5 030 3EX5 030-1	

Table 13: Overview of monitoring devices for surge arresters

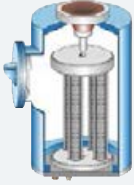
	Surge counter with leakage current indication	Sensor and display	Control spark gap	LCM 500
				
	Electromechanic	Electromechanic	Spark gap	Electronic
	Number of surge current impulses Total leakage current (including DC)	Number of surge current impulses Total leakage current	Number of surge current impulses	Total leakage current 3 rd harmonic of leakage current
	None	None	None	Battery/mains
	Special model AC: wired via aux. contact	Wired	Special model: via optical fiber*	Special model
	Integrated into ground wire	Sensor integrated into ground wire/display wired	Integrated into ground wire	Portable/clamp-on ammeter
	3EX5 050 3EX5 050-1 3EX5 050-2	3EX5 060 3EX5 062	3EX6 040 3EX6 020*	LCM 500

Arresters

[siemens.com/energy/arrester](https://www.siemens.com/energy/arrester)

Instrument Transformers

Customer partnership around the globe

More than half a million units delivered to 170 countries worldwide.

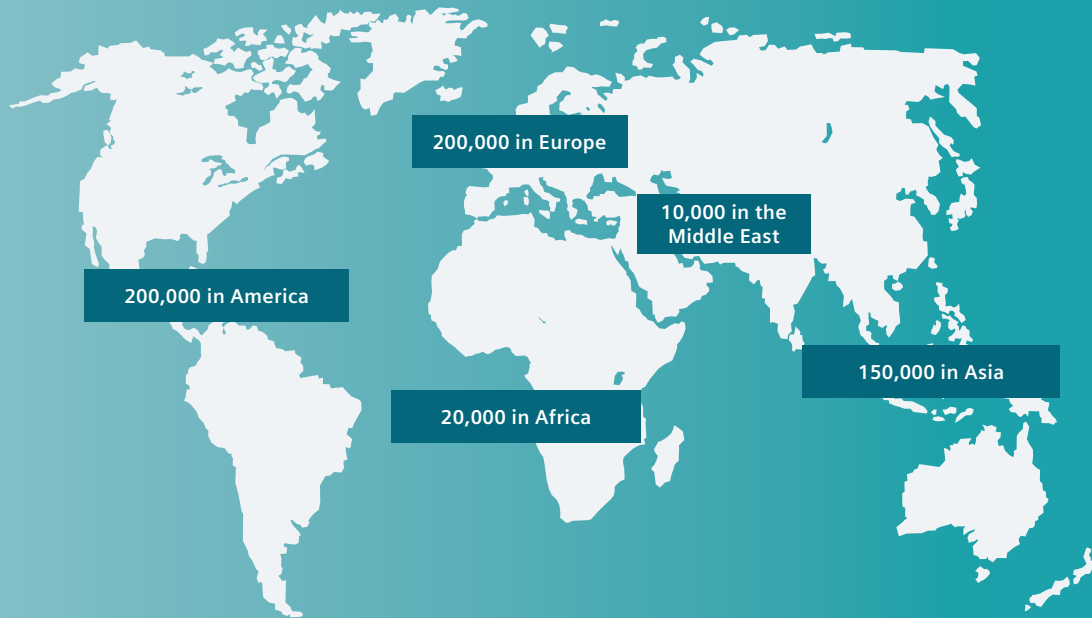

Proven reliability

- Operational experience of more than 100 years
- Complete product portfolio for AIS & GIS applications
- Its passion for quality ensures that Siemens meets and exceeds some of the industry's most rigorous standards and customer specifications, making the Siemens products some of the most reliable in the world
- Continuous investment in research and innovation helps shape industry standards and develop new technologies to fulfill the customers' expectations
- Global organization with local reach, readily accessible to customers via a wide network of sales and support centers



Continuous innovation since 1900

1904	Haefely founded (today Trench France)
1919	Scarpa E Magnano founded (today Trench Italia)
1920 – 1927	Inductive oil-insulated instrument transformers (OIF)
1937	Capacitive voltage transformers (CVT)
1946	MWB founded (today Trench Germany)
1962	Trench Electric founded (today Trench Canada)
1965	First voltage transformer for SF ₆ -insulated switchgear (GIS)
mid 1970 _s	New global generation of explosion-resistant oil-insulated instrument transformers
1978	First AIS gas-insulated instrument transformer (GIF) leading to development of the SF ₆ -insulated portfolio up to 800 kV
1993	MWB China established
2004	Trench acquired by Siemens
2005	Establishment of Trench High Voltage Products Ltd., Shenyang, (successor of Trench Fushun Bushing Co., Ltd.)
2008	Intelligent evolution: new global generation of enhanced design CVTs Siemens India founded
2012	First 1200 kV CVT
2015	Optical current transformer & current transformer for DC measurement

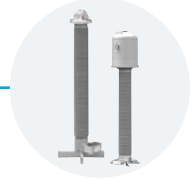
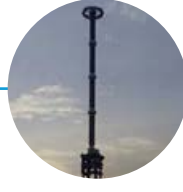
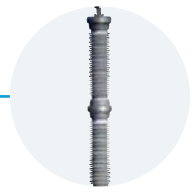

High-Voltage Instrument Transformers

Introduction

Electrical instrument transformers transform high currents and voltages into standardized low and easily measurable values that are isolated from the high voltage. When used for metering purposes, instrument transformers provide voltage or current signals that are very accurate representations of the transmission line values in both magnitude and phase. These signals allow accurate determination of revenue billing.

When used for protection purposes, the instrument transformer outputs must accurately represent the transmission line values during both steady-state and transient conditions. These critical signals provide the basis for circuit-breaker operation under fault conditions, and as such are fundamental to network reliability and security.

Instrument transformers used for network control supply important information for determining the state of the operating conditions of the network.

Reliability and security

Reliability of an instrument transformer refers to its ability to consistently satisfy prescribed performance criteria over its expected useful lifetime under specified operating conditions. Security refers to the acceptability and consequences of the instrument transformer failure mode in the event that it does fail, due to either being subjected to stresses in excess of those for which it was designed, or due to reaching the end of its expected service life.

The reliability and security characteristics of an instrument transformer are governed by the electrical and insulation design, the manufacturing and processing technology used, and the specific physical arrangement. The partial discharge performance under in-service conditions is a determining factor in the life expectancy and long-term reliability of an instrument transformer.

IEC standards for oil-immersed or gas-filled devices require a partial discharge value of less than 10 pC at U_{max} . Due to the demanding requirements of today's HV and UHV networks, the Trench Group has chosen to adopt even more stringent internal requirements. As such, Trench instrument transformers typically perform much better than required by these standards, and have proven field experience.

Oil-immersed instrument transformers

The reliability and security of Trench oil-insulated instrument transformers is proven by in-service experience spanning almost 100 years, with more than 100,000 units in operation under a wide range of environmental condi-

tions in almost every country worldwide. The transformer is based on a state-of-the-art design and a secure failure mode approach. In the event of unexpected stresses from the network, secure failure is achieved through the use of a "barrier construction" design in the free oil section. This approach consists of inserting insulating barriers at critical points through the free oil space, thereby preventing the formation of fiber bridges.

Furthermore, a rupture of the housing, particularly of the hollow insulator with built-in finely graded capacitor bushing, is improbable because of the safe dimensioning of the bushing and the solid electrical connection between the core housing and the ground.

If overpressure occurs, protection is guaranteed by the:

- Welded elastic housing
- Stainless-steel bellows for oil expansion.

Both the welded seam, which connects the upper and lower portions of the head housing, and the metallic bellows are designed to act as pressure relief points in the event of severe internal pressure buildup.

Because the unit has a normal internal oil pressure of approximately 1 bar absolute, it is possible to design these pressure relief points to rupture at very moderate pressures. Additional safety is achieved by the selection of composite insulators, available for the whole range as an alternative to the traditional porcelain.

Pressure relief for capacitor voltage transformers is provided by a bellows puncture pin, and through the use of porcelain, which is strong enough to release any rapid pressure rise through the seal plates at the ends of the porcelain rather than via explosion of the porcelain itself.

Gas-insulated instrument transformers

The reliability and security of Trench gas-insulated instrument transformers is based on over 50 years of innovation with gas-insulated units operating under a wide range of environmental conditions.

Explosion-proof design

The current Trench gas-insulated instrument transformers were initially designed in 1965 at the request of customers who sought to achieve explosion-proof operation. SF₆ gas insulation, combined with composite insulators, is particularly suitable for this, because in the event of an internal flashover, the pressure increase will be linear and hence technically manageable. A controlled pressure relief device at the head of the transformer (rupture disc) eliminates mechanical stresses in the housing, meaning that only the rupture disc is released. Gas escapes, however the complete transformer remains intact and no explosion occurs.



Fig. 44: 420 kV gas-insulated current transformers



Fig. 45: 800 kV gas-insulated current transformers

Most reliable insulation properties

SF₆ gas is the main insulation medium between high-voltage and earth potential. A stable quality can be guaranteed by the use of SF₆ gas in accordance with IEC 60137 (2005) / ASTM 2472 D thanks to how this inert gas shows no aging even under the highest electrical and thermal stresses. The insulation properties remain unchanged throughout its lifetime. All of these features guarantee an operational period of many years without the need to control the insulation condition.

Full functional security and monitoring

The guaranteed SF₆ leakage rate is less than 0.5% per year. The gas pressure can be checked on site or by means of a remote control device, for example, a densimeter with contacts for remote control. In the case of loss of SF₆ pressure, the transformer still operates at rated pressure.

Environmentally safe under severe conditions

SF₆ gas is non-toxic, non-flammable and non-corrosive, being chemically stable with high breakdown strength and minimal effects on the environment. This medium allows easy waste management of the transformers. Furthermore, the hydrophobic features of the composite insulator result in faultless operation even in saline fog or polluted conditions. The change of cores or windings can also be easily implemented, even after years, to meet new requirements such as additional metering, thus offering long-term benefits.



Fig. 46: 765 kV gas-insulated voltage transformer



Fig. 47: 300 kV oil-immersed current transformers in Alberta, Canada

Current transformers

All Trench current transformer (CT) designs are based on "head type" construction. CTs are available with either oil (fig. 47) or SF₆ gas dielectric systems (fig. 44, 45).

Features of oil-immersed current transformers

- Compliant with all national and international standards
- Available for the full voltage range from 72.5 kV up to 550 kV and full current range from a few amperes up to 5,000 A with multiple-turn primaries for small primary currents
- Exceptional control of internal and external insulation stresses through the use of a proprietary finely graded bushing system
- Short, symmetrically arranged low-reactance bar-type primary conductor permits higher short-circuit currents up to 100 kA and avoids large voltage drops across the primary winding
- Uniformly distributed secondary windings guarantee accurate transformation at both rated and high currents
- Superior transient performance
- Virtually unaffected by stray external magnetic fields
- Ratio change available either on primary side or secondary side
- Excellent seismic performance due to low weight, minimal oil volume, optimized design of flanges, large range of porcelain strengths, and interconnections

- Hermetically sealed by stainless-steel metallic bellows and high-quality fluorosilicone O-rings
- Exclusive use of corrosion-resistant materials
- Accuracy stable over lifetime
- Full range of products available with composite insulator.

Features of gas-insulated current transformers

- Compliant with all national and international standards
- Available for the full voltage range from 72.5 kV up to 800 kV, and full current range from 100 A up to 6,000 A
- Optimum field grading is achieved by a fine condenser grading system specially developed for this application
- Low-reactance, bar-type primary providing optimal short-circuit performance
- Multiple-turn primaries for small primary currents and uniformly distributed secondary windings guarantee accurate transformation at both rated and high currents
- Superior transient performance
- Replacing cores on assembled units is possible without affecting the integrity of the high-voltage insulation
- Explosion-proof design thanks to the compressible insulation medium SF₆ gas and rupture disc
- Excellent seismic performance due to composite insulator properties
- Exclusive use of corrosion-resistant materials
- Accuracy stable over lifetime.



Fig. 48: 550 kV zero-flux current transformer

DC (zero-flux) current transformers for AIS

AIS current transformers for DC measurement consist of a zero-flux sensor that is implemented into the shell of a GIF current transformer. It is a compact solution for HVDC switchgear (fig. 48).

Features of DC current transformers

- Based on proven AC design
- Available for 550 kV
- High accuracy
- Harmonics measurement
- Additional Rogowski coil for measurement of very high frequencies
- Compact design
- Explosion proof
- No fire hazard
- Designed for indoor and outdoor installation
- Low investment in civil works
- Can be placed in converter hall with small footprint.

Our portfolio also includes optical current transformers (see chapter on non-conventional instrument transformers).



Fig. 49: 420 kV oil-paper-insulated inductive voltage transformers

Inductive voltage transformers

Trench inductive voltage transformers are designed to provide voltage for metering and protection applications. They are available with either oil (fig. 49) or SF₆ gas dielectric systems (fig. 46).

Features of oil-immersed inductive voltage transformers

- Compliant with all national and international standards
- Available from 72.5 kV up to 550 kV
- Excellent control of internal and external insulation stresses through the use of a proprietary finely graded bushing system
- Optimized high-voltage coil ensures identical electric stresses under both transient and steady-state conditions
- Suitable for line discharging
- Superior transient performance
- Virtually unaffected by stray external magnetic fields
- Applicable as a low-cost alternative to small power transformers
- Excellent seismic performance due to low weight, minimal oil volume, optimized design of flanges, large range of porcelain strengths, and interconnections
- Hermetically sealed stainless-steel metallic bellows for units rated 123 kV and above
- Exclusive use of corrosion-resistant materials
- Accuracy stable over lifetime
- Full range of products available with composite insulator.



Fig. 50: 550 kV oil-immersed combined instrument transformers



Fig. 51: 800 kV gas-insulated combined instrument transformers

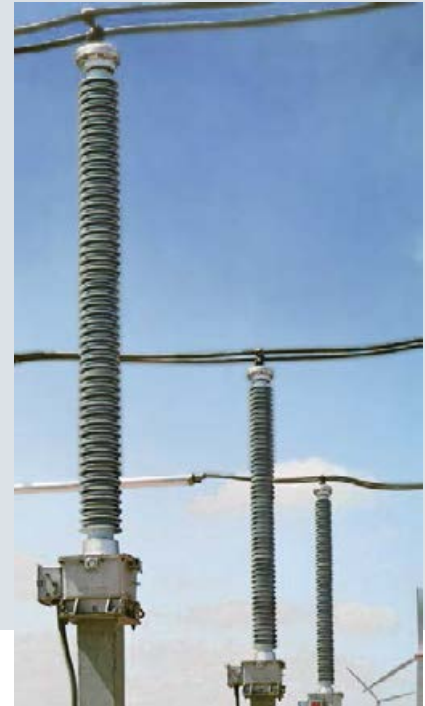

Fig. 52: 245 kV capacitor voltage transformers at Oncor substation (USA)

Features of gas-insulated inductive voltage transformers

- Compliant with all national and international standards
- Available for the full voltage range from 72.5 kV up to 800 kV
- Optimum field grading accomplished by a fine condenser grading system specially developed for this application
- Optimized high-voltage coil ensures identical electric stresses under both transient and steady-state conditions
- Suitable for line discharging
- Virtually unaffected by external stray magnetic fields
- Wide-range ferroresonance-free design without the use of an external damping device (please ask for details)
- Applicable as a low-cost alternative to small power transformers
- Explosion-proof design thanks to the compressible insulation medium SF₆ gas and rupture disc
- Excellent seismic performance due to the properties of the composite insulator
- Exclusive use of corrosion-resistant materials
- Accuracy stable over lifetime.

Combined instrument transformers

The combined instrument transformer offers the station designer the ability to accommodate the current transformer and the voltage transformer in one free-standing unit. This allows optimum use of substation space while

yielding cost savings by elimination of one set of mounting pads and support structures. In addition, installation time is greatly reduced. Combined ITs are available with either oil (fig. 50) or SF₆-gas dielectric systems (fig. 51).

Features of oil-immersed combined instrument transformers

- Compliant with all national and international standards
- Available for voltage range from 72.5 kV up to 300 kV and full current range of 0.5 A up to 5,000 A
- Comparably smaller footprint as a consequence of combining the voltage and current-sensing functions into one unit
- Exceptional control of internal and external insulation stresses through the use of a proprietary finely graded bushing system
- Short, symmetrically arranged low-reactance, bar-type primary conductor permits higher short-circuit currents and avoids large voltage drops across primary winding
- Uniformly distributed secondary windings guarantee accurate transformation at both rated and high current
- Suitable for line discharging
- Superior transient performance
- Virtually unaffected by stray external magnetic fields
- Excellent seismic capability as a consequence of low weight, minimal oil volume, optimized design of flanges, large range of porcelain strengths, and interconnections



Fig. 53: 362 kV gas-filled combined instrument transformer

- Hermetically sealed by stainless-steel metallic bellows and high-quality fluorosilicone O-rings
- Exclusive use of corrosion-resistant materials
- Accuracy stable over lifetime
- Full range of products available with composite insulator.

Features of gas-insulated combined instrument transformers

- Low weight and compact head-type design with voltage transformer section located on top of the current transformer
- Compliant with all national and international standards
- The single-section high-voltage coil (not cascaded) of the voltage transformer section enables a product range for combined instrument transformers of up to 800 kV
- Comparably smaller footprint as a consequence of combining the voltage and current-sensing functions into one unit
- Optimum field grading is accomplished by a fine condenser grading system specially developed for this application
- Low-reactance type primary conductor allows for high short-circuit currents and covers all core standards
- Suitable for line discharging
- Virtually unaffected by external stray magnetic fields
- Wide-range ferroresonance-free design without the use of an external damping device

- Explosion-proof design thanks to the compressible insulation medium SF₆ gas and rupture disc
- Excellent seismic performance due to the properties of the composite insulator
- Exclusive use of corrosion-resistant materials
- Accuracy stable over lifetime.

Capacitor voltage transformers (oil-immersed)

Coupling capacitors (CC) are utilized to couple high-frequency carrier signals to the power line. A CC supplied with an electromagnetic unit is called a capacitor voltage transformer (CVT) and is used to provide voltage for metering and protection applications (fig. 52).

Features of capacitor voltage transformers

- Compliant with all national and international standards
- Available for the high and ultra-high voltage range from 72.5 kV up to 1,200 kV
- Capable of carrier coupling PLC signals to the network
- Optimized insulation system design utilizing state-of-the-art processing techniques with either mineral oil or synthetic insulating fluids
- Stability of capacitance and accuracy over lifetime due to superior clamping system design
- Superior transient response characteristics



Fig. 54: Energy storage capacitor

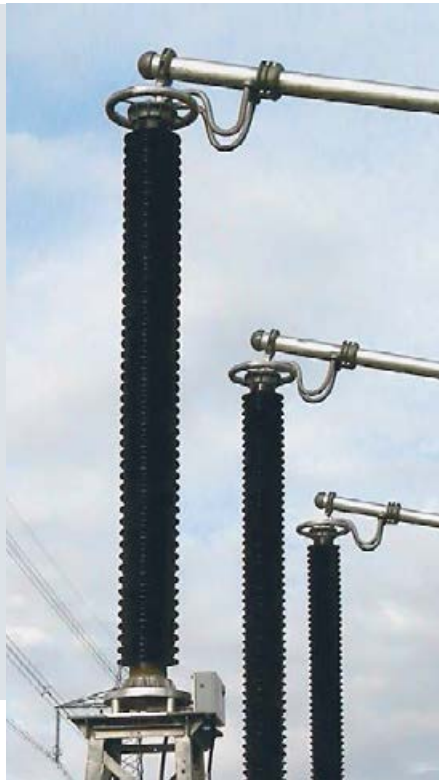

Fig. 55: 420 kV RC dividers (AC)
for AIS at Singlewell Substation,
National Grid, UK



Fig. 56: 145 kV RC divider for GIS

- Not subject to ferroresonance oscillations with the network or circuit-breaker capacitor
- High-capacitance CVTs can provide enhanced circuit-breaker short line fault/TRV performance when installed in close proximity to EHV circuit-breakers
- Oil expansion by way of hermetically-sealed stainless-steel bellows ensures the integrity of the insulation system over time
- Bellows puncture pin enables release of internal pressure in the event of severe service conditions leading to internal discharges
- Maintenance-free oil-filled cast-aluminum basebox
- Superior transient response characteristics
- Extra high-strength porcelain provides both superior seismic performance and the ability to mount large line traps directly onto the CVT, which saves on installation costs
- Internal company routine tests and quality requirements exceed international standards
- Full range of products available with composite insulator.

Special capacitors

Trench also produces a large range of products based on capacitive elements. Tailor-made products and systems include test capacitors, protection capacitors, energy storage capacitors (fig. 54), TRV capacitors, grading capacitors, HVAC

and HVDC capacitors (coupling capacitors), and resistive-capacitive voltage dividers (see chapter on RC dividers).

Features of special capacitors

- Stacked capacitor packs – controlled pressure
- Common material – paper / foil
- Resistors in parallel a/o serial
- Oil- or gas-insulated
- Available as porcelain- or composite insulators.

RC dividers

Resistive-capacitive voltage dividers, also called resistive-capacitive voltage transformers (RCVT), are designed for measurement of the voltage in HVDC transmission systems, air-insulated (AIS) (fig. 55), or gas-insulated (GIS) switchgear (fig. 56). In AC transmission systems, the transformers can be used for the measurement of harmonics, providing an accurate representation of the voltage over a wide frequency band (typically from DC up to 500 kHz). Their wide linearity range and output signals are also suitable for modern secondary equipment such as digital protection relays or merging units.

Features of RC dividers

- Designed for single-phase or three-phase system
- Suitable for voltage measurements
- Conform to microprocessor-based secondary technology



Fig. 57: 170 kV MoW (RTCVT)



Fig. 58: 420 kV core-in-air current transformer for GIS

- Ferroresonance-free
- Excellent transient characteristics
- Able to perform voltage test on site
- Not necessary to disconnect the RCVT during high-voltage tests on GIS switchgear
- Suitable for NCIT applications
- Significant size and weight reduction.

Master of Waves (MoW)

With the increasing importance of measuring efficiency and accuracy across the energy chain, Trench has developed a new product that combines the performance of a standard CVT with that of an RC voltage divider and is particularly suitable for higher accuracy harmonics measurement applications. The customer simply has to connect the existing low-voltage circuits to the CVT side of the MoW and connect the cable to the RCVT side for harmonics measurement (fig. 57).

Features of MoW

- Available from 72.5 kV to 245 kV, other voltages upon request
- Significant space saving and lower footprint in substation
- Oil-insulated
- Available with porcelain or composite insulators.

Instrument transformers for GIS

Trench also manufactures current and voltage transformers, as well as RC dividers for gas-insulated switchgear.

Features of current transformers for GIS (fig. 58)

- Custom-designed instrument transformers for each specific application and extended function designs comply with dimensional restrictions, flange sizes, and insulator requirements
- Available up to 550 kV
- Core-in-air (1-phase units) and core-in-gas solutions (1-phase and 3-phase units) available
- Core-in-air solutions enable a minimum use of SF₆
- Perfect transient response time
- Shielded against transient overvoltages in accordance with IEC standards. Special additional shielding is available
- Guaranteed SF₆ leakage rate of less than 0.5% per year
- Explosion-proof design thanks to SF₆ and rupture disc
- All components designed and tested for mechanical stress to withstand up to at least 20 G
- Accuracy classes in accordance with DIN VDE 0414-9-1/-2, IEC 61869, ANSI: IEEE C57.13 (other standards and classes upon request)
- Shock indicators warn against inadmissible acceleration during transportation
- Stable accuracy over lifetime.

Features of inductive-type instrument transformers for GIS (fig 59)

- Compliant with all national and international standards regarding pressure vessel codes
- Available up to 800 kV
- Custom-designed voltage transformers for each specific application and extended function designs comply with dimensional restrictions, flange sizes, and insulator requirements
- Standard designs for single-phase and three-phase units
- Prevention of stable ferroresonance occurrence through integrated ferroresonance suppression
- Shielded against transient overvoltages in accordance with IEC standards. Special additional shielding is available
- Guaranteed SF₆ leakage rate of less than 0.5% per year
- Explosion-proof design thanks to SF₆ and rupture disc
- All components designed and tested for mechanical stress to withstand up to at least 20 g
- Accuracy classes in accordance with DIN VDE0414-9-1/-2, IEC 61869, ANSI: IEEE C57.13 (other standards and classes upon request)
- Shock indicator warning against unauthorized acceleration during transportation
- Stable accuracy over lifetime.

Electronic voltage measuring system for HVDC

Trench offers special voltage transformers for HVDC systems. These units are primarily used to control the HV valves of the rectifiers or inverse rectifiers. The measuring system consists of an RC voltage divider that provides inputs to a specially designed electronic power amplifier. The high-voltage divider can be supplied either for outdoor operation or for installation into SF₆ gas-insulated switchgear (GIS). The resulting system can accurately transform voltages within a defined burden range with linear frequency response of ANSI up to approximately 10 kHz. Thus, the system is ideal for measurement of dynamic and transient phenomena and harmonics associated with HVDC systems.

Non-conventional instrument transformers

In digital substations with low input power requirements (<2.5 VA), a solution for voltage and current measurement can be provided by non-conventional instrument transformers (NCIT). The NCIT technologies offered by Trench are:

RC dividers for voltage measurement (RCVT - described in a previous chapter) and optical current transformers (OCT).

Trench optical current transformers utilize the Faraday effect for current measurement. The OCT is a potential-free measurement system providing a digital output in accordance with the IEC 61850-9-2 protocol (fig. 60).

Features of optical current transformers

- Available for the complete high-voltage range up to 800 kV
- Free-standing or suspended solution



Fig.59: 145 kV inductive voltage transformer for GIS

Fig.60: Optical current transformer

- Full flexibility due to modular system
- Complete absence of electronics within the OCT and on bay level
- Low inherent temperature dependency
- Complete electrical insulation between primary and secondary equipment due to optical fibers
- High bandwidth (harmonics measurement possible)
- Small size and lightweight
- Eco-friendly solution (insulated with dry air)
- Compatible with process bus in accordance with IEC 61850.

Power Voltage Transformers/Station-Service Voltage Transformers

Power voltage transformers for AIS

Power voltage transformers (power VTs) enable power supply for remote customers without the need for major investments. The power VTs simply have to be connected directly to the high-voltage overhead line to ensure customized power supply. A power VT for AIS is shown in fig. 61.

Features of power VTs for AIS

- Combination of inductive voltage transformer and power transformer
- Available in SF₆ insulation for the full voltage range from 72.5 kV up to 550 kV



Fig. 61: 145 kV power VT for AIS



Fig. 62: 145 kV power VT for GIS

- Excellent control of internal and external insulation stresses through the use of a proprietary finely graded bushing system
- Output power up to 125 kVA in single-phase operation
- Three-phase operation possible with three times higher total output power
- Custom-fit secondary voltage – standard 120/240V
- Additional adjustment transformers for secondary voltage available
- Metering and protection windings
- 30 kV lightning impulse withstand for secondary and HV neutral
- Overload capability in cycle operation
- Cable discharge option
- Terminal box protection class IP55 / NEMA 4X
- Primary protection by circuit-breaker
- Explosion-proof due to the compressible insulation medium SF₆ and rupture disc
- Seismic performance tested up to 0.5 g (higher verified by calculation)
- Exclusive use of corrosion-resistant material
- Easy transportation and handling due to light weight
- Online monitoring system for low- and high-voltage coils
- Remote supervision of insulation condition
- Minimum maintenance
- Mobile solution on trailer available.

Applications

- Substation Service Voltage Transformer
- Power supply for remote farms and small villages
- Auxiliary power supply for substations
- Power supply during substation construction works.

Power voltage transformers for GIS

An inductive voltage transformer with different active parts becomes a “power VT”, which then allows for a high-voltage test of the primary system without special high-voltage test equipment. A power VT for GIS is shown in *fig. 62*.

Features of power VTs for GIS

- Same dimension as standard VTs, and can be operated like a standard VT
- Available from 72.5 kV up to 245 kV
- After testing, the switchgear can be put into operation without mechanical work on the primary circuit (i.e., normally the high-voltage test set must be removed)
- Easy support from neutral testing companies (e.g., OMICRON) or testing institutes
- Power supply via standard socket outlet (e.g., single-phase, 230 V, 16 A)
- Easy transportation and handling due to light weight
- SF₆ gas handling at site not required for test preparation
- Low investment in site-based testing facilities.



Fig. 63: Test+ systems

High-Voltage Test Systems

Test+ portfolio

Trench AC high-voltage test systems cover an extensive operating range; from feeding, controls, instrumentation, data recording, and protection, to individual HV setups. See *fig. 63*.

Features of Trench HV test systems

- Available from 230 kV up to 1,200 kV
- Versions for GIS and for AIS testing (fully encapsulated gas-insulated setups; setups in air with "open" high voltage, classical lab type)
- Combined version for GIS & AIS testing with same system
- Individual customized system setup
- Small, optimized footprint
- Safe HV testing: no open high voltage in GIS version
- Highly sensitive PD testing
- Effective self-shielding
- Extremely low PD noise in GIS version
- Usable in noisy, non-shielded production halls.

Applications

- AC testing & PD measurement
- Accuracy calibration (for VTs and sensors)
- "Classical" laboratories
- Factory labs
- Mobile testing on site.

An overview of the range of Trench instrument transformers and their standard ratings can be seen in *table 14* to *table 20*.

Instrument transformers

➔ [siemens.com/energy/instrument-transformers](https://www.siemens.com/energy/instrument-transformers)

Trench Group

➔ [trench-group.com](https://www.trench-group.com)

Current transformers for air-insulated switchgear (AIS)

											
Type		SAS			TAG			IOSK			
Voltage range	[kV]	72.5 – 800			72.5 – 550			72.5 – 550			
Insulation medium		SF ₆			SF ₆			Oil			
Composite insulator		x			x			x			
Porcelain insulator					x			x			
Technical data											
Voltage level	[kV]	72.5	123	145	170	245	300	362	420	550	800
Rated power-frequency withstand voltage	[kV]	140	230	275	325	460	460	510	630	680	975
Rated lightning impulse withstand voltage	[kV]	325	550	650	750	1,050	1,050	1,175	1,425	1,550	2,100
Rated switching impulse withstand voltage	[kV]	–	–	–	–	–	850	950	1,050	1,175	1,550
Rated normal current up to	[A]	5,000 (6,000 on special request for gas-insulated units)									
Output current	[A]	1 – 2 – 5									
Rated short-time thermal current	[kA]	63 (100 on special request)									
Rated duration of short circuit	[s]	1 – 3									
Rated dynamic current	[kA]	160 (200 on special request)									
Rated frequency	[Hz]	16 2/3 – 50 – 60									
Creepage distance	[mm/kV]	25 – 31 (higher upon request)									
Temperature range	[°C]	–50 – +40 (other values upon request)									
Insulation class		E (SF ₆ -insulated devices) – A (oil-insulated devices)									
Metering accuracy class		0.1 – 0.2 – 0.2S – 0.5 – 0.5S – 1.0									
Protection accuracy class		5P – 10P – TPY – TPX – TPZ – TPS – PR – PX									
Values in accordance with IEC; other values like ANSI are available											

Table 14: Technical data of Trench current transformers for air-insulated switchgear (AIS); type SAS, TAG, IOSK

Voltage transformers/RC dividers for air-insulated switchgear (AIS)



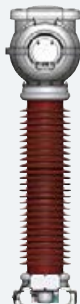
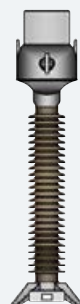

											
Type		SVS	TVG	VEOT/VEOS	TCVT	AC RCD	DC RCD				
Voltage range	[kV]	72.5 – 800	72.5 – 420	72.5 – 550	72.5 – 1200	72.5 – 800	72.5 – 800				
Insulation medium		SF ₆	SF ₆	Oil	Oil	Oil	Oil/SF ₆				
Composite insulator		x	x	x	x	x	x				
Porcelain insulator			x	x	x	x	x				
Technical data											
Voltage level	[kV]	72.5	123	145	170	245	300	362	420	550	800
Rated power-frequency withstand voltage	[kV]	140	230	275	325	460	460	510	630	680	975
Rated lightning impulse withstand voltage	[kV]	325	550	650	750	1,050	1,050	1,175	1,425	1,550	2,100
Rated switching impulse withstand voltage	[kV]	–	–	–	–	–	850	950	1,050	1,175	1,550
Output voltage	[V]	110/√3 – 200/√3 (other values upon request) (AC&DC RC divider: 5 – 200V)									
Rated voltage factor		1.2 – 1.5 – 1.9 (other values upon request)									
Rated frequency	[Hz]	16 2/3 – 50 – 60 (AC&DC RC divider: 0 – 1 MHz)									
Creepage distance	[mm/kV]	25 – 31 (higher upon request)									
Temperature range	[°C]	–50 – +40 (other values upon request)									
Insulation class		E (SF ₆ insulated devices) – A (oil-insulated devices)									
Metering accuracy class		0.1 – 0.2 – 0.5 – 1.0 – 3.0									
Output burden (only AC)		for different classes according to customer specification (very low output burden for RC divider > 100 kΩ)									
Protection accuracy class		3P – 6P									
Output burden (only AC)		for different classes according to customer specification									
Thermal limiting output	[VA]	3,000 ¹⁾									
Values in accordance with IEC; other values like ANSI are available; ¹⁾ valid only for voltage transformers											

Table 15: Technical data of Trench voltage transformers for air-insulated switchgear (AIS); type SVS, TVG, VEOT/VEOS, TCVT, AC RCD, DC RCD

Combined instrument transformers for air-insulated switchgear (AIS)

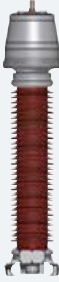

											
Type		SVAS	AVG	IVOKT							
Voltage range	[kV]	72.5 – 800	72.5 – 245	72.5 – 300							
Insulation medium		SF ₆	SF ₆	Oil							
Composite insulator		×	×	×							
Porcelain insulator			×	×							
Technical data											
Voltage level	[kV]	72.5	123	145	170	245	300	362	420	550	800
Rated power-frequency withstand voltage	[kV]	140	230	275	325	460	460	510	630	680	975
Rated lightning impulse withstand voltage	[kV]	325	550	650	750	1,050	1,050	1,175	1,425	1,550	2,100
Rated switching impulse withstand voltage	[kV]	–	–	–	–	–	850	950	1,050	1,175	1,550
Rated frequency	[Hz]	16 2/3 – 50 – 60									
Creepage distance	[mm/ kV]	25 – 31 (higher upon request)									
Temperature range	[°C]	–50 – +40 (other values upon request)									
CT ratings											
Rated normal current up to	[A]	5,000 (6,000 on special request for gas-insulated units)									
Output current	[A]	1 – 2 – 5									
Rated short-time thermal current	[kA]	63 (100 on special request)									
Rated duration of short circuit	[s]	1 – 3									
Rated dynamic current	[kA]	160 (200 on special request)									
Insulation class		E (SF ₆ -insulated devices) – A (oil-insulated devices)									
Metering accuracy class		0.1 – 0.2 – 0.2S – 0.5 – 0.5S – 1.0									
Protection accuracy class		5P – 10P – TPY – TPX – TPZ – TPS – PR – PX									
VT ratings											
Output voltage	[V]	110/√3 – 200/√3 (other values upon request)									
Rated voltage factor		1.2 – 1.5 – 1.9 (other values upon request)									
Metering accuracy class		0.1 – 0.2 – 0.5 – 1.0 – 3.0									
Output burden		for different classes according to customer specification									
Protection accuracy class		3P – 6P									
Output burden		for different classes according to customer specification									
Thermal limiting output	[VA]	3000 (other values upon request)									
Values in accordance with IEC; other values like ANSI are available											

Table 16: Technical data of Trench combined instrument transformers for air-insulated switchgear (AIS); type SVAS, AVG, IVOKT

Current transformers for gas-insulated switchgear (GIS)

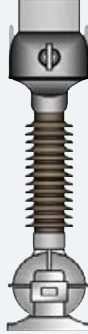

											
Type		SAD/SA									
Voltage range	[kV]	72.5 – 550					72.5 – 550				
Insulation medium		SF ₆					–				
Technical data SAD/SA											
Voltage level	[kV]	72.5	123	145	170	245	300	362	420	550	
Output current	[A]	1 – 5									
Rated short-time thermal current	[kA]	31.5 (from 72.5 - 145 kV)			50 (from 170 - 245 kV)		63 (from 300 - 362 kV)		80 (from 420 - 550 kV)		
Rated duration of short circuit	[s]	1 – 3									
Rated dynamic current	[kA]	78.75			125		160				
Rated frequency	[Hz]	16 2/3 – 50 – 60									
Temperature range	[°C]	–35 – +55									
Insulation class		E, F									
Metering accuracy class		0.1 – 0.2 – 0.2S – 0.5 – 0.5S – 1.0									
Protection accuracy class		5P – 10P – TPY – TPX – TPZ – TPS – PR – PX									
Values in accordance with IEC; other values like ANSI are available											

Table 17: Technical data of Trench current transformers for gas-insulated switchgear (GIS); type SAD/SA

Voltage transformers/RC dividers for gas-insulated switchgear (GIS)



											
Type		SUD/SU					RCVD				
Voltage range	[kV]	72.5 – 800					72.5 – 550				
Insulation medium		SF ₆					Oil / SF ₆				
Technical data SUD/SU											
Voltage level	[kV]	72.5	123	145	170	245	300	362	420	550	800
Rated power-frequency withstand voltage	[kV]	140	230	275	325	460	460	510	630	680	975
Rated lightning impulse withstand voltage	[kV]	325	550	650	750	1,050	1,050	1,175	1,425	1,550	2,100
Rated switching impulse withstand voltage	[kV]	–	–	–	–	–	850	950	1,050	1,175	1,550
Output voltage	[V]	110/√3 – 200/√3 (other values upon request) (AC & DC RC divider: 5 – 200V)									
Rated voltage factor		1.2 – 1.5 – 1.9 (other values upon request)									
Rated frequency	[Hz]	16 ⅔ – 50 – 60									
Temperature range	[°C]	–30 – +55 (other values upon request)									
Insulation class		E									
Metering accuracy class		0.1 – 0.2 – 0.5 – 1.0 – 3.0									
Output burden		for different classes according to customer specification									
Protection accuracy class		3P – 6P									
Output burden		for different classes according to customer specification									
Thermal limiting output		2,000					3,000 ¹⁾				
IID		x	x	x	x	x	x	x	x	x	x
Values in accordance with IEC; other values like ANSI are available ¹⁾ valid only for voltage transformers											

Table 18: Technical data of Trench voltage transformers / RC dividers for gas-insulated switchgear (GIS); type SUD/SU RCVD

Power voltage transformers for air-insulated switchgear (AIS)



Type

PSVS

Technical data

Voltage level	[kV]	123	145	170	245	300	362	420	550
Rated power-frequency withstand voltage	[kV]	230	275	325	460	460	510	630	680
Rated lightning impulse withstand voltage	[kV]	550	650	750	1,050	1,050	1,175	1,425	1,550
Rated switching impulse withstand voltage	[kV]	–	–	–	–	850	950	1,050	1,175
Output power	[kVA]	up to 125							
Standard output voltage	[V]	120/240							
Rated voltage factor		1.5 (30 s)							
Rated frequency	[Hz]	50 – 60							
Creepage distance	[mm/kV]	25 – 31 (higher upon request)							
Standard temperature range	[°C]	–50 ¹⁾ – +40 ¹⁾							
Insulation class		E							
Metering accuracy class		0.2 ²⁾ – 0.5 ²⁾ – 1.0 ²⁾ – 3.0							
Protection accuracy class		3P ²⁾ – 6P ²⁾							

Values in accordance with IEC; other values like ANSI are available ¹⁾ lower or higher temperature upon request ²⁾ not under full load condition

Table 19: Technical data of Trench power voltage transformers for air-insulated switchgear (AIS); type PSVS

Power voltage transformers for gas-insulated switchgear (GIS)



Type

PSUD

Technical data

Voltage level	[kV]	72.5	123	145	170	245
Rated power-frequency withstand voltage	[kV]	140	230	275	325	460
Rated lighting impulse withstand voltage	[kV]	325	550	650	750	1,050
Rated switching impulse withstand voltage	[kV]	–	–	–	–	–
Rated frequency	[Hz]	50 – 60				
Output power	[kVA]	depends on customer-specific load cycle				
Output voltage	[V]	as required (typically $110/\sqrt{3}$)				
Rated voltage factor		1.9 for 8 h				
Temperature range	[°C]	–30 – +50				
Insulation class		E				
Metering class		according to IEC 61869-3				
Protection class						

Values in accordance with IEC; other values like ANSI are available

Table 20: Technical data of Trench power voltage transformers for gas-insulated switchgear (GIS); type PSUD

Coil Products

Customer partnership around the globe

More than 250,000 coil products delivered to more than 170 countries. More than 60 years of operational experience.



Proven reliability

- Trench developed the technology that is air core reactors today
- Trench is the largest reactor manufacturer in the world
- Over 250,000 units in service worldwide
- Product lifetime of 30 years and more
- All units custom-designed based on:
 - More than 60 years of experience
 - Continuous R&D and product improvement
 - Four competence centers around the world



Continuous innovation since 1900

1900 – Beginnings

- Open-style windings
- Cast in concrete, large cables, air between turns
- Technology limited to small coils and distribution voltages

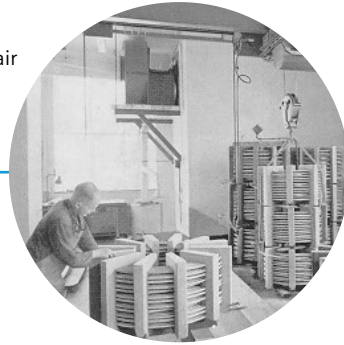

1960 – State of the art

- 1954 Spezialelektra founded (today Trench Austria)
- 1962 Trench Electric founded (today Trench Canada)
- Winding design encapsulated in epoxy resin and filament fiberglass
- Small diameter conductors
- Windings film insulated
- Parallel winding design



70's to 90's – Development

- Development of specialty cables and insulation systems
- Higher short-circuit ratings
- New applications: SVC, filters, HVDC, low-loss shunt reactors



Transmission focus

- Large series reactors: EHV, current limiting & power flow control
- Acoustic design
- Seismic designs for very large coils
- Higher voltage shunt reactors

2000's



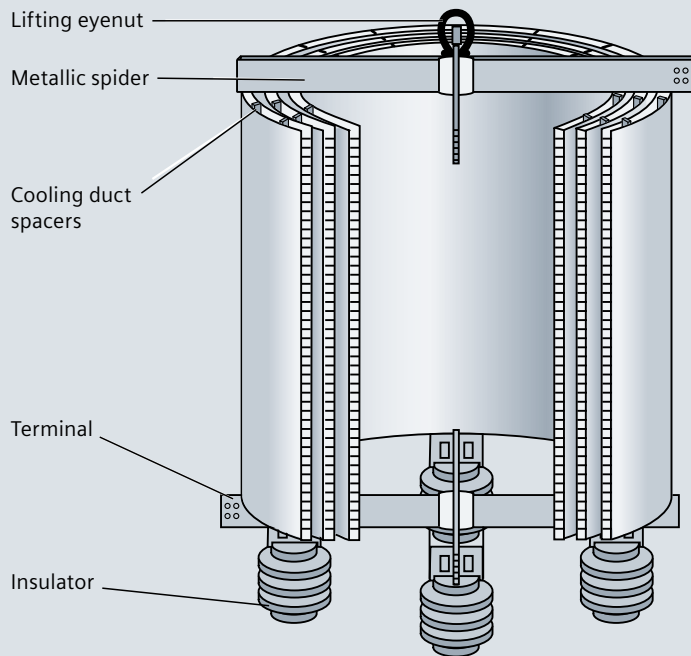

Fig. 64: Typical Trench air-core dry-type reactor construction

Introduction

With 60 years of successful field experience, Trench is the recognized world leader in the design and manufacturing of air-core dry-type power reactors for all utility and industrial applications. The unique custom design approach, along with fully integrated engineering and manufacturing facilities in North America, Brazil, Europe and China have made Trench the technical leader for high-voltage inductors worldwide.

A deep commitment to the power industry, along with extensive investment in engineering, manufacturing and test capability, give Trench customers the utmost in high-quality, reliable products that are individually designed for each application. Trench reactor applications have grown from small-distribution class, current-limiting reactors to complex EHV-applied reactors surpassing 300 MVA per phase.

Trench Management System is certified in accordance with ISO 9001, ISO 14001 and OHSAS 18001. Trench's highly developed research and development program constantly addresses new technologies and their potential application in reactor products. Trench welcomes challenges for new applications for power reactors.

Design features

Design features of air-core dry-type reactors are:

- Epoxy-impregnated, fiberglass-encapsulated construction
- Aluminum construction throughout with all current-carrying connections welded
- Highest mechanical and short-circuit strength
- Essentially zero radial-voltage stress, with uniformly graded axial-voltage distribution between terminals
- Low noise levels are maintained throughout the life of the reactor
- Weatherproof construction, with minimum maintenance requirements
- Design service life in excess of 30 years
- Designs available in compliance with ANSI/IEEE, IEC, and other major standards.

Construction

A Trench air-core dry-type reactor consists of a number of parallel-connected, individually insulated, aluminum (copper on request) conductors (fig. 64). These conductors can be small wire or proprietary cables which are custom-designed and custom-manufactured. The size and type of conductor used in each reactor is dependent on the reactor specification. The various styles and sizes of conductors available ensure an optimum performance at the most economical cost.



Fig. 65: Line traps

The windings are mechanically reinforced with epoxy-resin-impregnated fiberglass, which after a carefully defined oven-cure cycle produces an encapsulated coil. A network of horizontal and vertical fiberglass ties coupled with the encapsulation minimizes vibration in the reactor and achieves the highest available mechanical strength. The windings are terminated at each end to a set of aluminum bars called a spider. This construction results in a very rigid unit, capable of withstanding the stresses developed under the most severe short-circuit conditions.

Exceptionally high levels of terminal pull, tensile strength, wind loading, and seismic withstand can be accommodated with the reactor. This unique design can be installed in all types of climates and environments, and still offer optimum performance.

Trench air-core dry-type reactors are installed in polluted and corrosive areas, and enable trouble-free operation. In addition to the standard fixed reactance type of coil, units can be supplied with taps for variable inductance. A number of methods are available to vary inductance for fine-tuning, or to provide a range of larger inductance steps.

In addition, Trench utilizes various other designs, e.g., iron-core and water-cooled.



Fig. 66: 3-phase stacked current-limiting reactor

Line traps

Line traps (*fig. 65*) are connected in series with HV transmission lines. The main function of the line trap is to provide a high impedance at power-line-carrier frequencies (30-500 kHz) while introducing negligible impedance at the power frequency (50 or 60 Hz). The high impedance limits the attenuation of the carrier signal within the power system by preventing the carrier signal from being:

- Dissipated in the substation
- Grounded in the event of a fault outside the carrier transmission path
- Dissipated in a tap line or a branch of the main transmission path.

Series reactors

Reactors are connected in series with the line or feeder. Typical uses are fault-current reduction, load balancing in parallel circuits, and limiting inrush currents of capacitor banks, etc.

Current-limiting reactors

Current-limiting reactors reduce the short-circuit current to levels within the rating of the equipment on the load side of the reactor (*fig. 66*). Applications range from the simple distribution feeder reactor to large bus-tie and load-balancing reactors on systems rated up to 765 kV/2100 kV BIL.



Fig. 67: Tertiary-connected shunt reactors

Capacitor reactors

Capacitor reactors are designed to be installed in series with a shunt-connected capacitor bank to limit inrush currents due to switching, to limit outrush currents due to close-in faults, and to control the resonant frequency of the system due to the addition of the capacitor banks. Reactors can be installed on system voltages through 765 kV/2100 kV BIL. When specifying capacitor reactors, the requested continuous current rating should account for harmonic current content, tolerance on capacitors, and allowable system overvoltage.

Buffer reactors for electric arc furnaces

The most effective performance of electric arc furnaces is achieved by operating the furnace at low electrode current and long arc length. This requires the use of a series reactor in the supply system of the arc furnace transformer for stabilizing the arc.

Duplex reactors

Duplex reactors are current-limiting reactors that consist of two half coils, magnetizing against each other. These reactors provide a desirable low reactance under normal conditions, and a high reactance under fault conditions.

Load-flow control reactors

Load-flow control reactors are series-connected on transmission lines of up to 800 kV. The reactors change the line impedance characteristic such that load flow can be controlled, thus ensuring maximum power transfer over adjacent transmission lines.

Filter reactors

Filter reactors are used in conjunction with capacitor banks to form tuned harmonic filter circuits, or in conjunction with capacitor banks and resistors to form broadband harmonic filter circuits. When specifying filter reactors, the magnitudes of fundamental and harmonic frequency current should be indicated. If inductance adjustment for fine-tuning is required, the required tapping range and tolerances must be specified. Many filter applications require a Q factor that is much lower than the natural Q of the reactor. This is often achieved by connecting a resistor in the circuit.

An economical alternative is the addition of a de-Q'ing ring structure on a reactor. This can reduce the Q factor of the reactor by as much as one tenth without the need to install additional damping resistors. These rings, mounted on the reactor, are easily coupled to the magnetic field of the



Fig. 68: Pole bus smoothing reactor for UHVDC Agra (BIL 1,300 kV; 2,680 A; 75 mH) – tests at HSP Cologne

reactor. This eliminates the concern of space, connection, and the reliability of additional components such as resistors.

Shunt reactors

Shunt reactors are used to compensate for capacitive VARs generated by lightly loaded transmission lines or underground cables. They are normally connected to the transformer tertiary winding (*fig. 67*), but can also be directly connected to systems of up to 345 kV.

Thyristor-controlled shunt reactors (TCR) are extensively used in static VAR systems in which reactive VARs are adjusted by thyristor circuits. Static VAR compensator reactor applications normally include:

- Thyristor-controlled shunt reactors. The compensating power is changed by controlling the current through the reactor by means of the thyristor valves.
- Thyristor-switched capacitor reactors (TSC)
- Filter reactors (FR).

HVDC reactors

HVDC lines are used for long-distance bulk power transmission as well as back-to-back interconnections between different transmission networks. HVDC reactors normally include smoothing reactors, AC and DC harmonic filter

reactors, and AC and DC PLC noise filter reactors. In addition, self-commutated HVDC schemes include converter reactors.

Smoothing reactors

Smoothing reactors (*fig. 68*) are used to reduce the magnitude of the ripple current in a DC system. They are required on HVDC transmission lines for system voltages of up to 800 kV. They are also used in power electronics applications such as variable-speed drives and UPS systems. Several design and construction techniques are offered by Trench.

Test lab reactors

Test lab reactors are installed in high-voltage and high-power test laboratories. Typical applications include current-limiting, synthetic testing of circuit-breakers, inductive energy storage, and artificial lines.

Neutral earthing reactors

Neutral earthing reactors limit the line-to-earth fault current to specified levels. Specification should also include unbalanced condition continuous current and short-circuit current duration.



Fig. 69: Arc-suppression coil 110 kV

Arc-suppression coils

Single-phase neutral earthing (grounding) reactors (arc-suppression coils) are intended to compensate for the capacitive line-to-earth current during a 1-phase earth fault. The arc-suppression coil (ASC) represents the central element of the Trench earth-fault protection system (fig. 69).

Because the electric system is subject to changes, the inductance of the ASC used for neutral earthing must be variable. The earth-fault protection system developed by Trench utilizes the plunger core coil (moveable-core design). Based on extensive experience in design, construction and application of ASCs, Trench products can meet the most stringent requirements for earth-fault compensating techniques.



Fig. 70: Variable shunt reactor

Variable shunt reactors (VSR)

Variable shunt reactors (fig. 70) are connected in parallel to the lines, and supply the grid with inductive reactive power where fast control of reactive power is not necessary. VSRs utilize a plunger core technology to provide variation in reactive power.

Functions which can be achieved by a VSR are:

- Maintain steady-state voltage limit condition
- Keep reactive power flow within pre-defined limits
- Maintain a desired power factor.

Typical network conditions which favor the application of variable shunt reactors can be:

- Networks with distributed power generation
- Strongly varying loads connected through long overhead lines or by cables
- Grid connection of remote renewables (e.g., wind power).



Fig. 71: Capacitor filter protection relay – CPR500

Capacitor filter protection relay (CPR)

CPRs (fig. 71) are specifically designed to provide comprehensive protection of medium- and high-voltage capacitor banks and filter installations.

The new CPR500 additionally features a capacitive touch user interface, graphical display, and optional IEC 61850 communication multi-language support.

Protection functions are:

- Peak repetitive overvoltage protection to the 50th harmonic
- Overcurrent, undercurrent and earth-fault protection
- Neutral unbalance protection with residual compensation
- Line unbalance protection
- Thermal protection for capacitor, inductor and resistor elements
- Dual breaker fail protection with programmable logic
- Capacitor re-switching protection.

Coils

➔ [siemens.com/energy/coils](https://www.siemens.com/energy/coils)

Trench Group

➔ [trench-group.com](https://www.trench-group.com)

Bushings

Customer partnership around the globe

More than 1.2 million bushings products delivered around the world in the last 25 years.

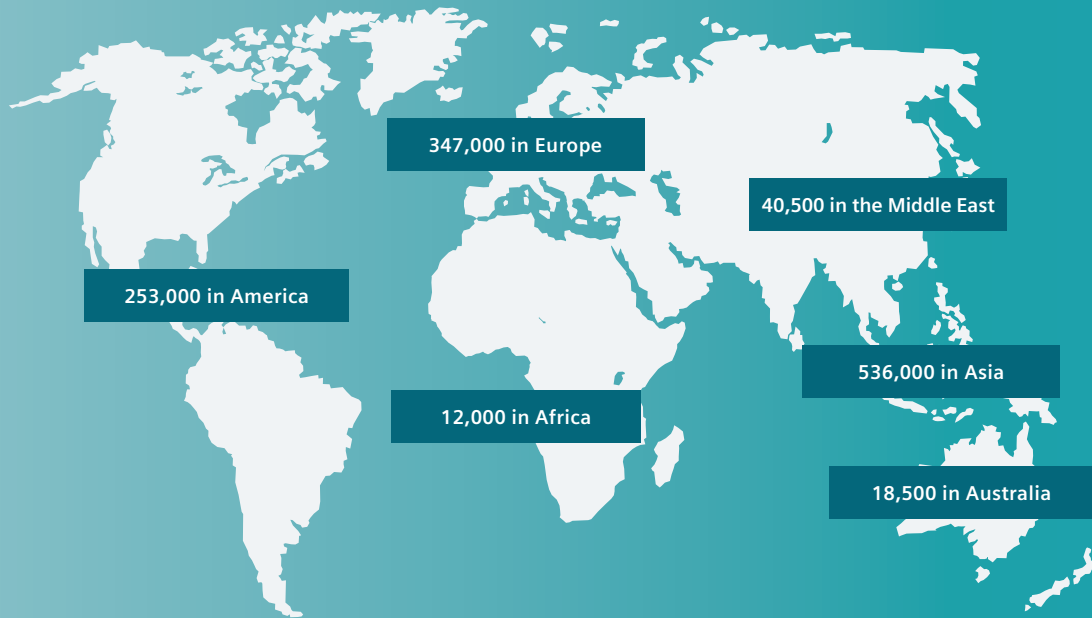

Proven reliability

HSP & Trench bushings are certified in accordance with the latest international standards, such as ISO/EN, IEC, ANSI, CSA. This ensures a failsafe product lifecycle up to 30 years!

Mean time between failures (MTBF)

- MTBF RIP bushings 38,000 years
- MTBF OIP bushings 10,200 years



Continuous innovation
since 1913

1913 First production of condenser bushings made of impregnated paper

1958 Oil-impregnated transformer bushing 380 kV



1960 Initial production of bushings made of resin-impregnated paper



1987 First 420 kV GIS outdoor bushing with silicone sheds



1997 First dry version of 500 kV HVDC RIP transformer and wall bushings



2009 First dry version of 800 kV HVDC RIP transformer and wall bushings



2012 First dry version of 1,100 kV HVDC RIP transformer bushing



2013 First 800 kV RIP transformer bushing with heatpipe technology



2014 Initial production of bushings made of resin-impregnated synthetic



Introduction

HSP Hochspannungsgeräte GmbH – known as HSP – and Trench have a long history, and are renowned in the manufacturing of high-voltage bushings and equipment. Both are world leaders in power engineering and in the design of specialized electrical products.

As “HSP & Trench Bushing Group”, they share their knowledge in the development, design and production of AC and DC bushings up to 1,200 kV. Customers can benefit substantially from their close cooperation in terms of innovation, joint research and development, and common design.

The Bushing Group provides a wide range of bushing products, including bushings for power transformers and HVDC transmission. The portfolio includes resin-impregnated paper bushings (RIP), resin-impregnated synthetic bushings (RIS), oil-impregnated paper bushings (OIP), and SF₆-gas bushings up to 1,200 kV. Whatever the customer’s requirements, the Bushing Group has the right bushing for his application.

Their technologies have been successfully in service for more than 60 years. The Bushing Group operates globally from their production locations in Troisdorf (Germany), St. Louis (France), Shenyang (China), and their sales office in Pickering (Canada).

High-Voltage Bushings

A bushing is an electrical engineering component that insulates a high-voltage conductor passing through a metal enclosure or a building. Bushings are needed on:

- Transformers
- Buildings
- Gas-insulated switchgear (GIS)
- Generators
- Other high-voltage equipment.

Typical environmental conditions are:

- Oil-to-air
- Oil-to-gas
- Oil-to-oil
- SF₆-to-air
- Air-to-air.

The internal insulation of a bushing is made of a combination of different insulating materials:

- Oil-impregnated paper (OIP)
- Resin-impregnated paper (RIP)
- SF₆ gas.

The external insulation is made up of:

- Resin for indoor applications
- Porcelain or fiberglass tubes with silicone rubber sheds for outdoor application.

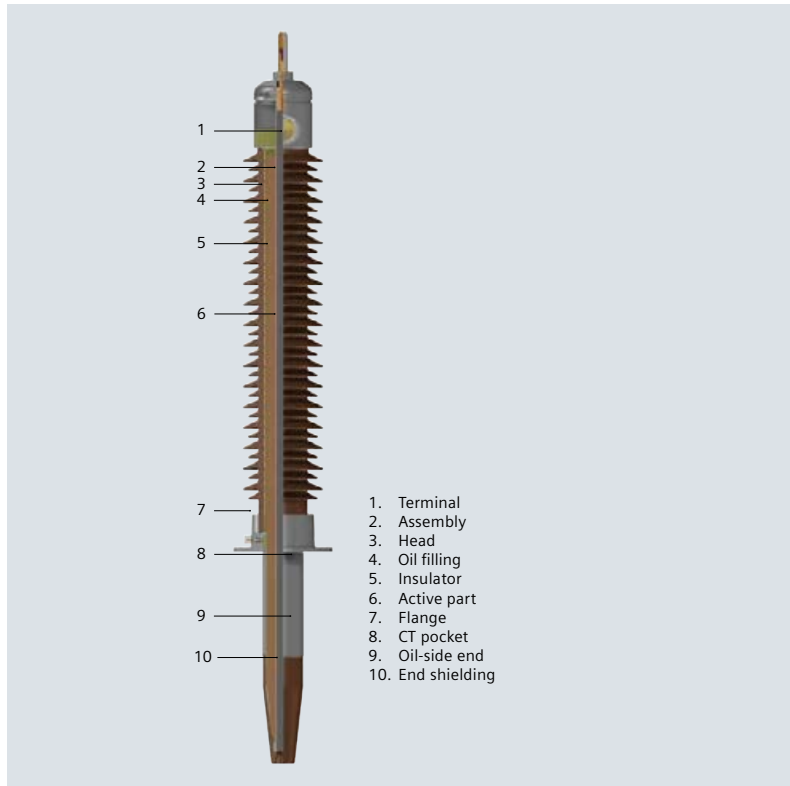

Fig. 72: Transformer bushing – oil-impregnated paper (OIP) design – sectional view

Selected state-of-the-art bushing designs are described in the following sections.

Transformer bushings: oil-impregnated paper design (OIP)

An oil-impregnated paper transformer bushing is made up of the following components (*fig. 72*):

1. Terminal

Terminal (Al or Cu) for connection of overhead lines or busbars and arcing horns. State-of-the-art designs provide maintenance-free termination, and ensure that the connection does not become loose during operation.

2. Assembly

The whole bushing is secured together by the central tube or conductor.

3. Head

Al-casted head with oil expansion chamber and oil level indicator. The chamber is hermetically sealed against the atmosphere.

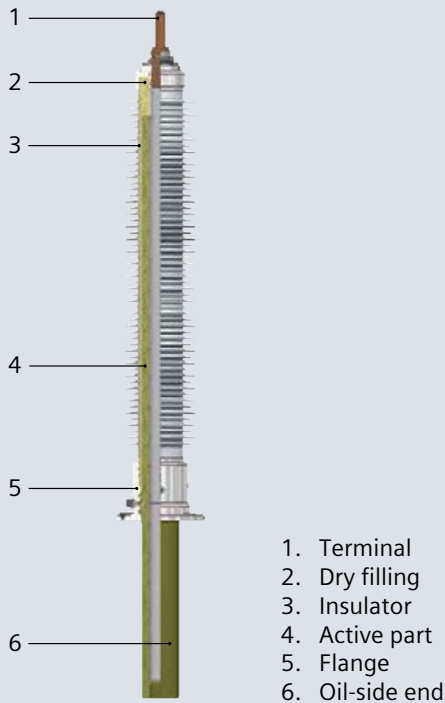

Fig. 73: Transformer bushing – resin-impregnated paper (RIP) design – sectional view

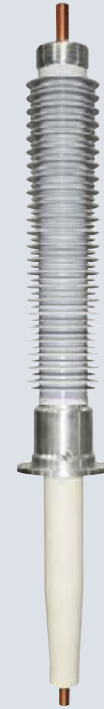

Fig. 74: Transformer bushing – resin-impregnated synthetic (RIS) design

4. Oil filling

State-of-the-art bushings are filled with dried, degassed insulating mineral oil.

5. Insulator

Porcelain insulator made of high-grade electrotechnical porcelain in accordance with IEC 815. The insulator is connected to the mounting flange using Portland cement, and sealed with O-ring gasket. Composite insulators are increasingly in demand and are readily available.

6. Active part

The active part comprises oil-impregnated wide-band paper with conductive layers made of aluminum foil to control the electrical field radially and axially. Depending on the current rating, the paper and foil are wound on either a central tube or a solid conductor.

7. Flange

The mounting flange with integrated test tap made of corrosion-free aluminum alloy is machined to ensure an excellent seal between the bushing and the transformer.

8. CT pocket

If current transformers are required on the bushing, the ground sleeve can be extended.

9. Oil-side end

The insulator on the oil side is made of an epoxy-resin tube. It is designed to stay installed during the in-tank drying process of the transformer, and can withstand temperatures of up to 130 °C.

10. End shielding

For voltages starting with 52 kV, a special aluminum electrode is cast into the end of the epoxy-resin tube. This end shielding controls the electrical field strength in this area to earth.

**Transformer bushings:
resin-impregnated paper design (RIP) and resin-impregnated synthetic design (RIS)**

An resin-impregnated paper and resin-impregnated synthetic transformer bushing is made up of the following components (fig. 73, 74).



Fig. 75: Transformer bushing – high current



Fig. 76: Transformer bushing – oil-to-gas

1. Terminal

Terminal (Al or Cu) for connection of overhead lines or busbars and arcing horns. State-of-the-art designs provide maintenance-free termination and ensure that the connection does not become loose in service.

2. Dry filling

State-of-the-art bushings are filled with dry-type foam.

3. Insulator

The external insulation consists of a composite insulator with silicone sheds. These are vulcanized on the mechanical support, a high-quality wound insulating tube made of epoxy resins with glass fiber laminate structure. In most cases, the flange is part of the insulator.

4. Active part

The active part is a capacitive-graded type. It is made of resin-impregnated paper (RIP) or resin-impregnated synthetic (RIS) with coaxially placed conductive layers made of aluminum foil to control the electrical field radially and axially. Depending on the current rating and the connection type, it is wound and impregnated under vacuum on either a central tube or a solid conductor.

5. Flange

The mounting flange with integrated test tap made of corrosion-free aluminum alloy is machined to ensure an excellent seal between the bushing and the transformer.

6. Oil-side end (including CT pocket, if required)

The transformer side of the active part (4) is directly immersed in the transformer oil. No additional housing tube is required. In case evacuation of the transformer is required, there are no restrictions regarding level and time up to the operating temperature of the bushing. The materials RIP and RIS are suitable for such treatment.

Connections

The modular bushing systems offer a large choice of connecting systems. There are three connecting systems available.

Removable cable bolt or removable solid conductor:

At the upper end of the bushing head, there is a clamp through which the conductor or the cable bolt is fixed. A releasable cross-pinned fitting at the clamping device prevents it from slipping into the transformer during operation. It also serves as a locking element. The bolt is



Fig. 77: Transformer bushing – 800 kV UHVDC – project Yunnan-Guangdong, China

sealed through double seals. The clamp is made of stainless steel, and all screws are made of non-corrosive steel. The venting of the central tube is located on one side under the edge of the clamp, and can be operated independently of the conductor bolt. In addition to the cable bolt, solid conductor bolts are available, for example, for higher-current applications. These bolts are centered against the inner wall of the central tube with insulated spacers. Solid conductor bolts can be provided with a separation point, preferably at the flange or to suit any particular case. The bolts are equipped with a threaded hole at the top, so that a draw wire or a rod can be screwed in, and the bolt pulled through the central tube.

Fixed undetachable conductor bolt: the active part (4) is directly impregnated on the solid conductor. In contrast to standard designs, there is no gap between conductor and central tube. Therefore, no oil from the transformer can access the bushing. The advantage of this design is that it provides a completely oil-free bushing.

Transformer bushings: high current

High-current bushings for transformer-to-phase busbar-isolated connections are designed for 24 kV to 52 kV and for currents from 7,800 A to 31,500 A. Conductors are usually aluminum (or copper on request). The main insulation is vacuum-impregnated epoxy condenser (*fig. 75*).

Other transformer bushings: oil-to-gas and oil-to-oil

Oil-to-gas types are used for the direct connection of power transformers to gas-insulated switchgear; oil-to-oil types are designed for direct connections within the power transformer (*fig. 76*). Both consist of a main insulating body of RIP (resin-impregnated paper). The condenser core is made of special resin vacuum-impregnated paper incorporating grading foils to ensure uniform voltage distribution. This insulation has proven its reliability over 40 years of service in various system applications. A high-quality insulation enables a compact design. Furthermore, bushings with this insulation have a low partial discharge level, not only at operating voltage but also above.



Fig. 78: Wall bushing – 800 kV HVDC – project Yunnan-Guangdong, China

HVDC bushings: transformer and wall

The growing demand for HVDC transmission requires reliable and efficient transformer and wall bushings of up to 1,000 kV DC (fig. 80). RIP solutions are often preferred due to their superior performance in heavily polluted areas, or due to their mechanical strength regarding seismic behavior.

An example of a state-of-the-art solution is the Yunnan-Guangdong/China project (fig. 77, fig. 78), which incorporates wall bushings and transformer bushings up to 800 kV.

Wall bushings

Wall bushings (fig. 79) are designed for use in high-voltage substations for roofs or walls according to their positioning:

- Indoor/indoor bushings for dry indoor conditions
- Outdoor/indoor bushings for use between open air (outer atmosphere) and dry indoor conditions
- Outdoor/outdoor bushings where both ends are in contact with the open air (outer atmosphere).

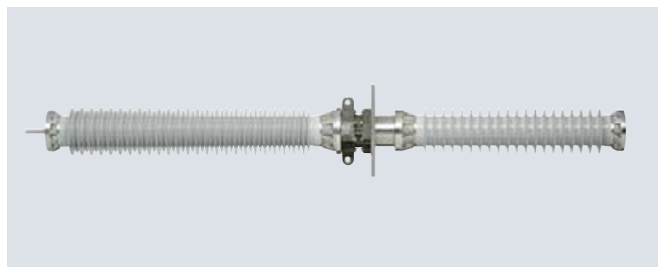

Fig. 79: Wall bushing – air-to-air

The main insulating body is capacitive-graded. A number of conductive layers are coaxially located at calculated distances between the central tube and the flange. This leads to a virtual linearization of the axial distribution of voltage on the bushing surface resulting in minimum stress on the surrounding air.



Fig. 80: Transformer bushing – 500 kV HVDC – project Three Gorges, China



Fig. 81: GIS bushing – 420 kV SF₆ outdoor bushing with composite housing

GIS bushings

These bushings are designed for use in GIS substations largely to connect to overhead lines. Designs are either electrode design up to 245 kV, or condenser design above 245 kV (fig. 81). Composite designs are increasingly in demand, especially for higher voltage ranges and in polluted areas.

Generator bushings

Generator bushings (fig. 82) are designed for leading the current induced in the stator windings through the pressurized hydrogen-gastight, earthed generator housing. Generator bushings are available from 12 kV to 36 kV and for current ratings of up to 50,000 A. They are natural, gas, or liquid-cooled.

Bushings

➔ [siemens.com/energy/bushings](https://www.siemens.com/energy/bushings)

Trench Group

➔ [trench-group.com](https://www.trench-group.com)

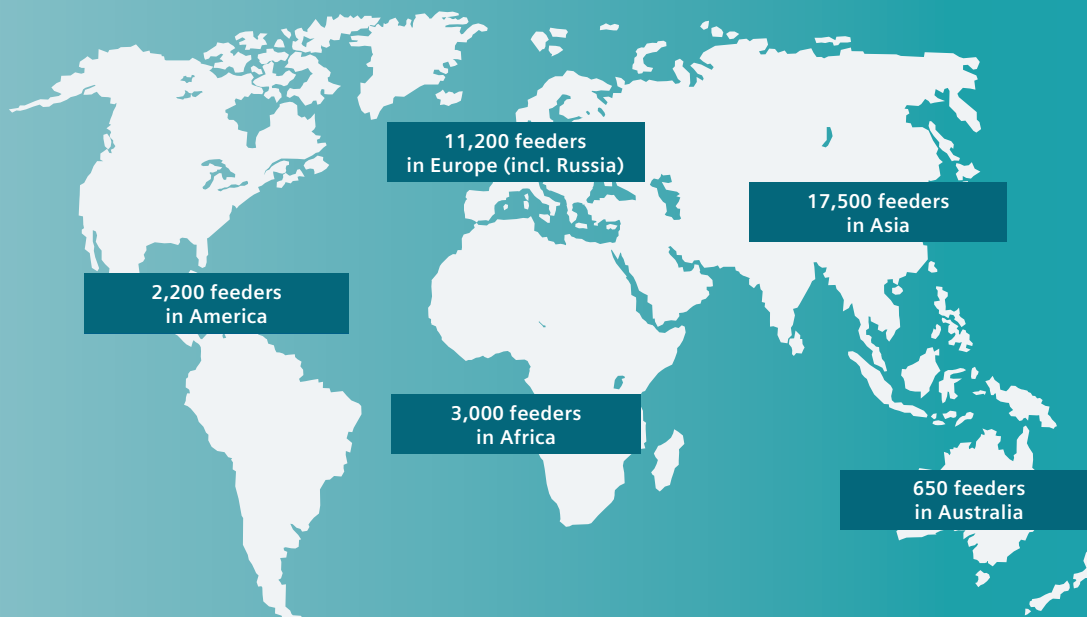

Fig. 82: Generator bushing

Gas-Insulated Switchgear

Customer partnership around the globe

More than 34,500 feeders worldwide and more than 420,000 bay-years of operation.



Proven reliability

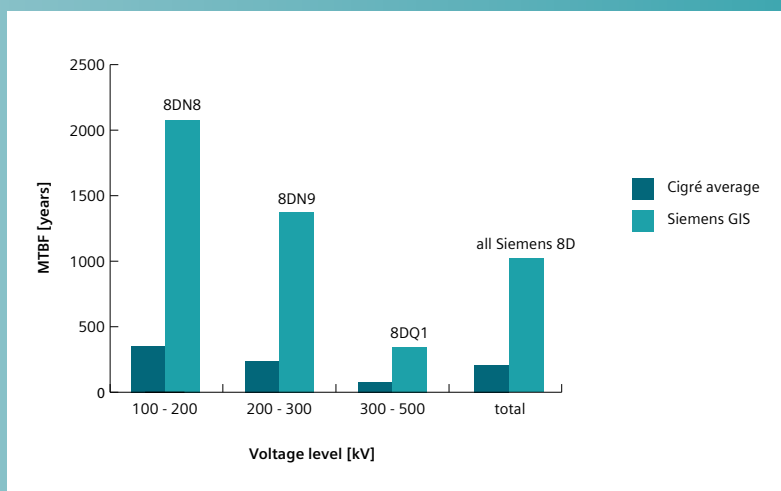

fig. 1: Comparison of Siemens MTBF with Cigré average MTBF ^{1) 2)}

¹⁾ Source: Cigré's 3rd Survey WG A3.06, 10/2012; calculations based on Cigré 513; table 5-52.

²⁾ The reliability statistics for each GIS type are compared with the data of the corresponding voltage level from Cigré's 3rd Survey WG A3.06, 10/2012.

Continuous innovation since 1968











1968	<p>First production of GIS in Berlin factory Products manufactured:</p> <ul style="list-style-type: none"> • 8DN8 (145 kV, 170 kV) • 8DN9 (245 kV) • 8DQ1 (420 kV, 550 kV) 		<p>Production start of 123 kV GIS, first GIS still in service after more than 45 years</p>	
1972	<p>Production start of 245 kV GIS</p>			
1974	<p>Production start of 420 kV GIS</p>			
1976	<p>Production start of 145 kV, 3-phase GIS</p>			
1986	<p>Production start of GIS up to 300 kV</p>			
1988	<p>Production start of 550 kV GIS</p>			
2001	<p>GIS factory in Shanghai Products manufactured:</p> <ul style="list-style-type: none"> • SMART 145 kV • 8DN8 (145 kV) • 8DN9 (245 kV) • 8DQ1 (550 kV) 			
2009	<p>GIS factory in Aurangabad Products manufactured:</p> <ul style="list-style-type: none"> • 8DN8 (145 kV) • 8DN9 (245 kV) • 8DQ1 (420 kV) 			
2010	<p>Production start of 420 kV single-break</p>			
2011	<p>Production start of 170 kV, 63 kA GIS</p>			
2012	<p>Production start of upgraded 420 kV GIS up to 80 kA</p>			
2013	<p>Production start of 245 kV, 80/90 kA GIS</p>			
2016	<p>Production start of 72,5 kV vacuum and clean-air GIS</p>			

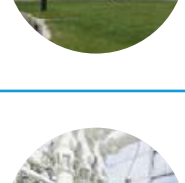

Fig. 83: 8DN8 GIS for a rated voltage of 110 kV

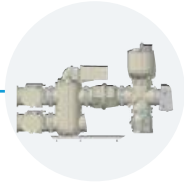
Characteristic features of gas-insulated switchgear

Since 1968, the concept of Siemens gas-insulated metal-enclosed high-voltage switchgear has proved itself in more than 34,500 feeders in all regions of the world (table 21). Gas-insulated metal-enclosed high-voltage switchgear (GIS) is constantly gaining ground on other types of switchgear because it offers the following outstanding advantages:

- **Minimum space requirements:**
Where the availability of land is low and/or prices are high, e.g., in urban centers, industrial conurbations, mountainous regions with narrow valleys, or in underground power plants, gas-insulated switchgear is replacing conventional switchgear due to its very small space requirements.
- **Full protection against contact with live parts:**
The surrounding metal enclosure ensures maximum safety for personnel under all operating and fault conditions.
- **Protection against pollution:**
Its metal enclosure fully protects the switchgear interior against environmental effects such as salt deposits in coastal regions, industrial vapors and precipitates, and sandstorms. The compact switchgear can be installed as an indoor or outdoor solution.
- **Free choice of installation site:**
The small site area required for gas-insulated switchgear saves expensive grading and foundation work, e.g., in permafrost zones. Another advantage is the rapid on-site installation and commissioning because of the short erection time and the use of prefabricated and factory-tested bay units.

- **Protection of the environment:**
The necessity to protect the environment often makes it difficult to install outdoor switchgear that has a conventional design. Gas-insulated switchgear, however, can almost always be designed to blend well with the surroundings. Thanks to its modular design, gas-insulated metal-enclosed switchgear is very flexible, and meets all the requirements for configuration relating to network design and operating conditions.

Each circuit-breaker bay includes the full range of disconnecting and earthing switches (regular or make-proof), instrument transformers, control and protection equipment, and interlocking and monitoring facilities commonly used for this type of installation.

Besides the traditional circuit-breaker bay, other circuits such as single busbar, single-busbar arrangement with bypass busbar, coupler and bay for double and triple busbar can be supplied.

Product range of GIS for substations

The Siemens product range covers GIS from 72.5 up to 550 kV rated voltage (table 22).

The development of this switchgear has been based on two overall production targets: to meet the high technical standards required of high-voltage switchgear, and to provide maximum customer benefit.

More than 50 years experience with gas-insulated switchgear	
1960	Start of fundamental studies in research and development of SF ₆ technology
1964	Delivery of first SF ₆ circuit-breaker
1968	Delivery of first GIS
1974	Delivery of first GIL (420 kV)
1997	Introduction of intelligent, bay-integrated control, monitoring and diagnostic
1999	Introduction of newest GIS generation: self-compression interrupter unit and spring-operated mechanism
2000	Introduction of the trendsetting switchgear concept HIS (Highly Integrated Switchgear) for extension, retrofit and new compact AIS substations
2005	First GIS with electrical endurance capability (class E2)
2007	Introduction of 72.5 kV GIS – a new dimension in compactness
2009	New generation of 145 kV 40 kA GIS
2010	New generation of 420 kV 63 kA GIS
2011	New 170 kV 63 kA GIS
2012	New 420 kV 80 kA GIS
2013	New 245 kV 80/90 kA GIS
2016	New 72,5 kV vacuum and clear-air GIS

Table 21: Siemens experience with gas-insulated switchgear







									
Switchgear type			8DM1	8DN8	8DN9	8DQ1			
Rated voltage	kV	up to	72.5	145 / 170	245	420	420	420	550
Rated frequency	Hz		50			50 / 60			
Rated short-duration power-frequency withstand voltage (1 min)	kV	up to	140	275 / 325	460	650	650	650	740
Rated lightning impulse withstand voltage (1.2 / 50 μs)	kV	up to	325	650 / 750	1,050	1,425	1,425	1,425	1,550
Rated switching impulse withstand voltage (250 / 2,500 μs)	A	up to	–	–	–	1,050	1,050	1,050	1,175
Rated normal current busbar	A	up to	–	3,150 / 4,000	4,000	6,300	6,300	6,300	5,000
Rated normal current feeder	kA	up to	1,250	3,150 / 4,000	4,000	5,000	5,000	5,000	5,000
Rated short-circuit breaking current	kA	up to	25	40 / 63	50	63 / 80* / 90*	80	80	63
Rated peak withstand current	kA	up to	62,5	108 / 170	135	170 / 216* / 243*	216	216	170
Rated short-time withstand current (up to 3 s)	kA	up to	–	40 / 63	50	63 / 80*	80	80	63
Rated short-time withstand current (up to 1 s)	kA	up to	25	–	–	90*	–	–	–
Leakage rate per year and gas compartment (type-tested)	%		< 0.1						
Driving mechanism of circuit-breaker			Stored-energy spring (common pole drive)	Stored-energy spring (common or single pole drive)	Stored-energy spring (single pole drive)				
Rated operating sequence			O-0.3 s-CO-3 min-CO CO-15 s-CO						
Insulation medium			Clean-air	SF ₆					
Interrupter technology			Vacuum	Self-compression principle					
Installation			Indoor / outdoor		Indoor	Indoor / outdoor			
Standards			IEC	IEC/IEEE/GOST					
Bay width	mm		1,200	800 / 1,000	1,500	2,200	3,600		
First major inspection	years		> 25						
Expected lifetime	years		> 50						

Table 22: Product range of GIS

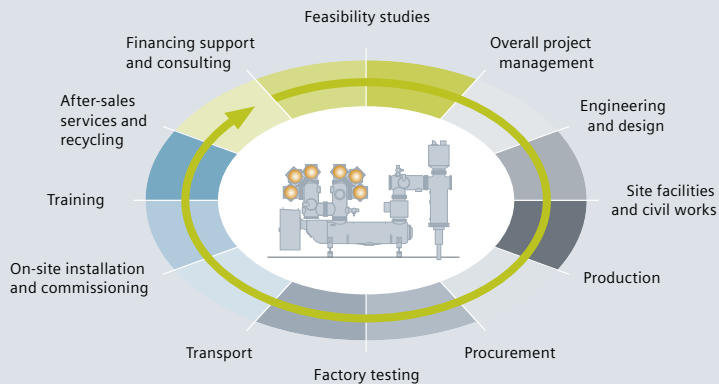

Fig. 84: GIS for the full value chain

This objective can only be achieved by incorporating all processes in the quality management system, which has been introduced and certified in accordance with EN 29001/DIN EN ISO 9001.

Siemens GIS switchgear meets all performance, quality and reliability demands including:

- **Compact and low-weight design:**
Small building dimensions and low floor loads, a wide range of options for the utilization of space, and less space taken up by the switchgear.
- **Safe encapsulation:**
An outstanding level of safety based on new manufacturing methods and optimized shape of enclosures.
- **Environmental compatibility:**
No restrictions regarding location choice due to minimum space requirements, extremely low noise and EMC emission, as well as effective gas-sealing system (leakage < 0.1 % per year per gas compartment). Modern spring mechanisms that are currently available for the whole GIS 8D product spectrum eliminate the need for hydraulic oil.
- **Economical transport:**
Simplified fast transport and reduced costs because of minimum shipping units.
- **Low operating costs:**
The switchgear is virtually maintenance-free, e.g.,

contacts of circuit-breakers and disconnectors are designed for extremely long endurance, motor operating mechanisms are lubricated for life, and the enclosure is corrosion-free. This means that the first inspection is only required after 25 years of operation.

- **High reliability:**
The longstanding experience of Siemens in design, production and commissioning – more than 420,000 bay operating years in over 34,500 feeders worldwide – is testament to the fact that the Siemens products are highly reliable. The mean time between failures (MTBF) is more than 1,000 bay years for major faults. A quality management system certified in accordance with ISO 9001, which is supported by highly qualified employees, ensures high quality throughout the whole process chain. Our services provide added value through constant project-related support and consulting right from the start – and throughout the entire life cycle of our switchgear right up to disposal and recycling of old switchgear (fig. 84).
- **Smooth and efficient installation and commissioning:**
Transport units are fully assembled, tested at the factory, and filled with SF₆ gas at reduced pressure. Coded plug connectors are used to cut installation time and minimize the risk of cabling failures.
- **Routine tests:**
All measurements are automatically documented and stored in the electronic information system, which provides quick access to measured data for years.



Fig. 85: 8DM1 switchgear bay up to 72,5 kV

Clean-air compact switchgear (fig. 85)

Based on more than 40 years of experience in producing medium-voltage vacuum interrupters and more than 3 million delivered units, Siemens introduced this proven technology to high-voltage power networks in 2010. All installed vacuum circuit-breakers up to 72.5 kV are under successful operation. (See chapter Live-Tank Circuit-Breakers for 72.5 kV up to 800 kV/Live-tank circuit-breakers with vacuum technology, page 13.)

Siemens vacuum circuit-breakers are designed in a well-proven modular platform concept. Operating mechanism, control system, base frame, kinematic chain, and insulator designs are based on decades of manufacturing and operating experience.

The vacuum high-voltage circuit-breaker offers the same benefits as the Siemens SF₆ circuit-breaker portfolio:

- Reliable making and breaking capabilities
- Excellent interrupting performance at rated nominal current and rated short-circuit current
- High-performance and maintenance-free operating mechanism
- Highest availability and long working life.

Clean-air as insulating medium

Vacuum interrupting technology enables the implementation of clean-air as insulating medium for 72.5 kV gas-insulated switchgear (GIS). The clean-air is compressed up to the operation pressure into the single switchgear gas compartment, consisting of vacuum circuit-breaker, disconnectors and earthing switches.

A compact and maintenance-free GIS solution is designed for offshore wind turbine installations based on proven component technology.

Vacuum interrupter and Siemens' clean-air technology realize the F-gas (fluorinated greenhouse gas)-free insulation, and support the demand for fully environmentally compatible switchgear. Our environmentally friendly portfolio will be further extended.

Main features

- Worldwide leading F-gas-free environmentally friendly and CO₂ neutral technology
- Innovative clean-air insulation medium
- Proven vacuum interrupter unit technology
- Compact GIS solution designed for offshore wind turbine installations
- Optimal installation, commissioning, operation and service concept
- Completely factory-assembled and tested switchgear
- Shipped in single transport unit, ready for cable connection
- Same GIS dimensions for all typical switchgear configurations
- One gas compartment for circuit-breaker, disconnectors and earthing switches
- Component design based on well-proven technology
- Cable terminals for T-connectors
- Maintenance-free operation
- Safe and easy handling and operation
- High operational safety.

➔ [siemens.com/energy/gas-insulated-switchgear/8dm1](https://www.siemens.com/energy/gas-insulated-switchgear/8dm1)

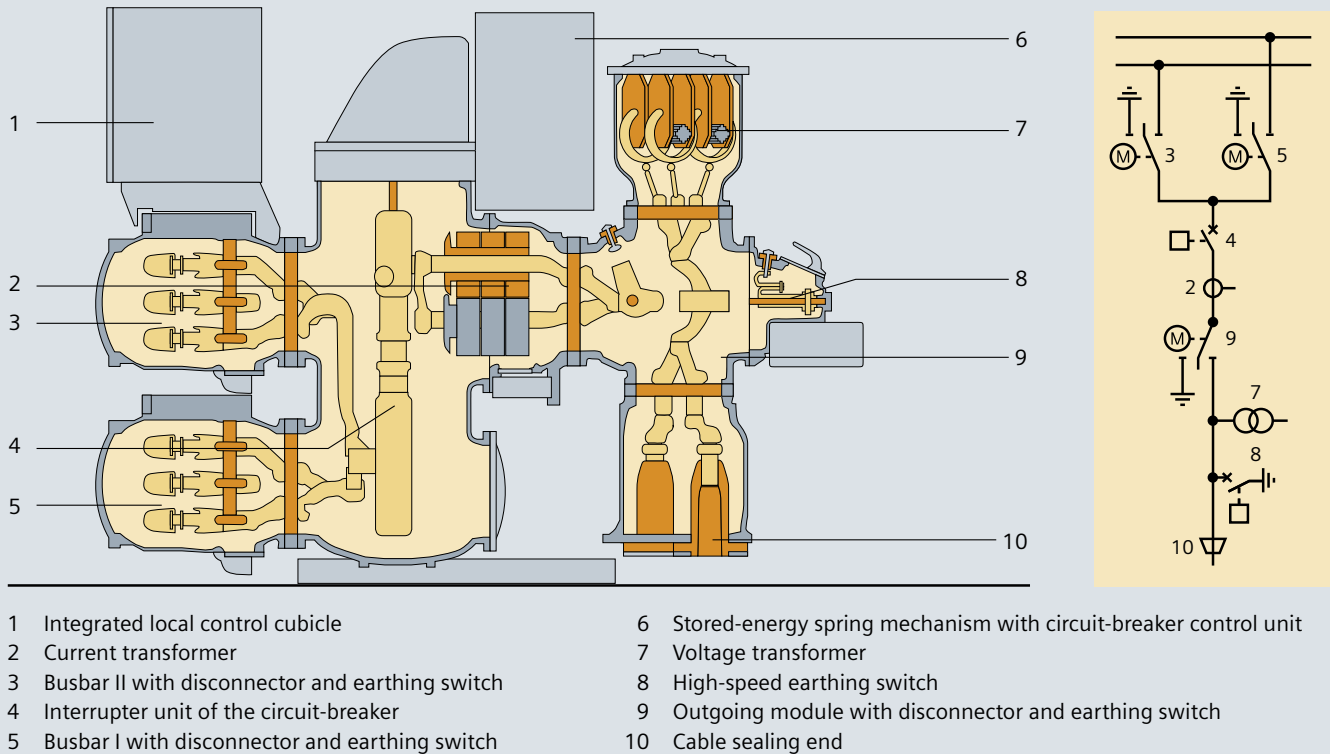

Fig. 86: 8DN8 switchgear bay up to 145 kV

3-phase enclosures are used for SF₆-insulated switchgear type 8DN8 up to 170 kV to achieve small and compact component dimensions. The low bay weight ensures low floor loading, and helps to reduce the cost of civil works and minimize the footprint. The compact low-weight design allows installation almost anywhere. Capital cost is reduced by using smaller buildings or existing ones, e.g., when replacing medium-voltage switchyards with the 145 kV GIS (fig. 87).

The bay is based on a circuit-breaker mounted on a supporting frame (fig. 86). A special multifunctional cross-coupling module combines the functions of the disconnecter and earthing switch in a 3-position switching device. It can be used as:

- An active busbar with an integrated disconnecter and work-in-progress earthing switch (fig. 86, pos. 3 and 5)
- An outgoing feeder module with an integrated disconnecter and work-in-progress earthing switch (fig. 86, pos. 9)
- A busbar sectionalizer with busbar earthing.

Cable termination modules can be equipped with either conventional sealing ends or the latest plug-in connectors

(fig. 86, pos. 10). Flexible 1-pole modules are used to connect overhead lines and transformers with a splitting module that links the 3-phase-enclosed switchgear to the 1-pole connections.

Thanks to their compact design, the completely assembled and factory-tested bays can be shipped as a single transport unit. Fast erection and commissioning on site ensure the highest possible quality.



Fig. 87: 8DN8 GIS for a rated voltage of 145 kV

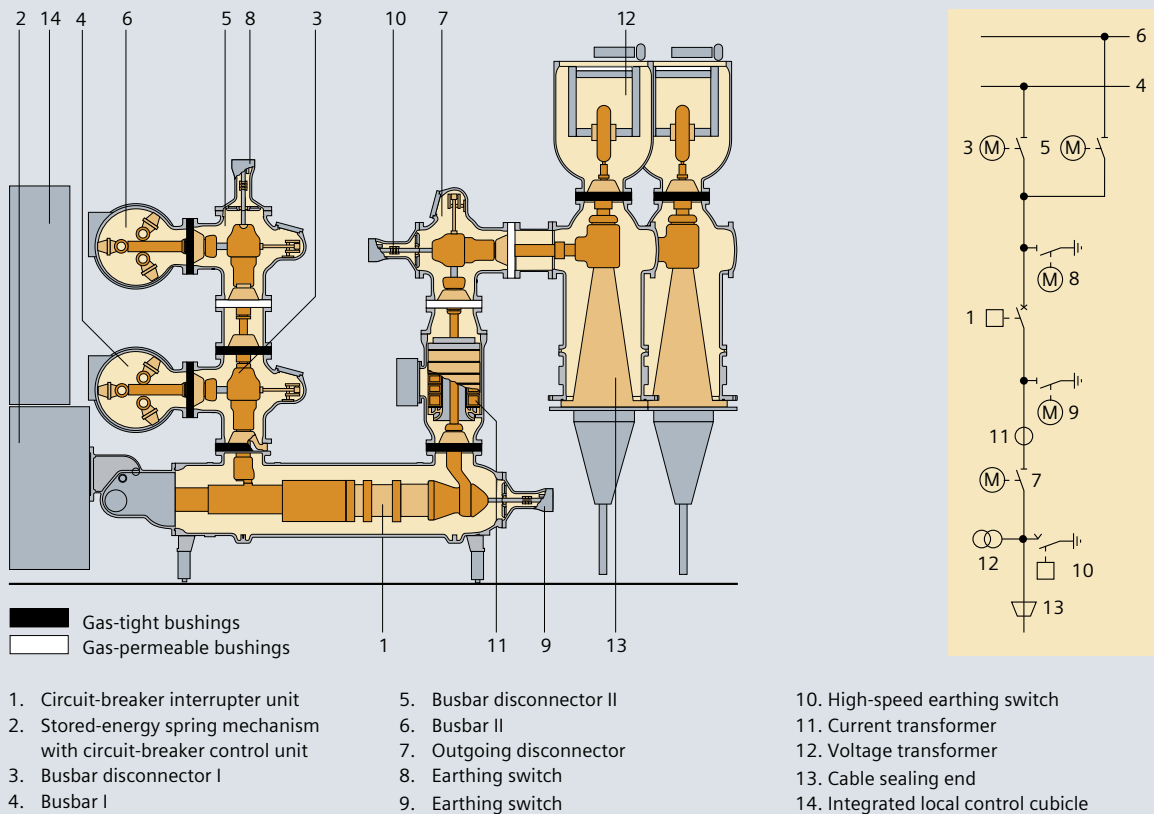

Fig. 88: 8DN9 switchgear bay up to 245 kV

The feeder control and protection can be installed in a bay-integrated local control cubicle mounted onto the front of each bay (fig. 86, pos. 1). Moreover, state-of-the-art monitoring devices are available at the system operator's request, e.g., for partial discharge online monitoring.

➔ [siemens.com/energy/gas-insulated-switchgear/8dn8](https://www.siemens.com/energy/gas-insulated-switchgear/8dn8)

The clear bay configuration of the lightweight and compact 8DN9 switchgear is evident at first glance. Control and monitoring facilities are easily accessible despite the switchgear's compact design.

The horizontally arranged circuit-breaker forms the basis of every bay configuration. The operating mechanism is easily accessible from the operator area. The other bay modules – of 1-phase-enclosed switchgear design, for example the circuit-breaker module – are located on top of the circuit-breaker. The 3-phase-enclosed passive busbar is partitioned off from the active equipment (fig. 88, fig. 89).

Thanks to "single-function" assemblies (assignment of just one task to each module) and the versatile modular structure, even unconventional arrangements can be set up from a pool of only 20 different modules. The modules are

connected to each other with a standard interface that allows implementation of an extensive range of bay structures. Switchgear design with standardized modules and the scope of services ensure that all types of bay structures can be set up in a small area. The compact design enables the supply of complete bays that are fully assembled and tested at the factory, providing smooth and efficient installation and commissioning.



Fig. 89: 8DN9 switchgear for a rated voltage of 245 kV, with a 3-phase-enclosed passive busbar

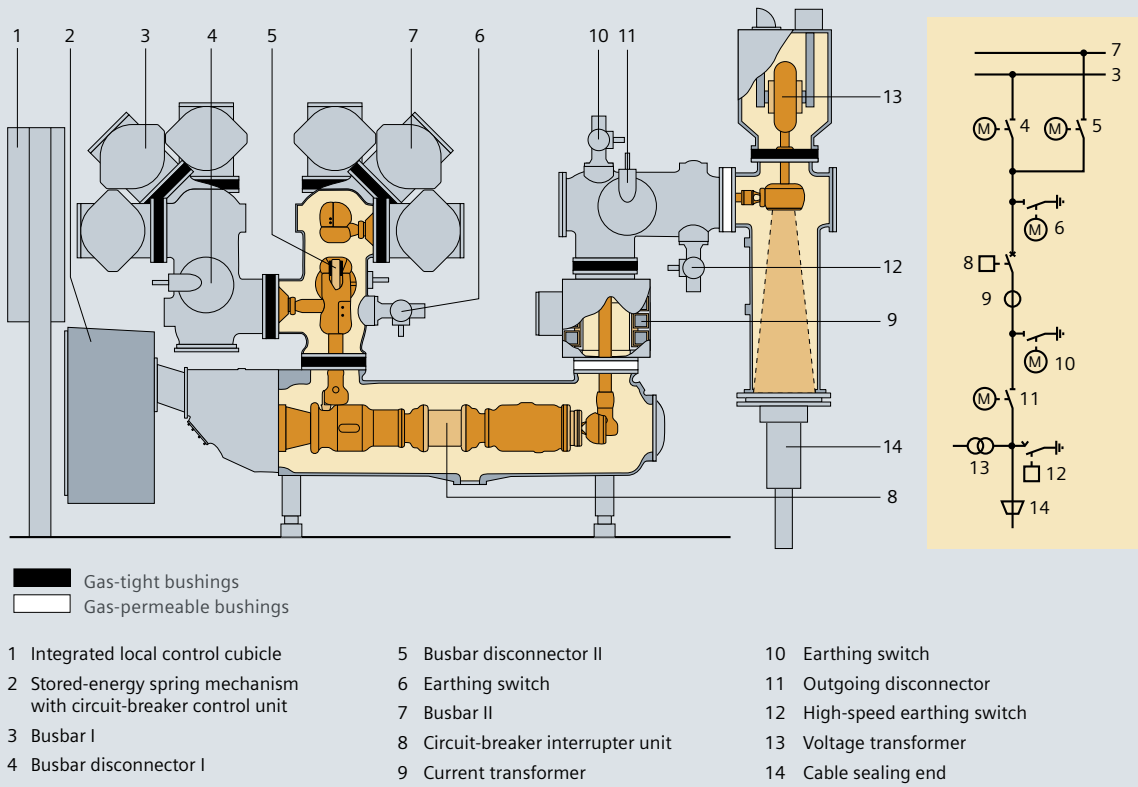

Fig. 90: 8DQ1 switchgear bay up to 420 kV

SF₆-insulated switchgear for up to 550 kV, type 8DQ1, is a 1-phase-enclosed switchgear system for high-power switching stations with individual enclosure of all modules.

The base unit for the switchgear is a horizontally arranged circuit-breaker on top of which the housing containing the disconnectors, earthing switches, current transformers, among others, are mounted. The busbar modules are partitioned off from the active equipment (fig. 90, fig. 91, fig. 92).

Other features of switchgear include:

- Circuit-breakers with single interrupter unit up to operating voltages of 420 kV (fig. 81, fig. 83), with two interrupter units up to operating voltages of 550 kV (fig. 91)
- Short-circuit breaking currents up to 63 kA within 2 cycles for 50 Hz/60 Hz and 80 kA up to 420 kV
- Horizontal arrangement of the circuit-breakers in the lower section provides low center of gravity for the switchgear
- Utilization of the circuit-breaker transport frame as a supporting device for the entire bay

- Reduced length of sealing surfaces, thus decreasing the risk of leakage through use of only a few modules and equipment combinations in one enclosure.



Fig. 91: 8DQ1 switchgear for a rated voltage of 550 kV



Fig. 92: 8DQ1 switchgear for a rated voltage of 420 kV

Specification guide for metal-enclosed SF₆-insulated switchgear

Note: The points below are not considered exhaustive but are a selection of the important specifications. They cover the technical data applicable to metal-enclosed SF₆-insulated switchgear for switching and distributing power in cable and/or overhead-line systems and transformers. Key technical data are contained in the data sheet and in the single-line diagram (SLD) attached to the inquiry.

A general SLD and a sketch showing the general arrangement of the substation will be part of a proposal. Any switchgear quoted will be complete and will form a functional, safe and reliable system after installation, even if certain required parts have not been specifically included in the inquiry.

- Applicable standards
 - All equipment is designed, built, tested and installed in accordance with the latest guidelines of the applicable IEC standards:
 - IEC 62271-1 “High-voltage switchgear and controlgear: Common specifications”
 - IEC 62271-203 “High-voltage switchgear and controlgear: Gas-insulated metal-enclosed switchgear for rated voltages above 52 kV”
 - IEC 62271-100 “High-voltage switchgear and controlgear: Alternating-current circuit-breakers”
 - IEC 62271-102 “High-voltage switchgear and controlgear: Alternating current disconnectors and earthing switches”
 - IEC 60044 “Instrument transformers: Current transformers”
 - National standards available on request.

Local conditions

The equipment is tested for indoor and outdoor applications. All the buyer has to provide is a flat concrete floor with the cutouts for cable installation – if required. The switchgear comes equipped with adjustable supports (feet). If steel support structures are required for the switchgear, Siemens can also provide these. For design purposes, the indoor temperatures should be between -5 °C and +40 °C, and outdoor temperatures should be between -30 °C and +40 °C (+50 °C). For parts to be installed outdoors (overhead-line connections), the conditions described in IEC 62271-203 must be observed. For the enclosures, aluminum or aluminum alloys are preferred.

A minimum of one-site installation will ensure maximum reliability. Up to six single or three double switchgear bays, fully assembled and tested, come as a single transport unit. Subassembly size is only restricted by transport requirements. Siemens can provide the enclosure in a material and thickness suited to withstand an internal arc and prevent burn-throughs or punctures within the first stage of protection, relating to the rated short-circuit current of the given GIS type.

All assemblies are designed to allow absorption of thermal expansion and contraction caused by varying temperatures. Adjustable metal bellow compensators are installed for this purpose. Density monitors with electrical contacts for at least two pressure levels are installed to allow gas monitoring in the enclosures. The circuit-breakers can be monitored with density gauges that are fitted in the circuit-breaker control units.

Siemens ensures that the pressure loss for each individual gas compartment – i.e., not just for the complete switchgear – will not exceed 0.1 % per year. Each gas-filled compartment comes equipped with static filters that are capable of absorbing any water vapor that penetrates into the switchgear for a period of at least 25 years. There are long intervals between required inspections, which keeps maintenance costs to a minimum. The first minor inspection is due after ten years. The first major inspection is usually required after more than 25 years of operation unless the permissible number of operations is reached before that date.

Arrangement and modules

Arrangement

The system consists of the enclosed 1-phase or 3-phase type. The assembly is made up of completely separate pressurized sections, and is thus designed to minimize any danger to the operating staff and reduce risk of damage to adjacent sections, even if problems with the equipment arise. Rupture diaphragms are provided to prevent the enclosures from bursting in an uncontrolled manner. Suitable deflectors provide protection for the operating personnel. For maximum operating reliability, internal relief devices are not installed because these would affect adjacent compartments. The modular design, complete segregation, arc-proof bushing, and plug-in connections allow speedy removal and replacement of any section with only minimal effects on the remaining pressurized switchgear.

Busbar module

The busbar modules of adjacent bays are connected with expansion joints, which absorb constructional tolerances and temperature-related movements in a longitudinal and transverse direction to the busbar. Axially guided sliding contacts between the conductors compensate temperature-related expansions in conductor length (fig. 93).

Circuit-breakers

(see chapter *Circuit-Breakers from 72.5 kV up to 800 kV*)

The circuit-breakers operate according to the dynamic self-compression principle. The number of interrupting units per phase depends on the circuit-breaker's performance. The arcing chambers and circuit-breaker contacts are freely accessible. The circuit-breaker is suitable for out-of-phase switching and is designed to minimize over-voltages. The specified arc interruption performance has to be consistent across the entire operating range, from line-charging currents to full short-circuit currents.

The circuit-breaker is designed to withstand at least 10 operations (depending on the voltage level) at full short-circuit rating. Opening the circuit-breaker for service or maintenance is not necessary. The maximum tolerance for phase displacement is 3 ms, which is the time between the first and the last pole's opening or closing. A standard station battery required for control and tripping may also be used for recharging the operating mechanism. The drive and the energy storage system are provided by a stored-energy spring mechanism that holds sufficient energy for all standard IEC close-open duty cycles. The control system provides alarm signals and internal interlocks, but inhibits tripping or closing of the circuit-breaker when the energy capacity in the energy storage system is insufficient or the SF₆ density within the circuit-breaker drops below the minimum permissible level.

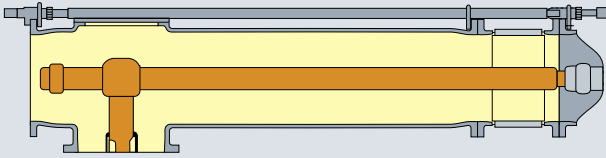

Fig. 93: All busbars of the enclosed 3-phase or the 1-phase (fig.) type are connected with plugs from one bay to the next

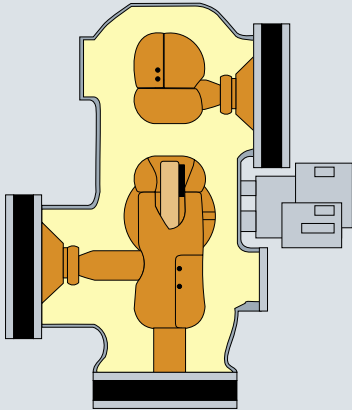

Fig. 94: Disconnectors: In the open position, disconnectors assure a dielectrically safe gap between system parts at different potentials; for example, the busbar disconnector isolates the feeders from the busbar. Cast-resin bushings keep the contact system in place, and the pressurized gas serves as the high-voltage insulating medium between live parts and the metal housing. The conductor terminals vary for different types of adjacent modules. Up to two earthing switches can be installed simultaneously

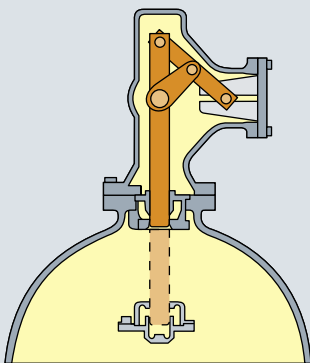

Fig. 95: Earthing switches: Earthing switches (work-in-progress earthing switches or busbar earthing switches, for example) are used for properly connecting de-energized live parts of the high-voltage system to the earthing system. On the outgoing side of the feeders, a make-proof version (high-speed) is frequently used to dissipate inductive and capacitive currents from parallel cables or overhead lines, or to reduce the risk to the GIS system in case of faulty connections. In the insulated design, they are also used for measuring purposes and for testing protection relays

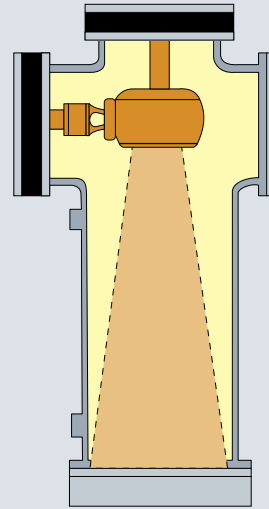

Fig. 96: Example for 1-phase cable termination: Cable termination modules conforming to IEC are available for connecting the switchgear to high-voltage cables. The standardized construction of these modules allows connection of various cross-sections and insulation types. Parallel cable connections for higher rated currents are also possible with the same module

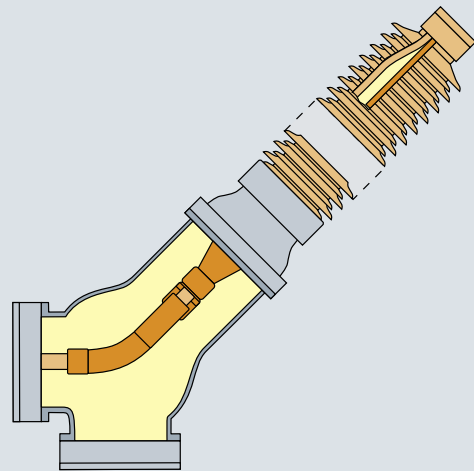

Fig. 97: Overhead-line terminations: High-voltage bushings are used for the SF₆-to-air transition. The bushings can be matched to specific requirements with regard to clearance and creepage distances. They are connected to the switchgear by means of angular-type modules of variable design

Disconnectors

All disconnectors (isolators) are of the single-break type. DC motor operation (110, 125, 220, or 250 V), which is fully suited to remote operation, and a manual emergency operating mechanism are provided. Each motor operating mechanism is self-contained and equipped with auxiliary switches in addition to the mechanical indicators. The bearings are lubricated for life (fig. 94).

Earthing switches

Work-in-progress earthing switches are generally provided on either side of the circuit-breaker. Additional earthing switches may be used to earth busbar sections or other groups of the assembly. DC motor operation (110, 125, 220, or 250 V) that is fully suited for remote operation, and a manual emergency operating mechanism are provided. Each motor operating mechanism is self-contained and equipped with auxiliary position switches in addition to the mechanical indicators. The bearings are lubricated for life. Make-proof high-speed earthing switches are generally installed at the cable and overhead-line terminals. They are equipped with a rapid closing mechanism to provide short-circuit making capacity (fig. 95).

Instrument transformers

Current transformers (CTs) encompass the dry-type design. Epoxy resin is not used for insulation purposes. The cores have the accuracies and burdens that are shown on the SLD. Voltage transformers are of the inductive type, with ratings of up to 200 VA.

Cable terminations

1-phase or 3-phase, SF₆-gas-insulated metal-enclosed cable end housings are provided. The cable manufacturer has to supply the stress cone and suitable sealings to prevent oil or gas from leaking into the SF₆ switchgear. Siemens will supply a mating connection piece to be fitted to the cable end. The cable end housing is suitable for oil-type, gas-pressure-type cables with plastic insulation (PE, PVC, etc.) as specified on the SLD or the data sheets. Additionally, devices for safely isolating a feeder cable and connecting a high-voltage test cable to the switchgear or cable can be provided (fig. 96).

Overhead-line terminations

The terminations for connecting overhead lines come complete with SF₆-to-air bushings, but without line clamps (fig. 97).

Transformer/reactor termination module

These terminations form the direct connection between the GIS and oil-insulated transformers or reactance coils. Standardized modules provide an economical way of matching them to various transformer dimensions (fig. 98).

Control and monitoring

An electromechanical or solid-state interlocking control



Fig. 98: Transformer termination

board is normally supplied for each switchgear bay. This fault-tolerant interlocking system prevents all operating malfunctions. Mimic diagrams and position indicators provide the operating personnel with clear operating instructions. Provisions for remote control are included. Gas compartments are constantly monitored by density monitors that provide alarm and blocking signals via contacts.

Required tests

Partial discharge tests

All solid insulators fitted in the switchgear are subjected to a routine partial discharge test prior to installation. At 1.2 times the line-to-line voltage, no measurable discharge is allowed. This test ensures maximum safety in terms of insulator failure, a good long-term performance, and thus a very high degree of reliability.

Pressure tests

Each cast-aluminum enclosure of the switchgear is pressure-tested for at least twice the service pressure.

Leakage tests

Leakage tests performed on the subassemblies ensure that the flanges and cover faces are clean and that the guaranteed leakage rate is not exceeded.

Power frequency tests

Each assembly is subjected to power-frequency withstand tests, including sensitive partial discharge detection, to verify correct installation of the conductors, and to make

sure that the insulator surfaces are clean and the switchgear as a whole is not subject to internal faults.

Additional technical data

Siemens will point out any dimensions, weights, or other switchgear data that may affect local conditions and handling of the equipment. Each quotation includes drawings showing the switchgear assembly.

Instructions

Detailed instruction manuals on the installation, operation and maintenance of the equipment are supplied, and all equipment is delivered by Siemens.

Scope of supply

Siemens supplies the following items for all GIS types and interfaces as specified:

- The switchgear bay, including circuit-breakers, disconnectors and earthing switches, instrument transformers, and busbar housings, as specified. For the different feeder types, the following limits apply:
 - Cable feeder:
According to IEC 60859, the termination housing, conductor coupling, and connecting plate are part of the GIS delivery, while the cable stress cone with the matching flange is part of the cable supply (fig. 96).
 - Overhead-line feeder:
The connecting stud at the SF₆-to-air bushing is supplied without the line clamp (fig. 97).
 - Transformer feeder:
Siemens supplies the connecting flange at the switchgear bay and the connecting bus ducts to the transformer, including any expansion joints. The SF₆-to-oil bushings plus terminal enclosures are part of the transformer delivery unless otherwise agreed (fig. 98).
Note: This point always requires close coordination between the switchgear manufacturer and the transformer supplier.
- Each feeder bay is equipped with earthing pads. The local earthing network and the connections to the switchgear are included in the installation contractor's scope.
- Initial SF₆-gas filling for the entire switchgear supplied by Siemens is included. Siemens will also supply all gas interconnections from the switchgear bay to the integral gas service and monitoring panel.
- Terminals and circuit protection for auxiliary drives and control power are provided with the equipment. Feeder circuits and cables, as well as the pertaining installation material will be supplied by the installation contractor.
- The local control, monitoring and interlocking panels are supplied for each circuit-breaker bay to form fully operational systems. Terminals for remote monitoring and control are also provided.
- Siemens will supply the above-ground mechanical support structures; embedded steel and foundation work is part of the installation contractor's scope.

Gas-insulated switchgear

➔ [siemens.com/energy/gas-insulated-switchgear](https://www.siemens.com/energy/gas-insulated-switchgear)

Silicone Long Rod Insulators

3FL silicone long rod insulators - performance meets durability

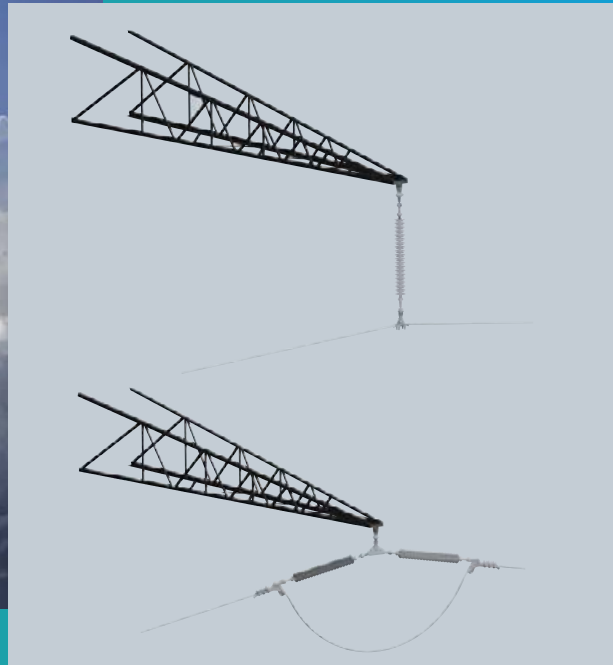

Fig. 99: 3FL long rod insulators can be used either as suspension or tension insulators

Good reasons to use 3FL

The new Siemens silicone long rod insulators, type 3FL, combine the highest levels of electrical insulation and mechanical tensile strength with a compact, lightweight design. Thanks to their superior design and minimized weight, 3FL long rod insulators are especially suited for overhead compact-line applications where low tower design and short line spans are required. They are also more economical to transport and install.

Design

The 3FL insulator housing is a one-piece HTV¹ silicone rubber housing made by the one-shot injection molding process. The HTV silicone is directly molded onto the core rod by overlapping the triple junction point and part of the metal end fittings. The design ensures a total enclosure of the most sensitive part of a silicone insulator – the junction zone (metal end fitting/FRP rod/sili-

cone housing), where the highest electrical field strength is usually concentrated. This overlapping system eliminates any need for traditional sealing systems while preventing any moisture ingress attacks.

Core

The core rod is a boron-free, corrosion-resistant ECR² glass-fiber-reinforced plastic (FRP rod). Due to the extremely high hydrolysis and acid resistance of the FRP rod, the risk of so-called brittle fracture is completely eliminated for 3FL insulators.

End fittings

The end fittings, made of hot-dip galvanized forged steel or ductile cast iron, are directly attached to the FRP core rod by a circumferential crimping process. Each crimping process is strongly monitored with a special control system. A complete range of end fittings in

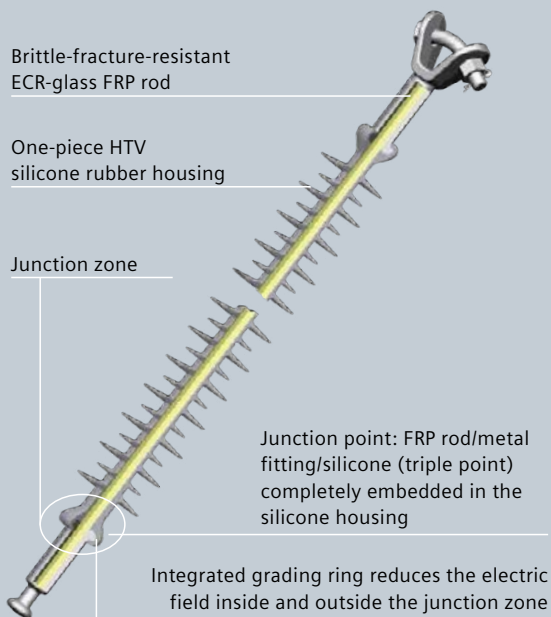

Fig. 100: 3FL – a superior design to meet the highest requirements



Fig. 101: HTV silicone rubber for best pollution performances

accordance with the latest IEC and ANSI standards is available up to 210 kN of SML. The 3FL is 100% exchangeable and compatible with existing insulators and line hardware of all types.

The special design of the end fitting in the junction minimizes the electrical field strength and partial discharge inside the junction zone as well as on the silicone housing surface, by utilizing an integrated grading ring. This reliably prevents corrosion of the insulating material and eliminates the risk of subsequent failure of the insulator.

3FL – HTV silicone rubber housing for best pollution performances

The excellent pollution layer characteristics of the HTV silicone rubber ensure maximum reliability of the 3FL insulator, even under extreme operational conditions. The high hydrophobic housing prevents the formation of conductive film on its surface. Even the most severe ambient conditions, such as salt fog in coastal regions or dust-laden

air in industrial areas, cannot impair the intrinsic hydrophobicity of the HTV silicone rubber. Surface currents and discharges are ruled out. Neither water nor dirt on the housing surface can cause insulator flashovers – a significant factor for insulator performance.

Quality from Siemens

Thanks to a long-established Siemens tradition and experience in high-voltage equipment, spanning more than a century, each production step for the 3FL – beginning with numerous incoming raw material inspections through to the assembly of the individual components and routine tests of the finished product – is rigorously monitored and strictly controlled.

¹ HTV: High-temperature vulcanizing

² ECR glass: Electrical- and corrosion-resistant glass

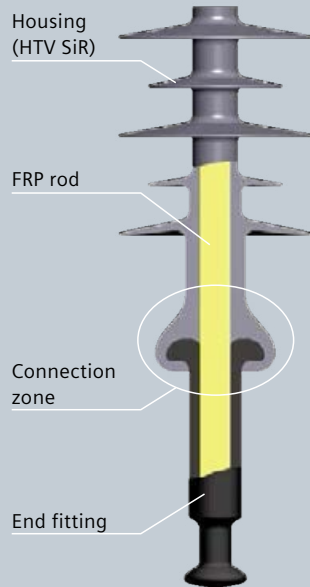

Fig. 102: 3FL cross section

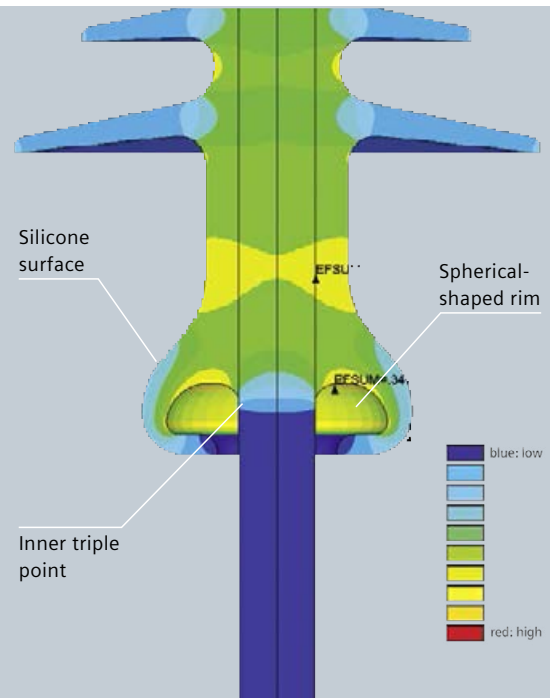

Fig. 103: E-field distribution (%/mm) in silicone housing and in FRP core rod at 3FL insulator high-voltage end

Maximized Service Life

No moisture ingress

The one-piece housing of the 3FL insulators, i.e., weathersheds and core rod sheath (coating) is one-piece and has only one internal interface throughout the whole insulator, namely the boundary interface between the housing and the FRP core rod. This design eliminates all internal interfaces between weathersheds and the core rod coating. These kinds of longitudinal interfaces are normally very sensitive to tangential electrical field stress, which in worst-case scenarios can easily lead to erosion damage of the polymer interfaces. In particular, they can lead to erosion of the bonding between sheds and rod sheath, and thus damage the insulator housing.

Furthermore, the junction point in the connection zone, where all three elements (FRP rod, metal end fitting, and silicone housing) meet, is absolutely water- and air-tight sealed during manufacturing by the use of an overmolding housing system. It completely encloses this junction point

with the HTV silicone rubber of the housing itself. The highest bonding strength of the one-piece HTV silicone housing to the FRP core rod, combined with the overmolding design system, prevent moisture ingress at the connection zone of the insulator.

Minimized electrical field strength

Following numerous electrical calculations regarding E-field distribution along the insulator and the connection zone on the high-voltage side in particular, the design of the 3FL insulator was optimized for maximum reduction of electrical field stress, reduced corona effect, and minimized RIV value. Two design factors ensure improved life expectancy by reducing electrical field stress in the triple point and on the silicone surface:

- The spherical-shaped rim of the end fitting inside the housing homogenizes the E-field distribution on the high-voltage side of the 3FL insulator with an integrated grading ring up to 170 kV.

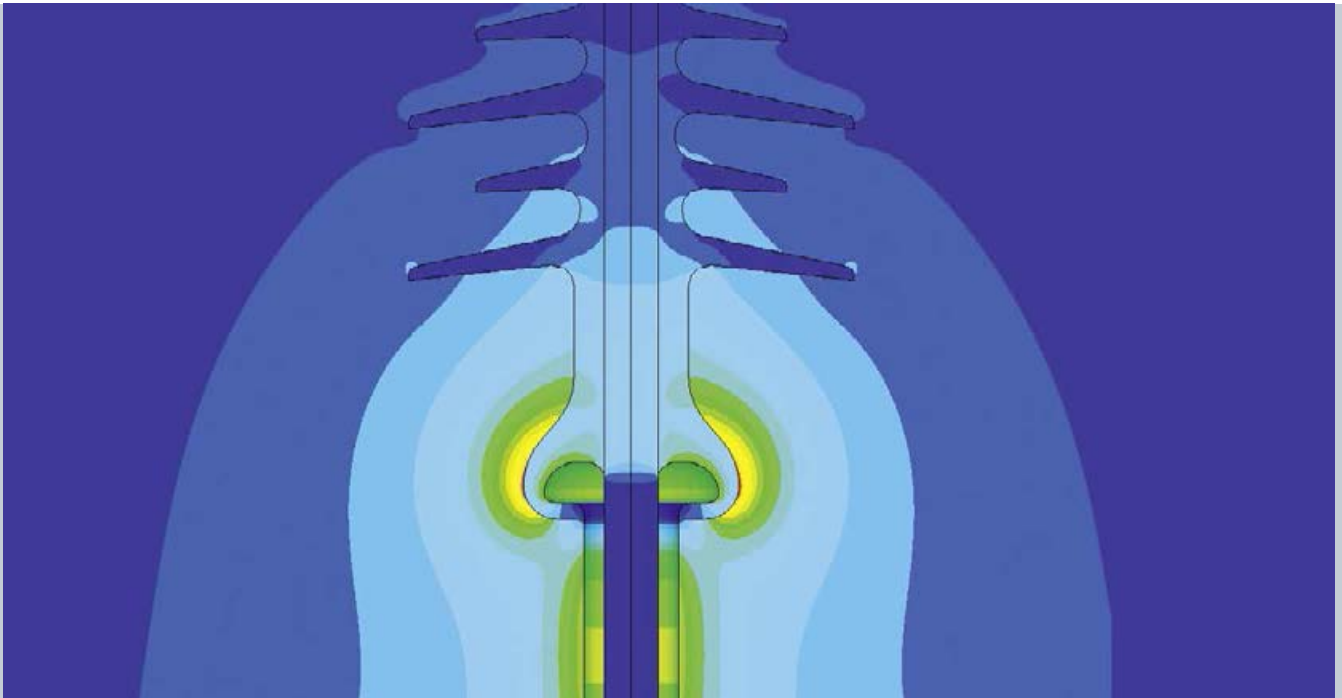

Fig. 104: E-field distribution (%/mm) at 3FL insulator high-voltage end

- The overmolded design system and the silicone housing shape at the connection zone reduce the electrical field strength inside the housing, particularly at the inner triple point as well as on the silicone surface directly. This is achieved by displacing the higher electrical field strength outside the housing (i.e., to the surrounding air area), and by taking advantage of the higher silicone relative permittivity.

3FL insulators can therefore be applied on 170 kV systems without the need for additional grading/corona rings.

Standards and tests

All 3FL long rod insulators are designed and tested in compliance with the latest IEC standards.

Each Siemens 3FL insulator that leaves the factory is routinely tested with a corresponding mechanical tensile test load of at least 50 percent of the defined SML load for at least ten seconds.

Product standards	
IEC 61109	Insulators for overhead lines – composite suspension and tension insulators for a.c. systems with a nominal voltage greater than 1,000 V
IEC 62217	Polymeric insulators for indoor and outdoor use with a nominal voltage >1,000 V
IEC 60815	Selection and dimensioning of high-voltage insulators intended for use in polluted conditions
IEC 61466-1, -2	Composite string insulator units for overhead lines with a nominal voltage greater than 1,000 V

Long rod insulators

➔ [siemens.com/energy/insulators](https://www.siemens.com/energy/insulators)

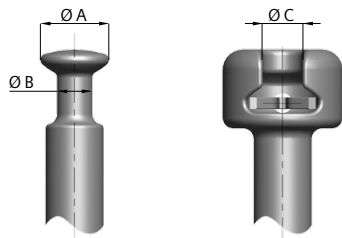

Socket and ball acc. to IEC 60120				
Designation	SML	Dimensions in mm		
		A	B	C
16	70 kN/ 100 kN/ 120 kN	33	17	19
20	160 kN/ 210 kN	41	21	23

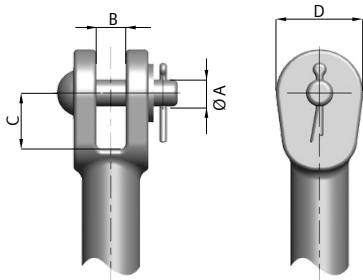

Clevis acc. to IEC 60471 and IEC 61466-1					
Designation	SML	Dimensions in mm			
		A	B	C	D
13L	70 kN	13	14	17	42
16L	100/120 kN	16	18	32	46
16N	100/120 kN	16	18	32	46
19L	160 kN	19	20	37	56
19N	160 kN	19	22.5	26	56
22L	210 kN	22	20	43	60
22N	210 kN	22	26	30	60

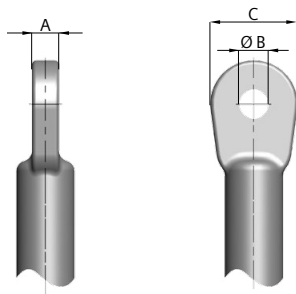

Tongue acc. to IEC 60471 and IEC 61466-1				
Designation	SML	Dimensions in mm		
		A	B	C
13L	70 kN	13	14	42
16L	100 kN/ 120 kN	16	17.5	46
16N	100 kN/ 120 kN	12.7	17.5	46
19L	160 kN	19	20	56
19N	160 kN	19	20.6	46
22L	210 kN	19	24	60
22N	210 kN	22	23.8	52

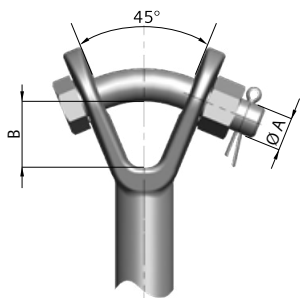

Y-clevis acc. to IEC 61466-1			
Designation	SML	Dimensions in mm	
		A	B
16	70 kN	16	32
19	100/120 kN	19	34
22	160/210 kN	22	41

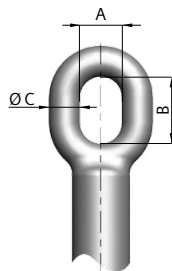

Eye acc. to IEC 61466-1				
Designation	SML	Dimensions in mm		
		A	B	C
17	70 kN	20	32	15
24	100 kN/ 120 kN	24	48	19
25	160 kN/ 210 kN	25	50	22
30	160 kN/ 210 kN	30	60	25

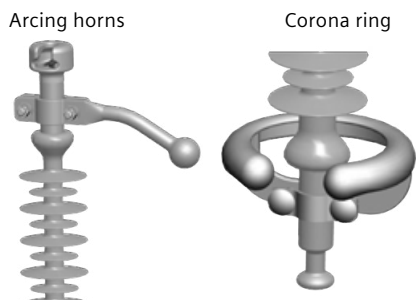

Recommended corona rings (diameter in mm) by line voltage

Line voltage (kV)	Ground end (top end fitting)	Line end (conductor end fitting)
≤ 170 kV	None	None
245 kV	None	Ø 210
300 kV	None	Ø 330
362 kV	None	Ø 330
420 kV	Ø 210	Ø 330
550 kV	Ø 210	Ø 420

Accessories

Arc protection devices such as arcing horns and corona rings for reduction of electrical field stress and corona effect are carefully designed based on numerous electrical simulations regarding electrical field distribution. For system voltages above 170 kV, corona rings are included in the 3FL insulator application as a standard feature. Customer-specific solutions and other connection and cable clamps are also available on request.

Maximum values		units	3FL2	3FL3	3FL4	3FL5	3FL6
Highest voltage for equipment, U_m	from	kV	12	72.5	72.5	72.5	72.5
	to	kV	72.5	550	550	550	550
Nominal system voltage, U_n	from	kV	10	60	60	60	60
	to	kV	69	500	500	500	500
Specified mechanical load, SML class	–	kN	70	100	120	160	210
Maximum section length, length increments 52 mm (with socket and ball)	from	mm	332	821	821	871	871
	to	mm	782	6,125	6,125	6,125	6,125

Long Rod Insulators Type 3FL2, SML 70 kN

3FL2 long rod insulators are designed to meet the highest requirements in distribution power systems up to 72 kV. They have high lightning impulse, power-frequency withstand voltages, and a long creepage class (> 31 mm/kV). 3FL2 insulators are available with mechanical ratings up to SML = 70 kN.

End fittings with SML = 70 kN

Designation as per standard	Standard	Connection length
Name/size		V, mm
Ball 16	IEC 60120	75
Socket 16A	IEC 60120	79
Clevis 13L	IEC 60471	87
Tongue 13L	IEC 60741	87
Y-clevis 16	IEC 61466-1	94
Eye 17	IEC 61466-1	93

Technical data 3FL2

Highest voltage for equipment	Typical nominal system voltages	Lightning impulse withstand voltage (1.2/50 μ s, dry)	Power-frequency withstand voltage (50 Hz, 1 min., wet)	Arcing distance	Creepage distance	Housing length	Section length* (with socket and ball)	Catalog number	Weight (with socket and ball)
U_m , kV	U_n , kV	LIWL _{min} , kV	PFWL _{min} , kV	S, mm	C, mm	H, mm	L, mm		W, kg
12.0	10, 11, 12	158	73	214	426	178	331	3FL2 018-4SB11-1XX1	1.6
24.0	15, 20, 22, 24	216	89	300	805	268	421	3FL2 027-4SB11-1XX1	2.0
36.0	30, 33, 35, 36	243	111	390	1,184	358	511	3FL2 036-4SB11-1XX1	2.4
72.5	60, 66, 69, 72	400	200	660	2,321	628	781	3FL2 063-4SB11-1XX1	3.6

*Reference value of the section length of an insulator for version with socket and ball end fittings of size 16 in accordance with IEC 60120. To obtain the section length of an insulator equipped with other end fittings, the housing length and connection lengths (see table "End fittings") of both end fittings must be added together.

Long Rod Insulators 3FL3 and 3FL4

3FL silicone long rod insulators for suspension and tension applications are available in lengths suitable for 60 kV through 550 kV. Length increments are 52 mm. A few selected insulator lengths are listed in the following table. Intermediate, shorter, or longer lengths are available on request.

		3FL3	3FL4
Specified mechanical load	SML:	100 kN	120 kN
Routine test load	RTL:	50 kN	60 kN

Technical data 3FL3 and 3FL4											
Highest voltage for equipment based on 25 mm/kV	Lightning impulse withstand voltage (1.2/50 μ s, dry)	Switching impulse withstand voltage (250/2,500 μ s, positive, wet)	Power-frequency withstand voltage (50 Hz, 1 min, wet)	Arcing distance	Standard creepage distance catalog code: 3	Extra-high creepage distance catalog code: 4	Nominal housing length	Section length* with socket and ball	Catalog code	Grading ring diameter top/ bottom (earth / HV side)	Approx. net weight for standard creepage distance
U_m kV	LIWV kV	SIWV min kV	PFVV kV	S mm	C mm	C mm	H mm	L mm	3FL_1_2_3_4_521-1_6_71	D mm	W kg
<72.5	449	–	160	644	1,706	2,291	614	821	3FLx - 061-3SB11-1XX1	x / x	3.2
72.5	476	–	180	696	1,868	2,516	666	873	3FLx - 067-3SB11-1XX1	x / x	3.3
72.5	503	–	200	748	2,031	2,740	718	925	3FLx - 072-3SB11-1XX1	x / x	3.4
72.5	530	–	220	800	2,194	2,964	770	977	3FLx - 077-3SB11-1XX1	x / x	3.5
72.5	556	–	240	852	2,356	3,189	822	1,029	3FLx - 082-3SB11-1XX1	x / x	3.6
72.5	583	–	260	904	2,519	3,413	874	1,081	3FLx - 087-3SB11-1XX1	x / x	3.7
72.5	610	–	280	956	2,681	3,637	926	1,133	3FLx - 093-3SB11-1XX1	x / x	3.8
72.5	637	–	300	1,008	2,844	3,862	978	1,185	3FLx - 098-3SB11-1XX1	x / x	3.9
72.5	664	–	320	1,060	3,007	4,086	1,030	1,237	3FLx - 103-3SB11-1XX1	x / x	4.0
123	690	–	340	1,112	3,169	4,310	1,082	1,289	3FLx - 108-3SB11-1XX1	x / x	4.1
123	717	–	360	1,164	3,332	4,535	1,134	1,341	3FLx - 113-3SB11-1XX1	x / x	4.2
123	744	–	380	1,216	3,494	4,759	1,186	1,393	3FLx - 119-3SB11-1XX1	x / x	4.3
145	771	–	400	1,268	3,657	4,983	1,238	1,445	3FLx - 124-3SB11-1XX1	x / x	4.4
145	797	–	420	1,320	3,820	5,208	1,290	1,497	3FLx - 129-3SB11-1XX1	x / x	4.5
145	824	–	440	1,372	3,982	5,432	1,342	1,549	3FLx - 134-3SB11-1XX1	x / x	4.6
145	851	–	460	1,424	4,145	5,656	1,394	1,601	3FLx - 139-3SB11-1XX1	x / x	4.7
170	882	–	469	1,476	4,307	5,881	1,446	1,653	3FLx - 145-3SB11-1XX1	x / x	4.8
170	913	–	478	1,528	4,470	6,105	1,498	1,705	3FLx - 150-3SB11-1XX1	x / x	4.9
170	943	–	488	1,580	4,633	6,329	1,550	1,757	3FLx - 155-3SB11-1XX1	x / x	5.0
170	974	–	497	1,632	4,795	6,554	1,602	1,809	3FLx - 160-3SB11-1XX1	x / x	5.1
170	1,005	–	506	1,684	4,958	6,778	1,654	1,861	3FLx - 165-3SB11-1XX1	x / x	5.2
170	1,036	–	515	1,736	5,120	7,002	1,706	1,913	3FLx - 171-3SB11-1XX1	x / x	5.3
170	1,066	–	525	1,788	5,283	7,227	1,758	1,965	3FLx - 176-3SB11-1XX1	x / x	5.4
170	1,097	–	534	1,840	5,446	7,451	1,810	2,017	3FLx - 181-3SB11-1XX1	x / x	5.5
170	1,128	–	543	1,892	5,608	7,675	1,862	2,069	3FLx - 186-3SB11-1XX1	x / x	5.6
170	1,159	–	552	1,944	5,771	7,900	1,914	2,121	3FLx - 191-3SB11-1XX1	x / x	5.7
170	1,189	–	562	1,996	5,933	8,124	1,966	2,173	3FLx - 197-3SB11-1XX1	x / x	5.8
245	1,220	–	571	2,003	6,096	8,348	2,018	2,225	3FLx - 202-3SB11-1XS1	x / Ø210	6.8
245	1,251	–	580	2,055	6,259	8,573	2,070	2,277	3FLx - 207-3SB11-1XS1	x / Ø210	6.9
245	1,282	–	586	2,107	6,421	8,797	2,122	2,329	3FLx - 212-3SB11-1XS1	x / Ø210	7.0
245	1,313	–	593	2,159	6,584	9,021	2,174	2,381	3FLx - 217-3SB11-1XS1	x / Ø210	7.1
245	1,344	–	599	2,211	6,747	9,246	2,226	2,433	3FLx - 223-3SB11-1XS1	x / Ø210	7.2
245	1,375	–	605	2,263	6,909	9,470	2,278	2,485	3FLx - 228-3SB11-1XS1	x / Ø210	7.3
245	1,406	–	612	2,315	7,072	9,694	2,330	2,537	3FLx - 233-3SB11-1XS1	x / Ø210	7.4
245	1,437	–	618	2,367	7,234	9,919	2,382	2,589	3FLx - 238-3SB11-1XS1	x / Ø210	7.5
245	1,468	1,032	625	2,419	7,397	10,143	2,434	2,641	3FLx - 243-3SB11-1XS1	x / Ø210	8.4
300	1,499	1,042	631	2,456	7,560	10,367	2,486	2,693	3FLx - 249-3SB11-1XM1	x / Ø330	8.5
300	1,530	1,052	637	2,508	7,722	10,592	2,538	2,745	3FLx - 254-3SB11-1XM1	x / Ø330	8.6
300	1,561	1,062	644	2,560	7,885	10,816	2,590	2,797	3FLx - 259-3SB11-1XM1	x / Ø330	8.7
300	1,623	1,081	656	2,664	8,210	11,265	2,694	2,901	3FLx - 269-3SB11-1XM1	x / Ø330	8.9
300	1,654	1,091	663	2,716	8,373	11,489	2,746	2,953	3FLx - 275-3SB11-1XM1	x / Ø330	9.0
300	1,716	1,111	676	2,820	8,698	11,938	2,850	3,057	3FLx - 285-3SB11-1XM1	x / Ø330	9.2
362	1,778	1,130	688	2,924	9,023	12,386	2,954	3,161	3FLx - 295-3SB11-1XM1	x / Ø330	9.4
362	1,809	1,140	695	2,976	9,186	12,611	3,006	3,213	3FLx - 301-3SB11-1XM1	x / Ø330	9.5
362	1,840	1,150	701	3,028	9,348	12,835	3,058	3,265	3FLx - 306-3SB11-1XM1	x / Ø330	9.6
362	1,873	1,170	709	3,132	9,673	13,284	3,162	3,369	3FLx - 316-3SB11-1XM1	x / Ø330	9.8

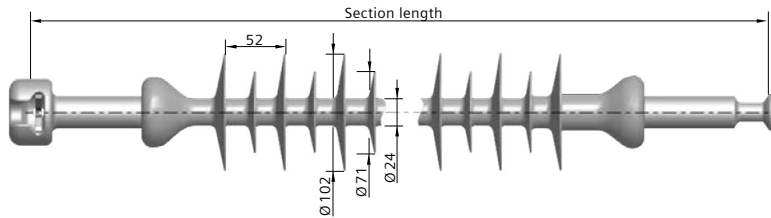

- ¹ Specified mechanical load (SML): use "3" for 100 kN; use "4" for 120 kN.
² Nominal housing length in mm/10. ³ Standard creepage distance: "3"; Extra-high creepage distance: "4".
⁴ Upper end fitting (earth side) ⁵ Bottom end fitting (high-voltage side)
⁶ Upper corona ring (earth side) ⁷ Bottom corona ring (high-voltage side).
 For all insulator types having no pre-installed corona rings and indicated by the code "X" optional corona rings can be added, if requested. For this, use the smallest corona ring available, i.e., catalog code "S"; please refer to page 10 for further catalog numbering information.

Technical data 3FL3 and 3FL4												
Highest voltage for equipment based on 25 mm/kV	Lightning impulse withstand voltage (1.2/ 50 µs, dry)	Switching impulse withstand voltage (250/ 2500 µs, positive, wet)	Power-frequency withstand voltage (50 Hz, 1 min., wet)	Arcing distance	Standard creepage distance catalog code: 3	Extra-high creepage distance catalog code: 4	Nominal housing length	Section length* with socket and ball	Catalog code		Grading ring diameter top/bottom (earth / HV side)	Approx. net weight for standard creepage distance
U_m kV	LIWV kV	SIWV min kV	PFVV kV	S mm	C mm	C mm	H mm	L mm	3FL_1_2_3_4_5_21-1_6_71	D mm	W kg	
362	1,889	1,179	713	3,184	9,836	13,508	3,214	3,421	3FLx - 321-3SB11-1XM1	x / Ø330	9.9	
362	1,922	1,199	720	3,288	10,161	13,957	3,318	3,525	3FLx - 332-3SB11-1XM1	x / Ø330	10.1	
362	1,939	1,209	724	3,340	10,324	14,181	3,370	3,577	3FLx - 337-3SB11-1XM1	x / Ø330	10.2	
420	1,971	1,229	732	3,399	10,649	14,629	3,474	3,681	3FLx - 347-3SB11-1SM1	Ø210 / Ø330	11.3	
420	2,004	1,248	740	3,503	10,974	15,078	3,578	3,785	3FLx - 358-3SB11-1SM1	Ø210 / Ø330	11.5	
420	2,037	1,268	748	3,607	11,300	15,527	3,682	3,889	3FLx - 368-3SB11-1SM1	Ø210 / Ø330	11.7	
420	2,054	1,278	752	3,659	11,462	15,751	3,734	3,941	3FLx - 373-3SB11-1SM1	Ø210 / Ø330	11.8	
420	2,070	1,288	756	3,711	11,625	15,975	3,786	3,993	3FLx - 379-3SB11-1SM1	Ø210 / Ø330	11.9	
420	2,103	1,307	763	3,815	11,950	16,424	3,890	4,097	3FLx - 389-3SB11-1SM1	Ø210 / Ø330	12.1	
420	2,136	1,327	771	3,919	12,275	16,873	3,994	4,201	3FLx - 399-3SB11-1SM1	Ø210 / Ø330	12.3	
420	2,169	1,346	779	4,023	12,600	17,321	4,098	4,305	3FLx - 410-3SB11-1SM1	Ø210 / Ø330	12.5	
420	2,185	1,356	783	4,075	12,763	17,546	4,150	4,357	3FLx - 415-3SB11-1SM1	Ø210 / Ø330	12.6	
420	2,201	1,366	787	4,127	12,926	17,770	4,202	4,409	3FLx - 420-3SB11-1SM1	Ø210 / Ø330	12.7	
420	2,218	1,376	791	4,179	13,088	17,994	4,254	4,461	3FLx - 425-3SB11-1SM1	Ø210 / Ø330	12.8	
420	2,251	1,396	798	4,283	13,413	18,443	4,358	4,565	3FLx - 436-3SB11-1SM1	Ø210 / Ø330	13.0	
550	2,284	1,415	806	4,362	13,739	18,892	4,462	4,669	3FLx - 446-3SB11-1SL1	Ø210 / Ø420	14.8	
550	2,300	1,425	810	4,466	14,064	19,340	4,566	4,773	3FLx - 457-3SB11-1SL1	Ø210 / Ø420	15.0	
550	2,300	1,425	810	4,674	14,714	20,238	4,774	4,981	3FLx - 477-3SB11-1SL1	Ø210 / Ø420	15.4	
550	2,300	1,425	810	4,778	15,040	20,686	4,878	5,085	3FLx - 488-3SB11-1SL1	Ø210 / Ø420	15.6	
550	2,300	1,425	810	4,882	15,365	21,135	4,982	5,189	3FLx - 498-3SB11-1SL1	Ø210 / Ø420	15.8	
550	2,300	1,425	810	4,986	15,690	21,584	5,086	5,293	3FLx - 509-3SB11-1SL1	Ø210 / Ø420	16.0	
550	2,300	1,425	810	5,090	16,015	22,032	5,190	5,397	3FLx - 519-3SB11-1SL1	Ø210 / Ø420	16.2	
550	2,300	1,425	810	5,194	16,340	22,481	5,294	5,501	3FLx - 529-3SB11-1SL1	Ø210 / Ø420	16.4	
	2,300	1,425	810	5,350	16,828	23,154	5,450	5,657	3FLx - 545-3SB11-1SL1	Ø210 / Ø420	16.7	
	2,300	1,425	810	5,454	17,153	23,603	5,554	5,761	3FLx - 555-3SB11-1SL1	Ø210 / Ø420	16.9	
	2,300	1,425	810	5,558	17,479	24,051	5,658	5,865	3FLx - 566-3SB11-1SL1	Ø210 / Ø420	17.1	
	2,300	1,425	810	5,662	17,804	24,500	5,762	5,969	3FLx - 576-3SB11-1SL1	Ø210 / Ø420	17.4	
	2,300	1,425	810	5,818	18,292	25,173	5,918	6,125	3FLx - 592-3SB11-1SL1	Ø210 / Ø420	17.7	

End fittings types and standards			
Type	Standard	Catalog code	Length V
Ball 16	IEC 60120	B	108 mm
Socket 16A	IEC 60120	S	99 mm
Socket 16B	IEC 60120	R	103 mm
Clevis 16L	IEC 60471	C	119 mm
Tongue 16L	IEC 60741	T	118 mm
Y-clevis 19	IEC 61466-1	Y	127 mm
Eye 24	IEC 61466-1	E	128 mm

Section length adjustment table* for other end fittings combinations, Base end fittings: socket and ball (catalog code: SB)			
Upper end fitting (earth side)	Bottom end fitting (high-voltage side)	Catalog code	Length change, mm
Clevis 16L	Tongue 16L	CT	+30
Clevis 16L	Clevis 16L	CC	+31
Clevis 16L	Eye 24	CE	+40
Clevis 16L	Ball 16	CB	+20
Tongue 16L	Tongue 16L	TT	+29
Eye 24	Ball 16	EB	+29
Eye 24	Eye 24	EE	+49
Y-clevis 19	Eye 24	YE	+48
Y-clevis 19	Ball 16	YB	+28

* To determine the section length of an insulator with a different end fitting combination than socket and ball, please add the appropriate adjustment section length shown in the table above. For all other configurations not shown in this table, contact your Siemens representative.

Long Rod Insulators 3FL5 and 3FL6

3FL silicone long rod insulators for suspension and tension applications are available in lengths appropriate for 60 kV through 550 kV. Length increments are 52 mm. A few selected insulator lengths are listed in the following table. Intermediate, shorter or longer lengths available on request.

		3FL5	3FL6
Specified mechanical load	SML:	160 kN	210 kN
Routine test load	RTL:	80 kN	105 kN

Technical data 3FL5 and 3FL6											
Highest voltage for equipment based on 25 mm/kV	Lightning impulse withstand voltage (1.2/50 μ s, dry)	Switching impulse withstand voltage (250/2,500 μ s, positive, wet)	Power-frequency withstand voltage (50 Hz, 1 min, wet)	Arcing distance	Standard creepage distance catalog code: 3	Extra-high creepage distance catalog code: 4	Nominal housing length	Section length* with socket and ball	Catalog code	Grading ring diameter top/ bottom (earth / HV side)	Approx. net weight for standard creepage distance
U_m kV	LIWV kV	SIWV min kV	PFWV kV	S mm	C mm	C mm	H mm	L mm	3FL_1_2_3_4_521-1_6_71	D mm	W kg
<72.5	449	–	160	643	1,702	2,288	614	878	3FLx - 061-3SB21-1XX1	x / x	5.2
72.5	476	–	180	695	1,865	2,512	666	930	3FLx - 067-3SB21-1XX1	x / x	5.3
72.5	503	–	200	747	2,027	2,736	718	982	3FLx - 072-3SB21-1XX1	x / x	5.4
72.5	530	–	220	799	2,190	2,961	770	1,034	3FLx - 077-3SB21-1XX1	x / x	5.6
72.5	556	–	240	851	2,352	3,185	822	1,086	3FLx - 082-3SB21-1XX1	x / x	5.7
72.5	583	–	260	903	2,515	3,409	874	1,138	3FLx - 087-3SB21-1XX1	x / x	5.9
72.5	610	–	280	955	2,678	3,634	926	1,190	3FLx - 093-3SB21-1XX1	x / x	6.0
72.5	637	–	300	1,007	2,840	3,858	978	1,242	3FLx - 098-3SB21-1XX1	x / x	6.1
123	664	–	320	1,059	3,003	4,082	1,030	1,294	3FLx - 103-3SB21-1XX1	x / x	6.3
123	690	–	340	1,111	3,166	4,307	1,082	1,346	3FLx - 108-3SB21-1XX1	x / x	6.4
123	717	–	360	1,163	3,328	4,531	1,134	1,398	3FLx - 113-3SB21-1XX1	x / x	6.5
123	744	–	380	1,215	3,491	4,755	1,186	1,450	3FLx - 119-3SB21-1XX1	x / x	6.7
145	771	–	400	1,267	3,653	4,980	1,238	1,502	3FLx - 124-3SB21-1XX1	x / x	6.8
145	797	–	420	1,319	3,816	5,204	1,290	1,554	3FLx - 129-3SB21-1XX1	x / x	6.9
145	824	–	440	1,371	3,979	5,428	1,342	1,606	3FLx - 134-3SB21-1XX1	x / x	7.1
145	851	–	460	1,423	4,141	5,652	1,394	1,658	3FLx - 139-3SB21-1XX1	x / x	7.2
170	882	–	469	1,475	4,304	5,877	1,446	1,710	3FLx - 145-3SB21-1XX1	x / x	7.3
170	913	–	478	1,527	4,466	6,101	1,498	1,762	3FLx - 150-3SB21-1XX1	x / x	7.5
170	943	–	488	1,579	4,629	6,325	1,550	1,814	3FLx - 155-3SB21-1XX1	x / x	7.6
170	974	–	497	1,631	4,792	6,550	1,602	1,866	3FLx - 160-3SB21-1XX1	x / x	7.7
170	1,005	–	506	1,683	4,954	6,774	1,654	1,918	3FLx - 165-3SB21-1XX1	x / x	7.9
170	1,036	–	515	1,735	5,117	6,998	1,706	1,970	3FLx - 171-3SB21-1XX1	x / x	8.0
170	1,066	–	525	1,787	5,279	7,223	1,758	2,022	3FLx - 176-3SB21-1XX1	x / x	8.1
170	1,097	–	534	1,839	5,442	7,447	1,810	2,074	3FLx - 181-3SB21-1XX1	x / x	8.3
170	1,128	–	543	1,891	5,605	7,671	1,862	2,126	3FLx - 186-3SB21-1XX1	x / x	8.4
170	1,159	–	552	1,943	5,767	7,896	1,914	2,178	3FLx - 191-3SB21-1XX1	x / x	8.5
170	1,189	–	562	1,995	5,930	8,120	1,966	2,230	3FLx - 197-3SB21-1XX1	x / x	8.7
245	1,220	–	571	2,002	6,092	8,344	2,018	2,282	3FLx - 202-3SB21-1XS1	x / Ø210	9.7
245	1,251	–	580	2,054	6,255	8,569	2,070	2,334	3FLx - 207-3SB21-1XS1	x / Ø210	9.8
245	1,282	–	586	2,106	6,418	8,793	2,122	2,386	3FLx - 212-3SB21-1XS1	x / Ø210	10.0
245	1,313	–	593	2,158	6,580	9,017	2,174	2,438	3FLx - 217-3SB21-1XS1	x / Ø210	10.1
245	1,344	–	599	2,210	6,743	9,242	2,226	2,490	3FLx - 223-3SB21-1XS1	x / Ø210	10.2
245	1,375	–	605	2,262	6,906	9,466	2,278	2,542	3FLx - 228-3SB21-1XS1	x / Ø210	10.4
245	1,406	–	612	2,314	7,068	9,690	2,330	2,594	3FLx - 233-3SB21-1XS1	x / Ø210	10.5
245	1,437	–	618	2,366	7,231	9,915	2,382	2,646	3FLx - 238-3SB21-1XS1	x / Ø210	10.6
245	1,468	1,032	625	2,403	7,393	10,139	2,434	2,698	3FLx - 243-3SB21-1XM1	x / Ø210	11.5
300	1,499	1,042	631	2,455	7,556	10,363	2,486	2,750	3FLx - 249-3SB21-1XM1	x / Ø330	11.7
300	1,530	1,052	637	2,507	7,719	10,588	2,538	2,802	3FLx - 254-3SB21-1XM1	x / Ø330	11.8
300	1,561	1,062	644	2,559	7,881	10,812	2,590	2,854	3FLx - 259-3SB21-1XM1	x / Ø330	11.9
300	1,623	1,081	656	2,663	8,206	11,261	2,694	2,958	3FLx - 269-3SB21-1XM1	x / Ø330	12.2
300	1,654	1,091	663	2,715	8,369	11,485	2,746	3,010	3FLx - 275-3SB21-1XM1	x / Ø330	12.3
300	1,716	1,111	676	2,819	8,694	11,934	2,850	3,114	3FLx - 285-3SB21-1XM1	x / Ø330	12.6
362	1,778	1,130	688	2,923	9,019	12,382	2,954	3,218	3FLx - 295-3SB21-1XM1	x / Ø330	12.9
362	1,809	1,140	695	2,975	9,182	12,607	3,006	3,270	3FLx - 301-3SB21-1XM1	x / Ø330	13.0
362	1,840	1,150	701	3,027	9,345	12,831	3,058	3,322	3FLx - 306-3SB21-1XM1	x / Ø330	13.1
362	1,873	1,170	709	3,131	9,670	13,280	3,162	3,426	3FLx - 316-3SB21-1XM1	x / Ø330	13.4

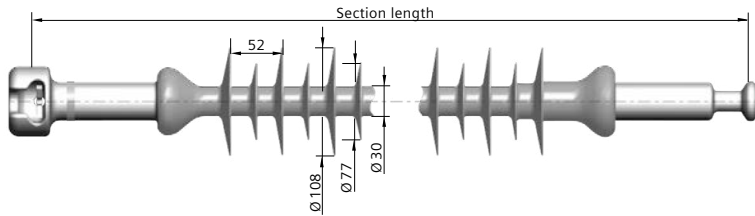

¹ Specified mechanical load (SML): use "3" for 100 kN; use "4" for 120 kN.
² Nominal housing length in mm/10. ³ Standard creepage distance: "3"; Extra-high creepage distance: "4".
⁴ Upper end fitting (earth side) ⁵ Bottom end fitting (high-voltage side)
⁶ Upper corona ring (earth side) ⁷ Bottom corona ring (high-voltage side).
 For all insulator types having no preinstalled corona rings and indicated by the code "X" optional corona rings can be added, if requested. For this, use the smallest corona ring available, i.e. catalog code "S", please refer to page 10 for further catalog numbering information.

Technical data 3FL5 and 3FL6

Highest voltage for equipment based on 25 mm/kV	Lightning impulse withstand voltage (1.2/ 50 µs, dry)	Switching impulse withstand voltage (250/ 2500 µs, positive, wet)	Power-frequency withstand voltage (50 Hz, 1 min., wet)	Arcing distance	Standard creepage distance catalog code: 3	Extra-high creepage distance catalog code: 4	Nominal housing length	Section length* with socket and ball	Catalog code	Grading ring diameter top/bottom (earth / HV side)	Approx. net weight for standard creepage distance
U_m kV	LIWV kV	SIWV min kV	PFVV kV	S mm	C mm	C mm	H mm	L mm	3FL_1_2_3_4_5_21-1_6_7_1	D mm	W kg
362	1,889	1,179	713	3,183	9,832	13,504	3,214	3,478	3FLx - 321-3SB21-1XM1	x / Ø330	13.6
362	1,922	1,199	720	3,287	10,158	13,953	3,318	3,582	3FLx - 332-3SB21-1XM1	x / Ø330	13.8
362	1,939	1,209	724	3,339	10,320	14,177	3,370	3,634	3FLx - 337-3SB21-1XM1	x / Ø330	14.0
420	1,971	1,229	732	3,398	10,645	14,625	3,474	3,738	3FLx - 347-3SB21-1SM1	Ø210 / Ø330	15.1
420	2,004	1,248	740	3,502	10,971	15,074	3,578	3,842	3FLx - 358-3SB21-1SM1	Ø210 / Ø330	15.4
420	2,037	1,268	748	3,606	11,296	15,523	3,682	3,946	3FLx - 368-3SB21-1SM1	Ø210 / Ø330	15.6
420	2,054	1,278	752	3,658	11,459	15,747	3,734	3,998	3FLx - 373-3SB21-1SM1	Ø210 / Ø330	15.8
420	2,070	1,288	756	3,710	11,621	15,971	3,786	4,050	3FLx - 379-3SB21-1SM1	Ø210 / Ø330	15.9
420	2,103	1,307	763	3,814	11,946	16,420	3,890	4,154	3FLx - 389-3SB21-1SM1	Ø210 / Ø330	16.2
420	2,136	1,327	771	3,918	12,272	16,869	3,994	4,258	3FLx - 399-3SB21-1SM1	Ø210 / Ø330	16.5
420	2,169	1,346	779	4,022	12,597	17,317	4,098	4,362	3FLx - 410-3SB21-1SM1	Ø210 / Ø330	16.7
420	2,185	1,356	783	4,074	12,759	17,542	4,150	4,414	3FLx - 415-3SB21-1SM1	Ø210 / Ø330	16.9
420	2,201	1,366	787	4,126	12,922	17,766	4,202	4,466	3FLx - 420-3SB21-1SM1	Ø210 / Ø330	17.0
420	2,218	1,376	791	4,178	13,085	17,990	4,254	4,518	3FLx - 425-3SB21-1SM1	Ø210 / Ø330	17.1
420	2,251	1,396	798	4,282	13,410	18,439	4,358	4,622	3FLx - 436-3SB21-1SM1	Ø210 / Ø330	17.4
550	2,284	1,415	806	4,361	13,735	18,888	4,462	4,726	3FLx - 446-3SB21-1SL1	Ø210 / Ø420	19.2
550	2,300	1,425	810	4,465	14,060	19,336	4,566	4,830	3FLx - 457-3SB21-1SL1	Ø210 / Ø420	19.5
550	2,300	1,425	810	4,673	14,711	20,234	4,774	5,038	3FLx - 477-3SB21-1SL1	Ø210 / Ø420	20.0
550	2,300	1,425	810	4,777	15,036	20,682	4,878	5,142	3FLx - 488-3SB21-1SL1	Ø210 / Ø420	20.3
550	2,300	1,425	810	4,881	15,361	21,131	4,982	5,246	3FLx - 498-3SB21-1SL1	Ø210 / Ø420	20.6
550	2,300	1,425	810	4,985	15,686	21,580	5,086	5,350	3FLx - 509-3SB21-1SL1	Ø210 / Ø420	20.8
550	2,300	1,425	810	5,089	16,012	22,028	5,190	5,454	3FLx - 519-3SB21-1SL1	Ø210 / Ø420	21.1
550	2,300	1,425	810	5,193	16,337	22,477	5,294	5,558	3FLx - 529-3SB21-1SL1	Ø210 / Ø420	21.4
	2,300	1,425	810	5,349	16,825	23,150	5,450	5,714	3FLx - 545-3SB21-1SL1	Ø210 / Ø420	21.8
	2,300	1,425	810	5,453	17,150	23,598	5,554	5,818	3FLx - 555-3SB21-1SL1	Ø210 / Ø420	22.1
	2,300	1,425	810	5,557	17,475	24,047	5,658	5,922	3FLx - 566-3SB21-1SL1	Ø210 / Ø420	22.3
	2,300	1,425	810	5,661	17,800	24,496	5,762	6,026	3FLx - 576-3SB21-1SL1	Ø210 / Ø420	22.6
	2,300	1,425	810	5,817	18,288	25,169	5,918	6,182	3FLx - 592-3SB21-1SL1	Ø210 / Ø420	23.0

End fittings types and standards

Type	Standard	Catalog code	Length V
Ball 20	IEC 60120	B	135 mm
Socket 20	IEC 60120	S	129 mm
Clevis 19L	IEC 60471	C	145 mm
Clevis 22L	IEC 60471	C	154 mm
Tongue 19L	IEC 60741	T	144 mm
Tongue 22L	IEC 60741	T	153 mm
Y-clevis 22	IEC 61466-1	Y	156 mm
Eye 25	IEC 61466-1	E	153 mm

Section length adjustment table* for other end fittings combinations, Base end fittings: socket and ball (catalog code: SB)

Upper end fitting (earth side)	Bottom end fitting (high-voltage side)	Catalog code	Length change, mm
Clevis 19L	Tongue 19L	CT	+25
Clevis 19L	Clevis 19L	CC	+26
Clevis 19L	Eye 25	CE	+34
Clevis 19L	Ball 20	CB	+16
Tongue 19L	Tongue 19L	TT	+24
Eye 25	Ball 20	EB	+24
Eye 25	Eye 25	EE	+42
Y-clevis 22	Eye 25	YE	+45
Y-clevis 22	Ball 20	YB	+27

* To determine the section length of an insulator with a different end fitting combination than socket and ball, please add the appropriate adjustment section length shown in the table above. For all other configurations not shown in this table, contact your Siemens representative.

Service

Customer partnership around the globe

Worldwide, more than 2,000 customer service employees (including OEM-certified technicians, engineers and supervisors) service the installed base around the globe with switchgear built since 1960.

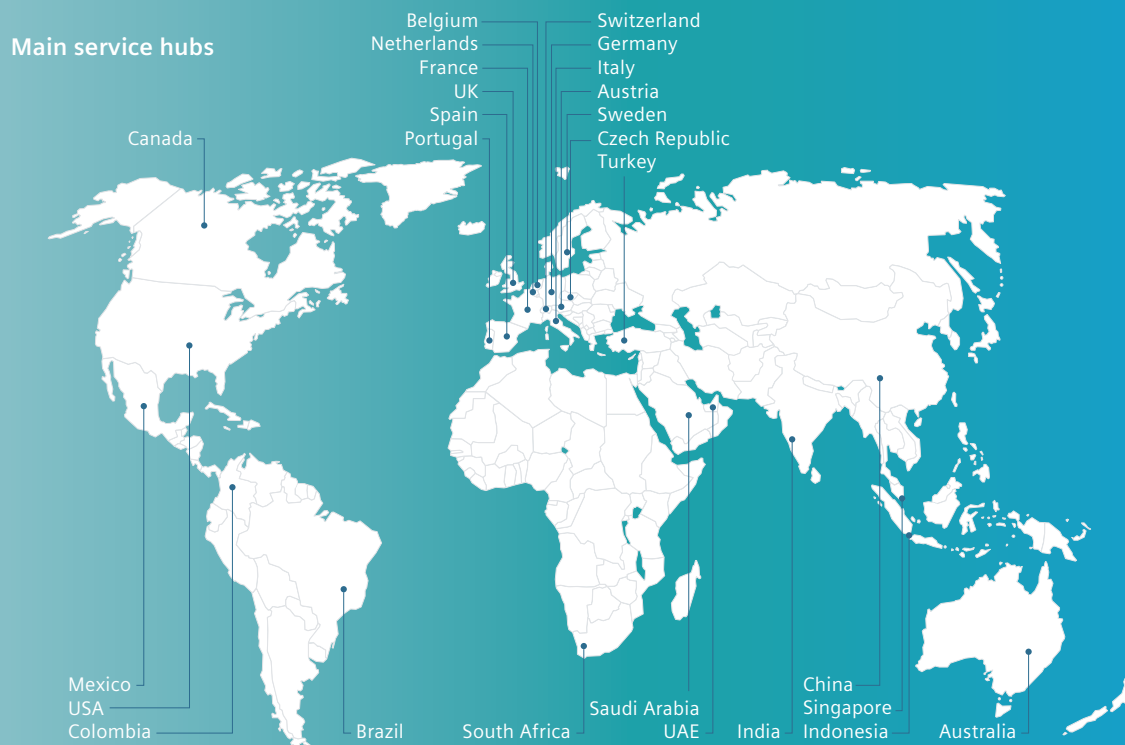

Proven reliability

- The services comprise high-voltage switchgear from Siemens, Magrini Galileo, Merlin Gerin, Elin Holec, and Reyrolle – fast, safely and reliably
- Siemens is a competent and dependable partner throughout the entire T&D asset lifespan of over 50 years
- The services cover the complete range of requirements during an asset's life
- A worldwide presence and 24/7 availability ensure short response times
- Recommendations and advice based on OEM knowledge and decades of experience
- Innovative service solutions, e.g., retrofit, ensure that the customer's equipment remains state of the art





Fig. 105: SF₆ tightness test

Service for High-Voltage Products

General

Siemens' services for high-voltage products keep the customer's equipment up to date and even increase its performance, while at the same time saving on investments and reducing lifecycle costs.

The offer comprises:

Audits and consulting

- Standardized audits
- Offline measurements and condition assessments.

Maintenance and inspection

- Time-based maintenance
- Condition-based maintenance
- Long-term maintenance contracts.

Repair services and spare parts

- Emergency service and 24/7 support
- Repair services
- Spare parts
- Strategic Spare Parts Solution (SSPS).

Modernization and extension

- Retrofit
- Bay extension
- Switchgear modification.

Condition monitoring

- UHF Partial Discharge Monitoring (Assetguard PDM)
- SF₆ Gas Density Monitoring (Assetguard GDM)
- Integrated Substation Condition Monitoring (ISCM).

Audits and consulting

Siemens is renowned for providing expertise that extends across all transmission and distribution equipment. Standardized audit tools deliver objective and comparable condition assessments. In addition to regular inspections during maintenance services, Siemens offers extended diagnostics and condition assessments to enhance maintenance and asset management strategies (see fig. 105, for example). Standardized audits is an approach that includes information gathering, visual inspections, and extended diagnostics. The results are displayed in user-friendly and well-structured reports that can be used immediately by decision makers in asset management. Offline condition assessments focus on in-depth equipment checkups,



Fig. 106: Contact check of the interrupter unit

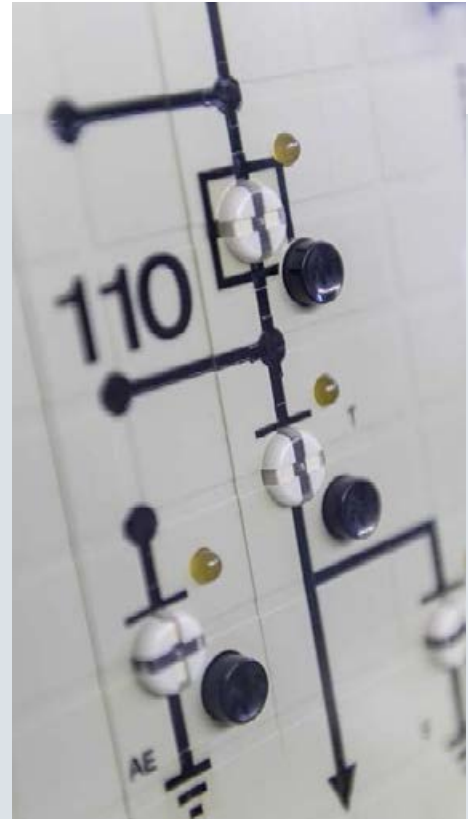

Fig. 107: Control board

including analysis, measurements, functional tests, and electrical and mechanical health checks. Certified service engineers record failures on site and provide recommendations for necessary measures.

Maintenance and inspection

Siemens' services cover all required overhauls and condition assessments for fault-free switchgear operation (see *fig. 106*, for example). Maintenance serves to monitor the customer's equipment and increase its wear-and-tear reserve, which maintains and even improves its reliability. The services are pre-defined according to manufacturer recommendations, but can be flexibly adapted to individual requirements. Time- and condition-based maintenance is offered. Time-based maintenance follows the OEM's recommended time schedule of regular service visits to ensure the reliable operation of the serviced equipment. Condition-based maintenance is a process-driven measure that is triggered when a critical condition or deteriorating performance of an asset is indicated.

Repair services and spare parts

Repair measures aim to quickly return the equipment to a functional condition. One essential prerequisite for success-

ful and fast fault recovery is the availability of the necessary spare parts. If a failure occurs, Siemens can provide assistance by means of an emergency service that includes 24/7 availability, as well as contractually determined reaction times and repair services on-site. These are based on an international network of spare-part suppliers, repair workshops, and service centers.

Modernization and extension

To keep up with the pace of technological development and to extend asset lifetime, modernizations such as retrofits can provide a cost-effective solution. Offerings like bay extensions (with original or state-of-the-art technology) and switchgear modifications (upratings and upgrading) maintain and even increase the performance of the customer's switchgear.

Siemens develops customized solutions that include design, testing and installation. As one of the world's leading suppliers of switchgear technology, Siemens offers a comprehensive range of services for all current as well as phased-out switchgear types.



Fig. 108: Condition monitoring, visualization

Condition monitoring

Siemens leverages the “power of data” by capturing, processing and analyzing data, which provides a solid basis for actions, both for daily operations and long-term planning of asset performance management. The offering ranges from stand-alone products (Assetguards) to complex monitoring systems for substations, based on ISCM technology. The Assetguard range of solutions covers all essential monitoring elements for both gas-insulated switchgear and air-insulated switchgear: UHF partial discharge monitoring, SF₆ gas density monitoring, and circuit-breaker monitoring.

Key features of the Assetguards:

Assetguard PDM (Partial Discharge Monitoring)

- Pattern recognition to determine the PD root cause
- Early detection of increasing and pending failures
- Avoidance of disruptive failures
- Reduction of HV test commissioning time
- More than 20 years of expertise.

Assetguard GDM (Gas Density Monitoring)

- SF₆ inventory management for reporting of instances
- Accuracy down to 0.5% of leakage per annum
- Bonus improvement and avoidance of penalties possible

- Automatic trend detection and prediction
- Avoidance of unexpected tripping.

Furthermore, the integrated software platform ISCM enables the integration of different substation assets, such as transformers. The HMI not only provides a fast and user-friendly front-end overview (see fig. 108, for example), but also incorporates powerful expert modes, whereby detailed investigation such as trend analysis, automated reporting, and defect location can take place. In addition, all condition monitoring products and systems can be monitored remotely by Siemens.

Trainings

The Siemens Power Academy TD offers, among others, trainings on primary equipment, e.g., high-voltage gas- or air-insulated switchgear, and circuit-breakers. An overview about trainings is available at

➔ [siemens.com/poweracademy](https://www.siemens.com/poweracademy)

Service

➔ [siemens.com/td-services](https://www.siemens.com/td-services)

Published by
© Siemens AG 2016

Energy Management
High-Voltage Products
Freyeslebenstrasse 1
91058 Erlangen, Germany

For more information, please contact
our Customer Support Center.
Phone: +49 180 524 70 00
Fax: +49 180 524 24 71
(Charges depending on provider)
E-mail: support.energy@siemens.com

Article No. EMHP-B10010-00-7600
Printed in Germany
Dispo 30002
003000/78455 | 0516

All rights reserved.
Trademarks mentioned in this document
are the property of Siemens AG, its
affiliates, or their respective owners.

Subject to changes and errors. The information
given in this document only contains general
descriptions and/or performance features
which may not always specifically reflect those
described, or which may undergo modification
in the course of further development of the
products. The requested performance features
are binding only when they are expressly
agreed upon in the concluded contract.

For further
information, scan
the QR code and
visit our website

