

SOLUS Legend™

User Manual



ZEESC336A Rev. A

Start 



Quick Links

Click a Topic

Using Page Controls   

Table of Contents (TOC)

General Information

Basic Operation & Navigation

Quick Reference Information

Maintenance

ShopStream Connect™

SureTrack®

Snap-on Cloud

Wi-Fi Connection

Customer Support / Training



Scanner Automotive

Scanner Motorcycle

Scanner Demonstration

Vehicle Code Scan

Data Cable



OBD-II/EOBD



Quick Lookups



Previous Vehicles & Data



Tools

Table of Contents

Safety Information	vi
Using This Manual	viii
Section 1: Quick Reference	1
Section 2: General Information	3
Basic Features	3
Powering the Diagnostic Tool	4
Vehicle Power	4
Internal Battery Pack	4
AC Power Supply	4
Technical Specifications	5
Section 3: Basic Operation and Navigation	6
Turning On/Off and Emergency Shutdown	6
Turning On	6
Turning Off	6
Emergency Shutdown	6
Control Buttons	7
Basic Navigation	7
Home Screen Layout.....	7
Home Screen Icons	8
WiFi Connection	8
Title Bar	8
Common Toolbar Control Icons	9
Scroll Bar	9
Screen Messages	10
Snap-on Messages	10
General System Messages	10
Vehicle Communication Messages	10
Section 4: Data Cable Connections	11
Data Cable Connection (OBD-II/EOBD Vehicles).....	11
Optional OBD-II/EOBD Data Cable	12
Data Cable Connection OBD-I Vehicles	13

Section 5: Scanner Demo	14
Section 6: Scanner - Automotive	19
Basic Operation	19
Scanner Overview	19
Scanner - Starting / Stopping	20
Features and Icons	20
Scanner Features	20
Basic Scanner Operation (Quick Start)	21
Vehicle Identification	21
System Main Menu Options	24
Codes - View / Save	24
Codes Menu	24
Code Scan (with Vehicle System Report/Snap-on Cloud)	26
Viewing and Saving Data (PIDs)	26
Scanner Control Icons	27
About the Data Buffer	27
About Cursors	28
Pausing and Reviewing Active Data	28
Saving Data Files	30
Using Zoom	31
Changing Data Views - PID List / Graphs	32
Selecting PIDs to Display (custom display)	33
Locking PIDs (to always display at top)	33
Using Triggers	34
Functional Tests	38
Troubleshooter	39
Section 7: Scanner - Motorcycle	41
Basic Operation	41
Scanner Overview	41
Scanner - Starting / Stopping	41
Features and Icons	42
Scanner Features	42
Scanner Control Icons	43
Basic Scanner Operation (Quick Start)	43
Data Cable Connection	44
Vehicle Identification / System Selection	44



System Main Menu Options..... 47

Codes - View / Scan / Save 47

 Viewing Codes 47

 Clear Codes 48

 Code Scan 48

Section 8: Vehicle Code Scan / (Snap-on Cloud) 51

Using Code Scan 52

 Total Number of Systems (modules) Analyzed 53

 List of All the Systems Analyzed with DTCs Totals 54

 Global OBDII DTCs 54

 Readiness Monitor Test Status 55

Vehicle System Report
(Snap-on Cloud) 55

 Printing the Vehicle System Report..... 55

Section 9: Quick Lookups 56

Oil Specs and Resets 56

 Operation..... 57

 Reset Procedure 60

Tire and Wheel Service..... 62

 Operation..... 63

Section 10: OBD-II/EOBD 67

Basic Operations 67

 Screen Layout and Toolbar Controls..... 67

 Connecting the Data Cable 67

 Saving and Reviewing Data Files..... 67

OBD-II/EOBD Menu..... 68

 OBD Health Check 68

 OBD Direct 70

Section 11: Previous Vehicles and Data..... 74

Previous Vehicles and Data Menu 74

 Vehicle History 74

 View Saved Data..... 75

 Viewing Codes and Code Scan Results..... 75

 Delete Saved Data 76

Section 12: Tools 77

Tools Menu 77

 Connect-to-PC (File Transfer) 78

Get Connected 78

Configure Shortcut Button..... 79

System Information 79

Settings 80

Section 13: Wi-Fi Connection / Troubleshooting 86

Checking if Wi-Fi is Connected 86

Turning Wi-Fi On and Connecting to a Network..... 87

Add Network Advanced (Connecting to a hidden network)..... 88

Wi-Fi Testing 88

Wi-Fi Troubleshooting and Status Messages..... 89

 Informative Messages 91

Section 14: Snap-on Cloud 92

Key Features 92

Important Notes 92

Registration - Getting Started 92

 Snap-on Cloud - New User Registration 93

 Snap-on Cloud - SureTrack User Setup 94

 Snap-on Cloud Setup Information Screen 95

Using the Snap-on Cloud 95

 Quick Reference (print / download / share) 95

 Logging in to the Snap-on Cloud (registered user) 96

 Navigating the Snap-on Cloud (Toolbars)..... 96

 My Files..... 97

 Search..... 100

 Favorites 100

 Profile 101

Section 15: SureTrack® 105

Main Topic Links..... 105

Quick Reference..... 105

 SureTrack Community FAQ's 105

 Using SureTrack for the First Time 105

 Login Scenarios 105

Creating an Account / Logging In 105

 Finding your SureTrack Authorization Code 105

 Creating a SureTrack Account..... 106

 Logging In (active account)..... 108

 Logging In with New Authorization Code (active account) 109

 Logging In with New Authorization Code (expired account) 110



SureTrack (Scanner)..... 111
 Basic Operation and Navigation 111
 SureTrack Online 115
 SureTrack Features..... 115
 1Search™ Limited 115
 SureTrack Screens..... 116

Section 16: ShopStream Connect™ 119

Using SSC (Connecting to your PC)..... 119
 SSC Main Screen 120
 Scanner DataViewer 121
 Image Viewer 121
 Printing the (Code Scan) Vehicle System Report 122
 Customizing the (Code Scan) Vehicle System Report 123
 Software Upgrades and Updates 125
 End User License Agreement 126

Section 17: Maintenance 127

Cleaning and Inspecting the Diagnostic Tool..... 127
 Cleaning the Touch Screen 127
 Battery Pack Service..... 127
 Safety 127
 Ordering a New Battery Pack..... 128
 Removing / Installing the Battery Pack..... 128
 Disposing of the Battery Pack 129

Customer Support / Training 130

Legal Information..... 133



Safety Information

READ ALL INSTRUCTIONS

For your own safety, the safety of others, and to prevent damage to the product and vehicles upon which it is used, it is important that all instructions and safety messages in this manual and the accompanying *Important Safety Instructions* manual be read and understood by all persons operating, or coming into contact with the product, before operating. We suggest you store a copy of each manual near the product in sight of the operator.

For your safety, read all instructions. Use your diagnostic tools only as described in the tool user's manual. Use only manufacturer recommended parts and accessories with your diagnostic tools.

This product is intended for use by properly trained and skilled professional automotive technicians. The safety messages presented throughout this manual and the accompanying *Important Safety Instructions* manual are reminders to the operator to exercise extreme care when using this product.

There are many variations in procedures, techniques, tools, and parts for servicing vehicles, as well as in the skill of the individual doing the work. Because of the vast number of test applications and variations in the products that can be tested with this instrument, we cannot possibly anticipate or provide advice or safety messages to cover every situation. It is the responsibility of the automotive technician to be knowledgeable of the system being tested. It is essential to use proper service methods and test procedures. It is important to perform tests in an appropriate and acceptable manner that does not endanger your safety, the safety of others in the work area, the equipment being used, or the vehicle being tested.

It is assumed that the operator has a thorough understanding of vehicle systems before using this product. Understanding of these system principles and operating theories is necessary for competent, safe and accurate use of this instrument.

Before using the equipment, always refer to and follow the safety messages and applicable test procedures provided by the manufacturer of the vehicle or equipment being tested. Use the product only as described in its user manual. Use only manufacturer recommended parts and accessories with your product.

Read, understand and follow all safety messages and instructions in this manual, the accompanying *Important Safety Instructions* manual, and on the test equipment.

Environmental Conditions:

- This product is intended for indoor use only
- This product is rated for Pollution Degree 2 (normal conditions)

Safety Signal Words

All safety messages contain a safety signal word that indicates the level of the hazard. An icon, when present, gives a graphical description of the hazard. Safety Signal words are:



Indicates an imminently hazardous situation which, if not avoided, will result in death or serious injury to the operator or to bystanders.



Indicates a potentially hazardous situation which, if not avoided, could result in death or serious injury to the operator or to bystanders.



Indicates a potentially hazardous situation which, if not avoided, may result in moderate or minor injury to the operator or to bystanders.



Safety Message Conventions

Safety messages are provided to help prevent personal injury and equipment damage. Safety messages communicate the hazard, hazard avoidance and possible consequences using three different type styles:

- Normal type states the hazard.
- **Bold** type states how to avoid the hazard.
- *Italic type states the possible consequences of not avoiding the hazard.*

An icon, when present, gives a graphical description of the potential hazard.

Safety Message Example



Risk of electric shock.

- **Prior to recycling the battery pack, protect exposed terminals with heavy insulating tape to prevent shorting.**
- **Disconnect all test leads and turn diagnostic tools off before removing the battery pack.**
- **Do not attempt to disassemble the battery or remove any component projecting from or protecting the battery terminals.**
- **Do not expose the diagnostic tool or battery pack to rain, snow, or wet conditions.**
- **Do not short circuit the battery terminals.**

Electric shock can cause injury.

Important Safety Instructions

For a complete list of safety messages, refer to the accompanying *Important Safety Instructions manual*.

SAVE THESE INSTRUCTIONS

Using This Manual





Hyperlinks

Selectable hyperlinks are provided throughout this manual to quickly take you to related topics, procedures, and websites. Hyperlinks are identified by **Blue** colored text.

Text Hyperlink Example: <http://diagnostics.snapon.com>

Page Navigation Controls

The following navigation controls are provided on the top of each page of the user manual. They can be used in addition to the viewer controls in the toolbar.

Icon	Description
Quick Links Menu	Opens the Quick Links menu within the Table of Contents (TOC) section. From Quick Links you can link to most topics in this manual.
	
Jump Back	Click to move back one page.
	
Jump Forward	Click to move forward one page.
	

Content

This manual contains basic operating instructions and is structured in a manner to help you become familiar with your diagnostic tool features and perform basic operations.

The illustrations in this manual are intended as reference only and may not depict actual screen results, information, functions or standard equipment. Contact your sales representative for availability of other functions and optional equipment.

Conventions

The following conventions are used.

Terminology

The terms “Scanner” and “Scanner function” are used to describe the Scanner Function(s) of the diagnostic tool.

Examples:

- Select **Scanner** from the Home screen.
- From the Scanner main menu select **Continue**.
- The Scanner function provides many diagnostic tests.

The term “select” describes tapping/touching an icon on the touch screen, or highlighting an icon or menu choice and then selecting the confirmation menu choice such as **Continue, Accept, OK, Yes, or other similar** choice.

Abbreviated example for the following procedure: “Select **Brightness**”

1. Navigate to and highlight the **Brightness** selection.
2. Select **OK, or similar**, button.



Symbols

Different types of arrows are used. The “greater than” arrow (>) indicates an abbreviated set of selection (navigation) instructions.

Abbreviated example for the following procedure: “Select **Tools > Connect-to-PC**”

1. Select **Tools** from the home screen.
2. Highlight **Connect-to-PC** on the Tools menu.
3. Select **Connect-to-PC**.

The solid arrows (◀, ▶, ▼, ▲) are navigational instructions for the four directions of the directional buttons.

Example: Press the down ▼ arrow.

Bold Text

Bold emphasis is used in procedures to highlight selectable items such as control buttons, icons and menu options.

Example: Press the **OK** button

Notes and Important Messages

The following messages are used.

Notes

A NOTE provides helpful information such as additional explanations, tips, and comments.

Example:

NOTE

For additional information refer to...

Important

IMPORTANT indicates a situation which, if not avoided, may result in damage to the test equipment or vehicle.

Example:

IMPORTANT

Do not disconnect the data cable while the diagnostic tool is communicating with the ECM.

IMPORTANT

Read all applicable [Safety Information](#) before using this diagnostic tool!

Procedures

An arrow icon in the left-margin area indicates a procedure.

Example:



To change screen views:

1. Select the **Graph** icon.
The dropdown menu displays.
2. Select an option from the menu.
The screen layout changes to the format selected.





Finding the Diagnostic Tool Serial Number and Software Version

The diagnostic tool serial number is located on the back of the diagnostic tool housing. The serial number and software version can also be viewed onscreen from the System Information screen (**Tools > System Information**) see [System Information](#) on page 79,

Connecting to Wi-Fi

Note: These instructions are intended as quick reference only, for additional information see [Wi-Fi Connection / Troubleshooting](#) on page 86.

1. From the Home screen, select **Tools > Settings > Configure Wi-Fi**.
2. Select the **Wi-Fi** icon  to turn Wi-Fi on.
3. The Wi-Fi icon will change to , indicating Wi-Fi is on.
4. Select your wireless network from the list (*typical list shown below*), then select **Connect**.



Wi-Fi Applications

The following automotive integrated Repair Information Applications provide up-to-date service/repair information directly to your diagnostic tool, via wireless network connection to our Snap-on Web Services Network:

- **SureTrack®**
- **Tire and Wheel Service (within Quick Lookups)**
- **Oil Specs and Resets (within Quick Lookups)**

To use these applications you must have authorized access. If your access to these applications has expired, contact your sales representative.

NOTE

Performance varies depending on your wireless network equipment and ISP.

Snap-on Cloud

This diagnostic tool includes a built-in Wi-Fi feature that automatically transfers code scan reports to the Snap-on Cloud.

The Snap-on Cloud is a mobile-friendly cloud-based application designed specifically for technicians to store, organize, share and print information. See [Snap-on Cloud](#) on page 92 for additional information.



SureTrack

This diagnostic tool includes a built-in Wi-Fi feature that automatically transfers code scan reports to the Snap-on Cloud

Using SureTrack for the First Time

If you have purchased a new diagnostic tool, you will need to create a SureTrack account before you can access SureTrack. See [Creating a SureTrack Account](#) on page 106 for instructions.

Reactivating SureTrack

If you have recently purchased a qualifying upgrade/plan, you will need to reactivate your account to access SureTrack. See [Logging In \(active account\)](#) on page 108 for instructions.

Printing Data and Screenshots

Use ShopStream Connect to print data files and screenshots from the diagnostic tool. See [ShopStream Connect™](#) on page 119.

Diagnostic Tool Accessories

Find diagnostic tool accessories using our Interactive Accessories Catalog:

visit <http://diagnostics.snapon.com> and enter “accessories catalog” in the Search field.

Additional accessory information is located in our Vehicle Application Guide:

visit <http://diagnostics.snapon.com> and enter “application guide” in the Search field.

Contact your sales representative to purchase product accessories.



The SOLUS Legend™ is an automotive and motorcycle diagnostic scan tool with exclusive automotive SureTrack® and Quick Lookups repair information features.

This section describes basic feature locations, how the diagnostic tool is powered and basic specifications.

Main Topic Links

- [Basic Features](#) page 3
- [Powering the Diagnostic Tool](#) page 4
 - [Vehicle Power](#) page 4
 - [Internal Battery Pack](#) page 4
 - [AC Power Supply](#) page 4
- [Technical Specifications](#) page 5

2.1 Basic Features



- 1— Touch Screen
- 2— Control Panel

Figure 2-1 Front view

Connectors and jacks for data communication cables and the AC power supply are located on the top of the diagnostic tool.



Figure 2-2 Top view

- 1— **Battery Status Indicator LED**
- 2— **Power Supply Jack** - AC power supply connection
- 3— **Mini USB Jack** - USB cable connection used to transfer saved data files to a personal computer
- 4— **Micro secure digital (uSD) Card** - contains operating system programming. **IMPORTANT** The uSD card must be installed for the diagnostic tool to operate. Do not remove the uSD card while the diagnostic tool is powered on.
- 5— **Data Cable Connector** - Data cable connection used to connect the diagnostic tool to a vehicle data link connector (DLC)



- 1— Built in-Stand

Figure 2-3 Back view



2.2 Powering the Diagnostic Tool

Your diagnostic tool can receive power from any of the following sources:

- [Vehicle Power](#)
- [Internal Battery Pack](#)
- [AC Power Supply](#)

2.2.1 Vehicle Power

The diagnostic tool is designed to be powered from the vehicle. All OBD-II/EOBD vehicles have vehicle battery power (B+) available on the data link connector (DLC). The diagnostic tool is powered through the Data Cable when connected to the vehicle DLC.

A green LED indicator on the DLC end of the data cable, illuminates when power is being supplied to the cable. If the LED fails to illuminate, check that the data cable is properly connected and then check the DLC power circuit. See [Data Cable Connections](#) on page 11 for additional data cable information.

An optional power cable is required when testing non-OBD-II/EOBD or models that do not have vehicle battery power (B+) available on the DLC. Contact your sales representative for availability.

IMPORTANT

Never connect the optional power cable to the power supply input jack on the diagnostic tool when the diagnostic tool is communicating with a vehicle.

2.2.2 Internal Battery Pack

The diagnostic tool can be powered from the internal rechargeable battery pack. A fully charged battery pack provides sufficient power for about 3 hours of continuous operation. For battery pack removal and installation instructions see, [Removing / Installing the Battery Pack](#) on page 128.

Battery Pack Charging



Battery charging occurs whenever the data cable is connected to a vehicle DLC. Battery charging also occurs when the AC power supply is connected to a live AC power source, and connected to the diagnostic tool. Use the supplied AC power supply to charge the battery pack.

Insert the end of the AC power supply cable into the diagnostic tool power supply jack, then connect the AC power supply to an approved AC power source.

IMPORTANT

Only use the supplied AC power supply. Never connect the power supply to the diagnostic tool when the tool is communicating with a vehicle.

The Battery Status Indicator LED (located next to the power supply jack) indicates battery status.

Battery Status LED	Description
	Green - battery is fully charged, or the diagnostic tool is being powered by the AC power supply.
	Red - battery is charging
	Amber - indicates a battery issue. This is usually caused by excessive battery temperature (above 104°F/40°C), which disables charging. Allow the diagnostic tool to cool down before continuing operation.

2.2.3 AC Power Supply

The diagnostic tool can be powered from a standard AC outlet using the AC power supply. The AC power supply converts alternating current (AC) to direct current (DC) to power the diagnostic tool. The connector on the end of the output cable of the AC power supply connects to the AC power supply jack on top of the diagnostic tool. Use only the AC power supply provided.

IMPORTANT

Never connect the AC power supply to the diagnostic tool when the diagnostic tool is communicating with a vehicle.



2.3 Technical Specifications

Item	Description / Specification
Touch Screen	Resistive Touch Panel
Display	8.0 inch diagonal, Color LCD
	800 x 480 resolution SWVGA
Battery	Rechargeable lithium-ion battery pack
	Approximately 3 hour run time
	Approximately 5 hour charge time
Power Supply	Supply Rating; 15VDC, 2A
DC Operating Voltage	10 to 30VDC
Width	11.06 in. (281.0 mm)
Height	6.29 in. (160.0 mm)
Depth	1.58 in. (40.3 mm)
Weight (including battery):	2.65 lb (1.20 kg)
Operating Temperature Range (ambient)	At 0 to 90% relative humidity (non-condensing) 32 to 113°F (0 to 45°C)
Storage Temperature (ambient)	At 0 to 70% relative humidity (non-condensing) -4 to 140°F (-20 to 60°C)
Operating Altitude	Maximum 2000 m
Environmental Conditions	This product is intended for indoor use only
	This product is rated for Pollution Degree 2 (normal conditions)

This section describes basic diagnostic tool operation, navigation, screen layout, icon functions, and screen messages. Before you operate the diagnostic tool, make sure the battery pack is fully charged or the diagnostic tool is powered by the AC power supply.

Main Topic Links

- [Turning On/Off and Emergency Shutdown](#) page 6
- [Control Buttons](#) page 7
- [Basic Navigation](#) page 7
- [Home Screen Icons](#) page 8
- [Common Toolbar Control Icons](#) page 9
- [Screen Messages](#) page 10

3.1 Turning On/Off and Emergency Shutdown

The following sections describe how to turn the diagnostic tool on and off and how to perform an emergency shutdown.

3.1.1 Turning On

To manually turn on the diagnostic tool, press and release the **Power** button (*Figure 3-1*).

The diagnostic tool will automatically turn on when:

- a live AC power supply is connected to the diagnostic tool
- the Data Cable is connected to a vehicle (that has 12VDC at the data link connector (DLC))

3.1.2 Turning Off

IMPORTANT

*All vehicle communication must be stopped **BEFORE** turning off the diagnostic tool. A warning message displays if you attempt to turn the diagnostic tool off while communicating with the vehicle. Forcing a shut down while communicating may lead to ECM problems on some vehicles. Never disconnect the Data Cable when the diagnostic tool is communicating with the vehicle ECM.*



To turn off the diagnostic tool:

1. Press the **N/Cancel** button or select the **Back** or **Home** icon to navigate to the Home screen.
If applicable, a “stopping communication” message appears briefly before the Home screen displays.
2. If applicable, disconnect the Data Cable from the vehicle.
3. Press and release the **Power** button.
A confirmation screen displays.
4. Press the **Y/Accept** button or select **OK** from the menu to turn the diagnostic tool off. To continue operating, press the **N/Cancel** button or select **Cancel** from the menu.

3.1.3 Emergency Shutdown

IMPORTANT

Using the emergency shutdown procedure while communicating with the vehicle ECM may lead to ECM problems on some vehicles.

During normal operation turn the diagnostic tool off using the *Turning Off* procedure above. The emergency shutdown procedure should only be used if the diagnostic tool does not respond to navigation or control buttons or exhibits erratic operation. To force an emergency shutdown, press and hold the **Power** button for five seconds until the diagnostic tool turns off.

3.2 Control Buttons

There are four “push type” control buttons and one “thumb pad rocker type” multi-directional button located on the right side of the diagnostic tool. All other diagnostic tool operations are controlled through the touch screen.



Figure 3-1 Front view

Item	Button	Description
1		N/Cancel - Push type button <ul style="list-style-type: none"> To exit a menu or program. To close an open list and return to the previous menu or screen. To answer “No” when a yes/no choice is given.
2		Y/Accept - Push type button <ul style="list-style-type: none"> To confirm a selection from a menu or program. To select an item that was highlighted using the direction arrows. To advance to the next screen in a series. To answer “Yes” when a yes or no choice is given.

Item	Button	Description
3		Directional - Thumb pad rocker type buttons <p>Buttons move the cursor or highlight in their respective direction:</p> <ul style="list-style-type: none"> Up (▲) Down (▼) Left (◀) Right (▶)
4		S (Shortcut) - Push type button <p>Programmable function button that can provide a shortcut for performing a variety of routine tasks. Refer to Configure Shortcut Button on page 79 for additional information.</p>
5		Power (On/Off) - Push type button <p>Turns the diagnostic tool on and off. Also, press and hold for 5 seconds for emergency shutdown.</p>

3.3 Basic Navigation

3.3.1 Home Screen Layout

The Home screen includes a title bar and main body. The Home screen contains the primary diagnostic tool function icons.

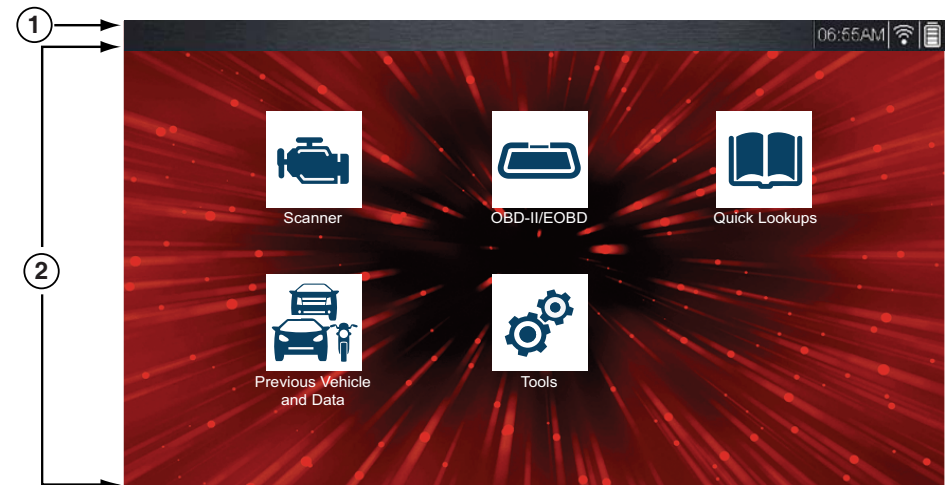





- 1— Title Bar
- 2— Main Body

Figure 3-2 Home screen



3.3.2 Home Screen Icons

Each available diagnostic tool function is represented by a icon on the Home screen. Select an icon from the Home screen to start a function. You can also use the control buttons to select an icon. Use the directional button to highlight the desired function and then press the **Y/Accept** to select it.

Function Name	Function Icon	Description
Scanner		Used to communicate with the electronic control systems of a vehicle. This function allows you to retrieve diagnostic trouble codes (DTCs), view PID data and perform diagnostic tests. See Scanner - Automotive on page 19 for details.
OBD-II/EOBD		Allows you to access generic OBD-II/EOBD data and tests without identifying the vehicle being tested. See OBD-II/EOBD on page 67 for details.
Quick Lookups		Provides quick access to the OEM Oil Specs and Resets and Tire and Wheel Service information and TPMS functions. See Quick Lookups on page 56 .
Previous Vehicles & Data		Allows you to quickly reconfigure the diagnostic tool to a recently tested vehicle and to access saved data files. See Previous Vehicles and Data on page 74 for details.
Tools		Allows you to adjust diagnostic tool settings to your personal preferences and perform other special functions. See Tools on page 77 for details.

3.3.3 WiFi Connection

See [Wi-Fi Connection / Troubleshooting on page 86](#).

3.3.4 Title Bar

The title bar ([Figure 3-2](#)) at the top of the screen provides basic information about current diagnostic tool operating conditions. Title bar options vary depending upon vehicle make and model, what function is active, what test is being performed, or what menu is selected. The title bar contains information only, there are no selectable items.





Elements of the Title bar let you know at a glance:

- Which diagnostic tool function is active
- The current time
- Wi-Fi signal strength
- The source and status of the power being supplied to the diagnostic tool

A real time clock displays to the left of the power supply icon. The clock is powered by a dedicated internal battery, so the correct time is maintained even when the main battery pack is discharged. Use the Tools function to set the clock and format how time is displayed. See [Clock Settings on page 83](#) for additional information.

The Title bar displays other information that varies depending upon what functions are being performed. Other information may include:

- The identification (ID) of the test vehicle
- The name of the active menu or function
- The name of the test being performed

Icon	Function	Icon	Function
	Full Battery Charge Level - Indicates power is being supplied by the internal battery pack. Horizontal bars diminish as the battery discharges.		External Power Connected - Indicates power is being supplied through the data cable connection to a vehicle or by the AC Power Supply and charging the battery pack.
	Low Battery Charge Level - Indicates the internal battery pack is low and needs to be recharged immediately. A warning message will also display on the screen when the battery gets low.		Wi-Fi Signal Strength - Indicates signal strength of the wireless network connection. 3 bars - full strength signal 1 bar - weak signal



3.3.5 Common Toolbar Control Icons

Common control icon functions are described in the following table. Specific function control icons are described in their applicable sections. Displayed control icons vary depending on the active function or test.

Select a control icon to perform a function. You can also use the control buttons to select an icon. Use the directional button to highlight the desired function and then press the **Y/Accept** button to select it.

Icon	Function	Icon	Function
	Back - Returns to the previously viewed screen. Icon is located on the left-hand edge of the toolbar.		Pause - Pauses active data collection.
	Home - Returns to the Home screen. Icon is located next to the Back icon on the left side of the toolbar.		Start (Capture) - Resumes active data collection.
	Save - Writes data from buffer memory to a file. The saved "movie" file can be accessed for future reference by selecting Previous Vehicles and Data > View Saved Data .		Tools - Opens the Tools menu.

3.3.6 Scroll Bar

A vertical scroll bar appears along the right-hand edge of the screen when additional data expands above or below what is currently on the screen (*Figure 3-3*).

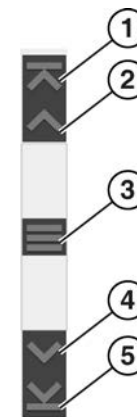

Figure 3-3 Scroll bar

- 1— **Beginning** - Moves to beginning of data displayed.
- 2— **Step up** - Moves up one increment of the data displayed.
- 3— **Slider (position indicator)** - Select and drag the **Slider** to scroll through data. The slider indicates the relative position of the current screen to the total available data.
- 4— **Step down** - Moves down one increment of the data displayed.
- 5— **End** - Moves to end of data displayed.

The Up and Down directional buttons can also be used to move through the data one line at a time. Press and hold a directional button to rapidly scroll through data.



3.4 Screen Messages

3.4.1 Snap-on Messages

Periodically messages will be displayed to inform you of software updates and upgrades, as well as other important information.

These messages require confirmation to resume tool operation. Select **Confirm** or **OK** to resume operation.

3.4.2 General System Messages

There are four types of general system messages that may be displayed:

Message Type	Description
Loading and Connecting	Loading and connecting messages display when the diagnostic tool is performing an internal operation, such as loading a database, establishing communications with the vehicle, or initiating a test. The message automatically clears once the internal operation is complete.
Confirmation	Confirmation messages inform you when you are about to perform an action that cannot be reversed or when an action has been initiated that requires a confirmation to continue. When a response is not required, the message displays briefly, then disappears.
Warning	Warning messages inform you when completing the selected action may result in an irreversible change or in the loss of data. A confirmation is required to continue.
Error	Error messages inform you when a system or procedural error has occurred, for example if the data cable becomes disconnected during operation.

3.4.3 Vehicle Communication Messages

When “no communication” messages are displayed, it indicates the diagnostic tool and the vehicle electronic control module are not communicating.

The following conditions cause “no communication” messages to display:

- The diagnostic tool is unable to establish a communication link with the vehicle.
- The vehicle is not equipped with the system that was selected.
- There is a loose connection.
- There is a blown vehicle fuse.
- There is a wiring fault on the vehicle.
- There is a circuit fault in the data cable or adapter.
- Incorrect vehicle identification was entered.

Refer to the Vehicle Communication Software manuals for manufacturer-specific problems.

This section describes basic data cable connection for automotive applications.

i NOTE

For motorcycle applications see, [Data Cable Connection](#) on page 44.

Connection of the data cable to the diagnostic tool and vehicle data link connector (DLC) is required for diagnostic tool operations that require communication with the vehicle.

Main Topic Links

- [Data Cable Connection \(OBD-II/EOBD Vehicles\)](#) page 11
- [Data Cable Connection OBD-I Vehicles](#) page 13
- For motorcycles see, [Data Cable Connection](#) page 44

4.1 Data Cable Connection (OBD-II/EOBD Vehicles)

IMPORTANT

Only use original Snap-on data cables and accessories with your diagnostic tool. Total data cable length must not exceed 114.17 inches (2.9 meters).



Basic data cable connection procedure:

For OBD-II/EOBD compliant vehicles use the supplied DA-4 data cable.

1. Connect the data cable to the diagnostic tool ([Figure 4-1](#)).



Figure 4-1 DA-4 data cable (26-pin end) connection to diagnostic tool

2. After identifying the vehicle using the Scanner or OBD-II/EOBD function (see [Vehicle Identification](#) on page 21) review any on-screen information that may be provided for data cable connection, usage and DLC location ([Figure 4-2](#)).

i NOTE

On-screen cable and adapter connection instructions may be provided while using the Scanner and OBD-II/EOBD functions. The instructions may also include the location of the vehicle DLC.

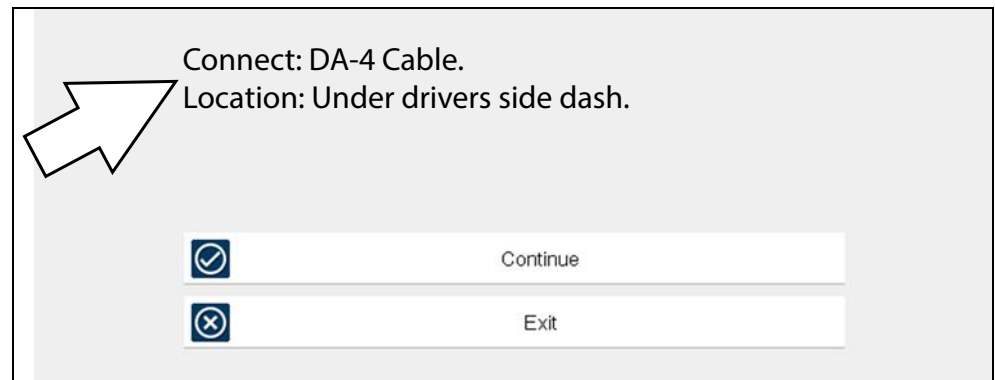

Figure 4-2 Vehicle data cable connection information

**NOTE**

The supplied 9 ft. (2.7 m) DA-4 data cable, includes an LED flashlight on the vehicle DLC connector end (Figure 4-3). The LED flashlight is powered by the diagnostic tool battery.

- If needed, press the LED flashlight button switch on the end of the data cable to turn the LED flashlight on (Figure 4-3), and locate the DLC.

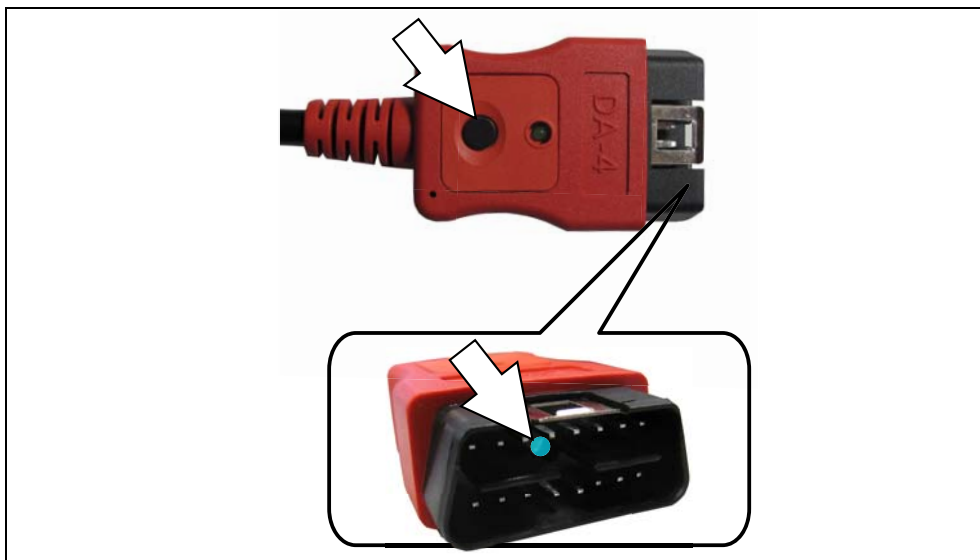

Figure 4-3 DA-4 data cable LED flashlight

- Connect the 16-pin (J-1962) end of DA-4 cable (Figure 4-4) to the vehicle DLC.

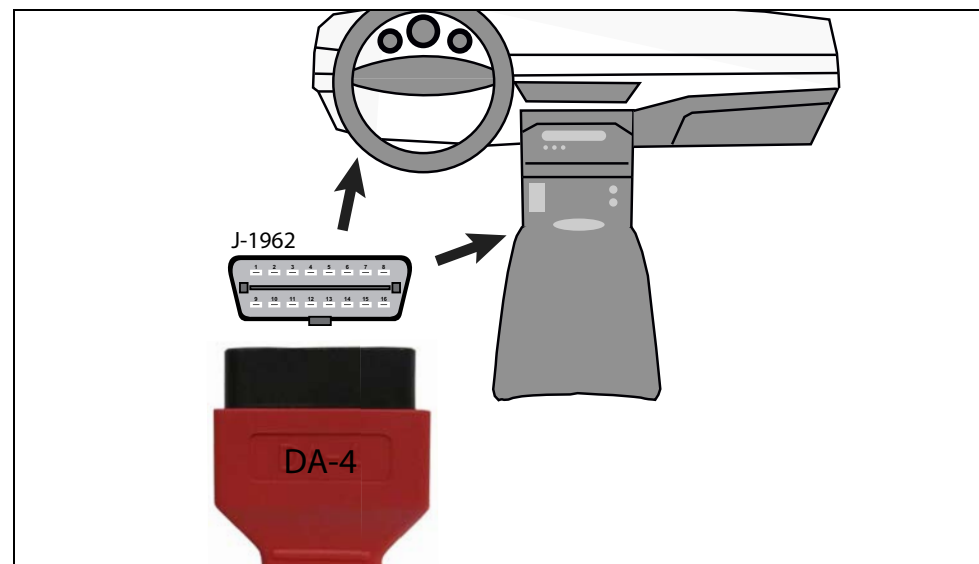

Figure 4-4 DA-4 data cable (16-pin end) connection to vehicle DLC (typical DLC locations)

- Select **Continue** once the data cable is connected. The diagnostic tool establishes communication with the vehicle, then displays a list of available tests, see [Scanner - Automotive](#) on page 19 for additional information.

4.1.1 Optional OBD-II/EOBD Data Cable

A shorter 6 ft. (1.8 m) DA-4 OBD-II data cable is available as an option. Contact your sales representative to purchase all optional accessories.

IMPORTANT

Only use original Snap-on data cables and accessories with your diagnostic tool. Total data cable length must not exceed 114.17 inches (2.9 meters).



4.1.2 Data Cable Connection OBD-I Vehicles

For most OBD-I (non-OBD-II/EOBD) compliant vehicles you can use the supplied DA-4 data cable with the optional DA-5 adapter and an optional manufacturer specific OBD-I adapter (*Figure 4-5*).

- The 26-pin end "A" of the DA-4 cable (*Figure 4-5*) connects to the diagnostic tool.
- The 16-pin end "B" of the DA-4 cable (*Figure 4-5*) connects to the DA-5 adapter "C".
- One end of the manufacturer specific adapter "D" (*Figure 4-5*) connects to the DA-5 adapter.
- The other end of the manufacturer specific adapter "E" (*Figure 4-5*) connects to the vehicle.

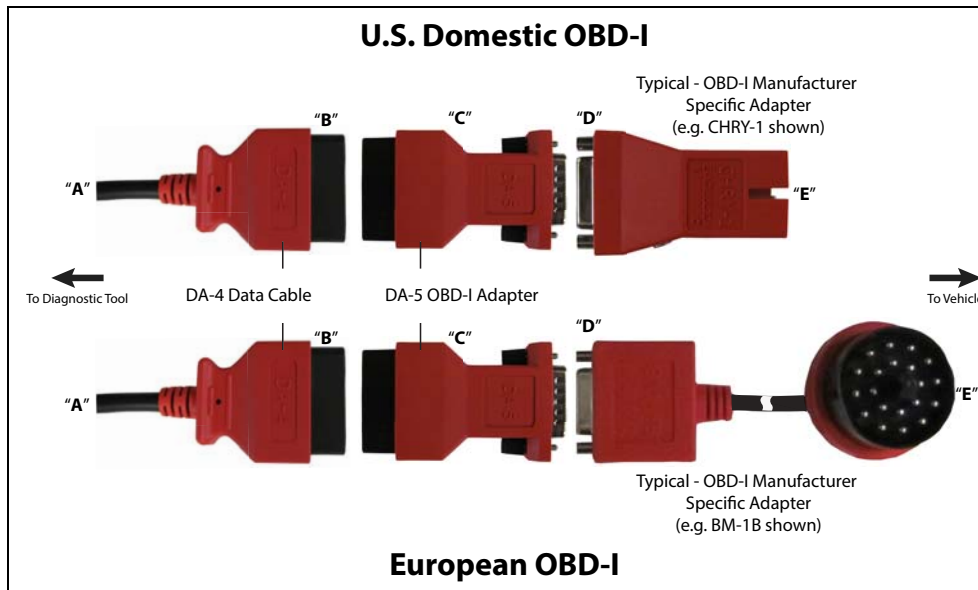

Figure 4-5 Typical connections using DA-5 adapter (two examples)

IMPORTANT

Only use original Snap-on data cables and accessories with your diagnostic tool. Total data cable length must not exceed 114.17 inches (2.9 meters).

Optional OBD-I Data Cables and Adapters

- An optional **OBD-I data cable adapter (DA-5)** is available, which allows connection of the supplied DA-4 (OBD-II/EOBD) cable to the DA-5 adapter. The DA-5 adapter connects to the manufacturer specific OBD-I adapter. This may be used instead of the optional OBD-I data cable.
- An optional **OBD-I data cable** is available, which allows direct connection between the diagnostic tool and the manufacturer specific OBD-I adapter. This may be used instead of the optional DA-5 adapter.
- An optional **U.S. domestic and Asian vehicle OBD-I adapter kit** is available for select vehicles. The kit includes multiple manufacturer specific adapters and cables for OBD-I connection.
- An optional **European vehicle OBD-I adapter kit** is available for select vehicles. The kit includes multiple manufacturer specific adapters, cables and personality keys, providing OBD-I connection capabilities for select vehicles such as Mercedes Benz, VW and BMW. Depending on your diagnostic tool, optional European vehicle software may be required.

Contact your sales representative to purchase all optional accessories and software.



This guide provides step-by-step instructions that allow you to get started using your diagnostic tool, and become familiar with some of the common Scanner and OBD-II functions.

Two built-in demonstration modes allow you to walk-through these functions without connecting to a vehicle:

- [Scanner Demonstration](#)
- [OBD-II/EOBD Demonstration](#)

To become familiar with other capabilities of the Scanner function, watch our product training videos at:

<http://diagnostics.snapon.com/trainingsolutions>

IMPORTANT

Do not connect the diagnostic tool to a vehicle when using the demonstration modes.

Scanner Demonstration

The Scanner demonstration program allows you to navigate through many functions of the Scanner, and displays vehicle data (PIDs) and trouble codes (captured from actual vehicle) to simulate what you might see on an actual vehicle.

The following Scanner demonstrations are intended to be completed in sequence:

- 1 - **Vehicle Identification**
- 2 - **Scan for Engine Codes and Save the Codes**
- 3 - **View, Configure and Save Engine Data (PIDs)**
- 4 - **Perform a Functional Test**
- 5 - **Perform a Code Scan**
- 6 - **View Saved Files (Codes, Code Scan and Data Files)**
- 7 - **Activate a Previously Identified Vehicle and View Engine Data (PIDs)**



Scanner Demo 1 - Vehicle Identification

The first process in communicating with any vehicle is identifying the vehicle. The following walk-through will guide you through this process using the Scanner demonstration mode.

1. From the Home screen, select **Scanner** .
2. Select **Automotive**.
3. The manufacturer (vehicle make) menu displays, select **Demonstration**.

IMPORTANT

Do not connect a vehicle to the diagnostic tool while using the Demonstration program.

4. The simulated Vehicle ID process starts. There are three demonstration vehicles to choose from, for this demonstration select **Chevrolet**.
5. The year menu displays, select **2016-G**
6. The model menu displays, select **Tahoe (4WD) Demo - K**
7. The engine menu displays, select **5.3 V8 (L83) - C**
8. The vehicle confirmation screen displays, select **OK**. (Selecting OK loads the specific vehicle database, in this instance it's our demonstration database).
9. A message displays "**Demo mode: Do not connect to vehicle.**" Select **Continue**.

After the vehicle has been identified, a systems menu displays This menu shows all of the vehicle systems available (supported by the vehicle) for testing. Typical systems choices may include:

• Code Scan	• Body Control Module	• Radio
• Clear All Codes Read by Code Scan	• Door Module - Driver	• Seat Module - Driver
• Engine	• Door Module - Passenger	• Suspension (ESC). If Equipped.
• Transmission	• Heating and Air Conditioning	• Theft Deterrent
• Antilock Brakes	• Instrument Panel Cluster	• Tire Pressure Monitor
• Airbag	• Passenger Presence System	• Transfer Case



Most of the system menu choices are directly related to a specific vehicle system (e.g. Engine, Airbag, Tire Pressure Monitor), with the exception of Code Scan and Clear All Codes Read by Code Scan. Code Scan is a time-saving feature that allows you to scan all supported vehicle systems at once for diagnostic trouble codes (DTCs).

Choosing a vehicle system opens the main menu for that system, which provides options for you to analyze and interact with that system. You can choose to scan for DTCs, clear DTCs, view parameter data (PIDs), perform functional tests and more.

10. Proceed to *Scanner Demo 2*.

Scanner Demo 2 - Scan for Engine Codes and Save the Codes

This demonstration simulates performing a typical check for engine trouble codes, and saving the codes for review at a later time.

1. Select **Engine**.
2. Select **Codes Menu > Display Codes > DTC Display**.
A list of current DTCs is displayed.
3. Select **Save** . A confirmation message will briefly display to inform you that the data file has been saved.
4. Press **Back**  three (3) times to return to the Main Menu (Engine).
5. Proceed to *Scanner Demo 3*

Scanner Demo 3 - View, Configure and Save Engine Data (PIDs)

This demonstration simulates viewing engine data (PIDs) in list and graph views, creating a custom data list, and saving the data for review at a later time.

Viewing PIDs:

1. From the Main Menu (Engine), select **Data Display > Engine Data**.
The Engine Data list is displayed showing all supported PIDs. Use the scroll bar to view all the data.





Changing the displayed view:

2. Select **View**  and then select **PID list** (to display PIDs in a list format) or **4 graphs** (to display 4 PID graphs onscreen). Use the scroll bar to view all the data.

Saving a PID data file:

3. Select **Save** . A confirmation message will briefly display to inform you that the data file has been saved.

Creating a custom PID list:

4. Select **Custom Data** , then select the **Deselect All** .
5. Select **Engine Speed (RPM)**, **MAF Sensor (g/s)**, and **HO2S B1 S1 (V)** from the list. A check mark appears in the box to indicate a selected item.
6. Select **Back** .
You have just created a custom PID list. To change your list, select the Custom Data icon again and modify your selection.
7. Press **Back**  two (2) times to return to the Main Menu (Engine).
8. Proceed to *Scanner Demo 4*



Scanner Demo 4 - Perform a Functional Test

This demonstration simulates performing a functional component test.

NOTE

This functional test demonstration is intended to show a typical testing scenario. The data displayed will not change when performing a test, as it may when testing an actual vehicle.

1. From the Main Menu (Engine) select **Functional Tests**.
2. Select **Output Controls > EVAP Vent Solenoid Valve**
3. A message displays “Test will not function correctly if on-board EVAP diagnostic is running.”, select **Continue**.

The test screen displays showing PIDs related to the system being tested and a functional test icon at the top labeled EVAP Vent Solenoid Valve.

4. Select the **EVAP Vent Solenoid Valve** icon and choose an option **Venting** or **Not Venting**. Notice the current state is indicated “Venting/Not Venting” in the title bar just above the data list on the right side. Toggle the functional icon **Venting/Not Venting** to see the status change.
5. Press **Back**  until the Systems Menu displays.
6. Proceed to *Scanner Demo 5*





Scanner Demo 5 - Perform a Code Scan

This demonstration simulates performing a typical code scan of all supported vehicle systems, and saving the code scan data.

1. From the Systems Menu select **Code Scan**.

The Code Scan results screen displays and starts the automated process of scanning vehicle systems for codes. A status indicator is displayed at the top of the list as the scan is performed.

2. Use the scroll bar to view the complete list.
3. Select **Save** . A confirmation message will briefly display to inform you that the file has been saved.
4. Press **Home**  to return to the Home screen.
5. Proceed to *Scanner Demo 6*



Scanner Demo 6 - View Saved Files (Codes, Code Scan and Data Files)

This demonstration walks you through opening the data files saved in the previous demos.

1. From the Home screen select **Previous Vehicles and Data** .
2. Select **View Saved Data**.



A list of all saved files is displayed (most current at top).

- Code and Code Scan data files are saved with an .XML file extension and show the date saved and vehicle information.
 - Engine data files are saved with an .SCM file extension and also show the date saved and vehicle information.
3. Select the saved data file to view it. If needed, use the scroll bar to view all the data.
 4. Select **Back**  to return to the Previous Vehicles and Data main menu.
 5. Proceed to *Scanner Demo 7*



Scanner Demo 7 - Activate a Previously Identified Vehicle and View Engine Data (PIDs)

This demonstration simulates activating a previously identified vehicle, and viewing engine data.

1. From the Previous Vehicles and Data main menu select **Vehicle History**.
A list of all previously identified vehicles is displayed.
2. For the purpose of this exercise we will select our same demo vehicle, select **2016 Chevrolet Tahoe (4WD) Demo 5.3L V8 (L83)**. **Note:** If other vehicles have been previously identified, they will display in the list.
3. A vehicle confirmation screen displays, select **Continue**.
4. A message displays “**Demo mode: Do not connect to vehicle.**”, select **Continue**.
5. From the Main Menu (Engine), select **Data Display > Engine Data**.
The Engine Data list is displayed showing all supported PIDs. Use the scroll bar to view all the data.
6. Select **Back**  two times (2) to return to Main Menu (Engine), or select **Home**  once to return to the Home screen.

End of Scanner demonstration.

OBD-II/EOBD Demonstration

The OBD-II/EOBD training program allows you to navigate through many functions of OBD-II/EOBD, and displays vehicle data (PIDs) and trouble codes (captured from actual vehicle) to simulate what you might see on an actual vehicle.

NOTE

The OBD-II/EOBD function allows you to access “generic” OBD-II/EOBD data (data limited to emission related diagnostics only). The Scanner function allows you to access vehicle specific systems, parameters and enhanced diagnostics.

The following OBD-II/EOBD demonstrations are intended to be completed in sequence:

- 1 - Start Communication / Vehicle Identification
- 2 - Check Monitors Complete This Cycle
- 3 - Display Current Data
- 4 - Display Trouble Codes
- 5 - Find Trouble Code and Drive Cycle Information
- 6 - Display and Save Freeze Frame Data

OBD-II/EOBD Demo 1 - Start Communication / Vehicle Identification

This demonstration starts the OBD-II/EOBD training demonstration, simulating typical vehicle connection and identification.

1. From the Home screen, select **OBD-II/EOBD** .
2. The main menu displays, select **OBD Direct**.

IMPORTANT





Do not connect a vehicle to the diagnostic tool while using the Demonstration program.

3. Select **OBD Training Mode**.
4. Select **Start Communication**.
5. The demonstration vehicle data is loaded and a confirmation screen displays, select **Continue**.
6. The OBD-II/EOBD Service menu displays.

7. Proceed to *OBD-II/EOBD Demo 2*.

OBD-II/EOBD Demo 2 - Check Monitors Complete This Cycle

This demonstration simulates a typical check of OBD monitors that have run during the current drive cycle.



1. From the OBD-II/EOBD Service menu, select **Readiness Monitors**.
2. Select **Monitors Complete This Cycle**.
3. With the monitor data displayed, select **View**  and then select **PID list** (to display as a list).
4. A list of monitors is displayed showing status indication (e.g. Test Complete , Not Supported  or Not Complete ).

Note: Use the scroll bar to view all the data.

- Select **Back**  two (2) times to return the OBD-II/EOBD Service menu.
5. Proceed to *OBD-II/EOBD Demo 3*.

OBD-II/EOBD Demo 3 - Display Current Data



This demonstration simulates a typical check of current OBD data, viewing OBD data (PIDs) in list and graph views, and creating a custom data list.

1. From the OBD-II/EOBD Service menu select **(\$01) Display Current Data**.
The Engine Data list is displayed. This list shows all supported PIDs, use the scroll bar to view all the data.
2. Select **Custom Data** , then select the **Deselect All** .
3. Select **Short Term Fuel Trim Bank 1(%)** and **Short Term Fuel Trim Bank 2(%)**.
4. Select **Back** .

You have just created a custom PID list. To change your list, select the Custom Data icon again and modify your selection.

5. With the data displayed, select **View**  and then select **PID list** (to display PIDs in a list) or **2 graphs** (to display each PID as a graph).

Notes:

- Use the scroll bar to view all the data in the file, if needed.
- Use the navigation controls to navigate through the data.
- Select the **View** icon  to view the data as a list or graphs.
- Select the **Zoom** icon  and choose a zoom in option (e.g. +2) to view data detail in the graph.

6. Select **Back**  to return to the OBD-II/EOBD Service menu.
7. Proceed to *OBD-II/EOBD Demo 4*.



OBD-II/EOBD Demo 4 - Display Trouble Codes

This demonstration simulates a typical check of current OBD trouble codes.

1. From the OBD-II/EOBD Service menu select **(\$03) Display Trouble Codes**.
A list of OBD trouble codes (DTCs) is displayed.
2. Select **Back**  to return to the OBD-II/EOBD Service menu.
3. Proceed to *OBD-II/EOBD Demo 5*.







OBD-II/EOBD Demo 5 - Find Trouble Code and Drive Cycle Information:

This demonstration walks you through a typical lookup of OBD trouble code reference information and generic drive cycle information within Fast-Track Troubleshooter.

1. From the OBD-II/EOBD Service menu select **Fast-Track Troubleshooter**
2. Select **Engine**.
3. Select ***CODE TIPS**
4. Select ***P0xxx DTC TIP LISTS**
5. Select ***P02xx FUEL & AIR METERING**
6. Select **P0265**
A brief code description is given along with possible causes.
7. Select the **Save Note** icon  to save the note for review* later.
8. Select **Back**  until you return to the OBD-II/EOBD Service menu.
9. Proceed to *OBD-II/EOBD Demo 6*.

OBD-II/EOBD Demo 6 - Display and Save Freeze Frame Data:

This demonstration walks you through a typical check of OBD Freeze Frame data, and shows how to save and review the data.

1. From the OBD-II/EOBD Service menu select **(\$02) Display Freeze Frame Data**.
A freeze frame list of data is displayed. **Note:** Use the scroll bar to view all the data.
2. Select **Save** . A confirmation message will briefly display to inform you that a file has been saved.
3. Select **Back**  once, then press **Home**  once to return to the Home screen.
4. From the Home screen select **Previous Vehicles and Data** .
5. Select **View Saved Data**.
A list of all saved files is displayed (most current at top). OBD-II/EOBD Freeze Frame files are saved with an .SCM file extension, show the date saved and are labeled OBD.
6. Select the saved Freeze Frame file to view it.
Notes:
 - Use the scroll bar to view all the data in the file, if needed.
 - Use the navigation controls to navigate through the data.
7. Select **Back**  once, then press **Home**  once to return to the Home screen.

End of OBD-II/EOBD demonstration.



This section describes the basic operation of the Scanner function for automotive applications.



The **Scanner** icon is located on the Home screen.

The Scanner function allows your diagnostic tool to communicate with the electronic control modules (ECMs) of the vehicle being serviced. This allows you to perform tests, view diagnostic trouble codes (DTCs), and live data parameters from various vehicle systems such as the engine, transmission, antilock brake system (ABS) and more.

Main Topic Links

- [Features and Icons](#) page 20
- [Scanner - Starting / Stopping](#) page 20
- [Scanner Control Icons](#) page 27
- [Vehicle Identification](#) page 21
- [Codes Menu](#) page 24
- [Codes - View / Save](#) page 24
- [Using Code Scan](#) page 48
- [Viewing and Saving Data \(PIDs\)](#) page 26
- [Functional Tests](#) page 38
- [SureTrack \(Scanner\)](#) page 111

6.1 Basic Operation

6.1.1 Scanner Overview

Scanner is a menu driven application that communicates with vehicle control modules to access diagnostic trouble codes (DTCs), parameter data (PIDs), functional tests, and more. To navigate the application, use your fingertip or the control buttons to make onscreen menu selections to access the desired data, test or function.

Screen messages appear when additional input is needed before proceeding. There are three types of on-screen messages; confirmations, warnings, and errors.

- **Confirmation Messages** - Confirmation messages inform you when you are about to perform an action that cannot be reversed or when an action has been initiated and your confirmation is needed to continue. When a user-response is not required to continue, the message displays briefly before automatically disappearing.
- **Warning Messages** - Warning messages inform you when completing the selected action may result in an irreversible change or loss of data.
- **Error Messages** - Error messages inform you when a system or procedural error has occurred. Examples of possible errors include a disconnected cable or a peripheral, such as a printer, is powered off.

6.1.2 Scanner - Starting / Stopping

▶ To start the Scanner function:

1. From the Home screen, select the **Scanner** icon.
2. Select **Automotive** or **Motorcycle**.

The vehicle identification process starts. The vehicle must be correctly identified for the diagnostic tool to communicate, and display data correctly.

For an introduction to using Scanner for Motorcycles, see [Scanner - Motorcycle](#) on page 41.

3. Follow the onscreen instructions to identify the vehicle and connect the data cable. See [Vehicle Identification](#) on page 21.

ⓘ NOTE

Damage to the vehicle electronic control module (ECM) may occur if communication is disrupted. Make sure the data cable is properly connected at all times during testing. Exit all tests before disconnecting the data cable or powering down the diagnostic tool.

The Scanner function remains open as long as there is an active communication link with the vehicle. You must interrupt this communication link in order to exit from tests and power down the diagnostic tool. A warning message displays if you attempt to shut down while the diagnostic tool is communicating with the vehicle.

▶ To exit the Scanner function:

1. From any active Scanner screen, select the **Back** icon on the toolbar.
The “stopping communications” message briefly displays followed by the Data menu.
2. From the Data Menu, select **Back** on the toolbar.
The “stopping communications” message displays again, then the Main menu. Once the Main menu is displayed, communication has been terminated and it is safe to return to the Home screen and power down the diagnostic tool.

6.2 Features and Icons

The following general features and control icons apply to both the Scanner and the OBD-II/EOBD functions.

6.2.1 Scanner Features

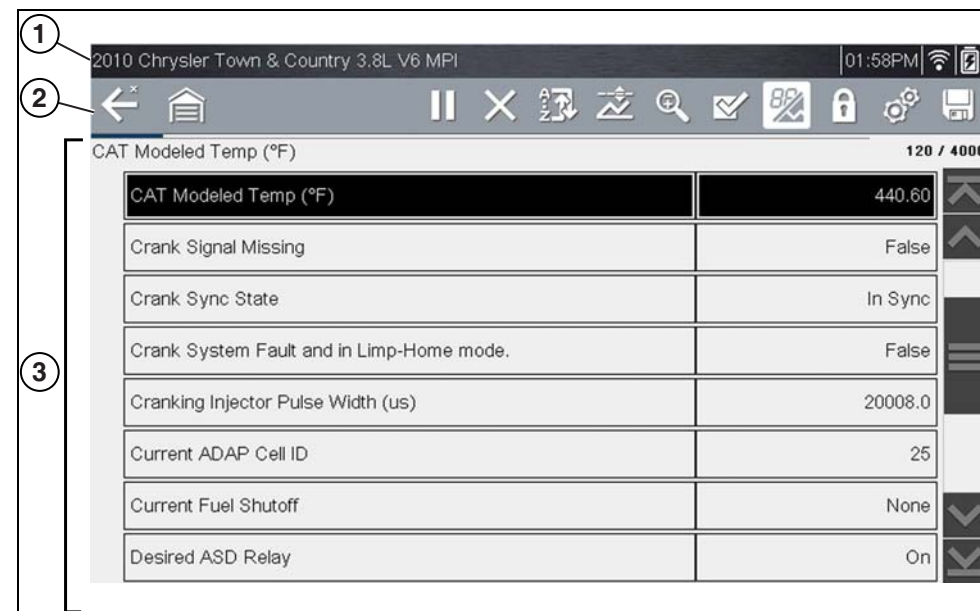

- 1— Title bar**—shows active test, vehicle and diagnostic tool status. The Title bar appears for all functions and displays information only, there are no selectable items. See [Title Bar](#) on page 8.
- 2— Toolbar**—contains control icons
- 3— Main body**—displays menus, code results, PIDs, etc.

Figure 6-1 Scanner screen features



6.2.2 Basic Scanner Operation (Quick Start)

This section lists the basic scanner operation steps, and is only intended as a quick-start reference. Refer to the supporting topics in this section for detailed operation information.



Getting Started (Basic Steps)

i NOTE

Menus, options and procedures may vary by vehicle. The following instructions apply to most OBD-II vehicles. Not all vehicles support the Auto ID and, or Instant ID feature.

1. Turn the vehicle ignition switch on.
2. Connect the data cable to the vehicle DLC. See [Data Cable Connection \(OBD-II/EOBD Vehicles\)](#) on page 11.
The diagnostic tool will turn on automatically when connected to the vehicle.
3. Select **Scanner** from the Home screen.

i NOTE

While using the Scanner and OBD-II/EOBD functions, on-screen data cable connection instructions are provided. The instructions may include the location of the vehicle DLC.

4. Depending on the vehicle, Instant ID may occur. See [Instant ID](#) on page 23 for additional information.
5. If Instant ID is not supported, after selecting vehicle make (and year if needed), choose **Automatic ID** or **Manual ID** and enter the vehicle information at the screen prompts to continue. See [Vehicle Identification](#) on page 21.
If Automatic ID is selected, the identification process automatically completes (if supported by the vehicle).
6. Select a **Vehicle System** (e.g. Engine, Transmission).
7. Select a **Vehicle System Test/Function** (e.g. Codes Menu) to perform. See [System Main Menu Options](#) on page 24.

6.2.3 Vehicle Identification

The vehicle must be correctly identified for the diagnostic tool to communicate, and display data correctly. Menus and navigation will vary by vehicle.

Depending on the vehicle, the vehicle identification process may require manual entry of the vehicle information, or it may be automated. The following three Scanner functions are available to identify the vehicle:

Instant ID - Automatically completes the identification process upon initial communication between diagnostic tool and the vehicle using OBD-II VIN mode \$09. Instant ID requires specific vehicle support and procedures, see [Instant ID](#) on page 23 for additional information.

Auto ID - Automatically completes the identification process after the vehicle make and year are manually entered.

Manual ID - Allows for manual entry of all required vehicle identification criteria.



Use the following procedure to identify a vehicle.

i NOTE

The following procedure applies to most OBD-II vehicles, and may vary depending on the vehicle. Not all vehicles support the Instant ID and/or Auto ID functions.

1. Connect the data cable to the diagnostic tool. See [Data Cable Connection \(OBD-II/EOBD Vehicles\)](#) on page 11.
2. Turn the vehicle ignition switch on.
3. Connect the data cable to the vehicle data link connector (DLC). See [Data Cable Connection \(OBD-II/EOBD Vehicles\)](#) on page 11.

i NOTE

On-screen cable and adapter connection instructions may be provided while using the Scanner and OBD-II/EOBD functions. The instructions may also include the location of the vehicle DLC ([Figure 6-2](#)).

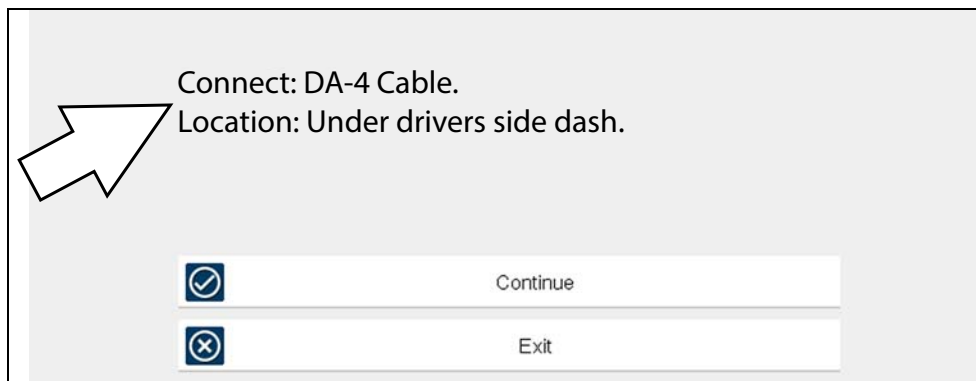

Figure 6-2 Vehicle connection data cable message

4. If the diagnostic tool is off, when the OBD-II data cable is connected to the vehicle DLC, the diagnostic tool should automatically turn on. If the tool did not turn on when the data cable was connected to the vehicle, check the vehicle DLC for power. Most OBD-II vehicles supply power to the DLC, which in-turn supplies power and turns on the diagnostic tool when the cable is connected.
5. If required, turn the diagnostic tool on.
6. Depending on the vehicle:
 - a. Instant ID may occur, as indicated by an audible "beep" approximately 6 seconds after boot-up. Select the **Scanner** icon, then wait for the vehicle confirmation screen ([Figure 6-3](#)) and select **OK** to continue. Then proceed to **step 6**. See [Instant ID](#) on page 23, for additional information about this function.

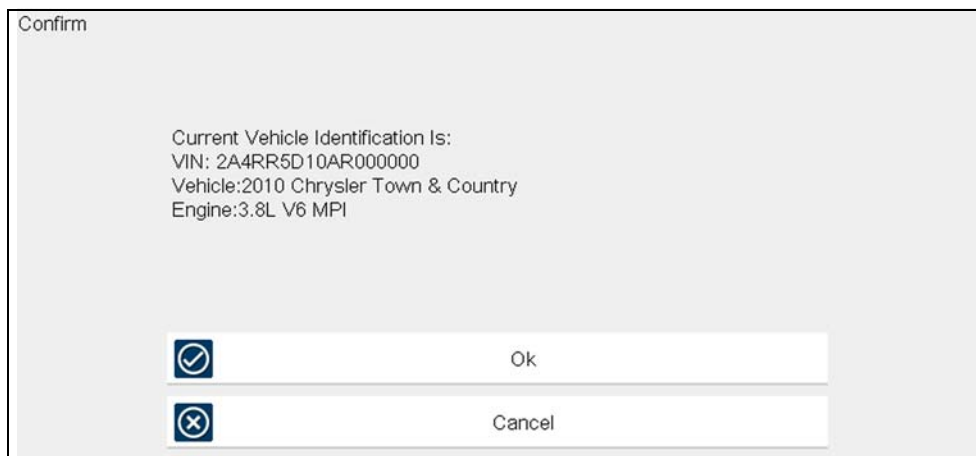

Figure 6-3 Vehicle confirmation screen

- b. If Instant ID is not supported, you will be prompted to select the vehicle make and year (If needed). Then a menu option is displayed to choose either **Automatic ID** or **Manual ID**.

- Selecting **Automatic ID** (If supported by the vehicle) will briefly display a communications screen informing you that the diagnostic tool is attempting to establish communication with the vehicle and determine vehicle identification.

Once the vehicle has been identified, the vehicle confirmation screen displays. If the vehicle information is correct, select **OK** to continue, then proceed to step 6.

If the vehicle does not support Auto ID, the diagnostic tool will attempt to identify the vehicle and then display a message indicating that vehicle identification cannot be made. If this occurs, proceed to "**Selecting Manual ID**" next.

- **Selecting Manual ID** allows you to manually enter all the vehicle information to identify the vehicle.

b1.) Follow the screen prompts to enter all the information required to identify the vehicle.

b2.) Once the vehicle has been identified, the vehicle confirmation screen displays ([Figure 6-3](#)). If the vehicle information is correct, select **OK** to continue, then proceed to step 6.

7. After the vehicle is identified, a menu of available systems, and options are displayed. Select a system or option ([Figure 6-4](#)).

i NOTE

Only the systems and options supported for the vehicle are included in the menu list.

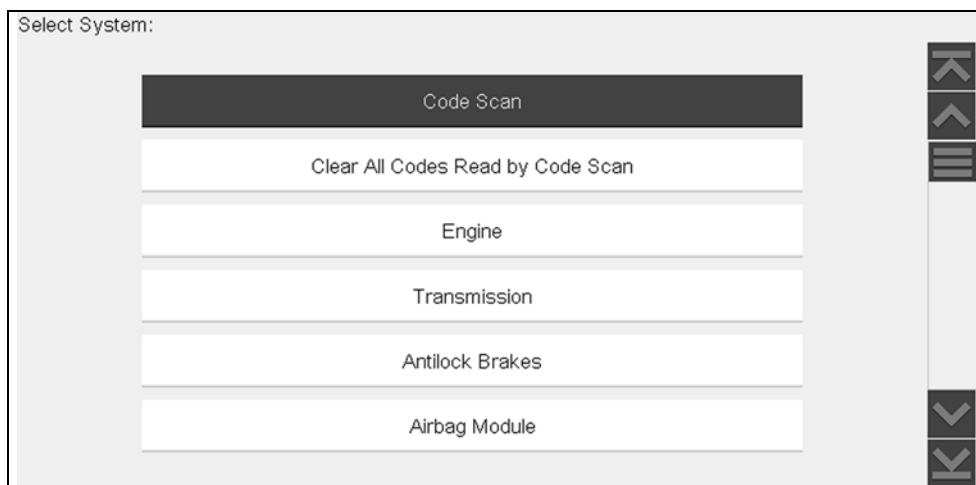

Figure 6-4 Typical systems menu

If a system (e.g. Engine, Transmission, Antilock Brakes, etc) is selected, the diagnostic tool may establish communication with the vehicle, then display the system main menu (available tests) (Figure 6-5). For sub-menu option information, see [System Main Menu Options](#) on page 24.

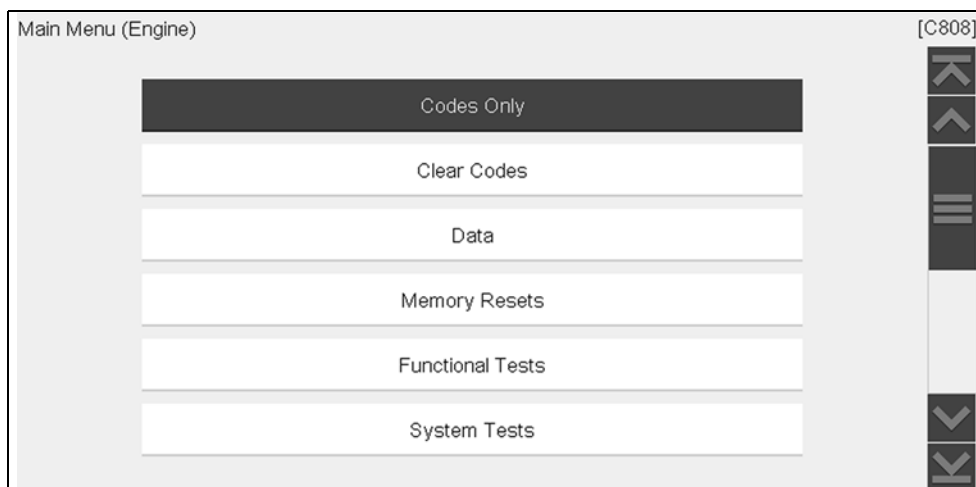

Figure 6-5 System main menu

Instant ID

The Instant ID function, can save time when initially identifying a vehicle, by automatically communicating with the vehicle to complete the vehicle identification process.

This function requires specific vehicle support requirements, and connection procedures to operate.

- **Vehicle requirements:**
 - Vehicle must support Mode \$09 VIN.
 - **Note:** Mode \$09 VIN is mandated on 2008 and newer vehicles.
 - Vehicle must be equipped with Hi Speed CAN or J1850 communication protocol.
- **Connection procedure requirements:**
 - 1.) Turn the vehicle ignition on.
 - 2.) Connect the data cable to the diagnostic tool.
 - 3.) Connect the data cable to the vehicle data link connector (DLC).
 - 4.) The diagnostic tool should turn on automatically. If required, turn the diagnostic tool on.

An audible "beep" will sound approximately 6 seconds after boot-up, if the VIN is read.

Note: No visual confirmation is displayed.

 - 5.) Select **Scanner**.

When Scanner is selected, a screen may briefly appear informing you the diagnostic tool is attempting to automatically complete the vehicle identification process.

 - 6.) After the vehicle has been identified, the vehicle confirmation screen displays. If the vehicle information is correct, select **OK** to continue.

i NOTE

Depending on the vehicle, Instant ID may occur automatically and only ask you to confirm the vehicle, or additional screen prompts may be displayed to enter vehicle information.

**NOTE**

If the Scanner feature is exited during the session that Instant ID was used, selecting Scanner again, will not ID the vehicle again. To quickly ID the vehicle again, select it from **Previous Vehicles and Data > Vehicle History**.

If the vehicle is not automatically identified, follow the screen prompts to enter the information required to identify the vehicle.

Alternative Vehicle Identification

Occasionally, you may try to identify a test vehicle that the Scanner does not recognize, the database does not support, or has some unique characteristics that prevents it from communicating with the Scanner. In these instances, there is an alternate choice that allows you to establish communication with the vehicle:

- **OBDII/EOBD Function**—this function allows you to connect to the OBDII equipped vehicle and perform basic OBD-II or EOBD diagnostic functions, see [OBD-II/EOBD](#) on page 67 for additional information.

6.2.4 System Main Menu Options

Once a System is selected (e.g. Engine, Transmission, Antilock Brakes, etc) is selected, the diagnostic tool may establish communication with the vehicle, then display the System Main Menu (available tests).

NOTE

Menus and navigation will vary by vehicle.

The System Main Menu may include:

- **Codes Menu**—displays diagnostic trouble code (DTC) records from the vehicle electronic control module. Selecting may open a submenu of viewing options.
- **Clear Codes**—erases DTC records and other data from the ECM. This selection is found on a Codes submenu for some models.
- **Data Display**— displays PID data from the vehicle electronic control module. Selecting may open a submenu of viewing options.
- **Functional Tests**—provides specific subsystem tests. The tests vary depending on the manufacturer and model.

- **Actuator Tests**—similar to functional tests, checks the operation of certain actuators, such as solenoid valves and relays.
- **Memory Resets**—allows you to reprogram adaptive values for certain components after making repairs. Selecting opens a submenu. These options are found on the Functional Tests Menu for some models.
- **System Tests**—provides specific subsystem testing. Performing these tests is similar to functional tests.
- **Generic Functions**—lets you access certain available Generic OBD II functions from a proprietary menu (1996 and newer vehicles only).
- **Troubleshooter**—provides step-by-step procedures, integrating PIDs and retrieving trouble codes when appropriate, for specific symptoms of the identified vehicle.

The following sections, describe some of the System Main Menu items listed above.

6.3 Codes - View / Save**6.3.1 Codes Menu**

After selecting a System, this selection “Codes Menu” may appear as a different name (e.g Codes, Codes Menu, Codes Only, Codes (No Data), Service Codes) or something similar depending on the vehicle manufacturer. Options may include:

- [Display Codes](#)
- [Clear Codes](#) on page 25
- [Freeze Frame/Failure Records](#) on page 25

Display Codes

This function opens either a list of diagnostic trouble codes (DTCs) stored in the selected vehicle electronic control module (ECM), or a submenu of DTC viewing options. The code list includes the DTC and a brief description ([Figure 6-6](#)).

If SureTrack® (optional) is active and data is available for a selected DTC, additional troubleshooting information from SureTrack (e.g. Common Replaced Parts data ([Figure 6-6](#)), Real Fix and Related Fixes) may also be available. For additional information about using SureTrack, see [SureTrack \(Scanner\)](#) on page 111.

Quick Link: [SureTrack \(Scanner\)](#)

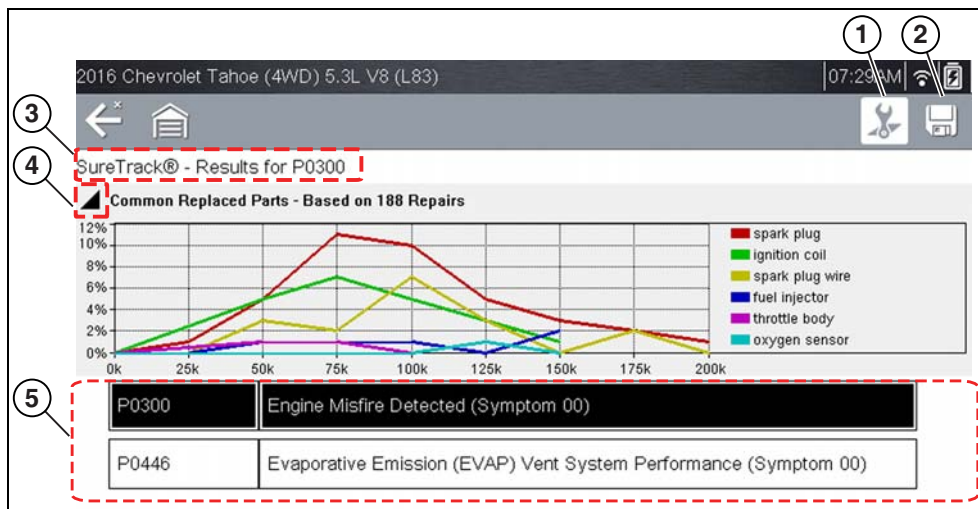

- 1— **Fix It! Icon** — opens SureTrack Dashboard, see [Dashboard](#) on page 113
- 2— **Save Icon** — saves the displayed DTCs to an (.XML) file, see [Viewing Codes and Code Scan Results](#) on page 75
- 3— **SureTrack Status Bar** — displays active SureTrack status or result
- 4— **Common Replaced Parts Graph Icon** — toggles graph display on/off
- 5— **DTC Results List** — displays current DTCs

Figure 6-6 DTC results

Submenu options may include:

- **Trouble Code Information**—opens a list of codes in ECM memory
- **History Codes**—opens a list of codes whose symptoms are not currently present. History codes indicate an intermittently occurring problem.
- **Failed This Ignition**—opens a list of codes that set during the current ignition cycle.
- **MIL SVS or Message Requested**—displays ECM requests to turn on the malfunction indicator lamp (MIL) or service vehicle soon (SVS) lamp, or display a driver information alert.
- **Last Test Failed**—displays a complete list of failed tests.
- **Test Failed Since Code Cleared**—displays a list of tests that failed since the last time codes were cleared from ECM memory.

Clear Codes

The diagnostic tool clears codes from the vehicle electronic control module memory on most vehicles. If this function is not available on the test vehicle, Clear Codes does not appear as a menu option.



To clear codes:

1. Select **Clear Codes** from the Codes Menu.
A confirmation message displays.
2. Make sure any conditions shown on the confirmation message are met, then select **Yes**.
A “codes cleared” message displays once the operation is complete.
3. Select **Continue** to return to the Codes Menu.

IMPORTANT

Clearing codes erases all temporary ECM information, including Freeze Frame/Failure Records. Make sure no vital diagnostic information will be lost before clearing codes.

Freeze Frame/Failure Records

Selecting **Freeze Frame/Failure Records**, displays the DTC that was set.

Then when the Freeze Frame icon ([Figure 6-7](#)) is selected, the corresponding Freeze Frame data that was captured when the ECM commanded the malfunction indicator lamp (MIL) to turn on, is displayed.

SureTrack (if activated) repair information may be available for the selected code. Select the **Fix It!** icon on the toolbar to display the information.

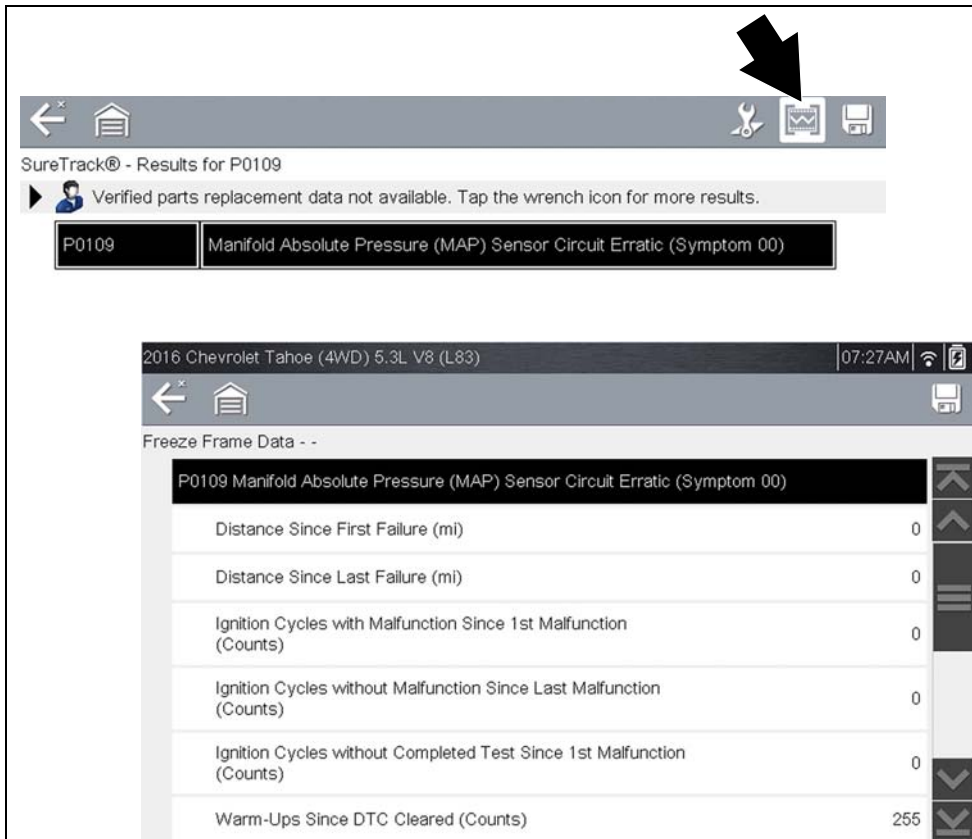

Figure 6-7

6.3.2 Code Scan (with Vehicle System Report/Snap-on Cloud)

Code Scan is available from the Vehicle System menu, and when selected it scans the vehicle control modules for codes. For detailed information see [Vehicle Code Scan / \(Snap-on Cloud\)](#) on page 51.

6.4 Viewing and Saving Data (PIDs)

Selecting **Data** or other similar data menu option (depending on the vehicle manufacturer) displays PID data for the selected system ([Figure 6-8](#)).



Figure 6-8 Data display (PID List view)

During data display the main body of the screen is divided into two columns; the left-hand column has a description of the parameter and the right-hand column shows the current parameter value or state. PIDs are listed in the order in which they are transmitted by the ECM, so variations between years, makes, and models will occur. The toolbar control icons are described in [Scanner Control Icons](#) on page 27 and [Common Toolbar Control Icons](#) on page 9.

To display the next data list, select the **Right Arrow** icon ([Figure 6-9](#)).



Figure 6-9

6.4.1 Scanner Control Icons

The scanner toolbar contains control icons. Control icons may vary depending on the active function or test. An inverted (highlighted) icon indicates it is selected. Other control icons (not shown) are described in [Common Toolbar Control Icons](#) on page 9.

Icon	Function	Icon	Function
	Start (Capture) - Resumes active data collection.		Save - Writes data from buffer memory to a file. The saved "movie" file can be accessed for future reference by selecting Previous Vehicles and Data > View Saved Data .
	Pause - Pauses active data collection.		Custom Data List - Opens a menu for selecting which PIDs display in the list.
	Clear - Erases all the PID data in the buffer and begins a new recording. Selecting opens a confirmation message.		Change View - Changes display options between PID list or graph displays.
	Trigger - Opens a menu that allows you to set, arm, and clear threshold values that automatically trigger PID data to be saved from buffer memory to a file.		Lock/Unlock - Locks or unlocks the highlighted parameter. Locked PIDs move to the top of the list and do not scroll as you move through the data.
	Zoom - Incrementally increases and decreases the scale of the data being displayed.		Sort - Determines the order in which PIDs are listed on the screen.
	Step Forward - Allows forward movement in singular steps. (Note: To quickly step forward during Scanner data review, press and hold the icon down.)		Step Back - Allows backward movement in singular steps. (Note: To quickly step backward during Scanner data review, press and hold the icon down.)
	Skip Forward - Allows forward movement in multiple steps.		Skip Back - Allows backward movement in multiple steps.

6.4.2 About the Data Buffer

The diagnostic tool has the capability to collect, store and save PID data utilizing internal storage memory and buffer memory.

When Data is displayed onscreen, a data buffer automatically starts to store it in buffer memory. The data buffer runs continuously (storing data) until the Pause, Clear, or Save icon is selected.

Buffer memory is limited to a predetermined "total" size. When buffer memory reaches it's full capacity, the data buffer will continue to store new data, however earlier stored data will be removed to allow room for the new data being stored.

The most recent data is always available for review when Pause is pressed, and can be reviewed using the toolbar controls.

The Data Buffer Indicator ([Figure 6-10](#) left arrow) can be used to visually see the amount of stored buffer data. This graphical indicator uses a bar graph to show how much stored data is in the memory buffer.

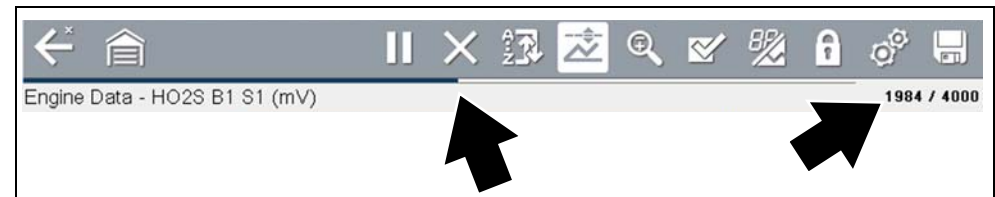

Figure 6-10

The Data Buffer Position Counter ([Figure 6-10](#) right arrow and [Figure 6-11](#)) indicates:

- first value = the numerical position of the active data point as displayed within buffer memory
- second value = indicates the maximum data buffer size value (e.g. 4000)

[Figure 6-11](#) (right arrows) shows the relationship between the graph scale and the first value in the Position Counter.

During data review a slider on the bar graph ([Figure 6-11](#) left arrow), indicates the position of the current data point as displayed in relation to the entire memory buffer contents.

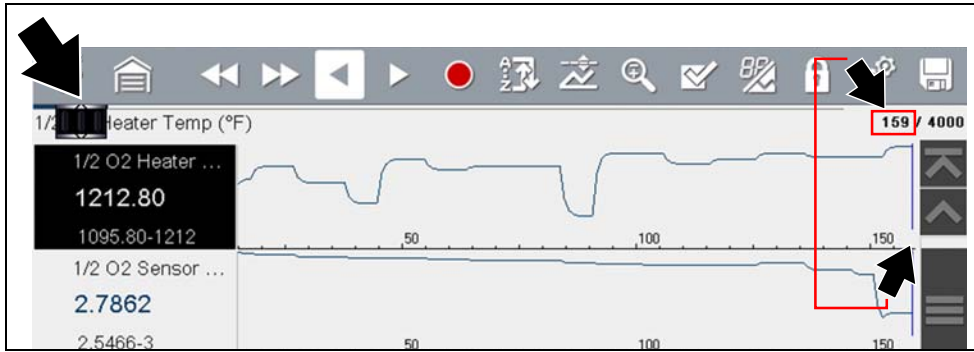

Figure 6-11

6.4.3 About Cursors

Vertical cursors are automatically displayed (in graphical PID views) to mark specific data reference points.

Gray (Pause/Save) - If you select Pause or Save while collecting data, a vertical gray cursor is automatically placed at that point in the data to indicate where the data was paused or saved.

- Each time Pause is pressed an additional cursor is added, and appears when Record is pressed to resume data collection.
- Each time Save is pressed an additional cursor is added, and appears when the data starts again after a slight pause to save the file.
- Cursors are displayed in all PIDs as reference markers.
- Cursors are retained and appear in saved data files.

Blue (Current Position) - If you select Pause while collecting data, a vertical blue cursor is displayed as an indicator to your position in the data and is denoted by the current position value in the counter display.

- Cursors are displayed in all PIDs as reference markers.
- Depending on the amount of data saved the blue cursor may be initially located on the far left next to the description, or the far right next to the scroll bar making it difficult to see. If this happens, use the control icons (Step/Skip) to move the data until you can see the cursor.

Red (Triggered PID Activation Point) - When using triggers, a vertical red cursor is displayed in the data of the triggered PID at the point where the trigger was activated.

- When multiple PIDs are armed, only the PID that is triggered first will display a red cursor.

Green (Trigger Activation Reference Point) - When using triggers, green vertical cursors are displayed in all PIDs (except the PID that was triggered) as reference to the triggered PID activation point.

- When a trigger is activated the displayed red and green cursors are all vertically aligned in the graphed data to show the relationship of the trigger point in all PIDs.

6.4.4 Pausing and Reviewing Active Data

During normal operation, data from the vehicle's ECM is continuously being stored in buffer memory as it is displayed onscreen. The Pause icon, allows you to temporarily pause data collection to review it in detail.



To pause and review active data:

While collecting data, select the **Pause** icon ([Figure 6-12](#)).

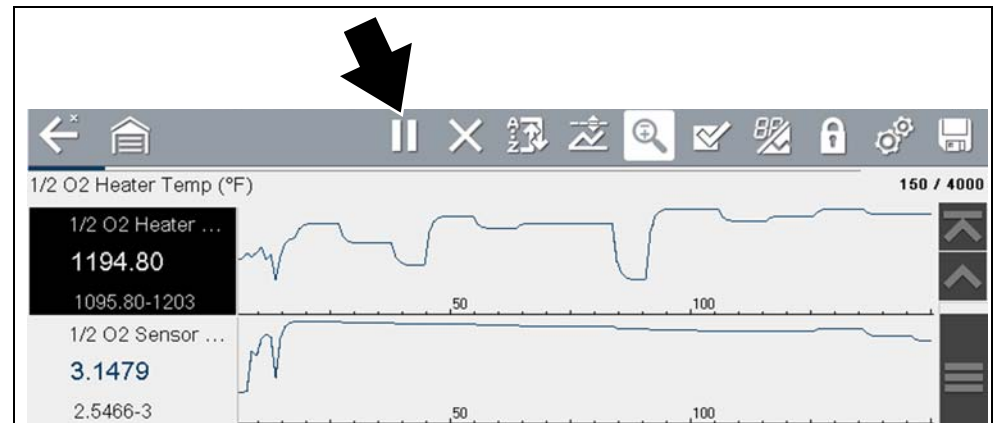

Figure 6-12

Toolbar control icons are described in [Scanner Control Icons](#) on page 27 and [Common Toolbar Control Icons](#) on page 9.

After Pause is pressed:

- Review control icons are displayed in the toolbar ([Figure 6-13](#)). Use the control icons to accurately move through the data.
- The blue (vertical cursor) ([Figure 6-13](#)) indicates your position in the data and is denoted by the current position value in the counter display. This cursor displays in all PIDs.

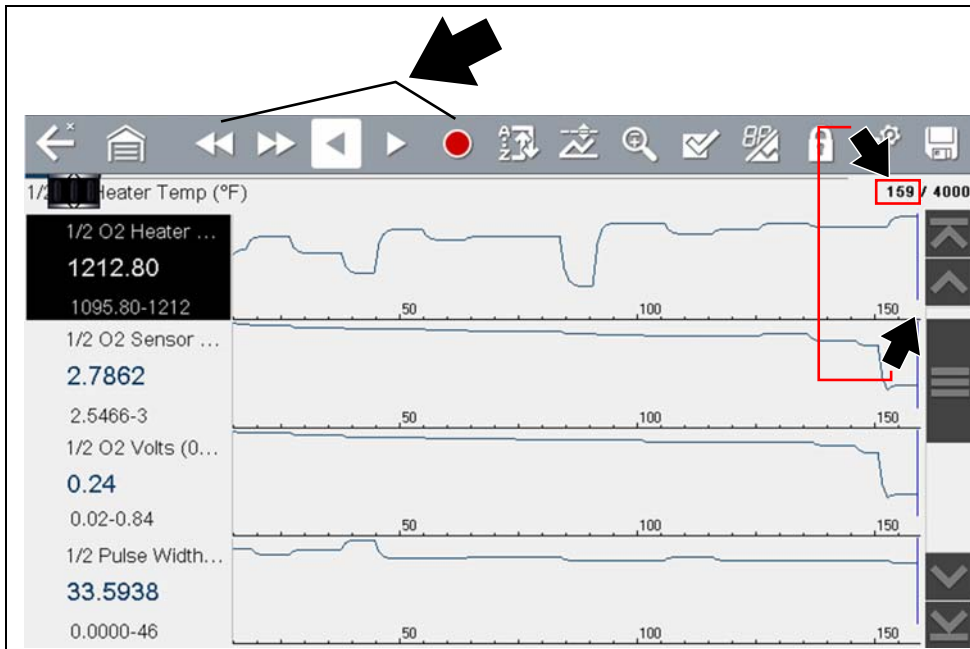

Figure 6-13

NOTE

The **Shortcut** icon can be set to perform the Pause/Play function. See [Configure Shortcut Button](#) on page 79 for additional information.

▶ To resume data collection (after pausing):

- Select the **Start** icon .

The screen changes back to display data ([Figure 6-14](#)).

A vertical gray cursor is displayed on all PIDs, indicating where the data was paused ([Figure 6-14](#)).

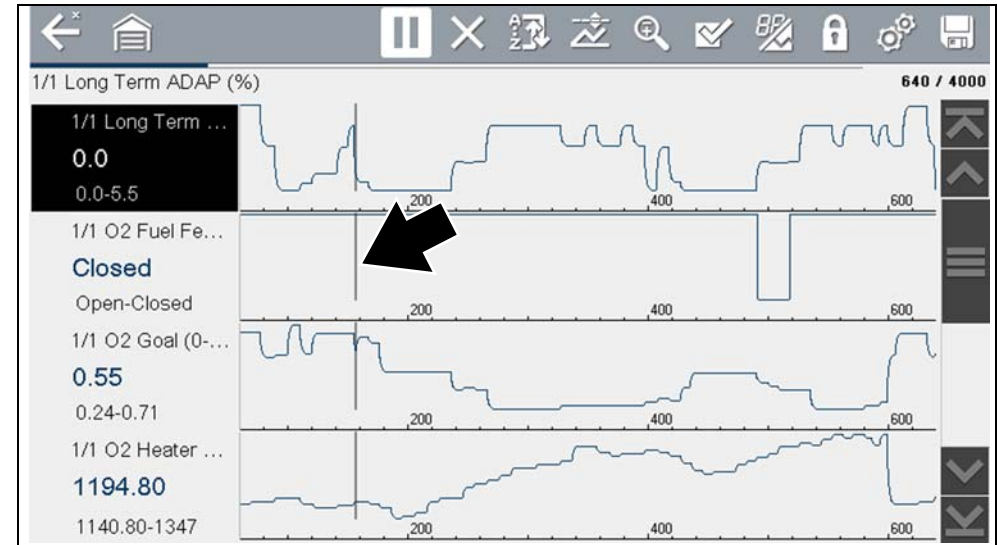

Figure 6-14

6.4.5 Saving Data Files

Saving data is useful when trying to isolate an intermittent problem or to verify a repair. During normal operation, data from the vehicle's ECM is continuously being stored in buffer memory as it is displayed onscreen. Selecting **Save** writes stored buffer memory to a file.

NOTE

The **Save icon** performs the same function as "Save Movie" function choice for the programmable **Shortcut** button, see [Configure Shortcut Button](#) on page 79 for details.

To save data:

While capturing or reviewing data, select the **Save** icon.

An onscreen message is displayed to indicate the data file is being saved ([Figure 6-15](#)).

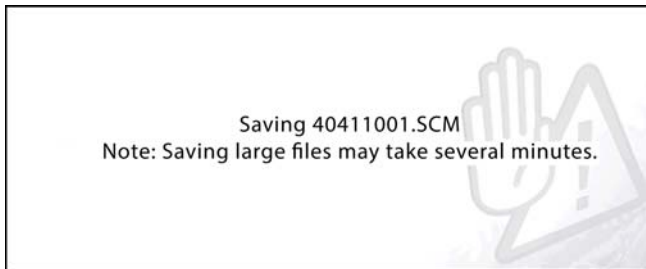

Figure 6-15 Save dialog box

To view saved data (on the diagnostic tool):

The saved file can be viewed by selecting **Previous Vehicles and Data > View Saved Data**. See [View Saved Data](#) on page 75 for basic navigation.

1. Select the desired data file (.SCM file extension).
2. Change the view type and zoom levels as needed.
3. In graph view, use the control icons to move through the data ([Figure 6-16](#)).
Toolbar control icons are described in [Scanner Control Icons](#) on page 27 and [Common Toolbar Control Icons](#) on page 9.

The blue (vertical cursor) ([Figure 6-16](#)) indicates your position in the data and is denoted by the current position value ([Figure 6-16](#)) in the counter display. The cursor displays in all PIDs.

Depending on the amount of data saved the cursor may be initially located on the far left next to the description, or the far right next to the scroll bar making it difficult to see. If this happens, use the control icons to move the data until you can see the cursor.

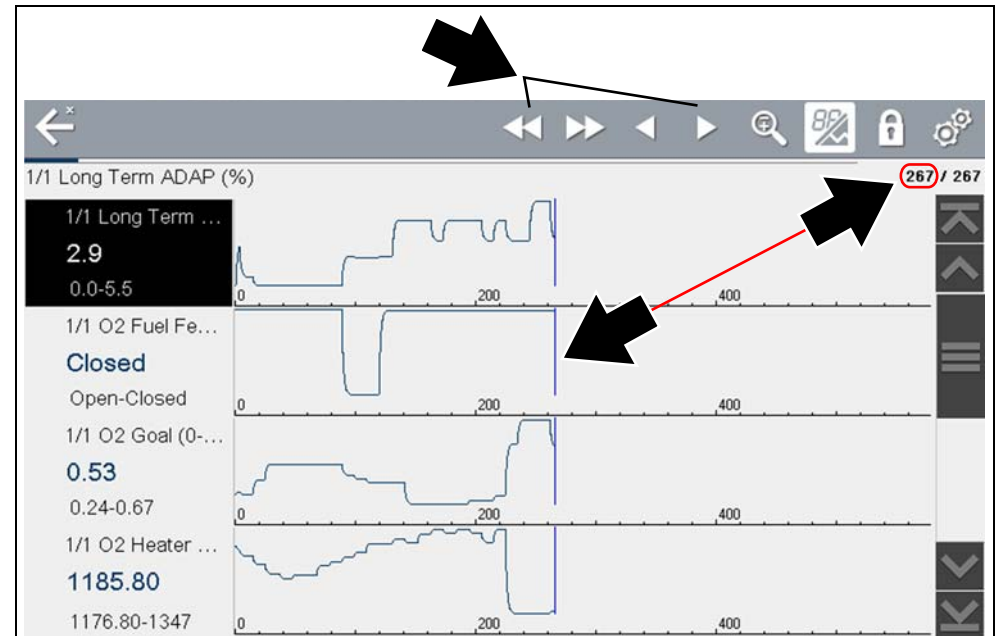

Figure 6-16

Pressing the Save icon more than once in the same data collection session will create multiple (.SCM) files. Each file will contain gray (vertical cursors) ([Figure 6-16](#)) indicating where the data was paused.

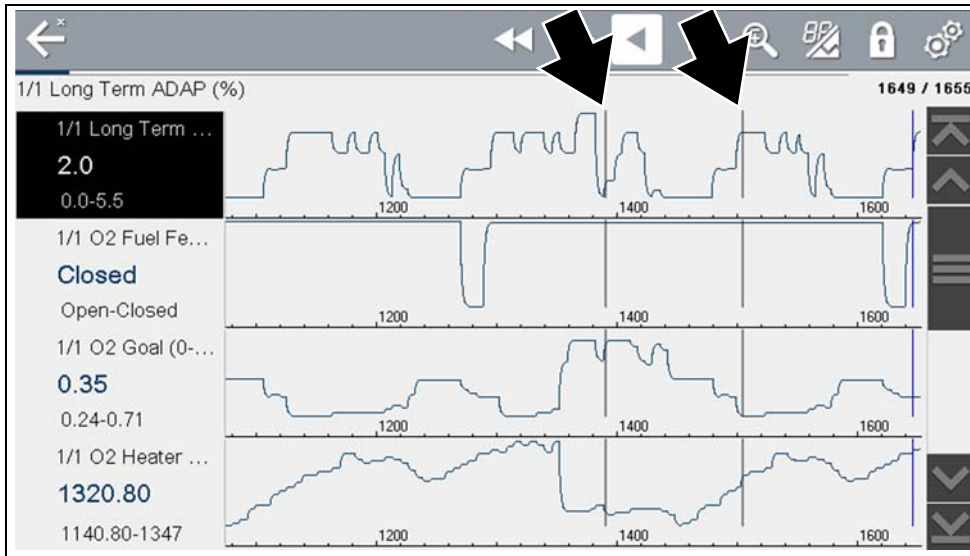

Figure 6-17

▶ To view saved data (on a PC)

Saved data files can also be downloaded to a personal computer (PC) using the Mini USB jack. Once connected to the PC, the data files can be printed, transferred, and copied using ShopStream Connect. ShopStream Connect is an application that creates an interface between the diagnostic tool and a PC. The ShopStream Connect application is available free online, see [ShopStream Connect™](#) on page 119.

6.4.6 Using Zoom



The zoom function allows you to change the magnification level of the graphed data during data collection and review. Changing magnification levels allows you to compress or expand the displayed data to quickly find glitches, or signal losses.

When the **Zoom** icon is selected the dropdown menu allows you to select the display magnification level from a range of -2X to +8X. The "Zoom Out" option displays up to half of the maximum amount of data that can be collected, on one screen. The default magnification level is 1x.

Examples: Top (+4X), Middle (1X), Bottom (Zoom Out)



Figure 6-18 Zoom examples

6.4.7 Changing Data Views - PID List / Graphs



Selecting the **View** icon ([Figure 6-19](#)) opens a drop-down menu of viewing options:

- PID List
- 1 Graph
- 2 Graphs
- 4 Graphs

The PID List view is a 2-column display with the name of the parameters in the left column and their current values in the right column ([Figure 6-19](#)).

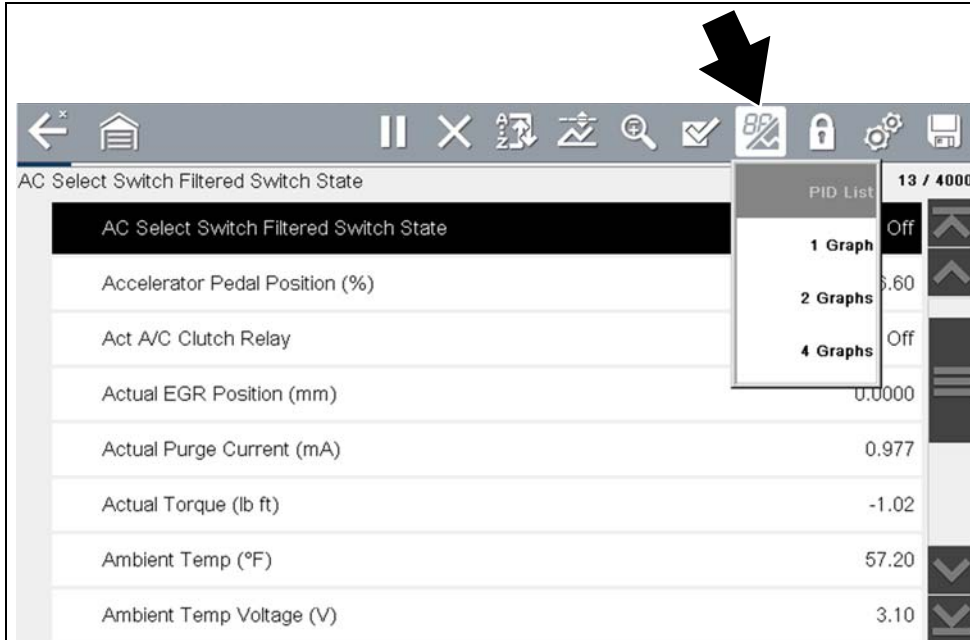

Figure 6-19 PID List view

The 1, 2, and 4 Graph views divide the screen horizontally to simultaneously display data graphs for the indicated number of parameters ([Figure 6-20](#)).

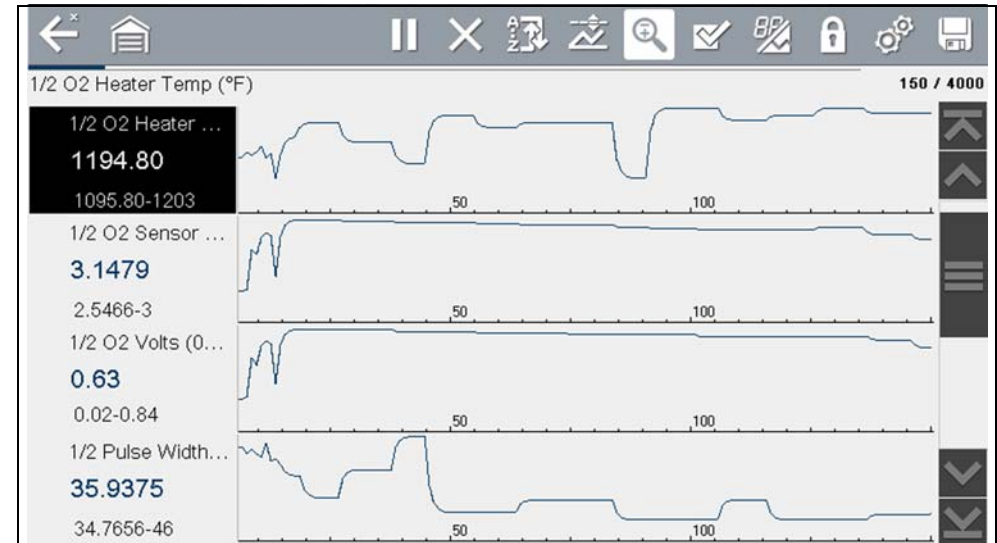

Figure 6-20 Four graph view

In graph view the text block ([Figure 6-21](#)) to the left of the graph displays:

- Top - PID description
- Middle - Current value or state
- Bottom - Active minimum and maximum values

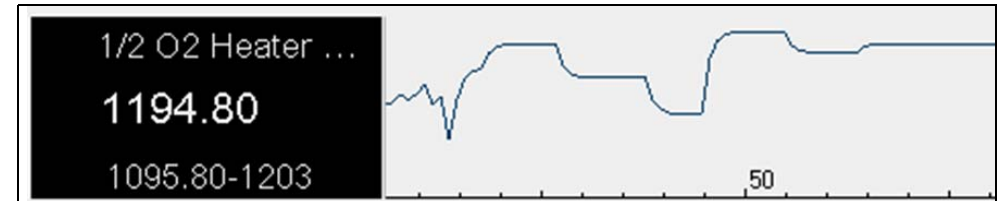

Figure 6-21



6.4.8 Selecting PIDs to Display (custom display)



The **Custom Data List** icon on the toolbar is used to select which PIDs to display. Minimizing the number of PIDs displayed allows you to focus on any suspicious or symptom-specific data parameters. You can add or remove most PIDs from the list, as certain vital PIDs may not be removed. These appear in gray at the top of the list along with a lock icon, and they cannot be selected.

NOTE

Limiting the number of parameters that display to those that apply to a particular situation results in a faster data refresh rate, and reduces the amount of memory used for saved files.



To create a custom data list:

1. Select the **Custom Data List** icon on the toolbar.

The data selection screen displays ([Figure 6-22](#)) and selection icons appear. Check marks to the left of the parameter description indicate which parameters are selected for display.

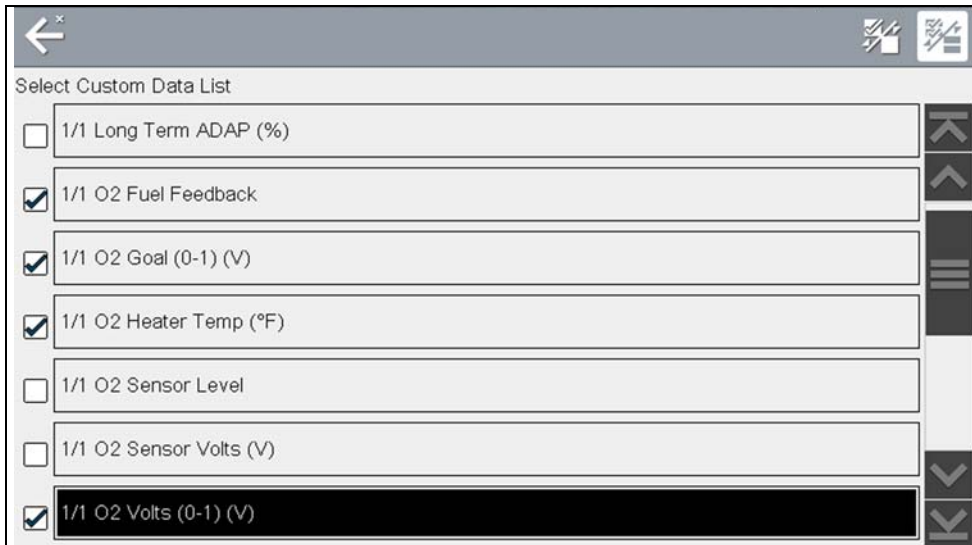

Figure 6-22 Data custom PID selection

The toolbar icons provide options for selecting and deselecting parameters to include or remove from the custom data list:

Icon	Description
	Select/Deselect - hide or display individual PIDs in the list
	Select All/Deselect All - hide or display all PIDs in the list.

2. Create a custom data list by selecting (check mark) the parameters to include.
3. Select **Back** to display the updated data list.

6.4.9 Locking PIDs (to always display at top)



Use the **Lock/Unlock** icon to hold selected lines of the data in place and prevent them from scrolling, or to release previously locked lines of data. Up to three lines of data may be held at a time. This feature allows you to position related parameters together, making it easier to monitor their values and spot inconsistencies.

Locked parameters display as the top frames on the main body of the display screen, as well as at their usual position within the data list ([Figure 6-23](#)). A lock icon appears to the left of the parameter name to indicate it is locked.



To lock parameters:

1. Highlight the parameter to be locked.
2. Select the **Lock/Unlock** icon on the toolbar to lock it.
A copy of the locked parameter is now shown at the top of the data list, and a lock icon appears alongside the parameter name.
3. Highlight and select additional parameters to lock.

Up to three parameters can be locked at a time. Once locked, a parameter remains locked until it is manually unlocked, or communication with the vehicle is stopped.

1/1 Long Term ADAP (%)		147 / 4000
1/1 Long Term ADAP (%)	4.3	
1/1 O2 Heater Temp (°F)	1329.80	
1/1 O2 Sensor Level	High	
1/1 Long Term ADAP (%)	4.3	
1/1 O2 Fuel Feedback	Closed	
1/1 O2 Goal (0-1) (V)	0.35	
1/1 O2 Heater Temp (°F)	1329.80	
1/1 O2 Sensor Level	High	

Figure 6-23 Locked parameters

NOTE

If three parameters are locked, one of them must first be unlocked before another parameter can be locked.

- To unlock parameters:**
1. Scroll through the data list and highlight the parameter to be unlocked, or released.
 2. Select the **Lock/Unlock** icon on the toolbar.
The released parameter and the lock icon disappear from the list at the top of the data list.
 3. Repeat Step 1 and Step 2 to release other parameters if needed.

6.4.10 Using Triggers

Trigger Description and Features



Setting PID triggers allows you to configure the diagnostic tool to automatically save PID data to a file, when a PID value meets an upper/lower limit (trigger point).

When a PID value meets the trigger point it activates the trigger which captures a short recording of all available PID data and saves it as a data file.

You can review the saved data file to closely evaluate not only the PID that triggered the event, but all the PIDs being monitored to collectively see what was happening at the time of the event.

Examples of the following trigger states (Armed / Not Activated - upper image) and (Activated - lower image) are shown in (Figure 6-24).

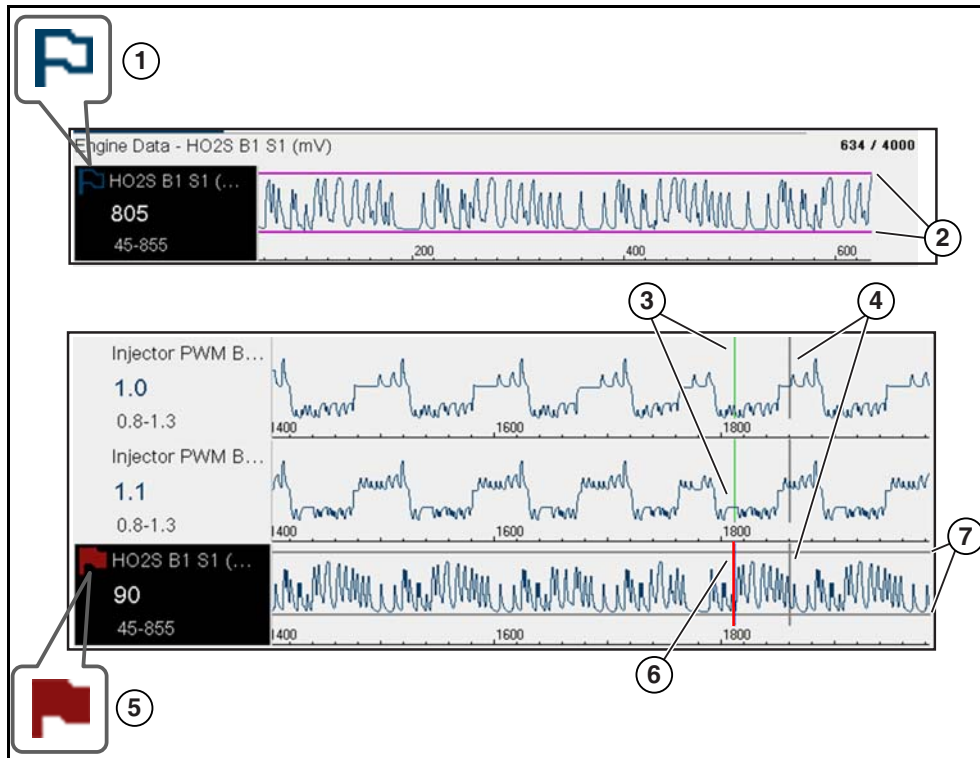



Figure 6-24

- 1— **Armed PID Trigger Indicator** - A blue outlined flag indicates the PID trigger is armed.
- 2— **Upper and Lower Limit Lines (Armed)** - Colored limit lines indicate the trigger is armed but not activated.
- 3— **Trigger Activation Point Reference Cursor** - Green cursors lines are displayed on all the other PID graphs to indicate their relationship to where the trigger occurred.
- 4— **Pause Cursor** - A vertical gray cursor line is displayed (all PIDs) as a marker in the where the data was paused and the file was saved.
- 5— **Activated PID Trigger Indicator** - A red flag indicates the PID trigger has activated.
- 6— **Trigger Activation Point Cursor** - A red cursor line is displayed in the PID data where the trigger was activated.
- 7— **Upper and Lower Limit Lines (Not Armed and Activated)** - Gray limit lines are displayed when the trigger is armed but not activated and after the trigger has been activated.

PID Trigger Status Icons

The icons (below) are used to help you quickly identify the status of individual PID triggers:

Icon	Description
 Trigger Armed	Trigger has been set (configured) and is armed.
 Trigger Activated	Trigger has been activated (upper or lower limit has been met).

▶ Setting triggers:

To use triggers, they must be turned on (set/configured), and then armed. Use the following procedures to setup PID triggers.

1. Highlight the PID to setup with a trigger.
2. Select the **Trigger** icon.

Selecting the **Trigger** icon ([Figure 6-25](#)) displays trigger menu options:

- **Set Trigger**—opens setup screen for upper/lower limits (trigger points)
- **Arm Trigger**—arms the trigger to capture data
- **Clear All Triggers**—deletes all previously set triggers

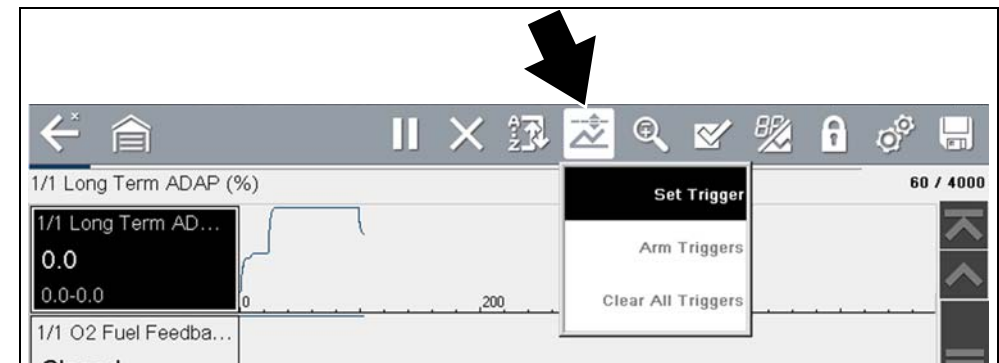

Figure 6-25 Trigger menu

If triggers are already set, the menu options are:

- **Clear Trigger**—deletes the highlighted trigger
- **Disarm Trigger**—disarms the highlighted trigger
- **Clear All Triggers**—deletes all set triggers

3. Select **Set Trigger**.

A graph of the highlighted PID and setup icons display (*Figure 6-26*).

The upper trigger point must be set first. A red horizontal line is displayed across the data graph (*Figure 6-26*) representing the upper trigger point.

4. Use the plus (+) and minus (-) icons (*Figure 6-26*), or the up ▲ and down ▼ arrow buttons to change the position of the upper trigger point.
5. Select ✓, or press the **Y/✓** button, to set the upper trigger point.

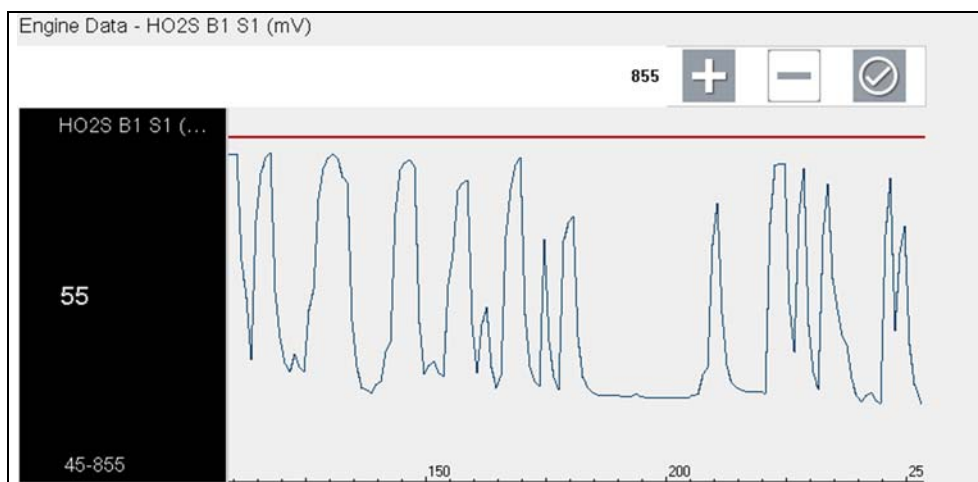

Figure 6-26 Trigger setup - upper limit

The upper trigger line changes color to gray and the lower trigger line displays in red (*Figure 6-27*).

6. Change the position of the lower trigger line in the same manner as the upper.
7. When finished, select ✓, or press the **Y/✓** button, to set the lower trigger level.

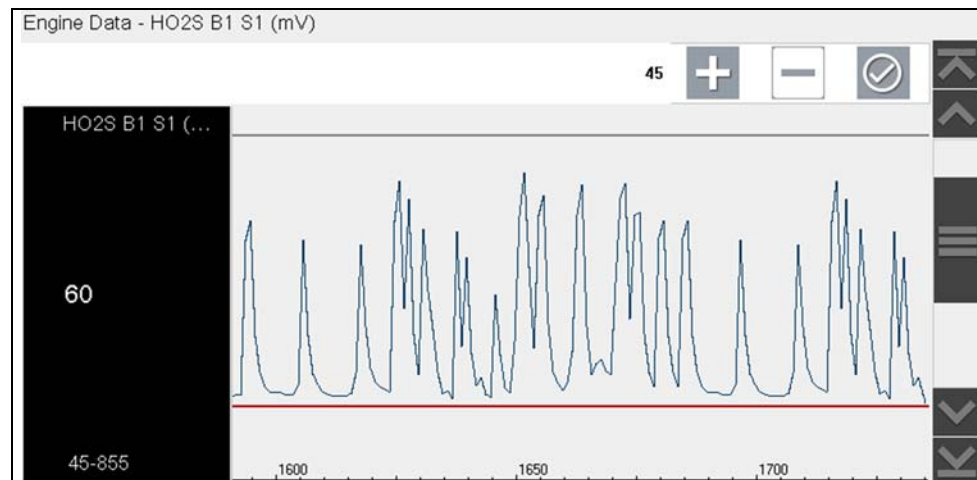

Figure 6-27 Trigger setup - lower limit

The display returns to the PID data view and the trigger points appear as horizontal lines across the designated graph (*Figure 6-28*). Repeat this procedure to establish trigger points for other parameters (up to three) if desired.

i NOTE

Only three parameters can have trigger levels set at one time, but only one of the conditions needs to be satisfied for triggering to occur.

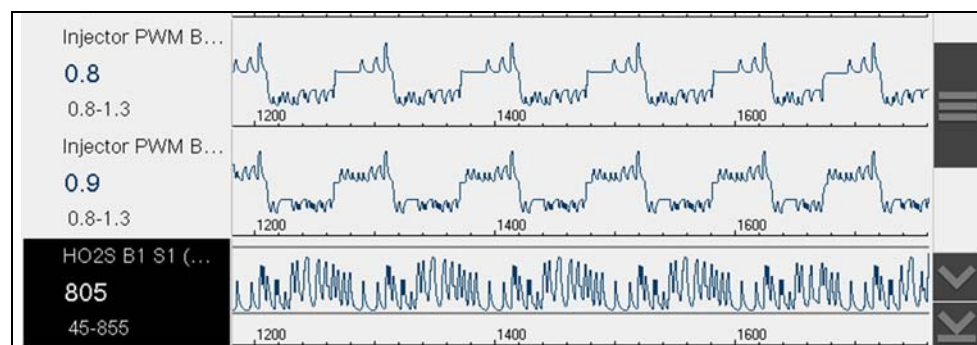

Figure 6-28 Trigger set (not armed)



Arming triggers:

1. Select the **Trigger** icon.
2. Select **Arm Triggers**.

The trigger point lines change color to indicate an armed condition (Figure 6-29).

All set PID triggers are armed simultaneously (if more than one is set). Once armed it remains armed until you clear it or the trigger is activated.

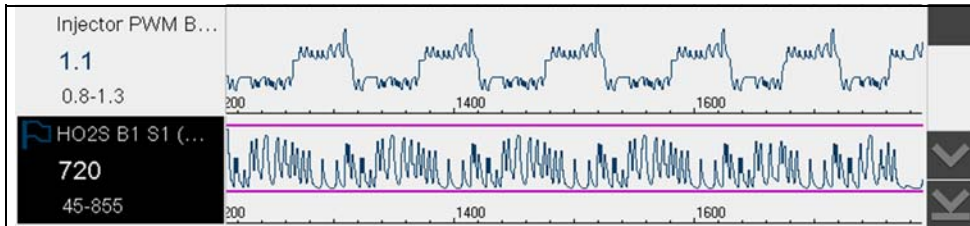

Figure 6-29 Trigger armed

About Activated Triggers

A trigger is activated (displays red flag)  when a PID value meets an upper/lower limit (trigger point).

When a trigger is activated:

- Data collection is briefly paused as the Scanner captures a recording of all available PID data, and saves it as a data file.
- A gray cursor line is displayed to indicate the point at which the data was paused or saved.
- An audible alarm is sounded
- A message displays indicating a data file was saved.
- Data collection continues.
- The activated PID trigger is disarmed. **Note** - if a different PID trigger is activated subsequently, an additional data file will be recorded.
- A red cursor line is displayed on the graph of the PID with the activated trigger to indicate where the trigger occurred. A green cursor line is displayed on all the other PID graphs to indicate their relationship to where the trigger occurred.

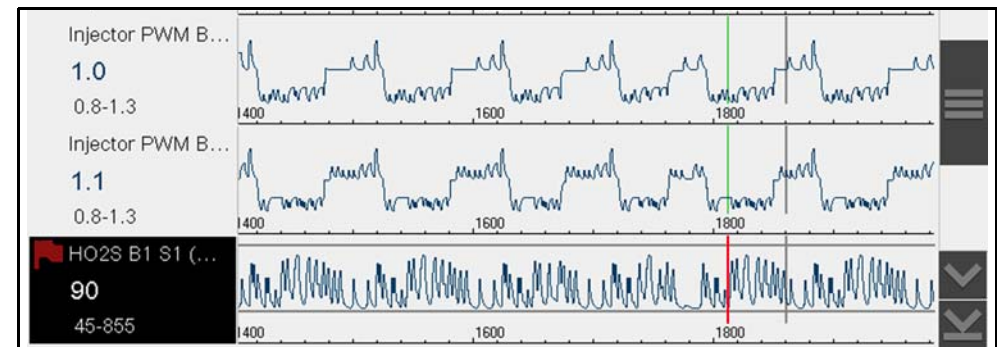

Figure 6-30 Trigger activated

6.5 Functional Tests

The **Functional Tests** selection is used to access vehicle-specific subsystem tests. Available tests vary by manufacturer, year, and model. Only the tests available for the identified vehicle display in the menu.

There are several types of functional tests:

- **Information Tests**—these are read-only tests, like selecting “VIN” from a Functional Tests menu to display the VIN of the identified vehicle.
- **Toggle Tests**—these tests switch a component, such as a solenoid, relay, or switch, between two operating states.
- **Variable Control Tests**—these tests command a certain value for a system or component, such as varying spark timing in 1° increments or EGR valve duty cycle in 10% increments.
- **Reset Tests**—these tests reset the adaptive, or learned, values that are stored in the vehicle electronic control module memory.
- **Scripted Tests**—these tests are software routines that place the vehicle into special operating modes for performing certain repairs, such as bleeding brakes with ABS.

Selecting Functional Tests opens a menu of test options that varies by make, year, and model. Selecting a menu option either activates the test or opens a submenu of additional choices. Follow all screen instructions while performing tests. How and what information is presented on the screen varies according to the type of test being performed and the vehicle being serviced.

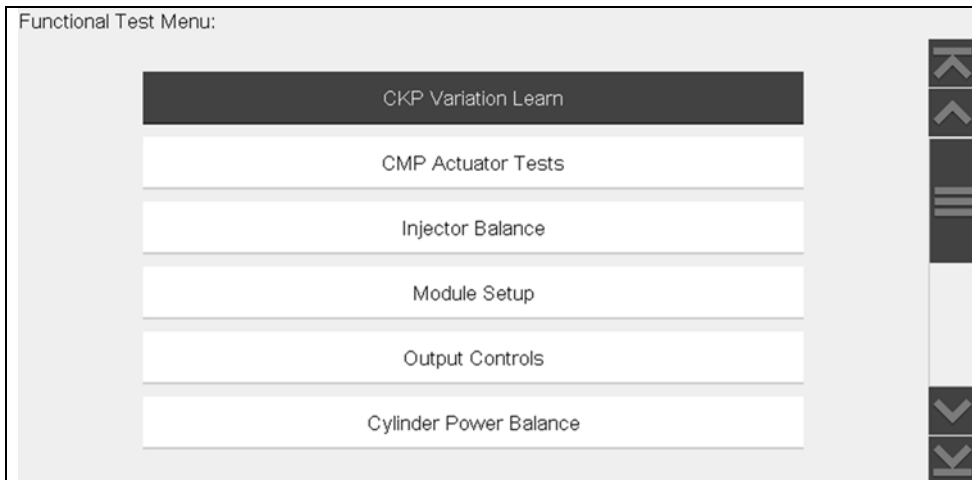

Figure 6-31 Functional test menu

Toggle and variable control tests often display functional test controls on the toolbar at the top of the screen with PID data in the main body.

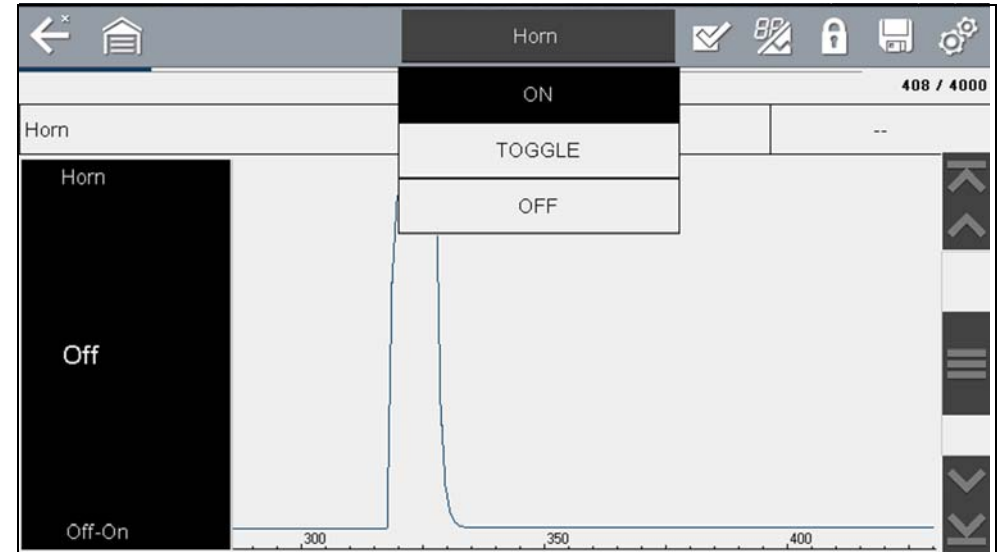

Figure 6-32 Functional test example

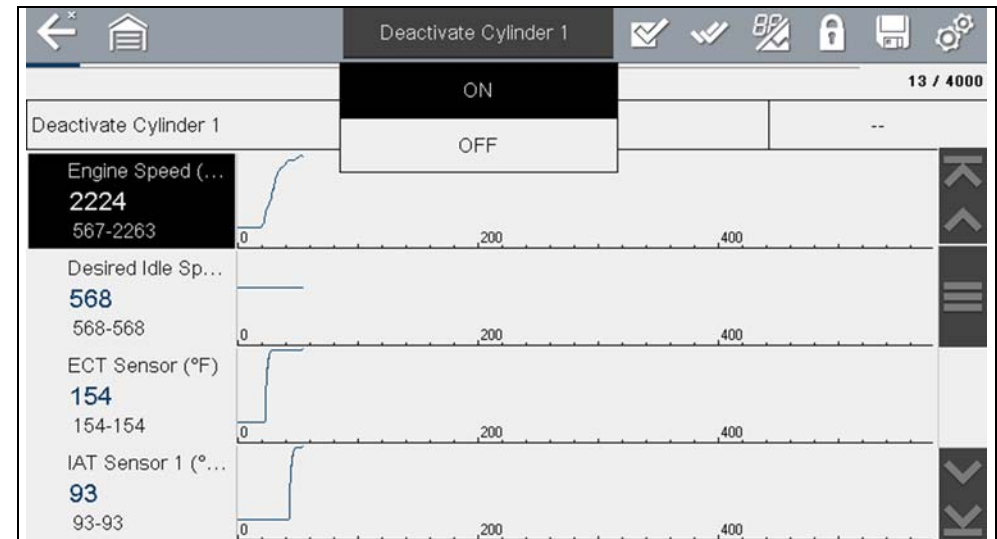

Figure 6-33 Functional test example

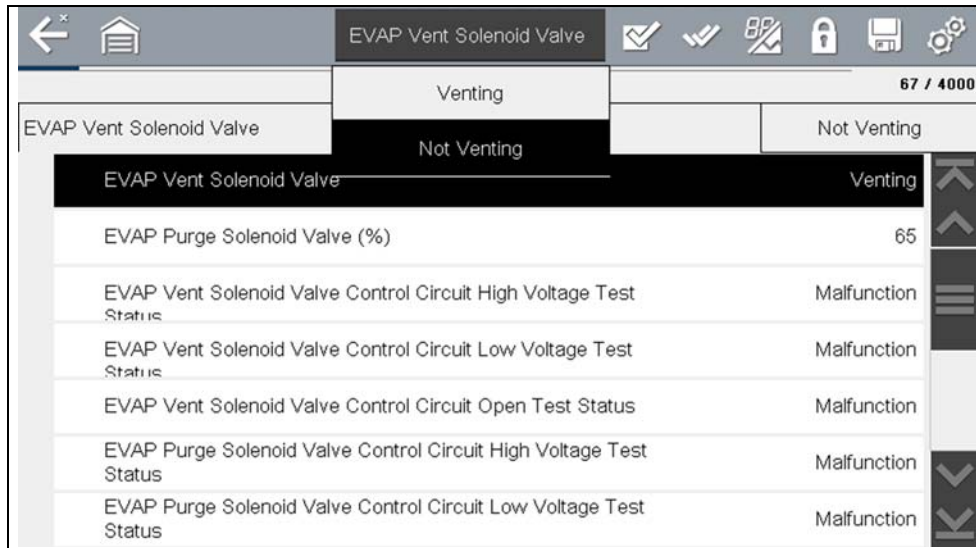

Figure 6-34 Functional test example

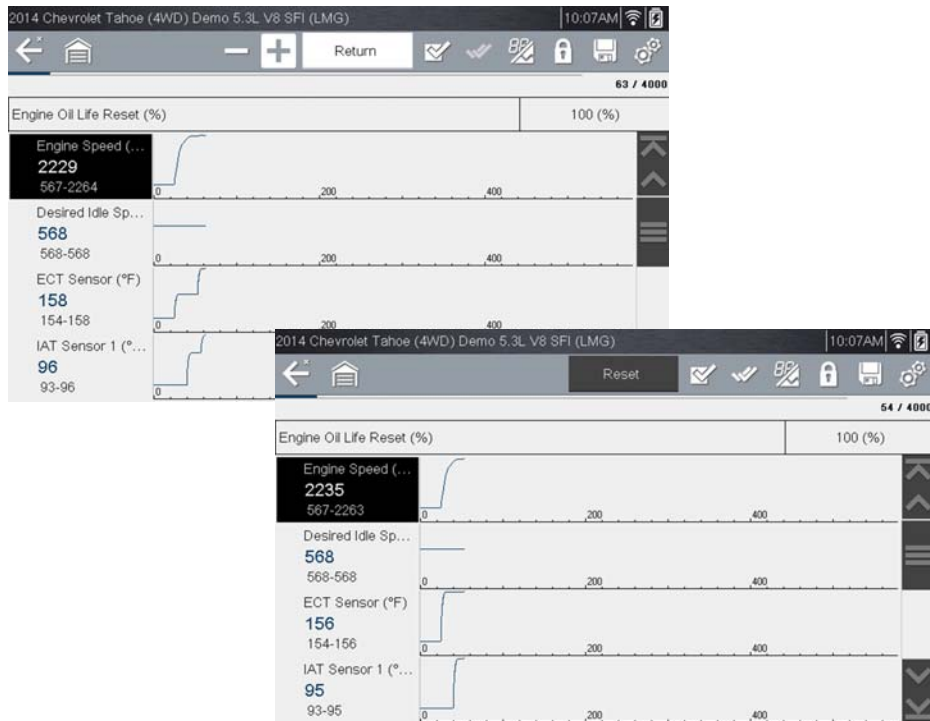

Figure 6-35 Functional test example

A Test icon on the toolbar activates the test, and a Return, or similarly named, icon cancels the test. For variable control tests, the variable value displays between the main body and the toolbar. Plus and Minus icons on the toolbar increase and decrease the variable value.

A Data List icon, is available on the toolbar for some tests. This feature allows you to change which data list displays in the main body without exiting the functional test. The icon is only available when the test is inactive.



6.6 Troubleshooter

NOTE

Troubleshooter appears in a Scanner Main Menu only if tips are available for the system selected on the identified vehicle.

Troubleshooter is a database of experience-based repair strategies and information, that has been compiled and validated by experienced technicians. Troubleshooter simplifies the diagnosis process, as it contains information on virtually all common diagnostic trouble code (DTC) problems and driveability symptoms.

Troubleshooter information is organized into a series of diagnostic tips that are designed to quickly lead you to the root cause of a particular problem. The tips are vehicle-specific, which means only tips that relate to the identified vehicle are presented. Selecting opens a menu that may include:

- **Code Tips**—provides detailed information on setting conditions, testing, and interpreting test results for specific codes ([Figure 6-36](#) and [Figure 6-37](#)).
- **Symptom Tips**—provides diagnostic tests and procedures based on vehicle operation.
- **Time Savers**—provides supplemental information, such as firing order and #1 cylinder location, that may be needed to make a diagnosis.
- **Common Problems**—provides advice and remedies for certain “pattern failures” that have been experienced on vehicles of the same model.
- **Tests and Procedures**—explains how to perform certain tests on the specific test vehicle. Some tips provide specifications and installation information as well.

- **Fast-Track Data Scan**—contains information and guidelines on how to validate data readings for certain sensors and actuators, PID data values are provided.
- **Fast-Track Fixes**—provides actual repair information for related repairs.

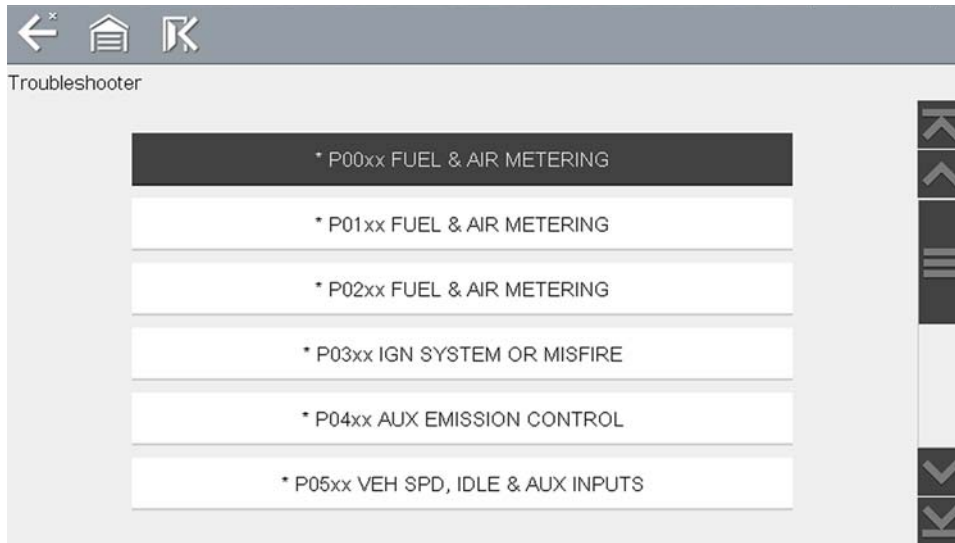

Figure 6-36 Troubleshooter code tip menu

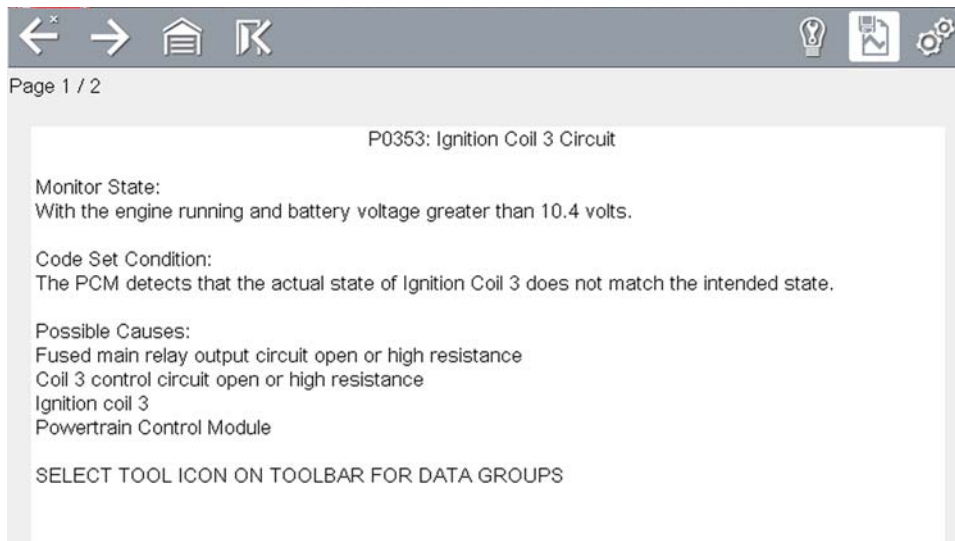

Figure 6-37 Troubleshooter tip (Example: P0353)



This section describes basic Scanner functions including data cable connection, and how to display diagnostic trouble codes for motorcycle applications. Many of the Scanner functions are similar or identical in operation as the automotive Scanner, for Scanner operations not listed in this section see [Scanner - Automotive](#) on page 19.



The **Scanner** icon is located on the Home screen.

The Scanner function allows your diagnostic tool to communicate with the control modules of the motorcycle being serviced. This allows you to perform tests, view diagnostic trouble codes (DTCs), and live data parameters from various vehicle systems such as the engine, antilock brakes (ABS), body control module and more.

IMPORTANT

This manual is intended to be used for P1000 motorcycle scanner operations. For automotive operations, see the Ethos Edge user manual at: <http://diagnostics.snapon.com/usermanuals>

Main Topic Links

- [Scanner Overview](#) page 41
- [Features and Icons](#) page 42
- [Scanner - Starting / Stopping](#) page 41
- [Scanner Control Icons](#) page 43
- [Basic Scanner Operation \(Quick Start\)](#) page 43
- [Data Cable Connection](#) page 44
- [Vehicle Identification / System Selection](#) page 44
- [System Main Menu Options](#) page 47
- [Codes - View / Scan / Save](#) page 47
- [Code Scan](#) page 48

7.1 Basic Operation

7.1.1 Scanner Overview

Scanner is a menu driven application that communicates with control modules to access diagnostic trouble codes (DTCs), parameter data (PIDs), functional tests, and more. To navigate the application, use your fingertip or the control buttons to make onscreen menu selections to access the desired data, test or function.

Screen messages appear when additional input is needed before proceeding. There are three types of on-screen messages; confirmations, warnings, and errors.

- **Confirmation Messages** - Confirmation messages inform you when you are about to perform an action that cannot be reversed or when an action has been initiated and your confirmation is needed to continue. When a user-response is not required to continue, the message displays briefly before automatically disappearing.
- **Warning Messages** - Warning messages inform you when completing the selected action may result in an irreversible change or loss of data.
- **Error Messages** - Error messages inform you when a system or procedural error has occurred.

7.1.2 Scanner - Starting / Stopping



To start the Scanner function:

1. From the Home screen, select the **Scanner** icon.
2. Select **Motorcycle**.

The vehicle identification process starts. The motorcycle must be correctly identified for the diagnostic tool to communicate, and display data correctly.

3. Follow the onscreen instructions to identify the motorcycle and connect the data cable. See [Vehicle Identification / System Selection](#) on page 44.

NOTE

Damage to electronic control modules may occur if communication is disrupted. Make sure the data cable is properly connected at all times during testing. Exit all tests before disconnecting the data cable or powering down the diagnostic tool.

The Scanner function remains open as long as there is an active communication link with the motorcycle. You must interrupt this communication link in order to exit from tests and power down the diagnostic tool. A warning message displays if you attempt to shut down while the diagnostic tool is communicating with the motorcycle.

**To exit the Scanner function:**

1. From any active Scanner screen, select the **Back** icon on the toolbar.
The “stopping communications” message briefly displays followed by the Data menu.
2. From the Data Menu, select **Back** on the toolbar.
The “stopping communications” message displays again, then the Main menu. Once the Main menu is displayed, communication has been terminated and it is safe to return to the Home screen and power down the diagnostic tool.

7.2 Features and Icons

7.2.1 Scanner Features

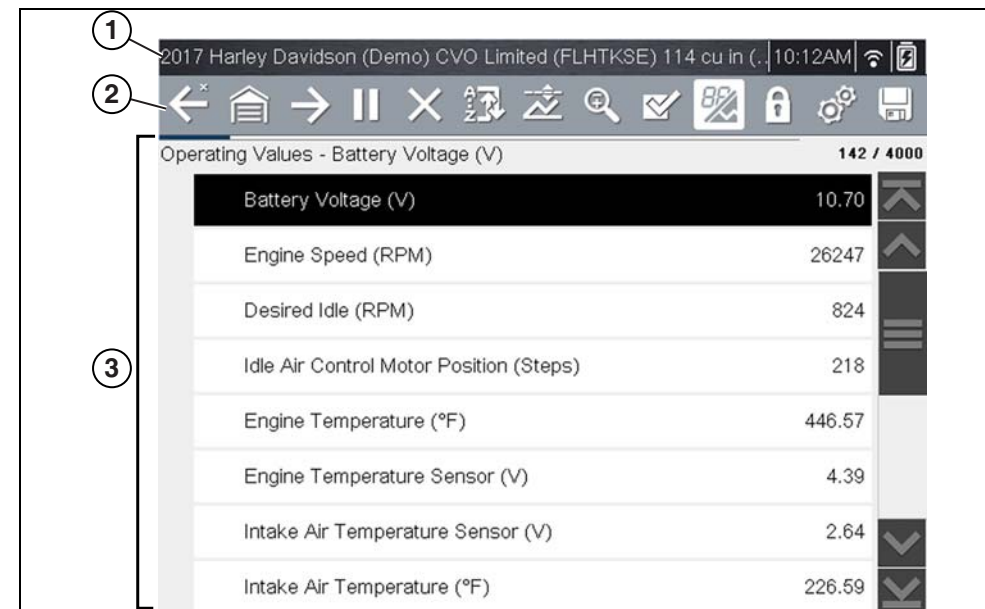

1— Title bar—shows active test, vehicle and diagnostic tool status. The Title bar appears for all functions and displays information only, there are no selectable items. See [Title Bar](#) on page 8.

2— Toolbar—contains control icons

3— Main body—displays menus, code results, PIDs, etc.

Figure 7-1 Scanner screen features

7.2.2 Scanner Control Icons

The scanner toolbar contains control icons. Control icons may vary depending on the active function or test. An inverted (highlighted) icon indicates it is selected. Other control icons (not shown) are described in [Common Toolbar Control Icons](#) on page 9.

Icon	Function	Icon	Function
	Start (Capture) - Resumes active data collection.		Save - Writes data from buffer memory to a file. The saved "movie" file can be accessed for future reference by selecting Previous Vehicles and Data > View Saved Data .
	Pause - Pauses active data collection.		Custom Data List - Opens a menu for selecting which PIDs display in the list.
	Clear - Erases all the PID data in the buffer and begins a new recording. Selecting opens a confirmation message.		Change View - Changes display options between PID list or graph displays.
	Trigger - Opens a menu that allows you to set, arm, and clear threshold values that automatically trigger PID data to be saved from buffer memory to a file.		Lock/Unlock - Locks or unlocks the highlighted parameter. Locked PIDs move to the top of the list and do not scroll as you move through the data.
	Zoom - Incrementally increases and decreases the scale of the data being displayed.		Sort - Determines the order in which PIDs are listed on the screen.
	Step Forward - Allows forward movement in singular steps. (Note: To quickly step forward during Scanner data review, press and hold the icon down.)		Step Back - Allows backward movement in singular steps. (Note: To quickly step backward during Scanner data review, press and hold the icon down.)
	Skip Forward - Allows forward movement in multiple steps.		Skip Back - Allows backward movement in multiple steps.

7.2.3 Basic Scanner Operation (Quick Start)

This section lists the basic scanner operation steps, and is only intended as a quick-start reference. Refer to the supporting topics in this section for detailed operation information.

Getting Started (Basic Steps)

NOTE

Menus, options and procedures will vary across motorcycle manufacturers and models.

1. Select **Scanner** from the Home screen.
2. Select **Motorcycle**.
3. Follow the prompts to identify the motorcycle (e.g. make, year, model), then select **OK** to confirm.
4. Follow the onscreen instructions to connect the **DA-5** data cable and **Smart Vehicle Interface (SVI)** to the motorcycle diagnostic connector. See [Data Cable Connection](#) on page 44.
5. Turn the ignition on and move the "run" switch to on, or start the engine.

NOTE

Ensure the LEDs on the SVI and DA-5 cables are on when establishing communication between the motorcycle and diagnostic tool.

6. Follow the prompts to select a **System** (e.g. Engine, ABS, Radio).
7. Select a **Function/Test** (e.g. Codes Menu, Code Scan, Data Display, Functional Tests). See [System Main Menu Options](#) on page 47.

NOTE

When the diagnostic tool is communicating with a motorcycle an icon is displayed in the title bar.

Icon	Function
	Indicates active Scanner communication (displayed in title bar)

7.2.4 Data Cable Connection

NOTE

On-screen data cable connection instructions are provided.

As an example, [Figure 7-2](#) shows a typical data cable connection using the supplied DA-5 data cable and the Harley-Davidson HAR-2 Smart Vehicle Interface (SVI), other manufacturers are similar.

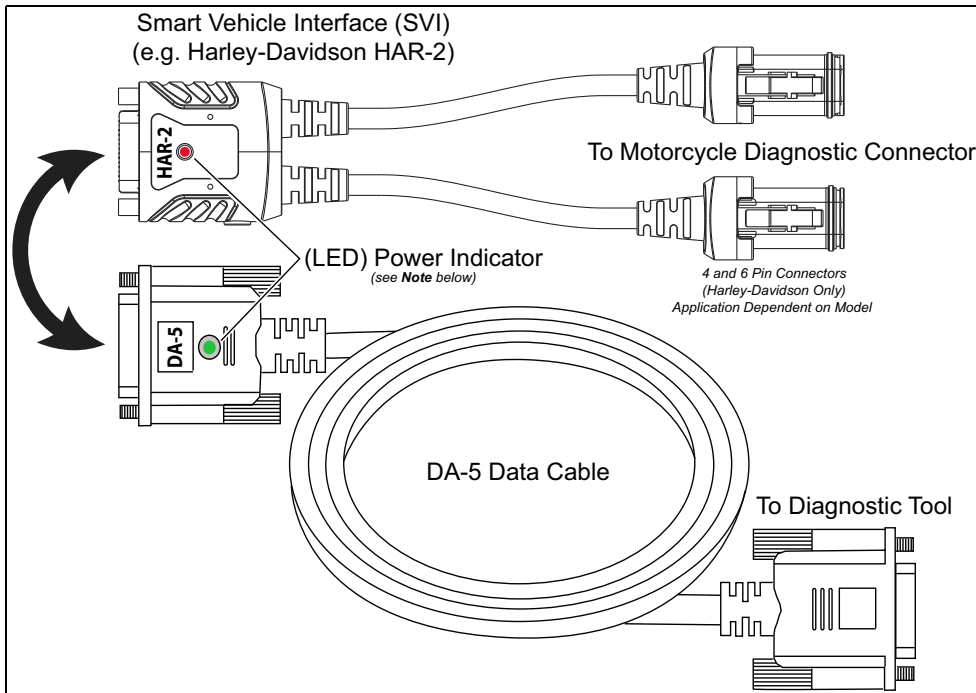

Figure 7-2

NOTE

Contact your sales representative to purchase additional Smart Vehicle Adapters (SVIs) for other Motorcycle manufacturers.

1. Follow the onscreen instructions to connect the **Smart Vehicle Interface (SVI)** to the motorcycle diagnostic connector.

NOTE

The SVI requires 12VDC power to communicate. Power is normally supplied through the motorcycle diagnostic connector, however the supplied 12VDC power accessory cable (not shown) can be used when power is needed. When the LED is on, the SVI is being powered.

2. Connect the **DA-5** data cable to the SVI and diagnostic tool.

NOTE

Ensure the LEDs on the SVI and DA-5 cables are on when establishing communication between the motorcycle and diagnostic tool.

7.2.5 Vehicle Identification / System Selection

The motorcycle must be correctly identified for the diagnostic tool to communicate, and display data correctly. Menus and navigation will vary by make and model.

Depending on the motorcycle, the identification process may require manual entry of the motorcycle information, or it may be automated. The following Scanner functions are available to identify the motorcycle:

Auto ID - Automatically completes the identification process after the motorcycle make and year are manually entered.

Manual ID - Allows for manual entry of all required motorcycle identification criteria.



Use the following procedure to identify a motorcycle.

NOTE

The following procedure applies to most motorcycles, and may vary depending on the motorcycle. Not all motorcycles support the Auto ID feature.

1. Select **Scanner** from the Home screen.
2. Follow the prompts to identify the motorcycle (e.g. make, year, model).



A menu option may be displayed to choose either **Automatic ID** or **Manual ID**.

- Selecting **Automatic ID** (If supported) will briefly display a communications screen informing you that the diagnostic tool is attempting to establish communication and determine vehicle identification.

Once the vehicle has been identified, the vehicle confirmation screen displays. If the vehicle information is correct, select **OK** to continue, then proceed to step 3.

If the vehicle does not support Auto ID, the diagnostic tool will attempt to identify the vehicle and then display a message indicating that vehicle identification cannot be made. If this occurs, proceed to “**Selecting Manual ID**” next.

- Selecting **Manual ID** allows you to manually enter all the vehicle information to identify the vehicle. Follow the screen prompts to enter all the information required to identify the vehicle. Once the vehicle has been identified, the vehicle confirmation screen displays ([Figure 7-3](#)). If the vehicle information is correct, select **OK** to continue, then proceed to step 3.

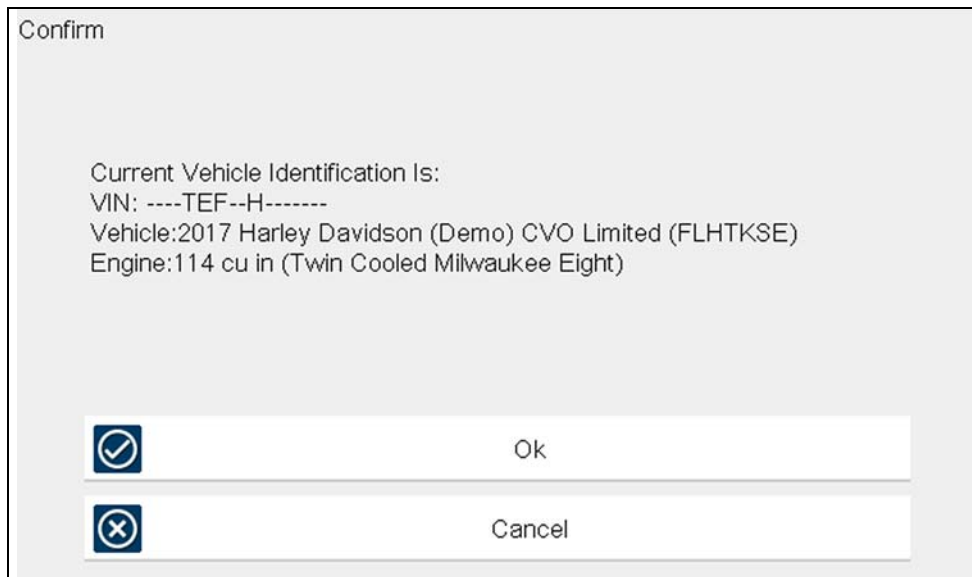

Figure 7-3 confirmation screen

After the motorcycle is identified, prompts will indicate to turn the motorcycle ignition on and connect the data cable.

Depending on the motorcycle, a menu option to select a system list display type may be provided ([Figure 7-4](#)).

Some motorcycles may support a “Fitted Systems” display type. In this situation a menu option is provided to display the fitted systems or all systems. Selecting Fitted Systems will only display systems that the diagnostic tool is communicating with. Selecting All Systems will display every system possibly supported.

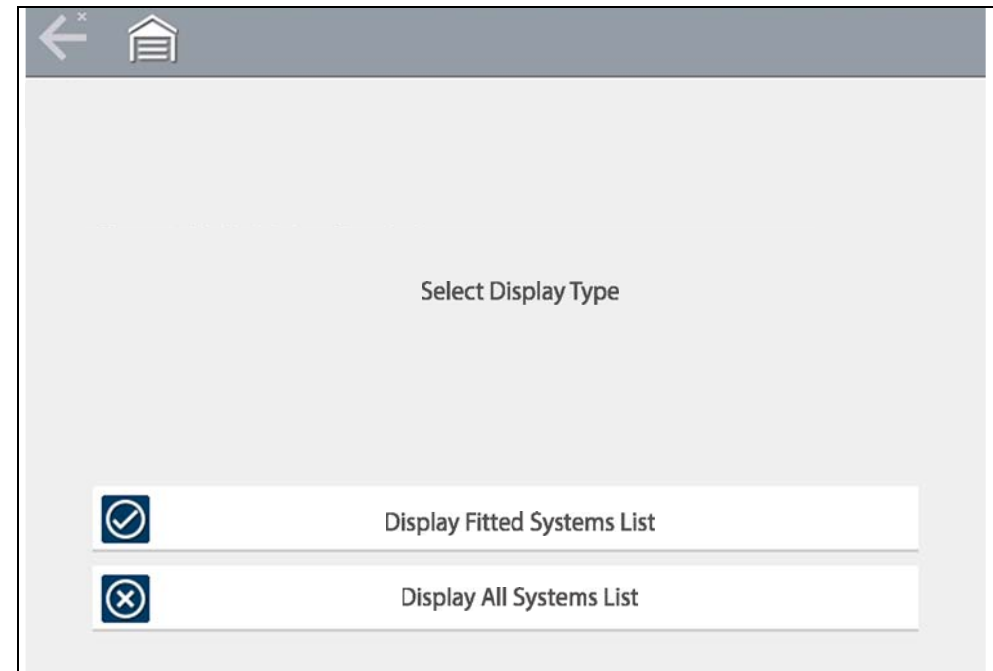

Figure 7-4

3. A menu of available systems and/or options is displayed. Select a system or option ([Figure 7-5](#)) to continue.

By default, System options are displayed by category (e.g. Audio/Video, Body Controls, Instruments, etc.). In this mode commonly used selections are at the top of the list.

Depending on your preference, select the icon ([arrow in Figure 7-5](#)) to toggle the display between a categorized ([Figure 7-5](#)) and non-categorized ([Figure 7-6](#)) list.

When a system (e.g. Engine, Antilock Brakes, etc) is selected, the diagnostic tool will attempt to establish communication with that motorcycle system, then (once connected) will display that system's main menu, see [System Main Menu Options](#) on page 47.

For Code Scan information, see [Code Scan](#) on page 48.

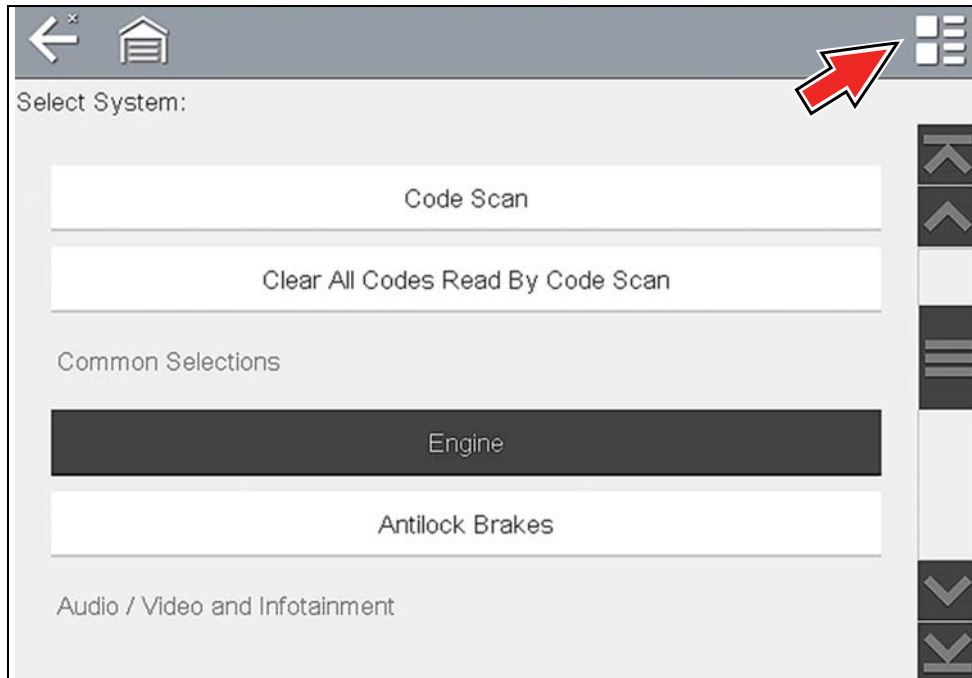

Figure 7-5 Typical systems menu (categorized list view)

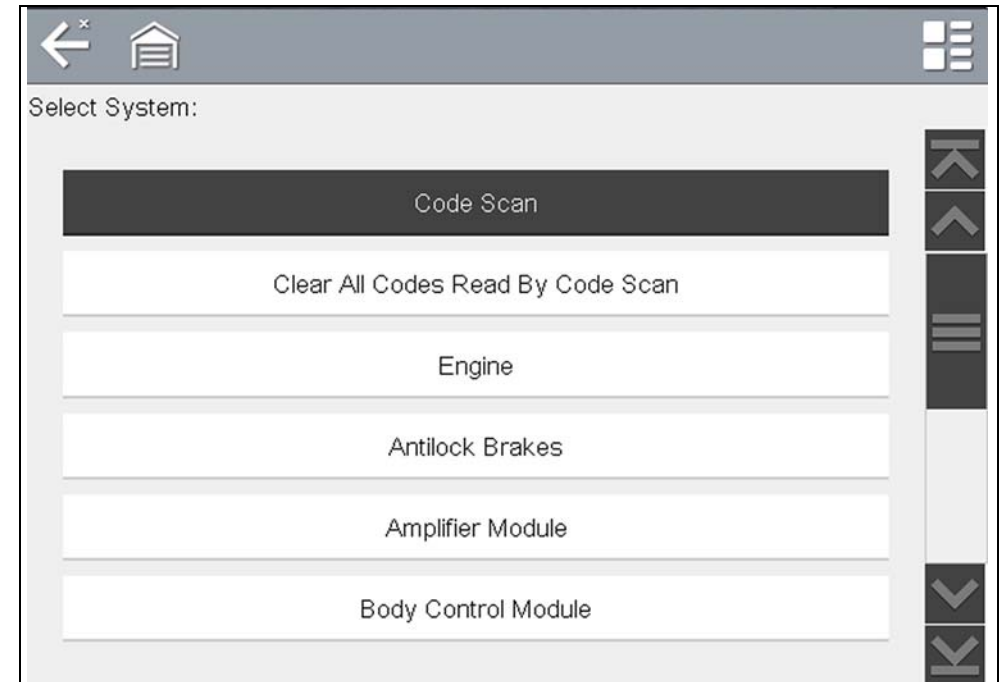

Figure 7-6 Typical systems menu (non-categorized list view)

7.3 System Main Menu Options

Once a System is selected (e.g. Engine, Antilock Brakes, etc) is selected, the diagnostic tool will attempt to establish communication with the motorcycle, then (once connected) will display (Figure 7-7) the system main menu (available tests).

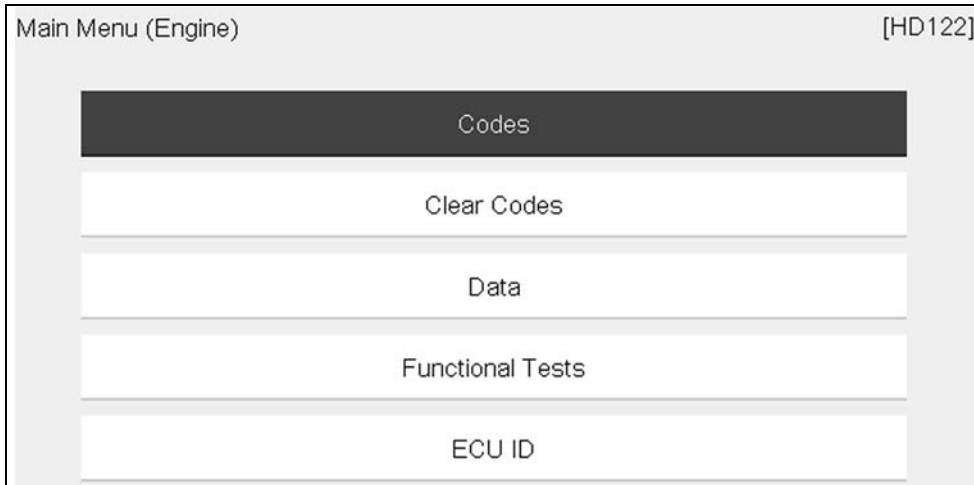

Figure 7-7 Typical (Engine) main menu

- Menus and navigation will vary by motorcycle make and model.

The System Main Menu may include these typical selections:

- **Codes**—displays diagnostic trouble code (DTC) records from the control modules. Selecting may open a submenu of viewing options. See [Viewing Codes on page 47](#).
- **Clear Codes**—erases DTC records and other data from the ECM. This selection is found on a Codes submenu for some models. See [Clear Codes on page 48](#).
- **Data**— displays PID data from the control modules. Selecting may open a submenu of viewing options. See [View Saved Data on page 75](#).
- **Functional Tests**—provides specific subsystem tests. The tests vary depending on the manufacturer and model. See [Functional Tests on page 38](#).
- **ECU ID**—provides specific ECU information for the selected module.

7.4 Codes - View / Scan / Save

7.4.1 Viewing Codes

After selecting a System, “Codes” may appear as a menu selection (Figure 7-7) from the Main System Menu. Depending on the motorcycle manufacturer, a different name may be used (e.g. Codes Menu, Codes Only, Codes (No Data), Service Codes, etc).

Selecting this function opens a list of diagnostic trouble codes (DTCs) stored in the selected control module. The code list includes the DTC and a brief description (Figure 7-8).

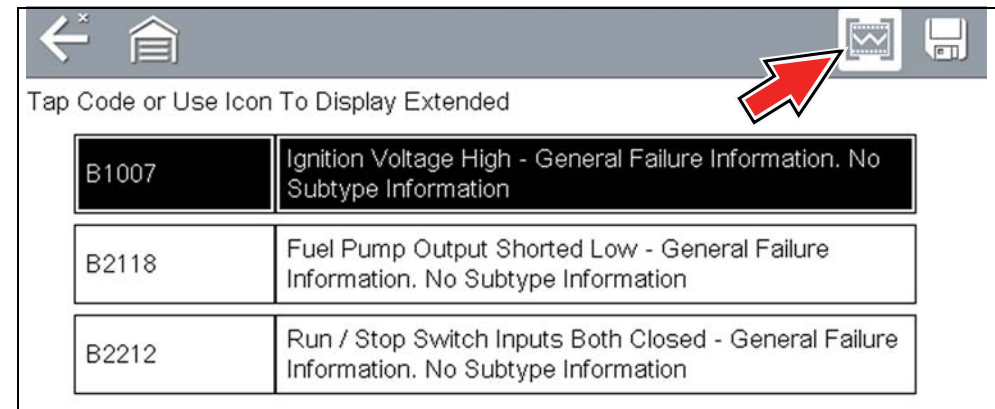

Figure 7-8 DTC results

Select the code or the Extended DTC Data icon (Figure 7-8) for additional information. The Extended DTC Data icon only displays if the motorcycle supports this feature and information is available.

Extended DTC Data may include:

- **Odometer Mileage**
- **Occurrence**
- **Trips Since First Failure**
- **Trips Since Last Failure**

7.4.2 Clear Codes

The diagnostic tool can clear codes from the electronic control module(s). This selection only displays if the motorcycle supports this feature.

-  **To clear codes:**
1. Select **Clear Codes** from the Codes Menu.
A confirmation message displays.
 2. Make sure any conditions shown on the confirmation message are met, then select **Yes**.
A “codes cleared” message displays once the operation is complete.
 3. Select **Continue** to return to the Codes Menu.

IMPORTANT

Clearing codes erases all temporary ECM information. Make sure no vital diagnostic information will be lost before clearing codes.

7.4.3 Code Scan

Code Scan is available from the Main System Menu, and when selected it scans the control modules for codes. The results of the scan are configured into a report that is accessible and printable using ShopStream Connect™. The report can be printed, downloaded, attached to an e-mail or other social media app to share with others. For additional information on using ShopStream Connect, see [ShopStream Connect™](#) on page 119.

IMPORTANT

PRE / POST Scan Importance - As many systems do not turn on the check engine light or other indicator, performing a code scan before making any repairs may help in troubleshooting, by identifying possible unknown issues that may be related to the present symptoms.

Performing pre and post scans also allows you to record in report format the pre-condition of the vehicle and compare the post scan after work is complete to confirm the repairs were completed properly.

NOTES

The Code Scan function and results are dependent upon the vehicle. Not all vehicles may support this function.

Selecting **Code Scan** from the Vehicle System menu ([Figure 7-9](#)) starts an active scan of vehicle control modules, and opens the Code Scan results screen ([Figure 7-10](#)).

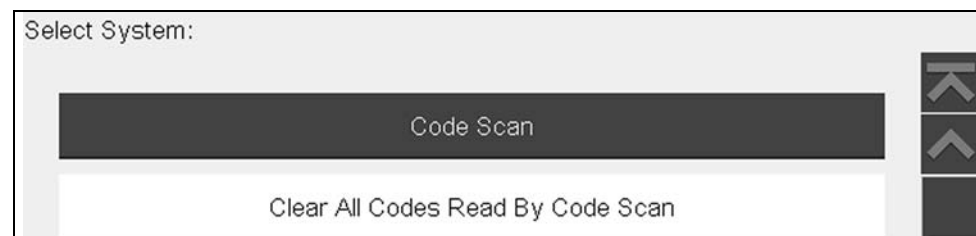

Figure 7-9 Code Scan

When initially started, progress status is shown at the top indicating the active scanning progress. Once completed, code results are displayed by system.

The following are displayed as the modules are scanned and are described in the following sections.

- [Code Scan Toolbar](#)
- [Total Number of Systems \(modules\) Analyzed](#)
- [List of All the Systems Analyzed with DTCs Totals](#)



Code Scan Toolbar

The following Code Scan related control icons are used:

Icon	Function
	Refresh - Refreshes the code scan data (restarts the code scan)
	System - Opens the main menu of the system selected (highlighted)
	Save - Saves the code scan results as an (.XML) file. See Viewing Codes and Code Scan Results on page 75 .

Total Number of Systems (modules) Analyzed

The total number of systems analyzed is actively displayed at the top of the screen as they are scanned.

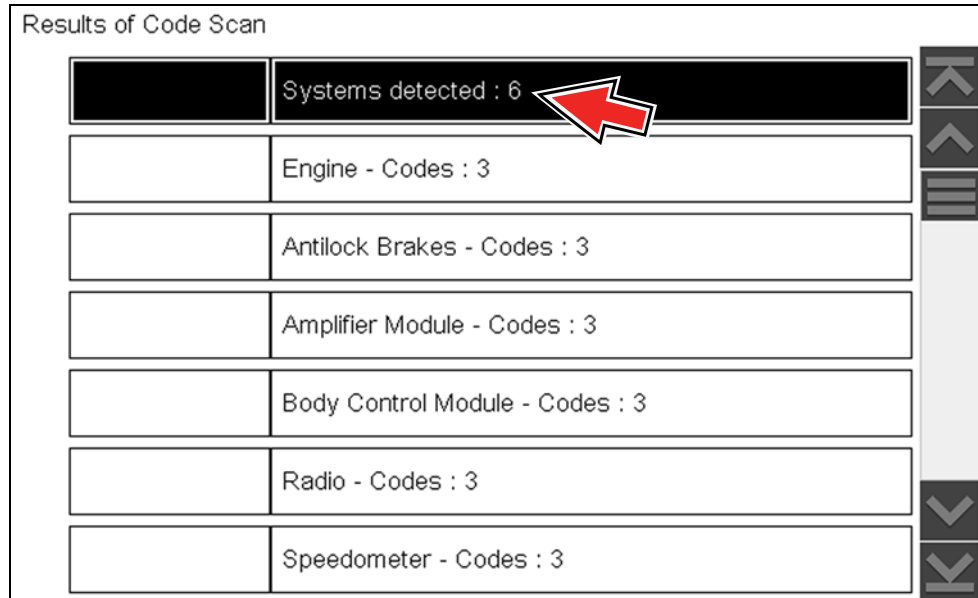

Figure 7-10 Code Scan systems analyzed result total

List of All the Systems Analyzed with DTCs Totals

A categorized system list with DTC totals is displayed in the order they are scanned. To view the main menu for a system in the list, select the system, then select the **System** icon ([Figure 7-11](#)).

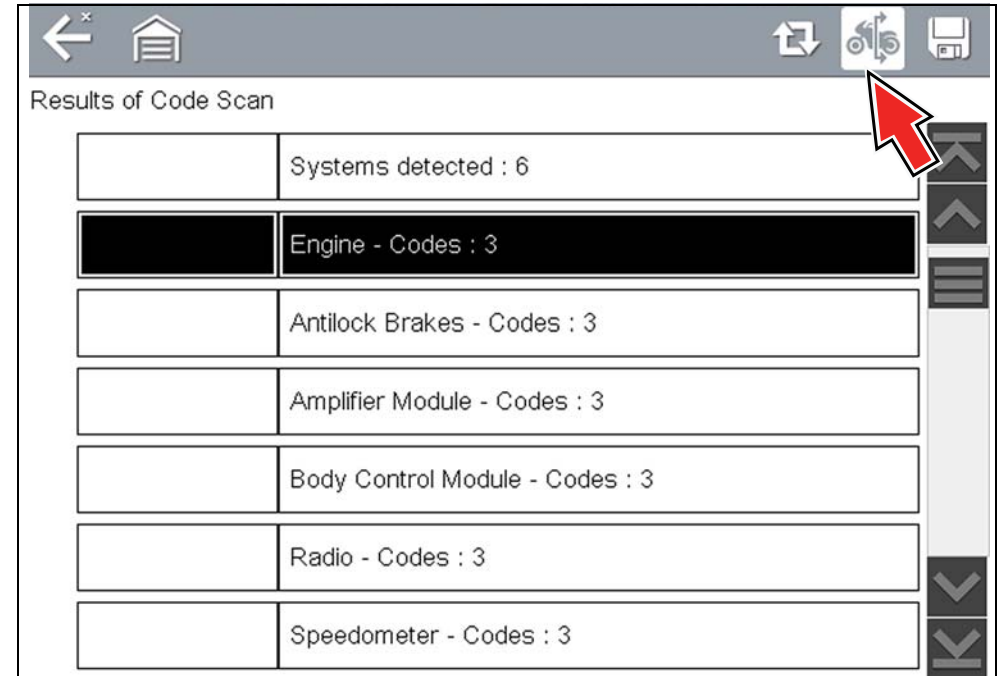



Figure 7-11 System icon (opens Main Menu)



Saving Codes and Code Scan Results

Icon	Function
	Save - Saves the displayed code list results as an (.XML) file.

When using the code scan feature, or when viewing individual system codes (e.g. engine, antilock brakes) selecting the **Save** icon from the toolbar saves the results as a report formatted file.

To manually save the code scan report:

1. Perform a code scan.
2. After the code scan has completed, select **Save**.

A confirmation message is displayed indicating that the file was saved.

Message Example: "Saving A2810005.XML"

The saved file(s) can be viewed on the diagnostic tool - See [Viewing Codes and Code Scan Results](#) on page 75.

Printing Codes and Code Scan Results

The code scan report and saved codes can be printed using ShopStream Connect - See [Printing the \(Code Scan\) Vehicle System Report](#) on page 122.

Clear All Codes Read by Code Scan

Selecting **Clear All Codes Read by Code Scan** erases all DTCs from all vehicle system modules that were read by Code Scan.

Section 8

Vehicle Code Scan / (Snap-on Cloud)

PRE/POST SCAN VEHICLE SYSTEM REPORTS

Code Scan allows you to quickly scan all supported vehicle control modules for codes. In addition, Global OBD-II codes and Readiness Monitors are scanned giving you a complete health check of vehicle systems.

One of the benefits of performing a code scan is that you can quickly show your customer diagnostic related issues with a pre scan report, and then after repairing the issues you can use the post scan report to show that the repairs were completed (*Figure 8-1*). In addition, code scans are automatically configured into a Vehicle System Report and uploaded to your Snap-on Cloud account. From the Snap-on Cloud you can print, save and transfer the report, for more information, see [Vehicle System Report \(Snap-on Cloud\)](#) on page 55.

IMPORTANT

PRE / POST Scan Importance - As many systems do not turn on the check engine light or other indicator, performing a vehicle code scan before making any repairs may help in troubleshooting, by identifying possible unknown issues that may be related to the present symptoms.

Performing pre and post scans also allows you to record in report format the pre-condition of the vehicle and compare the post scan after work is complete to confirm the repairs were completed properly.

Pre and post scan is required by some manufacturers for pre and post collision work as well as by some insurance companies.

The figure displays two side-by-side screenshots of a 'Vehicle System Report' for a 2016 Nissan Rogue. The left report is labeled 'Pre Scan' and shows several error codes in red, including C1704 (Low Pressure Left Front), C1706 (Low Pressure Right Rear), C1707 (Low Pressure Left Rear), and multiple codes from the Body Control Module and Tire Pressure Monitor. The right report is labeled 'Post Scan' and shows all systems as green, indicating that the issues have been resolved. Red arrows point to the 'Code Scan Results' and 'Readiness Monitors' sections in both reports to highlight the changes.

Section	Pre Scan Status	Post Scan Status
Engine	0	0
Transmission	0	0
Antilock Brakes	0	0
Airbag	0	0
Body Control Module - Codes	3 (Error)	0
Electronic Power Steering	0	0
Intelligent Power Distribution Module	0	0
Meter	0	0
Tire Pressure Monitor - Codes	3 (Error)	0
OBDII	0	0
Readiness Monitors	Tests Incomplete	Tests Complete

Figure 8-1

Main Topic Links

- [Using Code Scan](#) page 52
- [Vehicle System Report \(Snap-on Cloud\)](#) page 55
- [Printing the Vehicle System Report](#) page 55

8.1 Using Code Scan

NOTE

The Code Scan function and results are dependent upon the vehicle. Not all vehicles may support this function.

After you have connected and identified a vehicle through Scanner, Code Scan is available from the Vehicle System menu.

Selecting **Code Scan** from the Vehicle System menu ([Figure 8-2](#)) starts an active scan of vehicle control modules, and opens the Code Scan results screen ([Figure 8-3](#)).

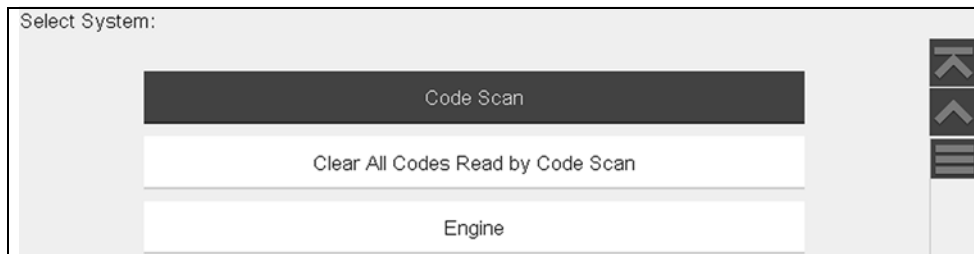

Figure 8-2

NOTE

Selecting **Clear All Codes Read by Code Scan** ([Figure 8-2](#)) erases all DTCs from all vehicle system modules that were read by Code Scan. Selecting this function may not clear global OBD-II codes on some vehicles.

When initially opened ([Figure 8-3](#)), a progress bar is shown at the top indicating the active scanning progress. Once completed, code results are displayed by system.

The following results are displayed as the modules are scanned and are described in the following sections.

- [Total Number of Systems \(modules\) Analyzed](#)
- [List of All the Systems Analyzed with DTCs Totals](#)
- [Global OBDII DTCs](#)
- [Readiness Monitor Test Status](#)

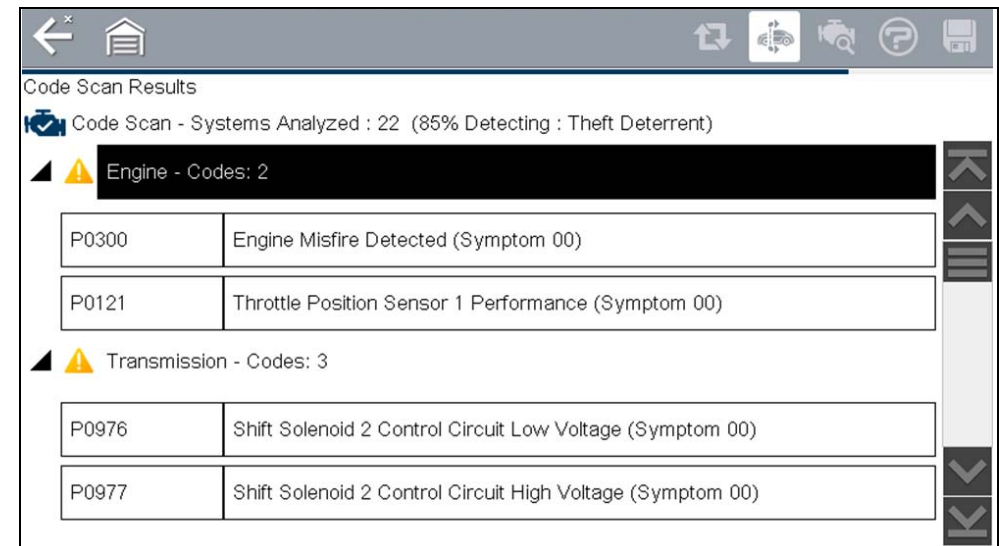





Figure 8-3 Code Scan in process

Code Scan control icons are located on the upper toolbar ([Figure 8-3](#)), and provide the following functions.

Icon	Function
	Refresh - Refreshes the code scan data (restarts the code scan)
	System - Opens the main menu of the system selected (highlighted)
	Diagnose - Opens Intelligent Diagnostics for the code selected (highlighted)
	Save - Saves the code scan results as an (.XML) file. See Viewing Codes and Code Scan Results on page 75.

After the code scan has completed it is automatically saved as an .XML file on the diagnostic tool, and is uploaded to your account on the Snap-on Cloud (if registered and connected).

A confirmation message is displayed indicating that the file was saved (e.g. **Message Example:** "Saving A2810005.XML").

To view the report on the diagnostic tool, see [Viewing Codes and Code Scan Results](#) on page 75.

To view/print the report on the Snap-on Cloud, see [Vehicle System Report \(Snap-on Cloud\)](#) on page 55.

i NOTE

The code scan can also be saved manually by selecting the **Save** icon.

8.1.1 Total Number of Systems (modules) Analyzed

The total number of systems analyzed is actively displayed at the top of the screen as they are scanned.

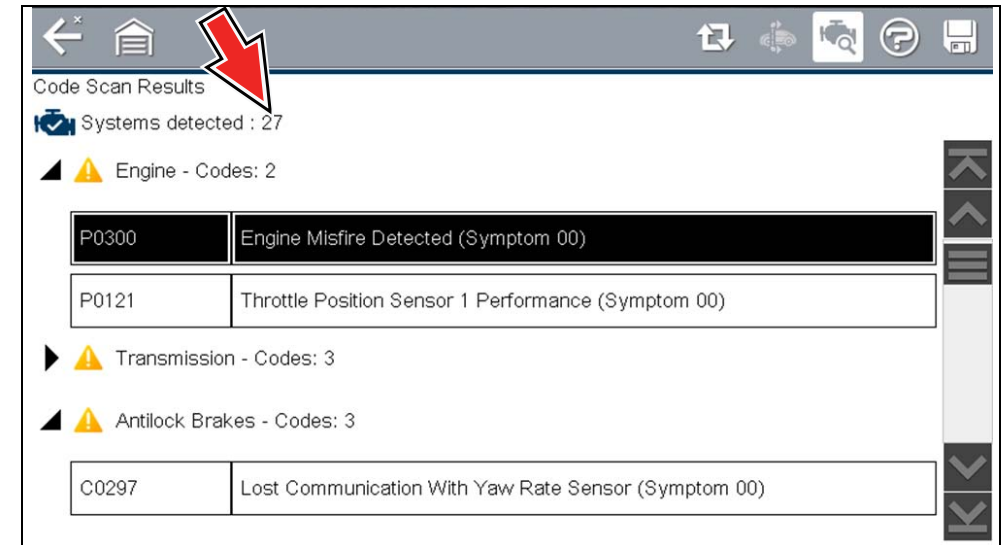

Figure 8-4 Code Scan systems analyzed result total

8.1.2 List of All the Systems Analyzed with DTCs Totals

A categorized system list with DTC totals is displayed in the order they are scanned. To view the main menu for a system in the list, select the system, then select the **System** icon (Figure 8-5).

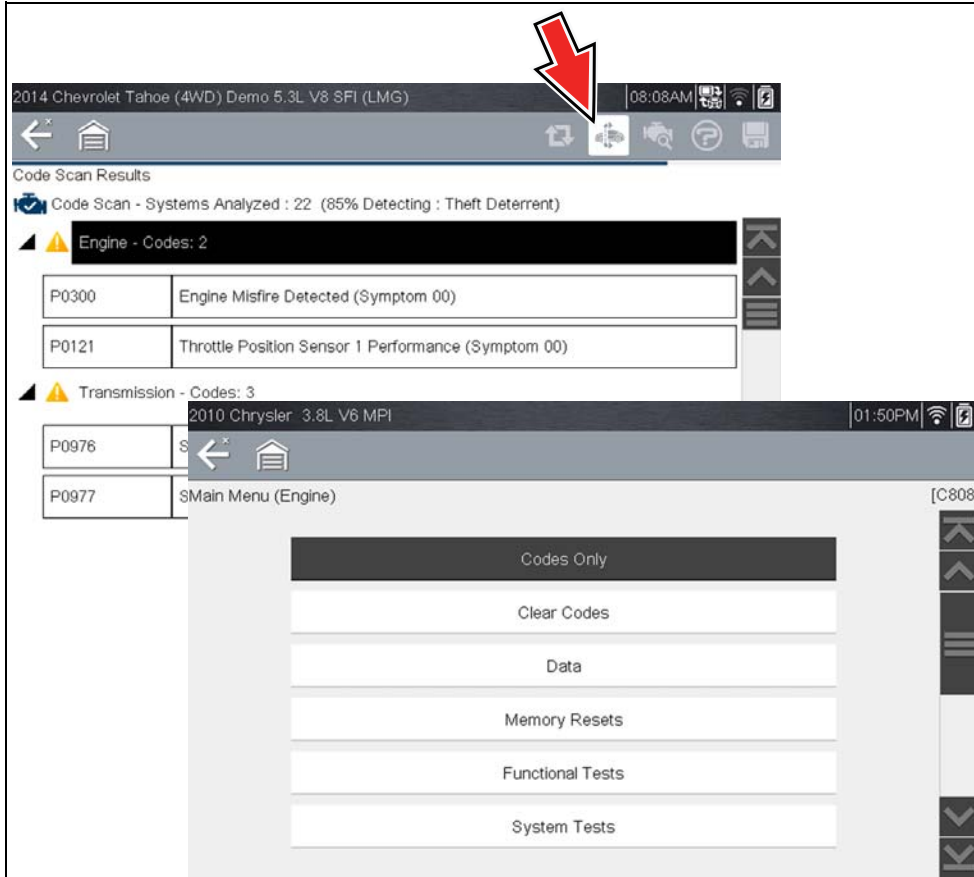

Figure 8-5 System icon (opens Main Menu)

Select the **expand/collapse** icon (Figure 8-6) on the left side of a system category title to expand or collapse a systems' DTC list.

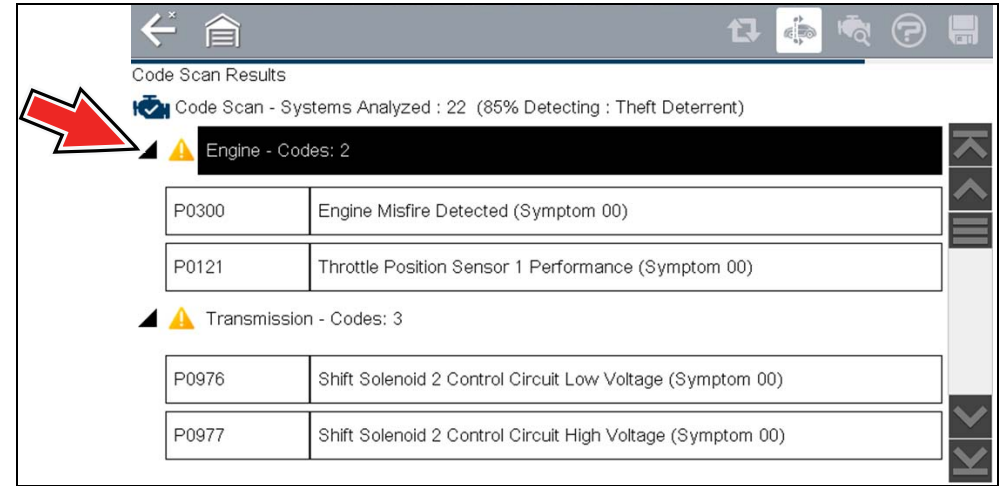

Figure 8-6 Expand/Collapse Icon (expanded result)

8.1.3 Global OBDII DTCs

Towards the end of the Code Scan list Global OBDII DTCs are displayed.

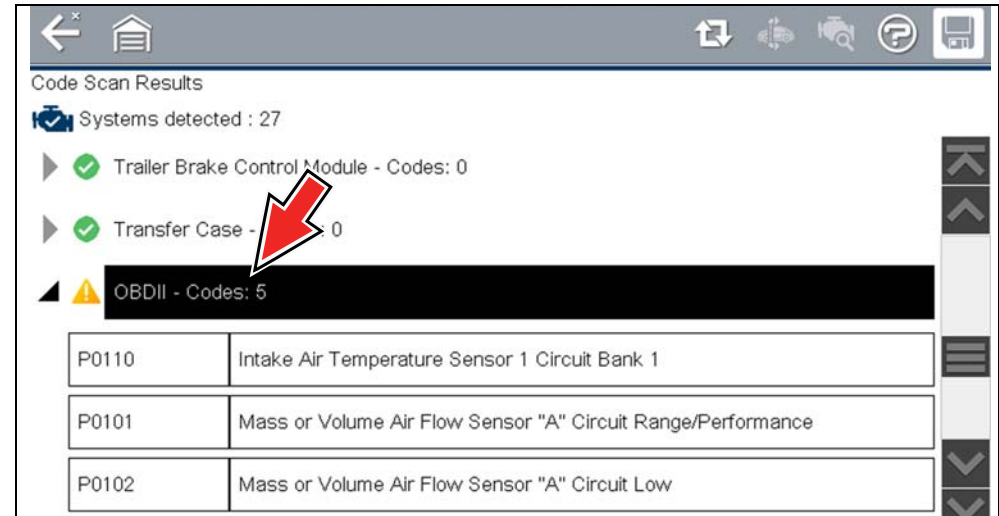

Figure 8-7

NOTE

Some 2005 to 2008 vehicles may not display global OBD-II information in the Code Scan list. A message will be displayed to inform you the OBD-II - codes and monitors for this vehicle may be accessed using the global OBD-II function. See [OBD-II/EOBD](#) on page 67.

8.1.4 Readiness Monitor Test Status

At the end of the Code Scan list, readiness monitor test results are displayed as “Tests Complete” or “Not Complete”.

Quick reference indicators are used to show monitor status.

Green icon “✓” mark - Monitor test is complete

- **Grey icon “—” mark** - Monitor test is not complete

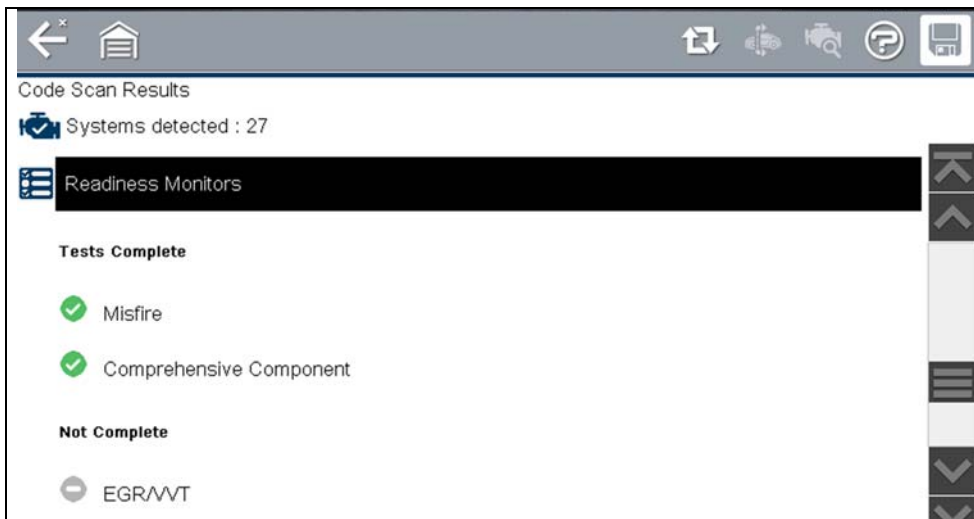

Figure 8-8

NOTE

Monitors that are not supported by the vehicle are not displayed in Code Scan.

8.2 Vehicle System Report (Snap-on Cloud)

After a code scan is completed the results of the scan are automatically configured into a Vehicle System Report that is uploaded and saved to your Snap-on Cloud account (if registered and connected). Report examples are shown in [Figure 8-1](#).

From the Snap-on Cloud the report can be printed, downloaded, attached to an e-mail or other social media app to share with others. For additional information, see [Snap-on Cloud](#) on page 92.

NOTE

Code scan reports are automatically saved to the Snap-on Cloud each time a code scan is performed.

The code scan/vehicle system report includes:

- Basic vehicle information
- A list of the code scan results by system
- Individual system DTCs with a brief description
- Global OBD codes
- Readiness monitor test status

8.2.1 Printing the Vehicle System Report

Use the Snap-on Cloud to print the vehicle system report from your PC or mobile device, see [Quick Reference \(print / download / share\)](#) on page 95.

The vehicle system report can also be customized and printed using ShopStream Connect - See [Printing the \(Code Scan\) Vehicle System Report](#) on page 122.



This section describes the basic operation, and navigation of the following Quick Lookup functions:

- Oil Specifications and Resets
- Tire and Wheel Service

The **Quick Lookups** icon is located on the Home screen.

Main Topic Links

- [Oil Specs and Resets](#) page 56
- [Tire and Wheel Service](#) page 62

9.1 Oil Specs and Resets

Oil Specifications and Resets is located in the Quick Lookups main menu (Quick Lookups > Oil Specs and Resets).

Oil Specs and Resets is a integrated Information Service that provides up-to-date OEM information on your diagnostic tool. Quick Lookups provides both OEM information and Scanner functions in one place.

Typical OEM information provided:

- **Fluid capacity and specifications**
- **Service reset procedures and information**
- **Scanner Functional Resets**

NOTES

— *Oil Specs and Resets vehicle coverage is the same as the Scanner vehicle coverage.*

— *Not all vehicles may have on-board diagnostic tool reset capabilities, or have information available.*

— *To use the Oil Specs and Resets feature you must have authorized access, contact your sales representative for details.*

— *The diagnostic tool is equipped with the ability to connect to a Wi-Fi network, however the connection is solely dedicated to our Snap-on Web Services Network. Before you begin using an integrated Information Service you must connect to a wireless network. See [Wi-Fi Connection / Troubleshooting](#) on page 86 for instructions.*

— *If you experience a wireless network connection loss, Oil Specs and Resets information will not refresh and/or may cause the function to stop. To continue use, you must re-establish your Internet connection.*

— *Performance may vary depending on your wireless network equipment and ISP.*

9.1.1 Operation

NOTE

The information and procedures provided by the Oil Specs and Resets function is vehicle specific, therefore a vehicle must be identified before information can be displayed.

▶ Using the Oil Specs and Resets function

There are two methods to access this function:

- **From the Home screen** - select the **Quick Lookups** icon (*Figure 9-1*), then select **Oil Specs and Resets**, then proceed to Step 1.
- **From within a current Scanner session** - select **Oil Specs and Resets** from the System menu (*Figure 9-2*), follow the screen prompts to identify the vehicle and then proceed to Step 4.



Figure 9-1 Home Screen - Quick Lookups Icon

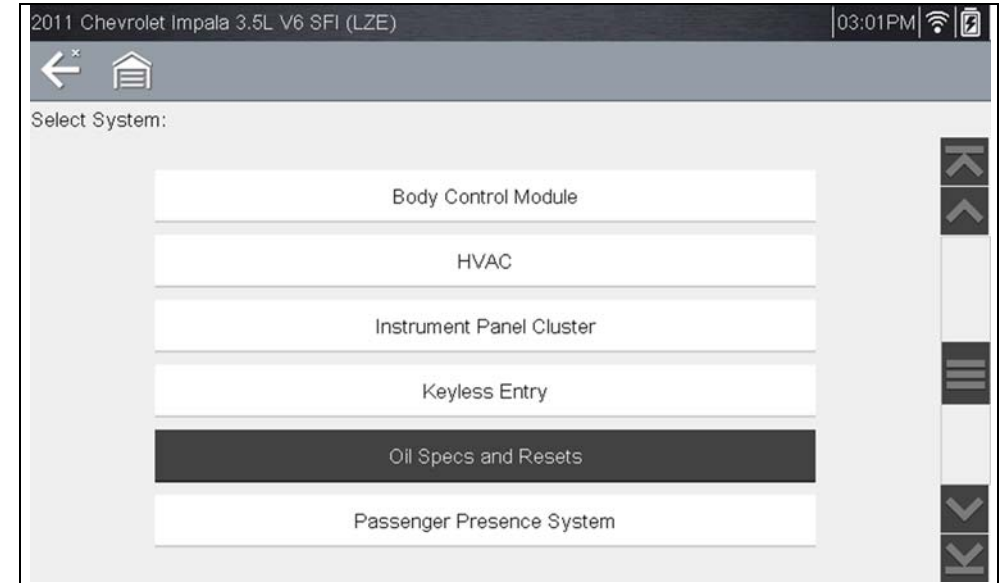

Figure 9-2 Scanner System Menu - Oil Specs and Resets Option

1. Follow the screen prompts to select the vehicle, **Manufacturer, Year and Model**.
2. Select **OK** to confirm the vehicle.
3. (If applicable) Follow the screen prompts to select the vehicle sub-model options.
4. After the Fluid Capacity screen displays, navigate to either of the following options:
 - Perform a service interval reset using the diagnostic tool.
 - View OEM service reset instructions and related information.

NOTE

Depending on the active function, descriptive information is displayed in the main body of the screen. If applicable, use the scroll bar or directional buttons (▲, ▼) to scroll up/down to view all of the information.



Icons

The following provides a brief description of the related Oil Specs and Resets toolbar icon functions. Detailed descriptions are provided in the following sections.

Icon	Icon Name	Description
	Fluid Capacity	Displays OEM recommended engine oil specification and capacity information.
	Functional Reset (Scanner)	Opens the Scanner service reset menu for the selected vehicle, providing options for available resets using the diagnostic tool.
	Reset Procedure	Displays OEM service interval reset instructions, to perform a manual reset of the service indicator.

Fluid Capacity

Selecting **Fluid Capacity** displays OEM recommended fluid specifications (*Figure 9-3*).

NOTE

The Fluid Capacity screen is the default screen.

Typical information may include:

- Vehicle application information
- Oil capacity specifications with or without oil filter
- Oil rating, weight and type
- Special notes

2012 Chevrolet Impala 3.6L V6 (LFX) 01:32PM

Oil Specs and Resets
Fluid Capacities

Note:
Use only engine oil licensed to the dexos1 specification, or equivalent, of the proper SAE viscosity grade. ACDelco dexos1 Synthetic Blend is recommended. If in an area of extreme cold, where the temperature falls below -20Deg.F (-29Deg.C), an SAE 0W-30 oil may be used. An oil of this viscosity grade will provide easier cold starting for the engine at extremely low temperatures.

Fluid Type	Application	Standard	Metric	Fluid Spec	S/H
Engine Oil	Police Package	5.10 QTS.	4.83 L	API - SAE 5W-30	Standard

Note:
Use only engine oil licensed to the dexos1 specification, or equivalent, of the proper SAE viscosity grade. ACDelco dexos1 Synthetic Blend is recommended. If in an area of extreme cold, where the temperature falls below -20Deg.F (-29Deg.C), an SAE 0W-30 oil may be used. An oil of this viscosity grade will

Figure 9-3 Typical Oil Specification Result



Functional Reset

Selecting **Functional Reset** opens the service interval reset menu (within the Scanner function) for the selected vehicle, and includes functional resets for the oil service indicator and other supported resets.

IMPORTANT

Instructions may be provided, that are required to be performed before selecting or completing the reset function itself. Follow all instructions as written.

NOTES

Functional resets are not available for all vehicles, and will vary depending on vehicle support.

A “grayed out” or non-selectable icon indicates that functional resets are not available for the selected vehicle.

Service interval reset menus and selections, will vary by manufacturer.

1. Select the **Functional Reset** icon.

The Scanner function opens to the service interval reset menu for the selected vehicle.

2. Select the applicable menu option(s) to perform the functional reset.
3. Read and perform any instructions that are provided.
4. If applicable, once the reset has completed select **OK** or **Continue**.

The following screen examples ([Figure 9-4](#)) illustrate the typical engine oil life indicator reset menu navigation for a 2011 Honda Accord. Other vehicle manufacturer menu navigation will vary.

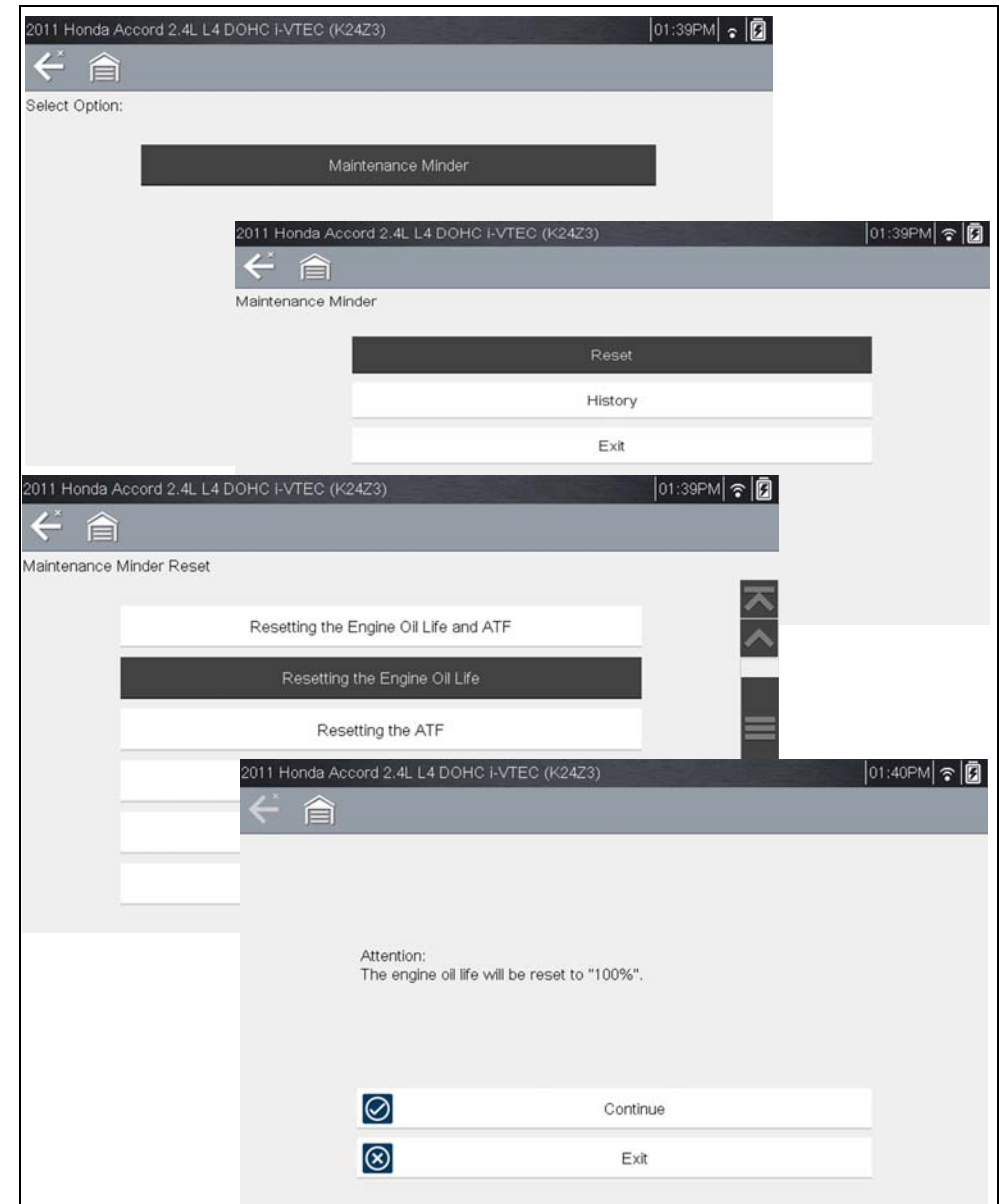

Figure 9-4

9.1.2 Reset Procedure

Selecting **Reset Procedure** displays OEM oil service reset instructions. Typical information may include:

- Step-by-step instructions for manually resetting the oil service reset indicator using on-board vehicle functionality (e.g. instrument cluster controls, accelerator pedal, information or media center controls, multi-function switch, etc.)
- Special notes, and/or instructions
- Theory of operation

i NOTE

During content download, icons may be used as image place holders until the image is fully downloaded, and can be displayed.

Use the scroll bar or directional buttons (▲, ▼) to scroll up/down to view all of the information.

The following are examples ([Figure 9-5](#)) of typical oil service reset instructions. Instructions and screens will vary by vehicle.

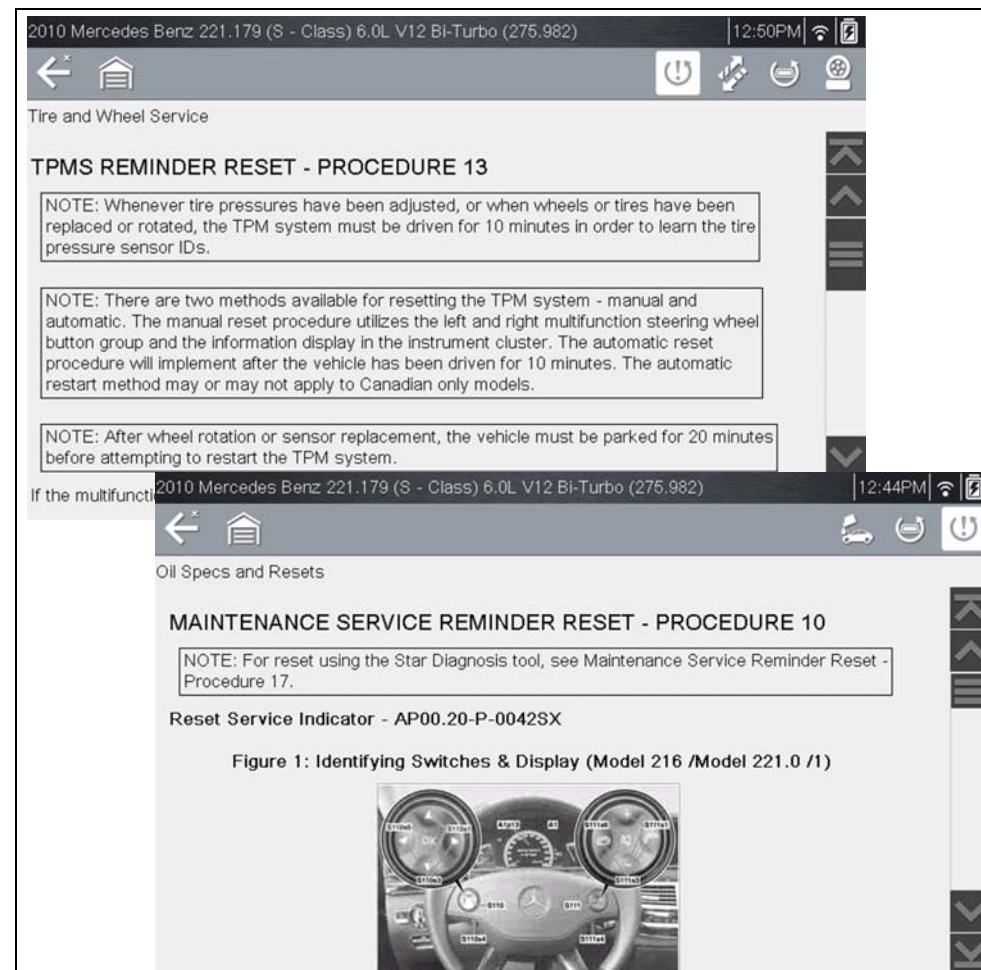

Figure 9-5



Viewing Images

Images may be provided within the reset instructions. Depending on the image, it may require enlargement to see details within the image.

If you need to see an image in greater detail, tap the image to select it ([Figure 9-6](#)).



Figure 9-6

Selecting an image, opens it in a viewer window ([Figure 9-7](#)).



Figure 9-7

Use the zoom and pan features described in this section to adjust the image as needed.

Zoom

From the image viewer window, select the + and - icons from the toolbar to incrementally increase or decrease the image displayed ([Figure 9-8](#)).

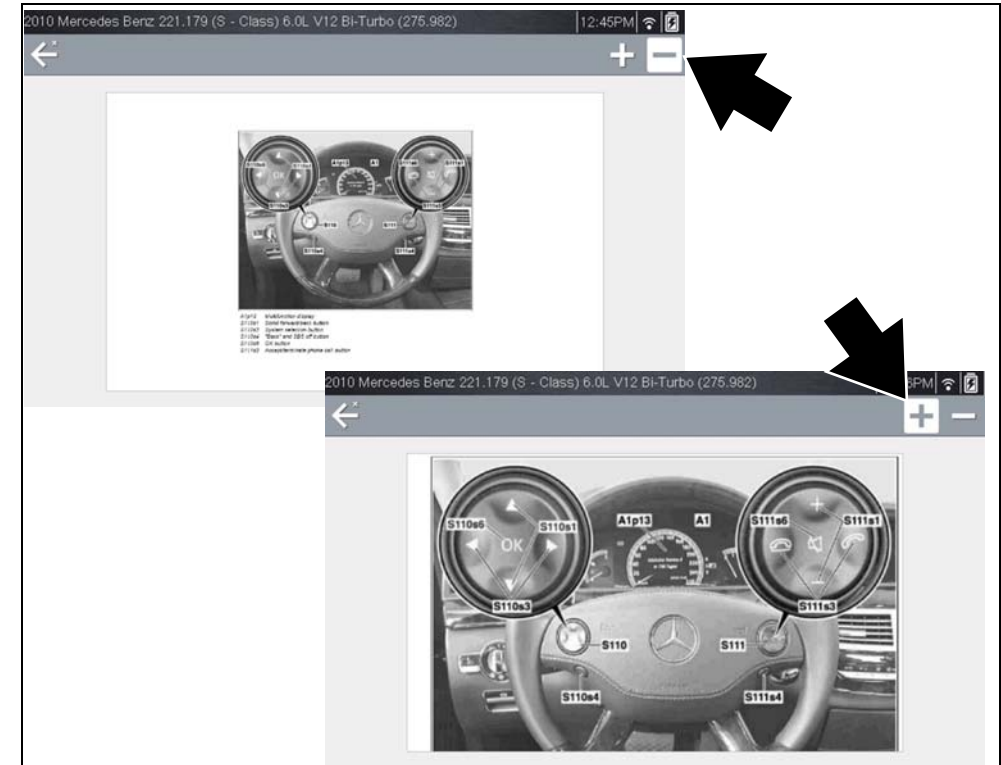

Figure 9-8



Pan

To move the image, touch, hold and drag the image on the screen to reposition it ([Figure 9-9](#)).

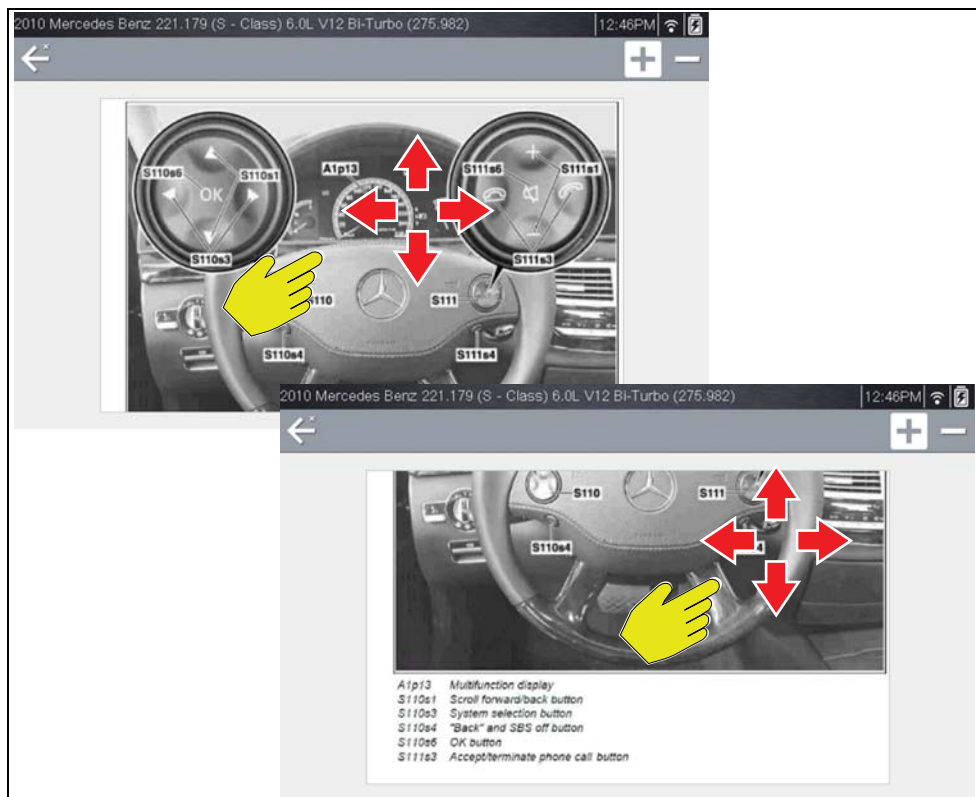

Figure 9-9

9.2 Tire and Wheel Service

Tire and Wheel Service is located in the Quick Lookups main menu (Quick Lookups > Tire and Wheel Service).

Tire and Wheel Service is an integrated Information Service that provides up-to-date information on your diagnostic tool. This feature allows you quick access to the following information:

- **Tire Pressure Monitoring System (TPMS) Indicator Reset Procedures**
- **TPMS Relearn Procedures**
- **Tire Pressure Sensor Removal/Installation Procedures**
- **Tire Fitment Specifications**

Tire and Wheel Service can also provide (when available) quick access to the following diagnostic functions when connected to a vehicle:

- **View and Clear TPMS Related Codes**
- **View TPMS Related Data**
- **Perform TPMS Related Functional Tests**
- **View TPMS Troubleshooter Information**

NOTES

— *Tire and Wheel Service vehicle coverage is the same as the Scanner vehicle coverage.*

— *Not all vehicles may have on-board diagnostic tool reset capabilities, or have information available.*

— *To use the Tire and Wheel Service feature you must have authorized access, contact your sales representative for details.*

— *The diagnostic tool is equipped with the ability to connect to a Wi-Fi network, however the connection is solely dedicated to our Snap-on Web Services Network.*

Before you begin using an integrated Information Service you must connect to a wireless network. See [Wi-Fi Connection / Troubleshooting](#) on page 86 for instructions.

— If you experience a wireless network connection loss, Tire and Wheel Service information will not refresh and/or may cause the function to stop. To continue use, you must re-establish your Internet connection.

— Performance may vary depending on your wireless network equipment and ISP.

9.2.1 Operation

NOTE

The information and procedures provided by the Tire and Wheel Service function is vehicle specific, therefore a vehicle must be identified before information can be displayed.

Using the Tire and Wheel Service function

There are two methods to access this function:

- **From the Home screen** - select the **Quick Lookups** icon ([Figure 9-10](#)), then select **Tire and Wheel Service**, then proceed to Step 1.
- **From within a current Scanner session** - select **Tire and Wheel Service** (or applicable choice) from the System menu ([Figure 9-11](#)), follow the screen prompts to identify the vehicle, and then proceed to Step 4.

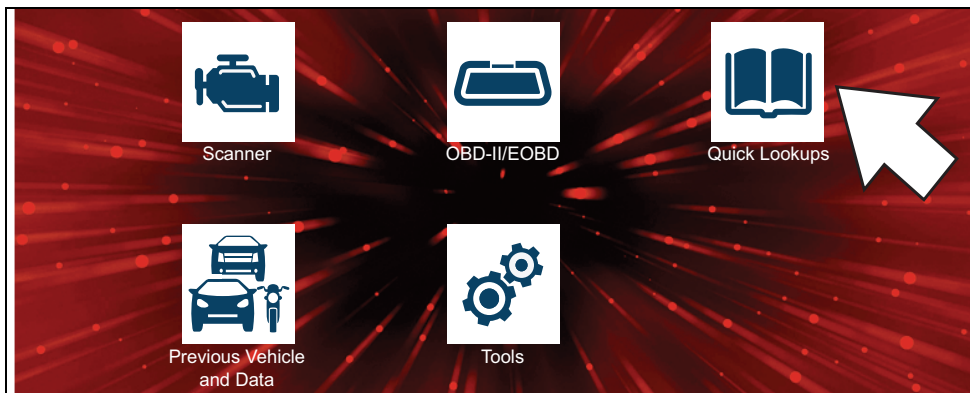

Figure 9-10 Home Screen - Quick Lookups Icon



Figure 9-11 Scanner System Menu - Tire and Wheel Service Option





1. Follow the screen prompts to select the vehicle, **Manufacturer, Year and Model**.
2. Select **OK** to confirm the vehicle.
3. (If applicable) Follow the screen prompts to select the vehicle sub-model options.
4. After the TPMS Indicator Reset instruction screen displays, you can navigate to other options as needed, see [Tire and Wheel Service Toolbar Icons](#).

NOTE

Depending on the active function, descriptive information is displayed in the main body of the screen. If applicable, use the scroll bar or directional buttons (▲, ▼) to scroll up/down to view all of the information.

Tire and Wheel Service Toolbar Icons

The following provides a brief description of the related Tire and Wheel Service toolbar icon functions. Detailed descriptions are provided in the following sections.

Icon	Icon Name	Description
	TPMS Indicator Reset	Displays TPMS indicator reset instructions, to perform a manual reset of the TPMS indicator. See TPMS Indicator Reset .
	TPMS Remove & Repair (TPMS Service)	Displays TPMS service information. See TPMS Remove & Repair (TPMS Service) .
	Scanner Functions	Opens the TPMS test related Scanner menu. Options may include, view and clear codes, display data, and access functional tests using the diagnostic tool.
	Tire/Wheel Specifications (Fitment)	Displays OEM tire and wheel specifications.

TPMS Indicator Reset



Selecting the **TPMS Indicator Reset** icon displays TPMS indicator reset instructions. Typical information may include:

- Instructions for manually resetting the TPMS indicator using on-board vehicle functionality.
- Special notes, and/or instructions
- Theory of operation

During content download, progress messages may display until the image is fully downloaded, and can be displayed.

NOTE

When viewing images within the displayed OEM procedures, use the same navigation functionality (e.g. pan, zoom, etc) as previously described in *Oil Specs and Resets*, see [Viewing Images](#) on page 61.

Use the scroll bar or directional buttons (▲, ▼) to scroll up/down to view all of the information.

The following example ([Figure 9-12](#)) shows typical TPMS indicator reset instructions. Instructions and screens will vary by vehicle.

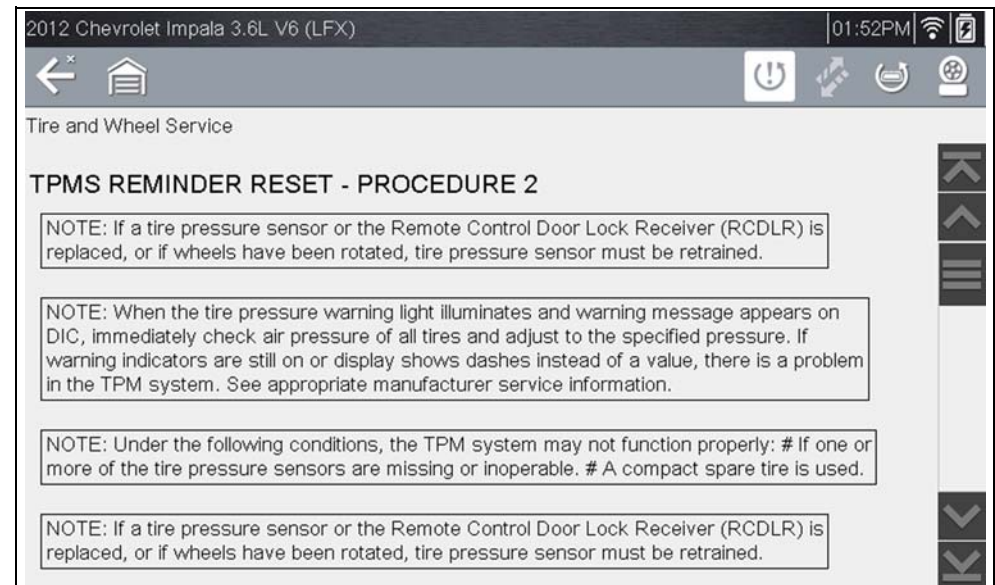

Figure 9-12

TPMS Remove & Repair (TPMS Service)



Selecting the **Remove & Repair (TPMS Service)** icon displays TPMS service information. Typical information may include:

- Removal and installation instructions.
- Relearn/enable procedures
- Diagnostic testing procedures
- Theory of operation

During content download, progress messages may display until the image is fully downloaded, and can be displayed.

NOTE

When viewing images within the displayed OEM procedures, use the same navigation functionality (e.g. pan, zoom, etc) as previously described in *Oil Specs and Resets*, see [Viewing Images](#) on page 61.

Use the scroll bar or directional buttons (▲, ▼) to scroll up/down to view all of the information.

The following are examples (Figure 9-13) of typical TPMS service procedures. Instructions and screens will vary by vehicle.

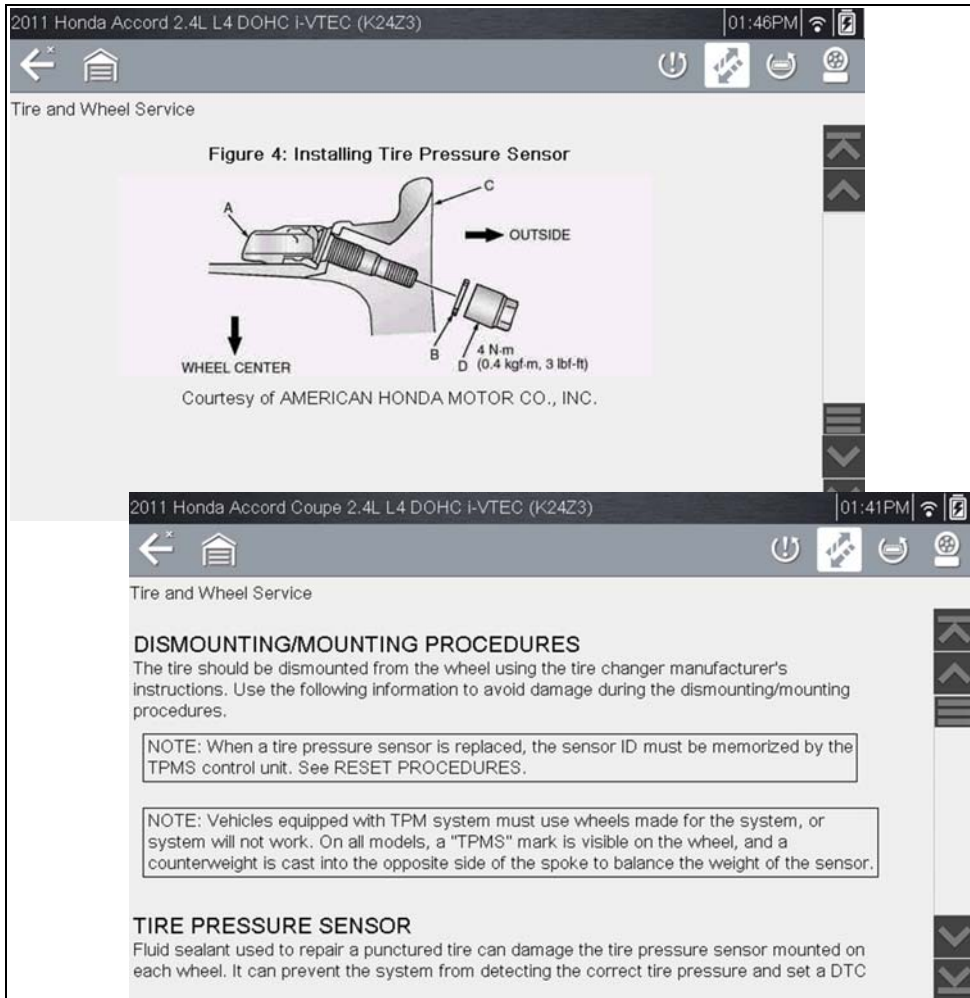

Figure 9-13

Scanner Functions



Selecting the **Scanner Function** icon opens the TPMS Scanner test menu for the selected vehicle. Options may include:

- View and Clear Codes
- View Data
- Perform TPMS Related Functional Tests/Resets
- View TPMS Troubleshooter Information

IMPORTANT

Functional test instructions may be provided, that are required to be performed before selecting or completing the function itself. Follow all instructions as written.

NOTES

Scanner functions require connection and communication with the vehicle.

Functional tests/resets are not available for all vehicles, and will vary depending on vehicle support.

A "grayed out" or non-selectable icon indicates that functional resets/rests are not available for the selected vehicle.

Service test/reset menu titles will vary by manufacturer.

The following screen examples (Figure 9-14) illustrate some typical TPMS functional test screens.

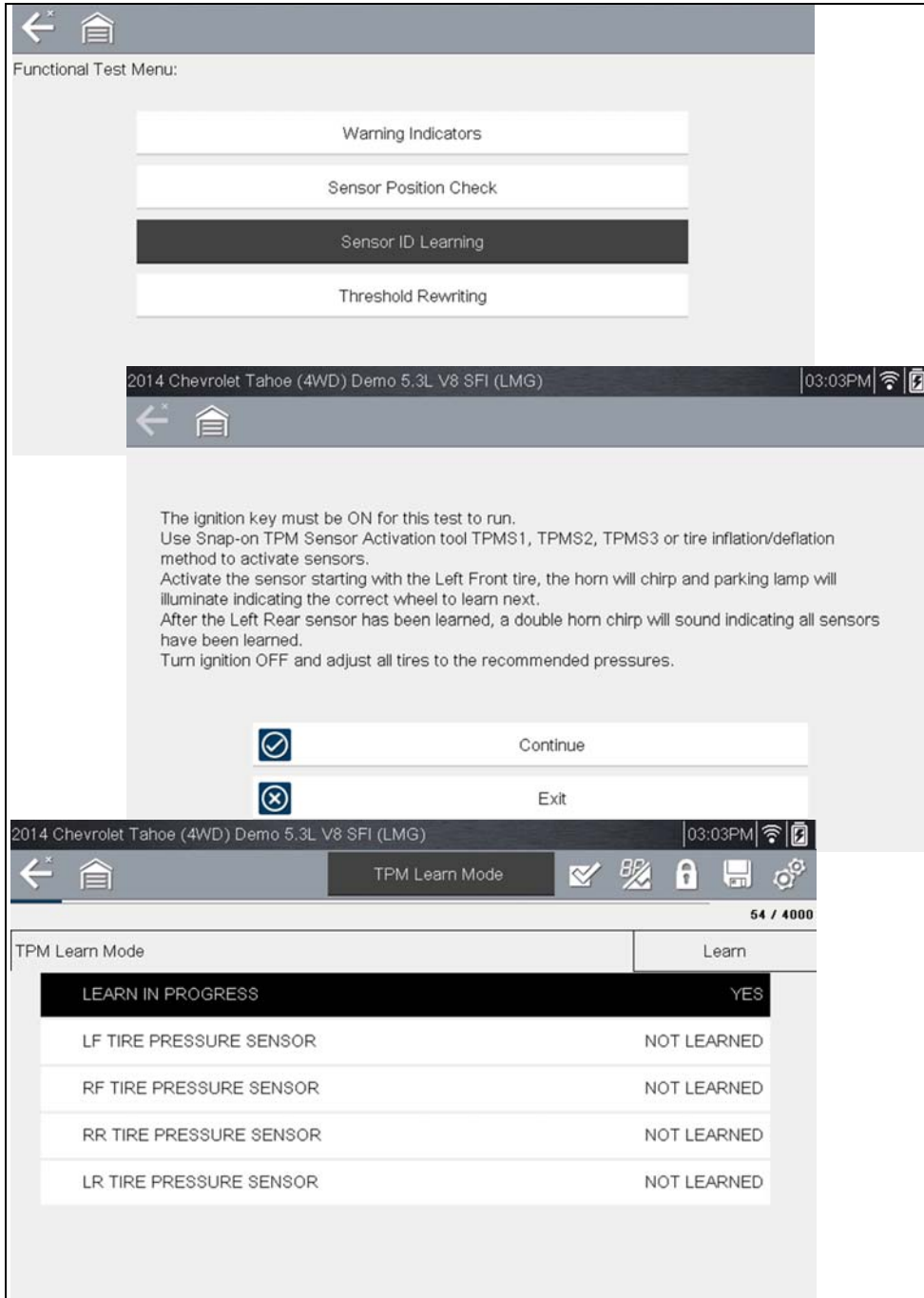

Figure 9-14

Tire/Wheel Specifications (Fitment)



Selecting **Tire/Wheel Specifications** displays OEM tire and wheel specifications (Figure 9-15).

Typical information may include:

- Tire size and pressure
- Wheel hub stud size and lug torque
- Wheel size

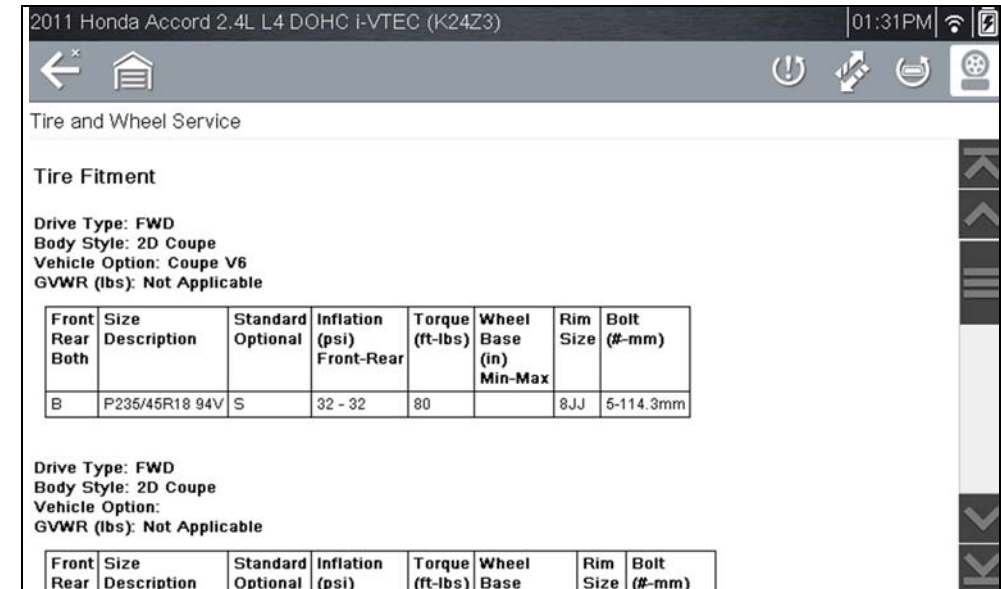

Figure 9-15 Typical Tire and Wheel Specification Result



This section describes the basic operation of the OBD-II/EOBD function.



The **OBD-II/EOBD** icon is located on the Home screen.

The OBD-II/EOBD function allows you to access “generic” OBD-II/EOBD data.

Generic OBD-II/EOBD data is data limited to emission related diagnostics such as:

- Checking for emissions-related diagnostic trouble codes (DTCs)
- Checking the cause of an illuminated malfunction indicator lamp (MIL)
- Checking monitor status prior to emissions certification testing

To access other available electronic control module (ECM) data for vehicle specific systems, parameters or enhanced diagnostics use the Scanner function, see “Scanner - Automotive” on page 19.

i NOTE

The OBD-II/EOBD function can also be used to access “generic” OBD-II/EOBD data for OBD-II/EOBD compliant vehicles that are not included in the Scanner function databases.

Main Topic Links

- [Basic Operations](#) page 67
- [OBD-II/EOBD Menu](#) page 68
- [OBD Health Check](#) page 68
- [OBD Direct](#) page 70
- [Connector Information](#) page 73
- [Manual Protocol Selection](#) page 73
- [Codes](#) page 68
- [Pending Codes](#) page 68
- [Readiness Monitors](#) page 71
- [MIL Status](#) page 71

- [Fast-Track Troubleshooter](#) page 71
- [\(\\$01\) Display Current Data](#) page 71
- [\(\\$02\) Display Freeze Frame Data](#) page 71
- [\(\\$03\) Display Trouble Codes](#) page 71
- [\(\\$04\) Clear Emissions Related Data](#) page 71
- [\(\\$05, 06, 07\) Display Test param./Results](#) page 72
- [\(\\$06\) On-board Monitored Systems](#) page 72
- [\(\\$07\) DTCs Detected During Last Drive](#) page 72
- [\(\\$08\) Request Control of On-board System](#) page 72
- [\(\\$09\) Read Vehicle Identification](#) page 72
- [\(\\$09\) In-use Performance Tracking](#) page 72
- [\(\\$0A\) Emission Related DTC with Permanent Status](#) page 73

10.1 Basic Operations

10.1.1 Screen Layout and Toolbar Controls

Screen layout and toolbar controls are similar to the Scanner function, see [Scanner Control Icons](#) on page 27.

10.1.2 Connecting the Data Cable

Connection of the data cable to the diagnostic tool and vehicle DLC is required for OBD-II/EOBD testing, see [Data Cable Connection \(OBD-II/EOBD Vehicles\)](#) on page 11.

10.1.3 Saving and Reviewing Data Files

Save and Pause control icon operation and data review procedures are the same as used for the Scanner function, see [Scanner - Automotive](#) on page 19.

10.2 OBD-II/EOBD Menu

The following options are available from the OBD-II/EOBD menu:

- [OBD Health Check](#)
- [OBD Direct](#)

10.2.1 OBD Health Check

The OBD-II Health Check offers a way to quickly check for and clear emissions-related diagnostic trouble codes (DTCs), and to check readiness monitors for emissions testing. Selecting opens a connection message. Select **Continue** or press the **Y/✓** button to open a submenu of test options (*Figure 10-1*).

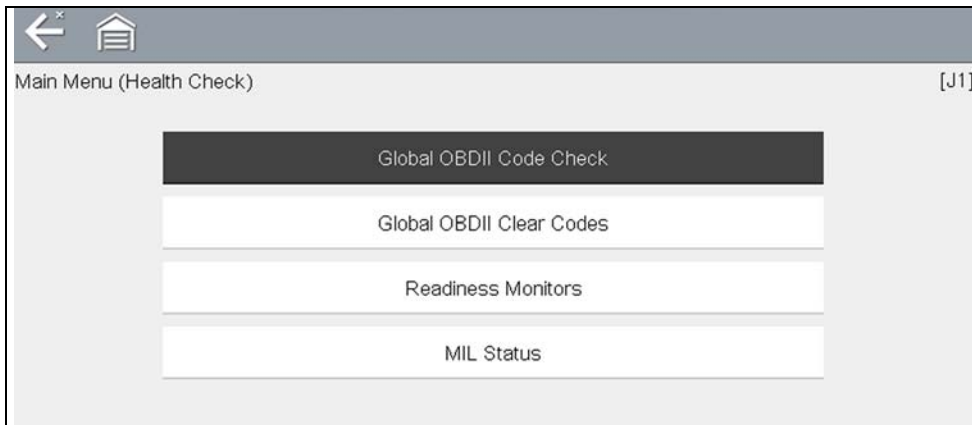

Figure 10-1 OBD Health Check menu

Global OBD II Code Check

Global OBDII Code Check displays stored emission related generic DTCs reported by the ECM. Selecting opens a submenu with two choices: Codes and Pending Codes. Either option opens a code list (*Figure 10-2*).

The DTC results screen is similar to the same screen used in the Scanner function, as both display the SureTrack results message below the toolbar. However, SureTrack is not accessible in OBD-II/EOBD mode. SureTrack is only accessible in the Scanner function where the vehicle has been identified.

NOTE

SureTrack is not accessible in OBD-II/EOBD mode.

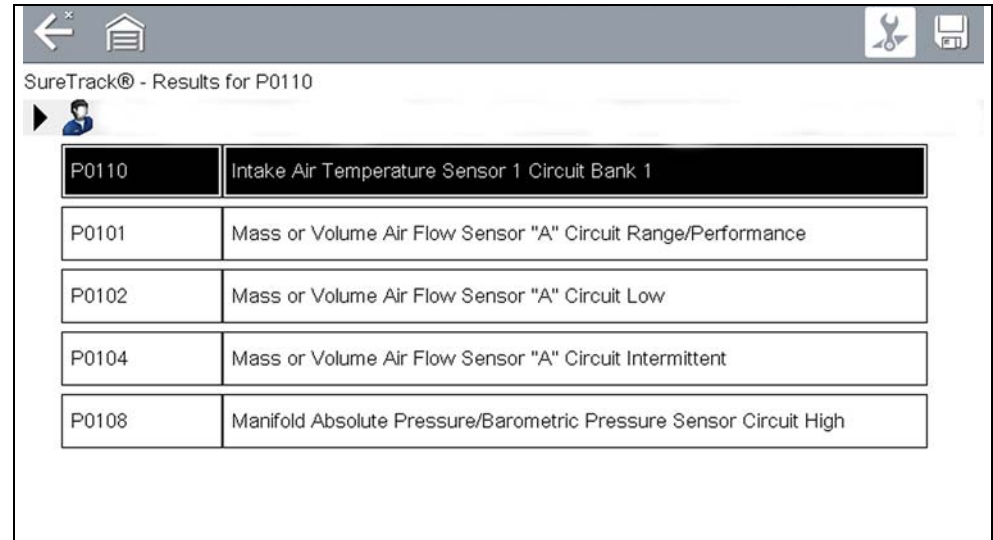

Figure 10-2 DTC Results Screen

Codes

The Codes option displays a list of current emission related DTCs.

OBD-II/EOBD Codes have a priority according to their emission severity. The priority of the code determines the illumination of the MIL and the code erase procedure. Vehicle manufacturers have implemented the ranking differently, so there are differences between makes.

Pending Codes

The purpose of this service is to enable the diagnostic tool to obtain “pending” or maturing diagnostic trouble codes. These are codes whose setting conditions were met during the last drive cycle, but need to be met on two or more consecutive drive cycles before the DTC actually sets.



NOTE

Save valuable time by using this service to verify test results after a single drive cycle following a vehicle repair and code clearing procedure.

- If a test failed during the drive cycle, the DTC associated with that test is reported. If the pending fault does not occur again within 40 to 80 warm-up cycles, the fault is automatically cleared from memory.
- Test results reported by this service do not necessarily indicate a faulty component or system. If test results indicate another failure after additional driving, then a DTC is set to indicate a faulty component or system, and the MIL is illuminated.

Refer to the [Global OBD Vehicle Communication Software Manual](#) for additional information.

Global OBD II Clear Codes

This option is used to clear all emission related diagnostic data, such as DTCs, freeze frame data, and test results, from the memory of the selected ECM. Although OBD-II/EOBD displays generic OBD-II/EOBD data only, clearing codes erases all of the stored data, including any enhanced codes and freeze frame information.

A confirmation screen displays when the clear codes option is selected to prevent accidental loss of data. Select to continue from the confirmation screen. Refer to the [Global OBD Vehicle Communication Software Manual](#) for additional information.

Readiness Monitors

This test checks the status of the readiness monitoring system. An OBD-II /EOBD control system runs continuous and periodic tests to check the status of emission-related subsystems to gauge the integrity of the electronic operations. Two options are available for Readiness Monitors:

- **Monitors Complete Since DTC Cleared**—displays the status of all monitors that have run since the last time ECM memory was erased.
- **Monitors Complete This Cycle**—displays the status of the monitors that ran during the current drive cycle only.

Selection of either option displays test results as shown in the data viewer ([Figure 10-3](#)).

Quick reference indicators are used to show monitor status on the left side of the screen ([Figure 10-3](#)):

- **Green icon “✓” mark** - Monitor test is complete
- **Gray icon “—” mark** - Monitor test is not complete
- **Red icon “X” mark** - Monitor test is not supported by vehicle

ID : \$	E8
✓ MISFIRE	TEST COMPLETE
✓ FUEL SYSTEM	TEST COMPLETE
✓ COMPONENTS	TEST COMPLETE
— CATALYST	NOT COMPLETE
✗ HEATED CATALYST	NOT SUPPORTED
— EVAPORATIVE SYSTEM	NOT COMPLETE
✗ SEC. AIR SYSTEM	NOT SUPPORTED

Figure 10-3 Readiness monitor test report

Use the scroll bar to view the entire list of Readiness Monitors.

Selecting **Save** from the toolbar saves the monitor data as an .SCM file for review at a later time. See [View Saved Data on page 75](#) for additional information.

MIL Status

This test checks the ECM commanded state (on or off) if the malfunction indicator lamp.

10.2.2 OBD Direct

OBD Direct includes the following menu and submenu choices:

- **OBD Diagnose**
 - **Start Communication** - initiates a test session
 - **Connector Information** - provides DLC location details
 - **Manual Protocol Selection** - provides choices for communication protocol
- **OBD Training Mode** - allows you to familiarize yourself with the capabilities of OBD-II/EOBD while navigating through menus without being connected to a vehicle.

Start Communication

Use the following procedure to begin an OBD-II/EOBD test session:



To perform an OBD-II/EOBD Test:

1. Connect the data cable to the test vehicle.
2. Select **Start Communications** from the OBD-II/EOBD menu.

A series of messages are displayed indicating automatic detection of vehicle type (12 or 24 V) has occurred and then the detected controllers are displayed. The diagnostic tool establishes a communication link with the test vehicle, then opens an information screen (*Figure 10-4*).

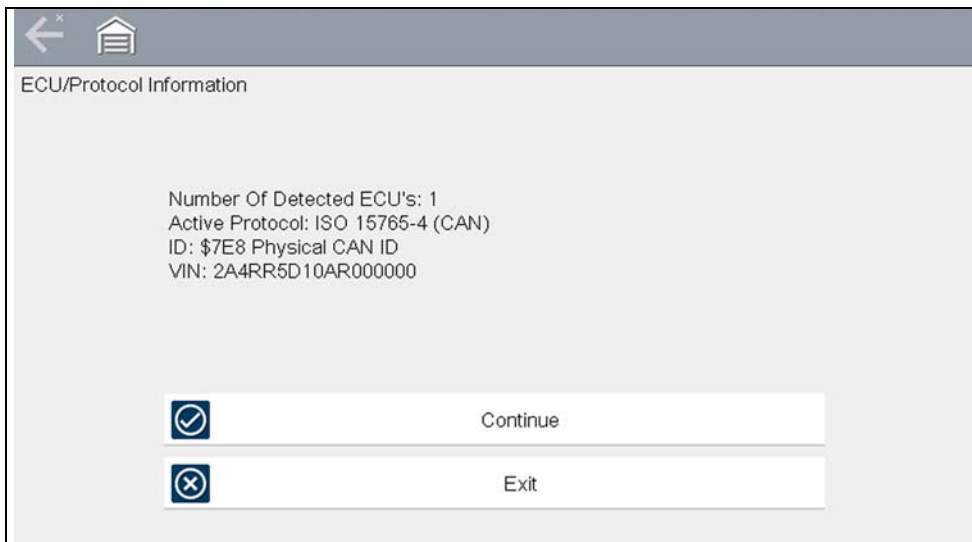

Figure 10-4 Protocol information

The information screen shows how many control modules were detected, which ECM is communicating, and which communication protocol is being used.

3. Select Continue.

A Select Service menu of available tests opens:

- *Readiness Monitors on page 71*
- *MIL Status on page 71*
- *Fast-Track Troubleshooter on page 71*
- *(\$01) Display Current Data on page 71*
- *(\$02) Display Freeze Frame Data on page 71*
- *(\$03) Display Trouble Codes on page 71*
- *(\$04) Clear Emissions Related Data on page 71*
- *(\$05, 06, 07) Display Test param./Results on page 72*
- *(\$08) Request Control of On-board System on page 72*
- *(\$09) Read Vehicle Identification on page 72*
- *(\$09) In-use Performance Tracking on page 72*
- *(\$0A) Emission Related DTC with Permanent Status on page 73*

IMPORTANT

All service modes are not supported by all vehicles, so the available menu selections will vary.

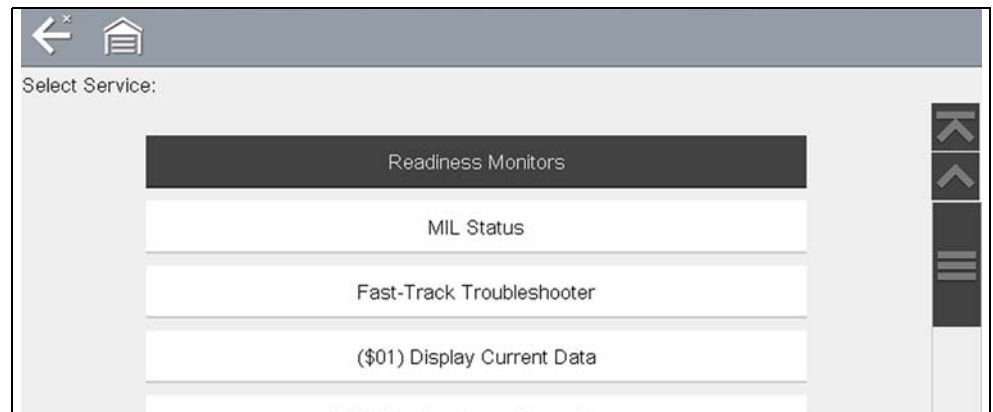

Figure 10-5 Service mode menu

4. Select a test to continue.

Readiness Monitors

Use this menu item to check the readiness of the monitoring system. Monitors not supported will display “not supported”. Scroll, if needed, to view the entire list of monitors ([Figure 10-3](#)). Selecting Readiness Monitors opens a submenu with two choices:

- **Monitors Complete Since DTC Cleared**—displays the results of all monitor tests that have run since the last time the vehicle electronic control module (ECM) memory was cleared.
- **Monitors Complete This Cycle**—displays only the results of monitor tests that ran during the current drive cycle, they reset when the ignition is switched off.

MIL Status

This item is used to check the current condition of the malfunction indicator lamp (MIL). Additional information, such as which ECM commanded the MIL on and the distance driven while the MIL is on (if supported), can also be displayed.

Fast-Track Troubleshooter

Fast-Track[®] Troubleshooter is a database of experience-based repair strategies and information, that has been compiled and validated by top-notch technicians. The Troubleshooter system simplifies the diagnosis process, as it contains information on virtually all common diagnostic trouble code (DTC) problems and driveability symptoms for most vehicles covered by the vehicle communication software.

(\$01) Display Current Data

Use this test to display the serial data transmitted by the selected vehicle electronic control module (ECM). The main body of the screen has two columns; the left-hand column is a description of the parameter and the right-hand column is the parameter value or state. Viewing options and operations are the same as the Scanner function, see [Scanner - Automotive](#) on page 19 for more information.

ID : \$	E8
ENGINE SPEED(1/min)	2033
ABSOLUTE THROTTLE POSITION(%)	16.5
ABSOLUTE THROTTLE POSITION B(%)	16.9
RELATIVE THROTTLE POSITION(%)	6.3
COMMANDED THROTTLE ACT.CONTROL(%)	6.7
ACCELERATOR PEDAL POSITION D(%)	15.7
ACCELERATOR PEDAL POSITION E(%)	7.5

Figure 10-6 Current data display

(\$02) Display Freeze Frame Data

Freeze frame data provides a “snapshot” of critical parameter values at the time a DTC set.

This item is used to display freeze frame data for any stored emission related diagnostic trouble codes (DTCs). In most cases the stored frame is the last DTC that occurred. Certain DTCs, those that have a greater impact on vehicle emissions, have a higher priority. In these cases, the highest priority DTC is the one for which the freeze frame records are retained.

(\$03) Display Trouble Codes

This is used to display any stored emission related DTCs reported by the ECM. The display is similar to the Scanner function code display (see [Codes - View / Save](#) on page 24 for details). The list does not include enhanced DTCs in this mode.

(\$04) Clear Emissions Related Data

This item is used to clear all emission related diagnostic data, such as DTCs, freeze frame data, and test results, from the memory of the selected ECM.

**To clear emission related Data:**

1. Select **Clear Emissions Related Data** from the menu.
A confirmation message displays to help prevent loss of any vital data (Figure 10-7).

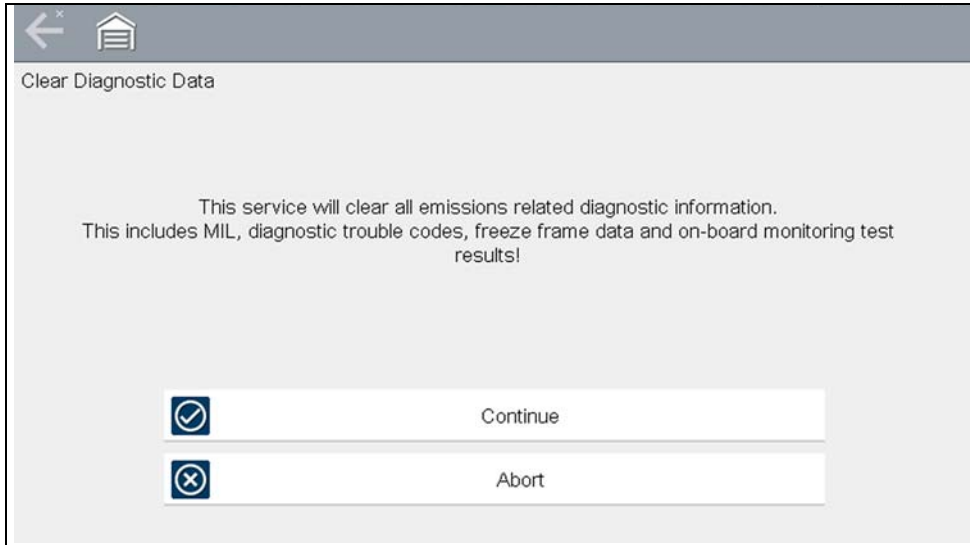

Figure 10-7 Clear codes confirmation message

2. Continue from the confirmation message.
The screen updates several times as ECM memory is erased, then a “data has been cleared” message displays.
3. Select **Continue** to return to the Select Service menu.

(\$05, 06, 07) Display Test param./Results

This option opens a submenu of parameters and test results from various sensors, monitor test results, and a record of DTC setting conditions detected during the last drive cycle. The submenu includes:

- [\(\\$05\) Oxygen Sensor Monitoring](#)
- [\(\\$06\) On-board Monitored Systems](#)
- [\(\\$07\) DTCs Detected During Last Drive](#)

(\$05) Oxygen Sensor Monitoring

This option opens a menu of tests available for checking the integrity of the oxygen (O₂) sensors. Making a selection displays all of the pertinent O₂ sensor parameters for the specific test. The test identification (ID) displays at the top of the data list.

(\$06) On-board Monitored Systems

This option opens a menu of tests from the monitored systems. The available data is for specific systems and components that the on-board diagnostic system monitors continuously, such as misfire, or non-continuously, such as the catalyst system. Making a menu selection displays the test results.

(\$07) DTCs Detected During Last Drive

This test opens a record of any DTCs that set during the last completed drive cycle. Select to open the DTC list.

(\$08) Request Control of On-board System

This service enables bidirectional control of the ECM. This service allows the diagnostic tool to control the operation of an on-board system, test, or component.

(\$09) Read Vehicle Identification

The purpose of this service is to enable the diagnostic tool to request and display vehicle-specific information, such as the vehicle identification number (VIN), the calibration identification, and the calibration verification number (CVN), of the test vehicle. Select a menu item to retrieve the information. Select **Return** to go back to the menu.

(\$09) In-use Performance Tracking

This option displays the “In-use Performance Tracking” of data. It is a record of the number of times each of the monitor tests have been completed. Select **Return** to go back to the menu.



(\$0A) Emission Related DTC with Permanent Status

This option displays a record of any “permanent” codes. A permanent status DTC is one that was severe enough to illuminate the MIL at some point, but the MIL may not be on at the present time.

Whether the MIL was switched off by clearing codes or because the setting conditions did not repeat after a specified number of drive cycles, a record of the DTC is retained by the ECM. Permanent status codes automatically clear after repairs have been made and the related system monitor runs successfully.

Connector Information

This option opens a database of vehicle diagnostic connector locations that includes most makes and models. The menu driven interface leads you quickly to difficult to find test connectors.



To locate a vehicle diagnostic connector:

1. Select **Connector Information** from the System menu.
A list of vehicle manufacturers displays.
2. Select a manufacturer from the list.
A list of models available from the selected manufacturer displays.
3. Select a model from the list.
If a cable adapter is needed, which one and how to connect it displays.
4. Select **Continue**.
Information on where to locate the vehicle diagnostic connector displays.
5. Select **Continue** to return to the System menu.

Manual Protocol Selection

Communication protocol is a standardized way of transferring data between an ECM and a diagnostic tool. Global OBD may use the following communication protocols:

- ISO 15765-4 (CAN)
- ISO 27145 (WWHOBD CAN)
- ISO J1939 (CAN)
- ISO 9141-2 (K-LINE)
- SAE J1850 PWM (Pulse Width Modulation)
- SAE J1850 VPW (Variable Pulse Width)

- ISO 14230-4 (Keyword Protocol 2000)
- SAE J2284/ISO 15765-4 (CAN)

When initially attempting to establish communication with the ECM the diagnostic tool attempts to communicate trying each protocol in order to determine which one is being used. During normal operation the communication protocol is automatically detected. If automatic detection fails, communication protocol can be manually selected.

IMPORTANT

Using unsupported OBD communication protocols may activate warning lights and can set network related faults. Only use the manual selection option when OBD protocol is already known.

Select **Manual Protocol Selection** to open a menu of options (*Figure 10-8*).

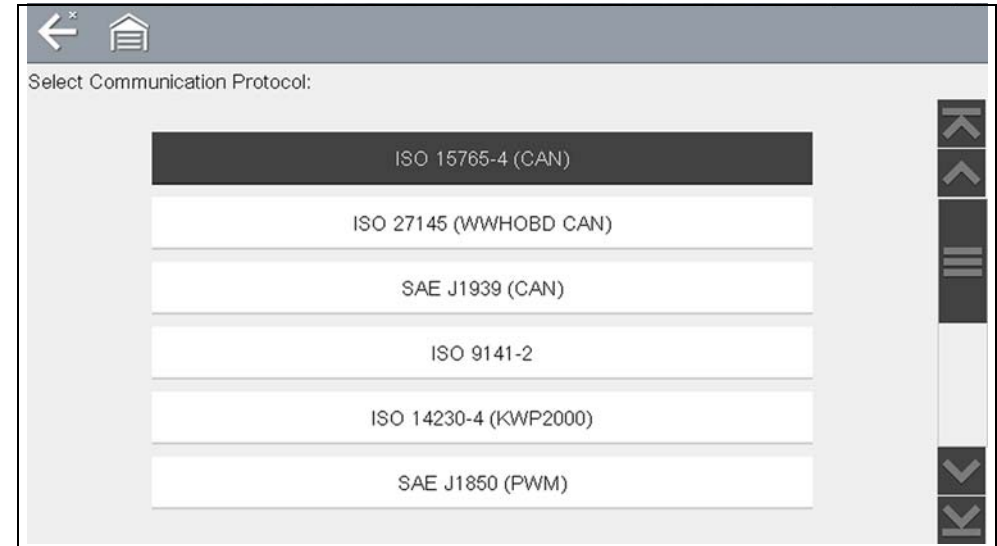
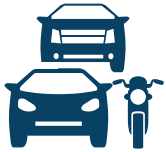

Figure 10-8 Manual protocol selection menu

Select the **Back** icon or press the **N/X** button to return to the OBD-II/EOBD Main menu.



This section describes the basic operation of the Previous Vehicles and Data function.



The **Previous Vehicles and Data** icon is located on the Home screen. This function allows you to select recently tested vehicles and access saved data files.

Main Topic Links

- [Vehicle History](#) page 74
- [View Saved Data](#) page 75
- [Viewing Codes and Code Scan Results](#) page 75
- [Delete Saved Data](#) page 76

11.1 Previous Vehicles and Data Menu

The following options are available from the Previous Vehicles and Data menu:

- [Vehicle History](#)
- [View Saved Data](#) on page 75
- [Delete Saved Data](#) on page 76

11.1.1 Vehicle History

The diagnostic tool stores the identification of the last twenty-five vehicles tested, so there is no need to go through the complete vehicle identification sequence when performing a retest after repairs have been made. The oldest vehicle record is deleted when a new vehicle is identified once there are twenty-five vehicles on file.



Figure 11-1 Vehicle history list



To select from the vehicle History:

1. Select **Previous Vehicles and Data** from the Home screen.
2. Select **Vehicle History** from the menu.
A list of up to 25 previously tested vehicles displays. Each vehicle is given a unique file name. Scroll to view the entire list.
3. With the item to be opened highlighted, either select the vehicle ID or press the **Y/✓** button.
The appropriate software loads and a vehicle ID confirmation screen displays.
4. Select **OK** or press the **Y/✓** button to continue.
The System Menu for the selected vehicle displays.

11.1.2 View Saved Data

Selecting the **View Saved Data** menu option opens a list of all the saved data (movie) files and screen images that are stored in memory. Saved files are listed in chronological order by the date and time that they were created with the most recent files are at the top of the list.

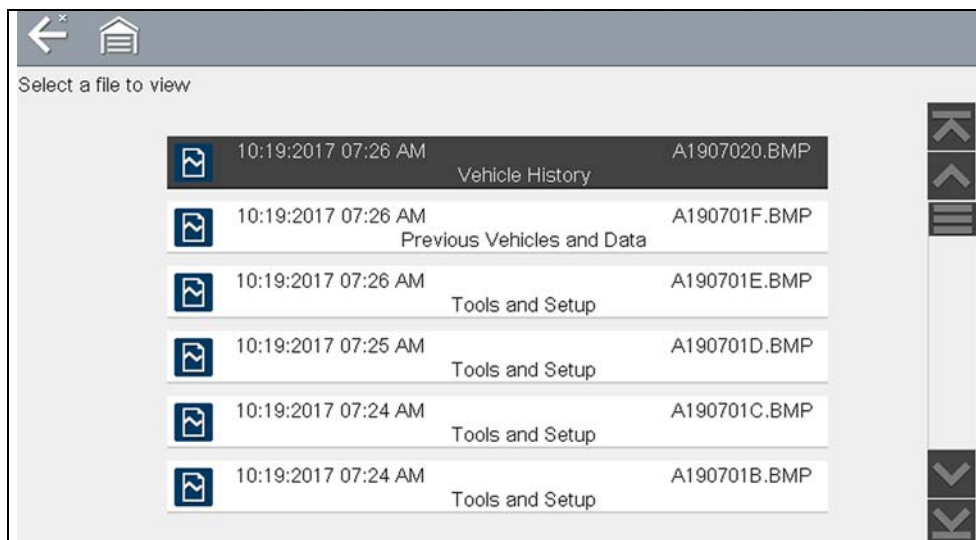

Figure 11-2 Saved data list

Selecting a file from the list, opens the file.

Saved data files can also be downloaded to a personal computer (PC) using the Mini USB jack. Once connected to the PC, the data files can be printed, transferred, and copied using ShopStream Connect. ShopStream Connect is a PC application that creates an interface between the diagnostic tool and a PC. See [ShopStream Connect™](#) on page 119.

To connect to a PC, see [Connect-to-PC \(File Transfer\)](#) on page 78.

NOTE

A maximum of 50 files are displayed. To view all (if more than 50) files stored, transfer the files to a PC and use ShopStream Connect. See [Connect-to-PC \(File Transfer\)](#) on page 78 for additional information.

▶ To review a saved data file or image:

1. Select **Previous Vehicles and Data** from the Home screen.
2. Select **View Saved Data** from the menu.
3. Select a file to review from the list.

11.1.3 Viewing Codes and Code Scan Results

When code scan or single system code results are saved, they are saved in (.XML) file format ([Figure 11-3](#)).

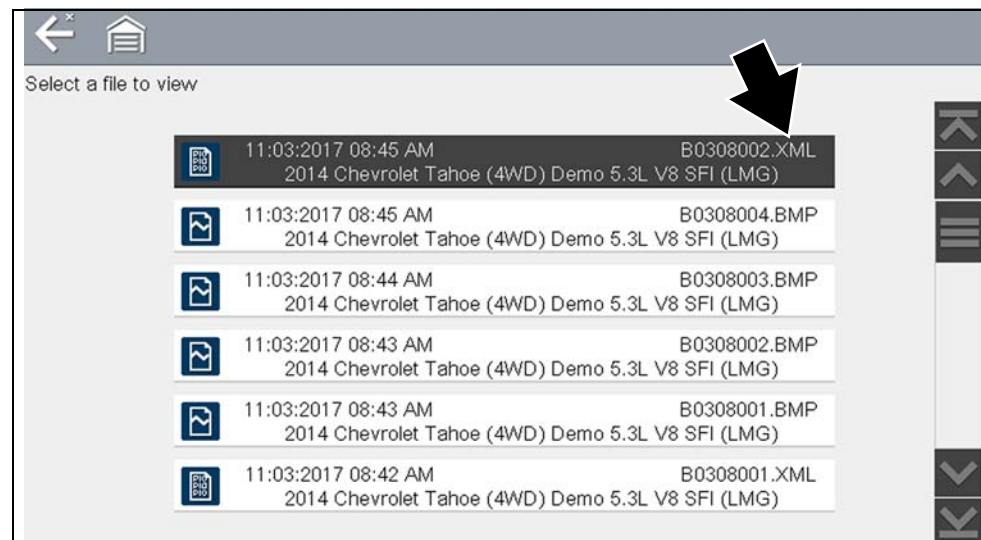

Figure 11-3 Typical - Code Results (.XML) file

The saved (.XML) file(s) can be viewed using two methods:

- On the diagnostic tool - See [Viewing Code Results on the diagnostic tool](#) on page 76.
- In ShopStream Connect - See [Viewing Codes and Code Scan Results](#) on page 75, and [ShopStream Connect™](#) on page 119.

▶ Viewing Code Results on the diagnostic tool

Selecting a system code or a code scan .XML file from the saved file list, opens that file onscreen (*Figure 11-4*).

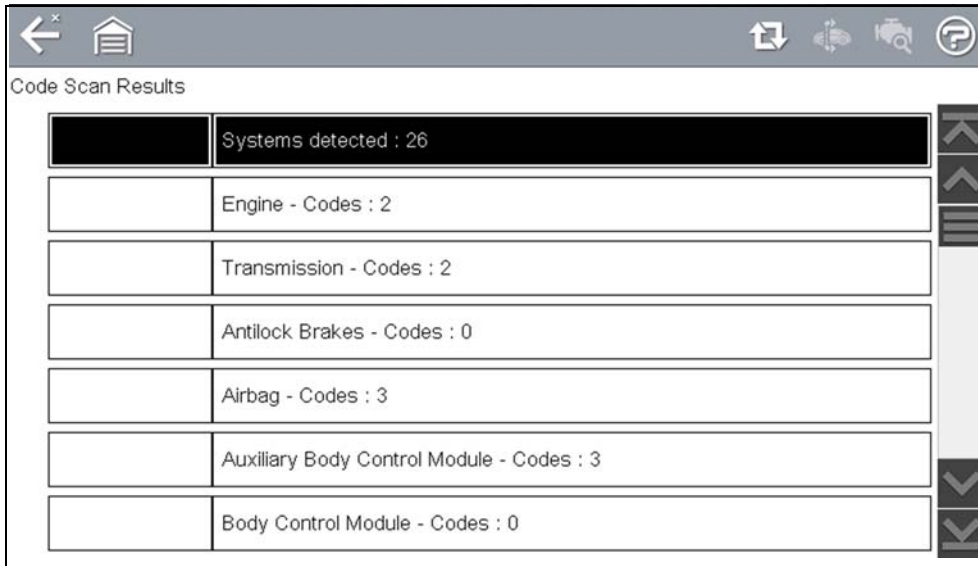

Figure 11-4 Typical - Code Scan Results (.XML file) viewed onscreen

11.1.4 Delete Saved Data

This menu option is used to permanently erase saved files from memory.

▶ To delete a saved file:

1. Select **Previous Vehicles and Data > Delete Saved Data**.

The list of saved files displays.

Select the file(s) to be deleted using the checkboxes.

Use the **Select All / Deselect All** icon as necessary.

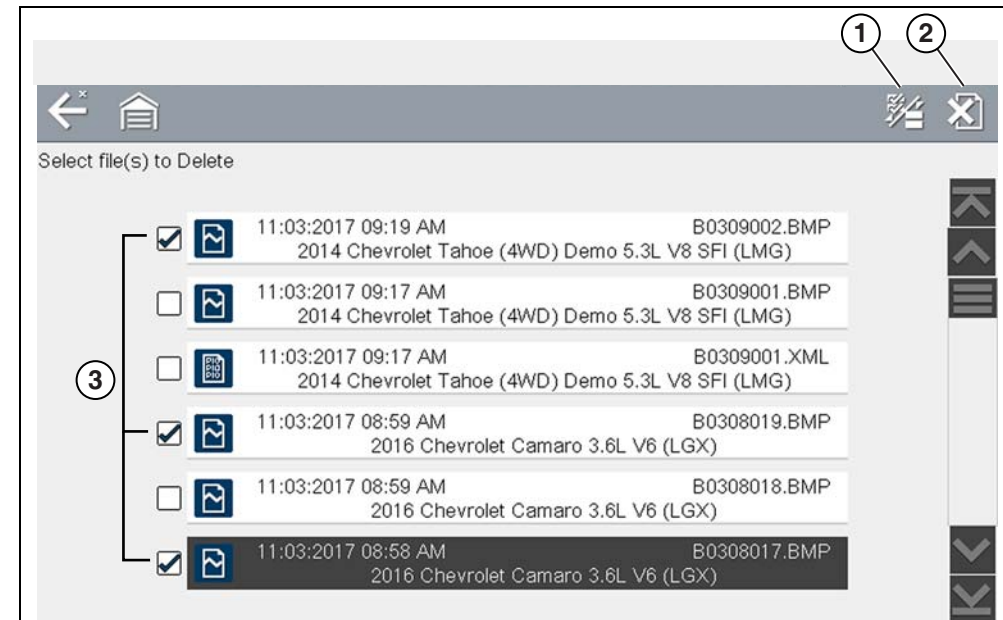

- 1— **Select All / Deselect All** Icon
- 2— **Delete** Icon
- 3— **Selected files to be deleted**

Figure 11-5

2. The files with checkboxes will be deleted. To delete the files select the **Delete** icon.
3. A confirmation message displays. Select an option:
 - **OK**—permanently deletes the selected file
 - **Cancel**—returns to the saved files list without deleting the selected file.



This section describes the basic operation of the Tools function.



The **Tools** icon is located on the Home screen. This function allows you to configure diagnostic tool settings to your preferences.

Main Topic Links

- [Connect-to-PC \(File Transfer\)](#) page 78
- [Configure Shortcut Button](#) page 79
- [Get Connected](#) page 78
- [System Information](#) page 79
- [Settings](#) page 80
- [DISPLAY \(settings\)](#) page 80
 - [High Contrast Toolbar](#) page 81
 - [Brightness](#) page 80
 - [Color Theme](#) page 81
 - [Font Type](#) page 82
 - [Backlight Time](#) page 82
 - [Touch Screen Calibration](#) page 82
 - [Time Zone](#) page 83
 - [Clock Settings](#) page 83
 - [Daylight Savings Time](#) page 83
 - [Time Format](#) page 84
 - [Date Format](#) page 84
- [AUTO VIN](#) page 84
- [Wi-Fi Connection / Troubleshooting](#) page 86

12.1 Tools Menu

The following options are available from the Tools menu:

- [Connect-to-PC \(File Transfer\)](#)—use to transfer and share files with a personal computer (PC)
- [Get Connected](#)—use to transfer and share files with a personal computer (PC)
- [Configure Shortcut Button](#) on page 79—use to change the function of the shortcut button
- [System Information](#) on page 79—use to view configuration information for the diagnostic tool
- [Settings](#) on page 80—use to configure certain characteristics of the diagnostic tool

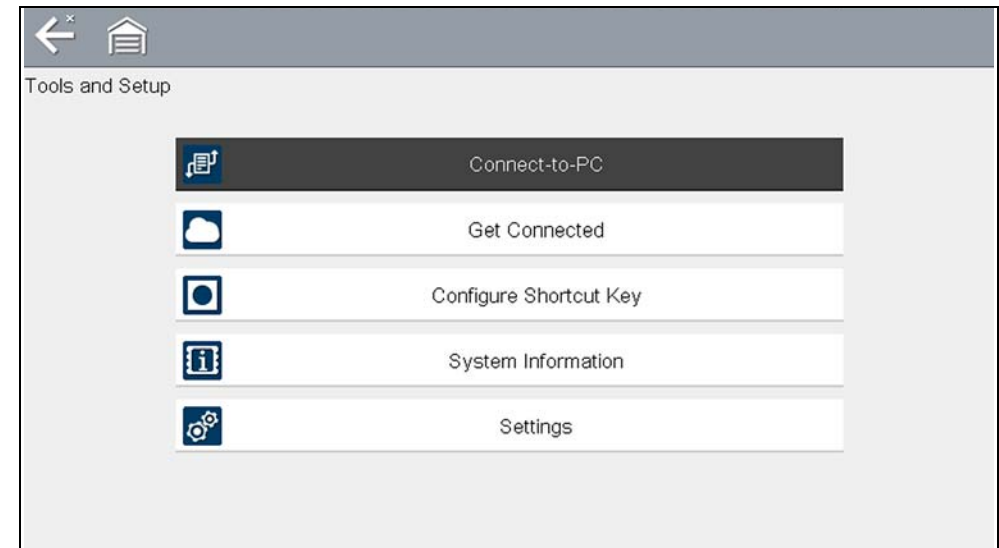

Figure 12-1 Tools menu

12.1.1 Connect-to-PC (File Transfer)

Connect-to-PC allows you to transfer saved data files on your diagnostic tool to your personal computer using a USB cable.

The optional ShopStream Connect™ PC software allows you to view, print and save data files on your PC. In addition, you can download software updates from the PC to the diagnostic tool. These features provide an ideal way to manage saved data files. The ShopStream Connect application is available free online, see [ShopStream Connect™](#) on page 119.



To connect the diagnostic tool to a PC:

1. Select **Tools** from the Home screen.
2. Select **Connect-to-PC**.
A screen message displays stating that the diagnostic tool is in Connect-to-PC mode.
3. Connect the supplied USB cable to the diagnostic tool and then to the PC.
The diagnostic tool, displays as an external drive. Using Windows File Explorer locate the "USERDATA" folder to find saved screenshots (.BMP), code files (.XML), and data files (.SCM).
4. When finished, select **Exit** to return to the Tool menu, and disconnect the USB cable.

12.1.2 Get Connected

Get Connected allows you view ([Figure 12-2](#)) the diagnostic tool serial number, PIN and Code needed for Snap-on Cloud registration. See [Snap-on Cloud](#) on page 92 for more information.

NOTE

The PIN and Code numbers will change each time you view the Get Connected screen ([Figure 12-2](#)). This is normal, any displayed set of PIN and Code numbers may be used to register.

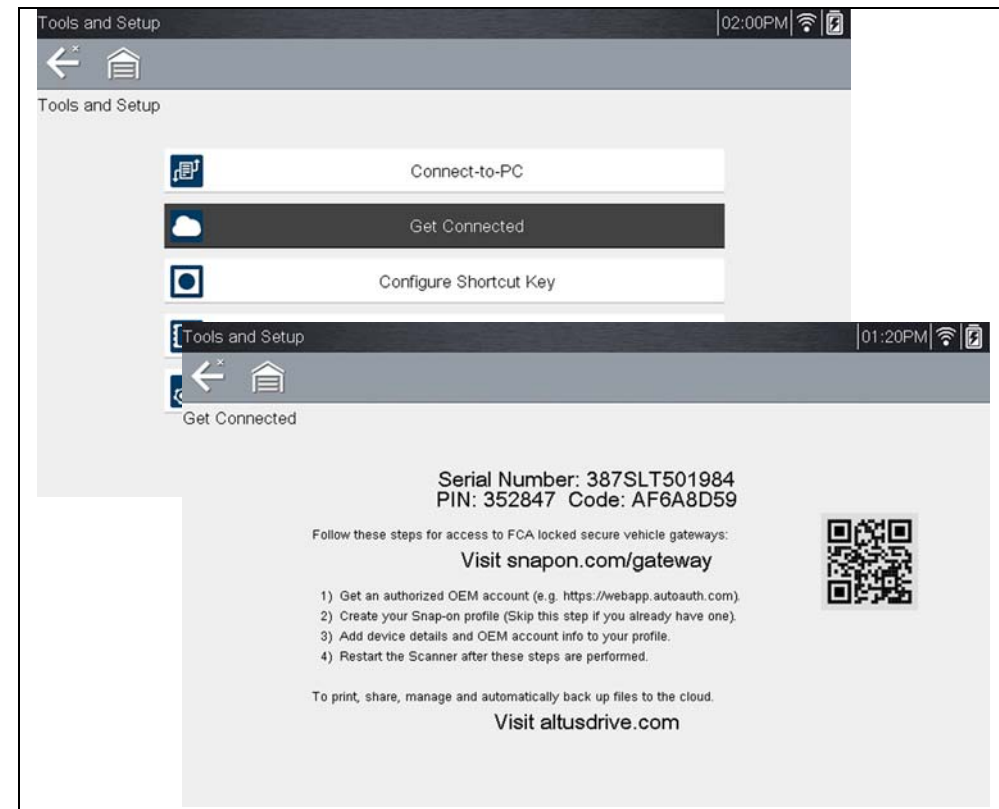



Figure 12-2



12.1.3 Configure Shortcut Button

This feature allows you to change the function of the **Shortcut** button. Options are:

- **Brightness**—opens the brightness setting screen.
- **Save Screen**—saves a bitmap image of the visible screen.
- **Save Movie**—writes PID data from buffer memory to a file for future playback.
- **Show Shortcut Menu**—opens the menu so you can quickly select from any of the functions.
- **Toggle Start/Pause**—programs the Shortcut button to work as the Pause and Start icons.

-  **To assign a function to the Shortcut button:**
1. Select **Tools** from the Home screen.
The Tools menu opens.
 2. Select **Configure Shortcut button** from the menu.
 3. Select a function from the menu.
 4. Select the **Back** on the toolbar or press the **N/X** button to return to the options menu.

12.1.4 System Information

System Information allows you to view patent information and system information, such as the software version and serial number of your diagnostic tool.

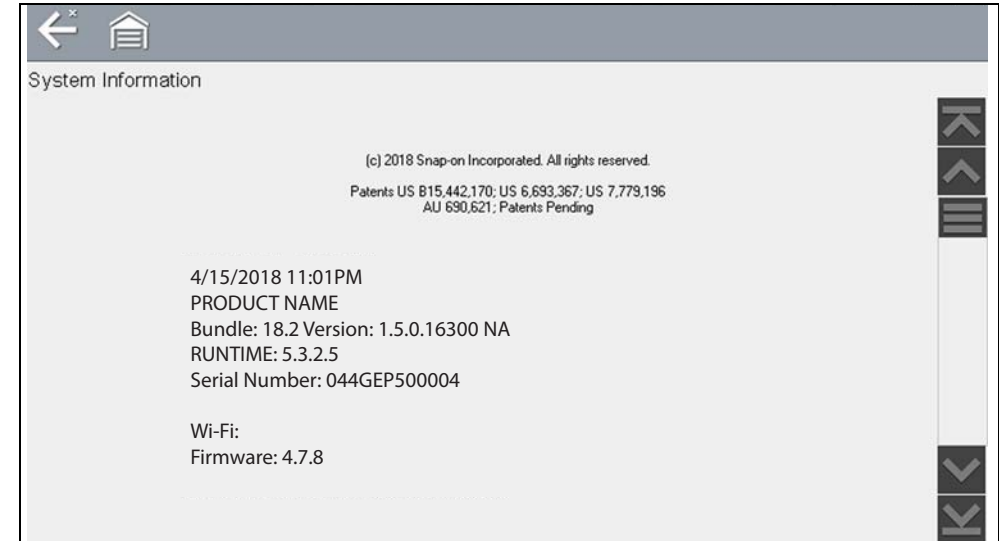



Figure 12-3 System information

-  **To display the System information screen:**
1. Select **Tools** from the Home screen to open the menu.
 2. Select **System Information** from the menu.
The System Information screen displays.
 3. Scroll as needed to view all of the data.
 4. Select **Back** on the toolbar or press the **N/X** button to return to the options menu.

12.1.5 Settings

This Tools selection allows you to adjust certain basic diagnostic tool functions to your personal preferences. Selecting opens an additional menu that offers the following:

- System Settings - see [System Settings](#) on page 80
- Configure Wi-Fi - see [Wi-Fi Connection / Troubleshooting](#) on page 86
- Configure Scanner - see [Configuring Scanner](#) on page 84
- Configure Units - see [Configure Units](#) on page 85

System Settings

Selecting System Settings opens a menu with three options; Display, Date & Time and Auto VIN. Selecting either Display or Date & Time opens an additional menu (see below). Selecting Auto VIN provides the option to turn the Instant Vehicle ID feature on/off.

Display options include:

- [Brightness](#) on page 80—adjusts the intensity of the screen back lighting.
- [Color Theme](#) on page 81—changes the background color of the screen display.
- [High Contrast Toolbar](#) on page 81—enhances toolbar graphics for poor lighting conditions.
- [Font Type](#) on page 82—switches between standard and bold text for better visibility.
- [Backlight Time](#) on page 82—adjusts how long the screen stays on with an idle diagnostic tool.
- [Touch Screen Calibration](#) on page 82—calibrates the touch screen display.

Date & Time options include:

- [Time Zone](#) on page 83—sets the internal clock to the local time standard.
- [Clock Settings](#) on page 83—sets the time on the internal clock.
- [Daylight Savings Time](#) on page 83—configures the clock for Daylight Savings Time.
- [Time Format](#) on page 84—switches the time displays between a 12 or 24 hour clock.
- [Date Format](#) on page 84—configures how the month, date, and year displays.

Auto VIN — to turn Instant Vehicle ID feature on/off, see [AUTO VIN](#) on page 84

DISPLAY (settings)

Brightness

Selecting this option opens the brightness setting screen for adjusting the back lighting of the display ([Figure 12-4](#)).



Figure 12-4 Brightness setting

Each push of the **Plus** and **Minus** icons, or the up (▲) and down (▼) arrows, incrementally changes the back lighting up or down respectively.

Select **Back** from the toolbar or press the **N/X** button to exit.

Color Theme

This option allows you to select between a white and black background for the screen. The black background can be beneficial when working under poor lighting conditions.

Engine Data - Engine Speed (RPM)		61 / 4000
Engine Speed (RPM)	2224	↑
Desired Idle Speed (RPM)	568	↑
ECT Sensor (°F)	156	≡
IAT Sensor 1 (°F)	95	≡
Ambient Air Temperature (°F)	87	≡
Cold Startup	Yes	≡
MAF (g/s)	19.35	↓
Engine Load (%)	19	↓

Figure 12-5 Night Theme

Selecting opens a menu with two choices: **Day Theme** (white background) and **Night Theme** (black background). Make a selection and a “please wait” message momentarily displays followed by the Home screen. The new toolbar setting is now active.

High Contrast Toolbar

This option allows you to switch to a high contrast toolbar. This toolbar features black and white icons with crisp graphics that are easier to see in poor lighting conditions or bright sunlight.

Engine Data - Engine Speed (RPM)		118 / 4000
Engine Speed (RPM)	572	↑
Desired Idle Speed (RPM)	568	↑
ECT Sensor (°F)	152	≡
IAT Sensor 1 (°F)	93	≡
Ambient Air Temperature (°F)	87	≡
Cold Startup	Yes	≡
MAF (g/s)	6.39	↓
Engine Load (%)	20	↓

Figure 12-6 High-contrast toolbar

Selecting opens a menu with two choices; Color Toolbar and High Contrast Toolbar. Select and a “please wait” message displays followed by the Home screen. The new setting is now active.



Font Type

This option allows you to select between standard and bold faced type for the display screen. Bold type makes screen writing more legible under poor lighting or bright sunlight conditions.

Selecting opens a menu with two choices: Normal Font and Bold Font. Select a menu item or scroll and then press the **Y/✓** button to make a selection. The change is instantaneous. Select the Back or Home icon on the toolbar to return to either the Settings menu or the Home screen.

Backlight Time

This option allows you to configure how long the screen backlight remains on when the diagnostic tool is inactive. The following choices are available:

- Always On
- 15 Seconds
- 30 Seconds
- 45 Seconds
- 60 Seconds

Select the menu item desired, or scroll and then press the **Y/✓** button to make a selection. Select **Back** or **Home** on the toolbar to return to either the Settings menu or the Home screen.

Touch Screen Calibration

Calibrating the touch screen maintains the accuracy of the touch-sensitive display.

IMPORTANT

To avoid serious damage to the diagnostic tool, always complete the touch screen calibration sequence once it has begun. Never turn off the diagnostic tool while a screen calibration is in process.

-  **To calibrate the touch screen:**
1. Select **Tools** from the Home screen.
 2. Select **Settings>System Settings>Display>Touch Calibration**.
The calibration screen opens ([Figure 12-7](#)).

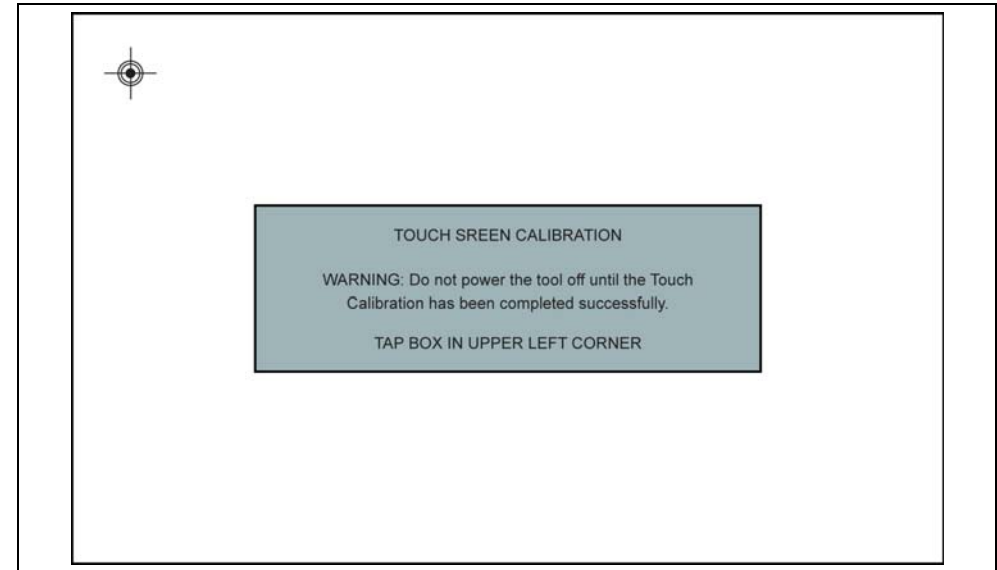

Figure 12-7 Touch screen calibration

3. Select the center of each alignment indicator on the screen as they display in the corners of the screen, starting in the upper left corner.
 4. Once all four indicators have been selected, the verification process starts the procedure again. Select the center of each alignment indicator when prompted.
 - If the calibration is successful, the “Touch Calibration Results - Passed” screen is displayed ([Figure 12-8](#)). Press the **Y** button to complete the process and return to the Display menu.
 - If the calibration is not successful, the “Touch Calibration Results - Failed” screen is displayed. Press the **Y** button to perform the procedure again.
- The results screen ([Figure 12-8](#)) shows the entered calibration of each indicator. Ideal calibration would be to select each indicator exactly in the center, however selection inside the displayed circle is acceptable. If selecting the center is difficult using your finger, use a touch screen stylus (not included).

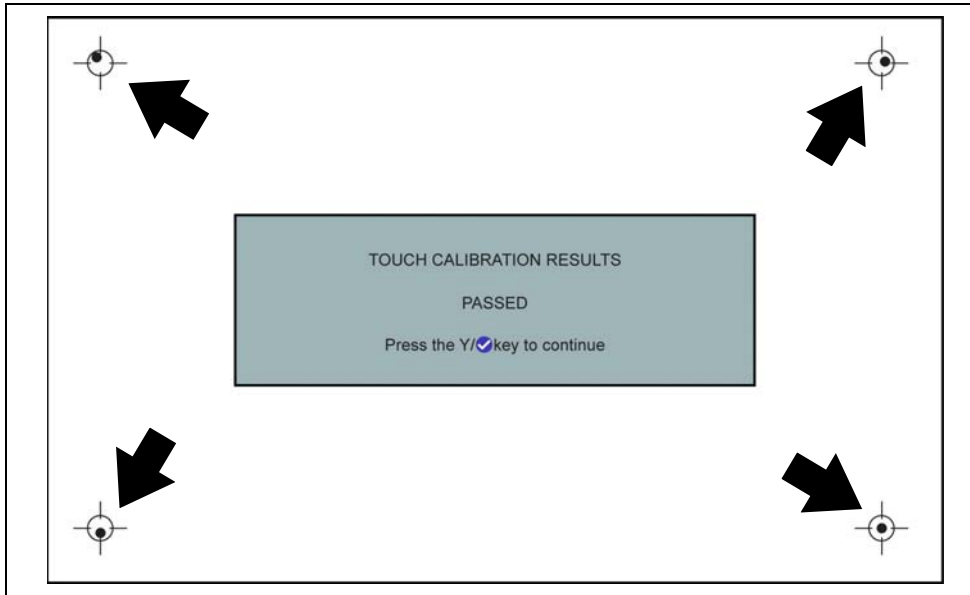

Figure 12-8 Touch screen calibration - Passed

DATE & TIME (settings)

Time Zone

This option opens a menu of time zone settings. Scroll to highlight, then select the local time zone. The display returns to the Settings menu once a time zone is selected.

Clock Settings

This option opens a window for resetting the time on the real-time clock.



To set the clock:

1. Select **Tools** from the Home screen to open the menu.
2. Select **Settings** from the menu.
3. Select **Clock Settings** from the menu.

A warning message briefly displays followed by the Clock Settings screen (Figure 12-9).

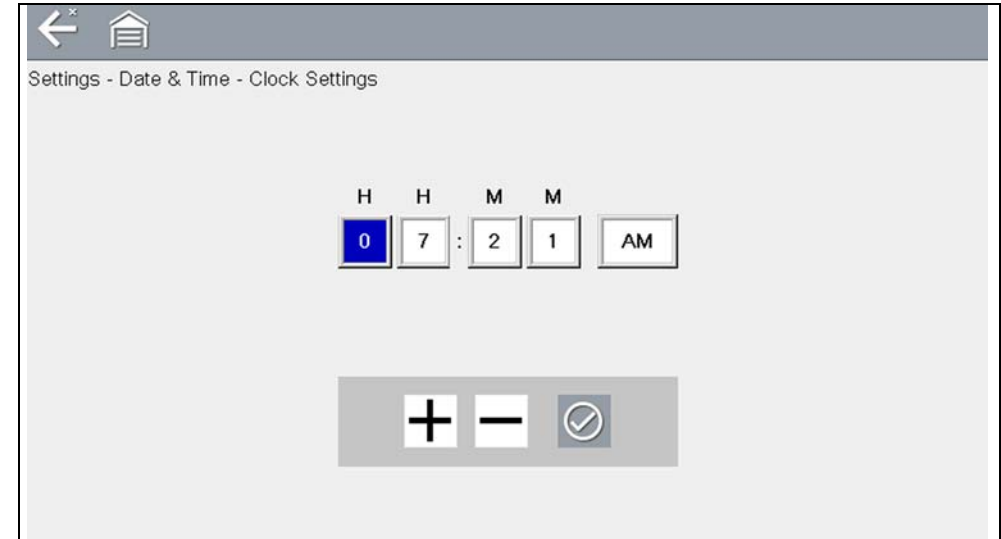

Figure 12-9 Clock settings

4. Select the **up (+)** icon on the screen or press the **up (▲)** button to incrementally increase the number in the highlighted field. Select the **down (-)** icon on the screen or press the **down (▼)** button to incrementally decrease the number.
5. Select the **check (✓)** icon on the screen or press the **Y/✓** button to move the highlight to the next field.
6. Repeat Step 4 and Step 5 until the correct time is displayed.
7. Select the **Back** icon on the toolbar or press the **N/X** button to close the Clock Settings window and return to the Settings menu.

Daylight Savings Time

This option opens a menu to configure the internal clock for Daylight Savings Time. Choose from:

- **ON**—sets the clock for Daylight Savings time.
- **OFF**—sets the clock for standard time.

Make either selection, then select the **Back** icon or press the **N/X** button to return to the menu.

Time Format

This option determines whether time is displayed on a 12 or 24 hour clock. Selecting opens a menu with two choices:

- **24 Hour Format**
- **12 Hour Format**

Make either selection, then select the **Back** icon or press the **N/X** button to return to the menu.

Date Format

This option allows you to select how date information is displayed. Select from:

- **(MM_DD_YYYY)**—Month, Day, Year
- **(DD_MM_YYYY)**—Day, Month, Year
- **(YYYY_MM_DD)**—Year, Month, Day

Make a selection, then select the **Back** icon or press the **N/X** button to return to the menu.

AUTO VIN

This option allows you to turn on/off the Instant Vehicle ID feature. See [Instant ID](#) on page 23 for information on using the Instant ID feature.

Configure Wi-Fi

Selecting Configure Wi-Fi allows you to configure and troubleshoot the diagnostic tool Wi-Fi connection, see [Wi-Fi Connection / Troubleshooting](#) on page 86.

Configuring Scanner

This option allows you to change the scanner display to toggle scales on and off. Scales are the graduations and values that display on the horizontal axis at the base of the parameter graphs. The waveform fills the entire graph area with scales switched off.

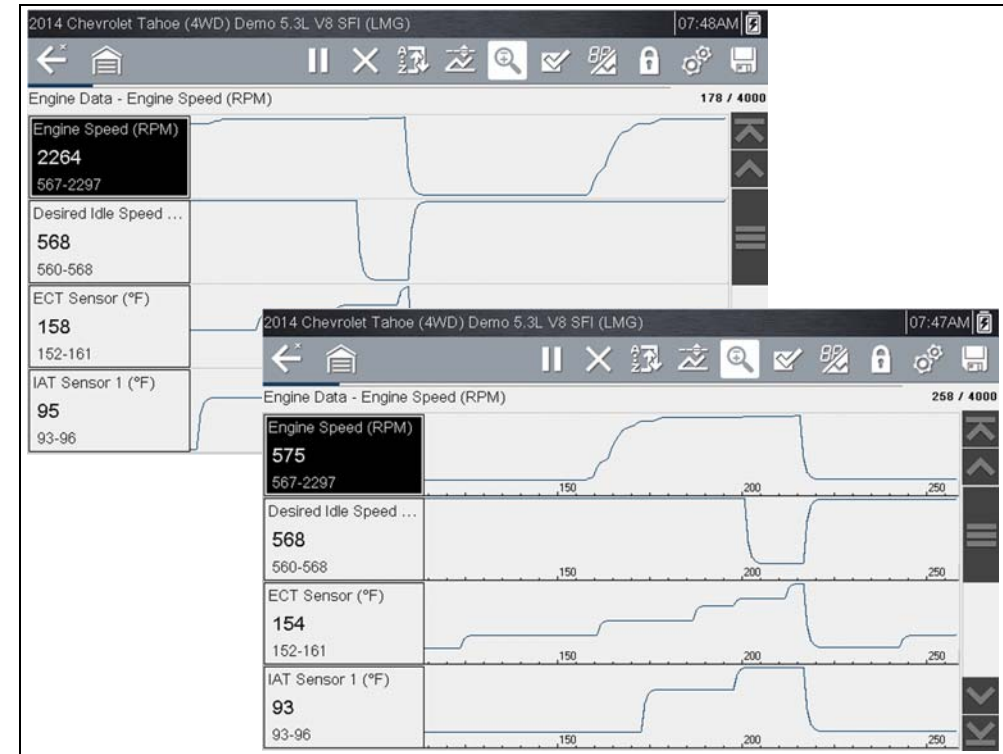

Figure 12-10 Scales hidden (upper), displayed (lower)



To change hide/show scales:

1. Select **Tools** from the Home screen.
2. Select **Settings** from the Tools and Setup menu.
3. Select **Configure Scanner** from the Settings menu.
4. Highlight either menu entry to make a selection:
 - **Show Graph Scale**—to switch the scales on.
 - **Hide Graph Scale**—to switch the scales off.
5. Select the **Back** icon or press the **N/X** button to return to the Settings menu.



Configure Units

Selecting opens a dialog box that allows you to choose between US customary or metric units of measure for various units.

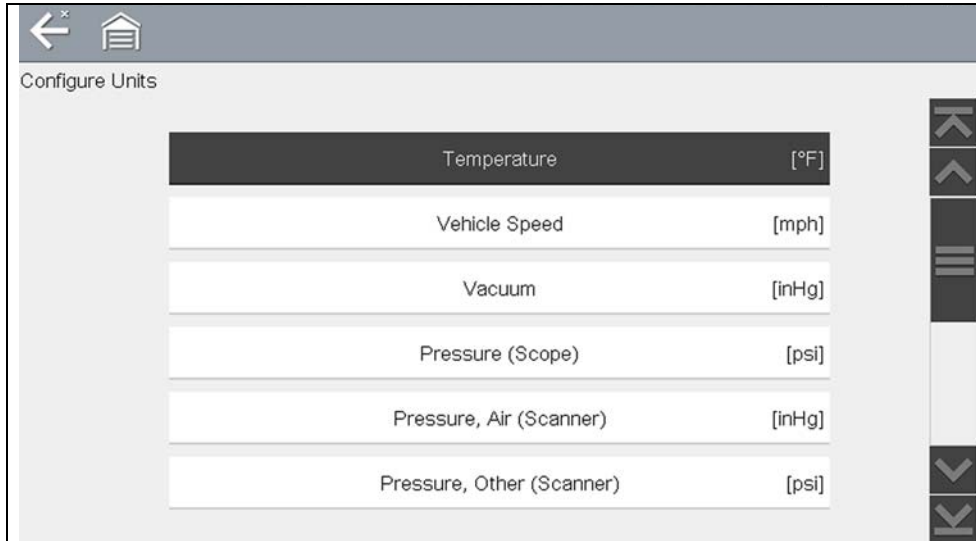



Figure 12-11 *Configure units menu*

-  **To change the units setup:**
1. Select **Tools** from the Home screen to open the menu.
 2. Select **Configure Units** to open the menu.
 3. Select an item from the Configure Units menu.
 4. Select a setting from the listed choices.
 5. Select **Back** on the toolbar or press the **N/X** button to return to the options menu.



The diagnostic tool is equipped with many features that require Wi-Fi connection. The Wi-Fi connection is solely dedicated to our Snap-on Web Services Network. To use features like the Snap-on Cloud, SureTrack, and Oil Specs and Resets, a Wi-Fi connection is required. Authorization and registration is also required to use some of these features.

This section includes information on Wi-Fi connection and troubleshooting.

Main Topic Links

- [Checking if Wi-Fi is Connected](#) page 86
- [Turning Wi-Fi On and Connecting to a Network](#) page 87
- [Add Network Advanced \(Connecting to a hidden network\)](#) page 88
- [Wi-Fi Testing](#) page 88
- [Wi-Fi Troubleshooting and Status Messages](#) page 89

13.1 Checking if Wi-Fi is Connected

The Wi-Fi indicator is displayed in the title bar when Wi-Fi is on (*Figure 13-1*).

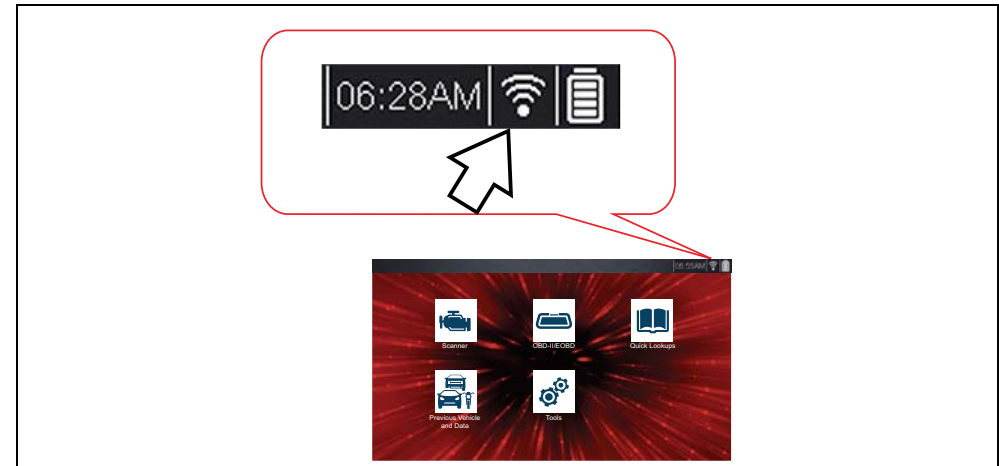

Figure 13-1

	1 to 3 solid bars - Wi-Fi is on and connected to a network. Three bars indicates maximum strength signal.
	Flashing - Wi-Fi is on, but not connected. See Wi-Fi Troubleshooting and Status Messages on page 89.
	No bars - No signal / out of range.

13.2 Turning Wi-Fi On and Connecting to a Network

- From the Home screen, select **Tools > Settings > Configure Wi-Fi**. Familiarize yourself with the following Wi-Fi icons located in the toolbar.

Wi-Fi Icon (toggle type)	Wi-Fi Test Icon
Indicates Wi-Fi is OFF (select to turn ON)	Select to open Wi-Fi Test screen
Indicates Wi-Fi is ON (select to turn OFF)	
Displayed on Wi-Fi configuration screen only	

- Select the **Wi-Fi icon** to turn Wi-Fi on (Figure 13-2).

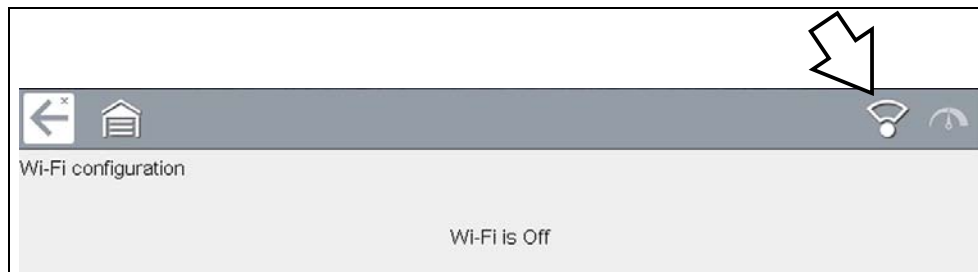

Figure 13-2 Wi-Fi Icon (shown off)

- The Wi-Fi icon will change to , indicating Wi-Fi is on. The screen will change to display available supported network connections.
- Select your network. Use the scroll feature to show all active connections (Figure 13-3).

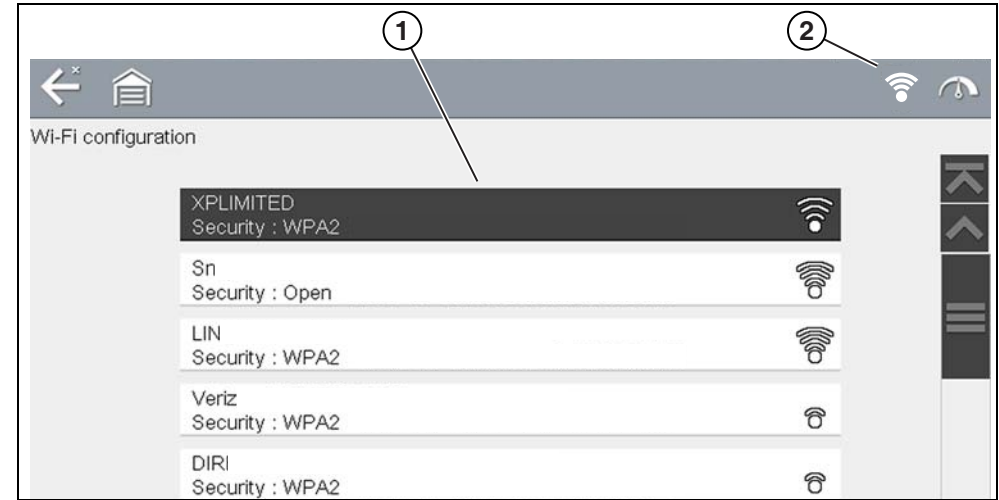

Figure 13-3 Wi-Fi Configuration Screen

- 1— Available Network Connections
- 2— Wi-Fi Icon (Wi-Fi shown on)

NOTES

A password is required when choosing a secured (protected) network. Enter the password using the on-screen keyboard and then select the check mark on the keyboard to continue.

Networks with a proxy, challenge page, or that require the user to accept terms of usage are not supported.

Wi-Fi performance varies depending on your wireless network equipment and ISP.

- Select **Connect** to connect to your desired network or **Cancel** to cancel the request.
- From the Connect confirmation screen select **OK** to continue using this connection or **Forget** to disconnect this connection.
- The screen will change to display your confirmed network connection and Snap-on Cloud registration information. For Snap-on Cloud registration information see [Snap-on Cloud](#) on page 92.
- If the status message “Not Connected” is displayed, retry the configuration process or see [“Wi-Fi Testing”](#) on page 88 for additional information.



13.3 Add Network Advanced (Connecting to a hidden network)

The Add Network selection allows you to connect to a network that is not broadcasting its name (not visible in the displayed network list). These networks are also known as "hidden" networks.

To connect to a hidden network you will first need to know the following:

- Network Security Type
 - Open (only need SSID)
 - WPA or WPA2 (Pre-shared key)
 - WEP (WEP key)
- Network name or SSID (Service Set Identifier)
- Network Password



Connecting to a Hidden Wi-Fi Network

1. From the Home screen, navigate to **Tools > Settings > Configure Wi-Fi**.
2. Select **Add Network Advanced** from the network list (scroll to end of list).
3. Select security type Open, WPA, WPA2, or WEP. Refer to the router user manual or your IT administrator to determine the type.
4. Enter the network name or SSID
5. Enter the network password.
6. Select **Connect** at the prompt to connect to the network.
7. Select **OK** at the confirmation screen to continue using this connection, or **Forget** to disconnect this connection.

13.4 Wi-Fi Testing

If you are experiencing network connection issues, an automated testing feature is available to quickly test your network connection.



Testing Connections

1. Before you start the automated testing procedure, turn off the diagnostic tool and then turn it on. This clears previous testing messages from memory.
2. Connect to your desired network, see ["Turning Wi-Fi On and Connecting to a Network" on page 87](#).
3. From the Wi-Fi configuration screen, select the **Wi-Fi Test** icon to open the network connection test screen ([Figure 13-4](#)).

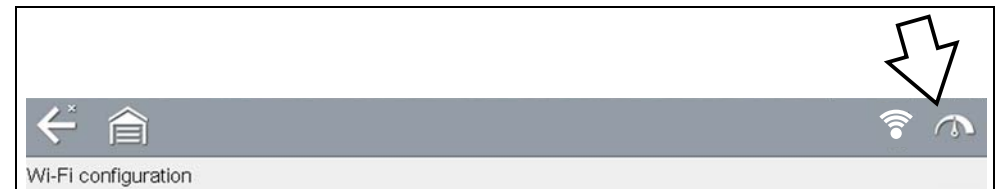

Figure 13-4 Wi-Fi Test Icon

The network connection test is an automated test that begins when the screen is displayed. Network connection systems are tested in sequence and display a status indicator

(Red = test failed, Yellow = test is process, or Green = test completed satisfactorily) when finished ([Figure 13-5](#)).

Connectivity of the following systems are checked:

- **Hardware**
- **Router**
- **Internet**
- **HTTP**
- **Web Services Network**

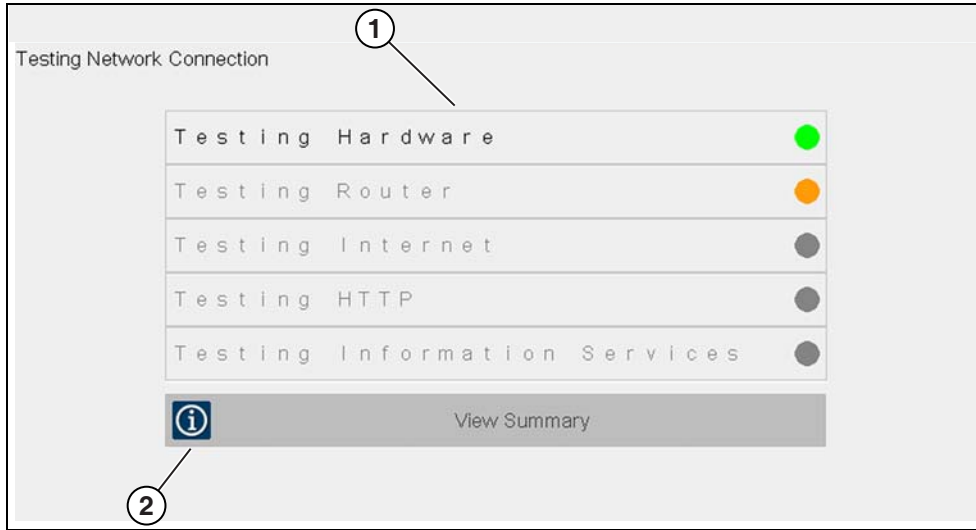

Figure 13-5 Connection Tests

1— Connection Tests

2— View Summary

- If a connection issue(s) is present, select **View Summary** to review the results. The summary information is helpful if you are experiencing difficulties with your connection (Figure 13-6). Scroll through the summary information to review the test results for each system and Tip messages for the current connection issue. See *Connection Tests - Troubleshooting* chart in “[Wi-Fi Troubleshooting and Status Messages](#)” on page 89 for additional information.

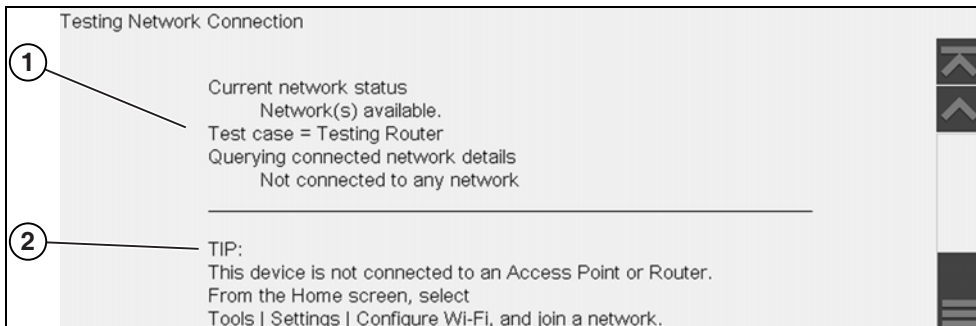

Figure 13-6 View Summary

1— Connection Test Results

2— Connection Issue Tip Message

13.5 Wi-Fi Troubleshooting and Status Messages

The following troubleshooting information is not inclusive and is meant as a guide only. Other issues and solutions may arise that are not stated here. The following description of terms are provided for reference as used in the following troubleshooting chart:

- **Router** - The data transmission device directly connected to your ISP.
- **Remote Wireless Access Point** - A wireless connection device between the router and your diagnostic tool.
- **Wi-Fi Radio** - The internal diagnostic tool radio transmitting and receiving Wi-Fi signals.
- **Network Connection** - Also called Wi-Fi connection. The configured Wi-Fi router connection the diagnostic tool connects to. This connection can be secured (password protected) or unsecured (open).

Router Information

Router compatibility and setup are important factors to check when trying to determine connectivity problems. Although we have tested this device at the factory to verify connectivity, we cannot guaranty its connectivity with your specific equipment. There may be some situations that require your time for router connection troubleshooting and/or additional consultation and equipment. Snap-on Incorporated is not responsible for any costs incurred for any additional equipment, labor or consultation charges or any other costs that may result from correcting non-connectivity issues with this device.



Check Router Settings

Verify the following router settings **BEFORE** you begin troubleshooting a non-connectivity or “No Connection” problem. After each check, make any corrections as necessary then retest for connectivity. **Contact your IT administrator or ISP for assistance.**

1. Check your router connection and if applicable, the remote wireless access point connection.
2. Clear saved Wi-Fi networks, see [Clearing Wi-Fi Networks on page 90](#).
3. Verify:
 - (a). Router is configured to use Dynamic Host Configuration Protocol (DHCP), not a static IP address.
 - (b). Router and/or settings for this device are configured to 2.4GHz. 5GHz is not supported.
 - (c). Router is configured to B/G and/or N standard wireless networks to 2.4GHz. 5GHz is not supported. See your router "User Guide" for setup, connection and troubleshooting procedures.
4. Check for router firmware and update to current version, if applicable.
5. Restart or reset the router. See your router "User Guide" for procedures.
6. Connect to a different router.

Clearing Wi-Fi Networks

1. Select the Wi-Fi network that you are trying to connect to from the list of saved networks on the Wi-Fi configuration menu.
The Wi-Fi Summary page displays.
2. Select **FORGET**
The Wi-Fi Configuration menu displays.
3. Repeat steps (1) and (2) for ALL saved Wi-Fi networks.
4. Once all saved Wi-Fi networks have been deleted (forgotten) turn off the diagnostic tool.
5. Turn on the diagnostic tool and connect to the desired Wi-Fi network, see [Turning Wi-Fi On and Connecting to a Network on page 87](#).

General -Troubleshooting		
Problem	Possible Cause	Corrective Action
Repair Information Applications (e.g. Oil Specs and Resets) are not available	Access has expired	Contact your sales representative.
	Access may be temporarily unavailable	Try to access the function at a later time as updates may be in process.
	Wi-Fi radio is turned Off	1. From the Home screen, navigate to Tools > Settings > Configure Wi-Fi . 2. Select the Wi-Fi icon and turn the Wi-Fi radio on. The Wi-Fi icon will change from a green check mark icon to red "X" mark icon indicating Wi-Fi radio is on. 3. Connect to a known good network.
	Not connecting to a network	1. Clear saved Wi-Fi networks, see Clearing Wi-Fi Networks on page 90 . 2. Connect to a network. 3. From the Configure Wi-Fi screen select the Wi-Fi Test icon and review the results. See Connection Tests - Troubleshooting in the following table .
Wi-Fi connection drops off or disconnects intermittently	Wi-Fi Signal strength insufficient	Check Wi-Fi signal strength - out of range or interference. Move closer (within 50 Ft. (15 M) or into a direct open sight-line of the router or if applicable, remote wireless access point. Eliminate interference from overhead lights, windows, walls, other wireless devices, metal objects and devices that emit electrostatic discharge.
	Router overloaded	Disconnect/disable other Wi-Fi devices connected to the router.



13.5.1 Informative Messages

Messages may be displayed to inform you of pending issues or general status. Depending on your access and connection status, the following are typical messages that may be displayed:

- **Content May Be Available!** - indicates content may be available, however you are not currently connected to the Web Services Network. This message may be caused by a Wi-Fi connection issue, or you do not have access to the feature. See [Wi-Fi Troubleshooting and Status Messages on page 89](#) for Troubleshooting information.
- **No connection. Please try again later.** - indicates you are not currently connected to the Web Services Network, except when displayed in the OBD/EOBD function as Repair Information Applications are not accessible in OBD/EOBD mode. If this message is displayed in the Scanner function, it may be caused by a Wi-Fi connection issue, or you do not have access to the feature. See [Wi-Fi Troubleshooting and Status Messages on page 89](#) for Troubleshooting information.
- **Loading content** - indicates information is being accessed from the Web Services Network.
- **A new diagnostic software upgrade is available. Contact your sales representative for details.**
- **Your access has expired. See your Sales representative to renew.** - indicates your access to the Web Services Network has expired and you should contact your sales representative.

Connection Tests - Troubleshooting		
Failed Test	Possible Cause (Displayed Tip Message*)	Corrective Action / Checks
Hardware	Wi-Fi radio not responding and/or will not turn off	Contact Customer Support for assistance.
	Wi-Fi radio not responding and/or will not initialize	
	Missing or corrupt firmware file(s)	
Router	This device is not connected to a router	Check Wi-Fi signal strength - out of range or interference. Move closer (within 50 Ft. (15 M) or into a direct open sight-line of the router or if applicable, remote wireless access point. Eliminate interference from overhead lights, windows, walls, other wireless devices, metal objects and devices that emit electrostatic discharge.
		Check router connection and setup. See Check Router Settings on page 90 for procedure.
Internet	This device is not connected to the Internet or has no DNS	Check router connection and setup. See Check Router Settings on page 90 for procedure.
		Domain Name System (DNS) server not connected. Contact your Internet service provider (ISP).
HTTP	This device cannot communicate using HTTP	Check if your Internet access uses a "Proxy" or "Accepting terms in a browser" protocol, or uses a challenge page. These protocols are not supported by this device. Contact your IT administrator or ISP for options.
Web Services Network (e.g.access to Oil Specs and Resets)	Your access has expired	Contact your sales representative.
	Repair Information Services may be temporarily unavailable or Not connecting to a network	Try to access at a later time as Repair Information Services may be performing updates to the service. Check router connection and setup. See Check Router Settings on page 90 for procedure.
* See Wi-Fi Testing on page 88 for additional information.		



This diagnostic tool includes a built-in feature that automatically transfers code scan reports to the Snap-on Cloud (ALTUSDRIVE.com).

Snap-on Cloud is a mobile-friendly cloud-based application designed specifically for technicians to store, organize and share information.

See [Vehicle Code Scan / \(Snap-on Cloud\)](#) on page 51 for information on using Code Scan.

Main Topic Links

- [Quick Reference \(print / download / share\)](#) page 95
- [Registration - Getting Started](#) page 92
- [Using the Snap-on Cloud](#) page 95
 - [Snap-on Cloud - New User Registration](#) page 93
 - [Snap-on Cloud - SureTrack User Setup](#) page 94
 - [Logging in to the Snap-on Cloud \(registered user\)](#) page 96
 - [Navigating the Snap-on Cloud \(Toolbars\)](#) page 96
 - [My Files](#) page 97
 - [Search](#) page 100
 - [Favorites](#) page 100
 - [Profile](#) page 101
 - [Sharing/E-mail an Individual Report \(Link icon\)](#) page 99
 - [Using Profile Manager](#) page 101
 - [Logging Out of the Snap-on Cloud](#) page 104

14.1 Key Features

- Automatically transfer code scan reports to the Snap-on Cloud.
- Access and manage your Snap-on Cloud account, using your mobile device or PC.
- Share/send report files via e-mail, or other mobile apps.
- Tag reports (attach a descriptive key-name) to help you organize and search report files.
- Use the Search function to quickly find files by Tag, Description and Title.

14.2 Important Notes

- To use the Snap-on Cloud, account setup and diagnostic tool Wi-Fi connection is required.
- The diagnostic tool only transfers code scan reports to the Snap-on Cloud.
- Snap-on Cloud is continuously monitored for inappropriate content. Abuse (as determined by moderator) will result in account deactivation.

14.3 Registration - Getting Started

To use the Snap-on Cloud:

- The diagnostic tool must be connected to a Wi-Fi network
- Account registration is required online
 - If you are a new user, you will need to create a new account, see [Snap-on Cloud - New User Registration](#).
 - If you already have a SureTrack® account, see [Snap-on Cloud - SureTrack User Setup](#).

14.3.1 Snap-on Cloud - New User Registration

 If you are a new user, follow these steps to register and create a new account:

NOTE

Account setup is only required one time.

NOTE

If you are a SureTrack user, see [Snap-on Cloud - SureTrack User Setup](#).

1. Connect the diagnostic tool to a Wi-Fi network, see [Wi-Fi Connection / Troubleshooting](#) on page 145.
2. Write down the Serial Number, PIN and Code that are displayed when the device connects to the Wi-Fi network ([Figure 14-1](#)), or leave the screen displayed. Registration information can also be found in the Tools menu, see [Snap-on Cloud Setup Information Screen](#) on page 95.



Figure 14-1

NOTE

The PIN and Code numbers will change each time you view the Snap-on Cloud Get Connected screen ([Figure 14-3](#) and [Figure 14-1](#)). This is normal, any displayed set of PIN and Code numbers may be used to register.

3. Using a mobile device or PC, visit <https://ALTUSDRIVE.com> and select **Create Individual Account** from the Login screen.
4. Enter the required information and create a **Username** and **Password**, then select **Create**.
5. At the “Success” confirmation screen, select **Done**.
6. Log in using your **Username** and **Password**.
7. Answer the security questions, then select **Submit**.
8. From Technician Profile Manager select the **Device Management** tab.
9. Select **Add Device**, then enter your **Serial Number**, **PIN**, **Code**, and Device Name and select Save when done.
10. Log out of Profile Manager, then select the **ALTUS Home Page** browser tab to get started.
11. Turn the diagnostic tool off, and then on.
12. See [Using the Snap-on Cloud](#).

Your diagnostic tool is now registered to your Snap-on Cloud online account. Code scan reports will be automatically sent (only when connected to Wi-Fi) to your online account from the device.

NOTE

If the device is not connected to a Wi-Fi network when the code scan is performed, the report will not be sent to your Snap-on Cloud account. Wi-Fi connection is required to upload the report.

14.3.2 Snap-on Cloud - SureTrack User Setup

 If you already have a SureTrack account, follow these steps to register and setup your Snap-on Cloud account:

From a PC or mobile device:

1. Connect the diagnostic tool to a Wi-Fi network, see [Wi-Fi Connection / Troubleshooting on page 145](#).
2. Write down the Serial Number, PIN and Code that are displayed when the device connects to the Wi-Fi network ([Figure 14-2](#)), or leave the screen displayed. Registration information can also be found in the Tools menu, see [Snap-on Cloud Setup Information Screen on page 95](#).



Figure 14-2

NOTE

The PIN and Code numbers will change each time you view the Snap-on Cloud Get Connected screen ([Figure 14-3](#) and [Figure 14-2](#)). This is normal, any displayed set of PIN and Code numbers may be used to register.

3. Using a mobile device or PC, visit <https://ALTUSDRIVE.com> and select **Login** (upper right screen).
4. Log in using your SureTrack **Username** and **Password**.
5. Open the **Profile Manager** (additional login may be required).
6. From the **Device Management** tab, select **Add Device**.

7. Enter your **Serial Number, PIN, Code, and Device Name**.

8. Log out of Profile Manager, then select the **ALTUS Home Page** browser tab to get started.

9. Turn the diagnostic tool off, and then on.

10. See [Using the Snap-on Cloud](#).

Your diagnostic tool is now registered to your Snap-on Cloud online account. Code scan reports will be automatically sent (only when connected to Wi-Fi) to your online account from the device.

NOTE

If the device is not connected to a Wi-Fi network when the code scan is performed, it will not be sent to the Snap-on Cloud account. Wi-Fi connection is required to upload.

14.3.3 Snap-on Cloud Setup Information Screen

From the Home screen, selecting **Tools > Get Connected** allows you view (Figure 14-3) the diagnostic tool serial number, PIN and Code needed to register.

NOTE

The PIN and Code numbers will change each time you view the Snap-on Cloud Get Connected screen (Figure 14-3 and Figure 14-1). This is normal, any displayed set of PIN and Code numbers may be used to register.

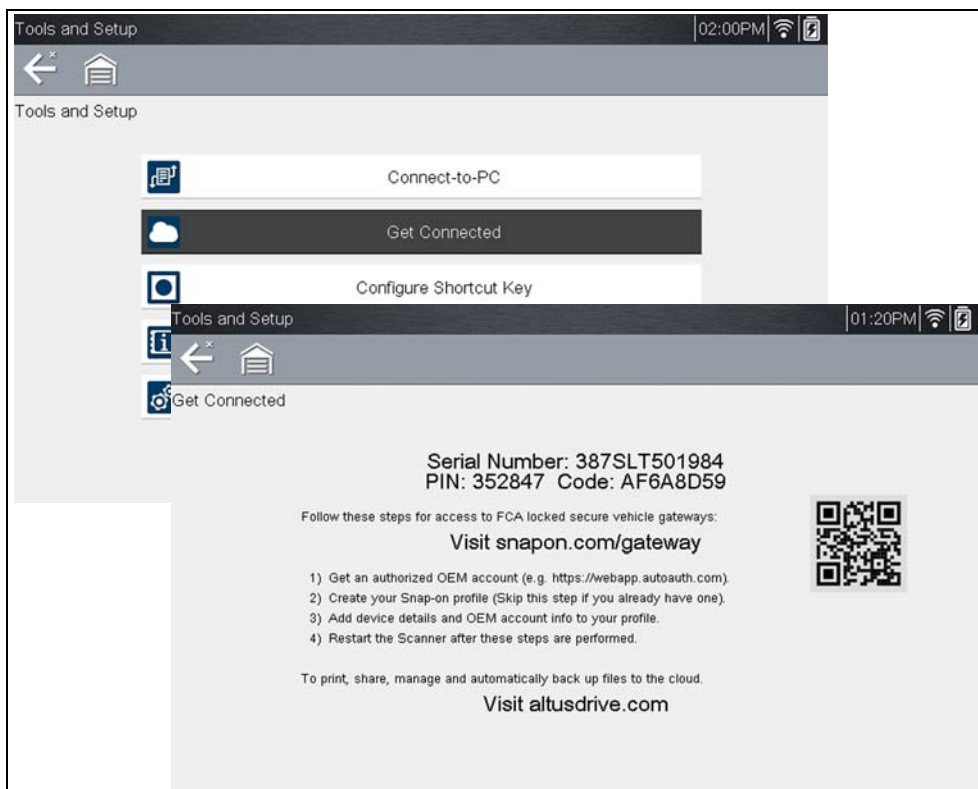

Figure 14-3

14.4 Using the Snap-on Cloud

To use the Snap-on Cloud:

- A Snap-on Cloud account is required, see [Registration - Getting Started](#) on page 92.
- The diagnostic tool must be connected to a Wi-Fi network, see [Wi-Fi Connection / Troubleshooting](#) on page 145.

14.4.1 Quick Reference (print / download / share)

- **Downloading Files** - Select the menu icon on the file card (upper right), then select **Download** from the menu options. See (callout #4) in [My Files](#) on page 97.
- **Printing Files** - Select the menu icon on the file card (upper right), then select **Download** from the menu options (see callout #4 in [My Files](#) on page 97), once downloaded print the file from your device. Alternate Method - open the file in a new browser tab (see [File Detail \(Tags\)](#) on page 98) and use the browser viewer tools to print the file. **Note:** All browsers may not support this feature.
- **Sharing Individual Files** - Select the link icon on the file card (lower center), then select **Copy to Clipboard** from the pop-up window. See [Sharing/E-mail an Individual Report \(Link icon\)](#) on page 99.
- **Sharing the Entire Gallery of Files** - Select the menu icon from the upper toolbar (upper right), then select **Copy to Clipboard** from the pop-up window. See [Sharing all Reports \(Share My Gallery\)](#) on page 99.



14.4.2 Logging in to the Snap-on Cloud (registered user)



Logging in to the Snap-on Cloud (registered user):

1. Using your mobile device or PC visit ALTUSDRIVE.com.
2. Select the **Login** icon (*Figure 14-4*).

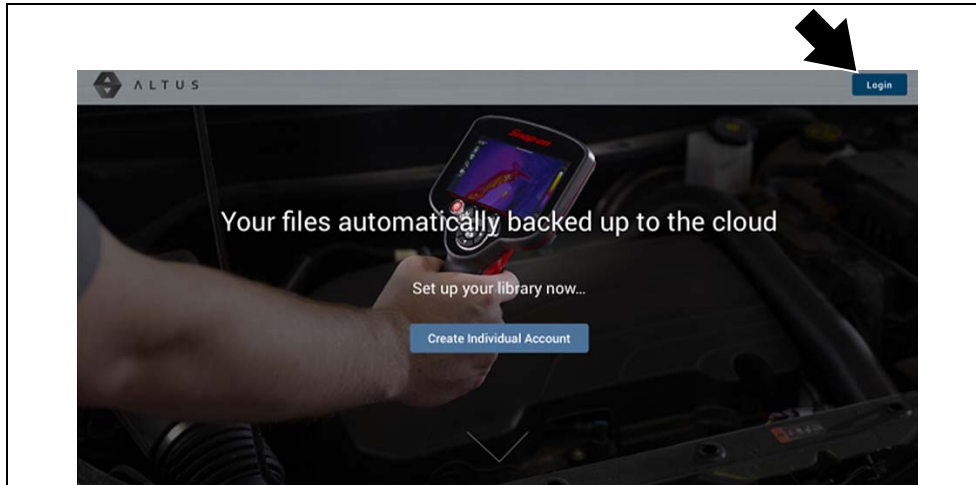

Figure 14-4

3. Log in using your **Username** and **Password** (*Figure 14-5*).

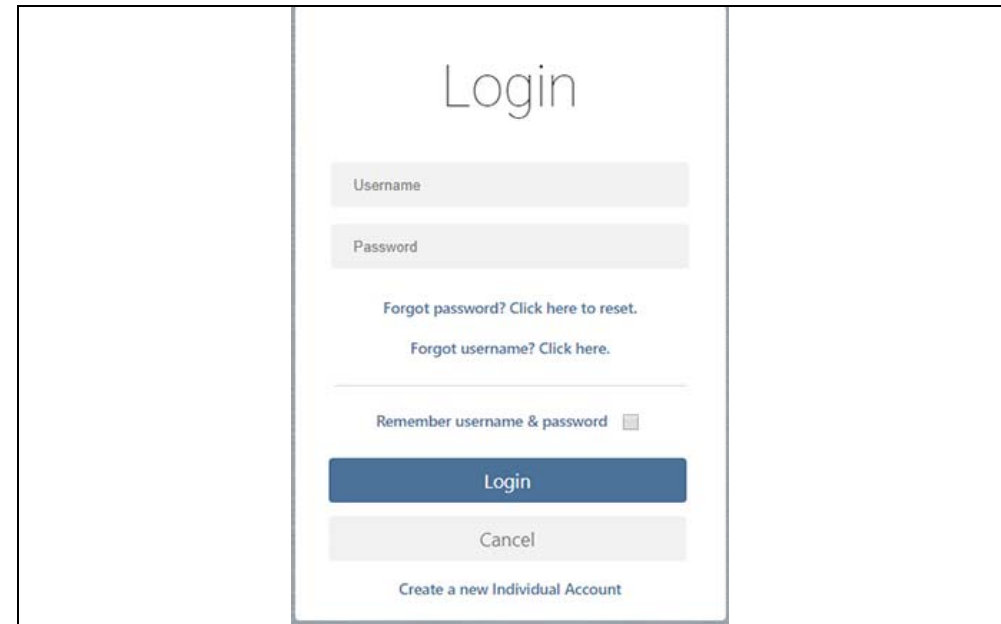

Figure 14-5

14.4.3 Navigating the Snap-on Cloud (Toolbars)

The upper and lower toolbars are available from all screens.

The upper toolbar includes a menu icon (right side) (*Figure 14-6*). This menu allows you to share your entire gallery, see [Sharing all Reports \(Share My Gallery\)](#) on [page 99](#).



Figure 14-6

The lower toolbar (*Figure 14-7*) includes the following links:

- [My Files](#), see [page 97](#)
- [Search](#), see [page 100](#)
- [Favorites](#), see [page 100](#)
- [Profile](#), see [page 101](#)



Figure 14-7

14.4.4 My Files

My Files displays all the code scan reports uploaded from the diagnostic tool (Figure 14-8). Each report is displayed in a navigation card.

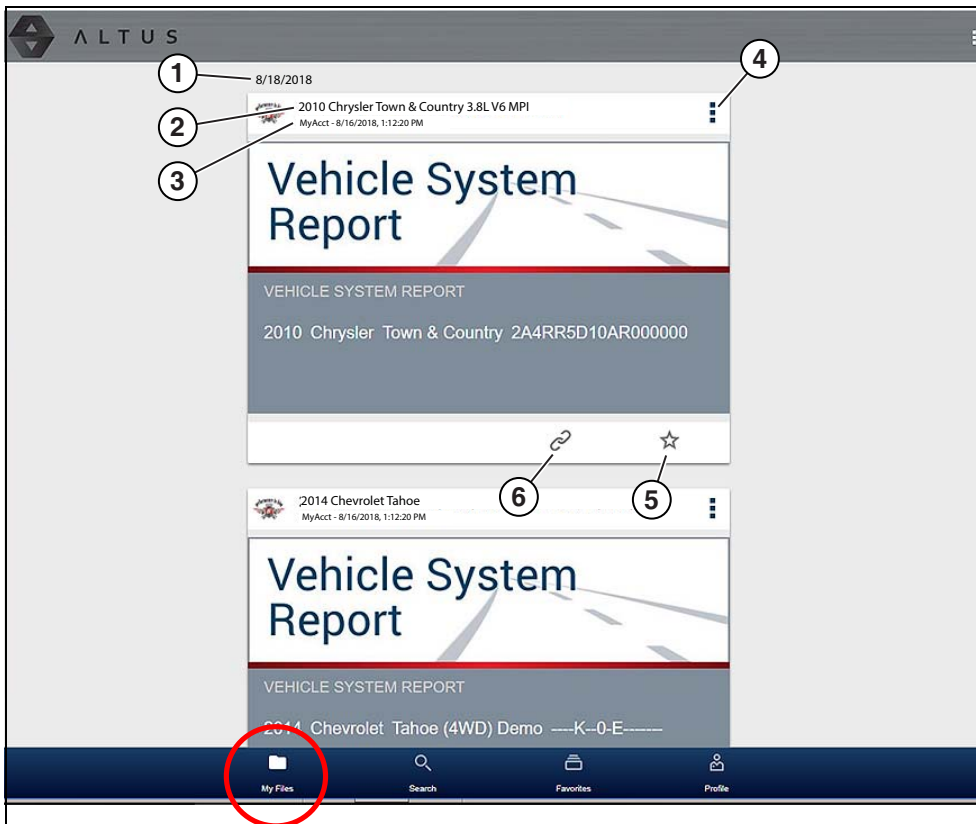

Figure 14-8

- 1— Report Upload Date** - Reports are displayed with the most recent uploads at the top. The Report upload date is displayed at the upper left. The date is shown once at the top of the series of reports, scroll up / down to see all files within a specific date.

- 2— Report File Name** - See [File Detail \(Tags\)](#) on page 98 for additional information.
- 3— Your Account Username (and timestamp)** - See [Account](#) on page 102 for additional information. The timestamp indicates the date/time the file posted.
- 4— Menu Icon** - options:
- **Download** - Select to download the report to your device.
 - **Delete** - Select to delete the report.
- 5— Favorites Icon** - See [Favorites](#) on page 100 for additional information.
- 6— Link icon** - See [Sharing/E-mail an Individual Report \(Link icon\)](#) on page 99 for additional information.

Selecting a report opens the report File Details. The File Detail screen allows you to edit report file metadata. See [File Detail \(Tags\)](#) on page 98.



File Detail (Tags)

As shown in [Figure 14-10](#) selecting (touching) a report from My Files opens the report File Detail card. Selecting the report again opens that report in a new browser tab.

NOTE

Opening the file in a separate browser tab may allow you to use the browser viewer tools to print or download the file. This feature may not be available in all browsers.

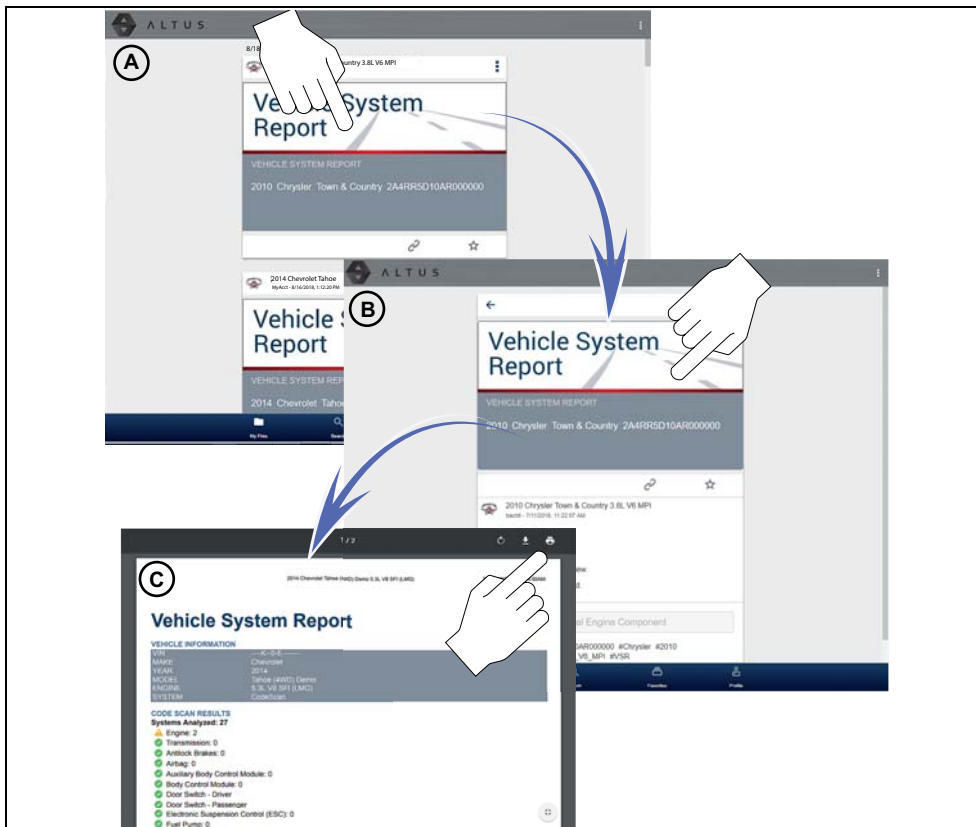

Figure 14-9

The following describes File Detail card features.

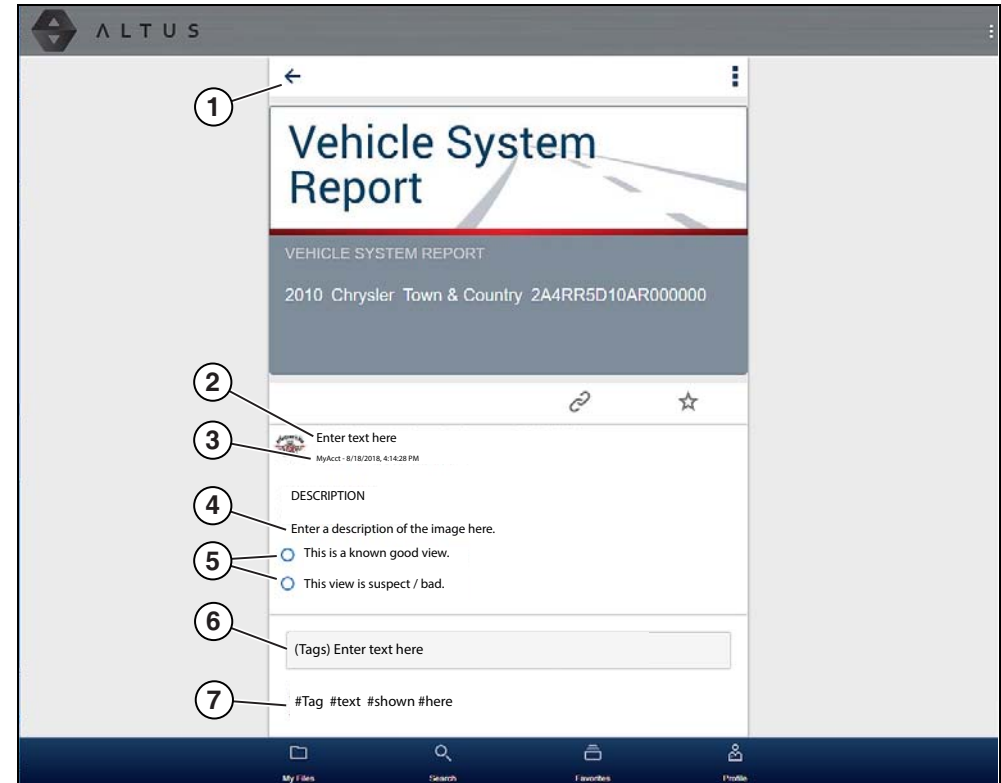

Figure 14-10

- 1— **Back Icon** - Returns to My Files
- 2— **Report Name** (user entered searchable text) - Select the report file name to open the editor. Enter text (alphanumeric) in the field as desired.
- 3— **Your Account Username (and timestamp)** - See [Account](#) on page 102 for additional information. The timestamp indicates the date/time the file posted.
- 4— **Description** (user entered searchable text) - Enter text (alphanumeric) in the description field as desired.
- 5— **Known Good / Bad Checkboxes** (user defined and searchable) - Selecting a checkbox automatically creates a tag (e.g. #good) and is displayed in the Active Tag(s) field.
- 6— **Tag** (user entered searchable text) - Enter text (alphanumeric) in this field as desired. Tagging a report allows you to associate (tag) descriptive text to a report. Tagging can be used to associate multiple reports with a common tag.



The tag text then can be used when performing a search to find all reports with the same tag. Each text entry (word) that is separated by a space (return) is added as a tag, and is displayed in the Active Tag field.

- 7— Active Tag(s)** - Displays the active tag(s). Tags can include the “good” or “bad” entry from the Known Good / Bad checkboxes, and text entered in the report Name, Description and Tag fields. Each entry is automatically preceded with the “#” symbol.

Sharing/E-mail an Individual Report (Link icon)

To share a report:

1. Select the **Link icon** (*Figure 14-11*) on the report card.



Figure 14-11

2. Select **Copy to Clipboard** (*Figure 14-12*) from the pop-up window.

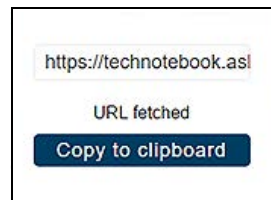

Figure 14-12

3. Open your (e-mail, text, social media, etc.) app and paste the URL into a message to share with others.

The URL link that is sent only displays:

- The Report
- Report Name
- Your User Name
- Date Report was posted
- Report Description

Sharing all Reports (Share My Gallery)

To share your entire gallery (all files in My Files):

1. Select the **Menu icon** (*Figure 14-13*) from the upper toolbar.



Figure 14-13

2. Select **Share My Gallery**.
3. Select **Copy to Clipboard** (*Figure 14-14*) from the pop-up window.



Figure 14-14

4. Open your (e-mail, text, social media, etc) app and paste the URL into a message to share with others.

The URL link that is sent only displays:

- The Reports
- Report Names
- Your User Name
- Date the Reports were posted
- Report Descriptions

14.4.5 Search

The Search screen allows you to perform text searches on all uploaded files and view the results.

To search for a specific file or set of files, enter a **search term** in the search box and select the **magnifying glass** icon (Figure 14-15) (or press Enter).

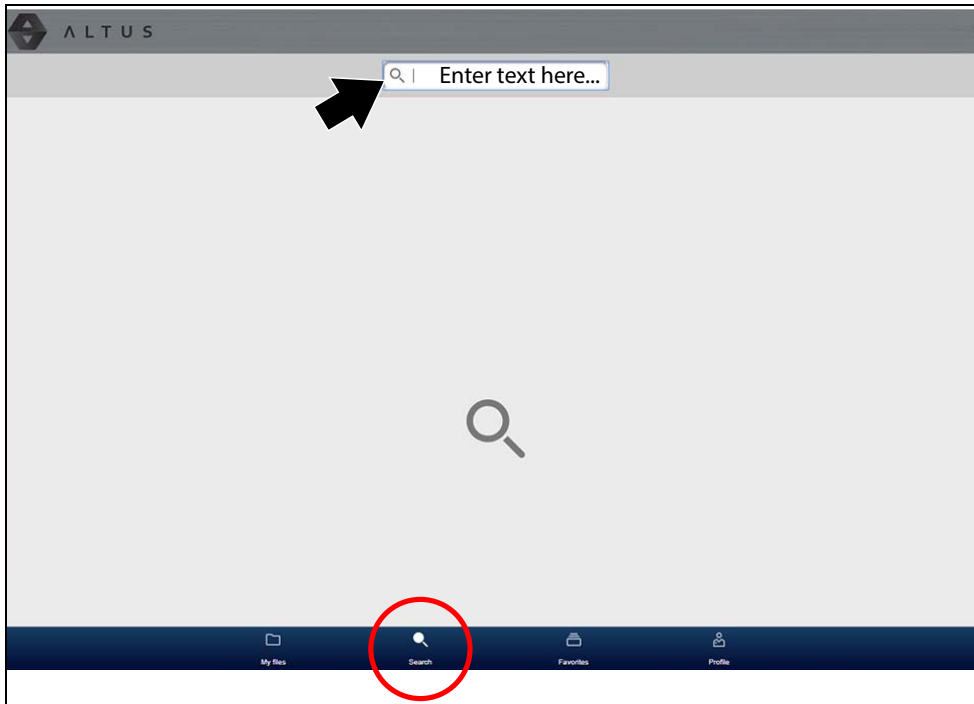

Figure 14-15

Search queries the following to find results:

- **Report File Name** - name can be either system assigned or user assigned
- **Known Good / Bad Checkboxes** - selecting a checkbox automatically creates a searchable tag (e.g. good or bad)
- **Description** - user entered text
- **Tag** - user entered text

See [File Detail \(Tags\)](#) on page 98 for additional information on the above “user entered” text.

14.4.6 Favorites

The Favorites screen displays all the reports selected as favorites (Figure 14-14).

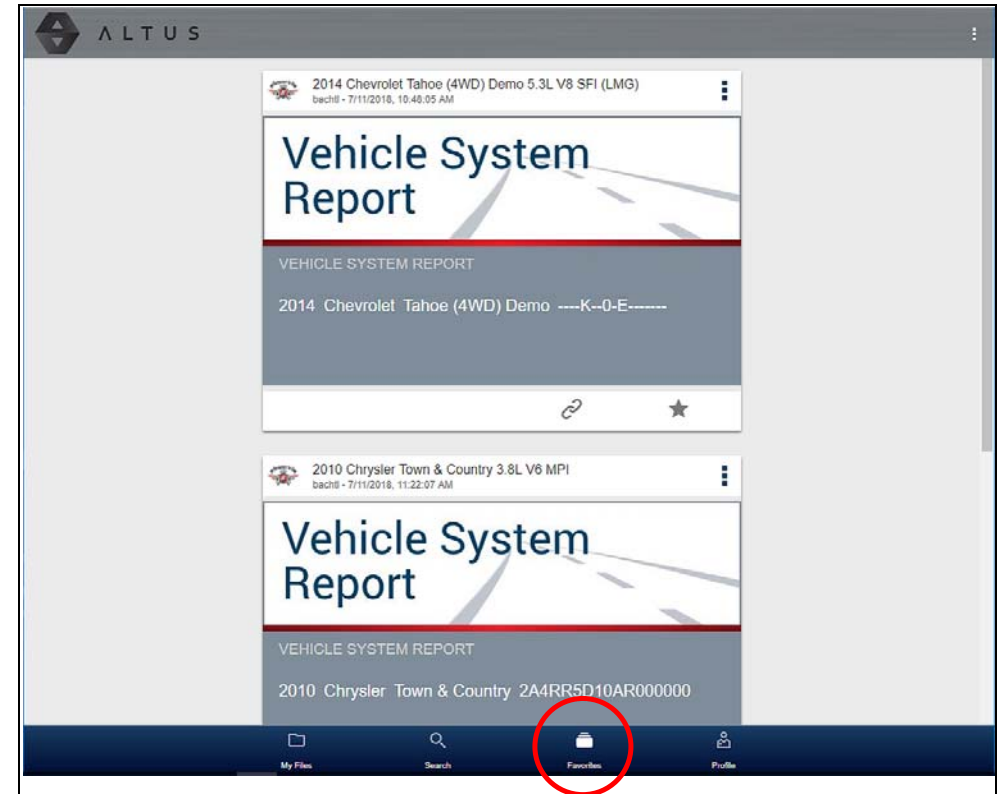

Figure 14-16

To set a file as a “Favorite”, select the **Favorite** icon (star symbol) to highlight the icon.

Description	Icon
Favorite (on)	
Favorite (off)	

The Favorites icon can be selected/deselected at anytime when displaying files.



14.4.7 Profile

The Profile screen allows you to:

- Open Profile Manager ([Figure 14-17](#)), see [Using Profile Manager on page 101](#)
- Logout of the Snap-on Cloud, see [Logging Out of the Snap-on Cloud on page 104](#)

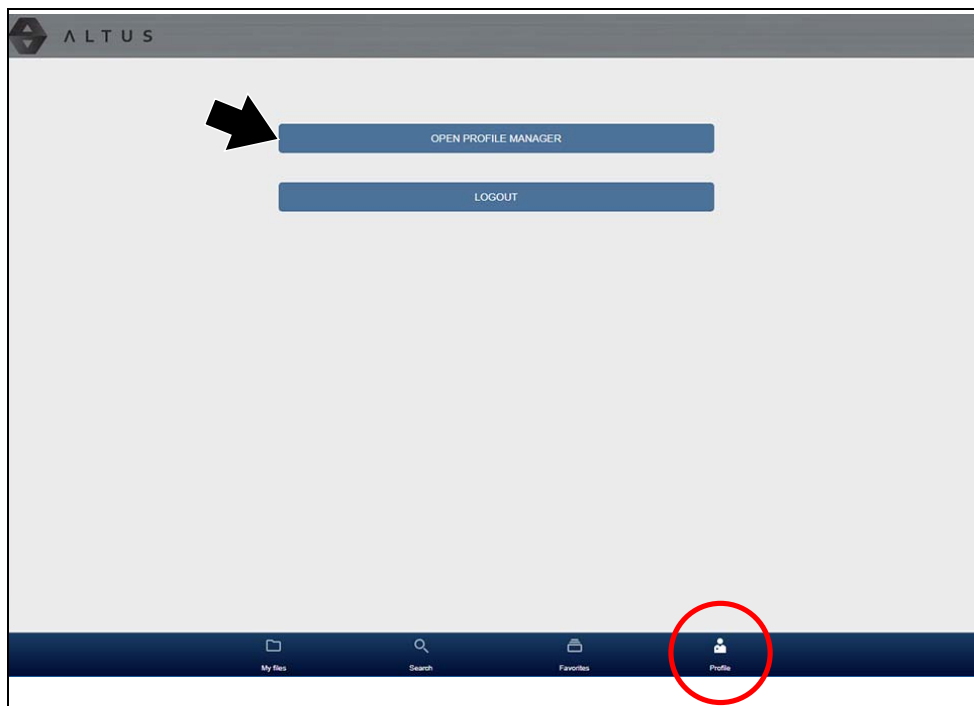

Figure 14-17

Using Profile Manager

To open the Profile Manager screen, select **Profile** from lower toolbar, then select **Open Profile Manager** ([Figure 14-17](#)).

NOTE

Profile Manager opens a new browser tab. To return to the Snap-on Cloud after logging out of Profile Manager, you must select the ALTUS Home Page browser tab.

Enter your **Username** and **Password** at the Login screen.

If you are a SureTrack user, please note that Profile Manager is the same as your SureTrack Profile Manager. Any changes you make will also be reflected in your SureTrack account.

Profile Manager includes five tabbed categories to help you manage your account information:

- [Account on page 102](#)
- [Personal Information on page 102](#)
- [Expertise on page 103](#)
- [Profile Picture on page 103](#)
- [Device Management on page 103](#)



Account

This screen manages the following account information ([Figure 14-18](#)):

- Authorization Key (not required for Snap-on Cloud account registration)
- Account Expiration Date
- Shop Nickname
- Email
- Username
- Password

Figure 14-18

Personal Information

This screen manages the following personal account information ([Figure 14-19](#)):

- First Name
- Last Name
- City
- State
- Zip Code

Figure 14-19



Expertise

(SureTrack users only) - Select the vehicles from the list that you have expertise with. When a question is asked within the SureTrack community about one of the selected vehicles, you will receive an email with the details and a link back to the question.

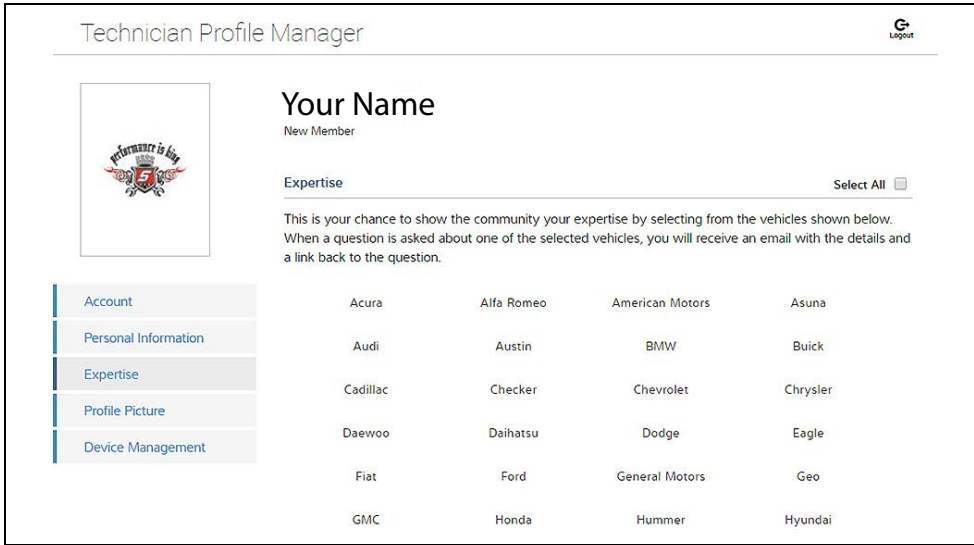

Figure 14-20

Profile Picture

This screen allows you to personalize your profile picture, by selecting one of the provided images.

Shop Information

Shop Information allows you to enter the name address, and phone number for your shop. This information is included as a header on the report.

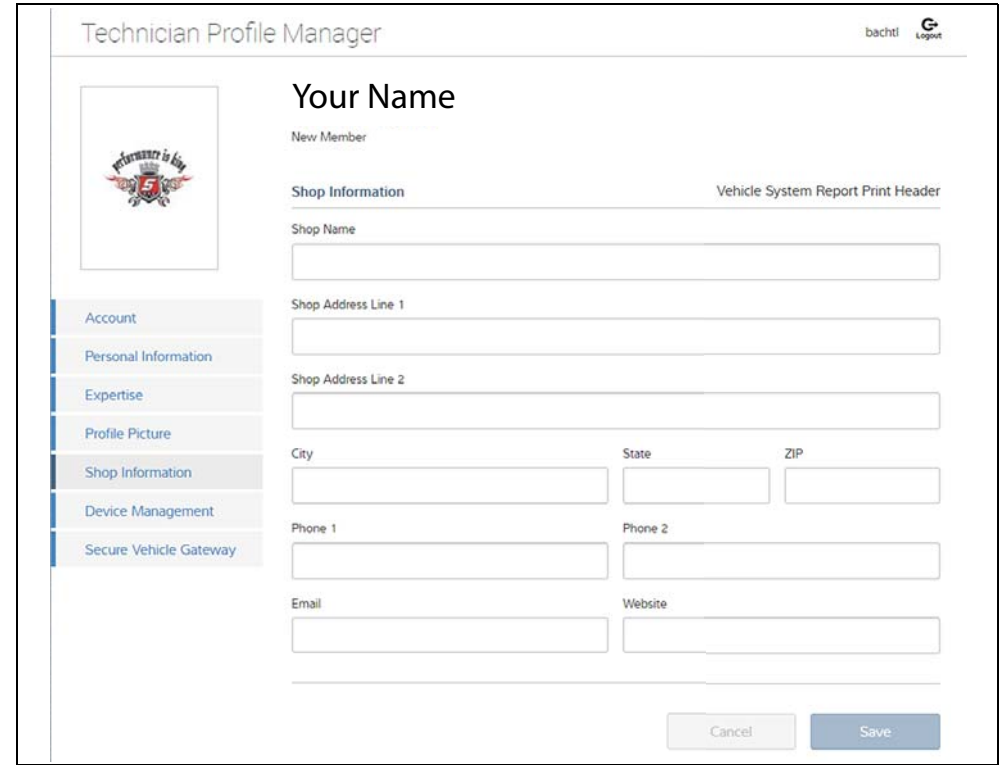

Figure 14-21

Device Management

This screen manages devices associated with your account (Figure 14-22):

Select **Add a Device** to setup and add an authorized device (e.g. diagnostic tool or Diagnostic Tool).

Enter the device:

- **Serial Number** - serial number of the device
- **PIN** - specific PIN associated to the device
- **Code** - authorization code specific to the device

Device Name - user define name

When finished select **Save** to save and link the device to your account.

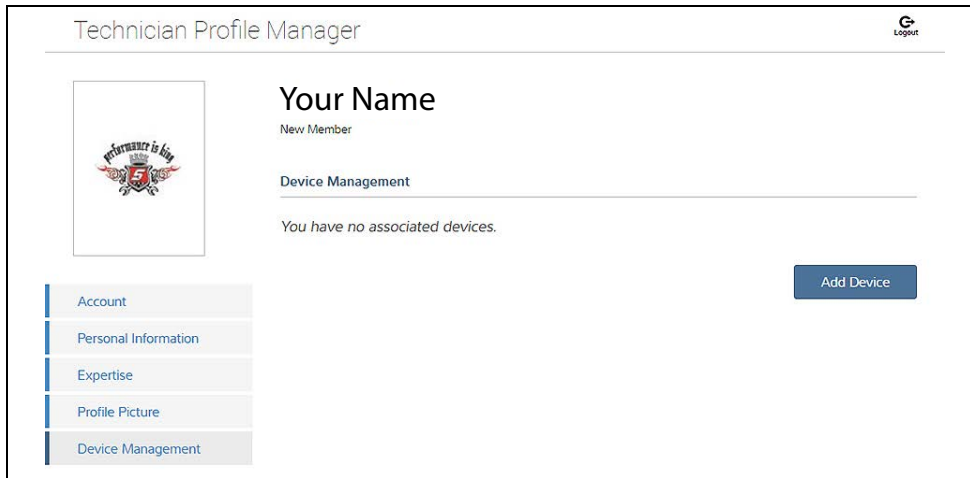

Figure 14-22

Logging Out of Profile Manager

Select the **logout** icon (upper right screen) to log out of Profile Manager (Figure 14-23).



Figure 14-23

NOTE

Profile Manager opens a new browser tab. To return to the Snap-on Cloud after logging out of Profile Manager, you must select the ALTUS Home Page browser tab.

Logging Out of the Snap-on Cloud

To log out of the Snap-on Cloud select **Profile** from lower toolbar, then select **Logout** (Figure 14-24).

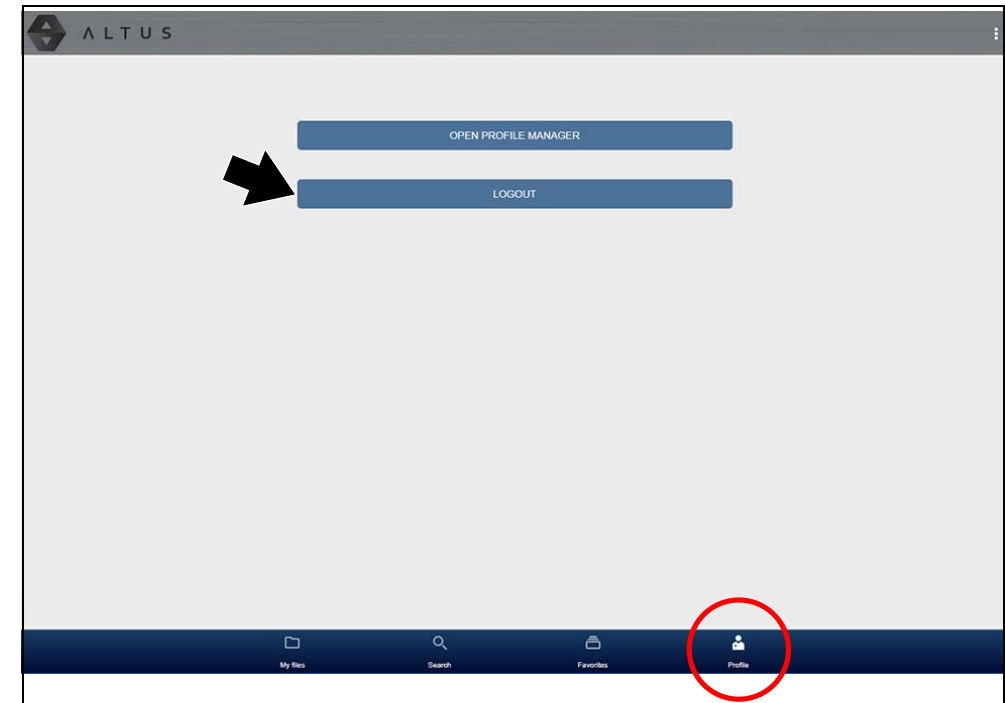

Figure 14-24



Introduction

SureTrack is an evolving database of "real-world" automotive repair knowledge based on expert knowledge and millions of actual repair orders. It was designed to help you improve automotive diagnostic accuracy and reduce repair times.

SureTrack information can be provided in two ways, by WiFi in the integrated Scanner function on your diagnostic tool, and through a web browser on a PC or mobile device.

i NOTE

SureTrack is not available for motorcycles.

15.1 Main Topic Links

- [Finding your SureTrack Authorization Code](#) page 105
- [Creating an Account / Logging In](#) page 105
- [Logging In \(active account\)](#) page 108
- [Logging In with New Authorization Code \(active account\)](#) page 109
- [Logging In with New Authorization Code \(expired account\)](#) page 110
- [SureTrack \(Scanner\)](#) page 111
- [SureTrack Online](#) page 115

15.2 Quick Reference

15.2.1 SureTrack Community FAQ's

For the latest SureTrack Community information and answers to frequently asked questions visit: mitchell1.com/support/suretrack-faqs/

15.2.2 Using SureTrack for the First Time

If you have purchased a new diagnostic tool, you will need to create a SureTrack account before you can access SureTrack. See [Creating a SureTrack Account](#) on page 106 for instructions.

15.2.3 Login Scenarios

- I already have an active SureTrack account with username and password - [Logging In \(active account\)](#) on page 108.
- SureTrack has already expired, but I purchased a qualifying upgrade/plan and have a new SureTrack authorization code (reactivation) - [Logging In with New Authorization Code \(expired account\)](#) on page 110.
- SureTrack is still active, but I have purchased a qualifying upgrade/plan and have a new SureTrack authorization code (reactivation) - [Logging In with New Authorization Code \(active account\)](#) on page 109.

15.3 Creating an Account / Logging In

15.3.1 Finding your SureTrack Authorization Code

When you purchase a qualifying upgrade/plan, or platform from your Snap-on Representative, you will receive a SureTrack authorization code. The authorization code is printed on your sales receipt. Authorization codes are 12 digit alphanumeric codes (e.g. 123ABCAP4-US).

Snap-on

Snap-on Tools Invoice

Sold By: T HOLMAN
Address: 60 N COURT
WOODSTOCK, GA

Sold To: Scanbay
Address: Scanbay
LINCOLNSHIRE, IL 60069-

Invoice Date - 11/4/2013 14:01:20
Account Type: RA
Invoice #: 104132

Phone: _____ Tax Exempt #: _____
Phone: _____ PO #: _____

Part #	Qty	Description	Line Type	Price	Discount	Total	Tax
EESP323U2	1	DO NOT ORDER - VERUS SB SW	Sale	999.00	0.00	999.00	74.93
Serial #: 13.4-333338564552303031303039							
EESPSURTRK0	1	SureTrack Authorization Code	Sale	0.00	0.00	0.00	.00
Serial #: 123456789-US							

SubTotal 7.50 % Tax
Freight
Grand Total

12 digit alpha-numeric code (e.g. 123ABCAP4-US)

Figure 15-1

NOTE

After obtaining a new upgrade/plan you will receive a new SureTrack authorization code.

Each time you purchase a qualifying diagnostics upgrade/plan you will be provided a new SureTrack authorization code. The authorization code will expire as noted in the upgrade/plan details. To log in with a new authorization code, see [Logging In with New Authorization Code \(expired account\)](#) on page 110.

15.3.2 Creating a SureTrack Account

Use Requirements

To use SureTrack you must:

- Create a SureTrack Account, see [Creating an Account](#) on page 106.
- Have a current SureTrack Authorization Code, see [Finding your SureTrack Authorization Code](#) on page 105.
- Have access to a PC with an Internet connection.

Creating an Account

If you are a new member (do not have an existing SureTrack account), you will need to complete the online registration before you can use SureTrack. Use the following procedure to create an account.

1. On your PC visit: <https://shopkeypro.com>
2. To create an account use the following illustrated instructions. Step numbers are provided in each illustration, follow the sequence to completion.

LOGIN

ShopKey5.com Users:
Click the "Login" button above and enter your ShopKey5 username and password to access ShopKey Pro.
Don't know your username and password?
Click here for information on retrieving them.

Estimate Guide & Vintage
Improvements to Estimate Guide and Vintage.

About ShopKey Pro
ShopKey Pro provides full OEM repair, estimating, maintenance and real-world experience based information in one easy-to-use product built to help auto service professionals work faster and more accurately.

Figure 15-2

Username

Password

Forgot password? Click here to reset.

Remember username & password

Login

Cancel

Create a new Individual Account

Figure 15-3

3 Enter all required* information.

Email
 Email Address*

Name
 First Name* Last Name* Phone Number

Address
 Address Line 1
 Address Line 2
 City* State* Zipcode

Online Profile
 Username* Password* Retype Password*

Cancel Create

4

Figure 15-4

Username Password

6

Forgot password? Click here to reset.

Remember username & password

7

Login

8 Cancel

Create a new Individual Account

Figure 15-6

Success X

Congradulations! Your account has been created.

This account can be used to contribute to the community and manage your profile.

To link this account to your shop, have your shop add you in Profile Manager.

5 Done

Figure 15-5

9 Choose 3 security questions.

Select three questions below. These questions will help us verify your identity should you forget your password.

Question 1: Choose a question...

Question 2: Choose a question...

Question 3: Choose a question...

Cancel Submit

10

Figure 15-7

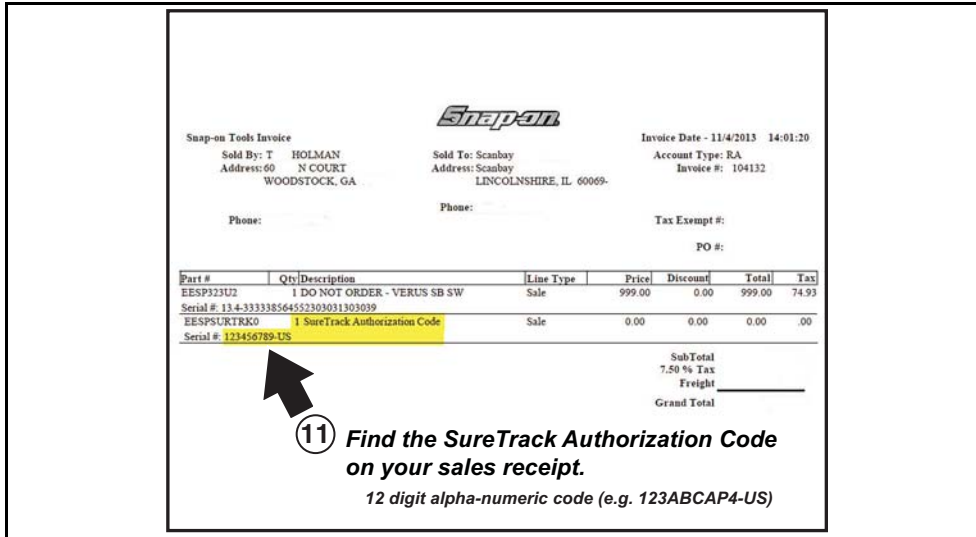

Figure 15-8



Figure 15-10

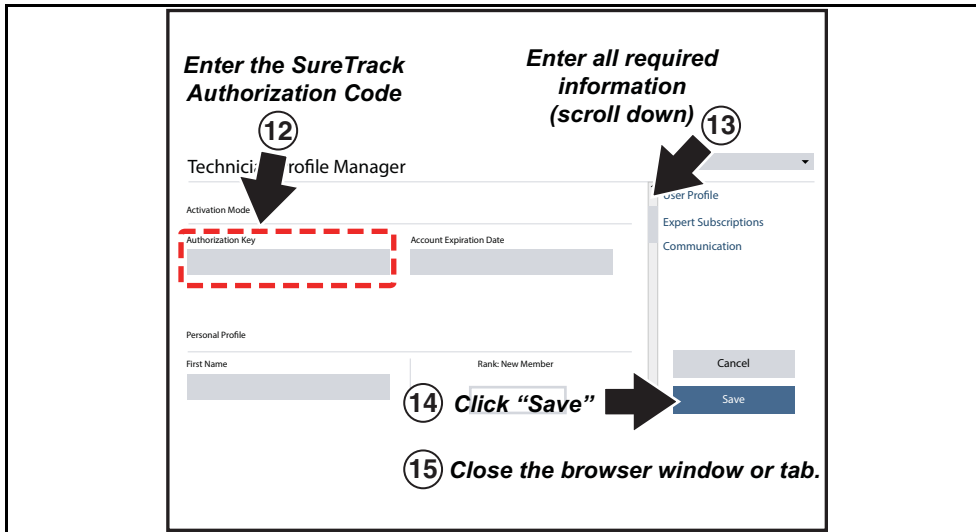

Figure 15-9

15.3.3 Logging In (active account)

If you have previously created a SureTrack account, and have a valid username and password, select **LOGIN** (Figure 15-11) from the ShopKey Pro start page, and then complete the login process (Figure 15-12). Once successfully logged in you will be directed to the 1Search Limited results page. See [SureTrack Screens](#) on page 116.

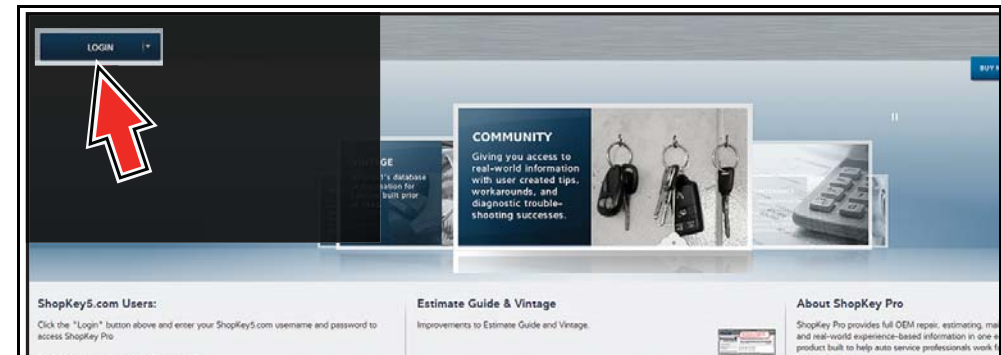

Figure 15-11

If you have previously selected the "remember me" checkbox in the login screen you will skip the login and be automatically directed to the 1Search Limited results page.

Figure 15-12 shows a login form with the following elements:

- Username input field (highlighted with a red dashed box)
- Password input field (highlighted with a red dashed box)
- Link: "Forgot password? Click here to reset."
- Remember username & password checkbox (highlighted with a red dashed box)
- Login button
- Cancel button
- Link: "Create a new Individual Account"

Figure 15-12

15.3.4 Logging In with New Authorization Code (active account)

Use the following instructions, if you have purchased a qualifying upgrade/plan and your SureTrack account is active (has not expired). To find your new authorization code, see [Finding your SureTrack Authorization Code on page 105](#).

1. Log in to ShopKeyPro.com using your current username and password.
2. At the ShopKey Pro start page, select your username ([Figure 15-13](#)), then select **Profile Manager** from the dropdown menu.

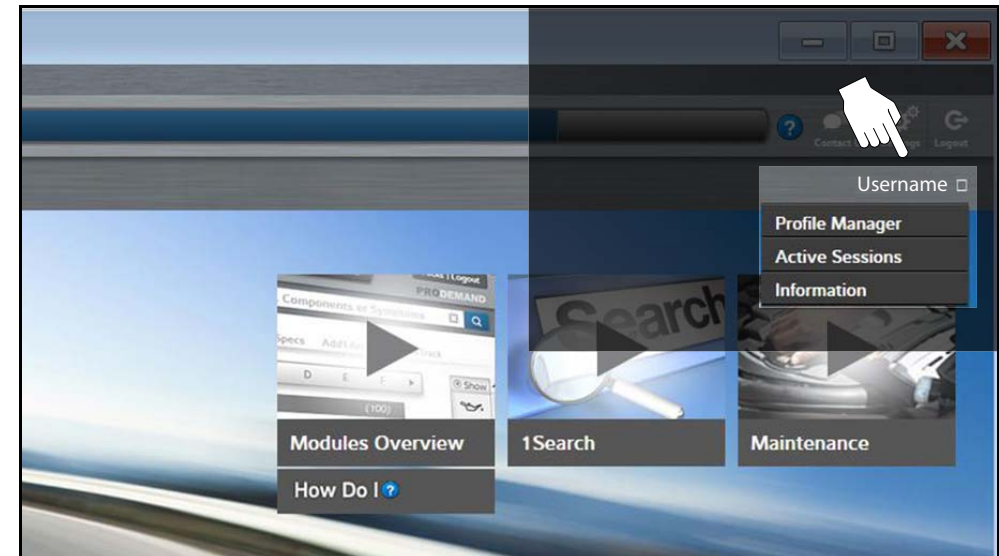

Figure 15-13

3. Log in to the Profile Manger ([Figure 15-14](#)) using your current username and password.
4. Enter your new **Authorization code** ([Figure 15-14](#)).

Figure 15-14 shows the Technician Profile Manager form. The form includes the following sections and fields:

- Technician Profile Manager (Title)
- Activation Mode (Field)
- Authorization Key (Field) - A red arrow points to this field with the text "Enter new code here."
- Account Expiration Date (Field)
- Personal Profile (Section)
 - First Name (Field)
 - Last Name (Field)
 - Rank: New Member (Text)
- User Profile (Section)
 - Expert Subscriptions (Text)
 - Communication (Text)

Figure 15-14

5. Review and update the rest of your profile and make sure all required fields are filled out.

6. Select **Save**.
7. Exit the Profile Manager by selecting your username (near the top right) and select **Logout**.
8. When the login screen displays, login using your current username and password.
9. Confirm the new expiration date by logging back into Profile Manger to check it.

15.3.5 Logging In with New Authorization Code (expired account)

Use the following instructions, if your SureTrack account has expired, and you have purchased a qualifying upgrade/plan. Your new upgrade/plan comes with a new SureTrack authorization code. To find your new authorization code, see [Finding your SureTrack Authorization Code on page 105](#).

1. Log in to ShopKeyPro.com using your using your current username and password.

When your SureTrack account has expired, and you try to login you are directed to an information window ([Figure 15-15](#)).

2. Scroll down and select the link shown in ([Figure 15-15](#))

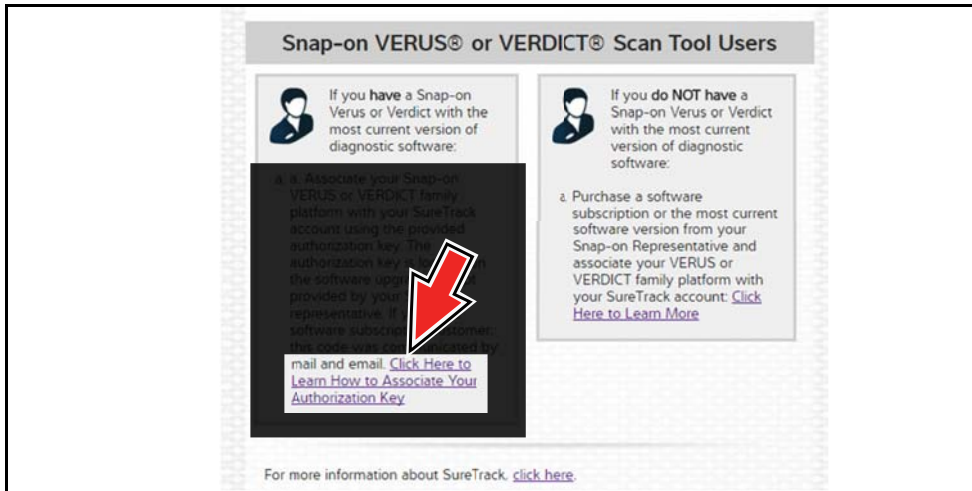

Figure 15-15

3. The SureTrack FAQ webpage opens ([Figure 15-16](#)).

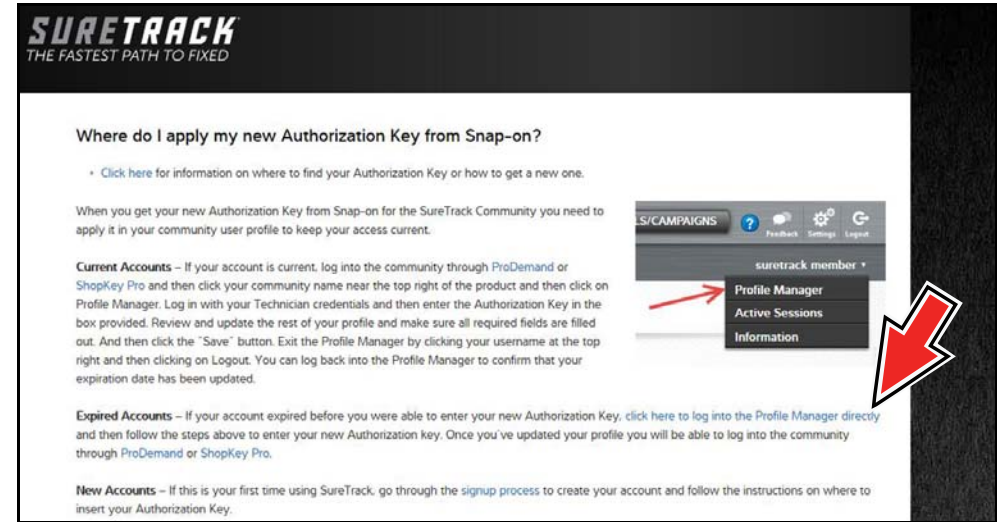

Figure 15-16

4. Scroll to the topic “Where do I apply my new Authorization Key from Snap-on?”
5. Select the link “click here to log into the profile manager login window directly”.
 - URL - <https://profilemanager.mitchell1.com/technicianprofile/index>

The SureTrack renewal window opens.

6. Enter your current username and password.

The SureTrack Profile Manager window opens.

7. Enter your new **Authorization code** ([Figure 15-17](#)).

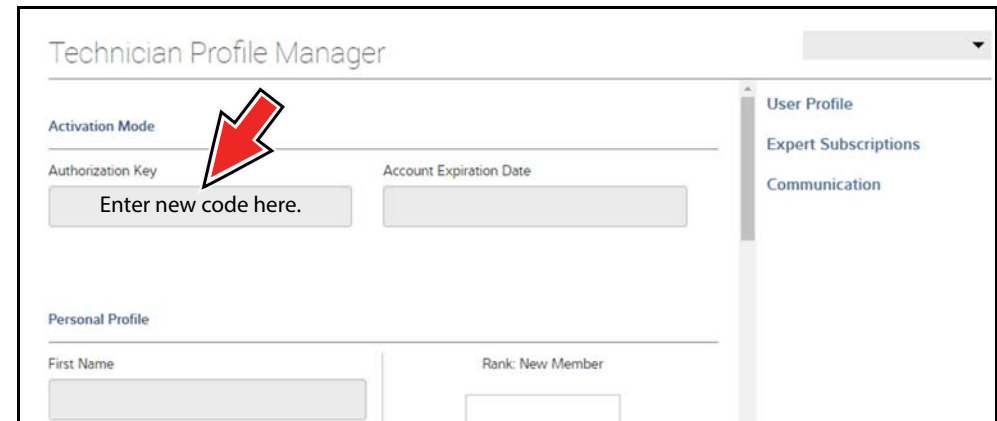

Figure 15-17



8. Review and update the rest of your profile and make sure all required fields are filled out.
9. Select **Save**.
10. Exit the Profile Manager by selecting your username (near the top right) and select **Logout**.
11. When the login screen displays, login using your current username and password.
12. Confirm the new expiration date by logging back into Profile Manager to check it.

15.4 SureTrack (Scanner)

SureTrack is available as an integrated Scanner function that provides you expert automotive information directly on your diagnostic tool, via WiFi connection to our Snap-on web services network.

SureTrack includes a comprehensive source of expert automotive knowledge for professional technicians, combining diagnostic experience and detailed vehicle-specific parts replacement records. SureTrack can provide you with vehicle specific part replacement, diagnostic and repair information related to the diagnostic trouble codes (DTCs) found when checking codes with the Scanner. If diagnostic Tips, Fixes or parts information is available for a DTC, simply select the applicable SureTrack icon from the DTC results list to review the information and start the repair.

SureTrack Features:

- Up-to-the-minute diagnostic intelligence based on vehicles currently being serviced by professional shops
- Provides the following diagnostic information (if available) all based on the vehicle ID and diagnostic trouble codes (DTCs) selected
- Common Replaced Parts Graph — displays the replacement parts most frequently used to successfully complete repairs based on actual vehicle repairs
- Tips - Experience-based diagnostic and repair tips and information for the selected DTC
- Related Tips - Additional Tips that may be related to the selected DTC
- Real Fixes - Verified successful repair information and/or procedures for the selected DTC
- Related Real Fixes - Additional Real Fixes that may be related to the selected DTC.

All information (e.g. replaced parts data, tips and fixes) have been obtained from professional automotive OEM and specialty technicians from a vast range of repair shops.

i NOTE

SureTrack Tips, Fixes, and Common Replaced Parts information may not always be available for every vehicle DTC. Only available information is displayed.

15.4.1 Basic Operation and Navigation

Before using SureTrack, you must:



- Verify that you have the current software upgrade installed. SureTrack is only active with current software versions. Contact your sales representative for purchasing information.
- Turn the Wi-Fi radio on. For Wi-Fi setup and connection see, [Wi-Fi Connection / Troubleshooting on page 86](#).



The diagnostic tool is equipped with the ability to connect to a Wi-Fi network, however the connection is solely dedicated to our Snap-on web services network. Before you begin using an integrated Wi-Fi function you must connect to a wireless network and turn the Wi-Fi radio on.

- Connect to a wireless network and the Internet. For Wi-Fi setup and connection see, [Wi-Fi Connection / Troubleshooting on page 86](#).

Icons

Before you begin using SureTrack, familiarize yourself with the SureTrack icons and their functions:

Icon	Icon Name	Description
	Fix It!	Opens the SureTrack dashboard and displays the Common Replaced Parts graph and Tips or Real Fixes for the selected DTC
	Related Tips	Displays Related Tips for the selected DTC

	Real Fixes	Displays Related and Real Fixes for the selected DTC
	Menu Exit	Exits the SureTrack dashboard
	Common Replaced Parts Graph	Toggles the Common Replaced Parts Graph display open/close

Viewing Information

SureTrack information is accessible (if available) when viewing DTCs within the Scanner function.

As an example, once the diagnostic tool has been connected to the test vehicle and the vehicle has been identified, navigate to **Engine > Codes Menu > Display Codes > All Powertrain Codes or Engine Trouble Code Information** to display the DTC results screen.

i NOTE

If SureTrack information is available for a selected DTC, the SureTrack status bar will display **"SureTrack - Results for XXX"** (XXX = the selected DTC).

If a DTC is present, select the DTC from the list to highlight it, then select the **Fix It!** icon ([Figure 15-18](#)) to see if SureTrack information is available. Selecting **Fix It!** opens the SureTrack dashboard. See ["Dashboard" on page 113](#) for additional information.

The Common Replaced Parts graph is displayed on the DTC results screen. If the graph is minimized select the Common Replaced Parts Graph icon, located to the left of Common Replaced Parts Graph title bar ([Figure 15-18](#)) to open (maximize) the graph.

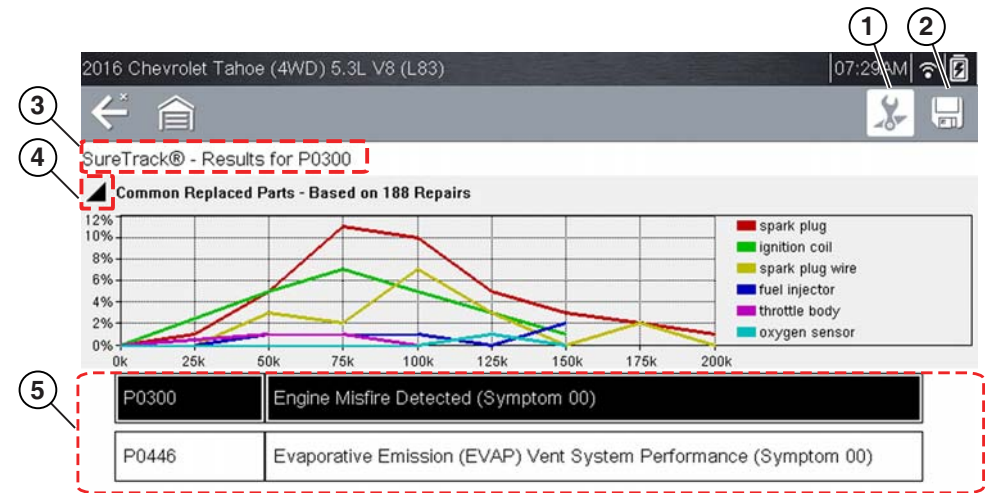
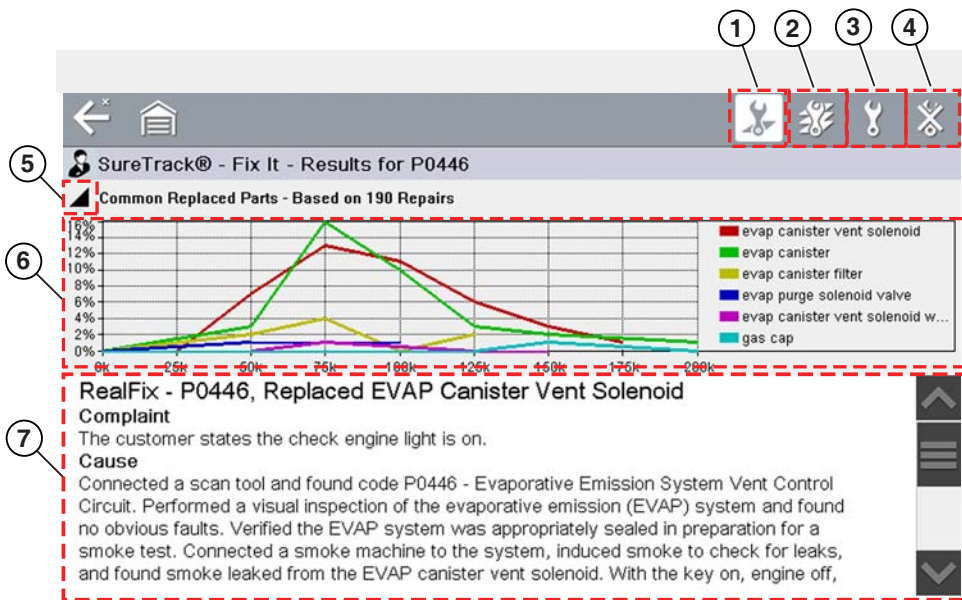

Figure 15-18 DTC Results with SureTrack

- 1— **Fix It! Icon** — opens the SureTrack Dashboard
- 2— **Save Icon** — saves the DTCs list (see, ["Saving Data Files" on page 30](#))
- 3— **SureTrack Status Bar** — displays the active SureTrack status or result
- 4— **Common Replaced Parts Graph Icon** — toggles the graph display open/close
- 5— **DTC Results List** — displays the current DTCs

Dashboard

Selecting the **Fix It!** icon from the DTC results screen opens the SureTrack dashboard. The initial Dashboard screen displays the Common Replaced Parts Graph and either a Tip or Real Fix for the selected DTC (depending on availability). The Related Tips and Real Fixes icons are also available from this screen (Figure 15-19).



- 1— Fix It! Icon
- 2— Related Tips Icon
- 3— Real Fixes Icon
- 4— Dashboard Exit Icon
- 5— Common Replaced Part Graph Icon — toggles graph display open/close
- 6— Common Replaced Part Graph
- 7— Tip

Figure 15-19 SureTrack Dashboard

Common Replaced Parts Graph

The Common Replaced Parts graph (if available) is displayed by selecting the **Fix It!** icon or can be viewed directly from the DTC results screen by selecting the **Common Replaced Parts Graph** icon, located to the left of Common Replaced Parts Graph title bar. The Common Replaced Parts graph shows the percentage of verified fixes (using the parts listed) derived from the total number of repairs by mileage. The graph may display one or more replacement parts based on the captured information.

The example below (Figure 15-20) shows two common replaced parts used in the repair of DTC P0106. In this example, the PCV valve is the most common replaced part based on 973 repairs involving vehicles with up to 200k miles, 17% of those 973 repairs occurred at 125k miles.

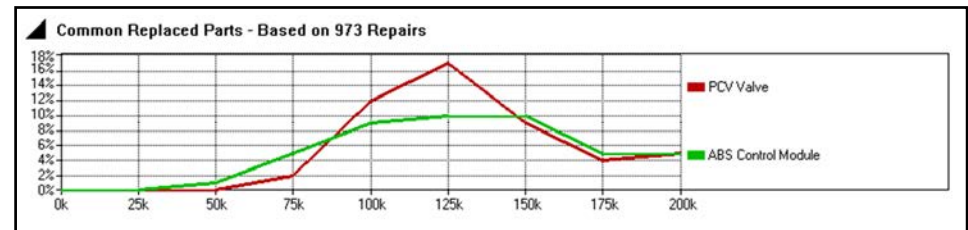

Figure 15-20 Common Replaced Parts Graph



Tips and Related Tips

- **Tips** - Experience-based diagnostic and repair tips and information for the selected DTC
- **Related Tips** - Additional **Tips** that may be related to the selected DTC

Tips have been researched and obtained from professional automotive OEM and specialty technicians from a vast range of repair shops. Tips may not be available for every vehicle and/or DTC.

Tips (if available) can be displayed in two ways:

- Selecting the **Fix It!** icon from the DTC results screen opens the SureTrack dashboard which may include Tip(s) for the selected DTC. If Tips are not available for the DTC, Real Fixes may be displayed.

Selecting the **Related Tips** icon will display a list of Related Tips. Selecting an item from the list, opens additional details about the Related Tip ([Figure 15-21](#)).

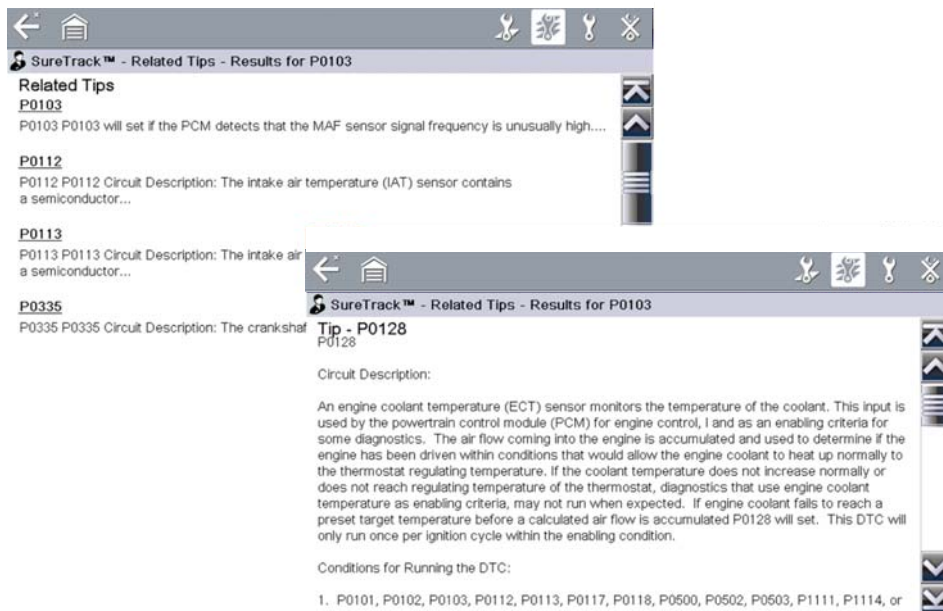

Figure 15-21 Tip(s) Screens

Real Fixes and Related Fixes

- **Real Fixes** - Verified successful repair information and/or procedures for the selected DTC.
- **Related Real Fixes** - Additional **Real Fixes** that may be related to the selected DTC.

Fixes have been researched and obtained from professional automotive OEM and specialty technicians from a vast range of repair shops. Fixes may not be available for every vehicle and/or DTC.

Fixes (if available) can be displayed in two ways:

- Selecting the **Fix It!** icon ([Figure 15-19](#)) from the DTC results screen opens the SureTrack dashboard which may include Real Fixes for the selected DTC. If Real Fixes are not available for the DTC, Tips may be displayed.

Selecting the **Real Fixes** icon ([Figure 15-19](#)) displays Related and Real Fixes (if available). Selecting an item from the list opens additional details about the Fix in a Complaint, Cause, Correction format ([Figure 15-22](#)).



Figure 15-22 Related Real Fixes Screens



SureTrack Status Messages

Status messages may be displayed to inform you of pending issues or general status. Depending on your software version and connection status, the following messages may be displayed in the SureTrack status bar:

- **SureTrack Content May Be Available!** - indicates SureTrack content may be available, however you are not currently connected to the SureTrack database. This message may be caused by a Wi-Fi connection issue, or if you do not have the current software upgrade installed. See [Wi-Fi Connection / Troubleshooting on page 86](#) for SureTrack Troubleshooting information.
- **No connection to SureTrack. Please try again later.** - indicates you are not currently connected to the SureTrack database, except when displayed in the OBD/EOBD function as SureTrack is not accessible in OBD/EOBD mode. If this message is displayed in the Scanner function, it may be caused by a Wi-Fi connection issue, or if you do not have the current software upgrade installed.
- **Loading content from SureTrack** - indicates SureTrack information is being accessed from the SureTrack database.
- **A new diagnostic software upgrade is available. See your sales representative for details** - indicates your access to SureTrack will be expiring soon and you should contact your sales representative to purchase the current software upgrade.
- **Your SureTrack access has expired. See your Sales representative to renew.** - indicates your access to SureTrack has expired and you should contact your sales representative to purchase the current software upgrade.
- **Verified parts replacement data not available. Tap the wrench icon for more results.** - indicates that Common Replaced Parts information (graph) is not available, however other types of SureTrack information may be (e.g. Real Fixes and Tips). Select the **Fix It!** icon to see if other information is available.

15.5 SureTrack Online

15.5.1 SureTrack Features

SureTrack is an integrated part of ShopKey Pro, and includes two navigation modules providing search and forum capabilities:

- 1Search™ *Limited*
- Sure Track Community.

15.5.2 1Search™ *Limited*

The **1Search *Limited*** module includes the following information features:

- **Real Fixes and Tips** - real-world fixes and repair tips captured from actual repair orders and the experiences of professional technicians.
- **Common Repair Procedures Graph** - graphical display of the specific parts and procedures most frequently used to fix the selected code or symptom.
- **ProView** - provides graphical displays showing the direct relationship between a code or symptom to the component used to fix them.
- **Component Tests** - includes instructions on how to test the component, and descriptions of component operation, component locations, test locations, connector end views and even sample waveforms.
- **TSB's** - OEM technical service bulletins.
- **Safety Recalls and Campaigns** - safety recall and service campaign information.

SureTrack Community

The **Sure Track Community** module is a forum-based application that connects you with a community of other professional technicians to find and share information, ask questions, and provide your own tips.

15.5.3 SureTrack Screens

SureTrack Home Page (within ShopKey Pro)

The SureTrack Home page within ShopKey Pro includes:

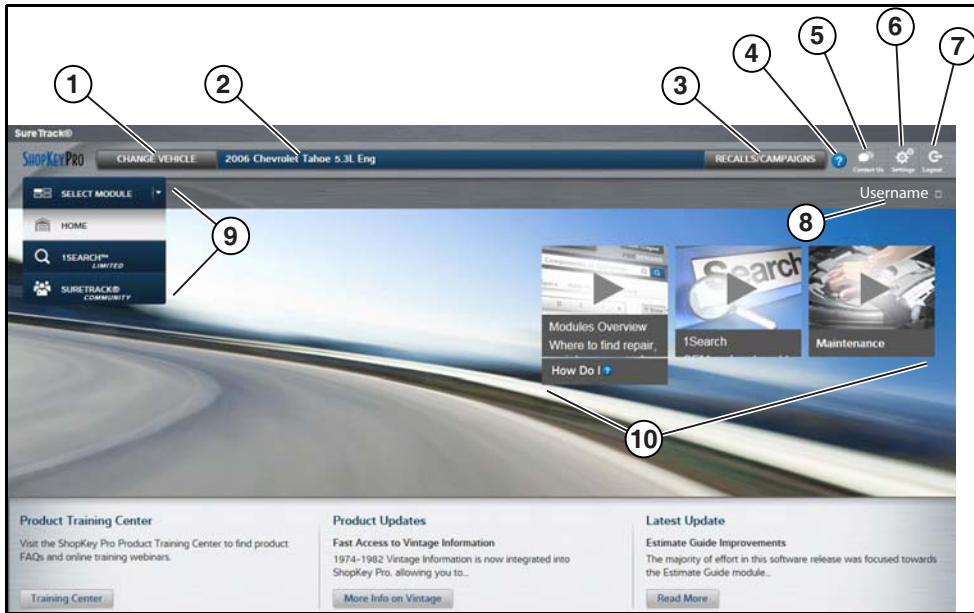

Figure 15-23

1. **Change Vehicle*** - dropdown menu provides options to change the active vehicle
2. **Active Vehicle*** - displays active vehicle
3. **Recall/Campaigns*** - displays available OEM recalls and campaigns
4. **Help*** - provides SureTrack and ShopKey Pro online help topics
5. **Contact Us*** - provides options for contacting ShopKey Pro customer service
6. **Settings*** - provides general setting options and information
7. **Logout*** - logs you off of ShopKey Pro
8. **User ID options menu*** - displays username, selecting opens Profile Manager and other options
9. **Main Menu (dropdown)*** - Options are Home, 1Search *Limited*, and SureTrack Community
10. **General Training and Information Links** (various)

* available on all pages

1Search *Limited* Top 10 Results Page

Selecting 1Search *Limited* displays a Top 10 results page which includes:

Based on Analysis of 27,218 Repairs			
Commonly Replaced COMPONENTS	Common DTCs	Common SYMPTOMS	Top Search LOOKUPS
1. Disc Brake Pad 3,514	1. P0449: Evaporative E... 279	1. Coolant Leaks From V... 354	1. Fuses And Circuit Bre...
2. Brake Rotor 2,773	2. P0455: Evaporative E... 207	2. Noise Heard From Bra... 297	2. Engine Water Pump
3. Battery 2,295	3. C0327 109	3. Engine Does Not Start 243	3. Hvac System
4. Drive Belt 1,741	4. P0442: Evaporative E... 100	4. Fluid Leaks From Vehi... 239	4. Fuse/Relay Box
5. Evap Canister Vent So... 1,257	5. P0446: Evaporative E... 91	5. Air Conditioning Inope... 184	5. Transfer Case
6. Engine Water Pump 1,135	6. P0172: System Too Ri... 44	6. Air Bag Light On 175	6. Parking Aid System
7. Wheel Hub Assembly 897	7. P0496: Evaporative E... 44	7. Noise Heard 129	7. Door Module
8. Hvac Blower Motor R... 841	8. P0030 42	8. 4wd Light On 109	8. Evaporative Emission...
9. Spark Plug 802	9. P0175: System Too Ri... 41	9. Blower Motor Inopera... 106	9. Fuel Tank
10. Tires 796	10. P0053 34	10. Engine Runs Rough 104	10. Drive Belt

Figure 15-24

- **Search Bar** - use the search bar to enter a code, component or symptom to search. For best results keep search terms short (e.g. water pump, not - water pump replacement).
- **Page Tabs** - use the page tabs to navigate to related information (e.g. Index, SureTrack, ProView, etc) varies per application
- **Quick-links** - Technical Service Bulletins (TSBs) is the only available option
- **Repair Totals indicator** - displays the total number of repairs that all displayed data was based on
- **Top 10 lists** - display the most popular repairs and lookups by existing users for the selected vehicle (select an item from any list to view the Results Index, see [Results Index Page on page 117](#))
 - Top 10 - Commonly Replaced Components
 - Top 10 - Common DTCs
 - Top 10 - Common Symptoms
 - Top 10 - Top Search Lookups



Results Index Page

The Results Index page includes:

- **OEM Plus Results** - provides results that best match the exact search criteria, ranked in order with the closest match at the top.
- **SureTrack Results** - provides probable components related to the search criteria, ranked in order from the most likely to the least likely component.

Select an item from either list to view the results, see [SureTrack Results Page](#) on page 117).

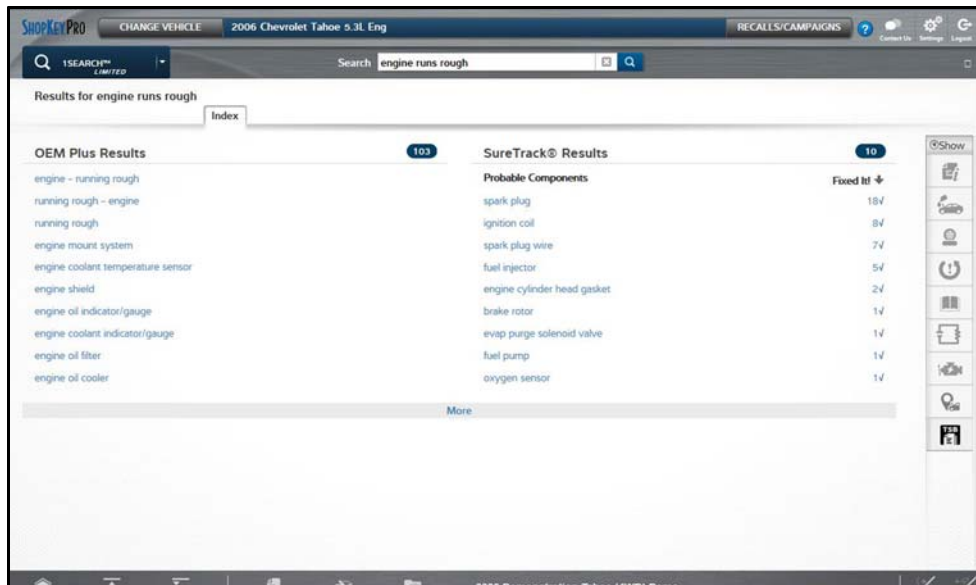

Figure 15-25

SureTrack Results Page

Selecting an item from the Results Index page displays applicable repair information on the SureTrack results page.



Figure 15-26

Information may include:

- **Real Fixes and Tips** - real-world fixes and repair tips captured from actual repair orders and the experiences of professional technicians.
- **Common Repair Procedures Graph** - graphical display of the specific parts and procedures most frequently used to fix the selected code or symptom.
- **Component Tests** - includes instructions on how to test the component, and descriptions of component operation, component locations, test locations, connector end views and even sample waveforms.
- **TSB's** - OEM technical service bulletins.
- **Safety Recalls and Campaigns** - safety recall and service campaign information.



ProView Results Page

Selecting the **ProView** tab from the SureTrack results page opens ProView. ProView provides graphical displays showing the direct relationship between a code or symptom to the component used to fix them.

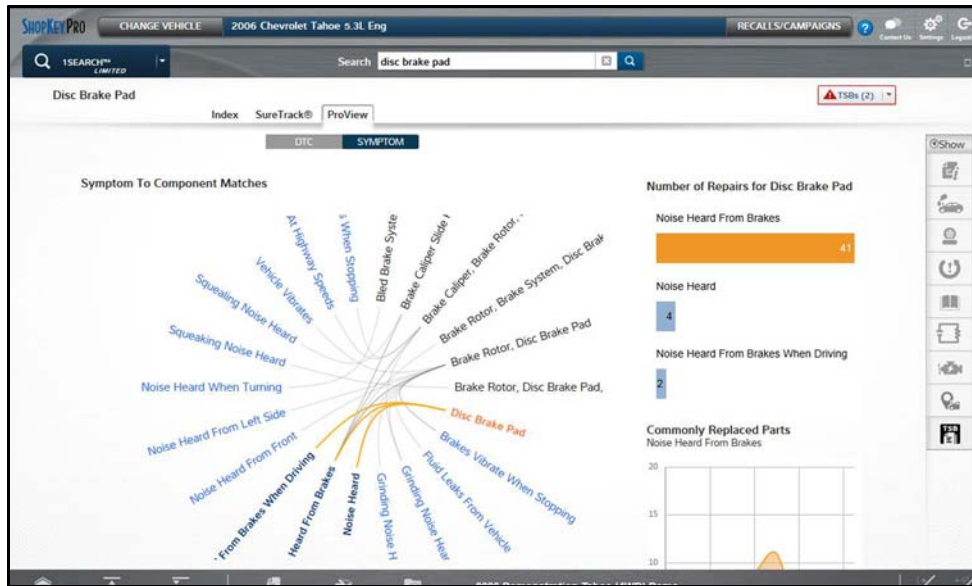

Figure 15-27

Information may include:

- **Radial Graph** - showing the relationship of the code or symptom to possible at fault components.
- **Component Frequency Graphs** - showing the most commonly replaced component for that code or symptom.
- **Common Replaced Parts Graphs** - showing the mileage at which the most common component is replaced.



Introduction

This section provides a brief introduction to the features and operation of ShopStream Connect (SSC).

SSC is a companion PC application (provided at no charge) that extends the capabilities of your diagnostic tool, by connecting to your PC.

SSC allows you to:

- Print data files, screenshots and code scan reports
- Download software upgrades and updates to your PC, and then install them on to your diagnostic tool.
- Transfer data files bi-directionally between your diagnostic tool and your PC.
- View, save and manage your data files on your PC.
- Add or edit notes and comments to your data files.

The ShopStream Connect (SSC) software is available online at:

<http://diagnostics.snapon.com/ssc>

Complete ShopStream Connect operation instructions can be found in the ShopStream Connect User Manual, located online at:

<http://diagnostics.snapon.com/usermanuals>

Main Topic Links

- [Using SSC \(Connecting to your PC\)](#) page 119
- [SSC Main Screen](#) page 120
- [Scanner DataViewer](#) page 121
- [Image Viewer](#) page 121
- [Printing the \(Code Scan\) Vehicle System Report](#) page 122
- [Customizing the \(Code Scan\) Vehicle System Report](#) page 123
- [Software Upgrades and Updates](#) page 125

16.1 Using SSC (Connecting to your PC)



To connect and use SSC with your diagnostic tool:

1. Download and install SSC on your PC from:
<http://diagnostics.snapon.com/ssc>
2. Turn your diagnostic tool on.
3. Connect the supplied USB cable from the USB jack on your diagnostic tool to your PC:
4. From the diagnostic tool Home screen, select **Tools > Connect-to-PC**.

The “**Device is now in Connect-to-PC mode**” screen message is displayed (*Figure 16-1*) and the ShopStream Connect software will open automatically on your PC (*Figure 16-2*).

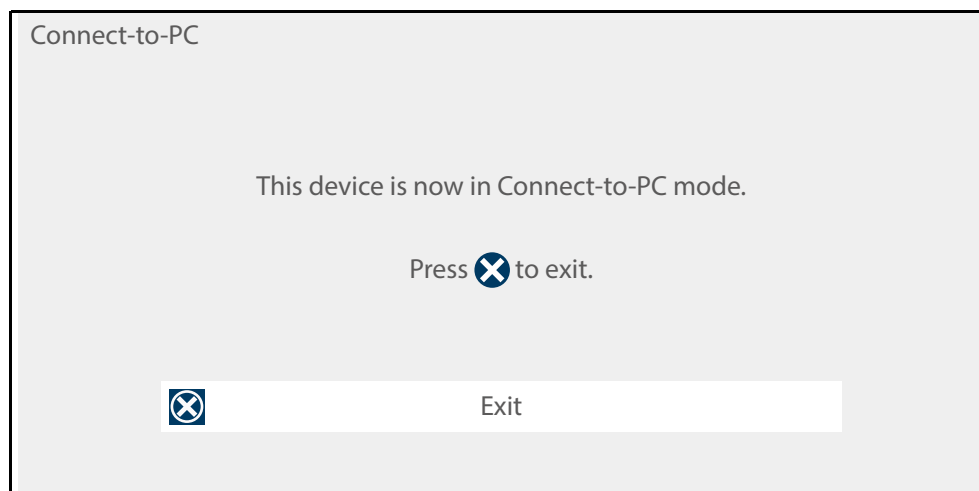

Figure 16-1

If the ShopStream Connect software does not open, open it from the Windows Start menu or use the ShopStream Connect shortcut icon on the Windows desktop (automatically created during installation).

16.2 SSC Main Screen

The ShopStream Connect software will open automatically when you connect the diagnostic tool to your PC USB connection, *Using SSC (Connecting to your PC)* on page 119.

The following shows the main screen layout for ShopStream Connect software.

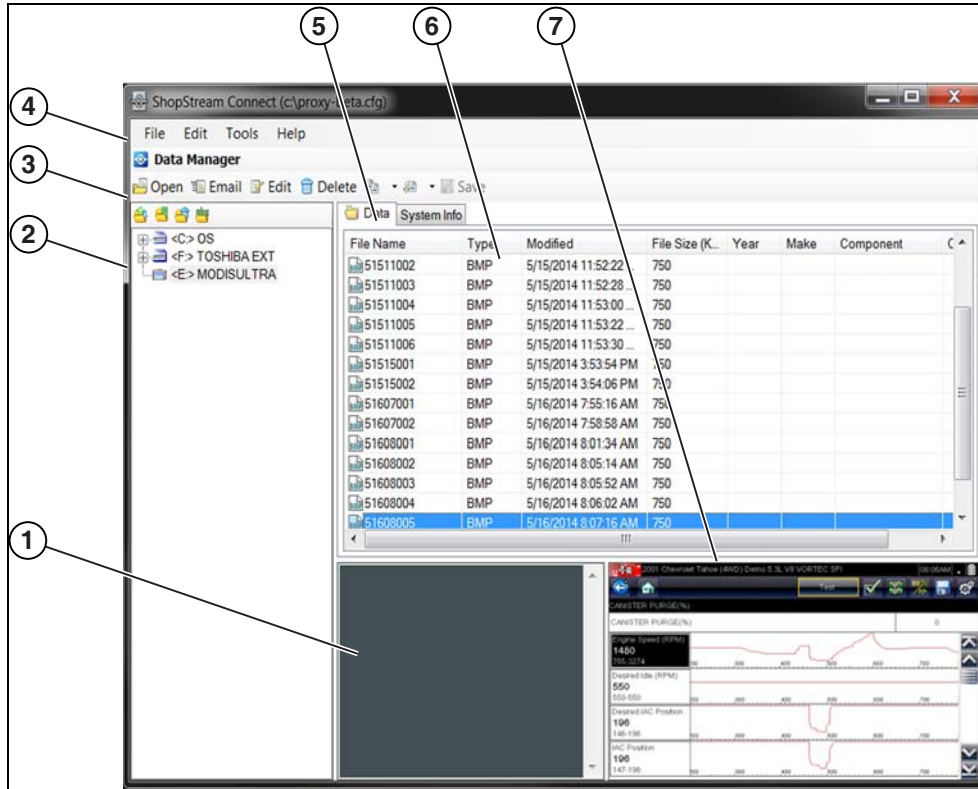

Figure 16-2

- 1— **Notes Window**—allows you add notes to select data files. Select Save from the menu bar to save your notes. *NOTE: Not all file types allow notes, the Notes window will be grayed out when a file type that does not support notes is highlighted. Some image files may display notes for reference purposes (the notes are grayed out and not editable).*
- 2— **File directory structure**—displays the file directory structure of your PC in standard Windows format, and shows any connected diagnostic tools at the bottom of the data list.

- 3— **Data Manager Toolbar**—provides control icons that perform a variety of operations on data files.
- 4— **Main Menu bar**—contains **File**, **Edit**, **Tools**, and **Help** menus.
- 5— **Tabs**—provides access to data files and presets stored on the diagnostic tool or on the PC, and also allows viewing of software revision details of the diagnostic tool.
- 6— **Main display**—shows stored data files details. *NOTE: The files listed are sortable (ascending/descending) by clicking on the column tab at the top (e.g. File Name, Type, etc.) Sort preferences are saved when the ShopStream Connect program is closed.*
- 7— **Preview**—displays a sample of the file if the selected file is a image file.

16.3 Scanner DataViewer

SSC allows you to view data files recorded with your diagnostic tool, on your PC. When a Scanner data file is selected, it opens and displays in the Scanner DataViewer (Figure 16-3). Scanner DataViewer allows you play the data file and custom configure the data in a number of ways.



- 1— Menu bar
- 2— Display toolbar
- 3— Graph display
- 4— Properties icon
- 5— Vertical Scroll bar
- 6— Zoom controls
- 7— Slider bar
- 8— Navigation toolbar
- 9— Parameter text list
- 10— Highlighted PIDs - indicates graphs currently displayed
- 11— Parameter configuration tabs

Figure 16-3

16.4 Image Viewer

SSC allows you to view and print .bmp, .jpg and .sps image files (screenshots) saved on your diagnostic tool, with your PC.

NOTE

File extension types vary depending on the diagnostic tool. Not all the file extensions described here may be available on your diagnostic tool.



- 1— Exit - closes the Image Viewer
- 2— Print - prints the image
- 3— Print Preview - allows the image to be previewed before printing
- 4— Captured Screen Image

Figure 16-4

16.5 Printing the (Code Scan) Vehicle System Report

To print the Vehicle System Report, the saved code scan .XML file must be opened using ShopStream Connect.

To print the Vehicle System Report using ShopStream Connect:

1. Double-click the code scan .XML file from the file list to open the Vehicle System Report (Figure 16-5) in the Code Scan Viewer (Figure 16-6).

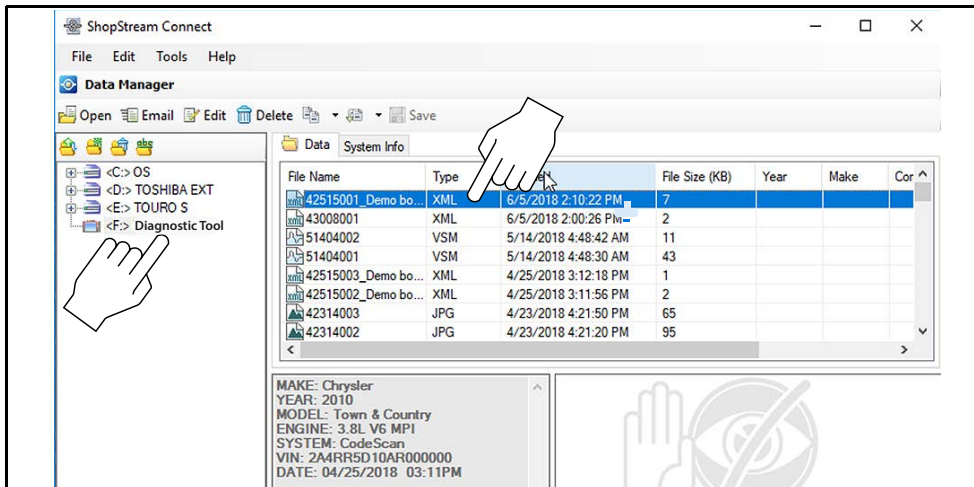

Figure 16-5

2. Select **Print** or **Print Preview** from the Code Scan Viewer menu to print or preview the Vehicle System Report (Figure 16-6).

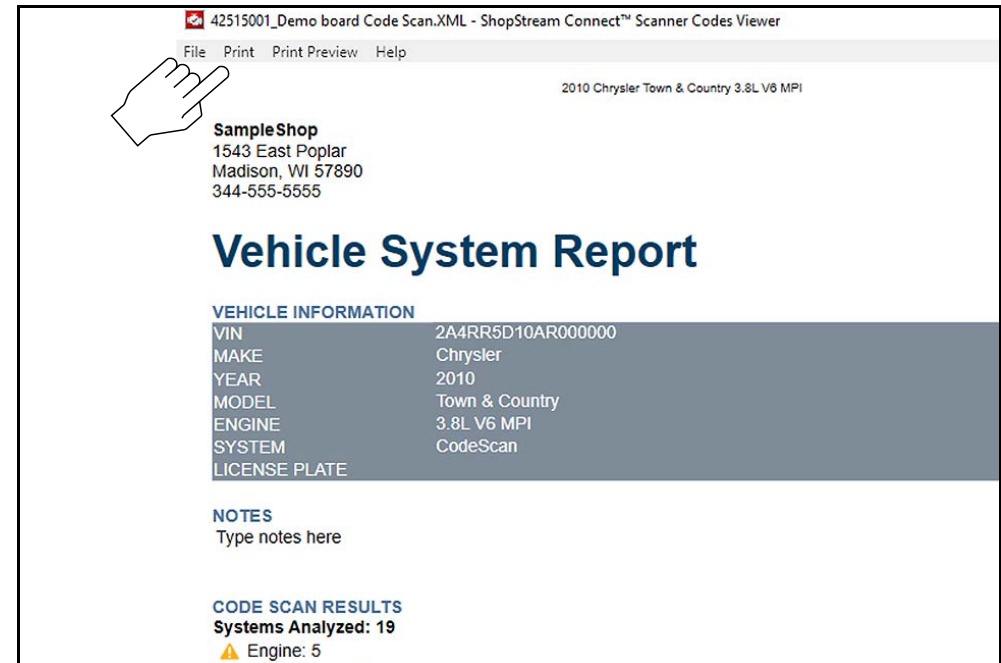

Figure 16-6

Selecting **Print** opens the Windows print dialog window (Figure 16-7). Select your printer from the list, then select **Print** to print the report.

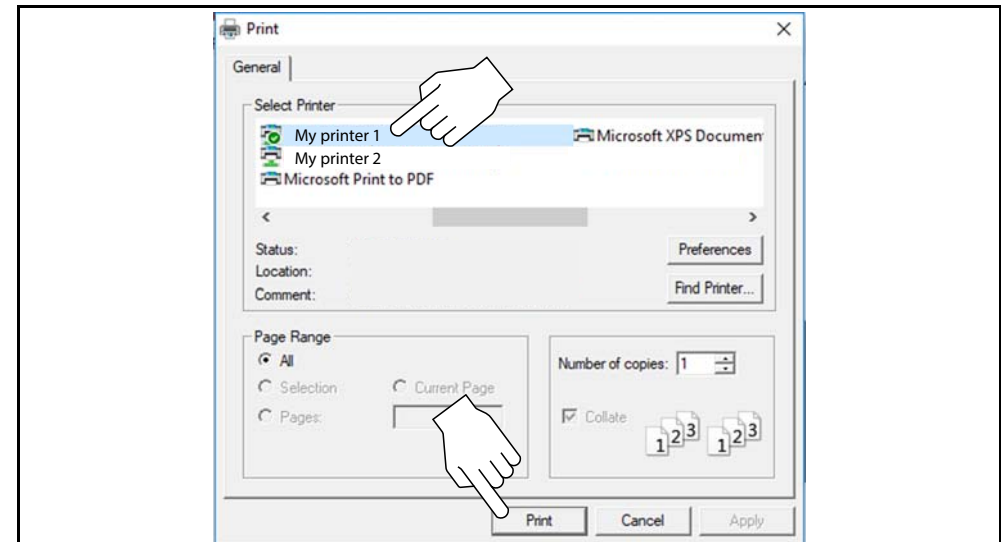

Figure 16-7



16.6 Customizing the (Code Scan) Vehicle System Report

Select fields of the Vehicle System Report can be edited, and you can also add notes to the report using ShopStream Connect.

To add Pre Scan or Post Scan to the report header:

1. Double-click the code scan .XML file from the file list to open the Vehicle System Report (Figure 16-8) in the Code Scan Viewer.
2. Hover the cursor over the area shown in Figure 16-8, and select the desired option to add to the report header.

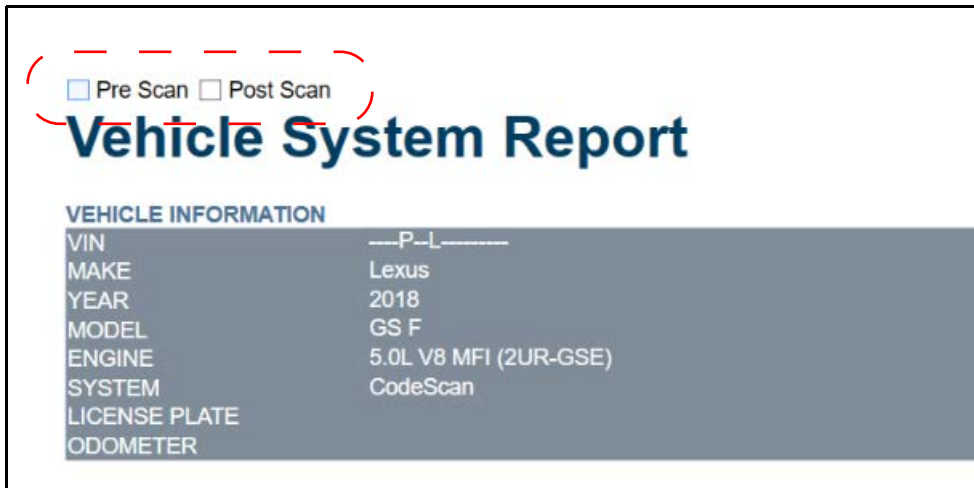

Figure 16-8

To edit the Shop Information (header) of the Vehicle System Report:

1. From ShopStream Connect, select **Tools > Options > Edit Shop Info** (Figure 16-9).

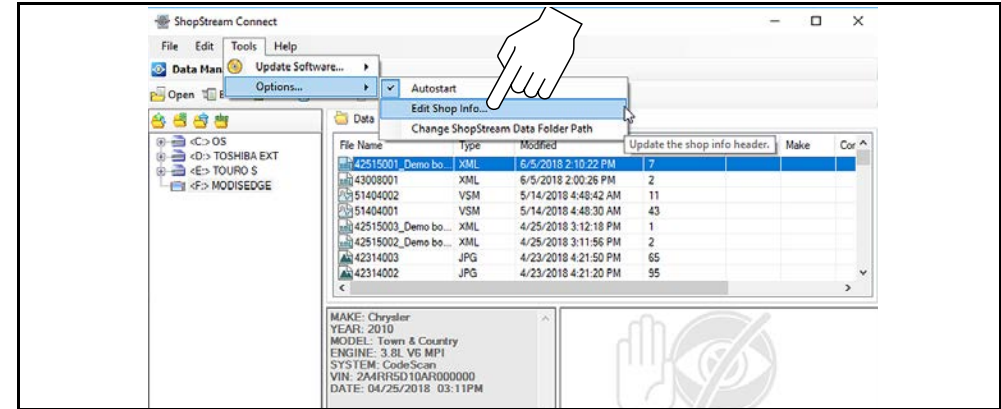

Figure 16-9

2. The **Shop Info** dialog box opens (Figure 16-10) allowing you to enter the name address, and phone number for your shop. This information is included as a header on the report.



Shop Name: SampleShop Zipcode: 57890

Address 1: 1543 East Poplar Phone 1: 344-555-5555

Address 2: Phone 2:

City: Madison

State/Province, County: WI

Messages

Line 1: Use Shop Info in Printout Header

Line 2: Use timestamp in Vehicle System Report

Line 3:

Save Cancel

Print Header Preview

```
6/6/2018 2:57 PM
SampleShop
1543 East Poplar
Madison WI 57890
344-555-5555
```

Figure 16-10

A preview panel at the bottom of the box shows how the information will appear on a print out (Figure 16-10).

3. Check the “**Use Shop Info in Printout Header**” box to show the Shop Info in the printout (Figure 16-10).
4. Check the “**Use timestamp in Vehicle System Report**” box to show the time the vehicle was scanned in the printout (Figure 16-10).
5. When you are finished editing, select **Save** (Figure 16-10) to save the information and close the dialog box.

To edit the VIN and License Plate fields, and/or add notes to the Vehicle System Report:

1. From ShopStream Connect, open the code scan .XML file to be edited (Figure 16-11).
2. Click in the editable fields as shown in (Figure 16-11) to change the values or add notes.
3. Check the “**Add the notes to the printed copy**” box to show the notes in the printout (Figure 16-11).

42515001_Demo board Code Scan.XML - ShopStream Connect™ Scanner Codes Viewer

File Print Print Preview Help

2010 Chrysler Town & Country 3.8L V6 MPI

SampleShop
1543 East Poplar
Madison, WI 57890
344-555-5555

Vehicle System Report

VEHICLE INFORMATION

VIN	
MAKE	Chrysler
YEAR	2010
MODEL	Town & Country
ENGINE	3.8L V6 MPI
SYSTEM	CodeScan
LICENSE PLATE	

NOTES

Add the notes to the printed copy

CODE SCAN RESULTS

System Analyzed: 19

- ▲ Airbag: 5
- ▲ Airbag: 2
- ▲ Airbag: 2
- ▲ Central Gateway (FCM): 0
- ▲ Door Module - Front Left (DMFL): 2
- ▲ Door Module - Front Right (DMFR): 2
- ▲ Door Module - Rear Left (DMRL): 2
- ▲ Door Module - Rear Right (DMRR): 2
- ▲ Heat Ventilation A/C (HVAC): 1
- ▲ Instrument Cluster Module (CCN): 0
- ▲ Power Liftgate Module (PLGM): 1
- ▲ Power Sliding Door Module - Left (PSDML): 3
- ▲ Power Sliding Door Module - Right (PSDMR): 2

Figure 16-11



16.7 Software Upgrades and Updates

Upgrade/Update Descriptions:

- **Software Upgrade** - a software upgrade is a new software version (contact your sales representative for purchase information).
- **Software Update** - a software update is a service release for installed software. These are available free of charge, and are provided as necessary to update installed software. When your diagnostic tool is connected to a PC using SSC, the SSC software will automatically check for updates, and if an update is available, it will provide installation instructions. Follow the screen prompts to accept, download and install the software.

NOTE

To receive updates or upgrades, SSC software must be installed on your PC and have connection to the Internet.



Example - Updating diagnostic tool software:

1. Select **Tools > Update Software >** (diagnostic tool type - e.g. **ETHOS Edge**, **MODIS Edge**, **SOLUS Edge**, etc.) from the Menu bar (*Figure 16-12*).

The software checks the Snap-on web server for available updates.

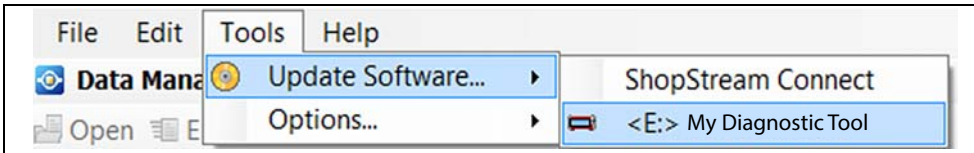

Figure 16-12

2. If service release updates are available, select **Next** to continue, then select **Download** and follow the on-screen instructions to complete the installation (*Figure 16-13*).

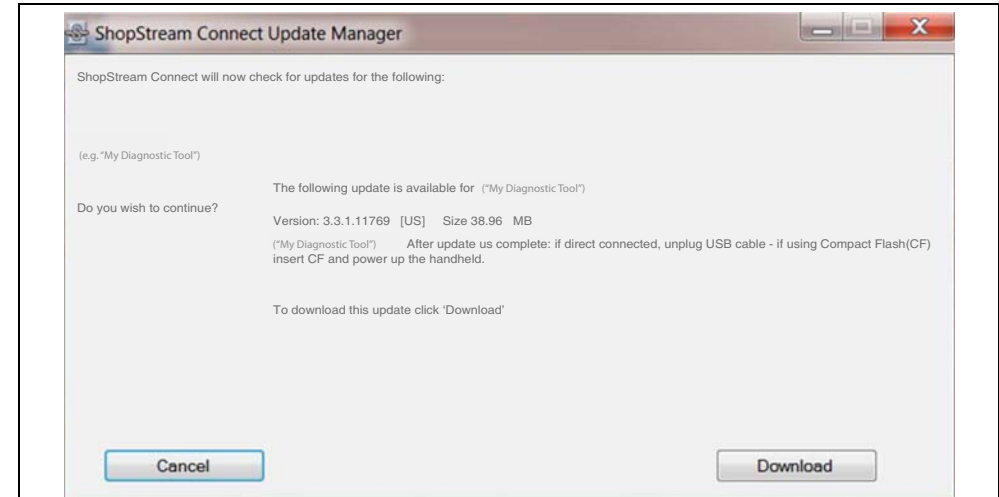

Figure 16-13

NOTE

For additional information on ShopStream Connect software updates and upgrades, download the ShopStream Connect User Manual from our website: <http://diagnostics.snapon.com/usermanuals>



16.7.1 End User License Agreement

Before software installation at initial purchase, and before all subsequent software updates/upgrades installations End User License Agreement (EULA) acceptance is required.

IMPORTANT

Use of Software is governed by the terms and conditions of the End User License Agreement. The diagnostic tool should not be initially operated until the End User License Agreement is read. Use of the device acknowledges your acceptance of the End User License Agreement. The Snap-on Incorporated Software End User License Agreement is available at: <https://eula.snapon.com/diagnostics>

To Accept: at the screen prompt ([Figure 16-14](#)) click the checkbox on the left side of the window, and then select **Agree and Continue**. The software will be installed automatically.

[Figure 16-14](#) below represents a typical EULA acceptance agreement screen.

THIS IS A LEGALLY BINDING AGREEMENT WITH SNAP-ON INCORPORATED AND YOU CONFIRM THAT YOU HAVE THE AUTHORITY TO ENTER INTO THIS AGREEMENT ON BEHALF OF YOURSELF AND/OR ON BEHALF OF THE PERSON OR ENTITY WHO ACQUIRED THE SOFTWARE. BY CHECKING THE BOX AND CLICKING "AGREE AND CONTINUE," YOU UNDERSTAND AND AGREE TO THE TERMS AND CONDITIONS FOUND AT: <https://eula.snapon.com/diagnostics>, AND THAT YOU HAVE ACCESSED AND READ SUCH TERMS. IF YOU DO NOT OR CANNOT AGREE TO THESE TERMS, YOU MUST CLICK "I DECLINE."

I Decline **Agree and Continue**

Figure 16-14 Typical EULA acceptance screen

To Decline: at the screen prompt ([Figure 16-14](#)) select **I Decline**. A confirmation message is displayed providing options to Go Back or Exit the software installation ([Figure 16-15](#)).

By declining the license agreement, you will exit the upgrade process.

Are you sure that you want to exit?

Go Back **Exit**

Figure 16-15 Typical EULA acceptance screen



This section describes basic cleaning and battery replacement procedures for your diagnostic tool.

Main Topic Links

- [Cleaning and Inspecting the Diagnostic Tool](#) page 127
- [Battery Pack Service](#) page 127
- [Cleaning the Touch Screen](#) page 127
- [Safety](#) page 127
- [Ordering a New Battery Pack](#) page 128
- [Removing / Installing the Battery Pack](#) page 128
- [Disposing of the Battery Pack](#) page 129

17.1 Cleaning and Inspecting the Diagnostic Tool

Periodically perform the following tasks to keep your diagnostic tool in proper working order:

- Check the housing, cables and connectors for dirt and damage before and after each use.
- At the end of each work day, wipe the diagnostic tool housing, cables and connectors clean with a damp cloth.

IMPORTANT

Do not use any abrasive cleansers or automotive chemicals on the diagnostic tool.

17.1.1 Cleaning the Touch Screen

The touch screen can be cleaned with a soft cloth and a mild window cleaner.

IMPORTANT

Do not use any abrasive cleansers or automotive chemicals on the touch screen.

17.2 Battery Pack Service

17.2.1 Safety

Follow all safety guidelines when handling the battery pack.



! WARNING

Risk of electric shock.

- **Prior to recycling the battery pack, protect exposed terminals with heavy insulating tape to prevent shorting.**
 - **Disconnect all test leads and turn diagnostic tools off before removing the battery pack.**
 - **Do not attempt to disassemble the battery or remove any component projecting from or protecting the battery terminals.**
 - **Do not expose the diagnostic tool or battery pack to rain, snow, or wet conditions.**
 - **Do not short circuit the battery terminals.**
- Electric shock can cause injury.*

WARNING

Risk of explosion.

- **The Lithium battery is factory replaceable only, incorrect replacement or tampering with the battery pack may cause an explosion.**

Explosion can cause death or serious injury.

IMPORTANT

The battery pack contains no user serviceable components. Tampering with the battery pack terminals or housing will void the product warranty.

Keep the following in mind when using and handling the battery pack:

- Do not short circuit battery pack terminals.
- Do not immerse the diagnostic tool or battery pack in water, or allow water to enter the diagnostic tool or battery pack.
- Do not crush, disassemble, or tamper with the battery pack.
- Do not heat the battery pack to over 100°C (212°F), or dispose of it in a fire.
- Do not expose the battery pack to excessive physical shock or vibration.
- Keep the battery pack out of reach of children.
- Do not use a battery pack that appears to have suffered abuse or damage.
- Charge the battery pack in the appropriate charger only.
- Do not use a battery charger that has been modified or damaged.
- Use the battery pack for the specified product only.
- Store the battery pack in a cool, dry, well ventilated area.

NOTE

The battery pack should be used within a short period of time (about 30 days) after charging to prevent loss of capacity due to self-discharging.

If long-term storage of the battery pack is necessary, it should be stored in a cool, dry, well ventilated place with a 30 to 75 percent state of charge to prevent loss of characteristics.

To prolong the life of your battery, turn off the diagnostic tool when not in use. The diagnostic tool has a built in charger that recharges the battery on demand whenever it is connected to a power source.

17.2.2 Ordering a New Battery Pack

If the battery pack needs to be replaced, contact your sales representative to order a new battery pack.

IMPORTANT

Only use the recommended Snap-on replacement battery pack.

17.2.3 Removing / Installing the Battery Pack

IMPORTANT

If replacing the battery pack, only use the recommended Snap-on replacement battery pack.

To remove the battery pack:

1. Loosen the two battery cover screws on the back-side of the diagnostic tool (*Figure 17-1*).
2. Pull up and out on the lower edge of the battery cover to release it.
3. Remove the battery pack in the same manner as the battery cover, pulling the bottom edge up and tilting out.

To install the battery pack:

1. Position the battery pack as shown below with the arrows facing up (*Figure 17-1*).
2. Tilt the top of the battery in to align the tabs, then down to install into place.
3. Install the battery pack cover, in the opposite manner as removal, aligning the tabs and tilting down and in, into place.
4. Tighten the battery cover screws. ***Do not overtighten the screws!***

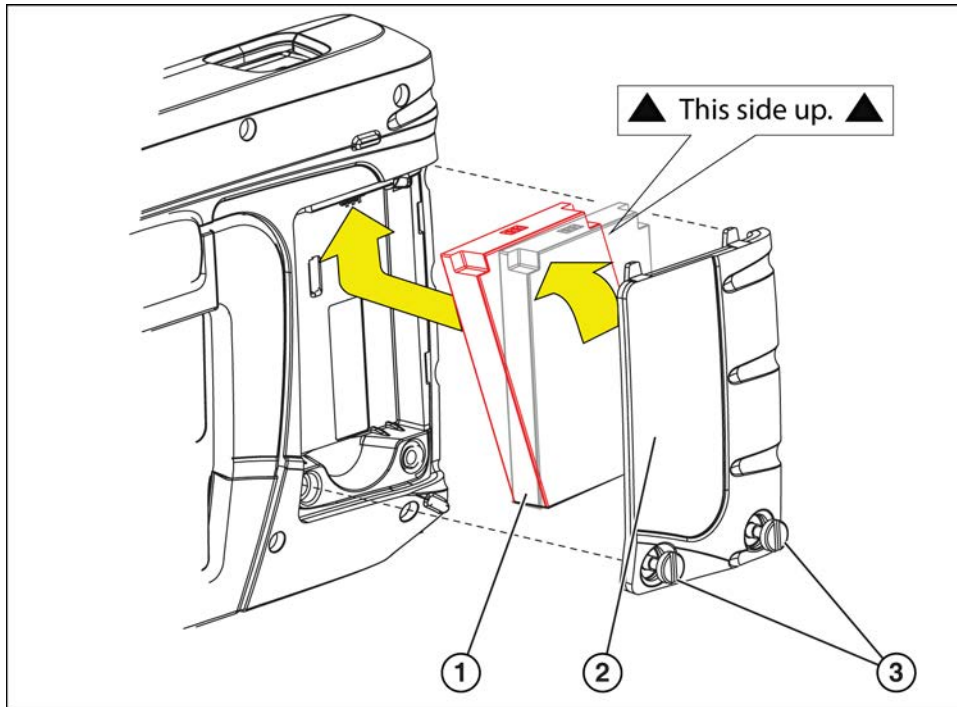

- 1— Battery Pack
- 2— Battery Cover
- 3— Battery Cover Screws

Figure 17-1 Battery pack

17.2.4 Disposing of the Battery Pack

Always dispose of the battery pack according to local regulations, which vary for different countries and regions. The battery pack, while non-hazardous waste, does contain recyclable materials. If shipping is required, ship the battery pack to a recycling facility in accordance with local, national, and international regulations.

IMPORTANT

Always dispose of materials according to local regulations.

For additional information within the **United States of America** contact:

- Rechargeable Battery Recycling Corporation (RBRC) at www.call2recycle.org
Phone - 800 822-8837

For additional information within **Canada** contact:

- Rechargeable Battery Recycling Corporation (RBRC) at www.call2recycle.ca
Phone - 888 224 9764

Products bearing the WEEE logo (*Figure 17-2*) are subject to European Union regulations.



Figure 17-2 WEEE logo

Contact your sales representative for details.



Customer Support / Training

Support Contact Information

Phone / E-mail - Technical Assistance

1-800-424-7226 / diagnostics_support@snapon.com

or use our online contact form

- <https://www1.snapon.com/diagnostics/us/Contact>

Website Links:

Snap-on Diagnostics and Information

- <http://diagnostics.snapon.com>

Manuals / Technical Documentation - This manual is periodically revised to ensure the latest information is included. Download the latest version of this manual and other related technical documentation at:

- <http://diagnostics.snapon.com/usermanuals>

For technical assistance in all other markets, contact your selling agent.

Product Training Videos

Diagnostic tool specific training videos are available on our website. Follow along and learn the basics of diagnostic tool operation with our free training videos.

Videos are product specific and are available at:

<http://diagnostics.snapon.com> - Click on the "Training & Support" tab, select the applicable diagnostic tool, then select "See Training".

i NOTE

Sample titles are listed below. Not all titles may be available for all diagnostic tools, and are subject to change.

Snap-on® Training Solutions® - Training Videos (examples)	
Introduction and Navigation	Global OBD-II
Scanner Codes	Digital Multimeter
Scanner Data in PID View	Graphing Multimeter & Lab Scope
Scanner Data in Graphing View	Guided Component Tests
Fast-Track® Troubleshooter	Vehicle Specs & Resets
Functional Tests	SureTrack® & Wi-Fi



Diagnostic Quick Tips - Video Series

Snap-on Diagnostic Quick Tips videos are available at no charge on our website and on our YouTube channel. These videos are developed from real repair case studies to help professional technicians use diagnostic tools to solve specific vehicle problems (e.g. performing a Ford Relative Injector Flow Test).

Additional videos are also available showing specific diagnostic tool features (e.g. ShopStream Connect - Software Updates).



Figure 18-1

Videos are available at:

<http://diagnostics.snapon.com> - Click on the “Training & Support” tab, select the applicable diagnostic tool, then select “See Quick Tips”

<https://www.youtube.com/user/snaponscanner/videos> - Use the search function to find a title, or enter “Diagnostic Quick Tips” in the search field to see a list of all applicable titles.

NOTES

URL links (above) and titles listed (below) are subject to change and may not be available in all markets.

A sample list of titles are listed below, other titles may be available.

Some videos may not be applicable for use with all diagnostic tools.

Snap-on® Training Solutions® - Diagnostic Quick Tips Videos (examples)

Air/Fuel Ratio Sensor Test	Fuel Injector Voltage and Current Tests (Scope)
Alternator Ripple Test (Scope)	Fuel Pump Current Ramp Test (Scope)
BMW® Rain Sensor Calibration	Harley-Davidson® ABS Brake Bleed
CAN Bus Diagnostics (Scope)	Harley-Davidson® Functional Tests
Chevrolet® Volt Coolant Pump Bleed	Harley-Davidson® Key Fob Programming
Chrysler HVAC Test	Hyundai Blind Spot Detection System Calibration
Chrysler VVT System Cleaning	Hyundai Occupant Detection System Reset
Chrysler Wheel & Tire Calibrations	Ignition Coil Current and Voltage Comparison
COP Ignition Test	Ignition Coil Current Ramp Test
Dual Screen Diagnostics: Scanner vs. Scope	Ignition Coil Primary Voltage Test
Electronic Throttle Control System Diagnostics	Ignition System Diagnostics Using the SIA2000 (Scope)
FIAT® 500 Proxi Alignment	MINI Battery Relearn
FIAT® 500 Throttle Body Relearn	Multi Channel Cam / Crank Correlation
Flex Ray Bus Diagnostics	OBD-II Mode 10 Permanent Codes
Ford Battery Monitor System	Oil Specs & Service Light Resets
Ford Coil Current RFI Test (Scope)	PID Trigger Functions (Scanner)
Ford Flash Reprogramming	Piezo Injectors Signature Test
Ford Misfire Monitor Neutral Profile Correction (Scanner)	Relative Compression Test (Scope)
Ford PATS Key Programming	ShopStream Connect - Data Manipulation
Ford Relative Compression Test	ShopStream Connect - Software Updates



Snap-on® Training Solutions® - Diagnostic Quick Tips Videos (examples)	
Ford Relative Injector Flow Test	Speed Up Your Diagnostics (Scanner)
Ford TPMS Reprogramming	The Power of Troubleshooter Tips (Scanner)
Ford® 6.7L Transmission Solenoid Characterization	Top Level Menus: Built In Scope Training
Ford® Diesel Injector Coding	Toyota EVAP Test
VW / Audi Flexible Service Reset (Scanner)	Toyota Multiple Freeze Frame (Scanner)
	Toyota Transmission Compensation Coding



Legal Information

Trademarks

Snap-on and SureTrack are trademarks registered in the United States and other countries of Snap-on Incorporated. All other marks are trademarks or registered trademarks of their respective holders.

Copyright Information

© 2019 Snap-on Incorporated. All rights reserved.

Software License Information

Use of Software is governed by the terms and conditions of the End User License Agreement. The diagnostic tool should not be initially operated until the End User License Agreement is read. Use of the device acknowledges your acceptance of the End User License Agreement. The Snap-on Incorporated Software End User License Agreement may be provided with the diagnostic tool, and is available at: <https://eula.snapon.com/diagnostics>

Patent Information

For a listing of Snap-on products that are protected by patents in the United States and elsewhere, visit: <https://patents.snapon.com>

Manual Application

This manual includes information and images applicable to diagnostic software version 19.4. Some information within this manual may not be applicable to other diagnostic software versions.

Disclaimer of Warranties and Limitation of Liabilities

All pictures and illustrations shown are for reference purposes only. All information, specifications and illustrations in this manual are based on the latest information available at the time of printing and are subject to change without notice. While the authors have taken due care in the preparation of this manual, nothing contained herein:

- Modifies or alters in any way the standard terms and conditions of the purchase, lease, or rental agreement under the terms of which the equipment to which this manual relates was acquired.
- Increases in any way the liability to the customer or to third parties.

Snap-on[®] reserves the right to make changes at any time without notice.

IMPORTANT

Before operating or maintaining this unit, please read this manual carefully paying extra attention to the safety warnings and precautions.

Manuals / Technical Documentation - The information in this manual is periodically revised to ensure the latest information is included. Download the latest version of this manual and other related technical documentation from the Snap-on Diagnostics website.



FCC Compliance Statement

This equipment has been tested and found to comply with the limits for a Class B digital device, pursuant to part 15 of the FCC rules. These limits are designed to provide reasonable protection against harmful interference in a residential installation. This equipment generates, uses and can radiate radio frequency energy and, if not installed and used in accordance with the instructions, may cause harmful interference to radio communications. However, there is no guarantee that interference will not occur in a particular installation. If this equipment does cause harmful interference to radio or television reception, which can be determined by turning the equipment off and on, the user is encouraged to try to correct the interference by one or more of the following measures:

- Reorient or relocate the receiving antenna.
- Increase the separation between the equipment and receiver.
- Connect the equipment into an outlet on a circuit different from that to which the receiver is connected.
- Consult the dealer or an experienced radio/TV technician for help.

CAUTION

You are cautioned that changes or modifications not expressly approved by the party responsible for compliance could void your authority to operate the equipment.

FCC RF Radiation Exposure Statement

1. This transmitter must not be co-located or operating in conjunction with any other antenna or transmitter.
2. This equipment complies with FCC RF radiation exposure limits set forth for an uncontrolled environment. This device was tested for typical lap held operations with the device contacted directly to the human body to the back side of the Display Unit. To maintain compliance with FCC RF exposure compliance requirements, avoid direct contact to the transmitting antenna during transmitting.
3. According to FCC 15.407(e), the device is intended to operate in the frequency band of 5.15GHz to 5.25GHz under all conditions of normal operation. Normal operation of this device is restricted to indoor use only to reduce any potential for harmful interference to co-channel MSS operations.