

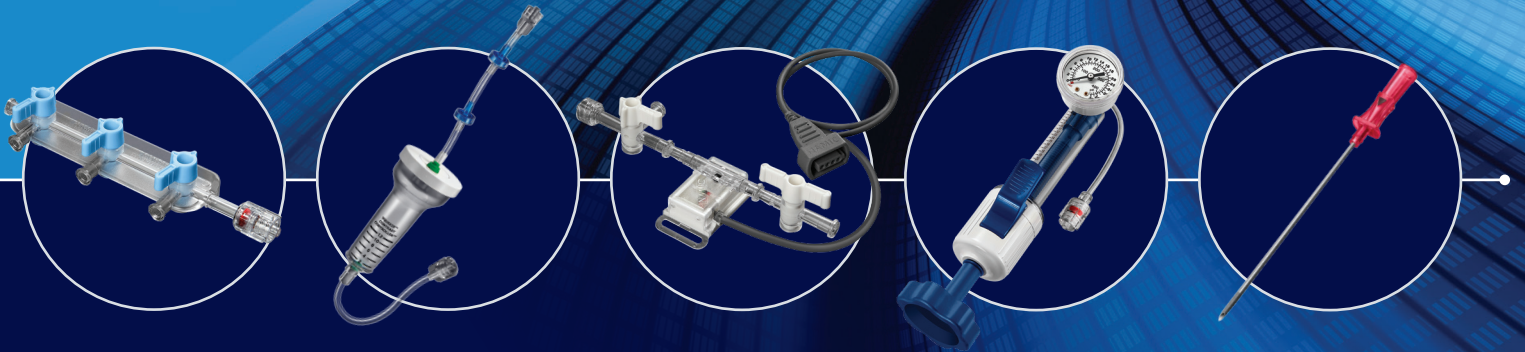

Cardiac and peripheral fluid management

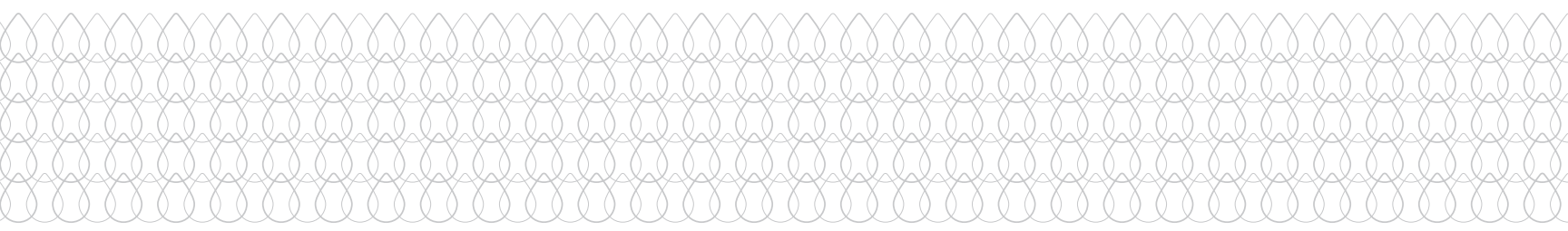

At the heart of excellence



Care by the
numbers:

80,000+

Medline-manufactured
products address all
med-surg and lab needs

50+

clinically-trained product
specialists ensure your
products meet the demands
of your lab

30+

manufacturing
centers in 7 countries

43+

network of distribution
centers, nationwide

99%

of the U.S. receives
next-day delivery



You're under pressure to deliver high quality, consistent patient care efficiently and cost effectively.

Sourcing products physicians trust, managing supply issues and budget pressures can take time away from patient care and outcomes, challenging your teams' confident performance.

Realize care excellence with comprehensive solutions that optimize your clinical and financial performance.

Set up your cath lab and IR department for success with a partner you can trust to deliver intuitive access, fluid management, and patient monitoring products. Our manufacturing and logistics network ensures consistently high service levels.

We work with you to fully understand your product and operational challenges, help you identify gaps, workarounds, opportunities, and solutions, so you can streamline operations and deliver optimal patient care.

Tailored to your specific needs, Namic custom kits help you realize operational efficiencies.

Choose any of the items in this catalog to get started. Our high-quality product portfolio is built around your clinical requirements.

01	KIT OPTIMIZATION		
	Custom Kits	8	
...	Standard Kits	12	
02	FLUID MANAGEMENT		
	Manifolds	22	
	Syringes	28	
	Contrast Management	42	
	Stopcocks	46	
	Fluid Delivery Sets	52	
	Closed Fluid Systems	56	
	Contrast Injection Lines	62	
	Fluid Management Accessories	68	
	Safety	70	
...	Labels	74	
03	PATIENT MONITORING		
	Disposable Transducers	78	
	Pressure Monitoring Lines	80	
	Arterial Line Kits	82	
	Transducer Accessories	83	
	Reusable Pressure Transducer Cables	84	
04	INTERVENTIONAL ESSENTIALS		
	Y-Adaptor Kits	90	
	Hemostatic Click Device	92	
	Tri-Adaptor Kits	93	
	Inflation Devices	94	
	Insertion Tools	96	
	Torque Devices	96	
...	Hemostatic Flow Valve	96	
05	ACCESS		
	Angiographic Introducer Needles	100	
	Mini Access Kits	104	
	Diagnostic Guidewires	106	
	Guidewire Bowls	110	
	Dual Securement Guidewire Clip	111	
...	Needle Holders	112	

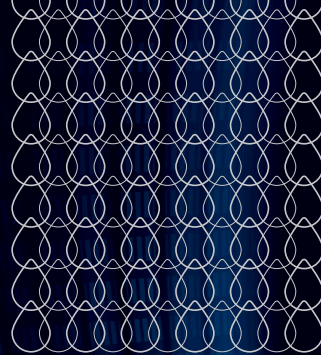

KIT OPTIMIZATION

Custom Kits	8
Catheterization (Cath) Lab Kits	8
Interventional Radiology Kits	10
Standard Kits	12
Left Heart Kits	12
Right Heart Kits	16
Interventional Radiology Kits	17
Access Kits	18

KIT OPTIMIZATION

Optimize efficiency and patient care

Maximize efficiency and performance with custom kits. Strategically assembled with the specific components you need, they help streamline operations and control costs.

#1

Medical custom
kit manufacturer
in the U.S.¹



Custom Kits

Angiographic control syringe

Designed to deliver smooth aspiration, less force and high flow rates

Compensator manifold

Integrated manifold gives control to one operator allowing for faster set-up and debubbling.

Dual access protection station

Includes a dual check valve, that allows access to both saline flush and waste bag

Squeeze contrast controller

Proven to maximize your budget, reduce contrast waste and prevent cross contamination

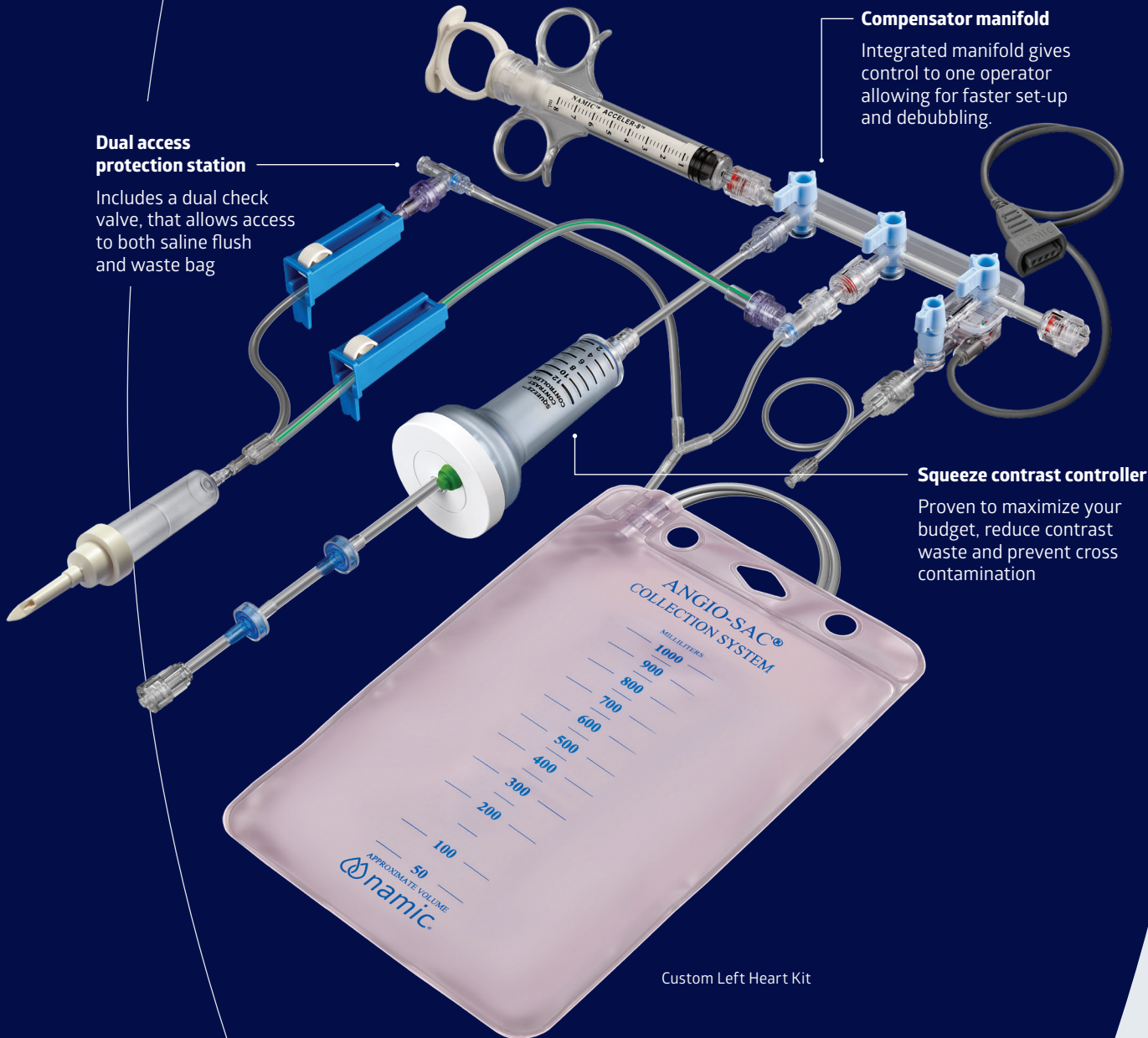

Custom Left Heart Kit

► Cath Lab Kits

Namic fluid management system helps meet the challenges of the cardiac catheterization lab. Kits are assembled to optimize your standard of care while streamlining the ordering process.

There's no time to question device quality or the utility of the setup which is why Namic kits are constructed for confidence in angiographic procedures.

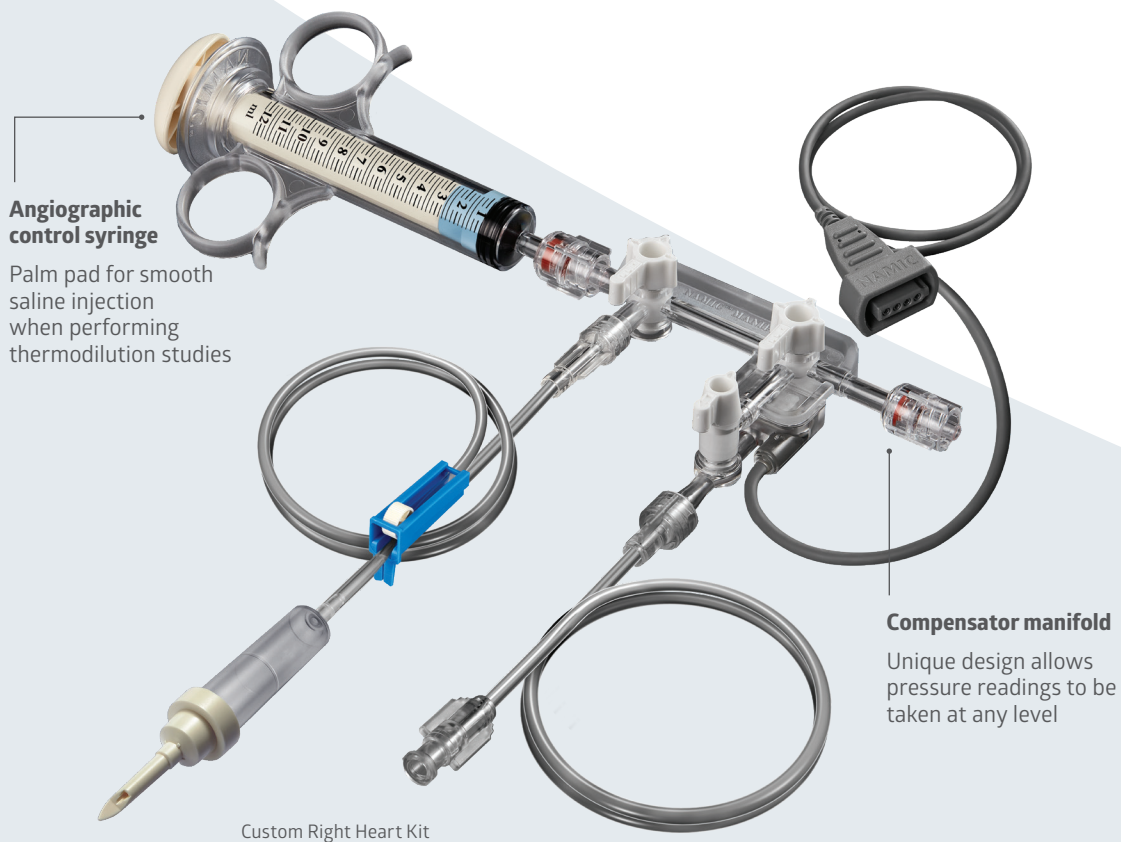

We can create custom kits for cath lab procedures such as:

- Left Heart Kits
- Right Heart Kits
- TAVR Kits
- Structural Heart Kits

Custom Kits

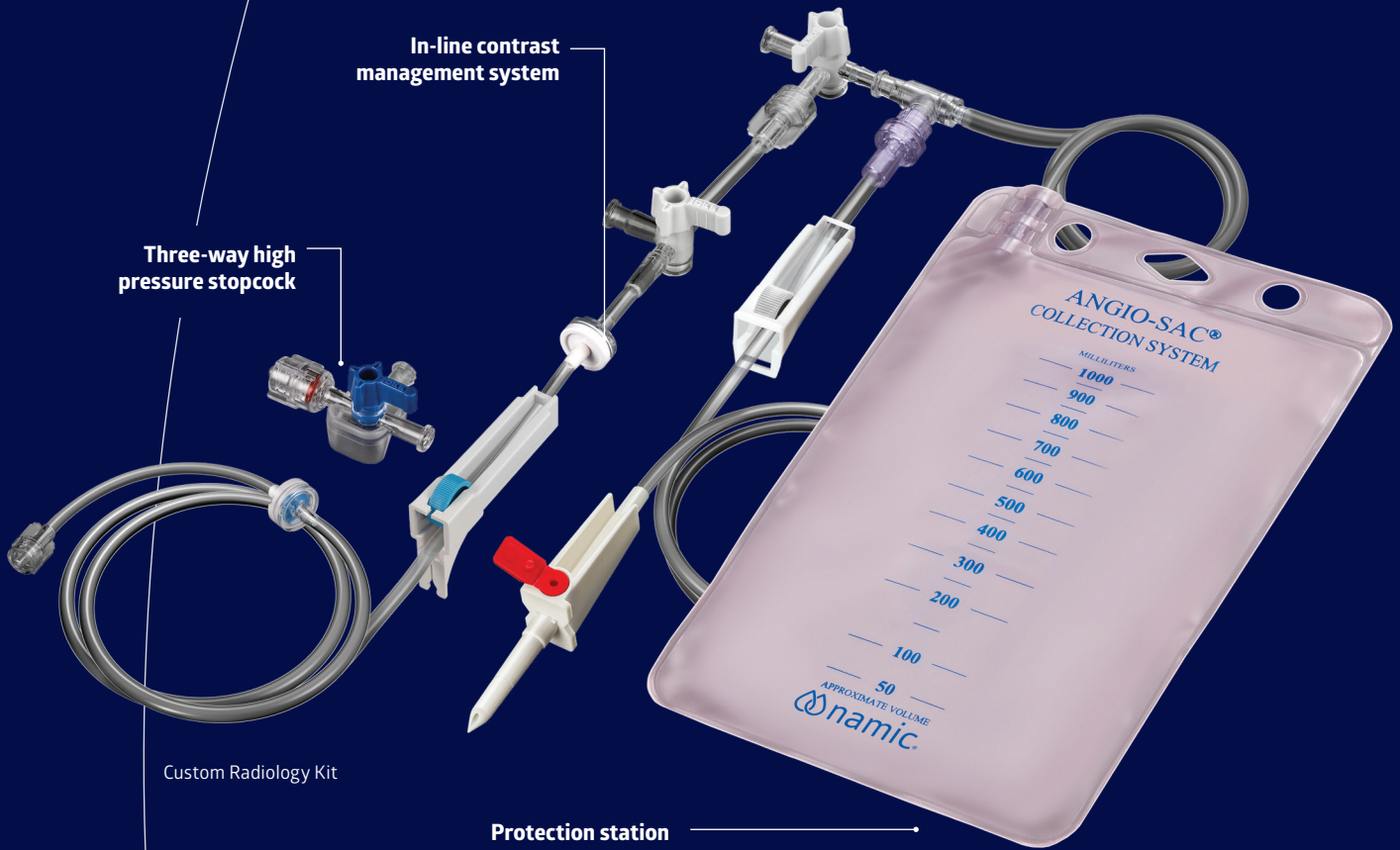

Custom Radiology Kit

Protection station

Closed fluid system helps minimize exposure to bloodborne pathogens



Fluid waste bowl



Diagnostic guidewire

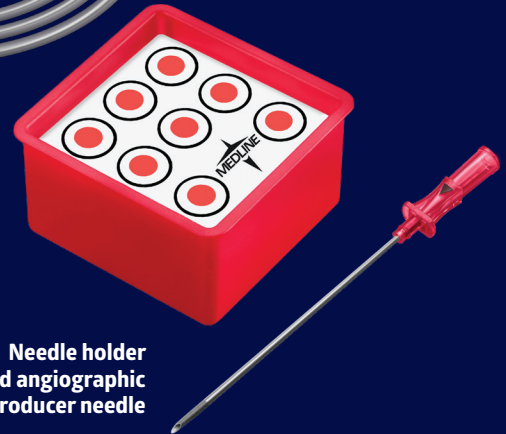

► Interventional Radiology Kits

Today's vascular and radiology labs care for patients requiring more diverse procedures than ever before.

You need devices you can trust and that perform consistently. Namic fluid management products are designed to meet the true challenges of your practice or lab. Since 1969, Namic products have been widely used in the industry, with features that answer clinical and operational needs.

Colored syringes: Polycarbonate

Clear polycarbonate design allows for visual inspection of air bubbles. Available in different colors and sizes.



flexCIL contrast injection line

Flexible, high-pressure contrast injection lines available in various lengths to suit your lab's needs

We can create custom kits for interventional lab procedures such as:

- Protection Station Waste Kits
- Neuroradiology Kits
- Access Kits
- Syringe Kits

Standard Kits

Angiographic control syringe

Narrow barrel design for smooth aspiration and easy injection

Finger grip style manifold

Comfortable grip with smooth turns

Large bore tubing vented spike head

Allows for faster and easier contrast aspiration

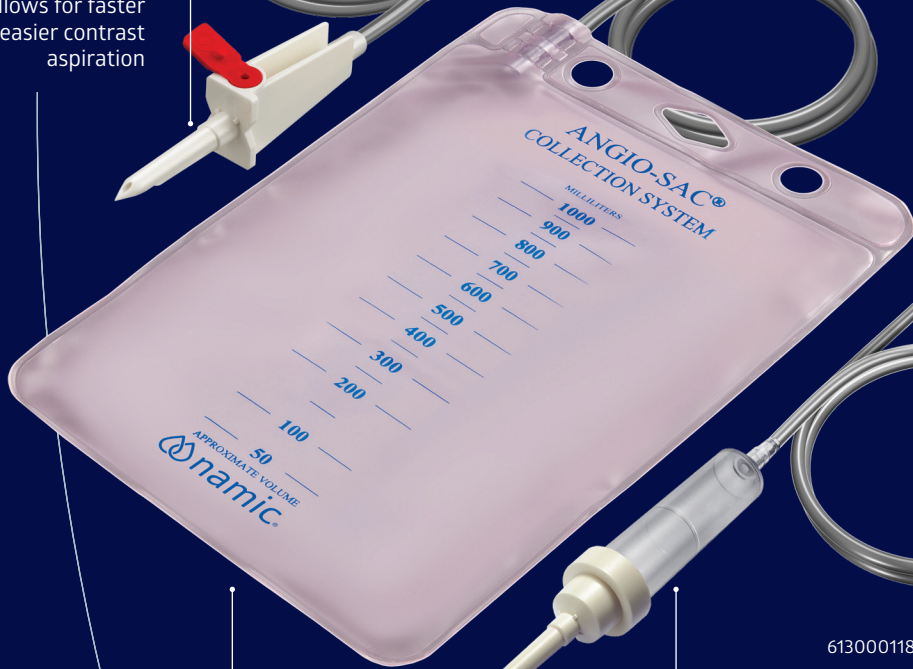

613000118

Closed fluid system

Decreasing potential for exposure to bloodborne pathogens

IV tubing: Drip chamber non-vented

Allows for pressurization of saline

Standard Left Heart Kits

Standard Left Heart Kits with Pressure Monitoring Tubing

Designed for administering saline and contrast and collecting waste

- Each includes 72" pressure monitoring tubing with male-to-female luer lock connection
- Customer selects transducer of their choice

Item No.	Manifold				Saline Port		Contrast Port		10 mL Control Syringe
	Ports		Handle		Protection Station	IV Tubing: Nonvented Drip Chamber	Squeeze Contrast Controller	Large Bore Tubing: Vented Spike Head	
	3	4	OFF	ON					
613000160	■		■		■		■		■
613000118	■		■		■			■	■
613000142	■		■			■	■		
613000100	■		■			■		■	■
613000112	■		■			■		■	▲
613000106	■		■			■		■	
91301301*	■		■			■		●	
91301303*	■			■		■		●	
613000161	■			■	■		■		■
613000119	■			■	■			■	■
613000101	■			■		■		■	■
613000113	■			■		■		■	▲
613000107	■			■		■		■	
613000192		■	■			■	■		
613000204		■	■			■		■	
613000193		■		■		■	■		
613000205		■		■		■		■	

*Includes 48" pressure monitoring line with male-to-female luer lock connection.

Kits only available in the U.S.

▲ 10 mL Fixed Male Luer Lock Control Syringe

● IV Tubing: Vented Spike Head

Standard Kit Components



One-Way Three-Way Transducer



Protection Station

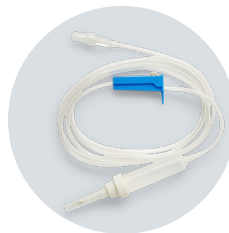

IV Tubing: Non-Vented Drip Chamber

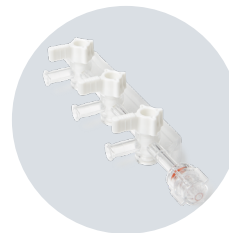

Finger Grip Style Manifold



Squeeze

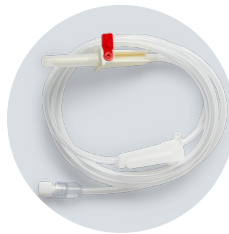

Large Bore: Vented Spike Head



10mL Control Syringe Rotating Adaptor



10mL Control Syringe: Fixed Male Luer Lock

Standard Kits



613000138

Standard Left Heart Kits

Standard Left Heart Kits with One-Way Three-Way Transducer

Each includes 72" pressure monitoring tubing and standard manifold

Item No.	Manifold		Ports		Handle		Saline Port		Contrast Port		10 mL Control Syringe
	3	4	OFF	ON	Protection Station	IV Tubing: Nonvented Drip Chamber	Squeeze Contrast Controller	Large Bore Tubing: Vented Spike Head			
613000102	■		■			■			■	■	
613000103	■			■		■			■	■	
613000108	■		■			■			■	■	
613000120	■		■		■				■	■	
613000121	■			■	■				■	■	
613000138	■		■			■	■			■	
613000162	■		■		■		■			■	
613000163	■			■	■		■			■	
613000181	■			■	■		●				
613000194		■	■			■	■				
613000206		■	■			■			■		
613000207		■		■		■			■		

● Fluid Delivery Set with Squeeze chamber, Not for contrast management.

Kits only available in the U.S.

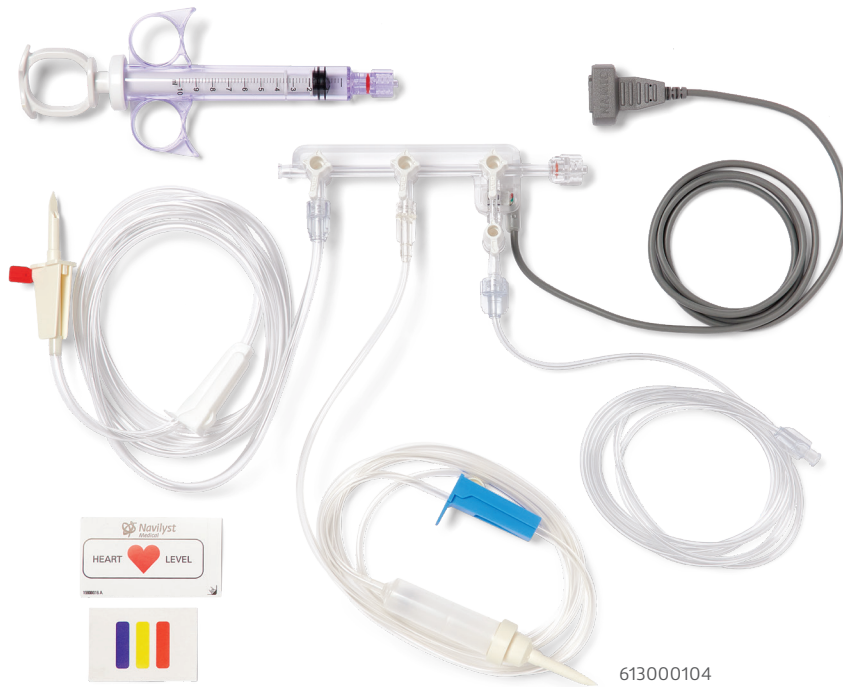

For more information on compensator manifolds refer to page 22

Standard Left Heart Kits with Integrated Compensator Manifold

Each includes 72" compensator line

Item No.	Manifold				Saline Port		Contrast Port		10 mL Control Syringe
	3	4	OFF	ON	Protection Station	IV Tubing: Non-Vented Drip Chamber	Squeeze Contrast Controller	Large Bore Tubing: Vented Spike Head	
613000104	■		■			■		■	■
613000110	■		■			■		■	
613000122	■		■		■			■	■
613000123	■			■	■			■	■
613000164	■		■		■		■		■
613000165	■			■	■		■		■
613000209		■		■		■		■	

Kits only available in the U.S.

Standard Left Heart Kits with Integrated Perceptor Manifold

Complete with specified manifold, 182 cm (72") chambered IV spike with filter and a 182 cm (72") vented IV spike

Item No.	Manifold				Saline Port		Contrast Port	
	3	4	OFF	ON	Protection Station	IV Tubing: Non-Vented Drip Chamber	Squeeze Contrast Controller	IV Tubing: Vented Spike Head
91301307	■		■			■		■
91301308	■			■		■		■

Standard Kits



613000211

Standard Right Heart Kits

Standard Right Heart Kits

Item No.	Ports	Handle Style	Manifold Type	IV Tubing: Non-Vented Drip Chamber	Transducer Type	72" Pressure Monitoring Tubing
613000210	2	ON	Standard	■	One-Way Three-Way	■
613000211	2	OFF	Standard	■	One-Way Three-Way	■
613000218	1	OFF	3-Way Stopcock		One-Way Three-Way	■
613000212	2	ON	Compensator	■	Integrated	■
613000213	2	OFF	Compensator	■	Integrated	■
613000214	1	OFF	Compensator	■	Integrated	■

Kits only available in the U.S.

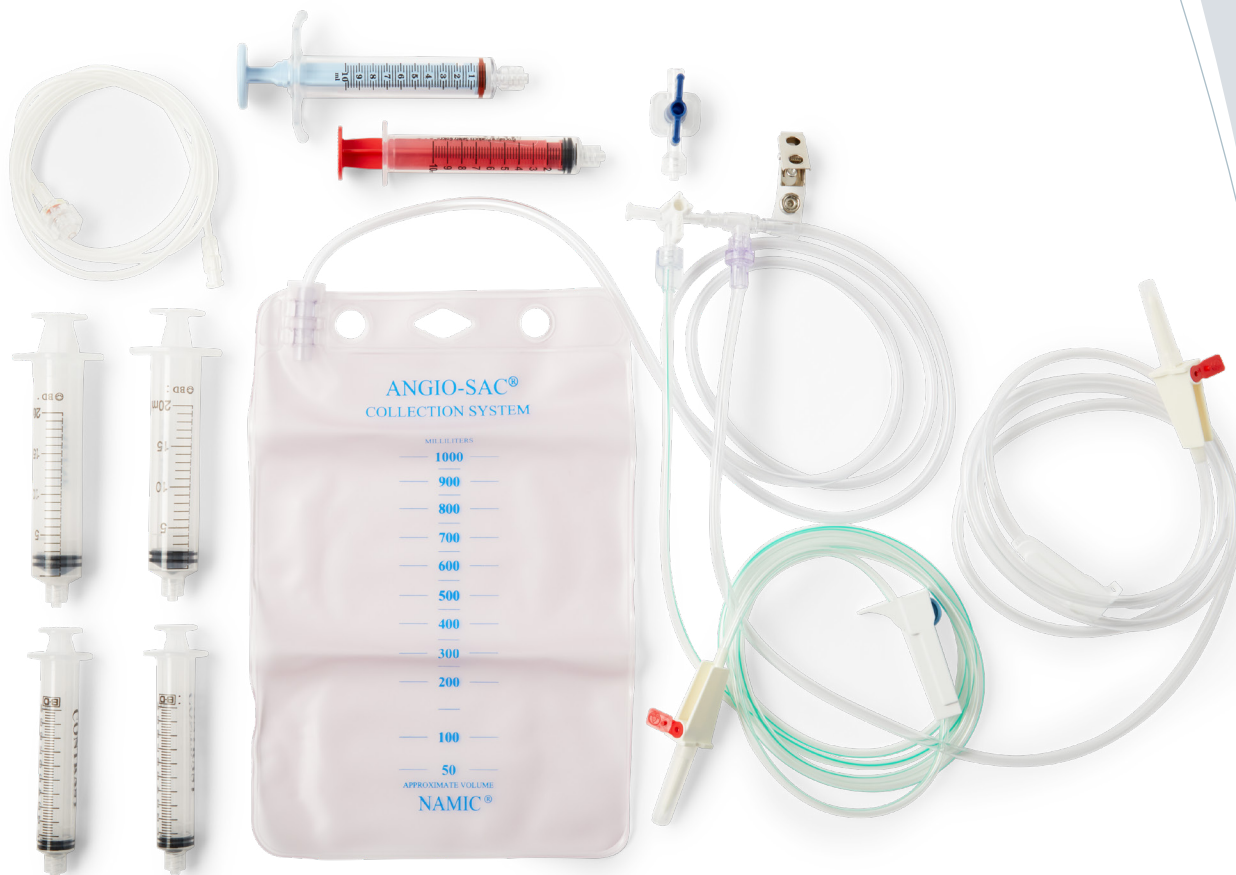

91310330

Standard Interventional Radiology Kits

Protection station system for easy access to saline, waste and contrast

- Each contain high pressure 1-way stopcock with fixed male luer lock
- Packaged 10 Per Box

Item No.	Closed Fluid System	10 mL Colored Syringe: Polycarbonate	122 (48") flexCIL Contrast Injection Line	Colored Syringe: Polypropylene
91310200	Protection Station			
91310210	Protection Station	■		
91310220	Protection Station	■	■	
91310230 [†]	Protection Station	■	■	5*
91310300	Protection Station Plus			
91310310	Protection Station Plus	■		
91310320	Protection Station Plus	■	■	
91310330	Protection Station Plus	■	■	5*

[†] Includes Saline, Contrast, Lidocaine labels

*2 - 10mL Clear, 1 - 10mL Red, 2 - 20mL Clear

Standard Kits

Standard Access Kits

Each include 18G x 2.75" introducer needle, and 18G x 1.5" and 25G x 1.5" hypodermic needles

Item	10 mL Colored Syringe: Polycarbonate				10 mL Medication Syringe: Polypropylene	10 mL Medication Control Syringe	Needle Nest	Marker and Medication Label Set
	Blue	Yellow	Red	White				
613000221					2			White Label Sheet
613000222			1		3	2		Colored Label Sheet
613000223	2	1	1	3				Colored and White Label Sheet
613000224	2	1	1	3			■	Colored and White Label Sheet

Kits only available in the U.S.

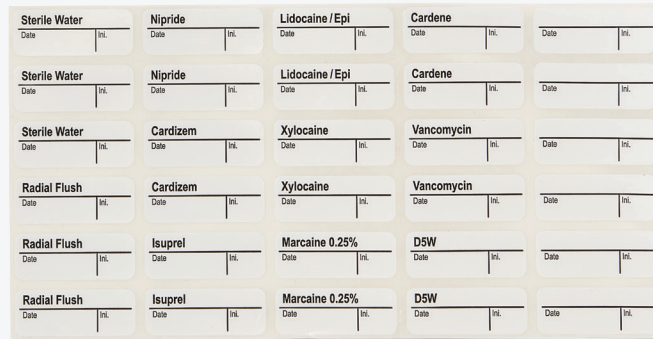
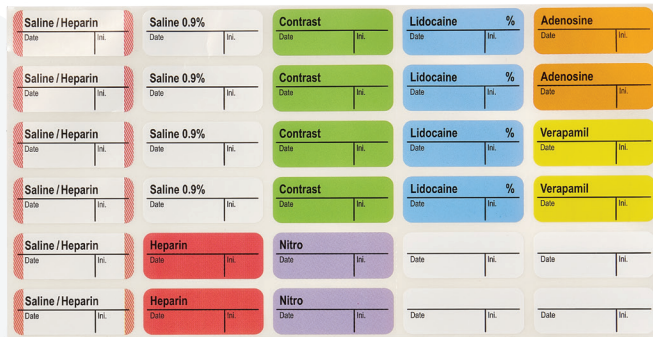

613000224

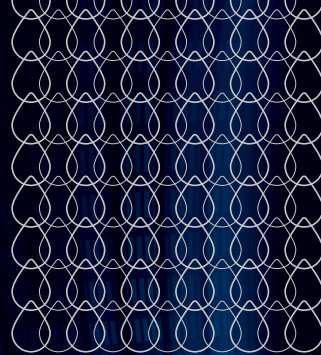

FLUID MANAGEMENT

Manifolds	22
Syringes	28
Contrast Management	42
Stopcocks	46
Fluid Delivery Sets	52
Closed Fluid Systems	56
Contrast Injection Lines	62
Fluid Management Accessories	68
Safety	70
Labels	74

FLUID MANAGEMENT

Optimize outcomes with the gold standard in patient care

You need devices you can trust that perform consistently. Our forward-thinking solutions are designed to bring flexibility, quality and choice to angiographic procedures.

3 million*

Namic fluid management
products support over
3 million vascular
procedures a year¹

¹Based on 2020 unit sales



Manifolds

► Compensator Manifolds

- Transducer is closer to the patient's heart and the source of pressure than with standard pole-mounted versions to enhance waveform fidelity
- Allows a single operator in the sterile field to zero and debubble
- Used with a pressure monitoring line that compensates for manifold movement to maintain constant pressure readings
- Fewer stopcock manipulations needed

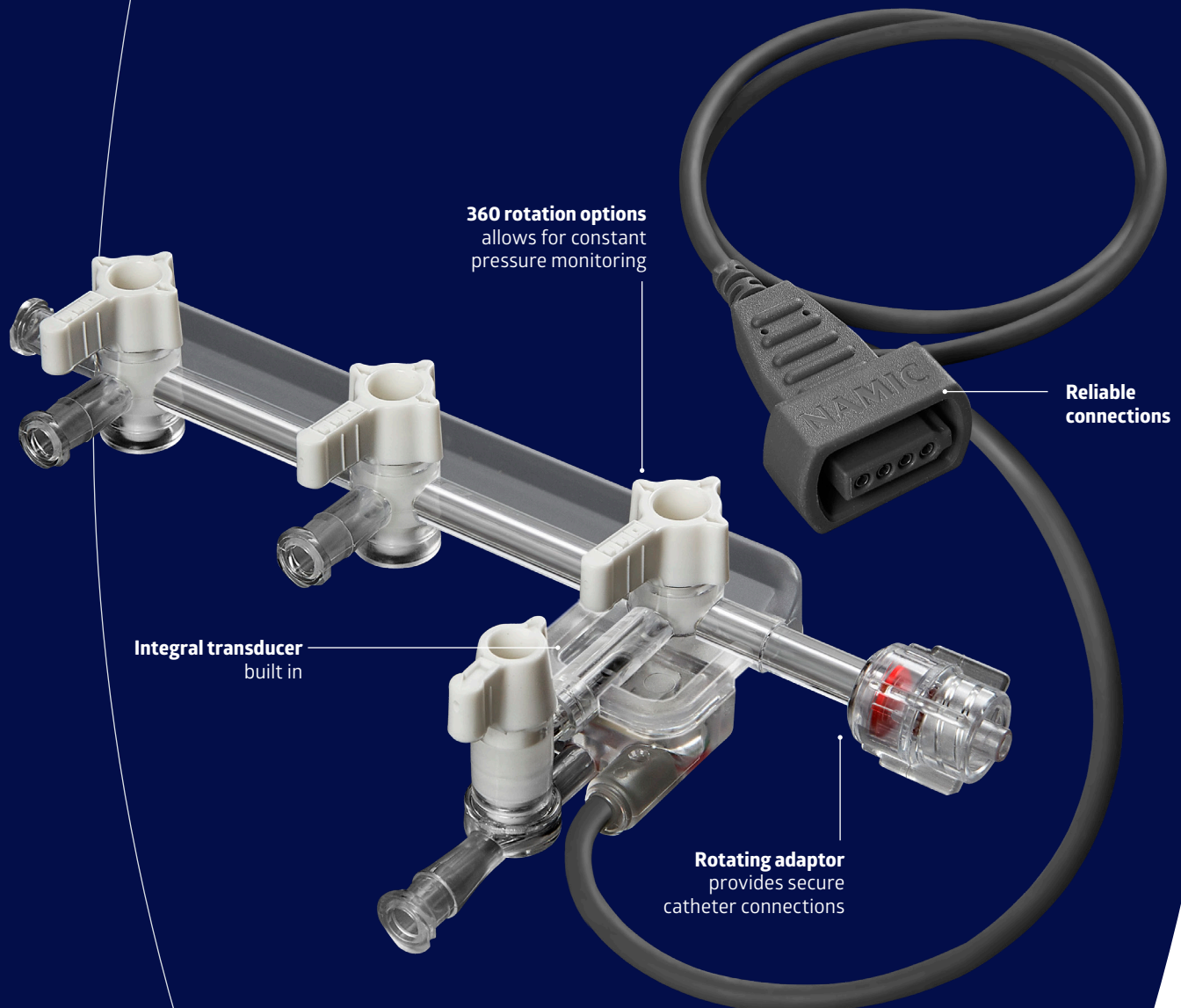

70058307

Compensator Manifolds

- Pressure Rating: 200 PSI
- Finger Grip Profile
- Packaged 10 Per Box

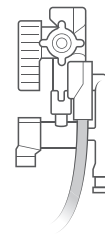
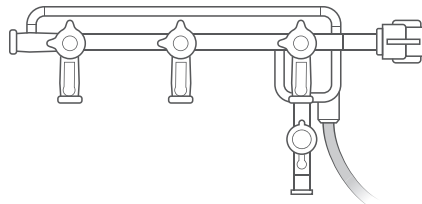

Item No.	Ports	Orientation	Handle	Kit Component
70058107	1	Right	OFF	40258107
70058108	1	Right	ON	40258108
70058207	2	Right	OFF	40258207
70058208	2	Right	ON	40258208
70058307	3	Right	OFF	40258307
70058308	3	Right	ON	40258308
70058407	4	Right	OFF	40258407
70058408	4	Right	ON	40258408

Perceptor Manifolds

- Uni-body manifold with integral transducer
- No compensation with a pressure monitoring line required
- Accurate pressures at the heart level

- Finger Grip Profile
- Packaged 10 Per Box

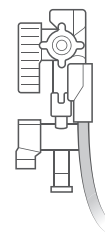
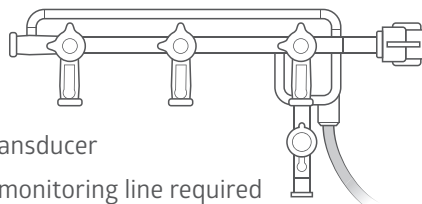

Item No.	Ports	Orientation	Handle	Pressure Rating	Kit Component
64037107	1	Right	OFF	500 PSI	40337107
70038107	1	Right	OFF	200 PSI	40238107
70038108	1	Right	ON	200 PSI	40238108
70038207	2	Right	OFF	200 PSI	40238207
70038208	2	Right	ON	200 PSI	40238208
70038217	2	Left	OFF	200 PSI	40238217
70038307	3	Right	OFF	200 PSI	40238307
64039307	3	Right	OFF	500 PSI	44039307
70038308	3	Right	ON	200 PSI	40238308
70038317	3	Left	OFF	200 PSI	40238317
70038407	4	Right	OFF	200 PSI	40238407
70038408	4	Right	ON	200 PSI	40238408
70038417	4	Left	OFF	200 PSI	40238417

Manifolds

▶ Manifolds

- Designed to provide access to saline, contrast, pressure monitoring and waste management systems
- Easy to use with smooth-turning handles
- 200 PSI and 500 PSI available

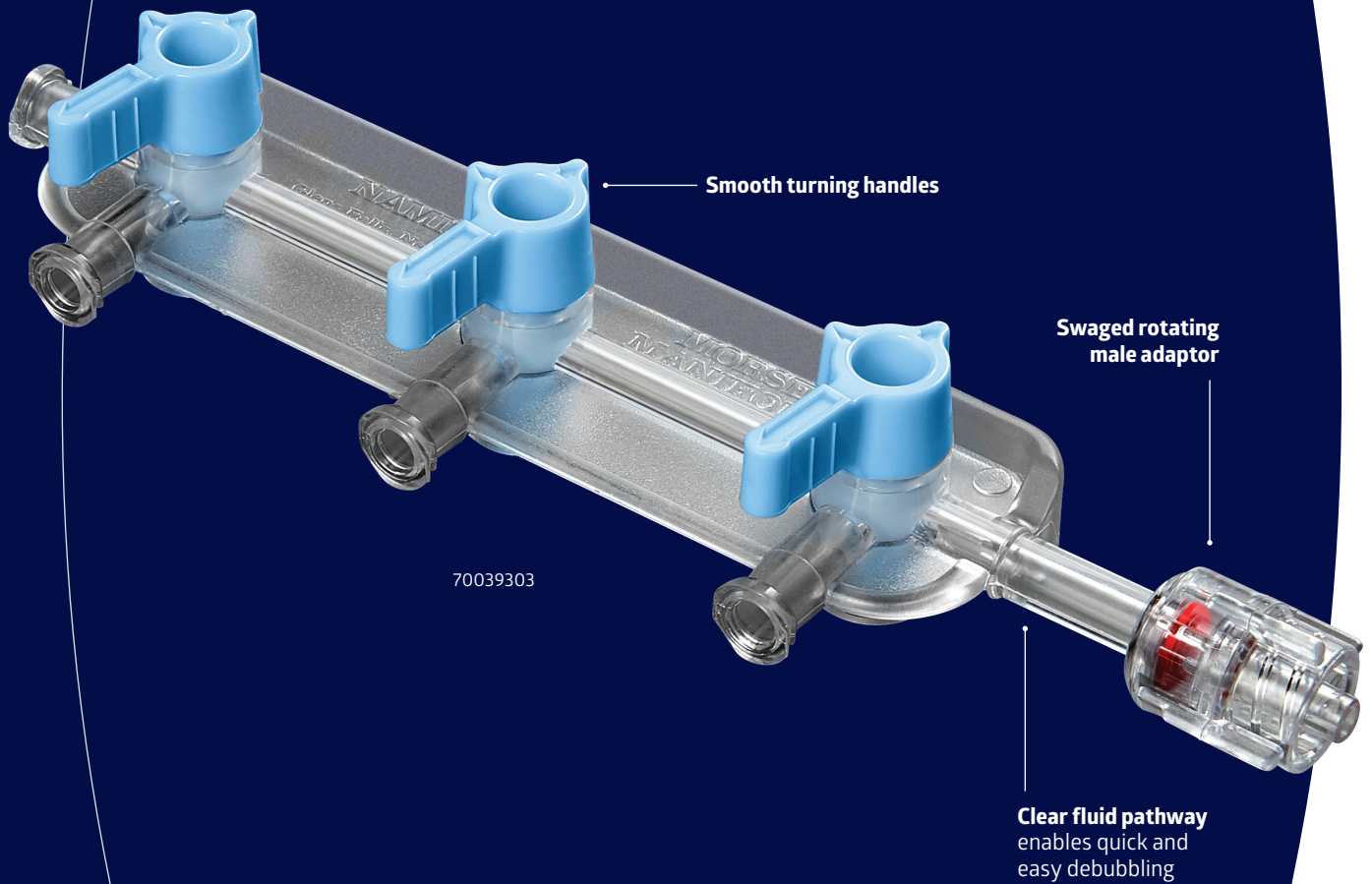

Block Style Manifolds

Medium Pressure

- Pressure Rating: 200 PSI
- Regular Handle Style
- Packaged 25 Per Box

Item No.	Ports	Orientation	Handle	Kit Component
70039200	2	Right	OFF	40239200
70039202	2	Right	ON	40239202
70039212	2	Left	OFF	40239212
70039301	3	Right	OFF	40239301
70039303	3	Right	ON	40239303
70039313	3	Left	OFF	40239313
70039402	4	Right	OFF	40239402
70039404	4	Right	ON	40239404
70039414	4	Left	OFF	40239414

High Pressure

- Pressure Rating: 500 PSI
- Regular Handle Style
- Packaged 25 Per Box

Item No.	Ports	Orientation	Handle	Kit Component
70037200	2	Right	OFF	40237200
70037202	2	Right	ON	40237202
70037212	2	Left	OFF	40237212
70037301	3	Right	OFF	40237301
70037303	3	Right	ON	40237303
70037313	3	Left	OFF	40237313
70037402	4	Right	OFF	40237402
70037404	4	Right	ON	40237404
70037414	4	Left	OFF	40237414



OFF Handle

Finger Grip Style Manifolds

Medium Pressure

- Pressure Rating: 200 PSI
- Regular Handle Style
- Packaged 25 Per Box

Item No.	Ports	Orientation	Handle	Kit Component
70038200	2	Right	OFF	40238200
70038202	2	Right	ON	40238202
70038212	2	Left	OFF	40238212
70038301	3	Right	OFF	40238301
70038303	3	Right	ON	40238303
70038313	3	Left	OFF	40238313
70038402	4	Right	OFF	40238402
70038404	4	Right	ON	40238404
70038414	4	Left	OFF	40238414



ON Handle

Manifolds

Manifolds with 6" Extension Tubing

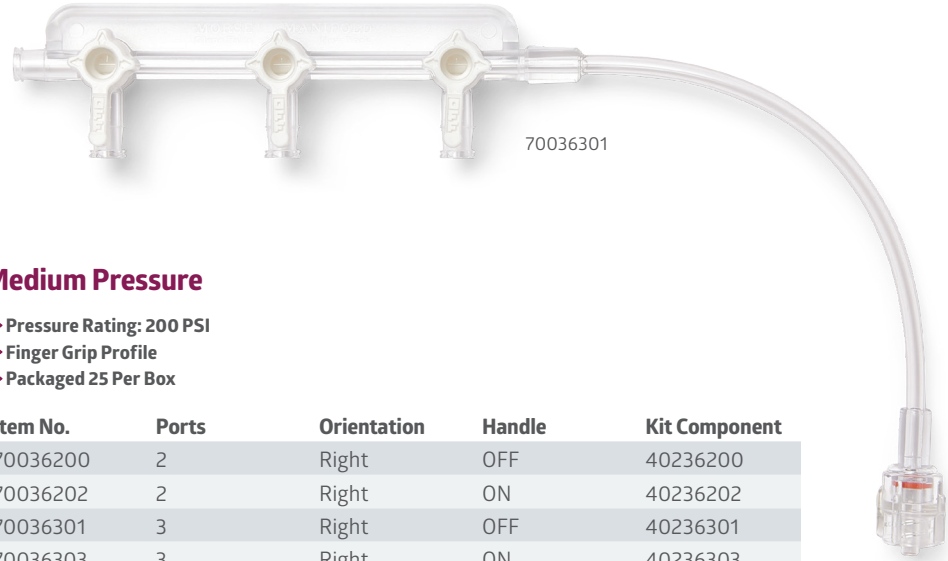

Medium Pressure

- Pressure Rating: 200 PSI
- Finger Grip Profile
- Packaged 25 Per Box

Item No.	Ports	Orientation	Handle	Kit Component
70036200	2	Right	OFF	40236200
70036202	2	Right	ON	40236202
70036301	3	Right	OFF	40236301
70036303	3	Right	ON	40236303



Star Handle Manifolds

Medium Pressure

- Pressure Rating: 200 PSI
- Wide Profile
- Packaged 25 Per Box

Item No.	Ports	Orientation	Handle	Kit Component
64038200	2	Right	OFF	40338200
64038202	2	Right	ON	41338202
64038301	3	Right	OFF	40338301
64038303	3	Right	ON	41338303
64038402	4	Right	OFF	40338402
64038404	4	Right	ON	41338404



64038303

Monitoring Manifolds

- Traditional monitoring manifold with all female ports
- Easy to use with smooth-turning handles
- Allows for multiple transducer mountings
- Ribbed back for mounting to a pole



Ribbed back

70039354

All Female Ports

- ◆ Regular Handle Style
- ◆ Block Profile
- ◆ Packaged 25 Per Box

Item No.	Ports [†]	Orientation	Handle	Kit Component
70039352*	4	Universal	OFF	40239352
70039353*	5	Universal	OFF	40239353
70039354*	6	Universal	OFF	40239354
70039355*	7	Universal	OFF	40239355

*Utilizes clamp 64000270

[†] Includes both end ports

Syringes

▶ Legacy Control Syringes

- Namic has a long history of providing control syringes used in the Cath Lab and Interventional Radiology space
- Clear polycarbonate material enables clear visualization
- Designed to aid aspiration and injection of saline or contrast
- Complete with fixed Luer lock or rotating adaptor



Narrow barrel
design for smooth
injection and easy
aspiration

70084007

Rotating male adaptor

Thumb Ring Plunger Style, Narrow Barrel

● Packaged 25 Per Case

Item No.	Volume	Fitting	Finger Style	0.5 mL Reservoir	Kit Component
70083003	7 mL	Fixed Male Luer Lock	Finger Ring	Yes	40083003
70083007	7 mL	Rotating Male Adaptor	Finger Ring	Yes	40083007
70083013	7 mL	Fixed Male Luer Lock	Finger Ring		40083013
70083017	7 mL	Rotating Male Adaptor	Finger Ring		40083017
70084003	8 mL	Fixed Male Luer Lock	Finger Ring	Yes	40084003
70084007	8 mL	Rotating Male Adaptor	Finger Ring	Yes	40084007
70084013	8 mL	Fixed Male Luer Lock	Finger Ring		40084013
70084017	8 mL	Rotating Male Adaptor	Finger Ring		40084017



Finger Ring
70083007

Thumb Ring Plunger Style

● Packaged 10 Per Case

Item No.	Volume	Fitting	Finger Style	0.5 mL Reservoir	Kit Component
70085003	10 mL	Fixed Male Luer Lock	Finger Ring	Yes	40085003
70085004	10 mL	Fixed Male Luer Lock with 5.08 cm (2") Tubing	Finger Ring	Yes	40085004
70085005	10 mL	Extended Rotating Male Adaptor	Finger Ring	Yes	40085005
70085007	10 mL	Rotating Male Adaptor	Finger Ring	Yes	40085007
70085107	10 mL	Rotating Male Adaptor	Finger Grip	Yes	40085107
70087003	12 mL	Fixed Male Luer Lock	Finger Ring	Yes	40087003
70087107	12 mL	Rotating Male Adaptor	Finger Grip	Yes	40087107
70087007	12 mL	Rotating Male Adaptor	Finger Ring	Yes	40087007
70088003	12 mL	Fixed Male Luer Lock	Finger Ring		40088003
70088007	12 mL	Rotating Male Adaptor	Finger Ring		40088007
70075023	20 mL	Fixed Male Luer Lock	Finger Ring	Yes	40075023
70075027	20 mL	Rotating Male Adaptor	Finger Ring	Yes	40075027



Finger Grip
70085107

Palm Pad Plunger Style

● Packaged 10 Per Case

Item No.	Volume	Fitting	Finger Style	0.5 mL Reservoir	Kit Component
70095003	10 mL	Fixed Male Luer Lock	Finger Ring	Yes	40095003
70095007	10 mL	Rotating Male Adaptor	Finger Ring	Yes	40095007
70095107	10 mL	Rotating Male Adaptor	Finger Grip	Yes	40095107
70097003	12 mL	Fixed Male Luer Lock	Finger Ring	Yes	40097003
70097007	12 mL	Rotating Male Adaptor	Finger Ring	Yes	40097007
70097107	12 mL	Rotating Male Adaptor	Finger Grip	Yes	40097107
70098007	12 mL	Rotating Male Adaptor	Finger Ring		40098007
70098107	12 mL	Rotating Male Adaptor	Finger Grip		40098107



Palm Pad
70095007

Saver-7 and Acceler-8 angiographic control syringes require less force during injections[†]

Comparative Benchtop Testing[†]

Smoother injection and aspiration in comparison to commonly used 8 mL Control Syringes

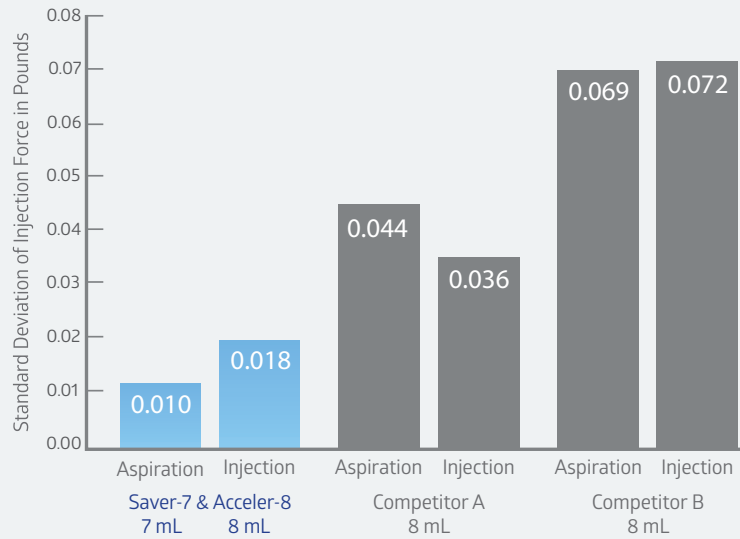

Less injection force (lbs) required to inject contrast through a 4F diagnostic catheter at 4 mL per second (n=20)



[†]Testing performed with data on file. Bench test results may not necessarily be indicative of clinical performance.

Standard Control Syringes

Thumb Ring Plunger Style, Narrow Barrel

● Packaged 10 Per Case

Item No.	Volume	Fitting	Finger Style	0.5 mL Reservoir	Kit Component
DYNJSYR10CB	10 mL	Fixed Male Luer Lock	Finger Ring	Yes	120185
DYNJSYR10CWRB	10 mL	Rotating Male Adaptor	Finger Ring	Yes	120184
DYNJSYR8C	8 mL	Fixed Male Luer Lock	Finger Ring	Yes	89371
DYNJSYR8CWR	8 mL	Rotating Male Adaptor	Finger Ring	Yes	89369



DYNJSYR10CWRB

Thumb Ring Plunger Style

● Packaged 10 Per Case

Item No.	Volume	Fitting	Finger Style	0.5 mL Reservoir	Kit Component
DYNJSYR10C	10 mL	Fixed Male Luer Lock	Finger Ring	Yes	88618
DYNJSYR10CWR	10 mL	Rotating Male Adaptor	Finger Ring	Yes	81015
DYNJSYR12C	12 mL	Fixed Male Luer Lock	Finger Ring	Yes	88619
DYNJSYR12CWR	12 mL	Rotating Male Adaptor	Finger Ring	Yes	81016

Palm Pad Plunger Style

● Packaged 10 Per Case

Item No.	Volume	Fitting	Finger Style	0.5 mL Reservoir	Kit Component
DYNJSYR10CP	10 mL	Fixed Male Luer Lock	Finger Ring	Yes	96725
DYNJSYR10CRP	10 mL	Rotating Male Adaptor	Finger Ring	Yes	96723
DYNJSYR12CP	12 mL	Fixed Male Luer Lock	Finger Ring	Yes	96726
DYNJSYR12CRP	12 mL	Rotating Male Adaptor	Finger Ring	Yes	96724

Syringe Tip Styles



Fixed Male Luer Lock



Rotating Male Adaptor

Plunger Styles



Thumb Ring



Palm Pad

Syringes

Colored Syringes: Polycarbonate

- Allows for smooth aspiration and injection of contrast and saline
- Can be added to angiography kits and vascular access packs
- Colors enable color coding for easy selection

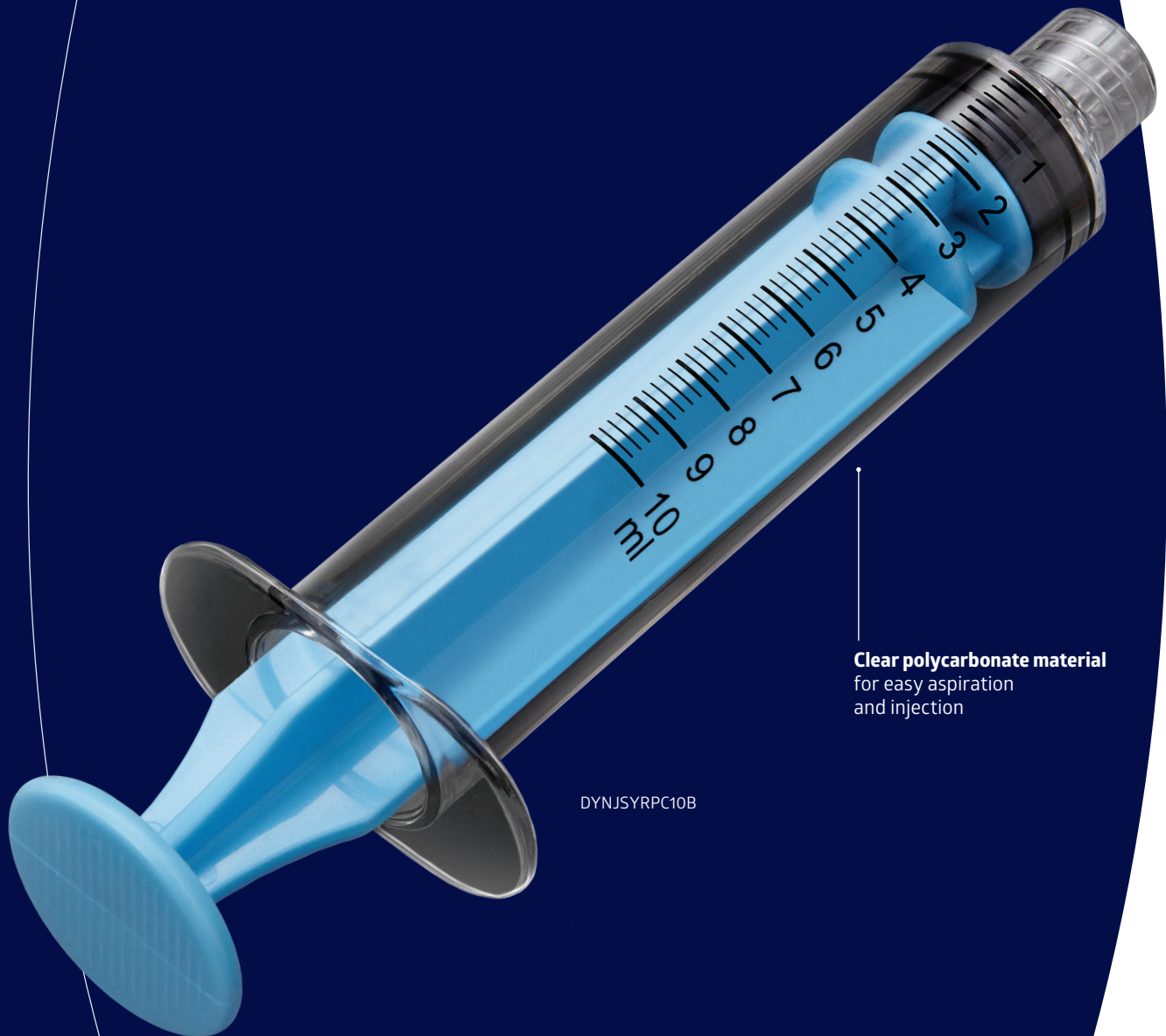

Clear polycarbonate material
for easy aspiration
and injection

DYNJSYRPC10B

Colored Syringes—Polycarbonate

- Fixed Male Luer Lock Fitting
- Packaged 10 Per Box

Size: 1 mL			Size: 3 mL		Size: 6 mL	
	Item No.	Kit Component	Item No.	Kit Component	Item No.	Kit Component
COLOR	Blue	DYNJSYRPC1B 83454	DYNJSYRPC3B 83551	DYNJSYRPC6B 83557		
	Dark Green	DYNJSYRPC1DG 92186	DYNJSYRPC3DG 92190	DYNJSYRPC6DG 92194		
	Green	DYNJSYRPC1G 92185	DYNJSYRPC3G 92189	DYNJSYRPC6G 92193		
	Red	DYNJSYRPC1R 83456	DYNJSYRPC3R 83553	DYNJSYRPC6R 83558		
	Purple	DYNJSYRPC1P 92187	DYNJSYRPC3P 92188	DYNJSYRPC6P 92192		
	White	DYNJSYRPC1W 83453	DYNJSYRPC3W 83550	DYNJSYRPC6W 83556		
	Yellow	DYNJSYRPC1Y 83455	DYNJSYRPC3Y 83552	DYNJSYRPC6Y 92191		
Size: 10 mL			Size: 20 mL		Size: 30 mL	
	Item No.	Kit Component	Item No.	Kit Component	Item No.	Kit Component
COLOR	Blue	DYNJSYRPC10B 83560	DYNJSYRPC20B 83592	DYNJSYRPC30B 83598		
	Dark Green	DYNJSYRPC10DG 83565	DYNJSYRPC20DG 92207	DYNJSYRPC30DG 92213		
	Green	DYNJSYRPC10G 83563	DYNJSYRPC20G 93302	DYNJSYRPC30G 92212		
	Red	DYNJSYRPC10R 83562	DYNJSYRPC20R 83594	DYNJSYRPC30R 91766		
	Purple	DYNJSYRPC10P 83564	DYNJSYRPC20P 92205	DYNJSYRPC30P 83599		
	White	DYNJSYRPC10W 83559	DYNJSYRPC20W 83591	DYNJSYRPC30W 83597		
	Yellow	DYNJSYRPC10Y 83561	DYNJSYRPC20Y 83593	DYNJSYRPC30Y 92211		



From left to right:
DYNJSYRPC3R,
DYNJSYRPC6W,
DYNJSYRPC10G,
DYNJSYRPC20Y,
DYNJSYRPC30B

Syringes

Pre-Labeled Colored Syringes—Polycarbonate

- ◆ Fixed Male Luer Lock Fitting
- ◆ Packaged 10 Per Box

Size: 3 mL—Pre-Labeled

		VERSED		XYLOCAINE	
COLOR		Item No.	Kit Component	Item No.	Kit Component
Blue		DYNJSYRVER3B	83551, 127813	DYNJSYRXYL3B	83551, 44120
Green		DYNJSYRVER3G	92189, 127813	DYNJSYRXYL3G	92189, 44120
Red		DYNJSYRVER3R	83553, 127813	DYNJSYRXYL3R	83553, 44120

Size: 10 mL—Pre-Labeled

		CONTRAST		HEPARIN	
COLOR		Item No.	Kit Component	Item No.	Kit Component
Blue		DYNJSYRCT10B	83571	DYNJSYRHEP10B	83566
Dark Green		DYNJSYRCT10DG	83565, 40934	DYNJSYRHP10DG	83565, 40619
Green		DYNJSYRCT10G	83575	DYNJSYRHEP10G	83570
Red		DYNJSYRCT10R	83573	DYNJSYRHEP10R	83568
White		DYNJSYRCT10W	83574	DYNJSYRHEP10W	83569
Yellow		DYNJSYRCT10Y	83572	DYNJSYRHEP10Y	83567

		FENTANYL		FLUSH	
COLOR		Item No.	Kit Component	Item No.	Kit Component
Blue		DYNJSYRFEN10B	83560, 127812	DYNJSYRFLS10B	83590
Green		DYNJSYRFEN10G	83563, 127812	DYNJSYRFLS10G	83563
Red		DYNJSYRFEN10R	83562, 127812	DYNJSYRFLS10R	83562, 127811

		LIDOCAINE		NITRO	
COLOR		Item No.	Kit Component	Item No.	Kit Component
Blue		DYNJSYRLID10B	83576	DYNJSYRNIT10B	83581
Dark Green		DYNJSYRLID10DG	92199	DYNJSYRNT10DG	83585
Green		DYNJSYRLID10G	83579	DYNJSYRNIT10G	83584
Red		DYNJSYRLID10R	83578	DYNJSYRNIT10R	83583
White		DYNJSYRLID10W	92198	DYNJSYRNIT10W	83559, 40936
Yellow		DYNJSYRLID10Y	83577	DYNJSYRNIT10Y	83582

		SALINE		XYLOCAINE	
COLOR		Item No.	Kit Component	Item No.	Kit Component
Blue		DYNJSYRSAL10B	83586	DYNJSYRXYL10B	83589
Dark Green		DYNJSYRSL10DG	83565, 40949	—	—
Green		DYNJSYRSAL10G	92202	—	—
Red		DYNJSYRSAL10R	83587	DYNJSYRXYL10R	83562, 44120
White		DYNJSYRSAL10W	83588	—	—
Yellow		DYNJSYRSAL10Y	92201	—	—



Top to bottom:
DYNJSYRNIT10B,
DYNJSYRSL10DG,
DYNJSYRSAL10W

Colored Syringes: Polycarbonate Wing Style

- Fixed Male Luer Lock Fitting
- Available with a 0.5 mL reservoir
- Palm Plunger Style
- Packaged 25 Per Box

10 mL Long Wing Style

	Item No.	0.5 mL Reservoir	Kit Component	
COLOR	Pale Blue	70505103	Yes	40505103
	Pale Blue	—	—	40506103
	Bright Blue	—	Yes	40505113
	Yellow	—	Yes	40505123
	Yellow	—	—	40506123
	Purple	—	Yes	40505133
	Red	—	Yes	40505163
	White	—	Yes	40505173
	White	—	—	40400502*

*Removable Plunger

10 mL Short Wing Style

	Item No.	Kit Component	
COLOR	Pale Blue	70506203	40506203
	Bright Blue	—	40506213
	Yellow	—	40506223
	Purple	—	40506233
	Red	—	40506263
	White	—	40506273



70506203



70505103

Syringes

▶ Colored Syringes: Polypropylene

- Polypropylene syringes are provided in a large variety of sizes
- Provides a visual system to accurately identify the correct fluid
- Smooth operation for ease of use



DYNJPOLYCON1

Colored Syringes—Polypropylene

- Fixed Male Luer Lock Fitting
- Packaged 10 Per Box

		Size: 3 mL		Size: 5 mL	
		Item No.	Kit Component	Item No.	Kit Component
COLOR	Blue	DYNJSYRPP3B	91822	DYNJSYRPP5B	91827
	Green	DYNJSYRPP3G	91821	—	—
	Red	DYNJSYRPP3R	91820	DYNJSYRPP5R	91825
	Purple	DYNJSYRPP3P	91840	DYNJSYRPP5P	91841
	White	DYNJSYRPP3W	91823	DYNJSYRPP5W	91828
	Yellow	DYNJSYRPP3Y	91824	DYNJSYRPP5Y	91829

		Size: 10 mL		Size: 20 mL	
		Item No.	Kit Component	Item No.	Kit Component
COLOR	Blue	DYNJSYRPP10B	91832	DYNJSYRPP20B	91837
	Green	DYNJSYRPP10G	91831	DYNJSYRPP20G	91836
	Red	DYNJSYRPP10R	91830	DYNJSYRPP20R	91835
	Purple	DYNJSYRPP10P	91842	—	—
	White	DYNJSYRPP10W	91833	DYNJSYRPP20W	91838
	Yellow	DYNJSYRPP10Y	91834	DYNJSYRPP20Y	91839



Shown here:
DYNJSYRPP3G,
DYNJSYRPP5W,
DYNJSYRPP10P,
DYNJSYRPP20R,
DYNJSYRPP10B

- Luer Slip Fitting
- Packaged 10 Per Box

Size: 10 mL

		Item No.	Kit Component
COLOR	Blue	DYNJSYSPP10B	91872
	Red	DYNJSYSPP10R	91874

Colored Control Syringe—Polypropylene

- Fixed Male Luer Lock Fitting
- Thumb Ring Finger Style

Size: 10 mL

		Item No.	Kit Component	Pkg.
COLOR	Green	DYNJSYCPP10G	91879	10/bx
	Red	DYNJSYCPP10R	91878	10/bx
	White	DYNJPOLYCON1	91881	100/bx
	Yellow	DYNJSYCPP10Y	91876	10/bx



DYNJSYCPP10Y

Syringes

Angiographic Contrast Injection Syringes

- Single-use power injector syringes deliver contrast agents in high-pressure injection systems
- Made from clarified polypropylene to allow optimal detection of air bubbles
- Dual-seal plunger designed to prevent air aspiration or leakage
- Tapered luer tip for bubble removal



VINC8530210

Injection Syringes

- Includes Fill Tube
- Packaged 50 Per Box

Item No.	Size	Fits
VINC8530155	150 mL	Medrad Mark V, Mark V Plus, and Provis injectors
VINC8530210	200 mL	Medrad Mark V, Mark V Plus, and Provis injectors
VINC8536150	150 mL	Liebel Flarsheim Angiomat 6000 and Angiomat Illumena Injectors (Adapter/Pressure Jacket required for use on Illumena)

CT Transfer Sets

Item No.	Length	Type	Pkg.	Kit Component
DYNJTSETA23	23"	Vented Spike	100/cs	129592
DYNJTSET23M	23"	Vented Sosa Spike with Ball Valve	100/cs	133443
VINC4053041	7"	Transfer Set (fill set) with Long Spike	100/cs	—



DYNJTSETA23

▶ CT Contrast Injection Syringe Kits

- Direct connect tip design, allows for a quick, leak-free connection of transfer sets, spikes and extension lines, while reducing waste
- Extended length plunger provides trouble-free syringe filling



VINC8530125

● Packaged 50 Per Box

Item No.	Size	Includes	Fits
VINC8530125	125 mL	Fill Tube	Mallinckrodt Optivantage and Liebel-Flarshiem CT9000 series injectors
VINC8530126	125 mL	60" Low Pressure Extension Line and Spike	Mallinckrodt Optivantage and Liebel-Flarshiem CT9000 series injectors
VINC8530127	125 mL	Short and Long Spike	OptiVantage Injectors
VINC8530211	200 mL	Fill Tube and 60" Low Pressure Extension Line	Medrad MCT, MCT Plus, and Envision/Vistron. Liebel-Flarshiem CT9000 series injectors (adapter required)

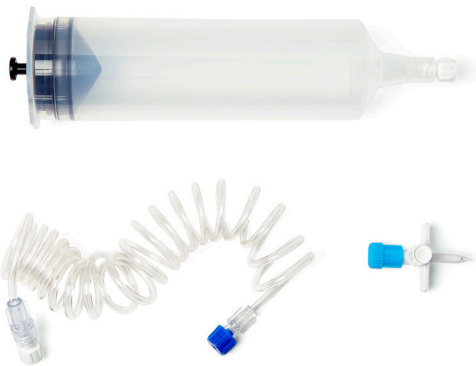

VINC8530126



VINC8530127

► MRI Contrast Injection Syringe Kits

- Maximize contrast delivery with an efficient and disposable system
- Two contrast spikes allow for greater flexibility with practice needs
- Clear barrel design helps make it easier to identify the presence of air

► Packaged 50 Per Box

Item No.	Size	Includes	Fits
VINC8530078	60 mL	96" Coiled Y-line with 2 Check-Valves, and 2 Short Spikes	Liebel-Flarsheim Optistar
VINC8532201	(1) 65 mL Syringe, (1) 115 mL Syringe	96" Y Line with 1 Check Valve, 1 Long and 1 Short Spike	Spectris Solaris
VINC8532207	(2) 65 mL Syringes	96" Y Line with 1 Check Valve, 1 Long and 1 Short Spike	Spectris



VINC8530078

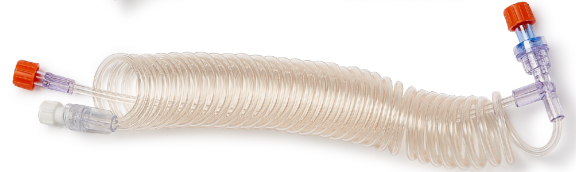

VINC8532201

Low Pressure Tubing

- Helps prevent over-tightening, luer breakage and sticking
- Compatible with needle-less valves and multiple connections
- Provides higher flow rates and less pressure during injection



VINC4052604

Contrast Tubing

● Packaged 100 Per Case

Item No.	Length	Type	Fits
VINC4050060	60"	Coiled Extension Line	Mallinckrodt pre-filled syringes
VINC4052155	60"	Y-Line with 2 Check valves	Optivantage
VINC4052604	60"	Y-Line with 1 Check valve	Optivantage
VINC4050061	60"	Coiled Extension Line with Check valve	Variety
VINC4051549	60"	Coiled Y-line without Check valves	Optivantage
VINC4051559	60"	60" Straight Y-Line with 1 Check valve	Variety
VINC4052962	96"	Coiled Y-Line with 1 Check valve for MRI	Mallinckrodt Injectors

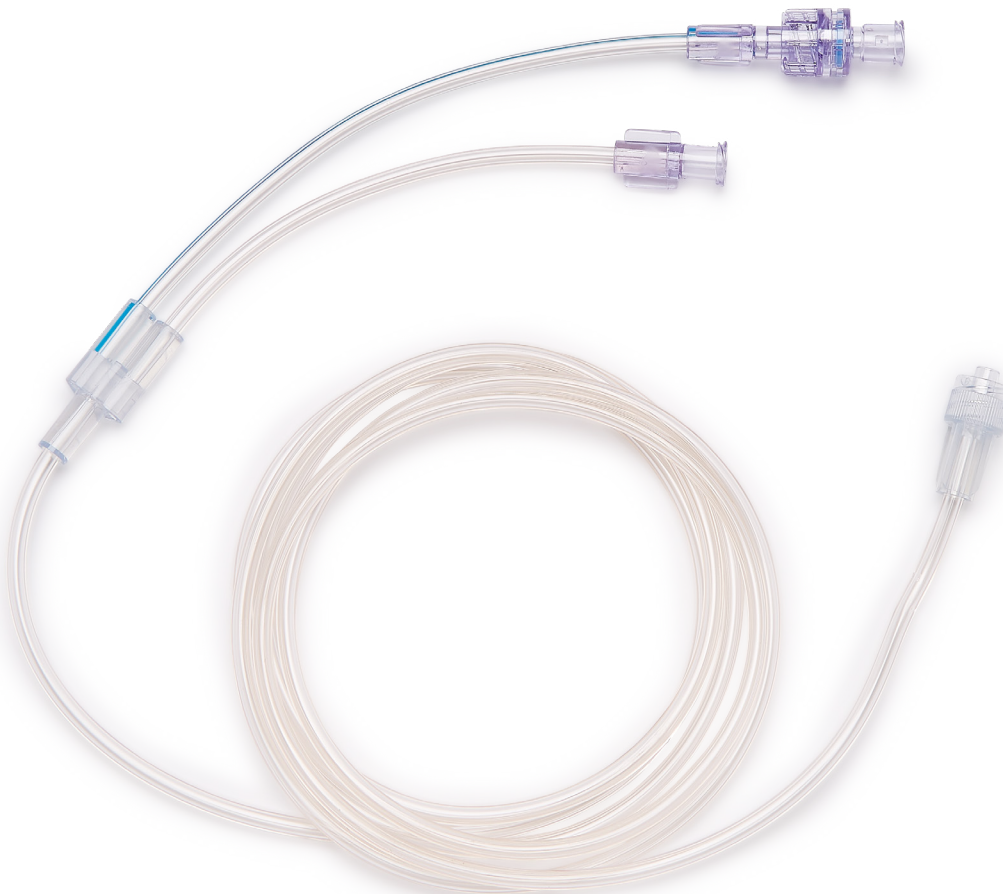

VINC4051559

Contrast Management

Contrast Management Systems

- Squeeze contrast controller safely and effectively reduces contrast waste, maximizing your budget
- Unique design lets you use one container of contrast media on multiple patient cases
- Proven microbial barrier prevents cross contamination

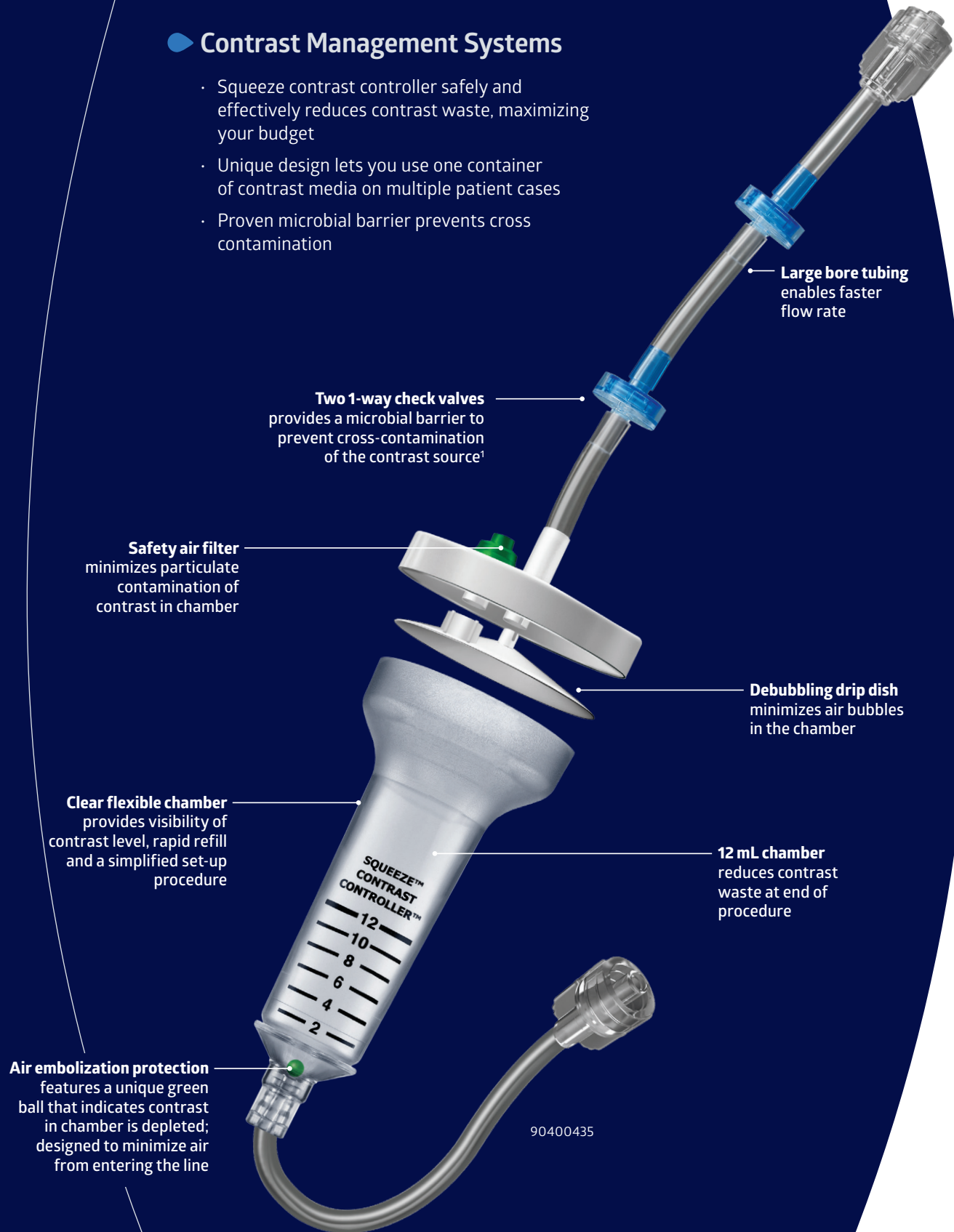

Large bore tubing enables faster flow rate

Two 1-way check valves provides a microbial barrier to prevent cross-contamination of the contrast source!

Safety air filter minimizes particulate contamination of contrast in chamber

Debubbling drip dish minimizes air bubbles in the chamber

Clear flexible chamber provides visibility of contrast level, rapid refill and a simplified set-up procedure

12 mL chamber reduces contrast waste at end of procedure

Air embolization protection features a unique green ball that indicates contrast in chamber is depleted; designed to minimize air from entering the line

90400435

Contrast Management Systems with Squeeze Chamber

- Two One-Way Check Valves
- Includes Green Ball
- Packaged 10 Per Case

Item No.	Tubing Length	3-Way Stopcock	Tubing Type	Fitting	Kit Component
90400435	183 cm (72")	No	IV Tubing	Male-Male Luer Lock	40400435
—	183 cm (72")	Yes	IV Tubing	Male-Male Luer Lock	49000080
—	274 cm (108")	No	IV Tubing	Male-Male Luer Lock	49000181
—	5 cm (2"), 183 cm (72")	Yes No	Large Bore	Male-Female Luer Lock Male-Male Luer Lock	49000139, 45602640*
—	5 cm (2"), 183 cm (72")	No No	Large Bore	Male-Male Luer Lock Male-Female Luer Lock	49000139, 45602545*

*Kit components attached together

Non-Chambered In-Line Contrast Management Systems

- Tubing Length: 183 cm (72")
- Includes Two One-Way Check Valves and Roller Clamp
- Male-Male Luer Lock Fitting
- Packaged 10 Per Case

Item No.	Tubing Color	Tubing Type	Stopcock	Kit Component
—	Green Striped	IV	No	40400018
64000010	Clear	IV	3-Way	40400010
—	Clear	Large Bore	No	49000245

How to fill a squeeze contrast chamber



Step 1

While pressing and holding the green vent button, squeeze the chamber. Press firmly to evacuate air from the system.

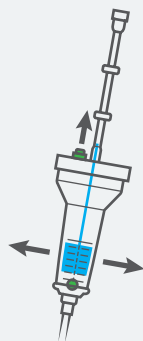

Step 2

Simultaneously release the chamber and the button. The chamber will fill with 10–12 mL of contrast.



Step 3

If the green ball is seated in the base of the chamber, squeeze the base firmly to dislodge the ball. The ball will float freely to the surface.



Step 4

Aspirate contrast through the tubing assembly. Debubble the system. The tubing assembly is now ready to use.

Contrast Management

Transfer Spikes

- Interchangeable for use with contrast or saline solutions

Non-Pressurized

Vented

Item No.	Spike or Chamber	Length	Tubing Size	Stopcock	Kit Component	Pkg.
90400039	Spike Head	3.8 cm (1.5")	Large Bore	1-Way	40400039	25/cs
90400839	Spike Head	15.2 cm (6")	Large Bore	1-Way	40400839	25/cs
DYNJSSPIKE	Spike Head	10 cm (4")	Large Bore	Pinch Clamp	90509	20/cs
DYNJVSPIKE3	Spike Head	15 cm (6")	Large Bore	3-Way	96700	25/cs
—	Spike Head	3.8 cm (1.5")	Large Bore	3-Way	45627083	
64000090	Chamber	7.6 cm (3")		1-Way	40400001	25/cs

Pressurized

Item No.	Spike or Chamber	Length	Vented	Tubing Size	Stopcock	Kit Component
—	Sosa Spike Head	5 cm (2")	Yes	Large Bore	1-Way	46601501

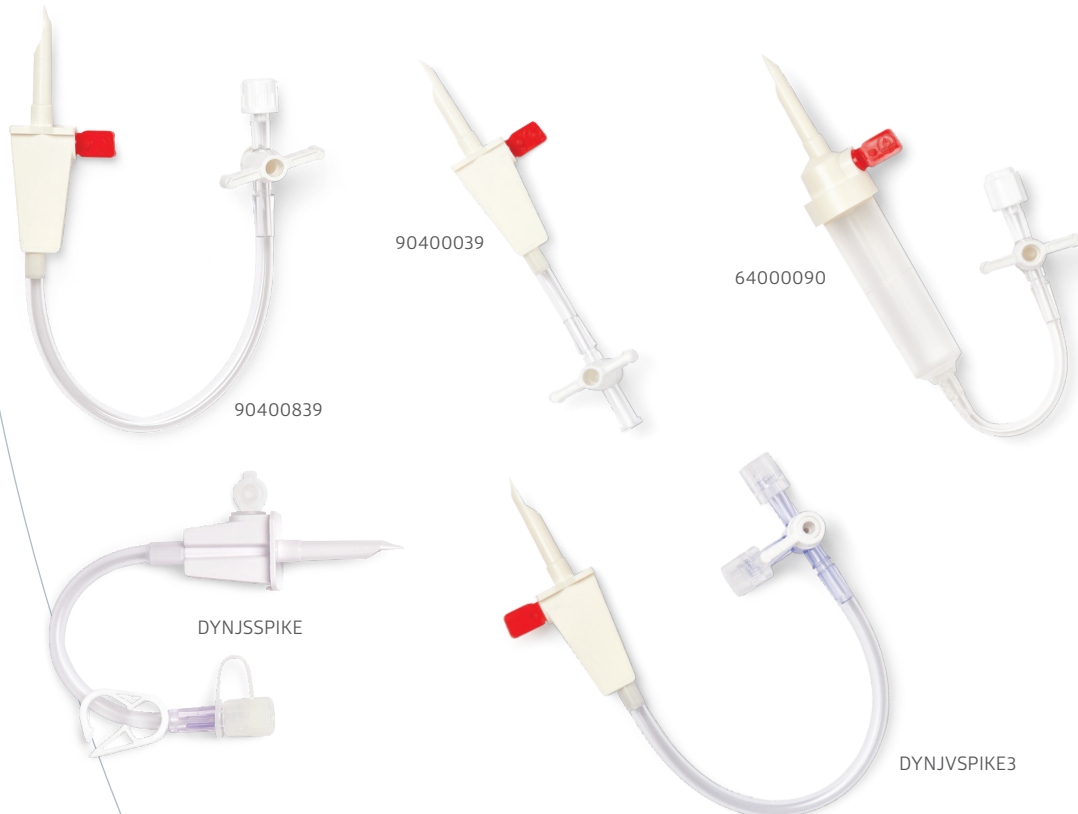

► Tumescence Syringe Kit—Large Bore

- The addition of undirected valves prevents the risk of reverse injection or aspiration of fluid from the patient

◆ Packaged 10 Per Case

Item No.	Tubing Length	Vented	Check Valve	Fluid Capacity	Kit Component
DYNJTUMSYR	183 cm (72")	Yes	Yes	15 mL	35003, 81016, 92890

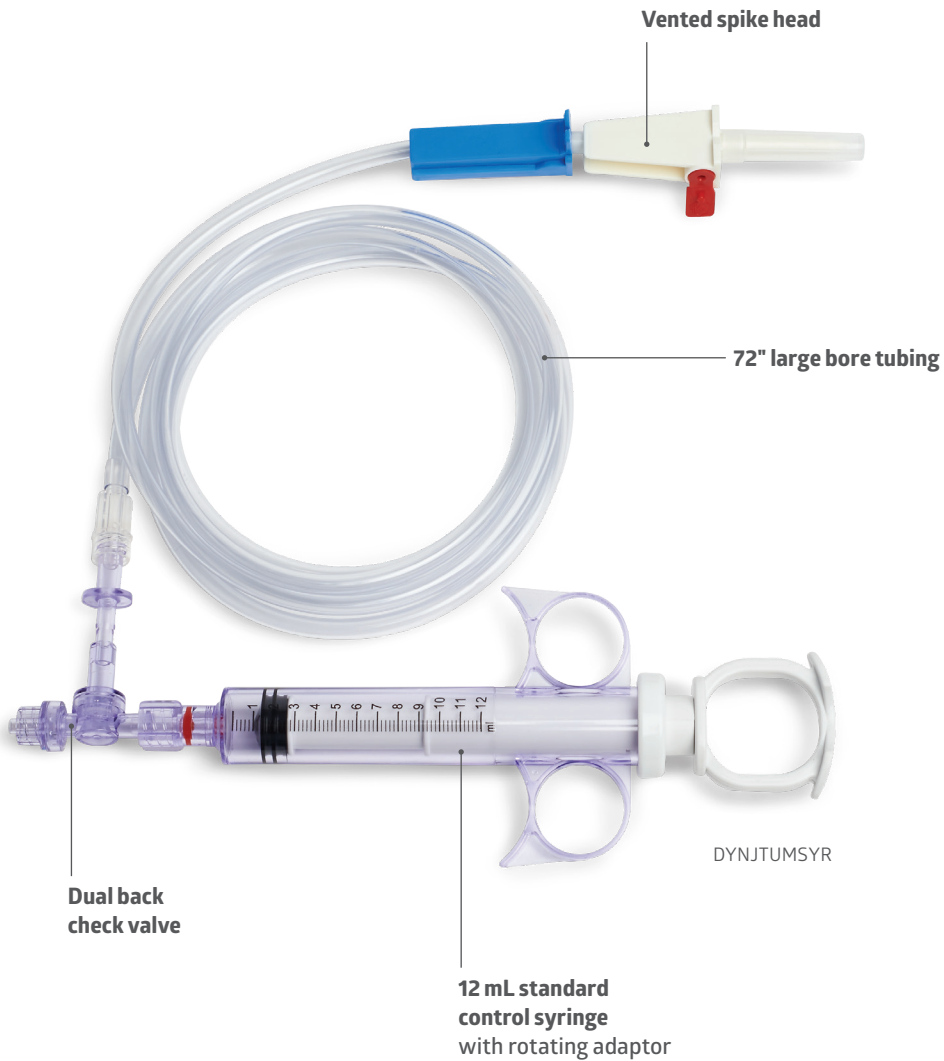

Stopcocks

► One-, Three- and Four-Way Stopcocks

- Externally operated valve helps regulate the flow of liquid
- Responsive on/off valve for greater efficiency



One-way stopcock

70055017



Three-way stopcock

70055009

► Stopcocks—One-Way Body Style

Low Pressure

Item No.	Pressure Rating	Fitting	Kit Component	Pkg.
DYNJSC1FF	45 PSI	Female-Female	96277	50/cs
70015015	200 PSI	Rotating Male Collar	40015015	50/cs
70015016	200 PSI	Male Slip Tip	40015016	50/cs

Medium Pressure

Item No.	Pressure Rating	Fitting	Kit Component	Pkg.
DYNJSC1MPNS	500 PSI	Rotating Male Collar	81205	20/cs
DYNJSC1MPFLS	500 PSI	Male Slip Tip	SPT-STOPLIP	20/cs

High Pressure

Item No.	Pressure Rating	Fitting	Kit Component	Pkg.
DYNJSC101HP	1050 PSI	Rotating Male Adaptor	97453	50/cs
70055017	1050 PSI	Fixed Male Luer Lock	40055017	50/cs



Rotating Male Collar
70015015

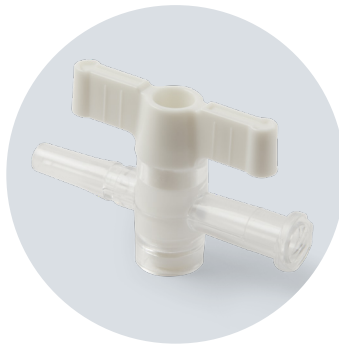

Male Slip Tip
70015016



Female-Female
DYNJSC1FF



Rotating Male Adaptor
DYNJSC101HP



Fixed Male Luer Lock
70055017

Stopcocks

► Stopcocks—Three-Way Body Style



Fixed Male Luer Lock
70015003



Rotating Male Collar
70015002



Male Slip Tip
70015000



ON Handle



OFF Handle

Low Pressure

Item No	Pressure Rating	Handle	Fitting	Kit Component	Pkg.
DYNJSC301	45 PSI	OFF	Rotating Male Collar	90126	20/cs
DYNJSC302	45 PSI	ON	Rotating Male Collar	91627	20/cs
70015003	200 PSI	OFF	Fixed Male Luer Lock	40015003	50/cs
70015002	200 PSI	OFF	Rotating Male Collar	40015002	50/cs
70015000	200 PSI	OFF	Male Slip Tip	40015000	50/cs

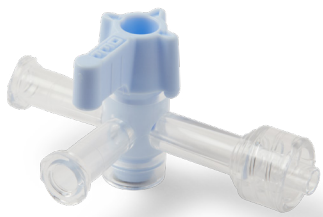

Fixed Male Luer Lock
70035003



Rotating Male Collar
70035002

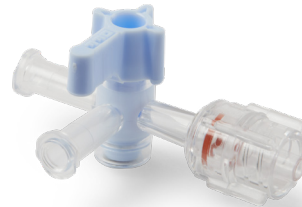

Rotating Male Adaptor—Right Handed
70035009



Fixed Male Luer Lock
70055003



Rotating Male Adaptor—Right Handed
70055009

Medium Pressure

Item No	Pressure Rating	Handle	Fitting	Kit Component	Pkg.
70035009	400 PSI	OFF	Rotating Male Adaptor—Right Handed	40035009	50/cs
70035002	400 PSI	OFF	Rotating Male Collar	40035002	50/cs
70035008	400 PSI	OFF	Rotating Male Adaptor—Left Handed	40035008	50/cs
70035003	400 PSI	OFF	Fixed Male Luer Lock	40035003	50/cs
DYNJSC303	500 PSI	OFF	Rotating Male Adaptor—Right Handed	91628	20/cs
DYNJSC304	500 PSI	ON	Rotating Male Adaptor—Right Handed	90127	20/cs

High Pressure

Item No	Pressure Rating	Handle	Fitting	Kit Component	Pkg.
DYNJSC305HP	1050 PSI	OFF	Rotating Male Adaptor—Right Handed	91629	20/cs
DYNJSC306HP	1050 PSI	ON	Rotating Male Adaptor—Right Handed	90128	20/cs
70055003	1050 PSI	OFF	Fixed Male Luer Lock	40055003	50/cs
70055009	1050 PSI	OFF	Rotating Male Adaptor—Right Handed	40055009	50/cs
DYNJSC3HPOL	1050 PSI	ON	Rotating Male Adaptor—Right Handed	131053	20/cs
70055008	1050 PSI	OFF	Rotating Male Adaptor—Left Handed	40055008	50/cs
DYNJSC3HPFL	1050 PSI	OFF	Rotating Male Adaptor—Right Handed	131054	20/cs

Stopcocks

Stopcocks—Four-Way Body Style

- Handles OFF
- Packaged 50 Per Case

Low Pressure

Item No.	Pressure	Pressure Rating	Fitting	Kit Component
DYNJSC401*	High-Flow/ Low Pressure	45 PSI	Rotating Male Collar	81203
70015012	Low	200 PSI	Rotating Male Collar	40015012
70015013	Low	200 PSI	Fixed Male Luer Lock	40015013
70015010	Low	200 PSI	Male Slip Tip	40015010

*Flow rate is 200mL/minute

Medium Pressure

Item No.	Pressure	Pressure Rating	Fitting	Kit Component
70035012	Medium	400 PSI	Rotating Male Collar	40035012
70035013	Medium	400 PSI	Fixed Male Luer Lock	40035013



Male Slip Tip
70015010



Fixed Male Luer Lock
70035013



Rotating Male Collar
70015012

Drug Resistant Stopcock—Four-Way Body Style

- Helps prevent cracking, crazing and hazing of medical devices
- Provides durability with excellent clarity
- May improve patient safety by encouraging worldwide consistency in small-bore connectors for liquids and gases in healthcare applications
- Resistant against all of the following for 96 hours¹ to help reduce possible complications while maintaining the polymer performance level of the stopcock: Fusid, Heparin, Propofol, Noradrenaline, Nactrapid (Insulin), Vancomycin

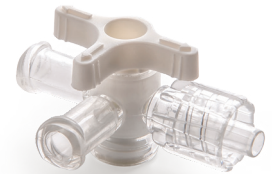

DYNJSC402

- Packaged 50 Per Case

Item No.	Pressure	Pressure Rating	Fitting	Kit Component
DYNJSC402	Low Pressure	45 PSI	Rotating Male Collar	131645

Extension Sets with Stopcocks

- 3- and 4-way body stopcocks with extension tubing
- Available with pressure monitoring tubing or IV tubing

Pressure Monitoring Tubing

- ◆ Male Luer Lock Fitting
- ◆ Packaged 25 Per Case

Item No.	Body Style	Length	Kit Component
90703050	3-Way	11.43 cm (4.5")	40703050
90703062	3-Way	15.24 cm (6")	40703062
90703092	3-Way	22.86 cm (9")	40703092
90703122	3-Way	30.48 cm (12")	40703122

IV Tubing

- ◆ Male Slip Tip Fitting
- ◆ Packaged 25 Per Case

Item No.	Body Style	Length	Kit Component
70015312	3-Way	30.48 cm (12")	40015312
70015320	3-Way	50.80 cm (20")	40015320
70015333	3-Way	83.82 cm (33")	40015333
70015412	4-Way	30.48 cm (12")	40015412
70015420	4-Way	50.80 cm (20")	40015420
70015433	4-Way	83.82 cm (33")	40015433

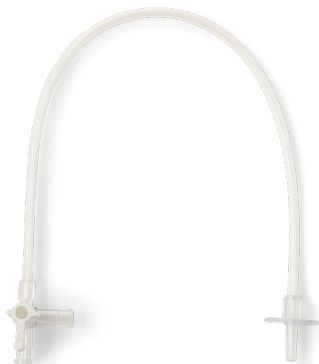

70015312



90703122

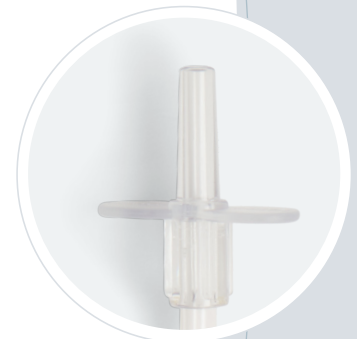

Male Slip Tip

Fluid Delivery Sets

▶ IV Tubing: Drip Chamber

- Designed for saline or contrast dye in operating rooms and labs
- Roller clamp allows flow adjustment
- Available with and without Micron Filter
- Available with and without vent
- Macro Drip Chamber (20 drops/mL)
- Micro Drip Chamber (60 drops/mL)

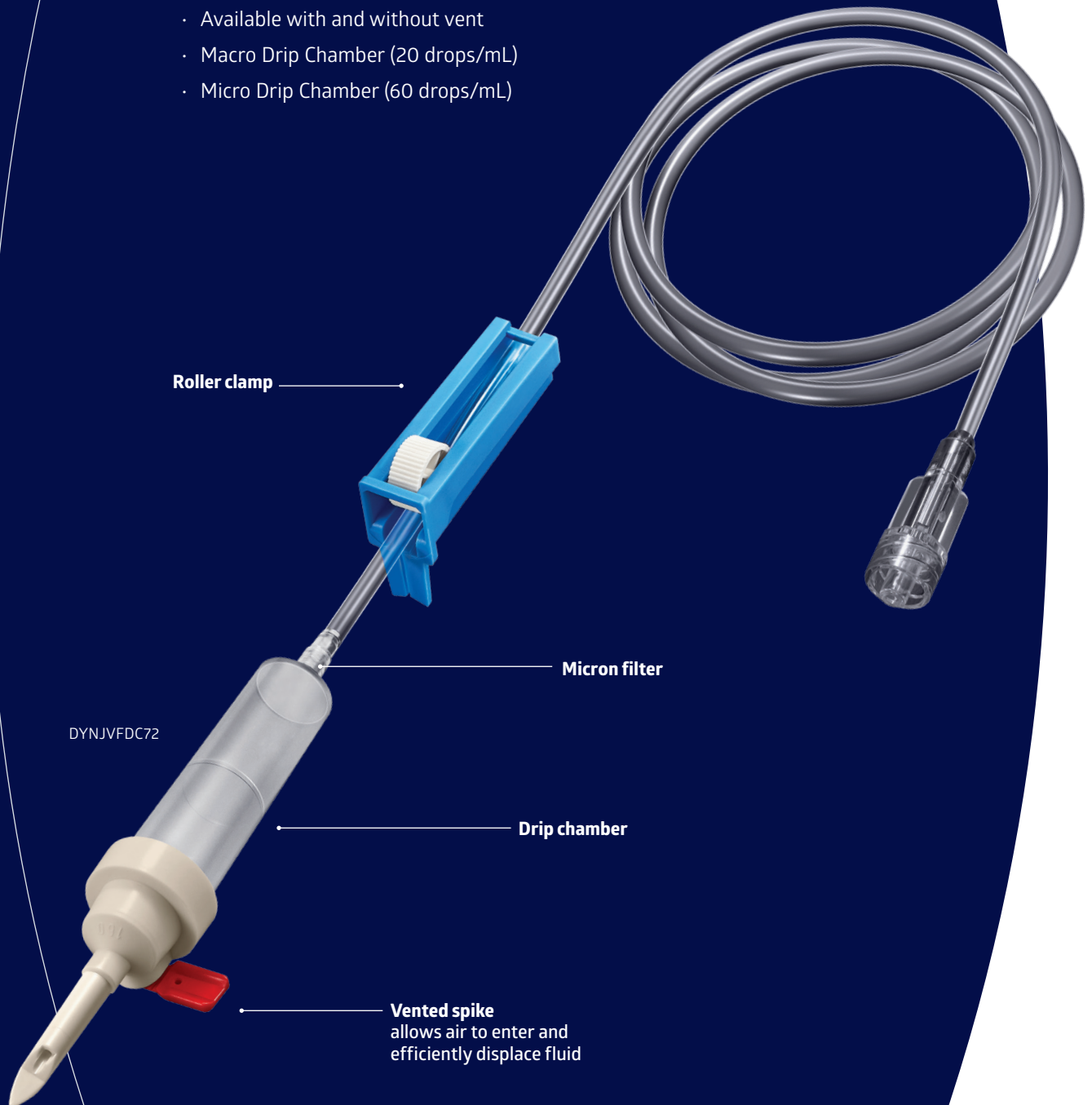

IV Tubing: Vented Drip Chamber

- Macro Chamber Drip
- Packaged 25 Per Case

Vented without Micron Filter

Item No.	Tubing Length	Style	Kit Component
DYNJVNF48	121.92 cm (48")	Single	92524
DYNJVNF60	152.40 cm (60")	Single	129483
91300005	182.88 cm (72")	Single	10029130
DYNJVFD108	274.32 cm (108")	Single	128481

Vented with Micron Filter

Item No.	Tubing Length	Style	Kit Component
DYNJVFD60	152.40 cm (60")	Single	129482
DYNJVFD72*	182.88 cm (72")	Single	49000053

*Functional Match to Kit Component

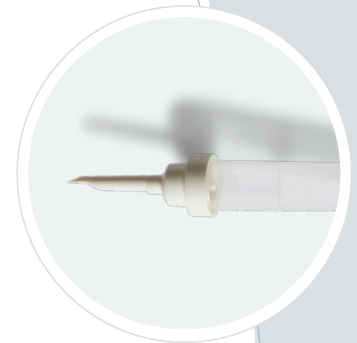

DYNJLBD72

IV Tubing: Non-Vented Drip Chamber

- Packaged 25 Per Case

Non-Vented without Micron Filter

Item No.	Tubing Length	Style	Chamber Drip	Kit Component
91300012	121.92 cm (48")	Bifurcated	Macro	10027012
91300035	182.88 cm (72")	Bifurcated	Macro	10027035
91300013	121.92 cm (48")	Trifurcated	Macro	10027013

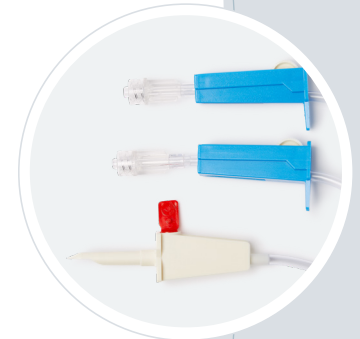

DYNJVSPK48BI

Non-Vented with Micron Filter

Item No.	Tubing Length	Style	Chamber Drip	Kit Component
91300011	121.92 cm (48")	Single	Macro	40427048
91300001	121.92 cm (48")	Single	Micro	10027001
DYNJNVFD60	152.40 cm (60")	Single	Macro	124539
91300052	182.88 cm (72")	Single	Macro	10027052
DYNJNVFDB72	182.88 cm (72")	Bifurcated	Macro	92531
DYNJNVFDT72	182.88 cm (72")	Trifurcated	Micro	129484
91300009	274.32 cm (108")	Single	Macro	10029118
99000070	342.90 cm (135")	Single	Macro	40427028
99000069	342.90 cm (135")	Single	Micro	40427015
—	152.40 cm (60")	Bifurcated	Macro	40438285
—	182.88 cm (72")	Bifurcated	Macro	10029203

Fluid Delivery Sets

IV Tubing: Drip Chamber

CONTINUED

Colored IV Tubing: Drip Chamber

● Single Line

Non-Vented with Micron Filter

		Item No.	Tubing Length	Chamber Drip	Kit Component
Color	Red	—	182.88 cm (72")	Macro	49000191
	Green	—	182.88 cm (72")	Macro	49000190
	Blue	—	182.88 cm (72")	Macro	49000192
	Red	—	243.84 cm (96")	Macro	46638110
	Blue	—	243.84 cm (96")	Macro	46638111
	Red	—	342.90 cm (135")	Macro	49000225
	Blue	—	342.90 cm (135")	Macro	49000226
	Yellow	—	342.90 cm (135")	Macro	49000227
	Green	—	342.90 cm (135")	Macro	49000228
	Red	—	342.90 cm (135")	Micro	49000221
	Blue	—	342.90 cm (135")	Micro	49000222
	Yellow	—	342.90 cm (135")	Micro	49000223
	Green	—	342.90 cm (135")	Micro	49000224

Non-Vented without Micron Filter

		Item No.	Tubing Length	Chamber Drip	Kit Component
Color	Red	—	182.88 cm (72")	Macro	45638144
	Yellow	—	182.88 cm (72")	Macro	45638145
	Green	—	182.88 cm (72")	Macro	49000040
	Blue	—	182.88 cm (72")	Macro	45638174

Vented with Micron Filter

		Item No.	Tubing Length	Chamber Drip	Kit Component
Color	Yellow	—	182.88 cm (72")	Macro	48838075
	Blue	—	182.88 cm (72")	Macro	48838076

Vented without Micron Filter

		Item No.	Tubing Length	Chamber Drip	Kit Component
Color	Red	—	243.84 cm (96")	Macro	49000112
	Yellow	—	243.84 cm (96")	Macro	49000114
	Blue	—	243.84 cm (96")	Macro	49000113

Large Bore Tubing: Drip Chamber

● Packaged 25 Per Case

Item No.	Tubing Length	Vent	Filter	Kit Component
DYNJLBD72	182.88 cm (72")	No	No	35004

IV Tubing: Spike Head

◆ Packaged 25 Per Case

Item No.	Tubing Length	Style	Vent	Kit Component
DYNJVSPK48	121.92 cm (48")	Single	Yes	40427038
DYNJVSPK60	152.40 cm (60")	Single	Yes	129479
91300004	182.88 cm (72")	Single	Yes	40427004
91300040	182.88 cm (72")	Single	No	40427040
91300007	274.32 cm (108")	Single	Yes	40427007
DYNJVSPK48BI	121.92 cm (48")	Bifurcated	Yes	129480
—	172.72 cm (68")	Bifurcated	Yes	40427059

Colored IV Tubing: Spike Head

Color	Item No.	Tubing Length	Vent	Kit Component
Green	—	182.88 cm (72")	Yes	40429019
Blue	—	182.88 cm (72")	Yes	45638152
Red	—	182.88 cm (72")	Yes	40445254
Yellow	—	182.88 cm (72")	Yes	45638137

Large Bore Tubing: Spike Head

◆ Packaged 25 Per Case

Item No.	Tubing Length	Style	Vent	Pressurized	Kit Component
91300020	2.86 cm (1.125")	Single with Female Fitting	Yes	No	41300020
DYNJLBNVSK48	121.92 cm (48")	Single	No	No	129475
DYNJLBVSPK48	121.92 cm (48")	Single	Yes	No	129476
DYNJLBVSPK60	152.40 cm (60")	Single	Yes	No	129478
91300026	182.88 cm (72")	Single	Yes	No	40427275
91300021	182.88 cm (72")	Single with Sosa Spike	Yes	Sosa	41300031
90500070	182.88 cm (72")	Single with Dual Back Check Valve	Yes	No	40401601
—	274.32 cm (108")	Single	Yes	Sosa	41300032

Colored Large Bore Tubing: Spike Head

Color	Item No.	Tubing Length	Vent	Kit Component
Blue	—	182.88 cm (72")	Yes	49000056
Yellow	—	182.88 cm (72")	Yes	45638095
Red	—	182.88 cm (72")	Yes	49000057

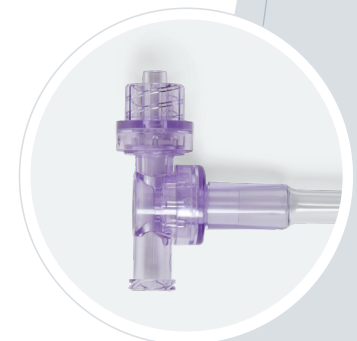

90500070

Closed Fluid Systems

▶ Protection Station Plus

- Designed for easy access to saline flush and contrast media with closed fluid waste containment
- For reduced exposure to bloodborne pathogens during procedures
- Simpler setup and cleanup



64000934

How the namic protection station closed fluid system works

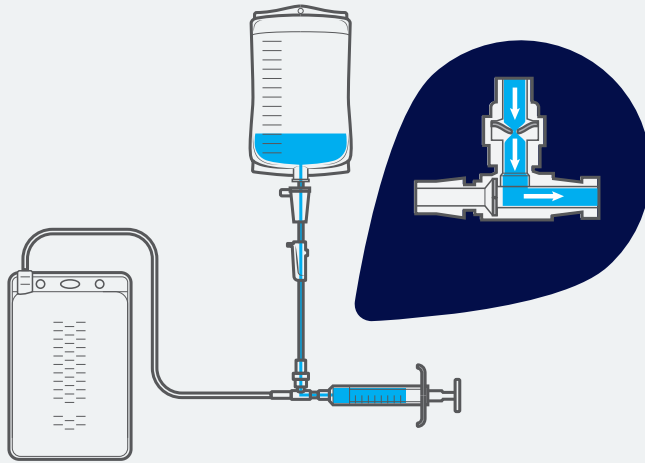

Aspiration

As syringe is aspirated, 1-way valve leading to saline opens, filling syringe, while the valve to the waste bag closes.

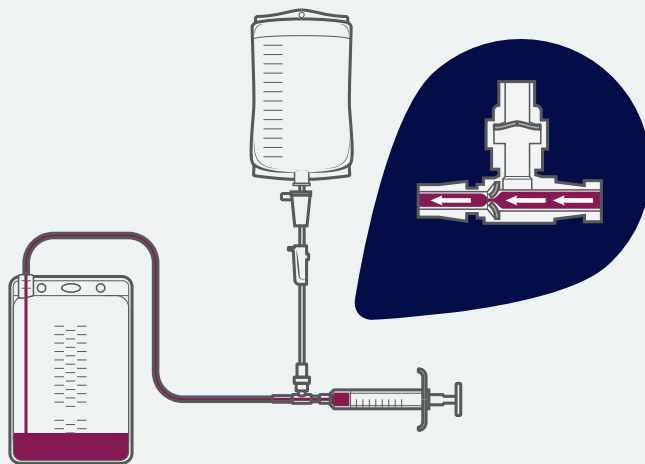

Injection

1-way valve leading into waste bag opens when syringe fluids are infused, allowing the passage of bodily fluids while the valve to the saline closes.

Closed Fluid Systems

Protection Station

◆ Packaged 20 Per Case

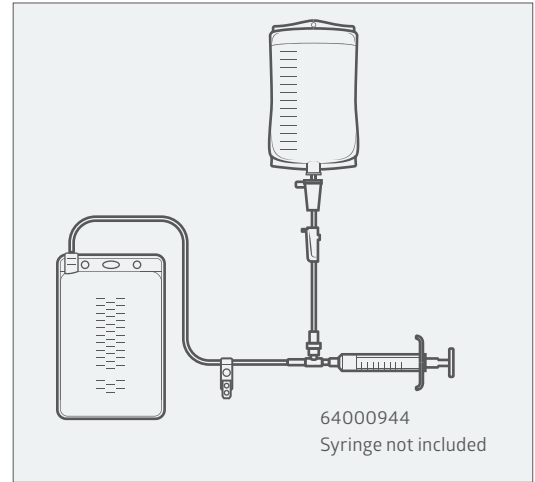

Vented Spike Head

Item No.	Pressurized	Number of Lines	Fitting	Strap Clip	Kit Component
64000934	No	Single	Female		40400900
64000944	No	Single	Female	■	40400900; 10045242
94000904	No	Bifurcated	Female	■	40400904; 10045242

Drip Chamber

Item No.	Pressurized	Number of Lines	In-Line Stopcock	Fitting	Reflux Valve	Strap Clip	Kit Component
DYNJWBDC*	Yes	Single		Female			40400950
94000952	Yes	Single	■	Male			40400952; 10027052; 40027180
64000936†	Yes	Single		Male			40400950; 40027180;
94000954	Yes	Bifurcated		Female	■	■	40400954; 10045242; 40400102
—	Yes	Bifurcated Dual Access		Female	■		46627307; 40400102

*Functional Match to Kit Component

†Packaged 10/bx

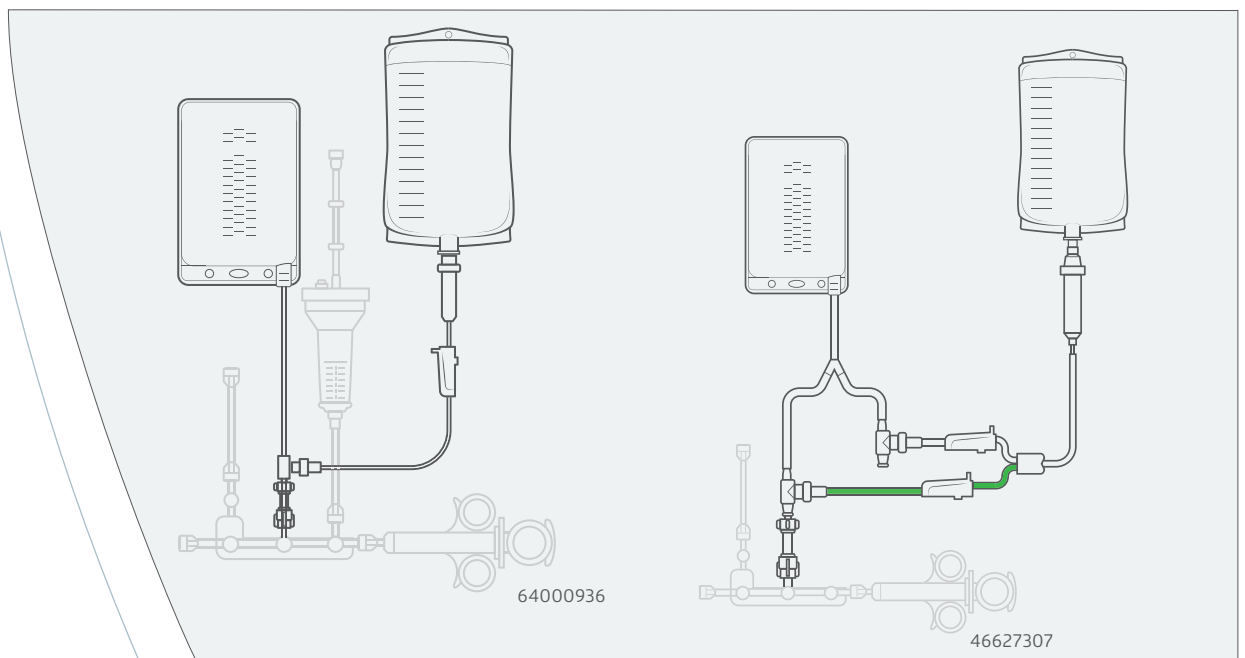

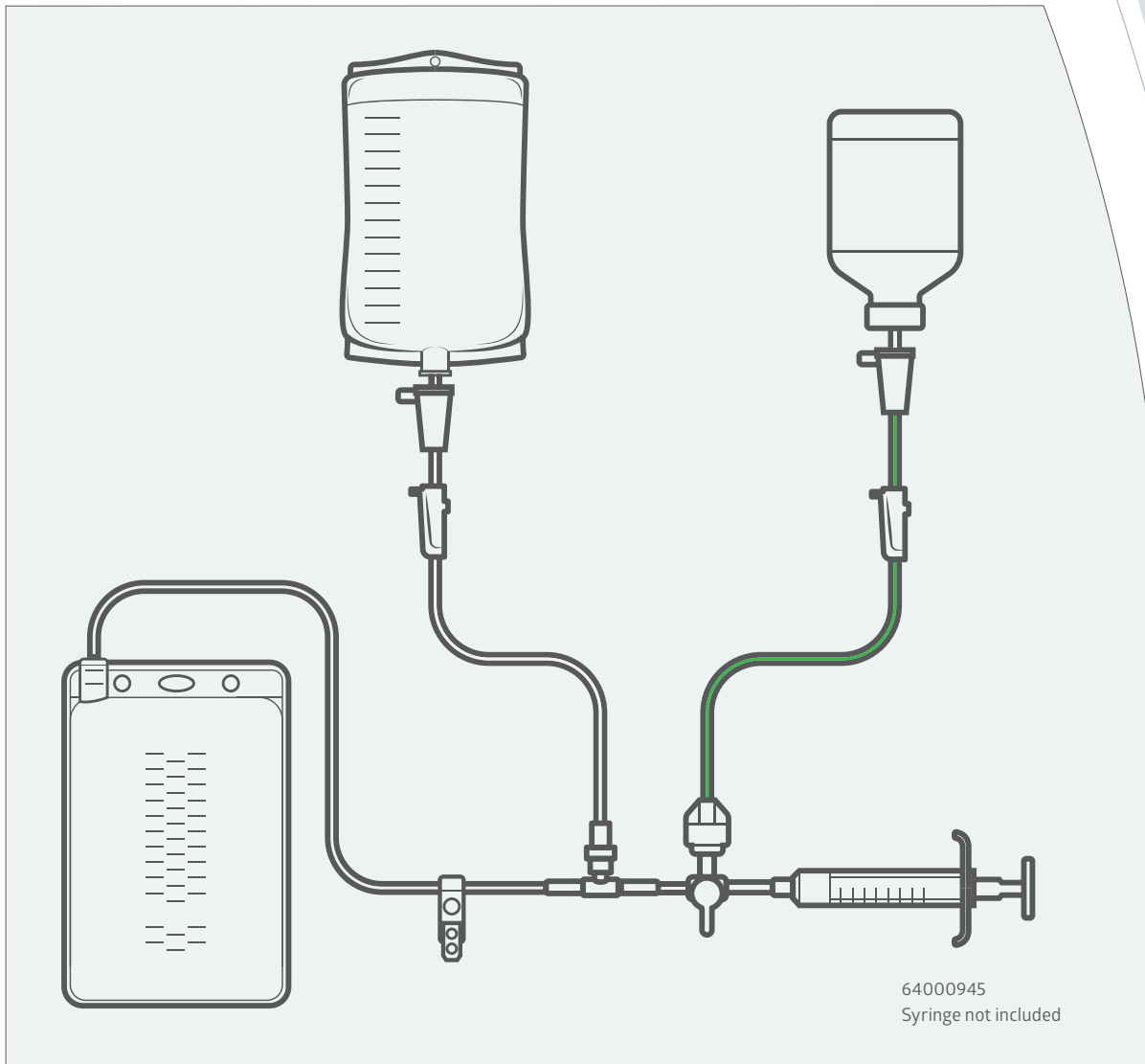

Protection Station Plus

- Female Fitting
- Packaged 20 Per Case

Item No.	Pressurized	Bonded Reflux Valve	Contrast Line	Strap Clip	Kit Component
6400935	No		Green Striped		40400910; 40429019
6400945	No		Green Striped	■	40400910; 40429019; 10045242
—	No		Blue Striped, Large Bore	■	40400910; 49000056; 10045242
—	Yes	■	Green Striped	■	45627690; 40429019; 10045242

Closed Fluid Systems

Protection Station Plus with Contrast Management

- Female Fitting
- Contrast Line with two In-Line Check Valves
- Packaged 20 Per Case

Item No.	Pressurized	Bonded Reflux Valve	Strap Clip	Kit Component
—	No			40400910; 40400010
—	No		■	40400910; 40400010; 10045242
64000955	No			40400911; 40400018*
—	No	■	■	45627690; 40400010; 10045242

*Green striped tubing

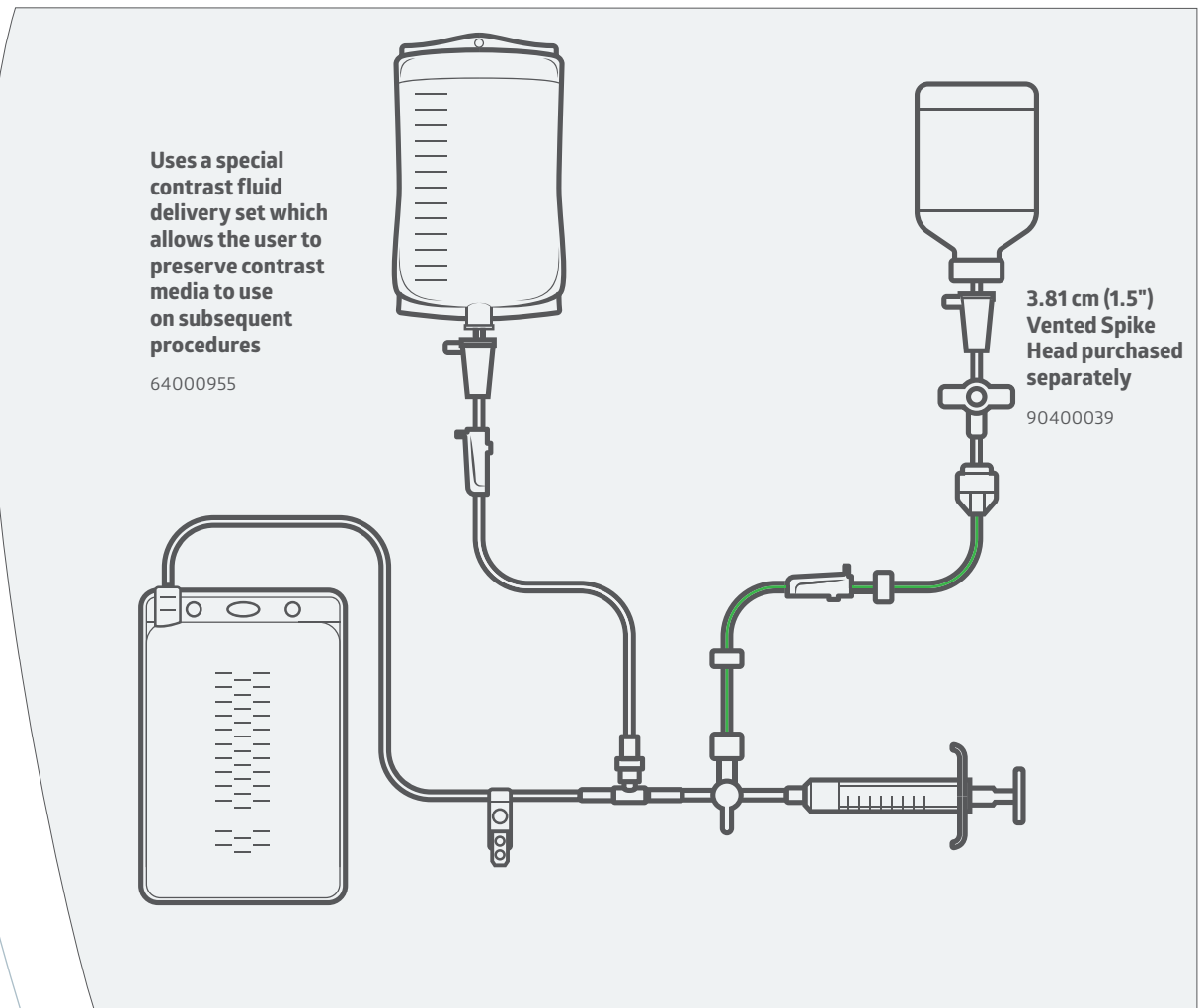

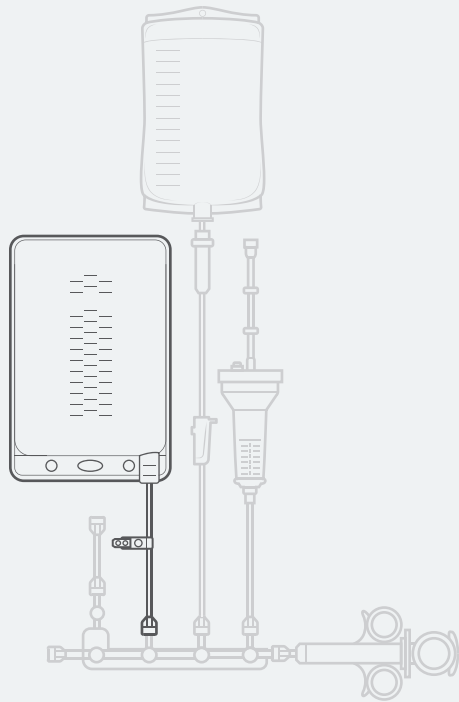

Optional Drape Clip
90500018

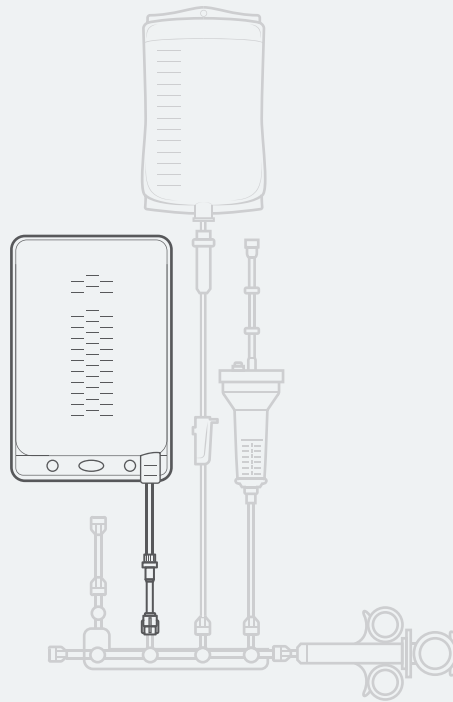

In-Line Check Valve
40400933

► Waste Collection System

Item No.	System	Bag Size	Fitting	Check Valve	Strap Clip	Kit Component	Pkg.
90500018	Collection Station, 72" tubing	1000 mL	Male			10500026; 10045242	25/bx
—	Collection Station, 72" tubing	1000 mL	Male	■		40400933	
64000925	Collection Station, 48" tubing	1000 mL	Female	■		40400906	10/bx
90500028	Collection System with Drainage Clamp, 72" tubing	1500 mL	Male	■	■	40500028; 10045242	25/bx
—	Collection System with Drainage Clamp, 48" tubing	1500 mL	Male			10500022	
90500040	Abscess Drainage Set	1000 mL				40400940	10/bx
90500050	Palestrant Irrigation and Drainage Set	1500 mL			■	40500050, 10500022, 10045242	5/bx
90500060	Filling Station		Female			40400106; 10027052; 40427275	10/bx
90500065	Filling Station Plus	1000 mL	Female			40400106; 10027052; 40427275; 10500026	10/bx

Contrast Injection Lines

Tubing Types

	Pressure	Clarity	Flexibility
LPCIL	500 PSI	High	Medium
HPCIL	1000 PSI	High	Low
flexCIL	1200 PSI	Medium	High
clearaCIL	1200 PSI	High	Medium

▶ LPCIL—Low Pressure Contrast Injection Line

- 500 PSI
- Medium Flexibility
- High Clarity
- 4.04 mm (0.159") outer diameter; 2.26 mm (0.089") inner diameter
- Packaged 25 Per Case

Male–Female Luer Lock

Item No.	Length	Kit Component
91021102	25 cm (10")	41021102
91021202	51 cm (20")	41021202
91021302	76 cm (30")	41021302
91021482	122 cm (48")	41021482
—	152 cm (60")	41021602
—	183 cm (72")	41021722

Male–Male Luer Lock

Item No.	Length	Kit Component
—	51 cm (20")	41022202
—	122 cm (48")	41022482
—	183 cm (72")	41022722

Rotating Male Adaptor–Male

Item No.	Length	Kit Component
—	25 cm (10")	45632124

Rotating Male Adaptor–Female

Item No.	Length	Kit Component
—	25 cm (10")	49000153
—	51 cm (20")	45632116
—	122 cm (48")	45632106

91021102



HPCIL—High Pressure Contrast Injection Line

- 1000 PSI
- Low Flexibility
- High Clarity
- 4.78 mm (0.188") outer diameter; 2.26 mm (0.089") inner diameter
- Packaged 25 Per Case

Male–Female Luer Lock

Item No.	Length	Kit Component
91011102	25 cm (10")	41011102
91011202	51 cm (20")	41011202
91011302	76 cm (30")	41011302
91011482	122 cm (48")	41011482
91011602	152 cm (60")	41011602
DYNJTBGHP72F*	183 cm (72")	41011722
DYNJTBGHP84F	213 cm (84")	127313
DYNJTBGHP96F*	244 cm (96")	41011962

Male–Male Luer Lock

Item No.	Length	Kit Component
—	152 cm (60")	41012602

Rotating Male Adaptor–Female

Item No.	Length	Kit Component
91001103	25 cm (10")	41001103
91001203	51 cm (20")	41001203
91001303	76 cm (30")	41001303
91001483	122 cm (48")	41001483
91001603	152 cm (60")	41001603
DYNJTBGHP72R*	183 cm (72")	45632122
—	203 cm (80")	41001803
DYNJTBGHP84R*	213 cm (84")	127311
DYNJTBGHP96R*	244 cm (96")	127309

* Functional Match to Kit component



91011482

Contrast Injection Lines

flexCIL High Pressure Contrast Injection Line

- Made of braided polyurethane for extra strength and maximum flexibility
- Designed to withstand up to 1,200 PSI
- 3.58 mm outer diameter; 1.8 mm inner diameter



91051483

flexCIL High Pressure Contrast Injection Line

- 1200 PSI
- High Flexibility
- Medium Clarity
- 3.6 mm (0.142") outer diameter; 1.8 mm (0.071") inner diameter
- Packaged 25 Per Case

Male Luer Lock–Female

Item No.	Length	Kit Component
—	10 cm (4")	41051042
91051102	25 cm (10")	41051102
91051202	51 cm (20")	41051202
91051302	76 cm (30")	41051302
91051482	122 cm (48")	41051482
91051602	152 cm (60")	41051602
91051722	183 cm (72")	41051722
DYNJBRT84F	213 cm (84")	127638
DYNJBRT96F	244 cm (96")	127636

Rotating Male Adaptor–Female

Item No.	Length	Kit Component
91051103	25 cm (10")	41051103
91051203	51 cm (20")	41051203
91051303	76 cm (30")	41051303
91051483	122 cm (48")	41051483
91051603	152 cm (60")	41051603
91051723	183 cm (72")	41051723
DYNJBRT84R	213 cm (84")	127639
DYNJBRT96R	244 cm (96")	127637

Female–Female Luer Lock

Item No.	Length	Kit Component
—	122 cm (48")	41051481

flexCIL High Pressure Contrast Injection Line with Drape Clip

- Includes Drape Clip
- Packaged 25 Per Case

Male Luer Lock–Female

Item No.	Length	Kit Component
92051102	25 cm (10")	41051102; 10045242
92051202	51 cm (20")	41051202; 10045242
92051302	76 cm (30")	41051302; 10045242
92051482	122 cm (48")	41051482; 10045242
92051602	152 cm (60")	41051602; 10045242
92051722	183 cm (72")	41051722; 10045242
DYNJBRTC84F	213 cm (84")	127638; 103098
DYNJBRTC96F	244 cm (96")	127636; 103098

Rotating Male Adaptor–Female

Item No.	Length	Kit Component
92051103	25 cm (10")	41051103; 10045242
92051203	51 cm (20")	41051203; 10045242
92051303	76 cm (30")	41051303; 10045242
92051483	122 cm (48")	41051483; 10045242
92051603	152 cm (60")	41051603; 10045242
92051723	183 cm (72")	41051723; 10045242
DYNJBRTC84R	213 cm (84")	127639; 103098
DYNJBRTC96R	244 cm (96")	127637; 103098



91051482

Contrast Injection Lines

▶ clearaCIL High Pressure Contrast Injection Line

- Clear and flexible for easy debubbling and positioning
- Dual-layer nylon and urethane for added strength and clarity
- Designed to withstand up to 1,200 PSI
- 3.58 mm outer diameter; 1.8 mm inner diameter

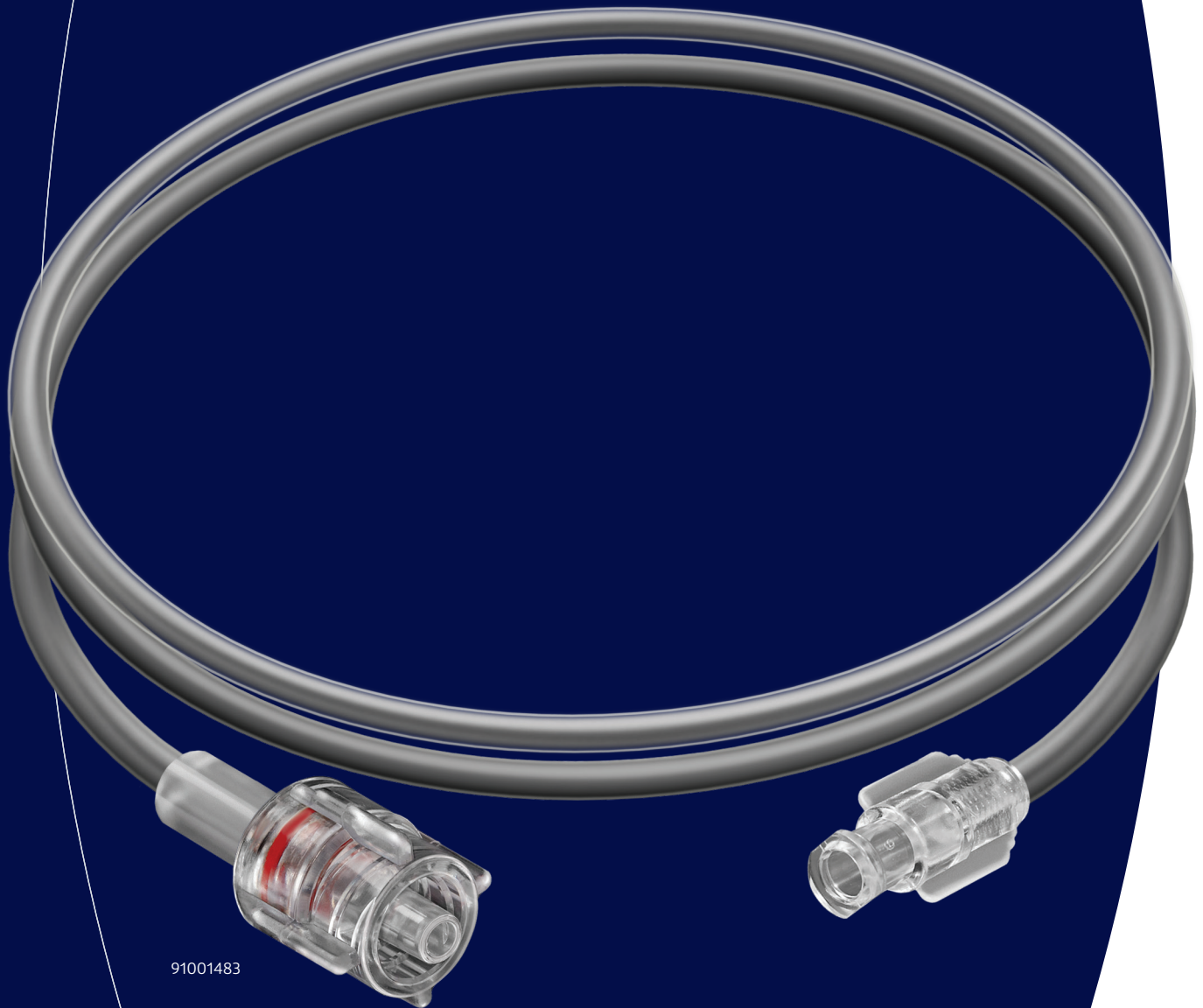

91001483

clearaCIL High Pressure Contrast Injection Line

- 1200 PSI
- Medium Flexibility
- High Clarity
- 3.58 mm (0.141") outer diameter; 1.8 mm (0.071") inner diameter
- Packaged 25 Per Case

Male-Female Luer Lock

Item No.	Length	Kit Component
91031102	25 cm (10")	41031102
91031202	51 cm (20")	41031202
91031302	76 cm (30")	41031302
91031482	122 cm (48")	41031482

Rotating Male Adaptor-Female

Item No.	Length	Kit Component
91031103	25 cm (10")	41031103
91031203	51 cm (20")	41031203
91031303	76 cm (30")	41031303
91031483	122 cm (48")	41031483

clearaCIL High Pressure Contrast Injection Line with Drape Clip

Male-Female Luer Lock

Item No.	Length	Kit Component
92031102	25 cm (10")	41031102; 10045242
92031202	51 cm (20")	41031202; 10045242
92031302	76 cm (30")	41031302; 10045242
92031482	122 cm (48")	41031482; 10045242

Rotating Male Adaptor-Female

Item No.	Length	Kit Component
92031103	25 cm (10")	41031103; 10045242
92031203	51 cm (20")	41031203; 10045242
92031303	76 cm (30")	41031302; 10045242
92031483	122 cm (48")	41031483; 10045242



Fluid Management Accessories

► Caps and Port Protectors

- Cap stopcocks, tubing and manifolds to protect against particulates
- Available in red, white and blue
- High-density polyethylene
- Non-vented



Caps and Port Protectors

- Universal Male-Female Fitting
- Packaged 100 Per Case

Item No.	Color	Kit Component
DYNJCAP	White	956690
DYNJCAPR	Red	114306
DYNJCAPB	Blue	—

DYNJCAPR



Connectors and Adaptors

- Luer locks enable connections across a wide variety of components
- Clear polycarbonate

- Packaged 50 Per Case

Item No.	Fittings	Tubing	Kit Component
DYNJADAPMM*	Rotating Male Luer Lock-Male		40027180
DYNJADAPMF	Rotating Male Luer Lock-Female		40044103
90705101	Fixed Female-Female	5 cm (2")	40705101
90705202	Fixed Male-Male	5 cm (2")	40705202

* Functional Match to Kit component



90705202

90705101

Closed Valves

- Prevent the accidental contamination of fluids or medications
- Polycarbonate with silicone disc
- 45 PSI
- Flow rate: 325 mL/min

- Packaged 50 Per Case



DYNJCHKVALVE

Item No.	Fitting	Kit Component
DYNJCHKVALVE	Fixed Male-Female	40400102

Safety

▶ Fluid Decanters

- Our fluid decanters help ensure an aseptic transfer or removal of fluids from flexible and rigid containers

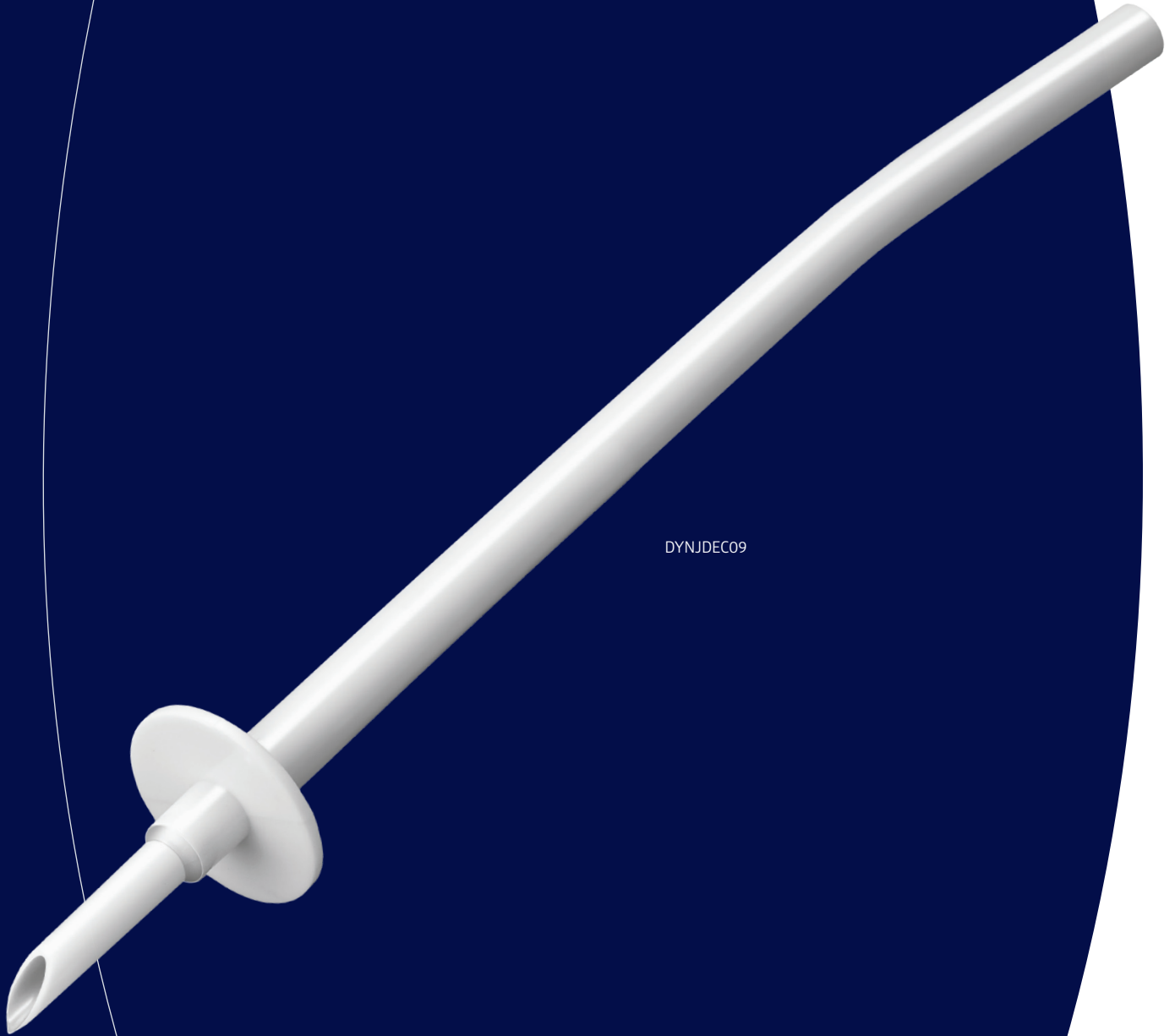

DYNJDEC09

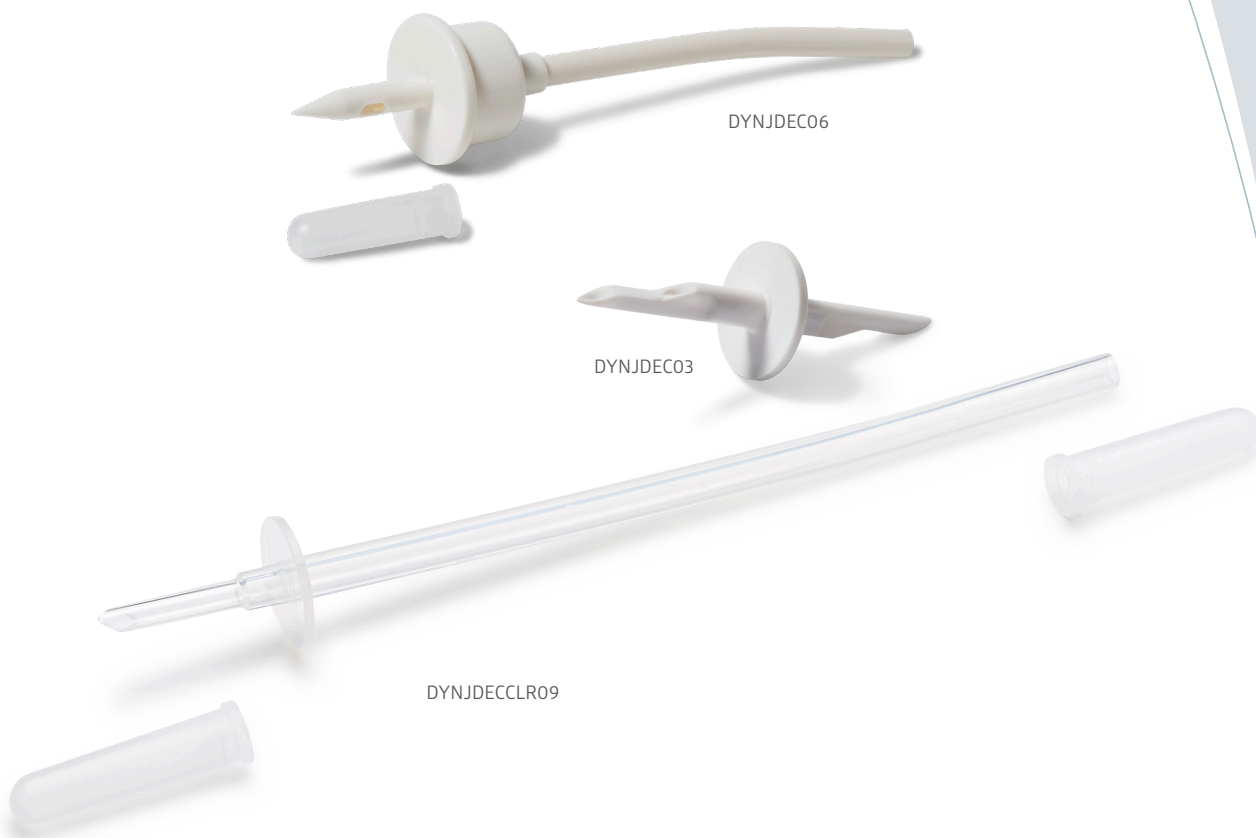

Fluid Decanters

● Packaged 50 per case

Item No.	Description	Kit Component
DYNJDEC03	3" Opaque Transfer	47578
DYNJDEC06	6" Opaque Vial	83480
DYNJDEC09	9" Opaque Bag	92101
DYNJDEC09CLR	9" Clear Bag	124719

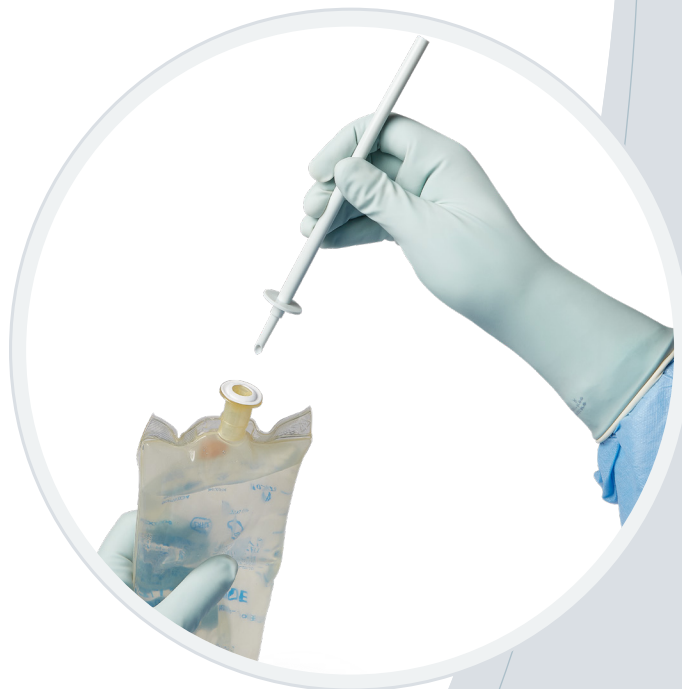

Safety

◆ Basin Safety

- Safety-Splash 500 mL fluid waste bowl is a self-contained fluid management system that holds biohazardous waste from cardiac catheterization, angiography and O.R. procedures
- The absorbent pads help eliminate the need to transport medical waste in liquid form and help minimize the risk of exposure for healthcare workers



DYNJSPLASH2

Fluid Waste Bowls

● Packaged 24 per case

Item No.	Absorbent Material	Color
DYNJSPLASH1	Solidifier	Gold
DYNJSPLASH2	Absorbent Material	Blue
DYNJSPLASH3	None	Blue



DYNJSPLASH1



DYNJSPLASH3

Needle Safety and Waste Management Kit

- Everything you need for needle and fluid safety

● Packaged 24 Per Case

Item No.	Includes	Kit Component
DYNJNDLN SPL	DYNJNDLNEST and DYNJSPLASH2	126794, 35862



Labels

Standard Label Kits

- Synthetic material stays intact when exposed to fluids
- Water-resistant inks won't bleed or dissolve
- Kits include permanent marker with ultrafine point
- Black and white or color options available

◆ Packaged 12 sets/cs

DYNJCATHLBL13

Item No.	Total Number of Labels	Standard Straight Labels															Curved Bowl Labels					Kit Components					
		Blank	Adenosine	Aminophylline	Cardizem	Contrast	Heparin	Heparin/Saline	Levophed	Lidocaine	Morphine Sulfate	Nicardipine	Nipride	Nitro	Prep Solution	Saline	Specimen	Sterile Water	TPA	Verapamil	Versed		Blank	Contrast	Heparin/Saline	Prep Solution	Saline
DYNJCATHLBL	30	10	1		4	2	4	2				2	4						1							95806*	
DYNJCATHLBL1	39	9	1	1	4	1	3	1	4	1	1	1	1	4	2	1	1	1	1							127824*	
DYNJCATHLBL13	46	9	1	1	4	1	3	1	4	1	1	1	1	4	2	1	1	1	1	2	1	2	1	1		127824, 127818*	
DYNJCATHLBL2	31	13	1	1	3	1	3	1	2		1	1	1	1				1								127823*	
DYNJCATHLBL3	18	13	1	1	3	1	3	1	2		1	1	1	1				1		3		2				127823, 127820*	
DYNJCATHLBL4	21	14	1	1	3	1	3	1	2		1	1	1	1				1		2	1	2	1	1		127823, 127819*	
DYNJCATHLBL5	15	9			1	1	1	1					1	1												127822*	
DYNJCATHLBL6	20	9			1	1	1	1					1	1						3		2				127822, 127820*	
DYNJCATHLBL7	22	9			1	1	1	1					1	1						2	1	2	1	1		127822, 127819*	
DYNJCATHLBL8	15	15																								127821*	
DYNJCATHLBL9	20	15																		5						127821, 129737*	
DYNJCATHLBL10	22	15																		7						127821, 129735*	
DYNJCATHLBL11	5																			3		2				127820*	
DYNJCATHLBL12	7																			2	1	2	1	1		127819*	
DYNJCATHLBL13	7																			2	1	2	2			125616*	
—	30	4	2		4	2	6	4						4				2								11245256**	
—	30	4	2		4	2	6	4						4				2								11245258	
—	30	4	2		4	2	6	4						4				2								11245259†	
—	30	6		2								2												3		(2) Cardene (2) D5W (2) Isuprel (2) Lidocaine/Epi (3) Radial Flush (2) Vancomycin (2) Xylocain (2) Marcaine .25%	11245260

* Includes Kit Component 44035 (Marker)
 ** Labels have a transparent background
 † Colored label sheet

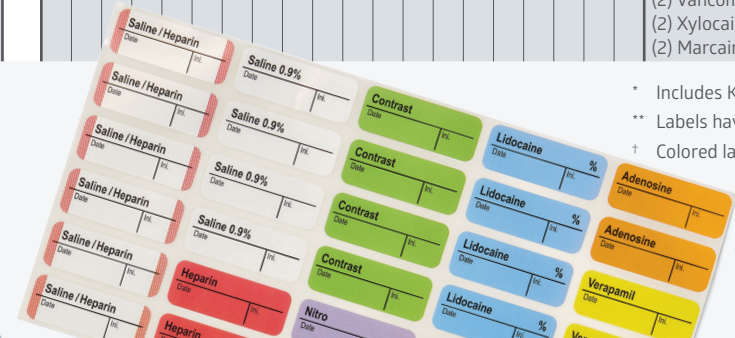

11245259

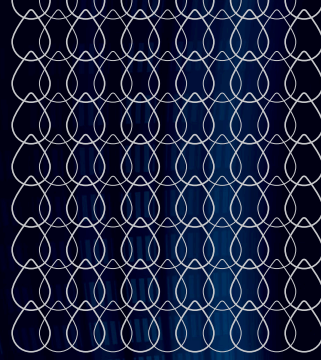

PATIENT MONITORING

Disposable Transducers	78
Pressure Monitoring Lines	80
Arterial Line Kits	82
Transducer Accessories	83
Reusable Pressure Transducer Cables	84

PATIENT MONITORING

Deliver an enhanced patient experience.

A broad scope of innovative and outcome driven solutions ensure waveform accuracy and blood pressure monitoring reliability for improved procedural efficiency.



100%

We test 100% of our transducers for leakage and accuracy.¹



Patient Monitoring

► Disposable Pressure Transducers

- Clear, visible fluid path makes it easy to flush and debubble the line
- Accurate and real-time internal pressure measurements

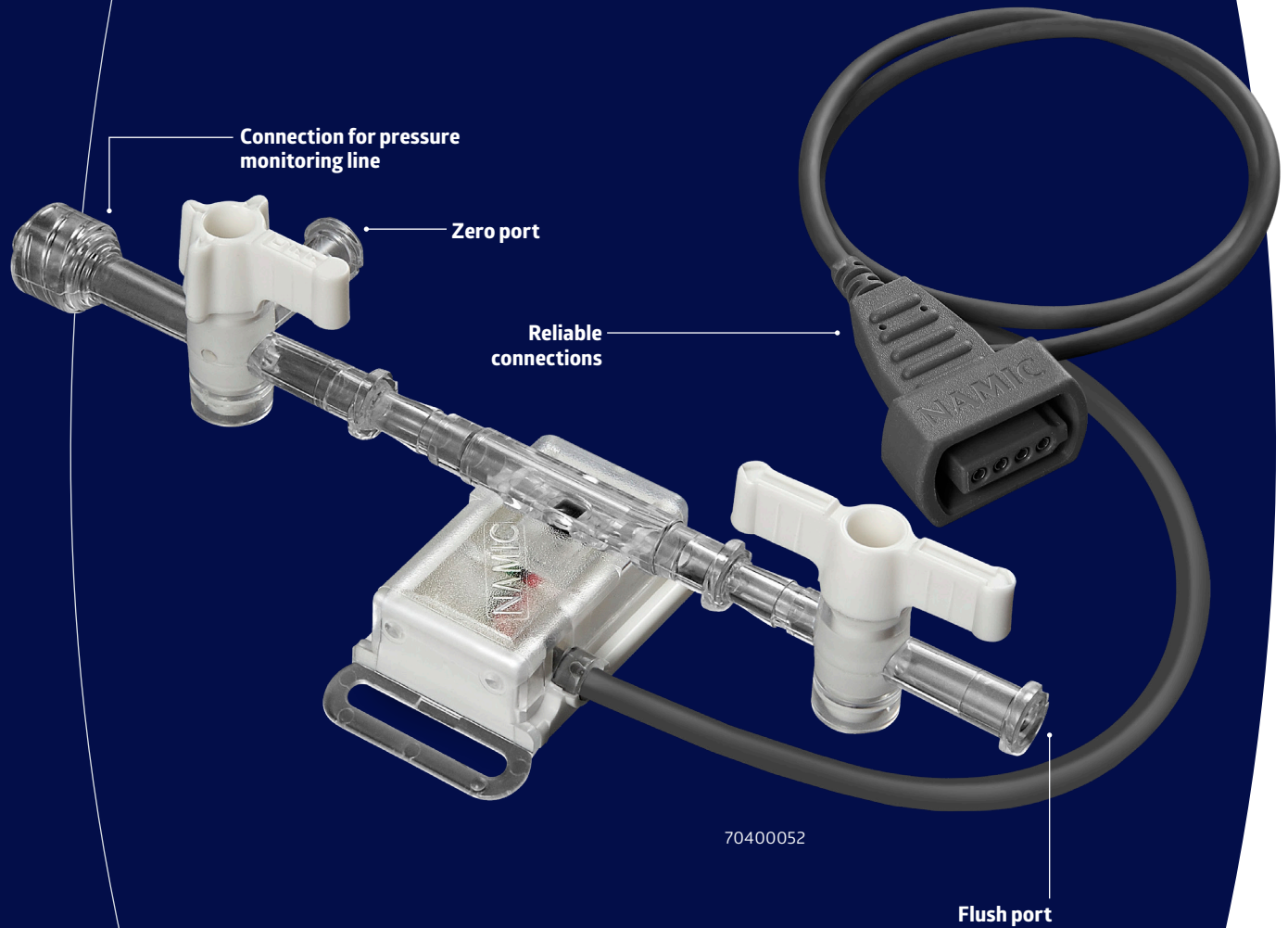



Disposable Pressure Transducers

Item No.	Stopcocks	Flush Device	Cable Length	Pkg	Kit Component
70030013	None	No	61 cm (24")	10/bx	40030013
70030014	None	No	122 cm (48")	10/bx	40030014
70400057	1-Way	No	122 cm (48")	20/bx	40400057
70400052	1-Way and 3-Way	No	61 cm (24")	20/bx	40400052
70036001	3-Way	3 mL/hr	61 cm (24")	10/bx	40400050
70400055	3-Way and 1-Way	No	61 cm (24")	20/bx	40400055
70030020	3-Way Horizontal	No	122 cm (48")	20/bx	40030020
70030021	3-Way Vertical	No	122 cm (48")	20/bx	40030021

Patient Monitoring

▶ Pressure Monitoring Lines

- Compatible with manifolds, tubing, stopcocks and other components
- Effective transmission of internal blood pressure from the patient to the transducer
- High-quality waveforms with improved fidelity



90701482

Adult Pressure Monitoring Lines

Male-Female Luer Lock

- Packaged 25 Per Box
- Inner diameter 0.059" (1.50 mm);
Outer diameter 0.128" (3.25 mm)

Item No.	Tubing Length	Kit Component
90701062	15.24 cm (6")	40701062
90701122	30.5 cm (12")	40701122
90701242	61 cm (24")	40701242
90701362	91 cm (36")	40701362
90701482	122 cm (48")	40701482
90701602	152 cm (60")	40701602
90701722	183 cm (72")	40701722
90701842	213 cm (84")	40701842
90701962	244 cm (96")	40701962

Male-Male Luer Lock

- Packaged 25 Per Box
- Inner diameter 0.059" (1.50 mm);
Outer diameter 0.128" (3.25 mm)

Item No.	Tubing Length	Kit Component
—	15.24 cm (6")	40702062
90702122	30.5 cm (12")	40702122
90702242	61 cm (24")	40702242
90702362	91 cm (36")	40702362
90702482	122 cm (48")	40702482
90702602	152 cm (60")	40702602
90702722	183 cm (72")	40702722
90702842	213 cm (84")	40702842
90702962	244 cm (96")	40702962

Pediatric Pressure Monitoring Lines

Male-Female Luer Lock

- Packaged 25 Per Box
- Inner diameter 0.044" (1.12 mm);
Outer diameter 0.098" (2.50 mm)

Item No.	Tubing Length	Kit Component
90711062	15.24 cm (6")	40711062
90711122	30.5 cm (12")	40711122
90711242	61 cm (24")	40711242
90711362	91 cm (36")	40711362
90711482	122 cm (48")	40711482
90711722	183 cm (72")	40711722

Male-Male Luer Lock

- Packaged 25 Per Box
- Inner diameter 0.044" (1.12 mm);
Outer diameter 0.098" (2.50 mm)

Item No.	Tubing Length	Kit Component
—	15.24 cm (6")	40712062
90712122	30.5 cm (12")	40712122
90712242	61 cm (24")	40712242
90712362	91 cm (36")	40712362
90712482	122 cm (48")	40712482
90712722	183 cm (72")	40712722



Patient Monitoring

Arterial Line Kits

- Disposable transducer features a 3 mL/hour flush device
- 72" administration set with micron-filtered drip chamber
- 48" and 12" pressure monitoring lines
- Two 3-way stopcocks

Pressure Monitoring Line 1

Item No.	Description	Pkg.
70036148	48" (122 cm) Male-Female Luer Lock	10/cs
70036160	60" (152 cm) Male-Female Luer Lock	10/cs

Available in additional configurations

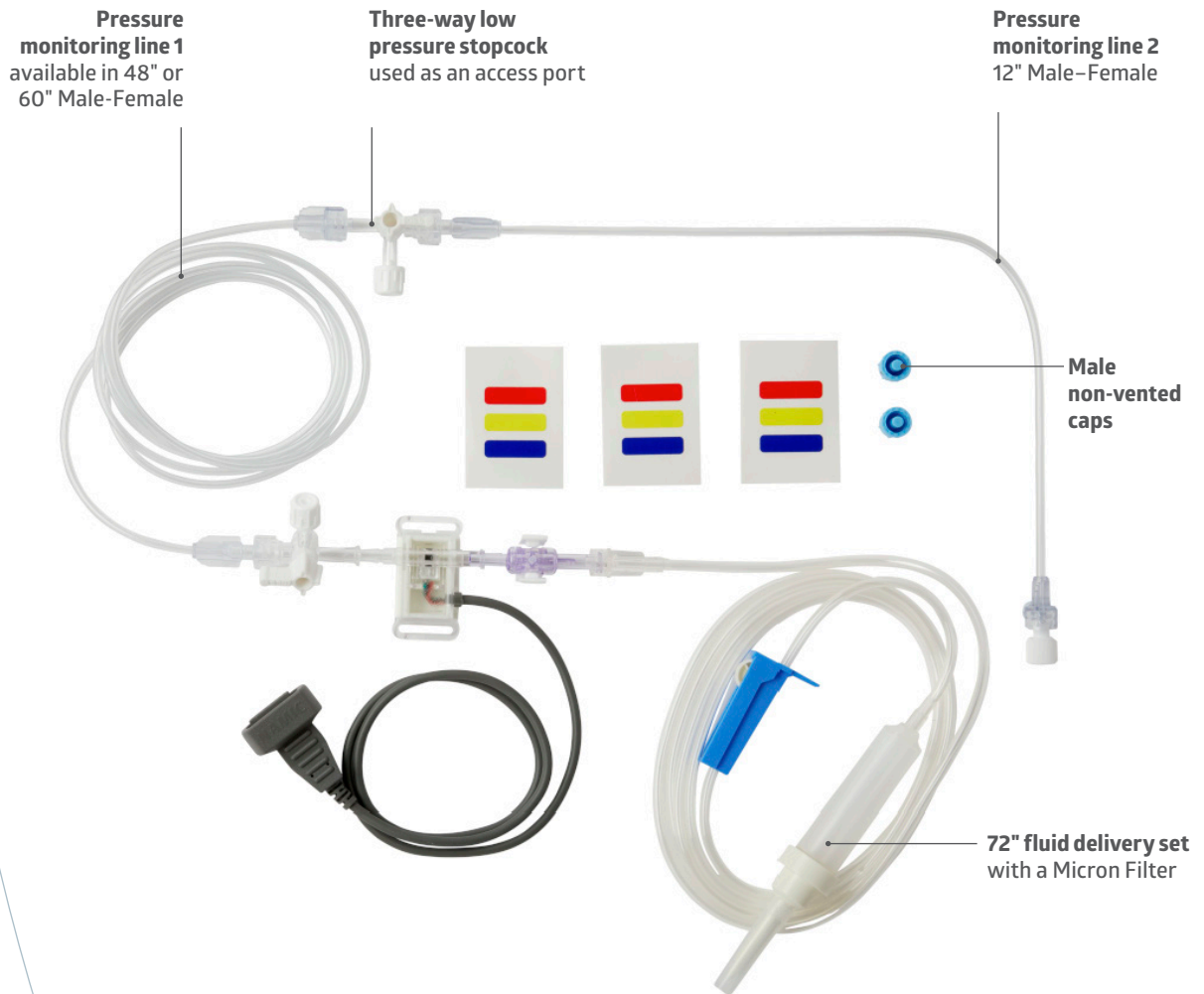

Transducer Accessories

- Designed to safely hold transducers in place for accurate readings
- Fully reusable for long-term savings
- Only compatible with Namic disposable transducers

Mounting Plates

Item No.	Transducer Slots	Pkg.
70030152	2	Each
64000153	4	Each

Pole Clamps

Item No.	Material	Transducer Position	Pkg.
64000270	Metal	Vertical	Each
70030051	Plastic	Vertical	Each
70030053	Metal	Vertical	Each
70030054	Metal	Horizontal	Each



70030152 and 70030051



70030053 and 64000153

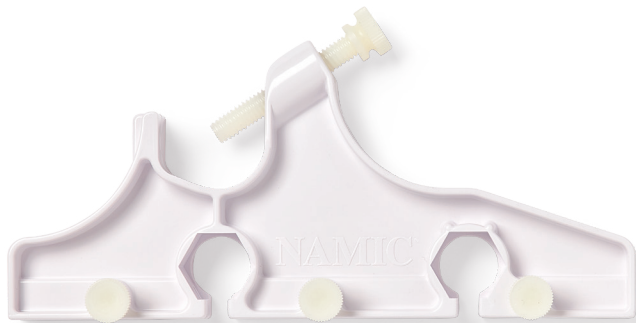

70030051



70030152

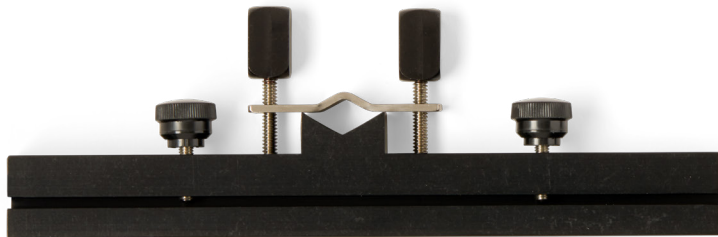

70030054

Patient Monitoring

Reusable Pressure Transducer Cables

- Reusable hemodynamic cables
- Connects the transducer to the hemodynamic system
- Durable design to ensure firm connection
- Additional cables available upon request

● **Packaged Individually**

Additional
cables
available

Camtronics/Emageon/Merge/ Amicas/Medcon/Mckesson

Popular Models Include

Physiolog PDM
3.X PB100 TCS Symphony/Windsurfer

Item No.	Length	Shape	Number of Pins
64042051	6'	Round	4
64042050	12'		



Camtronics/Emageon/Merge/ Amicas

Popular Model Includes

PDM V2

Item No.	Length	Shape	Number of Pins
64042061	12'	Round	4



Phillips/Hewlett Packard

Popular Models Include

Rifle Shot, Intellivue, Haemosphere, HP70, XPER Flex, MP5, MP30

Item No.	Length	Shape	Number of Pins
70040613	6'	Round	12
70041203	12'		

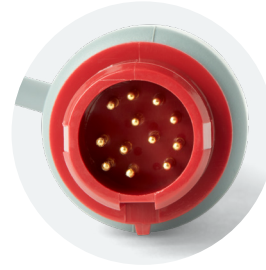

Marquette/GE

Popular Models Include

Tram Series (X00), Maclab 7000, Dash 4000, Innova

Item No.	Length	Shape	Number of Pins
64040633	6'	Rectangular	11
70041223	12'		



Marquette/GE

Popular Models Include

Tram 7000, 7200, 2000 Series

Item No.	Length	Shape	Number of Pins
70040624	6'	Round	7
70041214	12'		



Nihon Kohden

Popular Models Include

Lifescopes Series

Item No.	Length	Shape	Number of Pins
70040625	6'	Round	5
70041215	12'		



Patient Monitoring

Reusable Transducer Cables CONTINUED

Prucka/Cardiolab

Popular Model Includes

CLAB II, Art-1, Art-2

Item No.	Length	Shape	Number of Pins
64042029	12'	Round	5



Siemens/Drager/Infinity

Popular Models Include

Physiolog PDM Sensis, Infinity, Hemomed/Hemopod, Artis, Delta

Item No.	Length	Shape	Number of Pins
70040614	6'	Round	6
70041204	12'		

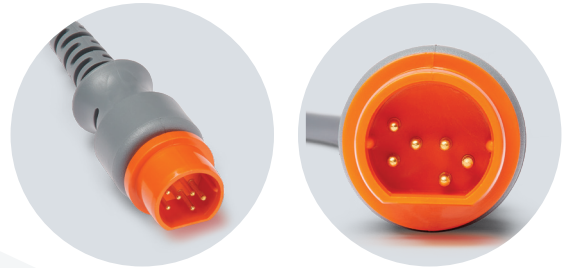

Bard Siemens/Drager/Infinity Space Lab/Tektonix

Popular Models Include

CPS Transak System 8000, North American Models, Mindray PM9000

Item No.	Length	Shape	Number of Pins
70040621	6'	Round	6
70041211	12'		



Witt Biomedical/Phillips

Popular Models Include

Series IV Digital Front End, Xper IM

Item No.	Length	Shape	Number of Pins
64042053	6'	Rectangular	5
64042054	12'		



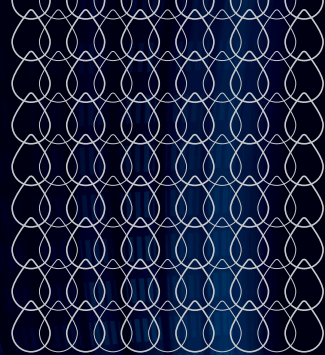

INTERVENTIONAL ESSENTIALS

Y-Adaptors	90
Hemostatic Click Device	92
Tri-Adaptors	93
Inflation Devices	94
Insertion Tools	96
Torque Devices	96
Hemostatic Flow Valve	96

INTERVENTIONAL ESSENTIALS

Innovations to simplify interventions.

Our advanced medical devices
simplify complex procedures and
common clinical challenges.

Proven quality,
trusted performance
and accessories
you can count on.



Interventional Essentials

► Y-Adaptor Kits

- For a secure hemostasis seal with the capability to use interventional components
- Y-Adaptor enables two access ports
- Complete with namic torque device and insertion tool
- Choose a fine threaded Y-adaptor for accuracy and control; An intermediate threaded Y-adaptor offers a fine balance between speed and control

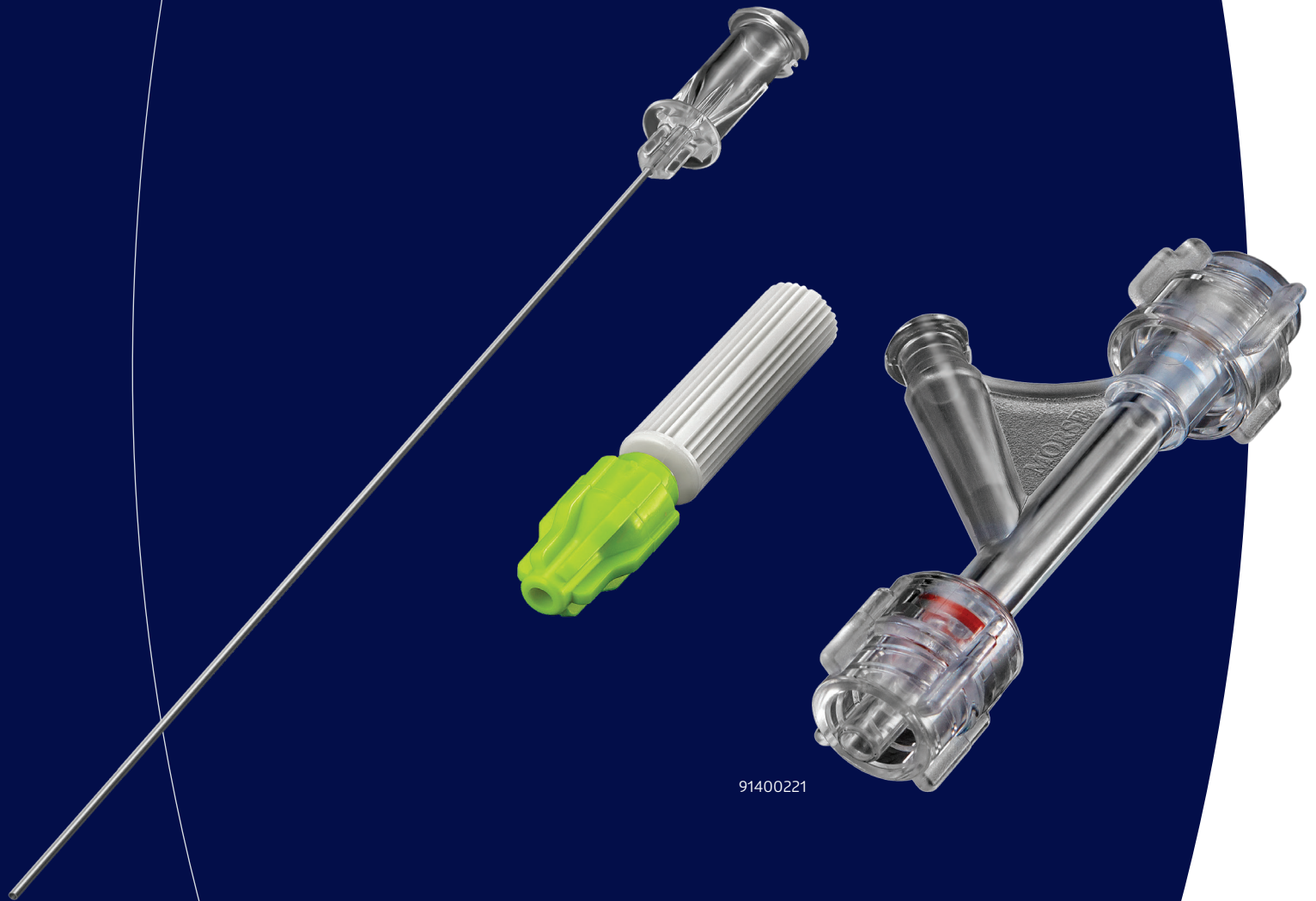

91400221

Option 125 Y-Adaptor

- 3.18 mm (0.125", 9.5 F)
- Intermediate threading
- Namic insertion tool with a maximum wire diameter of 0.018"
- 200 PSI 14 BAR Pressure Rating
- Packaged 5 Per Case



91400225

Item No.	Torque Device	Kit Component
91400025	No	41400025, 10045075
91400225	0.25-0.46 mm (0.010"-0.018")	41400025, 10045075, 41400303
DYNJHEMOTRQ	0.23mm-0.56mm (0.009" to 0.022")	41400025, 41400303

Gateway Y-Adaptor

- 2.99 mm (0.118", 9 F) internal through lumen
- Intermediate threading
- 200 PSI 14 BAR Pressure Rating
- Packaged 10 Per Case



H74904494102

Item No.	Insertion Tool	Torque Device	Kit Component
H74904494102	0.46 mm (0.018")	0.25-0.46 mm (0.010"-0.018")	48500002, 48500004, 48500003

Original Y-Adaptor

- 2.54 mm (0.100", 7.6 F) straight-through lumen
- Intermediate and fine threading available
- Namic insertion tool with a maximum wire diameter of 0.018"
- 200 PSI 14 BAR Pressure Rating
- Packaged 5 Per Case



64000122

Item No.	Threading	Adaptor Extension	Torque Device	Kit Component
91400021	Fine	No	No	41400021, 10045075
91400221	Fine	No	0.25-0.46 mm (0.010"-0.018")	41400021, 10045075, 41400303
91400023	Fine	20.32 cm (8")	No	41400023, 10045075
64000122	Intermediate	No	No	41400122, 10045075
64000222	Intermediate	No	0.25-0.46 mm (0.010"-0.018")	41400122, 10045075, 41400303

Interventional Essentials

Y-Adaptor Kits CONTINUED



Large Bore Y-Adaptor

- 2.87 mm (0.113", 8.6 F) straight-through lumen
- Fine threading
- Namic insertion tool with a maximum wire diameter of 0.018"
- 200 PSI 14 BAR Pressure Rating
- Packaged 5 Per Case

Item No.	Adaptor Extension	Torque Device	Kit Component
64000123	No	No	41400123, 10045075
64000223	No	0.25-0.46 mm (0.010"-0.018")	41400123, 10045075, 41400303
64000124	25.40 cm (10")	No	41400124, 10045075
64000224	25.40 cm (10")	0.25-0.46 mm (0.010"-0.018")	41400124, 10045075, 41400303

Hemostatic Click Device

- Protects against back bleeding in the semi-closed and fully closed position
- Helps prevent air ingress into the device when the valve is in the semi-open and closed position
- Self-closing safety mechanism and audible click indication for ease of use



DYNJYCLICKA

Item No.	Guidewire Compatibility	Pressure Rating	Flow Rate	Pkg.	Kit Component
DYNJYCLICKA	0.014"-0.038" diameter	600 PSI	15cc per second	25/cs	95734

► Tri-Adaptor Kits

- For a secure hemostasis seal with the capability to use interventional components
- Tri-adaptor for dual wire placement
- Complete with namic torque device and insertion tool

Option 125 Tri-Adaptor

- 3.18 mm (0.125", 9.5 F) main lumen, 2.79 mm (0.110") side lumen
- Intermediate threading
- Namic insertion tool with a maximum wire diameter of 0.018"
- 200 PSI 14 BAR Pressure Rating
- Packaged 5 Per Case

Item No.	Torque Device	Kit Component
91400035	No	4140035, 10045075
91400235	0.25–0.46 mm (0.010"–0.018")	4140035, 10045075, 41400303



Original Tri-Adaptor

- 2.54 mm (0.100", 7.6 F) main lumen, 2.36 mm (0.093") side lumen
- Intermediate threading
- Namic insertion tool with a maximum wire diameter of 0.018"
- 200 PSI 14 BAR Pressure Rating
- Packaged 5 Per Case

Item No.	Torque Device	Kit Component
91400031	No	4140031, 10045075
91400231	0.25–0.46 mm (0.010"–0.018")	4140031, 10045075, 41400303



Interventional Essentials

► Inflation Devices

- 20 mL disposable device is capable of producing a maximum pressure of 30 ATM/bars
- Fitted with a threaded plunger assembly with lock/release bar, a flexible high-pressure extension tube and a 3-way medium stopcock
- Designed to generate positive and negative pressure and monitor positive pressure over a range of zero to +30 ATM/bar (zero to +441 PSI)

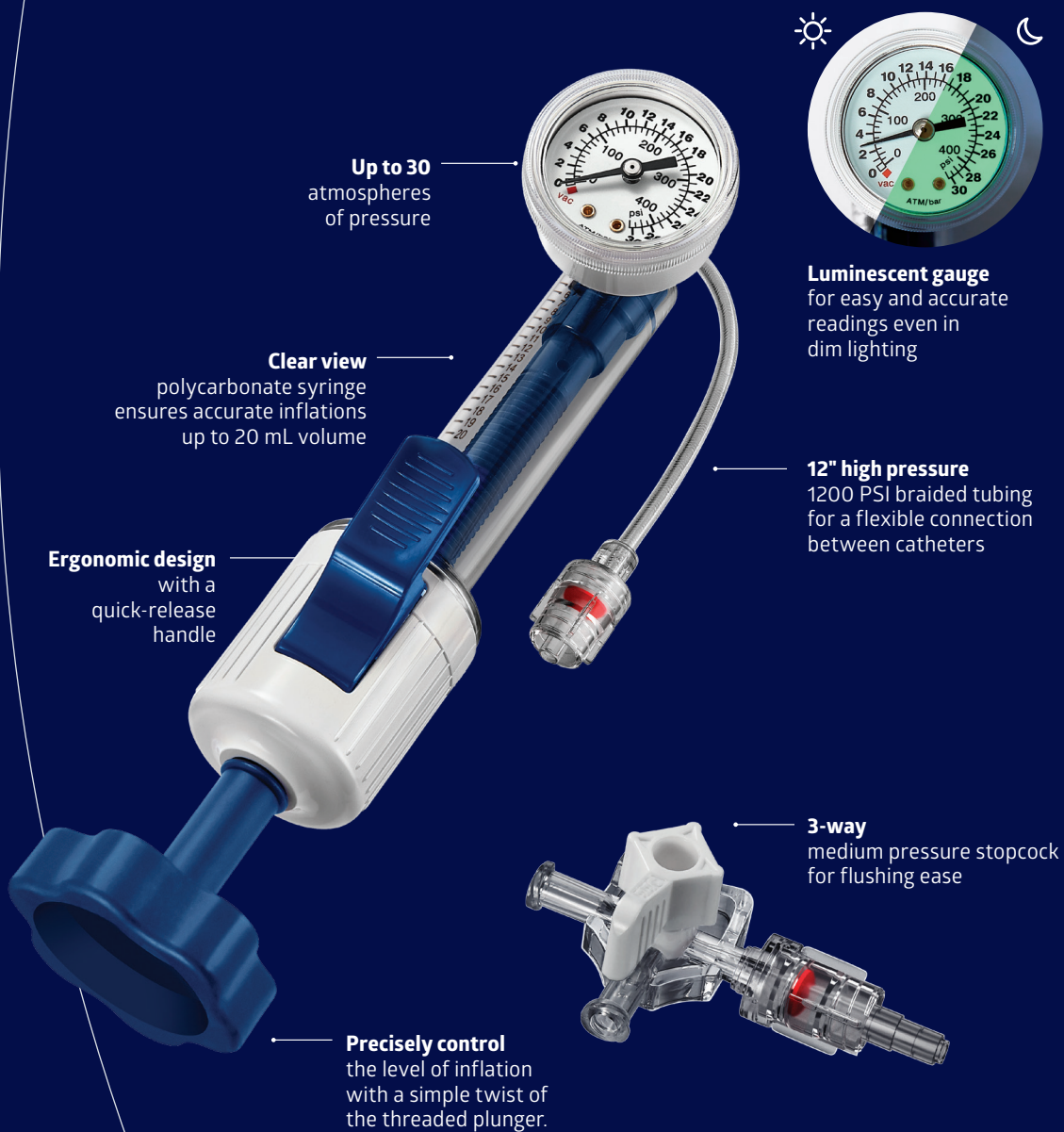

Up to 30
atmospheres
of pressure

Clear view
polycarbonate syringe
ensures accurate inflations
up to 20 mL volume

Ergonomic design
with a
quick-release
handle

Precisely control
the level of inflation
with a simple twist of
the threaded plunger.



Luminescent gauge
for easy and accurate
readings even in
dim lighting

12" high pressure
1200 PSI braided tubing
for a flexible connection
between catheters

3-way
medium pressure stopcock
for flushing ease

DYNJINFLATE

Inflation Device

Item No.	Pressure Range	Barrel Volume	Luminescent Gauge	Latch Type
DYNJINFLETE	0-30ATM	20 mL	Yes	Press-to-Release



DYNJINFLETE2

Inflation Device Kits

- 3-way, high pressure rotating adaptor stopcock
- Packaged 5 Per Case
- Namic insertion tool with a maximum wire diameter of 0.018"

Item No.	Y-Adaptor Type	Torque Device	Pressure Monitoring Line
DYNJINFLETE2	Gateway Plus Y-Adaptor	0.25–0.46 mm (0.010"–0.018")	12" Male-Female
DYNJINFLETE3	Option 125 Y-Adaptor	0.25–0.46 mm (0.010"–0.018")	12" Male-Female
DYNJINFLETE4	Large Bore Y-Adaptor	0.25–0.46 mm (0.010"–0.018")	12" Male-Female
DYNJINFLETE5	Original Y-Adaptor	0.25–0.46 mm (0.010"–0.018")	12" Male-Female
DYNJINFLETE6	Original Y-Adaptor with 8" Extension	0.25–0.46 mm (0.010"–0.018")	12" Male-Female

Interventional Essentials

Insertion Tools

- Designed for quick and easy placement of the guidewire through a Y-adaptor
- Helps protect delicate guidewire tips

Item No.	Color	Maximum Wire Used	Pkg.	Kit Component
91400400	Clear Hub	0.46 mm (0.018")	10/bx	10045075
H74904490202	Yellow Hub	0.46 mm (0.018")	10/bx	48500004
DYNJINSERT	Clear Hub	0.64mm (0.025")	20/cs	93102



91400400



H74904490202



DYNJINSERT

Torque Devices

- Large textured handle for easy gripping
- Exceptional torque control

Item No.	Color	Wire Size Accepted	Pkg.	Kit Component
DYNJSPDTRQ	White	0.23–0.56mm (0.009"–0.022")	25/cs	—
91400300	Neon Yellow	0.25–0.46 mm (0.010"–0.018")	10/cs	41400303
H74904487202	Yellow Body/ White Tip	0.25–0.46 mm (0.010"–0.018")	20/cs	48500003
DYNJTORQDEVX	White	0.36–0.89 mm (0.014"–0.035")	25/cs	88318
H74902470012	Blue/Teal and White	0.36–0.46 mm (0.014"–0.018")	10/cs	—
DYNJTORQDEWV	White	0.36–0.56 mm (0.014"–0.022")	25/cs	118501
DYNJTORQDEVY	Luminescent	0.36–0.56 mm (0.014"–0.022")	25/cs	128351



DYNJSPDTRQ



91400300



H74904487202



H74902470012



DYNJTORQDEWV



DYNJTORQDEVY

Hemostatic Flow Valve

- Enables smooth and easy handling of guidewires

Item No.	Male Luer Lock Standard	Guidewire Compatibility	Pressure Rating	Pkg.	Kit Component
DYNJHFLOW	ISO 594-1 and ISO 594-2	0.014"–0.038" diameter	1200 PSI	25/cs	93956



DYNJHFLOW

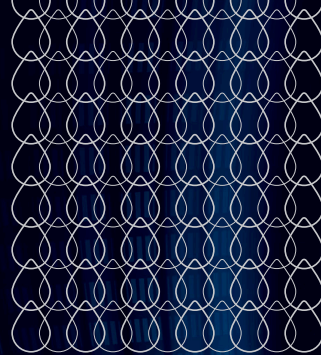

ACCESS

Angiographic Introducer Needles	100
Mini Access Kits	104
Diagnostic Guidewires	106
Guidewire Bowls	110
Dual Securement Guidewire Clip	111
Needle Holders	112

ACCESS

Positive outcomes start with precision access.

Driven by precision, quality and innovation, our thoughtfully designed kits and essentials ensure you can start every procedure with confidence.



90%

Over 90% of kits contain one or more access components¹

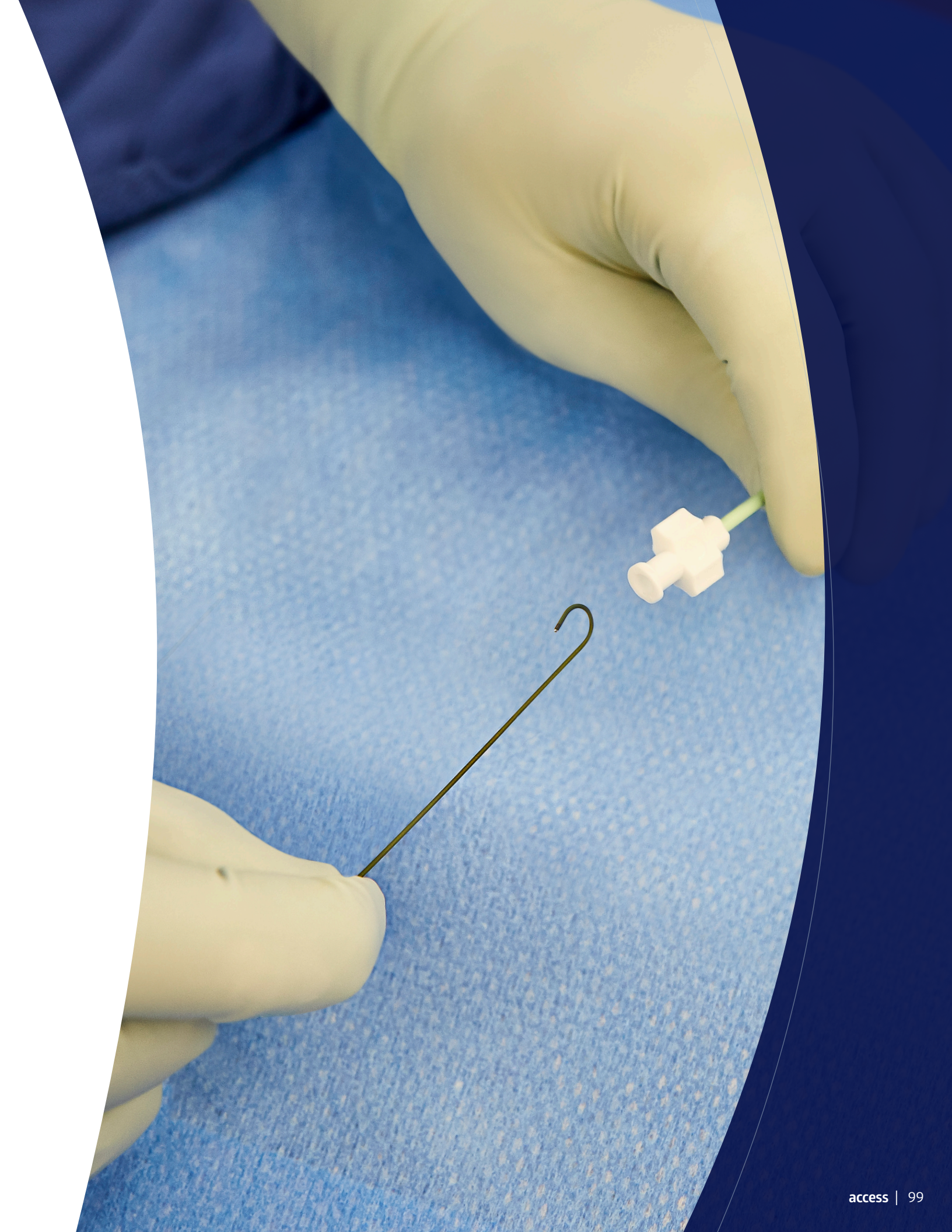

▶ Angiographic Introducer Needles

- Used to gain access to the veins or arteries
- Designed for smooth guidewire insertion and needle removal over the wire

Features unique hub design
with an ergonomic feel and
reference point to help you
orient the bevel

DYNJNDLI187E

Echogenic tip
allows visualization
of the needle under
ultrasonography

Increased sharpness
facilitates entry into
tissue and vessel walls

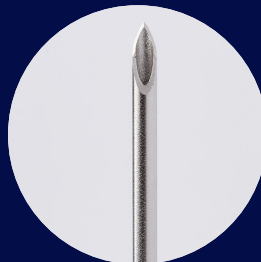

Thin Wall



Extra Thin Wall



Special Ultra Thin Wall
Echogenic

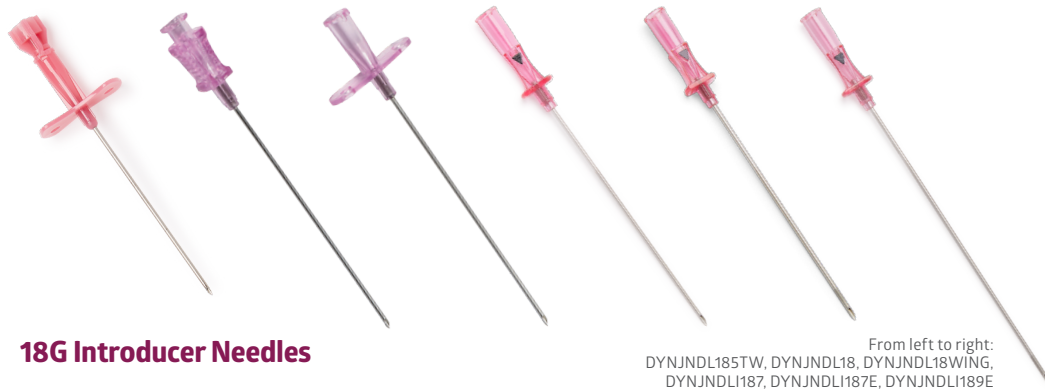

18G Introducer Needles

From left to right:
DYNJNDL185TW, DYNJNDL18, DYNJNDL18WING,
DYNJNDL187, DYNJNDL187E, DYNJNDL189E

- Packaged 25 Per Case
- 0.038" (0.97mm) guidewire compatibility

One-Wall Needle

Item No	Needle Length	Bevel Indicator	Wall Thickness	Finish	Kit Component
DYNJNDL18	2.75" (7 cm)		Extra Thin	Smooth	83499
DYNJNDL187	2.75" (7 cm)	■	Special Ultra Thin	Smooth	125609
DYNJNDL187E	2.75" (7 cm)	■	Special Ultra Thin	Echogenic	126591
DYNJNDL189E	3.5" (9 cm)	■	Special Ultra Thin	Echogenic	125610

One-Wall Needle with Wings

Item No	Needle Length	Bevel Indicator	Wall Thickness	Finish	Kit Component
DYNJNDL18WING	2.75" (7 cm)		Extra Thin	Smooth	84880

One-Wall Needle with Courmand Shield

Item No	Needle Length	Bevel Indicator	Wall Thickness	Finish	Kit Component
DYNJNDL185TW	2.125" (5.4 cm)		Thin	Smooth	29310

19G Introducer Needles

- Packaged 25 Per Case
- 0.038" (0.97mm) guidewire compatibility

One-Wall Needle

Item No	Needle Length	Bevel Indicator	Wall Thickness	Finish	Kit Component
DYNJNDL195UT	2" (5 cm)	■	Extra Thin	Smooth	129661
DYNJNDL19	2.75" (7 cm)		Special Ultra Thin	Smooth	84881
DYNJNDL197	2.75" (7 cm)	■	Special Ultra Thin	Smooth	127581
DYNJNDL199E	3.5" (9 cm)	■	Thin	Echogenic	127580

One-Wall Needle with Seldinger Shield

Item No	Needle Length	Bevel Indicator	Wall Thickness	Finish	Kit Component
DYNJNDL197UT	2.875" (7.3 cm)		Thin	Smooth	MMP1300-19U

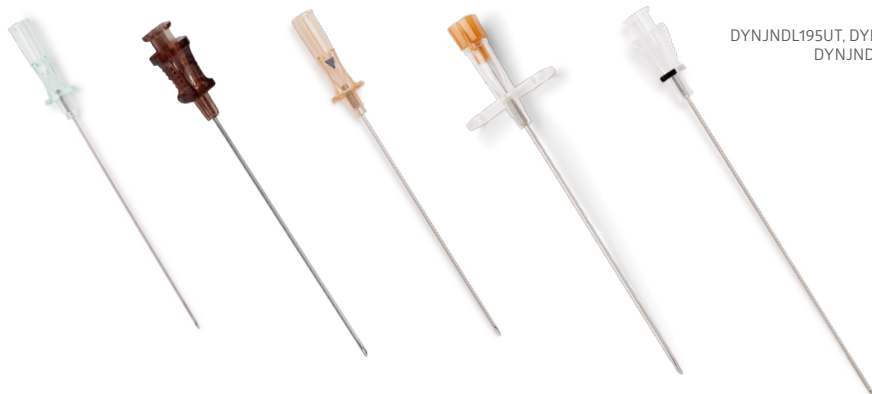

From left to right:
DYNJNDL195UT, DYNJNDL19, DYNJNDL197,
DYNJNDL197UT, DYNJNDL199E



Bevel Indicator

Angiographic Introducer Needles

CONTINUED



20G Introducer Needles

- Packaged 25 Per Case
- 0.025" (0.64mm) guidewire compatibility

Item No	Needle Length	Bevel Indicator	Wall Thickness	Finish	Kit Component
DYNJNDL20	2.75" (7 cm)		Extra Thin	Smooth	89331
DYNJNDLI207E	2.75" (7 cm)	■	Special Ultra Thin	Echogenic	127579

21G Introducer Needles

- Packaged 25 Per Case
- 0.021" (0.53mm) guidewire compatibility

Item No	Needle Length	Bevel Indicator	Wall Thickness	Finish	Kit Component
DYNJNDL2125T	1.0" (2.5 cm)	■	Thin	Smooth	129662
DYNJNDLI214	1.5" (4 cm)	■	Thin	Smooth	127578
DYNJNDLI214E	1.5" (4 cm)	■	Thin	Echogenic	119911
DYNJNDLX214	1.5" (4 cm)	■	Extra Thin	Smooth	127570
DYNJNDLX214E	1.5" (4 cm)	■	Extra Thin	Echogenic	127571
DYNJNDL21	2.75" (7 cm)		Thin	Smooth	89332
DYNJNDL21E	2.75" (7 cm)	■	Thin	Echogenic	103763
DYNJNDLI217	2.75" (7 cm)	■	Thin	Smooth	127577
DYNJNDLI217E	2.75" (7 cm)	■	Thin	Echogenic	95334
DYNJNDLX217	2.75" (7 cm)	■	Extra Thin	Smooth	127568
DYNJNDLX217E	2.75" (7 cm)	■	Special Ultra Thin	Echogenic	127569
DYNJNDLI219	3.5" (9 cm)	■	Thin	Smooth	127576
DYNJNDLI219E	3.5" (9 cm)	■	Thin	Echogenic	127575



From left to right:
 DYNJNDL2125T, DYNJNDL21, DYNJNDL21E
 DYNJNDLI217, DYNJNDLX217,
 DYNJNDLX217E, DYNJNDLI219E



DYNJNDL22

22G Introducer Needle

- Packaged 25 Per Case
- 0.018" (0.46mm) guidewire compatibility

Item No	Needle Length	Bevel Indicator	Wall Thickness	Finish	Kit Component
DYNJNDL22	2.75" (7 cm)		Thin	Smooth	89346

24G Introducer Needles

- Packaged 25 Per Case
- 0.010" (0.25mm) guidewire compatibility

Item No	Needle Length	Bevel Indicator	Wall Thickness	Finish	Kit Component
DYNJNDLI242E	1.0" (2.5 cm)	■	Extra Thin	Smooth	127574
DYNJNDLI244E	1.5" (4 cm)	■	Extra Thin	Smooth	127573
DYNJNDLI247E	2.75" (7 cm)	■	Extra Thin	Smooth	127572



From left to right:
DYNJNDLI242E, DYNJNDLI244E,
DYNJNDLI247E

▶ Mini Access Kits

- Enable successful radial placement during vein or vascular procedures
- Kink-resistant dilator and sheath for a smooth procedure flow
- Built for smooth insertions and atraumatic design

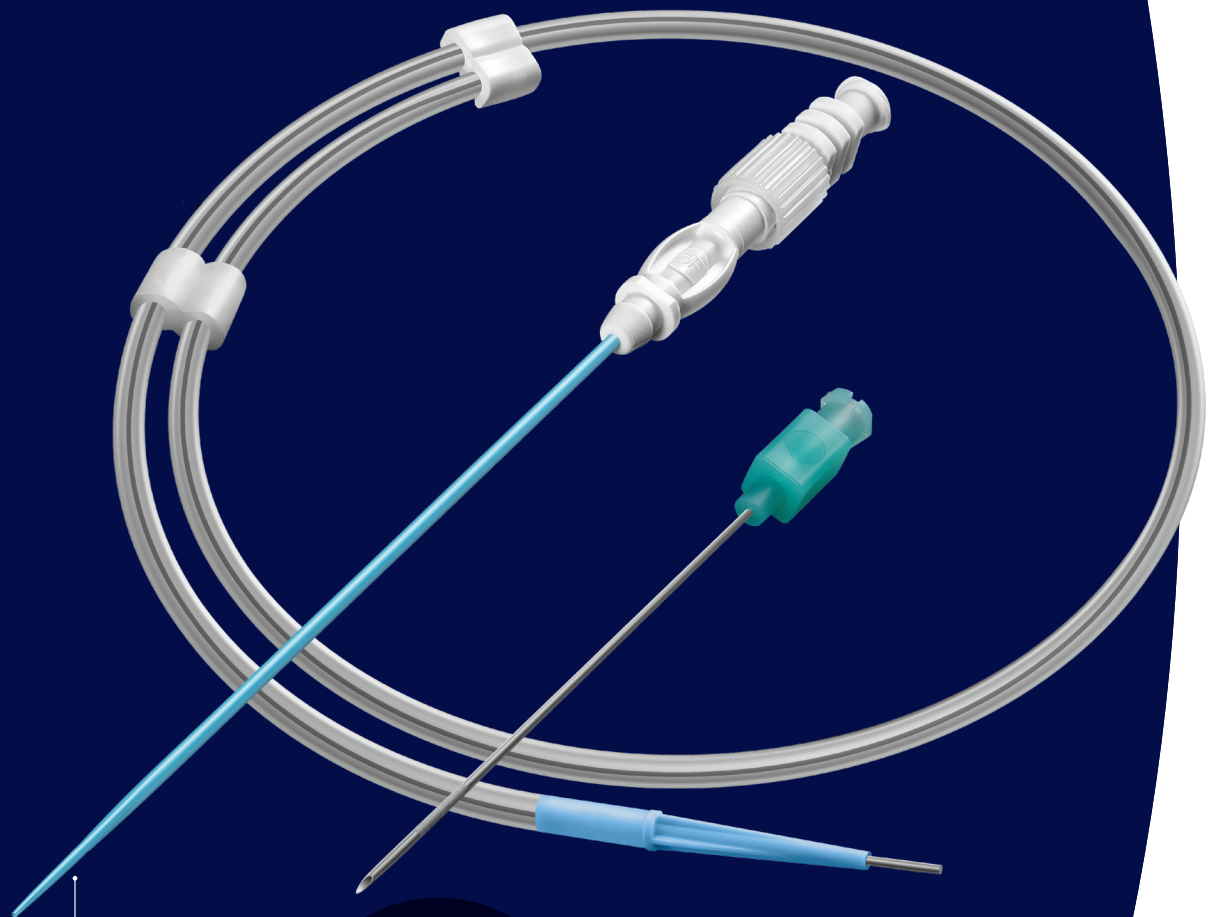

10 cm sheath
available in a stiff or
regular style to fit
your needs



Echogenic markings
to provide clear
visibility of needle

DYNJMAST10

21Gx2.75" (7CM) Introducer Needles

- 0.018" diameter x 45 cm length mandrel style guidewire
- 10 cm introducer sheath length

Stainless Steel Guidewire/ Stainless Steel Tip

Item No	Size	Style	Needle Finish
DYNJMAST11	4 FR	Regular	Echogenic
DYNJMAST01	4 FR	Regular	Smooth
DYNJMAST07	4 FR	Stiff	Echogenic
DYNJMAST13	4 FR	Stiff	Smooth
DYNJMAST19	5 FR	Regular	Echogenic
DYNJMAST02	5 FR	Regular	Smooth
DYNJMAST08	5 FR	Stiff	Echogenic
DYNJMAST17	5 FR	Stiff	Smooth

21Gx1.5" 4 (CM) Introducer Needles

- 0.018" diameter x 45 cm length mandrel style guidewire
- 10 cm introducer sheath length

Stainless Steel Guidewire/ Stainless Steel Tip

Item No	Size	Style	Needle Finish
DYNJMAST21	4 FR	Regular	Smooth
DYNJMAST29	4 FR	Regular	Echogenic
DYNJMAST25	4 FR	Stiff	Echogenic
DYNJMAST31	4 FR	Stiff	Smooth
DYNJMAST37	5 FR	Regular	Echogenic
DYNJMAST22	5 FR	Regular	Smooth
DYNJMAST26	5 FR	Stiff	Echogenic
DYNJMAST35	5 FR	Stiff	Smooth

Nitinol Core/Tungsten Tip Guidewire

Item No	Size	Style	Needle Finish
DYNJMAST03A	4 FR	Regular	Smooth
DYNJMAST12	4 FR	Regular	Echogenic
DYNJMAST09	4 FR	Stiff	Echogenic
DYNJMAST14	4 FR	Stiff	Smooth
DYNJMAST04	5 FR	Regular	Smooth
DYNJMAST16	5 FR	Regular	Echogenic
DYNJMAST10	5 FR	Stiff	Echogenic
DYNJMAST18	5 FR	Stiff	Smooth

Nitinol Core/Tungsten Tip Guidewire

Item No	Size	Style	Needle Finish
DYNJMAST23	4 FR	Regular	Smooth
DYNJMAST27	4 FR	Stiff	Echogenic
DYNJMAST30	4 FR	Regular	Echogenic
DYNJMAST32	4 FR	Stiff	Smooth
DYNJMAST24	5 FR	Regular	Smooth
DYNJMAST28	5 FR	Stiff	Echogenic
DYNJMAST34	5 FR	Regular	Echogenic
DYNJMAST36	5 FR	Stiff	Smooth

Prefer a different wire tip metal?

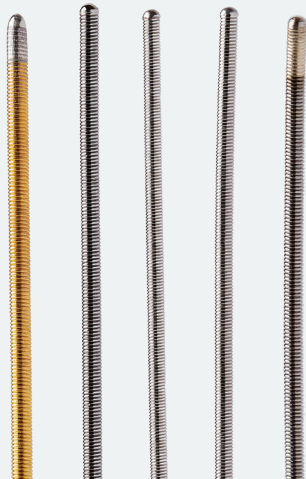

Radiopaque properties allow for viewing under fluoroscopy.

Choose from gold, tungsten, platinum, palladium or stainless steel



DYNJMAST01
Introducer Tip

▶ Diagnostic Guidewires

- Guidewires are used to facilitate catheter placement in the vascular system
- Our complete line of diagnostic guidewires provides a perfect fit for all your procedural needs
- Industry-leading pre-coated design ensures uniformity, lubricity and adhesion for reduced friction and atraumatic results

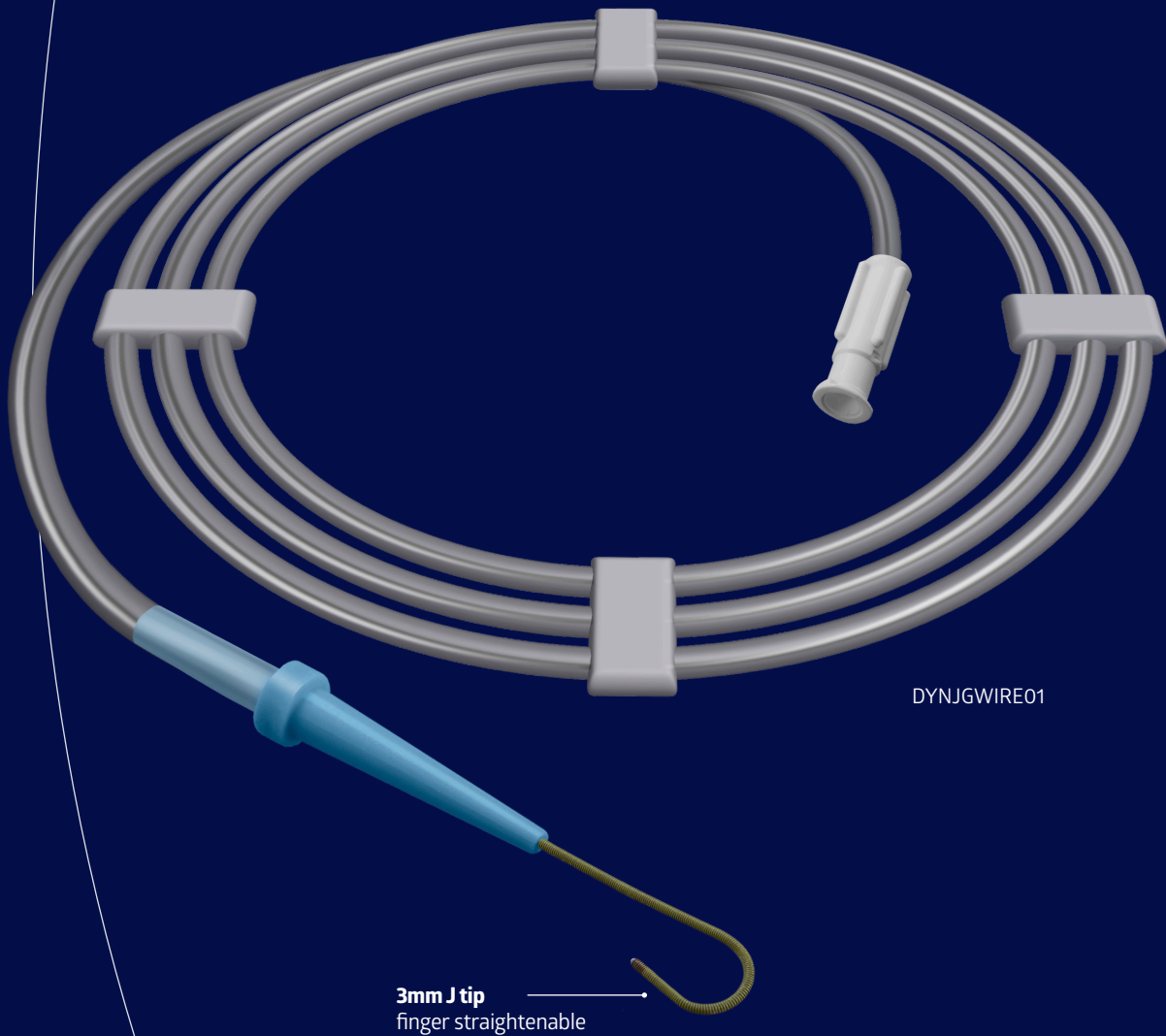

Tip Styles



Straight Tip
DYNJGWIRE31



3mm J Tip
DYNJGWIRE28



15mm J Tip
DYNJGWIRE29

Diagnostic Guidewires

● Packaged 10 Per Case

Item No	Length	Material	Tip	Coating	Core	Extra Body Support	Heparin Bond	Double Ended	Straightenable	Radiopaque	Kit Component
0.018" Diameter Guidewires											
DYNJGWIRE23	45 cm	Stainless Steel	Straight	Uncoated	Mandrel						94375
DYNJGWIRE24*	45 cm	Nitinol	Straight	Uncoated	Mandrel					■	94378
DYNJGWIRE21	65 cm	Core/ Stainless	Angled	PTFE	Mandrel						119907
DYNJGWIRE44	130 cm	Steel Coil	Straight	Hydrophillic	Mandrel					■	128735
DYNJGWIRE46	260 cm	Stainless Steel	3mm J	PTFE	Fixed					■	94209
DYNJGWIRE25*	260 cm		Straight	PTFE	Mandrel					■	125826
DYNJGWIRE47	260 cm		Straight	PTFE	Fixed						94212

0.025" Diameter Guidewires

DYNJGWIRE43	33 cm	Stainless Steel	Straight	Uncoated	Fixed			■			126443
DYNJGWIRE40	145 cm		3mm J	PTFE	Fixed				■		127759
DYNJGWIRE32	145 cm		Straight	PTFE	Fixed						127751

0.032" Diameter Guidewires

DYNJGWIRE27	60cm	Stainless Steel	Straight	PTFE	Fixed						127946
DYNJGWIRE41	145cm		3mm J	PTFE	Fixed				■		127760

*Tungsten tip guidewire

Diagnostic Guidewires

Diagnostic Guidewires

CONTINUED

- Stainless steel material
- Packaged 10 Per Case

Item No	Length	Tip	Coating	Extra Body Support	Heparin Bond	Double Ended	Straightenable Radiopaque	Kit Component
0.035" Diameter Guidewires—Straight tip, fixed core								
DYNJGWIRE30	145 cm	Straight	PTFE		■			127749
DYNJGWIRE37	145 cm	Straight	PTFE					125448
DYNJGWIRE09	150 cm	Bentson	PTFE		■			88925
DYNJGWIRE48	150 cm	Bentson	PTFE					107802
DYNJGWIRE22	150 cm	Straight	Silicone					125448
DYNJGWIRE54	180 cm	Straight	PTFE					138566
DYNJGWIRE45	180 cm	Bentson	PTFE					129573
DYNJGWIRE33	260 cm	Straight	PTFE					127752
DYNJGWIRE49	260 cm	Bentson	PTFE					125612
0.035" Diameter Guidewires—J tip, fixed core								
DYNJGWIRE31	145 cm	1.5 mmJ	PTFE			■	■	127750
DYNJGWIRE26	175 cm	1.5 mmJ - Rosen	PTFE				■	127746
DYNJGWIRE52	210 cm	1.5 mmJ	PTFE				■	135892
DYNJGWIRE51	260 cm	1.5 mmJ - Rosen	PTFE		■		■	133170
DYNJGWIRE16	70 cm	3 mm J	Uncoated			■	■	31038
DYNJGWIRE42	145 cm	3 mm J	PTFE				■	127947
DYNJGWIRE01	150 cm	3 mm J	PTFE				■	13060
DYNJGWIRE02	150 cm	3 mm J	PTFE	Heavy Duty			■	32736
DYNJGWIRE04	150 cm	3 mm J	PTFE		■		■	22603
DYNJGWIRE05	150 cm	3 mm J	PTFE	Firm			■	22604
DYNJGWIRE10	150 cm	3 mm J	PTFE			■	■	29307
DYNJGWIRE11	150 cm	3 mm J	PTFE			■	■	49744
DYNJGWIRE53	150 cm	3 mm J - Amplatz	PTFE				■	138058
DYNJGWIRE03	180 cm	3 mm J	PTFE				■	88920
DYNJGWIRE13	180 cm	3 mm J	PTFE			■	■	88923
DYNJGWIRE50	210 cm	3 mm J	PTFE				■	126459
DYNJGWIRE20	260 cm	3 mm J	PTFE				■	102980
DYNJGWIRE55	150 cm	6 mm J	PTFE				■	138587
DYNJGWIRE29	145 cm	15 mmJ	PTFE				■	127748

- Stainless steel material
- Packaged 10 Per Case

Item No	Length	Tip	Coating	Extra Body Support	Heparin Bond	Double Ended	Straightenable	Radiopaque	Kit Component
---------	--------	-----	---------	--------------------	--------------	--------------	----------------	------------	---------------

0.038" Diameter Guidewires—Straight tip, fixed core

DYNJGWIRE38	145 cm	Straight	PTFE						127757
DYNJGWIRE14	150 cm	Bentson	PTFE						88924
DYNJGWIRE34	260 cm	Straight	PTFE						127753

0.038" Diameter Guidewires—J tip, fixed core

DYNJGWIRE36	145 cm	3 mm J	PTFE				■		127755
DYNJGWIRE06	150 cm	3 mm J	PTFE				■		17839
DYNJGWIRE08	150 cm	3 mm J	PTFE	Firm			■		22605
DYNJGWIRE28	175 cm	3 mm J	PTFE				■		127747
DYNJGWIRE12	180 cm	3 mm J	PTFE	Heavy Duty			■		88921
DYNJGWIRE39	260 cm	3 mm J	PTFE				■		127758

0.035" Diameter Guidewires—J tip, moveable core

DYNJGWIRE17	150 cm	3 mm J	PTFE				■		13129
DYNJGWIRE18	150 cm	3 mm J	PTFE		■		■		22609

0.038" Diameter Guidewires—J tip, moveable core

DYNJGWIRE35	145 cm	3 mm J	PTFE		■		■		127754
DYNJGWIRE19	150 cm	3 mm J	PTFE				■		17297



▶ Guidewire Bowls

- Provide a secure location while preparing for a procedure
- Easy to grasp while wearing surgical gloves

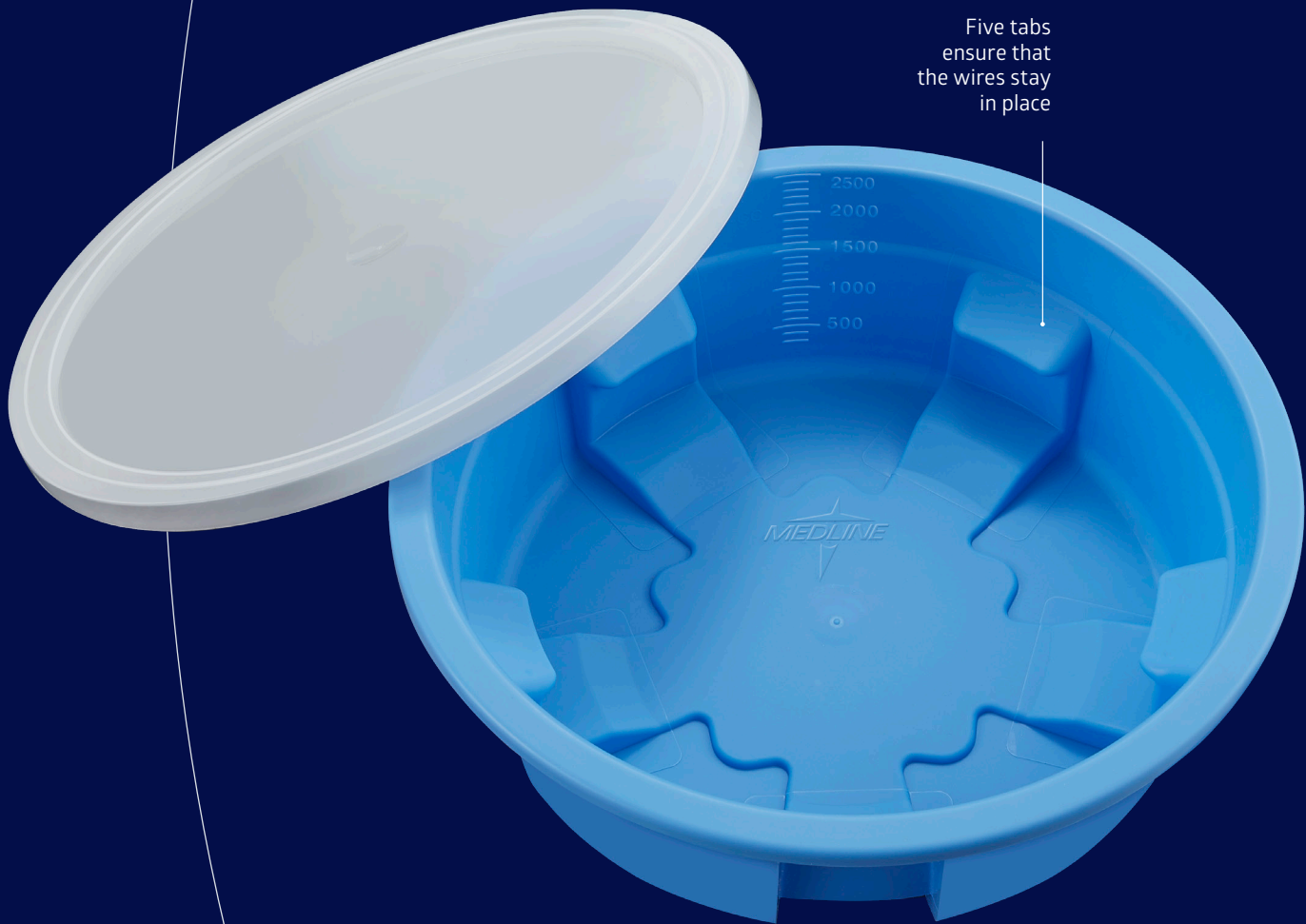

Five tabs ensure that the wires stay in place

DYNJGUIDEWIRE

Guidewire Bowls

Item No.	Diameter	Fluid Capacity	Pkg.	Kit Component
DYNJGUIDEWIRE	8.5"	2,500 ml	28/cs	96360
DYNJGUIDEB2	11"	5,000 ml	10/cs	119542

► Dual Securement Guidewire Clip

- Securely and gently holds any flexible elongated medical device, such as a guidewire, catheter, or balloon, in between uses during or after a procedure
- Adhesive backing to allow for placement on a back table cover or drape

Item No.	Pkg.	Kit Component
DYNJWIREPRO	20/cs	137357

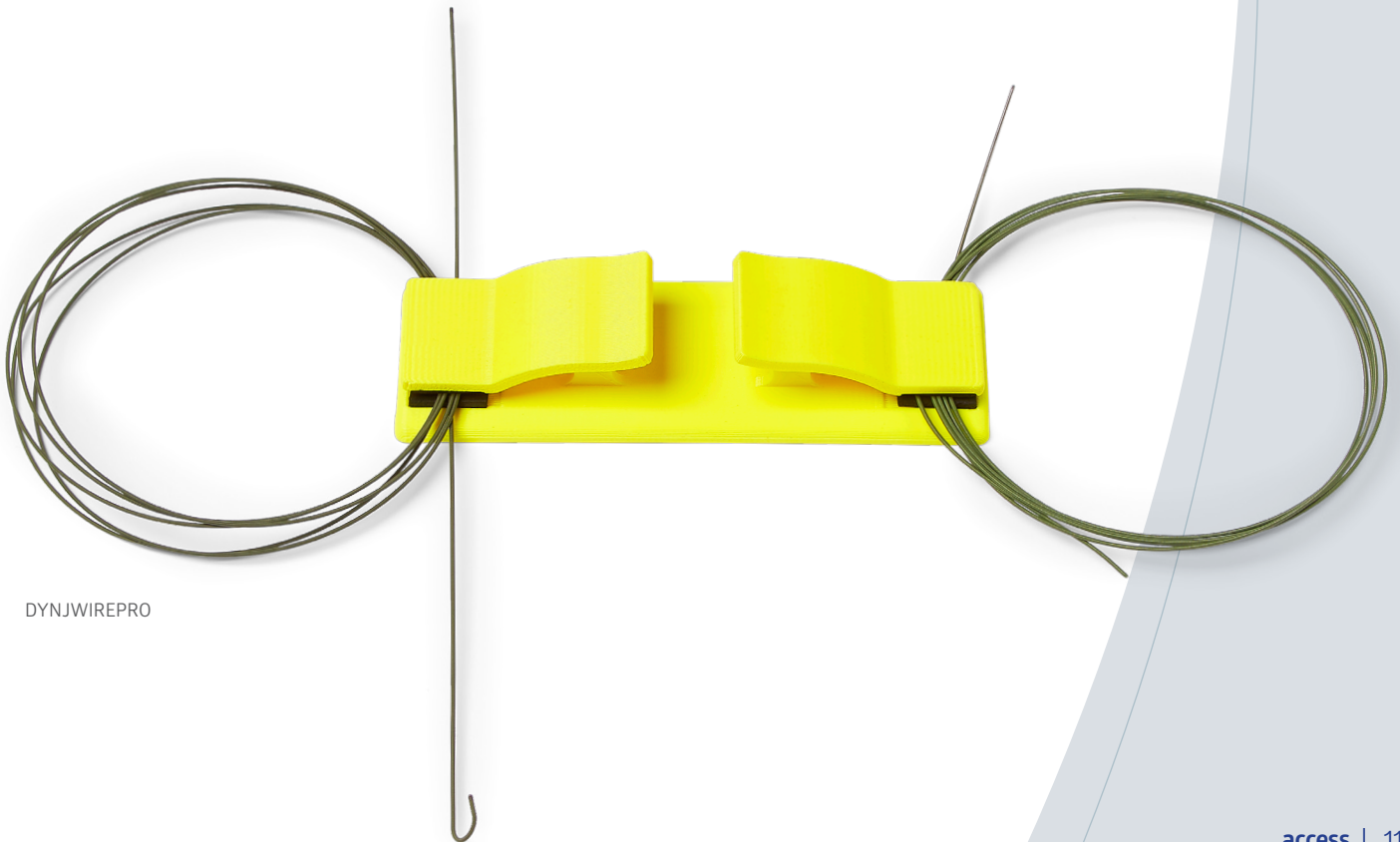

DYNJWIREPRO

Needle Holders

- Core-resistant foam needle holder offer safe, temporary placement of needles and scalpels—pre- or post procedure
- Strong adhesive strip holds firmly in place to any surface including back table covers
- Supports filled syringes

DYNJNDLNEST2



DYNJNDLNEST4

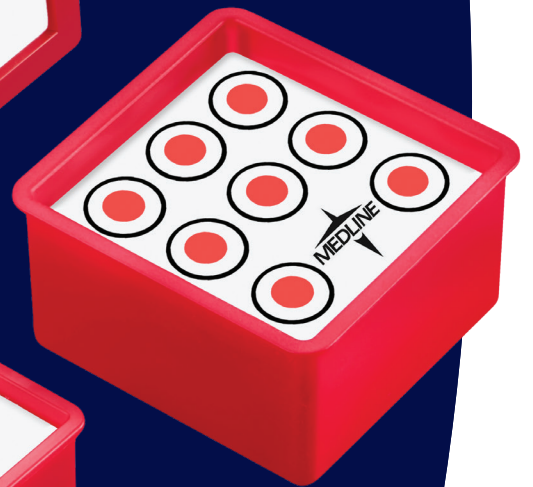

DYNJNDLNEST

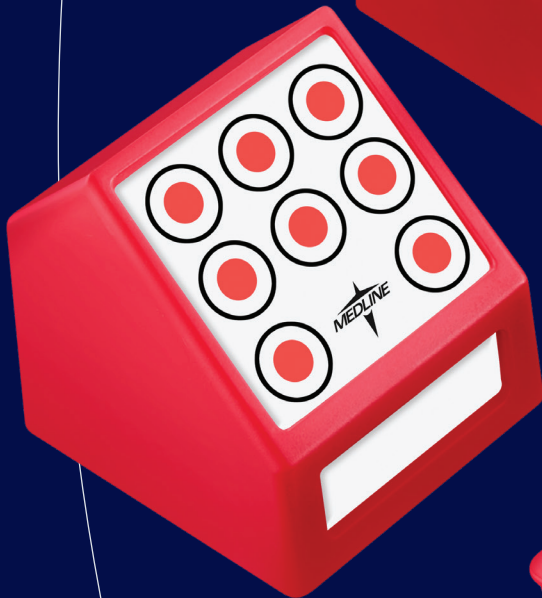

DYNJNDLNEST3

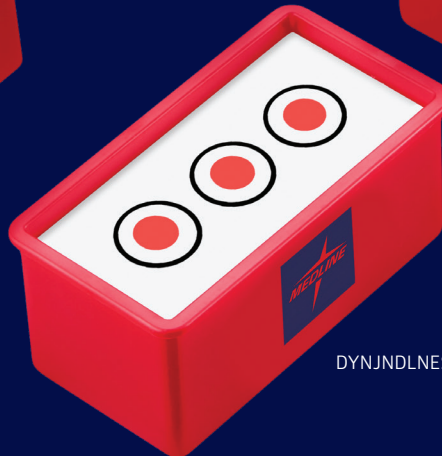



DYNJNDLNEST3

Needle Holders

Item No.	Placement Points	Side Port	Pkg.	Kit Component
DYNJNDLNEST	8		50/cs	35862
DYNJNDLNEST2	9	Yes	25/cs	126646
DYNJNDLNEST3	3		50/cs	127396
DYNJNDLNEST4	9	Yes	50/cs	132481



DYNJNDLNEST2



**We make
healthcare
run better™**

Medline Industries, Inc.
Three Lakes Drive, Northfield, IL 60093
Medline United States | 1-800-MEDLINE (633-5463)
medline.com | info@medline.com

Medline Canada
1-800-268-2848 | medline.ca | canada@medline.com
Medline México
01-800-831-0898 | medlinemexico.com | mexico@medline.com

Follow us    

References: 1. Data on file.

Some products may not be available for sale in Mexico or Canada. We reserve the right to correct any errors that may occur within this brochure.
© 2020 Medline Industries, Inc. All rights reserved. Medline is a registered trademark of Medline Industries, Inc. MKT19W796046 / e20434 / 2K / SG / 23 & 79