

Aurora

Instruction Manual



WELCOME

Congratulations on becoming an official owner of the Nanoleaf Aurora, a product that will let you create incredible lighting displays by snapping together panels with ease. Remember, you can purchase expansion packs to grow the Aurora, and unleash your creativity to the fullest! Without further ado, let the excitement begin!

WHAT'S IN THE BOX?

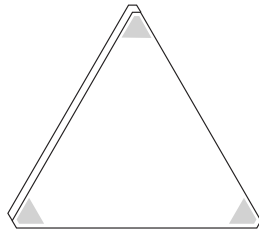

x9

Panels

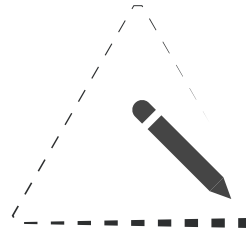

x9

Stencil Paper

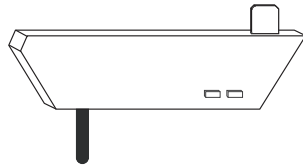

x1

Controller

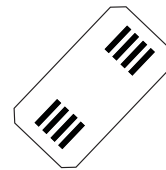

x9

Linkers

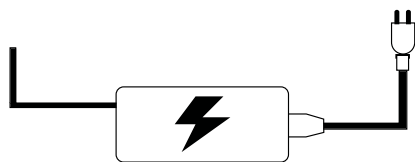

x1

Power Supply

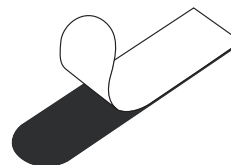

x28

Mounting Tape

HARDWARE SET-UP

Slow down tiger! Before you stick the panels onto the wall, be sure to plug it in and try it out on a table first.

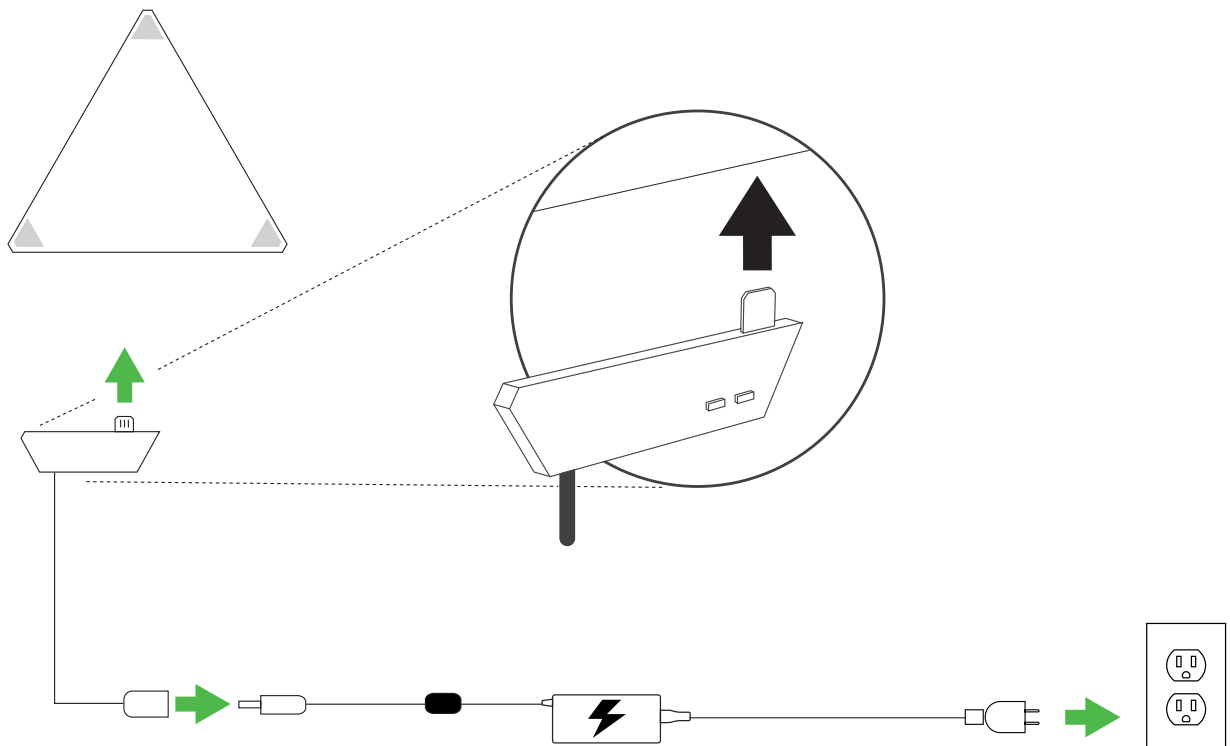
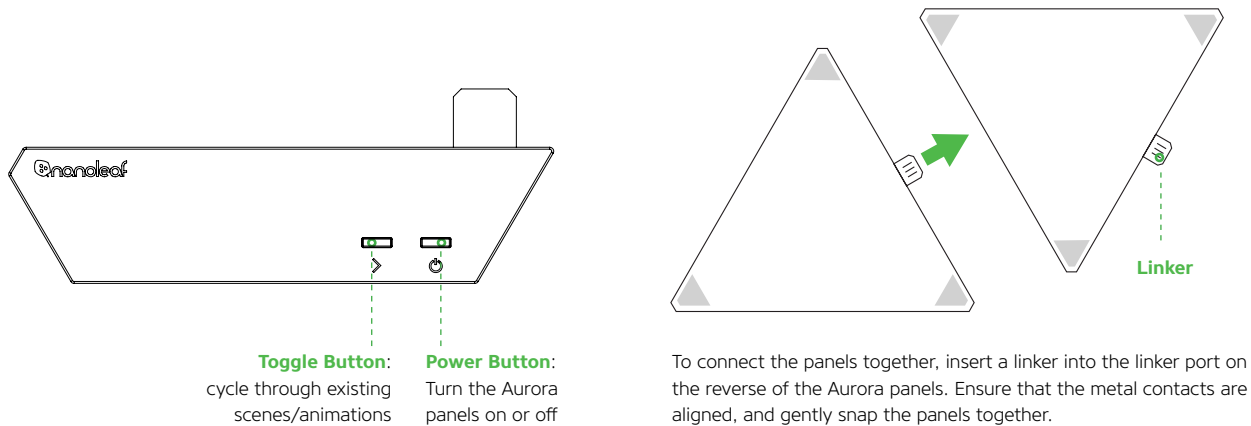

Connect the controller to any free edge on any panel. Then connect the power supply to the wire coming out of the controller. Use the included mounting tape to securely attach the panels and controller to your desired flat surface. [Click here](#) to watch an instructional video on how to install the panels using the provided mounting tape. Once everything is set up, connect the power cable to an AC outlet in order to power up your Aurora.

Recommended Installation Requirements

This device should only be installed in an indoor environment on a flat surface that can withstand the weight of the panels. Make sure that the surface is dry and clean from any dust or oil. For optimal performance it is recommended that Nanoleaf Aurora be installed in a location that provides sufficient airflow around the panels. It is recommended that the Nanoleaf Aurora be installed away from other devices designed to receive or transmit radio signals. Locate your Aurora within 20 meters from your home wireless (Wifi) router with at most one wall between them.

SOFTWARE SET-UP

The software setup will be easiest if your Aurora is powered on and you see colors moving across it. Boot up time for your Aurora is about 1 minute.

1. Download the “Nanoleaf Smarter Series” app from the Apple App Store or Google Play Store and launch it.
2. Go through the setup steps in the App to connect your Aurora to your home network and pair with your device.

CONTROL VIA APP

Animations make up the core of the Aurora software experience. Animations are saved settings for your Aurora to display. There are 3 main components to an Animation:



1. Layout: The configuration of the Aurora panels is automatically detected and shown in the App. With two fingers, you can pinch to zoom and rotate the Aurora so it matches the panels' physical orientation.



2. Palette: this is a set of colors you use to create your animation. We've included a few in the App, but you can create as many Palettes as you like. You can use up to 20 colors in a Palette.









CONTROL VIA APP



3. Effect: this is how the Aurora will display your color palette.

- a. **Static:** Tap a Palette color and tap a panel to paint it.
Hold your finger over a panel to change the brightness of that individual panel.
- b. **Random:** This will take your Palette colors and randomly animate them across your panels.
- c. **Flow:** Imagine pouring each Palette color onto your panels. Watch the color flow in a direction of your choosing.
- d. **Wheel:** Provides a continuous moving gradient of color created from your Palette.
- e. **Highlight:** Just like random, but you will mostly see the color on the left of your Palette. The other colors fade in periodically.
- f. **Fade:** The aurora cycles through your Palette colors all together.
- g. **Burst:** Your Palette colors radiate out from the center of the Aurora panels.

4. Options: these modify how an Effect Type works.

- a. **Speed:** How quickly do you want your Animations to go?
This acts a bit differently depending on the Effect type.
- b.  OR  : For the Random, Highlight, 12 and Fade Effects, this changes how long the Aurora panels stay at a given color.  moves from color to color without delay,  will pause at each color before moving to the next.
- c. **Direction:** This tells the Aurora which way to direct your color in Flow and Wheel. This direction depends on the rotation you've selected for the panels.
- d.  OR  : This changes how many palette colors are shown on the Aurora at once. The higher the number, the more of your Palette is painted across your Aurora!

VOICE CONTROL

You can easily control your Aurora by voice in a few different ways. In the App, make sure to name your Aurora something easy to say.



Siri

"Turn [My Aurora] on/off."

"Set [My Aurora] to 10% brightness."

"Dim [My Aurora]."

"Set [Animation Name]"

"Set [My Aurora] to Green"

Amazon Echo

Planned support for Q4 2016 with commands to be announced.



TIPS & TROUBLESHOOTING

The following recommendations can help your Nanoleaf Aurora achieve the best wireless range & network reception.

Best Locations for Nanoleaf Aurora:

- Place your Aurora in an open area where there are few obstructions, such as large pieces of furniture or walls. Place it away from metallic surfaces.
- Avoid placing your Aurora behind furniture or inside cabinets.
- Don't place your Aurora in areas surrounded by metal surfaces on three or more sides. This can cause signal issues.
- Try to place your Aurora at least 25 feet (8 meters) away from any microwave oven, 2.4 GHz cordless phone, Wifi devices, or other source of interference.
- Place your Aurora as close to your Wifi home router as possible. For best performance, keep the distance below 65 feet (20 meters) and have no more than one wall in between.

PROBLEMS & SOLUTIONS

Wi-Fi Troubleshooting

1. Wifi Status Indicator. After the 1 minute bootup, the Wifi Status indicator will show wifi status.
 - a. Solid: Your Aurora is ready to be connected to your home network.
 - b. Flashing (1s interval): Wifi configuration has timed out. Power cycle or hold the on button and animation select button together for 5 seconds.
 - c. Unlit: Wifi is configured and connected to your router.
 - d. Flashing (4s interval): Wifi is configured, but the Aurora cannot connect to the target network. It will continue trying unless you reset the Wifi by holding the on button and animation select button together for 5 seconds.

I can't see my Aurora in the App for setup:

1. If the Wifi status indicator is lit:
 - a. Make sure your mobile device wifi is on.
 - b. Try moving your mobile device closer to your Aurora. The App connects directly to the Aurora in order to setup wifi.
 - c. Try turning your mobile device wifi off and back on
2. If the Wifi status indicator is not lit, your Aurora is already on a wifi network.
 - a. Make sure your mobile device is on the same network
 - b. Try turning your mobile device wifi off and back on.
3. If the Wifi status indicator is flashing:
 - a. See Wifi troubleshooting section for more details.

Resetting the Aurora

1. **Resetting Wifi settings.** This will allow you to connect your Aurora to a new network.
 - While the software is running (after 1-2 minute bootup sequence) press the Toggle and Power buttons together and hold for 5 seconds. The wifi status LED will light up. Once the LED lights up, release the buttons.
2. **Soft Reset.** This will reset wifi and all pairing information, although will keep your saved animations.
 - While the software is running (after 1-2 minute bootup sequence) press the Toggle and Power buttons together and hold for 15 seconds. The wifi status LED will light up after 5 seconds and start flashing after 15 seconds.
3. **Hard Reset.** This will reset your Aurora to factory settings, deleting wifi settings, pairing information, and saved animations. Factory animations will be restored.
 - Disconnect power to the Aurora. Then hold the Toggle and Power buttons together and reconnect the power without releasing the buttons. After about 7 seconds, the wifi status LED will start to flash rapidly. Once the flashing begins, you can release the buttons. You must then wait 3 minutes for the Aurora to reset itself to factory defaults and boot up.

My beautiful Aurora masterpiece with 50 panels is not functioning correctly:

We are afraid that only 30 panels are supported by a single controller and power supply. If you are inspired to go big, you will need to have separate controllers and power supplies each handling at most 30 panels. You can pair more than one Aurora system with your smartphone.

Check out helpdesk.nanoleaf.me for further troubleshooting and hardware reset instructions.

SUPPORT

For technical support and assistance for your Nanoleaf Aurora,
Please go to helpdesk.nanoleaf.me.

FAQ

Please visit our online user manual page for a complete list of frequently asked questions
and answers: www.nanoleaf.me/myaurora

WARRANTY

Nanoleaf Aurora is protected under a 3 year limited warranty.

Please visit www.nanoleaf.me/myaurora to register for and download the warranty.

HARDWARE COMPLIANCE & CERTIFICATIONS

Nanoleaf Aurora adheres to the certification requirements for various regions around the world.

To see a full list of Nanoleaf Aurora certifications and to ensure Nanoleaf Aurora complies with the certification requirements in your region, please go to www.nanoleaf.me/legals.

This device complies with part 15 of the FCC Rules. Operation is subject to the following two conditions: (1) This device may not cause harmful interference, and (2) this device must accept any interference received, including interference that may cause undesired operation. This Class B digital apparatus complies with CAN ICES3 (B)/NMB3 (B) This digital apparatus does not exceed the Class B limits for radio noise emissions from digital apparatus as set out in the Radio Interference Regulations of the Canadian Department of Communications. This device has been tested and found to comply with the limits for a Class B digital device pursuant to Part 15 of the FCC rules.

Any Changes or modifications not expressly approved by the party responsible for compliance could void the user's authority to operate the equipment.

This equipment complies with FCC radiation exposure limits set forth for an uncontrolled environment.

This transmitter must not be co-located or operating in conjunction with any other antenna or transmitter.

This device complies with ISED licence-exempt RSS standard(s). Operation is subject to the following two conditions:

- (1) this device may not cause interference, and
- (2) this device must accept any interference, including interference that may cause undesired operation of the device.

Le présent appareil est conforme aux CNR d'ISED applicables aux appareils radio exempts de licence. L'exploitation est autorisée aux deux conditions suivantes :

- (1) l'appareil ne doit pas produire de brouillage, et
- (2) l'utilisateur de l'appareil doit accepter tout brouillage radioélectrique subi, même si le brouillage est susceptible d'en compromettre le fonctionnement.

ISED Radiation Exposure Statement:

This equipment complies with ISED RF radiation exposure limits set forth for an uncontrolled environment. This transmitter must not be co-located or operating in conjunction with any other antenna or transmitter.

This equipment should be installed and operated with minimum distance 20cm between the radiator & your body.

Cet appareil est

conforme aux limites d'exposition de rayonnement RF ISED établies pour un environnement non contrôlé.

Cet émetteur ne doit pas être co-implanté ou fonctionner en conjonction avec toute autre antenne ou transmetteur

Cet équipement doit être installé et utilisé avec une distance minimale de 20cm entre le radiateur & votre corps.

CHANGES & MODIFICATION

Changes or modifications made to this device may void certification of the device. Changes or modifications made to this unit not expressly approved by the party responsible for compliance could void the user's authority to operate the equipment.

INTERFERENCE

Nanoleaf Aurora has been designed to minimise interference with other radio, broadcast or receiving devices. The manufacturer is not responsible for any interference caused as a result of modifications to the product or by failure to adhere to the "Warnings and Cautions" section of this document.

This device generates radio frequency energy and, if not installed in accordance with the "recommended installation requirements" may cause harmful interference to radio communication devices. If the device is causing radio interference, it is recommended that the user try:

- a) relocating the device to a different place;
- b) adjust the antenna on the receiving device;
- c) consult a technician experienced in radio interference.

WARNINGS & CAUTIONS

Please read this safety information carefully and keep this user manual for later reference.

Nanoleaf Aurora is not designed for use in:

- Enclosed locations that limit the flow of air and/or trap excessive amounts of heat
- Emergency exits or emergency lights
- Conjunction with 3rd party sensors/timing devices that are not approved by Nanoleaf®
- Places where there is a risk of electric shock
- Outdoor areas
- Wet or damp conditions
- Excessively hot environments (e.g. close to ovens, radiators, heaters, etc.)
- Regions or countries other than that in which the product was intended for.

When using Nanoleaf Aurora:

- Do not open the device, as this will void the warranty.
- Do not place any metallic or conductive objects near the exposed contacts on the Aurora controller, power supply, linkers, or back of the Aurora panels.
- Do not allow small children to operate this device unsupervised. This device contains small parts that may be a choking hazard to small children.
- Do not clean the device when it is on and or connected to power.
- Clean the panels with a soft dry cloth, do not use cleaning agents.
- Do not bend the panels with the linker still attached.
- Do not attach the panels together with anything other than its original panel linkers.
- Do not puncture the panels with any nails or screws during installation.
- Do not attach the panels to a ceiling without extra adhesives to secure the panels from falling.
- Do not attach the panels to the floor where it may get stepped on.
- Do not place the panels in water, or expose the panels to water.
- Do not use mounting tape for the following surfaces: Unpainted brick wall, wall paper, uneven/bumpy surfaces,

DESIGN IDEAS

The more the merrier! Here are just a few examples of what you can create with more Aurora panels:

with 9 Panels

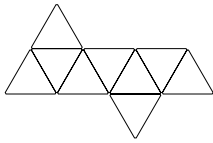

The Napping Unicorn

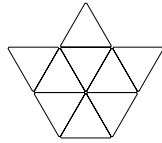

The Matrix Crown

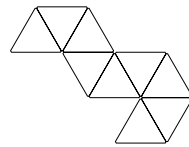

The Free Bird

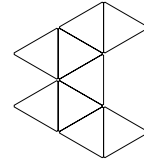

The Swanky Pacman

with 12 Panels

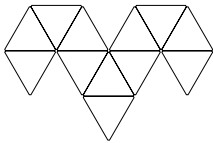

The Dodgy Ram

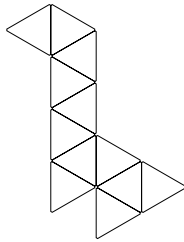

The Cuddly Giraffe

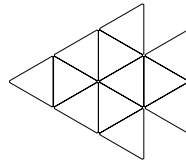

The Sparkly Nemo

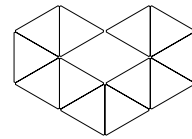

The Lovey Dovey

with 15 Panels

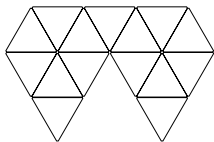

The Siamese Diamond

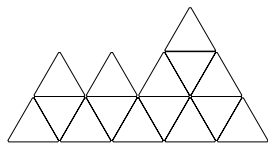

The Homely Mountains

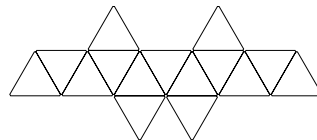

The Huggable Sloth

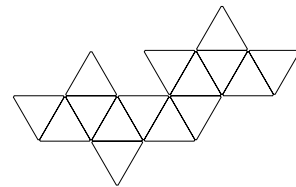

The Snuggling Kittens

with 30 Panels

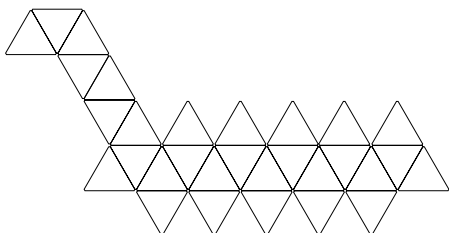

The Slurpasaurus Rex

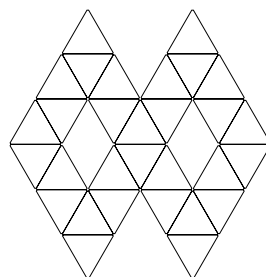

The Divine Infinity

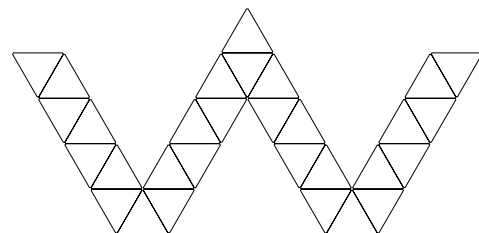

The Wiggly Worm

GET SOCIAL

Share your masterpiece with us!
Let your voice be heard!
Leave a review for this product by visiting:



nanoleaf.me/aurora



@nanoleaf



@nanoleaf



/nanogridsolar



/thenanoleaf