

The Atlas Copco logo is displayed in white text on a teal rectangular background in the top right corner of the image.A large teal triangular graphic in the bottom left corner contains a white technical drawing of a circular component with various dimensions and labels, serving as a background for the title text.

Calibration and testing of tightening systems pocket guide

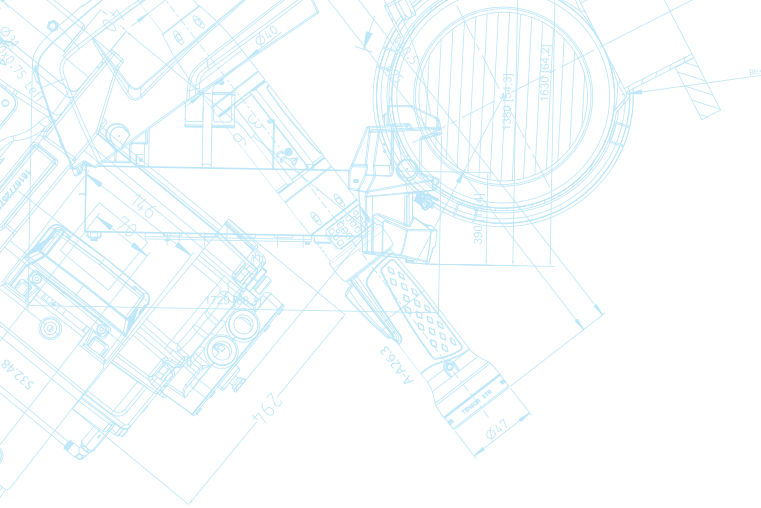

Calibration services from Atlas Copco

With calibration laboratories accredited by local accreditation bodies in several locations around the globe, Atlas Copco has a special position among tool manufacturers. However, the calibration services offered are not limited to torque. Atlas Copco is also a provider of calibration services of angle, force and electrical values. Atlas Copco operates calibration laboratories in over 20 countries across the globe. Of course, most calibration services and machine capability testing can also be performed at customers' plants. Customers often request these on-site services to minimize downtimes. Our accredited laboratories are certified according to ISO/IEC 17025 and meet all the requirements of quality standards including ISO 9001, ISO 10012 and IATF 16949.

Calibration and testing of tightening systems

1. Introduction	4
2. Why are measurements and calibration required?	4
3. Definitions	4
4. Norms and standards	8
5. Measurement and calibration laboratories	10
6. Types of calibrations	11
7. Calibration procedure	13
8. Certificate requirements	15
9. Calibration intervals	16
10. Who is allowed to carry out calibrations?	16
11. Particularities of angle calibration	17
12. Special considerations for calibration work in connection with tightening systems	18
13. Particularities of force calibration	19
14. Hydraulic wrenches	20
15. What type of calibration makes sense?	22
16. Quality assurance, liability and environmental protection	22
17. Industry requirements	25
18. Asset management	26
19. Benefits of calibration	27
20. Further information sources	27
21. Your professional calibration service provider	28
22. Our logistics solutions	28
23. Training, seminars and workshops	30
Appendix	31

1 Introduction



Tensor electric nutrunner with controller

This pocket guide is intended to help you achieve reliability, quality and safety in the use of bolted assembly tools – for example, considering product liability issues. The guide defines key terms of measurement and calibration regarding industrial tools and provides a large number of suggestions, for example, on the intervals and methods for testing of electric and pneumatic nutrunners. Also covered are matters such as who is allowed to perform calibrations of the measuring equipment and relevant calibration procedures.

2 Why are measurements and calibration required?

Pneumatic and electric tools need to be measured and verified at regular intervals. Calibrated measuring equipment is used for this purpose. This ensures that the tools function correctly and precisely.

With present quality requirements, this procedure is essential due to the ultimate product responsibility of the manufacturers. Only tools that have been properly serviced and adjusted ensure proper production results and avoid incorrect tightenings which might be expensive and safety-critical. With regular measurements and calibration, manufacturers can avoid production problems and possible legal consequences.

Proper measurements are a fundamental and essential element of industrial quality assurance. This applies not only to the international standards for quality management systems (ISO 9001, ISO 10012, QS 9000, IATF 16949 etc.) but also concerns product liability issues (see page 22) and environmental protection.

Accuracy is ensured by calibrating and, if necessary adjusting the measuring equipment. A number of standards state requirements concerning equipment calibration; some quality standards call for regular calibration so that the deviation between the actual reading and the correct value is known at all times. Equipment must be appropriately calibrated to reach the accuracy required in its field of application.



Measuring equipment can only work accurately if it is tested and calibrated at regular intervals.

3 Definitions

This section explains the definitions of a few key terms in order to avoid misunderstandings. In practice, these terms are often used in incorrect contexts or are understood incorrectly.

Calibration

Calibration is the determination and documentation of the deviation between the reading of a measuring instrument or a control unit to the value indicated by a higher-level reference device. This means that two values are compared with each other, one of which is known and fixed.

During the calibration of a measuring instrument, the correlation between the input and the output is determined and documented under defined conditions. The input is the physical parameter to be measured, for example, torque or rotational angle. The output is often an electrical signal of the measuring instrument but may also be a displayed value.



Calibration: Using a defined measurement system, two values are compared with each other: the value given by the device to be calibrated and the value given by the reference.

Adjustment

Adjustment is the process of setting a measuring instrument in such a way that the deviation between the actual and the required measured value is as small as possible and is within the equipment specification. Adjustment represents a physical change to the measuring instrument.

Adjustment is often closely connected with calibration. The objective of the two processes is to detect and document deviations. If the reading given by a measurement device or the output of a controller is found to be outside the admissible tolerance limits during the calibration process, the equipment must be adjusted until the measured values are within these tolerance limits.



Adjustment: If the reading of a measurement device or the output of a controller is outside the acceptable tolerance limits, the equipment needs to be adjusted.

Measurement

Measurement means determining whether a requirement, such as the correct functionality or accuracy of a system or measuring instrument, is met. Normally, the result of a measurement is a measured value or a series of measured values. A measurement result always represents an estimation that is more or less precise and includes a measurement uncertainty. The objective of measurement is to make a clear statement regarding an unknown factor.

Standards (measurement standards)

In English, the term “standard” is used both to refer to a written document stating requirements and to a standard measurement instrument used in calibration processes. This paragraph deals solely with standard measurement instruments.

A standard is definition of a given quantity – i.e., it is a sort of reference. A well-known standard in this sense is the atomic clock kept by the German National Institute (PTB) in Brunswick. This effectively “standardizes” time by defining a second using a constant in atomic physics. This constant is realized using cesium atomic clocks. On this basis, we all know how long a second or an hour is and whether our clock runs properly or needs adjustment. Another very well known standard is the primary kilogram (mass) of the International Bureau of Weights and Measures (BIPM) in Sèvres in France.



Primary kilogram

There are also standards for other physical dimensions such as torque, force or temperature. Most countries have their own national standards which apply

to the specific country but are also compared on an international level. Standards used in the production process are referred to as working standards.

Verification

Verification is the process of checking against a reference unit to confirm that an instrument fits the specification provided by its manufacturer.

Certification

Certification is a confirmation of processes and routines concerning norms and standards by an independent, accredited certification body.

The certificate issued by the certification body is a confirmation of compliance with standards. Certificates are often issued with expiry dates and are verified independently to ensure compliance.

Accuracy

Accuracy describes the ability of a measuring instrument or a machine to deliver values that are near to the true value. The machine capability indices C_m and C_{mk} are often mentioned in connection with accuracy. These indices were established in the automotive industry as a method of assessing the quality and suitability of power tools.

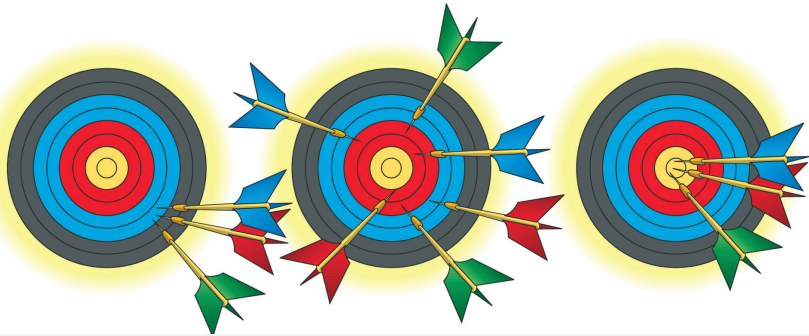

Left: High C_m value but low C_{mk} value. With reference to a nutrunner this would mean that the unit worked with high repeatability but always achieved the wrong results.

Center: Low C_m value and low C_{mk} value. The nutrunner delivers a different result for almost every tightening.

Right: high C_m value and high C_{mk} value. In this particular case, the nutrunner always delivers the correct result with high repeatability or is always within the specified torque range.

The machine capability index (C_m value) is a measure of the general ability of the tool to produce required quality at the operating point. The operating point should be at the center of the specified range. The index indicates the repeatability of the machine. Systematic errors are not taken into consideration. The critical machine capability index (C_{mk} value) however, indicates the deviation between the operating point of the tool and the target value. In other words it gives an indication of compliance with the required operating point. C_{mk} also takes systematic errors of the machine into consideration.

The lower the standard deviation in relation

to the specified range, the higher the C_m value and the more reliable the production process. In other words, if you throw three darts at the board, they will always hit a specific field but this will not always be the bull's-eye. If the machine is set precisely to the center of the specified range, the C_{mk} value will be equal to the C_m value. As the setting moves away from the center of the specified range, the C_{mk} value will be reduced. The aim is to achieve C_m and C_{mk} values that are as high as possible. The diagram with the dartboards gives a graphic illustration of this point.

A high C_{mk} value can only be reached with a high C_m value!

Measurement uncertainty

Measurement uncertainty is a measure of the accuracy of a measuring instrument at operating conditions. Measurement uncertainty is not a fixed quantity but is determined individually for each measuring instrument. It is used to determine whether a measuring instrument is suitable for the required quality process. The optimal choice of a measuring instrument saves costs as excessive accuracy may be expensive.

Tolerance

The tolerance is the difference between the upper and lower limit, i.e., the admissible deviation from a target value. In other words, deviations from a target value are permitted as long as the measured value is within the defined tolerance.

Traceability

Traceability describes a process by which the value indicated by a measuring instrument is compared with the national standard through one or more steps. In each step, a measurement instrument is compared with a measuring standard (reference)

which has been calibrated using a higher level measuring standard.

Any measured value is subject to a measurement uncertainty. This uncertainty grows with increasing distance from the highest-level standard in the hierarchy (see diagram below). Each standard or measuring instrument should be calibrated using higher-level reference. As a rule of thumb, the standard (reference) used for calibrations should have at least five times higher accuracy than the device being calibrated.



Traceability: Even measurement standards (references) are not always absolutely accurate. Within the calibration hierarchy, the measurement uncertainty of the standards used increases from top to bottom. Each measurement standard or measuring instrument should therefore be calibrated using standards of higher accuracy.



Measuring instruments

Both the devices used for measurements and the standards (references) used for verifying these devices are measuring instruments. In addition, a distinction is often made between instruments used for quality assurance and those which are used for other purposes.



Measuring instruments used for quality assurance, such as the transducer shown above connected to a data analyzer, or the torque/angle wrench shown on the right, must always be properly calibrated using references of higher accuracy.

4 Norms and standards

The most important norms and standards for quality assurance and industrial production are briefly explained below. This list does not claim to be exhaustive.

ISO 9000: This international standard defines basic principles and terms for quality management systems. The standard describes the requirements to be met by the management of the company in order to comply with certain

requirements in the implementation of quality management. It may be used both for the implementation of quality management within a company and to demonstrate to third parties that the company complies with certain requirements.

ISO 9001: This international standard defines the prerequisites to the quality management system in the event that an organization needs to demonstrate that its products conform to the requirements of customers and legislation and that it aims to improve customer satisfaction. The standard outlines a model for an entire quality management system.

QS 9000: This American standard was developed to meet special requirements of car manufacturers on the USA market. It adapted the ISO 9001 system to the special needs of the automotive industry. Since 2006 all QS 9000 certifications are terminated and have been replaced by the international standard IATF 16949.

IATF 16949: Requirements for Quality Management Systems. This specification describes special requirements for the application of ISO 9001 to vehicle and spare part production in the automotive industry. The previous version of this standard was known as ISO/TS 16949.

VDA 6.1 - 6.4: These codes of practice of the German automotive industry are binding on suppliers of German car manufacturers and are quite similar to the requirements of IATF 16949. The VDA 6 is classified into two areas, management and products & processes.

ISO/IEC 17025: This standard defines general requirements for the competence of measurement and calibration laboratories. ISO/IEC 17025 enables accredited laboratories to demonstrate that they generate valid measurement results, thereby promoting confidence in their work.

ISO 10012: This standard describes quality requirements for measurement management systems. The standard provides guidance for the effective management of measurement processes and metrological confirmation of measuring equipment and helps in ensuring that both measuring equipment and measurement processes are suitable for the intended purpose.



By the way : If you are interested in detailed definitions of the relevant terms, you will find further information in the "International Vocabulary of Basic and General Terms in Metrology" issued by VIM.

The following norms and standards describe the most important calibration and measurement procedures used in connection with tightening systems:

EURAMET/cg-14: This is one of the most important standards for torque calibration. It describes calibration procedures for torque measuring instruments. The results of the calibration process are classified. The class indicates the accuracy of the measuring equipment concerned. This standard is very similar to the German DIN 51309 upon which it is based.

DIN 51309: see above.

VDI/VDE 2646: A German standard that defines the minimum requirements for the calibration of torque measuring equipment. It is often referred to as a factory standard as the procedure is considerably simpler than the EURAMET cg-14. Other than in EURAMET cg-14, the measurement results are not classified.

VDI/VDE 2645-2: This relatively new standard describes very comprehensive procedures for machine capability testing (MCT) on power tools used in tightening systems. This procedure uses different kinds of statistical analyses of the measured readings in order to provide an assessment of the tool's performance. This standard covers only tools that have a controllable target variable such as torque. Stall-type tools are not covered by this standard.

VDI/VDE 2647: This standard defines the procedure for tool type testing (homologation, see page 13) of power tools. The standard is very comprehensive and is used as a verification that a certain tool type is adequate for a particular production process.

VDI/VDE 2648: This standard defines procedures for the traceable calibration of rotational angle sensors and measuring equipment which

measure the rotational angle either directly (part 1) or indirectly via a gyroscope (part 2). This is currently the only verified calibration standard on the international market for angle calibration of transducers and is thus used as a basis for many national norms in this area.

ISO 5393: specifies a performance test method for power assembly tools. This is the only international norm covering this subject and has recently been updated and extended to cover pneumatic as well as electric/battery powered tightening systems. This norm does not recommend nor set any acceptance criteria.

ISO 6789: This norm defines the calibration procedure for torque wrenches, and is divided into two parts. Part 1 is intended for the manufacturers of the wrenches and describes the minimum requirements for declaration of conformance. Part 2 describes instead the requirements for calibration and determination of measurement uncertainty. This second part is the relevant one for industrial users.

ISO 376: This standard describes the calibration procedure for force transducers. Such transducers can, among others, be used for calibration of press systems used in many assembly processes. The calibration process covers both tension and compression. The launch of this standard has unified and replaced a number of national standards.

VDI 2862: Although not a calibration standard, this norm describes the classification of joints using threaded fasteners and is a guide to the selection of the correct tools for a particular application. This on the other hand, has a large impact on the type of calibration needed for particular tools.



VDI: Association of German Engineers actively developing national norms and specifications for areas where an international norm is not available, is outdated or does not meet the current requirements of the industry. A number of the VDI norms have over the years become international de-facto standards and/or are often used as a basis for international norms.



ISO: International Organization for Standardization creates norms and standards that can be used to ensure that materials, products, processes and services are suitable for their purpose.



A calibration expert performing professional calibration in an accredited calibration laboratory

5 Measurement and calibration laboratories

Users can choose between many different calibration laboratories and a number of different calibration and measurement procedures. It is not always easy to find the laboratory or procedure that is appropriate for a specific purpose.

Almost every country has an accreditation body that is responsible for ensuring the quality of national calibration laboratories. Accredited laboratories are subject to continuous impartial

assessment and monitoring. This ensures the high quality and reliability of the calibration services performed by accredited laboratories.

In general, it is necessary to distinguish between accredited calibration laboratories and non-accredited factory calibration laboratories.

Accredited calibration laboratories

Accredited calibration laboratories perform calibration work on measuring instruments for the measured dimensions and within the measuring ranges defined by their accreditation. The calibration certificates issued confirm that the calibration work performed has followed defined standards or procedures and is traceable to national measurement standards. This traceability is required by the ISO 9000 family of standards and by ISO/IEC 17025.

Most national accreditation bodies are members of ILAC (the International Laboratory Accreditation Cooperation). This means that calibration certificates are recognized in other ILAC member countries as well.

Non-accredited factory calibration laboratories

Factory calibration laboratories are not accredited by a national authority or institution. They perform measurements and calibration work in accordance with their own procedures. Strict compliance with the applicable norms and standards is not ensured. The measuring references used may or may not be calibrated in a traceable way. The quality of these laboratories is normally not supervised by any independent institute. It is therefore highly questionable whether calibration certificates issued by these laboratories would be recognized by a court of law in product liability proceedings. In such liability proceedings, the court has to determine whether appropriate quality assurance processes were applied and if the calibration procedures are in accordance with the current state of the art of calibration. Only in exceptional cases do factory calibration laboratories meet all of these requirements.



Accredited laboratories perform calibrations on measuring instruments which are clearly defined in their accreditation. This work is regularly verified and monitored by their national accreditation body.

Factory calibration laboratories are not accredited by a national authority or institution and there is a lack of independent control and verification of procedures and results.

6 Types of calibrations

Many laboratories and providers of calibrations offer a wide variety of measurement and calibration services. Selecting the right one is not a trivial matter, on the contrary it is essential for quality and safety reasons. The first step is to define whether a tool for production or a measuring instrument is going to be calibrated as the procedures are very different and also have different aims. Production tools need to fulfill requirements of reproducibility and stability in the manufacturing line, whereas measuring equipment needs much higher accuracy but does not necessarily need to have the same kind of durability as production tools. In both cases the issue of traceability of results is crucial.

Accredited calibration (measuring equipment)

Accredited calibrations are performed in accordance with defined norms and standards using validated procedures which can only be performed by accredited calibration laboratories. The measuring equipment used for calibration must be traceable to national standards. In addition, the measurement uncertainty must be calculated and stated in the certificate. Accredited calibration laboratories have considerable metrological expertise.

For this reason, an accredited calibration

certificate provides evidence in case of any related product liability issues (see page 15). Also, through the ILAC agreement an accredited calibration certificate is valid internationally.

Typically accredited calibrations of torque measuring instruments are performed in accordance with the European standard EURAMET cg-14 or similar national standard. Accredited angle calibrations are carried out according to the VDI/VDE 2648 or corresponding national adaption of this norm (see page 9).

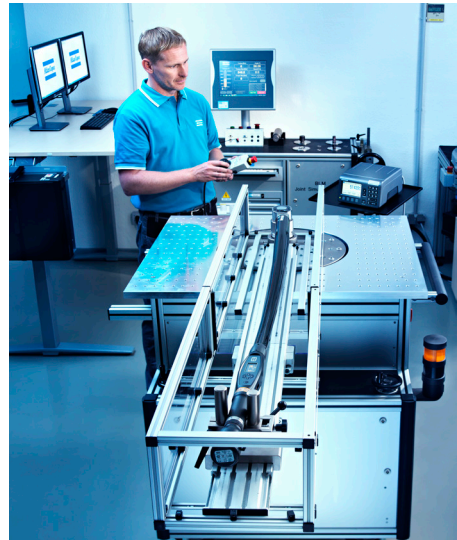

Performing an accredited calibration of measuring equipment.



ILAC (International Laboratory Accreditation Cooperation): an agreement signed by almost all industrialized countries. Certificates from accredited laboratories of the member states are recognized by other ILAC member countries.

Trend: The number of accredited calibrations is increasing rapidly in order to avoid the large number of dubious calibrations being offered by questionable non-accredited calibration providers.

Factory calibration (measuring equipment)

Factory calibration (also sometimes referred to as “working standard calibration” or “ISO calibration”) normally involves a simplified measurement procedure under the sole responsibility of the calibration laboratory. The scope of calibration differs from laboratory to laboratory and may often be highly restricted. Factory calibration services do not necessarily comply with the requirements of national or international standards. The measuring instruments used might lack the traceability to national standards. Also, quite often there is no statement of the measurement uncertainty. There is no formal obligation considering the content of the calibration certificate. This is indeed a problem, which in recent years, has grown bigger as a number of non-accredited calibration providers have started offering dubious calibration services at a very low price. For this reason, the general trend is towards accredited calibrations which ensure the trustworthy and documented measuring results.

However, many accredited calibration laboratories also offer factory calibrations as a simplified, low-cost alternative. Reputable calibration laboratories offering factory calibration services still operate in accordance with defined, validated measurement procedures. They are often simplified but based upon national or international standards and are apparent to the user. These accredited laboratories ensure the traceability of the reference equipment and also when performing factory calibrations.

Accredited calibration (production tools)

A number of countries (especially in Asia as well as North and South America) offer accredited calibrations for production tools. The reason why such calibrations are not offered globally is an ongoing dispute on whether and how dynamic production tools can be calibrated. This fact has led to the situation that some national institutes offer this kind of accreditations and other do not. Also a major issue here is that so far, none of the national institutes offering these accreditations

have been able to agree upon one common calibration procedure. This has resulted in very many dissimilar calibration procedures and results, which are not comparable, making international recognition of such calibration certificates impossible in most cases. Therefore these kind of accredited calibrations are unfortunately not covered by the ILAC agreement.



Bottom brackets for bicycles have right- and left-handed threads. In order to achieve the correct torque, nutrunners must therefore operate equally accurate in clockwise and counter clockwise directions.

Machine capability tests (production tools)

A machine capability test (sometimes also referred to as tool calibration or comparison measurement) is performed in order to determine the C_m and C_{mk} values of the tool. On the basis of the results and their statistical evaluation, it is possible to determine whether a tool is suitable for a specific application or not.

Well-equipped laboratories are able to simulate the actual tightening application (for example, using a test bench, see photo on page 13). Often, a series of “soft” and “hard” tightenings are simulated to determine whether the tool complies with the relevant requirements.

Unlike the “accredited tool calibration” (see above), a machine capability test (MCT) is a process which is internationally recognized by the industry. The most well-known international standard describing how such MCTs should be

performed is the ISO 5393. Another standard which in the past years has won international acceptance is the German VDI/VDE 2645-2.



The machine capability of tightening tools needs to be tested regularly using measuring equipment, which is traceably calibrated, such as this test bench.



Homologation (production tools)

Unlike the MCT where a single tool is being tested a homologation is a tool type test. For this purpose, up to three of the same type are subject to this quite time-consuming procedure. Some of the test runs are performed under extreme conditions. The test period is considerably longer than for a MCT. The homologation procedure also determines typical C_m and C_{mk} values of the



tool. Often, homologation is performed in order to obtain approval for the use of a particular machine type for a production process. In the automotive industry, homologation is often required and is performed according to the VDI/VDE 2647.

Homologation may also be performed if there is reason to suspect that quality problems are caused by a specific type of tool. The objective in this case is to obtain comprehensive information on the behavior of the particular tool type.

7 Calibration procedure

A typical calibration procedure follows a number of defined steps (see diagram on next page):

1. Test of functions and visual inspection to identify any damage to the equipment to be calibrated. The objective is to identify any damage to the housing, display, cables or contacts of the equipment. The inspection also covers any accessories as well as the technical documentation required for the calibration (such as technical data, operating instructions, service documents).

A test of functions is then performed on the equipment to be calibrated. This test verifies proper operation of the equipment and also covers basic settings, self-test functions and zero point alignment.

2. Following the inspection, it is necessary to decide whether the equipment is suitable for calibration in its current state or if it needs to be repaired. If repair is necessary, the calibration

laboratory contacts the customer in order to agree on the scope and cost of repair work. If it is not feasible to repair the equipment, the laboratory suggests that the equipment should be scrapped and replaced.

3. If the equipment is suitable for calibration, a calibration procedure according to the defined norm or standard is carried out. If the equipment needs to be optimized and this has been agreed upon with the customer, an adjustment of the device is performed. Following the adjustment the calibration procedure is again repeated.
4. After the calibration procedure has been completed, the laboratory specialists check the plausibility of the measured data. In the event of deviations, the calibration procedure may be repeated or the equipment may need to be repaired.
5. If the results of the plausibility check are acceptable, a calibration certificate and any other relevant documents are issued in accordance with the applicable norms and standards. Finally, the equipment which has been calibrated is labeled. Labeling normally includes a recommendation of the next due date. However the final responsibility of the right calibration interval lies with the customer.



Factory calibration label

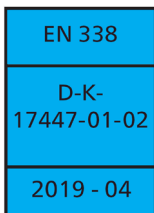

Accredited calibration label (scale: 1:1)

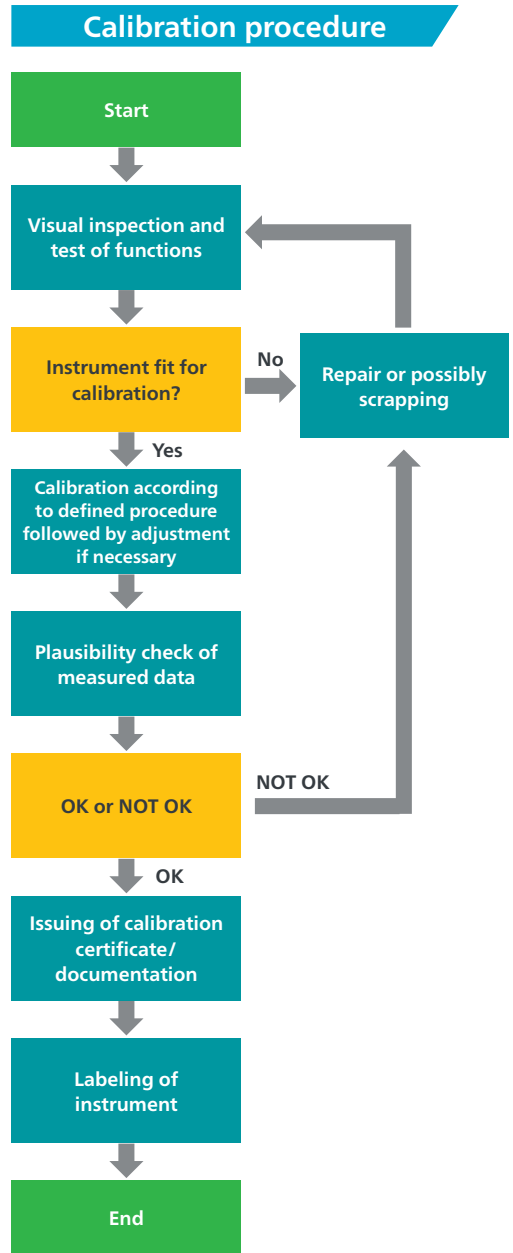

Typical calibration procedure, from visual inspection and test of functions, through calibration and plausibility checking of results, followed by documentation and labeling of the device.

8 Certificate requirements

What information should a certificate include? The kinds of certificates provided by different service providers differ heavily.

The information which is required in an accredited calibration certificate is clearly defined and must cover the following points:

- Unique identification of measuring instrument (type and serial no.)
- Calibration date
- Customer and customer's address
- List of references and information on traceability to national standards
- Calibration procedure / norm
- Ambient conditions
- Achieved calibration results (if applicable, before and after adjustment)
- Measurement uncertainty
- Validity interval
- Adjustment or calibration value
- Possible restrictions on use (depending on results)
- Individual calibration number for the measuring instrument
- Unique identification of the accredited calibration laboratory
- Names and signatures of persons who performed the calibration
- Name and signature of calibration laboratory manager or his deputy

When it comes to factory calibrations the situation is not as clear. As factory calibrations are the sole responsibility of the calibration provider, the factory calibration certificates issued may differ substantially. There are currently no binding requirements and the certificate issued may range from a simple sales slip without signature or stamp to a very comprehensive calibration certificate of several pages.

However, even in the case of a factory calibration, professional calibration laboratories offering a high-quality service will ensure that the

certificates cover at least the following:

- Unique identification of measuring instrument
- Calibration date
- List of references and information on traceability to national standards
- Calibration procedure / norm
- Calibration results
- Individual calibration number for the measuring instrument
- Ambient conditions
- Identification of institute and signature of person who performed calibration

The certificate issued for a machine capability test (MCT) is similar to a calibration certificate but depends to some extent on the type of device and the procedure applied. Proper certificates should include no less than the following information:

- Unique identification of tool
- Customer and customer's address
- Test date
- List of references
- Test procedure / standard
- Maximum, minimum, specified target and measured values
- Adjustment value
- Defined error limits
- Determined C_m and C_{mk} values
- Identification of institute and signature of person who performed calibration

In all cases, no matter if factory or accredited, missing or incomplete information is a sign of lack of competence of the laboratory or service provider and should be questioned by the customer. A proper certificate is needed in case of any liability issues and to prove the traceability of results. Missing, misleading or wrong information is a severe risk for customers.

Right: Minimum information provided by professional laboratories in a calibration certificate. You will find samples of accredited calibration and machine capability test certificates in the appendix.



Calibration intervals depend on the specific application and need to be determined individually. In many cases, annual calibration is recommended for measuring instruments and production equipment.

9 Calibration intervals

Customers frequently ask about calibration intervals required for measuring instruments and production equipment. It is not possible to give a general answer to this question as a calibration result always represents a snapshot of current conditions and change over time. The calibration intervals required depend on a number of factors including the following:

- Quantity measured or produced
- Admissible tolerances
- Condition of measuring instruments and equipment
- Stability of past calibration results
- Accuracy required
- Quality assurance requirements
- Ambient conditions

This means that calibration intervals depend on the user and the specific application and need to be individually determined and monitored. Normally, the company's quality manager is responsible for this task. In the case of new equipment, it may be beneficial to adapt the calibration intervals gradually to reflect actual conditions.

In this approach, calibration intervals are initially

set to a relatively short period. The time interval for subsequent calibrations can then be extended or shortened, depending on the long-term stability of the calibration results. However, in most cases, annual calibration is appropriate for measuring instruments and production equipment. In many safety critical applications an interval of 6 months or even 3 months is used instead.

10 Who is allowed to carry out calibrations?

There are almost no restrictions on who can perform calibrations. When selecting a calibration company or laboratory, you should make sure that you select a professional partner that applies appropriate procedures. As calibration is not a legally protected procedure, there are many providers on the market who do not offer a professional service. Rather, there is a high number of low-budget calibration providers offering calibration services of highly dubious quality.

In fact, it is not just the calibration label on the equipment that is important. The calibration procedure which has been applied and the documentation of the achieved results are of

Inspection		Adjustment value

N·m

Label for machine capability test and/or maintenance.

utmost importance. The following questions also need to be considered:

1. Have all the measuring ranges of the calibration object been measured?
2. Are the results within the specific range of the laboratory? (Laboratories are certified with respect to measurement ranges and measurement uncertainties. If a lab indicates higher accuracy than they are actually able to measure, this does not indicate a professional approach and shows serious lack of knowledge.)
3. In technical terms, is the laboratory in a position and does it have the necessary competence to perform the calibrations?
4. Do you receive a comprehensive calibration report (see section 8, page 15) or only a calibration certificate that does not provide calibration results and measurement uncertainties?
5. Did the calibration provider perform safety and functional tests of the device prior to calibration? A good way of ensuring safe and reliable calibration services is to select an accredited calibration laboratory. However, you should pay attention to the measured dimensions (torque, force, etc.) for which the laboratory is accredited. Not every calibration carried out by an accredited laboratory is in fact an accredited calibration.

As a general principle, accredited laboratories offer considerable metrological competence. A conformity procedure ensures that only validated measurement methods and properly traceable reference equipment is used for calibrations. Accredited laboratories are continuously monitored by national accreditation bodies and therefore ensure high quality calibration services.

You will find a more extensive checklist for the selection of an appropriate calibration service provider in the appendix.



Make sure that you select a professional partner (and not a low-budget calibration supplier with services of highly dubious quality)!

11 Particularities of angle calibration

Rotational angle calibration is performed according to the standard VDI/VDE 2648 (see page 9). A distinction is made between direct measuring systems, such as torque and rotational angle transducers (VDI/VDE 2648, Part 1) and indirect measurement systems, such as torque and rotational angle wrenches (VDI/VDE 2648, Part 2).

In the first case, with direct measurement systems, the procedure involves defining a 0° point and performing measurements in different steps from this point. The measurements are normally performed in both directions, clockwise and counterclockwise.

In the case of indirect measurement systems, the matter is rather more complicated. High-quality torque and angle wrenches operate with gyroscopes of similar type to those used in aircrafts. These instruments do not have a defined 0° point. For this reason, they are also referred to as no-reference systems. The calibration of such systems is highly complex and can only be carried out by accredited laboratories with special equipment. During such calibration work, the rotational angle is measured under a torque load in order to verify proper functionality and results under real operating conditions.



Rotational angle calibration system for direct and indirect measurement systems.



Attention

Not every calibration performed by an accredited laboratory is in fact an accredited calibration.



12 Special considerations for calibration work in connection with tightening systems

For calibration work on tightening systems, there are two measured dimensions that are especially important: torque and rotational angle. These two dimensions may be considered either separately or in combination.

Torque

In connection with tightening systems, torque calibration is the most widely used approach to ensure the proper functioning of the equipment used and the quality of bolted joints. It is normal practice to use measuring instruments in production to verify the quality achieved by a tightening tool.

Rotational angle

Rotational angle calibration is important in connection with angle-controlled tightening procedures. In practice, these procedures are

not yet used as frequently as torque-controlled tightening procedures, but they are very useful in certain applications and are becoming increasingly important. Using the rotational angle to control the tightening process, one must also calibrate the rotational angle in order to ensure that the measurements (and so the bolted joints) are correct. This also applies to quality control equipment measuring “installed torque” (e.g., torque/angle wrenches) as here the angle is used as one essential parameter for evaluation of results.

Torque and rotational angle

As bolted joints become more complex, the topic of rotational angle calibration becomes more important for companies. Especially in the case of safety-critical joints (category A joints defined by VDI 2862), it is necessary to document a monitoring variable (e.g., angle) in addition to the control variable (e.g., torque). In such cases, rotational angle is often the most practicable solution. Examples of safety-critical bolted joints can be found in safety belt or airbag installations in cars, electrical grounding connections of white goods (e.g., washing machine) or on the rotor blades of wind turbines. If these bolted joints fail, there is a direct risk of injury or death.

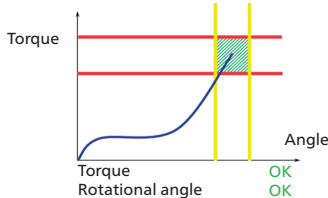
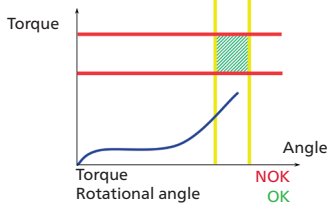
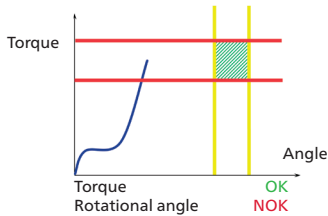

Torque/rotational angle plots

The bolted joint can only be considered correct if both variables are OK at the same time (bottom graph).

In the case of bolted joints tightened with a combined torque and rotational angle procedure,



Please make sure that rotational angle calibration of transducers or wrenches is only performed in connection with torque calibration. Torque calibration is used as a basis for the determination of certain key parameters.



Atlas Copco has developed an own standard for testing and calibration of press tools. This standard not only covers force but also calibration of displacement as both variables are needed in an assembly process.

both values – torque and rotational angle – must be within the specified “window”; otherwise, the bolted joint as a whole cannot be rated as OK (see graphs on page 19).

13 Particularities of force calibration

In many production facilities force systems are being used, typical applications can be assembly of bearings or plugs. Obviously such press systems also need to be calibrated to ensure proper functionality and quality of products.

As this kind of systems are production tools a MCT (see page 12) would be a suitable kind of calibration to ensure functionality. However, as of this moment there is no such international and verified procedure which can be applied here. For this reason manufacturers of such systems use their own procedures. In most cases such systems need a calibration of force but also a calibration of displacement as both variables are used in an assembly process. The calibration of displacement in particular is often forgotten when calibrating such systems, this however, can be crucial to overall assembly quality.

The force calibration of measuring instruments to perform the calibration or MCT of the above mentioned tools is standardized. A force calibration of force transducers is performed according to the international standard ISO 376.



Calibration of a press tool system performed in a laboratory

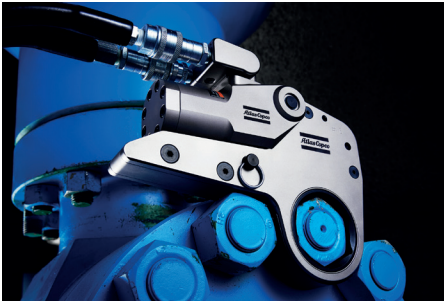

Hydraulic torque wrench (left) and calibration of such a tool (the hydraulic pump unit can be seen at the front).



14 Hydraulic wrenches

Hydraulic torque wrenches are frequently used in the chemical and petrochemical industry, in pipeline constructions and in the assembly of wind power systems. These tools use high oil pressures to achieve very high torque levels, which are often considerably above 20,000 N·m. However, hydraulic torque wrenches operate very slowly, which is why they are mostly used for final tightening stages. They are very different from the electric controlled nutrunner systems described in previous chapters. These controlled systems are normally operated in two stages, with a very fast run-down stage followed by a significantly slower and more accurate final tightening stage.

Hydraulic torque wrenches are driven and controlled by special pump units with oil pressure of up to 700 bar. The pump pressure itself is set using a pressure gauge; the pressure is used as a means of setting an approximate torque value. The pressure and torque relation is defined based on a table supplied with the wrench unit - pressure versus torque (see page 20).

Dynamic testing is not possible

These tools are often used for critical applications and therefore need to be tested and calibrated just like normal electric or pneumatic nutrunners. However, dynamic testing in accordance with ISO 5393 or VDI/VDE 2645 is not meaningful

here. These standards describe highly dynamic processes which is the case with electric controlled tightening systems but does not apply to hydraulic wrenches. With wrenches of this type the process is close to static since the final tightening stage only covers an angle of a few degrees and is performed very slowly.

As a result, there are many service providers on the market who work in very different ways, some of which are not professional. In addition, a variety of different test procedures are used which do not even meet the very basic requirements for ensuring proper functioning and appropriate results.

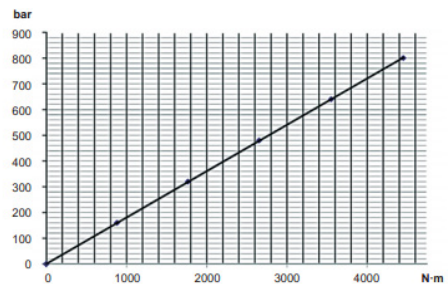

Torque/pressure diagram for the setting of hydraulic torque wrenches. The oil pressure is used as a variable for setting the torque required.

International calibration standards not yet available

A number of different national committees are currently working on a standard for the testing and calibration of hydraulic torque wrenches. Until such a standard has been issued, it is extremely important to ensure that the calibration procedures used at least meet the basic requirements concerning the traceability and repeatability of the test results.

Some of the calibration procedures currently used, which the user should be warned about, test the hydraulic torque wrench only in a limited torque range, meaning the user cannot be certain that the tool is working properly over the entire range. Currently there are few test systems which can perform measurements above 20 000 N·m. As a result, torque wrenches which operate above this torque range can only be tested up to the maximum torque level of the testing system. Higher torque levels are then often extrapolated. It is clear that approaches of this type are unprofessional and also extremely dangerous because the user cannot be sure that the torque wrench will function properly at higher torque levels. This also applies to testing procedures which only involve measurements at two or three measuring points and simply interpolate the other values in order to save time and money. As the calibration procedures used have not yet

been standardized, approaches of this type are unfortunately very common on the market. Users therefore need to check their service providers closely.

If traceable measured values are not available and the testing procedure is not documented, it will be difficult to achieve sustainable high quality. It will also be difficult in the case of product liability proceedings to provide evidence that a manufacturer has ensured a secure process chain without any gaps.

A revised and expanded edition of VDI 2862 has been issued at the end of 2013. Apart from the use of tightening tools, this standard also defines requirements for the classification of tightening operations, not only for the automobile industry, as was previously the case, but also for the general industry, where hydraulic torque wrenches are frequently used.

Therefore, manufacturers are under an obligation to document tightening results of hydraulic wrenches and to perform regular calibrations, especially if they are used for category A bolted joints (= classification of bolted joint as "safety-critical" because there is a risk of death or injury in the event of failure). Bolted joints are often crucially important for safety, not only in industrial plants and wind farms. In petrochemical plants too, faulty bolted joints pose a considerable risk of environmental damage that can lead to severe liability issues.



Test procedures with interpolated and extrapolated measured values are unprofessional and impose considerable risks!



Hydraulic torque wrenches are frequently used in the process and wind power industries.

15 What type of calibration makes sense?

In order to answer the question of what type of calibration service makes sense for an individual user, it is necessary to understand the individual needs and to draw a distinction between nutrunners used for production on the one hand and measuring instruments on the other hand. In general, the quality manager of a company is the one to set the rules for how measuring instruments and tools should be calibrated or tested. This person is then also responsible for achieving the necessary quality level and documentation of results for any future needs. However some general recommendations which are most common in the industry can be summarized as follows.

Production equipment

Production equipment, such as electric and pneumatic nutrunners, needs to undergo regular testing. Standardized machine capability tests (MCT) following the ISO 5393, are a very favorable solution as they are globally recognized. The same might soon be the case for the VDI/VDE 2645-2 standard which is rapidly gaining global acceptance.

Accredited tool calibrations (see page 12) on the other hand are less recommended in global operations as the procedures are not internationally valid and differ too much between the different markets. For local production and operations however, this might be a suitable option.

Homologations (see page 13) are only recommended in response to a specific requirement (i.e., tender specification) or if there are reasons to suspect the tool is causing quality issues. Homologations are very extensive



All production tools need to be properly tested on regular basis.

Accredited calibrations are the best choice for calibrations of measuring instruments.

and provide information that is far more comprehensive than a MCT or a tool calibration. These kind of tests is meaningful as a final verification in R&D projects. Here the results show whether a tool has reached the targets which were set for the development of the product at the very beginning of a project.

Measuring instruments

In the case of measuring instruments such as torque transducers, accredited calibrations are normally recommended. Standards like ISO 9001, ISO 10012 and IATF 16949 require measuring equipment to be calibrated in a traceable way. Accredited calibrations meet these requirements at all times and the calibration certificates issued are internationally recognized; this often saves additional costs. Also, in general, the trend is towards accredited calibrations as the number of dubious calibration providers (non-accredited) has been growing, creating big problems for the industry.

Where there is no specific requirement for calibration or testing based on quality standards, factory calibrations can be recommended as an alternative. In addition, there are some measuring dimensions for which the accreditation bodies do not yet issue accreditations, such as ultrasound. In such cases too, factory calibrations are a feasible alternative.

Transducers and other measuring equipment that are used as reference standards must always be subject to accredited calibration. Otherwise, traceability to national reference standards is not ensured. This traceability is normally the sole purpose of such reference equipment.

16 Quality assurance, liability and environmental protection

"Quality" is a term that is widely used in a number of very different contexts. Sometimes, the term is even used to deliberately mislead customers and to give them a false sense of security. The

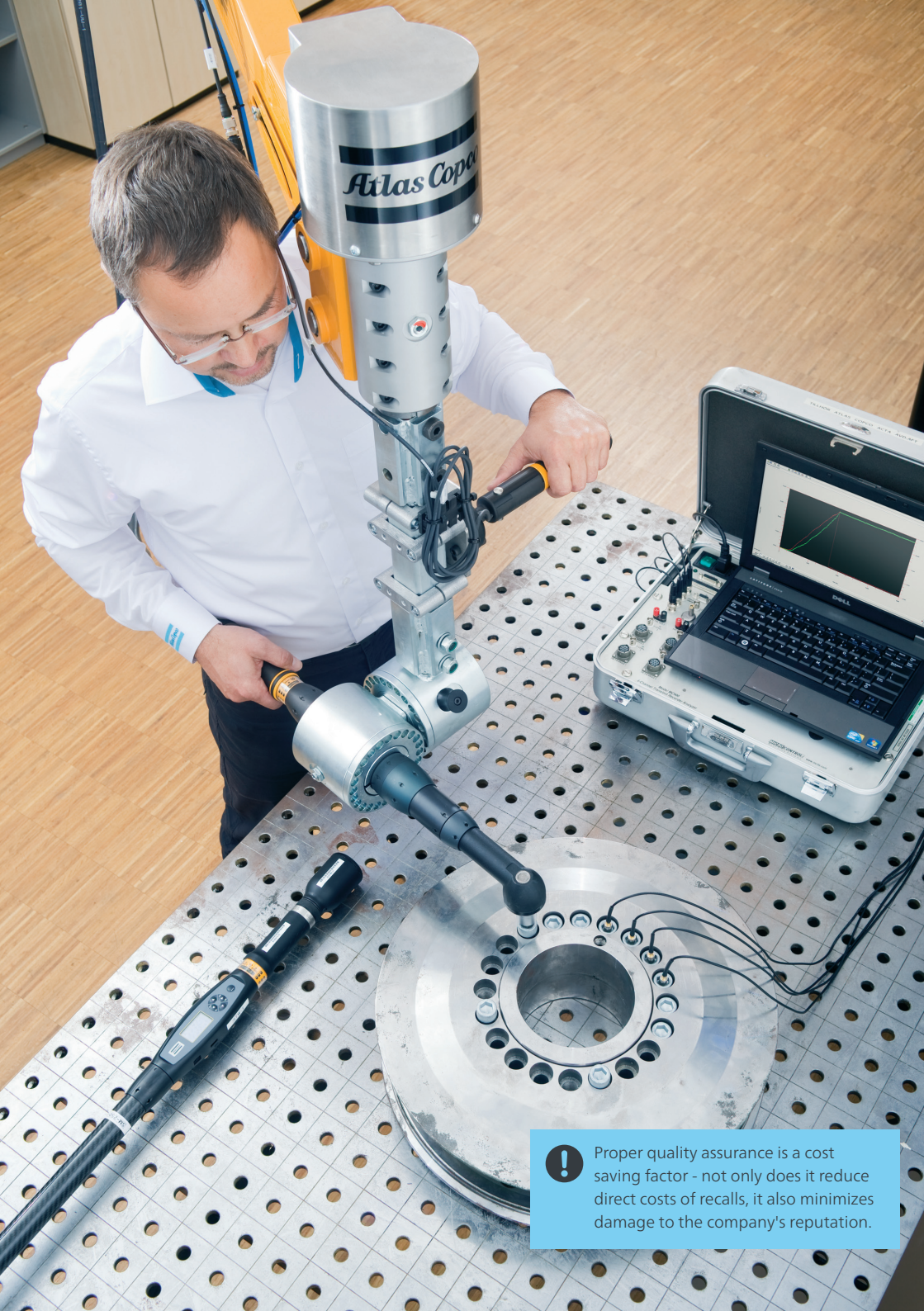

Proper quality assurance is a cost saving factor - not only does it reduce direct costs of recalls, it also minimizes damage to the company's reputation.

introduction of the ISO 9001 standard at least provided a first definition which is of considerable importance for the industry. On this basis, it is possible to assess quality using defined benchmarks and to make comparisons. For both, consumers and manufacturers, this means greater security.

How can we ensure continuously high quality? The ISO 9001 standard provides answers and practical hints. Organizations and companies certified on this basis are committed to comply with defined procedures. For example, documentation and traceability of results and properly working measuring equipment are essential requirements. All measuring equipment and references must be properly calibrated at regular intervals and such calibrations need to fulfill certain requirements.

Quality assurance lays the foundation for product liability. Product liability describes the liability to pay damages for delivering defective goods and for damages caused by such. Initially, every customer might claim compensation if it can be proven that the manufacturer is responsible for the faulty goods. As one concrete example, the Product Liability Act based on EC Directive 85/374 EC has been implemented in all of the member states of the EU; similar laws are implemented in other countries worldwide.

The Product Liability Act applies to all companies and organizations selling or distributing products in the European Union. Similar applies for other countries having similar laws. The effects of product liability are especially dramatic in the USA, where huge amounts of damages may be awarded in the case of defective goods or products. Less spectacular, but often equally costly, are the recall campaigns frequently announced by manufacturers and importers.

Due to higher pace in the production, need of lowering costs and consequently shorter life-cycles of products the number of re-calls has risen dramatically in the past years. All of this being consequence of insufficient implementation of steps needed to secure quality in production. Luckily due to traceability an effective re-call is possible. However, the costs are always very high compared to quality assurance from the very beginning. This implies that proper quality assurance is a clear cost saving factor in the long

run, not only providing better products to the customers but also minimizing the damage to the reputation of companies on the market.

Product liability for a period of up to 60 years is not unusual in the automotive and aerospace industries. In connection with the Product Liability Act, manufacturers must select suitable measuring equipment for the measurement tasks involved. They need to keep full documentation of the proper use of such equipment and they should implement systematic measuring equipment control procedures. This obligation also calls for companies to keep precise documentation and to maintain the measurement standards which have been used. Manufacturers who have complied with all these requirements will find it easier to defend themselves against product liability claims.

Quality not only relates to product safety and responsibility, but also with environmental aspects. Properly tested measuring equipment and tools are also a prerequisite for efficient, environmentally friendly production. This is why environmental protection is increasingly becoming an integral component of the entire product lifecycle from design and development, through use, to disposal and recycling. Environmental management systems are audited and certified in accordance with ISO 14001.



Product liability for up to 60 years is not unusual in the automotive and aerospace industries.

The light-weight design and construction of vehicles results in resource and energy savings. However, this trend leads to an increased number of safety critical tightenings. The risk of failure of these joints needs to be kept to an absolute minimum as they have a direct impact on safety. The equipment used for calibration of such tightening systems needs to meet the highest standards in order to be fulfilling the tough requirements.



Professional software with the guidance of a technician and automatized evaluation of results, ensures proper calibration results.

17 Industry requirements

In industry, carmakers in particular have played a pioneering role in quality assurance and safety. Automobile industry requirements are often gradually accepted and implemented as standard procedure in other sectors of industry.

What does industry actually require? One of the key elements, in accordance with the ISO 9001 standards concerning quality assurance, is the management of measuring instruments and production equipment. This approach is intended to ensure that all the equipment relevant for product quality actually functions properly. For this purpose, all equipment needs to be calibrated regularly. Such calibrations must be traceable to national standards. In addition, the measured results must be documented.



Measuring instruments and production equipment needs to be calibrated at regular intervals. Calibrations must be traceable to national standards.

The traceability of calibration results to the national standards should be attested by laboratories issuing calibration certificates. However, international recognition of factory calibration certificates has become increasingly questionable in view of the proliferation of

unqualified calibration service providers. For this reason, auditors increasingly call for calibration certificates issued by an organization participating in the International Laboratory Accreditation Cooperation (ILAC, see page 28).

For instance, national accreditation bodies such as the German DAkkS, British UKAS or Italian ACCREDIA are member organizations and the corresponding calibration certificates are accepted not only within the European Union but also in most industrialized countries worldwide. This ensures compliance with all relevant requirements concerning the competence of calibration providers.

Even though certification to ISO 9001 is regarded as a minimum requirement in most sectors, such certification is nowadays often insufficient and extended standards like the ISO 10012 or the IATF 16949 for the automobile industry are commonly required.

IATF 16949 combines the requirements of various national standards and is based on ISO 9001. The standard is recognized by virtually all the world's carmakers and indicates a way out of the certification maze apparent in the automobile industry. Formerly, multiple certifications were often required as different standards applied



in various European countries and America (for example QS 9000 in the USA, VDA 6.1 in Germany, EAQS in France and AVSQ in Italy).

Major carmakers such as Daimler, General Motors and Ford have decided only to award contracts to suppliers who are certified to IATF 16949 (see box below). As a result, IATF 16949 automatically applies to the entire automobile industry supply chain and to both direct and indirect suppliers. Therefore, a certification according to IATF 16949 is highly recommended in view of the need for worldwide recognition by major carmakers.



IATF 16949 contains a direct reference to ISO/IEC 17025 (General requirements for the competence of testing and calibration laboratories), a standard which states clear requirements for calibration laboratories. In the standard, it is stressed that the introduction of a quality management system in accordance with ISO 9001 is not sufficient for a calibration laboratory because ISO/IEC 17025 defines technical competence requirements which are not covered by ISO 9001. The calibration laboratory must therefore not only operate a quality management system but also demonstrate that it is technically competent. This means that the laboratory must be in a position to meet minimum technical requirements and to achieve technically well-founded results.

The standard also states that top management must ensure that suitable communication processes are in place within the laboratory and that communications concerning the effectiveness of the management system take place. The laboratory also need to ensure that feedback is received from its customers; this refers to both positive and negative information. This information flow is intended to ensure the improvement of the management system, testing and calibration activities and the benefits to customers. ISO/IEC 17025 specifically requires the continuous improvement of the entire laboratory management system.

18 Asset management

Apart from the standards mentioned previously, it is also necessary to refer to ISO 10012 in the context of calibration of tightening systems.

This standard states general requirements for the handling and metrological confirmation of measuring equipment. It also contributes to effective management of measuring equipment and the determination whether this equipment and measurement processes are suitable for the intended purpose. A sufficient asset management system is essential for product quality and in order to minimize the risk of incorrect measurement results.

The purpose of management of measuring equipment is to create confidence in the measuring results. In this way, quality fluctuations in products and services are prevented. ISO 10012 is often used for the definition of product properties and for the assessment and auditing of asset management systems.

In particular, ISO 10012 states specific requirements for the calibration of all \ equipment using traceable standards. Companies are required to maintain documentation of all calibrations performed within the traceability chain. It is also necessary to ensure that all measuring instruments are securely and permanently marked in order to indicate the status of calibration. Such marking must clearly indicate the deadline for the next calibration of the measuring instrument. The standard also defines minimum requirements for the information to be provided in calibration certificates.

Annual accredited calibrations meet all the requirements of industry stated previously as well as many other requirements and save a considerable amount of effort and trouble. Calibrations by accredited laboratories give the user confidence that the measurement results are reliable. They also enhance confidence levels among customers and the competitiveness of the companies concerned on the national and international market. Accredited calibration ensures results that are internationally comparable and audit proof.



Annual accredited calibration meets all the requirements of industry stated previously as well as many other requirements. It also saves a considerable amount of effort and trouble.

19 Benefits of calibration

Proper calibrations do indeed cost some effort and money, which is why it is important to know what the effects are and what specific benefits these services bring to your company.

The main benefits are as follows:

- Security for the manufacturer or supplier
- Safety for the user
- Traceability of results
- Quality assurance in production
- Compliance with quality standards
- Higher customer satisfaction
- International recognition (accredited certificates)



- Compliance with strict requirements such as those of the automobile industry
- Evidence in connection with product liability

These benefits are essential for virtually any company.

At first glance, measurements and calibrations are often seen as a waste of time and a cost factor. However, this view changes as soon as manufacturers have to bear liability for their products. In comparison with impending claims for damages, the cost of thorough testing or calibration is of secondary importance and can be seen as a highly cost-effective investment. This means that professional calibration of equipment is essential for companies who want to operate professionally on the market in the long term, at the same time maintaining high levels of customer satisfaction.



Key benefits: Traceability of results, reduced rework, and evidence in case of product liability proceedings.

20 Further information sources

Other recommended information sources on calibration and quality assurance:

www.atlascopco.com/en-us/itba/service/service-offerings/maintenance/calibration

Atlas Copco, your competent calibration service provider, offers a full service including measuring equipment management.

www.european-accreditation.org

Association of the European accreditation organizations with the objective of mutual recognition. Most European accreditation bodies are members of EA.

www.ilac.org

ILAC: International Laboratory Accreditation Cooperation. The EA is a member of ILAC. As a result, accredited certificates are recognized by the ILAC members.

www.iso.org

ISO: International Organization for Standardization. Develops and publishes International Standards relevant to the industry worldwide.

Should you have any questions concerning this topic, please do not hesitate to contact your Atlas Copco Service contact: www.atlascopco.com

We will be pleased to inform you about our professional trainings in various topics including calibrations. These and other courses can be adapted to your specific requirements and can also be held on-site at your facilities.

In the appendix you will find sample machine capability tests and accredited calibration certificates as well as a check list for the selection of calibration service providers.

21 Your professional calibration service provider

Atlas Copco is your calibration partner. As an expert in tightening tools and quality assurance equipment, we want to support you in calibration of your equipment allowing you to concentrate

on your core activities. We perform both accredited and factory calibrations.

All the reference equipment used by Atlas Copco is controlled and calibrated on a regular basis, directly traceable to the national standards.

We offer our calibration services in more than 20 markets around the world and we are also able to perform most calibrations directly on-site at your premises in order to minimize downtime and logistics issues.

22 Our logistics solutions

Re-usable transport system and collection service

Atlas Copco offers transport options tailored to your specific needs, from insured shipment with tracking functions through to collection and delivery services. We ensure that your valuable equipment is handled safely, efficiently and in an environmentally friendly manner.

We offer the following options:

Standard shipment: You can check the shipment status of your measurement equipment

Atlas Copco has received national accreditations for calibration centres all over the world – on-site calibration is possible at most occasions as well.



Brazil	Rede Brasileira de Calibração (RBC)
Germany	Deutschland Akkreditierungsstelle (DAkkS)
China	China National Accreditation Service for Conformity Assessment (CNAS)
Eastern Europe	Czech Accreditation Institute (CAI)
India	National Accreditation Board for Testing and Calibration Laboratories (NABL)
Italy	Accredia - L'Ente Italiano di Accreditamento (ACCREDIA)
Mexico	Entidad mexicana de acreditación, a.c. (EMA)
South Africa	South African National Accreditation System (SANAS)
United Kingdom	The United Kingdom Accreditation Service (UKAS)
United States	Laboratory Accreditation Bureau (L-A-B)
Global	International Laboratory Accreditation Cooperation (ILAC)



Atlas Copco

www.atlascopco.com



338343

Atlas Copco

at all times. Upon request, we can also ship equipment by overnight express.

Re-usable transport system: You just call us and we collect your equipment, which is shipped and returned to you in an environmentally friendly and re-usable shipment box. You retain the box until you need it the next time. We assume full responsibility for shipment. This solution is easy to use and reduces administrative expenses for our customers.

Collection and delivery service: If you require special attention for your measurement equipment, we offer a collection and delivery service with trained drivers. You can be sure that your measurement equipment is in safe hands.

23 Training, seminars and workshops

Atlas Copco offers a large number of training courses, seminars and workshops to refresh and enhance the expert knowledge of our customers.

Seminar: Quality management – calibration for tightening systems

This seminar deals with the calibration of measurement equipment in connection with machine capability tests on tightening tools. The program includes presentations and practical exercises. Participants enhance their specialist knowledge in the following fields: calibration and machine capability tests; norms, standards and regulations for tightening and calibration systems; calibration with reference to product liability and product safety; tightening processes with reference to calibration; measurement equipment capability; check measurements; basic principles of statistics in this area.

Main focuses of seminar:

- Significance of calibration and machine capability test
- Types of calibration and tests
- Norms and standards
- Calibration and tool testing in practice
- Differences between machine capability test, calibration and adjustment
- Reading and interpreting certificates
- How to distinguish between good, professional certificates and suspect certificates

Experts from Atlas Copco Tools prepare participants for impending ISO or certification audits in workshops tailored to customers' specific requirements.



Appendix

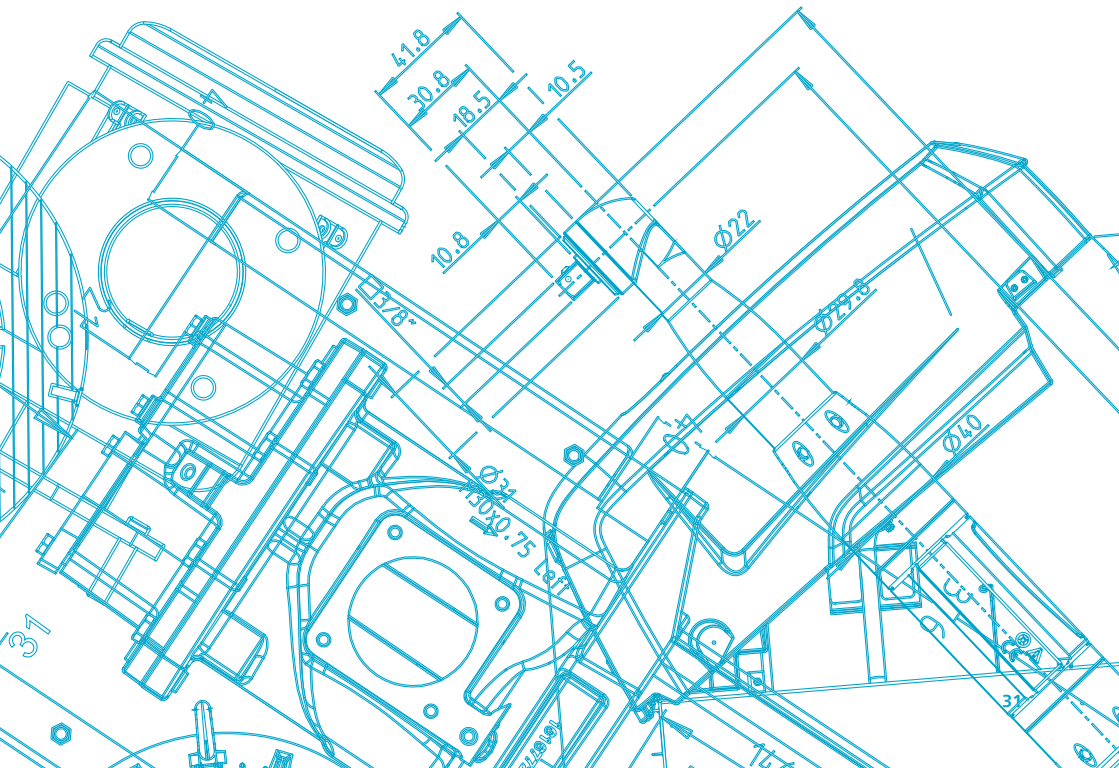

Sample machine capability test certificate, page 1

Atlas Copco

Zertifikat CERTIFICATE

Kunde Muster GmbH
Customer D-12345 Musterstadt

Zertifikats-Nr.: 40092304
Certificate No.:

Gegenstand der Prüfung
Test Object

Hersteller ATLAS COPCO TOOLS AB
Manufacturer
Maschinentyp ETV ES61-100-B13
Tool Type
Steuerung Power Focus 600
Controller
Sonderantrieb -
Crawfoot

Serien-Nr.: B 5690878
Ser. No.:
Serien-Nr.: A 4450252
Ser. No.:
Serien-Nr.: -
Ser. No.:

Kunden-ID:
Customer ID:
Kunden-ID:
Customer ID:
Hersteller
Manufacturer

Md- min 40 N·m
max 100 N·m
Test-Md 100 N·m

Motor **Serien-Nr.:**
Motor **Ser. No.:**
Drehmomentsensor **Serien-Nr.:**
Torque Transducer **Ser. No.:**
Drehwinkelsensor **Serien-Nr.:**
Angle encoder **Ser. No.:**

Artikelnummer:
Article number:
TC-Faktor: 0,000
TC-Factor:

Referenz (Gebrauchsnormal)

Reference:

Hersteller ATLAS COPCO
Manufacturer
Prüfgerät* JSB 3860 (Local)
Testing device*
Sensor 3 - Brake - 25-250 Nm
Sensor
Rückführung EN1981 D-K-17447-01-02 2014-07
Standard

Serien-Nr.: 3860.576
Ser. No.:
Serien-Nr.: 188.1724
Ser. No.:

*Die Messunsicherheit der Gegenmeseinrichtung beträgt 1%.
Die Ergebniswerte wurden mit der oben genannten Gegenmeseinrichtung ermittelt.
*The uncertainty of the measuring device is 1%.
All results are measured with the testing device mentioned above.

Die Prüfung des Werkzeuges erfolgte auf einer Messbank. Das Werkzeug wurde in der Messvorrichtung werkerunabhängig fixiert.
The test of the tool was performed on a simulator bench. The test object was fixed on a mounting plate.

Das Verfahren zur Prüfung der Maschinenfähigkeit erfolgte dynamisch und in Anlehnung an die Richtlinie VDI/VDE 2647.
The process of testing the machine capability was done dynamically and lean upon the guideline of VDI/VDE 2647.

Dieses Zertifikat dokumentiert die indirekte Rückführbarkeit auf nationale Standards zur Darstellung der Einheiten in Übereinstimmung mit dem Internationalen Einheitensystem (SI). Die Rückführung der Messmittel ist gemäß DIN ISO 9001 durch das akkreditierte Kalibrierlabor DAkkS D-K-17447-01, belegbar sichergestellt.
This certificate documents the traceability to national standards which implement the unit of measurement according to the International Systems of Units (SI). The traceability of the stated results is given through the accredited laboratory D-K-17447-01.

Für die Einhaltung einer angemessenen Frist zur Wiederholung der Kalibrierung ist der Benutzer verantwortlich. Es wird empfohlen diese aber alle 12 Monate zu wiederholen.
The user is obliged to have the object recalibrated at appropriate intervals.
It is recommended to repeat this every 12 months.

Prüfdatum
Date of measurement
29.01.2015

Bearbeiter
Responsible
D. Kubullek

Druckdatum
Date of print
29.01.2015

Atlas Copco Tools Central Europe GmbH
Langemarkstraße 35
45141 Essen

Internet:
www.atlascopco.de
www.kalibrierdienst.de

Tel. +49 (0) 201 - 21 77 - 0
Fax +49 (0) 201 - 21 77 - 197
cal-service@de.atlascopco.com

Sample machine capability test certificate, page 2



Zertifikat CERTIFICATE

Zertifikats-Nr.: 40092304
Certificate No.:

Hersteller
Manufacturer
Maschinentyp
Tool Type
Steuerung
Controller

ATLAS COPCO TOOLS AB
ETV ES61-100-B13
Power Focus 600

Serien-Nr.: B 5690878
Ser. No.:
Serien-Nr.: A 4450252
Ser. No.:

Kunden-ID:
Customer ID:
Kunden-ID:
Customer ID:

Vorgegebene Werte zum Schraubfall [N·m] Target values [N·m]	Md - Max Md - max	Md - Soll Md - target	Md - Min Md - min	Toleranz tolerance
	107,50	100	92,50	7,5%

Erzielte Messwerte [N·m] für den Schraubfall 30°

Results [N·m] for joint 30°

Nr. No.	Referenz Reference	Nr. No.	Referenz Reference	Nr. No.	Referenz Reference	Nr. No.	Referenz Reference	Nr. No.	Referenz Reference
1	97,98	6	101,47	11	101,96	16	101,91	21	102,25
2	100,65	7	100,57	12	99,79	17	101,22	22	100,09
3	100,06	8	102,37	13	101,76	18	102,33	23	103,72
4	99,95	9	100,63	14	101,45	19	100,74	24	102,94
5	100,93	10	102,14	15	103,20	20	102,29	25	100,58

Erzielte Messwerte [Drehwinkel] für den Schraubfall 30°

Results [Angle] for joint 30°

Nr. No.	Referenz Reference	Nr. No.	Referenz Reference	Nr. No.	Referenz Reference	Nr. No.	Referenz Reference	Nr. No.	Referenz Reference
1	29	6	31	11	32	16	32	21	32
2	31	7	31	12	30	17	32	22	31
3	30	8	32	13	32	18	32	23	33
4	30	9	31	14	32	19	31	24	33
5	31	10	32	15	33	20	32	25	31

Statistik der Referenz Statistics of Reference

Anz. Messungen No. of lightnings	25	
Mittelwert Referenz Mean value of reference	101,32	N·m
Höchster Wert Max. torque	103,72	N·m
Niedrigster Wert Min. torque	97,98	N·m

Justierwert [N·m] ==> Adjustment value [N·m] ==>	203,5
Standardabweichung Standard deviation	
1s ==>	1,267
3s ==>	3,801
6s ==>	7,601

Toleranzklasse Class of tolerance	Cm	Cmk
7,5% ==>	1,973	1,626

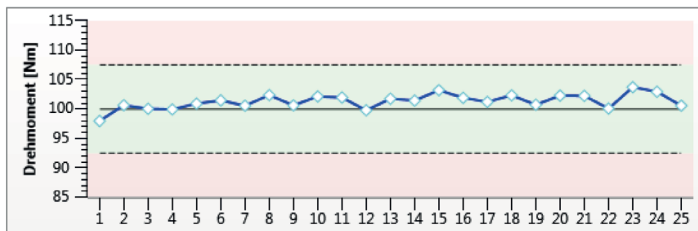

Sample calibration certificate, page 1

Kalibrierlaboratorium für mechanische, elektrische, thermodynamische und dimensionelle Messgrößen
 Calibration laboratory for mechanical, electrical, thermodynamic and dimensional measuring quantities



Sustainable Productivity

akkreditiert durch die / accredited by the

Deutsche Akkreditierungsstelle GmbH



Deutsche
Akkreditierungsstelle
D-K-17447-01-02

als Kalibrierlaboratorium im / as calibration laboratory in the

Deutschen Kalibrierdienst

DKD

EN376

D-K-

17447-01-02

2013-05

Kalibrierschein

Kalibrierzeichen

Calibration certificate

Calibration mark

Gegenstand: **Drehmomentsensor**

Object:

Dieser Kalibrierschein dokumentiert die Rückführung auf nationale Normale zur Darstellung der Einheiten in Übereinstimmung mit dem Internationalen Einheitensystem (SI).

Hersteller: **Atlas Copco BLM**

Manufacturer:

Die DAkkS ist Unterzeichner der multilateralen Übereinkommen der European co-operation for Accreditation (EA) und der International Laboratory Accreditation Cooperation (ILAC) zur gegenseitigen Anerkennung der Kalibrierscheine.

Typ: **IRTT-B 500A-20**

Type:

Für die Einhaltung einer angemessenen Frist zur Wiederholung der Kalibrierung ist der Benutzer verantwortlich.

Fabrikat/Serien-Nr. **43360080**

Serial number:

This calibration certificate documents the traceability to national standards, which realize the units of measurement according to the International System of Units (SI).

Auftraggeber: **Musterfirma GmbH**

Customer:

**Teststrasse 12
D - 35578 Wetzlar**

The DAkkS is signatory to the multilateral agreements of the European co-operation for Accreditation (EA) and of the International Laboratory Accreditation Cooperation (ILAC) for the mutual recognition of calibration certificates.

Auftragsnummer: **40000944**

Order no.:

The user is obliged to have the object recalibrated at appropriate intervals.

Anzahl der Seiten: **4**

Number of pages:

Datum der Kalibrierung: **2013-05-14**

Date of calibration:

Dieser Kalibrierschein darf nur vollständig und unverändert weiterverbreitet werden. Auszüge oder Änderungen bedürfen der Genehmigung sowohl der Deutschen Akkreditierungsstelle GmbH als auch des ausstellenden Kalibrierlaboratoriums. Kalibrierscheine ohne Unterschrift haben keine Gültigkeit.

This calibration certificate may not be reproduced other than in full except with the permission of both the Deutsche Akkreditierungsstelle GmbH and the issuing laboratory. Calibration certificates without signature are not valid.

Datum

Date

Leiter des Kalibrierlaboratoriums

Head of the calibration laboratory

Bearbeiter

Person in charge

2013-05-23

Michael Skibinski

Annika Kranz

Atlas Copco Tools Central Europe GmbH

Langemarckstr. 35
D - 45141 Essen

Fon: +49 (0)201 / 2177 - 767
Fax: +49 (0)201 / 2177 - 197

cal-service@de.atlascopco.com
www.kalibrierdienst.de
www.atlascopco.de

Sample calibration certificate, page 2

Seite 2 zum Kalibrierschein vom 2013-05-23
Page 2 of the calibration certificate from 2013-05-23

EN376
D-K- 17447-01-02
2013-05

In case of doubts the German text of this certificate is valid.

- 1 Kalibrierverfahren / Calibration Procedure :** DIN 51309:2005-12 Klasse 1 / DIN 51309:2005-12 Class 1
- 2 Kalibriereinrichtung / Calibration device :** 2kN-m - Drehmoment- Bezugsnormmesseinrichtung
- 2.1 Messunsicherheit für jede Drehmomentstufe in % /
Uncertainty of measurement related to torque in %
- | | |
|-------------------------------|--|
| Drehmoment /
Torque in N·m | Erw. Messunsicherheit /
Exp. Uncertainty (k = 2) in % : |
| 100 | 0,1 |
| 200 | 0,1 |
| 300 | 0,1 |
| 400 | 0,1 |
| 500 | 0,1 |
- 2.2 DKD Bezugsnorm / Reference transducer : TT 1 - 1000 Nm, 36762-04
- 2.3 Anzeigergerät / Indication device : MGC+ mit ML30, Ch1
- Seriennummer / Serial number : DNR #010058
- Hersteller / Manufacturer : HBM (Deutschland)
- 2.4 Einstellung des Anzeigergerätes /
Settings of the indication device :
- | | |
|---------------------------------------|---------------|
| Speisespannung / Supply voltage : | 5V |
| Filtereinstellung / Filter settings : | 1,5 Hz Bessel |
| Auflösung / Resolution : | 0,000001 |
| Anzeigeeinheit / Indication unit : | mV/V |
- 2.5 Anschlusskabel / Input cable :
Schaltungsart / Circuit type : Raute, 3m
- 2.6 Einspannteile / Adaptors : 6-Leiter
Lamellenkupplung Typ Rexnord
- 3 Kalibriergegenstand / Calibration device :** IRTT-B 500A-20, 43360080
- 3.1 Anzeigergerät / Indication device : MGC+ mit ML30, Ch2
- Seriennummer / Serial number : DNR #010058
- Hersteller / Manufacturer : HBM (Deutschland)
- 3.2 Einstellung des Anzeigergerätes /
Settings of the indication device :
- | | |
|---------------------------------------|------|
| Speisespannung / Supply voltage : | 5 V |
| Ziffernschritt / Numeral resolution : | 0,01 |
| Anzeigeeinheit / Indication unit : | N·m |
- 3.3 Anschlusskabel / Input cable :
Schaltungsart / Circuit type : 16229-903010-0,2m
4-Leiter
- 3.4 Kalibriertwert alt / calibration value old : 453,40 Nm
- Kalibriertwert neu / calibration value new : 454,63 Nm**
- 4 Kalibrieranordnung / Calibration installation :**
- 4.1 Einbaustellungen / Mounting positions : 2 x 90°
- 4.2 Einspannteile / Adaptors : 4-Kant nach DIN3120 / 4-Square according to DIN3120
- 4.3 Drehmomentvektor / Torque vector : horizontal
- 5 Umgebungsbedingungen / Conditions :**
- 5.1 Ort der Kalibrierung / Place of calibration : Permanentes Laboratorium Essen
- 5.2 Vor der Kalibrierung / Before the calibration : 21 °C
- 5.3 Nach der Kalibrierung / After the calibration : 21 °C
- 5.4 Relative Luftfeuchte / Relative humidity : 26 %
- 6 Aufnehmernullsignale / Transducer zero signals :**
- vor Einbau / before mounting : entfällt
- nach Kalibrierung / after calibration : entfällt

7 Zusätzliche Angaben / Additional information :

Berechnete Werte sind um die jeweilige Nullanzeige reduziert. Die Ergebnisse sind in der letzten Stelle gerundet.
Calculated values are reduced by the respective zero signal. The calculated values are rounded in the last decimal.

Abweichend zu DIN51309:2005 wurde auch das relative Unsicherheitsintervall für Fall I bestimmt.
In deviation to DIN51309:2005 also the relative uncertainty interval for case I was determined.

$$W^*(M_K) = \frac{|f_0(M_K)|}{|Y(M_K)|} \cdot 100\% + k \cdot u(M_K)$$

Atlas Copco Tools Central Europe GmbH
Langemarkstr. 35
D - 45141 Essen

Fon: +49 (0)201 / 2177 - 767
Fax: +49 (0)201 / 2177 - 197

cal-service@de.atlascopco.com
www.kalibrierdienst.de
www.atlascopco.de

Sample calibration certificate, page 3

EN376
D-K- 17447-01-02
2013-05

Seite 3 zum Kalibrierschein vom 2013-05-23
Page 3 of the calibration certificate from 2013-05-23

8 Auswertung / Analysis
8.1 Kalibrierergebnis / Calibration results

Drehmoment / torque	Fall I / case I		Fall II / case II	
	Signal / signal	rel. Uns.-intervall / rel. uncert. interval k = 2	Signal / signal	rel. Uns.-intervall / rel. uncert. interval k = 2
in N-m	in N-m	in %	in N-m	in %
Rechtsdrehmoment / clockwise torque				
0	0,00		-0,07	
100	99,80	0,620	99,88	0,628
200	199,86	0,345	199,98	0,360
300	299,94	0,229	300,06	0,281
400	400,08	0,199	400,16	0,244
500	500,25	0,202	500,25	0,202
Linksdrehmoment / anticlockwise torque				

8.2 Klasseneinstufung nach DIN 51309:2005 / Classification according to DIN 51309:2005

Klasse Class	Fall I / case I		Fall II / case II	
	von / from in N-m	bis / to in N-m	von / from in N-m	bis / to in N-m
Rechtsdrehmoment / clockwise torque				
1	100	500	100	500
2				
5				
Linksdrehmoment / anticlockwise torque				
1				
2				
5				

9 Kennwerte nach DIN 51309:2005 / Classification criteria according to DIN 51309:2005

M_K in N-m	Fall I / case I				Fall II / case II				r in N-m
	$\frac{b}{Y}$ in %	$\frac{f_0}{Y_E}$ in %	$\frac{f_q}{Y}$ in %	$\frac{b}{Y_h}$ in %	$\frac{f_0}{Y_E}$ in %	$\frac{h}{Y_h}$ in %	$\frac{f_q}{Y_h}$ in %		
500	0,134	-	0,049	0,134	-	-	0,049	0,01	
400	0,175	-	0,020	0,175	-	0,052	0,039	0,01	
300	0,217	-	-0,022	0,217	-	0,107	0,021	0,01	
200	0,310	-	-0,070	0,310	-	0,150	-0,010	0,01	
100	0,491	-	-0,205	0,491	-	0,180	-0,123	0,01	
0	-	0,068	-	-	0,068	-	-	-	

Angegeben ist die erweiterte Messunsicherheit, die sich aus der Standardmessunsicherheit durch Multiplikation mit dem Erweiterungsfaktor $k=2$ ergibt. Sie wurde gemäss DAkkS-DKD-3 ermittelt. Der Wert der Messgröße liegt im Regelfall mit einer Wahrscheinlichkeit von annähernd 95% im zugeordneten Wertintervall.

Stated is the extended measurement uncertainty which results from the standard measurement uncertainty multiplied by the extension factor $k=2$. Determined according to DAkkS-DKD-3. Generally, the reading is located in the associated range with a probability of approx. 95%.

Atlas Copco Tools Central Europe GmbH
Langemarckstr. 35
D - 45141 Essen

Fon: +49 (0)201 / 2177 - 767
Fax: +49 (0)201 / 2177 - 197

cal-service@de.atlascopco.com
www.kalibrierdienst.de
www.atlascopco.de

Sample calibration certificate, page 4

Seite 4 zum Kalibrierschein vom 2013-05-23
Page 4 of the calibration certificate from 2013-05-23

EN376
D-K- 17447-01-02
2013-05

10 Messdaten / measuring data in N-m

Rechtsdrehmoment / clockwise torque								
0	-0,01	0,06	0,06	0,00	-0,34	0,34	0,00	0,06
100	-	-	-	99,55	99,73	-	100,04	100,19
200	-	-	-	199,55	199,85	-	200,17	200,35
300	-	-	-	299,61	299,93	-	300,26	300,45
400	-	-	-	399,73	399,94	-	400,43	400,53
500	520,55	524,68	524,84	499,91	499,91	524,56	500,58	500,58
N-m	1. Vorbel. preload	2. Vorbel. preload	3. Vorbel. preload	0° auf / inc	0° ab / dec	Vorbel. preload	90° auf / inc	90° ab / dec

Links drehmoment / anticlockwise torque								
N-m	1. Vorbel. preload	2. Vorbel. preload	3. Vorbel. preload	0° auf / inc	0° ab / dec	Vorbel. preload	90° auf / inc	90° ab / dec

11 Darstellung der Ergebnisse in Diagrammen / Results in diagrams

Bezugswert / Reference value: 500,00 N-m

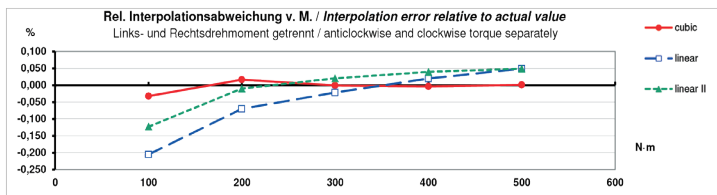
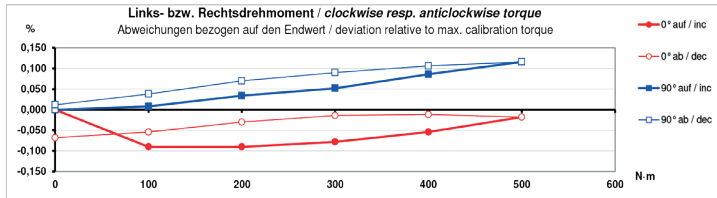

Hinweis:

Die Deutsche Akkreditierungsstelle GmbH ist Unterzeichner der multilateralen Übereinkommen der European co-operation for Accreditation (EA) und der International Laboratory Accreditation Cooperation (ILAC) zur gegenseitigen Anerkennung der Kalibrierscheine. Die weiteren Unterzeichner innerhalb und außerhalb Europas sind den Internetseiten von EA (www.european-accreditation.org) und ILAC (www.ilac.org) zu entnehmen.

The Deutsche Akkreditierungsstelle GmbH is signatory to the multilateral agreement of the European co-operation for Accreditation (EA) and the ILAC for the mutual recognition of calibration certificates. The other signatories within and outside of Europe are found in the websites of EA (www.european-accreditation.org) and ILAC (www.ilac.org).

Atlas Copco Tools Central Europe GmbH
Langemarkstr. 35
D - 45141 Essen

Fon: +49 (0)201 / 2177 - 767
Fax: +49 (0)201 / 2177 - 197

cal-service@de.atlascopco.com
www.kalibrierdienst.de
www.atlascopco.de

