

SOLE[™]
FITNESS

OWNER'S MANUAL

Model: 16208980920

*Please carefully read this entire manual
before operating your new bike.*

ATTENTION: *Before returning your Sole product to any retailer, or if you require any assistance with assembly or technical support please call us first for assistance at 1-888-707-1880. Thank you for your Sole purchase.*

TABLE OF CONTENTS

Product Registration	2
Important Safety Instructions	3
Important Electrical Instructions	4
Important Operation Instructions	4
R92 Assembly Instructions	7
Fitness Bike Features	11
Operation of Your New Fitness Bike	12
Bluetooth® Connectivity	15
Programmable Features	18
Using Heart Rate Monitor	23
General Maintenance	25
R92 Exploded View Diagram	26
R92 Parts List	27
Manufacturer's Limited Warranty	31

ATTENTION

THIS FITNESS BIKE IS INTENDED FOR **RESIDENTIAL USE ONLY** AND IS WARRANTED FOR THE APPLICATION. ANY OTHER APPLICATION **VOIDS** THIS WARRANTY IN ITS ENTIRETY.

Ver.C

SOLE

FITNESS

CONGRATULATIONS ON YOUR NEW BIKE AND WELCOME TO THE SOLE FAMILY!

Thank you for your purchase of this quality Sole bike from Dyaco Canada Inc. Your new bike has been manufactured by one of the leading fitness manufacturers in the world and is backed by one of the most comprehensive warranties available. Dyaco Canada Inc. will do all we can to make your ownership experience as pleasant as possible for many years to come.

If you have any questions about your new Sole product or questions about the warranty contact Dyaco Canada Inc. at 1-888-707-1880.

Please take a moment at this time to record below the name of the dealer, their telephone number, and the date of purchase for easy contact in the future. We appreciate your confidence in SOLE and we will always remember that you are the reason that we are in business. Please complete and mail your registration card today and enjoy your new bike.

Yours in Health,
Dyaco Canada Inc.

Name of Dealer _____

Telephone Number of Dealer _____

Purchase Date _____

PRODUCT REGISTRATION

RECORD YOUR SERIAL NUMBER

Please record the Serial Number of this fitness product in the space provided below.

Serial Number _____



Register your purchase

The self-addressed product registration card must be completed in full and returned to Dyaco Canada Inc. You can also go to www.solefitness.ca to register online.

IMPORTANT SAFETY INSTRUCTIONS

WARNING - Read all instructions before using this equipment.

- Do not operate fitness bike on deeply padded, plush or shag carpet. Damage to both carpet and fitness bike may result.
- Keep children under the age of 13 away from this machine. There are obvious pinch points and other caution areas that can cause harm.
- Keep hands away from all moving parts.
- Never operate the fitness bike if it has a damaged cord or plug. If the fitness bike is not working properly, call your dealer.
- Keep the cord away from heated surfaces.
- Never drop or insert any object into any openings.
- Do not use outdoors.
- To disconnect, turn all controls to the off position, remove tether cord, then remove the plug from the outlet.
- Do not attempt to use your fitness bike for any purpose other than for the purpose it is intended.
- The hand pulse sensors are not medical devices. Various factors, including the user's movement, may affect the accuracy of heart rate readings. The pulse sensors are intended only as exercise aids in determining heart rate trends in general.
- Wear proper shoes. High heels, dress shoes, sandals or bare feet are not suitable for use on your fitness bike. Quality athletic shoes are recommended to avoid leg fatigue or injury.
- This appliance is not intended for use by persons with reduced physical, sensory or mental capabilities, or lack of experience and knowledge, unless they have been given supervision or instruction concerning use of the appliance by a person responsible for their safety.

SAVE THESE INSTRUCTIONS - THINK SAFETY!

IMPORTANT ELECTRICAL INSTRUCTIONS

WARNING!

NEVER remove any cover without first disconnecting AC power.

If voltage varies by ten percent (10%) or more, the performance of your fitness bike may be affected. **Such conditions are not covered under your warranty.** If you suspect the voltage is low, contact your local power company or a licensed electrician for proper testing.

NEVER expose this fitness bike to rain or moisture. This product is **NOT** designed for use outdoors, near a pool or spa, or in any other high humidity environment. The operating temperature specification is 40 to 120 degrees Fahrenheit, and humidity is 95% non-condensing (no water drops forming on surfaces).

IMPORTANT OPERATION INSTRUCTIONS

- **NEVER** operate this fitness bike without reading and completely understanding the results of any operational change you request from the computer.
- **NEVER** use your fitness bike during an electrical storm. Surges may occur in your household power supply that could damage fitness bike components. Unplug the fitness bike during an electrical storm as a precaution.
- Do not use excessive pressure on console control keys. They are precision set to function properly with little finger pressure. If you feel the buttons are not functioning properly with normal pressure contact your **SOLE** dealer.

R92 ASSEMBLY PACK CHECKLIST

1 HARDWARE STEP 1

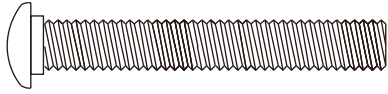

#65. 3/8" x 53L_
Carriage Bolt (2 pcs)

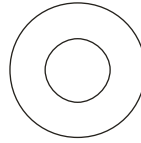

#77. 3/8" x 19mm x 1.5T
Flat Washer (6 pcs)



#191. 3/8" x 16 x 12.5T_
Cap Nut (2 pcs)

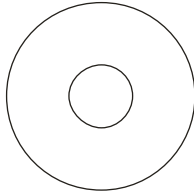

#84. 3/8" x 25mm x 2T
Flat Washer (2 pcs)

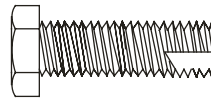

#176. 3/8" x 3/4"
Hex Head Bolt (6 pcs)

2 HARDWARE STEP 2



#71. 3/8" x 1-3/4"
Hex Head Bolt (2 pcs)

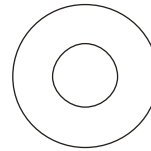

#77. 3/8" x 19mm x 1.5T
Flat Washer (4 pcs)



#89. 3/8" x 7T
Nyloc Nut (4 pcs)



#175. 3/8" x 2-3/4"
Hex Head Bolt (2 pcs)

3 HARDWARE STEP 3



#68. 5/16" x 5/8"
Hex Head Bolt (8 pcs)

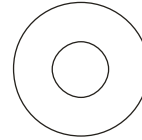

#76. 5/16" x 18mm x 1.5T
Flat Washer (6 pcs)



#82. 5/16" x 1.5T
Split Washer (2 pcs)

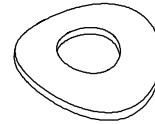

#83. 5/16" x 19mm x 1.5T
Curved Washer (2 pcs)

4 HARDWARE STEP 4

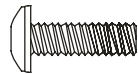

#98. M6 x 15mm
Phillips Head Screw
(4 pcs)

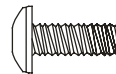

#99. M5 x 12mm
Phillips Head Screw
(4 pcs)

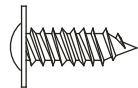

#105. Ø4 x 16mm
Sheet Metal Screw
(4 pcs)



#192. 3.5 x 12L_
Sheet Metal Screw
(4 pcs)

ASSEMBLY TOOLS

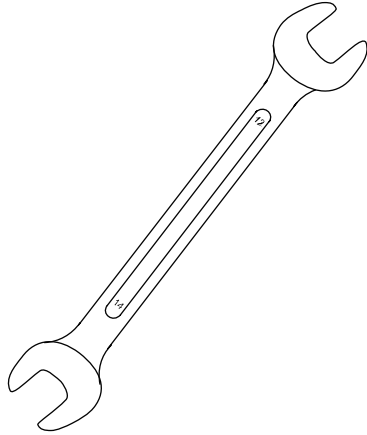

#112. 12/14mm Wrench

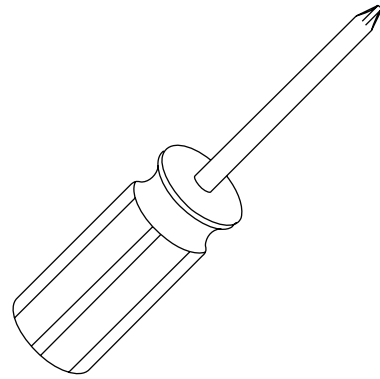

#114. Phillips Head Screwdriver

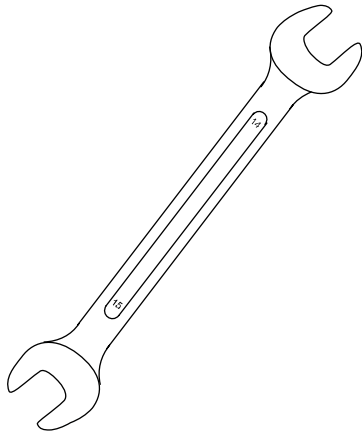

#132. 14/15mm Wrench

R92 ASSEMBLY INSTRUCTIONS

PRE-ASSEMBLY

1. Using a razor knife (Box Cutter) cut the outside, bottom, edge of box along the dotted Line. Lift Box over the unit and unpack.
2. Carefully remove all parts from carton and inspect for any damage or missing parts. If damaged parts are found, or parts are missing, contact your dealer immediately.
3. Locate the hardware package. Remove the tools first. Remove the hardware for each step as needed to avoid confusion. The numbers in the instructions that are in parenthesis (#) are the item number from the assembly drawing for reference.

1 REAR STABILIZER & SEAT BACK

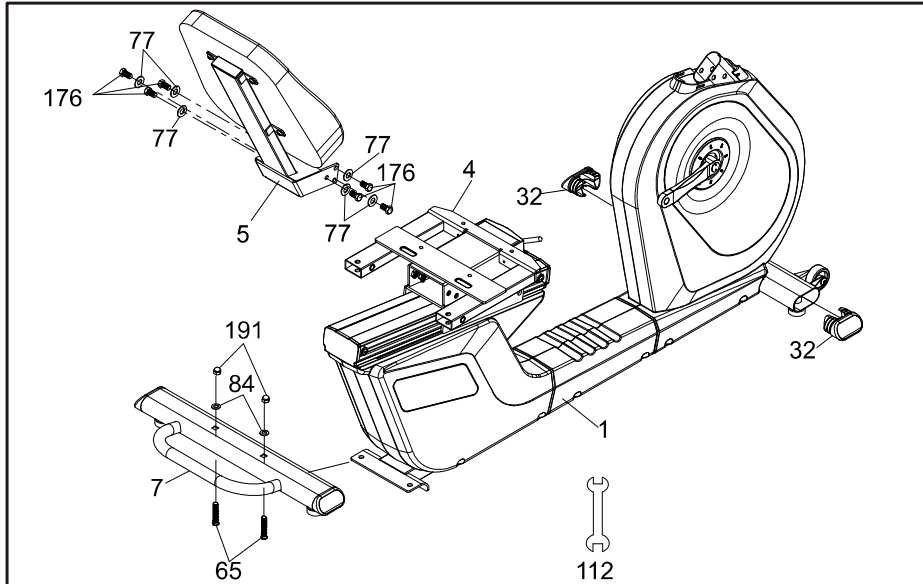

HARDWARE STEP 1

- #65. 3/8" x 53L_ Carriage Bolt (2 pcs)
- #77. 3/8" x 19mm x 1.5T Flat Washer (6 pcs)
- #84. 3/8" x 25mm x 2T Flat Washer (2 pcs)
- #176. 3/8" x 3/4" Hex Head Bolt (6 pcs)
- #191. 3/8" x 16 x 12.5T_ Cap Nut (2 pcs)

1. Attach the Rear Stabilizer (7) onto the Main Frame (1) with two Hex Head Bolts (65) and two Flat Washers (84) using the 12/14mm Wrench (112).
2. Attach the Seat Back Bracket (5) onto the Seat Carriage (4) with six Hex Head Bolts (176) and six Flat Washers (77) using the 12/14mm Wrench (112).
3. Insert an end cap (32) into each opening of the Front Stabilizer Tube. You may need to tap them in with a rubber mallet if they are tight.

2 SEAT HANDLE BAR

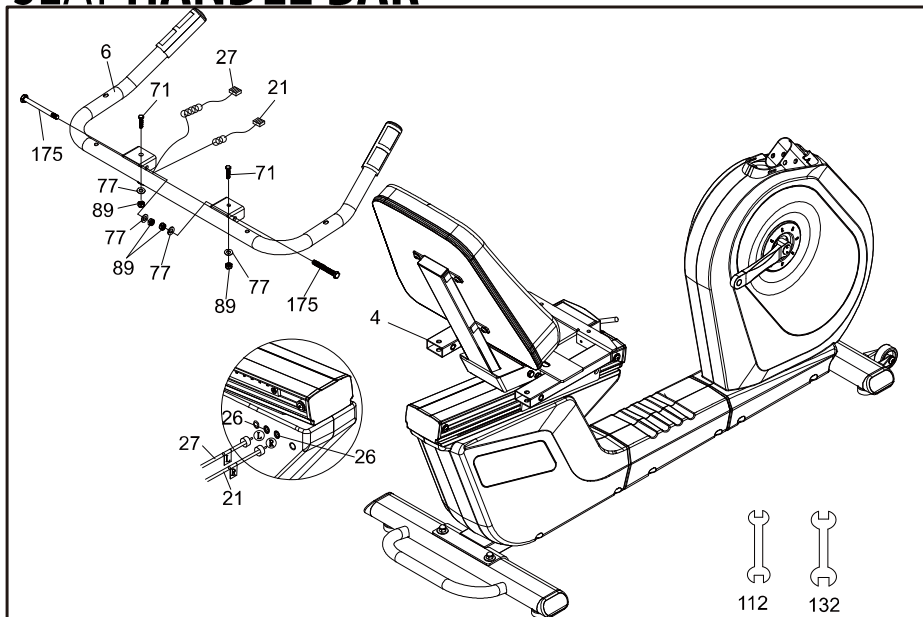

HARDWARE STEP 2

- #71. 3/8" x 1-3/4" Hex Head Bolt (2 pcs)
- #77. 3/8" x 19mm x 1.5T Flat Washer (4 pcs)
- #89. 3/8" x 7T Nyloc Nut (4 pcs)
- #175. 3/8" x 2-3/4" Hex Head Bolt (2 pcs)

1. Install the Seat Handle Bar (6) onto the Seat Carriage (4) with two vertical Hex Head Bolts (71), two horizontal Hex Head Bolts (175), four Flat Washers (77) and four Nyloc Nuts (89) using the 12/14mm Wrench (112) and 14/15mm Wrench (132).
2. Plug the two Hand pulse Cables (21) & (27) into the rear two ports (26) located on the left side rear cover, just under the seat (see inset illustration).

3 CONSOLE MAST

HARDWARE STEP 3

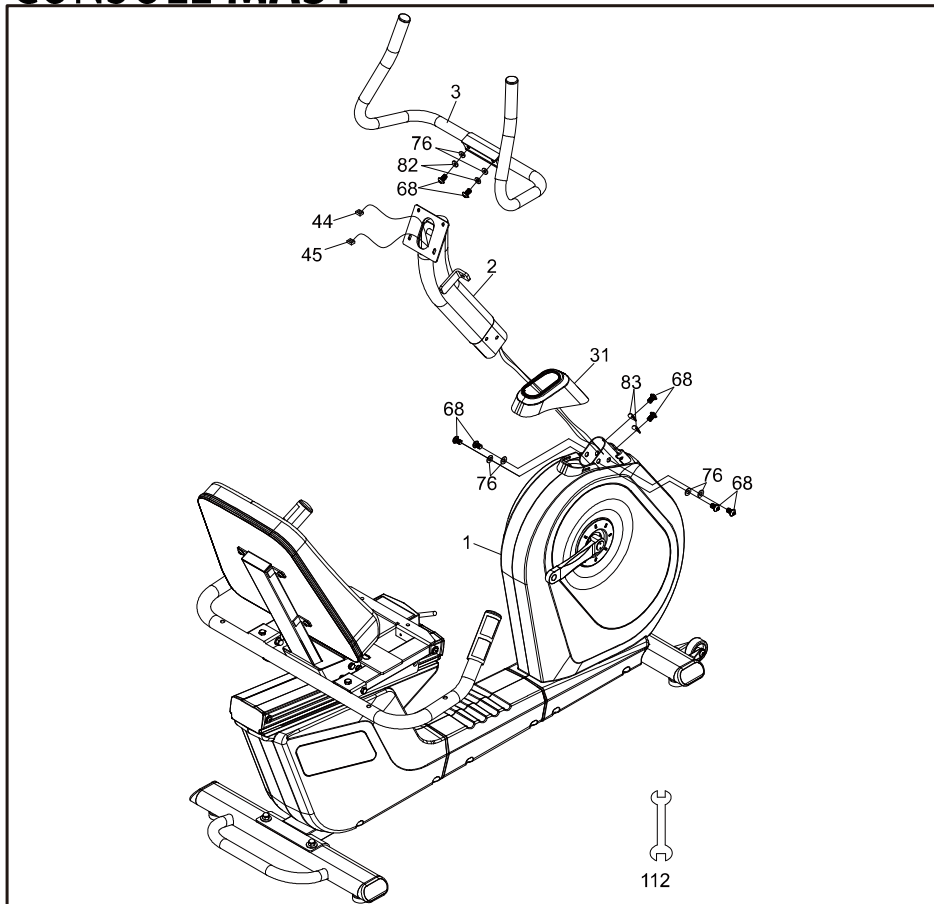

#68. 5/16" x 5/8"
Hex Head Bolt (8 pcs)
#76. 5/16" x 18mm x
1.5T Flat Washer (6 pcs)
#82. 5/16" x 1.5T
Split Washer (2 pcs)
#83. 5/16" x 19mm x
1.5T Curved Washer
(2 pcs)

1. Install the Console Mast Cover (**31**) onto the Console Mast (**2**). Make sure the plastic cover is in the correct orientation
2. Feed the twist tie that is attached to the Computer Cable (**44**) and Hand pulse Cable (**45**) through the bottom of the Console Mast Tube (**2**) and out through the opening at the top.
3. Install the Console Mast Tube (**2**) into the receiving tube (pull gently upwards on the cable ends to prevent pinching the cables because damage to the electronics could occur) of the Main Frame (**1**) with six Hex Head Bolts (**68**), four Flat Washers (**76**) on the sides of the tube and two Curved Washers (**83**) on the front of the tube by using the 12/14mm Wrench (**112**).
4. Remove the white Styrofoam pad (factory installed to prevent bolts from being accidentally dropped into the Bike).
5. Remove the plastic tie from the center of the handlebar (**3**). Install the Mast Handle bar Assembly (**3**) onto the Console Mast (**2**) with two Hex Head Bolts (**68**), two Flat Washers (**76**) and two Split Washers (**82**) using the 12/14mm Wrench (**112**).

4 SEAT/PEDAL & PLASTIC PARTS

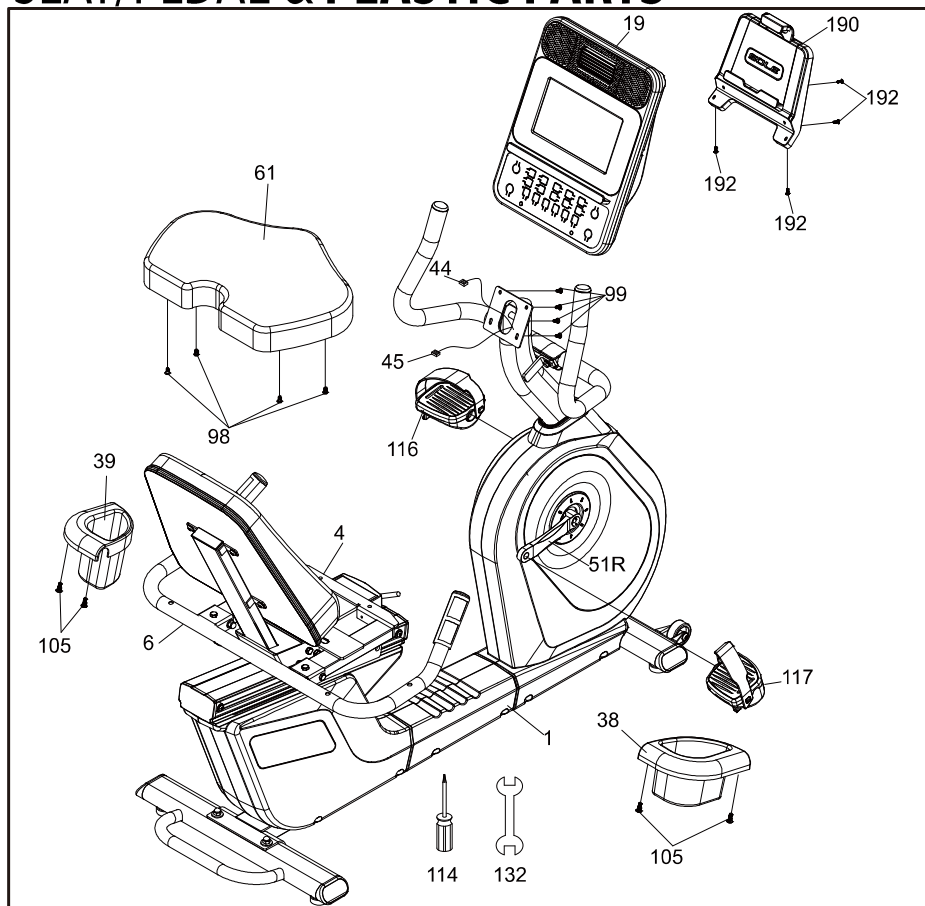

HARDWARE STEP 4

- #98. M6 x 15mm Phillips Head Screw (4 pcs)
- #99. M5 x 12mm Phillips Head Screw (4 pcs)
- #105. Ø4 x 16mm Sheet Metal Screw (4 pcs)
- #192. 3.5 x 12L_ Sheet Metal Screw (4 pcs)

1. Install the Seat (**61**) on the Seat Carriage (**4**) with the four Phillips Head Screws (**98**) using the Phillips Head Screw Driver (**114**).
2. Plug in the Computer Cable (**44**) and Hand pulse Cable (**45**) into the connector in the back of the Console Assembly (**19**). Install the console onto the mounting plate with four Phillips Head Screws (**99**) using the Phillips Head Screw Driver (**114**). Be careful not to pinch the cables between the console and the mounting plate. This could short the cables and damage the electronics.
3. Install the Drink Bottle Holders (**39 L**, **38 R**) onto left and right sides of the Seat Handle Bar (**6**) with four Sheet Metal Screws (**105**) using the Phillips Head Screw Driver (**114**).
4. Install the Pedals (**116 L**, **117 R**) in the Pedal Cranks using the 14/15mm Wrench (**132**). Keep in mind that the Pedal (**116 L**) has a reverse thread and will be screwed into the crank in the opposite rotational pattern right hand threads. There is an "L" stamped into the end of the threaded post of the left pedal and an "R" in the right. Make sure to tighten the pedals as firmly as you possibly can. It may be necessary to re-tighten the pedals if you notice a thumping sound when pedaling the bike. A clicking noise, or thumping sound during pedaling is usually caused by the pedals being loose.
5. Install the Tablet Holder (**190**) to back of the console with four Sheet Metal Screws (**192**) by using Phillips Head Screw Driver (**114**).

FITNESS BIKE FEATURES

FOOT PEDALS

Through research performed with a leading sports scientist and physical rehabilitation expert, Sole engineering has developed a breakthrough in pedal design. Typical stationary exercise bikes are wider than a normal road bike. The reason is to allow for the braking mechanism, pulleys, drive components and plastic covers. Since the bike is wider, so is the distance between the pedals; this width between the pedals is called the Q factor.

Sole has designed our pedal system so the Q factor is the smallest in the industry, but we did not stop there. We have also custom designed and tooled a new pedal that provides a two degree inward tilt to compensate for the Q factor not being perfect. Having a small Q factor in addition to the two-degree inward tilt of the pedals puts the user into a biomechanical neutral alignment. This means that your feet, ankles, knees and hips are lined up properly ensuring a comfortable workout.

SEAT ADJUSTMENT

You are able to adjust the seat position while seated. Pull up on the lever located in front of the seat and slide the carriage forward or backwards. The correct position is when there is a slight bend in your knee when the pedal is at its farthest position forward (3 o'clock position when looking from the right side of the bike). Release the lever and you are ready to begin.

PEDAL STRAP ADJUSTMENT

Adjust each pedal strap so that they are snug around your feet. You have the option of adjusting the hole location on one or both sides of the pedal.

Charge Portable Devices with USB port

USB Port Charging function:

Charge your personal device during your workout using the fitness equipment's on-console USB port.

To charge your mobile electronics make sure the fitness equipment power is on.

Step 1: Connect your USB charging cable (not included) to the USB Power Port and to your device.

Step 2: Check to make sure your device icon indicates it is charging.

NOTE :

* USB charging cable is not included, make sure compatible USB charging cable is being used.

** Your device "charging" icon may or may not indicate it is charging. Depending on the amount of current your particular device requires for charging the icon may not be on but your device is still charging, but possibly at a lower charge rate.

***The USB port on the console is capable of powering USB devices. It provides up to 5Vdc/0.5 amp of power and meets USB 2.0 regulations. You will not be able to save your workout data to a USB via this port; it is used for charging purposes only.

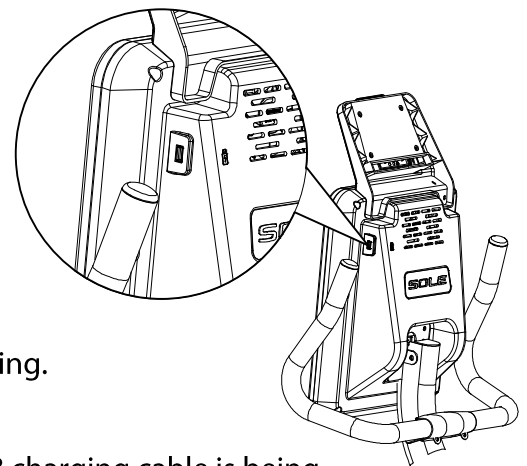

OPERATION OF YOUR FITNESS BIKE

GETTING FAMILIAR WITH THE CONTROL PANEL

CONSOLE



POWER UP

When power is connected to the fitness bike the console will automatically power up. These models operate on 12V/3.3A DC which is supplied by the power pack that is connected to 115 VAC. There is a power switch located where the line cord plugs into the unit on the front of the bike .

When it is first powered on, the console will perform an internal self-test. During this time all the lights will turn on. When the lights go off, the **Message Window** will show a software version (i.e.: VER 1.0) and the **Distance** window will display an odometer reading. The odometer reading displays how many virtual miles the fitness bike has gone. The **Time** window displays how many hours the fitness bike has been used.

The odometer and time will remain displayed for only a few seconds then the console will go to the startup display. The dot matrix display will be scrolling through the different workout profiles and the **Message Window** will scroll the start-up message. You may now begin to use the console.

CONSOLE OPERATION

START KEY

This is the quickest way to start a workout. After the console powers up, just press the **Start** key to begin. This will initiate the Start key mode. In Start key, the time will count up from zero. The resistance level and incline can be adjusted manually by pressing the **Level** ▲/▼ buttons. The dot matrix display will be showing a track with a blinking dot indicating your progress as it travels around the track.

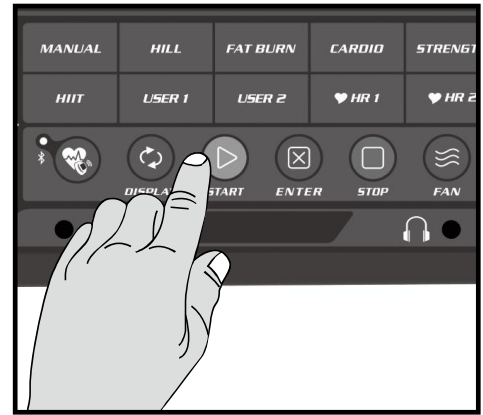

BASIC INFORMATION

The **Message Window** will initially display **Laps** completed. Each time the **Display** button is pressed the next set of information will appear. The order of information displayed will be: **Speed, RPM, Level, Watts, Segment Time** and **Data Scan** mode. In **Data Scan** mode, the displayed information will change every 4 seconds in the **Message Window**.

The fitness bike has a built in heart rate monitoring system. Simply grasping the **Contact Heart Rate Sensors** on the handle bars or wearing the chest strap transmitter will start the heart (see Heart Rate Programs) Icon blinking (this may take a few seconds). The **Pulse Window** will display your heart rate in beats per minute and the HR bar graph will show your current % in relation to projected heart rate maximum. The chest strap is a more accurate and reliable method of heart rate reading. The hand pulse sensors are subject to false readings depending on user physiology and workout habits including how one grips the sensors or how sweaty their hands are.

The **Stop** button actually has several functions. Pressing the **Stop** key once during a program will **Pause** the program for 5 minutes. If you need to get a drink, answer the phone or any of the many things that could interrupt your workout, this is a great feature. To resume your workout during **Pause** just press the **Start** key. If the **Stop** button is pressed twice during a workout the program will end and a **Workout Summary** is displayed.



If the **Stop/Reset** key is held down for 3 seconds the console will perform a complete **Reset**. During data entry for a program the **Stop/Reset** key performs a **Previous Screen** function. This allows you to go back one step in the programming each time you press the **Stop** key.

There is an **Audio In Jack** (🎧) on the front of the console and built-in speakers. You may plug any low-level audio source signal into this port. Audio sources include MP3, iPod, portable radio, CD player or even a TV or computer audio signal. There is also a **Headphone Jack** (🎧) for private listening.

PROGRAMMING THE CONSOLE

Each of the programs can be customized with your personal information and changed to suit your needs. Some of the information asked for is necessary to ensure the readouts are correct. You will be asked for your **Age** and **Weight**. Entering your **Age** is necessary during the Heart Rate control program to ensure the correct settings are entered in the program; entering your **Weight** aides in calculating a more correct **Calorie** reading. Although we cannot provide an exact calorie count we do want to be as close as possible.

A message about Calories: Calorie readings on every piece of exercise equipment, whether it is in a gym or at home, are not accurate and tend to vary widely. They are meant only as a guide to monitor your progress from workout to workout. The only way to measure your calorie burn accurately as in a clinical setting connected to a host of machines. This is because every person is different and burns calories at a different rate.

ENTERING A PROGRAM AND CHANGING SETTINGS

Press each program button to scroll through the program selections. The profile for each program will be displayed in the dot matrix window. Press the **Enter** key to select a program and begin customizing the settings. If you want to workout without entering new settings, then just press the **Start** key. This will bypass the programming of data and take you directly to the start of your workout. If you want to change the personal settings, then just follow the instructions in the **MessageWindow**. If you start a program without changing the settings, the default settings will be used.

Note: Age and Weight default settings will change when you enter a new number. So the last Age and Weight entered will be saved as the new default settings. If you enter Age and Weight the first time you use the fitness bike you will not have to enter it every time you work out unless either Age or Weight has changed or someone else enters a different Age and Weight.

New Sole App to be used in conjunction with select Apple & Android devices!

In order to help you achieve your exercise goals, Sole has added an exciting new feature to all of our products. Your new exercise machine comes equipped with a Bluetooth® transceiver that will allow it to interact with selected phones or tablet computers via the Sole Fitness App.

Just download the free Sole Fitness App from the Apple Store or Google Play, and then follow the instructions in the App to sync with your exercise machine. This allows you to view current workout data in three different Display screens on your device. Easily switch back and forth from the workout display view to internet/social media/email sites via icons on the display screen. When your workout is finished, the data is automatically saved to the built-in personal calendar for future reference.

Our new Sole Fitness App also allows you to sync your workout data with one of many fitness cloud sites we support: iHealth, MapMyFitness, Record or Fitbit.

Syncing the App with your exercise machine:

After downloading the App, make sure Bluetooth® is enabled on your device, then click the icon in the top left corner to search for Sole equipment.



After the equipment is detected, click Connect. When the App and equipment are synced, the Bluetooth® icon on the equipment's console will light up. You may now start using your new Sole product!

If the bike is not connected to the app, the console will display "SYNC" when the workout is over, and you can connect using your phone or tablet to store the bike's workout data in the App. (The console can only store the last workout data, when the bike returns to IDLE MODE, the workout data will be erased)

*Note: Your device will need to be running on a minimum operating system of iOS 7 or Android 4.4 for the Sole Fitness App to operate properly.

Console + Sole APP + Bluetooth chest strap instructions :

1. When the bike is connected to the APP, press the BLE HR icon.

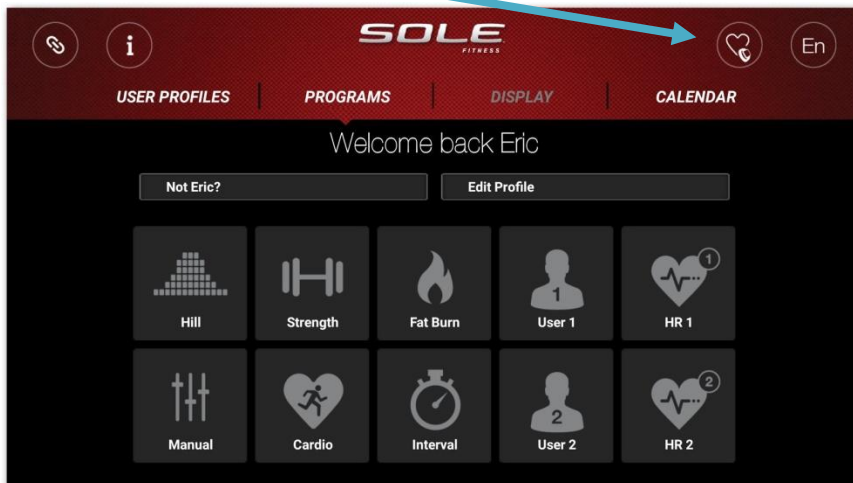

2. Select the heart rate tracking device you use and press Connect.

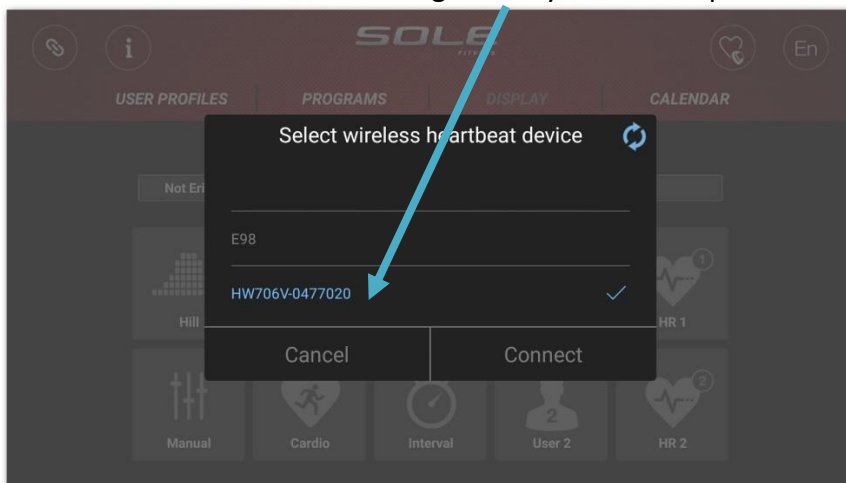

3. During workout, the BLE HR icon will lit up and your heart rate information will be shown on the display.

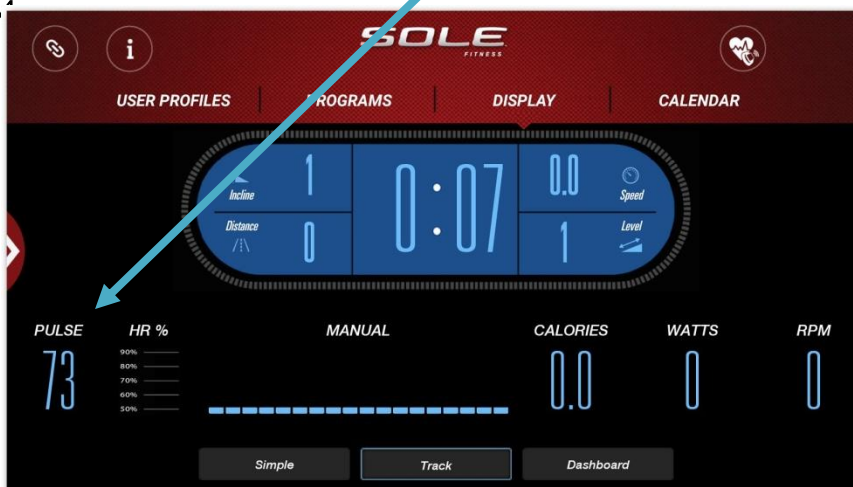

*Note: Using the APP with the Bluetooth chest strap does not apply to the HRC mode.

The exercise equipment's Bluetooth device (BLE 4.0), in addition to the App can be connected, but also configured to connect Bluetooth wireless heart rate chest strap transmitter (BLE 4.0) receive function, because the sharing of Bluetooth device, you need to use the heart rate key on the key board to do the function switch, the operating procedures are described as follows:

1. In the idle mode, the heart rate Bluetooth LED on the keypad is not lit, and the Bluetooth function is only used in connection with the App.
2. Under the idle mode, press the heart rate key on the key board, the Bluetooth LED light is on, this time the Bluetooth function is only used in connection with Bluetooth wireless heart rate chest strap, please wear the Bluetooth wireless heart rate chest strap, with the console connection, the console shows Bluetooth wireless heart rate value.
3. When the workout is over, the Bluetooth of the console will automatically be switched to the connected App for use.

The exercise equipment is configured with Bluetooth wireless music receive function, using a mobile phone or tablet to open the Bluetooth device, search for the name "Bt-speaker" Bluetooth, click on the connection can transmit the phone or tablet music to the exercise equipment.

PROGRAMMABLE FEATURES

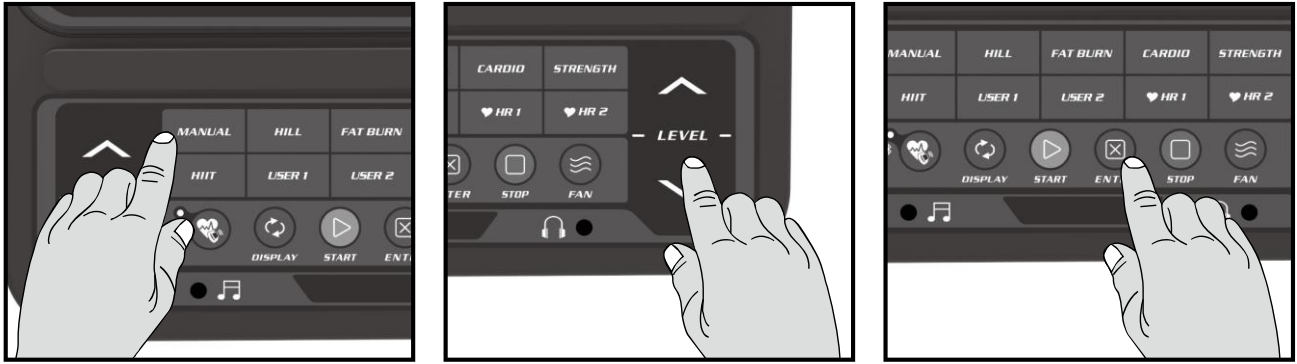

MANUAL PROGRAM

The Manual program works as the name implies, manually. This means that you control the workload yourself and not the computer.

1. Press the **Manual** program button then press the **Enter** key.
2. The **Message Window** will ask you to enter your **Age**. You may adjust the age setting using the **Level ▲/▼** keys, then press the **Enter** key to accept the new number and proceed on to the next screen.
3. You are now asked to enter your **Weight**. You may adjust your weight setting using the **Level ▲/▼** keys, then press **Enter** to continue.
4. Next is the **Time**. You may adjust the length of **Time** by pressing the **Level ▲/▼** keys, then press **Enter** to continue.
5. Now you are finished editing the settings and can begin your workout by pressing the **Start** key. You can also go back and modify your settings by pressing the **Stop** key to go back one level of the programming screen.
6. Once the program starts the fitness bike will be set to level one. This is the easiest level and it is a good idea to stay at level one for a while to warm up. If you want to increase the work load at any time press the **Level ▲** key; the **Level ▼** key will decrease the workload.
7. During the Manual program you will be able to scroll through the data in the **Message Window** by pressing the **Display** key.
8. When the program ends the **Message Window** will show a summary of your workout. The summary will be displayed for a short time then the console will return to the start-up display.

PRESET PROGRAMS

The fitness bike has five different programs that have been designed for a variety of workouts. These five programs have factory preset work level profiles for achieving different goals.

Hill

The **Hill** program simulates going up and down a hill. The resistance in the pedals will steadily increase and then decrease during the program.

WORK

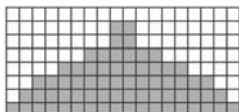

Fat Burn

The **Fat Burn** program is designed, as the name implies, to maximize the burning of fat. There are many schools of thought on the best way to burn fat but most experts agree that a lower exertion level that stays at a steady workload is the best. The absolute best way to burn fat is to keep your heart rate at around 60% to 70% of its maximum potential. This program does not use heart rate but simulates a lower, steady exertion workout.

WORK

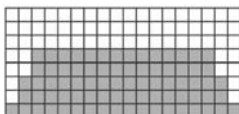

Cardio

The **Cardio** program is designed to increase your cardiovascular function and endurance. This is exercise for your heart and lungs. It will build up your heart muscle and increase blood flow and lung capacity. This is achieved by incorporating a higher level of exertion with slight fluctuations in work.

WORK

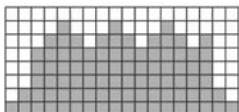

Strength

The **Strength** program is designed to increase muscular strength in your lower body. This program will steadily increase in resistance to a high level and forces you to sustain it. This is designed to strengthen and tone your legs and glutes (muscles of the butt).

WORK

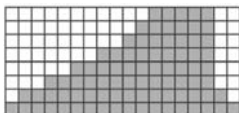

HIIT

The **HIIT** program takes you through high levels of intensity followed by periods of low intensity. This program increases your endurance by depleting your oxygen level followed by periods of recovery to replenish oxygen. Your cardiovascular system gets programmed to use oxygen more efficiently this way. This program also forces your body to become more efficient due to spikes in heart rate, between recovery periods. This aids in heart rate recovery from intense activities.

WORK

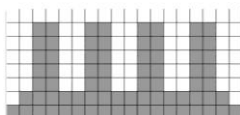

PROGRAMMING PRESET BUTTONS

1. Press the desired program button then press the **Enter** key.
2. The **MessageWindow** will ask you to enter your **Age**. You may adjust the age setting, using the **Level ▲/▼** keys, then press the **Enter** key to accept the new number and proceed on to the next screen.
3. You are now asked to enter your **Weight**. You may adjust the weight number using the **Level ▲/▼** keys then press **Enter** to continue.
4. Next is **Time**. You may adjust the **Time** and press **Enter** to continue.
5. Now you are asked to adjust the **Max Level**. This is the peak exertion level you will experience during the program (the highest colored segment/box of the program profile). Adjust the level and then press **Enter**.
6. Now you are finished editing the settings and can begin your workout by pressing the **Start** key. You can also go back and modify your settings by pressing the **Stop** key to go back one level, or screen.
7. During the program you will be able to scroll through the data in the **MessageWindow** by pressing the **Display** key.
8. When the program ends the **MessageWindow** will show a summary of your workout. The summary will be displayed for a short time then the console will return to the start-up display.

CUSTOM USER DEFINED PROGRAMS

The customizable User programs allow you to build and save your own workout. You can build your own custom program by following the instructions below.

1. Select the **User** program (**User 1** or **User 2**) then press **Enter**. If you have already saved a program to either **User 1** or **User 2**, it will be displayed and you are ready to begin. If not, you will have the option of inputting a username. In the **Message Window**, the letter "A" will be blinking. Use the **Level** buttons to select the appropriate first letter of your name (pressing the Up button will switch to the letter "B"; pressing the Down button will switch to letter "Z"). Press **Enter** when the desired letter is displayed. Repeat this process until all of the characters of your name have been programmed (maximum 7 characters). When finished press **Stop**.
2. If there is a program already stored in **User** when you press the key, you will have an option to run the program as it is or delete the program and build a new one. At the welcome message screen, when pressing **Start** or **Enter** you will be prompted: Run Program? Use the **Level ▲/▼** to select Yes or No. If you select No, you will then be asked if you want to delete the currently saved program. It is necessary to delete the current program if you want to build a new one.
3. The **MessageWindow** will ask you to enter your **Age**. You may enter your age using the **Level ▲/▼** keys, then press the **Enter** key to accept the new number and proceed on to the next screen.
4. You are now asked to enter your **Weight**. You may adjust the weight number using the **Level ▲/▼** keys, then press **Enter** to continue.
5. Next is **Time**. You may adjust the **Time** using the **Level ▲/▼** keys and press **Enter** to continue.
6. Now the first column will be blinking and you are asked to adjust the level for the first segment of the workout. When you finish adjusting the first segment, or if you don't want to change, then press **Enter** to continue to the next segment. The next segment will show the same level as the previously adjusted segment. Repeat the same process as the last segment then press **Enter**. Continue this process until all eighteen segments have been set.
7. The **MessageWindow** will then tell you to start to begin (and save the program) or **Enter** to modify the program. Pressing **Stop** will exit to the start up screen.
8. If you want to increase or decrease the workload at any time during the program press the **Level ▲/▼** key. This will only affect the **Level** for the present column in the profile. When the profile changes to the next column it will return to the preset work level.
9. During the **User 1** or **User 2** program you will be able to scroll through the data in the **Message Window** by pressing the **Display** key.
10. When the program ends the Message Window will show a summary of your workout. The summary will be displayed for a short time then the console will return to the start-up display.

HEART RATE PROGRAMS

Before we get started, a word about Heart Rate:

The old motto, “no pain, no gain”, is a myth that has been overpowered by the benefits of exercising comfortably. A great deal of this success has been promoted by the use of heart rate monitors. With the proper use of a heart rate monitor, many people find that their usual choice of exercise intensity was either too high or too low and exercise is much more enjoyable by maintaining their heart rate in the desired benefit range.

To determine the benefit range in which you wish to train, you must first determine your Maximum Heart Rate. This can be accomplished by using the following formula: 220 minus your age. This will give you the Maximum Heart Rate (MHR) for someone of your age. To determine the effective heart rate range for specific goals you simply calculate a percentage your MHR. Your Heart rate training zone is 50% to 90% of your maximum heart rate. 60% of your MHR is the zone that burns fat while 80% is for strengthening the cardio vascular system. This 60% to 80% is the zone to stay in for maximum benefit.

For someone who is 40 years old their target heart rate zone is calculated:

$$220 - 40 = 180 \text{ (maximum heart rate)}$$

$$180 \times .6 = 108 \text{ beats per minute}$$

(60% of maximum)

$$180 \times .8 = 144 \text{ beats per minute}$$

(80% of maximum)

So for a 40 year old the training zone would be 108 to 144 beats per minute.

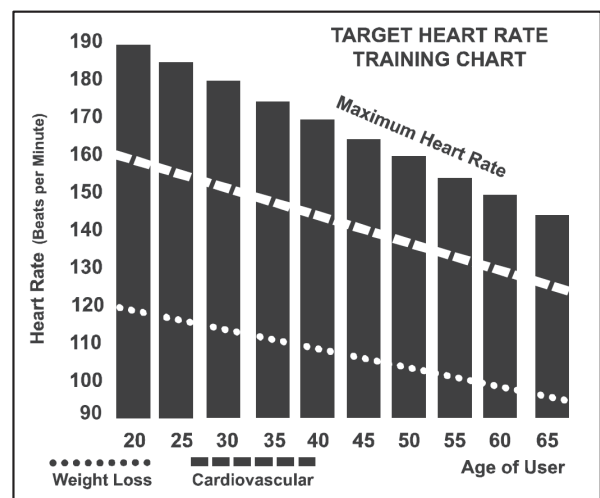

If you enter your age during programming the console will perform this calculation automatically. Entering your age is used for the Heart Rate control programs. After calculating your MHR you can decide upon which goal you would like to pursue.

The two most popular reasons for, or goals, of exercise are cardiovascular fitness (training for the heart and lungs) and weight control. The black columns on the chart above represent the MHR for a person whose age is listed at the bottom of each column. The training heart rate, for either cardiovascular fitness or weight loss, is represented by two different lines that cut diagonally through the chart. A definition of the lines' goal is in the bottom left-hand corner of the chart. If your goal is cardiovascular fitness or if it is weight loss, it can be achieved by training at 80% or 60%, respectively, of your MHR on a schedule approved by your physician. Consult your physician before participating in any exercise program.

With all SOLE Heart Rate Control fitness bike machines you may use the heart rate monitor feature without using the Heart Rate Control program. This function can be used during manual mode or during any of the nine different programs. The Heart Rate Control program automatically controls resistance at the pedals.

RATE OF PERCEIVED EXERTION

Heart rate is important but listening to your body also has a lot of advantages. There are more variables involved in how hard you should workout than just heart rate. Your stress level, physical health, emotional health, temperature, humidity, the time of day, the last time you ate and what you ate, all contribute to the intensity at which you should workout. If you listen to your body, it will tell you all of these things.

The rate of perceived exertion (RPE), also know as the Borg scale, was developed by Swedish physiologist G.A.V. Borg. This scale rates exercise intensity from 6 to 20 depending upon how you feel or the perception of your effort.

The scale is as follows:

Rating Perception of Effort

- 6 Minimal
- 7 Very,very light
- 8 Very,very light +
- 9 Very light
- 10 Very light +
- 11 Fairly light
- 12 Comfortable
- 13 Somewhat hard
- 14 Somewhat hard +
- 15 Hard
- 16 Hard +
- 17 Very hard
- 18 Very hard +
- 19 Very,very hard
- 20 Maximal

You can get an approximate heart rate level for each rating by simply adding a zero to each rating. For example a rating of 12 will result in an approximate heart rate of 120 beats per minute. Your RPE will vary depending up the factors discussed earlier. That is the major benefit of this type of training. If your body is strong and rested, you will feel strong and your pace will feel easier. When your body is in this condition, you are able to train harder and the RPE will support this. If you are feeling tired and sluggish, it is because your body needs a break. In this condition, your pace will feel harder. Again, this will show up in your RPE and you will train at the proper level for that day.

USING HEART RATE TRANSMITTER

How to wear your wireless chest strap transmitter:

1. Attach the transmitter to the elastic strap using the locking parts.
2. Adjust the strap as tightly as possible as long as the strap is not too tight to remain comfortable.
3. Position the transmitter with the logo centered in the middle of your body facing away from your chest (some people must position the transmitter slightly left of center). Attach the final end of the elastic strap by inserting the round end and, using the locking parts, secure the transmitter and strap around your chest.
4. Position the transmitter immediately below the pectoral muscles.
5. Sweat is the best conductor to measure very minute heart beat electrical signals. However, plain water can also be used to pre-wet the electrodes (2 ribbed oval areas on the reverse side of the belt and both sides of the transmitter). It's also recommended that you wear the transmitter strap a few minutes before your work out. Some users, because of body chemistry, have a more difficult time in achieving a strong, steady signal at the beginning. After "warming up", this problem lessens. As noted, wearing clothing over the transmitter/strap doesn't affect performance.
6. Your workout must be within range - distance between transmitter/receiver – to achieve a strong steady signal. The length of range may vary somewhat but generally stay close enough to the console to maintain good, strong, reliable readings. Wearing the transmitter immediately against bare skin assures you of proper operation. If you wish, you may wear the transmitter over a shirt. To do so, moisten the areas of the shirt that the electrodes will rest upon.

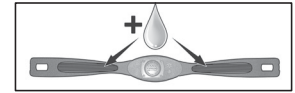

Note: The transmitter is automatically activated when it detects activity from the user's heart. Additionally, it automatically deactivates when it does not receive any activity. Although the transmitter is water resistant, moisture can have the effect of creating false signals, so you should take precautions to completely dry the transmitter after use to prolong battery life (estimated transmitter battery life is 2500 hours). The replacement battery is Panasonic CR2032.

ERRATIC OPERATION

Caution! Do not use this fitness bike for Heart Rate Control unless a steady, solid Actual Heart Rate value is being displayed. High, wild, random numbers being displayed indicate a problem.

Areas to look for interference which may cause erratic heart rate:

1. Microwave ovens, TV's, small appliances, etc.
 2. Fluorescent lights.
 3. Some household security systems.
 4. Perimeter fence for a pet.
 5. Some people have problems with the transmitter picking up a signal from their skin. If you have problems try wearing the transmitter upside down. Normally the transmitter will be oriented so the logo is right side up.
 6. The antenna that picks up your heart rate is very sensitive. If there is an outside noise source, turning the whole machine 90 degrees may de-tune the interference.
 7. Another Individual wearing a transmitter within 3' of your machine's console.
- If you continue to experience problems contact your dealer.

HEART RATE CONTROL PROGRAM OPERATION

Both programs operate the same, the only difference is that **HR1** is set to 60% and **HR2** is set to 80% of the maximum heart rate. They both are programmed the same way.

To start an **HRC** program follow the instructions below or just select the **HR1** or **HR2** program, then the **Enter** button and follow the directions in the **MessageWindow**.

1. Press the **HR1** or **HR2** key then press the **Enter** key.
2. The **MessageWindow** will ask you to enter your **Age**. You may enter your **Age**, using the **Level▲/▼** keys, then press the **Enter** key to accept the new number and proceed on to the next screen.
3. You are now asked to enter your **Weight**. You may adjust the **Weight** number using the **Level▲/▼** keys, then press **Enter** to continue.
4. Next is **Time**. You may adjust the **Time** and press **Enter** to continue.
5. Now you are asked to adjust your **Target Heart Rate**. This is the heart rate level you will strive to reach and maintain during the program. Adjust the level and then press **Enter**.
***NOTE:** The heart rate that appears is based on the % you accepted in Step 2. If you change this number it will either increase or decrease the % from Step 2.*
6. Now you are finished editing the settings and can begin your workout by pressing the **Start** key. You can also go back and modify your settings by pressing the **Enter** key. ***NOTE:** At any time during the editing of Data you can press the **Stop** key to go back one level, or screen.*
7. If you want to increase or decrease the workload at any time during the program press the **Level▲/▼** key. This will allow you to change your target heart rate at any time during the program.
8. During the **HR1** or **HR2** programs you will be able to scroll through the data in the **MessageWindow** by pressing the adjacent **Display** key.
9. When the program ends you may press **Start** to begin the same program again or **Stop** to exit the program.

GENERAL MAINTENANCE

1. Wipe down all areas in the sweat path with a damp cloth after each workout.
2. If a squeak, thump, clicking or rough feeling develops the main cause is most likely one of two reasons:
 - I. The hardware was not sufficiently tightened during assembly. All bolts that were installed during assembly need to be tightened as much as possible. It may be necessary to use a larger wrench than the one provided if you cannot tighten the bolts sufficiently. Ninety percent of calls to the service department for noise issues can be traced to loose hardware.
 - II. The crank arm nut needs to be retightened
 - III. If squeaks or other noises persist, check that the unit is properly leveled. There are 2 leveling pads on the bottom of the rear stabilizer, use a 14mm wrench (or adjustable wrench) to adjust the levelers.

MAINTENANCE MENU IN CONSOLE SOFTWARE

The console has built in maintenance/diagnostic software. The software will allow you to change the console settings from English to Metric and turn off the beeping of the speaker when a key is pressed for example. To enter the Maintenance Menu (may be called Engineering mode, depending on version) press and hold down the **Start**, **Stop** and **Enter** keys. Keep holding the keys down for about 5 seconds and the **Message Window** will display "Engineering mode". Press the **Enter** button to access the menu below. Press the **Level ▲/▼** keys to navigate the menu.

A. Key Test

B. Display Test

C. Functions

- I. **ODO Reset** - Resets the odometer reading to zero
- II. **Units** - Choose from English(Imperial) or Metric display readings
- III. **Display Mode** - Turn off to have the console power down automatically after 30 minutes of inactivity
- IV. **Motor Test** - Continually runs the tensioning gear motor
- V. **Manual** - Allows stepping of the gear motor
- VI. **Pause Mode** - Turn on to allow 5 minutes of pause, turn off to have console pause indefinitely
- VII. **Key Tone** - Turn on or off the beep sound when a key is pressed

D. Security

E. Factory Settings - For Factory use only

F. Exit

R92 PARTS LIST

Key	Part	Part Description	Q'ty
1	9809201	Main Frame	1
2	9809202	Console Mast	1
3	9809203	Mast Handle bar Assembly	1
4	9809204	Seat Carriage	1
5	9809205	Seat Back Bracket	1
6	9809206	Seat Handle Bar	1
7	9809207	Rear Stabilizer	1
8	9809208	Crank Axle	1
9L	9809209L	Seat Wheel Adjustment Plate (L)	2
9R	9809209R	Seat Wheel Adjustment Plate (R)	2
10	9809210	Idler Wheel Assembly	1
11	9809211	Seat Stop Axle	2
12	9809212	Seat Position Latch	1
13	9809213	Backing Plate	3
14	9809214	Aluminum Track	1
15	9809215	Rack	1
16	9809216	Spacer for Stopper Axle	4
17	9809217	Ø35 × 10m/m_Rubber Foot	4
18	9809218	Transportation Wheel	2
19	9809219	Console Assembly	1
20	9809220	Drive Pulley	1
21	9809221	950m/m_Handpulse W/Cable Assembly(R)	1
23	9809223	Ø32(1.8T)_Button Head Plug	2
24	9809224	Ø25.4 × 2.0T_Button Head Plug	2
25	9809225	Seat Track Wheel	8
26	9809226	300m/m_Handpulse Wire	2
27	9809227	750m/m_Handpulse W/Cable Assembly(L)	1
28	9809228	Crank Arm End Cap	2
29	9809229	Front Shroud (L)	1
30	9809230	Front Shroud (R)	1
31	9809231	Console Mast Cover	1
32	9809232	End Cap	4
33L	9809233L	Beam Cover (L)	1
33R	9809233R	Beam Cover (R)	1
34	9809234	Round Disk Cover, Crank	2
35	9809235	Rear Shroud (L)	1
36	9809236	Rear Shroud (R)	1
38	9809238	Drink Bottle Holder (R)	1
39	9809239	Drink Bottle Holder (L)	1
41	9809241	Transformer Power Cord	1
43	9809243	Gear Motor	1
44	9809244	750m/m_Computer Cable	1
45	9809245	2300m/m_Handpulse Wire	1

Key	Part	Part Description	Q'ty
46	9809246	300m/m_Sensor W/Cable	1
48	9809248	1100m/m_DC Power Cord	1
51L	9809251L	Crank Arm(L)	1
51R	9809251R	Crank Arm(R)	1
52	9809252	6004_Bearing	2
53	9809253	6203_Bearing	2
54	9809254	Drive Belt	1
55	9809255	Flywheel	1
56	9809256	Magnet	1
61	9809261	Seat	1
62	9809262	Steel Cable	1
63	9809263	Seatback Cushion	1
64	9809264	Handgrip Foam	2
65	9809265	3/8" × 53L_Carriage Bolt	2
66	9809266	1/4" × 3/4" _Hex Head Bolt	4
68	9809268	5/16" × 5/8" _Hex Head Bolt	8
71	9809271	3/8" × 1-3/4" _Hex Head Bolt	2
72	9809272	1/4" × 13 × 1T_Flat Washer	5
73	9809273	Ø1/4" × 19 × 1.5T_Flat Washer	4
75	9809275	Ø17 × 23.5 × 1T_Flat Washer	1
76	9809276	Ø5/16" × Ø18 × 1.5T_Flat Washer	7
77	9809277	Ø3/8" × Ø19 × 1.5T_Flat Washer	15
78	9809278	Ø3/16" × Ø15 × 1.5T_Flat Washer	3
79	9809279	Ø8 × Ø18 × 3T_Knurled Lock Washer	4
81	9809281	3/8" × 3/4" _Button Head Socket Bolt	1
82	9809282	5/16" × 1.5T_Split Washer	8
83	9809283	Ø5/16" × 19 × 1.5T_Curved Washer	2
84	9809284	Ø3/8" × Ø25 × 2T_Flat Washer	2
85	9809285	Ø17_C Ring	1
86	9809286	Ø20_C Ring	2
87	9809287	M8 × 80m/m_J Bolt	1
88	9809288	M8 × 7T_Nyloc Nut	5
89	9809289	3/8" × 7T_Nyloc Nut	5
90	9809290	1/4" × 5.5T_Nyloc Nut	4
91	9809291	5/16" × 6T_Nyloc Nut	3
93	9809293	M6 × 38m/m_Socket Head Cap Bolt	1
94	9809294	5/16" × 3/4" _Hex Head Bolt	6
95	9809295	M5 × 12m/m_Flat Head Socket Screw	10
97	9809297	Ø3 × 20m/m_Tapping Screw	4
98	9809298	M6 × 15m/m_Phillips Head Screw	8
99	9809299	M5 × 12m/m_Phillips Head Screw	9
101	98092101	5 × 16m/m_Tapping Screw	13
103	98092103	3.5 × 16m/m_Sheet Metal Screw	21
104	98092104	Spring	1
105	98092105	4 × 16m/m_Sheet Metal Screw	4

Key	Part	Part Description	Q'ty
106	98092106	5/16" × 1-3/4" _Button Head Socket Bolt	2
108	98092108	M10 × 1.25m/m _Nut	2
109	98092109	3/8" × 7T _Nut	8
110	98092110	3/8" × 2" _Flat Head Socket Bolt	4
111	98092111	M5 × P0.8 × 10L _Flat Phillips Head Screw	8
112	98092112	12/14m/m _Wrench	1
114	98092114	Phillips Head Screw Driver	1
116	98092116	Pedal (L)	1
117	98092117	Pedal (R)	1
119	98092119	3/8"-UNF26 × 3T _Nut	1
120	98092120	3/8"-UNF26 × 4T _Nut	1
121	98092121	3/8"-UNF26 _Nut	2
122	98092122	Drink Bottle(Optional)	1
123	98092123	Chest Strap(Optional)	1
125	98092125	Seat Carriage Cover	1
126	98092126	HGP Wire Grommet	1
129	98092129	M6 × 6T _Nyloc Nut	1
130	98092130	Ø5/16" × 16 × 1T _Flat Washer	3
131	98092131	Power Adaptor	1
132	98092132	14/15m/m _Wrench	1
135	98092135	Aluminum Axle End Cap	2
141	98092141	Handle Bar Cover	1
143	98092143	Seat Track Fixing Plate	1
148	98092148	Block	1
152	98092152	400m/m _Audio Cable (Optional)	1
153	98092153	Console Holder Assembly	1
154	98092154	5/16" × 2-1/2" _Hex Head Bolt	1
157	98092157	5/16" × 25 × 3T _Nylon Washer	2
159	98092159	On/Off Switch Bracket	1
160	98092160	5/16" × 16 × 1.5T _Flat Washer	6
161	98092161	M6 × 10L _Flat Phillips Head Screw	4
162	98092162	Ø1/4" × Ø16 × 1T _Flat Washer	4
163	98092163	Sleeve	4
164	98092164	M6 × 19L _Nut	4
165	98092165	M6 × 10L _Button Head Socket Bolt	4
166	98092166	PU Wheel	4
167	98092167	Seat Front/Aft Adjustment Lever	1
168	98092168	Lever Anchor	1
169	98092169	M5 × 25m/m _Flat Head Socket Screw	2
170	98092170	Ø15 × Ø6 × 4T _Nylon Washer	1
171	98092171	M5 × 45m/m _Socket Head Cap Bolt	1
172	98092172	Ø5 × Ø10 × 1T _Flat Washer	1
173	98092173	M5 × 5T _Nyloc Nut	1
175	98092175	3/8" × 2- 3/4" _Hex Head Bolt	2
176	98092176	3/8" × UNC16 × 3/4" _Hex Head Bolt	6

Key	Part	Part Description	Q'ty
177	98092177	Rubber Foot Pad	1
178	98092178	Square End Cap	1
179	98092179	M8 × 15m/m_Button Head Socket Bolt	4
185	98092185	3/8" × 4T_Nut	1
189	98092189	Rubber Pad	1
190	98092190	Tablet Holder (Bottom)	1
190-1	98092190-1	Tablet Holder Adjustable Clip	1
190-2	98092190-2	Tablet Holder (Front)	1
191	98092191	3/8" × UNC16 × 12.5T_Cap Nut	2
192	98092192	3.5 × 12L_Sheet Metal Screw	8

MANUFACTURER'S LIMITED WARRANTY

Dyaco Canada Inc. warrants all its fitness bike parts for a period of time listed below from the date of retail sale, as determined by sale receipt. Dyaco Canada Inc.'s responsibilities include providing new or remanufactured parts, at Dyaco Canada Inc.'s option, and technical support to our independent dealers and servicing organizations. In the absence of a dealer or service organization, these warranties will be administered by Dyaco Canada Inc. directly to a consumer. The warranty period applies to the following components:

R92 - RESIDENTIAL WARRANTY (All service is performed In-Home)

Parts/Electronics	3 Years
Frame	Lifetime
Labour	1 Year

This warranty applies only to products in ordinary household use, and the consumer is responsible for the items listed below:

1. The warranty registration card must be completed and returned to the address listed on the card within 10 days of the original purchase to validate the Dyaco Canada Inc.'s limited warranty.
2. Proper use of the fitness bike in accordance with the instructions provided in this manual.
3. Proper installation in accordance with instructions provided with the fitness bike and with all local electric codes.
4. Proper connection to a grounded power supply of sufficient voltage, replacement of blown fuses, repair of loose connections or defects in house wiring.
5. Expenses for making the fitness bike accessible for servicing, including any item that was not part of the fitness bike at the time it was shipped from the factory.
6. Damages to the fitness bike finish during shipping, installation or following installation.
7. Routine maintenance of this unit as specified in this manual.

EXCLUSIONS

This warranty does not cover the following:

1. CONSEQUENTIAL, COLLATERAL, OR INCIDENTAL DAMAGES SUCH AS PROPERTY DAMAGE AND INCIDENTAL EXPENSES RESULTING FROM ANY BREACH OF THIS WRITTEN OR ANY IMPLIED WARRANTY.
Note: Some areas do not allow the exclusion or limitation of incidental or consequential damages, so this limitation or exclusion may not apply to you.
2. Service call reimbursement to the consumer. Service call reimbursement to the dealer that does not involve malfunction or defects in workmanship or material, for units that are beyond the warranty period, for units that are beyond the service call reimbursement period, for fitness bike not requiring component replacement, or fitness bike not in ordinary household use.
3. Damages caused by services performed by persons other than authorized Dyaco Canada Inc. service companies; use of parts other than original Dyaco Canada Inc. parts; or external causes such as corrosion, discoloration of paint or plastic, alterations, modifications, abuse, misuse, accident, improper maintenance, inadequate power supply, or acts of God.
4. Products with original serial numbers that have been removed or altered.
5. Products that have been: sold, transferred, bartered, or given to a third party.
6. Products that do not have a warranty registration card on file at Dyaco Canada Inc. Dyaco Canada Inc. reserves the right to request proof of purchase if no warranty record exists for the product.
7. THIS WARRANTY IS EXPRESSLY IN LIEU OF ALL OTHER WARRANTIES EXPRESSED OR IMPLIED, INCLUDING THE WARRANTIES OF MERCHANTABILITY AND/OR FITNESS FOR A PARTICULAR PURPOSE.
8. Product use in any environment other than a residential setting.
9. Warranties outside of North America may vary. Please contact your local dealer for details.

SERVICE

Keep your bill of sale. The labour warranty period is twelve (12) months from the date on the bill of sale. If service is performed, it is in your best interest to obtain and keep all receipts. This written warranty gives you specific legal rights. You may also have other rights that vary in different areas. Service under this warranty must be obtained by following these steps, in order:

1. Contact your selling authorized SOLE dealer.
2. If you have any questions about your new product or questions about the warranty contact Dyaco Canada Inc. at 1-888-707-1880.
3. If no local service is available, Dyaco Canada Inc. will repair or replace the parts, at Dyaco Canada Inc.'s option, within the warranty period at no charge for parts. All transportation costs, both to our factory and upon return to the owner, are the responsibility of the owner. The owner is responsible for adequate packaging upon return to Dyaco Canada Inc. Dyaco Canada Inc. is not responsible for damages that occur during shipping. Make all freight damage claims with the appropriate freight carrier. DO NOT SHIP ANY UNIT TO OUR FACTORY WITHOUT A RETURN AUTHORIZATION NUMBER. All units arriving without a return authorization number will be refused.
4. For any further information, or to contact our service department by mail, send your correspondence to:

Dyaco Canada Inc.
5955 Don Murie Street
Niagara Falls, ON
L2G 0A9

Product features or specifications as described or illustrated are subject to change without notice. All warranties are made by Dyaco Canada Inc.

Customer Service 1-888-707-1880
Email: customerservice@dyaco.ca

dyaco

Please visit us online for information about our other brands and products manufactured and distributed by Dyaco Canada Inc.

SPIRIT

spiritfitness.ca

XTEERRA

xterrafitness.ca

UFC

dyaco.ca/UFC/UFC-home.html

SOLE
FITNESS

solefitness.ca

EVERLAST

dyaco.ca/products/everlast.html

Johnny G
by **SPIRIT**

spiritfitness.ca/johnnyg.html

TRAINOR
SPORTS

trainorsports.ca

For more information, please contact Dyaco Canada Inc.

T: 1-888-707-1880 | 5955 Don Murie St., Niagara Falls, Ontario L2G 0A9 | sales@dyaco.ca

Dyaco Canada Inc. dyaco.ca

SOLE[™]
FITNESS