



# MARVERA

## Basic Manual

[Contents](#)

---

[Safety Precautions](#)

---

[Basic Operations](#)

---

[Character Input](#)

---

[Phone](#)

---

[Phone Book](#)

---

[Mail](#)

---

[LINE](#)

---

[Internet](#)

---

[Camera](#)

---

[TV \(1Seg\)](#)

---

[Useful Functions](#)

---

[Settings](#)

---

[Appendix](#)

---

## Preface

Thank you for purchasing the "MARVERA" (simply called the "product" or "main unit" from here on). Before using the product, be sure to read "Basic Manual" (this manual) and "Setting Guide" to ensure correct use. After you have finished reading the manuals, be sure to keep them accessible. If you lose "Basic Manual" and "Setting Guide", contact an au shop or Customer Service Center.

## List of Packaged Items

Before you start using the product, make sure that you have all the following packaged items with the product.

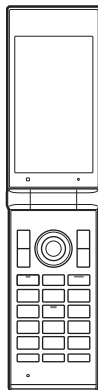

Main unit

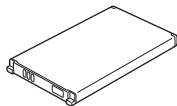

Battery Pack  
(KYF35UAA)

- 取扱説明書 (Basic Manual) (Japanese)
- 設定ガイド (Setting Guide) (Japanese)

The following items are not included in the package.

- Desktop holder (KYF35PUA)
- microSD memory card
- AC adapter
- Earphone
- 3.5  $\phi$ -microUSB conversion adapter 01 (0301QNA)
- microUSB cable



### memo

- ◎ Purchase a specified charger (sold separately).
- ◎ Illustrations of cell phones in this manual are only for reference. They may look different from the actual product.

## Operating Instructions

### ■ "Setting Guide" and "Basic Manual" (This manual)

Handles only basic operations for main features.



## Illustrations and Descriptions in This Manual

### ■ Note on Key Illustrations

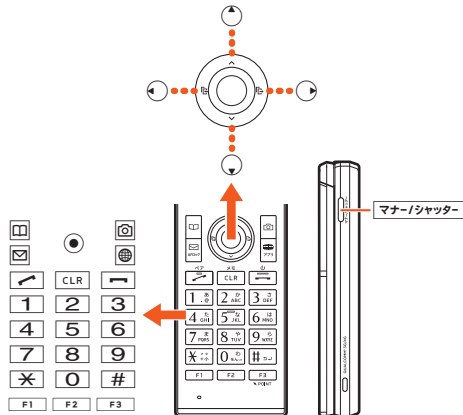
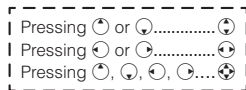
In this manual, the key illustrations are simplified as shown below.



## ■ Description of Operations for Selecting Item/Icon/Button, etc.

In this manual, step descriptions for selecting a menu item/icon/on-screen button, etc. with  or  and then pressing  (OK/Check/Set/Commit/Done) are abbreviated as [Operation].

**Example: To edit phone book contacts**

### 1 From the standby screen, press → (Menu) → [Edit]

Indicates to select "Edit" with  and commit with .

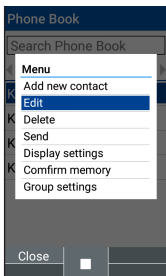

#### memo

◎ For details on key operation, refer to "Learn Basic Key Operations" (▶ P.64).













## ■ Notes on Illustrations/Screenshots

This manual indicates the screen displays and describes operation assuming an au Nano IC Card 04 LE is installed.

The illustrations and screenshots in this manual may look different from the actual product or screens. Note that part of the screen may be omitted.



#### memo

- ◎ In this manual, keys, screenshots and icons are described based on default settings of the product with the body color "DARK NAVY". However, actual keys, screenshots and icons may differ or be partially omitted.
- ◎ Contents at the bottom of the screen that can be operated by pressing , , , ,  are indicated in parentheses, such as  (Menu).
  - \* However, ,  (Check)/ (Set)/ (Commit)/ (Done) are abbreviated as  only.
- ◎ Menu items, layers and icons described in this manual may be different according to functions and conditions to use.
- ◎ In this manual, "au Nano IC Card 04 LE" is abbreviated as "au IC card".

- ◎ In this manual, "microSD™ memory card (commercially available)" and "microSDHC™ memory card (commercially available)" are abbreviated as "microSD memory card" or "microSD".
- ◎ All of the indicated amounts exclude tax unless otherwise specified.
- ◎ Company names and product names referred to in this manual are trademarks or registered trademarks of the respective companies. The TM, ® marks may be omitted in this manual.

# Contents

Preface .....	ii
List of Packaged Items.....	ii
Operating Instructions.....	1
Illustrations and Descriptions in This Manual .....	1

## Contents .....4

## Safety Precautions.....7

Safety Precautions .....	7
When Using the Product.....	7
Safety Precautions (Observe Strictly) .....	9
Material List .....	24
Handling Precautions .....	25
Notes on Waterproof/Dustproof/Shockproof Properties..	32
Important Items to Remember before Use.....	32
Precautions on Charging .....	35
Draining the Product .....	36
Notes on Using Bluetooth <sup>®</sup> /Wireless LAN (Wi-Fi <sup>®</sup> )	
Function .....	38
Cautions on Using 2.4 GHz Band .....	38
Security Code/PIN Code .....	40
Notes on Security Code .....	40
Notes on PIN Code .....	40
Notes on Data Communication Charges.....	41
Notes on Applications.....	42
Cell Phone Etiquette .....	42

## Basic Operations .....44

Basic Operations .....	44
Names and Functions of Parts.....	44
Smart Sonic Receiver .....	47
Using the Pointer.....	48
Touch Pointer Operation.....	48
Pointer Operation .....	50
Switching to English Display .....	51
Using the Standby Screen.....	52
Using Widgets and Indicators.....	52
Editing Widgets in the Standby Screen .....	53
Monitoring the Product's Status .....	53
Viewing Icons.....	53
Notification/Settings Panel .....	54
Charging/Notification Indicator .....	55
Auto Assist .....	55
Using the Sub-display.....	56
Using the Main Menu .....	57
Using Applications/Services .....	62
Changing the Main Menu.....	62
Updating LINE.....	63
Using the Custom Menu .....	63
Registering Applications to the Custom Menu.....	63
Using the Custom Menu to Activate Apps.....	63
Rearranging Applications .....	63
Deleting Applications.....	63
Learn Common Operations .....	64
Learn Basic Key Operations .....	64
Using Checkboxes.....	65
Disabling Manner/Shutter Key Operation when the Product is Folded (Key Lock) .....	65

## **Character Input.....66**

<b>Character Input.....</b>	<b>66</b>
<b>Learn How to Enter Characters.....</b>	<b>66</b>

## **Phone.....70**

<b>Phone.....</b>	<b>70</b>
<b>Making a call.....</b>	<b>70</b>
Entering a Phone Number and Making a Call.....	70
Using Call Histories and Making a Call.....	72
Using Speed Dial and Making a Call.....	73
Calling Overseas from au Phones (au International Call Service).....	73
<b>Receiving a Call.....</b>	<b>74</b>
Answering an Incoming Call.....	74
Rejecting an Incoming Call.....	75
<b>Checking Your Phone Number.....</b>	<b>75</b>
Checking Your Profile.....	75
Editing Your Profile.....	75

## **Phone Book.....76**

<b>Phone Book.....</b>	<b>76</b>
<b>Registering to the Phone Book.....</b>	<b>76</b>
<b>Using the Phone Book List.....</b>	<b>76</b>
Displaying the Phone Book List.....	76
<b>Using Information Registered for Contacts.....</b>	<b>77</b>

## **Mail.....79**

<b>E-mail.....</b>	<b>79</b>
<b>Checking E-mail.....</b>	<b>79</b>
<b>Sending E-mail.....</b>	<b>82</b>
Adding/Deleting Recipients.....	83
<b>Receiving E-mail.....</b>	<b>84</b>
Inquiring for and Receiving New Mail.....	84
<b>SMS (C-mail).....</b>	<b>85</b>
<b>Sending SMS.....</b>	<b>85</b>
<b>Receiving SMS.....</b>	<b>86</b>

## **LINE.....88**

<b>LINE.....</b>	<b>88</b>
------------------	-----------

## **Internet.....89**

<b>Internet Access.....</b>	<b>89</b>
<b>Accessing the Internet.....</b>	<b>89</b>
Using Data Communication.....	89
<b>Browser.....</b>	<b>90</b>
<b>Displaying Webpages.....</b>	<b>90</b>
<b>Using the Pointer.....</b>	<b>90</b>

## **Camera.....91**

<b>Camera.....</b>	<b>91</b>
Viewfinder Layout.....	92
Capturing Still Pictures/Video.....	93

<b>TV (1Seg) .....</b>	<b>95</b>
<b>TV (1Seg).....</b>	<b>95</b>
Using TV (1Seg).....	95
Making Initial TV Settings .....	96
Viewing TV Programs .....	97
Viewing a TV Program.....	97
Exiting TV (1Seg).....	97
<b>Useful Functions .....</b>	<b>98</b>
テレビde写真 (Photos on TV).....	98
FM radio.....	99
Alarm .....	99
Using the Menu in the Alarm List.....	100
Using the Weather Forecast Alarm .....	100
Flashlight.....	101
Kanji Check .....	102
Screenshot .....	102
Battery Care Mode.....	102
<b>Settings .....</b>	<b>103</b>
Settings .....	103
Displaying the Settings Menu .....	103
Setting the Manner Mode.....	103
Wireless LAN (Wi-Fi®) function .....	105
Wireless LAN (Wi-Fi®) Function .....	105
Using the Wireless LAN (Wi-Fi®) Function .....	106

Enabling the Wireless LAN (Wi-Fi®) Function .....	106
Connecting to a Wi-Fi® Network .....	106
Disconnecting from an Access Point.....	106

## **Appendix..... 107**

<b>Appendix .....</b>	<b>107</b>
<b>Updating Software.....</b>	<b>107</b>
Downloading and Updating Software .....	107
<b>Troubleshooting .....</b>	<b>108</b>
<b>位置検索サポート (Location Search Support) .....</b>	<b>110</b>
<b>After-Sales Service.....</b>	<b>111</b>
<b>SIM Unlock.....</b>	<b>116</b>
<b>Related Accessories.....</b>	<b>117</b>
<b>Using a microUSB Earphone .....</b>	<b>118</b>
Receiving a Call .....	120
<b>Main Specifications.....</b>	<b>120</b>
<b>Specific Absorption Rate (SAR) of Cell Phones.....</b>	<b>122</b>
<b>FCC Notice.....</b>	<b>124</b>
<b>Export Administration Regulations .....</b>	<b>125</b>
<b>Intellectual Property Rights.....</b>	<b>126</b>
Trademarks .....	126
License.....	129



## Safety Precautions

### When Using the Product

- Before you start using the product, be sure to read "Safety Precautions" in this manual to ensure correct use.
- Before you assume that the product is malfunctioning, check "Troubleshooting" in this manual. Or, check for possible remedies in "トラブル診断" (Japanese) of au homepage:  
<https://www.au.com/trouble-check/>
- Communication is not possible even inside the service area in places where the signal does not reach (e.g. tunnels and basements). Also, communication may not be possible in poor reception areas. Communication may be interrupted if you move into poor reception areas during communications.
- Since this product uses radio waves, the possibility of communication intercepts by third parties cannot be eliminated (though the LTE/UMTS/GSM system has highly secure confidential communication features).
- VoLTE (LTE network) by au is used when connecting with emergency call receiving agencies within Japan. You cannot connect using 3G (circuit-switched network).
- The product is compatible with au World Service. Each network service described in this manual varies depending on the area and service content.
- Since the product is a radio station under the Radio Law, you may be asked to temporarily submit the product for inspection in accordance with the Radio Law.
- The IMEI information of your cell phone is automatically sent to KDDI CORPORATION for maintenance and monitoring operational status of your cell phone.
- If you are using the product overseas, check the relevant laws and regulations of the country/region you visit beforehand.
- The Company is not liable for any damages arising from earthquakes, lightning, storms, floods or other natural disasters, as well as fires, actions by third parties, other accidents, intentional or mistaken operation by the customer, or use under other unusual conditions outside the responsibility of the Company.
- The Company is not liable for any incidental damages (change/disappearance of saved content, loss of business income, disruption of business, etc.) arising from use of or inability to use the product.
- The Company is not liable for any damages arising from failure to observe the described content of this manual.

- The Company is not liable for any damages arising, for example, from malfunction caused by combination with connected devices or software not related to the Company.
  - Captured image data or downloaded data may sometimes be altered or lost due to faults, repair or other handling of the product. The Company is not liable for any damage or lost income resulting from recovery of these data.
  - It is recommended you keep a copy of important data on your PC's hard disk, etc. Whatever the cause of the defect or malfunction may be, the Company assumes no responsibility for alteration or loss of saved data.
  - Contents saved in the product, such as contacts, mails and favorites might be altered or lost by an accident, fault, repair or mishandling. Be sure to keep a copy of important contents. Note that the Company assumes no responsibility for any damages or lost profits resulting from altered or lost contents.
  - Note that content data (both charged or free of charge) saved on the product cannot be returned to the customer when the product is replaced for repair of a fault, for example.
- The product uses liquid crystal for its main display. The main display response speed may become slow when the ambient temperature is low, which is due to the characteristics of liquid crystal and is not a malfunction. The main display response speed will return to normal at room temperature.
  - Although the display used on the product is made using high-precision technology, some pixels (dots) might be lit or out at all times. This is not a malfunction.
  - You are recommended to store copies of individual data such as photos/movies you took and music in your PC by sending each file as mail attachment, etc. Note, however, that you may not be able to make copies of some copyrighted data even by the above-mentioned means.
  - Do not discard the product together with regular trash. Please cooperate in the collection of the product (including optional parts) when it is no longer needed to protect the environment and effectively use resources. Old products are collected at au shops and other places.
  - If the confirmation screen such as terms and conditions, etc. appears when you use applications and functions of the product, follow the on-screen instructions.

\* "The Company" as appears in this manual refers to the following companies:

Sold by: KDDI CORPORATION, OKINAWA

CELLULAR TELEPHONE COMPANY

Manufactured by: KYOCERA Corporation



### memo

- Reproduction of the content of this manual in part or in whole is prohibited.
- The content of this manual is subject to change without notice.
- Every effort has been made in the preparation of this manual. Should you notice any unclear points, omissions, etc., feel free to contact us.

## Safety Precautions (Observe Strictly)

- Before using the product, thoroughly read this "Safety Precautions" for proper use.
- These precautions describe instructions that should be observed to prevent injury to the customer and others, or damage to property using the product.
- The signs below differentiate between the levels of danger that can occur if the product is not used within the specified guidelines.



**DANGER**

This sign denotes that "death or serious injury"<sup>\*1</sup> may directly result from improper use".



**WARNING**

This sign denotes that "death or serious injury"<sup>\*1</sup> may result from improper use".









**CAUTION**

This sign denotes that "minor injury"<sup>\*2</sup> or damage to property<sup>\*3</sup> may result from improper use".

- \*1 Serious injury: This refers to loss of sight, injury, burns (high- and low-temperature), electric shock, broken bones, injuries with residual aftereffects from poisoning, etc., and injuries requiring hospital admission for treatment or long-term hospital attendance as an outpatient.
- \*2 Minor injury: This refers to injuries, burns (high- and low-temperature), electric shock, etc. that do not require hospital admission for treatment or long-term hospital attendance as an outpatient.
- \*3 Physical damage: This refers to extended damage to buildings, furniture, livestock or pets.

### Explanation of Graphic Symbols Used in This Manual

	Indicates an action that is not allowed.		Indicates that handling with wet hands is not allowed.
	Indicates that disassembly is not allowed.		Indicates an action based on instructions that must be done.

	Indicates that use in a place where the product is likely to get wet or allowing the product to get wet is not allowed.		Indicates that the power plug must be disconnected from the power outlet.
---	---	---	---

### Precautions Common to the Main Unit, Battery Pack, Back Cover, Charger, au IC Card, Peripheral Devices

#### **DANGER**

-  **Do not use, store or leave the product in hot places (e.g. by the fire, near a heater, under a kotatsu or futon, in direct sunlight, in a car in the hot sun).**  
Doing so may cause fire, burns, injuries, or electric shock.



**Do not put the product into or near a heating cooking device such as a microwave oven or IH cooker, or high-pressure container such as a pressure cooker.**

Doing so may cause fire, burns, injuries, or electric shock.



**Do not put sand, dirt, or mud on the product or put it on them directly. Do not touch the product with hands to which sand or others adhere.**

Doing so may cause fire, burns, injuries, or electric shock.

For details on water/dust resistance, refer to the following.

▶ P.32 "Notes on Waterproof/Dustproof/Shockproof Properties"



**Do not charge when the product is wet with water (drinking water, perspiration, seawater, urine of pet animals, etc.).**

Doing so may cause fire, burns, injuries, or electric shock.

For details on water resistance, refer to the following.

▶ P.32 "Notes on Waterproof/Dustproof/Shockproof Properties"



**Do not subject the product to strong pressure or break the product. Especially when bringing the product putting in a pocket of clothes, do not let the product hit against surroundings or being put between the objects.**

Doing so may cause fire, burns, or injury due to battery damage.

\* Examples to avoid

- Sitting or squatting with the product put in a pocket of trousers or skirt
- Putting the product in a pocket of outer wear and catching them in a door or a door of car
- Stepping on the product on a soft object such as a sofa, bed, or bedding, or on a floor



**Do not disassemble or modify in that manner.**

Doing so may cause fire, burns, injuries, or electric shock.



**Do not let the product get wet with water (drinking water, perspiration, seawater, urine of pet animals, etc).**

Doing so may cause fire, burns, injuries, or electric shock.

For details on water resistance, refer to the following.

▶ P.32 "Notes on Waterproof/Dustproof/Shockproof Properties"



**Do not put water (drinking water, perspiration, seawater, urine of pet animals, etc.) into the charging terminal or the external connection terminal.**

Doing so may cause fire, burns, injuries, or electric shock.

For details on water resistance, refer to the following.

▶ P.32 "Notes on Waterproof/Dustproof/Shockproof Properties"



**Use the optional products specified by au.**

Not doing so may cause fire, burns, injuries, or electric shock.



## WARNING



**Do not drop, trample, or throw the product or give a strong force or vibration to it.**

Doing so may cause fire, burns, injuries, or electric shock.



**Do not allow conductive materials (metal pieces, pencil lead, etc.) to come in contact with the charging terminal or the external connection terminal, and do not allow dust to get inside.**

Doing so may cause fire, burns, injuries, or electric shock.



**Do not cover or wrap the product with bedding, etc. while using or charging the product.**

Doing so may cause fire or burns.



**If charging is not completed after the specified charging time, stop charging.**

Overcharging may cause fire, burns, or injuries.

- 
-  **Make sure to turn off the product or stop charging before you get close to places like a gas station where a flammable gas or dust can be generated.**

Using the product in places where a flammable gas can be generated may cause an explosion or fire. When using Osaifu-Keitai at a gas station, be sure to turn off the power in advance. (If Osaifu-Keitai lock has been set, cancel the lock before turning off the power.)

- 
-  **Perform the following operations while using, charging, or keeping the product if there are odors, noise, smoke, overheating, discoloring, deformation, or other abnormalities.**

- Remove the power plug from the wall outlet.
  - Turn the product OFF.
  - Remove the battery pack from the product.
- Not doing the above operations may cause fire, burns, injuries, or electric shock.



## CAUTION

- 
-  **Do not use the damaged product.**  
Doing so may cause fire, burns, or injuries.
- 

- 
-  **Do not leave the product on unstable or sloping surfaces. Be careful especially when the product is set to vibrate.**

The product may fall and cause injuries.

- 
-  **Do not use or store the product in humid or dusty places, or places that get hot.**

Doing so may cause fire, burns, or electric shock.

For details on water/dust resistance, refer to the following.

▶ P.32 "Notes on Waterproof/Dustproof/ Shockproof Properties"

- 
-  **When children use the product, do not let them use incorrectly without instruction by an adult for proper use.**

Doing so may cause injuries.

- 
-  **Do not store the product within the reach of small children.**

Doing so may cause accidental swallowing, injuries, or electric shock.



---

-  **Be careful when using the product continuously for a long time or charging as it gets hot. Also, avoid touching the product for a long time by falling asleep unintentionally.**

The product, battery pack, or specified charger (sold separately) may become hot when using for a long time such as apps, calling, data communication, watching TV or videos, or while charging. Depending on your physical predisposition and physical condition, contacting with a high temperature part may cause skin redness, itching, rash, or low-temperature burns.



### ■ Main unit

## DANGER

-  **Do not throw the product into fire or apply heat.**  
Doing so may cause fire, burns, or injuries.
-  **Do not apply excessive force such as sticking a nail into the product, hitting it with a hammer, or stepping on it.**  
Doing so may cause fire, burns, or injuries.

-  **If the substance inside the product comes into contact with your eyes or mouth, immediately rinse the area with clean water, and then see a doctor right away.**  
Not doing so may cause loss of sight or poor physical condition due to the influence of the substance, etc. inside the product.

## WARNING

-  **Do not send data by infrared communication with the infrared port pointing toward eyes.**  
Doing so may adversely affect on eyes.
-  **Do not operate to point the infrared port toward some other infrared device when using infrared communication function.**  
Doing so may cause an accident, etc because of malfunction of infrared device.





**Do not lighten or flash the lighting part of the light close to person's eye. Be especially careful to keep a sufficient distance from small children.**

Not doing so may cause vision disturbance. Also, it may cause an accident such as injuries due to dizziness or shocks.



**Do not lighten or flash the light to point at the eyes of someone driving a car, etc.**

Doing so may interfere with driving and cause an accident.



**Do not watch a repeatedly flickering screen for a long time.**

Doing so may cause muscle spasms or loss of consciousness, etc.



**Do not allow water or other liquids (drinking water, perspiration, seawater, urine of pet animals, etc.), metal pieces, flammable material or foreign object into the au IC card slot or the microSD memory card slot on the product. Do not mistake the place and direction of the au IC card or the microSD memory card.**

Doing so may cause fire, burns, injuries, or electric shock.



**Do not expose the camera lens to direct sunlight for an extended period.**

Doing so may cause fire, burns, or injuries by the light-collecting mechanism of the lens.



**Turn off the product or set it to Airplane mode before going aboard an airplane.**

Since using the product on airplanes is restricted, follow the instructions given by the respective airlines.

If any functions that power on the product automatically are activated, deactivate them.

The product's signals may adversely affect on-board electronic equipment.

If you commit a prohibited act while using the product on an airplane, you might be punished by law.



**Follow the instructions given by the respective medical institution regarding the use of the product in a hospital.**

Turn off the product in areas where the use of the product is prohibited.

If any functions that power on the product automatically are activated, deactivate them.

The product's signals may affect electronic equipment and electronic medical equipment.



**When using the handsfree call, ringtone is ringing, or in the standby mode, be sure to keep the product off of the ears. Also, when playing games, video, or music with an earphone microphone connected to the product, adjust the volume to the proper level.**

When using the handsfree call, loud noise sounds from the product.

Even in the standby mode, ringtone and vibrator may work suddenly.

Using continuously for a long time with too loud volume may cause a hearing loss, etc.

And, if you cannot hear the sound around you clearly, it may cause an accident.



**If you have a weak heart, be careful when setting the ringtone vibration and incoming volume.**

Sudden ringtone vibration and ringtone surprise you, it may cause harmful effect on heart.



**To use electronic medical equipment, check with electronic medical equipment manufacturer or vendor to determine how devices are affected by radio waves before using.**

Not doing so may cause harmful effect on electronic medical equipment, etc.



**Turn the product off near high-precision electronic control equipment or electronic equipment using low-power signals.**

Not doing so may cause the equipment to fail or malfunction.

\* Examples of electronic equipment to avoid  
A hearing aid, an implanted pacemaker, an implanted cardioverter-defibrillator, other electronic medical equipment, or other automatic control devices, etc. To use an implanted pacemaker, an implanted cardioverter-defibrillator, or other electronic medical equipment, check with electronic medical equipment manufacturer or vendor to determine how devices are affected by radio waves before using.

- 
-  **When the display or camera lens is accidentally broken, be careful of broken glass or exposed internal parts of the product.**

Not doing so may cause burns, injuries, or electric shock with damaged parts or exposed parts.



## CAUTION

- 
-  **Do not swing the product around by holding strap, etc.**

Doing so may cause injuries or other accidents.

- 
-  **If the display breaks and the fluid, etc. leaks out from inside, do not let the fluid contact with the skin on your face or hands or clothes.**

Doing so may cause eye or skin problems. If the substance inside the display comes into contact with your eyes or mouth, immediately rinse the area with clean water. If the fluid, etc. enters your eyes or mouth, immediately see a doctor after rinsing.

---

- 
-  **When removing the back cover, do not apply excessive force.**

Doing so may cause injuries with the back cover damaged.

- 
-  **Do not nip a part of your body such as fingers while attaching the back cover.**

Doing so may cause injuries.

- 
-  **Do not use with the back cover removed.**

Doing so may cause burns, injuries, or electric shock.

- 
-  **To use the product in car, check with automobile manufacturer or dealer to determine how vehicle devices are affected by radio waves before using.**

In rare cases, using the phone in some vehicle models can cause the vehicles electronic equipment to malfunction. In that case, stop using the product immediately.

- 
-  **If you develop skin problems, stop using the product immediately, and see a doctor.**

Itching, rashes, eczema, etc. sometimes occurs depending on your physical constitution and condition.

For material of each part ►P.24 "Material List"

---

- 
-  **Be careful not to nip a part of your body such as fingers while opening and closing the product.**

Nipping a part of your body such as fingers may cause injuries.

---

-  **Make sure that there is no adhered metal pieces (cutter blade, staples, etc.) as the speaker part of this product generates magnetism.**

Not doing so may cause injuries with adhered metal pieces.

---

-  **Use the product in a well-lighted area and put some distance between you and the display when watching the display.**

Using the product in dark places or near eyes may affect your vision.

---

## **Battery Pack**

### **DANGER**

-  **Do not allow metal objects (such as necklaces and hairpins) or conductive materials to come in contact with the contact terminal. Also, do not carry or store the battery pack with them.**

Doing so may cause fire, burns, or injuries.

---

-  **If the battery pack does not fit into the product, do not forcibly attach the battery pack. If it is difficult to remove the battery pack from the product, do not forcibly remove the battery pack.**

Doing so may cause fire, burns, or injuries.

---

-  **Do not throw the product into fire or apply heat.**

Doing so may cause fire, burns, or injuries.

---

-  **Do not apply excessive force such as sticking a nail into the product, hitting it with a hammer, or stepping on it.**

Doing so may cause fire, burns, or injuries.

---

-  **Confirm the direction of the battery pack when attaching the battery pack into the product.**

Improper connection may cause fire, burns, or injuries due to battery pack ignition, rupture, overheat, or leak.

---

- 
-  **If the substance inside the battery pack comes into contact with your eyes, do not rub the contacted area but immediately rinse the area with clean water, and then see a doctor right away.**

Not doing so may cause loss of sight or poor physical condition due to the influence of the substance inside the battery pack.

## **WARNING**

-  **Do not use the product if there are odors, overheating, discoloring, deformation, or other abnormalities.**  
Doing so may cause fire, burns, or injuries.

-  **Do not touch the battery pack with wet hands.**  
Doing so may cause burns or electric shock.

-  **Stop using the product immediately and move the battery pack away from fire if you notice leakage of substance, etc. inside the battery pack or unusual odor.**  
Not doing so may cause the leaked fluid to catch fire resulting in ignition or rupture.
- 

- 
-  **Prevent a pet from biting the battery pack.**  
Not doing so may cause fire, burns, or injuries due to battery pack ignition, rupture, overheat, or leak.

## **CAUTION**



-  **If fluid, etc. leaks out from the battery pack, do not let the fluid contact with the skin on your face or hands or clothes.**  
Doing so may cause eye or skin problems.  
If the substance inside the display comes into contact with your eyes or mouth, immediately rinse the area with clean water. If the fluid, etc. enters your eyes or mouth, immediately see a doctor after rinsing.

-  **Do not discard the old product together with regular trash.**  
Doing so may cause fire, burns, or injuries. Also, may cause environmental disruption. Insulate all terminals of the battery pack with insulation tape when it is no longer needed. Bring them to a sales outlet such as au Shop, or if your local municipality has a battery recycling program, dispose of them as provided for.
-

- 
-  **Do not use or charge a wet battery pack.**  
Doing so may cause fire, burns, or injuries.

## Charger

### **WARNING**

- 
-  **Do not use if the cord of the specified charger (sold separately) is damaged.**  
Doing so may cause fire, burns, or electric shock.
- 
-  **Do not use the specified charger (sold separately) in a humid place such as a bathroom.**  
Doing so may cause fire, burns, or electric shock.
- 
-  **Do not touch the specified charger (sold separately) if you hear thunder.**  
Doing so may cause electric shock.
- 

- 
-  **Do not short the charging terminal while it is connected to an outlet. Do not allow any part of your body such as your hands or fingers to come into contact with the charging terminal.**  
Doing so may cause fire, burns, or electric shock.

- 
-  **Do not place heavy objects on the cord of the specified charger (sold separately), or do not pull the cord with excessive force.**  
Doing so may cause fire, burns, or electric shock.

- 
-  **When you plug/unplug the specified charger (sold separately) into/from the outlet, do not contact metal straps or other metal objects with the jack.**  
Doing so may cause fire, burns, or electric shock.

- 
-  **Do not connect a transformer for overseas travel (travel converter) to the specified charger (sold separately).**  
Doing so may cause ignition, overheating, or electric shock.
-



**Do not apply excessive force on the connection part with the specified charger (sold separately) connected to the product.**

Doing so may cause fire, burns, injuries, or electric shock.



**Do not touch the cord, charging terminal or power plug of the specified charger (sold separately) with wet hands.**

Doing so may cause fire, burns, or electric shock.



**Use the product at the specified power supply voltage. When charging the product overseas, use the specified charger (sold separately) for global use.**

Incorrect power supply voltage may cause fire, burns, or electric shock.

AC adapter : 100 V AC (Connect to an AC outlet for internal household use)

AC adapter for global use : 100 V AC - 240 V AC (Connect to an AC outlet for internal household use)



**Wipe off dust on the power plug.**

Not doing so may cause fire, burns, or electric shock.



**Fully plug the specified charger (sold separately) into the outlet.**

Not doing so may cause fire, burns, or electric shock.



**When you disconnect the power plug from an outlet, do not pull the cord of the specified charger (sold separately) with excessive force. Instead, grasp the adapter to disconnect.**

Pulling the cord of the specified charger (sold separately) may damage the cord and cause fires, burns, electric shock, etc.



**When plugging/unplugging the specified charger (sold separately) into/from the product, do not pull the cord with excessive force. Instead, plug/unplug it straightly toward the jack to connect.**

Not doing so may cause fire, burns, injuries, or electric shock.



**Stop using the product immediately if you notice deformation of the charging terminal. Also, stop using the product after recovering the original form of the terminal.**

Short-circuiting of the charging terminal may cause fire, burns, injuries, or electric shock.



**When the specified charger (sold separately) is not to be used for a long time, disconnect the power plug from the outlet.**

Not doing so may cause fire, burns, or electric shock.



**Immediately remove the power plug from the outlet if water or other fluids (drinking water, perspiration, seawater, urine of pet animals, etc.) get on the adapter.**

Not doing so may cause fire, burns, or electric shock.



**Always remove the power plug from an outlet when cleaning the equipment.**

Not doing so may cause fire, burns, or electric shock.



## CAUTION



**Do not touch the specified charger (sold separately) for a long time when connected to an outlet.**

Doing so may cause burns.

### ■ au IC Card



## CAUTION



**Be careful of the cut surface when handling an au IC card as it may damage a part of your body such as fingers, etc.**

The cut surface may be sharp, and it may cause injuries.



## ■ Use near Medical Instruments and Inside Medical Facilities

### **WARNING**

-  **Wearers of medical equipment such as implanted pacemakers or defibrillators must carry and use the product at least 15 cm away from the implanted device.**

Radio waves may affect the performance of electronic medical equipment.

-  **When using electronic medical devices as home medical treatment other than an implanted pacemaker and an implanted cardioverter-defibrillator outside medical facilities, check individually with the manufacturer of the electronic medical equipment regarding the influence of radio waves.**

Radio waves may affect the performance of electronic medical equipment.

-  **Make sure that the product will not emit any signals (turn off power, put it in Airplane mode, etc.) if within 15 cm of those around you, such as where crowded and you cannot move freely.**

Since there may be people with an implanted pacemaker or an implanted cardioverter-defibrillator nearby. Radio waves may affect the performance of electronic medical equipment.

-  **When using the product in medical facilities, be sure to observe the regulations of the facility.**

Radio waves may affect the performance of electronic medical equipment.

## Material List

### ■ MARVERA KYF35 main unit

Part	Material	Surface Treatment
Window panel (main), camera plate	PMMA + PC resin	Hard coat processing
Ring camera	Aluminum alloy	Anodized aluminum
Manner/shutter key, outer case (hinge cover), back cover	PC resin	Acrylic UV cured coating
Charging terminal	Zinc alloy	Gold plating (with Cu, Ni, Ni + Pd)
Outer case (LCD case, KEY case)	PA + GF resin	Acrylic UV cured coating
Outer case (LCD rear plate)	PMMA resin	Acrylic UV cured coating

Part	Material	Surface Treatment
Infrared port window, phone book key, camera key, browser key, mail key, cursor key, call/pair key, clear/memo key, power/end key, number keys, custom keys	PMMA resin	—
Center key	Aluminum alloy	Anodized aluminum
Key sheet	PET resin	UV curable
Cushion (the bottom of number keys)	UV curable resin	—
Dummy SD card (protective card)	POM resin	—

### ■ Battery Pack (KYF35UAA)

Part	Material	Surface Treatment
Outer region	PC resin	—
Label	PET	—
Terminals	Copper	Gold plating (with Ni plating)

## Handling Precautions

These precautions are provided to prevent product faults and to ensure that performance can be fully demonstrated.

Thoroughly read these precautions to ensure correct use.

### ■ Precautions common to the main unit, battery pack, back cover, charger, au IC card, peripheral devices

- Do not apply excessive force to the product during use. Be sure not to put the product into a tightly packed bag or place a heavy object on the product in a bag. Sitting on the product in your pocket might damage the display or internal circuit board resulting in a damage or malfunction.  
Keeping an external connection device connected to the external connection terminal might damage the connector resulting in a malfunction. Such damage and malfunction are not covered by the warranty, even if there is no external damage.



- To ensure waterproof property (equivalent to IPX5 and IPX8) of the product, use the product with the back cover tightly closed.  
Note that the waterproof property is not guaranteed in every usage condition. Do not allow water to get inside the product or splash water on the battery pack, specified charger (sold separately), or optional accessories. Do not attach/remove the back cover of the product in the rain or with any water on its surface. Doing so may cause water intrusion resulting in internal corrosion.  
Malfunctions determined to be caused by such water intrusion are not covered by the warranty.
- Do not use the product in extremely hot, cold or humid places.  
(Use within an ambient temperature range of 5°C to 35°C and humidity range of 35% to 85%).
  - Charger
  - Peripheral devices
- Do not use the product in extremely hot, cold or humid places.  
(Use within an ambient temperature range of 5°C to 35°C and humidity range of 35% to 85%. Temporary use at 36°C to 40°C is allowed.)
  - Main unit
  - Battery pack, au IC card (attached to the main unit)

- Do not use in places subject to lots of dust or vibration. Doing so may cause malfunction.
  - Clean the external connection terminal now and then with a dry cotton swab. Soiling may result in a poor connection. Avoid using excessive force, which can bend the external connection terminal.
  - Clean the product with a soft dry cloth (such as the type used for eyeglasses). Forcefully rubbing with a dry cloth may scratch the display. The display may be stained if splash or smear is left attached to the surface. Wiping the product using alcohol, thinner, benzene, detergent, etc. might erase the printing on the outer cover or cause malfunction.
  - Use as far away as possible from fixed-line phones, TVs and radios. Use nearby might affect them.
  - The product may become warm while charging or during other operations, depending on the situation, but this is not abnormal.
  - Turn off the power of the product before removing the battery pack. If you remove the battery pack with the power on, saved data might be altered or lost.
  - Do not place near corrosive chemicals or in places where corrosive gas is generated. Doing so may cause malfunction.
  - Do not use outside when you can hear thunder. Doing so might risk lightning strikes and electric shock.
- 
- Be sure to use only the specified peripheral devices. Use of other peripheral devices might cause malfunction.
  - Do not put the product in a cooking apparatus such as microwave oven or a pressure vessel. Doing so may cause malfunction.
  - The customer is not allowed to disassemble, modify or repair the product. Doing so may cause malfunction. Modification of the product is in violation of the Radio Law and Telecommunications Business Law.
  - To prevent short-circuiting of the connection terminal, do not allow your fingers or any other part of your body or conductive materials (metal, pencil lead, etc.) to come in contact with or enter these areas. Doing so may cause malfunction.
  - In the event that the product gets wet while charging, immediately disconnect the power plug of the specified charger (sold separately).
  - Do not use the product while driving a car or riding a motorbike or bicycle or while walking. Use of a mobile device while driving a car or motorbike is prohibited by law. Use of a cell phone while riding a bicycle may be punishable by some regulations.
  - Using or charging the product in a bag or while it is covered with bedding might cause malfunction.

- When using a specified charger (sold separately) or external device, insert/remove the connector straight to/from the terminal. Improper connection may cause a fault.
- Do not expose the camera lens to direct sunlight for an extended period. Doing so may cause malfunction.
- Do not store the product in places subject to direct sunlight (e.g. in a car), places that get hot, places that get extremely cold, and in humid or dusty places. Doing so may cause malfunction.
- Do not leave the product on unstable or sloping surfaces. Be careful especially when the product is charging or set to vibrate. The product may fall and cause malfunction.
- For charging the product, do not exceed the rating of an outlet or wiring device by overloading an electrical circuit, etc.

### ■ Main unit

- Do not forcefully press, tap or intentionally subject the display to strong impact. Doing so may cause scratching or damage.
- Do not forcefully press your fingernails, sharp objects, or hard objects against keys or display surface. Doing so may cause scratching or damage.
- You can operate in the same way as a touchpad (touch pointer) by touching the keys of the product (touch area) with your fingers. However, even if you touch the touch area, the operation may not work in the following cases. And it may cause false operations.
  - With gloves on
  - With fingernails
  - With another object placed on the operation area
  - With a protective film or sticker adhered
  - With any water or condensation
  - With wet or sweaty fingers
  - Under water

- Never use the modified product. Use of a modified device violates the Radio Law and Telecommunications Business Law.  
The product has acquired such certification as conformity with technical regulations for a specified radio station based on the Radio Law and conformity with technical regulations for a terminal device based on the Telecommunications Business Law, and the "Technical Conformity Mark " can be confirmed internally in the product.  
From the standby screen, press  → [Settings] → [More settings] → [About phone] → [Compliance information]
- If modifications are made to the internal components by removing the screws of the product, the certifications of conformity with technical regulations will become invalid. Never use the product without these certifications valid. Doing so violates the Radio Law and Telecommunications Business Law.
- Take care not to place magnetized items such as magnetic cards, speakers and TV sets near the product, as it might cause malfunction.  
Putting strong magnetism close to the product might cause false operation.
- Do not bring magnetized cards such as cash cards, credit cards and prepaid cards closer to the product. Doing so may result in loss of recorded information.

- When you put the product in your pocket or bag, take care so that the display does not come in contact with metal objects or other hard objects. Not doing so may cause scratching or damage. Be aware that any metal or other hard cell phone strap that comes into contact with the display may scratch or damage them.
- When suddenly brought into a warm place from a cold place, or when in a humid location, or when used where temperature suddenly changes (e.g. near the air discharge port of an air conditioner), water drops (i.e. condensation) sometimes are formed inside the product. Note that when used under conditions such as this, humidity might cause corrosion or a fault.
- While writing/reading data to/from a microSD memory card, do not subject the product to vibration or impact, remove the battery pack, or turn off the power. Doing so may cause data loss or malfunction.
- Covering the light sensor with your fingers, a sticker, etc. may prevent the light sensor from responding to the ambient light level surroundings and operating properly.
- Do not use with the back cover removed. Do not leave or store in that manner. Doing so may allow dust or other foreign matter to enter and cause a fault. (▶ P.34 "Attaching the back cover")

- Do not allow liquids, metal pieces, or other foreign matter into the au IC card slot or the microSD memory card slot on the product. Doing so may cause malfunction.
- Do not give strong impact on the product such as dropping, throwing, stomping. Doing so may cause malfunction.
- Do not put the product directly on sand at a beach, etc. If sand or other small particles might get inside the mouthpiece (microphone) or speaker, etc., it might cause the volume to drop or malfunction.
- Take care not to cover the mouthpiece (microphone) with your fingers during a call. It prevents your voice from being heard by the other party.

#### ■ Touch area

- Perform the touch operations with fingers. Do not operate with pointed objects such as a ball-point pen or pencil, etc. Doing so may cause scratching or damage to the touch area as well as false operation.
- Do not put stickers, sheets, etc on the touch area. Doing so may cause false operation.
- If the touch area is soiled or wet with perspiration or water, it may cause false operation. In that case, clean the touch area with a soft cloth.

#### ■ Battery pack



#### Li-ion00

**(The battery pack of the product is a lithium-ion battery.)**

- The battery pack is not fully charged at the time of purchase. Charge the battery before using the product. Also charge the battery after long periods of disuse before using the product.
- Use in very hot or cold environments, for example, when left in an automobile with the windows closed in summer, will cause the battery capacity to drop and shorten the available battery usage time. This will also shorten the battery pack's service life. Try to use the battery pack at room temperature as much as possible.
  - When the battery pack is not to be used for a long time, remove the battery pack from the main unit, and store it away from hot and humid places.
  - The battery pack is a consumable item. If the performance of a battery pack does not recover (e.g. the usable time after each charge has become extremely short), the battery pack is at the end of service life, so stop use and buy a new one of the specified type. Note that the length of service life varies depending on the usage condition, etc.

- Battery packs sometimes swell up as they approach the end of their service life depending on the usage condition. This is due to the properties of lithium-ion batteries, and is not a problem in terms of safety.
- Do not use a battery pack that has been damaged or that is leaking battery fluid. Doing so may cause malfunction.
- Do not wet the battery pack with water, etc. A wet battery pack may cause malfunction. If you drop the product into water by mistake, immediately turn off the power, remove the battery pack, and contact an au shop or Repair and Delivery Support Center. Never charge a wet battery pack.

#### ■ Charger

- Do not wrap power cords of the specified charger (sold separately) around the charger. Do not forcibly bend the specified charger's (sold separately) plug or the connection between the connector and power cord. Do not place heavy objects on the cord of the specified charger (sold separately) or microUSB cable, or do not pull the cord with excessive force. Doing so may cause malfunction.
- When unplugging the power plug of the specified charger (sold separately) from the outlet, hold the power plug to do so. If you pull the cable, it might be damaged.

#### ■ au IC Card

- Do not forcibly remove or insert the au IC card. Be careful not to exert excessive force when inserting the card into your au cell phone.
- You are responsible for any damage caused by inserting your au IC card into some other IC card reader/writer, etc.
- Do not put stickers, etc. on the au IC card.
- Do not insert au IC card with a conversion adapter attached to. Doing so may cause malfunction.
- Do not damage the card (use in a hot place, throw into fire, contact the metal part with foreign object, give an impact, bend, apply a load, moisten, etc.). Doing so may cause data loss or malfunction.

#### ■ Camera

- When photographing important occasions, take a trial shot and check the shot image to make sure it is correctly shot.
- Do not shoot in areas where shooting is prohibited.



### ■ Copyrights and rights of portrait

- If the data you shot or recorded using the product or the data you downloaded from the Internet, etc. is in part or in whole protected by the third party's copyright, you are not allowed to copy, distribute, publicly send, modify the data without consent of the copyright holder, except for personal use, under the copyright law.

In addition, do not use or modify portraits or names of other individuals without their consent, as it may infringe on rights of portrait.

Note that shooting and recording might be restricted at some live performances, shows and exhibitions even for personal use.

- Be careful about the copyright and portrait right when posting photos you shot, etc. on Internet homepages.

### ■ Back up content on the product

- Please back up important content recorded or downloaded to the product to an outside source. Content recorded to memory on the product sometimes disappears or is altered by unexpected factors, such as static electricity or a fault, or by repair, mishandling, etc.

### ■ FCC certification information

- This product is certified by the Federal Communications Commission (FCC). The product's FCC ID is JOYEA05. You can view this certification in the following way. How to confirm:  
From the standby screen, press  → [Settings] → [More settings] → [About phone] → [Compliance information]

## Notes on Waterproof/Dustproof/ Shockproof Properties

The product has the protection rating (JIS C 0920) for water resistance equivalent to IPX5<sup>\*1</sup> and IPX8<sup>\*2</sup> as well as dust resistance equivalent to IP5X<sup>\*3</sup> on the condition that the back cover is completely attached (by Company test methods).

And the product has shock resistance that meet the MIL-SPEC<sup>\*4</sup> (based on in-house testing).

Before using the product, thoroughly read "Important Items to Remember before Use" to ensure correct use. Failure to follow the contents described in these sections may cause the intrusion of water, sand or other foreign material, resulting in overheating, ignition, electric shock, injury or a fault.

- \*1 IPX5 equivalent means that the product will maintain its operability as a phone even if it is sprayed with water from a 6.3 mm diameter nozzle at a distance of about 3 meters for more than 3 minutes at a rate of about 12.5 liters per minute from any direction.
- \*2 IPX8 equivalent means that the product will maintain its operability as a phone with no water getting inside the main unit even if it is gently submerged in a tank of still tap water at room temperature to a depth of 1.5 meter for about 30 minutes.

\*3 IP5X equivalent means protection level that the product will securely maintain its operability as a communication device even after it has been placed in an apparatus with grit and dust of diameters of 75  $\mu\text{m}$  or less and shaken for 8 hours. (Invasion of grit and dust cannot be prevented completely.)

\*4 MIL-SPEC  
Drop testing (in which the product is dropped in 26 directions from a height of 1.22 m) was conducted in accordance with MIL-STD-810G Method 516.7: Shock-Procedure IV formulated by the U.S. Department of Defense. The product shock resistance assumes usage in daily situations; subjecting the product to excessive shock such as by throwing or causing/letting the product fall forcefully may break the product. Note also that the product gets scratches, etc. by falling impact even though its functionality of the product remains intact.

Operation of the product in every possible condition during actual use is not guaranteed. Malfunctions determined to be caused by mishandling by the customer are not covered by the warranty.

## Important Items to Remember before Use

- Make sure the back cover is completely attached. Water resistance is effective when completely sealed.
- Never open/close the back cover when the product or your hands are wet.

- Do not let the product submerged into or get wet with the liquids (seawater, water from a swimming pool, hot water of hot spring, water containing soap, detergent, bath powder, alcohol, soft drink, seasoning, etc.) other than tap water. Also, do not use it in a place where it gets wet with pet urine. If the product gets splashed, immediately rinse it off with tap water.
  - Do not place the product directly on sand at a beach, etc. Sand or other small particles might get inside the mouthpiece (microphone), or speaker, causing the volume to drop. If sand gets inside the product from hinges, it might cause overheating or a fault.
  - Do not use the product underwater.
  - Do not use or leave the product in a humid place such as a bathroom or kitchen for an extended period of time.
  - Moisture may still remain after draining. While this will not affect use, you should not leave the product next to items you do not want to get wet. The product may wet clothing, inside of carry bag, etc.
  - Drain any water in the mouthpiece (microphone), or speaker that may be affecting audibility.
  - The product is not designed to resist water pressure. Avoid exposing to high water pressure or submersing in water for a long period.
- Do not wash the product in a washing machine or ultrasonic bath.
  - Do not immerse the product into a bathtub. The product is not designed to be heat resistant.
  - The rapid changes of temperature may cause condensation, resulting in malfunction. Wait until the product reaches room temperature before you bring the product from a cold place into a warm bathroom.
  - The product does not float on water.
- **Back cover**
- Make sure the back cover is completely attached. Any minute particles becoming lodged between contact surfaces (a single hair, etc.), no matter how small, can cause seepage.
  - Do not wear gloves while removing/attaching the back cover. Any minute particles becoming lodged between contact surfaces (a single hair, etc.), no matter how small, can cause seepage. Before closing the cover, wipe any water, soiling, etc. with a dry, clean cloth, no matter how small.
  - Any deterioration or damage with the back cover will affect water resistance.

### Attaching the back cover

Note the orientation of the back cover and place it on the product with the product closed, and attach the back cover.

After attaching the back cover, trace the circumference of the back cover in direction ① with finger and press in direction ② to install the back cover completely.

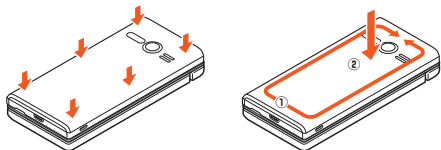

### ■ If any liquid other than plain water gets on the product

- If anything other than water (seawater, washing detergent, alcohol, etc.) gets on the product, immediately rinse with water.
- You can wash the product under a mild flow (up to 6 liters per minute) of tap water at room temperature (5°C to 35°C) at a distance of about 10 cm from the faucet or showerhead.
- If soiled, wash by hand without using a brush, etc., holding the product so that the back cover does not open.

### ■ After the product gets wet

- After becoming wet, drain water, and then without removing the back cover, wipe both the product and back cover with a dry, clean cloth.
- In cold regions, any water on the product may freeze. Using the product with frozen water may cause malfunction. Do not leave water drop on the product.

### ■ Rubber seal

- The rubber seal on the back of the back cover is important in maintaining water resistance. Do not scratch or remove it.

- Be careful not to pinch the rubber seal when closing the back cover. Trying to close the cover with a seal pinched can scratch the seal and affect water resistance. Any minute particles becoming lodged between contact surfaces (a single hair, etc.), no matter how small, can cause seepage.
- Any liquid other than water (alcohol, etc.) on the product can affect product durability.
- Do not insert pointed objects in the back cover. Doing so may damage/deform the product or scratch the seal, allowing water seepage.
- Parts used for maintaining water resistance should be replaced every 2 years regardless of their appearance. Contact your nearest au shop for replacement.

#### ■ Heat resistance

- Do not submerge the product in hot water or get it wet with hot water. Do not use the product in saunas or expose it to hot air from hair dryer, etc. The product is not designed to be heat resistant.

#### ■ Shock

- The product is resistant to shock, but the product shock resistance assumes usage in daily situations; subjecting the product to excessive shock such as by throwing or causing/letting the product fall forcefully may break the product.

## Precautions on Charging

- Accessories and optional accessories are not water/dust resistant. Note the following before and after charging.
- Never charge the battery if the product is wet. Doing so may cause fire, burns, injuries, or electric shock.
- Make sure the product is not wet. If charging after the product has gotten wet, first drain water well and wipe with a dry, clean cloth, etc., before placing in the desktop holder (KYF35PUA) (sold separately).
- Do not touch the specified charger (sold separately), desktop holder (KYF35PUA) (sold separately) with wet hands. Doing so may cause electric shock.
- Do not expose the specified charger (sold separately) and desktop holder (KYF35PUA) (sold separately) to water. Do not use it near water, such as in a bathroom, shower room, kitchen, or washroom. Doing so may cause fire, burns, electric shock, or a fault. Do not bring it into a bathroom, etc. even when you are not charging with them. Doing so may cause fire, burns, electric shock, or a fault.
- Make sure that any water drop or foreign object is not in the external connection terminal.

## Draining the Product

If you use the product after it gets wet, drain the mouthpiece (microphone), speaker, and charger terminal. If you use the product after it gets wet, water remaining in those parts might wet your clothes or bag, or the sound might become hard to hear.

Follow the steps below to drain water.

### 1 Wipe the surface of the product well with a lint-free, dry, and clean cloth, etc.

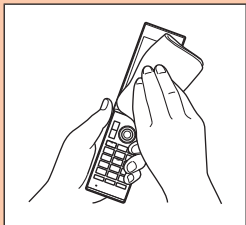

### 2 Shake the product

- ① Hold the product firmly and shake it in the direction of arrows until water does not come out.
  - \* When shaking the product, stay alert to your surroundings.
  - \* Be careful not to have the product pop out, and hold it firmly to drain water.

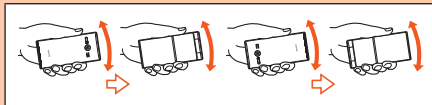

- ② Wipe away any drained water.
  - \* Water is particularly difficult to drain from the mouthpiece (microphone), speaker, and charger terminal. Hold the product with each part facing downward and pat on a cloth.
- ③ Place the product on a dry towel or cloth and leave at room temperature.

- 3 Gently pat the product on a lint-free, dry, clean cloth, etc. and wipe away any water in gaps in the mouthpiece (microphone), speaker, hinges, external connection terminal, etc.**

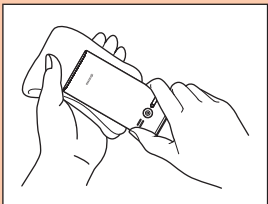

- 4 After adequately removing drained water from the product, leave to dry at room temperature for at least an hour.**

Even after you take these procedures, water may remain on the product. Do not place the product near things that you do not want to wet. Also, take care not to wet your clothes, bag, etc.

## Notes on Using Bluetooth®/ Wireless LAN (Wi-Fi®) Function

- The Bluetooth® and wireless LAN (Wi-Fi®) functions of the product conform to domestic standards of Japan, FCC standards, and have been certified.
- In some countries/regions, the use of the Bluetooth® and wireless LAN (Wi-Fi®) functions may be restricted. If you are using the product overseas, check the relevant laws and regulations of the country/region you visit.
- The 2.4 GHz band used by wireless LAN (Wi-Fi®) and Bluetooth® devices is operated by various other devices. For this reason, the communication speed and connectable range may be decreased, or disconnection may occur, due to interference from other devices.
- Do not use this product in places where electromagnetic waves are generated or near electric products, AV and OA equipment, or other magnetized devices.
- Subjecting this product to magnetic or electrical noise might increase noise and prevent it from performing communications. (This product is particularly susceptible to noise when used near a microwave oven.)
- Using this product near a TV, radio or similar

appliance might cause reception interference and disrupt TV images.

- Searching might not be successful if there are multiple wireless LAN (Wi-Fi®) access points near the product or the same channel is being used.
- Since using the product on airplanes is restricted, follow the instructions given by the respective airlines.
- The communication speed and connectable range vary depending on the distance between communication devices, obstacles and the devices used.

## Cautions on Using 2.4 GHz Band

- The frequencies used by the Bluetooth® and/or Wireless LAN (Wi-Fi®) function of this product are in the 2.4 GHz band. In this frequency band, other similar wireless stations, in-plant wireless stations for mobile unit identification that require a license to use, such as factory production lines, specific small power wireless stations that do not require licenses, amateur wireless stations (collectively called "other wireless stations" from here on) are operated in addition to home electrical appliances such as microwave ovens, devices for industrial, scientific and medical devices.
  1. Before using the product, make sure that "other wireless stations" are not in operation nearby.



2. In the event that instances of radio wave interference have occurred between the product and "other wireless stations", immediately either relocate the product or stop operation of the device (stop the emission of radio waves).
3. If unsure or require assistance, contact an au shop or Customer Service Center.



### memo

- The connections between this product and all other Bluetooth® and wireless LAN (Wi-Fi®) devices have not been confirmed. Therefore, connections with all Bluetooth® and wireless LAN (Wi-Fi®) devices are not guaranteed.
- This product supports security features for wireless communications that are compliant with the Bluetooth® and wireless LAN (Wi-Fi®) standard specifications, but the security may not be sufficient depending on the usage environment and configuration. Be careful when making data communication using Bluetooth® or wireless LAN function (Wi-Fi®).
- Wireless LAN (Wi-Fi®) has the advantage that it can be freely connected anywhere within the radio wave range, as it uses radio waves for exchanging information. At the same time, there is a risk that a malicious third party may obtain unauthorized access if security settings have not been configured. You are recommended to configure security settings before use at your decision and responsibility.
- The Company assumes no responsibility for leakage of data or information that may occur during Bluetooth®/wireless LAN (Wi-Fi®) communication.

- Since Bluetooth® and wireless LAN (Wi-Fi®) functions use the same frequency band, using both of the functions at the same time may cause radio wave interference resulting in decreased communication speed or disconnection from the network. If connection fails, stop using either of the Bluetooth® and wireless LAN (Wi-Fi®) functions.

Bluetooth® and wireless LAN (Wi-Fi®) functions of this product use frequencies in the 2.4 GHz band.

- Bluetooth® function: 2.4FH1/XX1



This product uses the 2.4 GHz band. FH-SS is used as the modulation scheme. The interference distance is about 10 m or less.

- Wireless LAN (Wi-Fi®) function: 2.4DS4/OF4



This product uses the 2.4 GHz band. DS-SS and OFDM are used as the modulation schemes. The interference distance is about 40 m or less.

- This means that all bandwidths are used, and that band of mobile unit identification devices can be avoided.

- Available channels vary depending on countries.
- For use in an airplane, check with the airline company in advance.

## Security Code/PIN Code

### Notes on Security Code

The product has various security codes that you can use.

The available security codes are as follows. Do not forget the various security codes that are set as they are necessary for various operations and contracts. Be sure to change initial codes to your own codes before using the product.

#### Security code

Example of usage	<p>①To do remote operation of voice mail and call forwarding services from a landline phone</p> <p>②To use Customer Service Center and to do various inquiries, applications, and modifications on the au homepage</p>
Initial value	A four digit number chosen by the customer and noted on the application form

#### Auto lock

Example of usage	To set/cancel the auto lock setting
Initial value	Follow the initial settings by default

#### Lock No ("Osaifu-Keitai lock")

Example of usage	To use "Osaifu-Keitai lock"
Initial value	1234

### Notes on PIN Code

#### PIN Code

To prevent unauthorized use of the au IC card by a third party, you can set the product to require PIN code entry every time the power is turned on. You also need to enter PIN code when setting whether PIN code entry is required.

If PIN code is incorrectly entered three times consecutively, the PIN code will be locked. You can unlock the PIN code using PUK code.

- At the time of purchase, the PIN code is "1234", and entry is not required. You can change the PIN code to any 4- to 8-digit number and the product to require entry if necessary.
- To use the product with a PIN code required, be sure to change the PIN code to your own number you have chosen.

## ■ PUK code

In case PIN code is locked, you can unlock it by entering PUK code.

- PUK code is an 8-digit number given at the time of purchase, which is printed on the back of the plastic card on which your au IC card is attached.
- After entering PUK code, you need to set a new PIN code.
- If PUK code is incorrectly entered ten times consecutively, contact an au shop, PiPit or Customer Service Center.
- PIN code is not reset by initializing the product.

**<Please copy this section and use>**

【Password entry field】	
au ID account ID	Auto Lock: Lock No.
<input type="text"/>	<input type="text"/>
au ID account password	Auto Lock: Password
<input type="text"/>	<input type="text"/>

- \* Strictly manage your account and password to prevent a third party from obtaining them.

## Notes on Data Communication Charges

- Since constant Internet connection is possible with the product, data communication may be performed automatically by some applications, resulting in high data communication charges. Therefore, subscription to a data flat-rate service/data communication charge discount service is recommended.
  - Connection for browsing homepages, downloading applications, communication using applications, sending/receiving e-mails and configuring various settings is by the Internet, and data communication charge applies.
- \* Data communication charge does not apply to wireless LAN (Wi-Fi®) connection.

## Notes on Applications

- To download applications, first set an au ID and download from au Smart Pass. For details on setting an au ID, refer to the "Setting Guide".  
This product does not permit use of Google Play™ or EZweb.
- Be sure to check the security of the application, then install it at your own risk. Some applications might cause virus infection, damage various data, and send out your location information, usage history or personal information stored in your cell phone via the Internet.
- The Company assumes no responsibility for any problems that might be caused by applications you have installed. In such case, you may be charged a repair fee even during the warranty period.
- The Company assumes no responsibility for any disadvantage brought to you or any third party by applications you have installed.
- Some applications require that a microSD memory card be inserted.
- Some applications keep the screen turned on while they are active, or rapidly drain the battery while running in the background.

- Changes to method of operation or to screen display may occur without notice due to version upgrades of applications pre-installed on the product or that were installed later. Note that there may be differences with descriptions in this manual.

## Cell Phone Etiquette

### ■ Use of Cell Phones is Not Allowed in the Following Places!

- Do not listen to music, watch videos or TV (1Seg) while driving a car or motorbike, or riding a bicycle. Use of cell phones while driving a car or motorbike is prohibited by law. (Use of cell phones while riding a bicycle may also be punishable by law.) In addition, stay alert to the traffic around you even when walking. Surrounding sounds might not be heard clearly, and gazing at the screen may distract your attention causing a traffic accident. Be especially careful at railroad crossings, station platforms and pedestrian crossings.
- Since using the product on airplanes is restricted, follow the instructions given by the respective airlines.

## ■ Be Considerate of People Around You

- Do not make calls in theaters, museums, libraries, and other similar places. Turn off the power or turn on the manner mode so as not to disturb others around you with your ringtones.
- Do not use the cell phone outside in town where you might hinder other pedestrians.
- Viewing a cell phone screen while walking is a serious hazard. Do not suddenly stop to talk on/operate the cell phone or do so while walking.
- Move to areas where you will not inconvenience others on bullet trains, in hotel lobbies, etc.
- Refrain from talking in a loud voice.
- Be careful of sound leakage from earphones in trains or other places with many people around you.
- Obtain the permission of other people before you take their photos with the cell phone's camera.
- When using the camera, follow common rules of etiquette regarding camera use.
- Some people close to you in crowded places such as packed trains may be using a cardiac pacemaker. Turn on "Airplane mode" or turn the cell phone off in such places.  
How to set Airplane mode:  
From the standby screen, press  → [Settings] → [Wireless/Network] → [Airplane mode]
- Abide by the rules of hospitals and other medical institutions where it is forbidden to use or carry cell phones.

# Basic Operations

## Names and Functions of Parts

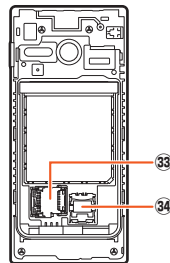
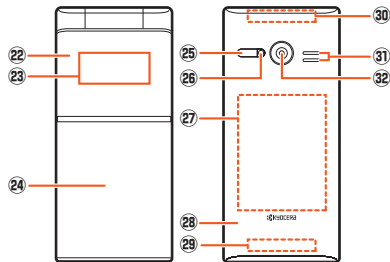
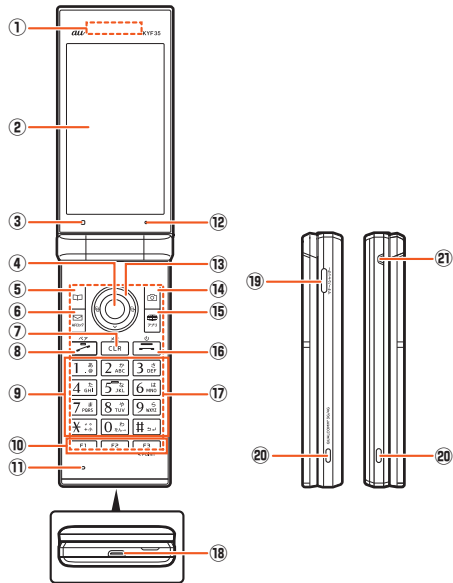

**① Earpiece (receiver)**

Hear the other party's voice on call, playing sound of the auto answering, etc. by Smart Sonic Receiver (▶P.47)

**② Display (main display)****③ Light sensor**

Detects brightness when "Brightness level" of the display is set to "Auto".

**④ ● Center key**

Decides the menu or items to select.

In the standby screen, press to display the main menu. Holding down for at least 1 second in the standby screen disables the long-pressing operation of manner/shutter key when the product is folded (▶P.65).

**⑤ ☰ Phone book key**

In the standby screen, press to activate the phone book menu. Holding down for at least 1 second in the standby screen displays the phone book edit screen.

**⑥ ✉ Mail key**

In the standby screen, press to activate the E-mail menu. Holding down for at least 1 second in the standby screen activates the SMS menu.

**⑦ CLR Clear/Memo key**

While using the product, return to the previous screen.

From the standby screen, press to display the auto answering list screen. Holding down for at least 1 second in the standby screen sets/cancels the auto answering function.

**⑧ Call/Pair key**

From the standby screen, press  without entering a phone number to display the confirmation screen of pair registering. And register a person to pair to use the pair function. When a person with an e-mail address is registered to pair 1, the usage condition of the phone can be notified. Holding down for at least 1 second in the standby screen activates the fake incoming call function to use.

**⑨ 0 - 9, \*, # Number keys****⑩ F1 - F3 Custom keys 1 - 3**

Activate application assigned to each Custom key. Hold down each key for the following operations.

Hold down  for at least 1 second: Display application history

Hold down  for at least 1 second: Display notifications

Hold down  for at least 1 second: Pointer ON/OFF while the Pointer-capable function/application is activated

**⑪ Mouthpiece (microphone)**

Relays your voice to the other party. Also use to record audio. Take care not to cover with your fingers, etc.

**⑫ Air vent**

Since the product is water/dust resistant, the sealing performance is high. Therefore, an air vent (hole to ventilate) is equipped.

- The air vent does not affect water/dust resistance.
- Do not cover the air vent with a protective sheet or sticker.

**⑬  Cursor key**

 **Left key/incoming call history**

 **Right key/outgoing call history**

 **Up key**

 **Down key**

**⑭  Camera key**

In the standby screen, press to activate the camera function. Holding down for at least 1 second in the standby screen displays the folder list of data folder.

**⑮  Browser key**

Displays browser menu.

Hold down the key for at least 1 second to display the Application screen (▶P.62).

**⑯  Power/End call key**

While using the product, end call or exit functions. Hold down to turn the product on or off.

**⑰ Touch area (Touch pointer)**

You can operate in the same way as a touchpad by touching the touch area of the product with fingers. (▶P.48)

**⑱ External connection terminal**

Connecting a Common AC Adapter 05 (sold separately), microUSB cable 01 (sold separately), etc.

**⑲  Manner/Shutter key**

In the standby screen, press to display the manner menu. In the standby screen or with the product closed, hold down to enter/exit the manner mode. Press to light or switch the sub-display with the product closed.

While the camera is activated, capture/save a photo.

**⑳ Charging terminal**

Terminal for charging with the desktop holder (KYF35PUA) (sold separately).

**㉑ Strap eyelet****㉒ Charging/Notification indicator**

Lights red during charging.

Flashes according to settings for new call or new mail.

Flashes yellow when 位置検索サポート (Location Search Support) (▶P.110) is determining location.

**㉓ Sub-display**

Notifies you with information when a call is received, new mail is received, an alarm sounds, etc.



#### ②4 FeliCa antenna

Hold it over a reader/writer when using Osaifu-Keitai®.

\* FeliCa sticker indicates the position to hold over. Even if the sticker comes off, it does not affect the model or performance.

#### ②5 Infrared port

Transfer data by infrared communication.

#### ②6 Photo light/Flash light

Lights when using the photo light/flash light.

#### ②7 Battery Pack

#### ②7 Back cover

#### ②9 Built-in GPS/Wi-Fi®/Bluetooth® /sub-antenna\*

#### ③0 Built-in main antenna\*

#### ③1 Speaker

Ringtones, alarms, etc. sound from here.

#### ③2 Camera (lens)

#### ③3 microSD memory card slot

#### ③4 au IC card slot

\* The antenna is built into the product. Covering the antenna with your hand might affect communication quality.

## Smart Sonic Receiver

The product is equipped with Smart Sonic Receiver that transmits sound by vibrating the display. The earpiece (receiver) does not have any holes, however, you can use the product as usual.

### ■ Touching to Your Ear

Hold the receiver area up to your ear as shown so that your ear is covered, blocking surrounding sound and increasing audibility. Move the product up and down, left and right to suit your hearing and surroundings.

Earpiece (receiver)



Mouthpiece  
(microphone)

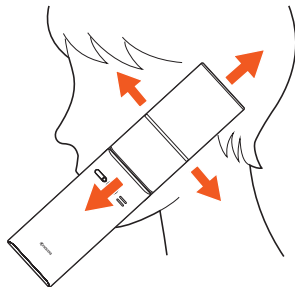

## Using the Pointer

The product supports two types of pointer operations, "Touch pointer" mode that is an touchpad-like operation to touch the touch area with your fingers, and "Navigation keys" mode that is a pointer operation by pressing  $\odot/\odot/\odot/\odot$ . Activate a Pointer-capable function/application and turn the Pointer ON to use the on-screen pointer. It is set the navigation keys mode at the time of purchase when you set the pointer to ON.

### 1 Activate a pointer-capable function/application

" $\blacksquare$ " (OFF)"/" $\blacksquare$ " (ON) is displayed in the status bar, and " $\blacktriangleright$ " (pointer) is displayed when the pointer is ON.

- If the Pointer is OFF, refer to "Turn ON the Touch Pointer" (▶P.48)"/"Turn ON the Pointer" (▶P.50).
- If a confirmation screen is displayed, confirm the content and select "Close this screen". Checkmark "Don't ask again" to no longer display the confirmation screen when next activating the Pointer. And, select "Go to User Guide" to display the touch pointer operation guide.

## Switching the Pointer Mode

- 1 From the standby screen, press  $\odot$  → [Settings] → [More settings] → [Pointer] → [Mode] → [Touch]/[Navigation keys].  
Toggle the pointer mode.

## Touch Pointer Operation

You can operate the pointer on the screen in the same way as a touch pad when using browser, LINE, etc.

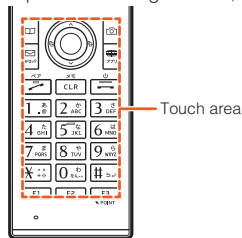

## Turn ON the Touch Pointer

- 1 Hold down  $\boxed{F3}$  for at least 1 second  
Toggle the touch pointer ON/OFF.
  - Key operation (except  $\odot$ ) is still possible when the pointer is ON (except some applications).

## ■ Tap/Double-tap

Lightly touch the touch area and then immediately release your finger. Tapping the touch area twice consecutively in the same position is called double-tap.

- Move "↖" to a desired item and tap, then the item is confirmed (okayed).

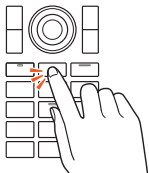

## ■ Long-touch

Lightly touch the touch area and then keep touching it.

- Long-touch the touch area to change "↖" to "⦿". Long-touch it again to return to "↖".



## ■ Slide

While lightly touching a touch area, slide in a desired direction or to a desired position. The arrow moves in the direction you slide it.

- Long-touch the touch area to change "↖" to "⦿", and slide to scroll the screen.
- With the pointer at the edge of the screen, slide toward off the screen to scroll. Or slide two fingers on the screen to scroll in the direction of the slide.



## ■ Flick

Touch on the touch area and flick up/down/left/right. The arrow moves in the direction you flick it.

- Long-touch the touch area to change "↖" to "⦿", and flick to scroll the screen.
- With the pointer at the edge of the screen, flick toward off the screen to scroll. Or flick two fingers on the screen to scroll in the direction of the flick.

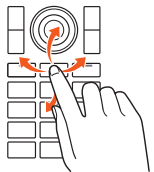

## Zoom-in/Zoom-out

While touching the touch area with two fingers, spread them apart (zoom-in) or pinch the fingers together (zoom-out).

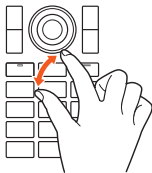

### memo

- The touch area is designed to be lightly touched by fingers. Avoid pressing forcefully with fingers or using sharp objects (ballpoint pen, pin, etc.).
- The touch area might not respond in the following cases. And it may cause false operations.
  - With gloves on
  - With fingernails
  - With another object placed on the operation area
  - With a sticker, etc. adhered
  - With any water or condensation
  - With wet or sweaty fingers
  - Under water

## Pointer Operation

Move the pointer on the screen up/down/left/right to operate the browser, etc.

## Turn ON the Pointer

### 1 Hold down **F3** for at least 1 second

Toggle the pointer ON/OFF.

- Key operation (except  $\uparrow/\downarrow/\leftarrow/\rightarrow/\bullet$ ) is still possible when the pointer is ON (except some applications).

## Move

By pressing  $\uparrow/\downarrow/\leftarrow/\rightarrow$ , and you can move the pointer up/down/left/right.







## Select







With the pointer at buttons or items to select, the buttons or items are confirmed (okayed) by pressing  $\bullet$ .



## Scroll

With the pointer at the up/down/left/right edge of the screen, move toward off the screen using ///.



- By long-pressing  for more 2 seconds, the Pointer changes to "", and you can scroll the screen using ///.

## Switching to English Display

You can switch the display from Japanese to English.

### 1 From the standby screen, press

The main menu is displayed.

### 2 [設定 (Settings)] → [その他の設定 (More settings)] → [言語と入力 (Language & input)] → [言語 (Language)] → [English] →

\* The message "起動中のアプリ、メール送受信、ダウンロードなどが終了される場合があります。変更しますか?" (Applications, mail transmission/reception, and downloads may be terminated. Change the language?) appears, confirm the content and then [はい (Yes)].

## Using the Standby Screen

Check the status of the product in the standby screen.

### ■ Viewing the Standby Screen



#### ① Status bar

Notification and status icons are displayed (▶P.53).

#### ② Widget area

Use widgets and applications.

- "Widget" is an indicator by which you can easily check information in the standby screen such as clock, pedometer, calendar.

#### ③ Indicators

Notifications for missed calls, new e-mail/SMS, etc. are displayed.

You can hide indicators by pressing /CLR.

- Select a notification → Press , or activate an application and confirm the contents to erase the indicator.

## Using Widgets and Indicators

You can use the widgets and indicators in the standby screen.

### ■ Using Widgets

1 From the standby screen, press →

Select a widget →

- You can also select a widget with from the widget selection screen.

### ■ Selecting Indicators

1 From the standby screen, press →

Select an item →

- When the indicators are not displayed, close the product and open it again to display the indicators.

## Editing Widgets in the Standby Screen

Edit widgets displayed in the standby screen.

**1** From the standby screen, press  →  
Select a widget →  (Edit)

**2** Select a widget to edit or an open space  
→ 











<b>3</b> Add	Add a widget to the selected open space. Select the widget you want to add from "Widget" or "Application".
Sort	Sort selected widgets. To sort, move a widget you want to move to a new position →  .
Delete	Delete a selected widget. Widgets are deleted only from the screen, not from the main unit completely. Therefore, you can add deleted widgets again.
Change clock color	Change the color of the clock widget.

## Monitoring the Product's Status

### Viewing Icons

Notification icons for missed calls, new mail, and running operations are displayed on the left of the status bar, and status icons for product status are displayed on the right.

### Main Notification Icons

Icon	Description
	Missed call
	New e-mail message
	New SMS message
	Scheduled TV (1Seg) viewing started
	FM radio ON in the background
	Call in progress, call being received
	Auto answering exists
	Internal memory low
	Software update available
	Icons collected • It is displayed when all of the icons cannot be displayed on the status bar.

## Main Status Icons

Icon	Description
	Time
	Battery level 100% /  Empty /  Charging : Battery Care Mode is set to "ON"
	Airplane mode is set
	Signal strength (received field strength) : Level 4  : Out of service area : In communication <ul style="list-style-type: none"> <li>An icon for the network is displayed.   : 4G (LTE) available  : Roaming</li> </ul>
	au IC card uninserted
	Manner mode status : Manner mode  : Drive mode : Silent mode  : Original mode
	During a call using hands-free
	Ringtone volume at "0"
	In-call microphone is "OFF"
	Wi-Fi® signal strength -  : Level display  : In communication
	Bluetooth® in use : standby  : connected
	Auto answering set : Set /  : Full

## Notification/Settings Panel

In the notification panel, you can check notifications and activate applications.

In the settings panel, you can quickly toggle Wi-Fi®, Bluetooth®, and other applications ON/OFF.

### 1 Hold down for at least 1 second

The notification/settings panel is displayed.

- From the standby screen, you can also press → select the status bar → to display the notification/settings panel.

### Viewing the Notification/Settings Panel

Press / to toggle between the notification panel and settings panel.

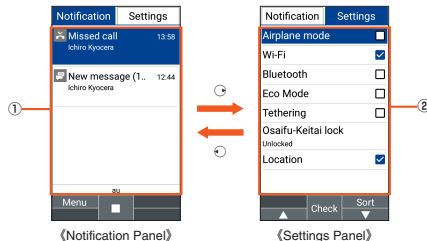



## ① Notification area

Check product status and notification content.

## ② Settings menu

Set frequently-used functions to ON/OFF.

## ■ Using the Notification Panel

### 1 Select notification you want to use in the notification panel →

You can activate the application corresponding to a notification.

## ■ Deleting Notifications

### 1 Select notification you want to delete in the notification panel → (Menu) → [Delete one] → [YES] → [OK]

Select "Delete all" to delete all notifications. Some notifications for battery level, etc. cannot be deleted.

## ■ Using the Settings Panel



**Example:** To toggle Wi-Fi® ON/OFF

### 1 In the settings panel, [Wi-Fi]

Press to toggle Wi-Fi® ON/OFF.



#### memo

- ① Press  /  while the notification/settings panel is displayed to hide the notification/settings panel.

## Charging/Notification Indicator

Lighting/Blinking the charging/notification indicator notifies you the timing for charging, charging status, missed calls, or new mail, etc.

LED Color and Functioning	Notification Contents
Light-up in red	Indicates that the product is in charging.
Flashing in blue	Indicates missed calls or notification messages when receiving a call.*
Flashing in red	Indicates the impossible for power-on caused by shortage of battery level and a charging abnormality.

\* These are default settings. You can change the LED setting in "Sound/Notification" (▶P.103) of the settings menu.

## Auto Assist

It supports you according to your actions or lifestyle such as notifying you of new mails again when you pick up the product (▶P.103).

## Using the Sub-display

The sub-display displays a date and time, device status such as the manner mode and battery level, caller name, and pedometer, etc.

The sub-display lights when you press **マナー/シャッター** while the product is closed or after you close the product.

### Viewing the Sub-display



《With Clock・Notification icons》

《With Status icons》

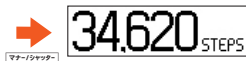

《With Pedometer》

## Main Icons

Icon	Description
	Signal strength (received field strength) ■ Strong / ■ Fair / ■ Weak / ■ Weak / ✕ Out of service area / ✕ Airplane mode is set • An icon for the network is displayed. 📶 : 4G (LTE) available 🌐 : Roaming
	Battery level 🔋 100% / 🔋 Empty / 🔋 Charging 🔋 Battery care mode ON
	Manner mode status ❤️ : Manner mode   🚗 : Drive mode 🤫 : Silent mode   👤 : Original mode
	Missed call
	Auto answering exists
	New e-mail/Unreceived e-mail
	New SMS
	Wi-Fi connected/Wi-Fi connected (Open)

## Using the Main Menu

### 1 From the standby screen, press

The main menu is displayed.

### 2 Select menu →

Menu items correspond to the number keys ([0] - [9], [X], [#]). Press a key to select a menu item.

## Viewing the Main Menu

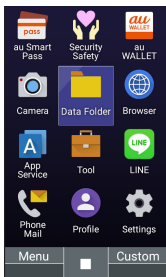

《Main Menu》

## Main Menu Application List

Menu	Description
au Smart Pass	This is a portal application to maximize "au Smart Pass" as well as daily tools such as the latest news and transfer information. Also coupons, presents, data storage and security apps are available. Please enjoy your safety and comfortable cell phone life. You can download applications that support "Free" of au Smart Pass you can download.
Security/Safety	
My au	Display My au (au Customer Support) webpage. You can change your rate plan, apply for optional services and so on at My au (au Customer Support) website.

Menu	Description
Security/Safety	
au 災害対策 (au Disaster Countermeasure)	This is an application in which you can use Disaster Message Board, Emergency Rapid Mail (Earthquake Early Warning and Disaster and Evacuation Information and Tsunami Warning and Emergency Warning) and Disaster Voice Messaging Service.
Data Storage App	This is an application in which you can have au server hold your phone book and save your data, such as photos and phone book saved in your phone with a microSD memory card. You can also migrate your data between your phones with this app.
遠隔操作サポート (Remote Support Service)	Call for technical supports on the phone operations by sharing the screen that you are watching with au operators.

Menu	Description
Security/Safety	
AnshinFilter for au	This is an application which limits the access to the inappropriate applications and web pages so that your child can use your phone safely. AnshinFilter for au is a Pointer-capable application.
安心ナビ (Security Navi (device being searched for))	You can confirm the position of the child in this application. It is available by performing partner registration from a terminal of the protector.
mamorino Watchナビ (mamorino Watch Navi)	Use mamorino Watchナビ (mamorino Watch Navi).
ウイルスバスター for au (VirusBuster for au)	Block improper applications and sites in order to protect young people.

Menu	Description
Security/Safety	
どこから電話 for au (Docokara denwa for au)	When you receive phone calls from public institutions or stores, this app shows the name of the place automatically based on the information in ハロページ (HELLOPAGE, telephone directory) and other sources. This app also blocks scam and spam calls or gives you warnings when your phone receives any.
au WALLET	You can charge your au WALLET CARD, check the card balance, the point balance, the privilege and so on conveniently, through the screen optimized for cell phone.
Camera	Capture photos/movies. (▶P.91)
Data Folder	View captured photos/movies, downloaded files, etc.
Browser	View webpages in the same way as a computer. The browser is a Pointer-capable application.

Menu	Description
Application*	
LISMO	LISMO is music player. It can play the music files on the device and also you can buy a song from Music Store.
Music Store	Music Store has lots of latest songs, popular songs, albums and video clips. You can preview and buy them easily.
au WALLET Market	au Wallet Market is a new service that is designed to help you fulfill your living needs and well-being through purchasing "little fine products" via e-commerce and au shops. You can check your purchased items, and also change your orders at your nearest au shops or e-commerce (LUXA).

Menu	Description
Application*	
Uta Pass	Uta Pass is online streaming service; all-you-can-listen more than 3000 playlists with latest J-POP hits and POP of EURO and US.
Wowma!	This is an official application of "au Shopping Mall" where you can enjoy online shopping for Accessories, Foodies, Apparels, and More.
au 助手席ナビ (au Navi for passenger seat)	Joshuseki-Navi (passenger seat navigation) is a car navigation service to be used by those sitting in the passenger seat.
au ナビウォーク (au Navi Walk)	Help you navigate route combining public transportation and walk.
モバオク (Mobaoku)	Connect to the Mobaoku auction site.
モバイルSuica (Mobile Suica)	Suica and mobile device have become one, more convenient mobile Suica.

Menu	Description
Application*	
楽天Edyアプリ (Rakuten Edy app)	This is an electronic money app that you can pay for shopping.
テレビde写真 (Photos on TV)	Display photos, etc. saved to the product wirelessly on TV by connecting a テレビde写真 (Photos on TV) receiver (sold separately) to a TV.
au Wi-Fi接続 ツール (au Wi-Fi connection tool)	It is an application to conveniently assist connection to au's publicly available wireless LAN service, "au Wi-Fi SPOT" and au's indoor Wi-Fi router, "Wi-Fi HOME SPOT".
auシェアリンク (au share link)	This application allows you to enjoy the convenience of having both a cell phone and tablet. View notifications for new calls and e-mail (@ezweb.ne.jp) to your cell phone on a tablet, as well as operate your cell phone from a tablet screen.
Weather	Check weather information for the current location and area that you set.

Menu	Description
Tool	
Clock/Calender	Use the functions such as clock, calender, alarm, timer.
Notepad	Use a notepad.
Calculator	Use the calculator.
Pedometer	Use the pedometer.
Infrared	Exchange data between the product and an infrared-capable device.
Osaifu-Keitai	Use Osaifu-Keitai® services.
TV	View digital terrestrial broadcast service (1Seg) for mobile devices. (▶P.95)
FM radio	Use FM radio. (▶P.99)
辞書 (Dictionary)	Use a dictionary.
Kanji Check	Use the kanji checker. (▶P.102)
Flashlight	Use the flash light.
Sound Recorder	Use the sound recorder.
Barcode Reader	Use the barcode reader.
Eco Mode	Use Eco Mode.
Auto assist	Use Auto assist.

Menu	Description
LINE	LINE is a new communication application which allows you to make free voice calls and send free messages anytime and anywhere. (▶P.88) LINE is a Pointer-capable application.
Phone/Mail	
Call Log	View incoming and outgoing histories as well as call frequency.
Phone Book	Register contacts to the phone book and use registered information. (▶P.76)
Auto answering	When you cannot answer the phone, it plays a response message and records a caller's message.
Voice memo	Record a conversation between the other party and you during a call.
Call Settings	Make call settings.
Speed dial	Display the speed dial list. (▶P.73)

Menu	Description
Phone/Mail	
E-mail	Exchange mail using an e-mail (@ezweb.ne.jp) address. (▶ P.79)
SMS	Exchange SMS with phone number destinations. (▶ P.85)
Profile	Check and edit your profile. (▶ P.75)
Settings	Set and manage functions from the settings menu. (▶ P.103)

\* Downloaded and added applications appear in "Free" (▶ P.62).



### memo

- Some functions used with activated functions may incur communication charges.
- After application version upgrades, etc., the appearance of applications and icons on the product may differ from as shown in this manual. This is not a malfunction.
- Preinstalled applications are not deleted even after performing an all reset.

## Using Applications/Services

Use installed applications and download additional applications with "Application".

### 1 From the standby screen, press → [App Service]

The Application screen is displayed.

- From the standby screen, you can also hold down for at least 1 second to display the Application screen.
- Press to toggle tabs.

### 2 Select an application →

## Searching for Applications

### 1 From the Application screen,

- Display the Free tab.

### 2 (Get app)

The au Smart Pass site is displayed. Follow the on-screen instructions to search for and download the application.

## Changing the Main Menu

### 1 From the standby screen, press → (Menu)

### 2 [Layout] → to select a menu →



## Updating LINE

Update the LINE application.

**1** From the standby screen, press  → [LINE]



**2**  (Menu) → [Updating]

From here on, follow the on-screen instructions.

## Using the Custom Menu

Register preferred applications to the custom menu for quick access.

## Registering Applications to the Custom Menu



**1** From the standby screen, press  →  (Custom)

The custom menu is displayed.

**2** Select "Add application" where you want to register an application → 

**3** Select an application to register → 

## Using the Custom Menu to Activate Apps

**1** From the standby screen, press  →  (Custom)

**2** Select an application → 

## Rearranging Applications

**1** In the custom menu, select the application you want to rearrange →  (Menu)

**2** [Sort] → Select the location where you want to rearrange the application → 

## Deleting Applications

**1** In the custom menu, select the application you want to delete →  (Menu)

**2** [Delete] → Checkmark the application you want to delete →  (Delete)

- The checkmarked application is deleted.
- You can select all with , and deselect all with .





## Learn Common Operations



### Learn Basic Key Operations

#### Using Functions that Appear at the Bottom of the Screen



Press the key corresponding to a function that appears at the bottom of the screen.



- ① For "HF ON", press .
- ② For "Menu", press .
- ③ For "Mic OFF", press .
- ④ For "Setting", press .
- ⑤ For "Profile", press .

- When an image is displayed and functions are not displayed at the bottom of the screen, press , , , etc. to display them.

#### To Select Items

To select a displayed item, select the item using  or  and press .

#### To Return to Previous Screen

You can press  to return to the previous screen.

#### To Return to the Standby Screen

To return to the standby screen from any function, press .



- After a certain period of no key operation, the product may return to the standby screen automatically.
- If activating a function while in a call, the call may be interrupted.
- The function or application being used is ended.

#### To Enter Numbers



You can press  to  to enter numbers.

If "▲" and "▼" are displayed above and below the number entry field, you can press  to increase or decrease the number.

## ■ To Move to Previous or Next Data

While displaying mail, etc., you can press  to move to the next data or  to move to the previous data.

## ■ To Scroll the Page

When browsing a webpage or displaying a mail list, message, data list, etc., you can press  to scroll up or  to scroll down.

## ■ Using Checkboxes



If a checkbox is displayed next to a setting item, you can select the item or checkbox to enable or disable the item.

When performing operations on data such as "Copy multiple" or "Delete multiple", you can select checkboxes to select or deselect items.

Icon example	Description
<input checked="" type="checkbox"/>	Setting is enabled or item is selected.
<input type="checkbox"/>	Setting is disabled or item is not selected.

## Disabling Manner/Shutter Key Operation when the Product is Folded (Key Lock)

### 1 From the standby screen, hold down for at least 1 second → [OK]

After closing the product, setting/canceling the manner mode by long pressing  is disabled. Hold down  for at least 1 second again to enable.



#### memo

- ◎ Even if you disable and close the product, you can press  to stop alarms, mail ringtone, and switch the sub-display's display.

# Character Input

## Learn How to Enter Characters

### Key Assignments for Character Entry

Character type	Hiragana/Kanji	2-byte alphabet	Numbers (2-byte/1-byte)
①	▶ あいうえおあいうえお	▶ .@ _ / : ~ ? , ' 1	1
	Katakana (2-byte/1-byte)	1-byte alphabet	Dial entry
	▶ アイウエオアイウエオ	▶ .@ _ / : ~ ? , ' 1	1
②	Hiragana/Kanji	2-byte alphabet	Numbers (2-byte/1-byte)
	▶ かきくけこ	▶ abcABC2	2
	Katakana (2-byte/1-byte)	1-byte alphabet	Dial entry
	▶ カキクケコ	▶ abcABC2 *	2
③	Hiragana/Kanji	2-byte alphabet	Numbers (2-byte/1-byte)
	▶ さしすせそ	▶ defDEF3	3
	Katakana (2-byte/1-byte)	1-byte alphabet	Dial entry
	▶ サシスセソ	▶ defDEF3 *	3

Character type	Hiragana/Kanji	2-byte alphabet	Numbers (2-byte/1-byte)
④	▶ たちつてとっ	▶ ghiGHI4	4
	Katakana (2-byte/1-byte)	1-byte alphabet	Dial entry
	▶ タチツテット	▶ ghiGHI4 *	4
⑤	Hiragana/Kanji	2-byte alphabet	Numbers (2-byte/1-byte)
	▶ なにぬねの	▶ jklJKL5	5
	Katakana (2-byte/1-byte)	1-byte alphabet	Dial entry
	▶ ナニヌネノ	▶ jklJKL5 *	5
⑥	Hiragana/Kanji	2-byte alphabet	Numbers (2-byte/1-byte)
	▶ はひふへほ	▶ mnoMNO6	6
	Katakana (2-byte/1-byte)	1-byte alphabet	Dial entry
	▶ ハヒフヘホ	▶ mnoMNO6 *	6
⑦	Hiragana/Kanji	2-byte alphabet	Numbers (2-byte/1-byte)
	▶ まみむめも	▶ pqrPQRS7	7
	Katakana (2-byte/1-byte)	1-byte alphabet	Dial entry
	▶ マミムメモ	▶ pqrPQRS7 *	7

Character type	Hiragana/Kanji	2-byte alphabet	Numbers (2-byte/1-byte)
8	▶ やゆよやゆよ	▶ tuvTUV8	8
	Katakana (2-byte/1-byte)	1-byte alphabet	Dial entry
	▶ ヤユヨヤユヨ	▶ tuvTUV8*	8
Character type	Hiragana/Kanji	2-byte alphabet	Numbers (2-byte/1-byte)
9	▶ らりるれろ	▶ wxyzWXYZ9	9
	Katakana (2-byte/1-byte)	1-byte alphabet	Dial entry
	▶ ラリルレロ	▶ wxyzWXYZ9*	9
Character type	Hiragana/Kanji	2-byte alphabet	Numbers (2-byte/1-byte)
0	▶ わをんわ。ー〜!? space	▶ 0 space !"# \$ % & ' ( ) * + , - . / : ; < = > ? @ [ ¥ ] ^ _ ` {   } ~	0
	Katakana (2-byte/1-byte)	1-byte alphabet	Dial entry
	▶ ワワンワ。ー〜!? space	▶ 0 space !"# \$ % & ' ( ) * + , - . / : ; < = > ? @ [ ¥ ] ^ _ ` {   } ~	0

\* When entering at the start of a line, a capital letter is displayed first.



Character type	Hiragana/Kanji	Katakana (2-byte/1-byte)	Alphabet (2-byte/1-byte)	Numbers (2-byte/1-byte)	Dial entry
✳	Toggle large/small (where characters allow)		Toggle large/small (where characters allow)	*	Short press... ✳
	Add*(ten-ten) or° (maru) (where characters allow)		When characters finalized, ▶ . , - ! ?		Hold down... +(plus)
Character type	Hiragana/Kanji	Katakana (2-byte/1-byte)	Alphabet (2-byte/1-byte)	Numbers (2-byte/1-byte)	Dial entry
#	When entering text, display one character before (back function)		When characters finalized, linebreak	#	Short press... #
					Hold down... ; (pause)

Character type	Hiragana/ Kanji	Katakana (2-byte/1-byte)	Alphabet (2-byte/1-byte)	Numbers (2-byte/1-byte)	Dial entry
	Display function quoting, useful phrases, etc. from menu Toggle normal conversion and prediction conversion (when character type is "漢")				—
Character type	Hiragana/ Kanji	Katakana (2-byte/1-byte)	Alphabet (2-byte/1-byte)	Numbers (2-byte/1-byte)	Dial entry
	When entering text, display list of Emoji, DEmoji, (^_^)(facemarks), or symbol Toggle Emoji, DEmoji, (^_^)(facemarks), and symbol lists When entering text (while displaying conversion candidate), toggle input mode and prediction conversion				—
Character type	Hiragana/ Kanji	Katakana (2-byte/1-byte)	Alphabet (2-byte/1-byte)	Numbers (2-byte/1-byte)	Dial entry
	Toggle character type Toggle previous category/page (when Emoji, DEmoji, (^_^)(facemarks), symbol, or conversion candidates selected)				—

Character type	Hiragana/ Kanji	Katakana (2-byte/1-byte)	Alphabet (2-byte/1-byte)	Numbers (2-byte/1-byte)	Dial entry
	Undo finalized characters Toggle next category/page (when Emoji, DEmoji, (^_^)(facemarks), symbol, or conversion candidates selected)				—
Character type	Hiragana/ Kanji	Katakana (2-byte/1-byte)	Alphabet (2-byte/1-byte)	Numbers (2-byte/1-byte)	Dial entry
	Move cursor left Select conversion candidate During prediction conversion, shorten selected range				—
Character type	Hiragana/ Kanji	Katakana (2-byte/1-byte)	Alphabet (2-byte/1-byte)	Numbers (2-byte/1-byte)	Dial entry
	Move cursor right Select conversion candidate During prediction conversion, broaden selected range (When the specified prediction for number of characters) When cursor at end of text string, enter 1-byte/2-byte space				—
Character type	Hiragana/ Kanji	Katakana (2-byte/1-byte)	Alphabet (2-byte/1-byte)	Numbers (2-byte/1-byte)	Dial entry
	Move cursor up a line Select conversion candidate				—

Character type	Hiragana/Kanji	Katakana (2-byte/1-byte)	Alphabet (2-byte/1-byte)	Numbers (2-byte/1-byte)	Dial entry
	Move cursor down a line Select conversion candidate When cursor at end of text string, linebreak				—
Character type	Hiragana/Kanji	Katakana (2-byte/1-byte)	Alphabet (2-byte/1-byte)	Numbers (2-byte/1-byte)	Dial entry
	Toggle 2-byte/1-byte				—
Character type	Hiragana/Kanji	Katakana (2-byte/1-byte)	Alphabet (2-byte/1-byte)	Numbers (2-byte/1-byte)	Dial entry
	Short press....Delete 1 character to right of cursor If no character to right of cursor, delete 1 character to left When selecting conversion candidate, stop conversion and delete 1 character				Short press.... Delete 1 place
	Hold down....Delete all characters to right of cursor When cursor is at start or end of text string, delete all characters				Hold down.... Delete all

## ■ To Change the Character Type to Enter

Pressing  (Char.) on the character entry screen changes the character type. Press  to toggle 2-byte/1-byte.



## Phone

### Making a call

### Entering a Phone Number and Making a Call

#### 1 From the standby screen, enter phone number

The dial screen is displayed and the number is entered. When calling to fixed-line phones, enter the area code first even if the recipient is in the same city.

 : Move cursor position

 : Delete one number place

Hold down  for at least 1 second: Return to the standby screen

 (Register): Register an entered number to the phone book. (▶ P.76)

#### 2 → Talk

• You can also press  (Call) → [Call] to make a call.

Operations during a call:

 (HF ON/HF OFF): Hands-free call ON/OFF

 (Menu): Display menu

 (Setting): Heard effect adjustment

Adjust how the other party sounds.

 (Mic OFF/Mic ON): Mute ON/OFF

 (Profile): Display profile

 : Adjust call volume (volume of other party's voice)





 : Place call on hold

 : Voice memo

#### 3

• You can also fold the product to end a call.

#### memo

- Note that even if you cover the microphone, the sound can be conveyed to the other party.
- Even if "Airplane mode" is set, you can call emergency numbers (110, 119, 118).
- To play a voice memo, from the standby screen,  → [Phone Mail] → [Voice memo] → Select a voice memo →  →  (Play).
- The maximum recording time for the voice memo is 20 minutes per memo, and the maximum number of voice memos to record is 100. When 100 voice memos are recorded, an unprotected confirmed voice memo will be deleted from the oldest memo in order. When all of the voice memos are unconfirmed or protected, the voice memo recording is unavailable.
- To operate on the screen with the screen turned off during a call, press any key other than  to turn on the screen.



## ■ Emergency Call Location Notification

The product supports "Emergency call location notification" so that if you make an emergency call to Police, Fire and Ambulance or Regional Coast Guard Headquarters, your current location (GPS information) will be transmitted to the agency receiving the emergency call.



### memo

- VoLTE (LTE network) by au is used when connecting with emergency call receiving agencies within Japan. You cannot connect using 3G (circuit-switched network).
- In this section, Police (110), Fire and Ambulance (119) and Regional Coast Guard Headquarters (118) are collectively referred to as the emergency call receiving agency.
- This feature may not yet be available at some emergency call receiving agencies.
- If you add "184" before the Japan emergency call number 110/119/118, the emergency call responding agency will not be notified of your location, the same as your phone number.
- In places where signal reception from GPS satellites or a base station is relatively poor, such as in an underground mall, inside a building or behind a tall building, the emergency call receiving agency may be notified of some other place different from your actual location.
- When GPS cannot be used to notify of your location, base station signal is used instead.

- When making an emergency call to Police, Fire and Ambulance or Regional Coast Guard Headquarters, always confirm where you are, and tell them your exact location on the phone. Note that depending on the area where you are calling, your call may not be connected to the agency having jurisdiction over that area.
- If the emergency call receiving agency determines that human lives and health are in danger, they will be able to acquire the caller's location information during the call or within a certain period of time after the call.
- When incoming reject is set and you make an emergency call, the incoming reject setting will be automatically disabled for 5 minutes in order to receive calls from the emergency call receiving agency.

## ■ Using ; (Pause) Dialing and Making a Call

Enter the push signals to send beforehand and then press  during the call to send the push signals. This is a convenient feature when using information services and automatic reservation services.

**Example:**To dial "03-0001-XXXX (bank phone number)" and send the branch "22X" and the account "123XX"

**1** Enter phone number → Hold down 

The first ; (pause) is entered.

## 2 Enter push signals to send

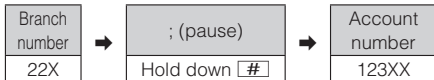

The second ; (pause) is entered.

- \* Enter a ; (pause) between several push signals to send them linked together.

## 3 → [Yes] → [Yes]

After dialing, a confirmation screen is displayed. Confirm that the destination has answered the call and then select "Yes". A push signal is sent each time you select "Yes" and press .

### memo

- ◎ Pause dialing may not be sent correctly if transmission signal is poor.









## Using Call Histories and Making a Call

### 1 From the standby screen, press (Incoming history) / (Outgoing history)

The incoming history/outgoing history screen is displayed.

In addition to incoming and outgoing histories, you can also check outgoing call frequency.

- Press  to toggle the outgoing history, incoming history, and call frequency screens.

-  : Incoming call
-  : Incoming call (Auto answering exists)
-  : Missed call
-  : Missed call (Auto answering exists)
-  : Missed call (one-ring phone scam\*)
-  : Call rejected
-  : Outgoing call
-  : au voice memo message

- \* Missed calls of less than 3 seconds are deemed to be one-ring phone scam calls. These may be calls to get the customer to call back and connect them to a malicious pay-for program. Use caution.

### 2 Select contact to call from history →

Place a call to the selected person.

- Select an entry in the incoming history/outgoing history screen →  (Detail) and the incoming history/outgoing history details screen is displayed. Details cannot be displayed from the call frequency screen.

## Using Speed Dial and Making a Call

You can make calls quickly to contacts registered to speed dial.

### Registering to Speed Dial

- 1 From the standby screen, press → [Phone Mail] → [Speed dial]
- 2 Select <Not Registered> for the number to register → (Edit)
  - If a number is selected with a destination already registered, operations such as dialing are available.
- 3 Select the destination to register → → [OK]

### Dialing with Speed Dial

- 1 From the standby screen, enter the speed dial number (0 to 99)
  - 2
- You can also press (Call) → [Call] to make a call.

## Calling Overseas from au Phones (au International Call Service)

You can make international calls without any special procedure from the product.

**Example: To call "212-123-XXXX" in the USA from the product**

- 1 Enter the international access code "010"  
Holding down for at least 1 second in the standby screen, the dial screen is displayed with "+" and adds "010" when the number is dialed.
- 2 Enter the country code of the USA "1"
- 3 Enter the area code "212"  
If the area code starts with "0", dial it without including the "0" (There are some exceptions such as fixed-line phones in some countries or regions including Italy etc.).
- 4 Enter the phone number of the other party  
"123XXXX" →



### memo

◎ You can also press (Call) → [Add Special No.] → [Intl Call] to enter the country code when entering a phone number.

- Ⓒ The monthly limit fee is set for the au International Call Service. The au International Call Service is unavailable from when the limit fee is confirmed to be exceeded until the end of the same month.
- Ⓒ Even if you cannot use the service by exceeding the limit fee, you can use from the first day of the next month. Also, you can use the domestic call as usual while the service is stopped.
- Ⓒ International call charges are billed together with monthly local call charges.
- Ⓒ If you do not wish to use the service, you can set not to use the au International Call Service.  
For au International Call Service:  
From an au cell phone (without area code), **157** (toll free)  
From fixed line phones **☎0077-7-111** (toll free)  
Open 9:00 to 20:00 (everyday)

## Receiving a Call

### Answering an Incoming Call

#### 1 While receiving a call, / (Answer)

The call starts.

#### 2 Talk →

#### Screen When a Call is received.

- The following is displayed when a call is received.
- If the other party's number is sent, it is displayed. If the number is registered in the phone book, their name and other information are also displayed.

- If the other party's number is not sent, the reason is displayed.

"ID Unsent" "Pay Phone" "Not Support"

- \* The other party is calling from a phone unable to send the number.





### memo

- Ⓒ If you are not subscribed to LTE NET or LTE NET for DATA, set "Cellular data" in "Data usage" to OFF.

#### If you did not answer a call

- Ⓒ  is displayed in the status bar. In the notification panel, the time and number of an incoming call or registered name in phone book is displayed.

#### To turn the ringtone or vibration off while receiving a call

- Ⓒ Press  while receiving a call to turn the ringtone or vibration off.
- Ⓒ Press  while receiving a call to change the volume of the ringtone.

#### If you receive a call while you are using another function

- Ⓒ If you are using the phone book or other function when receiving a call, the call takes priority.
- Ⓒ If you were recording a movie, recording stops and recorded data is saved.
- Ⓒ If you were recording using a sound recorder, recording stops.
- Ⓒ If the product is in the manner mode (Drive mode), the answering memo activates automatically.

## Rejecting an Incoming Call

### 1 While receiving a call, (Reject)

The ringtone stops and the incoming call is disconnected. The other party will hear voice guidance.



- While receiving a call, you can also press  to reject the call.

## Checking Your Phone Number

## Checking Your Profile

### 1 From the standby screen, press → [Profile]

The Profile screen appears.



- From the standby screen, you can also press  →  to check.

## Editing Your Profile

### 1 From the profile screen, press (Menu) → [Edit]

The profile edit screen is displayed.

### 2 Enter required items

- During editing, you can add items by pressing  (Menu) → [Add another field] → checkmark the item to add → .

### 3 (Set) → [OK]



#### memo

- Items to note for editing your profile are the same as for editing the phone book. For details, refer to "Registering to the Phone Book" (▶ P.76).
- From the profile screen, you can reset your profile by pressing  (Menu) → [Reset] → [Yes] → [OK].

## Phone Book



### Registering to the Phone Book

You can register contact information including phone number and e-mail address. You can also set ringtone, vibration, etc. individually for contacts.

#### 1 From the standby screen, press for at least 1 second

The phone book edit screen is displayed.

#### 2 Set required items

- While registering, you can add items by pressing  (Menu) → [Add another field] → checkmark the item to add →  (Add).

#### 3 (Set) → [OK]



#### memo

- If the number is a landline number, enter the area code first.
- If the name includes 1-byte alphabet and numbers, it may be displayed in the order of given name, family name.
- If a caller's number is withheld, "Incoming settings" does not operate.

- Numbers and names registered in the phone book can become erased due to accident or malfunction. Keeping a separate copy of numbers and other important information is recommended. The Company is not liable for any damages or lost profits whatsoever due to alteration or loss of contact information resulting from accident or malfunction.
- Not to usually display a certain contact, set "Secret setting" to ON. To display a secret contact, change the setting with "Display settings".

### Using the Phone Book List

#### Displaying the Phone Book List

#### 1 From the standby screen, press

The contacts list (name order) is displayed.

- When the contacts list is in "Group" view, a contacts list screen (group order) is displayed. Selecting a group displays a contacts list for that group.

## ■ Viewing the Contacts List

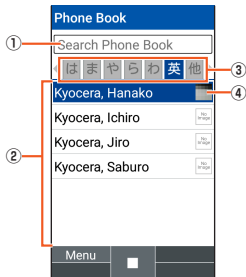

《Contacts List (Name Order)》

### ① Search by number keys

You can search for contacts by pressing the number keys in the contacts list and entering characters to search. Pressing **[CLR]** deletes characters to search and ends search.

### ② Contacts

Contacts are displayed for the selected tab.

### ③ Tabs

### ④ Image

The registered image is displayed when "Display photo" is set to "Displayed" in the display setting.



memo

○ Press to switch tabs.

## Using Information Registered for Contacts

- 1 From the standby screen, press →  
Select the contact →

The phone book simple screen is displayed.

- 2 (Detail)

The phone book detail screen is displayed.

## ■ Viewing Phone Book Simple/Detail Screen

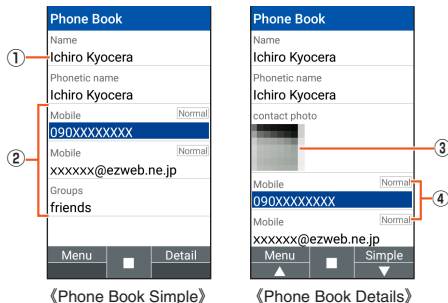

- ◎ You can set a normally used phone number/e-mail address by selecting a phone number/e-mail address and pressing → [Default phone No.]/[Default mail Address].
- ◎ You can press (Menu) → [Edit] to edit registered information.

### memo

- ◎ You can make calls, create e-mail, etc. by selecting registered information and pressing .



## E-mail

### Checking E-mail

Received e-mail is saved in the "Inbox". Sent e-mail is saved in the "Outbox". Received and sent e-mail that meets filtering criteria is saved in a designated folder. Saved e-mail that has not been sent and send-failed e-mail are stored in the "Unsent" box.

#### 1 From the standby screen, press

The folder list is displayed.

#### 2 [Inbox] / [Outbox] / [Unsent] / Select folder





The e-mail list is displayed.

-  (2Line/3Line): Switch mail list views.

#### 3 Select e-mail →

The e-mail message is displayed.

-  (Prev): View previous e-mail
-  (Next): View next e-mail



### memo

- Once the capacity of the "Inbox" is exceeded, oldest read e-mail is automatically deleted. E-mail that is unread, protected, or for which the text body is unreceived is not deleted.
- New e-mail cannot be received if the "Inbox" is full and it contains all unread e-mail.
- Once the capacities of the "Outbox" and "Unsent" box are exceeded, oldest sent e-mail is automatically deleted. If there is no sent e-mail that can be deleted, send-failed e-mail is deleted, followed by unsent e-mail. Protected e-mail is not deleted.

## ■ Viewing the Folder List

In the folder list, the "Inbox", "Outbox", folders, etc. are displayed. Folders created by selecting "Create new folder" are displayed.

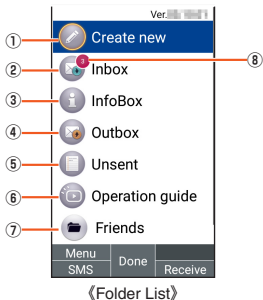

① **Create new**

② **Inbox**

③ **InfoBox**

View InfoBox mail.

④ **Outbox**

⑤ **Unsent**

⑥ **Operation guide**

⑦ **Created folder**

⑧ **Number of unread/unsent e-mail**

## ■ Viewing the E-mail List



《Received E-mail List》

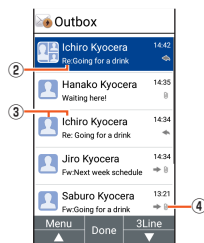

《Sent E-mail List》

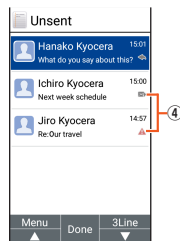

《Unsent E-mail List》

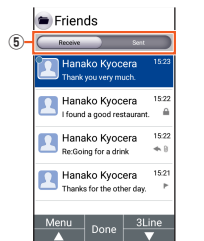

《E-mail List (Folders)》

- ① ● : E-mail with unread
- : E-mail with unreceived text body

## ② Subject

## ③ Recipient's/sender's name or e-mail address

The registered image/name is displayed if the e-mail address is registered in the contacts. If the e-mail address is unregistered, the e-mail address is displayed.

If a sender designation is set for the received e-mail, the set name is displayed.

- If the e-mail address is registered in the contacts, the registered name takes priority.

## ④ Icons

- ↩ : Replied-to e-mail
- ➡ : E-mail that has been forwarded
- ↔ : Replied-to e-mail/e-mail that has been forwarded
- 📎 : Electronic file attached
- 🔒 : Protected mail
- 🚩 : Flagged e-mail
- ⚠ : Send failure mail
- 🔄 : Auto-resend e-mail

## ⑤ Received/sent slider

Switch between received and sent e-mail lists in a folder.

## ■ Viewing an E-mail Message

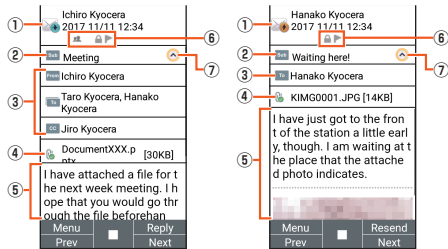

《Received E-mail Message》

《Sent E-mail Message》

## ① Recipient's/sender's name or e-mail address

## ② Subject

## ③ Sender's name or e-mail address









## To / CC : Recipient's names or e-mail addresses

## ④ Electronic file

- 📎 : Saved electronic file
- 📎 : Save-failed electronic file
- 📎 : Saved inline electronic file
- 📎 : Unreceived electronic file
- 📎 : Receive-failed electronic file

## ⑤ Mail text

## ⑥ Icons

-  : Replied-to e-mail
-  : E-mail that has been forwarded
-  : Replied-to e-mail/e-mail that has been forwarded
-  : Multiple recipients
-  : E-mail received with BCC recipients
-  : E-mail waiting to be automatically resent
-  : Send failure mail
-  : Protected mail
-  : Flagged e-mail

⑦  /  : Show/hide details

## Sending E-mail

1 From the standby screen, press  →  
[Create new]

The e-mail create screen is displayed.

2 Select the address entry field → 

3 Address book	Enter e-mail address from contacts as a recipient.
Address group	Enter all e-mail addresses registered to a contacts group as the recipients. If the number of e-mail addresses in the group exceeds the limit available for recipients, addresses are entered up to the limit.
Receive history	Select and enter an e-mail address from the received e-mail history/sent e-mail history.
Send history	
Profile	Enter own e-mail address registered in the product as recipient.
Direct input	Enter e-mail address directly.
Paste	Paste copied e-mail address.

\* Items displayed depend on conditions.

**4** Select subject field →  (Edit) → Enter subject

**5** Select text field →  → Enter text

**6**  (Send) → [Send]



### memo

- You can press  (Save) in the e-mail create screen to save e-mail that is being created to the "Unsent" box.
- デコレーションアニメ (decoration anime) is not supported.
- In the subject or text, you cannot enter 1-byte katakana or 1-byte Japanese symbols (ー、ゝ、゚、゛、゜、ゝ、゚、゛、゜).
- Up to 1000 e-mails as the total for all recipients can be sent in one day.
- One e-mail can be sent to up to 30 recipients (including To, Cc, Bcc, up to 64 1-byte characters per e-mail) at a time.
- Emoji sent to an other-brand cell phone, PC, etc. may sometimes be converted to the other-brand emoji or may not be displayed properly. Emoji sent to another au phone may sometimes be converted to a differently designed au emoji.
- The confirmation screen when sending an e-mail can be disabled.
- By setting "Automatic resend" to ON, you can have failed e-mail automatically sent again later.
- You can insert up to 20 (totaling up to 100 KB) DEmoji in the mail text.
  - \* Once a DEmoji is entered, the same DEmoji can be entered repeatedly any number of times.

## Adding/Deleting Recipients

### ■ Adding a recipient

**1** E-mail create screen → Select the empty address entry field → 

A menu for selecting a recipient entry method is displayed. Refer to step **3** of "Sending E-mail" (▶ P.82).

### ■ Deleting a recipient

**1** E-mail create screen → Select a recipient to delete →  → [Delete] → [Delete]



### memo

- You can change the recipient type (To/Cc/Bcc) by selecting "To" → . You cannot change the recipient type for the topmost recipient.

## Receiving E-mail

### 1 Receiving E-mail

Once an e-mail is received, you are notified of the new mail in the following ways.

- "✉" is displayed in the status bar and a ringtone sounds.
- The e-mail address, name, and subject are displayed in the status bar. If a sender designation is set for the received e-mail, the set name is displayed. If the e-mail address is registered in the contacts, the registered name takes priority.
- The charging/notification indicator flashes.
- If the product is folded, "✉" is displayed in the sub-display.  
The e-mail address (or name registered in the phone book if the e-mail address is registered there) is displayed.

### 2 From the standby screen, press ✉ → [Inbox]

The e-mail list is displayed.

### 3 Select a received e-mail → ⦿

The e-mail message is displayed.

## memo

- ⦿ E-mail is received in the background even while using e-mail or other functions. "✉" is displayed in the status bar and a ringtone sounds. However, e-mail is not received in the background if "Auto-receive" is set to OFF.
- ⦿ If "Auto-receive" is set to OFF or there is a receive failure, a ringtone sounds and "✉" is displayed. Use "Receive" to receive the e-mail.
- ⦿ Data fees may be incurred even if mail is not properly received due to reception conditions or the data being received.
- ⦿ The maximum size of mail text that can be received is 1 MB per e-mail. If a mail text exceeds that, a message appears at the end of the received portion indicating that it is truncated.
- ⦿ Received e-mail may not be correctly displayed depending on the content of the mail.

## Inquiring for and Receiving New Mail

You can inquire for and receive new mail if "Auto-receive" is set to OFF or there is an e-mail receive failure.

### 1 From the standby screen, press ✉

The folder list is displayed.

### 2 ⦿ (Receive)



Confirm whether there is new e-mail.

## SMS (C-mail)

### Sending SMS

You can send messages (mail text body) with kanji, hiragana, katakana, alphabet and numbers, symbol, Emoji, and (^\_^)(facemarks).

#### 1 From the standby screen, hold down for at least 1 second

Alternatively, to access the screen from the standby screen,  →  (SMS).

The SMS menu screen is displayed.

#### 2 [Create new]

- When sending SMS to a contact who you received SMS from before, you can also select a message to "Reply" in the inbox to create SMS. In this instance, proceed to step **4**.

#### 3 [Address book]/[Direct input] → Enter the phone number of a recipient

Select a recipient from the phone book or directly enter it.

Before sending SMS overseas, enter "010" and the "country code" at the start of the phone number for the recipient.

"010" + "country code" + "phone number for recipient"

- \* If quoting the cell phone number for the recipient from the phone book, etc., select the recipient entry field again and enter "010" and the "country code".
- \* If the cell phone number for the recipient starts with a "0", enter the number without the "0".

#### 4 Enter text

You can enter up to 670 2-byte/1,530 1-byte characters in the mail text.

- \* You can enter up to 70 2-byte/160 1-byte characters in the mail text to devices from other domestic/overseas mobile operators.

#### 5 (Send)



memo

- © Before step **5**, you can press  to display "Draft" in the thread list and save mail without sending it.

- ◎ The SMS center holds SMS as follows.

Time holdable (accumulated)	Up to 72 hours * SMS that has accumulated for more than 72 hours is erased.
Number holdable	300 * It may not be possible for the SMS center to hold SMS depending on conditions of the receiving customer's phone/service use or the sending customer's phone model.

- ◎ Accumulated SMS is delivered at the following times.

Delivery soon after accumulating	All SMS held at the SMS center is delivered each time new SMS accumulates.
Delivery by retry function	If SMS could not be delivered soon after accumulating, such as when the other party was in poor signal conditions or your product was powered off, SMS is repeatedly sent to them by the retry function for a maximum of 72 hours.
Delivery after completion of call	If SMS could not be delivered soon after accumulating, all SMS held at the SMS center is delivered once you complete a call on the product.

\* For international SMS, the delivery timing may differ.

- ◎ SMS cannot be sent without displaying the number of the sender.
- ◎ Emoji sent to an other-brand cell phone may sometimes be converted to the other-brand emoji or may not be displayed properly. Emoji sent to another au phone may sometimes be converted to a differently designed au emoji.
- ◎ A "▲" may be displayed, although rarely, for a sent message that was sent successfully but where signal was weak, etc.
- ◎ For details on international SMS, refer to the au homepage.  
<https://www.au.com/mobile/service/global/sms/>

## Receiving SMS

### 1 Receive an SMS

Once an SMS is received, you are notified of the new mail in the following ways.

- A new SMS icon is displayed in the standby screen, "SMS" in the status bar, and a mail ringtone sounds.
- If the product is folded, "SMS" is displayed in the sub-display.
- The charging/notification indicator flashes.

### 2 From the standby screen, press for at least 1 second

The SMS menu screen is displayed.

### 3 [Inbox] → Select a message to check →

The received SMS is displayed.

"Unread" is displayed for unread SMS in the inbox.





## memo

- Receiving SMS is free of charge.
- You can confirm the phone number of the sender with received SMS.
- Received SMS may not be correctly displayed depending on the content of the mail.
- Shortage of the internal storage makes impossible to receive SMS properly.
- While data is being backed up or restored with the Data Storage App, do not exit the SMS app. This may prevent data from being properly received.

## LINE

LINE is a new communication application which allows you to make free voice calls and send free messages anytime and anywhere.

- Updating the application and registration of an account is required for using LINE. For details on using LINE, visit the LINE website, or from the LINE screen → [Others] → [Settings] → [Help] and refer to the help.
- LINE is a Pointer-capable application.

### 1 From the standby screen, press → [LINE]

The LINE top page is displayed.

You can also activate LINE by pressing  at the time of purchase.

When using LINE for the first time, update the application, and a login screen will appear. Terms of use, etc. appear when registering a new account. Confirm the content and follow the on-screen instructions.



#### memo

- © Games and some other functions cannot be used on the product.

## Internet Access

### Accessing the Internet

You can access the Internet by data communication or the wireless LAN (Wi-Fi®) function.



#### memo

- ◎ Data communication is available only with subscription to LTE NET or LTE NET for DATA.
- ◎ EZweb site is not available. The contents used by conventional 3G cell phones are continuously unavailable. Your cancellation procedure in person is required.

### Using Data Communication

This product provides easy access to the Internet for data communication with use of "LTE NET" or "LTE NET for DATA". Settings for connecting to the Internet with LTE NET are pre-installed on the product, and activating an application that requires an Internet connection automatically connects the product to the Internet.

To access the Internet with LTE NET for DATA, in the standby screen, → [Settings] → [Wireless/Network] → [Cellular networks] → [Access Point Names] → [LTE NET for DATA].



#### memo

- ◎ Subscription to LTEフラット (LTE flat) or other data communication flat-rate/discount service allows you to use an Internet connection with flat-rate charges. For details on LTE NET, LTE NET for DATA, and data communication flat-rate/discount services, refer to the latest au総合カタログ (au general catalog)/the au homepage.

### Notes on Software Update

- Using large-volume data communication, such as browsing websites containing images, downloading video and other data, and using applications that use data communication results in high data communication charges. Therefore, subscription to a flat-rate/discount service for data communication charges is recommended.
- To prevent excessive burdens on the network, communication speed is sometimes reduced due to continued large-volume data transfers, busy network conditions, etc.

### How to Confirm Your Data Communication Charges

You can confirm your data communication charges at the following URL.

<https://www.au.com/support/>

- Subscription required for first-time use.

## Browser

You can use the browser to view webpages in the same way as with a PC.

- The browser is a Pointer-capable application.
- Some webpages cannot be optimally displayed on the product's screen.

## Displaying Webpages

### 1 From the standby screen, press

The browser menu is displayed.

2 Homepage	Connect to the Internet and view webpages.
My au	Display My au (au Customer Support) webpage.
MARVERA guide	You can check detailed explanations of this product with images.
Favorites	Use and manage registered bookmarks.
Web Search	Enter a URL directly to display a site. You can also enter keywords to search for information on webpages.

History	Display the browsing history.
Download	Display the download history.
Browser Settings	Change browser settings.

## Using the Pointer

You can use the Pointer's features to smoothly browse webpages. For details on the Pointer, refer to "Using the Pointer" (▶P.48).

### 1 Hold down for at least 1 second

To turn the Pointer ON.

### 2 Use the pointer to operate

For details on the Pointer operations, refer to "Touch Pointer Operation" (▶P.48) or "Pointer Operation" (▶P.50).



## Camera

- Fingerprints and smudges on the lens may cause images to appear unclear. Before capturing images, wipe the lens with a soft cloth. Rubbing forcefully may scratch the lens.
  - Avoid fingers, hair, strap, etc. from covering the lens during image capture. Hold the strap if it interferes with capture.
  - Take precautions for hand-held shake. The product moving may cause blurry images, so hold the product firmly or use the self-timer. Especially indoors and in other low-light conditions, hand-held shake can occur more easily. Blurry images also occur more easily when the subject moves.
  - Release the shutter after confirming that the subject is properly displayed in the display. Moving the camera while releasing the shutter may cause images to be blurry.
  - When recording movies, avoid covering the microphone with fingers. Loudness of voices and surroundings during recording may affect the sound quality of the microphone.
- Focusing may not be possible for the following types of subjects.
    - Low-contrast subjects such as plain walls
    - Subjects with strong backlighting
    - Shiny subjects that reflect light brightly
    - Subjects with a pattern that repeats horizontally such as blinds
    - Several subjects with differing distances from the camera
    - Subjects in dark conditions
    - Fast-moving subjects
  - Do not shine the photo light near eyes. Do not look directly into shining photo light. Do not shine photo light at other persons' eyes. Doing so may affect vision or cause other impairment.
  - Even in the manner mode, the shutter clicks for photos. Also during movie shooting, start and stop beeps sound. The volume cannot be adjusted.
  - When using the self-timer for image capture and the product is placed on an unstable surface, the product vibrates such as when you receive a call. It may cause the product to fall.

- You should refrain from any activity which may infringe copyrights when duplicating, editing, etc. images taken or recorded with the product, as well as any activity which may infringe portrait rights such as use or modification of other person's portraits without permission. Photography or recording of live performances, entertainment, exhibits, etc. may also be prohibited even if intended only for personal enjoyment.
- Creating a public nuisance with use of the product camera may be punishable by law.
- Photos with location information appended and uploaded to the Internet can allow third parties to obtain the location information.

## Viewfinder Layout

### 1 From the standby screen, press

- From the standby screen, you can also press  → [Camera] to activate the camera.
- When microSD memory card is installed, the confirmation screen is displayed. Follow the on-screen instructions.
- To switch the location to save data to, press  (Menu) → [Setting] → [General Setting] → [Data Storage] → [Internal storage]/[microSD].

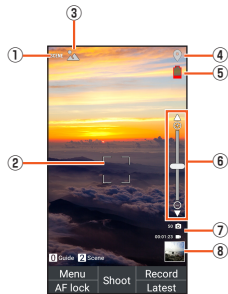

## ① Capture mode icons

A mode icon is displayed when the capture mode is "Continuous", "Scene", "Effect", or "Time-lapse".

- Depending on the set effect, an adjustment bar is displayed for adjusting the setting.

## ② Focus frame

## ③ Capture scene icon/seconds icon

- When the capture mode is "Scene", an icon is displayed for the set scene.
- When the capture mode is "Time-lapse", an icon for the number of seconds is displayed.

## ④ Determining location/add location information

- 📍 (Determining location)   📍 (Determined)
- 🚫 (Could not determine)

## ⑤ Battery level

Displayed when battery is low.

## ⑥ Zoom

Press  to display a zoom bar and adjust the zoom.

## ⑦ Capture shots/Time remaining

Displayed when storage where captured data is stored is low.

## ⑧ Preceding shot/Recorded data

Display thumbnail of preceding shot/recorded data.

Press  (Latest) to display the data.

## Capturing Still Pictures/Video

### 1 From the standby screen, press

The monitor screen is displayed.

### ■ Shooting a photo

### 2 (Shoot) or

The camera focuses and the shot is taken. Captured data is automatically saved.

- The captured image is displayed if "Auto review" is set to ON. Press  (Delete) → [Yes] to delete the captured image.

### ■ Recording a movie

### 2 (Record)

Recording starts.

During recording, press  (Shoot) or  to capture a photo.

### 3 (Stop)

Recording stops. Recorded data is automatically saved.



## memo

- Closing the product during recording stops recording.
- Although the product features continuous AF for maintaining continuous autofocus, it may take time for the camera to focus depending on the subject.
- You can set Smile shutter to "ON" and use self-timer shooting to have the camera take one shot after the countdown, and then take another once it detects a smile.
- During recording, recording is only by the mouthpiece (microphone).



## TV (1Seg)

### Using TV (1Seg)

TV (1Seg) is a digital terrestrial TV broadcast service for mobile devices, and allows reception of image and audio as well as data broadcast.

For details on the 1Seg service, refer to the below website.

The Association for Promotion of Advanced Broadcasting Services

<http://www.apab.or.jp/en/>

### ■ Precautions When Using TV (1Seg)

- No communication charges or data communication charges are incurred for using TV. However, data communication charges are incurred for use of additional services associated with data broadcast that use data transmission. Regarding NHK reception fees, inquire with NHK.
- TV is for digital terrestrial TV broadcast 1Seg in Japan only. Overseas, 1Seg cannot be used due to differing broadcast formats and frequencies. Also, BS and 110-degree CS digital broadcasts cannot be viewed.
- While displaying the TV screen, the product may become warm and cause low-temperature burns, etc. if used in contact with the skin for an extended period.

- Do not use TV while operating a vehicle or motorcycle, or riding a bicycle. Use of cell phones while driving a car or motorbike is prohibited by law. (Use of cell phones while riding a bicycle may also be punishable by law.) In addition, stay alert to the traffic around you even when walking. Surrounding sounds might not be heard clearly, and gazing at the screen may distract your attention causing a traffic accident. Be especially careful at railroad crossings, station platforms and pedestrian crossings.
- Listening at a volume that is loud to the ears continuously for an extended period may affect hearing.
- Be careful of sound leakage from earphones in trains or other places with many people around you.
- TV cannot be activated with a low battery.

### ■ Signal

Signal may be weak in the following places and may affect picture/sound quality or prevent reception.

- Areas that are distant from or extremely close to the broadcast station
- In a moving train/car, underground shopping district, tunnel, indoors, etc.
- In a valley or shade of a building
- Near high-power lines, neon lighting, a radio station, railway track, highway, etc.
- Other places where interfering signals are strong or signals are blocked

To improve signal reception, try the following.

- When viewing indoors, view near a window for better reception.

### ■ TV Antenna

The product has a built-in antenna.

### ■ Operation at Low Battery Level or High Temperature

TV (1Seg) cannot be used when the battery is low or the product is at a high temperature. TV (1Seg) also cannot be activated with a low battery.

## Making Initial TV Settings

Set an area for viewing the first time activating TV. Once settings are complete, you can view TV programs.

**1 From the standby screen, press**  → [Tool] → [TV]

**2 Select an area** → 

**3 Select a prefecture** → 

**4 Select a locality** → 

The product searches for available channels, and a channel list is displayed.

**5 Confirm the channel list** →  → [OK]

The TV screen is displayed.

## Viewing TV Programs

### Viewing a TV Program

- 1 From the standby screen, press **TV** → [Tool] → [TV]

The TV screen is displayed.

### Viewing the TV Screen

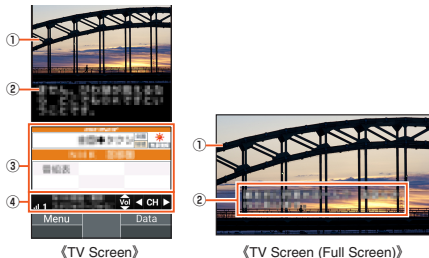

- ① Image
- ② Subtitles
- ③ Data broadcast
- ④ Viewing remote control

### Key Operation while Viewing TV

**↑** : Adjust volume (volume at 15 levels or mute)

**↺** : Switch channels

**0 - 9**, **\***, **#** : Change to assigned channel

Press **DATA** (Data) to use data broadcast.

**↑** : Move cursor, scroll

**○** : Select item

**DATA** (Vol/Ch) / **CLR** : Switch to TV viewing operation

#### memo

- When activating TV (1Seg) or changing channels, it may take time to obtain data for data broadcast and TV image due to digital broadcasting characteristics.
- Image and sound may be disrupted or stop due to signal conditions.
- You can turn the product sideways to view in full screen.

### Exiting TV (1Seg)

- 1 From the TV screen, press **EXIT** → [Yes]

## テレビde写真 (Photos on TV)

You can display photos, etc. saved to the product wirelessly on TV by connecting "テレビde写真 (Photos on TV) receiver (sold separately)" to a TV.

### 1 Connect テレビde写真 (Photos on TV) receiver (sold separately) to a TV

- For details, refer to the instruction manual of テレビde写真 (Photos on TV) receiver (sold separately).

### 2 Display a screen to display on TV with the product

### 3 (Menu) → [テレビde写真 (Photos on TV)] → [Display]

### 4 Select "au\_XXXXXX" displayed on the TV screen →

- You can also activate テレビde写真 (Photos on TV) by pressing  at the time of purchase.
- Select "How to use", "Functional description" to confirm the guide of テレビde写真 (Photos on TV).
- On the standby screen, press  (select "Connecting to television" when the notification display exists) to shift to the image list screen, disconnect or change the connection.



## memo

- You can use this function by a device that supports Miracast.
  - \* It may not be available depending on your receiver.
- The volume adjustment by the product may not be available when テレビde写真 (Photos on TV) receiver (sold separately) is connected.

## FM radio

You can use analogue FM radio by connecting a separately sold earphone or conversion adapter, etc. to the product. Since wide FM (FM supplemental broadcast) is supported, AM radio programs are available to listen to.

- Connecting an earphone changes the sound to the earphone output.





**1** Connect a separately sold earphone or conversion adapter, etc.



**2** From the standby screen, press  → [Tool] → [FM radio] → [OK]

**3** Select an area → 



**4** Select a prefecture → 

### Operations on FM radio screen

- : Switch the Speaker to ON/OFF when an earphone is connected
- : Adjust the volume
- : Switch the frequency (short-press for tuning, long-press for auto tuning)
- : Exit FM radio
-  (Menu): Enter the frequency, add to the favorites, set the auto exit timer, change the area

-  (Favorite): Display frequencies that you registered
- : Switch to the background play

### memo

- Since the data communication is not used, no communication charges occur.
- A separately sold earphone, conversion adapter, AC adapter or USB cable functions as an antenna. However, you may hear a noise depending on the reception environment or cable conditions, or while charging.
- Radio reception may be interfered indoors or in a vehicle. Radio reception is improved near a window.
- To restart FM radio during the background play, hold down  for at least 1 second → select a FM radio notification → . To exit FM radio, press  → [Yes].

## Alarm

A specified time is notified by alarm or vibration.

**1** From the standby screen, press  → [Tool] → [Clock/Calender] → [Alarm]  
The alarm list is displayed.

**2**  (Menu) → [Add]  
Select an alarm →  (Edit) to edit the alarm.

**3** Set each item

Alarm set time	Set the time to play alarm.
Repeat	Set to repeat alarm.
Label	Change the alarm name.
Sound	Change the alarm sound.
Alarm volume	Set the alarm volume.
Weather forecast alarm	▶P.100 "Using the Weather Forecast Alarm"
Snooze settings	Set whether to use the snooze or set the snooze interval.
Vibration pattern	Set the vibration pattern.
Silence after	Set the period to play alarm.

#### 4 (Set) → [OK]



#### memo

- Pressing  on the alarm list screen switches to "ON"/"OFF".
- Even if "Auto power on" (▶P.100) is set to ON with the product powered off, the product turns on and the alarm sounds as the alarm set time comes.

#### When the alarm set time comes

- It notifies you by alarm or vibration.
  - To cancel the alarm, press any key.
- To stop the snooze, hold down  for at least 1 second.

## Using the Menu in the Alarm List

### 1 From the alarm list screen, press (Menu)

2 Add	▶P.99 "Alarm"
Delete	Delete one or selected alarms.
Settings	<p><b>Prioritize alarm</b> Set whether to play alarm in the manner mode.</p> <p><b>Auto power on</b> Set whether to power on the product and play alarm at a set time with the product turned off.</p>

## Using the Weather Forecast Alarm

When the alarm sounds, the current weather condition and weather forecast for the entire day are read out. And when the chance of rain is high, you can set the alarm to sound early.

### 1 From the Alarm setting screen, [Weather forecast alarm] → [Yes]

- When a weather application setting screen appears, follow the on-screen instructions to set.

<b>2</b> Read out the weather forecast	Set to read out the weather forecast when the alarm sounds.
Get up early	When the chance of rain is high, set the alarm to sound early.



### memo

- The alarm and "Read out the weather forecast" sound at the same time. In this period, the alarm volume goes down.
- When "Read out the weather forecast" is set to ON, stop the ringing alarm to activate the weather application.
- Even when "Auto power on" (▶ P.100) is set to ON, the alarm does not sound by "Get up early" if the product is powered off.

## Flashlight

- 1** From the standby screen, press → [Tool] → [Flashlight]

The flashlight turns on.

- Press , to turn off the flashlight. Or when the specified lighting time elapses, the flashlight turns off.
- Press to switch to turn the light on/off.
- Press (Menu) to set the brightness, blink speed and light time.
- Press to switch to Light on/Blink.





### memo

- Do not shine the flashlight near eyes. If the flashlight is lit, do not look directly into it. Do not shine the flashlight at other person's eyes. Doing so may affect vision or cause other impairment.

## Kanji Check

You can enlarge a Kanji character with a lot of stroke counts to display and check it. You can check 100 characters at once.

**1** From the standby screen, press  → [Tool] → [Kanji Check]

**2** Enter a Kanji to check →  (Done) → Select a character with  



An entered character is displayed one by one on the Kanji check screen.



### memo

- Press  (Edit) on the kanji check screen to edit the entered character.

## Screenshot

**1** Hold down  and  for at least 1 second at the same time

Capture the displayed screen by screenshot.

- You can confirm captured screenshots in "Pictures" of Data Folder.





### memo

- Screenshot may not be available depending on applications or functions such as the TV screen.

## Battery Care Mode

You can extend the battery life without fully charging the battery.

**1** From the standby screen, press  → [Settings] → [Eco/Battery] → [Battery care mode] → [ON]

When the battery care mode is set, the heart mark  is attached to the battery icon.



### memo

- Charging stops at 85% when the battery care mode is turned ON. The battery usable time becomes short on one charge.
- When charging reaches 85%, the charging/notification indicator goes out.
- When the battery care mode is set to ON at 86% or more, charging does not start until charging decreases to 85%.



## Settings

### Displaying the Settings Menu

Set and manage functions from the settings menu.

- 1 From the standby screen, press  → [Settings]

Item	Description
au ID Setting	Set an au ID.
Wallpaper/ Display	Set wallpaper and display brightness, change font size, etc.
Sound/ Notification	Make the manner mode settings, and change the volume, sound and LED for new call, vibration pattern, etc. when receiving a call.
Lock	Make product lock settings.
Wireless/ Network	Make settings for Wi-Fi®, Bluetooth®, Osaifu-Keitai®, airplane mode, mobile networks, tethering, VPN or other network, etc.
Eco/Battery	Set Eco Mode and check battery usage.

Item	Description
Auto assist	It supports you according to your actions or lifestyle such as turning on the sub-display, notifying you of unconfirmed missed calls again when you pick up the product.
All reset	Initialize the product.
More settings	Set the custom keys, pointer, security, storage, applications, location information, accounts, language and input, date and time, user accessibility, device information, etc.

### Setting the Manner Mode

Select the manner mode so as not to disturb others around you in public places.

- 1 From the standby screen, press  → [Settings] → [Sound/Notification] → [Manner mode]

The manner mode setting menu is displayed.

- 2 Manner mode Does not sound ringtone from the speaker of the product. And turns the vibration ON.

Silent mode	Does not sound ringtone, and turns the vibration OFF.
Drive mode	Does not sound ringtone, and turns the vibration OFF. Plays a guidance and notifies the caller that you are driving a car when receiving a call.
Original mode	Edit the manner mode according to your preference such as setting the ringtone volume for each incoming call type.



### memo

- Use of cell phones while driving a car may cause traffic accidents, and is prohibited by law. Set the manner mode to "Drive mode" while driving a car.
- From the standby screen, press **マナー/シャッター** to display the manner mode setting menu and set the manner mode.
- In the standby screen or with the product closed, hold down **マナー/シャッター** for at least 1 second to return to the manner mode that you previously set. Hold down **マナー/シャッター** for at least 1 second again to exit the manner mode.
- Even in the manner mode, the shutter clicks for photos. Also during movie shooting, start and stop beeps sound. And the alarm may sound according to the alarm setting (except the drive mode).

- When "Drive mode" is selected, it plays a guidance and notifies the caller that you are driving a car, and then activates the auto answering automatically.
- While data is played in the muting state in the manner mode, press **🔊** to adjust the volume.

## Wireless LAN (Wi-Fi®) function

### Wireless LAN (Wi-Fi®) Function

Use your home Wireless LAN (Wi-Fi®) or public wireless LAN to connect to the Internet service.

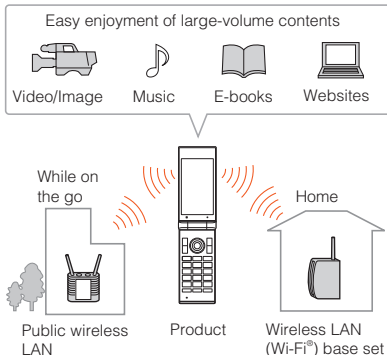

### memo



- For use at home, make sure you have an Internet connection and a wireless LAN (Wi-Fi®) base set (Wi-Fi® network).
- Before using out on the go, first check the Wi-Fi® network connection, the homepage of the public wireless LAN service provider, etc. where you will be using the product. A separate subscription may be required for service.
- Connection with all public wireless LAN services is not guaranteed.
- Wireless LAN (Wi-Fi®) function has the advantage that it can be freely connected anywhere within the radio wave range, as it uses radio waves for exchanging information. However, not making security settings allows the risk of malicious use by third parties. At the customer's discretion and responsibility, it is recommended that you make security settings before using the product.

## Using the Wireless LAN (Wi-Fi®) Function

### Enabling the Wireless LAN (Wi-Fi®) Function

- 1 From the standby screen, press  → [Settings] → [Wireless/Network] → [Wi-Fi]  
The Wi-Fi® settings screen is displayed.
- 2 Checkmark "Wi-Fi"  
Wi-Fi® switches ON.

### Connecting to a Wi-Fi® Network



- 1 From the standby screen, press  → [Settings] → [Wireless/Network] → [Wi-Fi]  
When Wi-Fi® is activated, a list of connectable access points is displayed in the Wi-Fi® settings screen.
- 2 Select an access point → 
- 3 Enter the password →  (Connect)  
You can set "Show password" to ON to display a password as you enter it.



#### memo

- Some access points do not require a password.
- Depending on your environment, transmission speed may drop or a connection may be unavailable.

### Disconnecting from an Access Point

- 1 From the standby screen, press  → [Settings] → [Wireless/Network] → [Wi-Fi]
- 2 Select the connected access point →  →  (Forget)



#### memo

- After disconnecting from an access point, a password may be required to reconnect.

## Appendix

### Updating Software

You can update the product to the most recent software for optimal performance and to get the latest enhancements.

#### ■ Notes on Software Update

- When software update is necessary, you will be informed on au homepage, etc. For details, contact an au shop or Customer Service Center (call toll-free 157). In addition, users of the product will receive a notice from au, when software update is necessary to improve the functionality of the product.
- It is recommended to back up your data before updating software.
- If software update has failed or stopped, perform the same procedure again.
- If the software update fails, it may become impossible to operate the product. If this happens, bring it to an au shop or PiPit (not accepted by some shops).
- When using the product overseas, the software update functions may not be available.
- Any operations are not available during software update. Calling 110 (Police), 119 (Fire/Ambulance),

- 118 (Maritime rescue) and 157 (Customer Service Center) is not available. Alarm does not work, either.
- Fully charge before update. If the update is started with the battery power low or battery power becomes low during update, software update cannot be done.
- Check out the signal reception status. The software update may fail if the product is in a place with bad signal reception status.

### Downloading and Updating Software

The product supports the software update.

**1** From the standby screen, press  → [Settings] → [More settings] → [About phone] → [Software update]

**2** [Software update]

From here on, follow the on-screen instructions.





#### memo

- ⓘ After a software update, the product cannot revert to the previous version software.

## Troubleshooting

Before you assume that the product is malfunctioning, check the following:

Trouble	Detail	Page
Cannot operate/The screen does not respond/ Cannot turn off the power	You can force the product to power off and reboot by holding down  and  at the same time for at least 11 seconds.	—
The power is turned off automatically	Is the battery adequately charged?	—
The power is turned off while the wake-up logo is displayed	Is the battery adequately charged?	—

Trouble	Detail	Page
Cannot make calls	Is the power turned on?	—
	Is the correct au IC card inserted?	P.47
	Was the number entered correctly? (Was the area code entered?)	P.70
	Did you press  after entering the number?	P.70
	Is "Airplane mode" still set?	P.54
Cannot receive calls	Is the signal good enough?	P.54
	Is the product within the service area?	P.54
	Is the power turned on?	—
	Is the correct au IC card inserted?	P.47
	Is "Incoming Reject" still set?	—
	Is "Airplane mode" still set?	P.54
	Is "Call forwarding services" still set?	—

Trouble	Detail	Page
"📶" (out of service area) appears	Is the product within the service area or where signal is good enough?	P.54
	Is the built-in antenna covered with finger, etc.?	P.47
	Is a card inserted other than the correct au IC card?	P.47
Cannot operate the keys panel	Is the power turned on?	—
	Is the product still locked?	—
	Turn off the power and then turn it on again.	—
The Pointer does not move as intended	Check the correct way for using the Pointer.	P.48
	Close the product and then open it again.	—
	Turn off the power and then turn it on again.	—
A message indicating that charging is necessary is displayed	The battery is almost empty.	P.54

Trouble	Detail	Page
The product answers calls when it shouldn't	Is Auto answering set?	P.54
The battery pack can only be used a short time	Is it adequately charged? • Charge until the red charging/notification indicator goes out.	—
	Is Battery care mode still set?	P.102
	Does the battery pack have adequate service life remaining?	P.29
	Is the product left in the place for a long period where "📶" (out of service area) appears?	P.54
When making a call, there is a busy signal and the call does not go through	Is the product within the service area or where signal is good enough?	P.54
	The wireless line is extremely busy or the party is calling. Retry later.	—

Trouble	Detail	Page
There is no TV (1Seg) display / picture stops / audio stops / picture is snowy	Is the battery low?	P.54
	Is the digital terrestrial TV broadcast signal adequate?	P.96
	Does the location where you are watching match the selected region?	P.96
	Is the product at a normal temperature? The product may stop functioning if at a high/low temperature.	P.25
Camera does not operate	Is the battery low?	P.54
	Is the product at a normal temperature? The product may stop functioning if at a high/low temperature.	P.25
FM radio is not tuned/ Can hear a noise	Is the product connected to a separately sold earphone or conversion adapter, etc.? Since a cable such as earphones functions as FM radio antenna, be sure to connect it.	P.99
	You may hear a noise depending on the reception environment or cable conditions, or while charging.	P.99

If symptoms do not improve after checking each of the above, information is provided through "トラブル診断" (Japanese) of au homepage:

<https://www.au.com/trouble-check/>

## 位置検索サポート (Location Search Support)

You can use 位置検索サポート (Location Search Support) to have the Customer Service Center find your au phone's approximate location or lock the screen or Osaifu-Keitai if misplaced or lost.

### ■ Calling the Customer Service Center and Searching Location or Remotely Locking/Unlocking the Product

From a fixed-line phone, ☎0077-7-113 (toll free)

From an au cell phone, 113 without area code (toll free)

Business hours: 24 hours (7 days a week)

- Follow voice guidance to complete procedure.

### ■ Switching Location Search Setting

The locationing setting on the product is preset to "Allow" to allow it to be found.

You can switch the locationing setting to "Disallow" in the following operations.



**1** From the standby screen, press  → [Settings] → [More settings] → [Location]

**2** [Easy-to find Your Device Service] → [Allow]/[Disallow]



### memo

© For details, refer to "取扱説明書 詳細版 (Full Instruction Manual)" (Japanese). "取扱説明書 詳細版 (Full Instruction Manual)" (Japanese) is available on the au homepage.

## After-Sales Service

### When Asking for Repair

For repair, contact Repair and Delivery Support Center.

During the warranty period	Repairs will be done based on the terms of services of the free-of-charge repair warranty.
Outside the warranty period	We shall repair the product for a charge as requested by the customer if repair renders it usable.

\* The warranty period is one year from the day when you purchase the product.



### memo

- © Before handing in the product for repair, make a backup of the contents of memory since they may disappear during repair. Note that the Company shall not be liable for any damages and loss of income should the contents of memory be altered or lost.
- © Recycled parts that meet the Company's quality standards are sometimes used for repair.
- © au cell phones collected by Replacement cell phone delivery service which you used before are recycled to cell phones for replacement after repairs. Also parts replaced by au after-sales service are collected and recycled by the Company. They are not returned to customers.

- ◎ Instances where the product has been changed, modified, or analyzed (including software modification or analysis (including rooting, etc.) reverse-engineered, reverse-compiled, or reverse-assembled) or has been repaired at a location other than an authorized repair location designated by the Company may not be covered by warranty or may prevent the product from being accepted for repairs.
- ◎ The battery pack is not covered by the free-of-charge repair warranty except for events arising from defects in battery materials and manufacturing.

### ■ Performance Parts for Repair

The Company retains performance parts for repair of the product main unit and its peripherals for 4 years after discontinuation of production. Performance parts for repair refers to parts required for maintaining the functions of the product.

### ■ Terms of Services of Free-of-Charge Repair Warranty

1. When you apply for repair, inform us of your serial number (IMEI number). You can check the main unit or the sticker attached on the packaging box for the serial number (IMEI number).
2. Repairs will be done based on the terms of services of the free-of-charge repair warranty when the product is used correctly based on the instruction manual and the product is malfunctioning.
3. Repairs will be charged in the following cases even during the warranty period. (Also, the product cannot be repaired in some cases.)
  - ① When the product is not used correctly based on the instruction manual.
  - ② When the product is malfunctioning or damaged due to modification and repair.
  - ③ When the product is repaired by repair offices other than the company specified.
  - ④ When the product is malfunctioning or damaged due to a handling fault or accident. Or when there are some traces that the product is damaged by falling, water or humidity.
  - ⑤ When the product is malfunctioning or damaged due to earthquakes, storms, floods or other natural disasters, as well as fires, salt, abnormal voltage, etc.

4. Repairs may be refused depending on the damage condition of devices.
  5. Note that the company shall not be liable for any damages and loss arising from the product malfunction.
  6. The Company assumes no responsibility for any accidents when the product is connected with an unspecified device.
  7. On-site repair is not available.
  8. This warranty is valid only in Japan. (This warranty is valid only in Japan.)
- \* The warranty guarantees that free-of-charge repairs will be done based on the terms of period and conditions indicated above. Therefore, the warranty does not limit your legal rights against persons in charge of the warranty and other operators.

### ■ Repair and Delivery Support

An after-sales service membership program on a monthly basis called "Repair and Delivery Support" (monthly fee: 380 yen, tax excluded) is available for using your au cell phone for a long time without worries. This service expands coverage for many troubles including malfunction, theft and loss. For details of this service, check on the au homepage or contact Repair and Delivery Support Center.



### memo

- ◎ You can apply for membership only at the time of purchasing your au cell phone.
- ◎ Once you cancel the membership, you cannot reapply for it until you purchase an au cell phone next time.
- ◎ Note that when changing the model or purchasing an extra cell phone, this service only covers the most recently purchased au cell phone.
- ◎ When an au cell phone is handed over to you or someone else, the "Repair and Delivery Support" membership is also handed over to the successor of the cell phone.
- ◎ When you get a new au cell phone by changing the model, purchasing an extra cell phone, etc., the "Repair and Delivery Support" membership for the old au cell phone is automatically canceled.
- ◎ Service contents are subject to change without notice.

### ■ au IC Card

The au IC card is lent to you by au. In case of loss or damage, the card will be replaced at your expense. When malfunction is suspected, or in case of theft or loss, contact an au shop or PiPit.

## ■ au After-Sales Service Information

Service contents			Repair and Delivery Support	
			Member	Non-member
Replacement cell phone delivery service	Spontaneous failure	1st year	Free	
		2nd year and later	Refer to the table of the service charge in "Replacement cell phone delivery service" (Member) service charge.	
	Partial damage, water soak, irreparable damage, theft and loss			

Service contents			Repair and Delivery Support	
			Member	Non-member
Holding over and repair	Spontaneous failure	1st year	Free	Free
		2nd year and later	Free of charge (three-year warranty)	
	Partial damage		Customer charge Upper limit 5,000 yen	Actual cost
	Water soak and irreparable damage		Customer charge 10,000 yen	
Theft and loss		N/A	N/A (By model replacement)	

\* Charge amounts are all tax excluded

■ "Replacement cell phone delivery service"  
(Member) service charge

Applicable condition	1st	2nd
Normal	5,000 yen/ Long Benefit*1 3,000 yen	8,000 yen/ Long Benefit*1 6,000 yen
Applied both "WEB割引 (Discount for web application)" *2/"代用機な し割引 (Discount for nonuse of substitute)" *3	4,000 yen/ Long Benefit*1 2,000 yen	7,000 yen/ Long Benefit*1 5,000 yen
Applied only "代用機なし 割引 (Discount for nonuse of substitute)" *3	4,500 yen/ Long Benefit*1 2,500 yen	7,500 yen/ Long Benefit*1 5,500 yen

\* Charge amounts are all tax excluded

- \*1 Customers in 3rd year (25 months) of subscription or all subscription lines in a family discount plan to which the customer belongs are eligible. Customers using a data communication device or tablet are eligible if they are subscribing to a set discount plan (WIN Single Set Discount Service or Smartphone Set Discount) and the subscription for the line covered under the set discount is in its 3rd year.
- \*2 WEB割引 (Discount for web application): If you apply "交換用携帯電話機お届けサービス (Replacement mobile phone delivery service)" from the au homepage, 500 yen will be discounted from service charge.  
"代用機なし割引 (Discount for nonuse of substitute)" is applied automatically as the substitution is not available for "WEB割引 (Discount for web application)".
- \*3 代用機なし割引 (Discount for nonuse of substitute): If you do not use the substitution when using "交換用携帯電話機お届けサービス" (Replacement mobile phone delivery service), 500 yen will be discounted from service charge.  
For details, refer to au homepage.

## Online Replacement Service (available 24 hours a day) (Japanese)

\* From the PCs and smartphones only

<https://www.au.com/support/service/mobile/trouble/repair/application/>



### memo

#### Replacement cell phone delivery service

- If you have a problem with your au cell phone, call us to have a replacement one (of the same model and color\*) delivered to your specified address. Please return your old faulty au cell phone within 14 days after the cell phone for replacement is delivered to you.
  - \* If a same-model/-color cell phone cannot be provided, a cell phone for replacement will be provided in a model and color that we specify .
- You can use this service up to twice within one year starting from the day when you first use this service. If you have not used this service over the past one year at the time of your application for this service, the application will be regarded as your first time. If you have, the application will be regarded as your second time.
  - \* For details, refer to au homepage.
- If you use this service for theft and loss, and need to have another au IC card reissued at the same time, 1,900 yen will be required separately for the au IC card reissue fee.

#### Holding over and repair

- Damages and malfunctions intentionally caused by the customer as well as those due to modification (e.g. disassembly, change of parts, painting, etc.) by the customer are not covered by this service.
- You cannot receive a refund for replacement of the outer casing due to stains, scratches, paint removal, etc. on the outer casing.

## SIM Unlock

This product can be SIM-unlocked. SIM-unlocking the product allows other-carrier SIM cards to be used with it.

- Requests can be made for SIM-unlocking on the au homepage or at an au shop.
- Some services, functions, etc. may have restrictions when an other-carrier SIM card is used. The Company does not guarantee operation whatsoever.
- To make settings after SIM-unlocking the product, from the standby screen, press → [Settings] → [More settings] → [About phone] → [SIM card status].
- For details, refer to the au homepage.

<https://www.au.com/support/service/mobile/procedure/simcard/>

## Related Accessories

- **Battery Pack (KYF35UAA)**
- **Back cover (dark navy) (KYF35TLA)**  
Back cover (wine red) (KYF35TRA)  
Back cover (pearl silver) (KYF35TSA)
- **Desktop holder (KYF35PUA)**  
(sold separately)
- **テレビde写真 (Photos on TV) receiver (0603RKA)** (sold separately)
- **au Carrying Case F Black (0105FCA)** (sold separately)  
**au Carrying Case G Black (0106FCA)** (sold separately)  
**au Carrying Case H Black (0107FCA)** (sold separately)

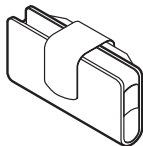

au Carrying Case G Black

- **Common AC Adapter 03 (0301PQA)** (sold separately)  
**Common AC Adapter 03 Navy (0301PBA)** (sold separately)  
**Common AC Adapter 03 Green (0301PGA)** (sold separately)  
**Common AC Adapter 03 Pink (0301PPA)** (sold separately)  
**Common AC Adapter 03 Blue (0301PLA)** (sold separately)  
**Common AC Adapter 05 (0501PWA)** (sold separately)  
**AC Adapter JUPITRIS (White) (L02P001W)** (sold separately)  
**AC Adapter JUPITRIS (Red) (L02P001R)** (sold separately)  
**AC Adapter JUPITRIS (Blue) (L02P001L)** (sold separately)  
**AC Adapter JUPITRIS (Pink) (L02P001P)** (sold separately)  
**AC Adapter JUPITRIS (Champagne Gold) (L02P001N)** (sold separately)
- **Portable charger 02 (0301PFA)** (sold separately)

- **microUSB cable 01 (0301HVA)**  
(sold separately)
- **microUSB cable 01 Navy (0301HBA)**  
(sold separately)
- **microUSB cable 01 Green (0301HGA)**  
(sold separately)
- **microUSB cable 01 Pink (0301HPA)**  
(sold separately)
- **microUSB cable 01 Blue (0301HLA)**  
(sold separately)
- **Flat microUSB conversion adapter 01 (0301QXA)** (sold separately)
- **3.5  $\phi$ -microUSB conversion adapter 01 (0301QNA)** (sold separately)
- **microUSB monaural earphone 01 (0301QLA)** (sold separately)
- **microUSB stereo earphone conversion adapter 01 (0301QVA)** (sold separately)



#### memo

◎ Accessories can be purchased at au online shop.  
<http://auonlineshop.kddi.com/>

## Using a microUSB Earphone

### ■ Using an Earphone (Commercially Available) with a microUSB Stereo Earphone Conversion Adapter 01 (Sold Separately)

An earphone (sold separately) can be used by connecting a microUSB stereo earphone conversion adapter 01 (sold separately).

- 1 Connect the earphone (commercially available) and microUSB stereo earphone conversion adapter 01 (sold separately)**
- 2 Insert the microUSB stereo earphone conversion adapter 01 (sold separately) in the product**

Check the orientation of the microUSB plug of the microUSB stereo earphone conversion adapter 01 (sold separately), and insert in the external connection terminal without bending.



microUSB stereo earphone conversion adapter 01 (sold separately)

Earphone (commercially available)

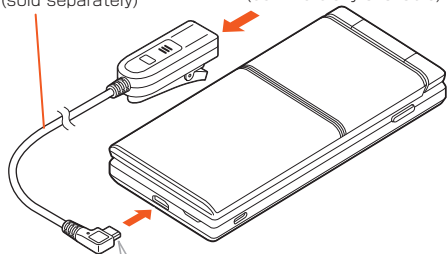

With the projection facing down

### memo

© Depending on the earphone (commercially available), you may not be able to connect it to the microUSB stereo earphone conversion adapter 01 (sold separately).

## ■ Using a microUSB Monaural Earphone 01 (Sold Separately)

Connect the microUSB monaural earphone 01 (sold separately) directly to the product

### 1 Connect the microUSB monaural earphone 01 (sold separately) to the product

Check the orientation of the microUSB plug of the microUSB monaural earphone 01 (sold separately), and insert in the external connection terminal without bending.

### memo

© For inquiries regarding the microUSB monaural earphone 01 (sold separately), visit the au homepage (<http://www.au.com/english/>).

## Receiving a Call

### 1 While receiving a call, press the switch on the microUSB stereo earphone conversion adapter 01 (sold separately) / microUSB monaural earphone 01 (sold separately)

- While receiving a call, hold the switch down for at least 1 second on the microUSB stereo earphone conversion adapter 01 (sold separately) / microUSB monaural earphone 01 (sold separately) to reject the call.
- During a call, press the switch on the microUSB stereo earphone conversion adapter 01 (sold separately) / microUSB monaural earphone 01 (sold separately) to toggle the mute ON/OFF.

### 2 To end the call, hold the switch down for at least 1 second on the microUSB stereo earphone conversion adapter 01 (sold separately) / microUSB monaural earphone 01 (sold separately)

## Main Specifications

### ■ Main unit

Main display	Approx. 3.4 inches, approx.16.77 million colors, Transparent TFT	
	854 × 480 dots (FWVGA)	
Sub-display	Approx. 0.9 inches, 1 color, Organic EL display	
Weight	Approx. 139 g (including the battery pack)	
Dimensions (W × H × D)	Approx. 51 × 113 × 17.2 mm (Thickest part: 17.6 mm)	
Internal memory		ROM: Approx. 8 GB RAM: Approx. 1 GB
Continuous talk time	In Japan	Approx. 670 minutes
	Overseas (GSM)	Approx. 430 minutes
Continuous standby time	In Japan	Approx. 590 hours
	Overseas (GSM)	Approx. 620 hours
Continuous tethering time	Approx. 450 minutes (WAN side LTE)*1	

Maximum number of Wi-Fi tethering connection devices	10 devices	
Charging times (estimate)	Common AC Adapter 05 (sold separately)	Approx. 140 minutes
Effective camera pixels	Approx. 13 million pixels	
Camera imaging element	CMOS	
Wireless LAN (Wi-Fi®) function	IEEE802.11b/g/n compatible	
Bluetooth® function	Compatible version	Bluetooth® standards Ver.4.1 compatible*2
	Output	Class1
	Communication range*3	10 m
	Supported Bluetooth profile*4	GATT (Generic Attribute Profile) SPP (Serial Port Profile) A2DP (Advanced Audio Distribution Profile) AVRCP (Audio/Video Remote Control Profile)

Bluetooth® function	Supported Bluetooth profile*4	HSP (Headset Profile) HFP (Hands-Free Profile) OPP (Object Push Profile) PBAP (Phone Book Access Profile) PAN (Personal Area Networking Profile) PAN-NAP (Personal Area Networking-Network Access Point) PAN USER (Personal Area Networking-User) SCMS-T (Serial Copy Management System-T) DUN (Dial-Up Networking Profile)*5
	Frequency bands	2.4 GHz band
1Seg continuous watching time		Approx. 7 hours and 50 min.

\*1 Measured by a WAN side LTE and Wi-Fi receiver respectively. Wi-Fi is 802.11h. (Measured by data transfer at speeds of TCP 1.2 Mbps for downlinks or its equivalents)

\*2 It is confirmed that the product and all Bluetooth® devices are compliant with Bluetooth® standards designated by Bluetooth SIG, and they are authenticated. However, procedures may differ or data transfer may not be possible depending on the device's characteristics or specifications.

- \*3 It changes according to objects obstructing devices and signal reception.
- \*4 Specifications provided in Bluetooth® standards for making communication between Bluetooth®-compatible devices in accordance with their intended use.
- \*5 Supported for some car navigation systems only. See the au homepage for usage.

### ■ Battery Pack (KYF35UAA)

Battery type	Lithium-ion battery
Rating	3.8 V, 1,700 mAh
Dimensions (W × H × D)	Approx. 42.2 × 64.2 × 5.2 mm
Weight	Approx. 31 g



#### memo

- ◎ The continuous talk time and continuous standby time may drop to less than half depending on the battery charging status, usage environment such as temperature, reception condition at the location where the product is used, and the function settings.

## Specific Absorption Rate (SAR) of Cell Phones

This model KYF35 cell phone complies with Japanese technical regulations for exposure to radio waves and international guidelines on radio wave protection. This cell phone has been designed in observance of the Japanese technical regulations (\*1) regarding exposure to radio waves\* and limits to exposure to radio waves recommended by equivalent international guidelines. These international guidelines were set out by the International Commission on Non-Ionizing Radiation Protection (ICNIRP), which is in collaboration with the World Health Organization (WHO), and the permissible limits include a substantial safety margin designed to assure the safety of all persons, regardless of age and health condition.

The Japanese technical regulations and international guidelines define the limits using a unit of measurement known as the Specific Absorption Rate (SAR), which represents the average amount of radio frequency energy absorbed by the human body. The SAR limit for cell phones is 2.0 W/kg. The highest SAR value for this cell phone when tested for use at the ear is 0.560 W/kg (\*2). The highest SAR value for this cell phone when tested for use on the body is 0.509 W/kg (\*2). There may be slight differences in SAR levels among

individual products, but they all satisfy the limit.

The actual SAR of this cell phone while talking on the phone can be well below that indicated above. This is due to the cell phone being designed to only output the minimum power required to communicate with a base station. Therefore in general, the closer you are to a base station, the lower the power output of the cell phone is.

This cell phone can be used in positions other than against your head. Use a carrying case or similar accessory that holds the phone at least 1.5 cm separated from the body and ensure no metal parts are located between you and the cell phone. Under these conditions, this cell phone satisfies Japanese technical regulations and international guidelines for radio wave protection.

The World Health Organization has stated that "a large number of studies have been performed over the last two decades to assess whether mobile phones pose a potential health risk. To date, no adverse health effects have been established as being caused by mobile phone use".

If you would like to know more detailed information, please refer to the WHO website.

[http://www.who.int/docstore/peh-emf/publications/facts\\_press/fact\\_english.htm](http://www.who.int/docstore/peh-emf/publications/facts_press/fact_english.htm)

Please refer to the websites listed below if you would like to know more detailed information regarding SAR.

---

Ministry of Internal Affairs and Communications website

<http://www.tele.soumu.go.jp/j/ele/index.htm>

Association of Radio Industries and Businesses website

<http://www.arib-emf.org/01denpa/denpa02-02.html>

au homepage

<https://www.au.com/english/>

---

\*1 Technical regulations are defined by the Ministerial Ordinance Related to Radio Law (Article 14-2 of Radio Equipment Regulations).

\*2 This includes the wireless function that can be used simultaneously.

## FCC Notice

This device complies with part 15 of the FCC Rules. Operation is subject to the following two conditions: (1) This device may not cause harmful interference, and (2) this device must accept any interference received, including interference that may cause undesired operation.

Note:

This equipment has been tested and found to comply with the limits for a Class B digital device, pursuant to part 15 of the FCC Rules. These limits are designed to provide reasonable protection against harmful interference in a residential installation. This equipment generates, uses, and can radiate radio frequency energy and, if not installed and used in accordance with the instructions, may cause harmful interference to radio communications.

However, there is no guarantee that interference will not occur in a particular installation. If this equipment does cause harmful interference to radio or television reception, which can be determined by turning the equipment off and on, the user is encouraged to try to correct the interference by one or more of the following measures:

- Reorient or relocate the receiving antenna.



- Increase the separation between the equipment and receiver.
- Connect the equipment into an outlet on a circuit different from that to which the receiver is connected.
- Consult the dealer or an experienced radio/TV technician for help and for additional suggestions.

### Warning

The user is cautioned that changes or modifications not expressly approved by the manufacturer could void the user's authority to operate the equipment.



#### FCC RF EXPOSURE INFORMATION

Warning! Read this information before using your phone.

Warning! Read this information before using your phone. In August 1996, the Federal Communications Commission (FCC) of the United States, with its action in Report and Order FCC 96-326, adopted an updated safety standard for human exposure to radio frequency electromagnetic energy emitted by FCC regulated transmitters. Those guidelines are consistent with the safety standard previously set by both U.S. and international standards bodies. The design of this phone complies with the FCC guidelines and these international standards.

### **Body-worn Operation**

This device was tested for typical body-worn operations with the back of the phone kept 0.39 inches (1.0 cm) from the body. To comply with FCC RF exposure requirements, a minimum separation distance of 0.39 inches (1.0 cm) must be maintained between the user's body and the back of the phone, including the antenna. All beltclips, holsters and similar accessories used by this device must not contain any metallic components. Body-worn accessories that do not meet these requirements may not comply with FCC RF exposure limits and should be avoided. This device is not intended to be used with a lanyard or strap on the body. The device contains a mounting point that may be used to attach the device to equipment, a backpack or tool belt, etc.

### **Turn off your phone before flying**

You should turn off your phone when boarding any aircraft. To prevent possible interference with aircraft systems, U.S. Federal Aviation Administration (FAA) regulations require you to have permission from a crew member to use your phone while the plane is on the ground. To prevent any risk of interference, FCC regulations prohibit using your phone while the plane is in the air.

## **Export Administration Regulations**

This product and its accessories may be subject to the Japan Export Administration Regulations ("Foreign Exchange and Foreign Trade Law" and its related laws). In addition, U.S. Re-export Regulations (Export Administration Regulations and the related laws and regulations) may apply to this product and its accessories. To export and re-export this product and its accessories take the required measures on your responsibility and at your expenses. For details on the procedures, contact the Ministry of Economy, Trade and Industry, the U.S. Department of Commerce.

## Intellectual Property Rights

### Trademarks

Company names and product names referred to in this manual are trademarks or registered trademarks of the respective companies.



TRENDMICRO and VirusBuster are registered trademarks of Trend Micro.

Microsoft®, Windows® and Windows® 7/Windows® 8/Windows® 8.1/Windows® 10 are registered trademarks of Microsoft Corporation in the U.S.A. and other countries.

The official name for Microsoft® Windows® is Microsoft® Windows® Operating System.

Microsoft®, Microsoft® Excel®, Microsoft® PowerPoint®, Windows Media®, and Exchange® are trademarks or registered trademarks of Microsoft Corporation in the United States and other countries.

Microsoft® Word and Microsoft® Office are product names of Microsoft Corporation in the United States.

QR code is a registered trademark of DENSO WAVE INCORPORATED.

The microSD and microSDHC logos are trademarks of SD-3C, LLC.

Bluetooth® and logo are registered trademarks owned by the Bluetooth SIG, Inc., and KYOCERA Corporation is licensed to use those trademarks.

Wi-Fi®, WPA®, Wi-Fi CERTIFIED logo, and Wi-Fi Protected Setup logo are registered trademarks of Wi-Fi Alliance.

Wi-Fi CERTIFIED™ and Wi-Fi Protected Setup are trademarks of Wi-Fi Alliance.

FeliCa is a contactless IC card technology developed by Sony Corporation.

FeliCa is a registered trademark of Sony Corporation.

 is a registered trademark of FeliCa Networks, Inc.

LINE is a trademark or registered trademark of LINE Corporation.

iWnn of OMRON SOFTWARE Co., Ltd. is used for conversion methods for Japanese language, and for phrase prediction methods for English.

iWnn IME©OMRON SOFTWARE Co., Ltd. 2009-2017 All Rights Reserved.



THIS PRODUCT IS LICENSED UNDER THE MPEG-4 VISUAL PATENT PORTFOLIO LICENSE FOR THE PERSONAL AND NON-COMMERCIAL USE OF A CONSUMER FOR (i) ENCODING VIDEO IN COMPLIANCE WITH THE MPEG-4 VISUAL STANDARD ("MPEG-4 VIDEO") AND/OR (ii) DECODING MPEG-4 VIDEO THAT WAS ENCODED BY A CONSUMER ENGAGED IN A PERSONAL AND NONCOMMERCIAL ACTIVITY AND/OR WAS OBTAINED FROM A VIDEO PROVIDER LICENSED BY MPEG LA TO PROVIDE MPEG-4 VIDEO. NO LICENSE IS GRANTED OR SHALL BE IMPLIED FOR ANY OTHER USE. ADDITIONAL INFORMATION INCLUDING THAT RELATING TO PROMOTIONAL, INTERNAL AND COMMERCIAL USES AND LICENSING MAY BE OBTAINED FROM MPEG LA, LLC. SEE [HTTP://WWW.MPEGLA.COM](http://www.mpegla.com).

- (1) ACCESS, the ACCESS logo, and NetFront are registered trademarks or trademarks of ACCESS CO., LTD. in the United States, Japan and/or other countries.
- (2) This software is based in part on the work of the Independent JPEG Group.

The product is equipped with DeepCore® 3.0 Plus by E-Globaledge Corporation as infrared communication function.

Copyright © 2013 E-Globaledge Corp. All Rights Reserved.

The product includes pictograms licensed by NTT DOCOMO, INC.

The product contains fonts provided by LIM Corporation LTD.

"MovieSolid", the function to avoid blurring videos, is a product of Morpho, Inc. "MovieSolid" is a registered trademark of Morpho, Inc.

"Morpho Rapid Effect", the image effect technology, is a product of Morpho, Inc. "Morpho Rapid Effect" is a registered trademark of Morpho, Inc.

"Morpho Effect Library", the image effect technology, is a product of Morpho, Inc. "Morpho Effect Library" is a trademark of Morpho, Inc.

"Suica" and "Mobile Suica" are registered trademarks of East Japan Railway Company.

"Rakuten Edy" is a trademark or registered trademark of Rakuten Edy, Inc.

HELLOPAGE is a registered trademark of NTT.

"どこから電話" is a trademark of SOURCENEXT corporation.

All other company names and product names are trademarks or registered trademarks of respective companies referred to in this manual.

Users of the product are authorized to use software installed into the product described in this instruction manual. Pay attention to the following points when using the software.

- (a) The software installed on this product or part of it may not be altered, delivered, modified, analyzed, reverse-engineered, derived, and any such actions are prohibited.
- (b) Illegally importing the software or a part of it is prohibited.
- (c) This Software is provided without implied warranties of merchantability, fitness for a particular purpose and noninfringement of third party rights.

Note that the existing license agreement takes priority for usage of GNU General Public License (GPL), GNU Library/Lesser General Public License (LGPL) included in software, software based on other open source software license and software that KYOCERA Corporation is licensed.

For information on the Open source software, refer to "Open source software" as follows;

### ■Open Source Software

Note that the existing license agreement takes priority for usage of GNU General Public License (GPL), GNU Library/Lesser General Public License (LGPL) included in software, software based on other open source software license and software that KYOCERA Corporation is licensed. The exact terms of GPL, LGPL and some other licenses are reproduced in "About phone" in this product. For details, refer to Kyocera homepage.

This product includes software copyrighted by KYOCERA Corporation and licensed software. Copyright of the software designed and developed complying with the open source software standard belongs to KYOCERA Corporation or the third parties, distribution, reproduction, transformation and transmission over public lines without consent of KYOCERA Corporation are prohibited, unless you are authorized or permitted by Copyright Law.

### ■Recording diagnosis and usage condition data

KYOCERA Corporation asks for users' cooperation in order to improve the quality of products and services. KYOCERA Corporation records and saves data of failure diagnosis and the usage conditions (application usage by users, log related to error, detail information of application usage by users (specified functions, usage frequency, memory/battery status)) in the product in

order to track and cope with diagnosis events such as unexpected shutdown or system error for the purpose of improvement of quality and services. Those information may be collected upon repair request by user after obtaining the user agreement.

## License

### 【OpenSSL License】

Copyright © 1998-2011 The OpenSSL Project. All rights reserved.

This product includes software developed by the OpenSSL Project for use in the OpenSSL Toolkit. ( <http://www.openssl.org/> )

THIS SOFTWARE IS PROVIDED BY THE OpenSSL PROJECT "AS IS" AND ANY EXPRESSED OR IMPLIED WARRANTIES, INCLUDING, BUT NOT LIMITED TO, THE IMPLIED WARRANTIES OF MERCHANTABILITY AND FITNESS FOR A PARTICULAR PURPOSE ARE DISCLAIMED. IN NO EVENT SHALL THE OpenSSL PROJECT OR ITS CONTRIBUTORS BE LIABLE FOR ANY DIRECT, INDIRECT, INCIDENTAL, SPECIAL, EXEMPLARY, OR CONSEQUENTIAL DAMAGES (INCLUDING, BUT NOT LIMITED TO, PROCUREMENT OF SUBSTITUTE GOODS OR SERVICES; LOSS OF USE, DATA, OR PROFITS; OR BUSINESS INTERRUPTION) HOWEVER CAUSED AND ON ANY THEORY OF LIABILITY, WHETHER IN CONTRACT, STRICT LIABILITY, OR TORT (INCLUDING NEGLIGENCE OR OTHERWISE) ARISING IN ANY WAY OUT OF THE USE OF THIS SOFTWARE, EVEN IF ADVISED OF THE POSSIBILITY OF SUCH DAMAGE.

### 【Original SSLey License】

Copyright © 1995-1998 Eric Young (eay@cryptsoft.com) All rights reserved.

This product includes cryptographic software written by Eric Young (eay@cryptsoft.com)

THIS SOFTWARE IS PROVIDED BY ERIC YOUNG "AS IS" AND ANY EXPRESS OR IMPLIED WARRANTIES, INCLUDING, BUT NOT LIMITED TO, THE IMPLIED WARRANTIES OF MERCHANTABILITY AND FITNESS FOR A PARTICULAR PURPOSE ARE DISCLAIMED. IN NO EVENT SHALL THE AUTHOR OR CONTRIBUTORS BE LIABLE FOR ANY DIRECT, INDIRECT, INCIDENTAL, SPECIAL, EXEMPLARY, OR CONSEQUENTIAL DAMAGES (INCLUDING, BUT NOT LIMITED TO, PROCUREMENT OF SUBSTITUTE GOODS OR SERVICES; LOSS OF USE, DATA, OR PROFITS; OR BUSINESS INTERRUPTION) HOWEVER CAUSED AND ON ANY THEORY OF LIABILITY, WHETHER IN CONTRACT, STRICT LIABILITY, OR TORT (INCLUDING NEGLIGENCE OR OTHERWISE) ARISING IN ANY WAY OUT OF THE USE OF THIS SOFTWARE, EVEN IF ADVISED OF THE POSSIBILITY OF SUCH DAMAGE.

# For inquiries, call:

## Customer Service Center

For general, charge, operations (toll free)

Business hours 9:00 to 20:00 (7 days a week)

From fixed-line phones: | From au cell phones:

 0077-7-111 | 157 area code not required

Pressing "zero" will connect you to an operator,  
after calling "157" on your au cellphone.

---

In case above numbers are not available (for free),

 0120-977-033 (except Okinawa)

 0120-977-699 (Okinawa)

## For service canceling procedure in case of loss or theft (toll free)

Business hours 24-hour (7 days a week)

From fixed-line phones: | From au cell phones:

 0077-7-113 | 113 area code not required

---

In case above numbers are not available (for free),

 0120-925-314

## Repair and Delivery Support Center

For loss, theft or damage (toll free)

Business hours 9:00 to 20:00 (7 days a week)

From fixed-line phones/au cell phones,

 0120-925-919



**キケン!**  
水ぬれ充電

濡れた状態での充電は、  
異常な発熱・焼損などの原因となり  
大変危険です。



モバイルリサイクルネットワーク  
携帯電話・PHSのリサイクルにご協力を。

Cell phone and PHS operators collect and recycle unused  
telephones, batteries and battery chargers at stores  
bearing the  logo regardless of brand and manufacturer  
to protect the environment and reuse valuable resources.

August 2017, 1.1 Edition

Sales: KDDI CORPORATION・OKINAWA CELLULAR TELEPHONE COMPANY

Manufactured by: KYOCERA Corporation

# ■ About stop of LINE push notification service

LINE Corporation will stop the push notification service of this model's LINE app around the end of March 2020.

After the push notification service stopped, you will not be notified the received messages and free calls while LINE app is not running.

You can check received messages and call history when you open the LINE app.

February 28, 2020