

ONE-BOX™ Non-Metallic Outlet Boxes

For new or retrofit construction.

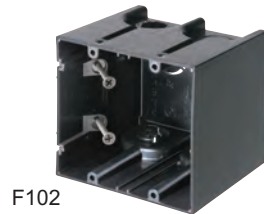

CATALOG NUMBER	UPC/DCI/NAED MFG #018997	DESCRIPTION/ CU. IN.	UNIT PKG	STD PKG	DIM A	DIM B	DIM C
F101	43626	Single Gang Vert. / 22.5	50	50	2.280	3.720	3.510
F101H	43634	Single Gang Horiz. / 22.5	25	25	3.720	2.280	3.500
F102	43640	2-Gang Vert. / 42.0	25	25	4.110	3.740	3.510
F102D	43544	Voltage Divider	25	25	.233	3.560	3.400
F103	43641	3-Gang Vert. / 61.0	25	25	5.930	3.740	3.510
F104	43642	4-Gang Vert. / 80.0	10	10	7.740	3.740	3.510

Add suffix "GC" to Catalog # when ordering in Canada, for example F101GC.



E170558



F101H

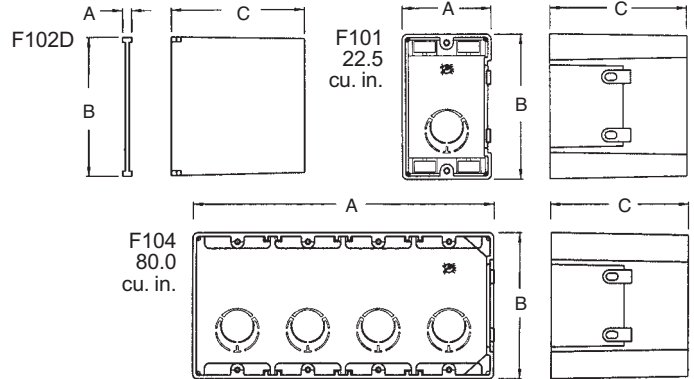

Installation Instructions

F101 NEW CONSTRUCTION

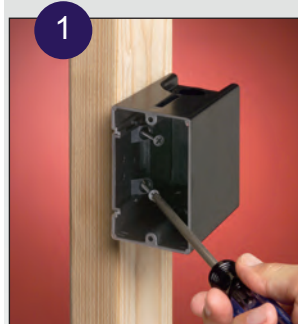

1 Attach ONE-BOX to wood or steel stud with captive installation screws. If the box is too far forward or back, simply back the screws out and reposition.



2 Pull wire through the knockout connector. (Ships with installed NM cable connector.)

MOUNTS DIRECTLY TO WOOD OR STEEL STUD

Features and Benefits

- For a variety of wall thicknesses – the ONE-BOX is removable, adjustable, and remountable even after the wall is in place
- Fast and easy to install
- Mounts directly to a wood or steel stud for a super secure installation
- Angled screws inside the ONE-BOX affix it firmly to the stud
- For both power and low voltage applications with the F102D voltage divider installed

F101 Installation Instructions - RETROFIT

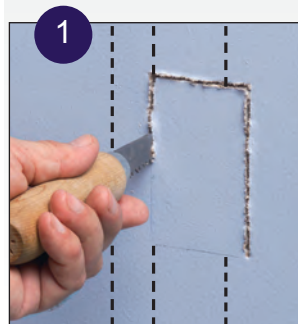

1 For old work, position ONE-BOX adjacent to stud. Use box as the template to cut hole.

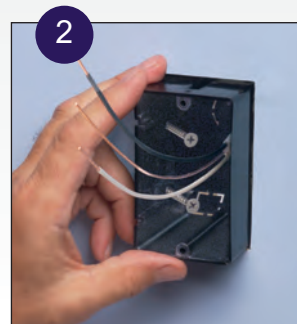

2 Pull wire. Insert ONE-BOX.

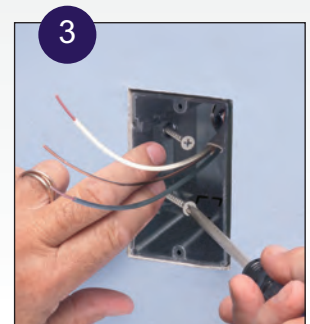

3 Mount ONE-BOX directly to stud with shipped in place screws.



Non-Metallic Outlet Box for New Construction

Adjustable for wall thicknesses from 1/4" to 1-1/2". It's perfect for use when the final wall thickness is unknown. Mounts directly to a wood or steel stud.

CATALOG NUMBER	UPC/DCI/NAED MFG #018997	DESCRIPTION/ CU. IN.	UNIT PKG	STD PKG	DIM A	DIM B	DIM C
FA101	04241	Single Gang / 22.5	25	25	3.720	2.299	3.875
FA102	04242	2-Gang/ 22.5	10	10	3.720	4.111	3.875
FA102D	04245	Voltage Divider	25	25	3.531	3.775	.109
FA103	04243	3-Gang / 65.0	10	10	3.720	5.923	3.875
FA104	04244	4-Gang / 87.0	10	10	3.720	7.735	3.875

Add suffix "GC" to Catalog # when ordering in Canada, for example FA101GC.



E170558 LR49636

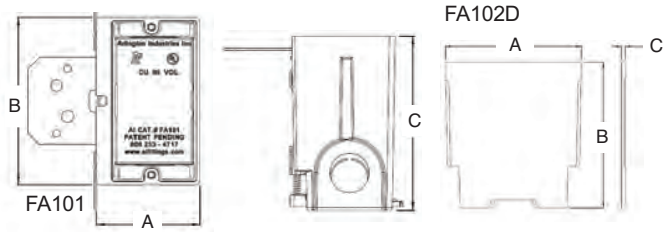

FA101



FA102

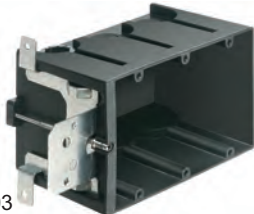

FA103



FA104



FA102D

Features and Benefits

- Fast and easy to install
- No more set back boxes - IN/OUT BOX depth adjusts before OR after the wall finish is done
- Depth adjustment screw is accessible even after the wall finish is in place
- Secure installation - Mounts to wood or steel studs in new construction
- Complies with 2011 NEC, 314.20 for set back boxes
- FA102D low voltage separator for use with multiple gang versions

Installation Instructions



1 Attach IN/OUT BOX to wood or steel stud with captive installation screws. Feed the wires through the knockout.



2 If the box is too far forward or back, simply adjust the depth by turning the screw.

FA101 NEW CONSTRUCTION

MOUNTS DIRECTLY TO WOOD OR STEEL STUD

ONE-BOX™ Vapor Boxes for Devices

Versatile, non-conductive outlet box for new construction. Mounts directly to a wood or steel stud.

New!



F101F



FN102F



F103F



FN104FD

CATALOG NUMBER	UPC/DCI/NAED MFG #018997	DESCRIPTION/ CU. IN.	UNIT PKG	STD PKG	DIM A	DIM B	DIM C	DIM D
F101F	12520	Single Gang Screw-on / 22.0	25	25	5.990	4.500	3.510	.240
F102F	06900	Two-Gang Screw-on / 42.0	10	10	5.990	6.313	3.510	.240
F103F	06901	Three-Gang Screw-on / 59.0	10	10	5.990	8.125	3.510	.240
F104F	06902	Four-Gang Screw-on / 81.0	10	10	5.990	9.937	3.510	.240
FN101F	15130	Single Gang Nail-on / 23.0	20	20	5.990	4.500	3.510	.240
FN102F	15132	Two-Gang Nail-on / 43.5	10	10	5.990	6.313	3.510	.240
FN103F	15134	Three-Gang Nail-on / 63.5	10	10	5.990	8.125	3.510	.240
FN104F	15136	Four-Gang Nail-on / 85.3	10	10	5.990	9.937	3.510	.240
FN101FD*	15131	Single Gang Double Drywall Nail-on / 28.0	20	20	5.990	4.500	4.344	1.312
FN102FD*	15133	Two-Gang Double Drywall Nail-on / 53.0	10	10	5.990	6.312	4.344	1.312
FN103FD*	15135	Three-Gang Double Drywall Nail-on / 77.8	10	10	5.990	8.124	4.344	1.312
FN104FD*	15137	Four-Gang Double Drywall Nail-on / 103.5	10	10	5.990	9.936	4.344	1.312

* For use with double drywall installation and has a Two hour fire rating. Add suffix "GC" to Catalog # when ordering in Canada, for example F101FGC. Refer to Q-1 and Q-2 for additional Vapor Boxes.



E170558

Features and Benefits

- Fast and easy to install
- Mounts directly to a wood or steel stud for a super secure installation
- Flange forms a protective barrier against air infiltration

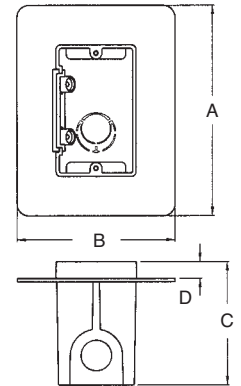

Multi-gang boxes work with the F102D divider

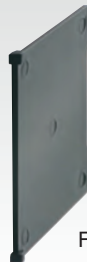

F102D

Features and Benefits

- For both power and low voltage applications with the F102D voltage divider installed

See Page P-7 for Ordering Details.



Recessed Indoor IN BOX™ for New & Retrofit Construction

Non-metallic, recessed electrical boxes with trim plates and wall plates. Low voltage divider included for multiple gang boxes.



DVFR1W

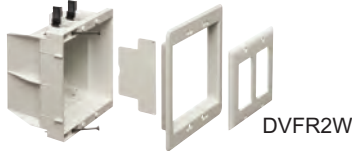

DVFR2W



DVFR3W



DVFR4W

CATALOG NUMBER	UPC/DCI/NAED MFG #018997	DESCRIPTION / CU. IN.	UNIT	STD PKG	DIM A	DIM B	DIM C
DVFR1W	14330	Single Gang / 21.0	1	4	4.200	6.698	.750
DVFR1BL	14329	Single Gang, Black / 21.01	1	4	4.200	6.698	.750
DVFR2W	14331	2-Gang, White / 34.0	1	4	6.012	6.698	.750
DVFR2BL	14335	2-Gang, Black / 34.0	1	4	6.012	6.698	.750
DVFR3W	14340	3-Gang, White / 49.3	1	1	7.930	6.818	3.875
DVFR3BL	14341	3-Gang, White / 49.3	1	1	7.930	6.818	3.875
DVFR4W	14342	4-Gang, White / 64.5	1	1	9.742	6.818	3.875
DVFR4BL	14343	4-Gang, White / 64.5	1	1	9.742	6.818	3.875
DVFRFC	14337	2-Gang, White Cover	10	10	6.012	6.698	1.017
DVFRBLC	14336	Black Cover	10	10	6.012	6.698	1.017

*Includes Voltage Separator for power and/or low voltage.

†Add suffix "GC" to Catalog # when ordering in Canada, for example DVFR1WGC.



E170558 LR49636



DVFRBLC

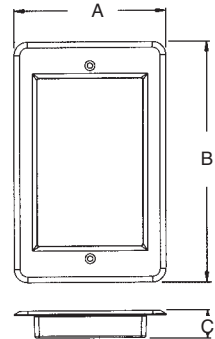
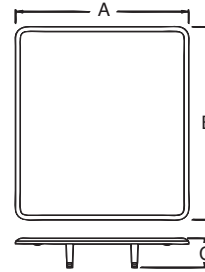

Single Gang Indoor IN BOX includes... Recessed box, trim plate, (1) standard duplex and (1) standard GFCI face plate, (1) NM94 cable connector, (2) mounting screws, and (2) installation screws.

Features and Benefits

- Recessed box allows items, such as furniture, to be placed closer to the wall
- Plugs don't extend past the wall like a regular box
- Trim plate is textured/paintable
- For power or low voltage applications
- Mounting wings hold bracket securely against wall when screws are tightened



New Work... Screws provided for fast and easy mounting to stud



Attractive! DVFR1W shown.



Optional box cover. DVFRFC shown.

Scan For Video



DVFR1W

Scan For Video



DVFR2W



Box positioning tabs are set for 1/2" or 5/8" drywall.

DVFRFC can be used with the following Arlington Boxes...

- DVFR1W
- DVFR1BL
- DVFR2W
- DVFR2BL
- TVBS505
- TVBU505
- TVBU505BL
- TVBR505K

Recessed Steel TV BOX™

New!

For new or existing construction. Metallic recessed combo boxes for power and/or low voltage for class 2 wiring of satellite or cable TV, speakers, etc.

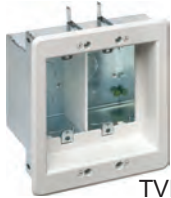

TVBS505



TVBS507



TVBS613

CATALOG NUMBER	UPC/DCI/NAED MFG #018997	DESCRIPTION	UNIT PKG	STD PKG	DIM A	DIM B	DIM C
TVBS505*	37955	2-Gang steel box w/ White non-metallic trim plate	1	1	6.818	6.698	3.937
TVBS507	37956	3-Gang steel box w/ white non-metallic trim plate	1	1	6.818	7.930	3.937
TVBS613	09633	4-Gang steel box with white non-metallic trim plate	1	1	7.000	17.000	3.848
TVBS613BL	09660	4-Gang steel box with black non-metallic trim plate	1	1	7.000	17.000	3.848
TVB613C	09631	4-Gang white cover	5	5	7.000	17.000	.127

*Optional box covers available on page P-9.

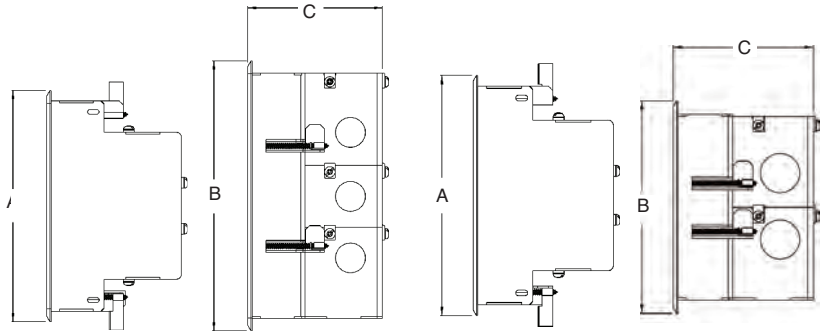

Features and Benefits

- Steel box with non-metallic paintable white or black trim plate
- Easy to install, secure installation
- Mounting wings on two- and three- gang styles hold boxes securely against the wall in retrofit projects
- Boxes screw-mount to stud in new construction
- Two hour fire rating
- Optional covers for unused boxes

Installation Instructions



New Work

Attach box to stud using #6 screws. Pull wires. (New Installation)



Retrofit

Cut a hole using enclosure, without trimplate, as a template. (Mounting wings hold box in wall. Retrofit)



After drywall is installed, add trim plate, then install enclosure assembly to the wall with outer screws.



Finished Installed Shot.

Scan For Video





Multiple Gang Recessed TV BOX™ for Power and Low Voltage

For new or existing construction. Non-metallic, recessed combo boxes for power and low voltage for class 2 wiring of satellite or cable TV, speakers, etc.



TVBU507



TVBU507BL

TVBR505K Kit

Includes: Recessed combo box; (1) tamper-resistant duplex receptacle, (1) CEDH1, (1) CED130, and (1) wall plate.

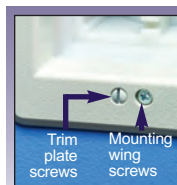
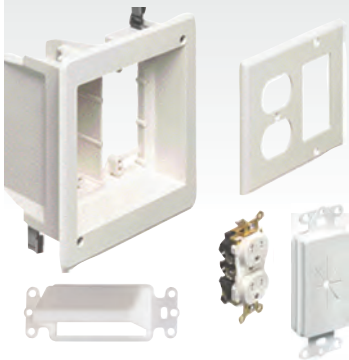

Photo B - Screws

CATALOG NUMBER	UPC/DCI/NAED MFG #018997	DESCRIPTION	UNIT	STD	DIM A	DIM B	DIM C
TVBU505*	90680	2-Gang, White, (1) Power/ (1) LV	1	4	6.942	6.254	3.750
TVBU505BL*	09681	2-Gang, Black, (1) Power/ (1) LV	1	4	6.942	6.254	3.750
TVBR505K*	09682	Kit, 2-Gang, White, (1) Power/ (1) LV	1	4	6.942	6.254	3.750
TVBU507	09661	3-Gang, White, (1) Power/ (2) LV	1	4	7.930	6.818	3.875
TVBU507BL	09662	3-Gang, Black, (1) Power/ (2) LV	1	4	7.930	6.818	3.875

Add suffix "GC" to Catalog # when ordering in Canada, for example TVBU505GC.

*Optional box covers available on page P-9.



E170558 LR49636

Features and Benefits

- Recessed combo box allows you to mount LCD/plasma TVs and other system components flush against the wall
- For new work...Use supplied screws to install on stud. For convenience, box positioning tabs are set for 1/2" or 5/8" drywall
- Trim plate is textured/paintable and covers edges of cut wall surface
- Mounting wings hold bracket securely against wall when screws are tightened
- For walls up to 1-1/2" thick
- Use with Arlington's SCOOP™ series entrance hoods and plates (see pages O-6 to O-8)

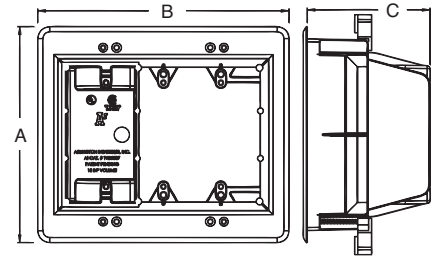

18.0 cu. in. TVBU507

Includes...

Recessed combo box; (1) trim plate; (1) decorator style cover plate; and installation screws.

Installation Instructions - New Work (TVBU507 shown)



1 Attach box to stud. Use tabs for proper positioning of box depth. See 2.



2 Positioning tabs are set for 1/2" or 5/8" drywall.



3 Attach paintable trim plate with screws provided. See Photo B.



4 Tighten mounting wing screws to pull the box securely against the wall board. See Photo B.

Retrofit Work (TVBU507 shown)



1 Using box, without trim plate as a template, mark location. Cut hole.



2 Attach trim plate to box. See Photo B. Pull wire/cables. Install box assembly in opening.

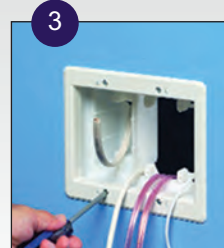

3 Tighten mounting wing screws to pull the box securely against the wall board. See Photo B.



4 TVBU505 with power in one side; low voltage in the other. CED13 (page O-6) used to secure wall plate to box.

Scan For Video



Plastic Recessed TV Box™ with Angled Openings

New!

For new or existing construction. Non-Metallic recessed combo boxes for power and low voltage for class 2 wiring of satellite or cable TV, speakers, etc.

CATALOG NUMBER	UPC/DCI/NAED MFG #018997	DESCRIPTION	UNIT PKG	STD PKG	DIM A	DIM B	DIM C
TVB712	09712	Power and/or low voltage	1	1	10.210	7.561	3.906
TVB713	09713	Power and multiple low voltage openings w/ interchangeable tray.	1	1	17.000	7.000	3.906
TVB613C	09631	4-Gang white cover	5	5	17.000	7.000	.127

Add suffix "GC" to Catalog # when ordering in Canada, for example TVB713GC.



TVB712

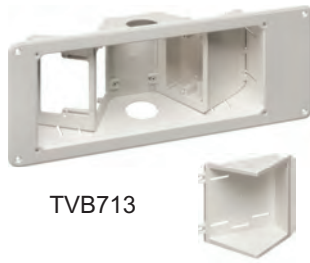

TVB713

E170558

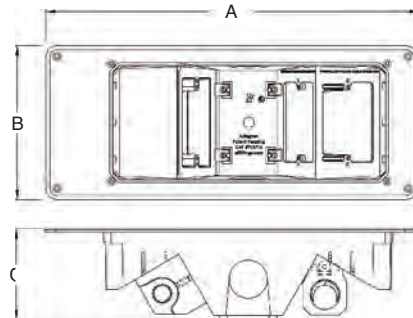

Installation Instructions

Retrofit



Cut a hole using enclosure next to stud. Use box without trimplate, as a template. Pull Wires and insert box in hole.

New Work



Attach box to stud through slotted holes. Use minimum of (2) #6 x 1-5/8" wood screws. Pull wires.



Assemble trimplate. (Retrofit must also use a minimum of (2) #6 x 1-5/8" wood screws in adjacent stud.)



Installed TVB712.



Installed TVB713.

Features and Benefits

- Non-metallic, paintable trim plate
- For new or old work
 - Positioning tabs for 1/2" wall thickness assure accurate placement on stud in new construction
 - For retrofit, use enclosure (without the trim plate) as a template for the wall opening
- Optional covers for unused boxes

Scan For Video





TV BRIDGE™ II Kits

Non-metallic pre-wired, pre-assembled box kits for flat screen TV installations. *New!*

Features and Benefits

- Pre-wired for easy install
- Mounting wing screws hold the boxes secure against the wall
- Plugs and connections stay inside the recessed boxes so TV mounts flush against the wall
- No mess! - wires stay hidden behind the wall

CATALOG NUMBER	UPC/DCI/NAED MFG #018997	DESCRIPTION	UNIT PKG	STD PKG
TVBRA1K	24180	w/ single-gang boxes	1	1
TVBRA2K	24181	w/ 2-Gang power/low voltage box	1	1
TVBRA3K	24195	2-Gang power/low voltage box	1	1
TVB712BK	12781	w/ 2-Gang power/low voltage box (power w/ angled opening)	1	1

*Add suffix "GC" to Catalog # when ordering in Canada, for example TVBRA1KGC.



Specialty Boxes

	TVBRA1K	TVBRA2K	TVBRA3K	TVB712BK
Kits				
Contents	Single gang recessed box containing an outlet is connected to 7 feet of NM cable. Second single gang recessed box connected to the NM cable and includes a pre-wired 4 foot 110V outlet plug, trim, and face plate.	Double gang recessed box containing low-voltage and power outlet connected to 7 feet of NM cable. Second Double Gang recessed box containing low-voltage and power connected to the NM cable and includes a pre-wired 4 foot 110V outlet plug, trim plate and face plate.	Double gang recessed box containing low-voltage and power outlet connected to 7 feet of NM cable. Second single gang recessed box connected to the NM cable and includes a pre-wired 4 foot 110V outlet plug, trim, and face plate.	Double gang recessed box containing low-voltage and an angled power outlet connected to 7 feet of NM cable. Second Double Gang recessed box containing low-voltage and power connected to the NM cable and includes a pre-wired 4 foot 110V outlet plug, trim plate and face plate.

Installation Instructions



Cut Top hole in wall for the TV. Cut Lower hole directly below the top hole, close to existing outlet. Drop the pre-wired device box assembly and cable through the top hole. Insert box and tighten wings.



Pull pre-wired device assembly through the bottom hole.



Attach device box to trim plate with screws provided. Secure trim plate to wall with mounting wing screws. Install CED130 in 2-Gang boxes. Pull cables.



CAM-LIGHT™ BOX for Suspended Ceilings

Offers a great way to install fixtures and smoke detectors (and more) on a suspended ceiling, drywall ceiling or wall.



FL430

Features and Benefits

- Designed to install fixtures and more to a suspended ceiling panel – fast with a 4" hole saw
- Rated up to 50 lbs on a suspended ceiling (or drywall ceiling) in combination with the drop wire for support
- Rated up to 10 lbs on a drywall ceiling without drop wire (not for fixtures)
- Rated up to 7 lbs on walls
- Mounting wings hold box securely against ceiling or wall when screws are tightened
- Box may be turned to any angle for proper inline positioning of exit signs and direct lighting
- White, non-metallic, paintable flange
- Steel box version for use where metal raceways are required
- Steel version installs with 4-1/2" hole saw
- Boxes have 1/2" and 3/4" knockouts
- To install a security camera on this box check out our CAM-KIT™ camera mounting kit (SC5) on page M-4

CATALOG NUMBER	UPC/DCI/NAED MFG #018997	DESCRIPTION/ CUBIC INCH	UNIT	STD PKG	DIM A	DIM B	DIM C
FL430*	09740	Non-Metallic / 27.0	1	10	7.380	3.085	1.331
FL430S	09741	Steel / 24.0	1	10	7.345	2.375	1.688

*Add suffix "GC" to Catalog # when ordering in Canada, for example FL430GC.

Box includes 12' of drop wire, and box. Non-metallic box also includes (2) NM94 cable connectors.



E253895 LR49636



FL430S

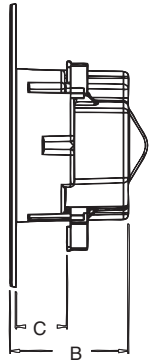
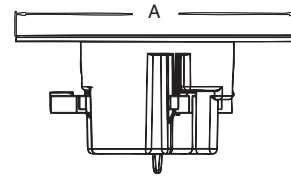

Installation Instructions

FL430 for Fixtures



1 Cut hole in a ceiling grid with 4" hole saw. 4-1/2" for steel.



2 Install CAM-LIGHT™ box. Rotate to desired position. Tighten mounting wing screws.



3 Add drop wire to loop. Attach to framing member above.



4 To Complete: Using the appropriate KO (1/2" or 3/4") install NM94 cable connector (supplied) and pull cable. Install fixture per manufacturer's instructions.

Scan For Video





Power and Low Voltage Box for New Construction

Non-metallic, combination power and low voltage box. For power, phone/cable, and fiber optic installations.



Power Low Voltage

CATALOG NUMBER	UPC/DCI/NAED MFG #018997	UNIT PKG	STD PKG	DIM A	DIM B	DIM C
LVD2	10957	25	25	3.625	5.360	5.000

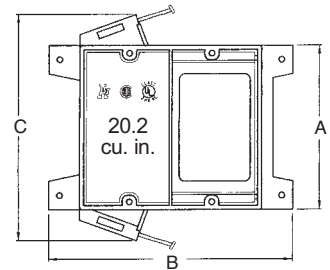

Features and Benefits

- Neatly installs power and phone/cable outlets together, in one location
- Saves time and money
- For wood stud installation, LVD2 features parked in place nails ready for use
- For metal stud installation, LVD2 features screw holes on either side of the front flange (screws not included)
- For raceway, the low voltage side provides a combo 1/2" and 3/4" KO
- Two hour fire rating

Installation Instructions

For New Construction



Simple, Nail On Installation...



or Screw onto Metal Stud!

COMPETITIVELY PRICED!

Power and Low Voltage Box for Existing Construction

Non-metallic, combination power and low voltage box. For power, phone/cable, and fiber optic installations.

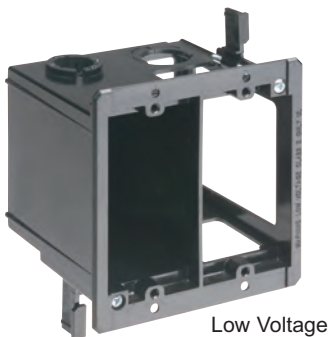

Power Low Voltage

CATALOG NUMBER	UPC/DCI/NAED MFG #018997	UNIT PKG	STD PKG	DIM A	DIM B
LVDR2	01000	25	25	4.250	4.185

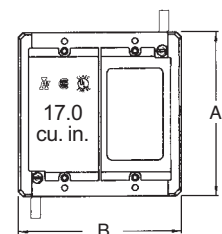

Features and Benefits

- Saves time and money...competitively priced!
- Neatly installs power and phone/cable outlets together, in one location
- Fast and easy installation...bracket is its own template for cut out
- Adjusts to fit 1/4" to 1-1/2" thick wallboard, paneling, or drywall
- For raceway, the low voltage side provides a combo 1/2" and 3/4" KO
- Mounting wings hold bracket securely against wall when screws are tightened
- Includes installed NM connector on power side
- Two hour fire rating

Specialty Boxes

HOLE SAW BOX™ for Device Retrofit Construction 17.6 Cu. In. Volume

Non-metallic, 3-1/4" diameter sconce/device box for existing construction. Fits duplex receptacles and most GFCIs.



Features and Benefits

- Ready to use, easy to install
- 17.6 cu. inch SUPER-SIZE capacity
- No loose parts – self-contained
- Ships with installed NM cable connector and captive fixture bracket installation screws
- Saves time – installs with a 3-1/4" standard hole saw
- Saw teeth cut a path through the drywall for the device screws and hold the device firmly in place
- Rated for light duty 3 lb. fixtures
- Two hour fire rating

CATALOG NUMBER	UPC/DCI/NAED MFG #018997	DESCRIPTION/ ATTACHMENT	UNIT PKG	STD PKG	DIM A	DIM B	DIM C	DIM D
FSC3227R	12525	Retrofit / Screws, Bracket	25	25	4.100	3.220	2.780	1.540



E170558



SAVES TIME!
Quick, super-easy installation with a hole saw.

17.6 cu. in.

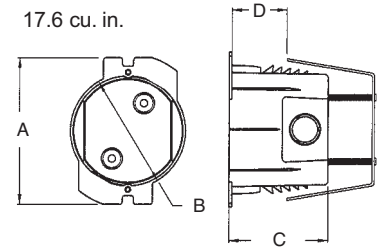

Installation Instructions

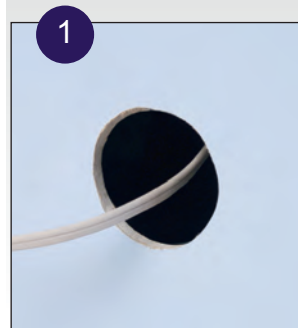

1
Cut hole with a 3-1/4" standard hole saw and pull wire. Push box through drywall. Built-in "teeth" create a path for device screws.

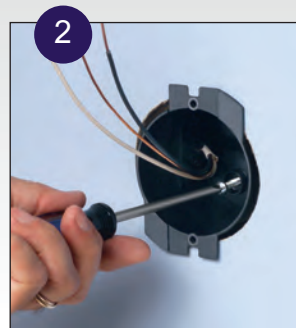

2
Pull NM cable through installed connector. Tighten bracket screws inside box to seat bracket securely against drywall.

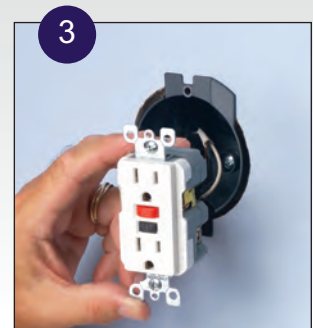

3
Install device (GFCI shown) and not provided maxi-size cover plate.

Small Diameter Sconce Boxes for Retrofit Construction

Non-metallic, 3-1/4" diameter sconce/fixture boxes with large interior volume. 6.8 cu. in.



FSC3212R

CATALOG NUMBER	UPC/DCI/NAED MFG #018997	DESCRIPTION/ ATTACHMENT	UNIT PKG	STD PKG	DIM A	DIM B	DIM C
FSC3212R	43633	Retrofit / Screws, Bracket	25	25	4.280	3.250	1.240



E170558

Features and Benefits

- Ready to use, easy to install
- No loose parts – totally self-contained
- Ships with installed NM cable connector and captive fixture bracket installation screws
- Small diameter allows most sconce light canopies to cover the box, hiding it completely
- For retrofit construction: sconce lights up to 3 lbs.

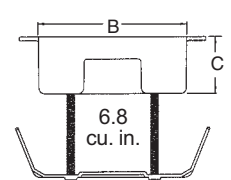
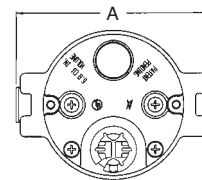

FSC3212R

Installation Instructions

FSC3212R - RETROFIT



Cut hole in drywall. Insert box and bracket. Box is secured by tightening screws that pull bracket against drywall.
FITS DOUBLE DRYWALL OR UP TO 1.90".



USE THIS BOX TO CENTER A SCONCE LIGHT OVER A MIRROR!



One-Piece, Non-Metallic Boxes

Single and 2-gang boxes for retrofit installations. Provides fast installation with a hole saw.

CATALOG NUMBER	UPC/DCI/NAED MFG #018997	DESCRIPTION/ ATTACHMENT	UNIT PKG	STD PKG	DIM A	DIM B	DIM C
FD1RP	75229	Single-Gang / 18.0 cu. in. / 3.5" diam. hole saw	25	25	5.635	3.885	3.085
FD2RP	75301	2-Gang / 31.0 cu. in. / 4.5" diam. hole saw	10	10	5.704	5.454	2.938

Add suffix "GC" to Catalog # when ordering in Canada, for example FD1RPGC.



E170558 LR49636



FD2RP install complete!

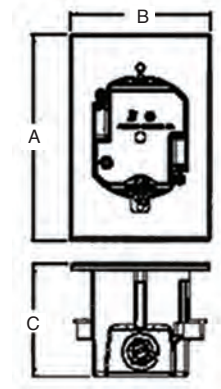

FD1RP



FD2RP

Features and Benefits

- Easiest and fastest installation of a device in a retrofit project
- Single-gang FD1RP installs with a 3.5" hole saw and 2-Gang FD2RP installs with a 4.5" hole saw
- Textured paintable front surface
- Adjusts to fit 1/4" to 1-1/2" wall thicknesses
- Mounting wings hold bracket securely against wall when screws are tightened
- Finishes with any standard, mid-size, or maximum wall plate
- Secure, level device installation
- Includes an installed NM cable connector

Installation Instructions



1 Determine box location. Cut opening with a hole saw; 3.5" for single-gang FD1RP, 4.5" for the 2-gang FD2RP.



2 Pull cable(s) from behind the wall. (Easy cable access is another reason to use Arlington's FDRP boxes.)

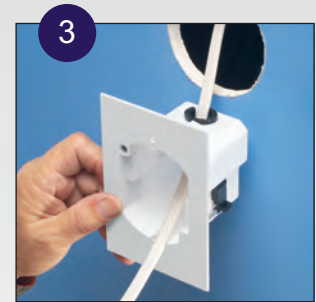

3 Push cable through connector. Insert box into the opening. Shown with single-gang FD1RP.



4 Level the box. Tighten the mounting "wing" screws to pull the box snug against the drywall.



5 If desired, paint front surface to match wall. Install device.



6 Finish with any standard or mid-size wall plate. (Front surface shown unpainted.)

Scan For Video



Specialty Boxes

Non-Metallic and Plated Steel 4x4 Boxes

For retrofit construction. Screw hole patterns for 4x4 and 2-gang devices. Available in non-metallic (black and red plastic) and plated steel versions.

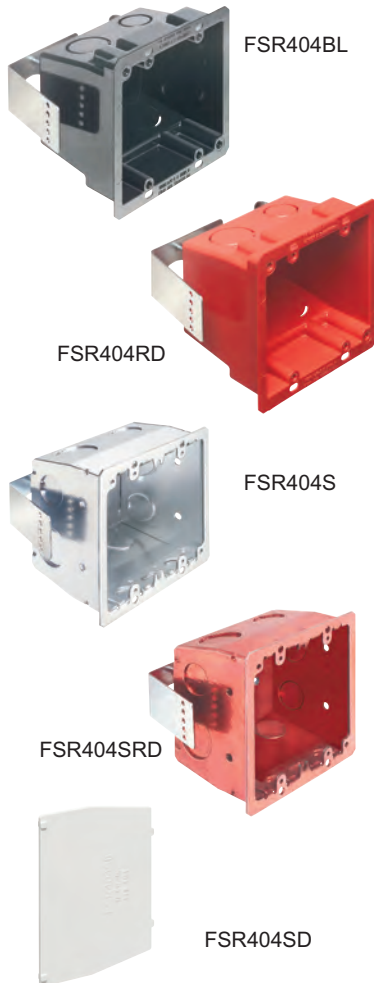

CATALOG NUMBER	UPC/DCI/NAED MFG #018997	DESCRIPTION/ ATTACHMENT	UNIT PKG	STD PKG	DIM A	DIM B	DIM C
FSR404BL	00596	Plastic 4x4 Box, Black	25	25	4.250	4.185	2.796
FSR404RD	00598	Plastic 4x4 Box, Red	25	25	4.250	4.185	2.796
FSR404S*	00597	Steel 4x4 Box, Plated	25	25	4.250	4.185	2.815
FSR404SRD*	00599	Steel 4x4 Box, Red	25	25	4.250	4.185	2.815
FSR404SD*	00600	Steel 4x4 Box, Divider	25	25	3.581	0.141	2.750

*CSA listed.



For wall thicknesses up to 1-1/4" – field modify bracket for thicknesses greater than 1-1/4".

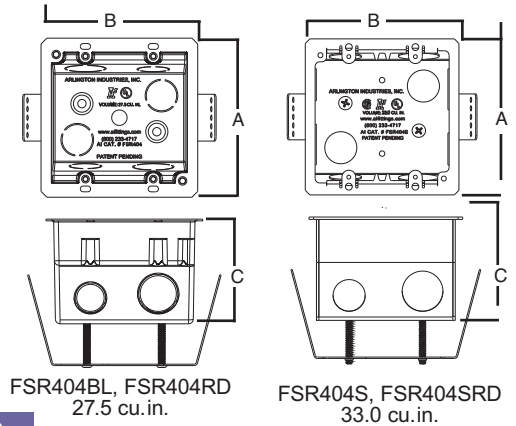

Typical Installation of Low Voltage Fire Alarm Box using Red 4x4 Box

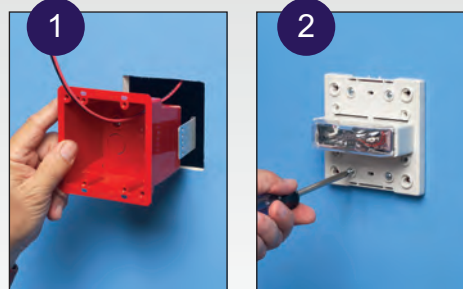

1 Determine position of device. Cut hole. Pull wire(s) through appropriate knockout (connector). Install box in opening. FSR404RD shown.

2 Install fire alarm (or other device) through the screw holes in the box.

Typical Installation of Device using Steel or Black Plastic 4x4 Box

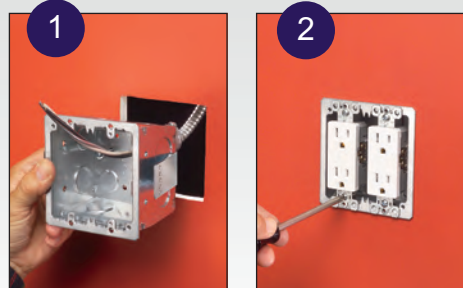

1 Determine position of device. Cut hole. Pull wire(s) through appropriate knockout (connector). Install box in opening. FSR404S shown.

2 Install devices through the screw holes in the box.

Eliminate all this!...

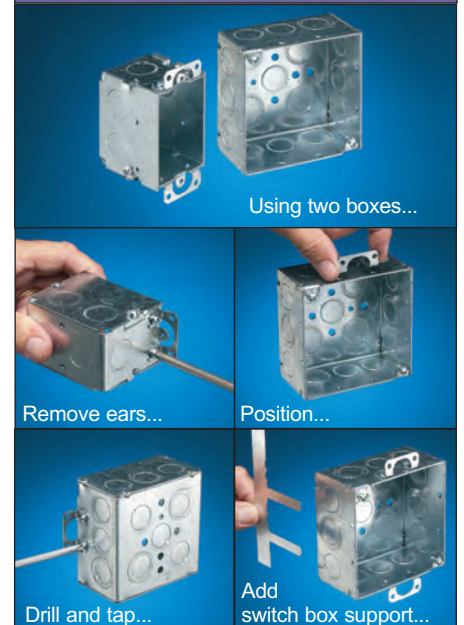

Features and Benefits

- Non-metallic and steel versions in red are ideal for installations of fire alarms or signaling devices
- 1/2" and 3/4" knockouts
- Spring clip holds box securely against wall when screws are tightened
- Weight rating: 6 lbs. for walls; 10 lbs. for ceilings
- Non-metallic boxes include (2) NM94 cable connectors



Gangable Plastic Boxes

New!

Nail and screw-on gangable plastic boxes for new and old work.

CATALOG NUMBER	UPC/DCI/NAED MFG #018997	DESCRIPTION	UNIT PKG	STD PKG	DIM A	DIM B	DIM C
FE102C	01582	Gangable Box Divider	10	10	3.688	3.500	2.686
FE102D	01586	Voltage Divider	25	25	3.476	3.335	.125
FE102E	01585	Gangable End Box	10	10	4.250	3.500	2.236
FEN102	01580	Gangable Nail-On Box	1	10	6.002	3.500	2.609
FER102	01583	Gangable Retrofit Box	1	10	4.258	3.500	2.097
FER102C	01584	Gangable Box Divider	10	10	3.615	3.500	1.812
FES102	01581	Gangable Screw-On Box	1	10	3.688	3.500	2.044

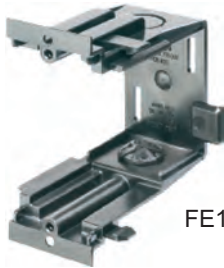

FE102C



FE102D



FE102E



FEN102



E170558

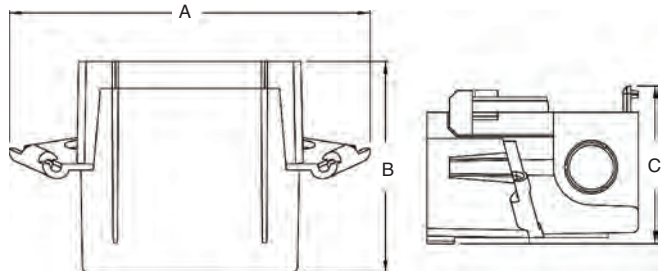

Features and Benefits

- Use a screwdriver to disassemble or separate the parts. Add or remove the center section(s), then snap the pieces back together... fast and easy!
- Great-looking installation of multiple gang boxes
- Nail or screw-on styles for new construction
- For old work, mounting wings hold the box securely against the wall
- UL Listed

Installation Instructions

Assemble



Each section adds one gang to the box. Snap the pieces together to make your desired box. From three to ten gangs.

Disassemble

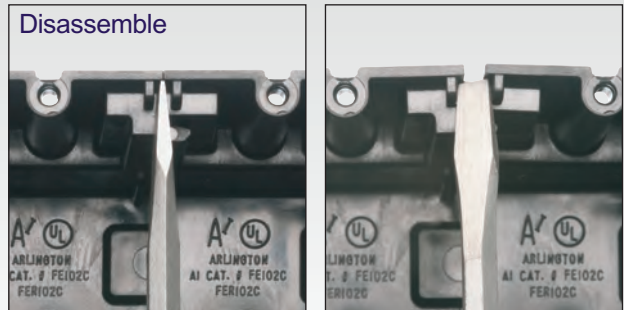

To disassemble or separate the parts, insert a screwdriver between the tabs at the top of the box (on each side) as shown above, and twist.



FES102

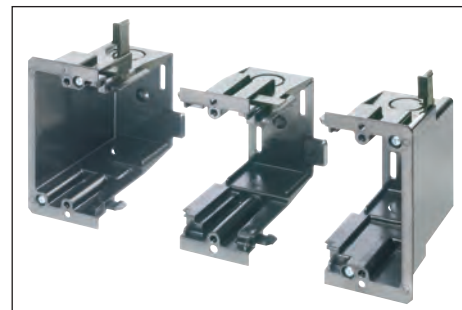

Scan For Video



Specialty Boxes



ONE-BOX™ Side Mount Vapor Boxes for Fixtures *New!*

Economical L-shaped fan/fixture boxes mount securely to joist with a shipped-in-place center screw.



FB442F



FB442FD

CATALOG NUMBER	UPC/DCI/NAED MFG #018997	DESCRIPTION/ CU. IN.	UNIT PKG	STD PKG	DIM A	DIM B	DIM C	DIM D
FB442F	76220	Joist Mount / 15.5	25	25	4.240	3.885	.562	2.948
FB443F	76222	Fan or Fixture / 18.8	25	25	4.240	5.183	.562	4.246
FB442FD*	76221	Joist Mount Double Drywall / 25.0	25	25	4.227	4.635	1.312	2.948
FB443FD*	76223	Fan or Fixture Double Drywall / 28.5	25	25	4.227	5.933	1.312	4.246

* For use with double drywall installation. Add suffix "GC" to Catalog # when ordering in Canada, for example FB442FGC. Refer to chart on page Q-17 for load ratings and number of single conductors. Refer to P-8 for additional Vapor Boxes.



E170558 E170558

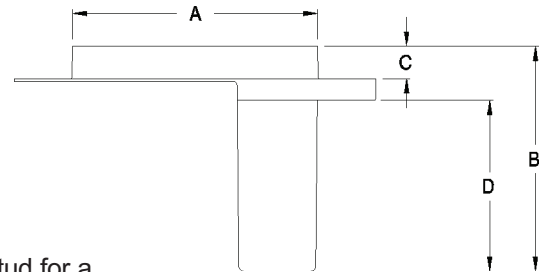

Features and Benefits

- Fast and easy to install
- Mounts directly to a wood or steel stud for a super secure installation
- Flange forms a protective barrier against air infiltration
- Two hour fire rating for Double Drywall version ONLY

Fan/Fixture Boxes

ONE-BOX™ Side Mount Vapor Boxes for Fixtures *New!*

Plastic Vapor Box with Adjustable Steel Bracket for Fans/Fixtures

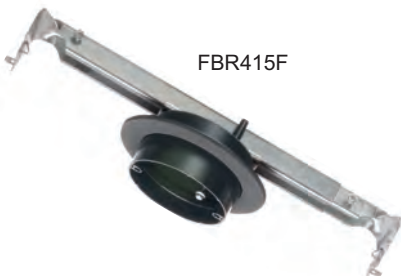

FBR415F



FBR425F

CATALOG NUMBER	UPC/DCI/NAED MFG #018997	DESCRIPTION/ CU. IN.	UNIT PKG	STD PKG	DIM A	DIM B
FBR415F	72204	Joist Mount / 15.5	25	25	2.658	16" to 24"
FBR425F*	72205	Fan or Fixture / 18.8	25	25	3.408	16" to 24"

* For use with double drywall installation. Add suffix "GC" to Catalog # when ordering in Canada, for example FBR415GC. Refer to chart on page Q-17 for load ratings and number of single conductors. Refer to P-8 for additional Vapor Boxes.



E170558 E170558

Features and Benefits

- Fast and easy to install
- Mounts directly to a wood or steel stud for a super secure installation
- Flange forms a protective barrier against air infiltration
- Two hour fire rating for Double Drywall version ONLY

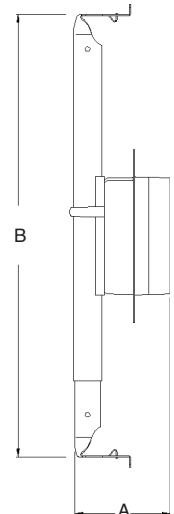

ONE-BOX™ Vapor *New!* Boxes for Fixtures

Versatile, non-conductive Fixture box for new construction. Mounts directly to a wood or steel stud.



F426F



FN430F

CATALOG NUMBER	UPC/DCI/NAED MFG #018997	DESCRIPTION/ CU. IN.	UNIT PKG	STD PKG	DIM A	DIM B	DIM C
F426F	06903	Round Screw-on 28.0	20	20	6.250	4.230	.500
FN430F	15100	Round Nail-on 30.5	20	20	6.250	4.230	.500
FN440F*	15120	Round Nail-on 39.5	20	20	6.250	4.230	1.250

* For use with double drywall installation. Add suffix "GC" to Catalog # when ordering in Canada, for example F426FGC. Refer to chart on page Q-17 for load ratings and number of single conductors. Refer to P-8 for additional Vapor Boxes.

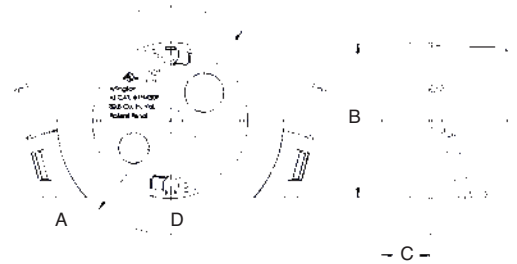

Features and Benefits

- Non-metallic, non-conductive
- Ships with captive mounting screws
- Includes additional gasket material for knockouts
- Two hour fire rating for Double Drywall version ONLY

Steel ONE-BOX™

Designed for new construction or retrofit, side-mounts to a joist for a super secure, fan-rated installation - with no wobble.



CATALOG NUMBER	UPC/DCI/NAED MFG #018997	DESCRIPTION/ STYLE	UNIT PKG	STD PKG	DIM A	DIM B	DIM C
FBS1423	76190	2-3/8" Box Depth / 23.0 Cu. In.	10	10	3.572	4.250	2.375

Mounts on Side of Joist. Refer to chart on page Q-17 for load ratings and number of single conductors.

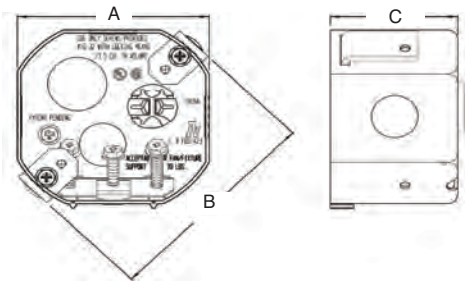

Features and Benefits

- Fast, easy installation.
- Tabs for 1/2" positioning
- Installation screws ship captive
- Installed NM cable connector
- Two # 10 thread holes, including screws for fan
- Two # 8 thread holes, including screws for fixtures.
- UL rated 70 lb. fan/fixture; cUL rated 50 lb.fan/fixture

NEW CONSTRUCTION



RETROFIT





Steel Pan Fan & Fixture Mounting Boxes

Ceiling fan/fixture pan boxes mount directly to a joist for a secure installation. Steel box.



CATALOG NUMBER	UPC/DCI/NAED MFG #018997	DESCRIPTION / CU. IN.	UNIT PKG	STD PKG	DIM A	DIM B
FBS405	76185	For 1/2" or 5/8" Drywall 6.0 Cu. In.	25	25	.570	4.250
FBS407	76187	For 5/8" Drywall 8.0 Cu. In.	25	25	.660	4.250
FBS405T*	40500	For 1/2" or 5/8" Drywall 6.0 Cu. In.	25	25	.570	4.250
FBS407T*	40700	For 5/8" Drywall 8.0 Cu. In.	25	25	.720	4.250

*Fan/fixture mounting bracket attaches to box through threaded openings using provided #10 screws.

Refer to chart on page Q-17 for load ratings and number of single conductors.



E48106 LR49636

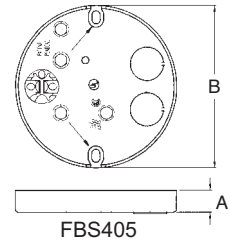

FBS405

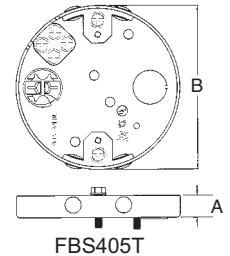

FBS405T

Each fan/fixture box includes...

Installation screws, installed NM cable connector, mud cover, additional KOs, and two screws for fan/fixture bracket installation (screwed in place until removed by installer).

Features and Benefits

- No loose parts to misplace, totally self-contained!
- Center screw is shipped-in-place
- Competitively priced
- Protective plastic tips on the installation screws for added safety
- Plated steel finish
- Combination hex/Phillips head screws for easy installation with power screwdrivers
- Fan/fixture installation screws are "parked"...ready for easy fan/fixture bracket installation!
- UL rated: 70 lb. fan, 200 lb. fixture; CSA rated: 50 lb. fan/fixture

FBS405 Installation Instructions



1

Install FBS405 on joist using shipped-in-place screw near center of box.



2

Remove parked-in-place screws to mount bracket

Drill (2) 1/8" diameter holes into joist through the elongated openings on each side of box. Remove the (2) long screws noted above to mount the fan/fixture bracket.



3

Mount the fan/fixture bracket into the drilled holes. And you're ready to install the fan or fixture.

Note: Install fan or fixture (not included) in accordance with manufacturer's instructions and all local applicable electrical codes, using the parked screws provided.

Steel, Octagonal Fan & Fixture Joist Mounting Boxes

Ceiling fan/fixture boxes mount directly to a joist for a super-secure installation. Two styles. Ships ready-to-install.



FBS415



FBS415S

CATALOG NUMBER	UPC/DCI/NAED MFG #018997	DESCRIPTION / STYLE	UNIT	STD	DIM A	DIM B	DIM C	DIM D
FBS415	75204	1-1/2" Box Depth 14.6 Cu. In. Mounts Under Joist	25	25	4.250	3.572	1.500	-
FBS420	75200	2" Box Depth 20.0 Cu. In. Mounts Under Joist	25	25	4.250	3.572	2.000	-
FBS415S	75206	1-1/2" Box Depth 14.6 Cu. In. Mounts on Side of Joist	25	25	4.250	3.572	2.500	6.000
FBS420S	75202	2" Box Depth 20.0 Cu. In. Mounts on Side of Joist	25	25	4.250	3.572	2.500	6.000

Refer to chart on page Q-17 for load ratings and number of single conductors. .



E48106 LR49636

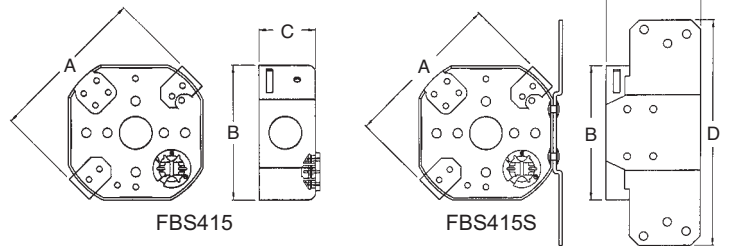

Features and Benefits

- No loose parts to misplace, totally self-contained!
- Combination hex/Phillips head screws for easy installation with power screwdrivers.
- FBS415/FBS420 are UL rated: 70 lb. fan, 200 lb. fixture;
- CSA rated: 50 lb. fan/fixture
- FBS415S/FBS420S are UL rated: 70 lb. fan/fixture; CSA rated: 50 lb.fan/fixture

*FBS415/FBS420
Mount UNDER Joist*

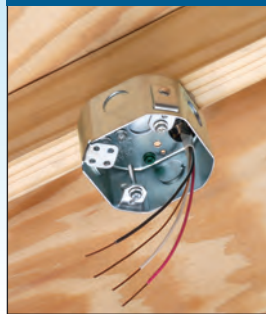

*FBS415S/FBS420S
Mount on SIDE of Joist*



Each fan/fixture box includes...

Installed NM cable connector, mud cover, multiple KOs, four installation screws parked-in-place (ready for installer), and two screws for fan/fixture bracket installation (screwed in place until removed by installer).

Note: Install fan or fixture (not included) in accordance with manufacturer's instructions and all local applicable electrical codes, using the parked screws provided.



Steel Fan & Fixture Mounting Box with Adjustable Mounting Bracket for New Construction

Heavy-duty, plated steel fan/fixture box with fully adjustable mounting bracket. Adjusts from 16" to 24" o.c. spacing.



Features and Benefits

- No loose parts to misplace
- Heavy-duty plated steel construction eliminates fan wobble
- Versatile 16" to 24" on-center positioning
- Bracket preset for 1/2" ceiling thicknesses
- Works on ceilings up to 1-1/4" thick – fully adjustable! For ceiling material greater than 5/8", convenient indicator marks allow you to bend the bracket at the scoreline matching your ceiling depth for a flush ceiling installation.
- Locator tabs included for installation ease
- Fan/fixture installation screws are "parked"...ready for easy fan/fixture bracket installation!
- UL rated: 70 lb. fan/fixture at 24" o.c. and 110 lb. fan/fixture at 16" o.c.;
- CSA rated: 50 lb. fan/fixture

CATALOG NUMBER	UPC/DCI/NAED MFG #018997	DESCRIPTION / STYLE	UNIT PKG	STD PKG	DIM A	DIM B
FBRS415	72250	For up to 1-1/4" ceiling thickness 15.6 Cu. In.	25	25	4.250	3.572

For fan/fixture BOX dimensions, refer to FBS415 on page Q-4.

Refer to chart on page Q-17 for load ratings and number of single conductors.

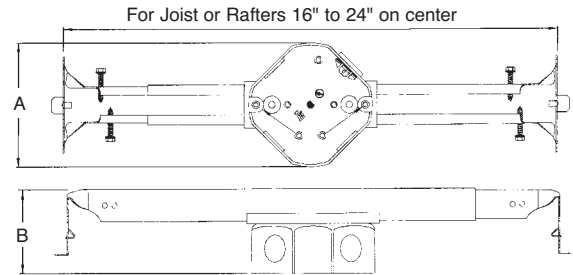

Installation Instructions for 1/2" Ceilings

1. Nail "tooth" to joist to temporarily hold bracket in place.
2. Remove parked screws provided on each side of bracket and use them to attach bracket to joists.
3. Use provided box screw to adjust box position from 16" to 24" on-center between joists.
4. Use provided parked fan/fixture installation screws to install fan/fixture mounting bracket. (Installation of drywall not shown.)

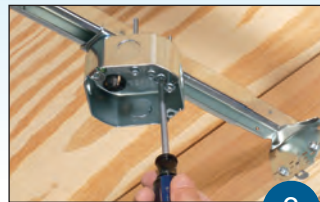
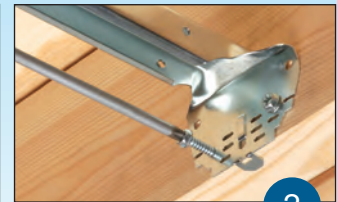
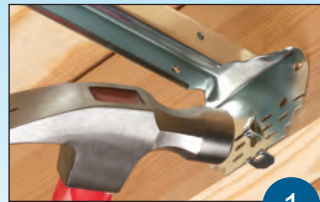

FBRS415 includes...

Box/bracket, screws to adjust box position, installed NM cable connector & mud cover, multiple KOs, four installation screws parked-in-place (ready for installer), and two screws for fan/fixture bracket installation (screwed in place until removed by installer).

Mounts easily and securely between joists...adjusts from 16" to 24" o.c.

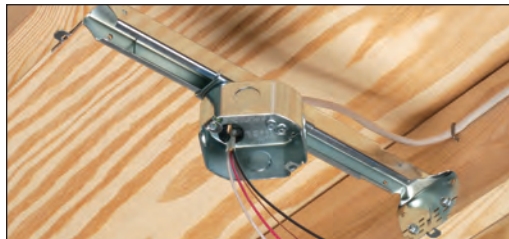

Bend bracket along the scorelines for 3/4", 1", or 1-1/4" ceiling depths!



Note: Install fan or fixture (not included) in accordance with manufacturer's instructions and all local applicable electrical codes, using the parked screws provided.

Steel Fan & Fixture Box Kits for Suspended Ceilings

Plated steel fan/fixture box with adjustable mounting bar. For mounting a fan or fixture on a suspended ceiling grid. FS420SCL and FS427SCL for fixtures only.



FBRS420SC



FS420SCL



FS427SCL

Features and Benefits

- Installs quickly and securely, saves 30 minutes of installation time
- Ships fully assembled
- Comes preset for a 24" grid
- No parts to lose – installation and adjustment screws ship parked in place
- FBRS420SC features breakable, mounting clips to lower box position for ceiling tiles that extend below the grid
- FBRS420SC has "parked" fan/fixture installation screws – ready for easy fan/fixture bracket installation!
- FBRS420SC is UL rated: 70 lb. fan, 70 lb. fixture; CSA rated: 50 lb. fan/fixture
- FS420SCL is UL and CSA rated: 50 lb. fixture
- FS427SCL is UL and CSA rated: 50 lb. fixture

CATALOG NUMBER	UPC/DCI/NAED MFG #018997	DESCRIPTION / STYLE	UNIT	STD PKG	DIM A	DIM B	DIM C
FBRS420SC*†	75300	For Suspended Ceilings 2" Box Depth 20.0 Cu. In.	1	10	4.805	8.343	24.000
FS420SCL	12526	For Suspended Ceilings 2" Box Depth 20.0 Cu. In.	1	10	3.041	3.982	25.000
FS427SCL	12537	For Suspended Ceilings 1-1/2" Box Depth 30.0 Cu. In.	1	10	3.222	3.500	24.000

* Listed for use in environmental air handling spaces per

† Packaged with Wire Grabber™ Kit on page R-2

2011 NEC code requirements 300-22(c).

Refer to chart on page Q-17 for load ratings and number of single conductors.



E48106 LR49636

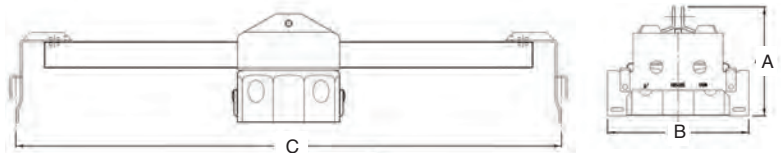

FBRS420SC Installation Instructions



1

1. Cut a 4-1/16" diameter hole in the center of a 24" ceiling tile. Place box over hole. Snap ends of support bar over the ceiling grid.



2

2. Pull cable through installed NM cable connector and remove captive screws for fan/fixture bracket installation.



FBRS420SC Installation Option

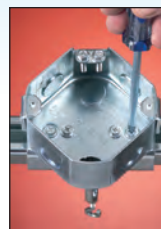

To Mount Box Off-Center: Loosen screws and slide box into position.

Installation with FL430 is even faster and it costs less than our FS420SCL fixture box with adjustable bracket.

Note: Install fan or fixture (not included) in accordance with manufacturer's instructions and all local applicable electrical codes, using the parked screws provided.



Steel Fan & Fixture Box with Adjustable Mounting Bracket for Existing Construction

Heavy-duty, plated steel fan/fixture box with fully adjustable mounting bracket for retrofit installations. Adjusts from 16" to 24" o.c. spacing.



CATALOG NUMBER	UPC/DCI/NAED MFG #018997	DESCRIPTION / STYLE	UNIT PKG	STD PKG	DIM A	DIM B	DIM C
FBRS4200R	75325	2" Box Depth 20.0 Cu. In.	1	10	3.563	3.438	13.979

Refer to chart on page Q-17 for load ratings and number of single conductors.



New Higher Weight Ratings

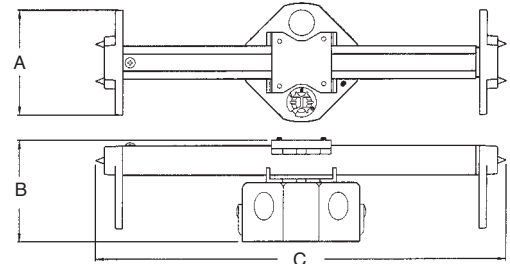

For Joist or Rafters 16" to 24" on center

FBRS4200R includes...
Box/bracket, screws to adjust box position, installed NM cable connector, multiple KOs, and two screws for fan/fixture bracket installation (screwed in place until removed by installer).

Features and Benefits

- No parts to lose – installation and adjustment screws ship parked in place
- Installs quickly and securely between joists or rafters 16" to 24" o.c.
- Fan/fixture installation screws are "parked"...ready for easy fan/fixture bracket installation!
- UL rated: 75 lb. fan, 150 lb. fixture; CSA rated: 50 lb. fan/fixture

Note: Install fan or fixture (not included) in accordance with manufacturer's instructions and all local applicable electrical codes, using the parked screws provided.

Installation Instructions



1. Cut a 4-1/16" diameter hole in ceiling. Remove box from sled and fit mounting bracket into hole. Position bracket between joists, with bracket resting on the ceiling.

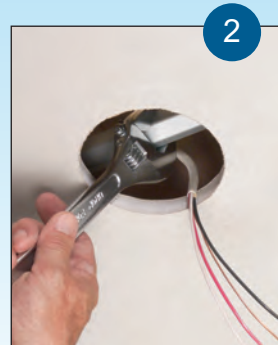

2. Tighten the hex bar with a wrench to secure bracket between joists. As the hex bar is tightened, bracket ends bite into the joists, holding the unit secure.

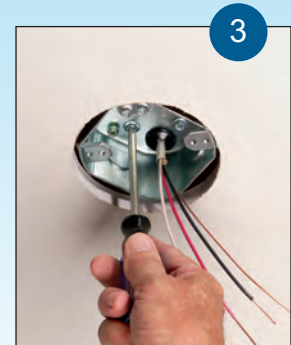

3. Pull cable through installed NM cable connector. Reattach box, and center it in hole. Attach fan/fixture bracket with supplied screws.

Scan For Video



Fan/Fixture Boxes

Steel Fan & Fixture Pan Box with Adjustable Mounting Bracket for Wood I-Joists in Existing Construction

Heavy-duty, plated steel fan/fixture box with fully adjustable mounting bracket. For retrofit installations on wood I-beams or rafters set 16 to 24 inches on-center.



Features and Benefits

- No parts to lose – installation and adjustment screws ship parked in place
- Installs quickly and securely on wood I-beams
- Position the box anywhere along the bracket to center the fan/fixture in the room
- Fan/fixture installation screws are “parked”...ready for easy fan/fixture bracket installation!
- UL rated: 35 lb. fan, 50 lb. fixture; CSA rated: 50 lb. fan/fixture

Note: Install fan or fixture (not included) in accordance with manufacturer’s instructions and all local applicable electrical codes, using the parked screws provided.

CATALOG NUMBER	UPC/DCI/NAED MFG #018997	DESCRIPTION / STYLE	UNIT PKG	STD PKG	DIM A	DIM B	DIM C
FBRS407R	72248	For 1/2" or 5/8" Drywall 8.0 Cu. In.	1	10	3.620	2.098	13.25

Refer to chart on page Q-17 for load ratings and number of single conductors.

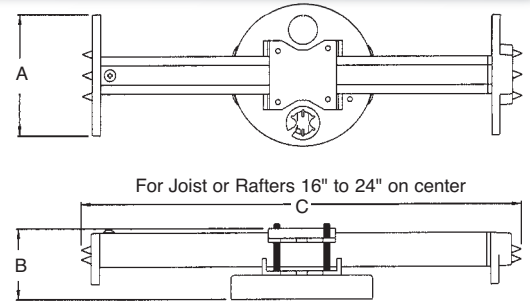

FBR407R includes...

Box/bracket, screws to adjust box position, installed NM cable connector, multiple KOs, and two screws for fan/fixture bracket installation (screwed in place until removed by installer).

Installation Instructions

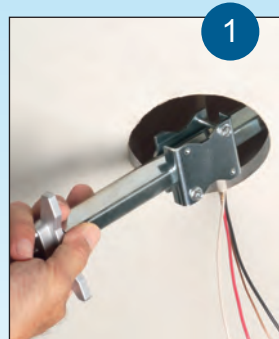

1. Cut a 4-3/8" diameter hole in ceiling. Remove pan box from sled and fit mounting bracket into hole, positioning between wood I-joists with feet resting on ceiling.

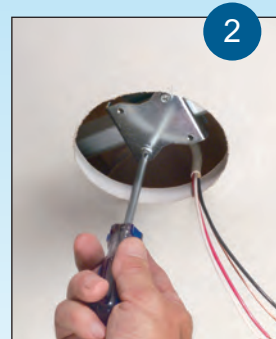

2. Loosen sled screws and slide over to access hex bar. (Note: no need to remove sled.)

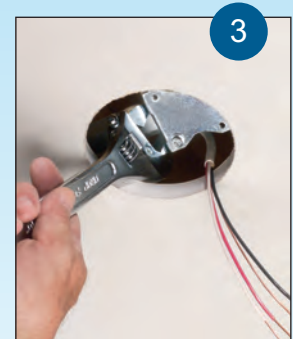

3. Tighten hex bar with a wrench to embed points and secure between I-joists.

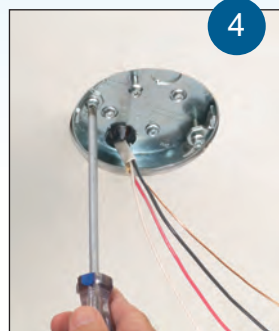

4. Tighten sled to hex in center of hole. Pull cable through NM cable connector and remount box. Attach fan/fixture bracket with supplied screws.

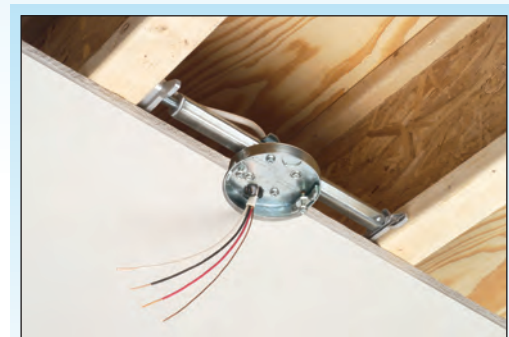

Cut away showing FBR407R installed between wood I-beams



Fan & Fixture Mounting Boxes

Ceiling fan/fixture pan boxes.



Features and Benefits

- No loose parts to misplace – totally self-contained!
- Fan/fixture installation screws are “parked”...ready for easy fan/fixture bracket installation!
- Works well on double joists or wood I-beams
- Combination hex/Phillips head screws for easy installation with power screwdrivers
- Two hour fire rating
- UL rated: 70 lb. fan, 200 lb. fixture; CSA rated: 50 lb. fan/fixture

CATALOG NUMBER	UPC/DCI/NAED MFG #018997	DESCRIPTION / STYLE	UNIT PKG	STD PKG	DIM A	DIM B	DIM C
FB405	72185	For 1/2" or 5/8" Drywall 6.0 Cu. In.	25	25	2.315	.570	4.250
FB4050*	28101	For 1/2" or 5/8" Drywall 6.0 Cu. In.	100	100	2.315	.570	4.250
FB407	72177	For 5/8" Drywall 8.0 Cu. In.	25	25	2.315	.660	4.250
FB4070	28102	For 5/8" Drywall 8.0 Cu. In.	100	100	2.315	.660	4.250

*Bulk packing for lower cost.

Refer to chart on page Q-17 for load ratings and number of single conductors.



E170558 LR49636

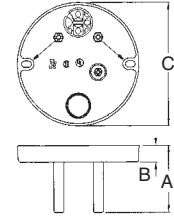

Each fan/fixture box includes...

A ready-to-tighten center screw, installed NM cable connector, mud cover, second KO, and two screws for fan/fixture bracket installation (screwed in place until removed by installer).

Note: Install fan or fixture (not included) in accordance with manufacturer's instructions and all local applicable electrical codes, using the parked screws provided.

Fan & Fixture Mounting Boxes

Boxes accommodate 1/2" or 5/8" drywall with 3/4" furring strips or hat channel.



FB412



FB423

Note: Install fan or fixture (not included) in accordance with manufacturer's instructions and all local applicable electrical codes, using the parked screws provided.

CATALOG NUMBER	UPC/DCI/NAED MFG #018997	DESCRIPTION / STYLE	UNIT PKG	STD PKG	DIM A	DIM B	DIM C
FB412	72189	Pan Box 14.4 Cu. In.	25	25	3.000	1.250	4.250
FB423	72190	Press-On Box 19.5 Cu. In.	25	25	3.000	1.250	4.250

Refer to chart on page Q-17 for load ratings and number of single conductors.



E170558 LR49636

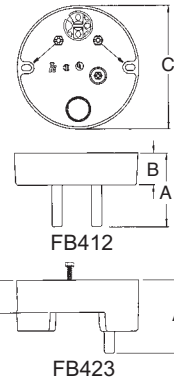

Each fan/fixture box includes...

A ready-to-tighten center screw, installed NM cable connector, mud cover, second KO, and two screws for fan/fixture bracket installation (screwed in place until removed by installer).

FB412



Features and Benefits

- No loose parts to misplace – totally self-contained!
- For use with 1/2" or 5/8" drywall with 3/4" furring strips or hat channel
- Also for double 5/8" drywall
- Attaches securely to joist through shipped-in-place center screw
- Two hour fire rating
- UL rated: 70 lb. fan; 200 lb. fixture; CSA rated: 50 lb. fan/fixture

Fan/Fixture Boxes

Nail On Fan & Fixture Boxes with Steel Mounting Bracket

Plastic box with steel mounting bracket for fast and easy nail on installation to a single or double joist.



FB417S



FB417SLP - Low Profile

CATALOG NUMBER	UPC/DCI/NAED MFG #018997	DESCRIPTION / STYLE	UNIT	STD	DIM A	DIM B	DIM C
FB417S	72171	For up to 1-1/2" ceiling thickness (Including drywall on furring strips or hat channel) 20.0 Cu. In.	25	25	4.563	3.500	4.279
FB417SLP	72199	For 1/2" to 5/8" Ceiling thicknesses only 20.0 Cu. In.	25	25	6.625	2.906	4.570

Refer to chart on page Q-17 for load ratings and number of single conductors.



E170558 LR49636

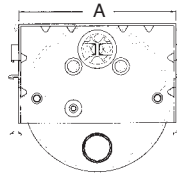

FB417S

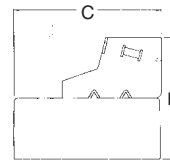

FB417SLP

Each fan/fixture box includes...

Plastic box with steel mounting bracket, installed NM cable connector, mud cover, second KO, two parked-in-place bracket nails, and two fan/fixture bracket installation screws (screwed in place until removed by installer).

Features and Benefits

- No loose parts to misplace – totally self-contained!
- FB417S features convenient indicator marks for 1/2", 5/8", and 3/4" ceiling thicknesses
- Works well on single or double wood joists
- Fan/fixture installation screws are "parked"...ready for easy fan/fixture bracket installation!
- FB417SLP also works with wood and manufactured I-beams
- Two hour fire rating
- UL rated: 70 lb. fan/fixture; CSA rated: 50 lb. fan/fixture

Installation Instructions



Nails to SINGLE JOIST

Saves Time!

Nails to the Joist for a Super Secure Installation!

All photos shown with FB417S



DOUBLE JOIST

Note: Install fan or fixture (not included) in accordance with manufacturer's instructions and all local applicable electrical codes, using the parked screws provided.



Fan & Fixture Mounting Box

Our deepest L-shaped fan/fixture box mounts securely to single or double joists with a shipped-in-place center screw.

Locator posts for positioning of bracket installation screws



CATALOG NUMBER	UPC/DCI/NAED MFG #018997	DESCRIPTION / STYLE	UNIT PKG	STD PKG	DIM A	DIM B	DIM C
FB444	72187	For 1/2" or 5/8" Drywall 25.6 Cu. In.	25	25	5.330	4.000	4.716

Refer to chart on page Q-17 for load ratings and number of single conductors.



E170558 LR49636

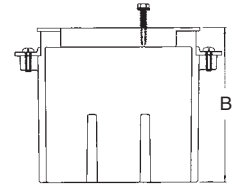
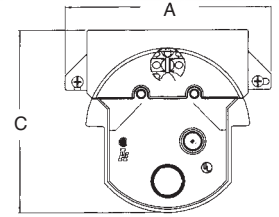

FB444 includes...

A ready-to-tighten center screw, installed NM cable connector, mud cover, multiple KOs, and two screws for fan/fixture bracket installation (screwed in place until removed by installer).

Installation Instructions



1. Position box alongside joist. Tighten center screw, mounting box to joist.



2. Position mounting bracket over locator posts to assure proper position.



3. Remove captive bracket installation screws. Use them to mount fan/fixture bracket.



Optional
If necessary, the bottom of the box can be opened to access wires.



4. Pull wires through knockout. (Installation of drywall not shown.)

Features and Benefits

- No loose parts to misplace – totally self-contained!
- Arlington's deepest fan box!
- Easy wire access
- Locator posts assure proper positioning of fan/fixture bracket
- Fan/fixture installation screws are "parked"...ready for easy fan/fixture bracket installation!
- UL rated: 70 lb. fan, 200 lb. fixture; CSA rated: 50 lb. fan/fixture

Note: Install fan or fixture (not included) in accordance with manufacturer's instructions and all local applicable electrical codes, using the parked screws provided.

Press-On Fan & Fixture Mounting Boxes

The fastest, easiest way to mount fans and fixtures. Ships ready-to-install!



FB415

Features and Benefits

- No loose parts to misplace, totally self-contained!
- Gripping tangs press-hold to the joist while you reach for your screwdriver
- Comes with NM connector installed and mud cover in place
- Fan/fixture installation screws are “parked”...ready for easy fan/fixture bracket installation!
- FB426F’s flanged design forms a protective barrier against air infiltration
- UL rated: 70 lb. fan, 200 lb. fixture; CSA rated: 50 lb. fan/fixture

Note: Install fan or fixture (not included) in accordance with manufacturer’s instructions and all local applicable electrical codes, using the parked screws provided.

CATALOG NUMBER	UPC/DCI/NAED MFG #018997	DESCRIPTION / STYLE	UNIT	STD PKG	DIM A	DIM B	DIM C
FB415	72167	For 1/2" or 5/8" Drywall 10.3 Cu. In.	25	25	2.250	.500	4.250
FB4150*	72182	For 1/2" or 5/8" Drywall 10.3 Cu. In.	100	100	2.250	.500	4.250
FB426	72179	For 1/2" or 5/8" Drywall 16.0 Cu. In.	25	25	2.625	.500	4.250

*Bulk packing for lower cost.

Refer to chart on page Q-17 for load ratings and number of single conductors.



E170558 LR49636

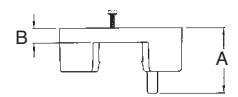
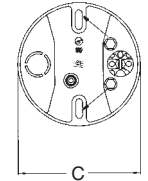

Each fan/fixture box includes...

Press-on box with ready-to-tighten center screw, installed NM cable connector, mud cover, second KO, and two screws for fan/fixture bracket installation (screwed in place until removed by installer).

Installation Instructions

FB415

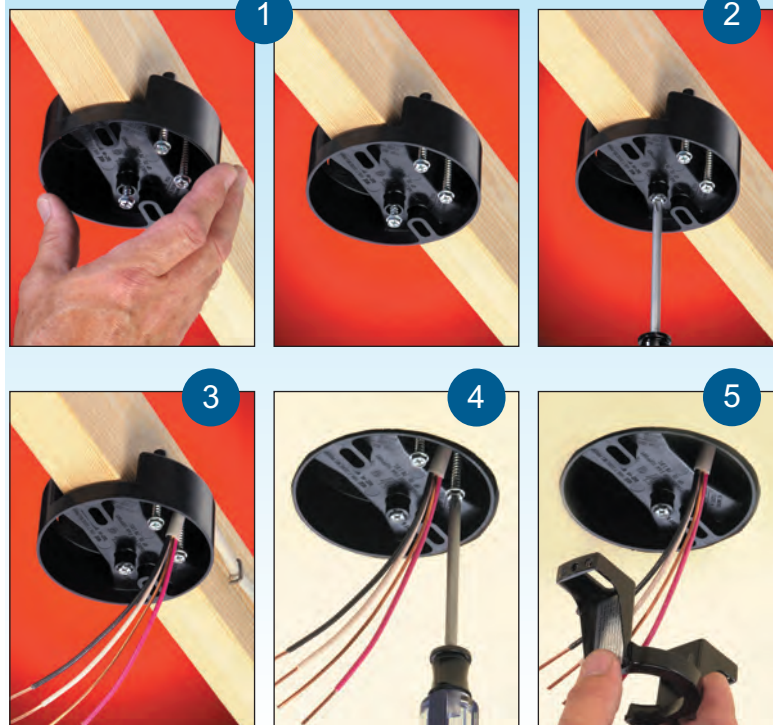

1. Press box onto joist. Gripping tangs hold the box in place temporarily.
2. Tighten center screw to secure to joist.
3. Push NM cable through connector.
4. Remove two long, “parked” screws for installation of bracket.
5. Use the screws to install fan/fixture bracket through the oval slots in the box, directly into the joist.



Fan & Fixture Mounting Boxes

Our lowest cost L-shaped fan/fixture boxes mount securely to single or double joists with a shipped-in-place center screw.

Locator posts for positioning of bracket installation screws



CATALOG NUMBER	UPC/DCI/NAED MFG #018997	DESCRIPTION / STYLE	UNIT	STD	DIM A	DIM B	DIM C	DIM D
FB442	72194	For 1/2" or 5/8" Drywall 13.4 Cu. In.	25	25	4.236	3.773	4.250	3.273
FB443	72197	For 1/2" or 5/8" Drywall 17.96	25	25	4.236	5.071	4.250	4.571

Refer to chart on page Q-17 for load ratings and number of single conductors.



E170558 LR49636

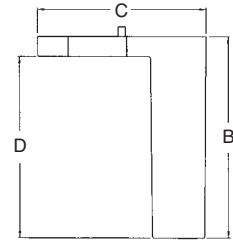
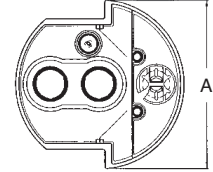

Each fan/fixture box includes...

A ready-to-tighten center screw, installed NM cable connector, mud cover, multiple KOs, and two screws for fan/fixture bracket installation (screwed in place until removed by installer).

Features and Benefits

- No loose parts to misplace – totally self-contained!
- Locator posts assure proper positioning of fan/fixture bracket
- Competitively priced
- Fan/fixture installation screws are “parked”...ready for easy fan/fixture bracket installation!
- UL rated: 70 lb. fan, 200 lb. fixture; CSA rated: 50 lb. fan/fixture

Installation Instructions



1. Position box alongside joist. Tighten center screw, mounting box to joist.



2. Position mounting bracket over locator posts to assure proper position. Pull wires through KO.



3. Remove captive bracket installation screws. Use them to mount fan/fixture bracket. (Installation of drywall not shown.)

Note: Install fan or fixture (not included) in accordance with manufacturer's instructions and all local applicable electrical codes, using the parked screws provided.

Fan & Fixture Mounting Box with Adjustable Brackets for New Construction

Mounts fans and fixtures on cathedral ceilings between two framing members for perfect centering within room.



Features and Benefits

- Expandable brackets hold box securely between joists – no need to cut and nail 2x4s to center the fan or fixture
- Allows fans/fixtures to be perfectly centered within room
- Large, 8" square mounting surface handles newer fans with larger canopies
- No loose parts to misplace – totally self-contained!
- Installs quickly and securely
- Includes a template to level and position brackets between rafters
- Taller sides fit cathedral ceilings with angles greater than 80°
- Paintable, textured finish
- Fan/fixture installation screws are "parked" ...ready for easy fan/fixture bracket installation!
- UL rated: 70 lb. fan/fixture; CSA rated: 50 lb. fan/fixture

Note: Install fan or fixture (not included) in accordance with manufacturer's instructions and all local applicable electrical codes, using the parked screws provided.

CATALOG NUMBER	UPC/DCI/NAED MFG #018997	DESCRIPTION / STYLE	UNIT	STD PKG	DIM A	DIM B
FBX900	75224	Adjustable. Fits Cathedral Ceilings 80° or Greater, 14.5 Cu. In.	1	1	2.300	13.200

For fan/fixture BOX information, refer to FB900 on page Q-15.

Refer to chart on page Q-17 for load ratings and number of single conductors.



E170558 LR49636

FBX900 includes...

Expandable brackets with mounting screws, screws to adjust box position, mounting block with built-in electrical box, installed NM94 cable connector, and two parked-in-place fan/fixture bracket installation screws (ready for installer).

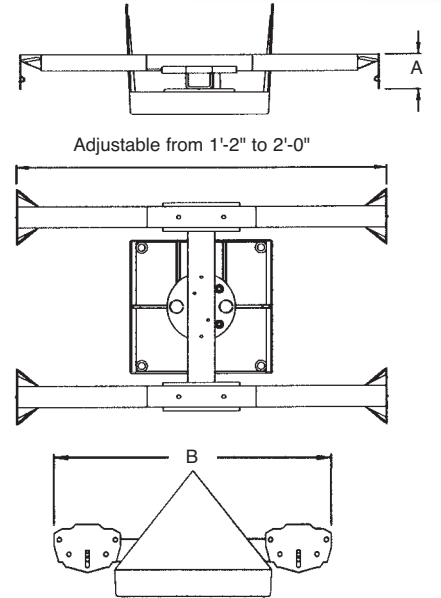

Installation Instructions

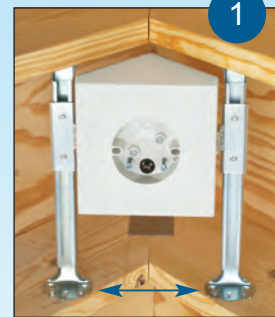
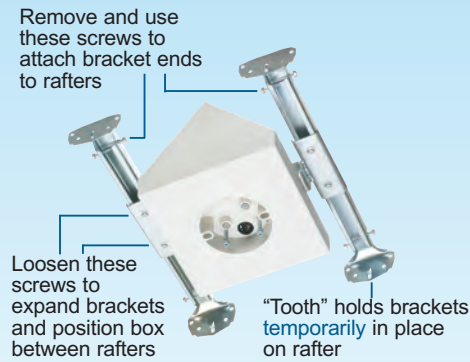

For proper fan/fixture installation, use supplied template to level and position brackets between rafters. Remove captive screws on sides of brackets and use to attach FBX900 assembly to rafters.

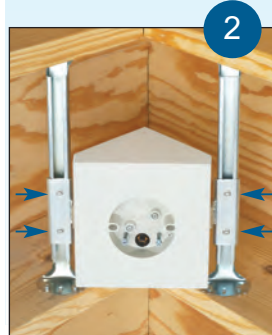

Loosen the screws noted above. Slide box to center it between rafters. Tighten screws. Install wires.

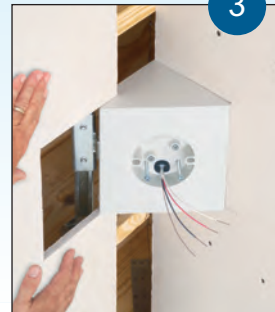

Cut and position drywall to fit around the box. (Note: captive screws in box.) Install fan or fixture per manufacturer's instructions using captive Installation screws.

Scan For Video





Fan & Fixture Mounting Boxes for New Construction

Mounts fans and fixtures on sloped or cathedral ceilings.

CATALOG NUMBER	UPC/DCI/NAED MFG #018997	DESCRIPTION / STYLE	UNIT	STD PKG	DIM A	DIM B	DIM C	DIM D
FB450	75240	Fits Sloped Ceilings up to 45° / 14.5 Cu. In.	1	6	8.000	8.000	9.729	3.875
FB900	75250	Fits Cathedral Ceilings 80° or greater, 14.5 Cu. In.	1	6	8.000	8.000	6.364	3.875

Refer to chart on page Q-17 for load ratings and number of single conductors.



FB450



FB900

THE SIMPLE WAY TO A GREAT FINISH!

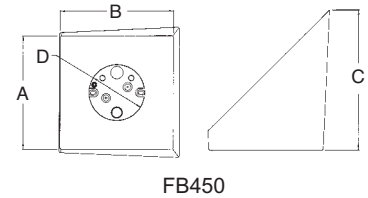

FB450

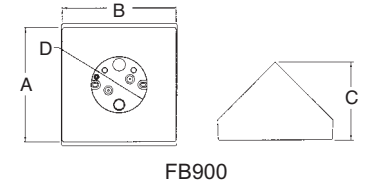

FB900

Each fan/fixture box includes...

Mounting block with built-in electrical box, installed NM94 cable connector, two installation screws ready to tighten, and two parked-in-place fan/fixture bracket installation screws (ready for installer).

Installation Instructions

FB450



Trim a 2x8, approximately 18" long. Allow the panel to extend 9-11" past the FB450.



Install the FB450 on the 2x8 using the (2) #8 x 1-1/2" long parked screws provided.



Score and trim the FB450 as necessary, keeping bottom of box level. (Short side needs to touch rafter.) Trim wood as necessary to butt it to rafter. Nail or screw assembly to rafter.

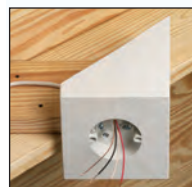

Push the cable through the installed cable connector in the electrical box.

FB900



Cut a 2x4 approximately 14" long to span the pitched rafters.

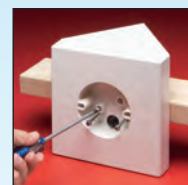

Install the FB900 in the center of the cut 2x4 using the (2) #8 x 1-1/2" long parked screws provided.



Position the 2x4 with the FB900 attached to the angled rafters, keeping bottom of box level, and the short sides of the box touching the angled rafters. Nail or screw the assembly, spanning both angled rafters.



Push the cable through the installed cable connector in the electrical box.

Features and Benefits

- No loose parts to misplace – totally self-contained!
- Large, 8" square mounting surface handles newer fans with larger canopies
- Installs quickly and securely
- FB900 has taller sides to fit cathedral ceilings with angles greater than 80°
- Paintable, textured finish
- Fan/fixture installation screws are "parked"...ready for easy fan/fixture bracket installation!
- UL rated: 70 lb. fan, 200 lb. fixture; CSA rated: 50 lb. fan/fixture

Note: Install fan or fixture (not included) in accordance with manufacturer's instructions and all local applicable electrical codes, using the parked screws provided.

8" Mounting Block

With built-in box for fan and fixture installations.



CATALOG NUMBER	UPC/DCI/NAED MFG #018997	DESCRIPTION / STYLE	UNIT PKG	STD PKG	DIM A	DIM B	DIM C
MB8	42330	Flat Mount 6.1 Cu. In.	1	10	8.000	3.792	.740

Refer to chart on page Q-17 for load ratings and number of single conductors.



E170558 LR49636

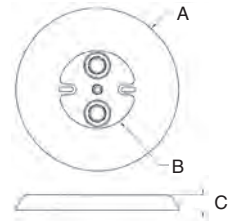

MB8 includes...

Two #10 x 3" wood screws, one #8 x 1-1/2" wood screw, two KOs, and one NM94 non-metallic cable connector.

Features and Benefits

- Ceiling medallion and electrical box combined
- Supports flood lights, smoke detectors, fans, light fixtures - any fixture needing a safe, strong installation.
- UV rated plastic
- For interior or exterior use
- Mounts directly to soffit or ceiling joist without the need to cut ceiling drywall
- Paintable
- UL rated: 70 lb. fan, 200 lb. fixture; CSA rated: 50 lb. fan/fixture

Installation Instructions

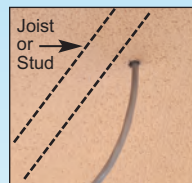

1. Locate the ceiling joist using a stud finder or similar device. Drill a hole approximately 1/2" in diameter, in the ceiling next to the joist. Remove desired knockout. Insert the cable connector into the opening. Pull the NM cable through the connector.
2. Using the #8 x 1-1/2" wood screws provided, mount the MB8 to the joist (through the ceiling).
3. Install the fixture or fan mounting bar (provided with the fixture or fan) directly to the joist with the (2) #10 x 3" wood screws and lock washers provided. Wire the fixture or fan following the instructions included with the product.

Note: Install fan or fixture (not included) in accordance with manufacturer's instructions and all local applicable electrical codes, using the parked screws provided.



Fan/Fixture Box Rating and Number of Single Conductors

CATALOG NUMBER	CUBIC INCHES	UL FAN LOAD RATING (LBS.)	CSA FAN LOAD RATING (LBS.)	UL FIXTURE STATIC RATING (LBS.)	CSA FIXTURE STATIC RATING (LBS.)	# OF SINGLE CONDUCTORS		
						#14	#12	#10
F426F	28.0	-	-	50	50	-	-	-
FB405	6.0	70	50	200	50	3	-	-
FB4050	6.0	70	50	200	50	3	-	-
FB407	8.0	70	50	200	50	4	3	3
FB4070	8.0	70	50	200	50	4	3	3
FB412	14.4	70	50	200	50	7	6	5
FB415	10.3	70	50	200	50	5	4	4
FB4150	10.3	70	50	200	50	5	4	4
FB417S	20.0	70	50	70	50	10	8	8
FB417SLP	20.0	70	50	70	50	10	8	8
FB423	19.5	70	50	200	50	9	8	7
FB426	16.0	70	50	200	50	8	7	6
FB426F	16.0	70	50	200	50	8	7	6
FB442	13.4	70	50	200	50	6	4	4
FB442F	15.5	70	50*	200	50*	-	-	-
FB442FD	25.0	70	50*	200	50*	-	-	-
FB443	17.96	70	50	200	50	8	7	7
FB443F	18.8	70	50*	200	50*	-	-	-
FB443FD	28.5	70	50*	200	50*	-	-	-
FB444	25.6	70	50	200	50	13	11	10
FB450	14.5	70	50	200	50	7	6	5
FB900	14.5	70	50	200	50	7	6	5
FBR415F	18.3	70	50*	200	50*	-	-	-
FBR425F	27.3	70	50*	200	50*	-	-	-
FBRS407R	8.0	35	50	50	50	4	3	3
FBRS415	15.6	70 @ 24" o.c. 110 @ 16" o.c.	50	90 @ 24" o.c. 150 @ 16" o.c.	50	7	6	6
FBRS4200R	20.0	70 @ 24" o.c. 150 @ 16" o.c.	50	70 @ 24" o.c. 150 @ 16" o.c.	50	-	-	-
FBRS420R	20.0	35	50	50	50	10	8	8
FBRS420SC	20.0	70	50	50	50	10	8	8
FBS1423	23.0	70	50	70	50	-	-	-
FBS405	6.0	70	50	200	50	3	-	-
FBS405T	6.0	70	50	200	50	3	-	-
FBS407	8.0	70	50	200	50	4	3	3
FBS407T	8.0	70	50	200	50	4	3	3
FBS415	14.6	70	50	200	50	7	6	6
FBS415S	14.6	70	50	70	50	7	6	6
FBS420	20.0	70	50	200	50	10	8	8
FBS420S	20.0	70	50	70	50	10	8	8
FBX900	14.5	70	50	70	50	7	6	5
FN430F	30.5	-	-	50	50	-	-	-
FN440F	39.5	-	-	50	50	-	-	-
MB8	6.1	70	50	200	50	3	-	-

* cUL listed

Fan/Fixture Boxes



Roof Topper™

New!

Supports raise conduit or raceway 4" - or more - off the roof surface.

CATALOG NUMBER	UPC/DCI/NAED MFG #018997	DESCRIPTION	UNIT PKG	STD PKG	DIM A	DIM B	DIM C	DIM D	DIM E
RTS4	10492	9" W x 5-5/8" H	10	10	9.500	1-5/8	4.000	10.732	6.000
RTS12	10490	9" W x 12" H	5	5	9.500	1-5/8	10.625	11.779	8.870
RTS421	10493	21" x 5-5/8" H	5	5	9.500	1-5/8	4.000	10.732	6.000
RTS1221	10491	21" W x 12" H	5	5	9.500	1-5/8	10.625	11.779	8.870
RTS402	00916	9"W x 4-7/8"H	10	10	10.000	1-5/8	4.185	10.000	6.000
RTSB405	00910	Base only 5"W x 4"H	10	10	5.281	-	4.000	6.530	6.000
RTSB409	00911	Base only 9"W x 4"H	10	10	9.500	-	4.000	10.732	6.000
RTSB1209	00912	Base only 9"W x 10-3/8"H	5	5	9.000	-	10.625	11.779	8.870
RTSE405	00913	Base with strut 5"W x 5-5/8"H	10	10	4.750	1-5/8	4.000	6.530	6.000
RTSE409	00914	Base with strut 9"W x 5-5/8"H	10	10	9.000	1-5/8	4.000	10.730	6.000
RTSE1209	00915	Base with strut 9"W x 12"H	5	5	9.000	1-5/8	10.625	11.779	8.870

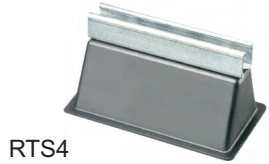

RTS4



RTS12

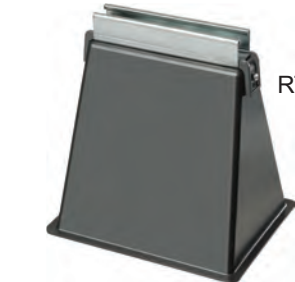

RTSE1209



RTS421



RTS1221



RTS402

Roof Topper ... for sturdy, efficient, reliable support of rooftop conduit!

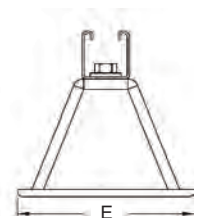
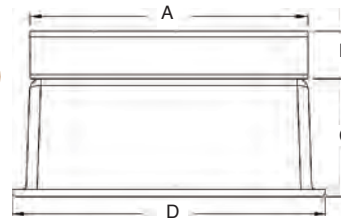

Features and Benefits

- Allows the contractor to comply with 2011 NEC for temperature adjustment for conduit.
- Made of 100% recycled material, the heavy-duty base sits on the roof deck without the need for mechanical fasteners.
- UV resistant
- Most ship assembled with strut and/or threaded rod installed on base
- Supports up to 2,000 lbs



Miscellaneous

Wire Grabber™ *New!* and Kits

Reliable drop wire support when hanging fixture boxes, fixtures, cable tray and other static load items.



FLG3



DWB0805



DWYH0805



DWYT8030



BW580

CATALOG NUMBER	UPC/DCI/NAED MFG #018997	DESCRIPTION	UNIT PKG	STD PKG	LENGTH
DWB0805	06805	Single Kit	1	10	5'
DWB0812	06883	w/ Looped End holds static loads up to	1	10	12'
DWB0815	06815	100 lbs w/ supplied	1	10	15'
DWB0820	06820	.080" wire)	1	10	20'
DWB0830	06830		1	10	30'
DWH0805	15022	Straight Kit with Hooks holds static loads up to	1	10	5'
DWH0810	15023	100 lbs	1	10	10'
DWT0805	15020	Straight Kit with Toggles holds static loads up to	1	10	5'
DWT0810	15021	100 lbs	1	10	10'
DWY2H0810	11312	Two Pack	2	10	10'
DWYH0805	11307	"Y" Kit	1	10	5'
DWYH0810	11308	with Toggles	1	10	10'
DWYH0815	11309	holds static loads up to 100 lbs	1	10	15'
DWYH0820	11310	(w/ supplied	1	10	20'
DWYH0830	11311	.080" wire)	1	10	30'
DWY2T0810	11306	Two Pack	2	10	10'
DWY2T0812	11314	Two Pack	2	10	12'
DWYT0805	11301		1	10	5'
DWYT0810	11302		1	10	10'
DWYT0812	11313	"Y" Kit with Hooks holds	1	10	12'
DWYT0815	11303	static loads up to 100 lbs	1	10	15'
DWYT0820	11304		1	10	20'
DWYT0830	11305		1	10	30'
FLG3	01590	Wire hanger for static loads.	50	50	-
BW562	83775	500' Roll of .062" Galvanized Braided Support Wire	1	4	500'
BW580	21250	500' Roll of .080" Galvanized Braided Support Wire	1	4	500'

Secure grip on wire:

Tightening this screw engages six points of contact on wire. (components)
FLG3 ships fully assembled

Easy to use:

Push wire through connector and out the other side. Loop wire back through connector. Tighten screw.

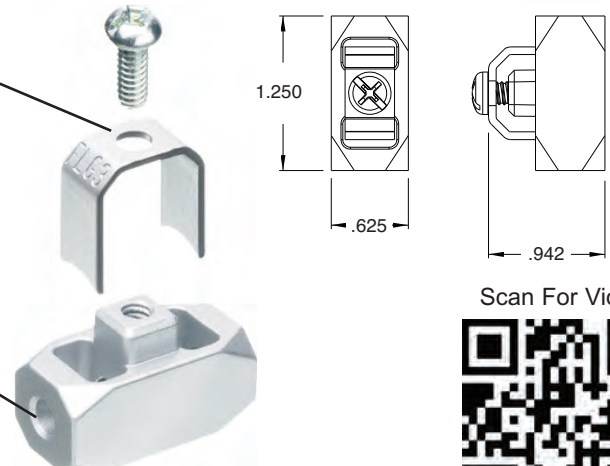

Scan For Video





Snap-on Wire Clip

New!

Galvanized Steel Wire Clip, designed to hold cables/cords securely in place. Ideal for solar panel installation.

CATALOG NUMBER	UPC/DCI/NAED MFG #018997	DESCRIPTION	UNIT PKG	STD PKG	DIM A	DIM B	DIM C
SC100	06300	Plated Spring Steel Wire Clip	100	1000	.484	.375	.731



Features and Benefits

- Wire Clip Capacity:
 - ONE cable: min .160" to max .425"
 - TWO cables: min .160" to max .300"
- Smooth finish on clip prevents cable damage
- Locking tab secures clip onto sheet metal, fits sheet metal frame up to .080" thick
- Easy, time-saving installation

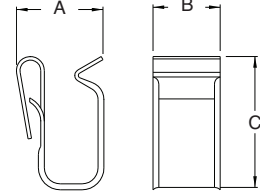

Installation Instructions



Choose the method of attachment that works best for you.



1 Snap Wire Clip onto sheet metal up to .080" thick.



2 Snap one or two USE-2 or PV cables securely in place.

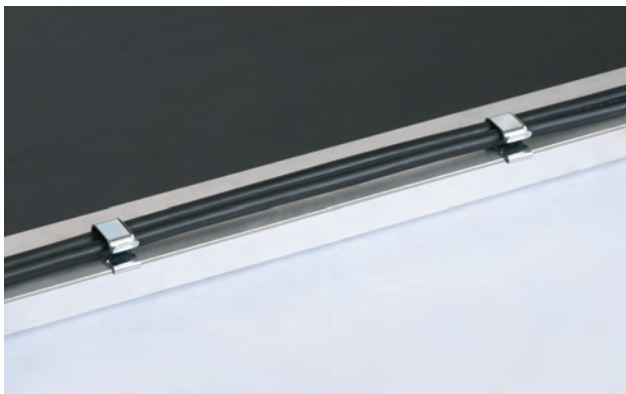

Box Extenders

Levels and supports the wiring device where the box is set back from the wall surface. Extends the box up to 1-1/2".

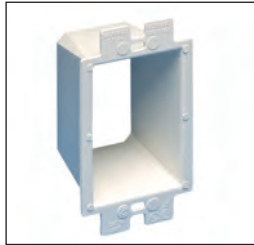

BE1

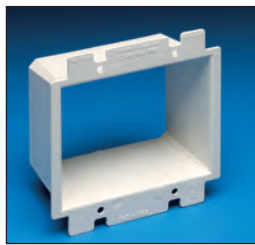

BE2

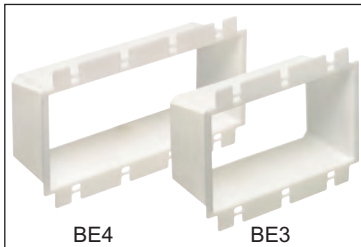

BE4

BE3

Scan For Video



**HEAVY-DUTY PLASTIC,
UL LISTED!**

CATALOG NUMBER	UPC/DCI/NAED MFG #018997	UNIT PKG	STD PKG	DIM A	DIM B	DIM C
BE1	40160	25	250	2.313	4.188	1.813
BE1BAG	51905	1	100	2.313	4.188	1.813
BE2	48960	25	25	4.100	4.188	1.813
BE3	48967	10	10	5.937	4.188	1.813
BE4	48968	10	10	7.749	4.188	1.813

BE1BAG includes two #6 x 2" long screws.



Two Hour Fire Rating

Features and Benefits

- Allows the contractor to comply with 2011 NEC Article 314.20
- Levels and supports the wiring device where the box is set back from the wall surface (adjusts up to a 1-1/2" box extension)
- Works in handy boxes and 4" square electrical boxes with plaster rings for single switches or receptacle
- Functions with all standard devices, switches, and GFCIs
- Manufactured from 105°C continuous use 94V0 rated flame retardant plastic for safer installations

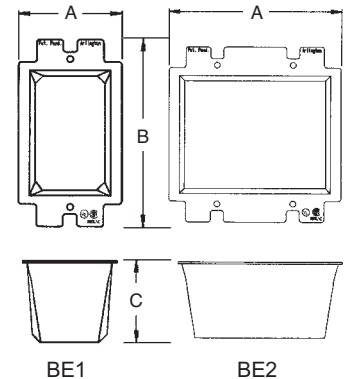

BE1

BE2

Installation Instructions

Problem...
Electrical box set back from wall surface.

To install without removing device wires, tilt the device through the BE1 at a slight angle, straighten it and tighten the screws!

SOLUTION...



1
Pull wires through, then press the BE1 firmly into the electrical box.



2
Attach wires to receptacle. Then tighten screws for a level, fully supported, code compliant installation.

Ceiling Box Extender

For set back ceiling boxes. Fits 3-1/2" and 4" round or octagonal boxes.



CATALOG NUMBER	UPC/DCI/NAED MFG #018997	UNIT PKG	STD PKG	DIM A	DIM B	DIM C
BE1R	40161	25	25	4.850	4.350	1.500



Two Hour Fire Rating

Features and Benefits

- Complies with 2011 NEC Article 314.20
- Extends box up to 1-1/2" to bring it level with ceiling surface
- Trims to accommodate shallow boxes or to avoid obstructions
- Manufactured from 105°C continuous use 94V0 rated flame retardant plastic for safer installations

