

PCE Americas Inc.
711 Commerce Way
Suite 8
Jupiter
FL-33458
USA
From outside US: +1
Tel: (561) 320-9162
Fax: (561) 320-9176
info@pce-americas.com

PCE Instruments UK Ltd.
Units 12/13
Southpoint Business Park
Ensign way
Hampshire / Southampton
United Kingdom, SO31 4RF
From outside UK: +44
Tel: (0) 2380 98703 0
Fax: (0) 2380 98703 9
info@pce-instruments.com

www.pce-instruments.com/english
www.pce-instruments.com



FORCE GAUGE

PCE-FB Series

Contents:

1. Introduction	3
2. Basic Set	3
3. Safety instructions	4
3.1 Main safety rules	4
3.2 Safety rules	5
3.2.1 Transport safety rules	5
3.2.2 Safety rules during mounting	5
3.2.3 Safety rules during start-up and operation	8
3.2.4 Safety rules during conservation	10
3.2.5 Safety rules during disassembly and utilization	10
4. Fast start	11
5. Force meter general view	12
6. Technical data	13
7. Keys and indicators	15
8. Preparing the force gauge for operation	16
9. General rules for use	18
10. Accumulators exchange	19
11. Turning on the force gauge	20
12. Description of measurement methods	21
12.1 Measuring actual and peak value of a pressure/pull force	21
12.2 Force characteristics measurement, measurement registration to memory	23
12.3 Measurement of the mass – using the gauge as scales	24
13. Connecting external devices	27
14. User's Menu	28
14.1 Measurement	28
14.1.1 Measurement speed	29
14.1.2 Units	29
14.1.3 Auto-zeroing	31
14.1.4 Comparison with threshold values MIN / OK / MAX	32
14.2 Memory	33
14.2.1 Gathering results	34
14.2.2 Presentation of collected measurements (Statistics)	35
14.2.3 Save, read, erase memory (Statistics)	35
14.3 Configuration	37
14.3.1 Setting serial ports	38
14.3.2 Force meter calibration	39
14.3.3 Information	39
14.3.4 Setting date and time	41
14.3.5 LCD settings	42
14.3.6 Selecting the menu language	43
14.3.7 Printout settings	44
14.3.8 Turning the sound ON/OFF when using the keypad (beep)	45
14.3.9 Automatic power OFF (Auto-OFF)	45
14.3.10 Monitoring the batteries' charge level (Battery)	46
14.3.11 External input	48
14.3.12 Firmware update	48
14.3.13 Defaults	49
15. Maintenance, troubleshooting and repairing minor types of damage	50
16. Force gauge menu diagram	51
Declaration of Conformity	54

1. Introduction

The FB series force gauges are designed for measuring pressure or pulling force in laboratory, manufacturing and quality control applications.

Measurements up to 200N are executed by holding the gauge in hand. Measurements from 200N to 500N require using a double-hand handle (additional equipment). It is also possible to use the force gauge mounted on a stand (additional equipment).

To measure bigger forces (over 500N) force gauges with external sensor are used. External sensor is usually mounted to user's object using special mounting elements.

The RS232C and USB interface allows the measurement results to be transmitted to a computer or a printer for further analysis or recording.

Force gauge is a measuring device and it wasn't designed to be used as a lifting equipment in the sense of 2006/42/WE directive.

Additional information regarding FB00 force gauge are located in Appendix A (p.41).

2. Basic Set

The basic set includes the following elements:

1. Force gauge,
2. Accumulators NiMH 2700mAh – 4 pcs.
3. Power supply unit ~230 V 50 Hz / =12 V; 1.25 A,
4. MicroSD card “pusher”
5. Force gauge–computer cable
6. Operation manual
7. Warranty card.

Moreover:

for FB5-FB500: Push tips – 4 pcs, 1 hook tip, 1 extension piece

for FB1k-FB50k: bearings – 2 pcs

The software can be downloaded here:

https://www.pce-instruments.com/english/download-win_4.htm

3. Safety instructions

3.1 Main safety rules

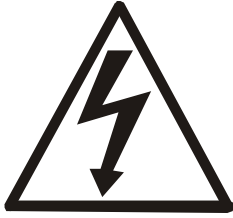

Read carefully the safety instructions included below. Observe these instructions to avoid electrocution or damage to the force gauge itself or other devices connected to the force gauge.

- Repairs and any necessary adjustments may only be conducted by qualified personnel.
- Do not use the force gauge when any part of the enclosure has been removed.
- Do not use the force gauge in potentially explosive atmospheres.
- Do not use the force gauge in areas with a high humidity.
- In the case of suspected damage to the force gauge, turn off the gauge and do not use it until it is examined by a specialised servicing facility.
- Force gauge wasn't designed to be used as a lifting equipment.

3.2 Safety rules

3.2.1 Transport safety rules

Force meter and included equipment should be transported from producer to receiver in original company box.

To transport force meter during exploitation original producer case should be used.

3.2.2 Safety rules during mounting

Force meter equipment mounting should be done on working table (with universal tools if necessary). Mounting way should provide inseparability of the force meter set during work.



Producer declares endurance (load capacity) of supplied equipment according to table 1. For other hanging elements (not supplied by producer) the assembler takes responsibility.

Table 1

Force meter type	Sling type with articulation *	Measurement range	Required endurance of other hanging elements
FB5	-	5N	7,5N
FB10	-	10N	15N
FB20	-	20N	30N
FB50	-	50N	75N
FB200	-	200N	300N
FB500	-	500N	750N
FB1k	DAS 12 T/K	1kN	1,5kN
FB2k		2kN	3kN
FB5k		5kN	7,5kN
FB10k		10kN	15kN
FB20k	DAS 20 T/K	20kN	30kN
FB50k	BEM 25-20-501	50kN	75kN
FB100k	EM 45-21-501	100kN	150kN
FB150k		150kN	225kN

* The producer reserves the right to use any other equivalent accessories.

The length of the wire that connects meter to sensor (force meters with external sensor) should be matched during ordering process so that it is possible to secure user from results of equipment failure. If the standard length (1,5 meter) is not

enough please order longer wire or adapter (adapter use needs another force meter calibration),

- The hanging elements must be screwed into the tapped hole provided for the entire length of the sensor and then use nuts.

During mounting force gauges assembler must accomplish several conditions to select properly elements:

- A) Measurement range of used force meter sensor and slings with articulation (marked with Max sticker on sensor) must be wider than predicted max load
- B) Each hanging element used by assembler that is not supplied by force meter producer eg. Shackle, rope or chain should meet the requirements of static endurance with margin safety no less than 150% of force gauge measurement range consistent with table 1.

Assembler must provide safe and solid mechanical connection off all elements and their inseparability during force meter work. During mounting assembler should use protective gloves and tools that enable safe work.

Example 1 - Suspension

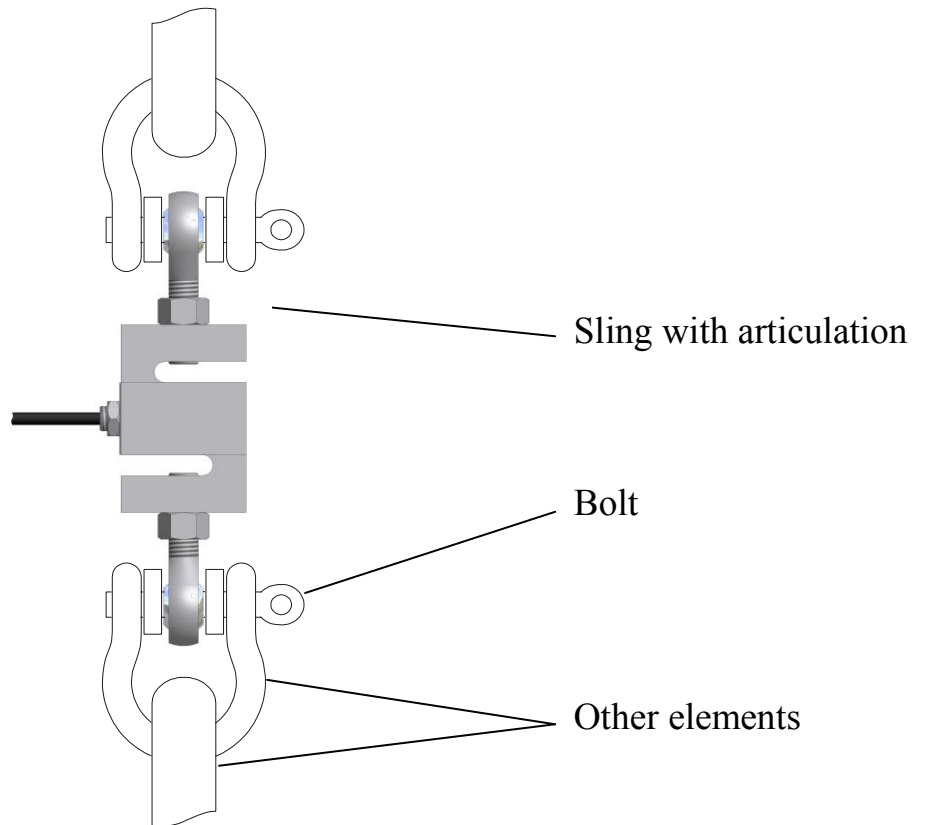

Bolt and other connection elements should sustain load even to 150% of force meter measurement range (150% Max). Moreover bolt should be matched to articulation diameter with tolerance – 0,5mm and should be protected against moving in articulation. Articulation should be secured using pads against sharp slip.

Example 2 - Persistent connection

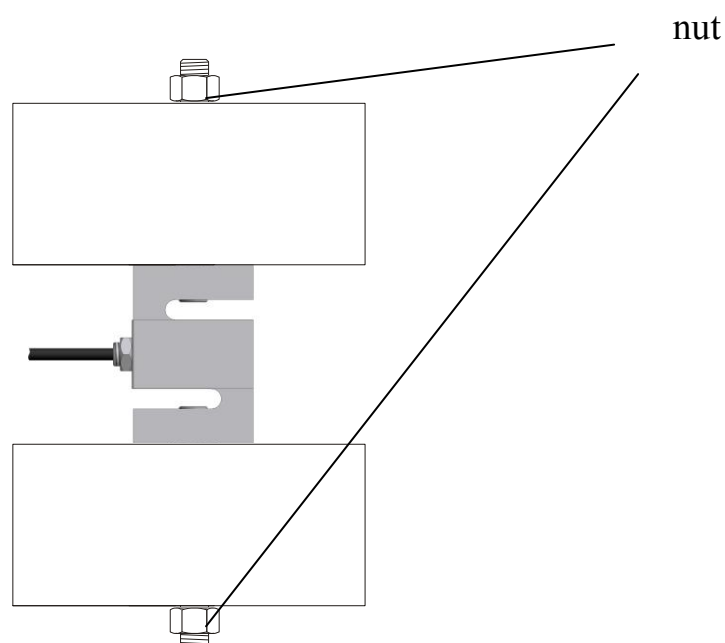

Screw connection should be realized using screws with proper thread that ensure connection endurance not less than 150% of force gauge measuring (150% Max).

3.2.3 Safety rules during start-up and operation



Force meter with equipment supplied by producer is a safe device, what was achieved by application of fire protection and elimination of mechanical, chemical, explosive etc threads.

Measurement post that consists of force gauge must be complete and safely mounted by contractor.

Measurement post which consists force gauge should ensure safety of the user in case of:

- a) collapse of lifted load,
- b) breaking thread, cracks or crushing of sensor,
- c) breaking or crushing other elements supplied by force gauge producer,
- d) breaking other connection elements (not supplied by force gauge producer),
- e) electric shock,
- f) electrolyte leakage from batteries located inside force meter.

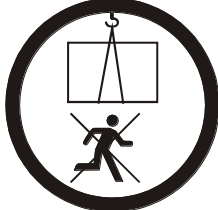
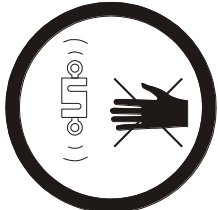
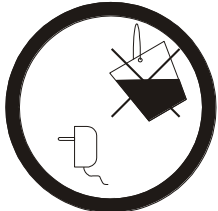
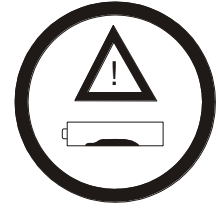
In order to avoid danger we suggest to:

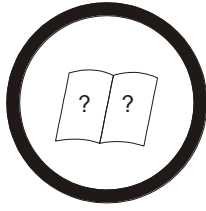
Lp.	Recommendation	Warnings
1	It is forbidden to stand under the load. Use additional security elements: barriers, dangerous zone entrance signalizations etc.	
2	Keep safe distance from loaded elements , use safety gloves if necessary.	
3	Avoid contact with flood, water or other liquids due to high voltage 230V.	
4	Damaged accumulators handle with care. Use rubber gloves and safety glasses if necessary.	
5	The proper disposal of used force meter.	
6	User manual training.	
7	Periodic monitoring of connections	<div style="border: 1px solid black; padding: 5px; width: fit-content;"> <p>Next control date: </p> </div>

Specific recommendation:



It is unacceptable for people to stay under lifted load. Falling down of load can cause damage to human life and health.



Risk of electric shock due to the use of ~230V 50Hz voltage via external feeder. It is unacceptable to spill the feeder or use it when the enclosure is damaged cause it may cause electric shock.



In order to avoid leakage of electrolyte from accumulators immediate disposal of used accumulators from force meter is suggested.

3.2.4 Safety rules during conservation

Force meter doesn't need conservation except accumulators exchange when used – that happens when after full recharge the force meter working time is shorter more than 20% from the value suggested by producer.

External force sensor elements need cleaning from dust and dirt. If the articulation locks the hanging element need to be exchanged for a new one. Other hanging elements need to be checked according to the assembler.



If the force meter or other hanging element seems to be damaged immediately stop operation.

3.2.5 Safety rules during disassembly and utilization

Before force meter disassembly unload force meter. Secure other hanging elements. According to the applicable regulations on the protection of the environment, do not put worn electronic devices in containers for common waste.



When put out of operation, a worn force gauge can be delivered to bodies authorised to collect old electronic equipment or to the point of purchase.

4. Fast start

Prepare force meter to work by selecting proper measuring tip (force gauge with internal sensor) or after mounting proper working post (force gauge with external sensor).

Turn on force meter by using *ON/OFF* key and leave the device in stationary position. That will enable zeroing, software version displaying and zero indication. Force meter is ready to work after following screen displays:

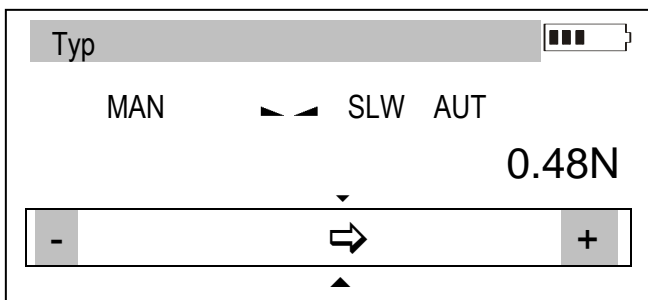
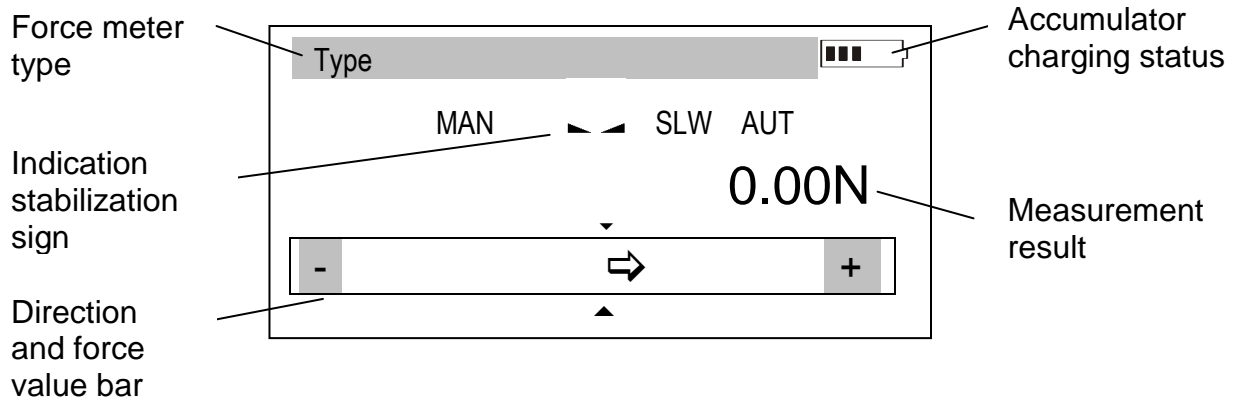

The force measurement is continuous. Display continuously indicates actual force value measured by meter. Force direction is signalized by an arrow in lower part of screen and a sign + (pressing force) or - (pulling force). Saving actual force indication to memory is done by pressing *MEM* key.

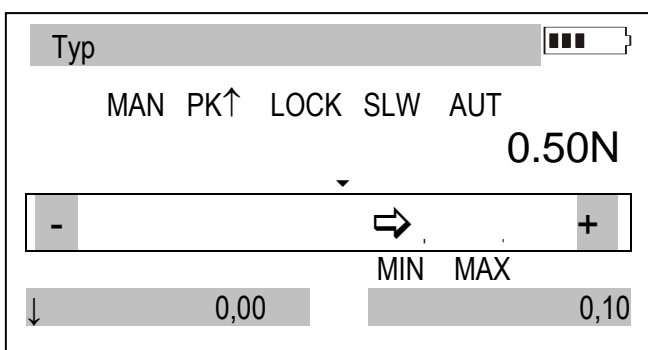

Changing actual force value indication into peak value measurement is done by pressing *PEAK* key. Indication stabilization sign changes into *LOCK* sign and force meter changes mode into peak value for force in both directions. Pressing again *PEAK* key changes mode into one-direction peak value: first for pressure force (*PK↑*) and after another *PEAK* pressing for pulling (*PK↓*), zeroing is done by *→0←* key.

Attention:

Dynamical forces measurement should be carried out by saving to memory series of measurements with given sample time, then display force characteristics and statistical results (rozdz. 14.3 *Memory*).

5. Force meter general view

FB5÷FB500 force meter:

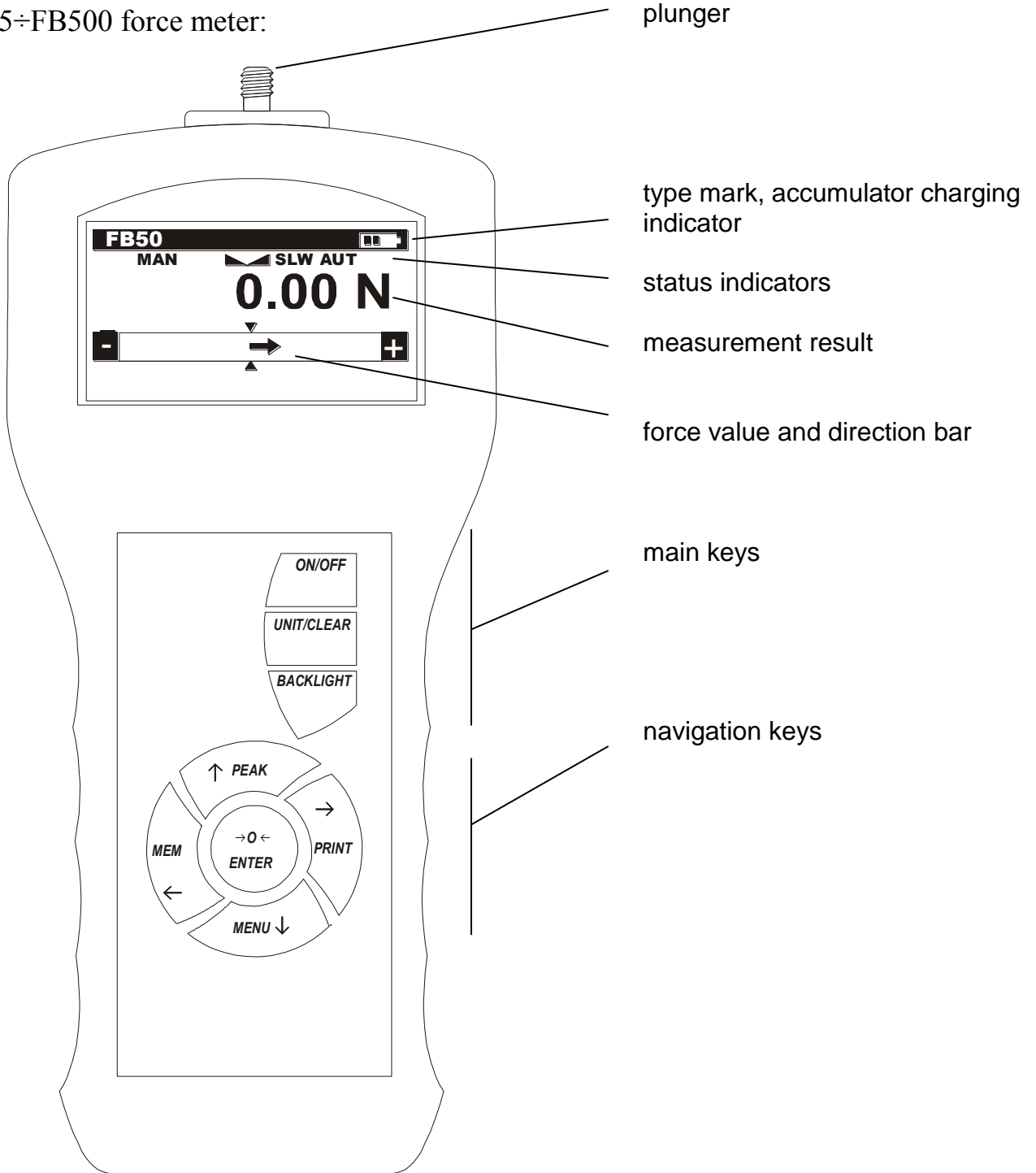

6. Technical data

Type	FB5	FB10	FB20	FB50	FB200	FB500
Maximum force measured	5N (~0,5kg)	10N (~1kg)	20N (~2kg)	50N (~5kg)	200N (~20kg)	500N (~50kg)
Reading graduation (d)	0,001N	0,002N	0,005N	0,01N (1g)	0,05N (5g)	0,1N (10g)
Accuracy	±0,1% F.S.					
Measurement units	N, g, lb, oz, kg, kgf, lbf, ozf					
Maximum overload	20%					
Operating temperature	-10 ÷ 40°C					
Internal resolution	24 bits (16mln graduation)					
Process speed	10 or 40 measurements/s					
Internal memory capacity	1x6400 measurements					
Interface	RS-232C and USB, options: Bluetooth, WE trigger gate, WY transoptor MicroSD card slot: compatibility with SDSC (standard) cards and SDHC class 4					
Assisting software	FM (time characteristics, statistic analysis, data archiving)					
Display	LCD graphical 61x34mm					
Measurement options	Maximal value measurement, serial measurement, dynamic measurement (time diagrams)					
Power supply	Ni-Mh batteries set 2700mAh (LP703048P6H type) + supply ~230V 50Hz / 12V 1,2A					
Accumulator working time	~20h (~45h backlighting off)					
Measurement mantrel	11mm (thread M6x8mm)					
Dimensions	215x100x40mm					
Weight	430g (without batteries)					

Type	FB1k	FB2k	FB5k	FB10k	FB20k
Maximum force measured	1kN (~100kg)	2kN (~200kg)	5kN (~500kg)	10kN (~1t)	20kN (~2t)
Reading graduation (d)	0,2N (20g)	0,5N (50g)	1N (100g)	2N (200g)	5N (500g)
Accuracy	±0,1% F.S.				
Measurement units	N, g, lb, oz, kg, kgf, lbf, ozf				
Maximum overload	20%				
Operating temperature	-10 ÷ 40°C				
Internal resolution	24 bits (16mln graduation)				
Process speed	10 or 40 measurements/s				
Internal memory capacity	1x6400 measurements				
Interface	RS-232C and USB, options: Bluetooth, WE trigger gate, WY transoptor MicroSD card slot: compatibility with SDSC (standard) cards and SDHC class 4				
Assisting software	FM (time characteristics, statistic analysis, data archiving)				
Display	LCD graphical 61x34mm				
Measurement options	Maximal value measurement, serial measurement, dynamic measurement (time diagrams)				
Power supply	Ni-Mh batteries set 2700mAh (LP703048P6H type) + supply ~230V 50Hz / 12V 1,2A				
Accumulator working time	~20h (~45h backlighting off)				
Measurement mantrel	-				
Dimensions	215x100x40mm + sensor				
Weight	350g (without batteries) +sensor weight				

Type	FB50k	FB100k	FB150k
Maximum force measured	50kN (~5t)	100kN (~10t)	150kN (~15t)
Reading graduation (d)	10N (1kg)	20N (2kg)	50N (5kg)
Accuracy	±0,1% F.S.		
Measurement units	N, g, lb, oz, kg, kgf, lbf, ozf		
Maximum overload	20%		
Operating temperature	-10 ÷ 40°C		
Internal resolution	24 bits (16mln graduation)		
Process speed	10 or 40 measurements/s		
Internal memory capacity	1x6400 measurements		
Interface	RS-232C and USB, options: Bluetooth, WE trigger gate, WY transoptor MicroSD card slot: compatibility with SDSC (standard) cards and SDHC class 4		
Assisting software	FM (time characteristics, statistic analysis, data archiving)		
Display	LCD graphical 61x34mm		
Measurement options	Maximal value measurement, serial measurement, dynamic measurement (time diagrams)		
Power supply	Ni-Mh batteries set 1000mAh (LP703048P6H type) + supply ~230V 50Hz / 12V 1,2A		
Accumulator working time	~20h (~45h backlighting off)		
Measurement mantrel	-		
Dimensions	215x100x40mm + sensor		
Weight	350g (without batteries) + sensor weight		

7. Keys and indicators

Main keys:

ON/OFF	- ON / OFF key (standby),
UNIT/CLEAR	- Change units / cancel selection or change a parameter value, - <i>Press and hold</i> – resetting of registered data,
BACKLIGHT	- Turn on illumination (ECO mode),

Navigation keys:

↑	- Move cursor up or increase the digit marked by the cursor,
↓	- Move cursor down or decrease the digit marked by the cursor,
→	- Move to the next menu level or display the next option,
←	- Move to the previous menu level or display the previous option,
ENTER	- Confirm the entered parameter or select a highlighted option.

Function Keys:

MENU	- Meter function menu (diagram menu - chapter 18),
PEAK	- Measure the maximum value,
MEM	- Save the result to the memory, press and hold – save to memory menu, - Longer press – when measurements are registered in memory longer press causes entering data storage choice menu,
PRINT	- Print result (transmission via RS-232C connector).
→0←	- Force meter indications zeroing

Status indicators:

MIN/OK/MAX	- Indications below MIN; in range MIN÷MAX; above MAX
MAN/ACQ	- Manual/automatic measurements mode
▶ ◀/LOCK	- Indicates that the weighing result has stabilised,
PK↑ / PK↓	- Direction of measured force, -
SLW/FST	- Slow/fast measurement mode,
AUT	- Autozeroing on
SD	- microSD card mounted

Note:

Numbers are entered using the navigation keys. First, the cursor is placed in the right digit position.

8. Preparing the force gauge for operation



If the force gauge has been transported from an area with low temperature to an area with a higher temperature, e.g. during winter, water may condensate on the gauge's enclosure. In such a case, do not turn on the gauge's power supply, as it may lead to damage to the gauge or improper operation. Before turning on the gauge, leave it for 1 hour to acclimatise.

1. Take the gauge out of the case.
2. Fit a measurement tip suitable for the measurements to be conducted on the gauge plunger.

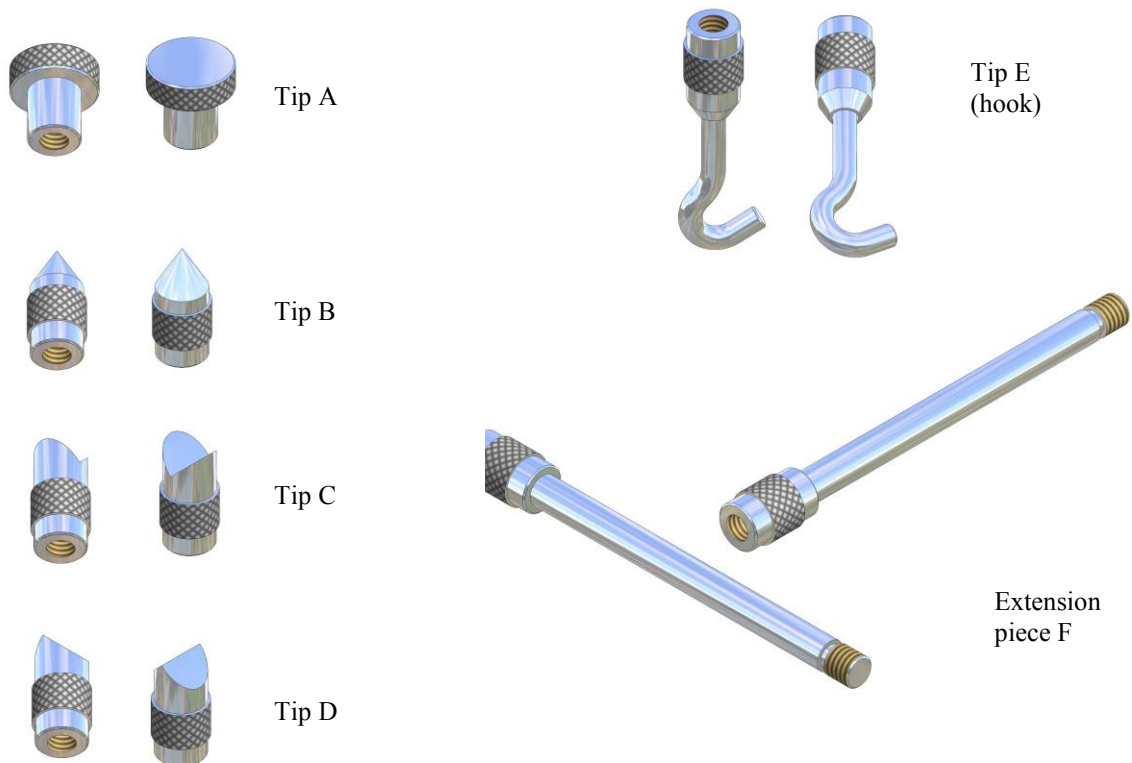

Intended use of the individual tips:

- tip A – measurement of surface pressure force,
- tip B – measurement of point pressure force,
- tip C – measurement of pressure on an axis or an edge,
- tip D – measurement of edge pressure force,
- tip E – hook for measuring pull force or suspending and weighing an object,
- tip F – extension piece suitable for all types of above-mentioned tips.

3. Check if there are 4 accumulators in container at the back of force meter. In order to charge accumulators, connect the supply. During charging using force meter is possible.

Attention:

Force gauges with a range from 1kN to 150kN are equipped with an external force sensor connected by a rod with a plug. Bearings are connected to the extensometric force gauge in order to avoid unwanted stress when mounting load (FB100k and FB150k are supplied without bearings).

The meter is delivered in two carrying cases (separate for the meter and for the sensor).

9. General rules for use



When transporting the force gauge, unscrew the measurement tip and put the gauge in the case to protect it against accidental pressure on the gauge plunger.

1. When conducting measurements by hand, make sure that the direction of the measured force is identical with the gauge's axis (axis of the gauge plunger). Otherwise, only a component force along the gauge's axis will be measured.
2. The force gauge allows for resetting in the entire measurement range (this operation is called taring in the case of measuring the mass) by pressing the $\rightarrow(0)\leftarrow$ key. Resetting/taring does not extend the measurement range but only subtracts the entered reference value from the measured value.
3. The measurement mechanism is a precision device and is sensitive to shocks and vibrations. It is not allowed to hit the measurement tip against any objects.
4. Do not overload the gauge above the maximum overload value (20%).
5. Accumulators set situated inside the force gauge housing, should be exchanged when working time decreases to 20 % of nominal time (below 4 hours).

10. Accumulators exchange

If during exploitation time working time of fully charged accumulators shortens to 20% of the nominal value (under 4h), replace them with new ones.

In order to exchange accumulators open the cover by tilting bracket and put new ones as indicated at the bottom of the housing (correct polarization).

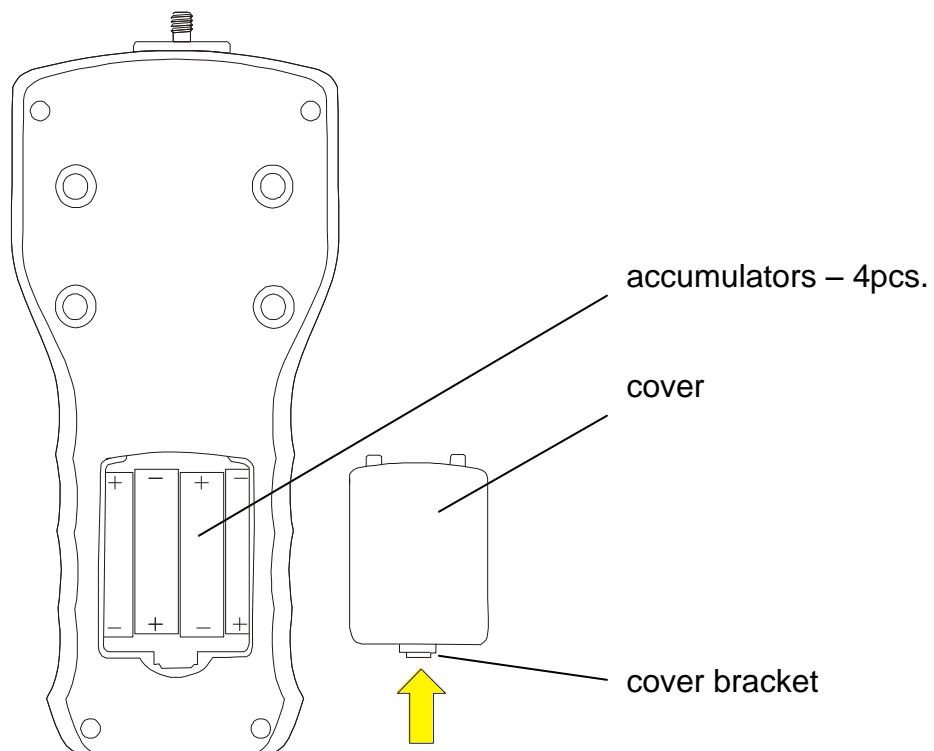

11. Turning on the force gauge



Place the gauge in the operating position, e.g. horizontal position (by laying it on a table). Turn on the gauge by pressing the *ON/OFF* key.

When necessary, plug the gauge's power supply unit to a ~230 V/50 Hz socket and connect the power supply unit's plug to the gauge's 12 V socket.

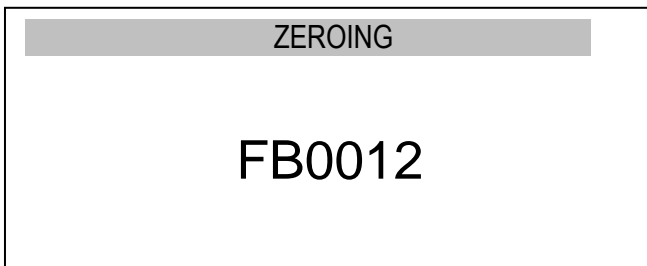

The gauge automatically tests the electronic subassemblies and then resets. During this operation, the gauge should remain stationary and its sensor should not be affected by any forces.

After the resetting has been successfully completed, the gauge indicates zero.

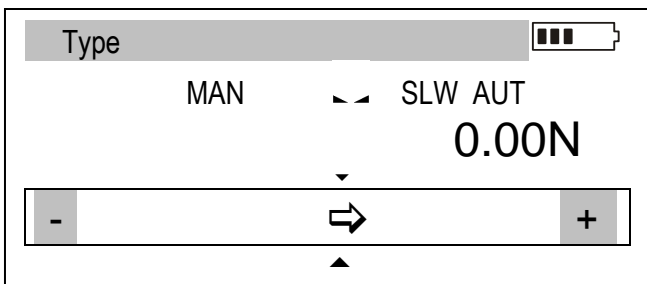

Unsuccessful resetting is signalled by an appropriate message.

Note:

It is possible to accelerate the resetting process by pressing the *MENU* key, which will recall the results from the previous resetting.

If the batteries are low, leave the gauge's external power supply unit ON until they are fully recharged. The batteries' charge level is signalled by an indicator in the upper section of the display.

12. Description of measurement methods

The gauge can be used to measure pressure and pull forces. In addition, when mounted properly, it can be used as suspension scales to measure the mass.

12.1 Measuring actual and peak value of a pressure/pull force

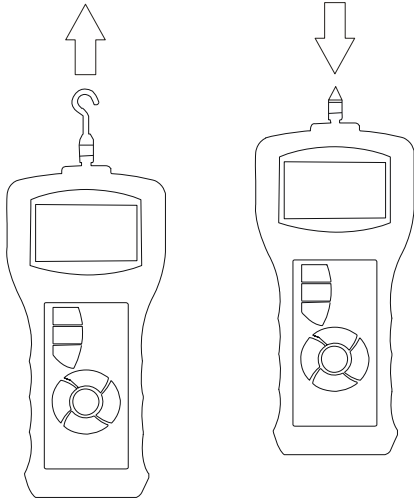

Before starting the measurement, choose a suitable measurement tip, screw it to the gauge plunger and reset the gauge in the operating position, e.g. horizontal position (laying the gauge on a table).

Measuring pressure and pulling force

In case of force meters with external sensor force meter zeroing should be executed after mounting measurement post without any load.

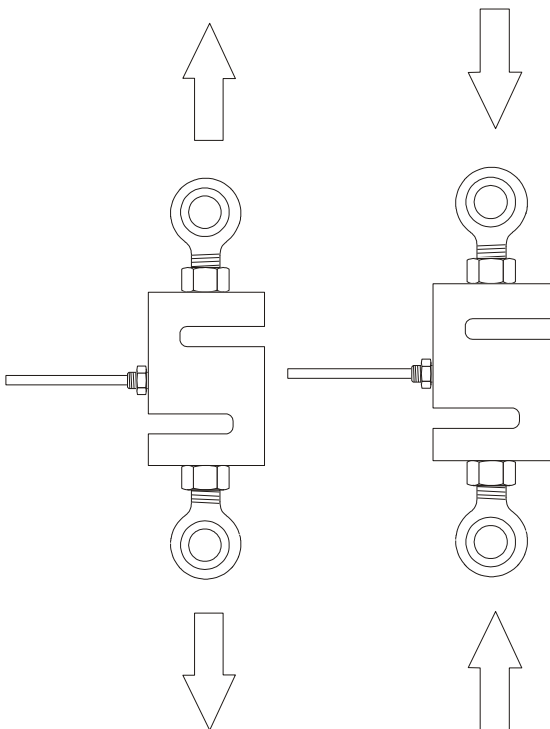

Attention:

Using sling with articulation is recommended for any force direction.

Measuring pressure and pulling force

The zeroing process starts automatically after turning on the gauge or by pressing the $\rightarrow 0 \leftarrow$ key.

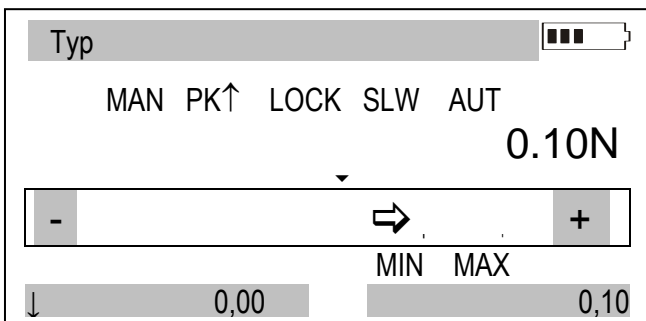
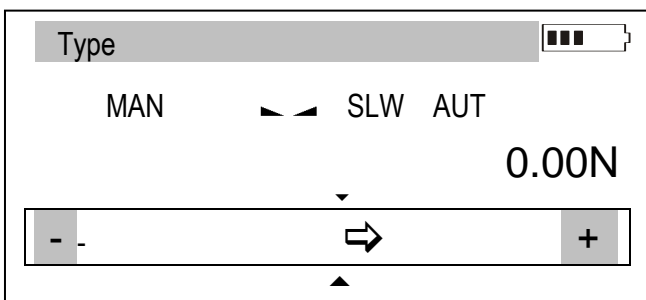
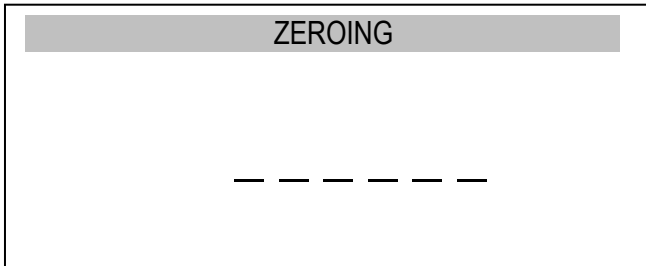

To perform the measurement, indicate the force direction using an arrow in the display's lower bar section and "+" (pressure) or "-" (pull force) symbol.

To change the measurement from the actual value (continuous measurement) to the maximum value (peak measurement), use the *PEAK* key – stabilization indicator is replaced by *LOCK* indicator. Pressing again *PEAK* button will change direction of the measured force ($PK\uparrow$, $PK\downarrow$), zeroing by using $\rightarrow 0 \leftarrow$ key.

When measuring maximum value, at the bottom of the screen appears a bar showing actual force value and maximum force value for other force direction if it was measured before - otherwise 0,00 value will indicate.

12.2 Force characteristics measurement, measurement registration to memory

In order to enable changing force measurement and to create results visualizations (graphs or histograms), force gauge is equipped with actual results buffer memory (RAM), EEPROM memory and microSD card (option). Detailed description of available options can be found in 14 chapter.

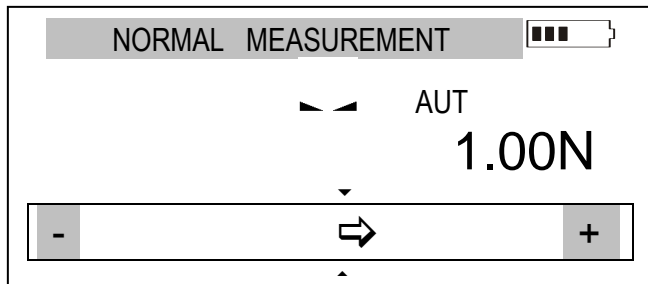

After pressing MEM key results are stored in buffer memory. Quantity of result in a 1 serie is set in *Memory/Setting/Quantity* .

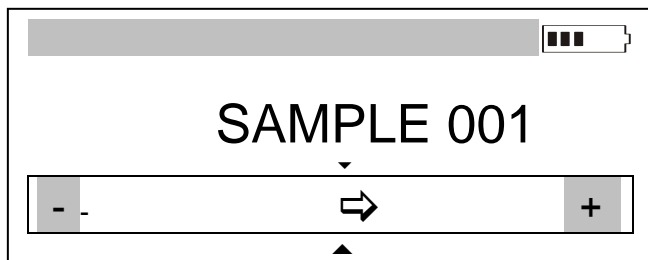

If indicator *MAN* (manual mode) is displayed, after pressing *MEM* key single measurement is stored.

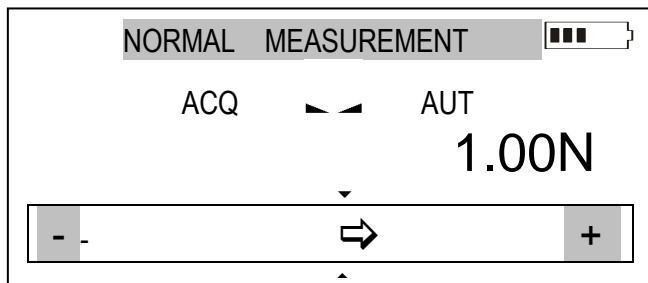

When ACQ indication is turned on, *MEM* key starts storing measurements in equal time intervals.

During storing measurements successive sample numbers are displayed and total quantity.

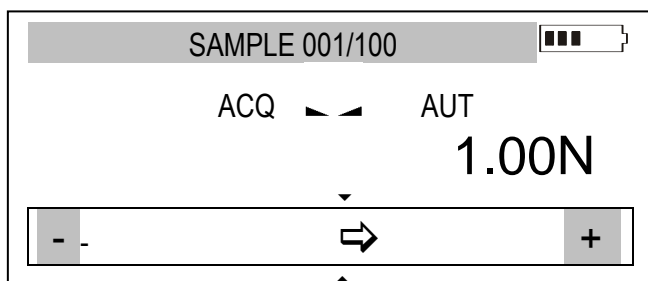

During measurement storing, numbers of samples and total sum of samples are displayed.

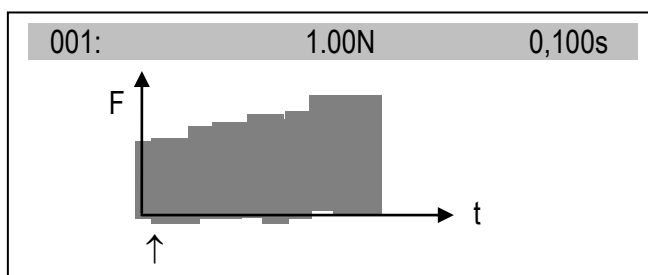

After storing all samples a graph is displayed.

ENTER – returns to force indications, *MEM* – *Statistics* results displaying. *Statistics* option is used for obligatory storing or deleting actual results (next measurement is possible only after deleting).

UNIT/CLEAR enables quick exit from *Statistics* option.

12.3 Measurement of the mass – using the gauge as scales

When using an additional element (bowl, basket, etc.) for suspending an object to be weighed, the gauge can be used to measure the mass. In the case of measurements which do not require a high level of precision, the gauge can be hand-held. To ensure maximum precision of the measurement, the gauge should be mounted on a stand using the four threaded holes at the bottom of the enclosure or it can be suspended using a special suspension element (option available on request).

While the measurement of the force is independent of geographical factors, the measurement of mass requires gravity force. Since the value of the gravity force used to calculate the mass depends on the gravitational acceleration in the location where the gauge is used, the device is calibrated for a specific value of the gravitational acceleration.

Example: Force gauge calibrated by producer in Gdansk (54° 21' N, h=114m above sea-level), during weighing 5kg will indicate 5,000kg, but when it will be moved to Katowice (50° 15' N, h=250m above sea-level.) it will indicate 4,998kg.

The factory preset value is the gravitational acceleration ($g_R = 9.81415 \text{ m/s}^2$).

When using force gauge as a balance in place with

significantly different gravity force (more than $\pm 0,00 200 \text{ m/s}^2$) inscribe proper gravity force or inscribe latitude with above sea-level value. To do that use *Calibration* option from force gauge menu.

The values of the gravitational acceleration for some of the Polish cities are presented in the table below.

Gravitational acceleration for selected cities

City	$g_R[\text{m/s}^2]$	City	$g_R[\text{m/s}^2]$
AXIS	9.81415	Olsztyn	9.81354
Gdańsk	9.81446	Łódź	9.81164
Gdynia	9.81453	Mława	9.81295
Białystok	9.81294	Opole	9.81076
Bydgoszcz	9.81327	Piła	9.81330
Chojnice	9.81342	Poznań	9.81266
Cieszyn	9.80960	Przemyśl	9.80991
Częstochowa	9.81061	Przeworsk	9.81009
Elbląg	9.81430	Radom	9.81146
Ełk	9.81361	Rybnik	9.81008
Gliwice	9.81025	Rzeszów	9.81010
Gorzów Wielkopolski	9.81305	Słupsk	9.81449
Grudziądz	9.81368	Suwałki	9.81377
Kalisz	9.81184	Szczecin	9.81370
Katowice	9.81008	Tarnów	9.81005
Kielce	9.81063	Toruń	9.81313
Koszalin	9.81427	Warszawa	9.81240
Kraków	9.81005	Włocławek	9.81288
Leszno	9.81206	Wrocław	9.81131
Lublin	9.81128	Zielona Góra	9.81190

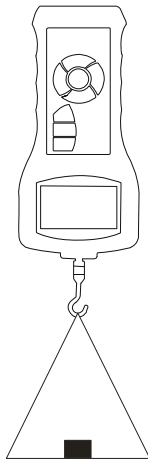

Measurement using a hand-held gauge (only up to 200N)

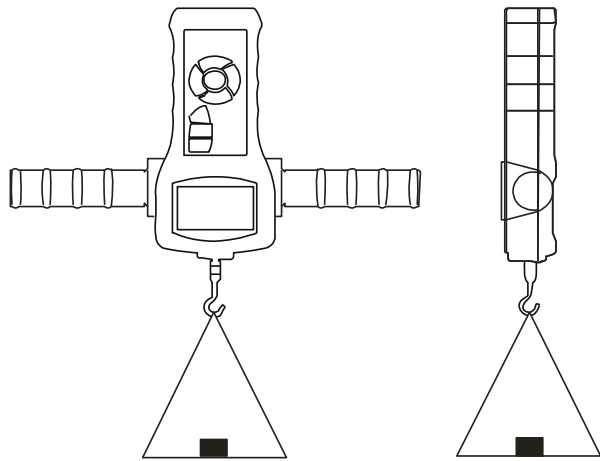

Measurement with double-hand grip (on request)

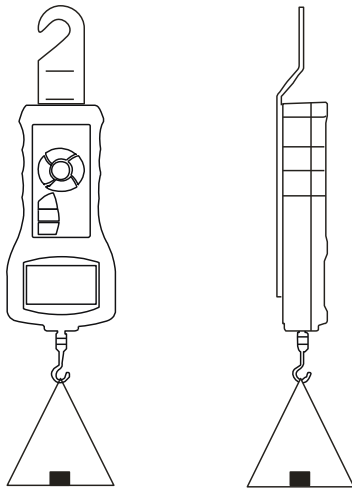

Suspended weight measurement (suspension element available on request)

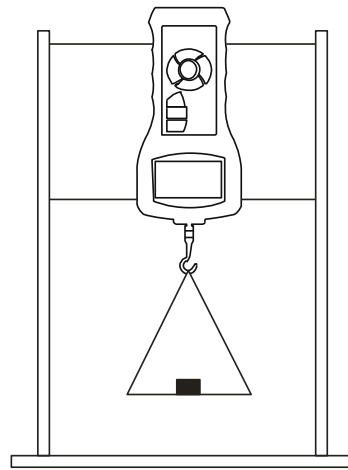

Measurement using force gauge mounted on stand (on request)

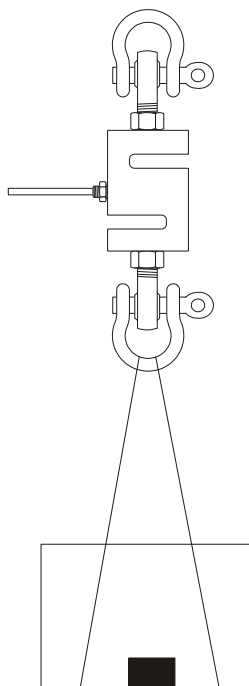

Hanging work mode
- Force meter with external sensor



Screw the hook tip to the gauge plunger, suspend a bowl on the hook and place the gauge in the operating position (as shown in the figure). The display's indications will rotate by 180°.

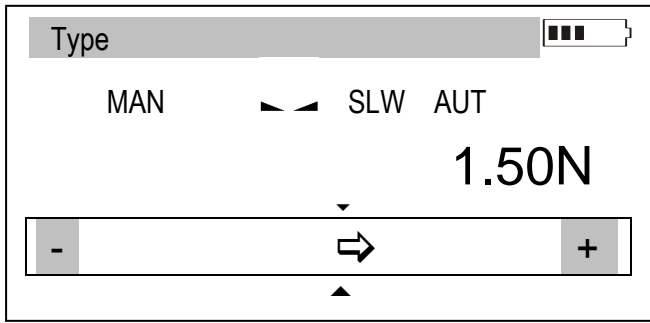

To change displaying force units, press the *UNIT/CLEAR*.

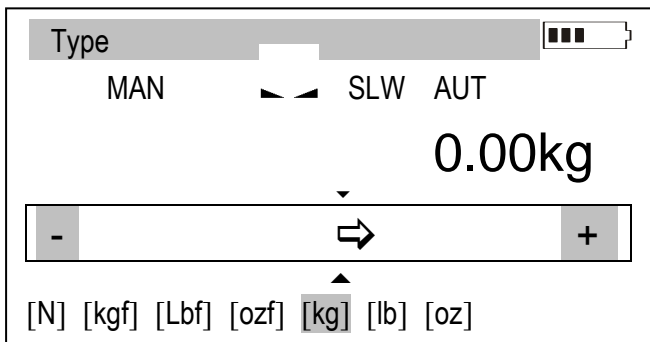

By pressing several times cursor is moved between different units until the proper one is chosen.

Reset the gauge in the operating position by pressing the →0← key.



Place the object to be weighed on the bowl.

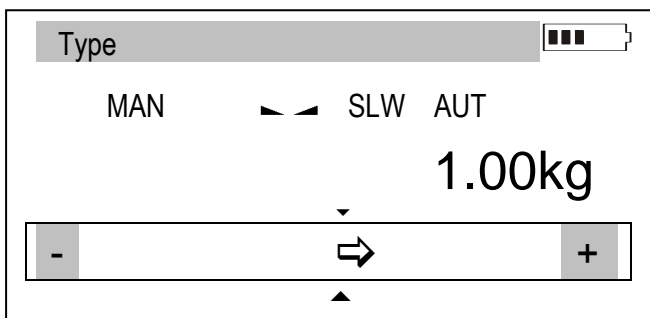

Read the mass.

13. Connecting external devices

The force gauge is equipped with a socket for an external power supply unit, RS232C interface (RJ joint), USB interface and optional THR (thresholds) output.

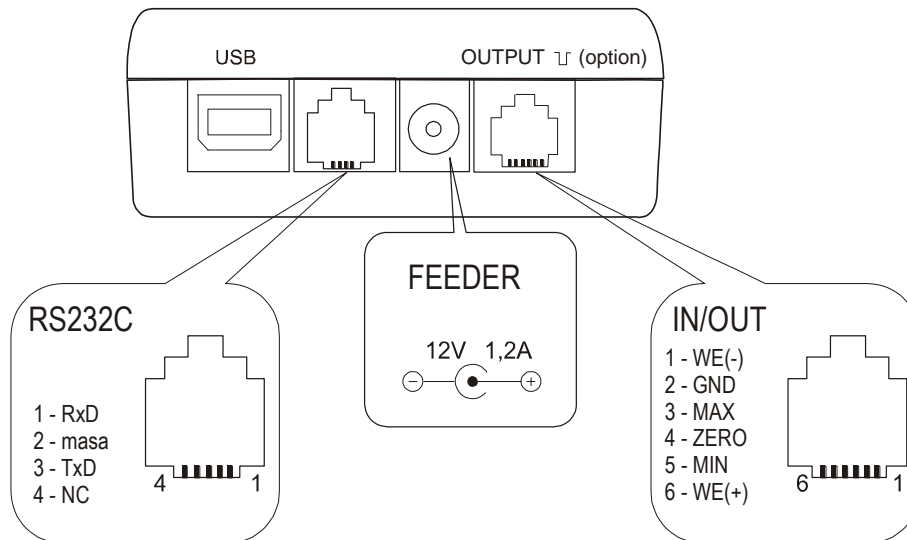

Installation manual and drivers can be found on CD disc supplied together with force meter.

Joint ampacity OUTPUT: $I_{\max}=25\text{mA}$ / $U_{\text{nom}}=24\text{V}$ (open collector type, emitters connected– GND).

IN voltage range WE(+)/WE(-): $U_{\text{in}}=12\text{-}18\text{V}$ / $I_{\text{in max}}=50\text{mA}$

Description of the data transmission (USB, RS232) protocol when working with a computer (*LonG*):

The force gauge transmits the result as follows (8 bits, 1 stop, no parity, 4800 bps):

Computer→Gauge: initiating signal S I CR LF (53 h 49 h 0Dh 0 Ah),

Gauge→Computer: gauge indication according to the following format (16 bytes):

Description of individual bytes:

byte	1	- “-“ or space
byte	2	- space
byte	3÷4	- digit or space
byte	5÷9	- digit, comma or space
byte	10	- digit
byte	11	- space
byte	12	- k, l, c, p or space
byte	13	- g, b, t, c or %
byte	14	- space
byte	15	- CR
byte	16	- LF

14. User's Menu

The User's Menu includes all functions and options necessary to operate the gauge or extend its functionalities.

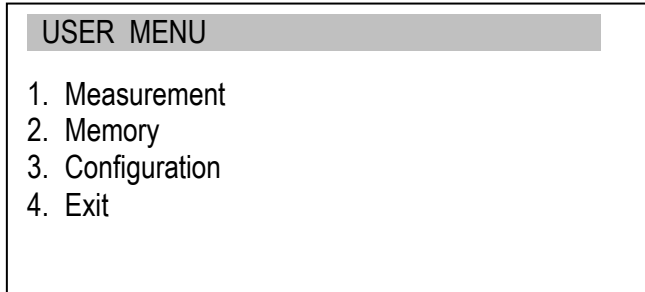

To use the options of the USER's MENU, use the *MENU* key. Move the cursor to the desired option and press *ENTER*.

The menu includes:

1. *Measurement* – measurement settings,
2. *Memory* – data readout and saving options,
3. *Configuration* – calibration and other options,
4. *Exit*.

14.1 Measurement

This selection includes the following functions to effectively assist you with the measurement:

- measurement speed in automatic mode,
- measurement unit choice,
- automatic zeroing,
- comparison with two threshold values (*MIN / MAX*),
- measured force direction change (accepted as plus +),
- automatic saving of *PEAK* function result after force termination.

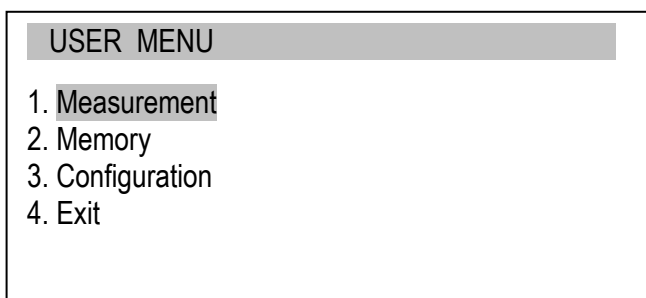

Move the cursor to *Measurement* and press *ENTER*.

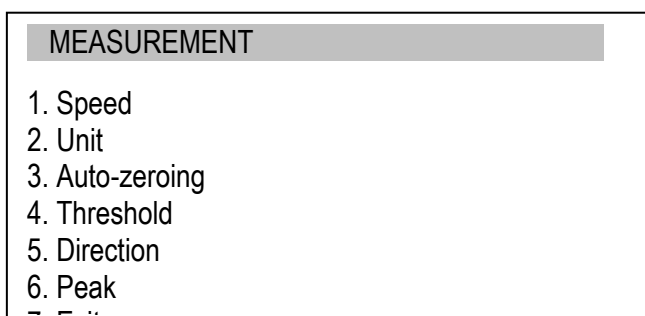

Move the cursor to the desired application and press *ENTER*.

14.1.1 Measurement speed

To obtain clear measurement results, it is recommended to adjust the speed of measurement to the dynamic properties of the measured object.

<p>USER MENU</p> <ol style="list-style-type: none">1. Measurement2. Memory3. Configuration4. Exit
<p>MEASUREMENT</p> <ol style="list-style-type: none">1. Speed2. Unit3. Auto-zeroing4. Threshold5. Direction6. Exit
<p>SPEED</p> <p><input type="checkbox"/> SLOW / 10Hz</p> <p><input type="checkbox"/> FAST / 40Hz</p> <p>Exit</p>

Press *ENTER* to select one of the options:

- *SLOW* – slow measurement (10 measurements/s),
- *FAST* – fast measurement (40 measurements/s).

14.1.2 Units

Force units:

- niuton (N) – basic force in SI unit
- kilogram-force (kgf): $1\text{kgf}=9,80665\text{N}$
- pound-force (lbf): $1\text{lbf}=4,4482\text{N}$
- ounce-force (ozf): $1\text{ozf}=0,278\text{N}$

User can also choose mass units:

- kilogram (kg) $1\text{kg} \approx 9,81415\text{N}$
- english pound: $1\text{lb} = 453,592374\text{g}$
- ounce: $1\text{oz} = 28,349523\text{g}$

To change the units, press the *UNIT/CLEAR* or *MENU* key several times.

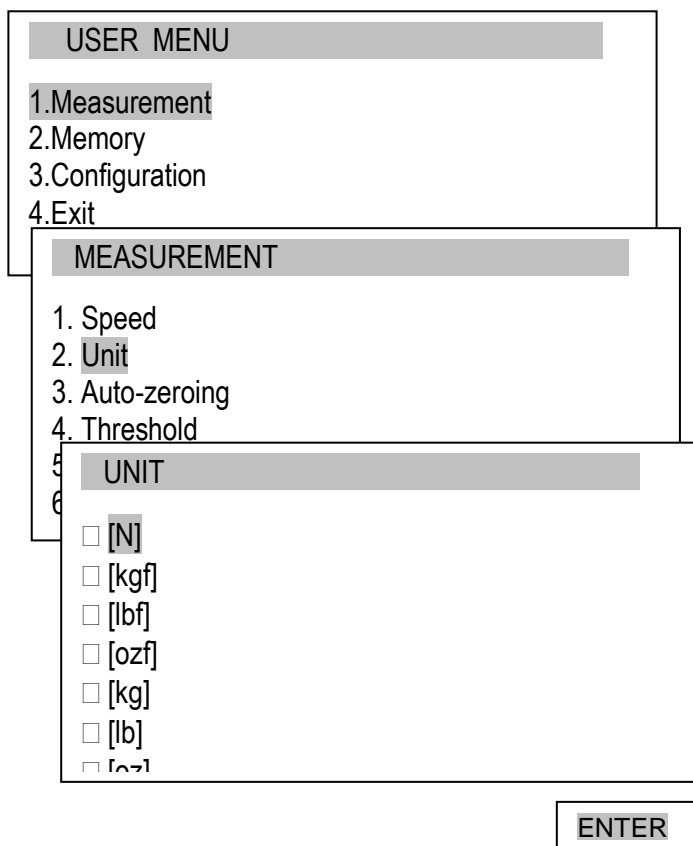

Press the *MENU* key, move the cursor to *Unit* and press *ENTER*.

Move the cursor to the desired unit and press *ENTER*.

During mass measurement the force meter measures gravitation force and converts it to mass. Calculating force and mass unit is depended to gravitation force of the place of measurement. Default value is the producer gravitation value $g = 9,81415\text{m/s}^2$. During very precise mass measurements ($\pm 0,1\%$ of range) it is crucial to inscribe proper gravitation value of the measurement place (*Calibration* options).

14.1.3 Auto-zeroing

When activated, this option automatically maintains zero indications on the gauge, if the gauge’s sensor is not affected by any external force or if the zero indication was produced by pressing the $\rightarrow 0 \leftarrow$ key. The range of values (calculated in the gauge’s reading graduation near zero) subject to the reset must be entered under the *Range* option (2 digits).

USER MENU

- 1.Measurement
- 2.Memory
- 3.Configuration
- 4.Exit

MEASUREMENT

1. Speed
2. Unit
3. Auto-zeroing
4. Threshold
5. Direction
6. Exit

Use the navigation keys and *ENTER* to select *Status* and one of the following options:

- *ON* – auto-zeroing ON,
- *OFF* – auto-zeroing OFF.

Next, select *Range* and use \uparrow , \downarrow , \rightarrow , \leftarrow and *ENTER* to enter the auto-reset range (in reading graduation).

AUTO-ZEROING

1. Status	<ON>
2. Range	2 d
3. Art.zero	<OFF><SET>
3. Exit	

Additional option *Art.zero* enables to set device start zero to the value indicated before entering the *MENU* .

↑

↓

ENTER

AUTO-ZEROING

1. Status	<ON> <OFF>
2. Range	2 d
3. Art.zero	
4. Exit	

←

→

ENTER

14.1.4 Comparison with threshold values MIN / OK / MAX

This selection includes the following functions to effectively assist you with the measurement:

- memory operations and data analysis,
- comparison with two threshold values (*MIN* / *MAX*).

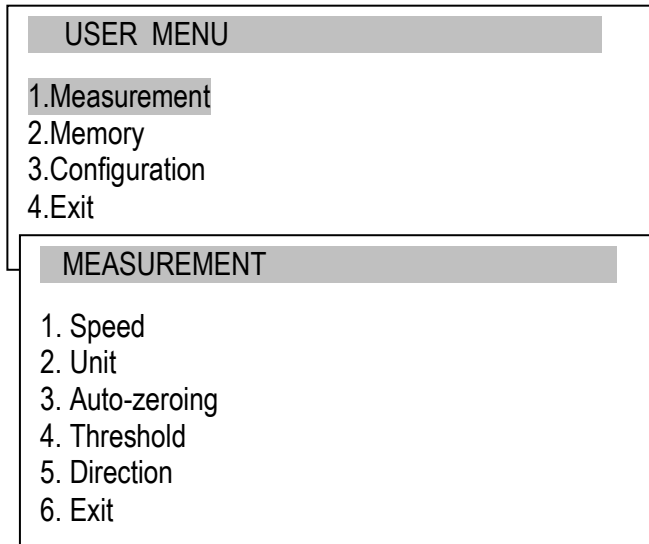

Move the cursor to *Applications* and press *ENTER*.

Move the cursor to *Threshold* and press *ENTER*.

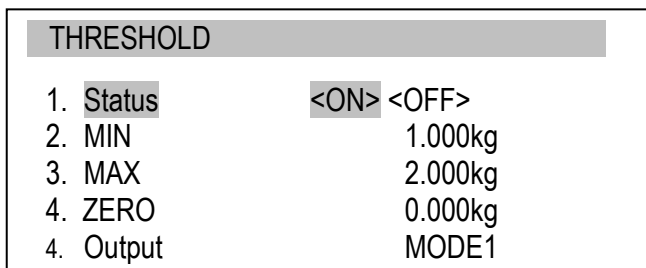

Activate the comparison by setting *Status* to *ON*:

- enter the *MIN* value – lower threshold,
- enter the *MAX* value – upper threshold,
- enter *ZERO* – zero signalling threshold.

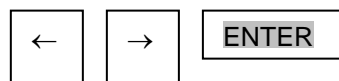

Select the option for *OUTPUT* and sound signalling (*Buzzer*):

- *MODE1* – short signal upon exceeding *MIN*, long signal upon exceeding *MAX*,
- *MODE2* – interrupted signal below *MIN*, above *MAX* – continuous signal, for *OK* – no signal.

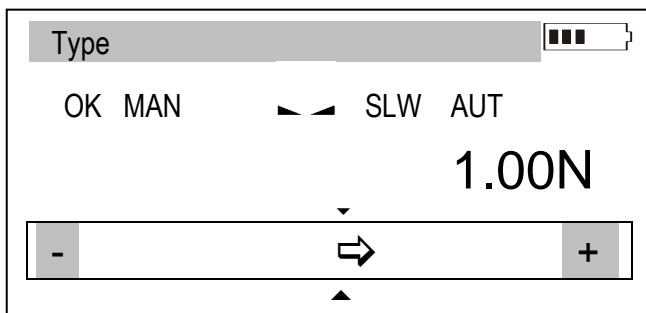

Exit the menu, start the measurement and observe the *MIN*, *OK* and *MAX* indicators on the gauge's display.

14.2 Memory

During measurements in automatic mode results are saved in volatile memory (RAM – erasing data after supply off). Saving, readout, erasing data (single series of measurements) in EEPROM and resetting volatile memory (RAM) is done by options in lower part of *Statistics* function screen. It is possible to view results on force meter (chart, histogram, table).

Using microSD card enables to save and later readout of many series of measurements in chosen file. It is possible to write custom names (inscribed by user) of folders and files.

MicroSD memory card can be put out from force meter in order to edit files on computer (.txt) and import them to other specialized software. In order to do that use microSD/SD adapter and readout files on computer.

Put microSD card into force meter using pushing element. The card plunges completely into housing and locks. SD or SDH (SDHC) icon appears on display. Push the card in order to unlock it.

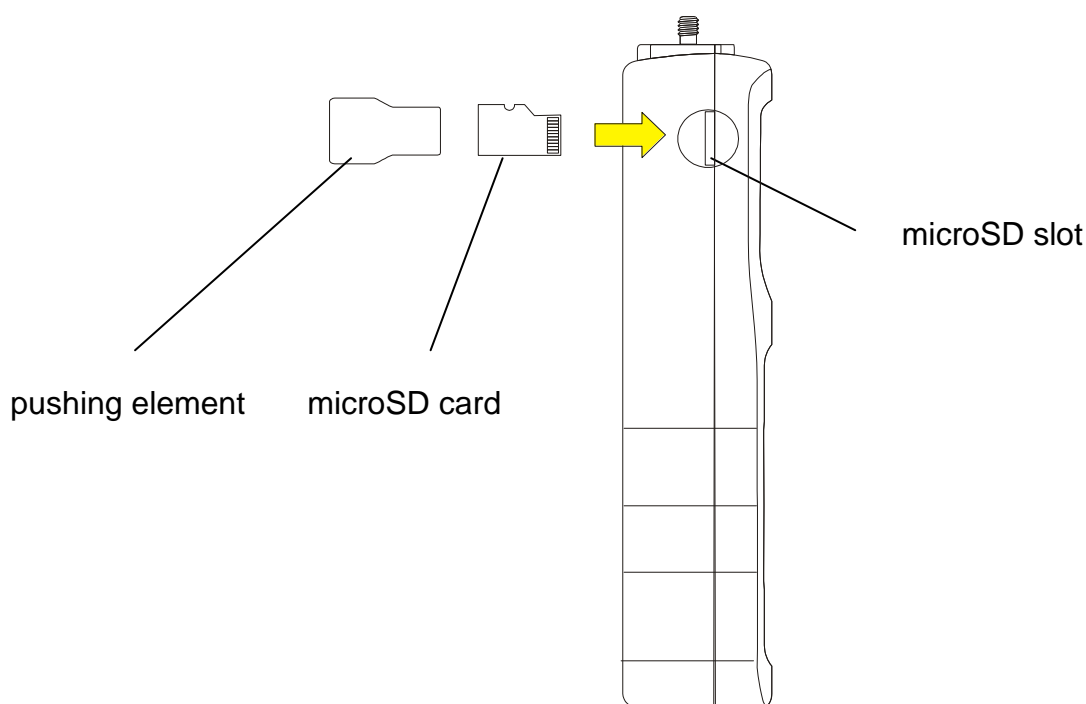

Memory option enables to:

- select gathering results mode,
- exposure of gathered measurements, storing, readout, deleting memory (*Statistics*),
- exit.

14.2.1 Gathering results

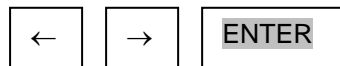
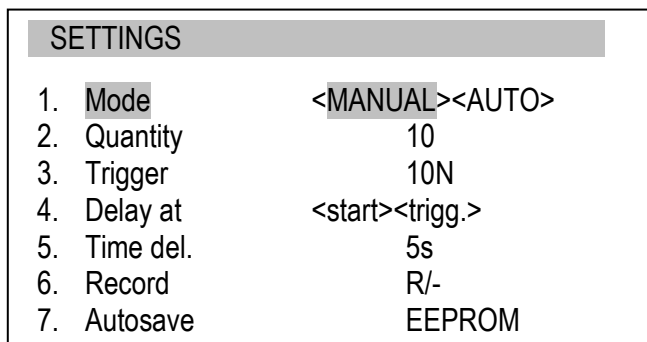
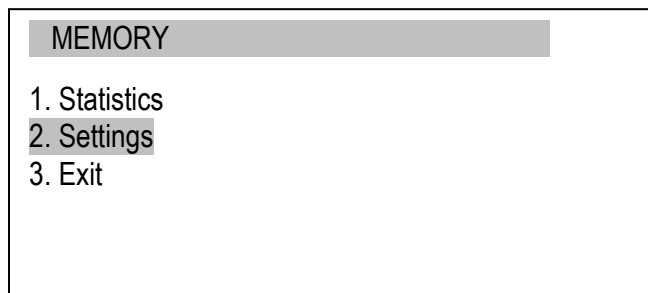
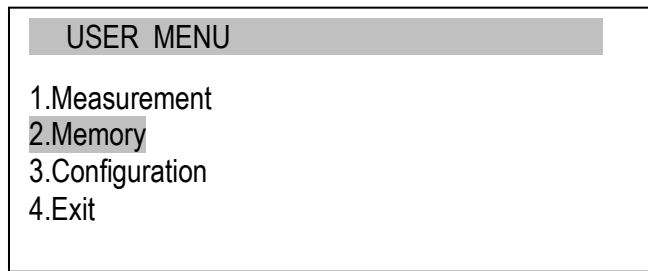

Move the cursor to *Memory* and press *ENTER*.

Move the cursor to *Settings* and press *ENTER*.

Setting the mode for collecting data:

- *MANUAL* – each time after *MEM* is pressed,

- *AUTO* – automatically at specified intervals.

Insert quantity of samples (max 100)

After choosing *Manual* mode user should specify whether he wants to save the time of each measurement (*R/D&T* option).

In *Autosave* option user can choose the place of autosaving results (*EEPROM* or *SDCARD*).

In automatic mode it is possible to set result storing delay time (*Time del.*; during countdown *TRG* indicator blinks) and trigger level (*Trigger*) – that is the force level above which registration process begins.

In automatic mode (*AUTO*) it is also possible to set measurements recording delay (*Time del.* ; during countdown *TRG* indicator blinks) and trigger level (*Trigger*) – the force value above which registration process begins.

To start the collection of measurements, exit the menu and press *MEM* several times or press *MEM* for automatic save. When in the automatic save mode, press and hold *MEM* to go to the data save menu.

After collecting measurements they are exposed (*Statistics*).

14.2.2 Presentation of collected measurements (Statistics)

The *Statistics* option allows for the following forms of presentation of the collected data:

<PRINT> – transmission to a printer,

<HISTOGRAM> – bar graph,

<GRAPH> – graph with a time axis.

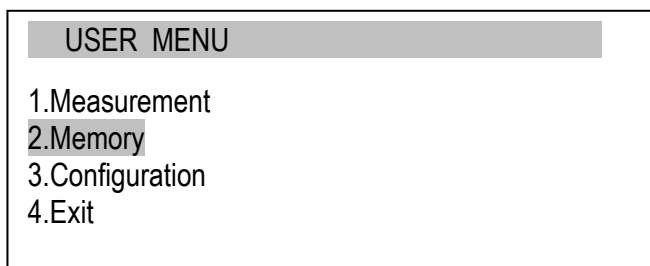

Move the cursor to *Memory* and press *ENTER*.

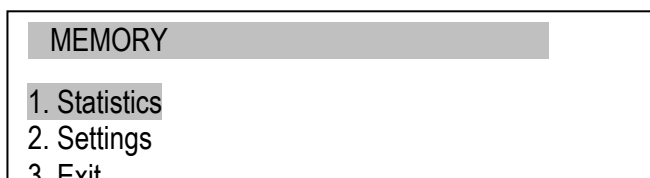

Move the cursor to *Statistics* and press *ENTER*.

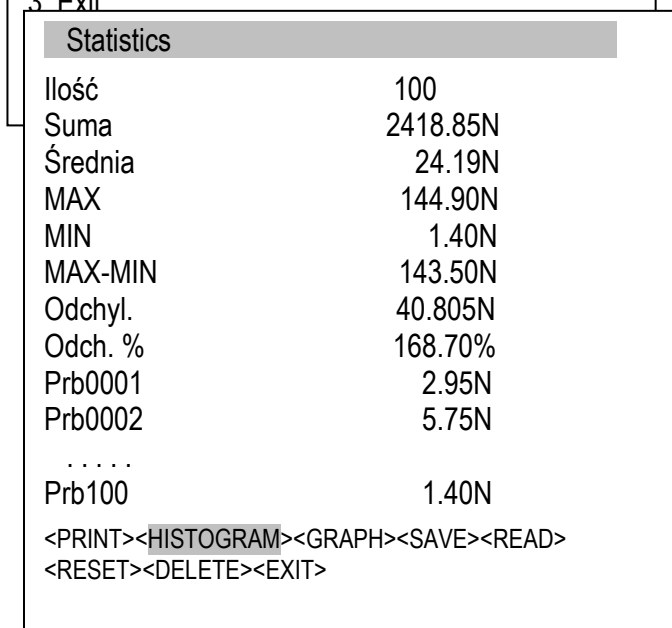

Select one of the options from the lower menu bar:

- *PRINT* – transmission to a printer,

- *HISTOGRAM* – bar graph,

- *GRAPH* – graph with a time axis.

...

- *RESET* – erases the entire memory,

- *DELETE* – deletes a selected memory file.

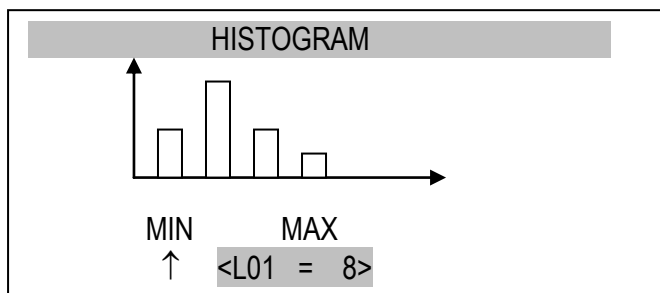

Indicators <L... =..> provide the size of the bar indicated by the ↑ arrow.

To move the arrow (scroll the graph), use the ← and → keys.



14.2.3 Save, read, erase memory (Statistics)

The *Statistics* option allows for the following:

- < *SAVE* > – saves the data currently presented,
- < *READ* > – reads a file from the memory,
- < *RESET* > – erases the data currently presented,
- < *DELETE* > – delete selected data file.

These options show up in the bottom bar (change option using ← or → keys).

USER MENU	
1. Measurement	
2. Memory	
3. Configuration	
4. Exit	

In order to choose saving location move the cursor to *Memory* and press *ENTER*.

MEMORY	
1. Statistics	
2. Settings	
3. Exit	

Move the cursor to *Settings* and press *ENTER*. Choose *Mode*. In *Auto* mode results are saved to RAM memory. In *Manual* mode saving to RAM, EEPROM or microSD card is possible.

SETTINGS	
1. Mode	<MANUAL><AUTO>
2. Quantity	10
3. Trigger	10N
4. Delay at	<start><trigg.>
5. Time del.	5s
6. Record	R/-
7. Autosave	<OFF><EEPROM><SDCARD>

In order to save file on SD card set *Autosave* to *SDCARD* and move cursor to *SD card* position and press *ENTER*.

←	→	↑	↓	ENTER
---	---	---	---	-------

The following options will appear:

- *Folder* – enables to inscribe the name of the folder on microSD card,
- *FILE* – enables to inscribe file name on microSD card,
- *EXIT* – exit.

SD CARD	
1. Folder	FB_DATA
2. FILE	data001.txt
3. Exit	

←	→	↑	↓	ENTER
---	---	---	---	-------

14.3 Configuration

This selection includes all options for setting the gauge's modes of operation.

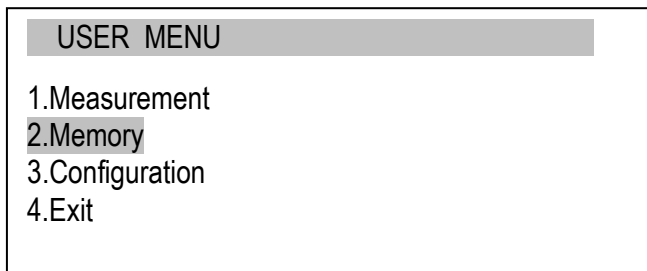

Move the cursor to *Configuration* and press *ENTER*.

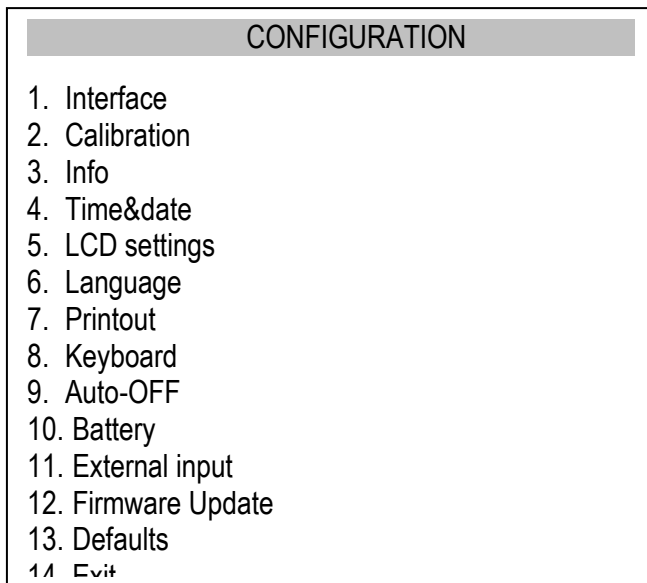

Move the cursor to the desired option and press *ENTER*.

ENTER

14.3.1 Setting serial ports

The parameters of the serial connector must be suitable for the device receiving the signal.

USER MENU
1.Measurement
2.Memory
3.Configuration
4.Exit

CONFIGURATION
1.Interface
2.Calibration
3.Info
4.Date/time
...

INTERFACE
1. RS-232C
2. USB
3. Exit

INTERFACE	
1. Baudrate	4800
2. Bits	8-bit
3. Parity	none
4. Sending	NORMAL
5. Exit	

INTERFACE	
1. Baudrate	4800
2. Bits	8-bit
3. Parity	none
4. Sending	<NORMAL><NO STB><AUTOSTB> <CONTIN.>
5. Exit	



Parameters to be set:

- *Baudrate* – transmission and receiving rate (4,800 ÷ 115,200 bps),
- *Bits* – number of bits which constitute a character (7 or 8 bits),
- *Parity* – control of parity (no control, even – confirmation of parity, or odd – confirmation of odd parity),
- *Sending* – transmission method during measurement:
 - *NORMAL* – after using the *PRINT* key, with stable result,
 - *NOSTB* – after using the *PRINT* key, irrespectively of the result stability,
 - *AUTOSTB* – automatically after the result has stabilised,
 - *REMOVE* – automatically after unload (under 10d or zero signalization threshold) previous stable result is send; if *PEAK* option is on, after unloading zeroing of indications is carried out,
 - *CONTIN.* – continuous transmission, approx. every 0.1 s.

When the force meter is equipped with two serial interfaces (RS232C and USB) in submenu *Interface* two options are available *RS232C* and *USB*. After choosing proper port all settings are done the same way as above.

14.3.2 Force meter calibration

To calibrate the gauge, select the method of applying load. For this purpose, use a stand or suspend a standard of mass on the gauge.

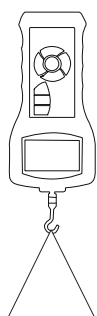

Reset the gauge without load using the →0← key.

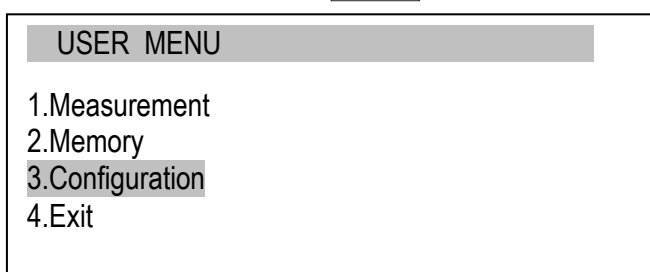

Use the navigation keys and *ENTER* to select *Calibration* and *Load*.

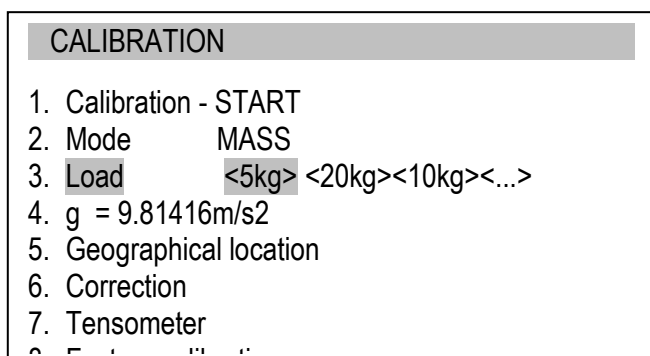

Select the load depending on the standard of mass. The <...> option allows for entering any value.

Enter the gravitational acceleration to correctly convert mass (kg) into force (N).

If the exact “g” value is not known, enter the parameters of the geographical location (latitude and above mean sea level). The “g” value will be calculated automatically.



Apply the standard of mass to the gauge.

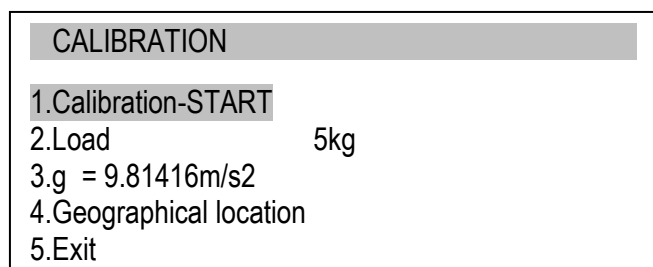

Use the navigation keys and *ENTER* to select *Calibration* and wait until the calibration process is completed.

Correction option enables changing force indications with inscribed value.



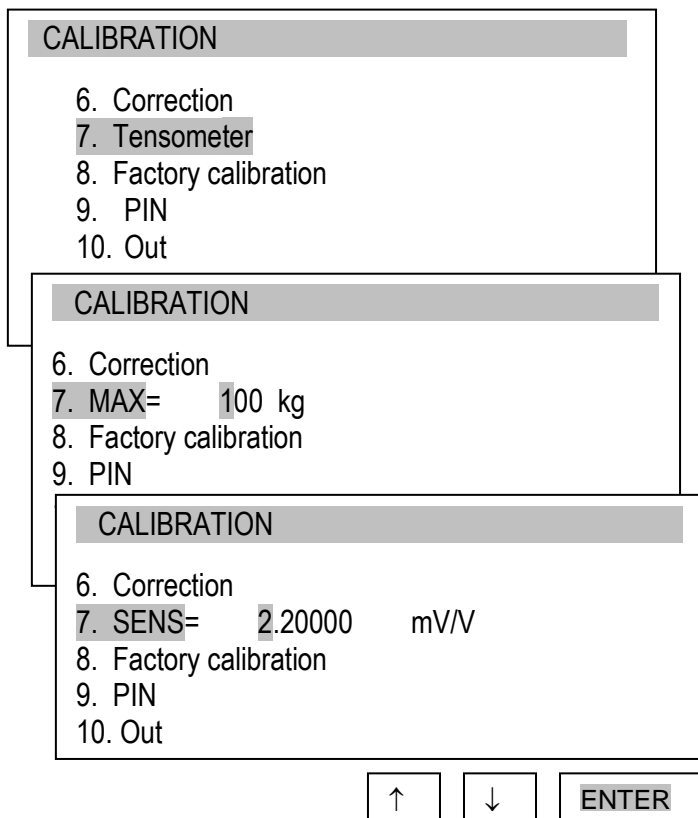

Tensometer option enables direct inscribing range (MAX) and sensitivity (SENS) of tensometric sensor by using navigation keys. Measurement range doesn't change.

Factory calibration returns to initial factory calibration values

PIN option enables to block access to calibration with PIN code written by user.

14.3.3 Information

Option gives basic information about the device.

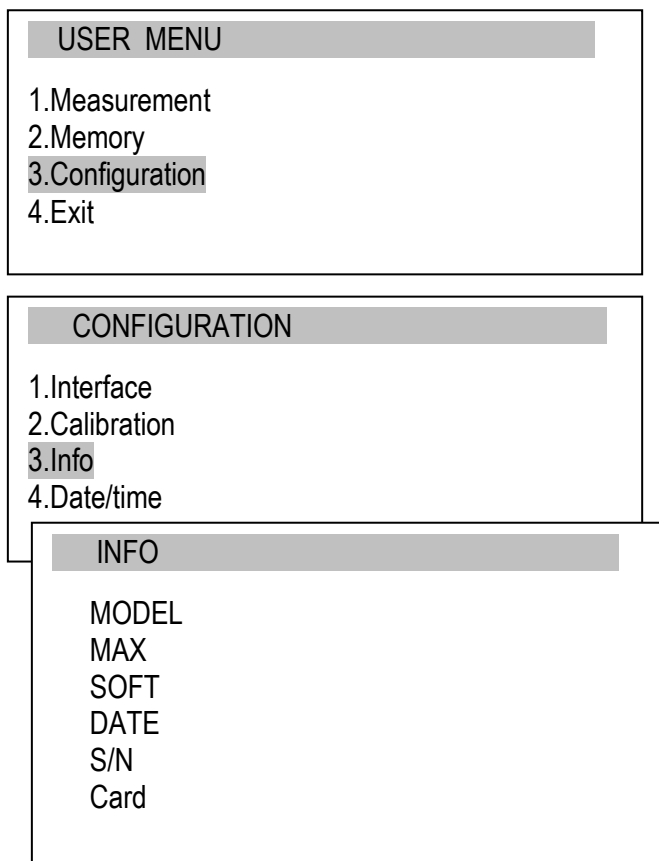

Available information:

- force meter type (*Model*)
- measurement range (*MAX*)
- internal software version (*SOFT*)
- serial number (*S/N*)
- production date (*DATE*)
- memory card type (*Card*)
- producer name

14.3.4 Setting date and time

This option is used for entering the current date and time. Access to this setting is secured by the PIN code.

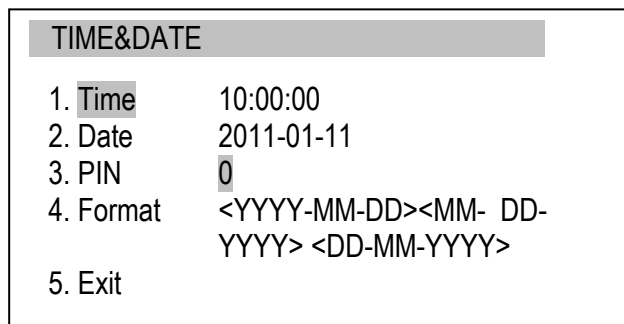
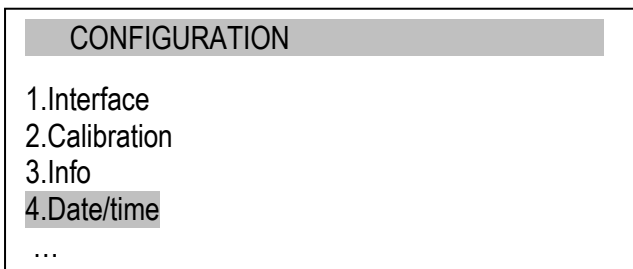
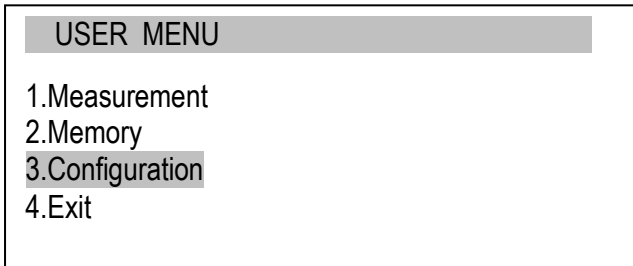

Use the navigation keys and *ENTER* to select *Date and time*. If a *PIN* has already been entered (other than 0), after selecting *Time* or *Date*, the cursor will move to the *PIN* option, where a correct 4-digit *PIN* has to be entered. To enter the correct digits, use the \uparrow , \downarrow , \rightarrow , \leftarrow keys and *ENTER*.

To enter a new code (*NEW*), select the *PIN* option. When entering a new code, type in the same number twice (message: *REP.*).

The *FORMAT* option allows for the selection of the date format on print-outs.

14.3.5 LCD settings

This option adjusts the gauge's display to external lighting conditions.

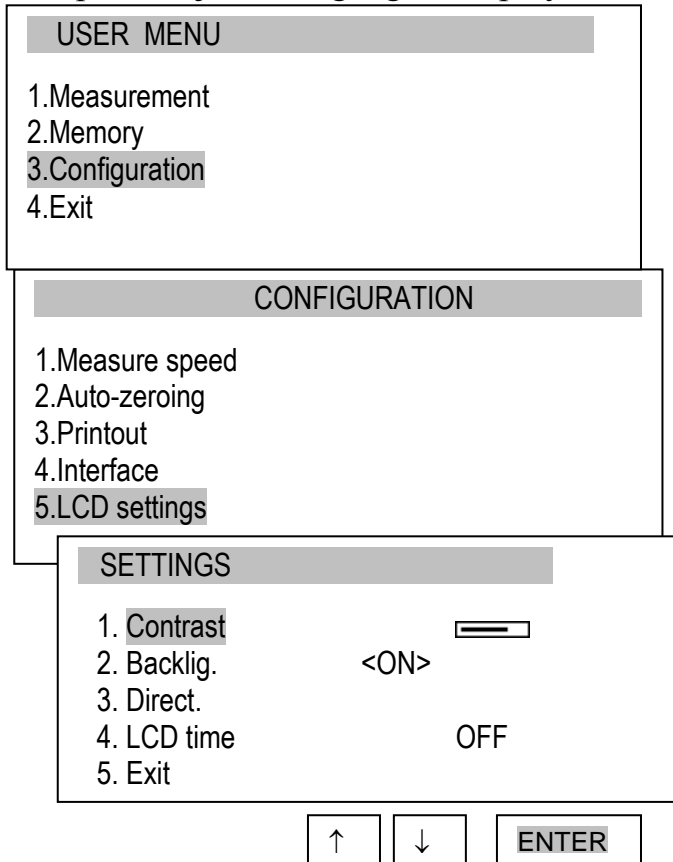

Use the navigation keys and *ENTER* to select *LCD settings*. Next, use *→*, *←* and *ENTER* to set the contrast at which the display is best legible.

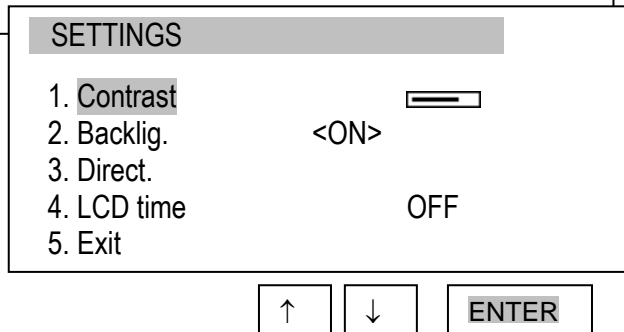

When setting *Backlig.*

(backlighting), select one of the following options:

- *OFF* – backlighting OFF,
- *ON* – backlighting continuously ON,
- *ECO* – to backlight, use the *BACKLIGHT* key,
- *BAT* – backlighting is turned off after 30 seconds to save the batteries.

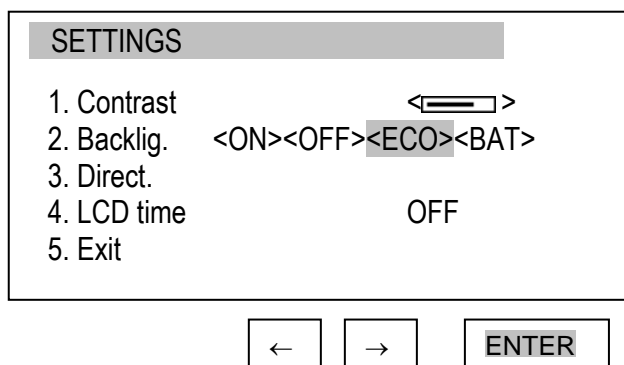

The *DIRECT.* (direction) option is used for selecting the display's direction:

- *AUTO* – automatic rotation of the displayed image,
- *UP* – standard direction,
- *DOWN* – inverted image.

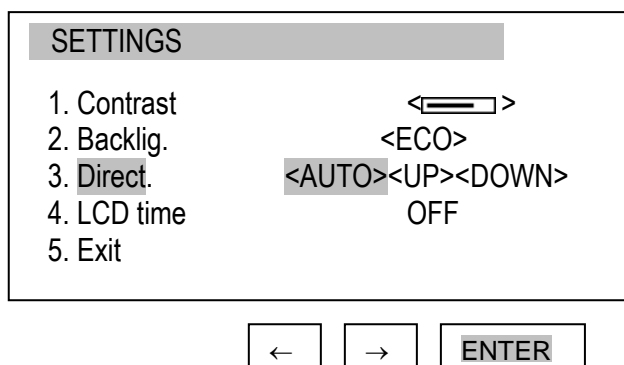

The *LCD TIME* option displays the date and time during measurement in the display's upper bar.

14.3.6 Selecting the menu language

Three menu languages are available:

- <PL> – Polish,
- <ENG> – English,
- <DE> – German,
- <ESP> - Spanish.

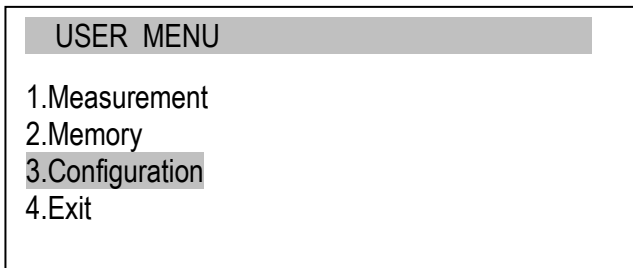

Use the navigation keys and *ENTER* to select *Language*. To select one of the available menu languages, use the →, ← keys and *ENTER*.

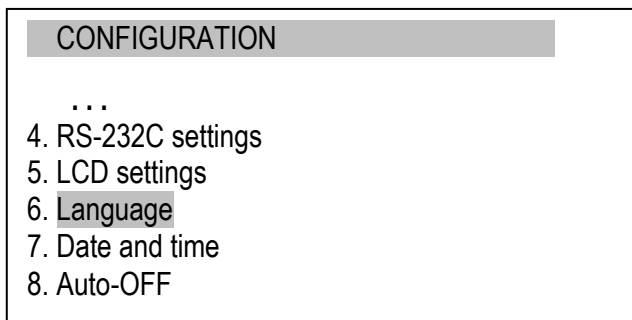

To enter a new code (*NEW*), select the *PIN* option. When entering a new code, type in the same number twice (message: *REP.*).

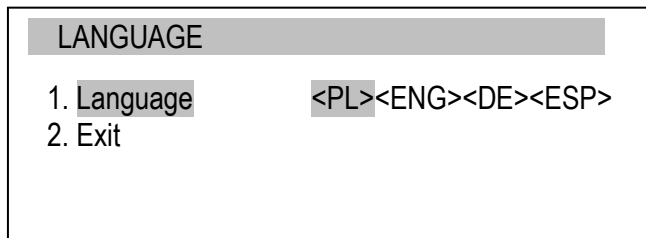

14.3.7 Printout settings

According to the requirements of GLP procedures, it is possible to use an external printer to produce print-outs from the gauge including text information.

USER MENU
1.Measurement
2.Memory
3.Configuration
4.Exit

CONFIGURATION
5. LCD settings
6. Language
7. Printout
4 Interface

PRINTOUT
<input type="checkbox"/> Heading
<input type="checkbox"/> Date
<input type="checkbox"/> Time
<input type="checkbox"/> ID1>
<input type="checkbox"/> ID2>
<input type="checkbox"/> ID3>
<input type="checkbox"/> Number

ENTER →

PRINTOUT
<input type="checkbox"/> Heading
<input type="checkbox"/> Date
<input type="checkbox"/> Time
<input type="checkbox"/> ABCD
<input type="checkbox"/> ID2
<input type="checkbox"/> ID3

↑ ↓ ↓ ↑ ENTER

Use the navigation keys and *ENTER* to select *Printout* and the suitable print components.

ID1, *ID2*, *ID3* – text strings (up to 20 characters) forming the lines of the print-out, entered using the gauge's navigation keys (starting from →).

To enter the characters, select *ID* using *ENTER* and press →. The characters are entered using the navigation keys ↑ and ↓. To move the cursor to the consecutive positions, use ← and →. To confirm the entered string, press *ENTER*. To delete a character, enter space

14.3.8 Turning the sound ON/OFF when using the keypad (beep)

This options turns ON or OFF the sound signalling that a key on the keypad has been pressed. When the sound is turned on, the user usually does not apply excessive force when pushing the keys.

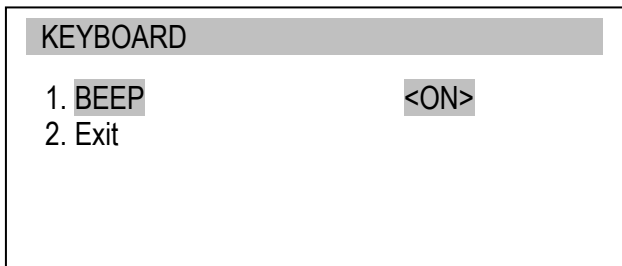
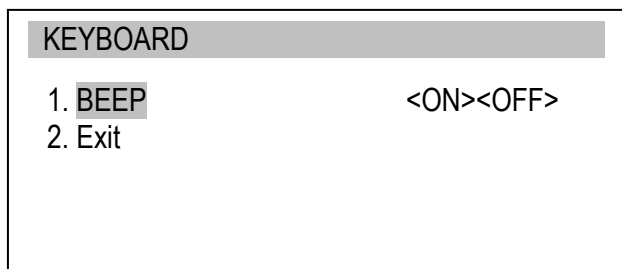
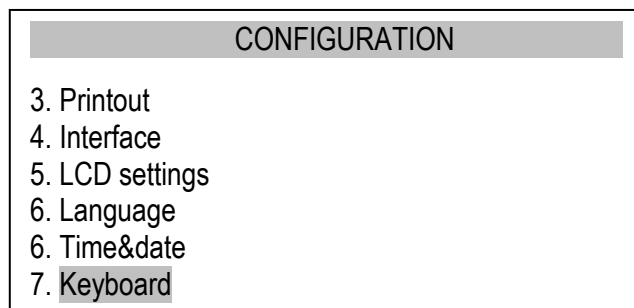
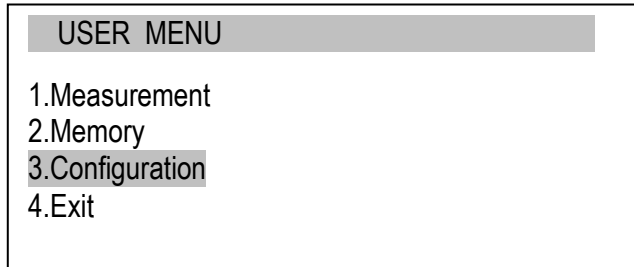

Use the navigation keys and *ENTER* to select *Keypad* and *Buzzer*, and one of the following options:
 - *ON* – sound ON,
 - *OFF* – sound OFF.

14.3.9 Automatic power OFF (Auto-OFF)

This option allows for an automatic cut-off of the gauge's power supply to save the battery's energy.

USER MENU
1.Measurement
2.Memory
3.Configuration
4.Exit

CONFIGURATION
1.Interface
2.Calibration
3.Info
4.Time&date
5.LCD settings
6.Language
7.Printout
8.Keyboard
9.Auto-OFF
10.Battery
11.External input
12.Firmware Update
13.Defaults
14 Exit

AUTO-OFF	
1. Status	OFF
2. Exit	

↑	↓	ENTER
---	---	-------

AUTO-OFF	
1. Status:	<OFF> <BAT> <ON>
2. Exit	

←	→	ENTER
---	---	-------

Use the navigation keys and *ENTER* to select *Auto-OFF* and *Status*, and one of the following options:

- *ON* – the power is turned off after 5 minutes, the indications remain unchanged,
- *BAT* – the power is turned off when the battery is low,
- *OFF* – the power is not turned off.

14.3.10 Monitoring the batteries' charge level (Battery)

This option is used for reading the charge level of the batteries and allows for the charging to be turned off to protect ordinary batteries, if such batteries are used instead of rechargeable batteries.



Charging ordinary batteries used instead of rechargeable batteries may lead to major damage to the gauge.

USER MENU

- 1.Measurement
- 2.Memory
- 3.Configuration
- 4.Exit

CONFIGURATION

- 1.Interface
- 2.Calibration
- 3.Info
- 4.Time&date
- 5.LCD settings
- 6.Language
- 7.Printout
- 8.Keyboard
- 9.Auto-OFF
- 10.Battery
- 11.External input

Use the navigation keys and *ENTER* to select *Battery* and *Charging*, and one of the following options:

- *ON* – charging ON,
- *OFF* – charging OFF.

BATTERY

1. Charging OFF
2. Level
3. Exit

↑ ↓ ENTER

BATTERY

1. Charging <OFF> <ON>
2. Level
3. Exit

← → ENTER

14.3.11 External input

This option can be used when force gauge is applied in any kind of automated process. THRESHOLD (optionally) output is used for this function so when using this option threshold function should be turned off.

USER MENU	
1.Measurement	
2.Memory	
3.Configuration	
4.Exit	

CONFIGURATION	
...	
8. Keyboard	
9. Auto-OFF	
10. Battery	
11. External input	

EXTERNAL INPUT	
1. Status :	<OFF><TRIGGER><GATE>
2. Exit	

Using navigation keys and *ENTER* key choose *Configuration* option and then *External input*. Choose *Status* option and using ← and → keys choose from:

- *OFF* – function off,

- *TRIGGER*:

a) manual measurement mode – measurement storing initiated by a single external signal,

b) automatic measurement mode – storing of set quantity of measurements initiated by a single external signal,

- *GATE*:

a) manual measurement mode - measurement storing initiated by a single external signal while *MEM* key is pressed,

b) automatic measurement mode – storing of set quantity of measurements initiated by external signal state time window.

14.3.12 Firmware update

Option designated for service

Option enables program update by connecting force gauge to computer using RS232 or USB interface. *Firmware update* message on force gauge's display is connected with this option. To delete this message, disconnect the force gauge from supply.

14.3.13 Defaults

This option restores factory settings (default settings) for all options.

USER MENU
1.Measurement
2.Memory
3.Configuration
4.Exit

CONFIGURATION
...
7. Date and time
8. Auto-OFF
9. Battery
10. Defaults

DEFAULTS
Restore default settings?
NO
YES

↑	↓	ENTER
---	---	-------

Use the navigation keys and *ENTER* to select *Reset settings* and the option *YES*.

As a result of restoring factory settings, the gauge will reset and start continuous measurement.

15. Maintenance, troubleshooting and repairing minor types of damage

1. Keep the gauge clean.
2. When using the force gauge, make sure that no contamination gets between the gauge plunger and the enclosure. Upon identifying any contamination, remove it using a tool which does not conduct electricity.
3. Unauthorised person may not perform any repairs.
4. Have the gauge repaired by your local servicing facility. A list of servicing facilities is enclosed in the warranty.

Messages and faults:

Message/fault	Cause	Recommendation
The message RESETTING is displayed for an extended period of time.	Resetting process disturbed	Keep the gauge in motionless position and press $\rightarrow T(0) \leftarrow$
Message: AD range exceeded (+/-)	Resetting process disturbed	Put the gauge in horizontal position and turn it off and on using the ON/OFF key.
The values indicated by the gauge diverge significantly from correct values	Gauge out of adjustment	Contact a servicing facility to calibrate the gauge
Units displayed are different from the selected units	UNIT/CLEAR key pressed by accident	Press the UNIT/CLEAR key several times to display the correct units

16. Force gauge menu diagram

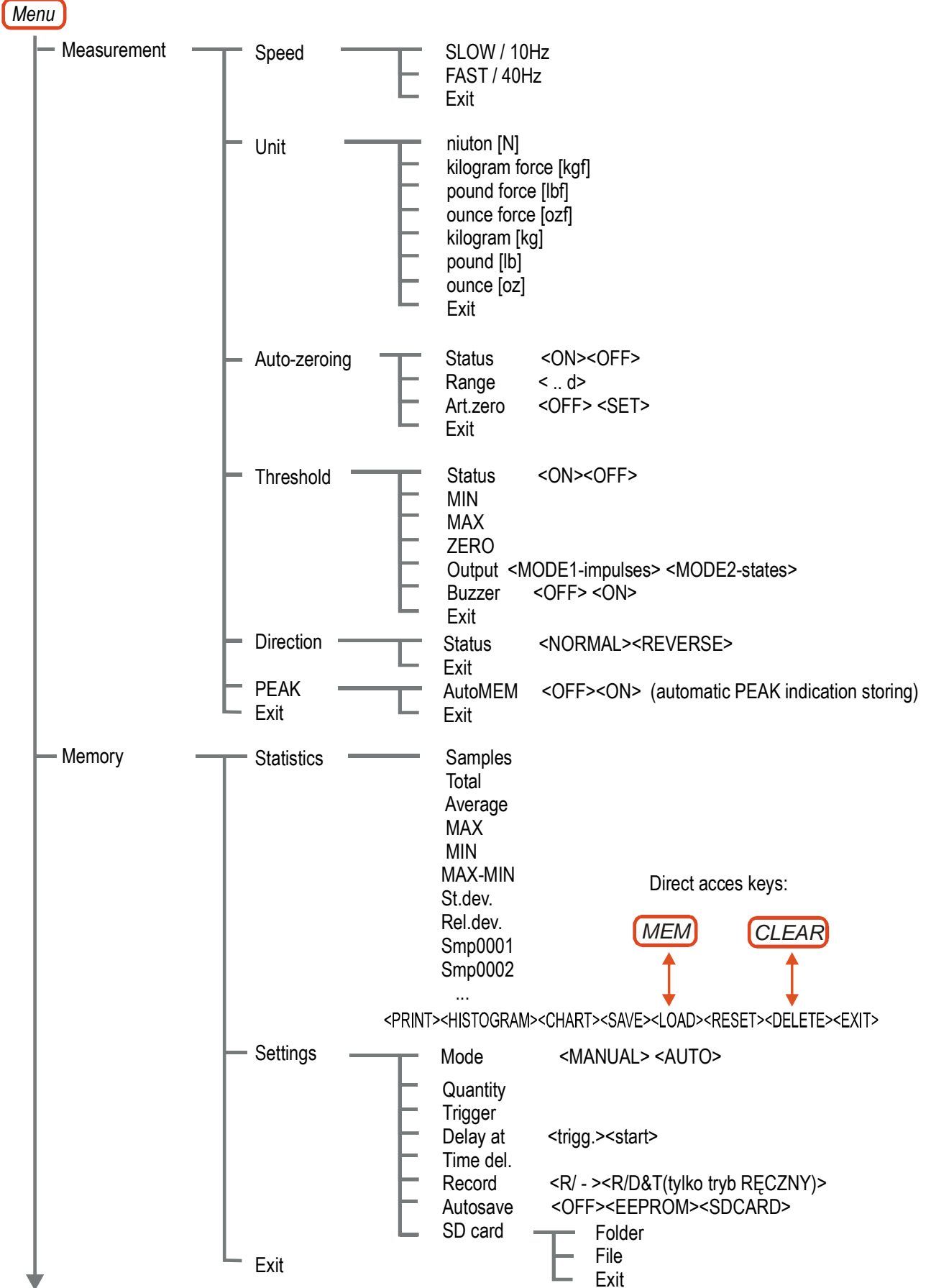

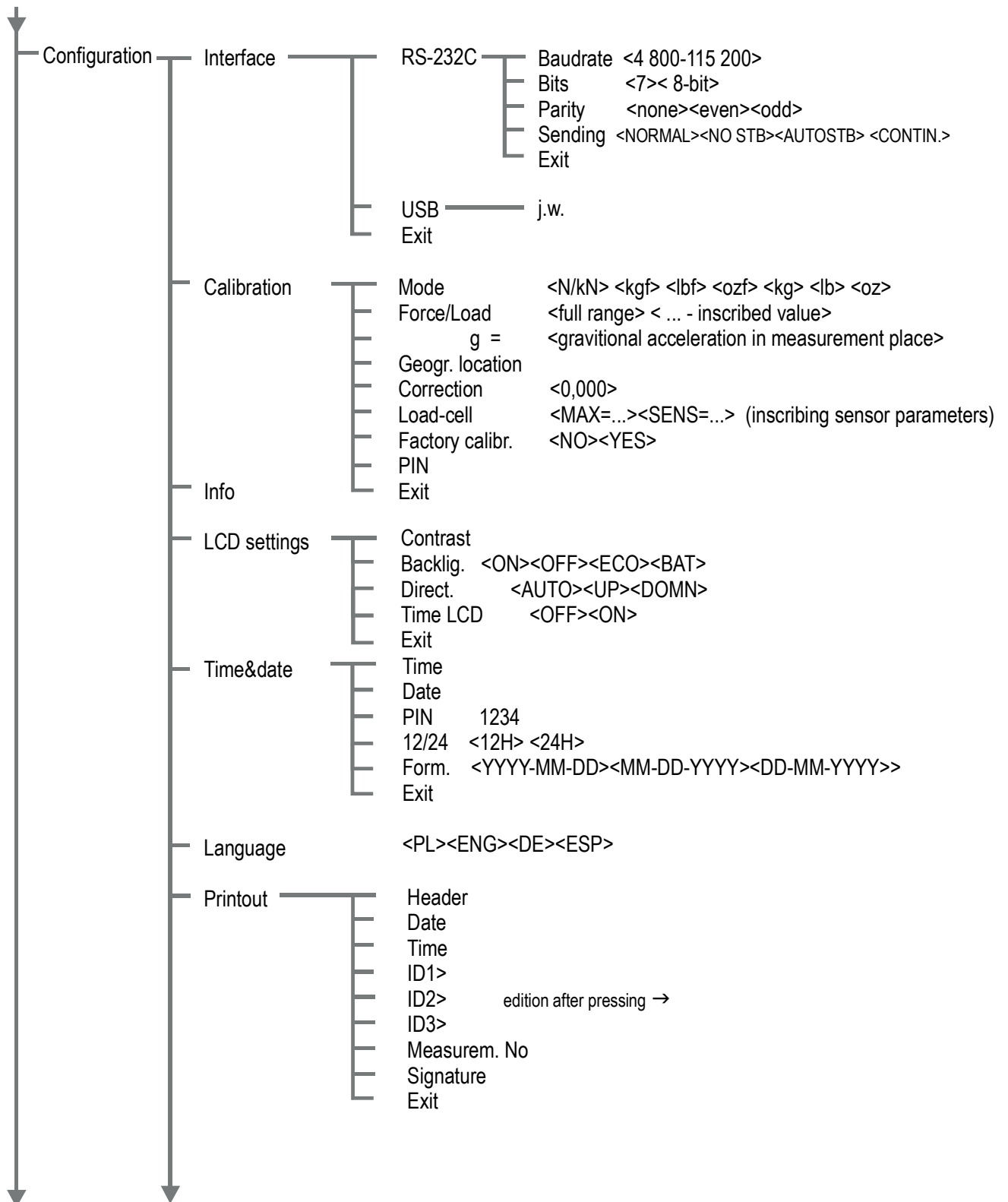

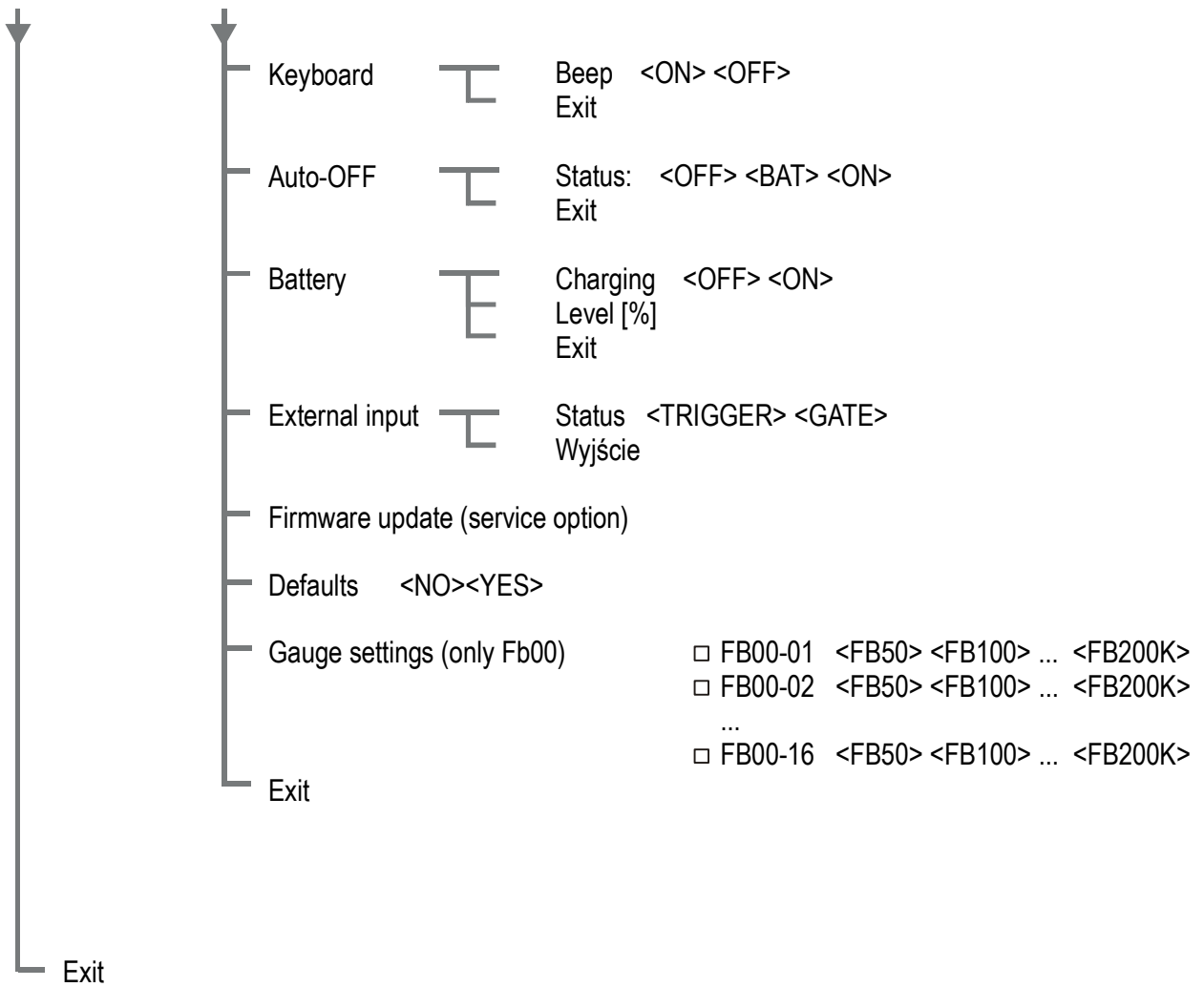

Declaration of Conformity



We:

AXIS Spółka z o.o. 80-125 Gdańsk, ul.Kartuska 375B

confirm with all responsibility that force gauges:

*FB5, FB10, FB20, FB50, FB200, FB500,
FB1k, FB2k, FB5k, FB10k, FB20k, FB50k, FB150k*

marked with CE mark comply with the following:

1. Directive 2004/108/EC (electromagnetic compatibility) and harmonized norms:
 - PN-EN 61000-4-3+A1:2008+A2:2011
 - PN-EN 61000-6-3:2008+A1:2011
 - PN-EN 55011:2007+A2:2007

Additional information:

- Conformity evaluation were carried out by Laboratorium Badawcze Oddziału Instytutu Elektrotechniki in Gdańsk, accredited by PCA (AB007), examination report nr 109/LMC-738/2009 from 28.09.2009 r..

Gdańsk, 22-08-2014 r.

Per pro Director of *AXIS* Sp. z o.o.:

Production Manager Jan Kończak



Signature

Appendix A

FB00 meter with external sensor

1. General description

FB00 force gauge requires joining the force sensor by using connector situated in meter housing. Moreover it is crucial to set force gauge working parameters.

After this actions earlier chapters of the manual are applied.

2. Extensometer sensor assembly

To connect sensor use pin supplied with force gauge according to diagram:

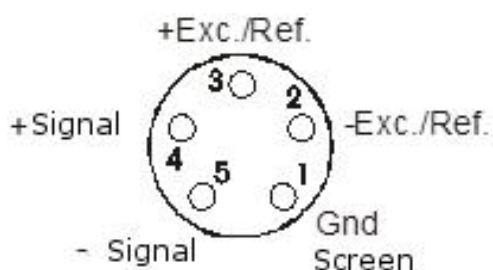

(View
from
inside)

Common conduit colors:

+Exc./Ref. – Red

-Exc./Ref – Black

+S – Green

-S – White

Gnd - braid

3. Meter configuration

In order to achieve proper force gauge parameters use additional options *Configuration / Gauge setting*.

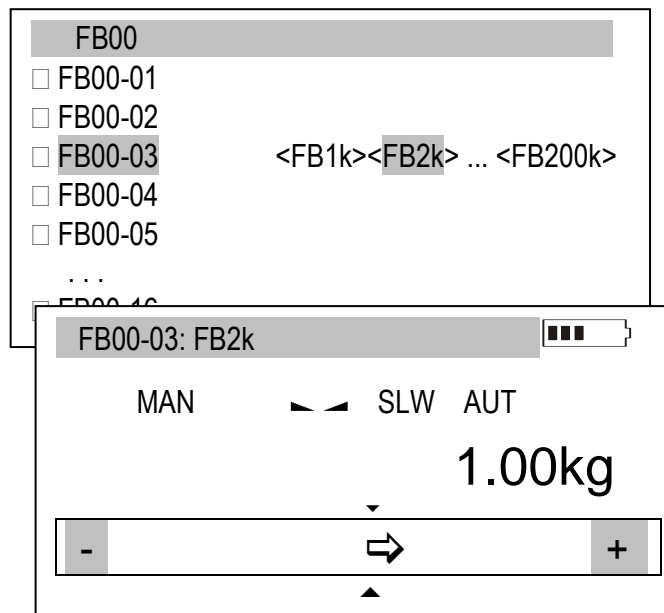
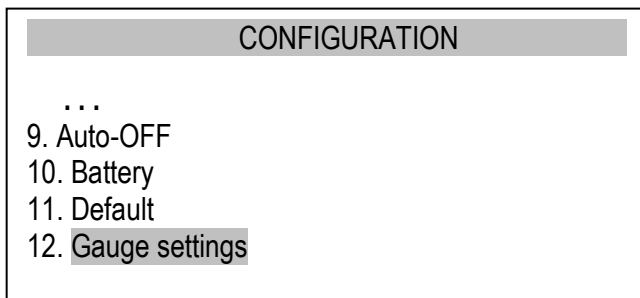
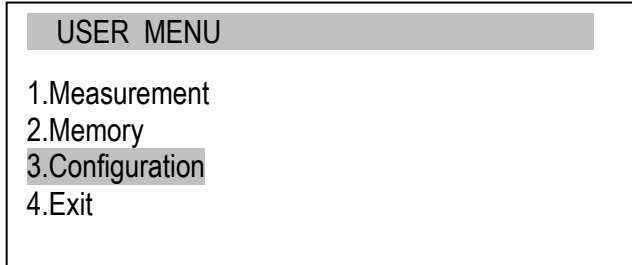

Using navigation keys and *ENTER* key choose *Configuration and Gauge settings* option.

Choose indication – number of used sensor for example :
For number 3 it can be FB00-2. Press *ENTER* and choose metrological type proper for the sensor. Example: FB2k for 2kN sensor. Confirm using *ENTER* key.

The selected type is indicated in the upper bar.

After choosing proper type calibration should be executed. Calibrations are also stored after turning off or changing sensor number.

4. Meter calibration

FB00 meter calibration method doesn't differ from the description in 15.2 chapter - *Calibration*. Calibration weight value must respond to force gauge parameters.

Notes