



ENVIROMUX® Series

Temperature/Humidity Sensor Installation Manual



ENVIROMUX-STS-E7, STHSM-E7
Temperature/Humidity sensors



ENVIROMUX-STS-O
Outdoor Temperature sensor



ENVIROMUX-STHS-N4085IND
Temperature/Humidity sensor



ENVIROMUX-STHSB
Temperature/Humidity Sensor

TABLE OF CONTENTS

Introduction..... 1
Mounting..... 1
 Mounting Instruction 3
Connect Sensors..... 4
 RJ45 Sensors 4
 ENVIROMUX-STHS-PRCIND100-Pxx 5
 ENVIROMUX-STHS-LCDW 6
 RJ45 Sensor Cable..... 12

TABLE OF FIGURES

Figure 1- Keyhole slot for standard mounting 1
Figure 2- DIN rail clip 1
Figure 3- Connect Sensors using CAT5 cable with RJ45 connectors..... 4
Figure 4- A portion of the sensor configuration page 4
Figure 5- Precision wide-range temperature/humidity sensor..... 5
Figure 6- ENVIROMUX-STHS-LCDW 6

INTRODUCTION

Many different sensors can be connected to the ENVIROMUX Series Enterprise Environment Monitoring Systems. Series models covered by this manual include ENVIROMUX-SEMS-16U and ENVIROMUX-16D/5D/2D. A complete listing of available sensors and accessories can be found at

<http://www.networktechinc.com/enviro-rems.html> for the ENVIROMUX-SEMS-16U,

<http://www.networktechinc.com/environment-monitor-16d.html> for the ENVIROMUX-16D,

<http://www.networktechinc.com/environment-monitor-5d.html> for the ENVIROMUX-5D,

<http://www.networktechinc.com/environment-monitor-2d.html> for the ENVIROMUX-2D, and Manuals for each Environment Monitoring System covering installation and configuration for all features can also be found at these websites.

This manual is only provided to instruct how to install the ENVIROMUX temperature and humidity sensors to these systems.

MOUNTING

Most of the ENVIROMUX Temperature and Humidity sensors are intended for indoor use only. These sensors can be mounted in any position but include a keyhole slot on the back to enable quick wall-mounting if desired.

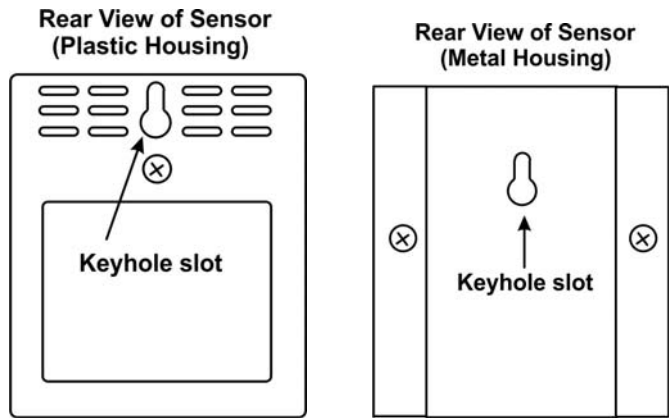

Figure 1- Keyhole slot for standard mounting

If you have purchased an ENVIROMUX Sensor with a DIN rail clip for DIN rail mounting, see the drawing (page 2) for instructions to install the sensor to the DIN rail.

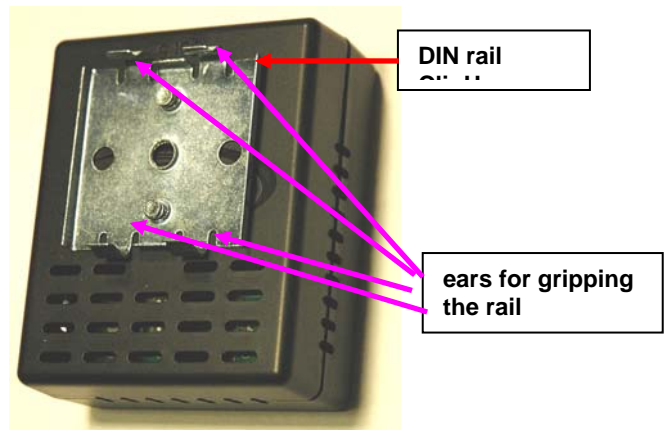
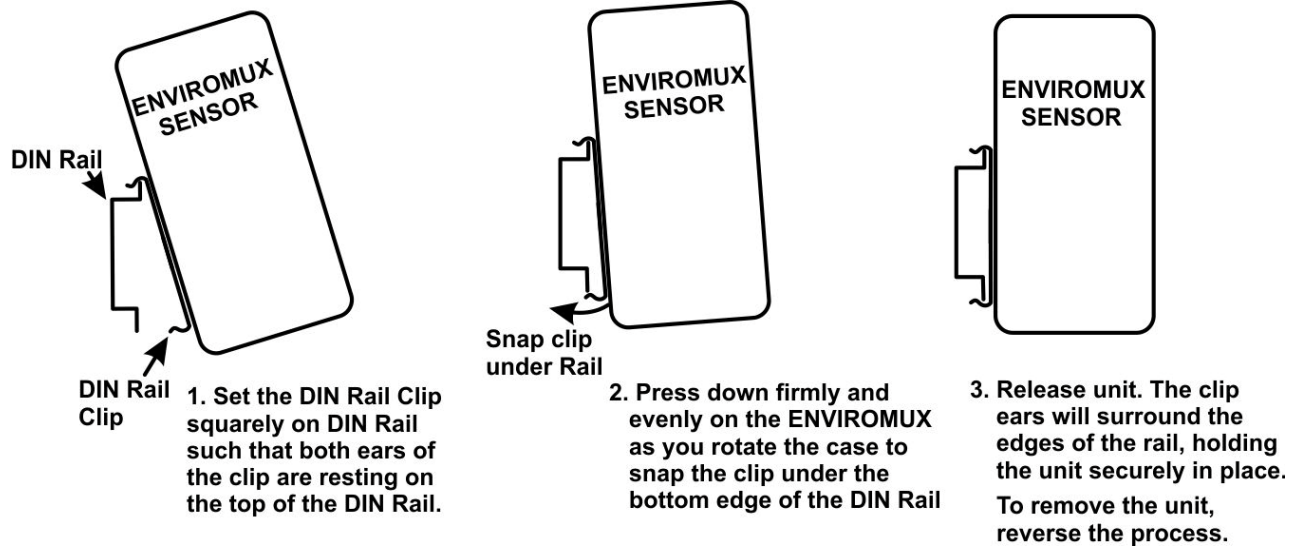

Figure 2- DIN rail clip

NTI ENVIROMUX TEMPERATURE/HUMIDITY SENSOR ATTACHMENT



ENVIROMUX-STHS-LCDW

The ENVIROMUX-STHS-LCDW is a Temperature and Humidity sensor built into a large wall-mount LCD display with 2" character height for easy viewing from a distance. There are two key-hole slots on the back, 4-1/2" apart, for hanging the sensor on the wall. A template has been provided to make placement and hardware location easy. There are also two brackets (with screws) that can be mounted to the sides. These are provided for an alternate method of mounting.



Frontview of ENVIROMUX-STHS-LCDW
(Shown without side mounting brackets)



Rearview of ENVIROMUX-STHS-LCDW

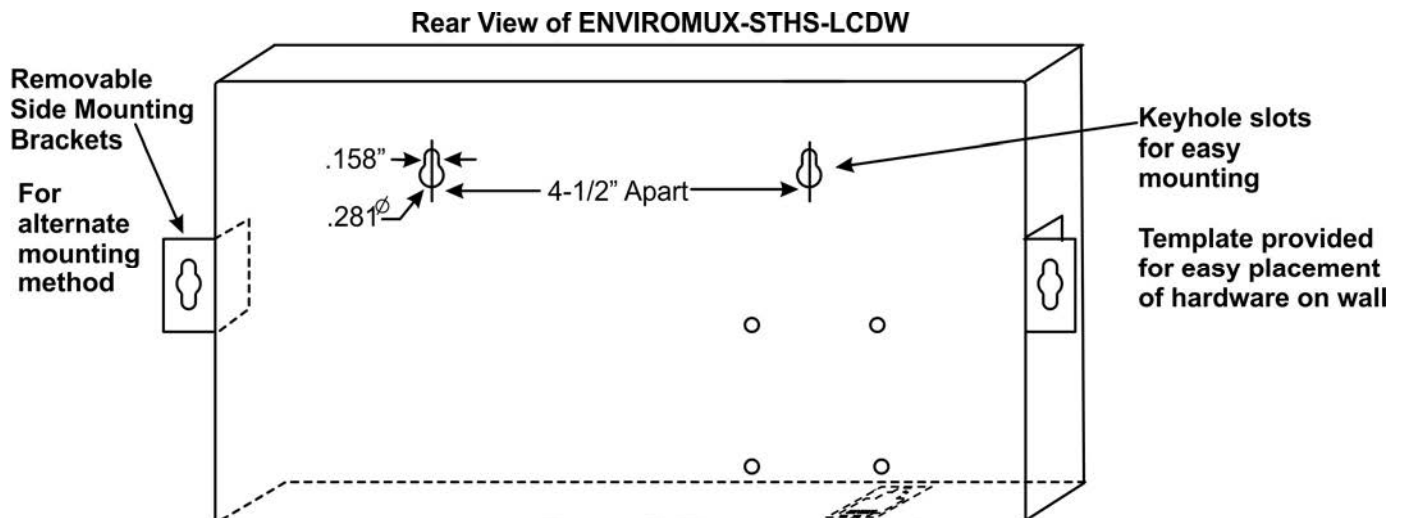

NTI ENVIROMUX TEMPERATURE/HUMIDITY SENSOR ATTACHMENT



Template for easy mounting the ENVIROMUX-STHS-LCDW

Mounting Instruction

Using Side Brackets

1. Mount one side bracket to each side of the sensor with the screws provided.
2. Position sensor and mark top of keyholes.
3. Drill two 3/16" diameter holes where top of keyholes were marked.
4. Insert wall anchors (provided) and start the mounting screws.
5. Hang the sensor on the screws and snug down the screws.

Using Rear Keyhole Slots

1. Position template at mounting location and mark top of keyholes.
2. Drill two 3/16" diameter holes where top of keyholes were marked.
3. Insert wall anchors (provided) and start the mounting screws.
4. Screw in until head of screw is approximately 1/8-3/16" from the wall.
5. Hang the sensor on the screws.

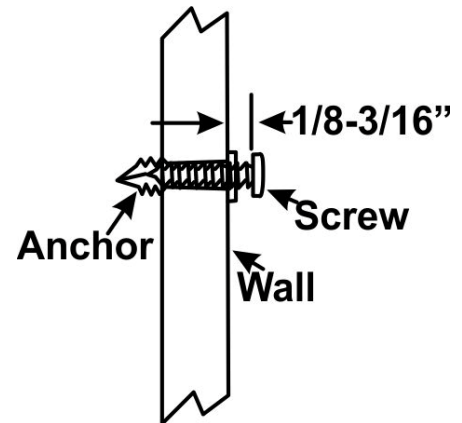

CONNECT SENSORS

RJ45 Sensors

The temperature and humidity sensors for the ENVIROMUX-16D/5D/2D and ENVIROMUX-SEMS-16(U) Enterprise Environment Monitoring Systems have RJ45 connection ports. Connect each sensor to one of the female connectors labeled "RJ45 Sensors" on the ENVIROMUX using CAT5 cable. The male RJ45 connectors should snap into place. (See page 12 for wiring specification and pinout.) The CAT5 cable that connects the sensor to the ENVIROMUX can be up to 1000 feet in length (except for ENVIROMUX-STHS-LCDW, which is limited to 150 feet).

Note: It is very important to locate the temperature and/or humidity sensors away from ventilation sources and fans.

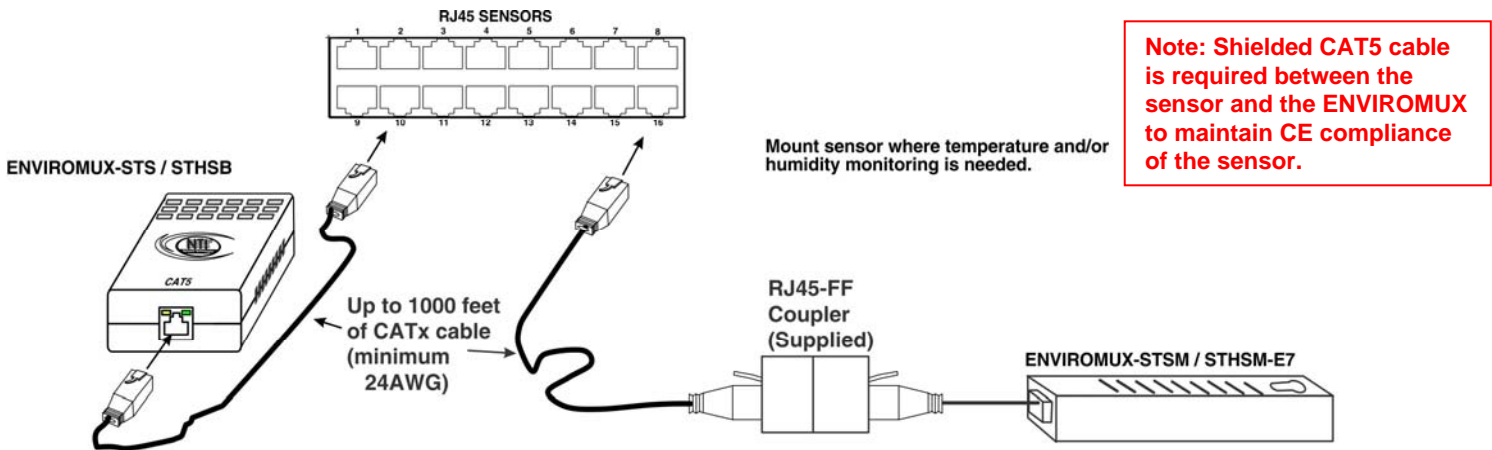

Figure 3- Connect Sensors using CAT5 cable with RJ45 connectors

Application Note:

When connecting temperature and humidity sensors to the ENVIROMUX, the web interface will identify the sensor accordingly for the type of sensor it is. The status bar and configuration page will enter the maximum and minimum range that this type of sensor can display if used with the ENVIROMUX, not necessarily the operating range of the sensor itself. The various temperature and humidity sensor models offered by NTI have varying ranges of performance capabilities, as indicated in the table on page 11. Be sure to match the sensor installed to the operating range of the environment it will be expected to work in. Using a sensor outside of its intended temperature range may result in damage to the sensor.

Sensor #2.1 Configuration (Type: Temperature Combo)

| Sensor Settings | |
|-----------------|---|
| Description | Sensor #2.1 <small>Descriptive name for the sensor</small> |
| Group | 1 <small>Select which group the sensor belongs to</small> |
| Units | Deg. F <small>Select the units for the sensor</small> |
| Min. Level | -4.0 <small>Min. supported value for the sensor</small> |
| Max. Level | 185.0 <small>Max. supported value for the sensor</small> |

This is the range the ENVIROMUX will display, not necessarily the range the sensor will work within. See specifications for the sensor being installed for the proper operating environment.

Figure 4- A portion of the sensor configuration page

NTI ENVIROMUX TEMPERATURE/HUMIDITY SENSOR ATTACHMENT

ENVIROMUX-STHS-PRCIND100-Pxx

The ENVIROMUX-STHS-PRCIND100-Pxx is a precision wide-range extreme environment sensor that includes a probe-type temperature sensor attached to the aluminum case with a special extreme-environment cable. The cable length is defined by the “xx” in the “Pxx”. When installing this temperature sensor, the temperature sensing probe and attached cable are the only portions of the sensor that can be exposed to the full extreme environment that this sensor is rated for (-40 to 212°F (-40 to 100°C)). The aluminum case and the components therein are rated for -40 to 185°F (-40 to 85°C) and must be located in an environment within that range. Most CATx cables are rated 32 to 140°F (0 to 60°C).

Note: When mounting the temperature probe, be sure not to obstruct the holes in the probe tubing as this will adversely affect the sensor's ability to sense humidity.

Note: The ENVIROMUX-2D/5D/16D must be running firmware version 2.18 or later to support this sensor.

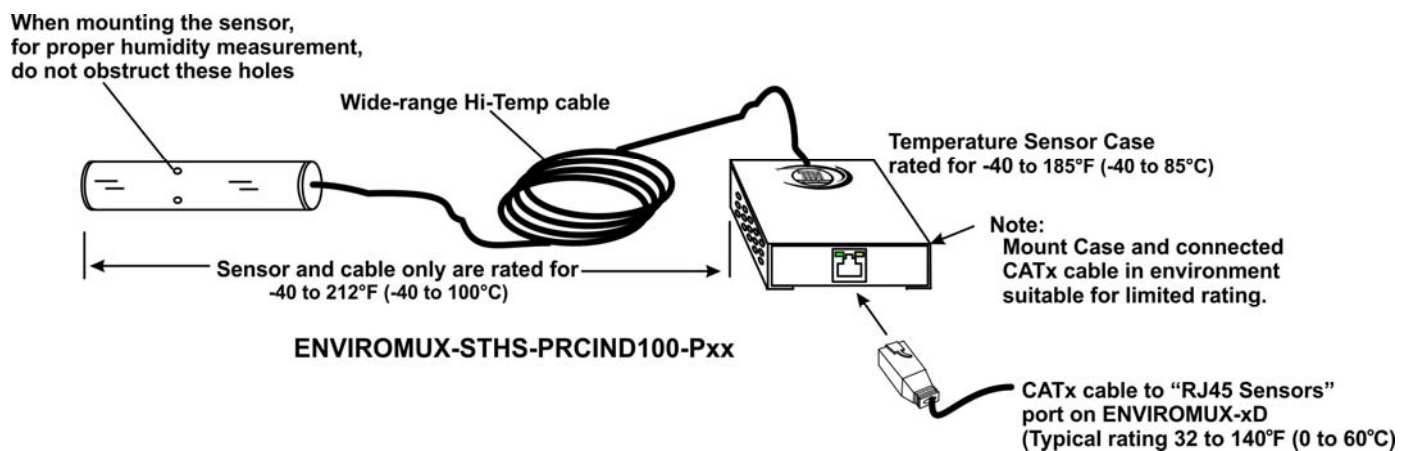

Figure 5- Precision wide-range temperature/humidity sensor

NTI ENVIROMUX TEMPERATURE/HUMIDITY SENSOR ATTACHMENT

ENVIROMUX-STHS-LCDW

ENVIROMUX-xD firmware version 2.31 or later is required to support this sensor.

The ENVIROMUX-STHS-LCDW is a temperature/humidity sensor with built-in LCD display that has 2" tall characters for easy viewing from greater distances. It has a temperature range of -4 to 140°F (-20 to 60°C) ±0.7°F (±0.4°C) and will sense 0 to 90% relative humidity ±4% RH (30°C). It includes two touch-sensitive buttons. One to control the LCD display illumination, and the other to cycle the display mode between temperature in degrees Fahrenheit, temperature in degrees Celsius, and percentage of humidity. The ENVIROMUX-STHS-LCDW includes slots on the back for hidden mounting hardware and two brackets for alternative mounting from the sides.

To use the **MODE** button, touch and release to cycle the display from Degrees F. to Degrees C, and to percentage of Humidity, and once again to return to Degrees F. The display will hold the mode set, each time, until MODE is touched again.

To use the **LIGHT** button, touch to illuminate the display for 5 seconds. To keep the display illuminated, touch and hold the LIGHT button for at least 6 seconds. Touch and release again to have illumination stop after 5 more seconds.

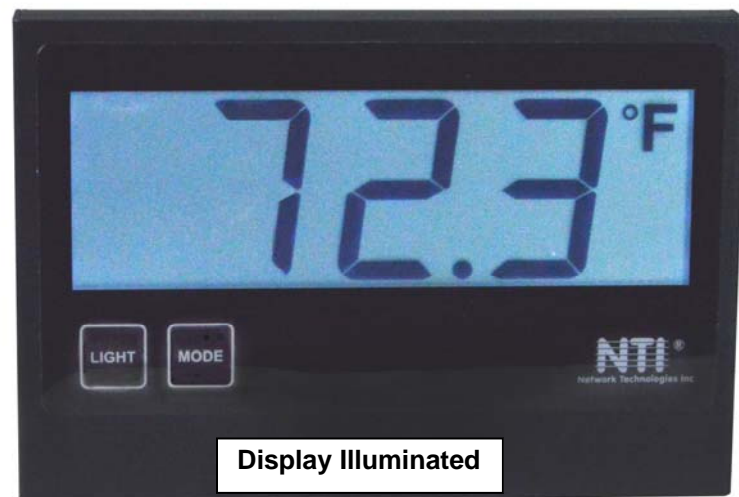
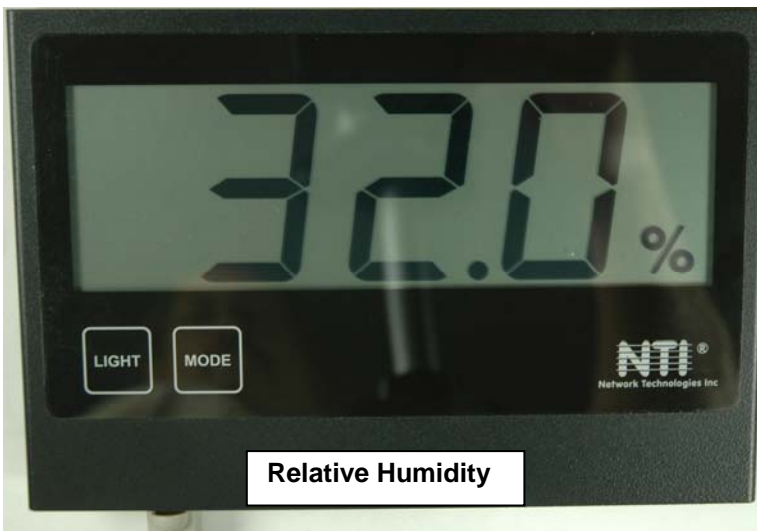
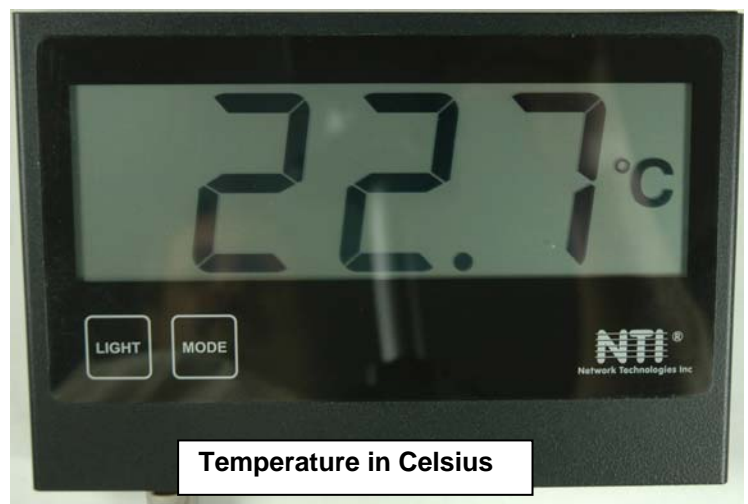
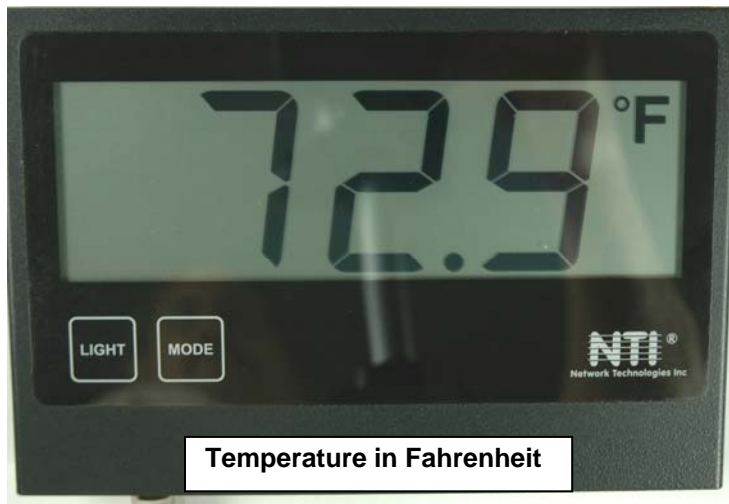
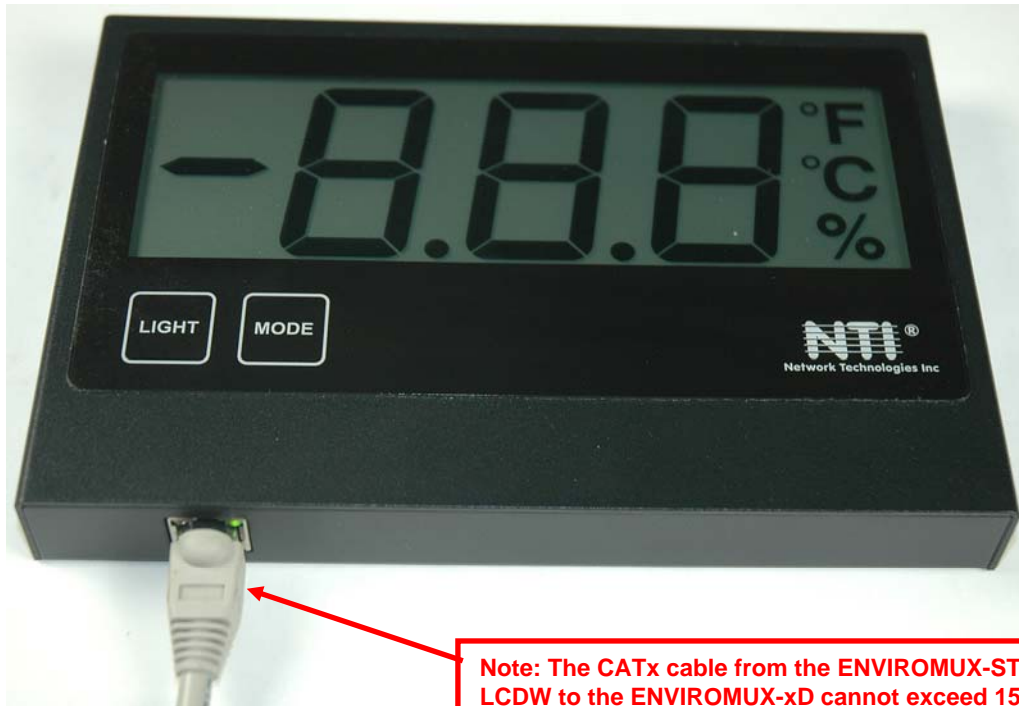

Figure 6- ENVIROMUX-STHS-LCDW

To mount the sensor, use the hardware provided to secure the sensor to the wall (see pages 2- 3). Once it is mounted, connect a CATx cable between the RJ45 connector and the ENVIROMUX monitoring system.

NTI ENVIROMUX TEMPERATURE/HUMIDITY SENSOR ATTACHMENT



Note: The CATx cable from the ENVIROMUX-STHS-LCDW to the ENVIROMUX-xD cannot exceed 150ft. If longer than 150 foot cable is used, the MODE button will not function when the backlighting is ON

The cable from the ENVIROMUX will attach to the sensor at the RJ45 port on the bottom of the ENVIROMUX-STHS-LCDW. The ENVIROMUX-STHS-LCDW will be powered by the ENVIROMUX Monitoring System through the CATx cable. We recommend using CAT5/5e/6/6a cable (minimum 24 AWG) up to 150 ft (45.7 m) long.

Note: If a longer cable is used (up to 1000ft), the MODE button will not work when the display is illuminated by pressing the LIGHT button.

NTI ENVIROMUX TEMPERATURE/HUMIDITY SENSOR ATTACHMENT

ENVIROMUX-STS-O Outdoor Temperature Sensor Cable Restraint Assembly Procedure



The ENVIROMUX-STS-O Outdoor Temperature Sensor includes a water-tight cable restraint to be applied to the Cat5/5e/6/6a shielded cable to be used to connect the sensor to an ENVIROMUX-16D/5D/2D and ENVIROMUX-SEMS-16(U) unit. To make sure the connection is water-tight upon completion, follow the steps below.

1. Insert the seal ring into the housing.

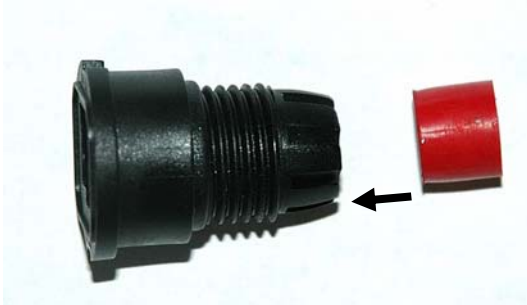

2. Strip the CATx shielded cable jacket (6mm-7mm O.D.) approximately 1/2" and insert the cable through the sealing nut, screw nut, and housing. (Note: Heat shrink tubing can be applied to cable to increase the O.D. of the CATx cable to 6mm-7mm.)

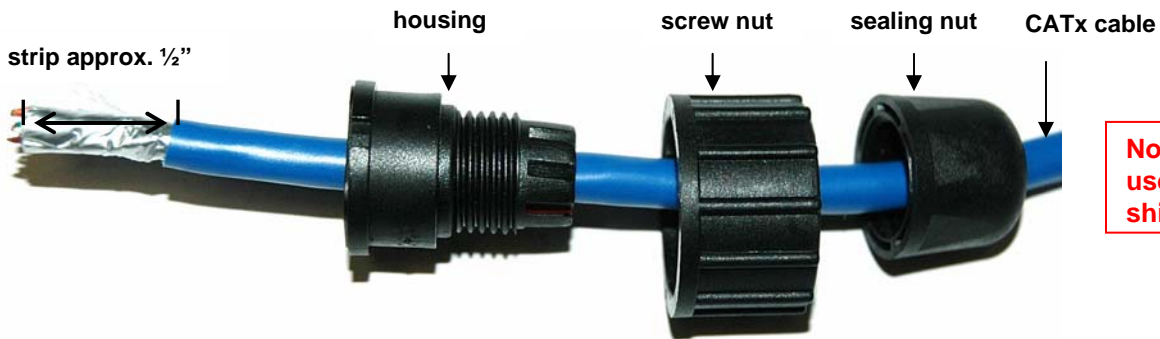

3. Terminate the CATx shielded cable with an RJ45 connector.



4. Set the RJ45 connector into the housing such that the snap handle is in the notch.

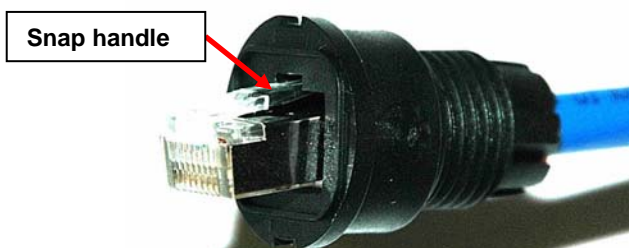

NTI ENVIROMUX TEMPERATURE/HUMIDITY SENSOR ATTACHMENT

5. Make certain that the seal ring is fully-seated into the housing.

THIS STEP IS EXTREMELY IMPORTANT TO ENSURE A WATER-TIGHT SEAL!

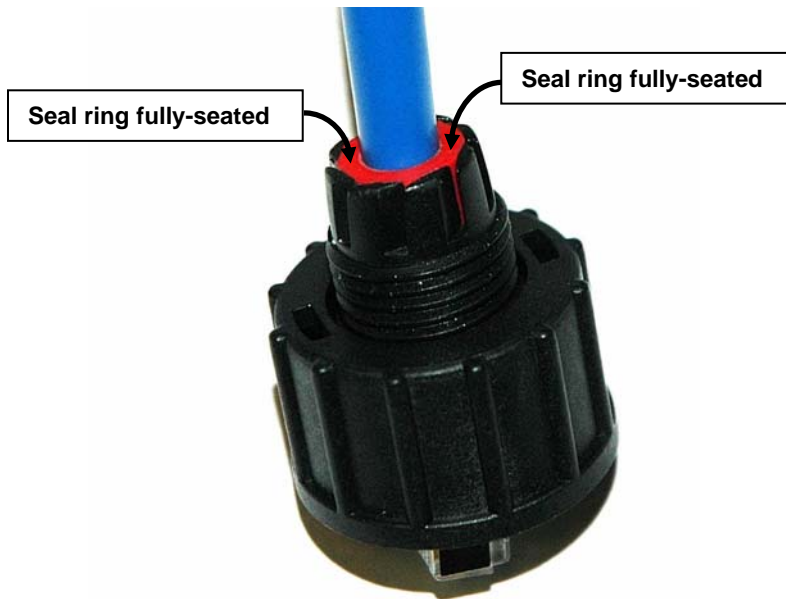

6. Plug the assembly into the socket on the ENVIROMUX-STS-O and secure the screw nut. Then apply the sealing nut and securely tighten.

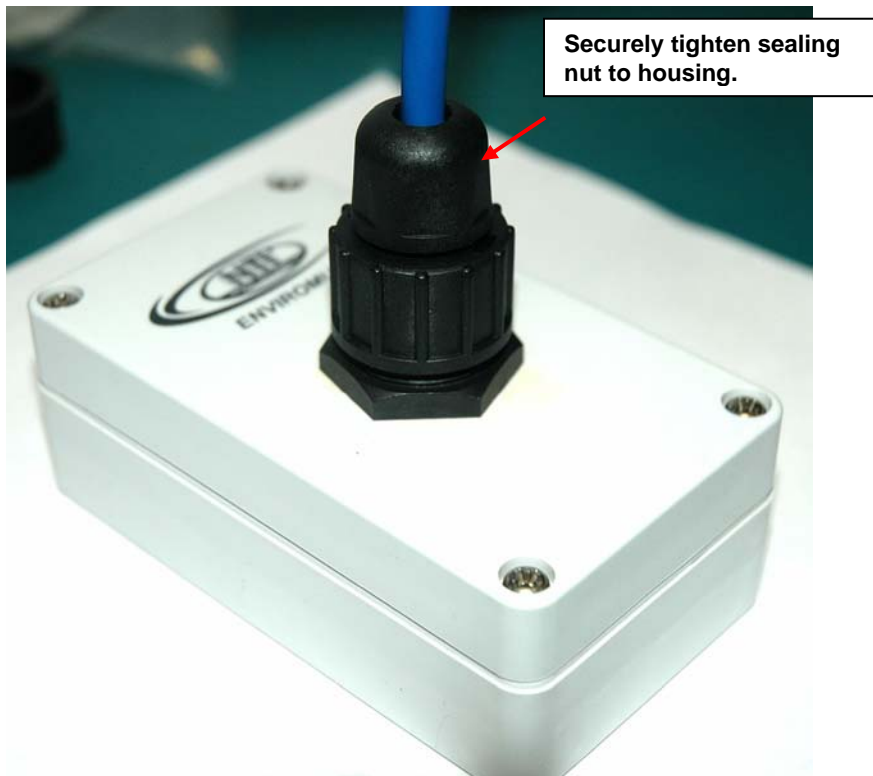

NTI ENVIROMUX TEMPERATURE/HUMIDITY SENSOR ATTACHMENT

Mounting

To mount the ENVIROMUX-ST5-O, two brackets have been provided that are each secured with a screw (provided).

Install each bracket with the raised ridge towards the front of the sensor, so that the bracket sits flat and squarely against the sensor case.

Do not overtighten screws or stripping of the case will occur.

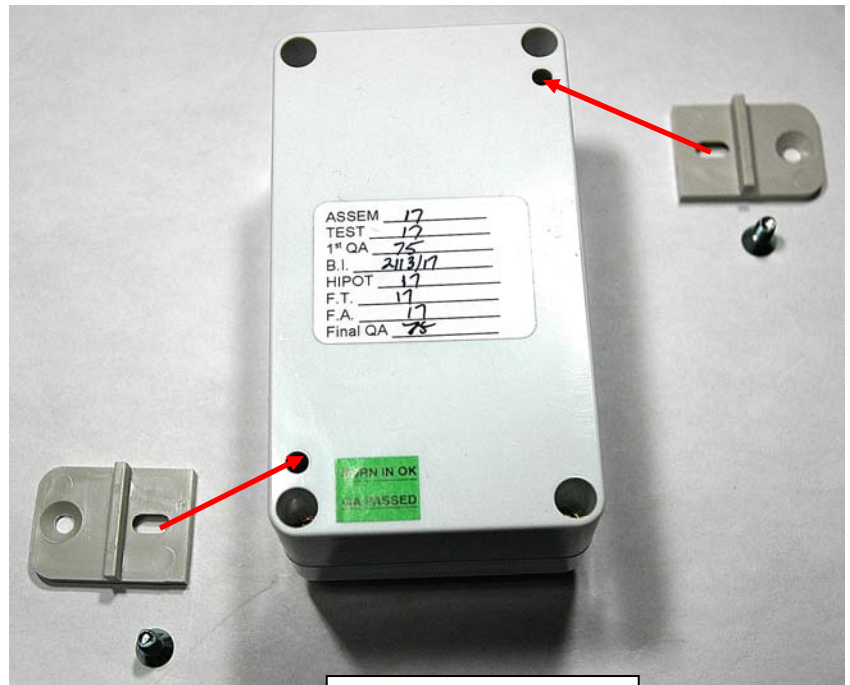

Brackets and screws ready to install.



Brackets and screws installed.

Sensor ready to mount



NTI ENVIROMUX TEMPERATURE/HUMIDITY SENSOR ATTACHMENT

TEMPERATURE AND HUMIDITY SENSORS

| SENSOR MODEL | OPERATING TEMPERATURE RANGE | HUMIDITY RANGE | ACCURACY |
|--|---------------------------------|--|--|
| ENVIROMUX-STTS | 32 to 122°F (0 to 50°C) | n/a | ±0.9°F (±0.5°C) |
| ENVIROMUX-STTS-O | -40°F to 185°F (-40°C to +85°C) | n/a | ±0.9°F (±0.5°C) |
| ENVIROMUX-STSM-E7 | -4 to 185°F (-20 to 85°C) | n/a | ±1.26°F (±0.70°C) for -4 to 41°F (-20 to 5°C) ±0.72°F (±0.40°C) for 41 to 140°F (5 to 60°C) |
| ENVIROMUX-STHS-99 | 32 to 176°F (0 to 80°C) | <ul style="list-style-type: none"> • 20 to 80% RH, ±3% • 10 to 90% RH, ±4% • 0 to 99% RH, ±5% | ±2°F (0 to 50°C, ±1°C) |
| ENVIROMUX-STHSB / ENVIRMUX-STHSM-E7 | -4 to 185°F (-20 to 85°C) | 0 to 90% RH | ±0.7°F (±0.4°C). ±4% RH (30°C) |
| ENVIROMUX-STHS-LCD(W) | -4 to 140°F (-20 to 60°C) | 0 to 90% RH | ±0.7°F (±0.4°C). ±4% RH (30°C) |
| ENVIROMUX-STHS-PRC | 32 to 140°F (0 to 60°C) | 10% to 80% RH | ± 0.4°F(±0.2°C) ± 1.8%RH@86°F (30°C) |
| ENVIROMUX-STHS-PRCIND-x | -40 to 185°F (-40 to 85°C) | 10% to 80% RH | ± 0.4°F(±0.2°C) ± 1.8%RH@86°F (30°C) |
| ENVIROMUX-STHS-PRCIND100-Pxx | -40 to 212°F (-40 to 100°C) | 10% to 80% RH | ± 0.4°F(±0.2°C) ± 1.8%RH@86°F (30°C) |
| ENVIROMUX-STSP ENVIROMUX-STSP-SL-7 | -40 to 185°F (-40 to 85°C) | n/a | ±1.0°F (±0.5°C). |
| ENVIROMUX-STTS-PRC | 32 to 140°F (0 to 60°C) | n/a | ±0.2°F (±0.1°C). |

Sensor Calibration

All temperature/humidity combination sensors and humidity-only sensors are factory-calibrated and are not designed to be calibrated in the field. In the event recalibration of your sensor is desired, please contact NTI for an RMA to return your sensor. Sensors within warranty will be recalibrated at no charge. Normal labor charges will apply to sensors out of warranty.

Power Consumption

All of our temperature and temperature/humidity sensors operate at 5VDC and draw between 10-56mA (the highest being the ENVIROMUX-STHS-LCDW).

Accuracy

The reported accuracy of these sensors is based on an environment of moving air. In a stagnant air environment, the sensor may read higher than actual temperature

NTI ENVIROMUX TEMPERATURE/HUMIDITY SENSOR ATTACHMENT

RJ45 Sensor Cable

The CAT5 connection cable between the ENVIROMUX and connected external sensors is terminated with RJ45 connectors and must be wired according to the EIA/TIA 568 B industry standard. Wiring is as per the table and drawing below. The sensors that connect to “RJ45 Sensor” ports (ENVIROMUX-16(U)/xD) are all designed to use cables wired to this standard.

| Pin | Wire Color | Pair |
|-----|--------------|------|
| 1 | White/Orange | 2 |
| 2 | Orange | 2 |
| 3 | White/Green | 3 |
| 4 | Blue | 1 |
| 5 | White/Blue | 1 |
| 6 | Green | 3 |
| 7 | White/Brown | 4 |
| 8 | Brown | 4 |

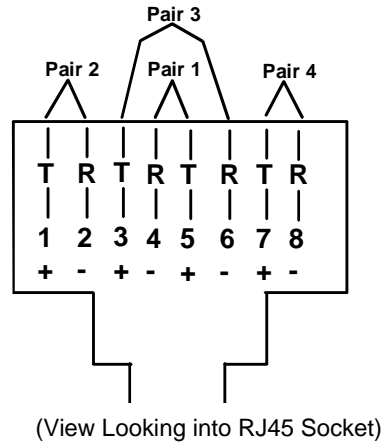

TRADEMARK

ENVIROMUX is a registered trademark of Network Technologies Inc in the U.S. and other countries.

COPYRIGHT

Copyright © 2008, 2017 by Network Technologies Inc. All rights reserved. No part of this publication may be reproduced, stored in a retrieval system, or transmitted, in any form or by any means, electronic, mechanical, photocopying, recording, or otherwise, without the prior written consent of Network Technologies Inc, 1275 Danner Drive, Aurora, Ohio 44202.

CHANGES

The material in this guide is for information only and is subject to change without notice. Network Technologies Inc reserves the right to make changes in the product design without reservation and without notification to its users.

MAN215 REV 5/10/2017