



# **mcsSprinklers**

**Irrigation Control**

Version 2.18

# Table of Contents

1	Overview .....	9
1.1	Version Comparison .....	9
1.2	Acknowledgements .....	17
2	System Architecture .....	18
2.1	Controller Selection .....	19
3	Installation .....	21
3.1	Standalone .....	21
3.1.1	Windows PC Host .....	21
3.2	Homeseer .....	22
3.3	Registration .....	23
3.3.1	Standalone .....	23
3.3.2	Homeseer Plug-in .....	25
3.4	Startup .....	25
3.5	Initial Setup .....	26
3.5.1	Visual User Interface .....	26
3.5.2	Quick Start – Learn by Example .....	30
3.5.3	Sample Scenarios .....	31
3.5.3.1	Scenario 1 – One Zone Setup .....	31
3.5.3.2	Scenario 2 – Basic Homeseer Setup of Two Sprinkler Valves .....	31
3.5.3.3	Scenario 3 - Replacement for Stand-alone Timer .....	33
3.5.3.4	Scenario 4 - Typical Use of Features .....	35
3.5.3.5	Scenario 5 – Dual PC – Dual Hardware Interface Configuration .....	37
3.5.3.6	Scenario 6 – Dual PC – Single Hardware Interface Configuration .....	38
4	Physical Installation .....	40
4.1	Field Wiring .....	40
4.2	Controller Connection .....	40
4.2.1	Controller to PC .....	40
4.2.2	Communication Test .....	48
4.2.3	HomeSeer Devices .....	49
4.2.4	Interface Protocol .....	50
4.2.5	Valve Wire to Controller .....	50
4.2.6	Internet Connection and Local Area Network .....	54
4.2.7	External Application Interface .....	62
4.2.7.1	xAP .....	62
4.2.7.2	MQTT .....	64
4.2.7.3	Homeseer .....	64
4.2.7.4	Weatherhawk .....	65
5	Automated Control Strategy .....	66
5.1	Control Based upon Time vs. Soil Moisture Content .....	66
5.2	Watering Duration and Interval .....	67
5.2.1	Gross Estimated Runtimes for Small to Medium Turf Areas .....	69
5.2.2	Suggestions for Calibration of Calculated Evaporation .....	78
5.3	Zone Sequencing .....	79
5.4	Syringing .....	81
5.5	Watering Restrictions .....	81
5.6	Water Use Management .....	83
5.6.1	Water User Monitoring .....	83
5.6.2	Water Use Measurement and Display .....	84
5.7	Fertigation .....	85
6	Manual Control Options .....	89
6.1	Web Browser .....	89

6.2	Remote with iPhone/iPad/iPod/Android .....	92
6.3	Remote with Palm pad or Power line Controller .....	94
6.4	Remote with Wireless Handheld PDA .....	95
	When accessing mcsSprinklers from a PDA or other remote host the LAN firewall becomes a consideration. The firewall must allow this communication. In some cases it is possible to setup a rule to allow mcsSprinklers.exe to pass through the LAN or WAN firewall. In some cases it will require an advanced setup where the specific browser port (default 8008) needs to have the exception. See <a href="http://windows.microsoft.com/en-us/windows-8/windows-firewall-from-start-to-finish">http://windows.microsoft.com/en-us/windows-8/windows-firewall-from-start-to-finish</a> .....	96
6.5	Crestron Control .....	96
6.6	Voice Control .....	97
7	Status Reporting .....	98
7.1	General Status.....	98
7.2	Reference Pictures .....	99
7.3	History Calendar.....	100
7.4	Zone Status .....	105
7.5	Run List .....	105
7.6	Priority Messages .....	106
7.7	Log of Valve Control.....	108
8	Interface Details.....	110
8.1	Rain8 Module Control .....	110
8.1.1	Rain8-Net .....	110
8.1.2	Rain8-Wireless .....	110
8.1.3	Rain8-X10 .....	110
8.1.4	Rain8-X10-2.....	110
8.1.5	EtherRain .....	110
8.1.6	Homeseer Virtual Devices .....	110
8.2	Alternate Sensor Interface .....	111
8.2.1	Weather Data .....	111
8.2.2	Local Sensor Data.....	111
8.2.3	Inhibit Device .....	112
8.2.4	ET Radiation Sensor.....	112
8.2.5	Water Meter.....	112
8.3	Alternate Control Operations.....	112
8.3.1	Homeseer .....	112
8.3.2	xAPBSC.Cmd.....	114
8.3.3	xAP-X10 / Homeseer-X10 .....	114
9	Redundancy and Backup .....	115
9.1	Single PC Configuration.....	115
9.2	Dual PC Configuration .....	115
9.2.1	Control Moding .....	115
9.2.2	Independent Applications to Support Redundancy.....	117
9.2.3	Associated xAP Interface .....	118
9.3	Multiple Rain8Net Networks.....	118
9.4	Configuration Backup and Selection .....	122
10	Setup Reference.....	124
10.1	Setup1-Devices .....	124
10.1.1	Module PC Interface.....	124
10.1.2	Interface Test .....	124
10.1.3	Homeseer Devices .....	124
10.1.1	MQTT Broker.....	124
10.1.1	MQTT Topics .....	124
10.1.2	Rain8 Net and Rain8 WiFi Master Modules.....	125
10.1.3	Rain8 Net and Rain8 WiFi .....	125
10.1.4	Rain8 UPB.....	125
10.1.5	Rain8 Wireless and X10 Power line Interface Module Assignments .....	125
10.1.6	House.....	125

10.1.7	Bank 1 to 8.....	125
10.1.8	Bank 9 to 16.....	126
10.1.9	Rain8 Wireless Valve 8 Configuration.....	126
10.1.10	Address.....	126
10.1.11	Valve 8 in Module.....	126
10.1.12	EtherRain Modules.....	126
10.1.13	Raspberry Pi Relay Configuration.....	126
10.1.14	Rain8 EPROM and Timers.....	126
10.1.15	Programming Port.....	127
10.1.16	Module Type.....	127
10.1.17	Module Address.....	127
10.1.18	Rain8-Net Timer Disable.....	127
10.1.19	Rain8-Wireless Valve 8 Use.....	127
10.1.20	Rain8-X10-2 Status Response.....	127
10.1.21	Rain8 Timers.....	127
10.2	Setup2 - Wiring.....	129
10.2.1	Wire Harness.....	129
10.2.2	Wire Color.....	129
10.2.3	Control Valve.....	129
10.2.4	Location.....	129
10.3	Setup3 - Layout.....	130
10.3.1	Identification.....	130
10.3.2	Assigned Use.....	130
10.3.3	Minutes.....	130
10.4	Setup4 - Zone.....	131
10.4.1	Valve.....	131
10.4.2	Auto Minutes.....	131
10.4.3	Manual Minutes.....	131
10.4.4	Syringing Minutes.....	131
10.4.5	Soil Efficiency and Rain Factors.....	131
10.4.6	Fertigation Factor.....	131
10.4.7	Calc Flow.....	131
10.4.8	Max Flow.....	131
10.5	Setup5 – Area.....	132
10.5.1	Zones in Area.....	132
10.5.2	Area Control Strategy.....	132
10.5.3	Area Zone Sequence Control.....	132
10.5.4	Interzone Scheduling Delays.....	133
10.5.5	Area Water Supply.....	133
10.5.6	Pump Control Valve.....	133
10.5.7	Well or Water Storage Discharge and Recharge Times.....	133
10.5.8	Flow Volume.....	133
10.5.9	Water Leak Monitoring.....	133
10.5.10	Fertigation Valve.....	133
10.5.11	Fertigation Control.....	133
10.5.12	Fertigation Instrumentation Source.....	134
10.5.13	Area Start Times and Duration Factors.....	134
10.5.14	Area Inhibit Times.....	134
10.5.15	Area Restrictions.....	134
10.5.16	Area Miscellaneous.....	134
10.5.17	Seasonal Percentages.....	135
10.6	Setup6 - Site.....	136
10.6.1	Watering Restrictions.....	136
10.6.2	Don't on Day of Week.....	136
10.6.3	Don't Between Hours.....	136
10.6.4	Don't Even Odd Days.....	136

10.6.5	Min Days Between Watering.....	136
10.6.6	Don't with Wind.....	136
10.6.7	Don't with Temperature .....	136
10.6.8	Max Cycles per Day .....	136
10.6.9	Don't with precipitation forecast and actual .....	136
10.6.10	Don't with Evapotranspiration.....	137
10.6.11	Record inhibit reason in Message Log.....	137
10.6.12	Don't With Homeseer Device.....	137
10.6.13	Water Holding / Presssure Tank .....	137
10.6.14	Syringing Options .....	137
10.6.15	Manual Mode Update Options.....	137
10.6.16	All Zones Watering Duration Adjustments .....	137
10.6.17	Seasonal Percentages .....	137
10.6.18	All Zones Adjustment Percentage .....	137
10.6.19	Miscellaneous Options.....	137
10.6.20	Site Name .....	138
10.6.21	Valve Safety .....	138
10.6.22	Pump Safety.....	138
10.6.23	Control Log.....	138
10.6.24	Zone Starting Notification .....	138
10.6.25	Soil Moisture Calculation Synchronization .....	138
10.6.26	Rules for Inhibits when Zone is ON .....	138
10.6.27	Rules for Site Inhibits for Mist Areas .....	138
10.7	Setup7 - Remote Control .....	139
10.7.1	W800 for Handheld Wireless Input .....	139
10.7.2	Crestron Serial .....	139
10.7.3	Voice Recognition and Reporting.....	139
10.7.4	Direct Valve Control .....	139
10.7.5	Disable Alias Valve Control.....	139
10.7.6	Remote Control Activation Setup.....	139
10.7.7	Zone.....	139
10.7.8	Valve.....	140
10.7.9	Voice.....	140
10.7.10	RF Code.....	140
10.8	Setup8 - Weather .....	141
10.8.1	Time and Weather Setup .....	141
10.8.2	Alternate Weather Source.....	141
10.8.3	Alternate Forecast Source.....	141
10.8.4	Local Weather Source.....	141
10.8.5	Weather Sensor Source.....	142
10.8.6	Method to Download Internet Data .....	142
10.9	Setup9 - Other.....	143
10.9.1	Version Options Displayed.....	143
10.9.2	Configuration Administration.....	143
10.9.3	Load Configuration.....	143
10.9.4	Save Configuration .....	143
10.9.5	Restore Configuration from Auto Backup .....	143
10.9.6	Update mcsSprinklers Version from Web or Local Backup.....	143
10.9.7	HTTP Browser Interface.....	143
10.9.8	Browser Display Options.....	143
10.9.9	Popup Calendar Characteristics .....	144
10.9.10	Sensor Units of Measure.....	144
10.9.11	Email Notification .....	144
10.9.12	Login Username and Password for Internet (WAN) Access .....	145
10.9.13	Redundancy Backup Mode.....	145
10.9.14	Homeseer Devices .....	145

10.9.15	Homeseer Notification Options .....	145
10.9.16	Homeseer Display Options .....	145
10.9.17	Database Options .....	146
10.9.18	Help .....	146
10.9.19	Context Help.....	146
10.9.20	Debug Data Files .....	146
10.9.21	Version Options Displayed.....	147
10.10	Setup10 – xAP / MQTT Reporting.....	148
10.11	Setup11 – Picture Entry .....	149
10.11.1	Pictures .....	149
11	AccuWeather Location Codes .....	150
12	Rain8 Hardware Setup.....	236
12.1	Rain8 Net.....	236
12.1.1	Equipment List .....	236
12.1.2	Installation .....	236
12.1.3	EPROM Programming for use with mcsSprinklers.....	238
12.2	Rain8 Wireless.....	240
12.2.1	Equipment List .....	240
12.2.2	Installation .....	240
12.2.3	EPROM Programming for use with mcsSprinklers.....	241
12.2.4	Check Out.....	242
12.3	Rain8 X10.....	243
12.3.1	Equipment List .....	243
12.3.2	Installation .....	243
12.3.3	EPROM Programming for use with mcsSprinklers.....	245
12.4	Rain8 X10 II.....	247
12.4.1	Equipment List .....	247
12.4.2	Installation .....	247
12.4.3	EPROM Programming for use with mcsSprinklers.....	249
12.4.4	Troubleshooting with the Status LED .....	250
12.5	Rain8 UPB.....	252
12.5.1	Equipment List .....	252
12.5.2	Installation .....	252
12.5.3	EPROM Programming for use with mcsSprinklers.....	254
12.5.4	The Rain8UPB and UPStart .....	255
12.5.5	Troubleshooting with the Status LED .....	256
13	RS-232 Adapters .....	257
13.1	USB – Serial.....	257
14	User Access Control and Confirmation Prompts.....	258

## List of Figures

Figure 1	System Architecture .....	19
Figure 2	Desktop Tray Access to Status Pages .....	22
Figure 3	Standalone Registration Page.....	25
Figure 4	Homeseer Licensing of mcsSprinklers.....	25
Figure 5	Startup Splash Screen.....	26
Figure 6	Visual User Interface.....	27
Figure 7	Views Available from Graphical UI .....	30
Figure 8	Rain8 Address and Timer Setup.....	42
Figure 9	Rain8 Modules to PC Connection Setup.....	42
Figure 10	X10 Interface Characterization .....	43

Figure 11 Rain8 X10-based Module Address Setup .....	44
Figure 12 Rain8 Net-based Module Address Setup.....	45
Figure 13 Rain8 UPB Module Address Setup .....	45
Figure 14 EtherRain Module Address Setup .....	46
Figure 15 MQTT Setup for Valve Control .....	47
Figure 16 Raspberry Pi GPIO Selection .....	48
Figure 17 RPi GPIO Connector Layout.....	48
Figure 18 Communication Test for Rain8Net and Rain8UPB .....	49
Figure 19 Identification of Homeseer Devices .....	49
Figure 20 Serial IO Communications Diagnostic Window .....	50
Figure 21 Harnesses Wiring to Rain8 Valve Setup .....	51
Figure 22 Layout Page.....	52
Figure 23 Zone Parameters Setup.....	54
Figure 24 Zone Program Time Tailoring.....	54
Figure 25 Weather Source Selections .....	56
Figure 26 Local Weather Station Data Source .....	57
Figure 27 Weather Site Download Test.....	58
Figure 28 Individual Sensor Source Selections .....	59
Figure 29 Port Selections for Remote Access .....	60
Figure 30 Help Setup Options .....	61
Figure 31 Browser Links to Help and Other Pages .....	61
Figure 32 Launch of Interface Nodes and xAP Message Selection.....	62
Figure 33 xAP / MQTT Reporting Device Selection .....	63
Figure 34 xAP Environment Options .....	63
Figure 35 Homeseer Interface Options.....	64
Figure 36 Timed Programs Setup Matrix .....	66
Figure 37 Zone Moisture Trends in Area .....	71
Figure 38 Area Control Strategy Selections .....	72
Figure 39 Zone - Area Sequence Control Selections.....	72
Figure 40 Zone - Area Scheduling Delays .....	73
Figure 41 Water Supply / Pump / Meter setup .....	74
Figure 42 Fertigation Control and Instrumentation .....	74
Figure 43 Adjustments in Timed Control and Seasonal Variation .....	76
Figure 44 Miscellaneous Scheduling Option Setup.....	77
Figure 45 Area-Specific Restrictions and Carryover.....	78
Figure 46 Round Robin Scheduling Status.....	80
Figure 47 Syringing Control Options .....	81
Figure 48 Site Watering Restrictions Setup.....	83
Figure 49 Measured Water Consumption .....	85
Figure 50 Fertigation Valve on General Status Page.....	86
Figure 51 Fertigation Data on Calendar Detail for Zone Valve .....	87
Figure 52 Fertigation Calendar Detail for Fertigation Valve.....	88
Figure 53 Manual Controls from General Status Page .....	89
Figure 54 Composite Controls Available on General Status for Manual Control .....	91
Figure 55 Zone Status Page View .....	91
Figure 56 Phone App Landscape Remote .....	92
Figure 57 Phone App Portrait Remote.....	92
Figure 58 Command Fusion Gui Designer for Upload.....	93
Figure 59 W800 Port Selection for Internal W800 Connection.....	94
Figure 60 Remote Control Setup Page .....	95
Figure 61 Handheld Remote Control Browser Page .....	96
Figure 62 Crestron Interface Port Selection .....	97
Figure 63 General Status Customizations.....	99
Figure 64 Reference Picture Popup .....	100
Figure 65 Annual Trend Popup .....	101
Figure 66 Sensor Calendar with Popup Detail.....	102

Figure 67 Zone History Calendar Popup .....	104
Figure 68 Run List Page .....	106
Figure 69 Priority Message Page .....	106
Figure 70 Typical Outlook Email Settings .....	107
Figure 71 Email Notification of Major Events Setup .....	108
Figure 72 Log of Prior Week Valve Actions .....	109
Figure 73 Dual PC Setup .....	116
Figure 74 Redundancy and Moding Status Devices .....	117
Figure 75 xapmcsRain8Net Setup .....	120
Figure 76 Rain8Net Configured for Multiple Masters/IPs .....	121
Figure 77 Rain8 Net Manual Entry of Module Numbers .....	121
Figure 78 Configuration Save and Restore .....	122
Figure 79 Automatic Configuration Load Scheduling .....	123
Figure 80 Rain8 Master and Expansion Wiring .....	238
Figure 81 Rain8Net EPROM Setup.....	239
Figure 82 Rain8 Wireless EPROM Setup .....	242
Figure 83 Rain8 X10 Power line and Valve Connections .....	245
Figure 84 Rain8X10 EPROM Setup .....	246
Figure 85 Rain8 X10 II Power line and Valve Connections .....	248
Figure 86 Rain8 X10 II EPROM Setup .....	250
Figure 87 UPB Rain8 Valve and 24VAC Connections .....	253
Figure 88 UPB PIM Connection to Rain8 .....	254
Figure 89 Rain8 UPB EPROM Setup.....	255

## List of Tables

Table 1 mcsSprinklers Version Comparison .....	11
Table 2 Voice Recognition Commands .....	97



# 1 Overview

mcsSprinklers is an integrated commercial / residential irrigation control package that uses readily-available personal computer resources or low powered dedicated computer to optimally irrigate an installation. It takes advantage of internet technology to obtain current environmental conditions as well as forecast data from which projected rainfall and evaporation is determined. It uses the Rain8 and EtherRain family of valve controllers to provide control via the existing power line, wired to the PC, or wireless. It also supports integration with Homeseer and xAP to augment the family of valves that can be controlled and further integration with other aspects of automation.

Irrigation control can be based upon calculated waterfall/evaporation, measured soil moisture, or three forms of periodic timed control. Mixtures of these modes can be used as well. Normal watering periods can be altered based upon current conditions such as wind speed, day-of-week, forecasted rainfall, and several other criteria to assure that water is applied only when needed and only when allowed by local regulations.

As well as the sophisticated automated modes of operation, it allows for several forms of manual intervention. Handheld remote control can be used to roam the irrigation zones and selectively turn on/off valves for head flow adjustments. Voice can be used to control zones and the current irrigation status can be vocally delivered with a voice request. Browser access from any internet location can also be used to manually control, observe status, or alter setup parameters.

mcsSprinklers maintains a record of all control actions taken from which utilization reports can be generated. It continually calculates soil moisture content based upon current environmental conditions and this combined with forecasted precipitation and sunlight is used to provide projections of future watering cycles.

Sprinkler valves are wired to automated valves such as the Rain8 modules in the same manner as valves are wired to traditional timed-controllers. This allows existing installations to be upgraded with a simple replacement of the old controller with automated Rain8 modules. Control via the power line or RF wireless yields minimum-effort solutions to retrofit existing installations.

## 1.1 Version Comparison

mcsSprinklers is available in three level of capability. The Basic Level Designed to perform manual and automatic timed control of up to 24 valves for all of the Rain8 family of modules. It's capabilities are approximately equivalent to a 24 program timed irrigation controller with the added benefit of desktop and internet access to provide for easy viewing and alterations of the schedules. It provides a rich user interface including graphical, touch screen and the ability for remote valve control with PDA or X10 palm pad.

The Standard Level is designed to achieve water cost savings and provide a rich set of control options. It takes into account weather conditions based upon internet data to both schedule when added moisture is needed and to not schedule due to wind and/or rainfall conditions. It provides visibility into historical valve activity and other parameters related to irrigation scheduling as well as all the features of mcsSprinklers Basic.

The Professional Level is designed for maximum customization and options. It supports active backup and email notification when attention is needed. Recordkeeping is enhanced with water use accounting and a more complete historical calendar. Additional control is available for liquid nutrient distribution (fertigation), use of moisture probes, and more flexible zone sequence control. Integration with other automation is provided with direct weather station interfaces, IP-based control, and xAP messaging. Support for the non-typical setups is provided in a unified manner that makes the complexity transparent. It includes all features available with the standard and basic version.

This manual describes the full capabilities of mcsSprinklers. Not all features described herein will be available with the Basic or Standard versions. It can be used as a guide to help understand what features are available in each version.

mcsSprinklers will configure itself based upon the license level and based upon responses provided in the setup interview. The intention is to minimize the complexity presented and only include features that are being used. Features that are tailored out of the setup screens based upon interview responses can be restored by using the “Expert Mode” setting on the Other Setup page. Features that are available with higher level versions can only be made available by licensing the higher level version. During the trial period the software can be configured for any of the three levels of capability so the level that contains the desired features can be evaluated.

Table 1 mcsSprinklers Version Comparison

Software Version	Basic	Standard	Professional
<b>HARDWARE INTERFACE</b>			
<b>Host Platform</b>	Windows XP,Vista,W7,WHS,+	Windows XP,Vista,W7,WHS,+	Windows XP to W10 Linux
<b>PC Interface</b>	Serial COM	Serial COM	Serial COM IP xAP MQTT
<b>X10 Interface</b>	ACK on Cmd	Ack on Cmd or Poll	Ack on Cmd or Poll Test Buttons Command Timing
<b>Rain8Net and WiFi Master Interfaces</b>	1	1	Multiple
<b>Rain8 Net and WiFi</b>	Itemize Units	Itemize Units	Itemize Units Search Command Timing Communication Test Command Buttons
<b>Rain8 UPB</b>	Yes, Itemize Units	Yes, Itemize Units	Yes, Itemize Units Communication Test Command Buttons
<b>Rain8 X10</b>	Yes	Yes	Yes
<b>Rain8 X10-2</b>	Yes	Yes	Yes
<b>Rain8 Wireless</b>	Yes	Yes	Yes
<b>Relay</b>	No	No	Raspberry Pi Sonoff Tasmota
<b>EtherRain</b>	No	No	Yes
<b>Rain8 EPROM Programming</b>	No	No	Yes

## SCHEDULING

<b>Control Strategy (Program)</b>	Day of Week Even-Odd Interval	Day of Week Even-Odd Interval Calculated ET	Day of Week Even-Odd Interval Moisture Probe Calculated ET Mist
<b>Zone Sequence Control</b>	One Zone at a Time in user-entered order	One Zone at a Time in user-entered order	One Zone at a Time One Zone per Area Multiple Simultaneous Zones External Control
<b>Run Styles</b>	Zone-to-Zone	Zone-to-Zone	Zone-to-Zone Round Robin Inter-zone Delays
<b>Program Modes</b>	Automatic Manual	Automatic Manual	Automatic Manual Syringing
<b>Program Start Times</b>	24	24	24 per program Sunrise/Sunset Offset Variable Duration
<b>Duration Resolution</b>	1 second	1 second	1 second
<b>Areas (Program Variants)</b>	1	8	8
<b>Month to Month Time Adjustments</b>	No	No	Yes
<b>Global Multi-zone program adjustments</b>	By Month	By Month	By Month, By Percentage
<b>Scheduling Restriction Setup</b>	Day of Week Even-odd Days Between Hours	Day of Week, Even-odd Days Between Hours Wind Speed Temperature	Day of Week Even-odd Days Between Hours Wind Speed Temperature

		Rainfall Rain Forecast	Rainfall Rain Forecast ET External Discrete Inhibit Max Cycles Between Hours by Area Log Restriction
<b>Pump Control</b>	Yes	Yes	Yes
<b>Water Flow Management</b>	No	No	Multiple valve control to achieve optimal pressure
<b>Water Source Management</b>	No	No	Discharge Rate Recharge Rate Budget Management Tank Management
<b>Fertigation Control</b>	No	No	Yes
<b>Soil Moisture Determination</b>	No	ET Calculation	Soil Efficiency Adjustment Crop Type Adjustment ET Calculation Moisture Sensor
<b>Evapotranspiration Calculation</b>	No	Hourly Weather	Historical Hourly Weather Weather Station
<b>Internet-based Weather</b>	No	OpenWeatherMap Weatherunderground NWS/EPA AccuWeather	OpenWeatherMap Weatherunderground NWS/EPA AccuWeather
<b>Weather station-based Weather</b>	No	No	Yes

## USER INTERFACE

<b>Phone (Apple/Android)</b>	No	Yes	Yes
<b>Remote/Handheld Control</b>	X10 Power line	X10 Power line RF	X10 Power line RF PDA IPhone/Android
<b>Browser/Internet Access</b>	Yes	Yes	Selectable HTTP port
<b>Browser Style Customization</b>	No	No	Yes
<b>Graphical User Interface</b>	Yes	Digital Pictures Calendar-based history	Digital Pictures Calendar-based history and status Current weather or other user-selected status devices
<b>Touchscreen/Kiosk User Interface</b>	600x800	600x800	600x800
<b>Imperial and Metric Display Units</b>	No	Yes	Yes
<b>Control and Status Browser Views</b>	Zone Status General Status Run Log Touch screen UI	Zone Status General Status Run Log Run Projection Touch screen UI	Zone Status General Status Run Log Run Projection Touch screen UI
<b>Scripting Automation Interface</b>	No	No	Yes

## RECORDS and HISTORY

<b>Wiring Color Record</b>	Yes	Yes	Yes
<b>Wire Harnesses</b>	3	32	32
<b>Zone, Area, and Site Digital Pictures</b>	No	Yes	Yes
<b>Water Use Accounting</b>	No	No	Measured Calculated
<b>Soil Moisture Trends</b>	No	Yes	Yes
<b>Valve Activation Logging</b>	No	Yes	Yes
<b>Number of Loadable Configurations</b>	Unlimited	Unlimited	Unlimited Scheduled
<b>Historical Database</b>	No	MS Access	MS Access SQL Server My SQL SQLite
<b>Historical Calendar</b>	No	Weather Items, Soil Moisture Level Runtime	Weather Items, Soil Moisture Level Runtime Water Use Fertigation
<b>Annual Trend Charts</b>	No	Yes	Yes
<b>Daily Detail Statistics</b>	No	Yes	Yes

## SAFETY and BACKUP

<b>Redundancy</b>	No	No	Self-Monitored
<b>Min and Max Safety Intervals</b>	No	No	Yes
<b>Communication retry and failure recovery</b>	Yes	Yes	Yes
<b>Internet Login Authentication</b>	Yes	Yes	Yes
<b>Email Notification</b>	No	No	Yes



## **1.2 Acknowledgements**

Version 1 of mcsSprinklers was introduced in 2003 into the Homeseer community. Many users provided valuable feedback to improve the usability of mcsSprinklers. Of particular value was the diversity of the needs and the operation in international locations. While all deserve acknowledgement, the memory of the early days is not complete. A partial accounting is Bkphillips (Anaheim, CA), Cecil, DC, Degabe (Loomis, CA), Droopyear (Szekesfehervar, Hungary), Frobnitz (France), JB Coulter (Visalia, CA), Jmonaco (Rocklink CA), ka7gzi (Kent, WA), Mario from Spain (Madrid, Spain), Mountainman (CO, USA), Pete (Lockport, IL), Smoothtk (Metamora, MI), uberseer (Sugar Land, TX)

Version 2 of mcsSprinklers was introduced in 2005 with a mixture of Standalone and Homeseer users providing ideas and assistance in making mcsSprinklers more user-friendly and feature rich. Version 2.6's new features are primarily the result of user suggestions and effort in assisting the incorporation. Scott Bunker, Castle Rock, CO provided WeatherUnderground as an optional source of Internet-based weather data as well as the Calendar popups. John Bonzey, Auburn, MA provided the handheld/Palm method of remote control. Doug Behl, Nevada City, CA for the large site considerations such as the popup pictures and area naming.

Some software components utilized within mcsSprinklers were obtained from internet sources. The tooltip capability for context help was provided by Erik Bosrup's overLIB. The graphical sliders were obtained from Erik Arvidsson. Graphic icons were adapted from various sources including user contributions on the Homeseer message board. The email facility was adapted from code posted by Gregg Housh.

## 2 System Architecture

The system architecture uses a modular and incremental structure that leverages modern computing technology, Internet, and low-cost interface electronics. The architecture is scalable from a single value residence controller to a very large commercial controller. It can operate within an existing small personal computer to minimize cost or run as a network of computers to maximize reliability.

The personal computer provides a dramatic improvement in the user interface in the operation of a sprinkler controller vs. dedicated controllers. The use of the Internet also provides a dramatic improvement in the efficiency of commercial and residential irrigation.

The two primary components to the irrigation controller are the electronic control of the sprinkler zone valves and the optimal scheduling of water distribution. Small Rain8 modules perform the electronic control. Each of these can control eight watering zones with wiring from the zone valve to the Rain8 module being the same as the wiring to traditional timed controllers.

The watering schedule is determined on the PC and this schedule is conveyed to the Rain8 modules in one of three mechanisms. This can be with a direct cable connection, an interface using existing house wiring, or a wireless radio frequency interface. The scheduling is setup by the user with a rich interactive interface and is augmented with real-time information about environmental conditions from the Internet.

This basic architecture is augmented with the ability to monitor local conditions with sensors such as a water flow meter, manually control the zones with a handheld remote or voice, add redundant components to accommodate unexpected failures, and use the Internet for off-site control and monitoring.

This architecture of mcsSprinklers is pictorialized in Figure 1 System Architecture. As of version 2.17 the redundant backup provisions have been depreciated. As of version 2.18 the voice provisions have been depreciated.

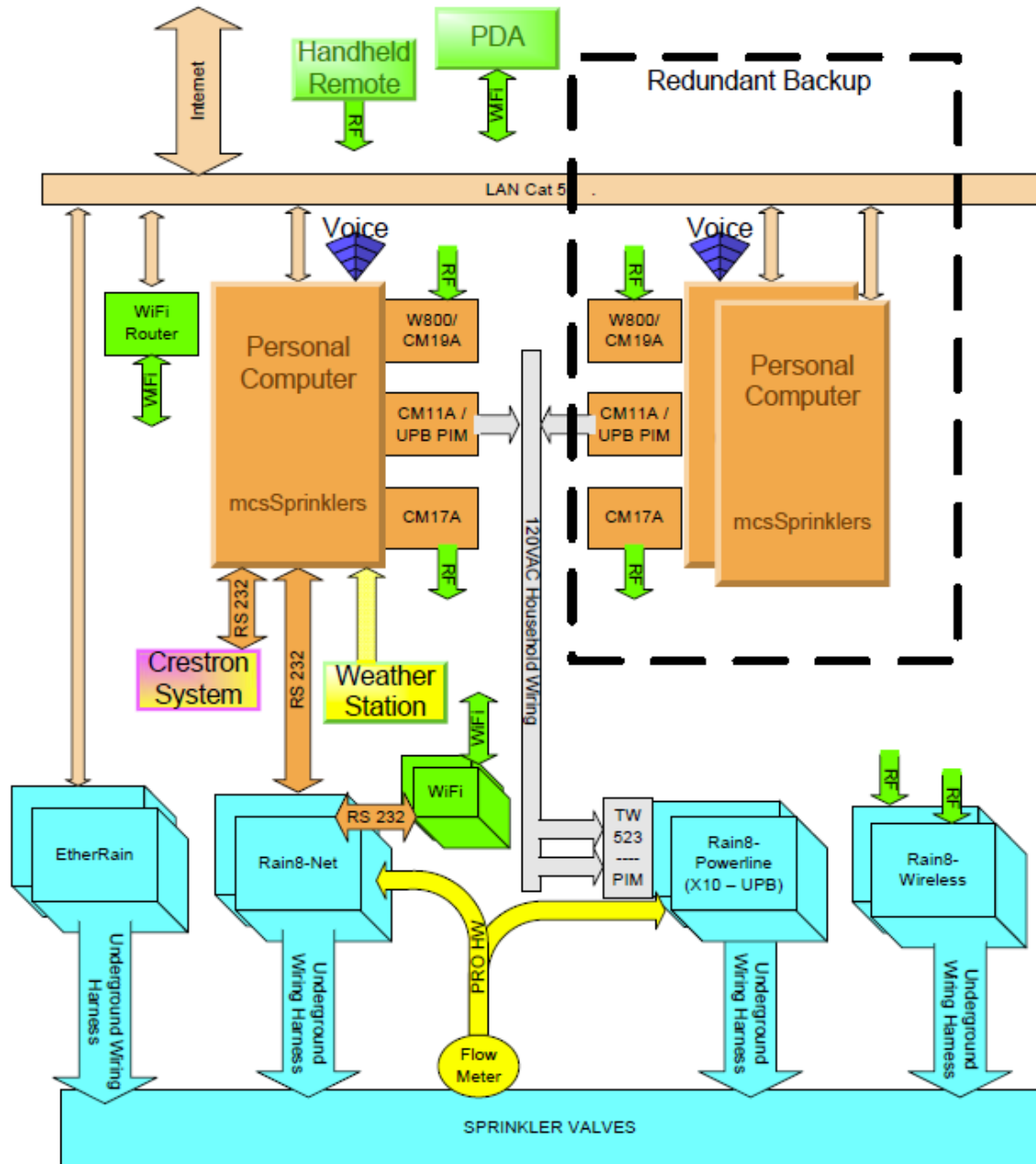

Figure 1 System Architecture

## 2.1 Controller Selection

The selection of a controller will depend primarily upon the means of physical connection that is most viable for a particular site. There are advantages and disadvantages with each option available.

Powerline connections are typically the easiest to retrofit since the powerline connection will be available at many locations. The powerline is shared for many uses and the potential exists that interference with communication can exist using the same shared wiring. X10 and UPB interfaces to the powerline are available. The X10 is lower cost and the UPB is more robust. In the X10 case there are two models. One provides a communication path to command a valve while the other provides both command and status.

The status is used to assure the command was received. The UPB provides both command and status. The Rain8UPB also provides a counter input that can be used to measure water use if a digital meter is available at the site.

At some locations a LAN is prewired and this makes for a very robust connection and is the most desired one from a reliability perspective. The EtherRain and Rain8Net via an IP/Serial adapter can be used in this environment. Variations of this are WiFi where the wired LAN is bridged with RF to allow communications over the air in a range of around 50 ft. The Rain8Net provides a counter input for water use measurements and allows each of the eight valves in the module to be independently used for zone valve, fertigation valve, and pump valve control. The EtherRain is able to only able to activate one of the eight zone valves at a time, cannot be used for fertigation valves, and pump control needs to be managed with the 7/1 variant of the EtherRain. These control restrictions affect the ability to run multiple zones in parallel to manage water flow rates.

The Rain8Net can also be used with a direct RS-232 wired connection between the computer and the controller. Since it is a dedicated wire it has good communication reliability. When the computer and the controller are in the same proximity then the addition of the direct wiring may not be burdensome. Consideration is also needed for the ability of the computer to support a RS-232 interface as many modern ones only support USB. If USB/RS-232 adapters are used care should be used to select ones that have good software driver support for the operation system to assure reliable communication.

## 3 Installation

### 3.1 Standalone

#### 3.1.1 Windows PC Host

The installation is performed with execution of the downloaded setup.exe or setup\_service.exe program. When either is run it will create a folder and install all necessary components under this folder. The default install location is C:\Program Files\mcsSprinklers for the standalone version or C:\Program Files\Homeseer PRO for the Homeseer plug-in version.

For the standalone install a tray icon is available to provide a quick user interface to mcsSprinklers. See Figure 2. For the non-service install this tray icon is required and it is optional for the service install. It is normally the case that the tray icon interface is started when the user logs into the computer. This can be automated by placing a shortcut to mcsSprinklers\_Tray.exe in the user's startup folder.

Following a service install the computer will be setup to automatically start the service when the computer starts. The service will not be running immediately after the install. It can be started by restarting the computer or by starting the mcsSprinklers service. While different versions of Windows have different ways to manage services, the following for WHS will be similar on others. Right-click Computer, Manage Computer, Services and Applications, Services, Right-click mcsSprinklers, Start.

When the mcsSprinklers service is started or when it is stopped an entry will be made in the Windows Event Log under the Application events. mcsSprinklers does not use the Windows Event Log for any other purpose. Events reported by mcsSprinklers will be local via browser on the Messages Page and available in text file in subfolder C:\Program Files\mcsSprinklers\HTML\mcsSprinklers\Data\StartupTrace.txt.

To install the tray icon on individual user login the file mcsSprinklers\_Tray.exe should have a shortcut placed in the user's startup folder. This folder can be reached with Right-click on Start button, Explore, Programs, Startup. mcsSprinklers\_Tray.exe will be in C:\Program Files\mcsSprinklers folder if a default install is performed. Rather than placing the icon in an individual user's startup folder it can be placed in the All Users folder so it will be available to all users upon their login.

When running on Windows version starting with Vista enhanced security needs to be considered. mcsSprinklers must be "run as administrator" since it communicates with hardware resources. When User Access Control (UAC) is enabled then a user prompt will be presented to confirm startup intent with the additional privileges. This prompt is usually not desirable, especially with unattended restarts. This can be overcome with a shortcut that enables elevated operation. A tutorial is provided at <http://www.sevenforums.com/tutorials/11949-elevated-program-shortcut-without-uac-prompt-create.html>. An extract from this location is embedded at the end of this manual.

mcsSprinklers\_Tray.exe can also be placed to run on any computer on the LAN to gain access to mcsSprinklers that is installed as a service. For this situation the tray option for "Tray Setup" should be used to change the address of where mcsSprinklers service is running. The default is the local computer, but can be changed to any computer name or IP address where mcsSprinklers service is running. The port selected on this setup needs to be the same as the used by the mcsSprinklers service. The default is 8008, but can be changed as part of the mcsSprinklers setup. Select the "Tray Setup" option again from the tray to close the setup form.

When remote access to the computer either through the LAN or WAN is desired then the firewall on the computer where mcsSprinklers is installed needs to be setup to allow mcsSprinklers passage. This is true for the remote tray icon or remote browser use in general.

The mcsSprinklers Tray will monitor the execution of mcsSprinklers when either locally or remotely referenced. Should it loose contact it will provide this indication with a popup balloon.

When mcsSprinklers is running as a service the Tray setup should be configured to Inhibit mcsSprinklers Launch Control. This will make the “Launch” option unavailable from the tray icon. When mcsSprinklers is installed as a desktop application rather than as a service then the tray icon can be used to control the execution of mcsSprinklers. In a normal setup the shortcut to mcsSprinklers\_Tray.exe will be placed in the startup folder and the tray launch control will be set to Auto start mcsSprinklers when the tray icon is started. This Auto start can be defeated with the “Manual” selection for launch control. Execution start and stop then will be through user action of the tray icon options.

When the tray is available it will be used to provide event message notification. When an event that warrants user attention is raised then the tray icon will change color to amber. It will also change color to green when at least one irrigation zone is running. For events a popup will appear for 20 seconds or until the mouse is used to acknowledge it. The Message Page is shown to display the events in a static format. Once the event is acknowledged the tray icon will change back to the blue or green color within sixty seconds unless further events are reported.

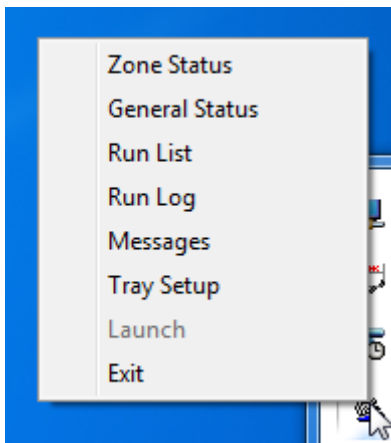

**Figure 2 Desktop Tray Access to Status Pages**

### **3.2 Homeseer**

For the Homeseer install the Homeseer Updater is used to assist in the installation. In this case care must be exercised to assure that the install is placed in the correct folder where Homeseer is running as different versions of Homeseer run in different folders. The menu items available in the standalone tray icon are available from the Homeseer menu where the Homeseer log is displayed.

When installation is performed on a Homeseer PRO-100 or similar processor then one needs to be aware that the C drive, where the system files are stored needs to be explicitly unlocked to allow files to be saved to this drive and this unlocking operation needs to occur prior to installing mcsSprinklers. After installation it can be write-protected again. If this step is not performed then the install will not persist during a power cycle of the PRO-100 or Hometroller.

## **3.3 Registration**

mcsSprinklers is licensed to run on one computer. It will operate on a trial basis for 30 (Homeseer) or 45 days (Standalone) and after that time it will no longer startup until registration is performed. The registration process will depend on whether mcsSprinklers is run standalone or as a plug-in to Homeseer.

### **3.3.1 Standalone**

mcsSprinklers provides a user interface via a web browser. The browser can be launched from a user desktop or Start menu and the URL completed to reference mcsSprinklers or it can be done from the mcsSprinklers tray icon if it is installed. See Figure 2. The default URL for registration is “http://localhost:8008/registration” with the browser launched from the same computer as the installed mcsSprinklers. This default can later be changed as part of the setup. Any status page request from the tray icon will also result in a registration page if registration has not been completed.

Until registration is completed the only page that is available from mcsSprinklers is the registration page so all other page requests will redirect to the registration page. The blank registration page is shown in Figure 3. Registration can be performed directly with the product serial number supplied with the purchased software. It can also be done by contacting customer service and providing proof of purchase information, Computer ID and Disk ID to obtain an unlock code.

Contact information of your choosing (e.g. name) can be entered so that customer support can identify you in the case that you misplace the registration information and the software is to be installed on another computer.

The zip code may also be entered at this time so that the proper environmental conditions can be setup or it may be entered later in the mcsSprinklers setup process on the “Others” setup page.

The registration information entered on the registration form is submitted using the “Register Now” button at the bottom of the form. This will transfer the information to the internet address identified as the Registration URL where it will be validated and retained for permanent records. No other information, except that shown on the form is transferred to this site.

On the embedded platform the registration page also contains settings to identify the time zone and the network setup. The network should be setup before attempting to register since mcsSprinklers needs access to the internet to perform the registration. To get access to the registration page from a browser there needs to be a DHCP server on the LAN to assign an IP address. The embedded computer network name is mcsSprinklers. If the embedded platform has WiFi capability then the setup for the wireless network will also be shown otherwise only a wired network setup will be available.





**Figure 3 Standalone Registration Page**

### 3.3.2 Homeseer Plug-in

When used as a Homeseer plugin, the registration process is managed by Homeseer Technologies (<http://www.homeseer.com>).

Three plugins are available and only one of these can be enabled. The plugin is a function of the license obtained and will be mcsSprinklersB (Basic), mcsSprinklersS (Standard) or mcsSprinklersP (Professional). The process is normally started by downloading the mcsSprinklers plug-in using the Homeseer updater. After the download is complete the Setup tab and then the Interfaces tab is selected to view the list of available plugins. The plugin will require either a registration key from Homeseer Technologies or can be activated using the Trial button. Once the trial button is selected, the enable link is activated. You may then click the grayed Enable button. The selection is then saved with the Save button. An enabled configuration setup for the Basic version is shown in Figure 4.

mcsSprinklersB			Enabled Config	N/A
mcsSprinklersP			Disabled	N/A
mcsSprinklersS			Disabled	N/A

**Figure 4 Homeseer Licensing of mcsSprinklers**

### 3.4 Startup

Following validation of the registration or the trial, mcsSprinklers will initiate its startup initialization. During this time it provides significant checks to assure data is consistent. While checking and when not running as a service it will show a splash screen such as Figure 5. At the bottom of the screen will be a progress bar that shows its relative progress and segment it is processing.

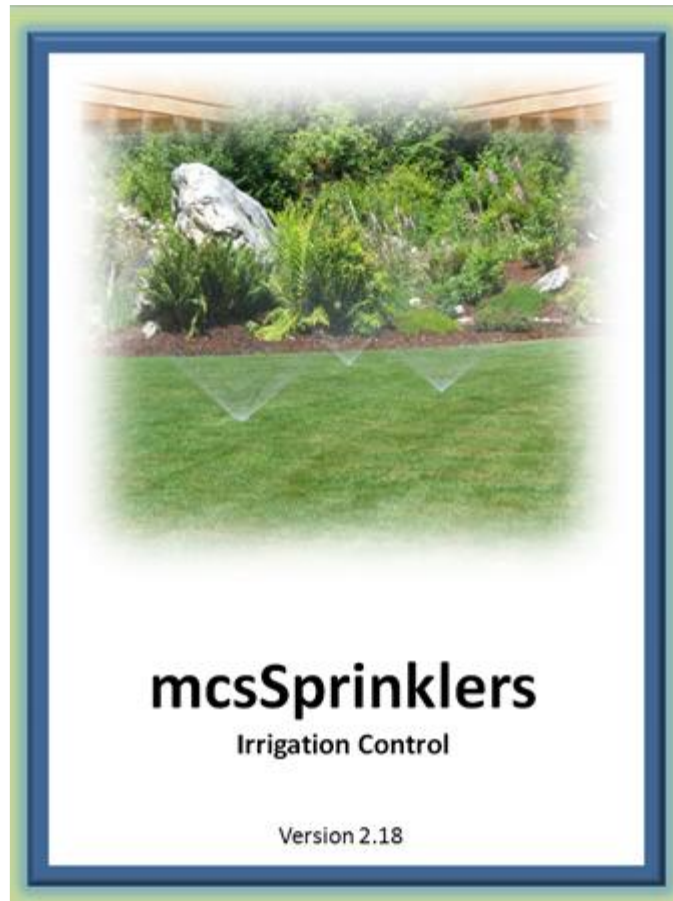

**Figure 5 Startup Splash Screen**

Following this check there will be a short delay while Windows manages its resources. Startup is complete when the mcsSprinklers icon appears in the Windows tray at the bottom right of the screen.

When performing setup operations mcsSprinklers looks for unexpected behaviors. Since it does not want to save a potentially corrupt setup it will not save changes made while errors are detected. The message log or the General Debug output file will provide further information about detected inconsistencies.

## **3.5 Initial Setup**

### **3.5.1 Visual User Interface**

The setup for various scenarios is shown by example in the remaining paragraphs of this section. Once the setup is complete the user has the option of visibility of finest details maintained by mcsSprinklers via the General Status, Zone Status and Run List pages. These views provide the visibility when needed, but for general operations for the majority of users the visual user interface will be the most frequently used view (Figure 6).

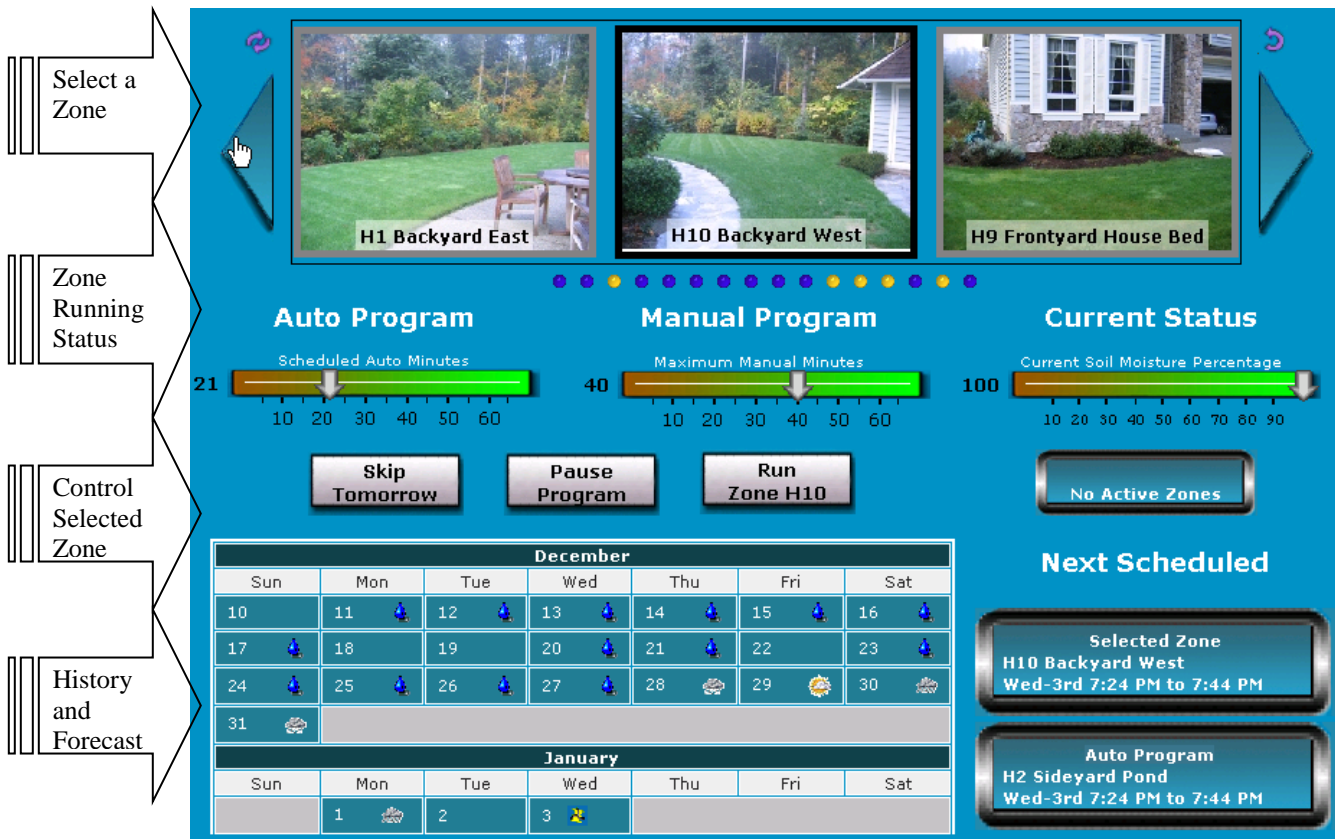

**Figure 6 Visual User Interface**

Each zone is identified by name and visually by photograph. The large arrows at the top scroll the zones until the desired zone is positioned in the center location with the black border. The selection can also be accomplished directly with a mouse click by clicking one of the dots below the photographs. These dots are in positional order and each represents a zone. They are colorized to identify when they are running (green), are disabled (yellow), have failed (red), and not currently running (blue).

When the mouse is placed over a zone status dot the rightmost picture will be replaced with the picture of the zone where the mouse is positioned. This allows the row of dots to be scanned to find the desired zone and then clicked to have the picture move to the center and it will then be the selected zone.

When the mouse is placed over the selected (middle) picture then the leftmost picture will change to a picture of the area in which the zone is located. This allows a context to be identified easily for larger installations. When the mouse moves away from the center selected zone picture then the prior zone picture will be restored.

When a zone is selected, adjustments to the settings for the zone can be made with the slider controls. These sliders will change the setup information on the Zone Setup and Area Setup pages. Either this graphical control or the setup pages can be used to accomplish the same changes. A more detailed setup with more options is available from the setup pages.

The scheduled irrigation program is the “Auto Program”. This program will be run based upon the control strategy setup in the Area Page. One of the auto program parameters is the duration that a zone will run. There are actually three parameters that determine the actual run time of a zone. One is the Zone time, one is the Area time, and the third is the Site time adjustment. The Zone time is the nominal time that a zone will run at the peak of the irrigation season. To account for seasonal variations an Area time factor is applied to this base Zone time. For example, in October the duration may be reduced by 30% from the

nominal July duration. A Site adjustment is also applied to allow all times to be adjusted upward or downward by the same percentage.

The touch screen interface provides access to the Zone time adjustment in the Auto Program column. The slider changes the Zone time with the number being shown actually being the composite of the Zone time, Area factor, and Site factor. For example if the Site adjustment is +10% and the Area factor is 70% and the nominal Zone time is 50 minutes, then the slider will show  $(50 * .70 * 1.10)$  39 minutes. If the slider is adjusted to 20 minutes then the nominal Zone time will change to  $(20 / .70 / 1.1)$  14 minutes. After changing the Auto Program slider to 20 in this example, then going to the Zone Setup page one will see a value of 14 for the Zone Auto program time. The number that is seen on the slider is the number of minutes that the zone will actually run based upon the other setup information.

There is also a slider under the Manual Program column. This slider is used to change the timeout duration for a zone when the zone is controlled manually. Manual control can be with a handheld device or from the browser. The time set for the manual duration timeout has no effect on the auto program times. If the manual time is set to zero then the zone cannot be manually controlled.

A control button is provided under the Manual Program slider. This button toggles between Run and Stop. When the Run button is activated then the manual program for that zone will be started. It will run the zone until the zone is stopped or until the manual program duration timeout is exceeded. When the button shows “Stop” then it will stop the currently active program for the zone. This means the zone could have been started manually or automatically and the same button is used to stop that zone from continuing.

Rather than stopping a zone it is also possible to pause the current program so that it can be resumed a short time later. That is done by using the “Pause” button. When selected, this button will toggle to read “Resume”. When “Resume” is selected then the current program will continue from the point it was paused.

Next to the Pause/Resume button is the “Skip” button. This button is used to skip all zones in tomorrow’s auto program. In essence it tells mcsSprinklers to not automatically run any zones even if they were scheduled for tomorrow. When the Skip is active then the button will change to “Allow” and the decision to not irrigate tomorrow can be rescinded.

There is a slider under the Current Status column. The value showing on this slider represents the percentage of soil moisture saturation. mcsSprinklers keeps track of the soil moisture content based upon weather information and the irrigation performed. When the control strategy is setup on the Area page to be one of the timed modes then soil moisture content is only informational and changing it with the slider has no direct effect. When the control strategy is based upon calculated soil moisture then a change of the slider will have a direct effect on the next irrigation time for the zone.

The next scheduled times for the currently selected zone as well as the time that the next scheduled zone will be run are shown under the area labeled “Next Schedule”. As the schedule changes or as zone completes its cycle the status information is updated to reflect the most current information. When the mouse is positioned over the “Auto Program” label at the lower right of the page a popup will appear that occupies most of the screen. This will show the full program with the zones listed in the order that will be run. The current soil moisture levels are also shown on this popup.

The screen updates are performed immediately upon user control of the buttons or sliders. It is updated a few times per minute as the irrigation schedule progresses. There are occasions where a browser loses sync with its server and the updates will stop. There is a small double arrow icon in the upper left of the page that can be used to refresh the screen to assure the information presented is the most current.

The currently active zone will automatically be shown as the selected zone when that zone starts its cycle. The status dots will update, as will the slider information about the selected zone without the need for a page refresh. The same is true for the Next Schedule information as it changes.

The current time and weather information is shown in the Current Status area. This information is updated as new weather data becomes available. The clock runs continually. The temperature and wind speed buttons can be selected to popup an annual trend chart showing either the temperature or wind speed trends. This annual information is available for all weather data and zone valve control information when accessed from the calendar from either the General Status or Zone Status pages.

The “Time Remaining” display at the center of the screen shows the number of minutes that are remaining to be run for all zones that are currently scheduled to run at the current time. It is updated each minute as the time counts down.

A three or four week window into the selected zone’s activity is shown in the lower left. The calendar shows each day the zone was run with a green sprinkler graphic and each day it had rained with a blue raindrop graphic. The weather forecast is shown for the next week and a blue sprinkler graphic positioned in the day of the next scheduled irrigation for the zone. A mouse click on a cell in the calendar will popup more detailed information about that day.

The two small icons at the top right and left of the page are navigation controls. The refresh icons were previously described to refresh the current display’s information. The icon on the upper right is used to get access to the other mcsSprinklers pages. From these pages additional setup can be done or more detailed status information gathered.

The top of graphical display contains three panels that will show different information based upon where the cursor is hovering on the screen. Figure 7 shows the three views. In all views the center panel shows the currently selected zone. The selected zone is the one where the remainder of the screen shows information and allows settings for this zone to be changed.

The top view is default view when the cursor is not positioned in a critical area. It provides the time of day and up to six current measurements. The measurements to be shown are user-selected from the General Status page.

The middle view is shown when the cursor is positioned over a colored dot (Figure 6). These dots are located immediately below the three panels. Each dot corresponds to a zone. The current setup for the zone is shown in the left panel. The right panel shows a picture of the zone.

The bottom view is shown when the cursor is positioned over the left or right scrolling arrows. It shows the picture of the zones that will move to the center panel position with a click of the right or left arrow button.



Figure 7 Views Available from Graphical UI

### 3.5.2 Quick Start – Learn by Example

When mcsSprinklers is started it will place itself as a small icon in the lower right tray of the PC desktop. The icon will be a blue or green base with water drops rising. Blue indicates that no zones are currently being watered and green when any zone is active. When the icon is clicked it will expand to show a menu of setup and operational selections. When used as a Homeseer plug-in then this icon is not available, but access is provided through the Homeseer menu.

The general setup flow is numerically identified in the popup menu. In some cases there is a dependency on the setup sequence, but in general any setup page can be edited at any time and in any order. The dependencies that exist relate to identification of a valve interface before the valve can be wired and the identification of how the valve is wired before it can be used in a control zone. This means that the Rain8/Devices setup needs to be done before the Wiring setup and the Wiring setup done before the Zone and Area setups.

A browser interface is used for each setup and control page. This means that the setup can be done from any location to which the PC has network connectivity. It also means that entries made on a page are not recognized until the “Save” button on top of each page is clicked and the screen redrawn.

Navigation among the various pages can be done from the tray icon / menu or it can be done from the links located at the top of each browser page.

To illustrate the basic setup flow a few scenarios will be used to base the setup actions. The first will be a minimal setup of one zone to be watered for 30 minutes every other day. Two other scenarios will be shown to illustrate some of the setup features.

Some of these scenarios are available as preconfigured setups that can be selected as the first item in the Setup Interview. The interview is selected from the tray icon.

### 3.5.3 Sample Scenarios

#### 3.5.3.1 Scenario 1 – One Zone Setup

A Rain8-Wireless unit is being used to control a single zone on a schedule of 30 minutes every other day. The computer has a CM17A/Firecracker installed on Com Port 1 to control the Rain8-Wireless.

Select **Setup1-Rain8**. Choose **Rain8-Wireless** to identify that the Rain8-Wireless is being used. It comes from the factory programmed as Unit B1 with timeout of 60 minutes in each zone. This is adequate for use in this scenario. If it were not then the Timer setup at the bottom of the page would be used to configure it as desired.

Enter 1 in the Module PC Interface group, Wireless port box to configure the CM17A/Firecracker to use port 1.

Click the radio button at the intersection of house row B and bank 1 to select the Wireless module type. This means that the module's valves will be associated with addresses B1 through B8. Click Save button at the top to record these settings.

Select **Setup2-Wiring**. To identify the wire connection between the valve and the Rain8 module, let us assume that the valve is connected to the Red wire and we will be using the second position on the module (B2) for this valve. The first column's pull down is selected to be RF B2. The second column contains a box to label this valve. Let us call it Lawn and enter this name in the box. Click the Save button.

At this point the Rain8 interface has been defined and the wiring to the valve located in the Lawn has been specified. The next step is to describe when to turn the valve on. The next step is on the **Setup4-Zone** page where the duration of 30 minutes is identified. There are twelve rows in the Area 1 group and any of these rows can be used. Select the pull down to pick the RF B2 Lawn valve. Enter 30 in the Auto minutes box. Click the Save Button.

Select **Setup5-Area**. A setup page for the areas will appear. We will use the Area 1 for this scenario. Click the radio button at the top for this area that identifies it to be an interval strategy. It is one of the five possible selections. Enter 2 in the box below it since the interval is every other day or 2.

This completes the setup for the scenario of a single valve using a Rain8 Wireless controller that is scheduled for watering for 30 minutes every other day. The zone will be watered starting at midnight every other day.

#### 3.5.3.2 Scenario 2 – Basic Homeseer Setup of Two Sprinkler Valves

mcsSprinklers is added to an existing Homeseer configuration where the sprinkler valve interface is the Homeseer X10 interface or virtual devices through other Homeseer plugin. A relay mapped to [1 and an appliance module at M16 will be used to control sprinkler valves. The valves are to be activated for 40 minutes each on Monday, Wednesday, and Friday and not allowed to be run between 10:00 AM and 4:15 PM

Select **Setup1-Devices**. To identify the devices that are being used, in the section titled “Homeseer X10-IO Devices” enter [1,M16 in the text box. Note the comma to separate the two virtual devices. No entries need to be made on any other boxes on this page since the control interface to the hardware is via Homeseer.

Click Save button at top to record these settings.

Select **Setup2-Wiring**. To identify the wire connection between the valves and the devices let us assume that the valves are connected to the Red and Blue wires in the wiring harness. Select the row where the wire color is red and from the pull down select [1. In the Location column give it a name. This name will be used to set the name of the Homeseer device.

Click Save button at top to record these settings.

Select **Setup4-Zone**. Since both valves are on the same M/W/F schedule they can be placed in the same zone. In the valve column select two rows and each valve. In the Auto Minutes column enter 40 for both since that is the duration the zone will be run each time it is activated. Soil Efficiency and Rain Factor will contain default values that do not need to be changed. They are used for control modes based on soil moisture content.

Click Save button at top to record these settings.

Select **Setup5-Area**. A setup for one area will be presented. It will show the zones associated with the area at the top and the 30/7 day history for the zone. The history will initially be blank. The M/W/F schedule is selected by clicking the “Day-of-Week” radio button and the check boxes for Monday, Wednesday, and Friday.

No specific start time is needed so the Area start times need no entry. No pump is specified so no entry is needed in this section either.

Click Save button at top to record these settings.

Select **Setup6-Restrictions**. A variety of restrictions can be imposed. In this case the desired restriction is entered into the “Don’t between hours” with values of 10:00 and 16:15

Click Save button at top to record these settings.

Select **Setup9-Other Setup**. The browser interface to mcsSprinklers can be serviced by the plug-in or by the Homeseer server. Select the desired radio button.

Real time weather data and forecasted weather as well as nominal seasonal percentages are based upon the zip code. Enter the zip code and click the Save button. The screen will be redrawn and available local weather site will be presented in the Time and Weather Setup section. Select at minimum, the primary site and backup sites if desired.

Near the bottom of the page are some setup options specific to Homeseer. The device codes shown for Manual mode and Seasonal control are moding devices. One toggles between manual and automatic modes and the other toggles between plug-in Enabled and Disabled. The display options relate to how the Homeseer Device Strings are formatted and the overall appearance of the browser page. The Database option allows selection of Microsoft Access vs. SQL Server for retention of historical information.



### 3.5.3.3 Scenario 3 - Replacement for Stand-alone Timer

A standard timer normally used for timed control of sprinkler zones is being removed and replaced with a Rain8 to achieve computer control of the sprinkler zones. The following objectives are to be satisfied:

1. 4 Zones are being controlled
2. Rain8-Net used for valve control
3. Watering scheduled for Monday, Wednesday and Friday for Lawn areas and daily for garden
4. Two lawn zones to be watered for 60 minutes, one for 30 minutes and the garden for 20 minutes
5. Watering cycle to start at 2:15 AM for the lawn and 1 hour after sunrise for the garden
6. Garden water is supplied by a pump while the others by city water
7. Com port 2 is available on the PC

The setup flow is the same as with scenario 1 starting with the Rain8 interface, its wiring, the control strategy for the areas, and the durations for the zones.

**Setup1-Rain8.** The Rain8-Net module needs an address. Since only one is being used, we can search to find it, or we can just program a specific address. In this case we will set it to 1 and then search to confirm. The first step is to remove the Rain8 module from connection to any valves. The programming of the unit cannot be done in an “installed” configuration. All programming is done from entries made in the EPROM Timers group at the bottom of the Setup1-Rain8 page. The programming port number is selected to identify the serial connection to the PC. The module type radio button is selected to be Rain8-Net. The address box entry is 1. The timeout/safety times will be set to 80 in this scenario since it is a reasonable value above the maximum time of 60 minutes that is planned. After all entries are made then the Write EPROM button is clicked. This will reprogram the connected module. After a few seconds the Read EPROM button can be clicked to read back the current settings to confirm that the proper settings were applied. The module can be removed from the programming port now and connected to the port that will be used for normal operation. These may be the same ports and in this case no move is required.

At this point we know the Rain8 module’s address is 1 so we can do a search and know what to expect. The search is done from the top of this same page. First the Rain8-Net interface port is identified to be 2 in the Interface group. This is the port that will be used to communicate with the Rain8-Net in a normal operational setup. The second group on the page contains two buttons. The rightmost one is clicked to start the search. The page will be redrawn with a window between the two buttons. A value will increment in this window to show the current address that is being searched for Rain8-Net modules. In this case we do not expect any after 1, so when a number greater than 1 appears the rightmost button can again be clicked to stop the search.

At this point the Rain8-Net module has been setup to interface to the valves.

**Setup2-Wiring.** Four valves are being connected so four wires will need to be identified to mark which wire is connected to which valve. A pump is being controlled so a fifth wire is also needed. If they are in the same harness then all can be specified in the Harness 1 group. Use the pull down on each row to make the linkage between water valve, wire color, and Rain8-Net valve control. The pull down will show NET 1 Valve 1 through 8 since that is what was previously identified. Each valve is given a name in the boxes on the rows. Let us use Front Yard, Back Yard, Flower Bed, and Garden. The pump will be called Pump.

**Setup4-Zone.** The four zones are organized into two areas per the setup that was done for the Area control times. The three lawn valves are identified with pull-downs in the Area 1 zone group and Auto times entered as 60, 60, and 30 in the three identified rows.

In the Area 2 Zones a single row will be selected to identify the garden valve and enter the 20-minute cycle.

The manual times for each of the 4 zones will also be entered with the same values so manual control of each zone can be done.

**Setup5-Area.** The lawn requires a M-W-F schedule while the garden requires a daily one. This implies that two areas need to be defined. The first will be for the lawn zones. The control strategy is selected to be Day-of-Week with the radio button at the top. The Monday, Wednesday, and Friday checkbox are checked. Watering is to start at two hours 15 minutes before sunrise, so -2:15 is entered into Time1 box with a relative to sunrise selection.

In Area2 the Interval radio button is selected and a value of 1 for the interval. The entry in the Time1 box will be 1 and the radio button checked to the time will be relative to sunrise. This area has a pump so the pull down is used to identify the wire connected to the pump.

**Setup8-Weather.** Since the time specified for the garden is relative to sunrise there needs to be location information entered so mcsSprinklers can computer sunrise and sunset times. This is done from the Setup8-Weather page with an entry in the Zip Code box. Since weather information is not needed the Internet download method can be set to Don't Download Weather and Forecast Data.

### 3.5.3.4 Scenario 4 - Typical Use of Features

A typical scenario will go beyond the setup for the quick start. The following example illustrates the setup that achieves the following objectives:

1. Sprinklers enabled in 15 zones of lawn when soil moisture below 0.5 equivalent rain inches
2. Sprinklers enabled every other day for 3 zone garden
3. Water can only be used for irrigation on even days of the month
4. Sprinklers disabled during the heat of the day
5. Sprinklers disabled when it is windy
6. Sprinklers disabled if rain forecasted within two days
7. Only enough water pressure to do one zone at a time
8. Need to do a precheck of the zones to confirm all valves and heads are in order
9. Rain8-X10-2 units to be used
10. Pump used for all irrigation

**Setup1-Rain8.** Similar procedure as in the prior scenarios with a caveat that the Rain8 X10-2 units need to be programmed with different house/bank codes. Assume the programming is setup for N1 through N8 and N9 through N16 to handle the 15 lawn zones. M1 through M8 for the garden zones. In the case of the M1 through M8 module it needs to be configured to use Valve 8 as the pump control. When all the three units have been programmed there will be 23 available zones and 1 pump, which is adequate for the 18-zone requirement.

No other X10 automation controller exists so the X10-2 modules can be configured in the optimal Ack on Cmd and Poll configuration and the default 5 seconds between commands is acceptable setup for the X10/RF Interface section.

**Setup2-Wiring.** Similar procedure as in other two scenarios.

**Setup4-Zone.** Similar procedure as in the other scenarios, but in this case we are also concerned with the ability to manually control the valves for only short duration testing. Because of this a time should be entered for each of the Manual time boxes that are being used. When a valve is turned on manually then it will run for the Manual time number of minutes or until it is manually turned off.

**Setup5-Area.** Similar procedure as in the other scenarios. In this case, however the control strategy for the lawn is selected to be calculated with the radio button and the threshold box under it is set to be 50%. For the Garden and Lawn the pump will be selected

Since the water pressure is limited then only one zone should be watered at a time. This specification is made in each of the two area sections of the page to specify that the sequencing is part of a single master sequence. If the checkbox is unchecked then the two lawn areas will be watered in parallel rather than in series.

**Setup6-Restrictions.** A variety of restrictions are imposed in this scenario. Each of these is entered on this page. The “heat of the day” limitation can be coded in the Between Hours boxes. Perhaps values of 11:00 and 18:00 would be appropriate times to not allow watering to occur. “Windy” may be translated to a value of 10 MPH for 5 minutes. This means that over a 5-minute period the average wind speed must be less than 10 MPH. Forecasted precipitation implies a reasonable probability of rain. An entry of 50 percent, 2 days, and the corresponding checkbox will result in a watering restriction if either of the next two days has at least a 50% probability of precipitation.

**Setup7-Remote Control.** The ability to pre-check the valves implies manual control, but also may imply the use of a remote control pad. The remote control pad will send RF codes consistent with X10 protocol and these need to be received and associated with specific valves. There are 18 zones so 18 discrete House/Unit code values will need to be entered. For simplicity the unit codes should be the same as the

valve codes. This means something like K1 through K3 and L1 through L15 could be entered into each box on the Remote Control Page. Remote input also implies an interface to remote signals. A W800 is attached to COM2 as the RF receiver so 2 is entered for the W800 port.

**Setup8-Weather.** The wind speed data is obtained from a local reporting station. The available stations are contained in the pull downs in the Weather group of this page. The stations are associated with zip codes so a change in zip code will change the list of available stations. Up to three stations can be specified to handle the cases when a station happens to be inoperative.

### 3.5.3.5 Scenario 5 – Dual PC – Dual Hardware Interface Configuration

This scenario cannot be setup on versions of mcsSprinklers after 2.16.

The dual PC configuration will build upon Scenario 4 setup by showing the additional considerations for the redundant configuration. There are a variety of redundant configuration setups. This one will assume the following hardware;

- Two CM11A Power line interfaces

- Two W800 RF Interfaces

- Two Computers running in Active/Standby irrigation mode

  - Computer 1 name is MAIN and contains CM11A interface and W800 interface

  - Computer 2 name is GARAGE and contains CM11A interface W800 interface

- Same Rain8 controller hardware as scenario 4

The setup will be performed on the primary computer first and then when completed a few changes will be made from the secondary computer. The following applies to the primary computer (MAIN). This computer needs to have the folder where mcsSprinklers is installed to be shared over the LAN. Consult your Windows operating system documentation to make this folder shared.

#### Computer # 1 (MAIN)

**Setup1-Rain8.** No Change

**Setup2-Wiring.** No Change

**Setup4-Zone.** No Change

**Setup5-Area.** No Change.

**Setup6-Restrictions.** No Change.

**Setup7-Remote Control .** No Change

**Setup9-Other.** Redundancy backup mode selected as “Standby Backup”. This will cause a blue highlight to the middle of the Others page when the Save is clicked.

#### Computer #2 (GARAGE)

On the second computer (GARAGE) the mcsSprinklers application is started after the computer # 1 setup is complete. This will allow the sharing of the setup that was previously done. It can be changed from either computer at any time and both will be updated.

**Setup9-Other.** Redundancy backup mode selected as “Standby Backup”. This will cause a blue highlight to the middle of the Others page when the Save is clicked. Note the backup mode setting is the same as on the first computer. The setup entries shown in blue are not shared so each needs to be made individually on each computer.

Redundancy Backup Mode\Path to primary mcsSprinklers edited to change the computer name (GARAGE) to (MAIN). This path is where the configuration information is stored. It will be stored only on one computer and MAIN was selected to be the primary. After editing it will show as \\GARAGE\C\Program Files\mcsSprinklers.

### 3.5.3.6 Scenario 6 – Dual PC – Single Hardware Interface Configuration

This scenario cannot be setup on versions of mcsSprinklers after 2.16.

The dual PC configuration will build upon Scenario 4 setup by showing the additional considerations for the redundant configuration. There are a variety of redundant configuration setups. This one will assume the following hardware

- One CM17A Wireless interface
- One W800 RF Interface
- Two Computers running in Active/Standby irrigation mode
  - Computer 1 name is MAIN and contains CM17A interface
  - Computer 2 name is GARAGE and contains W800 interface
- Same Rain8 controller hardware as scenario 4

The setup will be performed on the primary computer first and then when completed a few changes will be made from the secondary computer. The following applies to the primary computer (MAIN). This computer needs to have the folder where mcsSprinklers is installed to be shared over the LAN. Consult your Windows operating system documentation to make this folder shared.

#### Computer # 1 (MAIN)

**Setup1-Rain8.** Module PC Interface selects “External via XAP Address”. The address in the text box can be left blank since only one interface node will be implemented. Commands to control the Rain8Wireless will now be delivered as xAP messages over the LAN rather than as a direct connection to the CM17A.

**Setup2-Wiring.** No Change

**Setup4-Zone.** No Change

**Setup5-Area.** No Change.

**Setup6-Restrictions.** No Change.

**Setup7-Remote Control.** The W800 IP and W800 Port boxes are left blank. This means there is no W800 directly connected to this PC, but will get the W800 reports via the LAN.

**Setup9-Other.** Redundancy backup mode selected as “Standby Backup”. This will cause a blue highlight to the middle of the Others page when the Save is clicked.

Launch Redundant Application on Startup/Rain 8 Interfaces/Wireless Interface checkbox checked so that the interface to the CM17A will be activated next time mcsSprinklers starts. The interface software user interface will appear in the tray as a missile-like icon. When this icon is clicked a setup option will appear and the port number entered for the CM17A interface is entered. Note that is secondary setup can only be done after mcsSprinklers has been restarted.

Supplemental xAP Interface/Start Hub checkbox is checked. This will allow xAP communications on this computer.

#### Computer #2 (GARAGE)

On the second computer (GARAGE) the mcsSprinklers application is started after the computer # 1 setup is complete. This will allow the sharing of the setup that was previously done. It can be changed from either computer at any time and both will be updated.

**Setup9-Other.** Redundancy backup mode selected as “Standby Backup”. This will cause a blue highlight to the middle of the Others page when the Save is clicked. Note the backup mode setting is the same as on the first computer. The setup entries shown in blue are not shared so each needs to be made individually on each computer.

Redundancy Backup Mode\Path to primary mcsSprinklers edited to change the computer name (GARAGE) to (MAIN). This path is where the configuration information is stored. It will be stored only on one computer and MAIN was selected to be the primary. After editing it will show as \\GARAGE\C\Program Files\mcsSprinklers.

Launch Redundant Application on Startup/Rain 8 Interfaces/Handheld Remote checkbox should be checked so that the interface to the W800 will be activated next time mcsSprinklers starts. The interface software user interface will appear in the tray as a ray-like icon. When this icon is clicked a setup option will appear and the port number entered for the W800 interface is entered. Note that is secondary setup can only be done after mcsSprinklers has been restarted.

Supplemental xAP Interface/Start Hub checkbox is checked. This will allow xAP communications on this computer.

Supplemental xAP Interface/xAP UID changes from FF000800 to FF000900 to give the second instance of mcsSprinklers a unique identification on the LAN.

## 4 Physical Installation

The physical installation consists of routing wires from the field to the Rain8 or EtherRain controllers, the connection of controllers to the personal computer(s) and connection of the computer(s) to the Internet. Obviously each new location will have new wiring routed and valves installed. The setup for the initial configuration will be performed per the steps in the following paragraphs. [Version-Dependent Capability] If a second installation is done, then the setup can be based off of a prior install by transferring the configuration file contained in c:\program files\mcsSprinklers\mcsSprinklers.ini.

### 4.1 Field Wiring

Wires from the valves in the field are usually bundled in one or more harnesses and each wire in a harness is color-coded. When multiple harnesses are used then each harness needs to be manually labeled to assure that the proper harness is identified as it is being installed in the controller. Valve wiring is a low voltage-capacity where the wire gauge requirements are based upon the distance from the valve to the controller. There are no special electrical shielding requirements for wires in this harness. Wires may also be run for flow meters or moisture probes. These may have special requirements for shielding or proximity to other types of wires and this need to be obeyed for a successful install.

The terminal end of a wiring harness is connected to one or more Rain8 or EtherRain controllers. The Rain8 controllers are located at a convenient location that is protected from the weather. The controllers can be collocated or located at locations this is convenient based upon the source of the harness. A collocated organization will tend to have better long-term serviceability.

Each Rain8 or EtherRain module can accommodate seven or eight wires. Each wire is connected to a post in the terminal block. At least one common return wire needs to be installed in a terminal post. The 8th valve position in the terminal block may be connected to a valve or to a pump. The use of the pump control in this manner will dependent upon the type of Rain8 or EtherRain controller and this will be discussed later. The terminal block is not installed in the Rain8 at this time, but it should be manually labeled so the correct Rain8 controller is later mated to the proper terminal block.

### 4.2 Controller Connection

#### 4.2.1 Controller to PC

Three models of Rain8 controllers are available with the primary difference between each being the mechanism by which it is connected to the personal computer. The connection methods are a low-voltage cable, an interface to the high-voltage AC power line, and an interface for wireless radio frequency connection.

The Rain8-Net module uses a RS232 cable that plugs into a COM serial port of the PC. Additional Rain8-Net modules are interconnected with RS485 cables.

The Rain8-Wireless module listens for commands via radio frequency transmissions. The PC can generate these commands with an interface to one of its COM ports. The most basic of these interfaces is a CM17A/Firecracker. RF communications can penetrate walls, but are also sensitive to nearby RF noise sources. For this reason it may be desirable to connect an RS232 extension cable between the PC's COM port and the CM17A. Additional Rain8-Wireless modules are interconnected with RS485 cables.

The Rain8-Power line module listens for commands per the X10 protocol on the household AC wiring. The electronics at both the PC and Rain8-Power line end cannot be directly plugged into the 120VAC line. The Rain8-Power line module uses a TW523 adapter to protect it. Up to two Rain8-Power line modules can share one TW523 adapter. The PC-side connection is a CM11A connection to a PC's COM port. The CM11A and CM17A can share the same COM port if both types of Rain8 modules are used.



The EtherRain is connected to the LAN with typical Cat5/6 cable to an Ethernet switch or router. Multiple modules are connected via different ports on the switch or router.

Since multiple Rain8 modules can be used in a single installation it is necessary to configure each module to respond to a unique address. This configuration is done from the Setup1-Rain8 page. The programming of any Rain8 module is done one module at a time. The module is connected to a COM port on the PC. The module **cannot** have the terminal block with the valve wires connected. . In the basic and Standard versions of mcsSprinklers this is done with a utility program downloaded from the [WGL website](#). (download r82.zip for 2-way Rain8II or rain8config.zip for 1-way Rain8)

Figure 8 shows the segment of the Setup1-Rain8 page that is used for configuring the Rain8 module. The Rain8module contains an EPROM and all settings for the EPROM are done at one time. This includes the module address; pump configuration, and timer setup. The COM connection to the PC that is being used for the programming and the type of module is identified to start the process. The programming is performed by filling in all the fields shown in Figure 8 and then clicking the Write EPROM button. To confirm the setup was properly saved to the Rain8 device, click the Read EPROM button to read the current contents of the Rain8 EPROM.

After a module type selection is saved the remainder of the EPROM setup will show dark grey fields for the settings that are not available for the selected module type.

The timer values in the right column are used to set a minimum time for that valve. This should be set to a value greater than the amount of time you plan to have that zone run. They are used to protect the system by placing an absolute limit on the time that a valve will be allowed to remain open. In the case of the Rain8-Net, Rain8-UPB, and Rain8-X10-2 this safety feature can be overridden with the checkbox entry. The other modules have no override. Values in the range 1 to 250 are acceptable.

Note also the special configuration for a pump on the Rain8-Wireless unit. This model will allow the 8<sup>th</sup> valve to be slaved to the other seven with the intention that it will control a pump. When any of the first seven are ON then the 8<sup>th</sup> will be ON and when all are OFF then the 8<sup>th</sup> will be OFF.

**Rain8 EPROM and Timers**

<b>Programming Port</b>	
Programming Port	3
<b>Module Type</b>	
<input type="radio"/> NET	<input type="radio"/> RF
<input type="radio"/> X10	<input type="radio"/> X10-2
<input checked="" type="radio"/> UPB	
<b>Module Address</b>	
Module Address / House Code	2
Unit 1..8	<input checked="" type="radio"/> Unit 9..16
<b>Rain8-Net/X10-2/UPB Timers</b>	
<input type="checkbox"/> Enable Rain8-Net/X10-2/UPB Timers	
Rain8UPB Resolution	<input checked="" type="radio"/> Minutes <input type="radio"/> Seconds
<b>Rain8-UPB Network</b>	
NID	1
Link	
<b>Rain8-Wireless Valve 8 Use</b>	
<input checked="" type="radio"/> Use as a Valve <input type="radio"/> Use as a Pump	
<b>Rain8-X10-2 Status Response</b>	
<input checked="" type="radio"/> Ack on Poll Only <input type="radio"/> Ack on Cmd and Poll	

<b>Rain8 Timers</b>	
Valve 1	<input type="text"/> Minutes
Valve 2	<input type="text"/> Minutes
Valve 3	<input type="text"/> Minutes
Valve 4	<input type="text"/> Minutes
Valve 5	<input type="text"/> Minutes
Valve 6	<input type="text"/> Minutes
Valve 7	<input type="text"/> Minutes
Valve 8	<input type="text"/> Minutes

### Figure 8 Rain8 Address and Timer Setup

Once the controllers have been assigned an address and the other EPROM parameters set and saved the Rain8 modules can be connected to the terminal block. This can be done later as well. In either case the configurations that have been programmed need to be entered into the top part of the Setup1-Rain8 page unless the Homeseer interface is being used. In that case no entry is needed for the Wireless or Power line sections of Figure 9.

In operational use each type of module is connected via a COM port to the PC or via the Local Area Network (LAN) to another PC with a usable COM port. This COM port may or may not be different than the one used for programming the module. The port used is entered into the text box shown in Figure 9 if the local computer contains the CM17A/CM11A interface.

It is also possible to interface the module using a remote interface rather than one directly connected to the computer. The remote interface must be somewhere on the LAN and at the remote location an interface module will be installed and the interface software run. The interface modules are those shown in **Error! Reference source not found.** The remote vs. internal connection is selected and if remote, then the target address of the interface is entered. This address can be wild carded so an entry such as \*.\*.\* will usually accomplish the objective.

In the case of all Rain8 types except the Wireless, it is possible to interface these devices with LAN connection to an IP/Serial converter. These adapters can be wireless or wired. Communication to these devices can be direct to the IP and Port of the IP/Serial converter or can be through a port driver that maps the IP/Serial device to an extended COM port. The setup of the Rain8UPB in Figure 9 shows the connection directly to the IP/Serial device. If a COM port is used then the port entry would be simply the port number such as 6 and the IP entry would be blank such as is shown for the Rain8Net connection.

When using the Homeseer X10 interface, the entry that should be made is the list of Homeseer devices per Paragraph HomeSeer Devices or X10 devices per the grid of Figure 11

The Save button at the top of the page is used to record the settings.

Module PC Interface	
Rain8-Net	<input checked="" type="radio"/> Internal via Port <input type="text" value="3"/> IP <input type="text"/> <input type="radio"/> External via XAP Address <input type="text"/> <input type="radio"/> External via XAP Serial <input type="text"/>
Rain8-UPB	<input checked="" type="radio"/> Internal via Port <input type="text" value="3011"/> IP <input type="text" value="192.168.0.44"/> <input type="radio"/> External via XAP Address <input type="text"/> <input type="radio"/> External via XAP Serial <input type="text"/>
Rain8-Wireless	<input checked="" type="radio"/> Internal via Port <input type="text"/> <input type="radio"/> External via XAP Address <input type="text"/>
Rain8-Powerline	<input type="radio"/> Internal via Port <input type="text"/> IP <input type="text"/> <input checked="" type="radio"/> External via XAP Address <input type="text" value="mcs.CM11A.mcs6"/>

Figure 9 Rain8 Modules to PC Connection Setup

For the X10 power line and RF interfaces additional information is used to characterize how the interface will be used. This is shown in Figure 10. A gap is placed between X10 commands to relieve loading on the power line. This delay is entered as the number of seconds between each command. In the case of the Rain8X10-2 the module itself will provide a status response identifying the state of its valve. When the EPROM of the module is programmed it can be set to immediately respond with status after a command or it can be configured to respond with status only on a status request command. If it configured to respond only after a status request then mcsSprinklers will issue a status request after some delay after each valve command. The delay time is a user-selectable entry. In the case of the Homeseer configuration where the X10 interface is managed by Homeseer, then the EPROM must be configured to respond only on poll since Homeseer does not know how to deal with an automatic status response. The delay timing parameters are managed by mcsSprinklers to assure that reasonable values are entered. The typical response time between a Rain8X10-2 status request and its response is 3 to 4 seconds. This means that the command-to-command delay should be greater than 4 seconds to assure that the status is not being returned at the same time as the next command is being issued and the two collide.

The two buttons shown in the interface test (Figure 10) can be used to test the interface connection. In this case an ON command followed by a five second delay and then OFF is sent over the interface that corresponds to the button. These can be used to check the connectivity of the interface setup.

**Figure 10 X10 Interface Characterization**

The addresses that were assigned to the Rain8 modules are entered into the middle panels of the Setup1-Rain8 page. This area is shown in Figure 11, Figure 12 and Figure 13.

The Rain8 Net/WiFi can be connected to a single PC port or multiple ports. A typical configuration is a single port connection with all Rain8 modules connected together with RS485 daisy-chained cables between each module. In this case there is one master. If the rain8 modules cannot be physically daisy-chained and still connect to the valve wiring then multiple PC ports can be used to make the connection. In this case there are multiple masters. This selection is made in the Master Modules text box shown in Figure 12.

In the case of the Rain8-Net / WiFi there are two methods to identify the modules that will be put into service. One is to allow mcsSprinklers search for the modules and the other is to enter the module number in the text box. The easiest method is to enter the module numbers with a comma separating each in the text box provided. To use the search method the Find Rain8 Modules button is clicked. A new window will appear with the current address being search displayed. When this address goes beyond the highest number programmed into the EPROM then the same button can be clicked again to stop the search. It will stop itself at 255 if not manually stopped.

When multiple masters are connected then this process is repeated for each master. If the interface method is via xAP it can be considered a single master and all module numbers entered into a single text box.

The normal wait time allowed for a response from the Rain8Net is 5000 milliseconds. This can be increased to deal with an underpowered computer that may not be able to sustain the load it is carrying.

The Rain8Net supports a protocol that provide acknowledge of each command and allows the status of valves within the module to be queried. mcsSprinklers will always wait for acknowledgement and retry commands up to four times before declaring a valve failed. Options are available to allow mcsSprinklers to query the module after a command or every minute. If a status response is not what mcsSprinklers expected for the valve then mcsSprinklers will send command(s) as necessary to place the valves in the correct state. For the status polling to be effective the quality of the communication with the Rain8Net modules must be good. This is especially true when polling every minute. Some interfaces tend to buffer commands so the timing relationships are not maintained and responses will not be available in the expected time window allowed.

For the Rain8-UPB the modules are identified by a text box shown on Figure 13. Each Rain8-UPB module will occupy 8 UPB Device ID's. Module #1 will be DID's 1 through 8. Module #2 will be DID's 9 through 16, etc.

In the case of the other two module types there is no mechanism for the module to report its address when not connected to the programming port. For these, and when not using the Homeseer X10 Interface to control the module, the addresses of all units that are installed needs to be entered into the grid of Figure 11. This includes the identification of the module type and if it was programmed to respond to addresses 1 to 8 or 9 to 16.

Rain8 Wireless and X10 Powerline Interface Module Assignments								
House	Bank 1 to 8				Bank 9 to 16			
A	<input checked="" type="radio"/> None	<input type="radio"/> Wireless	<input type="radio"/> X10	<input type="radio"/> X10-2	<input checked="" type="radio"/> None	<input type="radio"/> Wireless	<input type="radio"/> X10	<input type="radio"/> X10-2
B	<input checked="" type="radio"/> None	<input type="radio"/> Wireless	<input type="radio"/> X10	<input type="radio"/> X10-2	<input checked="" type="radio"/> None	<input type="radio"/> Wireless	<input type="radio"/> X10	<input type="radio"/> X10-2
C	<input checked="" type="radio"/> None	<input type="radio"/> Wireless	<input type="radio"/> X10	<input type="radio"/> X10-2	<input checked="" type="radio"/> None	<input type="radio"/> Wireless	<input type="radio"/> X10	<input type="radio"/> X10-2
D	<input type="radio"/> None	<input type="radio"/> Wireless	<input type="radio"/> X10	<input checked="" type="radio"/> X10-2	<input type="radio"/> None	<input type="radio"/> Wireless	<input type="radio"/> X10	<input checked="" type="radio"/> X10-2
E	<input type="radio"/> None	<input type="radio"/> Wireless	<input type="radio"/> X10	<input checked="" type="radio"/> X10-2	<input checked="" type="radio"/> None	<input type="radio"/> Wireless	<input type="radio"/> X10	<input type="radio"/> X10-2
F	<input checked="" type="radio"/> None	<input type="radio"/> Wireless	<input type="radio"/> X10	<input type="radio"/> X10-2	<input checked="" type="radio"/> None	<input type="radio"/> Wireless	<input type="radio"/> X10	<input type="radio"/> X10-2
G	<input checked="" type="radio"/> None	<input type="radio"/> Wireless	<input type="radio"/> X10	<input type="radio"/> X10-2	<input checked="" type="radio"/> None	<input type="radio"/> Wireless	<input type="radio"/> X10	<input type="radio"/> X10-2
H	<input checked="" type="radio"/> None	<input type="radio"/> Wireless	<input type="radio"/> X10	<input type="radio"/> X10-2	<input checked="" type="radio"/> None	<input type="radio"/> Wireless	<input type="radio"/> X10	<input type="radio"/> X10-2
I	<input checked="" type="radio"/> None	<input type="radio"/> Wireless	<input type="radio"/> X10	<input type="radio"/> X10-2	<input checked="" type="radio"/> None	<input type="radio"/> Wireless	<input type="radio"/> X10	<input type="radio"/> X10-2
J	<input checked="" type="radio"/> None	<input type="radio"/> Wireless	<input type="radio"/> X10	<input type="radio"/> X10-2	<input checked="" type="radio"/> None	<input type="radio"/> Wireless	<input type="radio"/> X10	<input type="radio"/> X10-2
K	<input checked="" type="radio"/> None	<input type="radio"/> Wireless	<input type="radio"/> X10	<input type="radio"/> X10-2	<input checked="" type="radio"/> None	<input type="radio"/> Wireless	<input type="radio"/> X10	<input type="radio"/> X10-2
L	<input checked="" type="radio"/> None	<input type="radio"/> Wireless	<input type="radio"/> X10	<input type="radio"/> X10-2	<input checked="" type="radio"/> None	<input type="radio"/> Wireless	<input type="radio"/> X10	<input type="radio"/> X10-2
M	<input checked="" type="radio"/> None	<input type="radio"/> Wireless	<input type="radio"/> X10	<input type="radio"/> X10-2	<input checked="" type="radio"/> None	<input type="radio"/> Wireless	<input type="radio"/> X10	<input type="radio"/> X10-2
N	<input checked="" type="radio"/> None	<input type="radio"/> Wireless	<input type="radio"/> X10	<input type="radio"/> X10-2	<input checked="" type="radio"/> None	<input type="radio"/> Wireless	<input type="radio"/> X10	<input type="radio"/> X10-2
O	<input checked="" type="radio"/> None	<input type="radio"/> Wireless	<input type="radio"/> X10	<input type="radio"/> X10-2	<input checked="" type="radio"/> None	<input type="radio"/> Wireless	<input type="radio"/> X10	<input type="radio"/> X10-2
P	<input checked="" type="radio"/> None	<input type="radio"/> Wireless	<input type="radio"/> X10	<input type="radio"/> X10-2	<input checked="" type="radio"/> None	<input type="radio"/> Wireless	<input type="radio"/> X10	<input type="radio"/> X10-2

Figure 11 Rain8 X10-based Module Address Setup

Rain8 Net and Rain8 WiFi Master Modules		
Number of Rain8 Net and Rain8 WiFi Master modules <input type="text" value="2"/> (One master per PC port connection)		
Handling of Status from Rain8Net		
<input type="radio"/> No status request	<input type="radio"/> Request status after command	<input checked="" type="radio"/> Request status every minute

Rain8 Net and WiFi		
<input type="button" value="Send All-Off Command"/>	<input type="button" value="Communication Test"/>	<input type="button" value="Find Rain8 Modules"/>
Maximum time to wait for Rain8 Net and WiFi response <input type="text" value="5000"/> milliseconds		
Comma-separated Rain8 Net and WiFi Module Numbers <input type="text" value="1,2"/>		

Rain8 Net and WiFi # 2		
<input type="button" value="Send All-Off Command"/>	<input type="button" value="Communication Test"/>	<input type="button" value="Find Rain8 Modules"/>
Maximum time to wait for Rain8 Net and WiFi # 2 response <input type="text" value="5000"/> milliseconds		
Comma-separated Rain8 Net and WiFi # 2 Module Numbers <input type="text" value="3"/>		

**Figure 12 Rain8 Net-based Module Address Setup**

Rain8 UPB		
<input type="button" value="Send All-Off Command"/>	<input type="button" value="Communication Test"/>	
Comma-separated Rain8UPB Module Numbers <input type="text"/>		UPB Network ID <input type="text" value="1"/>

**Figure 13 Rain8 UPB Module Address Setup**

The EtherRain is identified by its Name, IP address and port. The “Find EtherRain Modules” button is used to populate the information. This will list each module on the LAN and complete the number of modules text box. If the information is correct the “Save Changes” button at the top of the page should be used to record the discovered information. When mcsSprinklers starts it will show a blue circle next to each EtherRain module name. It will change to green after successful communication to it and red after it fails to respond.

If a setup is being done without the EtherRain modules connected the “Number of Modules” text box should be completed and a set of blank rows will be presented as placeholders. The module names can be entered and the IP will be populated automatically later when the modules are connected. When taking this offline approach, it is important to correctly name the modules with the Quicksmart admin utility prior to connection to the LAN so the positional relationships of the modules will be maintained. During a Find operation mcsSprinklers will add modules to the list but will never remove modules. Modules are removed by clearing the name field and doing a “Save Changes”. Relative position is important so it will be better to rename modules rather than remove them to maintain zone identities that are later setup. This is true even if a module is permanently removed.

Each module must have a unique name and these can be programmed with the Quicksmart admin utility. The IP address is determined from the network definition. This will be either with DHCP by the LAN’s router or statically if so programmed with the Quicksmart admin utility. The default is DHCP. mcsSprinklers will be testing a change in IP address as it communicates with the EtherRain module and will perform the necessary updates should a DHCP assignment change.

Each EtherRain module will enforce a password access. mcsSprinklers expects the same password to be setup on each EtherRain module. The password is conveyed to mcsSprinklers as shown in Figure 14. The password will be “pw” unless changed with the Quicksmart admin utility.

EtherRain Modules		
<input type="button" value="Communication Test"/>	<input type="button" value="Find EtherRain Modules"/>	
After discovery use Save Changes if found modules are correct		
Handling of Status from EtherRain		
<input type="radio"/> No status request	<input checked="" type="radio"/> Request status after command	<input type="radio"/> Request status every minute
Number of Modules <input type="text" value="1"/>	<input type="radio"/> Identify by Module Name	<input checked="" type="radio"/> Identify by Static IP
Password <input type="text" value="••"/>	Maximum time to wait for response <input type="text" value="5000"/> milliseconds	
<input checked="" type="radio"/> Module 1 Name	IP <input type="text" value="192.168.0.99"/>	Port <input type="text" value="99"/>
Note: With multiple EtherRain modules the row position is significant as this will identify the module relative to zone definitions. If the row order is changed then the zone names previously setup will no longer be associated with the same EtherRain module.		

**Figure 14 EtherRain Module Address Setup**

Topics can be published using MQTT protocol to control valves if the valve interface supports this protocol. Two items need to be setup. The first is the identification of the MQTT broker that will be used to route the MQTT protocol. Mosquitto is a commonly used MQTT broker. The mcsSprinklers setup needs to match what the broke is expecting. In its most basic mode it will route all traffic and, in that case, only an IP address or network name of the broker is needed. The next level of security is username and password. The third level is message encryption that requires certifications used to understand the encryption. If MQTT is used for sensor inputs then the broker will need to be setup here to support subscription to the selected sensors.

The valve end points will accept commands on MQTT Topics and may provide acknowledge and status. The status is normally periodically provided and the acknowledge is provided immediately after command is received. In the mcsSprinklers setup the command Topic is in the first column and the status in the second with the first status row being the acknowledge Topic and the second one the status. In Figure 15 examples are provided in the lower four rows and second row where the end point provides both acknowledge and status. The first row has no feedback and the third row only has acknowledge feedback.

mcsSprinklers will use the acknowledge to flag a valve failure following incorrect response after command. It will use the status to confirm valve state and if it is not where mcsSprinklers believes it should be then it will send command to put it in the correct state.

MQTT Broker	
IP or Network Name	<input type="text" value="192.168.0.30"/>
Port	<input type="text" value="1883"/>
Security	<input type="text" value="None"/>
caCert File	<input type="text"/>
Client Cert File	<input type="text"/>
Username	<input type="text"/>
Password	<input type="text"/>

MQTT Topics	
Maximum time to wait for status response <input type="text" value="5000"/> milliseconds	<input type="button" value="Communication Test"/>
Publish Command	Subscribe Status
<input type="text" value="IrrigationTest2/cmdnd/NORESPONSE"/>	<input type="text"/>
<input type="text" value="IrrigationTest/cmdnd/POWER"/>	<input type="text" value="IrrigationTest/POWER"/> <input type="text" value="IrrigationTest/STATE:POWER"/>
<input type="text" value="IrrigationTest/NoCmdnd"/>	<input type="text" value="IrrigationTest/NoCmd"/>
<input type="text" value="IrrigationValve/cmdnd/POWER1"/>	<input type="text" value="IrrigationValve/POWER1"/> <input type="text" value="IrrigationValve/STATE:POWER1"/>
<input type="text" value="IrrigationValve/cmdnd/POWER2"/>	<input type="text" value="IrrigationValve/POWER2"/> <input type="text" value="IrrigationValve/STATE:POWER2"/>
<input type="text" value="IrrigationValve/cmdnd/POWER3"/>	<input type="text" value="IrrigationValve/POWER3"/> <input type="text" value="IrrigationValve/STATE:POWER3"/>
<input type="text" value="IrrigationValve/cmdnd/POWER4"/>	<input type="text" value="IrrigationValve/POWER4"/> <input type="text" value="IrrigationValve/STATE:POWER4"/>
<input type="text"/>	<input type="text"/>

**Figure 15 MQTT Setup for Valve Control**

When running on a Raspberry Pi or equivalent clone such as Odroid C1 there are direct IO connections to which a relay module can be connected and used for control of irrigation valves. See Figure 16. Any pin selected will be available as a zone within mcsSprinklers.

Raspberry Pi Relay Configuration							
Select the Raspberry Pi GPIO (Connector/Processor) pin to be used for relay controlled valves							
1 (3/2) <input type="checkbox"/>	2 (5/3) <input type="checkbox"/>	3 (7/4) <input checked="" type="checkbox"/>	4 (8/14) <input type="checkbox"/>	5 (10/15) <input type="checkbox"/>	6 (11/17) <input type="checkbox"/>	7 (12/18) <input type="checkbox"/>	8 (13/27) <input type="checkbox"/>
9 (15/22) <input type="checkbox"/>	10 (16/23) <input type="checkbox"/>	11 (18/24) <input type="checkbox"/>	12 (19/10) <input type="checkbox"/>	13 (21/9) <input type="checkbox"/>	14 (22/25) <input type="checkbox"/>	15 (23/11) <input type="checkbox"/>	16 (24/8) <input type="checkbox"/>
17 (26/7) <input type="checkbox"/>	18 (29/5) <input type="checkbox"/>	19 (31/6) <input type="checkbox"/>	20 (32/12) <input type="checkbox"/>	21 (33/13) <input type="checkbox"/>	22 (35/19) <input type="checkbox"/>	23 (36/16) <input type="checkbox"/>	24 (37/26) <input type="checkbox"/>
25 (38/20) <input type="checkbox"/>	26 (40/21) <input checked="" type="checkbox"/>						

**Figure 16 Raspberry Pi GPIO Selection**

Two nomenclatures are used for RPi GPIO identification. One is the connector pin on the board header and the other is the processor pin. The connector pin provides for the identification to aide in wiring the relays. Note that the RPi is not able to directly drive irrigation valves. A relay or equivalent device is needed to take the low level digital output and convert it to the 24VAC on/off control of the irrigation valve. The processor pin provides the identification for software control. If an RPi clone is used with different mappings then alternate wiring should be done based upon the processor pin that mcsSprinklers will be using for control. The connector layout is shown in Figure 17.

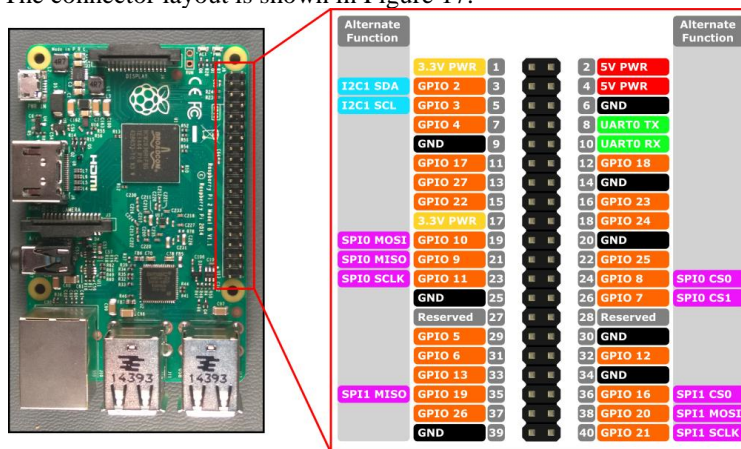

**Figure 17 RPi GPIO Connector Layout**

### 4.2.2 Communication Test

The ability to communicate between the computer and all the Rain8 modules depends upon solid connections between the modules and with the computer. The Rain8Net and Rain8UPB can be configured with multiple modules and a single interface to the computer. A communication test capability is included to evaluate the quality of the connection for these two types of modules. The communication test is run by clicking on one or the other of the Communication Test buttons on the Rain8 Setup page. (Figure 12 and Figure 13).

When activated a new browser display will show each of the defined valves and the status of communication with each. The test is performed by requesting a status from each valve. Counts are maintained for unexpected ON, unexpected OFF, and No-response timeouts and RS-232 protocol errors as shown in Figure 18. Colored icons are also shown in the Stat column to provide a quick visualization of the overall status.



The test is performed by setting a single valve in every module ON and then polling each module for the status of its eight valves. For a large number of Rain8 units consideration needs to be given to the amperage available from the 24VAC transformer as it will need to be able to power one valve per module simultaneously.

The results shown in Figure 18 illustrate a system where only the first Rain8Net module has a communication connection for a test that was run for 20 cycles with timeout showing 36 counts. This equates to timeouts on the commands and the retries of the commands. A situation like this is indicative of a lack of 24VAC applied to the modules or poor wiring between the first and second modules. The counts show the number of failures experienced. A count in the OFF column, for example, indicates that an OFF was expected, but not observed.

Test Cycles Attempted: 20			Now Testing Valve: 5				
Stat	Module	Zone	OFF Count	ON Count	Timeout Count	Framing Count	Break Count
●	NET Unit 1 Valve 1	R1 Harness1 Wire 1	0	0	0	0	0
●	NET Unit 1 Valve 2	R2 Harness1 Wire 2	0	0	0	0	0
●	NET Unit 1 Valve 3	R3 Harness1 Wire 3	0	0	0	0	0
●	NET Unit 1 Valve 4	R4 Rain8Net_Unit_1_Valve 4	0	0	0	0	0
●	NET Unit 1 Valve 5	R5 Rain8Net_Unit_1_Valve 5	0	0	0	0	0
●	NET Unit 1 Valve 6	R6 Rain8Net_Unit_1_Valve 6	0	0	0	0	0
●	NET Unit 1 Valve 7	R7 Rain8Net_Unit_1_Valve 7	0	0	0	0	0
●	NET Unit 1 Valve 8	R8 Harness1 Wire 8	0	0	0	0	0
●	NET Unit 2 Valve 1	R9 Harness2 Wire 1	0	0	36	0	0
●	NET Unit 2 Valve 2	R10 Rain8Net_Unit_2_Valve 2	0	0	36	0	0
●	NET Unit 2 Valve 3	R11 Rain8Net_Unit_2_Valve 3	0	0	36	0	0
●	NET Unit 2 Valve 4	R12 Rain8Net_Unit_2_Valve 4	0	0	36	0	0
●	NET Unit 2 Valve 5	R13 Rain8Net_Unit_2_Valve 5	0	0	36	0	0
●	NET Unit 2 Valve 6	R14 Rain8Net_Unit_2_Valve 6	0	0	36	0	0
●	NET Unit 2 Valve 7	R15 Rain8Net_Unit_2_Valve 7	0	0	36	0	0
●	NET Unit 2 Valve 8	R16 Harness2 Wire 8	0	0	36	0	0

Figure 18 Communication Test for Rain8Net and Rain8UPB

### 4.2.3 HomeSeer Devices

mcsSprinklers can accept any Homeseer devices to be used as the zone and pump valves. In this situation the physical interface to the valve is managed by Homeseer with the logical control of these devices performed by mcsSprinklers. It is possible to have a combination of directly-connected Rain8 units and Homeseer virtual devices. The list of Homeseer devices is identified as a comma-separated list of device codes as is shown in Figure 19.

Homeseer X10-IO Devices

Comma-separated list of Homeseer Devices to be used for valves or pumps

[1].[2].[3].[4].[5].[6].[7].[8]

Figure 19 Identification of Homeseer Devices

## 4.2.4 Interface Protocol

The Rain8-Net communication typically consists of a three-byte command followed by a three-byte acknowledges. mcsSprinklers confirms that the proper acknowledge bytes are received. If not, then it will retry once per command sent. When a valve control command is sent to the Rain8-Net, mcsSprinklers will also send a status request. If the expected status is not received then it will send the command a second time. Each Rain8-Net module can have up to four valves on at the same time. mcsSprinklers will verify that no more than four are on and will ignore commands for additional valve-on until other valves have been turned off.

The Rain8-Wireless communications via the CM17A interface uses the DTR and RTS discrete signals of the COM port to provide power and to command the transmission of RF codes. The modulation rate of DTR and RTS determine which RF code is transmitted. No status feedback is available on the RF interface.

The Rain8-Power line communications via the CM11A interface uses a five-byte command packet. Acknowledgement is received for a successful transmission and if not received the command is resent. This acknowledge, however, only relates to delivery of the command onto the power line. It does not necessarily it is received by the Rain8-Power line. The CM11A also listens to commands from other sources such as a remote-control device. The data reception events are processed by reading the delivered command.

An additional diagnostic aid is available to see the serial communication to the valve hardware. It is referenced from the Serial IO link or /iowindow page on the mcsSprinklers URL from the browser. Each character that is sent or received on the COM port is displayed in this window.

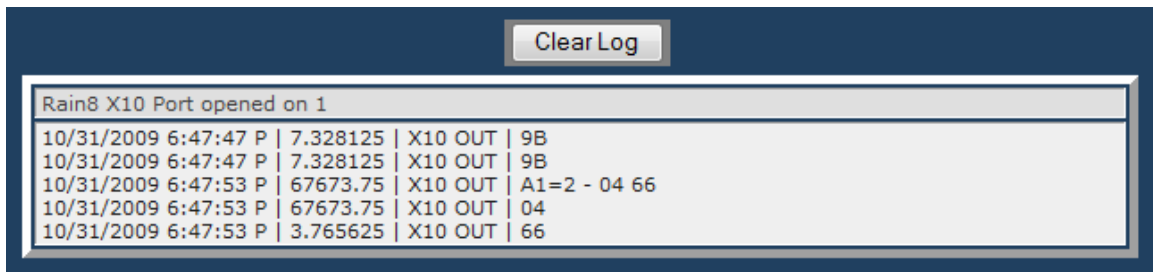

Figure 20 Serial IO Communications Diagnostic Window

## 4.2.5 Valve Wire to Controller

The valve wires have previously been routed from the field and installed in the Rain8 terminal blocks. The next step is to identify how these wires were connected to the terminal block (i.e. what valve wire is associated with which Rain8 valve control). This setup is done with the Setup2-Wiring page shown in Figure 21.

The control valves that are available will be shown in the pull down in the second column of the page. The valves available are those identified in the prior step. The Location column is used to provide a recognizable name for the zone that is controlled by the valve. This location name is used for status display and voice commands.

The Picture File is the file path to a digital image that shows the landscape covered by the valve wire. It is used later as a popup image for zone reference identification and as the primary identification method when using the touch-screen graphic interface.

The upper right corner of each harness group is a value that identifies how many wires are contained in the harness. It will default to 8 and can be expanded or reduced by changing the number in the box followed by a Save. The upper left contains a text box to enter any labeling information that may help to identify the

wire bundle. This labeling information is not used elsewhere. It is provided here as a means of retaining the information for future reference.

The page will always show one harness at the bottom that has no wires present. If wires are added followed by a Save, then a new blank harness will appear at the bottom.

Harness 1 Wiring		
Wire Harness 1 Name	<input type="text" value="Harness 1"/>	Max number of Wires in Harness 1 <input type="text" value="4"/>
Wire Color	Control Valve	Location
<input type="text" value="Red"/>	[NET 1 Valve 1] ▼	<input type="text" value="BackYard"/>
Picture File <input type="text" value="C:\Program Files\images\back.jpg"/>		<input type="button" value="Browse..."/>
<input type="text" value="Green"/>	[NET 1 Valve 2] ▼	<input type="text" value="SideYard"/>
Picture File <input type="text"/>		<input type="button" value="Browse..."/>
<input type="text" value="Blue"/>	[NET 1 Valve 3] ▼	<input type="text" value="Walkway"/>
Picture File <input type="text"/>		<input type="button" value="Browse..."/>
<input type="text" value="Brown"/>	[NET 1 Valve 4] ▼	<input type="text" value="Front Flowers"/>
Picture File <input type="text"/>		<input type="button" value="Browse..."/>

**Figure 21 Harnesses Wiring to Rain8 Valve Setup**

The Layout setup is used to make assignments as to how each valve will be used and make basic assignments of how long the valves will be enabled. The Zone setup is used to provide additional information about zone. This includes efficiency of application, and rate of drainage or sunlight exposure and water utilization rates. These setup options are shown in Figure 22 and Figure 23 .

Picture	Assigned Use	Minutes
 [NET 1 Valve 1] Sideyard Bushes	1 2 3 4 5 6 7 8 Area <input checked="" type="radio"/> <input type="radio"/> <input type="radio"/> <input type="radio"/> <input type="radio"/> <input type="radio"/> <input type="radio"/> <input type="radio"/> Pump <input type="radio"/> <input type="checkbox"/> <input type="checkbox"/> <input type="checkbox"/> <input type="checkbox"/> <input type="checkbox"/> <input type="checkbox"/> <input type="checkbox"/> Fert <input type="radio"/> <input type="checkbox"/> <input type="checkbox"/> <input type="checkbox"/> <input type="checkbox"/> <input type="checkbox"/> <input type="checkbox"/> <input type="checkbox"/> None <input type="radio"/>	Auto <input type="text" value="30"/> Manual <input type="text" value="20"/> Syring <input type="text" value="3"/>
 [NET 1 Valve 2] Backyard East	1 2 3 4 5 6 7 8 Area <input type="radio"/> <input checked="" type="radio"/> <input type="radio"/> <input type="radio"/> <input type="radio"/> <input type="radio"/> <input type="radio"/> <input type="radio"/> Pump <input type="radio"/> <input type="checkbox"/> <input type="checkbox"/> <input type="checkbox"/> <input type="checkbox"/> <input type="checkbox"/> <input type="checkbox"/> <input type="checkbox"/> Fert <input type="radio"/> <input type="checkbox"/> <input type="checkbox"/> <input type="checkbox"/> <input type="checkbox"/> <input type="checkbox"/> <input type="checkbox"/> <input type="checkbox"/> None <input type="radio"/>	Auto <input type="text" value="25"/> Manual <input type="text" value="20"/> Syring <input type="text" value="3"/>
 [NET 1 Valve 3] Garden Front	1 2 3 4 5 6 7 8 Area <input checked="" type="radio"/> <input type="radio"/> <input type="radio"/> <input type="radio"/> <input type="radio"/> <input type="radio"/> <input type="radio"/> <input type="radio"/> Pump <input type="radio"/> <input type="checkbox"/> <input type="checkbox"/> <input type="checkbox"/> <input type="checkbox"/> <input type="checkbox"/> <input type="checkbox"/> <input type="checkbox"/> Fert <input type="radio"/> <input type="checkbox"/> <input type="checkbox"/> <input type="checkbox"/> <input type="checkbox"/> <input type="checkbox"/> <input type="checkbox"/> <input type="checkbox"/> None <input type="radio"/>	Auto <input checked="" type="radio"/> <input type="text" value="15"/> Manual <input type="text" value="10"/> Syring <input type="text" value="1"/>
 [NET 1 Valve 4] Sideyard Rock	1 2 3 4 5 6 7 8 Area <input type="radio"/> <input type="radio"/> <input checked="" type="radio"/> <input type="radio"/> <input type="radio"/> <input type="radio"/> <input type="radio"/> <input type="radio"/> Pump <input type="radio"/> <input type="checkbox"/> <input type="checkbox"/> <input type="checkbox"/> <input type="checkbox"/> <input type="checkbox"/> <input type="checkbox"/> <input type="checkbox"/> Fert <input type="radio"/> <input type="checkbox"/> <input type="checkbox"/> <input type="checkbox"/> <input type="checkbox"/> <input type="checkbox"/> <input type="checkbox"/> <input type="checkbox"/> None <input type="radio"/>	Auto <input type="text" value="25"/> Manual <input type="text" value="20"/> Syring <input type="text" value="3"/>
[NET 1 Valve 5] Rain8_Unit_1_Valve 5		
[NET 1 Valve 6] Rain8_Unit_1_Valve 6		
[NET 1 Valve 7] Rain8_Unit_1_Valve 7		
[NET 1 Valve 8] Pump8	1 2 3 4 5 6 7 8 Area <input type="radio"/> <input type="radio"/> <input type="radio"/> <input type="radio"/> <input type="radio"/> <input type="radio"/> <input type="radio"/> <input type="radio"/> Pump <input checked="" type="radio"/> <input checked="" type="checkbox"/> <input checked="" type="checkbox"/> <input checked="" type="checkbox"/> <input type="checkbox"/> <input type="checkbox"/> <input type="checkbox"/> <input type="checkbox"/> Fert <input type="radio"/> <input type="checkbox"/> <input type="checkbox"/> <input type="checkbox"/> <input type="checkbox"/> <input type="checkbox"/> <input type="checkbox"/> <input type="checkbox"/> None <input type="radio"/>	Auto <input type="text"/> Manual <input type="text"/> Syring <input type="text"/>

Figure 22 Layout Page

The watering strategy to be applied to a zone is described in Automated Control Strategy. “Auto” Minutes applies to this strategy. The time for the first program is shown on the zone setup page. If multiple watering times (i.e. programs) are defined for an Area then a clickable icon will appear next to the Auto time entry. By default, the zone’s duration for each program is the same, but can be tailored with a different duration for each watering period. By selecting a zero value for a zone’s program the zone will be

excluded from this specific program, but still participate in others. Clicking the icon will bring up the panel as shown in Figure 24.

“Manual” Minutes applies to direct or remote control. Manual control will supersede auto program control and can be used as often as desired without affecting the total duration of the auto program.

“Syringing” Minutes is the light sprinkling of water on turf usually done during the hottest part of the day to prevent wilting. During the hottest days of the year the Evapotranspiration rate often exceeds the plants ability to draw water in from the soil. The result of this water deficit is wilt. To reduce the stress from this water deficit syringing is used. It does not actually replace the water in the soil but instead it reduces the wilting cycle by cooling off the turf and temporarily stopping wilt until rainfall or hand watering can be initiated.

“Soil” Efficiency factor relates to the effectiveness of water saturation when it is applied and the ability to retain water within the crop. Nominal soil and grass is represented by default 0.75. Higher factors will reflect a slower moisture loss rate.

“Rain” factor relates to the degree that rainfall will reach the soil level. Uncovered zones will be 1.0 and fully sheltered zones will be 0.0.

“Fert” factor is the fraction of zone’s time that the Area’s fertigation valve is enabled when the zone is enabled. This is used to apply liquid fertilizer through the irrigation system.

“Flow” Calc is the estimate of the gallon/liter per minute flow rate delivered by the total of all valves heads of the zone. The total cumulative flow volume is reported in a status device on the General Status page and Calendar.

“Flow” Max is the maximum daily water use to be measured for the zone. When this value is exceeded a notification will be provided via the message log and email if setup. This value is only used when a water meter is present to measure the water use when a zone is active. Another approach to water monitoring is based upon exceeding the averages that are expected. This is done from the Area Setup page.

The default number of zones allowed per area is 12. This can be changed by the text box entry in the upper right of each area’s set of zones. A Save is required to affect the change of this text box entry.

In the top left of each area is a location to enter the name of an Area. If it is used then this name will be added to status displays and control buttons to help identify the Area being viewed. The names selected should be short otherwise the long name may interfere with the space allocated for area identifications on the Zone Status page.

Area 1 Zones			
Valve	Minutes	Factors	Water Flow
[X10 H Valve 2] Sideyard Pond H2	Auto 40 Manual 30 Syring 0:0	Soil 0.75 Rain 1.0	Calc 0 gal/min Max 150 gal/day 30Day:0 gpm
[X10 H Valve 3] Sideyard Stream H3	Auto 40 Manual 30 Syring 0:0	Soil 0.75 Rain 1.0	Calc 0 gal/min Max 300 gal/day 30Day:0 gpm
[X10 H Valve 5] Sideyard Rock East H5	Auto 60 Manual 60 Syring 0:0	Soil 0.75 Rain 1.0	Calc 0 gal/min Max 200 gal/day 30Day:0 gpm
[X10 H Valve 6] Sideyard Rock West H6	Auto 60 Manual 60 Syring 0	Soil 0.75 Rain 1.0	Calc gal/min Max 1200 gal/day 30Day:0 gpm
[X10 H Valve 8] Sideyard House Bed H8	Auto 50 Manual 50 Syring	Soil 0.75 Rain 1.0	Calc gal/min Max 900 gal/day 30Day:0 gpm

Figure 23 Zone Parameters Setup

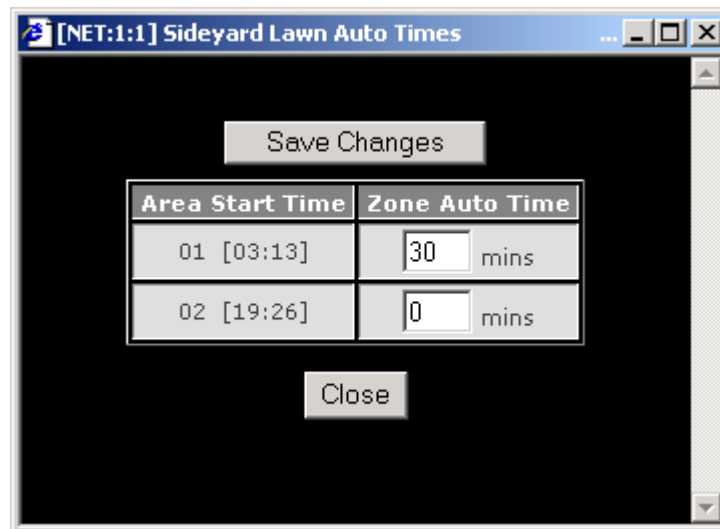

Figure 24 Zone Program Time Tailoring

## 4.2.6 Internet Connection and Local Area Network

An internet connection is not essential for basic operation, but features will not be available without it. Connection to the internet can be accomplished in several manners and the Windows operating system provides wizards to help achieve this objective.

McsSprinklers connects to Internet to obtain current environmental conditions from a local reporting station. This is done in both a single-PC setup and in a multiple-PC setup. When a redundant operation is

desired then the Internet connection needs to be available to all PCs on the Local Area Network. This can be achieved with a router that bridges the Internet and LAN. It can also be done with Internet Connection Sharing within the computer that has the direct or dial-up connection to the Internet.

Current weather information from the internet is available from the OpenWeatherMap network. It is also available from the WeatherUnderground network. This network is primarily personal weatherstations that upload to the WeatherUnderground server.

mcsSprinklers uses the standard port 80 and HTTP protocol to access external Internet locations. The zip code or Latitude/Longitude is used to identify local Forecast stations. The WeatherUnderground stations are identified by the their Station ID which can be obtained by using a Browser and navigating to the URL <http://www.wunderground.com/weatherstation/ListStations.asp?selectedState=WA&selectedCountry=United+States>. For non-USA location the navigation can be started at <http://www.wunderground.com/weatherstation/ListStations.asp>.

For current weather conditions a selection from one to three of these stations may be available with WeatherUnderground providing multiple. Not all stations report reliably so more than one should be selected as backup(s). Either OpenWeatherMap or WeatherUnderground can be used at one time with the selection made with the radio button shown on Figure 25. If OpenWeatherMap is used then there is no need to enter WeatherUnderground stations. The converse is also true.

Forecast weather conditions are also obtained from the Internet using either WeatherUnderground, OpenWeatherMap, AccuWeather or National Weather Service. The Setup8-Weather page segment to support these selections is shown in Figure 25. OpenWeatherMap requires an API key which is available for free at <https://openweathermap.org/appid>. For forecast information from WeatherUnderground there needs to be a free registration to obtain a license key from <http://www.wunderground.com/weather/api/d/pricing.html>. This license key as well as a station identifier are used on the setup. The station identifier can be zip code or a variety of other means to identify. Review of the Documentation tab from the same WeatherUnderground page where the license/API key is requested for other means to identify the location. For AccuWeather the stations can be zip code internationally from the codes list in Section 11. Free download of weather data often is limited on a daily basis. To assure the license terms are not violated a maximum daily download count can be specified.

Many reporting stations do not contain a full suite of sensors and are able to provided only a subset of weather data. The daily rainfall is one that may not be available. To help overcome this shortfall WeatherUnderground site can be selected to provide only rainfall information. When one is selected the rainfall will be provided by this source rather than from the other three potential sources. If desired the secondary or tertiary site can also be used for rainfall only.

It is possible that Forecast data or Weather data fails to be updated at the source site or the connection with the source site is lost. When Weather data is lost then the latest information from the Forecast site will be used. When Forecast data is lost then average values will be used to compute Evapotranspiration. The loss of either Weather or Forecast data will generate a message that can be viewed locally or will be optionally delivered via Email. The timeout threshold for this message is entered for each Weather and Forecast. A forecast site will only update hourly or less based upon licensing rules. A Weather site's update interval varies, but five minutes is typical. .

From a quality of information perspective a local weather station will provide the best set of data specific to a site. Current conditions from OpenWeatherMap or WU will provide the same quality of information and the selection should be based upon the proximity of the reporting station and the reliability of its feed. WeatherUnderground, AccuWeather or NWS provide equivalent forecast information. If NWS is used for forecast then the EPA should be used as the UV source if a local UV or ET measurements is not available. EPA is automatically used for Standard mcsSprinklers version as long as a zip code is present.

Time and Weather Setup		
Zip Code	Latitude 49.57135	Longitude 117.6488
Method to Determine Hourly and Daily ET		
<input checked="" type="radio"/> Calculate Based on Weather <input type="radio"/> Use Historical Averages <input type="radio"/> Calculate Based on Weather and Limit to within 50 % of Historical Average	Solar Intensity Factor	
Method to Download Internet Data		
<input checked="" type="radio"/> Download Using .NET <input type="radio"/> Dont Download Weather and Forecast Data		
Time Before Reporting Loss of Forecast Updates		150 minutes
Time Before Reporting Loss of Weather Updates		60 minutes
Evaluate Internet Download from Selected Stations		
Optional Alternate Weather Source		
<input checked="" type="radio"/> Use Open Weather Map <input type="radio"/> Use WeatherUnderground <input type="radio"/> None		
WU License/API Key	WeatherUnderground Station ID	
OWM License/API Key	Primary	
	Secondary	
	Tertiary	
	For Only Rainfall	
Optional Alternate Forecast Source		
<input type="radio"/> NWS/NOAA <input checked="" type="radio"/> OWM <input type="radio"/> WU <input type="radio"/> AccuWeather <input type="radio"/> None		
Location	License	
barnonehomeseer	....	
	Maximum Daily Downloads	

**Figure 25 Weather Source Selections**

Use of weather information from a local weather station is possible if a station is installed at the site. The interface mechanism available for local equipment follows a client-server model so that the local weather station can be used for multiple needs. This is either via an IP address using HTTP protocol or via the Windows File System using comma-separated-values (csv) file format.

The WeatherHawk is interfaced via its IP port. The port information needs to be entered if this weather station is to be used. The Davis Vantage Pro is interfaced via software provided by AmbientWeather.com Virtual Weather Station using the csv file mechanism provided by that software. Three separate csv files are available to allow different sources for different types of information to be obtained.

mcsSprinklers will read the current data from the file path that is entered here on the setup. The csv file can be located on the local computer or it can be obtained from a ftp or http server. If via URL then specify the path starting as ftp:// or http://. If file path then use a full computer path name.



The downloaded csv file can be in delimiter-separated columns or the columns can be at specific positions within a line of the file. If delimited then the delimiter is specified. Special names SPACE and TAB are used for the space and tab characters respectively. The data in the file that is to be used can be either the first row or the last row. This setup is shown in Figure 26

The screenshot shows a window titled "CSV and XML Sources" with three entries, each with a text input field for the file path/URL and a set of radio buttons for layout options. Entry 1: Path is "C:\VM\mcsSprinklers\_Tray\bin\x86\Debug\Data\CVS1.txt", "Use first record of file" is selected, and the delimiter is "SPACE". Entry 2: Path is "C:\VM\mcsSprinklers\_Tray\bin\x86\Debug\Data\CVS2.txt", "Use last record of file" is selected, and the delimiter is ".". Entry 3: Path is "http://myXMLSite.com/myXML.xml", "Use entire file" is selected, and the delimiter is "meter".

**Figure 26 Local Weather Station Data Source**

Once the internet weather data sources have been selected they can be tested to assure the site is operational and reasonable data is returned. The "Evaluate Internet Download from Selected Stations" button on Figure 25 is used to make an immediate query of all the sites. The results will be shown in a new page such as shown in Figure 27.

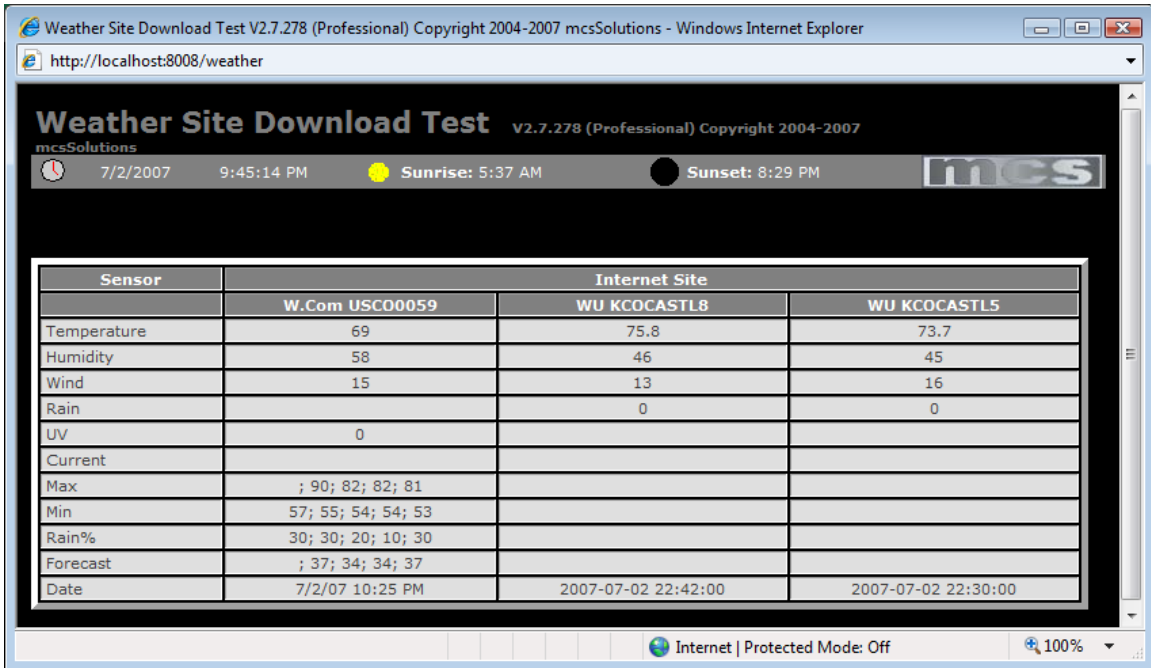

**Figure 27 Weather Site Download Test**

Each individual sensor can be obtained from one of the available selected sources. The default is to use the internet WU for the weather sensors, WeatherUnderground, AccuWeather or NOAA National Weather Service for the forecast sensors, and for mcsSprinklers to compute the remainder that are not available from these sources.

The ET “sensor” is important when ET-based scheduling is performed. Some local weather stations provide this as a direct measurement that can be used via xAP, MQTT, Weatherhawk, Homeseer or CSV mechanisms. Internet data containing ET is not available but can be computed from other sensor sources. These are temperature, wind, humidity and a measure of solar intensity. The solar source can be either from the Solar Radiation sensor or from the UV sensor. When selecting a computed ET don’t forget to also select the source for the sensors that are used in the ET computation.

On a sensor-by-sensor basis this can be changed as shown in Figure 28 if other sources are available. In the case of xAP, MQTT and Homeseer sourced sensors the selection of the specific address or device is necessary. For the others, only an indication of the source feed is necessary and mcsSprinklers will find it in the feed. The options that are available for Weather Sensor Source will depend upon other options selected as possible sources of weather data.

When the sensor values are viewed on the General Status page there will be a grayed-out identification of the source of the sensor. This may be a weather station address or a few letters to represent the source.

Weather Sensor Source	
<b>Temperature</b>	
<input type="radio"/> WU <input type="radio"/> Accuweather <input type="radio"/> CSV File 1 <input checked="" type="radio"/> CSV File 2 <input type="radio"/> CSV File 3 <input type="radio"/> None	
CSV File Column/Position: <input type="text" value="9"/>	
<b>Humidity</b>	
<input type="radio"/> WU <input type="radio"/> Accuweather <input type="radio"/> CSV File 1 <input type="radio"/> CSV File 2 <input checked="" type="radio"/> CSV File 3 <input type="radio"/> None	
CSV File Column/Position: <input type="text" value="5"/>	
<b>ET</b>	
<input type="radio"/> Computed from UV <input type="radio"/> Computed from Radiation <input type="radio"/> CSV File 1 <input type="radio"/> CSV File 2 <input type="radio"/> CSV File 3 <input checked="" type="radio"/> None	
Source data reporting: <input type="radio"/> Incremental <input checked="" type="radio"/> Hourly Total <input type="radio"/> Daily Total	
<b>Wind</b>	
<input checked="" type="radio"/> WU <input type="radio"/> Accuweather <input type="radio"/> CSV File 1 <input type="radio"/> CSV File 2 <input type="radio"/> CSV File 3 <input type="radio"/> None	
<b>Rain</b>	
<input type="radio"/> WU <input checked="" type="radio"/> CSV File 1 <input type="radio"/> CSV File 2 <input type="radio"/> CSV File 3 <input type="radio"/> None	
CSV File Column/Position: <input type="text" value="1"/>	
Source data reporting: <input type="radio"/> Incremental <input checked="" type="radio"/> Hourly Total <input type="radio"/> Daily Total <input type="radio"/> Yearly Total	
<b>Solar</b>	
<input checked="" type="radio"/> Computed from UV <input type="radio"/> None	
<b>UV</b>	
<input checked="" type="radio"/> WU <input type="radio"/> Accuweather <input type="radio"/> EPA <input type="radio"/> CSV File 1 <input type="radio"/> CSV File 2 <input type="radio"/> CSV File 3 <input type="radio"/> None	
<b>Solar Radiation</b>	
<input checked="" type="radio"/> WU <input type="radio"/> CSV File 1 <input type="radio"/> CSV File 2 <input type="radio"/> CSV File 3 <input type="radio"/> None	
<b>Current Icon</b>	
<input type="radio"/> Accuweather <input checked="" type="radio"/> None	
<b>Forecast Max</b>	
<input checked="" type="radio"/> Accuweather <input type="radio"/> None	
<b>Forecast Min</b>	
<input checked="" type="radio"/> Accuweather <input type="radio"/> None	
<b>Forecast Rain</b>	
<input checked="" type="radio"/> Accuweather <input type="radio"/> None	
<b>Forecast Icon</b>	
<input checked="" type="radio"/> Accuweather <input type="radio"/> None	

**Figure 28 Individual Sensor Source Selections**

McsSprinklers will also respond to browser requests from remote locations in the same manner that it responds to request from the Windows desktop of the local PC. The HTTP protocol supported by standard browsers such as Internet Explorer or Safari continues to be used, but the port defaults to 8008 rather than 80. This is to prevent contention with other potential servers on the local PC and to provide a degree of security since hackers focus on breaching port 80. When configured for operation with Homeseer it is also possible to utilize the Homeseer server for this purpose. In this case the selection of the server in Figure 29 is just the Homeseer radio button as compared to both the internal radio button and port number.

This port number can be changed if necessary from the Setup9-Others page as shown in Figure 29.

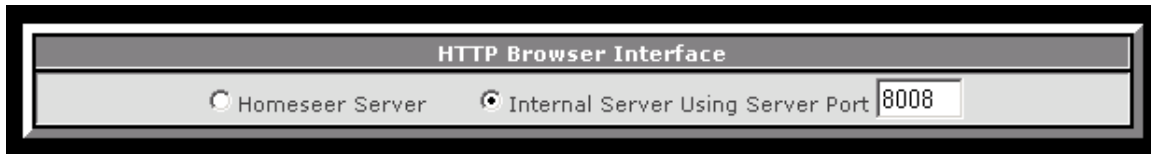

**Figure 29 Port Selections for Remote Access**

The browser interface to the setup of the various mcsSprinkler pages provides context-sensitive help. As the mouse hovers over the darker header banner of any group a popup tooltip will appear to the right of the mouse to provide information on the setup of that section. As the user becomes more familiar with the setup procedures this popup can be disabled with the setup setting on Setup9-Others page as shown in Figure 30.

The Expert Mode setting, also on Figure 30, is used to toggle between presentation of the setup based upon the interview answers vs. showing all possible setup options. When the interview is completed then the setup pages will only show those settings applicable to the hardware configuration and software options selected. When the interview has not been started or is incomplete then many setup options will not be visible unless the Expert Mode checkbox is set.

Data can be collected to capture internal logic decisions to help investigate unexpected behaviors. When enabled, with "Produce Debug Data Files" checkbox a debug text file will be created for each new start of mcsSprinklers and at the start of each day. The amount of data collected can be limited, and should be limited, on embedded platforms, by indicating the maximum size of the folder for the debug files. When this threshold is reached then older files are removed. A selected debug file can be emailed if email has been setup or it can be individually selected with right-click hyperlink on the filename. The date in the filename and the Last Modified date can be used to identify the period of time a particular debug file has collected data. If the most current debug file is to be used for analysis then it should first be flushed and closed using the "Write Current Debug Data File" button.

If debug data is not going to be collected locally then a specific path can be specified. In this case the visibility of the content is not available for email etc. Direct means to access the specified folder will be needed to use the collected data.

Help			
Context Help			
<input checked="" type="radio"/> Show Help with Mouse Over Header	<input checked="" type="radio"/> Expert Mode - Show All Available Setup Settings		
<input type="radio"/> Context Help is not Needed	<input type="radio"/> User Mode - Show Only Settings Enabled in Interview		
Debug Data Files			
<input checked="" type="checkbox"/> Produce Debug Data Files	Current Debug Size is 6.104 Megabytes		
<input type="button" value="Write Current Debug Data File"/>	Max Allowed Size is <input type="text" value="100"/> Megabytes		<input type="button" value="Delete All Debug Data Files"/>
Email	Debug Data File (Right-Click to Upload)	File Last Modified Date	Size in MBytes
<input type="button" value="Email"/>	GeneralDebug08_13_2011_15_10_51.txt	8/13/2011 3:10:51 PM	0
<input type="button" value="Email"/>	GeneralDebug08_13_2011_15_14_13.txt	8/13/2011 3:14:13 PM	0
<input type="button" value="Email"/>	GeneralDebug08_13_2011_15_17_36.txt	8/13/2011 3:17:36 PM	0
<input type="button" value="Email"/>	GeneralDebug08_13_2011_15_20_58.txt	8/13/2011 3:20:58 PM	0
<input type="button" value="Email"/>	GeneralDebug08_13_2011_15_24_21.txt	8/13/2011 3:24:21 PM	0
<input type="button" value="Email"/>	GeneralDebug08_13_2011_15_27_43.txt	8/13/2011 3:27:43 PM	0
<input type="button" value="Email"/>	GeneralDebug08_13_2011_15_31_06.txt	8/13/2011 3:31:06 PM	0
<input type="button" value="Email"/>	GeneralDebug8_13_2011_3_36_29_PM.txt	8/13/2011 3:38:30 PM	0.014
<input type="button" value="Email"/>	GeneralDebug8_13_2011_3_38_30_PM.txt	8/13/2011 3:41:00 PM	0.055
<input type="button" value="Email"/>	GeneralDebug8_13_2011_3_42_35_PM.txt	8/13/2011 8:32:48 PM	6.023
External Drive Debug File Path (Leave default unless external drive connected)			
<input type="text"/>			

**Figure 30 Help Setup Options**

Even when context help has been disabled the full help features of this manual are available with the Help that can be accessed from the links at the top of each setup page. See Figure 31.

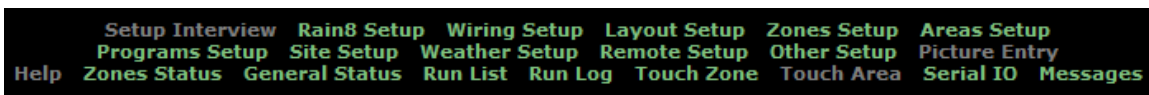

**Figure 31 Browser Links to Help and Other Pages**

[Version-Dependent Capability] Six interface applications are provided to allow these interfaces to be supported outside of the core mcsSprinklers scheduler. This becomes significant in redundant architectures so individual nodes can be managed with minimum operational interdependencies. When configured for redundant operation the interfaces should be run as independent nodes rather than as part of mcsSprinklers. This implies that the prior setup of the Wireless and Power line interfaces should be configured for xap/external rather than internal. See Figure 9.

## 4.2.7 External Application Interface

### 4.2.7.1 xAP

[Version-Dependent Capability] xAP is used as the primary external interface to mcsSprinklers. The first reference to xAP is on the Rain8 setup page shown in Figure 9. If the power line or wireless interface can be better placed close to the valves under control rather than at the controlling computer then remote xAP nodes for these interfaces can be running at other computers and controlled via xAP messaging. The x10 schema is used in this scenario. Other schema supported are Writelog, Basic Status and Control and Weather which can be enabled on the Weather Setup of Local Interfaces as shown in Figure 32. Additional setup is also available to change the default protocol and UID of the mcsSprinklers node.

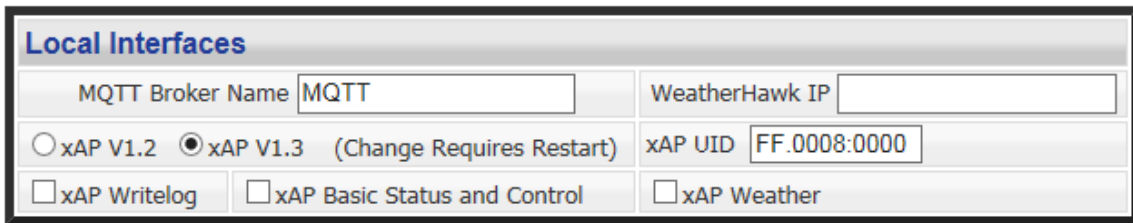

Local Interfaces	
MQTT Broker Name	MQTT
WeatherHawk IP	
<input type="radio"/> xAP V1.2	<input checked="" type="radio"/> xAP V1.3 (Change Requires Restart)
xAP UID	FF.0008:0000
<input type="checkbox"/> xAP Writelog	<input type="checkbox"/> xAP Basic Status and Control
<input type="checkbox"/> xAP Weather	

**Figure 32 Launch of Interface Nodes and xAP Message Selection**

The redundant architecture option provides a means to assure maximum availability of the control function. A second aspect of assured operation is command redundancy and safety provisions. The timeout safety was previously shown in Figure 8. It provides the safety against excessive water delivery at the point of the Rain8 module. Within the PC, OFF commands can be delivered at times when a zone is not being watered. These can be setup to be hourly and/or daily. Setup options are also available to repeat any ON or OFF command to assure that the command is received by the Rain8. In the case of the Rain8-Net module there exists a two-way interface so the PC always obtains positive status of the state of the valves and the need for special safety provision are reduced. The Rain8-Wireless and Rain8-Power line have no mechanism to report valve status back to the PC so command redundancy is a good idea. These safety setups are performed on the Setup6-Site page as shown in Figure 44.

Other xAP applications can interact with mcsSprinklers using the messaging providing in the Supplemental xAP Interface section. Valves can be controlled and checked for status with BSC schema. Error reporting from mcsSprinklers can be done with the Homeseer.Event/Event.log schema. Historical information that is normally recorded by mcsSprinklers can also be made available for external database or other uses through reporting with BSC schema. [Version Dependent] Centralized configuration setup can be accomplished with the Homeseer.Config schema. Remote audio and speech recognition is done with the Voice schema.

mcsSprinklers will listen for BSC events and info messages that have been setup as the source of its information. For example, the external inhibit (UID=09) will be seen as a xapbsc.event or xapbsc.info message with a target unspecified or specified to be mcsSprinklers. The ON/OFF state value in this message will control the external inhibit function. The reminder of the xapbsc.event or xapbsc.info messages will use either the Text or Level key to update the value conveyed in the message. An example may be a wind speed measurement made with a local sensor rather than one obtained from the WeatherUnderground internet site.

There is also a set of xapbsc.cmd messages that can be used to control mcsSprinklers actions much like the buttons that control it from the General Status page. A button on the General Status page will also respond to a xapbsc.cmd message with an ON/OFF control. The UID for these controls can be seen from the xAP Reporting page as shown in Figure 33

Each of these message schemas for the indicated purpose can be enabled or disabled selectively. When other xAP applications are present on the same computer then a xAP hub must run. If no others are being

used the mcsSprinklers can launch one. xAP also requires unique IDs for each xAP node so the ID is made configurable so no conflict will occur.

When the Basic Status and Control is selected then an additional browser link is provided that allows the selection of which devices will report when its state changes and of these which will set the database key to allow xap-enabled databases to maintain the history of the device. This page is shown in Figure 33.

Identification		xAP		MQTT		
ID	xAP Subaddress/MQTT Topic(name only)	UID	BSC	State	Value	String
R1	frontgarden.sprinklers__r1.relay	0101	<input type="checkbox"/>	<input type="checkbox"/>	<input type="checkbox"/>	<input type="checkbox"/>
R2	frontlawn.sprinklers__r2.relay	0102	<input type="checkbox"/>	<input type="checkbox"/>	<input type="checkbox"/>	<input type="checkbox"/>
R3	frontlawnstreet.sprinklers__r3.relay	0103	<input type="checkbox"/>	<input type="checkbox"/>	<input type="checkbox"/>	<input type="checkbox"/>
R4	leftsidelawn.sprinklers__r4.relay	0104	<input type="checkbox"/>	<input type="checkbox"/>	<input type="checkbox"/>	<input type="checkbox"/>
R5	leftbackgarden.sprinklers__r5.relay	0105	<input type="checkbox"/>	<input type="checkbox"/>	<input type="checkbox"/>	<input type="checkbox"/>
R6	backlawn.sprinklers__r6.relay	0106	<input type="checkbox"/>	<input type="checkbox"/>	<input type="checkbox"/>	<input type="checkbox"/>
R7	rightbackgarden.sprinklers__r7.relay	0107	<input type="checkbox"/>	<input type="checkbox"/>	<input type="checkbox"/>	<input type="checkbox"/>
R8	farbackgarden.sprinklers__r8.relay	0108	<input type="checkbox"/>	<input type="checkbox"/>	<input type="checkbox"/>	<input type="checkbox"/>
R9	middlebacklawn.sprinklers__r9.relay	0201	<input type="checkbox"/>	<input type="checkbox"/>	<input type="checkbox"/>	<input type="checkbox"/>
R17	e1.sprinklers__r17.relay	C101	<input type="checkbox"/>	<input checked="" type="checkbox"/>	<input type="checkbox"/>	<input type="checkbox"/>
R18	e2.sprinklers__r18.relay	C102	<input type="checkbox"/>	<input type="checkbox"/>	<input type="checkbox"/>	<input type="checkbox"/>
S1	forcemaxdayswithoutwater.sprinklers__s1.switch	0001	<input type="checkbox"/>	<input type="checkbox"/>	<input type="checkbox"/>	<input type="checkbox"/>
S2	inhibitdayofweek.sprinklers__s2.switch	0002	<input type="checkbox"/>	<input type="checkbox"/>	<input type="checkbox"/>	<input type="checkbox"/>
S3	inhibitbetweenhours.sprinklers__s3.switch	0003	<input type="checkbox"/>	<input type="checkbox"/>	<input type="checkbox"/>	<input type="checkbox"/>

**Figure 33 xAP / MQTT Reporting Device Selection**

Additional specification for the xAP environment is also contained on the Weather Page. In this case a set of local sensors rather than internet sensors can be specified as a xAP source per Figure 28. These setup features also provide for special control device and database options. These are shown in Figure 34.

Notification specified will result in xAP event messages before an area’s watering starts or a record of Rain8-Net actions. The Display options will control how the browser status information is displayed and the content of the xapbsc Display Text key. The database will default to Microsoft Access, but if MS SQL Server is available then it may be used. Normally when SQL is used, the database entry is left blank so the default server will be used.

**External xAP Source Options**

Valve Protect Device Code

**Database Options**

None   
  Access   
  SQLite   
  SQL Server   
 SQL Source    
  MySQL

SQL/MySQL Username    
 SQL/MySQL Password

Note: for SQL Server Integrated Security leave username and password settings blank  
 Change in database requires a restart of mcsSprinklers

**Figure 34 xAP Environment Options**

### 4.2.7.2 MQTT

MQTT is another standard external communication protocol supported by mcsSprinklers. xAP messages are routed via xAP hub that resides locally on each computer running xAP. MQTT messages are routed by a MQTT broker that can be anywhere on the LAN. The computer name of this broker needs to be identified to allow mcsSprinklers to subscribe and publish to this broker. This is also setup on the Weather Setup of Local Interfaces.

MQTT protocol can be used as a source of sensor data, manual control and to obtain status of changes in mcsSprinklers devices. The MQTT broker is identified on the Weather Setup page under external interfaces. Once a broker is identified (Figure 32) then options for MQTT inputs are made available on Weather Setup, Area and other pages.

mcsSprinklers will publish changes in any of its devices on the three properties of state, value and string. To reduce verbosity a filter is setup as shown on Figure 33. Only those devices with checkboxes checked will be published. In the Figure 33 example only zone R17 will publish changes of its ON/OFF state. The topic in this example will be of format “ComputerName/mcsSprinklers/e1/state” and the message body will be either “ON” or “OFF”.

### 4.2.7.3 Homeseer

The interface to Homeseer is customized with virtual devices, browser display, and various other options. The virtual devices are used to identify valves, pumps, restrict watering cycles, and control moding. The Browser interface can be tailored for display characteristics that will yield similar properties to other Homeseer pages. The valve and pump devices are identified in the Setup1-Rain8/Devices page as shown in Figure 19. The restrictions interface on the Setup6-Site page as shown in Figure 48. The other interface parameters are on the Setup9-Other page as shown in Figure 35.

mcsSprinklers normally obtains sensor information from its internet connection that is setup on the Weather Setup page. This can be superseded with data from Homeseer Virtual Device Strings. When a device code is entered into the section “HomeSeer Sourced Sensors” then the data will come from the Device String and data received for the specific sensor from the Internet will be ignored.

Homeseer Setup Options		
<b>Devices</b>		
Valve House Code <input type="text" value="R"/> restart needed if changed	Status House Code <input type="text" value="S"/> restart needed if changed	Create Predict Devices <input type="checkbox"/>
Valve Protect Device Code or Ref <input type="text"/>	Allow non-x10 Alias for Remote Control (HS Restart) <input type="checkbox"/>	Use 0/1 rather than OFF/ON to Control HS Device <input type="checkbox"/>
<b>Notification Options</b>		
Send All Valve Actions to Homeseer Log <input type="checkbox"/>	Log Valve Actions <input type="checkbox"/>	Log Inhibit Reason <input type="checkbox"/>
<b>Display Options</b>		
Use External Includes <input type="checkbox"/>	Exclude Header <input type="checkbox"/>	

Figure 35 Homeseer Interface Options



#### **4.2.7.4 Weatherhawk**

The WeatherHawk is a IP-based weatherstation. If weather data is being obtained from this source then the IP of this unit is specified as shown on Figure 32. Decoding of the WeatherHawk protocol is handle natively in mcsSprinklers

## 5 Automated Control Strategy

### 5.1 Control Based upon Time vs. Soil Moisture Content

Traditional irrigation controllers determine when to initiate a cycle based upon some elapsed time since the last time the cycle was run. This may be something like every three days or Monday, Wednesday, and Friday. These controls also consider time of day so it may be possible to irrigate at 6 AM and 7 PM on the same day.

The duration between irrigation cycles is selected so that the soil does not become excessively dry. In peak summer times this will be more often than in the spring and fall periods. Heat waves and cool periods also occur during the seasons and these tend to result in soil moisture that is dryer than desired and irrigation at times when the foliage does not require additional water. The timed programs can be adjusted to deal with these variations or left unchanged and allow the plants to be exposed to the stress. The third choice is to allow the controller determine the next irrigation cycle based upon the soil moisture content rather than based upon some time interval.

mcsSprinklers provides the flexibility to allow either a time-based control or a moisture-based control or a combination of both. For time-based control the interval can be determined either based upon the weekly calendar or upon a daily interval. The start time during the day can be specified. Actually up to 24 different start times can be entered to spread out the irrigation over the day. Each of these start times is called a Program so up to 24 programs can be run.

Each Program can control multiple zones during an irrigation cycle. The time each zone is ON during the cycle can be changed on a Program-to-Program basis. For example, two Programs can be defined where the first runs at 6 AM and three zones are each run for 20 minutes. The second runs at 3 PM and only runs one of the three zones for 10 minutes to provide supplemental water to a part of the site that has high sun exposure.

The setup of the Timed Program Control can be done in either of two ways. One is from the Timed Programs selection from the menu. This will show a grid where each zone is listed in the rows and each Program time is listed in the columns. See Figure 36.

Area 1 Program Times	1	2	3	4	5
	10:00	11:00	12:00	17:00	
Zone Auto Time	Mins	Mins	Mins	Mins	Mins
[NET 1 Valve 1] Front Lawn	15	15	0	15	
[NET 1 Valve 2] Front Shrubs	5	5	0	5	
[NET 1 Valve 3] Back Lawn	5	5	0	5	
[NET 1 Valve 4] Side Lawn	5	5	0	5	
[NET 1 Valve 5] Herbs	3	3	3	3	

**Figure 36 Timed Programs Setup Matrix**

In the example shown in Figure 36 there are four Programs defined and a blank column where the next program can be entered. There are five zones in each Program. At 10 AM a cycle will start where the Front Lawn will be ON for 15 minutes, then the Front Shrubs will be ON for 5 minutes, etc. Another cycle

will start at 11 AM. A third will start at 12 Noon and this cycle will only turn ON the Herbs zone for 3 minutes. The last Program of the day will run at 5 PM.

The selection of the days when these programs will run is done on the Area Setup page per the Control Strategy where the Control Strategy is Day-Of-Week, Even-Odd, or Interval. The Measured and ET Calculated control strategies do not have Timed Programs since their cycle start times are a function of soil moisture rather than time.

The selection of zones for the Programs is done in the Zone Setup page where the zones that have been defined in the Wiring Page are mapped into specific Areas. For the purpose of understanding the Timed Programs, an Area can be thought of as an independent control box. Since each of eight Areas can have an independent control strategy and 24 Programs can be defined for each Area, there is a total of  $8 \times 24 = 184$  Programs available.

Setup and editing of aspects of the Timed Programs can also be done from the Area, Zone, and Zone Status pages. The Area page provides the mechanism to add and change Program start times. See Figure 43. The durations for a zone for each of its programs can be edited from the popup that is produced by clicking the clock icon for the zone on the Zone Setup or Zone Status page. See Figure 24. Times can be entered in integer format for whole minute durations. If resolution to the second is desired then the durations should be entered in the format mm:ss.

## 5.2 Watering Duration and Interval

The intention of an automated control strategy is to provide appropriate amounts of water at appropriate times to maintain adequate soil moisture over a given area. In a basic situation this objective can be achieved by applying a set amount of water at regular intervals. In more sophisticated situations this objective is achieved by applying water when the soil moisture content becomes sufficiently low. In both of these situations there may be overriding considerations such as local water conservation regulations that limit when water can be used for irrigation.

The basic automation is achieved using a control model similar to standard timer-based sprinkler controllers. These controllers can be setup to water a zone on a regular interval or on a specific set of days of a week. The timed controller will enable cycling of typically four to twelve zones in sequence. Multiple controllers can be used to satisfy the needs of multiple distribution areas.

In a fixed-time / fixed-interval strategy the amount of water delivered is independent of the environmental conditions that drive the actual amount of water that is needed to maintain the desired soil moisture level. Hot-sunny days will extract more moisture from the plants and soil than cool-cloudy days. Wind also has a contributory effect on moisture loss and the need for replacement of this loss.

The amount of water actually needed is a function of several parameters. The primary factors are moisture loss, soil quality, foliage type, and efficiency of the sprinkler head distribution. All of these factors except moisture loss are known at the time that irrigation valves and sprinkler heads are installed. The moisture loss changes continuously based upon rainfall, solar radiation, temperature, wind speed, and some other less-dominant factors. The moisture loss is generally characterized as Evapotranspiration.

The general watering requirement can be algorithmically described as

$$V = ( E_{t_0} \times K_c \times K_d \times K_s \times F_r - P_r )$$

Where  $E_{t_0}$  = Evapotranspiration  
 $K_c$  = Foliage characteristic  
 $K_d$  = Distribution efficiency  
 $K_s$  = Soil porosity  
 $F_r$  = Flow rate

**P<sub>r</sub>** = Precipitation rate  
**V** = Volume of water required

It is generally the intention to encourage the foliage roots to penetrate lower into the soil so they will have a strong footing and be less sensitive to surface variation in moisture. This means that the objective of the irrigation controller is to deliver moisture to a desired soil depth. This depth is achieved with traditional installations by saturating the surface with a sufficient volume of water that it will soak down to the desired level. This implies that water delivery will be in bursts rather than a continuous misting.

**K<sub>c</sub>** Foliage characteristic, **K<sub>e</sub>** Distribution efficiency, **K<sub>s</sub>** Soil porosity, and **F<sub>r</sub>** Flow rate are factors for which information is not readily available on an installation-by-installation basis. What is available, however, is an approximation based upon experience, of how long a specific zone should be watered to saturate the soil to the desired depth. This means the installer simply is required to provide the zone watering duration and the controller can determine when to activate a watering cycle based upon the following formula:

$$I = \frac{1}{(E_{t_0} \times K_e - P_r)}$$

Where **E<sub>t<sub>0</sub></sub>** = Evapotranspiration  
**K<sub>e</sub>** = Efficiency of moisture retention  
**P<sub>r</sub>** = Precipitation rate  
**I** = Days per watering cycle

The **E<sub>t<sub>0</sub></sub>** Evapotranspiration and **P<sub>r</sub>** Precipitation rate can be determined from weather data from a nearby weather reporting station and this data is available in real-time over the Internet. **K<sub>e</sub>** Efficiency of moisture retention is available as a tweaking factor should some adjustments be necessary for off-nominal conditions.

mcsSprinklers provides a factor that can be used to adjust **K<sub>e</sub>**, which is the Soil Factor. Smaller values of Soil Factor will result in more frequent watering cycles. The default values for this factor is 0.75.

In a traditional timer-based controller both the interval and duration of watering are setup at time of installation. With the ability to adjust to changing environmental conditions the interval can be dynamically changed and unnecessary watering cycles avoided.

This same benefit can be achieved with use of moisture probes. Actual measurements of the moisture content are made when a dryness threshold is reached and a watering cycle is scheduled. While this does have the advantage of a more positive measurement it also has two downsides. The first is that moisture sensors require additional hardware to be installed. The second is that moisture flow patterns in soil tend to change over time so moisture at a strategically placed sensor will change over time, yet the watering needs for the area will remain consistent.

The ET can be used to determine the frequency of watering. Each watering cycle will be a specified number of minutes. The following information from <http://www.washoeet.dri.edu/preciprates.html> provides a good aid in determining the duration.

## 5.2.1 Gross Estimated Runtimes for Small to Medium Turf Areas

*Bill Carlos, Horticulturist, University of Nevada Cooperative Extension  
John C. Guitjens Ph.D., Prof, Environmental Resource Science, University of Nevada College of Agriculture*

---

The following suggested sprinkle runtimes and irrigation rates are for residential turf areas. Site specific runtimes will vary because of lawn shape and slope, nozzle size, and sprinkler head spacing. Runtimes are based on the manufacturer information and names of products are used for illustration purposes only. The impact rotor runtimes are longer because of a larger radius and, therefore, a larger area, and a smaller delivery rate.

### Small Lawn Areas

#### *Pop-up Toro 570*

is based on 30 pounds per square inch (psi) of water pressure, a delivery rate of 3.60 gallons per minute (gpm) for a full circle nozzle, a sprinkler head of 15 ft, a spray radius of 15ft, and matched precipitation rates (MPR).

**Please note:** run times will vary with ET rates.

#### Runtime calculation

Reference Evapotranspiration =  $E_{to}=0.35$  inches per day = 0.029 ft per day of water depth

- Assume an irrigation efficiency = 85% (=0.85)
- The area used here is square and the sprinkler head spacing 15 ft x 15 ft = 225 ft<sup>2</sup>
- The conversion of cubic feet to gallons = 7.48 gal/ft<sup>3</sup>
- $0.029 \text{ ft} / 0.85 \text{ irrigation efficiency} = 0.034 \text{ ft}$  of water application depth
- $0.034 \text{ ft} \times 225 \text{ ft}^2 = 7.65 \text{ ft}^3$
- $7.65 \text{ ft}^3 \times 7.48 \text{ gal/ ft}^3 = 57.2 \text{ gal}$
- $57.2 \text{ gal} / 3.60 \text{ gal/minute} = 15.9 \text{ minutes per day}$  (approx. 16 minutes per day)

### Medium Lawn Area

#### *RainBird Mini Paw, Impact Rotor Pop-Up Sprinkler*

is based on 25 psi, a delivery rate of 2.60 gpm for a full circle rotor, a sprinkler spacing of 20ft, and a spray radius of 20 ft.

#### Runtime calculation:

Reference Evapotranspiration =  $E_{to}=0.35$  inches per day = 0.029 ft per day of water depth

- Assume an irrigation efficiency = 85% (=0.85)
- The area used here is square and the sprinkler head spacing 20 ft x 20 ft = 400 ft<sup>2</sup>
- The conversion of cubic feet to gallons = 7.48 gal/ft<sup>3</sup>

- $0.029 \text{ ft}/0.85 \text{ irrigation efficiency} = 0.034 \text{ ft}$  of water application depth
- $0.034 \text{ ft} \times 400 \text{ ft}^2 = 13.6 \text{ ft}^3$
- $13.6 \text{ ft}^3 \times 7.48 \text{ gal}/\text{ft}^3 = 102 \text{ gal}$
- $102 \text{ gal}/2.60 \text{ gal}/\text{minute} = 39 \text{ minutes per day}$

### Medium Turf Areas

#### *Toro 340 Series Stream Rotors*

is based on 35 psi, a delivery rate of 3.10 gpm for a full circle rotor, a sprinkler spacing of 15ft, and a spray radius of 15 ft.

#### Runtime calculation:

Reference Evapotranspiration =  $E_{to} = 0.35$  inches per day =  $0.029 \text{ ft}$  per day of water depth

- Assume an irrigation efficiency = 85% (=0.85)
- The area used here is square and the sprinkler head spacing  $15 \text{ ft} \times 15 \text{ ft} = 225 \text{ ft}^2$
- The conversion of cubic feet to gallons =  $7.48 \text{ gal}/\text{ft}^3$
- $0.029 \text{ ft}/0.85 \text{ irrigation efficiency} = 0.034 \text{ ft}$  of water application depth
- $0.034 \text{ ft} \times 225 \text{ ft}^2 = 7.65 \text{ ft}^3$
- $7.65 \text{ ft}^3 \times 7.48 \text{ gal}/\text{ft}^3 = 57.2 \text{ gal}$
- $57.2 \text{ gal}/3.10 \text{ gal}/\text{minute} = 18.5 \text{ minutes per day}$  (approx. 20 minutes per day)

#### Reference:

Rain Bird. 1999-2000 Catalog. Landscape Irrigation Products

Toro. 2000-2001, Irrigation Product Catalog

The watering schedule is setup in mcsSprinklers on the Setup4-Zones and Setup5-Areas setup pages. A Zone represents the set of sprinkler heads that are controlled by a single valve. An Area represents a set of zones that use the same watering schedule. mcsSprinklers supports multiple zones within an Area and multiple areas. Zones within an area are scheduled in sequence and in the order used in the Setup4-Zones setup page. Areas are scheduled in parallel, but this can be changed to sequential with a checkbox setting on the Setup5-Areas setup page under Zone Sequence Control. Sequential Area would be used when you have insufficient water pressure to run 2 areas at the same time.

The setup of a zone for automatic watering requires two user inputs. One is the time that a zone should remain on when started and the second is the efficiency factor. These are the **I** and **K<sub>e</sub>** from the equation above.

The setup of an area's watering schedule includes the type of strategy, start time preferences, and water supply considerations. Five strategies are available. Three are timed and two are based upon soil moisture. The "Calculated ET" strategy determines moisture content based upon **Et<sub>o</sub>** and the "Measured" strategy determines moisture content based upon a moisture sensor probe. Entries are available for moisture content thresholds that will trigger the start of a new cycle. A value of 0 is reasonable for a calculated threshold while the value for the probe will depend upon the interface parameters of the probe.

The “Calculated ET” strategy depends upon sensor input to perform the hourly calculation of ET. These sensors can come from local sources or the internet. Since sensor data is not 100% reliable mcsSprinklers provides some options for how ET is determined. These are selected on the Other Setup page as shown in Figure 25 under Method to Determine Hourly and Daily ET. When reliable data is available then the option to Calculate based on Weather is the appropriate selection. When data is not available or reliability is poor then use of the historical averages are best. When data is essentially good, but some protection for bad data is desired then the third option to provide a limit on ET is used. In this case the weather sensor data will be used for the ET calculation, but when the ET varies from the historical average then it will be limited. For example, if a 50% limit is used and the historical hourly ET is 0.001 inch, then the computed ET value for the hour will be no less than 0.0005 and no more than 0.0015.

Every minute mcsSprinklers estimates the soil moisture content based upon current measurements or the ET which is calculated hourly. These measurements are rainfall, solar radiation, temperature, and wind from the Internet and moisture probe if it is available. mcsSprinklers also contains a monthly total ET database. A linear interpolation based upon the day between two months to get the expected daily ET. The integral under the hourly ET curve for the day will be the expected daily ET. A triangle function is used that starts at sunrise and stops at sunset with the peak at solar noon and then pick off the hourly ET values from the slope of this triangle. The use of the ET from the weather calculation, from the historical database or from a blend of the two is a user option on the Other Setup page. When the two calculation methods are blended the historical calculation forms a limit band with a user-specified tolerance. Current calculations will allow the ET to vary within this band, but not vary beyond it. The General Status page display of the Hourly ET value will show (CALC) or (LIMITED) depending upon the current calculation being inside or outside the historical tolerance band.

The soil moisture calculation for a zone is suspended when a zone’s sprinkler valve is turned on. During this watering period the estimated moisture content is proportionately increased until the watering is completed with a resultant moisture level of 100% (1.0). This soil moisture level is available for viewing on the Zone Status page and is available for use in one of the two soil-moisture control strategies.

mcsSprinklers contains a monthly total ET database. A linear interpolation based upon the day between two months to get the expected daily ET. The integral under the hourly ET curve for the day will be the expected daily ET. A triangle function that starts at sunrise and stops at sunset with the peak at solar noon and then pick off the hourly ET values from the slope of this triangle.

The setup of the automatic control strategy is done on Setup5-Areas page. A non-editable section is at the top of the area that shows the zones that have been assigned to the area. This is shown in Figure 37.

Zones in Area 1 (Sideyard Lawn)	
[X10 H Valve 2] Sideyard Pond (H2)	[X10 H Valve 3] Sideyard Stream (H3)
[X10 H Valve 5] Sideyard Rock East (H5)	[X10 H Valve 6] Sideyard Rock West (H6)
[X10 H Valve 8] Sideyard House Bed (H8)	

**Figure 37 Zone Moisture Trends in Area**

The zone identification contains all information about the zone that has been previously entered. The graphic is an aide to see the rates of moisture loss that are calculated based upon the zone soil and rain efficiency factors as well as the Area’s min threshold when using the calculated control strategy.

Selection of one of the five strategies for any Area that will be used is required and when selected any additional entries under it are needed. The first three are time-based strategies which are the traditional modes for irrigation control. The next two are based upon the foliage’s need for water which is either

measured or calculated based upon Evapotranspiration. The last is for misting control that is triggered based upon temperature. This setup is shown in Figure 38.

Area 1 Control Strategy					
<input type="radio"/> Day-Of-Week	<input type="radio"/> Even-Odd	<input type="radio"/> Interval	<input checked="" type="radio"/> Measured	<input type="radio"/> ET (Calculated)	<input type="radio"/> Mist
Sunday <input type="checkbox"/> Monday <input type="checkbox"/> Tuesday <input type="checkbox"/> Wednesday <input type="checkbox"/> Thursday <input type="checkbox"/> Friday <input type="checkbox"/> Saturday <input type="checkbox"/>	<input checked="" type="radio"/> Odd Days <input type="radio"/> Even Days	Every <input type="text"/> days  Starting Date <input type="text"/>	Soil Sensor Scale 100% (wet) <input type="text" value="100"/>  Trigger <input type="text" value="30"/>  0% (dry) <input type="text" value="0"/>	Min Moisture When soil moisture goes below <input type="text" value="50%"/> a new cycle will start <input checked="" type="radio"/> Set to 100% after cycle <input type="radio"/> Add 50% during cycle	Temperature When temp goes above <input type="text"/> mist will start and resume after <input type="text"/> min delay <input type="text"/>
Time delay after cycle to allow moisture sensor to register moisture <input type="text" value="10"/> minutes					
Measure soil moisture by Area <input checked="" type="radio"/> Measure soil moisture by Zone <input type="radio"/> Measured Input Source: <input type="radio"/> None <input checked="" type="radio"/> xAP <input type="radio"/> CSV1 <input type="radio"/> CSV2 <input type="radio"/> CSV3 (CSV file on Weather Page) Soil Sensor Source Address <input type="text" value="mcs.OneWire.mcs6:xapmcs1Wire_Soil_Moisture.11000010F3612430.Moisture"/>					

**Figure 38 Area Control Strategy Selections**

Sequence control will usually be set so that only one zone at the site is running at a time. This is the situation because of limited water pressure availability. If pressure is adequate for more than a single zone then the default of one zone at a time can be increased. This can be done by either identifying the number of zones that can be running at the same time or it can be done by identifying the flow rate that can be supported. In the latter case mcsSprinklers will use the zone by zone flow rates setup on the Zone Setup Page to schedule the zones to come as close to using the available flow capacity. In the case of pump-driven areas it is usually an advantage to keep the pump running rather than having it cycle. The sequence controls for zones part of a single master sequence with simultaneous zone per site are used for this selection. The other options are described in paragraph 10.5.3 and the setup is shown in Figure 39.

In the case of mist control strategy the sequence control is not available. When the misting criteria has been satisfied for an area then all zones of that area will be enabled and this will occur independent of any other Area zones that may be running. When Etherrain is the used for a mist zone then care is needed to assure only one valve per Etherrain module is assigned to a mist area since only one value per module is allowed to be running. Likewise this Etherrain module cannot be used for other Area zones that may be active at the same time misting is active.

Area 1 Zone Sequence Control	
<input type="radio"/> Zones part of single master sequence	<input checked="" type="radio"/> Maximum Simultaneous Zones by Site <input type="text" value="1"/> <input type="radio"/> Maximum Gallon per Minute Flow by Site <input type="text" value="40"/>
<input checked="" type="radio"/> Zones independently run within each area	<input checked="" type="radio"/> Maximum Simultaneous Zones by Area <input type="text" value="1"/> <input type="radio"/> Maximum Gallon per Minute Flow by Area <input type="text" value="40"/>
<input type="radio"/> Zones in area by user (Zone controlled by external automation controller)	

**Figure 39 Zone - Area Sequence Control Selections**



Two forms of altering the normal back-to-back auto-mode scheduling of zones are provided. One is round-robin control where the total time for all zones in an Area is modulated based upon the round-robin settings. If two round-robin cycles are selected then the zones in the area will be turn ON and OFF two times with the run time for the zone split evenly between the two cycles. An additional delay at the end of the Area's cycle can also be specified to give additional time before the next cycles is started.

The other alteration is by inserting a fixed delay between when one zone completes and the next starts. This may be used if the water supply needs time to recharge. The delay setup entries are made in the section shown in Figure 40.

Area 1 InterZone Scheduling Delays	
Run zones of area in round-robin style with duration distributed over	<input type="text" value="1"/> round-robin cycles
and delay of	<input type="text" value="1"/> minutes between each cycle
Add delay of	<input type="text" value="0"/> minutes between each zone

**Figure 40 Zone - Area Scheduling Delays**

The pump entry is optional, but if a pump is involved then the control valve for this area's zones needs to be identified with the pull down. If it is wired such that control voltage will turn it ON, then Enable=on should be selected. The Enable=off is used for inverse control.

If some form of holding tank, lake or well is used that has limited capacity then the discharge interval and recharge interval can be specified. When the run time or recharge times are exceeded the area will be inhibited and an Area inhibit notification will be provided.

If the ability exists to measure water usage while the Area has zones active then the source for the water meter measurement can be entered. mcsSprinklers will read the meter as it controls zones and will then make this information available on the General Status and Calendar views. The pump and water flow metering setup is shown in Figure 41.

The monitoring of water use, when a meter is used, can be done by monitoring for an absolute daily amount that is setup on the Zone Setup page or by monitoring exceeding an average that has been experienced in the recent past. The averaging approach is setup as shown in Figure 41 where the duration of the average is specified and the percentage over this average that will produce a message and possible email if setup.

Area 1 Water Supply		
Area 1 Pump Control Valve		Max Flow per Day
<input type="text" value=""/>	<input checked="" type="radio"/> Enable=On <input type="radio"/> Enable=Off	<input type="text" value=""/> gallons
Well or Water Storage Discharge and Recharge Times		
Maximum continuous ON duration	<input type="text" value=""/> minutes	Minimum recharge time
		<input type="text" value=""/> minutes
Area 1 Flow Volume Meter Source		
Input Source: <input checked="" type="radio"/> None <input type="radio"/> xAP <input type="radio"/> UPB <input type="radio"/> Rain8Net <input type="radio"/> CSV		
ID <input type="text" value=""/>		
gallons per Count <input type="text" value=""/>		
Area 1 Water Leak Monitoring		
Period to establish average use	<input type="text" value="90"/> days	Overage percentage for notification
		<input type="text" value="30"/> %

### Figure 41 Water Supply / Pump / Meter setup

Another optional capability is the control of a valve that is used to dispense liquid fertilizer. This feature is enabled when a valve is selected for the Fertigation control valve. When selected the Zone setup page will provide additional fields to specify the percentage of time the Fertigation valve should be ON when the zone is ON. This provides zone-by-zone control of Fertigation.

The other Fertigation settings on the Area setup page are used to alter the Fertigation percentages using adaptive control rather than fixed percentage control and to identify a meter source if the liquid fertilizer container volume can be measured. When the volume switch engaged then mcsSprinklers will provide a notification that a refill is needed. The Fertigation setup is shown in Figure 42.

Area 1 Fertigation	
Area 1 Fertigation Control Valve	Area 1 Fertigation Control
<input type="text"/>	<input checked="" type="radio"/> Fixed Rate <input type="radio"/> Variable Rate
Area 1 Fertigation Instrumentation Source	
Input Source:	<input checked="" type="radio"/> None <input type="radio"/> xAP <input type="radio"/> UPB <input type="radio"/> Rain8Net
ID	<input type="text"/>

Figure 42 Fertigation Control and Instrumentation

The start times are also optional for the timed modes and not available for the measured and ET calculated modes. If an area is watered multiple times within the same day then the start times for each of these cycles must be entered. The times can be an absolute time using a 24-hour clock or values relative to sunrise or sunset.

Up to three Inhibit times applicable for only zone in the area can be entered. This provides the same functionality as the between hours inhibit on the Restriction Page described in paragraph 5.5, but is applied on an area-by-area basis. Time can be sunrise-relative. For example, a value of -2 will indicate two hours before sunrise.

Associated with each of the start times is a factor to apply to the duration for a zone. This allows different durations to be used throughout the day. If two start times are entered and duration factors of 1.0 and 0.2 for a zone with auto duration of 60 minutes, then the first cycle of the day will be for 60 minutes and the second will be for  $60 * 0.2 = 12$  minutes.

The Seasonal percentages also apply to a zone's duration. These are applied on a month-by-month basis. A month that has a 70% value for its seasonal percentage will reduce the zone's duration by 30%. If it was setup for 60 minutes and the month's seasonal percentage is 70% then the actual duration when a cycle is run will be  $60 * .7 = 42$  minutes. Note that the time slot factors also apply with the resultant time being the composite of the two.

When a control strategy based upon soil moisture is used then the scheduling automatically changes based up daily and seasonal variations. When a time-based strategy is used this automatic adjustment does not occur. mcsSprinklers provides a means to accomplish a similar effect on a monthly basis. In this case the watering times are scaled by a percentage factor so when watering does occur it will occur for a shorter period as the seasonal need for additional moisture is reduced. When a zip code is first selected the historical percentages for each month will be inserted as the starting point. These can be manually changed and will remain until the zip code is changed.

The setup segment is shown in Figure 43 and Figure 44. The seasonal variations can be manually entered per Figure 43 or the entire group for all areas can be done with the radio setting of Figure 44. A global

selection for 100% removes the effect of seasonal variation. A global setting to Historical averages sets all values to their historical ETo's for each month.

The adjustment provided in Figure 44 in the range of -20 to +20 percent can be used to adjust the auto duration program of all zones without affecting the seasonal variation. It can be considered a tuning adjustment which is also available from the touch page interface via a slider.

The Site Name is used to associate a picture filename as well as label the status device that represents the composite of any zone being active. If the name is left blank the status device will be named "Sprinklers Active". See Section 7.2 for more information on the management of popup pictures.

Area 1 Start Times and Duration Factors		
Time Reference	Program Time	Dur Factor
<input checked="" type="radio"/> Absolute Time <input type="radio"/> From Sunrise <input type="radio"/> From Sunset	[05:30] 5:30	1
<input checked="" type="radio"/> Absolute Time <input type="radio"/> From Sunrise <input type="radio"/> From Sunset	[09:44] 9:44	1
<input checked="" type="radio"/> Absolute Time <input type="radio"/> From Sunrise <input type="radio"/> From Sunset	[16:10] 16:10	1
<input checked="" type="radio"/> Absolute Time <input type="radio"/> From Sunrise <input type="radio"/> From Sunset	[16:20] 16:20	1
<input checked="" type="radio"/> Absolute Time <input type="radio"/> From Sunrise <input type="radio"/> From Sunset		1

Area 1 Inhibit Times	
<input checked="" type="radio"/> Always enforce inhibit <input type="radio"/> Finish started zone <input type="radio"/> Finish all zones in started area	
<input checked="" type="checkbox"/> Sun <input checked="" type="checkbox"/> Mon <input checked="" type="checkbox"/> Tue <input checked="" type="checkbox"/> Wed <input checked="" type="checkbox"/> Thu <input checked="" type="checkbox"/> Fri <input type="checkbox"/> Sat	
<input checked="" type="radio"/> Absolute Time <input type="radio"/> From Sunrise <input type="radio"/> From Sunset	[01:00 - 03:00] From 1 to 3
<input checked="" type="checkbox"/> Sun <input checked="" type="checkbox"/> Mon <input checked="" type="checkbox"/> Tue <input checked="" type="checkbox"/> Wed <input checked="" type="checkbox"/> Thu <input checked="" type="checkbox"/> Fri <input checked="" type="checkbox"/> Sat	
<input type="radio"/> Absolute Time <input checked="" type="radio"/> From Sunrise <input type="radio"/> From Sunset	[07:32 - 09:32] From 1 to 3
<input checked="" type="checkbox"/> Sun <input checked="" type="checkbox"/> Mon <input checked="" type="checkbox"/> Tue <input checked="" type="checkbox"/> Wed <input checked="" type="checkbox"/> Thu <input checked="" type="checkbox"/> Fri <input checked="" type="checkbox"/> Sat	
<input type="radio"/> Absolute Time <input type="radio"/> From Sunrise <input checked="" type="radio"/> From Sunset	[09:36 - 19:36] From -10 to 0
<input type="checkbox"/> Sun <input type="checkbox"/> Mon <input type="checkbox"/> Tue <input type="checkbox"/> Wed <input type="checkbox"/> Thu <input type="checkbox"/> Fri <input type="checkbox"/> Sat	
<input checked="" type="radio"/> Absolute Time <input type="radio"/> From Sunrise <input type="radio"/> From Sunset	From to

Area 1 Restrictions and Carryover	
Minimum Days between Watering	Maximum Days without Watering
<b>Don't with Wind</b>	<b>Don't with Temperature</b>
Speed Above mph for 20 mins	Below Average of F
<b>Don't Even-Odd Days</b>	
Not on Odd Days <input type="checkbox"/>	Not on Even Days <input type="checkbox"/>
<b>Scheduling Carryover to Next Day</b>	
<input checked="" type="radio"/> Do not allow scheduling carryover <input type="radio"/> Schedule zones next day when not completed	

Area 1 Seasonal Percentages - 100 percent nominal for summer			
Jan 100	Apr 100	Jul 100	Oct 100
Feb 100	May 100	Aug 100	Nov 100
Mar 100	Jun 100	Sep 100	Dec 100

Figure 43 Adjustments in Timed Control and Seasonal Variation

The Site page provides a global inhibit to prevent irrigation during certain times of the day. Time of day inhibits can also be entered for specific areas. This becomes useful when using a measured or calculated strategy for some, but not all areas. By using the time of day inhibits shown in Figure 43 the start time can be controlled.

These inhibit time boxes allow use of the “+” and “-“to indicate a time that is relative to sunrise. Numbers without this prefix are absolute times using a 24 hour clock. A time of 2:30 PM would be entered as 14:30. When a zone is otherwise available for irrigation, but inhibited due to the Area Time of Day inhibit, then the General Status Between Hours inhibit will be shown.

All Zone Watering Duration Adjustments					
<table border="1"> <thead> <tr> <th>Seasonal Percentages</th> <th>All Zone Adjustment Percentage</th> </tr> </thead> <tbody> <tr> <td> <input checked="" type="radio"/> Do Not Change  <input type="radio"/> Set All to Historical Average  <input type="radio"/> Set All to 100%                 </td> <td>                     Duration adjust in range -20 to +20 percent  <input type="text" value="0"/> </td> </tr> </tbody> </table>	Seasonal Percentages	All Zone Adjustment Percentage	<input checked="" type="radio"/> Do Not Change <input type="radio"/> Set All to Historical Average <input type="radio"/> Set All to 100%	Duration adjust in range -20 to +20 percent <input type="text" value="0"/>	
Seasonal Percentages	All Zone Adjustment Percentage				
<input checked="" type="radio"/> Do Not Change <input type="radio"/> Set All to Historical Average <input type="radio"/> Set All to 100%	Duration adjust in range -20 to +20 percent <input type="text" value="0"/>				
Miscellaneous Options					
<table border="1"> <thead> <tr> <th colspan="2">Site Name</th> </tr> </thead> <tbody> <tr> <td>Name for Site (Composite of All Zones)</td> <td><input type="text"/></td> </tr> </tbody> </table>		Site Name		Name for Site (Composite of All Zones)	<input type="text"/>
Site Name					
Name for Site (Composite of All Zones)	<input type="text"/>				
<table border="1"> <thead> <tr> <th>Safety</th> <th>Control Log</th> </tr> </thead> <tbody> <tr> <td> <input type="checkbox"/> Repeat Command  <input type="checkbox"/> Hourly Off Safety  <input type="checkbox"/> Daily Off Safety                 </td> <td> <input type="checkbox"/> Include Status in Valve Log                 </td> </tr> </tbody> </table>	Safety	Control Log	<input type="checkbox"/> Repeat Command <input type="checkbox"/> Hourly Off Safety <input type="checkbox"/> Daily Off Safety	<input type="checkbox"/> Include Status in Valve Log	
Safety	Control Log				
<input type="checkbox"/> Repeat Command <input type="checkbox"/> Hourly Off Safety <input type="checkbox"/> Daily Off Safety	<input type="checkbox"/> Include Status in Valve Log				

**Figure 44 Miscellaneous Scheduling Option Setup**

Global site restrictions defined on the Site page provide scheduling inhibits that apply to the entire site. Each area also has a set of area-specific inhibits that control only the scheduling of zones within the area. This setup is shown in Figure 45. Use of area-specific inhibits may be appropriate, as an example, when drip zones are used that are not affected by wind, but lawn zones are.

Area 1 Restrictions and Carryover	
Minimum Days between Watering <input type="text" value="4"/>	Maximum Days without Watering <input type="text" value=""/>
Don't with Wind	Don't with Temperature
Speed Above <input type="text" value="15"/> mph for <input type="text" value="20"/> mins	Below Average of <input type="text" value=""/> F
Don't Even-Odd Days	
Not on Odd Days <input type="checkbox"/> Not on Even Days <input type="checkbox"/>	
Don't with External Inhibit	
Input Source: <input checked="" type="radio"/> None <input type="radio"/> xAP <input type="radio"/> UPB <input type="radio"/> Rain8Net <input type="radio"/> CSV	
ID <input type="text" value=""/>	
<input checked="" type="radio"/> ON = Inhibit <input type="radio"/> OFF = Inhibit	
Don't with Precipitation Forecast and Actual	
<input checked="" type="checkbox"/> Within Next <input type="text" value="1"/> Days With <input type="text" value="50"/> Percent Probability	
<input checked="" type="checkbox"/> Within Prior <input type="text" value="1"/> Days For <input type="text" value="0.2"/> Inches	
<input checked="" type="checkbox"/> On Today For <input type="text" value="0.1"/> Inches	
Don't when Water Consumption Exceeds Limit	
<input type="radio"/> None <input type="radio"/> Today <input type="radio"/> This Week <input checked="" type="radio"/> This Month <input type="radio"/> 24 hrs <input type="radio"/> 7 days <input type="radio"/> 30 days	
<input type="text" value="9000"/> gallons	
Scheduling Carryover to Next Day	
<input checked="" type="radio"/> Do not allow scheduling carryover <input type="radio"/> Schedule zones next day when not completed	
Operation of Inhibit Tomorrow and Inhibit Today for this Area	
<input type="radio"/> Run this area even when inhibits active <input checked="" type="radio"/> Do not run this area when inhibit active	
Soil Moisture Accounting when Soil Oversaturates	
<input checked="" type="radio"/> Increase up to 200%, control 100% to 0% <input type="radio"/> Increase up to 200%, control 200% to 0%	

Figure 45 Area-Specific Restrictions and Carryover

## 5.2.2 Suggestions for Calibration of Calculated Evaporation

There are many factors that affect the soil moisture content. mcsSprinklers attempts to simplify the setup for this calculation; however it is still not a simple matter.

There are two primary considerations. One is how long should a zone be watered and the second is how often should it be watered. The duration is based upon the volume of water that can be applied over a fixed area of crop. This is dictated by the water flow rates and the efficiency of the irrigation heads at evenly dispersing the water. mcsSprinklers does not attempt to calculate the duration, but will adjust the duration on a month to month basis to account for seasonal factors related to soil moisture content. A nominal duration of 30 to 60 minutes is a reasonable starting point. Observe the moisture content in the soil immediately after a cycle and make adjustments up or down to achieve the desired result.

If allowed to run in auto mode, mcsSprinklers will always engage a zone for the duration specified. When the cycle is complete it assumes that the moisture content is at 100%. This is true if the moisture content was 0 or 50% when the cycle started.

The adjustments to be made with the software settings related to how long does it take for the moisture to be released from the soil. There are two factors that can be controlled on a zone by zone basis, one factor on an area by area basis, and one factor that can be applied to the entire system. The zone-based factors are soil and rain efficiency. The area factor is the minimum threshold. The system-wide factor is solar intensity.

A typical summer day will lose moisture from the soil due to Evapotranspiration at a nominal rate of about 0.25 inch per day. This, of course, varies by location. Monthly averages for summer range between 5 and 10 inches within the United States. The primary contributor to moisture loss is solar radiation and there is usually no readily available sensor or source for this information. mcsSprinklers uses the internet-published UV index to make an estimate in most case. It will also use the in-the-shade vs. in-the-sun temperature sensors to estimate it if those sensors sources are available and selected. There is a degree of uncertainty and variance between locations that some calibration of the solar effects is needed. This is most easily done with a container of water left exposed to the environment for a 24 hour period. The measured evaporation vs. the calculated daily ET for the same period will provide an insight if any changes to the nominal 1.0 solar factor are needed. An increase to 1.1 will yield roughly a 10% increase in moisture loss over a 24 hour period.

If your intention is to irrigate when 0.4 inch of moisture is lost then you will set the Area's min threshold to 60%. This means mcsSprinklers will try to keep the moisture content in the range between 60% and 100%. It depends upon you to set the duration of a watering cycle and select a distribution system that will provide an average of 0.4 inches of water over all zones in the area. You can calculate the time needed based upon the gallon per minute rating of your system or you can measure the effective moisture after a cycle has completed.

With the solar factor and the min threshold applied a reasonable nominal schedule should not be available. It is often the case that exposure to sunlight, soil quality, or type of crop will vary between zones in an area. This is where the soil factor can be applied. If the crop retains water better than grass then it should be adjusted downward. If the soil is sandy then the efficiency factor should be adjusted upward

When the software is initially used it may be useful to run it in a timed mode (Day-of-week, Even-Odd, or Interval) using your best judgment as to the frequency of irrigation that is appropriate. The Area Setup page will show a graphic of the calculated moisture content over the past seven days. During this experimental period the objective is see a saw tooth pattern where the flat spots at the top and bottom are minimized.. For example, assume a two-day interval is being used. This means that the moisture level should go from saturated (100%) to dry (0%) over a two day period. If this is happening then no adjustments are needed.

If it only goes down from 100% to 50% over two days then the moisture loss calculation needs to be tuned to yield a faster moisture loss rate. The moisture loss is computed each hour based upon the average ET calculation over the past hour. This calculation is driven primarily by solar radiation and this measurement is not directly available from the internet in real time so estimates need to be made. The estimates can be adjusted with the Soil Efficiency factor on the Zone Setup. Since the factor is associated with only one zone then different values can be used to account for shade and soil type.

### **5.3 Zone Sequencing**

Area irrigation is enabled by the control strategy and the restrictions applied to an area. Once an area has been enabled then the zones will cycle based upon the order that the zone was setup in the Zone Setup page. If the Area sequence control is set for use of a single master sequence then the sequence order will be by Area. If the Area sequence control is set for Area Sequence then multiple areas can be active at the same time with the zone order within an area being the order setup on the Zone Setup page. A normal sequence will irrigate a zone for the duration setup for the auto program for that zone. This value is a combination of three setup entries. The first is the Auto minutes on the Zone Setup page. The second is the Duration Factor associated with an Area Setup page Start Time. These start times are only available

in the three timed control strategy and not available in the ET calculated or measured strategies. The third is also on the Area Setup page and is the Seasonal Percentages that are entered on a month by month basis. For example, Auto Time = 50, Dur Factor = .8, Seasonal Percentage = 90 will result in a zone run time of  $(50 * 0.8 * 90/100) = 36$  minutes.

A zone is normally run for the full duration before the next zone is started. To reduce runoff from too much water at one time, a round-robin sequence can be setup on the Area Setup page to split the area's irrigation into shorter time bursts. This is setup using the InterZone Scheduling delays. If, for example, an Area has three zones with 6 minutes run time per zone with a round-robin setup for 6 cycles. This means that the total of 18 minutes in the area will be run with 6 cycles of 1 minute each in the order Zone 1, Zone 2, Zone 3, Zone 1, Zone 2, etc. Progress in the round-robin cycle can be observed on the Zone Status page such as shown in Figure 46. In this figure it shows that B1 Status is "Round Robin" and it has 4 minutes left to complete. This means the zone is not currently active, but it will be cycling with other zones in the same area in a round robin fashion. B2 is the zone that is currently running in the area. Zone B3 is also round robin and is have 5 minutes remaining to complete.

The scheduling model used by mcsSprinklers starts at midnight and goes for 24 hours. At midnight of the next day a control cycle will start for the times and conditions setup for that new day. A carryover provision exists, if selected on the Area Setup Page as shown in Figure 45, will allow zones that did not complete the day's scheduled irrigation to continue to run past midnight until completion. This carryover is intended to deal with situations where a scheduled irrigation did not complete due to some temporary inhibit conditions that delayed the schedule. It is not intended to allow full irrigation schedules to shift into the next day. This means that a normal irrigation cycle will start sometime after midnight, but generally not just before midnight.

Lawn and Garden Calculated ET (50%)		Run Area 1 Now		
<b>B1: Front Lawn</b>		● Status: Round Robin		
<input type="checkbox"/> Disable Automatic Control		Round Robin with 4 mins left		
<input type="checkbox"/> Enable Manual for 1 mins		Last on Today 9:39 AM		
<input type="checkbox"/> 50% <input type="checkbox"/> 100% <input type="text"/> % Set Soil Moisture		Cycles: 2	Wk Mins: 214	Soil: 67%
<b>B2: Back Lawn</b>		● Status: Watering Now		
<input type="checkbox"/> Disable Automatic Control		Started at 9:39 AM with 5 mins left		
<input type="checkbox"/> Enable Manual for 2 mins		Last on Today 9:39 AM		
<input type="checkbox"/> 50% <input type="checkbox"/> 100% <input type="text"/> % Set Soil Moisture		Cycles: 1	Wk Mins: 157	Soil: 58%
<b>B3: Garden</b>		● Status: Round Robin		
<input type="checkbox"/> Disable Automatic Control		Round Robin with 5 mins left		
<input type="checkbox"/> Enable Manual for 2 mins		Last on Today 9:38 AM		
<input type="checkbox"/> 50% <input type="checkbox"/> 100% <input type="text"/> % Set Soil Moisture		Cycles: 1	Wk Mins: 118	Soil: 58%

**Figure 46 Round Robin Scheduling Status**

Additional timing variation can be achieved with the round-robin by adding a delay between each zone's control. A delay can be added between each zone, independent of round-robin scheduling as well.

Zones are scheduled for irrigation per the Control Strategy, but this schedule is affected by inhibit conditions. It is possible that one or more inhibits are active throughout the entire scheduled period for a zone. When a zone has multiple start times (i.e. multiple programs) and a program is not run due to inhibits then this program will be skipped. When all programs within a day have been skipped due to inhibits then



a carryover into the next day can be setup to allow the zone to be run at the first available time in the next day. This setting is part of the Restrictions and Carryover on the Area Page as shown in Figure 45.

Situations can occur when rainfall causes a zone to calculate moisture levels greater than 100%. For periods of continuous rain a zone may record up to 200% soil moisture level. When the rain stops and evapotranspiration starts the moisture accounting will either go immediately to 100% or it will gradually decrease based upon the calculated moisture loss. If the soil conditions are such that 100% is truly saturation then the option to snap to 100% is the appropriate setting. If the soil conditions will actually hold more than the assumed 100% then a gradual decrease is the appropriate setting.

## 5.4 Syringing

Syringing is the light sprinkling of water on turf usually done during the hottest part of the day to prevent wilting. During the course of the day, the sun evaporates tremendous amounts of water from the soil and plant tissue. Evaporation through plant tissue is called Evapotranspiration. During the hottest days of the year the Evapotranspiration rate often exceeds the plants ability to draw water in from the soil. The result of this water deficit is wilt. Often times during clear sunny days you can see the turf turning shades of blue and gray. These are signs that the turf grass plants are in need of water and if water is not applied at that time the grass will die. This is most important as Annual Bluegrass is a very shallow rooted winter annual and if it dies it will not recover until new seeds germinate in the fall. To reduce the stress from this water deficit syringing is implemented. Syringing is not actually replacing the water in the soil but instead it reduces the wilting cycle by cooling off the turf and temporarily stopping wilt until rainfall or hand watering can be initiated.

Control for syringing is done from a combination of the Zone Setup page shown in Figure 23 and Other Setup page shown in Figure 47. Syringing can be selected on a zone by zone basis on the Zone Setup page where the number of minutes to run during the syringing cycle is specified. The actually running of the once-per-day cycle is controlled by time, temperature threshold, or ET threshold.

The syringing cycle will obey all Restriction and Area Page restrictions except the Between Hours restriction and Start Time designators. When run it will act as a manual control cycle, hence have precedence over the auto control cycle. Other zones that may be in an auto cycle at the syringing time will be delayed until all syringing is completed.

Syringing Options	
<input checked="" type="radio"/> Disable Syringing	<input type="radio"/> Run Once when Temperature goes above <input type="text" value="79"/>
<input type="radio"/> Run Once Starting at Time <input type="text" value="14:45"/>	<input type="radio"/> Run Once when Hourly ETx100 goes over <input type="text" value="3"/>

Figure 47 Syringing Control Options

## 5.5 Watering Restrictions

It may be possible to run the sprinklers on a schedule that is close to optimal for the interest of the foliage, but this is not the only realistic consideration. It really does not make sense to water in the middle of a downpour, nor does it make sense to water in the evening when there may be recreational use of the area. It may also be the case that local regulations limit when water can be used for irrigation.

These perturbations to an ideal cycle are easily expressed in terms of when not to water. Selection of specific days of the week in which not to water provides a lifestyle input. Input for the time-of-day when watering should not happen provide a second form of the lifestyle preferences.

The time-of-day also has scientific significance. Water should be applied at a time-of-day when it has an opportunity to soak into the soil. When applied in the middle of a sunny day most of it will be burned-off

rather than soaked-in. In many climates surface water will encourage undesirable fungus growth. The length of time that surface water is present should be minimized to combat fungus. This means that the best time to apply water is at sunrise so it will have time to soak and remaining water quickly burned-off. There are two ways to control when watering will occur. . The first is with start time preferences as shown in Figure 41. The second is to limit when watering cannot occur per the setup shown in the Between Hours selections of Figure 48.

It is also desirable to restrict the normal watering cycle to conserve either water or money. Any wind over a light breeze will affect the location where the sprinkler water falls. Wind cannot be controlled, but when it is windy it is smart to not run the sprinklers.

For similar reasons it is also does not make sense to run the sprinklers when it is raining. Not only is it a conservation/cost issue, but it also reflects on being a good neighbor and not doing something that appears dumb. Going beyond this it also makes sense to take advantage of Mother Nature. If she is going to be providing the necessary rainfall in the near future then just wait for her and save your water for a non-rainy day.

Rain restrictions take three forms: Prior actual rain, actual rain today, or forecasted rain. Selecting the corresponding checkbox can employ any of the three. A minimum rainfall level that must be achieved can further qualify them. These are in units of the rain sensor (in or mm) and are entered into the text boxes. Actual rain is determined from the rain sensor. Forecasted rain is determined from the icon for each of the future day's forecast. Most forecast sites do a new day rollover sometime around sunset. This means that the forecast can change in the evening and a restriction may active or be removed as the accounting is rolled. To deal with this is may also be advantageous to set a time restriction for the evening hours.

Most jurisdictions water conservation rules can be accommodated with a setting that will not allow an even-day or odd-day watering. In other cases the ban-period period may be extended to two or more days.

To prevent excessive cycles the Max Cycles In Day option can be used to put an upper limit. This would normally come into play if the calculation for evaporation or the measurement sensor produces excessive control demands. (i.e. the sensor is stuck)

If some type of rain moisture pad, security interlock or other form of discrete input is available then it can be used to inhibit irrigation. The source of this discrete needs to be identified as well as the polarity to use to indicate an inhibit condition. The external inhibits can be obtained from a variety of sources. This includes internet sources for XML and text file sources on the local network or computer. The setup of these sources is done on the Weather Setup page.

If irrigation water consumption is being measured or being estimated based upon flow rates then this parameter can also be used as a means to restrict irrigation. There may be water cost rate schedules that may make use of water beyond some threshold prohibitively expensive. A limit can be selected to be within the current day, week or month period or it can be set to be a fixed interval or one, seven or thirty days. For example, if a consumption limit is set to 1000 gallons for the month and on the 20<sup>th</sup> of the month this level has been utilized then no more auto-schedule irrigation will be allowed for the remainder of the month.

The interval selected for water consumption restriction is the same interval that is used for the Site status device where the water consumption is displayed. If no interval is selected then the default display will be for water use within the last 30 days. If no restriction is needed, yet different intervals desired on the display then setup a restriction with a level that will not be achieved.

It is possible that a normal day's irrigation cycle will not complete before midnight due to exercise of restrictions that limit the amount of time that is available to run during a day. If a timed control strategy is used for a zone that does not complete then a notification message will be delivered at midnight to indicate that the zone did not complete during the day and it will be run the following day at the first available time.

When this situation occurs for the other control strategies no message will be delivered since the scheduling is not based upon a specific day's control.

All of these restrictions and preferences can be specified in mcsSprinklers. Most of them are collocated on the Setup6-Site setup page. It is shown in Figure 48. Note that Area-specific restrictions can also be defined per Figure 45.

Watering Restrictions	
<b>Don't on Day of Week</b>	<b>Don't Between Hours</b>
Sunday <input type="checkbox"/> Monday <input type="checkbox"/> Tuesday <input type="checkbox"/> Wednesday <input type="checkbox"/> Thursday <input type="checkbox"/> Friday <input type="checkbox"/> Saturday <input type="checkbox"/>	Between <input type="text" value="0"/> and <input type="text" value="5"/> Between <input type="text" value="22"/> and <input type="text" value="24"/> Between <input type="text"/> and <input type="text"/> <input type="checkbox"/> Allow areas started before time inhibit to finish during inhibited times
<b>Don't Even-Odd Days</b>	<b>Max Cycles Per Day</b>
Not on Odd Days <input type="checkbox"/> Not on Even Days <input type="checkbox"/>	Max Cycles <input type="text" value="24"/> per day
<b>Don't with Wind</b>	<b>Don't with Temperature</b>
Speed Above <input type="text"/> mph for <input type="text" value="20"/> mins	Below Average of <input type="text"/> F
<b>Don't with Precipitation Forecast and Actual</b>	
<input checked="" type="checkbox"/> Within Next <input type="text" value="1"/> Days With <input type="text" value="50"/> Percent Probability	
<input type="checkbox"/> Within Prior <input type="text" value="1"/> Days For <input type="text"/> Inches	
<input checked="" type="checkbox"/> On Today For <input type="text"/> Inches	
<b>Don't with Evaptranspiration</b>	
<input type="checkbox"/> Daily ET Below <input type="text" value="0.1"/> for <input type="text" value="1"/> Days	
<b>Don't with External Inhibit</b>	
Input Source: <input checked="" type="radio"/> None <input type="radio"/> xAP <input type="radio"/> UPB <input type="radio"/> Rain8Net <input type="radio"/> CSV ID <input type="text"/> <input checked="" type="radio"/> ON = Inhibit <input type="radio"/> OFF = Inhibit	
<b>Don't when Water Consumption Exceeds Limit</b>	
<input type="radio"/> None <input type="radio"/> Today <input type="radio"/> This Week <input checked="" type="radio"/> This Month <input type="radio"/> 24 hrs <input type="radio"/> 7 days <input type="radio"/> 30 days <input type="text" value="1000"/> gallons	
<b>Record Inhibit Reason in Message Log</b>	
<input checked="" type="checkbox"/> Log Inhibit Reason	

Figure 48 Site Watering Restrictions Setup

## 5.6 Water Use Management

### 5.6.1 Water User Monitoring

Water use monitoring can be setup and when the daily use is beyond the threshold a notification will be delivered. This notification will be in the message log and email if setup. Three levels of monitoring can be setup. These are at the zone, at the area, and at the site.

The Zone Setup page provides provisions for entry of a maximum expected water use for each zone. If a value is entered and the measured water use for that zone exceeds the maximum then a notification will be provided. This form of notification will not provide water-leakage type information since measurement at the zone level is only made when the zone is ON. This capability depends upon an external water meter to measure water flow for the area.

The Area Setup page provides an entry for a maximum flow for the area. The flow maximum is associated with the water meter for the area and it is monitored at all times. The notification in this case will detect line breakages assuming that the meter is only monitoring irrigation water.

## 5.6.2 Water Use Measurement and Display

The volume of water being utilized for irrigation can be measured and/or calculated by mcsSprinklers. Measurements are provided by external water meter sensor(s). Calculations are based upon flow rate information for a zone.

If calculations of water use are to be maintained by mcsSprinklers then the flow rates for each zone need to be entered on the Zone Setup page as shown in Figure 23. mcsSprinklers will accumulate the water use based upon the run times for each zone. This water use can be viewed as a running total as a status device on the General Status page. Day-by-Day and hour-by-hour visibility of the water use can be viewed from the calendar popup when the water flow status device calendar icon is clicked.

















If water flow meters are available then they can be used to measure the water use during the time a zone is active. In this case the Calc entry on the Zone Setup page should be left blank. The average of the use over the last 30 days will be shown for reference and this value will be used to project future water use while a zone is running. A Max flow per day value can be entered. When this value is exceeded a message will be recorded and email notification performed if email is setup.

Provisions exist for one water meter per area. If only one water meter exists then the same meter source location should be used for each area.

When a zone is turned ON mcsSprinklers will take a snapshot of the water meter reading and then accumulate the water meter readings as long as the zone remains ON. If multiple zones are ON at the same time then mcsSprinklers will assume each zone has an equal consumption.

The water use can be viewed on the General Status page in the Area and Site status devices as a rolling total over the past 30 days. The raw water meter readings are also shown for each meter when a meter is present. An example can be seen in Figure 49. In this example one meter was present at the site. The current meter reading was 1125 gallons. The site had consumed 1416 gallons over the past 30 days. Of these 170 gallons were in Area 1, 180 in Area 4, and the remainder in Area 5.

When the calendar icon is clicked for an area or site then the daily water use values will be displayed as shown in Figure 66. Further detail on an hourly basis is seen by clicking on the calendar day. If visibility for a specific zone is desired then the calendar can be access from the General Status page zone status calendar icon as shown in Figure 53.

	170 gal/month	S45	Area 1 Status	Today 10:05:16 AM	OFF ON
	0 gal/month	S46	Area 2 Status	Today 10:05:16 AM	OFF ON
	0 gal/month	S47	Area 3 Status	Today 10:05:16 AM	OFF ON
	180 gal/month	S48	Area 4 Status	Today 10:05:16 AM	OFF ON
	1066 gal/month	S49	Area 5 Status	Today 10:05:16 AM	OFF ON
	1416 gal/month	S53	Site Status	Today 10:05:16 AM	OFF ON
	 1125 gal	S54	Water Meter 1	7/21/2006 11:43:47 PM	
	 1125 gal	S55	Water Meter 2	7/21/2006 11:43:47 PM	
	 1125 gal	S56	Water Meter 3	7/21/2006 11:43:47 PM	
	 1125 gal	S57	Water Meter 4	7/21/2006 11:43:47 PM	
	 1125 gal	S58	Water Meter 5	7/21/2006 11:43:47 PM	

**Figure 49 Measured Water Consumption**

If there is a storage or pressure tank that is being used at the site and mcsSprinklers should assure that the tank has sufficient water prior to running a zone then the Water Tank parameters should be setup on the Site Setup Page. The model for management of the tank is to establish a full volume, the minimum volume at which irrigation should be allowed and the rate at which the tank is being filled from its water source. mcsSprinklers will account for water that is being used based upon measurements or flow rates setup and will account for the refill rates. When the tank level goes below the minimum threshold then irrigation is inhibited. It will remain inhibited until the tank is refilled to the 50% level between the minimum and full settings. The current level of the tank can be observed from the Water Tank status device on the General Status Page.

## 5.7 Fertigation

Fertigation is the application of liquid fertilizer through the irrigation system. mcsSprinklers controls fertigation based upon setup information contained on the Zone Setup and Area Setup pages. The Zone Setup provides the nominal factor that determines how long a fertigation valve will remain ON with respect the full run time of the zone. If the Zone Setup page has Fertigation factors of 0.5 and 1.0 then the first zone will enable the fertigation valve for 50% of the run time for the zone and the second zone will enable the fertigation valve for 100% of the zone's run time.

The identification of the valve to be used for fertigation is identified on the Area Setup page as shown below. The pink arrow shows the segment of the Area Setup that applies to fertigation.

The fertigation can be controlled based upon a fixed percentage of the zone run time or it can be controlled based upon a variable percentage. The variable control will increase the percentage when the time between irrigation cycles increases and will decrease it when the time becomes short.

A fertigation instrumentation source is provided. This is intended to provide a measurement that will allow mcsSprinklers to provide a notification via message and email when the fertigation media has reached a low level.

mcsSprinklers maintains a database that will show minutes of fertigation for each zone as well as for the total minutes the fertigation valve is ON. Status information is available from the page as shown in Figure 50 and from calendar popup such as are shown in Figure 51 and Figure 52. The general status shows a level indicator icon for the fertigation supply/valve and provides the number of minutes that the fertigation valve has been ON over the past 30 days. When the value is ON then the icon is animated to show consumption.

Status	ID	Name	Changed	Control
OFF Soil 100%	R9	U1	Today 9:09:06 PM	OFF ON
OFF Soil 100%	R10	U2	Today 9:13:01 PM	OFF ON
Fert 10575 mins/month	R11	U3	Today 9:12:59 PM	
Pump	R12	U4 Pump	Yesterday 6:53:46 PM	
	S10	Inhibit Min Days Between Water	8/9/2006 7:39:45 PM	
Inhibited	S11	Inhibit StartTime Area 1	Today 9:13:56 PM	

**Figure 50 Fertigation Valve on General Status Page**

To the left of the level indicator and the zone valve icons are calendar icons. When clicked then a calendar popup is shown. The calendar provides a nominal 90 day view of past and projected behaviors.

One calendar view is displayed when the calendar for the zone valve icon is clicked. When any day's cell is clicked on the calendar then a detail popup will show the daily detail for the selected day. A second calendar view is shown when the calendar icon next to the fertigation valve is clicked. In this case the calendar shows the icon associated with the fertigation valve for any day that the fertigation valve was ON. There is also a level-indicator icon where the level is angled. This is the projected day when the next fertigation will occur.

When any day's cell is clicked then the detail for the day pops up.

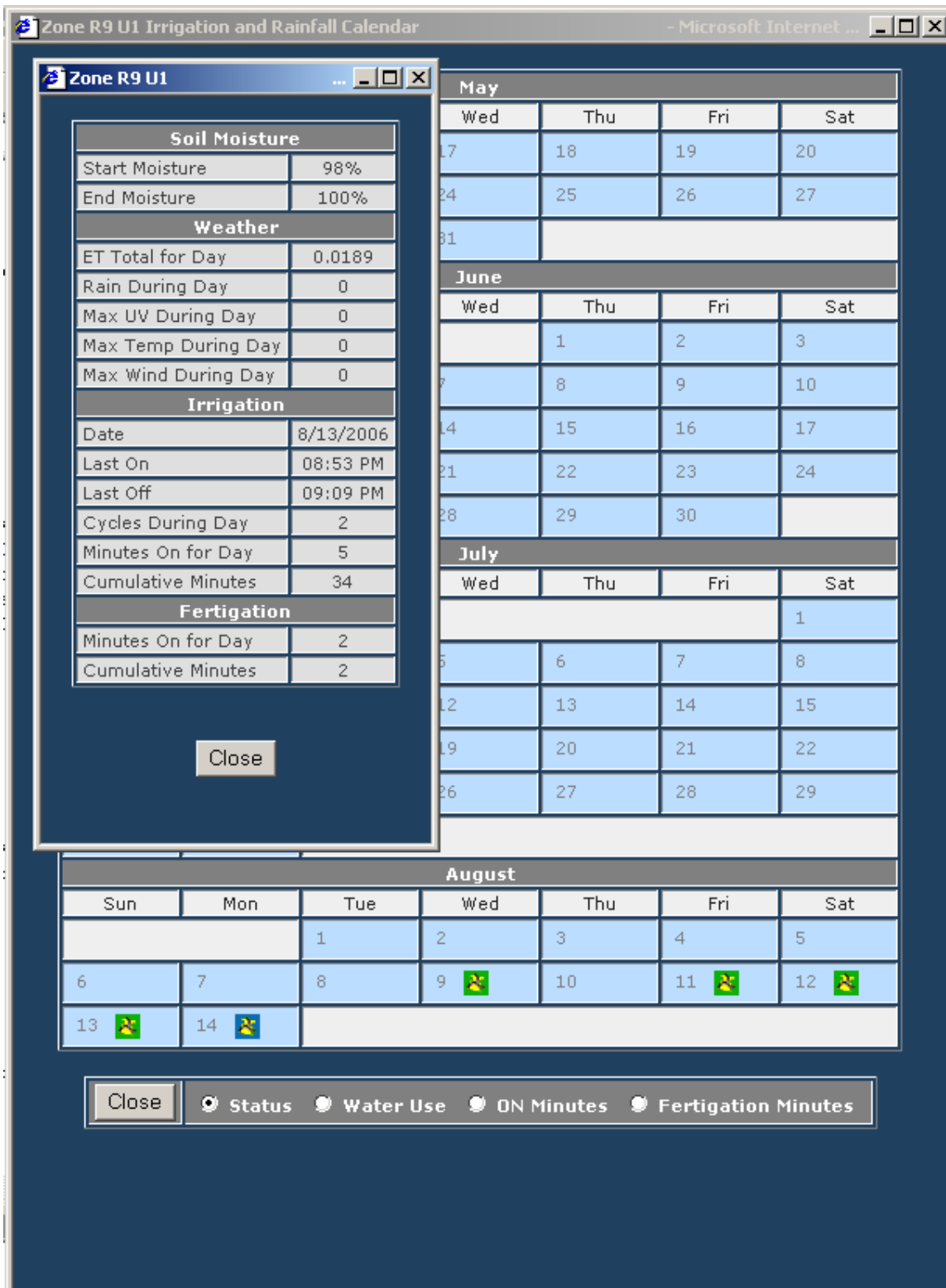

Figure 51 Fertigation Data on Calendar Detail for Zone Valve

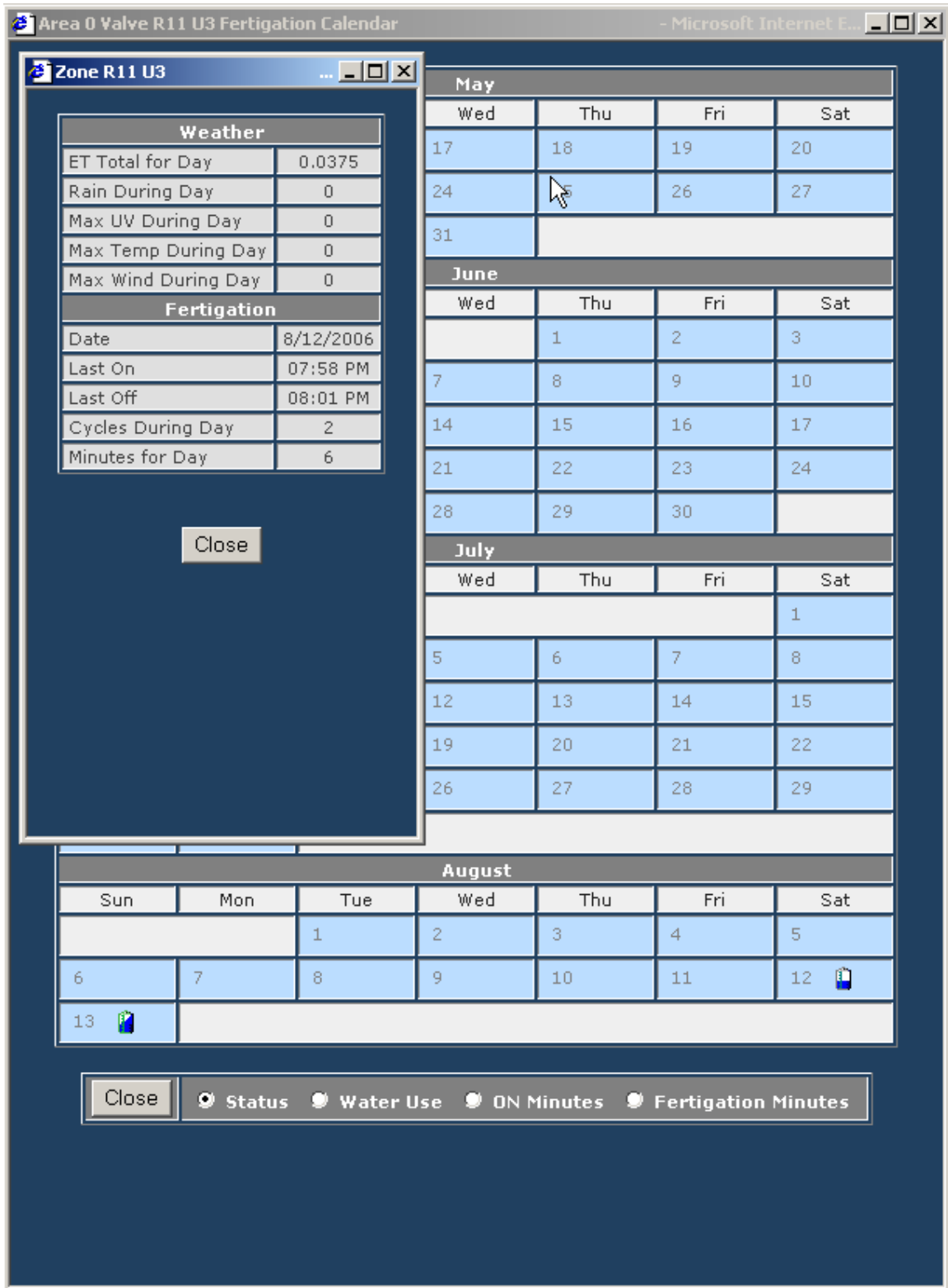

Figure 52 Fertigation Calendar Detail for Fertigation Valve



## 6 Manual Control Options

While the focus of mcsSprinklers is to provide a fully automated irrigation solution, it also integrates the automatic modes with a manual control capability. The manual control will override the automatic control when this mode of operation is enabled. This means that the “Don’t Water” and “Start Time” restrictions imposed on the automatic control are not obeyed for manual control.

Seasonal/Emergency actions take priority over individual zone Manual Control actions. When mcsSprinklers has been put into Seasonal Shutdown it will continue to perform all data collection operations, but there will be no valve activation performed by either automatic or manual actions.

A zone will remain under manual control until the zone has been watered once. Manual control for that zone will be deactivated. Automatic control will resume if it has not been disabled by the checkbox on the web page or toggled via the Alias Device.

The following elements of mcsSprinklers are involved with manual mode operations:

1. Browser Control
2. Handheld Remote Control
3. Power line Remote Control
4. Voice Control

### 6.1 Web Browser

Two browser views can be used to control manual operations. The General Status page will provide a clickable button for each valve and pump as well as master controls for Seasonal and Manual modes. Figure 53 shows these controls for two zones.



Status	ID	Name	Changed	Control
OFF Soil 100%	G1	Right Gate	Yesterday 12:54:32 PM	OFF ON
OFF Soil 50%	G2	Right Tree Bubbler	Yesterday 1:30:24 AM	OFF ON
OFF Soil 45%	G3	Right Far Street	Yesterday 1:30:24 AM	OFF ON
OFF Soil 43%	G4	Left Grass	Yesterday 1:30:24 AM	OFF ON

**Figure 53 Manual Controls from General Status Page**

The Seasonal or Emergency Shutdown button is used to totally disable all control functionality of mcsSprinklers. When it is clicked its label and function will change to restore normal control operations. This is the only place where this master control can be energized.

The ON and OFF buttons in the right-most column are used to individually turn a zone ON or OFF at the soonest possible time. This time will normally be immediately, but could be at some later time if other zones are scheduled for watering before this zone. When the zone does start then it will continue for the number of minutes previously entered for the manual duration. This setup is on the Setup4-Zones page as shown in Figure 21.

When a zone is manually turned ON then the manual mode master button at the top of the page will be relabeled to an Exit button. When the Exit button is clicked then all zones that have been manually started will be stopped immediately. Individual zones can be manually stopped with the OFF button associated with the zone.

The second browser page that provides manual control ability is the Zone Status page with an example shown in Figure 55. There are several elements integrated into this view. Those that relate to manual control operations are the four center buttons on the top row and the checkbox and textbox in the left column associated with manual control of a specific zone.

The Stop button has the same function as the Exit button on the General Status page. It will stop the watering off all zones for the remainder of the day. This Stop button will change to a Restart button when a manual stop has been performed.

The “Inhibit Tomorrow” button has a similar function to the “Inhibit Today” button, but it applies to all zones that would otherwise be activated tomorrow so that they will not be activated tomorrow. The Inhibit Tomorrow button affects only auto mode operations. When tomorrow arrives the manual mode operations can be used to override the inhibit introduced by Inhibit Tomorrow. The override can also be done with the “Inhibit Today” button which will have changed to “Allow Today” if the day became inhibited due to the “Inhibit Tomorrow” selection the prior day.



Both the “Inhibit Tomorrow” and “Inhibit Today” buttons can be configured to only function on selected Areas as illustrated in Figure 45. When the inhibit function has been disabled on the Area page then the zones of that area will continue to irrigate based upon the Area’s control strategy even when either “Inhibit Tomorrow” and “Inhibit Today” are activated. This could be useful if certain Areas will always be run when others are subject to the manual inhibit control buttons.

There is a status device on the General Status page that reflects the currently active inhibit condition based upon yesterday’s use of “Inhibit Tomorrow” or today’s use of “Inhibit Today”. If you change your mind when tomorrow arrives then the OFF control on the General Status page for the Inhibit Tomorrow Carry forward status can be used to re-enable auto mode control. The ON control of this device can also be used to inhibit the current days auto cycle.

When a zone has completed a watering cycle today then the Zone Status page will present a third Auto Mode control button “Rest Watered Today”. Use of this button will reset all zones so that it appears as if not watering cycles have occurred today. For the three timed control strategies there will also be a checkbox for each zone “Reset to Allow Cycle Today” that will allow selective zones to be reset rather than all zones. The selective update is actioned with the “Update” button after the checkbox(es) has been checked.

A full manual cycle can be started with the “Stat All Manual” button. Individual areas can be manually started with the “Run Area ...Now” button. Individual zones can be manually started by checking the “Enable Manual Control” checkbox on the zone and when all desired zones have been checked then the “Start Manual” button clicked.. Unlike on the General Status page, the number of minutes for manual control can be entered at the same time the manual control action is taken.

Controls are also provided on the General Status page to give access to manual control. This includes the individual zones as well as the area and complete set of zones. Figure 54 shows the OFF and ON controls provided on the General Status page for the composite areas and total of all zones. Manual control can also be performed from the Zone Status page as shown in Figure 55. In this case the desired manual control zones are selected with checkbox, the durations can be edited, and then started with Start Selected Manual button at the top of the page. All zones can also be run in manual mode with the Start All Manual or Manual Run Site Now buttons.

	S40	Area 1 Active	Today 5:28:40 PM	OFF ON	
	Watering Now	S41	Area 2 Active	Today 5:41:50 PM	OFF ON
	S42	Area 3 Active	4/3/2006 9:47:28 PM	OFF ON	
	Watering Now	S48	Sprinklers Active	Today 5:41:50 PM	OFF ON

**Figure 54 Composite Controls Available on General Status for Manual Control**

**Master Controls**









Both Modes	Auto Mode	Manual Mode
<input type="button" value="Zone Sort"/> <input type="button" value="Stop All"/> <input type="button" value="Pause"/> <input type="button" value="Save Changes"/>	<input type="button" value="Skip Cycle"/> <input type="button" value="Inhibit Tomorrow"/> <input type="button" value="Inhibit Today"/>	<input type="button" value="Start Selected Manual"/> <input type="button" value="Start All Manual"/>

**Site**

0%  100%  % Set Soil Moisture

**Area 1 - Sideyard Lawn Calculated ET (20% Trigger)**

20%  100%  % Set Moisture

<b>H2: Sideyard Pond</b>	 	<b>Status: Seasonal Shutdown</b>
<input type="checkbox"/> Disable Automatic Control	Projected for Today 10:11 AM for 40 mins	
<input type="checkbox"/> 20% <input type="checkbox"/> 100% <input style="width: 40px;" type="text"/> % Set Moisture	Moisture  Now:5%	
<input type="checkbox"/> Enable Manual for <input style="width: 30px;" type="text" value="30"/> mins	Cycles: 0	Wk Mins: 0
	Last on Sat-23th 2:15 PM	
<b>H3: Sideyard Stream</b>	 	<b>Status: Seasonal Shutdown</b>
<input type="checkbox"/> Disable Automatic Control	Projected for Today 10:51 AM for 40 mins	
<input type="checkbox"/> 20% <input type="checkbox"/> 100% <input style="width: 40px;" type="text"/> % Set Moisture	Moisture  Now:5%	
<input type="checkbox"/> Enable Manual for <input style="width: 30px;" type="text" value="30"/> mins	Cycles: 0	Wk Mins: 0
	Last on Sat-23th 2:16 PM	
<b>H5: Sideyard Rock East</b>	 	<b>Status: Seasonal Shutdown</b>
<input type="checkbox"/> Disable Automatic Control	Projected for Today 11:31 AM for 60 mins	
<input type="checkbox"/> 20% <input type="checkbox"/> 100% <input style="width: 40px;" type="text"/> % Set Moisture	Moisture  Now:5%	
<input type="checkbox"/> Enable Manual for <input style="width: 30px;" type="text" value="60"/> mins	Cycles: 0	Wk Mins: 0
	Last on Sat-23th 2:18 PM	

**Figure 55 Zone Status Page View**

The Sprinkler Control page provides a more complete view of the sprinkler status. It, along with VR, is the mechanism by which manual watering times can be specified. This view also enabled multiple zones to be scheduled for a manual cycle. In this case each zone to be enabled for manual control is indicated with a check in the enable manual control checkbox and the Start Manual button clicked to accept this request.

When the Area Sort button is used to provide zone organization by Area then additional controls are provided to start all zones within a specific area and to set the soil moisture levels for an area or for the entire site.

## 6.2 Remote with iPhone/iPad/iPod/Android

A general interface capability for remote access exists with browser-oriented interfaces that can be used with remote devices where firewall access has been provided to the mcsSprinklers HTTP server. Specialized Apps that run on Apple or Google phone or tablet platforms are also available. A landscape view provides the ability to gesture swipe through each zone or each area to provide manual control as well as observe current status. See Figure 56 . An up/down gesture toggles between Area and Zone views. The left/right gesture cycles through each zone or area. The zone identification is the zone picture on the center left and its scheduling information is in the middle right. The top contains the most recent message feedback. The bottom contains buttons that affect the operation. The WAN button is used to toggle between WAN vs. LAN server for the zone picture. If accessing from a remote location over the internet then the WAN should be selected. When a button is selected it will appear as depressed.

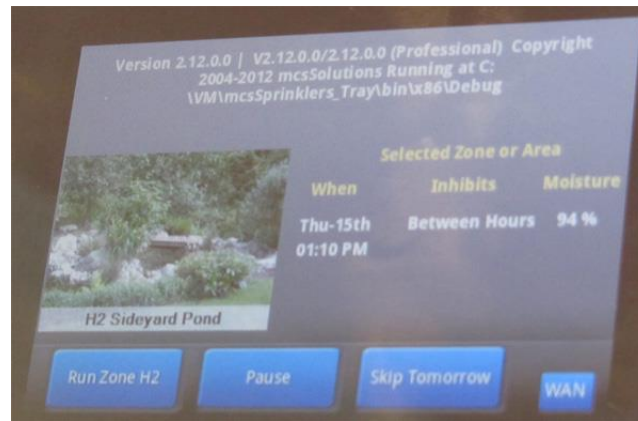

Figure 56 Phone App Landscape Remote

A portrait view is used to observe the next scheduled zone. See Figure 57. The swipe gesture has no effect as the next scheduled zone is not dependent upon user action. A Pause button is provided for the case where user inhibit of this and any other zones can be performed.

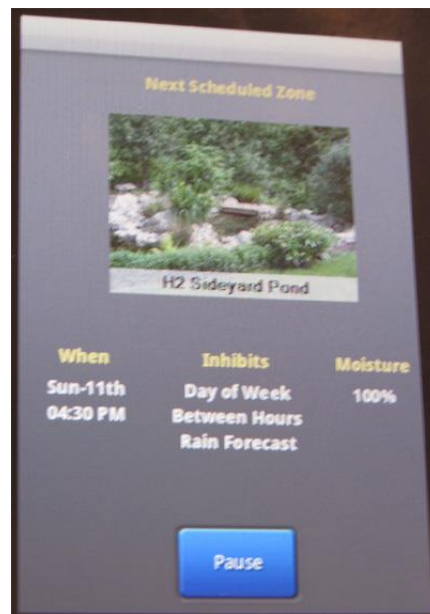
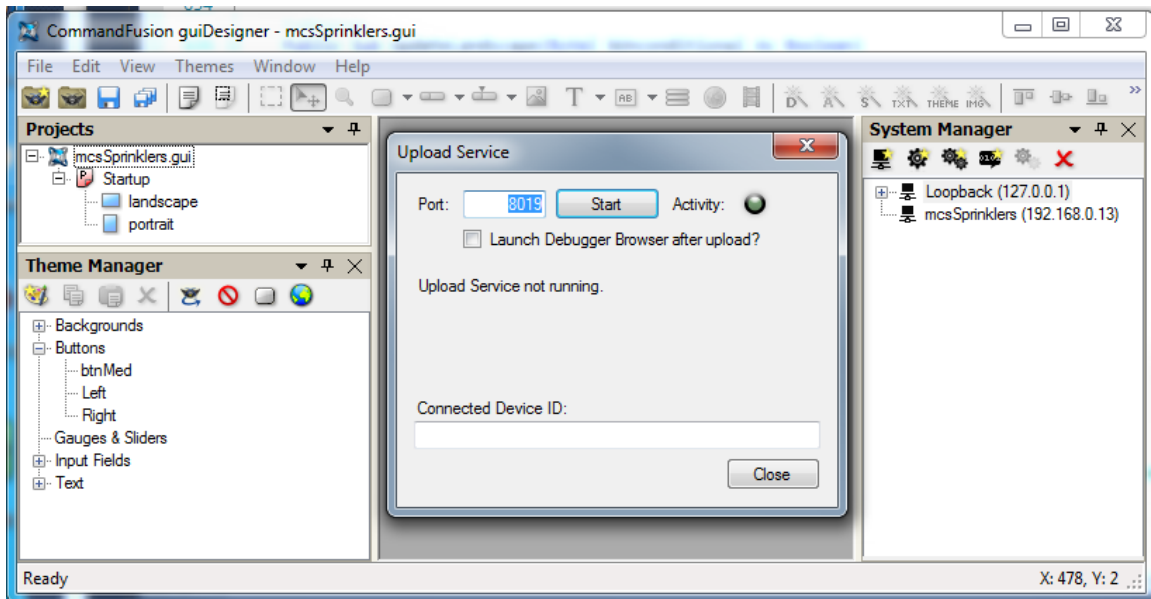

Figure 57 Phone App Portrait Remote

The installation of the Apps requires three pieces. One is the App itself that is available from Apple's or Google's marketplace that goes under the name iViewer 4 and was developed by Command Fusion. <http://www.commandfusion.com>. The Android iViewer client is not as mature as the one for Apple products. A designer application is available from Command Fusion downloads and it is the mechanism by which the mcsSprinklers landscape and portrait views are downloaded into the phone or tablet. A screenshot of the designer with the upload service prompt is shown in Figure 58. The two views are available in the Command Fusion Designer Project File "mcsSprinklers.gui" that can be found in the \bin folder of the mcsSprinklers install.

A user is welcome to customize the layout of the two views prior to transferring to the phone or tablet, but the customization will be only cosmetic and not functional. For example, a new button could not be added since mcsSprinklers would not know about the function of that new button.

A dedicated port is used to communicate between the PC and the client. This port is setup on mcsSprinklers Other Page and it is also setup with settings on the client. The third location is on the download of the landscape and portrait skins from the PC to the client. Port 8019 has been used during testing. Note that mcsSprinklers or the download service of the designer can be connected to the port to the client, but not both at the same time. When downloading the skins to the client, mcsSprinklers should not be running.



**Figure 58 Command Fusion Gui Designer for Upload**

The process to follow to setup the application consists of:

1. On some PC open CommandFusion guiDesigner after download from [commandfusion.com](http://commandfusion.com)
2. Select File and navigate to mcsSprinklers install folder \bin\CommandFusion\mcsSprinklers.gui
3. Under File, select start Upload Service or click F12.
4. On iPhone/iPad/Ipod, download iViewer (version 4) APP
5. From Settings select iViewer to get to application-specific settings
6. Select File URL to be PC LAN IP where guiDesigner is installed
7. Select Reload GUI layout
8. Exit settings and start iViewer
9. On the PC the Activity icon in upload services will blink and the GUI will appear on iViewer APP.

10. At some convenient time return to Settings and deselect the Gui Reload so that it will no longer transfer the GUI on each start of iViewer. The Upload Service on the PC can be stopped and the guiDesigner on the PC can be exited.
11. On Android the same process is followed as the Iphone/Ipad/IPod starting but step 6 access to application settings is from the iViewer application with the grid or vertical ellipse icon in the tray at the bottom. Different Android OS versions may have different approach to changing application settings.

### 6.3 Remote with Palm pad or Power line Controller

Manual control of the sprinkler valves from a Browser or with Voice can be achieved without any additional setup. In the case of the handheld remote additional setup is required to associate a remote control code with a zone. This association is done from the Setup7-Remote Control page. This page is shown in Figure 60. In this example remote codes N2 and N10 are associated with the Garden and Lawn zones, respectively. The use of the handheld remotes ON and OFF buttons will now have the same functionality as the individual zone ON/OFF buttons on the browser pages.

In addition to this association there also needs to be a mechanism by which the PC can recognize the remote control codes that are being transmitted. The W800 interface is able to perform this function. It can be run on any PC on the Local Area Network including the local PC. If from the local PC then selecting the checkbox can automatically start it shown on Figure 32 of the Setup9-Others page.

The normal use is with the internal interface using the com port assignment made on the Setup7-Remote page per Figure 59. There are three text box entries available. If the W800 is connected to a serial port on the same computer as mcsSprinklers then the W800 IP text box is left blank and the port number is placed in the W800 port box. This will be a number such as 1, 2, etc. If the W800 is interfaced via the LAN then the IP and port are entered in these two boxes such as is shown in Figure 59.

RF transmissions such as from a palm pad actually send the same command multiple times with each push of the button. It is done to assure that at least one reaches the receiver. To assure that only one is received the extra ones are filtered-out for a short period of time. This filtering interval is the Debounce Period entry. The value of 1000 means that the same button press will be ignored for one second. If the value is reduced to 500 then two of the same button pushes within one second will be accepted.

W800 For Handheld Wireless Input		
W800 IP	192.168.0.40	W800 Port 3003
Debounce Period		1000 milliseconds

**Figure 59 W800 Port Selection for Internal W800 Connection**

The same remote functionality is achieved with an X10 mini/maxi controller that provides a set of buttons that can be activated to send codes over the power line. In this case the W800 interface is not needed. The CM11A that is used to drive the power line will also function to listen to commands.

<b>Disable Direct Valve Control</b>		<b>Disable Alias Valve Control</b>	
<input type="checkbox"/> Disable Remote Direct Valve Control		<input type="checkbox"/> Disable Remote Valve Control via Alias	















  

Remote Control Activation Setup		
Zone	Valve	RF Code
Rain8_Unit__Valve	X10 H- Valve 1	I1
Rain8_Unit__Valve	X10 H- Valve 2	I2
Rain8_Unit__Valve	X10 H- Valve 3	I3
Rain8_Unit__Valve	X10 H- Valve 4	I4
Rain8_Unit__Valve	X10 H- Valve 5	I5
Rain8_Unit__Valve	X10 H- Valve 6	I6
Rain8_Unit__Valve	X10 H- Valve 7	I7
Rain8_Unit__Valve	X10 H- Valve 8	I8
Rain8_Unit__Valve	X10 H- Valve 9	I9
Rain8_Unit__Valve	X10 H- Valve 10	I10
Rain8_Unit__Valve	X10 H- Valve 11	I11
Rain8_Unit__Valve	X10 H- Valve 12	I12
Rain8_Unit__Valve	X10 H- Valve 13	I13
Rain8_Unit__Valve	X10 H- Valve 14	I14
Rain8_Unit__Valve	X10 H- Valve 15	I15
Rain8_Unit__Valve	X10 H- Valve 16	I16
Area 1 Status	H2,H3,H4,H5,H6,H8	
Area 2 Status	H1,H10	
Area 3 Status	H7,H9	
Area 4 Status	H11,H12,H15	
Area 5 Status	H13,H14,H16	

Figure 60 Remote Control Setup Page

### 6.4 Remote with Wireless Handheld PDA

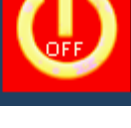
It is possible to control mcsSprinklers valves with a small handheld computer such as a Palm. A special browser page is used to provide just the essential information necessary to accomplish this control. The URL to access this page is the URL of the computer and port where mcsSprinklers is running with the page parameter of "handheld". For example <http://192.168.0.31:8008/handheld>. The page presented is a condensed version of the General Status page where no graphics are presented and only devices that have control buttons are listed. The layout is shown in Figure 61. The screen width is tailored for a 320 pixel wide screen and no graphics are included so as to minimize the resources needed in the PDA. The four buttons in the top row can be used to sort the rows per the column title.

Status	ID	Name	Control	
1 Minutes Left	A1	Front Lawn		
OFF Soil 100%	A2	Rear Flowers		
S22		Inhibit Today-Tomorrow		
1Minutes Left	S45	Area 1 Status		
1Minutes Left	S53	Site Status		
S92		Skip Tomorrow		
S93		Manual Stop		

**Figure 61 Handheld Remote Control Browser Page**

When accessing mcsSprinklers from a PDA or other remote host the LAN firewall becomes a consideration. The firewall must allow this communication. In some cases it is possible to setup a rule to allow mcsSprinklers.exe to pass through the LAN or WAN firewall. In some cases it will require an advanced setup where the specific browser port (default 8008) needs to have the exception. See <http://windows.microsoft.com/en-us/windows-8/windows-firewall-from-start-to-finish>

## 6.5 Crestron Control

mcsSprinklers can be used in conjunction with a Crestron system that has been configured for use with Rain8Net modules. Automatic water-saving control and remote internet access will be provided by mcsSprinklers and the Crestron touch screens can also be used for manual control of the zones or as an alternate automatic scheduling mechanism for a sequence of zones.

In this configuration the Crestron RS232 output is directed to a Serial COM port on the PC on which mcsSprinklers is running. This port is selected as the Crestron port on the Remote Setup Page per Figure 62. Note that a crossover RS232 cable will be required between the Crestron Processor and PC so that the RxData and TxData lines are swapped.





**Figure 62 Crestron Interface Port Selection**

## 6.6 Voice Control

Voice control has been depreciated as of mcsSprinklers version 2.17.

Voice can be used to command a zone on or off and obtain status of the currently running zone or the next zone scheduled. A sprinkler zone is identified by its named location. These location names were previously completed on the Setup2-Wiring page as shown in Figure 21.

The syntax of the voice commands is itemized in Table 2. Examples of their use are also shown in the Voice column on the Setup7-Remote Control page per Figure 60. When duration is specified it must be in minutes. Single minute increments up to 20 and then five-minute increments up to 95 are accepted.

**Table 2 Voice Recognition Commands**

<b>Objective</b>	<b>Voice Command</b>
Obtain status of active zone, or next scheduled zone and any inhibits that are active	Sprinkler Status
Turn off a sprinkler zone	Turn Off ZoneName
Turn off a sprinkler zone	Turn ZoneName Off
Turn on a sprinkler zone for a 20 minutes	Turn On For 20 Minutes ZoneName
Turn on a sprinkler zone for a 20 minutes	Turn ZoneName On For 20 Minutes

The voice command can come from either a microphone on the local PC or on one from another PC on the LAN. In the LAN-activated configuration the xapmcsVoice.exe program must be running on the computer with the microphone.

A voice command can also request status. The computer will respond with identification of any zone that is currently running and the projected next start time of the other zones.

## 7 Status Reporting

Status is available from the two browser pages from which manual control is performed, from the run list page and via computer generated speech in response to the voice status request. A tray icon is also used to provide a quick status from the local desktop. The icon appears as a colored base with water drops spewing upward. The base is green with one or more zones are being irrigated. It is yellow then a Message Page entry has been made for notification. It is blue at all other times.

### 7.1 General Status

The General Status page provides current status for over 70 aspects of the scheduling. Most of the status fields will be obvious by their name. The Predicted Rain and Predicted Evaporation are a composite of 3 days of rain/evaporation data and these are the values used to base calculated control strategy actions. ET is a one-hour Evapotranspiration index. Max Light and One Day Rain reflect the maximum solar intensity and maximum one-day rainfall that was measured in the last 30 days. If none is measured then this value will typically be 0.5 inch. The Forecasted levels are based upon these maximums.

The top segment of the status reporting is shown in Figure 53. This page has column header buttons that can be clicked to sort the order of the reported status. Each status line contains a graphic or textual representation of the status in the first column and a description of the status being reported in the others. Often the status field is blank and it indicates an inactive situation. The color of the zone valve and the pump change to red when a communication failure occurs. This applies to the Rain8-Net since it provides a positive feedback of status. When a zone is delivering water then the status icon is animated. The tray icon also changes color to green when a zone is being watered.

The calculation of ET is dependent upon internet data with particular attention given to UV (S78) and Temperature (S69). If these values are not updated with internet data then the moisture calculations will not be accurate and could result in incorrect watering cycles if the Area is using the Calculated ET control strategy. Status devices S87 and S88 provide feedback as to when the last Forecast data and Weather data has been received.

The General Status page also provides clickable access to additional information. Icons that precede a name indicate that a picture is available for viewing about that name. See 7.2 for more information about pictures. Icons in the status column that look like a calendar can be clicked to provide the 90-day history of that item. See section 7.3 for more information about the history presentation.

Figure 63 illustrates the method for producing a customized General Status view. This allows selected status devices to be hidden so the status views will show only those pieces of information that are of interest. When the “View All / Hide Selected” button at the top of the page is toggled the Hide (H) column will be presented. This column contains checkboxes to allow rows to be selectively hidden. After all desired customizations have been made then the “Save View” button is clicked to retain the settings. When the “Hide Selected” button is clicked then only those rows with unchecked Hide column checkboxes will be shown. See Figure 53 for view of the General Status after customizations have been exercised.

The General Status view also provides a method to tailor the touch screen page view for the professional version. The touch screen shows six measurements such as temperature and rainfall. The selection of the six to be viewed from the touch screen page is made from the “T” column of the General Status page. The first six selected sensors from the checked “T” column will be used on the touch screen page.

Note that when the Hide column is visible the General Status page will not refresh automatically. This allows undisturbed editing of the checkboxes.

SaveView		Hide Selected		Seasonal or Emergency Shutdown		
Status	H	ID	Name	Changed	Control	
OFF Soil -50%	<input type="checkbox"/>	K4	AC Shrubs and Maple	Yesterday 1:30:24 AM	OFF	ON
0.04	<input checked="" type="checkbox"/>	S31	Actual Rain Prior 1 Day	Today 9:56:19 AM		
0	<input checked="" type="checkbox"/>	S30	Actual Rain Prior 2 Day	5/18/2006 8:37:11 AM		
0	<input checked="" type="checkbox"/>	S29	Actual Rain Prior 3 Day	Yesterday 12:00:18 AM		
0	<input checked="" type="checkbox"/>	S28	Actual Rain Prior 4 Day	Today 9:56:19 AM		
0.01	<input checked="" type="checkbox"/>	S27	Actual Rain Prior 5 Day	Today 9:56:19 AM		
	<input type="checkbox"/>	S53	All Zones	Today 11:02:12 AM	OFF	ON
	<input type="checkbox"/>	S47	Area 3 Active	Today 11:02:12 AM	OFF	ON
	<input type="checkbox"/>	S48	Area 4 Active	5/11/2006 7:33:14 AM	OFF	ON
	<input type="checkbox"/>	S49	Area 5 Active	5/14/2006 10:04:28 AM	OFF	ON
	<input type="checkbox"/>	S50	Area 6 Active	5/12/2006 2:28:37 PM	OFF	ON
	<input type="checkbox"/>	S51	Area 7 Active	5/11/2006 1:08:46 PM	OFF	ON
	<input type="checkbox"/>	S52	Area 8 Active	5/13/2006 1:19:37 PM	OFF	ON
Auto	<input type="checkbox"/>	S79	Auto-Manual Mode	5/18/2006 11:46:43 AM		
2.6.60	<input type="checkbox"/>	S82	Available Version	5/18/2006 8:37:12 AM		
3	<input checked="" type="checkbox"/>	S54	Average Wind for 60 Mins	Today 12:02:55 PM		
	<input type="checkbox"/>	S46	Backyard	Yesterday 12:54:32 PM	OFF	ON
OFF Soil -50%	<input type="checkbox"/>	J12	Bubblers Stair Deck	Yesterday 1:30:24 AM	OFF	ON

Figure 63 General Status Customizations

## 7.2 Reference Pictures

mcsSprinklers provides the facility to manage drawings and pictures that are provided by the user. These pictures will provide a visual for the site, for an area, for a zone, or for wiring. The picture is presented as a browser popup window and is produced when a camera/picture icon is clicked. As an example observe the popup window and the picture icon for device S46 in Figure 64.

During startup of mcsSprinklers it will look in the relative folder path “\HTML\mcsSprinklers\Pictures\” where the base folder is the install folder of mcsSprinklers which is typically “C:\Program Files\mcsSprinklers”. Any .jpg, .png, or .gif file that it finds in that folder that has the same name as the name of a wiring harness, site, area, or zone will be used as picture icons on the General Status, Zone Setup, or Wiring setup pages. If the touch screen view is going to be used then only .jpg files should be used to identify the zones and areas.

The Site name is entered on the Others Setup Page. The Wiring Harness names are entered on the Wiring Setup Page. The Area names are entered on the Zone Setup Page. In the example of Figure 64 the Area 2

name entered on the Zone Setup page is “Backyard”. The file “Backyard.jpg” exists in the folder “C:\Program Files\mcsSprinklers\HTML\mcsSprinklers\Pictures\”. Note there was also a file of the name “Front” and one of the three accepted file types in the same folder since device S45 Area 1 name is Front.

The search for picture files only occurs during startup because it also reads the file contents to determine its size. The processing time to perform this size analysis is undesirable to be repeat for each setup change. This means that after the site, wiring, area, and zone names have been entered there will be a restart of mcsSprinklers needed before the associated pictures will be recognized.

mcsSprinklers will also allow the pictures to be identified as part of the setup on the Wiring, Zone and Other setup pages. In this case they can be located anywhere on the LAN and mcsSprinklers will provide a browse capability to locate them. It will then move them and rename them into Pictures folder. In this case no restart of mcsSprinklers is needed after pictures are identified.

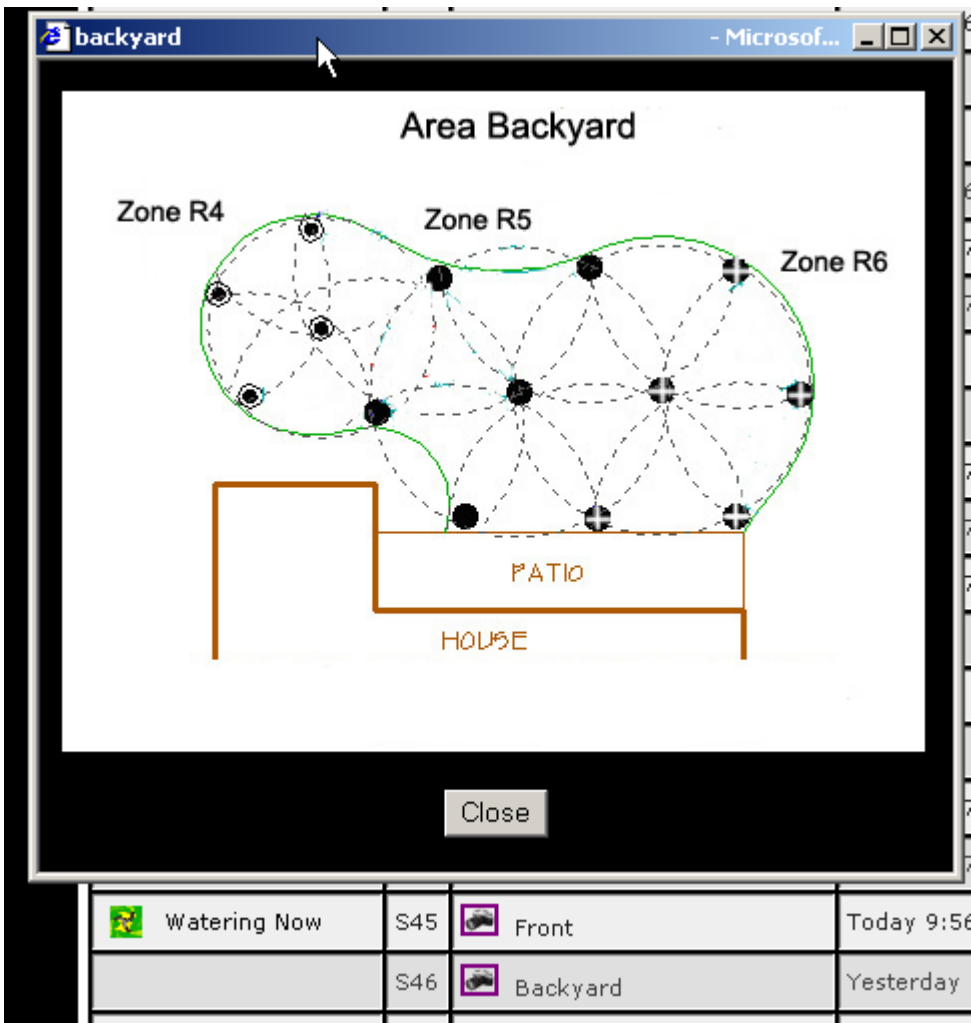
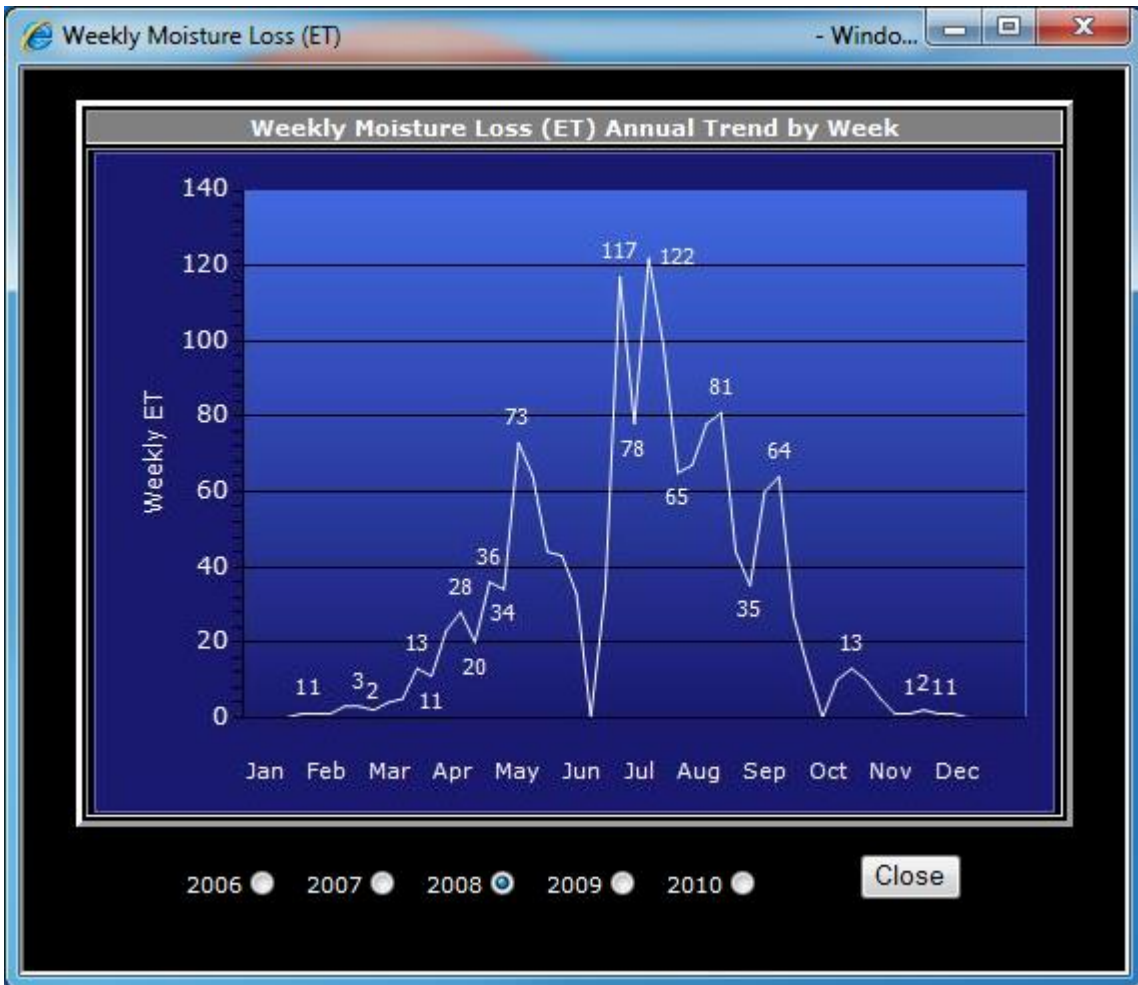

Figure 64 Reference Picture Popup

### 7.3 History Calendar

The Zone and sensor history is viewed in a calendar format for the last 90 days plus future days up to the next projected watering day for the zone. The calendar is a popup that is accessed by clicking on the calendar icon for a zone or sensor from the General Status page or Zone Status page. The number of days to display is a user preference item that can be changed from the Other Setup page.

The calendar presents a seasonal view of the irrigation history. More detailed information is shown when the day in the calendar is clicked. A broader annual trend is viewed by clicking the “Annual” button at the bottom of the calendar. A sample annual trend chart is shown in Figure 65.



**Figure 65 Annual Trend Popup**

The sensor calendars will show the daily sensor measurement. Depending upon a sensor this will be the cumulative or the maximum sensor value for the day. A monthly value is also presented in the header of each calendar month. When the day in a cell is clicked then an hour-by-hour accounting of the sensor is provided in a detail popup. These two popups are shown in Figure 66.

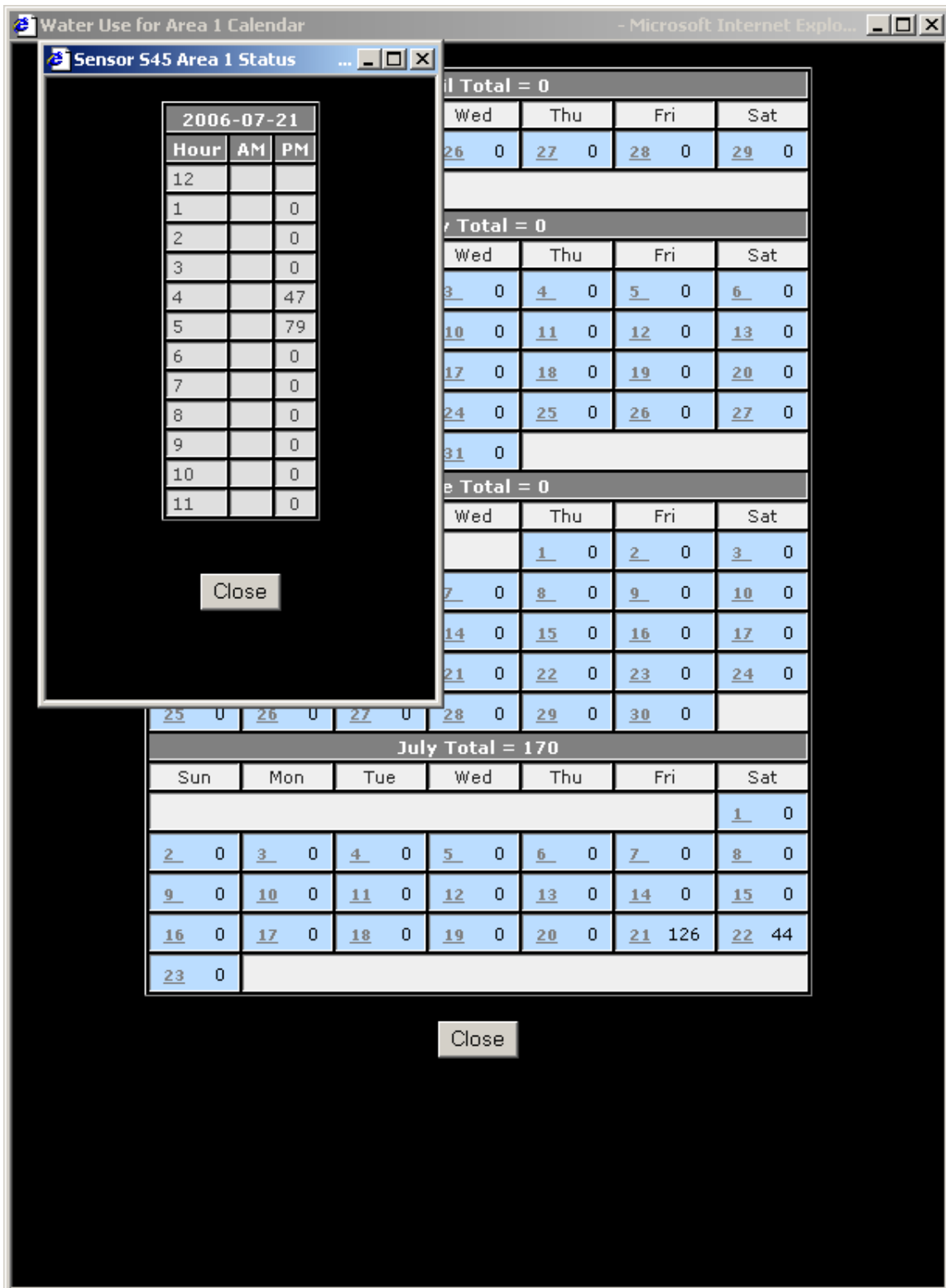

Figure 66 Sensor Calendar with Popup Detail

The zone calendars have three options available. The status option show irrigation days, rainfall days, and forecast using icons. Figure 67 shows a typical zone calendar in the status mode. A green sprinkler icon is

shown for each day the zone was run. A blue raindrop will be shown for each day where rainfall occurred. The future days will be shown with the weather icon and/or blue sprinkler icon for the projected next irrigation day. The mid-day current weather condition icon will be shown in lieu of the raindrop icon when no rain was recorded for the day if the icon source is selected on the Weather Setup Page. When a calendar cell in the area reserved for an icon is clicked a detail popup is presented. The information in this popup shows the statistics for the zone for the selected day as well as the total time that the zone has operated.

The zone calendar includes a radio button selection to change the zone view from status to either run minutes or water use for the zone. The calendar's presented for these other two modes will use a format similar to the sensor calendar.

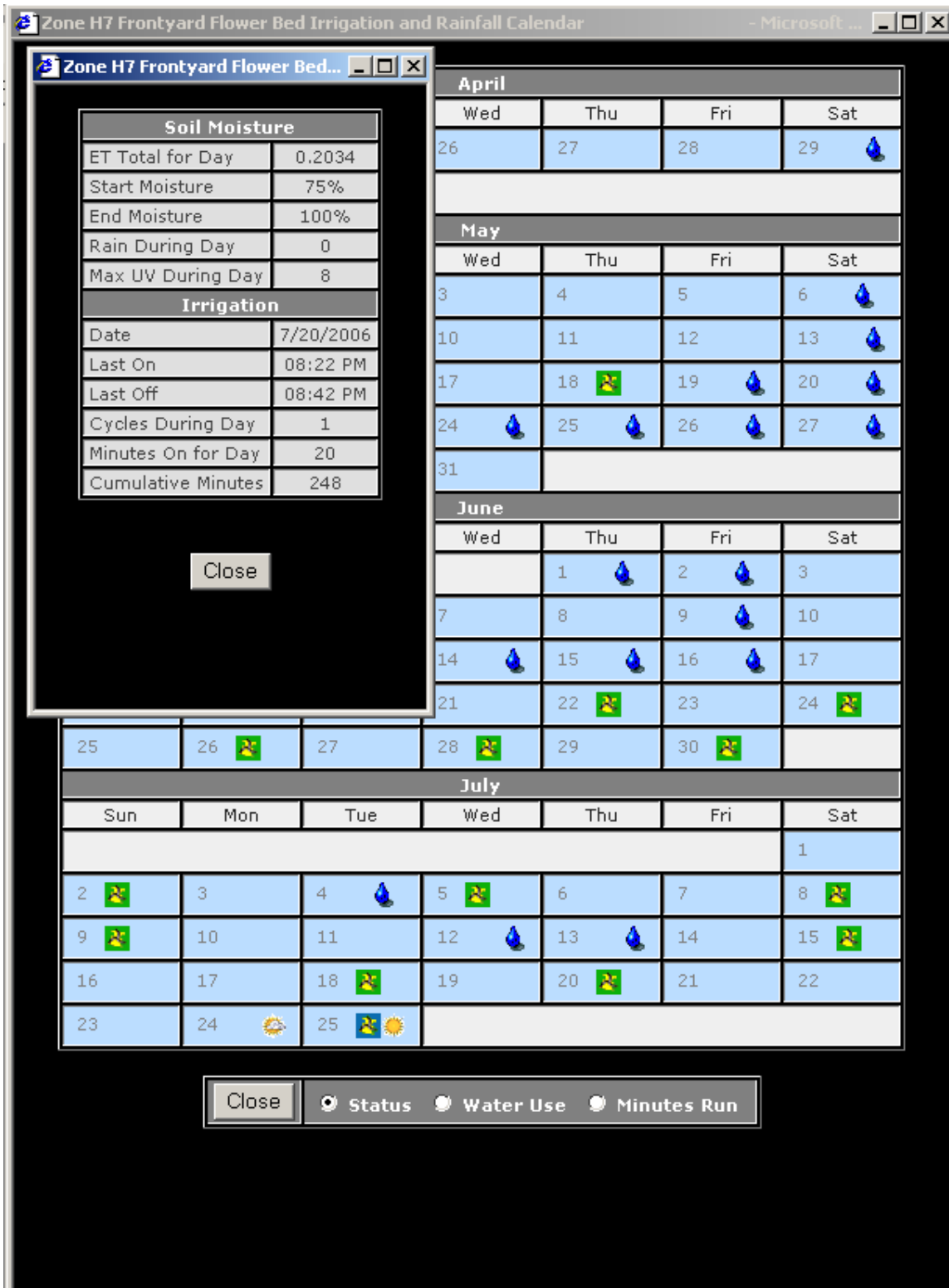

Figure 67 Zone History Calendar Popup



## 7.4 Zone Status

The zone status page is shown in Figure 55. Ten pieces of information are provided for each zone. At the top in the Area header bar is the area to which it belongs and the Control Strategy for this area. This information is only provided on the Area Sort.

The Zone header contains the Device Code and Name of the device, the zone's watering status with both a color dot and description, number of minutes for which it has been watered during the week and the calculated moisture level of the soil in this zone.

The control status is shown by a color dot and text description. The colors can be as follows:

- Blue – watered earlier today
- Green – watering now
- Yellow – to be watered within the next day
- Red – not to be watered within 24 hours

When blue, the zone is prevented from watering again today, but the web page will show a checkbox that resets this condition for any Blue dot zone. This checkbox can also be reset via use of the Alias device setup on the Area Tabs.

The day and time of the next predicted water time is shown for each day. If the control strategy is time-based then the prediction should be accurate. If the control strategy is closed loop then the accuracy will be greater as the next watering time approaches. It is also dependent upon the quality of the parameters provided to calculate soil moisture and the quality of the weather forecast.

Zones can be deselected from automatic control with a checkbox entry. It will retain this “disabled” status until the checkbox is cleared.

The two rows in the left column are used to enable and disable automatic and manual control respectively. Automatic control times are done in the Area Tabs of the setup page and can be changed from the web view in the text box on the first row of the zone information. The number entered is an integer number of minutes. Manual control times are done with the text box on this web view.

The prefix to the automatic control time text box is the predicted time when the zone will next be run based upon the current parameters defined for sprinkler control. Below this predicted next watering time is the actual last watering time.

If the zone has been watered today then another checkbox will appear to the right of the last watering time. If this checkbox is checked, then this zone will again be enabled for watering today.

On the right is a graphic showing the moisture level over the last seven days. It is scaled with the control threshold as the minimum level and 100% as the maximum. The current moisture level graphic is also shown.

## 7.5 Run List

The run list is a view that shows the projected watering time for all enabled zones. It is sorted in order of run time to provide a quick view of the sequence that is projected based upon the control strategies and current conditions. The page can be seen in Figure 68.

The Status indication will typically be green when a zone is running and yellow or light blue depending upon how far into the future the projection is. The zone name includes a clickable icon to get to the calendar view of the zone for a history of that zone's activity. The remaining columns show the information about the zone and its projected next watering time.

Stat	Zone	Area	Soil	Projected
●	R1: Front By House	Around House	0%	Today 9:00 PM
●	R2: Front By Street	Around House	0%	Today 9:28 PM
●	R3: Front Side	Around House	0%	Today 10:04 PM
●	R4: Back By Fence	Around House	0%	Today 10:24 PM
●	R5: Back Side	Around House	0%	Today 11:00 PM
●	R6: Back By House	Around House	0%	Mon-10th 12:00 AM

Figure 68 Run List Page

## 7.6 Priority Messages

When mcsSprinklers is trying to provide notification of an unusual situation then it will provide a popup from the tray icon. This occurs when internet data update has stopped, a change in the active redundancy occurs, irrigation could not complete for the day, or a significant unexpected software event.

The log of message since the start of the mcsSprinklers session can be viewed by either of two means. One is via the messages option when the tray icon is clicked. The messages can also be viewed from the browser interface by selecting the Messages link at the top of each page. A page similar to Figure 69 will be shown.

The messages are also contained in the mcsSprinklers subfolder HTML\mcsSprinklers\Data\StartupTrace.txt and can be copied for other reference. This file is created at each mcsSprinklers startup so if a copy is desired then it must be made before a restart.

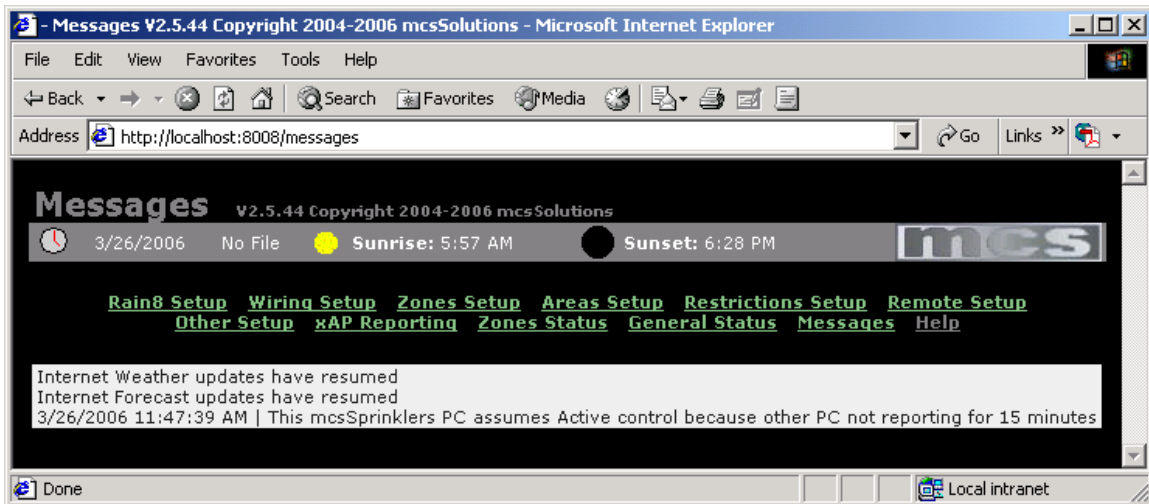

Figure 69 Priority Message Page

Priority messages can be viewed at any time. An Email notification can also be provided when such a message occurs. This notification is setup on the Other Page with the notification setting shown in Figure 71. When the message is delivered it will contain the message in the subject of the email and the entire contents of the log in the message body. The same email can also be sent to mcsSprinklers.com to assist in product support by selecting the CC checkbox on the email notification section. Email messages are

limited to one per 60 minutes. The message will provide notification of potential action necessary. A more complete accounting of items needing attention can be viewed from the Message Page.

mcsSprinklers delivers Email directly to your Email server. Some Email servers require authentication with user name and password and some use POP for the login. If your Email Server requires either of these then the appropriate fields in the email notification need to be entered. One approach to assess what is required is to observe how your email client is setup (e.g. Microsoft Outlook) to send and receive email. The same settings used there will be used here. If you use Outlook you can view the settings starting at the Outlook menu, Tools/Options/Mail Setup/Email Accounts/View Existing/Select Account/Change to bring up the form such as shown in Figure 70. Note that for mcsSprinklers the Outgoing server (SMTP) is the one of interest. mcsSprinklers does not accept external email so the Incoming server name is not needed in the mcsSprinklers setup. Different versions of Outlook and different email clients will have different methods to setup the email account, but the SMTP server and logon information is usually included as part of its setup.

The screenshot shows the 'E-mail Accounts' dialog box in Outlook. The title bar reads 'E-mail Accounts'. Below the title bar, the section is titled 'Internet E-mail Settings (POP3)' with a subtitle 'Each of these settings are required to get your e-mail account working.' and an icon of an envelope. The dialog is divided into four main sections: 'User Information', 'Server Information', 'Logon Information', and 'Test Settings'.  
- **User Information:** 'Your Name:' is 'myName', 'E-mail Address:' is 'myName@myEmail.com'.  
- **Server Information:** 'Incoming mail server (POP3):' is 'does not matter', 'Outgoing mail server (SMTP):' is 'stmpout.net'.  
- **Logon Information:** 'User Name:' is 'myEmail', 'Password:' is '\*\*\*\*\*', 'Remember password' is checked, and 'Log on using Secure Password Authentication (SPA)' is unchecked.  
- **Test Settings:** A note says 'After filling out the information on this screen, we recommend you test your account by clicking the button below. (Requires network connection)'. There is a 'Test Account Settings ...' button and a 'More Settings ...' button.  
At the bottom, there are three buttons: '< Back', 'Next >', and 'Cancel'.

**Figure 70 Typical Outlook Email Settings**

The “Send a Test Email” button can be used to try the settings that you have entered. If success you will receive an email message. If there was a problem then the information provided by your Email server will be visible from the Messages Link or Messages Menu item.

Email Notification		
Email address to send notifications of major events myName@myEmail.com		CC mcsSprinklers.com <input type="checkbox"/>
SMTP Mail Server smtpout.net	SMTP Port 25	Authentication Required <input type="checkbox"/>
Account Username myEmail		Account Password ●●●●●●
POP Server	POP Server 110	<input type="checkbox"/> Login via POP
Send a Test Email		

Figure 71 Email Notification of Major Events Setup

## 7.7 Log of Valve Control

Each valve control action is logged in a database and this log can be reviewed to provide evidence if a zone has been run. The log is accessed from the “Log” browser link at the top of each page. It will show the sequential record of each valve action over the past week. Figure 72 shows a typical log. The order can be sorted using the Time, Valve, Location, or Status buttons. The view can be restricted to less than seven days by entry of a Since date and using the Log Since button. The entire log can be deleted with the Clear Log Button.

The Control Log selection as part of the Miscellaneous Options on the Site Page is available to toggle the inclusion/exclusion of the STATUS\_REQUEST and response in the log. This selection is shown in Figure 44.

# Control Log

V2.6.42 Copyright 2004-2006 mcsSolutions



5/9/2006

No File



Sunrise: 5:55 AM



Sunset: 8:05 PM



[Rain8 Setup](#) [Wiring Setup](#) [Zones Setup](#) [Areas Setup](#) [Restrictions Setup](#) [Remote Setup](#)  
[Other Setup](#) [Zones Status](#) [General Status](#) [Log](#) [Messages](#) [Help](#)

Clear Log		Log Since 5/9/2006	
Time	Valve	Location	Status
5/9/2006 10:48:01 AM	I1	Rain8 Left Front Entry Shrubs	on
5/9/2006 10:50:49 AM	I1	Rain8 Left Front Entry Shrubs	off
5/9/2006 10:52:04 AM	I1	Rain8 Left Front Entry Shrubs	on
5/9/2006 10:52:56 AM	I1	Rain8 Left Front Entry Shrubs	off
5/9/2006 10:53:05 AM	B1	Rain8 B1	on
5/9/2006 10:53:15 AM	B1	Rain8 B1	STATUS REQUEST
5/9/2006 10:54:32 AM	B1	Rain8 B1	off
5/9/2006 10:54:42 AM	B1	Rain8 B1	STATUS REQUEST
5/9/2006 10:55:05 AM	I2	Rain8 Left Lower Entry Shrubs	on
5/9/2006 10:56:05 AM	B1	Rain8 B1	off
5/9/2006 10:56:15 AM	B1	Rain8 B1	STATUS REQUEST
5/9/2006 10:56:36 AM	I2	Rain8 Left Lower Entry Shrubs	off
5/9/2006 10:57:59 AM	B1	Rain8 B1	on
5/9/2006 10:58:09 AM	B1	Rain8 B1	STATUS REQUEST
5/9/2006 10:59:08 AM	B1	Rain8 B1	off
5/9/2006 10:59:18 AM	B1	Rain8 B1	STATUS REQUEST

Figure 72 Log of Prior Week Valve Actions

## **8 Interface Details**

### **8.1 Rain8 Module Control**

#### **8.1.1 Rain8-Net**

The Rain8-Net is managed directly via a serial port on the local PC. A valve command is delivered, the Rain8-Net acknowledges the commanded valve state, and mcsSprinklers status devices are updated. Three retries will be performed should the expected acknowledge not be received. After three retries the valve status will be set to Fail. In a Homeseer configuration the fail status will be observed as Unknown status.

For Rain8Net devices connected through IP/Serial adapters, mcsSprinklers will cycle power on these devices when a connection is lost and cannot be reestablished. To take advantage of this capability there needs to be a device such as an appliance module that can be controlled by X10, UPB, xAP or Homeseer device.

#### **8.1.2 Rain8-Wireless**

The Rain8-Wireless is managed via a local serial port, via xAP-X10 command, or the Homeseer X10 interface should this Homeseer interface support RF X10. In all cases the command is delivered and mcsSprinklers status updated at time of command. There is no confirmation of the commanded state.

#### **8.1.3 Rain8-X10**

Rain8-X10 control operations are the same as the Rain8-Wireless.

#### **8.1.4 Rain8-X10-2**

When the Rain8-X10-2 is connected to the local PC port managed by mcsSprinklers then the Rain8-X10-2 module should be configured to provide an acknowledge on command. mcsSprinklers will expect the status acknowledge from the Rain8 and retry and report fail status as is done with the Rain8-Net. mcsSprinklers status is only updated on receipt of Rain8-X10-2 status.

When the Rain8-X10-2 is controlled by another interface then it should be configured to provide status only when polled. This will reduce the potential for power line collisions that can occur when the controlling interface is not expecting the immediate status response. In these cases mcsSprinklers will issue a Status Request thirty seconds after the command was issued. While other power line activity may be occurring at this time, there will not be any other mcsSprinklers power line commands at this time. mcsSprinklers status is updated on command as is done with the Rain8-X10, and if the response to the Status Request is different than the command then the mcsSprinklers status will be updated to the reported status.

#### **8.1.5 EtherRain**

The EtherRain is connected to the local PC via a LAN connection using an IP address. The EtherRain module is managed as a set of eight valves. When communications are lost to the module then all eight valves are considered failed. Two retries are used for each communication attempt before failure is declared.

#### **8.1.6 Homeseer Virtual Devices**

When the Homeseer interface is used for X10 or other virtual devices then mcsSprinklers will use the status provided by Homeseer. mcsSprinklers status will be updated on command and changed if Homeseer provides a later change of status. Commands going through the Homeseer interface will occur no faster than one command per 3 seconds. This is done to minimize the chance of power line bandwidth overutilization.

## **8.2 Alternate Sensor Interface**

### **8.2.1 Weather Data**

Weather data can be obtained from a variety of sources that are selected on the Setup8 - Weather Page. These can be from the Internet from AccuWeather, US National Weather Service, WeatherUnderground, and OpenWeatherMap. It can be obtained via the LAN using xAP message schema Weather.Report or xAPBSC and MQTT Topics. It can be obtained from the LANs file system using a text file in a comma-separated-values format. It can also be obtained from Homeseer virtual devices when interfaced via Homeseer.

Weather information is expected from the xAP interface using the Weather.Report schema for both localized current weather and the more general Forecast. Should either of these sources become stale, mcsSprinklers will initiate the collection of data from the Internet. The xAP priority exists because some environments use xAP to obtain data from the internet and the priority schema reduce the internet access traffic.

Forecast data will be obtained no more often than once per 30 minutes. OpenWeatherMap or WeatherUnderground data will be obtained on 5-minute intervals except when Wind is selected as a restriction criterion and then it will be done on 1-minute intervals. The WeatherUnderground data will be obtained from the primary source when available. After three “no reports” from that site the secondary and then tertiary site will be used.

Since weather and forecast data is obtained from the internet there must be a connection to the internet that allows mcsSprinklers to access the reporting sites. This means an always-on internet connection must be available and any firewall must allow mcsSprinklers to pass data. The reporting sites selected for Current Weather and Forecast are also expected to update their information on a regular basis. Should any barrier to successful updates occur for one hour of Current Weather or two hours of Forecast then mcsSprinklers will provide notification. In a Homeseer environment status will be provided by changing the status of the Last Weather or Last Forecast status devices. In the Standalone environment it will popup a message from its tray icon. When this situation occurs, it may be useful to observe the contents of the files starting with “~” in the C:\Program Files\mcsSprinklers\Data\mcsSprinklers or C:\Program Files\Homeseer 2\Data\mcsSprinklers folders on the computer. These will contain the last downloaded data from the internet sites.

When internet weather data becomes stale then mcsSprinklers reverts to using historical ET values for the calculated control strategy. When only the OpenWeatherMap or WeatherUnderground data becomes stale then mcsSprinklers will use the current temperature, humidity, and wind speed from the forecast site. The loss of internet data will only affect the calculated control strategy and the status showing in the General Status page.

### **8.2.2 Local Sensor Data**

Weather data will be used for the primary sensors unless an alternate is provided. In a Homeseer configuration the alternate is identified by virtual device code. Any non-blank device code will become the source of the sensor rather than from the weather data report. The Homeseer Device String is expected to contain the data. HTML tags can exist in the Device String content and these will be removed by mcsSprinklers.

xAPBSC.Event or xAPBSC.Info schema messages can be used as external means. The Target address will be blank or resolve to mcsSprinklers address for it to be accepted. The sensor value can be contained in either the Text or the Level key of the BSC message.

MQTT subscription to any topic from a single MQTT broker can be used. The numeric value of the received message will be used. The MQTT broker is identified by its network name.

The Weatherhawk weather station is interfaced using the LAN and a HTTP protocol supported by the Weatherhawk. This is done via the IP addresses setup for the Weatherhawk.

Other weather instruments are typically interfaced using the computer's file system and a text file. The software interfacing the weather instrument will produce a comma-separated-values text file with the current conditions reported by the instrument. mcsSprinklers will periodically read the first line of this text file and extract the data in the column specified in the Setup8-Weather for CSV input. Column 1 is the first column number. Data will be time-stamped by mcsSprinklers when it is input. Any timestamp produced to the weather instrument interface software is ignored. Multiple lines are also ignored so it is not possible to import historical data into the mcsSprinklers database but can only input current conditions.

The preferred method to accept csv data is with a one-line file. It is also possible to accept a larger file and use the last line of the file. Provisions exists to process multiple lines to sum data over an hourly interval should it be necessary. The options for these capabilities will be provided when the sensor is selected to have a csv source.

The csv file can be local to the computer, the LAN or retrieved via http or ftp protocol for a remote location. If the start of the file name is http: or ftp: then it will be retrieved via IP interface. If running on a Linux system then the file path can be relative to the root of the data drive and this is indicated by not using a slash at the start of the path. For all other Windows and Linux cases the file name should be the full path.

### **8.2.3 Inhibit Device**

A user-controllable inhibit device is available as a Homeseer virtual device or as a xAPBSC.Event/xAPBSC.Info message. The Homeseer Device Status is used with values that resolve to ON (2) to cause the inhibit restriction condition to occur. The xAP BSC message State key is used with a value of ON to activate the inhibit condition. If the inhibit via xAP is connected to something like a rain sensor then some form of periodic messages are recommended to assure that mcsSprinklers will be aware of the unit's status.

### **8.2.4 ET Radiation Sensor**

The primary contributor to the ET calculation is solar radiation. If the ET sensor is specified then it will be used. The expected ET sensor value is the daily ET which will increase throughout the day and then reset to 0 at midnight.

If both a Temperature Sensor and Solar Sensor are identified then the solar radiation will be based upon these. The Solar sensor in this context is the "in the sun" temperature while the Temperature Sensor is the "in the shade" temperature.

### **8.2.5 Water Meter**

The water meter is associated with a pump within an Area. The water meter sensor can still be used when no pump device is indicated. If a single meter exists for the site then this same meter address should be used for each Area so the water use for all zones will be measured.

The water meter input is expected to measure the daily water use in terms of gallons or liters. It can also measure the running total that does not reset at midnight.

## **8.3 Alternate Control Operations**

### **8.3.1 Homeseer**

Homeseer presents a virtual device interface that is user-controllable and this interface can be used via the Homeseer user interface or scripting. Any control that is available on the mcsSprinklers General Status



page will be available for control via Homeseer. Any status on this same page will be available to Homeseer as a Device Status or Device String depending upon the control and context. The Device Value will also be populated with the numeric value of the device scaled by 100.

The scripting interface for a Homeseer user is via the plug-in object. The object of interest for the Professional level is `hs.GetPluginEx("mcsSprinklersP")` when iterating or `hs.Plugin("mcsSprinklersP")` otherwise. `mcsSprinklersS` or `mcsSprinklersB` is used for other levels. For standalone the object is `CreateObject("hspi_mcsSprinklers.hspi")`. Manual control of valves can also be done via their device code per the rules of the remote setup.

A typical use to determine number of minutes remaining on the current program schedule where the device S53 is the site status device.

```
Set mcs = CreateObject("hspi_mcsSprinklers.hspi")
sMinutesToGo = mcs.RemainingMinutes("S53")
```

The interface method prototypes are listed below.

```
Public Sub ForceNewDay()
    'reset all internal state information to a start of new day
    state
```

```
Public Property Get NextSprinklerZone(jArea As Integer) As String
    'Find the next zone in each area to be watered today
    'Return the next one independent of zone if jArea = 0
    'Otherwise return the next one
```

```
Public Property Get CurrentSprinklerZone(iArea As Integer) As String
    'Return the currently active zone of an area
```

```
Public Property Get PreviousSprinklerZone(iArea As Integer) As String
    'Return the previously active zone of an area
    'If Area input = 0 then find the most recently changed valve
    overall
```

```
Public Sub SetManualControl(sDC As Variant, iDuration As Variant)
    'set manual control duration of selected device
```

```
Public Function ScheduledMinutes(sDC As String) As Long
    'Return number of run minutes for auto program of selected
    zone
    'Selected device can be valve or area or site status devices
```

```
Public Function RemainingMinutes(sDC As String) As Long
    'Return number of run minutes remaining for selected zone
    that is active
    'Selected device can be valve or area or site status devices
    'Return 0 if not active
```

```

Public Function RemainingMinutes(bNoHTML As Boolean) As String
    'Return number of minutes remaining in currently running zone
    'or time when next zone is projected to start
    'Can be formatted with Icons in HTML based upon bNoHTML
    'Also includes the device code and zone name

Public Function OverallStatus (bStripHTML As Boolean) As String
    'Return a descriptive string for overall site status
    'This is intended to be available for other display devices

Public Function LoadSettings(sFile As String) As Boolean
    'Return true if load was successful
    'Used to command a configuration change from a file in the
    \Config\Alternate folder

```

### 8.3.2 xAPBSC.Cmd

xAPBSC.Cmd schema can be used to control any button that is available on the General Status page. The UID's for this control can be observed on the xAP Reporting page from a Browser. The subaddress or ID can be wildcarded per xAP rules if desired.

Only devices that have been checked on the xAP Reporting page will be processed. The same is true when using xAPBSC.Query to obtain current status from mcsSprinklers. Only devices that have been explicitly selected will respond to the Query.

xAPBSC can also be used to control valves if the valves are checked. The control, however, will only be allowed if an alias has been setup on the Remote Page for the valve.

### 8.3.3 xAP-X10 / Homeseer-X10

The Remote page of mcsSprinklers is used to associate relationships between an X10 valve and an X10 address that can be used manually control this valve. xAP-X10 or Homeseer X10 events are used to signal mcsSprinklers to take the desired control action. The alternate X10 address is referred to as the Alias.

If Homeseer is used to command the same X10 address as the valve then mcsSprinklers will attempt to override the control action at its next 1 minute control cycle. xAP-X10 commands received for valves that are controlled by the serial port managed by mcsSprinklers will be accepted for the Alias. Direct valve control will be ignored.

## 9 Redundancy and Backup

Dual computer redundancy has been depreciated as of mcsSprinklers 2.17.

mcsSprinklers is designed with considerations for use of redundancy and automatic reversion to backup sources and control. It can be configured to operate on a single computer or cooperatively on two computers. It can accept weather and forecast data from external sources and when not received from those sources it will obtain them locally from the internet. Internet weather data can be obtained from up to three sources and when these sources are not reporting then it will use the data from the forecast.

It also provides a self-monitoring capability for backup operation on a single PC or embedded platform. In the self-monitoring case, which is enabled with checkbox entry, the system looks for the mcsSprinklers process to disappear and will then restart it. mcsSprinklers performs its scheduling based upon a midnight to midnight interval. A restart at midnight option is also provided to assure each day starts with a clean slate and any anomalies will not propagate between days.

Testing can be done on the backup and monitoring operations with use of the “Test” button in the “Redundancy Backup Mode” section. When this button is clicked then mcsSprinklers will not send its health data and the backup mechanisms will kick-in after sufficient timeout. This will typically be from 10 to 15 minutes after the “Test” button is clicked. It can be clicked again to re-enable transmission of health data.

After a setting is changed for monitoring or backup then mcsSprinklers should be restarted to assure a proper startup sequence for the backup functions. This is not necessary and should not be done when the “Test” button is used.

### 9.1 Single PC Configuration

In a single PC configuration a backup is achieved by monitoring the operation of mcsSprinklers. When the monitor detects incorrect operation it will restart the PC, restart mcsSprinklers or halt mcsSprinklers to allow it to be restarted by other mechanisms. This mode of operation is selected with the Redundancy Backup Mode radio button set to “Monitored” per Figure 73. For this operation to be effective a shortcut to mcsSprinklers.exe must exist in the Window’s startup folder.

The monitoring is performed using xAP communication of a Role schema that is monitored by xapmcsMonitorRole.exe. xAP communications require a xAP hub to be running and this is satisfied by xapmcsHub.exe. Both of these applications are started when the Monitored mode is selected.

### 9.2 Dual PC Configuration

The multiple computer reduncancy configurations have been depreciated as of V 2.17.

#### 9.2.1 Control Moding

When mcsSprinklers is installed on two computers on the same LAN they can be configured to operate in either an active/standby or and active/active mode. In active/standby then the primary computer is controlling the valves and the standby computer is doing the same internal computations and observing the behavior of the primary computer. When the primary computer appears to have failed then the standby computer will then take over control of the valves. In an active/active mode then both computers are controlling the valves at the same time. There are tradeoffs between the two modes that will be discussed later. The Active/Standby (Standby Backup setting) is the recommended if dual hardware interfaces (e.g. two CM11A for power line interface) are used. Active/Active or Active/Standby is appropriate if single hardware interfaces exist.

The setup for dual PC operation is done on the Other Page in the section “Redundancy Backup Mode” as shown in Figure 73. Note that the blue color for most of these setup items. The blue indicates that the setting needs to be made individually on each of the two computers. The blue color appears when a Standby or Active backup mode is selected.

One of the computers needs to be identified as the primary. The primary is where the non-blue configuration information is retained. This means that all the setup, excluding the small segment shown in blue in Figure 73 is stored on the primary computer and referenced by the secondary computer using the network file sharing capability. This means that the mcsSprinklers folder (e.g. C:\Program Files\mcsSprinklers) must be a shared folder on the primary computer. The setup of file sharing is dependent upon the Windows operating system version.

The path to the primary computer needs to be entered as the full network path such as is shown in Figure 73.

The Takeover user-entry is the time for the secondary computer to wait before it assumes primary control. Internally the monitoring is done on five minute intervals so any value under 10 will produce unreliable results with primary control switching often. When in Active Backup (Active/Active) mode the takeover time does not have any operational significance since both computers are always actively controlling the values. What it does affect is the time it takes for the status device 73 to report a failed redundant computer. This status is shown in Figure 74. This notification will also show up as a priority message as is shown in Figure 69.

Redundancy Backup Mode		
<input type="radio"/> No Backup <input type="radio"/> Monitored <input type="radio"/> Standby Backup <input checked="" type="radio"/> Active Backup		Takeover in <input type="text" value="15"/> Minutes
Path to primary mcsSprinklers <input type="text" value="\\MCS5\c\Program Files\mcsSprinklers"/>		
Launch Redundant Applications on Startup		
Rain8 Interfaces	Control Interfaces	Data Collection
<input type="checkbox"/> Powerline Interface <input type="checkbox"/> Wireless Interface	<input type="checkbox"/> Voice Control <input type="checkbox"/> Handheld Remote	<input type="checkbox"/> Current Weather <input type="checkbox"/> Forecast Weather
Supplemental xAP Interface		
xAP UID <input type="text" value="FF000900"/>	<input type="checkbox"/> Writelog	<input type="checkbox"/> Basic Status and Control
<input type="checkbox"/> Start Hub	<input type="checkbox"/> Voice	<input checked="" type="checkbox"/> Weather Input

Figure 73 Dual PC Setup

☉ Today 11:09 AM	S70	Last Forecast Received	Today 10:59:29 AM	
☉ Today 11:36 AM	S71	Last Weather Received	Today 10:53:19 AM	
irrigation active	S72	Self Redundancy Mode	Today 11:08:30 AM	
irrigation active	S73	Other Redundancy Mode	Today 10:53:19 AM	
Auto	S74	Auto-Manual Mode	Today 10:48:08 AM	
	S75	Skip Tomorrow	Today 10:48:06 AM	<input type="checkbox"/> OFF <input type="checkbox"/> ON
	S76	Manual Stop	Today 10:48:06 AM	<input type="checkbox"/> OFF <input type="checkbox"/> ON
	S77	Manual Override	Today 10:48:06 AM	
	S78	Seasonal Control	Today 10:48:06 AM	

**Figure 74 Redundancy and Moding Status Devices**

## 9.2.2 Independent Applications to Support Redundancy

mcsSprinklers contains interface drivers for the power line CM11A, RF output CM17A, RF input W800, Voice, and internet for forecast and weather. All of these interfaces are also available as independent applications that are interfaced to mcsSprinklers via the LAN using a xAP message protocol.

With the use of external interfaces then additional levels of redundancy and backup exist. For example, assume the X10 power line interface is setup on the Rain8 page to use xAP as the interface rather than an internal communication port. This then allows the Power line Interface application to be run independently and this same application can be used by both the primary and secondary computer. This works well in an active/active configuration to avoid potential X10 power line collisions that reduce the reliability.

It is also possible to run these impendent interfaces on a third computer or to run them on multiple computers which each computer having the redundant interfacing hardware. The way the system is configured is determined by the failure modes that one is trying to overcome.

When running in active/active mode then it is important that both computers see the same inputs. This included internet data and manual control inputs. If a W800 is used to accept handheld remote control inputs from a palm pad then this same input should be seen by both computers. To support this configuration there should be one W800 that is interfaced as an indecent application. This application can be run on any computer, and can be launched automatically by mcsSprinklers if it is on the same computer as mcsSprinklers. This is the checkbox entry for “Handheld Remote”.

The same rationale applies for the Forecast and Weather internet data. If the internet data is available from the independent application then mcsSprinklers will use it. If two mcsSprinklers computers are running, then both will see the data at the same time. If these independent applications are not run then each mcsSprinklers will recognize the data is not being received and will go to the internet to obtain the data. The two computers may or may not be scheduling in the same manner depending upon the success of the internet connection.

Status devices 72 and 73 show the current redundancy mode. These can be viewed in Figure 74. Device 72 reflects the computer on which the page is being viewed and device 73 reflects the reported status from the other computer. When the other computer fails to report in the user-specified takeover time then the status of device 73 will show a failed condition. Other than the failure condition a status of “irrigation standby” may also be observed when configured for active/standby operations.

### 9.2.3 Associated xAP Interface

The xAP LAN protocol imposes some needs on the configuration when redundancy is applied. When xAP is used then one xAP hub must be running on each involved computer. If one does not already exist then it can be launched by mcsSprinklers by checking the Start Hub checkbox.

Furthermore each application that uses xAP as a communication mechanism needs to have a unique identifier. The default for mcsSprinklers is FF000800. The default for the secondary mcsSprinklers is FF000900. These can be changed as necessary to assure that each application has a unique identifier.

## 9.3 Multiple Rain8Net Networks

When using the power line to provide distribution of commands to the Rain8X10 or the Rain8UPB there is usually no need to have more than a single power line interface for mcsSprinklers to manage. In the case of a large wired network using the Rain8Net then situations may arise where more than a single Rain8Net or Rain8 WiFi master will be put into service. This is especially true if the Rain8Net is in the Rain8 WiFi configuration where multiple WiFi IP addresses are being employed.

The multiple network configurations are supported by one of two methods. One is with multiple ports on the host PC and the other is with distributed interfaces using the LAN and xAP. When using multiple ports on the host PC then the setup is simply the identification of the number of masters and the port for each master on the Rain8 setup page. The only special consideration is that each Rain8 module must have a unique module address even though it is interfaced to different ports.

The multiple network configurations using the xAP interface within mcsSprinklers is supported with an instance of xapmcsRain8Net for each Rain8Master or WiFi IP address. Each instance of xapmcsRain8Net can run on the same computer as mcsSprinklers or they can be run on different computers within the same LAN. When run on the same computer then each instance will have its own folder from which to execute. To create the folder structure for xapmcsRain8Net then a new folder should be created and xapmcsRain8Net copied to that folder. An HTML folder should also be created within this new folder. The files, excluding subfolders, from the mcsSprinklers\HTML folder should be copied to the new HTML folder. This is repeated for as many instances as needed.

To automate the startup process a shortcut can be added to the Windows startup folder for each instance of xapmcsRain8Net. There will also be a shortcut to mcsSprinklers so that all software components will start at the same time. One instance of xapmcsHub must also be run on each computer on which either xapmcsRain8Net or mcsSprinklers is run. A shortcut to this in the startup folder is also appropriate.

Once the folder structure is setup then each instance of xapmcsRain8Net is configured to give each its unique identification and define the Rain8Net modules that it will interface. When first run an icon like  will appear in the tray. The setup can be accessed by clicking on the icon and selecting Browser. to bring up the page shown in Figure 75

A unique HTTP Server Port, xAP Identification, and Serial connection are needed for each instance. The default server port is 8016 so it is best to change the HTTP port for all but the last one configured so remote administration can be achieved with multiple instances running.

The Serial connectivity is the same type of setup as with mcsSprinklers where either an IP address and port or just a local serial port can be selected.

The xAP UID should be unique, but the first two characters must be FF and the last two 00. The instance number can be any alphanumeric text. The text entered will also appear in the tray icon the next time xapmcsRain8Net is started.

The tray icon can be hidden or left showing in the tray. Remote administration can be gained from a browser with the URL set to the computer network id followed by the server port and /status. (e.g. <http://mycomputer:8016/status>)

After the Rain8Net modules to be interfaced are connected then the “Find Rain8 Modules” button can be clicked in the same manner that was described for mcsSprinklers or the module numbers can be entered into the text box for the Rain8 Net module setup.

After the “Save Changes” button is clicked then a listing of the valves for all modules entered will show at the top of the page. Each valve that will be used should be indicated with a checkbox in the “Used” column. A name in Location column can also be entered to help identify it. It can be the same name entered on the Wiring page of mcsSprinklers, but need not be.

ON and OFF buttons will appear for any valve that is indicated as being used. These will provide local control of the valves independent of mcsSprinklers. They are primarily a diagnostic aide since control will normally be done via mcsSprinklers.

The “Send All-Off Command” button will command all the valves to the OFF state. The “Query Rain8Net Modules” button will refresh the status from the modules.

Save Changes    Refresh

Used	Status	ID	Name	Location	Changed	Control
<input checked="" type="checkbox"/>	OFF	01	Module 1_Valve1	Building 11 Front	Today 7:02:10 PM	OFF   ON
<input checked="" type="checkbox"/>	OFF	02	Module 1_Valve2	Building 11 Rear	Today 7:03:10 PM	OFF   ON
<input type="checkbox"/>	OFF	03	Module 1_Valve3		Today 4:36:03 PM	
<input type="checkbox"/>	OFF	04	Module 1_Valve4		Today 4:36:03 PM	
<input type="checkbox"/>	OFF	05	Module 1_Valve5		Today 4:36:03 PM	
<input type="checkbox"/>	OFF	06	Module 1_Valve6		Today 4:36:03 PM	
<input type="checkbox"/>	OFF	07	Module 1_Valve7		Today 4:36:03 PM	
<input type="checkbox"/>	OFF	08	Module 1_Valve8		Today 4:36:03 PM	

**HTTP / Browser**

HTTP Server Port <input style="width: 90%;" type="text" value="8116"/>	Browser Background <input style="width: 90%;" type="text" value="#000000"/>	Style Sheet <input style="width: 90%;" type="text" value="StyleNoBody.css"/>
---	--	---

**Connectivity**

Serial Comm IP Address <input style="width: 95%;" type="text" value="192.168.0.44"/>	Serial Comm Port <input style="width: 95%;" type="text" value="3010"/>
---	---

**xAP Identification**

xAP UID <input style="width: 95%;" type="text" value="FF001200"/>	Instance Number <input style="width: 95%;" type="text" value="1"/>
--	---

**Tray Icon**

Hide Tray Icon

**Rain8 Net**

<span>Send All-Off Command</span>	<span>Find Rain8 Modules</span>
-----------------------------------	---------------------------------

Comma-separated Rain8Net Module Numbers

**Refresh**

Query Rain8Net Modules

**Figure 75 xapmcsRain8Net Setup**



The tray icon also provides an I/O window popup that can also be used for diagnostics to observe the raw communications with the Rain8Net modules. This is similar to the Rain8/W800 I/O popup of mcsSprinklers.

After each instance of xapmcsRain8Net is configured then it can be put into service with mcsSprinklers. The two setup items in mcsSprinklers necessary to integrate into this configuration that are contained on the Rain8 Page of mcsSprinklers and shown in Figure 76 and Figure 77. The Rain8-Net interface is selected to be External via XAP Address with a text box entry of “mcs.Rain8Net.>”. The modules are identified by entering their module number in the text box of Figure 77. The “Find Rain8 Modules” will not be effective since the modules are not locally connected to mcsSprinklers internal port.

Module PC Interface	
Rain8-Net	<input type="radio"/> Internal via Port <input type="text"/> IP <input type="text"/> <input checked="" type="radio"/> External via XAP Address <input type="text" value="mcs.Rain8Net.&gt;"/> <input type="radio"/> External via XAP Serial <input type="text"/>
Rain8-UPB	<input checked="" type="radio"/> Internal via Port <input type="text"/> IP <input type="text"/> <input type="radio"/> External via XAP Address <input type="text"/> <input type="radio"/> External via XAP Serial <input type="text"/>
Rain8-Wireless	<input checked="" type="radio"/> Internal via Port <input type="text"/> <input type="radio"/> External via XAP Address <input type="text"/>
Rain8-Powerline	<input checked="" type="radio"/> Internal via Port <input type="text"/> IP <input type="text"/> <input type="radio"/> External via XAP Address <input type="text"/>

**Figure 76 Rain8Net Configured for Multiple Masters/IPs**

Rain8 Net	
<input type="button" value="Send All-Off Command"/>	<input type="button" value="Communication Test"/>
<input type="button" value="Find Rain8 Modules"/>	
Maximum time to wait for Rain8Net response	<input type="text" value="500"/> milliseconds
Comma-separated Rain8Net Module Numbers	<input type="text" value="2,1"/>

**Figure 77 Rain8 Net Manual Entry of Module Numbers**

When mcsSprinklers commands a valve of a module that is interfaced through xapmcsRain8Net it will send a message over the LAN. The module that recognizes the command will act upon it and provide a status response when the valve hardware indicates the desired position has been achieved.

If a status response is not received by mcsSprinklers within 15 seconds then it will reissue the command up to two additional times. Three no responses or the unexpected response will cause mcsSprinklers to show the valve as failed on its status display. This is the same behavior as if the valve was connected internally by mcsSprinklers.

## 9.4 Configuration Backup and Selection

mcsSprinklers maintains configuration setup information for the currently active setup is retained in the file ...\\Config\\mcsSprinklers.ini. Each time a configuration change is made it saves a backup copy of the prior configuration in the same location with a numeric suffix added to the filename. Up to 10 backups are saved in this manner. Restoration of one of these backups can be performed from the Other page, Configuration Administration section, Restore Configuration from Auto Backup selection as shown in Figure 78. The date of each of these backups will be shown in reverse chronological order.

It is also possible to develop more than one configuration, save the configuration, and then restore it. For example, there may be a springtime configuration, a summer one, and a third used to winterize the system. After all the settings are made as desired for a specific configuration then it is saved by giving it a simple name (i.e. not a file path or file name) and clicking the Save button from the Configuration Administration section. The configuration can be restored using the Load Configuration pull down from the same area.

The configurations can be manually loaded at any time or they can be scheduled for any day of the year to be loaded at midnight. The automatic scheduling could be used for situations where seasonal adjustments are necessary that go beyond the normal range of parameters provided by mcsSprinklers. To use the automatic scheduling of configuration changes there will need to be a set of configurations saved. Access to schedule these is from the calendar icon shown in Figure 78. Use of this icon will bring up the annual calendar. Clicking any cell in the calendar will make a second popup visible where the scheduled configuration file can be observed, changed or a new one entered. See Figure 79.

It is also possible to “undo” the last Load Configuration selection by selecting the “Restore to Before Last Loaded Configuration” button. When this is done the configuration that was active immediately before the Load Configuration operation will be restored.

The screenshot displays a software interface for configuration management. At the top, a header reads "Configuration Administration". Below this is a section titled "Load Configuration" which is split into two tabs: "Scheduled" and "Manual Now". The "Scheduled" tab contains a calendar icon, while the "Manual Now" tab features a dropdown menu. Underneath these tabs is a "Save Configuration" section with a text input field and a "Save" button. Below the save section, the text "Last Loaded Configuration: Summer2006" is displayed. A button labeled "Restore to Before Last Loaded Configuration" is positioned below this text. The bottom section is titled "Restore Configuration from Auto Backup" and includes a "Date of Backup" dropdown menu.

Figure 78 Configuration Save and Restore

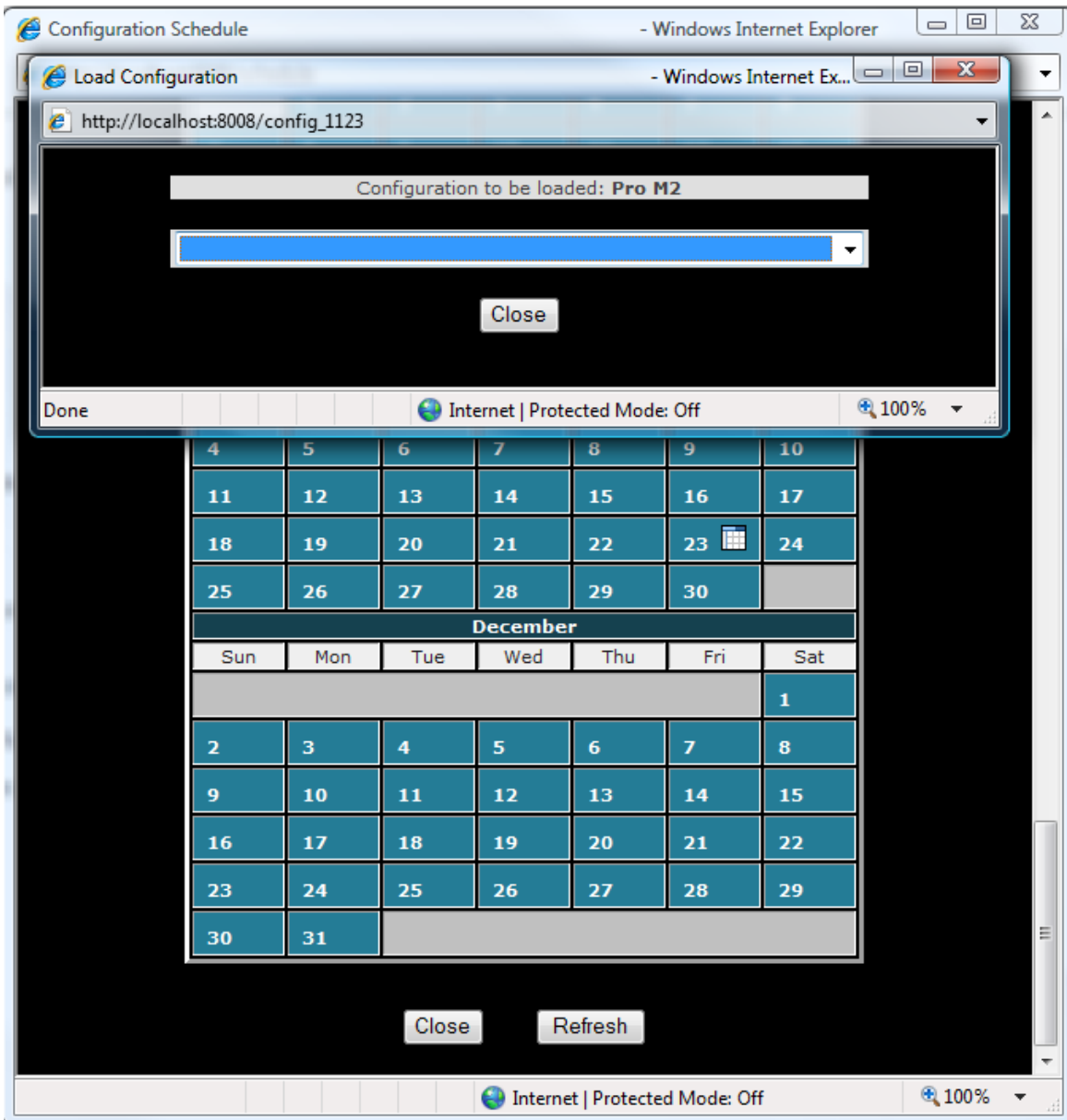

Figure 79 Automatic Configuration Load Scheduling

## 10 Setup Reference

### 10.1 Setup1-Devices

#### 10.1.1 Module PC Interface

The interface to the Rain8 modules can be either directly connected to a COM port on this PC or available on any PC that is on the same network. The radio button selection determines the interface location for each type of Rain8 Module and the box is used to enter the COM number or the Xap address.

The Xap address can be wild carded such as \*.CM11A.\* to indicate that any CM11A xAP node should respond to a command. An explicit target, such as mcs.CM11A.MyPC can also be used to specify as particular node on the network that is responsible for the power line interface with the CM11A.

The Xap Serial is used when the serial port is connected via xAP protocol using the xAPBSC schema. The Netiom is one device that supports this type of connection.

The Homeseer interface applies to the mcsSprinklers as a Homeseer plug-in and the interface is achieved using the ExecX10 Homeseer scripting method.

It is generally the case that internal COM ports are dedicated to a specific application and the same port cannot be used amongst applications. In the case of the Power line and Wireless interfaces they can share the same port if desired.

#### 10.1.2 Interface Test

When the RF button is pressed then an ON, 5-second delay, and then OFF is sent to device address A1. The same is done when the Power line button is clicked except the commands are delivered on the selected power line interface.

These buttons are intended to provide a means to test the connectivity of the Rain8 modules to the PC.

#### 10.1.3 Homeseer Devices

Devices that are to be controlled by the Homeseer generic X10 or IO interfaces are itemized in this list. Commas are used to separate device codes. For example] 3,]45,A5,B15.

#### 10.1.1 MQTT Broker

When using MQTT for either sensor input or valve control a broker is needed to route the MQTT messages. It can be identified to IP or by network host name. Normally port 1883 is used but can be changed. The broker can be setup to allow anonymous traffic or with more security using username and password. Similarly, it can be setup using encryption with encryption certificates identified.

#### 10.1.1 MQTT Topics

When MQTT is used to communicate to valves then each valve will need a Topic that is sent by mcsSprinklers when it wants to turn a valve on or off. mcsSprinklers will also listen to status returned from the valve device. Two entries are provided. The first is the Topic for the acknowledge that the commanded position was achieved. The second is if the valve device sends periodic status updates.

### **10.1.2 Rain8 Net and Rain8 WiFi Master Modules**

A typical Rain8Net or Rain8Wifi configuration will have one port on the PC with one or more Rain8 modules daisy-chained. It is also possible to use multiple ports on the PC with each connected to one or more Rain8 modules. This second configuration is most appropriate with the modules need to be physically separated.

The communication protocol is also specified in this section for how mcsSprinklers obtains valve status from each Rain8Net module. Each command sent to the Rain8Net is always confirmed and retried when necessary. Valve status is optional and can be after each command or every minute. If communications interface is robust then the polling every minute will assure proper synchronization between the hardware and software. If the interface does not maintain timing between commands very well then unexpected mcsSprinklers recovery actions can be observed.

### **10.1.3 Rain8 Net and Rain8 WiFi**

The All-off button will turn all valves connected to the Rain8-Net off. The Find Modules button will scan the Rain8-Net for all modules connected. A new window will show the current address being searched. At any time the search can be aborted by clicking the same button that now has an Abort label. Rather than searching it is likely easier to just enter the module IDs using a comma to separate each if more than one module is being used.

When communicating with the Rain8Net there will be some delay before a response is received. The value selected is the threshold before a retry is attempted and then eventually a failure declared. If the Rain8Net is connected via an IP/Serial device and communications are via IP then a reset of the IP/Serial device can be specified when there is an inability to establish a connection to the device. To use this capability the IP/Serial device needs to be plugged into a device to which power can be controlled. The control can be via X10, UPB, xAP xAPBSC schema or Homeseer device code. The address or device code is entered into the reset device field and the delay field will contain the time it takes for the IP/Serial device to power up and complete its initialization.

### **10.1.4 Rain8 UPB**

The All-off button will turn all valves connected to the Rain8-UPB off. The Module number box identifies the Rain8UPB modules that are connected. The module ID's are defined when the EPROM is programmed. They will be 1, 2, etc and correspond to UPB DIDs 1 through 8, 9 through 16, etc. The Network ID text box is used to enter the UPB NID.

### **10.1.5 Rain8 Wireless and X10 Power line Interface Module Assignments**

Rain8 Wireless and Power line modules are organized into lower bank and upper bank configuration where the lower bank is associated with unit addresses 1 to 8 and the upper bank with addresses 9 to 16. Each unit is also associated with a house code. The map of the type of interface vs. the house and bank is made by selecting the type of module radio button at the intersection of the House row and Bank column.

### **10.1.6 House**

This is the identification of the house code for the module.

### **10.1.7 Bank 1 to 8**

Select the radio button that identifies how a Rain8 module has been programmed. It is the intersection of the selected house code and lower bank.

### **10.1.8 Bank 9 to 16**

Select the radio button that identifies how a Rain8 module has been programmed. It is the intersection of the selected house code and upper bank.

### **10.1.9 Rain8 Wireless Valve 8 Configuration**

Rain8 Wireless can be configured to allow value number 8 of the module to be slaved to the other 7 valves or to operate independently. When independent, the module will control 8 valves. When slaved it will control 7 valves plus a pump.

### **10.1.10 Address**

Address of Valve 8 of the module

### **10.1.11 Valve 8 in Module**

Radio button is used to identify how the module has been programmed. When independent is selected then the module supports 8 valves. When slaved, the last valve will be on when any other valve is on and off when all other 7 valves are off.

### **10.1.12 EtherRain Modules**

EtherRain modules are identified by IP address and port. All modules are assumed to have the same username and password setup during configuration with the Quicksmart admin utility. Once the number of modules are selected then rows will be available to enter the IP address and port for each module. While identification by both module name and static IP are supported, the static IP will provide a more reliable operation.

### **10.1.13 Raspberry Pi Relay Configuration**

The Raspberry Pi contains a GPIO connector on which connection to relays can be made. The RPi output does not have sufficient current capacity to drive irrigation valves. The RPi has had two GPIO pinout connector has 40 pins. 26 of these are connected to the RPi processor for use as configurable inputs and outputs. mcsSprinklers uses only the output configuration to provide the logic levels to control relay-driven irrigation valves. The setup provides both the connector pin and the processor pin nomenclature. Any pin with a checkbox will be used as a zone for mcsSprinklers control. The others will not be used by mcsSprinklers.

### **10.1.14 Rain8 EPROM and Timers**

All Rain8 modules need to be programmed to identify as a minimum the address to which it will respond. Programming is done one module at a time with a direct connection to the PC and without any transformer or valves connected to the Rain8.

The programming of each Rain8 unit, independent of model, is done off-line via the Communication port identified in the programming port text box. The same port that is used for Rain8 Wireless or Rain8 Net can be used here, but the others will be disconnected when programming of the timers is started.

There are differences in the programming of the Timer EEPROMS so the type of unit needs to be identified. This is done with the three-option radio button in the Module Type group.

When reading the EEPROM, via the “Read Timeout Timers” button the House/Bank or Net address fields are populated based upon the contents of the EEPROM that was read.

When programming the units the address or House/ Bank code entries need to be entered before the “Download” button is clicked. In the case of the Power line and Wireless versions a House code and upper/lower bank specification needs to be entered before downloading timer values. Note that when the

download does occur the House code will be programmed into the unit as well. For the Rain8 Net the address in the range 1 to 255 is entered into the provided text box.

The right part of the Timers group contains a row for each Rain8 valve. The text boxes are used to enter the timeout values to be programmed into the EEPROM. They are in decimal minutes and different units have a different range of values that are valid.

The Download and Read button can be used at any time the unit is connected to the Programming Port to either download or confirm the contents. Note that the Communication port provides the power to the Rain8 when it is being programmed so no connection to the 24VAC transformer is needed during programming.

### **10.1.15 Programming Port**

The COM port number is entered into the box. This is the port to which a Rain8 module is connected to allow its memory to be read and changed.

### **10.1.16 Module Type**

Identify the type of Rain8 module that is connected to the programming port. The section is made with the radio buttons.

### **10.1.17 Module Address**

The Rain8-Net uses a numeric address in range 1 to 255. The other units use an alphabetic house code in the range A to P plus and identification of the bank. The selection made for the Wireless and Power line modules will have a corresponding entry in the above table when the unit is deployed.

### **10.1.18 Rain8-Net Timer Disable**

All Rain8 models can use timers as a safety measure. With only the Rain8-Net can these timers be disabled to allow a valve to remain on for an indefinite time. The checkbox is used to make this selection for the Rain8-Net model.

### **10.1.19 Rain8-Wireless Valve 8 Use**

The Rain8 Wireless model can be configured as 7-independent and 1-slave or 8 independent valves. When configured in the 7/1 mode then the slave valve will be ON when any of the other 7 is ON and OFF when all the other 7 are OFF.

### **10.1.20 Rain8-X10-2 Status Response**

The Rain8 2 Way can deliver a status response following each command or it can deliver this response only when requested using an X10 Status Request command. In a shared environment where the X10 interface is not managed by mcsSprinklers then the unit should be configured for poll status response only. In this case it will operate much like a 1-Way Rain8 X10 with the ability to poll. When managed directly by mcsSprinklers then the immediate status response is used to update the actual valve status only when an acknowledge is received rather than update upon command sent.

### **10.1.21 Rain8 Timers**

Timer values for each valve are entered in the text box. Maximum values are 250 minutes. Minimum values are 1 minute. A value must be specified except in the case for the Rain8-Net module when the timers are disabled.

Direct control of the Rain 8 series of irrigation controllers is provided via mcsSprinklers. The setup of the Rain8 is done on the "Rain8" Tab.

All Rain8 devices can be programmed with a timeout for a zone. When programming the timeout, a single Rain8 unit is connected to the Communication port for programming. Programming cannot be done in a multiple configuration or via mechanisms other than a direct connection to a serial port.



## **10.2 Setup2 - Wiring**

### **10.2.1 Wire Harness**

A wire harness represents a bundle of wire routed between the valve head and the Rain8 module. Any of the wires in the harness that are used will be assigned to a control valve. A harness can be given a name to assist with later identification. This name is not used later in the setup.

### **10.2.2 Wire Color**

Wire colors in the standard wire harness are listed. If physical wire colors are different then the color codes relationships will need to be edited. This accounting is only provided for convenience as the wire number does not have any effect on the irrigation capability. It will only be useful for later maintenance.

### **10.2.3 Control Valve**

The pull down contains all the Rain8 modules that were identified on the Rain8 Setup. The particular valve to which the wire is connected is selected with the pull down. Care should be taken so the same value is not assigned to two wires.

### **10.2.4 Location**

The location box is used to identify the valve with a friendly name. This name will be displayed on status pages and will be the name used in voice control.

## **10.3 Setup3 - Layout**

The layout page allows the valves that are defined in the wiring setup to be assigned to Areas or used for pump or fertigation control. When the valve is assigned to an Area, then its run time can be entered for the auto programs, manual operation or syringing. The layout page is shown in Figure 22.

Three columns of information are shown for each valve defined in the system. The column title button can be used to sort the valves by physical name, assignment or auto program time. The defined valves will be shown in a row with a light or medium gray background. The undefined valves will be listed in a blue background.

### **10.3.1 Identification**

The Picture column shows the information that was entered on the Wiring Page that identifies a valve. If a picture is available it will be shown. The textual description under the picture contains the physical valve identification and the zone name associated with this valve.

### **10.3.2 Assigned Use**

Each defined valve can be assigned to an Area, used to control a pump or fertigation valve, or left unassigned. The radio buttons in the matrix are used to identify the assignment. When used for pump or fertigation then the same valve can be assigned to multiple areas. The example in Figure 22 shows how the 8<sup>th</sup> valve of a Rain8Net module is assigned as the pump for Areas 1, 2 and 3. The zone valves that are assigned to an area can only be assigned to a single area. The first four valves are assigned as zones individually in Areas 1, 2 and 3.

The assignments made here will also be reflected in other setup pages. Zone assignments will be seen on the Zone Setup and Area Setup pages. The Pump and Fertigation assignments will also be visible on the Area setup page.

### **10.3.3 Minutes**

Three base irrigation times based upon the irrigation mode are shown in the Minutes column. The Auto time is the number of minutes that the valve will be turned on for the first time that a valve is activated on a day that the Area control strategy enables the valve. If there are multiple times used during the day for the same valve then a clock icon will show to the left the Auto entry. Another popup page such as is shown in Figure 24 will be shown if the clock icon is clicked. This page will allow other times to be viewed and changed. Other views of the daily program can be seen on the Timed Programs Page and the Area Page.

The Manual time is the maximum number of minutes that a valve will be allowed to run when the zone is manually enabled. A valve is manually enabled from a variety of locations including the Zone Status, General Status or remote mechanisms.

The Syringing time is the number of minutes that a valve will be activated when the syringing stress conditions have been satisfied. The syringing conditions are setup on the Site Page.

The values for the duration of three modes can also be setup on the Zone Setup Page. The Zone Setup Page will also allow for additional information that zone operations.

## **10.4 Setup4 - Zone**

The valves identified in this area group will be controlled by the control strategy of the associated area. This control strategy is defined in the Area Setup Page. Up to twelve zones can be grouped into an area. When an area is scheduled for watering then each zone, in the order entered, will be sequentially watered.

### **10.4.1 Valve**

The control valve for the zone is entered with the pull down. Selections available are those that have been defined in the Rain8 Setup and Wiring Setup pages.

### **10.4.2 Auto Minutes**

The number of minutes of watering for the selected valve is entered in the text box. This will be the number of minutes the valve will remain ON when an automatic watering cycle occurs. Integer values are used to indicate minutes. If durations with resolution to approximately one second is desired then the value is entered in the format mm:ss.

### **10.4.3 Manual Minutes**

The number of minutes of watering for the selected valve is entered in the text box. This will be the number of minutes the valve will remain ON when a manual control via the Web page, Voice, or RF Remote is actioned. Integer values are used to indicate minutes. If durations with resolution to approximately one second is desired then the value is entered in the format mm:ss.

### **10.4.4 Syringing Minutes**

The number of minutes of watering for the selected value for the mid-day syringing cycle. This is typically under five minutes and is activated based upon the Syringing control on the Other Setup page. Integer values are used to indicate minutes. If durations with resolution to approximately one second is desired then the value is entered in the format mm:ss.

### **10.4.5 Soil Efficiency and Rain Factors**

The Soil Efficiency and Rain Factor entries allow tweaking of the soil moisture content algorithm. Soil Efficiency relates to the ability of the soil to retain water with is a result of a combination of soil type and crop type. Higher values indicate that the soil will tend to retain moisture or the crop is efficient in holding moisture and does not allow moisture loss through its structure. A nominal value is 0.75. The Rain Factor relates to the degree that rainfall is allowed to reach the zone. A nominal value is 1.0 and a value of 0 indicates that the zone is covered and rainfall will not reach the soil level.

### **10.4.6 Fertigation Factor**

The fraction of time (from 0.0 to 1.0) to be applied to the zone's Auto Minutes for control of the fertigation valve that is identified on the Area setup page. The fertigation valve is slaved to the zone valve when turned ON and the turn OFF will be determined by the factor.

### **10.4.7 Calc Flow**

The entry is used to estimate water consumption when a metered source is not available. The number entered represents the gallons per minute or liters per minute of water use when the value is ON

### **10.4.8 Max Flow**

The max flow value is used in conjunction with a water meter. When the meter measurement for the zone exceeds the max flow value then a notification will be provided.

## **10.5 Setup5 – Area**

### **10.5.1 Zones in Area**

This section is for information only to show which zone have been defined for the specific area. The information about the zone includes the Harness ID, Wire Color, Value ID, Zone Name, and in the Homeseer case, the device code. For each zone two pieces of historical information is shown. The 30 day rate is the rate at which a watering cycle occurs. In non-timed modes this will be the soil moisture loss rate. Bar chart that shows the calculated percentage of moisture in the soil for a zone over the past seven days. This may be useful trend view to help adjust factors on the Zone and Area pages that characterize a zone's soil moisture.

### **10.5.2 Area Control Strategy**

One of six control strategies needs to be selected. The first three are variations of watering at fixed times. The next two schedule watering based upon sensor information. In the case of the interval method a starting day value can be entered that will allow different areas to be done using the interval methods, but occur on different phases of the interval. The last is misting control that is triggered based upon reaching a temperature threshold. The number of valves to control within an Area is selectable by user based upon a count or based upon a water flow capacity for all Areas except misting. When misting is active then all zones of the misting Area will run simultaneously for the duration setup for each zone.

To support the Measured method there are three types of information that are entered to characterize the desired operation. The soil sensor scale are three values that represent the 100%, 0% and the level at which an irrigation cycle will be started. The sensor that will be providing the soil moisture readings can be from a xAP or Homeseer virtual device source. This is selected with a radio button followed by entry of the source address. There is usually a delay between when irrigation occurs and when the moisture sensor registers the increase in moisture. A fixed delay is specified to prevent a second irrigation cycle from starting before the sensor registers the increased moisture. When the Calculated method is used then the sensor information will be collected from local sensors or the Internet based upon the weather station selected on the Other Setup page. The threshold entry in the box is the calculated ET value based upon these sensors at which an irrigation cycle will start.

### **10.5.3 Area Zone Sequence Control**

Three sequence options are available. The first runs all zones of the site in sequence with the number on the same time selectable by site. The second treats each area's zones independently with a maximum number of zones on at the same time selected by area. The last allows user to externally control sequencing while restrictions and pump control continue to be managed by mcsSprinklers.

In a setup where a single limited-pressure water source is available the selection will be normally to be make zones part of a single master sequence. If each area has a pump or the single source capacity can support multiple zones at the same time then the Zones in area sequence will be the normal selection. The Zones in area parallel selection is most appropriate for water features such as fountains where these features will all be started at the same time.

In a setup were adequate water pressure and flow rates are available then zones can be scheduled to run simultaneously to utilize the available flow. This can be done by identifying the number of zones that can be running at the same time or by the flow rate that can be supported. In the second case the zone by zone flow rates from the Zone Setup Page are used to support the scheduling.

For misting Areas sequence control is not available. Misting will occur based only on temperature limits and independent of any other zones in other Areas that may be active.

#### **10.5.4 Interzone Scheduling Delays**

A zone will normally be allowed to run for the auto duration specified. This total duration can be split into equal time segments so the zones in the area are watered in a round-robin fashion until the total duration has been done. The number of round-robin cycles is a text box entry. A delay between each round-robin cycle can also be added to assure that adequate time for water absorption exists between each cycle.

A fixed delay between each zone can also be added to account for other factors that dictate that irrigation is spaced over time rather than continuous.

#### **10.5.5 Area Water Supply**

This setup is used when control or monitoring of the water source is needed. When no entries are made then the assumption is that the water supply is always available.

#### **10.5.6 Pump Control Valve**

The pull down is used to identify the Rain8 valve that is to control the water source. If the water supply is enabled when the Rain8 valve is turned ON then the Enable=on selection is made. If the polarity is reversed then the other radio button selection is made.

#### **10.5.7 Well or Water Storage Discharge and Recharge Times**

If irrigation is limited by capacity of well or other holding tank then provisions can be specified as to how long an area can be continuously be running and then how long to wait for recharge.

#### **10.5.8 Flow Volume**

If a water meter is available to measure water flow when the area is active then select the source of the reading from this meter. It can be a xAP address, UPB Counter Input DID, or Homeseer device code where the Device String contains the meter reading. If the same meter is used for multiple areas then include the meter in each area.

The meter will be read when a zone is turned ON and when turned OFF to determine the consumption by that zone.

#### **10.5.9 Water Leak Monitoring**

Monitoring for excessive water use with a valve is turned on is setup by identifying the period of time in the recent past for which the average water use will be established. The second setup parameter is the percentage about this average that is needed to be considered excessive and for which notification is desired.

#### **10.5.10 Fertigation Valve**

Select valve that is used to control fertigation unit. The valve has previously been identified on the Wiring setup, but not assigned to any zone.

#### **10.5.11 Fertigation Control**

Select fixed percentage to use exactly the run time percentages setup on the Zone setup page for fertigation or variable to adjust this value based upon frequency of irrigation so more is applied as the irrigation period increases.

### **10.5.12 Fertigation Instrumentation Source**

If the media container has a sensor to indicate low volume then the source of this sensor is entered. This will allow mcsSprinklers to provide the notification when the media needs to be refilled.

### **10.5.13 Area Start Times and Duration Factors**

For timed control strategies watering will occur starting at midnight if no other restrictions are in force. The default start time can be changed with an entry in the Time 1 box. If more than one cycle is needed in a day then Time 2 through Time 24 boxes can be used to achieve up to 24 cycles in a day. The numbers entered for the time can be absolute times or times relative to sunrise and sunset based upon the radio button selections. These times only apply to the three timed control strategies.

A zone will be watered for the auto duration specified for the zone. The duration can be changed so each cycle within a day can have a different duration. 24 time slots are available. A factor of 0.5 will decrease the Zone duration by 50%. A factor of 1.5 will increase it 50%.

### **10.5.14 Area Inhibit Times**

The Area inhibit times perform the same function as the Restriction page between hours inhibit however they only apply to the zone in a specific area. For the span of time between the From and To entries no watering will occur for the area. The times are entered in the format of HH:MM or just HH if no minutes are used. The times are based on a 24 hour clock with values of 0 and 24 being equivalent. The inhibit times will prevent a zone from starting. A zone or area that is already started before the inhibit period can be allowed to complete based upon settings.

### **10.5.15 Area Restrictions**

Minimum days between watering will assure that an automatic watering cycle will occur no faster than the specified time. The maximum days values will assure the foliage will be watered at least as often as the specified interval. The maximum days does not override other restrictions.

Both the min and max considerations are most appropriate for the calculated ET and measured soil moisture control strategies. With timed strategies the interval between watering will be well-defined by the control strategy except in cases where restrictions may be such that watering times are skipped.

The Wind and Temperature restrictions are the same as the site restrictions for these parameters but apply only to a single area. When the weather conditions satisfy the thresholds then a zone that is currently running in the area will be stopped. A zone in the area will not be started if the weather threshold inhibits the irrigation. The Zone Status page indication will show the zone to be “Delayed” and the General Status page will show an area-specific restriction for this area.

### **10.5.16 Area Miscellaneous**

The carryover allows a zone that was inhibited during all scheduled periods of a day to be scheduled for irrigation on the following day independent of the control strategy scheduling. If, for example, an even-odd strategy is being used and the zone did not complete on the scheduled even day, then if carryover is enabled it will be scheduled to run on the next (odd) day.

Situations can occur when rainfall causes a zone to calculate moisture levels greater than 100%. For periods of continuous rain a zone may record up to 200% soil moisture level. When the rain stops and evapotranspiration starts the moisture accounting will either go immediately to 100% or it will gradually decrease based upon the calculated moisture loss. If the soil conditions are such that 100% is truly saturation then the option to snap to 100% is the appropriate setting. If the soil conditions will actually hold more than the assumed 100% then a gradual decrease is the appropriate setting.

Manual inhibit controls exist to keep irrigation from occurring on the current or next day. These controls can be set to be ignored such as may be desirable for drip scheduling that may not disturb the rationale why near term irrigation should be prevented.

### **10.5.17 Seasonal Percentages**

The values associated with each month will be multiplied by the Automatic watering times entered on the Zone Setup page and this product used as the actual watering time. It is intended to account for seasonal variation when using a timed control strategy. The control strategy is setup on the Area Setup page. 100 percent is nominal for summer. When a new zip code is entered the percentages will change to default to monthly average ET for the zip code. They can be changed and the values will be retained until the next zip code change. Seasonal percentages are not used for areas under mist, ET calculated or measured control strategies.

## **10.6 Setup6 - Site**

### **10.6.1 Watering Restrictions**

Watering restrictions limit times when watering will be performed. If no restrictions are selected then the watering schedule will be based solely on the Control Strategy setup page.

### **10.6.2 Don't on Day of Week**

For any day of the week where the checkbox is checked there will be no watering performed.

### **10.6.3 Don't Between Hours**

Limitations on the time of day that watering can occur is specified as a pair of times using a 24 hour clock. No watering will occur between each pair of times entered. The times can be entered as just an hour or as an hour and minutes using a colon separator (e.g. 10 or 10:14). A checkbox is provided to identify if the between hours restriction applies to any zone or applies to the start time for an area. When checked then any area that has started before the inhibited times will be allowed to run to completion during the restricted times. When it is not checked then no irrigation will be allowed during the restricted times.

### **10.6.4 Don't Even Odd Days**

Checks in either of the two checkboxes can be used if watering is not to occur on even-numbered days or odd-numbered days. This may be useful if local regulations dictate such restrictions.

### **10.6.5 Min Days Between Watering**

Entry in this box can be made to assure that watering does not occur too often. This is typically useful to encourage plant roots to travel deeper.

### **10.6.6 Don't with Wind**

Wind will typically disturb the watering efficiency. To avoid this situation watering can be restricted to periods without excessive wind. The threshold is entered in the first box. The period for which this average speed must be maintained is entered in the second box. Too low values in either of these boxes could result in a repeated starting and stopping of the watering valve.

### **10.6.7 Don't with Temperature**

The average temperature over the past one hour is used as the decision criteria. When it is under the user-entered value then watering in all zones will be suspended. A blank entry is used to not employ this restriction.

### **10.6.8 Max Cycles per Day**

Entry in this box is used to place a threshold on a watering cycle. It is appropriate for measured and calculated control modes where the watering period is determined by sensors. These sensors could fail or provide bad readings and could cause excessive watering.

### **10.6.9 Don't with precipitation forecast and actual**

Entries in this area are used to conserve water when either rainfall is forecast or significant rain has occurred recently. A line is enabled with a checkbox. If the optional entries on each line are left blank then values of zero will be used for rainfall probability or amount of rain that has fallen.



### **10.6.10 Don't with Evapotranspiration**

Moisture loss is calculated based upon sensor inputs. When the moisture loss is calculated to be less than some threshold then a cycle can be selected to be inhibited. A value of 0 for Days is the current day only. A value of 1 is for the max daily ET from yesterday through today.

### **10.6.11 Record inhibit reason in Message Log**

Each minute an evaluation is performed to enable a zone. When a zone is inhibited due to a restriction then this restriction can be recorded in the message log for later reference. The message log does not persist beyond mcsSprinklers sessions.

### **10.6.12 Don't With Homeseer Device**

Virtual device code that will inhibit watering when on.

### **10.6.13 Water Holding / Pressure Tank**

The water tank is modeled as a full level, a low level at which irrigation should be inhibited and a rate at which the tank is being filled. If a water tank is not being used then the full level should be set to 0 to indicate the lack of such a tank.

### **10.6.14 Syringing Options**

These settings define under what condition the syringing cycle, as defined in the Zone Setup page, is started. The cycle is run up to once per day and behaves like a manual control operation other than being started automatically. It can be triggered based upon a time of day, temperature or ET reaching a threshold or temperature reaching a low limit.

### **10.6.15 Manual Mode Update Options**

Time of last valve action and soil moisture content are always managed in the auto control modes. In the manual mode the time and/or soil moisture can be left unchanged or can be updated as is done in the auto mode. One may not want to update these when an auto control strategy depends upon them such as min days between watering.

### **10.6.16 All Zones Watering Duration Adjustments**

These options provide a mechanism to change the auto program durations for all zones.

### **10.6.17 Seasonal Percentages**

Each area can adjust the watering duration based upon the monthly calendar. These percentages can be manually changed on each area page or globally changed to either historical ETo rates or to 100%. 100% will have the effect of no duration adjustment based upon calendar.

### **10.6.18 All Zones Adjustment Percentage**

The percentage applied here in the range of -20 to +20 is applied to the watering times for the auto program that have been setup on the Zone Setup page, coupled with the Area Setup page seasonal duration factors to arrive at an actual zone watering time.

### **10.6.19 Miscellaneous Options**

These options provide zone control selections and command redundancy or safety.

### **10.6.20 Site Name**

The name entered here can be used as the filename of a picture or drawing of the site layout off all areas and zones. This picture then can be viewed by clicking on picture icon on the General Status page for the device with the entered site name.

### **10.6.21 Valve Safety**

A command is normally given once for each control action to be taken. It is possible to repeat the command to assure that the valve controller does recognize it. As added safety it possible to send OFF commands every hour and/or every new day to all valves that are currently suppose to be off.

### **10.6.22 Pump Safety**

A pump is normally controlled the same as a valve with a single command to turn on and then a single command to turn off. It is not desirable that a pump be on when no valve is open such as might occur if the valve has failed or if the pump off command was not acted upon. When the pump safety is enabled then the pump off command will be delivered every 60 seconds when no zone in the pump's area is on.

### **10.6.23 Control Log**

A log of valve control actions is maintained and can be viewed from a browser link. This log will include the ON and OFF commands. If desired it can include the STATUS\_REQUEST and STATUS\_ON/STATUS\_OFF used for the Rain8X10-2 to assure that the command was accepted.

### **10.6.24 Zone Starting Notification**

The Starting Zone device code (S66) contains the zone identification of the zone that has just turn on. This device will also pulse ON if a notification time is setup. This can then be used as a trigger for something such as a Homeseer event.

### **10.6.25 Soil Moisture Calculation Synchronization**

Soil moisture of zones in an area will tend to drift due to timing between irrigation of the first and last zone. This drift can be overcome by synchronization of the soil moisture content of all zones in the area upon completion of the Area's irrigation cycle. This will only apply if the factors of the zone for moisture loss rates are the same.

### **10.6.26 Rules for Inhibits when Zone is ON**

When an inhibit becomes active when a zone is running the zone will normally pause until the inhibit has been lifted. This behavior can be changed to allow the zone to complete.

### **10.6.27 Rules for Site Inhibits for Mist Areas**

The site inhibits can be ignored or honored based upon this setting.

## **10.7 Setup7 - Remote Control**

### Remote Control Activation Setup

Manual control of individual zones can be achieved with a Browser, Voice, or RF Remote Pad. The Browse control will be via use of the button provided on the browser page. The voice uses the syntax illustrated in the third column of this table where the valve name used is the one setup on the Wiring Setup Page. When the voice command does not include the number of minutes then it will default to the manual minutes defined on the Zones Setup page. The RF Remote Pad address to zone relationship is entered in the last column of this table.

### **10.7.1 W800 for Handheld Wireless Input**

If a W800 is interfaced to this computer and is to be used for handheld remote input then enter the serial com port on which the W800 is installed. A handheld remote may be a palm pad or other X10-type wireless device. The entries in this section indicate where the W800 is interfaced and the sensitivity to multiple button pushes.

### **10.7.2 Crestron Serial**

Remote control of Rain8Net valves can be achieved with a serial port connection to a Crestron processor and associated Crestron system components. The port number used on the PC is entered in the setup text box. A crossover RS232 cable is needed between the Crestron and PC to make the physical connection for this form of external control.

### **10.7.3 Voice Recognition and Reporting**

Voice recognition can be enabled to accept voice commands to control valves or to request the status of pending valve actions. If not checked then VR and TTS are not enabled. When enabled then voice commands per the sample patterns shown on the browser page can be used to active controls or obtain current and pending status.

### **10.7.4 Direct Valve Control**

Valves can be remotely controlled by using the direct X10 device code or an alias device to perform the control. This option disables the remote control by use of the same X10 codes as the valve. This would be selected to prevent extraneous X10 commands from controlling the irrigation.

### **10.7.5 Disable Alias Valve Control**

Valves can be remotely controlled by using the direct X10 device code or an alias device to perform the control. This option disables the remote control via the alias devices. This would be selected so remote is only enabled during specific times thus preventing unexpected irrigation control.

### **10.7.6 Remote Control Activation Setup**

This section allows an X10 code to be associated with a zone. This X10 code is called the alias device. It is normally an RF to allow the irrigation field to be walked and the zones controlled. It can also be a power line X10 as well.

### **10.7.7 Zone**

The zone name is the same as the name entered in the Wiring Setup page. It is used to identify the desired valve as part of the voice command.

### **10.7.8 Valve**

The valve ID is the same as the valves selected in the Rain8 Setup page. It is used here only aid in identification of the desired value.

### **10.7.9 Voice**

Two forms of voice syntax are shown to illustrate the command expected. The general form is the word Turn followed by On, Off, or the zone name. The third word in the command phrase will be the zone name or on, or off depending upon the second word. In the case of an ON command an optional number of minutes can be spoken followed by the word minutes. Voice control has been depreciated as of V2.16.

### **10.7.10 RF Code**

The RF address that is associated with the zone is entered in the box. When this RF code is received then the zone will turn ON for the manual minutes or turn OFF, depending upon the RF command. The manual minutes are entered on the Zone Setup page.

## **10.8 Setup8 - Weather**

### **10.8.1 Time and Weather Setup**

Sunrise, sunset and weather information are based upon location. The zip code is used to determine the location.

Weather data is obtained from the Internet with the zip code as the means of identification of the local vicinity. The forecast data is provided by AccuWeather, OpenWeatherMap, NWS or WeatherUnderground. The OpenWeatherMap or WeatherUnderground network of reporting sites provides the current weather data. Up to three sites can be selected. The primary will be used unless it fails to report then the other sites will be used. This will provide forecast information and default ET profile.

ET Calculations require a measure of the solar radiation which is generally not directly available. mcsSprinklers estimates this value based upon other weather-related information. A calibration factor is provided to allow refinement of this estimate for a specific location. The nominal value is 1. If increased to 1.5 then the ET will be approximately increased by a factor of 1.5. This will yield moisture loss at 1.5 times the initial estimated rate.

### **10.8.2 Alternate Weather Source**

Current weather conditions can be obtained from WeatherUnderground sites. The A WeatherUnderground station codes are entered based upon viewing the below link and navigating to your location.

<http://www.wunderground.com/weatherstation/ListStations.asp?selectedState=WA&selectedCountry=United+States>.

Multiple stations can be selected from either provider, but only one provider can be used at time.

### **10.8.3 Alternate Forecast Source**

Weather forecast and solar data can be obtained from AccuWeather, OpenWeatherMap, NWS or WeatherUnderground. When obtained from WeatherUnderground or OpenWeatherMap a API license key must be obtained. See paragraph 4.2.6 for registration information for WeatherUnderground forecast feed. NWS data is based upon latitude and longitude so no additional entries are needed when using NWS.

### **10.8.4 Local Weather Source**

When a local weather station is available it can provide the most customized current conditions information. Weather stations can be interfaced via an IP LAN connection for the Weatherhawk weather station or via a comma-separated data file for most other weather stations that support a PC interface. If the IP interface is used, then the IP address is entered on the setup. If a data file is used, then the path to the data file is entered and this can be aided by browsing the file system.

Source data from files can be either XML key where the entire file is processed or it can be data in a row/column format where either the first row or last row of data is processed. If XML then the key is expected to be alphanumeric. If in a fixed column or in a delimiter separated relative column then the numeric column or position is specified.

### **10.8.5 Weather Sensor Source**

Various internet and local weather station sources of weather sensor and forecast can be used. In some case one source may provide more reliable data than another source. Each sensor source that is to be used by mcsSprinklers can be individually selected from the available sources that have been identified from the various optional sources. In some cases only the sensor source needs to be selected. Where additional parameters, such as the column position of a data file source are needed an entry position will be made available to make that entry.

### **10.8.6 Method to Download Internet Data**

Internet is normally used to download weather data. If there is a need to restrict this ability then it can be disabled with a single setting. This will, however, stop the availability of this data. Notifications are provided if for any reason a download could not be accomplished. Separate timeouts are provided for weather and forecast times.

## **10.9 Setup9 - Other**

### **10.9.1 Version Options Displayed**

mcsSprinklers runs in either of three set of capabilities enabled with the highest level available dependent upon the license obtained. Selection of a lower version is primarily intended for trial mode evaluation and can also be advantageous during the interview process to allow essential setup to first be performed and then the more advances setup later.

### **10.9.2 Configuration Administration**

Setup configurations can be saved and restored to accommodate different control configurations. An auto backup is produced each time a configuration change is made. This time-tagged backup can be restored as well.

### **10.9.3 Load Configuration**

Saved configurations can be loaded that exists on either the host computer or the client computer. A pull down selection of all previously saved configurations on the host computer is presented or a file system browse button is available for finding the files on the client computer. When one is selected the current configuration will be restored to the selected one. If configurations are available on the client (browser's computer) then they can uploaded to the host by browsing the client file system for the desired ini file.

### **10.9.4 Save Configuration**

Configurations can be saved on the host computer and each is identified by a user-entered name. After the name is entered the Save button is used to actually perform the save of the current configuration.

### **10.9.5 Restore Configuration from Auto Backup**

Each time the Save Changes button is used to record a change to the current configuration a backup is automatically made. The configuration can be restored from this prior state by selecting it from the pull down. Up to ten backups will be saved.

### **10.9.6 Update mcsSprinklers Version from Web or Local Backup**

mcsSprinklers updated are often available. The latest available is shown on the Version column for "Web" in this section. This is updated each midnight or with use of the Refresh button on the same row. If the Update button is used then the current version will be replaced by the one from the web site. The current one will become a backup and can be reloaded by selecting to restore from local on the desired row of this section. Each version update will result in a restart of mcsSprinklers.

### **10.9.7 HTTP Browser Interface**

Browser interface to mcsSprinklers is via a specific port to provide maximum security. A few ports have specific purposes, but most are available.

### **10.9.8 Browser Display Options**

The colors and general style of the browser user interface presentation can be altered to better suit user preferences. The overall style is controlled by the style sheet. Individual foreground colors and the overall background colors are independent of the style sheet. The icon size on the General Status page can also be adjusted as well as the overall width of the tables in which the data is formatted.

The General Status and Zone Status pages have information that can change over time. The Refresh setting in this section is used to identify the interval at which the browser page will update for these two status pages.

The browser size and position can be explicitly controlled by setting the four browser window settings. This will assure that the browser will always be the same each time a mcsSprinklers page displayed. If they are left blank then the browser will appear per the Windows default position and size algorithm.

A MCS or Homeseer logo exists in the page title area in the upper right of each mcsSprinklers page. Clicking on this logo will redirect the browser to the URL entered into the setup. If the URL entry is blank the redirection will be to the General Status page of mcsSprinklers. The use of a user-specified URL will enable convenient exit from mcsSprinklers to other browser pages.

The touch pages contain a picture of the zone with overlaid text that contains the zone identification. This identification can be set to include the zone device code and location or just the location.

In a Homeseer configuration the Rain8Net/UPB device codes are special characters that are at times awkward to view. Rather than showing these code for identification a Z## nomenclature can be used where the ## is a sequential number.

The popup charts that show annual trends for sensor and computed values can be displayed in HTML or .NET charting. The .NET capability exists with .NET 3.5 and later and is a more pleasing display format. For platforms that do not have these resources of a Homeseer environment where this capability is not supported then a basic HTML format is provided.

### **10.9.9 Popup Calendar Characteristics**

A calendar view is generated by clicking a calendar icon. It will show a user-specified number of historical days and future days until the next scheduled irrigation time. The calendar can have scroll bars applied which is appropriate for longer history.

### **10.9.10 Sensor Units of Measure**

Allow to change from English units to metric units when the checkbox is checked. This applies to the display of the data as well as the download.

### **10.9.11 Email Notification**

Email can be delivered when major events occur. These events consist of loss of internet weather or forecast and change in redundancy configuration and unexpected software operations. The email address to deliver the notification is entered into the text box.

The delivery of email will use the same SMTP server for which your Email is provided. The access information to use this server needs to be entered. To confirm a proper setup a button is provided to send a test email.

When email is delivered a copy can also be sent to mcsSprinklers.com to provide input for support.

Some may have difficulty using the internal email function due to setup demands of their service provider. There is a free SMTP product that can be loaded on the same computer where MCS runs. It is available at [softstack.com/freesmtp.html](http://softstack.com/freesmtp.html). Their instructions say to put localhost in the smtp blank of the client but 127.0.0.1 in both the SMTP and POP3 boxes may yield better results. The destination email also needs to be setup there.



### **10.9.12 Login Username and Password for Internet (WAN) Access**

Access to mcsSprinklers via a browser from within the household or LAN is allowed with no special security provisions other than knowledge of the browser URL that should be used. The assumption is that any user that has local access also has authorization.

When the access is from an external location over the internet then authentication can be requested to prevent unintentional access to the setup and control of the irrigation system. A username and password is used to provide this authorization. The username is visible and the password is encrypted on the mcsSprinklers setup. If no username is entered in the setup then no authentication will be requested from users over the internet.

### **10.9.13 Redundancy Backup Mode**

A single computer configuration is enabled by selecting either or both self-monitoring or restart at midnight. In this case a second application “RESTART” will be started that monitors the behavior of mcsSprinklers and will restart if it exists, fails to produce heartbeat or at the start of each day. A dual computer configuration is enabled by selecting either Standby Backup or Active Backup on both computers where mcsSprinklers is installed. The transition from standby to active is made when the active computer fails to report for the specified takeover period. Most setup information is maintained on only one computer and this is designated as the primary. The path to the mcsSprinklers install on the primary computer is used by the secondary computer to access the setup information.

### **10.9.14 Homeseer Devices**

mcsSprinklers uses House codes to identify a device while Homeseer uses a reference number. The valves are associated with one House code while the status devices are associated with a second one. Defaults House codes are R and S, respectively. A Homeseer device can be controlled as a valve protect device to accept the transient ON/OFF loads as zone valves are switched can be specified. This device will turn OFF before any zone valve is turned OFF and will turn ON after the zone valve has been set to the ON position. This can also be used to simulate a master valve for the entire site. This valve protect device, if used, can be specified as a number if it is a device reference number or as a House/Device code otherwise.

The Remote setup page assumes an X10 RF type device to be used for remote activation. If other virtual devices are used for this purpose then the alternate HS interface is indicated via checkbox.

On/Off as conveyed in the Homeseer DeviceStatus is the normal valve control mechanism. If 0/1 using the DeviceValue is to be used then this is indicated via checkbox. This only applies to Homeseer versions prior to HS3.

The predicted time of the next irrigation cycle for each zone is available on the Run List, Zone Status and other mcsSprinklers browser pages. This information can also be placed in a set of additional Homeseer devices and then can be used for other display options of events. If selected a second device will be created for each zone and will contain the time when the next irrigation cycle is expected to start.

### **10.9.15 Homeseer Notification Options**

mcsSprinklers maintains its log of valve actions and is visible from the Run Log link. The valve actions can also be sent to the Homeseer log. The internally managed hardware (i.e. Rain8Net) valve actions will not normally be available to the Homeseer log, but this option can be selected. The Homeseer log can also be the repository for changes in the reason an Area is inhibited.

### **10.9.16 Homeseer Display Options**

The browser pages can be formatted without header content for display in dedicated applications. When this option is selected it will suppress the contents at the top of each display page. It can also be formatted using a custom header.

### 10.9.17 Database Options

SQL, MySQL, SQLite or Access options are available. If Access or SQLite is used then enter full path to the database .mdb/db file. If SQL or MySQL is used then enter the name of the SQL table. Different version of MySQL and MS SQL Server have different connection mechanisms so this will affect the information entered during setup.

MS SQL Server has provisions for security based upon the Windows login credentials or based upon a username/password explicitly for the database instance. If the Windows login credentials are used then the username/password fields are left blank on the mcsSprinklers setup. MySQL requires the database to have a username/password.

For MS SQL and MySQL the database is identified by a simple name such as “mcssprinklers”. For Access and SQLite the database is a file path. It will be type “.db” for SQLite and “.mdb” for Access. Note that MySQL, in particular, is sensitive to the case of the names used and the expectation is that lower case is used.

The SQL Source identifies the instance of the MySQL or MS SQL server. In some versions this can be left blank so the default server on the network will be used. In other cases and especially in the express versions of MS SQL an explicit instance name needs to be specified. In earlier Express versions the instance id is sufficient (e.g. SQLEXPRESS). In later versions both the computer/network name is needed and the instance (e.g. MYCOMPUTER\MYINSTANCE). Later versions have tighter security. If mcsSprinkres and MY SQL are on the same computer and integrated security it used then the setup of SQL Source will append “;Trusted\_Connection=True” (e.g. MYCOMPUTER\MYINSTANCE;Trusted\_Connection=True). If the database is on another computer then the integrated security cannot be used.

### 10.9.18 Help

Help is available in document form and in context of the setup being performed. Debugging options also exists to assist in troubleshooting unexpected behaviors.

### 10.9.19 Context Help

When the mouse hovers over the dark headers of each setup page a popup window will appear to provide information about the setup options within that area. This popup can be disabled with the mouse over header checkbox.

Expert mode makes all possible setting visible on the setup page. When not checked then only settings that are necessary based upon interview responses are shown on the setup pages.

### 10.9.20 Debug Data Files

Debug information can be logged to text files. The general debug will contain scheduling and control information. For most analysis activities there are four pieces of information that are needed. One is the [mcsSprinklers.ini](#) file that contains the configuration. The second is StartupTrace.txt file that constraints the information shown on the Message Page. The third is the detail debug information that is in the General Debug file. This debug file has a file name that contains the date at which the file was created. A new file is created with each restart, each new day, and upon use of the Write button. The last piece of information is a description of what the observed failure is, the approximate time it happened and the actions taken that caused it. If the observed failure happened with the software as you are now running it then you need to flush the debug information to a file. You do this with the Write button in the Debug area. This will flush the buffered debug information to a General Debug file and create a new General Debug file.

The GeneralDebug file of interest will be the one that was just closed and not the one that was just created since then new one contains only future debug information. When sending debug information be careful to

send a file that spans the time when a failure is observed. The file name will contain the time it started and the File Last Modified Date will show the last time data was written to the file. These are both visible in Debug File section. For all except the currently active file these two dates will show the date range for which the data was collected.

The easiest way to provide the necessary files is to use the Email button on the Other Page on the row that the debug file of interest. This email to yourself will contain the [mcsSprinklers.ini](#), StartupTrace.txt and selected GeneralDebug files so all that needs to be done is forward this email and include a description of the problem.

The folder size where debug files are located can be limited to not exceed available memory capacity. This is especially important on the embedded platforms where memory is limited. This user setting defaults to 100 megabytes. It is also possible to use an external drive to collect this data and in that case the path is entered to this drive.

### **10.9.21 Version Options Displayed**

The degree of configurability is based upon the license obtained. To simplify the configuration it may be desirable to reconfigure to a version that has fewer setup options. Only those versions available for the license obtained will be displayed. If the version is changed then mcsSprinklers should be restarted.

## **10.10 Setup10 – xAP / MQTT Reporting**

When the “Basic Status and Control” checkbox or the MQTT broker is identified in the Local Interfaces section of the “Weather Setup” page is checked then the xAP Reporting page is made available via a browser link at the top of page. The xAP/MQTT Reporting page will itemize all the control and status devices maintained by mcsSprinklers and include checkboxes that allow selection of which status information should be reported upon change of the mcsSprinklers device. The BSC checkbox, when checked, will generate a xAP BSC schema message for each change in the value of the device. The MQTT State/Value/String checkboxes will publish changes in these three properties of the mcsSprinklers device. This page is shown in Figure 33.

## **10.11 Setup11 – Picture Entry**

### **10.11.1 Pictures**

Pictures of the zone that a valve controls can be selected and these pictures will be available during the setup and during general monitoring of the irrigation. The source pictures can be any size and can come from any location on the client's computer network. The Browse buttons are used to locate the original pictures. mcsSprinklers will copy, resize and label these pictures for service via the browser through which access to mcsSprinklers is made. Note that the picture image upload is dependent upon network and processor speeds so allow sufficient time before attempting to view the pictures.

Use of pictures is optional. When a display of a picture is available the camera icon will appear in the applicable context.

## 11 AccuWeather Location Codes

Country	City	Location Code
Afghanistan	Herat, AF	ASI AF AF011 HERAT
Afghanistan	Kabul, AF	ASI AF AF013 KABUL
Afghanistan	Kandahar, AF	ASI AF AF014 KANDAHAR
Afghanistan	Mazar-I-Sharif, AF	ASI AF AF004 MAZAR-I-SHARIF
Albania	Tirana, AL	EUR AL AL024 TIRANA
Algeria	Alger, DZ	AFR DZ AG004 ALGER
Algeria	Annaba, DZ	AFR DZ AG039 ANNABA
Algeria	Batna, DZ	AFR DZ AG006 BATNA
Algeria	Bechar, DZ	AFR DZ AG007 BECHAR
Algeria	Bejaia, DZ	AFR DZ AG008 BEJAIA
Algeria	Biskra, DZ	AFR DZ AG009 BISKRA
Algeria	Blida, DZ	AFR DZ AG010 BLIDA
Algeria	Chlef, DZ	AFR DZ AG014 CHLEF
Algeria	Constantine, DZ	AFR DZ AG015 CONSTANTINE
Algeria	Mostaganem, DZ	AFR DZ AG030 MOSTAGANEM
Algeria	Oran, DZ	AFR DZ AG032 ORAN
Algeria	Setif, DZ	AFR DZ AG037 SETIF
Algeria	Sidi-Bel-Abbes, DZ	AFR DZ AG038 SIDI-BEL-ABBES
Algeria	Skikda, DZ	AFR DZ AG015 SKIKDA
Algeria	Tebessa, DZ	AFR DZ AG042 TEBESSA
Algeria	Tiaret, DZ	AFR DZ AG043 TIARET
American Samoa	Pago Pago, AS	OCN AS AS000 PAGO PAGO
Andorra	Andorra La Vella, AD	EUR AD AN000 ANDORRA LA VELLA
Angola	Benguela, AO	AFR AO AO002 BENGUELA
Angola	Huambo, AO	AFR AO AO002 HUAMBO
Angola	Lobito, AO	AFR AO AO007 LOBITO
Angola	Luanda, AO	AFR AO AO006 LUANDA
Angola	Lubango, AO	AFR AO AO010 LUBANGO
Antigua And Barbuda	Saint John, AG	CAC AG AC003 SAINT JOHN
Argentina	Avellaneda, AR	SAM AR AR001 AVELLANEDA
Argentina	Bahia Blanca, AR	SAM AR AR001 BAHÍA BLANCA
Argentina	Buenos Aires, AR	SAM AR AR007 BUENOS AIRES
Argentina	Catamarca, AR	SAM AR AR002 CATAMARCA
Argentina	Comodoro Rivadavia, AR	SAM AR AR004 COMODORO RIVADAVIA
Argentina	Concordia, AR	SAM AR AR008 CONCORDIA
Argentina	Cordoba, AR	SAM AR AR005 CÓRDOBA
Argentina	Corrientes, AR	SAM AR AR006 CORRIENTES
Argentina	Formosa, AR	SAM AR AR009 FORMOSA
Argentina	General San Martin, AR	SAM AR AR011 GENERAL SAN MARTÍN

Argentina	La Plata, AR	SAM AR AR001 LA PLATA
Argentina	Lanus, AR	SAM AR AR001 LANUS
Argentina	Lomas De Zamora, AR	SAM AR AR001 LOMAS DE ZAMORA
Argentina	Mar Del Plata, AR	SAM AR AR001 MAR DEL PLATA
Argentina	Mendoza, AR	SAM AR AR013 MENDOZA
Argentina	Moron, AR	SAM AR AR001 MORÓN
Argentina	Neuquen, AR	SAM AR AR015 NEUQUÉN
Argentina	Parana, AR	SAM AR AR022 PARANÁ
Argentina	Posadas, AR	SAM AR AR014 POSADAS
Argentina	Quilmes, AR	SAM AR AR001 QUILMES
Argentina	Resistencia, AR	SAM AR AR003 RESISTENCIA
Argentina	Rio Cuarto, AR	SAM AR AR005 RÍO CUARTO
Argentina	Rosario, AR	SAM AR AR021 ROSARIO
Argentina	Salta, AR	SAM AR AR017 SALTA
Argentina	San Fernando, AR	SAM AR AR001 SAN FERNANDO
Argentina	San Isidro, AR	SAM AR AR001 SAN ISIDRO
Argentina	San Juan, AR	SAM AR AR018 SAN JUAN
Argentina	San Nicolas, AR	SAM AR AR001 SAN NICOLÁS
Argentina	San Salvador De Jujuy, AR	SAM AR AR010 SAN SALVADOR DE JUJUY
Argentina	Santa Fe, AR	SAM AR AR021 SANTA FÉ
Argentina	Santiago Del Estero, AR	SAM AR AR022 SANTIAGO DEL ESTERO
Argentina	Tucuman, AR	SAM AR AR024 SAN MIGUEL DE TUCUMÁN
Argentina	Vicente Lopez, AR	SAM AR AR001 VICENTE LÓPEZ
Armenia	Kirovakan, AM	ASI AM AM006 KIROVAKAN
Armenia	Leninakan, AM	ASI AM AM007 LENINAKAN
Armenia	Yerevan, AM	ASI AM AM011 YEREVAN
Australia	Adelaide, AU	OCN AU SA ADELAIDE
Australia	Brisbane, AU	OCN AU QLD BRISBANE
Australia	Cairns, AU	OCN AU QLD CAIRNS
Australia	Canberra, AU	OCN AU ACT CANBERRA
Australia	Darwin, AU	OCN AU NT DARWIN
Australia	Geelong, AU	OCN AU VIC GEELONG
Australia	Gold Coast, AU	OCN AU QLD GOLD COAST
Australia	Hobart, AU	OCN AU TAS HOBART
Australia	Melbourne, AU	OCN AU VIC MELBOURNE
Australia	Newcastle, AU	OCN AU NSW NEWCASTLE
Australia	Perth, AU	OCN AU WA PERTH
Australia	Sydney, AU	OCN AU NSW SYDNEY
Australia	Townsville, AU	OCN AU QLD TOWNSVILLE
Australia	Wollongong, AU	OCN AU NSW WOLLONGONG
Austria	Graz, AT	EUR AT AU006 GRAZ

Austria	Innsbruck, AT	EUR AT AU007 INNSBRUCK
Austria	Linz, AT	EUR AT AU004 LINZ
Austria	Salzburg, AT	EUR AT AU005 SALZBURG
Austria	Vienna, AT	EUR AT AU009 WIEN
Azerbaijan	Baku, AZ	ASI AZ AJ009 BAKU
Azerbaijan	Gandja, AZ	ASI AZ AJ020 GANDJA
Azerbaijan	Sumgait, AZ	ASI AZ AJ052 SUMGAIT
Bahrain	Manama, BH	MEA BH BA002 MANAMA
Bangladesh	Barisal, BD	ASI BD BG003 BARISAL
Bangladesh	Chittagong, BD	ASI BD BG001 CHITTAGONG
Bangladesh	Comilla, BD	ASI BD BG001 COMILLA
Bangladesh	Dhaka, BD	ASI BD BG002 DHAKA
Bangladesh	Dinajpur, BD	ASI BD BG004 DINAJPUR
Bangladesh	Jamalpur, BD	ASI BD BG004 JAMALPUR
Bangladesh	Jessore, BD	ASI BD BG003 JESSORE
Bangladesh	Khulna, BD	ASI BD BG003 KHULNA
Bangladesh	Mymensingh, BD	ASI BD BG002 MYMENSINGH
Bangladesh	Narayanganj, BD	ASI BD BG002 NARAYANGANJ
Bangladesh	Nawabganj, BD	ASI BD BG002 NAWABGANJ
Bangladesh	Pabna, BD	ASI BD BG004 PABNA
Bangladesh	Rajshahi, BD	ASI BD BG004 RAJSHAHI
Bangladesh	Rangpur, BD	ASI BD BG004 RANGPUR
Bangladesh	Saidpur, BD	ASI BD BG004 SAIDPUR
Bangladesh	Tangail, BD	ASI BD BG002 TANGAIL
Bangladesh	Tongi, BD	ASI BD BG002 TONGI
Barbados	Bridgetown, BB	CAC BB BB008 BRIDGETOWN
Belarus	Baranovichi, BY	EUR BY BO001 BARANOVICHI
Belarus	Bobruisk, BY	EUR BY BO005 BOBRUISK
Belarus	Borisov, BY	EUR BY BO004 BORISOV
Belarus	Brest, BY	EUR BY BO001 BREST
Belarus	Gomel, BY	EUR BY BO002 GOMEL
Belarus	Grodno, BY	EUR BY BO003 GRODNO
Belarus	Lida, BY	EUR BY BO003 LIDA
Belarus	Minsk, BY	EUR BY BO000 MINSK
Belarus	Mogilev, BY	EUR BY BO005 MOGILEV
Belarus	Novopolotsk, BY	EUR BY BO000 NOVOPOLOTSK
Belarus	Orsha, BY	EUR BY BO007 ORSHA
Belarus	Pinsk, BY	EUR BY BO001 PINSK
Belarus	Soligorsk, BY	EUR BY BO004 SOLIGORSK
Belarus	Vitebsk, BY	EUR BY BO007 VITEBSK
Belgium	Antwerpen, BE	EUR BE BE001 ANTWERPEN
Belgium	Brugge, BE	EUR BE BE011 BRUGGE
Belgium	Bruxelles, BE	EUR BE BE003 BRUXELLES



Belgium	Charleroi, BE	EUR BE BE004 CHARLEROI
Belgium	Gent, BE	EUR BE BE009 GENT
Belgium	Liege, BE	EUR BE BE005 LIÈGE
Belgium	Namur, BE	EUR BE BE008 NAMUR
Belize	Belmopan, BZ	CAC BZ BH002 BELMOPAN
Benin	Cotonou, BJ	AFR BJ BN000 COTONOU
Benin	Parakou, BJ	AFR BJ BN000 PARAKOU
Benin	Porto-Novo, BJ	AFR BJ BN000 PORTO-NOVO
Bermuda	Hamilton, BM	NAM BM BD002 HAMILTON
Bhutan	Thimphu, BT	ASI BT BT016 THIMPHU
Bolivia	Cochabamba, BO	SAM BO BL002 COCHABAMBA
Bolivia	La Paz, BO	SAM BO BL004 LA PAZ
Bolivia	Oruro, BO	SAM BO BL005 ORURO
Bolivia	Potosi, BO	SAM BO BL007 POTOSÍ
Bolivia	Santa Cruz, BO	SAM BO BL003 SANTA CRUZ
Bolivia	Sucre, BO	SAM BO BL001 SUCRE
Bolivia	Tarija, BO	SAM BO BL009 TARIJA
Bosnia And Herzegovina	Banja Luka, BA	EUR BA BK002 BANJA LUKA
Bosnia And Herzegovina	Doboj, BA	EUR BA BK002 DOBOJ
Bosnia And Herzegovina	Mostar, BA	EUR BA BK001 MOSTAR
Bosnia And Herzegovina	Prijedor, BA	EUR BA BK002 PRIJEDOR
Bosnia And Herzegovina	Sarajevo, BA	EUR BA BK001 SARAJEVO
Bosnia And Herzegovina	Tuzla, BA	EUR BA BK001 TUZLA
Bosnia And Herzegovina	Zenica, BA	EUR BA BK001 ZENICA
Botswana	Francistown, BW	AFR BW BC000 FRANCISTOWN
Botswana	Gaborone, BW	AFR BW BC009 GABORONE
Botswana	Ghanzi, BW	AFR BW BC000 GHANZI
Botswana	Kanye, BW	AFR BW BC000 KANYE
Botswana	Kasane, BW	AFR BW BC000 KASANE
Botswana	Mahalapye, BW	AFR BW BC000 MAHALAPYE
Botswana	Mamuno, BW	AFR BW BC000 MAMUNO
Botswana	Maun, BW	AFR BW BC000 MAUN
Botswana	Molepolole, BW	AFR BW BC000 MOLEPOLOLE
Botswana	Selebi-Phikwe, BW	AFR BW BC001 SELEBI-PHIKWE
Botswana	Serowe, BW	AFR BW BC000 SEROWE
Botswana	Tshabong, BW	AFR BW BC000 TSHABONG
Brazil	Alagoinhas, BR	SAM BR BR002 ALAGOINHAS

Brazil	Alvorada, BR	SAM BR BR004 ALVORADA
Brazil	Americana, BR	SAM BR BR023 AMERICANA
Brazil	Ananindeua, BR	SAM BR BR013 ANANINDEUA
Brazil	Anapolis, BR	SAM BR BR027 ANÁPOLIS
Brazil	Apucarana, BR	SAM BR BR015 APUCARANA
Brazil	Aracaju, BR	SAM BR BR024 ARACAJU
Brazil	Aracatuba, BR	SAM BR BR023 ARAÇATUBA
Brazil	Araguaina, BR	SAM BR BR025 ARAGUAINA
Brazil	Arapiraca, BR	SAM BR BR002 ARAPIRACA
Brazil	Araraquara, BR	SAM BR BR023 ARARAQUARA
Brazil	Araras, BR	SAM BR BR023 ARARAS
Brazil	Atibaia, BR	SAM BR BR023 ATIBAIA
Brazil	Bage, BR	SAM BR BR019 BAGÉ
Brazil	Barbacena, BR	SAM BR BR012 BARBACENA
Brazil	Barra Mansa, BR	SAM BR BR017 BARRA MANSA
Brazil	Barreiras, BR	SAM BR BR005 BARREIRAS
Brazil	Barretos, BR	SAM BR BR023 BARRETOS
Brazil	Barueri, BR	SAM BR BR023 BARUERI
Brazil	Bauru, BR	SAM BR BR023 BAURU
Brazil	Belem, BR	SAM BR BR013 BELÉM
Brazil	Belford Roxo, BR	SAM BR BR017 BELFORD ROXO
Brazil	Belo Horizonte, BR	SAM BR BR012 BELO HORIZONTE
Brazil	Betim, BR	SAM BR BR012 BETIM
Brazil	Boa Vista, BR	SAM BR BR021 BOA VISTA
Brazil	Botucatu, BR	SAM BR BR023 BOTUCATU
Brazil	Braganca Paulista, BR	SAM BR BR023 BRAGANÇA PAULISTA
Brazil	Brasilia, BR	SAM BR BR007 BRASILIA
Brazil	Cabo Frio, BR	SAM BR BR017 CABO FRIO
Brazil	Cachoeirinha, BR	SAM BR BR015 CACHOEIRINHA
Brazil	Cachoeiro De Itapemirim, BR	SAM BR BR008 CACHOEIRO DE ITAPEMIRIM
Brazil	Camacari, BR	SAM BR BR005 CAMACARI
Brazil	Camaragibe, BR	SAM BR BR026 CAMARAGIBE
Brazil	Campina Grande, BR	SAM BR BR014 CAMPINA GRANDE
Brazil	Campinas, BR	SAM BR BR023 CAMPINAS
Brazil	Campo Grande, BR	SAM BR BR010 CAMPO GRANDE
Brazil	Canoas, BR	SAM BR BR019 CANOAS
Brazil	Carapicuíba, BR	SAM BR BR023 CARAPICUÍBA
Brazil	Cariacica, BR	SAM BR BR008 CARIACICA
Brazil	Caruaru, BR	SAM BR BR026 CARUARU
Brazil	Cascavel, BR	SAM BR BR006 CASCAVEL
Brazil	Castanhal, BR	SAM BR BR013 CASTANHAL
Brazil	Catanduva, BR	SAM BR BR023 CATANDUVA

Brazil	Caucaia, BR	SAM BR BR006 CAUCAIA
Brazil	Caxias, BR	SAM BR BR009 CAXIAS
Brazil	Caxias Do Sul, BR	SAM BR BR019 CAXIAS DO SUL
Brazil	Chapeco, BR	SAM BR BR022 CHAPECÓ
Brazil	Codo, BR	SAM BR BR009 CODO
Brazil	Colombo, BR	SAM BR BR015 COLOMBO
Brazil	Contagem, BR	SAM BR BR012 CONTAGEM
Brazil	Cotia, BR	SAM BR BR023 COTIA
Brazil	Crato, BR	SAM BR BR006 CRATO
Brazil	Criciúma, BR	SAM BR BR022 CRICIÚMA
Brazil	Cubatao, BR	SAM BR BR023 CUBATAO
Brazil	Cuiaba, BR	SAM BR BR010 CUIABÁ
Brazil	Curitiba, BR	SAM BR BR015 CURITIBA
Brazil	Diadema, BR	SAM BR BR023 DIADEMA
Brazil	Divinópolis, BR	SAM BR BR012 DIVINÓPOLIS
Brazil	Dourados, BR	SAM BR BR011 DOURADOS
Brazil	Duque De Caxias, BR	SAM BR BR017 DUQUE DE CAXIAS
Brazil	Embu, BR	SAM BR BR023 EMBU
Brazil	Feira De Santana, BR	SAM BR BR005 FEIRA DE SANTANA SAM BR BR023 FERRAZ DE
Brazil	Ferraz De Vasconcelos, BR	VASCONCELOS
Brazil	Florianópolis, BR	SAM BR BR022 FLORIANÓPOLIS
Brazil	Fortaleza, BR	SAM BR BR006 FORTALEZA
Brazil	Foz Do Iguacu, BR	SAM BR BR015 FOZ DO IGUAÇU
Brazil	Franca, BR	SAM BR BR005 FRANCA
Brazil	Francisco Morato, BR	SAM BR BR023 FRANCISCO MORATO
Brazil	Franco Da Rocha, BR	SAM BR BR023 FRANCO DA ROCHA
Brazil	Garanhuns, BR	SAM BR BR026 GARANHUNS
Brazil	Goiania, BR	SAM BR BR027 GOIÂNIA SAM BR BR012 GOVERNADOR
Brazil	Governador Valadares, BR	VALADARES
Brazil	Gravataí, BR	SAM BR BR019 GRAVATAI
Brazil	Guarapuava, BR	SAM BR BR015 GUARAPUAVA
Brazil	Guaratingueta, BR	SAM BR BR023 GUARATINGUETÁ
Brazil	Guaruja, BR	SAM BR BR023 GUARUJÁ
Brazil	Guarulhos, BR	SAM BR BR023 GUARULHOS
Brazil	Hortolandia, BR	SAM BR BR023 HORTOLANDIA
Brazil	Ibirite, BR	SAM BR BR012 IBIRITÉ
Brazil	Ilheus, BR	SAM BR BR005 ILHÉUS
Brazil	Imperatriz, BR	SAM BR BR009 IMPERATRIZ
Brazil	Indaiatuba, BR	SAM BR BR023 INDAIATUBA
Brazil	Ipatinga, BR	SAM BR BR012 IPATINGA
Brazil	Itabori, BR	SAM BR BR017 ITABORAÍ

Brazil	Itabuna, BR	SAM BR BR005 ITABUNA
Brazil	Itaituba, BR	SAM BR BR013 ITAITUBA
Brazil	Itajai, BR	SAM BR BR022 ITAJAÍ
Brazil	Itapecerica Da Serra, BR	SAM BR BR023 ITAPECERICA DA SERRA
Brazil	Itapetininga, BR	SAM BR BR026 ITAPETININGA
Brazil	Itapevi, BR	SAM BR BR023 ITAPEVI
Brazil	Itaquaquetuba, BR	SAM BR BR023 ITAQUAQUECETUBA
Brazil	Itu, BR	SAM BR BR023 ITU
Brazil	Jacarei, BR	SAM BR BR023 JACAREÍ
Brazil	Jaragua, BR	SAM BR BR022 JARAGUÁ DO SUL
Brazil	Jau, BR	SAM BR BR023 JAÚ
Brazil	Jequie, BR	SAM BR BR023 JEQUIÉ
Brazil	Joao Pessoa, BR	SAM BR BR014 JOAO PESSOA
Brazil	Joinville, BR	SAM BR BR022 JOINVILLE
Brazil	Juazeiro, BR	SAM BR BR005 JUAZEIRO
Brazil	Juazeiro do Norte, BR	SAM BR BR006 JUÀZEIRO DO NORTE
Brazil	Juiz De Fora, BR	SAM BR BR012 JUIZ DE FORA
Brazil	Jundiai, BR	SAM BR BR023 JUNDIAÍ
Brazil	Lages, BR	SAM BR BR027 LAGES
Brazil	Limeira, BR	SAM BR BR023 LIMEIRA
Brazil	Linhares, BR	SAM BR BR008 LINHARES
Brazil	Londrina, BR	SAM BR BR015 LONDRINA
Brazil	Luziania, BR	SAM BR BR027 LUZIÂNIA
Brazil	Macaé, BR	SAM BR BR017 MACAÉ
Brazil	Macapa, BR	SAM BR BR003 MACAPÁ
Brazil	Magé, BR	SAM BR BR017 MAGÉ
Brazil	Manaus, BR	SAM BR BR004 MANAUS
Brazil	Maraba, BR	SAM BR BR013 MARABA
Brazil	Maracanau, BR	SAM BR BR006 MARACANAU
Brazil	Marilia, BR	SAM BR BR023 MARÍLIA
Brazil	Maringa, BR	SAM BR BR015 MARINGÁ
Brazil	Maua, BR	SAM BR BR023 MAUÁ
Brazil	Moji Das Cruzes, BR	SAM BR BR023 MOJI DAS CRUZES
Brazil	Montes Claros, BR	SAM BR BR012 MONTES CLAROS
Brazil	Mosoro, BR	SAM BR BR018 MOSSORÓ
Brazil	Natal, BR	SAM BR BR018 NATAL
Brazil	Niteroi, BR	SAM BR BR017 NITERÓI
Brazil	Nossa Senhora Do Socorro, BR	SAM BR BR024 NOSSA SENHORA DO SOCORRO
Brazil	Nova Friburgo, BR	SAM BR BR017 NOVA FRIBURGO
Brazil	Nova Iguacu, BR	SAM BR BR017 NOVA IGUAÇU
Brazil	Novo Hamburgo, BR	SAM BR BR019 NÔVO HAMBURGO
Brazil	Olinda, BR	SAM BR BR026 OLINDA

Brazil	Osasco, BR	SAM BR BR023 OSASCO
Brazil	Palmas, BR	SAM BR BR015 PALMAS
Brazil	Paranagua, BR	SAM BR BR015 PARANAGUÁ
Brazil	Parnaíba, BR	SAM BR BR016 PARNAÍBA
Brazil	Passo Fundo, BR	SAM BR BR019 PASSO FUNDO
Brazil	Passos, BR	SAM BR BR012 PASSOS
Brazil	Patos De Minas, BR	SAM BR BR012 PATOS DE MINAS
Brazil	Paulista, BR	SAM BR BR026 PAULISTA
Brazil	Pelotas, BR	SAM BR BR019 PELOTAS
Brazil	Petrolina, BR	SAM BR BR026 PETROLINA
Brazil	Petropolis, BR	SAM BR BR017 PETRÓPOLIS
Brazil	Pindamonhangaba, BR	SAM BR BR023 PINDAMONHANGABA
Brazil	Pinhais, BR	SAM BR BR012 PINHAIS
Brazil	Piracicaba, BR	SAM BR BR023 PIRACICABA
Brazil	Pocos De Caldas, BR	SAM BR BR012 POÇOS DE CALDAS
Brazil	Ponta Grossa, BR	SAM BR BR015 PONTA GROSSA
Brazil	Porto Alegre, BR	SAM BR BR019 PORTO ALEGRE
Brazil	Porto Velho, BR	SAM BR BR020 PORTO VELHO
Brazil	Pouso Alegre, BR	SAM BR BR012 POUSO ALEGRE
Brazil	Praia Grande, BR	SAM BR BR023 PRAIA GRANDE
Brazil	Presidente Prudente, BR	SAM BR BR023 PRESIDENTE PRUDENTE
Brazil	Queimados, BR	SAM BR BR017 QUEIMADOS
Brazil	Recife, BR	SAM BR BR026 RECIFE
Brazil	Resende, BR	SAM BR BR017 RESENDE
Brazil	Ribeirao Das Neves, BR	SAM BR BR012 RIBEIRAO DAS NEVES
Brazil	Ribeirao Pires, BR	SAM BR BR023 RIBEIRAO PIRES
Brazil	Ribeirao Preto, BR	SAM BR BR023 RIBEIRAO PRÊTO
Brazil	Rio Branco, BR	SAM BR BR001 RIO BRANCO
Brazil	Rio Claro, BR	SAM BR BR017 RIO CLARO
Brazil	Rio De Janeiro, BR	SAM BR BR017 RIO DE JANEIRO
Brazil	Rio Grande, BR	SAM BR BR019 RIO GRANDE
Brazil	Rio Verde, BR	SAM BR BR027 RIO VERDE
Brazil	Rondonopolis, BR	SAM BR BR010 RONDONÓPOLIS
Brazil	Sabara, BR	SAM BR BR012 SABÁRA
Brazil	Salvador, BR	SAM BR BR005 SALVADOR
Brazil	Santa Cruz Do Sul, BR	SAM BR BR019 SANTA CRUZ DO SUL
Brazil	Santa Luzia, BR	SAM BR BR014 SANTA LUZIA
Brazil	Santa Maria, BR	SAM BR BR019 SANTA MARIA
Brazil	Santa Rita, BR	SAM BR BR014 SANTA RITA
Brazil	Santarem, BR	SAM BR BR013 SANTARÉM
Brazil	Santo Andre, BR	SAM BR BR023 SANTO ANDRÉ
Brazil	Santos, BR	SAM BR BR023 SANTOS
Brazil	Sao Bernardo Do Campo, BR	SAM BR BR023 SAO BERNARDO DO

	BR	CAMPO
Brazil	Sao Caetano Do Sul, BR	SAM BR BR023 SAO CAETANO DO SUL
Brazil	Sao Goncalo, BR	SAM BR BR014 SAO GONÇALO
Brazil	Sao Joao De Meriti, BR	SAM BR BR017 SAO JOAO DE MERITI
Brazil	Sao Jose Do Rio Preto, BR	SAM BR BR017 SAO JOSÉ DO RIO PRÊTO
Brazil	Sao Jose Dos Campos, BR	SAM BR BR012 SAO JOSÉ DOS CAMPOS
Brazil	Sao Jose Dos Pinhais, BR	SAM BR BR015 SAO JOSÉ DOS PINHAIS
Brazil	Sao Leopoldo, BR	SAM BR BR019 SAO LEOPOLDO
Brazil	Sao Paulo, BR	SAM BR BR023 SAO PAULO
Brazil	Sao Vicente, BR	SAM BR BR023 SAO VICENTE
Brazil	Serra, BR	SAM BR BR023 SERRA
Brazil	Sertaozinho, BR	SAM BR BR023 SERTAOZINHO
Brazil	Sete Lagoas, BR	SAM BR BR012 SETE LAGOAS
Brazil	Sobral, BR	SAM BR BR006 SOBRAL
Brazil	Sorocaba, BR	SAM BR BR023 SOROCABA
Brazil	Sumare, BR	SAM BR BR023 SUMARÉ
Brazil	Susano, BR	SAM BR BR023 SUSANO
Brazil	Taboao Da Serra, BR	SAM BR BR023 TABOAO DA SERRA
Brazil	Taubate, BR	SAM BR BR023 TAUBATÉ
Brazil	Teofilo Otoni, BR	SAM BR BR012 TEÓFILO OTONI
Brazil	Teresina, BR	SAM BR BR016 TERESINA
Brazil	Teresopolis, BR	SAM BR BR017 TERESÓPOLIS
Brazil	Timon, BR	SAM BR BR009 TIMON
Brazil	Toledo, BR	SAM BR BR012 TOLEDO
Brazil	Uberaba, BR	SAM BR BR012 UBERABA
Brazil	Uberlandia, BR	SAM BR BR012 UBERLÂNDIA
Brazil	Uruguaiana, BR	SAM BR BR019 URUGUAIANA
Brazil	Varginha, BR	SAM BR BR012 VARGINHA
Brazil	Varzea Grande, BR	SAM BR BR010 VARZEA GRANDE
Brazil	Viamao, BR	SAM BR BR019 VIAMAO
Brazil	Vila Velha, BR	SAM BR BR026 VILA VELHA
Brazil	Vitoria, BR	SAM BR BR015 VITÓRIA
Brazil	Vitoria Da Conquista, BR	SAM BR BR005 VITÓRIA DA CONQUISTA
		SAM BR BR026 VITÓRIA DE SANTO
Brazil	Vitoria De Santo Antao, BR	ANTAO
Brazil	Volta Redonda, BR	SAM BR BR017 VOLTA REDONDA
British Virgin Islands	Road Town, VG	CAC VG VI--- ROAD TOWN
Brunei	Bandar Seri Begawan, BN	ASI BN BX000 BANDAR SERI BEGAWAN
Bulgaria	Bourgas, BG	EUR BG BU002 BOURGAS
Bulgaria	Dobritch, BG	EUR BG BU003 DOBRITCH
Bulgaria	Nikopol, BG	EUR BG BU012 NIKOPOL
Bulgaria	Plovdiv, BG	EUR BG BU013 PLOVDIV

Bulgaria	Rousse, BG	EUR BG BU015 ROUSSÉ
Bulgaria	Sofia, BG	EUR BG BU021 SOFIA
Bulgaria	Stara Zagora, BG	EUR BG BU022 STARA ZAGORA
Bulgaria	Varna, BG	EUR BG BU024 VARNA
Burkina Faso	Bobo Dioulasso, BF	AFR BF UV000 BOBO DIOULASSO
Burkina Faso	Ouagadougou, BF	AFR BF UV010 OUAGADOUGOU
Burma/Myanmar	Bassein, MM	ASI MM BM001 BASSEIN
Burma/Myanmar	Mandalay, MM	ASI MM BM008 MANDALAY
Burma/Myanmar	Monywa, MM	ASI MM BM011 MONYWA
Burma/Myanmar	Moulmein, MM	ASI MM BM009 MOULMEIN
Burma/Myanmar	Pegu, MM	ASI MM BM002 PEGU
Burma/Myanmar	Sittwe, MM	ASI MM BM010 SITTWE
Burma/Myanmar	Taunggyi, MM	ASI MM BM012 TAUNGGYI
Burma/Myanmar	Yangon, MM	ASI MM BM014 YANGON
Burundi	Bujumbura, BI	AFR BI BY000 BUJUMBURA
Cambodia	Bat Dambang, KH	ASI KH CB002 BAT DAMBANG
Cambodia	Kampong Cham, KH	ASI KH CB003 KAMPONG CHAM
Cambodia	Phnom Penh, KH	ASI KH CB012 PHNOM PENH
Cameroon	Bafoussam, CM	AFR CM CM008 BAFOUSSAM
Cameroon	Bamenda, CM	AFR CM CM007 BAMENDA
Cameroon	Douala, CM	AFR CM CM005 DOUALA
Cameroon	Edea, CM	AFR CM CM005 EDÉA
Cameroon	Garoua, CM	AFR CM CM006 GAROUA
Cameroon	Maroua, CM	AFR CM CM004 MAROUA
Cameroon	Ngaoundere, CM	AFR CM CM001 NGAOUNDERE
Cameroon	Nkongsamba, CM	AFR CM CM005 NKONGSAMBA
Cameroon	Yaounde, CM	AFR CM CM002 YAOUNDE
Canada	Abbotsford, CA	NAM CA BC ABBOTSFORD
Canada	Barrie, CA	NAM CA ON BARRIE
Canada	Brampton, CA	NAM CA ON BRAMPTON
Canada	Brantford, CA	NAM CA ON BRANTFORD
Canada	Burlington, CA	NAM CA NL BURLINGTON
Canada	Burnaby, CA	NAM CA BC BURNABY
Canada	Calgary, CA	NAM CA AB CALGARY
Canada	Cambridge, CA	NAM CA ON CAMBRIDGE
Canada	Coquitlam, CA	NAM CA BC COQUITLAM
Canada	East York, CA	NAM CA ON EAST YORK
Canada	Edmonton, CA	NAM CA AB EDMONTON
Canada	Etobicoke, CA	NAM CA ON ETOBICOKE
Canada	Gatineau, CA	NAM CA QC GATINEAU
Canada	Guelph, CA	NAM CA ON GUELPH
Canada	Halifax, CA	NAM CA NS HALIFAX
Canada	Hamilton, CA	NAM CA ON HAMILTON

Canada	Kelowna, CA	NAM CA BC KELOWNA
Canada	Kingston, CA	NAM CA ON KINGSTON
Canada	Kitchener, CA	NAM CA ON KITCHENER
Canada	Laval, CA	NAM CA QC LAVAL
Canada	London, CA	NAM CA ON LONDON
Canada	Longueuil, CA	NAM CA QC LONGUEUIL
Canada	Markham, CA	NAM CA ON MARKHAM
Canada	Mississauga, CA	NAM CA ON MISSISSAUGA
Canada	Moncton, CA	NAM CA NB MONCTON
Canada	Montreal, CA	NAM CA QC MONTRÉAL
Canada	Nepean, CA	NAM CA ON NEPEAN
Canada	North York, CA	NAM CA ON NORTH YORK
Canada	Oakville, CA	NAM CA ON OAKVILLE
Canada	Oshawa, CA	NAM CA ON OSHAWA
Canada	Ottawa, CA	NAM CA ON OTTAWA
Canada	Peterborough, CA	NAM CA ON PETERBOROUGH
Canada	Quebec, CA	NAM CA QC QUÉBEC
Canada	Regina, CA	NAM CA SK REGINA
Canada	Richmond, CA	NAM CA BC RICHMOND
Canada	Richmond Hill, CA	NAM CA ON RICHMOND HILL
Canada	Saint Catharines, CA	NAM CA ON SAINT CATHARINES
Canada	Saint John, CA	NAM CA NB SAINT JOHN
Canada	Saint John'S, CA	NAM CA QC SAINT JOHN'S
Canada	Saskatoon, CA	NAM CA SK SASKATOON
Canada	Scarborough, CA	NAM CA ON SCARBOROUGH
Canada	Sherbrooke, CA	NAM CA NS SHERBROOKE
Canada	Sudbury, CA	NAM CA ON SUDBURY
Canada	Surrey, CA	NAM CA PE SURREY
Canada	Three Rivers, CA	NAM CA QC TROIS-RIVIÈRES
Canada	Thunder Bay, CA	NAM CA ON THUNDER BAY
Canada	Toronto, CA	NAM CA ON TORONTO
Canada	Vancouver, CA	NAM CA BC VANCOUVER
Canada	Vaughan, CA	NAM CA AC003 VAUGHAN
Canada	Victoria, CA	NAM CA BC VICTORIA
Canada	Windsor, CA	NAM CA NL WINDSOR
Canada	Winnipeg, CA	NAM CA MB WINNIPEG
Canada	York, CA	NAM CA QC YORK
Cape Verde	Praia, CV	AFR CV CV000 PRAIA
Cayman Islands	George Town, KY	CAC KY CJ000 GEORGE TOWN
Central African Republic	Bangui, CF	AFR CF CT000 BANGUI
Chad	N'Djamena, TD	AFR TD CD004 N'DJAMENA
Chile	Antofagasta, CL	SAM CL CI002 ANTOFAGASTA



Chile	Arica, CL	SAM CL CI012 ARICA
Chile	Calama, CL	SAM CL CI002 CALAMA
Chile	Chillan, CL	SAM CL CI005 CHILLÁN
Chile	Concepcion, CL	SAM CL CI005 CONCEPCIÓN
Chile	Copiapo, CL	SAM CL CI004 COPIAPÓ
Chile	Coquimbo, CL	SAM CL CI006 COQUIMBO
Chile	Iquique, CL	SAM CL CI012 IQUIQUE
Chile	La Serena, CL	SAM CL CI006 LA SERENA
Chile	Los Angeles, CL	SAM CL CI005 LOS ANGELES
Chile	Osorno, CL	SAM CL CI008 OSORNO
Chile	Puente Alto, CL	SAM CL CI011 PUENTE ALTO
Chile	Puerto Montt, CL	SAM CL CI008 PUERTO MONTT
Chile	Punta Arenas, CL	SAM CL CI009 PUNTA ARENAS
Chile	Quilpue, CL	SAM CL CI013 QUILPUÉ
Chile	Rancagua, CL	SAM CL CI007 RANCAGUA
Chile	San Bernardo, CL	SAM CL CI011 SAN BERNARDO
Chile	Santiago, CL	SAM CL CI011 SANTIAGO
Chile	Talca, CL	SAM CL CI010 TALCA
Chile	Talcahuano, CL	SAM CL CI005 TALCAHUANO
Chile	Temuco, CL	SAM CL CI003 TEMUCO
Chile	Valdivia, CL	SAM CL CI008 VALDIVIA
Chile	Valparaiso, CL	SAM CL CI013 VALPARAÍSO
Chile	Vina Del Mar, CL	SAM CL CI013 VIÑA DEL MAR
China	Acheng, CN	ASI CN CH011 ACHENG
China	Anda, CN	ASI CN CH011 ANDA
China	Ankang, CN	ASI CN CH022 ANKANG
China	Anlu, CN	ASI CN CH013 ANLU
China	Anqing, CN	ASI CN CH001 ANQING
China	Anshan, CN	ASI CN CH001 ANSHAN
China	Anyang, CN	ASI CN CH012 ANYANG
China	Atushi, CN	ASI CN CH028 ATUSHI
China	Baicheng, CN	ASI CN CH028 BAICHENG
China	Baiyin, CN	ASI CN CH001 BAIYIN
China	Baoding, CN	ASI CN CH001 BAODING
China	Baoji, CN	ASI CN CH018 BAOJI
China	Baoshan, CN	ASI CN CH031 BAOSHAN
China	Baotou, CN	ASI CN CH019 BAOTOU
China	Bazhou, CN	ASI CN CH008 BAZHOU
China	Beian, CN	ASI CN CH016 BEIAN
China	Beihai, CN	ASI CN CH007 BEIHAI
China	Beijing, CN	ASI CN CH002 BEIJING
China	Beipiao, CN	ASI CN CH018 BEIPIAO
China	Benxi, CN	ASI CN CH018 BENXI

China	Binzhou, CN	ASI CN CH023 BINZHOU
China	Cangzhou, CN	ASI CN CH004 CANGZHOU
China	Changchun, CN	ASI CN CH017 CHANGCHUN
China	Changde, CN	ASI CN CH014 CHANGDE
China	Changji, CN	ASI CN CH028 CHANGJI
China	Changsha, CN	ASI CN CH014 CHANGSHA
China	Changshu, CN	ASI CN CH015 CHANGSHU
China	Changzhi, CN	ASI CN CH023 CHANGZHI
China	Changzhou, CN	ASI CN CH015 CHANGZHOU
China	Chaohu, CN	ASI CN CH001 CHAOHU
China	Chaoyang, CN	ASI CN CH017 CHAOYANG
China	Chaozhou, CN	ASI CN CH006 CHAOZHOU
China	Chengde, CN	ASI CN CH010 CHENGDE
China	Chengdu, CN	ASI CN CH026 CHENGDU
China	Chenzhou, CN	ASI CN CH014 CHENZHOU
China	Chifeng, CN	ASI CN CH019 CHIFENG
China	Chongqing, CN	ASI CN CH003 CHONGQING
China	Chuxiong, CN	ASI CN CH030 CHUXIONG
China	Chuzhou, CN	ASI CN CH001 CHUZHOU
China	Cixi, CN	ASI CN CH001 CIXI
China	Daan, CN	ASI CN CH026 DAAN
China	Dali, CN	ASI CN CH030 DALI
China	Dalian, CN	ASI CN CH018 DALIAN
China	Dandong, CN	ASI CN CH018 DANDONG
China	Dangyang, CN	ASI CN CH013 DANGYANG
China	Danjiangkou, CN	ASI CN CH013 DANJIANGKOU
China	Danyang, CN	ASI CN CH015 DANYANG
China	Daqing, CN	ASI CN CH011 DAQING
China	Datong, CN	ASI CN CH001 DATONG
China	Daxian, CN	ASI CN CH026 DAXIAN
China	Dengzhou, CN	ASI CN CH023 DENGZHOU
China	Deyang, CN	ASI CN CH026 DEYANG
China	Dezhou, CN	ASI CN CH023 DEZHOU
China	Dingzhou, CN	ASI CN CH010 DINGZHOU
China	Dongchuan, CN	ASI CN CH030 DONGCHUAN
China	Dongguan, CN	ASI CN CH016 DONGGUAN
China	Dongsheng, CN	ASI CN CH019 DONGSHENG
China	Dongtai, CN	ASI CN CH015 DONGTAI
China	Dongyang, CN	ASI CN CH011 DONGYANG
China	Dongying, CN	ASI CN CH019 DONGYING
China	Dujun, CN	ASI CN CH016 DUJUN
China	Dunhua, CN	ASI CN CH017 DUNHUA
China	Dunhuang, CN	ASI CN CH005 DUNHUANG

China	Enshi, CN	ASI CN CH013 ENSHI
China	Fengcheng, CN	ASI CN CH016 FENGCHENG
China	Fenghua, CN	ASI CN CH031 FENGHUA
China	Foshan, CN	ASI CN CH006 FOSHAN
China	Fuan, CN	ASI CN CH004 FUAN
China	Fujin, CN	ASI CN CH011 FUJIN
China	Fulin, CN	ASI CN CH014 FULIN
China	Fushun, CN	ASI CN CH018 FUSHUN
China	Fuxin, CN	ASI CN CH018 FUXIN
China	Fuyang, CN	ASI CN CH001 FU YANG
China	Fuyu, CN	ASI CN CH011 FUYU
China	Fuzhou, CN	ASI CN CH004 FUZHOU
China	Ganzhou, CN	ASI CN CH016 GANZHOU
China	Gaocheng, CN	ASI CN CH013 GAOCHENG
China	Gejiu, CN	ASI CN CH030 GEJIU
China	Gongzhuling, CN	ASI CN CH017 GONGZHULING
China	Guanghan, CN	ASI CN CH001 GUANGHAN
China	Guangshui, CN	ASI CN CH013 GUANGSHUI
China	Guangyuan, CN	ASI CN CH026 GUANGYUAN
China	Guangzhou, CN	ASI CN CH006 GUANGZHOU
China	Guichi, CN	ASI CN CH001 GUICHI
China	Guilin, CN	ASI CN CH016 GUILIN
China	Guiyang, CN	ASI CN CH007 GUIYANG
China	Haicheng, CN	ASI CN CH004 HAICHENG
China	Haikou, CN	ASI CN CH009 HAIKOU
China	Haining, CN	ASI CN CH031 HAINING
China	Hami, CN	ASI CN CH028 HAMI
China	Hancheng, CN	ASI CN CH022 HANCHENG
China	Handan, CN	ASI CN CH016 HANDAN
China	Hangzhou, CN	ASI CN CH031 HANGZHOU
China	Hanzhong, CN	ASI CN CH022 HANZHONG
China	Harbin, CN	ASI CN CH011 HARBIN
China	Hebi, CN	ASI CN CH012 HEBI
China	Hechi, CN	ASI CN CH007 HECHI
China	Hefei, CN	ASI CN CH001 HEFEI
China	Hegang, CN	ASI CN CH001 HEGANG
China	Heihe, CN	ASI CN CH011 HEIHE
China	Hengshui, CN	ASI CN CH010 HENGSHUI
China	Hengyang, CN	ASI CN CH014 HENG YANG
China	Heshan, CN	ASI CN CH006 HESHAN
China	Hetian, CN	ASI CN CH004 HETIAN
China	Heyuan, CN	ASI CN CH006 HEYUAN
China	Heze, CN	ASI CN CH023 HEZE

China	Hohhot, CN	ASI CN CH019 HOHHOT
China	Honghu, CN	ASI CN CH009 HONGHU
China	Houma, CN	ASI CN CH025 HOUMA
China	Huadian, CN	ASI CN CH017 HUADIAN
China	Huaian, CN	ASI CN CH025 HUAIAN
China	Huaibei, CN	ASI CN CH001 HUAIBEI
China	Huaihua, CN	ASI CN CH014 HUAIHUA
China	Huainan, CN	ASI CN CH004 HUAINAN
China	Huaiyin, CN	ASI CN CH015 HUAIYIN
China	Huanghua, CN	ASI CN CH010 HUANGHUA
China	Huangshan, CN	ASI CN CH023 HUANGSHAN
China	Huangshi, CN	ASI CN CH001 HUANGSHI
China	Huaying, CN	ASI CN CH026 HUAYING
China	Huixian, CN	ASI CN CH005 HUIXIAN
China	Huizhou, CN	ASI CN CH006 HUIZHOU
China	Huludao, CN	ASI CN CH018 HULUDAO
China	Hunjiang, CN	ASI CN CH017 HUNJIANG
China	Huzhou, CN	ASI CN CH031 HUZHOU
China	Jiageda, CN	ASI CN CH019 JIAGEDA
China	Jiamusi, CN	ASI CN CH011 JIAMUSI
China	Jian, CN	ASI CN CH016 JIAN
China	Jiangmen, CN	ASI CN CH006 JIANGMEN
China	Jiangshan, CN	ASI CN CH001 JIANGSHAN
China	Jiangyin, CN	ASI CN CH004 JIANGYIN
China	Jiangyou, CN	ASI CN CH026 JIANGYOU
China	Jiaojiang, CN	ASI CN CH031 JIAOJIANG
China	Jiaozhou, CN	ASI CN CH023 JIAOZHOU
China	Jiaozuo, CN	ASI CN CH012 JIAOZUO
China	Jiaxing, CN	ASI CN CH031 JIAXING
China	Jieshou, CN	ASI CN CH001 JIESHOU
China	Jilin, CN	ASI CN CH007 JILIN
China	Jimo, CN	ASI CN CH023 JIMO
China	Jinan, CN	ASI CN CH007 JINAN
China	Jinchang, CN	ASI CN CH005 JINCHANG
China	Jingdezhen, CN	ASI CN CH016 JINGDEZHEN
China	Jingmen, CN	ASI CN CH004 JINGMEN
China	Jingzhou, CN	ASI CN CH013 JINGZHOU
China	Jinhua, CN	ASI CN CH008 JINHUA
China	Jining, CN	ASI CN CH019 JINING
China	Jinshi, CN	ASI CN CH031 JINSHI
China	Jinxi, CN	ASI CN CH016 JINXI
China	Jinzhou, CN	ASI CN CH018 JINZHOU
China	Jishou, CN	ASI CN CH014 JISHOU

China	Jiujiang, CN	ASI CN CH016 JIUJIANG
China	Jiuquan, CN	ASI CN CH005 JIUQUAN
China	Jiutai, CN	ASI CN CH008 JIUTAI
China	Jixi, CN	ASI CN CH001 JIXI
China	Jiyuan, CN	ASI CN CH012 JIYUAN
China	Kaifeng, CN	ASI CN CH012 KAIFENG
China	Kaili, CN	ASI CN CH008 KAILI
China	Kaiyuan, CN	ASI CN CH018 KAIYUAN
China	Kashi, CN	ASI CN CH028 KASHI
China	Kelamayi, CN	ASI CN CH028 KELAMAYI
China	Kunming, CN	ASI CN CH030 KUNMING
China	Kunshan, CN	ASI CN CH001 KUNSHAN
China	Laiwu, CN	ASI CN CH016 LAIWU
China	Laiyang, CN	ASI CN CH023 LAIYANG
China	Laizhou, CN	ASI CN CH004 LAIZHOU
China	Langfang, CN	ASI CN CH010 LANGFANG
China	Lanxi, CN	ASI CN CH001 LANXI
China	Lanzhou, CN	ASI CN CH005 LANZHOU
China	Laohekou, CN	ASI CN CH013 LAOHEKOU
China	Leiyang, CN	ASI CN CH014 LEIYANG
China	Leling, CN	ASI CN CH023 LELING
China	Lengshuijiang, CN	ASI CN CH014 LENGSHUIJIANG
China	Lengshuitan, CN	ASI CN CH014 LENGSHUITAN
China	Leshan, CN	ASI CN CH026 LESHAN
China	Lhasa, CN	ASI CN CH029 LHASA
China	Lianyuan, CN	ASI CN CH014 LIANYUAN
China	LianYunGang, CN	ASI CN CH015 LIANYUNGANG
China	Liaocheng, CN	ASI CN CH023 LIAOCHENG
China	Liaoyang, CN	ASI CN CH018 LIAOYANG
China	Linyi, CN	ASI CN CH023 LINYI
China	Lishui, CN	ASI CN CH031 LISHUI
China	Liuzhou, CN	ASI CN CH007 LIUZHOU
China	Luoyang, CN	ASI CN CH012 LUOYANG
China	Maanshan, CN	ASI CN CH026 MAANSHAN
China	Macheng, CN	ASI CN CH001 MACHENG
China	Maoming, CN	ASI CN CH006 MAOMING
China	Meihekou, CN	ASI CN CH017 MEIHEKOU
China	Meixian, CN	ASI CN CH004 MEIXIAN
China	Mianyang, CN	ASI CN CH004 MIANYANG
China	Miluo, CN	ASI CN CH014 MILUO
China	Mishan, CN	ASI CN CH011 MISHAN
China	Mudanjiang, CN	ASI CN CH011 MUDANJIANG
China	Nanchang, CN	ASI CN CH016 NANCHANG

China	Nanchong, CN	ASI CN CH026 NANCHONG
China	Nangong, CN	ASI CN CH010 NANGONG
China	Nanjing, CN	ASI CN CH016 NANJING
China	Nanning, CN	ASI CN CH007 NANNING
China	Nanping, CN	ASI CN CH004 NANPING
China	Nantong, CN	ASI CN CH015 NANTONG
China	Nanyang, CN	ASI CN CH004 NANYANG
China	Neijiang, CN	ASI CN CH026 NEIJANG
China	Ningbo, CN	ASI CN CH031 NINGBO
China	Ningde, CN	ASI CN CH004 NINGDE
China	Panjin, CN	ASI CN CH018 PANJIN
China	Panzhuhua, CN	ASI CN CH026 PANZHUIHUA
China	Pingdingshan, CN	ASI CN CH012 PINGDINGSHAN
China	Pingdu, CN	ASI CN CH016 PINGDU
China	Pingliang, CN	ASI CN CH005 PINGLIANG
China	Puqi, CN	ASI CN CH013 PUQI
China	Putian, CN	ASI CN CH004 PUTIAN
China	Puyang, CN	ASI CN CH012 PUYANG
China	Qianjiang, CN	ASI CN CH007 QIANJIANG
China	Qidong, CN	ASI CN CH014 QIDONG
China	Qingdao, CN	ASI CN CH023 QINGDAO
China	Qingtongxia, CN	ASI CN CH020 QINGTONGXIA
China	Qingyuan, CN	ASI CN CH018 QINGYUAN
China	Qingzhou, CN	ASI CN CH004 QINGZHOU
China	Qinhuangdao, CN	ASI CN CH010 QINHUANGDAO
China	Qinyang, CN	ASI CN CH012 QINYANG
China	Qinzhou, CN	ASI CN CH007 QINZHOU
China	Qiqihar, CN	ASI CN CH011 QIQIHAR
China	Qitaihe, CN	ASI CN CH011 QITAIHE
China	Quanzhou, CN	ASI CN CH004 QUANZHOU
China	Qufu, CN	ASI CN CH023 QUFU
China	Qujing, CN	ASI CN CH030 QUJING
China	Quzhou, CN	ASI CN CH010 QUZHOU
China	Renqiu, CN	ASI CN CH010 RENQIU
China	Rizhao, CN	ASI CN CH023 RIZHAO
China	Rongcheng, CN	ASI CN CH010 RONGCHENG
China	Ruian, CN	ASI CN CH004 RUIAN
China	Ruichang, CN	ASI CN CH016 RUICHANG
China	Ruzhou, CN	ASI CN CH004 RUZHOU
China	Sanmenxia, CN	ASI CN CH012 SANMENXIA
China	Sanming, CN	ASI CN CH004 SANMING
China	Sanya, CN	ASI CN CH009 SANYA
China	Shahe, CN	ASI CN CH001 SHAHE

China	Shanghai, CN	ASI CN CH024 SHANGHAI
China	Shangluo, CN	ASI CN CH022 SHANGLUO
China	Shangqiu, CN	ASI CN CH012 SHANGQIU
China	Shangrao, CN	ASI CN CH016 SHANGRAO
China	Shangzhi, CN	ASI CN CH011 SHANGZHI
China	Shangzhou, CN	ASI CN CH026 SHANGZHOU
China	Shantou, CN	ASI CN CH006 SHANTOU
China	Shanwei, CN	ASI CN CH004 SHANWEI
China	Shaoguan, CN	ASI CN CH006 SHAOGUAN
China	Shaowu, CN	ASI CN CH004 SHAOWU
China	Shaoxing, CN	ASI CN CH031 SHAOXING
China	Shaoyang, CN	ASI CN CH014 SHAOYANG
China	Shashi, CN	ASI CN CH001 SHASHI
China	Shenyang, CN	ASI CN CH018 SHENYANG
China	Shenzhen, CN	ASI CN CH031 SHENZHEN
China	Shihezi, CN	ASI CN CH028 SHIHEZI
China	Shijiazhuang, CN	ASI CN CH010 SHIJIAZHUANG
China	Shishi, CN	ASI CN CH004 SHISHI
China	Shishou, CN	ASI CN CH013 SHISHOU
China	Shiyan, CN	ASI CN CH013 SHIYAN
China	Shizuishan, CN	ASI CN CH020 SHIZUISHAN
China	Shuangcheng, CN	ASI CN CH011 SHUANGCHENG
China	Suihua, CN	ASI CN CH011 SUIHUA
China	Suining, CN	ASI CN CH014 SUINING
China	Suizhou, CN	ASI CN CH013 SUIZHOU
China	Suqian, CN	ASI CN CH015 SUQIAN
China	Suzhou, CN	ASI CN CH015 SUZHOU
China	Tacheng, CN	ASI CN CH028 TACHENG
China	Taian, CN	ASI CN CH018 TAIAN
China	Taiyuan, CN	ASI CN CH025 TAIYUAN
China	Taizhou, CN	ASI CN CH015 TAIZHOU
China	Taizhou, CN	ASI CN CH015 TAIZHOU
China	Tangshan, CN	ASI CN CH010 TANGSHAN
China	Taonan, CN	ASI CN CH017 TAONAN
China	Tengzhou, CN	ASI CN CH023 TENGZHOU
China	Tianjin, CN	ASI CN CH027 TIANJIN
China	Tianmen, CN	ASI CN CH011 TIANMEN
China	Tianshui, CN	ASI CN CH005 TIANSHUI
China	Tiefa, CN	ASI CN CH018 TIEFA
China	Tieli, CN	ASI CN CH011 TIELI
China	Tieling, CN	ASI CN CH018 TIELING
China	Tongchuan, CN	ASI CN CH022 TONGCHUAN
China	Tonghua, CN	ASI CN CH017 TONGHUA

China	Tongjiang, CN	ASI CN CH011 TONGJIANG
China	Tongliao, CN	ASI CN CH019 TONGLIAO
China	Tongling, CN	ASI CN CH001 TONGLING
China	Tongren, CN	ASI CN CH008 TONGREN
China	Tulufan, CN	ASI CN CH028 TULUFAN
China	Tumen, CN	ASI CN CH017 TUMEN
China	Wafangdian, CN	ASI CN CH022 WAFANGDIAN
China	Wanxian, CN	ASI CN CH003 WANXIAN
China	Weifang, CN	ASI CN CH023 WEIFANG
China	Weihai, CN	ASI CN CH023 WEIHAI
China	Weihui, CN	ASI CN CH012 WEIHUI
China	Weinan, CN	ASI CN CH022 WEINAN
China	Wendeng, CN	ASI CN CH023 WENDENG
China	Wenzhou, CN	ASI CN CH031 WENZHOU
China	Wuan, CN	ASI CN CH014 WUAN
China	Wugang, CN	ASI CN CH014 WUGANG
China	Wuhai, CN	ASI CN CH019 WUHAI
China	Wuhan, CN	ASI CN CH013 WUHAN
China	Wuhu, CN	ASI CN CH001 WUHU
China	Wulumuqi, CN	ASI CN CH028 WULUMUQI
China	Wuxi, CN	ASI CN CH003 WUXI
China	Wuxue, CN	ASI CN CH013 WUXUE
China	Wuyishan, CN	ASI CN CH004 WUYISHAN
China	Wuzhong, CN	ASI CN CH020 WUZHONG
China	Wuzhou, CN	ASI CN CH007 WUZHOU
China	Xiamen, CN	ASI CN CH004 XIAMEN
China	Xian, CN	ASI CN CH010 XIAN
China	Xiangfan, CN	ASI CN CH013 XIANGFAN
China	Xiangtan, CN	ASI CN CH026 XIANGTAN
China	Xiangxiang, CN	ASI CN CH014 XIANGXIANG
China	Xianning, CN	ASI CN CH013 XIANNING
China	Xiantao, CN	ASI CN CH013 XIANTAO
China	Xianyang, CN	ASI CN CH004 XIANYANG
China	Xiaogan, CN	ASI CN CH013 XIAOGAN
China	Xiaoshan, CN	ASI CN CH031 XIAOSHAN
China	Xichang, CN	ASI CN CH026 XICHANG
China	Xifeng, CN	ASI CN CH023 XIFENG
China	Xingcheng, CN	ASI CN CH025 XINGCHENG
China	Xinghua, CN	ASI CN CH015 XINGHUA
China	Xingtai, CN	ASI CN CH010 XINGTAI
China	Xingyi, CN	ASI CN CH008 XINGYI
China	Xining, CN	ASI CN CH021 XINING
China	Xinji, CN	ASI CN CH010 XINJI



China	Xintai, CN	ASI CN CH008 XINTAI
China	Xinxiang, CN	ASI CN CH012 XINXIANG
China	Xinyang, CN	ASI CN CH012 XINYANG
China	Xinyi, CN	ASI CN CH006 XINYI
China	Xinyu, CN	ASI CN CH012 XINYU
China	Xinzhou, CN	ASI CN CH001 XINZHOU
China	Xuchang, CN	ASI CN CH001 XUCHANG
China	Xuzhou, CN	ASI CN CH015 XUZHOU
China	Yaan, CN	ASI CN CH026 YAAN
China	Yakeshi, CN	ASI CN CH019 YAKESHI
China	Yanan, CN	ASI CN CH022 YANAN
China	Yancheng, CN	ASI CN CH023 YANCHENG
China	Yangjiang, CN	ASI CN CH006 YANGJIANG
China	Yangquan, CN	ASI CN CH025 YANGQUAN
China	Yangzhou, CN	ASI CN CH015 YANGZHOU
China	Yanji, CN	ASI CN CH012 YANJI
China	Yantai, CN	ASI CN CH023 YANTAI
China	Yibin, CN	ASI CN CH026 YIBIN
China	Yichang, CN	ASI CN CH013 YICHANG
China	Yichun, CN	ASI CN CH011 YICHUN
China	Yinchuan, CN	ASI CN CH020 YINCHUAN
China	Yingcheng, CN	ASI CN CH013 YINGCHENG
China	Yingkou, CN	ASI CN CH018 YINGKOU
China	Yingtán, CN	ASI CN CH016 YINGTAN
China	Yining, CN	ASI CN CH016 YINING
China	Yiwu, CN	ASI CN CH028 YIWU
China	Yixing, CN	ASI CN CH015 YIXING
China	Yiyang, CN	ASI CN CH012 YIYANG
China	Yizhou, CN	ASI CN CH010 YIZHOU
China	Yongan, CN	ASI CN CH025 YONGAN
China	Yongzhou, CN	ASI CN CH014 YONGZHOU
China	Yuanjiang, CN	ASI CN CH030 YUANJIANG
China	Yuci, CN	ASI CN CH025 YUCI
China	Yueyang, CN	ASI CN CH014 YUEYANG
China	Yulin, Guangxi, CN	ASI CN CH007 YULIN
China	Yulin, Shaanxi, CN	ASI CN CH022 YULIN
China	Yumen, CN	ASI CN CH005 YUMEN
China	Yuncheng, CN	ASI CN CH025 YUNCHENG
China	Yutian, CN	ASI CN CH010 YUTIAN
China	Yuxi, CN	ASI CN CH004 YUXI
China	Yuyao, CN	ASI CN CH004 YUYAO
China	Yuzhou, CN	ASI CN CH012 YUZHOU
China	Zaozhuang, CN	ASI CN CH023 ZAOZHUANG

China	Zhalantun, CN	ASI CN CH019 ZHALANTUN
China	Zhangjiagang, CN	ASI CN CH015 ZHANGJIAGANG
China	Zhangjiakou, CN	ASI CN CH010 ZHANGJIAKOU
China	Zhangshu, CN	ASI CN CH015 ZHANGSHU
China	Zhangye, CN	ASI CN CH005 ZHANGYE
China	Zhangzhou, CN	ASI CN CH004 ZHANGZHOU
China	Zhanjiang, CN	ASI CN CH006 ZHANJIANG
China	Zhaodong, CN	ASI CN CH011 ZHAODONG
China	Zhaoqing, CN	ASI CN CH006 ZHAOQING
China	Zhaotong, CN	ASI CN CH030 ZHAOTONG
China	Zhaoyang, CN	ASI CN CH015 ZHAOYANG
China	Zhengzhou, CN	ASI CN CH012 ZHENGZHOU
China	Zhenjiang, CN	ASI CN CH015 ZHENJIANG
China	Zhicheng, CN	ASI CN CH031 ZHICHENG
China	Zhongshan, CN	ASI CN CH004 ZHONGSHAN
China	Zhoushan, CN	ASI CN CH031 ZHOUSHAN
China	Zhucheng, CN	ASI CN CH015 ZHUCHENG
China	Zhuhai, CN	ASI CN CH006 ZHUHAI
China	Zhuji, CN	ASI CN CH023 ZHUJI
China	Zhumadian, CN	ASI CN CH012 ZHUMADIAN
China	Zhuozhou, CN	ASI CN CH010 ZHUOZHOU
China	Zhuzhou, CN	ASI CN CH014 ZHUZHOU
China	Zibo, CN	ASI CN CH023 ZIBO
China	Zigong, CN	ASI CN CH026 ZIGONG
China	Zixing, CN	ASI CN CH014 ZIXING
China	Zunyi, CN	ASI CN CH008 ZUNYI
Colombia	Armenia, CO	SAM CO CO021 ARMENIA
Colombia	Barrancabermeja, CO	SAM CO CO024 BARRANCABERMEJA
Colombia	Barranquilla, CO	SAM CO CO004 BARRANQUILLA
Colombia	Bello, CO	SAM CO CO002 BELLO
Colombia	Bucaramanga, CO	SAM CO CO024 BUCARAMANGA
Colombia	Buenaventura, CO	SAM CO CO027 BUENAVENTURA
Colombia	Buga, CO	SAM CO CO027 BUGA
Colombia	Cali, CO	SAM CO CO027 CALI
Colombia	Cartagena, CO	SAM CO CO008 CARTAGENA
Colombia	Cartago, CO	SAM CO CO027 CARTAGO
Colombia	Cucuta, CO	SAM CO CO005 CUCUTA
Colombia	Dos Quebradas, CO	SAM CO CO027 DOS QUEBRADAS
Colombia	Envigado, CO	SAM CO CO002 ENVIGADO
Colombia	Florencia, CO	SAM CO CO005 FLORENCIA
Colombia	Floridablanca, CO	SAM CO CO024 FLORIDABLANCA
Colombia	Girardot, CO	SAM CO CO011 GIRARDOT
Colombia	Ibague, CO	SAM CO CO026 IBAGUÉ

Colombia	Itagui, CO	SAM CO CO002 ITAGÜÍ
Colombia	Maicao, CO	SAM CO CO016 MAICAO
Colombia	Manizales, CO	SAM CO CO002 MANIZALES
Colombia	Medellin, CO	SAM CO CO002 MEDELLÍN
Colombia	Monteria, CO	SAM CO CO010 MONTERIA
Colombia	Neiva, CO	SAM CO CO015 NEIVA
Colombia	Palmira, CO	SAM CO CO027 PALMIRA
Colombia	Pasto, CO	SAM CO CO018 PASTO
Colombia	Pereira, CO	SAM CO CO022 PEREIRA
Colombia	Popayan, CO	SAM CO CO007 POPAYAN
Colombia	Santa Fe De Bogota, CO	SAM CO CO000 SANTA FE DE BOGOTA
Colombia	Santa Marta, CO	SAM CO CO018 SANTA MARTA
Colombia	Sincelejo, CO	SAM CO CO025 SINCELEJO
Colombia	Soacha, CO	SAM CO CO011 SOACHA
Colombia	Sogamoso, CO	SAM CO CO000 SOGAMOSO
Colombia	Soledad, CO	SAM CO CO004 SOLEDAD
Colombia	Tulua, CO	SAM CO CO027 TULUA
Colombia	Tunja, CO	SAM CO CO019 TUNJA
Colombia	Valledupar, CO	SAM CO CO008 VALLEDUPAR
Colombia	Villavicencio, CO	SAM CO CO017 VILLAVICENCIO
Comoros	Moroni, KM	AFR KM CN004 MORONI
Cook Islands	Rarotonga, CK	OCN CK CW--- RAROTONGA
Costa Rica	Alajuela, CR	CAC CR CS001 ALAJUELA
Costa Rica	Cartago, CR	CAC CR CS002 CARTAGO
Costa Rica	San Jose, CR	CAC CR CS007 SAN JOSE
Croatia	Osijek, HR	EUR HR HR011 OSIJEK
Croatia	Rijeka, HR	EUR HR HR013 RIJEKA
Croatia	Split, HR	EUR HR HR016 SPLIT
Croatia	Zagreb, HR	EUR HR HR004 ZAGREB
Cuba	Bayamo, CU	CAC CU CU005 BAYAMO
Cuba	Camaguey, CU	CAC CU CU001 CAMAGÜEY
Cuba	Cienfuegos, CU	CAC CU CU003 CIENFUEGOS
Cuba	Guantanamo, CU	CAC CU CU006 GUANTÁNAMO
Cuba	Holguin, CU	CAC CU CU007 HOLGUÍN
Cuba	La Habana, CU	CAC CU CU004 LA HABANA
Cuba	Las Tunas, CU	CAC CU CU010 LAS TUNAS
Cuba	Matanzas, CU	CAC CU CU011 MATANZAS
Cuba	Pinar Del Rio, CU	CAC CU CU012 PINAR DEL RÍO
Cuba	Sancti Spiritus, CU	CAC CU CU013 SANCTI SPÍRITUS
Cuba	Santa Clara, CU	CAC CU CU015 SANTA CLARA
Cuba	Santiago De Cuba, CU	CAC CU CU014 SANTIAGO DE CUBA
Cyprus	Limassol, CY	MEA CY CY004 LIMASSOL
Cyprus	Nicosia, CY	MEA CY CY005 NICOSIA

Czech Republic	Brno, CZ	EUR CZ EZ007 BRNO
Czech Republic	Olomouc, CZ	EUR CZ EZ004 OLOMOUC
Czech Republic	Ostrava, CZ	EUR CZ EZ004 OSTRAVA
Czech Republic	Plzen, CZ	EUR CZ EZ008 PLZEN
Czech Republic	Praha, CZ	EUR CZ EZ001 PRAHA
Democratic Republic of Congo	Kinshasa, CD	AFR CD CG007 KINSHASA
Denmark	Aalborg, DK	EUR DK DA007 AALBORG
Denmark	Aarhus, DK	EUR DK DA001 AARHUS
Denmark	Copenhagen, DK	EUR DK DA012 COPENHAGEN
Denmark	Esbjerg, DK	EUR DK DA008 ESBJERG
Denmark	Fredericia, DK	EUR DK DA014 FREDERICIA
Denmark	Frederikshavn, DK	EUR DK DA007 FREDERIKSHAVN
Denmark	Haderslev, DK	EUR DK DA011 HADSERSLEV
Denmark	Helsingoer, DK	EUR DK DA004 HELSINGOER
Denmark	Herning, DK	EUR DK DA009 HERNING
Denmark	Hilleroed, DK	EUR DK DA004 HILLEROED
Denmark	Hjoerring, DK	EUR DK DA007 HJOERRING
Denmark	Hoersholm, DK	EUR DK DA004 HOERSHOLM
Denmark	Holbaek, DK	EUR DK DA015 HOLBAEK
Denmark	Holstebro, DK	EUR DK DA009 HOLSTEBRO
Denmark	Horsens, DK	EUR DK DA014 HORSENS
Denmark	Koegel, DK	EUR DK DA010 KOEGE
Denmark	Kolding, DK	EUR DK DA014 KOLDING
Denmark	Naestved, DK	EUR DK DA013 NAESTVED
Denmark	Odense, DK	EUR DK DA005 ODENSE
Denmark	Randers, DK	EUR DK DA001 RANDERS
Denmark	Roskilde, DK	EUR DK DA010 ROSKILDE
Denmark	Silkeborg, DK	EUR DK DA001 SILKEBORG
Denmark	Skive, DK	EUR DK DA016 SKIVE
Denmark	Slagelse, DK	EUR DK DA015 SLAGELSE
Denmark	Soenderborg, DK	EUR DK DA011 SOENDERBORG
Denmark	Svendborg, DK	EUR DK DA005 SVENDBORG
Denmark	Taastrup, DK	EUR DK DA006 TAASTRUP
Denmark	Vejle, DK	EUR DK DA014 VEJLE
Denmark	Viborg, DK	EUR DK DA005 VIBORG
Djibouti	Djibouti, DJ	AFR DJ DJ003 DJIBOUTI
Dominica	Roseau, DM	CAC DM DO003 ROSEAU
Dominican Republic	San Pedro De Macoris, DO	CAC DO DR026 SAN PEDRO DE MACORIS
Dominican Republic	Santiago De Los Caballeros, DO	CAC DO DR028 SANTIAGO DE LOS CABALLEROS

Dominican Republic	Santo Domingo, DO	CAC DO DR005 SANTO DOMINGO
East Timor	Dili, TL	ASI TL TT000 DILI
Ecuador	Ambato, EC	SAM EC EC018 AMBATO
Ecuador	Cuenca, EC	SAM EC EC001 CUENCA
Ecuador	Esmeraldas, EC	SAM EC EC008 ESMERALDAS
Ecuador	Guayaquil, EC	SAM EC EC010 GUAYAQUIL
Ecuador	Ibarra, EC	SAM EC EC011 IBARRA
Ecuador	Loja, EC	SAM EC EC012 LOJA
Ecuador	Machala, EC	SAM EC EC007 MACHALA
Ecuador	Manta, EC	SAM EC EC014 MANTA
Ecuador	Milagro, EC	SAM EC EC010 MILAGRO
Ecuador	Portoviejo, EC	SAM EC EC014 PORTOVIEJO
Ecuador	Quevedo, EC	SAM EC EC013 QUEVEDO
Ecuador	Quito, EC	SAM EC EC017 QUITO
Ecuador	Riobamba, EC	SAM EC EC005 RIOBAMBA
Ecuador	Santo Domingo De Los Colorados, EC	SAM EC EC017 SANTO DOMINGO DE LOS COLORADOS
Egypt	Alexandria, EG	AFR EG EG006 ALEXANDRIA
Egypt	Aswan, EG	AFR EG EG016 ASWAN
Egypt	Banha, EG	AFR EG EG012 BANHA
Egypt	Cairo, EG	AFR EG EG011 CAIRO
Egypt	Damanhur, EG	AFR EG EG003 DAMANHÛR
Egypt	El-Mahalla El-Kubra, EG	AFR EG EG005 EL-MAHALLA EL-KUBRA
Egypt	Faiyum, EG	AFR EG EG004 FAIYÛM
Egypt	Giza, EG	AFR EG EG008 GIZA
Egypt	Imbaba, EG	AFR EG EG008 IMBABA
Egypt	Ismailia, EG	AFR EG EG007 ISMAILIA
Egypt	Kena, EG	AFR EG EG024 KENA
Egypt	Mansura, EG	AFR EG EG001 MANSÛRA
Egypt	Menia, EG	AFR EG EG010 MENIA
Egypt	Port Said, EG	AFR EG EG019 PORT SAID
Egypt	Sohag, EG	AFR EG EG023 SOHAG
Egypt	Suez, EG	AFR EG EG014 SUEZ
Egypt	Tanta, EG	AFR EG EG005 TANTA
Egypt	Zagazig, EG	AFR EG EG015 ZAGAZIG
El Salvador	Ahuachapan, SV	CAC SV ES001 AHUACHAPAN
El Salvador	Apopa, SV	CAC SV ES010 APOPA
El Salvador	Ilopango, SV	CAC SV ES010 ILOPANGO
El Salvador	Mejicanos, SV	CAC SV ES010 MEJICANOS
El Salvador	Nueva San Salvador, SV	CAC SV ES005 NUEVA SAN SALVADOR
El Salvador	San Martin, SV	CAC SV ES010 SAN MARTIN
El Salvador	San Miguel, SV	CAC SV ES010 SAN MIGUEL

El Salvador	San Salvador, SV	CAC SV ES010 SAN SALVADOR
El Salvador	Santa Ana, SV	CAC SV ES012 SANTA ANA
El Salvador	Soyapango, SV	CAC SV ES010 SOYAPANGO
Equatorial Guinea	Malabo, GQ	AFR GQ EK000 MALABO
Eritrea	Asmara, ER	AFR ER ER000 ASMARA
Estonia	Tallinn, EE	EUR EE EN001 TALLINN
Estonia	Tartu, EE	EUR EE EN012 TARTU
Ethiopia	Addis Ababa, ET	AFR ET ET000 ADDIS ABABA
Ethiopia	Bahir Dar, ET	AFR ET ET000 BAHIR DAR
Ethiopia	Dessie, ET	AFR ET ET000 DESSIE
Ethiopia	Dire Dawa, ET	AFR ET ET000 DIRE DAWA
Ethiopia	Gondar, ET	AFR ET ET000 GONDAR
Ethiopia	Jimma, ET	AFR ET ET000 JIMMA
Ethiopia	Mekele, ET	AFR ET ET000 MEKELE
Falkland Islands	Stanley, FK	SAM FK FK--- STANLEY
Faroe Islands	Thorshavn, FO	EUR FO FO--- THORSHAVN
Fiji	Suva, FJ	OCN FJ FJ001 SUVA
Finland	Espoo, FI	EUR FI FI002 ESPOO
Finland	Helsinki, FI	EUR FI FI002 HELSINKI
Finland	Oulu, FI	EUR FI FI007 OULU
Finland	Tampere, FI	EUR FI FI005 TAMPERE
Finland	Turku, FI	EUR FI FI005 TURKU
Finland	Vantaa, FI	EUR FI FI002 VANTAA
France	Aix-En-Provence, FR	EUR FR FR021 AIX-EN-PROVENCE
France	Amiens, FR	EUR FR FR019 AMIENS
France	Angers, FR	EUR FR FR018 ANGERS
France	Annecy, FR	EUR FR FR022 ANNECY
France	Avignon, FR	EUR FR FR021 AVIGNON
France	Besancon, FR	EUR FR FR010 BESANÇON
France	Bordeaux, FR	EUR FR FR002 BORDEAUX EUR FR FR012 BOULOGNE-
France	Boulogne-Billancourt, FR	BILLANCOURT
France	Brest, FR	EUR FR FR006 BREST
France	Briançon, FR	EUR FR FR021 BRIANÇON
France	Caen, FR	EUR FR FR004 CAEN
France	Clermont-Ferrand, FR	EUR FR FR003 CLERMONT-FERRAND
France	Dijon, FR	EUR FR FR005 DIJON
France	Gap, FR	EUR FR FR021 GAP
France	Grenoble, FR	EUR FR FR022 GRENOBLE
France	Le Havre, FR	EUR FR FR011 LE HAVRE
France	Le Mans, FR	EUR FR FR018 LE MANS
France	Lille, FR	EUR FR FR017 LILLE

France	Limoges, FR	EUR FR FR012 LIMOGES
France	Lyon, FR	EUR FR FR022 LYON
France	Marseille, FR	EUR FR FR021 MARSEILLE
France	Metz, FR	EUR FR FR015 METZ
France	Montélimar, FR	EUR FR FR022 MONTÉLIMAR
France	Montpellier, FR	EUR FR FR013 MONTPELLIER
France	Mulhouse, FR	EUR FR FR001 MULHOUSE
France	Nantes, FR	EUR FR FR018 NANTES
France	Nice, FR	EUR FR FR021 NICE
France	Nîmes, FR	EUR FR FR013 NÎMES
France	Orleans, FR	EUR FR FR007 ORLÉANS
France	Paris, FR	EUR FR FR012 PARIS
France	Pau, FR	EUR FR FR022 PAU
France	Perpignan, FR	EUR FR FR013 PERPIGNAN
France	Reims, FR	EUR FR FR008 REIMS
France	Rennes, FR	EUR FR FR006 RENNES
France	Rouen, FR	EUR FR FR011 ROUEN
France	Saint Etienne, FR	EUR FR FR022 SAINT-ÉTIENNE
France	Strasbourg, FR	EUR FR FR001 STRASBOURG
France	Toulon, FR	EUR FR FR021 TOULON
France	Toulouse, FR	EUR FR FR016 TOULOUSE
France	Tours, FR	EUR FR FR007 TOURS
France	Villeurbanne, FR	EUR FR FR012 VILLEURBANNE
French Guiana	Cayenne, GF	SAM GF FG001 CAYENNE
French Polynesia	Papeete, PF	OCN PF FP000 PAPEETE
Gabon	Libreville, GA	AFR GA GB001 LIBREVILLE
Gabon	Pointe-Noire, GA	AFR GA GB003 POINTE-NOIRE
Georgia	Batumi, GE	ASI GE GG000 BATUMI
Georgia	Kutaisi, GE	ASI GE GG000 KUTAISI
Georgia	Rustavi, GE	ASI GE GG000 RUSTAVI
Georgia	Sukhumi, GE	ASI GE GG000 SUKHUMI
Georgia	Tbilisi, GE	ASI GE GG000 TBILISI
Germany	Aachen, DE	EUR DE GM011 AACHEN
Germany	Augsburg, DE	EUR DE GM002 AUGSBURG
Germany	Bergisch Gladbach, DE	EUR DE GM011 BERGISCH GLADBACH
Germany	Berlin, DE	EUR DE GM003 BERLIN
Germany	Bielefeld, DE	EUR DE GM011 BIELEFELD
Germany	Bochum, DE	EUR DE GM011 BOCHUM
Germany	Bonn, DE	EUR DE GM011 BONN
Germany	Bottrop, DE	EUR DE GM011 BOTTROP
Germany	Braunschweig, DE	EUR DE GM009 BRAUNSCHWEIG
Germany	Bremen, DE	EUR DE GM005 BREMEN
Germany	Bremerhaven, DE	EUR DE GM005 BREMERHAVEN

Germany	Chemnitz, DE	EUR DE GM014 CHEMNITZ
Germany	Cottbus, DE	EUR DE GM004 COTTBUS
Germany	Darmstadt, DE	EUR DE GM007 DARMSTADT
Germany	Dortmund, DE	EUR DE GM011 DORTMUND
Germany	Dresden, DE	EUR DE GM014 DRESDEN
Germany	Duisburg, DE	EUR DE GM011 DUISBURG
Germany	Dusseldorf, DE	EUR DE GM011 DÜSSELDORF
Germany	Erfurt, DE	EUR DE GM017 ERFURT
Germany	Erlangen, DE	EUR DE GM002 ERLANGEN
Germany	Essen, DE	EUR DE GM011 ESSEN
Germany	Frankfurt Am Main, DE	EUR DE GM007 FRANKFURT AM MAIN
Germany	Freiburg Im Breisgau, DE	EUR DE GM001 FREIBURG IM BREISGAU
Germany	Furth, DE	EUR DE GM002 FÜRTH
Germany	Gelsenkirchen, DE	EUR DE GM011 GELSENKIRCHEN
Germany	Gera, DE	EUR DE GM017 GERA
Germany	Gladbach, DE	EUR DE GM011 MÖNCHENGLADBACH
Germany	Göttingen, DE	EUR DE GM007 GÖTTINGEN
Germany	Hagen, DE	EUR DE GM015 HAGEN
Germany	Halle, DE	EUR DE GM009 HALLE
Germany	Hamburg, DE	EUR DE GM006 HAMBURG
Germany	Hamm, DE	EUR DE GM009 HAMM
Germany	Hannover, DE	EUR DE GM009 HANNOVER
Germany	Heidelberg, DE	EUR DE GM001 HEIDELBERG
Germany	Heilbronn, DE	EUR DE GM001 HEILBRONN
Germany	Herne, DE	EUR DE GM011 HERNE
Germany	Hildesheim, DE	EUR DE GM009 HILDESHEIM
Germany	Ingolstadt, DE	EUR DE GM002 INGOLSTADT
Germany	Kaiserslautern, DE	EUR DE GM012 KAISERSLAUTERN
Germany	Karlsruhe, DE	EUR DE GM001 KARLSRUHE
Germany	Kassel, DE	EUR DE GM007 KASSEL
Germany	Kiel, DE	EUR DE GM016 KIEL
Germany	Koblenz, DE	EUR DE GM012 KOBLENZ
Germany	Koln, DE	EUR DE GM011 KÖLN
Germany	Krefeld, DE	EUR DE GM011 KREFELD
Germany	Leipzig, DE	EUR DE GM014 LEIPZIG
Germany	Leverkusen, DE	EUR DE GM011 LEVERKUSEN
Germany	Lubeck, DE	EUR DE GM016 LÜBECK
Germany	Ludwigshafen, DE	EUR DE GM012 LÜDWIGSHAFEN AM RHEIN
Germany	Magdeburg, DE	EUR DE GM015 MAGDEBURG
Germany	Mainz, DE	EUR DE GM002 MAINZ
Germany	Mannheim, DE	EUR DE GM001 MANNHEIM
Germany	Moers, DE	EUR DE GM011 MOERS



Germany	Mulheim, DE	EUR DE GM011 MÜLHEIM AN DER RUHR
Germany	Munich, DE	EUR DE GM002 MÜNCHEN
Germany	Munster, DE	EUR DE GM007 MÜNSTER
Germany	Neuss, DE	EUR DE GM011 NEUSS
Germany	Nurnberg, DE	EUR DE GM002 NÜRNBERG
Germany	Oberhausen, DE	EUR DE GM007 OBERHAUSEN
Germany	Offenbach Am Main, DE	EUR DE GM007 OFFENBACH AM MAIN
Germany	Oldenburg, DE	EUR DE GM009 OLDENBURG
Germany	Osnabruck, DE	EUR DE GM009 OSNABRÜCK
Germany	Paderborn, DE	EUR DE GM011 PADERBORN
Germany	Pforzheim, DE	EUR DE GM001 PFORZHEIM
Germany	Potsdam, DE	EUR DE GM004 POTSDAM
Germany	Recklinghausen, DE	EUR DE GM011 RECKLINGHAUSEN
Germany	Regensburg, DE	EUR DE GM002 REGENSBURG
Germany	Remscheid, DE	EUR DE GM011 REMSCHIED
Germany	Reutlingen, DE	EUR DE GM001 REUTLINGEN
Germany	Rostock, DE	EUR DE GM010 ROSTOCK
Germany	Saarbrucken, DE	EUR DE GM013 SAARBRÜCKEN
Germany	Salzgitter, DE	EUR DE GM009 SALZGITTER
Germany	Schwerin, DE	EUR DE GM010 SCHWERIN
Germany	Siegen, DE	EUR DE GM011 SIEGEN
Germany	Solingen, DE	EUR DE GM011 SOLINGEN
Germany	Stuttgart, DE	EUR DE GM001 STUTT GART
Germany	Ulm, DE	EUR DE GM001 ULM
Germany	Wiesbaden, DE	EUR DE GM007 WIESBADEN
Germany	Witten, DE	EUR DE GM011 WITTEN
Germany	Wolfsburg, DE	EUR DE GM009 WOLFSBURG
Germany	Wuppertal, DE	EUR DE GM011 WUPPERTAL
Germany	Wurzburg, DE	EUR DE GM002 WÜRZBURG
Germany	Zwickau, DE	EUR DE GM014 ZWICKAU
Ghana	Accra, GH	AFR GH GH000 ACCRA
Ghana	Bolgatanga, GH	AFR GH GH000 BOLGATANGA
Ghana	Cape Cost, GH	AFR GH GH000 CAPE COST
Ghana	Ho, GH	AFR GH GH000 HO
Ghana	Koforidua, GH	AFR GH GH000 KOFORIDUA
Ghana	Kumasi, GH	AFR GH GH010 KUMASI
Ghana	Obuasi, GH	AFR GH GH000 OBUASI
Ghana	Sekondi-Takoradi, GH	AFR GH GH000 SEKONDI-TAKORADI
Ghana	Sunyani, GH	AFR GH GH000 SUNYANI
Ghana	Tamale, GH	AFR GH GH000 TAMALE
Ghana	Tema, GH	AFR GH GH000 TEMA
Gibraltar	Gibraltar, GI	EUR GI GI--- GIBALTAR
Greece	Athinai, GR	EUR GR GR007 ATHINAI

Greece	Iraclion, GR	EUR GR GR020 IRACLION
Greece	Larissa, GR	EUR GR GR034 LARISSA
Greece	Patrai, GR	EUR GR GR003 PATRAI
Greece	Piraevs, GR	EUR GR GR007 PIRAIÉVS
Greece	Salonika, GR	EUR GR GR048 SALONIKA
Greece	Volos, GR	EUR GR GR038 VOLOS
Greenland	Nuuk, GL	ARC GL GL003 NUUK
Grenada	Saint George'S, GD	CAC GD GJ003 SAINT GEORGE'S
Guadeloupe	Basse-Terre, KN	CAC GP GP--- BASSE-TERRE
Guam	Agana, GU	OCN GU GU000 AGANA
Guatemala	Guatemala, GT	CAC GT GT007 GUATEMALA
Guinea	Conakry, GN	AFR GN GV004 CONAKRY
Guinea-Bissau	Bissau, GW	AFR GW PU000 BISSAU
Guyana	Georgetown, GY	SAM GY GY003 GEORGETOWN
Haiti	Cap-Haitien, HT	CAC HT HA004 CAP-HAITIEN
Haiti	Carrefour, HT	CAC HT HA001 CARREFOUR
Haiti	Delmas, HT	CAC HT HA003 DELMAS
Haiti	Port-Au-Prince, HT	CAC HT HA007 PORT-AU-PRINCE
Honduras	San Pedro Sula, HN	CAC HN HO006 SAN PEDRO SULA
Honduras	Tegucigalpa, HN	CAC HN HO008 TEGUCIGALPA
Hong Kong	Hong Kong, HK	ASI HK HK--- HONG KONG
Hungary	Budapest, HU	EUR HU HU006 BUDAPEST
Hungary	Debrecen, HU	EUR HU HU008 DEBRECEN
Hungary	Gyor, HU	EUR HU HU012 GYÖR
Hungary	Kecskemet, HU	EUR HU HU001 KECSKEMÉT
Hungary	Miskolc, HU	EUR HU HU021 MISKOLC
Hungary	Nyiregyhaza, HU	EUR HU HU029 NYIREGYHAZA
Hungary	Pecs, HU	EUR HU HU025 PÉCS
Hungary	Stuhlweissenburg, HU	EUR HU HU011 SZÉKESFEHÉRVAR
Hungary	Szeged, HU	EUR HU HU030 SZEGED
Iceland	Reykjavik, IS	ARC IS IC010 REYKJAVIK
India	Abohar, IN	ASI IN IN028 ABOHAR
India	Adoni, IN	ASI IN IN002 ADONI
India	Agartala, IN	ASI IN IN032 AGARTALA
India	Agra, IN	ASI IN IN033 AGRA
India	Ahmedabad, IN	ASI IN IN012 AHMEDABAD
India	Ahmednagar, IN	ASI IN IN021 AHMEDNAGAR
India	Aizawl, IN	ASI IN IN024 AIZAWL
India	Ajmer, IN	ASI IN IN029 AJMER
India	Akola, IN	ASI IN IN021 AKOLA
India	Aligarh, IN	ASI IN IN033 ALIGARH
India	Alipur, IN	ASI IN IN036 ALIPUR
India	Allahabad, IN	ASI IN IN033 ALLAHABAD

India	Alwar, IN	ASI IN IN029 ALWAR
India	Ambala, IN	ASI IN IN013 AMBALA
India	Amravati, IN	ASI IN IN020 AMRAVATI
India	Amritsar, IN	ASI IN IN028 AMRITSAR
India	Amroha, IN	ASI IN IN033 AMROHA
India	Anand, IN	ASI IN IN012 ANAND
India	Arcot, IN	ASI IN IN031 ARCOT
India	Arrah, IN	ASI IN IN005 ARRAH
India	Asansol, IN	ASI IN IN005 ASANSOL
India	Aurangabad, IN	ASI IN IN021 AURANGABAD
India	Baharampur, IN	ASI IN IN036 BAHARAMPUR
India	Bahraich, IN	ASI IN IN033 BAHRAICH
India	Baleshwar, IN	ASI IN IN026 BALESHWAR
India	Bally, IN	ASI IN IN036 BALLY
India	Balurghat, IN	ASI IN IN036 BALURGHAT
India	Bangalore, IN	ASI IN IN017 BANGALORE
India	Bankura, IN	ASI IN IN036 BANKURA
India	Baranagar, IN	ASI IN IN035 BARANAGAR
India	Barddhaman, IN	ASI IN IN036 BARDDHAMAN
India	Bareilly, IN	ASI IN IN033 BAREILLY
India	Basirhat, IN	ASI IN IN036 BASIRHAT
India	Batala, IN	ASI IN IN015 BATALA
India	Beawar, IN	ASI IN IN029 BEAWAR
India	Belgaum, IN	ASI IN IN017 BELGAUM
India	Bellary, IN	ASI IN IN017 BELLARY
India	Bhadravati, IN	ASI IN IN017 BHADRAVATI
India	Bhagalpur, IN	ASI IN IN005 BHAGALPUR
India	Bharatpur, IN	ASI IN IN020 BHARATPUR
India	Bharuch, IN	ASI IN IN012 BHARUCH
India	Bhatpara, IN	ASI IN IN036 BHATPARA
India	Bhavnagar, IN	ASI IN IN012 BHAVNAGAR
India	Bhilai Nagar, IN	ASI IN IN020 BHILAI NAGAR
India	Bhilwara, IN	ASI IN IN029 BHILWARA
India	Bhind, IN	ASI IN IN020 BHIND
India	Bhiwandi, IN	ASI IN IN021 BHIWANDI
India	Bhiwani, IN	ASI IN IN013 BHIWANI
India	Bhopal, IN	ASI IN IN020 BHOPAL
India	Bhubaneswar, IN	ASI IN IN026 BHUBANESWAR
India	Bhuj, IN	ASI IN IN012 BHUJ
India	Bhusawal, IN	ASI IN IN021 BHUSAWAL
India	Bid, IN	ASI IN IN021 BID
India	Bidar, IN	ASI IN IN017 BIDAR
India	Bihar Sharif, IN	ASI IN IN005 BIHAR SHARIF

India	Bijapur, IN	ASI IN IN017 BIJAPUR
India	Bikaner, IN	ASI IN IN029 BIKANER
India	Bilaspur, IN	ASI IN IN020 BILASPUR
India	Bokaro Steel City, IN	ASI IN IN005 BOKARO STEEL CITY
India	Brahmapur, IN	ASI IN IN026 BRAHMAPUR
India	Budaun, IN	ASI IN IN033 BUDAUN
India	Bulandshahr, IN	ASI IN IN033 BULANDSHAHR
India	Burhanpur, IN	ASI IN IN020 BURHANPUR
India	Calcutta, IN	ASI IN IN036 CALCUTTA
India	Chandannagar, IN	ASI IN IN036 CHANDAN NAGAR
India	Chandigarh, IN	ASI IN IN006 CHANDIGARH
India	Chandrapur, IN	ASI IN IN021 CHANDRAPUR
India	Chapra, IN	ASI IN IN005 CHAPRA
India	Chitradurga, IN	ASI IN IN017 CHITRADURGA
India	Chittoor, IN	ASI IN IN002 CHITTOOR
India	Coimbatore, IN	ASI IN IN031 COIMBATORE
India	Cuddalore, IN	ASI IN IN031 CUDDALORE
India	Cuddapah, IN	ASI IN IN002 CUDDAPAH
India	Cuttack, IN	ASI IN IN026 CUTTACK
India	Damoh, IN	ASI IN IN020 DAMOH
India	Darbhanga, IN	ASI IN IN005 DARBHANGA
India	Davangere, IN	ASI IN IN017 DAVANGERE
India	Dehradun, IN	ASI IN IN033 DEHRADUN
India	Delhi, IN	ASI IN IN010 DELHI
India	Dewas, IN	ASI IN IN020 DEWAS
India	Dhanbad, IN	ASI IN IN005 DHANBAD
India	Dhule, IN	ASI IN IN021 DHULE
India	Dibrugarh, IN	ASI IN IN004 DIBRUGARH
India	Dindigul, IN	ASI IN IN031 DINDIGUL
India	Durg, IN	ASI IN IN020 DURG
India	Durgapur, IN	ASI IN IN036 DURGAPUR
India	Eluru, IN	ASI IN IN002 ELURU
India	English Bazar, IN	ASI IN IN036 ENGLISH BAZAR
India	Erode, IN	ASI IN IN031 ERODE
India	Etawah, IN	ASI IN IN029 ETAWAH
India	Faizabad, IN	ASI IN IN033 FAIZABAD
India	Faridabad, IN	ASI IN IN013 FARIDABAD
India	Farrukhabad-Cum-Fategarh, IN	ASI IN IN033 FARRUKHABAD-CUM- FATEGARH
India	Fatehpur, IN	ASI IN IN029 FATEHPUR
India	Firozabad, IN	ASI IN IN017 FIROZABAD
India	Gadag, IN	ASI IN IN017 GADAG-BETGERI
India	Gandhidham, IN	ASI IN IN012 GANDHIDHAM

India	Gandhinagar, IN	ASI IN IN012 GANDHINAGAR
India	Gaya, IN	ASI IN IN005 GAYA
India	Ghaziabad, IN	ASI IN IN033 GHAZIABAD
India	Godhra, IN	ASI IN IN012 GODHRA
India	Gorakhpur, IN	ASI IN IN033 GORAKHPUR
India	Gudivada, IN	ASI IN IN002 GUDIVADA
India	Gulbarga, IN	ASI IN IN017 GULBARGA
India	Guna, IN	ASI IN IN020 GUNA
India	Guntur, IN	ASI IN IN002 GUNTUR
India	Gurgaon, IN	ASI IN IN013 GURGAON
India	Guruvayur, IN	ASI IN IN018 GURUVAYUR
India	Gwalior, IN	ASI IN IN020 GWALIOR
India	Habra, IN	ASI IN IN036 HABRA
India	Haora, IN	ASI IN IN036 HAORA
India	Hapur, IN	ASI IN IN033 HAPUR
India	Hardwar, IN	ASI IN IN033 HARDWAR
India	Hassan, IN	ASI IN IN017 HASSAN
India	Hathras, IN	ASI IN IN033 HATHRAS
India	Hindupur, IN	ASI IN IN002 HINDUPUR
India	Hisar, IN	ASI IN IN013 HISAR
India	Hoshiarpur, IN	ASI IN IN028 HOSHIARPUR
India	Hospet, IN	ASI IN IN017 HOSPET
India	Hubli, IN	ASI IN IN017 HUBLI-DHARWAD
India	Hyderabad, IN	ASI IN IN002 HYDERABAD
India	Imphal, IN	ASI IN IN022 IMPHAL
India	Indore, IN	ASI IN IN020 INDORE
India	Jabalpur, IN	ASI IN IN020 JABALPUR
India	Jaipur, IN	ASI IN IN029 JAIPUR
India	Jalandhar, IN	ASI IN IN028 JALANDHAR
India	Jalgaon, IN	ASI IN IN021 JALGAON
India	Jalna, IN	ASI IN IN021 JALNA
India	Jamnagar, IN	ASI IN IN012 JAMNAGAR
India	Jamshedpur, IN	ASI IN IN005 JAMSHEDPUR
India	Jaunpur, IN	ASI IN IN033 JAUNPUR
India	Jhansi, IN	ASI IN IN033 JHANSI
India	Jodhpur, IN	ASI IN IN029 JODHPUR
India	Jorhat, IN	ASI IN IN004 JORHAT
India	Junagadh, IN	ASI IN IN012 JUNAGADH
India	Kakinada, IN	ASI IN IN002 KAKINADA
India	Kalyan, IN	ASI IN IN021 KALYAN
India	Kamarhati, IN	ASI IN IN036 KAMARHATI
India	Kamptee, IN	ASI IN IN021 KAMPTEE
India	Kanchipuram, IN	ASI IN IN031 KANCHIPURAM

India	Kanchrapara, IN	ASI IN IN036 KANCHRAPARA
India	Kanhangad, IN	ASI IN IN018 KANHANGAD
India	Kannur, IN	ASI IN IN018 KANNUR
India	Kanpur, IN	ASI IN IN033 KANPUR
India	Karaikkudi, IN	ASI IN IN031 KARAIKKUDI
India	Karimnagar, IN	ASI IN IN002 KARIMNAGAR
India	Karnal, IN	ASI IN IN013 KARNAL
India	Karur, IN	ASI IN IN031 KARUR
India	Katihar, IN	ASI IN IN005 KATIHAR
India	Khammam, IN	ASI IN IN002 KHAMMAM
India	Khandwa, IN	ASI IN IN020 KHANDWA
India	Kharagpur, IN	ASI IN IN005 KHARAGPUR
India	Kochi, IN	ASI IN IN018 KOCHI
India	Kolar, IN	ASI IN IN017 KOLAR
India	Kolar Gold Fields, IN	ASI IN IN017 KOLAR GOLD FIELDS
India	Kolhapur, IN	ASI IN IN021 KOLHAPUR
India	Kollam, IN	ASI IN IN018 KOLLAM
India	Korba, IN	ASI IN IN020 KORBA
India	Kota, IN	ASI IN IN029 KOTA
India	Kothagudem, IN	ASI IN IN002 KOTHAGUDEM
India	Kottayam, IN	ASI IN IN018 KOTTAYAM
India	Kozhikode, IN	ASI IN IN018 KOZHIKODE
India	Krishnanagar, IN	ASI IN IN036 KRISHNANAGAR
India	Kumbakonam, IN	ASI IN IN031 KUMBAKONAM
India	Kurnool, IN	ASI IN IN002 KURNOOL
India	Lucknow, IN	ASI IN IN033 LUCKNOW
India	Ludhiana, IN	ASI IN IN028 LUDHIANA
India	Machilipatnam, IN	ASI IN IN002 MACHILIPATNAM
India	Madras, IN	ASI IN IN031 MADRAS
India	Madurai, IN	ASI IN IN031 MADURAI
India	Mahbubnagar, IN	ASI IN IN002 MAHBUBNAGAR
India	Mahesana, IN	ASI IN IN012 MAHESANA
India	Malegaon, IN	ASI IN IN021 MALEGAON
India	Mandya, IN	ASI IN IN017 MANDYA
India	Mangalore, IN	ASI IN IN017 MANGALORE
India	Mathura, IN	ASI IN IN033 MATHURA
India	Maunath Bhanjan, IN	ASI IN IN033 MAUNATH BHANJAN
India	Medinipur, IN	ASI IN IN036 MEDINIPUR
India	Meerut, IN	ASI IN IN033 MEERUT
India	Mirzapur-Cum-Vindhyachal, IN	ASI IN IN033 MIRZAPUR-CUM- VINDHYACHAL
India	Moga, IN	ASI IN IN028 MOGA
India	Moradabad, IN	ASI IN IN033 MORADABAD

India	Morena, IN	ASI IN IN020 MORENA
India	Morvi, IN	ASI IN IN012 MORVI
India	Mumbai, IN	ASI IN IN021 MUMBAI
India	Munger, IN	ASI IN IN005 MUNGER
India	Murwara, IN	ASI IN IN020 MURWARA
India	Muzaffarnagar, IN	ASI IN IN033 MUZAFFARNAGAR
India	Muzaffarpur, IN	ASI IN IN005 MUZAFFARPUR
India	Mysore, IN	ASI IN IN017 MYSORE
India	Nabadwip, IN	ASI IN IN036 NABADWIP
India	Nadiad, IN	ASI IN IN012 NADIAD
India	Nagercoil, IN	ASI IN IN031 NAGERCOIL
India	Nagpur, IN	ASI IN IN021 NAGPUR
India	Naihati, IN	ASI IN IN036 NAIHATI
India	Nanded, IN	ASI IN IN021 NANDED
India	Nandyal, IN	ASI IN IN002 NANDYAL
India	Navsari, IN	ASI IN IN012 NAVSARI
India	Nellore, IN	ASI IN IN002 NELLORE
India	New Delhi, IN	ASI IN IN010 NEW DELHI
India	Neyveli, IN	ASI IN IN031 NEYVELI
India	Nizamabad, IN	ASI IN IN002 NIZAMABAD
India	Ondal, IN	ASI IN IN036 ONDAL
India	Ongole, IN	ASI IN IN002 ONGOLE
India	Pali, IN	ASI IN IN020 PALI
India	Panihati, IN	ASI IN IN036 PANIHATI
India	Panipat, IN	ASI IN IN013 PANIPAT
India	Parbhani, IN	ASI IN IN021 PARBHANI
India	Patan, IN	ASI IN IN012 PATAN
India	Pathankot, IN	ASI IN IN028 PATHANKOT
India	Patiala, IN	ASI IN IN028 PATIALA
India	Patratu, IN	ASI IN IN005 PATRATU
India	Pilibhit, IN	ASI IN IN033 PILIBHIT
India	Pollachi, IN	ASI IN IN031 POLLACHI
India	Pondicherry, IN	ASI IN IN027 PONDICHERRY
India	Porbandar, IN	ASI IN IN012 PORBANDAR
India	Proddatur, IN	ASI IN IN002 PRODDATUR
India	Pune, IN	ASI IN IN021 PUNE
India	Puri, IN	ASI IN IN026 PURI
India	Purnia, IN	ASI IN IN005 PURNIA
India	Rae Bareli, IN	ASI IN IN033 RAE BARELI
India	Raichur, IN	ASI IN IN017 RAICHUR
India	Raiganj, IN	ASI IN IN036 RAIGANJ
India	Raipur, IN	ASI IN IN033 RAIPUR
India	Rajahmundry, IN	ASI IN IN002 RAJAHMUNDRY

India	Rajapalaiyam, IN	ASI IN IN031 RAJAPALAIYAM
India	Rajkot, IN	ASI IN IN012 RAJKOT
India	Rajnandgain, IN	ASI IN IN020 RAJNANDGAIN
India	Rampur, IN	ASI IN IN036 RAMPUR
India	Ranaghat, IN	ASI IN IN036 RANAGHAT
India	Ranchi, IN	ASI IN IN005 RANCHI
India	Ratlam, IN	ASI IN IN020 RATLAM
India	Raurkela, IN	ASI IN IN026 RAURKELA
India	Rewa, IN	ASI IN IN020 REWA
India	Rohtak, IN	ASI IN IN013 ROHTAK
India	Saharanpur, IN	ASI IN IN033 SAHARANPUR
India	Salem, IN	ASI IN IN031 SALEM
India	Sambalpur, IN	ASI IN IN026 SAMBALPUR
India	Sambhal, IN	ASI IN IN033 SAMBHAL
India	Sangli, IN	ASI IN IN021 SANGLI
India	Santipur, IN	ASI IN IN036 SANTIPUR
India	Satna, IN	ASI IN IN020 SATNA
India	Serampore, IN	ASI IN IN036 SERAMPORE
India	Shahjahanpur, IN	ASI IN IN033 SHAHJAHANPUR
India	Shillong, IN	ASI IN IN023 SHILLONG
India	Shimoga, IN	ASI IN IN017 SHIMOGA
India	Sikar, IN	ASI IN IN029 SIKAR
India	Silchar, IN	ASI IN IN004 SILCHAR
India	Siliguri, IN	ASI IN IN036 SILIGURI
India	Sirsa, IN	ASI IN IN013 SIRSA
India	Sitapur, IN	ASI IN IN033 SITAPUR
India	Sivakasi, IN	ASI IN IN031 SIVAKASI
India	Solapur, IN	ASI IN IN021 SOLAPUR
India	Sonipat, IN	ASI IN IN013 SONIPAT
India	South Dum Dum, IN	ASI IN IN036 SOUTH DUM DUM
India	Surat, IN	ASI IN IN012 SURAT
India	Tenali, IN	ASI IN IN002 TENALI
India	Thane, IN	ASI IN IN021 THANE
India	Thanjavur, IN	ASI IN IN031 THANJAVUR
India	Thiruvananthapuram, IN	ASI IN IN018 THIRUVANANTHAPURAM
India	Thrissur, IN	ASI IN IN018 THRISSUR
India	Tiruchchirappalli, IN	ASI IN IN031 TIRUCHCHIRAPPALLI
India	Tirunelveli, IN	ASI IN IN031 TIRUNELVELI
India	Tirupati, IN	ASI IN IN002 TIRUPATI
India	Tiruppur, IN	ASI IN IN031 TIRUPPUR
India	Tiruvannamalai, IN	ASI IN IN031 TIRUVANNAMALAI
India	Titagarh, IN	ASI IN IN036 TITAGARH
India	Tonk, IN	ASI IN IN029 TONK



India	Tumkur, IN	ASI IN IN017 TUMKUR
India	Tuticorin, IN	ASI IN IN031 TUTICORIN
India	Udaipur, IN	ASI IN IN029 UDAIPUR
India	Udupi, IN	ASI IN IN017 UDUPI
India	Ujjain, IN	ASI IN IN020 UJJAIN
India	Ulhasnagar, IN	ASI IN IN021 ULHASNAGAR
India	Unnao, IN	ASI IN IN033 UNNAO
India	Vadodara, IN	ASI IN IN012 VADODARA
India	Valparai, IN	ASI IN IN031 VALPARAI
India	Valsad, IN	ASI IN IN012 VALSAD
India	Varanasi, IN	ASI IN IN033 VARANASI
India	Vellore, IN	ASI IN IN031 VELLORE
India	Vijayawada, IN	ASI IN IN002 VIJAYAWADA
India	Visakhapatnam, IN	ASI IN IN002 VISAKHAPATNAM
India	Wadhwan, IN	ASI IN IN012 WADHWAN
India	Warangal, IN	ASI IN IN002 WARANGAL
India	Wardha, IN	ASI IN IN021 WARDHA
India	Yamunanagar, IN	ASI IN IN013 YAMUNANAGAR
India	Yavatmal, IN	ASI IN IN021 YAVATMAL
Indonesia	Ambon, ID	ASI ID ID015 AMBON
Indonesia	Balikpapan, ID	ASI ID ID013 BALIKPAPAN
Indonesia	Bandjarmasin, ID	ASI ID ID011 BANDJARMASIN
Indonesia	Bandung, ID	ASI ID ID004 BANDUNG
Indonesia	Bogor, ID	ASI ID ID026 BOGOR
Indonesia	Cirebon, ID	ASI ID ID026 CIREBON
Indonesia	Jakarta, ID	ASI ID ID009 JAKARTA
Indonesia	Jambi, ID	ASI ID ID010 JAMBI
Indonesia	Kediri, ID	ASI ID ID002 KEDIRI
Indonesia	Kotabaru, ID	ASI ID ID011 KOTABARU
Indonesia	Madiun, ID	ASI ID ID007 MADIUN
Indonesia	Magelang, ID	ASI ID ID004 MAGELANG
Indonesia	Malang, ID	ASI ID ID026 MALANG
Indonesia	Manado, ID	ASI ID ID022 MANADO
Indonesia	Medan, ID	ASI ID ID027 MEDAN
Indonesia	Padang, ID	ASI ID ID006 PADANG
Indonesia	Pakan Baru, ID	ASI ID ID018 PAKAN BARU
Indonesia	Palembang, ID	ASI ID ID024 PALEMBANG
Indonesia	Pematang Siantar, ID	ASI ID ID027 PEMATANG SIANTAR
Indonesia	Pontianak, ID	ASI ID ID006 PONTIANAK
Indonesia	Probolinggo, ID	ASI ID ID007 PROBOLINGGO
Indonesia	Samarinda, ID	ASI ID ID013 SAMARINDA
Indonesia	Semarang, ID	ASI ID ID004 SEMARANG
Indonesia	Sukabumi, ID	ASI ID ID026 SUKABUMI

Indonesia	Surabaya, ID	ASI ID ID026 SURABAYA
Indonesia	Surakarta, ID	ASI ID ID004 SURAKARTA
Indonesia	Tegal, ID	ASI ID ID004 TEGAL
Indonesia	Ujungpandang, ID	ASI ID ID019 UJUNG Pandang
Indonesia	Yogyakarta, ID	ASI ID ID005 YOGYAKARTA
Iran	Abadan, IR	MEA IR IR016 ABADAN
Iran	Ahwaz, IR	MEA IR IR016 AHWAZ
Iran	Amol, IR	MEA IR IR021 AMOL
Iran	Andimeshk, IR	MEA IR IR016 ANDIMESHK
Iran	Arak, IR	MEA IR IR020 ARAK
Iran	Ardabil, IR	MEA IR IR001 ARDABIL
Iran	Babol, IR	MEA IR IR021 BABOL
Iran	Bandar-E-Abbas, IR	MEA IR IR011 BANDAR-E-ABBAS
Iran	Birjand, IR	MEA IR IR015 BIRJAND
Iran	Bojnurd, IR	MEA IR IR015 BOJNURD
Iran	Borujerd, IR	MEA IR IR019 BORUJERD
Iran	Bukand, IR	MEA IR IR000 BUKAND
Iran	Bushehr, IR	MEA IR IR004 BUSHEHR
Iran	Dezful, IR	MEA IR IR016 DEZFUL
Iran	Esfahan, IR	MEA IR IR006 ESFAHAN
Iran	Gadamabad, IR	MEA IR IR009 GONBAD-E-KAVUS
Iran	Gorgan, IR	MEA IR IR002 GORGAN
Iran	Hamadan, IR	MEA IR IR010 HAMADAN
Iran	Ilam, IR	MEA IR IR012 ILAM
Iran	Karaj, IR	MEA IR IR026 KARAJ
Iran	Kashan, IR	MEA IR IR006 KASHAN
Iran	Kerman, IR	MEA IR IR013 KERMAN
Iran	Kermanshah, IR	MEA IR IR014 KERMANSHAH
Iran	Kord-Shahr, IR	MEA IR IR005 KORD-SHAHR
Iran	Mahabad, IR	MEA IR IR002 MAHABAD
Iran	Malayer, IR	MEA IR IR010 MALAYER
Iran	Mashhad, IR	MEA IR IR015 MASHHAD
Iran	Masjed Soleyman, IR	MEA IR IR016 MASJED SOLEYMAN
Iran	Najafabad, IR	MEA IR IR006 NAJAFABAD
Iran	Neyshabur, IR	MEA IR IR015 NEYSHABUR
Iran	Orumiyeh, IR	MEA IR IR029 ORUMIYEH
Iran	Qaem Shahr, IR	MEA IR IR021 QAEM SHAHR
Iran	Qarchak, IR	MEA IR IR026 QARCHAK
Iran	Qazvin, IR	MEA IR IR028 QAZVIN
Iran	Qods, IR	MEA IR IR024 QODS
Iran	Qom, IR	MEA IR IR020 QOM
Iran	Rasht, IR	MEA IR IR008 RASHT
Iran	Sanandaj, IR	MEA IR IR018 SANANDAJ

Iran	Sari, IR	MEA IR IR021 SARI
Iran	Shahrud, IR	MEA IR IR024 SHAHRUD
Iran	Shiraz, IR	MEA IR IR007 SHIRAZ
Iran	Sirjan, IR	MEA IR IR013 SIRJAN
Iran	Tabriz, IR	MEA IR IR002 TABRIZ
Iran	Tehran, IR	MEA IR IR026 TEHRAN
Iran	Varamin, IR	MEA IR IR026 VARAMIN
Iran	Yazd, IR	MEA IR IR027 YAZD
Iran	Zabol, IR	MEA IR IR025 ZABOL
Iran	Zahedan, IR	MEA IR IR025 ZAHEDAN
Iran	Zanjan, IR	MEA IR IR028 ZANJAN
Iraq	Amara, IQ	MEA IQ IZ015 AMARA
Iraq	Baghdad, IQ	MEA IQ IZ010 BAGHDAD
Iraq	Basra, IQ	MEA IQ IZ002 BASRA
Iraq	Diwaniya, IQ	MEA IQ IZ004 DIWANIYA
Iraq	Erbil, IQ	MEA IQ IZ006 ERBIL
Iraq	Hilla, IQ	MEA IQ IZ009 HILLA
Iraq	Kadhimain, IQ	MEA IQ IZ010 KADHIMAIN
Iraq	Karradah Sharqiyah, IQ	MEA IQ IZ010 KARRADAH SHARQIYAH
Iraq	Kerbala, IQ	MEA IQ IZ014 KERBALA
Iraq	Kirkuk, IQ	MEA IQ IZ008 KIRKUK
Iraq	Kut, IQ	MEA IQ IZ018 KUT
Iraq	Majnoon, IQ	MEA IQ IZ010 MAJNOON
Iraq	Mosul, IQ	MEA IQ IZ016 MOSUL
Iraq	Najaf, IQ	MEA IQ IZ005 NAJAF
Iraq	Ramadi, IQ	MEA IQ IZ001 RAMADI
Ireland	Cork, IE	EUR IE EI004 CORK
Ireland	Derry, IE	EUR IE EI000 DERRY
Ireland	Dublin, IE	EUR IE EI006 DUBLIN
Isle Of Man	Douglas, IM	EUR IM IM--- DOUGLAS
Israel	Ashdod, IL	MEA IL IS002 ASHDOD
Israel	Ashkelon, IL	MEA IL IS001 ASHKELON
Israel	Bat Yam, IL	MEA IL IS005 BAT YAM
Israel	Beer Sheva, IL	MEA IL IS001 BE'ER SHEBA
Israel	Bene Beraq, IL	MEA IL IS005 BENE BERAQ
Israel	Dimona, IL	MEA IL IS001 DIMONA
Israel	Eilat , IL	MEA IL IS001 EILAT
Israel	Hadera, IL	MEA IL IS004 HADERA
Israel	Haifa, IL	MEA IL IS004 HAIFA
Israel	Holon, IL	MEA IL IS005 HOLON
Israel	Jerusalem, IL	MEA IL IS006 JERUSALEM
Israel	Keriat Shmona, IL	MEA IL IS003 KERIAT SHMONA
Israel	Metula, IL	MEA IL IS003 METULA

Israel	Netanya, IL	MEA IL IS002 NETANYA
Israel	Petah Tiqwa, IL	MEA IL IS002 PETAH TIQWA
Israel	Ramat Gan, IL	MEA IL IS005 RAMAT GAN
Israel	Rishon Leziyyon, IL	MEA IL IS002 RISHON LEZIYYON
Israel	Tel Aviv-Yafo, IL	MEA IL IS005 TEL AVIV-YAFO
Italy	Bari, IT	EUR IT IT013 BARI
Italy	Bergamo, IT	EUR IT IT009 BERGAMO
Italy	Bologna, IT	EUR IT IT005 BOLOGNA
Italy	Brescia, IT	EUR IT IT009 BRESCIA
Italy	Cagliari, IT	EUR IT IT014 CAGLIARI
Italy	Catania, IT	EUR IT IT015 CATANIA
Italy	Ferrara, IT	EUR IT IT005 FERRARA
Italy	Firenze, IT	EUR IT IT016 FIRENZE
Italy	Foggia, IT	EUR IT IT013 FOGGIA
Italy	Forli, IT	EUR IT IT005 FORLI
Italy	Genova, IT	EUR IT IT008 GENOVA
Italy	Latina, IT	EUR IT IT007 LATINA
Italy	Livorno, IT	EUR IT IT016 LIVORNO
Italy	Messina, IT	EUR IT IT015 MESSINA
Italy	Milano, IT	EUR IT IT009 MILANO
Italy	Modena, IT	EUR IT IT005 MODENA
Italy	Monza, IT	EUR IT IT009 MONZA
Italy	Napoli, IT	EUR IT IT004 NAPOLI
Italy	Novara, IT	EUR IT IT012 NOVARA
Italy	Padova, IT	EUR IT IT020 PADOVA
Italy	Palermo, IT	EUR IT IT015 PALERMO
Italy	Parma, IT	EUR IT IT005 PARMA
Italy	Perugia, IT	EUR IT IT018 PERUGIA
Italy	Pescara, IT	EUR IT IT001 PESCARA
Italy	Prato, IT	EUR IT IT016 PRATO
Italy	Ravenna, IT	EUR IT IT005 RAVENNA
Italy	Reggio Di Calabria, IT	EUR IT IT003 REGGIO DI CALABRIA
Italy	Rimini, IT	EUR IT IT005 RIMINI
Italy	Roma, IT	EUR IT IT007 ROMA
Italy	Salerno, IT	EUR IT IT003 SALERNO
Italy	Sassari, IT	EUR IT IT014 SASSARI
Italy	Siracusa, IT	EUR IT IT015 SIRACUSA
Italy	Taranto, IT	EUR IT IT013 TARANTO
Italy	Terni, IT	EUR IT IT018 TERNI
Italy	Torino, IT	EUR IT IT012 TORINO
Italy	Trento, IT	EUR IT IT017 TRENTO
Italy	Trieste, IT	EUR IT IT006 TRIESTE
Italy	Venezia, IT	EUR IT IT020 VENEZIA

Italy	Verona, IT	EUR IT IT020 VERONA
Italy	Vicenza, IT	EUR IT IT020 VICENZA
Ivory Coast	Abidjan, CI	AFR CI IV002 ABIDJAN
Ivory Coast	Bouaké, CI	AFR CI IV000 BOUAKÉ
Ivory Coast	Yamoussoukro, CI	AFR CI IV057 YAMOOUSSOUKRO
Jamaica	Kingston, JM	CAC JM JM000 KINGSTON
Japan	Abiko, JP	ASI JP JA004 ABIKO
Japan	Ageo, JP	ASI JP JA035 AGEO
Japan	Akishima, JP	ASI JP JA041 AKISHIMA
Japan	Amagasaki, JP	ASI JP JA013 AMAGASAKI
Japan	Anjo, JP	ASI JP JA001 ANJO
Japan	Aomori, JP	ASI JP JA003 AOMORI
Japan	Asahikawa, JP	ASI JP JA012 ASAHIKAWA
Japan	Asaka, JP	ASI JP JA035 ASAKA
Japan	Ashikaga, JP	ASI JP JA039 ASHIKAGA
Japan	Atsugi, JP	ASI JP JA019 ATSUGI
Japan	Beppu, JP	ASI JP JA030 BEPPU
Japan	Chiba, JP	ASI JP JA004 CHIBA
Japan	Chigasaki, JP	ASI JP JA019 CHIGASAKI
Japan	Chofu, JP	ASI JP JA041 CHOFU
Japan	Daito, JP	ASI JP JA033 DAITO
Japan	Ebetsu, JP	ASI JP JA012 EBETSU
Japan	Ebina, JP	ASI JP JA019 EBINA
Japan	Fuji, JP	ASI JP JA038 FUJI
Japan	Fujieda, JP	ASI JP JA038 FUJIEDA
Japan	Fujimi, JP	ASI JP JA012 FUJIMI
Japan	Fujinomiya, JP	ASI JP JA038 FUJINOMIYA
Japan	Fukaya, JP	ASI JP JA035 FUKAYA
Japan	Fukui, JP	ASI JP JA006 FUKUI
Japan	Fukuoka, JP	ASI JP JA009 FUKUOKA
Japan	Fukuyama, JP	ASI JP JA011 FUKUYAMA
Japan	Funabashi, JP	ASI JP JA004 FUNABASHI
Japan	Gifu, JP	ASI JP JA009 GIFU
Japan	Habikino, JP	ASI JP JA033 HABIKINO
Japan	Hachinohe, JP	ASI JP JA003 HACHINOHE
Japan	Hachioji, JP	ASI JP JA041 HACHIOJI
Japan	Hakodate, JP	ASI JP JA012 HAKODATE
Japan	Hamamatsu, JP	ASI JP JA038 HAMAMATSU
Japan	Handa, JP	ASI JP JA001 HANDA
Japan	Higashihiroshima, JP	ASI JP JA011 HIGASHIHIROSHIMA
Japan	Higashikurume, JP	ASI JP JA041 HIGASHIKURUME
Japan	Higashimurayama, JP	ASI JP JA041 HIGASHIMURAYAMA
Japan	Higashiosaka, JP	ASI JP JA033 HIGASHIOSAKA

Japan	Hikone, JP	ASI JP JA036 HIKONE
Japan	Himeji, JP	ASI JP JA013 HIMEJI
Japan	Hino, JP	ASI JP JA041 HINO
Japan	Hirakata, JP	ASI JP JA033 HIRAKATA
Japan	Hiratsuka, JP	ASI JP JA019 HIRATSUKA
Japan	Hirosaki, JP	ASI JP JA003 HIROSAKI
Japan	Hiroshima, JP	ASI JP JA011 HIROSHIMA
Japan	Hitachi, JP	ASI JP JA014 HITACHI
Japan	Hofu, JP	ASI JP JA046 HOFU
Japan	Hoya, JP	ASI JP JA041 HOYA
Japan	Ibaraki, JP	ASI JP JA033 IBARAKI
Japan	Ichihara, JP	ASI JP JA004 ICHIHARA
Japan	Ichikawa, JP	ASI JP JA004 ICHIKAWA
Japan	Ichinomiya, JP	ASI JP JA001 ICHINOMIYA
Japan	Ikeda, JP	ASI JP JA029 IKEDA
Japan	Ikoma, JP	ASI JP JA028 IKOMA
Japan	Imabari, JP	ASI JP JA005 IMABARI
Japan	Inazawa, JP	ASI JP JA001 INAZAWA
Japan	Ise, JP	ASI JP JA023 ISE
Japan	Iseaki, JP	ASI JP JA010 ISESAKI
Japan	Ishinomaki, JP	ASI JP JA024 ISHINOMAKI
Japan	Itami, JP	ASI JP JA013 ITAMI
Japan	Iwakuni, JP	ASI JP JA046 IWAKUNI
Japan	Iwatsuki, JP	ASI JP JA035 IWATSUKI
Japan	Izumi, JP	ASI JP JA033 IZUMI
Japan	Joetsu, JP	ASI JP JA029 JOETSU
Japan	Kadoma, JP	ASI JP JA033 KADOMA
Japan	Kagoshima, JP	ASI JP JA018 KAGOSHIMA
Japan	Kakamigahara, JP	ASI JP JA009 KAKAMIGAHARA
Japan	Kakogawa, JP	ASI JP JA013 KAKOGAWA
Japan	Kamagaya, JP	ASI JP JA004 KAMAGAYA
Japan	Kanazawa, JP	ASI JP JA015 KANAZAWA
Japan	Kariya, JP	ASI JP JA001 KARIYA
Japan	Kashihara, JP	ASI JP JA028 KASHIHARA
Japan	Kashiwa, JP	ASI JP JA004 KASHIWA
Japan	Kasukabe, JP	ASI JP JA035 KASUKABE
Japan	Kawachinagano, JP	ASI JP JA033 KAWACHINAGANO
Japan	Kawagoe, JP	ASI JP JA035 KAWAGOE
Japan	Kawaguchi, JP	ASI JP JA035 KAWAGUCHI
Japan	Kawasaki, JP	ASI JP JA019 KAWASAKI
Japan	Kiryu, JP	ASI JP JA010 KIRYU
Japan	Kisarazu, JP	ASI JP JA004 KISARAZU
Japan	Kishiwada, JP	ASI JP JA033 KISHIWADA

Japan	Kitakyushu, JP	ASI JP JA007 KITAKYUSHU
Japan	Kitami, JP	ASI JP JA012 KITAMI
Japan	Kobe, JP	ASI JP JA013 KOBE
Japan	Kochi, JP	ASI JP JA038 KOCHI
Japan	Kodaira, JP	ASI JP JA041 KODAIRA
Japan	Kofu, JP	ASI JP JA047 KOFU
Japan	Koganei, JP	ASI JP JA041 KOGANEI
Japan	Kokubunji, JP	ASI JP JA041 KOKUBUNJI
Japan	Komaki, JP	ASI JP JA001 KOMAKI
Japan	Komatsu, JP	ASI JP JA015 KOMATSU
Japan	Koriyama, JP	ASI JP JA008 KORIYAMA
Japan	Koshigaya, JP	ASI JP JA035 KOSHIGAYA
Japan	Kumagaya, JP	ASI JP JA035 KUMAGAYA
Japan	Kumamoto, JP	ASI JP JA021 KUMAMOTO
Japan	Kurashiki, JP	ASI JP JA031 KURASHIKI
Japan	Kure, JP	ASI JP JA011 KURE
Japan	Kurume, JP	ASI JP JA007 KURUME
Japan	Kusatsu, JP	ASI JP JA010 KUSATSU
Japan	Kushiro, JP	ASI JP JA012 KUSHIRO
Japan	Kuwana, JP	ASI JP JA023 KUWANA
Japan	Kyoto, JP	ASI JP JA022 KYOTO
Japan	Machida, JP	ASI JP JA041 MACHIDA
Japan	Maebashi, JP	ASI JP JA010 MAEBASHI
Japan	Matsubara, JP	ASI JP JA033 MATSUBARA
Japan	Matsudo, JP	ASI JP JA004 MATSUDO
Japan	Mishima, JP	ASI JP JA038 MISHIMA
Japan	Mito, JP	ASI JP JA014 MITO
Japan	Miyakonojo, JP	ASI JP JA025 MIYAKONOJO
Japan	Miyazaki, JP	ASI JP JA025 MIYAZAKI
Japan	Moriguchi, JP	ASI JP JA033 MORIGUCHI
Japan	Morioka, JP	ASI JP JA016 MORIOKA
Japan	Muroran, JP	ASI JP JA012 MURORAN
Japan	Musashino, JP	ASI JP JA041 MUSASHINO
Japan	Nagano, JP	ASI JP JA026 NAGANO
Japan	Nagaoka, JP	ASI JP JA029 NAGAOKA
Japan	Nagareyama, JP	ASI JP JA035 NAGAREYAMA
Japan	Nagasaki, JP	ASI JP JA027 NAGASAKI
Japan	Nagoya, JP	ASI JP JA001 NAGOYA
Japan	Nara, JP	ASI JP JA028 NARA
Japan	Narashino, JP	ASI JP JA004 NARASHINO
Japan	Neyagawa, JP	ASI JP JA033 NEYAGAWA
Japan	Niigata, JP	ASI JP JA029 NIIGATA
Japan	Niihama, JP	ASI JP JA005 NIIHAMA

Japan	Niiza, JP	ASI JP JA035 NIIZA
Japan	Nishinomiya, JP	ASI JP JA013 NISHINOMIYA
Japan	Nishio, JP	ASI JP JA001 NISHIO
Japan	Nobeoka, JP	ASI JP JA025 NOBEOKA
Japan	Noda, JP	ASI JP JA004 NODA
Japan	Numazu, JP	ASI JP JA038 NUMAZU
Japan	Obihiro, JP	ASI JP JA012 OBIHIRO
Japan	Odawara, JP	ASI JP JA019 ODAWARA
Japan	Ogaki, JP	ASI JP JA009 OGAKI
Japan	Oita, JP	ASI JP JA030 OITA
Japan	Okayama, JP	ASI JP JA031 OKAYAMA
Japan	Okazaki, JP	ASI JP JA001 OKAZAKI
Japan	Okinawa, JP	ASI JP JA032 OKINAWA
Japan	Ome, JP	ASI JP JA041 OME
Japan	Omiya, JP	ASI JP JA014 OMIYA
Japan	Omuta, JP	ASI JP JA007 OMUTA
Japan	Osaka, JP	ASI JP JA009 OSAKA
Japan	Ota, JP	ASI JP JA006 OTA
Japan	Otaru, JP	ASI JP JA012 OTARU
Japan	Otsu, JP	ASI JP JA036 OTSU
Japan	Oyama, JP	ASI JP JA038 OYAMA
Japan	Saga, JP	ASI JP JA020 SAGA
Japan	Sagamihara, JP	ASI JP JA019 SAGAMIHARA
Japan	Sakai, JP	ASI JP JA014 SAKAI
Japan	Sanda, JP	ASI JP JA013 SANDA
Japan	Sapporo, JP	ASI JP JA012 SAPPORO
Japan	Sasebo, JP	ASI JP JA027 SASEBO
Japan	Sayama, JP	ASI JP JA035 SAYAMA
Japan	Sendai, JP	ASI JP JA018 SENDAI
Japan	Seto, JP	ASI JP JA001 SETO
Japan	Shimizu, JP	ASI JP JA029 SHIMIZU
Japan	Shimonoseki, JP	ASI JP JA046 SHIMONOSEKI
Japan	Shizuoka, JP	ASI JP JA038 SHIZUOKA
Japan	Soka, JP	ASI JP JA035 SOKA
Japan	Suita, JP	ASI JP JA033 SUITA
Japan	Suzuka, JP	ASI JP JA023 SUZUKA
Japan	Tachikawa, JP	ASI JP JA041 TACHIKAWA
Japan	Tajimi, JP	ASI JP JA009 TAJIMI
Japan	Takamatsu, JP	ASI JP JA017 TAKAMATSU
Japan	Takaoka, JP	ASI JP JA043 TAKAOKA
Japan	Takarazuka, JP	ASI JP JA013 TAKARAZUKA
Japan	Takasaki, JP	ASI JP JA010 TAKASAKI
Japan	Takatsuki, JP	ASI JP JA033 TAKATSUKI



Japan	Tama, JP	ASI JP JA031 TAMA
Japan	Toda, JP	ASI JP JA035 TODA
Japan	Tokorozawa, JP	ASI JP JA035 TOKOROZAWA
Japan	Tokushima, JP	ASI JP JA040 TOKUSHIMA
Japan	Tokuyama, JP	ASI JP JA046 TOKUYAMA
Japan	Tokyo, JP	ASI JP JA041 TOKYO
Japan	Tomakomai, JP	ASI JP JA012 TOMAKOMAI
Japan	Tondabayashi, JP	ASI JP JA033 TONDABAYASHI
Japan	Tottori, JP	ASI JP JA042 TOTTORI
Japan	Toyama, JP	ASI JP JA043 TOYAMA
Japan	Toyohashi, JP	ASI JP JA001 TOYOHASHI
Japan	Toyokawa, JP	ASI JP JA001 TOYOKAWA
Japan	Toyonaka, JP	ASI JP JA033 TOYONAKA
Japan	Toyota, JP	ASI JP JA001 TOYOTA
Japan	Tsu, JP	ASI JP JA023 TSU
Japan	Tsuchiura, JP	ASI JP JA014 TSUCHIURA
Japan	Tsukuba, JP	ASI JP JA014 TSUKUBA
Japan	Tsuruoka, JP	ASI JP JA045 TSURUOKA
Japan	Ube, JP	ASI JP JA046 UBE
Japan	Ueda, JP	ASI JP JA026 UEDA
Japan	Uji, JP	ASI JP JA022 UJI
Japan	Urasoe, JP	ASI JP JA032 URASOE
Japan	Urawa, JP	ASI JP JA035 URAWA
Japan	Urayasu, JP	ASI JP JA041 URAYASU
Japan	Utsunomiya, JP	ASI JP JA039 UTSUNOMIYA
Japan	Wakayama, JP	ASI JP JA044 WAKAYAMA
Japan	Yachiyo, JP	ASI JP JA012 YACHIYO
Japan	Yaizu, JP	ASI JP JA038 YAIZU
Japan	Yamagata, JP	ASI JP JA045 YAMAGATA
Japan	Yamaguchi, JP	ASI JP JA046 YAMAGUCHI
Japan	Yamato, JP	ASI JP JA028 YAMATO
Japan	Yao, JP	ASI JP JA033 YAO
Japan	Yatsushiro, JP	ASI JP JA021 YATSUSHIRO
Japan	Yokkaichi, JP	ASI JP JA030 YOKKAICHI
Japan	Yokohama, JP	ASI JP JA019 YOKOHAMA
Japan	Yokosuka, JP	ASI JP JA019 YOKOSUKA
Japan	Yonago, JP	ASI JP JA042 YONAGO
Japan	Zama, JP	ASI JP JA019 ZAMA
Jordan	Amman, JO	MEA JO JO002 AMMAN
Jordan	Irbid, JO	MEA JO JO009 IRBID
Kazakhstan	Aktau, KZ	ASI KZ KZ000 AKTAU
Kazakhstan	Aktobe, KZ	ASI KZ KZ000 AKTOBE
Kazakhstan	Almaty, KZ	ASI KZ KZ001 ALMATY

Kazakhstan	Astana, KZ	ASI KZ KZ004 ASTANA
Kazakhstan	Ekibastuz, KZ	ASI KZ KZ010 EKIBASTUZ
Kazakhstan	Ist-Kamenogorsk, KZ	ASI KZ KZ014 IST-KAMENOGORSK
Kazakhstan	Karaganda, KZ	ASI KZ KZ000 KARAGANDA
Kazakhstan	Kustanai, KZ	ASI KZ KZ012 KUSTANAI
Kazakhstan	Kyzylorda, KZ	ASI KZ KZ013 KYZYLORDA
Kazakhstan	Pavlodar, KZ	ASI KZ KZ010 PAVLODAR
Kazakhstan	Petropavlovsk, KZ	ASI KZ KZ015 PETROPAVLOVSK
Kazakhstan	Semipalatinsk, KZ	ASI KZ KZ014 SEMIPALATINSK
Kazakhstan	Taraz, KZ	ASI KZ KZ016 TARAZ
Kazakhstan	Temirtau, KZ	ASI KZ KZ011 TEMIRTAU
Kazakhstan	Uralsk, KZ	ASI KZ KZ006 URALSK
Kenya	Eldoret, KE	AFR KE KE007 ELDOROT
Kenya	Kisumu, KE	AFR KE KE006 KISUMU
Kenya	Kitale, KE	AFR KE KE007 KITALE
Kenya	Machakos, KE	AFR KE KE003 MACHAKOS
Kenya	Malindi, KE	AFR KE KE002 MALINDI
Kenya	Mombasa, KE	AFR KE KE002 MOMBASA
Kenya	Nairobi, KE	AFR KE KE004 NAIROBI
Kenya	Nakuru, KE	AFR KE KE007 NAKURU
Kenya	Nanyuki, KE	AFR KE KE007 NANYUKI
Kinshasa	Boma, CD	AFR CD CG002 BOMA
Kinshasa	Bukavu, CD	AFR CD CG011 BUKAVU
Kinshasa	Kananga, CD	AFR CD CG004 KANANGA
Kinshasa	Kikwit, CD	AFR CD CG001 KIKWIT
Kinshasa	Kisangani, CD	AFR CD CG010 KISANGANI
Kinshasa	Kolwezi, CD	AFR CD CG006 KOLWEZI
Kinshasa	Likasi, CD	AFR CD CG006 LIKASI
Kinshasa	Lubumbashi, CD	AFR CD CG006 LUBUMBASHI
Kinshasa	Matadi, CD	AFR CD CG002 MATADI
Kinshasa	Mbandaka, CD	AFR CD CG003 MBANDAKA
Kinshasa	Mbuji-Mayi, CD	AFR CD CG005 MBUJI-MAYI
Kiribati	Tarawa, KI	OCN KI KR000 TARAWA
Kuwait	As Salimiyah, KW	MEA KW KU000 AS SALIMIYAH
Kuwait	Jalib as-Suyuh, KW	MEA KW KU000 JALIB AS-SUYUH
Kuwait	Kuwait City, KW	MEA KW KU000 KUWAIT CITY
Kyrgyzstan	Bishkek, KG	ASI KG KG002 BISHKEK
Kyrgyzstan	Osh, KG	ASI KG KG006 OSH
Laos	Luang Prabang, LA	ASI LA LA008 LUANG PRABANG
Laos	Vientiane, LA	ASI LA LA017 VIENTIANE
Latvia	Daugavpils, LV	EUR LV LG006 DAUGAVPILS
Latvia	Riga, LV	EUR LV LG026 RIGA
Lebanon	Beirut, LB	MEA LB LE002 BEIRUT

Lebanon	Jbeil, LB	MEA LB LE005 JBEIL
Lebanon	Sidon, LB	MEA LB LE000 SIDON
Lebanon	Tripoli, LB	MEA LB LE003 TRIPOLI
Lebanon	Tyre, LB	MEA LB LE000 TYRE
Lesotho	Maseru, LS	AFR LS LT000 MASERU
Liberia	Monrovia, LR	AFR LR LI007 MONROVIA
Libya	Al Khums, LY	AFR LY LY006 AL KHUMS
Libya	Benghazi, LY	AFR LY LY012 BENGHAZI
Libya	Misurata, LY	AFR LY LY016 MISURATA
Libya	Sebha, LY	AFR LY LY018 SEBHA
Libya	Tripoli, LY	AFR LY LY021 TRIPOLI
Libya	Zuwarah, LY	AFR LY LY008 ZUWARAH
Liechtenstein	Vaduz, LI	EUR LI LS000 VADUZ
Lithuania	Kaunas, LT	EUR LT LH013 KAUNAS
Lithuania	Klaipeda, LT	EUR LT LH017 KLAIPEDA
Lithuania	Panevezhis, LT	EUR LT LH030 PANEVEZHIS
Lithuania	Vilnius, LT	EUR LT LH054 VILNIUS
Macau	Macao, MO	ASI MO MC--- MACAO
Macedonia	Skoplje, MK	EUR MK MK000 SKOPLJE
Madagascar	Antananarivo, MG	AFR MG MA001 ANTANANARIVO
Malawi	Blantyre-Limbe, MW	AFR MW MI000 BLANTYRE-LIMBE
Malawi	Lilongwe, MW	AFR MW MI000 LILONGWE
Malaysia	Alor Setar, MY	ASI MY MY002 ALOR SETAR
Malaysia	George Town, MY	ASI MY MY010 GEORGE TOWN
Malaysia	Ipoh, MY	ASI MY MY008 IPOH
Malaysia	Johore Bharu, MY	ASI MY MY001 JOHORE BHARU
Malaysia	Klang, MY	ASI MY MY013 KLANG
Malaysia	Kota Bahru, MY	ASI MY MY003 KOTA BAHRU
Malaysia	Kota Kinabalu, MY	ASI MY MY011 KOTA KINABALU
Malaysia	Kuala Lumpur, MY	ASI MY MY015 KUALA LUMPUR
Malaysia	Kuala Terengganu, MY	ASI MY MY014 KUALA TERENGGANU
Malaysia	Kuantan, MY	ASI MY MY007 KUANTAN
Malaysia	Kuching, MY	ASI MY MY012 KUCHING
Malaysia	Petaling Jaya, MY	ASI MY MY000 PETALING JAYA
Malaysia	Sandakan, MY	ASI MY MY011 SANDAKAN
Malaysia	Seremban, MY	ASI MY MY006 SEREMBAN
Malaysia	Shah Alam, MY	ASI MY MY000 SHAH ALAM
Malaysia	Sibu, MY	ASI MY MY012 SIBU
Malaysia	Sungai Petani, MY	ASI MY MY002 SUNGAI PETANI
Malaysia	Taiping, MY	ASI MY MY008 TAIPING
Maldives	Male, MV	ASI MV MV012 MALE
Mali	Bamako, ML	AFR ML ML000 BAMAKO
Mali	Timbuktu, ML	AFR ML ML000 TIMBUKTU

Malta	Valletta, MT	EUR MT MT--- VALLETTA
Martinique	Fort-De-France, MQ	CAC MQ MB--- FORT-DE-FRANCE
Mauritania	Nouakchott, MR	AFR MR MR005 NOUAKCHOTT
Mauritius	Beau Bassin, MU	AFR MU MP008 BEAU BASSIN
Mauritius	Port Louis, MU	AFR MU MP009 PORT LOUIS
Mexico	Acapulco, MX	NAM MX MX012 ACAPULCO
Mexico	Aguascalientes, MX	NAM MX MX001 AGUASCALIENTES
Mexico	Ahome, MX	NAM MX MX025 AHOME
Mexico	Benito Juarez-Cancun-Qroo, MX	NAM MX MX023 BENITO JUAREZ-CANCUN-QROO
Mexico	Cajeme, MX	NAM MX MX026 CAJEME
Mexico	Campeche, MX	NAM MX MX004 CAMPECHE
Mexico	Celaya, MX	NAM MX MX011 CELAYA
Mexico	Centro, MX	NAM MX MX010 CENTRO
Mexico	Chihuahua, MX	NAM MX MX006 CHIHUAHUA
Mexico	Ciudad Madero, MX	NAM MX MX028 CIUDAD MADERO
Mexico	Ciudad Victoria, MX	NAM MX MX002 CIUDAD VICTORIA
Mexico	Coatzacoalcos, MX	NAM MX MX030 COATZACOALCOS
Mexico	Colimas, MX	NAM MX MX019 COLIMAS
Mexico	Cordoba, MX	NAM MX MX030 CÓRDOBA
Mexico	Cuernavaca, MX	NAM MX MX017 CUERNAVACA
Mexico	Culican, MX	NAM MX MX025 CULIACÁN
Mexico	Durango, MX	NAM MX MX010 DURANGO
Mexico	Ecatepec, MX	NAM MX MX015 ECATEPEC
Mexico	Ensenada, MX	NAM MX MX002 ENSENADA
Mexico	Gomez Palacio, MX	NAM MX MX010 GÓMEZ PALACIO
Mexico	Guadalajara, MX	NAM MX MX014 GUADALAJARA
Mexico	Guadalupe, MX	NAM MX MX005 GUADALUPE
Mexico	Hermosillo, MX	NAM MX MX002 HERMOSILLO
Mexico	Irapuato, MX	NAM MX MX011 IRAPUATO
Mexico	Jalapa, MX	NAM MX MX027 JALAPA
Mexico	Juarez, MX	NAM MX MX015 CIUDAD JUÁREZ
Mexico	La Paz, MX	NAM MX MX003 LA PAZ
Mexico	Leon, MX	NAM MX MX011 LEÓN
Mexico	Lopez Mateos, MX	NAM MX MX015 CIUDAD LÓPEZ MATEOS
Mexico	Los Mochis, MX	NAM MX MX025 LOS MOCHIS
Mexico	Matamoros, MX	NAM MX MX028 MATAMOROS
Mexico	Mazatlan, MX	NAM MX MX025 MAZATLÁN
Mexico	Merida, MX	NAM MX MX002 MÉRIDA
Mexico	Mexicali, MX	NAM MX MX002 MEXICALI
Mexico	Mexico City, MX	NAM MX MX009 MEXICO CITY
Mexico	Minatitlan, MX	NAM MX MX030 MINATITLÁN

Mexico	Monclova, MX	NAM MX MX007 MONCLOVA
Mexico	Monterrey, MX	NAM MX MX005 MONTERREY
Mexico	Morelia, MX	NAM MX MX016 MORELIA
Mexico	Naucalpan, MX	NAM MX MX015 NAUCALPAN
Mexico	Netzahualcoyotl, MX	NAM MX MX027 NETZAHUALCÓYOTL
Mexico	Nogales, MX	NAM MX MX030 NOGALES
Mexico	Nuevo Laredo, MX	NAM MX MX028 NUEVO LAREDO
Mexico	Oaxaca, MX	NAM MX MX020 OAXACA DE JUÁREZ
Mexico	Obregon, MX	NAM MX MX026 CIUDAD OBREGÓN
Mexico	Orizaba, MX	NAM MX MX030 ORIZABA
Mexico	Pachuca, MX	NAM MX MX013 PACHUCA
		NAM MX MX030 POZA RICA DE
Mexico	Poza Rica De Hidalgo, MX	HIDALGO
Mexico	Puebla De Zaragoza, MX	NAM MX MX021 PUEBLA DE ZARAGOZA
Mexico	Queretaro, MX	NAM MX MX022 QUERÉTARO
Mexico	Reynosa, MX	NAM MX MX028 REYNOSA
Mexico	Salamanca, MX	NAM MX MX011 SALAMANCA
Mexico	Saltillo, MX	NAM MX MX007 SALTILLO
Mexico	San Luis Potosi, MX	NAM MX MX024 SAN LUIS POTOSÍ
Mexico	Tampico, MX	NAM MX MX028 TAMPICO
Mexico	Tapachula, MX	NAM MX MX005 TAPACHULA
Mexico	Tehuacan, MX	NAM MX MX021 TEHUACÁN
Mexico	Tepic, MX	NAM MX MX018 TEPIC
Mexico	Tijuana, MX	NAM MX MX002 TIJUANA
Mexico	Tlalnepantla, MX	NAM MX MX015 TLALNEPANTLA
Mexico	Tlalpan, MX	NAM MX MX009 TLALPAN
Mexico	Tlaquepaque, MX	NAM MX MX014 TLAQUEPAQUE
Mexico	Tlaxcala, MX	NAM MX MX029 TLAXCALA
Mexico	Toluca, MX	NAM MX MX015 TOLUCA
Mexico	Torreón, MX	NAM MX MX006 TORREÓN
Mexico	Uruapan, MX	NAM MX MX016 URUAPAN
Mexico	Veracruz Llave, MX	NAM MX MX030 VERACRUZ LLAVE
Mexico	Villahermosa, MX	NAM MX MX027 VILLAHERMOSA
Mexico	Xochimilco, MX	NAM MX MX009 XOCHIMILCO
Mexico	Zacatecas, MX	NAM MX MX032 ZACATECAS
Mexico	Zamora De Hidalgo, MX	NAM MX MX016 ZAMORA DE HIDALGO
Mexico	Zapopan, MX	NAM MX MX014 ZAPOPAN
Moldova	Beltsy, MD	EUR MD MD000 BELTSY
Moldova	Kishinev, MD	EUR MD MD000 KISHINEV
Monaco	Monaco, MC	EUR MC MN000 MONACO
Mongolia	Ulaanbaatar, MN	ASI MN MG021 ULAANBAATAR
Montenegro	Podgorica, CS	EUR CS YI002 PODGORICA
Montserrat	Plymouth, MS	CAC MS MH001 PLYMOUTH

Morocco	Agadir, MA	AFR MA MO041 AGADIR
Morocco	Beni Mellal, MA	AFR MA MO006 BÉNI-MELLAL
Morocco	Casablanca, MA	AFR MA MO008 CASABLANCA
Morocco	El Jadida, MA	AFR MA MO010 EL JADIDA
Morocco	Fes, MA	AFR MA MO016 FÈS
Morocco	Kenitra, MA	AFR MA MO019 KÉNITRA
Morocco	Khouribga, MA	AFR MA MO022 KHOURIBGA
Morocco	Marrakech, MA	AFR MA MO025 MARRAKECH
Morocco	Meknes, MA	AFR MA MO026 MEKNÈS
Morocco	Oujda, MA	AFR MA MO029 OUJDA
Morocco	Rabat, MA	AFR MA MO030 RABAT
Morocco	Safi, MA	AFR MA MO031 SAFI
Morocco	Sale, MA	AFR MA MO030 SALÉ
Morocco	Tanger, MA	AFR MA MO035 TANGER
Morocco	Tetouan, MA	AFR MA MO040 TÉTOUAN
Mozambique	Beira, MZ	AFR MZ MZ008 BEIRA
Mozambique	Bilene, MZ	AFR MZ MZ002 BILENE
Mozambique	Chidenguele, MZ	AFR MZ MZ002 CHIDENGUELE
Mozambique	Chimoio/Beira Corridor, MZ	AFR MZ MZ004 CHIMOIO/BEIRA CORRIDOR
Mozambique	Inhaca Island, MZ	AFR MZ MZ005 INHACA ISLAND
Mozambique	Inhambane, MZ	AFR MZ MZ003 INHAMBANE
Mozambique	Inhasoro, MZ	AFR MZ MZ003 INHASORO
Mozambique	Lichinga, MZ	AFR MZ MZ007 LICHINGA
Mozambique	Maputo, MZ	AFR MZ MZ005 MAPUTO
Mozambique	Mozambique Island, MZ	AFR MZ MZ006 MOZAMBIQUE ISLAND
Mozambique	Nacala, MZ	AFR MZ MZ006 NACALA
Mozambique	Nampula, MZ	AFR MZ MZ006 NAMPULA
Mozambique	Pemba, MZ	AFR MZ MZ001 PEMBA
Mozambique	Ponta do Ouro, MZ	AFR MZ MZ005 PONTA DO OURO
Mozambique	Quelimane, MZ	AFR MZ MZ010 QUELIMANE
Mozambique	Vilanculos, MZ	AFR MZ MZ003 VILANCULOS
Mozambique	Xai Xai, MZ	AFR MZ MZ002 XAI XAI
Namibia	Windhoek, NA	AFR NA WA005 WINDHOEK
Nepal	Biratnagar, NP	ASI NP NP000 BIRATNAGAR
Nepal	Kathmandu, NP	ASI NP NP000 KATHMANDU
Nepal	Lalitpur, NP	ASI NP NP000 LALITPUR
Netherlands		
Antilles	Willemstad, AN	CAC AN NT--- WILLEMSTAD
Netherlands	Almere, NL	EUR NL NL002 ALMERE
Netherlands	Amersfoort, NL	EUR NL NL010 AMERSFOORT
Netherlands	Amsterdam, NL	EUR NL NL008 AMSTERDAM
Netherlands	Apeldoorn, NL	EUR NL NL004 APELDOORN

Netherlands	Arnhem, NL	EUR NL NL004 ARNHEM
Netherlands	Breda, NL	EUR NL NL007 BREDA
Netherlands	Dordrecht, NL	EUR NL NL012 DORDRECHT
Netherlands	Ede, NL	EUR NL NL004 EDE
Netherlands	Eindhoven, NL	EUR NL NL007 EINDHOVEN
Netherlands	Emmen, NL	EUR NL NL001 EMMEN
Netherlands	Enschede, NL	EUR NL NL009 ENSCHEDE
Netherlands	Geleen-Sittard, NL	EUR NL NL006 GELEEN-SITTARD
Netherlands	Groningen, NL	EUR NL NL005 GRONINGEN
Netherlands	Haarlem, NL	EUR NL NL008 HAARLEM
Netherlands	Haarlemmermeer, NL	EUR NL NL008 HAARLEMMERMEER
Netherlands	Heerlen-Kerkrade, NL	EUR NL NL006 HEERLEN-KERKRADE
Netherlands	Leiden, NL	EUR NL NL012 LEIDEN
Netherlands	Maastricht, NL	EUR NL NL006 MAASTRICHT
Netherlands	Nijmegen, NL	EUR NL NL004 NIJMEGEN
Netherlands	Rotterdam, NL	EUR NL NL012 ROTTERDAM
Netherlands	S-Gravenhage, NL	EUR NL NL012 S-GRAVENHAGE
Netherlands	S-Hertogenbosch, NL	EUR NL NL007 S-HERTOGENBOSCH
Netherlands	Tilburg, NL	EUR NL NL007 TILBURG
Netherlands	Utrecht, NL	EUR NL NL010 UTRECHT
Netherlands	Zaanstad, NL	EUR NL NL008 ZAANSTAD
Netherlands	Zoetermeer, NL	EUR NL NL012 ZOETERMEER
Netherlands	Zwolle, NL	EUR NL NL009 ZWOLLE
New Caledonia	Noumea, NC	OCN NC NC000 NOUMEA
New Zealand	Auckland, NZ	OCN NZ NZ000 AUCKLAND
New Zealand	Christchurch, NZ	OCN NZ NZ000 CHRISTCHURCH
New Zealand	Dunedin, NZ	OCN NZ NZ000 DUNEDIN
New Zealand	Hamilton, NZ	OCN NZ NZ000 HAMILTON
New Zealand	Manukau, NZ	OCN NZ NZ000 MANUKAU
New Zealand	Napier-Hastings, NZ	OCN NZ NZ000 NAPIER-HASTINGS
New Zealand	Northshore, NZ	OCN NZ NZ000 NORTHSHORE
New Zealand	Waitakere, NZ	OCN NZ NZ000 WAITAKERE
New Zealand	Wellington, NZ	OCN NZ NZ000 WELLINGTON
Nicaragua	Chinandega, NI	CAC NI NU003 CHINANDEGA
Nicaragua	Granada, NI	CAC NI NU006 GRANADA
Nicaragua	Leon, NI	CAC NI NU008 LEON
Nicaragua	Managua, NI	CAC NI NU010 MANAGUA
Nicaragua	Masaya, NI	CAC NI NU011 MASAYA
Niger	Maradi, NE	AFR NE NG004 MARADI
Niger	Niamey, NE	AFR NE NG005 NIAMEY
Niger	Zinder, NE	AFR NE NG008 ZINDER
Nigeria	Aba, NG	AFR NG NI008 ABA
Nigeria	Abeokuta, NG	AFR NG NI000 ABEOKUTA

Nigeria	Abuja, NG	AFR NG NI000 ABUJA
Nigeria	Ado-Ekiti, NG	AFR NG NI000 ADO-EKITI
Nigeria	Calabar, NG	AFR NG NI000 CALABAR
Nigeria	Ede, NG	AFR NG NI000 EDE
Nigeria	Enugu, NG	AFR NG NI000 ENUGU
Nigeria	Ibadan, NG	AFR NG NI029 IBADAN
Nigeria	Ife, NG	AFR NG NI000 IFE
Nigeria	Ikere-Ekiti, NG	AFR NG NI000 IKERE-EKITI
Nigeria	Ila, NG	AFR NG NI000 ILA
Nigeria	Ilesha, NG	AFR NG NI000 ILESHA
Nigeria	Ilorin, NG	AFR NG NI000 ILORIN
Nigeria	Iwo, NG	AFR NG NI000 IWO
Nigeria	Kaduna, NG	AFR NG NI019 KADUNA
Nigeria	Kano, NG	AFR NG NI020 KANO
Nigeria	Lagos, NG	AFR NG NI024 LAGOS
Nigeria	Maiduguri, NG	AFR NG NI000 MAIDUGURI
Nigeria	Mushin, NG	AFR NG NI024 MUSHIN
Nigeria	Ogbomosho, NG	AFR NG NI000 OGBOMOSHO
Nigeria	Onitsha, NG	AFR NG NI000 ONITSHA
Nigeria	Oshogbo, NG	AFR NG NI000 OSHOGBO
Nigeria	Oyo, NG	AFR NG NI029 OYO
Nigeria	Port Harcourt, NG	AFR NG NI031 PORT HARCOURT
Nigeria	Zaria, NG	AFR NG NI000 ZARIA
North Korea	Chechon, KP	ASI KP KN000 CHECHON
North Korea	Chejung, KP	ASI KP KN000 CHEJUNG
North Korea	Haeju, KP	ASI KP KN005 HAEJU
North Korea	Hamhung, KP	ASI KP KN003 HAMHUNG
North Korea	Hyesan, KP	ASI KP KN013 HYESAN
North Korea	Inchon, KP	ASI KP KN007 INCHON
North Korea	Kaesong, KP	ASI KR KS001 KAESONG
North Korea	Kanggye, KP	ASI KP KN001 KANGGYE
North Korea	Pyongyang, KP	ASI KP KN000 PYONGYANG
North Korea	Sariwon, KP	ASI KP KN004 SARIWON
North Korea	Taejon, KP	ASI KP KN010 TAEJON
North Korea	Wonsan, KP	ASI KR KS009 WONSAN
Norway	Aalesund, NO	EUR NO NO007 AALESUND
Norway	Arendal, NO	EUR NO NO002 ARENDAL
Norway	Bergen, NO	EUR NO NO006 BERGEN
Norway	Bodoe, NO	EUR NO NO009 BODOE
Norway	Drammen, NO	EUR NO NO003 DRAMMEN
Norway	Fredrikstad, NO	EUR NO NO012 FREDRIKSTAD
Norway	Geilo, NO	EUR NO NO003 GEILO
Norway	Hammerfest, NO	EUR NO NO004 HAMMERFEST



Norway	Haugesund, NO	EUR NO NO013 HAUGESUND
Norway	Hemsedal, NO	EUR NO NO003 HEMSEDAL
Norway	Hoenefoss, NO	EUR NO NO003 HOENEFOSS
Norway	Krageroe, NO	EUR NO NO016 KRAGEROE
Norway	Kristiansand, NO	EUR NO NO018 KRISTIANSAND
Norway	Kristiansund, NO	EUR NO NO007 KRISTIANSUND
Norway	Larvik, NO	EUR NO NO019 LARVIK
Norway	Lillehammer, NO	EUR NO NO010 LILLEHAMMER
Norway	Lofoten, NO	EUR NO NO009 LOFOTEN
Norway	Molde, NO	EUR NO NO007 MOLDE
Norway	Oslo, NO	EUR NO NO011 OSLO
Norway	Stavanger, NO	EUR NO NO013 STAVANGER
Norway	Toensberg, NO	EUR NO NO019 TOENSBERG
Norway	Tromsoe, NO	EUR NO NO017 TROMSOE
Norway	Trondheim, NO	EUR NO NO015 TRONDHEIM
Norway	Trysil, NO	EUR NO NO005 TRYSIL
Oman	Muscat, OM	MEA OM MU006 MUSCAT
Pakistan	Bahawalnagar, PK	ASI PK PK007 BAHAWALNAGAR
Pakistan	Burewala, PK	ASI PK PK007 BUREWALA
Pakistan	Chiniot, PK	ASI PK PK007 CHINIOT
Pakistan	Dadu, PK	ASI PK PK008 DADU
Pakistan	Daska, PK	ASI PK PK007 DASKA
Pakistan	Dera Ghazi Khan, PK	ASI PK PK007 DERA GHAZI KHAN
Pakistan	Faisalabad, PK	ASI PK PK007 FAISALABAD
Pakistan	Gojra, PK	ASI PK PK007 GOJRA
Pakistan	Gujranwala, PK	ASI PK PK007 GUJRANWALA
Pakistan	Gujrat, PK	ASI PK PK007 GUJRAT
Pakistan	Hafizabad, PK	ASI PK PK007 HAFIZABAD
Pakistan	Hyderabad, PK	ASI PK PK007 HYDERABAD
Pakistan	Islamabad, PK	ASI PK PK004 ISLAMABAD
Pakistan	Jacobabad, PK	ASI PK PK008 JACOBABAD
Pakistan	Jaranwala, PK	ASI PK PK007 JARANWALA
Pakistan	Jhang, PK	ASI PK PK007 JHANG
Pakistan	Jhelum, PK	ASI PK PK007 JHELUM
Pakistan	Kamoke, PK	ASI PK PK007 KAMOKE
Pakistan	Karachi, PK	ASI PK PK008 KARACHI
Pakistan	Kasur, PK	ASI PK PK007 KASUR
Pakistan	Khairpur, PK	ASI PK PK008 KHAIRPUR
Pakistan	Khanewal, PK	ASI PK PK007 KHANEWAL
Pakistan	Khanpur, PK	ASI PK PK007 KHANPUR
Pakistan	Kohat, PK	ASI PK PK005 KOHAT
Pakistan	Lahore, PK	ASI PK PK007 LAHORE
Pakistan	Larkana, PK	ASI PK PK008 LARKANA

Pakistan	Mangora, PK	ASI PK PK001 MANGORA
Pakistan	Mardan, PK	ASI PK PK005 MARDAN
Pakistan	Mirpur Khas, PK	ASI PK PK008 MIRPUR KHAS
Pakistan	Multan, PK	ASI PK PK007 MULTAN
Pakistan	Muridke, PK	ASI PK PK007 MURIDKE
Pakistan	Nawabshah, PK	ASI PK PK008 NAWABSHAH
Pakistan	Okara, PK	ASI PK PK007 OKARA
Pakistan	Pakpattan, PK	ASI PK PK007 PAKPATTAN
Pakistan	Peshawar, PK	ASI PK PK005 PESHAWAR
Pakistan	Quetta, PK	ASI PK PK002 QUETTA
Pakistan	Rahimyar Khan, PK	ASI PK PK007 RAHIMYAR KHAN
Pakistan	Rawalpindi, PK	ASI PK PK007 RAWALPINDI
Pakistan	Sadiqabad, PK	ASI PK PK007 SADIQABAD
Pakistan	Sahiwal, PK	ASI PK PK007 SAHIWAL
Pakistan	Sargodha, PK	ASI PK PK007 SARGODHA
Pakistan	Sukkur, PK	ASI PK PK008 SUKKUR
Pakistan	Tandoadam, PK	ASI PK PK008 TANDOADAM
Panama	Ciudad De Colon, PA	CAC PA PM004 CIUDAD DE COLON
Panama	Panama, PA	CAC PA PM008 PANAMA
Panama	San Miguelito, PA	CAC PA PM008 SAN MIGUELITO
Papua New Guinea	Port Moresby, PG	OCN PG PP013 PORT MORESBY
Paraguay	Asuncion, PY	SAM PY PA008 ASUNCION
Paraguay	Ciudad Del Este, PY	SAM PY PA001 CIUDAD DEL ESTE
Paraguay	San Lorenzo, PY	SAM PY PA008 SAN LORENZO
Peru	Arequipa, PE	SAM PE PE004 AREQUIPA
Peru	Ayacucho, PE	SAM PE PE005 AYACUCHO
Peru	Cajamarca, PE	SAM PE PE006 CAJAMARCA
Peru	Chiclayo, PE	SAM PE PE014 CHICLAYO
Peru	Chimbote, PE	SAM PE PE002 CHIMBOTE
Peru	Cuzco, PE	SAM PE PE008 CUZCO
Peru	Huancayo, PE	SAM PE PE012 HUANCAYO
Peru	Huanuco, PE	SAM PE PE010 HUÁNUCO
Peru	Ica, PE	SAM PE PE011 ICA
Peru	Iquitos, PE	SAM PE PE016 IQUITOS
Peru	Juliaca, PE	SAM PE PE021 JULIACA
Peru	Lima, PE	SAM PE PE015 LIMA
Peru	Piura, PE	SAM PE PE020 PIURA
Peru	Pucallpa, PE	SAM PE PE025 PUCALLPA
Peru	Sullana, PE	SAM PE PE020 SULLANA
Peru	Tacna, PE	SAM PE PE023 TACNA
Peru	Trujillo, PE	SAM PE PE013 TRUJILLO
Philippines	Angeles, PH	ASI PH RP006 ANGELES

Philippines	Bacolod, PH	ASI PH RP000 BACOLOD
Philippines	Bago, PH	ASI PH RP010 BAGO
Philippines	Baguio, PH	ASI PH RP011 BAGUIO
Philippines	Batangas, PH	ASI PH RP016 BATANGAS
Philippines	Butuan, PH	ASI PH RP022 BUTUAN
Philippines	Cabanatuan, PH	ASI PH RP023 CABANATUAN
Philippines	Cadiz, PH	ASI PH RP024 CADIZ
Philippines	Cagayan De Oro, PH	ASI PH RP026 CAGAYAN DE ORO
Philippines	Calbayog, PH	ASI PH RP027 CALBAYOG
Philippines	Caloocan, PH	ASI PH RP028 CALOOCAN
Philippines	Cebu, PH	ASI PH RP037 CEBU
Philippines	Cotabato, PH	ASI PH RP039 COTABATO
Philippines	Dagupan, PH	ASI PH RP040 DAGUPAN
Philippines	Davao, PH	ASI PH RP133 DAVAO
Philippines	General Santos, PH	ASI PH RP049 GENERAL SANTOS
Philippines	Iligan, PH	ASI PH RP052 ILIGAN
Philippines	Iloilo, PH	ASI PH RP055 ILOILO
Philippines	Legaspi, PH	ASI PH RP067 LEGASPI
Philippines	Lipa, PH	ASI PH RP069 LIPA
Philippines	Lucena City, PH	ASI PH RP070 LUCENA CITY
Philippines	Makati, PH	ASI PH RP077 MAKATI
Philippines	Mandaluyong, PH	ASI PH RP035 MANDALUYONG
Philippines	Mandaue, PH	ASI PH RP072 MANDAUE
Philippines	Manila, PH	ASI PH RP073 MANILA
Philippines	Marawi, PH	ASI PH RP074 MARAWI
Philippines	Muntinlupa, PH	ASI PH RP103 MUNTINLUPA
Philippines	Naga, PH	ASI PH RP082 NAGA
Philippines	Olongapo, PH	ASI PH RP089 OLONGAPO
Philippines	Ormoc, PH	ASI PH RP090 ORMOC
Philippines	Ozamis, PH	ASI PH RP092 OZAMIS
Philippines	Pagadian, PH	ASI PH RP093 PAGADIAN
Philippines	Pasay, PH	ASI PH RP098 PASAY
Philippines	Pasig, PH	ASI PH RP103 PASIG
Philippines	Puerto Princesa, PH	ASI PH RP099 PUERTO PRINCESA
Philippines	Quezon City, PH	ASI PH RP100 QUEZON CITY
Philippines	Roxas, PH	ASI PH RP027 ROXAS
Philippines	San Carlos, PH	ASI PH RP107 SAN CARLOS
Philippines	San Pablo, PH	ASI PH RP110 SAN PABLO
Philippines	Silay, PH	ASI PH RP111 SILAY
Philippines	Surigao, PH	ASI PH RP118 SURIGAO
Philippines	Tacloban, PH	ASI PH RP121 TACLOBAN
Philippines	Toledo, PH	ASI PH RP127 TOLEDO
Philippines	Zamboanga, PH	ASI PH RP130 ZAMBOANGA

Pitcairn Islands	Adamstown, PN	OCN PN PC--- ADAMSTOWN
Poland	Bialystok, PL	EUR PL PL010 BIALYSTOK
Poland	Bielsko-Biala, PL	EUR PL PL012 BIELSKO-BIALA
Poland	Bydgoszcz, PL	EUR PL PL002 BYDGOSZCZ
Poland	Bytom, PL	EUR PL PL012 BYTOM
Poland	Chorzow, PL	EUR PL PL012 CHORZÓW
Poland	Czestochowa, PL	EUR PL PL012 CZESTOCHOWA
Poland	Dabrowa Gornicza, PL	EUR PL PL012 DABROWA GÓRNICZA
Poland	Elblag, PL	EUR PL PL014 ELBLAG
Poland	Gdansk, PL	EUR PL PL011 GDANSK
Poland	Gdynia, PL	EUR PL PL011 GDYNIA
Poland	Gliwice, PL	EUR PL PL012 GLIWICE
Poland	Gorzow Wielkopolski, PL	EUR PL PL005 GORZÓW WIELKOPOLSKI
Poland	Jastrzebie, PL	EUR PL PL012 JASTRZEBIE-ZDRÓJ
Poland	Kalisz, PL	EUR PL PL015 KALISZ
Poland	Katowice, PL	EUR PL PL012 KATOWICE
Poland	Kielce, PL	EUR PL PL013 KIELCE
Poland	Koszalin, PL	EUR PL PL016 KOSZALIN
Poland	Krakow, PL	EUR PL PL006 KRAKÓW
Poland	Legnica, PL	EUR PL PL001 LEGNICA
Poland	Lodz, PL	EUR PL PL003 LÓDZ
Poland	Lublin, PL	EUR PL PL004 LUBLIN
Poland	Olsztyn, PL	EUR PL PL014 OLSZTYN
Poland	Opole, PL	EUR PL PL008 OPOLE
Poland	Plock, PL	EUR PL PL007 PLOCK
Poland	Poznan, PL	EUR PL PL015 POZNAN
Poland	Radom, PL	EUR PL PL007 RADOM
Poland	Ruda Slaska, PL	EUR PL PL012 RUDA SLASKA
Poland	Rybnik, PL	EUR PL PL012 RYBNIK
Poland	Rzeszow, PL	EUR PL PL009 RZESZÓW
Poland	Slupsk, PL	EUR PL PL011 SLUPSK
Poland	Sosnowiec, PL	EUR PL PL012 SOSNOWIEC
Poland	Szczecin, PL	EUR PL PL016 SZCZECIN
Poland	Tarnow, PL	EUR PL PL004 TARNÓW
Poland	Torun, PL	EUR PL PL007 TORUN
Poland	Tychy, PL	EUR PL PL012 TYCHY
Poland	Walbrzych, PL	EUR PL PL001 WALBRZYCH
Poland	Warszawa, PL	EUR PL PL007 WARSZAWA
Poland	Wloclawek, PL	EUR PL PL002 WLOCLAWEK
Poland	Wroclaw, PL	EUR PL PL001 WROCLAW
Poland	Zabrze, PL	EUR PL PL012 ZABRZE
Poland	Zielona Gora, PL	EUR PL PL005 ZIELONA GÓRA
Portugal	Amadora, PT	EUR PT PO012 AMADORA

Portugal	Castelo Branco, PT	EUR PT PO006 CASTELO BRANCO
Portugal	Coimbra, PT	EUR PT PO007 COIMBRA
Portugal	Évora, PT	EUR PT PO008 ÉVORA
Portugal	Faro, PT	EUR PT PO009 FARO
Portugal	Funchal, PT	EUR PT PO013 FUNCHAL
Portugal	Guarda, PT	EUR PT PO010 GUARDA
Portugal	Leiria, PT	EUR PT PO011 LEIRIA
Portugal	Lisbon, PT	EUR PT PO012 LISBOA
Portugal	Ponta Delgada, PT	EUR PT PO002 PONTA DELGADA
Portugal	Portalegre, PT	EUR PT PO014 PORTALEGRE
Portugal	Porto, PT	EUR PT PO015 PORTO
Portugal	Santarém, PT	EUR PT PO016 SANTARÉM
Portugal	Setúbal, PT	EUR PT PO017 SETÚBAL
Portugal	Viana do Castelo, PT	EUR PT PO018 VIANA DO CASTELO
Portugal	Vila Real, PT	EUR PT PO019 VILA REAL
Portugal	Viseu, PT	EUR PT PO020 VISEU
Puerto Rico	Arecibo, PR	CAC PR PR000 ARECIBO
Puerto Rico	Bayamon, PR	CAC PR PR000 BAYAMÓN
Puerto Rico	Caguas, PR	CAC PR PR000 CAGUAS
Puerto Rico	Carolina, PR	CAC PR PR000 CAROLINA
Puerto Rico	Guaynabo, PR	CAC PR PR000 GUAYNABO
Puerto Rico	Mayaguez, PR	CAC PR PR000 MAYAGÜEZ
Puerto Rico	Ponce, PR	CAC PR PR000 PONCE
Puerto Rico	San Juan, PR	CAC PR PR000 SAN JUAN
Qatar	Ar Rayyan, QA	MEA QA QA000 AR RAYYAN
Qatar	Doha, QA	MEA QA QA001 DOHA
Republic of Congo	Brazzaville, CG	AFR CG CF002 BRAZZAVILLE
Reunion	Saint-Denis, RE	AFR RE RE--- SAINT-DENIS
Romania	Arad, RO	EUR RO RO002 ARAD
Romania	Bacau, RO	EUR RO RO004 BACAU
Romania	Baia Mare, RO	EUR RO RO026 BAIA MARE
Romania	Botosani, RO	EUR RO RO007 BOTOSANI
Romania	Braila, RO	EUR RO RO008 BRAILA
Romania	Brasov, RO	EUR RO RO009 BRASOV
Romania	Bucuresti, RO	EUR RO RO010 BUCURESTI
Romania	Buzau, RO	EUR RO RO011 BUZAU
Romania	Cluj-Napoca, RO	EUR RO RO001 CLUJ-NAPOCA
Romania	Constanta, RO	EUR RO RO015 CONSTANTA
Romania	Craiova, RO	EUR RO RO018 CRAIOVA
Romania	Drobeta Turnu-Severin, RO	EUR RO RO027 DROBETA TURNU- SEVERIN
Romania	Galati, RO	EUR RO RO019 GALATI

Romania	Iasi, RO	EUR RO RO025 IASI
Romania	Oradea, RO	EUR RO RO005 ORADEA
Romania	Piatra Neamt, RO	EUR RO RO029 PIATRA NEAMT
Romania	Pitesti, RO	EUR RO RO003 PITESTI
Romania	Ploiesti, RO	EUR RO RO031 PLOIESTI
Romania	Rimnicu Vilcea, RO	EUR RO RO039 RIMNICU VILCEA
Romania	Satu-Mare, RO	EUR RO RO033 SATU-MARE
Romania	Sibiu, RO	EUR RO RO034 SIBIU
Romania	Suceava, RO	EUR RO RO035 SUCEAVA
Romania	Timisoara, RO	EUR RO RO037 TIMISOARA
Romania	Tirgu-Mures, RO	EUR RO RO028 TIRGU-MURES
Russia	Abakan, RU	ASI RU RS033 ABAKAN
Russia	Achinsk, RU	ASI RU RS041 ACHINSK
Russia	Angarsk, RU	ASI RU RS021 ANGARSK
Russia	Arkhangelsk, RU	ASI RU RS005 ARKHANGELSK
Russia	Armavir, RU	ASI RU RS040 ARMAVIR
Russia	Arzamas, RU	ASI RU RS055 ARZAMAS
Russia	Astrakhan, RU	ASI RU RS006 ASTRAKHAN
Russia	Balakovo, RU	ASI RU RS069 BALAKOVO
Russia	Balashikha, RU	ASI RU RS051 BALASHIKHA
Russia	Barnaul, RU	ASI RU RS043 BARNAUL
Russia	Belgorod, RU	ASI RU RS008 BELGOROD
Russia	Berezniki, RU	ASI RU RS062 BEREZNIKI
Russia	Biisk, RU	ASI RU RS003 BIISK
Russia	Biysk, RU	ASI RU RS003 BIYSK
Russia	Blagoveshchensk, RU	ASI RU RS007 BLAGOVESHCHENSK
Russia	Bratsk, RU	ASI RU RS021 BRATSK
Russia	Bryansk, RU	ASI RU RS010 BRYANSK
Russia	Cheboksary, RU	ASI RU RS016 CHEBOKSARY
Russia	Chelyabinsk, RU	ASI RU RS013 CHELYABINSK
Russia	Cherepovets, RU	ASI RU RS089 CHEREPOVETS
Russia	Cherkessk, RU	ASI RU RS029 CHERKESSK
Russia	Chita, RU	ASI RU RS014 CHITA
Russia	Dimitrovgrad, RU	ASI RU RS085 DIMITROVGRAD
Russia	Dzerzhinsk, RU	ASI RU RS055 DZERZHINSK
Russia	Ekaterinburg, RU	ASI RU RS075 EKATERINBURG
Russia	Elektrostal, RU	ASI RU RS051 ELEKTROSTAL
Russia	Elets, RU	ASI RU RS046 ELETS
Russia	Elista, RU	ASI RU RS026 ELISTA
Russia	Engels, RU	ASI RU RS069 ENGELS
Russia	Glazov, RU	ASI RU RS084 GLAZOV
Russia	Gorkey, RU	ASI RU RS055 NIZHNY NOVGOROD
Russia	Groznyi, RU	ASI RU RS012 GROZNYI

Russia	Irkutsk, RU	ASI RU RS021 IRKUTSK
Russia	Ivanovo, RU	ASI RU RS023 IVANOVO
Russia	Izhevsk, RU	ASI RU RS084 IZHEVSK
Russia	Kaliningrad, RU	ASI RU RS025 KALININGRAD
Russia	Kaluga, RU	ASI RU RS027 KALUGA
Russia	Kamenskiy, RU	ASI RU RS075 KAMENSK-URALSKY
Russia	Kansk, RU	ASI RU RS041 KANSK
Russia	Kazan, RU	ASI RU RS077 KAZAN
Russia	Kemerovo, RU	ASI RU RS031 KEMEROVO
Russia	Khabarovsk, RU	ASI RU RS032 KHABAROVSK
Russia	Khanty-Mansiysk, RU	ASI RU RS034 KHANTY-MANSIYSK
Russia	Khimki, RU	ASI RU RS052 KHIMKI
Russia	Kirov, RU	ASI RU RS035 KIROV
Russia	Kiselevsk, RU	ASI RU RS031 KISELEVSK
Russia	Kislovodsk, RU	ASI RU RS074 KISLOVODSK
Russia	Kolomna, RU	ASI RU RS010 KOLOMNA
Russia	Komsomolsk-Na-Amure, RU	ASI RU RS032 KOMSOMOLSK-NA-AMURE
Russia	Korolev, RU	ASI RU RS051 KOROLEV
Russia	Kostroma, RU	ASI RU RS039 KOSTROMA
Russia	Kovrov, RU	ASI RU RS087 KOVROV
Russia	Krasnodar, RU	ASI RU RS040 KRASNODAR
Russia	Krasnoyarsk, RU	ASI RU RS041 KRASNOYARSK
Russia	Kurgan, RU	ASI RU RS043 KURGAN
Russia	Kursk, RU	ASI RU RS044 KURSK
Russia	Lipetsk, RU	ASI RU RS046 LIPETSK
Russia	Magadan, RU	ASI RU RS047 MAGADAN
Russia	Magnitogorsk, RU	ASI RU RS013 MAGNITOGORSK
Russia	Maikop, RU	ASI RU RS001 MAIKOP
Russia	Makhachkala, RU	ASI RU RS017 MAKHACHKALA
Russia	Mezhdurechensk, RU	ASI RU RS031 MEZHDURECHENSK
Russia	Miass, RU	ASI RU RS013 MIASS
Russia	Michurinsk, RU	ASI RU RS076 MICHURINSK
Russia	Moscow, RU	ASI RU RS052 MOSKVA
Russia	Murmansk, RU	ASI RU RS053 MURMANSK
Russia	Murom, RU	ASI RU RS087 MUROM
Russia	Mytishchi, RU	ASI RU RS051 MYTISHCHI
Russia	Naberezhnyye Chelny, RU	ASI RU RS077 NABEREZHNYYE CHELNY
Russia	Nakhodka, RU	ASI RU RS063 NAKHODKA
Russia	Nalchik, RU	ASI RU RS024 NALCHIK
Russia	Naryan-Mar, RU	ASI RU RS054 NARYAN-MAR
Russia	Neftekamsk, RU	ASI RU RS007 NEFTEKAMSK
Russia	Nevinnomyssk, RU	ASI RU RS074 NEVINNOMYSSK

Russia	Nizhnekamsk, RU	ASI RU RS077 NIZHNEKAMSK
Russia	Nizhnevartovsk, RU	ASI RU RS034 NIZHNEVARTOVSK
Russia	Nizhniy Novgorod, RU	ASI RU RS055 NIZHNIY NOVGOROD
Russia	Nizhny Tagil, RU	ASI RU RS075 NIZHNY TAGIL
Russia	Noginsk, RU	ASI RU RS018 NOGINSK
Russia	Norilsk, RU	ASI RU RS041 NORILSK
Russia	Novocheboksarsk, RU	ASI RU RS016 NOVOCHEBOKSARSK
Russia	Novocherkassk, RU	ASI RU RS059 NOVOCHERKASSK
Russia	Novokuznetsk, RU	ASI RU RS031 NOVOKUZNETSK
Russia	Novomoskovsk, RU	ASI RU RS080 NOVOMOSKOVSK
Russia	Novorossiysk, RU	ASI RU RS079 NOVOROSSIYSK
Russia	Novoshakhtinsk, RU	ASI RU RS065 NOVOSHAKHTINSK
Russia	Novosibirsk, RU	ASI RU RS057 NOVOSIBIRSK
Russia	Novotroitsk, RU	ASI RU RS057 NOVOTROITSK
Russia	Obninsk, RU	ASI RU RS027 OBNINSK
Russia	Odintsovo, RU	ASI RU RS051 ODINTSOVO
Russia	Omsk, RU	ASI RU RS058 OMSK
Russia	Orehovo-Zuevo, RU	ASI RU RS051 OREKHOVO-ZUEVO
Russia	Orel, RU	ASI RU RS062 OREL
Russia	Orenburg, RU	ASI RU RS059 ORENBURG
Russia	Orsk, RU	ASI RU RS059 ORSK
Russia	Penza, RU	ASI RU RS061 PENZA
Russia	Perm, RU	ASI RU RS062 PERM
Russia	Pervouralsk, RU	ASI RU RS075 PERVOURALSK ASI RU RS028 PETROPAVLOVSK- KAMCHATSKY
Russia	Petropavlovsk, RU	ASI RU RS030 PETROZAVODSK
Russia	Petrozavodsk, RU	ASI RU RS051 PODOLSK
Russia	Podolsk, RU	ASI RU RS031 PROKPYEVSK
Russia	Prokpyevsk, RU	ASI RU RS064 PSKOV
Russia	Pskov, RU	ASI RU RS074 PYATIGORSK
Russia	Pyatigorsk, RU	ASI RU RS065 ROSTOV-NA-DONU
Russia	Rostov-Na-Donu, RU	ASI RU RS003 RUBTSOVSK
Russia	Rubtsovsk, RU	ASI RU RS079 RYBINSK
Russia	Rybinsk, RU	ASI RU RS066 RYZAN
Russia	Ryzan, RU	ASI RU RS073 SAINT PETERSBURG
Russia	Saint Petersburg, RU	ASI RU RS007 SALAVAT
Russia	Salavat, RU	ASI RU RS068 SAMARA
Russia	Samara, RU	ASI RU RS050 SARANSK
Russia	Saransk, RU	ASI RU RS059 SARATOV
Russia	Saratov, RU	ASI RU RS051 SERPUKHOV
Russia	Serpukhov, RU	ASI RU RS005 SEVERODVINSK
Russia	Severodvinsk, RU	ASI RU RS079 SEVERSK
Russia	Seversk, RU	



Russia	Shakhty, RU	ASI RU RS065 SHAKHTY
Russia	Shchelkovo, RU	ASI RU RS051 SHCHELKOVO
Russia	Smolensk, RU	ASI RU RS072 SMOLENSK
Russia	Sochi, RU	ASI RU RS040 SOCHI
Russia	Solikamsk, RU	ASI RU RS062 SOLIKAMSK
Russia	Stary Oskol , RU	ASI RU RS008 STARY OSKOL
Russia	Stavropol, RU	ASI RU RS074 STAVROPOL
Russia	Sterlitamak, RU	ASI RU RS041 STERLITAMAK
Russia	Surgut, RU	ASI RU RS068 SURGUT
Russia	Syktyvkar, RU	ASI RU RS036 SYKTYVKAR
Russia	Syzran, RU	ASI RU RS085 SYZLAN
Russia	Taganrog, RU	ASI RU RS065 TAGANROG
Russia	Tambov, RU	ASI RU RS076 TAMBOV
Russia	Tolyatti, RU	ASI RU RS068 TOLYATTI
Russia	Tomsk, RU	ASI RU RS079 TOMSK
Russia	Tula, RU	ASI RU RS080 TULA
Russia	Tver, RU	ASI RU RS082 TVER
Russia	Tyumen, RU	ASI RU RS083 TYUMEN
Russia	Tyumen, RU	ASI RU RS083 TYUMEN
Russia	Ufa, RU	ASI RU RS007 UFA
Russia	Ulan-Ude, RU	ASI RU RS086 ULAN-UDE
Russia	Ulyanovsk, RU	ASI RU RS085 ULYANOVSK
Russia	Velikiy Novgorod, RU	ASI RU RS056 VELIKIY NOVGOROD
Russia	Vladikavkaz, RU	ASI RU RS070 VLADIKAVKAZ
Russia	Vladimir, RU	ASI RU RS087 VLADIMIR
Russia	Vladivostok, RU	ASI RU RS063 VLADIVOSTOK
Russia	Volgodonsk, RU	ASI RU RS065 VOLGODONSK
Russia	Volgograd, RU	ASI RU RS088 VOLGOGRAD
Russia	Vologda, RU	ASI RU RS089 VOLOGDA
Russia	Volzhskiy, RU	ASI RU RS088 VOLZHSKIY
Russia	Voronezh, RU	ASI RU RS090 VORONEZH
Russia	Votkinsk, RU	ASI RU RS084 VOTKINSK
Russia	Yakutsk, RU	ASI RU RS091 YAKUTSK
Russia	Yaroslavl, RU	ASI RU RS093 YAROSLAVL
Russia	Yoshkar-Ola, RU	ASI RU RS049 YOSHKAR-OLA
Russia	Yuzhno-Sahalinsk, RU	ASI RU RS067 YUZHNO-SAHALINSK
Russia	Zelenograd, RU	ASI RU RS052 ZELENOGRAD
Russia	Zlatoust, RU	ASI RU RS013 ZLATOUST
Rwanda	Kigali, RW	AFR RW RW009 KIGALI
Saint Helena	Jamestown, SH	AFR SH SH000 JAMESTOWN
Saint Kitts And Nevis	Basseterre, GP	CAC KN SC003 BASSETERRE
Saint Lucia	Castries, LC	CAC LC ST002 CASTRIES

Saint Pierre And Miquelon	Saint-Pierre, PM	NAM PM SB000 SAINT-PIERRE
Saint Vincent And The Grenadines	Kingstown, VC	CAC VC VC005 KINGSTOWN
Samoa	Apia, WS	OCN WS WS000 APIA
San Marino	San Marino, SM	EUR SM SM008 SAN MARINO
Sao Tome And Principe	Sao Tome, ST	AFR ST TP002 SAO TOME
Saudi Arabia	Al khobar, SA	MEA SA SA008 AL KHOBAR
Saudi Arabia	Dammam, SA	MEA SA SA008 DAMMAM
Saudi Arabia	Jeddah, SA	MEA SA SA011 JEDDAH
Saudi Arabia	Makkah, SA	MEA SA SA011 MAKKAH
Saudi Arabia	Medina, SA	MEA SA SA005 MEDINA
Saudi Arabia	Riyadh, SA	MEA SA SA007 RIYADH
Saudi Arabia	Ta'if, SA	MEA SA SA011 TA'IF
Senegal	Dakar, SN	AFR SN SG001 DAKAR
Senegal	Kaolack, SN	AFR SN SG004 KAOLACK
Senegal	Mbour, SN	AFR SN SG009 MBOUR
Senegal	Saint Louis, SN	AFR SN SG000 SAINT LOUIS
Senegal	Thies, SN	AFR SN SG009 THIÈS
Senegal	Ziguinchor, SN	AFR SN SG010 ZIGUINCHOR
Serbia	Beograd, CS	EUR CS YI003 BEOGRAD
Serbia	Cacak, CS	EUR CS YI003 CACAK
Serbia	Kragujevac, CS	EUR CS YI003 KRAGUJEVAC
Serbia	Kraljevo, CS	EUR CS YI003 KRALJEVO
Serbia	Krusevac, CS	EUR CS YI003 KRUSEVAC
Serbia	Leskovac, CS	EUR CS YI003 LESKOVAC
Serbia	Nis, CS	EUR CS YI003 NIS
Serbia	Novi Sad, CS	EUR CS YI003 NOVI SAD
Serbia	Pancevo, CS	EUR CS YI003 PANCEVO
Serbia	Smederevo, CS	EUR CS YI003 SMEDEREVO
Serbia	Subotica, CS	EUR CS YI003 SUBOTICA
Serbia	Zrenjanin, CS	EUR CS YI003 ZRENJANIN
Seychelles	Victoria, SC	AFR SC SE000 VICTORIA
Sierra Leone	Freetown, SL	AFR SL SL004 FREETOWN
Singapore	Singapore, SG	ASI SG SN--- SINGAPORE
Slovakia	Bratislava, SK	EUR SK LO002 BRATISLAVA
Slovakia	Kosice, SK	EUR SK LO003 KOSICE
Slovenia	Ljubljana, SI	EUR SI SI000 LJUBLJANA
Solomon Islands	Honiara, SB	OCN SB BP000 HONIARA
Somalia	Mogadishu, SO	AFR SO SO002 MOGADISHU
South Africa	Alexander Bay, ZA	AFR ZA SF008 ALEXANDER BAY

South Africa	Alexandra, ZA	AFR ZA SF004 ALEXANDRA
South Africa	Aliwal North, ZA	AFR ZA SF002 ALIWAL NORTH
South Africa	Alldays, ZA	AFR ZA SF009 ALLDAYS
South Africa	Amanzimtoti, ZA	AFR ZA SF005 AMANZIMTOTI
South Africa	Badplaas, ZA	AFR ZA SF006 BADPLAAS
South Africa	Barberton, ZA	AFR ZA SF006 BARBERTON
South Africa	Barkly West, ZA	AFR ZA SF008 BARKLY WEST
South Africa	Barrydale, ZA	AFR ZA SF011 BARRYDALE
South Africa	Beaufort West, ZA	AFR ZA SF011 BEAUFORT WEST
South Africa	Bela-Bela, ZA	AFR ZA SF005 BELA-BELA
South Africa	Belfast, ZA	AFR ZA SF006 BELFAST
South Africa	Benoni, ZA	AFR ZA SF004 BENONI
South Africa	Bethlehem, ZA	AFR ZA SF003 BETHLEHEM
South Africa	Bhisho, ZA	AFR ZA SF002 BHISHO
South Africa	Bloemfontein, ZA	AFR ZA SF003 BLOEMFONTEIN
South Africa	Boksburg, ZA	AFR ZA SF004 BOKSBURG
South Africa	Botshabelo, ZA	AFR ZA SF007 BOTSHABELO
South Africa	Brits, ZA	AFR ZA SF007 BRITS
South Africa	Burgersdorp, ZA	AFR ZA SF002 BURGERSDORP
South Africa	Caledon, ZA	AFR ZA SF011 CALEDON
South Africa	Calvinia, ZA	AFR ZA SF008 CALVINIA
South Africa	Cape Point, ZA	AFR ZA SF011 CAPE POINT
South Africa	Cape Town , ZA	AFR ZA SF011 CAPE TOWN
South Africa	Carnarvon, ZA	AFR ZA SF008 CARNARVON
South Africa	Ceres, ZA	AFR ZA SF011 CERES
South Africa	Chrissiesmeer, ZA	AFR ZA SF006 CHRISSIESMEER
South Africa	Clanwilliam, ZA	AFR ZA SF011 CLANWILLIAM
South Africa	Clarens, ZA	AFR ZA SF003 CLARENS
South Africa	Coffee Bay, ZA	AFR ZA SF002 COFFEE BAY
South Africa	Colesberg, ZA	AFR ZA SF008 COLESBERG
South Africa	Cradock, ZA	AFR ZA SF002 CRADOCK
South Africa	Danielskuil, ZA	AFR ZA SF008 DANIELSKUIL
South Africa	De Aar, ZA	AFR ZA SF008 DE AAR
South Africa	Dewetsdorp, ZA	AFR ZA SF003 DEWETSDORP
South Africa	Dundee, ZA	AFR ZA SF005 DUNDEE
South Africa	Durban, ZA	AFR ZA SF005 DURBAN
South Africa	East London, ZA	AFR ZA SF002 EAST LONDON
South Africa	Edenburg, ZA	AFR ZA SF003 EDENBURG
South Africa	Ellisras, ZA	AFR ZA SF009 ELLISRAS
South Africa	Empangeni, ZA	AFR ZA SF005 EMPANGENI
South Africa	Ermelo, ZA	AFR ZA SF006 ERMELO
South Africa	Eshowe, ZA	AFR ZA SF005 ESHOWE
South Africa	Excelsior, ZA	AFR ZA SF003 EXCELSIOR

South Africa	Fauresmith, ZA	AFR ZA SF003 FAURESMTIH
South Africa	Ficksburg, ZA	AFR ZA SF003 FICKSBURG
South Africa	Fort Beaufort, ZA	AFR ZA SF002 FORT BEAUFORT
South Africa	Franschhoek, ZA	AFR ZA SF011 FRANSCHHOEK
South Africa	Fraserburg, ZA	AFR ZA SF008 FRASERBURG
South Africa	Gansbaai, ZA	AFR ZA SF011 GANSBAAI
South Africa	George, ZA	AFR ZA SF011 GEORGE
South Africa	Germiston, ZA	AFR ZA SF004 GERMISTON
South Africa	Giants Castle, ZA	AFR ZA SF005 GIANTS CASTLE
South Africa	Gordons Bay, ZA	AFR ZA SF011 GORDONS BAY
South Africa	Graaff Reinet, ZA	AFR ZA SF002 GRAAFF REINET
South Africa	Grabouw, ZA	AFR ZA SF011 GRABOUW
South Africa	Grahamstown, ZA	AFR ZA SF002 GRAHAMSTOWN
South Africa	Graskop, ZA	AFR ZA SF006 GRASKOP
South Africa	Griekwastad, ZA	AFR ZA SF008 GRIEKWASTAD
South Africa	Groblersdal, ZA	AFR ZA SF006 GROBLERSDAL
South Africa	Haenertsburg, ZA	AFR ZA SF009 HAENERTSBURG
South Africa	Harrismith, ZA	AFR ZA SF003 HARRISMITH
South Africa	Hartbeespoort, ZA	AFR ZA SF007 HARTBESPOORT
South Africa	Hartenbos, ZA	AFR ZA SF011 HARTENBOS
South Africa	Hazyview, ZA	AFR ZA SF006 HAZYVIEW
South Africa	Heidelberg, ZA	AFR ZA SF004 HEIDELBERG
South Africa	Hermanus, ZA	AFR ZA SF011 HERMANUS
South Africa	Hibberdene, ZA	AFR ZA SF005 HIBBERDENE
South Africa	Hluhluwe, ZA	AFR ZA SF005 HLUHLUWE
South Africa	Hoedspruit, ZA	AFR ZA SF009 HOEDSPRUIT
South Africa	Hogsback, ZA	AFR ZA SF002 HOGSBACK
South Africa	Hondeklip Bay, ZA	AFR ZA SF008 HONDEKLIP BAY
South Africa	Howick, ZA	AFR ZA SF005 HOWICK
South Africa	Ixopo, ZA	AFR ZA SF005 IXOPO
South Africa	Jacobsdal, ZA	AFR ZA SF003 JACOBSDAL
South Africa	Johannesburg, ZA	AFR ZA SF004 JOHANNESBURG
South Africa	Joubertina, ZA	AFR ZA SF002 JOUBERTINA
South Africa	Kakamas, ZA	AFR ZA SF008 KAKAMAS
South Africa	Kamieskroon, ZA	AFR ZA SF008 KAMIESKROON
South Africa	Kempton Park, ZA	AFR ZA SF004 KEMPTON PARK
South Africa	Kimberley, ZA	AFR ZA SF008 KIMBERLEY
South Africa	King Williams Town, ZA	AFR ZA SF002 KING WILLIAMS TOWN
South Africa	Klerksdorp, ZA	AFR ZA SF007 KLERKSDORP
South Africa	Knysna, ZA	AFR ZA SF011 KNYSNA
South Africa	Kokstad, ZA	AFR ZA SF005 KOKSTAD
South Africa	Komatipoort, ZA	AFR ZA SF006 KOMATIPOORT
South Africa	Kroonstad, ZA	AFR ZA SF003 KROONSTAD

South Africa	Krugersdorp, ZA	AFR ZA SF004 KRUGERSDORP
South Africa	Kuruman, ZA	AFR ZA SF008 KURUMAN
South Africa	Ladysmith, ZA	AFR ZA SF005 LADYSMITH
South Africa	Langebaan, ZA	AFR ZA SF011 LANGEBAAN
South Africa	Lephalale, ZA	AFR ZA SF009 LEPHALALE
South Africa	Levubu, ZA	AFR ZA SF009 LEVUBU
South Africa	Lichtenburg, ZA	AFR ZA SF007 LICHTENBURG
South Africa	Loeriesfontein, ZA	AFR ZA SF008 LOERIESFONTEIN
South Africa	Lydenburg, ZA	AFR ZA SF006 LYDENBURG
South Africa	Mafikeng, ZA	AFR ZA SF007 MAFIKENG
South Africa	Magaliesburg, ZA	AFR ZA SF004 MAGALIESBURG
South Africa	Malmesbury, ZA	AFR ZA SF011 MALMESBURY
South Africa	Margate, ZA	AFR ZA SF005 MARGATE
South Africa	Mazeppa Bay, ZA	AFR ZA SF002 MAZEPPA BAY
South Africa	Messina, ZA	AFR ZA SF009 MESSINA
South Africa	Middelburg, ZA	AFR ZA SF006 MIDDELBURG
South Africa	Midrand, ZA	AFR ZA SF004 MIDRAND
South Africa	Mmabatho, ZA	AFR ZA SF007 MMABATHO
South Africa	Mokopane, ZA	AFR ZA SF009 MOKOPANE
South Africa	Mooi River, ZA	AFR ZA SF005 MOOI RIVER
South Africa	Mossel Bay, ZA	AFR ZA SF011 MOSSSEL BAY
South Africa	Mthatha, ZA	AFR ZA SF002 MTHATHA
South Africa	Musina, ZA	AFR ZA SF009 MUSINA
South Africa	Nelspruit, ZA	AFR ZA SF006 NELSPRUIT
South Africa	Newcastle, ZA	AFR ZA SF005 NEWCASTLE
South Africa	Ngqura, ZA	AFR ZA SF002 NGQURA
South Africa	Nieu Bethesda, ZA	AFR ZA SF002 NIEU BETHESDA
South Africa	Nieuwoudtville, ZA	AFR ZA SF008 NIEUWOUDTVILLE
South Africa	Nylstroom, ZA	AFR ZA SF009 NYLSTROOM
South Africa	Ohrigstad, ZA	AFR ZA SF006 OHRIGSTAD
South Africa	Oudtshoorn, ZA	AFR ZA SF011 OUDTSHOORN
South Africa	Paarl, ZA	AFR ZA SF011 PAARL
South Africa	Petrusburg, ZA	AFR ZA SF003 PETRUSBURG
South Africa	Phalaborwa, ZA	AFR ZA SF009 PHALABORWA
South Africa	Philippolis, ZA	AFR ZA SF003 PHILIPPOLIS
South Africa	Piet Retief, ZA	AFR ZA SF006 PIET RETIEF
South Africa	Pietermaritzburg, ZA	AFR ZA SF005 PIETERMARITZBURG
South Africa	Pietersburg, ZA	AFR ZA SF009 PIETERSBURG
South Africa	Pilgrims Rest, ZA	AFR ZA SF006 PILGRIMS REST
South Africa	Plettenberg Bay, ZA	AFR ZA SF011 PLETTENBERG BAY
South Africa	Polokwane, ZA	AFR ZA SF009 POLOKWANE
South Africa	Port Alfred, ZA	AFR ZA SF002 PORT ALFRED
South Africa	Port Elizabeth, ZA	AFR ZA SF002 PORT ELIZABETH

South Africa	Port Shepstone, ZA	AFR ZA SF005 PORT SHEPSTONE
South Africa	Port St. Johns, ZA	AFR ZA SF002 PORT ST. JOHNS
South Africa	Postmasburg, ZA	AFR ZA SF008 POSTMASBURG
South Africa	Potchefstroom, ZA	AFR ZA SF007 POTCHEFSTROOM
South Africa	Potgietersrus, ZA	AFR ZA SF009 POTGIETERSRUS
South Africa	Pretoria, ZA	AFR ZA SF004 PRETORIA
South Africa	Prieska, ZA	AFR ZA SF008 PRIESKA
South Africa	Queenstown, ZA	AFR ZA SF002 QUEENSTOWN
South Africa	Richards Bay, ZA	AFR ZA SF005 RICHARDS BAY
South Africa	Riversdale, ZA	AFR ZA SF011 RIVERSDALE
South Africa	Robertson, ZA	AFR ZA SF011 ROBERTSON
South Africa	Roodepoort, ZA	AFR ZA SF004 ROODEPOORT
South Africa	Rustenburg, ZA	AFR ZA SF007 RUSTENBURG
South Africa	Sabie, ZA	AFR ZA SF006 SABIE
South Africa	Saint Francis, ZA	AFR ZA SF002 SAINT FRANCIS
South Africa	Saint Lucia, ZA	AFR ZA SF005 SAINT LUCIA
South Africa	Saldanha, ZA	AFR ZA SF011 SALDANHA
South Africa	Sandton, ZA	AFR ZA SF004 SANDTON
South Africa	Sasolburg, ZA	AFR ZA SF003 SASOLBURG
South Africa	Sedgefield, ZA	AFR ZA SF011 SEDFIELD
South Africa	Skukuza, ZA	AFR ZA SF006 SKUKUZA
South Africa	Slangkop, ZA	AFR ZA SF011 SLANGKOP
South Africa	Smithfield, ZA	AFR ZA SF003 SMITHFIELD
South Africa	Somerset East, ZA	AFR ZA SF002 SOMERSET EAST
South Africa	Somerset West, ZA	AFR ZA SF011 SOMERSET WEST
South Africa	Soweto, ZA	AFR ZA SF004 SOWETO
South Africa	Springbok, ZA	AFR ZA SF008 SPRINGBOK
South Africa	Springs, ZA	AFR ZA SF004 SPRINGS
South Africa	Standerton, ZA	AFR ZA SF006 STANDERTON
South Africa	Standerton, ZA	AFR ZA SF006 STANDERTON
South Africa	Stellenbosch, ZA	AFR ZA SF011 STELLENBOSCH
South Africa	Stillbaai, ZA	AFR ZA SF011 STILLBAAI
South Africa	Strand, ZA	AFR ZA SF011 STRAND
South Africa	Sutherland, ZA	AFR ZA SF005 SUTHERLAND
South Africa	Swellendam, ZA	AFR ZA SF011 SWELLENBAM
South Africa	Taung, ZA	AFR ZA SF007 TAUNG
South Africa	Tembisa, ZA	AFR ZA SF004 TEMBISA
South Africa	Thabazimbi, ZA	AFR ZA SF009 THABAZIMBI
South Africa	Thohoyandou, ZA	AFR ZA SF009 THOHYANDOU
South Africa	Tzaneen, ZA	AFR ZA SF009 TZANEEN
South Africa	Uitenhage, ZA	AFR ZA SF002 UITENHAGE
South Africa	Ulundi, ZA	AFR ZA SF005 ULUNDI
South Africa	Umhlanga Rock, ZA	AFR ZA SF005 UMHLANGA ROCK

South Africa	Umlazi, ZA	AFR ZA SF005 UMLAZI
South Africa	Umtata, ZA	AFR ZA SF002 UMTATA
South Africa	Underburg, ZA	AFR ZA SF005 UNDERBURG
South Africa	Upington, ZA	AFR ZA SF008 UPINGTON
South Africa	Uvongo, ZA	AFR ZA SF005 UVONGO
South Africa	Vaalwater, ZA	AFR ZA SF009 VAALWATER
South Africa	Vanderbijlpark, ZA	AFR ZA SF004 VANDERBIJLPARK
South Africa	Vereeniging, ZA	AFR ZA SF004 VEREENIGING
South Africa	Virginia, ZA	AFR ZA SF003 VIRGINIA
South Africa	Volksrust, ZA	AFR ZA SF006 VOLKSRUST
South Africa	Vredendal, ZA	AFR ZA SF011 VREDENDAL
South Africa	Vryburg, ZA	AFR ZA SF007 VRYBURG
South Africa	Vryheid, ZA	AFR ZA SF005 VRYHEID
South Africa	Welkom, ZA	AFR ZA SF003 WELKOM
South Africa	Wellington, ZA	AFR ZA SF011 WELLINGTON
South Africa	Wepener, ZA	AFR ZA SF003 WEPENER
South Africa	White River, ZA	AFR ZA SF006 WHITE RIVER
South Africa	Wilderness, ZA	AFR ZA SF011 WILDERNESS
South Africa	Winburg, ZA	AFR ZA SF003 WINBURG
South Africa	Witbank, ZA	AFR ZA SF006 WITBANK
South Africa	Worcester, ZA	AFR ZA SF011 WORCESTER
South Africa	Zastron, ZA	AFR ZA SF003 ZASTRON
South Korea	Andong, KR	ASI KR KS010 ANDONG
South Korea	Ansan, KR	ASI KR KS009 ANSAN
South Korea	Cheju, KR	ASI KR KS003 CHEJU
South Korea	Cheongju, KR	ASI KR KS001 CHEONGJU
South Korea	Chuncheon, KR	ASI KR KS007 CHUNCHEON
South Korea	Chungju, KR	ASI KR KS001 CHUNGJU
South Korea	Hanam, KR	ASI KR KS009 HANAM
South Korea	Iri, KR	ASI KR KS004 IRI
South Korea	Kangnung, KR	ASI KR KS007 KANGNUNG
South Korea	Kimhae, KR	ASI KR KS011 KIMHAE
South Korea	Kunsan, KR	ASI KR KS004 KUNSAN
South Korea	Kwangchu, KR	ASI KR KS008 KWANGCHU
South Korea	Kyong Ju, KR	ASI KR KS010 KYONG JU
South Korea	Masan, KR	ASI KR KS011 MASAN
South Korea	Onyang, KR	ASI KR KS002 ONYANG
South Korea	Pohang, KR	ASI KR KS010 POHANG
South Korea	Pusan, KR	ASI KR KS012 PUSAN
South Korea	Seoul, KR	ASI KR KS013 SEOUL
South Korea	Suwon, KR	ASI KR KS002 SUWON
South Korea	Taebaek, KR	ASI KR KS007 TAEBAEK
South Korea	Taegu, KR	ASI KR KS002 TAEGU

South Korea	Uijeongbu, KR	ASI KR KS009 UIJEONGBU
South Korea	Ulsan, KR	ASI KR KS016 ULSAN
South Korea	Wonju, KR	ASI KR KS007 WONJU
South Korea	Yosu, KR	ASI KR KS005 YOSU
Spain	Acala De Henares, ES	EUR ES SP013 ALCALÁ DE HENARES
Spain	Albacete, ES	EUR ES SP006 ALBACETE
Spain	Alcobendas, ES	EUR ES SP013 ALCOBENDAS
Spain	Alcorcon, ES	EUR ES SP013 ALCORCÓN
Spain	Algeciras, ES	EUR ES SP001 ALGECIRAS
Spain	Alicante, ES	EUR ES SP016 ALICANTE
Spain	Almeria, ES	EUR ES SP001 ALMERÍA
Spain	Badajoz, ES	EUR ES SP010 BADAJOZ
Spain	Badalona, ES	EUR ES SP008 BADALONA
Spain	Baracaldo, ES	EUR ES SP017 BARACALDO
Spain	Barcelona, ES	EUR ES SP008 BARCELONA
Spain	Bilbao, ES	EUR ES SP017 BILBAO
Spain	Burgos, ES	EUR ES SP007 BURGOS
Spain	Cadiz, ES	EUR ES SP001 CÁDIZ
Spain	Cartagena, ES	EUR ES SP014 CARTAGENA
Spain	Castellon, ES	EUR ES SP016 CASTELLÓN DE LA PLANA
Spain	Cordoba, ES	EUR ES SP001 CÓRDOBA
Spain	Elche, ES	EUR ES SP016 ELCHE
Spain	Fuenlabrada, ES	EUR ES SP013 FUENLABRADA
Spain	Getafe, ES	EUR ES SP013 GETAFE
Spain	Gijon, ES	EUR ES SP003 GIJÓN
Spain	Granada, ES	EUR ES SP001 GRANADA
Spain	Huelva, ES	EUR ES SP001 HUELVA
Spain	Jaen, ES	EUR ES SP001 JAÉN
Spain	Jerez, ES	EUR ES SP001 JÉREZ DE LA FRONTERA
Spain	La Laguna, ES	EUR ES SP018 LA LAGUNA
Spain	Las Palmas De Gran Canaria, ES	EUR ES SP018 LAS PALMAS DE GRAN CANARIA
Spain	Leganes, ES	EUR ES SP013 LEGANÉS
Spain	Leon, ES	EUR ES SP007 LEÓN
Spain	Lleida, ES	EUR ES SP008 LLEIDA
Spain	Logrono, ES	EUR ES SP012 LOGROÑO
Spain	Madrid, ES	EUR ES SP013 MADRID
Spain	Malaga, ES	EUR ES SP001 MÁLAGA
Spain	Mataro, ES	EUR ES SP008 MATARÓ
Spain	Mostoles, ES	EUR ES SP013 MÓSTOLES
Spain	Murcia, ES	EUR ES SP014 MURCIA
Spain	Ourense, ES	EUR ES SP011 OURENSE
Spain	Oviedo, ES	EUR ES SP003 OVIEDO



Spain	Palma De Mallorca, ES	EUR ES SP004 PALMA DE MALLORCA
Spain	Pamplona, ES	EUR ES SP015 PAMPLONA
Spain	Sabadell, ES	EUR ES SP008 SABADELL
Spain	Salamanca, ES	EUR ES SP007 SALAMANCA
Spain	San Sebastian, ES	EUR ES SP011 SAN SEBASTIÁN
Spain	Santa Coloma De Gramanet, ES	EUR ES SP008 SANTA COLOMA DE GRAMANET
Spain	Santa Cruz De Tenerife, ES	EUR ES SP018 SANTA CRUZ DE TENERIFE
Spain	Santander, ES	EUR ES SP005 SANTANDER
Spain	Sevilla, ES	EUR ES SP001 SEVILLA
Spain	Tarragona, ES	EUR ES SP008 TARRAGONA
Spain	Tarrasa, ES	EUR ES SP008 TARRASA
Spain	The Groyne, ES	EUR ES SP011 LA CORUÑA
Spain	Valencia, ES	EUR ES SP016 VALENCIA
Spain	Valladolid, ES	EUR ES SP007 VALLADOLID
Spain	Vigo, ES	EUR ES SP011 VIGO
Spain	Zaragoza, ES	EUR ES SP002 ZARAGOZA
Sri Lanka	Colombo, LK	ASI LK CE009 COLOMBO ASI LK CE009 DEHIWALA-MOUNT LAVINIA
Sri Lanka	Dehiwala, LK	ASI LK CE010 JAFFNA
Sri Lanka	Jaffna, LK	ASI LK CE001 KANDY
Sri Lanka	Kandy, LK	ASI LK CE009 MORATUWA
Sri Lanka	Moratuwa, LK	AFR SD SU027 JUBA
Sudan	Juba, SD	AFR SD SU029 KASSALA
Sudan	Kassala, SD	AFR SD SU005 KHARTOUM
Sudan	Khartoum, SD	AFR SD SU005 KHARTOUM NORTH
Sudan	Khartoum North, SD	AFR SD SU028 KOSTI
Sudan	Kosti, SD	AFR SD SU016 NYALA
Sudan	Nyala, SD	AFR SD SU005 OMDURMAN
Sudan	Omdurman, SD	AFR SD SU029 PORT SUDAN
Sudan	Port Sudan, SD	SAM SR NS007 PARAMARIBO
Suriname	Paramaribo, SR	AFR SZ WZ000 MBABANE
Swaziland	Mbabane, SZ	EUR SE SW006 AARE
Sweden	Aare, SE	EUR SE SW021 BORAAS
Sweden	Boraas, SE	EUR SE SW003 GAEVLE
Sweden	Gaevle, SE	EUR SE SW021 GOTHENBURG
Sweden	Göteborg, SE	EUR SE SW013 HELSINGBORG
Sweden	Helsingborg, SE	EUR SE SW002 IDRE
Sweden	Idre, SE	EUR SE SW007 JOENKOEPING
Sweden	Joensuu, SE	EUR SE SW008 KALMAR
Sweden	Kalmar, SE	EUR SE SW001 KARLSKRONA
Sweden	Karlskrona, SE	EUR SE SW017 KARLSTAD
Sweden	Karlstad, SE	

Sweden	Kiruna, SE	EUR SE SW010 KIRUNA
Sweden	Kristianstad, SE	EUR SE SW013 KRISTIANSTAD
Sweden	Linköping, SE	EUR SE SW012 LINKÖPING
Sweden	Luleå, SE	EUR SE SW010 LULEÅ
Sweden	Lund, SE	EUR SE SW013 LUND
Sweden	Malmö, SE	EUR SE SW013 MALMÖ
Sweden	Norrköping, SE	EUR SE SW012 NORRKÖPING
Sweden	Oestersund, SE	EUR SE SW006 OESTERSUND
Sweden	Orebro, SE	EUR SE SW011 ÖREBRO
Sweden	Sälen, SE	EUR SE SW002 SÄLEN
Sweden	Skövde, SE	EUR SE SW021 SKÖVDE
Sweden	Stockholm, SE	EUR SE SW015 STOCKHOLM
Sweden	Sundsvall, SE	EUR SE SW019 SUNDSVALL
Sweden	Trelleborg, SE	EUR SE SW013 TRELLEBORG
Sweden	Trollhättan, SE	EUR SE SW021 TROLLHÄTTAN
Sweden	Uddevalla, SE	EUR SE SW021 UDDEVALLA
Sweden	Umeå, SE	EUR SE SW018 UMEÅ
Sweden	Uppsala, SE	EUR SE SW016 UPPSALA
Sweden	Västerås, SE	EUR SE SW020 VÄSTERÅS
Sweden	Visby, SE	EUR SE SW004 VISBY
Sweden	Ystad, SE	EUR SE SW013 YSTAD
Switzerland	Bâle, CH	EUR CH SZ005 BÂLE
Switzerland	Berne, CH	EUR CH SZ006 BERNE
Switzerland	Geneve, CH	EUR CH SZ008 GENÈVE
Switzerland	Lausanne, CH	EUR CH SZ024 LAUSANNE
Switzerland	Luzern, CH	EUR CH SZ012 LUZERN
Switzerland	Winterthur, CH	EUR CH SZ026 WINTERTHUR
Switzerland	Zurich, CH	EUR CH SZ026 ZÜRICH
Syria	Aleppo, SY	MEA SY SY009 ALEPPO
Syria	Al-Hasakeh, SY	MEA SY SY001 AL-HASAKEH
Syria	Al-Rakka, SY	MEA SY SY004 AL-RAKKA
Syria	Damascus, SY	MEA SY SY008 DAMASCUS
Syria	Hama, SY	MEA SY SY010 HAMA
Syria	Homs, SY	MEA SY SY011 HOMS
Syria	Lattakia, SY	MEA SY SY002 LATTAKIA
Taiwan	Hsinchu, TW	ASI TW TW018 HSINCHU
Taiwan	Hualien, TW	ASI TW TW018 HUALIEN
Taiwan	Kao-Hsiung, TW	ASI TW TW006 KAO-HSIUNG
Taiwan	Keelung, TW	ASI TW TW018 KEELUNG
Taiwan	Taichung, TW	ASI TW TW018 TAICHUNG
Taiwan	Tainan, TW	ASI TW TW018 TAINAN
Taiwan	Taipei, TW	ASI TW TW018 TAIPEI
Taiwan	Taitung, TW	ASI TW TW018 TAITUNG

Tajikistan	Dushanbe, TJ	ASI TJ TI000 DUSHANBE
Tanzania	Arusha, TZ	AFR TZ TZ000 ARUSHA
Tanzania	Dar Es Salaam, TZ	AFR TZ TZ000 DAR ES SALAAM
Tanzania	Dodoma, TZ	AFR TZ TZ000 DODOMA
Tanzania	Mbeya, TZ	AFR TZ TZ000 MBEYA
Tanzania	Morogoro, TZ	AFR TZ TZ000 MOROGORO
Tanzania	Mwanza, TZ	AFR TZ TZ000 MWANZA
Tanzania	Shinyanga, TZ	AFR TZ TZ000 SHINYANGA
Tanzania	Tanga, TZ	AFR TZ TZ000 TANGA
Tanzania	Zanzibar, TZ	AFR TZ TZ000 ZANZIBAR
Thailand	Bangkok, TH	ASI TH TH017 BANGKOK
Thailand	Chiang Mai, TH	ASI TH TH008 CHIANG MAI
Thailand	Chon Buri, TH	ASI TH TH010 CHON BURI
Thailand	Kanchanaburi, TH	ASI TH TH014 KANCHANABURI
Thailand	Khon Kaen, TH	ASI TH TH015 KHON KAEN
Thailand	Nakhon Pathom, TH	ASI TH TH026 NAKHON PATHOM
Thailand	Nakhon Ratchasima, TH	ASI TH TH028 NAKHON RATCHASIMA
Thailand	Nakhon Sawan, TH	ASI TH TH029 NAKHON SAWAN
Thailand	Nakhon Si Thammarat, TH	ASI TH TH030 NAKHON SI THAMMARAT
Thailand	Pathum Thani, TH	ASI TH TH036 PATHUM THANI
Thailand	Pattaya, TH	ASI TH TH010 PATTAYA
Thailand	Phuket, TH	ASI TH TH047 PHUKET
Thailand	Rayong, TH	ASI TH TH052 RAYONG
Thailand	Samut Prakan, TH	ASI TH TH056 SAMUT PRAKAN
Thailand	Samut Sakhon, TH	ASI TH TH057 SAMUT SAKHON
Thailand	Saraburi, TH	ASI TH TH059 SARABURI
Thailand	Songkhla, TH	ASI TH TH063 SONGKHLA
Thailand	Sukhothai, TH	ASI TH TH064 SUKHOTHAI
Thailand	Surat Thani, TH	ASI TH TH066 SURAT THANI
Thailand	Ubon Ratchathani, TH	ASI TH TH071 UBON RATCHATHANI
Thailand	Udon Thani, TH	ASI TH TH072 UDON THANI
The Bahamas	Nassau, BS	CAC BS BF016 NASSAU
The Gambia	Banjul, GM	AFR GM GA001 BANJUL
Togo	Lome, TG	AFR TG TO000 LOME
Tonga	Nuku'Alofa, TO	OCN TO TO002 NUKU'ALOFA
Trinidad And Tobago	Port-of-Spain, TT	CAC TT TD005 PORT-OF-SPAIN
Tunisia	Bizerte, TN	AFR TN TS008 BIZERTE
Tunisia	Gabes, TN	AFR TN TS013 GABES
Tunisia	Kairouan, TN	AFR TN TS005 KAIROUAN
Tunisia	Sfax, TN	AFR TN TS015 SFAX
Tunisia	Tunis, TN	AFR TN TS000 TUNIS
Turkey	Adana, TR	MEA TR TU001 ADANA

Turkey	Adiyaman, TR	MEA TR TU002 ADIYAMAN
Turkey	Afyon, TR	MEA TR TU003 AFYON
Turkey	Aksaray, TR	MEA TR TU042 AKSARAY
Turkey	Ankara, TR	MEA TR TU007 ANKARA
Turkey	Antalya, TR	MEA TR TU008 ANTALYA
Turkey	Aydin, TR	MEA TR TU011 AYDIN
Turkey	Balikesir, TR	MEA TR TU012 BALIKESIR
Turkey	Batman, TR	MEA TR TU000 BATMAN
Turkey	Bursa, TR	MEA TR TU021 BURSA
Turkey	Corum, TR	MEA TR TU024 CORUM
Turkey	Cotyaeum, TR	MEA TR TU054 KÜTAHYA
Turkey	Denizli, TR	MEA TR TU025 DENIZLI
Turkey	Diyarbakir, TR	MEA TR TU026 DIYARBAKIR
Turkey	Edirne, TR	MEA TR TU027 EDIRNE
Turkey	Elazig, TR	MEA TR TU028 ELAZIG
Turkey	Erzurum, TR	MEA TR TU030 ERZURUM
Turkey	Eskisehir, TR	MEA TR TU031 ESKISEHIR
Turkey	Gaziantep, TR	MEA TR TU032 GAZIANTEP
Turkey	Gebze, TR	MEA TR TU052 GEBZE
Turkey	Hatay, TR	MEA TR TU036 HATAY
Turkey	Icel, TR	MEA TR TU037 IÇEL
Turkey	Iskenderun, TR	MEA TR TU036 ISKENDERUN
Turkey	Isparta, TR	MEA TR TU039 ISPARTA
Turkey	Istanbul, TR	MEA TR TU040 ISTANBUL
Turkey	Izmir, TR	MEA TR TU041 IZMIR
Turkey	Kahramanmaras, TR	MEA TR TU042 KAHRAMANMARAS
Turkey	Karabuk, TR	MEA TR TU000 KARABUK
Turkey	Karaman, TR	MEA TR TU044 KARAMAN
Turkey	Kayseri, TR	MEA TR TU047 KAYSERI
Turkey	Kirikkale, TR	MEA TR TU000 KIRIKKALE
Turkey	Kocaeli, TR	MEA TR TU052 KOCAELI
Turkey	Konya, TR	MEA TR TU053 KONYA
Turkey	Malatya, TR	MEA TR TU055 MALATYA
Turkey	Manisa, TR	MEA TR TU056 MANISA
Turkey	Mardin, TR	MEA TR TU047 MARDIN
Turkey	Ordu, TR	MEA TR TU062 ORDU
Turkey	Osmaniye, TR	MEA TR TU000 OSMANIYE
Turkey	Sakarya, TR	MEA TR TU065 SAKARYA
Turkey	Samsun, TR	MEA TR TU066 SAMSUN
Turkey	Siirt, TR	MEA TR TU000 SIIRT
Turkey	Sivas, TR	MEA TR TU071 SIVAS
Turkey	Tarsus, TR	MEA TR TU037 TARSUS
Turkey	Tekirdag, TR	MEA TR TU072 TEKIRDAG

Turkey	Trabzon, TR	MEA TR TU074 TRABZON
Turkey	Urfa, TR	MEA TR TU067 URFA
Turkey	Usak, TR	MEA TR TU076 USAK
Turkey	Van, TR	MEA TR TU077 VAN
Turkey	Zonguldak, TR	MEA TR TU000 ZONGULDAK
Turkmenistan	Ashkhabad, TM	ASI TM TX001 ASHKHABAD
Turkmenistan	Chardzhou, TM	ASI TM TX004 CHARDZHOU
Turkmenistan	Tashauz, TM	ASI TM TX003 TASHAUZ
Turks And Caicos Islands	Grand Turk, TC	CAC TC TK--- GRAND TURK
Uganda	Arua, UG	AFR UG UG000 ARUA
Uganda	Entebbe, UG	AFR UG UG000 ENTEBBE
Uganda	Fort Portal, UG	AFR UG UG000 FORT PORTAL
Uganda	Gulu, UG	AFR UG UG000 GULU
Uganda	Jinja, UG	AFR UG UG000 JINJA
Uganda	Kampala, UG	AFR UG UG000 KAMPALA
Uganda	Lira, UG	AFR UG UG000 LIRA
Uganda	Masaka, UG	AFR UG UG000 MASAKA
Uganda	Mbale, UG	AFR UG UG000 MBALE
Uganda	Mbarara, UG	AFR UG UG000 MBARARA
Uganda	Moroto, UG	AFR UG UG000 MOROTO
Uganda	Port Bell, UG	AFR UG UG000 PORT BELL
Uganda	Soroti, UG	AFR UG UG000 SOROTI
Ukraine	Alchevsk, UA	EUR UA UP012 ALCHEVSK
Ukraine	Berdyansk, UA	EUR UA UP004 BERDYANSK
Ukraine	Bila Tserkva, UA	EUR UA UP009 BELAYA TSERKOV
Ukraine	Cherkassy, UA	EUR UA UP024 CHERKASSY
Ukraine	Chernigov, UA	EUR UA UP001 CHERNIGOV
Ukraine	Chernovtsy, UA	EUR UA UP002 CHERNOVTSY
Ukraine	Dneprodzerzhinsk, UA	EUR UA UP003 DNEPRODZERZHINSK
Ukraine	Dnepropetrovsk, UA	EUR UA UP003 DNEPROPETROVSK
Ukraine	Donetsk, UA	EUR UA UP006 DONETSK
Ukraine	Gorlovka, UA	EUR UA UP004 GORLOVKA
Ukraine	Ivano-Frankovsk, UA	EUR UA UP005 IVANO-FRANKOVSK
Ukraine	Kertch, UA	EUR UA UP011 KERTCH
Ukraine	Kherson, UA	EUR UA UP007 KHERSON
Ukraine	Khmelnitsky, UA	EUR UA UP008 KHMELNITSKY
Ukraine	Kiev, UA	EUR UA UP009 KIEV
Ukraine	Kirovograd, UA	EUR UA UP010 KIROVOGRAD
Ukraine	Kramatorsk, UA	EUR UA UP004 KRAMATORSK
Ukraine	Lugansk, UA	EUR UA UP012 LUGANSK
Ukraine	Lutsk, UA	EUR UA UP020 LUTSK
Ukraine	Lvov, UA	EUR UA UP013 LVOV

Ukraine	Lysychansk, UA	EUR UA UP012 LYSYCHANSK
Ukraine	Makeyevka, UA	EUR UA UP004 MAKEYEVKA
Ukraine	Mariupol, UA	EUR UA UP004 MARIUPOL
Ukraine	Melitopol, UA	EUR UA KZ000 MELITOPOL
Ukraine	Odessa, UA	EUR UA UP015 ODESSA
Ukraine	Pavlograd, UA	EUR UA UP003 PAVLOGRAD
Ukraine	Poltava, UA	EUR UA UP026 POLTAVA
Ukraine	Rovno, UA	EUR UA UP016 ROVNO
Ukraine	Sevastopol, UA	EUR UA UP011 SEVASTOPOL
Ukraine	Severodonetsk, UA	EUR UA UP012 SEVERODONETSK
Ukraine	Simferopol, UA	EUR UA UP011 SIMFEROPOL
Ukraine	Slavyansk, UA	EUR UA UP004 SLAVYANSK
Ukraine	Stakhanov, UA	EUR UA UP012 STAKHANOV
Ukraine	Sumy, UA	EUR UA UP017 SUMY
Ukraine	Ternopol, UA	EUR UA UP018 TERNOPOL
Ukraine	Uzhgorod, UA	EUR UA UP021 UZHGOROD
Ukraine	Zaporozhye, UA	EUR UA UP022 ZAPOROZHYE
Ukraine	Zhitomir, UA	EUR UA UP023 ZHITOMIR
United Arab Emirates	Abu Dhabi, AE	MEA AE AE002 ABU DHABI
United Arab Emirates	Al Ain, AE	MEA AE AE002 AL AIN
United Arab Emirates	Al Fujairah, AE	MEA AE AE003 AL FUJAIRAH
United Arab Emirates	Dubai, AE	MEA AE AE005 DUBAI
United Arab Emirates	Ras Al Khaimah, AE	MEA AE AE006 RAS AL KHAIMAH
United Arab Emirates	Sharjah, AE	MEA AE AE004 SHARJAH
United Kingdom	Aberdeen, UK	EUR UK UK002 ABERDEEN
United Kingdom	Ashfield, UK	EUR UK UK001 ASHFIELD
United Kingdom	Banstead, UK	EUR UK UK224 BANSTEAD
United Kingdom	Barking and Dagenham, UK	EUR UK UK001 BARKING AND DAGENHAM
United Kingdom	Barnet, UK	EUR UK UK001 BARNET
United Kingdom	Barnsley, UK	EUR UK UK001 BARNSLEY
United Kingdom	Basildon, UK	EUR UK UK001 BASILDON
United Kingdom	Baskingstoke and Deane, UK	EUR UK UK001 BASKINGSTOKE AND DEANE
United Kingdom	Bath and North East Somerset, UK	EUR UK UK001 BATH AND NORTH EAST SOMERSET
United Kingdom	Bedford, UK	EUR UK UK001 BEDFORD
United Kingdom	Bedworth, UK	EUR UK UK238 BEDWORTH
United Kingdom	Belfast, UK	EUR UK UK002 BELFAST

United Kingdom	Bexley, UK	EUR UK UK001 BEXLEY
United Kingdom	Birmingham, UK	EUR UK UK001 BIRMINGHAM
United Kingdom	Blackburn, UK	EUR UK UK001 BLACKBURN
United Kingdom	Blackpool, UK	EUR UK UK001 BLACKPOOL
United Kingdom	Bolton, UK	EUR UK UK001 BOLTON
United Kingdom	Bournemouth, UK	EUR UK UK001 BOURNEMOUTH
United Kingdom	Bradford, UK	EUR UK UK001 BRADFORD
United Kingdom	Braintree, UK	EUR UK UK001 BRAINTREE
United Kingdom	Brent, UK	EUR UK UK001 BRENT
United Kingdom	Bridgend, UK	EUR UK UK003 BRIDGEND
United Kingdom	Brighton, UK	EUR UK UK001 BRIGHTON
United Kingdom	Bristol, UK	EUR UK UK001 BRISTOL
United Kingdom	Bromley, UK	EUR UK UK001 BROMLEY
United Kingdom	Bury, UK	EUR UK UK001 BURY
United Kingdom	Caerphilly, UK	EUR UK UK004 CAERPHILLY
United Kingdom	Calderdale, UK	EUR UK UK001 CALDERDALE
United Kingdom	Cambridge, UK	EUR UK UK001 CAMBRIDGE
United Kingdom	Camden, UK	EUR UK UK001 CAMDEN
United Kingdom	Canterbury, UK	EUR UK UK001 CANTERBURY
United Kingdom	Cardiff, UK	EUR UK UK004 CARDIFF
United Kingdom	Carlisle, UK	EUR UK UK001 CARLISLE
United Kingdom	Chelmsford, UK	EUR UK UK001 CHELMSFORD
United Kingdom	Cheltenham, UK	EUR UK UK001 CHELTENHAM
United Kingdom	Chester, UK	EUR UK UK001 CHESTER
United Kingdom	Chesterfield, UK	EUR UK UK001 CHESTERFIELD
United Kingdom	Chichester, UK	EUR UK UK001 CHICHESTER
United Kingdom	Colchester, UK	EUR UK UK001 COLCHESTER
United Kingdom	Conwy, UK	EUR UK UK004 CONWY
United Kingdom	Coventry, UK	EUR UK UK001 COVENTRY
United Kingdom	Crewe, UK	EUR UK UK001 CREWE
United Kingdom	Croydon, UK	EUR UK UK001 CROYDON
United Kingdom	Darlington, UK	EUR UK UK001 DARLINGTON
United Kingdom	Derby, UK	EUR UK UK001 DERBY
United Kingdom	Doncaster, UK	EUR UK UK001 DONCASTER
United Kingdom	Dover, UK	EUR UK UK001 DOVER
United Kingdom	Dudley, UK	EUR UK UK001 DUDLEY
		EUR UK UK002 DUMFRIES AND
United Kingdom	Dumfries and Galloway, UK	GALLOWAY
United Kingdom	Dundee, UK	EUR UK UK002 DUNDEE
United Kingdom	Ealing, UK	EUR UK UK001 EALING
United Kingdom	Eastleigh, UK	EUR UK UK001 EASTLEIGH
United Kingdom	Edinburgh, UK	EUR UK UK002 EDINBURGH
United Kingdom	Elmbridge, UK	EUR UK UK001 ELMBRIDGE

United Kingdom	Enfield, UK	EUR UK UK001 ENFIELD
United Kingdom	Exeter, UK	EUR UK UK001 EXETER
United Kingdom	Falkirk, UK	EUR UK UK002 FALKIRK
United Kingdom	Fareham, UK	EUR UK UK001 FAREHAM
United Kingdom	Gateshead, UK	EUR UK UK001 GATESHEAD
United Kingdom	Gedling, UK	EUR UK UK001 GEDLING
United Kingdom	Glasgow, UK	EUR UK UK002 GLASGOW
United Kingdom	Gloucester, UK	EUR UK UK001 GLOUCESTER
United Kingdom	Guildford, UK	EUR UK UK001 GUILDFORD
United Kingdom	Hackney, UK	EUR UK UK001 HACKNEY
United Kingdom	Halton, UK	EUR UK UK001 HALTON
United Kingdom	Hammersmith and Fulham, UK	EUR UK UK001 HAMMERSMITH AND FULHAM
United Kingdom	Haringey, UK	EUR UK UK001 HARINGEY
United Kingdom	Harrogate, UK	EUR UK UK001 HARROGATE
United Kingdom	Harrow, UK	EUR UK UK001 HARROW
United Kingdom	Havant, UK	EUR UK UK148 HAVANT EUR UK UK001 HAVANT AND WATERLOO
United Kingdom	Havant and Waterloo, UK	
United Kingdom	Havering, UK	EUR UK UK001 HAVERING
United Kingdom	Hillingdon, UK	EUR UK UK001 HILLINGDON
United Kingdom	Horsham, UK	EUR UK UK001 HORSHAM
United Kingdom	Hounslow, UK	EUR UK UK001 HOUNSLOW
United Kingdom	Ipswich, UK	EUR UK UK001 IPSWICH
United Kingdom	Islington, UK	EUR UK UK001 ISLINGTON EUR UK UK001 KENSINGTON AND CHELSEA
United Kingdom	Kensington and Chelsea, UK	
United Kingdom	Kings Lynn and West Norfolk, UK	EUR UK UK001 KINGS LYNN AND WEST NORFOLK
United Kingdom	Kingston-Upon-Hull, UK	EUR UK UK001 KINGSTON-UPON-HULL EUR UK UK001 KINGSTON-UPON- THAMES
United Kingdom	Kingston-Upon-Thames, UK	
United Kingdom	Kirklees, UK	EUR UK UK001 KIRKLEES
United Kingdom	Lambeth, UK	EUR UK UK001 LAMBETH
United Kingdom	Lancaster, UK	EUR UK UK001 LANCASTER
United Kingdom	Leeds, UK	EUR UK UK001 LEEDS
United Kingdom	Leicester, UK	EUR UK UK001 LEICESTER
United Kingdom	Lewisham, UK	EUR UK UK001 LEWISHAM
United Kingdom	Lisburn, UK	EUR UK UK002 LISBURN
United Kingdom	Liverpool, UK	EUR UK UK001 LIVERPOOL
United Kingdom	London, UK	EUR UK UK001 LONDON
United Kingdom	Luton, UK	EUR UK UK001 LUTON
United Kingdom	Macclesfield, UK	EUR UK UK001 MACCLESFIELD
United Kingdom	Maidstone, UK	EUR UK UK001 MAIDSTONE



United Kingdom	Manchester, UK	EUR UK UK001 MANCHESTER
United Kingdom	Mansfield, UK	EUR UK UK001 MANSFIELD
United Kingdom	Merton, UK	EUR UK UK001 MERTON
United Kingdom	Milton Keynes, UK	EUR UK UK001 MILTON KEYNES
United Kingdom	Newbury, UK	EUR UK UK001 NEWBURY
United Kingdom	Newcastle-Under-Lyme, UK	EUR UK UK001 NEWCASTLE-UNDER-LYME
United Kingdom	Newcastle-Upon-Tyne, UK	EUR UK UK001 NEWCASTLE-UPON-TYNE
United Kingdom	Newham, UK	EUR UK UK001 NEWHAM
United Kingdom	Newport, UK	EUR UK UK001 NEWPORT
United Kingdom	Northampton, UK	EUR UK UK001 NORTHAMPTON
United Kingdom	Norwich, UK	EUR UK UK001 NORWICH
United Kingdom	Nottingham, UK	EUR UK UK001 NOTTINGHAM
United Kingdom	Nuneaton, UK	EUR UK UK238 NUNEATON
United Kingdom	Nuneaton and Bedworth, UK	EUR UK UK001 NUNEATON AND BEDWORTH
United Kingdom	Oldham, UK	EUR UK UK001 OLDHAM
United Kingdom	Oxford, UK	EUR UK UK001 OXFORD
United Kingdom	Peterborough, UK	EUR UK UK001 PETERBOROUGH
United Kingdom	Plymouth, UK	EUR UK UK001 PLYMOUTH
United Kingdom	Poole, UK	EUR UK UK001 POOLE
United Kingdom	Portsmouth, UK	EUR UK UK001 PORTSMOUTH
United Kingdom	Preston, UK	EUR UK UK001 PRESTON
United Kingdom	Reading, UK	EUR UK UK001 READING
United Kingdom	Redbridge, UK	EUR UK UK001 REDBRIDGE
United Kingdom	Reigate, UK	EUR UK UK224 REIGATE
United Kingdom	Reigate and Banstead, UK	EUR UK UK001 REIGATE AND BANSTEAD
United Kingdom	Rhondda Cynon Taff, UK	EUR UK UK004 RHONDDA CYNON TAFF
United Kingdom	Rochdale, UK	EUR UK UK001 ROCHDALE
United Kingdom	Rotherham, UK	EUR UK UK001 ROTHERHAM
United Kingdom	Salford, UK	EUR UK UK001 SALFORD
United Kingdom	Salisbury, UK	EUR UK UK001 SALISBURY
United Kingdom	Sandwell, UK	EUR UK UK001 SANDWELL
United Kingdom	Scarborough, UK	EUR UK UK001 SCARBOROUGH
United Kingdom	Sefton, UK	EUR UK UK001 SEFTON
United Kingdom	Sevenoaks, UK	EUR UK UK001 SEVENOAKS
United Kingdom	Sheffield, UK	EUR UK UK001 SHEFFIELD
United Kingdom	Slough, UK	EUR UK UK001 SLOUGH
United Kingdom	Solihull, UK	EUR UK UK001 SOLIHULL
United Kingdom	Southampton, UK	EUR UK UK001 SOUTHAMPTON
United Kingdom	Southend-On-Sea, UK	EUR UK UK001 SOUTHEND-ON-SEA
United Kingdom	Southwark, UK	EUR UK UK001 SOUTHWARK
United Kingdom	St Albans, UK	EUR UK UK001 ST ALBANS

United Kingdom	St Helens, UK	EUR UK UK001 ST HELENS
United Kingdom	Stafford, UK	EUR UK UK001 STAFFORD
United Kingdom	Stockport, UK	EUR UK UK001 STOCKPORT
United Kingdom	Stockton-On-Tees, UK	EUR UK UK001 STOCKTON-ON-TEES
United Kingdom	Stoke-On-Trent, UK	EUR UK UK001 STOKE-ON-TRENT
United Kingdom	Stratford-On-Avon, UK	EUR UK UK001 STRATFORD-ON-AVON
United Kingdom	Stroud, UK	EUR UK UK001 STROUD
United Kingdom	Sunderland, UK	EUR UK UK001 SUNDERLAND
United Kingdom	Sutton, UK	EUR UK UK001 SUTTON
United Kingdom	Swansea, UK	EUR UK UK004 SWANSEA
United Kingdom	Tendring, UK	EUR UK UK001 TENDRING
United Kingdom	Thamesdown, UK	EUR UK UK001 THAMESDOWN
United Kingdom	Thanet, UK	EUR UK UK001 THANET
United Kingdom	Tonbridge, UK	EUR UK UK160 TONBRIDGE EUR UK UK001 TONBRIDGE AND
United Kingdom	Tonbridge and Malling, UK	MALLING
United Kingdom	Torbay, UK	EUR UK UK001 TORBAY
United Kingdom	Tunbridge Wells, UK	EUR UK UK001 TUNBRIDGE WELLS
United Kingdom	Wakefield, UK	EUR UK UK001 WAKEFIELD
United Kingdom	Walsall, UK	EUR UK UK001 WALSALL
United Kingdom	Warrington, UK	EUR UK UK001 WARRINGTON
United Kingdom	Warwick, UK	EUR UK UK001 WARWICK
United Kingdom	Waterloo, UK	EUR UK UK148 WATERLOO
United Kingdom	Westminster, UK	EUR UK UK001 WESTMINSTER
United Kingdom	Wigan, UK	EUR UK UK001 WIGAN
United Kingdom	Winchester, UK	EUR UK UK001 WINCHESTER
United Kingdom	Windsor and Maidenhead, UK	EUR UK UK001 WINDSOR AND MAIDENHEAD
United Kingdom	Wirral, UK	EUR UK UK001 WIRRAL
United Kingdom	Wokingham, UK	EUR UK UK001 WOKINGHAM
United Kingdom	Wolverhampton, UK	EUR UK UK001 WOLVERHAMPTON
United Kingdom	Wycombe, UK	EUR UK UK001 WYCOMBE
United Kingdom	York, UK	EUR UK UK001 YORK
United States	Abilene, TX, US	NAM US TX ABILENE
United States	Akron, OH, US	NAM US OH AKRON
United States	Albany, NY, US	NAM US NY ALBANY
United States	Albuquerque, NM, US	NAM US NM ALBUQUERQUE
United States	Alexandria, VA, US	NAM US VA ALEXANDRIA
United States	Allentown, PA, US	NAM US PA ALLENTOWN
United States	Amarillo, TX, US	NAM US TX AMARILLO
United States	Anaheim, CA, US	NAM US CA ANAHEIM
United States	Anchorage, AK, US	NAM US AK ANCHORAGE
United States	Ann Arbor, MI, US	NAM US MI ANN ARBOR

United States	Annapolis, MD, US	NAM US MD ANNAPOLIS
United States	Arlington, VA, US	NAM US VA ARLINGTON
United States	Arlington, TX, US	NAM US TX ARLINGTON
United States	Arvada, CO, US	NAM US CO ARVADA
United States	Athens, GA, US	NAM US GA ATHENS
United States	Atlanta, GA, US	NAM US GA ATLANTA
United States	Augusta, GA, US	NAM US GA AUGUSTA
United States	Aurora, CO, US	NAM US CO AURORA
United States	Aurora, IL, US	NAM US IL AURORA
United States	Austin, TX, US	NAM US TX AUSTIN
United States	Bakersfield, CA, US	NAM US CA BAKERSFIELD
United States	Baltimore, MD, US	NAM US MD BALTIMORE
United States	Baton Rouge, LA, US	NAM US LA BATON ROUGE
United States	Beaumont, TX, US	NAM US TX BEAUMONT
United States	Bellevue, WA, US	NAM US WA BELLEVUE
United States	Berkeley, CA, US	NAM US CA BERKELEY
United States	Birmingham, AL, US	NAM US AL BIRMINGHAM
United States	Bismarck, ND, US	NAM US ND BISMARCK
United States	Boise, ID, US	NAM US ID BOISE
United States	Boston, MA, US	NAM US MA BOSTON
United States	Bridgeport, CT, US	NAM US CT BRIDGEPORT
United States	Brownsville, TX, US	NAM US TX BROWNSVILLE
United States	Buffalo, NY, US	NAM US NY BUFFALO
United States	Burbank, CA, US	NAM US CA BURBANK
United States	Cambridge, MA, US	NAM US MA CAMBRIDGE
United States	Cape Coral, FL, US	NAM US FL CAPE CORAL
United States	Carrollton, TX, US	NAM US TX CARROLLTON
United States	Carson City, NV, US	NAM US NV CARSON CITY
United States	Casper, WY, US	NAM US WY CASPER
United States	Cedar Rapids, IA, US	NAM US IA CEDAR RAPIDS
United States	Chandler, AZ, US	NAM US AZ CHANDLER
United States	Charleston, WV, US	NAM US WV Charleston
United States	Charleston, SC, US	NAM US SC Charleston
United States	Charlotte, NC, US	NAM US NC CHARLOTTE
United States	Chattanooga, TN, US	NAM US TN CHATTANOOGA
United States	Chesapeake, VA, US	NAM US VA CHESAPEAKE
United States	Cheyenne, WY, US	NAM US WY CHEYENNE
United States	Chicago, IL, US	NAM US IL CHICAGO
United States	Chula Vista, CA, US	NAM US CA CHULA VISTA
United States	Cincinnati, OH, US	NAM US OH CINCINNATI
United States	Clarksville, TN, US	NAM US TN CLARKSVILLE
United States	Clearwater, FL, US	NAM US FL CLEARWATER
United States	Cleveland, OH, US	NAM US OH CLEVELAND

United States	Colorado Springs, CO, US	NAM US CO COLORADO SPRINGS
United States	Columbia, SC, US	NAM US SC COLUMBIA
United States	Columbus, OH, US	NAM US OH COLUMBUS
United States	Columbus, GA, US	NAM US GA COLUMBUS
United States	Concord, CA, US	NAM US CA CONCORD
United States	Coral Springs, FL, US	NAM US FL CORAL SPRINGS
United States	Corona, CA, US	NAM US CA CORONA
United States	Corpus Christi, TX, US	NAM US TX CORPUS CHRISTI
United States	Costa Mesa, CA, US	NAM US CA COSTA MESA
United States	Dallas, TX, US	NAM US TX DALLAS
United States	Daly City, CA, US	NAM US CA DALY CITY
United States	Dayton, OH, US	NAM US OH DAYTON
United States	Denver, CO, US	NAM US CO DENVER
United States	Des Moines, IA, US	NAM US IA DES MOINES
United States	Detroit, MI, US	NAM US MI DETROIT
United States	Dothan, AL, US	NAM US AL Dothan
United States	Dover, CO, US	NAM US CO DOVER
United States	Dover, DE, US	NAM US DE DOVER
United States	Downey, CA, US	NAM US CA DOWNEY
United States	Durham, NC, US	NAM US NC DURHAM
United States	Eau Claire, WI, US	NAM US WI Eau Claire
United States	El Monte, CA, US	NAM US CA EL MONTE
United States	El Paso, TX, US	NAM US TX EL PASO
United States	Elizabeth, NJ, US	NAM US NJ ELIZABETH
United States	Elk Grove, CA, US	NAM US CA ELK GROVE
United States	Erie, PA, US	NAM US PA ERIE
United States	Escondido, CA, US	NAM US CA ESCONDIDO
United States	Eugene, OR, US	NAM US OR EUGENE
United States	Evansville, IN, US	NAM US IN EVANSVILLE
United States	Fayetteville, NC, US	NAM US NC FAYETTEVILLE
United States	Fayetteville, AR, US	NAM US AR Fayetteville
United States	Flint, MI, US	NAM US MI FLINT
United States	Fontana, CA, US	NAM US CA FONTANA
United States	Fort Collins, CO, US	NAM US CO FORT COLLINS
United States	Fort Lauderdale, FL, US	NAM US FL FORT LAUDERDALE
United States	Fort Wayne, IN, US	NAM US IN FORT WAYNE
United States	Fort Worth, TX, US	NAM US TX FORT WORTH
United States	Frankfort, KY, US	NAM US KY FRANKFORT
United States	Fremont, CA, US	NAM US CA FREMONT
United States	Fresno, CA, US	NAM US CA FRESNO
United States	Fullerton, CA, US	NAM US CA FULLERTON
United States	Gainesville, FL, US	NAM US FL Gainesville
United States	Garden Grove, CA, US	NAM US CA GARDEN GROVE

United States	Garland, TX, US	NAM US TX GARLAND
United States	Gary, IN, US	NAM US IN GARY
United States	Gilbert, AZ, US	NAM US AZ GILBERT
United States	Gillette, NJ, US	NAM US NJ GILLETTE
United States	Gillette, WY, US	NAM US WY GILLETTE
United States	Glendale, CA, US	NAM US CA GLENDALE
United States	Grand Island, NE, US	NAM US NE Grand Island
United States	Grand Prairie, TX, US	NAM US TX GRAND PRAIRIE
United States	Grand Rapids, MI, US	NAM US MI GRAND RAPIDS
United States	Green Bay, WI, US	NAM US WI GREEN BAY
United States	Greensboro, NC, US	NAM US NC GREENSBORO
United States	Hampton, VA, US	NAM US VA HAMPTON
United States	Harrisburg, PA, US	NAM US PA HARRISBURG
United States	Hartford, CT, US	NAM US CT HARTFORD
United States	Hattiesburg, MS, US	NAM US MS Hattiesburg
United States	Hayward, CA, US	NAM US CA HAYWARD
United States	Helena, MT, US	NAM US MT HELENA
United States	Henderson, NV, US	NAM US NV HENDERSON
United States	Hialeah, FL, US	NAM US FL HIALEAH
United States	Hollywood, FL, US	NAM US FL HOLLYWOOD
United States	Honolulu, HI, US	NAM US HI HONOLULU
United States	Houston, TX, US	NAM US TX HOUSTON
United States	Huntington Beach, CA, US	NAM US CA HUNTINGTON BEACH
United States	Huntsville, AL, US	NAM US AL HUNTSVILLE
United States	Independence, MO, US	NAM US MO INDEPENDENCE
United States	Indianapolis, IN, US	NAM US IN INDIANAPOLIS
United States	Inglewood, CA, US	NAM US CA INGLEWOOD
United States	Irvine, CA, US	NAM US CA IRVINE
United States	Irving, TX, US	NAM US TX IRVING
United States	Jackson, MS, US	NAM US MS JACKSON
United States	Jackson, WY, US	NAM US WY JACKSON
United States	Jackson, MI, US	NAM US MI Jackson
United States	Jacksonville, FL, US	NAM US FL JACKSONVILLE
United States	Jefferson City, MO, US	NAM US MO JEFFERSON CITY
United States	Jersey City, NJ, US	NAM US NJ JERSEY CITY
United States	Joliet, IL, US	NAM US IL JOLIET
United States	Juneau, AK, US	NAM US AK JUNEAU
United States	Kansas City, MO, US	NAM US MO KANSAS CITY
United States	Kansas City, KS, US	NAM US KS KANSAS CITY
United States	Knoxville, TN, US	NAM US TN KNOXVILLE
United States	Lafayette, LA, US	NAM US LA LAFAYETTE
United States	Lakewood, CO, US	NAM US CO LAKEWOOD
United States	Lancaster, CA, US	NAM US CA LANCASTER

United States	Lansing, MI, US	NAM US MI LANSING
United States	Laramie, WY, US	NAM US WY LARAMIE
United States	Laredo, TX, US	NAM US TX LAREDO
United States	Las Vegas, NV, US	NAM US NV LAS VEGAS
United States	Lexington, KY, US	NAM US KY LEXINGTON
United States	Lincoln, NE, US	NAM US NE LINCOLN
United States	Little Rock, AR, US	NAM US AR LITTLE ROCK
United States	Livonia, MI, US	NAM US MI LIVONIA
United States	Long Beach, CA, US	NAM US CA LONG BEACH
United States	Los Angeles, CA, US	NAM US CA LOS ANGELES
United States	Louisville, KY, US	NAM US KY LOUISVILLE
United States	Lowell, MA, US	NAM US MA LOWELL
United States	Lubbock, TX, US	NAM US TX LUBBOCK
United States	Madison, WI, US	NAM US WI MADISON
United States	Manchester, NH, US	NAM US NH MANCHESTER
United States	Mcallen, TX, US	NAM US TX MCALLEN
United States	Memphis, TN, US	NAM US TN MEMPHIS
United States	Mesa, AZ, US	NAM US AZ MESA
United States	Mesquite, TX, US	NAM US TX MESQUITE
United States	Miami, FL, US	NAM US FL MIAMI
United States	Milwaukee, WI, US	NAM US WI MILWAUKEE
United States	Minneapolis, MN, US	NAM US MN MINNEAPOLIS
United States	Mobile, AL, US	NAM US AL MOBILE
United States	Modesto, CA, US	NAM US CA MODESTO
United States	Montgomery, AL, US	NAM US AL MONTGOMERY
United States	Montpelier, VT, US	NAM US VT MONTPELIER
United States	Moreno Valley, CA, US	NAM US CA MORENO VALLEY
United States	Myrtle Beach, SC, US	NAM US SC Myrtle Beach
United States	Naperville, IL, US	NAM US IL NAPERVILLE
United States	Nashville, TN, US	NAM US TN NASHVILLE
United States	New Haven, CT, US	NAM US CT NEW HAVEN
United States	New Orleans, LA, US	NAM US LA NEW ORLEANS
United States	New York, NY, US	NAM US NY NEW YORK
United States	Newark, NJ, US	NAM US NJ NEWARK
United States	Newport News, VA, US	NAM US VA NEWPORT NEWS
United States	Norfolk, VA, US	NAM US VA NORFOLK
United States	North Las Vegas, NV, US	NAM US NV NORTH LAS VEGAS
United States	Norwalk, CA, US	NAM US CA NORWALK
United States	Oakland, CA, US	NAM US CA OAKLAND
United States	Oceanside, CA, US	NAM US CA OCEANSIDE
United States	Oklahoma City, OK, US	NAM US OK OKLAHOMA CITY
United States	Olympia, WA, US	NAM US WA OLYMPIA
United States	Omaha, NE, US	NAM US NE OMAHA

United States	Ontario, CA, US	NAM US CA ONTARIO
United States	Orange, CA, US	NAM US CA ORANGE
United States	Orlando, FL, US	NAM US FL ORLANDO
United States	Overland Park, KS, US	NAM US KS OVERLAND PARK
United States	Oxnard, CA, US	NAM US CA OXNARD
United States	Palmdale, CA, US	NAM US CA PALMDALE
United States	Panama City, FL, US	NAM US FL Panama City
United States	Pasadena, CA, US	NAM US CA PASADENA
United States	Pasadena, TX, US	NAM US TX PASADENA
United States	Paterson, NJ, US	NAM US NJ PATERSON
United States	Pembroke Pines, FL, US	NAM US FL PEMBROKE PINES
United States	Peoria, IL, US	NAM US IL PEORIA
United States	Philadelphia, PA, US	NAM US PA PHILADELPHIA
United States	Phoenix, AZ, US	NAM US AZ PHOENIX
United States	Pierre, SD, US	NAM US SD PIERRE
United States	Pittsburgh, PA, US	NAM US PA PITTSBURGH
United States	Plano, TX, US	NAM US TX PLANO
United States	Pomona, CA, US	NAM US CA POMONA
United States	Port Saint Lucie, FL, US	NAM US FL PORT SAINT LUCIE
United States	Portland, OR, US	NAM US OR PORTLAND
United States	Portsmouth, VA, US	NAM US VA PORTSMOUTH
United States	Providence, RI, US	NAM US RI PROVIDENCE
United States	Provo, UT, US	NAM US UT PROVO
United States	Pueblo, CO, US	NAM US CO PUEBLO
United States	Raleigh, NC, US	NAM US NC RALEIGH
United States	Rancho Cucamonga, CA, US	NAM US CA RANCHO CUCAMONGA
United States	Reno, NV, US	NAM US NV RENO
United States	Richmond, VA, US	NAM US VA RICHMOND
United States	Riverside, CA, US	NAM US CA RIVERSIDE
United States	Rochester, NY, US	NAM US NY ROCHESTER
United States	Rock Springs, MD, US	NAM US MD ROCK SPRINGS
United States	Rock Springs, WY, US	NAM US WY ROCK SPRINGS
United States	Rockford, IL, US	NAM US IL ROCKFORD
United States	Roswell, NM, US	NAM US NM Roswell
United States	Sacramento, CA, US	NAM US CA SACRAMENTO
United States	Saint Louis, MO, US	NAM US MO SAINT LOUIS
United States	Saint Paul, MN, US	NAM US MN SAINT PAUL
United States	Salem, OR, US	NAM US OR SALEM
United States	Salinas, CA, US	NAM US CA SALINAS
United States	Salt Lake City, UT, US	NAM US UT SALT LAKE CITY
United States	San Antonio, TX, US	NAM US TX SAN ANTONIO
United States	San Bernardino, CA, US	NAM US CA SAN BERNARDINO
United States	San Diego, CA, US	NAM US CA SAN DIEGO

United States	San Francisco, CA, US	NAM US CA SAN FRANCISCO
United States	San Jose, CA, US	NAM US CA SAN JOSE
United States	Santa Ana, CA, US	NAM US CA SANTA ANA
United States	Santa Clara, CA, US	NAM US CA SANTA CLARA
United States	Santa Clarita, CA, US	NAM US CA SANTA CLARITA
United States	Santa Fe, NM, US	NAM US NM SANTA FE
United States	Santa Rosa, CA, US	NAM US CA SANTA ROSA
United States	Savannah, GA, US	NAM US GA SAVANNAH
United States	Scottsdale, AZ, US	NAM US AZ SCOTTSDALE
United States	Seattle, WA, US	NAM US WA SEATTLE
United States	Shreveport, LA, US	NAM US LA SHREVEPORT
United States	Simi Valley, CA, US	NAM US CA SIMI VALLEY
United States	Sioux Falls, SD, US	NAM US SD SIOUX FALLS
United States	South Bend, IN, US	NAM US IN SOUTH BEND
United States	Spokane, WA, US	NAM US WA SPOKANE
United States	Springfield, IL, US	NAM US IL SPRINGFIELD
United States	Springfield, MA, US	NAM US MA SPRINGFIELD
United States	Springfield, MO, US	NAM US MO SPRINGFIELD
United States	St Petersburg, FL, US	NAM US FL ST PETERSBURG
United States	Stamford, CT, US	NAM US CT STAMFORD
United States	Steamboat Springs, CO, US	NAM US CO STEAMBOAT SPRINGS
United States	Sterling Heights, MI, US	NAM US MI STERLING HEIGHTS
United States	Stockton, CA, US	NAM US CA STOCKTON
United States	Sunnyvale, CA, US	NAM US CA SUNNYVALE
United States	Syracuse, NY, US	NAM US NY SYRACUSE
United States	Tacoma, WA, US	NAM US WA TACOMA
United States	Tallahassee, FL, US	NAM US FL TALLAHASSEE
United States	Tampa, FL, US	NAM US FL TAMPA
United States	Tempe, AZ, US	NAM US AZ TEMPE
United States	Thousand Oaks, CA, US	NAM US CA THOUSAND OAKS
United States	Toledo, OH, US	NAM US OH TOLEDO
United States	Topeka, KS, US	NAM US KS TOPEKA
United States	Torrance, CA, US	NAM US CA TORRANCE
United States	Traverse City, MI, US	NAM US MI Traverse City
United States	Trenton, NJ, US	NAM US NJ TRENTON
United States	Tucson, AZ, US	NAM US AZ TUCSON
United States	Tulsa, OK, US	NAM US OK TULSA
United States	Valdosta, GA, US	NAM US GA Valdosta
United States	Vallejo, CA, US	NAM US CA VALLEJO
United States	Vancouver, WA, US	NAM US WA VANCOUVER
United States	Ventura, CA, US	NAM US CA VENTURA
United States	Virginia Beach, VA, US	NAM US VA VIRGINIA BEACH
United States	Waco, TX, US	NAM US TX WACO



United States	Warren, MI, US	NAM US MI WARREN
United States	Washington, DC, US	NAM US DC WASHINGTON
United States	Waterbury, CT, US	NAM US CT WATERBURY
United States	West Covina, CA, US	NAM US CA WEST COVINA
United States	West Valley City, UT, US	NAM US UT WEST VALLEY CITY
United States	Westminster, CO, US	NAM US CO WESTMINSTER
United States	Wichita, KS, US	NAM US KS WICHITA
United States	Wichita Falls, TX, US	NAM US TX WICHITA FALLS
United States	Winston-Salem, NC, US	NAM US NC WINSTON-SALEM
United States	Worcester, MA, US	NAM US MA WORCESTER
United States	Yonkers, NY, US	NAM US NY YONKERS
Uruguay	Montevideo, UY	SAM UY UY010 MONTEVIDEO
Uzbekistan	Almalyk, UZ	ASI UZ UZ013 ALMALYK
Uzbekistan	Andizhan, UZ	ASI UZ UZ001 ANDIZHAN
Uzbekistan	Angren, UZ	ASI UZ UZ013 ANGREN
Uzbekistan	Bukhara, UZ	ASI UZ UZ002 BUKHARA
Uzbekistan	Chirchik, UZ	ASI UZ UZ013 CHIRCHIK
Uzbekistan	Fergana, UZ	ASI UZ UZ003 FERGANA
Uzbekistan	Karshi, UZ	ASI UZ UZ008 KARSHI
Uzbekistan	Kokand, UZ	ASI UZ UZ003 KOKAND
Uzbekistan	Margilan, UZ	ASI UZ UZ003 MARGILAN
Uzbekistan	Namangan, UZ	ASI UZ UZ006 NAMANGAN
Uzbekistan	Navoi, UZ	ASI UZ UZ007 NAVOI
Uzbekistan	Nukus, UZ	ASI UZ UZ009 NUKUS
Uzbekistan	Samarkand, UZ	ASI UZ UZ010 SAMARKAND
Uzbekistan	Tashkent, UZ	ASI UZ UZ013 TASHKENT
Uzbekistan	Termez, UZ	ASI UZ UZ012 TERMEZ
Vanuatu	Vila, VU	OCN VU NH009 VILA
Vatican City	Vatican City, VA	EUR VA - VATICAN CITY
Venezuela	Acarigua-Araure, VE	SAM VE VE019 ACARIGUA-ARAURE
Venezuela	Barcelona, VE	SAM VE VE002 BARCELONA
Venezuela	Barinas, VE	SAM VE VE005 BARINAS
Venezuela	Barquisimeto, VE	SAM VE VE014 BARQUISIMETO
Venezuela	Baruta, VE	SAM VE VE016 BARUTA
Venezuela	Bolivar, VE	SAM VE VE006 CIUDAD BOLÍVAR
Venezuela	Cabimas, VE	SAM VE VE025 CABIMAS
Venezuela	Caracas, VE	SAM VE VE011 CARACAS
Venezuela	Carupano, VE	SAM VE VE020 CARÚPANO
Venezuela	Catia La Mar, VE	SAM VE VE011 CATIA LA MAR
Venezuela	Ciudad Guayana, VE	SAM VE VE006 CIUDAD GUAYANA
Venezuela	Coro, VE	SAM VE VE012 CORO
Venezuela	Cumana, VE	SAM VE VE020 CUMANÁ
Venezuela	Guanare, VE	SAM VE VE019 GUANARE

Venezuela	Guarenas, VE	SAM VE VE016 GUARENAS
Venezuela	La Victoria, VE	SAM VE VE004 LA VICTORIA
Venezuela	Lagunillas, VE	SAM VE VE015 LAGUNILLAS
Venezuela	Los Teques, VE	SAM VE VE016 LOS TEQUES
Venezuela	Maracaibo, VE	SAM VE VE025 MARACAIBO
Venezuela	Maracay, VE	SAM VE VE004 MARACAY
Venezuela	Maturin, VE	SAM VE VE017 MATURÍN
Venezuela	Merida, VE	SAM VE VE015 MÉRIDA
Venezuela	Petare, VE	SAM VE VE016 PETARE
Venezuela	Puerto Cabello, VE	SAM VE VE007 PUERTO CABELLO
Venezuela	Punto Fijo, VE	SAM VE VE012 PUNTO FIJO
Venezuela	San Cristobal, VE	SAM VE VE021 SAN CRISTÓBAL
Venezuela	Turmero, VE	SAM VE VE002 TURMERO
Venezuela	Valencia, VE	SAM VE VE007 VALENCIA
Venezuela	Valera, VE	SAM VE VE022 VALERA
Vietnam	Campha, VN	ASI VN VM052 CAMPHA
Vietnam	Cantho, VN	ASI VN VM041 CANTHO
Vietnam	Da Nang, VN	ASI VN VM016 DA NANG
Vietnam	Dalat, VN	ASI VN VM037 DALAT
Vietnam	Haiphong, VN	ASI VN VM029 HAIPHONG
Vietnam	Hanoi, VN	ASI VN VM017 HANOI
Vietnam	Ho Chi Minh City, VN	ASI VN VM060 HO CHI MINH CITY
Vietnam	Hon Gai, VN	ASI VN VM052 HON GAI
Vietnam	Hue, VN	ASI VN VM044 HUÉ
Vietnam	Longxuyen, VN	ASI VN VM060 LONGXUYEN
Vietnam	Mytho, VN	ASI VN VM059 MYTHO
Vietnam	Namdinh, VN	ASI VN VM042 NAMDINH
Vietnam	Nhatrang, VN	ASI VN VM011 NHATRANG
Vietnam	Qui Nhon, VN	ASI VN VM019 QUI NHON
Vietnam	Rach Gia, VN	ASI VN VM060 RACH GIA
Vietnam	Thai Nguyen, VN	ASI VN VM057 THAI NGUYEN
Vietnam	Vinh, VN	ASI VN VM060 VINH
Western Sahara	El Aaiun, EH	AFR EH WI--- EL AAIUN
Yemen	Aden, YE	MEA YE YM001 ADEN
Yemen	Hodeidah, YE	MEA YE YM004 HODEIDAH
Yemen	Sanaa, YE	MEA YE YM000 SANAA
Yemen	Taiz, YE	MEA YE YM008 TAIZ
Zambia	Chingola, ZM	AFR ZM ZA001 CHINGOLA
Zambia	Kabwe, ZM	AFR ZM ZA007 KABWE
Zambia	Kitwe, ZM	AFR ZM ZA001 KITWE
Zambia	Luanshya, ZM	AFR ZM ZA001 LUANSHYA
Zambia	Lusaka, ZM	AFR ZM ZA000 LUSAKA
Zambia	Mufulira, ZM	AFR ZM ZA001 MUFULIRA

Zambia	Ndola, ZM	AFR ZM ZA001 NDOLA
Zimbabwe	Bulawayo, ZW	AFR ZW ZI005 BULAWAYO
Zimbabwe	Chitungwiza, ZW	AFR ZW ZI003 CHITUNGWIZA
Zimbabwe	Gweru, ZW	AFR ZW ZI000 GWERU
Zimbabwe	Harare, ZW	AFR ZW ZI003 HARARE
Zimbabwe	Mutare, ZW	AFR ZW ZI000 MUTARE

## 12 Rain8 Hardware Setup

### 12.1 Rain8 Net

The Rain8net is a modular 8-zone sprinkler controller module that is driven by a RS232 serial port. Additional units may be daisy chained to provide control and 24 VAC power to as many as 2040 irrigation zones from a single COM port.

A 12 position terminal strip is found on all modules. Connect the 24 VAC to only one module; the remaining modules are powered by means of the 8-conductor network cable.

There is a single RS232 connection between the controlling computer and the "master" Rain8. The 24VAC power and network communications are transferred from master to slave-to-slave etc.

If the Rain8Net is used in a multi-master configuration, such as when the valve clusters are in locations where it is easier to run two connections from the PC than to run a connection between the two valve clusters. A remote connection such as using an IP/RS232 adapter may be a situation where this is appropriate.

The network connection for the slave units is an 8 conductor RJ45. Each slave has a pair of these modular jacks to pass on data and power to the next one in a daisy chain. Each slave also has a RS232 connection that is used only to assign the address during the initial configuration.

#### 12.1.1 Equipment List

##### Initial Module

1. Rain8net controller with detachable terminal block in place.
2. 24VAC transformer
3. RS232 Cable with DB9 Connectors

##### Expansion / Slave Module(s)

1. Rain8net controller with detachable terminal block in place.
2. Network cable, item 10004

##### Interface Components

Serial Surge Protection

#### 12.1.2 Installation

##### Controller Location

- Select a mounting location that is close to an electrical outlet and the valve wires that will connect to it.
- The controller should not be exposed to water. If used outside, it is necessary to provide a weather proof housing for your Rain8. <http://www.wgldesigns.com/r8outdoor.html>
- Mount your controller to a smooth dry surface by means of the enclosed Velcro strips.

##### Wiring the Valves

- If the maximum distance is less than 600 feet, use a single 20 gauge, plastic insulated wire for each valve.
- Each valve has two wires. One wire is designated as the common. All of the common valve wires can be connected together to one wire going to the controller.
- All connections should be made using wire nuts in grease caps to prevent corrosion.
- Only one valve should be connected to each zone.
- The rated output is 24 VAC at .25 amps (250ma), per zone. Some valves require a greater current than .25 amps to initially open and drop back to a lower value. This will present no problem as long as the drop back value is .25 amps or less.

### **Connecting the Valve Wires to the Controller**

Determine which valve is to be connected to each zone. Insert each valve wire into its respective position on the terminal strip and gently tighten the setscrew.

Connect the common wire from the valves to the terminal labeled “common”.

### **Connecting the Counter/Switch Wires to the Controller**

Connect the rain sensor or flow meter to terminals identified as “input” and second “24VAC”( #12).

### **Connecting the Transformer (Master unit only)**

Connect the 24-VAC transformer to the two terminals labeled “24 VAC”. Note that this is required only on the first module installed as the power for additional units is supplied by means of the network connections.

### **Wiring the RS232 connection (Master unit only)**

Connect the RS232 cable’s RJ11 plug to the RJ11 jack labeled “RS-232” on the left side of the module. The other end of the cable with the DB9 connector attaches to your computer’s serial port. The maximum allowed distance for this connection is 1000’.

**It is strongly recommended that a RS232  
Serial Surge Protector be installed on  
outdoor installations of the Rain8net**

**Available from <http://www.tmanufacturing.com>**

### **Adding additional modules**

As many as 254 additional 8 zone modules may be added by daisy chaining the modules “Rain8 Network Jacks”. See Figure 80.

Individual Rain8net modules are shipped set to an address of “1” and the default run timers disabled. For most eight zone, single module applications this is the desired configuration and the hardware installation is complete.

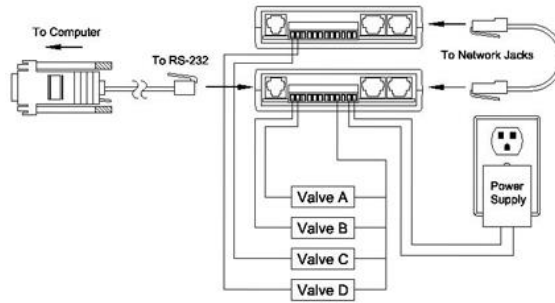

**Figure 80 Rain8 Master and Expansion Wiring**

**Prepare to Configure the Rain8 module (only if you are installing multiple modules)**

Please note that the Rain8 terminal strip is removable. Gently unplug the portion with screw heads from the socket mounted on the PCB. Remove the Rain8 from the wall and bring it to the location of the PC that will be used for programming.

Connect the DB9 cable and adapter into the RJ11 jack on the Rain8 labeled “RS-232”. The DB9 end is plugged into a serial port on your PC. It is not necessary to provide power for the unit as it can derive what it needs for programming from the serial port.

It is very important that no attempt is made to program modules that are still connected to the network.

### 12.1.3 EPROM Programming for use with mcsSprinklers

Setup of the Rain8 EPROM is done from the Rain8 Setup page of mcsSprinklers. Figure 81 shows the setup parameters that are available. It can also be done with a Rain8Cfg.exe utility that is available from <http://wgl designs.com>.

- At this point there is no need for anything to be connected to the Rain8 other than the serial cable. The power for the unit is derived from the serial port.
- Select the PC serial port that is connected to the Rain8
- Select desired address (1 – 255) for this module. Each module that is programmed must have a unique address. Convention is to start at 1 and proceed upward.
- Select the Enable Rain8 Timers checkbox so the Rain8 will turnoff each zone as a safety precaution
- Enter the timeout amount for each of the 8 valves. This value will be a few minutes longer than the longest that a zone will be run at any one time
- Click on the Write EPROM button to save the setup
- Click on the Read EPOM button to confirm the setup

Rain8 EPROM and Timers	
	<input type="button" value="Read EPROM"/> <input type="button" value="Write EPROM"/>
	<b>Rain8 Timers</b>
	Valve 1 <input type="text"/> Minutes
	Valve 2 <input type="text"/> Minutes
	Valve 3 <input type="text"/> Minutes
	Valve 4 <input type="text"/> Minutes
	Valve 5 <input type="text"/> Minutes
	Valve 6 <input type="text"/> Minutes
	Valve 7 <input type="text"/> Minutes
	Valve 8 <input type="text"/> Minutes
<b>Programming Port</b>	
Programming Port	<input type="text"/>
<b>Module Type</b>	
	<input checked="" type="radio"/> NET
<b>Module Address</b>	
Module Address	<input type="text"/>
<b>Rain8-Net Timers</b>	
	<input type="checkbox"/> Enable Rain8-Net Timers

**Figure 81 Rain8Net EPROM Setup**

## 12.2 Rain8 Wireless

The Rain8wireless is an 8-zone irrigation controller capable of accepting X10 RF codes to control each zone.

### 12.2.1 Equipment List

#### Initial Module

1. Rain8 Wireless controller with detachable terminal block in place.
2. 24VAC transformer
3. RS232 Cable with DB9 Connectors
4. Coax Cable
5. Antenna and mounting bracket

#### Expansion / Slave Module(s)

1. Rain8 Wireless controller with detachable terminal block in place.
2. Network cable

#### Interface Components

CM17A X10 RF PC Interface

### 12.2.2 Installation

#### Controller Location

- Select a mounting location that is close to an electrical outlet and the valve wires that will connect to it.
- The controller should not be exposed to water. If used outside, it is necessary to provide weather proof housing for your Rain8. <http://www.wgldesigns.com/r8outdoor.html>
- Mount your controller to a smooth dry surface by means of the enclosed Velcro strips.

#### Connecting the Antenna

- Connect one end the RG6 coaxial cable to the F connector on the Rain8 module.
- Connect the other end to the quarter wave whip antenna.
- The antenna should be mounted on the furnished bracket at a location clear of interfering RF noise and metallic items like air handling ducts.

#### Wiring the Valves

- If the maximum distance is less than 600 feet, use a single 20 gauge, plastic insulated wire for each valve.
- Each valve has two wires. One wire is designated as the common. All of the common valve wires can be connected together to one wire going to the controller.
- All connections should be made using wire nuts in grease caps to prevent corrosion.
- Only one valve should be connected to each zone.
- The rated output is 24 VAC at .25 amps (250ma), per zone. Some valves require a greater current than .25 amps to initially open and drop back to a lower value. This will present no problem as long as the drop back value is .25 amps or less.

#### Connecting the Valve Wires to the Controller



- Determine which valve is to be connected to each zone. Insert each valve wire into its respective position on the terminal strip and gently tighten the setscrew.
- Connect the common wire from the valves to the terminal labeled “common”.

#### **Connecting the Transformer & Interface**

- Locate the two terminals labeled “24-vac in”. Connect the two transformer wires to these terminals.

#### **Prepare to Program the Rain8 module**

- Please note that the Rain8 terminal strip is removable. Gently unplug the portion with screw heads from the socket mounted on the PCB. Remove the Rain8 from the wall and bring it to the location of the PC that will be used for programming. Disconnect Antenna coax.
- Connect the Rain8wireless RJ11 RS232 jack on the left side of the housing to a serial (COM) port on your PC with the WGL 10002 cable.
- Important! At completion of programming, disconnect serial cable before reconnecting terminal strip and antenna.

### **12.2.3 EPROM Programming for use with mcsSprinklers**

At this point **there should be nothing connected to the Rain8 other than the serial cable**. The power for the unit is derived from the serial port.

Setup of the Rain8 EPROM is done from the Rain8 Setup page of mcsSprinklers. Figure 81 shows the setup parameters that are available. It can also be done with a Rain8Cfg.exe utility that is available from <http://wgl designs.com>.

Setup of the Rain8 EPROM is done from the Rain8 Setup page of mcsSprinklers. Figure 82 shows the setup parameters that are available. It can also be done with a Rain8Cfg.exe utility that is available from <http://wgl designs.com>.

- At this point there is no need for anything to be connected to the Rain8 other than the serial cable. The power for the unit is derived from the serial port.
- Select the PC serial port that is connected to the Rain8
- Select desired address for this module. Each module that is programmed must have a unique address. The address consists of an X10 House code in the range “A” through “P” and one of two banks of eight unit codes.
- Select the Enable Rain8 Timers checkbox so the Rain8 will turnoff each zone as a safety precaution
- Enter the timeout amount for each of the 8 valves. This value will be a few minutes longer than the longest that a zone will be run at any one time

- The Rain8 Wireless can be configured so the 8th valve will turn ON when any of the other seven are ON. Since mcsSprinklers manages the pump, the selection for this setting should be to configure to use valve 8 as a valve.
- Click on the Write EPROM button to save the setup
- Click on the Read EPOM button to confirm the setup

Rain8 EPROM and Timers	
	<input type="button" value="Read EPROM"/> <input type="button" value="Write EPROM"/>
<b>Programming Port</b>	
Programming Port	<input type="text"/>
<b>Module Type</b>	
<input checked="" type="radio"/> RF	
<b>Module Address</b>	
X10 House Code	<input type="text"/>
Unit 1..8	<input checked="" type="radio"/> Unit 9..16 <input type="radio"/>
<b>Timers</b>	
<input type="checkbox"/> Enable Timers	
<b>Rain8-Wireless Valve 8 Use</b>	
<input checked="" type="radio"/> Use as a Valve <input type="radio"/> Use as a Pump	
<b>Rain8 Timers</b>	
Valve 1	<input type="text"/> Minutes
Valve 2	<input type="text"/> Minutes
Valve 3	<input type="text"/> Minutes
Valve 4	<input type="text"/> Minutes
Valve 5	<input type="text"/> Minutes
Valve 6	<input type="text"/> Minutes
Valve 7	<input type="text"/> Minutes
Valve 8	<input type="text"/> Minutes

Figure 82 Rain8 Wireless EPROM Setup

## 12.2.4 Check Out

To test these new settings, **unplug the RS232 cable** and return the Rain8 to its original location. Plug in the terminal and connect the antenna. Verify the 24-vac transformer is plugged in. Connect the antenna coax cable.

Using the settings of the module configured at E1, sending the X10 signal E1-ON with a X10 PalmPad HR12A would cause the valve connected to terminal 1 to open. Sending it an E1-OFF it would close. If nothing were done, it would turn itself off at the end of three minutes. If the EPROM was configured with a different X10 code then selected the one used rather than E1.

## 12.3 Rain8 X10

The Rain8 is an 8-zone irrigation controller capable of controlling irrigation zones using X10 power line protocol. A CM11A is connected to the PC that host mcsSprinklers to provide the power line commands to the Rain8 X10.

### 12.3.1 Equipment List

#### Initial Module

1. Rain8 module
2. 110 to 24-vac, 20VA transformer
3. Modular cable, black
4. RS232 serial cable, DB9 both ends.
5. PSC05 power line interface

#### Expansion / Slave Module(s)

1. Rain8 module
2. Modular cable, black
3. Modular cable splitter

#### Interface Components

1. CM11A X10 Power line PC Interface
2. 5 for 1 splitter 80069

### 12.3.2 Installation

#### Controller Location

- Select a mounting location that is close to an electrical outlet and the valve wires that will connect to it.
- The controller should not be exposed to water. If used outside, it is necessary to provide a weather proof housing for your Rain8. <http://www.wgldesigns.com/r8outdoor.html>
- Mount your controller to a smooth dry surface by means of the enclosed Velcro strips.

#### Wiring the Valves

- If the maximum distance is less than 600 feet, use a single 20 gauge, plastic insulated wire for each valve.
- Each valve has two wires. One wire is designated as the common. All of the common valve wires can be connected together to one wire going to the controller's "common" terminal.
- All connections should be made using wire nuts in grease caps to prevent corrosion.
- Only one valve should be connected to each zone.
- The rated output is 24 VAC at .35 amps (350ma), per zone. Some valves require a greater current than .35 amps to initially open and drop back to a lower value. This will present no problem as long as the drop back value is .35 amps or less.

#### Connecting the Valve Wires to the Controller

- Determine which valve is to be connected to each zone. Insert each valve wire into its respective position on the terminal strip and gently tighten the setscrew.
- Connect the common wire from the valves to the terminal labeled “common”.

#### **Connecting the Transformer & Interface**

- Locate the two terminals labeled 24-vac on the Rain8 module and connect an appropriate length of 18 gauge, 2 conductor zip cord to the transformer screw terminals. The same is done for the 24VAC power connection for all expansion Rain8 units.

#### **Warning!**

Make sure that 24VAC terminal 11 on one unit connects to terminal 11 on the next and 24VAC terminal 12 to 12 in a similar manner. Your Rain8 modules and transformer will be damaged if the wires connecting between units are reversed.

- Connect the Rain8 to a PSC05 power line interface using only the WGL furnished black modular cable. An alternate power line interface, the Smarthome powerlinc 1132B, can be used rather than the PSC05. In this case, connect it to the Rain8 module using only the RJ11 to RJ45 (wide plug) cable that came with the 1132B.
- Up to 5 Rain8 modules may share a single power line interface.

#### **PSC05 interface**

- A 2 for 1 splitter is provided in this package for two Rain8s sharing one Interface for 16-zone operation. PSC05 or TW523 only.
- A 5 for 1 splitter (item 80069) is available for installations of up to 40 zones.

#### **Powerlinc 1132B interface**

- A 5 for 1 splitter (item 80071) is available for PowerLinc installations of up to 40 zones.
- Use the enclosed black modular cable to connect from the splitter to each Rain8 module.

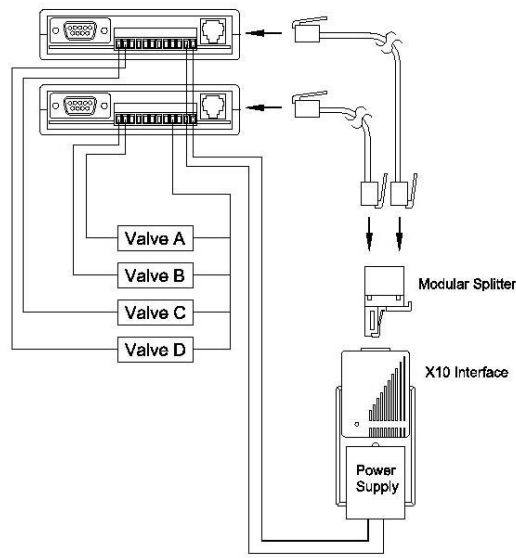

**Figure 83 Rain8 X10 Power line and Valve Connections**

**Prepare to Program the Rain8 module**

- Please note that the Rain8 terminal strip is removable. Gently unplug the portion with screw heads from the socket mounted on the PCB. Remove the Rain8 from the wall and bring it to the location of the PC that will be used for programming.
- Connect the DB-9 connector on the Rain8 to a serial cable, with the other end plugged into a serial port on your PC. It is not necessary to provide power for the unit as it can derive what it needs for programming from the serial port.

**12.3.3 EPROM Programming for use with mcsSprinklers**

Setup of the Rain8 EPROM is done from the Rain8 Setup page of mcsSprinklers. Figure 84 shows the setup parameters that are available. It can also be done with a Rain8Cfg.exe utility that is available from <http://wgl designs.com>.

- At this point there is no need for anything to be connected to the Rain8 other than the serial cable. The power for the unit is derived from the serial port.
- Select the PC serial port that is connected to the Rain8
- Select desired address for this module. Each module that is programmed must have a unique address. The address consists of an X10 House code in the range “A” through “P” and one of two banks of eight unit codes.
- Select the Enable Rain8 Timers checkbox so the Rain8 will turnoff each zone as a safety precaution
- Enter the timeout amount for each of the 8 valves. This value will be a few minutes longer than the longest that a zone will be run at any one time

- Click on the Write EPROM button to save the setup
- Click on the Read EPOM button to confirm the setup

Rain8 EPROM and Timers	
	<input type="button" value="Read EPROM"/> <input type="button" value="Write EPROM"/>
	<b>Rain8 Timers</b>
<b>Programming Port</b>	Valve 1 <input type="text"/> Minutes
Programming Port <input type="text"/>	Valve 2 <input type="text"/> Minutes
<b>Module Type</b>	Valve 3 <input type="text"/> Minutes
<input checked="" type="radio"/> X10	Valve 4 <input type="text"/> Minutes
<b>Module Address</b>	Valve 5 <input type="text"/> Minutes
X10 House Code <input type="text"/>	Valve 6 <input type="text"/> Minutes
Unit 1..8 <input checked="" type="radio"/> Unit 9..16 <input type="radio"/>	Valve 7 <input type="text"/> Minutes
<b>Timers</b>	Valve 8 <input type="text"/> Minutes
<input type="checkbox"/> Enable Timers	

**Figure 84 Rain8X10 EPROM Setup**

## 12.4 Rain8 X10 II

The Rain8II is an 8-zone irrigation controller that responds to ON and OFF X10 commands that are unique to each zone. This product supports the standard X10 Status Request codes for true 2-way operation. A CM11A is connected to the PC that hosts mcsSprinklers to provide the power line commands to the Rain8 X10 II.

### 12.4.1 Equipment List

#### Initial Module

1. Rain8II module
2. 110 to 24-vac, 20VA, wall-mounted transformer
3. Black modular cable
4. RS232 serial cable, DB9 both ends.
5. PSC05 Power line interface

#### Expansion Module(s)

1. Rain8II module
2. Black modular cable
3. Modular cable splitter

#### Other Interface Components

1. CM11A PC Power line Interface
2. 5 for 1 splitter 80069

### 12.4.2 Installation

#### Controller Location

- Select a mounting location that is close to an electrical outlet and the valve wires that will connect to it.
- The controller should not be exposed to water. If used outside, it is necessary to provide a weather proof housing for your Rain8. <http://www.wgl designs.com/r8outdoor.html>
- Mount your controller to a smooth dry surface by means of the enclosed Velcro strips.

#### Wiring the Valves

- If the maximum distance is less than 600 feet, use a single 20 gauge, plastic insulated wire for each valve.
- Each valve has two wires. One wire is designated as the common. All of the common valve wires can be connected together to one wire going to the controller.
- All connections should be made using wire nuts in grease caps to prevent corrosion.
- Only one valve should be connected to each zone.
- The rated output is 24 VAC at .25 amps (250ma), per zone. Some valves require a greater current than .25 amps to initially open and drop back to a lower value. This will present no problem as long as the drop back value is .25 amps or less.

#### Connecting the Valve Wires to the Controller

- Determine which valve is to be connected to each zone. Insert each valve wire into its respective position on the terminal strip and gently tighten the setscrew.
- Connect the common wire from the valves to the terminal labeled “common”.

### Connecting the Transformer & Interface

- Locate the two terminals labeled 24-vac on the Rain8 module and connect an appropriate length of 18 gauge, 2 conductor zip cord to the transformer screw terminals. The same is done for the 24VAC power connection for all expansion Rain8 units.

#### **Warning!**

Make sure that 24VAC terminal 11 on one unit connects to terminal 11 on the next and 24VAC terminal 12 to 12 in a similar manner. Your Rain8 modules and transformer will be damaged if the wires connecting between units are reversed.

- Connect the Rain8 to a PSC05 power line interface using only the WGL furnished black modular cable. An alternate power line interface, the Smarthome powerlinc 1132B, can be used rather than the PSC05. In this case, connect it to the Rain8 module **using only the RJ11 to RJ45 (wide plug) cable that came with the 1132B.**

- Up to 5 Rain8 modules may share a single power line interface.

•

#### **PSC05 interface**

- A 2 for 1 splitter is provided in this package for two Rain8s sharing one Interface for 16-zone operation. PSC05 or TW523 only.
- A 5 for 1 splitter (item 80069) is available for installations of up to 40 zones.

#### **Powerlinc 1132B interface**

- A 5 for 1 splitter (item 80071) is available for PowerLinc installations of up to 40 zones.
- Use the enclosed black modular cable to connect from the splitter to each Rain8 module.

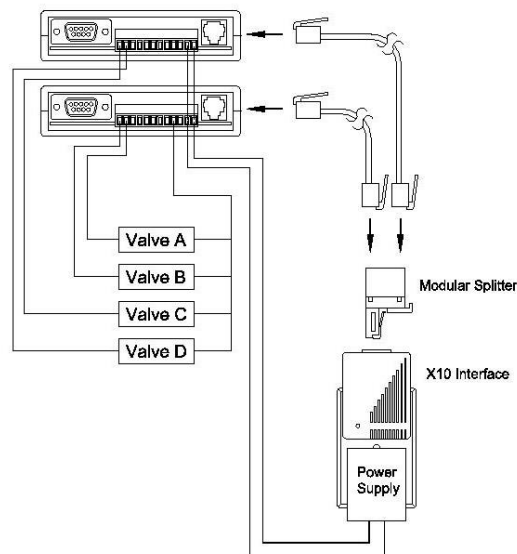

**Figure 85 Rain8 X10 II Power line and Valve Connections**



### Prepare to Program the Rain8 module

- Please note that the Rain8 terminal strip is removable. Gently unplug the portion with screw heads from the socket mounted on the PCB. Remove the Rain8 from the wall and bring it to the location of the PC that will be used for programming.
- Connect the DB-9 connector on the Rain8 to a serial cable, with the other end plugged into a serial port on your PC. It is not necessary to provide power for the unit as it can derive what it needs for programming from the serial port.

### 12.4.3 EPROM Programming for use with mcsSprinklers

Setup of the Rain8 EPROM is done from the Rain8 Setup page of mcsSprinklers. Figure 86 shows the setup parameters that are available. It can also be done with a Rain8Cfg.exe utility that is available from <http://wgl designs.com>.

- At this point there is no need for anything to be connected to the Rain8 other than the serial cable. The power for the unit is derived from the serial port.
- Select the PC serial port that is connected to the Rain8
- Select desired address for this module. Each module that is programmed must have a unique address. The address consists of an X10 House code in the range “A” through “P” and one of two banks of eight unit codes.
- Select the Enable Rain8 Timers checkbox so the Rain8 will turnoff each zone as a safety precaution.
- Enter the timeout amount for each of the 8 valves. This value will be a few minutes longer than the longest that a zone will be run at any one time
- The Rain8 X10 II is a two way X10 device that is able to provide its status immediately after a command is received or provide its status only when explicitly polled for a status response. When using mcsSprinklers as the only X10 controller then the configuration of “Ack on Cmd and Poll” will provide the most efficient user of the power line bandwidth. The “Ack on Poll Only” can be used in all cases where compatibility with other X10 controllers is a concern.
- Click on the Write EPROM button to save the setup
- Click on the Read EPOM button to confirm the setup

Rain8 EPROM and Timers	
	<input type="button" value="Read EPROM"/> <input type="button" value="Write EPROM"/>
<b>Programming Port</b>	
Programming Port	<input type="text"/>
<b>Module Type</b>	
<input checked="" type="radio"/> X10-2	
<b>Module Address</b>	
X10 House Code	<input type="text"/>
Unit 1..8	<input checked="" type="radio"/> Unit 9..16 <input type="radio"/>
<b>X10-2 Timers</b>	
<input type="checkbox"/> Enable X10-2 Timers	
<b>Rain8-X10-2 Status Response</b>	
<input checked="" type="radio"/> Ack on Poll Only <input type="radio"/> Ack on Cmd and Poll	
<b>Rain8 Timers</b>	
Valve 1	<input type="text"/> Minutes
Valve 2	<input type="text"/> Minutes
Valve 3	<input type="text"/> Minutes
Valve 4	<input type="text"/> Minutes
Valve 5	<input type="text"/> Minutes
Valve 6	<input type="text"/> Minutes
Valve 7	<input type="text"/> Minutes
Valve 8	<input type="text"/> Minutes

Figure 86 Rain8 X10 II EPROM Setup

## 12.4.4 Troubleshooting with the Status LED

This Rain8 features a status LED visible from the bottom on the module just the left of the RJ11 interface jack.

### No LED

The Rain8 is not running. Verify 24VAC transformer is connected to the last two terminals on the detachable terminal strip.

### Steady LED

Everything is working okay. No incoming X10 commands.

### Regular flashing LED

No power line interface detected. Check modular cable and verify correct type. Verify interface plugged in to outlet and connected to Rain8.

If is still flashing try replacing cable or interface module.

### Intermittent flashing LED, 1 – 2 seconds OFF

Normal operation.

Incoming X10 command detected with a house code and unit code that is enabled. The specified zone will now have 24VAC between in and the common terminal(s).

### Intermittent flashing LED, very short OFF

Incoming X10 signal detected with house & unit codes that are **not** enabled. No zones will be active. Verify Rain8 configuration matches transmitted X10 address.

## 12.5 Rain8 UPB

The Rain8upb is a modular 8-zone sprinkler controller module that is driven by a UPB power line interface (PIM). It is configured as either a master or expansion unit. The difference being that only the master is connected to the PIM and 24VAC transformer.

A system UPB configuration consists of a UPB PIM connected to the PC running mcsSprinklers, a UPB PIM connected to the master Rain8 UPB module, 24VAC transformer connected to the master Rain8 UPB module, optional expansion modules that are connected with daisy chained RJ45 wiring.

### 12.5.1 Equipment List

#### Initial Module

1. Rain8upb master module
2. 110 to 24-vac, 20VA, transformer
3. 3 piece RJ11 – DB9 cable assembly

#### Expansion / Slave Module(s)

1. Rain8upb controller with detachable terminal block in place.
2. Network cable, item 10004

#### Interface Components

1. Rain8 Master UPB power line interface (PIM).
2. PC UPB power line interface (PIM)  
(PCS PIM-R, Simply Automated UMC-DB9 or HAI 36A00-1)

### 12.5.2 Installation

#### Controller Location

- Select a mounting location that is close to an electrical outlet and the valve wires that will connect to it.
- The controller should not be exposed to water. If used outside, it is necessary to provide a weather proof housing for your Rain8. <http://www.wgldesigns.com/r8outdoor.html>
- Mount your controller to a smooth dry surface by means of the enclosed Velcro strips.

#### Wiring the Valves

- If the maximum distance is less than 600 feet, use a single 20 gauge, plastic insulated wire for each valve.
- Each valve has two wires. One wire is designated as the common. All of the common valve wires can be connected together to one wire going to the controller.
- All connections should be made using wire nuts in grease caps to prevent corrosion.
- Only one valve should be connected to each zone.
- The rated output is 24 VAC at .35 amps (350ma), per zone. Some valves require a greater current then .35 amps to initially open and drop back to a lower value. This will present no problem as long as the drop back value is .35 amps or less.

#### Connecting the Valve Wires to the Controller

- Determine which valve is to be connected to each zone. Insert each valve wire into its respective position on the terminal strip and gently tighten the setscrew.
- Connect the common wire from the valves to the terminal labeled “com”.

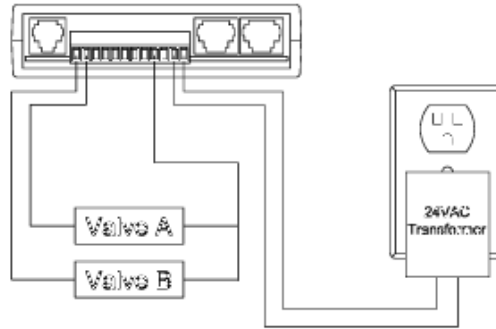

Figure 87 UPB Rain8 Valve and 24VAC Connections

#### Connecting the Counter/Switch Wires to the Controller

- Connect the rain sensor or flow meter to terminals identified as “input” and second “24VAC”( #12).

#### Connecting the Transformer (Master unit only)

Connect the 24-VAC transformer to the two terminals labeled “24 VAC”. Note that this is required only on the first module installed as the power for additional units is supplied by means of the network connections.

#### Connecting the UPB PIM (Master unit only)

There are two techniques for connecting the UPB PIM to the RJ11 jack on your Rain8 module depending on which manufacturer's PIM you are using

1. The HAI PIM connects directly to the Rain8 using the 6-conductor modular cable that came with your Rain8upb. Do not use the cable that came with your HAI PIM.  
**OR**
2. The PCS & Simply Automated PIMs have female DB9 jacks so it is necessary to use the enclosed DB9 – RJ11 adapter and the M-M gender changer in addition to the modular cable.

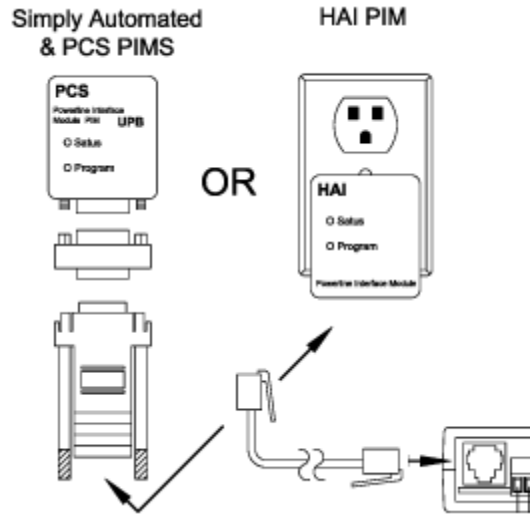

**Figure 88 UPB PIM Connection to Rain8**

Congratulations you are now ready to apply power. The first thing you should see is the green LED blinking. This indicates the Rain8upb is looking for a PIM. When it finds one, the LED stops blinking and stays on steady. This normally just takes a few seconds.

**Prepare to Program the Rain8 module**

- Using the RJ11 cable and the DB9 adapter (but not the gender changer), connect DB9 end to a COM port or USB adapter on your PC. Connect the RJ11 end to the jack labeled “PIM-config” on the left.
- It is not necessary to provide 24VAC power at this point as it is supplied over the RS232 link. The green LED to the left of the RJ45 jacks should be off.

### **12.5.3 EPROM Programming for use with mcsSprinklers**

Setup of the Rain8 EPROM is done from the Rain8 Setup page of mcsSprinklers. Figure 86 shows the setup parameters that are available. It can also be done with a Rain8Cfg.exe utility that is available from <http://wgldesigns.com>.

- At this point there is no need for anything to be connected to the Rain8 other than the serial cable. The power for the unit is derived from the serial port.
- Select the PC serial port that is connected to the Rain8
- Select desired address for this module. There are two part to the UPB address. One is the network address (NID) and the second is the device ID (DID). These are selected based upon compatibility with other UPB components installed at the site. If no others are installed then values of 1 for the NID will be fine. It will also need to be configured in the UPB Processor Interface Module (PIM) for network compatibility.
- The module ID will need to be unique for each Rain8 module. Each module maps into 8 UPB DID’s. For use of UPB DID’s 1 through 8, a value of 1 would be entered into the Module ID setup field to indicate that this UPB Rain8 Module #1. If the value of 2 is entered for the DID, then the UPB DID’s

to which the module will respond will be 9 through 16. The same relationship exists for modules 3 and above.

- Select the Enable Rain8 Timers checkbox so the Rain8 will turnoff each zone as a safety precaution.
- Enter the timeout amount for each of the 8 valves. This value will be a few minutes longer than the longest that a zone will be run at any one time
- The timer resolution expected by mcsSprinklers is in Minutes so that selection should be made at the radio button.
- mcsSprinklers will support either a counter input for water use measurement or a switch input for an inhibit. Select the radio for how it will be used in this application. If input is not used then select the unused radio position. The input data will be presented on a UPB DID that is entered on the input. This is a single DID and not a Rain8 Module ID that is used for the output control. If the counter input data is to be delivered when UPB DID 99 is queried, then a value of 99 would be entered on the setup. The same is true for any other input UPB DID
- Click on the Write EPROM button to save the setup
- Click on the Read EPROM button to confirm the setup

Rain8 EPROM and Timers		
<b>Programming Port</b>		
Programming Port	<input type="text"/>	
<b>Module Type</b>		
	<input checked="" type="radio"/> UPB	
<b>Module Address</b>		
Module Address	<input type="text"/>	
<b>UPB Timers</b>		
	<input type="checkbox"/> Enable UPB Timers	
Rain8UPB Resolution <input checked="" type="radio"/> Minutes <input type="radio"/> Seconds		
<b>Rain8-UPB Network</b>		
PIM NID	<input type="text"/>	Input DID <input type="text"/>
<b>Rain8-UPB Input Signal</b>		
	<input checked="" type="radio"/> Input Unused <input type="radio"/> Counter <input type="radio"/> Switch	
<input type="button" value="Read EPROM"/> <input type="button" value="Write EPROM"/>		
<b>Rain8 Timers</b>		
Valve 1	<input type="text"/>	Minutes
Valve 2	<input type="text"/>	Minutes
Valve 3	<input type="text"/>	Minutes
Valve 4	<input type="text"/>	Minutes
Valve 5	<input type="text"/>	Minutes
Valve 6	<input type="text"/>	Minutes
Valve 7	<input type="text"/>	Minutes
Valve 8	<input type="text"/>	Minutes

**Figure 89 Rain8 UPB EPROM Setup**

## 12.5.4 The Rain8UPB and UPStart

In the UPB world everything is setup with UPStart. The export from UPStart is used as the input when other automation is integrated with UPB. Unfortunately UPStart does not see the Rain8UPB as a standard UPB module. The solution is to create 8 UPB Appliance modules with their DID's mapped into the 8 Rain8 DIDs to become "place holders" for the Rain8UPBs.

To installer must enter the module numbers that were previously programmed into the Rain8UPB. For example you have one Rain8UPB module and it is configured to be module ID #3, the actual UPB device ID's will be 17 through 24 for these 8 valves. As the user/installer you need to select module ID's that will result in Device IDs that are not already being used by UPStart.

If what you have selected overlaps with your existing UPB network then you will need to reprogram the Rain8UPB to find an unused sequence of UPB DID's. It also means that in the future when you add other UPB modules you will not want to add these at the same device address as the Rain8UPBs.

## 12.5.5 Troubleshooting with the Status LED

This Rain8 features a status LED visible from the bottom on the module just the left of the RJ45 network jacks.

### **No LED**

The Rain8 is not running. Verify 24VAC transformer is connected to the last two terminals.

### **Steady LED**

Everything is working okay. No incoming commands.

### **Regular flashing LED**

No PIM detected. Check modular cable and verify correct type. Verify interface plugged in to outlet and connected to Rain8.

### **Intermittent flashing LED, 1 – 2 seconds OFF**

Normal operation to turn on or off a zone.

Incoming command detected with a NID code and DID code that is enabled. The specified zone will now have 24VAC between in and the common terminal(s).

### **Intermittent flashing LED, very short OFF**

Incoming UPB signal detected with NID or DID codes that are **not** enabled. No zones will be active.

### **Checking it out**

Checkout can be done after setup of the Rain8UPB within mcsSprinklers by running the Communication test. It can also be setup with a test application that is available from <http://wgl designs.com/rain8upb.html> This program runs on a PC and requires a second PIM to communicate with the power line and present UPB signals to your Rain8UPB.

1. Verify your Rain8upb's green LED is on steady.
2. Select the COM port number your second PIM is connected to and click "connect".
3. Enter the NID that was configured earlier.
4. Enter the assigned rain8 module number.
5. Click on the key that represents the zone you wish to activate.
6. Click on "send on cmd" and specified zone should now have 24VAC between its terminal and common (COM).
7. If the "auto query" is enabled, an automatic status request is transmitted each time a command is sent. The results of the query are a solid green circle if the zone is active and a checkered one if it is off. A gray circle indicates no response from the query. Possibly due to no matching NID or DID. The query command can also be sent manually by clicking its button.



## 13 RS-232 Adapters

### 13.1 USB – Serial

USB to RS-232 COM adapters are available at most computer hardware suppliers. Typically the hardware quality is similar for most products, but the software drivers do vary in quality. Products based upon the FTDI chipset have well supported software drivers. Two known products that have had good success are:

Byterunner: [http://www.byterunner.com/byterunner/new\\_frontpage=usbserialadapters](http://www.byterunner.com/byterunner/new_frontpage=usbserialadapters)

Digi Edgeport: <http://www.digi.com/products/usb/edgeport.jsp#overview>

#### IP – Serial

IP to RS-232 adapters have been in use for 20+ years in applications of printer and terminal servers. This means surplus hardware is often available for the wired version of IP to Serial. New technology is in widespread use with many suppliers that have both wired and WiFi versions.

Two primary issue that have been experienced are software drivers and voltage levels. A driver can be used to emulate a COM port such as redirector software from Lantronix. This is needed for the Basic and Standard mcsSprinklers versions. The Professional version is able to communicate directly in IP using a raw (no protocol) mode. The driver problem typically arises as new operating systems are released and especially for the x64 versions.

The second issue is for voltage level. Many IP/Serial products use TTL (3.5V/0V) rather than RS-232 (12V/-12V). The standard Rain8Net operates at the lower voltage levels, but the Rain8Net PRO does not.

Some suppliers for new products are:

Control DeviceMaster: <http://www.comtrol.com/pub/products/category/cid/63>

Lantronix: <http://www.lantronix.com/device-networking/embedded-device-servers/>

#### Bluetooth – Serial

Bluetooth is a new technology with wireless connectivity that has coverage typical of a home installation. While the advertised range is over 100 ft, it will depend upon installation specifics that allow clear RF transmission.

A supplier which has yielded good results is:

WCSC: [http://store.wcscnet.com/cgi/display.cgi?item\\_num=HDWBTRS232](http://store.wcscnet.com/cgi/display.cgi?item_num=HDWBTRS232)

## 14 User Access Control and Confirmation Prompts

When running on Windows version starting with Vista enhanced security needs to be considered. mcsSprinklers must be “run as administrator” since it communicates with hardware resources. When User Access Control (UAC) is enabled then a user prompt will be presented to confirm startup intent with the additional privileges. This prompt is usually not desirable, especially with unattended restarts. This can be overcome with a shortcut that enables elevated operation. A tutorial is provided at <http://www.sevenforums.com/tutorials/11949-elevated-program-shortcut-without-uac-prompt-create.html> which is shown in the steps below.

**1.** Press the Windows + R keys to open the Run dialog, type **taskschd.msc**, and press Enter.

**NOTE:** This will open Task Scheduler. This file is located at:  
**C:\Windows\system32\taskschd.msc.**

**2.** While having **Task Scheduler Library** selected in the left pane, click/tap on **Create task** in the far right pane. (see screenshot below)

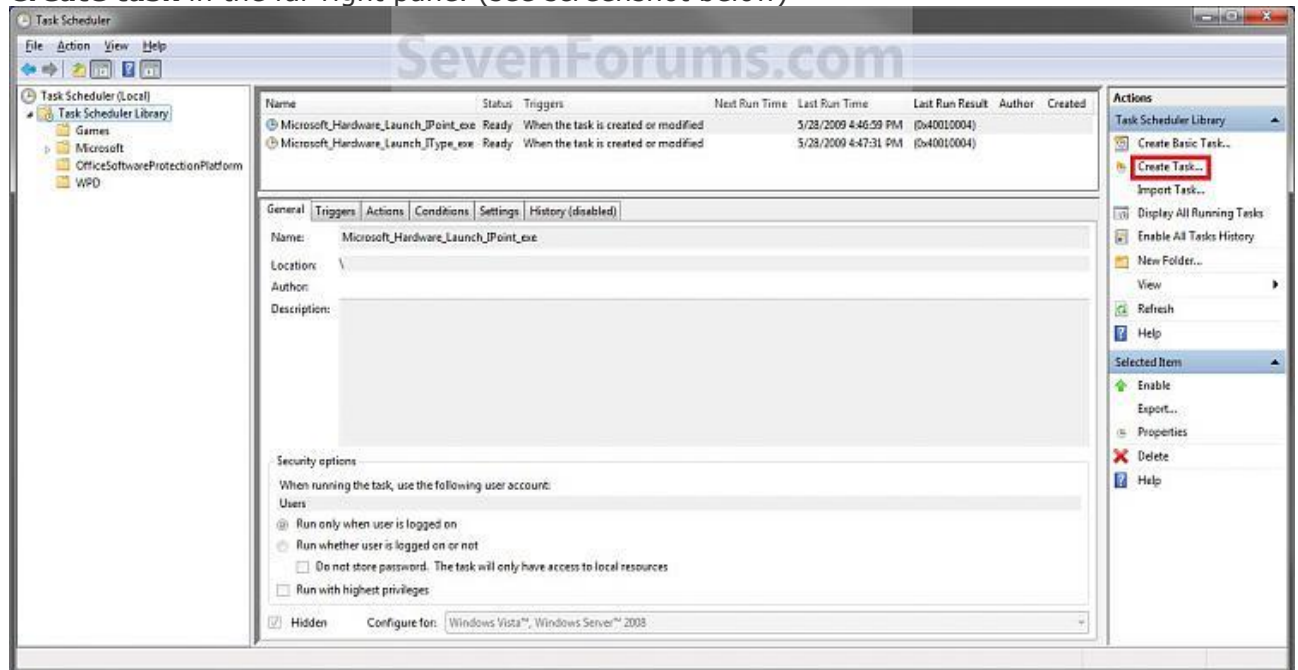

**3.** Under the **General** tab, type in the "Name" of the program you want to create this shortcut for. (see screenshot below)

**NOTE:** This will be the name of the task. As an example, I will use **CCleaner** for that program. Make note of this name, you will need it later in **step 12 and 14** below.

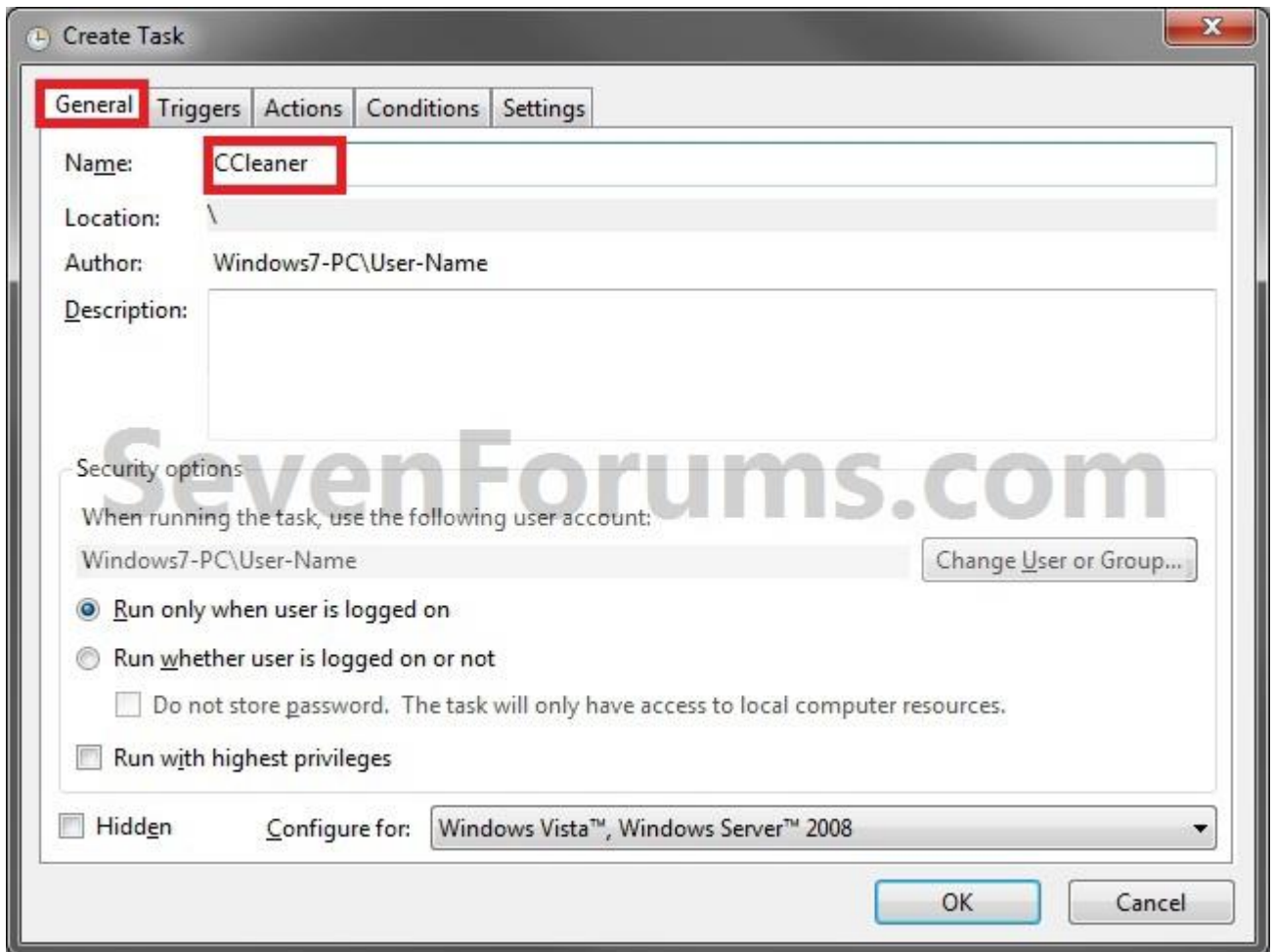

4. Check the **Run with highest privileges** box. (See screenshot below)

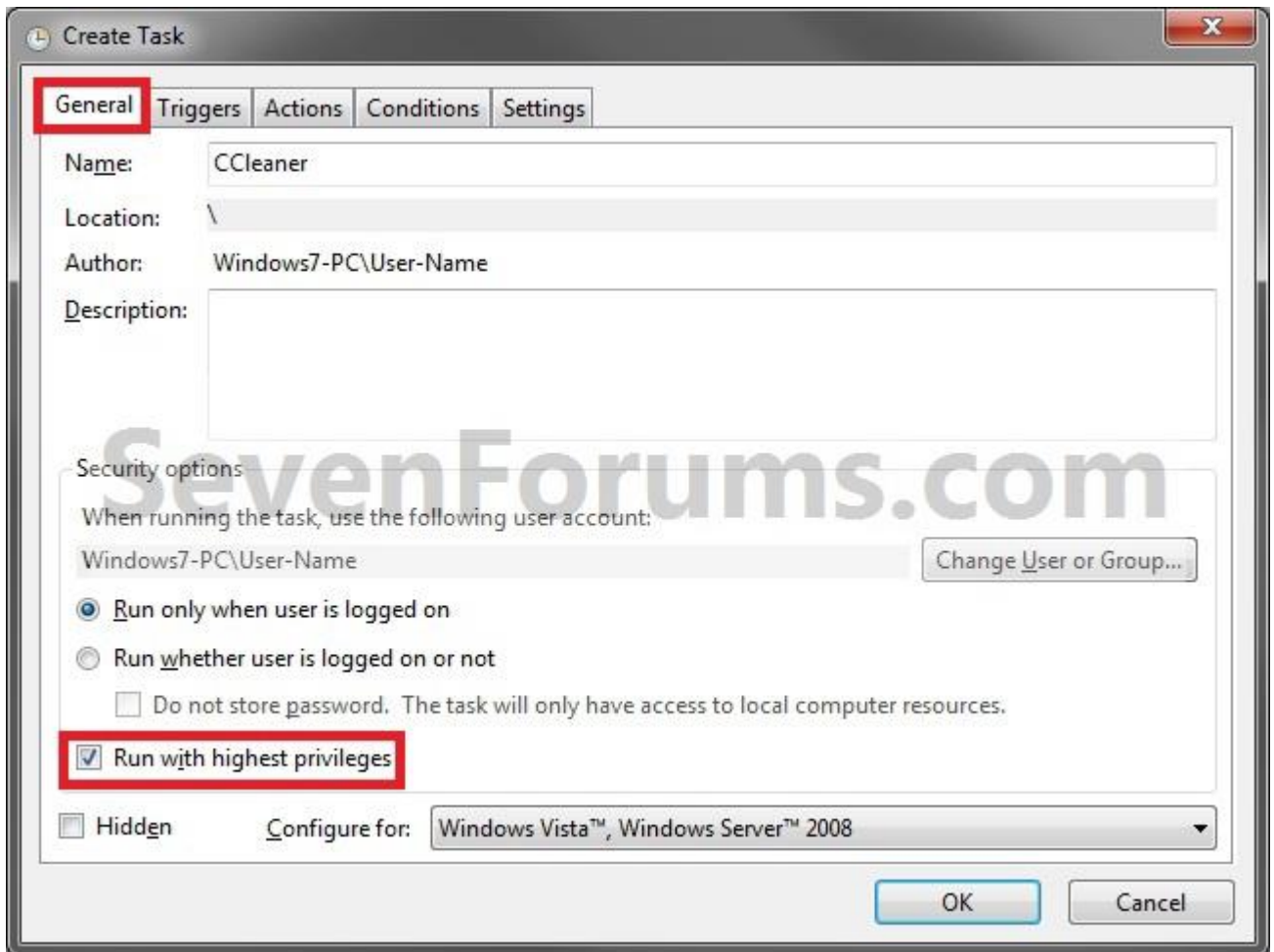

5. Click/tap on the **Configure for** drop down box to open it, and select **Windows® 7, Windows Server™ 2008 R2** or the Windows you are currently in. (see screenshot above and below)

**NOTE:** This is like *compatibility mode*. If the program does not support running in Windows 7 normally, then you can select the OS that it does support running in instead to have it run in compatibility mode as if it was running in that OS instead of Windows 7.

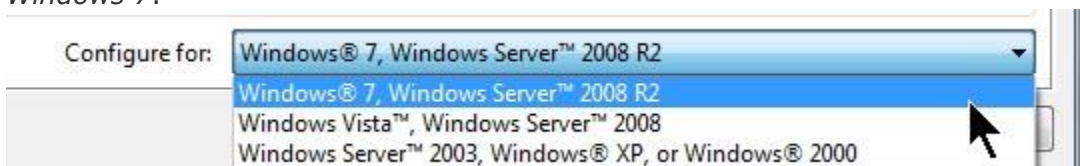

6. Click/tap on the **Actions** tab, then on the **New** button. (see screenshot below)

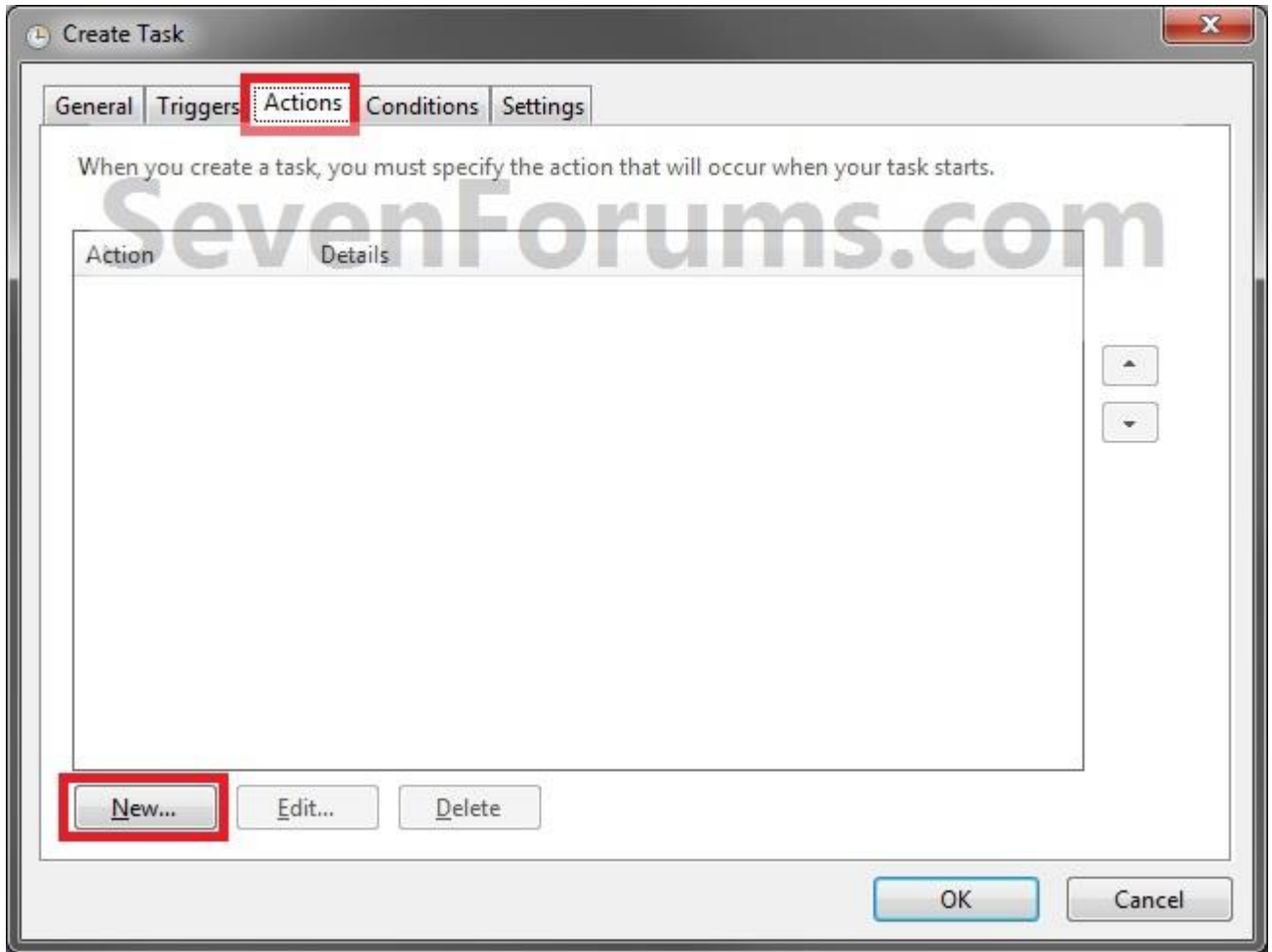

**7.** In the **Program/script:** box in the Actions tab, **copy** and paste the path below. (see screenshot below step 9)

**NOTE:** Thank you to [chillz](#) for the updated steps 7 and 8.

**%windir%\System32\cmd.exe**

**8.** In the **Add arguments (optional):** box in the Actions tab, type in the argument below. (see screenshot below step 9)

**NOTE:** Substitute **Task Name** in the argument below with the name you entered in **step 3** (ex: CCleaner) within quotes, and substitute **Full Path of Program** in the argument below with the actual full path of the program's .exe file within quote.

**/c start "Task Name" "Full Path of Program"**

**For example:**

Code:

```
/c start "CCleaner" "C:\Program Files \CCleaner\CCleaner64.exe"
```

**9.** Click/tap on **OK**. (see screenshot below)

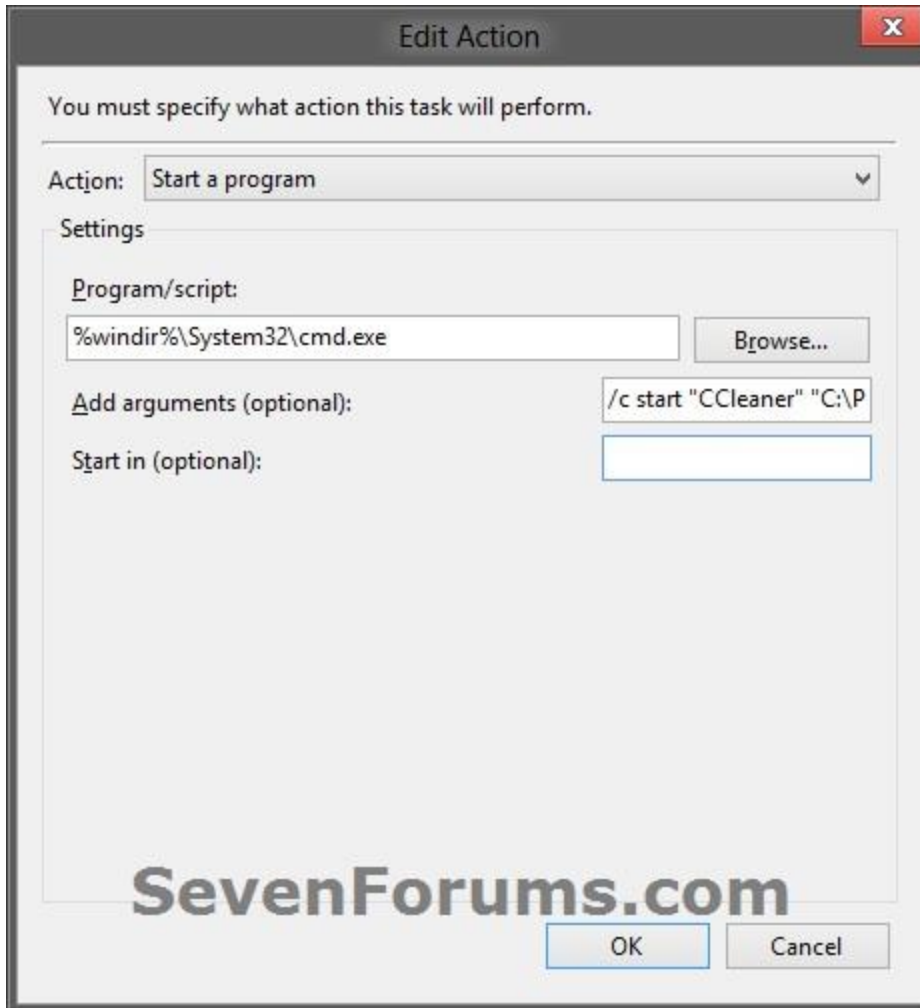

**10.** Click/tap on the **Conditions** tab, and uncheck the **Stop if the computer switches to battery power** box first, then uncheck the **Start the task only if the computer is on AC power** box. (see screenshots below)

**NOTE:** This step is mostly for laptops, so that you will be able to run the program when the laptop is running on battery power.

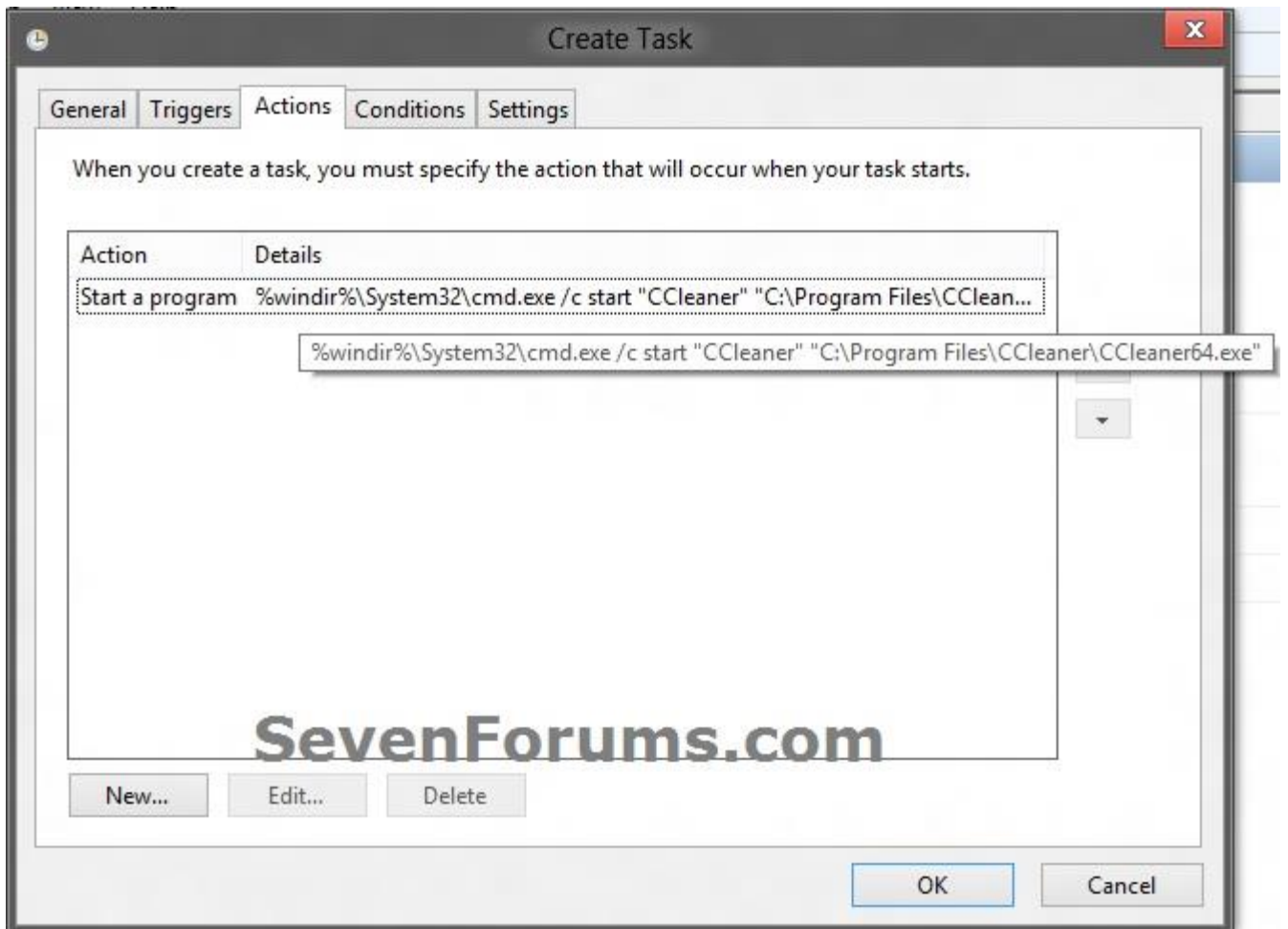

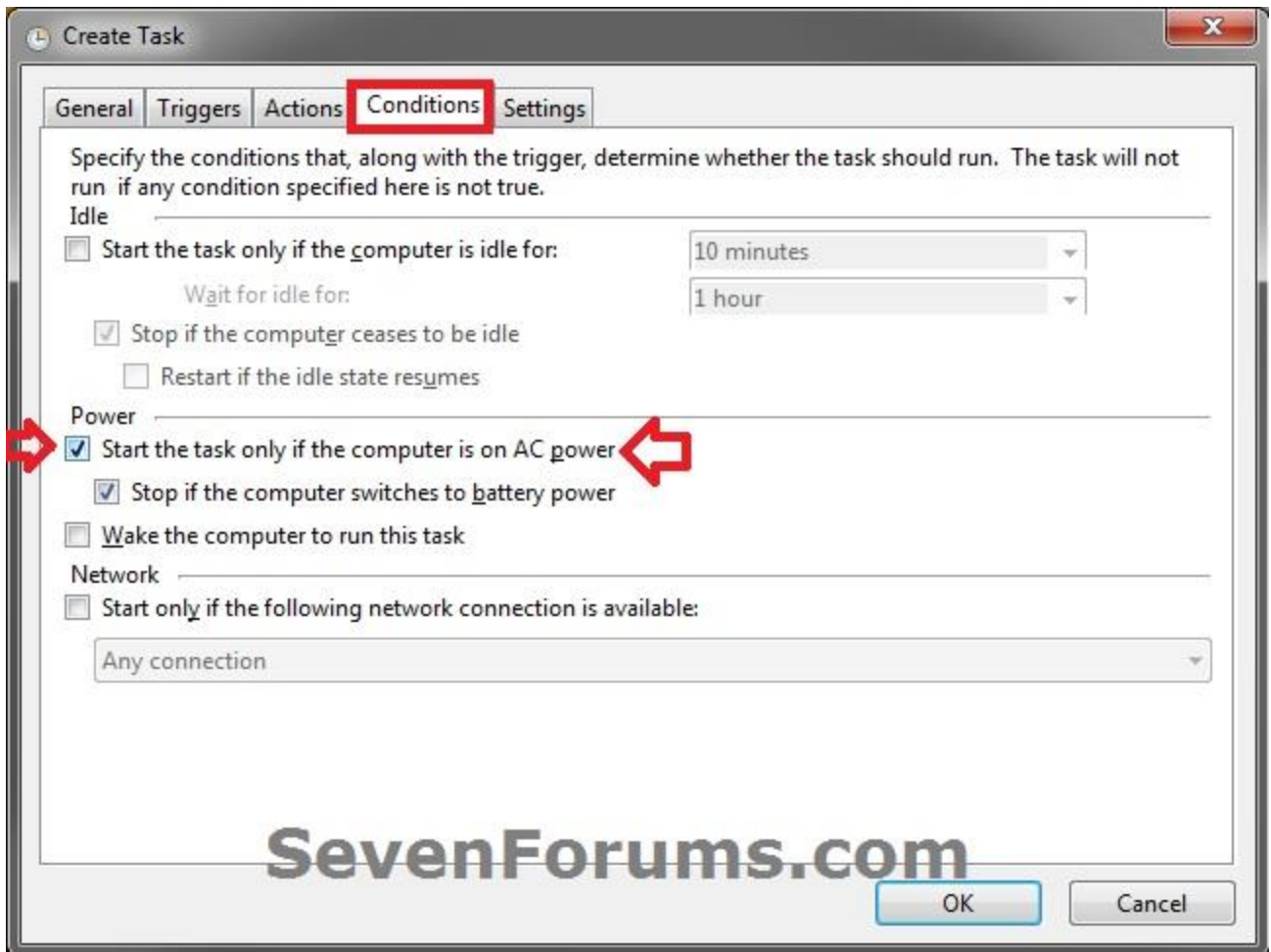

**11.** Click/tap on **OK**. (See screenshots above)

**12.** You will now see your **new task** created with the name (ex: CCleaner) you gave it in **step 3**. Close Task Scheduler. (see screenshot below)



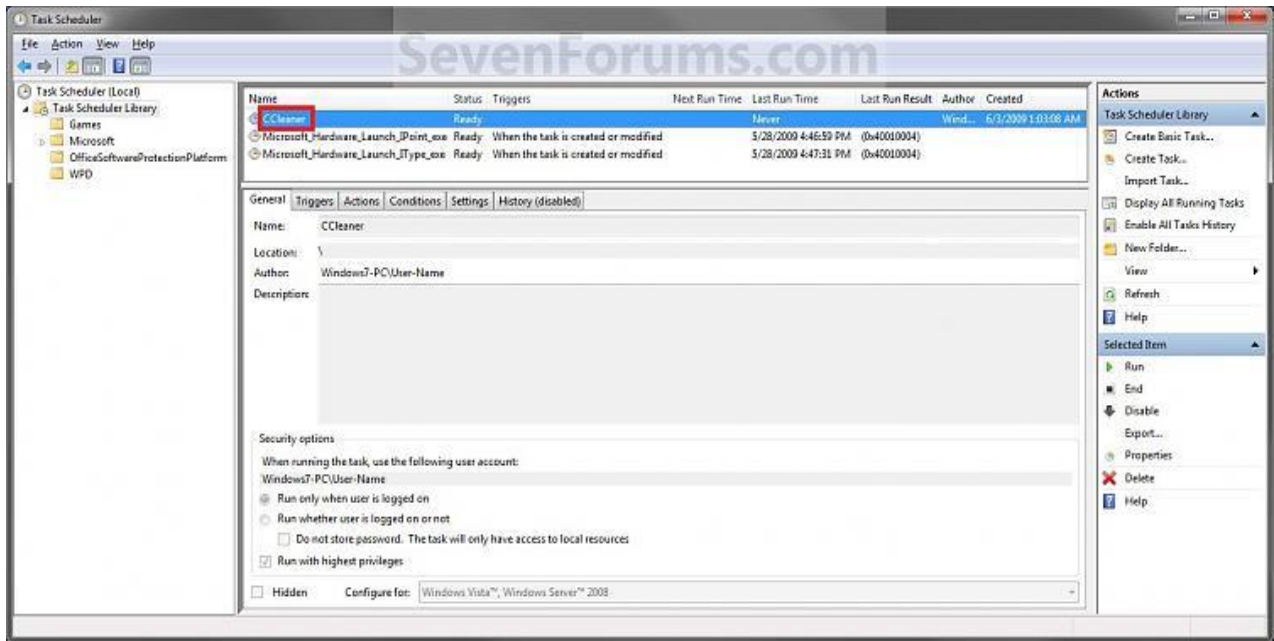

**13.** Right click or press and hold on an empty area of your **desktop** , then click/tap on **New** and **Shortcut**.

**14.** Type in the target below for the location field, then click/tap on the **Next** button. (see screenshot below)

**NOTE:** Substitute **task-name** in the target with the name (ex: CCleaner) within quotes that you used in **step 3**.

**schtasks /run /tn "task-name"**

**For example:** For my task name **CCleaner** I used from step 3, I would type:  
**schtasks /run /tn "CCleaner"**

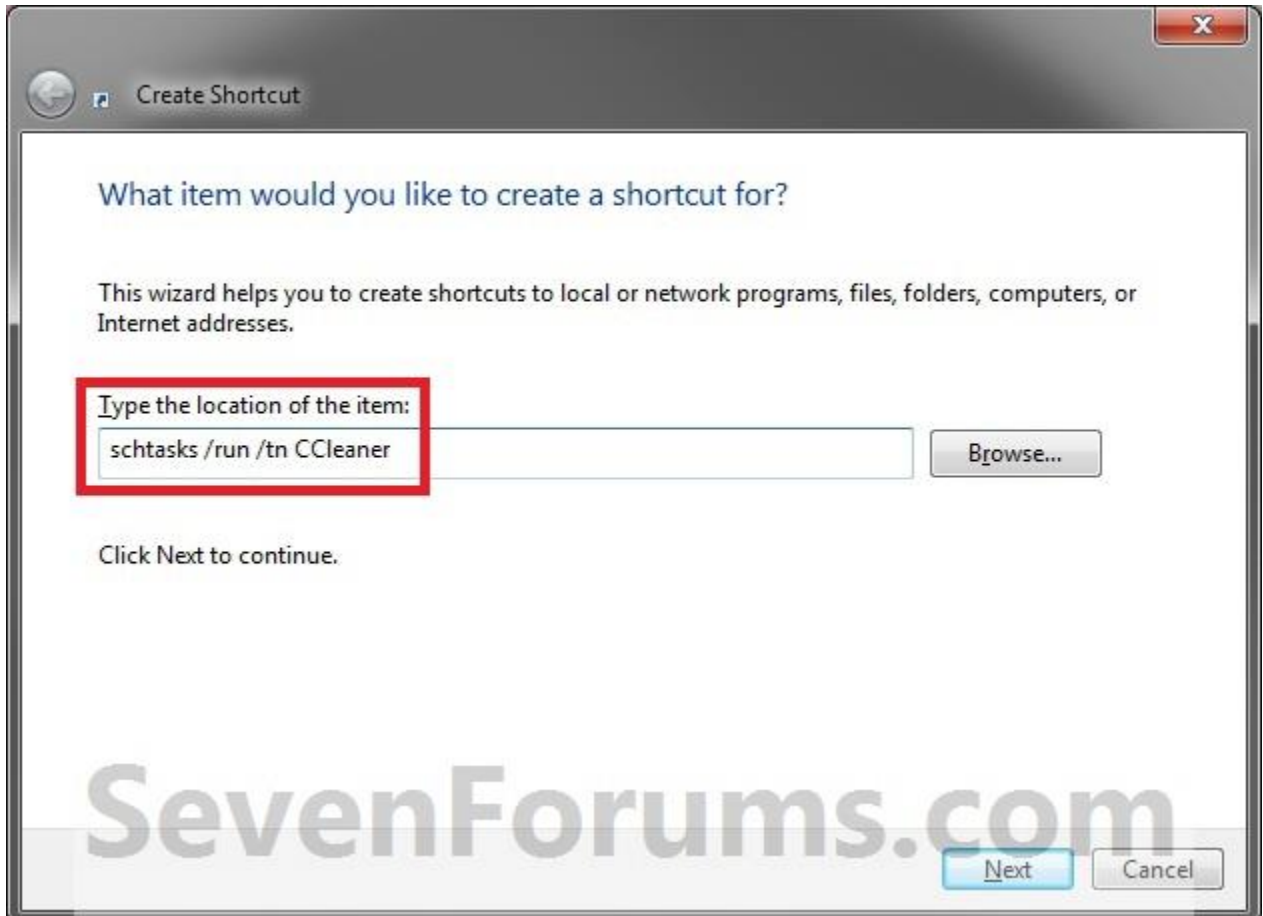

**15.** Type in a name you want for the shortcut (ex: CCleaner), then click/tap on the **Finish** button. (see screenshot below)



**16.** Right click on the new shortcut (ex: CCleaner) on the desktop, then click/tap on **Properties**.

**17.** Click/tap on the **Shortcut** tab, and on the **Change Icon** button. (see screenshot below)

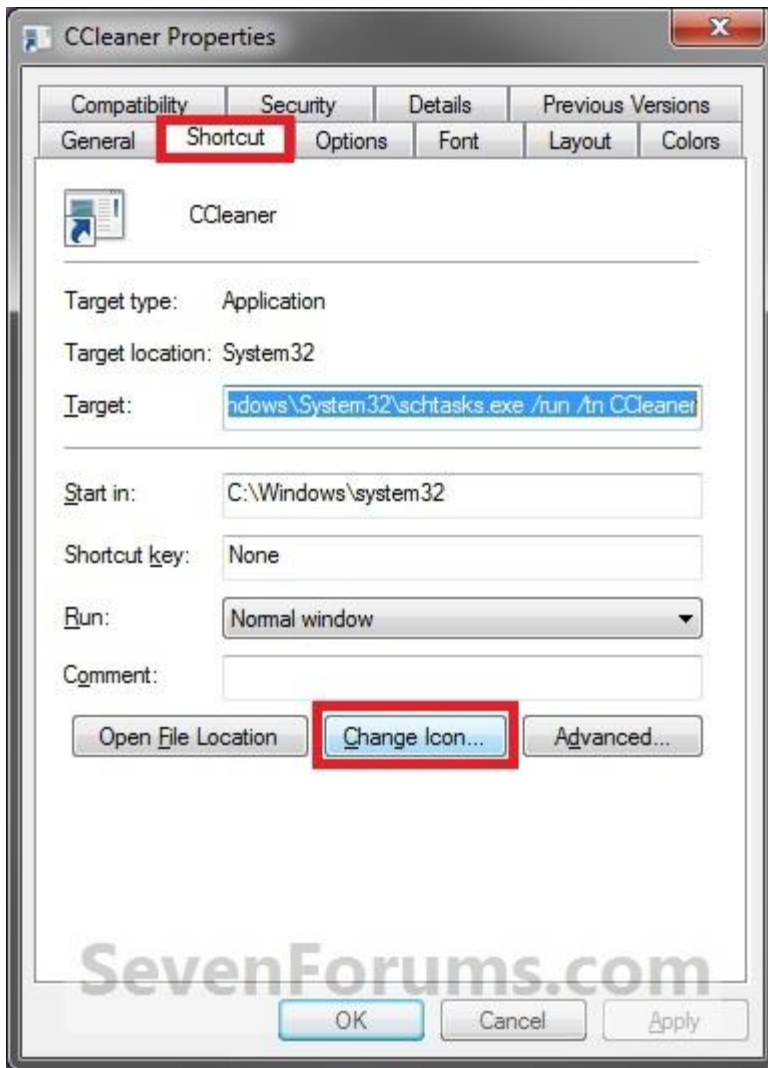

18. Click/tap on **OK**. (see screenshot below)

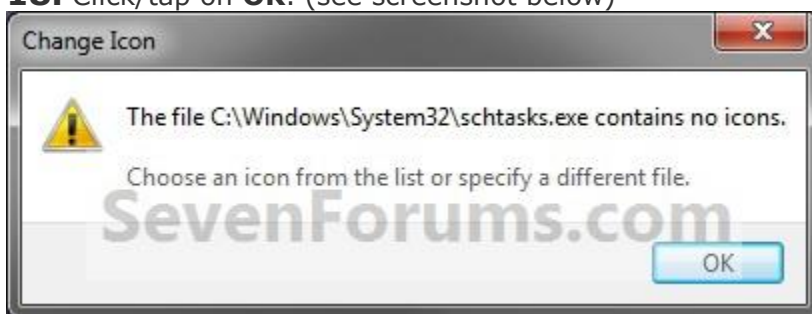

19. Click/tap on the **Browse** button. (see screenshot below)



**20.** Navigate to the .exe file of the program that you have created this shortcut with, select it, and click/tap on **Open**. (see screenshot below)

**NOTE:** If you have a icon of your own that you would prefer to use instead, then navigate to where you have that icon saved at instead.

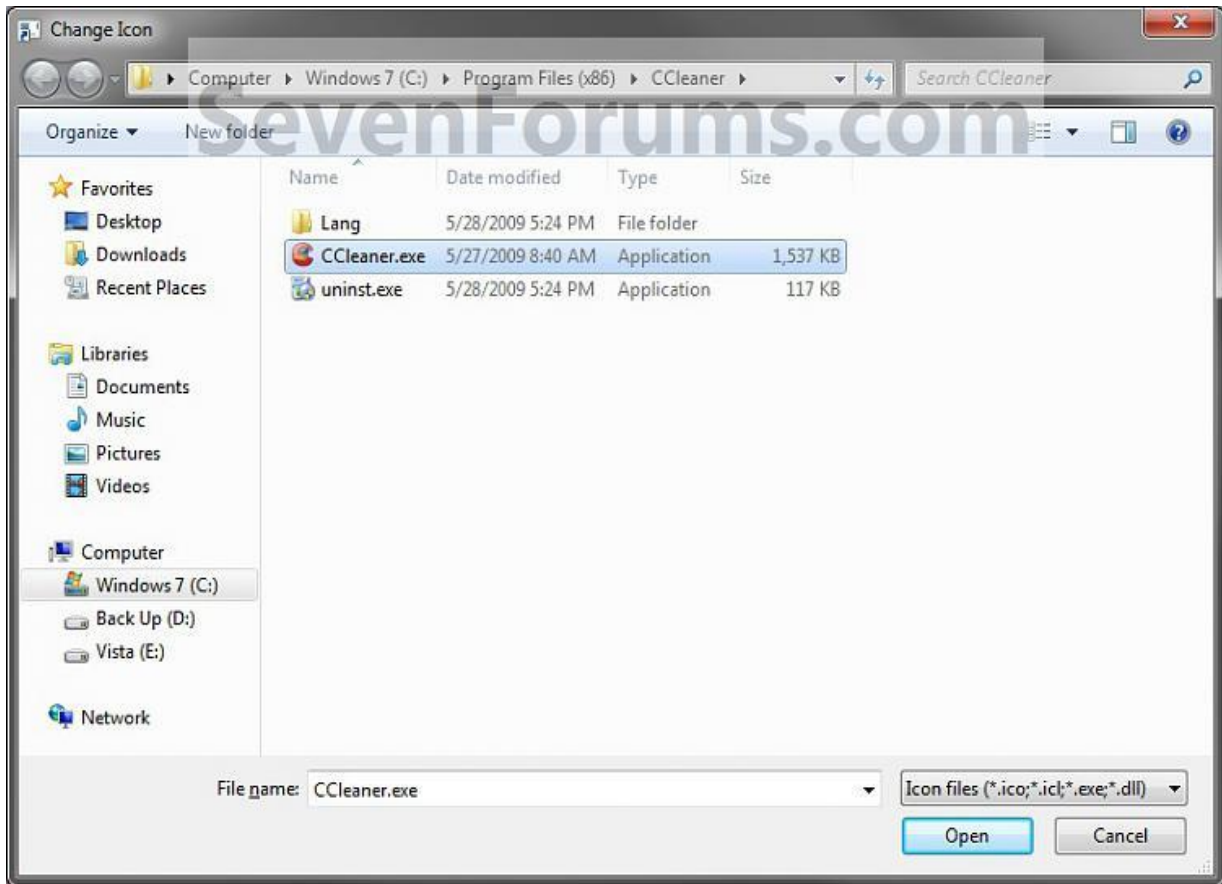

**21.** Select the icon you want for the shortcut, then click/tap on **OK**. (see screenshot below)



22. Click/tap on **OK**. (see screenshot below)

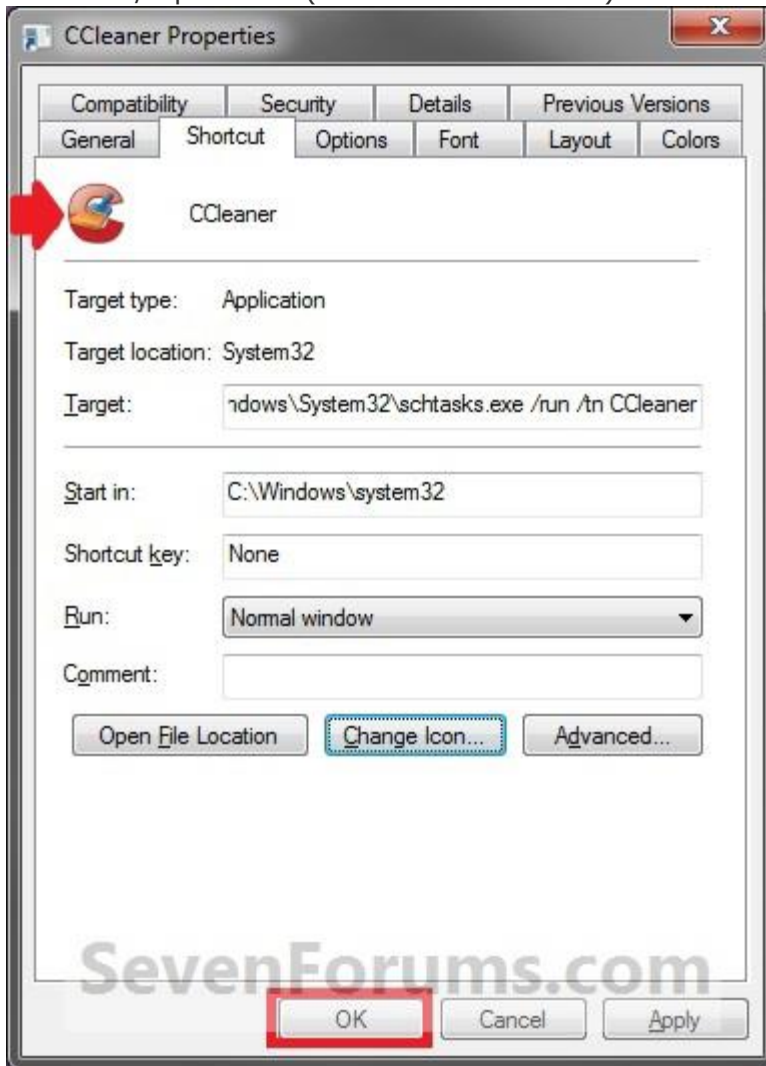

23. You can now use this elevated shortcut to **run at startup in your "Startup" folder, run at startup as a task, Pin to Start Menu, Pin to Taskbar, assign a keyboard shortcut**, or move to where you like for **easy** use.

#### Note

If you would like to stop the **quick flashing CMD pop-up** when using the shortcut, then you can do this below to do so.

- Right click on the shortcut and click on **Properties**.
- Click on the **Shortcut** tab.
- Select **Minimized** in the drop down menu to the left of **Run**, and click/tap **OK**.

24. When you run this new elevated shortcut, you will now no longer have to click/tap on **YES** to approve the **UAC** prompt to allow the program **run as administrator**.



*Tip*

### **To Undo and Remove this Task:**

- While having **Task Scheduler Library** selected in the left pane, right click on the task in the right pane that you created in step 12, then click on **Delete** and **Yes** to approve.
- Delete the shortcut.