

ADDON C3



User guide

 **audio pro**

CONNECTED

WELCOME TO WIRELESS HiFi

The Audio Pro Connected HiFi products lets you enjoy wireless multiroom sound that enables you to enjoy your favorite music anywhere and everywhere around your home.

By utilizing your existing home network and the Audio Pro app on your iOS or Android™ device, you can explore, browse, and play music from your own music library or from many online streaming music services.

In addition to easy wifi connection there is also Bluetooth wireless technology if you don't have a network. You can also connect your TV, turntable or cd-player by cable to enjoy all your music.

The legendary Audio Pro sound quality is included.



Your new speaker has Spotify Connect built in.

You need a Spotify premium account to take advantage of Spotify Connect. Spotify Connect lets you control the music playing on your device, using the Spotify app on your mobile, tablet or PC. Listening is seamless. You can take calls, play games, even switch your phone off – all without interrupting the music. Learn more at spotify.com/connect

The Spotify software is subject to third party licenses found here: www.spotify.com/connect/third-party-licenses



The Wi-Fi CERTIFIED Logo is a certification mark of the Wi-Fi Alliance.



AirPlay

© Apple, the Apple logo, Airplay, iPad, iPhone, and iPod touch are trademarks of Apple Inc., registered in the U.S. and other countries. App Store is a service mark of Apple Inc.



The Bluetooth® word mark and logos are registered trademarks owned by Bluetooth SIG, Inc. and any use of such marks by AUDIO PRO AB, is under license. Other trademarks and trade names are those of their respective owners.

CONTROLS

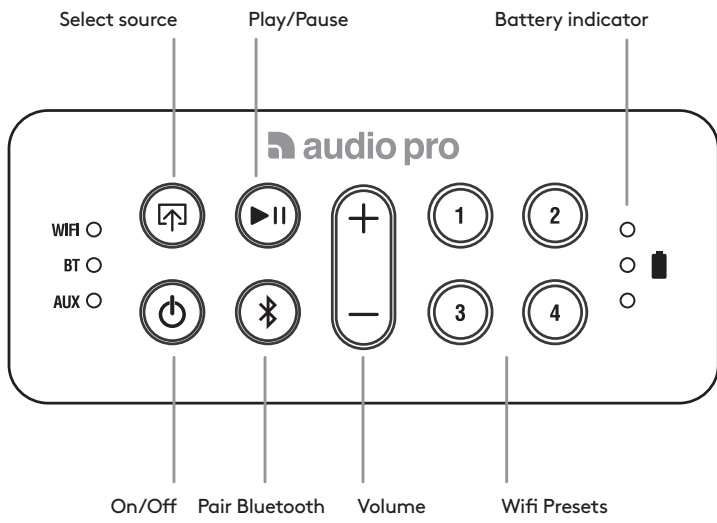

REAR VIEW/CONNECTIONS

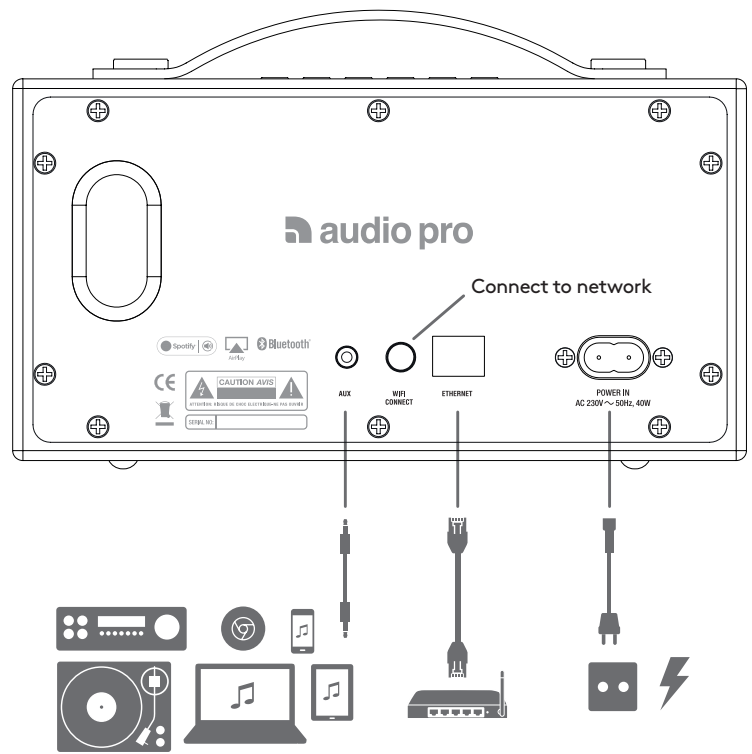

CONNECTING TO THE NETWORK



KEY REQUIREMENTS

- **NETWORK:** Your network must have a high-speed internet connection, as the Audio Pro system is designed to utilise free, online software updates.

PLEASE NOTE:

Audio Pro speakers communicate via a 2.4GHz home network with support for 802.11 b/g/n wireless technology. 5GHz networks are not supported in an Audio Pro setup.

- **ROUTER:** High-speed DSL/cable modem, or fibre-to-the-home broadband connection for proper playback of internet-based music services. Different routers provide different levels of performance. Please use a good wireless router to achieve the best possible performance.

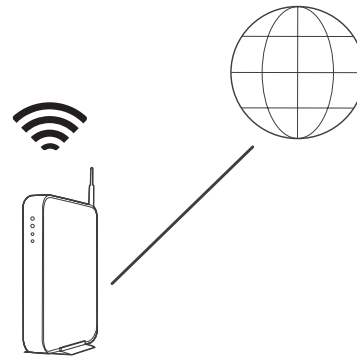

YOU NEED THIS:

Wireless router with internet connection.



iOS or Android device connected to your network.

1. CONNECT TO POWER

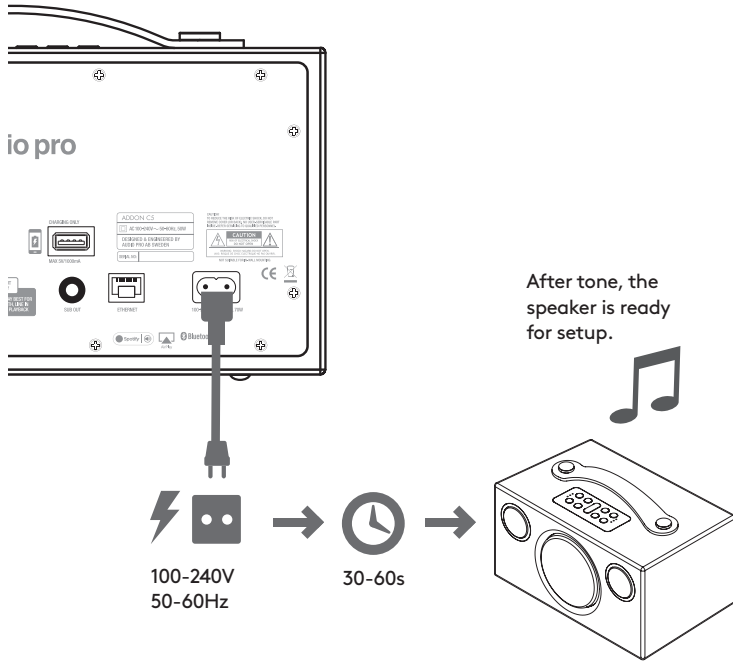

! Place the speaker close to the router when carrying out the setup. You can subsequently view the signal strength in the app in order to test other positions.

OPTION - OPTIONAL

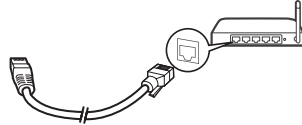

Connect to a wired network with an Ethernet cable.

2. DOWNLOAD THE APP

Search for "Audio Pro Control"



Launch the app and follow the instructions.

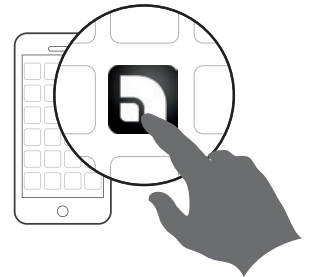

3. ADD A SPEAKER

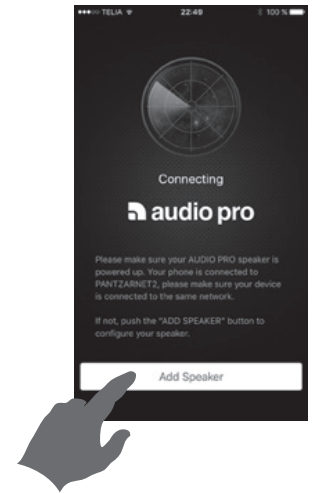

APP OVERVIEW

MAIN VIEWS

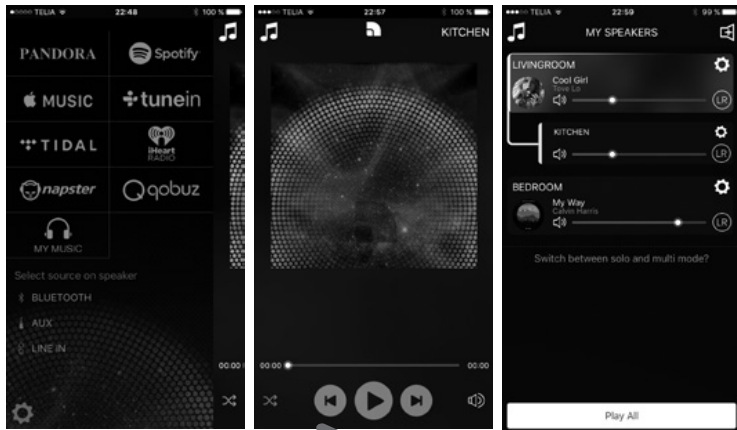

1. Music services and sources
2. Player view
3. Speaker/device list

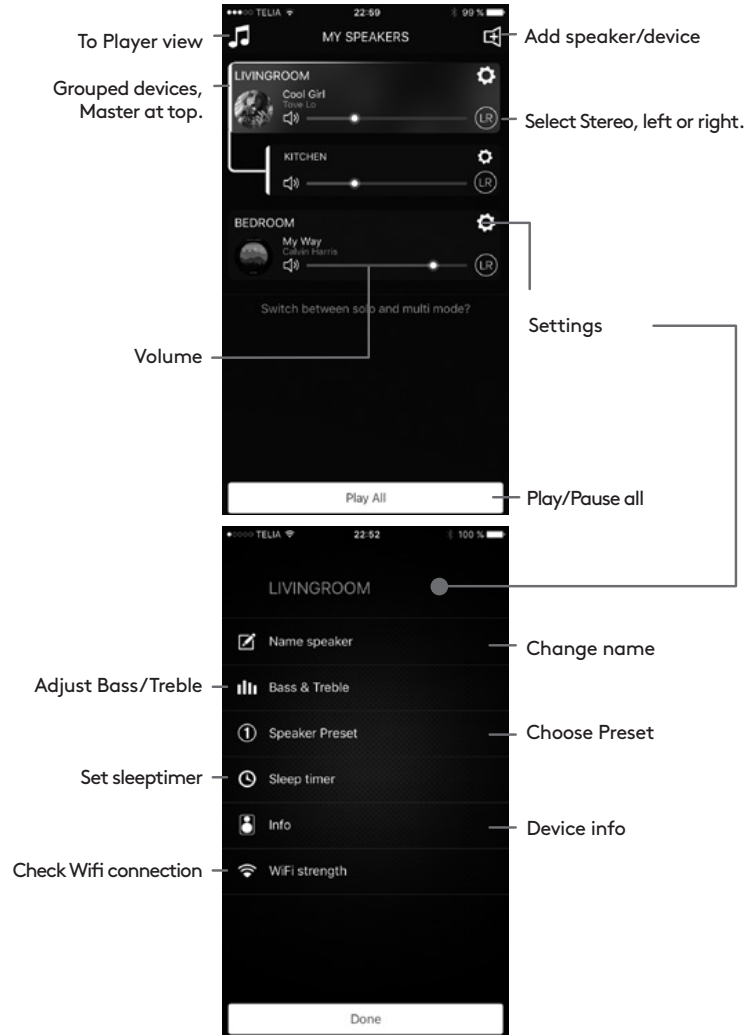

GROUPING SPEAKERS



Press and hold down the speaker field while dragging it onto the other field in order to group.
To ungroup, press and hold down the speaker field while dragging it under the dotted line.

! The speaker onto which you release the speaker field becomes the master speaker. Music will play on all speakers in a group. Their volumes can be adjusted separately. Up to 6 speakers can be combined in one group.

MAKING A PRESET

1. ON THE SPEAKER

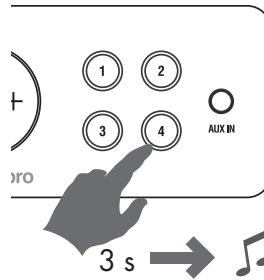

Play content in the app.
Press the preset button for approx. 3 s until sound is heard. Done!

2. IN THE APP

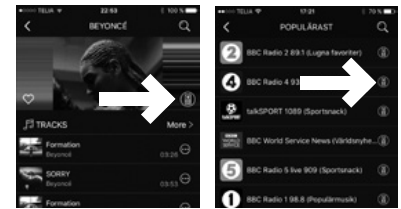
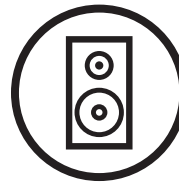

Tidal

Tune-in

When in the app using the various services, press the speaker icon.

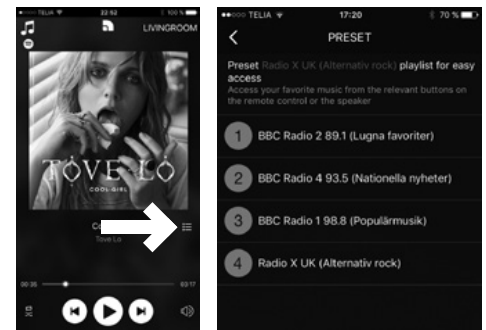

Spotify

PLAYING FROM SPOTIFY

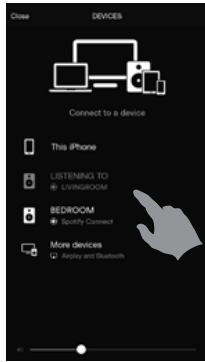
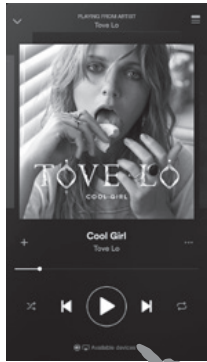
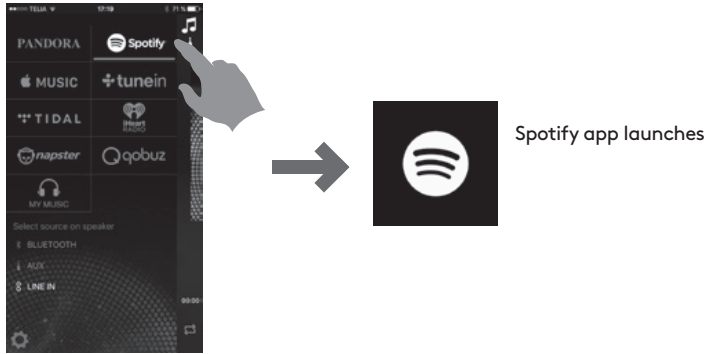

PLAYING FROM APPLE MUSIC USING AIRPLAY

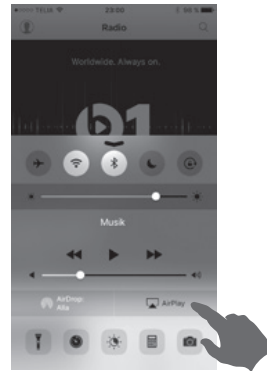
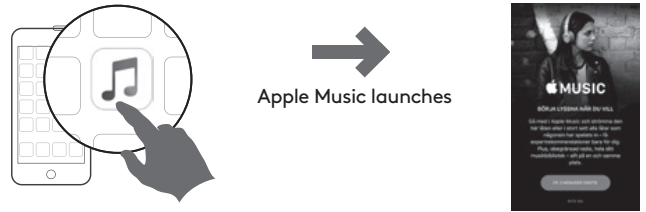

! You need a Spotify premium account to take advantage of Spotify Connect.

RESTREAMING



Connected devices sound can be played to more speakers wirelessly. Choose master speaker in group to play.

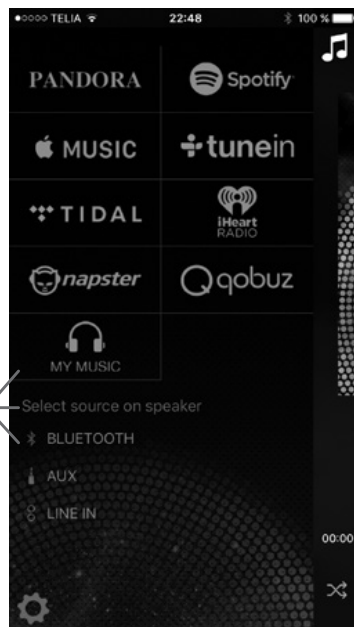

Välj ansluten källa.
Choose the connected
input source.
Wählen Sie die anges-
chlossene Quelle.
Kies de verbonden bron.

BLUETOOTH PAIRING

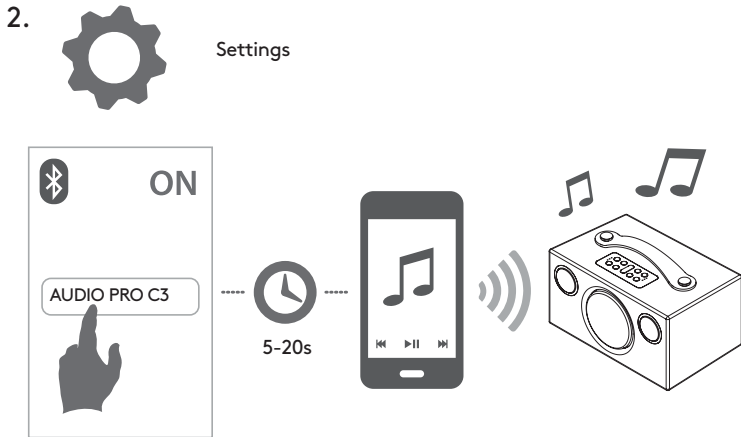
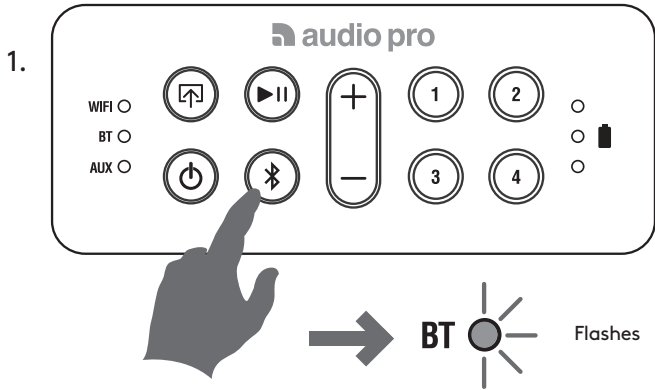

PLAYING FROM CONNECTED DEVICES

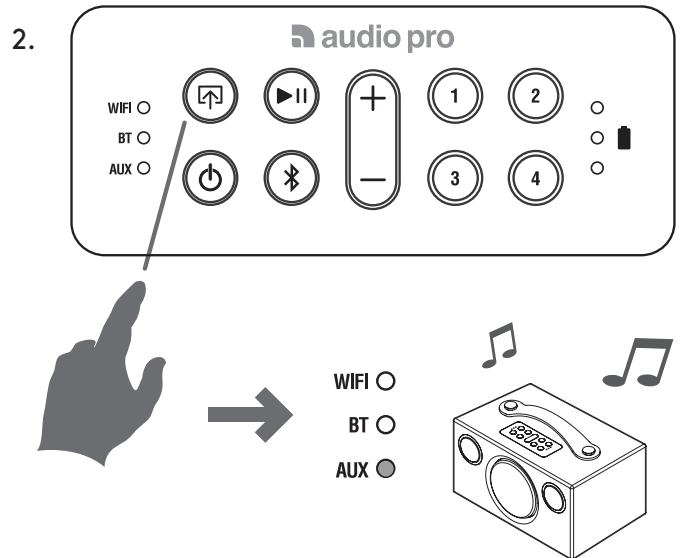
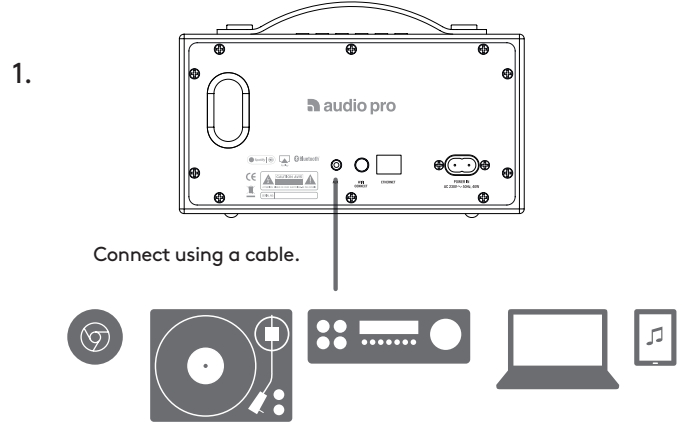

FAQ

MY SPEAKER WILL NOT CONNECT TO MY NETWORK

- Make sure your mobile device is connected to your wireless network before you try to connect your speaker.
- Place the speaker close to the router when carrying out the setup. You can subsequently view the signal strength for other positions in the app.
- Our speakers can only connect to a 2.4 GHz wireless network.
- Try connecting the speaker with an Ethernet cable.

I GET THE MESSAGE "DEVICE CONNECTION FAILED"

- Move the speaker closer to the router.
- Make sure your mobile device is connected to the same network.
- Press the "Wi-Fi Connect" button on the rear of the speaker and press the "Add Speaker" icon in the app.

MUSIC CUTS OUT/STUTTERS OR EXPERIENCES DELAYS

- Make sure your internet connection is working correctly.
- Check for other devices in the network, they might be using a lot of bandwidth. Especially downloads or the streaming of high resolution video.
- Check the signal strength in the Audio Pro app; if the signal strength is low, move closer to the router or connect using an Ethernet cable.

THE AUDIO IS DELAYED WHEN CONNECTED TO MY TV

- Move the playback switch on the rear to "Input Play".

SPECIFICATIONS ADDON C3

Type: Powered portable stereo speaker with bass reflex

Battery: Up to 30h (at 50% vol). 12h at 100% vol.

(WiFi mode may have shorter battery time.)

Amplifier: Digital Class D amplifier, 2x5W + 1x15W

Tweeter: 2 x ¾" textile dome tweeter

Woofer: 1 x 3.5"

Frequency range: 60 – 20.000Hz

Crossover frequency: 5.200Hz

Dimensions HxWxD: 115 x 215 x 135 mm

Inputs: Bluetooth standard V4.0, Aux In 3.5mm stereo, Ethernet

Wireless network compatibility: 802.11 b/g/n, 2.4GHz only

Supported audio formats: MP3, WMA, AAC, FLAC, Apple Lossless

Power consumption WiFi/STB/ON: 01.8W/0.47W/3.8W

CHANGING BATTERY

Only use Audio Pro original battery!

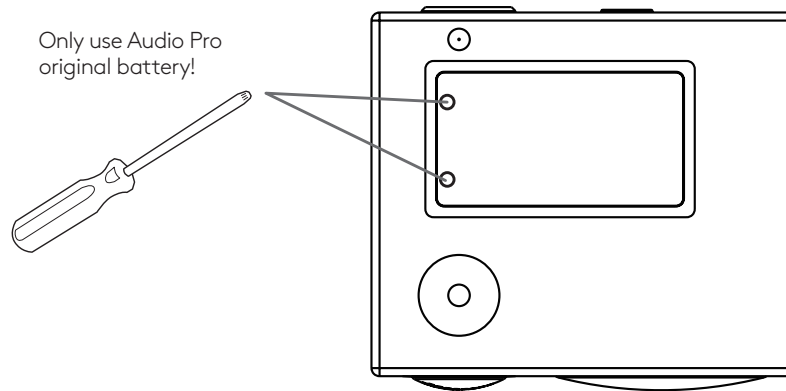

IMPORTANT SAFETY INSTRUCTIONS

1. Read these instructions.
2. Keep these instructions.
3. Heed all warnings.
4. Follow all instructions.
5. Do not use this device near water.
6. Only clean with a dry cloth.
7. Do not block any vents. Install in accordance with the manufacturer's instructions.
8. Do not install near any heat sources such as radiators, heaters, stoves, or other devices (including amplifiers) that produce heat.
9. Do not defeat the safety purpose of the polarized or grounding-type plug. A polarized plug has two blades with one wider than the other. A grounding type plug has two blades and a third grounding prong. The wide blade or the third prong are provided for your safety. If the provided plug does not fit into your outlet, consult an electrician for replacement of the obsolete outlet.
10. Protect the power cord from being walked on or pinched particularly at the plugs, convenience receptacles, and the point where they exit from the device.
11. Only use attachments/accessories specified by the manufacturer.
12. Use only with the cart, stand, tripod, bracket, or table specified by the manufacturer, or sold with the device. When a cart is used, use caution when moving the cart/device combination to avoid injury from tip-over.
13. Unplug this device during lightning storms or during long periods of disuse.
14. Refer all servicing to qualified service personnel. Servicing is required when the device has been damaged in any way, such as power-supply cord or plug damages, liquid has been spilled or objects have fallen into the device, the device has been exposed to rain or moisture, does not operate normally, or has been dropped.
15. Do not install this equipment in a confined or built-in space such as a book case or similar unit, and maintain well-ventilated conditions. The ventilation should not be impeded by covering the vents with items such as newspaper, table-cloths, curtains etc.
16. **WARNING:** Please refer the information on exterior bottom enclosure for electrical and safety information before installing or operating the device.
17. **WARNING:** To reduce the risk of fire or electric shock, do not expose this device to rain or moisture. The device should not be exposed to dripping or splashing and objects filled with liquids, such as vases, should not be placed on the apparatus.
18. **CAUTION:** Danger of explosion if battery is incorrectly replaced. Only replace with the same or equivalent type.
19. **WARNING:** The battery (battery or batteries or battery pack) should not be exposed to excessive heat such as sunshine, fire or the like.
20. **WARNING:** The mains plug/appliance coupler is used as a cut-off device, the cut-off device should remain readily operable.
21. **Correct Disposal of this product.** This marking indicates that this product should not be disposed with other household wastes throughout the EU. To prevent possible harm to the environment or human health from uncontrolled waste disposal, recycle it responsibly to promote the sustainable reuse of material resources. To return your used device, please use the return and collection systems or contact the retailer where the product was purchased. They can take this product for environmental safe recycling.

Operating Temperatures: 5 – 40 deg °C / 41 – 104 deg °F



CAUTION: RISK OF ELECTRIC SHOCK, DO NOT OPEN
ATTENTION: RISQUE DE CHOC ELECTRIQUE-NE PAS OUVRIR

WARNING: To reduce the risk of electric shock, do not remove cover (or back) as there are no user-serviceable parts inside. Refer servicing to qualified personnel.

⚡ This lightning flash with arrowhead symbol within an equilateral triangle is intended to alert the user to the presence of non-insulated “dangerous voltage” within the product’s enclosure that may be of sufficient magnitude to constitute a risk of electric shock.

⚠ The exclamation point within an equilateral triangle is intended to alert the user to the presence of important operating and maintenance instructions in the literature accompanying the appliance.

Protective earthing terminal. The apparatus should be connected to a mains socket outlet with a protective earthing connection.

CE Conformity

G-Lab GmbH declares that this device complies with the essential requirements and other relevant provisions of European Directive 1999/5/EC. The declaration of conformity may be consulted upon request to G-Lab GmbH, Zug, Switzerland or on <http://genevalab.com>.



This product can be recycled. Products bearing this symbol must NOT be discarded with normal household waste. At the end of the product’s life, take it to a collection point designated for recycling of electrical and electronic devices. Find out more about return and collection points through your local authority.

The European Directive on Waste Electrical and Electronic Equipment (WEEE) was implemented to dramatically reduce the amount of waste going to landfills, thereby reducing the environmental impact on the planet and human health. Please act responsibly by recycling used products. If this product is still usable, consider giving it away or selling it.

Used batteries: Please dispose of used batteries properly, following the local regulations. Do not place the battery in fire.



Geneva® is a registered trademark of G-Lab GmbH.

Apple, iPod, iPhone and iPad are trademarks of Apple Computer, Inc. registered in the U.S. and other countries.

The Bluetooth® word mark and logos are registered Trademarks owned by Bluetooth SIG, Inc.

© 2017 G-Lab GmbH. Manual for Acustica lounge

model A170

FCC

THIS DEVICE COMPLIES WITH PART 15 OF THE FCC RULES. OPERATION IS SUBJECT TO THE FOLLOWING TWO CONDITIONS:

- 1 - THIS DEVICE MAY NOT CAUSE HARMFUL INTERFERENCE.
- 2 - THIS DEVICE MUST ACCEPT INTERFERENCE RECEIVED, INCLUDING INTERFERENCE THAT MAY CAUSE UNDESIRE OPERATION.

MODEL: ADDON C3. FCC ID: 2AGNC-C3

FCC WARNING

Any Changes or modifications not expressly approved by the party responsible for compliance could void the user's authority to operate the equipment. This device complies with part 15 of the FCC Rules.

Operation is subject to the following two conditions:

- (1) This device may not cause harmful interference, and
- (2) this device must accept any interference received, including interference that may cause undesired operation.

The distance between user and products should be no less than 20cm. This equipment complies with FCC radiation exposure limits set forth for an uncontrolled environment. Note: This equipment has been tested and found to comply with the limits for a Class B digital device, pursuant to part 15 of the

FCC Rules. These limits are designed to provide reasonable protection against harmful interference in a residential installation.

This equipment generates, uses and can radiate radio frequency energy and, if not installed and used in accordance with the instructions, may cause harmful interference to radio communications. However, there is no guarantee that interference will not occur in a particular installation. If this equipment does cause harmful interference to radio or television reception, which can be determined by turning the equipment off and on, the user is encouraged to try to correct the interference by one or more of the following measures:

- Reorient or relocate the receiving antenna.
- Increase the separation between the equipment and receiver.
- Connect the equipment into an outlet on a circuit different

IC

This device complies with Industry Canada licence-exempt RSS standard(s). Operation is subject to the following two conditions: (1) This device may not cause interference, and (2) This device must accept any interference, including interference that may cause undesired operation of the device.

The distance between user and products should be no less than 20cm

Le présent appareil est conforme aux CNR d'Industrie Canada applicables aux appareils radio exempts de licence. L'exploitation est autorisée aux deux conditions suivantes:

- (1) l'appareil ne doit pas produire de brouillage, et
 - (2) l'utilisateur de l'appareil doit accepter tout brouillage radioélectrique subi, même si le brouillage est susceptible d'en compromettre le fonctionnement.
- la distance entre l'utilisateur et les produits devraient être au moins 20 cm

© AUDIO PRO AB, SWEDEN. ALL RIGHTS RESERVED.
TRADEMARKS ARE THE PROPERTY OF AUDIO PRO AB, SWEDEN.
Audio Pro, Garnisonsgatan 52, SE-250 24 Helsingborg, Sweden

© Audio Pro AB Sweden

Audio Pro®, the Audio Pro logotype, the 'a' symbol, and ace-bass® are all registered trademarks of Audio Pro AB, Sweden. All rights reserved. Audio Pro follows a policy of continuous advancement in development. Specifications may be changed without notice.

Google, the Google logo, Google Apps, Android, Android Market, Google Places, Google Maps, YouTube, Google Navigation, Google Calendar, Gmail and Google Search are trademarks of Google Inc. The Android robot is created and shared by Google and used according to the Creative Commons 3.0 Attribution License.

All other products and services mentioned may be trademarks or service marks of their respective owners.

THIS DOCUMENT CONTAINS INFORMATION THAT IS SUBJECT TO CHANGE WITHOUT NOTICE.



www.audiopro.com
www.facebook.com/audiopro