



Growing the **HEAVY DUTY** After market

INTRODUCING FORMERLY "DEALER ONLY" PARTS



Coolant Tubes, Heating and Cooling

Tubos de refrigerante,
calefacción y refrigeración

page
04

Door Handles and Body Parts

Manijas de las puertas y
partes para la carrocería

page
10

Fluid Reservoirs and Engine Parts

Recipientes de líquido
y partes para el motor

page
20

Fuel Senders, Fuel and Emissions

Envíos de combustible,
combustible y emisiones

page
32

Headlights and Lighting

Faros
e iluminación

page
42

Hood Springs, Latches and Components

Resortes del capó, cierres y
componentes

page
46

Speed and Tachometer Sensors

Sensores de velocidad
y sensores de tacómetro

page
56

Window Regulators and Window Parts

Reguladores de ventana y
partes para la ventana

page
62

Wiper Transmissions and Dash Components

Transmisiones de
limpiaparabrisas y componentes
para el tablero de instrumentos

page
72

Coolant Tubes, Heating and Cooling

Pages 04-08



Door Handles and Body Parts

Pages 10-18



Fluid Reservoirs and Engine Parts

Pages 20-31



Fuel Senders, Fuel and Emissions

Pages 32-39



Headlights and Lighting

Pages 42-45



Hood Springs, Latches and Components

Pages 46-54



Speed Sensors and Tachometer Sensors

Pages 56-61



Window Regulators and Window Parts

Pages 62-71



Wiper Transmissions and Dash Components

Pages 72-74



table of contents

Coolant Tubes, Heating and Cooling Tubos de refrigerante, calefacción y refrigeración	page 04
Door Handles and Body Parts Manijas de la puerta y partes para la carrocería	page 10
Fluid Reservoirs and Engine Parts Recipientes de líquido y partes para el motor	page 20
Fuel Senders, Fuel and Emissions Envíos de combustible, combustible y emisiones	page 32
Headlights and Lighting Luces delanteras e iluminación	page 42
Hood Springs, Latches and Components Resortes del capó, cierres y componentes	page 46
Speed Sensors and Tachometer Sensors Sensores de velocidad y sensores de tacómetro	page 56
Window Regulators and Window Parts Reguladores de ventana y partes para la ventana	page 62
Wiper Transmissions and Dash Components Transmisiones de limpiaparabrisas y componentes para el tablero de instrumentos	page 72
Alphabetical Interchange by Part Type Intercambio alfabético por el tipo de pieza	page 76
OE to Dorman Interchange De equipo original a Intercambio de Dorman	page 78
Interchange by Manufacturer Intercambio de fabricante	page 80
Interchange by Dorman Number Intercambio de equipo original	page 82

Coolant Tubes, Heating and Cooling

Tubos de refrigerante, calefacción y refrigeración

When you think about the environment in which a coolant tube operates, it's hard to believe they are made the way they are. You've seen these parts replaced over and over again. Coolant tubes fail early and often. Why? The parts are poorly designed!

You're sick of it, and so are we. So we decided to do something about it! Through the collection and examination of failed OE parts, our product team has been able to target the most failure prone coolant tubes, the ones you have to replace at an alarming rate. We've beefed up the weak spots. We've gotten rid of mild steel and replaced it with high-quality stainless. The result: a more reliable solution for you and your truck.

Los tubos del refrigerante transportan agua desde el radiador hasta el bloque del motor. Debido a esta proximidad con el motor, estas piezas son estresadas constantemente por las vibraciones y las altas temperaturas que existen bajo el capó del camión. El estrés de este entorno puede causar los tubos a corroer, mohorarse, romperse y fugas, resultando en las tasas de sustitución alto.

Los tubos refrigerantes reestructurados por Dorman están contruidos con un material actualizado de acero inoxidable. Esto ayuda a reducir la corrosión, resultando en una piezas de muy buena calidad y muy confiable.



OE NUMBERS CAN
TYPICALLY BE
FOUND STAMPED
ON THE ENDS OF
COOLANT TUBES



Coolant Tube

Dorman# 936-5201 **OE#** A05-16380-003

Make: Freightliner

Years: 2011-99

Models: Century Class, Argosy, Columbia

Notes: Detroit Diesel Series 60



Material Upgraded to Stainless Steel

Coolant Tube

Dorman# 936-5202 **OE#** A05-16384-001

Make: Freightliner

Years: 2011-90

Models: FLD, Century, Columbia

Notes: Caterpillar C15 3406E



Material Upgraded to Stainless Steel

Coolant Tube

Dorman# 936-5403 **OE#** K181-5141

Make: Kenworth

Years: 2011-90

Models: W900B, W900L

Notes: Caterpillar C15 3406E, & 3176



Material Upgraded to Stainless Steel

Coolant Tube

Dorman# 936-5404 **OE#** K181-5483

Make: Kenworth

Years: 2003-90

Models: T800, T600

Notes: Caterpillar C15 3406E, & Acert



Material Upgraded to Stainless Steel

Coolant Tubes, Heating and Cooling

Tubos de refrigerante, calefacción y refrigeración



Coolant Tube

Dorman# 936-5405 **OE#** K181-5597

Make: Kenworth

Years: 2011-95

Models: W900L, W900B

Notes: Caterpillar C15 3406E

Material Upgraded to Stainless Steel



Coolant Tube

Dorman# 936-5401 **OE#** 07-06464

Make: Peterbilt

Years: 2004-90

Models: 379, 378, 377, 357

Notes: Cummins N14

Material Upgraded to Stainless Steel



Coolant Tube

Dorman# 936-5402 **OE#** 07-06462

Make: Peterbilt

Years: 2005-87

Models: 379, 378, 377, 357

Notes: Caterpillar C15 3406E

Material Upgraded to Stainless Steel



Coolant Tube

Dorman# 936-5501 **OE#** 20561364

Make: Volvo

Years: 2008-01

Models: VN

Notes: Cummins & Volvo N14, D12

Material Upgraded
to Stainless Steel

Coolant Tube

Dorman# 936-5502 OE# 20357260

Make: Volvo

Years: 2011-00

Models: VN, VNL, VHD

Notes: Cummins & Volvo ISX, D12



Material Upgraded to Stainless Steel

Air Door Actuator

Dorman# 604-5101 OE# 3542606C1

Make: International

Years: 2009-03

Models: 4000, 7000,
8000, 9000, Prostar



Heater Hose Connector

Dorman# 800-401 OE# 15622861

Make: GMC

Years: 2002-30

Models: C3500, C4500, C5500

Notes: Heater hose inlet of $\frac{5}{8}$ and
thread size $\frac{1}{2}$ NPT



HVAC Knob Kit

Dorman# 702-5402 OE# FD1240

Make: Kenworth

Years: 2009-03

Models: T-Series, W-Series

Notes: Bergstrom HVAC system



Kit Includes Three Knobs

Coolant Tubes, Heating and Cooling

Tubos de refrigerante, calefacción y refrigeración



HVAC Knob Kit

Dorman# 702-5401 OE# 121-0001-000

Make: Peterbilt

Years: 2011-87

Models: 357, 367, 375, 378, 379, 386, 387, 330, 335

Notes: Sprague HVAC system

Kit Includes Three Knobs



Radiator Fan Assembly

Dorman# 620-5601 OE# 8-97383-808-0

Make: Isuzu

Years: 2010-94

Models: NPR



For Our Latest Parts
And Complete Applications



Also Available From **DORMAN**®

NYLON FUEL LINE REPAIR KIT 800-300



Over 99 Pieces

- Quick Fix For The Unexpected Repair
- Eliminates Need To Wait On Parts

Repair a Broken Plastic End

Replace a Section of Nylon Line

Replace the Entire Plastic Fuel Line Assembly

Replace a Rusted Section

Replace the Entire Steel Line

GIVE CUSTOMERS A REPAIR ALTERNATIVE!

STEEL FUEL LINE REPAIR KIT 800-500



FREE TOOLS INCLUDED



Over 150 Pieces

- Fix The Fuel Line, Don't Replace It
- On The Vehicle Repair Saves Bay Time!
- No Waiting For Special Order OE Assemblies

Solutions to These Common Fuel Line Problems:



A/C LINE REPAIR KIT 800-600



NEW!

Over 60 Pieces

ON-THE-CAR REPAIR SOLUTION



Repairs:
Save Time and Money by Repairing **Only** the Damaged Section



Door Handles and Body Parts

Manijas de las puertas y partes para la carrocería

When you consider the amount of wear and tear a door handle goes through in a typical day, it's no surprise why you replace them so often. They take a beating. Truckers pull themselves into the cab using the exterior handles to support their weight, and lean on the interior handles again on the way out of the truck. When you couple this level of wear and tear with constant exposure to the elements you are left with handles that are rusted, damaged and broken.

At Dorman we've focused on the door handles that give you the most problems. We've developed replacement parts for the handles that frequently fail and give you one headache after another. The handles you've sent to us, and asked us to develop an aftermarket alternative for! Dorman HD Solutions has the handles you need. We've got your alternative solution to the dealer.

Manijas de las puertas, se someten a un gran desgaste cada momento que es conducido por un camión. Hay una enorme cantidad de fuerza aplicada a la manija cuando entra y sale de la cabina. Este alto nivel de desgaste se combina con la constante exposición a los elementos y las razones por las cuales debilitan a los tiradores de las puertas aclarándose con el tiempo. Una vez se oxida y se corroe la manija mientras entra y sale de la cabina pueden causar daños e incluso romper la pieza.



OE NUMBERS
CAN TYPICALLY
BE FOUND ON
THE BACK OF
DOOR HANDLES



Handle, Exterior Front Right

Dorman# 760-5201 **OE#** A18-42228-003

Make: Freightliner

Years: 2011-00

Models: Columbia



Handle, Exterior Front Left

Dorman# 760-5202 **OE#** A18-42228-002

Make: Freightliner

Years: 2011-00

Models: Columbia



Handle, Exterior Front Left

Dorman# 760-5203 **OE#** A18-42228-000

Make: Freightliner

Years: 2011-96

Models: Condor



Handle, Exterior Front Right

Dorman# 760-5204 **OE#** A18-42228-001

Make: Freightliner

Years: 2011-96

Models: Condor



Door Handles and Body Parts

Manijas de las puertas y partes para la carrocería



Handle, Exterior Front Left

Dorman# 760-5205 OE# A18-35381-000

Make: Freightliner

Years: 2007-91

Models: Classic Cab, FLD



Handle, Exterior Front Right

Dorman# 760-5206 OE# A18-35381-001

Make: Freightliner

Years: 2007-91

Models: Classic Cab, FLD



Handle, Exterior Front Left/Right

Dorman# 760-5207(R) OE# (R) A18-53241-001,
760-5208(L) A18-47729-003

(L) A18-53241-000,
A18-47729-002

Make: Freightliner

Years: 2011-08

Models: Cascadia, Business M2, Business Class



Handle, Exterior Front Right

Dorman# 760-5603 OE# 15619625

Make: GMC

Years: 2003-95

Models: Topkick, Kodiak

Handle, Exterior Front Left

Dorman# 760-5604 **OE#** 15619624

Make: GMC

Years: 2003-95

Models: GMC Top Kick and Kodiack Truck



Handle, Exterior Front Right/Left

Dorman# 760-5101 **OE#** 3550931C91

Make: International

Years: 2008-97

Models: 2000, 3000, 4000, 7000,
8000, 9000 Series



Handle, Exterior Front Right

Dorman# 760-5105 **OE#** 2594006C1

Make: International

Years: 2011-08

Models: International Prostar



Handle, Exterior Front Left

Dorman# 760-5106 **OE#** 2594003C1

Make: International

Years: 2011-08

Models: International Prostar



Door Handles and Body Parts

Manijas de las puertas y partes para la carrocería



Handle, Exterior

Dorman# 760-5601(L) **OE#** 8-97867-721-1
760-5602(R) 8-97867-722-1

Make: Isuzu
Years: 2000-94
Models: NPR, NKR



Handle, Exterior Front Left/Right

Dorman# 760-5404(L) **OE#** K294-411PAK
760-5405(R) K294-411RPAK

Make: Kenworth
Years: 2001-95
Models: T-Series

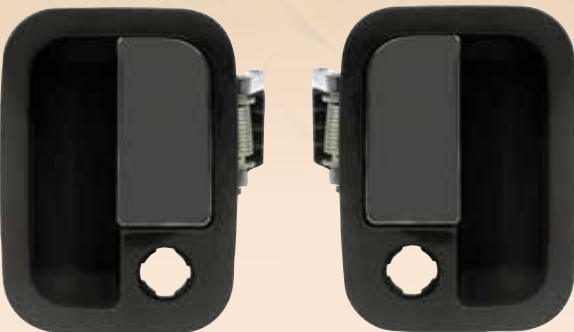

Handle, Exterior

Dorman# 760-5403(L) **OE#** R56-1025
760-5408(R) R56-1025R

Make: Kenworth
Years: 2011-01
Models: T270, T300 T370, T660
Note: Daylight Door



Handle, Exterior Front Right/Left

Dorman# 760-5501 **OE#** 25192012

Make: Mack
Years: 2007-95
Models: LE613

Handle, Exterior Front Right/Left

Dorman# 760-5502 **OE#** 25191926

Make: Mack

Years: 2005-90

Models: CH613

Note: Steel Door



Handle, Exterior Front Left

Dorman# 760-5401 **OE#** 20-08179L

Make: Peterbilt

Years: 2005-83

Models: 330, 335, 349, 357, 358, 359,
362, 365, 370, 372, 375, 376,
377, 378, 379, 400



Handle, Exterior Front Right

Dorman# 760-5402 **OE#** 20-08179R

Make: Peterbilt

Years: 2005-83

Models: 330, 335, 349, 357, 358, 359,
362, 365, 370, 372, 375, 376,
377, 378, 379, 400



Handle, Exterior

Dorman# 760-5403(L) **OE#** R56-1025
760-5408(R) R56-1025R

Make: Peterbilt

Years: 2011-01

Models: 325, 330, 357, 386,
387, 388, 389

Note: Daylight Door

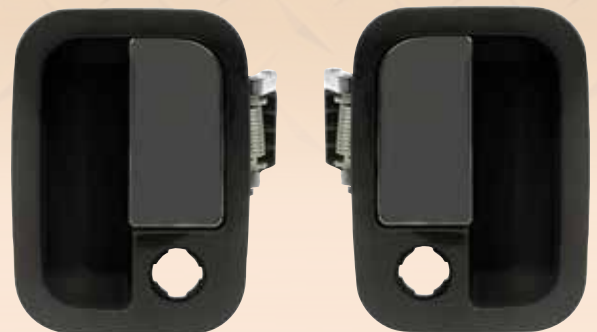

Door Handles and Body Parts

Manijas de las puertas y partes para la carrocería



Handle, Interior Front Right

Dorman# 761-5103 OE# 2505425C1

Make: International

Years: 2012-10

Models: Durastar



Handle, Interior Front Left

Dorman# 761-5104 OE# 2505424C1

Make: International

Years: 2012-10

Models: Durastar

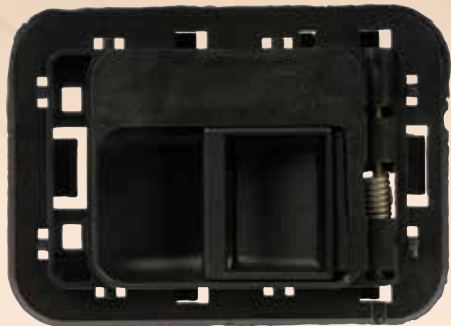

Handle, Interior Front Left

Dorman# 761-5406 OE# K294-426PAK

Make: Kenworth

Years: 2001-95

Models: T-Series and W-Series

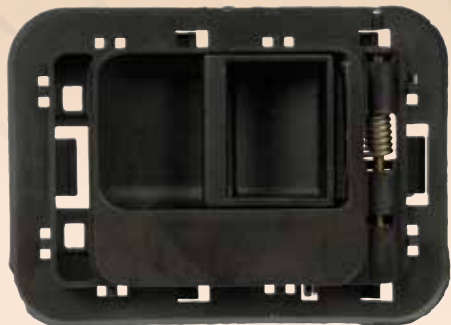

Handle, Interior Front Right

Dorman# 761-5407 OE# K294-426RPAK

Make: Kenworth

Years: 2001-95

Models: T-Series and W-Series

Brake Pedal Pad

Dorman# 20759 OE# 3920296

Make: GMC

Years: 1998-91

Models: Topkick, Kodiak



Door Check Kit

Dorman# 924-5401 OE# 20-11525M001

20-18727

R65-6019

20-12066

Make: Peterbilt

Years: 2005-87

Models: 357, 367, 375, 377, 378, 379



One Kit Includes Four Parts
The Dealer Only Offers Separately

Door Hinge

Dorman# 924-5103 OE# 3549259C1

Make: International

Years: 2011-02

Models: 4000, 7000, 8000, Lonestar,
Prostar, Terrastar, CXT, RXT, MXT



Door Hinge

Dorman# 924-5603 OE# 8-97852-007-3

Make: Isuzu

Years: 2000-94

Models: NPR



Door Handles and Body Parts

Manijas de las puertas y partes para la carrocería



Right Lower

Left Lower

Mirror Bracket

Dorman# 924-5105(LL) **OE#** 2597071C91
924-5106(RL) 2597075C91

Make: International

Years: 2012-02

Models: 3000, 4000, 7000 8000 Series,
Prostar, Lonestar, RXT, Terrastar



Mirror Motor

Dorman# 924-5204 **OE#** 28569

Make: Freightliner

Years: 2011-08

Models: Cascadia



Mirror Switch

Dorman# 901-5201 **OE#** 34103PF

Make: Freightliner

Years: 2009-03

Models: FLC, Century



Shift Boot

Dorman# 924-5405 **OE#** 2K042-79

Make: Kenworth

Years: 2011-99

Models: T-Series and W-Series

Notes: Square shift boot

SIGN UP NOW!

**BE THE FIRST
TO KNOW!**



ABOUT FORMERLY "DEALER ONLY" PARTS

- Sign up for The HD Solutions
Be the First to Know Program
- Get New Product Update Emails or Texts
 - Learn More About The Latest Formerly Dealer Only Parts



Fluid Reservoirs and Engine Parts

Recipientes de líquido y partes para el motor

You've all heard the horror stories. A truck is out of service because of a leaking fluid reservoir. You lose your patience, your temper and worst of all - your profit. These reservoirs are exposed to the harsh conditions that exist under the hood of your truck. Extreme temperatures and constant vibrations yield an endless struggle that these parts will ultimately lose.

By soliciting the help of technicians, Dorman has been able to leverage firsthand experience to identify the most in-demand fluid reservoirs. The coolant tanks and washer bottles that never seem to stay on your truck long enough. We've examined common failure patterns and redesigned our parts to reduce or eliminate these conditions. We've upgraded materials. We've eliminated leak prone areas.

Los depósitos de líquidos se encuentran normalmente cerca del motor del camión. Las temperaturas extremadamente altas y las fuertes vibraciones que caracterizan a este entorno contribuyen significativamente a fallas en los depósitos de líquidos. Cuando están expuestos a altas temperaturas durante un período prolongado de tiempo, las botellas pueden fundirse y deformarse, resultando en pérdidas. La presión adicional de las vibraciones del motor puede causar ciertos materiales quebrarse y romperse.

Los depósitos de líquidos también se reemplazan con frecuencia debido al desgaste de los lugares de montaje. Con el tiempo, las temperaturas extremas y las vibraciones del motor pueden debilitar el montaje hasta el punto de hacer grietas o romperlo, necesitando un reemplazo de embalse.



OE NUMBERS CAN TYPICALLY BE FOUND ON THE SURFACE OF FLUID RESERVOIR CAPS



OE NUMBERS CAN TYPICALLY BE FOUND PRINTED ON THE SIDE OF FLUID RESERVOIRS



Coolant Tank

Dorman# 603-5201 OE# 05-23045-000

Make: Freightliner

Years: 2009-04

Models: Century, Columbia, CL112, CL120



Coolant Tank

Dorman# 603-5202 OE# 05-23195-000

Make: Freightliner

Years: 2011-05

Models: M2 Business Class

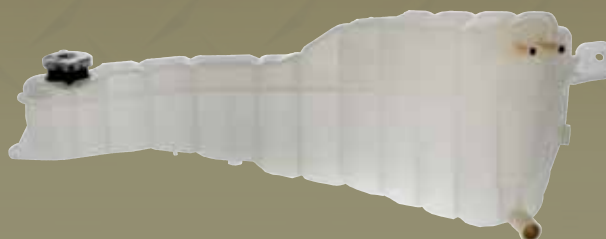

Coolant Tank

Dorman# 603-5601 OE# 15161670

Make: GMC

Years: 2008-03

Models: 6000, 7000, 8000, C4500,
C5500, Topkick and Kodiak



Coolant Tank

Dorman# 603-5101 OE# 2002105C3

Make: International

Years: 2007-02

Models: 2000 Series, 4000 Series



Fluid Reservoirs and Engine Parts

Recipientes de líquido y partes para el motor



Coolant Tank

Dorman# 603-5103 OE# 2508700C92

Make: International

Years: 2010-03

Models: 9000 Series

Notes: Improved Clear Design Eliminates Fluid Level Indicator Ports - Reducing Potential Leaks



Coolant Tank

Dorman# 603-5603 OE# 8972230122

Make: Isuzu

Years: 2010-96

Models: NPR, NQR, NRR



Coolant Tank

Dorman# 603-5501 OE# 25133601

Make: Mack

Years: 2008-04

Models: CV713



Coolant Tank

Dorman# 603-5502 OE# 25174629

Make: Mack

Years: 2008-04

Models: CV713

Coolant Tank

Dorman# 603-5403 OE# N5346001

Make: Peterbilt

Years: 2010-08

Models: 335, 337, 340, 348, 349, 352, 353,
357, 359, 362, 365, 367, 372, 375,
376, 377, 378, 379, 384, 385, 386,
387, 388, 389

Notes: Using a Cummins and Caterpillar
Engine With BEHR Cooling Module.



Washer Tank

Dorman# 603-5602 OE# 8978550656

Make: Isuzu

Years: 2010-96

Models: NPR, NQR, NRR

Notes: Improved Clear Design Eliminates
Fluid Level Indicator Ports -
Reducing Potential Leaks



Washer Tank

Dorman# 603-5401 OE# K114-20

Make: Kenworth

Years: 2002-99

Models: T Series, W900, C500,



Washer Tank

Dorman# 603-5503 OE# 25128217

Make: Mack

Years: 2010-05

Models: MR688S



Fluid Reservoirs and Engine Parts

Recipientes de líquido y partes para el motor



Washer Tank

Dorman# 603-5402 OE# N5355001

Make: Peterbilt

Years: 2010-08

Models: 335, 337, 340, 348, 349, 352, 353, 357, 359, 362, 365, 367, 372, 375, 376, 377, 378, 379, 384, 385, 386, 387, 388, 389

Notes: Using a Cummins and Caterpillar Engine With BEHR Cooling Module.



Washer Tank

Dorman# 603-5404 OE# R86-6001

Make: Peterbilt

Years: 2005-90

Models: 357, 367, 375, 377, 378, 379



Coolant Level Sensor

Dorman# 924-5205 OE# 06-62384-002

Make: Freightliner

Years: 2010-07

Models: Cascadia, Coronado, Columbia

Notes: Fits A05-25263-005 Coolant Bottle



Coolant Tank Cap

Dorman# 902-5201 OE# 05-20763-001

Make: Freightliner

Years: 2009-04

Models: Century, Columbia, CL112, CL120

Notes: Fits OEM Reservoir # 05-23045-000
Fits Dorman Reservoir # 603-5201

Coolant Tank Cap

Dorman# 902-5202 OE# 05-17223-002

Make: Freightliner

Years: 2011-05

Models: M2 Business Class

Notes: Fits OEM Reservoir # 05-23195-000
Fits Dorman Reservoir # 603-5202



Coolant Tank Cap

Dorman# 902-5601 OE# 15075118

Make: GMC

Years: 2008-03

Models: 6000, 7000, 8000, C4500,
C5500 Topkick and Kodiak

Notes: Fits OEM Reservoir # 15161670
Fits Dorman Reservoir # 603-5601



Coolant Tank Cap

Dorman# 902-5101 OE# 2039390C3

Make: International

Years: 2007-02

Models: 2000 Series, 4000 Series

Notes: Fits OEM Reservoir # 2002105C3
Fits Dorman Reservoir # 603-5101



Coolant Tank Cap

Dorman# 902-5102 OE# 3578833C3

Make: International

Years: 2010-03

Models: 9000 Series

Notes: Fits OEM Reservoir # 2508700C92
Fits Dorman Reservoir # 603-5103



Fluid Reservoirs and Engine Parts

Recipientes de líquido y partes para el motor

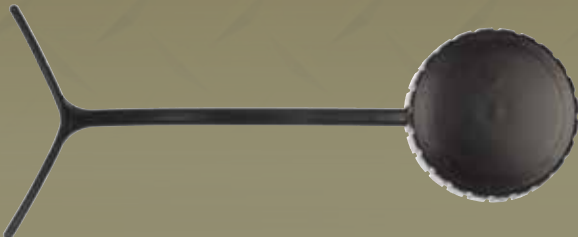

Coolant Tank Cap

Dorman# 902-5404 OE# 3150-063415A

Make: Mack

Years: 2008-04

Models: CV713

Notes: Fits OEM Reservoir # 25133601
Fits Dorman Reservoir # 603-5501



Coolant Tank Cap

Dorman# 902-5502 OE# 5481-9916238

Make: Mack

Years: 2008-04

Models: CV713

Notes: Fits OEM Reservoir # 25174629
Fits Dorman Reservoir # 603-5502



Coolant Tank Cap

Dorman# 902-5402 OE# N5348001

Make: Peterbilt

Years: 2010-08

Models: 335, 337, 340, 348, 349, 352, 353, 357, 359, 362, 365, 367, 372, 375, 376, 377, 378, 379, 384, 385, 386, 387, 388, 389

Notes: Fits OEM Reservoir # N5346001
Fits Dorman Reservoir # 603-5403



Coolant Tank Cap

Dorman# 902-5403 OE# RC0050

Make: Peterbilt

Years: 2010-08

Models: 335, 337, 340, 348, 349, 352, 353, 357, 359, 362, 365, 367, 372, 375, 376, 377, 378, 379, 384, 385, 386, 387, 388, 389

Notes: Fits OEM Reservoir # N5346001
Fits Dorman Reservoir # 603-5403

Washer Tank Cap

Dorman# 902-5404 OE# FLM-063361

Make: Freightliner

Years: 2000-93

Models: FLD Class

Notes: Fits OEM Reservoir # FLM065400



Washer Tank Cap

Dorman# 902-5401 OE# C5720S

Make: Kenworth

Years: 2002-99

Models: T Series, W900, C500,

Notes: Fits OEM Reservoir # K114-20
Fits Dorman Reservoir # 603-5401



Washer Tank Cap

Dorman# 902-5401 OE# 25171612

Make: Mack

Years: 2004-02

Models: MR688S

Notes: Fits OEM Reservoir # 25128217
Fits Dorman Reservoir # 603-5503



Washer Tank Cap

Dorman# 902-5401 OE# Not Sold Separately

Make: Peterbilt

Years: 2010-08

Models: 335, 337, 340, 348, 349, 352, 353, 357,
359, 362, 365, 367, 372, 375, 376, 377,
378, 379, 384, 385, 386, 387, 388, 389

Notes: Fits OEM Reservoir # N5355001
Fits Dorman Reservoir # 603-5402



Fluid Reservoirs and Engine Parts

Recipientes de líquido y partes para el motor



Washer Tank Cap

Dorman# 902-5404 OE# 63361

Make: Peterbilt

Years: 2005-90

Models: 357 362 365 372 375

Notes: Fits OEM Reservoir # R86-6001
Fits Dorman Reservoir # 603-5404



Oil Cooler Line

Dorman# 625-250 OE# F5HZ6A715AA

Make: Ford

Years: 1998-95

Models: F700; V8 - 7.0L (429 CID)



Oil Cooler Line

Dorman# 625-251 OE# F5HZ6A715BA

Make: Ford

Years: 1998-95

Models: F700; V8 - 7.0L (429 CID)



Oil Cooler Line

Dorman# 625-185 OE# 15791673

Make: GMC

Years: 2008-03

Models: C4500, C5500; V8 - 8.1L (496 CID)

Oil Cooler Line

Dorman# 625-187 OE# 15791675

Make: GMC

Years: 2008-03

Models: C4500/C5500; V8 - 8.1L (496 CID)



Oil Cooler Line

Dorman# 625-188 OE# 93440852

Make: GMC

Years: 2002-01

Models: C6500/C7500, School Bus;
V8 - 8.1L (496 CID)



Oil Cooler Line

Dorman# 625-189 OE# 93440853

Make: GMC

Years: 2002-01

Models: C6500/C7500, School Bus;
V8 - 8.1L (496 CID)



Oil Cooler Line

Dorman# 625-190 OE# 15022583

Make: GMC

Years: 2000-98

Models: C6500/C7500, 2000-99, School Bus;
V8 - 7.4L (454 CID)



Fluid Reservoirs and Engine Parts

Recipientes de líquido y partes para el motor

Oil Cooler Line

Dorman# 625-191 OE# 15149877

Make: GMC

Years: 1998-97

Models: C6500/C7500,
V8 - 6.0L (366 CID); C6500/
C7500, V8 - 7.4L (454 CID);
C6500/C7500, V8- 7.0L (427 CID)



Oil Cooler Line

Dorman# 625-192 OE# 15022583

Make: GMC

Years: 1998-97

Models: C6500/C7500,
V8 - 6.0L (366 CID);
C6500/C7500, V8- 7.0L (427 CID)



Oil Cooler Line

Dorman# 625-195 OE# 15706746

Make: GMC

Years: 2000-99

Models: C6500/C7500, School Bus, V8-7.4L;
School Bus, V8-6.0L & V8-7.0L;
C6500/C7500, V8-6.0L & V8-7.0L;
Delivery Truck, V8-6.0L & V8-7.0L



Oil Cooler Line

Dorman# 625-196 OE# 15706745

Make: GMC

Years: 2000-96

Models: C6500/C7500, V8-7.4L; School Bus,
V8-6.0L & V8-7.0L; C6500/C7500,
V8-6.0L & V8-7.0L; Delivery Truck,
V8-6.0L & V8-7.0L



Oil Cooler Line

Dorman# 625-193 OE# 15149878

Make: GMC

Years: 1998-97

Models: C6500/C7500;
V8 - 6.0L (366 CID),
V8- 7.0L (427 CID)



Oil Cooler Line

Dorman# 625-194 OE# 15028506

Make: GMC

Years: 1998-97

Models: C6500/C7500; V8 - 6.0L (366
CID), V8- 7.0L (427 CID)

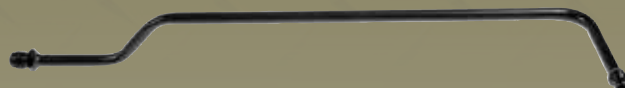

Oil Cooler Line Connector

Dorman# 800-707 OE# 15170197
15797464

Make: GMC

Years: 2007-03

Models: C3500, C4500, C5500

Notes: Transmission cooler line to radiator



Power Steering Pump Pulley

Dorman# 300-120 OE# 2477954

Make: GMC

Years: 2000-81

Models: Chevrolet/GMC Truck; 2000-83
School Bus, Steel Conventional; 96-
81 Topkick, Kodiak, forward control



Fuel Senders, Fuel and Emissions

Envíos de combustible, combustible y emisiones

You hear about it every day. It's the same old story. The cost of fuel is rising and proper fuel management is becoming more important than ever. You more than likely take the appropriate steps to make sure that you are conserving as much fuel as possible. You go to extreme lengths to make sure you aren't wasting money. Nothing could be worse than going to these lengths only to find out that your fuel sender isn't displaying an accurate fuel level.

In researching the Dorman HD Solutions fuel senders, our product team reached out to technicians and repair shops in an effort to develop comprehensive solutions to common problems associated with faulty fuel senders. As a result, we provide a complete offering of part alternatives to failure prone fuel level senders. These senders are sold as a kit and each includes the gasket needed for a complete repair. This comprehensive solution helps you to cut down on product cost and repair time.

Los remitentes de combustible se encuentran dentro del tanque de combustible y constantemente están sumergidos en el combustible. Con el tiempo, la exposición a este entorno puede causar daños a las unidades. El combustible puede hacerse gelatina (gel) y se adhieren a distintas zonas del remitente, causando lecturas inexactas o un brazo de nivel incautado. También, los aditivos del combustible pueden ser desgastados fuera del material del remitente, causando patrones similares de fracaso.

Como el costo del combustible sigue aumentando, preocuparse por el combustible es cada vez más importante que nunca. Sin embargo, es difícil vigilar adecuadamente la eficiencia del combustible sin obtener una lectura del nivel de combustible precisa. Lecturas del nivel de combustible falso pueden resultar en pérdida de tiempo y gastos innecesarios.



OE NUMBERS
CAN TYPICALLY
BE FOUND ON THE
MOUNTING PLATES
OR SHAFT OF
FUEL SENDERS



Fuel Sender

Dorman# 285-5203 OE# A22-42390-005

Make: Freightliner

Years: 1999-94

Models: Classic, FL, FLD Series



Fuel Sender

Dorman# 285-5101 OE# 2585993C91

Make: International

Years: 2011-01

Models: 3200 Bus Chassis, 4100, 4200, 4300, 4400, 5500i, 5600i, Severe Service, 7300, 7400, 7500, 7600, Severe Service



Fuel Sender

Dorman# 285-5103 OE# 3596382C92

Make: International

Years: 2011-96

Models: 9400 premium Conventional., 9800 Premium Cab Over Engine, 9900 Premium Conventional

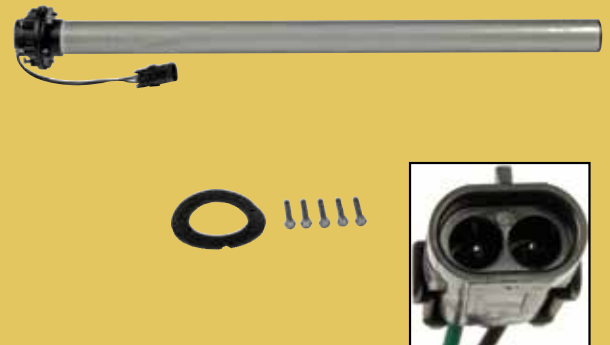

Fuel Sender

Dorman# 285-5104 OE# 476846C2

Make: International

Years: 2011-97

Models: 1400, 1600, Stripped Chassis, 1652, UPS Chassis, 2500, 2600, 3000, 3400, 3600, 3700, 3800, 3900, Bus Chassis, 4500, 4600, 4700, 4800, 4900, 5000 Severe Service, 7100, 8100 Heavy Tractor.

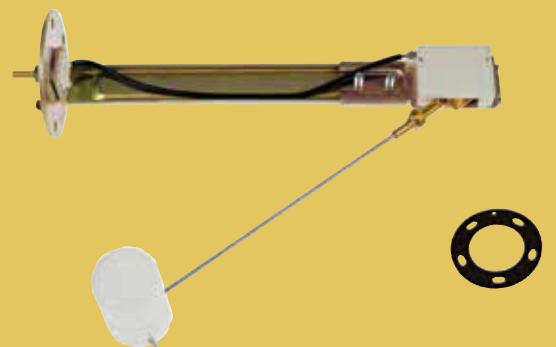

Fuel Senders, Fuel and Emissions

Envíos de combustible, combustible y emisiones



Fuel Sender

Dorman# 285-5105 **OE#** 497840C96

Make: International

Years: 1991-85

Models: All International models

Notes: 100 & 50 Gallon 23" Tanks, 50 60 70 and 90 Gallon 26" Tanks



Fuel Sender

Dorman# 285-5404 **OE#** Q21-1024-622

Make: Kenworth

Years: 2011-87

Models: All Kenworths with a fuel tank sender for 24.5 diameter fuel tank

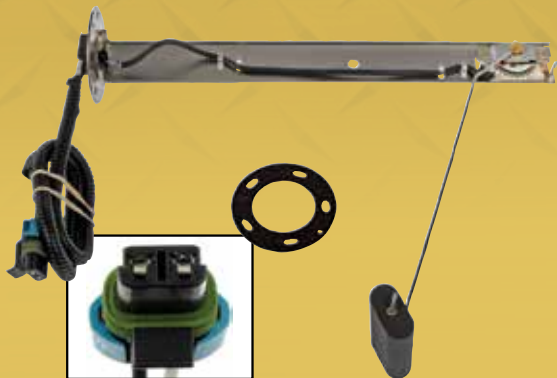

Fuel Sender

Dorman# 285-5405 **OE#** Q21-1024-559

Make: Kenworth

Years: 2011-87

Models: All Kenworths with a fuel tank sender for 22.5 diameter fuel tank



Fuel Sender

Dorman# 285-5406 **OE#** Q21-1043-622

Make: Kenworth

Years: 2011-87

Models: All Kenworths with a fuel tank sender for 24.5 diameter fuel tank

Fuel Sender

Dorman# 285-5501 OE# 20506805

Make: Mack
Years: 2011-07
Models: GU, CTP, CT



Fuel Sender

Dorman# 285-5502 OE# 25172994

Make: Mack
Years: 2003
Models: CV



Fuel Sender

Dorman# 285-5503 OE# 16MB48DP13

Make: Mack
Years: 2003-91
Models: DM, MR Models Rectangle Tank



Fuel Sender

Dorman# 285-5504 OE# 25172995

Make: Mack
Years: 2004-02
Models: CV



Fuel Senders, Fuel and Emissions

Envíos de combustible, combustible y emisiones



Fuel Sender

Dorman# 285-5505 **OE#** 16MB48DP29

Make: Mack
Years: 2010-08
Models: CH,CX



Fuel Sender

Dorman# 285-5506 **OE#** 25101400

Make: Mack
Years: 2003-95
Models: CH,CX

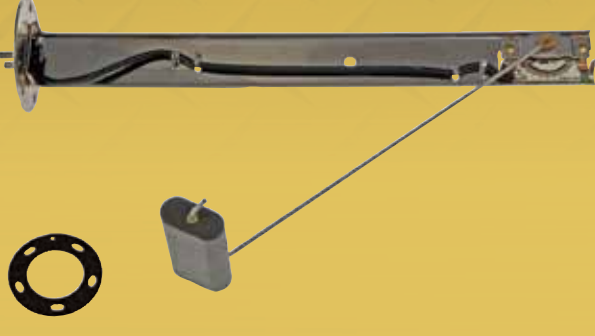

Fuel Sender

Dorman# 285-5507 **OE#** 25195325

Make: Mack
Years: 2009-89
Models: RD

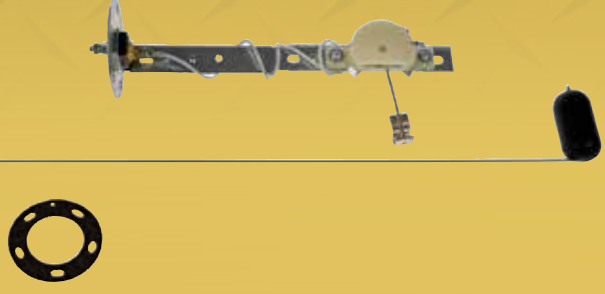

Fuel Sender

Dorman# 285-5508 **OE#** 8609-NC2759

Make: Mack
Years: 2011-95
Models: Universal Fit

Fuel Sender

Dorman# 285-5401 OE# K21-6001-661

Make: Peterbilt

Years: 2011-87

Models: All Peterbilt models

Notes: With a 26" diameter fuel tank



Fuel Sender

Dorman# 285-5402 OE# K21-6001-585

Make: Peterbilt

Years: 2011-87

Models: All Peterbilt models

Notes: With a 23" diameter fuel tank



Fuel Sender

Dorman# 285-5403 OE# 391PLP

Make: Peterbilt & Kenworth

Years: 2011-87

Models: All Models

Notes: Universal Fit

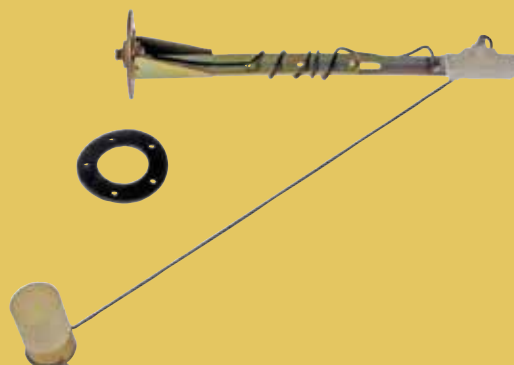

Fuel Sender

Dorman# 285-5509 OE# 3092993

Make: Volvo

Years: 2009-90

Models: WA, WG, WX

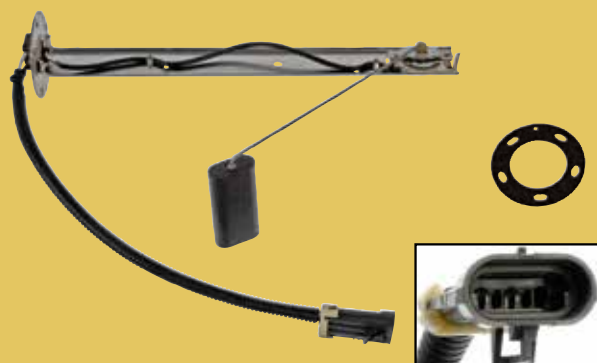

Fuel Senders, Fuel and Emissions

Envíos de combustible, combustible y emisiones



DEF Cap

Dorman# 904-5701 OE# 52122496AD

Make: Dodge

Years: 2012-10

Models: All Medium and Heavy Duty Trucks



DEF Cap

Dorman# 904-5301 OE# AU5Z5K204A

Make: Ford

Years: 2012-10

Models: All Light and Medium Duty Trucks



DEF Cap

Dorman# 904-5201 OE# 04-27757-000

Make: Freightliner

Years: 2012-10

Models: All Medium and Heavy Duty Trucks



DEF Cap

Dorman# 904-5601 OE# 22753134

Make: GM

Years: 2012-10

Models: All Light and Medium Duty Trucks

DEF Cap

Dorman# 904-5401 OE# 908-0223-01

Make: Kenworth
Years: 2012-10
Models: All Trucks



DEF Cap

Dorman# 904-5501 OE# 21148728

Make: Mack
Years: 2012-10
Models: All Trucks
Notes: Non-Locking Tanks
(Mack and Volvo)



DEF Cap

Dorman# 904-5401 OE# 908-0223-01

Make: Peterbilt
Years: 2012-10
Models: All Trucks



DEF Cap

Dorman# 904-5502 OE# 21148725

Make: Volvo
Years: 2012-10
Models: All Trucks
Notes: Locking Tanks
(Mack and Volvo)





SOLUTIONS

A Better Alternative to the OE Dealer

Dorman offers Formerly “Dealer Only” Parts to the Heavy Duty Aftermarket

Customers benefit from the added value of the products offered through the Dorman HD Solutions™ program:

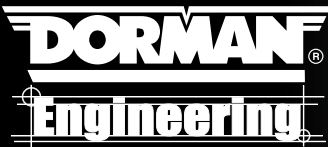

Dorman parts are often redesigned to provide a more reliable parts solution. Through the collection and examination of failed OE parts our engineers are able to determine how and why parts fail. Even more importantly, they are able to redesign parts with a focus on reducing (or eliminating) common failure patterns. Better designs and better materials result in more reliable parts you can take advantage of.



Many Dorman parts are offered as Complete Kits. With an eye towards saving you time and money, Dorman’s product teams solicit feedback from technicians and field professionals to properly understand everything that is required for a complete repair for some specific parts. The input Dorman collects from professionals with firsthand experience is then leveraged into the development of Dorman Complete Kits – parts that provide you with everything needed to complete the job. One phone call, one part number – saves you money and cuts down on repair time.

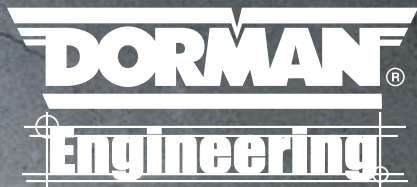

IMPROVED PARTS FOR BETTER RELIABILITY

Hood Cable

Our heavier gauge cable is designed with upgraded materials, increasing strength and reliability.

Dorman #
924-5402



Original Hood Cable

Fluid Reservoir

Our transparent bottle makes the need for a sight gauge obsolete, thereby eliminating two possible leak points.

Dorman #
603-5602



Original Fluid Reservoir



INCLUDES EVERYTHING NEEDED FOR A COMPLETE REPAIR

Door Check

One Dorman kit saves time and money by providing four parts that the Dealer offers only separately.



Dorman # 924-5401 (Includes All Parts Shown)

Headlights and Lighting

Faros e iluminación

Nothing ruins the appearance of a stunning truck like a faded or broken headlight. You work hard to keep your rig looking great. In an instant, a collision or debris kicked up from the road can ruin that image. Headlights also wear over time and leave you with that yellowish tint that we have all seen before. You never want to see these situations happen but, unfortunately, they are inevitable.

With new CSA regulations in place, the stakes have never been higher. Drivers are at risk of having their licenses suspended if they fail to comply with these regulations. You can no longer afford to put off the replacement of a headlight. The next time you find yourself in this situation, rest assured that Dorman will be your source for application-specific headlights.

Los faros pueden sustituirse por una variedad de razones diferentes. Quizás las razones más evidentes para sustituir los faros son las colisiones. Es prácticamente inevitable que con el tiempo un camión esté involucrado en un accidente, y los faros tendrán que ser sustituido inmediatamente.

Los faros también pueden desgastarse con el tiempo. Los materiales del lente con el cual se construyen los faros pueden desgastarse, causando la emisión un tinte amarillento opaco al rayo de luz. Reglamentaciones nuevas del CSA amenazan con poner faltas a la licencia del conductor, así que deben cambiarse las luces desgastadas y opacas sin ninguna demora.



OE NUMBERS CAN
TYPICALLY BE FOUND
ON THE BACKSIDE
OF HEADLIGHT
ASSEMBLIES



Headlight Right

Dorman# 888-5101 OE# 3605817C92

Make: International

Years: 2011-09

Models: WorkStar



Headlight Left

Dorman# 888-5102 OE# 3605816C92

Make: International

Years: 2011-09

Models: WorkStar



Headlight Right

Dorman# 888-5103 OE# 3502929C94

Make: International

Years: 2008-94

Models: 5900, 9200



Headlight Left

Dorman# 888-5104 OE# 3502928C94

Make: International

Years: 2008-94

Models: 5900, 9200





Headlight Right

Dorman# 888-5105 **OE#** 3574388C91

Make: International

Years: 2011-08

Models: 4000, 7000, 8500, and RXT



Headlight Left

Dorman# 888-5106 **OE#** 3574387C91

Make: International

Years: 2011-08

Models: 4000, 7000, 8500, and RXT



Fog Light

Dorman# 924-5201 **OE#** A06-75742-000

Make: Freightliner

Years: 2010-04

Models: Columbia



Headlight Screw

Dorman# 924-5104 **OE#** 500565C91

Make: International

Years: 2005-84

Models: 9400, S-Series, Prostar and 9670

Headlight Switch

Dorman# 901-5206 OE# A06-30769-010

Make: Freightliner

Years: 2011-01

Models: Columbia



**BE THE FIRST
TO KNOW!** 

ABOUT FORMERLY "DEALER ONLY" PARTS

Sign up for Dorman HD Solutions
Be the First to Know Program

Receive the latest New Product
Releases for all of our Formerly
"Dealer Only" Parts.

- Get New Product Emails
- Learn More About
Formerly Dealer
Only Parts

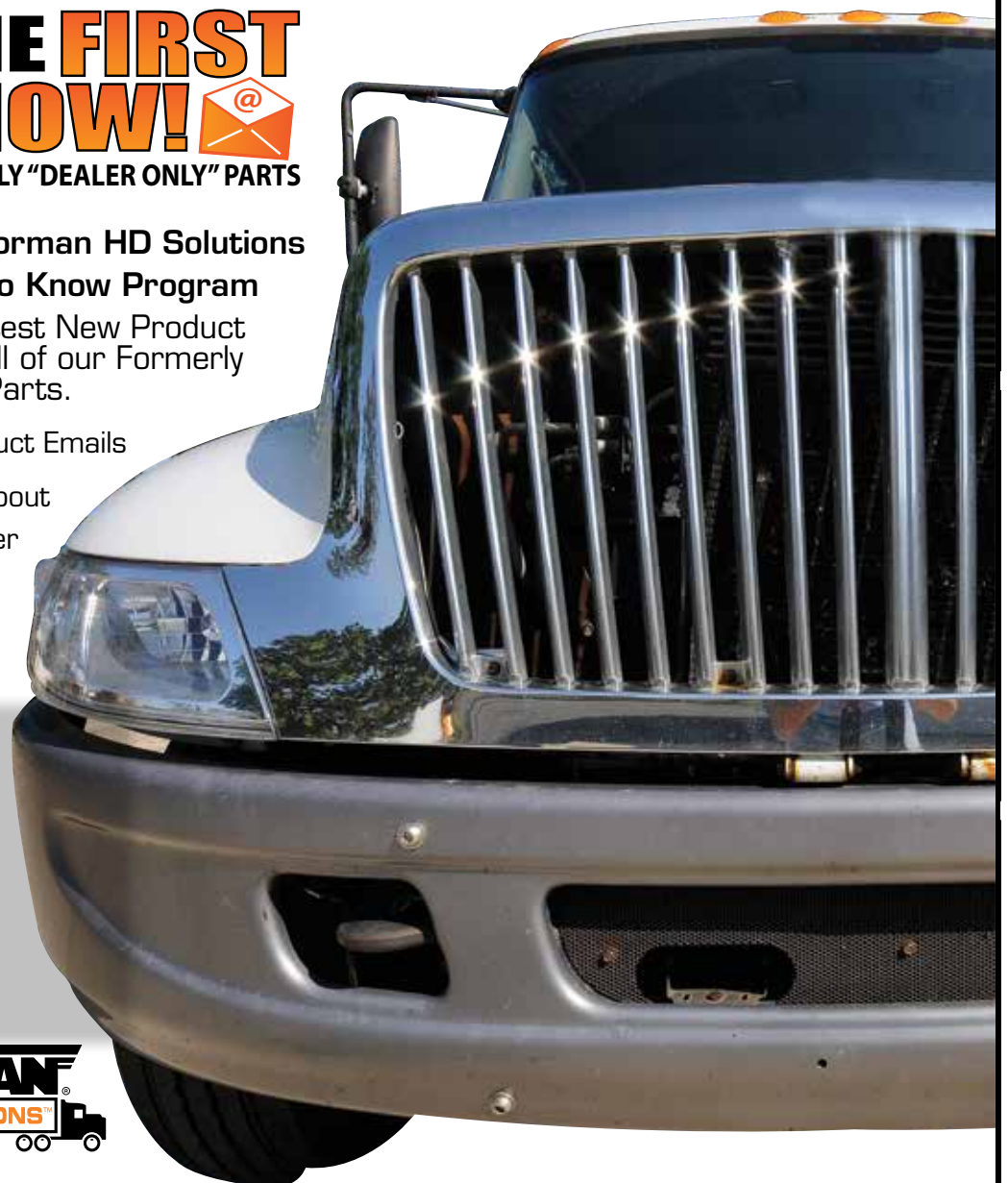

Hood Springs, Latches and Components

Resortes del capó, cierres y componentes

It seems that any time you open the hood of a truck you see nothing but rust on the components that actually hold that hood in place! When you think about the weight associated with the hood of a truck it is shocking that the hood components expected to support this load are often found in such deteriorating condition. Aside from exposure to contaminants, excessive engine heat and vibration – the parts also suffer from poor designs!

Dorman has been able to identify and develop a complete line of alternatives for these failure prone components. By hitting the streets and examining both fleet and salvage vehicles, our engineers have identified the most sought out hood components and made them more reliable. Materials have been improved from low-grade metals to high quality stainless steel and many components are offered as complete kits containing everything you will need to complete the job.

Los Resortes del capó se encuentran bajo el capó del camión, donde nada protege contra la exposición del aire húmedo y las condiciones climáticas difíciles. Como muchas otras piezas, los resortes del capó son vulnerables a óxido y la corrosión, que hace que se debiliten. Como el capó de un camión es muy pesado, un resorte debilitado puede fácilmente soltarse y romperse.

El capó típicamente es sostenido por una serie de resortes. Si uno de los resortes falla, por excesivo peso los demás resortes potencialmente podrían provocar un fallo también.

La exposición extendida a temperaturas frías también puede ser perjudicial para los resortes del capó, causando que sean frágiles y se debiliten. Como los resortes deben expandirse para acomodar el peso del capó cuando esté abierto, los efectos perjudiciales del clima frío pueden hacerlos más susceptibles a soltarse y romperse.



OE NUMBERS CAN
TYPICALLY BE FOUND
PRINTED ON THE
SURFACE OF HOOD
LATCHES OR ON THE
MOUNTING BRACKETS

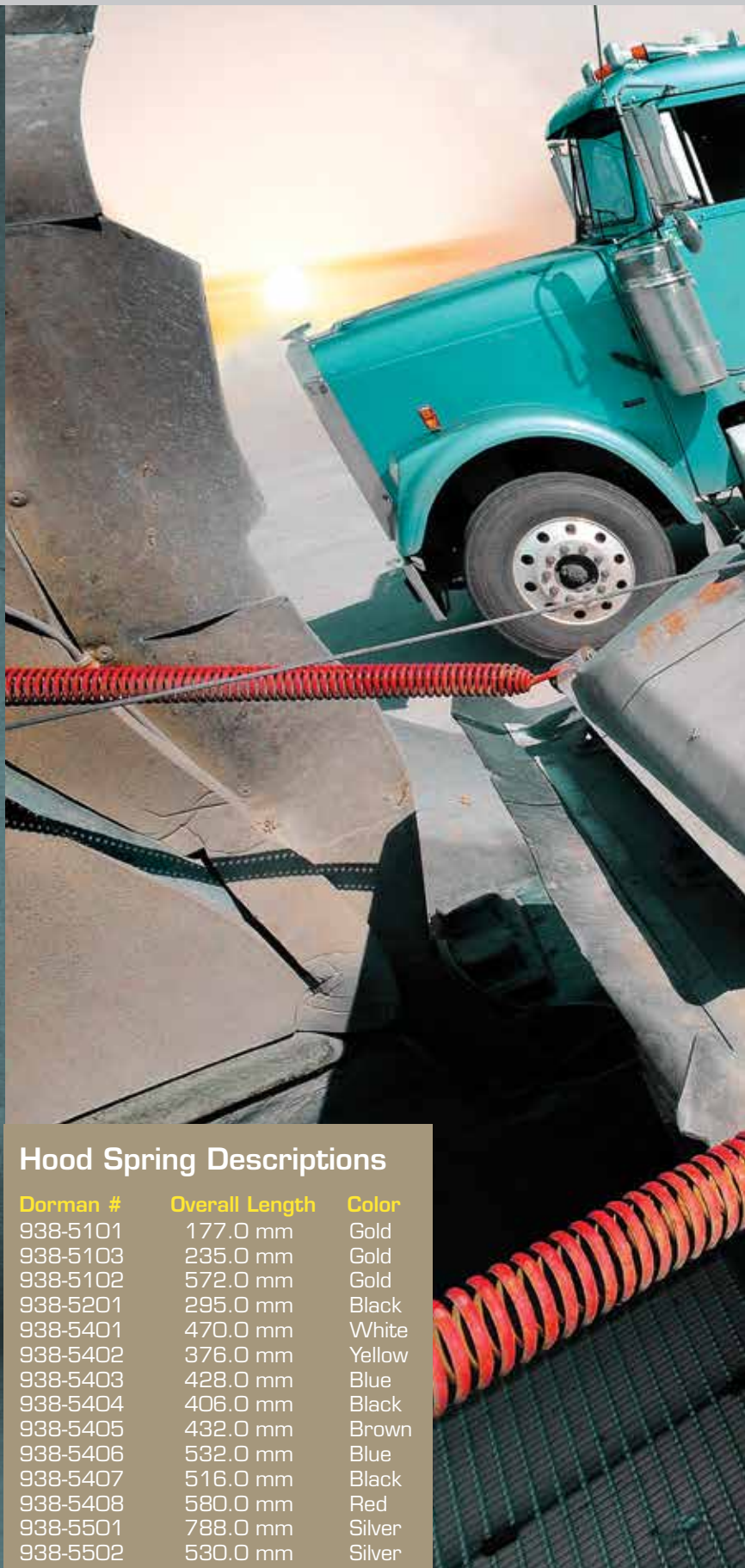

Hood Spring Descriptions

Dorman #	Overall Length	Color
938-5101	177.0 mm	Gold
938-5103	235.0 mm	Gold
938-5102	572.0 mm	Gold
938-5201	295.0 mm	Black
938-5401	470.0 mm	White
938-5402	376.0 mm	Yellow
938-5403	428.0 mm	Blue
938-5404	406.0 mm	Black
938-5405	432.0 mm	Brown
938-5406	532.0 mm	Blue
938-5407	516.0 mm	Black
938-5408	580.0 mm	Red
938-5501	788.0 mm	Silver
938-5502	530.0 mm	Silver

Hood Spring

Dorman# 938-5201 OE# 17-12069-001

Make: Freightliner

Years: 2005-89

Models: FLD/FLC, Classic models

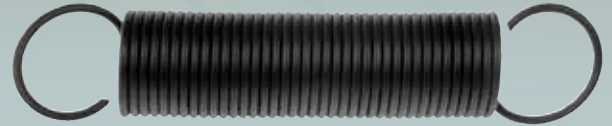

Hood Spring

Dorman# 938-5101 OE# 1675762C3

Make: International

Years: 2001-89

Models: S-model, 3000 series bus,
4000 series



Hood Spring

Dorman# 938-5102 OE# 3588532C2

Make: International

Years: 2011-86

Models: 2000, 8000, 9000 series



Hood Spring

Dorman# 938-5103 OE# 598574C3

Make: International

Years: 2010-96

Models: 9200 and 9400 only



Hood Springs, Latches and Components

Resortes del capó, cierres y componentes



Hood Spring

Dorman# 938-5401 **OE#** L71-1002

Make: Kenworth

Years: 2011-99

Models: W900L w/ Fiberglass hood



Hood Spring

Dorman# 938-5402 **OE#** K224-95

Make: Kenworth

Years: 2003-98

Models: T400, T450, T800



Hood Spring

Dorman# 938-5403 **OE#** K224-86

Make: Kenworth

Years: 2006-98

Models: C500B, T800, W900B



Hood Spring

Dorman# 938-5404 **OE#** K224-35

Make: Kenworth

Years: 2006-98

Models: C500, W900B

Hood Spring

Dorman# 938-5405 OE# L71-1004

Make: Kenworth

Years: 2011-99

Models: W900L w/ Metton hood



Hood Spring

Dorman# 938-5408 OE# K224-81

Make: Kenworth

Years: 2006-98

Models: T600, T800, W900



Hood Spring

Dorman# 938-5501 OE# 25171284

Make: Mack

Years: 2011-99

Models: Vision, CX models inc CXP



Hood Spring

Dorman# 938-5502 OE# 25158019

Make: Mack

Years: 2011-99

Models: CH models, CV models



Hood Springs, Latches and Components

Resortes del capó, cierres y componentes



Hood Spring

Dorman# 938-5406 **OE#** 13-04638

Make: Peterbilt

Years: 2008-87

Models: 357, 377, 379 with 119"
(long hood)



Hood Spring

Dorman# 938-5407 **OE#** 13-03569

Make: Peterbilt

Years: 2008-87

Models: 357, 378, 377, 379, with 127"
(short hood)



Hood Latch Kit Right/Left

Dorman# 315-5201 **OE#** 17-12438-000

Make: Freightliner

Years: 2009-97

Models: FLD 120, Classic

Notes: Straight Front Axle

Kits Include Latch, Mounting Brackets and Hardware.

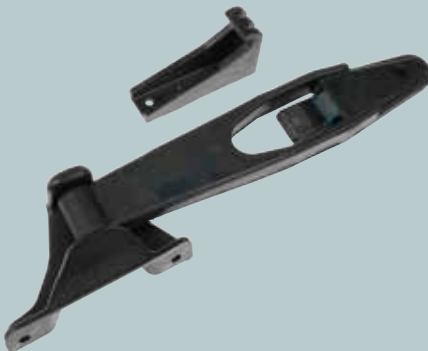

Hood Latch Kit Right

Dorman# 315-5202 **OE#** A17-15553-001

Make: Freightliner

Years: 2008-95

Models: Columbia

Kits Include Latch, Mounting Brackets and Hardware.

Hood Springs, Latches and Components

Resortes del capó, cierres y componentes

Hood Latch Kit Left

Dorman# 315-5203 **OE#** A17-15553-000

Make: Freightliner

Years: 2008-95

Models: Columbia



Kits Include Latch, Mounting Brackets and Hardware.

Hood Latch Kit Right

Dorman# 315-5204 **OE#** 17-12435-001

Make: Freightliner

Years: 2009-97

Models: FLD 120, Classic

Notes: Offset Axle



Kits Include Latch, Mounting Brackets and Hardware.

Hood Latch Kit Left

Dorman# 315-5205 **OE#** 17-12435-000

Make: Freightliner

Years: 2008-01

Models: 2009-97

Notes: Offset Axle



Kits Include Latch, Mounting Brackets and Hardware.

Hood Latch Kit Right/Left

Dorman# 315-5101 **OE#** 499523C3 (Latch Only),
1699929C9

Make: International

Years: 2011-79

Models: 1000, 2000, 4000, 7000, 8000,
9000 and S-Series



Kits Include Latch, Mounting Brackets and Hardware.

Hood Springs, Latches and Components

Resortes del capó, cierres y componentes



Hood Latch Kit Right/Left

Dorman# 315-5401 **OE#** L56-0001

Make: Kenworth

Years: 2011-87

Models: W900, T600, T300, T800

Kits Include Latch, Mounting Brackets and Hardware.



Hood Latch Kit Right/Left

Dorman# 315-5402 **OE#** K147-107

Make: Kenworth

Years: 2005-87

Models: Models W900B, T600A

Notes: 1987-85 T800

Kits Include Latch, Mounting Brackets and Hardware.

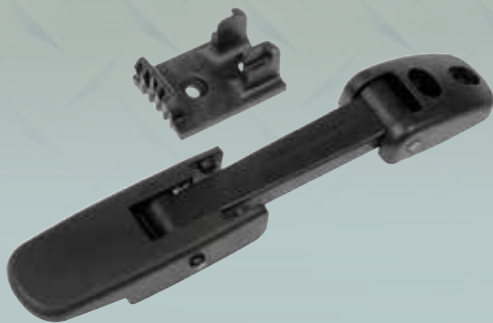

Hood Latch Kit Right

Dorman# 315-5502 **OE#** 25169065

Make: Mack

Years: 2011-01

Models: CH, CHN, CXN, CV

Notes: From 05/09/01

Kits Include Latch, Mounting Brackets and Hardware.



Hood Latch Kit Left

Dorman# 315-5503 **OE#** 25159428

Make: Mack

Years: 2011-02

Models: CH, CHN, CXN, CV

Notes: From 05/09/01

Kits Include Latch, Mounting Brackets and Hardware.

Hood Springs, Latches and Components

Resortes del capó, cierres y componentes

Hood Latch Kit Right/Left

Dorman# 315-5401 **OE#** L56-0001 (Latch Only),
23-13857 (Kit)

Make: Peterbilt

Years: 2011-87

Models: 357, 359, 367, 377, 378, 379,
388, 389



Kits Include Latch, Mounting Brackets and Hardware.

Hood Latch Kit Right/Left

Dorman# 315-5501 **OE#** 8174018

Make: Volvo

Years: 2002-91

Models: AC, WA, WC, WG, WI



Kits Include Latch, Mounting Brackets and Hardware.

Hood Cable

Dorman# 924-5206 **OE#** A17-12082-000

Make: Freightliner

Years: 2005-89

Models: FLD, FLC, Classic models

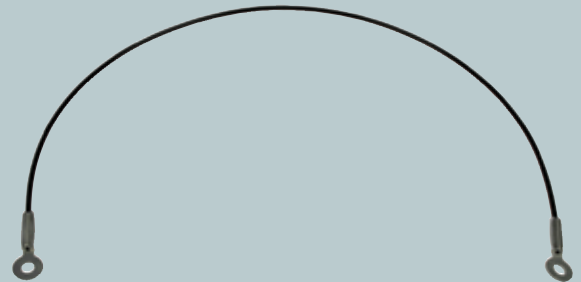

Hood Cable

Dorman# 924-5207 **OE#** A17-12081-000

Make: Freightliner

Years: 2005-89

Models: FLD, FLC, Classic models



Hood Springs, Latches and Components

Resortes del capó, cierres y componentes

Hood Cable



Dorman# 924-5501 **OE#** 25152850

Make: Mack

Years: 1995-90

Models: CH models with Axle Forward

Hood Cable



Dorman# 924-5502 **OE#** 25171452

Make: Mack

Years: 2003-90

Models: RD models

Hood Cable



Dorman# 924-5402 **OE#** L92-6000-0718

Make: Peterbilt

Years: 2005-87

Models: 357, 367, 375, 377, 378, 379

Notes: Improved Design With Heavier Cable Gauge And Upgraded Materials

Left



Right



Hood Rest

Dorman# 924-5203(R) **OE#** A17-13787-003
924-5202(L) A17-13787-002

Make: Freightliner

Years: 2008-01

Models: Columbia

Now It's Faster & Easier to Find the Parts You Need



powered by 

SEARCH ENHANCEMENTS:

✓ Synonyms / Aliases



✓ Auto-Complete

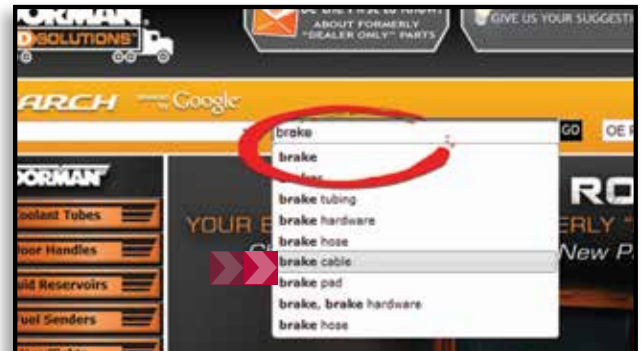

✓ Vehicle Application Search with keyword

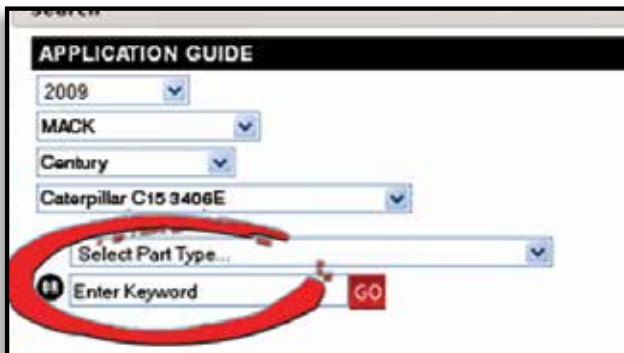

✓ Spelling suggestions enhancement



Speed Sensors and Tachometer Sensors

Sensores de velocidad y sensores de tacómetro

Speed sensors and tachometer sensors are responsible for reading important information regarding the performance of your truck. Unfortunately, these sensors are not always engineered to handle these tasks. The parts are constantly stressed due to their location. Plastic material is often used to create these parts which can become brittle and wear from the extreme temperatures and road debris that constantly bombard them.

Our focus in developing alternatives for speed and tachometer sensors centers on overcoming these common failure patterns. After investing resources examining faulty sensors with an eye towards alternative designs, our parts were developed using a magnetic sensor made from a stronger aluminum material. This improvement eliminates many of the problems associated with plastic sensors. With the Dorman HD Solutions sensors, you are left with a more dependable part and a more dependable truck.

Los sensores de velocidad y tacómetro están bajo constante presión debido a su ubicación. La exposición a los elementos amenaza la longevidad de estas piezas: el calor y frío extremo pueden desgastar los materiales de los cual están contruidos los sensores. Por otra parte, el agua de la carretera puede salpicar en ellos y potencialmente congelar en hielo, haciendo la función magnética funcione pobremente y posiblemente se desgaste en tamaño. Incluso los desechos levantados desde la carretera durante la operación del vehículo pueden dañar los sensores. Cualquiera que sea la causa, con el tiempo, la parte puede dañarse, causando información inexacta para el conductor del camión.



Speed Sensor

Dorman# 505-5201 OE# SAA85920008

Make: Freightliner

Years: 2011-89

Models: All Freightliner models

Notes: A screw in speed sensor with a Merritor transmission with an internal tone ring



Speed Sensor

Dorman# 505-5104 OE# 2503117C1

Make: International

Years: 1998-90

Models: 9600, 9700

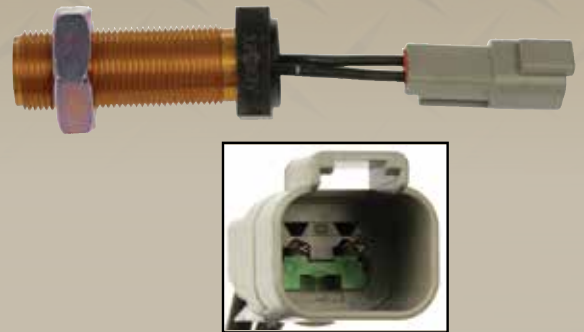

Speed Sensor

Dorman# 505-5105 OE# 3528003C1

Make: International

Years: 2007-97

Models: 1000, 4000, 5000, 7000, 8000, and 9000 series

Notes: Built after May 1997 and later

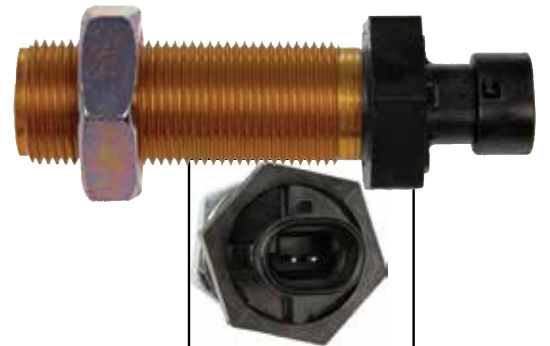

Speed Sensor

Dorman# 505-5505 OE# 25166488

Make: Mack

Years: 2010-89

Models: All Mack models

Notes: Screw in sensor with Eaton Transmission



Speed Sensors and Tachometer Sensors

Sensores de velocidad y sensores de tacómetro



Speed Sensor

Dorman# 505-5512 OE# 20706327

Make: Mack

Years: 2011-97

Models: All Mack models

Notes: Push in sensor in timing cover or bell housing



Speed Sensor

Dorman# 505-5510 OE# 8029939

Make: Volvo

Years: 2011-89

Models: All Volvo models

Notes: Detroit Diesel



Tachometer Sensor

Dorman# 505-5501 OE# 64MT2105M

Make: Mack

Years: 1995-87

Models: RD, CH Models

Notes: Mack engine

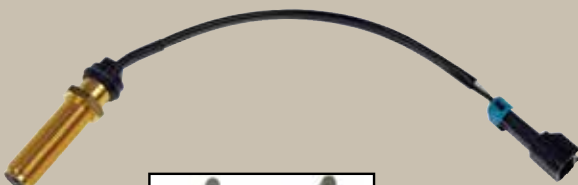

Tachometer Sensor

Dorman# 505-5504 OE# 64MT435

Make: Mack

Years: 2001-90

Models: CH, MR models

Notes: Magnum 430HP

Tachometer Sensor

Dorman# 505-5506 OE# 64MT440M

Make: Mack

Years: 2010-89

Models: RD, CH Models

Notes: All except Magnum 430HP



Tachometer Sensor

Dorman# 505-5511 OE# 8078108

Make: Volvo

Years: 2011-89

Models: All Volvo models

Notes: Detroit Diesel



Tachometer & Speed Sensor

Dorman# 505-5406 OE# Q21-6005

Make: Kenworth

Years: 2011-95

Models: All Kenworth models

Notes: Eaton trans with internal tone ring, mounts in tailshaft

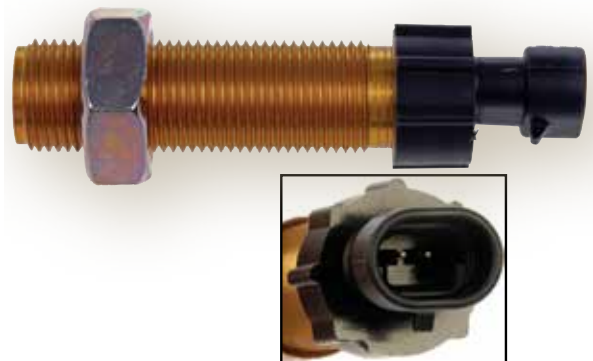

Tachometer & Speed Sensor

Dorman# 505-5407 OE# K3454

Make: Kenworth

Years: 2011-95

Models: All Kenworth models

Notes: Eaton trans that has external tone ring (2 pin connector)



Speed Sensors and Tachometer Sensors

Sensores de velocidad y sensores de tacómetro

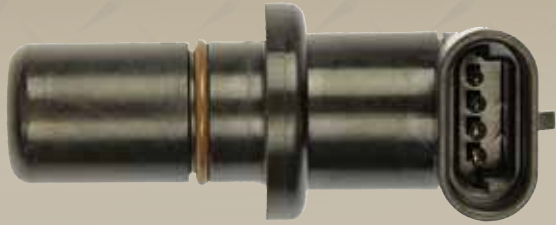

Tachometer & Speed Sensor

Dorman# 505-5408 **OE#** K3455

Make: Kenworth

Years: 2011-95

Models: All Kenworth models

Notes: Eaton trans that has external tone ring (4 pin connector)



Tachometer & Speed Sensor

Dorman# 505-5507 **OE#** 64MT412M

Make: Mack

Years: 1990-67

Models: RD, CH, MR, DM models



Tachometer & Speed Sensor

Dorman# 505-5406 **OE#** Q21-6005

Make: Peterbilt

Years: 2011-95

Models: All Peterbilt models

Notes: Eaton trans with internal tone ring, mounts in tailshaft



Tachometer & Speed Sensor

Dorman# 505-5407 **OE#** K3454

Make: Peterbilt

Years: 2011-95

Models: All Peterbilt models

Notes: Eaton trans that has external tone ring (2 pin connector)

Tachometer & Speed Sensor

Dorman# 505-5408 **OE#** K3455

Make: Peterbilt

Years: 2011-95

Models: All Peterbilt models

Notes: Eaton trans that has external tone ring (4 pin connector)

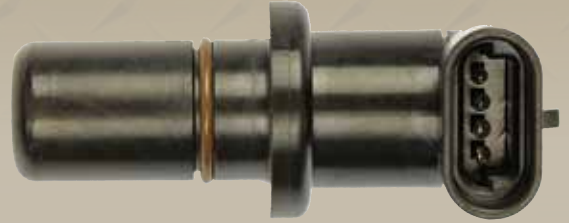

4WD Transfer Case Motor

Dorman# 600-909 **OE#** 88962312

Make: GMC

Years: 2008-05

Models: C4500, C5500 Series



Window Regulators and Window Parts

Reguladores de ventana y partes para la ventana

There is no feeling quite like it. The sky is blue, the sun is shining, and you have your arm rested on your door with the wind in your hair. It is an amazing feeling. Nothing should prevent a driver from being able to experience this sense of freedom. Unfortunately, a damaged window regulator will do just that.

You roll your window down for a variety of reasons: paying tolls, smoking, enjoying the weather, communicating with people and any number of other reasons. Losing the ability to simply operate the window normally can make your drive uncomfortable. Poor design and low quality materials are often contributing factors when dealing with broken regulators. Through the collection of these failed samples and rigorous cycle testing done in our state-of-the-art laboratory Dorman has developed window regulators that meet the needs of the only person that matters... you.

Los reguladores de la ventana comúnmente fallan debido a la frecuencia con que se utilizan las piezas. El conductor baja sus ventanas por diferentes razones: fumar, pagar peajes, disfrutando del clima, comunicarse con personas, etc. Su funcionamiento regular hace que esta pieza se desgaste en una cantidad considerable.

Los reguladores de la ventana manual tienen los dientes del engranaje que permiten a la ventana para subir o bajar. Estos dientes pueden desgastarse con el tiempo y eventualmente causar que el regulador brinque o deje de funcionar completamente.

Los reguladores de la ventana con motores de potencia también suelen fallar. Con el tiempo, los cables que suben y bajan la ventana pueden debilitarse y soltarse, y pueden desgastar los dientes del engranaje del motor del interfaz con el regulador. Con cualquiera de estos acontecimientos va a necesitar reemplazar la pieza.



OE NUMBERS CAN
TYPICALLY BE FOUND
STAMPED ON THE
MOUNTING BRACKETS
OR BODY OF WINDOW
REGULATORS



Window Regulator, Manual

Front Right

Dorman# 740-652 **OE#** E7TZ 1523200-A

Make: Ford

Years: 1991-80

Models: F350, F450, F550, F650,
F750, F800



Window Regulator, Manual

Front Left

Dorman# 740-653 **OE#** E7TZ 1523201-A

Make: Ford

Years: 1991-80

Models: F350, F450, F550, F650,
F750, F800

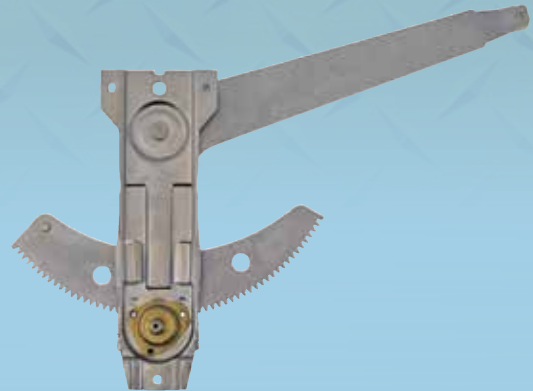

Window Regulator, Manual

Front Left

Dorman# 749-075 **OE#** 22071951

Make: GMC

Years: 2002-90

Models: Kodiak/Topkick 4500, 5500



Window Regulator, Manual

Front Right

Dorman# 749-076 **OE#** 22071950

Make: GMC

Years: 2002-90

Models: Kodiak/Topkick 4500, 5500



Window Regulators and Window Parts

Reguladores de ventana y partes para la ventana



Window Regulator, Manual

Front Right

Dorman# 740-5103 **OE#** 1686705C91

Make: International

Years: 2005-84

Models: S-Series and 4000 Series

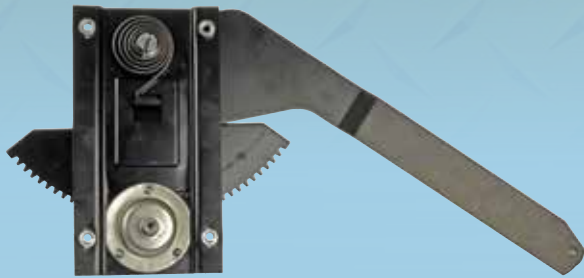

Window Regulator, Manual

Front Left

Dorman# 740-5104 **OE#** 1686704C91

Make: International

Years: 2005-84

Models: S-Series and 4000 Series



Window Regulator, Manual

Front Left

Dorman# 740-5501 **OE#** 25191027

Make: Mack

Years: 2011-90

Models: MR688S, MR686S



Window Regulator, Manual

Front Right

Dorman# 740-5502 **OE#** 25191633

Make: Mack

Years: 2011-90

Models: MR688S, MR686S

Window Regulator, Manual

Front Left

Dorman# 740-5503 **OE#** 25113357

Make: Mack

Years: 2011-90

Models: MR688S, MR686S



Window Regulator, Manual

Front Right

Dorman# 740-5504 **OE#** 25114490

Make: Mack

Years: 2011-90

Models: MR688S, MR686S



Window Regulator, Manual

Front Left

Dorman# 740-5505 **OE#** 25161668

Make: Mack

Years: 2001-90

Models: RD688S, RD686S



Window Regulator, Manual

Front Right

Dorman# 740-5506 **OE#** 25160158

Make: Mack

Years: 2001-90

Models: RD688S, RD686S



Window Regulators and Window Parts

Reguladores de ventana y partes para la ventana



Window Regulator, Manual

Front Left

Dorman# 740-5507 **OE#** 25169077

Make: Mack

Years: 2002-97

Models: CH613



Window Regulator, Manual

Front Right

Dorman# 740-5508 **OE#** 25169076

Make: Mack

Years: 2002-97

Models: CH613



Window Regulator, Power

Front Left

Dorman# 748-180 **OE#** 8C3Z2523201C

Make: Ford

Years: 2005-04

Models: Excursion, 2010-04 F-250SD, F-350SD, F-450SD, F-550SD

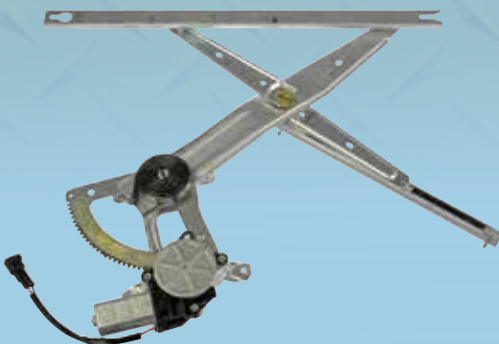

Window Regulator, Power

Front Right

Dorman# 748-181 **OE#** 8C3Z2523200C

Make: Ford

Years: 2005-04

Models: Excursion, 2010-04 F-250SD, F-350SD, F-450SD, F-550SD

Window Regulator, Power

Front Left

Dorman# 748-212 **OE#** 1C3Z2523201BA

Make: Ford

Years: 2003-00

Models: Excursion, F-250SD, F-350SD,
F-450SD, F-550SD

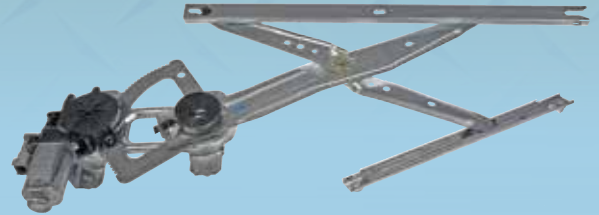

Window Regulator, Power

Front Right

Dorman# 748-213 **OE#** 1C3Z2523200BA

Make: Ford

Years: 2003-00

Models: Excursion, F-250SD, F-350SD,
F-450SD, F-550SD



Window Regulator, Power

Front Right

Dorman# 741-5201 **OE#** A18-48952-001

Make: Freightliner

Years: 2011-90

Models: FLD, FLD Classic



Window Regulator, Power

Front Left

Dorman# 741-5202 **OE#** A18-48952-000

Make: Freightliner

Years: 2011-90

Models: FLD, FLD Classic



Window Regulators and Window Parts

Reguladores de ventana y partes para la ventana

Window Regulator, Power

Front Right

Dorman# 741-5203 **OE#** A18-52044-001

Make: Freightliner

Years: 2011-97

Models: CST112, C112, CST120, C120, Century, Argosy



Window Regulator, Power

Front Left

Dorman# 741-5204 **OE#** A18-52044-000

Make: Freightliner

Years: 2011-97

Models: CST112, C112, CST120, C120, Century, Argosy



Window Regulator, Power

Front Right

Dorman# 741-654 **OE#** 22071948

Make: GMC

Years: 2002-90

Models: Kodiak/Topkick 4500, 5500



Window Regulator, Power

Front Left

Dorman# 741-655 **OE#** 22071949

Make: GMC

Years: 2002-90

Models: Kodiak/Topkick 4500, 5500



Window Regulator, Power

Front Right

Dorman# 741-5101 **OE#** 3515113C92

Make: International

Years: 2011-03

Models: 2000, 3000, 4000, 7000, 8000,
9000 Series



Window Regulator, Power

Front Left

Dorman# 741-5102 **OE#** 3515112C92

Make: International

Years: 2011-03

Models: 2000, 3000, 4000, 7000, 8000,
9000 Series



Window Regulator, Power

Front Left

Dorman# 741-5403 **OE#** R21-1005

Make: Kenworth

Years: 2011-09

Models: W900, T600, T800

Notes: Daylite Door



Window Regulator, Power

Front Right

Dorman# 741-5404 **OE#** R21-1005R

Make: Kenworth

Years: 2011-09

Models: W900, T600, T800

Notes: Daylite Door



Window Regulators and Window Parts

Reguladores de ventana y partes para la ventana

Window Regulator, Power

Front Left

Dorman# 741-5401 **OE#** R21-6011

Make: Peterbilt

Years: 2005-87

Models: 357, 365, 367, 378, 379, 388, 389



Window Regulator, Power

Front Right

Dorman# 741-5402 **OE#** R21-6011R

Make: Peterbilt

Years: 2005-87

Models: 357, 365, 367, 378, 379, 388, 389

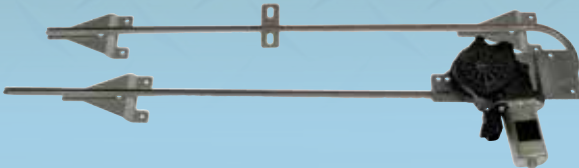

Window Regulator, Power

Front Left

Dorman# 741-5405 **OE#** R21-6013

Make: Peterbilt

Years: 2011-06

Models: 386, 387



Window Regulator, Power

Front Right

Dorman# 741-5406 **OE#** R21-6013R

Make: Peterbilt

Years: 2011-06

Models: 386, 387



Window Lift Motor Kit

Dorman# 742-142	OE# 10414628	21171231
	10414630	21171235
Make: GMC,	10414632	22143945
	15221956	22143947
Years: 2009-03	16630577	22154977
	16630579	22154979
Models: Kodiak/Topkick	21096870	
4500, 5500,	21170781	
6500, 7500,		
8500		



Window Lift Motor Kit

Dorman# 742-143	OE# 10414629	21171230
	10414631	21171234
Make: GMC,	10414633	22063224
	15221951	22143946
Years: 2009-03	16628208	22143948
	16630576	22154978
Models: Kodiak/Topkick	16630578	22154980
4500, 5500,	21096871	
6500, 7500,	21170780	
8500		



Window Switch

Dorman# 901-5204	OE# A06-30769-008
Make: Freightliner	
Years: 2011-01	
Models: Columbia	



Window Switch

Dorman# 901-5205	OE# A06-30769-027
Make: Freightliner	
Years: 2011-01	
Models: Columbia	



Wiper Transmissions and Dash Components

Transmisiones del limpiaparabrisas y componentes para el tablero de instrumentos

Your truck needs to be on the road regardless of the weather conditions. Rain, snow or sleet won't prevent you from making your delivery. When a truck is out in these conditions the vehicle is depending heavily on the windshield wiper system. As you know, nothing is more critical to this system than a solid wiper transmission.

Unfortunately these parts are often developed poorly. Plastic is frequently used as a bushing in the pivot assemblies. This material fatigues quickly and can end up causing the failure of the entire unit. Dorman has developed part alternatives for the wiper transmissions that fail the most regularly. We've taken the time to work with technicians and fleet specialist to determine which units fail and take steps to develop solutions that keep you and your truck running reliably. The next time the weather is worrisome you won't have to worry at all.

Las transmisiones del limpiaparabrisas aguantan mucho desgaste. El plástico que se utiliza como un casquillo en muchos de los enchufes es particularmente sujetas a daños. El plástico se fatiga fácilmente y finalmente fracasa, haciendo que la transmisión del limpiaparabrisas fracase. Si los pivotes son expulsados de la línea al limpiar los desechos en el parabrisas a mano o con unas herramientas, pueden producir efectos similares. Independientemente de la causa, una transmisión dañada debe ser reemplazada inmediatamente.

Los camiones tienen que estar en el camino independientemente de las condiciones meteorológicas. Por lo tanto, es esencial un sistema fiable de limpiaparabrisas, y nada es más importante para este sistema que la transmisión del limpiaparabrisas. Controla las manijas del limpiaparabrisas, ayudando a asegurar que el parabrisas se mantenga claro durante la lluvia, aguanieve y nieve.



Wiper Transmissions and Dash Components

Transmisiones del limpiaparabrisas y componentes para el tablero de instrumentos

Wiper Transmission

Dorman# 602-5601 **OE#** 8-97855-154-0
8-97855-152-0
8-94165-462-1
8-94165-540-0

Make: Isuzu
Years: 2011-95
Models: NPR/NQR



Instrument Cluster Remanufactured

Dorman# 599-5101 **OE#** 3525091C91

Make: International
Years: 2008-97
Models: 3000 Series buses, 4700 and 4900 Medium Duty Trucks
Notes: With a Mechanical Oil Pressure Gauge



Instrument Cluster Remanufactured

Dorman# 599-5102 **OE#** 3595124C2

Make: International
Years: 2008-97
Models: 2500 Series, 3000 Series buses, 4700 and 4900 Medium Duty Trucks, 8100, 8600 Heavy Duty Trucks
Notes: With a Electronic Oil Pressure Gauge



Multi-Function Switch

Dorman# 978-5201 **OE#** A06-36956-002

Make: Freightliner
Years: 2011-02
Models: M2, C2, Cab & Chassis, Business Class Models



Wiper Transmissions and Dash Components

Transmisiones del limpiaparabrisas y componentes para el tablero de instrumentos



Multi-Function Switch

Dorman# 978-5101 **OE#** 2502912C91

Make: International

Years: 2010-96

Models: Series 3000, 4000 Thomas School Buses with International Chassis



Wiper Nozzle Kit

Dorman# 924-5101 **OE#** 1696499C1

Make: International

Years: 2012-01

Models: 3000,4000, 7000, 8000, 9000



Wiper Nozzle Kit

Dorman# 924-5403 **OE#** 106.811

Make: Peterbilt

Years: 2011-87

Models: 330, 335,357, 367, 375, 377, 378, 379, 388, 389

Notes: Kit Includes Three Nozzles

SIGN UP NOW!

**BE THE FIRST
TO KNOW!**



ABOUT FORMERLY "DEALER ONLY" PARTS

- Sign up for The HD Solutions
Be the First to Know Program**
- Get New Product Update Emails or Texts
 - Learn More About The Latest Formerly Dealer Only Parts



Alphabetical Interchange By Part Type

Intercambio alfabético por el tipo de pieza

Part Type	Dorman No.	OE No.	Page No.
A			
Air Door Actuator.....	604-5101	3542606C1	7
B			
Brake Pedal Pad.....	20759	3920296	17
C			
Coolant Level Sensor.....	924-5205	06-62384-002	24
Coolant Tank.....	603-5101	2002105C3	21
Coolant Tank.....	603-5103	2508700C92	22
Coolant Tank.....	603-5201	05-23045-000	21
Coolant Tank.....	603-5202	05-23195-000	21
Coolant Tank.....	603-5403	N5346001	23
Coolant Tank.....	603-5501	25133601	22
Coolant Tank.....	603-5502	25174629	22
Coolant Tank.....	603-5601	15161670	21
Coolant Tank.....	603-5603	8972230122	22
Coolant Tank Cap.....	902-5101	2039390C3	25
Coolant Tank Cap.....	902-5102	3578833C3	25
Coolant Tank Cap.....	902-5201	05-20763-001	24
Coolant Tank Cap.....	902-5202	05-17223-002	25
Coolant Tank Cap.....	902-5402	N5348001	26
Coolant Tank Cap.....	902-5403	R00050	26
Coolant Tank Cap.....	902-5502	5481-9916238	26
Coolant Tank Cap.....	902-5601	15075118	25
Coolant Tank Cap.....	902-5601	15075118	25
Coolant Tube.....	936-5201	A05-16380-003	5
Coolant Tube.....	936-5202	A05-16384-001	5
Coolant Tube.....	936-5401	07-06464	6
Coolant Tube.....	936-5402	07-06462	6
Coolant Tube.....	936-5403	K181-5141	5
Coolant Tube.....	936-5404	K181-5483	5
Coolant Tube.....	936-5405	K181-5597	6
Coolant Tube.....	936-5501	20561364	6
Coolant Tube.....	936-5502	20357260	7
D			
DEF Cap.....	904-5201	04-27757-000	38
DEF Cap.....	904-5301	AU5Z5K204A	38
DEF Cap.....	904-5401	908-0223-01	39
DEF Cap.....	904-5401	908-0223-01	39
DEF Cap.....	904-5501	21148728	39
DEF Cap.....	904-5502	21148725	39
DEF Cap.....	904-5601	22753134	38
DEF Cap.....	904-5701	52122496AD	38
Door Check Kit.....	924-5401	20-11525M001	17
Door Check Kit.....	924-5401	20-12066	17
Door Check Kit.....	924-5401	20-18727	17
Door Check Kit.....	924-5401	R65-6019	17
Door Hinge.....	924-5103	3549259C1	17
Door Hinge.....	924-5603	8-97852-007-3	17
F			
Fog Light.....	924-5201	A06-75742-000	44
Fuel Senders.....	285-5101	2585993C91	33
Fuel Senders.....	285-5103	3596382C92	33
Fuel Senders.....	285-5104	476846C2	33
Fuel Senders.....	285-5105	497840C96	34
Fuel Senders.....	285-5203	A22-42390-005	33
Fuel Senders.....	285-5401	K21-6001-661	37
Fuel Senders.....	285-5402	K21-6001-585	37
Fuel Senders.....	285-5403	391PLP	37
Fuel Senders.....	285-5404	Q21-1024-622	34
Fuel Senders.....	285-5405	Q21-1024-559	34
Fuel Senders.....	285-5406	Q21-1043-622	34
Fuel Senders.....	285-5501	20506805	35
Fuel Senders.....	285-5502	25172994	35
Fuel Senders.....	285-5503	16MB48DP13	35
Fuel Senders.....	285-5504	25172995	35
Fuel Senders.....	285-5505	16MB48DP29	36
Fuel Senders.....	285-5506	25101400	36
Fuel Senders.....	285-5507	25195325	36
Fuel Senders.....	285-5508	8609-NC2759	36
Fuel Senders.....	285-5509	3092993	37
H			
Handle, Exterior.....	760-5101	3550931C91	13

Part Type	Dorman No.	OE No.	Page No.
H (Cont'd)			
Handle, Exterior.....	760-5105	2594006C1	13
Handle, Exterior.....	760-5106	2594003C1	13
Handle, Exterior.....	760-5201	A18-42228-003	11
Handle, Exterior.....	760-5202	A18-42228-002	11
Handle, Exterior.....	760-5203	A18-42228-000	11
Handle, Exterior.....	760-5204	A18-42228-001	11
Handle, Exterior.....	760-5205	A18-35381-000	12
Handle, Exterior.....	760-5206	A18-35381-001	12
Handle, Exterior.....	760-5207	A18-47729-003	12
Handle, Exterior.....	760-5207	A18-53241-001	12
Handle, Exterior.....	760-5208	A18-47729-002	12
Handle, Exterior.....	760-5208	A18-53241-000	12
Handle, Exterior.....	760-5401	2008179L	15
Handle, Exterior.....	760-5402	2008179R	15
Handle, Exterior.....	760-5403	R56-1025	14
Handle, Exterior.....	760-5403	R56-1025	15
Handle, Exterior.....	760-5404	K294-411PAK	14
Handle, Exterior.....	760-5405	K294-411RPAK	14
Handle, Exterior.....	760-5408	R56-1025R	14
Handle, Exterior.....	760-5408	R56-1025R	15
Handle, Exterior.....	760-5501	25192012	14
Handle, Exterior.....	760-5502	25191926	15
Handle, Exterior.....	760-5601	8-97867-721-1	14
Handle, Exterior.....	760-5602	8-97867-722-1	14
Handle, Exterior.....	760-5603	15619625	12
Handle, Exterior.....	760-5604	15619624	13
Handle, Interior.....	761-5103	2505425C1	16
Handle, Interior.....	761-5104	2505424C1	16
Handle, Interior.....	761-5406	K294-426PAK	16
Handle, Interior.....	761-5407	K294-426RPAK	16
Headlight.....	888-5101	3605817C92	43
Headlight.....	888-5102	3605816C92	43
Headlight.....	888-5103	3502929C94	43
Headlight.....	888-5104	3502928C94	43
Headlight.....	888-5105	3574388C91	44
Headlight.....	888-5106	3574387C91	44
Headlight Screw.....	924-5104	500565C91	44
Headlight Switch.....	901-5206	A06-30769-010	45
Heater Hose Connector.....	800-401	15622861	7
Hood Cable.....	924-5206	A17-12082-000	53
Hood Cable.....	924-5207	A17-12081-000	53
Hood Cable.....	924-5402	L92-6000-0718	54
Hood Cable.....	924-5501	25152850	54
Hood Cable.....	924-5502	25171452	54
Hood Latch Kit.....	315-5101	1699929C9	51
Hood Latch Kit.....	315-5101	499523C3	51
Hood Latch Kit.....	315-5201	17-12348-000	50
Hood Latch Kit.....	315-5202	A17-15553-001	50
Hood Latch Kit.....	315-5203	A17-15553-000	51
Hood Latch Kit.....	315-5204	17-12435-001	51
Hood Latch Kit.....	315-5205	17-12435-000	51
Hood Latch Kit.....	315-5401	1699929C9	52
Hood Latch Kit.....	315-5401	1699929C9	53
Hood Latch Kit.....	315-5401	L56-0001	52
Hood Latch Kit.....	315-5401	L56-0001	53
Hood Latch Kit.....	315-5402	K147-107	52
Hood Latch Kit.....	315-5501	8174018	53
Hood Latch Kit.....	315-5502	25169065	52
Hood Latch Kit.....	315-5503	25159428	52
Hood Rest.....	924-5202	A17-13787-002	54
Hood Rest.....	924-5203	A17-13787-003	54
Hood Spring.....	938-5101	1675762C3	47
Hood Spring.....	938-5102	3588532C2	47
Hood Spring.....	938-5103	598574C3	47
Hood Spring.....	938-5201	17-12069-001	47
Hood Spring.....	938-5401	L71-1002	48
Hood Spring.....	938-5402	K224-95	48
Hood Spring.....	938-5403	K224-86	48
Hood Spring.....	938-5404	K224-35	48
Hood Spring.....	938-5405	L71-1004	49
Hood Spring.....	938-5406	13-04638	50
Hood Spring.....	938-5407	13-03569	50
Hood Spring.....	938-5408	K224-81	49
Hood Spring.....	938-5501	25171284	49
Hood Spring.....	938-5502	25158019	49
HVAC Knob Kit.....	702-5401	121-0001-000	8
HVAC Knob Kit.....	702-5402	FD1240	7

Alphabetical Interchange By Part Type

Intercambio alfabético por el tipo de pieza

Part Type	Dorman No.	OE No.	Page No.
I			
Instrument Cluster.....	599-5101	3525091C91	73
Instrument Cluster.....	599-5102	3595124C2	73
M			
Mirror Bracket.....	924-5105	2597071C91	18
Mirror Bracket.....	924-5106	2597075C91	18
Mirror Motor.....	924-5204	28569	18
Mirror Switch.....	901-5201	34103PF	18
Multi-Function Switch.....	978-5101	2502912C91	74
Multi-Function Switch.....	978-5201	A06-36956-002	73
O			
Oil Cooler Line.....	625-185	15791673	28
Oil Cooler Line.....	625-187	15791675	29
Oil Cooler Line.....	625-188	93440852	29
Oil Cooler Line.....	625-189	93440853	29
Oil Cooler Line.....	625-190	15022583	29
Oil Cooler Line.....	625-191	15149877	30
Oil Cooler Line.....	625-192	15022583	30
Oil Cooler Line.....	625-193	15149878	31
Oil Cooler Line.....	625-194	15028506	31
Oil Cooler Line.....	625-195	15706746	30
Oil Cooler Line.....	625-196	15706745	30
Oil Cooler Line.....	625-250	F5H26A715AA	28
Oil Cooler Line.....	625-251	F5H26A715BA	28
Oil Cooler Line Connector.....	800-707	15170197	31
Oil Cooler Line Connector.....	800-707	15797464	31
P			
Power Steering Pump Pulley.....	300-120	2477954	31
R			
Radiator Fan Assembly.....	620-5601	8-97383-808-0	8
S			
Shift Boot.....	924-5405	K042-79	18
Speed Sensor.....	505-5104	2503117C1	57
Speed Sensor.....	505-5105	3528003C1	57
Speed Sensor.....	505-5201	SAA85920008	57
Speed Sensor.....	505-5505	25166488	57
Speed Sensor.....	505-5510	8029939	58
Speed Sensor.....	505-5512	20706327	58
Speed Sensor & Tachometer Sensor.....	505-5406	Q21-6005	59
Speed Sensor & Tachometer Sensor.....	505-5406	Q21-6005	59
Speed Sensor & Tachometer Sensor.....	505-5407	K3454	59
Speed Sensor & Tachometer Sensor.....	505-5407	K3454	60
Speed Sensor & Tachometer Sensor.....	505-5408	K3455	60
Speed Sensor & Tachometer Sensor.....	505-5408	K3455	61
Speed Sensor & Tachometer Sensor.....	505-5507	64MT412M	60
T			
Tachometer Sensor.....	505-5501	64MT2105M	58
Tachometer Sensor.....	505-5504	64MT435	58
Tachometer Sensor.....	505-5506	64MT440M	59
Tachometer Sensor.....	505-5511	8078108	59
Transfer Case Motor 4WD.....	600-909	88962312	61
W			
Washer Tank.....	603-5401	K114-20	23
Washer Tank.....	603-5402	N5355001	24
Washer Tank.....	603-5404	R86-6001	24
Washer Tank.....	603-5503	25128217	23
Washer Tank.....	603-5602	8978550656	23
Washer Tank Cap.....	902-5401	25171612	27
Washer Tank Cap.....	902-5401	C5720S	27
Washer Tank Cap.....	902-5404	3150-063415A	26
Washer Tank Cap.....	902-5404	63361	28
Washer Tank Cap.....	902-5404	FLM63361	27
Window Lift Motor Kit.....	742-142	10414628	71

Part Type	Dorman No.	OE No.	Page No.
W (Cont'd)			
Window Lift Motor Kit.....	742-142	10414630	71
Window Lift Motor Kit.....	742-142	10414632	71
Window Lift Motor Kit.....	742-142	15221956	71
Window Lift Motor Kit.....	742-142	16630577	71
Window Lift Motor Kit.....	742-142	16630579	71
Window Lift Motor Kit.....	742-142	21096870	71
Window Lift Motor Kit.....	742-142	21170781	71
Window Lift Motor Kit.....	742-142	21171231	71
Window Lift Motor Kit.....	742-142	21171235	71
Window Lift Motor Kit.....	742-142	22143945	71
Window Lift Motor Kit.....	742-142	22143947	71
Window Lift Motor Kit.....	742-142	22154977	71
Window Lift Motor Kit.....	742-142	22154979	71
Window Lift Motor Kit.....	742-143	10414629	71
Window Lift Motor Kit.....	742-143	10414631	71
Window Lift Motor Kit.....	742-143	10414633	71
Window Lift Motor Kit.....	742-143	15221951	71
Window Lift Motor Kit.....	742-143	16628208	71
Window Lift Motor Kit.....	742-143	16630576	71
Window Lift Motor Kit.....	742-143	16630578	71
Window Lift Motor Kit.....	742-143	21096871	71
Window Lift Motor Kit.....	742-143	21170780	71
Window Lift Motor Kit.....	742-143	21171230	71
Window Lift Motor Kit.....	742-143	21171234	71
Window Lift Motor Kit.....	742-143	22063224	71
Window Lift Motor Kit.....	742-143	22143946	71
Window Lift Motor Kit.....	742-143	22143948	71
Window Lift Motor Kit.....	742-143	22154978	71
Window Lift Motor Kit.....	742-143	22154980	71
Window Regulator; Manual.....	740-5103	1686705C91	64
Window Regulator; Manual.....	740-5104	1686704C91	64
Window Regulator; Manual.....	740-5501	25191027	64
Window Regulator; Manual.....	740-5502	25191633	64
Window Regulator; Manual.....	740-5503	25113357	65
Window Regulator; Manual.....	740-5504	25114490	65
Window Regulator; Manual.....	740-5505	25161668	65
Window Regulator; Manual.....	740-5506	25160158	65
Window Regulator; Manual.....	740-5507	25169077	66
Window Regulator; Manual.....	740-5508	25169076	66
Window Regulator; Manual.....	740-652	E7T21523200A	63
Window Regulator; Manual.....	740-653	E7T21523201A	63
Window Regulator; Manual.....	749-075	22071951	63
Window Regulator; Manual.....	749-076	22071950	63
Window Regulator; Power.....	741-5101	3515113C92	69
Window Regulator; Power.....	741-5102	3515112C92	69
Window Regulator; Power.....	741-5201	A18-48952-001	67
Window Regulator; Power.....	741-5202	A18-48952-000	67
Window Regulator; Power.....	741-5203	A18-52044-001	68
Window Regulator; Power.....	741-5204	A18-52044-000	68
Window Regulator; Power.....	741-5401	R21-6011	70
Window Regulator; Power.....	741-5402	R21-6011R	70
Window Regulator; Power.....	741-5403	R21-1005	69
Window Regulator; Power.....	741-5404	R21-1005R	69
Window Regulator; Power.....	741-5405	R21-6013	70
Window Regulator; Power.....	741-5406	R21-6013R	70
Window Regulator; Power.....	741-654	22071948	68
Window Regulator; Power.....	741-655	22071949	68
Window Regulator; Power.....	748-180	8C3Z2523201C	66
Window Regulator; Power.....	748-181	8C3Z2523200C	66
Window Regulator; Power.....	748-212	1C3Z2523201BA	67
Window Regulator; Power.....	748-213	1C3Z2523200BA	67
Window Switch.....	901-5204	A06-30769-008	71
Window Switch.....	901-5205	A06-30769-027	71
Wiper Nozzle Kit.....	924-5101	1696499C1	74
Wiper Nozzle Kit.....	924-5403	106.811	74
Wiper Transmission.....	602-5601	8-94165-462-1	73
Wiper Transmission.....	602-5601	8-97855-152-0	73
Wiper Transmission.....	602-5601	8-97855-154-0	73

OE to Dorman Interchange

De equipo original a Intercambio de Dorman

Make	OE No.	Dorman No.	Page No.	Make	OE No.	Dorman No.	Page No.
Coolant Tubes, Heating and Cooling				Fluid Reservoirs and Engine Parts (Cont'd)			
Freightliner	A05-16380-003	936-5201	5	GMC	15797464	800-707	31
Freightliner	A05-16384-001	936-5202	5	GMC	15706745	625-196	30
GMC	15622861	800-401	7	GMC	15706746	625-195	30
International	3542606C1	604-5101	7	GMC	15791673	625-185	28
Isuzu	8-97383-808-0	620-5601	8	GMC	15791675	625-187	29
Kenworth	FD1240	702-5402	7	GMC	2477954	300-120	31
Kenworth	K181-5141	936-5403	5	GMC	93440852	625-188	29
Kenworth	K181-5483	936-5404	5	GMC	93440853	625-189	29
Kenworth	K181-5597	936-5405	6	GMC	15075118	902-5601	25
Peterbilt	07-06462	936-5402	6	International	2002105C3	603-5101	21
Peterbilt	07-06464	936-5401	6	International	2039390C3	902-5101	25
Peterbilt	121-0001-000	702-5401	8	International	2508700C92	603-5103	22
Volvo	20357260	936-5502	7	International	3578833C3	902-5102	25
Volvo	20561364	936-5501	6	Isuzu	8972230122	603-5603	22
Door Handles and Body Parts				Isuzu	8978550656	603-5602	23
Freightliner	28569	924-5204	18	Kenworth	C57205	902-5401	27
Freightliner	34103PF	901-5201	18	Kenworth	K114-20	603-5401	23
Freightliner	A18-35381-000	760-5205	12	Mack	25128217	603-5503	23
Freightliner	A18-35381-001	760-5206	12	Mack	25133601	603-5501	23
Freightliner	A18-42228-000	760-5203	11	Mack	25174629	603-5502	22
Freightliner	A18-42228-001	760-5204	11	Mack	5481-9916238	902-5502	26
Freightliner	A18-42228-002	760-5202	11	Mack	3150063415A	902-5404	26
Freightliner	A18-42228-003	760-5201	11	Mack	25171612	902-5401	27
Freightliner	A18-53241-000	760-5208	12	Peterbilt	63361	902-5404	28
Freightliner	A18-47729-002	760-5208	12	Peterbilt	N5346001	603-5403	23
Freightliner	A18-47729-003	760-5207	12	Peterbilt	N5348001	902-5402	26
Freightliner	A18-53241-001	760-5207	12	Peterbilt	N5355001	603-5402	24
GMC	15619624	760-5604	13	Peterbilt	R86-6001	603-5404	24
GMC	15619625	760-5603	12	Peterbilt	RC0050	902-5403	26
GMC	3920296	20759	17	Fuel Senders, Fuel and Emissions			
International	2505424C1	761-5104	16	Dodge	52122496AD	904-5701	38
International	2505425C1	761-5103	16	Ford	AU5Z5K204A	904-5301	38
International	2594003C1	760-5106	13	Freightliner	04-27757-000	904-5201	38
International	2594006C1	760-5105	13	Freightliner	A22-42390-005	285-5203	33
International	2597071C91	924-5105	18	GM	22753134	904-5601	38
International	2597075C91	924-5106	18	International	2585993C91	285-5101	33
International	3549259C1	924-5103	17	International	3596382C92	285-5103	33
International	3550931C91	760-5101	13	International	476846C2	285-5104	33
Isuzu	8-97852-007-3	924-5603	17	International	497840C96	285-5105	34
Isuzu	8-97867-721-1	760-5601	14	Kenworth	908-0223-01	904-5401	39
Isuzu	8-97867-722-1	760-5602	14	Kenworth	Q21-1024-559	285-5405	34
Kenworth	K042-79	924-5405	18	Kenworth	Q21-1024-622	285-5404	34
Kenworth	K294-411PAK	760-5404	14	Kenworth	Q21-1043-622	285-5406	34
Kenworth	K294-411RPAK	760-5405	14	Mack	16MB48DP13	285-5503	35
Kenworth	K294-426PAK	761-5406	16	Mack	16MB48DP29	285-5505	36
Kenworth	K294-426RPAK	761-5407	16	Mack	20506805	285-5501	35
Kenworth	R56-1025	760-5403	14	Mack	21148728	904-5501	39
Kenworth	R56-1025R	760-5408	14	Mack	25101400	285-5506	36
Mack	25191926	760-5502	15	Mack	25172994	285-5502	35
Mack	25192012	760-5501	14	Mack	25172995	285-5504	35
Peterbilt	2008179L	760-5401	15	Mack	25195325	285-5507	36
Peterbilt	2008179R	760-5402	15	Mack	8609-NC2759	285-5508	36
Peterbilt	R56-1025	760-5403	15	Peterbilt	391PLP	285-5403	37
Peterbilt	R56-1025R	760-5408	15	Peterbilt	908-0223-01	904-5401	39
Peterbilt	20-12066	924-5401	17	Peterbilt	K21-6001-585	285-5402	37
Peterbilt	20-18727	924-5401	17	Peterbilt	K21-6001-661	285-5401	37
Peterbilt	R65-6019	924-5401	17	Volvo	21148725	904-5502	39
Peterbilt	20-11525M001	924-5401	17	Volvo	3092993	285-5509	37
Fluid Reservoirs and Engine Parts				Headlights and Lighting			
Ford	F5HZ6A715AA	625-250	28	Freightliner	A06-30769-010	901-5206	45
Ford	F5HZ6A715BA	625-251	28	Freightliner	A06-75742-000	924-5201	44
Freightliner	05-17223-002	902-5202	25	International	3502928C94	888-5104	43
Freightliner	05-20763-001	902-5201	24	International	3502929C94	888-5103	43
Freightliner	05-23045-000	603-5201	21	International	3574387C91	888-5106	44
Freightliner	05-23195-000	603-5202	21	International	3574388C91	888-5105	44
Freightliner	06-62384-002	924-5205	24	International	3605816C92	888-5102	43
Freightliner	FLM63361	902-5404	27	International	3605817C92	888-5101	43
GMC	15022583	625-190	29	International	500565C91	924-5104	44
GMC	15022583	625-192	30	Hood Springs, Latches and Components			
GMC	15028506	625-194	31	Freightliner	17-12348-000	315-5201	50
GMC	15075118	902-5601	25	Freightliner	17-12435-000	315-5205	51
GMC	15149877	625-191	30	Freightliner	17-12435-001	315-5204	51
GMC	15149878	625-193	31	Freightliner	17-12069-001	938-5201	47
GMC	15161670	603-5601	21	Freightliner	A17-12081-000	924-5207	53
GMC	15170197	800-707	31				

OE to Dorman Interchange

De equipo original a Intercambio de Dorman

Make	OE No.	Dorman No.	Page No.
Hood Springs, Latches and Components (Cont'd)			
Freightliner	A17-12082-000	924-5206	53
Freightliner	A17-13787-002	924-5202	54
Freightliner	A17-13787-003	924-5203	54
Freightliner	A17-15553-000	315-5203	51
Freightliner	A17-15553-001	315-5202	50
International	1675762C3	938-5101	47
International	3588532C2	938-5102	47
International	499523C3	315-5101	51
International	1699929C9	315-5101	51
International	598574C3	938-5103	47
Kenworth	L56-0001	315-5401	52
Kenworth	1699929C9	315-5401	52
Kenworth	K147-107	315-5402	52
Kenworth	K224-35	938-5404	48
Kenworth	K224-81	938-5408	49
Kenworth	K224-86	938-5403	48
Kenworth	K224-95	938-5402	48
Kenworth	L71-1002	938-5401	48
Kenworth	L71-1004	938-5405	49
Mack	25152850	924-5501	54
Mack	25158019	938-5502	49
Mack	25159428	315-5503	52
Mack	25169065	315-5502	52
Mack	25171284	938-5501	49
Mack	25171452	924-5502	54
Peterbilt	13-03569	938-5407	50
Peterbilt	13-04638	938-5406	50
Peterbilt	1699929C9	315-5401	53
Peterbilt	L56-0001	315-5401	53
Peterbilt	L92-6000-0718	924-5402	54
Volvo	8174018	315-5501	53
Speed Sensors and Tachometer Sensors			
Freightliner	SAA85920008	505-5201	57
GMC	88962312	600-909	61
International	2503117C1	505-5104	57
International	3528003C1	505-5105	57
Kenworth	K3454	505-5407	59
Kenworth	K3455	505-5408	60
Kenworth	Q21-6005	505-5406	59
Mack	20706327	505-5512	58
Mack	25166488	505-5505	57
Mack	64MT2105M	505-5501	58
Mack	64MT412M	505-5507	60
Mack	64MT435	505-5504	58
Mack	64MT440M	505-5506	59
Peterbilt	K3454	505-5407	60
Peterbilt	K3455	505-5408	61
Peterbilt	Q21-6005	505-5406	59
Volvo	8029939	505-5510	58
Volvo	8078108	505-5511	59
Window Regulators and Window Parts			
Ford	1C3Z2523200BA	748-213	67
Ford	1C3Z2523201BA	748-212	67
Ford	8C3Z2523200C	748-181	66
Ford	8C3Z2523201C	748-180	66
Ford	E7TZ1523200A	740-652	63
Ford	E7TZ1523201A	740-653	63
Freightliner	A06-30769-008	901-5204	71
Freightliner	A06-30769-027	901-5205	71
Freightliner	A18-48952-000	741-5202	67
Freightliner	A18-48952-001	741-5201	67
Freightliner	A18-52044-000	741-5204	68
Freightliner	A18-52044-001	741-5203	68
GMC	10414628	742-142	71
GMC	10414629	742-143	71
GMC	10414630	742-142	71
GMC	10414631	742-143	71
GMC	10414632	742-142	71
GMC	10414633	742-143	71
GMC	15221951	742-143	71
GMC	15221956	742-142	71
GMC	16628208	742-143	71
GMC	16630576	742-143	71
GMC	16630577	742-142	71
GMC	16630578	742-143	71

Make	OE No.	Dorman No.	Page No.
Window Regulators and Window Parts (Cont'd)			
GMC	16630579	742-142	71
GMC	21096870	742-142	71
GMC	21096871	742-143	71
GMC	21170780	742-143	71
GMC	21170781	742-142	71
GMC	21171230	742-143	71
GMC	21171231	742-142	71
GMC	21171234	742-143	71
GMC	21171235	742-142	71
GMC	22063224	742-143	71
GMC	22071948	741-654	68
GMC	22071949	741-655	68
GMC	22071950	749-076	63
GMC	22071951	749-075	63
GMC	22143945	742-142	71
GMC	22143946	742-143	71
GMC	22143947	742-142	71
GMC	22143948	742-143	71
GMC	22154977	742-142	71
GMC	22154978	742-143	71
GMC	22154979	742-142	71
GMC	22154980	742-143	71
International	1686704C91	740-5104	64
International	1686705C91	740-5103	64
International	3515112C92	741-5102	69
International	3515113C92	741-5101	69
Kenworth	R21-1005	741-5403	69
Kenworth	R21-1005R	741-5404	69
Mack	25113357	740-5503	65
Mack	25114490	740-5504	65
Mack	25160158	740-5506	65
Mack	25161668	740-5505	65
Mack	25169076	740-5508	66
Mack	25169077	740-5507	66
Mack	25191027	740-5501	64
Mack	25191633	740-5502	64
Peterbilt	R21-6011	741-5401	70
Peterbilt	R21-6011R	741-5402	70
Peterbilt	R21-6013	741-5405	70
Peterbilt	R21-6013R	741-5406	70
Wiper Transmissions and Dash Components			
Freightliner	A06-36956-002	978-5201	73
International	1696499C1	924-5101	74
International	2502912C91	978-5101	74
International	3525091C91	599-5101	73
International	3595124C2	599-5102	73
Isuzu	8-97855-154-0	602-5601	73
Isuzu	8-97855-152-0	602-5601	73
Isuzu	8-94165-462-1	602-5601	73
Isuzu	8-94165-540-0	602-5601	73
Peterbilt	106.811	924-5403	74

Interchange By Manufacturer

Intercambio de fabricante

Make	OE No.	Dorman No.	Page No.	Make	OE No.	Dorman No.	Page No.
D				G (Cont'd)			
Dodge	52122496AD	904-5701	38	GMC	10414632	742-142	71
F				GMC	15221956	742-142	71
Ford	F5HZ6A715AA	625-250	28	GMC	16630577	742-142	71
Ford	F5HZ6A715BA	625-251	28	GMC	16630579	742-142	71
Ford	E7TZ1523200A	740-652	63	GMC	21096870	742-142	71
Ford	E7TZ1523201A	740-653	63	GMC	21170781	742-142	71
Ford	8C3Z2523201C	748-180	66	GMC	21171231	742-142	71
Ford	8C3Z2523200C	748-181	66	GMC	21171235	742-142	71
Ford	1C3Z2523201BA	748-212	67	GMC	22143945	742-142	71
Ford	1C3Z2523200BA	748-213	67	GMC	22143947	742-142	71
Ford	AU5Z5K204A	904-5301	38	GMC	22154977	742-142	71
Freightliner	A22-42390-005	285-5203	33	GMC	22154979	742-142	71
Freightliner	17-12348-000	315-5201	50	GMC	10414629	742-143	71
Freightliner	A17-15553-001	315-5202	50	GMC	10414631	742-143	71
Freightliner	A17-15553-000	315-5203	51	GMC	10414633	742-143	71
Freightliner	17-12435-001	315-5204	51	GMC	15221951	742-143	71
Freightliner	17-12435-000	315-5205	51	GMC	16628208	742-143	71
Freightliner	SAA85920008	505-5201	57	GMC	16630576	742-143	71
Freightliner	05-23045-000	603-5201	21	GMC	16630578	742-143	71
Freightliner	05-23195-000	603-5202	21	GMC	21096871	742-143	71
Freightliner	A18-48952-001	741-5201	67	GMC	21170780	742-143	71
Freightliner	A18-48952-000	741-5202	67	GMC	21171230	742-143	71
Freightliner	A18-52044-001	741-5203	68	GMC	21171234	742-143	71
Freightliner	A18-52044-000	741-5204	68	GMC	22063224	742-143	71
Freightliner	A18-42228-003	760-5201	11	GMC	22143946	742-143	71
Freightliner	A18-42228-002	760-5202	11	GMC	22143948	742-143	71
Freightliner	A18-42228-000	760-5203	11	GMC	22154978	742-143	71
Freightliner	A18-42228-001	760-5204	11	GMC	22154980	742-143	71
Freightliner	A18-35381-000	760-5205	12	GMC	22071951	749-075	63
Freightliner	A18-35381-001	760-5206	12	GMC	22071950	749-076	63
Freightliner	A18-47729-003	760-5207	12	GMC	15619625	760-5603	12
Freightliner	A18-53241-001	760-5207	12	GMC	15619624	760-5604	13
Freightliner	A18-53241-000	760-5208	12	GMC	15622861	800-401	7
Freightliner	A18-47729-002	760-5208	12	GMC	15170197	800-707	31
Freightliner	34103PF	901-5201	18	GMC	15797464	800-707	31
Freightliner	A06-30769-008	901-5204	71	GMC	15075118	902-5601	25
Freightliner	A06-30769-027	901-5205	71	GMC	15075118	902-5601	25
Freightliner	A06-30769-010	901-5206	45	I			
Freightliner	05-20763-001	902-5201	24	International	2585993C91	285-5101	33
Freightliner	05-17223-002	902-5202	25	International	3596382C92	285-5103	33
Freightliner	FLM63361	902-5404	27	International	476846C2	285-5104	33
Freightliner	04-27757-000	904-5201	38	International	497840C96	285-5105	34
Freightliner	A06-75742-000	924-5201	44	International	499523C3	315-5101	51
Freightliner	A17-13787-002	924-5202	54	International	1699929C9	315-5101	51
Freightliner	A17-13787-003	924-5203	54	International	2503117C1	505-5104	57
Freightliner	28569	924-5204	18	International	3528003C1	505-5105	57
Freightliner	06-62384-002	924-5205	24	International	3525091C91	599-5101	73
Freightliner	A17-12082-000	924-5206	53	International	3595124C2	599-5102	73
Freightliner	A17-12081-000	924-5207	53	International	2002105C3	603-5101	21
Freightliner	A05-16380-003	936-5201	5	International	2508700C92	603-5103	22
Freightliner	A05-16384-001	936-5202	5	International	3542606C1	604-5101	7
Freightliner	17-12069-001	938-5201	47	International	1686705C91	740-5103	64
Freightliner	A06-36956-002	978-5201	73	International	1686704C91	740-5104	64
G				International	3515113C92	741-5101	69
GMC	22753134	904-5601	38	International	3515112C92	741-5102	69
GMC	3920296	20759	17	International	3550931C91	760-5101	13
GMC	2477954	300-120	31	International	2594006C1	760-5105	13
GMC	88962312	600-909	61	International	2594003C1	760-5106	13
GMC	15161670	603-5601	21	International	2505425C1	761-5103	16
GMC	15791673	625-185	28	International	2505424C1	761-5104	16
GMC	15791675	625-187	29	International	3605817C92	888-5101	43
GMC	93440852	625-188	29	International	3605816C92	888-5102	43
GMC	93440853	625-189	29	International	3502929C94	888-5103	43
GMC	15022583	625-190	29	International	3502928C94	888-5104	43
GMC	15149877	625-191	30	International	3574388C91	888-5105	44
GMC	15022583	625-192	30	International	3574387C91	888-5106	44
GMC	15149878	625-193	31	International	2039390C3	902-5101	25
GMC	15028506	625-194	31	International	3578833C3	902-5102	25
GMC	15706746	625-195	30	International	1696499C1	924-5101	74
GMC	15706745	625-196	30	International	3549259C1	924-5103	17
GMC	22071948	741-654	68	International	500565C91	924-5104	44
GMC	22071949	741-655	68	International	2597071C91	924-5105	18
GMC	10414628	742-142	71	International	2597075C91	924-5106	18
GMC	10414630	742-142	71	International	1675762C3	938-5101	47
				International	3588532C2	938-5102	47

Interchange By Manufacturer

Intercambio de fabricante

Make	OE No.	Dorman No.	Page No.
I (Cont'd)			
International	598574C3	938-5103	47
International	2502912C91	978-5101	74
Isuzu	8-97855-154-0	602-5601	73
Isuzu	8-97855-152-0	602-5601	73
Isuzu	8-94165-462-1	602-5601	73
Isuzu	8978550656	603-5602	23
Isuzu	8972230122	603-5603	22
Isuzu	8-97383-808-0	620-5601	8
Isuzu	8-97867-721-1	760-5601	14
Isuzu	8-97867-722-1	760-5602	14
Isuzu	8-97852-007-3	924-5603	17
K			
Kenworth	Q21-1024-622	285-5404	34
Kenworth	Q21-1024-559	285-5405	34
Kenworth	Q21-1043-622	285-5406	34
Kenworth	L56-0001	315-5401	52
Kenworth	1699929C9	315-5401	52
Kenworth	K147-107	315-5402	52
Kenworth	Q21-6005	505-5406	59
Kenworth	K3454	505-5407	59
Kenworth	K3455	505-5408	60
Kenworth	K114-20	603-5401	23
Kenworth	FD1240	702-5402	7
Kenworth	R21-1005	741-5403	69
Kenworth	R21-1005R	741-5404	69
Kenworth	R56-1025	760-5403	14
Kenworth	K294-411PAK	760-5404	14
Kenworth	K294-411RPAK	760-5405	14
Kenworth	R56-1025R	760-5408	14
Kenworth	K294-426PAK	761-5406	16
Kenworth	K294-426RPAK	761-5407	16
Kenworth	C5720S	902-5401	27
Kenworth	908-0223-01	904-5401	39
Kenworth	K042-79	924-5405	18
Kenworth	K181-5141	936-5403	5
Kenworth	K181-5483	936-5404	5
Kenworth	K181-5597	936-5405	6
Kenworth	L71-1002	938-5401	48
Kenworth	K224-95	938-5402	48
Kenworth	K224-86	938-5403	48
Kenworth	K224-35	938-5404	48
Kenworth	L71-1004	938-5405	49
Kenworth	K224-81	938-5408	49
M			
Mack	20506805	285-5501	35
Mack	25172994	285-5502	35
Mack	16MB48DP13	285-5503	35
Mack	25172995	285-5504	35
Mack	16MB48DP29	285-5505	36
Mack	25101400	285-5506	36
Mack	25195325	285-5507	36
Mack	8609-NC2759	285-5508	36
Mack	25169065	315-5502	52
Mack	25159428	315-5503	52
Mack	64MT2105M	505-5501	58
Mack	64MT435	505-5504	58
Mack	25166488	505-5505	57
Mack	64MT440M	505-5506	59
Mack	64MT412M	505-5507	60
Mack	20706327	505-5512	58
Mack	25133601	603-5501	22
Mack	25174629	603-5502	22
Mack	25128217	603-5503	23
Mack	25191027	740-5501	64
Mack	25191633	740-5502	64
Mack	25113357	740-5503	65
Mack	25114490	740-5504	65
Mack	25161668	740-5505	65
Mack	25160158	740-5506	65
Mack	25169077	740-5507	66
Mack	25169076	740-5508	66
Mack	25192012	760-5501	14
Mack	25191926	760-5502	15
Mack	25171612	902-5401	27

Make	OE No.	Dorman No.	Page No.
M (Cont'd)			
Mack	3150-063415A	902-5404	26
Mack	5481-9916238	902-5502	26
Mack	21148728	904-5501	39
Mack	25152850	924-5501	54
Mack	25171452	924-5502	54
Mack	25171284	938-5501	49
Mack	25158019	938-5502	49
P			
Peterbilt	K21-6001-661	285-5401	37
Peterbilt	K21-6001-585	285-5402	37
Peterbilt	391PLP	285-5403	37
Peterbilt	1699929C9	315-5401	53
Peterbilt	L56-0001	315-5401	53
Peterbilt	Q21-6005	505-5406	59
Peterbilt	K3454	505-5407	60
Peterbilt	K3455	505-5408	61
Peterbilt	N5355001	603-5402	24
Peterbilt	N5346001	603-5403	23
Peterbilt	R86-6001	603-5404	24
Peterbilt	121-0001-000	702-5401	8
Peterbilt	R21-6011	741-5401	70
Peterbilt	R21-6011R	741-5402	70
Peterbilt	R21-6013	741-5405	70
Peterbilt	R21-6013R	741-5406	70
Peterbilt	2008179L	760-5401	15
Peterbilt	2008179R	760-5402	15
Peterbilt	R56-1025	760-5403	15
Peterbilt	R56-1025R	760-5408	15
Peterbilt	N5348001	902-5402	26
Peterbilt	R00050	902-5403	26
Peterbilt	63361	902-5404	28
Peterbilt	908-0223-01	904-5401	39
Peterbilt	20-12066	924-5401	17
Peterbilt	20-18727	924-5401	17
Peterbilt	R65-6019	924-5401	17
Peterbilt	20-11525M001	924-5401	17
Peterbilt	L92-6000-0718	924-5402	54
Peterbilt	106.811	924-5403	74
Peterbilt	07-06464	936-5401	6
Peterbilt	07-06462	936-5402	6
Peterbilt	13-04638	938-5406	50
Peterbilt	13-03569	938-5407	50
V			
Volvo	3092993	285-5509	37
Volvo	8174018	315-5501	53
Volvo	8029939	505-5510	58
Volvo	8078108	505-5511	59
Volvo	21148725	904-5502	39
Volvo	20561364	936-5501	6
Volvo	20357260	936-5502	7

Interchange By OE Number

Intercambio de equipo original

OE No.	Make	Dorman No.	Page No.	OE No.	Make	Dorman No.	Page No.
04-27757-000	Freightliner	904-5201	38	21096870	GMC	742-142	71
05-17223-002	Freightliner	902-5202	25	21096871	GMC	742-143	71
05-20763-001	Freightliner	902-5201	24	21148725	Volvo	904-5502	39
05-23045-000	Freightliner	603-5201	21	21148728	Mack	904-5501	39
05-23195-000	Freightliner	603-5202	21	21170780	GMC	742-143	71
06-62384-002	Freightliner	924-5205	24	21170781	GMC	742-142	71
07-06462	Peterbilt	936-5402	6	21171230	GMC	742-143	71
07-06464	Peterbilt	936-5401	6	21171231	GMC	742-142	71
10414628	GMC	742-142	71	21171234	GMC	742-143	71
10414629	GMC	742-143	71	21171235	GMC	742-142	71
10414630	GMC	742-142	71	22063224	GMC	742-143	71
10414631	GMC	742-143	71	22071948	GMC	741-654	68
10414632	GMC	742-142	71	22071949	GMC	741-655	68
10414633	GMC	742-143	71	22071950	GMC	749-076	63
106.811	Peterbilt	924-5403	74	22071951	GMC	749-075	63
121-0001-000	Peterbilt	702-5401	8	22143945	GMC	742-142	71
13-03569	Peterbilt	938-5407	50	22143946	GMC	742-143	71
13-04638	Peterbilt	938-5406	50	22143947	GMC	742-142	71
15022583	GMC	625-190	29	22143948	GMC	742-143	71
15022583	GMC	625-192	30	22154977	GMC	742-142	71
15028506	GMC	625-194	31	22154978	GMC	742-143	71
15075118	GMC	902-5601	25	22154979	GMC	742-142	71
15075118	GMC	902-5601	25	22154980	GMC	742-143	71
15149877	GMC	625-191	30	22753134	GM	904-5601	38
15149878	GMC	625-193	31	2477954	GMC	300-120	31
15161670	GMC	603-5601	21	2502912C91	International	978-5101	74
15170197	GMC	800-707	31	2503117C1	International	505-5104	57
15221951	GMC	742-143	71	2505424C1	International	761-5104	16
15221956	GMC	742-142	71	2505425C1	International	761-5103	16
15619624	GMC	760-5604	13	2508700C92	International	603-5103	22
15619625	GMC	760-5603	12	25101400	Mack	285-5506	36
15622861	GMC	800-401	7	25113357	Mack	740-5503	65
15706745	GMC	625-196	30	25114490	Mack	740-5504	65
15706746	GMC	625-195	30	25128217	Mack	603-5503	23
15791673	GMC	625-185	28	25133601	Mack	603-5501	22
15791675	GMC	625-187	29	25152850	Mack	924-5501	54
15797464	GMC	800-707	31	25158019	Mack	938-5502	49
16628208	GMC	742-143	71	25159428	Mack	315-5503	52
16630576	GMC	742-143	71	25160158	Mack	740-5506	65
16630577	GMC	742-142	71	25161668	Mack	740-5505	65
16630578	GMC	742-143	71	25166488	Mack	505-5505	57
16630579	GMC	742-142	71	25169065	Mack	315-5502	52
1675762C3	International	938-5101	47	25169076	Mack	740-5508	66
1686704C91	International	740-5104	64	25169077	Mack	740-5507	66
1686705C91	International	740-5103	64	25171284	Mack	938-5501	49
1696499C1	International	924-5101	74	25171452	Mack	924-5502	54
1699929C9	International	315-5101	51	25171612	Mack	902-5401	27
1699929C9	Kenworth	315-5401	52	25172994	Mack	285-5502	35
1699929C9	Peterbilt	315-5401	53	25172995	Mack	285-5504	35
16MB48DP13	Mack	285-5503	35	25174629	Mack	603-5502	22
16MB48DP29	Mack	285-5505	36	25191027	Mack	740-5501	64
17-12069-001	Freightliner	938-5201	47	25191633	Mack	740-5502	64
17-12348-000	Freightliner	315-5201	50	25191926	Mack	760-5502	15
17-12435-000	Freightliner	315-5205	51	25192012	Mack	760-5501	14
17-12435-001	Freightliner	315-5204	51	25195325	Mack	285-5507	36
1C3Z2523200BA	Ford	748-213	67	2585993C91	International	285-5101	33
1C3Z2523201BA	Ford	748-212	67	2594003C1	International	760-5106	13
2002105C3	International	603-5101	21	2594006C1	International	760-5105	13
2008179L	Peterbilt	760-5401	15	2597071C91	International	924-5105	18
2008179R	Peterbilt	760-5402	15	2597075C91	International	924-5106	18
20-11525M001	Peterbilt	924-5401	17	28569	Freightliner	924-5204	18
20-12066	Peterbilt	924-5401	17	3092993	Volvo	285-5509	37
20-18727	Peterbilt	924-5401	17	3150-063415A	Mack	902-5404	26
20357260	Volvo	936-5502	7	34103PF	Freightliner	901-5201	18
2039390C3	International	902-5101	25	3502928C94	International	888-5104	43
20506805	Mack	285-5501	35	3502929C94	International	888-5103	43
20561364	Volvo	936-5501	6	3515112C92	International	741-5102	69
20706327	Mack	505-5512	58	3515113C92	International	741-5101	69

Interchange By OE Number

Intercambio de equipo original

OE No.	Make	Dorman No.	Page No.	OE No.	Make	Dorman No.	Page No.
3525091C91	International	599-5101	73	A18-47729-003	Freightliner	760-5207	12
3528003C1	International	505-5105	57	A18-48952-000	Freightliner	741-5202	67
3542606C1	International	604-5101	7	A18-48952-001	Freightliner	741-5201	67
3549259C1	International	924-5103	17	A18-52044-000	Freightliner	741-5204	68
3550931C91	International	760-5101	13	A18-52044-001	Freightliner	741-5203	68
3574387C91	International	888-5106	44	A18-53241-000	Freightliner	760-5208	12
3574388C91	International	888-5105	44	A18-53241-001	Freightliner	760-5207	12
3578833C3	International	902-5102	25	A22-42390-005	Freightliner	285-5203	33
3588532C2	International	938-5102	47	AU5Z5K204A	Ford	904-5301	38
3595124C2	International	599-5102	73	C5720S	Kenworth	902-5401	27
3596382C92	International	285-5103	33	E7TZ1523200A	Ford	740-652	63
3605816C92	International	888-5102	43	E7TZ1523201A	Ford	740-653	63
3605817C92	International	888-5101	43	F5HZ6A715AA	Ford	625-250	28
391PLP	Peterbilt	285-5403	37	F5HZ6A715BA	Ford	625-251	28
3920296	GMC	20759	17	FD1240	Kenworth	702-5402	7
476846C2	International	285-5104	33	FLM63361	Freightliner	902-5404	27
497840C96	International	285-5105	34	K042-79	Kenworth	924-5405	18
499523C3	International	315-5101	51	K114-20	Kenworth	603-5401	23
500565C91	International	924-5104	44	K147-107	Kenworth	315-5402	52
52122496AD	Dodge	904-5701	38	K181-5141	Kenworth	936-5403	5
5481-9916238	Mack	902-5502	26	K181-5483	Kenworth	936-5404	5
598574C3	International	938-5103	47	K181-5597	Kenworth	936-5405	6
63361	Peterbilt	902-5404	28	K21-6001-585	Peterbilt	285-5402	37
64MT2105M	Mack	505-5501	58	K21-6001-661	Peterbilt	285-5401	37
64MT412M	Mack	505-5507	60	K224-35	Kenworth	938-5404	48
64MT435	Mack	505-5504	58	K224-81	Kenworth	938-5408	49
64MT440M	Mack	505-5506	59	K224-86	Kenworth	938-5403	48
8029939	Volvo	505-5510	58	K224-95	Kenworth	938-5402	48
8078108	Volvo	505-5511	59	K294-411PAK	Kenworth	760-5404	14
8174018	Volvo	315-5501	53	K294-411RPAK	Kenworth	760-5405	14
8609-NC2759	Mack	285-5508	36	K294-426PAK	Kenworth	761-5406	16
88962312	GMC	600-909	61	K294-426RPAK	Kenworth	761-5407	16
8-94165-462-1	Isuzu	602-5601	73	K3454	Kenworth	505-5407	59
8-94165-540-0	Isuzu	602-5601	73	K3454	Peterbilt	505-5407	60
8972230122	Isuzu	603-5603	22	K3455	Kenworth	505-5408	60
8-97383-808-0	Isuzu	620-5601	8	K3455	Peterbilt	505-5408	61
8-97852-007-3	Isuzu	924-5603	17	L56-0001	Kenworth	315-5401	52
8978550656	Isuzu	603-5602	23	L56-0001	Peterbilt	315-5401	53
8-97855-152-0	Isuzu	602-5601	73	L71-1002	Kenworth	938-5401	48
8-97855-154-0	Isuzu	602-5601	73	L71-1004	Kenworth	938-5405	49
8-97867-721-1	Isuzu	760-5601	14	L92-6000-0718	Peterbilt	924-5402	54
8-97867-722-1	Isuzu	760-5602	14	N5346001	Peterbilt	603-5403	23
8C3Z2523200C	Ford	748-181	66	N5348001	Peterbilt	902-5402	26
8C3Z2523201C	Ford	748-180	66	N5355001	Peterbilt	603-5402	24
908-0223-01	Kenworth	904-5401	39	Q21-1024-559	Kenworth	285-5405	34
908-0223-01	Peterbilt	904-5401	39	Q21-1024-622	Kenworth	285-5404	34
93440852	GMC	625-188	29	Q21-1043-622	Kenworth	285-5406	34
93440853	GMC	625-189	29	Q21-6005	Kenworth	505-5406	59
A05-16380-003	Freightliner	936-5201	5	Q21-6005	Peterbilt	505-5406	59
A05-16384-001	Freightliner	936-5202	5	R21-1005	Kenworth	741-5403	69
A06-307 69-027	Freightliner	901-5205	71	R21-1005R	Kenworth	741-5404	69
A06-30769-008	Freightliner	901-5204	71	R21-6011	Peterbilt	741-5401	70
A06-30769-010	Freightliner	901-5206	45	R21-6011R	Peterbilt	741-5402	70
A06-36956-002	Freightliner	978-5201	73	R21-6013	Peterbilt	741-5405	70
A06-75742-000	Freightliner	924-5201	44	R21-6013R	Peterbilt	741-5406	70
A17-12081-000	Freightliner	924-5207	53	R56-1025	Kenworth	760-5403	14
A17-12082-000	Freightliner	924-5206	53	R56-1025	Peterbilt	760-5403	15
A17-13787-002	Freightliner	924-5202	54	R56-1025R	Kenworth	760-5408	14
A17-13787-003	Freightliner	924-5203	54	R56-1025R	Peterbilt	760-5408	15
A17-15553-000	Freightliner	315-5203	51	R65-6019	Peterbilt	924-5401	17
A17-15553-001	Freightliner	315-5202	50	R86-6001	Peterbilt	603-5404	24
A18-35381-000	Freightliner	760-5205	12	RC0050	Peterbilt	902-5403	26
A18-35381-001	Freightliner	760-5206	12	SAA85920008	Freightliner	505-5201	57
A18-42228-000	Freightliner	760-5203	11				
A18-42228-001	Freightliner	760-5204	11				
A18-42228-002	Freightliner	760-5202	11				
A18-42228-003	Freightliner	760-5201	11				
A18-47729-002	Freightliner	760-5208	12				