

2008 Durango



**DODGE**

**2008**

**OWNER'S MANUAL**

**Durango**

# TABLE OF CONTENTS

## SECTION

## PAGE

<b>1</b>	<b>INTRODUCTION .....</b>	<b>3</b>	<b>1</b>
<b>2</b>	<b>THINGS TO KNOW BEFORE STARTING YOUR VEHICLE .....</b>	<b>9</b>	<b>2</b>
<b>3</b>	<b>UNDERSTANDING THE FEATURES OF YOUR VEHICLE .....</b>	<b>79</b>	<b>3</b>
<b>4</b>	<b>INSTRUMENT PANEL AND CONTROLS .....</b>	<b>195</b>	<b>4</b>
<b>5</b>	<b>STARTING AND OPERATING .....</b>	<b>279</b>	<b>5</b>
<b>6</b>	<b>WHAT TO DO IN EMERGENCIES .....</b>	<b>377</b>	<b>6</b>
<b>7</b>	<b>MAINTAINING YOUR VEHICLE .....</b>	<b>393</b>	<b>7</b>
<b>8</b>	<b>MAINTENANCE SCHEDULES .....</b>	<b>453</b>	<b>8</b>
<b>9</b>	<b>IF YOU NEED CONSUMER ASSISTANCE .....</b>	<b>461</b>	<b>9</b>
<b>10</b>	<b>INDEX .....</b>	<b>471</b>	<b>10</b>



---

# INTRODUCTION

## CONTENTS

---

■ Introduction . . . . .	4	■ Warnings And Cautions . . . . .	7
■ Rollover Warning . . . . .	4	■ Vehicle Identification Number . . . . .	7
■ How To Use This Manual . . . . .	5	■ Vehicle Modifications/Alterations . . . . .	8

### INTRODUCTION

This Owner's Manual has been prepared with the assistance of service and engineering specialists to acquaint you with the operation and maintenance of your vehicle. It is supplemented by a Warranty Information Booklet and various customer-oriented documents. You are urged to read these publications carefully. Following the instructions and recommendations in this manual will help assure safe and enjoyable operation of your vehicle.

**NOTE:** After you read the manual, it should be stored in the vehicle for convenient reference and remain with the vehicle when sold so that the new owner will be aware of all safety warnings.

When it comes to service, remember that your authorized dealer knows your vehicle best, has the factory-trained technicians and genuine Mopar® parts, and is interested in your satisfaction.

### ROLLOVER WARNING

Utility vehicles have a significantly higher rollover rate than other types of vehicles. This vehicle has a higher ground clearance and a higher center of gravity than many passenger cars. It is capable of performing better in a wide variety of off-road applications. Driven in an unsafe manner, all vehicles can go out of control. Because of the higher center of gravity, if this vehicle is out of control it may roll over when some other vehicles may not.

Do not attempt sharp turns or abrupt maneuvers, or other unsafe driving actions that can cause loss of vehicle control. Failure to operate this vehicle safely may result in an accident, rollover of the vehicle, and severe or fatal injury. Drive carefully.

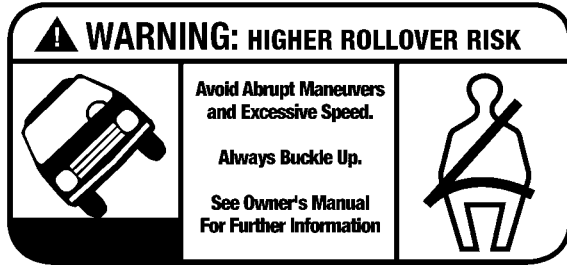

80bfe0f0

### Rollover Warning Label

Failure to use driver and passenger seat belts provided is a major cause of severe or fatal injury. In fact, the U.S. government notes that the universal use of existing seat

belts could cut the highway death toll by 10,000 or more each year and could reduce disabling injuries by two million annually. In a rollover crash, an unbelted person is significantly more likely to die than a person wearing a seat belt. Always buckle up.

### HOW TO USE THIS MANUAL

Consult the Table of Contents to determine which section contains the information you desire.

The detailed index at the back of this Owner's Manual contains a complete listing of all subjects.

Consult the following table for a description of the symbols that may be used on your vehicle or throughout this Owner's Manual:

## 6 INTRODUCTION



## WARNINGS AND CAUTIONS

This manual contains **WARNINGS** against operating procedures which could result in an accident or bodily injury. It also contains **CAUTIONS** against procedures which could result in damage to your vehicle. If you do not read this entire manual, you may miss important information. Observe all **WARNINGS** and **CAUTIONS**.

## VEHICLE IDENTIFICATION NUMBER

The Vehicle Identification Number (VIN) is found on the left front corner of the instrument panel, visible through the windshield. This number also appears on the Automobile Information Disclosure Label affixed to a window on your vehicle, the vehicle registration and title.

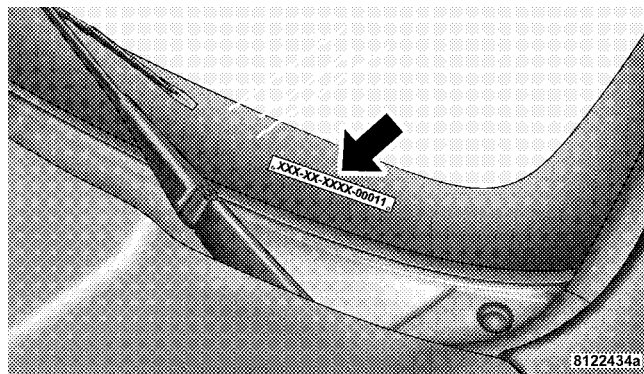

**VIN Location**

**NOTE:** It is illegal to remove the VIN.



## VEHICLE MODIFICATIONS/ALTERATIONS

### **WARNING!**

**Any modifications or alterations to this vehicle could seriously affect its roadworthiness and safety and may lead to an accident resulting in serious injury or death.**

# THINGS TO KNOW BEFORE STARTING YOUR VEHICLE

## CONTENTS

---

■ A Word About Your Keys . . . . .	.12	■ Security Alarm System — If Equipped . . . . .	.18
□ Ignition Key Removal . . . . .	.12	□ To Set The Alarm . . . . .	.19
□ Locking Doors With The Key . . . . .	.13	□ To Disarm The System . . . . .	.19
■ Sentry Key® . . . . .	.13	■ Illuminated Entry . . . . .	.20
□ Replacement Keys . . . . .	.15	□ Vehicles Equipped With Power Door Locks . . . . .	.20
□ Customer Key Programming . . . . .	.15	■ Remote Keyless Entry . . . . .	.21
□ General Information . . . . .	.16	□ To Unlock The Doors And Liftgate . . . . .	.21
■ Ignition And Steering Lock . . . . .	.17	□ To Lock The Doors And Liftgate . . . . .	.22
□ Ignition Accessory Delay Feature . . . . .	.18	□ Using The Panic Alarm . . . . .	.24

## 10 THINGS TO KNOW BEFORE STARTING YOUR VEHICLE

- General Information . . . . .25
- Programming Additional Transmitters . . . . .25
- Battery Replacement . . . . .27
- Remote Starting System — If Equipped . . . . .28
- Door Locks . . . . .29
  - Manual Door Locks . . . . .29
  - Power Door Locks . . . . .30
  - Child Protection Door Lock . . . . .33
- Windows . . . . .34
  - Power Windows . . . . .34
  - Auto Down . . . . .35
  - Auto Up Feature With Anti-Pinch Protection (Driver's And Front Passenger Door Only) . . . .35
  - Window Lockout Switch . . . . .36
- Liftgate . . . . .37
  - Power Liftgate — If Equipped . . . . .38
- Occupant Restraints . . . . .41
  - Lap/Shoulder Belts . . . . .42
  - Adjustable Upper Shoulder Belt Anchorage . . . .46
  - Second Row Center Seat Belt . . . . .47
  - Automatic Locking Retractors (ALR) Mode – If Equipped . . . . .47
  - Rear 60/40 Seat Third Row Center Three Point Belt — If Equipped . . . . .48
  - Seat Belt Pretensioners . . . . .50
  - Enhanced Driver Seat Belt Reminder System (BeltAlert®) . . . . .51

	<b>THINGS TO KNOW BEFORE STARTING YOUR VEHICLE</b>	<b>11</b>
<b>■</b> Engine Break-In Recommendations		.74
□ Seat Belts And Pregnant Women		.52
□ Seat Belt Extender		.53
□ Driver And Right Front Passenger Supplemental Restraint System (SRS)—Airbags		.53
□ Event Data Recorder (EDR)		.62
□ Child Restraint		.64
<b>■</b> Safety Tips		.75
□ Exhaust System		.75
□ Safety Checks You Should Make Inside The Vehicle		.76
□ Safety Checks You Should Make Outside The Vehicle		.77

### A WORD ABOUT YOUR KEYS

The authorized dealer that sold you your vehicle has the key code numbers for your vehicle locks. These numbers can be used to order duplicate keys from your authorized dealer. Ask your authorized dealer for these numbers and keep them in a safe place.

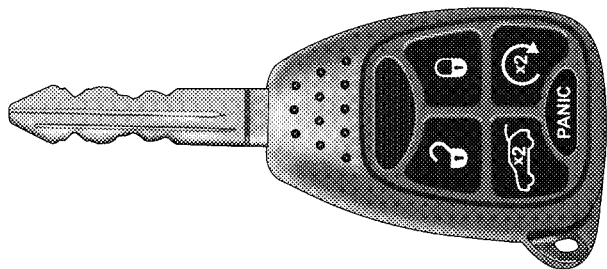

8165df1a

Ignition Key

### Ignition Key Removal

#### Automatic Transmission

Place the shift lever in PARK. Turn the ignition switch to the LOCK position and remove the key.

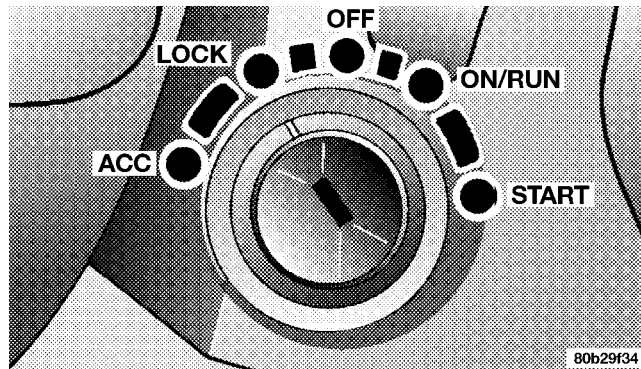

80b29f34

Ignition Switch Positions

**NOTE:** If you try to remove the key before you place the shift lever in PARK, the key may become trapped temporarily in the ignition cylinder. If this occurs, rotate the key to the right slightly, then remove the key as described. If a malfunction occurs, the system will trap the key in the ignition cylinder to warn you that this safety feature is inoperable. The engine can be started and stopped but the key cannot be removed until you obtain service.

### **WARNING!**

**Never leave children alone in a vehicle. Leaving unattended children in a vehicle is dangerous for a number of reasons. A child or others could be seriously or fatally injured. Don't leave the keys in the ignition. A child could operate power windows, other controls, or move the vehicle.**

### **CAUTION!**

**An unlocked vehicle is an invitation to thieves. Always remove key from the ignition and lock all doors when leaving the vehicle unattended.**

2

### **Locking Doors With The Key**

You can insert the key with either side up. To lock the door, turn the key rearward, to unlock the door, turn the key forward. For external door lock lubrication, refer to “Body Lubrication” in Section 7.

### **SENTRY KEY®**

The Sentry Key® Immobilizer system prevents unauthorized vehicle operation by disabling the engine. The system does not need to be armed or activated. Operation is automatic, regardless of whether the vehicle is locked or unlocked.

The system uses ignition keys which have an embedded electronic chip (transponder) to prevent unauthorized vehicle operation. Therefore, only keys that are programmed to the vehicle can be used to start and operate the vehicle. The system will shut the engine off in two seconds if someone uses an invalid key to try to start the engine.

**NOTE:** A key which has not been programmed is also considered an invalid key, even if it is cut to fit the ignition switch lock cylinder for that vehicle.

During normal operation, after turning on the ignition switch, the Vehicle Security Alarm Indicator Light will turn on for three seconds for a bulb check. If the light remains on after the bulb check, it indicates that there is a problem with the electronics. In addition, if the light begins to flash after the bulb check, it indicates that someone used an invalid key to try to start the engine. Either of these conditions will result in the engine being shut off after two seconds.

If the Vehicle Security Alarm Indicator Light turns on during normal vehicle operation (vehicle running for longer than 10 seconds), it indicates that there is a fault in the electronics. Should this occur, have the vehicle serviced as soon as possible.

**NOTE:**

- The Sentry Key® Immobilizer System is not compatible with some aftermarket remote starting systems. Use of these systems may result in vehicle starting problems and loss of security protection.
- Exxon/Mobil Speedpass™, additional Sentry Keys®, or any other transponder-equipped components on the same key chain will **not** cause a key related (transponder) fault unless the additional part is **physically held against the ignition key** being used when starting the vehicle. Cell phones, pagers, or other RF electronics will not cause interference with this system.

All of the keys provided with your new vehicle have been programmed to the vehicle electronics.

## Replacement Keys

**NOTE:** Only keys that are programmed to the vehicle electronics can be used to start and operate the vehicle. Once a Sentry Key® is programmed to a vehicle, it cannot be programmed to any other vehicle.

### CAUTION!

**Always remove the Sentry Keys® from the vehicle and lock all doors when leaving the vehicle unattended.**

At the time of purchase, the original owner is provided with a four-digit Personal Identification Number (PIN). Keep the PIN in a secure location. This number is required for authorized dealer replacement of keys. Duplication of keys may be performed at an authorized dealer or by following the customer key programming

procedure. This procedure consists of programming a blank key to the vehicle electronics. A blank key is one which has never been programmed.

**NOTE:** When having the Sentry Key® Immobilizer System serviced, bring all vehicle keys with you to an authorized dealer.

## Customer Key Programming

If you have two valid Sentry Keys®, you can program new Sentry Keys® to the system by performing the following procedure:

1. Cut the additional Sentry Key® Transponder blank(s) to match the ignition switch lock cylinder key code.
2. Insert the first valid key into the ignition switch. Turn the ignition switch to the ON position for at least three seconds, but no longer than 15 seconds. Then, turn the ignition switch to the LOCK position and remove the first key.



3. Insert the second valid key into the ignition switch. Turn the ignition switch to the ON position within 15 seconds. After 10 seconds, a chime will sound. In addition, the Vehicle Security Alarm Indicator Light will begin to flash. Turn the ignition switch to the LOCK position and remove the second key.

4. Insert a blank Sentry Key® into the ignition switch. Turn the ignition switch to the ON position within 60 seconds. After 10 seconds, a single chime will sound. In addition, the Vehicle Security Alarm Indicator Light will stop flashing. To indicate that programming is complete, the Vehicle Security Alarm Indicator Light will turn on again for three seconds and then turn off.

The new Sentry Key® is programmed. **The Remote Keyless Entry transmitter will also be programmed during this procedure.**

Repeat this procedure to program up to eight keys. If you do not have a programmed Sentry Key®, contact your authorized dealer for details.

**NOTE:** If a programmed key is lost, see your authorized dealer to have all remaining keys erased from the system's memory. This will prevent the lost key from starting your vehicle. The remaining keys must then be reprogrammed. All vehicle keys must be taken to an authorized dealer at the time of service to be reprogrammed.

### General Information

The Sentry Key® system complies with FCC rules Part 15 and with RSS-210 of Industry Canada. Operation is subject to the following conditions:

- This device may not cause harmful interference.
- This device must accept any interference that may be received, including interference that may cause undesired operation.

## IGNITION AND STEERING LOCK

In the LOCK position, the steering and ignition systems are locked to provide anti-theft protection for your vehicle. If the steering wheel is locked, it may be difficult to turn the key from the LOCK position when starting your vehicle. Move the steering wheel left and right while turning the key until it turns easily. The key can be inserted or withdrawn only in the LOCK position. Push in on the key in the ignition lock cylinder to rotate to the LOCK position.

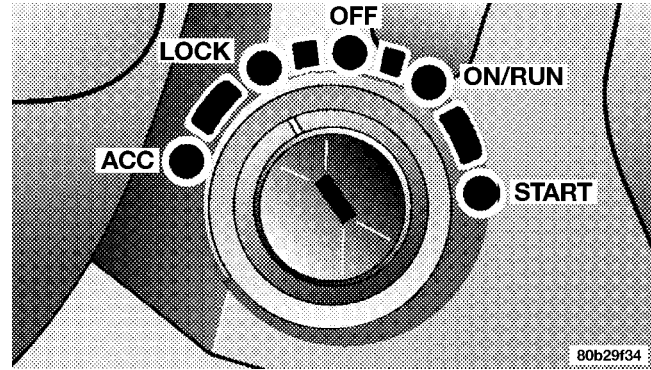

Ignition Switch Positions

**WARNING!**

**The key cannot be turned to LOCK until the shift lever is in the PARK position. Do not attempt to pull the shift lever out of PARK after the key is in the LOCK position.**

**NOTE:** The steering wheel will lock when the key is removed, and when the steering wheel is turned around 115 degrees clockwise or 65 degrees counterclockwise from the center position.

**Ignition Accessory Delay Feature**

The power window switches, radio, hands-free system (if equipped), and power outlets will remain active for 10 minutes after the ignition switch is turned off. Opening either front door will cancel this feature.

For vehicles equipped with the Electronic Vehicle Information Center (EVIC), the time for this feature is programmable. For details, refer to “Personal Settings (Customer-Programmable Features)”/“KEY OFF POWER DELAY > OFF” under “Electronic Vehicle Information Center (EVIC)” in Section 3 of this manual.

**SECURITY ALARM SYSTEM — IF EQUIPPED**

This system monitors the vehicle doors, liftgate, and ignition for unauthorized operation. When the Security Alarm System is activated, the system provides both audible and visual signals. The horn will sound repeatedly for three minutes and the headlights and Security light in the instrument cluster will flash for an additional 15 minutes. The engine will not run until the system is disarmed.

**To Set the Alarm:**

The Security Alarm System will set when you use the power door locks or use the Remote Keyless Entry Transmitter to lock the doors. After all the doors are closed and locked, the security light in the instrument cluster will flash rapidly to signal that the system is arming. The Security light in the instrument panel cluster will flash rapidly for about 15 seconds to indicate that the alarm is being set. After the alarm is set, the Security light will flash at a slower rate to indicate that the system is armed.

**NOTE:** If the Security light stays on continuously during vehicle operation, have the system checked by your authorized dealer.

**To Disarm the System:**

Use the Remote Keyless Entry Transmitter to unlock the doors. If something has triggered the system in your absence, the horn will sound three times when you unlock the doors. Check the vehicle for tampering.

The Security Alarm System will also disarm if the vehicle is started with a programmed Sentry Key®. If an unprogrammed Sentry Key® is used to start a vehicle, the engine will start and run for two seconds and then shut down. After six unsuccessful attempts at starting the engine, the system will shut down until the correct key is used. To exit alarming mode, press the RKE UNLOCK button or start the vehicle with a programmed Sentry Key®.

The Security Alarm System is designed to protect your vehicle; however, you can create conditions where the system will arm unexpectedly. If you remain in the

vehicle and lock the doors with the transmitter, the alarm will sound when you pull the door handle to exit.

**NOTE:** You may accidentally activate the Security Alarm System (horn sounds and lights flash) by entering the vehicle without using the key fob to unlock the door(s). The Security Alarm System can be disarmed with the key fob's UNLOCK button or by inserting a programmed Sentry Key® into the ignition and turning the key to the ON position.

## **ILLUMINATED ENTRY**

### **Vehicles Equipped With Power Door Locks**

All interior lights will illuminate in the vehicle when the doors are unlocked using the key fob.

The interior lights will remain on for 30 seconds after the last door is closed, or until all doors are closed and either the ignition is turned to the ON position or a key fob LOCK button is pressed.

There is also a battery saver feature that will turn the interior lights off after eight minutes if the ignition is OFF and a door is left open or the dimmer control is in the interior lights ON position.

## REMOTE KEYLESS ENTRY

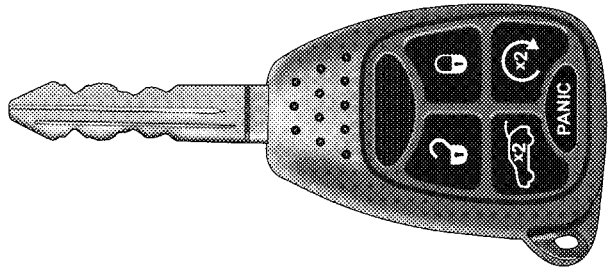

8165df1a

### Five Button Transmitter

**NOTE:** For the remote starting feature (if equipped), refer to “Remote Starting System” in section 2.

**NOTE:** For the power liftgate feature (if equipped), refer to the “Power Liftgate” in section 2.

**NOTE:** Your vehicle’s key fob may have three, four or five buttons (shown), depending on the optional features purchased with your vehicle.

This system allows you to lock or unlock the doors and liftgate or activate the panic alarm from distances a minimum of 66 ft (20 m) using a hand-held radio transmitter. The transmitter need not be pointed at the vehicle to activate the system.

**NOTE:** The line of transmission must not be blocked with metal objects.

### To Unlock the Doors and Liftgate:

Press and release the UNLOCK button on the key fob once to unlock only the driver’s door or twice to unlock all the doors and liftgate. When the UNLOCK button is pressed, the illuminated entry will initiate, and the parking lights will flash on twice.

## 22 THINGS TO KNOW BEFORE STARTING YOUR VEHICLE

The system can be programmed to unlock all the doors upon the first UNLOCK button press by following these procedures:

- For vehicles equipped with the Electronic Vehicle Information Center (EVIC), refer to “Personal Settings (Customer Programmable Features)” under “Overhead Console with Electronic Vehicle Information Center (EVIC) – If Equipped” in Section 3.
- For vehicles not equipped with the EVIC:
  1. Press and hold the LOCK button on a programmed key fob.
  2. Continue to hold the LOCK button at least four seconds, but not longer than 10 seconds, then press and hold the UNLOCK button.
  3. Release both buttons at the same time.

4. Test the feature while outside of the vehicle, by pressing the LOCK/UNLOCK button on the key fob.

**NOTE:** Pressing the LOCK button on the key fob while you are inside the vehicle will activate the Security Alarm. Opening a door with the Security Alarm activated will cause the alarm to sound. Press the UNLOCK button to deactivate the Security Alarm.

5. If the desired programming was not achieved or to reactivate this feature, repeat the above steps.

### **To Lock the Doors and Liftgate:**

Press and release the LOCK button on the key fob to lock all doors and liftgate. If the ignition is OFF when the doors are locked, the parking lights will flash on once and the horn will chirp once.

### Horn Chirp Programming

The horn chirp feature will be activated when shipped from the assembly plants. If desired, this feature can be disabled by following these procedures:

- For vehicles equipped with the Electronic Vehicle Information Center (EVIC), refer to “Personal Settings (Customer Programmable Features)” under “Overhead Console with Electronic Vehicle Information Center (EVIC) – If Equipped” in Section 3.
  - For vehicles not equipped with the EVIC:
1. Press and hold the LOCK button on the key fob.
  2. After holding the LOCK button for four seconds, also press the PANIC button within six seconds.
  3. Release both buttons at the same time.
  4. To reactivate this feature, repeat the above steps.

5. Test the horn chirp feature while outside of the vehicle by pressing the LOCK button on the key fob with the ignition in the OFF position and the key removed.

**NOTE:** Pressing the LOCK button on the key fob while you are inside the vehicle will activate the Security Alarm. Opening a door with the Security Alarm activated will cause the alarm to sound. Press the UNLOCK button to deactivate the Security Alarm.

6. If the desired programming was not achieved or to reactivate this feature, repeat the above steps.

### Flash Lights with Lock Programming

- For vehicles equipped with the Electronic Vehicle Information Center (EVIC), refer to “Personal Settings (Customer Programmable Features)” under “Overhead Console with Electronic Vehicle Information Center (EVIC) – If Equipped” in Section 3.



## 24 THINGS TO KNOW BEFORE STARTING YOUR VEHICLE

- For vehicles not equipped with the EVIC, perform the following procedure:

1. Press and hold the UNLOCK button on the key fob.
2. After holding the UNLOCK button for four seconds, also press the LOCK button within six seconds.
3. Release both buttons at the same time.
4. Test the flash lights with LOCK feature while outside of the vehicle, by pressing the LOCK button on the key fob with the ignition in the OFF position and the key removed.

**NOTE:** Pressing the LOCK button on the key fob while you are inside the vehicle will activate the Security Alarm. Opening a door with the Security Alarm activated will cause the alarm to sound. Press the UNLOCK button to deactivate the Security Alarm.

5. If the desired programming was not achieved or to reactivate this feature, repeat the above steps.

### **Using the Panic Alarm**

To activate the PANIC mode, while the ignition is OFF, press and release the PANIC button on the transmitter once. When the PANIC mode is activated, the interior lights will illuminate, the head lights and parking lights will flash and the horn will sound.

To cancel the PANIC mode, press and release the PANIC button on the transmitter a second time. PANIC mode will automatically cancel after three minutes or if the vehicle is started or exceeds 15 mph (24 km/h). During the PANIC mode, the door locks and Remote Keyless Entry systems will function normally. PANIC mode will not disarm the Security Alarm System on vehicles so equipped.

### General Information

This device complies with part 15 of FCC rules and with RS-210 of Industry Canada. Operation is subject to the following conditions:

1. This device may not cause harmful interference.
2. This device must accept any interference that may be received including interference that may cause undesired operation.

**NOTE:** Changes or modifications not expressly approved by the party responsible for compliance could void the user's authority to operate the equipment.

If your Remote Lock Control fails to operate from a normal distance, check for these two conditions.

1. Weak batteries in transmitter. The expected life of the batteries is five years.

2. Closeness to a radio transmitter, such as a radio station tower, airport transmitter, military base, and some mobile or CB radios.

### Programming Additional Transmitters

Vehicles will be shipped from the assembly plants with two key fob transmitters programmed only for that vehicle. A total of eight key fobs can be programmed for your vehicle. Additional key fobs can be programmed to your vehicle through the use of a currently programmed fob.

**NOTE:** When entering program mode using that key fob, all other programmed key fobs will be erased and you will have to reprogram them for your vehicle.

Use the following procedure to program additional key fobs if the vehicle is not equipped with Sentry Key®:

1. Enter your vehicle and close all doors.

2. Fasten your seat belt. Fastening the seat belt will cancel any chiming that may confuse you during this programming procedure.
  3. Place the key into the ignition.
  4. Turn the ignition to the ON position. **Do not start the engine.**
  5. Press and hold the UNLOCK button on the key fob.
  6. After holding the UNLOCK button for four seconds, also press the PANIC button within six seconds.
  7. When a single chime is heard, release both buttons. The chime is an indication that you have successfully entered program mode. All key fobs that are to be programmed must be done so within 60 seconds of when the chime was heard.
  8. Using the key fob to be programmed, press and release both the LOCK and UNLOCK buttons simultaneously.
  9. A single chime will be heard.
  10. Within four seconds of hearing the chime, press and release the UNLOCK button on the key fob.
  11. A single chime will be heard.
  12. Repeat steps 8 through 10 to program up to six additional key fobs.
  13. Turn the ignition to the OFF position.
  14. Your vehicle will remain in program mode up to 60 seconds from when the original chime was heard. After 60 seconds, all programmed key fobs function normally.
- NOTE:** If you do not have a programmed transmitter, contact your authorized dealer for details.

## Battery Replacement

The recommended replacement battery is CR2032.

**NOTE:** Perchlorate Material – special handling may apply. See [www.dtsc.ca.gov/hazardouswaste/perchlorate](http://www.dtsc.ca.gov/hazardouswaste/perchlorate).

1. If the key fob is equipped with a screw, remove the screw. With the transmitter buttons facing down, use a flat blade to pry the two halves of the transmitter apart. Make sure not to damage the elastomer seal during removal.

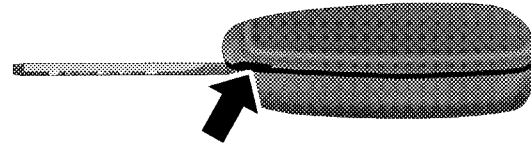

2

81182c72

### Separating Transmitter Halves

2. Remove and replace the battery. When replacing the battery, match the + sign on the battery to the + sign on the inside of the battery clip, located on the back cover. Avoid touching the new battery with your fingers. Skin oils may cause battery deterioration. If you touch a battery, clean it with rubbing alcohol.

3. To reassemble the transmitter case, snap the two halves of the case together. Make sure there is an even “gap” between the two halves. If equipped, install and tighten the screw until snug. Test transmitter operation.

### REMOTE STARTING SYSTEM — IF EQUIPPED

Your vehicle may be equipped with a remote starting system, which will allow the vehicle to be started from distances up to approximately 300 ft (91 m) away from the vehicle using the Remote Keyless Entry key fob which is part of your ignition key.

In order to remote start your vehicle, the hood, liftgate, and all the doors must be closed.

To remote start your vehicle, press the REMOTE START button on the key fob twice within three seconds. To indicate that the vehicle is about to start, the parking lights will flash and the horn will sound briefly.

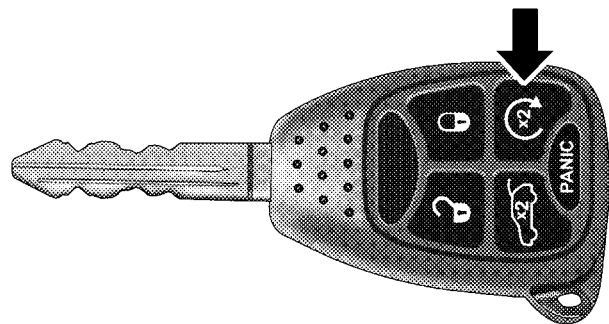

81a7e6cd

### Remote Start Transmitter

Once the vehicle has started, the engine will run for 15 minutes. To cancel remote start, press the REMOTE START button once.

To enter the vehicle while the engine is running during a remote start, you must first unlock the vehicle using the UNLOCK button on the key fob. After the vehicle is

unlocked, you have 60 seconds to enter the vehicle, insert the key in the ignition and move it to the RUN position; otherwise, the engine will cancel remote start and automatically turn off.

Remote start will also cancel if any of the following occur:

- If the engine stalls or RPM exceeds 2500
- Any engine warning lamps come on
- The hood is opened
- The hazard switch is pressed
- The transmission is moved out of PARK
- The brake pedal is pressed.

The vehicle can be started remotely up to a maximum of two times. The vehicle is also allowed a maximum of one failed start, where the remote start sequence was initiated but the engine stopped cranking without starting. After

either of these conditions, or if the Security Alarm System is alarming or if the PANIC button was pressed, the vehicle must be reset by inserting a valid key into the ignition and moving it to the RUN position, then back to LOCK.

## DOOR LOCKS

### Manual Door Locks

All the doors can be “manually” locked from the inside by pushing down the door lock plunger, located at the rear of the door. Both front doors may be opened from the inside with the door lock plunger in the down or locked position.

**WARNING!**

- For personal security and safety in the event of an accident, lock the vehicle doors when you drive as well as when you park and leave the vehicle.
- Never leave unattended children alone in a vehicle. Leaving children in a vehicle is dangerous for a number of reasons. A child or others could be seriously or fatally injured. Don't leave the keys in the ignition. A child could operate power windows, other controls, or move the vehicle.

**Power Door Locks**

A power door lock switch is on each front door trim panel. Use this switch to lock or unlock the doors.

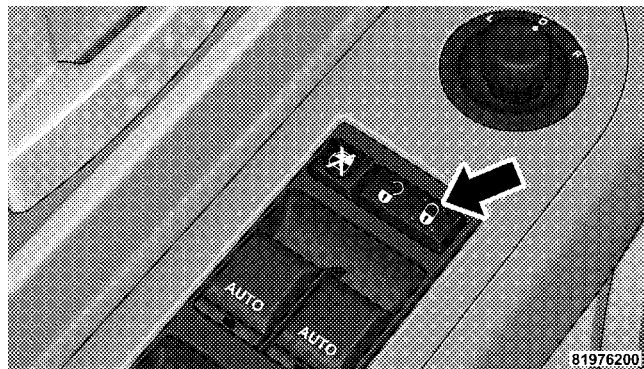

**Power Door Lock Switch**

If you press the power door lock switch while the key is in the ignition and any front door is open, the power locks will not operate. This prevents you from accidentally locking your keys in the vehicle. Removing the key or closing the door will allow the locks to operate. A chime will sound if the key is in the ignition switch and a door is open, as a reminder to remove the key.

### Automatic Door Locks

If this feature is enabled, your door locks will lock automatically when the vehicle's speed exceeds 15 mph (24 km/h).

### Automatic Door Lock Programming

This feature is enabled when your vehicle is shipped from the assembly plant and can be disabled by following these procedures:

- For vehicles equipped with the Electronic Vehicle Information Center (EVIC), refer to “Personal Settings (Customer Programmable Features)” under “Overhead Console with Electronic Vehicle Information Center (EVIC) – If Equipped” in Section 3.
  - For vehicles not equipped with the EVIC:
1. Enter your vehicle and close all doors.

2. Fasten your seat belt. Fastening the seat belt will cancel any chiming that may confuse you during this programming procedure.

3. Place the key into the ignition.

4. Within 10 seconds, cycle the key from the LOCK position to the ON position a minimum of four times, ending in the LOCK position (**do not start the engine**).

5. Within 30 seconds, press the driver's door lock switch in the LOCK direction.

6. A single chime will be heard to indicate the feature has been disabled.

7. To reactivate this feature, repeat the above steps.

8. If a chime is not heard, the program mode was canceled before the feature could be disabled. If necessary, repeat the above procedure.



**Auto Unlock On Exit — If Equipped**

This feature unlocks all of the doors of the vehicle when any door is opened (excluding the liftgate). This will occur only after the vehicle has been shifted into the PARK position after the vehicle has been driven (shifted out of PARK and all doors closed).

This feature will not operate if there is any manual operation of the power door locks (LOCK or UNLOCK).

**Auto Unlock On Exit Programming — If Equipped**

Customer programming sequence to enable or disable the Auto Unlock feature:

- For vehicles equipped with the Electronic Vehicle Information Center (EVIC), refer to “Personal Settings (Customer Programmable Features)” under “Overhead Console with Electronic Vehicle Information Center (EVIC) – If Equipped” in Section 3.
- For vehicles not equipped with the EVIC, performing the following procedure:

1. Enter your vehicle and close all doors.
2. Fasten your seat belt. Fastening the seat belt will cancel any chimes that may be confusing during this programming procedure.
3. Insert the key into the ignition.
4. Within 15 seconds, cycle the key from the LOCK position to the ON position a minimum of four times, ending in the LOCK position (**do not start the engine**).
5. Within 30 seconds, press the driver’s door lock switch in the UNLOCK direction.
6. A single chime will sound to indicate the feature has been changed.
7. Repeat the above steps to alternate the availability of this feature.
8. If a chime is not heard, the program mode was canceled before the feature could be changed. If necessary, repeat the above procedure.

### Child Protection Door Lock

To provide a safer environment for children riding in the rear seat, the rear doors of your vehicle have the child protection door lock system.

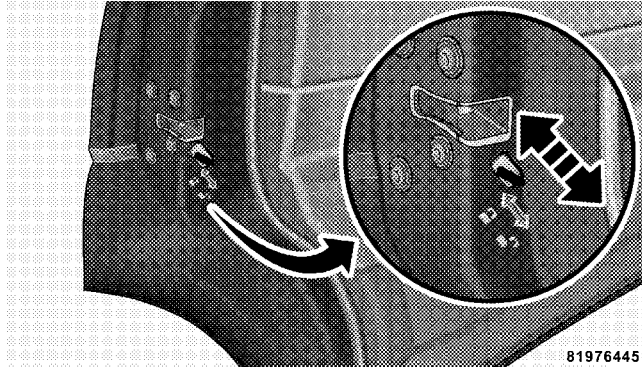

**Child Lock**

To use the system, open each rear door and slide the control UP to engage the locks and DOWN to disengage

the child protection locks. When the system on a door is engaged, that door can only be opened by using the outside door handle even if the inside door lock is in the unlocked position.

### WARNING!

**Avoid trapping anyone in a vehicle in a collision. Remember that the rear doors can only be opened from the outside when the child protection locks are engaged.**

**NOTE:** After setting the child protection door lock system, always test the door from the inside to make certain it is in the desired position.

**NOTE:** For emergency exit with the system engaged, move the door lock switch to the UNLOCK position, roll down the window and open the door with the outside door handle.

## WINDOWS

### Power Windows

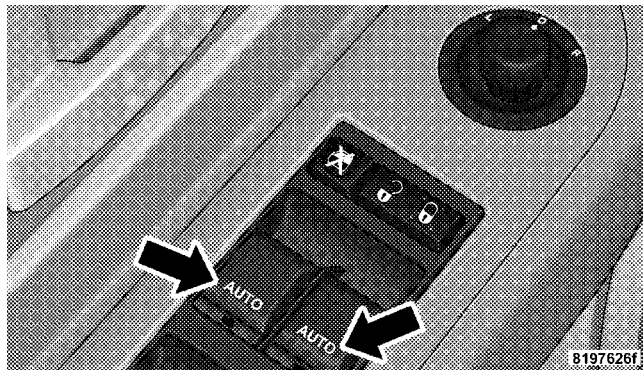

Window Switches

The control on the left front door has up-down switches that give you finger tip control of all four power windows. There is a single opening and closing switch on the passenger doors for passenger window control. The

windows will operate only when the ignition switch is turned to the ON position and for 10 minutes after the ignition is turned OFF or the driver's door is opened. This feature can be turned off by your authorized dealer.

**NOTE:** The Power Accessory Delay feature will allow the power windows to operate for 10 minutes after the ignition is turned OFF.

### WARNING!

**Never leave children alone in a vehicle. Leaving unattended children in a vehicle is dangerous for a number of reasons. A child or others could be seriously or fatally injured. Don't leave the keys in the ignition. A child could operate power windows, other controls, or move the vehicle.**

### Auto Down

The driver's and front passenger window switch has an Auto Down feature. Push the window switch past the first detent, release, and the window will go down automatically. To cancel the Auto Down movement, operate the switch in either the up or down direction and release the switch.

### Auto Up Feature with Anti-Pinch Protection (Driver's and Front Passenger Door Only)

Lift the window switch to the second detent, release, and the window will go up automatically.

To stop the window from going all the way up during the Auto Up operation, push down on the switch briefly.

To close the window part way, lift the window switch to the first detent and release when you want the window to stop.

**NOTE:** If the window runs into any obstacle during the auto-closure, it will reverse direction and then stop. Remove the obstacle and use the window switch again to close the window. Any impact due to rough road conditions may trigger the auto reverse function unexpectedly during auto-closure. If this happens, pull the switch lightly to the first detent and hold to close the window manually.

### **WARNING!**

**There is no anti-pinch protection when the window is almost closed. Be sure to clear all objects from the window before closing.**

### Resetting the Auto Up Feature

Should the Auto Up feature stop working, the window probably needs to be reset. To reset Auto Up:

Pull the window switch up and close the window completely, then pull and hold the switch for one second.

### Window Lockout Switch

The window lockout switch on the driver's door allows you to disable the window control on the other doors. To disable the window controls on the other doors, press the window lockout switch. To enable the window controls, press the window lockout switch again.

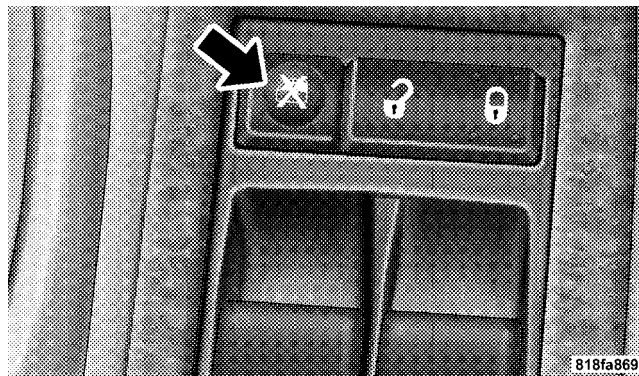

Window Lockout Switch

## LIFTGATE

The liftgate can be unlocked using the Remote Keyless Entry (RKE) Transmitter or by activating the power door lock switches located on the front doors.

**NOTE:** When the engine is running from a remote start (if equipped), the vehicle must first be unlocked by pressing the remote transmitter UNLOCK button prior to activating the power liftgate; otherwise, the engine will stop automatically.

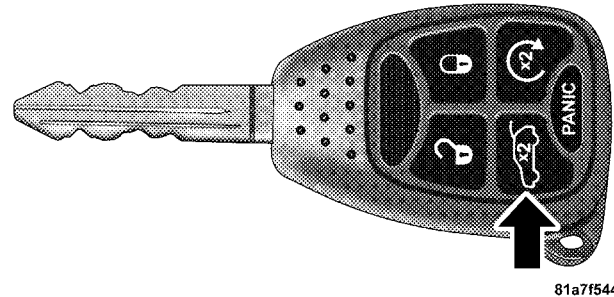

### Power Liftgate Button

Once unlocked, the liftgate can be opened or closed. To open the liftgate, pull the exterior handle and open the liftgate with one fluid motion.

The liftgate will not manually open if the vehicle is in gear or the vehicle speed is above 0 mph (0 km/h).

**NOTE:** If the liftgate is locked and is not equipped with a powered liftgate, pressing the button on the RKE Transmitter will result in the liftgate becoming unlocked for 30 seconds allowing you to manually access the liftgate area. The liftgate will re-lock automatically within 10 seconds once the liftgate is closed.

### Power Liftgate — If Equipped

The power liftgate may be opened manually or by using the button on the RKE Transmitter. Press the power liftgate button on the RKE Transmitter twice within five seconds, to open the power liftgate. Once the liftgate is fully open, pressing the power liftgate button twice within five seconds a second time will close the liftgate.

When the RKE Transmitter power liftgate button is pressed two times and the “Lamp Flash” feature is enabled, the turn signals will flash twice to signal that the liftgate is opening or closing.

The power liftgate may also be opened by pressing the switch located on the overhead console.

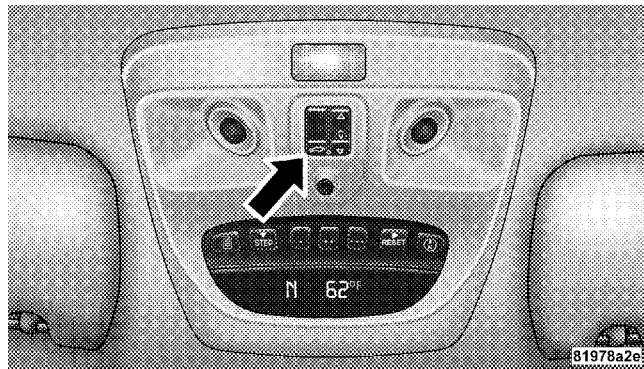

**Power Liftgate Switch**

**WARNING!**

**During power operation, personal injury or cargo damage may occur. Ensure the liftgate travel path is clear. Make sure the liftgate is closed and latched before driving away.**

A beeping signal will sound two seconds before the liftgate starts to open or close.

**NOTE:**

- If anything obstructs the power liftgate while it is closing or opening, the liftgate will automatically reverse to the closed or open position, provided it meets sufficient resistance.
- There are also pinch sensors attached to the side of the liftgate. Light pressure anywhere along these strips will cause the liftgate to return to the open position.

- The power liftgate must be in the full open position in order to power close. If the liftgate is not fully open, press the RKE Transmitter or overhead console button to fully open the liftgate and then press again to close.
- If the liftgate handle is pulled while the power liftgate is closing, the liftgate will reverse to the full open position.
- If the liftgate handle is pulled while the power liftgate is opening, the liftgate motor will disengage to allow manual operation.
- The power liftgate buttons will not operate if the vehicle is in gear or the vehicle speed is above 0 mph (0 km/h).
- The power liftgate will not operate in temperatures below  $-22^{\circ}\text{F}$  ( $-30^{\circ}\text{C}$ ) or temperatures above  $150^{\circ}\text{F}$  ( $65^{\circ}\text{C}$ ). Be sure to remove any buildup of snow or ice from the liftgate before pressing any of the power liftgate buttons.



#### 40 THINGS TO KNOW BEFORE STARTING YOUR VEHICLE

- If the power liftgate encounters multiple obstructions within the same cycle, the system will automatically stop and must be opened or closed manually.
- If your liftgate is power closing and you put the vehicle in gear, the liftgate will continue to power close. However, vehicle movement may result in a detection of an obstruction.

#### **WARNING!**

- **Driving with the liftgate open can allow poisonous exhaust gases into your vehicle. You and your passengers could be injured by these fumes. Keep the liftgate closed when you are operating the vehicle.**
- **If you are required to drive with the liftgate open, make sure that all windows are closed and the climate control blower switch is set at high speed. DO NOT use the recirculation mode.**

Gas props support the liftgate in the open position. However, because the gas pressure drops with temperature, it may be necessary to assist the props when opening the liftgate in cold weather.

## OCCUPANT RESTRAINTS

Some of the most important safety features in your vehicle are the restraint systems. These include the front and rear seat belts for the driver and all passengers, knee bolsters, front airbags for both the driver and front passenger, and left and right side curtain airbags for the driver and passengers seated next to a window. If you will be carrying children too small for adult-size seat belts, your seat belts or the LATCH feature (refer to the “Child Restraint” in this section), can be used to hold infant and child restraint systems.

Please pay close attention to the information in this section. It tells you how to use your restraint system properly to keep you and your passengers as safe as possible.

### WARNING!

**In a collision, you and your passengers can suffer much greater injuries if you are not properly buckled up. You can strike the interior of your vehicle or other passengers, or you can be thrown out of the vehicle. Always be sure you and others in your vehicle are buckled up properly.**

Buckle up even though you are an excellent driver, even on short trips. Someone on the road may be a poor driver and cause a collision that includes you. This can happen far away from home or on your own street.

Research has shown that seat belts save lives, and that they can reduce the seriousness of injuries in a collision. Some of the worst injuries happen when people are thrown from the vehicle. Seat belts reduce the possibility

of ejection and the risk of injury caused by striking the inside of the vehicle. **Everyone** in a motor vehicle should be belted at all times.

### **Lap/Shoulder Belts**

All seating positions in your vehicle have combination lap/shoulder belts. The belt webbing retractor is designed to lock during very sudden stops or collisions. This feature allows the shoulder part of the belt to move freely with you under normal conditions. But in a collision, the belt will lock and reduce the risk of your striking the inside of the vehicle or being thrown out.

### **WARNING!**

**It is extremely dangerous to ride in a cargo area, inside or outside of a vehicle. In a collision, people riding in these areas are more likely to be seriously injured or killed.**

**Do not allow people to ride in any area of your vehicle that is not equipped with seats and seat belts.**

**Be sure everyone in your vehicle is in a seat and using a seat belt properly.**

**WARNING!**

- **Wearing a seat belt incorrectly is dangerous. Seat belts are designed to go around the large bones of your body. These are the strongest parts of your body and can take the forces of a collision the best. Wearing your belt in the wrong place could make your injuries in a collision much worse. You might suffer internal injuries, or you could even slide out of part of the belt. Follow these instructions to wear your seat belt safely and to keep your passengers safe, too.**
- **Two people should never be belted into a single seat belt. People belted together can crash into one another in an accident, hurting one another badly. Never use a lap/shoulder belt or a lap belt for more than one person, no matter what their size.**

**Lap/Shoulder Belt Operating Instructions**

1. Enter the vehicle and close the door. Sit back and adjust the seat.

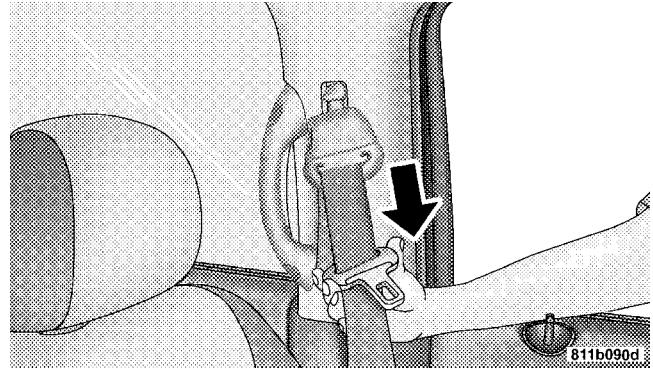
**Pulling Out Belt And Latch Plate**

2. The seat belt latch plate is above the back of the front seat, next to your arm in the rear seat. Grasp the latch

plate and pull out the belt. Slide the latch plate up the webbing as far as necessary to allow the belt to go around your lap.

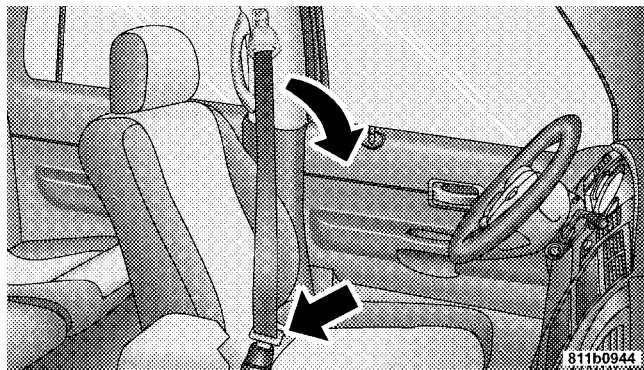

#### Removing Slack From Belt

3. When the belt is long enough to fit, insert the latch plate into the buckle until you hear a “click.”

#### WARNING!

- A belt buckled into the wrong buckle will not protect you properly. The lap portion could ride too high on your body, possibly causing internal injuries. Always buckle your belt into the buckle nearest you.
- A belt that is too loose will not protect you as well. In a sudden stop you could move too far forward, increasing the possibility of injury. Wear your seat belt snugly.
- A belt that is worn under your arm is very dangerous. Your body could strike the inside surfaces of the vehicle in a collision, increasing head and neck injury. And a belt worn under the arm can cause internal injuries. Ribs aren't as strong as shoulder bones. Wear the belt over your shoulder so that your strongest bones will take the force in a collision.
- A shoulder belt placed behind will not protect you from injury during a collision. You are more likely to hit your head in a collision if you do not wear your shoulder belt. The lap and shoulder belt are meant to be used together.

4. Position the lap belt across your thighs, below your abdomen. To remove slack in the lap belt portion, pull up on the shoulder belt. To loosen the lap belt if it is too tight, tilt the latch plate and pull on the lap belt. A snug belt reduces the risk of sliding under the belt in a collision.

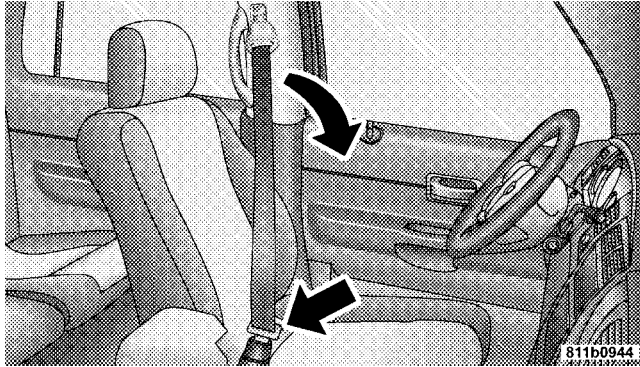

**Removing Slack From Belt**

### **WARNING!**

- A lap belt worn too high can increase the risk of internal injury in a collision. The belt forces won't be at the strong hip and pelvic bones, but across your abdomen. Always wear the lap belt as low as possible and keep it snug.
- A twisted belt can't do its job as well. In a collision it could even cut into you. Be sure the belt is straight. If you can't straighten a belt in your vehicle, take it to your authorized dealer and have it fixed.

5. Position the shoulder belt on your chest so that it is comfortable and not resting on your neck. The retractor will withdraw any slack in the belt.

6. To release the belt, push the red button on the buckle. The belt will automatically retract to its stowed position. If necessary, slide the latch plate down the webbing to allow the belt to retract fully.

**WARNING!**

A frayed or torn belt could rip apart in a collision and leave you with no protection. Inspect the belt system periodically, checking for cuts, frays, or loose parts. Damaged parts must be replaced immediately. Do not disassemble or modify the system. Seat belt assemblies must be replaced after a collision if they have been damaged (bent retractor, torn webbing, etc.). If the front airbags are deployed the front pretensioning retractors must be replaced.

**Adjustable Upper Shoulder Belt Anchorage**

In the front and second row outboard seats, the shoulder belt can be adjusted upward or downward to help position the belt away from your neck. Push in on the anchorage release button to release the anchorage, and then move it up or down to the position that fits you best.

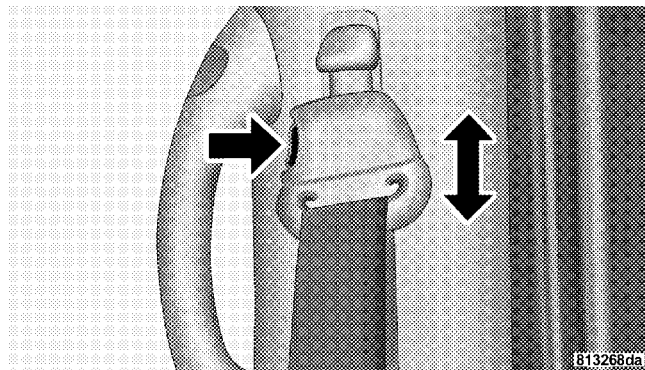

**Adjusting Upper Shoulder Belt**

As a guide, if you are shorter than average you will prefer a lower position, and if you are taller than average you'll prefer a higher position. When you release the anchorage, try to move it up or down to make sure that it is locked in the desired position. Pull the seatback forward to ensure that it is locked in the upright position.

**WARNING!**

**A 20% seatback that is not fully latched in the upright position will not protect you properly.**

**Second Row Center Seat Belt**

The center seating position in the second row has a seat belt assembly that can be converted from the normal emergency locking mode to the automatic locking mode. The seat belt should only be used in the automatic locking mode when a child seat is installed at this seating location.

When sitting in this seating location, ensure the seatback is fully engaged with the seatback latch by pushing rearward on the center seatback until you hear a click that signals latch engagement.

**Automatic Locking Retractors (ALR) Mode – If Equipped**

In this mode, the shoulder belt is automatically pre-locked. The belt will still retract to remove any slack in the shoulder belt. The automatic locking mode is available on all passenger seating positions with a combination lap/shoulder belt.

**When To Use The Automatic Locking Mode**

Use the automatic locking mode any time a child safety seat is installed in a passenger seating position. Children 12 years old and under should be properly restrained in the rear seat whenever possible.



### **How To Use The Automatic Locking Mode**

1. Buckle the combination lap/shoulder belt.
2. Grasp the shoulder portion and pull downward until the entire belt is extracted.
3. Allow the belt to retract. As the belt retracts, you will hear a clicking sound. This indicates the safety belt is now in the automatic locking mode.

### **How To Disengage The Automatic Locking Mode**

Disconnect the combination lap/shoulder belt and allow it to retract completely to disengage the automatic locking mode and activate the vehicle sensitive (emergency) locking mode.

### **Rear 60/40 Seat Third Row Center Three Point Belt — If Equipped**

The center three point seat belt for the third row rear seat may be disconnected to allow the 60% seatback to easily fold down. The keyed buckle latch plate (small latch plate at the end of the belt) can be detached from the keyed seat belt buckle (buckle without a red release button) located on the left inboard side of the third row bench seat. Insert the ignition key into the center white slot on the keyed buckle. The small latchplate can be removed when the key is pressed into the buckle. Allow the retractor to take up the surplus webbing, and insert the latch plates into the slots in the headliner for storage while the 60% seatback is folded down.

**WARNING!**

- If the small (keyed buckle) latch plate and keyed buckle are not properly connected when the seat belt is used by an occupant, the seat belt will not be able to provide the proper restraint and will increase the risk of injury in a collision.
- When reattaching the small (keyed buckle) latch plate and keyed buckle, ensure the seat belt webbing is not twisted. If the webbing is twisted, follow the preceding procedure to detach the small latch plate from the keyed buckle, untwist the webbing, and reattach the small latch plate and keyed buckle.

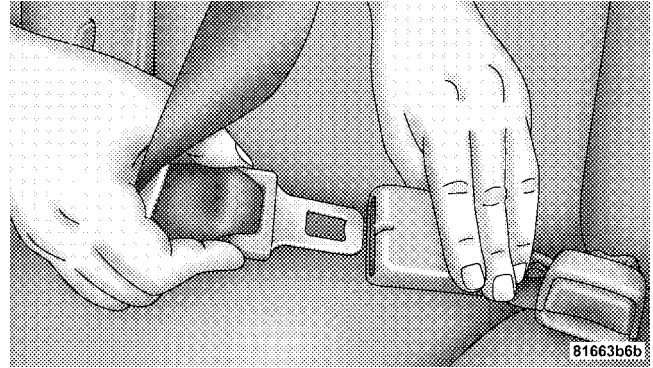
**Third Row Center Seat Belt**

## 50 THINGS TO KNOW BEFORE STARTING YOUR VEHICLE

To reattach the seat belt to the third row center seat, pull the small (keyed) buckle latch plate forward from the headliner slots and insert it into the keyed buckle until there is an audible click. Refer to the previous section for the proper seat belt usage.



**Third Row Center Seat Belt**

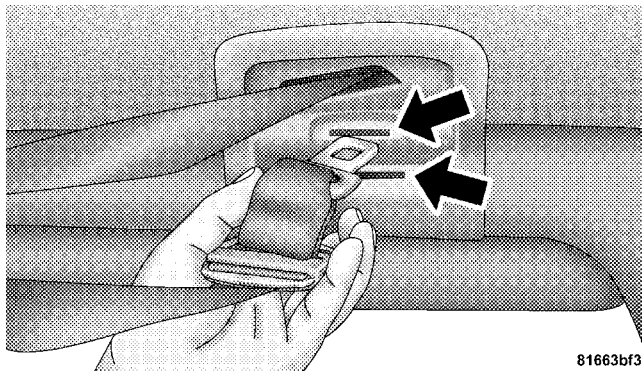

**Headliner Stowage Slots**

### **Seat Belt Pretensioners**

The seat belts for both front seating positions are equipped with pretensioning devices that are designed to remove any slack from the seat belt system in the event of a collision. These devices improve the performance of the seat belt by assuring that the belt is tight about the

occupant early in a collision. Pretensioners work for all size occupants, including those in child restraints.

**NOTE:** These devices are not a substitute for proper seat belt placement by the occupant. The seat belt still must be worn snugly and positioned properly.

The pretensioners are triggered by the Occupant Restraint Controller (ORC). Like the airbags, the pretensioners are single use items. After a collision that is severe enough to deploy the airbags and pretensioners, both must be replaced.

### **Enhanced Driver Seat Belt Reminder System (BeltAlert®)**

If the driver seat belt has not been buckled within 60 seconds of starting the vehicle and if the vehicle speed is greater than 5 mph (8 km/h), the Enhanced Warning System (BeltAlert®) will alert the driver to buckle their seat belt. The driver should also instruct all other occupants to buckle their seat belts. Once the warning is

triggered, the Enhanced Warning System (BeltAlert®) will continue to chime and flash the Seat Belt Warning Light for 96 seconds or until the driver's seat belt is buckled. The Enhanced Warning System (BeltAlert®) will be reactivated if the driver's seat belt is unbuckled for more than 10 seconds and the vehicle speed is greater than 5 mph (8 km/h).

Once the warning is triggered, it can be paused if the vehicle speed drops below 5 mph (8 km/h). The warning will be restarted if the vehicle speed becomes greater than 5 mph (8 km/h).

The Enhanced Warning System (BeltAlert®) can be enabled or disabled by your authorized dealer or by following these steps:

**NOTE:** The following steps must occur within the first 60 seconds of the ignition switch being turned to the ON or START position. DaimlerChrysler does not recommend deactivating the Enhanced Warning System (BeltAlert®).

1. Turn the ignition switch to the OFF position and buckle the driver's seat belt. **DO NOT** start the engine or press the TRIP RESET button.
2. Turn the ignition switch to the ON position and wait for the seat belt Warning Light to turn off. If during this time, the seat belt becomes unbuckled or the engine is cranked or started, programming will be cancelled.
3. Unbuckle and then re-buckle the driver's seat belt three times within 10 seconds, ending with the seat belt buckled. A chime will sound immediately (once the feature has toggled). If during this time the ignition switch is turned out of the ON position or the timer expires, programming mode will be cancelled.
4. Programming mode will be cancelled after the feature has toggled with the seat belt still buckled or if the ignition switch is turned to the LOCK position or 10 seconds after the feature has toggled.

The Enhanced Warning System (BeltAlert®) can be reactivated by repeating this procedure.

**NOTE:** Although the Enhanced Warning System (BeltAlert®) has been deactivated, the Seat Belt Warning Light will continue to illuminate while the driver's seat belt remains unbuckled.

### **Seat Belts and Pregnant Women**

We recommend that pregnant women use seat belts throughout their pregnancies. Keeping the mother safe is the best way to keep the baby safe.

Pregnant women should wear the lap part of the belt across the thighs and as snug against the hips as possible. Keep the belt low so that it does not come across the abdomen. That way the strong bones of the hips will take the force if there is a collision.

### Seat Belt Extender

If a seat belt is too short, even when fully extended, your authorized dealer can provide you with a seat belt extender. This extender should be used only if the existing belt is not long enough. When it is not required, remove the extender and store it.

#### WARNING!

Using a seat belt extender when not needed can increase the risk of injury in a collision. Only use the seat belt extender when the lap belt is not long enough when it is worn low and snug, and in the recommended seating positions. Remove and store the extender when not needed.

### Driver And Right Front Passenger Supplemental Restraint System (SRS)—Airbags

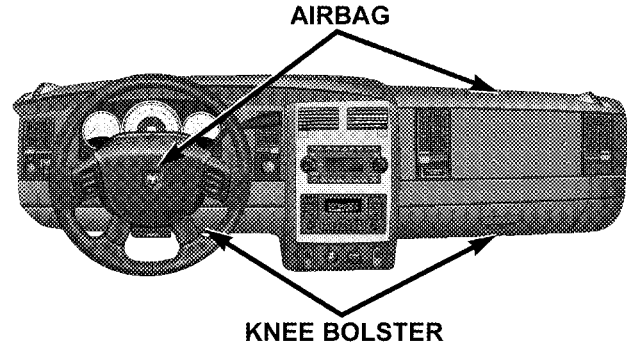

811cade0

This vehicle has airbags for both the driver and right front passenger as a supplement to the seat belt restraint systems. The driver's front airbag is mounted in the steering wheel. The passenger's front airbag is mounted

in the instrument panel, above the glove compartment. The words SRS/AIRBAG are embossed on the airbag covers.

**NOTE:** The front airbags are certified to the Federal regulations that allow less forceful deployment.

The front airbags have a multistage inflator design. This may allow the airbag to have different rates of inflation that are based on collision severity and occupant size.

This vehicle is also equipped with window bags to protect the driver, front, and rear passengers sitting next to a window. The window bags are located above the side windows. Their covers are also labeled SRS AIRBAG.

**NOTE:** Airbag covers may not be obvious in the interior trim, but they will open to allow airbag deployments.

### **WARNING!**

- **Do not put anything on or around the front airbag covers or attempt to manually open them. You may damage the airbags and you could be injured because the airbags are no longer functional. These protective covers for the airbag cushions are designed to open only when the airbags are inflating.**
- **Your vehicle is equipped with window bags. Do not stack luggage or other cargo up high enough to block the location of the window bag. The area where the window bag is located should remain free from any obstructions.**
- **Do not have any accessory items installed which will alter the roof, including adding a sunroof to your vehicle. Do not add roof racks that require permanent attachments (bolts or screws) for installation on the vehicle roof. Do not drill into the roof of the vehicle for any reason.**

**NOTE:** Do not use a clothing bar mounted to the coat hooks in this vehicle. A clothing bar will impede the proper performance of the window bags.

Along with the seat belts, front airbags work with the instrument panel knee bolsters to provide improved protection for the driver and front passenger. Window bags also work with seat belts to improve occupant protection.

The seat belts are designed to protect you in many types of collisions. The front airbags deploy in moderate to severe frontal collisions.

The window bag on the crash side of the vehicle is triggered in moderate to severe side collisions. Window bags will also deploy on rollover events. But even in collisions where the airbags work, you need the seat belts to keep you in the correct position for the airbags to protect you properly.

Here are some simple steps you can follow to minimize the risk of harm from a deploying airbag.

1. Children 12 years and under should always ride buckled up in a rear seat in an appropriate child restraint.

Infants in rear-facing child restraints should **NEVER** ride in the front seat of a vehicle with a passenger front airbag. An airbag deployment can cause severe injury or death to infants in that position.

You should read the instructions provided with your child restraint to make sure that you are using it properly.

2. All occupants should use their lap and shoulder belts properly.

3. The driver and front passenger seats should be moved back as far as practical to allow the airbag room to inflate.



4. If your vehicle has window bags, do not lean against the door or window. Airbags will inflate forcefully into the space between you and the door.

5. If the airbag system in this vehicle needs to be modified to accommodate a disabled person, contact the Customer Center. Refer to "If You Need Customer Assistance" in Section 9.

**WARNING!**

- **Relying on the airbags alone could lead to more severe injuries in a collision. The airbags work with your seat belt to restrain you properly. In some collisions the airbags won't deploy at all. Always wear your seat belts even though you have airbags.**
- **Being too close to the steering wheel or instrument panel during airbag deployment could cause serious injury. Airbags need room to inflate. Sit back, comfortably extending your arms to reach the steering wheel or instrument panel.**
- **If the vehicle has window bags, they also need room to inflate. Do not lean against the door or window. Sit upright in the center of the seat.**

## Airbag System Components

The airbag system consists of the following:

- Occupant Restraint Controller
- Side Remote Acceleration Sensors
- Airbag Warning Light
- Driver Airbag
- Passenger Airbag
- Window Bags above Side Windows
- Steering Wheel and Column
- Instrument Panel
- Interconnecting Wiring
- Knee Impact Bolsters
- Front Acceleration Sensors
- Driver and Front Passenger Seat Belt Pretensioners

## How the Airbag System Works

- The **Occupant Restraint Controller (ORC)** determines if a frontal collision is severe enough to require the airbags to inflate. The front airbag inflators are designed to provide different rates of airbag inflation from direction provided by the ORC. The ORC will detect a roll over when equipped with side airbags.

The ORC also monitors the readiness of the electronic parts of the system whenever the ignition switch is in the START or RUN positions. These include all of the items listed above except the steering wheel and column, and knee bolsters. If the key is in the OFF position, in the ACC position, or not in the ignition, the airbags are not “on” and will not inflate.

During a moderate-to-severe rear impact the ORC may deploy the seat belt pretensioners alone.



Also, the ORC turns on the AIRBAG warning light in the instrument cluster for six to eight seconds for a self-check when the ignition is first turned on. After the self-check, the AIRBAG warning light will turn off. If the ORC detects a malfunction in any part of the system, it turns on the AIRBAG warning light either momentarily or continuously. A single chime will sound if the light comes on again after initial start up.

### WARNING!

**Ignoring the AIRBAG warning light in your instrument panel could mean you won't have the airbags to protect you in a collision. If the light does not come on, stays on after you start the vehicle, or if it comes on as you drive, have the airbag system checked right away.**

- The **Driver and Passenger Airbag/Inflator Units** are located in the center of the steering wheel and the right side of the instrument panel. When the ORC detects a collision requiring the airbags, it signals the inflator units. A large quantity of nontoxic gas is generated to inflate the front airbags. Different airbag inflation rates may be possible based on collision severity. The steering wheel hub trim cover and the upper right side of the instrument panel separate and fold out of the way as the airbags inflate to their full size. The airbags fully inflate in about 50 - 70 milliseconds. This is about half of the time it takes to blink your eyes. The airbags then quickly deflate while helping to restrain the driver and front passenger. The driver's front airbag gas is vented through vent holes in the sides of the airbag. The passenger's front airbag gas is vented through vent holes in the sides of the airbag. In this way the airbags do not interfere with your control of the vehicle.

- The **Side Impact SRS Window Bags** are designed to activate only in certain side collisions or in a roll over event. When the ORC (with side impact option) detects a collision or roll over requiring the window bags to inflate, it signals the inflators on the crash side of the vehicle. Both window bags will inflate in a roll over event. A quantity of nontoxic gas is generated to inflate the window bag. The inflating window bag pushes the outside edge of the headliner out of the way and covers the window. The airbag inflates in about 30 milliseconds (about one quarter of the time it takes to blink your eyes) with enough force to injure you if you are not belted and seated properly, or if items are positioned in the area where the window bag inflates. This especially applies to children. The window bag is only about 3-1/2 in (9 cm) thick when it is inflated.

**NOTE:** At no time should any Supplemental Restraint System (SRS) component or SRS-related component or fastener be modified or replaced with any part except those which are approved by DaimlerChrysler/Mopar®.

- The **Knee Impact Bolsters** help protect the knees of the driver and the front passenger, and position everyone for the best interaction with the front airbag.

#### **If A Deployment Occurs**

The airbag system is designed to deploy the airbags when the impact sensors detect a moderate-to-severe frontal collision, to help restrain the driver and front passenger, and then immediately deflate.

**NOTE:** A frontal collision that is not severe enough to need airbag protection will not activate the system. This does not mean something is wrong with the airbag system.

If you do have a collision which deploys the airbags, any or all of the following may occur:

- The nylon airbag material may sometimes cause abrasions and/or skin reddening to the driver and front passenger as the airbags deploy and unfold. The abrasions are similar to friction rope burns or those you might get sliding along a carpet or gymnasium floor. They are not caused by contact with chemicals. They are not permanent and normally heal quickly. However, if you haven't healed significantly within a few days or if you have any blistering, see your doctor immediately. As the airbags deflate you may see some smoke-like particles. The particles are a normal by-product of the process that generates the nontoxic gas used for airbag inflation. These airborne particles may irritate the skin, eyes, nose, or throat. If you have skin or eye irritation, rinse the area with cool water. For nose or throat irritation, move to fresh air. If the

irritation continues, see your doctor. If these particles settle on your clothing, follow the garment manufacturer's instructions for cleaning.

- It is not advisable to drive your vehicle after the airbags have deployed. If you are involved in another collision, the airbags will not be in place to protect you.

### **WARNING!**

**Deployed airbags and seat belt pretensioners cannot protect you in another collision. Have the airbags, seat belt pretensioners, and the front passenger seat belt retractor assembly, replaced by an authorized dealer as soon as possible.**

## Maintaining Your Airbag System

### WARNING!

- **Modifications to any part of the airbag system could cause it to fail when you need it. You could be injured if the airbag system is not there to protect you. Do not modify the components or wiring, including adding any kind of badges or stickers to the steering wheel hub trim cover or the upper right side of the instrument panel. Do not modify the front bumper, vehicle body structure, or add aftermarket side steps or running boards.**
- **You need proper knee impact protection in a collision. Do not mount or locate any aftermarket equipment on or behind the knee bolsters.**
- **It is dangerous to try to repair any part of the airbag system yourself. Be sure to tell anyone who works on your vehicle that it has an airbag system.**

**NOTE:** Perchlorate Material – special handling may apply. See [www.dtsc.ca.gov/hazardouswaste/perchlorate](http://www.dtsc.ca.gov/hazardouswaste/perchlorate).

### Enhanced Accident Response System

If the airbags deploy after an impact and the electrical system remains functional, vehicles equipped with power door locks will unlock automatically, the engine will shut off and the hazard lights will turn on. In addition, approximately five seconds after the vehicle has stopped moving, the interior lights will light until the ignition switch is turned OFF.

### Airbag Light



You will want to have the airbags ready to inflate for your protection in an impact. While the airbag system is designed to be maintenance free, if any of the following occurs, have an authorized dealer service the system promptly:

- The airbag light does not come on or flickers during the six to eight seconds when the ignition switch is first turned ON.
- The light remains on or flickers after the six to eight second interval.
- The light flickers or comes on and remains on while driving.

**NOTE:** If the speedometer, tachometer or any engine related gauges are not working, the airbag control module may also be disabled. The airbags may not be ready

to inflate for your protection. Promptly check the fuse block for blown fuses. Refer to “Fuse Block” in Section 7. See your authorized dealer if the fuse is good.

### Event Data Recorder (EDR)

In the event of an accident, your vehicle is designed to record up to five seconds of specific vehicle data parameters (see the following list) in an event data recorder prior to the moment of airbag deployment and up to a quarter-second of high-speed deceleration data during and/or after airbag deployment. EDR data are **ONLY** recorded if an airbag deploys and are otherwise unavailable.

#### **NOTE:**

1. Under certain circumstances, EDR data may not be recorded (e.g., loss of battery power).

In conjunction with other data gathered during a complete accident investigation, the electronic data may be used by DaimlerChrysler Corporation and others to learn

more about the possible causes of crashes and associated injuries in order to assess and improve vehicle performance. In addition to crash investigations initiated by DaimlerChrysler Corporation, such investigations may be requested by customers, insurance carriers, government officials, and professional crash researchers, such as those associated with universities, and with hospital and insurance organizations.

In the event that an investigation is undertaken by DaimlerChrysler Corporation (regardless of initiative), the company or its designated representative will first obtain permission of the appropriate custodial entity for the vehicle (usually the vehicle owner or lessee) before accessing the electronic data stored, unless ordered to download data by a court with legal jurisdiction (i.e., pursuant to a warrant). A copy of the data will be provided to the custodial entity upon request. General data that does not identify particular vehicles or crashes

may be released for incorporation in aggregate crash databases, such as those maintained by the U.S. government and various states. Data of a potentially sensitive nature, such as would identify a particular driver, vehicle, or crash, will be treated confidentially. Confidential data will not be disclosed by DaimlerChrysler Corporation to any third party except when:

1. Used for research purposes, such as to match data with a particular crash record in an aggregate database, provided confidentiality of personal data is thereafter preserved
2. Used in defense of litigation involving a DaimlerChrysler Corporation product
3. Requested by police under a legal warrant
4. Otherwise required by law



Data parameters that may be recorded:

- Diagnostic trouble code(s) and warning light status for electronically-controlled safety systems, including the airbag system
- Airbag disable light status (if equipped)
- "Time" of airbag deployment (in terms of ignition cycles and vehicle mileage)
- Airbag deployment level (if applicable)
- Impact acceleration and angle
- Seat belt status
- Brake status (service and parking brakes)
- Accelerator status (including vehicle speed)
- Engine control status (including engine speed)
- Transmission gear selection
- Cruise control status

- Traction/stability control status
- Tire pressure monitoring system (TPMS) status (if equipped)

### **Child Restraint**

Everyone in your vehicle needs to be buckled up all the time - babies and children, too. Every state in the United States and all Canadian provinces require that small children ride in proper restraint systems. This is the law, and you can be prosecuted for ignoring it. Children 12 years and under should ride properly buckled up in a rear seat, if available. According to crash statistics, children are safer when properly restrained in the rear seats rather than in the front.

There are different sizes and types of restraints for children from newborn size to the child almost large enough for an adult seat belt. Always check the child seat Owner's Manual to ensure you have the right seat for your child. Use the restraint that is correct for your child.

## Infants and Small Children

- This vehicle is not capable of accommodating the installation of a car bed used for carrying newborn babies at the right front passenger seat position. If a car bed must be used to transport a newborn baby, the car bed must be installed in the second seating row only.
- Safety experts recommend that children ride rearward-facing in the vehicle until they are at least one year old and weigh at least 20 lbs (9 kg). Two types of child restraints can be used rearward facing: infant carriers and "convertible" child seats.
- The infant carrier is only used rearward-facing in the vehicle. It is recommended for children who weigh up to about 20 lbs (9 kg). "Convertible" child seats can be used either rearward-facing or forward-facing in the vehicle. Convertible child seats often have a higher weight limit in the rearward-facing direction than infant carriers do, so they can be used rearward-facing by

children who weigh more than 20 lbs (9 kg) but are less than one year old. Both types of child restraints are held in the vehicle by the lap/shoulder belt or the LATCH child restraint anchorage system. (Refer to "LATCH - Child Seat Anchorage System" in this section.)

- Rearward-facing child seats must **NEVER** be used in the front seat of a vehicle with a front passenger airbag. An airbag deployment could cause severe injury or death to infants in this position.

## Older Children and Child Restraints

Children who weigh more than 20 lbs (9 kg) and who are older than one year can ride forward-facing in the vehicle. Forward-facing child seats and convertible child seats used in the forward-facing direction are for children who weigh 20 to 40 lbs (9 to 18 kg) and who are older than one year. These child seats are also held in the vehicle by the lap/shoulder belt or the LATCH child restraint anchorage system. (Refer to "LATCH - Child Seat Anchorage System" in this section.)

The belt-positioning booster seat is for children weighing more than 40 lbs (18 kg), but who are still too small to fit the vehicle's seat belts properly. If the child cannot sit with knees bent over the vehicle's seat cushion while the child's back is against the seatback, they should use a belt-positioning booster seat. The child and belt-positioning booster seat are held in the vehicle by the lap/shoulder belt.

### **Children Too Large for Booster Seats**

Children who are large enough to wear the shoulder belt comfortably, and whose legs are long enough to bend over the front of the seat when their back is against the seatback should use the lap/shoulder belt in a rear seat.

- Make sure that the child is upright in the seat.
- The lap portion should be low on the hips and as snug as possible.

- Check belt fit periodically. A child's squirming or slouching can move the belt out of position.
- If the shoulder belt contacts the face or neck, move the child closer to the center of the vehicle. Never allow a child to put the shoulder belt under an arm.

### **WARNING!**

- **Improper installation can lead to failure of an infant or child restraint. It could come loose in a collision. The child could be badly injured or killed. Follow the manufacturer's directions exactly when installing an infant or child restraint.**
- **A rearward-facing infant restraint should only be used in a rear seat. A rearward-facing infant restraint in the front seat may be struck by a deploying passenger airbag which may cause severe injuries or be fatal to the infant.**

**Here are some tips for getting the most out of your child restraint:**

- Before buying any restraint system, make sure that it has a label certifying that it meets all applicable Safety Standards. The manufacturer recommends that you try a child restraint in the vehicle seats where you will use it before you buy it.
- The restraint must be appropriate for your child's weight and height. Check the label on the restraint for weight and height limits.
- Carefully follow the instructions that come with the restraint. If you install the restraint improperly, it may not work when you need it.
- The second row outside seating positions and all third row seats have cinching latch plates. The second row center position has an Automatic Locking Retractor. These are designed to keep the lap portion tight

around the child restraint so that it is not necessary to use a locking clip. If the seat belt has a cinching latch plate, pulling up on the shoulder portion of the lap/shoulder belt will tighten the belt. The cinching latch plate will keep the belt tight; however, any seat belt system will loosen with time, so check the belt occasionally and pull it tight if necessary. If the seat belt has an Automatic Locking Retractor, it will have a distinctive label. Pull the belt from the retractor until there is enough to allow you to pass through the child restraint and slide the latch plate into the buckle. Then, pull the belt until it is completely extended from the retractor. Allow the belt to return to the retractor, pulling on the excess webbing to tighten the lap portion about the child restraint. Refer to "Automatic Locking Mode" in this section.

- Buckle the child into the restraint exactly as the manufacturer's instructions tell you.

- When your child restraint is not in use, secure it in the vehicle with the seat belt or remove it from the vehicle. Do not leave it loose in the vehicle. In a sudden stop or collision, it could strike the occupants or seatbacks and cause serious personal injury.

### **LATCH - Child Seat Anchorage System (Lower Anchors and Tether for CHildren)**

Your vehicle's second row seat is equipped with the child restraint anchorage system called LATCH. The LATCH system provides for the installation of the child restraint without using the vehicle's seat belts, instead securing the child restraint using lower anchorages and upper tether straps from the child restraint to the vehicle structure. LATCH-compatible child restraint systems are now available. However, because the lower anchorages are to be introduced over a period of years, child restraint systems having attachments for those anchorages will continue to also have features for installation using the vehicle's seat belts. Child restraints having tether straps

and hooks for connection to the top tether anchorages have been available for some time. For some older child restraints, many child restraint manufacturers offer add-on tether strap kits or retro-fit kits. You are urged to take advantage of all the available attachments provided with your child restraint in any vehicle.

All three second row seating positions have lower anchorages that are capable of accommodating LATCH-compatible child seats having flexible, webbing-mounted lower attachments. Child seats with fixed lower attachments must be installed in the outboard positions only. Regardless of the specific type of lower attachment, **NEVER** install LATCH-compatible child seats such that two seats share a common lower anchorage. If you are installing LATCH-compatible child restraints in adjacent rear seating positions, you can use the LATCH anchors or the vehicle's seat belt for the outboard position, but you must use the vehicle's seat belt at the center position. If your child restraints are not LATCH-compatible, you can

only install the child restraints using the vehicle's seat belts. Refer to "Installing the LATCH-Compatible Child Restraint System" this section.

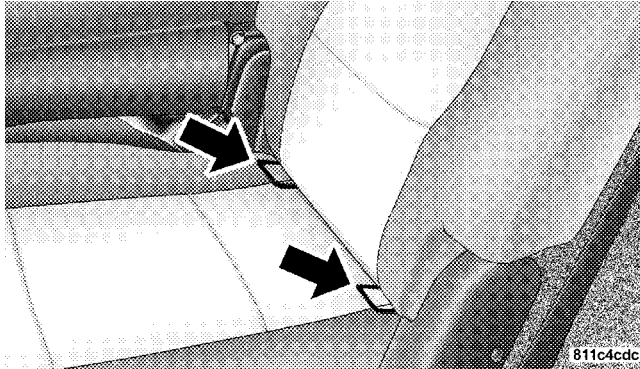

**Second Row Seat Left Side**

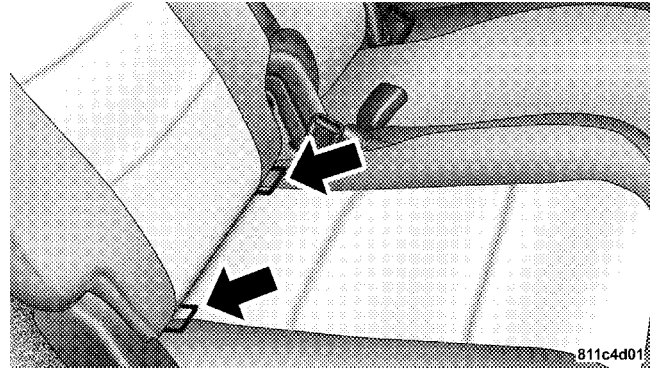

**Second Row Seat Right Side**

### **Installing the LATCH-Compatible Child Restraint System**

We urge that you carefully follow the directions of the manufacturer when installing your child restraint. Not all child restraint systems will be installed as described here. Again, carefully follow the installation instructions that

were provided with the child restraint system. The rear seat lower anchorages are round bars, located at the rear of the seat cushion where it meets the seatback, and are just visible when you lean into the rear seat to install the child restraint. You will easily feel them if you run your finger along the intersection of the seatback and seat cushion surfaces. In addition, there are tether strap anchorages behind each second row seating position located on the back of the seat. Many, but not all restraint systems will be equipped with separate straps on each side, with each having a hook or connector for attachment to the lower anchorage and a means of adjusting the tension in the strap. Forward-facing toddler restraints and some rear-facing infant restraints will also be equipped with a tether strap, a hook for attachment to the tether strap anchorage and a means of adjusting the tension of the strap. You will first loosen the adjusters on the lower straps and on the tether strap so that you can more easily attach the hooks or connectors to the vehicle

anchorages. Next, attach the lower hooks or connectors over the top of the anchorage bars, pushing aside the seat cover material. Then attach the tether strap to the anchorage located on the back of the seat, being careful to route the tether strap to provide the most direct path between the anchor and the child restraint. If your vehicle is equipped with adjustable rear head restraints, raise the head restraint and, route the tether strap under the head restraint and between the two posts. Finally, tighten all three straps as you push the child restraint rearward and downward into the seat, removing slack in the straps according to the child restraint manufacturer's instructions.

**NOTE:** When using the LATCH attaching system to install a child restraint, please ensure that all seat belts not being used for occupant restraints are stowed and out of reach of children. It is recommended that before installing the child restraint, buckle the seat belt so the seat belt is tucked behind the child restraint and out of

reach. If the buckled seat belt interferes with the child restraint installation, instead of tucking the seat belt behind the child restraint, route the seat belt through the child restraint belt path and then buckle it. This should stow the seat belt out of the reach of an inquisitive child. Remind all children in the vehicle that the seat belts are not toys and should not be played with, and never leave an unattended child in the vehicle.

### **WARNING!**

**Improper installation of a child restraint to the LATCH anchorages can lead to failure of an infant or child restraint. The child could be badly injured or killed. Follow the manufacturer's directions exactly when installing an infant or child restraint.**

### **Installing Child Restraints Using the Vehicle Seat Belt**

The second and third row seats have either cinching latch plates or Automatic Locking Retractors which are designed to keep the lap portion tight around the child restraint so that it is not necessary to use a locking clip. If the seat belt has a cinching latch plate, pulling up on the shoulder portion of the lap/shoulder belt will tighten the belt. The cinching latch plate will keep the belt tight, however, any seat belt system will loosen with time, so check the belt occasionally and pull it tight if necessary. If the seat belt has an Automatic Locking Retractor, it will have a distinctive label. Pull the belt from the retractor until there is enough to allow you to pass through the child restraint and slide the latch plate into the buckle. Then, pull the belt until it is completely extended from the retractor. Allow the belt to return to the retractor,



pulling on the excess webbing to tighten the lap portion around the child restraint. Refer to "Automatic Locking Mode" in this section.

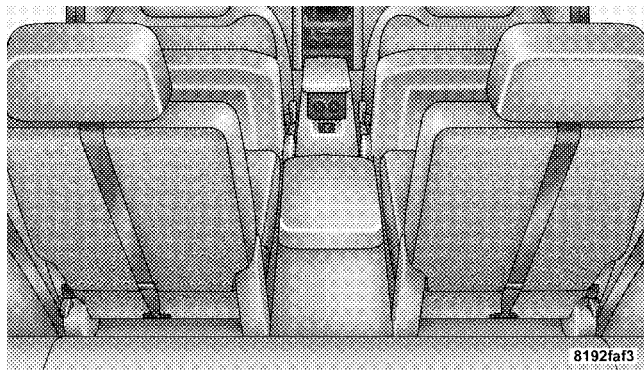

Second Row Seat Tether Anchors

### **Child Restraints in Third Row Seating (If Equipped)**

For vehicles equipped with third row split bench (60/40) seating, the tether strap anchorage is located on the seatback behind the center seating position. The hooks in the rear floor are **NOT** designed to withstand the forces that may occur during a crash.

#### **WARNING!**

**An incorrectly anchored tether strap could lead to increased head motion and possible injury to the child. Use only the anchor positions directly behind the child seat to secure a child restraint top tether strap. Children and infants are safer when properly restrained in a child restraint system secured in a rear seating position.**

### Child Restraint Tether Anchor

There are tether strap anchorages behind each seating position in the second row and behind the center seating position in the case of the third row seat (60/40) split bench, if equipped. To install child restraint tether anchors, follow these instructions:

1. Place the child restraint in the center seating position of the third row of seats.

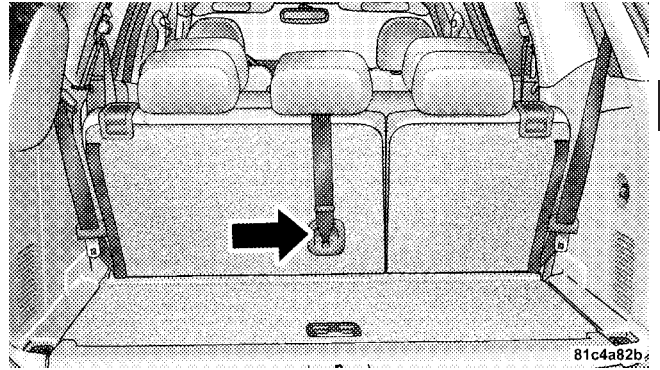

2

### Third Row Seat Tether Anchor

2. Route the tether strap under the head restraint and between the two headrest posts.
3. Attach the tether strap hook of the child restraint to the tether anchor located on the seatback and remove the slack in the tether strap according to the manufacturer's instructions.

**WARNING!**

**An incorrectly anchored tether strap could lead to seat failure and injury to the child. In a collision, the seat could come loose and allow the child to crash into the inside of the vehicle or other passengers, or even be thrown from the vehicle. Use only the anchor positions directly behind the child seat to secure a child restraint top tether strap. For instructions, refer to “Child Restraint Tether Anchor” in this section. See your authorized dealer for help if necessary.**

**Transporting Pets**

Airbags deploying in the front seat could harm your pet. An unrestrained pet will be thrown about and possibly injured, or injure a passenger during panic braking or in a collision. Pets should be restrained in the rear seat in pet harnesses or pet carriers that are secured by seat belts.

**ENGINE BREAK-IN RECOMMENDATIONS**

A long break-in period is not required for the engine in your new vehicle. Drive moderately during the first 300 mi (500 km). After the initial 60 mi (100 km), speeds up to 50 or 55 mph (80 or 90 km/h) are desirable. While cruising, brief full-throttle acceleration within the limits of local traffic laws contributes to a good break-in.

Avoid wide-open throttle acceleration in low gear.

The engine oil installed in the engine at the factory is a high-quality, energy-conserving type lubricant. Oil changes should be consistent with anticipated climate conditions under which vehicle operations will occur. For recommended viscosity and quality grades, refer to “Engine Oil” under “Maintenance Procedures” in Section 7.

**NON-DETERGENT OR STRAIGHT MINERAL OILS MUST NEVER BE USED.**

A new engine may consume some oil during its first few thousand miles (kilometers) of operation. This is a normal part of the break-in and is not an indication of difficulty.

## SAFETY TIPS

### Exhaust System

#### WARNING!

Exhaust gases contain carbon monoxide, an extremely toxic gas that by itself is colorless and odorless. To avoid inhaling these gases, the following precautions should be observed:

- Do not run the engine in a closed garage or in confined areas any longer than needed to move your vehicle in or out of the area.
- It may be necessary to sit in a parked vehicle with the engine running for more than a short period. If so, adjust your climate control system to force outside air into the vehicle. Set the blower at high speed and the controls in any position except OFF or RECIRC.
- The best protection against carbon monoxide entry into the vehicle body is a properly maintained engine exhaust system.

Be aware of changes in the sound of the exhaust system, exhaust fumes detected inside the vehicle, or damage to the underside or rear of the vehicle. Have a competent mechanic inspect the complete exhaust system and adjacent body areas for broken, damaged, deteriorated or mispositioned parts. Open seams or loose connections could permit exhaust fumes to seep into the passenger compartment. In addition, inspect the exhaust system each time the vehicle is raised for lubrication or oil change. Replace or adjust as required.

### **Safety Checks You Should Make Inside The Vehicle**

#### **Heater Defroster Ducts**

Inspect the heater defroster ducts for proper operation. Check for proper airflow through all defroster ducts. If there are any question regarding the operation of your heater defroster ducts, have the system checked by an authorized dealer.

#### **Seat Belts**

Inspect the belt system periodically, checking for cuts, frays and loose parts. Damaged parts must be replaced immediately. Do not disassemble or modify the system.

Seat belt assemblies must be replaced after an accident if they have been damaged (bent retractor, torn webbing, etc.) or if the front airbags have deployed. If there is any question regarding belt or retractor condition, replace the belt.

#### **Airbag Light**

The Airbag light should come on and remain on for six to eight seconds as a bulb check when the ignition switch is first turned ON. If the light is not lit during starting, see your authorized dealer. If the light stays on, flickers or comes on while driving, have the system checked by an authorized dealer. If there is a problem with the airbag light, the seat belt light will flash.

## **Safety Checks You Should Make Outside The Vehicle**

### **Tires**

Examine tires for tread wear or uneven wear patterns. Check for stones, nails, glass or other objects lodged in the tread.

Inspect for tread cuts or sidewall cracks. Check wheel nuts for tightness and tires for proper pressure.

### **Lights**

Check the operation of all exterior lights. Check turn signal and high beam indicator lights on the instrument panel.

### **Door Latches**

Check for positive closing, latching and locking.

### **Fluid Leaks**

Check area under vehicle after overnight parking for fuel, water, oil, or other fluid leaks. Also, if fuel fumes are detected, the cause should be located and corrected.



# UNDERSTANDING THE FEATURES OF YOUR VEHICLE

## CONTENTS

---

■ Mirrors . . . . .	.84	□ Automatic Dimming Driver's Exterior Mirror — If Equipped . . . . .	.88
□ Inside Day/Night Mirror . . . . .	.84	■ Hands-Free Communication (UConnect®) — If Equipped . . . . .	.88
□ Automatic Dimming Mirror — If Equipped . . .	.84	□ Operation . . . . .	.90
□ Outside Mirrors . . . . .	.85	□ Phone Call Features . . . . .	.97
□ Exterior Mirrors Folding Feature — If Equipped . . . . .	.85	□ UConnect® System Features . . . . .	100
□ Electric Remote-Control Mirrors . . . . .	.86	□ Advanced Phone Connectivity . . . . .	105
□ Illuminated Vanity Mirrors — If Equipped . . .	.87	□ Things You Should Know About Your UConnect® System . . . . .	107
□ Heated Mirrors — If Equipped . . . . .	.87		



- General Information . . . . . 115
- Voice Recognition System (VR) – If Equipped . . . 115
  - Voice Recognition System (VR) Operation . . . . 115
  - Commands . . . . . 116
  - Voice Training . . . . . 119
- Seats . . . . . 120
  - Front Seat Manual Seat Adjustment . . . . . 120
  - Front Seat Manual Seat Recliners . . . . . 121
  - Manual Lumbar Support Adjustment — If Equipped . . . . . 122
  - Adjustable Head Restraints — All Seating Positions . . . . . 122
  - 8-Way Driver’s Power Seat — If Equipped . . . 123
  - 4-Way Passenger’s Power Seat — If Equipped . . . . . 124
  - Heated Seats — If Equipped . . . . . 124
  - Second Row Bucket Seats — Fold And Tumble . . . . . 127
  - Second Row 40/20/40 Seat — Fold And Tumble . . . . . 130
  - Third Row Seat Bench — If Equipped . . . . . 133
  - Third Row 60/40 Folding — If Equipped . . . . 135
- Driver Memory System — If Equipped . . . . . 137
  - Setting Memory Positions And Linking Remote Keyless Entry Transmitter To Memory . . . . . 138
  - Memory Position Recall . . . . . 139
  - To Disable A Transmitter Linked To Memory . . 140

<ul style="list-style-type: none"> <li>□ Self-Limiting Control . . . . .141</li> <li>□ Driver Easy Exit And Easy Entry Control . . . .141</li> <li>■ To Open And Close The Hood . . . . .142</li> <li>■ Lights . . . . .144                     <ul style="list-style-type: none"> <li>□ Interior Lights . . . . .145</li> <li>□ Battery Saver . . . . .145</li> <li>□ Headlight Delay . . . . .146</li> <li>□ Automatic Headlights — If Equipped . . . . .147</li> <li>□ Headlights, Parking Lights, Panel Lights . . . .147</li> <li>□ Illuminated Entry . . . . .147</li> <li>□ Daytime Running Lights (Canada Only) . . . .148</li> <li>□ Lights-On Reminder . . . . .148</li> <li>□ Fog Lights — If Equipped . . . . .148</li> </ul> </li> </ul>	<ul style="list-style-type: none"> <li>□ Multifunction Control Lever . . . . .149</li> <li>■ Windshield Wipers And Washers . . . . .151                     <ul style="list-style-type: none"> <li>□ Windshield Wipers . . . . .151</li> <li>□ Windshield Washers . . . . .152</li> </ul> </li> <li>■ Tilt Steering Column . . . . .153</li> <li>■ Driver Adjustable Pedals — If Equipped . . . . .154                     <ul style="list-style-type: none"> <li>□ Adjustment . . . . .155</li> </ul> </li> <li>■ Electronic Speed Control — If Equipped . . . . .156                     <ul style="list-style-type: none"> <li>□ To Activate . . . . .156</li> <li>□ To Set At A Desired Speed . . . . .156</li> <li>□ To Deactivate . . . . .157</li> <li>□ To Resume Speed . . . . .157</li> <li>□ To Vary The Speed Setting . . . . .157</li> </ul> </li> </ul>
---	---

## 82 UNDERSTANDING THE FEATURES OF YOUR VEHICLE

- To Accelerate For Passing . . . . .159
- Rear Park Assist System — If Equipped . . . . .159
- Rear Camera — If Equipped . . . . .163
- Overhead Console . . . . .165
  - Courtesy/Reading Lights . . . . .166
- Overhead Console With Electronic Vehicle Information Center (EVIC) — If Equipped . . . . .166
  - Dome/Reading Lights . . . . .166
  - Electronic Vehicle Information Center (EVIC) — If Equipped . . . . .167
  - Compass/Temperature Button . . . . .173
- Garage Door Opener — If Equipped . . . . .176
  - Programming HomeLink® . . . . .177
  - Gate Operator/Canadian Programming . . . . .180
- Using HomeLink® . . . . .181
  - Reprogramming A Single HomeLink® Button . . . . .181
  - Security . . . . .181
  - Troubleshooting Tips . . . . .181
  - General Information . . . . .182
- Power Sunroof — If Equipped . . . . .182
  - Express Open Feature . . . . .183
  - Wind Buffeting . . . . .184
  - Sunroof Maintenance . . . . .184
- Electrical Power Outlets . . . . .185
  - 115V Inverter Outlet - If Equipped . . . . .185
  - Electrical Outlet Use With Engine Off (Battery Fed Configuration) . . . . .187

■ Floor Console . . . . .	188	■ Factory Installed Roof Luggage Rack . . . . .	191
□ Floor Console Features . . . . .	188	■ Cargo Management System—If Equipped . . . . .	193
□ Rear Floor Console Features – If Equipped . . .	190		

## MIRRORS

### Inside Day/Night Mirror

The mirror should be adjusted to center on the view through the rear window. A two-point pivot system allows for horizontal and vertical adjustment of the mirror.

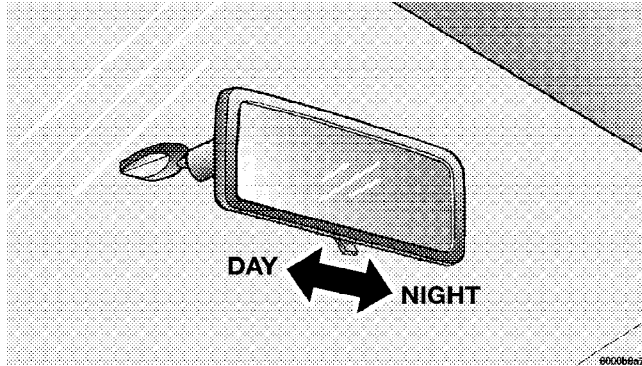

Day/Night Mirror

Annoying headlight glare can be reduced by moving the small control under the mirror to the NIGHT position (toward the rear of vehicle). The mirror should be adjusted while set in the DAY position (toward the windshield).

### Automatic Dimming Mirror — If Equipped

This mirror will automatically adjust for annoying headlight glare from vehicles behind you. You can turn the feature ON or OFF by pressing the button at the base of the mirror. A light in the button will indicate when the dimming feature is activated. This option also controls the driver side mirror when it is equipped with auto dimming glass.

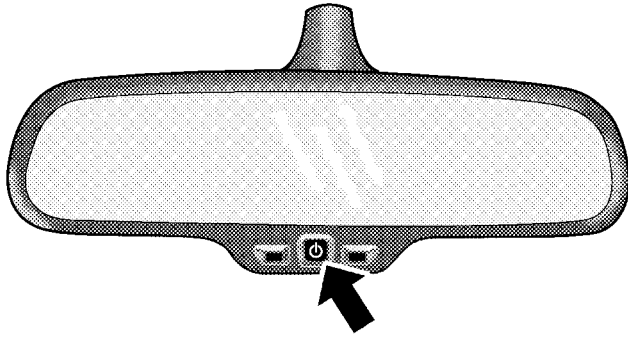

817892c4

**Automatic Dimming Mirror****CAUTION!**

To avoid damage to the mirror during cleaning, never spray any cleaning solution directly onto the mirror. Apply the solution onto a clean cloth and wipe the mirror clean.

**Outside Mirrors**

To receive maximum benefit, adjust the outside mirror(s) to center on the adjacent lane of traffic with a slight overlap of the view obtained on the inside mirror.

**Exterior Mirrors Folding Feature — If Equipped**

Folding exterior mirrors are hinged and may be moved either forward or rearward to resist damage.

### Electric Remote-Control Mirrors

The controls for the power mirrors are located on the driver's door trim panel.

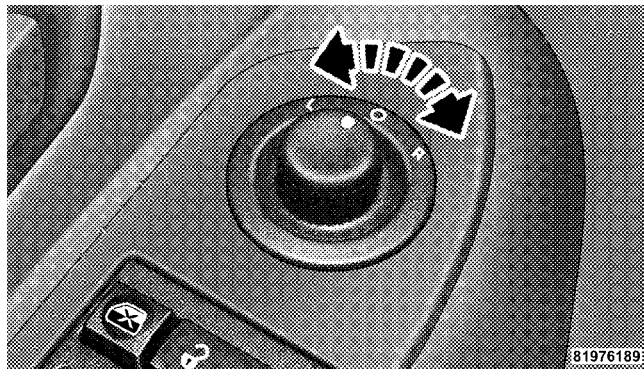

**Power Mirror Control**

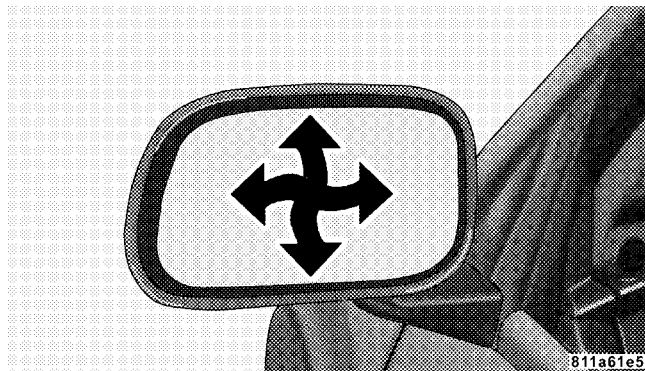

### Mirror Directions

To adjust a mirror, turn the control wand toward the left or right mirror positions indicated. Tilt the control wand in the direction you want the mirror to move. When finished adjusting the mirror, turn the control to the center position to prevent accidentally moving a mirror.

**WARNING!**

Vehicles and other objects seen in the right side convex mirror will look smaller and farther away than they really are. Relying too much on your right side mirror could cause you to collide with another vehicle or other object. Use your inside mirror when judging the size or distance of a vehicle seen in the right side mirror.

**Illuminated Vanity Mirrors — If Equipped**

An illuminated vanity mirror is on each sun visor. To use the mirror, rotate the sun visor down and swing the mirror cover upward. The lights will turn on automatically. Closing the mirror cover turns off the light.

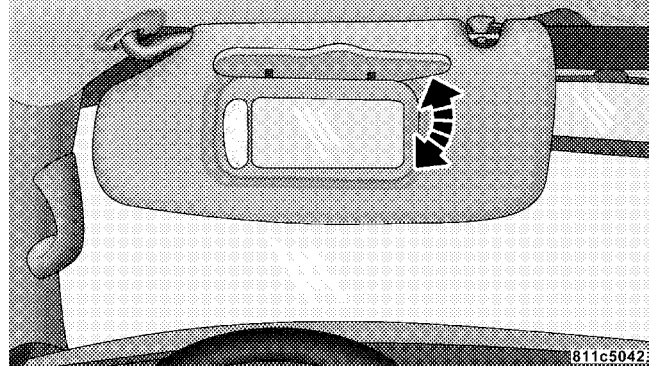
**Illuminated Vanity Mirror****Heated Mirrors — If Equipped**

Heated mirrors are automatically activated when you depress the rear window defroster switch located on the instrument panel. The light will illuminate to indicate



that the heating elements are ON. Turning OFF the rear window defroster or the ignition will deactivate the heated mirrors.

### **Automatic Dimming Driver's Exterior Mirror — If Equipped**

This mirror will automatically adjust for annoying light glare from vehicles behind you. This feature is controlled by the inside mirror and can be turned off by pressing the button at the base of the inside mirror.

### **HANDS-FREE COMMUNICATION (UConnect®) — IF EQUIPPED**

**NOTE:** The sales code RER radio contains an integrated Hands-Free Communication (UConnect®) system. Refer to your “Navigation User’s Manual” for UConnect® system operating instructions for this radio.

UConnect® is a voice-activated, hands-free, in-vehicle communications system. UConnect® allows you to dial a

phone number with your cellular phone using simple voice commands (e.g., “Call” ... “Mike” ... “Work” or “Dial” ... “248-555-1212”). Your cellular phone’s audio is transmitted through your vehicle’s audio system; the system will automatically mute your radio when using the UConnect® system.

**NOTE:** The UConnect® system requires a cellular phone equipped with the Bluetooth® “Hands-Free Profile,” Version 0.96 or higher. See the UConnect® website for supported phones.

**NOTE:** For UConnect® customer support, visit the following websites:

- [www.chrysler.com/uconnect](http://www.chrysler.com/uconnect)
- [www.dodge.com/uconnect](http://www.dodge.com/uconnect)
- [www.jeep.com/uconnect](http://www.jeep.com/uconnect)
- or call 1-877-855-8400

UConnect® allows you to transfer calls between the system and your cellular phone as you enter or exit your vehicle and enables you to mute the system's microphone for private conversation.

The UConnect® phonebook enables you to store up to 32 names, with four numbers per name. Each language has a separate 32-name phonebook accessible only in that language. This system is driven through your Bluetooth® "Hands-Free profile" cellular phone. UConnect® features Bluetooth® technology - the global standard that enables different electronic devices to connect to each other without wires or a docking station, so UConnect® works no matter where you stow your cellular phone (be it your purse, pocket, or briefcase), as long as your phone is turned on and has been paired to the vehicle's UConnect® system. The UConnect® system allows up to seven cellular phones to be linked to the system. Only one linked (or paired) cellular phone can be used with the

system at a time. The system is available in English, Spanish, or French languages (as equipped).

### **PHONE Button**



The rearview mirror contains the microphone for the system (depending on the type of mirror and radio equipped), and either the radio or the mirror has the two control buttons (PHONE Button and "Voice Recognition" button) that will enable you to access the system.

### **Voice Recognition Button**



Actual button location may vary with radio. The individual buttons are described in the "Operation" section.

The UConnect® system can be used with any Hands-Free Profile certified Bluetooth® cellular phone. See the UConnect® website for supported phones. If your cellular phone supports a different profile (e.g., Headset

Profile) you may not be able to use any UConnect® features. Refer to your cellular service provider or the phone manufacturer for details.

The UConnect® system is fully integrated with the vehicle's audio system. The volume of the UConnect® system can be adjusted either from the radio volume control knob or from the steering wheel radio control (right switch), if so equipped.

The radio display will be used for visual prompts from the UConnect® system such as "CELL" or caller ID on certain radios.

### **Operation**

Voice commands can be used to operate the UConnect® system and to navigate through the UConnect® menu structure. Voice commands are required after most UConnect® system prompts. You will be prompted for a specific command and then guided through the available options.

- Prior to giving a voice command, one must wait for the beep, which follows the "Ready" prompt or another prompt.
- For certain operations, compound commands can be used. For example, instead of saying "Setup" and then "Phone Pairing," the following compound command can be said: "Setup Phone Pairing."
- For each feature explanation in this section, only the combined form of the voice command is given. You can also break the commands into parts and say each part of the command when you are asked for it. For example, you can use the combined form voice command "Phonebook New Entry," or you can break the combined form command into two voice commands: "Phonebook" and "New Entry." Please remember, the UConnect® system works best when you talk in a normal conversational tone, as if speaking to someone sitting a few feet/meters away from you.

### **Voice Command Tree**

Refer to “Voice Tree” in this section.

### **Help Command**

If you need assistance at any prompt, or if you want to know your options at any prompt, say “Help” following the beep. The UConnect® system will play all the options at any prompt if you ask for help.

To activate the UConnect® system from idle, simply press the PHONE button and follow audible prompts for directions. All UConnect® system sessions begin with a press of the PHONE button on the radio control head.

### **Cancel Command**

At any prompt, after the beep, you can say “Cancel” and you will be returned to the main menu. However, in a few instances the system will take you back to the previous menu.

### **Pair (Link) UConnect® System to a Cellular Phone**

To begin using your UConnect® system, you must pair your compatible Bluetooth® enabled cellular phone.

To complete the pairing process, you will need to reference your cellular phone owner’s manual. The UConnect® website may also provide detailed instructions for pairing.

The following are general phone to UConnect® system pairing instructions:

- Press the PHONE button to begin.
- After the “Ready” prompt and the following beep, say “Setup Phone Pairing.”
- When prompted, after the beep, say “Pair a Phone” and follow the audible prompts.
- You will be asked to say a four-digit Personal Identification Number (PIN), which you will later need to

enter into your cellular phone. You can enter any four-digit PIN number. You will not need to remember this PIN number after the initial pairing process.

- For identification purposes, you will be prompted to give the UConnect® system a name for your cellular phone. Each cellular phone that is paired should be given a unique phone name.
- You will then be asked to give your cellular phone a priority level between 1 and 7, with 1 being the highest priority. You can pair up to seven cellular phones to your UConnect® system. However, at any given time, only one cellular phone can be in use, connected to your UConnect® system. The priority allows the UConnect® system to know which cellular phone to use if multiple cellular phones are in the vehicle at the same time. For example, if priority 3 and priority 5 phones are present in the vehicle, the UConnect® system will use the priority 3 cellular phone when you

make a call. You can select to use a lower priority cellular phone at any time (refer to "Advanced Phone Connectivity" in this section).

### **Dial by Saying a Number**

- Press the PHONE button to begin.
- After the "Ready" prompt and the following beep, say "Dial."
- The system will prompt you to say the number you want to call.
- For example, you can say "234-567-8901." The phone number that you enter must be of valid length and combination. Based on the country in which the vehicle was purchased, the UConnect® system limits the user from dialing an invalid combination of numbers. For example, in the U.S., 234-567-890 is nine digits long, which is not a valid U.S. phone number - the closest valid phone number has 10 digits.

- The UConnect® system will confirm the phone number and then dial. The number will appear in the display of certain radios.

### Call by Saying a Name

- Press the PHONE button to begin.
- After the "Ready" prompt and the following beep, say "Call."
- The system will prompt you to say the name of the person you want to call.
- After the "Ready" prompt and the following beep, say the name of the person you want to call. For example, you can say "John Doe," where John Doe is a previously stored name entry in the UConnect® phonebook. To learn how to store a name in the phonebook, refer to "Add Names to Your UConnect® Phonebook," in this section.

- The UConnect® system will confirm the name and then dial the corresponding phone number, which may appear in the display of certain radios.

### Add Names to Your UConnect® Phonebook

**NOTE:** Adding names to the phonebook is recommended when the vehicle is not in motion.

- Press the PHONE button to begin.
- After the "Ready" prompt and the following beep, say "Phonebook New Entry."
- When prompted, say the name of the new entry. Use of long names helps the voice recognition and it is recommended. For example, say "Robert Smith" or "Robert" instead of "Bob."

- When prompted, enter the number designation (e.g., "Home," "Work," "Mobile," or "Pager"). This will allow you to store multiple numbers for each phonebook entry, if desired.
- When prompted, recite the phone number for the phonebook entry that you are adding.

After you are finished adding an entry into the phonebook, you will be given the opportunity to add more phone numbers to the current entry or to return to the main menu.

The UConnect® system will allow you to enter up to 32 names in the phonebook with each name having up to four associated phone numbers and designations. Each language has a separate 32-name phonebook accessible only in that language.

### **Phonebook Download**

UConnect® allows the user to download entries from their phone via Bluetooth®. To use this feature, press the PHONE button and say "Phonebook Download." The system prompts, "Ready to accept "V" card entry via Bluetooth®..." The system is now ready to accept phonebook entries from your phone using the Bluetooth® Object Exchange Profile (OBEX). Please see your phone Owner's Manual for specific instructions on how to send these entries from your phone.

#### **NOTE:**

- Phone handset must support Bluetooth® OBEX transfers of phonebook entries to use this feature.
- Some phones cannot send phonebook entries if they are already connected to any system via Bluetooth®, and you may see a message on the phone display that the Bluetooth® link is busy. In this case, the user must first disconnect or drop the Bluetooth® connection to

the UConnect® system, and then send the address book entry via Bluetooth®. Please see your phone Owner's Manual for specific instructions on how to drop the Bluetooth® connection.

- If the phonebook entry is longer than 24 characters, it will only use the first 24 characters.

### **Edit Entries in the UConnect® Phonebook**

**NOTE:** Editing names in the phonebook is recommended when the vehicle is not in motion.

- Press the PHONE button to begin.
- After the "Ready" prompt and the following beep, say "Phonebook Edit."
- You will then be asked for the name of the phonebook entry that you wish to edit.

- Next, choose the number designation (home, work, mobile, or pager) that you wish to edit.
- When prompted, recite the new phone number for the phonebook entry that you are editing.

After you are finished editing an entry in the phonebook, you will be given the opportunity to edit another entry in the phonebook, call the number you just edited, or return to the main menu.

"Phonebook Edit" can be used to add another phone number to a name entry that already exists in the phonebook. For example, the entry John Doe may have a mobile and a home number, but you can add "John Doe's" work number later using the "Phonebook Edit" feature.



### **Delete Entries in the UConnect® Phonebook**

**NOTE:** Editing phonebook entries is recommended when the vehicle is not in motion.

- Press the PHONE button to begin.
- After the "Ready" prompt and the following beep, say "Phonebook Delete."
- After you enter the Phonebook Delete menu, you will then be asked for the name of the entry that you wish to delete. You can either say the name of a phonebook entry that you wish to delete or you can say "List Names" to hear a list of the entries in the phonebook from which you choose. To select one of the entries from the list, press the "Voice Recognition" button while the UConnect® system is playing the desired entry and say "Delete."

- After you enter the name, the UConnect® system will ask you which designation you wish to delete: home, work, mobile, pager, or all. Say the designation you wish to delete.
- Note that only the phonebook entry in the current language is deleted.

### **Delete All Entries in the UConnect® Phonebook**

- Press the PHONE button to begin.
- After the "Ready" prompt and the following beep, say "Phonebook Erase All."
- The UConnect® system will ask you to verify that you wish to delete all the entries from the phonebook.
- After confirmation, the phonebook entries will be deleted.
- Note that only the phonebook in the current language is deleted.

### List All Names in the UConnect® Phonebook

- Press the PHONE button to begin.
- After the "Ready" prompt and the following beep, say "Phonebook List Names."
- The UConnect® system will play the names of all the phonebook entries.
- To call one of the names in the list, press the "Voice Recognition" button during the playing of the desired name, and say "Call."

**NOTE:** The user can also exercise "Edit" or "Delete" operations at this point.

- The UConnect® system will then prompt you as to the number designation you wish to call.
- The selected number will be dialed.

### Phone Call Features

The following features can be accessed through the UConnect® system if the feature(s) are available on your cellular service plan. For example, if your cellular service plan provides three-way calling, this feature can be accessed through the UConnect® system. Check with your cellular service provider for the features that you have.

### Answer or Reject an Incoming Call - No Call Currently in Progress

When you receive a call on your cellular phone, the UConnect® system will interrupt the vehicle audio system, if on, and will ask if you would like to answer the call. Press the PHONE button to accept the call. To reject the call, press and hold the PHONE button until you hear a single beep, indicating that the incoming call was rejected.

### **Answer or Reject an Incoming Call - Call Currently in Progress**

If a call is currently in progress and you have another incoming call, you will hear the same network tones for call waiting that you normally hear when using your cell phone. Press the PHONE button to place the current call on hold and answer the incoming call.

**NOTE:** The UConnect® system compatible phones in the market today do not support rejecting an incoming call when another call is in progress. Therefore, the user can only answer an incoming call or ignore it.

### **Making a Second Call While Current Call in Progress**

To make a second call while you are currently on a call, press the “Voice Recognition” button and say “Dial” or “Call” followed by the phone number or phonebook entry you wish to call. The first call will be on hold while the second call is in progress. To go back to the first call, refer

to “Toggling Between Calls” in this section. To combine two calls, refer to “Conference Call” in this section.

### **Place/Retrieve a Call From Hold**

To put a call on hold, press the PHONE button until you hear a single beep. This indicates that the call is on hold. To bring the call back from hold, press and hold the PHONE button until you hear a single beep.

### **Toggling Between Calls**

If two calls are in progress (one active and one on hold), press the PHONE button until you hear a single beep, indicating that the active and hold status of the two calls have switched. Only one call can be placed on hold at one time.

### **Conference Call**

When two calls are in progress (one active and one on hold), press and hold the PHONE button until you hear a double beep indicating that the two calls have been joined into one conference call.

### Three-Way Calling

To initiate three-way calling, press the “Voice Recognition” button while a call is in progress, and make a second phone call, as described under “Making a Second Call While Current Call in Progress.” After the second call has established, press and hold the PHONE button until you hear a double beep, indicating that the two calls have been joined into one conference call.

### Call Termination

To end a call in progress, momentarily press the PHONE button. Only the active call(s) will be terminated and if there is a call on hold, it will become the new active call. If the active call is terminated by the far end, a call on hold may not become active automatically. This is cell phone-dependent. To bring the call back from hold, press and hold the PHONE button until you hear a single beep.

### Redial

- Press the PHONE button to begin.

- After the “Ready” prompt and the following beep, say “Redial.”
- The UConnect® system will call the last number that was dialed from your cellular phone.

**NOTE:** This may not be the last number dialed from the UConnect® system.

### Call Continuation

Call continuation is the progression of a phone call on the UConnect® system after the vehicle ignition key has been switched to OFF. Call continuation functionality available on the vehicle can be any one of three types:

- After the ignition key is switched to OFF, a call can continue on the UConnect® system either until the call ends, or until the vehicle battery condition dictates cessation of the call on the UConnect® system and transfer of the call to the mobile phone.

- After the ignition key is switched to OFF, a call can continue on the UConnect® system for a certain duration, after which the call is automatically transferred from the UConnect® system to the mobile phone.
- An active call is automatically transferred to the mobile phone after the ignition key is switched to OFF.

### **UConnect® System Features**

#### **Language Selection**

To change the language that the UConnect® system is using:

- Press the PHONE button to begin.
- After the "Ready" prompt and the following beep, say the name of the language you wish to switch to (English, Espanol, or Francais, if so equipped).
- Continue to follow the system prompts to complete language selection.

After selecting one of the languages, all prompts and voice commands will be in that language.

**NOTE:** After every UConnect® language change operation, only the language-specific 32-name phonebook is usable. The paired phone name is not language-specific and usable across all languages.

#### **Emergency Assistance**

If you are in an emergency and the mobile phone is reachable:

- Pick up the phone and manually dial the emergency number for your area.

If the phone is not reachable and the UConnect® system is operational, you may reach the emergency number as follows:

- Press the PHONE button to begin.

- After the "Ready" prompt and the following beep, say "Emergency" and the UConnect® system will instruct the paired cellular phone to call the emergency number. This feature is only supported in the U.S.

**NOTE:** The emergency number dialed is based on the country where the vehicle is purchased (911 for the U.S. and Canada and 060 for Mexico). The number dialed may not be applicable with the available cellular service and area.

The UConnect® system does slightly lower your chances of successfully making a phone call as to that for the cell phone directly.

Your phone must be turned on and paired to the UConnect® system to allow use of this vehicle feature in emergency situations, when the cell phone has network coverage and stays paired to the UConnect® system.

### **Towing Assistance**

If you need towing assistance:

- Press the PHONE button to begin.
- After the "Ready" prompt and the following beep, say "Towing Assistance."

**NOTE:** The Towing Assistance number dialed is based on the country where the vehicle is purchased (1-800-528-2069 for the U.S., 1-877-213-4525 for Canada, 55-14-3454 for Mexico City and 1-800-712-3040 for outside Mexico City in Mexico).

Please refer to the 24-Hour "Towing Assistance" coverage details in the Warranty information booklet and on the 24-Hour Towing Assistance Card.

**Paging**

To learn how to page, refer to "Working with Automated Systems." Paging works properly except for pagers of certain companies, which time out a little too soon to work properly with the UConnect® system.

**Voice Mail Calling**

To learn how to access your voice mail, refer to "Working with Automated Systems."

**Working with Automated Systems**

This method is used in instances where one generally has to press numbers on the cellular phone keypad while navigating through an automated telephone system.

You can use your UConnect® system to access a voice mail system or an automated service, such as a paging service or automated customer service line. Some services require immediate response selection. In some instances, that may be too quick for use of the UConnect® system.

When calling a number with your UConnect® system that normally requires you to enter in a touch-tone sequence on your cellular phone keypad, you can press the "Voice Recognition" button and say the sequence you wish to enter, followed by the word "Send." For example, if required to enter your PIN number followed with a pound, (3 7 4 6 #), you can press the "Voice Recognition" button and say, "3 7 4 6 # Send." Saying a number, or sequence of numbers, followed by "Send," is also to be used for navigating through an automated customer service center menu structure, and to leave a number on a pager.

You can also send stored UConnect® phonebook entries as tones for fast and easy access to voice mail and pager entries. To use this feature, dial the number you wish to call and then press the "Voice Recognition" button and say, "Send." The system will prompt you to enter the name or number and say the name of the phonebook entry you wish to send. The UConnect® system will then

send the corresponding phone number associated with the phonebook entry, as tones over the phone.

**NOTE:**

- You may not hear all of the tones due to cellular phone network configurations; this is normal.
- Some paging and voice mail systems have system time out settings too short that may not allow the use of this feature.

**Barge In - Overriding Prompts**

The “Voice Recognition” button can be used when you wish to skip part of a prompt and issue your voice recognition command immediately. For example, if a prompt is asking “Would you like to pair a phone, clear a...,” you could press the “Voice Recognition” button and say, “Pair a Phone” to select that option without having to listen to the rest of the voice prompt.

**Turning Confirmation Prompts On/Off**

Turning confirmation prompts off will stop the system from confirming your choices (e.g., the UConnect® system will not repeat a phone number before you dial it).

- Press the PHONE button to begin.
- After the “Ready” prompt and the following beep, say “Setup Confirmations.” The UConnect® system will play the current confirmation prompt status and you will be given the choice to change it.

**Phone and Network Status Indicators**

If available on the radio and/or on a premium display such as the instrument panel cluster, and supported by your cell phone, the UConnect® system will provide notification to inform you of your phone and network status when you are attempting to make a phone call using UConnect®. The status is given for roaming, network signal strength, phone battery strength, etc.



### Dialing Using the Cellular Phone Keypad

You can dial a phone number with your cellular phone keypad and still use the UConnect® system (while dialing via the cell phone keypad, the user must exercise caution and take precautionary safety measures). By dialing a number with your paired Bluetooth® cellular phone, the audio will be played through your vehicle's audio system. The UConnect® system will work the same as if you dial the number using voice recognition.

**NOTE:** Certain brands of mobile phones do not send the dial ring to the UConnect® system to play it on the vehicle audio system, so you will not hear it. Under this situation, after successfully dialing a number the user may feel that the call did not go through even though the call is in progress. Once your call is answered, you will hear the audio.

### Mute/Un-Mute (Mute Off)

When you mute the UConnect® system, you will still be able to hear the conversation coming from the other party, but the other party will not be able to hear you. In order to mute the UConnect® system:

- Press the "Voice Recognition" button.
- Following the beep, say "Mute."

In order to un-mute the UConnect® system:

- Press the "Voice Recognition" button.
- Following the beep, say "Mute off."

## Advanced Phone Connectivity

### Transfer Call to and from Cellular Phone

The UConnect® system allows ongoing calls to be transferred from your cellular phone to the UConnect® system without terminating the call. To transfer an ongoing call from your UConnect® paired cellular phone to the UConnect® system or vice versa, press the “Voice Recognition” button and say “Transfer Call.”

### Connect or Disconnect Link Between the UConnect® System and Cellular Phone

Your cellular phone can be paired with many different electronic devices, but can only be actively “connected” with one electronic device at a time.

If you would like to connect or disconnect the Bluetooth® connection between a UConnect® paired cellular phone and the UConnect® system, follow the instructions described in your cellular phone User’s Manual.

### List Paired Cellular Phone Names

- Press the PHONE button to begin.
- After the “Ready” prompt and the following beep, say “Setup Phone Pairing.”
- When prompted, say “List Phones.”
- The UConnect® system will play the phone names of all paired cellular phones in order from the highest to the lowest priority. To “select” or “delete” a paired phone being announced, press the “Voice Recognition” button and say “Select” or “Delete.” Also, see the next two sections for an alternate way to “select” or “delete” a paired phone.

### Select Another Cellular Phone

This feature allows you to select and start using another phone paired with the UConnect® system.

- Press the PHONE button to begin.
- After the "Ready" prompt and the following beep, say "Setup Select Phone" and follow the prompts.
- You can also press the "Voice Recognition" button any time while the list is being played, and then choose the phone that you wish to select.
- The selected phone will be used for the next phone call. If the selected phone is not available, the UConnect® system will return to using the highest priority phone present in or near (approximately within 30 ft (9 m) the vehicle.

### Delete UConnect® Paired Cellular Phones

- Press the PHONE button to begin.
- After the "Ready" prompt and the following beep, say "Setup Phone Pairing."
- At the next prompt, say "Delete" and follow the prompts.
- You can also press the "Voice Recognition" button at anytime while the list is being played, and then choose the phone you wish to delete.

## Things You Should Know About Your UConnect® System

### UConnect® Tutorial

To hear a brief tutorial of the system features, press the PHONE button and say “UConnect® Tutorial.”

### Voice Training

For users experiencing difficulty with the system recognizing their voice commands or numbers, the UConnect® system Voice Training feature may be used. To enter this training mode, follow one of the two following procedures:

From outside the UConnect® mode (e.g., from radio mode):

- Press and hold the “Voice Recognition” button for five seconds until the session begins, or,
- Press the “Voice Recognition” button and say the “Setup, Voice Training” command.

Repeat the words and phrases when prompted by the UConnect® system. For best results, the Voice Training session should be completed when the vehicle is parked with the engine running, all windows closed, and the blower fan switched off.

This procedure may be repeated with a new user. The system will adapt to the last trained voice only.

To restore the voice recognition system to factory default settings, enter the Voice Training session via the above procedure and follow the prompts.

### Voice Recognition (VR)

- For best performance, adjust the rear view mirror to provide at least ½ in (1 cm) gap between the overhead console (if equipped) and the mirror.
- Always wait for the beep before speaking.

- Speak normally, without pausing, just as you would speak to a person sitting a few feet/meters away from you.
- Make sure that no one other than you is speaking during a voice recognition period.
- Performance is maximized under:
  - low-to-medium blower setting,
  - low-to-medium vehicle speed,
  - low road noise,
  - smooth road surface,
  - fully closed windows,
  - dry weather condition.
- Even though the system is designed for users speaking in North American English, French, and Spanish accents, the system may not always work for some.
- When navigating through an automated system such as voice mail, or when sending a page, at the end of speaking the digit string, make sure to say "Send."
- Storing names in the phonebook when the vehicle is not in motion is recommended.
- It is not recommended to store similar sounding names in the UConnect® phonebook.
- UConnect® phonebook nametag recognition rate is optimized for the person who stored the name in the phonebook.
- You can say "O" (letter "O") for "0" (zero). "800" must be spoken "eight-zero-zero."
- Even though international dialing for most number combinations is supported, some shortcut dialing number combinations may not be supported.
- In a convertible vehicle, system performance may be compromised with the convertible top down.

### Far End Audio Performance

- Audio quality is maximized under:
  - low-to-medium blower setting,
  - low-to-medium vehicle speed,
  - low road noise,
  - smooth road surface,
  - fully closed windows,
  - dry weather conditions, and
  - operation from driver seat.
- Performance, such as audio clarity, echo, and loudness to a large degree rely on the phone and network, and not the UConnect® system.

- Echo at the far end can sometimes be reduced by lowering the in-vehicle audio volume.
- In a convertible vehicle, system performance may be compromised with the convertible top down.

### Bluetooth® Communication Link

Cellular phones have been found to lose connection to the UConnect® system. When this happens, the connection can generally be re-established by switching the phone off/on. Your cell phone is recommended to remain in Bluetooth® "ON" mode.

### Power-Up

After switching the ignition key from OFF to either ON or ACC position, or after a language change, you must wait at least five seconds prior to using the system.

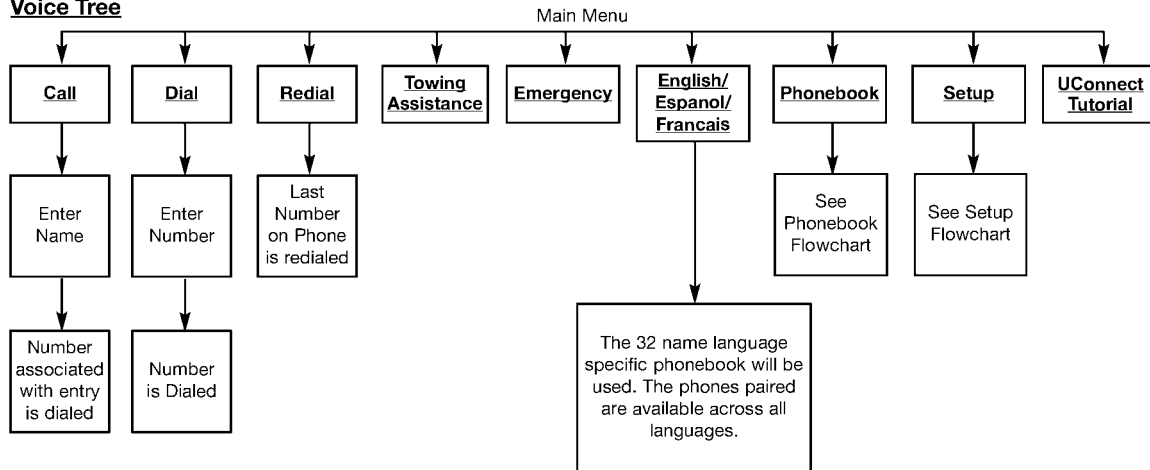
**Voice Tree**

**Note:** Available Voice commands are shown in bold face and are underlined.

**Voice Tree – Phonebook**

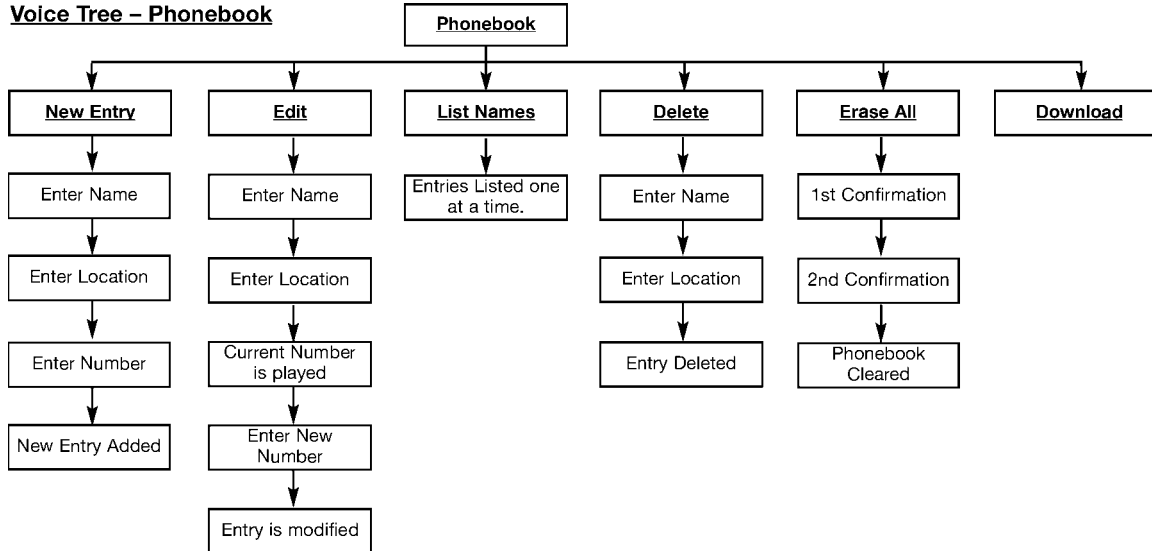

**Note:** Available Voice commands are shown in bold face and are underlined.

81c6bf80

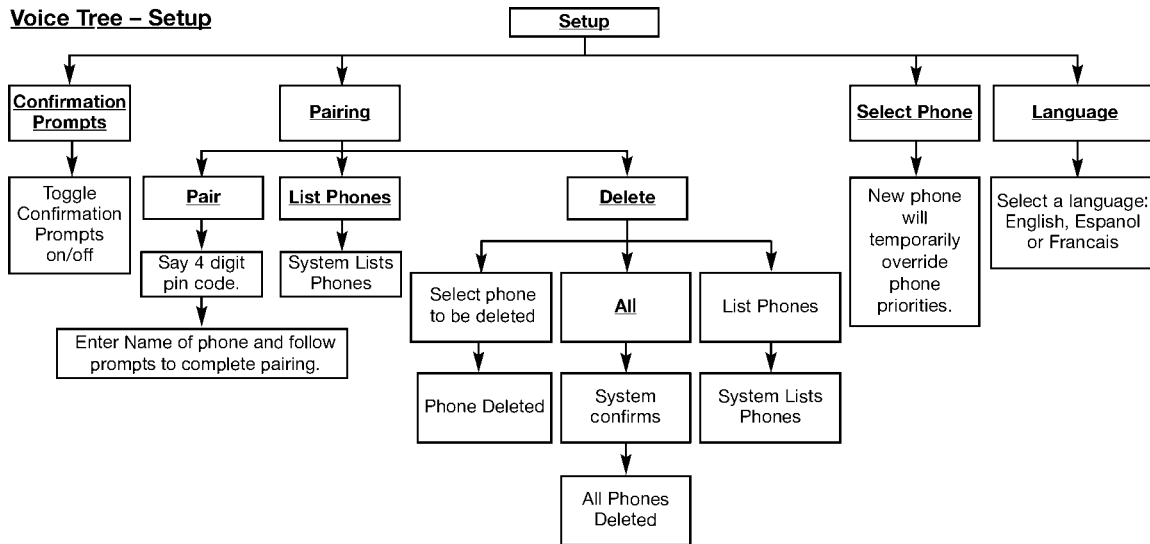

**Voice Tree – Setup**

**Note:** Available Voice commands are shown in bold face and are underlined.

Voice Commands	
Primary	Alternate(s)
zero	
one	
two	
three	
four	
five	
six	
seven	
eight	
nine	
star (*)	
plus (+)	
pound (#)	
add location	
all	

Voice Commands	
Primary	Alternate(s)
call	
cancel	
confirmation prompts	
continue	
delete	
dial	
download	
edit	
emergency	
English	
erase all	
Espanol	
Francais	
help	
home	

Voice Commands	
Primary	Alternate(s)
language	
list names	
list phones	
mobile	
mute	
mute off	
new entry	
no	
pager	
pair a phone	
phone pairing	pairing
phonebook	phone book
previous	
record again	
redial	

Voice Commands	
Primary	Alternate(s)
return to main menu	return or main menu
select phone	select
send	
set up	phone settings or phone set up
towing assistance	
transfer call	
UConnect® Tutorial	
try again	
voice training	
work	
yes	

### General Information

This device complies with part 15 of the FCC rules and RSS 210 of Industry Canada. Operation is subject to the following conditions:

- This device may not cause harmful interference.
- This device must accept any interference received, including interference that may cause undesired operation.

### VOICE RECOGNITION SYSTEM (VR) – IF EQUIPPED

#### Voice Recognition System (VR) Operation



This Voice Recognition System allows you to control your AM, FM radio, satellite radio, disc player, and a memo recorder.

**NOTE:** In a stressful situation, take care to speak into the Voice Interface System as calmly and normally as

possible. The ability of the Voice Interface System to recognize user voice commands may be negatively affected by rapid speaking or a raised voice level.

### WARNING!

**Any voice commanded system should be used only in safe driving conditions and all attention should be kept on the roadway ahead. Failure to do so may result in an accident causing serious injury or death.**

When you press the VR hard-key, you will hear a beep. The beep is your signal to give a command.

**NOTE:** If you do not say a command within a few seconds, the system will present you with a list of options.

If you ever wish to interrupt the system while it lists options, press the VR hard-key, listen for the beep, and say your command.

Pressing the VR hard-key while the system is speaking is known as “barging in.” The system will be interrupted and you can add or change commands. This will become helpful once you start to learn the options.

**NOTE:** At any time, you can say the words CANCEL, HELP, or MAIN MENU.

These commands are universal and can be used from any menu. All other commands can be used depending upon the active application.

For example, if you are in the disc menu and you are listening to FM radio, you can speak commands from the disc menu or from the FM radio menu.

When using this system, you should speak clearly and at a normal speaking volume.

The system will best recognize your speech if the windows are closed, and the heater/air-conditioning fan is set to low.

At any point, if the system does not recognize one of your commands, you will be prompted to repeat it.

To hear the first available Menu, press the VR hard-key and say HELP or MAIN MENU.

### **Commands**

The Voice Recognition System understands two types of commands. Global commands are available at all times. Local commands are available if the supported radio mode is active.

### **Changing the Volume**

1. Start a dialogue by pressing the VR hard-key.
2. Say a command (e.g., HELP).

3. Use the ON/OFF VOLUME rotary knob to adjust the volume to a comfortable level while the voice recognition system is speaking. Please note the volume setting for VR is different than the audio system.

### **Main Menu**

Start a dialogue by pressing the VR hard-key. You may say MAIN MENU to switch to the main menu.

In this mode, you can say the following commands:

- RADIO (to switch to the radio mode)
- DISC (to switch to the disc mode)
- MEMO (to switch to the memo recorder)

### **Radio AM (or Radio Long Wave or Radio Medium Wave - if equipped)**

To switch to the AM band say AM or RADIO AM. In this mode, you may say the following commands:

- FREQUENCY (to change the frequency)

- NEXT STATION (to select the next station)
- PREVIOUS STATION (to select the previous station)
- RADIO MENU (to switch to the radio menu)
- MAIN MENU (to switch to the main menu)

### **Radio FM**

To switch to the FM band say FM or RADIO FM. In this mode, you may say the following commands:

- FREQUENCY (to change the frequency)
- NEXT STATION (to select the next station)
- PREVIOUS STATION (to select the previous station)
- RADIO MENU (to switch to the radio menu)
- MAIN MENU (to switch to the main menu)

**Satellite Radio**

To switch to satellite radio mode say SAT or SATELLITE RADIO. In this mode, you may say the following commands:

- CHANNEL NUMBER (to change the channel by its spoken number)
- NEXT CHANNEL (to select the next channel)
- PREVIOUS CHANNEL (to select the previous channel)
- LIST CHANNEL (to hear a list of available channels)
- SELECT NAME (to say the name of a channel)
- RADIO MENU (to switch to the radio menu)
- MAIN MENU (to switch to the main menu)

**Disc**

To switch to the disc mode say DISC. In this mode, you may say the following commands:

- TRACK (#) (to change the track)
- NEXT TRACK (to play the next track)
- PREVIOUS TRACK (to play the previous track)
- MAIN MENU (to switch to the main menu)

**Memo**

To switch to the voice recorder mode say MEMO. In this mode, you may say the following commands:

- NEW MEMO (to record a new memo) — During the recording you may press the VR hard-key to stop recording. You continue by saying one of the following commands:
  - SAVE (to save the memo)

- CONTINUE (to continue recording)
- DELETE (to delete the recording)
- PLAY MEMOS (to play previously recorded memos)
  - During the playback you may press the VR hard-key to stop playing memos. You continue by saying one of the following commands:
  - REPEAT (to repeat a memo)
  - NEXT (to play the next memo)
  - PREVIOUS (to play the previous memo)
  - DELETE (to delete a memo)
- DELETE ALL (to delete all memos)

**NOTE:** Keep in mind that you have to press the VR hard-key first and wait for the beep, before speaking the “barge in” commands.

### Voice Training

For users experiencing difficulty with the system recognizing their voice commands or numbers, the UConnect® system Voice Training feature may be used.

1. Press the VR hard-key, speak “System Setup” and once you are in that menu then speak “Voice Training”. This will train your own voice to the system and will improve recognition.
2. Repeat the words and phrases when prompted by the UConnect® System. For best results, the Voice Training session should be completed when the vehicle is parked, engine running, all windows closed, and the blower fan switched off. This procedure may be repeated with a new user. The system will adapt to the last trained voice only.



## SEATS

### Front Seat Manual Seat Adjustment

The adjusting lever is at the front of the seat, near the floor. Lift the lever and move the seat to the desired position. Release the bar to lock the seat into position.

Using body pressure, move forward and rearward on the seat to be sure the seat adjusters have latched.

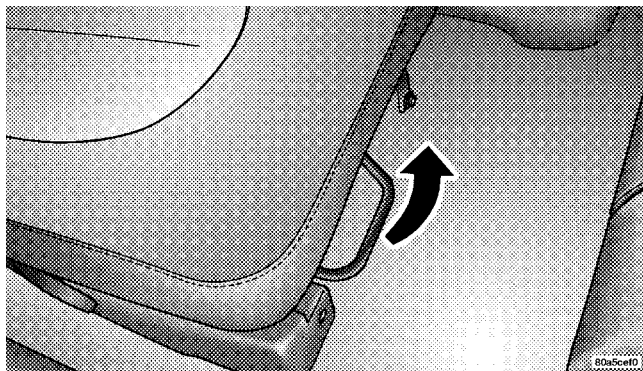

**Manual Seat Adjuster**

**WARNING!**

**Adjusting a seat while the vehicle is moving is dangerous. The sudden movement of the seat could cause you to lose control. The seat belt might not be properly adjusted and you could be injured. Adjust any seat only while the vehicle is parked.**

**Front Seat Manual Seat Recliners**

The bucket seats are equipped with recliners. The reclining mechanism is operated by a lever located on the right side of the passenger's seat and the left side of the driver's seat. To recline, lean forward slightly before lifting the lever, then push back to the desired position

and release the lever. Lean forward and lift the lever to return the seatback to its normal position. Using body pressure, lean forward and rearward on the seat to be sure the seatback is locked.

**WARNING!**

**Do not ride with the seatback reclined so that the shoulder belt is no longer resting against your chest. In a collision you could slide under the seat belt and be seriously or even fatally injured. Use the recliner only when the vehicle is parked.**

### Manual Lumbar Support Adjustment — If Equipped

The manual lumbar support adjustment lever is located on the right side of the driver's seat and on the left side of the passenger's seat. Moving the lumbar control lever fore and aft increases or decreases the lumbar support.

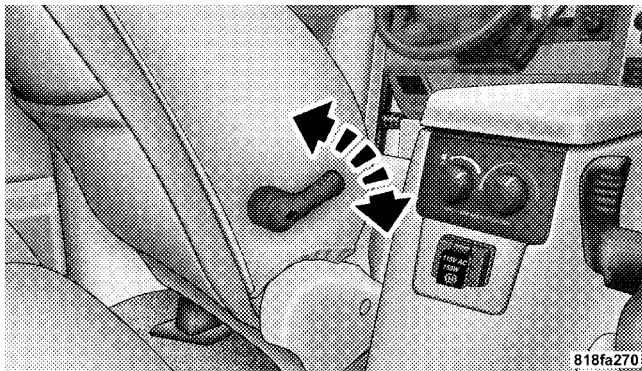

**Lumbar Support Adjustment Lever**

### Adjustable Head Restraints — All Seating Positions

Head restraints can reduce the risk of whiplash injury in the event of impact from the rear. Pull up or push down on the restraints so that the upper edge is as high as practical, at least to the level of the ears.

To lower the head restraint, depress the release button located at the base of the head restraint and push down on the head restraint.

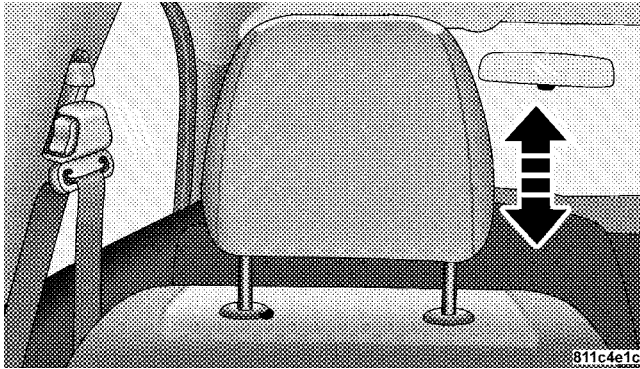

**Head Restraint Adjustment**

### **8-Way Driver's Power Seat — If Equipped**

The driver's power seat switches are located on the left side of the driver's seat lower side trim. The bottom switch controls up/down, forward/rearward, and tilt adjustment. The top switch controls the seatback recline adjustment.

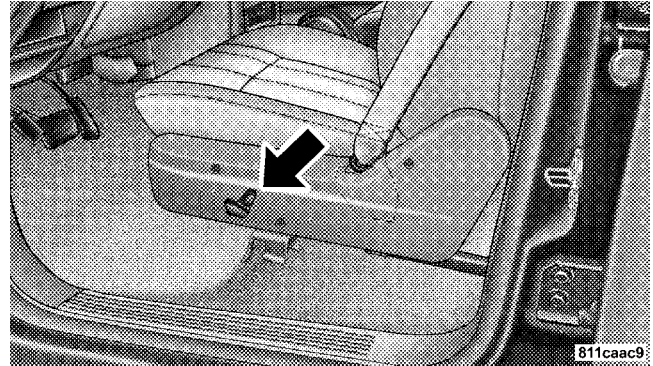

**Power Seat Switch Location**

### 4-Way Passenger's Power Seat — If Equipped

The front passenger's power seat switches are located on the right side of the passenger seat lower side trim. The bottom switch controls forward/rearward adjustment. The top switch controls the seatback recline adjustment.

**NOTE:** The 4-way seat does not have an up/down adjustment.

### Heated Seats — If Equipped

This feature heats the driver, front passenger and second row seats. The controls for the front heated seats are located on the instrument panel below the climate controls.

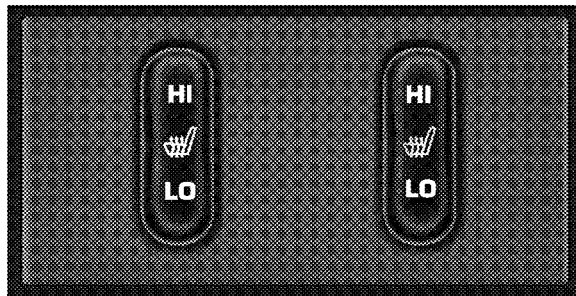

81228806

### Front Heated Seat Switches

The front heated seat system allows the driver and front passenger to select from two different levels of supplemental electrical seat heating, or no seat heating, to suit their individual comfort requirements.

With the ignition switch in the RUN position, depressing the heated seat switch rocker to its momentary high or

low position provides power to the heated seat element and maintains the requested temperature setting. If the heated seat switch is depressed to a different position (low or high) than the currently selected state, the requested temperature setting will change to a new selection. If the heated seat switch is depressed a second time to the same position as the currently selected state, the seat heater will turn off.

The controls for the second row heated seats are located on the center console between the second row seats.

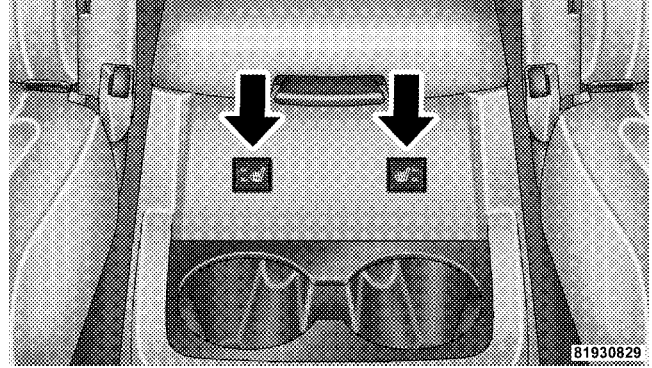

3

### Second Row Heated Seats Switches

Each heated seat switch has two settings (HI and LO). Press the switch once to obtain high heat level, then press the switch again to obtain low heat level. Pressing the switch a third time will turn the heated seats off. If you do not purposefully turn the switch off, the seat heating level will automatically change to the next lower level, or

off. Both of the indicators on identifies High heat level. The lower indicator on only identifies Low heat level.

**NOTE:** The HI heat setting will operate for approximately 30 minutes. After 30 minutes, the system will automatically transition to the low heat setting. The LO heat setting will operate for 30 minutes, then the system will turn off.

If the low heat setting is initially selected, the system will operate for 30 minutes and then turn off.

If the indicator light on the heated seat switch does not light, an indicator blinks when the switch is depressed or if the heated seats do not operate, the system should be serviced by a qualified technician.

### **WARNING!**

**Persons who are unable to feel pain to the skin because of advanced age, chronic illness, diabetes, spinal cord injury, medication, alcohol use, exhaustion or other physical condition must exercise care when using the seat heater. It may cause burns even at low temperatures, especially if used for long periods of time.**

**Do not place anything on the seat that insulates against heat, such as a blanket or cushion. This may cause the seat heater to overheat.**

**Second Row Bucket Seats — Fold and Tumble**

Second row bucket seats have seatback recliners on both seating positions. Raising the lever allows the seatback to be reclined an additional 11 degrees.

The second row bucket seats can be folded and tumbled forward for easy access to the third seat or rear cargo area.

To fold and tumble the seat, follow these steps:

1. Remove any obstructions from the floor in front of the seat.
2. Lower the head restraint to its full downward position.
3. Pull up on the seatback release lever located on the outboard side of the seat and push the seatback forward.

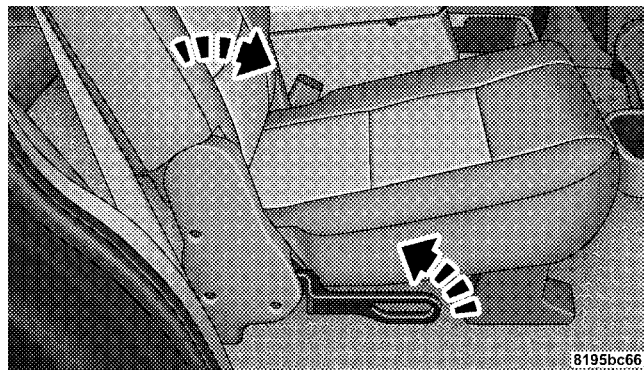

Folding The Seatback



4. Pull up on the release handle and lift to tumble the seat fully forward. If the seat contacts the rear of the front seat, move the front seat forward.

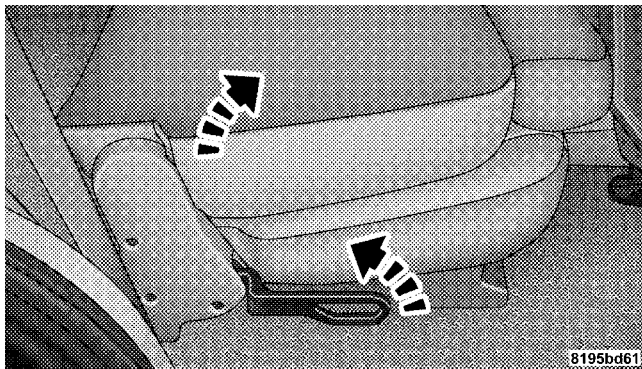

**Tumbling the Seat Forward**

To relatch the seat, tilt the seat rearward and push down firmly to engage the rear attachments. Then lift the seatback release lever and pull the seatback up to return it to its full upright position.

To fold and tumble the second row seats from the third row, fully raise the lever at the rear of the seat to fold the seatback. Continue lifting the lever to release the floor latches to tumble the seat.

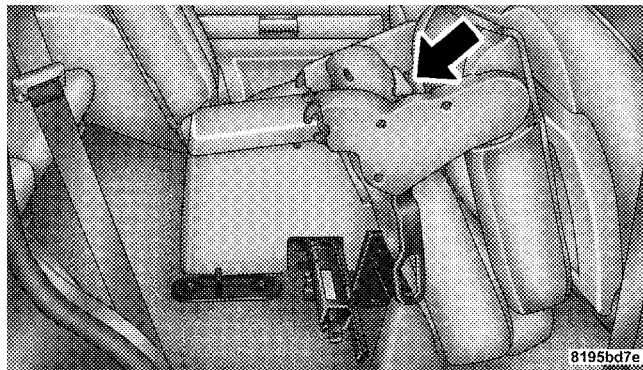

**Tumble Lever**

**WARNING!**

**In a collision, you or others in your vehicle could be injured if seats are not properly latched to their floor attachments. Always be sure the seats are fully latched.**

### Second Row 40/20/40 Seat — Fold and Tumble

The 40/20/40 seat configuration is standard on all models. This seat is equipped with a unique fold-and-tumble feature. The 40% seatbacks have spring loaded hinges which assist with the folding of the seatbacks.

Second row leather seats have seatback recliners at the 40% seating positions. Raising the lever allows the seatback to be reclined an additional 11 degrees.

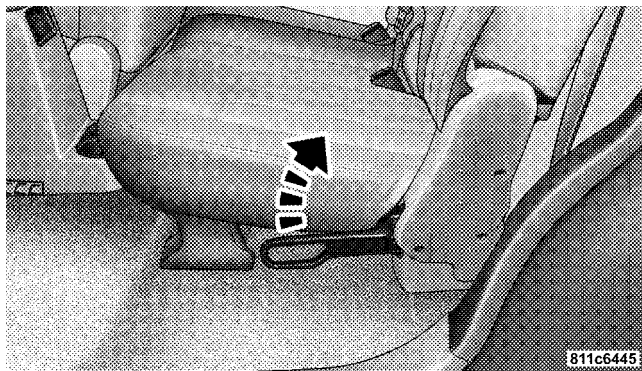

### Fold, Tumble And Recline Lever

To fold the 40% seatbacks, fully raise the lever on the side of the seat to release the seatback. The seatback can now be folded into the down position for use as a cargo floor, or the seat can now be tumbled forward to allow access to the rear of the vehicle.

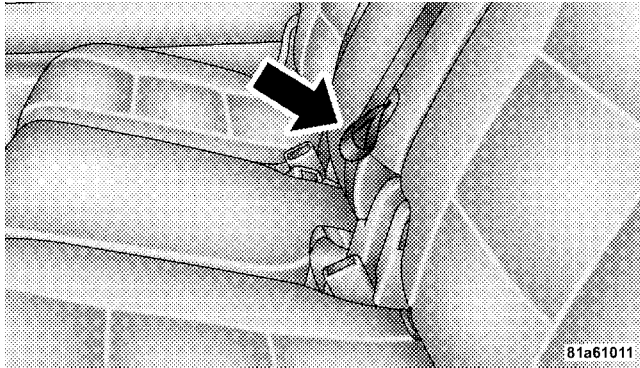

81a61011

### Rear 20% Seat Pull Strap

To fold the 20% seatback, pull the strap forward to release the seatback. Fold the seatback down for use as an armrest or to carry cargo. When returning the seatback to the upright position, push the seatback rearward to latch the seatback. Pull the seatback forward to ensure that it is locked in the upright position.

### WARNING!

The 20% seatback contains the center shoulder belt. A 20% seatback that is not fully latched in the upright position will not protect you properly.

3



811c644c

### Fold, Tumble And Recline Lever

To tumble the 40% seat, fully raise the lever on the side of the seat to release the floor latches and tumble the seat.

**WARNING!**

**Do not drive the vehicle with the outer 40% second row seats in the tumbled position. The outer 40% second row seats are only intended to be tumbled for entry and exit to the third row seat. Failure to follow these instructions could result in personal injury.**

**NOTE:** The seatback must be fully folded into the down position to allow the lever to be raised enough to release the floor latches.

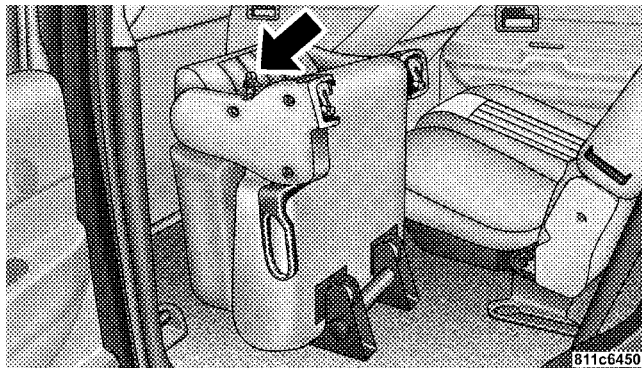

**Tumble Lever**

To fold and tumble the second row 40% seats from the third row, fully raise the lever at the rear of the seat to fold the seatback. Continue raising the lever to release the floor latches to tumble the seat.

**NOTE:** The head restraints must be lowered but do not have to be removed to fold and tumble the seats.

### Third Row Seat Bench — If Equipped

#### To Fold the Seats

Folding the third seat occurs in two stages: First, the cushion is lifted and moved forward from the pockets at the front of the cushion. The cushion will rest on the floor directly behind the second row seat. Second, the top of the back is folded forward and rests on the cushion. The back will not fold unless the cushion has been folded forward first.

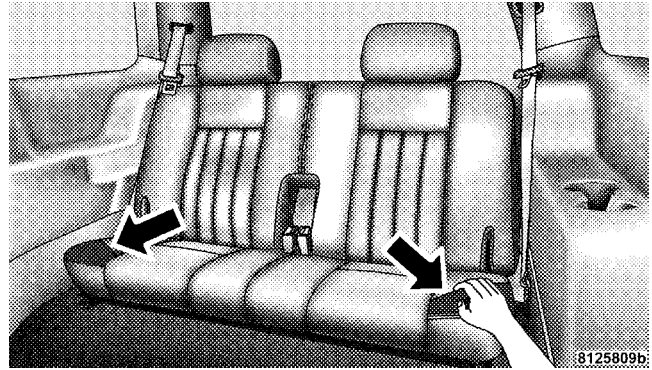

Seat Cushion Pockets

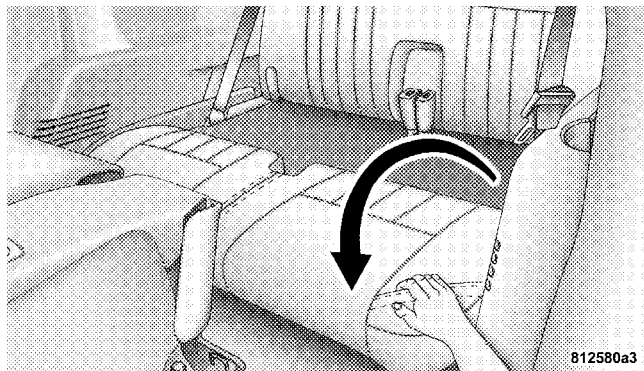

**Seat Cushion Movement Up And Forward**

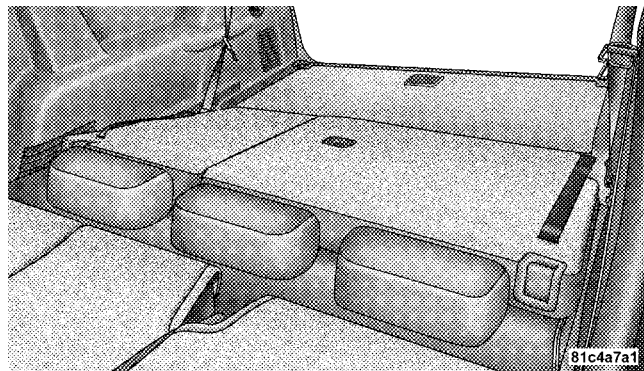

**Third Row Seat Folded Forward**

**CAUTION!**

**When loading cargo into the rear of your vehicle with the third row seat folded flat, be careful not to damage the material on the head restraints.**

**NOTE:** The seat belt buckles are hinged to fold with the seatback.

### **WARNING!**

Do not sit in the third row seat unless the cushion and back are properly engaged. Proper engagement can be verified by pushing/pulling on the upright seatback. The seatback will not move unless properly engaged.

Do not sit in the 3rd row seat with the second row seatback(s) folded or tumbled. In a collision, you could slide under the seat belt and be seriously or even fatally injured.

### **Third Row 60/40 Folding — If Equipped**

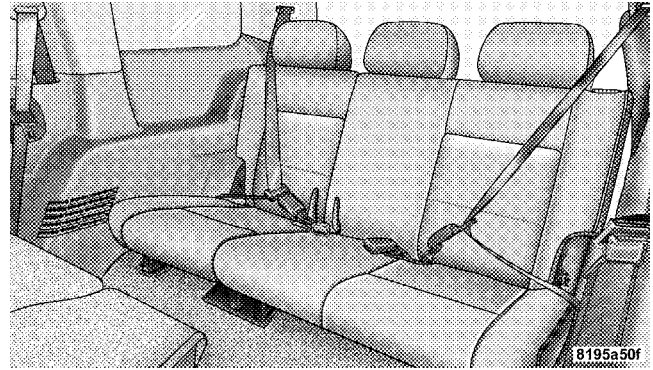

Third Row Seat



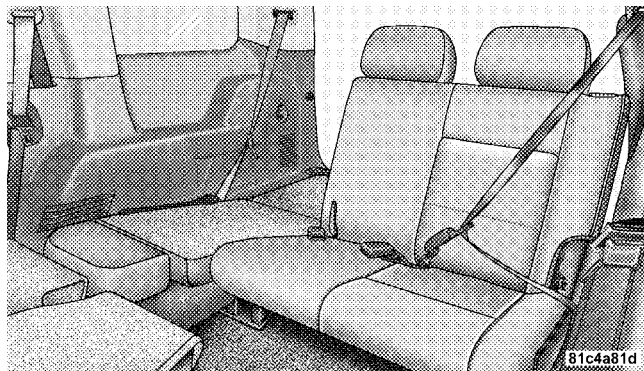

**Third Row Seat 40% Seatback Fold**

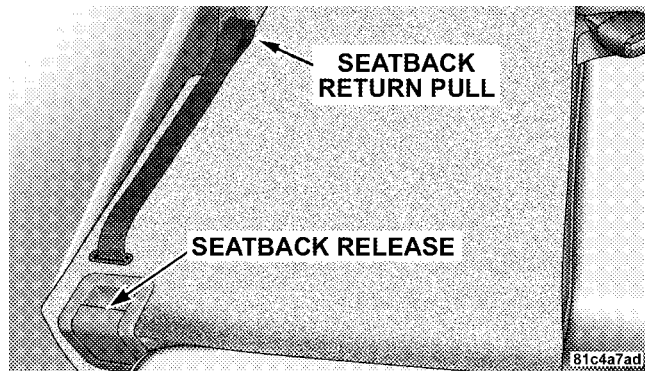

**Third Row Seat Features**

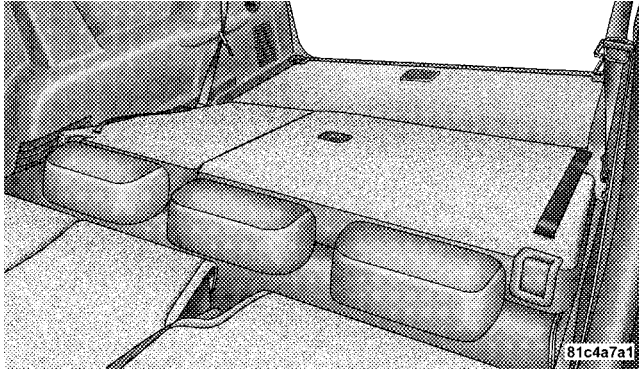

**Third Row Seat Folded Forward**

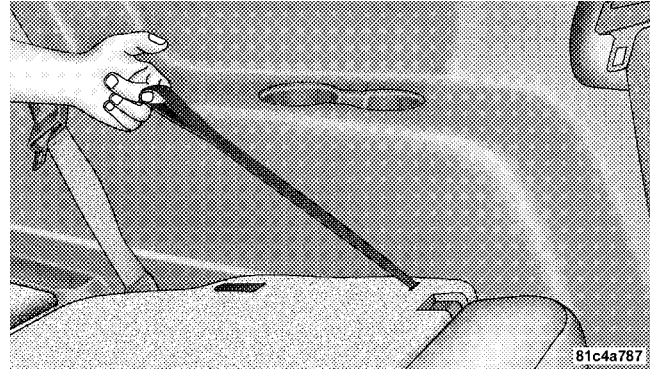

**Third Row Seat Return Pull Strap**

**DRIVER MEMORY SYSTEM — IF EQUIPPED**

Once programmed, the memory buttons 1 and 2 on the driver's door panel can be used to recall the driver's seat position, driver's outside mirror position, adjustable brake and accelerator pedals position, Automatic Temperature Control (ATC) temperature and radio station

preset settings. Your Remote Keyless Entry (RKE) Transmitters can also be programmed to recall the same positions when the UNLOCK button is pressed.

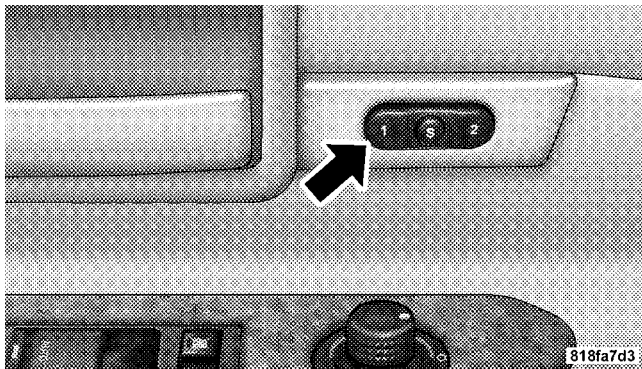

### Memory Buttons

Your vehicle was delivered with two RKE Transmitters. One or both transmitters can be linked to either memory

position. The memory system can accommodate up to two transmitters, each transmitter linked to either of the two memory positions.

### Setting Memory Positions and Linking Remote Keyless Entry Transmitter to Memory

**NOTE:** Each time the SET (S) button and a numbered button (1 or 2) are pressed, you erase the memory settings for that button and store new settings.

1. Adjust the driver's seat, recliner, and both sideview mirrors to the desired positions.

**NOTE:** Not all motors may be moved at one time. Please refer to the 8-way power seat description in this section.

2. Adjust the brake and accelerator pedals to the desired positions.

3. Turn on the radio and set the radio station presets (up to 10 AM and 10 FM stations can be set).
4. Adjust the Automatic Temperature Control (ATC) while the ATC is in Auto mode.
5. Press and release the SET (S) button located on the driver's door.
6. Within five seconds, press and release memory button 1 or 2 on the driver's door. The next step must be performed within 10 seconds if you desire to also use a RKE Transmitter to recall memory positions.
7. Press and release the LOCK button on one of the transmitters.
8. Insert the ignition key and turn the ignition switch to the ON position.

9. Repeat the above steps to set the next memory position using the other numbered memory button or to link another RKE Transmitter to memory.

**NOTE:** A chime sound may be heard if Setting Memory was inhibited for any reason.

### **Memory Position Recall**

**NOTE:**

- The driver's seat belt must be unbuckled to recall memory positions.
- The vehicle must be in PARK to recall memory positions.
- Not all motors may be moved at one time. Please refer to the 8-way power seat description in this section.

To recall the memory settings for driver one, press memory button number 1 on the driver's door or the UNLOCK button on the Remote Keyless Entry Transmitter linked to memory position 1.

To recall the memory setting for driver two, press memory button number 2 on the driver's door or the UNLOCK button on the Remote Keyless Entry transmitter linked to memory position 2.

A recall can be cancelled by pressing any of the memory buttons on the driver's door during a recall (S, 1, or 2), or pressing any one of the power seat buttons, or pressing the adjustable pedals button, or pressing either the LOCK or UNLOCK button on the Remote Keyless Entry Transmitter when not in the ignition switch. When a recall is cancelled, the driver's seat, and the pedals stop moving. A delay of one second will occur before another recall can be selected.

**NOTE:** A chime sound may be heard if Setting Memory was inhibited for any reason.

### **To Disable A Transmitter Linked to Memory**

1. Turn the ignition switch to the OFF position and remove the key.
2. Press and release the memory SET (S) button located on the driver's door.
3. Within 10 seconds, press and release the UNLOCK button on the Remote Keyless Entry Transmitter.

To disable another transmitter linked to either memory position, repeat steps 1-3 for each transmitter.

**NOTE:** The capability to link RKE Transmitters to memory is enabled when delivered from the factory. The capability to link RKE Transmitters to memory can be disabled (or later reenabled) by a qualified DaimlerChrysler representative. For vehicles equipped

with the Electronic vehicle Information Center (EVIC), refer to “Personal Settings (Customer Programmable Features)” under “Overhead Console with Electronic Vehicle Information Center (EVIC) – If Equipped” in Section 3.

### **Self-Limiting Control**

To improve vehicle reliability, the memory system includes a self-limiting control for full travel positioning of power seat and adjustable pedal movement (all directions). This self-limiting control may, however, develop an unintended movement limitation if an obstruction is encountered sometime during usage. One example of such an occurrence may include a box or package obstructing the full rearward movement of the driver's seat. Once the obstruction is removed, the self-limiting control may be restored to maximum position. The self-limiting control may be restored by first reaching the recently limited or obstructed position, then release and reactivate

the same button or buttons. Continued seat travel beyond the obstructed position will indicate the recently encountered self-limitation has been cleared.

### **Driver Easy Exit and Easy Entry Control**

This additional feature provides automatic driver's seat positioning which will enhance driver mobility out of and into the vehicle. The seat cushion will move rearward approximately 2.5 inches (60 mm) when the key is removed from the ignition switch. The seat will move forward approximately 2.5 inches (60 mm) when the key is placed into the ignition and turned out of the LOCK position. Each stored memory setting will have an associated Easy Exit and Easy Entry position. The Easy Exit and Easy Entry feature may be automatically disabled if the seat is positioned rearward enough and there is no benefit in moving the seat any farther rearward.

**NOTE:** The Easy Entry/Easy Exit feature can be enabled or disabled through the programmable features in

the Electronic Vehicle Information Center (EVIC). For details, refer to “Personal Settings (Customer Programmable Features)” under “Overhead Console with Electronic Vehicle Information Center (EVIC) – If Equipped” in Section 3.

### TO OPEN AND CLOSE THE HOOD

To open the hood, two latches must be released. First pull the hood release lever located under the left side of the instrument panel.



**Hood Release Lever**

Then push the safety latch lever to the left. It is located between the grille and hood opening right of the center.

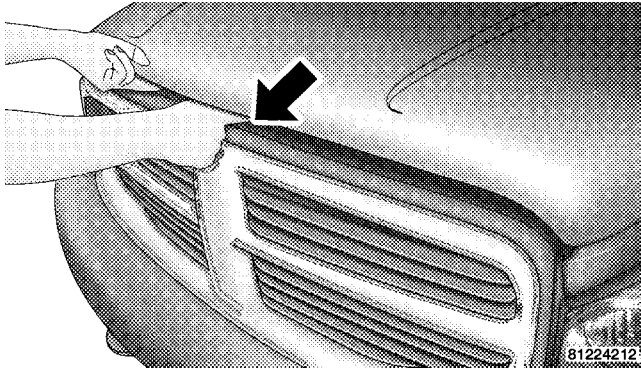

**Hood Safety Catch**

To prevent possible damage, do not slam the hood to close it. Use a firm downward push at the center front edge of the hood to ensure that both latches engage. Never drive your vehicle unless the hood is fully closed, with both latches engaged.

**NOTE:** Ensure hood prop rod is fully seated into clip before closing hood to prevent damage to grille.

### **WARNING!**

**If the hood is not fully latched, it could fly up when the vehicle is moving and block your forward vision. Be sure all hood latches are fully latched before driving.**



## LIGHTS

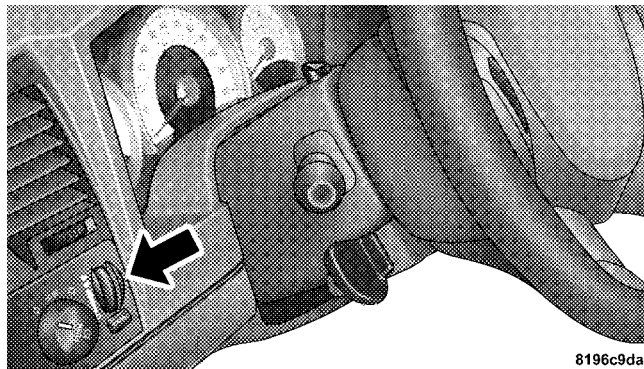

8196c9da

**Headlight Switch Location**

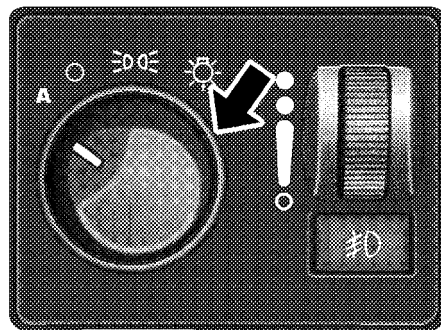

81b01c8a

**Headlight Switch**

## Interior Lights

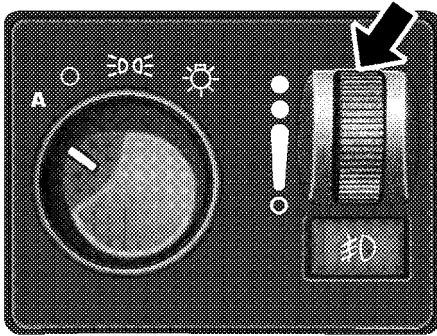

81b01c83

### Dimmer Control

Courtesy and dome lights are turned on when the front doors are opened, when the dimmer control (rotating wheel on the right side of the switch) is rotated to the second upward detent position, or when the UNLOCK button is pressed on the key fob. When a door is open

and the interior lights are on, rotating the dimmer control all of the way down to the OFF detent will cause all the interior lights to go out. This allows the doors to stay open for extended periods of time without discharging the vehicle's battery.

The brightness of the instrument panel lighting can be regulated by rotating the dimmer control up (brighter) or down (dimmer). When the headlights are ON you can supplement the brightness of the odometer, trip odometer, radio and overhead console by rotating the control up until you hear a click. This feature is termed the "Parade" mode and is useful when headlights are required during the day.

### Battery Saver

To protect the life of your vehicle's battery, load shedding is provided for both the interior and exterior lights.

If the ignition is off and any door is left ajar for eight minutes or the dimmer control is rotated upwards for 15 minutes, the interior lights will automatically turn off.

If the headlights remain on while the ignition is cycled off, the exterior lights will automatically turn off after eight minutes. If the headlights are turned on and left on for eight minutes while the ignition is off, the exterior lights will automatically turn off.

**NOTE:** Battery Saver mode is cancelled if the ignition is ON.

**NOTE:** While the engine is running, the system will deactivate the Fog Lights and Heated seats if a low battery system voltage is detected.

### **Headlight Delay**

To aid in your exit, your vehicle is equipped with a headlight delay that will leave the headlights on for 90 seconds. This delay is initiated when the ignition is cycled off while the headlight switch is on, and then the headlight switch is cycled off. The headlights will remain on for 90 seconds. Headlight delay can be cancelled by either turning the headlight switch ON then OFF or by turning the ignition ON.

The headlight delay time is programmable on vehicles equipped with the Electronic Vehicle Information Center (EVIC). For details, refer to “Personal Settings (Customer Programmable Features)” under “Overhead Console with Electronic Vehicle Information Center (EVIC) – If Equipped” in Section 3.

**Automatic Headlights — If Equipped**

Automatic headlights can be activated by rotating the rotary headlight switch to the symbol “A.” The headlights will turn on when the engine is running and the ambient light sensor indicates that the headlights should be activated. The headlights will turn off if the headlight switch is rotated to the OFF position or 90 seconds after the ignition is turned to OFF.

**Headlights, Parking Lights, Panel Lights**

When the headlight switch is rotated to the first position to the right, the parking lights, taillights, side marker lights, license plate light and instrument panel lights are all turned on. The headlights will turn ON when the switch is rotated to the second position.

Your vehicle is equipped with plastic headlight lenses that are lighter and less susceptible to stone breakage than glass headlights.

Plastic is not as scratch resistant as glass and therefore different lens cleaning procedures must be followed.

To minimize the possibility of scratching the lenses and reducing light output, avoid wiping with a dry cloth. To remove road dirt, wash with a mild soap solution followed by rinsing.

Do not use abrasive cleaning components, solvents, steel wool or other abrasive materials to clean the lenses.

**Illuminated Entry**

Headlights turn on for 90 seconds, when the Remote Keyless Entry UNLOCK button is pressed.

The illuminated entry time is programmable on vehicles equipped with the Electronic Vehicle Information Center (EVIC). For details, refer to “Personal Settings (Customer Programmable Features)” under “Overhead Console with Electronic Vehicle Information Center (EVIC) – If Equipped” in Section 3.

### Daytime Running Lights (Canada Only)

The headlights on your vehicle will illuminate when the engine is started. This provides a constant “Lights ON” condition until the ignition is turned OFF. The lights illuminate at reduced intensity. If the parking brake is applied the Daytime Running Lights (DRLs) will turn off. If the headlights are activated, the DRL feature will transition to the normal headlight operating mode.

### Lights-on Reminder

If the headlights, parking lights, or courtesy lights are left on after the ignition is turned OFF, a continuous fast chime will sound when the driver’s door is opened.

### Fog Lights — If Equipped

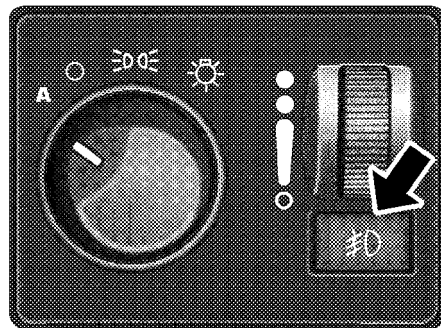

81b01c7e

### Fog Light Switch

The fog lights are turned on by placing the headlight rotary control in the parking light, headlight, or Auto position and pressing the fog light button. The fog lights will operate only when the parking lights are on or when the vehicle headlights are on low beam. An indicator light

located in the instrument cluster will illuminate when the fog lights are on. The fog lights will turn off when the switch is pressed in, when the headlight switch is rotated to the OFF position, or the high beam is selected.

### Multifunction Control Lever

The multifunction control lever is located on the left side of the steering column.

### Turn Signals

Move the lever up or down to signal a right-hand or left-hand turn.

The arrow on either side of the instrument cluster flashes to indicate the direction of the turn, and proper operation of the front and rear turn signal lights. If an indicator fails to light when the lever is moved, it would suggest that the switch or indicator lamp is defective.

If a defective bulb or wiring circuit is detected for the turn signal system, the arrow indicators will flash at a faster rate.

You can signal a lane change by moving the lever partially up or down.

**NOTE:** If a turn signal has been left on for at least a mile (a kilometer), a continuous chime will sound.

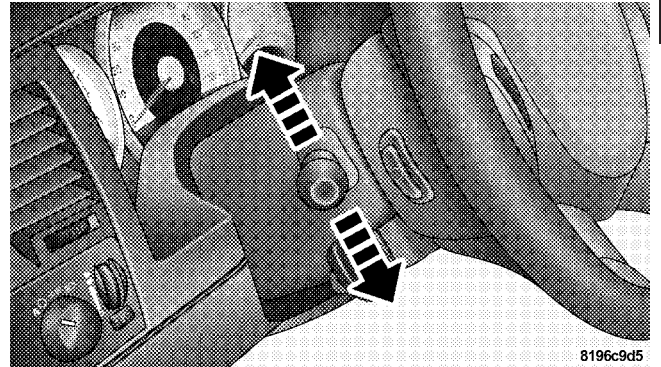

Turn Signal Lever

### **Turn Signal Auto-Mode**

Tap the multifunction control lever once and the turn signal (left or right) will flash three times, and automatically turn off.

### **Passing Light**

You can signal another vehicle with your headlights by partially pulling the multifunction lever toward the steering wheel. This will momentarily allow the high and low beams to energize at the same time. Within one second, the headlights will switch to high beams.

### **High Beam/Low Beam Select Switch**

Pull the multifunction control lever fully toward the steering wheel to switch the headlights from high or low beam.

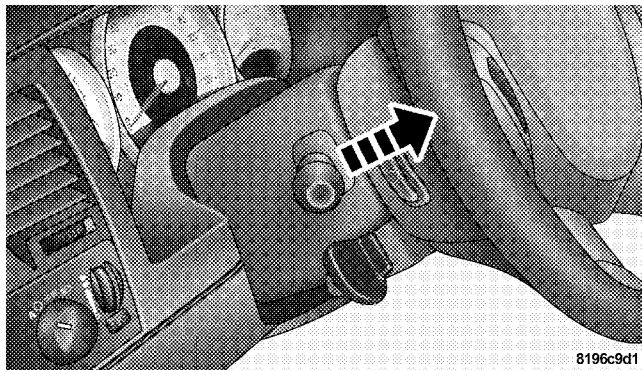

8196c9d1

**Dimmer Lever**

## WINDSHIELD WIPERS AND WASHERS

### Windshield Wipers

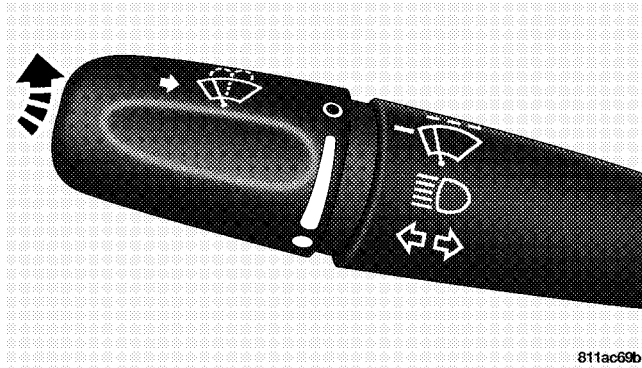

#### Windshield Wiper Switch

The wipers and washers are operated by a switch in the multifunction control lever. Turn the end of the handle to select the desired wiper speed.

### Intermittent Wiper System

The intermittent feature of this system was designed for use when weather conditions make a single wiping cycle, with a variable pause between cycles, desirable. For maximum delay between cycles, rotate the control knob into the upper end of the delay range.

The delay interval decreases as you rotate the knob until it enters the low continual speed position. The delay can be regulated from a maximum of about 15 seconds between cycles, to a cycle every 2 seconds. The delay intervals will double in duration when the vehicle speed is 10 mph (16 km/h) or less.



**WARNING!**

**Sudden loss of visibility through the windshield could lead to an accident. You might not see other vehicles or other obstacles. To avoid sudden icing of the windshield during freezing weather, warm the windshield with the defroster before and during windshield washer use.**

**NOTE:** Avoid using the wiper blades to remove frost or ice from the windshield.

**NOTE:** If the front wiper is operating when the ignition is turned OFF, the wiper will automatically return to the "Park" position. When the vehicle is restarted, the wipers will resume operation.

**Windshield Washers**

To use the washer, push in on the washer knob on the end of the multifunction control lever and hold while spray is desired. If the washer knob is depressed while in the delay range, the wiper will operate for several seconds after the washer knob is released. It will then resume the intermittent interval previously selected. If the washer knob is pushed for a period greater than one second while in the OFF position, the wiper will wipe approximately three wipes after the wash knob is released.

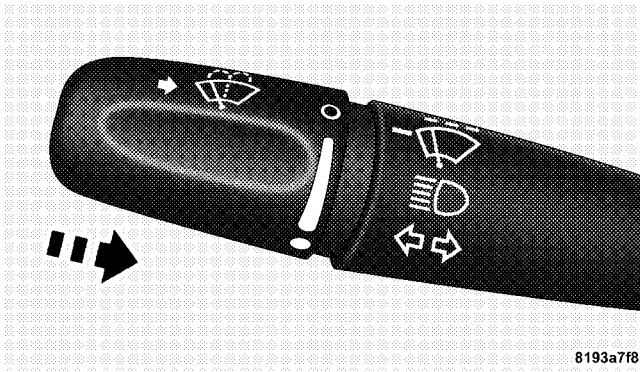

### Washer Fluid Switch

To prevent freeze-up of your windshield washer system in cold weather, select a solution or mixture that meets or exceeds the temperature range of your climate. This rating information can be found on most washer fluid containers.

### TILT STEERING COLUMN

To tilt the column, pull rearward on the lever below the turn signal control and move the wheel up or down as desired. Push the lever forward to lock the column firmly in place.

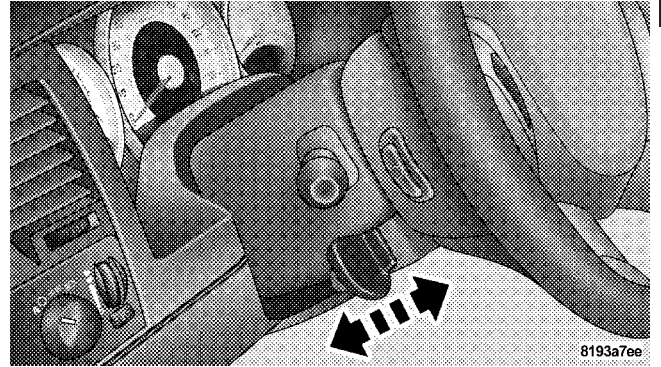

### Tilt Steering Column Lever

**WARNING!**

Tilting the steering column while the vehicle is moving is dangerous. Without a stable steering column, you could lose control of the vehicle and have an accident. Adjust the column only while the vehicle is stopped. Be sure it is locked before driving.

**DRIVER ADJUSTABLE PEDALS — IF EQUIPPED**

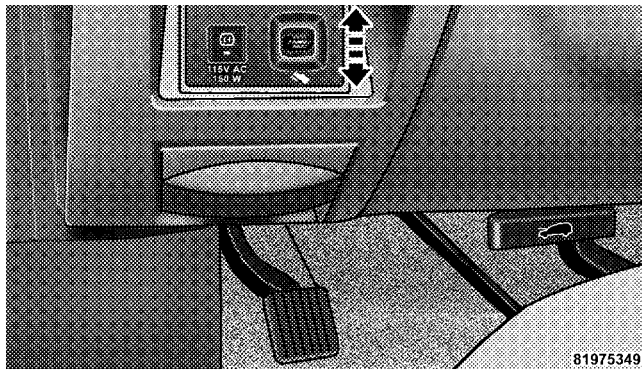

**Adjustable Pedals Switch**

The power adjustable accelerator and brake pedals allow the driver to establish a comfortable position relative to the steering wheel and pedals.

## Adjustment

1. Position the driver seat so that you are at least 10 in (254 mm) away from the airbag located in the center of the steering wheel.
2. Fasten and adjust the seatbelts.
3. Move the adjustable pedal switch, located to the left of the steering column near the parking brake release, up to move the pedals toward the driver or down to move the pedals away from the driver.
4. The pedals **cannot** be adjusted when the vehicle is in REVERSE or when the speed control is SET.

### CAUTION!

**Do not place any article under the adjustable pedals or impede its ability to move as it may cause damage to the pedal controls. Pedal travel may become limited if movement is stopped by an obstruction in the adjustable pedal's path.**

**ELECTRONIC SPEED CONTROL — IF EQUIPPED**

When engaged, this device takes over accelerator operation at speeds greater than (refer to the following table for the speed for your specific engine). The controls are mounted on the steering wheel.

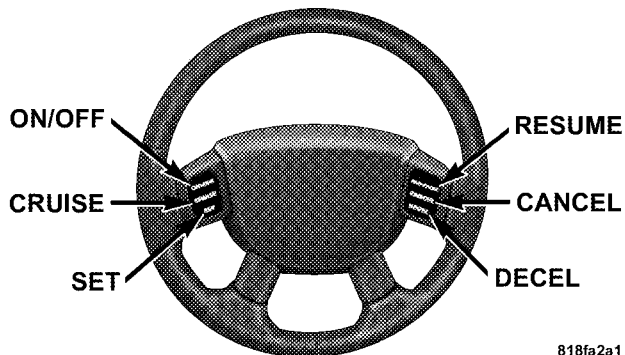

818fa2a1

**To Activate**

**NOTE:** The Vehicle Speed Control System has been designed to shut down if multiple speed control switch buttons (i.e., SET and CANCEL) are operated simultaneously in order to ensure proper operation. The System can be reactivated by pushing the speed control switch ON/OFF button and re-establishing the desired vehicle SET speed.

Push the ON/OFF button to the ON position. In the instrument cluster, the word “CRUISE” illuminates when the system is on.

**To Set At A Desired Speed**

When the vehicle has reached the desired speed, press and release the SET button. Release the accelerator and the vehicle will operate at the selected speed.

### To Deactivate

A soft tap on the brake pedal, normal braking, or pressing the CANCEL button will deactivate the speed control without erasing the memory. Pushing the ON/OFF button to the OFF position or turning off the ignition erases the memory.

#### **WARNING!**

**Leaving the Speed Control on when not in use is dangerous. You could accidentally set the system to cause it to go faster than you want. You could lose control and have an accident. Always leave the system off when you aren't using it.**

### To Resume Speed

To resume a previously set speed, push and release the RESUME button. Resume can be used at any speed above (refer to the following table for the speed for your specific engine).

### To Vary The Speed Setting

When the speed control is on, speed can be increased by pressing and holding the RESUME/ACCEL button. When the button is released, a new set speed will be established.

Tapping the RESUME/ACCEL button once will result in a speed increase (refer to the table below for the speed for your specific engine). Each time the button is tapped, speed increases, so tapping the button three times will increase speed by three increments.

Tapping the DECEL button once will result in a speed decrease (refer to the following table for the speed for your specific engine). Each time the button is tapped,

speed will decrease. For example, tapping the button three times will decrease the speed by three times the speed listed in the table below (refer to the following table for the speed for your specific engine).

To decrease speed while the speed control is on, press and hold the DECEL button. Release the button when the desired speed is reached, and the new speed will be set.

Functions	Speeds
Engage Speed	25 mph (40 km/h)
Minimum RESUME Speed	20 mph (32 km/h)
ACCEL Increase	1 mph (2 km/h)
DECEL Decrease	1 mph (2 km/h)
Dropout Speed	20 mph (32 km/h)

### To Accelerate For Passing

Depress the accelerator as you would normally. When the pedal is released, the vehicle will return to the set speed.

**NOTE:** When driving uphill, at elevations above 2,000 ft (610 m), or when the vehicle is heavily loaded (especially when towing) the vehicle may slow below the SET speed. If the vehicle speed drops below (refer to the previous table for the speed for your specific engine), the speed control will automatically disengage. If this happens, you can push down on the accelerator pedal to maintain the desired speed.

Vehicles equipped with an automatic transmission may exhibit several downshifts under the above conditions. To reduce the frequency of the downshifts and to improve vehicle performance, it is advisable to lock out OVERDRIVE by pressing the “TOW/HAUL” button located at the end of the gear shifter.

### WARNING!

**Speed Control can be dangerous where the system can't maintain a constant speed. Your vehicle could go too fast for the conditions, and you could lose control. An accident could be the result. Don't use Speed Control in heavy traffic or on roads that are winding, icy, snow-covered, or slippery.**

3

### REAR PARK ASSIST SYSTEM — IF EQUIPPED

**NOTE:** The manufacturer suggests disabling the Rear Park Assist System when towing a trailer. Refer to “Personal Settings (Customer Programmable Features)” under “Overhead Console with Electronic Vehicle Information Center (EVIC) – If Equipped” in Section 3.



This system is used to help drivers determine if an obstacle is in the way of the vehicle while it is backing up in addition to the use of inside rearview and outside mirrors.

When the driver selects REVERSE, the system scans for objects behind the vehicle using four sensors located in the rear bumper. Objects can be detected from up to 78.7 in (200 cm). A warning display above the rear window provides both visible and audible warnings indicating the range of the object.

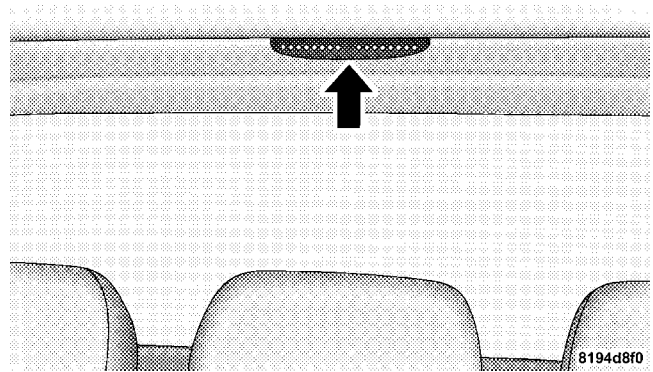

#### Rear Park Assist LEDs

The warning display contains two sets of yellow and red LEDs, one set to warn of obstacles behind the left rear of the vehicle and the other set to warn of obstacles behind the right rear of the vehicle. The driver can view the LEDs either through the rearview mirror or by looking at the display above the rear window.

The system dimly illuminates the two outermost yellow LEDs when it is ON and detecting no obstacles. The following chart shows the warning display operation when the system is detecting an obstacle:

### WARNING DISPLAY DISTANCES

DISPLAY LED	OBSTACLE DISTANCE FROM:		LED COLOR	AUDIBLE SIGNAL
	REAR CORNERS	REAR CENTER		
1st LED		78.7 in (200 cm)	Yellow	None
2nd LED		51.1 in (130 cm)	Yellow	None
3rd LED		45.2 in (115 cm)	Yellow	None
4th LED	31.5 in (80 cm)	39.3 in (100 cm)	Yellow	None
5th LED	25.5 in (65 cm)	33.5 in (85 cm)	Yellow	None
6th LED	20 in (50 cm)	27.6 in (70 cm)	Yellow	None
7th LED	16 in (40 cm)	19.7 in (50 cm)	Red	at 12 in (30 cm) Intermittent
8th LED	6 in (15 cm)	11.81 in (30 cm)	Red	at 8 in (20 cm) Continuous

**NOTE:** The Rear Park Assist system will MUTE the radio, if on, when the system is sounding an audio tone.

**WARNING!**

- Drivers must be careful when backing up, even when using the Rear Park Assist System. Always check carefully behind your vehicle, look behind you, and be sure to check for pedestrians, animals, other vehicles, obstructions, and blind spots before backing up. You are responsible for safety and must continue to pay attention to your surroundings. Failure to do so can result in serious injury or death.
- Before using the Rear Park Assist System, it is strongly recommended that the ball mount and hitch ball assembly is disconnected from the vehicle when the vehicle is not used for towing. Failure to do so can result in injury or damage to vehicles or obstacles because the hitch ball will be much closer to the obstacle than the rear fascia when the warning display turns the red LEDs ON. Also, the sensors could detect the ball mount and hitch ball assembly, depending on its size and shape, giving a false indication that an obstacle is behind the vehicle.

**CAUTION!**

- The Rear Park Assist System is only a parking aid and it is unable to recognize every obstacle, including small obstacles. Parking curbs might be temporarily detected or not detected at all. Obstacles located above or below the sensors will not be detected when they are in close proximity.
- The vehicle must be driven slowly when using the Rear Park Assist System to be able to stop in time when the obstacle is detected. It is recommended that the driver look over his/her shoulder when using the Rear Park Assist System.

**NOTE:**

- Ensure that the rear bumper is free of dirt and debris to keep the system operating properly.
- Jackhammers, large trucks, and other vibrations could affect the performance of the system.

If “Service Park Assist System” appears in the Electronic Vehicle Information Center (EVIC) after making sure the rear bumper is clean, please see your authorized dealer.

To turn on/off the rear park assist system, refer to “Personal Settings (Customer Programmable Features)” under “Overhead Console with Electronic Vehicle Information Center (EVIC) – If Equipped” in Section 3.

**REAR CAMERA — IF EQUIPPED**

Your vehicle may be equipped with a Rear Camera system that allows you to see an on-screen image (located in the screen of your Radio) of the rear of your vehicle whenever it is put into REVERSE. The camera is located in the light bar over the rear license plate.

**NOTE:** Refer to “Setting Display Properties” under “System Settings” in the Navigation User’s Manual for instructions regarding navigation screen brightness adjustments.

Use the following steps to access the Rear Backup Camera feature:

1. Start the engine.
2. Depress the brake pedal and place the shift lever in REVERSE.
3. Wait one to two seconds, and the camera view will display on the Radio screen.

**NOTE:** The camera view will display only while the vehicle is in REVERSE.

4. Perform a visual check of the rear area.

**NOTE:** CHECK ENTIRE SURROUNDINGS before backing up.

5. Slowly backup as necessary.

6. Place the shift lever in PARK or DRIVE to exit the Rear Backup Camera system.

**WARNING!**

**Drivers must be careful when backing up even when using the Rear Camera System. Always check carefully behind your vehicle, and be sure to check for pedestrians, animals, other vehicles, obstructions, or blind spots before backing up. You are responsible for the safety of your surroundings and must continue to pay attention while backing up. Failure to do so can result in serious injury or death.**

**CAUTION!**

- To avoid vehicle damage, the Rear Camera System should only be used as a parking aid and is unable to view every obstacle or object in your drive path.
- To avoid vehicle damage, the vehicle must be driven slowly when using the Rear Camera System to be able to stop in time when an obstacle is seen. It is recommended that the driver look frequently over his/her shoulder when using the Rear Camera System.

**NOTE:** If snow, ice, mud, or anything else builds up on the camera lens, clean the lens, rinse with water, and dry with a soft cloth. Do not cover the lens.

**OVERHEAD CONSOLE**

The overhead console has the following features:

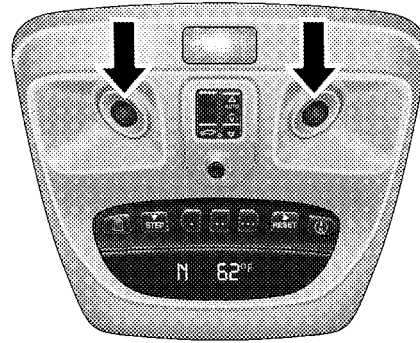

**Overhead Console**

- Courtesy Lights
- Garage Door Opener — If Equipped
- Electronic Vehicle Information Center (EVIC) — If Equipped

8192e899

### **Courtesy/Reading Lights**

Near the front of the console is one courtesy and two reading lights.

All lights illuminate as courtesy lights when a door is opened, when the dimmer control is rotated to the courtesy light position (fully upward position), or when the UNLOCK button is pressed on the Remote Keyless Entry (RKE) Transmitter, if so equipped. The two round lamps are also operated individually as reading lights by pressing the center of each lens.

**NOTE:** The courtesy/reading lights will remain on until the switch is pressed a second time, so be sure they have been turned off before leaving the vehicle. If the interior lights are left on after the vehicle is turned OFF, they will turn off after 15 minutes.

### **OVERHEAD CONSOLE WITH ELECTRONIC VEHICLE INFORMATION CENTER (EVIC) — IF EQUIPPED**

The overhead console contains dome/reading lights, and an Electronic Vehicle Information Center (EVIC).

#### **Dome/Reading Lights**

Located in the overhead console are two dome/reading lights.

The dome/reading lights illuminate when a door is opened or when the interior lights are turned on by rotating the dimmer control located on the headlight switch.

The reading lights are activated by pressing the center of each lens.

**NOTE:** The dome/reading lights will remain on until the switch is pressed a second time, so be sure they have been turned off before leaving the vehicle.

## Electronic Vehicle Information Center (EVIC) — If Equipped

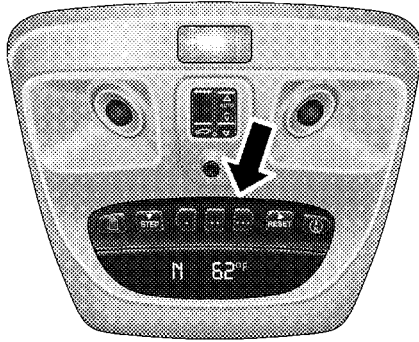

81970b55

### HG EVIC



Pressing the MENU button will change the display to one of the following features:

### Trip Functions

Pressing the STEP button allows you to scroll through one of the following Trip Function features:

- TRIP – Shows the total distance traveled since the last reset. To reset the TRIP function, press and hold the RESET button.
- ELAPSED TIME – Shows the total elapsed time of travel since the last reset. Elapsed time will increment when the ignition switch is in the ON/RUN or START positions.
- UNIT IN U.S./METRIC – Press the RESET button to toggle between U.S. and METRIC.
- AVG. MPG – Shows the average fuel economy since the last reset. When the fuel economy is reset, the display will show dashes for two seconds. Then the history information will be erased, and the **averaging will continue from the last fuel average reading**



**before the reset.** (Example: If your EVIC displays 18 AVG. MPG and the RESET button is pressed, the previous averaging history will be erased and the display will return to the 18 AVG. MPG, not to 0 AVG. MPG). The display may take several miles/kilometers for the value to change, depending upon driving habits. If equipped with a 5.7L engine and Multi Displacement System (MDS), FUEL SAVER may be displayed along with the actual AVG. MPG. If equipped with MDS option, the EVIC will display FUEL SAVER when in fuel economy mode.

- **MI TO EMPTY (Distance To Empty)** – Shows the estimated distance that can be traveled with the fuel remaining in the tank. This estimated distance is determined by a weighted average of fuel economy, according to the current fuel tank level. MI TO EMPTY cannot be reset through the RESET button.

**NOTE:** Significant changes in driving style or vehicle loading will greatly affect the actual drivable distance of the vehicle, regardless of the DTE displayed value.

- When the DTE value is less than 30 miles (48 km) estimated driving distance, the DTE display will change to a text display of "LOW FUEL." This display will continue until the vehicle runs out of fuel. Adding a significant amount of fuel to the vehicle will turn off the "LOW FUEL" text and a new DTE value will display.
- **Global Reset** – If the RESET button is pressed twice within two seconds while in any of the three resettable displays (AVG. MPG, ET (ELAPSED TIME) and TRIP), all three displays will be reset.

### System Status (EVIC Displays)

When the appropriate conditions exist, the EVIC displays the following messages:

- TURN SIGNALS ON (with a continuous warning chime)
- PERSONAL SETTINGS NOT AVAILABLE – Vehicle not in PARK
- LEFT/RIGHT FRONT DOOR AJAR (one or more, with a single chime if speed is above 1 mph/1 km/h)
- LEFT/RIGHT REAR DOOR AJAR (one or more, with a single chime if speed is above 1 mph/1 km/h)
- DOOR(S) AJAR (with a single chime if vehicle is in motion)
- LOW WASHER FLUID (with a single chime)
- OIL CHANGE REQUIRED (with a single chime)

- SERVICE PARK ASSIST SYSTEM (with a single chime)
- SERVICE PARK ASSIST SYSTEM
- COOLANT LOW
- LIFTGATE OPEN
- CHECK TPM SYSTEM (with single chime) (Premium TPM System Only)

### OIL CHANGE REQUIRED — If Equipped

Your vehicle is equipped with an engine oil change indicator system. The “Oil Change Required” message will flash in the EVIC display for approximately 10 seconds after a single chime has sounded to indicate the next scheduled oil change interval. The engine oil change indicator system is duty cycle based, which means the engine oil change interval may fluctuate dependent upon your personal driving style.

Unless reset, this message will continue to display each time you turn the ignition switch to the ON/RUN position. To turn off the message temporarily, press and release the MENU button. To reset the oil change indicator system (after performing the scheduled maintenance), refer to the following procedure.

1. Turn the ignition switch to the ON position (**Do not start the engine**).
2. Fully depress the accelerator pedal slowly three times within 10 seconds.
3. Turn the ignition switch to the OFF/LOCK position.

**NOTE:** If the indicator message illuminates when you start the vehicle, the oil change indicator system did not reset. If necessary, repeat this procedure.

### Personal Settings (Customer-Programmable Features)

Personal Settings allows the driver to set and recall features when the transmission is in PARK. If the transmission is not in PARK the EVIC will display NOT AVAILABLE and VEHICLE NOT IN PARK.



Press and release the MENU button until the Personal Settings displays on the EVIC.

Use the STEP button to display one of the following:

- “LANGUAGE” – When in this display, you may select one of several different languages for all display nomenclature, including the trip functions. Press the RESET button while in this display to select your preferred language. Then, as you continue, the information will display in the selected language.

- “AUTO DOOR LOCK > ON” – When ON is selected, all doors will lock automatically when the vehicle reaches a speed of 15 mph (24 km/h). To make your selection, press and release the RESET button until “ON” or “OFF” appears.
- “AUTO UNLOCK ON EXIT > ON” – When ON is selected, all doors will unlock when the vehicle is stopped and the transmission is in the PARK or NEUTRAL position and the driver’s door is opened. To make your selection, press and release the RESET button until “ON” or “OFF” appears.
- “RKE UNLOCK DRV DR 1st” – When **DRV DR 1st** is selected, only the driver’s door will unlock on the first press of the RKE UNLOCK button. When Driver Door 1st Press is selected, you must press the Remote Keyless Entry UNLOCK button twice to unlock the passenger’s doors. To make your selection, press and release the RESET button until “DRV DR 1st ” appears.
- “RKE UNLOCK ALL DR 1ST” – When All **ALL DR 1ST** is selected, all of the doors will unlock on the first press of the RKE UNLOCK button. To make your selection, press and release the RESET button until “All DR 1st” appears.
- MEM. RECALL WITH RKE > ON – When ON is selected, pressing the UNLOCK button on the RKE will recall the memory settings for the seat, mirror and radio. To make your selection, press and release the RESET button until “ON” or “OFF” appears.
- “SOUND HORN W/LOCK > ON” – When ON is selected, a short horn sound will occur when the Remote Keyless Entry LOCK button is pressed. This feature may be selected with or without the flash lights on lock/unlock feature. To make your selection, press and release the RESET button until “ON” or “OFF” appears.

- “FLASH LAMPS W/LOCK >ON” – When ON is selected, the front and rear turn signals will flash when the doors are locked or unlocked with the RKE Transmitter. This feature may be selected with or without the sound horn on lock feature selected. To make your selection, press and release the RESET button until “ON” or “OFF” appears.
  - “HEADLAMP OFF DELAY > 0 SEC” – When this feature is selected, the driver can choose to have the headlamps remain on for 0, 30, 60, or 90 seconds when exiting the vehicle. To make your selection, press and release the RESET button until “0,” “30,” “60,” or “90” appears.
- NOTE:** The headlamp switch must be in the “A” auto mode before this feature will work.
- HEADLAMPS W/WIPERS > ON – When ON is selected, the headlamps will automatically turn on when the wiper switch is activated.
  - EASY EXIT SEAT > ON – When ON is selected, and the key is removed from the ignition, the driver’s seat will automatically move rearward to allow easy exit.
  - TILT MIRRORS IN “R” > ON – When ON is selected, and the transmission is put in REVERSE, the outside mirrors will tilt downward.
  - “KEY OFF POWER DELAY> OFF” – When this feature is selected, the power window switches, radio, hands-free system (if equipped), and power outlets will remain active for up to 10 minutes after the ignition switch is turned off. Opening a vehicle door will cancel this feature. To make your selection, press and release the RESET button until “Off,” “45 sec.,” “5 min.,” “10 min.” appears.
  - “ILLUMINATED APRCH > OFF” – When this feature is selected, the headlights will activate and remain on for up to 90 seconds when the doors are unlocked with

the RKE Transmitter. To make your selection, press and release the RESET button until “OFF,” “30 sec.,” “60 sec.,” or “90 sec.” appears.

- **PARK ASST. SYSTEM > ON** – When YES is selected, the Rear Park Assist System is activated. When NO is selected, the System is deactivated.
- **“UNIT IN > U.S./METRIC”** – The EVIC odometer can be changed between English and Metric units of measure. To make your selection, press and release the RESET button until “US” or “METRIC” appears.
- **“COMPASS VARIANCE > 8”** – Press the RESET button to change the compass variance setting. Set this to your current location. If you change location, change your variance according to your variance on the variance map. Refer to Compass Variance Map in this section.

- **“COMPASS CALIBRATE > YES”** – Press the RESET button to manually calibrate the compass. Refer to Manual Compass Calibration in this section.

### Compass/Temperature Button



Pressing the Compass/Temperature button will return the display to the normal compass/temperature display.

3

**NOTE:** Temperature accuracy can be affected from heat soak. For best accuracy, the vehicle should be driven at a speed greater than 20 mph (32 km/h) for several minutes.

### Automatic Compass Calibration

This compass is self-calibrating, which reduces the need to calibrate the compass manually. When the vehicle is new, the compass may appear erratic and the EVIC will display “CAL” until the compass is calibrated. You may also calibrate the compass by completing one or more

360° turns at speeds less than 5 mph (8 km/h) (in an area free from large metal or metallic objects) until the “CAL” message displayed in the EVIC turns off. The compass will now function normally.

### Manual Compass Calibration

If the compass appears erratic and the “CAL” message does not appear in the EVIC display, you must put the compass into the Calibration Mode manually as follows:

1. Turn the ignition switch to the ON/RUN position.



2. Press the MENU button until “Personal Settings” is displayed.

3. Press the STEP button until “Calibrate Compass YES” is displayed.

4. Press and release the RESET button to start the calibration. The message “CAL” will display on the compass temperature screen in the EVIC.

5. Slowly drive the vehicle at a speed of 5 mph (8 km/h) in a complete 360° circle, (in an area free from large metal or metallic objects) until the “CAL” message turns off. The compass will now function normally.

### Compass Variance

Compass variance is the difference between magnetic North and geographic North. In some areas of the country, the difference between magnetic and geographic North is great enough to cause the compass to give false readings. If this occurs, the compass variance must be set using the following procedure:

**NOTE:** Magnetic materials should be kept away from the overhead console. This is where the compass sensor is located.

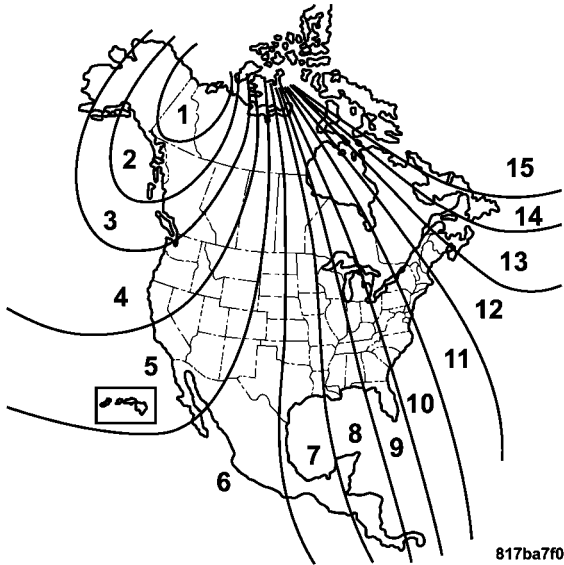

Variance Map

1. Turn the ignition switch to the ON/RUN position.
2. Press the MENU button until “Personal Settings” is displayed.
  - 
3. Press the STEP button until “Compass Variance” is displayed.
4. Press and release RESET button until the proper variance zone is selected according to the variance map.
5. Press and release the Compass/Temperature button to exit.



**GARAGE DOOR OPENER — IF EQUIPPED**

HomeLink® replaces up to three remote controls (hand-held transmitters) that operate devices such as garage door openers, motorized gates, lighting, or home security systems. The HomeLink® unit operates off your vehicle's battery.

The HomeLink® buttons are located in the overhead console, and contain one, two, or three dots/lines designating the different HomeLink® channels.

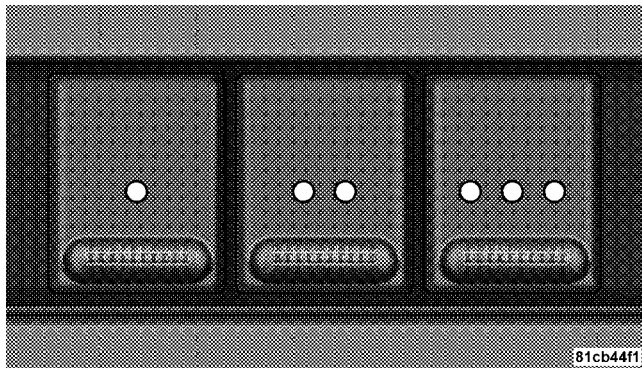

**HomeLink® Buttons**

**NOTE:** HomeLink® is disabled when the Vehicle Security Alarm is active.

**WARNING!**

Your motorized door or gate will open and close while you are training the Universal Transceiver. Do not train the transceiver if people or pets are in the path of the door or gate. Only use this transceiver with a garage door opener that has a “stop and reverse” feature as required by federal safety standards. This includes most garage door opener models manufactured after 1982. Do not use a garage door opener without these safety features. Call toll-free 1-800-355-3515 or, on the Internet at [www.HomeLink.com](http://www.HomeLink.com) for safety information or assistance.

**WARNING!**

Vehicle exhaust contains carbon monoxide, a dangerous gas. Do not run your vehicle in the garage while training the transceiver. Exhaust gas can cause serious injury or death.

3

**Programming HomeLink®****Before You Begin**

If you have not trained any of the HomeLink® buttons, erase all channels before you begin training.

To do this, press and hold the two outside buttons for 20 seconds. The EVIC will display “CLEARING CHANNELS.” Release the buttons when the EVIC message states “CHANNELS CLEARED.”

It is recommended that a new battery be placed in the hand-held transmitter of the device being programmed to HomeLink® for more efficient training and accurate transmission of the radio-frequency signal.

Your vehicle should be parked outside of the garage while training.

1. Turn the ignition switch to the ON/RUN position.
2. Place the hand-held transmitter 1 to 3 in (3 to 8 cm) from the HomeLink® buttons while keeping the EVIC display in view.

For optimal training, point the battery end of the hand-held transmitter away from the HomeLink.®

3. Simultaneously, press and hold both the chosen HomeLink® button and the hand-held transmitter button until the EVIC display changes from “CHANNEL # TRAINING” to “CHANNEL # TRAINED.”

Then release both the HomeLink® and hand-held transmitter buttons.

If the EVIC display states “DID NOT TRAIN” repeat Step 3. If the signal is too weak, replace the battery in the original hand-held transmitter.

It may take up to 30 seconds, or longer, in rare cases. The garage door may open and close while you train.

**NOTE:** Some gate operators and garage door openers may require you to replace Step 3 with procedures noted in the “Gate Operator/Canadian Programming” section.

4. Press and hold the just-trained HomeLink® button. If the channel has been trained, the EVIC display will now state “CHANNEL # TRANSMIT.”

If the EVIC display still states “CHANNEL # TRAINING” repeat Step 3.

**NOTE:** After training a HomeLink® channel, if the garage door does not operate with HomeLink® and the garage door opener was manufactured after 1995, the garage door opener may have rolling code. If so, proceed to the heading “Programming A Rolling Code System.”

### 5. PROGRAMMING A ROLLING CODE SYSTEM

At the garage door opener motor (in the garage), locate the “learn” or “training” button.

This can usually be found where the hanging antenna wire is attached to the garage door opener motor (it is NOT the button normally used to open and close the door).

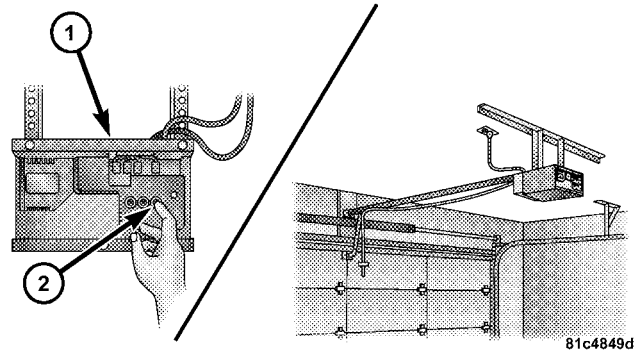

- 1 — Garage Door Opener
- 2 — Training Button

6. Firmly press and release the “learn” or “training” button. The name and color of the button may vary by manufacturer.

**NOTE:** There are 30 seconds in which to initiate the next step after the “Learn” button has been pressed.

7. Return to the vehicle and press the programmed HomeLink® button twice (holding the button for two seconds each time). If the device is plugged in and activates, programming is complete.

If the device does not activate, press the button a third time (for two seconds) to complete the training.

If you have any problems, or require assistance, please call toll-free 1-800-355-3515 or, on the Internet at [www.HomeLink.com](http://www.HomeLink.com) for information or assistance.

To program the remaining two HomeLink® buttons, repeat each step for each remaining button. DO NOT erase the channels.

### **Gate Operator/Canadian Programming**

Canadian radio-frequency laws require transmitter signals to “time-out” (or quit) after several seconds of transmission – which may not be long enough for HomeLink® to pick up the signal during programming.

Similar to this Canadian law, some U.S. gate operators are designed to “time-out” in the same manner.

It may be helpful to unplug the device during the cycling process to prevent possible overheating of the garage door or gate motor.

If you are having difficulties programming a garage door opener or a gate operator, replace “Programming HomeLink” Step 3 with the following:

**3. Continue to press and hold the HomeLink® button while you press and release - every two seconds (“cycle”) your hand-held transmitter until HomeLink® has successfully accepted the frequency signal. The EVIC display will change from “CHANNEL # TRAINING” to “CHANNEL # TRAINED.”**

If you unplugged the device for training, plug it back in at this time.

Then proceed with Step 4 under “Programming HomeLink®” earlier in this section.

### Using HomeLink®

To operate, simply press and release the programmed HomeLink® button. Activation will now occur for the trained device (i.e., garage door opener, gate operator, security system, entry door lock, home/office lighting, etc.) The hand-held transmitter of the device may also be used at any time.

### Reprogramming A Single HomeLink® Button

To reprogram a channel that has been previously trained, follow these steps:

1. Turn the ignition switch to the ON/RUN position.
2. Press and hold the desired HomeLink® button for 20 seconds until the EVIC display states “CHANNEL # TRAINING.” **Do not release the button.**
3. **Without releasing the button**, proceed with Programming HomeLink® Step 2 and follow all remaining steps.

### Security

It is advised to erase all channels before you sell or turn in your vehicle.

To do this, press and hold the two outside buttons for 20 seconds until the EVIC message states “CHANNELS CLEARED.” Note that all channels will be erased. Individual channels cannot be erased.

The HomeLink® Universal Transceiver is disabled when the Vehicle Security Alarm is active.

### Troubleshooting Tips

If you are having trouble programming HomeLink®, here are some of the most common solutions:

- Replace the battery in the original transmitter.
- Press the learn button on the garage door opener to complete the training for rolling code.

- Did you unplug the device for training, and remember to plug it back in?

If you are having any problems or require assistance, please call toll-free 1-800-355-3515 or, on the Internet at [www.HomeLink.com](http://www.HomeLink.com) for information or assistance.

### General Information

This device complies with FCC rules part 15 and Industry Canada RSS-210. Operation is subject to the following two conditions:

1. This device may not cause harmful interference
2. This device must accept any interference that may be received including interference that may cause undesired operation

**NOTE:** The transmitter has been tested and it complies with FCC and IC rules. Changes or modifications not expressly approved by the party responsible for compliance could void the user's authority to operate the device.

The term "IC:" before the certification/registration number only signifies that Industry Canada technical specifications were met.

### POWER SUNROOF — IF EQUIPPED

The power sunroof control is located between the sun visors on the overhead console.

Pressing the "open" end of the rocker switch once moves the panel to the open position.

To close the panel, the "close" end of the switch must be pressed and held.

Pressing the "vent" button from a fully closed position raises the trailing edge of the panel for ventilation. When the panel is venting, pressing the "close" end of the rocker switch returns it to the closed position. Both opening and closing operations in the vent mode occur only while the switch is held.

**NOTE:** The sunroof will continue to operate for 10 minutes after the ignition is turned OFF or until the driver's door is opened. This feature may be disabled by your authorized dealer.

### **Express Open Feature**

During the Express Open operation, any movement of the switch will stop the sunroof and it will remain in a partial open position. Again, momentarily pressing the switch rearward will activate the Express Open Feature.

To close the sunroof, hold the switch in the forward position. Again, any release of the switch will stop the movement and the sunroof will remain in a partial open condition until the switch is pushed forward again. To close fully, hold the switch in the forward position until the glass movement has stopped.

The sunshade can be opened manually. It will also open as the sunroof opens. The sunshade cannot be closed if the sunroof is open.

### **WARNING!**

**Never leave children alone in a vehicle. Leaving unattended children in a vehicle is dangerous for a number of reasons. A child or others could be seriously or fatally injured. Don't leave the keys in the ignition. A child could operate power windows, other controls, or move the vehicle.**



**WARNING!**

**In an accident, there is a greater risk of being thrown from a vehicle with an open sunroof. You could also be seriously injured or killed. Always fasten your seat belt properly and make sure all passengers are properly secured too.**

**Do not allow small children to operate the sunroof. Never allow fingers or other body parts, or any object to project through the sunroof opening. Injury may result.**

**Wind Buffeting**

Wind buffeting can be described as the perception of pressure on the ears or a helicopter type sound in the ears. Your vehicle may exhibit wind buffeting with the windows down, or the sunroof (if equipped) in certain open or partially open positions. This is a normal occurrence and can be minimized. If the buffeting occurs with the rear windows open, open the front and rear windows together to minimize the buffeting. If the buffeting occurs with the sunroof open, adjust the sunroof opening to minimize the buffeting, or open any window.

**Sunroof Maintenance**

Use only a nonabrasive cleaner and a soft cloth to clean the glass panel.

## ELECTRICAL POWER OUTLETS

This vehicle has three auxiliary power outlets that can provide up to 20 Amps of current for accessories designed for use with the standard power outlet adapters. The outlet located in the lower portion of the instrument panel has a snap on plastic cap so that it can be covered when not in use. As a safety precaution, the outlet in the instrument panel only operates with the ignition switch ON. When the optional Cigar Lighter heating element is used, it heats when pushed in and pops out automatically when ready for use. **To preserve the heating element, do not hold the lighter in the heating position.**

There are two additional 12 V/(20 total Amps for both outlets) power outlets, one located in the storage bin of the center console and another located in the right rear cargo area. These outlets can be reconfigured by the customer to operate only when the ignition is ON

(switched battery fed) or with the ignition ON or OFF (battery fed) to allow for cellular telephone charging and operation while the ignition is OFF.

**NOTE:** All accessories connected to these outlets should be removed or turned OFF when the vehicle is not in use to protect the battery against discharge (unless the customer has reconfigured the fuse block to switched battery feed). (See page 187 for more information.)

### 115V Inverter Outlet – If Equipped

This vehicle may also be equipped with a 115 Volt (150 Watts Maximum) outlet on the rear of the front center console. These outlets can power cell phones, electronics and other low power devices. This plug is controlled by a switch located in left lower instrument panel.

Press the switch to turn the power on to the outlet. Press the switch a second to turn the power off.

**NOTE:** When the inverter switch is pressed, there will be a delay of approximately one second before the inverter status indicator turns ON. The status Indicator of the AC power inverter indicates whether the inverter is producing AC power.

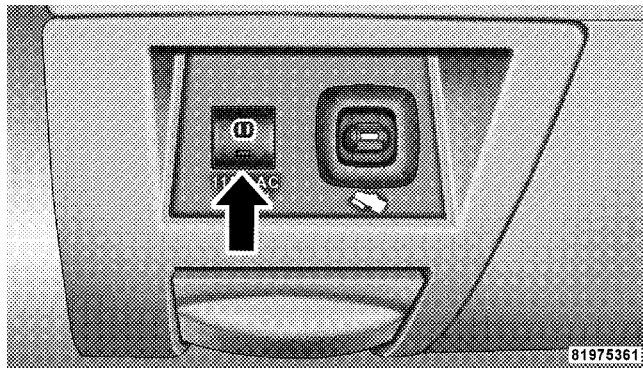

**115V Inverter Switch**

**NOTE:** Due to built-in overload protection, the inverter will shut down if the power rating is exceeded.

### **WARNING!**

**To void serious injury or death:**

- Do not use a 3-prong adapter.
- Do not insert any objects into the receptacles.
- Do not touch with wet hands.
- Close the lid when not in use.
- If this outlet is mishandled it may cause an electric shock and failure.

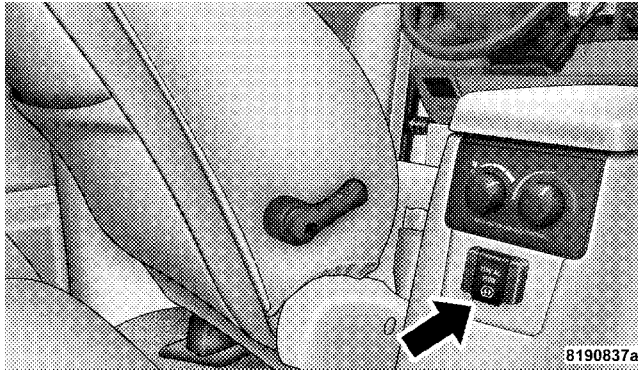

115V Inverter Plug

### Electrical Outlet Use With Engine OFF (Battery Fed Configuration)

#### CAUTION!

- Many accessories that can be plugged in draw power from the vehicle's battery, even when not in use (i.e., cellular phones, etc.). Eventually, if plugged in long enough, the vehicle's battery will discharge sufficiently to degrade battery life and/or prevent engine starting.
- Accessories that draw higher power (i.e., coolers, vacuum cleaners, lights, etc.), will discharge the battery even more quickly. Only use these intermittently and with greater caution.
- After the use of high power draw accessories, or long periods of the vehicle not being started (with accessories still plugged in), the vehicle must be driven a sufficient length of time to allow the generator to recharge the vehicle's battery.

### Reconfiguring Power Outlets

To reconfigure the outlets, be sure the ignition is OFF before removing the fuse. The reconfigurable fuse location is a special design that allows the fuse to be installed in two different ways. If the fuse is located in the "Upper or Top Position" the outlets will work at all times. If the fuse is located in the "Lower or Bottom Position" the power outlets will only work when the ignition is ON.

**NOTE:** The fuse block is located in the left side kick panel behind a removable cover near the park brake pedal. A fuse puller is attached to the inside surface of the fuse panel cover to aid in removing fuses, if necessary.

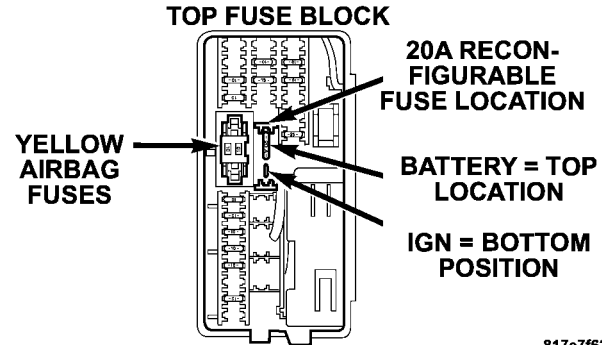

817e7f62

### FLOOR CONSOLE

#### Floor Console Features

The floor console between the driver's and front passenger's seat, has the following features:

- Miscellaneous storage compartments
- Portable phone storage bin

- Portable phone cord routing between lid and base on forward edge
- 12 Volt reconfigurable power outlet inside storage compartment
- Side open armrest lid
- Tissue holder pen holder
- Coin slots
- Removable CD bin
- 115 V Inverter Plug
- RCA Jacks

The coin slots are located under the instrument panel center stack.

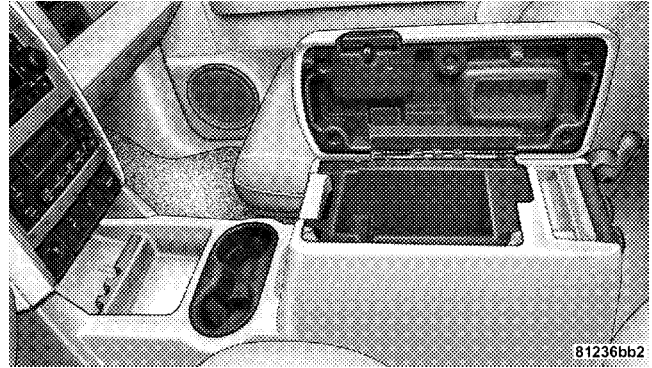

### Cupholders

Your vehicle has eight cupholders. four are located in the center console, two are located in the second row armrest, and two are located in the left-hand quarter panel for third row occupants.

**Power Outlet and Portable Phone Storage**

The console is equipped with a power outlet, portable phone storage bin, and phone cord routing. The phone storage bin can be used when easy access to the phone is needed. Also, the power outlet inside the console compartment can be used to power up the phone while it is being stored in the bin. To use, plug in the portable power recharge cord and place the cord along the opening under the forward portion of the storage bin. Close the console armrest lid and plug the power cord into the phone while resting the phone in the bin. The power outlet may be used for any portable item with a standard 12 volt power outlet adaptor, requiring up to 20 Amps of current.

**Rear Floor Console Features – If Equipped**

The rear floor console located between the second row bucket seat has the following features:

- Miscellaneous storage compartments
- Cupholders
- Portable phone cord routing on the sides of the console lid and the base.
- 12 Volt power outlet inside storage compartment
- Tissue holder and pen holder
- Second row heated seat switches (if equipped).

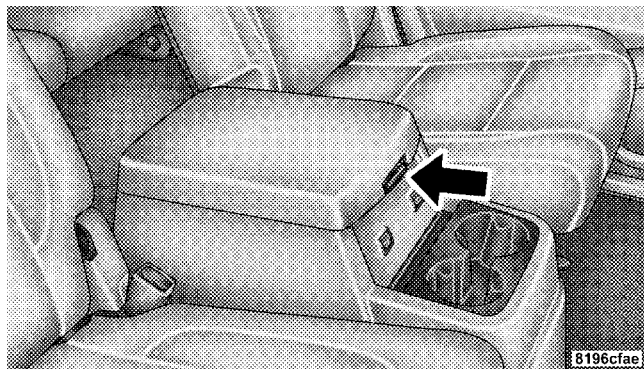

### Rear Floor Console

To access the storage bin, lift up on the console door latch.

### FACTORY INSTALLED ROOF LUGGAGE RACK

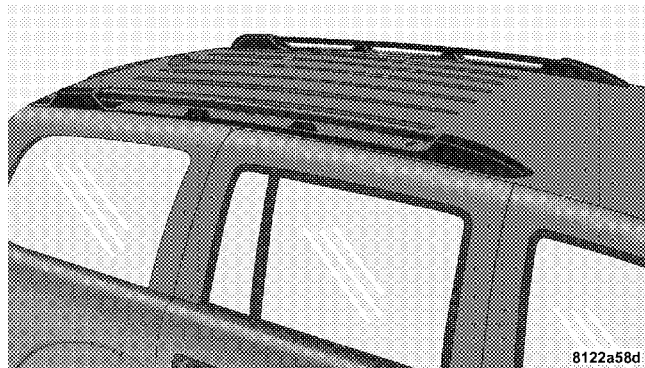

### Roof Luggage Rack

The load carried on the roof when equipped with a luggage rack must not exceed 150 lbs (68 kg), and should be uniformly distributed over the cargo area.



The side rails between the stations should be used to tie down cargo. Check the straps frequently to be sure that the load remains securely attached.

**NOTE:** Crossbars are offered by Mopar® accessories.

External racks do not increase the total load carrying capacity of the vehicle. Be sure that the total occupant and luggage load inside the vehicle, plus the load on the luggage rack, do not exceed the maximum vehicle load capacity.

### **CAUTION!**

**To avoid damage to the roof rack and vehicle, do not exceed the maximum roof rack load capacity. Always distribute heavy loads as evenly as possible and secure the load appropriately.**

**Long loads which extend over the windshield, such as wood panels or surfboards, should be secured to both the front and rear of the vehicle.**

**Place a blanket or other protection between the surface of the roof and the load.**

**Travel at reduced speeds and turn corners carefully when carrying large or heavy loads on the roof rack. Wind forces, due to natural causes or nearby truck traffic, can add sudden upward loads. This is especially true on large flat loads and may result in damage to the cargo or your vehicle.**

**WARNING!**

Cargo must be securely tied down before driving your vehicle. Improperly secured loads can fly off the vehicle, particularly at high speeds, resulting in personal injury or property damage. Follow the roof rack Cautions when carrying cargo on your roof rack.

**CARGO MANAGEMENT SYSTEM—IF EQUIPPED**

The cargo management system consists of a removable cargo liner and removable cargo organizer.

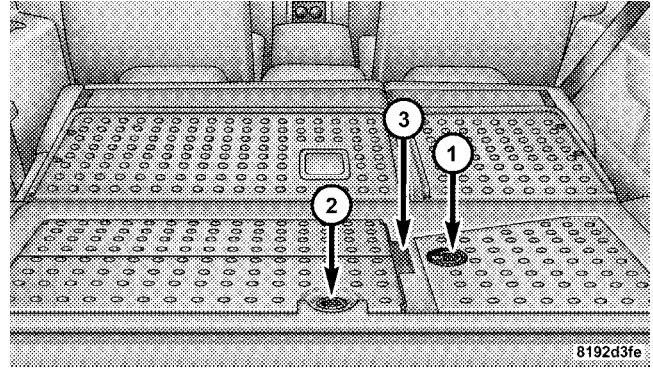

- 1 - Side Cover Latch
- 2 - Main Cover Latch
- 3 - Cargo Divider Handles

To open the side cover, pull on the cover latch, and attach the cord to the upper cargo net hook.

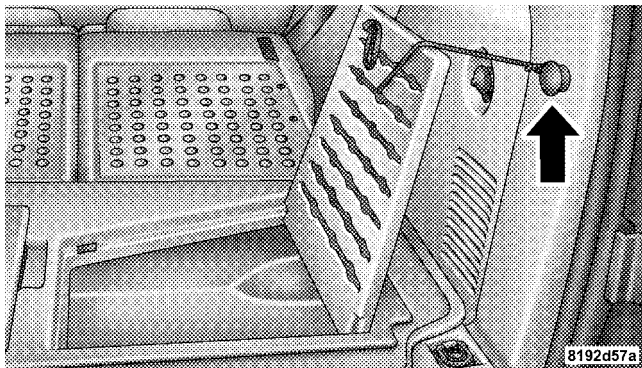

#### Side Cover

To open the main cover, pull up on the latch, and attach the cord to the rear seat head restraint post.

To open the cargo divider, lift up on the cargo divider handles, raising the doors to the full open position. Raise the side panels until they engage into the doors.

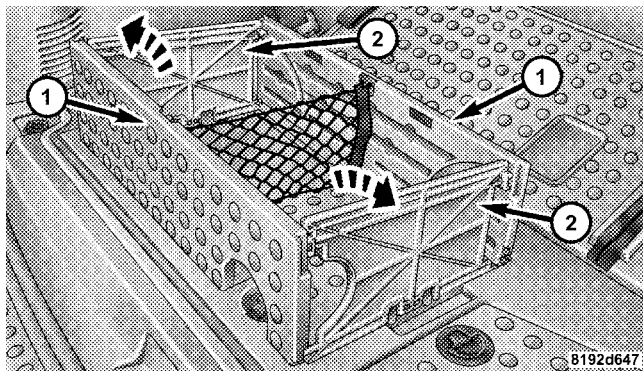

- 1 - Cargo Divider Door
- 2 - Cargo Divider Side Panel

To remove the cargo management system from the vehicle, pull the right-hand side of the organizer toward you so that the right pin slides out of the slot in the vehicle. Push the organizer to the right and lift out of the vehicle.

# INSTRUMENT PANEL AND CONTROLS

## CONTENTS

---

■ Instruments And Controls . . . . .	199	□ AM Reception . . . . .	214
■ Instrument Cluster . . . . .	200	□ FM Reception . . . . .	214
■ Instrument Cluster Description . . . . .	201	■ Sales Code REN — Multimedia System — If Equipped . . . . .	214
■ Electronic Digital Clock . . . . .	212	□ Operating Instructions — Satellite Radio (If Equipped) . . . . .	215
□ Clock Setting Procedure . . . . .	213	□ Operating Instructions — Voice Recognition System (VR) (If Equipped) . . . . .	215
■ Radio General Information . . . . .	213	□ Operating Instructions — Hands-Free Communication (UConnect®) (If Equipped) . . .	216
□ Radio Broadcast Signals . . . . .	213		
□ Two Types Of Signals . . . . .	213		
□ Electrical Disturbances . . . . .	214		

- Clock Setting Procedure . . . . .216
- Sales Code RER — Multimedia System —  
If Equipped . . . . .218
- Operating Instructions — Satellite Radio . . . . .219
- Operating Instructions — Hands-Free  
Communication (UConnect®) (If Equipped) . . .219
- Clock Setting Procedure . . . . .219
- Sales Code RES — AM/FM Stereo Radio With  
CD Player (MP3 AUX Jack) . . . . .222
- Operating Instructions - Radio Mode . . . . .222
- Operation Instructions - CD Mode For CD  
And MP3 Audio Play . . . . .228
- Notes On Playing MP3 Files . . . . .230
- List Button (CD Mode For MP3 Play) . . . . .233
- Info Button (CD Mode For MP3 Play) . . . . .233
- Sales Code REQ — AM/FM Stereo Radio And  
6-Disc CD/DVD Changer  
(MP3/WMA AUX Jack) . . . . .234
- Operating Instructions - Radio Mode . . . . .235
- Operation Instructions - (Disc Mode For CD  
And MP3/WMA Audio Play, DVD-Video) . . . .243
- Notes On Playing MP3/WMA Files . . . . .245
- List Button (Disc Mode For MP3/WMA  
Play) . . . . .247
- Info Button (Disc Mode For MP3/WMA  
Play) . . . . .247
- Satellite Radio (RSC) — If Equipped  
(RER/REQ/REN Radios Only) . . . . .250
- System Activation . . . . .250

- Electronic Serial Number/Sirius Identification Number (ENS/SID) . . . . .251
- Selecting Satellite Mode . . . . .251
- Satellite Antenna . . . . .251
- Reception Quality . . . . .251
- Operating Instructions - Satellite Mode . . . . .252
- Operating Instructions - Hands-Free Phone (If Equipped) . . . . .254
- Operating Instructions - Video Entertainment System (VES™) (If Equipped) . . . . .254
- Universal Consumer Interface (UCI) — If Equipped . . . . .254
  - Connecting The iPod® Device . . . . .255
  - Controlling The iPod® Using Radio Buttons . . . . .255
  - Play Mode . . . . .255
  - List Or Browse Mode . . . . .257
- Video Entertainment System (Sales Code XRV) — If Equipped . . . . .259
- Remote Sound System Controls — If Equipped . . . . .259
  - Right-Hand Switch Functions . . . . .259
  - Left-Hand Switch Functions For Radio Operation . . . . .260
  - Left-Hand Switch Functions For Media (i.e., CD) Operation . . . . .260
- Compact Disc Maintenance . . . . .260
- Radio Operation And Cellular Phones . . . . .261
- Climate Controls . . . . .262
  - Manual Control . . . . .262

## 198 INSTRUMENT PANEL AND CONTROLS

- Air Conditioning Operation . . . . .262
- Front Blower Control . . . . .263
- Front Mode Control . . . . .263
- Rear Temperature Control — If Equipped . . . .266
- Rear Window Defrosting And Rear Window Washer/Wiper . . . . .266
- Automatic Temperature Control (ATC) — If Equipped . . . . .266
- Automatic Control . . . . .267
- Level Of Automatic Control . . . . .267
- Manual Control (ATC) . . . . .268
- Rear Zone Climate Control — If Equipped . . .272
- Rear Rotary Temperature Control . . . . .273
- Front Unit To Rear Unit Chart . . . . .274
- Operating Tips . . . . .274
- Operating Tips Chart . . . . .276
- Rear Window Features . . . . .277
- Rear Window Wiper/Washer . . . . .277
- Rear Window Defrosting . . . . .278

## INSTRUMENTS AND CONTROLS

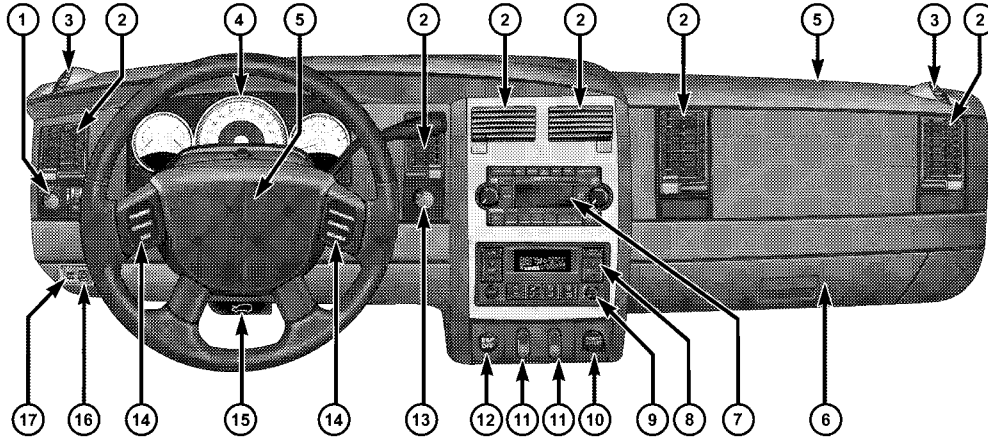

- 1. Headlight Switch
- 2. Air Outlets
- 3. Demister Outlets
- 4. Instrument Cluster
- 5. Airbags
- 6. Glove Box

- 7. Radio
- 8. Climate Controls
- 9. Rear Washer/Wiper
- 10. Power Outlet
- 11. Heated Seat Switches\*
- 12. Electronic Stability System (ESP) Off Switch

- 13. Transfer Case Switch\*
- 14. Speed Control Switches
- 15. Hood Release
- 16. Adjustable Pedal Control Switch\*
- 17. 115v Inverter Switch
- \*If Equipped

81954da5



Instrument Cluster

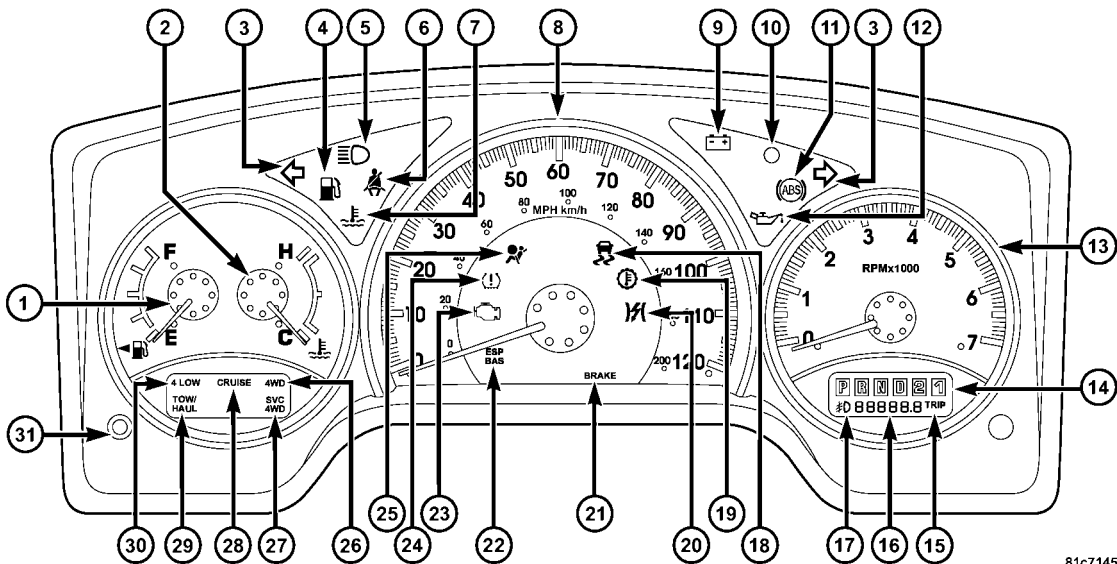

## INSTRUMENT CLUSTER DESCRIPTION

### 1. Fuel Gage



The fuel gage shows level of fuel in the tank when ignition switch is in the ON position.

### 2. Temperature Gage



The temperature gage indicates engine coolant temperature. Any reading within the normal range indicates that the cooling system is operating satisfactorily. The gage needle in V6 and V8 engines will likely indicate a high temperature when driving in hot weather, up mountain grades, in heavy traffic, or when towing a trailer. If the needle rises to the “H” mark, stop the vehicle, shift into NEUTRAL and increase engine speed for two to three minutes. If the temperature reading does not return to normal, see your authorized dealer for service immediately..

## CAUTION!

**Do not leave your vehicle unattended with the engine running as you would not be able to react to the temperature indicator if the engine overheats.**

The gage pointer will remain near its last reading when the engine is turned off. It will return to a true reading when the engine is restarted.

### 3. Turn Signal Indicators

When a turn signal is activated, a right-pointing or left-pointing arrow lights up and flashes to indicate the direction of the turn. These indicators also indicate proper operation of the front and rear turn signal lights. If either indicator flashes at a faster rate than normal, check for a defective bulb. If either indicator fails to light up when the lever is moved, check for a defective fuse or turn signal LED. A single chime is activated when the

left/right turn signal is left on with the engine RPM vehicle speed greater than 15 mph (24 km/h) for more than one mile.

#### 4. *Low Fuel Warning Light*



This indicator lights when the fuel gage reads 1/16 of a tank or less.

#### 5. *High Beam Indicator*



Indicates that headlights are on high beam.

#### 6. *Seat Belt Reminder Light*



This light comes on for several seconds after the ignition is turned ON as a reminder to “buckle up.” This light will remain on as long as the seat belt remains unbuckled. If this light flashes, it indicates a fault in the airbag system. Have the system checked by your authorized dealer.

#### 7. *Coolant Temperature Light*



This light warns of an overheated engine condition. For a bulb check, this light will come on momentarily when the ignition is turned ON. If the light turns on while driving, stop the vehicle, shift into NEUTRAL and increase the engine speed for two to three minutes. If the temperature reading does not return to normal, see your authorized dealer for service immediately.

### CAUTION!

**Driving with a hot engine cooling system could damage your vehicle. If the temperature light is on, safely pull over and stop the vehicle. Idle the vehicle in NEUTRAL with the air conditioner turned off until the light turns off. If the light remains on, turn the engine off immediately, and call for service.**

**WARNING!**

A hot engine cooling system is dangerous. You or others could be badly burned by steam or boiling coolant. You may want to call a service center if your vehicle overheats. If you decide to look under the hood yourself, refer to “Cooling System Pressure Cap” under “Cooling System” in Section 7. Follow the warnings under the paragraph.

**8. Speedometer**

The speedometer shows the speed of the vehicle.

**9. Voltage Light**

This light monitors the electrical system voltage. The light should turn on momentarily as the engine is started. If the light stays on or turns on while driving, it indicates a problem with the charging system. See your authorized dealer for service immediately.

**10. Security Light**

This light will flash rapidly for approximately 15 seconds when the Vehicle Security Alarm is arming. The light will flash at a slower speed continuously after the alarm is set. The Security light will also come on for about three seconds when the ignition is first turned on.

**11. ABS Warning Light**

This light monitors the Anti-Lock Brake System (ABS) which is described elsewhere in this manual. This light will come on when the ignition key is turned to the ON position and may stay on for approximately three seconds. If this light remains on or comes on during driving, it indicates that the Anti-Lock portion of the brake system is not functioning and that service is required. See your authorized dealer immediately. With the ABS malfunctioning, the Brake Assist System (BAS) and Electronic Stability Program (ESP) are also switched off. Both malfunction indicator lights illuminate with the engine running. If the

charging voltage falls below 10 volts, the malfunction indicator light illuminates and the ABS is switched off. When the voltage is above this value again, the malfunction indicator light should go out and the ABS is operational. If the malfunction indicator light stays illuminated, have the system checked at your authorized dealer as soon as possible.

### **12. Engine Oil Pressure Indicator Light**

 This light indicates that the engine oil pressure has become too low. For a bulb check, this light will come on momentarily when the ignition is turned ON. If the light turns on while driving, stop the vehicle and shut off the engine as soon as possible. See your authorized dealer for service immediately.

### **13. Tachometer**

This gage measures engine Revolutions-Per-Minute (RPM x 1000).

### **14. Gear Selector**

The electronic gear selector display is self-contained within the instrument cluster. It displays the position of the automatic transmission shift lever, and the relation of each position to all other positions. For a good signal the display will place a box around the selected transmission range (PRND21). If the PRNDL displays only the characters PRND21 (no boxes), have the system checked by an authorized dealer.

### **15. Odometer/Trip Odometer**

The odometer shows the total distance the vehicle has been driven. U.S. federal regulations require that upon transfer of vehicle ownership, the seller certify to the purchaser the correct mileage that the vehicle has been driven. Therefore, if the odometer reading is changed during repair or replacement, be sure to keep a record of the reading before and after the service so that the correct mileage can be determined.

The two trip odometers show individual trip mileage. To switch from odometer to trip odometers, press and release the Trip Odometer button.

To reset a trip odometer, display the desired trip odometer to be reset then push and hold the button until the display resets (approximately two seconds).

### ***Vehicle Warning Messages***

For non-Electronic Vehicle Information Center (EVIC) equipped vehicles, when the appropriate conditions exist, messages such as “door ajar” (indicates that a door(s) may be ajar), “gASCAP” (which indicates that your gas cap is possibly loose or damaged), “CHANGe OIL” (indicates that the engine oil should be changed), “Lo-WASH” (low washer fluid), and “noFUSE” (indicates that the IOD fuse is removed from the Integrated Power Module), will display in the odometer.

**NOTE:** If the vehicle is equipped with an EVIC, most warnings will display in the EVIC. For additional information, refer to “Electronic Vehicle Information Center (EVIC) — If Equipped” in Section 3.

The outside temperature will display in the odometer for non-EVIC equipped vehicles. Pressing the trip odometer RESET button toggles the feature back to the odometer.

### ***Change Oil Message***

Your vehicle is equipped with an engine oil change indicator system. The “Change Oil” message will flash in the instrument cluster odometer for approximately 12 seconds after a single chime has sounded to indicate the next scheduled oil change interval. The engine oil change indicator system is duty cycle based, which means the engine oil change interval may fluctuate dependent upon your personal driving style.

Unless reset, this message will continue to display each time you turn the ignition switch to the ON/RUN position. To turn off the message temporarily, press and release the Trip Odometer button on the instrument cluster. To reset the oil change indicator system (after performing the scheduled maintenance) refer to the following procedure.

1. Turn the ignition switch to the ON position (**Do not start the engine**).
2. Fully depress the accelerator pedal slowly three times within 10 seconds.
3. Turn the ignition switch to the OFF/LOCK position.

**NOTE:** If the indicator message illuminates when you start the vehicle, the oil change indicator system did not reset. If necessary repeat this procedure.

### **16. Odometer**

The odometer shows the total distance the vehicle has been driven.

U.S. federal regulations require that upon transfer of vehicle ownership, the seller certify to the purchaser the correct mileage that the vehicle has been driven. Therefore, if the odometer reading is changed during repair or replacement, be sure to keep a record of the reading before and after the service so that the correct mileage can be determined.

### **17. Fog Light Indicator**

 This light shows when the fog lights are ON.

### **18. Electronic Stability Program (ESP) Indicator Light**



The yellow ESP indicator light in the speedometer area illuminates with the key in the ignition switch turned to the ON/RUN position. It should go out with the engine running. The

ESP/TCS indicator light starts to flash as soon as the tires lose traction and the ESP system becomes active. The ESP/TCS indicator light also flashes when TCS is active. If the ESP/TCS indicator light begins to flash during acceleration, ease up on the accelerator and apply as little throttle as possible. Be sure to adapt your speed and driving to the prevailing road conditions. The ESP/TCS indicator light becomes illuminated when the ESP-OFF button has been pressed or ESP is only partially available, caused by lack of engine management or brake thermal model.

### 19. *Transmission Temperature Indicator*



This light indicates that there is excessive transmission fluid temperature that might occur with severe usage, such as trailer towing. If this light comes on, stop the vehicle and run the engine at idle or faster, with the transmission in NEUTRAL until the light goes off.

### 20. *Electronic Throttle Control (ETC)*



This light informs you of a problem with the Electronic Throttle Control system. If a problem is detected, the light will come on while the engine is running. If the light remains lit with the engine running your vehicle will usually be drivable, however, see your authorized dealer for service as soon as possible. If the light is flashing when the engine is running, immediate service is required and you may experience reduced performance, an elevated/rough idle or engine stall and your vehicle may require towing. The light will come on when the ignition is first turned on and remain on for 15 seconds as a bulb check. If the light does not come on during starting, have the system checked by your authorized dealer.

### 21. *BRAKE System Warning Light*

The red “BRAKE” warning light will come on when the ignition key is first turned on, and stay on briefly as a bulb check. If the bulb does not come on during starting,



have the bulb repaired promptly. If the light stays on, it may be an indication that the parking brake has not been released, or there is a low brake fluid level. If the light remains on when the parking brake has been disengaged, and the fluid level is at the full mark on the master cylinder reservoir, it indicates a possible brake hydraulic system malfunction or a problem with the Brake Booster. In this case, the light will remain on until the condition has been corrected. If the problem is related to the brake booster, the ABS pump will run when applying the brake.

If the parking brake is applied, the light will flash when the gear position is out of PARK for automatic transmissions.

**If brake failure is indicated, immediate repair is necessary. Operating the vehicle in this condition is dangerous!**

## 22. *ESP/BAS Warning Lamp*

### **ESP BAS**

The malfunction lamp for the ESP is combined with BAS. The yellow ESP/BAS warning lamp and the yellow ESP/TCS indicator light in the instrument cluster both come on when the ignition switch is turned to the ON position. They should go out with the engine running. If the ESP/BAS warning lamp comes on continuously with the engine running, a malfunction has been detected in either the ESP or the BAS system. If this light remains on after several ignition cycles, and the vehicle has been driven several miles at speeds greater than 30 mph (48 km/h), see your authorized dealer as soon as possible.

**NOTE:** The ESP/TCS indicator light and the ESP/BAS warning lamp come on momentarily each time the ignition switch is turned ON.

The ESP control system will make buzzing or clicking sounds when it is actively operating.

### 23. *Malfunction Indicator Light (MIL)*



This light is part of an onboard diagnostic system which monitors the emissions and engine control system. If the vehicle is ready for emissions testing, the light will come on when the ignition is first turned on and remain on, as a bulb check, until the engine is started. If the vehicle is not ready for emissions testing, the light will come on when the ignition is first turned on and remain on for 15 seconds, then blink for 10 seconds, and remain on until the vehicle is started. If the bulb does not come on during starting, see your authorized dealer as soon as possible.

If this light comes on and remains on while driving, it suggests a potential engine control problem and the need for system service. See your authorized dealer as soon as possible.

Although your vehicle will usually be drivable and not need towing, see your authorized dealer for service as soon as possible.

#### **CAUTION!**

**Prolonged driving with the MIL on could cause damage to the engine control system. It also could affect fuel economy and driveability.**

**If the MIL is flashing, severe catalytic converter damage and power loss will soon occur. Immediate service is required. See your authorized dealer for service immediately.**

4

### 24. *Tire Pressure Monitoring Telltale Light*



Each tire, including the spare (if provided), should be checked monthly when cold and inflated to the inflation pressure recommended

by the vehicle manufacturer on the vehicle placard or tire inflation pressure label. (If your vehicle has tires of a different size than the size indicated on the vehicle placard or tire inflation pressure label, you should determine the proper tire inflation pressure for those tires.)

As an added safety feature, your vehicle has been equipped with a Tire Pressure Monitoring System (TPMS) that illuminates a low tire pressure telltale when one or more of your tires is significantly under-inflated. Accordingly, when the low tire pressure telltale illuminates, you should stop and check your tires as soon as possible, and inflate them to the proper pressure. Driving on a significantly under-inflated tire causes the tire to overheat and can lead to tire failure. Under-inflation also reduces fuel efficiency and tire tread life, and may affect the vehicle's handling and stopping ability.

Please note that the TPMS is not a substitute for proper tire maintenance, and it is the driver's responsibility to

maintain correct tire pressure, even if under-inflation has not reached the level to trigger illumination of the TPMS low tire pressure telltale.

Your vehicle has also been equipped with a TPMS malfunction indicator to indicate when the system is not operating properly. The TPMS malfunction indicator is combined with the low tire pressure telltale. When the system detects a malfunction, the telltale will flash for approximately one minute and then remain continuously illuminated. This sequence will continue upon subsequent vehicle start-ups as long as the malfunction exists. When the malfunction indicator is illuminated, the system may not be able to detect or signal low tire pressure as intended. TPMS malfunctions may occur for a variety of reasons, including the installation of replacement or alternate tires or wheels on the vehicle that prevent the TPMS from functioning properly. Always check the TPMS malfunction telltale after replacing one or more

tires or wheels on your vehicle to ensure that the replacement or alternate tires and wheels allow the TPMS to continue to function properly.

### CAUTION!

The TPMS has been optimized for the original equipment tires and wheels. TPMS pressures and warning have been established for the tire size equipped on your vehicle. Undesirable system operation or sensor damage may result when using replacement equipment that is not of the same size, type, and/or style. Aftermarket wheels can cause sensor damage. Do not use tire sealant from a can, or balance beads if your vehicle is equipped with a TPMS, as damage to the sensors may result.

### 25. *Airbag Indicator*



The indicator lights and remains lit for six to eight seconds when the ignition is first turned ON. If the light does not come on when the ignition is first turned on, or the light stays on or comes on while driving, have the airbag system checked by an authorized dealer.

### 26. *4WD Indicator*

Indicates when the transfer case is in 4WD position.

### 27. *SVC (Service) 4WD Indicator*

The SVC 4WD lights will come on when the ignition key is turned to the ON position and will stay on for two seconds. If the light stays on or comes on during driving, it means that the 4WD system is not functioning properly and that service is required. See your authorized dealer for service.

**28. Cruise Light (Speed Control)**

This indicator lights when the electronic speed control system is turned on.

**29. TOW/HAUL**

The TOW/HAUL button is located at the end of the gear shift lever. This light will illuminate when the TOW/HAUL button has been selected.

**30. 4LOW Indicator**

Indicates transfer case is in 4LOW position.

**31. Odometer/Trip Odometer Button**

Press this button to toggle between the odometer and the trip odometer display. Holding the button in resets the trip odometer reading.

**ELECTRONIC DIGITAL CLOCK**

The clock and radio each use the display panel built into the radio. A digital readout shows the frequency and/or time in hours and minutes (depending on your radio model), whenever the ignition switch is in the ON or ACC position.

When the ignition switch is in the OFF position, or when the radio frequency is being displayed, timekeeping is accurately maintained.

On the AM/FM/CD (six-disc) radio, the time button alternates the location of the time and frequency on the display. On the AM/FM/CD (single-disc) radio, only one of the two, time or frequency, is displayed.

### **Clock Setting Procedure**

1. Press and hold the TIME button until the hours blink.
2. Adjust the hours by turning the right side TUNE/AUDIO control knob.
3. After the hours are adjusted, push the right side TUNE/AUDIO control knob to set the minutes.
4. Adjust the minutes by turning the right side TUNE/AUDIO control knob.
5. To exit, press any button/knob, or wait approximately five seconds.

### **RADIO GENERAL INFORMATION**

#### **Radio Broadcast Signals**

The radio will provide excellent reception under most operating conditions. Like any system, however, vehicle radios have performance limitations, due to mobile operation and natural phenomena, which might lead you to believe your sound system is malfunctioning. To help you understand and save you concern about these “apparent” malfunctions, you must understand a point or two about the transmission and reception of radio signals.

#### **Two Types of Signals**

There are two basic types of radio signals: AM or Amplitude Modulation, in which the transmitted sound causes the amplitude, or height, of the radio waves to vary; and FM or Frequency Modulation, in which the frequency of the wave is varied to carry the sound.

### Electrical Disturbances

Radio waves may pick up electrical disturbances during transmission. They mainly affect the wave amplitude, and thus remain a part of the AM reception. They interfere very little with the frequency variations that carry the FM signal.

### AM Reception

AM sound is based on wave amplitude, so AM reception can be disrupted by such things as lightning, power lines and neon signs.

### FM Reception

Because FM transmission is based on frequency variations, interference that consists of amplitude variations can be filtered out, leaving the reception relatively clear, which is the major feature of FM radio.

**NOTE:** The radio, steering wheel radio controls (if equipped), and 6-Disc CD/DVD changer (if equipped)

will remain active for up to 10 minutes after the ignition switch has been turned OFF. Opening a vehicle front door will cancel this feature.

### SALES CODE REN — MULTIMEDIA SYSTEM — IF EQUIPPED

**NOTE:** The sales code is located on the lower right side of the unit's faceplate.

The REN multimedia system contains a radio, CD/DVD player, USB port, a 20 gigabyte Hard Drive (HDD), and a "JukeBox" (virtual CD changer). Sirius Satellite Radio is optional. The 6.5-in touch screen allows for easy menu selection.

A 20 gigabyte hard drive (HDD) allows uploads of music and photos from CDs or through the USB port. The Gracenote database finds the artist, track, and title for the music.

An auxiliary input jack permits passengers to listen to a portable MP3 player through the vehicle's speakers. For vehicles equipped with the Vehicle Entertainment System (VES)<sup>®</sup>, separate audio outputs allow passengers to listen to the vehicle speakers while different audio tracks play through the system's wireless headphones. This means rear seat passengers can watch a DVD on the optional rear seat entertainment system while the driver and front seat passenger listen to the radio.

Other special features include direct tune, music type selections, easy store presets, backup camera display for vehicles equipped with a backup camera, and on some models a dual display screen operation. Refer to your Radio Specific User's Manual for detailed operating instructions.

### **Operating Instructions — Satellite Radio (If Equipped)**

Refer to your Radio Specific User's Manual for detailed operating instructions.

### **Operating Instructions — Voice Recognition System (VR) (If Equipped)**

For the radio, refer to "Voice Recognition System (VR) — If Equipped" in Section 3 of this manual for detailed operating instructions.

For Hands Free Phone Communication (UConnect<sup>®</sup>) "Voice Recognition System (VR) — If Equipped" refer to "Hands-Free Communication (UConnect<sup>®</sup>)" in Section 3 of this manual for detailed operating instructions.



### **Operating Instructions — Hands-Free Communication (UConnect®) (If Equipped)**

Refer to “Hands-Free Communication (UConnect®)” in Section 3 of this manual for detailed operating instructions.

### **Clock Setting Procedure**

#### **Setting the Clock**

1. Turn on the system.
2. Touch the screen where the time is displayed. The clock setting menu will appear on the screen.
3. To move the hour forward, touch the screen where the word “Hour” with the arrow pointing upward is displayed. To move the hour backward, touch the screen where the word “Hour” with the arrow pointing downward is displayed.

4. To move the minute forward, touch the screen where the word “Min” with the arrow pointing upward is displayed. To move the minute backward, touch the screen where the word “Min” with the arrow pointing downward is displayed.

5. To save the new time setting, touch the screen where the word “Save” is displayed.

#### **Changing Daylight Savings Time**

When selected, this feature will display the time of day in daylight savings time. Proceed as follows to change the current setting:

1. Turn on the system.
2. Touch the screen where the time is displayed. The clock setting menu will appear on the screen.

3. When this feature is on, a check mark will appear in the box next to the words “Daylight Savings.” Touch the screen where the words “Daylight Savings” are displayed to change the current setting.

### **Show Time if Radio is Off**

When selected, this feature will display the time of day on the touch screen when the system is turned off. Proceed as follows to change the current setting:

1. Turn on the system.
2. Touch the screen where the time is displayed. The clock setting menu will appear on the screen.
3. When this feature is on, a check mark will appear in the box next to the words “Show Time if Radio is Off.” Touch the screen where the words “Show Time if Radio is Off” are displayed to change the current setting.

### **Changing the Time Zone**

1. Turn on the system.
2. Touch the screen where the time is displayed. The clock setting menu will appear on the screen.
3. Touch the screen where the words “Set Time Zone” are displayed. The time zone selection menu will appear on the screen.
4. Select a time zone by touching the screen where your selection appears. If you do not see a time zone that you want to select, touch the screen where the word “Page” is displayed to view additional time zones in the menu.
5. Touch the screen where the word “Save” is displayed.

## **SALES CODE RER — MULTIMEDIA SYSTEM — IF EQUIPPED**

**NOTE:** The sales code is located on the lower right side of the unit's faceplate.

The RER multimedia system contains a radio, Sirius Satellite Radio player, Navigation system, CD/DVD player, USB port, 20 gigabyte Hard Drive (HDD), and the UConnect® Hands-Free Bluetooth® cellular system.

**NOTE:** If your vehicle is not equipped with UConnect®, the unit will respond with a “Feature Not Available” message when selecting controls related to this feature.

A 6.5-in touch screen allows easy menu selection, while the Advanced Voice Dialog System recognizes more than 1,000 words for audio, navigation, entertainment, and hands-free mobile phone use.

The satellite navigation capability combines a global-positioning system-based navigation system with an

integrated color screen to provide maps, turn identification, selection menus, and instructions for selecting a variety of destinations and routes.

A shared hard drive (HDD) for the navigation system, the database, and other radio features allows uploads of music and photos from CDs or through the USB port. The Gracenote database finds the artist, track, and title for the music.

An auxiliary input jack permits passengers to listen to a portable MP3 player through the vehicle's speakers. For vehicles equipped with the Vehicle Entertainment System™ (VES™), separate audio outputs allow passengers to listen to the vehicle speakers while different audio tracks play through the system's wireless headphones. This means rear seat passengers can watch a DVD on the optional rear-seat entertainment system while the driver and front seat passenger listen to the radio.

Other special features include direct tune, music type selections, traffic messaging (optional), easy store presets, parental lockout for VES™ (if equipped), backup camera display for vehicles equipped with a backup camera, and on some models a dual display screen operation. Refer to your “Navigation User’s Manual” for detailed operating instructions.

#### **Operating Instructions — Satellite Radio**

Refer to your “Navigation User’s Manual” for detailed operating instructions.

#### **Operating Instructions — Hands-Free Communication (UConnect®) (If Equipped)**

Refer to your “Navigation User’s Manual” for detailed operating instructions.

#### **Clock Setting Procedure**

The GPS receiver in this system is synchronized to the time data being transmitted by the GPS satellites. The satellites’ clock is Greenwich Mean Time (GMT). This is the worldwide standard for time. This makes the system’s clock very accurate once the appropriate time zone and daylight savings information is set.

#### **Changing the Time Zone**

1. Turn on the system.
2. Touch the screen where the time is displayed. The clock setting menu will appear on the screen. If the words “Time: GPS Time” are displayed at the top of the screen, proceed to Step 4. Otherwise, proceed to Step 3.
3. If the words “Time: User Clock” are displayed at the top of the screen, touch the bottom of the screen where the words “User Clock” are displayed. The GPS time setting menu will appear on the screen.

4. Touch the screen where the words “Set Time Zone” are displayed. The time zone selection menu will appear on the screen.
5. Select a time zone by touching the screen where your selection appears. If you do not see a time zone that you want to select, touch the screen where the word “Page” is displayed to view additional time zones in the menu.

### **Changing Daylight Savings Time**

When selected, this feature will display the time of day in daylight savings time. Proceed as follows to change the current setting:

1. Turn on the system.
2. Touch the screen where the time is displayed. The clock setting menu will appear on the screen.

3. When this feature is on, a check mark will appear in the box next to the words “Daylight Savings.” Touch the screen where the words “Daylight Savings” are displayed to change the current setting.

### **Setting the User Clock**

If you wish to set the clock to a time different from the system clock, you can manually adjust the time by performing the following:

1. Turn on the system.
2. Touch the screen where the time is displayed. The clock setting menu will appear on the screen. If the words “Time: User Clock” are displayed at the top of the screen, proceed to Step 4. Otherwise, proceed to Step 3.
3. If the words “Time: GPS Time” are displayed at the top of the screen, touch the bottom of the screen where the words “GPS Time” are displayed. The user clock time setting menu will appear on the screen.

4. To move the hour forward, touch the screen where the word “Hour” with the arrow pointing upward is displayed. To move the hour backward, touch the screen where the word “Hour” with the arrow pointing downward is displayed.
5. To move the minute forward, touch the screen where the word “Min” with the arrow pointing upward is displayed. To move the minute backward, touch the screen where the word “Min” with the arrow pointing downward is displayed.
6. To save the new time setting, touch the screen where the word “Save” is displayed.

### **Show Time if Radio is Off**

When selected, this feature will display the time of day on the touch screen when the system is turned off. Proceed as follows to change the current setting:

1. Turn on the system.
2. Touch the screen where the time is displayed. The clock setting menu will appear on the screen.
3. When this feature is on, a check mark will appear in the box next to the words “Show Time if Radio is Off.” Touch the screen where the words “Show Time if Radio is Off” are displayed to change the current setting.

## SALES CODE RES — AM/FM STEREO RADIO WITH CD PLAYER (MP3 AUX JACK)

**NOTE:** The radio sales code is located on the lower right side of your radio faceplate.

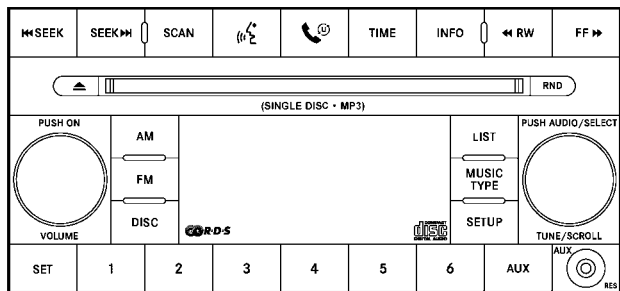

81c7c564

**RES Radio (Non-Satellite Model Shown - With Satellite Similar)**

### Operating Instructions - Radio Mode

**NOTE:** The ignition switch must be in the ON or ACC position to operate the radio.

#### Power Switch/Volume Control (Rotary)

Push the ON/VOLUME control knob to turn on the radio. Push the ON/VOLUME control knob a second time to turn off the radio.

#### Electronic Volume Control

The electronic volume control turns continuously (360 degrees) in either direction without stopping. Turning the ON/VOLUME control knob to the right increases the volume and to the left decreases it.

When the audio system is turned on, the sound will be set at the same volume level as last played.

#### SEEK Buttons

Press and release the SEEK buttons to search for the next listenable station in AM/FM mode. Press the right switch

to seek up and the left switch to seek down. The radio will remain tuned to the new station until you make another selection. Holding either button will bypass stations without stopping until you release it.

### **SCAN Button**

Pressing the SCAN button causes the tuner to search for the next listenable station in AM or FM frequencies, pausing for five seconds at each listenable station before continuing to the next. To stop the search, press the SCAN button a second time.

### **Voice Recognition System (Radio) — If Equipped**

Refer to “Voice Recognition System (VR) — If Equipped” in Section 3 of this manual for detailed operating instructions.

### **Voice Recognition Button (UConnect® Hands-Free Phone) — If Equipped**

Press this button to operate the Hands-Free Phone (UConnect®) feature (if equipped). Refer to “Hands-Free Communication (UConnect®)” in Section 3.

If your vehicle is not equipped with this or this feature is not available on your vehicle, a “Not Equipped With UConnect” message will display on the radio screen.

### **PHONE Button (UConnect® Hands-Free Phone) — If Equipped**

Press this button to operate the Hands-Free Phone (UConnect®) feature (if equipped). Refer to “Hands-Free Communication (UConnect®)” in Section 3.

If your vehicle is not equipped with this or this feature is not available on your vehicle, a “Not Equipped With UConnect®” message will display on the radio screen.



**TIME Button**

Press the TIME button and the time of day will display. In AM or FM mode, pressing the TIME button will switch between the time and frequency displays.

**Clock Setting Procedure**

1. Press and hold the TIME button, until the hours blink.
2. Adjust the hours by turning the right side TUNE/SCROLL control knob.
3. After adjusting the hours, press the right side TUNE/SCROLL control knob to set the minutes. The minutes will begin to blink.
4. Adjust the minutes using the right side TUNE/SCROLL control knob. Press the TUNE/SCROLL control knob to save time change.
5. To exit, press any button/knob or wait five seconds.

The clock can also be set by pressing the SETUP button. For vehicles equipped with satellite radio, press the SETUP button, use the TUNE/SCROLL control to select SET CLOCK, and then follow the above procedure, starting at Step 2. For vehicles not equipped with satellite radio, press the SETUP button and then follow the above procedure, starting at Step 2.

**INFO Button**

Press the INFO button for an RDS station (one with call letters displayed). The radio will return a Radio Text message broadcast from an FM station (FM mode only).

**RW/FF**

Pressing the RW (Rewind) or FF (Fast Forward) buttons causes the tuner to search for the next frequency in the direction of the arrows. This feature operates in either AM or FM frequencies.

**TUNE Control**

Turn the rotary TUNE/SCROLL control knob clockwise to increase or counterclockwise to decrease the frequency.

**Setting the Tone, Balance, and Fade**

Push the rotary TUNE/SCROLL control knob and BASS will display. Turn the TUNE/SCROLL control knob to the right or left to increase or decrease the bass tones.

Push the rotary TUNE/SCROLL control knob a second time and MID will display. Turn the TUNE/SCROLL control knob to the right or left to increase or decrease the mid range tones.

Push the rotary TUNE/SCROLL control knob a third time and TREBLE will display. Turn the TUNE/SCROLL control knob to the right or left to increase or decrease the treble tones.

Push the rotary TUNE/SCROLL control knob a fourth time and BALANCE will display. Turn the TUNE/SCROLL control knob to the right or left to adjust the sound level from the right or left side speakers.

Push the rotary TUNE/SCROLL control knob a fifth time and FADE will display. Turn the TUNE/SCROLL control knob to the left or right to adjust the sound level between the front and rear speakers.

Push the rotary TUNE/SCROLL control knob again to exit setting tone, balance, and fade.

**MUSIC TYPE Button**

Pressing this button once will turn on the Music Type mode for five seconds. Pressing the MUSIC TYPE button or turning the TUNE/SCROLL control knob within five seconds will allow the program format type to be selected. Many radio stations do not currently broadcast Music Type information.

Toggle the MUSIC TYPE button to select the following format types:

<b>Program Type</b>	<b>16-Digit Character Display</b>
No program type or undefined	None
Adult Hits	Adlt Hit
Classical	Classicl
Classic Rock	Cls Rock
College	College
Country	Country
Foreign Language	Language
Information	Inform
Jazz	Jazz
News	News
Nostalgia	Nostalgia
Oldies	Oldies

<b>Program Type</b>	<b>16-Digit Character Display</b>
Personality	Persnlty
Public	Public
Rhythm and Blues	R & B
Religious Music	Rel Musc
Religious Talk	Rel Talk
Rock	Rock
Soft	Soft
Soft Rock	Soft Rck
Soft Rhythm and Blues	Soft R&B
Sports	Sports
Talk	Talk
Top 40	Top 40
Weather	Weather

By pressing the SEEK button when the Music Type icon is displayed, the radio will be tuned to the next frequency

station with the same selected Music Type name. The Music Type function only operates when in the FM mode.

If a preset button is activated while in the Music Type (Program Type) mode, the Music Type mode will be exited and the radio will tune to the preset station.

### **SETUP Button**

Pressing the SETUP button allows you to select between the following items:

- **Set Clock** — Pressing the SELECT button will allow you to set the clock. Turn the TUNE/SCROLL control knob to adjust the hours and then press and turn the TUNE/SCROLL control knob to adjust the minutes. Press the TUNE/SCROLL control knob again to save changes.

### **AM and FM Buttons**

Press the buttons to select AM or FM modes.

### **SET Button — To Set the Pushbutton Memory**

When you are receiving a station that you wish to commit to pushbutton memory, press the SET button. The symbol SET 1 will now show in the display window. Select the button (1 to 6) you wish to lock onto this station and press and release that button. If a button is not selected within five seconds after pressing the SET button, the station will continue to play but will not be stored into pushbutton memory.

You may add a second station to each pushbutton by repeating the above procedure with this exception: Press the SET button twice and SET 2 will show in the display window. Each button can be set for SET 1 and SET 2 in both AM and FM. This allows a total of 12 AM and 12 FM stations to be stored into pushbutton memory. The stations stored in SET 2 memory can be selected by pressing the pushbutton twice.

Every time a preset button is used, a corresponding button number will display.

**Buttons 1 - 6**

These buttons tune the radio to the stations that you commit to pushbutton memory (12 AM and 12 FM stations).

**DISC Button**

Pressing the DISC button will allow you to switch from AM/FM modes to Disc modes.

**Operation Instructions - CD MODE for CD and MP3 Audio Play**

**NOTE:** The ignition switch must be in the ON or ACC position to operate the radio.

**NOTE:** This radio is capable of playing compact discs (CD), recordable compact discs (CD-R), rewritable compact discs (CD-RW), compact discs with MP3 tracks and multisession compact discs with CD and MP3 tracks.

**Inserting Compact Disc(s)**

Gently insert one CD into the CD player with the CD label facing up. The CD will automatically be pulled into the CD player and the CD icon will illuminate on the radio display. If a CD does not go into the slot more than an inch, a disc may already be loaded and must be ejected before a new disc can be loaded.

If you insert a disc with the ignition ON and the radio ON, the unit will switch from radio to CD mode and begin to play when you insert the disc. The display will show the disc number, the track number, and index time in minutes and seconds. Play will begin at the start of track 1.

**CAUTION!**

- **This CD player will accept 4-3/4 inch (12 cm) discs only. The use of other sized discs may damage the CD player mechanism.**
- **Do not use adhesive labels. These labels can peel away and jam the player mechanism.**
- **RES is a single CD player. Do not attempt to insert a second CD if one is already loaded.**
- **Dual-media disc types (one side is a DVD, the other side is a CD) should not be used, and they can cause damage to the player.**

**EJECT Button - Ejecting a CD**

Press the EJECT button to eject the CD.



If you have ejected a disc and have not removed it within 10 seconds, it will be reloaded. If the CD is not removed, the radio will reinsert the CD but will not play it.

A disc can be ejected with the radio and ignition OFF.

**NOTE:** Ejecting with ignition OFF is not allowed on convertible or soft-top models (if equipped).

**SEEK Button**

Press the right SEEK button for the next selection on the CD. Press the left SEEK button to return to the beginning of the current selection, or return to the beginning of the previous selection if the CD is within the first second of the current selection. Pressing and holding the SEEK button will allow faster scrolling through the tracks in CD, MP3 modes.

**SCAN Button**

Press the SCAN button to scan through each track on the CD currently playing.

**TIME Button**

Press this button to change the display from a large CD playing time display to a small CD playing time display.

**RW/FF**

Press the RW button to stop the CD at the beginning of the current CD track/title.

Press and hold FF (Fast Forward) and the CD player will begin to fast forward until FF is released or RW or another CD button is pressed. The RW (Reverse) button works in a similar manner.

**AM or FM Button**

Switches the AM or FM radio to the opposite radio mode.

**RND Button (Random Play Button)**

Press this button while the CD is playing to activate Random Play. This feature plays the selections on the compact disc in random order to provide an interesting change of pace.

Press the right SEEK button to move to the next randomly selected track.

Press the RND button a second time to stop Random Play.

**Notes On Playing MP3 Files**

The radio can play MP3 files; however, acceptable MP3 file recording media and formats are limited. When writing MP3 files, pay attention to the following restrictions.

**Supported Media (Disc Types)**

The MP3 file recording media supported by the radio are CDDA, CD-R, CD-RW, MP3, and CDDA+MP3.

**Supported Medium Formats (File Systems)**

The medium formats supported by the radio are ISO 9660 Level 1 and Level 2 and includes the Joliet extension. When reading discs recorded using formats other than ISO 9660 Level 1 and Level 2, the radio may fail to read

files properly and may be unable to play the file normally. UDF and Apple HFS formats are not supported.

The radio uses the following limits for file systems:

- Maximum number of folder levels: 8
- Maximum number of files: 255
- Maximum number of folders. (The radio display of file names and folder names is limited. For large numbers of files and/or folders, the radio may be unable to display the file name and folder name and will assign a number instead. With a maximum number of files, exceeding 20 folders will result in this display. With 200 files, exceeding 50 folders will result in this display.)
- Maximum number of characters in file/folder names:
  - Level 1: 12 (including a separator "." and a three-character extension)
  - Level 2: 31 (including a separator "." and a three-character extension)

Multisession disc formats are supported by the radio. Multisession discs may contain combinations of normal CD audio tracks and computer files (including MP3 files). Discs created with an option such as "keep disc open after writing" are most likely multisession discs. The use of multisession for CD audio or MP3 playback may result in longer disc loading times.

### Supported MP3 File Formats

The radio will recognize only files with the \*.MP3 extension as MP3 files. Non-MP3 files named with the \*.MP3 extension may cause playback problems. The radio is designed to recognize the file as an invalid MP3 and will not play the file.

When using the MP3 encoder to compress audio data to an MP3 file, the bit rate and sampling frequencies in the following table are supported. In addition, variable bit



rates (VBR) are also supported. The majority of MP3 files use a 44.1 kHz sampling rate and a 192, 160, 128, 96 or VBR bit rates.

MPEG Specification	Sampling Frequency (kHz)	Bit Rate (kbps)
MPEG-1 Audio Layer 3	48, 44.1, 32	320, 256, 224, 192, 160, 128, 112, 96, 80, 64, 56, 48, 40, 32
MPEG-2 Audio Layer 3	24, 22.05, 16	160, 128, 144, 112, 96, 80, 64, 56, 48, 40, 32, 24, 16, 8

ID3 Tag information for artist, song title, and album title are supported for version 1 ID3 tags. ID3 version 2 is not supported by the radios.

Playlist files are not supported. MP3 Pro files are not supported.

### Playback of MP3 Files

When a medium containing MP3 data is loaded, the radio checks all files on the medium. If the medium contains a lot of folders or files, the radio will take more time to start playing the MP3 files.

Loading times for playback of MP3 files may be affected by the following:

- Media - CD-RW media may take longer to load than CD-R media
- Medium formats - Multisession discs may take longer to load than non-multisession discs
- Number of files and folders - Loading times will increase with more files and folders

To increase the speed of disc loading, it is recommended to use CD-R media and single-session discs. To create a single-session disc, enable the “Disc at Once” option before writing to the disc.

**LIST Button (CD Mode for MP3 Play)**

Pressing the LIST button will bring up a list of all folders on the disc. Scrolling up or down the list is done by turning the TUNE/SCROLL control knob. Selecting a folder by pressing the TUNE/SCROLL control knob will begin playing the files contained in that folder (or the next folder in sequence if the selection does not contain playable files).

The folder list will time out after five seconds.

**INFO Button (CD Mode for MP3 Play)**

Pressing the INFO button repeatedly will scroll through the following TAG information: Song Title, Artist, File Name, and Folder Name (if available).

Press the INFO button once more to return to "elapsed time" priority mode.

Press and hold the INFO button for three seconds or more and the radio will display song titles for each file.

Press and hold the INFO button again for three seconds to return to "elapsed time" display.

**Operation Instructions - Auxiliary Mode**

The auxiliary (AUX) jack is an audio input jack, which allows the user to plug in a portable device such as an MP3 player, or cassette player, and utilize the vehicle's audio system to amplify the source and play through the vehicle speakers.

Pressing the AUX button will change the mode to auxiliary device if the AUX jack is connected.

**NOTE:** The AUX device must be turned on and the device's volume set to proper level. If the AUX audio is not loud enough, turn the device's volume up. If the AUX audio sounds distorted, turn the device's volume down.

**TIME Button (Auxiliary Mode)**

Press this button to change the display to time of day. The time of day will display for five seconds (when ignition is OFF).

**Operating Instructions - Hands-Free Phone (UConnect®) (If Equipped)**

Refer to “Hands-Free Communication (UConnect®)” in Section 3 of this manual.

**Operating Instructions - Satellite Radio Mode (If Equipped)**

Refer to “Satellite Radio” in this section.

**Operating Instructions - Video Entertainment System™ (VES™) (If Equipped)**

Refer to separate “Video Entertainment System™ (VES™) Guide.”

**SALES CODE REQ — AM/FM STEREO RADIO AND 6-DISC CD/DVD CHANGER (MP3/WMA AUX JACK)**

**NOTE:** The radio sales code is located on the lower right side of your radio faceplate.

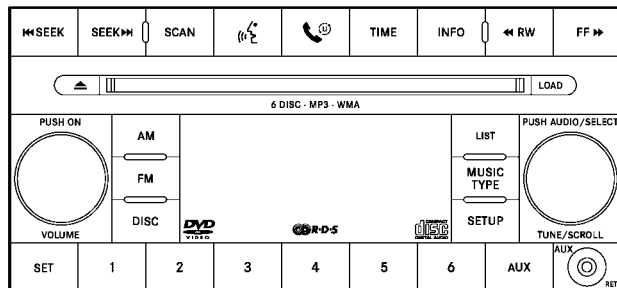

8189f6f9

**REQ Radio**

## Operating Instructions - Radio Mode

**NOTE:** The ignition switch must be in the ON or ACC position to operate the radio.

### Power Switch/Volume Control (Rotary)

Push the ON/VOLUME control knob to turn on the radio. Press the ON/VOLUME control knob a second time to turn off the radio.

### Electronic Volume Control

The electronic volume control turns continuously (360 degrees) in either direction without stopping. Turning the ON/VOLUME control knob to the right increases the volume and to the left decreases it.

When the audio system is turned ON, the sound will be set at the same volume level as last played.

### SEEK Buttons

Press and release the SEEK buttons to search for the next listenable station in AM/FM mode. Press the right switch

to seek up and the left switch to seek down. The radio will remain tuned to the new station until you make another selection. Holding either button will bypass stations without stopping until you release it.

### SCAN Button

Pressing the SCAN button causes the tuner to search for the next listenable station, in AM, FM or Satellite (if equipped) frequencies, pausing for five seconds at each listenable station before continuing to the next. To stop the search, press the SCAN button a second time.

### Voice Recognition Button (UConnect® Hands-Free Phone) — If Equipped

Press this button to operate the Hands-Free Phone (UConnect®) feature (if equipped). Refer to “Hands-Free Communication (UConnect®)” in Section 3.

If your vehicle is not equipped with or this feature is not available on your vehicle, a “UConnect® System Not Available” message will display on the radio screen.

**Phone Button (UConnect® Hands-Free Phone) — If Equipped**

Press this button to operate the Hands-Free Phone (UConnect®) feature (if equipped). Refer to “Hands-Free Communication (UConnect®)” in Section 3.

If your vehicle is not equipped with or this feature is not available on your vehicle, a “UConnect® System Not Available” message will display on the radio screen.

**TIME Button**

Press the TIME button and the time of day will display. In AM or FM mode, pressing the TIME button will switch between the time and frequency displays.

**Clock Setting Procedure**

1. Press and hold the TIME button until the hours blink.
2. Adjust the hours by turning the right side TUNE/SCROLL control knob.

3. After adjusting the hours, press the right side TUNE/SCROLL control knob to set the minutes. The minutes will begin to blink.

4. Adjust the minutes using the right side TUNE/SCROLL control knob. Press the TUNE/SCROLL control knob to save the time change.

5. To exit, press any button/knob or wait five seconds.

The clock can also be set by pressing the SETUP button and selecting the “SET HOME CLOCK” entry. Once in this display follow the above procedure, starting at step 2.

**INFO Button**

Press the INFO button for an RDS station (one with call letters displayed). The radio will return a Radio Text message broadcast from an FM station (FM mode only).

**RW/FF**

Pressing the RW (Rewind) or FF (Fast Forward) buttons causes the tuner to search for the next frequency in the direction of the arrows. This feature operates in AM, FM or Satellite (if equipped) frequencies.

**TUNE Control**

Turn the rotary TUNE/SCROLL control knob clockwise to increase or counterclockwise to decrease the frequency.

**Setting the Tone, Balance, and Fade**

Push the rotary TUNE/SCROLL control knob and BASS will display. Turn the TUNE/SCROLL control knob to the right or left to increase or decrease the bass tones.

Push the rotary TUNE/SCROLL control knob a second time and MID will display. Turn the TUNE/SCROLL control knob to the right or left to increase or decrease the mid range tones.

Push the rotary TUNE/SCROLL control knob a third time and TREBLE will display. Turn the TUNE/SCROLL control knob to the right or left to increase or decrease the treble tones.

Push the rotary TUNE/SCROLL control knob a fourth time and BALANCE will display. Turn the TUNE/SCROLL control knob to the right or left to adjust the sound level from the right or left side speakers.

Push the rotary TUNE/SCROLL control knob a fifth time and FADE will display. Turn the TUNE/SCROLL control knob to the left or right to adjust the sound level between the front and rear speakers.

Push the rotary TUNE/SCROLL control knob again to exit setting tone, balance, and fade.

**MUSIC TYPE Button**

Pressing this button once will turn on the Music Type mode for five seconds. Pressing the MUSIC TYPE button or turning the TUNE/SCROLL control knob within five seconds will allow the program format type to be selected. Many radio stations do not currently broadcast Music Type information.

Toggle the MUSIC TYPE button to select the following format types:

<b>Program Type</b>	<b>16-Digit Character Display</b>
No program type or undefined	None
Adult Hits	Adlt Hit
Classical	Classicl
Classic Rock	Cls Rock
College	College
Country	Country

<b>Program Type</b>	<b>16-Digit Character Display</b>
Foreign Language	Language
Information	Inform
Jazz	Jazz
News	News
Nostalgia	Nostalgia
Oldies	Oldies
Personality	Persnlty
Public	Public
Rhythm and Blues	R & B
Religious Music	Rel Musc
Religious Talk	Rel Talk
Rock	Rock
Soft	Soft
Soft Rock	Soft Rck
Soft Rhythm and Blues	Soft R&B

Program Type	16-Digit Character Display
Sports	Sports
Talk	Talk
Top 40	Top 40
Weather	Weather

By pressing the SEEK button when the Music Type icon is displayed, the radio will be tuned to the next frequency station with the same selected Music Type name. The Music Type function only operates when in the FM mode.

If a preset button is activated while in the Music Type (Program Type) mode, the Music Type mode will be exited and the radio will tune to the preset station.

### SETUP Button

Pressing the SETUP button allows you to select between the following items:

**NOTE:** Turn the TUNE/SCROLL control knob to scroll through the entries. Push the AUDIO/SELECT button to select an entry and make changes.

- **DVD Enter** - When the disc is in DVD Menu mode, selecting DVD Enter will allow you to play the current highlighted selection. Use the remote control to scroll up and down the menu (if equipped).
  - **DISC Play/Pause** - You can toggle between playing the DVD and pausing the DVD by pushing the SELECT button (if equipped).
- **DVD Play Options** - Selecting the DVD Play Options will display the following:
  - Subtitle – Repeatedly pressing SELECT will switch subtitles to different subtitle languages that are available on the disc (if equipped).





- **Audio Stream** – Repeatedly pressing SELECT will switch to different audio languages (if supported on the disc) (if equipped).
- **Angle** – Repeatedly pressing SELECT will change the viewing angle if supported by the DVD disc (if equipped).

**NOTE:** The available selections for each of the above entries varies depending upon the disc.

**NOTE:** These selections can only be made while playing a DVD.

- **VES Power** - Allows you to turn VES™ ON and OFF (if equipped).
- **VES Lock** - Locks out rear VES™ remote controls (if equipped).

- **VES CH1/CH2** - Allows the user to change mode of either the IR1 or IR2, wireless headphones by pressing the AUDIO/SELECT button (if equipped).
- **Set Home Clock** - Pressing the SELECT button will allow user to set the clock. Turn the TUNE/SCROLL control knob to adjust the hours and then press and turn the TUNE/SCROLL control knob to adjust the minutes. Press the TUNE/SCROLL control knob again to save changes.
- **Player Defaults** - Selecting this item will allow the user to scroll through the following items, and set defaults according to customer preference.

#### ***Menu Language — If Equipped***

Selecting this item will allow the user to choose the default startup DVD menu language (effective only if language supported by disc). If you want to select a language not listed, then scroll down and select "other."

Enter the four-digit country code using the TUNE/SCROLL control knob to scroll up and down to select the number and then push to select.

### ***Audio Language — If Equipped***

Selecting this item allows you to choose a default audio language (effective only if the language is supported by the disc). You can select a language not listed by scrolling down and selecting "other." Enter the country code using the TUNE/SCROLL control knob to scroll up and down to select the # and then push to select.

### ***Subtitle Language — If Equipped***

Selecting this item allows you to choose a default subtitle language (effective only if the language is supported by the disc). You can select a language not listed by scrolling down and selecting "other." Enter the country code using the TUNE/SCROLL control knob to scroll up and down to select the # and then push to select.

### ***Subtitles — If Equipped***

Selecting this item allows you to choose between subtitle OFF or ON.

### ***Audio DRC — If Equipped***

Selecting this item allows you to limit maximum audio dynamic range. The default is set to "High," and under this setting, dialogues will play at 11 db higher than if the setting is "Normal."

### ***Aspect Ratio — If Equipped***

Selecting this item allows you to choose between wide screen, pan scan, and letter box.

### ***AutoPlay — If Equipped***

When this is set to ON and a DVD video is inserted, it will bypass the DVD menu screen and automatically play the movie. In some rare cases, the DVD player may not

auto-play the main title. In such cases, use the MENU button on the remote control to select desired title to play.

**NOTE:** The user will have to set these defaults before loading a disc. If changes are made to these settings after a disc is loaded, changes will not be effective. Also, the defaults are effective only if the disc supports the customer-preferred settings.

### **AM and FM Buttons**

Press the buttons to select AM or FM Modes.

### **SET Button — To Set the Pushbutton Memory**

When you are receiving a station that you wish to commit to pushbutton memory, press the SET button. The symbol SET 1 will now show in the display window. Select the button (1-6) you wish to lock onto this station and press and release that button. If a button is not selected within five seconds after pressing the SET button, the station will continue to play but will not be stored into pushbutton memory.

You may add a second station to each pushbutton by repeating the above procedure with this exception: Press the SET button twice and SET 2 will show in the display window. Each button can be set for SET 1 and SET 2 in both AM and FM. This allows a total of 12 AM, 12 FM, and 12 Satellite (if equipped) stations to be stored into pushbutton memory. The stations stored in SET 2 memory can be selected by pressing the pushbutton twice.

Every time a preset button is used, a corresponding button number will display.

### **Buttons 1 - 6**

These buttons tune the radio to the stations that you commit to pushbutton memory {12 AM, 12 FM, and 12 Satellite (if equipped) stations}.

### **DISC Button**

Pressing the DISC button will allow you to switch from AM/FM modes to Disc modes.

**Operation Instructions - (DISC MODE for CD and MP3/WMA Audio Play, DVD-VIDEO)**

The radio DVD player and many DVD discs are coded by geographic region. These region codes must match in order for the disc to play. If the region code for the DVD disc does not match the region code for the radio DVD player, it will not play the disc. Customers may take their vehicle to an authorized dealer to change the region code of the player a maximum of five times.

**CAUTION!**

The radio may shut down during extremely hot conditions. When this occurs, the radio will indicate "Disc Hot" and shut off until a safe temperature is reached. This shutdown is necessary to protect the optics of the DVD player and other radio internal components.

**NOTE:** The ignition switch must be in the ON or ACC position to operate the radio.

**LOAD Button — Loading Compact Disc(s)**

Press the LOAD button and the pushbutton with the corresponding number (1-6) where the CD is being loaded. The radio will display PLEASE WAIT and prompt when to INSERT DISC. After the radio displays "INSERT DISC," insert the CD into the player.

Radio display will show "LOADING DISC" when the disc is loading and "READING DISC" when the radio is reading the disc.

**CAUTION!**

This CD player will accept 4-3/4 inch (12 cm) discs only. The use of other sized discs may damage the CD player mechanism.

**Eject Button — Ejecting Compact Disc(s)**

Press the eject button and the pushbutton with the corresponding number (1-6) where the CD was loaded and the disc will unload and move to the entrance for easy removal. Radio display will show "EJECTING DISC" when the disc is being ejected and prompt the user to remove the disc.

Press and hold the eject button for five seconds and all CDs will be ejected from the radio.

The disc can be ejected with the radio and ignition OFF.

**SEEK Button (CD MODE)**

Press the right SEEK button for the next selection on the CD. Press the left SEEK button to return to the beginning of the current selection, or return to the beginning of the previous selection if the CD is within the first second of the current selection. Pressing and holding the SEEK button will allow you to scroll through the tracks faster in CD, MP3/MWA modes.

**SCAN Button (CD MODE)**

Press the SCAN button to scan through each track on the CD currently playing.

**TIME Button (CD MODE)**

Press this button to change the display from a large CD playing time display to a small CD playing time display.

**RW/FF (CD MODE)**

Press and hold FF (Fast Forward) and the CD player will begin to fast forward until FF is released, or RW or another CD button is pressed. The RW (Reverse) button works in a similar manner.

**AM or FM Button (CD MODE)**

Switches the radio to the Radio mode.

### Notes On Playing MP3/WMA Files

The radio can play MP3/WMA files; however, acceptable MP3/WMA file recording media and formats are limited. When writing MP3/WMA files, pay attention to the following restrictions.

### Supported Media (Disc Types)

The MP3/WMA file recording media supported by the radio are CDDA, CD-R, CD-RW, MP3, WMA, DVD Video, DVD-R, DVD-RW, DVD+R, DVD+RW, and CDDA+MP3.

### Supported Medium Formats (File Systems)

The medium formats supported by the radio are ISO 9660 Level 1 and Level 2 and includes the Joliet extension. When reading discs recorded using formats other than ISO 9660 Level 1 and Level 2, the radio may fail to read files properly and may be unable to play the file normally. UDF and Apple HFS formats are not supported.

The radio uses the following limits for file systems:

- Maximum number of directory levels: 8
- Maximum number of files: 255
- Maximum number of folders: 100
- Maximum number of characters in file/folder names:
  - Level 1: 12 (including a separator "." and a three-character extension)
  - Level 2: 31 (including a separator "." and a three-character extension)

Multisession disc formats are supported by the radio. Multisession discs may contain combinations of normal CD audio tracks and computer files (including MP3/WMA files). Discs created with an option such as "keep disc open after writing" are most likely multisession discs. The use of multisession for CD audio or MP3/WMA playback may result in longer disc loading times.

If a disc contains multi-formats, such as CD audio and MP3/WMA tracks, the radio will only play the MP3/WMA tracks on that disc.

### Supported MP3/WMA File Formats

The radio will recognize only files with the \*.MP3/WMA extension as MP3/WMA files. Non-MP3/WMA files named with the \*.MP3/WMA extension may cause playback problems. The radio is designed to recognize the file as an invalid MP3/WMA and will not play the file.

When using the MP3/WMA encoder to compress audio data to an MP3/WMA file, the bit rate and sampling frequencies in the following table are supported. In addition, variable bit rates (VBR) are also supported. The majority of MP3/WMA files use a 44.1 kHz sampling rate and a 192, 160, 128, 96 or VBR bit rates.

MPEG Specification	Sampling Frequency (kHz)	Bit Rate (kbps)
MPEG-1 Audio Layer 3	48, 44.1, 32	320, 256, 224, 192, 160, 128, 112, 96, 80, 64, 56, 48
MPEG-2 Audio Layer 3	24, 22.05, 16	160, 128, 144, 112, 96, 80, 64, 56, 48

WMA Specification	Sampling Frequency (kHz)	Bit Rate (kbps)
WMA	44.1 and 48	48, 64, 96, 128, 160, 192 VBR

ID3 Tag information for artist, song title, and album title are supported for ID3 version 1 tags. ID3 version 2 is not supported by the radios.

Playlist files are not supported. MP3 Pro files are not supported.

### Playback of MP3/WMA Files

When a medium containing MP3/WMA data is loaded, the radio checks all files on the medium. If the medium contains a lot of folders or files, the radio will take more time to start playing the MP3/WMA files.

Loading times for playback of MP3/WMA files may be affected by the following:

- Media - CD-RW media may take longer to load than CD-R media
- Medium formats - Multisession discs may take longer to load than non-multisession discs
- Number of files and folders - Loading times will increase with more files and folders

To increase the speed of disc loading, it is recommended to use CD-R media and single-session discs. To create a single-session disc, enable the “Disc at Once” option before writing to the disc.

### LIST Button (DISC Mode for MP3/WMA Play)

Pressing the LIST button will bring up a list of all folders on the disc. Scrolling up or down the list is done by turning the TUNE/SCROLL control knob. Selecting a folder by pressing the TUNE/SCROLL control knob will begin playing the files contained in that folder (or the next folder in sequence if the selection does not contain playable files).

The folder list will time out after five seconds.

### INFO Button (DISC Mode for MP3/WMA Play)

Pressing the INFO button repeatedly will scroll through the following TAG information: Song Title, Artist, File Name, and Folder Name (if available).

Press the INFO button once more to return to “elapsed time” priority mode.

Press and hold the INFO button for three seconds or more and radio will display song titles for each file.



Press and hold the INFO button again for three seconds to return to "elapsed time" display.

### **Operation Instructions - Auxiliary Mode**

The auxiliary (AUX) jack is an audio input jack, which allows the user to plug in a portable device such as an MP3/WMA player, cassette player, or microphone and utilize the vehicle's audio system to amplify the source and play through the vehicle speakers.

Pressing the AUX button will change the mode to auxiliary device if the AUX jack is connected.

**NOTE:** The AUX device must be turned on and the device's volume set to proper level. If the AUX audio is not loud enough, turn the device's volume up. If the AUX audio sounds distorted, turn the device's volume down.

### **SEEK Button (Auxiliary Mode)**

No function.

### **SCAN Button (Auxiliary Mode)**

No function.

### **EJECT Button (Auxiliary Mode)**

No function.



### **TIME Button (Auxiliary Mode)**

Press the TIME button to change the display from elapsed playing time to time of day. The time of day will display for five seconds.

### **RW/FF (Auxiliary Mode)**

No function.

### **SET Button (Auxiliary Mode)**

No function.

**Operating Instructions — Voice Recognition System (VR) (If Equipped)**

For the radio, refer to “Voice Recognition System (VR) — If Equipped ” in Section 3 of this manual for detailed operating instructions.

For UConnect® “Voice Recognition System (VR) — If Equipped ” refer to “Hands-Free Communication (UConnect®)” in Section 3 of this manual for detailed operating instructions.

**Operating Instructions - Hands-Free Phone (UConnect®) (If Equipped)**

Refer to “Hands-Free Communication (UConnect®)” in Section 3 of this manual.

**Operating Instructions - Satellite Radio Mode (If Equipped)**

Refer to “Satellite Radio” in this section.

**Operating Instructions - Video Entertainment System (VES™) (If Equipped)**

Refer to separate “Video Entertainment System (VES™) Guide.”

***Dolby®***

Manufactured under license from Dolby Laboratories. “Dolby” and the double-D symbol are trademarks of Dolby Laboratories.

***Macrovision***

This product incorporates copyright protection technology that is protected by U.S. patents and other intellectual property rights. Use of this copyright protection technology must be authorized by Macrovision, and is intended for home and other limited viewing uses only, unless otherwise authorized by Macrovision. Reverse engineering or disassembly is prohibited

***DTS™***

"DTS" and "DTS 2.0" are trademarks of Digital Theater Systems, Inc.

**SATELLITE RADIO (RSC) — IF EQUIPPED  
(RER/REQ/REN RADIOS ONLY)**

Satellite radio uses direct satellite-to-receiver broadcasting technology to provide clear digital sound, coast to coast. The subscription service provider is Sirius Satellite Radio. This service offers up to 100 channels of music, sports, news, entertainment, and programming for children, directly from its satellites and broadcasting studios.

**NOTE:** Sirius service is not available in Hawaii and has limited coverage in Alaska.

**System Activation**

Sirius Satellite Radio service is pre-activated, and you may begin listening immediately to the one year of audio service that is included with the factory-installed satellite radio system in your vehicle. Sirius will contact you to supply a welcome kit and to confirm subscription information, including the setup of your on-line listening account at no additional charge. For further information, call the toll-free number 888-539-7474, or visit the Sirius web site at [www.sirius.com](http://www.sirius.com), or at [www.siriuscanada.ca](http://www.siriuscanada.ca) for Canadian residents. Please have the following information available when calling:

1. The Electronic Serial Number/Sirius Identification Number (ESN/SID).
2. Your Vehicle Identification Number.

## **Electronic Serial Number/Sirius Identification Number (ENS/SID)**

The Electronic Serial Number/Sirius Identification Number is needed to activate your Sirius Satellite Radio system. To access the ESN/SID, refer to the following steps:

### **ESN/SID Access**

With the ignition switch in the ON/RUN or ACC position and the radio ON, press the SETUP button and scroll using the TUNE/SCROLL control knob until Sirius ID is selected. Press the TUNE/SCROLL control knob and the Sirius ID number will display. The Sirius ID number display will time out in two minutes. Press any button on the radio to exit this screen.

## **Selecting Satellite Mode**

Press the SAT button until "SAT" appears in the display. A CD may remain in the radio while in the Satellite radio mode.

## **Satellite Antenna**

To ensure optimum reception, do not place items on the roof around the rooftop antenna location or strap items to the trunk lid around the trunk lid antenna (if equipped). Metal objects placed within the line of sight of the antenna will cause decreased performance. Larger luggage items such as bikes should be placed as far rearward as possible, within the loading design of the rack. Do not place items directly on or above the antenna.

## **Reception Quality**

Satellite reception may be interrupted due to one of the following reasons:

- The vehicle is parked in an underground parking structure or under a physical obstacle.

- Dense tree coverage may interrupt reception in the form of short audio mutes.
- Driving under wide bridges or along tall buildings can cause intermittent reception.
- Placing objects over or too close to the antenna can cause signal blockage.

### **Operating Instructions - Satellite Mode**

**NOTE:** The ignition switch must be in the ON or ACC position to operate the radio.

#### **SEEK Buttons**

Press and release the SEEK buttons to search for the next channel in Satellite mode. Press the right switch to seek up and the left switch to seek down. The radio will remain tuned to the new channel until you make another selection. Holding either button will bypass channels without stopping until you release it.

#### **SCAN Button**

Pressing the SCAN button causes the tuner to search for the next channel, pausing for eight seconds before continuing to the next. To stop the search, press the SCAN button a second time.

#### **INFO Button**

Pressing the INFO button will cycle between Artist, Song Title, and Composer (if available) information. Also, pressing and holding the INFO button for an additional three seconds will make the radio display the Song Title all of the time (press and hold again to return to normal display).

#### **RW/FF**

Pressing the RW (Rewind) or FF (Fast Forward) buttons causes the tuner to search for the next channel in the direction of the arrows.

**TUNE Control (Rotary)**

Turn the rotary TUNE/SCROLL control knob clockwise to increase or counterclockwise to decrease the channel.

**MUSIC TYPE Button**

Pressing this button once will turn on the Music Type mode for five seconds. Pressing the MUSIC TYPE button or turning the TUNE/SCROLL control knob within five seconds will allow the program format type to be selected.

Toggle the MUSIC TYPE button again to select the music type.

By pressing the SEEK button when the Music Type function is active, the radio will be tuned to the next channel with the same selected Music Type name.

If a preset button is activated while in the Music Type (Program Type) mode, the Music Type mode will be exited and the radio will tune to the preset channel.

**SETUP Button**

Pressing the SETUP button allows you to select the following items:

- Display Sirius ID number — Press the AUDIO/SELECT button to display the Sirius ID number. This number is used to activate, deactivate, or change the Sirius subscription.

**SET Button – To Set the Pushbutton Memory**

When you are receiving a channel that you wish to commit to pushbutton memory, press the SET button. The symbol SET 1 will now show in the display window. Select the button (1-6) you wish to lock onto this channel and press and release that button. If a button is not selected within five seconds after pressing the SET button, the channel will continue to play but will not be stored into pushbutton memory.

You may add a second channel to each pushbutton by repeating the above procedure with this exception: Press

the SET button twice and SET 2 will show in the display window. Each button can be set for SET 1 and SET 2. This allows a total of 12 Satellite channels to be stored into pushbutton memory. The channels stored in SET 2 memory can be selected by pressing the pushbutton twice.

Every time a preset button is used, a corresponding button number will display.

### **Buttons 1 - 6**

These buttons tune the radio to the channels that you commit to pushbutton memory (12 Satellite stations).

### **Operating Instructions - Hands-Free Phone (If Equipped)**

Refer to “Hands-Free Communication (UConnect®)” in Section 3 of this manual.

### **Operating Instructions - Video Entertainment System (VES™) (If Equipped)**

Refer to separate “Video Entertainment System (VES™) Guide.”

### **UNIVERSAL CONSUMER INTERFACE (UCI) — IF EQUIPPED**

**NOTE:** This section is for sales code RES and REQ radios only with UConnect®. For sales code REN touch screen radio, refer to the separate User’s Manual.

This feature allows you to plug an iPod® mobile digital device into the vehicle’s sound system through a connector (UCI connector) using an optional connection cable (available through MOPAR®). See your authorized dealer for details.

Using this feature,

- the iPod® audio can be played on the vehicle's sound system, providing metadata (Track Title, Artist, Album, etc.) information display on radio.
- the iPod® can be controlled using the radio buttons to Play, Browse and List the iPod® contents.
- the iPod® battery charges when plugged into the UCI connector.

### **Connecting The iPod® Device**

Use the optional connection cable to connect an iPod® to the vehicle's UCI connector (which is located in the glove box on some vehicles. This location may vary with vehicle). Once the iPod® is connected and synchronized to the vehicle system (this may take a few seconds to connect), the vehicle brand logo appears on the iPod® display, and it starts charging and is ready for use by pressing radio switches as described below.

### **Controlling The iPod® Using Radio Buttons**

To get into the UCI (iPod®) mode and access a connected iPod®, press the AUX button on the radio faceplate. Once in the UCI (iPod®) mode, the iPod® audio track (if available from iPod®) will start playing over the vehicle audio system.

### **Play Mode**

When switched to UCI mode the iPod® will be in Play mode. In Play mode, you may use the following buttons on the radio faceplate to control the iPod® and display data:

### ***TUNE/SCROLL Knob***

Use the TUNE/SCROLL knob to go to the next or previous track.

The TUNE/SCROLL knob functions similar to the scroll wheel on the iPod® mobile digital device.



Turning it clockwise (forward) by one click while playing a track skips to the next track.

Turning it counterclockwise (backward) by one click during the first two seconds of the track will jump to the previous track in the list and turning this button at any other time in the track will jump to the beginning of the current track.

#### ***RW (Rewind) Button***

Press and hold the RW button to move backward in the current track. Holding the RW button long enough will take you back to the beginning of the current track.

Pressing and releasing the RW button will go back five seconds of the current track.

#### ***FF (Fast Forward) Button***

Press and hold the FF button to move forward in the current track.

Pressing and releasing the FF button will go forward five seconds of the current track.

#### ***SEEK Buttons***

Use the SEEK buttons to move to the previous or the next track.

If the left (down) button is pressed during the first two seconds of the current track, it will go back to the previous track in the list; if you press this button at any other time in the current track it will go back to the beginning of the track.

If the right (up) button is pressed during Play mode, it will go to the next track in the list.

#### ***INFO Button***

Press the INFO button while a track is playing to see the information (Track Title, Artist, Album, etc.) for that track. Each press of the INFO button will take you to the next screen of data for that track. Once you have seen all

of the screens, the last press of the INFO button will take you back to the Play mode screen on the radio.

### ***REPEAT Button***

Press the REPEAT button to repeat the current playing track.

### ***SCAN Button***

Pressing the SCAN button will play the first five seconds of each track in the current list and then forward to the next song. To stop the SCAN mode and start playing the desired track, press the SCAN button again.

During the SCAN mode, you can also press the SEEK button to the left or right to go to the previous or next tracks.

### ***RND (Random) Button (RES Radios Only)***

Pressing the RND button will switch between the shuffle on and shuffle off modes of the iPod®. If the RND icon is showing on the radio display then the shuffle mode is on.

### **List or Browse Mode**

During Play mode, pressing any of the following buttons will take you to List mode. List mode enables you to scroll through the list of menus and tracks on the iPod® device.

### ***TUNE/SCROLL Knob***

In the List mode, the TUNE/SCROLL knob functions in a similar manner as the scroll wheel on the iPod®.

Turning the TUNE/SCROLL knob clockwise (forward) and counterclockwise (backward) scrolls through lists, displaying the track detail on the radio display. Once you have the track to be played highlighted on the radio display, press the TUNE/SCROLL knob to select and start playing the track. By turning the TUNE/SCROLL knob fast, you can jump through the list faster. During fast scroll, you may notice a slight delay in updating the information on the radio display.

During all List modes, the iPod® will display all lists in “wrap-around” mode. So if the track you wish to select is at the bottom of the list, you just turn the TUNE/SCROLL knob backward (counterclockwise) to get to the track faster.

### ***Radio Preset Buttons***

In the List mode, the radio preset buttons are used as shortcuts to the following lists on the iPod® device.

- 1 – Playlists
- 2 – Artists
- 3 – Albums
- 4 – Genres
- 5 - Audiobooks
- 6 – Podcasts

After pressing a preset button, you will see the list you are in on the top line and the first item in that list on the second line.

To exit the List mode without selecting a track, press the same preset button again to go back to Play mode.

### ***LIST Button***

Pressing the LIST button will take to the top level menu of the iPod®. This takes you to the same top level menu as on your iPod®. Turn the TUNE/SCROLL knob to list the top menu item you wish to select and then press the TUNE/SCROLL knob. This will take you to the next sub menu list item of the iPod® and you can follow the same steps to go to the desired track in that list. Not all iPod® sub menu levels are available on this system.

### ***MUSIC TYPE Button***

The MUSIC TYPE button is another shortcut button to the genre listing on your iPod®.

## VIDEO ENTERTAINMENT SYSTEM (SALES CODE XRV) — IF EQUIPPED

The optional Video Entertainment System™ (VES™) consists of a DVD player and LCD (liquid crystal display) screen, a battery-powered remote control, and two headsets. The system is located in the headliner behind the front row seat. Refer to your VES™ User's Manual for detailed operating instructions.

## REMOTE SOUND SYSTEM CONTROLS — IF EQUIPPED

The remote sound system controls are located on the rear surface of the steering wheel. The left- and right-hand controls are rocker-type switches with a pushbutton in the center of each switch. Reach behind the steering wheel to access the switches.

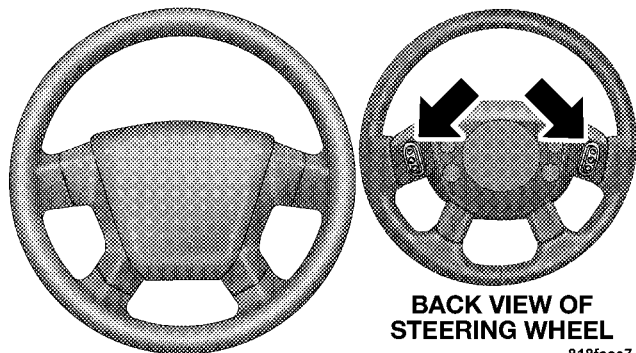

4

### Remote Sound Controls

#### Right-Hand Switch Functions

- Press the top of the switch to increase the volume.
- Press the bottom of the switch to decrease the volume.
- Press the button in the center of the switch to change modes (i.e., AM, FM, etc).

**Left-Hand Switch Functions for Radio Operation**

- Press the top of the switch to SEEK the next listenable station up from the current setting.
- Press the bottom of the switch to SEEK the next listenable station down from the current setting.
- Press the button in the center of the switch to tune to the next preset that you have programmed.

**Left-Hand Switch Functions for Media (i.e., CD) Operation**

- Press the top of the switch once to listen to the next track.
- Press the bottom of the switch once either to listen to the beginning of the current track or to listen to the beginning of the previous track if it is within one second after the current track begins to play.

- Press the switch up or down twice to listen to the second track, three times to listen to the third track, and so forth.
- Press the button located in the center of the switch to change to the next preset that you have programmed.

**COMPACT DISC MAINTENANCE**

To keep the compact discs in good condition, take the following precautions:

1. Handle the disc by its edge; avoid touching the surface.
2. If the disc is stained, clean the surface with a soft cloth, wiping from center to edge.
3. Do not apply paper or tape to the disc; avoid scratching the disc.
4. Do not use solvents such as benzine, thinner, cleaners, or antistatic sprays.

5. Store the disc in its case after playing.
6. Do not expose the disc to direct sunlight.
7. Do not store the disc where temperatures may become too high.

**NOTE:** If you experience difficulty in playing a particular disc, it may be damaged (i.e. scratched, reflective coating removed, a hair, moisture or dew on the disc) oversized, or have theft protection encoding. Try a known good disc before considering disc player service.

### **RADIO OPERATION AND CELLULAR PHONES**

Under certain conditions, the cellular phone being ON in your vehicle can cause erratic or noisy performance from your radio. This condition may be lessened or eliminated by relocating the cellular phone antenna. This condition is not harmful to the radio. If your radio performance does not satisfactorily “clear” by the repositioning of the antenna, it is recommended that the radio volume be turned down or off during cellular phone operation.

## CLIMATE CONTROLS

### Manual Control

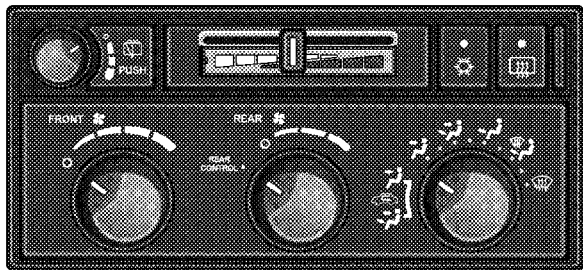

811a5530

### Manual Control

The air conditioning and heating system is designed to make you comfortable in all types of weather. The following describes its operation:

### Air Conditioning Operation



To turn the air conditioning ON or OFF, perform the following steps:

- Position the mode control button to the desired airflow setting.
- Set the front blower control to any desired speed.
- Press the Snowflake (A/C) button which is located to the right of the temperature control slide. An indicator light on the Snowflake (A/C) button shows that the air conditioning is ON.
- Press the Snowflake (A/C) button a second time to turn the air conditioning OFF.

**NOTE:** The compressor will not engage until the engine has been running for several seconds. Slight changes in engine speed or power may be noticed when the compressor cycles. This is a normal occurrence since the compressor will cycle on and off to maintain comfort and improve fuel economy.

## Front Blower Control

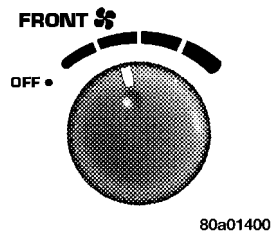

The front blower controls the amount of air delivered to the passenger compartment. There are four blower speeds. The fan speed increases as you turn the control clockwise. When the front blower control is turned to OFF, the blower will be turned off and the system will be positioned in recirculation mode.

## Front Mode Control



The mode control allows you to choose from several patterns of air distribution.

**NOTE:** To improve your selection choices, the system allows you to operate at intermediate positions between the major modes. These intermediate positions are identified by the small dots and give an even blend of both modes.



### Recirculation Mode (Panel or Bi-Level)

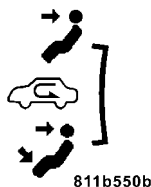

Select either the Panel or Bi-Level mode positions when the outside air contains smoke, odors, high humidity, or if rapid cooling of the interior is desired. This feature allows for recirculation of interior air only, when either of these positions are selected. Air

flows through the panel outlets or panel and floor outlets in these modes.

#### Panel

 Outside air flows through the outlets located in the instrument panel. These outlets can be adjusted to direct the airflow.

#### Bi-Level

 Air flows through the outlets located in the instrument panel and those located on the floor.

**NOTE:** There is a difference in temperature between the upper and lower outlets for added comfort. The warmer air goes to the floor outlets. This feature gives improved comfort during sunny but cool conditions.

#### Heat (Floor)

 Outside air flows primarily through the floor outlets located under the instrument panel. A small amount of air is directed through the defrost and side window demister outlets.

#### Mix

 Outside air flows in equal proportions through the floor and defroster outlet.

#### Defrost

 Outside air is primarily directed to the windshield through the defroster outlet located at the base of the windshield and side window demist outlets.

**NOTE:** The air conditioning compressor operates in both Mix and Defrost or a blend of these modes, even if the A/C button has not been pressed. This dehumidifies the air to help dry the windshield.

### Temperature Control

The temperature of the air is controlled by a slide located on the top center of the control panel. Move the slide left or right to change the temperature. The blue area of the scale indicates cooler temperatures while the red area indicates warmer temperatures.

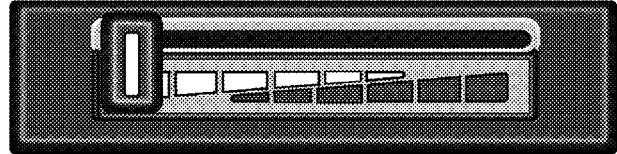

4

81228299

**Manual Temperature Control**

### Rear Temperature Control — If Equipped

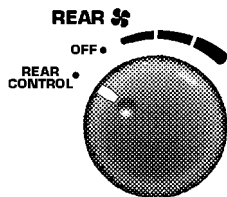

80a01401

Rotating this knob left to the REAR CONTROL position allows the passengers in the second and third row seats to control the blower speed and temperature by means of the rear control located in the rear of the center floor console as described under “Rear Zone Control.” Rotating this knob to the OFF position turns off the rear climate controls. Rotating this knob to the right of the OFF position allows the driver and front passenger to control the rear blower speed, and the rear temperature using the front temperature slide. The mode, front or rear, is always controlled by the front mode control. For example: Panel mode on the

front control will give you air from the outlets in the headliner in the rear. Floor mode in the front will give you air from the floor outlets in the rear.

### Rear Window Defrosting and Rear Window Washer/Wiper

See the “Rear Window Features” section of this book.

### Automatic Temperature Control (ATC) — If Equipped

The control can be turned on by pressing the Power knob. When the control is turned on, it will be in the last mode prior to being turned off. Pressing the Power knob again will turn off the control. The control can also be turned on by pressing any button and it will display the corresponding operation mode for that button.

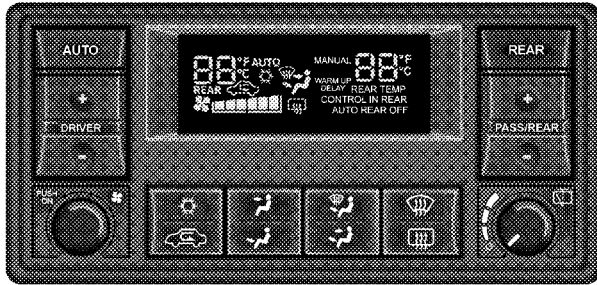

81965314

### Automatic Temperature Control

#### Automatic Control

The ATC system can maintain a steady comfort level in various weather conditions with a simple operation:

- Select your desired temperature setting by pressing the + or - side of the Temp rocker switches. A digital temperature setting for driver and passenger will be

displayed. The ATC system uses an infrared sensor located in the overhead console to measure the temperature of the driver and passengers. Based on the sensor input, the system will automatically control comfort by varying the temperature, fan speed, and mode. This maintains a comfortable temperature, even under changing conditions. It is important that objects are not blocking the infrared sensor. It is also important that objects are not used that may scratch or damage it in any way.

4

#### Level Of Automatic Control

72°F (22°C) is the recommended setting for maximum comfort for the average person, however, this may vary.

**NOTE:** The temperature setting can be adjusted at any time without affecting automatic control operation. It is not necessary to move the temperature setting for cold or hot vehicles. The system automatically adjusts the temperature, mode and fan speed to provide comfort as quickly as possible.

**NOTE:** In cold weather, the fan will not turn on in Auto mode until the engine coolant has warmed up sufficiently. This is indicated by the “WARM UP DELAY” message on the display.

**NOTE:** The temperature can be displayed in U.S. or Metric by selecting the U.S./METRIC Customer-Programmable feature. Refer to “Overhead Console Customer-Programmable Features” in Section 3. The mode will also be shown in the display and will change as required during automatic operation.

**NOTE:** The system can be put into recirculate mode without affecting ATC operation. This will prevent outside air from entering the vehicle. Use this mode to temporarily block out any outside odors, smoke, or dust.

### **Manual Control (ATC)**

You may also choose to customize your comfort by selecting the fan speed and mode manually. Turning the fan speed knob or any mode button places the system into manual operation.

While in manual operation there are six fan speeds available and the choice of any mode. The airflow temperature is adjusted automatically to maintain the desired comfort level. You can adjust the temperature by pressing the + or - Temp rocker switches.

### **FAN Control**

 Use this knob to regulate the amount of air delivered through the system in any mode you select. Rotation of the knob to increase (clockwise) or decrease (counterclockwise) fan speed.

### Air Conditioning Operation



Press this button to enable the air conditioning system. Compressor operation is automatic when you press the AUTO button and no snowflake is shown. A snowflake indicates that the A/C system is enabled. The snowflake will not be displayed in AUTO mode even though the A/C system is enabled.

The compressor may operate at any temperature above 32°F (0°C).

**NOTE:** The compressor will not engage until the engine has been running for several seconds. Slight changes in engine speed or power may be noticed when the compressor cycles. This is a normal occurrence since the compressor will cycle on and off to maintain comfort and improve fuel economy.

### Recirculate Button



Press this button to recirculate the air inside the vehicle. Outside air is prevented from entering the vehicle. Use this mode to temporarily block out any outside odors, smoke, dust or when rapid cooling of the interior is required.

Manual control of recirculation is possible only in Panel, Floor, and Bi-Level modes. It will not operate in Mix, or Defrost modes. The recirculation symbol will flash three times indicating recirculation is not available in these modes.

**NOTE:** If the interior of the windows begin to fog, press the Recirculate button to return to outside air. Some conditions will cause captured interior air to fog windows when in recirculate mode.

**Panel**

 Air flows through the outlets located in the instrument panel. These outlets can be adjusted to direct the airflow.

**Floor (Heat)**

 Air flows primarily through the floor outlets located under the instrument panel. A small amount of air is directed through the defrost and side window demister outlets.

**Mix**

 Outside air flows in equal proportions through the floor and defroster outlets.

**Bi-Level**

 Air flows through the outlets located in the instrument panel and those located on the floor.

**NOTE:** There is a difference in temperature between the upper and lower outlets for added comfort. The warmer

air goes to the floor outlets. This feature gives improved comfort during sunny but cool conditions.

**Defrost**

 Outside air is directed to the windshield through the defroster outlet located at the base of the windshield and side window demist outlets.

**NOTE:** The air conditioning compressor operates in both Mix and Defrost or a blend of these modes, even if the A/C snowflake button has not been pressed. This dehumidifies the air to help dry the windshield.

**Rear Temperature Control (ATC)**

The REAR button cycles through the following modes:

**Rear Control From Front**

This allows the driver or passenger to control the rear blower speeds rotating the Power/Fan knob and the rear temperature using the PASS/REAR Temp +/- rocker switch. While in this mode, pressing the POWER/FAN

knob will turn the rear system off. Pressing the Power/Fan knob will turn the rear system back on.

**NOTE:** The display will show a "REAR" fan speed graph and a "REAR" digital temp setting.

### **CONTROL IN REAR**

This allows the passengers in the second row seats to control the blower speed and temperature by means of the rear control located in the rear of the center floor console as described under the "Rear Zone Climate Control."

**NOTE:** The front display will show "CONTROL IN REAR."

### **REAR OFF**

This turns the rear system off. The control will return to the front system display after approximately five seconds if no buttons are pushed while in one of the rear system displays. You may also return to the front system display

sooner by pushing any button except the Power/Fan knob, the REAR button, or the driver/passenger Temp rocker buttons.

**NOTE:** The display will show "REAR OFF."

### **REAR AUTO**

This mode places the rear system in automatic temperature control. Rear temperature can be set as desired (72°F [22°C] recommended for average person) and will be displayed digitally on the front control when in rear mode.

### **Rear Window Defrosting and Rear Window Washer/Wiper**

Refer to "Rear Window Features" in Section 4.



### Rear Zone Climate Control — If Equipped

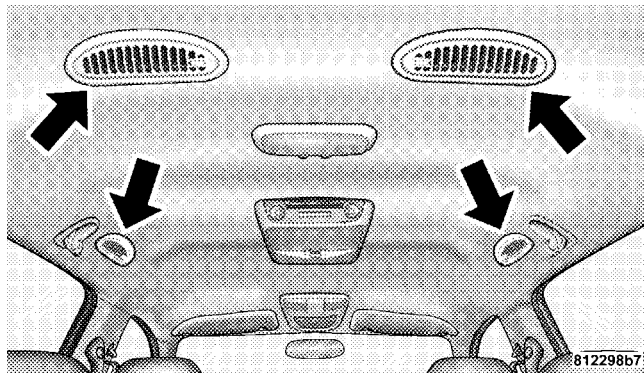

#### Rear Outlets

Headliner air comes from the outlets in the headliner. Each of these outlets can be individually adjusted to direct the flow of air. Moving the air vane knobs on the outlets to one side will shut off the airflow.

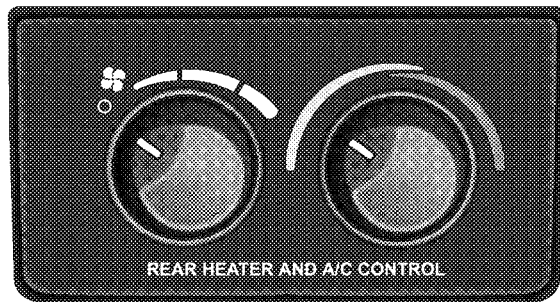

811aa87d

The rear compartment control uses two rotary knobs: one for the temperature control and the other for the fan speed control. The mode for the rear air conditioning and heating system is always controlled by the front control unit. Fan and temperature can be controlled from the front control unit or the rear control unit.

### Rear Rotary Blower Control

The second row seat occupants have control of the rear blower speed only when the front control unit is in the "REAR CONTROL" position or "CONTROL IN REAR for ATC."

The rear blower switch has an OFF position and a range of blower speeds. Rotating the rear blower control clockwise will increase the blower speed.

### Rear Rotary Temperature Control

The second row seat occupants have control of the rear temperature only when the front control unit is in the "REAR CONTROL" position.

To change the temperature in the rear of the vehicle, rotate the temperature control knob to the right or left. The blue area indicates cooler temperatures while the red area indicates warmer temperatures.

**NOTE:** For best operation, make sure that ventilation grilles located in the rear storage area are not obstructed by stowed articles.

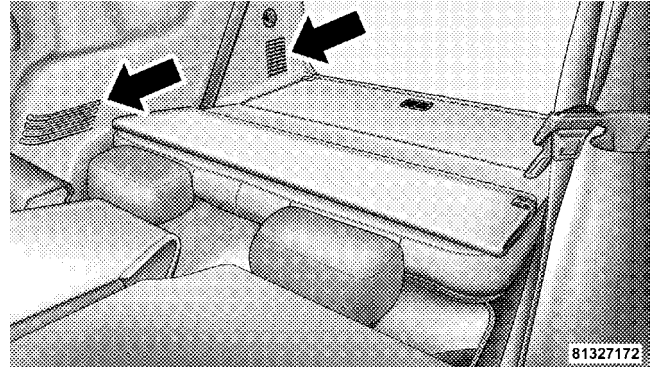

Rear Storage Ventilation Grilles

### Front Unit to Rear Unit Chart

If the Front Control is selected	Rear Airflow will come from
Panel	Headliner
Bi-Level	Headliner
Floor	Floor
Mix	Floor
Defrost	Floor

### Operating Tips

#### Fast Cooldown

For a fast cooldown, set the blower fan to the highest setting, set the mode control to the panel fresh position, press the Snowflake button to turn on the air conditioning, and drive with the windows open for the first few minutes. Once the hot air has been expelled, close the windows and set the mode selector to the Recirculation panel or Recirculation Bi-level position. When a comfortable condition has been reached, choose a mode position

and adjust the temperature control and blower speed as necessary to maintain comfort. For high humidity conditions, it may be necessary to remain in the Recirculation mode to maintain comfort.

#### Window Fogging

Windows will fog on the inside when the humidity inside the vehicle is high. This often occurs in mild or cool temperatures when it's rainy or humid. In most cases, turning on the air conditioning (pressing the snowflake button) will clear the fog. Adjust the temperature control, air direction and blower speed to maintain comfort.

As the temperature gets colder it may be necessary to direct air onto the windshield by using Mix Mode position on the control. Adjust the temperature control and blower speed to maintain comfort. Interior fogging on the windshield can be quickly removed by selecting the defrost mode.

Regular cleaning of the inside of the windows with a non-filming cleaning solution (vinegar and water works very well) will help prevent contaminants (cigarette smoke, perfumes, etc.) from sticking to the windows. Contaminants increase the rate of window fogging.





























### **Summer Operation**

Air conditioned vehicles must be protected with a high quality antifreeze coolant during summer to provide proper corrosion protection and to raise the boiling point of the coolant for protection against overheating. A 50 % concentration is recommended.

### **Winter Operation**

When operating the system during the winter months, make sure the air intake, located directly in front of the windshield, is free of ice, slush, snow, or other obstructions. This will also prevent snow ingestion into the ducts.

## Operating Tips Chart

WEATHER	CONTROL SETTINGS
<p>HOT WEATHER AND VEHICLE INTERIOR IS VERY HOT</p> 	<p>Start the vehicle, open the windows and turn the blower control to the high position (use AUTO mode if equipped). Set Mode control at  or . Set Temperature control to full cold and press the  button on. After the hot air has been expelled, close the windows and set the Mode control to the  setting at either  or , or press the  button (if equipped). Once comfortable, choose a mode position and adjust temperature control and blower speed as necessary for comfort.</p>
<p>WARM WEATHER</p> 	<p>If sunny (use AUTO mode if equipped), set the Mode control at  and press the  button on. If cloudy or dark, set the Mode control at . No  is necessary.</p>
<p>COOL OR COLD HUMID CONDITIONS</p> 	<p>If sunny (use AUTO mode if equipped), set the Mode control at  or , then press the  button on. If cloudy or dark, set the Mode control at . No  is necessary.</p>
<p>COLD DRY CONDITIONS</p> 	<p>In cloudy or dark weather (use AUTO mode if equipped), set the Mode control at . If sunny, set the Mode control at  or , and for snowy or very cold weather requiring extra heat to the windshield, use .</p>
<p>WINDOW FOGGING</p> 	<p>In most cases turning on the Air-Conditioning (press the  button) will clear the fog. Adjust temperature control, air direction and blower speed to maintain comfort. As it gets colder, it may be necessary to direct air onto the windshield. If so, set the Mode control at  or  and adjust temperature control and blower speed to maintain comfort. Higher blower speeds will reduce fogging. If equipped with AUTO, you must manually press the Defrost button to clear fog. (Defrost mode is not a feature of the Automatic Temperature Control).</p>

## REAR WINDOW FEATURES

### Rear Window Wiper/Washer

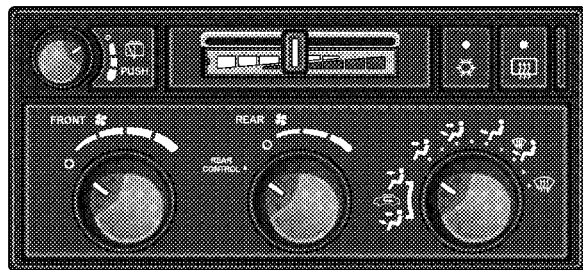

811a5530

**Manual Climate Control Panel**



818fa09b

**Automatic Climate Control Panel**



A rotating switch located on the climate control panel turns the rear wiper ON or OFF. Pressing the rotating switch inward activates the rear window washer. Rotating the switch will enable one of five intermittent delay times for the rear wiper. The delay times range from 20 to 1 second.

If the rear wiper is operating when the ignition is turned OFF, the wiper will automatically return to the Park position. When the vehicle is restarted, the wiper will resume operation.

### Rear Window Defrosting



A pushbutton type switch is located in the climate control panel. Press the switch and the rear window defroster and electric remote control heated mirrors (if equipped) will turn on. An amber indicator on the pushbutton will light when the defroster is turned on. A symbol will be displayed when the defroster is turned on with an ATC control. Push again to turn off prior to time-out. The defroster will automatically turn off after 15 minutes. For 10 more minutes of operation, push the button again. To prevent excessive battery drain, use the defroster only when the engine is operating.

### CAUTION!

**Use care when washing the inside of the rear window to prevent damage to heating elements. Use a soft cloth and a mild washing solution, wiping parallel to the heating elements. Also, keep all objects a safe distance from the window to prevent damaging the heating elements.**

# STARTING AND OPERATING

## CONTENTS

---

■ Starting Procedures . . . . .	283	□ Torque Converter Clutch . . . . .	290
□ Automatic Transmission . . . . .	283	■ Four-Wheel Drive Operation . . . . .	291
□ Normal Starting . . . . .	283	□ NV 140 Transfer Case Operating Information/Precautions - If Equipped . . . . .	291
■ Engine Block Heater - If Equipped . . . . .	286	□ NV 244 Generation II Transfer Case Operating Information / Precautions . . . . .	292
■ Automatic Transmission . . . . .	286	□ Shifting Procedure - NV 244 Generation II Transfer Case . . . . .	296
□ Brake/Transmission Interlock System . . . . .	286	■ Driving On Slippery Surfaces . . . . .	297
□ Gear Ranges . . . . .	287	■ Driving Through Water . . . . .	298
□ Overdrive Operation . . . . .	289		
□ When To Use Tow/Haul Mode . . . . .	290		



- Flowing/Rising Water . . . . .298
- Shallow Standing Water . . . . .298
- Parking Brake . . . . .300
- Brake System . . . . .302
  - Four-Wheel Anti-Lock Brake System (ABS) . . .302
- Power Steering . . . . .304
- Electronic Brake Control System . . . . .305
  - Anti-Lock Brake System (ABS) . . . . .306
  - BAS (Brake Assist System) . . . . .307
  - Traction Control System (TCS) . . . . .308
  - Electronic Roll Mitigation (ERM) . . . . .309
  - Electronic Stability Program (ESP) . . . . .310
- Multi-Displacement System (MDS) —  
5.7L Engine Only . . . . .314
- Tire Safety Information . . . . .315
  - Tire Markings . . . . .315
  - Tire Identification Number (TIN) . . . . .318
  - Tire Loading And Tire Pressure . . . . .319
- Tires — General Information . . . . .323
  - Tire Pressure . . . . .323
  - Tire Inflation Pressures . . . . .324
  - Radial Ply Tires . . . . .326
  - Compact Spare Tire — If Equipped . . . . .327
  - Limited-Use Spare — If Equipped . . . . .327
  - Tire Spinning . . . . .328

- Tread Wear Indicators . . . . . 329
- Life Of Tire . . . . . 329
- Replacement Tires . . . . . 330
- Alignment And Balance . . . . . 331
- Supplemental Tire Pressure Information —  
If Equipped . . . . . 332
- Tire Chains . . . . . 332
- Snow Tires . . . . . 333
- Tire Rotation Recommendations . . . . . 334
- Tire Pressure Monitor System (TPMS) —  
If Equipped . . . . . 335
  - Base System – If Equipped . . . . . 337
  - Premium System – If Equipped . . . . . 339
  - General Information . . . . . 342
- Fuel Requirements . . . . . 342
  - Reformulated Gasoline . . . . . 343
  - Gasoline/Oxygenate Blends . . . . . 344
  - MMT In Gasoline . . . . . 344
  - Materials Added To Fuel . . . . . 345
  - Fuel System Cautions . . . . . 345
  - Carbon Monoxide Warnings . . . . . 346
- Adding Fuel . . . . . 347
  - Fuel Filler Cap (Gas Cap) . . . . . 347
  - Loose Fuel Filler Cap (Gas Cap) Message . . . . . 348
- Flexible Fuel — If Equipped . . . . . 349
  - E-85 General Information . . . . . 349
  - Ethanol Fuel (E-85) . . . . . 350

- Fuel Requirements . . . . .350
- Selection Of Engine Oil For Flexible Fuel Vehicles (E-85) And Gasoline Vehicles . . . . .351
- Starting . . . . .351
- Cruising Range . . . . .352
- Replacement Parts . . . . .352
- Vehicle Loading . . . . .352
  - Certification Label . . . . .352
  - Curb Weight . . . . .354
  - Loading . . . . .354
- Trailer Towing . . . . .356
  - Common Towing Definitions . . . . .356
  - Trailer Hitch Classification . . . . .361
  - Trailer Towing Weights (Maximum Trailer Weight Ratings) . . . . .362
  - Trailer And Tongue Weight . . . . .362
  - Towing Requirements . . . . .364
  - Towing Tips . . . . .368
- Snowplow . . . . .370
- Recreational Towing (Behind Motorhome, Etc.) . . . . .371
  - Recreational Towing 2WD Models . . . . .371
  - Recreational Towing 4WD Models . . . . .371
- Equipment Identification Plate . . . . .376

## STARTING PROCEDURES

Before starting your vehicle, adjust your seat, adjust both inside and outside mirrors, and fasten your seat belts.

### WARNING!

**Be sure to turn off the engine and remove the key from the ignition switch if you want to rest or sleep in your car. Accidents can be caused by inadvertently moving the shift lever or by pressing the accelerator pedal. This may cause excessive heat in the exhaust system, resulting in overheating and vehicle fire which may cause serious or fatal injuries.**

### WARNING!

**Do not leave children or animals inside parked vehicles in hot weather. Interior heat build up may cause serious injury or death.**

### Automatic Transmission

Start the engine with the selector lever in NEUTRAL or PARK position. Apply the brake before shifting to any driving range.

### Normal Starting

Normal starting of either a warm or cold engine is obtained without pumping or depressing the accelerator pedal.

**Tip Start Feature**

Your vehicle has a “Tip Start” starting system. With “Tip Start” the driver does not need to hold the key in the START position until the vehicle starts, but can release the key (still in the ignition) and the vehicle will continue through the start cycle.

- Turn the ignition key to the START position until the start motor engages.
- Release the key (still in the ignition) and the starter will continue through the start cycle until the vehicle starts or for five seconds (whichever comes first).

**If Engine Fails To Start**

If the engine fails to start after you have followed the normal starting procedure, it may be flooded. Push the accelerator pedal all the way to the floor and hold it there while cranking the engine. This should clear any excess fuel in case the engine is flooded.

**CAUTION!**

**To prevent damage to the starter, do not crank the engine for more than 15 seconds at a time. Wait 10 to 15 seconds before trying again.**

**WARNING!**

**Never pour fuel or other flammable liquid into the throttle body air inlet opening in an attempt to start the vehicle. This could result in flash fire causing serious personal injury.**

**WARNING!**

**Do not attempt to push or tow your vehicle to get it started. Vehicles equipped with an automatic transmission cannot be started this way. Unburned fuel could enter the catalytic converter and once the engine has started, ignite and damage the converter and vehicle. If the vehicle has a discharged battery, booster cables may be used to obtain a start from a booster battery or the battery in another vehicle. This type of start can be dangerous if done improperly. Refer to “Jump Starting” in Section 6 for the proper jump-starting procedures and follow them carefully.**

If the engine has been flooded it may start to run, but not have enough power to continue running when the key is released. If this occurs, continue cranking with the accelerator pedal pushed all the way to the floor. Release the accelerator pedal and the key once the engine is running smoothly.

If the engine shows no sign of starting after two 15 second periods of cranking with the accelerator pedal held to the floor, the normal starting procedure should be repeated.

**After Starting**

The idle speed is automatically controlled on fuel injected engines and will decrease as the engine warms up.

### ENGINE BLOCK HEATER – IF EQUIPPED

The engine block heater warms the engine coolant and permits quicker starts in cold weather. Connect the cord to a standard 110-115 volt AC electrical outlet with a grounded, three wire extension cord.

The 3.7L/4.7L engine block heater cord is located at the front of the engine compartment near the radiator cap. The 5.7L engine block heater cord is located on the left side of the engine compartment and rearward of the power distribution center.

#### **WARNING!**

**Remember to disconnect the cord before driving. Damage to the 110-115 volt electrical cord could cause electrocution.**

### AUTOMATIC TRANSMISSION

The electronic PRNDL on the instrument cluster indicates the transmission gear selected. The shift lever is mounted on the right side of the steering column. To drive, move the shift lever from PARK or NEUTRAL to the desired drive position. Pull the shift lever toward you when shifting into REVERSE, 2nd, 1st or PARK, or when shifting out of PARK.

### Brake/Transmission Interlock System

This system prevents you from moving the gear shift out of PARK and into any gear unless the brake pedal is pressed. This system is active only while the ignition switch is in the ON position. Always depress the **brake pedal first**, before moving the gear selector out of PARK.

## Gear Ranges

DO NOT race the engine when shifting from PARK or NEUTRAL position into another gear range.

### ***“P” PARK***

Supplements parking brake by locking the transmission. Engine can be started in this range. Never use PARK while vehicle is in motion. Apply the parking brake when leaving the vehicle in this range. Always apply the parking brake first, then place the shift lever in PARK position.

### **WARNING!**

Your vehicle could move and injure you and others if it is not completely in PARK. Check by trying to move the gearshift lever back and forth without first pulling the lever toward you, after you have set it in PARK. Make sure it is in PARK before leaving the vehicle.

### **WARNING!**

Never use the PARK position on an automatic transmission as a substitute for the parking brake. Always apply the parking brake fully when parked to guard against vehicle movement and possible injury or damage.

### **WARNING!**

It is dangerous to shift the gear shift lever out of PARK or NEUTRAL if the engine speed is higher than idle speed. If your foot is not firmly on the brake pedal, the vehicle could accelerate quickly forward or in reverse. You could lose control of the vehicle and hit someone or something. Only shift into gear when the engine is idling normally and when your right foot is firmly on the brake pedal.



**“R” REVERSE**

Use this range only after the vehicle has come to a complete stop.

**“N” NEUTRAL**

Shift to NEUTRAL when the vehicle is standing for prolonged periods with the engine running. The engine may be started in this range. Set the parking brake if you must leave the vehicle.

**NOTE:** Towing the vehicle (except as specified under Towing A Disabled Vehicle), coasting, or otherwise driving the vehicle while in NEUTRAL can cause severe transmission damage

**“D” DRIVE**

For most city and highway driving.

**“2” 2nd**

For driving slowly in heavy city traffic or on mountain roads where more precise speed control is desirable. Use it also when climbing long grades, and for engine braking when descending moderately steep grades. To prevent excessive engine speed, do not exceed 45 mph (72 km/h) in this range.

**“1” 1st**

For driving up very steep hills and for engine braking at low speeds (25 mph {40 km/h} or less) when going downhill. To prevent excessive engine speed do not exceed 25 mph (40 km/h) in this range.

### OVERDRIVE Operation

The OVERDRIVE automatic transmission contains an electronically controlled fourth and fifth (if equipped) speed (OVERDRIVE). The transmission will automatically shift from DRIVE to OVERDRIVE if the following conditions are present:

- the transmission selector is in DRIVE;
- the engine coolant has reached normal operating temperature;
- vehicle speed is above approximately 30 mph (48 km/h);
- the TOW/HAUL switch has not been activated;
- transmission has reached normal operating temperature.

**NOTE:** If the vehicle is started in extremely cold temperatures, the transmission may not shift into OVERDRIVE and will automatically select the most desirable gear for operation at this temperature. Normal operation will resume when the transmission fluid temperature has risen to a suitable level. Refer also to the Note under torque converter clutch, later in this section.

If the transmission temperature gets extremely hot, the transmission will automatically select the most desirable gear for operation at this temperature. If the transmission temperature becomes hot enough, the “TRANS TEMP” light may illuminate and the transmission may downshift out of OVERDRIVE until the transmission cools down. After cooldown, the transmission will resume normal operation.

The transmission will downshift from OVERDRIVE to DRIVE if the accelerator pedal is fully depressed at vehicle speeds above approximately 35 mph (56 km/h).

### When To Use TOW/HAUL Mode

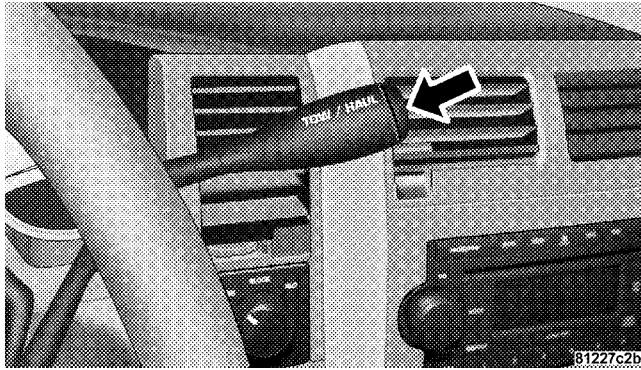

#### TOW/HAUL Button

When driving in hilly areas, towing a trailer, carrying a heavy load, etc., and frequent transmission shifting occurs, press the TOW/HAUL button. This will improve performance and reduce the potential for transmission overheating or failure due to excessive shifting. When

operating in TOW/HAUL mode, 5th gear (if equipped) is disabled and 2-3 and 3-4 shift patterns are modified. Shifts into OVERDRIVE (4th gear) are allowed during steady cruise (for improved fuel economy) and automatic closed-throttle downshifts to 3rd gear (for improved braking) will occur during steady braking.

The TOW/HAUL light will illuminate in the instrument cluster to indicate when the switch has been activated. Pressing the switch a second time restores normal operation. If the TOW/HAUL mode is desired, the button must be pressed each time the engine is started.

#### Torque Converter Clutch

A feature designed to improve fuel economy is included in all automatic transmissions. A clutch within the torque converter engages automatically at a calibrated speed at light throttle. It engages at higher speeds under heavier acceleration. This may result in a slightly different feeling or response during normal operation in high gear. When

the vehicle speed drops below a calibrated speed, or during acceleration, the clutch automatically and smoothly disengages. The feature is operational in OVERDRIVE and in DRIVE.

**NOTE:** The torque converter clutch will not engage until the transmission fluid and engine coolant are warm (usually after 1-3 mi [1.6 - 4.8 km] of driving). Because the engine speed is higher when the torque converter clutch is not engaged, it may seem as if the transmission is not shifting into Overdrive when cold. This is normal. Pressing the TOW/HAUL button, when the transmission is sufficiently warm, will demonstrate that the transmission is able to shift into, and out of, Overdrive. For vehicles with 4.7L or 5.7L engines (which have two Overdrive gears), the transmission may not shift into 5th gear until the transmission fluid and engine coolant are warm.

**NOTE:** If the vehicle has not been driven in several days, the first few seconds of operation after shifting the transmission into gear may seem sluggish. This is due to the fluid partially draining from the torque converter into the transmission. This condition is normal and will not cause damage to the transmission. The torque converter will refill within five seconds of shifting from PARK into any other gear position.

## FOUR-WHEEL DRIVE OPERATION

### NV 140 Transfer Case Operating Information/Precautions – If Equipped

The NV 140 is a single speed (4 HI range only) transfer case which provides convenient full-time 4-wheel drive. No driver interaction is required. This transfer case divides engine torque almost evenly with 48 percent of engine torque to the front axle and 52 percent of engine torque to the rear axle.

Proper operation of 4-wheel drive vehicles depends on tires of equal size, type and circumference on each wheel. Any difference in tire size can cause damage to the transfer case.

Because 4-wheel drive provides improved traction, there is a tendency to exceed safe turning and stopping speeds. Do not go faster than road conditions permit.

#### **4WD**

Normal 4-Wheel Drive High Range - Employs inter-axle differential. Allows front and rear wheels to rotate at different speeds. All road surfaces.

#### **NV 244 Generation II Transfer Case Operating Information / Precautions**

The NV 244 Generation II is an electric-shift transfer case and is operated by the 4WD Control Switch, which is located on the instrument panel.

The NV 244 Generation II transfer case provides four mode positions - Normal 4-wheel drive (4WD) high range, 4-wheel-drive lock (4WD LOCK), 4-wheel drive low (4WD LOW) range, and NEUTRAL.

This transfer case is equipped with an inter-axle differential that allows driving the vehicle in the normal all-wheel drive position (4WD) at all times on any given road surface, including dry, hard-surfaced roads. The 4WD mode allows the front and rear wheels to rotate at different speeds. This eliminates driveline binding and component wear normally associated with driving the vehicle in the 4WD LOCK position on dry, hard-surfaced roads. This feature provides the safety, security, and convenience of operating in all-wheel drive at all times regardless of road conditions.

When additional traction is required, the 4WD LOCK and 4WD LOW positions can be used to lock the front and rear driveshafts together, through the transfer case

inter-axle differential, and force the front and rear wheels to rotate at the same speed. This is accomplished by rotating the 4WD Control Switch to these positions. The 4WD LOCK and 4WD LOW positions are intended for loose, slippery road surfaces only. Driving in the 4WD LOCK and 4WD LOW positions on dry, hard-surfaced roads may cause increased tire wear and damage to the driveline components.

The transfer case NEUTRAL position is selected by depressing the recessed button located on the lower left hand corner of the 4WD Control Switch.

**NOTE:** The transfer case NEUTRAL position is to be used for recreational towing only. Refer to “Recreational Towing” under Section 5 for specific procedures on shifting into and out of NEUTRAL.

### **Transfer Case Position Indicator Lights**

Transfer case position indicator lights are located on the instrument cluster. If there are no indicator lights on or

flashing, the transfer case position is 4-wheel drive (4WD) and indicates the current and desired transfer case selection (4WD ⇔ 4WD LOCK).

The “SVC 4WD” warning light monitors the electric shift 4WD system. If this light remains on after engine start up or illuminates during driving, it means that the 4WD system is not functioning properly and that service is required. See your authorized dealer for service.

### **WARNING!**

**Always engage the parking brake when powering down the vehicle if the “SVC 4WD” light is illuminated. Not engaging the parking brake may allow the vehicle to roll, which may cause personal injury.**

**NOTE:** Do not attempt to make a shift while only the front or rear wheels are spinning. The NV 244 Generation

If transfer case is not equipped with a synchronizer and therefore the front and rear driveshaft speeds must be equal for the shift to take place. Shifting while only the front or rear wheels are spinning can cause damage to the transfer case.

When operating your vehicle in 4WD LOW, the engine speed is approximately three times that of the 4WD or 4WD LOCK positions at a given road speed. Take care not to overspeed the engine and do not exceed 25 mph (40 km/h).

Proper operation of 4-wheel drive vehicles depends on tires of equal size, type and circumference on each wheel. Any difference in tire size can cause damage to the transfer case.

Because 4-wheel drive provides improved traction, there is a tendency to exceed safe turning and stopping speeds. Do not go faster than road conditions permit.

### **WARNING!**

**You or others could be injured if you leave the vehicle unattended with the transfer case in the NEUTRAL position without first fully engaging the parking brake. The transfer case NEUTRAL position disengages both the front and rear driveshafts from the powertrain and will allow the vehicle to move, regardless of the transmission position. The parking brake should always be applied when the driver is not in the vehicle.**

For additional information on the appropriate use of each transfer case mode position, refer to the following information:

**4WD**

Normal 4-Wheel Drive High range employs the inter-axle differential. This range allows front and rear wheels to rotate at different speeds on all road surfaces.

**4WD LOCK**

The 4-Wheel Drive Lock (4WD LOCK) range, locks the transfer case inter-axle differential, forcing the front and rear wheels to rotate at the same speed. Additional traction for loose, slippery road surfaces only.

**4WD LOW**

The 4-Wheel Drive Low (4WD LOW) Range provides low speed 4-wheel drive. It locks the front and rear driveshafts together, forcing the front and rear wheels to rotate at the same speed. This range provides additional traction and maximum pulling power for loose or slippery road surfaces only. Do not exceed 25 mph (40 km/h).

**N**

The NEUTRAL ranged disengages both the front and rear driveshafts from the powertrain. NEUTRAL is used for flat towing behind another vehicle. Refer to “Recreational Towing” in Section 5.



## Shifting Procedure - NV 244 Generation II Transfer Case

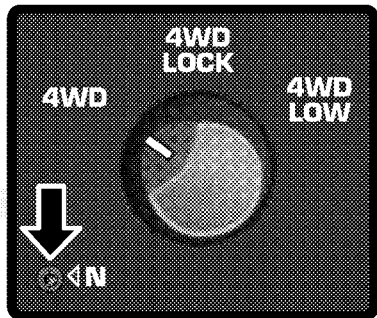

8197509c

**NOTE:** The 4x4 system will not allow shifts between 4WD/4WD LOCK if the rear wheels are spinning (no traction). In this situation, a position indicator light will flash and the original position indicator light will remain on. At this time, reduce speed and stop spinning the

wheels to complete the shift. There may be a delay up to 13 seconds for the shift to complete after the wheels have stopped spinning.

**NOTE:** Delayed shifting out of the 4WD LOCK position may be experienced due to uneven tire wear, low tire pressure, or excessive loading.

**NOTE:** When shifting into, or out of 4WD LOW, some gear noise may be heard. This noise is normal and is not detrimental to the vehicle or occupants.

Shifting can be performed with the vehicle rolling 2 to 3 mph (3 to 5 km/h) or completely stopped. USE EITHER OF THE FOLLOWING PROCEDURES:

### Preferred Procedure

1. With the engine running, slow the vehicle to 2 to 3 mph (3 to 5 km/h).
2. Shift the transmission into NEUTRAL.

3. While still rolling, rotate the transfer case control switch to the desired position.
4. After the position indicator light has stopped flashing, shift the transmission back into gear.

### **Alternate Procedure**

1. Bring the vehicle to a complete stop.
2. With the key ON and the engine either OFF or running, shift the transmission into NEUTRAL.
3. Rotate the transfer case control switch to the desired position.
4. After the position indicator light has stopped flashing, shift the transmission back into gear.

**NOTE:** The ignition key must be ON for a shift to take place and for the position indicator lights to be operable. If the key is not ON then the shift will not take place and no position indicator lights will be on or flashing.

**NOTE:** If any of the requirements to select a new transfer case position have not been met, the transfer case will not shift. The indicator light will flash and the current transfer case position will be maintained. To retry the selection, turn the control knob back to the current position, wait five seconds, and retry the shift.

### **DRIVING ON SLIPPERY SURFACES**

When driving on wet or slushy roads, it is possible for a wedge of water to build up between the tire and road surface. This is known as hydroplaning and may cause partial or complete loss of vehicle control and stopping ability. To reduce this possibility, the following precautions should be observed:

1. Slow down during rainstorms or when roads are slushy.
2. Slow down if road has standing water or puddles.

3. Replace tires when tread wear indicators first become visible.
4. Keep tires properly inflated.
5. Maintain sufficient distance between your vehicle and the car in front to avoid a collision in a sudden stop.

### **DRIVING THROUGH WATER**

Driving through water more than a few inches/millimeters deep will require extra caution to ensure safety and prevent damage to your vehicle.

### **Flowing/Rising Water**

#### **WARNING!**

**Do not drive on, or cross, a road or a path where water is flowing and/or rising (as in storm run-off). Flowing water can wear away the road or path's surface and cause your vehicle to sink into deeper water. Furthermore, flowing and/or rising water can carry your vehicle away swiftly. Failure to follow this warning may result in injuries that are serious or fatal to you, your passengers, and others around you.**

### **Shallow Standing Water**

Although your vehicle is capable of driving through shallow standing water, consider the following Caution and Warning before doing so.

**CAUTION!**

- Always check the depth of the standing water before driving through it. Never drive through standing water that is deeper than the bottom of the tire rims mounted on the vehicle.
- Determine the condition of the road or the path that is under water, and if there are any obstacles in the way, before driving through the standing water.
- Do not exceed 5 mph (8 km/h) when driving through standing water. This will minimize wave effects.

**CAUTION!**

- Driving through standing water may cause damage to your vehicle's drivetrain components. Always inspect your vehicle's fluids (i.e., engine oil, transmission, axle, etc.) for signs of contamination (i.e., fluid that is milky or foamy in appearance) after driving through standing water. Do not continue to operate the vehicle if any fluid appears contaminated, as this may result in further damage. Such damage is not covered by the New Vehicle Limited Warranty.
- Getting water inside your vehicle's engine can cause it to lock up and stall out, and cause serious internal damage to the engine. Such damage is not covered by the New Vehicle Limited Warranty.

**WARNING!**

- Driving through standing water limits your vehicle's traction capabilities. Do not exceed 5 mph (8 km/h) when driving through standing water.
- Driving through standing water limits your vehicle's braking capabilities, which increases stopping distances. Therefore, after driving through standing water, drive slowly and lightly press on the brake pedal several times to dry the brakes.
- Getting water inside your vehicle's engine can cause it to lock up and stall out, and leave you stranded.
- Failure to follow these warnings may result in injuries that are serious or fatal to you, your passengers, and others around you.

**PARKING BRAKE**

The foot operated parking brake is positioned below the lower left corner of the instrument panel. To release the parking brake, pull the parking brake release handle.

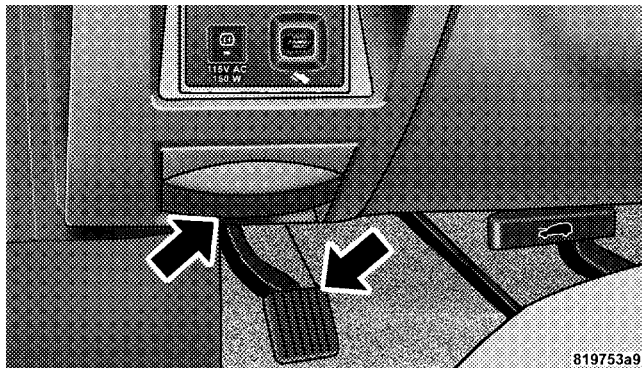

**Parking Brake**

Be sure the parking brake is firmly set when parked and the shift lever is in PARK position. When parking on a

hill, you should apply the parking brake before placing the shift lever in PARK; otherwise the load on the transmission locking mechanism may make it difficult to move the shift lever out of PARK.

**NOTE:** The instrument cluster brake warning light indicates only that the parking brake is applied. You must be sure the parking brake is fully applied before leaving the vehicle.

When parking on a hill, turn the front wheels toward the curb on a downhill grade and away from the curb on an uphill grade.

The parking brake should be applied whenever the driver is not in the vehicle.

### WARNING!

- **Always fully apply the parking brake when leaving your vehicle, or the vehicle may roll and cause damage or injury. Also be certain to leave an automatic transmission in Park. Failure to do so may cause the vehicle to roll and cause damage or injury.**
- **Be sure the parking brake is fully disengaged before driving, failure to do so can lead to brake failure and an accident.**
- **Never leave children alone in a vehicle. Leaving unattended children in a vehicle is dangerous for a number of reasons. A child or others could be seriously or fatally injured. Don't leave the keys in the ignition. A child could operate power windows, other controls, or move the vehicle.**

## BRAKE SYSTEM

In the event power assist is lost for any reason, (for example, repeated brake applications with the engine off), the brakes will still function. The effort required to brake the vehicle will be significantly increased over that required with the power system operating.

If either the front or rear hydraulic systems lose normal capability, the remaining system will still function with some loss of braking effectiveness. This will be evident by increased pedal travel during application, greater pedal force required to slow or stop, and activation of the Brake Warning Light and the ABS Light during brake use.

### Four-Wheel Anti-Lock Brake System (ABS)

The Anti-Lock Brake System (ABS) is designed to aid the driver in maintaining vehicle control under adverse braking conditions. The system operates with a separate computer to modulate hydraulic pressure to prevent wheel lock-up and help avoid skidding on slippery

surfaces. All vehicle wheels and tires must be the same size and type and tires must be properly inflated to produce accurate signals for the computer.

### WARNING!

**Significant over-or-under-inflation of tires, or mixing sizes of tires or wheels on the vehicle can lead to loss of braking effectiveness.**

The ABS conducts a low-speed self-test at about 12 mph (20 km/h). If you have your foot lightly on the brake while this test is occurring you may feel slight pedal movement. The movement can be more apparent on ice and snow. This is normal. The ABS pump motor runs during the self-test at 12 mph (20 km/h) and during an ABS stop. The pump motor makes a low humming noise during operation, which is normal.

At the instant one of the wheels is about to lock up, a slight pulsation can be felt in the brake pedal, indicating that the ABS is in the regulating mode. Keep firm and steady pressure on the brake pedal while experiencing the pulsation. Continuous, steady brake pedal pressure results in optimal braking power while maintaining the ability to steer the vehicle. In the case of an emergency brake maneuver, keep continuous full pressure on the brake pedal. In this manner only can the ABS be most effective. On slippery road surfaces, the ABS will respond even with light brake pedal pressure because of the increased likelihood of locking wheels. The pulsating brake pedal can be an indication of hazardous road conditions and functions as a reminder to take extra care while driving.

**WARNING!**

**ABS contains sophisticated electronic equipment. It may be susceptible to interference caused by improperly installed or high output radio transmitting equipment. This interference can cause possible loss of anti-lock braking capability. Installation of such equipment should be done by qualified professionals.**

**WARNING!**

**Pumping of the Anti-lock brakes will diminish their effectiveness and may lead to an accident. Pumping makes the stopping distance longer. Just press firmly on your brake pedal when you need to slow down or stop.**



**WARNING!**

- **ABS cannot prevent the natural laws of physics from acting on the vehicle, nor can it increase braking or steering efficiency beyond that afforded by the condition of the vehicle brakes and tires or the traction afforded.**
- **The ABS cannot prevent accidents, including those resulting from excessive speed in turns, following another vehicle too closely, or hydroplaning. Only a safe, attentive, and skillful driver can prevent accidents.**
- **The capabilities of an ABS equipped vehicle must never be exploited in a reckless or dangerous manner which could jeopardize the user's safety or the safety of others.**

When you are in a severe braking condition involving use of the ABS, you will experience some pedal drop as the vehicle comes to a stop. This is the result of the system reverting to the base brake system.

Engagement of the ABS may be accompanied by a pulsing sensation. You may also hear a clicking noise. These occurrences are normal, and indicate that the system is functioning properly.

**POWER STEERING**

The standard power steering system will give you good vehicle response and increased ease of maneuverability in tight spaces. The system will provide mechanical steering capability if power assist is lost.

If for some reason, the power assist is interrupted, it will still be possible to steer your vehicle. Under these conditions you will observe a substantial increase in steering effort, especially at very low vehicle speeds and during parking maneuvers.

**NOTE:** Increased noise levels at the end of the steering wheel travel are considered normal and does not indicate that there is a problem with the power steering system.

Upon initial start-up in cold weather, the power steering pump may make noise for a short period of time. This is due to the cold, thick fluid in the steering system. This noise should be considered normal, and does not in any way damage the steering system.

### **WARNING!**

**Continued operation with reduced power steering assist could pose a safety risk to yourself and others. Service should be obtained as soon as possible.**

### **CAUTION!**

**Prolonged operation of the steering system at the end of the steering wheel travel will increase the steering fluid temperature and should be avoided when possible. Damage to the power steering pump may occur.**

### **ELECTRONIC BRAKE CONTROL SYSTEM**

Your vehicle is equipped with an advanced electronic brake control system that includes Anti-Lock Brake System (ABS), Brake Assist System (BAS), Traction Control System (TCS), Electronic Roll Mitigation (ERM), Electronic Stability Program (ESP) and Trailer Sway Control (TSC). All six systems work together to enhance vehicle stability and control in various driving conditions, and are commonly referred to as ESP.

### Anti-Lock Brake System (ABS)

This system aids the driver in maintaining vehicle control under adverse braking conditions. The system controls hydraulic brake pressure to prevent wheel lockup and help avoid skidding on slippery surfaces during braking. Refer to “Anti-Lock Brake System” in Section 5 of this manual for more information about ABS.

**NOTE:** ABS improves steering control of the vehicle during hard braking maneuvers.

#### WARNING!

- **ABS cannot prevent the natural laws of physics from acting on the vehicle, nor can it increase braking or steering efficiency beyond that afforded by the condition of the vehicle brakes and tires or the traction afforded.**
- **The ABS cannot prevent accidents, including those resulting from excessive speed in turns, following another vehicle too closely, or hydroplaning. Only a safe, attentive, and skillful driver can prevent accidents.**
- **The capabilities of an ABS-equipped vehicle must never be exploited in a reckless or dangerous manner which could jeopardize the user’s safety or the safety of others.**

## BAS (Brake Assist System)

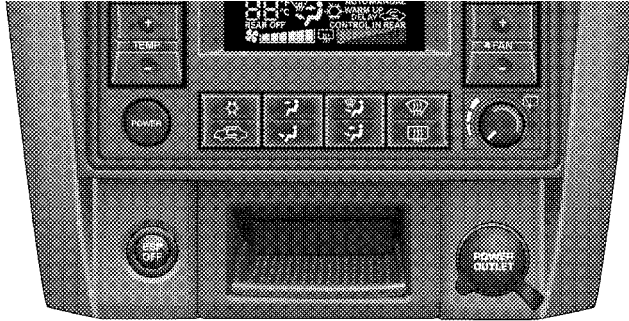

816638f2

### ESP OFF Switch Location

The BAS is designed to optimize the vehicle's braking capability during emergency braking maneuvers. The

system detects an emergency braking situation by sensing the rate and amount of brake application and then applies optimum pressure to the brakes. The system applies optimum pressure to the brakes in emergency braking conditions. This can help reduce braking distances. The BAS complements the ABS. Applying the brakes very quickly results in the best BAS assistance. To receive the benefit of the system, you must apply continuous braking pressure during the stopping sequence. Do not reduce brake pedal pressure unless braking is no longer desired.

Once the brake pedal is released, the BAS is deactivated.

**WARNING!**

- **BAS cannot prevent the natural laws of physics from acting on the vehicle, nor can it increase braking efficiency beyond that afforded by the condition of the vehicle brakes and tires or the traction afforded.**
- **The BAS cannot prevent accidents, including those resulting from excessive speed in turns, following another vehicle too closely, or hydroplaning. Only a safe, attentive, and skillful driver can prevent accidents.**
- **The capabilities of a BAS-equipped vehicle must never be exploited in a reckless or dangerous manner which could jeopardize the user's safety or the safety of others.**

**Traction Control System (TCS)**

This system monitors the amount of wheel spin of each of the driven wheels. If wheel spin is detected, brake pressure is applied to the slipping wheel(s) and engine power is reduced to provide enhanced acceleration and stability. A feature of the TCS system functions similar to a limited slip differential and controls the wheel spin across a driven axle. If one wheel on a driven axle is spinning faster than the other, the system will apply the brake of the spinning wheel. This will allow more engine torque to be applied to the wheel that is not spinning. This feature remains active even if TCS and ESP are in the "Partial Off" mode. Refer to "ESP (Electronic Stability Program)" in this Section. This brake pressure modulation transfers drive torque from slipping to non-slipping wheels to provide optimal forward traction.

### **Electronic Roll Mitigation (ERM)**

This system anticipates the potential for wheel lift by monitoring the driver's steering wheel input and the speed of the vehicle. When ERM determines that the rate of change of the steering wheel angle and vehicles speed are sufficient to potentially cause wheel lift, it applies the appropriate brake and may reduce engine power to lessen the chance that wheel lift will occur. ERM will only intervene during very severe or evasive driving maneuvers.

ERM can only reduce the chance of wheel lift occurring during severe or evasive driving maneuvers. It cannot prevent wheel lift due to other factors such as road conditions, leaving the roadway or striking objects or other vehicles.

### **WARNING!**

**Many factors, such as vehicle loading, road conditions and driving conditions, influence the chance that wheel lift or rollover may occur.**

- **ERM cannot prevent all wheel lift or rollovers, especially those that involve leaving the roadway or striking objects or other vehicles. Only a safe, attentive, and skillful driver can prevent accidents.**
- **The capabilities of an ERM-equipped vehicle must never be exploited in a reckless or dangerous manner which could jeopardize the user's safety or the safety of others.**

## Electronic Stability Program (ESP)

This system enhances directional control and stability of the vehicle under various driving conditions. ESP corrects for over/under steering of the vehicle by applying the brake of the appropriate wheel to assist in counteracting the over/under steer condition. Engine power may also be reduced to help the vehicle maintain the desired path.

ESP uses sensors in the vehicle to determine the vehicle path intended by the driver and compares it to the actual path of the vehicle. When the actual path does not match the intended path, ESP applies the brake of the appropriate wheel to assist in counteracting the oversteer or understeer condition.

- Oversteer - when the vehicle is turning more than appropriate for the steering wheel position.

- Understeer - when the vehicle is turning less than appropriate for the steering wheel position.

## ESP/TCS Indicator Light



The ESP/TCS Indicator Light starts to flash as soon as the tires lose traction and the TCS or ESP system becomes active. It will also flash once a swaying trailer is detected and the Trailer Sway Control (TSC) system activates. If the ESP/TCS Indicator Light begins to flash during acceleration, ease up on the accelerator and apply as little throttle as possible. Be sure to adapt your speed and driving to the prevailing road conditions.

**WARNING!**

- ESP cannot prevent the natural laws of physics from acting on the vehicle, nor can it increase the traction afforded.
- ESP cannot prevent accidents, including those resulting from excessive speed in turns, or hydroplaning. Only a safe, attentive, and skillful driver can prevent accidents.
- The capabilities of an ESP-equipped vehicle must never be exploited in a reckless or dangerous manner which could jeopardize the user's safety or the safety of others.

The ESP system has two available operating modes.

**4WD/4WD LOCK or 2WD Models****ON**

This is the normal operating mode for ESP in 4WD LOCK and in 2WD vehicles. Whenever the vehicle is started or the transfer case (if equipped) is shifted from 4WD LOW or NEUTRAL back to 4WD LOCK, the ESP system will be in this mode. This mode should be used for almost all driving situations. ESP should only be turned to "Partial Off" for specific reasons as noted below.



816638f6

**Partial Off**

This mode is entered by momentarily depressing the ESP OFF Control Switch. When in "Partial Off" mode, the engine management portion of ESP has been desensitized, the thresholds for ESP activation are raised, and the "ESP/TCS Indicator Light" will be illuminated. This mode is intended to be used if the vehicle is in deep snow, sand or gravel



conditions and more wheel spin than ESP would normally allow is required to gain traction. Trailer Sway Control (TSC) is not available when the system is in the "Partial Off" mode. To turn ESP on again, momentarily depress the ESP OFF Control Switch. This will restore the normal ON mode of operation. ESP always operates under braking, even with the switch in the OFF position.

**WARNING!**

**In the "Partial Off" mode, the engine torque reduction and stability features are desensitized. Therefore, the enhanced vehicle stability offered by ESP is unavailable.**

**NOTE:** To improve the vehicle's traction when driving with snow chains, or starting off in deep snow, sand or gravel, it may be desirable to switch to the "Partial Off" mode by pressing the ESP Control Switch. Once the

situation requiring ESP to be switched to the "Partial Off" mode is overcome, turn ESP on by momentarily depressing the ESP Control Switch. This may be done with the vehicle in motion.

### **4WD LOW Range**

#### ***Partial Off***

This is the normal operating mode for ESP in 4WD LOW. Whenever the vehicle is started in 4WD LOW or the transfer case (if equipped) is shifted from 4WD LOCK or NEUTRAL to 4WD LOW, the ESP system will be in this mode. In 4WD LOW, ESP function is desensitized until the vehicle reaches a speed of 30 mph (48 km/h). At 30 mph (48 km/h) the normal ESP stability function returns and the ESP/TCS Indicator Light turns off. When the vehicle speed drops below 25 mph (40 km/h) the ESP system goes back to Partial Off. ESP is desensitized at low vehicle speeds in 4WD LOW so that it will not interfere with off road driving but ESP function returns to provide

the stability feature at speeds above 30 mph (48 km/h). The ABS is in a special Off Road mode that allows wheels to lock at lower speeds if gravel is detected to shorten stopping distances.

**NOTE:** When the vehicle is in 4WD LOW, a feature of the ESP system remains active whether the ESP is on or off. This feature functions similar to a limited slip differential and controls the wheel spin across an axle. If one wheel on an axle is spinning faster than the other, the system will apply the brake of the spinning wheel and allow more engine torque to be applied to the wheel that is not spinning.

### **WARNING!**

**In the Partial Off mode, the engine torque reduction and stability features are desensitized. Therefore, the enhanced vehicle stability offered by ESP is unavailable.**

#### **ESP/BAS Warning Lamp and ESP/TCS Indicator Light**

The malfunction indicator for the ESP is combined with the BAS indicator. The yellow ESP/BAS Warning Light and the yellow ESP/TCS Indicator Light in the instrument cluster both come on when the ignition switch is turned to the ON position. They should both go out with the engine running. If the ESP/BAS Warning Light comes on continuously with the engine running, a malfunction has been detected in either the ESP or BAS system, or both. If this light remains on after several ignition cycles,

and the vehicle has been driven several miles at speeds greater than 30 mph (48 km/h), see your authorized dealer as soon as possible to have the problem diagnosed and corrected.

**NOTE:**

- The ESP Indicator Light and the ESP/BAS Warning Light come on momentarily each time the ignition switch is turned ON.
- Each time the ignition is turned ON, the ESP System will be ON even if it was turned off previously.
- The ESP Control System will make buzzing or clicking sounds when it is active. This is normal; the sounds will stop when ESP becomes inactive following the maneuver that caused the ESP activation.

**Trailer Sway Control (TSC)**

TSC uses sensors in the vehicle to recognize a swaying trailer and will take the appropriate actions to attempt to

stop the sway. The system will reduce engine power and apply individual brakes that will counter act the sway of the trailer. TSC will become active automatically once the swaying trailer is recognized. No driver action is required. TSC cannot stop all trailers from swaying. Always use caution when towing a trailer and follow the tongue weight recommendations. For additional information on towing a trailer with your vehicle, refer to "Trailer Towing" in Section 5.

**MULTI-DISPLACEMENT SYSTEM (MDS) — 5.7L Engine Only**

This feature offers improved fuel economy by shutting off four of the engine's eight cylinders during light load and cruise conditions. The system is automatic with no driver inputs or additional driving skills required.

**NOTE:** The MDS system may take some time to return to full functionality after a battery disconnect.

## TIRE SAFETY INFORMATION

### Tire Markings

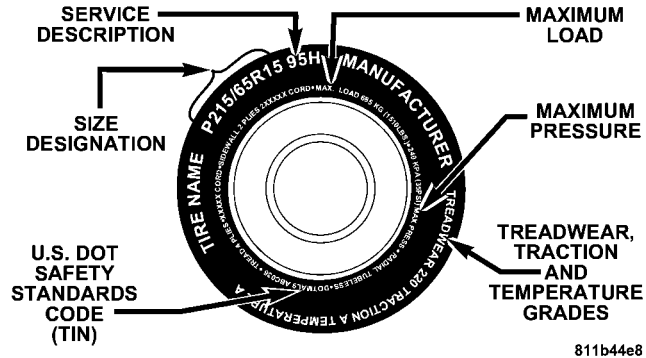

### NOTE:

- P (Passenger)-Metric tire sizing is based on U.S. design standards. P-Metric tires have the letter "P" molded into the sidewall preceding the size designation. Example: P215/65R15 95H.

- European Metric tire sizing is based on European design standards. Tires designed to this standard have the tire size molded into the sidewall beginning with the section width. The letter "P" is absent from this tire size designation. Example: 215/65R15 96H
- LT (Light Truck)-Metric tire sizing is based on U.S. design standards. The size designation for LT-Metric tires is the same as for P-Metric tires except for the letters "LT" that are molded into the sidewall preceding the size designation. Example: LT235/85R16.
- Temporary spare tires are high-pressure compact spares designed for temporary emergency use only. Tires designed to this standard have the letter "T" molded into the sidewall preceding the size designation. Example: T145/80D18 103M.
- High flotation tire sizing is based on U.S. design standards and it begins with the tire diameter molded into the sidewall. Example: 31x10.5 R15 LT.

## Tire Sizing Chart

<b>EXAMPLE:</b>
<p><b>Size Designation:</b></p> <p><b>P</b> = Passenger car tire size based on U.S. design standards            "...blank..." = Passenger car tire based on European design standards  <b>LT</b> = Light truck tire based on U.S. design standards  <b>T</b> = Temporary spare tire  <b>31</b> = Overall diameter in inches (in)</p>
<b>215</b> = Section width in millimeters (mm)
<p><b>65</b> = Aspect ratio in percent (%).            —Ratio of section height to section width of tire</p> <p><b>10.5</b> = Section width in inches (in)</p>
<p><b>R</b> = Construction code            —"R" means radial construction            —"D" means diagonal or bias construction</p>
<b>15</b> = Rim diameter in inches (in)

**EXAMPLE:****Service Description:****95** = Load Index

—A numerical code associated with the maximum load a tire can carry

**H** = Speed Symbol

—A symbol indicating the range of speeds at which a tire can carry a load corresponding to its load index under certain operating conditions

—The maximum speed corresponding to the speed symbol should only be achieved under specified operating conditions (i.e., tire pressure, vehicle loading, road conditions, and posted speed limits)

**Load Identification:****"...blank..."** = Absence of any text on the sidewall of the tire indicates a Standard Load (SL) Tire**Extra Load (XL)** = Extra load (or reinforced) tire**Light Load** = Light load tire**C,D,E** = Load range associated with the maximum load a tire can carry at a specified pressure**Maximum Load** — Maximum load indicates the maximum load this tire is designed to carry**Maximum Pressure** — Maximum pressure indicates the maximum permissible cold tire inflation pressure for this tire

**Tire Identification Number (TIN)**

The TIN may be found on one or both sides of the tire, however, the date code may only be on one side. Tires with white sidewalls will have the full TIN, including the date code, located on the white sidewall side of the tire.

Look for the TIN on the outboard side of black sidewall tires as mounted on the vehicle. If the TIN is not found on the outboard side, then you will find it on the inboard side of the tire.

**EXAMPLE:****DOT MA L9 ABCD 0301**

**DOT** = Department of Transportation

—This symbol certifies that the tire is in compliance with the U.S. Department of Transportation tire safety standards, and is approved for highway use

**MA** = Code representing the tire manufacturing location (two digits)

**L9** = Code representing the tire size (two digits)

**ABCD** = Code used by the tire manufacturer (one to four digits)

**03** = Number representing the week in which the tire was manufactured (two digits)

—03 means the 3rd week.

**01** = Number representing the year in which the tire was manufactured (two digits)

—01 means the year 2001

—Prior to July 2000, tire manufacturers were only required to have one number to represent the year in which the tire was manufactured. Example: 031 could represent the 3rd week of 1981 or 1991

## Tire Loading and Tire Pressure

### Tire Placard Location

**NOTE:** The proper cold tire inflation pressure is listed on either the face of the driver's door or the driver's side B-pillar.

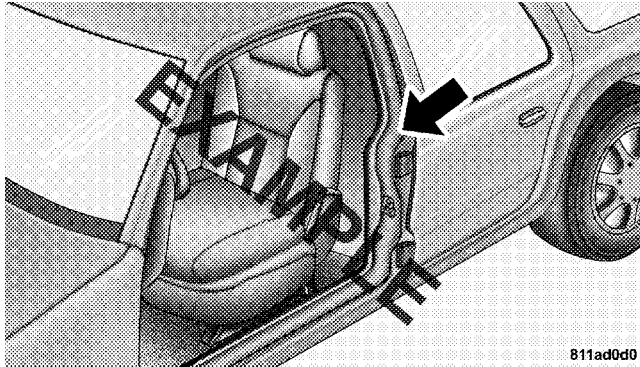

811ad0d0

**Tire Placard Location**

## Tire and Loading Information Placard

TIRE AND LOADING INFORMATION			
SEATING CAPACITY - TOTAL 5		FRONT 2	REAR 3
THE COMBINED WEIGHT OF OCCUPANTS AND CARGO SHOULD NEVER EXCEED XXX KG OR XXX LBS.			
TIRE	FRONT	REAR	SPARE
ORIGINAL TIRE SIZE	P195/70R14	P195/70R14	T125/70D15
COLD TIRE INFLATION PRESSURE	200kPa, 29PSI	200kPa, 29PSI	420kPa, 60PSI
SEE OWNER'S MANUAL FOR ADDITIONAL INFORMATION			4N109268

811b5a9a

### Tire And Loading Information Placard

This placard tells you important information about:

- 1) number of people that can be carried in the vehicle
- 2) total weight your vehicle can carry
- 3) tire size designed for your vehicle
- 4) cold tire inflation pressures for the front, rear, and spare tires.



## Loading

The vehicle maximum load on the tire must not exceed the load carrying capacity of the tire on your vehicle. You will not exceed the tire's load carrying capacity if you adhere to the loading conditions, tire size, and cold tire inflation pressures specified on the Tire and Loading Information placard and in the "Vehicle Loading" section of this manual.

**NOTE:** Under a maximum loaded vehicle condition, gross axle weight ratings (GAWRs) for the front and rear axles must not be exceeded. For further information on GAWRs, vehicle loading, and trailer towing, refer to "Vehicle Loading" in this section.

To determine the maximum loading conditions of your vehicle, locate the statement "The combined weight of occupants and cargo should never exceed XXX kg or XXX lbs." on the Tire and Loading Information placard. The

combined weight of occupants, cargo/luggage and trailer tongue weight (if applicable) should never exceed the weight referenced here.

### *Steps for Determining Correct Load Limit*

1. Locate the statement "The combined weight of occupants and cargo should never exceed XXX kg or XXX lbs" on your vehicle's placard.
2. Determine the combined weight of the driver and passengers that will be riding in your vehicle.
3. Subtract the combined weight of the driver and passengers from XXX kg or XXX lbs.
4. The resulting figure equals the available amount of cargo and luggage load capacity. For example, if "XXX" amount equals 1,400 lbs (635) and there will be five 150 lb (68 kg) passengers in your vehicle, the amount of available cargo and luggage load capacity is 650 lbs (295 kg) (since  $5 \times 150 = 750$ , and  $1400 - 750 = 650$  lbs (295 kg)).

5. Determine the combined weight of luggage and cargo being loaded on the vehicle. That weight may not safely exceed the available cargo and luggage load capacity calculated in Step 4.

6. If your vehicle will be towing a trailer, load from your trailer will be transferred to your vehicle. Consult this manual to determine how this reduces the available cargo and luggage load capacity of your vehicle.

**NOTE:** The following table shows examples on how to calculate total load, cargo/luggage, and towing capacities of your vehicle with varying seating configurations

and number and size of occupants. This table is for illustration purposes only and may not be accurate for the seating and load carry capacity of your vehicle.

**NOTE:** For the following example, the combined weight of occupants and cargo should never exceed 865 lbs (392 kg).

## 322 STARTING AND OPERATING

Occupants			Combined weight of occupants and cargo from Tire Placard	MINUS	Combined Occupant's weight	=	AVAILABLE Cargo/Luggage and Trailer Tongue Weight
TOTAL	FRONT	REAR					
EXAMPLE 1			865 lbs	minus	670 lbs	=	195 lbs
5	2	3					
EXAMPLE 2			865 lbs	minus	540 lbs	=	325 lbs
3	2	1					
EXAMPLE 3			865 lbs	minus	400 lbs	=	465 lbs
2	2	0					

811a4d11

**WARNING!**

Overloading of your tires is dangerous. Overloading can cause tire failure, affect vehicle handling, and increase your stopping distance. Use tires of the recommended load capacity for your vehicle. Never overload them.

**TIRES — GENERAL INFORMATION****Tire Pressure**

Proper tire inflation pressure is essential to the safe and satisfactory operation of your vehicle. Three primary areas are affected by improper tire pressure:

**1. Safety—****WARNING!**

- Improperly inflated tires are dangerous and can cause accidents.
- Under-inflation increases tire flexing and can result in tire failure.
- Over-inflation reduces a tire's ability to cushion shock. Objects on the road and chuckholes can cause damage that result in tire failure.
- Unequal tire pressures can cause steering problems. You could lose control of your vehicle.
- Over-inflated or under-inflated tires can affect vehicle handling and can fail suddenly, resulting in loss of vehicle control.
- Unequal tire pressures from one side of the vehicle to the other can cause the vehicle to drift to the right or left.
- Always drive with each tire inflated to the recommended cold tire inflation pressure.

### 2. *Economy*—

Improper inflation pressures can cause uneven wear patterns to develop across the tire tread. These abnormal wear patterns will reduce tread life resulting in a need for earlier tire replacement. Under-inflation also increases tire rolling resistance and results in higher fuel consumption.

### 3. *Ride Comfort and Vehicle Stability*—

Proper tire inflation contributes to a comfortable ride. Over inflation produces a jarring and uncomfortable ride.

### Tire Inflation Pressures

The proper cold tire inflation pressure is listed either on the face of the driver's door or on the driver's side "B" pillar.

Some vehicles may have Supplemental Tire Pressure Information for vehicle loads that are less than the

maximum loaded vehicle condition. These pressure conditions will be found in the "Supplemental Tire Pressure Information" section of this manual.

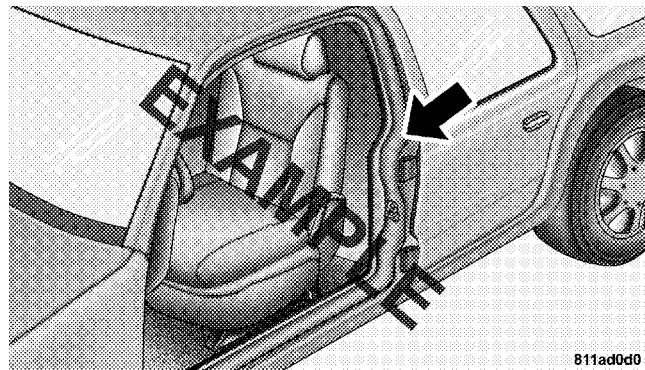

### Tire Placard Location

The pressure should be checked and adjusted as well as inspecting for signs of tire wear or visible damage at least once a month. Use a good quality pocket-type gauge to

check tire pressure. Do not make a visual judgement when determining proper inflation. Radial tires may look properly inflated even when they are under-inflated.

### CAUTION!

**After inspecting or adjusting the tire pressure, always reinstall the valve stem cap (if equipped). This will prevent moisture and dirt from entering the valve stem, which could damage the valve stem.**

Inflation pressures specified on the placard are always “cold tire inflation pressure.” Cold tire inflation pressure is defined as the tire pressure after the vehicle has not been driven for at least three hours, or driven less than 1 mi (1.6 km) after a three hour period. The cold tire inflation pressure must not exceed the maximum inflation pressure molded into the tire sidewall.

Check tire pressures more often if subject to a wide range of outdoor temperatures, as tire pressures vary with temperature changes.

Tire pressures change by approximately 1 psi (7 kPa) per 12°F (7°C) of air temperature change. Keep this in mind when checking tire pressure inside a garage, especially in the winter.

Example: If garage temperature = 68°F (20°C) and the outside temperature = 32°F (0°C) then the cold tire inflation pressure should be increased by 3 psi (21 kPa), which equals 1 psi (7 kPa) for every 12 °F (7°C) for this outside temperature condition.

Tire pressure may increase from 2 to 6 psi (13 to 40 kPa) during operation. DO NOT reduce this normal pressure build up or your tire pressure will be too low.

### **Tire Pressures for High Speed Operation**

The manufacturer advocates driving at safe speeds within posted speed limits. Where speed limits or conditions are such that the vehicle can be driven at high speeds, maintaining correct tire inflation pressure is very important. Increased tire pressure and reduced vehicle loading may be required for high-speed vehicle operation. Refer to original equipment or an authorized tire dealer for recommended safe operating speeds, loading and cold tire inflation pressures.

#### **WARNING!**

**High speed driving with your vehicle under maximum load is dangerous. The added strain on your tires could cause them to fail. You could have a serious accident. Don't drive a vehicle loaded to the maximum capacity at continuous speeds above 75 mph (120 km/h).**

### **Radial Ply Tires**

#### **WARNING!**

**Combining radial ply tires with other types of tires on your vehicle will cause your vehicle to handle poorly. The instability could cause an accident. Always use radial ply tires in sets of four (or six, in case of trucks with dual rear wheels). Never combine them with other types of tires.**

Cuts and punctures in radial tires are repairable only in the tread area because of sidewall flexing. Consult your authorized tire dealer for radial tire repairs.

### Compact Spare Tire — If Equipped

The compact spare is for temporary emergency use with radial tires. It is engineered to be used on your style vehicle only. Since this tire has limited tread life, the original tire should be repaired (or replaced) and reinstalled at the first opportunity.

#### WARNING!

Temporary use spare tires are for emergency use only. With these tires, do not drive more than 50 mph (80 km/h). Temporary use spare tires have limited tread life. When the tread is worn to the tread wear indicators, the temporary use spare tire needs to be replaced. Be sure to follow the warnings which apply to your spare. Failure to do so could result in spare tire failure and loss of vehicle control.

Do not install a wheel cover or attempt to mount a conventional tire on the compact spare wheel, since the wheel is designed specifically for the compact spare.

Do not install more than one compact spare tire/wheel on the vehicle at any given time.

#### CAUTION!

Because of the reduced ground clearance, do not take your vehicle through an automatic car wash with the compact spare installed. Damage to the vehicle may result.

### Limited-Use Spare — If Equipped

The limited-use spare tire is for temporary emergency use on your vehicle. This tire is identified by a limited-use spare tire warning label located on the limited-use spare tire and wheel assembly. This tire may look like the



original equipped tire on the front or rear axle of your vehicle, but it is not. Installation of this limited-use spare tire affects vehicle handling. Since it is not the same tire, replace (or repair) the original tire and reinstall on the vehicle at the first opportunity.

**WARNING!**

**The limited-use spare tires are for emergency use only. Installation of this limited-use spare tire affects vehicle handling. With this tire, do not drive more than 50 mph (80 km/h). Keep inflated to the cold tire inflation pressure listed on either your tire placard or limited-use spare tire and wheel assembly. Replace (or repair) the original tire at the first opportunity and reinstall it on your vehicle. Failure to do so could result in loss of vehicle control.**

**Tire Spinning**

When stuck in mud, sand, snow, or ice conditions, do not spin your vehicle's wheels faster than 30 mph (48 km/h) or for longer than 30 seconds continuously without stopping when you are stuck.

For additional information, refer to "Freeing A Stuck Vehicle" in Section 6.

**WARNING!**

**Fast spinning tires can be dangerous. Forces generated by excessive wheel speeds may cause tire damage or failure. A tire could explode and injure someone. Do not spin your vehicle's wheels faster than 30 mph (48 km/h) or for more than 30 seconds continuously when you are stuck, and don't let anyone near a spinning wheel, no matter what the speed.**

### Tread Wear Indicators

Tread wear indicators are in the original equipment tires to help you in determining when your tires should be replaced.

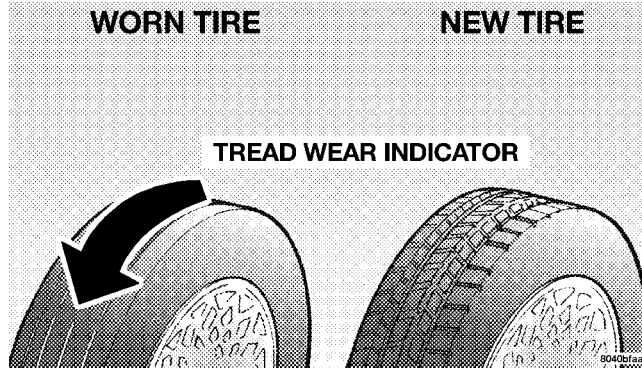

These indicators are molded into the bottom of the tread grooves. They will appear as bands when the tread depth becomes  $1/16$  in (2 mm). When the tread is worn to the tread wear indicators, the tire should be replaced.

Many states have laws requiring tire replacement at this point.

### Life of Tire

The service life of a tire is dependent upon varying factors including but not limited to:

- Driving style
- Tire pressure
- Distance driven

**WARNING!**

**Tires and spare tire should be replaced after six years, regardless of the remaining tread. Failure to follow this warning can result in sudden tire failure. You could lose control and have an accident resulting in serious injury or death.**

Keep dismounted tires in a cool, dry place with as little exposure to light as possible. Protect tires from contact with oil, grease, and gasoline.

**Replacement Tires**

The tires on your new vehicle provide a balance of many characteristics. They should be inspected regularly for wear and correct cold tire inflation pressure. The manufacturer strongly recommends that you use tires equivalent to the originals in size, quality and performance when replacement is needed (refer to the paragraph on “Tread Wear Indicators”). Refer to the “Tire and Loading Information” placard for the size designation of your tire. The service description and load identification will be found on the original equipment tire. Failure to use equivalent replacement tires may adversely affect the safety, handling, and ride of your vehicle. We recommend that you contact your original equipment or an authorized tire dealer with any questions you may have on tire specifications or capability.

**WARNING!**

- Do not use a tire, wheel size or rating other than that specified for your vehicle. Some combinations of unapproved tires and wheels may change suspension dimensions and performance characteristics, resulting in changes to steering, handling, and braking of your vehicle. This can cause unpredictable handling and stress to steering and suspension components. You could lose control and have an accident resulting in serious injury or death. Use only the tire and wheel sizes with load ratings approved for your vehicle.
- Never use a tire with a smaller load index or capacity, other than what was originally equipped on your vehicle. Using a tire with a smaller load index could result in tire overloading and failure. You could lose control and have an accident.
- Failure to equip your vehicle with tires having adequate speed capability can result in sudden tire failure and loss of vehicle control.

**CAUTION!**

Replacing original tires with tires of a different size may result in false speedometer and odometer readings.

**Alignment and Balance**

Poor suspension alignment may result in:

- Fast tire wear.
- Uneven tire wear, such as feathering and one-sided wear.
- Vehicle pull to right or left.

Tires may also cause the vehicle to pull to the left or right. Alignment will not correct this condition. See your authorized dealer for proper diagnosis.

Improper alignment will not cause vehicle vibration. Vibration may be a result of tire and wheel out-of-balance. Proper balancing will reduce vibration and avoid tire cupping and spotty wear.

### **SUPPLEMENTAL TIRE PRESSURE INFORMATION — IF EQUIPPED**

A light load vehicle condition is defined as two passengers [150 lbs (68 kg) each] plus 200 lbs (91 kg) of cargo. Cold tire inflation pressures for a lightly loaded vehicle will be found on the face of the driver's door.

### **TIRE CHAINS**

Use "Class S" chains on your vehicle, or other traction aids that meet SAE Type "S" specifications.

**NOTE:** Chains must be the proper size for the vehicle, as recommended by the chain manufacturer.

### **CAUTION!**

To avoid damage to your vehicle, tires or chains, observe the following precautions:

- Because of limited chain clearance between tires and other suspension components, it is important that only chains in good condition are used. Broken chains can cause serious vehicle damage. Stop the vehicle immediately if noise occurs that could suggest chain breakage. Remove the damaged parts of the chain before further use.
- Install chains as tightly as possible and then retighten after driving about 1/2 mile (0.8 km).
- Do not exceed 45 mph (72 km/h).
- Drive cautiously and avoid severe turns and large bumps, especially with a loaded vehicle.
- Do not install tire chains on front wheels of 4x2 vehicles.
- Do not drive for a prolonged period on dry pavement.
- Observe the tire chain manufacturer's instructions on method of installation, operating speed, and conditions for usage. Always use the lower suggested operating speed of the chain manufacturer if different than the speed recommended by the manufacturer.

These cautions apply to all chain traction devices, including link and cable (radial) chains.

Tire chain use is permitted only on the rear tires of your truck.

**NOTE:** The use of class “S” chains is permitted on your vehicle with P245/70R17 tires.

### **CAUTION!**

**Do not use tire chains on 4x4 trucks equipped with tires other than P245/70R17 tires. There may not be adequate clearance for the chains and you are risking structural or body damage to your vehicle. Do not use tire chains on the 4X2 front wheels of your vehicle. There may not be adequate clearance for the chains and you are risking structural or body damage to your vehicle.**

### **SNOW TIRES**

Snow tires should be of the same size and type construction as the front tires. Consult the manufacturer of the snow tire to determine any maximum vehicle speed requirement associated with the tire. These tires should always be operated at the vehicle maximum capacity inflation pressures under any load condition.

While studded tires improve performance on ice, skid and traction capability on wet or dry surfaces may be poorer than that of non-studded tires. Some states prohibit studded tires; therefore, local laws should be checked before using these tire types.

### TIRE ROTATION RECOMMENDATIONS

Tires on the front and rear axles of vehicles operate at different loads and perform different steering, driving, and braking functions. For these reasons, they wear at unequal rates and tend to develop irregular wear patterns. These effects can be reduced by timely rotation of tires. The benefits of rotation are especially worthwhile with aggressive tread designs such as those on all season type tires. Rotation will increase tread life, help to maintain mud, snow and wet traction levels, and contribute to a smooth, quiet ride.

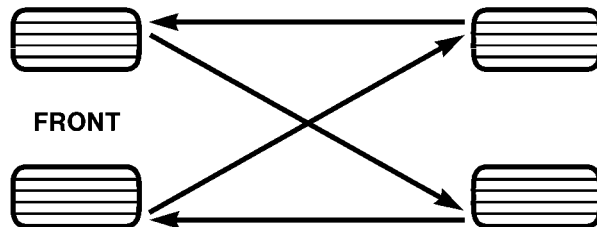

8031e864

Follow the recommended tire rotation frequency for your type of driving found in the “Maintenance Schedules” Section of this manual. More frequent rotation is permissible if desired. The reasons for any rapid or unusual wear should be corrected prior to rotation being performed.

## TIRE PRESSURE MONITOR SYSTEM (TPMS) — IF EQUIPPED

The Tire Pressure Monitoring System (TPMS) will warn the driver of a low tire pressure based on the vehicle recommended cold placard pressure (the placard is located on the driver's side B-pillar).

The tire pressure will vary with temperature by about 1 psi (6.9 kPa) for every 12°F (6.5°C). This means that when the outside temperature decreases, the tire pressure will decrease. Tire pressure should always be set based on cold inflation tire pressure. This is defined as the tire pressure after a vehicle has not been driven for more than three hours - and in outside ambient temperature. **Refer to the “Tires – General Information” in this section for information on how to properly inflate the vehicle's tires.** The tire pressure will also increase as the vehicle is driven - this is normal and there should be no adjustment for this increased pressure.

TPMS will warn the driver of a low tire pressure if the tire pressure falls below the low pressure warning threshold for any reason, including low temperature effects, or natural pressure loss through the tire.

The TPMS will continue to warn the driver of low tire pressure as long as the condition exists, and will not turn off until the tire pressure is at or above recommended cold placard pressure. Once the low tire pressure warning has been illuminated, the tire pressure must be increased to the recommended cold placard pressure in order for the TPMS warning light to be turned off. The system will automatically update and the TPMS warning light will extinguish once the updated tire pressures have been received. The vehicle may need to be driven for up to 10 minutes above 15 mph (25 km/h) to receive this information.



For example, your vehicle has a recommended cold (parked for more than three hours) placard pressure of 33 psi (227 kPa). If the ambient temperature is 68°F (20°C) and the measured tire pressure is 28 psi (193 kPa), a temperature drop to 20°F (-7°C) will decrease the tire pressure to approximately 24 psi (165 kPa). This tire pressure is sufficiently low enough to turn on the TPMS light. Driving the vehicle may cause the tire pressure to rise to approximately 28 psi (193 kPa), but the TPMS light will still be ON. In this situation, the TPMS light will turn off only after the tires have been inflated to the vehicle's recommended cold placard pressure value.

### CAUTION!

**The TPMS has been optimized for the original equipment tires and wheels. TPMS pressures have been established for the tire size equipped on your vehicle. Undesirable system operation or sensor damage may result when using replacement equipment that is not of the same size, type, and/or style. Aftermarket wheels can cause sensor damage. Do not use aftermarket tire sealants or balance beads if your vehicle is equipped with a TPMS, as damage to the sensors may result.**

**CAUTION!**

**After inspecting or adjusting the tire pressure always reinstall the valve stem cap. This will prevent moisture and dirt from entering the valve stem, which could damage the tire pressure monitoring sensor.**

**NOTE:**

- The TPMS is not intended to replace normal tire care and maintenance, or to provide warning of a tire failure or condition.
- The TPMS should not be used as a tire pressure gauge while adjusting your tire pressure.
- Driving on a significantly under-inflated tire causes the tire to overheat and can lead to tire failure.

Under-inflation also reduces fuel efficiency and tire tread life, and may affect the vehicle's handling and stopping ability.

- The TPMS is not a substitute for proper tire maintenance, and it is the driver's responsibility to maintain correct tire pressure using an accurate tire gauge, even if under-inflation has not reached the level to trigger illumination of the Tire Pressure Monitoring Telltale Lamp.
- Seasonal temperature changes will affect tire pressure, and the TPMS will monitor the actual tire pressure in the tire.

**Base System – If Equipped**

The Tire Pressure Monitor System (TPMS) uses wireless technology with wheel rim mounted electronic sensors to monitor tire pressure levels. Sensors, mounted to each wheel as part of the valve stem, transmit tire pressure readings to the receiver module.

**NOTE:** It is particularly important for you to check the tire pressure in all of your tires regularly and to maintain the proper pressure.

The TPMS consists of the following components:

- Receiver module
- Four tire pressure monitoring sensors
- Tire Pressure Monitoring Telltale Lamp

 The Tire Pressure Monitoring Telltale Lamp will illuminate in the instrument cluster, and an audible chime will be activated when one or more of the four active road tire pressures are low. Should this occur, you should stop as soon as possible, check the inflation pressure of each tire on your vehicle, and inflate each tire to the vehicle's recommended cold placard pressure value. The system will automatically update and the Tire Pressure Monitoring Telltale Lamp will extinguish once the updated tire pressures have been

received. The vehicle may need to be driven for up to 10 minutes above 15 mph (25 km/h) to receive this information.

The Tire Pressure Monitoring Telltale Lamp will flash on and off for 75 seconds, and remain on solid when a system fault is detected. The system fault will also sound a chime. If the ignition key is cycled, this sequence will repeat, providing the system fault still exists. The Tire Pressure Monitoring Telltale Lamp will turn off when the fault condition no longer exists. A system fault can occur by any of the following scenarios: 1) Jamming due to electronic devices or driving next to facilities emitting the same radio frequencies as the TPM sensors; 2) Installing some form of aftermarket window tinting that affects radio wave signals; 3) Lots of snow or ice around the wheels or wheel housings; 4) Using tire chains on the vehicle; 5) Using wheels/tires not equipped with TPM sensors.

**NOTE:** Your vehicle is equipped with a non-matching full size spare wheel and tire assembly.

1. This spare tire does not have a tire pressure monitoring sensor. Therefore, the TPMS will not monitor the tire pressure in the spare tire.
2. If you install the full size spare tire in place of a road tire that has a pressure below the low-pressure warning limit, upon the next ignition key cycle a chime will sound and the TPM Telltale Lamp will still turn ON due to the low tire.
3. However, after driving the vehicle for up to 10 minutes above 15 mph (25 km/h), the TPM Telltale Lamp will flash on and off for 75 seconds and then remain on solid.
4. For each subsequent ignition key cycle, a chime will sound and the TPM Telltale Light will flash on and off for 75 seconds and then remain on solid.

5. Once you repair or replace the original road tire, and reinstall it on the vehicle in place of the full size spare tire, the TPMS will update automatically and the TPM Telltale Lamp will turn OFF, as long as no tire pressure is below the low-pressure warning limit in any of the four active road tires. The vehicle may need to be driven for up to 10 minutes above 15 mph (25 km/h) in order for the TPMS to receive this information.

#### **Premium System – If Equipped**

The Tire Pressure Monitor System (TPMS) uses wireless technology with wheel rim mounted electronic sensors to monitor tire pressure levels. Sensors, mounted to each wheel as part of the valve stem, transmit tire pressure readings to the receiver module.

**NOTE:** It is particularly important for you to check the tire pressure in all of your tires regularly and to maintain the proper pressure.

The TPMS consists of the following components:

- Receiver module
- Four tire pressure monitoring sensors
- Three trigger modules (mounted in three of the four wheel wells).
- Various TPMS messages, which display in the Electronic Vehicle Information Center (EVIC), and a graphic displaying tire pressures.
- Yellow Tire Pressure Monitoring Telltale Light.

### **Tire Pressure Monitoring Low Pressure Warnings**

The Tire Pressure Monitoring Telltale Light will illuminate in the instrument cluster, and an audible chime will be activated when one or more of the four active road tire pressures are low. In addition, the EVIC will display a graphic of the pressure value(s) with the low tire(s) flashing.

Should a low tire condition occur on any of the four active road tire(s), you should stop as soon as possible, and inflate the low tire(s) that is flashing on the graphic display to the vehicle's recommended cold placard pressure value. The system will automatically update, the graphic display of the pressure value(s) will stop flashing, and the Tire Pressure Monitoring Telltale Light will extinguish once the updated tire pressure(s) have been received. The vehicle may need to be driven for up to 10 minutes above 15 mph (25 km/h) to receive this information.

### **Check TPMS Message**

The Tire Pressure Monitoring Telltale Light will flash on and off for 75 seconds, and remain on solid when a system fault is detected. The system fault will also sound a chime. The EVIC will display a "CHECK TPM SYSTEM" message for three seconds. This text message is then followed by a graphic display, with "- - -" in place of

the pressure value(s) indicating which tire pressure monitoring sensor(s) is not being received.

If the ignition key is cycled, this sequence will repeat, providing the system fault still exists. If the system fault no longer exists, the Tire Pressure Monitoring Telltale Light will no longer flash, the "CHECK TPM SYSTEM" text message will not be present, and a pressure value will be displayed instead of dashes. A system fault can occur by any of the following scenarios: 1) Jamming due to electronic devices or driving next to facilities emitting the same radio frequencies as the TPM sensors; 2) Installing some form of aftermarket window tinting that affects radio wave signals; 3) Lots of snow or ice around the wheels or wheel housings; 4) Using tire chains on the vehicle; 5) Using wheels/tires not equipped with TPM sensors.

**NOTE:** Your vehicle is equipped with a non-matching full size spare wheel and tire assembly.

1. This spare tire does not have a tire pressure monitoring sensor. Therefore, the TPMS will not monitor the tire pressure in the spare tire.
2. If you install the full size spare tire in place of a road tire that has a pressure below the low-pressure warning limit, upon the next ignition key cycle, a chime will sound and the TPM Telltale Light will still turn ON. In addition, the graphic in the EVIC will still display a flashing pressure value.
3. However, after driving the vehicle for up to 10 minutes above 15 mph (25 km/h), the TPM Telltale Light will flash on and off for 75 seconds and then remain on solid. The EVIC will display a "CHECK TPM SYSTEM" message for three seconds and then display dashes (- - -) in place of the pressure value.
4. For each subsequent ignition key cycle, a chime will sound and the TPM Telltale Light will flash on and off for 75 seconds and then remain on solid. The EVIC will

display a “CHECK TPM SYSTEM” message for three seconds, and then display dashes (- - -) in place of a pressure value.

5. Once you repair or replace the original road tire, and reinstall it on the vehicle in place of the full size spare tire, the TPMS will update automatically. In addition, the TPM Telltale Light will turn OFF and the graphic in the EVIC will display a new pressure value instead of dashes (- - -), as long as no tire pressure is below the low-pressure warning limit in any of the four active road tires. The vehicle may need to be driven for up to 10 minutes above 15 mph (25 km/h) in order for the TPMS to receive this information.

### General Information

This device complies with part 15 of the FCC rules and RSS 210 of Industry Canada. Operation is subject to the following conditions:

- This device may not cause harmful interference.

- This device must accept any interference received, including interference that may cause undesired operation.

The tire pressure sensors are covered under one of the following licenses:

United States . . . . . KR5S120123  
Canada . . . . . 2671-S120123

### FUEL REQUIREMENTS



All engines (except 5.7L engines) are designed to meet all emissions regulations and provide excellent fuel economy and performance when using high quality unleaded “regular” gasoline having an octane rating of 87. The use of premium gasoline is not recommended. Under normal conditions, the use of premium gasoline will not provide a benefit over high quality regular gasolines, and in some circumstances may result in poorer performance.



The 5.7L engine is designed to meet all emissions regulations and provide satisfactory fuel economy and performance when using high quality unleaded gasoline having an octane range of 87 to 89. The manufacturer recommends the use of 89 octane for optimum performance. The use of premium gasoline is not recommended. Under normal conditions, the use of premium gasoline will not provide a benefit over high quality regular and mid-grade gasolines, and in some circumstances may result in poorer performance.

Light spark knock at low engine speeds is not harmful to your engine. However, continued heavy spark knock at high speeds can cause damage and immediate service is required. Poor quality gasoline can cause problems such as hard starting, stalling, and hesitations. If you experience these symptoms, try another brand of gasoline before considering service for the vehicle.

Over 40 auto manufacturers worldwide have issued and endorsed consistent gasoline specifications (the Worldwide Fuel Charter, WWFC) which define fuel properties necessary to deliver enhanced emissions, performance, and durability for your vehicle. The manufacturer recommends the use of gasoline that meets the WWFC specifications if they are available.

### Reformulated Gasoline

Many areas of the country require the use of cleaner burning gasoline referred to as "Reformulated Gasoline." Reformulated gasolines contain oxygenates, and are specifically blended to reduce vehicle emissions and improve air quality.

We strongly support the use of reformulated gasolines. Properly blended reformulated gasolines will provide excellent performance and durability for the engine and fuel system components.



### Gasoline/Oxygenate Blends

Some fuel suppliers blend unleaded gasoline with oxygenates such as 10% ethanol, MTBE and ETBE. Oxygenates are required in some areas of the country during the winter months to reduce carbon monoxide emissions. Fuels blended with these oxygenates may be used in your vehicle.

#### CAUTION!

**DO NOT use gasoline containing Methanol or E85 Ethanol. Use of these blends may result in starting and driveability problems and may damage critical fuel system components.**

**NOTE: 4.7L Engine — If Equipped**, is now rated for E85 Ethanol use. Only vehicles with the E-85 fuel filler door label can operate on E-85. For more information, refer to “Flexible Fuel” in this section.

Problems that result from using methanol/gasoline or E85 Ethanol blends are not the responsibility of the manufacturer. While MTBE is an oxygenate made from Methanol, it does not have the negative effects of Methanol.

### MMT In Gasoline

MMT is a manganese containing metallic additive that is blended into some gasoline to increase octane. Gasoline blended with MMT provides no performance advantage beyond gasoline of the same octane number without MMT. Gasoline blended with MMT reduces spark plug life and reduces emission system performance in some vehicles. The manufacturer recommends that gasoline without MMT be used in your vehicle. The MMT content

of gasoline may not be indicated on the gasoline pump, therefore, you should ask your gasoline retailer whether or not his/her gasoline contains MMT. It is even more important to look for gasolines without MMT in Canada, because MMT can be used at levels higher than those allowed in the United States. MMT is prohibited in Federal and California reformulated gasoline.

### Materials Added To Fuel

All gasolines sold in the United States are required to contain effective detergent additives. Use of additional detergents or other additives is not needed under normal conditions and would result in unnecessary cost. Therefore, you should not have to add anything to the fuel.

## Fuel System Cautions

### CAUTION!

Follow these guidelines to maintain your vehicle's performance:

- The use of leaded gas is prohibited by Federal law. Using leaded gasoline can impair engine performance, damage the emission control system.
- An out-of-tune engine, or certain fuel or ignition malfunctions, can cause the catalytic converter to overheat. If you notice a pungent burning odor or some light smoke, your engine may be out of tune or malfunctioning and may require immediate service. Contact your authorized dealer for service assistance.
- When pulling a heavy load or driving a fully loaded vehicle when the humidity is low and the temperature is high, use a premium unleaded fuel to help prevent spark knock. If spark knock persists, lighten the load, or engine piston damage may result.
- The use of fuel additives which are now being sold as octane enhancers is not recommended. Many of these products contain high concentrations of methanol. Fuel system damage or vehicle performance problems resulting from the use of such fuels or additives is not the responsibility of the manufacturer.

**NOTE:** Intentional tampering with emissions control systems can result in civil penalties being assessed against you.

### Carbon Monoxide Warnings

#### **WARNING!**

**Carbon monoxide (CO) in exhaust gases is deadly. Follow the precautions below to prevent carbon monoxide poisoning:**

- **Do not inhale exhaust gases. They contain carbon monoxide, a colorless and odorless gas which can kill. Never run the engine in a closed area, such as a garage, and never sit in a parked vehicle with the engine running for an extended period. If the vehicle is stopped in an open area with the engine running for more than a short period, adjust the ventilation system to force fresh, outside air into the vehicle.**
- **Guard against carbon monoxide with proper maintenance. Have the exhaust system inspected every time the vehicle is raised. Have any abnormal conditions repaired promptly. Until repaired, drive with all side windows fully open.**
- **Keep the liftgate closed when driving your vehicle to prevent carbon monoxide and other poisonous exhaust gases from entering the vehicle.**

## ADDING FUEL

### Fuel Filler Cap (Gas Cap)

The gas cap is behind the fuel filler door. If the gas cap is lost or damaged, be sure the replacement cap is for use with this vehicle.

**NOTE:** To avoid contact between fuel cap and paint, hang tether strap over hook provided on inner fuel door.

#### CAUTION!

**Damage to the fuel system or emission control system could result from using an improper fuel tank filler tube cap (gas cap). A poorly fitting cap could let impurities into the fuel system.**

#### CAUTION!

**A poorly fitting gas cap may cause the Malfunction Indicator Light to turn on.**

#### CAUTION!

**To avoid fuel spillage and overfilling, do not “top off” the fuel tank after filling.**

**NOTE:** When the fuel nozzle “clicks” or shuts off, the fuel tank is full.

**WARNING!**

- Never have any smoking materials lit in or near the vehicle when the gas cap is removed or the tank filled.
- Never add fuel when the engine is running. This is in violation of most state and federal fire regulations and may cause the Malfunction Indicator Light to turn on.

**NOTE:** Tighten the gas cap about 1/4 turn until you hear one click. This is an indication that cap is properly tightened.

If the gas cap is not tightened properly, the Malfunction Indicator Light will come on. Be sure the gas cap is tightened every time the vehicle is refueled.

**WARNING!**

A fire may result if gasoline is pumped into a portable container that is inside of a vehicle. You could be burned. Always place gas containers on the ground while filling.

**Loose Fuel Filler Cap (Gas Cap) Message**

After fuel is added, the vehicle diagnostic system can determine if the fuel filler cap is loose, improperly installed, or damaged. A loose fuel filler cap message will be displayed in the instrument cluster. Tighten the gas cap until a "clicking" sound is heard. This is an indication that the gas cap is properly tightened. Press the odometer RESET button to turn the message off. If the problem persists, the message will appear the next time the vehicle is started. This might indicate a damaged cap. If

the problem is detected twice in a row, the system will turn on the Malfunction Indicator Light (MIL). Resolving the problem will turn the MIL light off.

### CAUTION!

Damage to the fuel system or emission control system could result from using an improper fuel tank filler cap (gas cap). A poorly fitting cap could let impurities into the fuel system.

## FLEXIBLE FUEL — IF EQUIPPED

### E-85 General Information

The information in this section is for Flexible Fuel vehicles only. These vehicles can be identified by the unique yellow fuel filler cap (gas cap) that shows E85 / Gasoline. This section only covers those subjects that are unique to these vehicles. Please refer to the other sections of this

manual for information on features that are common between Flexible Fuel and gasoline-only powered vehicles.

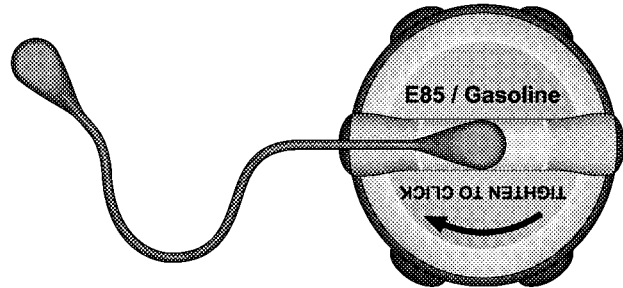

81ae46ab

E-85 Fuel Cap

**CAUTION!**

Only vehicles with the E-85 fuel filler cap (gas cap) can operate on E-85.



81ae46a9

E-85 Badge

**ETHANOL FUEL (E-85)**

E-85 is a mixture of approximately 85% fuel ethanol and 15% unleaded gasoline.

**WARNING!**

Ethanol vapors are extremely flammable and could cause serious personal injury. Never have any smoking materials lit in or near the vehicle when removing the fuel filler tube cap (gas cap) or filling the tank. Do not use E-85 as a cleaning agent and never use it near an open flame.

**Fuel Requirements**

Your vehicle will operate on both unleaded gasoline with an octane rating of 87, or E-85 fuel, or any mixture of these two.

For best results, a refueling pattern that alternates between E-85 and unleaded gasoline should be avoided. When you do switch fuels, it is recommended that you:

- do not switch when the fuel gauge indicates less than 1/4 full
- do not add less than five gallons (19 Liters) when refueling
- operate the vehicle immediately after refueling for a period of at least five minutes

Observing these precautions will avoid possible hard starting and/or significant deterioration in drivability during warm up.

**NOTE:** When the ambient temperature is above 90°F (32°C), you may experience hard starting and rough idle following startup, even if the above recommendations are followed.

### **Selection Of Engine Oil For Flexible Fuel Vehicles (E-85) and Gasoline Vehicles**

FFV vehicles operated on E-85 require specially formulated engine oils. These special requirements are included in Mopar® engine oils, and in equivalent oils meeting DaimlerChrysler Specification MS-6395. The manufacturer only recommends engine oils that are API Certified and meet the requirements of Material Standard MS-6395. MS-6395 contains additional requirements, developed during extensive fleet testing, to provide additional protection to DaimlerChrysler Corporation engines. Use Mopar® or an equivalent oil meeting the specification MS-6395.

### **Starting**

The characteristics of E-85 fuel make it unsuitable for use when ambient temperatures fall below 0°F (-18°C). In the range of 0°F (-18°C) to 32°F (0°C), you may experience an



increase in the time it takes for your engine to start, and a deterioration in drivability (sags and/or hesitations) until the engine is fully warmed up.

**CAUTION!**

**Do not use ethanol mixture greater than 85% in your vehicle. It will cause difficulty in cold starting and may affect drivability.**

**Cruising Range**

Because E-85 fuel contains less energy per gallon/Liter than gasoline, you will experience an increase in fuel consumption. You can expect your miles per gallon (mpg)/miles per liter and your driving range to decrease by about 30%, compared to gasoline operation.

**Replacement Parts**

Many components in your Flexible Fuel Vehicle (FFV) are designed to be compatible with ethanol. Always be sure that your vehicle is serviced with correct ethanol, compatible parts.

**CAUTION!**

**Replacing fuel system components with non-ethanol compatible components can damage your vehicle.**

**VEHICLE LOADING****Certification Label**

As required by National Highway Traffic Safety Administration Regulations, your vehicle has a certification label affixed to the driver's side door.

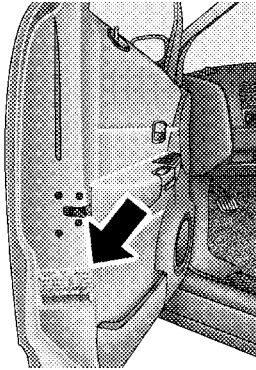

**Certification Label**

8120c1d2

This label contains the month and year of manufacture, Gross Vehicle Weight Rating (GVWR), Gross Axle Weight Rating (GAWR) front and rear, and Vehicle Identification Number (VIN). A Month-Day-Hour (MDH) number is included on this label and shows the month, day, and

hour of manufacture. The bar code that appears on the bottom of the label is your Vehicle Identification Number (VIN).

### **Gross Vehicle Weight Rating (GVWR)**

The GVWR is the total permissible weight of your vehicle including driver, passengers, vehicle, options, and cargo. The label also specifies maximum capacities of front and rear axle systems. Total load must be limited so that GVWR is not exceeded.

### **Payload**

The payload of a vehicle is defined as the allowable load weight a vehicle can carry including the weight of the driver, all passengers, options, and cargo.

### **Gross Axle Weight Rating (GAWR)**

The GAWR is the maximum permissible load on the front and rear axles. The load must be distributed in the cargo area so that the GAWR of each axle is not exceeded.

Each axle GAWR is determined by the component in the system with the lowest load carrying capacity (axle, springs, tires, or wheels).

Heavier axles or suspension components sometimes specified by purchasers for increased durability do not necessarily increase the vehicle's GVWR.

**Tire Size**

This is the minimum allowable tire size for your vehicle. Replacement tires must be equal to the load capacity of this tire size.

**Rim Size**

This is the rim size that is appropriate for the tire size listed.

**Inflation Pressure (Cold)**

This is the cold tire inflation pressure for your vehicle for all loading conditions up to full GAWR.

**Curb Weight**

The curb weight of a vehicle is defined as the total weight of the vehicle with all fluids, including vehicle fuel, at full capacity conditions, and with no occupants or cargo loaded into the vehicle. The front and rear curb weight values are determined by weighing your vehicle on a commercial scale before any occupants or cargo are added.

**Loading**

The actual total weight and the weight of the front and rear of your vehicle at the ground can best be determined by weighing it when it is loaded and ready for operation.

The entire vehicle should first be weighed on a commercial scale to ensure that the GVWR has not been exceeded. The weight on the front and rear of the vehicle should then be determined separately to be sure that the load is properly distributed over front and rear axle. Weighing the vehicle may show that the GAWR of either

the front or rear axles has been exceeded but the total load is within the specified GVWR. If so, weight must be shifted from front to rear or rear to front as appropriate until the specified weight limitations are met.

Store heavier items down low and be sure that the weight is distributed equally. Stow all loose items securely before driving.

Improper weight distribution can have an adverse effect on the way your vehicle steers and handles and the way the brakes operate.

### WARNING!

**Do not load your vehicle any heavier than the GVWR or the maximum front and rear GAWR. If you do, parts on your vehicle can break, or it can change the way your vehicle handles. This could cause you to lose control. Also, overloading can shorten the life of your vehicle.**

A loaded vehicle is shown in the following example. Note that neither GVWR nor GAWR capabilities are exceeded. Overloading can cause potential safety hazards and shorten service life.

**NOTE: The weights shown in this chart are not the weights for your vehicle. Also, the amount of load added to both the front and rear axles can be computed**

after the vehicle has been weighed both in its "curb weight" condition, and in its "loaded and ready for operation" condition.

**Gross Vehicle Weight Rating (GVWR) 6500 LBS.**

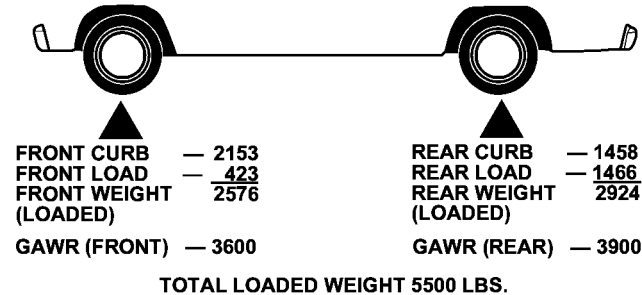

8120c425

## TRAILER TOWING

In this section you will find safety tips and information on limits to the type of towing you can reasonably do with your vehicle. Before towing a trailer carefully review this information to tow your load as efficiently and safely as possible.

To maintain warranty coverage, follow the requirements and recommendations in this manual concerning vehicles used for trailer towing.

### Common Towing Definitions

The following trailer towing related definitions will assist you in understanding the following information:

#### Gross Vehicle Weight Rating (GVWR)

The GVWR is the total allowable weight of your vehicle. This includes driver, passengers, cargo and tongue weight. The total load must be limited so that you do not exceed the GVWR.

### **Gross Trailer Weight (GTW)**

The Gross Trailer Weight (GTW) is the weight of the trailer plus the weight of all cargo, consumables and equipment (permanent or temporary) loaded in or on the trailer in its "loaded and ready for operation" condition. The recommended way to measure GTW is to put your fully loaded trailer on a vehicle scale. The entire weight of the trailer must be supported by the scale.

### **Gross Combination Weight Rating (GCWR)**

The Gross Combination Weight Rating (GCWR) is the total permissible weight of your vehicle and trailer when weighed in combination. (Note that GCWR ratings include a 150 lbs (68 kg) allowance for the presence of a driver.)

### **Gross Axle Weight Rating (GAWR)**

The GAWR is the maximum capacity of the front and rear axles. Distribute the load over the front and rear axles evenly. Make sure that you do not exceed either front or rear GAWR.

#### **WARNING!**

**It is important that you do not exceed the maximum front or rear GAWR. A dangerous driving condition can result if either rating is exceeded. You could lose control of the vehicle and have an accident.**

**Tongue Weight (TW)**

The downward force exerted on the hitch ball by the trailer is the tongue weight. In most cases it should not be less than 10% or more than 15% of the trailer load. You must consider this as part of the load on your vehicle.

**Frontal Area**

The maximum height and maximum width of the front of a trailer.

**TSC (Trailer Sway Control) – If Equipped**

- **Trailer Sway Control – Electronic**

TSC uses sensors in the vehicle to recognize a swaying trailer and will take the appropriate actions to attempt to stop the sway. The system will reduce engine power and apply individual brakes that will counteract the sway of the trailer. TSC will become active automatically once the swaying trailer is recognized. No driver action is required. TSC cannot stop all trailers from swaying. Always use caution when towing a trailer and follow the tongue weight recommendations. Even if your vehicle is equipped with electronic TSC, mechanical sway control is recommended when appropriate for the size of your trailer.

- **Trailer Sway Control – Mechanical**

The trailer sway control is a telescoping link that can be installed between the hitch receiver and the trailer tongue that typically provides adjustable friction associated with the telescoping motion to dampen any unwanted trailer swaying motions while traveling.

**Weight-Carrying Hitch**

A weight-carrying hitch supports the trailer tongue weight, just as if it were luggage located at a hitch ball or some other connecting point of the vehicle. These kind of hitches are the most popular on the market today and they're commonly used to tow small- and medium-sized trailers.

**Weight-Distributing Hitch**

A weight-distributing system works by applying leverage through spring (load) bars. They are typically used for heavier loads, to distribute trailer tongue weight to the tow vehicle's front axle and the trailer axle(s). When used in accordance with the manufacturers' directions, it provides for a more level ride, offering more consistent steering and brake control thereby enhancing towing safety. The addition of a friction/hydraulic sway control also dampens sway caused by traffic and crosswinds and contributes positively to tow vehicle and trailer stability. Trailer sway control and a weight distributing (load equalizing) hitch are recommended for heavier tongue weights and may be required depending on vehicle and trailer configuration/loading to comply with Gross Axle Weight Rating (GAWR) requirements.



**WARNING!**

An improperly adjusted Weight-Distributing Hitch system may reduce handling, stability, and braking performance, and could result in an accident.

Weight-Distributing Systems may not be compatible with surge brake couplers. Consult with your hitch and trailer manufacturer or a reputable recreational vehicle dealer for additional information.

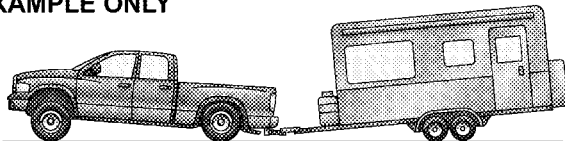
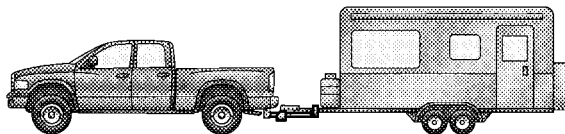
**EXAMPLE ONLY****FIG. 1 WITHOUT WEIGHT DISTRIBUTION (INCORRECT)****FIG. 2. WITH WEIGHT DISTRIBUTION (CORRECT)**

8181F965

**Weight-Distributing Hitch System**

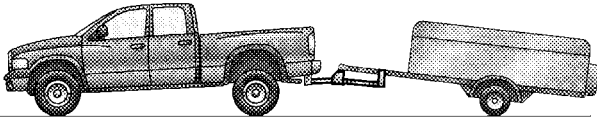
**EXAMPLE ONLY****FIG. 3 IMPROPER ADJUSTMENT (INCORRECT)**

8181F96F

### Improper Adjustment Of Weight-Distributing System Fifth-Wheel Hitch

A fifth-wheel hitch is a special high platform with a coupling that mounts over the rear axle of the tow vehicle in the truck bed. Connects a vehicle and fifth-wheel trailer with a coupling king pin.

**Gooseneck Hitch**

The gooseneck hitch employs a pivoted coupling arm which attaches to a ball mounted in the bed of a pickup truck. The coupling arm connects to the hitch mounted over the rear axle in the truck bed.

**Trailer Hitch Classification**

The rear bumper is intended to tow trailers up to 2,000 lbs (907 kg) without added equipment or alterations to the standard equipment. Your vehicle may be factory equipped for safe towing of trailers weighing over 2,000 lbs (907 kg) with the optional Trailer Tow Prep Package. See your authorized dealer for package content.

The following chart provides the industry standard for the maximum trailer weight a given trailer hitch class can tow and should be used to assist you in selecting the correct trailer hitch for your intended towing condition. Refer to “Trailer Towing Weights (Maximum Trailer

Weight Ratings)” for the website address that contains the necessary information for your specific drivetrain.

<b>Trailer Hitch Classification</b>	
<b>Class</b>	<b>Max. GTW (Gross Trailer Wt.)</b>
Class I - Light Duty	2,000 lbs (907 kg)
Class II - Medium Duty	3,500 lbs (1587 kg)
Class III - Heavy Duty	5,000 lbs (2268 kg)
Class IV - Extra Heavy Duty	10,000 lbs (4540 kg)
Fifth Wheel/ Gooseneck	Greater than 10,000 lbs (4540 kg)

All trailer hitches should be professionally installed on your vehicle.

### **Trailer Towing Weights (Maximum Trailer Weight Ratings)**

**NOTE:** For additional trailer towing information (maximum trailer weight ratings) refer to the following website addresses:

- [http:// www.dodge.com/towing](http://www.dodge.com/towing)
- [http:// www.dodge.ca](http://www.dodge.ca) (Canada)

### **Trailer and Tongue Weight**

Always load a trailer with 60% to 65% of the weight in the front of the trailer. This places 10% to 15% of the Gross Trailer Weight (GTW) on the tow hitch of your vehicle. Loads balanced over the wheels or heavier in the rear can cause the trailer to sway **severely** side to side which will cause loss of control of vehicle and trailer. Failure to load trailers heavier in front is the cause of many trailer accidents.

Never exceed the maximum tongue weight stamped on your bumper or trailer hitch.

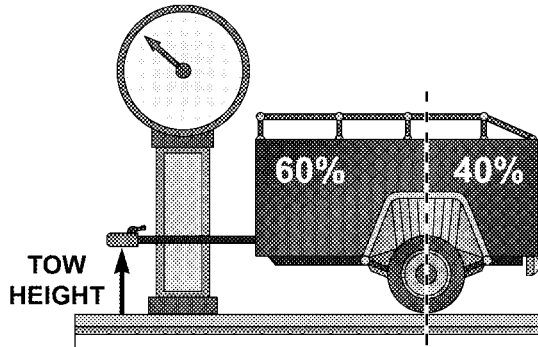

81546c40

Consider the following items when computing the weight on the rear axle of the vehicle:

- The tongue weight of the trailer.
- The weight of any other type of cargo or equipment put in or on your vehicle.
- The weight of the driver and all passengers.

**NOTE:** Remember that everything put into or on the trailer adds to the load on your vehicle. Also, additional factory-installed options, or dealer-installed options, must be considered as part of the total load on your vehicle. Refer to "Tire and Loading Information placard" under "Tire Safety Information" in Section 5.

### Towing Requirements

To promote proper break-in of your new vehicle drivetrain components the following guidelines are recommended:

#### CAUTION!

- Avoid towing a trailer for the first 500 mi (805 km) of vehicle operation. Doing so may damage your vehicle.
- During the first 500 mi (805 km) of trailer towing, limit your speed to 50 mph (80 km/h).

Perform the maintenance listed in Section 8 of this manual. When towing a trailer, never exceed the GAWR or GCWR ratings.

#### WARNING!

**Improper towing can lead to an injury accident. Follow these guidelines to make your trailer towing as safe as possible:**

**Make certain that the load is secured in the trailer and will not shift during travel. When trailering cargo that is not fully secured, dynamic load shifts can occur that may be difficult for the driver to control. You could lose control of your vehicle and have an accident.**

- When hauling cargo or towing a trailer, do not overload your vehicle or trailer. Overloading can cause a loss of control, poor performance or damage to brakes, axle, engine, transmission, steering, suspension, chassis structure or tires.

- Safety chains must always be used between your vehicle and trailer. Always connect the chains to the frame or hook retainers of the vehicle hitch. Cross the chains under the trailer tongue and allow enough slack for turning corners.
- Vehicles with trailers should not be parked on a grade. When parking, apply the parking brake on the tow vehicle. Put the tow vehicle automatic transmission in PARK. With a manual transmission, shift the transmission into REVERSE. And with 4-wheel drive vehicles, make sure the transfer case is not in NEUTRAL. Always, block or "chock" the trailer wheels.
- GCWR must not be exceeded.
- **Total weight must be distributed between the tow vehicle and the trailer so that the following four ratings are not exceeded:**
  1. GVWR

2. GTW

3. GAWR

4. Tongue weight rating for the trailer hitch utilized (This requirement may limit the ability to always achieve the 10% to 15% range of tongue weight as a percentage of total trailer weight.)

### Towing Requirements — Tires

- Do not attempt to tow a trailer while using a compact spare tire.
- Proper tire inflation pressures are essential to the safe and satisfactory operation of your vehicle. For proper tire inflation procedures, refer to "Tire Pressures" under "Tires-General Information" in Section 5.
- Also, check the trailer tires for proper tire inflation pressures before trailer usage.

- Check for signs of tire wear or visible tire damage before towing a trailer. For the proper inspection procedure, refer to “Tread Wear Indicators” under “Tires–General Information” in Section 5.
- When replacing tires, refer to “Replacement Tires” under “Tires–General Information” in Section 5. Replacing tires with a higher load carrying capacity will not increase the vehicle’s GVWR and GAWR limits.

#### **Towing Requirements — Trailer Brakes**

- Do **not** interconnect the hydraulic brake system or vacuum system of your vehicle with that of the trailer. This could cause inadequate braking and possible personal injury.
- An electronically actuated trailer brake controller is required when towing a trailer with electronically

actuated brakes. When towing a trailer equipped with a hydraulic surge actuated brake system, an electronic brake controller is not required.

- Trailer brakes are recommended for trailers over 1,000 lbs (454 kg) and required for trailers in excess of 2,000 lbs (907 kg).

#### **CAUTION!**

**If the trailer weighs more than 1,000 lbs (454 kg) loaded, it should have its own brakes and they should be of adequate capacity. Failure to do this could lead to accelerated brake lining wear, higher brake pedal effort, and longer stopping distances.**

**WARNING!**

**Do not connect trailer brakes to your vehicle's hydraulic brake lines. It can overload your brake system and cause it to fail. You might not have brakes when you need them and could have an accident.**

**Towing any trailer will increase your stopping distance. When towing you should allow for additional space between your vehicle and the vehicle in front of you. Failure to do so could result in an accident.**

**Towing Requirements — Trailer Lights and Wiring**

Whenever you pull a trailer, regardless of the trailer size, stop lights and turn signals on the trailer are required for motoring safety.

The Trailer Tow Package may include a 4- and 7-pin wiring harness. Use a factory approved trailer harness and connector.

**NOTE:** Do not cut or splice wiring into the vehicle's wiring harness.



The electrical connections are all complete to the vehicle but you must mate the harness to a trailer connector. Refer to the following illustrations:

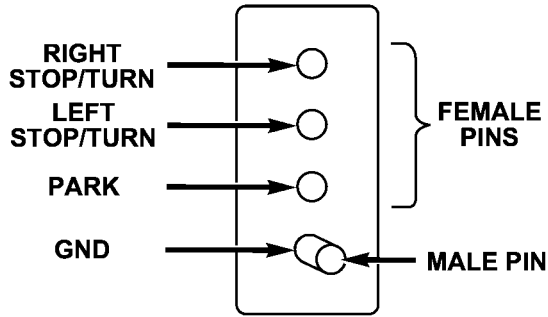

4-Pin Connector

813262be

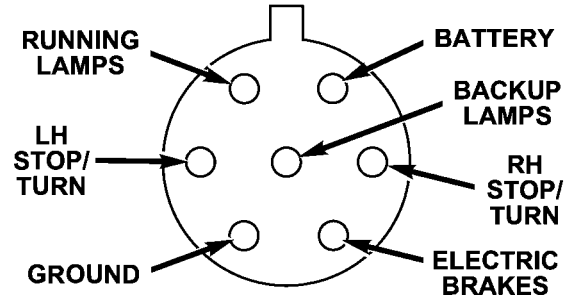

7-Pin Connector

812634c6

### Towing Tips

Before setting out on a trip, practice turning, stopping and backing the trailer in an area away from heavy traffic.

If using a manual transmission vehicle for trailer towing, all starts must be in 1st gear to avoid excessive clutch slippage.

### **Towing Tips — Automatic Transmission**

The “D” range can be selected when towing. However, if frequent shifting occurs while in this range, the TOW/HAUL feature should be selected.

**NOTE:** Using the TOW/HAUL feature while operating the vehicle under heavy operating conditions will improve performance and extend transmission life by reducing excessive shifting and heat build up. This action will also provide better engine braking.

The automatic transmission fluid and filter should be changed if you REGULARLY tow a trailer for more than 45 minutes of continuous operation. For transmission fluid change intervals, refer to “Maintenance Schedule” in section 8.

**NOTE:** Check the automatic transmission fluid level before towing.

### **Towing Tips — Tow/Haul (If Equipped)**

To reduce potential for automatic transmission overheating, turn the TOW/HAUL feature ON when driving in hilly areas or shift the transmission to Drive position 2 on more severe grades.

### **Towing Tips — Electronic Speed Control (If Equipped)**

- Don’t use in hilly terrain or with heavy loads.
- When using the speed control, if you experience speed drops greater than 10 mph (16 km/h), disengage until you can resume cruising speed.
- Use speed control in flat terrain and with light loads to maximize fuel efficiency.

**Towing Tips — Cooling System**

To reduce potential for engine and transmission overheating, take the following actions:

– ***City Driving***

When stopped for short periods of time, put transmission in NEUTRAL and increase engine idle speed.

– ***Highway Driving***

Reduce speed.

– ***Air Conditioning***

Turn off temporarily.

– refer to “Cooling System Operating” under “Maintenance Procedures” in section 8.

**SNOWPLOW**

**NOTE:** Do not use this vehicle for snowplow applications.

**WARNING!**

**Snowplows, winches, and other aftermarket equipment should not be added to the front end of your vehicle. The airbag crash sensors may be affected by the change in the front end structure. The airbags could deploy unexpectedly or could fail to deploy during a collision, resulting in serious injury or death.**

**CAUTION!**

Using this vehicle for snowplow applications can cause damage to the vehicle.

**WARNING!**

Attaching a snowplow to this vehicle could adversely affect performance of the airbag system in an accident. Do not expect that the airbag will perform as described earlier in this manual.

**RECREATIONAL TOWING (BEHIND MOTORHOME, ETC.)****Recreational Towing 2WD Models**

Recreational towing of 2WD models is not allowable. Towing the vehicle with the transmission in NEUTRAL can cause severe transmission damage. Removal of the driveshaft for towing is not recommended since this allows transmission fluid to leak out.

**Recreational Towing 4WD Models****CAUTION!**

Vehicles equipped with an NV 140 Transfer Case (which has no NEUTRAL position) may NOT be used for recreational towing.

**WARNING!**

You or others could be injured if you leave the vehicle unattended with the transfer case in the NEUTRAL position without first fully engaging the parking brake. The transfer case NEUTRAL position disengages both the front and rear driveshafts from the powertrain and will allow the vehicle to move despite the transmission position. The parking brake should always be applied when the driver is not in the vehicle.

**CAUTION!**

Internal damage to the transfer case will occur if a front or rear wheel lift is used when recreational towing.

**NOTE:** The NV 244 Generation II transfer case must be shifted into NEUTRAL for recreational towing. The NEUTRAL selection button is located on the lower left-hand corner of the 4WD Control Switch. Shifts into and out of transfer case NEUTRAL can take place with the selector switch in any mode position.

**Shifting into NEUTRAL**

Use the following procedure to prepare your vehicle for recreational towing.

**CAUTION!**

It is necessary to follow these steps to be certain that the transfer case is fully in NEUTRAL before recreational towing to prevent damage to internal parts.

1. Bring vehicle to a complete stop.
2. Shut engine OFF.

3. Turn the ignition key to the ON position without starting the engine.
4. Depress brake pedal.
5. Shift automatic transmission to NEUTRAL.
6. Using the point of a ballpoint pen or similar object, depress the recessed transfer case NEUTRAL button for four seconds.
7. After shift is completed and the NEUTRAL light comes on, release the NEUTRAL button.
8. Start the engine.
9. Shift the automatic transmission into REVERSE.
10. Release brake pedal for five seconds and ensure that there is no vehicle movement.
11. Repeat steps 9 and 10 with the transmission in DRIVE.

12. Turn ignition key to the unlocked OFF position.
13. Shift the automatic transmission into PARK.
14. Attach vehicle to tow vehicle with tow bar.

**NOTE:** Items 1 through 5 are requirements that must be met prior to depressing the NEUTRAL selection button, and must continue to be met until the four seconds elapses and the shift has been completed.

If any of these requirements (with the exception of Step 3 - Key ON) are not met prior to depressing the NEUTRAL button or are no longer met during the four second timer, then the NEUTRAL indicator light will flash continuously until all requirements are met or until the NEUTRAL button is released.

**NOTE:** The ignition key must be ON for a shift to take place and for the position indicator lights to be operable. If the key is not ON, the shift will not take place and no position indicator lights will be on or flashing.

**CAUTION!**

**Damage to the transmission may occur if the transmission is shifted into PARK with the transfer case in NEUTRAL and the engine RUNNING. With the transfer case in NEUTRAL, ensure that the engine is OFF prior to shifting the transmission into PARK.**

**Shifting Out of NEUTRAL**

Use the following procedure to prepare your vehicle for normal usage.

1. Bring vehicle to a complete stop.
2. Shut engine OFF.
3. Turn the ignition key to the ON position without starting the engine.
4. Depress brake pedal.

5. Shift the automatic transmission to NEUTRAL.
  6. Using the point of a ballpoint pen or similar object, depress the recessed transfer case NEUTRAL button for one second.
  7. After the NEUTRAL indicator light turns off, release the NEUTRAL button.
  8. After the NEUTRAL button has been released, the transfer case will shift to the position identified by the selector switch.
  9. Shift the automatic transmission into PARK.
  10. Start the engine.
  11. Shift the automatic transmission into DRIVE.
- NOTE:** Steps 1 through 5 are requirements that must be met prior to depressing the NEUTRAL selection button, and must continue to be met until one second elapses and the shift has been completed.

If any of these requirements are not met prior to depressing the NEUTRAL button or are no longer met during the one second time, then all of the position indicator lights will flash continuously until all requirements are met or until the NEUTRAL button is released.

**NOTE:** The ignition key must be ON for a shift to take place and for the position indicator lights to be operable. If the key is not ON, the shift will not take place and no position indicator lights will be on or flashing.

**NOTE:** A flashing NEUTRAL position indicator light indicates that shift requirements have not been met.

### CAUTION!

- **Do not use a bumper-mounted clamp-on tow bar on your vehicle. The bumper face bar will be damaged.**
- **Do not disconnect the rear driveshaft because fluid will leak from the transfer case and damage internal parts.**



### **EQUIPMENT IDENTIFICATION PLATE**

The equipment Identification Plate is located on the hood inner surface.

The following information about your vehicle is displayed on this plate: Model, Wheelbase, Vehicle Identification Number, Truck Order Number, and code numbers with descriptions of all production and special equipment on the truck as shipped from the factory.

**NOTE:** Always refer to the equipment identification plate when ordering parts.

---

# WHAT TO DO IN EMERGENCIES

## CONTENTS

---

■ Hazard Warning Flasher . . . . .	378	■ Jump-Starting Procedures . . . . .	388
■ Jacking And Tire Changing . . . . .	379	■ Freeing A Stuck Vehicle . . . . .	390
□ Jack Location . . . . .	380	■ Emergency Tow Hooks — If Equipped . . . . .	390
■ Jacking Instructions . . . . .	381	■ Towing A Disabled Vehicle . . . . .	391
□ Removing The Spare Tire . . . . .	381	□ Four-Wheel Drive Vehicles . . . . .	392
□ Tire Changing Procedure . . . . .	382	□ Two-Wheel Drive Vehicles . . . . .	392

### HAZARD WARNING FLASHER

The flasher switch is on the top of the steering column, just behind the steering wheel. Press the flasher switch and all front and rear directional signals will flash intermittently.

Press the switch a second time to turn off the emergency flashers.

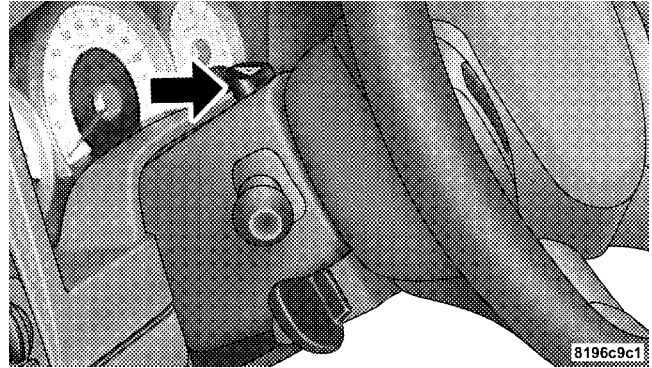

**Flasher Switch**

This is an emergency warning system and should not be used when the vehicle is in motion. Use it when your vehicle is disabled and is creating a safety hazard for other motorists.

If it is necessary to leave the vehicle to go for service, the flasher system will continue to operate with the ignition key removed and the vehicle locked.

## JACKING AND TIRE CHANGING

### WARNING!

- **Being under a jacked-up vehicle is dangerous. The vehicle could slip off the jack and fall on you. You could be crushed. Never put any part of your body under a vehicle that is on a jack. Never start or run the engine while the vehicle is on a jack. If you need to get under a raised vehicle, take it to a service center where it can be raised on a lift.**
- **The jack is designed to use as a tool for changing tires only. The jack should not be used to lift the vehicle for service purposes. The vehicle should be jacked on a firm level surface only. Avoid ice or slippery areas.**

### Jack Location

The scissor jack and tire changing tools are stowed under the second row seat.

The jack is secured in place with a winged stud and a fixed stud. It is very important to secure the jack tightly in place by engaging the slot in the base to the fixed stud under the middle seat. The winged stud inserts through the eyelet in the end of the jack's worm screw.

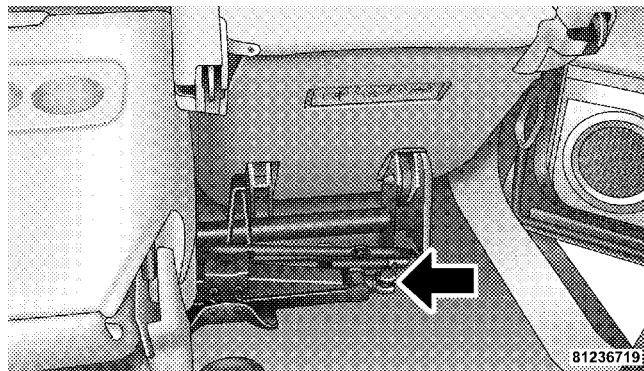

Jack Location

## JACKING INSTRUCTIONS

### Removing The Spare Tire

The spare tire on your vehicle is located underneath the vehicle in the rear.

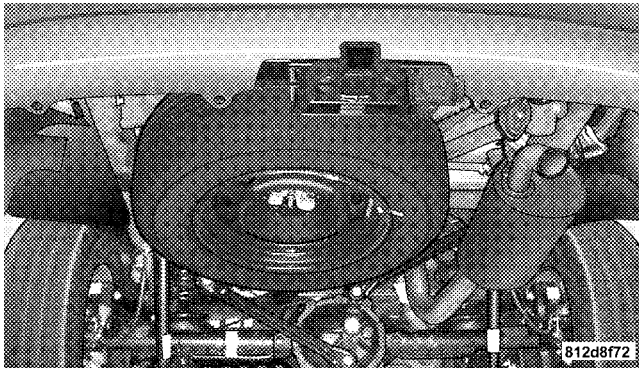

**Spare Tire Location**

Remove the spare tire before attempting to jack the vehicle.

1. Remove the rubber plug from the floor in the cargo area.

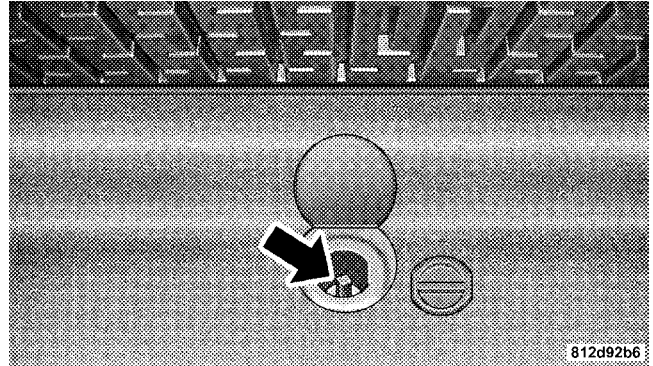

**Spare Tire Winch**

2. Engage the jack wrench extension to the spare tire winch through the hole in the floor.

3. Turn the wrench counterclockwise to lower the spare tire. Continue to turn the wrench until the spare tire can be pulled out from under the vehicle.

It is recommended that you stow the flat tire or spare to avoid tangling the loose cable.

### **CAUTION!**

**The winch mechanism is designed for use with the jack extension tube only. Use of an air wrench or other power tools is not recommended and can damage the winch.**

### **Tire Changing Procedure**

#### **WARNING!**

**Getting under a jacked-up vehicle is dangerous. The vehicle could slip off the jack and fall on you. You could be crushed. Never get any part of your body under a vehicle that is on a jack. Never start or run the engine while the vehicle is on a jack. If you need to get under a raised vehicle, take it to a service center where it can be raised on a lift.**

Do not raise this vehicle using a bumper jack. The scissor jack is designed as a tool for changing tires on this vehicle only. It is not recommended that the jack be used for service purposes or to lift more than one wheel at a time.

### Preparations

Park the vehicle on a firm level surface, avoiding ice or slippery areas. Set the parking brake and place the shift lever in PARK (automatic transmission). On 4-wheel drive vehicles, shift the transfer case to the “4L” position.

### WARNING!

**Do not attempt to change a tire on the side of the vehicle close to moving traffic. Pull far enough off the road to avoid the danger of being hit when operating the jack or changing the wheel.**

- Turn on the hazard warning flasher.

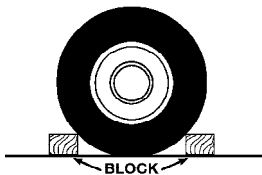

- Block both the front and rear of the wheel diagonally opposite the jacking position. For example, if the right front wheel is being changed, block the left rear wheel.
- Passengers should not remain in the vehicle when the vehicle is being jacked.

### Instructions



### Jack Warning Label

1. Remove the spare wheel, jack, and tools from storage.



2. Using the wheel wrench, loosen, but do not remove, the wheel nuts by turning them counterclockwise one turn while the wheel is still on the ground.
3. When changing a front wheel, place the jack under the frame rail behind the wheel. Locate the jack as far forward as possible on the straight part of the frame (prior to inboard transition). Operate the jack using the jack drive tube and the wheel wrench; the tube extension may be used but is not required.

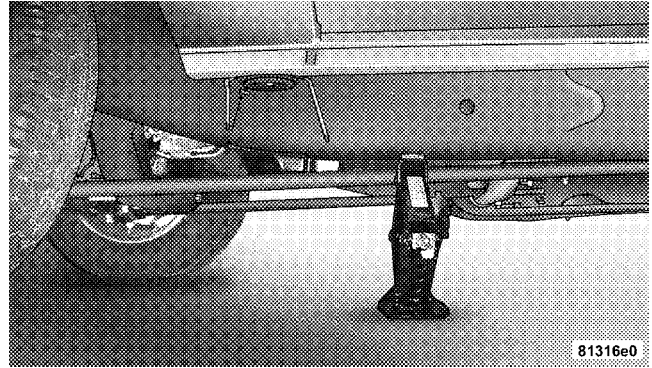

**Front Jacking Location**

When changing a rear wheel, assemble the jack drive tube to the jack and connect the drive tube to the extension tube. Place the jack under the axle as close to the tire as possible with the drive tubes extending to the rear. Connect the jack tube extension and wheel wrench.

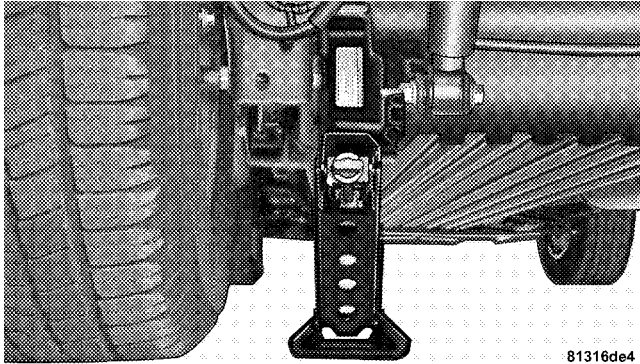

**Rear Left Jacking Location**

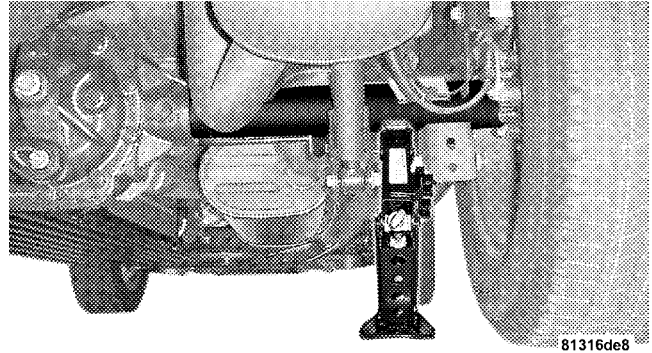

**Rear Right Jacking Location**

Before raising the wheel off the ground, make sure that the jack will not damage surrounding truck parts and adjust the jack position as required.

4. By rotating the wheel wrench clockwise, raise the vehicle until the wheel just clears the surface.

**WARNING!**

Raising the vehicle higher than necessary can make the vehicle unstable and cause an accident. It could slip off the jack and hurt someone near it. Raise the vehicle only enough to remove the tire.

5. Remove the wheel nuts and pull the wheel off. Install the spare wheel and wheel nuts with the cone shaped end of the nuts toward the wheel. Lightly tighten the nuts. To avoid risk of forcing the vehicle off the jack, do not fully tighten the nuts until the vehicle has been lowered.

**NOTE:** Do not oil wheel studs. For chrome wheels, do not substitute with chrome plated wheel nuts.

6. Using the wheel wrench, finish tightening the nuts in a crisscross pattern. Correct nut tightness is  $135 \pm 10$  ft lbs ( $183 \pm 14$  N·m) dynamic torque. If in doubt about the

correct tightness, have them checked with a torque wrench by your authorized dealer or at a service station.

**WARNING!**

A loose tire or jack thrown forward in a collision or hard stop could injure someone in the vehicle. Always stow the jack, tools and the extra tire and wheel in the places provided.

7. Remove wheel blocks. Do not install chrome or aluminum wheel center caps on the spare wheel. This may result in cap damage.

8. Lower the jack to its fully closed position. Stow the replaced tire, jack, and tools as previously described.

9. Adjust the tire pressure when possible.

**NOTE:** Do not oil wheel studs. For chrome wheels, do not substitute with chrome plated wheel nuts.

**WARNING!**

Carefully follow these tire changing warnings to help prevent personal injury or damage to your vehicle:

- Always park on a firm, level surface as far from the edge of the roadway as possible before raising the vehicle.
- Block the wheel diagonally opposite the wheel to be raised.
- Apply the parking brake firmly before jacking.
- Never start the engine with the vehicle on a jack.
- Do not let anyone sit in the vehicle when it is on a jack.
- Do not get under the vehicle when it is on a jack.
- Only use the jack in the positions indicated.
- If working on or near a roadway, be extremely careful of motor traffic.
- To assure that spare tires, flat or inflated, are securely stowed, spares must be stowed with the valve stem facing the ground.

**To Stow The Flat Or Spare**

Turn the wheel so that the valve stem is down. Slide the wheel retainer through the center of the wheel and position it properly across the wheel opening.

For convenience in checking the spare tire inflation, stow with the valve stem toward the rear of the vehicle.

Rotate the winch mechanism until the wheel is drawn into place against the underside of the vehicle. Continue to rotate until you feel the winch mechanism slip or click two times. It cannot be overtightened. Push against the tire several times to be sure it is firmly in place.

**JUMP-STARTING PROCEDURES****WARNING!**

- **Battery fluid is a corrosive acid solution; do not allow battery fluid to contact eyes, skin or clothing. Don't lean over battery when attaching clamps or allow the clamps to touch each other. If acid splashes in eyes or on skin, flush the contaminated area immediately with large quantities of water.**
- **A battery generates hydrogen gas which is flammable and explosive. Keep flame or spark away from the vent holes. Do not use a booster battery or any other booster source with an output that exceeds 12 volts.**

Check the Battery Test Indicator (if equipped). If a light or bright colored dot is visible in the indicator (if equipped), **DO NOT** jump-start the battery.

If the indicator (if equipped) is dark or shows a green dot, proceed as follows:

1. Wear eye protection and remove all metal jewelry such as watch bands or bracelets which might make an unintended electrical contact.
2. Park the booster vehicle within cable reach but without letting the vehicles touch. Set the parking brake, place the automatic transmission in PARK and turn the ignition OFF on both vehicles.
3. Turn OFF heater, radio and all unnecessary electrical loads.

4. Connect one end of a jumper cable to the positive terminal of the booster battery. Connect the other end of the same cable to the positive terminal of the discharged battery.

**WARNING!**

**Do not permit vehicles to touch each other as this could establish a ground connection and personal injury could result.**

5. Connect the other cable, first to the negative terminal of the booster battery and then to the engine of the vehicle with the discharged battery. Make sure you have a good contact on the engine.

**WARNING!**

**Do not connect the cable to the negative post of the discharge battery. The resulting electrical spark could cause the battery to explode.**

**During cold weather when temperatures are below freezing point, electrolyte in a discharged battery may freeze. Do not attempt jump-starting because the battery could rupture or explode. The battery temperature must be brought up above freezing point before attempting a jump-start.**

6. Start the engine in the vehicle which has the booster battery, let the engine idle a few minutes, then start the engine in the vehicle with the discharged battery.

7. When removing the jumper cables, reverse the above sequence exactly. Be careful of the moving belts and fan.

**WARNING!**

Any procedure other than above could result in:

1. Personal injury caused by electrolyte squirting out the battery vent;
2. Personal injury or property damage due to battery explosion;
3. Damage to charging system of booster vehicle or of immobilized vehicle.

**FREEING A STUCK VEHICLE**

If vehicle becomes stuck in snow, sand, or mud, it can often be moved by a rocking motion. Move the gear selector rhythmically between FIRST and REVERSE, while applying slight pressure to the accelerator.

The least amount of accelerator pedal pressure to maintain the rocking motion without spinning the wheels or racing the engine is most effective. Allow the engine to idle with the shift lever in NEUTRAL for at least one minute after every five rocking-motion cycles. This will minimize overheating and reduce the risk of transmission failure during prolonged efforts to free a stuck vehicle.

**EMERGENCY TOW HOOKS — IF EQUIPPED**

Your vehicle may be equipped with emergency tow hooks.

**NOTE:** For off-road recovery, it is recommended to use both of the front tow hooks to minimize the risk of damage to the vehicle.

**WARNING!**

Chains are not recommended for freeing a stuck vehicle. Chains may break, causing serious injury or death.

**WARNING!**

Stand clear of vehicles when pulling with tow hooks. Tow straps and chains may break, causing serious injury.

**CAUTION!**

Tow hooks are for emergency use only, to rescue a vehicle stranded off-road. Do not use tow hooks for tow truck hookup or highway towing. You could damage your vehicle.

**TOWING A DISABLED VEHICLE**

Proper towing or lifting equipment is required to prevent damage to your vehicle. Use of safety chains is recommended. **Attach towing device to main structural members of the vehicle — not to bumpers or associated brackets.** State and local laws, applying to vehicles under tow, must be observed.



**Four-Wheel Drive Vehicles**

The manufacturer recommends towing with all wheels **OFF** the ground. Acceptable methods are to tow the vehicle on a flatbed or with one end of the vehicle raised and the opposite end on a towing dolly.

**Two-Wheel Drive Vehicles**

Provided that the transmission is operable, tow with the transmission in **NEUTRAL** and the ignition key in the **OFF** position, along with the front wheels raised and the rear wheels on the ground. The speed must not exceed 30 mph (50 km/h), and the distance must not exceed 15 mi (25 km).

If the vehicle is to be towed more than 15 mi (25 km) or faster than 30 mph (50 km/h), it must be towed on a flatbed, or with the rear wheels raised and the front wheels on the ground, or with the front end raised and the rear wheels on a towing dolly.

**NOTE:** Towing the vehicle with the rear wheels on the ground at more than 30 mph (50 km/h) or for more than 15 mi (25 km), can cause severe transmission damage.

---

# MAINTAINING YOUR VEHICLE

## CONTENTS

---

■ Engine Compartment 3.7L V6 . . . . .	396	■ Maintenance Procedures . . . . .	402
■ Engine Compartment 4.7L V-8 . . . . .	397	□ Engine Oil . . . . .	402
■ Engine Compartment 5.7L HEMI V-8 . . . . .	398	□ Engine Oil Filter . . . . .	405
■ Onboard Diagnostic System — OBD II . . . . .	399	□ Drive Belts — Check Condition And Tension . .	406
□ Loose Fuel Filler Cap Message . . . . .	399	□ Spark Plugs . . . . .	406
■ Emissions Inspection And Maintenance Programs . . . . .	400	□ Engine Air Cleaner Filter . . . . .	407
■ Replacement Parts . . . . .	401	□ Engine Fuel Filter . . . . .	407
■ Dealer Service . . . . .	402	□ Catalytic Converter . . . . .	407
		□ Maintenance Free Battery . . . . .	409

- Power Steering — Fluid Check . . . . . 410
- Air Conditioner Maintenance . . . . . 411
- Front Suspension Ball Joints . . . . . 412
- Drive Shaft Constant Velocity Joints . . . . . 412
- Body Lubrication . . . . . 412
- Windshield Wiper Blades . . . . . 413
- Windshield And Rear Window Washers . . . . . 413
- Exhaust System . . . . . 414
- Cooling System . . . . . 415
- Emission Related Components . . . . . 420
- Brake System . . . . . 421
- Automatic Transmission . . . . . 423
- Transfer Case . . . . . 425
- Axles . . . . . 426
- Appearance Care And Protection From Corrosion . . . . . 427
- Fuse Block . . . . . 432
  - Fuses (Interior) . . . . . 432
  - Fuses (Power Distribution Center) . . . . . 435
  - Fuses (Integrated Power Module) . . . . . 438
- Vehicle Storage . . . . . 440
- Replacement Light Bulbs . . . . . 441
  - Bulb Replacement . . . . . 441
    - Headlights/Parking/Turn Signal . . . . . 441
    - Rear Side Marker, Tail Lights, Turn Signals And Backup Lights — Replacement . . . . . 443
    - License Lights . . . . . 447

<input type="checkbox"/> Center High-Mounted Stoplight . . . . .	448	<input checked="" type="checkbox"/> Fluids, Lubricants And Genuine Parts . . . . .	451
<input type="checkbox"/> Fog Lights . . . . .	449	<input type="checkbox"/> Engine . . . . .	451
<input checked="" type="checkbox"/> Fluids And Capacities . . . . .	450	<input type="checkbox"/> Chassis . . . . .	452

## ENGINE COMPARTMENT 3.7L V6

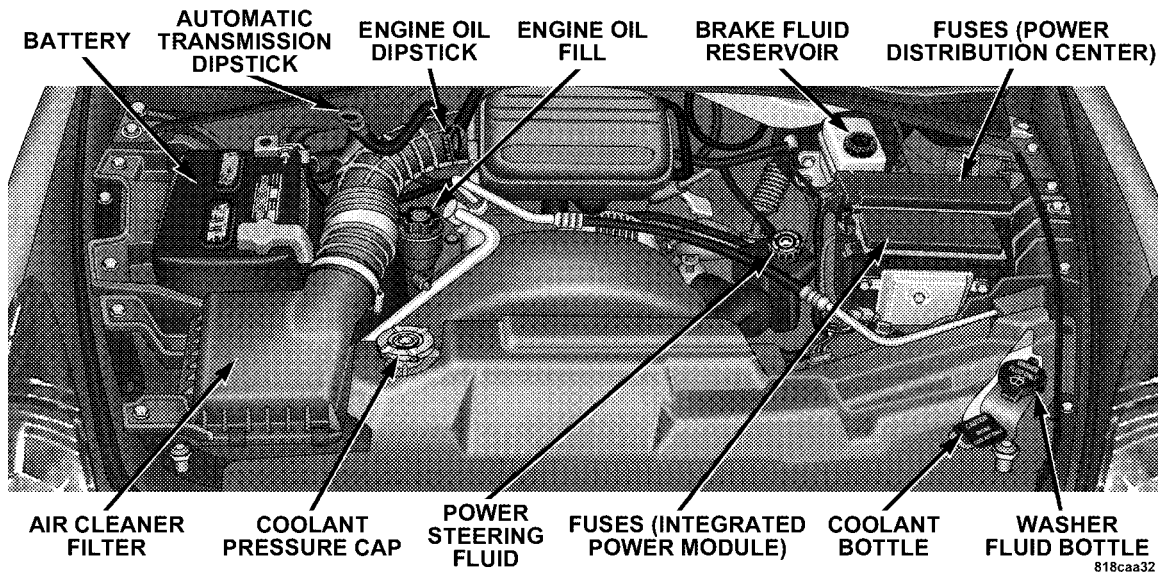

ENGINE COMPARTMENT 4.7L V-8

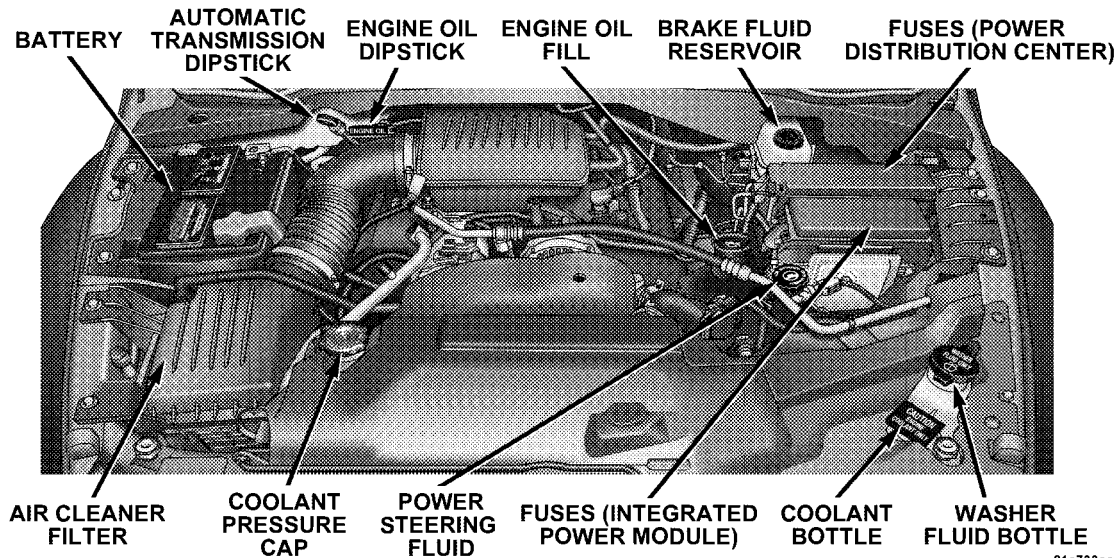

81c733ac

## ENGINE COMPARTMENT 5.7L HEMI V-8

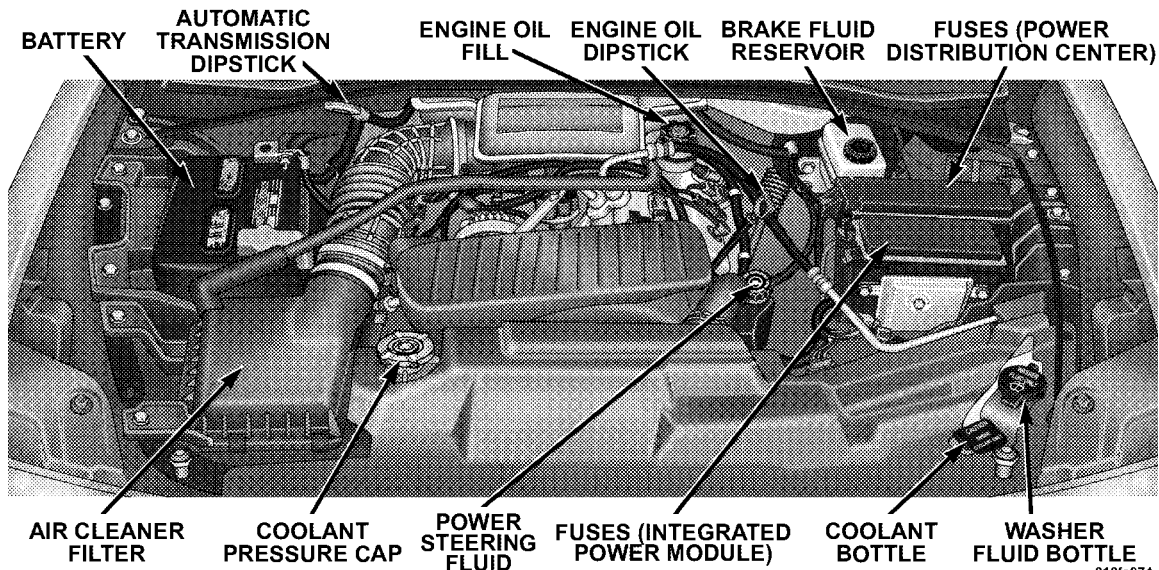

## ONBOARD DIAGNOSTIC SYSTEM — OBD II

Your vehicle is equipped with a sophisticated onboard diagnostic system called OBD II. This system monitors the performance of the emissions, engine, and automatic transmission control systems. When these systems are operating properly, your vehicle will provide excellent performance and fuel economy, as well as engine emissions well within current government regulations.

If any of these systems require service, the OBD II system will turn on the Malfunction Indicator Light (MIL). It will also store diagnostic codes and other information to assist your service technician in making repairs. Although your vehicle will usually be drivable and not need towing, see your authorized dealer for service as soon as possible.

### CAUTION!

- **Prolonged driving with the MIL on could cause further damage to the emission control system. It could also affect fuel economy and driveability. The vehicle must be serviced before any emissions tests can be performed.**
- **If the MIL is flashing while the engine is running, severe catalytic converter damage and power loss will soon occur. Immediate service is required.**

### Loose Fuel Filler Cap Message

After fuel is added, the vehicle diagnostic system can determine if the fuel filler cap is possibly loose, improperly installed, or damaged. A loose fuel filler cap message will be displayed in the instrument cluster. Tighten the gas cap until a "clicking" sound is heard. This is an indication that the gas cap is properly tightened. Press



the odometer RESET button to turn the message off. If the problem persists, the message will appear the next time the vehicle is started. This might indicate a damaged cap. If the problem is detected twice in a row, the system will turn on the MIL. Resolving the problem will turn the MIL off.

## EMISSIONS INSPECTION AND MAINTENANCE PROGRAMS

In some localities, it may be a legal requirement to pass an inspection of your vehicle's emissions control system. Failure to pass could prevent vehicle registration.



For states which have an I/M (Inspection and Maintenance) requirement, this check verifies the following: the Malfunction Indicator Lamp (MIL) is functioning and is not on when the engine is running, and that the On Board Diagnostic (OBD) system is ready for testing.

Normally, the OBD system will be ready. The OBD system may **not** be ready if your vehicle was recently serviced, if you recently had a dead battery, or a battery replacement. If the OBD system is determined not ready for the I/M test, your vehicle may fail the test.

Your vehicle has a simple ignition key actuated test which you can use prior to going to the test station. To check if your vehicle's OBD system is ready, you must do the following:

1. Insert your ignition key into the ignition switch.
2. Turn the ignition to the ON position, but do not crank or start the engine. If you crank or start the engine, you will have to start this test over.
3. As soon as you turn your key to the ON position, you will see your MIL symbol come on as part of a normal bulb check.

4. Approximately 15 seconds later, one of two things will happen:

a. The MIL will blink for approximately five seconds and then remain on until the first engine crank or the key is turned off. This means that your vehicle's OBD system is **not ready** and you should **not** proceed to the I/M station.

b. The MIL will remain fully illuminated until the first engine crank or the key is turned off. This means that your vehicle's OBD system is **ready** and you can proceed to the I/M station.

If your OBD system is **not ready**, you should see your authorized dealer or repair facility. If your vehicle was recently serviced or had a battery failure or replacement, you may need to do nothing more than drive your vehicle as you normally would in order for your OBD system to update. A recheck with the above test routine may then indicate that the system is now ready.

Regardless of whether your vehicle's OBD system is ready or not ready, if the MIL symbol is illuminated during normal vehicle operation, you should have your vehicle serviced before going to the I/M station. The I/M station can fail your vehicle because the MIL symbol is on with the engine running.

### REPLACEMENT PARTS

Use of genuine Mopar® parts for normal/scheduled maintenance and repairs is highly recommended to ensure the designed performance. Damage or failures caused by the use of non-Mopar® parts for maintenance and repairs will not be covered by the manufacturer's warranty.

## DEALER SERVICE

Your authorized dealer has the qualified service personnel, special tools and equipment to perform all service operations in an expert manner. Service Manuals are available which include detailed service information for your vehicle. Refer to these manuals before attempting any procedure yourself.

**NOTE:** Intentional tampering with emissions control systems can result in civil penalties being assessed against you.

### WARNING!

**You can be badly injured working on or around a motor vehicle. Do only that service work for which you have the knowledge and the proper equipment. If you have any doubt about your ability to perform a service job, take your vehicle to a competent mechanic.**

## MAINTENANCE PROCEDURES

The pages that follow contain the **required** maintenance services determined by the engineers who designed your vehicle.

Besides the maintenance items for which there are fixed maintenance intervals, there are other items that should operate satisfactorily without periodic maintenance. However, if a malfunction of these items does occur, it could adversely affect the engine or vehicle performance. These items should be inspected if a malfunction is observed or suspected.

### Engine Oil

#### Checking Oil Level

To assure proper lubrication of your vehicle's engine, the engine oil must be maintained at the correct level. The best time to check the engine oil level is about five minutes after a fully warmed up engine is shut off or before starting the engine after it has sat overnight.

Checking the oil while the vehicle is on level ground will improve the accuracy of the oil level readings. Always maintain the oil level within the SAFE zone on the dipstick. Adding 1 quart/liter of oil when the reading is at the bottom of the SAFE zone will result in a reading at the top of the SAFE zone on these engines.

### CAUTION!

Overfilling or underfilling the crankcase will cause oil aeration or loss of oil pressure. This could damage your engine.

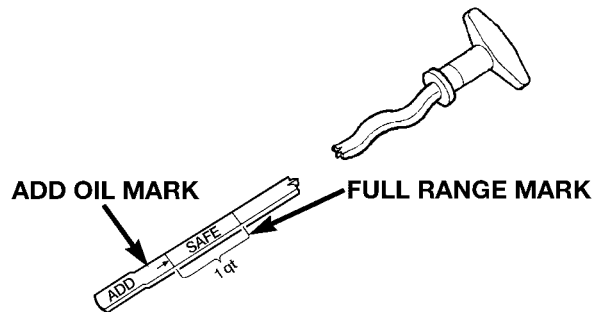

80c0715e

### Change Engine Oil

Follow the Maintenance Schedule for recommended engine oil and filter change intervals.

**NOTE:** Under no circumstances should oil change intervals exceed 6,000 miles (10 000 km) or 6 months, whichever comes first.

**4x4 Models, If Used Primarily For Off-Road Operation**  
Every 50 hours of use.

### Dusty Conditions

Driving through dust-laden air increases the problems of keeping abrasive materials out of the engine. Under these conditions, special attention should be given to the engine air cleaner and the crankcase inlet air cleaner. The crankcase ventilation system should also be checked periodically. Make sure that these units are always clean. This will tend to reduce to a minimum the amount of abrasive material that may enter the engine.

### Engine Oil Selection

For best performance and maximum protection under all types of operating conditions, the manufacturer only recommends engine oils that are API certified and meet the requirements of DaimlerChrysler Material Standard MS-6395.

### American Petroleum Institute (API) Engine Oil Identification Symbol



This symbol means that the oil has been certified by the American Petroleum Institute (API). The manufacturer only recommends API Certified engine oils.

### Engine Oil Viscosity (SAE Grade)

**SAE 5W-20 engine oil is recommended for all operating temperatures. This engine oil improves low temperature starting and vehicle fuel economy. The engine oil filler cap also shows the recommended engine oil viscosity for your vehicle.**

For information on engine oil filler cap location, see the Engine Compartment illustration in this section.

**NOTE:** Vehicles equipped with a 5.7L engine must use SAE 5W-20 oil. Failure to do so may result in improper operation of the Multiple Displacement System (MDS). Refer to “Multi Displacement System” under “Starting and Operating” in Section 5.

Lubricants which do not have both the engine oil certification mark and the correct SAE viscosity grade number should not be used.

### **Synthetic Engine Oils**

You may use synthetic engine oils provided the recommended oil quality requirements are met, and the recommended maintenance intervals for oil and filter changes are followed.

### **Materials Added to Engine Oils**

The manufacturer strongly recommends against the addition of any additives (other than leak detection dyes) to

the engine oil. Engine oil is an engineered product and its performance may be impaired by supplemental additives.

### **Disposing of Used Engine Oil and Oil Filters**

Care should be taken in disposing of used engine oil and oil filters from your vehicle. Used oil and oil filters, indiscriminately discarded, can present a problem to the environment. Contact your authorized dealer, service station, or governmental agency for advice on how and where used oil and oil filters can be safely discarded in your area.

### **Engine Oil Filter**

The engine oil filter should be replaced at every engine oil change.

### **Engine Oil Filter Selection**

The manufacturer's engines have a full-flow type oil filter. Use a filter of this type for replacement. The quality of replacement filters varies considerably. Only high

quality filters should be used to assure most efficient service. Mopar® Engine Oil Filters are a high quality oil filter and are recommended.

### **Drive Belts — Check Condition and Tension**

Belt tension is controlled by means of an automatic tensioner. No belt tension adjustments are required. However, belt and belt tensioner condition should be inspected at the specified intervals, and replaced if required. See your authorized dealer for service. At the mileage indicated in the maintenance schedule, all belts and tensioner should be checked for condition. Improper belt tension can cause belt slippage and failure. Belts should be inspected for evidence of cuts, cracks, glazing, or frayed cords and replaced if there is indication of damage which could result in belt failure. Low generator belt tension can cause battery failure. Also check belt routing to make sure there is no interference between the belts and other engine components.

### **Spark Plugs**

Spark plugs must fire properly to assure proper engine performance and emission control. The plugs installed in your vehicle should operate satisfactorily in normal service for the mileage indicated in the Maintenance Chart. New plugs should be installed at this mileage. The entire set should be replaced if there is any malfunction due to a faulty spark plug. For the proper type of spark plug for your vehicle, refer to "Spark Plugs" under Fluids, Lubricants and Genuine Parts" in this section.

#### **CAUTION!**

**When replacing plugs, do not overtighten. You could damage them and cause them to leak.**

### Engine Air Cleaner Filter

Follow the Maintenance Schedule for recommended engine air cleaner filter change intervals.

#### **WARNING!**

**The air cleaner can provide a measure of protection in the case of engine backfire. Do not remove the air cleaner unless such removal is necessary for repair or maintenance. Make sure that no one is near the engine compartment before starting the vehicle with the air cleaner removed. Failure to do so can result in serious personal injury.**

### Engine Fuel Filter

A plugged fuel filter can cause stalling, limit the speed at which a vehicle can be driven or cause hard starting. Should an excessive amount of dirt accumulate in the fuel tank, frequent filter replacement may be necessary. See your authorized dealer for service.

### Catalytic Converter

The catalytic converter requires the use of unleaded fuel only. Leaded gasoline will destroy the effectiveness of the catalyst as an emission control device.

Under normal operating conditions, the catalytic converter will not require maintenance. However, it is important to keep the engine properly tuned to assure proper catalyst operation and prevent possible catalyst damage.



**CAUTION!**

Damage to the catalytic converter can result if your vehicle is not kept in proper operating condition. In the event of engine malfunction, particularly involving engine misfire or other apparent loss of performance, have your vehicle serviced promptly. Continued operation of your vehicle with a severe malfunction could cause the converter to overheat, resulting in possible damage to the converter and the vehicle.

**NOTE:** Intentional tampering with emissions control systems can result in civil penalties being assessed against you.

**WARNING!**

A hot exhaust system can start a fire if you park over materials that can burn. Such materials might be grass or leaves coming into contact with your exhaust system. Do not park or operate your vehicle in areas where your exhaust system can contact anything that can burn.

In unusual situations involving grossly malfunctioning engine operation, a scorching odor may indicate severe and abnormal catalyst overheating. If this occurs, the vehicle should be stopped, the engine shut off and the vehicle allowed to cool. Thereafter, service, including a tune-up to manufacturer's specifications, should be obtained immediately.

To minimize the possibility of catalyst damage:

- Do not shut off the engine or interrupt the ignition when the transmission is in gear and the vehicle is in motion.
- Do not try to start engine by pushing or towing the vehicle.
- Do not idle the engine with any spark plug wires disconnected or removed, such as when diagnostic testing, or for prolonged periods during very rough idling or malfunctioning operating conditions.

### **Maintenance Free Battery**

The top of the maintenance free battery is permanently sealed. You will never have to add water, nor is periodic maintenance required.

### **WARNING!**

- **Battery fluid is a corrosive acid solution and can burn or even blind you. Don't allow battery fluid to contact your eyes, skin or clothing. Don't lean over a battery when attaching clamps. If acid splashes in eyes or on skin, flush the area immediately with large amounts of water.**
- **Battery gas is flammable and explosive. Keep flame or sparks away from the battery. Don't use a booster battery or any other booster source with an output greater than 12 volts. Don't allow cable clamps to touch each other.**
- **Battery posts, terminals and related accessories contain lead and lead compounds. Wash hands after handling.**

**CAUTION!**

- It is essential when replacing the cables on the battery that the positive cable is attached to the positive post and the negative cable is attached to the negative post. Battery posts are marked (+) positive and negative (-) and identified on the battery case.
- If a “fast charger” is used while battery is in vehicle, disconnect both vehicle battery cables before connecting the charger to battery. Do not use a “fast charger” to provide starting voltage.

**Power Steering — Fluid Check**

Checking the power steering fluid level at a defined service interval is not required. The fluid should only be checked if a leak is suspected, abnormal noises are apparent, and/or the system is not functioning as anticipated. Coordinate inspection efforts through an authorized DaimlerChrysler dealership.

**WARNING!**

Fluid level should be checked on a level surface and with the engine off to prevent injury from moving parts and to ensure accurate fluid level reading. Do not overfill. Use only manufacturers recommended power steering fluid.

If necessary, add fluid to restore to the proper indicated level. With a clean cloth, wipe any spilled fluid from all surfaces. For correct fluid type, refer to "Power Steering Reservoir" under "Fluids, Lubricants, and Genuine Parts" in this section.

### **Air Conditioner Maintenance**

For best possible performance, your air conditioner should be checked and serviced by an authorized dealer at the start of each warm season. This service should include cleaning of the condenser fins and a performance test. Drive belt tension should also be checked at this time.

### **WARNING!**

- **Use only refrigerants and compressor lubricants approved by the manufacturer for your air conditioning system. Some unapproved refrigerants are flammable and can explode, injuring you. Other unapproved refrigerants or lubricants can cause the system to fail, requiring costly repairs. Refer to Section 3 of the Warranty Information book for further warranty information.**
- **The air conditioning system contains refrigerant under high pressure. To avoid risk of personal injury or damage to the system, adding refrigerant or any repair requiring lines to be disconnected should be done by an experienced technician.**

**NOTE:** Use only manufacturer approved A/C System Sealers, Stop Leak Products, Seal Conditioners, Compressor Oils and Refrigerants.

### **Refrigerant Recovery and Recycling**

R-134a air conditioning refrigerant is a hydrofluorocarbon (HFC) that is endorsed by the Environmental Protection Agency and is an ozone-saving product. However, the manufacturer recommends that air conditioning service be performed by authorized dealers or other service facilities using recovery and recycling equipment.

### **Front Suspension Ball Joints**

The ball joints and seals should be inspected whenever the vehicle is serviced for other reasons. Damaged seals should be replaced to prevent leakage or contamination of the grease.

### **Drive Shaft Constant Velocity Joints**

All 4-wheel drive models are equipped with four constant velocity joints. Periodic lubrication of these joints is not required. However, the joint boot should be inspected for external leakage or damage periodically. If external leakage or damage is evident, the joint boot and grease should be replaced immediately. Continued operation could result in failure of the joint due to water and dirt contamination of the grease. This would require complete replacement of the joint assembly. Refer to the Service Manual for the detailed replacement procedure.

### **Body Lubrication**

Locks and all body pivot points, including such items as seat tracks, doors, liftgate, and hood hinges should be lubricated periodically to assure quiet, easy operation and to protect against rust and wear. Prior to the application of any lubricant, the parts concerned should be wiped clean to remove dust and grit; after lubricating excess oil and grease should be removed. Particular

attention should also be given to hood latching components to ensure proper function. When performing other underhood services, the hood latch release mechanism and safety catch should be cleaned and lubricated.

The external lock cylinders should be lubricated twice a year, preferably in the fall and spring. Apply a small amount of a high quality lubricant such as Mopar® Lock Cylinder Lubricant directly into the lock cylinder.

### **Windshield Wiper Blades**

The rubber edges of the wiper blades and the windshield should be cleaned periodically with a sponge or soft cloth and a mild nonabrasive cleaner. This will remove accumulations of salt or road film.

Operation of the wipers on dry glass for long periods may cause deterioration of the wiper blades. Always use washer fluid when using the wipers to remove salt or dirt from a dry windshield.

Avoid using the wiper blades to remove frost or ice from the windshield. Keep the blade rubber out of contact with petroleum products such as engine oil, gasoline, etc.

### **Windshield and Rear Window Washers**

The fluid reservoir for the windshield washers and the rear window washer is shared. The fluid reservoir is located in the engine compartment: be sure to check the fluid level at regular intervals. Fill the reservoir with windshield washer solvent only (not radiator antifreeze). When refilling the washer fluid reservoir, take some washer fluid and apply it to a cloth or towel and wipe clean the wiper blades; this will help blade performance. To prevent freeze-up of your windshield washer system in cold weather, select a solution or mixture that meets or exceeds the temperature range of your climate. This rating information can be found on most washer fluid containers.

The washer fluid reservoir will hold a full gallon/liter of fluid when the Low Washer Fluid Light illuminates.

**WARNING!**

**Commercially available windshield washer solvents are flammable. They could ignite and burn you. Care must be exercised when filling or working around the washer solution.**

### **Exhaust System**

The best protection against carbon monoxide entry into the vehicle body is a properly maintained engine exhaust system.

Whenever a change is noticed in the sound of the exhaust system, when exhaust fumes can be detected inside the vehicle, or when the underside or rear of the vehicle is

damaged, have a competent mechanic inspect the complete exhaust system and adjacent body areas for broken, damaged, deteriorated, or mispositioned parts. Open seams or loose connections could permit exhaust fumes to seep into the passenger compartment. In addition, inspect the exhaust system each time the vehicle is raised for lubrication or oil change. Replace as required.

**WARNING!**

**Exhaust gases can injure or kill. They contain carbon monoxide (CO) which is colorless and odorless. Breathing it can make you unconscious and can eventually poison you. To avoid breathing CO, follow the preceding safety tips.**

## Cooling System

### **WARNING!**

**You or others can be badly burned by hot coolant or steam from your radiator. If you see or hear steam coming from under the hood, don't open the hood until the radiator has had time to cool. Never try to open a cooling system pressure cap when the radiator is hot.**

### **Engine Coolant Checks**

Check the engine coolant (antifreeze) protection every 12 months (before the onset of freezing weather, where applicable). If coolant is dirty or rusty in appearance, the system should be drained, flushed and refilled with fresh coolant. Check the front of the A/C condenser and

radiator for any accumulation of bugs, leaves, etc. If dirty, clean by gently spraying water from a garden hose vertically down the face of the condenser and radiator.

Check the coolant recovery bottle tubing for brittle rubber, cracking, tears, cuts and tightness of the connection at the bottle and radiator. Inspect the entire system for leaks.

With the engine at normal operating temperature (but not running), check the cooling system pressure cap for proper vacuum sealing by draining a small amount of coolant from the radiator drain cock. If the cap is sealing properly, the engine coolant (antifreeze) will begin to drain from the coolant recovery bottle. **DO NOT REMOVE THE COOLANT PRESSURE CAP WHEN THE COOLING SYSTEM IS HOT.**



**Cooling System — Drain, Flush and Refill**

At the intervals shown on the Maintenance Schedules, the system should be drained, flushed and refilled.

If the solution is dirty or contains a considerable amount of sediment, clean and flush with a reliable cooling system cleaner. Follow with a thorough rinsing to remove all deposits and chemicals. Properly dispose of old antifreeze solution.

**Selection Of Coolant**

Use only the manufacturer's recommended coolant; for correct coolant type, refer to "Engine Coolant" under "Fluids, Lubricants and Genuine Parts" in this section.

**CAUTION!**

- **Mixing of coolants other than specified HOAT engine coolants may result in engine damage and may decrease corrosion protection. If a non-HOAT coolant is introduced into the cooling system in an emergency, it should be replaced with the specified coolant as soon as possible.**
- **Do not use plain water alone or alcohol-based engine coolant (antifreeze) products. Do not use additional rust inhibitors or antirust products, as they may not be compatible with the radiator engine coolant and may plug the radiator.**
- **This vehicle has not been designed for use with Propylene Glycol based coolants. Use of Propylene Glycol based coolants is not recommended.**

## Adding Coolant

Your vehicle has been built with an improved engine coolant that allows extended maintenance intervals. This coolant can be used up to 5 Years or 100,000 miles (160 000 km) before replacement. To prevent reducing this extended maintenance period, it is important that you use the same coolant throughout the life of your vehicle. Please review these recommendations for using Hybrid Organic Additive Technology (HOAT) coolant. When adding coolant:

- The manufacturer recommends using Mopar® Antifreeze/Coolant 5 Year/100,000 Mile Formula HOAT (Hybrid Organic Additive Technology)
- Mix a minimum solution of 50% HOAT engine coolant and distilled water. Use higher concentrations (not to exceed 70%) if temperatures below -34°F (-37°C) are anticipated.

- Use only high purity water such as distilled or deionized water when mixing the water/engine coolant solution. The use of lower quality water will reduce the amount of corrosion protection in the engine cooling system.

Please note that it is the owner's responsibility to maintain the proper level of protection against freezing according to the temperatures occurring in the area where the vehicle is operated.

**NOTE:** Mixing coolant types will decrease the life of the engine coolant and will require more frequent coolant changes.

## Cooling System Pressure Cap

The cap must be fully tightened to prevent loss of coolant, and to ensure that coolant will return to the radiator from the coolant recovery bottle.

The cap should be inspected and cleaned if there is any accumulation of foreign material on the sealing surfaces.

### WARNING!

- **The warning words “DO NOT OPEN HOT” on the cooling system pressure cap are a safety precaution. Never add coolant when the engine is overheated. Do not loosen or remove the cap to cool an overheated engine. Heat causes pressure to build up in the cooling system. To prevent scalding or injury, do not remove the pressure cap while the system is hot or under pressure.**
- **Do not use a pressure cap other than the one specified for your vehicle. Personal injury or engine damage may result.**

### Disposal of Used Engine Coolant

Used ethylene glycol based engine coolant is a regulated substance requiring proper disposal. Check with your local authorities to determine the disposal rules for your community. To prevent ingestion by animals or children do not store ethylene glycol based engine coolant in open containers or allow it to remain in puddles on the ground. If ingested by a child, contact a physician immediately. Clean up any ground spills immediately.

### Coolant Level

The coolant bottle provides a quick visual method for determining that the coolant level is adequate. With the engine cold, the level of the coolant in the coolant recovery bottle should be between the ranges indicated on the bottle dipstick.

The radiator normally remains completely full, so there is no need to remove the radiator cap unless checking for coolant freeze point or replacing coolant. Advise your

service attendant of this. As long as the engine operating temperature is satisfactory, the coolant bottle need only be checked once a month.

When additional coolant is needed to maintain the proper level, it should be added to the coolant bottle. Do not overfill.

### Points to Remember

**NOTE:** When the vehicle is stopped after a few miles (a few kilometers) of operation, you may observe vapor coming from the front of the engine compartment. This is normally a result of moisture from rain, snow, or high humidity accumulating on the radiator and being vaporized when the thermostat opens, allowing hot coolant to enter the radiator.

If an examination of your engine compartment shows no evidence of radiator or hose leaks, the vehicle may be safely driven. The vapor will soon dissipate.

- Do not overfill the coolant recovery bottle.
- Check coolant freeze point in the radiator and in the coolant recovery bottle. If antifreeze needs to be added, contents of coolant recovery bottle must also be protected against freezing.
- If frequent coolant additions are required, or if the level in the coolant recovery bottle does not drop when the engine cools, the cooling system should be pressure tested for leaks.
- Maintain coolant concentration at 50% HOAT engine coolant (minimum) and distilled/deionized water for proper corrosion protection of your engine which contains aluminum components.
- Make sure that the radiator and coolant recovery bottle overflow hoses are not kinked or obstructed.

- Keep the front of the radiator clean. If your vehicle is equipped with air conditioning, keep the front of the condenser clean, also.
- Do not change the thermostat for summer or winter operation. If replacement is ever necessary, install **ONLY** the correct type thermostat. Other designs may result in unsatisfactory coolant performance, poor gas mileage, and increased emissions.

### Emission Related Components

#### Fuel System Hoses and Vapor/Vacuum Harnesses

When the vehicle is serviced for scheduled maintenance, inspect surface of hoses and nylon tubing for evidence of heat and mechanical damage. Hard and brittle rubber, cracking, checking, tears, cuts, abrasions, and excessive swelling suggest deterioration of the rubber. Particular attention should be given to examining hose surfaces nearest to high heat sources, such as the exhaust manifold.

Ensure nylon tubing in these areas has not melted or collapsed.

Inspect all hose clamps and couplings to make sure they are secure and no leaks are present.

**NOTE:** Fluids such as oil, power steering fluid, and brake fluid are used during assembly plant operations to ease the assembly of hoses to couplings. Therefore, oil wetness at the hose-coupling area is not necessarily an indication of leakage. Actual dripping of hot fluid when systems are under pressure (during vehicle operation), should be noted before hose is replaced based on leakage.

You are urged to use only the manufacturer's specified hoses and clamps, or their equivalent in material and specification, in any fuel system servicing. It is mandatory to replace all clamps that have been loosened or removed during service. Care should be taken in installing new clamps to ensure they are properly torqued.

### **Positive Crankcase Ventilation (PCV) Valve**

Proper operation of the crankcase ventilation system requires that the PCV valve be free of sticking or plugging because of deposits. Deposits can accumulate in the PCV valve and passage with increasing mileage. Have the PCV valve, hoses, and passages checked for proper operation at the intervals specified. If the valve is plugged or sticking, replace with a new valve – **Do not attempt to clean the PCV valve!** Check ventilating hose for indication of damage or plugging with deposits. Replace if necessary.

### **Brake System**

#### **Power Disc Brakes (Front and Rear)**

Disc brakes do not require adjustment; however, several hard stops during the break-in period are recommended to seat the linings and wear off any foreign material.

### **Brake Master Cylinders**

The fluid level in the master cylinders should be checked whenever the vehicle is serviced, or immediately if the brake system warning light is on. If necessary, add fluid to bring level to the full mark on the side of the reservoir of the brake master cylinder. Be sure to clean the top of the master cylinder area before removing the cap. With disc brakes, fluid level can be expected to fall as the brake pads wear. Brake fluid level should be checked when pads are replaced. If the brake fluid level is abnormally low, check system for leaks.

For correct fluid type, refer to "Brake Master Cylinder" under "Fluids, Lubricants and Genuine Parts" in this section.

**WARNING!**

Use of brake fluid that may have a lower initial boiling point, or is unidentified as to specifications may result in sudden brake failure during hard prolonged braking. You could have an accident.

**WARNING!**

Overfilling the brake fluid reservoir can result in spilling brake fluid on hot engine parts and the brake fluid catching on fire.

Use only brake fluid that has been in a tightly closed container to avoid contamination from foreign matter or moisture.

**CAUTION!**

Do not allow a petroleum-base fluid to contaminate the brake fluid. Seal damage may result.

**Brake Hoses**

Inspection should be performed whenever the brake system is serviced or at intervals specified. Inspect hydraulic brake hoses for surface cracking, scuffing or worn spots. If there is any evidence of cracking, scuffing, or worn spots, the hose should be replaced immediately! Eventual deterioration of the hose can take place with possible burst failure.

**WARNING!**

**Worn brake hoses can burst and cause brake failure. You could have an accident. If you see any sign of cracking, scuffing, or worn spots, have the brake hoses replaced immediately.**

**Automatic Transmission****Fluid Level Check**

**NOTE:** If equipped with a dipstick, use the following procedure. If your vehicle has a capped dipstick, it is sealed and should not be tampered with. Your authorized dealer has the proper tools to ensure that the fluid level is set properly.

Check the fluid level while the transmission is at normal operating temperature 180°F (82°C). This occurs after at

least 15 miles (24 km) of driving. At normal operating temperature the fluid cannot be held comfortably between the fingertips.

To check the automatic transmission fluid level properly, the following procedure must be used:

1. Operate the engine at idle speed and normal operating temperature.
2. The vehicle must be on level ground.
3. Fully apply the parking brake and press the brake pedal.
4. Place the shift lever momentarily in each gear position ending with the lever in PARK.
5. Remove the dipstick, wipe it clean and reinsert it until seated.
6. Remove the dipstick again and note the fluid level on both sides. The fluid level should be between the “HOT”



(upper) reference holes on the dipstick at normal operating temperature. Verify that solid coating of oil is seen on both sides of the dipstick. If the fluid is low, add as required into the dipstick tube. **Do not overfill.** After adding any quantity of oil through the oil fill tube, wait a minimum of two minutes for the oil to fully drain into the transmission before rechecking the fluid level.

**NOTE:** If it is necessary to check the transmission **below** the operating temperature, the fluid level should be between the two “COLD” (lower) holes on the dipstick with the fluid at approximately 70°F (21°C) (room temperature). If the fluid level is correctly established at room temperature, it should be between the “HOT” (upper) reference holes when the transmission reaches 180°F (82°C). Remember it is best to check the level at the normal operating temperature.

### CAUTION!

**Be aware that if the fluid temperature is below 50°F (10°C) it may not register on the dipstick. Do not add fluid until the temperature is elevated enough to produce an accurate reading.**

7. Check for leaks. Release parking brake.

To prevent dirt and water from entering the transmission after checking or replenishing fluid, make certain that the dipstick cap is properly reseated. It is normal for the dipstick cap to spring back slightly from its fully seated position, as long as its seal remains engaged in the dipstick tube.

### **Automatic Transmission Fluid And Filter Change**

Follow the Maintenance Schedule for recommended transmission fluid and filter change intervals.

### Selection of Lubricant

It is important that the proper lubricant is used in the transmission to assure optimum transmission performance. Use only manufacturer's recommended transmission fluid; for correct fluid type, refer to "Automatic Transmission" under "Fluids, Lubricants and Genuine Parts" in this section. It is important that the transmission fluid be maintained at the prescribed level using the recommended fluid.

### Special Additives

Automatic Transmission Fluid (ATF) is an engineered product and its performance may be impaired by supplemental additives. Therefore, do not add any fluid additives to the transmission. The only exception to this policy is the use of special dyes to aid in detecting fluid leaks. In addition, avoid using transmission sealers as they may adversely affect seals.

### CAUTION!

**Using a transmission fluid other than the manufacturer's recommended fluid may cause deterioration in transmission shift quality and/or torque converter shudder. Using a transmission fluid other than the manufacturer's recommended fluid will result in more frequent fluid and filter changes. For correct fluid type, refer to "Automatic Transmission" under "Fluids, Lubricants and Genuine Parts" in this section.**

### Transfer Case

Inspect the transfer case for fluid leaks. If a fluid leak is evident the transfer case fluid level may be low. Have the transfer case serviced immediately.

**CAUTION!**

**Damage may result from operation of the vehicle with low transfer case fluid.**

**Drain And Refill**

Follow the Maintenance Schedule for recommended transfer case fluid change intervals.

**Lubricant Selection**

For correct fluid type, refer to "Transfer Case" under "Fluids, Lubricants and Genuine Parts" in this section.

**Axles**

For correct fluid type, refer to "Front or Rear Axle" under "Fluids, Lubricants and Genuine Parts" in this section.

**Drain And Refill**

Follow the Maintenance Schedule for recommended axle fluid change intervals.

**NOTE:** The presence of water in the gear lubricant will result in corrosion and possible failure of differential components. Operation of the vehicle in water, as may be encountered in some off-highway types of service, will require draining and refilling the axle to avoid damage.

**Rear Axle**

Rear Axle fluid levels should be  $7/8$  in (22 mm)  $\pm 1/4$  in (6 mm) below the fill hole for  $8 1/4$  in (21 cm) and  $9 1/4$  (23 cm) in axles should be  $1 5/8$  in (31 mm)  $\pm 1/4$  in (6 mm)

**Front Axle**

Front axle fluid level should be  $3/4$  in (20 mm)  $\pm 1/4$  in (6 mm) below the level of the fill hole.

## Appearance Care and Protection From Corrosion

### Protection of Body and Paint from Corrosion

Vehicle body care requirements vary according to geographic locations and usage. Chemicals that make roads passable in snow and ice, and those that are sprayed on trees and road surfaces during other seasons, are highly corrosive to the metal in your vehicle. Outside parking, which exposes your vehicle to airborne contaminants, road surfaces on which the vehicle is operated, extreme hot or cold weather and other extreme conditions will have an adverse effect on paint, metal trim, and underbody protection.

The following maintenance recommendations will enable you to obtain maximum benefit from the corrosion resistance built into your vehicle.

### What Causes Corrosion?

Corrosion is the result of deterioration or removal of paint and protective coatings from your vehicle.

The most common causes are:

- Road salt, dirt and moisture accumulation.
- Stone and gravel impact.
- Insects, tree sap and tar.
- Salt in the air near seacoast localities.
- Atmospheric fallout/industrial pollutants.

### Washing

- Wash your vehicle regularly. Always wash your vehicle in the shade using a mild car wash soap, and rinse the panels completely with clear water.
- If insects, tar or other similar deposits have accumulated on your vehicle, wash it as soon as possible.
- Use Mopar® Auto Polish to remove road film and stains and to polish your vehicle. Take care never to scratch the paint.

- Avoid using abrasive compounds and power buffing that may diminish the gloss or thin out the paint finish.

**CAUTION!**

**Do not use abrasive or strong cleaning materials such as steel wool or scouring powder, which will scratch metal and painted surfaces.**

**Special Care**

- If you drive on salted or dusty roads or if you drive near the ocean, hose off the undercarriage at least once a month.
- It is important that the drain holes in the lower edges of the doors, rocker panels and liftgate be kept clear and open.
- If you detect any stone chips or scratches in the paint, touch them up immediately. The cost of such repairs is considered the responsibility of the owner.
- If your vehicle is damaged due to an accident or similar cause which destroys the paint and protective coating have your vehicle repaired as soon as possible. The cost of such repairs is considered the responsibility of the owner.
- If you carry special cargo such as chemicals, fertilizers, de-icer salt, etc., be sure that such materials are well packaged and sealed.
- If a lot of driving is done on gravel roads, consider mud or stone shields behind each wheel.
- Use Mopar® touch up paint on scratches as soon as possible. Your authorized dealer has touch up paint to match the color of your vehicle.

### Wheel and Wheel Trim Care

All wheels and wheel trim, especially aluminum and chrome plated wheels, should be cleaned regularly with a mild soap and water to prevent corrosion. To remove heavy soil, use Mopar® Wheel Cleaner or select a non-abrasive, non-acidic cleaner. Do not use scouring pads, steel wool, a bristle brush or metal polishes. Only Mopar® cleaners are recommended. Do not use oven cleaner. Avoid automatic car washes that use acidic solutions or harsh brushes that may damage the wheels' protective finish.

### YES Essentials® Fabric Cleaning Procedure – If Equipped

YES Essentials® seats may be cleaned in the following manner:

- Remove as much of the stain as possible by blotting with a clean, dry towel.
- Blot any remaining stain with a clean, damp towel.

- For tough stains, apply Mopar® Total Clean or a mild soap solution to a clean, damp cloth and remove stain. Use a fresh, damp towel to remove soap residue.
- For grease stains, apply Mopar® Multi-Purpose Cleaner to a clean, damp cloth and remove stain. Use a fresh, damp towel to remove soap residue.
- Do not use any solvents or protectants on YES Essentials® products.

### Interior Care

Use Mopar® Fabric Cleaner to clean fabric upholstery and carpeting.

Use Mopar® Vinyl Cleaner to clean vinyl upholstery and trim.

Mopar® Total Clean is specifically recommended for leather upholstery.

Your leather upholstery can be best preserved by regular cleaning with a damp soft cloth. Small particles of dirt can act as an abrasive and damage the leather upholstery and should be removed promptly with a damp cloth. Stubborn soils can be removed easily with a soft cloth and Mopar® Total Clean. Care should be taken to avoid soaking your leather upholstery with any liquid. Please do not use polishes, oils, cleaning fluids, solvents, detergents, or ammonia based cleaners to clean your leather upholstery. Application of a leather conditioner is not required to maintain the original condition.

**WARNING!**

**Do not use volatile solvents for cleaning purposes. Many are potentially flammable, and if used in closed areas they may cause respiratory harm.**

**Cleaning Headlights**

Your vehicle has plastic headlights that are lighter and less susceptible to stone breakage than glass headlights.

Plastic is not as scratch resistant as glass and therefore different lens cleaning procedures must be followed.

To minimize the possibility of scratching the lenses and reducing light output, avoid wiping with a dry cloth. To remove road dirt, wash with a mild soap solution followed by rinsing.

Do not use abrasive cleaning components, solvents, steel wool or other aggressive material to clean the lenses.

**Glass Surfaces**

All glass surfaces should be cleaned on a regular basis with any commercial household-type glass cleaner. Never use an abrasive type cleaner. Use caution when cleaning inside rear windows equipped with electric

defrosters or windshields equipped with a windshield wiper de-icer. Do not use scrapers or other sharp instruments which may scratch the elements.

When cleaning the rear view mirror, spray cleaner on the towel or rag that you are using. Do not spray cleaner directly on the mirror.

### **Cleaning Plastic Instrument Cluster Lenses**

The lenses in front of the instruments in this vehicle are molded in clear plastic. When cleaning the lenses, care must be taken to avoid scratching the plastic.

1. Clean with a wet soft rag. A mild soap solution may be used, but do not use high alcohol content or abrasive cleaners. If soap is used, wipe clean with a clean damp rag.
2. Dry with a soft tissue.

### **Seat Belt Maintenance**

Do not bleach, dye or clean the belts with chemical solvents or abrasive cleaners. This will weaken the fabric. Sun damage will also weaken the fabric.

If the belts need cleaning, use a mild soap solution or lukewarm water. Do not remove the belts from the vehicle to wash them.

Replace the belts if they appear frayed or worn or if the buckles do not work properly.



## FUSE BLOCK

### CAUTION!

When replacing a blown fuse, it is important to use only a fuse having the correct amperage rating. The use of a fuse with a rating other than indicated may result in a dangerous electrical system overload. If a properly rated fuse continues to blow, it suggests a problem in the circuit that must be corrected.

**NOTE:** If you are leaving your vehicle dormant for longer than 21 days you may want to take steps to protect your battery. You may do this by disconnecting the battery or by disconnecting the two ignition-off draw (I.O.D.) fuses located in the auxiliary Power Distribution Center (PDC) in the engine compartment. The I.O.D. cavities include a snap-in retainer that allows the fuse to be disconnected without removing it from the fuse block. Pressing the I.O.D. fuse back into the cavity reconnects it.

### Fuses (Interior)

The fuse block contains blade-type mini-fuses, relays, and circuit breakers for high-current circuits. It is located in the left kick panel. It is accessible through a snap-in cover.

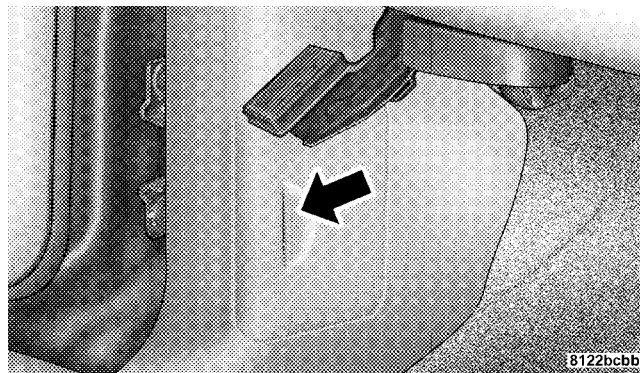

Interior Fuse Panel Cover

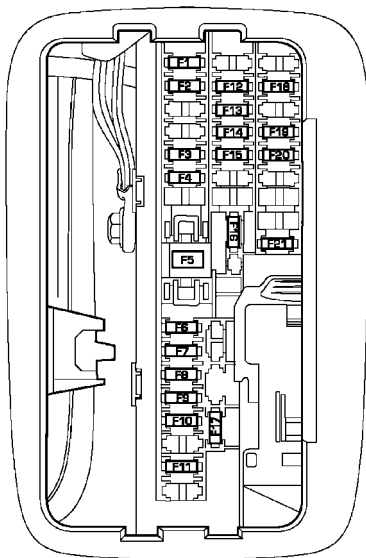

819625ae

**Interior Fuse Location**

Cavity	Mini Fuse/ Color	Description
F1	15 Amp Blue	Instrument Cluster Battery Feed
F 2	10 Amp Red	Spare
F3	10 Amp Red	Ignition Run/Start for Next Generation Con- troller (NGC), Inte- grated Power Module (IPM), A/C Relay and Fuel Pump Relay
F4	10 Amp Red	Door Node and Non- Memory Power Mirror Switch Battery Feed
F5	(2) 10 Amp Red	Airbags (two Fuses in Yellow Holder)
F6	2 Amp Clear	Ignition Run/Start Unlock

F7	25 Amp Natural	Radio Battery Feed
F8	10 Amp Red	Ignition Run/Start for Cluster/Transfer Case/Seat Sw. Back Lighting
F9	10 Amp Red	Satellite Digital Audio Receiver (SDAR)/ Digital Video Disc (DVD) Battery Feed
F10	10 Amp Red	Spare
F11	10 Amp Red	Heated Mirrors
F12	20 Amp Yellow	Cluster Battery Feed
F13	10 Amp Red	Ignition Run HVAC Module/Heated Rear Glass (EBL) Relay
F14	10 Amp Red	ABS Module Ignition Run

F15	15 Amp Blue	Battery Feed Bluetooth®, Compass/Trip Computer (CMTC), Sentry Key® Diagnostics
F16	20 Amp Yellow	Reconfigurable Power Outlets
F17	20 Amp Yellow	Ignition Run / Rear Park Assist / Second Row Heated Seats
F18	20 Amp Yellow	Cigar Lighter Ignition
F19	10 Amp Red	Spare Fuse
F20	15 Amp Blue	Heating & Air Conditioning w/ATC Only Battery Feed
F21	25 Amp Natural	Amplifier Battery Feed

## Fuses (Power Distribution Center)

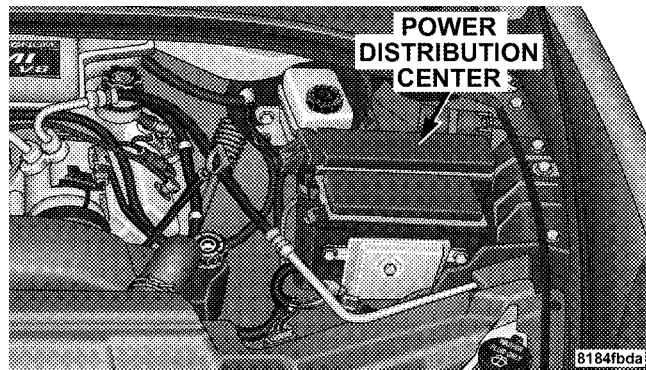

### Power Distribution Center

Your vehicle is equipped with an electrical power distribution center located in the left side of the engine compartment.

This center contains cartridge fuses, mini fuses and relays. A description of each fuse and component may be

stamped on the inside cover, otherwise the cavity number of each fuse is stamped on the inside cover that corresponds to the following chart. These fuses and relays can be obtained from your authorized dealer.

Cavity	Cartridge Fuse / Relay	Mini Fuse	Description
1	30 Amp Pink		Starter
2	30 Amp Pink		Front Wiper
3	40 Amp Green		Brake Batt
4	30 Amp Pink		JB Feed Acc # 2
5	40 Amp Green		Power Seats
6	30 Amp Pink		Run Remote Relay Feed

Cavity	Cartridge Fuse / Relay	Mini Fuse	Description
7	40 Amp Green		Blower Motor Relay Feed
8	40 Amp Green		JB Feed Acc Delay
9	Spare		
10	30 Amp Pink		ASD
11	40 Amp Green		Power Liftgate ( If Equipped)
12	40 Amp Green		JB Feed / Heated Rear Glass (EBL)/T-Case Brake
13	30 Amp Pink		JB Feed RR
14	40 Amp Green		ESP Pump

Cavity	Cartridge Fuse / Relay	Mini Fuse	Description
15	50 Amp Red		JB Feed
16		10 Amp Red	Spare
17		Spare	
18		20 Amp Yellow	Fuel Pump
19		20 Amp Yellow	Next Generation Controller (NGC)
20		25 Amp Clear	115V Power Inverter
21		20 Amp Yellow	ABS Batt
22		20 Amp Yellow	Next Generation Controller (NGC) Batt

Cavity	Cartridge Fuse / Relay	Mini Fuse	Description
23		20 Amp Yellow	Trailer Tow
24		15 Amp Blue	A/C Clutch
25		15 Amp Blue	Stop Lamp Switch
26		Spare	
27		20 Amp Yellow	Run/Start Relay Feed
28		Spare	
29	Relay		Run Start
30	Relay		Run Remote
31	Spare		
32	Relay		Starter

Cavity	Cartridge Fuse / Relay	Mini Fuse	Description
33	Relay		Electronic Automatic Transaxle (EATX)
34	Relay		AC Clutch
35	Relay		Fuel Pump Rly
36	Spare		
37	Relay		Stop Lamp Switch
38	Spare		
39	Relay		Blower Motor
40	Relay		Auto Shut Down (ASD) Rly

## Fuses (Integrated Power Module)

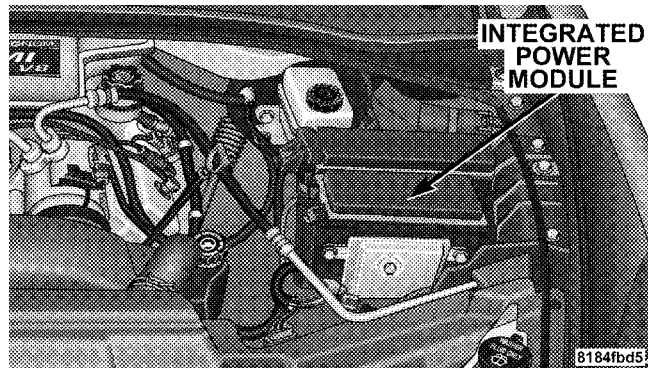

### Integrated Power Module

An integrated power module is located in the left side of the engine compartment. This center contains cartridge fuses, mini fuses and relays. A description of each fuse and component may be stamped on the inside cover,

otherwise the cavity number of each fuse is stamped on the inside cover that corresponds to the following chart.

Cavity	Cartridge Fuse / Relay	Mini Fuse	Description
1	Relay		Wiper On/Off Rly
2	Relay		Wiper Hi/Lo Rly
3	Relay		Horn Rly
4	Relay		Rear Wiper Rly
5	Relay		Lt Trailer-Tow Stop/ Turn Rly
6	Relay		Rt Trailer-Tow Stop/ Turn Rly
7	Relay		Park Lamps Rly
8		10 Amp Red	Lt Park Lamps
9		10 Amp Red	Trailer-Tow Park Lamps

Cavity	Cartridge Fuse / Relay	Mini Fuse	Description
10		10 Amp Red	Rt Park Lamps
11	Relay		Radiator Fan Hi Rly
12		20 Amp Yellow	Front Control Module (FCM) Batt #4
13		20 Amp Yellow	Front Control Module (FCM) Batt #2
14		20 Amp Yellow	Adjustable Pedal
15		20 Amp Yellow	Ft Fog Lamps
16		20 Amp Yellow	Horn
17		20 Amp Yellow	Rear Wiper

Cavity	Cartridge Fuse / Relay	Mini Fuse	Description
18		20 Amp Yellow	Front Control Module (FCM) Batt #1
19		20 Amp Yellow	Lt Trailer-Tow Stop/ Turn
20		20 Amp Yellow	Front Control Module (FCM) Batt #3
21		20 Amp Yellow	Rt Trailer-Tow Stop/ Turn
22	30 Amp Pink		Front Control Module (FCM) BATT # 5
23	40 Amp Green		Radiator Fan
24	Relay		Radiator Fan Lo Rly
25	Relay		Ft Fog Lamps Rly
26	Relay		Adjustable Pedal Rly



Cavity	Cartridge Fuse / Relay	Mini Fuse	Description
27		30 Amp Green	Ignition Off Draw (IOD) #1
28		30 Amp Green	Ignition Off Draw (IOD) #2
29			Spare
30			Spare

## VEHICLE STORAGE

If you are storing your vehicle for more than 21 days, we recommend that you take the following steps to minimize the drain on your vehicle's battery:

- Disconnect the Ignition Off Draw (I.O.D.) fuses located in the Power Distribution Center (PDC). The I.O.D. cavity includes a snap-in retainer that allows the fuse to be disconnected without removing it from the fuse block.
- The transfer case should be placed in the 4HI mode and kept in this position to minimize the battery drain.
- As an alternative to the above steps you may disconnect the negative cable from the battery.

## REPLACEMENT LIGHT BULBS

<b>LIGHT BULBS — Interior</b>	<b>Bulb No.</b>
Dome Light . . . . .	Not Serviceable
Liftgate Lamp . . . . .	567
Overhead Console Lights . . . . .	Not Serviceable
Reading Light . . . . .	Not Serviceable
Visor Vanity Lights . . . . .	Not Serviceable

<b>LIGHT BULBS — Exterior</b>	<b>Bulb No.</b>
Headlight . . . . .	H13
Front Park/Turn . . . . .	3457AK
Backup . . . . .	3057
Center High-Mounted Stop Light . . . . .	921
Front Side Marker . . . . .	168
Fog Lamp . . . . .	9145
License Plate Light . . . . .	168
Rear Tail, Stop, Turn Signal and Side Marker . . . . .	3057

## BULB REPLACEMENT

### Headlights/Parking/Turn Signal

1. Remove the two bolts attaching the headlight to the upper fender reinforcement. (Hood must be open to access bolts).

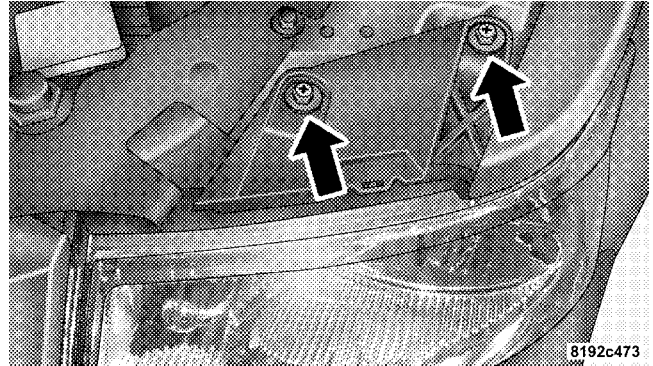

8192c473

2. Remove one nut that attaches the headlight to the inner fender panel. Access to the nut is possible by opening the fender panel access door which is located in the wheel liner.

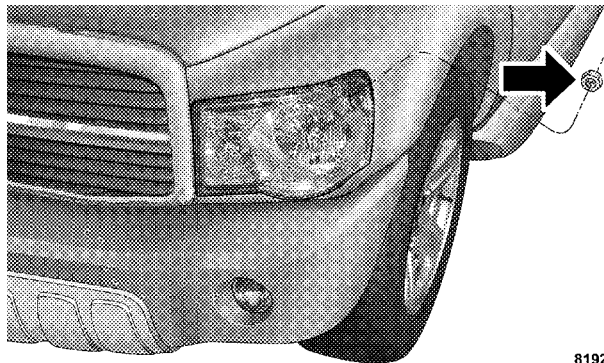

8192c6cd

3. Grasp the headlight and pull firmly to disengage the headlight from the fender panel.

4. While firmly holding the headlight in your hands, disconnect all connectors by following the procedure described in Step 5 below.

5. Remove the bulb connector from the headlight, making sure to pull and release the red tab on all connectors. Loosen the connector by pressing down on the black and/or green release which is located below or above the red tab. The green release is located above the red tab on the H13; the black release is located above the 3457AK red tab.

6. Twist and remove socket from lamp.

7. Remove bulb from socket and replace.

**NOTE:** These are halogen bulbs. Take care not to touch the bulb with your fingers. Body oils from your fingers could cause excessive heat build-up which reduces bulb life.

## Rear Side Marker, Tail Lights, Turn Signals And Backup Lights — Replacement

1. Remove the two push-pins from the tail light housing.

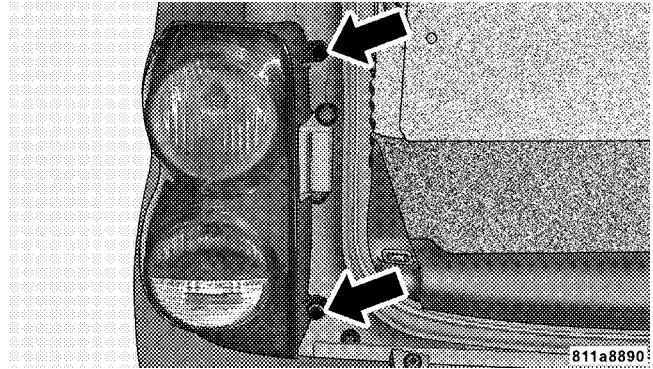
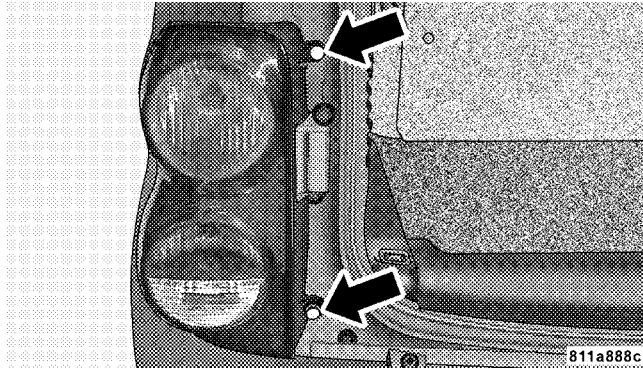

2. Rotate the light to the outboard side of the vehicle and remove.

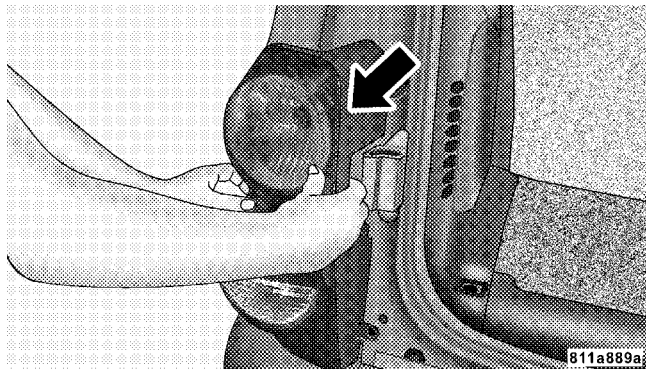

3. Unlock and remove electrical connector.

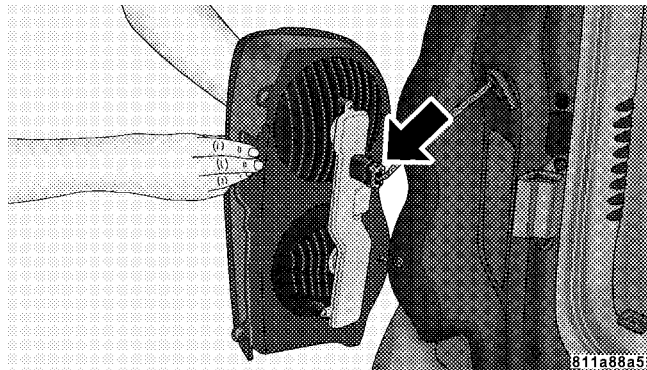

4. Remove the three screws holding the bulb strip to the back of the tail lamp.

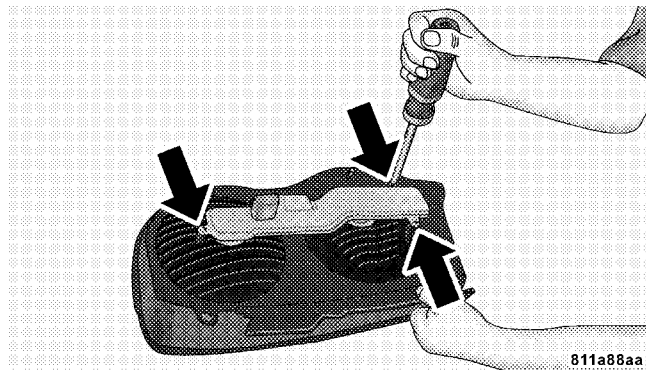

5. Remove the bulb strip from the tail light lens.

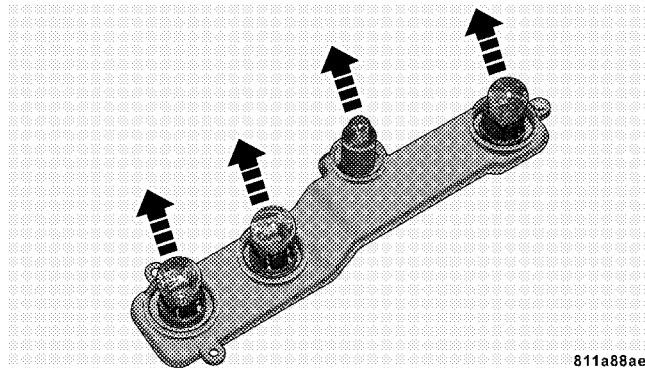

6. Remove bulbs from bulb strip by pulling the bulb straight out.

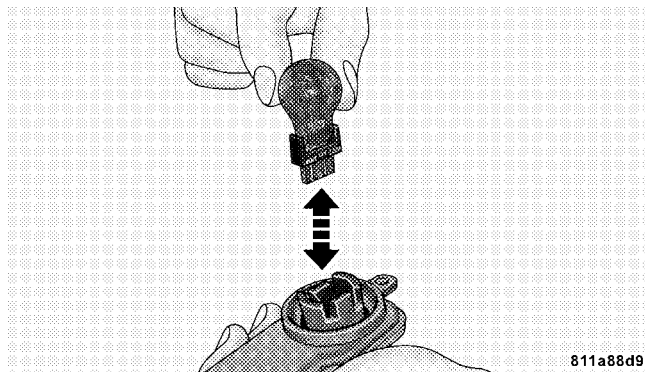
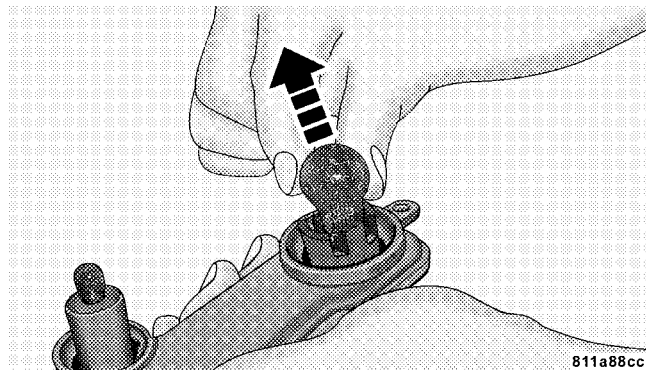

## License Lights

1. Remove the two screws securing the lens to the liftgate.

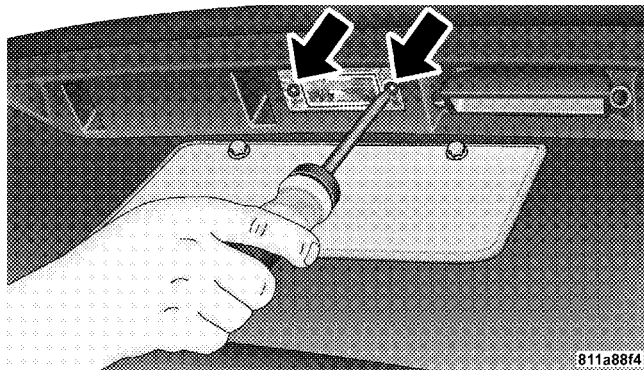

2. Rotate the socket 1/4 turn counterclockwise.

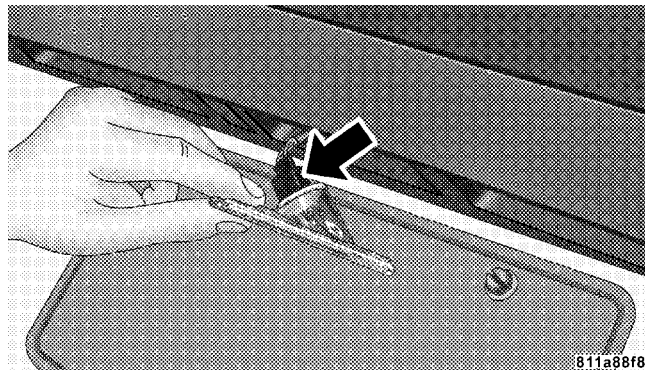

3. Pull bulb from socket.



### Center High-Mounted Stoplight

1. Remove two screws securing stoplight housing assembly to the liftgate.

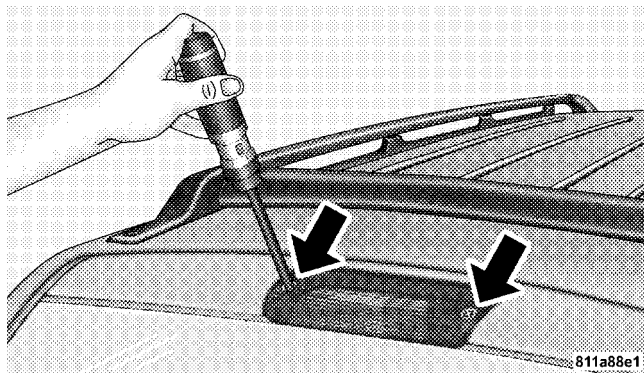

2. Turn socket 1/4 counterclockwise and free from housing.

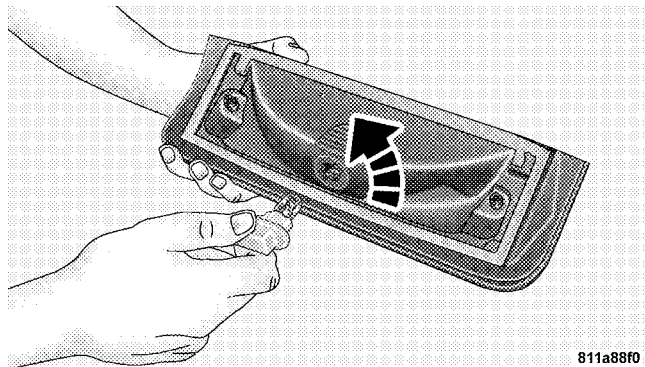

3. Pull bulb straight from socket to remove.

## Fog Lights

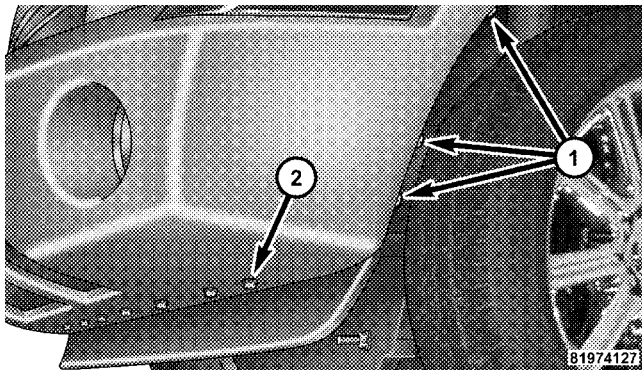

- 1 - Wheel Liner Screws  
2 - Far Left Air Dam Screw

To replace the left fog light bulb:

1. Remove the three wheel liner screws.

2. Remove the far left air dam screw at the bottom of the fascia.
3. Peel back the liner and access the fog light.
4. Rotate the socket and connector 1/4 turn counter-clockwise and pull straight rearward to disengage from the lamp.
5. Remove the bulb from the socket and replace.

The right fog light can be accessed from below the vehicle. Follow steps 4 and 5 of the left fog light to replace the bulb.

**NOTE:** These are Halogen bulbs. Take care not to touch the bulb with your fingers. Body oils from your fingers could cause excessive heat build-up, which reduces bulb life.

## FLUIDS AND CAPACITIES

	U.S.	Metric
<b>Fuel</b>		
3.7L/4.7L, 87 Octane	27 gal	102 L
5.7L, 89 Octane	27 gal	102 L
<b>Engine Oil (with filter)</b>		
3.7L, SAE 5W-20, API Certified	5 qts	4.7 L
4.7L, SAE 5W-20, API Certified	6 qts	5.7 L
5.7L, SAE 5W-20, API Certified	7 qts	6.6 L
<b>Cooling System (includes 2.1 Qts./2L for coolant bottle)</b>		
3.7L without Rear Heat (Mopar® Antifreeze/Coolant 5 Year/100,000 Mile Formula)	13.5 qts	12.9 L
3.7L with Rear Heat (Mopar® Antifreeze/Coolant 5 Year/100,000 Mile Formula)	14.5 qts	13.8 L
4.7L without Rear Heat (Mopar® Antifreeze/Coolant 5 Year/100,000 Mile Formula)	13.1 qts	12.5 L
4.7L with Rear Heat (Mopar® Antifreeze/Coolant 5 Year/100,000 Mile Formula)	14.2 qts	13.5 L
5.7L without Rear Heat (Mopar® Antifreeze/Coolant 5 Year/100,000 Mile Formula)	NA	NA
5.7L with Rear Heat (Mopar® Antifreeze/Coolant 5 Year/100,000 Mile Formula)	16.6 qts	15.8 L

**NOTE:** All fluid capacities are approximate.

## FLUIDS, LUBRICANTS AND GENUINE PARTS

### Engine

Component	Fluids, Lubricants and Genuine Parts
Engine Coolant	Mopar® Antifreeze/Coolant 5 Year/100,000 Mile Formula HOAT (Hybrid Organic Additive Technology)
3.7/4.7L/5.7L Engine Oil	Use API Certified SAE 5W-20 Engine Oil, meeting the requirements of DaimlerChrysler Material Standard MS-6395. Refer to your engine oil filler cap for correct SAE grade.
Engine Oil Filter	Mopar® Engine Oil Filter, P/N 5281090 or equivalent.
Spark Plugs (5.7L Engine)	REC14MCC4 (Gap 0.043 in [1.09 mm])
Spark Plugs (4.7L Engine)	Upper Bank — FR8TE2 (Gap 0.039 in [.99 mm]) Lower Bank — FR8T1332 (Gap 0.051 in [1.30 mm])
Spark Plugs (3.7L Engine)	ZFR6F-11G (Gap 0.043 in [1.09 mm])
Fuel Selection 5.7L	87 Octane Acceptable - 89 Octane Recommended
Fuel Selection 3.7L/4.7L	87 Octane

**Chassis**

Component	Fluids, Lubricants and Genuine Parts
Automatic Transmission	Mopar® ATF+4, Automatic Transmission Fluid.
Transfer Case	Mopar® ATF+4, Automatic Transmission Fluid.
Front Axle	SAE 75W-90 Multipurpose Type, GL-5 Gear Lubricant or equivalent.
Rear Axle	SAE 75W-140 Synthetic Gear Lubricant or equivalent.
Brake Master Cylinder	Mopar® DOT 3 and SAE J1703 should be used or equivalent. If DOT 3 brake fluid is not available, then DOT 4 is acceptable. Use only recommended brake fluids.
Power Steering Reservoir	Mopar® ATF+4, Automatic Transmission Fluid.

---

# MAINTENANCE SCHEDULES

## CONTENTS

---

<ul style="list-style-type: none"> <li>■ Emission Control System Maintenance . . . . . 454</li> <li>■ Maintenance Schedule . . . . . 454</li> </ul>	<ul style="list-style-type: none"> <li>□ Required Maintenance Intervals . . . . . 456</li> </ul>
---	--

### EMISSION CONTROL SYSTEM MAINTENANCE

The “Scheduled” maintenance services, listed in **bold type** on the following pages, must be done at the times or mileages specified to assure the continued proper functioning of the emission control system. These, and all other maintenance services included in this manual, should be done to provide best vehicle performance and reliability. More frequent maintenance may be needed for vehicles in severe operating conditions such as dusty areas and very short trip driving.

Inspection and service also should be done anytime a malfunction is suspected.

**NOTE:** Maintenance, replacement, or repair of the emission control devices and systems on your vehicle may be performed by any automotive repair establishment or individual, using any automotive part that has been certified pursuant to U.S. EPA or, in the State of California, California Air Resources Board regulations.

### MAINTENANCE SCHEDULE

The oil change indicator system will remind you that it is time to take your vehicle in for scheduled maintenance.

On Electronic Vehicle Information Center (EVIC) equipped vehicles “Oil Change Required” will be displayed in the EVIC and a single chime will sound, indicating that an oil change is necessary.

On non-EVIC equipped vehicles “Change Oil” will flash in the instrument cluster odometer and a single chime will sound, indicating that an oil change is necessary.

Based on engine operation conditions the oil change indicator message will illuminate, this means that service is required for your vehicle. Have your vehicle serviced as soon as possible, within the next 500 mi (805 km).

**NOTE:**

- The oil change indicator message will not monitor the time since the last oil change. Change your vehicle's oil if it has been 6 months since your last oil change even if the oil change indicator message is NOT illuminated.
- Change your engine oil more often if you drive your vehicle off-road for an extended period of time.
- Under no circumstances should oil change intervals exceed 6,000 mi (10 000 km) or 6 months, whichever comes first.

Your authorized dealer will reset the oil change indicator message after completing the scheduled oil change. If this scheduled oil change is performed by someone other than your authorized dealer the message can be reset by referring to the steps described under "OIL CHANGE REQUIRED - If Equipped" under "System Status (EVIC

Displays)" in Section 3, or under "Odometer/Trip Odometer" under "Instrument Cluster Description" in Section 4.

***At Each Stop for Fuel***

- Check the engine oil level about five minutes after a fully warmed engine is shut off. Checking the oil level while the vehicle is on level ground will improve the accuracy of the oil level reading. Add oil only when the level is at or below the ADD or MIN mark.
- Check the windshield washer solvent and add if required.

***Once a Month***

- Check tire pressure and look for unusual wear or damage.
- Inspect the battery and clean and tighten the terminals as required.



456 MAINTENANCE SCHEDULES

- Check the fluid levels of coolant reservoir, brake master cylinder, power steering and transmission and add as needed.
- Check all lights and other electrical items for correct operation.

**At Each Oil Change**

- Change the engine oil filter.
- Inspect the brake hoses and lines.

**CAUTION!**

**Failure to perform the required maintenance items may result in damage to the vehicle.**

**Required Maintenance Intervals**

**NOTE:** \*\* Vehicles built with the 4.7L engine are equipped with 16 spark plugs; one set is located on the top of the engine under the coils and the second set is located on the side of the engine.

The spark plugs located under the coils are a standard plug and must be changed every 30,000 mi (50 000 km).

The spark plugs located on the side of the engine are a premium plug and must be changed every 102,000 mi (170 000 km).

Maintenance Items	Perform Maintenance Every (Where time and mileage are listed, follow the interval that occurs first.)		
	Miles	Kilometers	or Months
Change the engine oil and engine oil filter.	6,000	10 000	6
Rotate tires.	6,000	10 000	6
If using your vehicle for any of the following: Dusty or off-road conditions. Inspect the engine air cleaner filter; replace if necessary.	12,000	20 000	12
Inspect the brake linings; replace if necessary.	12,000	20 000	12
Inspect the front and rear axle fluid; change if using your vehicle for police, taxi, fleet, off-road or frequent trailer towing.	18,000	30 000	18
Inspect the CV joints. Perform the first inspection at 12,000 mi (20 000 km) or 12 months.	24,000	40 000	24
Inspect exhaust system. Perform the first inspection at 12,000 mi (20 000 km) or 12 months.	24,000	40 000	24
Inspect the front suspension, tie rod ends and boot seals; replace if necessary.	24,000	40 000	24

## 458 MAINTENANCE SCHEDULES

Maintenance Items	Perform Maintenance Every (Where time and mileage are listed, follow the interval that occurs first.)		
	Miles	Kilometers	or Months
Replace the engine air cleaner filter.	30,000	50 000	30
Inspect the transfer case fluid.	30,000	50 000	30
<b>Replace the top row of spark plugs on 4.7L engines.</b> **	30,000	50 000	30
<b>Replace the spark plugs on 3.7L and 5.7L engines.</b>	30,000	50 000	30
Change the automatic transmission fluid & filter if using your vehicle for any of the following: police, taxi, fleet or frequent trailer towing.	60,000	100 000	60
Change the transfer case fluid if using your vehicle for any of the following: police, taxi, fleet, off-road or frequent trailer towing.	60,000	100 000	60
Inspect and replace PCV valve if necessary.	90,000	150 000	90
Flush and replace the engine coolant.	102,000	170 000	60
<b>Replace the ignition cables on 4.7L engines.</b>	102,000	170 000	102

Maintenance Items	Perform Maintenance Every (Where time and mileage are listed, follow the interval that occurs first.)		
	Miles	Kilometers	or Months
Replace the side row of spark plugs on 4.7L engines. **	102,000	170 000	102
Change the automatic transmission fluid & filter.	120,000	200 000	120
Replace accessory drive belt(s).	120,000	200 000	120

**WARNING!**

You can be badly injured working on or around a motor vehicle. Do only that service work for which you have the knowledge and the right equipment. If you have any doubt about your ability to perform a service job, take your vehicle to a competent mechanic.



# IF YOU NEED CONSUMER ASSISTANCE

## CONTENTS

---

■ Suggestions For Obtaining Service For Your Vehicle . . . . .	463	□ In Mexico Contact . . . . .	464
□ Prepare For The Appointment . . . . .	463	□ Customer Assistance For The Hearing Or Speech Impaired (TDD/TTY) . . . . .	465
□ Prepare A List . . . . .	463	□ Service Contract . . . . .	465
□ Be Reasonable With Requests . . . . .	463	■ Warranty Information (U.S. Vehicles Only) . . . . .	466
■ If You Need Assistance . . . . .	463	■ Mopar® Parts . . . . .	466
□ DaimlerChrysler Motors Corporation Customer Center . . . . .	464	■ Reporting Safety Defects . . . . .	466
□ DaimlerChrysler Canada Inc. Customer Center . . . . .	464	□ In The 50 United States And Washington, D.C. . . . .	466
		□ In Canada . . . . .	467

462 IF YOU NEED CONSUMER ASSISTANCE

---

- Publication Order Forms . . . . .467
- Department Of Transportation Uniform Tire  
Quality Grades . . . . .469
  - Treadwear . . . . .469

- Traction Grades . . . . .469
- Temperature Grades . . . . .470

## **SUGGESTIONS FOR OBTAINING SERVICE FOR YOUR VEHICLE**

### **Prepare For The Appointment**

If you're having warranty work done, be sure to have the right papers with you. Take your warranty folder. All work to be performed may not be covered by the warranty. Discuss additional charges with the service manager. Keep a maintenance log of your vehicle's service history. This can often provide a clue to the current problem.

### **Prepare A List**

Make a written list of your vehicle's problems or the specific work you want done. If you've had an accident or work done that is not on your maintenance log, let the service advisor know.

### **Be Reasonable With Requests**

If you list a number of items and you must have your vehicle by the end of the day, discuss the situation with the service advisor and list the items in order of priority. At many authorized dealers, you may obtain a rental vehicle at a minimal daily charge. If you need a rental, it is advisable to make these arrangements when you call for an appointment.

### **IF YOU NEED ASSISTANCE**

The manufacturer and its authorized dealers are vitally interested in your satisfaction. We want you to be happy with our products and services.

Warranty service must be done by an authorized dealer. We strongly recommend that you take your vehicle to your authorized selling dealer. They know you and your vehicle best, and are most concerned that you get prompt and high quality service. The manufacturer's authorized dealers have the facilities, factory-trained technicians,



special tools, and the latest information to ensure your vehicle is fixed correctly and in a timely manner.

This is why you should always talk to your authorized dealer's service manager first. Most matters can be resolved with this process.

- If for some reason you are still not satisfied, talk to the general manager or owner of the authorized dealership. They want to know if you need assistance.
- If your authorized dealership is unable to resolve the concern, you may contact the Manufacturer's Customer Center.

Any communication to the Manufacturer's Customer Center should include the following information:

- Owner's name and address
- Owner's telephone number (home and office)
- Authorized dealership name

- Vehicle Identification Number (VIN)
- Vehicle delivery date and mileage

### **DaimlerChrysler Motors Corporation Customer Center**

P.O. Box 21-8004

Auburn Hills, MI 48321-8004

Phone: (800) 992-1997

### **DaimlerChrysler Canada Inc. Customer Center**

P.O. Box 1621

Windsor, Ontario N9A 4H6

Phone: (800) 465-2001

### **In Mexico contact:**

Av. Prolongacion Paseo de la Reforma, 1240

Sante Fe C.P. 05109

Mexico, D. F.

In Mexico: (915) 729-1248 or 729-1240

Outside Mexico: (525) 729-1248 or 729-1240

**Customer Assistance for the Hearing or Speech Impaired (TDD/TTY)**

To assist customers who have hearing difficulties, the manufacturer has installed special TDD (Telecommunication Devices for the Deaf) equipment at its Customer Center. Any hearing or speech impaired customer, who has access to a TDD or a conventional teletypewriter (TTY) in the United States, can communicate with the manufacturer by dialing 1-800-380-CHRY.

**Service Contract**

You may have purchased a service contract for your vehicle to help protect you from the high cost of unexpected repairs after your manufacturer's New Vehicle Limited Warranty expires. The manufacturer stands behind only the manufacturer's Service Contracts. If you purchased a manufacturer's Service Contract, you will receive Plan Provisions and an Owner Identification Card in the mail within three weeks of your vehicle delivery date. If you have any questions about your service

contract, call the manufacturer's Service Contract National Customer Hotline at 1-800-521-9922.

The manufacturer will not stand behind any service contract that is not the manufacturer's Service Contract. It is not responsible for any service contract other than the manufacturer's Service Contract. If you purchased a service contract that is not a manufacturer's Service Contract, and you require service after your manufacturer's New Vehicle Limited Warranty expires, please refer to your contract documents, and contact the person listed in those documents.

We appreciate that you have made a major investment when you purchased your vehicle. Your authorized dealer has also made a major investment in facilities, tools, and training to assure that you are absolutely delighted with your ownership experience. You'll be pleased with their sincere efforts to resolve any warranty issues or related concerns.

**WARNING!**

**Engine exhaust, some of its constituents, and certain vehicle components contain, or emit, chemicals known to the State of California to cause cancer and birth defects or other reproductive harm. In addition, certain fluids contained in vehicles and certain products of component wear contain, or emit, chemicals known to the State of California to cause cancer and birth defects or other reproductive harm.**

**WARRANTY INFORMATION (U.S. Vehicles Only)**

See the Warranty Information Booklet for the terms and provisions of DaimlerChrysler's warranties applicable to this vehicle.

**MOPAR® PARTS**

MOPAR® fluids, lubricants, parts, and accessories are available from your authorized dealer. They will help you keep your vehicle operating at its best.

**REPORTING SAFETY DEFECTS****In the 50 United States and Washington, D.C.**

If you believe that your vehicle has a defect which could cause a crash or cause injury or death, you should immediately inform the National Highway Traffic Safety Administration (NHTSA) in addition to notifying the manufacturer.

If NHTSA receives similar complaints, it may open an investigation, and if it finds that a safety defect exists in a group of vehicles, it may order a recall and remedy campaign. However, NHTSA cannot become involved in individual problems between you, your authorized dealer, and the manufacturer.

To contact NHTSA, you may either call the Auto Safety Hotline toll free at 1-888-327-4236 (TTY: 1-800-424-9153), or go to <http://www.safercar.gov>; or write to: Administrator, NHTSA, 400 Seventh Street, SW., Washington, D.C. 20590. You can also obtain other information about motor vehicle safety from <http://www.safercar.gov>.

### **In Canada**

If you believe that your vehicle has a safety defect, you should contact the Customer Service Department immediately. Canadian customers who wish to report a safety defect to the Canadian government should write to: Transport Canada, Motor Vehicle Defect Investigations and Recalls, 2780 Sheffield Road, Ottawa, Ontario K1B 3V9.

### **PUBLICATION ORDER FORMS**

To order the following manuals, you may use either the website or the phone numbers listed below. Visa, Mastercard, American Express, and Discover orders are accepted. If you prefer mailing your payment, please call for an order form.

**NOTE:** A street address is required when ordering manuals (no P.O. Boxes).

- *Service Manuals*

These comprehensive Service Manuals provide the information that students and professional technicians need in diagnosing/troubleshooting, problem solving, maintaining, servicing, and repairing DaimlerChrysler Corporation vehicles. A complete working knowledge of the vehicle, system, and/or components is written in straightforward language with illustrations, diagrams, and charts.

- *Diagnostic Procedure Manuals*

Diagnostic Procedure Manuals are filled with diagrams, charts and detailed illustrations. These practical manuals make it easy for students and technicians to find and fix problems on computer-controlled vehicle systems and features. They show exactly how to find and correct problems the first time, using step-by-step troubleshooting and drivability procedures, proven diagnostic tests and a complete list of all tools and equipment.

- *Owner's Manuals*

These Owner's Manuals have been prepared with the assistance of service and engineering specialists to acquaint you with specific DaimlerChrysler Corporation vehicles. Included are starting, operating, emergency and maintenance procedures as well as specifications, capabilities and safety tips.

***Call toll free at:***

- **1-800-890-4038 (U.S.)**
- **1-800-387-1143 (Canada)**

Or

***Visit us on the Worldwide Web at:***

- **[www.techauthority.daimlerchrysler.com](http://www.techauthority.daimlerchrysler.com)**
- **[www.daimlerchrysler.ca/manuals](http://www.daimlerchrysler.ca/manuals)**

## DEPARTMENT OF TRANSPORTATION UNIFORM TIRE QUALITY GRADES

The following tire grading categories were established by the National Highway Traffic Safety Administration. The specific grade rating assigned by the tire's manufacturer in each category is shown on the sidewall of the tires on your vehicle.

All passenger car tires must conform to Federal safety requirements in addition to these grades.

### Treadwear

The treadwear grade is a comparative rating, based on the wear rate of the tire when tested under controlled conditions on a specified government test course. For example, a tire graded 150 would wear 1-1/2 times as well on the government course as a tire graded 100. The relative performance of tires depends upon the actual

conditions of their use, however, and may depart significantly from the norm due to variations in driving habits, service practices, and differences in road characteristics and climate.

### Traction Grades

The traction grades, from highest to lowest, are AA, A, B, and C. These grades represent the tire's ability to stop on wet pavement, as measured under controlled conditions on specified government test surfaces of asphalt and concrete. A tire marked C may have poor traction performance.

### WARNING!

**The traction grade assigned to this tire is based on straight-ahead braking traction tests, and does not include acceleration, cornering, hydroplaning, or peak traction characteristics.**

### Temperature Grades

The temperature grades are A (the highest), B, and C, representing the tire's resistance to the generation of heat and its ability to dissipate heat, when tested under controlled conditions on a specified indoor laboratory test wheel. Sustained high temperature can cause the material of the tire to degenerate and reduce tire life, and excessive temperature can lead to sudden tire failure. The grade C corresponds to a level of performance, which all passenger car tires must meet under the Federal Motor Vehicle Safety Standard No. 109. Grades B and A represent higher levels of performance on the laboratory test wheel, than the minimum required by law.

### WARNING!

**The temperature grade for this tire is established for a tire that is properly inflated and not overloaded. Excessive speed, under-inflation, or excessive loading, either separately or in combination, can cause heat buildup and possible tire failure.**

---

# INDEX



- ABS (Anti-Lock Brake System) . . . . . 203,302
- Adding Fuel . . . . . 347
- Adjustable Pedals . . . . . 154
- Air Cleaner, Engine (Engine Air Cleaner Filter) . . . 407
- Air Conditioner Maintenance . . . . . 262,411
- Air Conditioning . . . . . 262
- Air Conditioning, Operating Tips . . . . . 274
- Air Conditioning, Rear Zone . . . . . 266
- Air Conditioning Refrigerant . . . . . 411,412
- Air Conditioning System . . . . . 262,411
- Air Filter . . . . . 396,397,398,407
- Air Pressure, Tires . . . . . 324,332
- Airbag . . . . . 53,211
- Airbag Light . . . . . 62,76
- Alarm, Panic . . . . . 24
- Alarm (Security Alarm) . . . . . 18,203
- Alignment and Balance . . . . . 331
- Alterations/Modifications, Vehicle . . . . . 8
- Antenna, Satellite Radio . . . . . 251
- Antifreeze (Engine Coolant) . . . . . 416,417,450
- Disposal . . . . . 418
- Anti-Lock Brake System (ABS) . . . . . 302,306
- Anti-Lock Warning Light . . . . . 203
- Anti-Theft System . . . . . 18,203
- Appearance Care . . . . . 427
- Arming Theft System (Security Alarm) . . . . . 19
- Assistance Towing . . . . . 101
- Audio Systems (Radio) . . . . . 214,218
- Auto Unlock, Doors . . . . . 170
- Automatic Dimming Mirror . . . . . 84,88
- Automatic Door Locks . . . . . 31,170
- Automatic Headlights . . . . . 147
- Automatic Transaxle . . . . . 12,286
- Automatic Transmission . . . . . 283,286,423
- Adding Fluid . . . . . 424
- Fluid and Filter Changes . . . . . 424
- Fluid Level Check . . . . . 423
- Fluid Type . . . . . 452

Gear Ranges . . . . .	287	Brake Fluid . . . . .	452
Special Additives . . . . .	425	Brake System . . . . .	302,421
Torque Converter . . . . .	290	Anti-Lock (ABS) . . . . .	302,306
Axle Fluid . . . . .	452	Disc Brakes . . . . .	421
Axle Lubrication (Axle Fluid) . . . . .	426	Fluid Check . . . . .	421
		Hoses . . . . .	422
Ball Joints . . . . .	412	Master Cylinder . . . . .	421
Battery . . . . .	396,397,398,409	Parking . . . . .	300
Charging . . . . .	388	Warning Light . . . . .	203,207
Emergency Starting . . . . .	388	Brakes . . . . .	302
Gas Caution . . . . .	388	Brake/Transmission Interlock . . . . .	286
Keyless Transmitter Replacement (RKE) . . . . .	27	Break-In Recommendations, New Vehicle . . . . .	74
Saving Feature (Protection) . . . . .	145	Bulb Replacement . . . . .	441
Belts, Drive . . . . .	406	Bulbs, Light . . . . .	441
Belts, Seat . . . . .	42		
Body Mechanism Lubrication . . . . .	412	Calibration, Compass . . . . .	174
B-Pillar Location . . . . .	319	Camera, Rear . . . . .	163
Brake Assist System . . . . .	307	Capacities, Fluid . . . . .	450
Brake Control System, Electronic . . . . .	305		

- Caps, Filler  
  Fuel . . . . . 347  
  Oil (Engine) . . . . . 404  
  Power Steering . . . . . 410  
  Radiator (Coolant Pressure) . . . . . 417
- Car Washes . . . . . 427
- Carbon Monoxide Warning . . . . . 75,346
- Cargo Management System . . . . . 193  
  Cargo Organizer . . . . . 193
- Cargo Organizer . . . . . 193
- Cargo (Vehicle Loading) . . . . . 352
- Catalytic Converter . . . . . 407
- CD (Compact Disc) Player . . . . . 214,218
- Cellular Phone . . . . . 88,218,219,261
- Center High Mounted Stop Light . . . . . 448
- Certification Label . . . . . 352
- Charging . . . . . 388
- Chart, Tire Sizing . . . . . 316
- Child Restraint . . . . . 64,65,66  
  Child Restraint Tether Anchors . . . . . 68,73  
  Child Seat . . . . . 69
- Circuit Breakers . . . . . 432
- Cleaning  
  Wheels . . . . . 429
- Climate Control . . . . . 262
- Climate Control, Rear Zone . . . . . 266,272
- Clock . . . . . 212,216,219,224,236
- Compact Disc (CD) Maintenance . . . . . 260
- Compact Spare Tire . . . . . 327
- Compass Calibration . . . . . 174
- Compass Variance . . . . . 174
- Connector  
  UCI . . . . . 254  
  Universal Consumer Interface (UCI) . . . . . 254
- Console, Floor . . . . . 188,190
- Console, Overhead . . . . . 165,166
- Contract, Service . . . . . 465

Coolant Pressure Cap (Radiator Cap) . . . . .	396,397,398,417	Daytime Running Lights . . . . .	148
Cooling System . . . . .	415	Dealer Service . . . . .	402
Adding Coolant (Antifreeze) . . . . .	417	Defroster, Rear Window . . . . .	278
Coolant Capacity . . . . .	450	Defroster, Windshield . . . . .	76,264,270
Coolant Level . . . . .	415,418	Delay (Intermittent) Wipers . . . . .	151
Disposal of Used Coolant . . . . .	418	Diagnostic System, Onboard . . . . .	399
Drain, Flush, and Refill . . . . .	416	Digital Video Disc (DVD) Player . . . . .	214,218
Inspection . . . . .	418	Dimmer Switch, Headlight . . . . .	202
Points to Remember . . . . .	419	Dipsticks	
Pressure Cap . . . . .	417	Automatic Transmission . . . . .	423
Radiator Cap . . . . .	417	Oil (Engine) . . . . .	402
Selection of Coolant (Antifreeze) . . . . .	416,450,451	Power Steering . . . . .	410
Temperature Gauge . . . . .	201	Disarming, Theft System . . . . .	19
Cruise Control (Speed Control) . . . . .	156	Disc Brakes . . . . .	421
Cup Holder . . . . .	189	Disposal	
Customer Assistance . . . . .	463	Antifreeze (Engine Coolant) . . . . .	418
Data Recorder, Event . . . . .	62	Door Locks . . . . .	29
		Door Locks, Automatic . . . . .	170
		Door Opener, Garage . . . . .	176

- Drive Belts . . . . . 406
- Drive Shaft Universal Joints . . . . . 412
- Driving
  - Through Flowing, Rising, or Shallow Standing
- Water . . . . . 298
- DVD Player (Video Entertainment System) . . . . . 259
  
- E-85 Fuel . . . . . 349
- Electric Remote Mirrors . . . . . 86
- Electrical Power Outlets . . . . . 185
- Electronic Brake Control System . . . . . 305
  - Anti-Lock Brake System . . . . . 306
  - Brake Assist System . . . . . 307
  - Electronic Roll Mitigation . . . . . 309
  - Electronic Stability Program . . . . . 310
  - Traction Control System . . . . . 308
- Electronic Roll Mitigation (ERM) . . . . . 309
- Electronic Speed Control (Cruise Control) . . . . . 156
- Electronic Stability Program (ESP) . . . . . 208,310
  
- Electronic Vehicle Information Center (EVIC) . . . . . 163,167
- Emergency, In Case of
  - Freeing Vehicle When Stuck . . . . . 390
  - Jacking . . . . . 382
  - Tow Hooks . . . . . 390
  - Towing . . . . . 391
- Emission Control System Maintenance . . . . . 454
- Emission Related Components . . . . . 420
- Engine
  - Air Cleaner . . . . . 407
  - Block Heater . . . . . 286
  - Break-In Recommendations . . . . . 74
  - Compartment . . . . . 397,398
  - Coolant (Antifreeze) . . . . . 451
  - Exhaust Gas Caution . . . . . 40,75,346
  - Fails to Start . . . . . 284
  - Flooded, Starting . . . . . 284
  - Fuel Requirements . . . . . 450

Jump Starting . . . . .	388	Engine Fuel . . . . .	407
Multi-Displacement . . . . .	314	Engine Oil . . . . .	405,451
Oil . . . . .	402,450,451	Engine Oil Disposal . . . . .	405
Oil Filler Cap . . . . .	396,397,398,404	Flashers	
Oil Selection . . . . .	404,450	Hazard Warning . . . . .	378
Oil Synthetic . . . . .	405	Turn Signal . . . . .	149,201,443
Starting . . . . .	283	Flat Tire Stowage . . . . .	381,387
Temperature Gauge . . . . .	201	Flexible Fuel Vehicles	
Entry System, Illuminated . . . . .	20	Cruising Range . . . . .	352
Equipment Identification Plate . . . . .	376	Engine Oil . . . . .	351
Event Data Recorder . . . . .	62	Fuel Requirements . . . . .	349,350
Exhaust Gas Caution . . . . .	40,75,346,414	Replacement Parts . . . . .	352
Exhaust System . . . . .	75,414	Starting . . . . .	351
Extender, Seat Belt . . . . .	53	Flooded Engine Starting . . . . .	284
Exterior Lighting . . . . .	147	Floor Console . . . . .	188,190
Fabric Care . . . . .	429	Fluid, Brake . . . . .	421,452
Filters		Fluid Capacities . . . . .	450
Air Cleaner . . . . .	407	Fluid Level Checks	
		Automatic Transmission . . . . .	423

- Brake . . . . . 421  
Engine Oil . . . . . 402  
Power Steering . . . . . 410  
Transfer Case . . . . . 425  
Fluids, Lubricants and Genuine Parts . . . . . 451  
Fog Lights . . . . . 148,449  
Folding Rear Seat . . . . . 130,133  
Four Wheel Drive . . . . . 291  
    Operation . . . . . 291  
Four-Way Hazard Flasher . . . . . 378  
Freeing A Stuck Vehicle . . . . . 390  
Front Axle (Differential) . . . . . 426  
Fuel . . . . . 342  
    Filler Cap (Gas Cap) . . . . . 347,348  
    Filter . . . . . 407  
    Gauge . . . . . 201  
    Octane Rating . . . . . 342,451  
    Requirements . . . . . 342,450  
    Tank Capacity . . . . . 450  
Fuel, Flexible . . . . . *See Flexible Fuel Vehicles*  
Fuel System Caution . . . . . 349  
Fuses . . . . . 188,432,435,438  
Garage Door Opener (HomeLink®) . . . . . 176  
Gas Cap (Fuel Filler Cap) . . . . . 347,348,399  
Gas Gauge (Fuel Gauge) . . . . . 201  
Gasoline (Fuel) . . . . . 342  
Gasoline, Reformulated . . . . . 343  
Gauges  
    Coolant Temperature . . . . . 201  
    Fuel . . . . . 201  
    Odometer . . . . . 204,206  
    Speedometer . . . . . 203  
    Tachometer . . . . . 204  
Gear Ranges . . . . . 287  
General Information . . . . . 16,115,342  
Glass Cleaning . . . . . 430  
Gross Axle Weight Rating . . . . . 353,357

Gross Cargo Weight . . . . .	352	Heated Seats . . . . .	124
Gross Vehicle Weight Rating . . . . .	356	Heater . . . . .	262
GVWR . . . . .	353,356	Heater, Engine Block . . . . .	286
Hands-Free Phone (UConnect™) . . . . .	88,218,219	High Beam Indicator . . . . .	202
Hard Drive (HDD) . . . . .	214,218	High Beam/Low Beam Select (Dimmer) Switch . .	150
Hazard		Hitches	
Driving Through Flowing, Rising, or Shallow		Trailer Towing . . . . .	361
Standing Water . . . . .	298	HomeLink® (Garage Door Opener) Transmitter . . .	176
Hazard Warning Flasher . . . . .	378	Hood Release . . . . .	142
Headlights . . . . .	441	Hoses . . . . .	420
Cleaning . . . . .	430	Ignition . . . . .	12,17
Delay . . . . .	146	Key . . . . .	12
High Beam . . . . .	150	Lock . . . . .	17
High Beam/Low Beam Select Switch . . . . .	150	Ignition Key Removal . . . . .	12
Lights On Reminder . . . . .	148	Illuminated Entry . . . . .	20
Passing . . . . .	150	Immobilizer (Sentry Key) . . . . .	13
Replacing . . . . .	441	Infant Restraint . . . . .	64,65
Heated Mirrors . . . . .	87	Inflation Pressure Tires . . . . .	332



Information Center . . . . .	167	Key, Programming . . . . .	15
Information Center, Vehicle . . . . .	167	Key, Replacement . . . . .	15
Inside Rearview Mirror . . . . .	84	Key, Sentry (Immobilizer) . . . . .	13
Instrument Cluster . . . . .	201	Keyless Entry System . . . . .	21
Instrument Panel and Controls . . . . .	199	Keys . . . . .	12
Instrument Panel Lens Cleaning . . . . .	431	Knee Bolster . . . . .	53
Integrated Power Module (Fuses) . . . . .	438		
Interior Appearance Care . . . . .	429	Lane Change and Turn Signals . . . . .	149,201,443
Interior Fuses . . . . .	432	Lap/Shoulder Belts . . . . .	42,47
Interior Lighting . . . . .	145	LATCH (Lower Anchors and Tether for CHildren) . . . . .	68
Interior Lights . . . . .	145	Life of Tires . . . . .	329
Intermittent Wipers (Delay Wipers) . . . . .	151	Liftgate . . . . .	37
Introduction . . . . .	4	Lights . . . . .	77,144
Inverter Outlet (115V) . . . . .	185	Airbag . . . . .	62,211
		Anti-Lock Warning . . . . .	203
Jack Location . . . . .	379	Automatic Headlights . . . . .	147
Jack Operation . . . . .	380,382	Back-Up . . . . .	443
Jacking Instructions . . . . .	383	Brake Warning . . . . .	207

Bulb Replacement . . . . .	441	Park . . . . .	147
Center Mounted Stop . . . . .	448	Passing . . . . .	150
Courtesy/Reading . . . . .	166	Reading . . . . .	166
Cruise . . . . .	212	Seat Belt Reminder . . . . .	202
Daytime Running . . . . .	148	Service . . . . .	441
Dome . . . . .	166	Tire Pressure Monitoring (TPMS) . . . . .	209
Electronic Stability Program (ESP)		Traction Control . . . . .	310
Indicator . . . . .	208,310	Turn Signal . . . . .	149,443
Fog . . . . .	148,206,449	Warning (Instrument Cluster Description) . . . . .	201
Hazard Warning Flasher . . . . .	378	Loading Vehicle . . . . .	352
Headlights . . . . .	147	Tires . . . . .	319
High Beam . . . . .	150	Locks . . . . .	29
High Beam/Low Beam Select . . . . .	150	Automatic Door . . . . .	31
Instrument Cluster . . . . .	147,201	Child Protection . . . . .	33
Interior . . . . .	145,166	Door . . . . .	29
License . . . . .	447	Ignition . . . . .	17
Lights On Reminder . . . . .	148	Keys . . . . .	12
Low Fuel . . . . .	201,202	Power Door . . . . .	30
Malfunction Indicator (Check Engine) . . . . .	209	Steering Wheel . . . . .	17

- Lower Anchors and Tether for CHildren  
(LATCH) . . . . . 68
- Lubrication, Body . . . . . 412
- Lug Nuts . . . . . 386
- Luggage Carrier . . . . . 191
- Lumbar Support . . . . . 122
- Maintenance Free Battery . . . . . 409
- Maintenance Procedures . . . . . 402
- Maintenance Schedule . . . . . 454
- Malfunction Indicator Light (Check Engine) . . 209,400
- Manual, Service . . . . . 467
- Manual Transmission  
  Lubricant Selection . . . . . 452
- Map/Reading Lights . . . . . 166
- Memory Seat . . . . . 137
- Mirrors . . . . . 84  
  Automatic Dimming . . . . . 84,88  
  Electric Powered . . . . . 86
- Heated . . . . . 87
- Memory . . . . . 137
- Outside . . . . . 85
- Rearview . . . . . 84
- Vanity . . . . . 87
- Modifications/Alterations, Vehicle . . . . . 8
- Monitor, Tire Pressure System . . . . . 335
- Mopar Parts . . . . . 401,466
- MP3 Player . . . . . 214,218
- Multi-Displacement Engine System . . . . . 314
- Multi-Function Control Lever . . . . . 149
- Navigation Radio . . . . . 218
- Navigation System . . . . . 163,218
- New Vehicle Break-In Period . . . . . 74
- Occupant Restraints . . . . . 41
- Octane Rating, Gasoline (Fuel) . . . . . 342
- Oil Change Indicator . . . . . 169,205

Oil Change Indicator, Reset . . . . .	205	Overheating, Engine . . . . .	202
Oil, Engine . . . . .	402,451	Owner's Manual (Operator Manual) . . . . .	467
Capacity . . . . .	450	Panic Alarm . . . . .	24
Change Interval . . . . .	403	Park Sense System, Rear . . . . .	159
Dipstick . . . . .	402	Parking Brake . . . . .	300
Disposal . . . . .	405	Parking On Hill . . . . .	300
Filter . . . . .	405,451	Passing Light . . . . .	150
Filter Disposal . . . . .	405	Pedals, Adjustable . . . . .	154
Identification Logo . . . . .	404	Personal Settings . . . . .	170
Materials Added to . . . . .	405	Pets . . . . .	74
Recommendation . . . . .	404,450	Pets, Transporting . . . . .	74
Synthetic . . . . .	405	Phone, Cellular . . . . .	88,218,219
Viscosity . . . . .	404,450	Phone, Hands-Free (UConnect™) . . . . .	88,218,219
Onboard Diagnostic System . . . . .	399,400	Placard, Tire and Loading Information . . . . .	319
Opener, Garage Door (HomeLink®) . . . . .	176	Port	
Outside Rearview Mirrors . . . . .	85	Universal Serial Bus (USB) . . . . .	214,218
Overdrive . . . . .	204,289	USB . . . . .	214,218
Overdrive OFF Switch . . . . .	289	Positive Crankcase Valve . . . . .	421
Overhead Console . . . . .	165,166		

- Power
- Brakes . . . . . 421
  - Distribution Center (Fuses) . . . . . 396,397,398,435
  - Door Locks . . . . . 20,30
  - Lift Gate . . . . . 38
  - Mirrors . . . . . 86
  - Outlet (Auxiliary Electrical Outlet) . . . . . 185
  - Steering . . . . . 304,410
  - Steering Filler Cap . . . . . 396,397,398
  - Sunroof . . . . . 182
  - Windows . . . . . 34
- Power Steering Fluid . . . . . 452
- Pregnant Women and Seat Belts . . . . . 52
- Preparation for Jacking . . . . . 383
- Pretensioners
- Seat Belts . . . . . 50
- Programmable Electronic Features . . . . . 170
- Programming Transmitters  
(Remote Keyless Entry) . . . . . 25
- Radial Ply Tires . . . . . 326
- Radiator Cap (Coolant Pressure Cap) . . . . . 415,417
- Radio Broadcast Signals . . . . . 213
- Radio, Navigation . . . . . 218
- Radio Operation . . . . . 215,219,261
- Radio Remote Controls . . . . . 259
- Radio, Satellite . . . . . 214,215,218,219,250
- Radio (Sound Systems) . . . . . 214,218
- Rear Axle (Differential) . . . . . 426
- Rear Camera . . . . . 163
- Rear Cup Holder . . . . . 190
- Rear Liftgate . . . . . 37
- Rear Park Sense System . . . . . 159
- Rear Window Defroster . . . . . 278
- Rear Window Features . . . . . 277
- Rear Wiper/Washer . . . . . 277
- Rearview Mirrors . . . . . 84
- Reclining Front Seats . . . . . 121
- Recorder, Event Data . . . . . 62

Recreational Towing . . . . .	371	Roof Type Carrier . . . . .	191
Shifting into Transfer Case Neutral (N) . . . . .	372	Rotation, Tires . . . . .	334
Shifting out of Transfer Case Neutral (N) . . . . .	374	Safety Checks Inside Vehicle . . . . .	76
Reformulated Gasoline . . . . .	343	Safety Checks Outside Vehicle . . . . .	77
Refrigerant . . . . .	412	Safety Defects, Reporting . . . . .	466
Release, Hood . . . . .	142	Safety, Exhaust Gas . . . . .	40
Reminder, Seat Belt . . . . .	51	Safety Information, Tire . . . . .	315
Remote Keyless Entry (RKE) . . . . .	21	Safety Tips . . . . .	75
Remote Sound System (Radio) Controls . . . . .	259	Satellite Radio . . . . .	214,215,218,219,250
Remote Starting System . . . . .	28	Satellite Radio Antenna . . . . .	251
Replacement Keys . . . . .	15	Schedule, Maintenance . . . . .	454
Replacement Parts . . . . .	401	Seat Belt Maintenance . . . . .	431
Replacement Tires . . . . .	330	Seat Belt Reminder . . . . .	51
Reporting Safety Defects . . . . .	466	Seat Belts . . . . .	41,42,76
Resetting Oil Change Indicator . . . . .	169,205	And Pregnant Women . . . . .	52
Restraints, Child . . . . .	64,69	Child Restraint . . . . .	64,66
Restraints, Occupant . . . . .	41	Extender . . . . .	53
Rocking Vehicle When Stuck . . . . .	390	Front Seat . . . . .	42
Roll Over Warning . . . . .	4		

Pretensioners	50	Service Contract	465
Reminder	202	Service Manuals	467
Seats	120	Setting the Clock	213,216,219,224,236
Adjustment	120	Settings, Personal	170
Cleaning	429	Shifting	
Fold and Tumble Rear	127,130	Automatic Transmission	286
Heated	124	Transfer Case	291
Lumbar Support	122	Transfer Case, Shifting into Transfer Case	
Memory	137	Neutral (N)	372
Rear Folding	127,130	Transfer Case, Shifting out of Transfer Case	
Reclining	121	Neutral (N)	374
Security Alarm (Theft Alarm)	18,203	Shoulder Belt Upper Anchorage	46
Selection of Coolant (Antifreeze)	416,451	Shoulder Belts	42
Selection of Oil	404	Signals, Turn	149,201,443
Sentry Key (Immobilizer)	13	Snow Chains (Tire Chains)	332
Sentry Key Programming	15	Snow Plow	370
Sentry Key Replacement	15	Snow Tires	333
Service and Maintenance	402,454	Sound Systems (Radio)	214,218
Service Assistance	463	Spare Tire	327

Spark Plugs . . . . .	406	Sun Roof . . . . .	182
Speed Control (Cruise Control) . . . . .	156	Supplemental Tire Pressure Information . . . . .	332
Speedometer . . . . .	203	Synthetic Engine Oil . . . . .	405
Starting . . . . .	283	System, Navigation . . . . .	218
Automatic Transmission . . . . .	283	System, Remote Starting . . . . .	28
Emergency (Jump Starting) . . . . .	388		
Engine Block Heater . . . . .	286	Tachometer . . . . .	204
Engine Fails to Start . . . . .	284	Taillights . . . . .	443
Remote . . . . .	28	Temperature Control, Automatic (ATC) . . . . .	266
Starting Procedures . . . . .	283	Temperature Gauge, Engine Coolant . . . . .	201
Steering . . . . .		Tether Anchor, Child Restraint . . . . .	68
Column Controls . . . . .	149	Theft System Arming . . . . .	19
Column Lock . . . . .	17	Theft System Disarming . . . . .	19
Power . . . . .	304,410	Tilt Steering Column . . . . .	153
Wheel, Tilt . . . . .	153	Tire and Loading Information Placard . . . . .	319,332
Steering Wheel Mounted Sound System		Tire Identification Number (TIN) . . . . .	318
Controls . . . . .	259	Tire Markings . . . . .	315
Storage, Vehicle . . . . .	440	Tire Safety Information . . . . .	315
Stuck, Freeing . . . . .	390	Tires . . . . .	77,323,469



Aging (Life of Tires) . . . . .	329	Sizes . . . . .	316
Air Pressure . . . . .	323	Snow Tires . . . . .	333
Alignment . . . . .	331	Spare Tire . . . . .	381
Chains . . . . .	332	Spinning . . . . .	328
Changing . . . . .	381	Tread Wear Indicators . . . . .	329
Compact Spare . . . . .	327	Wheel Mounting . . . . .	382
General Information . . . . .	323	Wheel Nut Torque . . . . .	386
High Speed . . . . .	326	Tongue Weight/Trailer Weight . . . . .	362
Inflation Pressures . . . . .	324	Torque Converter Clutch . . . . .	290
Jacking . . . . .	382	Tow Hooks, Emergency . . . . .	390
Life of Tires . . . . .	329	Towing . . . . .	356
Load Capacity . . . . .	319,320	24-Hour Towing Assistance . . . . .	101
Pressure Monitor System (TPMS) . . . . .	335	Disabled Vehicle . . . . .	391
Pressure Warning Light . . . . .	209	Guide . . . . .	362
Quality Grading . . . . .	469	Recreational . . . . .	371
Radial . . . . .	326	Weight . . . . .	362
Replacement . . . . .	330	Towing Assistance . . . . .	101
Rotation . . . . .	334	Traction . . . . .	297
Safety . . . . .	315,323	Traction Control . . . . .	206,308

Trailer Towing . . . . .	356	Transmitter Battery Service (Remote Keyless Entry) . . . . .	27
Cooling System Tips . . . . .	370	Transmitter, Garage Door Opener (HomeLink®) . . .	176
Hitches . . . . .	361	Transmitter Programming (Remote Keyless Entry) . . . . .	25
Minimum Requirements . . . . .	364	Tread Wear Indicators . . . . .	329
Trailer and Tongue Weight . . . . .	362	Trip Odometer . . . . .	206
Wiring . . . . .	367	Trip Odometer Reset Button . . . . .	212
Trailer Towing Guide . . . . .	362	Turn Signals . . . . .	149,201,443
Trailer Weight . . . . .	362	UCI Connector . . . . .	254
Transaxle . . . . .	286	UConnect™ (Hands-Free Phone) . . . . .	88,218
Automatic . . . . .	12,286	Underhood Fuses . . . . .	435
Operation . . . . .	286	Uniform Tire Quality Grades . . . . .	469
Transfer Case . . . . .	425	Universal Consumer Interface (UCI) Connector . . .	254
Fluid . . . . .	452	Universal Serial Bus (USB) Port . . . . .	214,218
Transmission . . . . .	286,423	Universal Transmitter . . . . .	176
Automatic . . . . .	286,423	USB Port . . . . .	214,218
Filter . . . . .	424		
Fluid . . . . .	452		
Maintenance . . . . .	423		

- Vacuum/Vapor Harnesses . . . . . 420  
Vanity Mirrors . . . . . 87  
Variance, Compass . . . . . 174  
Vehicle Identification Number (VIN) . . . . . 7  
Vehicle Information Center . . . . . 167  
Vehicle Loading . . . . . 320,352  
Vehicle Modifications/Alterations . . . . . 8  
Vehicle Storage . . . . . 440  
Video Entertainment System (Rear Seat Video System) . . . . . 259  
Voice Recognition System (VR) . . . . . 115
- Warning Lights (Instrument Cluster Description) . . . . . 201  
Warning, Roll Over . . . . . 4  
Warnings and Cautions . . . . . 7  
Warranty Information . . . . . 466  
Washer, Adding Fluid . . . . . 396,397,398  
Washers, Windshield . . . . . 152
- Washing Vehicle . . . . . 427  
Water  
    Driving Through . . . . . 298  
Weight Load Carrying . . . . . 352  
Wheel Alignment and Balance . . . . . 331  
Wheel and Wheel Trim . . . . . 429  
Wheel and Wheel Trim Care . . . . . 429  
Wheel Changing . . . . . 381  
Wheel Mounting . . . . . 382  
Wheel Nut Torque . . . . . 386  
Wind Buffeting . . . . . 184  
Window Fogging . . . . . 274  
Windows . . . . . 34  
    Power . . . . . 34  
Windshield Defroster . . . . . 264,270  
Windshield Washers . . . . . 151,152,413  
    Fluid . . . . . 151,396,397,398,413  
Windshield Wiper Blades . . . . . 413  
Windshield Wipers . . . . . 151

Wiper Blade Replacement . . . . .	413
Wiper, Rear . . . . .	277
Wipers, Intermittent . . . . .	151
Wrecker Towing . . . . .	391
YES Essentials® Fabric Cleaning Procedure . . . . .	429



**Stick with the Specialists™**

DaimlerChrysler Corporation

81-326-0835



First Edition

Printed in U.S.A.