



User manual

Energy storage integrated inverter

Product Model: HYD 3K~6K-EP



Content

Preface.....	II
1. Basic safety information.....	- 1 -
1.1. Safety instructions.....	- 1 -
1.2. Symbols and signs.....	- 4 -
2. Product characteristics.....	- 6 -
2.1. Product informations.....	- 6 -
2.2. Size description.....	- 6 -
2.3. Function characteristics.....	- 7 -
2.4. Electrical block diagram.....	- 7 -
3. Installation.....	- 9 -
3.1. Checking Before Installation.....	- 9 -
3.2. Product Overview.....	- 11 -
3.3. Tools.....	- 12 -
3.4. Installation Environment.....	- 13 -
3.5. Determining the Installation Position.....	- 14 -
3.6. Moving the HYD 3K~6K-EP.....	- 14 -
3.7. Installing HYD 3K~6K-EP.....	- 15 -
4. Electrical Connections.....	- 17 -
4.1. Wire instructions.....	- 18 -
4.2. Connecting PGND Cables.....	- 18 -
4.3. PV Connection.....	- 20 -
4.4. Battery Connection.....	- 21 -
4.5. Load connection.....	- 22 -
4.6. Grid connection.....	- 23 -
4.7. External communication interface.....	- 25 -
5. Buttons and indicator lights.....	- 34 -
5.1. Buttons.....	- 34 -
5.2. Indicator lights and status.....	- 34 -
6. Operation.....	- 35 -
6.1. Double Check.....	- 35 -
6.2. First Time Setup (IMPORTANT!).....	- 35 -
6.3. Menu.....	- 37 -
7. Troubleshooting.....	- 51 -
8. Technical Data.....	- 58 -
9. Quality Assurance.....	- 65 -

Notice

This manual contains important safety instructions that must be followed during installation and maintenance of the equipment.

Save these instructions!

This manual must be considered as an integral part of the equipment. The manual must always accompany the equipment, even when it is transferred to another user or field.

Copyright Declaration

The copyright of this manual belongs to Shenzhen SOFARSOLAR Co., Ltd. Any corporation or individual should not plagiarize, partially copy or fully copy it (including software, etc.), and no reproduction or distribution of it in any form or by any means. All rights reserved.

SOFARSOLAR reserves the right of final interpretation. This manual is subject to change according to user's or customer's feedback. Please check our website at <http://www.sofarsolar.com> for latest version.

The current Version updated at 20210310.

Preface

**Note**

If you have any question or problem when you read the following information, please contact Shenzhen SOFARSOLAR Co., Ltd.

Outline

Please read the product manual carefully before installation, operation or maintenance. This manual contains important safety instructions and installation instructions that must be followed during installation and maintenance of the equipment.

Scope

This product manual describes the installation, electrical connections, commissioning, maintenance and troubleshooting of HYD 3K~6K-EP inverters:

HYD 3000-EP HYD 3680-EP HYD 4000-EP

HYD 4600-EP HYD 5000-EP HYD 5500-EP HYD 6000-EP





Keep this manual where it will be accessible at all times.

Target Group

This manual is intended for qualified electrical technical personnel who are responsible for inverter installation and commissioning in the PV power system and PV plant operator.

Symbols Used

This manual provides safety operation information and uses the symbol in order to ensure personal and property security and property security and use inverter efficiently when operating the inverter. You must understand these emphasized information to avoid the personal injury and property loss. Please read the following symbols used in this manual carefully.

 Danger	<p>Danger indicates a hazardous situation which, if not avoided, will result in death or serious injury.</p>
 Warning	<p>Warning indicates a hazardous situation which, if not avoided, could result in death or serious injury.</p>
 Caution	<p>Caution indicates a hazardous situation which, if not avoided, could result in minor or moderate injury.</p>
 Attention	<p>Attention indicates potential risks which, if not avoided, may lead to equipment fault or property damage.</p>
 Note	<p>Note provides tips that are valuable for the optimal operation of the product.</p>

1. Basic safety information

1.1. Safety instructions

Read and understand the instructions of this manual, and be familiar with relevant safety symbols in this chapter, then start to install and troubleshoot the equipment.

According to the national and state requirements, before connecting to the electrical grid, you must get permission from the local electrical grid operation can only be performed by qualified electrical engineer.

Please contact the nearest authorized service center if any maintenance or repair is needed. Contact your distributor for the information of the nearest authorized service center. Do NOT repair it by yourself, it may cause injury or property damage.

Before installing and maintaining the equipment, you should turn the DC switch OFF to cut off the high voltage DC of the PV array. You can also turn the switch in the PV combiner box OFF to cut off the high voltage DC. When the battery needs to be installed, please confirm the positive and negative terminals of the battery and turn OFF the battery. Otherwise, serious injury may be caused.

Qualified persons

The customer must make sure the operator has the necessary skill and training to do his/her job. Staff in charge of using and maintaining the equipment must be skilled, aware and mature for the described tasks and must have the reliability to correctly interpret what is described in the manual. For safety reason only a qualified electrician, who has received training and / or has demonstrated skills and knowledge in construction and in operation of this unit, can install this inverter. Shenzhen SOFARSOLAR Co., Ltd. does not take any responsibility for the property destruction and personal injury because of any incorrect use.

Installation requirements

Please install inverter according to the following section. Fix the inverter on an appropriate objects with enough load bearing capacity (such as walls, PV racks

etc.), and ensure that inverter is vertical placed. Choose a place suitable for installing electrical devices. And assure there is enough fire exit space, convenient for maintenance. Maintain proper ventilation to ensure enough air cycle to cool the inverter.

Transport requirements

If you find packing problems that may cause the damage of the inverter, or find any visible damage, please immediately notice the responsible transportation company. You can ask solar equipment installation contractor or Shenzhen SOFARSOLAR Co.Ltd. for help if necessary.

Transport of the equipment, especially by road, must be carried out with by suitable ways and means for protecting the components (in particular, the electronic components) from violent shocks, humidity, vibration, etc.

Labels on the equipment



The labels must NOT be hidden with objects and extraneous parts (rags, boxes, equipment, etc.); they must be cleaned regularly and kept visible at all times.

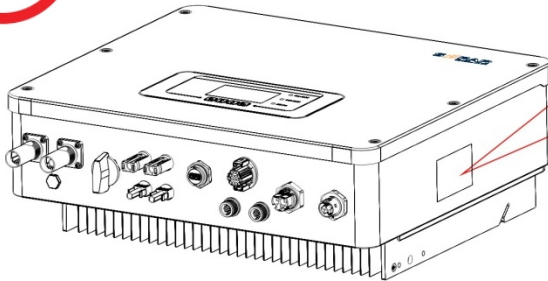



 Hybrid Inverter	
Model No:	HYD 6000-EP
Max.DC Input Voltage	600V
Operating MPPT Voltage Range	90V~580V
MAX.PV Isc	2x18A
Battery Type	Lead-acid,Lithium-ion
Battery Voltage Range	42-58V
Max.Charging Current	100A
Max.Discharging Current	100A
Max.Charging/Discharging Power	5000VA
Nominal Grid Voltage	230Vac
Nominal Output Voltage	230Vac
Max.Output Current	28.7A
Z _{source}	1.05 + j 0.32 ohm
Nominal Grid Frequency	50/60Hz
Power Factor	1 (adjustable+/-0.8)
Nominal Output Power	6000W
Backup Rated Current	26.1A
Backup Rated Apparent Power	5000VA
Ingress Protection	IP65
Operating Temperature Range	-30~+60°C
Protective Class	Class I
Manufacturer: Shenzhen SOFAR SOLAR Co., Ltd. Address: 401, Building 4, AnTongDa Industrial Park, District 68, KingDong Community,XinAn Street, BaoAn District, Shenzhen, China SAA183423 VDE0126-1-1,VDE-AR-N4105 G98,EN50438,AS4777,IUTE C15-712-1	

Electric connection



Please comply with all the current electrical regulations about accident prevention in dealing with the solar invert.





Before the electrical connection, make sure to use opaque material to cover the PV modules or to disconnect PV array DC switch. Exposure to the sun, PV array will produce a dangerous voltage!

	<p>All installation accomplished only by professional electrical engineer!</p> <p>Must be trained; Completely read the manual operation and understand relevant matter.</p>
Warning	
	<p>Get permission from the local electrical grid operator, complete all electrical connections by professional electrical engineer, then connect inverter to electrical grid.</p>
Attention	
	<p>It's forbidden to remove the tamper evident label, or open the inverter. Otherwise Sofarsolar will not provide warranty or maintenance!</p>
Note	

Operation

	<p>Touching the electrical grid or the terminal of the equipment may lead to electrocution or fire!</p> <p>Don't touch the terminal or conductor connected to the electrical grid.</p> <p>Pay attention to any instructions or safety documents related to grid connection.</p>
Danger	
	<p>Some internal components will be very hot when inverter is working. Please wear protective gloves!</p>
Attention	

Maintenance and repair

	<p>Before any repair work, turn OFF the AC circuit breaker between the inverter and electrical grid first, then turn OFF the DC switch.</p> <p>After turning OFF the AC circuit breaker and DC switch, wait for 5 minutes at least before carrying out any maintenance or repair work.</p>
Danger	
	<p>Inverter should work again after removing any faults. If you need any repair work, please contact with the local authorized service center.</p> <p>Can't open the internal components of inverter without authorized. Shenzhen SOFARSOLAR Co., Ltd. Does not take any responsibility for the losses from that.</p>
Attention	



EMC / noise level of inverter

Electromagnetic compatibility (EMC) refers to that one electrical equipment functions in a given electromagnetic environment without any trouble or error, and impose no unacceptable effect upon the environment. Therefore, EMC represents the quality characters of an electrical equipment. The inherent noise-immune character: immunity to internal electrical noise. External noise immunity: immunity

to electromagnetic noise of external system.Noise emission level: influence of electromagnetic emission upon environment.







	<p>Electromagnetic radiation from inverter may be harmful to health!</p> <p>Please do not continue to stay around the inverter in less than 20 cm when inverter is working.</p>
Danger	





1.2. Symbols and signs

	<p>Caution of burn injuries due to hot enclosure! You can only touch the screen and pressing key of the inverter while it's working.</p>
Caution	
	<p>PV array should be grounded in accordance to the requirements of the local electrical grid operator! We suggest that all PV module frames and inverter are reliably grounded to protect the PV system and personnel security.</p>
Attention	
	<p>Ensure input DC voltage < Max. DC voltage .Over voltage may cause permanent damage to inverter or other losses, which will not be included in warranty!</p>
Warning	

Signs on the inverter

There are some symbols which are related to security on the inverter. Please read and understand the content of the symbols, and then start the installation.

	<p>This symbol indicates a hazardous situation which could result in injuries, if not avoided.</p>
	<p>There is a residual voltage in the inverter! Before opening the equipment, operator should wait for five minutes to ensure the capacitor is discharged completely.</p>
	<p>Caution, risk of electric shock.</p>
	<p>Caution hot surface.</p>
	<p>Comply with the Conformite Europeenne (CE) certification.</p>
	<p>Grounding point.</p>
	<p>Please read this manual before install HYD 3K~6K-EP.</p>

	<p>This indicates the degree of protection of the equipment according to IEC standard 70-1 (EN 60529 June 1997).</p>
	<p>Positive pole and negative pole of the input voltage (DC).</p>
	<p>This side up, HYD 3K~6K-EP inverter must always be transported, handled and stored in such a way that the arrows always point upwards.</p>
	<p>RCM (Regulatory Compliance Mark) The product complies with the requirements of the applicable Australian standards.</p>

2. Product characteristics

2.1. Product informations

HYD 3K~6K-EP inverter is a single-phase photovoltaic energy storage inverter integrating grid-connected photovoltaic inverter and battery energy storage.

The HYD 3K~6K-EP inverter has a variety of built-in operating modes to suit the diverse user needs.

The HYD 3K~6K-EP inverter can provide a complete solution in the period of rising energy costs such as oil and coal, the energy subsidy of photovoltaic grid-connected system keeps falling. In the period of continuous power supply and emergency power supply demand in mountainous areas or base stations without power grid.

Fig. 2-1 HYD 3K~6K-EP inverter system diagram

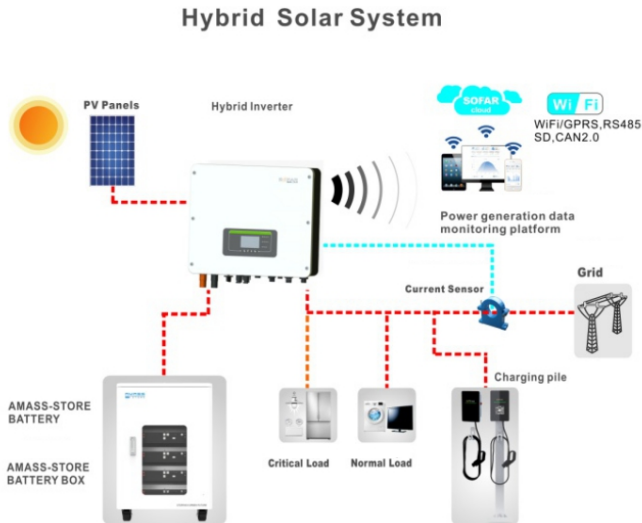

2.2. Size description

Fig. 2-2 Size chart

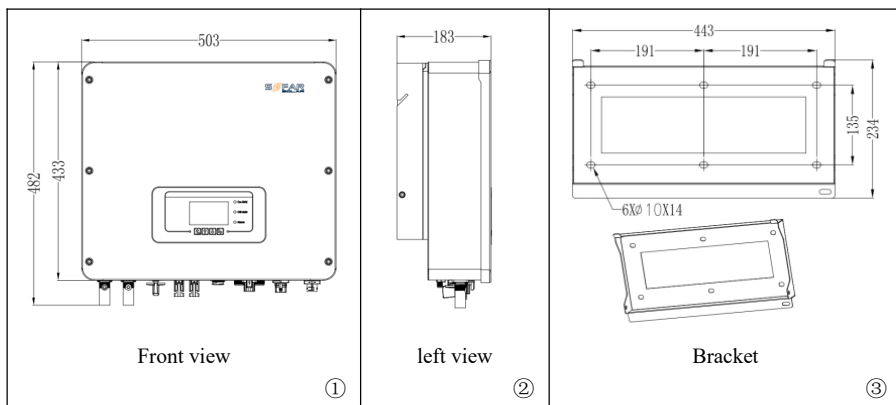

2.3. Function characteristics

The HYD 3K~6K-EP energy storage inverters allow up to 10% overloading to maximize power output, and the Uninterruptible Power Supply (UPS) mode can support inductive loads such as air conditioners or refrigerators with an automatic switchover time of less than 10 milliseconds.

- a. Dual MPP trackers with 1.5* DC overload.
- b. Flexible switching between grid-tied mode and energy storage mode.
- c. Max. battery charge and discharge efficiency 94.6%.
- d. 1 strings of battery input with maximum 100A charge and discharge current.
- e. Wide battery voltage range(90-580V).
- f. AC Multi-parallel function, more flexible system solution.
- g. Smart monitoring, RS485/WiFi/Bluetooth/GPRS(Optional).

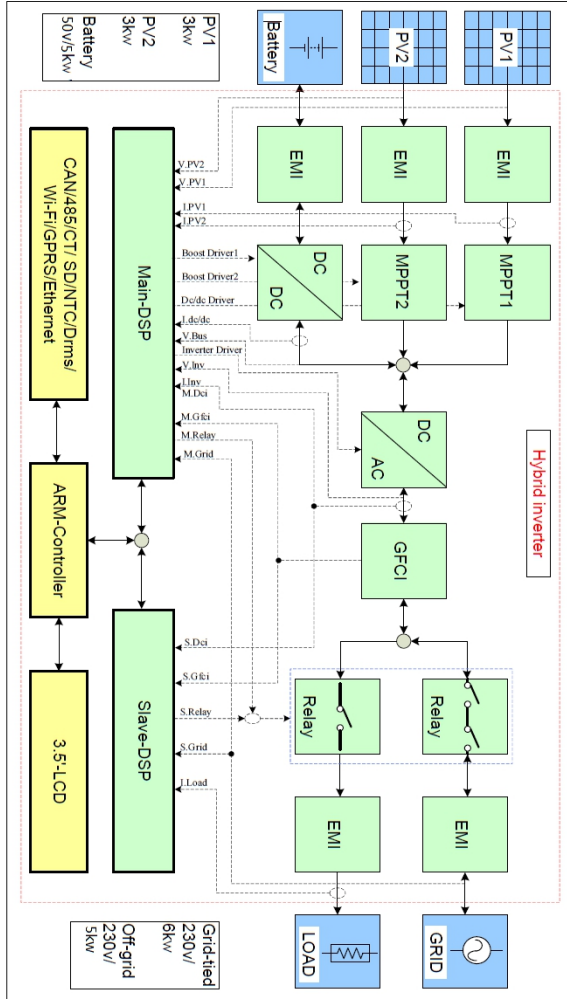

2.4. Electrical block diagram

Fig. 2-3 Electrical block diagram



3. Installation

Installation notes

 Danger	Do NOT install the HYD 3K~6K-EP on flammable material. Do NOT install the HYD 3K~6K-EP in an area used to store Flammable or explosive material.
 Caution	The enclosure and heat sink are very hot while the inverter is working, therefore do NOT install the HYD 3K~6K-EP in places where you might touch them inadvertently.
 Attention	Consider the weight of HYD 3K~6K-EP when transporting and moving the inverters. Choose an appropriate mounting position and surface. Assign at least two persons to install the inverter.

3.1. Checking Before Installation

Checking Outer Packing Materials







Packing materials and components may be damaged during transportation. Therefore, check the outer packing materials before installing the inverter. Check the outer packing materials for damage, such as holes and cracks. If any damage is found, do not unpack the HYD 3K~6K-EP and contact the dealer as soon as possible. You are advised to remove the packing materials within 24 hours before installing the HYD 3K~6K-EP inverter.



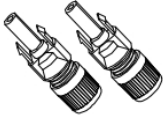
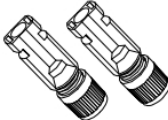

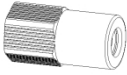
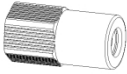

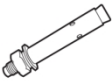
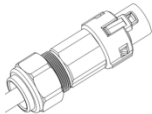
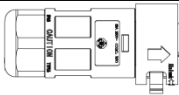
Checking Deliverables

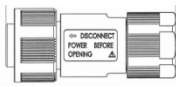
After unpacking the inverter, check whether deliverables are intact and complete. If any damage is found or any component is missing, contact the dealer.

Table3-1 Components and mechanical parts that should be delivered

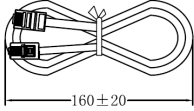
NO.	Picture	Description	Quantity
1		Inverter	1pcs

2		Rear panel	1pcs
3		PV+ input terminal	2pcs
4		PV- input terminal	2pcs
5		Metal terminals secured to PV+ input power cables	2pcs
6		Metal terminals secured to PV- input power cables	2pcs
7		BAT- input terminal	1pcs
8		BAT+ input terminal	1pcs
9		M6 Hexagon screws	3pcs
10		M8*80 Expansion bolts used to secure the wall-mount bracket to the wall	4pcs
11		AC Grid connector	1pcs
12		Load Output connector	1pcs
13		Link port connector	1pcs
14		8 pin terminal Matching terminal resistance (parallel system)	1pcs

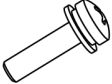
15		Split Core Current Transformer	1pcs
16		COM 16pin connector	1pcs
17		Communication cable	1pcs
18		DDSU666 Single-phase electronic type guide rail mounting electric energy meter	1pcs(optional)
19		Manual	1pcs
20		The warranty card	1pcs
21		Quality Certificate	1pcs
22		M4X14 Cross round head triple set screw (Only for DC switch lock)	1pcs

3.2. Product Overview

HYD 3K~6K-EP inverter is 100% strictly inspected before package and delivery. It is forbidden to put the HYD 3K~6K-EP inverter upside down during delivery.

	CAUTION
	Please check the product package and fittings carefully before installation.

Fig.3-2 HYD 3K~6K-EP inverter overview

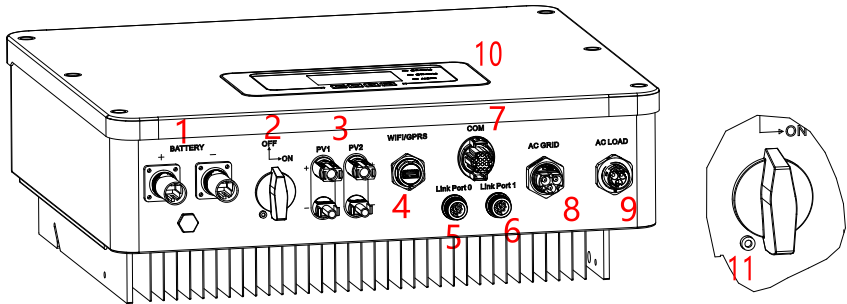

Table 3-2 HYD 3K~6K-EP inverter overview

1	Battery input terminals	7	COM
2	DC switch	8	Grid connection port
3	PV input terminals	9	Load connection port
4	USB/WiFi	10	LCD
5	Link Port 0	11*	DC switch lock (For Australian models)
6	Link Port 1		









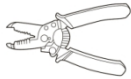

*Note: Lock the screw to limit the torque of the DC switch, making it impossible to twist the DC switch from OFF to ON, or ON to OFF. Remove the screw before turning the DC switch from OFF to ON or ON to OFF.

3.3. Tools

Prepare tools required for installation and electrical connections.

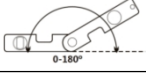
Table 3-3 Tools required for installation and electrical connections.

NO.	Tool	Model	Function
1		Hammer drill Recommend drill dia. 6mm	Used to drill holes on the wall.
2		Screwdriver	Wiring
3		Cross screwdriver	Remove and install AC terminal screws
4		Removal tool	Remove PV terminal

5		Wire stripper	Strip wire
6		4mm Allen Wrench	Turn the screw to connect rear panel with inverter.
7		Crimping tool	Used to crimp power cables
8		Multi-meter	Used to check grounding
9		With an open end of larger than or greater than 32 mm	Used to tighten expansion bolts
10		Marker	Used to mark signs
11		Measuring tape	Used to measure distances
12		Level	Used to ensure that the rear panel is properly installed
13		ESD gloves	Operators wear
14		Safety goggles	Operators wear
15		Anti-dust respirator	Operators wear

3.4. Installation Environment

- a. Choose a dry, clean, and tidy place, convenient for installation.
- b. Ambient temperature range: $-25^{\circ}\text{C} \sim 60^{\circ}\text{C}$.
- c. Relative humidity: $0 \sim 100\%$ (non-condensed).
- d. HYD 3K~6K-EP inverter shall be installed in a well-ventilated place.
- e. No flammable or explosive materials close to HYD 3K~6K-EP inverter.
- f. The AC overvoltage category of HYD 3K~6K-EP inverter is category III.
- g. Maximum altitude: 4000m.

3.5. Determining the Installation Position

Determine an appropriate position for installing the HYD 3K~6K-EP inverter. Comply with the following requirements when determining the installation position.

Fig. 3-3 Installation Position of HYD 3K~6K-EP inverter

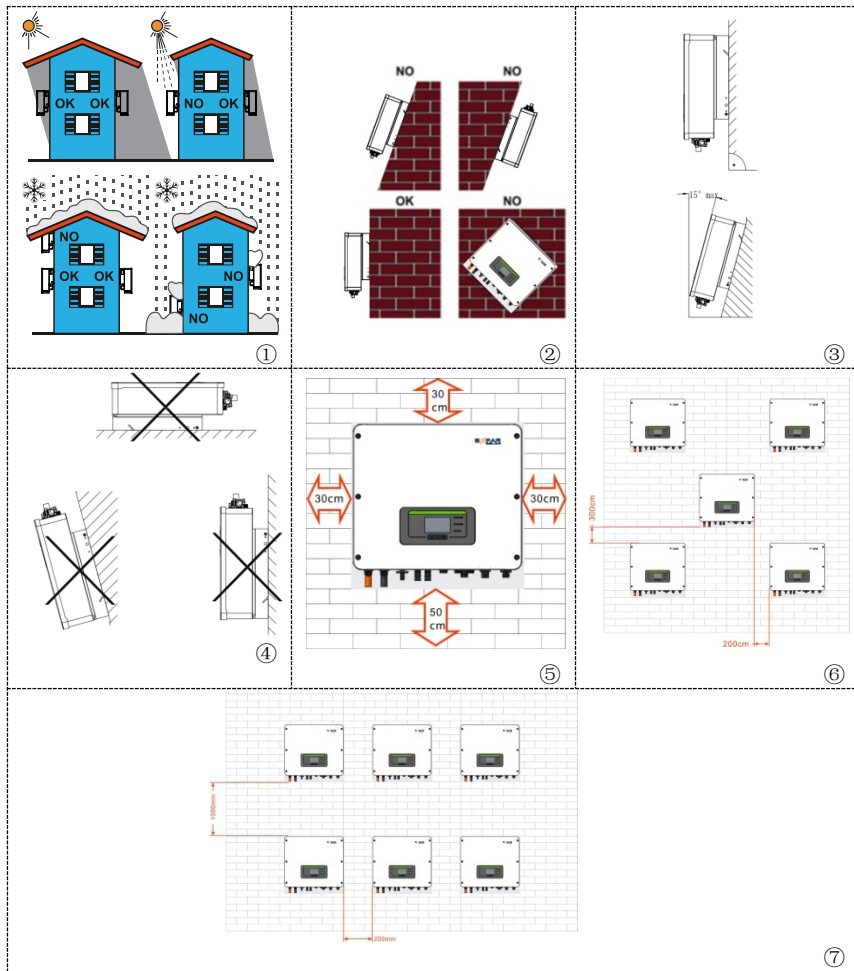

3.6. Moving the HYD 3K~6K-EP

Step 1 Open the packaging, insert hands into the slots on both sides of the

inverter and hold the handles, as shown in Fig.3-4.

Fig. 3-4 Moving the inverter

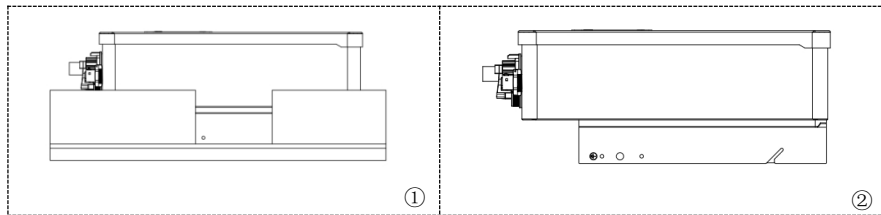

Step 2 Lift the inverter from the packing case and move it to the installation position.

 Attention	<p>To prevent device damage and personal injury, keep balance when moving the inverter because the inverter is heavy.</p> <p>Do not put the inverter with its wiring terminals contacting the floor because the power ports and signal ports are not designed to support the weight of the inverter. Place the inverter horizontally.</p> <p>When placing the inverter on the floor, put foam or paper under the inverter to protect its shell.</p>
---	---

3.7. Installing HYD 3K~6K-EP

Step 1 Determine the positions for drilling holes, ensure the hole positions are level, then mark the hole positions using a marker pen, use the hammer drill to drill holes on the wall (Aperture Φ 10 mm). When drilling, keep the impact drill perpendicular to the wall and drill slightly deeper than the length of the expansion pipe. After drilling, please check whether the hole position is suitable with the back plate. If the error is too large, please reposition the hole.

Step 2 Slowly hammer the expansion screw into the drilled hole.

Step 3 Position the back plate well, place the shrapnel and flat pad, and fix the back plate with hexagon nut.

Step 4 Hang the inverter on the back plate and lock the inverter and the back plate with M6 hex screw.

Step 5 You can secure the inverter to the rear panel and protect it from stealing by installing an anti-theft lock (this action is optional).

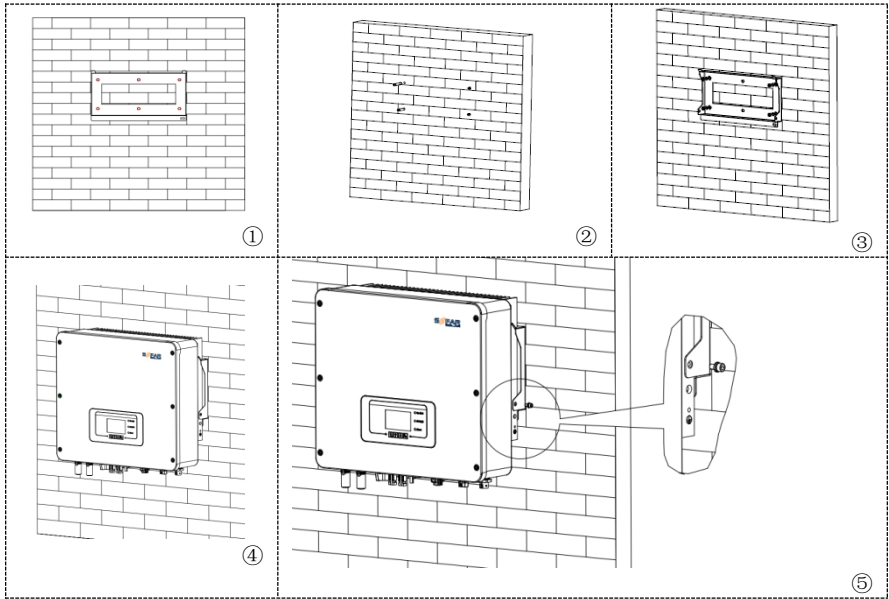

Fig. 3-5 Installing HYD 3K~6K-EP



4. Electrical Connections

Before performing electrical connections, ensure that the DC switch is OFF. Since the stored electrical charge remains in a capacitor after the DC switch is turned OFF. So it's necessary to wait for at least 5 minutes for the capacitor to be electrically discharged.

HYD 3K~6K-EP inverter is intended to be used in PV system with battery storage. If not used as intended, the protection provided by the equipment may be impaired.

	<p>Installation and maintenance of inverter, must be operated by professional electrical engineer.</p> <p>Wear rubber gloves and protective clothing (protective glasses and boots) when working on high voltage/high current systems such as inverter and battery systems.</p>
Attention	
	<p>PV modules generate electric energy when exposed to sunlight and can create an electrical shock hazard. Therefore, before connecting DC input power cable, cover PV modules using opaque cloth.</p>
Danger	
	<p>For HYD 3K~6K-EP, open-circuit voltage(Voc) of module arrays connected in series must be $\leq 580V$.</p>
Note	

The connected PV modules must have an IEC 61730 Class A rating

Table 4-1 Relevant current parameters of each model

Model	IscPV(absolute maximum)	Maximum output over current protection
HYD 3000-EP	18A/18A	15A
HYD 3680-EP		16A
HYD 4000-EP		20A
HYD 4600-EP		20.9A
HYD 5000-EP		21.7A
HYD 5500-EP		25A
HYD 6000-EP		27.3A



NOTE:The DVC is the voltage of a circuit which occurs continuously between any two live part in the worst-case rated operating condition when used as intended.

Table 4-2 The decisive voltage class(DVC)

Interface	DVC
PV input port	DVCC
Grid connection port	DVCC
Battery input port	DVCC
Load connection port	DVCC
USB/WiFi interface	DVCA
COM interface	DVCA
Link Port 0 & Link Port 1	DVCA

4.1. Wire instructions

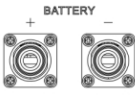
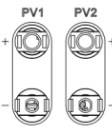
Table 4-3 Cable description

Component	Description	Recommended cable type	Recommended cable specifications	
	+: Connect the positive electrode of lithium battery	Outdoor multi-core copper cable	Conductor cross-sectional area:16mm ² ~20mm ²	
	-: Connect the negative electrode of lithium battery			
	+: Connect the positive electrode of photovoltaic cell	Industry common outdoor photovoltaic cable	Conductor cross-sectional area:4mm ² ~6mm ²	
	-: Connect the negative electrode of photovoltaic cell			
	Load	L	Outdoor multi-core copper cable	Conductor cross-sectional area:4mm ² ~6mm ²
		N		
		PE		
	AC	L	Outdoor multi-core copper cable	Conductor cross-sectional area:5mm ² ~8mm ²
		N		
		PE		

4.2. Connecting PGND Cables

Connect the inverter to the grounding electrode using protection ground

(PGND) cables for grounding purpose.

	The inverter is transformer-less, requires the positive pole and negative pole of the PV array are NOT grounded. Otherwise it will cause inverter failure. In the PV power system, all non current carrying metal parts (such as: PV module frame, PV rack, combiner box enclosure, inverter enclosure) should be connected to earth.
Attention	

The PGND cables are prepared ($\geq 4\text{mm}^2$ outdoor power cables are recommended for grounding purposes), the color of cable should be yellow-green.

Procedure:

Step 1 Remove the insulation layer with an appropriate length using a wire stripper, as shown in Fig.4-1.

Step 2 Insert the exposed core wires into the OT terminal and crimp them by using a crimping tool, as shown in Fig.4-1.

Step 3 Install the crimped OT terminal, flat washer using M5 screw, and tighten the screw to a torque of 3 N.m using an Allen wrench.

Note 1: L3 is the length between the insulation layer of the ground cable and the crimped part. L4 is the distance between the crimped part and core wires protruding from the crimped part.

Note 2: The cavity formed after crimping the conductor crimp strip shall wrap the core wires completely. The core wires shall contact the terminal closely.

Fig.4-1 Connecting PGND cable

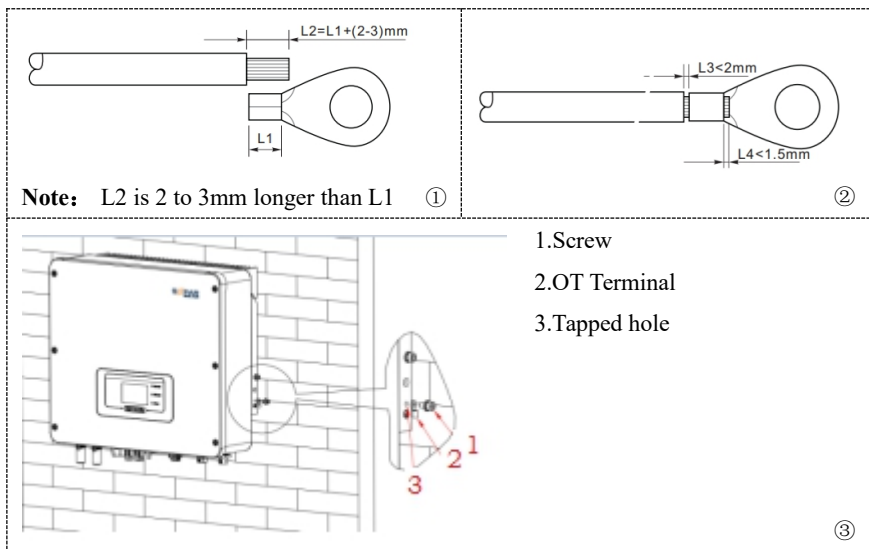

4.3. PV Connection

Procedure:

Step 1 Select the appropriate cable type and specifications according to the table4-3.Remove cable glands from the positive and negative connectors.(It is recommended that the positive and negative be distinguished by different colors).

Step 2 Remove the insulation layer with an appropriate length from the positive and negative power cables by using a wire stripper as show in Fig.①.

Step 3 Insert the stripped positive and negative power cables into the positive and negative metal terminals respectively and crimp them using a crimping tool. Ensure that the cables are crimped until they cannot be pulled out by force less than 400 N, as shown in Fig.②③.

Step 4 Insert crimped power cables into corresponding housings until you hear a "click" sound. The power cables snap into place.

Step 5 Reinstall cable glands on positive and negative connectors and rotate them against the insulation covers.

Step 6 Insert the positive and negative connectors into corresponding PV terminals of the inverter until you hear a "click" sound, as shown in Fig.⑥.

To remove the positive and negative connectors from the inverter, insert a removal wrench into the bayonet and press the wrench with an appropriate strength, as shown in Fig.⑦.

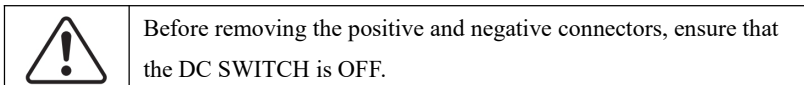
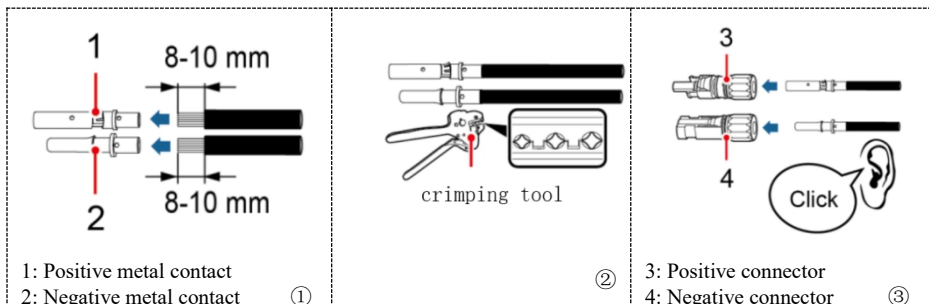
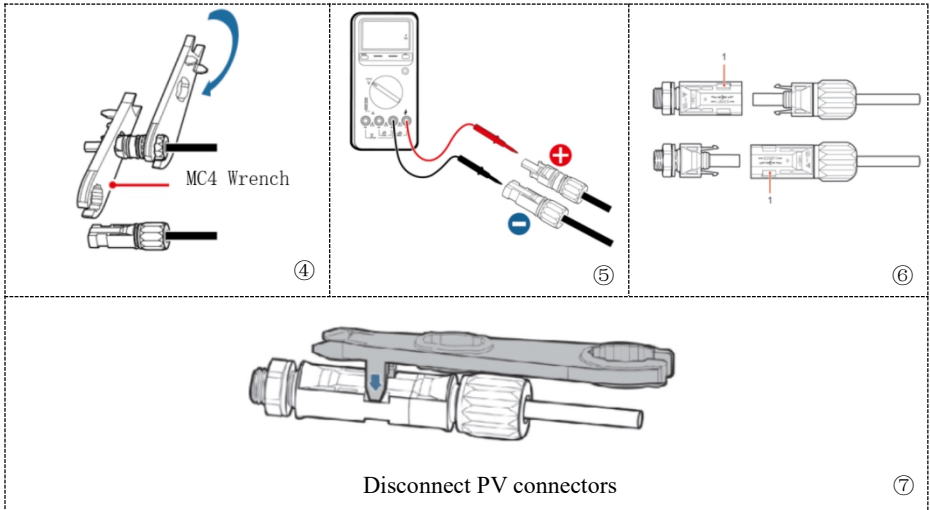

Fig.4-2 Connect PV





4.4. Battery Connection

Fig. 4-3 Install battery connection

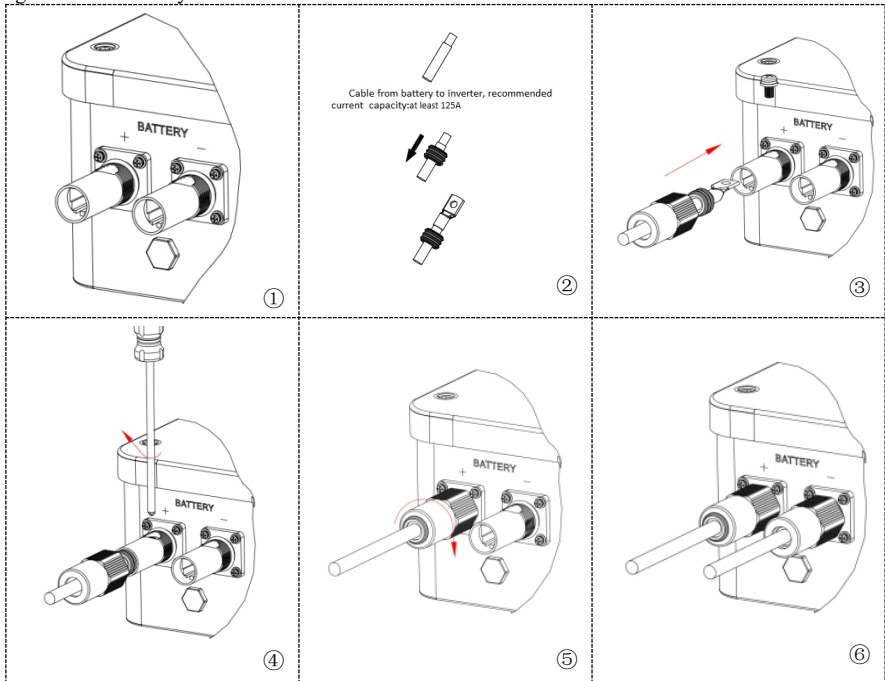

4.5. Load connection

Procedure:

Step 1 Select appropriate cables according to Table4-3, Remove the insulation layer of the load output cable using a wire stripper according to the figure shown below: A:15~25mm B:6~8mm .

Step 2 Disassemble the load connector according to the figure shown below: insert the load output cable (with its insulation layer stripped according to step 1) through the waterproof locking cable gland .

Step 3 Connect load output cable as per the following requirements:

Connect the yellow-green wire to the hole labeled "PE", fasten the wire using an Cross screwdriver;

Connect the brown wire to the hole labeled "L", fasten the wire using an Cross screwdriver;

Connect the blue wire to the hole labeled "N", fasten the wire using an Cross screwdriver.

Step 4 Insert the load connector and hear "click", then tighten the waterproof nut at the instantaneous value, as shown in the figure below, to ensure that the cable is firmly connected.

Step 5 Connect the connected load connector to the load connector of the inverter. Turn the ac connector knob to lock until you hear a "click" and the clasp is in place.

Removing the load connector Hold the button to unlock and rotate the knob counterclockwise to the unlock position, then pull out the load connector, the following figure ⑦, Make sure the grid is disconnected before removing the load connector .

Fig.4-4 Grid connection

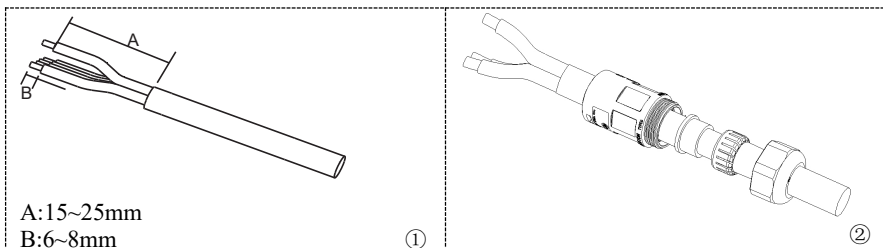

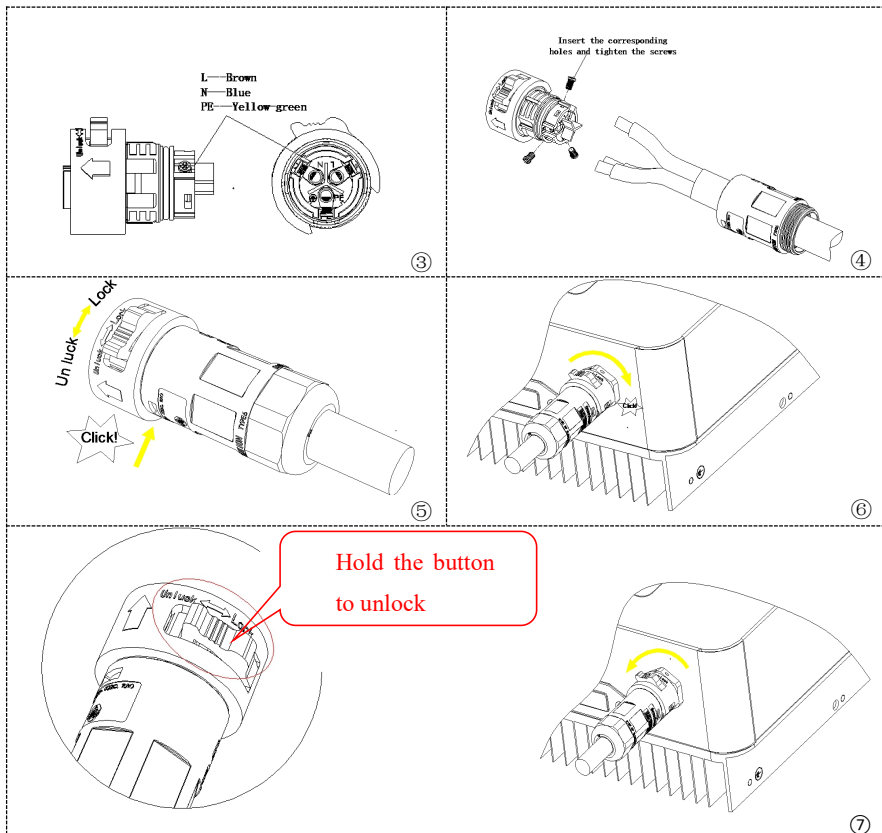

4.6. Grid connection

Sofarsolar has already integrated RCMU (residual current monitoring unit) inside inverter, If an external RCD is required, a type-A RCD with rated residual current of 100mA or higher is suggested.

Procedure:

Step 1 Select the appropriate cable type and specifications according to the table 4-3. Refer to Fig. ① for processing wire.

Step 2 Pass the wire through the terminal, as shown in Fig. ②.

Step 3 According to the mark, lock the wire into the keyhole on the terminal and tighten it with the hexagon socket wrench, as shown in Fig. ③④.

Step 4 Push the terminal forward until the sound of "click" is heard, as shown

in Fig.⑥).

Step 5 Connect the connected load terminal to the inverter load port, and push the terminal forward until the sound of "click" is heard, and the terminal connection is completed, as shown in Fig.⑦⑧).

If you need to remove the terminals from the machine, use the tool to press on the direction indicated by the big arrow and pull the terminals out.

Need to dismantle the end connection, to use the tool, as shown in figure attending ⑩⑪).

Fig.4-5 Load connection

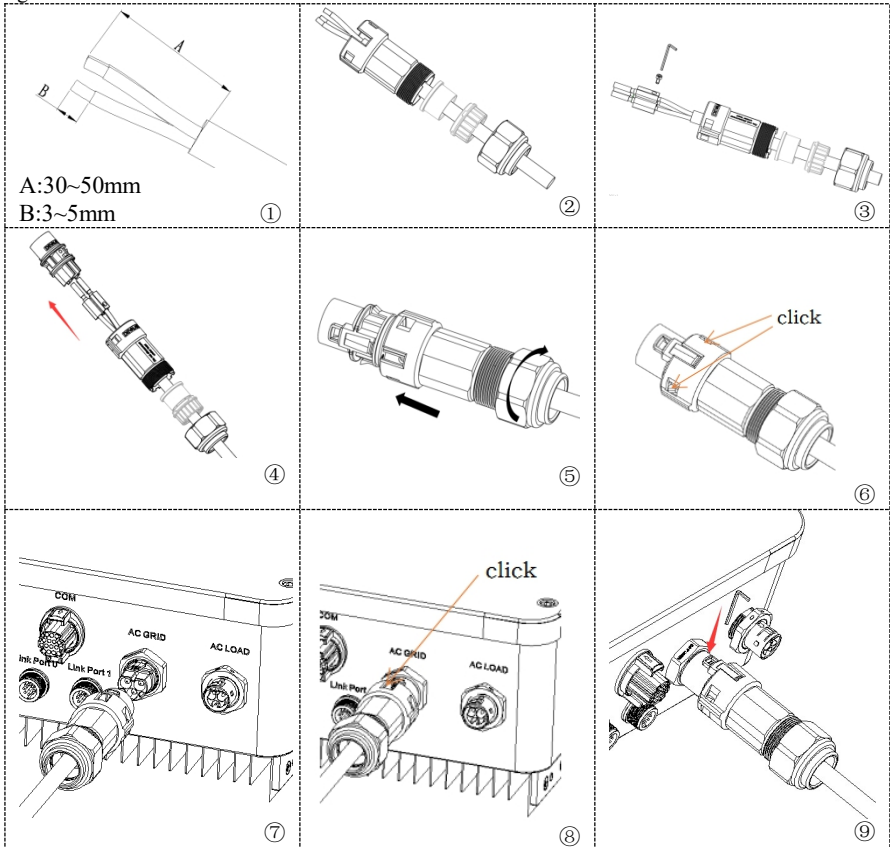

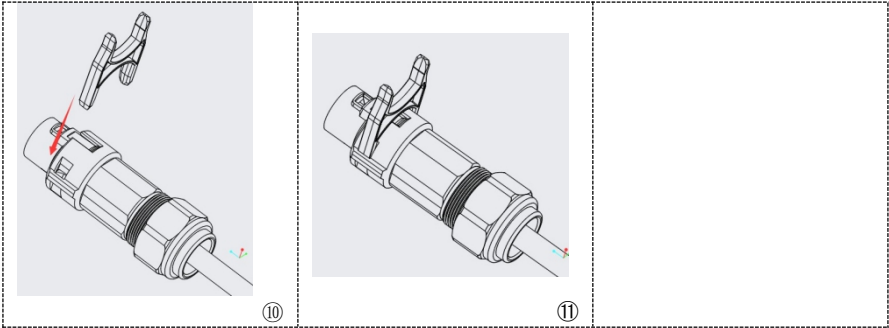

4.7. External communication interface

4.7.1 USB/WIFI communication interface

Fig.4-6 USB/WIFI communication interface

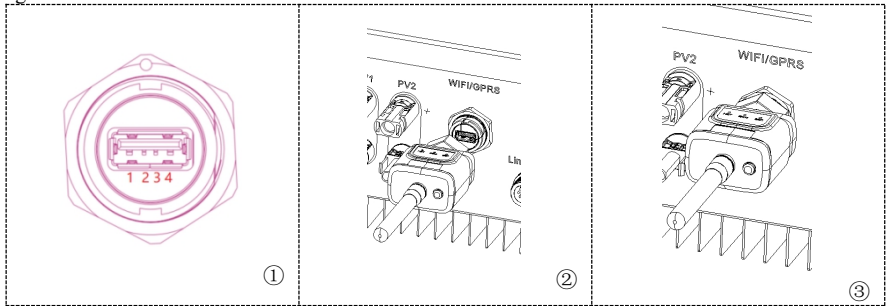

Table 4-4 Interface description

PIN	Definition	Function	Note
1	GND.S	USB power -	The USB power supply is 5V/1A; Cannot be used for external device charging
2	DP	USB data +	
3	DM	USB data -	
4	VBUS	USB power +	

Refer to the figure shown below.

Fig 4-7



Fig 4-8

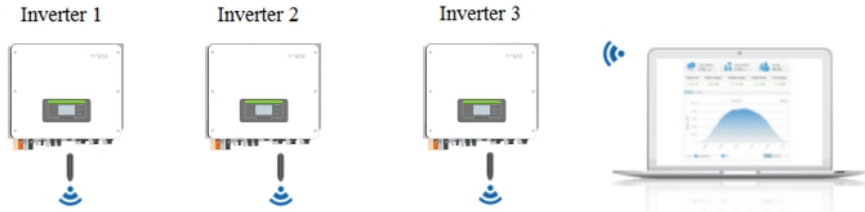

The operation information (generated energy, alert, operation status) of the inverter can be transferred to PC or uploaded to the server via WiFi/GPRS. Users can choose to use web or APP for monitoring and viewing according to their needs. They need to register an account and bind the device with the WiFi/GPRS SN number. The SN number of the WiFi/GPRS shall be affixed to the package box and the WiFi/GPRS.

Web: <https://home.solarmanpv.com> (Recommended browser: Chrome58, Firefox49, IE9 and above version) .

APP: Android: Go to Android Market and search “SolarMAN”.

IOS: Go to App Store and search “SolarMAN”.

SolarMAN-3.0-Web User Manual, Please visit the <https://doc.solarmanpv.com/web/#/7>.

SolarMAN-App User Manual, Please visit the <https://doc.solarmanpv.com/web/#/14>.

4.7.2 COM-Multifunction communication interface

Table 4-5 Interface description

PIN	Definition	Function	Note
1	CANH	CAN high data	Communication with lithium battery BMS, the inverter CAN be adaptive to lithium battery BMS to provide CAN communication and RS485 communication
2	CANL	CAN low data	
3	485-2TX+	RS485 differential signal +	
4	485-2TX-	RS485 differential signal -	
5	485-1TX+	RS485 differential signal +	Wired monitoring or inverter cascade monitoring
6	485-1TX-	RS485 differential signal -	
7	GND-S	(DRMS) logic interfaces are applicable to the following safety standards: Australia (AS4777), European General (50549), Germany (4105)	Logic interface connections
8	DRMS1/5		
9	DRMS2/6		
10	DRMS3/7		
11	DRMS4/8		
12	DRMS0		
13	CT-	The current sensor outputs a	Connect current sensor of power

		negative electrode	grid
14	CT+	The current sensor outputs a positive electrode	
15	RS485-B	RS485 differential signal +	Meter communication
16	RS485-A	RS485 differential signal -	

Fig.4-9 COM interface

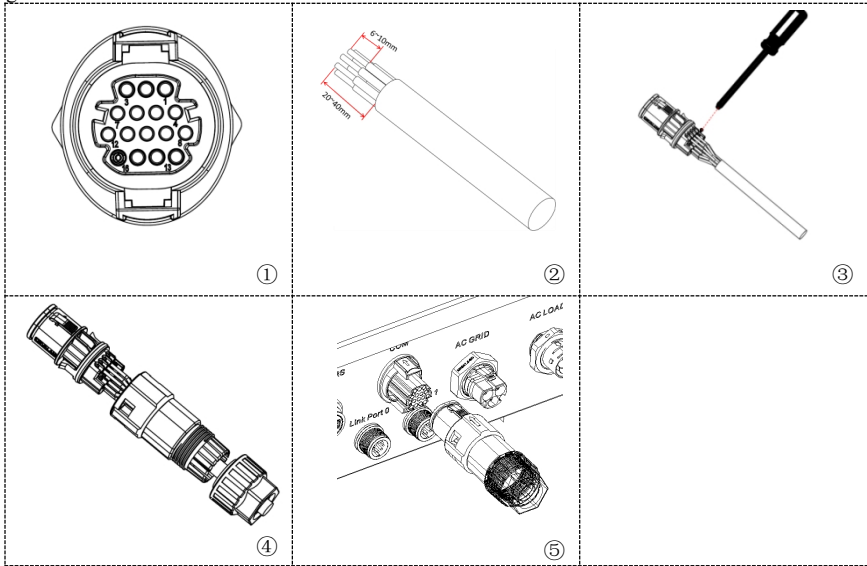

1. RS485 (Wired monitoring or inverter cascade monitoring)

Refer to the figure shown below, connect the RS485+ and RS485- of the inverter to the TX+ and TX- of the RS485 → USB adapter, and connect the USB port of the adapter to the computer. (NOTE : The length of the RS485 communication cable should be less than 1000 m)

Fig 4-10

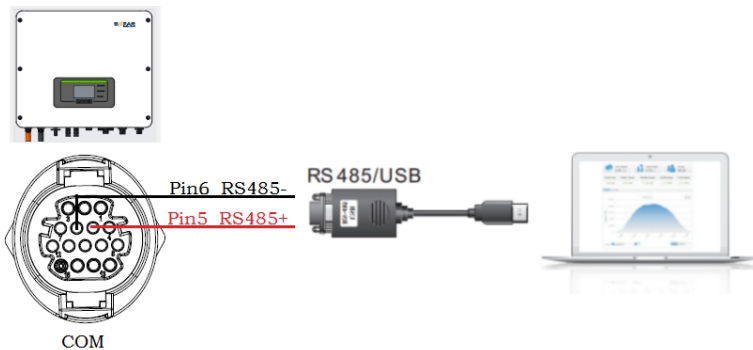

RS485 wires are connected in parallel between inverters, (NOTE : When multiple inverters are connected via RS485 wires, set communication address to differentiate the inverters , please refer to this manual<6.3.1System setting→8.Communication Addr>)

Fig.4-11 RS485 connection(cascade of monitoring between inverters)

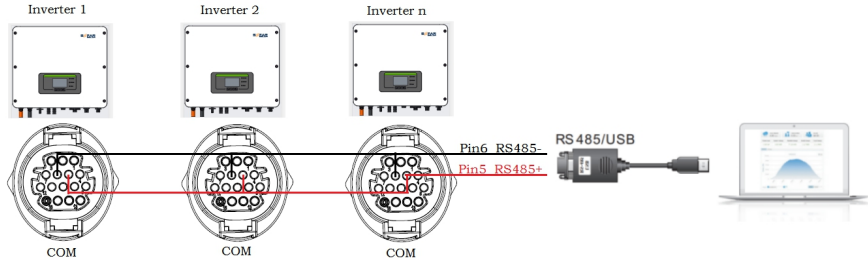

2. Logic interface

The logic interface pin definitions and circuit connections are as follows:

Logic interface pin are defined according to different standard requirements

(a) Logic interface for AS/NZS 4777.2:2015, also known as inverter demand response modes (DRMs).

The inverter will detect and initiate a response to all supported demand response commands within 2 s. The inverter will continue to respond while the mode remains asserted.

Table 4-6 Function description of the DRMs terminal

Pin NO.	Function
8	DRM1/5
9	DRM2/6
10	DRM3/7
11	DRM4/8
12	DRM0
7	GND-S

(b) Logic interface for VDE-AR-N 4105:2018-11, is in order to control and/or limit the inverter’s output power.

The inverter can be connected to a RRCR (Radio Ripple Control Receiver) in order to dynamically limit the output power of all the inverters in the installation.

Fig.4-12 Inverter – RRCR Connection

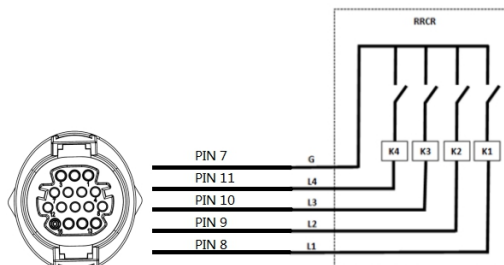

Table 4-7 Function description of the terminal

Pin NO.	Pin name	Description	Connected to (RRCR)
8	L1	Relay contact 1 input	K1 - Relay 1 output
9	L2	Relay contact 2 input	K2 - Relay 2 output
10	L3	Relay contact 3 input	K3 - Relay 3 output
11	L4	Relay contact 4 input	K4 - Relay 4 output
7	G	GND	Relays common node

Table 4-8 The inverter is preconfigured to the following RRCR power levels,close is 1, open is 0

L1	L2	L3	L4	Active Power	Cos(ϕ)
1	0	0	0	0%	1
0	1	0	0	30%	1
0	0	1	0	60%	1
0	0	0	1	100%	1

(c) Logic interface for EN50549-1:2019, is in order to cease active power output within five seconds following an instruction being received at the input interface.

Fig.4-13 Inverter – RRCR Connection

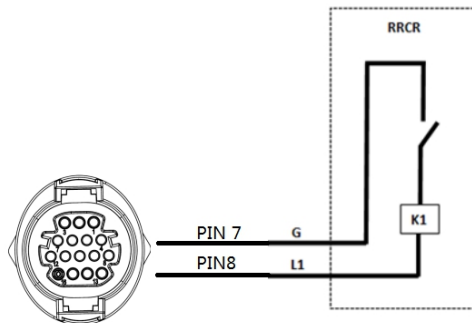

Table 4-9 Function description of the terminal

Pin NO.	Pin name	Description	Connected to (RRCR)
8	L1	Relay contact 1 input	K1 - Relay 1 output
7	G	GND	K1 - Relay 1 output

Table 4-10 The inverter is preconfigured to the following RRCR power levels,close is 1, open is 0

L1	Active Power	Power drop rate	Cos(ϕ)
1	0%	<5 seconds	1
0	100%	/	1

3.Meter/CT

PIN15 and PIN16 are used for meter communication, the electricity meter is shown in the fig.①, PIN15 and PIN16 correspond to 7,8 respectively on the electricity meter, as shown in fig.③.

The connection mode is shown in fig.②. The 1/2 and 3/4 on the electricity meter are connected to voltage signals L and N respectively. And the current needs to be connected through the current transformer,5,6 correspond to the current

transformer.

NOTE: The direction of the current transformer is shown in fig.④.

Fig.4-14 Meter

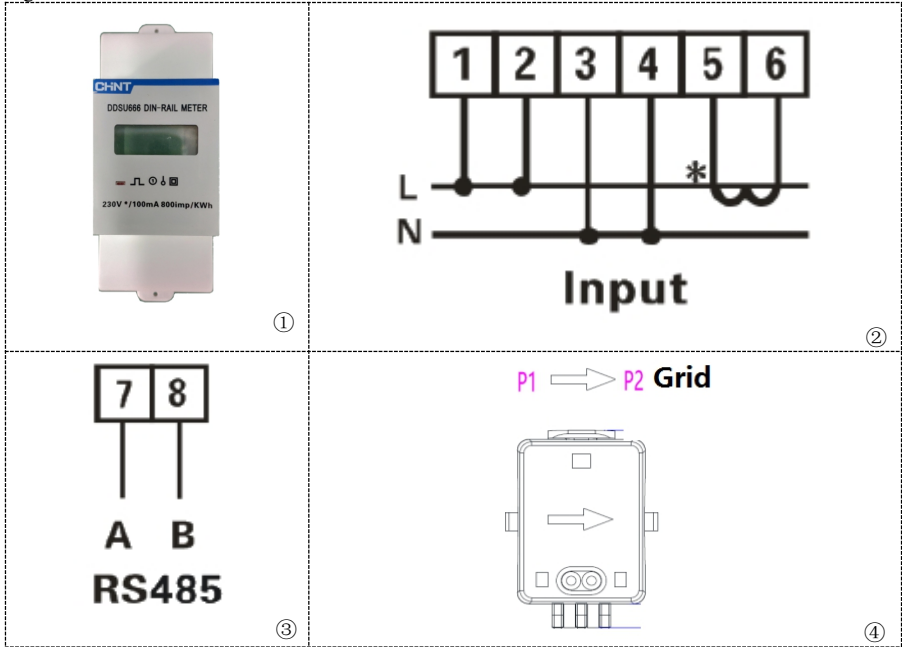

If you need to use the CT alone, attach the CT to PIN13 and PIN14.

There are two ways to get grid current information :

Plan A:CT

Plan B:Meter +CT

Fig. 4-15 Electrical connections (Plan A:CT)

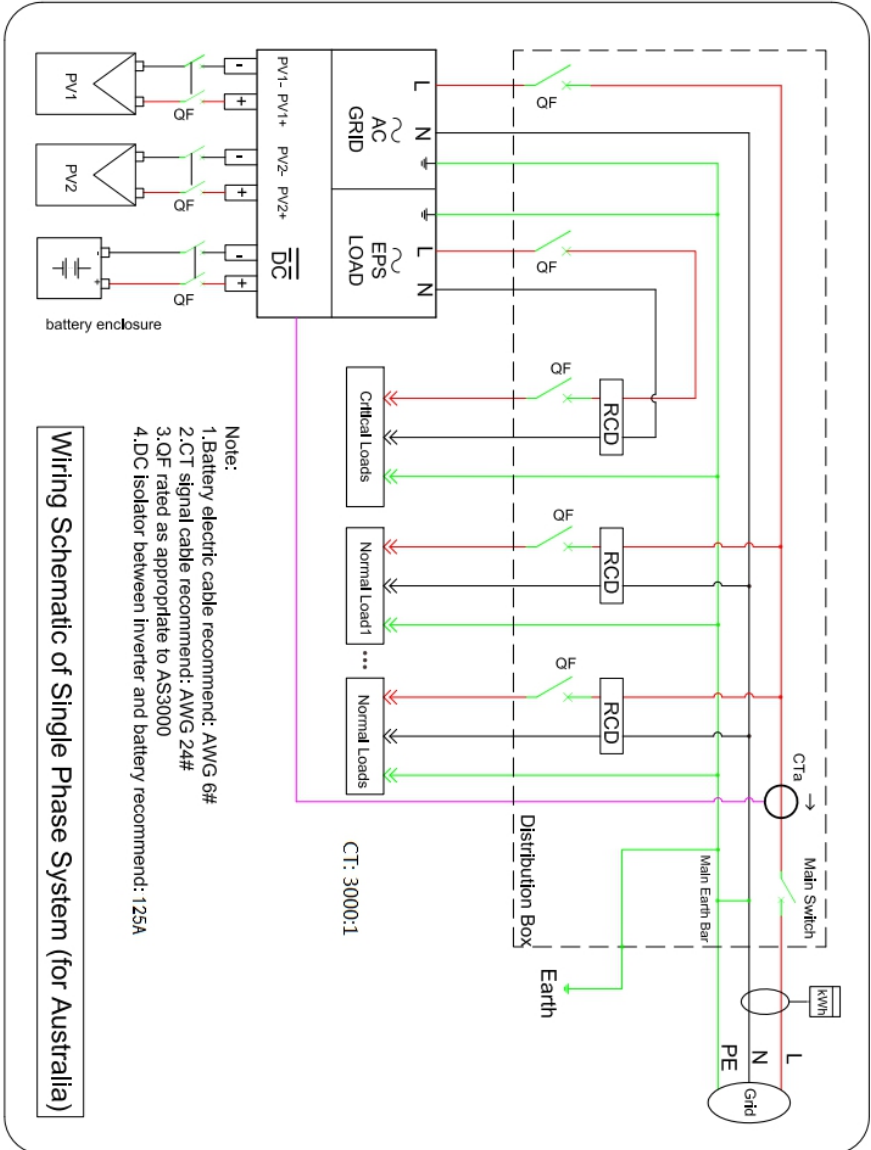
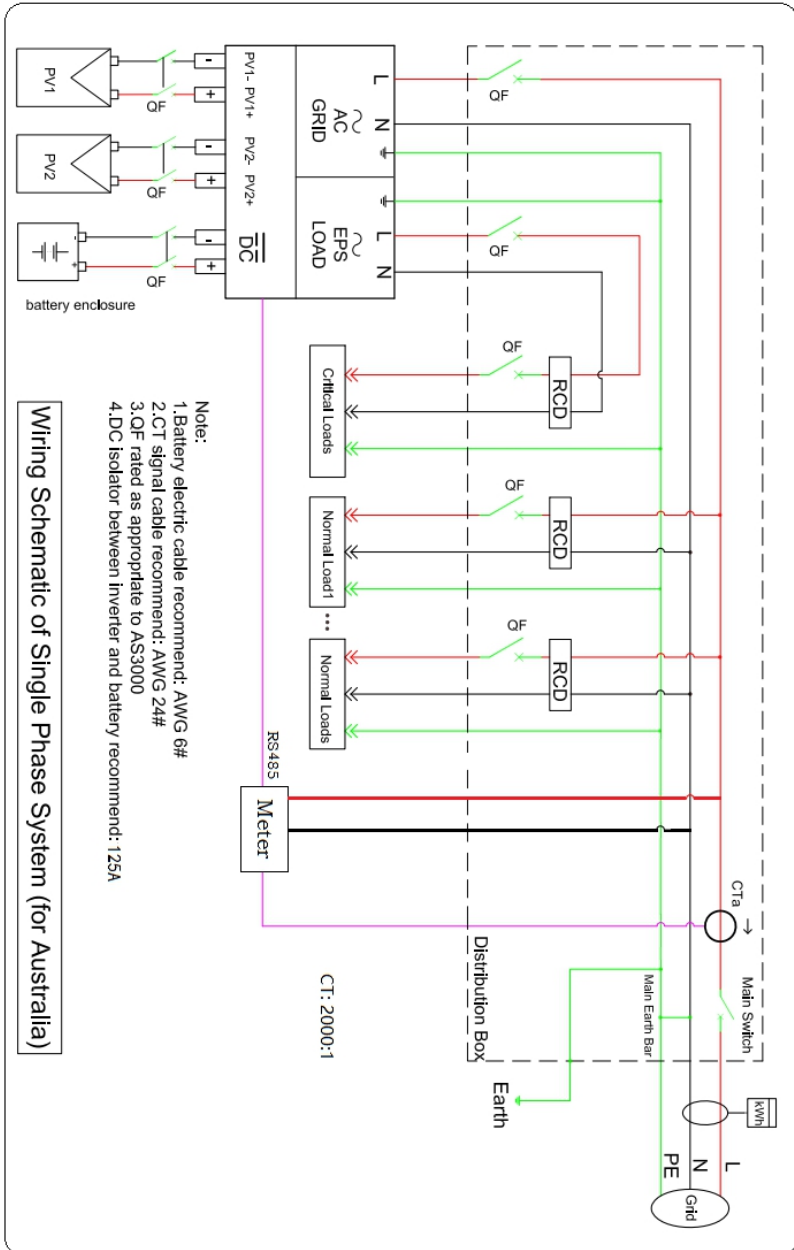
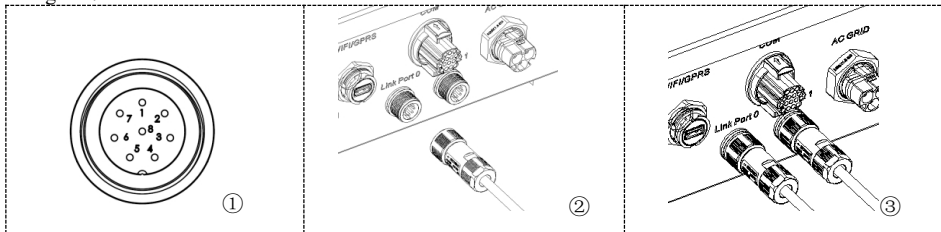

Fig. 4-16 Electrical connections (Plan B: Meter +CT)



4.7.3 Link Port 0&1-Cascade communication interface

Fig.4-17 Link Port



When using the parallel system, the inverter settings and notes please refer to this manual<6.3.2 Advanced setting→6.Parallel setting>.

Note(AC LOAD is also parallel for parallel machines):

1. The first and last inverters need to be connected with 8Pin connection terminals.
2. The cable length of the AC LOAD terminal connected from the LOAD terminal to each machine shall be consistent with the specification of the cable length, so as to ensure that the loop impedance is consistent and the current of the LOAD current diverted to each machine is nearly equal.
3. When the total power of AC Load is greater than 110% of the rated power of the machine (For example, one inverter AC LOAD has a maximum allowable power of 5.5kVA and six parallel machines AC LOAD has a maximum allowable power of 33kVA), the Load should not be connected to AC Load and should be connected to AC Grid.
4. When inverters in parallel, All AC grid should be Shared a total air switch; All AC LOAD should be Shared another total air switch .

Fig.4-18 parallel system

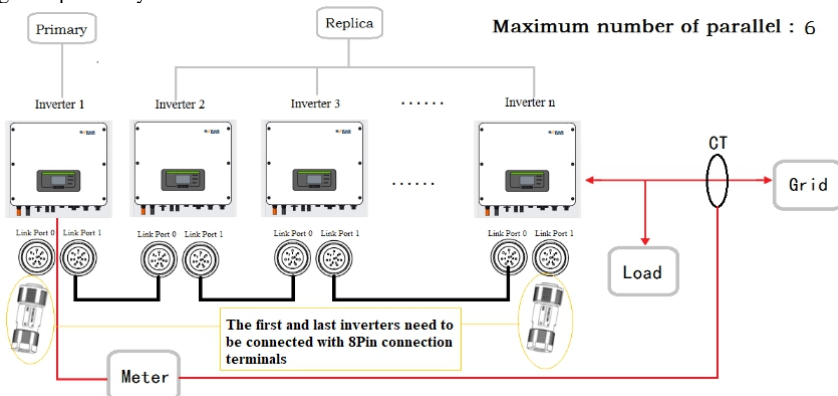

5. Buttons and indicator lights

Fig.5-1 Buttons and indicator lights

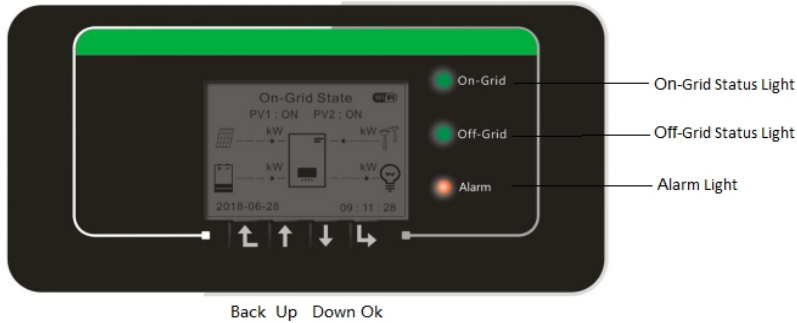

5.1. Buttons

- ✧ press “Back” to the previous screen or enter the main interface.
- ✧ press “Up” to the upper menu option or value plus 1.
- ✧ press “Down” to the lower menu option or value minus 1.
- ✧ Press “OK” to select the current menu option or switch to the next digit.

5.2. Indicator lights and status

Status	On Grid Green light	Off-Grid Green light	Alarm Red light
On-grid	ON		
Standby (On-Grid)	Flashing		
Off-Grid		ON	
Standby (Off-Grid)		Flashing	
Alarm			ON

6. Operation

6.1. Double Check

Please double check the following before operation.

1. Inverter is firmly fastened to the mounting bracket on the wall.
2. PV+/PV- wires are firmly connected, polarity and voltage are correct.
3. BAT+/BAT- wires are firmly connected, polarity and voltage are correct.
4. DC isolator is correctly connected between battery & inverter, DC isolator: OFF.
5. GRID / LOAD cables are firmly / correctly connected.
6. AC circuit breaker is correctly connected between inverter GRID port & GRID, circuit breaker: OFF.
7. AC circuit breaker is correctly connected between inverter LOAD port & critical load, circuit breaker: OFF.
8. For lithium battery, please ensure that the communication cable has been correctly connected.

6.2. First Time Setup (IMPORTANT!)

IMPORTANT: Please follow the following procedure to switch ON inverter.

1. Make sure there's no power generation in inverter's phase.
2. Turn ON DC switch.
3. Switch ON the battery. Turn ON DC isolator between battery & inverter.
4. Turn ON AC circuit breaker between the inverter GRID port & GRID.
5. Turn ON AC circuit breaker between the inverter LOAD port & critical load.
6. Inverter should start to operate now.

You need to set the following parameters before inverter starts to operate.

Table 6- 1 Set the parameters

Parameter	Note
1.OSD Language Option	The default English.
2.System time setting and confirmation	If you are connected to the host computer such as collector or mobile phone APP, the time should have been calibrated to the local time.
*3.Safety parameter import	You need to find the safety parameters file (named after the corresponding safety country) on the website, download it to the usb flash drive, and import it.
*4.Set battery parameters	Default values can be displayed according to the input channel configuration.
5. Setup is complete	

Table 6-2 List of regulated countries

Code	Country	Code	Country
000	000 Germany VDE4105	018	000 EU EN50438
	001 Germany BDEW		001 EU EN50549
	002 Germany VDE0126	019	000 IEC EN61727
001	000 Italia CEI-021 Internal	020	000 Korea
	001 Italia CEI-016 Italia	021	000 Sweden
	002 Italia CEI-021 External	022	000 Europe General
	003 Italia CEI0-21 In Areti	024	000 Cyprus
002	000 Australia	025	000 India
	001 Australia AU-WA	026	000 Philippines
	002 Australia AU-SA	027	000 New Zealand
	003 Australia AU-VIC	028	000 Brazil
	004 Australia AU-QLD		001 Brazil LV
	005 Australia AU-VAR		002 Brazil 230
	006 Australia AUSGRID		003 Brazil 254
007 Australia Horizon	029	000 Slovakia VSD	
003 000 Spain RD1699		001 Slovakia SSE	
004	000 Turkey	002 Slovakia ZSD	
005	000 Denmark	033	000 Ukraine
	001 Denmark TR322	035	000 Mexico LV
006	000 Greece Continent	038	000 Wide-Range-60Hz
	001 Greece island	039	000 Ireland EN50438
007	000 Netherland	040	000 Thailand PEA
008	000 Belgium		001 Thailand MEA
009	000 UK G59/G99	042	000 LV-Range-50Hz
	001 UK G83/G98	044	000 South Africa
010	000 China	046	000 Dubai DEWG
	001 China Taiwan		001 Dubai DEWG MV
011	000 France	107	000 Croatia

	001	France FAR Arrete23	108	000	Lithuania
012	000	Poland			

	CAUTION
	<p>It's very important to make sure that you have selected the correct country code according to requirements of local authority. Please consult qualified electrical engineer or personnel from electrical safety authorities about this.</p> <p>Shenzhen SOFARSOLAR Co., Ltd. is not responsible for any consequences arising out of incorrect country code selection.</p>

*4.Set battery parameters (Take the default input channel configuration as an example).Start with battery 1 and work your way up to battery n.

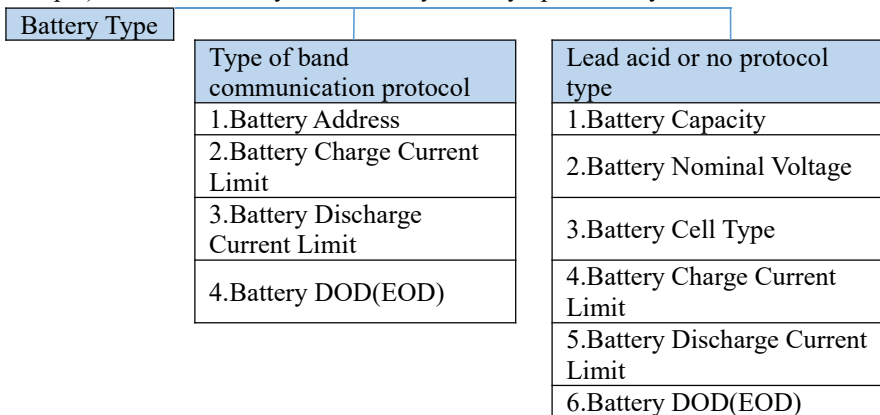
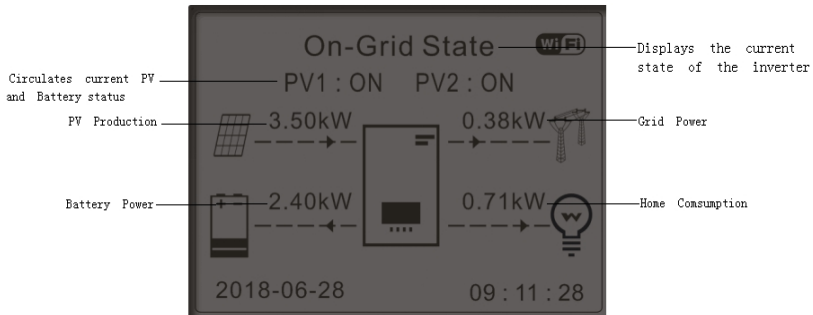

Table 6-2 Default values for other Settings

Item	The default state
Energy Storage Mode	Self-use mode
EPS Mode	Disable
Anti Reflux	Disable
IV Curve Scan	Disable
Logic interface	Disable

6.3. Menu

Fig 6-1. Main interface



In the main interface, press “Down” button to enter grid/battery parameters page.

Main interface	Down↓	Grid Output Information
		Grid(V)***.*V
		AC Current**.*A
		Frequency.....**.*Hz
		Battery Information (1)
		Batt (V).....***.*V
		Batt Chrs Curr.....**.*A
		Batt DisChrs Curr.....**.*A
	Down ↓	Batt Power.....**.*KW
		Batt1 Temp.....*°C
		Batt1 SOC.....**0%
		Batt1 Cycles.....*T

In the main interface, press “UP” button to enter PV parameters page.

Main interface	Up↑	PV Information
		PV1 Voltage.....***.*V
		PV1 Current.....**.*A
		PV1 Power.....**.*KW
		PV2 Voltage.....***.*V
		PV2 Current.....**.*A
		PV2 Power.....**.*KW
		Inverter Temp.....*°C

In the main interface, press “back” button to enter main menu. The main menu has the following six options.

Main interface	Back	1.System Settings
		2.Advanced Settings
		3.Energy Statistic
		4.System Information
		5.Event List

6.Software Update

6.3.1 System setting

1. System Setting	OK	1.Language Settings
		2.Time
		3.Safety Param.
		4.Energy Storage Mode
		5.Auto Test(Only for Italy)
		6.EPS Mode
		7.Communication Addr.

1. Language Settings

Used to set the menu display language.

1.Language Settings	OK	1. 中文	OK
		2.English	
		3.Italiano	
		4.	
		

2. Time

Set the system time for the inverter.

2.Time	OK	Time
		2020-05-13 17:07:00

3. Safety Param

User can modify the Safety Param of the machine through the usb flash disk, and the user needs to copy the parameter information that needs to be modified into the usb flash disk card in advance.

Note:To enable this feature, please contact the Sofarsolar technical support .

4. Energy Storage Mode

4.Energy Storage Mode	OK	1.Self-use Mode	OK
		2.Time-of-use Mode	
		3.Timing Mode	
		4.Passive Mode	OK

Self-use Mode

In Self-use mode, inverter will automatically charge & discharge the battery.

1) If PV generation = LOAD consumption ($\Delta P < 100W$) inverter won't charge or discharge the battery.	2) If PV generation > LOAD consumption, the surplus power will be stored in the battery.
--	--

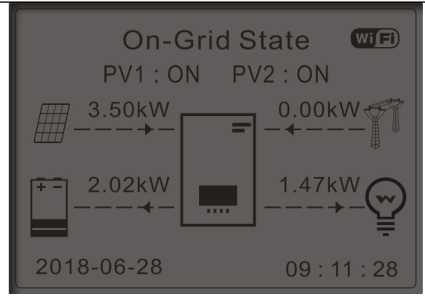
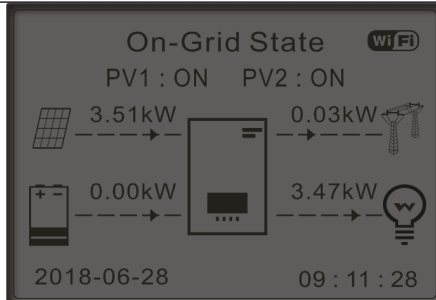

3) If the battery is full(or already at Max Charge Power), excess power will be exported to the grid.

4) If PV generation < LOAD consumption, it will discharge the battery to supply power to load.

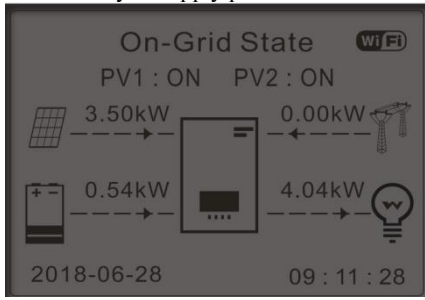
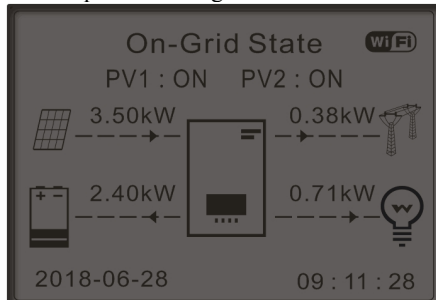

5) If PV generation + Battery < LOAD consumption, inverter will import power from the grid.

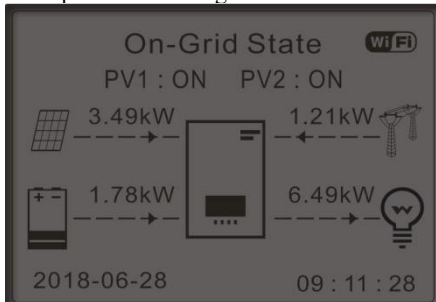

Time-of-use Mode

If electricity is more expensive in high demand time (peak rate) & electricity is much cheaper in low demand time (off-peak rate).

You can select an off-peak period to charge your battery. Outside the off-peak charge period, inverter is working in Auto Mode.

If your family normally go to work/school on weekdays & stay at home on weekends, which means the home electricity consumption is much higher on weekends. Thus, you need to store some cheap electricity on weekends only. This is

possible using our Time-of-use mode.

In summer, if your PV system can produce more electricity than your home electricity consumption. Then you don't need to set an off-peak charge period to charge your battery in summer at all. You can select an effective date (normally winter) for Time-of-use mode in this case. Outside the effective date, inverter is working in Auto Mode.

You can set multiple Time-of-use rules to meet your more complex requirement. Right now we support 4 rules maximum (rule 0/1/2/3).

2.Time-of-use Mode	OK	Set Time-of-use Mode
		Rules. 0: Enabled/Disabled
		From To SOC Charge
		02h00m - 04h00m 070% 01000W
		Effective date
		Dec. 22 - Mar. 21
		Weekday select
		Mon. Tue. Wed. Thu.
		Fri. Sat. Sun.

Set Timing Mode

Changing the value of a rule can set multiple timing rules.

3.Timing Mode	OK	Timing Mode
		Rules. 0:Enabled/Disabled
		Charge Start 22 h 00 m
		Charge End 05 h 00 m
		Charge Power 02000 W
		DisCharge Start 14 h 00m
		DisCharge End 16 h 00m
		DisCharge Power 02500 W

Passive Mode

For more detailed information, please ask representative of SOFAR to get a copy of passive mode communication protocol.

5. Auto Test (ONLY for Italian Market)

5.Auto Test	OK	1.Autotest Fast
		2.Autotest STD

Autotest Fast

1. Autotest Fast	OK	Start Autotest	Press "Ok" to start
		Testing 59.S1...	
		↓	Wait
		Test 59.S1 OK!	
		↓	Wait
		Testing 59.S2...	

↓	Wait
Test 59.S2 OK!	
↓	Wait
Testing 27.S1...	
↓	Wait
Test 27.S1 OK!	
↓	Wait
Testing 27.S2...	
↓	Wait
Test 27.S2 OK!	
↓	Wait
Testing 81>S1...	
↓	Wait
Test 81>S1 OK!	
↓	Wait
Testing 81>S2...	
↓	Wait
Test 81>S2 OK!	
↓	Wait
Testing 81<S1...	
↓	Wait
Test 81<S1 OK!	
↓	Wait
Testing 81<S2...	
↓	Wait
Test 81<S2 OK!	
↓	Press "Ok"
Auto Test OK!	
↓	Press "Down"
59.S1 threshold 253V 900ms	
↓	Press "Down"
59.S1: 228V 902ms	
↓	Press "Down"
59.S2 threshold 264.5V 200ms	
↓	Press "Down"
59.S2: 229V 204ms	
↓	Press "Down"
27.S1 threshold 195.5V 1500ms	
↓	Press "Down"
27.S1: 228V 1508ms	
↓	Press "Down"
27.S2 threshold 34.5V 200ms	
↓	Press "Down"
27.S2: 227V 205ms	

↓	Press “Down”
81>.S1 threshold 50.5Hz 100ms	
↓	Press “Down”
81>.S1 49.9Hz 103ms	
↓	Press “Down”
81>.S2 threshold 51.5Hz 100ms	
↓	Press “Down”
81>.S2 49.9Hz 107ms	
↓	Press “Down”
81<.S1 threshold 49.5Hz 100ms	
↓	Press “Down”
81<.S1 50.0Hz 105ms	
↓	Press “Down”
81<.S2 threshold 47.5Hz 100ms	
↓	Press “Down”
81<.S2 50.1Hz 107ms	

Autotest STD

2.Autotest STD Press OK to start

The test procedure is same as Autotest Fast, but it’s much more time consuming.

6. EPS Mode

6.EPS Mode OK **1.EPS Mode Control** OK **1.Enable EPS Mode** OK
2.Disable EPS Mode

1) If PV generation > LOAD consumption ($\Delta P > 100W$), inverter will charge battery.

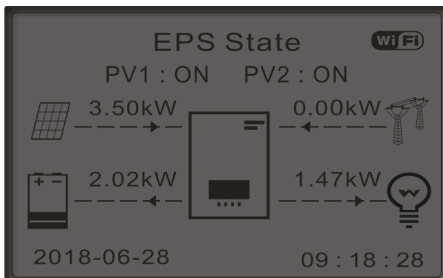

2) If PV generation = LOAD consumption, inverter won't charge or discharge battery.

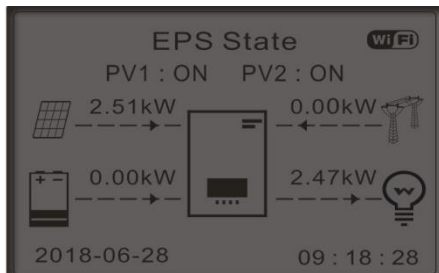

3) If PV generation < LOAD consumption ($\Delta P > 100W$), inverter will discharge battery.

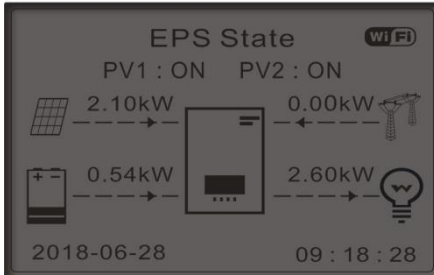

4) If PV generation is normal, but LOAD consumption=0, the surplus power will be stored in the battery.

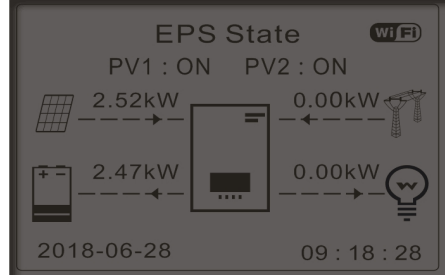

7. Communication Addr

7.Communication Addr OK

1.Communication Addr	OK
2.Baud Rate	OK

6.3.2 Advanced setting

2.Advanced setting OK

Input 0001

1.Battery Parameter
2.Anti Reflux
3.IV Curve Scan
4.Logic interface
5.Factory Reset
6.Parallel setting
7.Bluetooth Reset
8.CT Calibration

1. Battery Parameter

1.Battery Parameter OK

Battery Parameter1	OK
Battery Parameter2	OK

A.Inner BMS

1.Battery Parameter OK

1.Battery Type	5.Max Charge (A)
2.Battery Capacity	6.Max Discharge (A)
3.Nominol Bat Voltage	7.*Discharg Depth
4.Battery Cell Type	8.Save

OK

B.PYLON/SOFAR

1.Battery Parameter OK

1.Battery Type	4.Max Discharge (A)
2.Battery Address	5.Discharg Depth
3.Max Charge (A)	6.Save

OK

Depth of Discharge

For example: if Discharge Depth = 50% & EPS Discharge Depth = 80%.

While grid is connected: Inverter won't discharge the battery when its SOC is less than 50%.

In case of blackout: Inverter will work in EPS mode (if EPS mode is enabled) & keep discharging the battery till battery SOC is less than 20%.

7.Depth of Discharge	OK	Discharge Depth 50%
		EPS Discharge Depth 80%
		EPS Restore Depth 20%

2. Anti Reflux

The user can enable “Anti Reflux Control” to limit the max export power to grid. Reflux Power set is desired max export power to grid. Refer to 4.7.2 for connection of the system when using Anti Reflux function.

2.Anti Reflux	OK	1.Anti Reflux Control	OK	Enable
		2.Reflux Power	OK	Disable
				***KW

3. IV Curve Scan

The user can enable “IV Curve Scan” (MPPT scan) to make inverter to find the global max power point periodically to deliver max power from a partially shaded PV array.

The user can input scan period or make inverter to perform a scan right away.

3.IV Curve Scan	OK	1.Scan Control	OK	Enable
		2.Scan Period	OK	Disable
		3.Force Scan	OK	***min

4. Logic interface Control

Enable or disable logical interfaces. Please refer to this manual 4.7.2, inverter logic interface connection for details.

4.Logic interface Control	OK	Enable	OK
		Disable	OK

5. Factory Reset

5.Factory Reset	OK	1.Clear Energy Data	OK
		2.Clear Events	OK

Clean the inverter of the total power generation.

1.Clear Energy Data OK OK **Input 0001**

Clean up the historical events recorded in the inverter.

2..Clear Events OK OK

6. Parallel setting

Please refer to <4.7.3 Link Port 0&1-Cascade communication interface> for the connection method of the parallel system.

6.Parallel setting OK	1.Parallel Control
	2.Parallel Primary-Replica
	3.Parallel Address
	4.Save

1. Parallel Control: Enable or disable parallel functions. Both the master and the slave must enable this function.

2. Parallel Primary-Replica: Set up the Primary and Replica.Select one inverter as the Primary and set the others to Replica.

3. Parallel Address: Set the parallel address.Each inverter needs to set a parallel address, and the parallel address in a parallel system cannot be repeated.

(NOTE:The parallel address is different from the communication address used for monitoring.)

4. Save: Save after the setup is complete.

7. Bluetooth Reset

7.Bluetooth Reset OK OK

8. CT Calibration

To calibrate the direction and phase of the CT, the battery should be charged or discharged when using this function.

8.CT Calibration OK

Check if the battery is charging or discharging when calibration fails.

6.3.3 Energy Statistic

3.Energy Statistic OK	Today	
	PV	***KWH
	Load	***KWH
	Export	***KWH
	Import.....	***KWH
	Charge.....	***KWH

	Discharge.....***KWH
Down↓	Month
	PV***KWH
	Load***KWH
	Export***KWH
	Import.....***KWH
	Charge.....***KWH
Down↓	Year
	PV***KWH
	Load***KWH
	Export***KWH
	Import.....***KWH
	Charge.....***KWH
Down↓	Lifetime
	PV***KWH
	Load***KWH
	Export***KWH
	Import.....***KWH
	Charge.....***KWH
	Discharge.....***KWH

6.3.4 System information

4.System information	OK	1.Inverter Info
		2.Battery Info
		3.Safety Param.
1.Inverter Info	OK	Inverter Info (1)
		Product SN
		Software Version
		DSP1 Software Version
		DSP2 Software Version
Down↓		Inverter Info (2)
		Hardware Version
		Power Level
		Country
Down↓		Inverter Info (3)
		PV Input Mode
		Energy Storage Mode
		RS485 Address

		EPS Mode
	Down↓	Inverter Info (4)
		IV Curve Scan
		Logic Interface Control
		PF Time Setting
		QV Time Setting
	Down↓	Inverter Info (5)
		Power Factor
		Anti Reflux
		Insulation resistance
2.Battery Info	OK	Battery1/2 info(1)
		Battery Type
		Battery Capacity
		Over (V) Protection
		Discharge Depth
	Down↓	Inverter1/2 Info (2)
		Max Charge (A)
		Max Charge (V)
		Max Discharge (A)
		Min Discharge (V)
	Down↓	Inverter1/2 Info (3)
		Low(V)Protection
3.Safety Param.	OK	Safety Param.(1)
		OVP 1
		OVP 2
		UVP 1
		UVP 2
	Down↓	Safety Param. (2)
		OFP 1
		OFP 2
		UFP 1
		UFP 2
	Down↓	Safety Param. (3)
		OVP 10mins

6.3.5 Event List

Event List is used to display the real-time event records, including the total number of events and each specific ID No. and happening time. User can enter Event List interface through main interface to check details of real-time event

records, Event will be listed by the happening time, and recent events will be listed in the front.

5.Event List	OK	1.Current Event List	OK	ID042 IsoFault
		2.History Event List		

2.History Event List	OK	1.ID001 2020-4-3 14:11:45	OK	1.ID001 GridOVP
		2.ID005 2020-4-3 11:26:38		2.ID005 GFCI

6.3.6 Software Update

HYD 3K~6K-EP inverters offer software upgrade via usb flash drive to maximize inverter performance and avoid inverter operation error caused by software bugs.

Upgrade file folder name is firmwareHYD-EP. The three upgrade file names are HYD-EP_ARM.bin, HYD-EP_DSPM.bin, HYD-EP_DSPTS.bin.

Step 1 Insert the usb flash drive into the compute.

Step 2 SOFAR SOLAR will send the Software code to the user who needs to update. After user receive the file,please decompressing file and cover the original file in usb flash drive.

Step 4 Insert the usb flash drive into the USB/Wifi interface.

Step 5 Then turn on DC switch.

Step 6

6.Software Update	OK	Input password	OK	Input 0715
				Start Update
				Updating DSP1
				Updating DSP2
				Updating ARM

Step 7 If the following errors occur, please upgrade again.If this continues many times, contact technical support for help.

USB Fault	MDSP File Error	SDSP File Error
ARM File Error	Update DSP1 Fail	Update DSP2 Fail
Update ARM Fail		

Step 8 After the update is completed,turn off the DC breaker, wait for the LCD screen extinguish, then restore the WiFi connection and then turn on the DC breaker and AC breaker again,the inverter will enters the running state. User can check the current software version in SystemInfo>>SoftVersion.

7. Troubleshooting

This section contains information and procedures for solving possible problems with the inverter.

- This section help users to identify the inverter fault. Please read the following procedures carefully:
 - ❖ Check the warning, fault messages or fault codes shown on the inverter screen, record all the fault information.
 - ❖ If there is no fault information shown on the screen, check whether the following requirements are met:
 - Is the inverter mounted in a clean, dry place with good ventilation?
 - Is the DC switch turned ON?
 - Are the cables adequately sized and short enough?
 - Are the input and output connections and wiring in good condition?
 - Are the configuration settings correct for the particular installation?
 - Are the display panel and the communication cables properly connected and undamaged?
- Follow the steps below to view recorded problems: Press "Back" to enter the main menu in the normal interface. In the interface screen select "Event List", then press "OK" to enter events.
- Earth Fault Alarm

This inverter complies with IEC 62109-2 clause 13.9 for earth fault alarm monitoring.

If an Earth Fault Alarm occurs, the fault will be displayed on the LCD screen, the red light will be on, and the fault can be found in the history of the fault. For the machine installed with WiFi/GPRS, the alarm information can be seen on the corresponding monitoring website, and can also be received by the APP on the mobile phone.
- EventList information

Table 7-1 Eventlist

Code	Name	Description	Solution
ID001	GridOVP	The grid voltage is too high	If the alarm occurs occasionally, the possible cause is that the electric grid is abnormal occasionally. Inverter will automatically return to normal operating status when the electric grid's back to normal.
ID002	GridUVP	The grid voltage is too low	
ID003	GridOFF	The grid frequency is too high	
ID004	GridUFP	The grid frequency is too low	<p>If the alarm occurs frequently, check whether the grid voltage/frequency is within the acceptable range. If yes, please check the AC circuit breaker and AC wiring of the inverter.</p> <p>If the grid voltage/frequency is NOT within the acceptable range and AC wiring is correct, but the alarm occurs repeatedly, contact technical support to change the grid over-voltage, under-voltage, over-frequency, under-frequency protection points after obtaining approval from the local electrical grid operator.</p>
ID005	GFCI	Charge Leakage Fault	<p>Internal faults of inverter, switch OFF inverter, wait for 5 minutes, then switch ON inverter. Check whether the problem is solved.</p> <p>If no, please contact technical support.</p>
ID006	OVRT fault	OVRT function is faulty	
ID007	LVRT fault	LVRT function is faulty	
ID008	IslandFault	Island protection error	
ID009	GridOVPInstant1	Transient overvoltage of grid voltage 1	
ID010	GridOVPInstant2	Transient overvoltage of grid voltage 2	
ID011	VGridLineFault	Power grid line voltage error	
ID012	InvOVP	Inverter voltage overvoltage	
ID017	HwADFaultIGrid	Power grid current sampling error	
ID018	HwADFaultDCI	Wrong sampling of dc component of grid current	
ID019	HwADFaultVGri d(DC)	Power grid voltage sampling error (DC)	
ID020	HwADFaultVGri d(AC)	Power grid voltage sampling error (AC)	
ID021	GFCIDeviceFault (DC)	Leakage current sampling error (DC)	
ID022	GFCIDeviceFault (AC)	Leakage current sampling error (AC)	
ID023	HwADFaultDCV	Error in dc component sampling of load voltage	
ID024	HwADFaultIdc	Dc input current sampling error	

ID029	ConsistentFault_GFCI	Leakage current consistency error	
ID030	ConsistentFault_Vgrid	Grid voltage consistency error	
ID033	SpiCommFault(DC)	SPI communication error (DC)	
ID034	SpiCommFault(AC)	SPI communication error (AC)	
ID035	SChip_Fault	Chip error (DC)	
ID036	MChip_Fault	Chip error (AC)	
ID037	HwAuxPowerFault	Auxiliary power error	
ID041	RelayFail	Relay detection failure	
ID042	IsoFault	Low insulation impedance	Check the insulation resistance between the photovoltaic array and ground (ground), if there is a short circuit, the fault should be repaired in time.
ID043	PEConnectFault	Ground fault	Check ac output PE wire for grounding.
ID044	PvConfigError	Error setting input mode	Check the PV input mode (parallel/independent mode) Settings for the inverter. If not, change the PV input mode.
ID045	CTDisconnect	CT error	Check whether the CT wiring is correct.
ID048	FanFault	FanFault	Please check whether the fan 1 of inverter is running normally.
ID049	TempFault_Bat	Battery temperature protection	Make sure the inverter is installed where there is no direct sunlight.
ID050	TempFault_HeatSink1	Radiator 1 temperature protection	Please ensure that the inverter is installed in a cool/well ventilated place.
ID051	TempFault_HeatSink2	Radiator 2 temperature protection	Ensure the inverter is installed vertically and the ambient temperature is below the inverter temperature limit.
ID052	TempFault_HeatSin3	Radiator 3 temperature protection	
ID053	TempFault_HeatSink4	Radiator 4 temperature protection	
ID054	TempFault_HeatSin5	Radiator 5 temperature protection	
ID055	TempFault_HeatSin6	Radiator 6 temperature protection	
ID057	TempFault_Env1	Ambient temperature 1 protection	
ID058	TempFault_Env2	Ambient temperature 2 protection	
ID059	TempFault_Inv1	Module 1 temperature protection	
ID060	TempFault_Inv2	Module 2 temperature protection	
ID061	TempFault_Inv3	Module 3 temperature protection	
ID065	VbusRmsUnbalance	Unbalanced bus voltage RMS	Internal faults of inverter, switch OFF inverter, wait for 5 minutes, then switch ON inverter. Check whether the problem is solved.
ID066	VbusInstantUnbalance	The transient value of bus voltage is	

		unbalanced	If no, please contact technical support.
ID067	BusUVP	Busbar undervoltage during grid-connection	
ID068	BusZVP	Bus voltage low	
ID069	PVOVP	PV over-voltage	Check whether the PV series voltage (Voc) is higher than the maximum input voltage of the inverter. If so, adjust the number of PV modules in series and reduce the PV series voltage to fit the input voltage range of the inverter. After correction, the inverter will automatically return to its normal state.
ID070	BatOVP	Battery over-voltage	Check whether the battery overvoltage setting is inconsistent with the battery specification.
ID071	LLCBusOVP	LLC BUS overvoltage protection	Internal faults of inverter, switch OFF inverter, wait for 5 minutes, then switch ON inverter. Check whether the problem is solved. If no, please contact technical support.
ID072	SwBusRmsOVP	Inverter bus voltage RMS software overvoltage	
ID073	SwBusInstantOVP	Inverter bus voltage instantaneous value software overvoltage	
ID081	SwBatOCP	Battery overcurrent software protection	
ID082	DciOCP	Dci overcurrent protection	
ID083	SwOCPInstant	Output instantaneous current protection	
ID084	SwBuckBoostOCP	BuckBoost software flow	
ID085	SwAcRmsOCP	Output effective value current protection	
ID086	SwPvOCPInstant	PV overcurrent software protection	
ID087	IpvUnbalance	PV flows in uneven parallel	
ID088	IacUnbalance	Unbalanced output current	
ID097	HwLLCBusOVP	LLC bus hardware overvoltage	
ID098	HwBusOVP	Inverter bus hardware overvoltage	
ID099	HwBuckBoostOCP	BuckBoost hardware overflows	
ID100	HwBatOCP	Battery hardware overflows	
ID102	HwPVOCP	PV hardware overflows	
ID103	HwACOCP	Ac output hardware overflows	
ID110	Overload1	Overload protection 1	Please check whether the inverter is operating under overload.
ID111	Overload2	Overload protection 2	
ID112	Overload3	Overload protection 3	
ID113	OverTempDerati	Internal temperature is	Make sure the inverter is installed where

	ng	too high.	there is no direct sunlight. Please ensure that the inverter is installed in a cool/well ventilated place. Ensure the inverter is installed vertically and the ambient temperature is below the inverter temperature limit.
ID114	FreqDerating	AC frequency is too high	Please make sure the grid frequency and voltage is within the acceptable range.
ID115	FreqLoading	AC frequency is too low	
ID116	VoltDerating	AC voltage is too high	
ID117	VoltLoading	AC voltage is too low	
ID124	BatLowVoltageAlarm	Battery low voltage protection	Please check whether the battery voltage of the inverter is too low.
ID125	BatLowVoltageShut	Battery low voltage shutdown	
ID129	unrecoverHwAcOCP	Output hardware overcurrent permanent failure	Internal faults of inverter, switch OFF inverter, wait for 5 minutes, then switch ON inverter. Check whether the problem is solved. If no, please contact technical support.
ID130	unrecoverBusOV P	Permanent Bus overvoltage failure	
ID131	unrecoverHwBusOVP	Permanent Bus hardware overvoltage failure	
ID132	unrecoverIpvUnbalance	PV uneven flow permanent failure	
ID133	unrecoverEPSBatOCP	Permanent battery overcurrent failure in EPS mode	
ID134	unrecoverAcOCP Instant	Output transient overcurrent permanent failure	
ID135	unrecoverIacUnbalance	Permanent failure of unbalanced output current	
ID137	unrecoverPvConfigError	Input mode setting error permanent failure	
ID138	unrecoverPVOCP Instant	Input overcurrent permanent fault	
ID139	unrecoverHwPVOCP	Input hardware overcurrent permanent failure	
ID140	unrecoverRelayFail	Permanent relay failure	Internal faults of inverter, switch OFF inverter, wait for 5 minutes, then switch ON inverter. Check whether the problem is solved. If no, please contact technical support.
ID141	unrecoverVbusUnbalance	Bus voltage unbalanced permanent failure	
ID145	USBFault	USB fault	Check the USB port of the inverter
ID146	WifiFault	Wifi fault	Check the Wifi port of the inverter
ID147	BluetoothFault	Bluetooth fault	Check the bluetooth connection of the inverter
ID148	RTCFault	RTC clock failure	Internal faults of inverter, switch OFF inverter, wait for 5 minutes, then switch ON
ID149	CommEEPROM	Communication board	

	Fault	EEPROM error	inverter. Check whether the problem is solved. If no, please contact technical support.
ID150	FlashFault	Communication board FLASH error	
ID153	SciCommLose(DC)	SCI communication error (DC)	
ID154	SciCommLose(AC)	SCI communication error (AC)	
ID155	SciCommLose(Fuse)	SCI communication error (Fuse)	
ID156	SoftVerError	Inconsistent software versions	Contact for technical support and software upgrades.
ID157	BMSCommunicationFault	Communication failure of lithium battery	Make sure your battery is compatible with the inverter. CAN communication is recommended. Check the communication line or port of the battery and inverter for faults.
ID161	ForceShutdown	Force shutdown	The inverter is performed a forced shutdown
ID162	RemoteShutdown	Remote shutdown	The inverter is performed a remote shutdown.
ID163	Drms0Shutdown	Drms0 shutdown	The inverter is performed with a Drms0 shutdown.
ID165	RemoteDerating	Remote derating	The inverter is performed for remote load reduction.
ID166	LogicInterfaceDerating	Logic interface derating	The inverter is loaded by the execution logic interface.
ID167	AlarmAntiRefluxing	Anti reflux derating	The inverter is implemented to prevent countercurrent load drop.
ID177	BMS OVP	BMS over-voltage alarm	Internal failure of lithium battery, close inverter and lithium battery, and wait 5 minutes to open inverter and lithium battery. Check that the problem is resolved. If not, please contact technical support.
ID178	BMS UVP	BMS under-voltage alarm	
ID179	BMS OTP	BMS high temperature warning	
ID180	BMS UTP	BMS low temperature alarm	
ID181	BMS OCP	Warning of overload in charge and discharge of BMS	
ID182	BMS Short	BMS short circuit alarm	

Maintenance

Inverters generally do not need any daily or routine maintenance. Heat sink should not be blocked by dust, dirt or any other items. Before the cleaning, make sure that the DC SWITCH is turned OFF and the circuit breaker between inverter and electrical grid is turned OFF. Wait at least for 5 minutes before the Cleaning.

◇ Inverter cleaning

Please clean the inverter with an air blower, a dry & soft cloth or a soft bristle

brush. Do NOT clean the inverter with water, corrosive chemicals, detergent, etc.

✧ **Heat sink cleaning**

For the long-term proper operation of inverters, ensure there is enough space around the heat sink for ventilation, check the heat sink for blockage (dust, snow, etc.) and clean them if they exist. Please clean the heat sink with an air blower, a dry & soft cloth or a soft bristle brush. Do NOT clean the heat sink with water, corrosive chemicals, detergent, etc.

8. Technical Data

Battery Parameters

Datasheet	HYD 3000-EP	HYD 3680-EP	HYD 4000-EP	HYD 4600-EP	HYD 5000-EP	HYD 5500-EP	HYD 6000-EP
Battery type	Lithium-ion, Lead-acid						
Nominal battery voltage	48V						
Battery voltage range	42-58V						
Battery capacity	50-2000Ah						
Maximum charging / discharging power	3750W	4000W	4250W	5000W	5000W	5000W	5000W
Maximum charging current	75A	80A	85A	100A	100A	100A	100A
Maximum discharging current	75A	80A	85A	100A	100A	100A	100A
Depth of discharge	0-90% DOD adjustable (Lithium-ion)						
	0-50% DOD adjustable (Lead-acid)						
Charging curve	BMS (Lithium-ion)						
	3-Stage adaptive with maintenance (Lead-acid)						
Communication	CAN(RS485)						

PV String Input Data

Datasheet	HYD 3000-EP	HYD 3680-EP	HYD 4000-EP	HYD 4600-EP	HYD 5000-EP	HYD 5500-EP	HYD 6000-EP
Recommended Max. PV input power(Wp)	4500Wp	5400Wp	6000Wp	6900Wp	7500Wp	7500Wp	9000Wp
Max. DC power for single MPPT	3500W	3500W	3500W	3500W	3750W	3750W	4500W
Max. input voltage	600V						
Rated input voltage	360V						
Start-up voltage	100V						
MPPT operating voltage range	90-580V						
Full power MPPT voltage range(V)	160-520	180-520	200-520	230-520	250-520	250-520	300-520
Number of MPP trackers	2						
Max. input current per MPPT	13A/13A						
Max. input short circuit current per MPPT	18A/18A						

AC Output Data (ON-Grid)

Datasheet	HYD 3000-EP	HYD 3680-EP	HYD 4000-EP	HYD 4600-EP	HYD 5000-EP	HYD 5500-EP	HYD 6000-EP
Nominal AC power (W)	3000	3680	4000	4600	5000	5000	6000
Max. AC power output to utility grid (VA)	3300	3680	4400	4600	5000	5500	6000
Max. AC power from utility grid(VA)	6000	7360	8000	9200	10000	10000	12000
Max. AC current output to utility grid	15A	16A	20A	20.9A	21.7A	25A	27.3A
Max. AC current from utility grid	27.3A	32A	36.4A	41.8A	43.4A	43.4A	54.6A
Nominal grid voltage	L/N/PE, 220Vac, 230Vac,240Vac						
Grid voltage range	180Vac~276Vac(According to local standard)						
Nominal frequency	50/60Hz						
Grid Frequency range	45Hz~55Hz/55Hz~65Hz						
Power factor	1 default (adjustable+/-0.8)						
Output THDi (@Nominal output)	<3%						

AC Output Data (Off-Grid)

Datasheet	HYD 3000-EP	HYD 3680-EP	HYD 4000-EP	HYD 4600-EP	HYD 5000-EP	HYD 5500-EP	HYD 6000-EP
Max. apparent power (VA)	3000	3680	4000	4600	5000	5000	5000
Peak output power,Duration	3600VA, 60s	4400VA, 60s	4800VA, 60s	5520VA, 60s	6000VA, 60s	6000VA, 60s	6000VA, 60s
Max. output current	13.6A	16A	18.2A	20.9A	22.7A	22.7A	22.7A
Nominal voltage,Frequency	L/N/PE, 220V/230V/240V 50/60Hz						
THDv (@Liner load)	<3%						
Switch time	10ms(default)						

Efficiency And Protection

Datasheet	HYD 3000-EP	HYD 3680-EP	HYD 4000-EP	HYD 4600-EP	HYD 5000-EP	HYD 5500-EP	HYD 6000-EP
MPPT efficiency	99.9%						
European efficiency of solar inverter	97.2%	97.2%	97.2%	97.3%	97.3%	97.3%	97.5%
Max efficiency of solar inverter	97.6%	97.6%	97.6%	97.8%	97.8%	97.8%	98.0%
Max. charging efficiency of battery	94.6%						
Max. discharging efficiency of battery	94.6%						
DC switch	Yes						
PV reverse polarity protection	Yes						
Over current protection	Yes						
Over voltage protection	Yes						
PV insulation detection	Yes						
Ground fault monitoring	Yes						
Firm frequency response function	Optional						
SPD protection	MOV:Type III standard						

General Data

Datasheet	HYD 3000-EP	HYD 3680-EP	HYD 4000-EP	HYD 4600-EP	HYD 5000-EP	HYD 5500-EP	HYD 6000-EP
Dimension	482mm×503mm×183mm						
Weight	21.5kg						
Topology	High frequency insulation (for bat)						
Standby self-consumption	<10W						
Ambient temperature range	-30°C~60°C (Above 45°C Derating)						
Allowable relative humidity range	0~100%						
Noise	<25dB						
Max. operating altitude	<4000m						
Cooling	Natural						
Degree of protection	IP65						

Feature And Standard

Datasheet	HYD 3000-EP	HYD 3680-EP	HYD 4000-EP	HYD 4600-EP	HYD 5000-EP	HYD 5500-EP	HYD 6000-EP
Display	LCD						
Communication	Bluetooth / RS485 / WIFI / GPRS (optional)						
Parallel operation	YES						
Warranty	5 years or more						
Grid standards	VDE-AR-N 4105, VDE V 0126-1-1, AS/NZS 4777, CEI 0-21, G98/G99, TR321,TR322, EN 50438/EN50549, UTE C15-712-1, NRS 097-2-1, UNE 206 007-1						
Safety standards	IEC 62109-1/2, IEC 62040-1, IEC 62116, IEC 61727, IEC 61683, IEC 60068(1,2,14,30)						
EMC	EN 61000-6-2, EN 61000-6-3, EN 61000-3-2, EN 61000-3-3, EN 61000-3-11, EN 61000-3-12						

9. *Quality Assurance*

Standard warranty period

The standard warranty period of inverter is 60 months (5 years). There are two calculation methods for the warranty period:

1. Purchase invoice provided by the customer: the first flight provides a standard warranty period of 60 months (5 years) from the invoice date;
2. The customer fails to provide the invoice: from the production date (according to the SN number of the machine), Our company provides a warranty period of 63 months (5.25 years).
3. In case of any special warranty agreement, the purchase agreement shall prevail.

Extended warranty period

Within 12 months of the purchase of the inverter (based on the purchase invoice) or within 24 months of the production of the inverter(SN number of machine, based on the first date of arrival),Customers can apply to buy extended warranty products from the company's sales team by providing the product serial number, Our company may refuse to do not conform to the time limit extended warranty purchase application. Customers can buy an extended warranty of 5, 10, 15 years.

If the customer wants to apply for the extended warranty service, please contact the sales team of our company. to purchase the products that are beyond the purchase period of extended warranty but have not yet passed the standard quality warranty period. Customers shall bear different extended premium.

During the extended warranty period, pv components GPRS, WIFI and lightning protection devices are not included in the extended warranty period. If they fail during the extended warranty period, customers need to purchase and replace them from our company.

Once the extended warranty service is purchased, our company will issue the extended warranty card to the customer to confirm the extended warranty period.

Invalid warranty clause

Equipment failure caused by the following reasons is not covered by the warranty:

- 1) The "warranty card" has not been sent to the distributor or our company;

- 2) Without the consent of our company to change equipment or replace parts;
- 3) Use unqualified materials to support our company's products, resulting in product failure;
- 4) Technicians of non-company modify or attempt to repair and erase the product serial number or silk screen;
- 5) Incorrect installation, debugging and use methods;
- 6) Failure to comply with safety regulations (certification standards, etc.);
- 7) Damage caused by improper storage by dealers or end users;
- 8) Transportation damage (including scratches caused by internal packaging during transportation). Please claim directly from the transportation company or insurance company as soon as possible and obtain damage identification such as container/package unloading;
- 9) Failure to follow the product user manual, installation manual and maintenance guidelines;
- 10) Improper use or misuse of the device;
- 11) Poor ventilation of the device;
- 12) The product maintenance process does not follow relevant standards;
- 13) Failure or damage caused by natural disasters or other force majeure (such as earthquake, lightning strike, aware fire, etc.)

Statement

If you have purchased this product in Australia, you should be aware that this warranty is provided in addition to other rights and remedies held by a consumer at law.

Our goods come with guarantees that cannot be excluded under the Australian Consumer Law. You are entitled to a replacement or refund for a major failure and compensation for any other reasonably foreseeable loss or damage. You are also entitled to have the goods repaired or replaced if the goods fail to be of acceptable quality and the failure does not amount to a major failure.



Product Name: Energy storage integrated inverter

Company Name: Shenzhen SOFARSOLAR Co., Ltd.

ADD: 401, Building 4, AnTongDa Industrial Park, District 68, XingDong Community,
XinAn Street, BaoAn District, Shenzhen, Guangdong.P.R. China

Email: service@sofarsolar.com

Tel: 0510-6690 2300

Web: www.sofarsolar.com