

Test & Measurement product catalog

13



A Greater Measure of Confidence

KEITHLEY
A Tektronix Company

Semiconductor Test

4200-SCS
4200-BTI-A
2600-PCT-x
4200-PCT-x
Series S530
S500
ACS
ACS Basic Edition
ACS-2600-RTM

Parameter Analyzer	50
Ultra-Fast NBTI/PBTI Package for the Model 4200-SCS	57
Parametric Curve Tracer Configurations	64
Parametric Test Systems	68
Integrated Test Systems	74
Automated Characterization Suite Software	76
Semiconductor Parametric Test Software for Component and Discrete Devices	79
Wafer Level Reliability Option for ACS	81

Related Products

Series 2600B System SourceMeter® Multi-Channel I-V Test Solutions	10
Series 2400 SourceMeter Line	36
Semiconductor Switch Matrix Mainframes	214

Optoelectronics Test

Technical Information	82
Selector Guide	84
Pulsed Laser Diode Test System	85
Integrating Sphere for Pulsed Measurements	90
Laser Diode LIV Test System	93
SourceMeter® SMU Instruments	96
Dual-Channel Picoammeter for Photodiode Measurements	99
Integrating Sphere	100
TEC SourceMeter SMU Instrument	103
Autotuning TEC SourceMeter SMU Instrument	103
Laser Diode Mounts for LIV Test Systems	107

2520
2520INT
System 25
Series 2400
2502
2500INT
2510
2510-AT
8544,
8544-TEC

1.888.KEITHLEY (U.S. only)

www.keithley.com

A Greater Measure of Confidence

KEITHLEY
 A Tektronix Company

SEMICONDUCTOR

4200-SCS

Parameter Analyzer

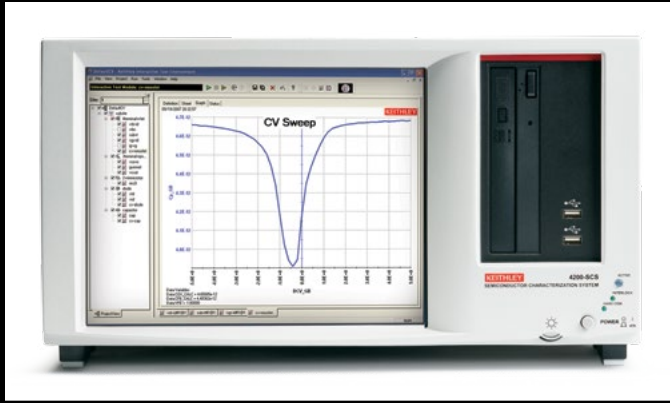

- **Over 450 application tests and data supplied for quick startup**
- **Performs DC I-V, C-V, and Pulsed I-V measurements**
- **Ultra-fast I-V modules synchronized for transient, waveform capture and pulsed I-V capabilities**
- **High speed, simultaneous data acquisition of I and V at 200MS/s**
- **Intuitive GUI for fast test setup, data analysis, graphing, and printing of test results**
- **Test sequencing and looping control without programming**
- **JEDEC-compliant reliability sample tests for stress/measure, looping, and data analysis**
- **Easily integrate switching matrixes or other external equipment**
- **Analytical prober and cryogenic temperature controller drivers included**

A Total Parametric Analysis System

The 4200-SCS with KITE software is a modular, fully integrated parameter analyzer that performs electrical characterization of materials, semiconductor devices, and processes. From basic I-V and C-V measurement sweeps to advanced ultra-fast pulsed I-V, waveform capture, and transient I-V measurements, the 4200-SCS provides the researcher or engineer with critical parameters needed for design, development, production, or reliability testing.

With a Microsoft® Windows® operating system, the 4200-SCS with KITE software provides sophisticated test capabilities with the ease of a graphical user interface, powerful graphing, and parameter extraction, enabling you to get to your results faster with minimal training.

Modular Design Accommodates Changing Test Requirements and Protects Your Investment

With nine measurement slots and a wide variety of instrument modules, you can configure the Model 4200-SCS precisely to your test requirements.

- **Precision DC I-V** measurements are the cornerstone of device and material testing. Up to nine medium or high power DC Source Measurement Units (SMUs) can source and measure voltage or current from 100fA to 1A and from 1 μ V to 210V. The current measurement resolution can be extended to 100nA with the addition of a Model 4200-PA pre-amplifier.
- **AC impedance** testing is easy with the most comprehensive C-V solutions in the market. The 4200-SCS can be configured to support multi-frequency, quasistatic, and very low frequency (VLF) C-V. The Model 4210-CVU Multi-Frequency C-V Module offers test frequencies from 1kHz to 10MHz and measures capacitance from attofarads to microfarads. The VLF C-V technique operates from 10mHz–10Hz.
- **Pulse and transient** measurements add a time domain dimension and allow for dynamic characteristics to be explored. The Model 4225-PMU Ultra-Fast I-V module has two independent voltage sources that can slew the voltage at IV/ns while simultaneously measuring both the voltage and the current. When multiple modules are installed, they are internally synchronized to less than 3ns.

Model	4200-SCS-PK1	4200-SCS-PK2	4200-SCS-PK3	4200-SCS
Description	2-channel, high resolution I-V	2-channel, high resolution I-V and C-V	4-channel, high resolution, high power I-V and C-V	Configured by user
Total # of SMUs	2 medium power	2 medium power	2 medium power, 2 high power	Up to 9 high or medium power
Total No. of PAs	1	1	2	Optional
Current Range and Resolution	100 mA / 0.1 fA	100 mA / 0.1 fA	1 A / 0.1 fA	1 A / 0.1 fA
Voltage Range and Resolution	± 210 V / 1 μ V	± 210 V / 1 μ V	± 210 V / 1 μ V	± 210 V / 1 μ V
Capacitance-Voltage Module	No	Yes	Yes	Optional
Pulse	No	No	No	Optional
Test Fixture	Yes 8101-PIV	Yes 8101-PIV	Yes 8101-PIV	Optional

1.888.KEITHLEY (U.S. only)

www.keithley.com

KEITHLEY

A Greater Measure of Confidence

A Tektronix Company

4200-SCS

Parameter Analyzer

Ordering Information

4200-SCS Customize to your test needs, or select from popular configured solutions tailored to your application.

Instrument Modules

- 4200-SMU** Medium Power Source-Measure Unit
- 4210-SMU** High Power Source-Measure Unit
- 4200-PA** Remote PreAmp Option for 4200-SMU and 4210-SMU
- 4210-CVU** Integrated C-V Instrument
- 4225-PMU** Ultra-Fast I-V Module
- 4225-RPM** Remote Amplifier/Switch
- 4220-PGU** High Voltage Pulse Generator

Probe Station Cable Kits

Multi-measurement Performance Cables

- 4210-MMPC-C** for Cascade Microtech
- 4210-MMPC-L** for Lucas Signatone
- 4210-MMPC-S** for Suss MicroTec
- 4210-MMPC-W** for Wentworth

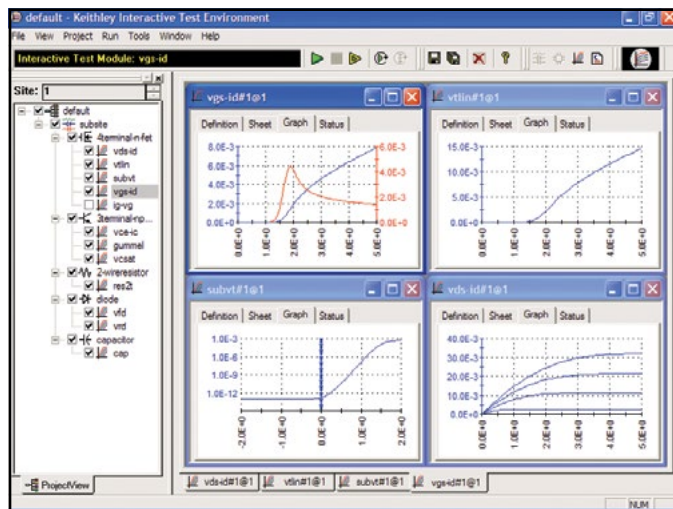

The Keithley Interactive Test Environment (KITE) is designed to let users understand device behavior quickly. When running a test sequence, users can view results and plots for completed tests while the sequence is still running.

KITE Simplifies Complex Testing

The Keithley Interactive Test Environment (KITE) provides a unified parameter measurement interface that allows characterization tests to be performed without complex programming. With the largest library of user-modifiable application tests on the market, more than 450 and growing, KITE makes it easy to begin making complex measurements immediately. Conveniently organized, libraries let you easily create a single test or a sequence of tests for:

- MOSFETs
- BJT transistors
- Diodes
- Resistors
- Capacitors
- Solar cells
- Carbon nanotubes
- Non-volatile memory (NVM)
- Nanoscale devices
- Reliability
- Failure analysis
- LED and OLED
- MEMS
- Biological devices
- Electrochemistry
- Modeling

Because you want test results quickly, real-time results are available numerically or graphically on the front panel display or can be saved to any drive connected to the 4200-SCS. Additionally, you can export data to a network drive and view the results at your convenience. During the research phase, KITE's built-in parameter extraction tools enable calculated parameters and test data to be graphed in KITE's sophisticated, report-ready graphing tool.

Effortless Test Sequencing

KITE provides "point and click" test sequencing on a device, a group of devices, or a number of probe sites on a wafer. One sequence can include DC I-V, C-V, and pulse tests.

Probe Station Control

Keithley provides integrated prober control for popular semiautomatic wafer probe stations. A "manual" prober mode prompts the operator to perform prober operations during a test sequence.

Providing Unparalleled Flexibility

In addition to KITE, three other software tools enable you to configure and operate the 4200-SCS:

- Keithley Configuration Utility (KCON) – Allows test engineers to define the configuration of GPIB instruments, switch matrices, and analytical probers connected to the 4200-SCS. It also provides diagnostic functions.
- Keithley User Library Tool (KULT) – Assists test engineers to create custom test routines as well as use existing Keithley and third-party C-language subroutine libraries. Users can edit and compile

1.888.KEITHLEY (U.S. only)

www.keithley.com

A Greater Measure of Confidence

KEITHLEY

A Tektronix Company

4200-SCS

Parameter Analyzer

subroutines, then integrate libraries of subroutines with KITE, allowing the 4200-SCS to control an entire test rack from a single user interface. (Note: Requires optional Model 4200-Compiler.)

- Keithley External Control Interface (KXCI) – Controls the 4200-SCS from an external computer via GPIB bus.

Model 4200-SMU Medium Power and 4210-SMU High Power SMU instruments

Precision DC I-V measurements are the cornerstone of device and materials electrical characterization. The SMU instruments in the 4200-SCS can source either voltage or current, and can simultaneously measure both the voltage and current. Typically, the DC I-V measurements performed by these SMU instruments are used for very precise (0.01%) or very sensitive (1fA, 1 μ V) measurements in the timeframe of milliseconds to seconds. The SMU instruments can also provide continuous power output, allowing tests to run for hours, or even weeks, without interruption.

The SMU instruments in the 4200-SCS are fully integrated in the 4200-SCS chassis and incorporate the latest measurement technologies including:

- 24-bit A/D converters on every SMU
- Full remote sense (Kelvin) capability
- Broadest dynamic range of current, from <1fA to 1A

- Broadest dynamic range of voltage from <1 μ V to 200V
- Up to nine medium or high power SMU instruments can source/measure simultaneously

The 4200-SCS has been used by thousands of engineers and researchers around the world to electrically characterize their devices and materials. This has resulted in the largest library of standard tests available. More than 400 different libraries are supplied, demonstrating precision DC I-V tests on:

- CMOS MOSFETS and devices
- Bipolar devices
- Diodes and pn junctions
- Solar cells
- Nanotech devices
- And nearly every other material and device imaginable

Additional capabilities include:

- Data for most types of tests can be acquired and plotted in real time with a resolution of milliseconds to seconds
- Wide variety of standard sweep types are available, including linear and log sweeps, voltage and current sweeps, and even arbitrary custom sweeps
- Up to nine SMU instruments can be installed in a single chassis, and all nine can be used simultaneously or independently.

Model 4210-CVU C-V Instrument

C-V measurements are as easy to perform as I-V measurements with the integrated C-V instrument. This optional capacitance-voltage instrument performs capacitance measurements from femtoFarads (fF) to microFarads (μ F) at frequencies from 1kHz to 10MHz. Also available is the 4200-CVU-PWR option that supports:

- High power C-V measurements up to 400V (200V per device terminal)—for testing high power devices, such as MEMs, LDMOS devices, displays, etc.
- DC currents up to 300mA—for measuring capacitance when a transistor is on.

The innovative design of the 4210-CVU has eight patents pending and is complemented by the broadest C-V test and analysis library available in any commercial C-V measurement solution. It also supplies diagnostic tools that ensure the validity of your C-V test results.

With this system, you can configure linear or custom C-V and C-f sweeps with up to 4096 data points. In addition, through the open environment of the 4200-SCS, you can modify any of the included tests, such as:

- C-V, C-t, and C-f measurements and analysis of:
 - Complete solar cell libraries, including DLCP
 - High and low κ structures
 - MOSFETs
 - BJTs
 - Diodes
 - III-V compound devices
 - Carbon nanotube (CNT) devices
- Doping profiles, T_{OX} , and carrier lifetime tests
- Junction, pin-to-pin, and interconnect capacitance measurements

The C-V instrument integrates directly into the Model 4200-SCS chassis. It can be purchased as an upgrade to existing systems or as an option for new systems.

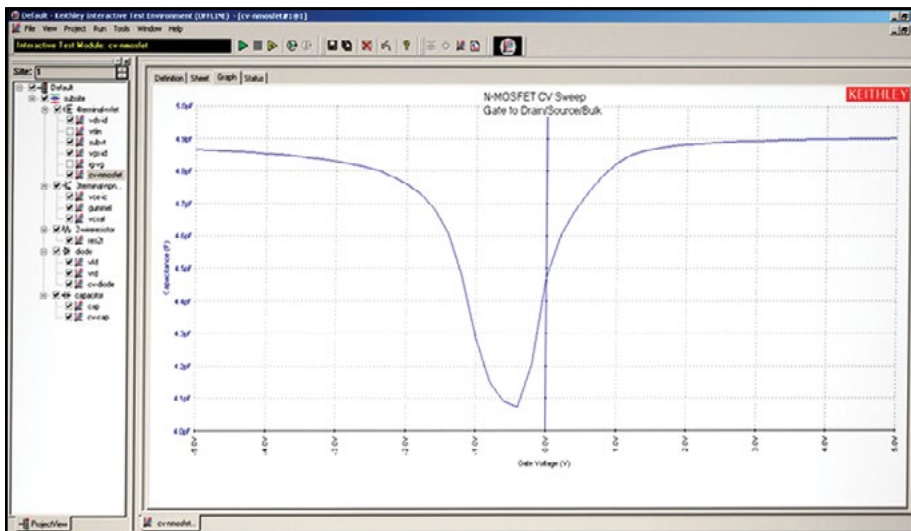

C-V curve from a MOSFET transistor measured with the 4210-CVU

1.888.KEITHLEY (U.S. only)

www.keithley.com

KEITHLEY

A Greater Measure of Confidence

A Tektronix Company

Model 4225-PMU Ultra-Fast I-V Module

The Model 4225-PMU Ultra Fast I-V Module is the latest addition to the growing range of instrumentation options for the Model 4200-SCS Parameter Analyzer. It integrates ultra-fast voltage waveform generation and signal observation capabilities into the Model 4200-SCS's already powerful test environment to deliver unprecedented I-V testing performance, expanding the system's materials, device, and process characterization potential dramatically. Just as important, it makes ultra-fast I-V sourcing and measurement as easy as making DC measurements with a traditional high-resolution source measure unit (SMU).

Three types of measurements are necessary to characterize a device, material, or process thoroughly. The first two are precision DC I-V measurements (usually made with the Model 4200-SCS's SMU instruments) and AC impedance measurements (which can be made with the Model 4210-CVU C-V Instrument). The Model 4225-PMU represents the last segment of this characterization triangle—ultra-fast I-V or transient I-V measurements.

Some of the functionality provided by the Model 4225-PMU includes:

- Voltage outputs with programmable timing from 60ns to DC in 10ns steps
- Measuring I and V simultaneously, at acquisition rates of up to 200 megasamples/second (MS/s)
- Choosing from two voltage source ranges ($\pm 10V$ or $\pm 40V$) and four current measurement ranges (800mA, 200mA, 10mA, 100 μA)
- Also, each module provides two channels of integrated simultaneous I-V sourcing and measurement; plug in up to six modules in a single chassis for twelve synchronized channels.

Two optional instruments offer additional functionality:

- The optional Model 4220-PGU Pulse Generator Unit offers a voltage-sourcing-only alternative to the 4225-PMU.
- The optional Model 4225-RPM Remote Amplifier/Switch expands current ranges (10mA, 1mA, 100 μA , 10 μA , 1 μA , 100nA), switches sourcing/measurement between the Model 4225-PMU, Model 4210-CVU, Model 4200-SMU, and 4210-SMU.

Each plug-in 4225-PMU module provides two channels of integrated sourcing and measurement but occupies only a single slot in the Model 4200-SCS's nine-slot chassis. Unlike competitive solutions, each channel of the 4225-PMU combines high speed voltage outputs (with pulse widths ranging from 60 nanoseconds to DC) with simultaneous current and voltage.

Model 4225-PMU Applications

- Ultra-fast general-purpose I-V measurements
- Pulsed I-V and transient I-V measurements
- Flash, PCRAM, and other non-volatile memory tests
- Isothermal testing of medium-sized power devices
- Materials testing for scaled CMOS, such as high- κ dielectrics
- NBTI/PBTI reliability tests



Each Model 4200-SCS chassis can accommodate up to six Model 4225-PMU modules to provide up to twelve ultra-fast source and measure channels.

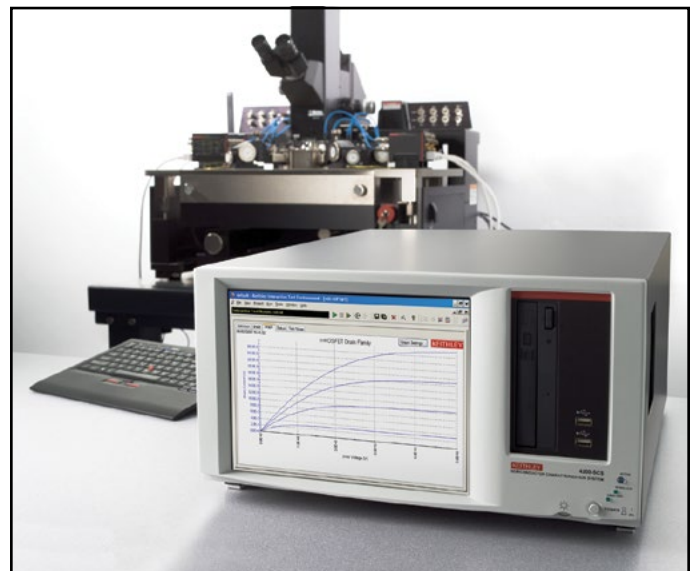

Cascade probe station with a Model 4225-RPM Remote Amplifier/Switch

1.888.KEITHLEY (U.S. only)

www.keithley.com

Multi-Measurement Cables

Keithley offers the only prober cable kits that support I-V, C-V, and Ultra-Fast I-V signals. These high performance cable kits simplify switching between DC I-V, C-V, and Ultra-Fast I-V testing configurations by eliminating the need for re-cabling when you change from one type of measurement to another. Their patent-pending design also eliminates the need to lift the probe needles for each cable change. The cable kits:

- Save time by avoiding the laborious process of re-cabling the connections from the test instruments to the prober every time a new measurement type is required.
- Prevent the cabling errors that often occur during difficult cable changes, which in turn prevents the measurement errors produced from faulty cabling.
- Reduce wafer pad damage by making setup changes while the probe needles remain in contact with the wafer. This also allows you to maintain the same contact impedance for each type of measurement.

The following cable kits are available:

- Model 4210-MMPC-C for Cascade Microtech probers
- Model 4210-MMPC-L for Lucas Signatone probers
- Model 4210-MMPC-S for SUSS MicroTec probers
- Model 4210-MMPC-W for Wentworth probers

Contact the factory for other supported probers.

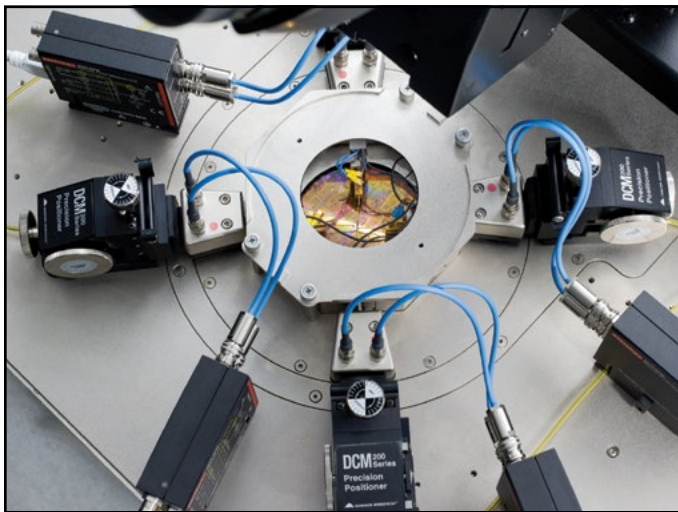

The 4210-MMPC cable kits include a provision for connecting the shields/grounds of all the probes together near the probe tips, providing the best high frequency performance.

How to Use

When changing between I-V and C-V measurements:

- DO NOT lift the probe needles
- DO NOT replace any cables

Simply reposition the cable at the bulkhead to access the appropriate instrument.

When performing Ultra-Fast I-V tests, one or more of the probes may need to be attached to the shield/ground of the pulse source. The cables facilitate this easily with supplied shorting caps.

Occasionally, two or more probes need to be connected in parallel. The patented design of the 4210-MMPC cable sets support this functionality.

For Even More Simplicity

You can eliminate the need to reposition cables at the bulkhead when switching between I-V, C-V and Ultra-Fast I-V measurements with Keithley's Model 4225-RPM Remote Amplifier/Switch. All instrument connections at the bulkhead are fed into the switch, which automatically connects the desired instrument to the positioner.

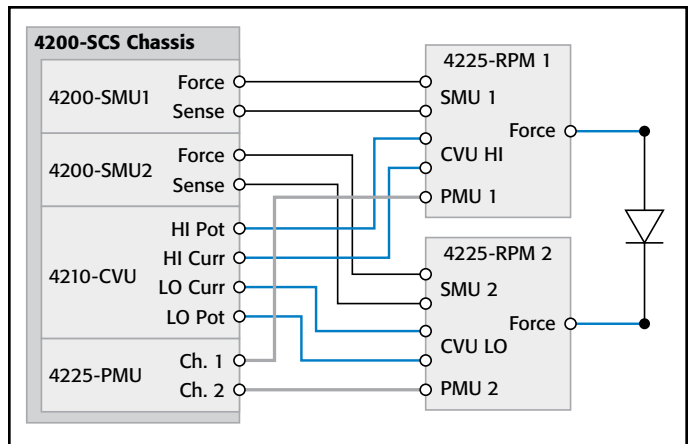

This closeup of two Model 4225-RPMs highlights the DC SMU, C-V, and ultra-fast I-V cable connections.

4200-SCS Condensed Specifications (Note: See the 4200 Technical Data Sheet for complete specifications.)

4200-SCS CHASSIS CORE CAPABILITIES

Integrate Intel Core2Duo processor, 2Gb Ram, 500Gb HDD, 1024X768 LCD, 9 slots, USB, Ethernet, GPIB, external monitor, over 200W of measurement power.

4200-SMU MEDIUM POWER SOURCE-MEASURE UNIT (2.1 watts max.)

MAXIMUM NUMBER OF UNITS PER CHASSIS: 9.
VOLTAGE RANGE: ±200V, 4 ranges from 200mV to 200V full scale.
BASIC VOLTAGE ACCURACY: 0.01% measure, 0.02% source.
VOLTAGE RESOLUTION: 0.1µV to 100µV.
CURRENT RANGE: ±100mA, 7 ranges from 100nA to 100mA full scale.
BASIC CURRENT ACCURACY: 0.03% measure, 0.04% source.
CURRENT RESOLUTION: 0.1pA to 100pA.
WITH OPTIONAL 4200-PA: Adds 5 low current ranges with resolution down to 0.1fA.

4210-SMU HIGH POWER SOURCE-MEASURE UNIT (21 watts max.)

MAXIMUM NUMBER OF UNITS PER CHASSIS: 9.
VOLTAGE RANGE: ±200V, 4 ranges from 200mV to 200V full scale.
BASIC VOLTAGE ACCURACY: 0.01% measure, 0.02% source.
VOLTAGE RESOLUTION: 0.1µV to 100µV.
CURRENT RANGE: ±1A, 8 ranges from 100nA to 1A full scale.
BASIC CURRENT ACCURACY: 0.03% measure, 0.04% source.
CURRENT RESOLUTION: 0.1pA to 100pA.
WITH OPTIONAL 4200-PA: adds 5 low current ranges with resolution down to 0.1fA.

4210-CVU MULTI-FREQUENCY CAPACITANCE-VOLTAGE UNIT

MAXIMUM NUMBER OF UNITS PER CHASSIS: 1 (consult factory for more).
MEASUREMENT PARAMETERS: Cp, Cs, G, R, D, Z, theta.
FREQUENCY RANGE: 1kHz to 10MHz variable.
MEASUREMENT RANGES: 100fF to 100µF typical full scale.
TYPICAL RESOLUTION: 1aF, 1nanoSiemens, 0.001 degree.
AC SIGNAL: 10mV to 100mV programmable.
DC BIAS: ±30V on either High or Low outputs (±60V differential), 10mA max current.
OPTIONAL 4200-CVU-PWR-PKG: Utilizes SMU instruments for ±200V (400V differential) up to 300mA.

RAMP RATE QUASISTATIC C-V

MAXIMUM NUMBER OF UNITS PER CHASSIS: Requires two SMU instruments per channel.
MEASUREMENT PARAMETERS: Cp, DCV, timestamp.
RANGING: 1pF to 1nF.
RAMP RATES: 0.1V/s to 1V/s.
DCV: ±200V.
TYPICAL ACCURACY: 5% at 1V/s ramp rate.

VERY LOW FREQUENCY C-V (VLF-CV)

MAXIMUM UNITS PER CHASSIS: Requires two SMU instruments (either Model 4200-SMU or 4210-SMU) and two Model 4200-PA Remote Preamplifiers. Any two SMU instruments/PAs can be used for a VLF C-V measurement.
MEASUREMENT PARAMETERS: CP-GP, Cp-D, Cs-Rs, Cs-D, R-jX, Z-Theta, DCV, Timestamp.
FREQUENCY RANGE: 10mHz to 10Hz.
MEASUREMENT RANGE: 1pF to 10nF.
TYPICAL RESOLUTION: 3.5 digits, minimum typical 10fF.
AC SIGNAL: 10mV to 3V rms.
DC BIAS: ±20V on the High terminal, 1µA maximum.

4225-PMU ULTRA-FAST I-V UNIT

MAXIMUM NUMBER OF UNITS PER CHASSIS: 6.
CHANNELS PER UNIT: 2 independent or synchronized.
VOLTAGE RANGE: ±40V, 2 ranges of 10V and 40V.
BASIC VOLTAGE ACCURACY: 0.25%.
VOLTAGE RESOLUTION: 250µV, 750µV.
CURRENT RANGE: ±800mA, 4 ranges from 100µA to 800mA.
BASIC CURRENT ACCURACY: 0.25%.
CURRENT RESOLUTION: 14 bits, 10nA to 10mA.
WITH OPTIONAL 4225-RPM REMOTE AMPLIFIER/SWITCH: Adds 3 low current ranges 100nA, 1µA, 10µA.
CORE A/D CONVERTER: Two per channel, 4 per unit, 5ns, 200MHz, 14 bits, 1GB memory.
CORE VOLTAGE SLEW RATE: 1V/ns.
BEST VOLTAGE PULSE WIDTH: 20ns to 10V.
TYPICAL CURRENT MEASURE PULSE WIDTH: 60ns.

EXTENDED WARRANTIES AND CALIBRATION SERVICES

EXTENDED WARRANTIES		CALIBRATION SERVICES	
The 1 year factory warranty is extended 3 or 5 years from date of shipment. Includes calibration and return shipping.		The calibration service provides 3 or 5 calibrations per year with before and after, ANSI/NCSL Z540-1 compliant data reports.	
4200-3Y-EW or 4200-5Y-EW	Includes 4200-SCS mainframe including all SMUs and preamplifiers.	4200-3Y-CAL or 4200-5Y-CAL	Includes the 4200-SCS mainframe, all SMUs and preamplifiers.
4210-3Y-EW or 4210-5Y-EW	Includes 4210-CVU module. Requires purchase of 4200-3Y or 4200-5Y extended warranty.	4200-CVU-3Y-CAL or 4200-CVU-5Y-CAL	Includes 4210-CVU module. Requires purchase of 4200-3Y-CAL or 4200-5Y-CAL.
4225-3Y-EW or 4225-5Y-EW	Includes 4225-PMU module. Requires purchase of 4200-3Y or 4200-5Y extended warranty.	4200-PMU-3Y-CAL or 4200-PMU-5Y-CAL	Includes 4225-PMU module. Requires purchase of 4200-3Y-CAL or 4200-5Y-CAL.
4225-RPM-3Y-EW or 4225-RPM-5Y-EW	Includes 4225-RPM module. Requires purchase of 4200-3Y or 4200-5Y extended warranty.	4200-RPM-3Y-CAL or 4200-RPM-5Y-CAL	Includes 4225-RPM module. Requires purchase of 4200-3Y-CAL or 4200-5Y-CAL.

4200-SCS

Parameter Analyzer

Instrument Modules

Instrument Modules	Description	Supplied Accessories
4200-SMU	Medium Power Source-Measure Unit for 4200-SCS, 100mA to 100fA, 200V to 1 μ V, 2 Watts	<i>If configured with a preamp:</i> (4) 4200-TRX-2 Ultra Low Noise Triax Cables, 2m (6.6 ft) (1) 236-ILC-3 Interlock Cable, 3m (10 ft) <i>If configured without a preamp:</i> (2) 4200-TRX-2 Ultra Low Noise Triax Cables, 2m (6.6 ft) (2) 4200-MTRX-2 Mini Ultra Low Noise Triax Cables, 2m (6.6 ft) (1) 236-ILC-3 Interlock Cable, 3m (10 ft)
4210-SMU	High Power Source-Measure Unit for 4200-SCS, 1A to 100fA, 200V to 1 μ V, 20 Watts	<i>If configured with a preamp:</i> (4) 4200-TRX-2 Ultra Low Noise Triax Cables, 2m (6.6 ft) (1) 236-ILC-3 Interlock Cable, 3m (10 ft) <i>If configured without a preamp:</i> (2) 4200-TRX-2 Ultra Low Noise Triax Cables, 2m (6.6 ft) (2) 4200-MTRX-2 Mini Ultra Low Noise Triax Cables, 2m (6.6 ft) (1) 236-ILC-3 Interlock Cable, 3m (10 ft)
4200-PA	Remote PreAmp Option for 4200-SMU and 4210-SMU, extends SMU to 0.1fA resolution	(1) 4200-RPC remote preamp cable, 2m (6.6 ft)
4210-CVU	Capacitance-Voltage (C-V) Module	(4) CA-447A SMA Cables, male to male, 100 Ω , 1.5m (5 ft) • (4) CS-1247 Female SMA to Male BNC Adapters (2) CS-701 BNC Tee Adapters • (1) TL-24 SMA Torque Wrench
4225-PMU	Ultra-Fast I-V Module	(4) SMA-to-SMA 50 Ω cables, 2m (6.6 ft) (2) SMA-to-SSMC Y-Cable Assembly, 6 in.
4225-RPM	Remote Amplifier/Switch	(1) SMA-to-SMA 50 Ω Cable, 20cm (7.9 in), (1) Triax-to-BNC Adapter, (1) BNC-to-SMA Adapter, (1) RPM Cable, 2.1m (6.9 ft)
4220-PGU	High Voltage Pulse Generator	(4) SMA-to-SMA 50 Ω cables, 2m (6.6 ft), (2) SMA-to-SSMC Y-Cable Assembly, 6 in.

Switching Systems and Cards

	Description	Supplied Accessories
707B	6-slot Switching Matrix Mainframe	CA-180-4A CAT 5 Ethernet Crossover Cable, 1m (3.3 ft) • CA-179-2A CAT 5 Ethernet Cable 3m (10 ft) CO-7 Line Cord • Rear Fixed Rack Mount Hardware
708B	Single-slot Switching Matrix Mainframe	CA-180-4A CAT 5 Ethernet Crossover Cable, 1m (3.3 ft) • CA-179-2A CAT 5 Ethernet Cable 3m (10 ft) • CO-7 Line Cord
7072	8 \times 12, Semiconductor Matrix Card	
7072-HV	8 \times 12, High Voltage, Semiconductor Matrix Card	
7173-50	4 \times 12, Two-Pole, High Frequency, Matrix Card	
7174A	8 \times 12, High Speed, Low Leakage Current, Matrix Card	

OPTIONAL ACCESSORIES

CONNECTORS AND ADAPTERS

CS-565	Female BNC to Female BNC Adapter
CS-701	BNC Tee Adapter (female, male, female)
CS-719	3-lug Triax Jack Receptacle
CS-1247	SMA Female to BNC Male Adapter
CS-1249	SMA Female to SMB Plug Adapter
CS-1251	BNC Female to SMB Plug Adapter
CS-1252	SMA Male to BNC Female Adapter
CS-1281	SMA Female to SMA Female Adapter
CS-1382	Female MMBX Jack to Male SMA Plug Adapter
CS-1390	Male LEMO Triax to Female SMA Adapter
CS-1391	SMA Tee Adapter (female, male, female)
CS-1479	SMA Male to BNC Male Adapter
237-BAN-3A	Triax Cable Center Conductor terminated in a safety banana plug
237-BNC-TRX	Male BNC to 3-lug Female Triax Adapter
237-TRX-BAR	3-lug Triax Barrel Adapter (female to female)
237-TRX-T	3-slot Male to Dual 3-lug Female Triax Tee Adapter
7078-TRX-BNC	3-Slot Male Triax to BNC Adapter
7078-TRX-GND	3-Slot Male Triax to Female BNC Connector (guards removed)

TEST FIXTURES

8101-4TRX	4-pin Transistor Fixture
8101-PIV	Pulse LV Demo Fixture
LR8028	Component Test Fixture

CABINET MOUNTING ACCESSORIES

4200-RM	Fixed Cabinet Mount Kit
---------	-------------------------

CABLES AND CABLE SETS

NOTE: All 4200-SCS systems and instrument options are supplied with required cables, 2m (6.5 ft.) length.

CA-19-2	BNC to BNC Cable, 1.5m
CA-404B	SMA to SMA Coaxial Cable, 2m
CA-405B	SMA to SMA Coaxial Cable, 15cm
CA-406B	SMA to SMA Coaxial Cable, 33cm
CA-446A	SMA to SMA Coaxial Cable, 3m
CA-447A	SMA to SMA Coaxial Cable, 1.5m
CA-451A	SMA to SMA Coaxial Cable, 10.8cm
CA-452A	SMA to SMA Coaxial Cable, 20.4cm
236-ILC-3	Safety Interlock Cable, 3m
237-ALG-2	Low Noise Triax Input Cable terminated with 3 alligator clips, 2m
4210-MMPC-C	Multi-Measurement (I-V, C-V, Pulse) Prober Cable Kit for Cascade Microtech I2000 prober series
4210-MMPC-S	Multi-Measurement (I-V, C-V, Pulse) Prober Cable Kit for SUSS MicroTec PA200/300 prober series
4200-MTRX-*	Ultra Low Noise SMU Triax Cable: 1m, 2m, and 3m options
4200-PRB-C	SMA to SSMC Y Cable with local ground
4200-RPC-*	Remote PreAmp Cable: 0.3m, 2m, 3m, 6m options
4200-TRX-*	Ultra Low Noise PreAmp Triax Cable: 0.3m, 2m, 3m options
7007-1	Double-Shielded Premium GPIB Cable, 1m
7007-2	Double-Shielded Premium GPIB Cable, 2m

ADAPTER, CABLE, AND STABILIZER KITS

4200-CVU-PWR	CVU Power Package for \pm 200V C-V
4200-CVU-PROBER-KIT	Accessory Kit for connection to popular analytical probers
4200-PMU-PROBER-KIT	General Purpose Cable/Connector Kit. For connecting the 4225-PMU to most triax and coax probe stations. One kit required per 4225-PMU module.
4200-Q-STBL-KIT	Addresses oscillation when performing pulse I-V tests on RF transistors

REMOTE PREAMP MOUNTING ACCESSORIES

4200-MAG-BASE	Magnetic Base for mounting 4200-PA on a probe platen
4200-TMB	Triaxial Mounting Bracket for mounting 4200-PA on a triaxial mounting panel
4200-VAC-BASE	Vacuum Base for mounting 4200-PA on a prober platen

SOFTWARE

ACS-BASIC	Component Characterization Software
-----------	-------------------------------------

DRIVERS

4200ICCAP-6.0	IC-CAP Driver and Source Code for 4200-SCS: UNIX/Windows (shareware only)
---------------	---

OTHER ACCESSORIES

EM-50A	Modified Power Splitter
TL-24	SMA Torque Wrench
4200-CART	Roll-Around Cart for 4200-SCS
4200-CASE	Transport Case for 4200-SCS
4200-MAN	Printed Manual Set

1.888.KEITHLEY (U.S. only)

www.keithley.com

KEITHLEY

A Greater Measure of Confidence

A Tektronix Company

4200-BTI-A

- **Best-in-class test speed allows faster, more complete device characterization**
 - Begin measuring BTI degradation as soon as 30ns after stress is removed
 - Measure transistor V_T in less than 1 μ s using I_D - V_G sweep method
- **Model 4225-RPM Remote Amplifier/Switch**
 - Switches automatically between low-level precision DC I-V (via standard SMUs) and ultra-fast I-V measurements with no need for re-cabling
 - Improves single-pulse source and measurement performance by minimizing cable parasitic effects and increasing low current sensitivity
- **Best high-speed, low-current measurement sensitivity available in a single-box integrated solution**
 - Supports sub-microsecond pulse characterization of drain current at reduced drain voltage, minimizing drain-to-source fields that could otherwise skew test results
 - Ensures the source/measure instrumentation won't be the limiting factor when making low-level measurements
 - Detects degradation trends sooner during the test, reduces the time needed to perform process reliability monitoring
- **Simple, predictable interconnect scheme prevents measurement problems due to incorrect DUT connections**

Ultra-Fast NBTI/PBTI Package for the Model 4200-SCS



The Model 4200-BTI-A Ultra-Fast BTI Package combines Keithley's advanced DC I-V and ultra-fast I-V measurement capabilities with automatic test executive software to provide the most advanced NBTI/PBTI test platform available in the semiconductor test industry. The 4200-BTI-A package, which builds on the Model 4200-SCS semiconductor parameter analyzer's powerful test environment, includes all the instruments, interconnects, and software needed to make the most sophisticated NBTI and PBTI measurements on leading-edge silicon CMOS technology:

- One Model 4225-PMU Ultra-Fast I-V Module
- Two Model 4225-RPM Remote Amplifier/Switches
- Automated Characterization Suite (ACS) Software
- Ultra-Fast BTI Test Project Module
- Cabling

APPLICATIONS

- **Single-Pulse Charge Trapping/ high- κ dielectric characterization**
- **Silicon-On-Insulator testing**
- **LDMOS/GaAs isothermal characterization**
- **Flash RTS ID**
- **Phase-change random access memory (PCRAM) testing**
- **Ultra-fast NBTI characterization**
- **Charge pumping measurements**
- **Thermal impedance characterization**
- **MEMs capacitor testing**
- **Random telegraph signal (RTS) CMOS**
- **Charge-based capacitance measurement (CBCM) Materials testing for scaled CMOS, such as high- κ dielectrics**
- **NBTI/PBTI reliability tests**

1.888.KEITHLEY (U.S. only)

www.keithley.com

A Greater Measure of Confidence

KEITHLEY

A Tektronix Company

4200-BTI-A

- **Optional Multi-Measurement Performance Cables (MMPC) optimize measurement performance of configurations that combine DC I-V, C-V, and ultra-fast I-V capabilities**
- **ACS software supports building complex test sequences including up to 20 measurement sequences and full prober integration**
 - DC I-V and ultra-fast I-V measurements can be easily integrated into a stress-measure sequence
 - Degradation and recovery behaviors can be characterized using either AC or DC stress
 - Combine spot measurements with precision SMU sweeps in pretesting and posttesting
 - Incorporate single pulse charge trapping (SPCT) measurements into longer stress-measure sequences
- **Support for handling large data sets required in device reliability modeling and process monitoring applications**
- **Support for hot chucks and fully and semi automatic probers, including wafer maps, wafer- and cassette-level sample plans**

Ultra-Fast NBTI/PBTI Package for the Model 4200-SCS

Model 4225-PMU Ultra-Fast I-V Module

This module is the hardware core of the ultra-fast I-V measurement capability essential for characterizing NBTI and PBTI degradation in microseconds, allowing for more accurate lifetime measurements for Designed-In Reliability (DIR) that support modeling for device and circuit design. It integrates a sophisticated two-channel waveform generator with high-speed voltage and current measurement capabilities, a deep measurement buffer, and a real-time test execution engine.

Unlike traditional pulse generation solutions, the Model 4225-PMU can be programmed to output the complex waveforms required in ultra-fast BTI testing. And, unlike traditional Arbitrary Waveform Generators (AWGs), the waveforms' duration and complexity aren't limited by bitmap or memory depth. Instead, the 4225-PMU employs a high-level waveform description language that uses the concept of segments, segment libraries, and looping. In addition, the waveform description specifies exactly when measurements must be made during the waveform and the type of measurement to be made.

Spot, step sweep, smooth sweep, and sample measurement types are supported and multiple measurement types can be linked to form a test sequence. The programmable sample period can be set as fast as 5ns, so most measurements will include multiple samples. The system's real-time test execution engine automatically calculates the mathematical mean of the samples, which reduces the volume of data that must be transferred and parsed during the course of the test. The resulting measurements are streamed back to the high-level test module for near-real-time analysis and test termination.

For additional information on this module's capabilities and specifications, consult the Model 4225-PMU data sheet.

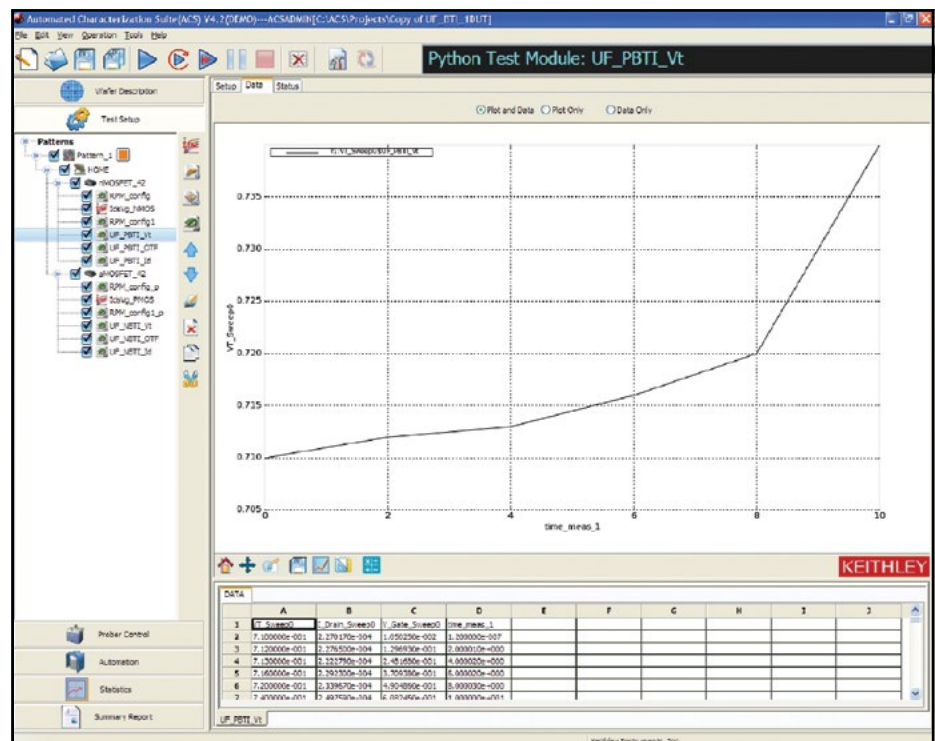

The Model 4225-PMU/4225-RPM's combination of superior speed and sensitivity allow characterizing voltage threshold (V_T) directly with high-speed I_D - V_C sweeps. Measuring V_T directly makes it unnecessary to correlate the single-point I_D measurement to actual V_T levels.

1.888.KEITHLEY (U.S. only)

www.keithley.com

KEITHLEY

A Greater Measure of Confidence

A Tektronix Company

4200-BTI-A

Ordering Information

4200-BTI-A

Ultra-Fast BTI Package for the Model 4200-SCS (includes one Model 4225-PMU Ultra-Fast I-V Module, two Model 4225-RPM Remote Amplifier/Switches, Ultra-Fast BTI Test Project Module, and one copy of the Automated Characterization Suite (ACS) software

Accessories Supplied

For the 4225-PMU:

SMA to SMA 50Ω cables, 2m (4 ea.)

SMA to SSMC Y-Cable Assembly, 6 in (2 ea.)

ACCESSORIES AVAILABLE

- 4210-MMPC-C Multi Measurement Performance Cables for Cascade probe stations using SSMC probe pin connections. One kit required per manipulator.
- 4210-MMPC-L Multi Measurement Performance Cables for Lucas Signatone probe stations using SSMC probe pin connections. One kit required per manipulator.
- 4210-MMPC-S Multi Measurement Performance Cables for Suss probe stations using SSMC probe pin connections. One kit required per manipulator.
- 4210-MMPC-W Multi Measurement Performance Cables for Wentworth probe stations using SSMC probe pin connections. One kit required per manipulator.
- 4225-PMU Extra Ultra-Fast I-V Module
- 4225-RPM Extra Remote Amplifier/Switch. Up to two of these units can be used with a single 4225-PMU module.
- 4200-PMU-PROBER-KIT General Purpose Cable/Connector Kit. For connecting the 4225-PMU to most triax and coax probe stations. One kit required per 4225-PMU module.

Ultra-Fast NBTI/PBTI Package for the Model 4200-SCS

Model 4225-RPM Remote Amplifier/Switch

This module is designed to maximize the Model 4225-PMU's current measurement sensitivity. The 4225-RPM's independent force and sense connections to the DUT maximize its pulse, DC, and C-V performance. Its built-in switching capabilities allow the Model 4200-SCS to switch automatically between making ultra-fast I-V measurements with the 4225-PMU and DC I-V measurements with the system's 4200-SMU and 4210 source-measure units (SMU instruments).

Model 4225-RPM modules are required for ultra-fast BTI testing; if the 4225-PMU module is used without them, it employs a recursive technique to compensate for cable influences such as load line effects and is typically used for isothermal I-V testing. This recursive technique is inappropriate for use in BTI reliability applications in which measurements must be both as short as possible and highly temporally deterministic in order to minimize the relaxation effects.

By making it possible to locate the pulse source close to the device under test (DUT), the 4225-RPM helps minimize the cable length and corresponding cable parasitic effects. The shorter cables result in reduced cable capacitance, reduced load-line effects, and reduced source overshoot. Placing the pulse source and high speed measurement circuits near the DUT allows the cable length to be reduced so that the round-trip propagation delay is shorter than the rise or fall time of the desired pulse.

For additional details and specifications on the Model 4225-RPM, consult the Model 4225-PMU data sheet.

Speed and Sensitivity

Bias temperature instability is a highly dynamic phenomenon that requires sensitive, high-speed measurements for accurate characterization. Assuming all other factors are constant, measurement physics largely defines the relationship between measurement speed and sensitivity. When making sub-millisecond measurements, all sources of noise must be taken into account; for sub-microsecond applications, quantum effects can't be ignored. The 4200-BTI-A package provides the optimal combination of measurement speed and sensitivity for ultra-fast BTI testing because it's engineered to approach the limits of measurement physics while ensuring high ease of use. The package is optimized to provide accurate ultra-fast results without the use of RF structures and interconnects.

Reduce Unwanted Source-Drain Fields

To eliminate hot carrier injection effects or unwanted charge displacement during BTI testing, minimizing drain-to-source fields is critical. All BTI characterization techniques involve measuring drain current with a voltage applied to the drain. Given that the drain current is proportional to the

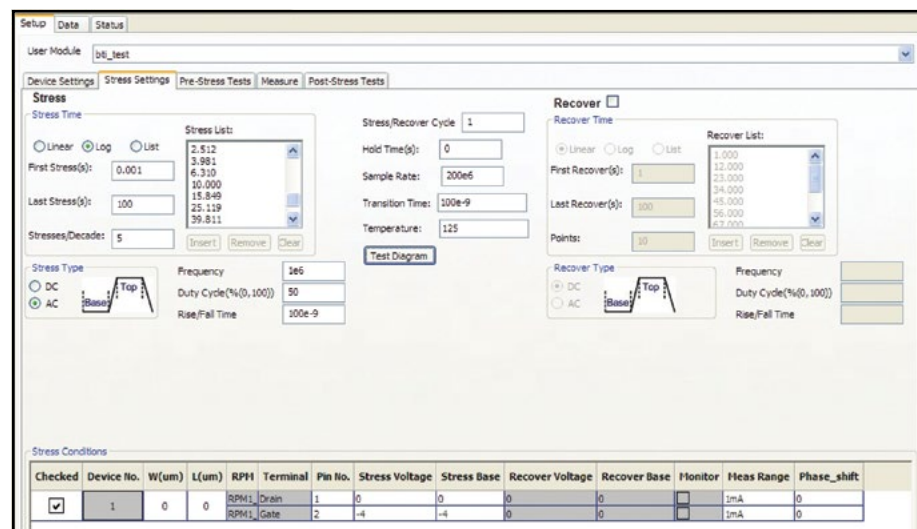

Define stress timing and stress conditions easily using familiar parameters like timing – log, linear, custom list; measurements per decade; AC or DC stress; optional recovery test sequence; and test sample rate (speed).

1.888.KEITHLEY (U.S. only)

www.keithley.com

A Greater Measure of Confidence

KEITHLEY

A Tektronix Company

4200-BTI-A

Ultra-Fast NBTI/PBTI Package for the Model 4200-SCS

Disadvantages of BTI systems developed in house

Until now, some researchers have been forced to configure their own ultra-fast BTI test systems. These in-house-developed systems typically combine a pulse generator or arbitrary waveform generator with an oscilloscope equipped with current probes or some type of transimpedance amplifier to help measure low current. Although it is possible to build a BTI system that is suitable for a very specific set of electrical conditions if the instruments and interconnect are carefully selected, several major technical challenges remain:

- **Waveform generation.** Standard pulse generators and arbitrary waveform generators are designed to generate a waveform on a fixed recurring interval, rather than the Log(time) scale required for most reliability tests, including NBTI and PBTI testing.
- **Measurement timing and data storage.** Although oscilloscopes can be configured to trigger based on a waveform feature (such as a falling edge, for example), they are not designed to store samples selectively for specific portions of the waveform. This makes it necessary to store very large data sets for postprocessing. Only the most expensive oscilloscopes or those with costly memory expansion options can store enough data to compensate for these shortcomings.
- **Precision, accuracy, and sensitivity.** Oscilloscopes, current probes, and transimpedance amplifiers all have independently defined performance specifications and they are not necessarily optimized to work together. It is often very difficult to combine these components in a way that provides optimal performance across a wide dynamic range in order to achieve precise and accurate current measurements at high speeds.
- **Interconnect.** Systems built in house typically use splitters and bias tees, which limit the performance of the test setup. For example, a bias tee might limit bandwidth from 100ns to 10 μ s. Although this is suitable for high speed measurements, it prevents making any meaningful prestress and poststress DC measurements as part of the stress–measure sequence. It also prevents making measurements in the intermediate range of 10 μ s to DC.
- **Test control and data management.** Traditional oscilloscopes don't support data streaming, so results transfer must wait until the test ends. Once the test is complete, massive amounts of data must be transferred to the control computer for postprocessing, which requires parsing complex waveforms into individual test results, followed by further reduction of the data into actual measurements.
- **Test termination.** Given that the test results can't be analyzed until the data is transferred from the oscilloscope, the test duration must be determined prior to test initiation. This makes it impossible to terminate the test based in parametric shifts or to detect catastrophic failures in real time.
- **Automation.** Wafer- or cassette-level automation requires control of both the test instruments and the wafer probe station, which systems built in house typically wouldn't provide. Also, incorporating sophisticated features like conditional test termination would add considerable complexity to the custom software necessary to run a system of this type.
- **Higher channel count.** Even for an in-house-built system that works well, pressures to increase the channel or test system count may arise. Typical test system maintenance issues such as calibration, operation, and correlation related to these custom setups can easily consume a disproportionate amount of the available resources.

drain-to-source field, the more sensitive the drain current measurement is, the lower the required drain voltage must be. The 4200-BTI-A package's superior low current measurement capability allows the use of lower drain voltages to produce more accurate results.

Reduced Relaxation Time

The 4225-BTI-A package's superior speed and sensitivity allow making degradation measurements faster than any other commercial test system available. Single-point ID spot measurements can be completed in less than 1 μ s and ten-point ID-VG step sweeps can be made in less than 10 μ s. A sub-microsecond smooth sweep can be performed in less than 1 μ s.

Software

The Ultra-Fast BTI test software module brings together the measurement capabilities of the Model 4225-PMU and 4225-RPM through an intuitive interface that doesn't compromise test flexibility. It makes it easy to define stress timing, stress conditions, and a wide range measurement sequences from spot I_D , On-The-Fly (OTF), or I_D - V_G sweeps. The test module allows measuring recovery effects as well as degradation. It also offers prestress and poststress measurement options that incorporate the Model 4200-SCS's DC SMU instruments for high-precision low-level measurements.

Stress Settings

The Ultra-Fast BTI Test Module employs familiar parameter setting for building stress–measure timing sequences. The stress set-up screen makes defining log or linear timing or building a custom list of time intervals to trigger intra-stress measurements both easy and quick.

Intuitive Test Sequence Development

The Ultra-Fast BTI Test Module makes creating a powerful test sequence as uncomplicated as selecting one or more measurement types, then entering the appropriate values for voltage levels and measurement parameters in the intuitive interface. No coding or script writing is required. Select from four measurement types and chain up to 20 measurements together to form a ready-to-run measurement sequence:

- **Spot.** The spot measurement is a single measurement made while the gate and drain are pulsed. The measurement result is the mean value of the samples taken after the drain settles and before the pulse ends.
- **Step Sweep.** The step sweep is very similar to a conventional DC SMU sweep, in which

1.888.KEITHLEY (U.S. only)

www.keithley.com

KEITHLEY

A Greater Measure of Confidence

A Tektronix Company

4200-BTI-A

Ultra-Fast NBTI/PBTI Package for the Model 4200-SCS

each step in the sweep includes a settling period and an integration (or averaging) period.

- **Smooth Sweep.** The smooth sweep does not include settling times, and the signal is sampled continuously throughout the sweep.
- **Sample.** A sample measurement is much like the smooth sweep measurement, except that it is performed at a constant set of voltage conditions on the gate and drain.

Test Automation Speeds Data Sample Acquisition

The ability to acquire large, statistically significant samples of data quickly is key to reliability modeling. Advances in ultra thin film transistors have further increased the required sample size due to the increasingly random nature of the defects in these devices. As a result, it's critical to use a test environment that supports wafer- and cassette-level automation. This environment must also be capable of handling the extremely large data sets associated with reliability testing. The test environment provided with the Automated Characterization Suite software supports full automation capabilities compatible with both semi and fully automatic probe stations.

Interconnect

The 4200-BTI-A package provides all the cabling and connectors required to connect to standard coaxial probe manipulators. For enhanced measurement accuracy, many users add an optional multi-measurement performance cable kit that connects the Model 4200-SCS to a probe manipulator, simplifying switching between DC I-V, C-V, and ultra-fast I-V testing configurations. This kit eliminates the need for re-cabling, as well as maximizing signal fidelity by eliminating the measurement errors that often result from cabling errors. Versions engineered for Cascade Microtech and SUSS MicroTec probers are available. There's also a general-purpose kit for connecting the 4225-PMU to other triaxial and coaxial probe stations.

Additional Applications

The Model 4225-PMU's ultra-fast I-V capabilities are not limited to low-voltage pMOS and nMOS reliability testing. It can drive up to 800mA or 40V with pulse widths from 30ns to several seconds in length. This remarkable dynamic range is suitable for a wide variety of other applications.

Keithley's Model 4200-SCS replaces a variety of electrical test tools with a single, tightly integrated characterization solution that's ideal for a wide variety of applications. To assure customers of the ongoing viability of their systems, Keithley has continually enhanced the system's hardware and software. This ongoing commitment ensures a cost-effective system upgrade path to address new testing needs as they arise. That means Model 4200-SCS users will never have to buy a new Parameter Analyzer because the old one is obsolete. The Model 4200-SCS is engineered to adapt readily to the industry's changing test needs—making our customers' capital investments stretch further and improving ROI.

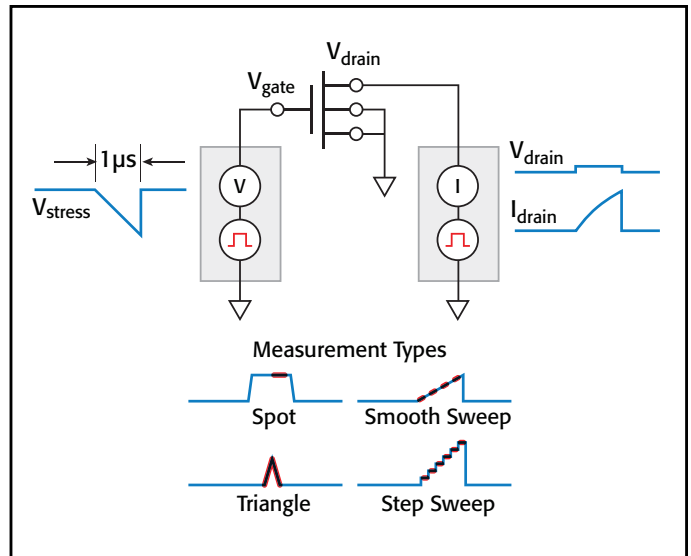

The Ultra-Fast BTI test software module supports spot, step sweep, smooth sweep, and sample measurement types. Each type's timing is defined by the test sample rate and the individual measurement settings. The software module also provides control over the voltage conditions between each element in the test sequence, for maximum flexibility and ease of use, even when defining complex test sequences.

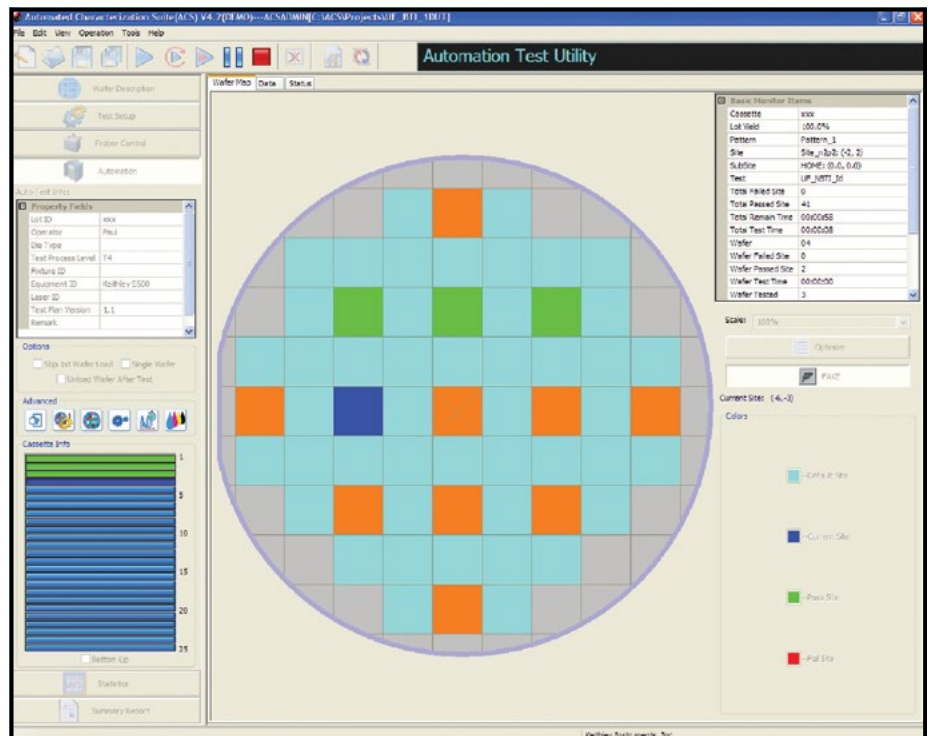

ACS software provides wafer- and cassette-level automation capabilities compatible with semi and fully automatic probe stations.

1.888.KEITHLEY (U.S. only)

www.keithley.com

A Greater Measure of Confidence

KEITHLEY

A Tektronix Company

4200-BTI-A

Ultra-Fast NBTI/PBTI Package for the Model 4200-SCS

Specifications

4225-RPM REMOTE AMPLIFIER/SWITCH Optional Accessory for the 4225-PMU

The 4225-RPM provides lower current measurement ranges to the 4225-PMU.

Low current measure ranges supports wide range of measurements, from nanotechnology to BTI (Bias Temperature Instability) on leading-edge CMOS devices

This is a single-channel accessory; order two Model 4225-RPMs to support the two channels of the Model 4225-PMU.

Supports switching to the Model 4200-SCS's SMU instruments or 4210-CVU, allowing for a wide range of tests without re-cabling.

Built-in bypass mode allows access to the Model 4225-PMU's higher current measurement ranges.

PULSE/LEVEL¹

	4225-PMU with 4225-RPM
V _{OUT}	-10 V to +10 V
Accuracy ² into open load	±(0.5% ±10 mV)
Resolution	< 0.5 mV
Output Connectors	Triaxes, source and sense
Baseline Noise	±(0.39% + 1 mV) RMS typical
Overshoot/Pre-shoot/Ringing ³	±2% of amplitude ±20 mV

4225-RPM REMOTE AMPLIFIER/SWITCH (must be used in conjunction with 4225-PMU)

TYPICAL MINIMUM TIMING PARAMETER FOR CURRENT MEASUREMENT

Range	100 nA	1 µA	10 µA	100 µA	1 mA	10 mA
Recommended Minimum Pulse Width ^{4,5}	134 µs	20.4 µs	8.36 µs	1.04 µs	370 ns	160 ns
Recommended Minimum Measure Window ⁵	10 µs	1.64 µs	1 µs	130 ns	40 ns	20 ns
Accuracy (DC)	±(0.5% + 1nA)	±(0.5% + 1nA)	±(0.5% + 30nA)	±(0.5% + 100nA)	±(0.5% + 1µA)	±(0.5% + 10µA)
Recommended Minimum Transition Time ^{5,6}	1 µs	360 ns	360 ns	40 ns	30 ns	20 ns
Noise ^{5,7}	200 pA	2 nA	5 nA	50 nA	300 nA	1.5 µA
Settling Time ^{5,8}	100 µs	15 µs	6 µs	750 ns	250 ns	100 ns

VOLTAGE MEASURE

±10V

RECOMMENDED MINIMUM PULSE WIDTH^{4,5}: 160ns.

RECOMMENDED MINIMUM MEASURE WINDOW⁵: 20ns.

ACCURACY (DC): 0.25% + 10mV.

RECOMMENDED MINIMUM TRANSITION TIME^{5,6}: 20ns.

NOISE^{5,7}: 1mV.

SETTLING TIME^{5,8}: 100ns.

NOTES

- Performance at the triax output connectors of the 4225-RPM when using a 2m RPM interconnect cable between the 4225-PMU and 4225-RPM Remote Pulse Measure unit.
- 100mV to 10V.
- Typical, with transition time of 100ns (0-100%).
- Recommended minimum pulse width = (Setting Time)/0.75
- Typical values, into an open.
- Recommended rise/fall time to minimize overshoot.
- RMS noise measured over the Recommended Minimum Measure Window for the given voltage or current range, typical.
- Time necessary for the signal to settle to the DC accuracy level. (Example: the 10mA measurement range's settling time refers to the period required for the signal to settle to within 0.35% of the final value. Calculated as Accuracy = 0.25% + 10µA = 0.25% + (10µA/10mA) = 0.25% + 0.1% = 0.35%.)

All specifications apply at 23° ±5°C, within one year of calibration, RH between 5% and 60%, after 30 minutes of warmup.

1.888.KEITHLEY (U.S. only)

www.keithley.com

KEITHLEY

A Tektronix Company

A Greater Measure of Confidence

4200-BTI-A

Ultra-Fast NBTI/PBTI Package for the Model 4200-SCS

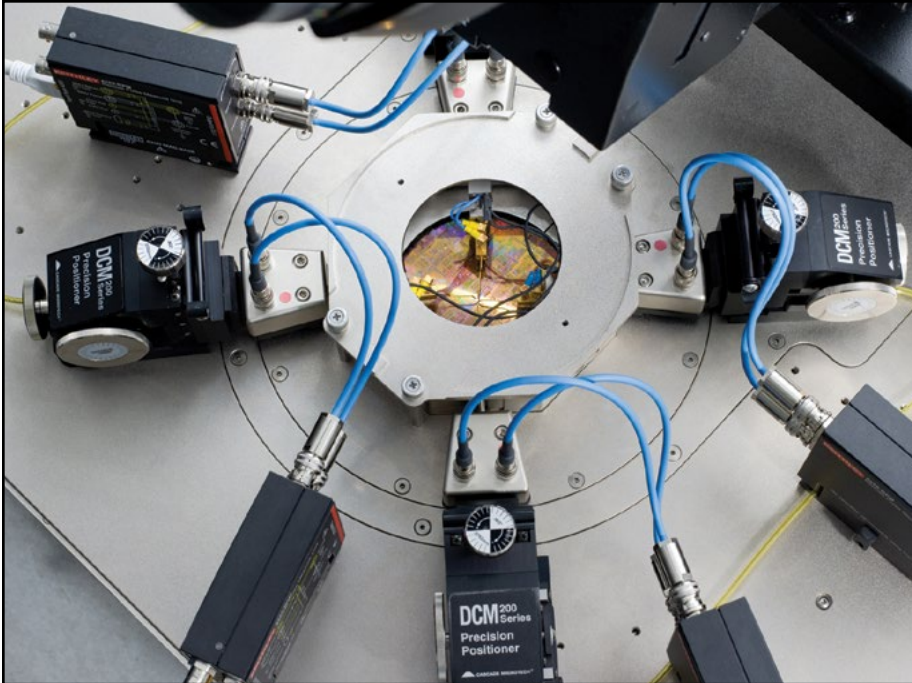

This top-down view of a Cascade Microtech analytical probe station illustrates best practices for interconnecting the Model 4225-RPM Remote Amplifier/Switch to the prober using the blue Multi-Measurement Performance cables.

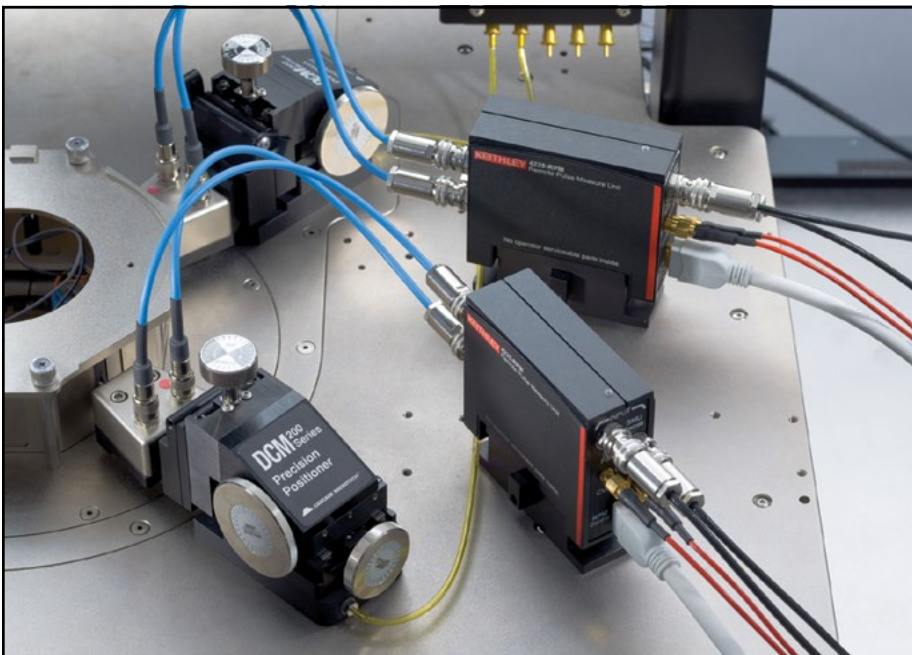

This closeup of two Model 4225-RPMs highlights the DC SMU, C-V, and ultra-fast I-V cable connections.

1.888.KEITHLEY (U.S. only)

www.keithley.com

A Greater Measure of Confidence

KEITHLEY
A Tektronix Company

2600-PCT-x 4200-PCT-x



Model 4200-PCT-4 on K420 Cart

- **Configurable power levels**
 - From 200V to 3kV
 - From 1A to 100A
- **Wide dynamic range**
 - From μV to 3kV
 - From fA to 100A
- **Capacitance-voltage methods**
 - $\pm 400\text{V}$ multi-frequency C-V
 - 200V ramp rate C-V
 - 20V very low frequency (VLF) C-V
- **DC or pulsed I-V to 50 μs**
- **High voltage and high current channels have both 24-bit precision A/D converters and 18-bit high speed (1 μs) digitizers**
- **Test management software includes both trace mode for real-time control and Parametric mode for parameter extraction**

APPLICATIONS

- Power semiconductor device characterization and testing
- Characterization of GaN and SiC, LDMOS, and other devices
- Reliability studies on power devices
- Incoming inspection and device qualification

1.888.KEITHLEY (U.S. only)

www.keithley.com

Parametric Curve Tracer Configurations



Model 2600-PCT-4

High Power Device Characterization

Characterizing and testing today's high power semiconductor devices and components is placing a high demand on test equipment. Device design engineers need equipment that can support them throughout the complete lifecycle of a power device. Today, high power characterization systems are available in two main forms — complete turnkey systems and building blocks that must be configured by the user

and completed with good software. Turnkey systems can be set up and running quickly, but they can be quite expensive and limited in the breadth of testing that can be performed.

Keithley's Parametric Curve Tracer configurations are complete solutions configured with a variety of high quality instruments, cables, test fixturing, and software. This building block approach offers the advantages of easy upgrading or modification to meet changing test needs. For example, a low cost 200V/10A system can be purchased initially, and 50A or 100A capability can be easily added later. Additionally, these instruments and accessories can be used across different test system platforms, such as for reliability or device qualification testing.

Keithley's Parametric Curve Trace configurations include everything necessary for the characterization engineer to develop a complete test system quickly. ACS Basic Edition software provides complete device characterization, including both real-time trace mode for quickly checking fundamental device parameters like breakdown voltage and full parametric mode for extracting precise device parameters. ACS Basic Edition goes beyond traditional curve tracer interfaces by offering a broad array of sample device libraries. More important, users have complete control of all test resources, allowing them to create more advanced tests than previously possible on a curve tracer.

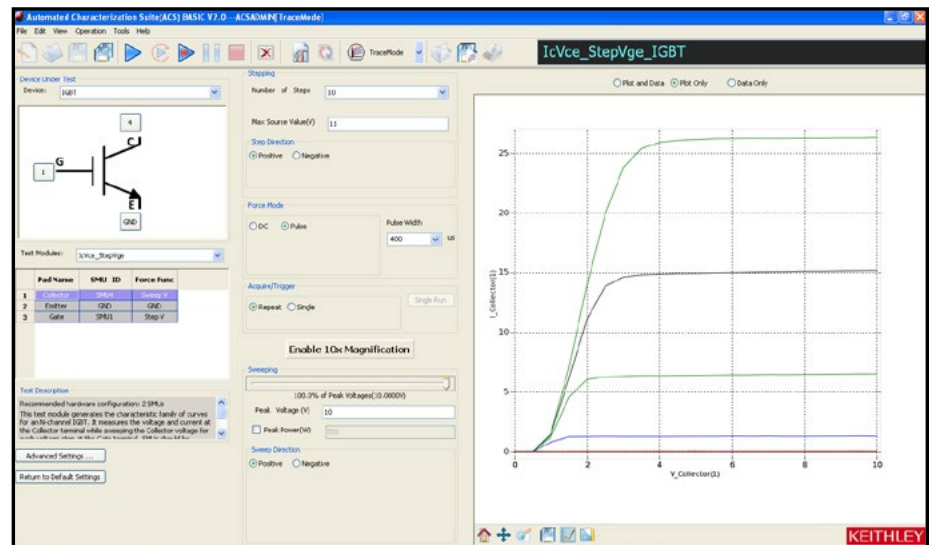

ACS Basic Edition Software quickly captures output characteristics of an IGBT device.

2600-PCT-x 4200-PCT-x

Ordering Information

- 2600-PCT-1** Low Power
- 2600-PCT-2** High Current
- 2600-PCT-3** High Voltage
- 2600-PCT-4** High Voltage and Current
- 4200-PCT-2** High Current + C-V
- 4200-PCT-3** High Voltage + C-V
- 4200-PCT-4** High Voltage and Current + C-V

Accessories Supplied

ACS-BASIC Component Test Software

8010 High Power Device Test Fixture (includes 8010-CTB, 8010-DTB, and 8010-DTB-220)

KUSB-488B USB to GPIB Adapter (Series 2600B configurations only)

All cables and adapters

Sample parts

4200-CVU-PWR (4200-SCS configurations only)

Note: Computer and monitor not included with 2600-PCT-x configurations

ACCESSORIES AVAILABLE

2651A	High Power System SourceMeter (adds 50A to any system, max 100A)
2657A	High Power System SourceMeter (adds 3kV to any system, max of one unit per system)
8010-CTB	Customizable Test Board
8010-DTB	Device Test Board with TO-247 socket
8010-DTB-220	Device Test Board with TO-220 socket
70161-MSA	Keyboard/Monitor Arm for K420 and K475 Carts
HV-CA-554-1	HV Triax Cables (three required for 2657A)
K475 Workstation Tower	Mobile cart for all PCT configurations
K420 Workbench Cart	Mobile cart for smaller PCT configurations

Parametric Curve Tracer Configurations

The Keithley Parametric Curve Trace configurations are complete characterization tools that include all of the key elements necessary for power device characterization.

The measurement channels consist of high quality Keithley SourceMeter (trademark) and/or Semiconductor Characterization instruments. The dynamic range and accuracy of these instruments is orders of magnitude beyond what a traditional curve tracer could offer.

To achieve this performance, Keithley has developed a set of precision cables to connect the instruments to the test fixture. For the high voltage channel, custom triax cables provide a guarded pathway that enables fast settling and very low currents, even at the full 3kV. For the high current channel, special low inductance cables provide fast rise time pulses to minimize device self heating effects.

Equally critical is a safe, efficient test fixture. The 8010 provides an interlocked, shielded environment that allows for both low current, high voltage testing and high current, low voltage testing. Included with the test fixture are the same high performance connectors that mate with the precision cables. Also included are protection circuits to prevent the high voltage channel from destroying the base/gate channel in the event of a device fault.

Configuration Selector Guide

Model ¹		Collector/ Drain Supply ²		Step Generator Base/Gate Supply	Auxiliary Supply
		High Voltage Mode	High Current Mode		
Low Power	2600-PCT-1	200 V/10 A	200 V/10 A	200 V/10 A	N/A
	2600-PCT-2	200 V/10 A	40 V/50 A	200 V/10 A	200 V/10 A
High Current	4200-PCT-2 plus C-V	200 V/1 A	40 V/50 A	200 V/1 A	200 V/1 A
	2600-PCT-3	3 kV/120 mA	200 V/10 A	200 V/10 A	200 V/10 A
High Voltage	4200-PCT-3 plus C-V	3 kV/120 mA	200 V/1 A	200 V/1 A	200 V/1 A
	2600-PCT-4	3 kV/120 mA	40 V/50 A	200 V/10 A	200 V/10 A
High Current and High Voltage	4200-PCT-4 plus C-V	3 kV/120 mA	40 V/50 A	200 V/1 A	200 V/1 A

1. Contact your Keithley field applications engineer for custom configurations
2. Add a Model 2651A to increase High Current Mode to either 50A or 100A.



Model 2600-PCT-4



Model 4200-SCS

1.888.KEITHLEY (U.S. only)

www.keithley.com

A Greater Measure of Confidence

KEITHLEY

A Tektronix Company

2600-PCT-x 4200-PCT-x

Parametric Curve Tracer Configurations

Typical Power Transistor Parameters

Parameter	Symbol	Test Method ¹	Maximum Range	Typical Best Resolution	Typical Accuracy
Breakdown Voltage	Bvdss, Bvceo	Id-Vd or Id (pulse)	±3000 V ²	100 μV, 10 fA	0.05% rdg + 0.05% rng
On-State Current (DC)	Vdson, Vcesat, Vf	Id-Vd	±20 A ⁴ , Optional: ±40 A ⁴	100 nA, 1 μV	0.05% rdg + 0.05% rng
On-State Current (Pulse)	Vdson, Vcesat, Vf	Id-Vd	±50 A ⁴ , Optional: ±100 A ⁴	100 μA, 1 μV	0.05% rdg + 0.05% rng
Drain/Collector Leakage Current	Idss, Ir/Icbo, Iceo	Id-Vd	±20 mA @ 3000 ^{2,5}	10 fA, 1 μV	0.2% rdg + 1% rng
Gate/Base Leakage Current	Igss, Ib	Ig-Vg	±1 A or, ±10 A Pulsed ³	10 fA, 1 μV	0.2% rdg + 1% rng
On-State Threshold Voltage or Cutoff Voltage	Vth, Vf, Vbeon, Vcesat	Id-Vg	±200 V ³	10 fA, 1 μV	0.2% rdg + 0.5% rng
Forward Transfer Admittance or Forward Transconductance	yfs Gfs, Hfe, gain	Vd-Id @ Vds	1 ms ~ 1000 s ⁶	1 pA, 1 μV	1%
On-State Resistance	RDS(on), Vcesat	Vd-Vg @ Id	<100 μΩ ⁷	10 μΩ, 1 μV	1%
Input Capacitance	Ciss	C-V 100 kHz	10 nF ⁸ ±200 V	10 fF, 10 μV	Better than 1% at C<10 nF
Output Capacitance	Coss	C-V 100 kHz	10 nF ⁸ ±200 V	10 fF, 10 μV	Better than 1% at C<10 nF
Reverse Transfer Capacitance	Crss	C-V 100 kHz	10 nF ⁸ ±200 V	10 fF, 10 μV	Better than 1% at C<10 nF

1. Test method used for extracting the parameter. Only typical MOSFET listed, but similar method for other devices.
2. Model 2657A High Power System SourceMeter® SMU Instrument.
3. Model 2636A SourceMeter SMU Instrument or Model 4210-SMU.
4. Model 2651A High Power System SourceMeter SMU Instrument or optional dual Model 2651A High Power System SourceMeter SMU Instruments.
5. Maximum 20mA at 3000V, 120mA at 1500V.
6. Typical extracted capability (Example: 1mA/1V ~ 1A/1mV).
7. Typical extracted capability (Example: 1mV/10A).
8. Max. ±200VDC (±400VDC differential) bias with 4210-CVU and 4200-CVU-PWR.

Flexible, safe test fixture for 3kV and 100A



8010 Test Fixture



High current, low inductance cables



High voltage, low noise triaxial cables

1.888.KEITHLEY (U.S. only)

www.keithley.com

KEITHLEY

A Greater Measure of Confidence

A Tektronix Company

2600-PCT-x 4200-PCT-x

Parametric Curve Tracer Configurations

Semiconductor Parametric Test Software for Component and Discrete Devices

ACS Basic Edition software is specifically tuned to take advantage of the high performance capabilities of the Keithley instrumentation and includes several sample libraries for performing common high power device tests. Unlike other systems, the software allows the user almost unlimited flexibility in configuring all of the measurement channels to create tests far beyond what a traditional curve tracer could achieve.

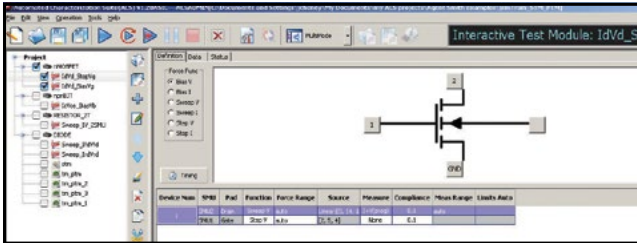

Multi test mode allows multiple tests to be performed on a device.

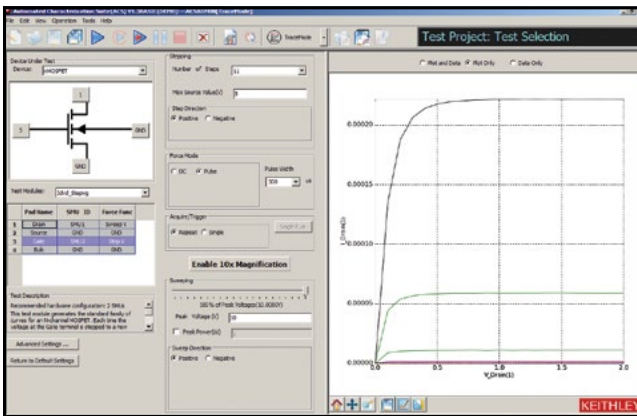

Trace mode supports interactive testing of a device.

SUMMARY OF TYPICAL TESTS

Device	Leakage	Breakdown	Gain	On-State
Bipolar Junction Transistor	IEBO, IEEO, IEVEB, ICVCB	BVCBO, BVCEI, BVCEO, BVCEV, BVEBO, BVECO	HFE	IBCO, IBEO, IBICVBE, IBVBE, ICBO, ICEV, ICVCE_BiasIB, ICVCE_BiasVB, ICVCE_StepIB, ICVCE_StepVB, VBCO, VCE
MOSFET	IDL, IDS_ISD, IGL, ISL	BVDSS, BVDSV, BVGDO, BVGDS, BVGSO	GM	IDVD_BiasVG, IDVD_StepVG, IDVG_BiasVD, IDVG_StepVD, IDVG_StepVSub, IGVG, VTCI, VTEXT, VTEXT_IISQ
Diode	IRDVRD	VBRIRD	NA	DYNAMICZ, IFDVF, VFDIFD, VRDIRD
Resistor	NA	NA	NA	IV
Capacitor	IV		NA	

FORMULATOR FUNCTION SUMMARY

Type	Functions
Math	ABS, AVG, DELTA, DIFF, EXP, LN, LOG, LOG10, SQRT
Parametric Extractions	GMMAX, RES, RES_4WIRE, RES_AVG, SS, SSVTCI, TTF_DID_LGT, TTF_LGDID_T, TTF_DID_T, TTF_LGDID_LGT, VTCI, VTILINGM, VTSATGM
Fitting	EXPFIT, EXPFITA, EXPFITB, LINFIT, LINFITSLP, LINFITXINT, LINFITYINT, REGFIT, REGFITSLP, REGFITXINT, REGFITXINT, REGFIT_LGX_LGY, REGFIT_LGX_X, REGFIT_X_LGY, TANFIT, TANFITSLP, TANFITXINT, TANFITYINT
Manipulation	AT, FINDD, FINDLIN, FINDU, FIRSTPOS, JOIN, LASTPOS, MAX, MAXPOS, MIN, MINPOS, POW, SMOOTH

Parametric curve tracer configurations

SEMICONDUCTOR

1.888.KEITHLEY (U.S. only)

www.keithley.com

KEITHLEY

A Greater Measure of Confidence

A Tektronix Company

S530

- Semiconductor industry's most cost-effective fully automatic parametric testers
- Optimized for use in environments with a broad mix of products, where high flexibility and system speed are critical
- Choice of low current or high voltage system configurations
 - Low current configuration supports measurement of low current characteristics such as sub-threshold leakage, gate leakage, etc.
 - High voltage configuration is optimized for monitoring processes used for GaN, SiC, and Si LDMOS power devices
- Compatible with popular fully automatic probe stations
- Instrument options for sourcing pulses, frequency measurements, and low voltage measurements
- Cabled-out tester configuration maximizes prober interface flexibility and expands voltage range
 - Compatible with Keithley's Model 9139A Probe Card Adapter
 - Supports reuse of existing five-inch probe card libraries
- Proven instrumentation technology ensures high measurement accuracy and repeatability in both the lab and the fab

Parametric Test Systems



Keithley's S530 Parametric Test Systems can address all the DC and C-V measurements required in process control monitoring, process reliability monitoring, and device characterization because they are built on proven sourcing and measurement technology.

Optimized for High-Mix Test Environments

S530 Parametric Test Systems are designed for production and lab environments that must handle a broad range of devices and technologies, offering industry-leading test plan flexibility, automation, probe station integration, and test data management capabilities. Keithley has brought more than 30 years of expertise in delivering a wide range of standard and custom parametric testers to customers around the world to the design of these test solutions.

Simple Software Migration and High Hardware Reuse

S530 systems are designed with capabilities that speed and simplify system startups and maximize reuse of your existing test resources. For example, the software that controls these systems is compatible with many new and legacy automatic probe stations, so you may be able to eliminate the cost of a new one. In addition, the S530's cabled-out configuration typically allows continued use of your existing probe card library. Several optional applications services can help you keep getting the full value of your existing prober and probe card investments. Keithley can also provide assistance to speed the development, conversion, or repurposing of your existing test recipes for use with S530 systems.

Semiconductor Industry's Most Powerful Standard Parametric Test System

Two different system configurations are available to address different parametric test application environments. The S530 Low Current System, which is configurable from two to eight source measure unit (SMU) channels, provides sub-picoamp measurement resolution and low current guarding all the way to the probe card, which makes it ideal for characterizing sub-micron silicon MOS technologies. The S530 High Voltage System, configurable from three to seven SMU channels, can source up to 1000V for use in the difficult breakdown and leakage tests that automotive electronics and power management devices demand.

1.888.KEITHLEY (U.S. only)

www.keithley.com

Table 1. S530 System Selector Guide

System Capabilities		Key Range and Offset Performance
S530 Low Current System <ul style="list-style-type: none"> • Source up to 200V or 1A • Measure current with femto-amp resolution and sub pico-amp offset • 2 to 8 SMU channels¹ • Options for C-V, pulse sourcing, frequency measurements, and low-voltage measurements • Up to 48 pins full Kelvin plus connection for chuck 		
S530 High Voltage System <ul style="list-style-type: none"> • Source up to 1000V or 1A • Use 200V SMU to measure current with femto-amp resolution and pico-amp offset • Use 1000V SMU to measure current with ten pico-amp resolution and nano-amp offset • 3 to 7 SMU channels¹ • Options for C-V, pulse sourcing, frequency measurements, and low-voltage measurements • Up to 24 pins full Kelvin plus connection for chuck 		

1. Depending on instrument options within the system.

All Series S530 systems are equipped with Keithley’s proven high power SMU instruments, which provide up to 20W source or sink capability on both the 200V and 20V ranges. This level of power is essential for complete characterization of the high power devices and circuits prevalent in today’s mobile devices. Whether the application is testing LDMOS Si or GaN BJTs, this higher power capability provides greater visibility into device performance. That means S530 systems can handle high power device testing without compromising the low current sub-picoamp sensitivity needed to monitor mainstream device processes. In contrast, competitive parametric test systems are limited to medium power 2W SMU instruments, so they cannot match the S530 systems’ range of applications.

Full Kelvin Standard Configurations

All too often, currents higher than a few milliamps lead to measurement errors as a result of voltage drops across the interface cables and pathways. To prevent this drop in measurement integrity, both the low current and high voltage S530 systems provide full Kelvin measurements (also known as remote voltage sense) at the probe card. Full Kelvin measurements are particularly critical to ensuring measurement accuracy given the 20W capability of the high power SMU instruments used in S530 systems.

Industry’s Most Powerful High Voltage Parametric Test System

The S530 High Voltage Semiconductor Parametric Test System is the only parametric tester available that’s capable of full Kelvin high voltage performance on up to 24 pins, a capability that’s invaluable for characterizing today’s higher power devices. The system incorporates a high voltage SMU that sources up to 1000V at 20mA (20W max.). Two high voltage pathways allow making either direct high-side current measurements (in which a single SMU is used to both source and measure the high side of the DUT) or higher sensitivity low-side low current measurements (in which one SMU is used to source high voltage to the high side of the DUT and a different SMU is used to force 0V and measure the current of the low side).

System Architecture

Each S530 system configuration is made up of five layers:

- Instruments layer – In addition to SMU instruments, the S530 offers options for sourcing pulses or making C-V, frequency, or low voltage measurements.
- Pathways layer – S530 systems provide high fidelity signal pathways that can be dynamically reconfigured to allow any instrument to be connected to any pin or set of pins during test.
- Cable interface layer – All system interconnects are constructed of fully shielded and guarded triaxial low leakage, high voltage cables to ensure higher measurement integrity.
- Probe card adapter (PCA) layer – This layer extends the shield and guard to the probe card to ensure measurement integrity. Also, the PCA provides auxiliary inputs for instruments that require direct access to the probe card and must bypass the signal path switch matrix.
- Probe card layer – This layer includes the custom cards supplied by your probe card vendors.

Signal Pathways

The core of each S530 test system is a set of high fidelity signal pathways through the system switch that direct signals between instruments and test pins. The S530 has eight high fidelity pathways that can be used to route instruments to pins dynamically. For example, up to eight SMU instruments can be routed to any pin (or number of pins) at one time. The S530 Low Current System uses switch matrices that deliver uniform performance across all eight pathways. The S530 High Voltage System uses switch matrices with specific pathways for high voltage/low leakage measurements and also for C-V. Refer to models 7174A and 7072-HV data sheets for more details.

Table 2. S530 Pathway Performance

Pathway Type	Key Characteristics	Maximum Voltage	Maximum Current	Comments
Low Current I-V ¹	Ultra low leakage	200V	1A	Limited to 200V max. Provides best low-level signal performance and excellent C-V performance.
High Voltage I-V ²	1300V	1300V	1A	Supports low-level measurements but not quite as low as the Low Current pathway.
General-Purpose I-V ²		200V	1A	Suitable for the majority of parametric tests, except for very low current and/or high voltage tests.
C-V ²		200V	1A	Excellent C-V performance but not suitable for DC I-V measurements.

1. Available only on low current system.

2. Available only on high voltage system.

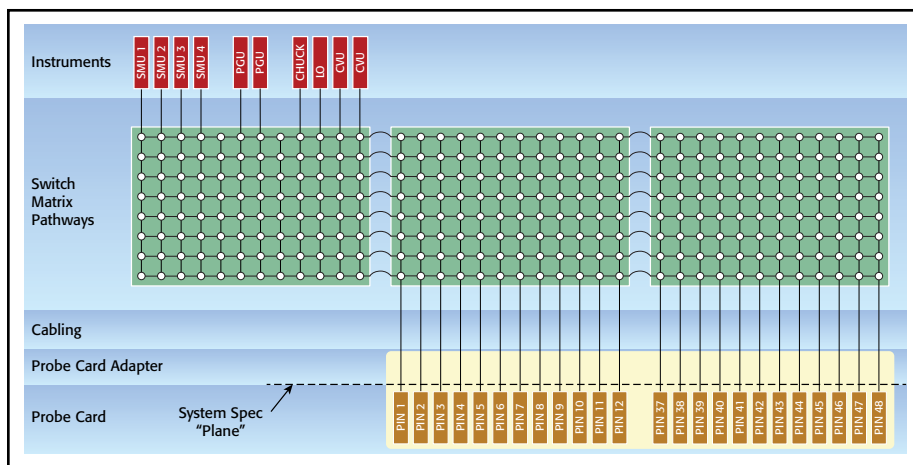

Every S530 system is made up of five layers: instruments, switch pathways, cable interface, probe card adapter, and probe card.

Proven SMU Technology

All source measurement units (SMU instruments) built into S530 Parametric Test Systems are based on Keithley's production-qualified instrument technology to ensure high measurement accuracy and repeatability and extended hardware life. The SMU instruments are four-quadrant sources, so they can source or sink current or voltage. In addition to precision sourcing circuits, they include programmable limits (compliance) across all ranges, which helps protect both devices and probe tips from damage due to device breakdown. Each SMU also measures both voltage and current while sourcing, which ensures that parameter calculations reflect actual conditions rather than simply the programmed conditions.

System Measurement Options

For a wider range of test structures and measurements, the S530 can be equipped with several measurement options:

- Capacitance-Voltage (C-V) Unit – Capable of measuring a 10pF capacitor at 1MHz with a typical accuracy of 1%.
- Pulse Generator Unit – The optional pulse generator unit supports open load pulse amplitudes from $\pm 100\text{mV}$ to $\pm 40\text{V}$, with pulse widths from 100ns to 1s and pulse transitions from 50ns to 200ms. Up to six pulse channels can be added (in increments of two channels). Add one to three dual-channel units for applications such as flash memory testing.
- Frequency measurements – For measuring test structures such as ring oscillators, a frequency measurement option is available for the S530. This option uses one port on the switch matrix and is intended to allow the user to measure ring oscillator structures. The option has a frequency range of 10kHz to 20MHz and can measure signals from 10mV rms to 1V rms.
- Low-voltage measurements – An optional 7½-digit digital multimeter (DMM) augments the voltage measurement capabilities to allow both differential and non-differential voltage measurements from sub-500 μV to 400V (up to 1000V in S530 High Voltage system) for measuring structures including van der Pauw, contact chains, metal resistors and other devices where small voltages must be measured accurately.

Ground Unit (GNDU)

All SMU instruments are referenced to the ground unit or GNDU. During a test, the GNDU provides both a common reference and a return path for current sourced by the SMU instruments. The GNDU signal is formed by combining all the Source LO and Sense LO signals and referencing them to system ground. The system can easily be configured for a range of ground system configurations to accommodate various probe station ground schemas.

1.888.KEITHLEY (U.S. only)

www.keithley.com

KEITHLEY

A Greater Measure of Confidence

A Tektronix Company

Standard 9139A Probe Card Adapter

The standard probe card adapter (PCA) for the S530 parametric test systems is the proven Model 9139A. Several key features and performance advantages have made it the industry's leading choice of PCA for more than 20 years:

- Low offset currents that maximize low current performance.
- Low noise performance that helps ensure the integrity of low-level voltage measurements.
- Minimally invasive, low profile design that allows easy camera integration.
- 64 inputs – Configurable to support both standard cable connections from the tester and auxiliary inputs for instruments that bypass the pathway matrix.
- 500V pin-to-pin isolation (1000V when connecting only to every other pin).

High flexibility cabled-out configuration

S530 systems are “cabled-out” configurations to provide the broad interconnect flexibility that high-mix fab and lab environments demand. These systems can be interfaced to a variety of probing solutions, including high performance circular probe cards, cost-effective rectangular edge-connector probe cards, and even special high performance cards for applications that involve extreme temperatures or demand high durability.

Table 4. S530 System Cabling Options

Cabling Options	Probe Card Type	Features	Benefits
Standard Keithley 9139A PCA (S400-type)	Circular ceramic	Extends driven guard to probe pin	Superior low current measurements. Supports up to 64 pins; easily configured for auxiliary inputs for additional instrument options
Custom Cabled to Existing PCA Type	Typically for five-inch rectangular probe cards using edge card connectors	Compatible with existing probe card library	Reduces migration cost by reusing existing probe cards
Unterminated Cables	Cables connected to pathway output with unterminated cable ends	Ready to cable to existing interface or fixture	Provides recommended cable to optimize system performance
No Cables	Custom probe card	No need to purchase a cable solution	Use cable system provided by custom probe card vendor

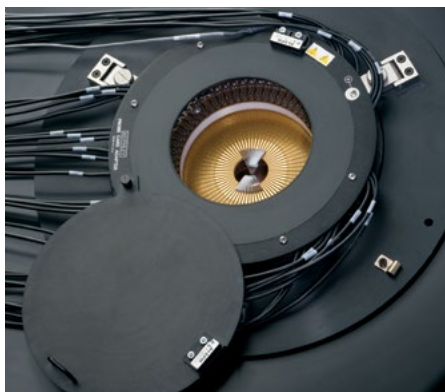

The Model 9139A Probe Card Adapter has been trusted by the industry for more than 10 years. Its combination of low current performance and high voltage capability makes it the ideal companion to the S530 Parametric Test Systems.

Alternative Probe Card Adapters (PCAs)

Optional probe card adapters are available for all S530 configurations. In the simplest form, the edge connector used to interface to a rectangular probe card (typically referred to as five-inch probe cards) is a PCA. This type of PCA provides the most cost-effective solution for applications involving mid-range signal levels. If desired, the Model 9139A PCA can be configured into any S530 system as an option. This PCA is designed for interfacing the system to circular probe cards (from Keithley-approved vendors) via pogo pin connections. Probe-station-specific adapter plates can be specified during ordering to ensure the Model 9139A's compatibility with a variety of popular probe stations.

Probe Cards

Unlike testhead-based systems, S530 systems are easily adaptable for use with a wide range of probe card types, so you likely won't need to

replace your existing (and expensive) probe card library. Although Keithley recommends the use of the Model 9139A PCA and approved probe card vendors, we recognize you have made a major investment in your current cards. If probe card reuse is critical to your capital equipment strategy, consult an applications team member to learn about connection options that can protect your probe card investment.

System Software

Keithley's S530 system relies on the Keithley Test Environment (KTE) software for test development and execution. Hosted a standard industrial PC with a Linux OS, KTE incorporates decades of Keithley parametric test experience into its latest generation test system. Measurement routines and test plans can be easily written, converted, or re-used, helping you get up and running faster. That simplifies using your S530 system effectively in conjunction with existing test systems. S530 software includes all the key system software operations:

- Wafer description
- Test macro development
- Test plan development
- Limits setting
- Wafer or cassette level testing with automatic prober control
- Test data management

User Access Points (UAPs) for Added Flexibility

User Access Points or UAPs can be used to modify the operational flow of the test sequence at key events like “load wafer,” “start test,” “end cassette,” etc. They are useful for adding system capabilities like reading wafer cassette RFID tags or reading wafer IDs using an OCR system. During test operation, an enabled UAP triggers the execution of one or more custom operations defined in a script or executable program.

System Diagnostics and Reliability Tools

Diagnostics can be performed routinely to ensure the system is performing as expected and won't generate false failures or false passes. The S530 systems' diagnostics capability verifies system functionality quickly and easily. Key steps in the diagnostics process include configuration verification, communications pathway tests, signal pathway testing, and SMU source-measure tests. Even the cable interface

1.888.KEITHLEY (U.S. only)

www.keithley.com

and PCA are included in the diagnostics process to ensure complete system functionality. This diagnostics process is designed to detect and localize a wide range of system problems, speed troubleshooting, and maximize uptime.

High Voltage Instrument Protection Modules

The S530 High Voltage System contains a 1kV SMU that might be used on one terminal of a DUT while applying a 200V SMU or the CVU to another terminal. If a test sequence or a failed DUT presents too much voltage to one of these lower voltage instruments, serious instrument damage is possible. To minimize the potential for these problems, Keithley engineers have developed protection modules that prevent damaging voltages from harming the 200V SMU instruments and CVU without compromising their low-level measurement capabilities.

Industrial PC with RAID Mirror Drive

Even the highest quality disk drives are subject to routine failures, so regular system backups are critical. S530 systems incorporate a high

reliability industrial controller including the RAID (Redundant Array of Independent Disks) option, designed to maintain a mirror of the master drive at all times. In the event of a drive failure, the mirror drive becomes the master and the user is notified that a drive replacement should be scheduled immediately. With a RAID mirror drive, a failed drive represents a scheduled repair rather than a downed system.

Support Services and Contracts

Keithley's worldwide network of service and applications professionals provides expert support services ranging from initial installation and calibration to repairs and test plan migration services. These services maximize system utilization and uptime while reducing your overall cost of ownership.

- **Installation and Probe Station Integration Services** – Includes the setup and verification of the system, as well as probe station integration. This includes setting up probe station communications and installing the probe card adapter.
- **Calibration Services** – All S530 Parametric Test Systems are calibrated onsite by a certified Keithley field service engineer.¹ Keithley provides a range of internationally recognized accredited calibration services, including A2LA (American Association for Laboratory Accreditation) accredited calibration.²
- **Repair Services** – Repair services ranging from on-site service contracts to self-service module-swaps are available.
- **Test Plan Migration Services** – Keithley's experienced applications engineers are skilled at converting your existing test plans to the S530 system software environment. This includes conversion of data objects like user test libraries, wafer description files, cassette plans, etc.
- **Correlation Studies** – Keithley applications engineers can perform correlation studies, comparing your existing parametric test system's capability to the S530's and analyzing the underlying performance differences.

1. While most components of the system are calibrated on site, certain components are calibrated at one of Keithley's worldwide network of service facilities.
2. A2LA accredited calibration services are available in the United States and Germany.

Specification Conditions

23°C ±5°C, 1 year.
RH between 5% and 60% after 1 hour warm-up.
System-level specifications are to the end of the Keithley PCA.
All specs are based on 1 year calibration cycle for individual instruments.
Measurement Specifications @ 1 PLC (Power Line Cycle) unless otherwise noted.
Capacitance Specifications are typical @ quiet mode.

General I/V Source Specifications

MAXIMUM OUTPUT POWER PER SMU: 20W (four quadrant source or sink operation).
COMPLIANCE: Compliance resolution and accuracy are determined by the corresponding range used.

Condensed Specifications

Low Current System

Current Range	Max. Voltage	MEASURE		SOURCE	
		Resolution	Accuracy	Resolution	Accuracy
1 A	200 V	10 µA	0.03% + 1.5 mA + 1.3 pA/V	20 µA	0.05% + 1.8 mA + 1.3 pA/V
100 mA	200 V	1 µA	0.02% + 20.0 µA + 1.3 pA/V	2 µA	0.03% + 30.0 µA + 1.3 pA/V
10 mA	200 V	100 µA	0.02% + 2.5 µA + 1.3 pA/V	200 nA	0.03% + 6.0 µA + 1.3 pA/V
1 mA	200 V	10 nA	0.02% + 200.0 nA + 1.3 pA/V	20 nA	0.03% + 300.0 nA + 1.3 pA/V
100 µA	200 V	1 nA	0.02% + 25.0 nA + 1.3 pA/V	2 nA	0.03% + 60.0 nA + 1.3 pA/V
10 µA	200 V	100 nA	0.03% + 1.5 nA + 1.3 pA/V	200 pA	0.03% + 5.0 nA + 1.3 pA/V
1 µA	200 V	10 pA	0.03% + 500.6 pA + 1.3 pA/V	20 pA	0.03% + 800.6 pA + 1.3 pA/V
100 nA	200 V	1 pA	0.06% + 100.6 pA + 1.3 pA/V	2 pA	0.06% + 100.6 pA + 1.3 pA/V
10 nA	200 V	100 fA	0.15% + 3.6 pA + 1.3 pA/V	200 fA	0.15% + 5.6 pA + 1.3 pA/V
1 nA	200 V	10 fA	0.15% + 880.0 fA + 1.3 pA/V	20 fA	0.15% + 2.6 pA + 1.3 pA/V
100 pA	200 V	1 fA	0.15% + 760.0 fA + 1.3 pA/V		

Voltage Range	Max. Current	MEASURE		SOURCE	
		Resolution	Accuracy	Resolution	Accuracy
200 V	100 mA	1 mV	0.02% + 50 mV	5 mV	0.02% + 50 mV
20 V	1 A	100 µV	0.02% + 5 mV	500 µV	0.02% + 5 mV
2 V	1 A	10 µV	0.02% + 480 µV	50 µV	0.02% + 730 µV
200 mV	1 A	1 µV	0.02% + 355 µV	5 µV	0.02% + 505 µV

Capacitance	10kHz	100kHz	1MHz
10 pF	0.50%	0.50%	1.00%
100 pF	0.50%	0.50%	1.00%
1 nF	0.50%	0.50%	4.00%
10 nF	0.50%	0.50%	5.00%
100 nF	1.00%	1.00%	5.00%

1.888.KEITHLEY (U.S. only)

www.keithley.com

KEITHLEY

A Greater Measure of Confidence

A Tektronix Company

High Voltage System ¹

Current Range	Max. Voltage	MEASURE		SOURCE	
		Resolution	Accuracy	Resolution	Accuracy
1 A	200 V	10 μ A	0.03% + 1.5 mA + 0.94 pA/V	20 μ A	0.05% + 1.8 mA + 0.94 pA/V
100 mA	200 V	1 μ A	0.02% + 20.0 μ A + 0.94 pA/V	2 μ A	0.03% + 30.0 μ A + 0.94 pA/V
20 mA	1100 V	100 μ A	0.04% + 1.2 μ A + 0.94 pA/V	500 nA	0.05% + 4.0 μ A + 0.94 pA/V
10 mA	200 V	100 μ A	0.02% + 2.5 μ A + 0.94 pA/V	200 nA	0.03% + 6.0 μ A + 0.94 pA/V
1 mA	1100 V	10 nA	0.03% + 200.0 nA + 0.94 pA/V	50 nA	0.03% + 300.0 nA + 0.94 pA/V
100 μ A	1100 V	1 nA	0.03% + 25.0 nA + 0.94 pA/V	5 nA	0.03% + 60.0 nA + 0.94 pA/V
10 μ A	1100 V	100 nA	0.03% + 1.5 nA + 0.94 pA/V	500 pA	0.03% + 5.0 nA + 0.94 pA/V
1 μ A	1100 V	10 pA	0.03% + 504.1 pA + 0.94 pA/V	50 pA	0.04% + 804.1 nA + 0.94 pA/V
100 nA	200 V	1 pA	0.06% + 104.1 pA + 0.94 pA/V	2 pA	0.06% + 104.1 pA + 0.94 pA/V
10 nA	200 V	100 fA	0.15% + 7.1 pA + 0.94 pA/V	200 fA	0.15% + 9.1 pA + 0.94 pA/V
1 nA	200 V	10 fA	0.15% + 4.4 pA + 0.94 pA/V	20 fA	0.15% + 6.1 pA + 0.94 pA/V
100 pA	200 V	1 fA	0.15% + 4.3 pA + 0.94 pA/V		

¹ Specifications using high performance pathways. When the general purpose pathways are used:

- Maximum voltage is limited to 200V.
- Leakage increases by 3.6pA/V.
- Less accuracy in lower ranges (100pA through 1 μ A).

Voltage Range	Max. Current	MEASURE		SOURCE	
		Resolution	Accuracy	Resolution	Accuracy
1000 V	20 mA	10 mV	0.015% + 50.2 mV	50 mV	0.02% + 100.2 mV
200 V	1 A	1 mV	0.015% + 50.0 mV	5 mV	0.02% + 50.1 mV
20 V	1 A	100 μ V	0.015% + 5.0 mV	500 μ V	0.02% + 5.1 mV
2 V	1 A	10 μ V	0.02% + 374.0 μ V	50 μ V	0.02% + 680.0 mV
200 mV	1 A	1 μ V	0.015% + 324.0 μ V	5 μ V	0.02% + 680.0 mV

Capacitance	10 kHz	100 kHz	1 MHz
10 pF	0.50%	0.50%	3.00%
100 pF	0.50%	0.50%	2.00%
1 nF	0.50%	0.50%	7.00%
10 nF	0.50%	0.50%	5.00%
100 nF	1.00%	1.00%	5.00%

Using dedicated C-V paths.

PULSE GENERATOR UNIT OPTION

NUMBER OF CHANNELS PER PGU: 2.

MAXIMUM VOLTAGE: ± 40 V.

TYPICAL PULSE WIDTH RANGE: 100ns to 1s.

TYPICAL PULSE TRANSITIONS: 50ns to 200ms.

FREQUENCY ANALYSIS OPTION

TYPICAL FREQUENCY MEASUREMENT RANGE:

10kHz to 20MHz.

TYPICAL AMPLITUDE MEASUREMENT RANGE:

10mV_{RMS} to 1V_{RMS}.

LOW-VOLTAGE DMM OPTION

7.5 digit resolution.

LOWEST RANGES: 100mV with 10nV resolution. 1V with 100nV resolution.

GENERAL

CABINET WIDTH AND DEPTH: 60.2cm \times 91.2cm (23.7 in. \times 35.9 in.).

NOMINAL LINE POWER: 100V, 115V, 220V, 240V (50Hz, 60Hz).

POWER CONSUMPTION: Rated at 2.4kVA for the 2kW power distribution unit.

RECOMMENDED OPERATING CONDITIONS:

Temperature: 23° \pm 5°C (73.4°F \pm 9°F).

Humidity: 30% to 60% relative humidity, non-condensing, after a two hour warm up time.

Refer to S530 Administrative Guide for more system and facilities details.

S500

- Highly configurable, instrument-based system
- Ideal for SMU-per-pin Wafer Level Reliability (WLR) testing, high speed parallel test, die sorting and binning, NBTI, Process Control Monitoring (PCM)
- Intuitive test setup, data gathering and analysis with ACS software
- Keithley's backplane provides high speed measurement throughput
- Flexible solution to meet emerging and mature testing needs
- Full control of automated and semi-automated probers
- Develop and execute tests at the device, site, wafer, and cassette level

Integrated Test System

Versatile Systems with the Instrument Advantage

S500 Integrated Test Systems are highly configurable, instrument-based systems for semiconductor characterization at the device, wafer, or cassette level. Built on our proven instrumentation, S500 Integrated Test Systems provide innovative measurement features and system flexibility, scalable to your needs. The unique measurement capability, combined with the powerful and flexible Automated Characterization Suite (ACS) software, provides a comprehensive range of applications and features not offered on other comparable systems on the market. Specific capabilities and system configurations include:

- Full-range source measure unit (SMU) instrument specifications, including sub-femtoamp measurement, ensure a wide range of measurements on almost any device.
- Pulse generation and ultra-fast I-V for memory characterization, charge pumping, single-pulse PIV (charge trap analysis), and PIV sweeps (self-heating avoidance).
- Low or high channel-count systems, including parallel test, with Keithley's system-enabling and scalable SMU instruments.
- High voltage, current, and power source-measure instrumentation for testing devices such as power MOSFETs and display drivers.
- Switching, probe cards, and cabling take the system all the way to your DUT.

Flexibility Combined with Applications Experience

S500 Integrated Test Systems are designed around three standard Keithley principles: configuration, integration, and customization. What this means to you is that you will receive a comprehensive test system for semiconductor characterization with both industry-leading Keithley hardware and highly configurable ACS software applications that include device characterization, reliability/WLR, parametric, and component functional test. With Keithley's proven instrumentation and user-friendly ACS software, the S500 is configured, integrated, and customized with the applications experience that only Keithley can provide.

Value-Focused Systems and Service

- Assessment of individual application needs for customization
- Proposal of integrated system configuration
- Installation and system user support
- Management of system-out cabling and probe card adaptation
- Implement training, test code development, and applications services
- Assurance of turnkey solutions for future applications



1.888.KEITHLEY (U.S. only)

www.keithley.com

Key System Components

- **4200-SCS lab-grade parameter analyzer characterizes devices using unique instrumentation modules such as sub-femtoamp SMU instruments, capacitance-voltage units, pulse generators, and ultra-fast I-V units**
- **Series 2600B family of System SourceMeter SMU Instruments offering a wide dynamic range of 1fA to 10A and 1 μ V to 200V, combines into a high channel-count system via the Keithley TSP-Link interface**
- **Model 707B high speed switch matrix integrates seamlessly with Series 2600B System SourceMeter SMU Instruments via the Keithley TSP-Link interface for a complete multipoint test solution**
- **Model 2410 High Voltage 20W SourceMeter Unit sources up to 1100V, 1A**
- **Model 2651A High Power System SourceMeter SMU Instrument offers 2000W pulsed power, 200W DC power, and up to 50A @ 40V with pA and μ V resolution**
- **ACS software provides intuitive test setup, data gathering and analysis for parametric characterization from single die to full cassette**
- **Full control of automated and semi-automated probers, as well as other test instruments, further simplifies device test and characterization**

Flexible and User-Friendly Software Environment

Each comprehensive S500 test system includes advanced components and productivity features to make workflow smooth and easy. The ACS application software is designed to perform complex functions, such as:

- Wafer description
- Test setup
- Prober control
- Test execution
- Real-time and post-test analysis

The integrated test plan and wafer description function allows the user to set up single or multiple test plans on one wafer and selectively execute them later, either manually or automatically. Additionally, the user has maximum flexibility for performing applications—easily switching between lab use (manual) and production (fully automated) using the same test plan.

High Throughput WLR

SMU-per-pin configuration is especially beneficial in scaled CMOS reliability testing.

- Ideal for DC “on-the-fly” NBTI testing
- High speed measurements produce lifetime predictions from two to five times faster than conventional WLR solutions
- Embedded Test Script Processor (TSP[®]) technology and deep measurement buffers ensure deterministic timing on all pins
- Up to 200V stress and picoamp measurements provide a wide range of capabilities and technologies
- Real-time plotting provides visibility into tests as they occur

Automated Device Characterization

Exceptional balance of high precision testing and automated data gathering.

- Flexible configurations to meet current and emerging test needs
- Powerful analysis, presentation, and reporting tools
- Control full and semi-automatic probers with intuitive setup and operation



Parametric Die Sort

Uniquely suited for multi-site parallel testing for die sort and other high throughput applications.

- Multi-group testing allows groups of SMU instruments to execute in parallel on different devices, structures, or dies
- True parallel test is enabled through distributed processing with embedded Test Script Processor (TSP[®]) technology in each SMU.
- High voltage and high current capabilities provide capabilities across a wide range of technologies
- Large library of ready-to-use tests and parameter extractions



ACS

- Supports a wide array of instruments and probers
- Intuitive GUI simplifies I-V tests, analysis and results from bench-top to fully automated parametric testers
- Develop and execute tests at the device, site, wafer and cassette level
- Intuitive GUI for test plan development and interactive operation
- Interactive and real-time data plotting
- Highly portable test projects with minimal or no modifications
- Supports multiple SMUs for parallel testing
- Flexible, modular software accommodates evolving and mature test requirements

APPLICATIONS

Compatible with emerging and mature testing needs for:

- Component test
- Component characterization
- Device characterization
- Parametric test
- Reliability test
- Die sort

Ordering Information

ACS Component Characterization Suite Software

Automated Characterization Suite Software

One Powerful Software Solution—A Wide Range of Hardware Configurations

Keithley's Automated Characterization Suite (ACS) is a flexible, interactive software test environment designed for device characterization, parametric test, reliability test and even simple functional tests. ACS supports a wide array of Keithley instrumentation and systems, hardware configurations, and test settings, from a few bench-top instruments for use in a QA lab to fully integrated and automated rack-based parametric testers.

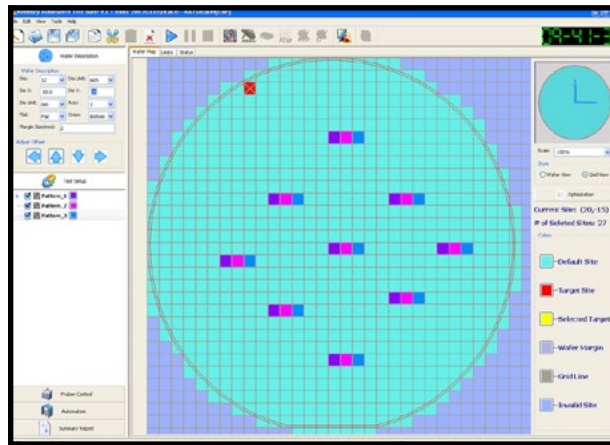

ACS offers exceptional testing and analysis flexibility, plus its intuitive GUI helps novice users be productive almost immediately, regardless of their level of programming experience. The GUI simplifies configuring test instrumentation, making I-V measurements, getting results, and analyzing them quickly because no coding is required. Even if you're an infrequent user, you can go from creating a new test setup to characterizing new devices in a fraction of the time older test development approaches require. Just as important, ACS provides all the tools you need to set up tests, analyze data, and export your results—without ever leaving the ACS environment.

ACS – From Lab to Fab

Series 2600B

Multiple Series 2600Bs

4200-SCS, 707B

S500

S530

Choose ACS for What It Gives You that Others Don't

There are many alternatives on the market for creating characterization applications, but ACS offers major advantages that competitive solutions can't match, such as a choice of three powerful project development options. With ACS, you can create the tests you need in the way that best suits your application's requirements and your own programming preferences.

- You say you're a researcher and you just need to make a quick test of common parameters and properties on a single device? We've packaged the same tests that our semiconductor customers use to verify their

products into **easy-to-use applications libraries**. These libraries help you get the data you need to validate your work quickly so you can get back to your research sooner.

- Need more test development flexibility? Our **interactive test development GUI** lets you select bias and sweep conditions, acquire raw data, then use the built-in Formulator tool to extract meaningful results—all without writing code.
- For the ultimate test development flexibility, modify one of the existing test scripts in our applications libraries using the **embedded script editing and debugging tools**.

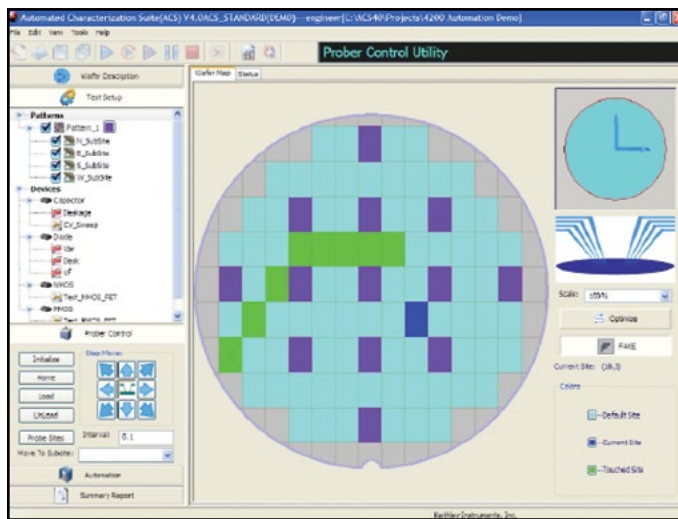

Interactive probe station control speeds and simplifies test development and debugging by combining interactive testing with manual probe station control.

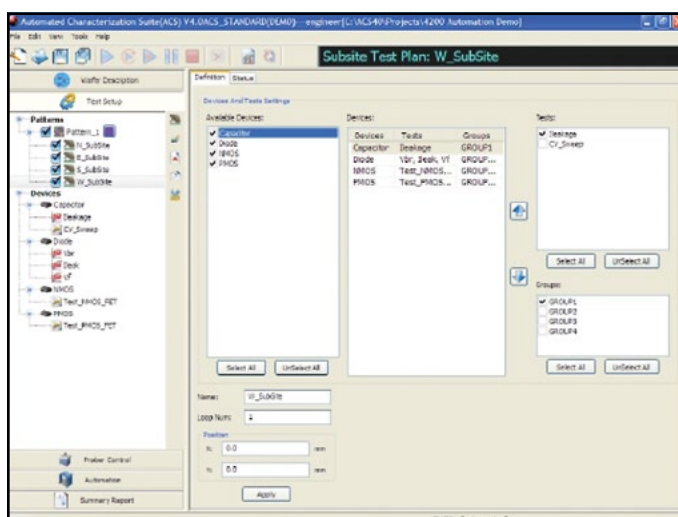

ACS lets you map devices and tests to sites and subsites, so there's no need to duplicate each test for each subsite, reducing your test development time significantly.

Automate Your Data Gathering Processes

Need the throughput advantages of a semi-automatic or fully automatic wafer probe station to get lots of data fast? The wafer prober automation option for ACS makes it easy to interface a variety of popular probe stations into your test setup. This option includes a wafer description utility (for creating a virtual wafer to use in creating wafer-level sampling plans), real-time wafer maps with binning capabilities (for designating a device's disposition before it's packaged, in die sorting, etc.), a cassette sample plan utility (for designating which wafers are to be tested), and a post-test cassette and wafer review utility (for exploring and comparing test results from multiple wafers interactively).

Many of the tools and capabilities built into ACS enhance automated device characterization:

- Wafer- and cassette-level automation
- Limits file generation tool
- Test results binning, including interactive binning plot
- Test map—map device and tests to sites and subsites
- Interactive probe station control mode
- Real-time plotting
- Single or per-wafer Keithley data file
- SQLite™ database and binning file output options
- Lot summary report generator
- Integrated support for Keithley Series 2600B and 2400 SourceMeter families
- Integrated scripting editor and GUI builder
- Integrated support for C (with 4200-SCS only), Python, and Lua (for Series 2600B) programming languages

Share Test Projects and Results

ACS offers a common set of key elements that work across a wide range of hardware configurations, which saves time and increases productivity. Systems perform consistently from one hardware implementation to another, so, for example, it's easy to transfer your knowledge of an ACS-based system used in single-device component characterization to another designed for wafer level testing.

Similarly, test projects and sequences you create for one Keithley ACS hardware configuration will run on compatible setups in other test settings

1.888.KEITHLEY (U.S. only)

www.keithley.com

KEITHLEY

with little or no modification. This portability across a range of configurations reduces the effort involved in transferring a new device from one lab or department to another and simplifies comparing results obtained in various test settings. This is possible because ACS employs common open-standard file interfaces for projects, wafer maps, output files, etc. as well as common test libraries and instrument drivers, which also means you can be confident of high results correlation whether your tests are run on a system with a single Series 2600B SMU instrument or a fully automated custom die sort tool with dozens of these instruments.

Maximize the Productivity of Your Keithley Hardware

The tools in ACS simplify test development and maximize the speed of each Keithley instrument linked into the system. For example, ACS builds on the throughput advantages inherent in Keithley's newest family of high performance source measurement units, the Series 2600B System SourceMeter® SMU instruments. These advantages include:

- The on-board Test Script Processor (TSP®) in each instrument that allows each 2600B to operate independently of the ACS system's controller
- The TSP-Link Technology high speed communications bus used to network multiple 2600B SMU instruments together
- True parallel test execution
- Precision timing

Together, ACS and Keithley TSP-based hardware offer the highest throughput in the industry to lower the cost of test without requiring you to spend time learning new programming concepts or languages before getting the data needed to accomplish your goals.

Add More Hardware to Adapt to Changing Needs

High scalability and a flexible architecture simplify configuring an ACS system to match your specific testing requirements or to upgrade an existing system to handle new test needs as they evolve. Our wide range of source-measure and switching capabilities provides a solid foundation for configuring customized applications because ACS software can control virtually any instrument or peripheral with a standard hardware interface. For example, third-party LCR meters can be easily integrated into any ACS system and drivers are available for popular instruments. Also, ACS's integrated scripting environment can control any GPIB instrument the application may require, such as a hot chuck controller.

Many ACS systems are configured using one or more of Keithley's innovative Series 2600B System SourceMeter SMU instruments, which are optimized for precision sourcing and measurement synchronization to capture high speed events. These systems offer unmatched testing speed and accuracy because they provide an SMU-per-pin architecture. ACS system configurations can support any number from two to more than 40 SMU instruments in a single rack for true parallel characterization applications.

ACS also makes it easy to integrate other types of Keithley hardware into your system, such as instruments to meet specialized test requirements, such as:

- High channel count switching—Model 707B Six-slot Switch Mainframe
- Combination of switching and measurement—Series 3700A Switch/Multimeters
- High voltage sourcing—Model 237 High Voltage Source-Measure Unit
- Higher resolution, lower current, or other capabilities such as C-V or pulse testing—Model 4200-SCS
- Wider dynamic range—Series 2400 SourceMeter SMU instruments

Broad Range of Applications

ACS-based Integrated Test Systems are complete solutions for applications such as parametric die sort and wafer level reliability testing. When paired with appropriate semi-automatic and fully automatic probe stations, their hardware configurations and test project development can be easily optimized for specific tasks. ACS leverages the on-board test script processors in Series 2600B System SourceMeter SMU instruments into a multi-processor environment that's ideal for true parallel test in both single- and multi-site configurations. This multi-processor environment provides high parallel throughput while speeding and simplifying test project development. Multi-site testing capabilities are embedded throughout ACS from the wafer description utility to the test results output file or binning file, for example:

- Multi-site parallel testing brings the highest possible throughput for both parametric die sort and WLR applications
- Configurable for special applications like MEMS testing
- Easily customize test flows with User Access Points (UAPs) that execute scripts or call custom utilities

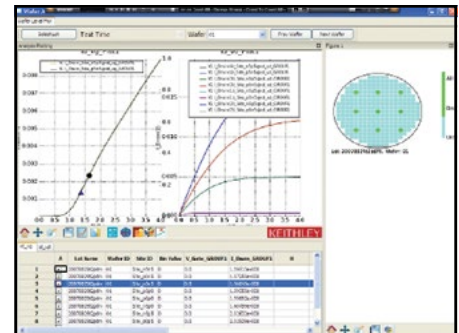

Wafer and binning map tools allow you to browse through the test results on either a wafer-by-wafer or site-by-site basis. You can also overlay traces from multiple sites to make quick comparisons.

ACS Basic Edition

Semiconductor Parametric Test Software for Component and Discrete Devices



- **Designed for packaged devices (MOSFETs, BJTs, IGBTs, diodes, resistors, etc.)**
- **Rich set of test libraries for fast and easy test setup and execution without programming**
- **Built-in data analysis tools for quick analysis of parametric data**
- **Supports Keithley's Series 2600B, Series 2400, and Model 2651A and Model 2657A System SourceMeter SMU instruments**
- **FREE optional off-line version for developing test setups on a different PC**
- **Windows® 7 and XP compatible**

Ordering Information

ACS-BASIC Component Characterization Software

ACS-BASIC-UPGRADE (available for existing ACS Basic customers)

Optimized for parametric testing of component and discrete (packaged) semiconductor devices, ACS Basic Edition maximizes the productivity of technicians and engineers in research and development. The versatile architecture of this software allows it to meet the wide ranging and ever changing requirements of semiconductor device testing. It supports all of Keithley's source and measure instrument products, including Series 2600B, Series 2400, and Model 2651A and Model 2657A SourceMeter® SMU instruments.

This powerful, yet cost effective solution includes Keithley's rich set of proven parametric libraries. Simply choose the desired test and begin running it to immediately start gathering data and analyzing it. Users also have the option of customizing any test with the embedded script editor.

The built-in data analysis tools allow users to quickly analyze the parametric data. For example, place device curves developed from newly collected data over "golden" curves for fast comparisons. To perform specialized calculations on raw data, use the mathematical formulator tool to create customized parameter calculations. Data can be easily saved in graphical and/or tabular formats.

ACS Basic offers three modes of operation:

- **Single Test Mode**—for single device, single test operations
- **Multi Test Mode**—for multiple test operations on a single device
- **Trace Mode**—for mapping out the operating range and characteristics of a semiconductor device while minimizing the risk of damage to it. This mode offers an interactive method of controlling the voltage level of a sweep with a slide bar or the arrow keys on the PC keyboard.

Related Products

For applications requiring wafer level testing, use ACS Integrated Test Systems or ACS Wafer Level Reliability Systems. These systems supply a wafer map, prober automation capabilities, and analysis options for yield monitoring as well as related statistical calculations for maximizing productivity in wafer level test environments.

ACCESSORIES AVAILABLE

2600-FIX-TRX	Grounded Phoenix-to-Triax Cable Adapter
8101-4TRX	Leaded Component Test Fixture
ACS-COMP	PC for Installed and Bench-top ACS Systems
KUSB-488A	IEEE-488.2 USB-to-GPIB Interface Adapter for USB Port
LR-8028	DIP Component Test Fixture

KEY APPLICATIONS

- **Materials and device development**
- **Quality assurance**
- **Device inspection**

1.888.KEITHLEY (U.S. only)

www.keithley.com

A Greater Measure of Confidence

KEITHLEY

A Tektronix Company

ACS Basic Edition

Semiconductor Parametric Test Software for Component and Discrete Devices

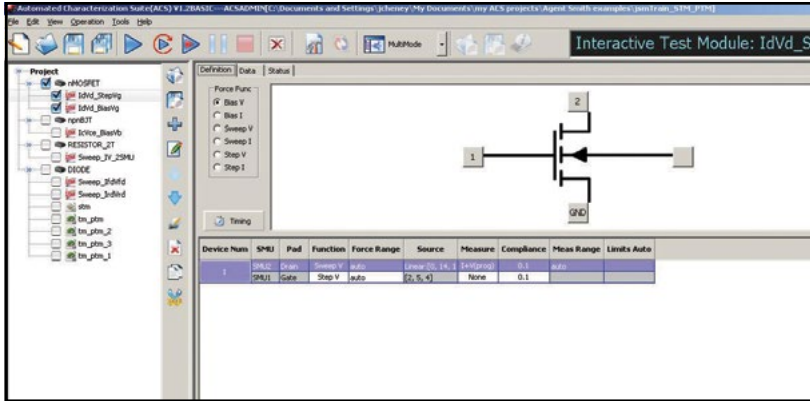

Multi Test Mode allows multiple tests to be performed on a device.

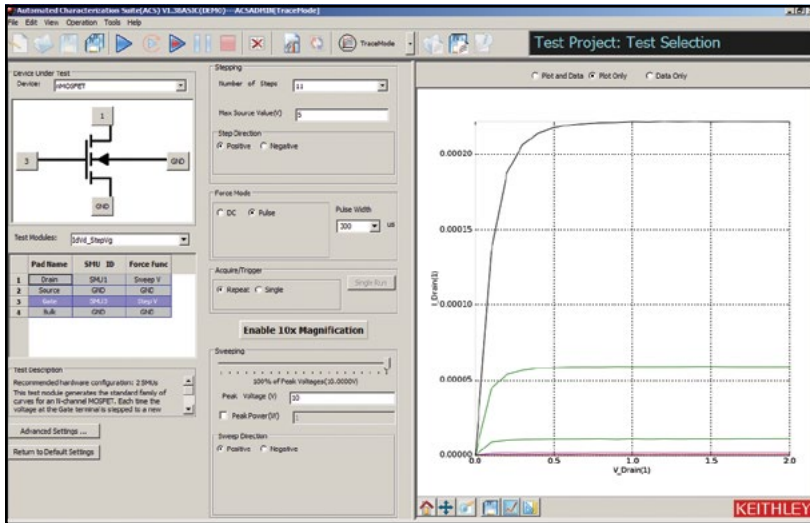

Trace Mode supports interactive testing of a device.

SUMMARY OF TYPICAL TESTS

Device	Leakage	Breakdown	Gain	On-State
Bipolar Junction Transistor	IEBO, IECO, IEVEB, ICVCB	BVCBO, BVCEI, BVCEO, BVCEV, BVEBO, BVECO	HFE	IBCO, IBEO, IBICVBE, IBVBE, ICBO, ICEV, ICVCE_BiasIB, ICVCE_BiasVB, ICVCE_StepIB, ICVCE_StepVB, VBCO, VCE
MOSFET	IDL, IDS_ISD, IGL, ISL	BVDSS, BVDSV, BVGDO, BVGDS, BVGSO	GM	IDVD_BiasVG, IDVD_StepVG, IDVG_BiasVD, IDVG_StepVD, IDVG_StepVSUB, IGVG, VTCl, VTEXT, VTEXT_IISQ
Diode	IRDVRD	VBRIRD	NA	DYNAMICZ, IFDVFED, VFDIFD, VRDIRD
Resistor	NA	NA	NA	IV
Capacitor	IV	NA	NA	

FORMULATOR FUNCTION SUMMARY

Type	Functions
Math	ABS, AVG, DELTA, DIFF, EXP, LN, LOG, LOG10, SQRT
Parametric Extractions	GMMAX, RES, RES_4WIRE, RES_AVG, SS, SSVTCI, TTF_DID_LGT, TTF_LGDID_T, TTF_DID_T, TTF_LGDID_LGT, VTCl, VTILINGM, VTSATGM
Fitting	EXPFIT, EXPFITA, EXPFITB, LINFIT, LINFITSPL, LINFITXINT, LINFITYINT, REGFIT, REGFITSPL, REGFITXINT, REGFITYINT, REGFIT_LGX_LGY, REGFIT_LGX_Y, REGFIT_X_LGY, TANFIT, TANFITSPL, TANFITXINT, TANFITYINT
Manipulation	AT, FINDD, FINDLIN, FINDU, FIRSTPOS, JOIN, LASTPOS, MAX, MAXPOS, MIN, MINPOX, POW, SMOOTH

ACS-2600-RTM

- Leverages unique strengths of Keithley Series 2600B System SourceMeter® SMU instruments – including system scalability and measurement speed
- System configurations from 2 to 44 channels
- Comprehensive JEDEC-compliant test suite
- Optimized for both emerging and mature technologies
- Supports both sequential and parallel testing
- Fully automatic single-site and multi-site capability
- Compatible with all popular wafer probe stations
- Real-time plotting and wafer mapping

APPLICATIONS

- **Device reliability**
 - HCI, NBTI, PBTI
- **Gate oxide integrity**
 - TDDB, V_{RAMP} , J_{RAMP}
- **Metal interconnect**
 - Isothermal electromigration
 - Poly heater
 - Constant current
 - ILD TDDB

Ordering Information

ACS-2600-RTM
Wafer Level Reliability
Option to ACS

Wafer Level Reliability Option to ACS



Keithley has taken the power of its Automated Characterization Suite (ACS) software and focused it on wafer level reliability (WLR) testing. ACS-2600-RTM is an option to ACS that leverages the measurement speed and system integration capabilities of Keithley's Series 2600B System SourceMeter® SMU instruments. The result—you can produce lifetime predictions from two to five times faster than you can with conventional WLR test solutions, allowing you to accelerate your technology development, process integration, and process monitoring for faster time to market.

With the ACS-2600-RTM option, ACS offers comprehensive single- and parallel-device WLR testing capability. Integrated with our innovative 2600B SourceMeter SMU instruments, your WLR system will provide unmatched testing speed and accuracy via an SMU-per-pin architecture. A single 2600B dual-channel source measure unit (SMU) is suitable for single-device reliability testing. Or take advantage of the TSP-Link Technology bus on the 2600B SMU instruments for systems with as many as 44 SMU channels (2 for each 2600B) for testing large numbers of devices in parallel and increasing overall system

productivity. In addition to precise low-level measurements, the 2600B SMU instruments can supply high voltage (200V) and high current (1.5A) sourcing and measurement to every test structure pad. This maximizes system flexibility, so you don't need one solution for gate oxide integrity and a different system for metal interconnect reliability. Looking for a complete system solution? Keithley offers ACS with its highly configurable S500 Integrated Test Systems and application development services.

Extensive Software Capabilities

No coding is required to take full advantage of the source-measure capability of the 2600Bs or the tools included in the ACS software environment. The ACS-2600-RTM option provides a powerful stress/measure sequencing tool with an interactive interface for testing device reliability, gate oxide integrity, and metal interconnects (EM). Its flexible test sequencing capabilities support pre- and post-testing, as well as intra-stress testing and stress monitoring. During testing, you can log raw reliability data into the database and/or plot it in real time. This real-time plotting provides a “sneak peek” at a test's outcome to let you know whether time-consuming tests are on track to deliver meaningful results. After testing, use the easy point-and-click analysis offered by the integrated Formulator, which is populated with standard parametric extraction calculations. In addition, a variety of modeling, line fitting, and standard math functions allow custom data manipulation without programming.

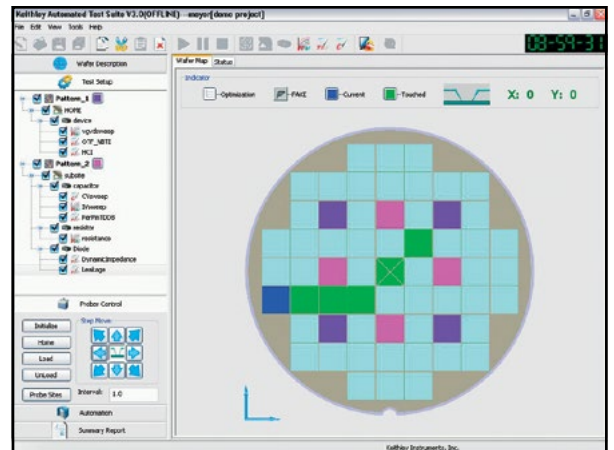

1.888.KEITHLEY (U.S. only)

www.keithley.com

A Greater Measure of Confidence

KEITHLEY

A Tektronix Company

Wafer level reliability option to ACS

SEMICONDUCTOR

Technical Information

Active optoelectronic device characterization requires more than a current source

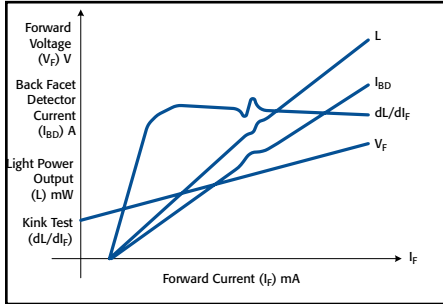

Figure 1. Classic LIV curves associated with semiconductor laser diodes.

Active optoelectronic devices are basic semiconductor junctions. To be fully tested, they require not only forward I-V characterization, but also reverse I-V characterization. While conventional laser diode drivers are valuable for providing drive current in the optics lab, these current sources aren't suitable for developing a complete understanding of a semiconductor device. The SourceMeter® line provides a full range of source and measure capability optimized for semiconductor characterization.

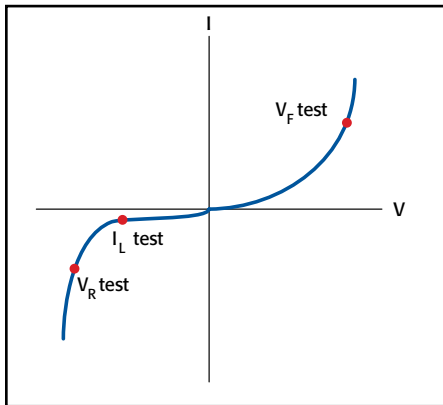

Figure 2. Characterization of semiconductor junctions requires measuring reverse breakdown (V_R), leakage current (I_L), and forward voltage (V_F).

A complete characterization of an active optoelectronic device requires forcing both forward and reverse currents and voltages. For instance, the reverse breakdown test requires sourcing

Optoelectronics Test

a very small, precise reverse current (10nA) while measuring the voltage. The limited current prevents permanent damage to the device, while allowing a precise breakdown voltage to be measured. Given the breakdown voltage, it's now possible to force a reverse bias that won't harm the device while leakage is measured. This leakage current value is often used to qualify the device for further testing.

Four-quadrant source capabilities

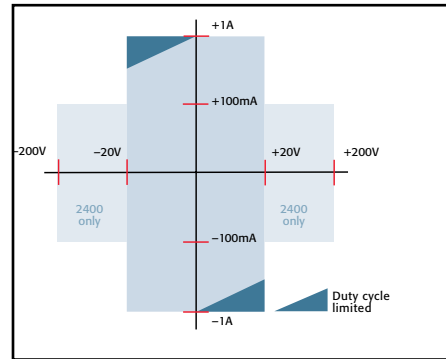

Figure 3. The Model 2400 can source or sink either current or voltage. Other SourceMeter SMU instruments offer different ranges, providing a very wide dynamic range from as low as a 1 μ A range or 200mV to 5A or 1000V.

The SourceMeter product line combines a full four-quadrant precision source (see Figure 3) with measurement capability. Source and measure ranges provide a very wide dynamic range from as low as a 1 μ A range or 200mV to 5A or 1000V. These very wide dynamic ranges allow testing diverse devices from delicate AlGaAs laser diodes to silicon avalanche photodiodes.

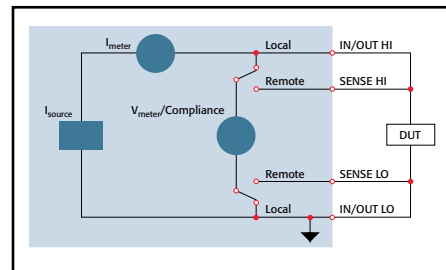

Figure 4. In current source mode, a SourceMeter SMU instrument can force current while measuring voltage. The remote voltage sense ensures the programmable voltage compliance isn't exceeded.

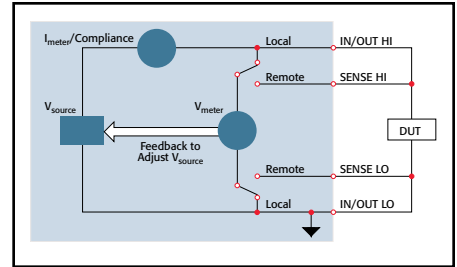

Figure 5. In voltage source mode, a SourceMeter SMU instrument forces a voltage and measures current. Remote sense of the voltage ensures the desired voltage at the DUT.

Verifying device connections

Series 2400 SourceMeter SMU instruments all offer the Contact Check option, which automatically verifies all test leads are connected to the DUT prior to energizing the test leads or executing a test sequence. Figure 6 shows Contact Check identifying a disconnected remote sense test lead. Without the sense test lead connected, the voltage compliance couldn't be controlled during test execution.

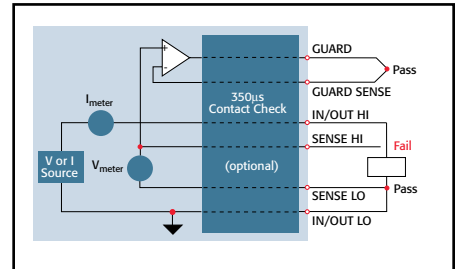

Figure 6. The contact check option verifies the force, sense, and guard test leads are properly connected to the DUT before testing begins.

Remote voltage measurement

SourceMeter SMU instruments offer two- or four-wire measurement configurations. Two-wire voltage measurement shares test leads with the source as shown in Figure 7a. When sourcing high currents, the voltage drop across the test lead becomes significant with respect to the forward voltage across the DUT.

1.888.KEITHLEY (U.S. only)

www.keithley.com

KEITHLEY

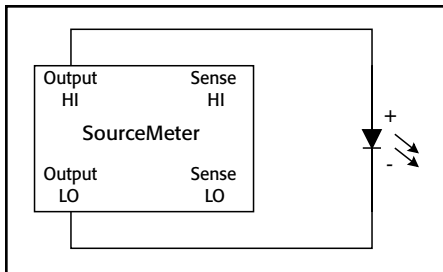

Figure 7a. Two-wire measurement

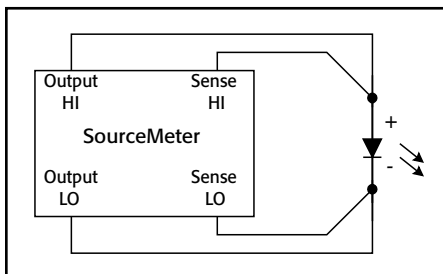

Figure 7b. Four-wire or Kelvin measurement

Four-wire voltage measurement uses dedicated test leads for measuring the voltage drop across the DUT. Since the voltage measurement circuit has very high impedance inputs, the current through the measuring test leads is low. The IR drop across the measurement test leads is an extremely small fraction of the voltage dropped across the DUT.

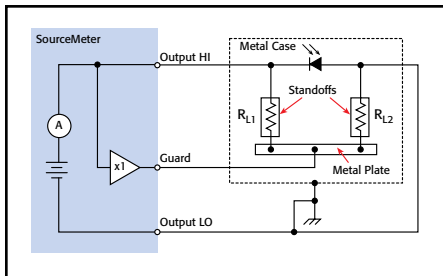

Figure 8. The cable guard circuit drives the guard conductor at the same potential as the output HI conductor.

Low level current measurements require a driven guard

Unique to precision measurement equipment, the driven guard minimizes the electrical potential difference between the conductors that surround the source test lead and the test lead (see Figure 8). When the electrical potential between the source test lead and guard test lead is low,

the potential leakage paths are neutralized. This technique requires an additional instrumentation amplifier that senses the output of the programmed source and drives the guard circuit with the same potential with enough current to overcome any leakage between the guard components and ground.

Deterministic trigger I/O

Conventional instruments typically support a simple trigger in/trigger out convention. The challenge to the engineer is controlling the trigger interaction between instruments. It is often that case that simple trigger I/O doesn't allow for differences in instrument behaviors or synchronization of multiple instruments. Figure 9 shows the trigger scheme available on most optoelectronic instrumentation.

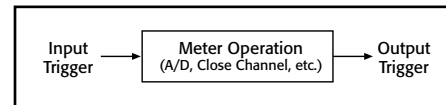

Figure 9. Typical trigger input/output scheme

A Series 2400 instrument breaks the measurement cycle into three parts, as shown in Figure 10. The three components are the source phase, delay phase, and measurement phase (also known as the SDM cycle.) The Series 2400 trigger model allows each phase in the SDM cycle to be programmed so that it can be gated by an input trigger and also to be programmed so that completion of each phase generates an output trigger.

While many instruments are limited to a single trigger in and single trigger out, Series 2400 instruments use a Trigger Link.

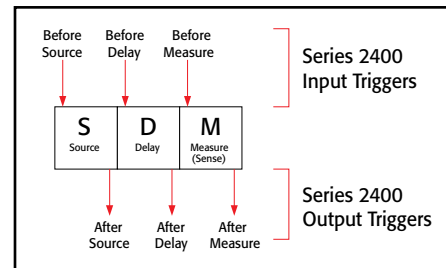

Figure 10. Series 2400 instrument's trigger input/output scheme

Precision characterization of active optoelectronic components often requires multiple instruments working together. For instance, two Series 2400 instruments can be used together: one SourceMeter SMU instrument to drive the device

and another SourceMeter SMU instrument connected to a photodiode to record the optical output of the active device. Figure 11 shows two Series 2400 instruments working synchronously together to characterize an LED.

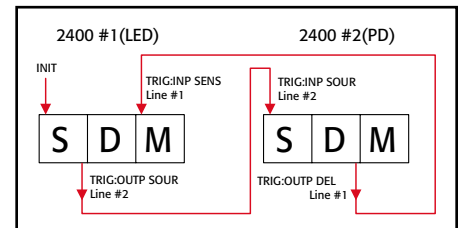

Figure 11. SDM triggers to synchronize two Series 2400 instruments.

Notice how trigger in and trigger out are tied to different parts of the SDM cycle to ensure that measurements on the LED and the PD are made at the same time. This same technique can be applied to ensure that the source current is stable prior to making an optical spectrum measurement with an additional instrument.

Complete DUT protection

DUT protection is a major concern for optoelectronic devices. SourceMeter SMU instruments are ideal for providing a safe electrical environment for delicate active optoelectronic devices.

- Normal output off mode drives the output terminals toward 0V. This action de-energizes the device and more importantly the inductive test leads. The rate of discharge can be controlled with the source range settings. This provides a better environment than shorting relays in conventional laser diode drivers.
- SourceMeter SMU instruments provide programmable compliance, range compliance, and voltage protection settings to ensure that the DUT isn't subjected to excess voltages or currents.
- Contact check ensures all test leads are in contact with the DUT prior to energizing the device.

In addition, the SourceMeter family is built on a heritage of precision semiconductor test and characterization of much more sensitive devices than active optoelectronic components.

LIV Test Systems

	2602B	2612B	System 25	2520
Page	10	10	93	85
Max. Drive Current	3 A DC / 10 A pulsed per channel	1.5 A DC / 10 A pulsed per channel	5 A	5 A
Source Mode	DC (Continuous Wave)	Pulse / DC (Continuous Wave)	DC (Continuous Wave)	Pulse / DC (Continuous Wave)
Number of Channels	1 Laser Drive, 1 Photodiode	1 Laser Drive, 1 Photodiode	1 Laser Drive, 2 Photodiode	1 Laser Drive, 2 Photodiode

Optical Power Measurement

	2502	6487	6485	Photodiode Measurement 2635B/2636B
Page	99	137	57	10

CURRENT MEASURE

From	15 fA	20 fA	20 fA	120 fA
To	20 mA	20 mA	20 mA	10 A

PHOTODIODE VOLTAGE BIAS

	100V (each channel)	500 V	none	200 V
--	------------------------	-------	------	-------

FEATURES

Optical Measurement Head	2500INT Series (Si & Ge) (190nm – 1800nm)	2500INT Series (Si & Ge) (190nm – 1800nm)	2500INT Series (Si & Ge) (190nm – 1800nm)	
Number of Channels	2	1	1	1/2
Instrument Connection	3-slot Triax	3-slot Triax	BNC	3-slot Triax
Communication	GPIB, RS-232	GPIB, RS-232	GPIB, RS-232	GPIB, RS-232, Ethernet (LXI)

Laser Diode and LED Current Drivers

	2601B	2611B	2401	2420	2440	2520	6220 6221
Page	10	10	96, 36	96 36	96 36	85	85

CURRENT SOURCE

From	5 pA	5 pA	±10 pA	±500 pA	±500 pA	70 μA	80 fA
To	3 A DC / 10 A pulsed per channel	1.5 A DC / 10 A pulsed per channel	±1.05 A	±3 A	±5A	+ 5A	±100 mA
Type	DC/Pulse	DC/Pulse	DC	DC	DC	DC/Pulse	DC/Pulse

VOLTAGE MEASURE

From	1 μV	1 μV	1 μV	10 μV	10 μV	60 μV	10 nV (w/2182A)
To	40 V	200 V	21 V	60 V	40 V	10 V	100 V (w/2182A)

FEATURES

Instrument Connection	Screw Terminal	Screw Terminal	Banana	Banana	Banana	10Ω BNC	3-slot Triax
Communication	GPIB/RS-232, TSP, Ethernet (LXI)	GPIB/RS-232, TSP, Ethernet (LXI)	GPIB/RS-232	GPIB/RS-232	GPIB/RS-232	GPIB/RS-232	GPIB/RS-232, Ethernet (6221 only)

1.888.KEITHLEY (U.S. only)

www.keithley.com

2520

Pulsed Laser Diode Test System



- Simplifies laser diode LIV testing prior to packaging or active temperature control
- Integrated solution for in-process LIV production testing of laser diodes at the chip or bar level
- Sweep can be programmed to stop on optical power limit
- Combines high accuracy source and measure capabilities for pulsed and DC testing
- Synchronized DSP based measurement channels ensure highly accurate light intensity and voltage measurements
- Programmable pulse on time from 500ns to 5ms up to 4% duty cycle
- Pulse capability up to 5A, DC capability up to 1A
- 14-bit measurement accuracy on three measurement channels (V_{fr} front photodiode, back photodiode)
- Measurement algorithm increases the pulse measurement's signal-to-noise ratio
- Up to 1000-point sweep stored in buffer memory eliminates GPIB traffic during test, increasing throughput
- Digital I/O binning and handling operations
- IEEE-488 and RS-232 interfaces



Remote Electrical Test Head included

recently, these producers were forced to use relatively slow and cumbersome test stands for testing laser diodes at the chip and bar level, which often led to production bottlenecks.

Higher Resolution for Higher Yields

To achieve the required signal-to-noise ratio, traditional chip- and bar-level LIV testing solutions have required the use of boxcar averagers or test system control software modifications to allow averaging several pulsed measurements. The resolution of these measurements is critical for the "kink" test and threshold current calculations. With earlier test system designs, particularly when performing the kink test, low resolution and poor linearity of the analog digitizer made it extremely difficult to discriminate between noise in the measurement and an actual device kink. The Model 2520's unique DSP-based measurement approach automatically

The Model 2520 Pulsed Laser Diode Test System is an integrated, synchronized system for testing laser diodes early in the manufacturing process, when proper temperature control cannot be easily achieved. The Model 2520 provides all sourcing and measurement capabilities needed for pulsed and continuous LIV (light-current-voltage) testing of laser diodes in one compact, half-rack instrument. The tight synchronization of source and measure capabilities ensures high measurement accuracy, even when testing with pulse widths as short as 500ns.

LIV Test Capability

The Model 2520 can perform pulsed LIV testing up to 5A and continuous LIV testing up to 1A. Its pulsed testing capability makes it suitable for testing a broad range of laser diodes, including the pump laser designs for Raman amplifiers. The instrument's ability to perform both DC and pulsed LIV sweeps on the same device simplifies analyzing the impact of thermal transients on the LIV characteristics of the laser diode.

Maximize Throughput and Eliminate Production Bottlenecks

By working in cooperation with leading laser diode manufacturers, Keithley designed the Model 2520 specifically to enhance chip- and bar-level test stand yield and throughput. Its integrated design, ease of use, high speed, and high accuracy provides a complete solution to help laser diode manufacturers meet their production schedules. Producers of laser diodes face constant pressure to increase test throughput and optimize return on investment for their capital equipment used in production testing. Until

APPLICATIONS

Production testing of:

- Telecommunication laser diodes
- Optical storage read/write head laser diodes
- Vertical Cavity Surface-Emitting Lasers (VCSELs)
- Thermal impedance
- Junction temperature response

1.888.KEITHLEY (U.S. only)

www.keithley.com

A Greater Measure of Confidence

KEITHLEY

A Tektronix Company

Multi-channel pulsed test of laser diodes

SEMICONDUCTOR

2520**Ordering Information****2520 Pulsed Laser Diode Test System with Remote Test Head****2520/KIT1****Pulsed Laser Diode Measurement Kit (includes 2520, 2520INT, and 3 ft. triax cable)****Accessories Supplied****User's Manual, Quick Reference Guide, Triax Cables (2), BNC 10Ω Coaxial Cables (4)****ACCESSORIES AVAILABLE**

2520INT-1-GE	Integrating Sphere (1 inch) with Germanium Detector
7007-1	Double Shielded GPIB Cable, 1m (3.3 ft.)
7007-2	Double Shielded GPIB Cable, 2m (6.6 ft.)
KPCI-488LPA	IEEE-488 Interface/Controller for the PCI Bus
KUSB-488B	IEEE-488 USB-to-GPIB Adapter for USB Port

SERVICES AVAILABLE

2520-3Y-EW	1-year factory warranty extended to 3 years from date of shipment
C/2520-3Y-DATA 3 (Z540-1 compliant)	calibrations within 3 years of purchase*

*Not available in all countries

Pulsed Laser Diode Test System

identifies the settled region of the pulsed waveforms measured. This means the Model 2520 stores only that portion of the pulse that is "flat" and contains meaningful data. All measurements made in the flat portion of the pulse are averaged to improve the Signal-to-Noise ratio still further. If greater resolution is required, the Model 2520 can be programmed to perform several pulse and measure cycles at the same pulse amplitude. By making it possible to conduct more thorough testing at the bar or chip level, the Model 2520 also eliminates the wasted time and costs associated with assembling then scrapping modules with non-compliant diodes.

Simple, One-Box Test Solution

The Model 2520 offers three channels of source and measurement circuitry. All three channels are controlled by a single digital signal processor (DSP), which ensures tight synchronization of the sourcing and measuring functions. The laser diode drive channel provides a current source coupled with voltage measurement capability. Each of the two photodetector channels supplies an adjustable voltage bias and voltage compliance, in addition to current measurement capability. These three channels provide all the source and measure capabilities needed for full LIV characterization of laser diodes prior to integration into temperature controlled modules. By eliminating the need for GPIB commands to perform test sweeps with multiple separate instruments, the Model 2520's integrated sourcing and measurement allows a significant improvement in throughput.

Remote Test Head Maximizes Signal-to-Noise Ratio

The mainframe and remote test head architecture of the Model 2520 is designed to enhance pulsed measurement accuracy, even at the sub-microsecond level. The remote test head ensures the measurement circuitry is located near the DUT, mounted on the fixture, minimizing cable effects. As the schematic in **Figure 1** shows, traditional semi-custom systems typically employed in the past require significant integration. The architecture of the Model 2520 (**Figure 2**) offers a far more compact and ready-to-use solution.

High Speed Pulse and Measure to Minimize Thermal Effects

The Model 2520 can accurately source and measure pulses as short as 500 nanoseconds to minimize unwanted thermal effects during LIV testing. Users can program the pulse width from 500ns to 5ms and pulse off time from 20μs to 500ms. There is a software duty cycle limit of 4% for currents higher than 1A. To ensure greater accuracy, the instrument provides pulse width programming resolution levels of 10μs (off time) and 100ns (on time).

Prior to the introduction of the Model 2520, test instrument limitations often placed barriers on test performance. However, with the Model 2520, the limiting factor is not the test instrument, but the

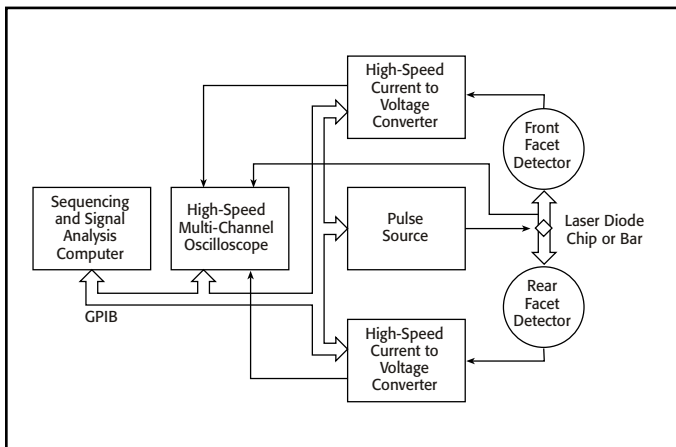

Figure 1. This schematic reflects the current testing practices of major laser diode manufacturers. Note that the use of discrete test components increases the integration and programming effort, while severely limiting the flexibility of the test system.

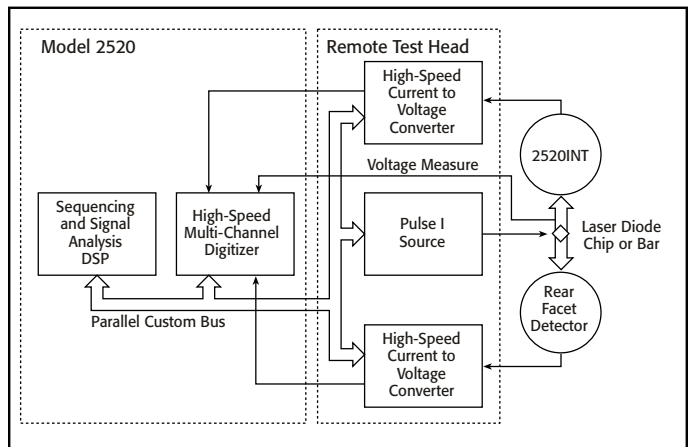

Figure 2. The Model 2520 integrates synchronization, source, and measure capabilities in a single half-rack instrument (with remote test head) to provide maximum flexibility and test throughput.

1.888.KEITHLEY (U.S. only)

www.keithley.com**KEITHLEY**

A Greater Measure of Confidence

A Tektronix Company

physics of the connections to the device. Keithley's optoelectronics applications engineers have addressed these issues by studying and documenting the optimum cable configuration to enhance measurement accuracy with extremely fast pulses. **Figure 3** illustrates the results of a typical pulse LIV sweep test with the Model 2520. In this test, a 100-point pulsed LIV sweep using a $1\mu\text{s}$ pulse width, at 1% duty cycle, was completed in just 110ms (including data transfer time), several orders of magnitude faster than existing, semi-custom test systems.

ESD Protection

A laser diode's material make-up, design, and small size make it extremely sensitive to temperature increases and electrostatic discharges (ESDs). To prevent damage, prior to the start of the test and after test completion, the Model 2520 shorts the DUT to prevent transients from destroying the device. The instrument's 500 nanosecond pulse and measure test cycle minimizes device heating during test, especially when a short duty cycle is used.

Test Sequencing and Optimization

Up to five user-definable test setups can be stored in the Model 2520 for easy recall. The Model 2520's built-in Buffer Memory and Trigger Link interface can reduce or even eliminate time-consuming GPIB traffic during a test sequence. The Buffer Memory can store up to 1000 points of measurement data during the test sweep. The Trigger Link combines six independent software selectable trigger lines on a single connector for simple, direct control over all instruments in a system. This interface allows the Model 2520 to operate autonomously following an input trigger. The Model 2520 can be programmed to output a trigger to a compatible OSA or wavelength meter several nanoseconds prior to outputting a programmed drive current value to initiate spectral measurements.

Accessories and Options

The Model 2520 comes with all the interconnecting cables required for the main instrument and the remote test head. Production test practices vary widely (automated vs. semi-automated vs. manual), so the cable assemblies from the remote test head to the DUT can vary significantly. To accommodate these differing requirements, Keithley has developed the Model 2520 RTH to DUT Cable Configuration Guide to help customers determine the proper cable assemblies to use to connect the remote test head (RTH) to the DUT.

Interface Options

The Model 2520 provides standard IEEE-488 and RS-232 interfaces to speed and simplify system integration and control. A built-in digital I/O interface can be used to simplify external handler control and binning operations.

Additional LIV Test Solutions

For production testing laser diodes after they have been packaged in temperature controlled modules, Keithley offers the Laser Diode LIV Test System with increased 28-bit core measurement resolution, allowing for more detailed characterization. This flexible system combines all the DC measurement capabilities required to test these modules with tight temperature control over the DUT in a modular instrument package. Configured from proven Keithley instrumentation, the basic configuration can be easily modified to add new measurement functions as new testing needs evolve.

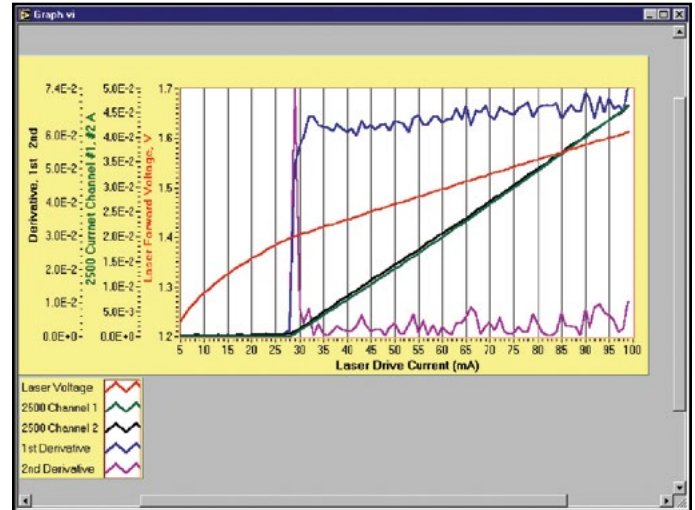

Figure 3. This plot illustrates the Model 2520's pulsed LIV sweep capability. The sweep was programmed from 0 to 100mA in 1mA steps. Pulse width was programmed at $1\mu\text{s}$ at 1% duty cycle, providing for a complete sweep in just 10ms (excluding data transfer time).



Figure 4. Model 2520 Remote Test Head

LASER DIODE PULSE OR DC CURRENT SOURCE SPECIFICATIONS

DRIVE CURRENT					OFF CURRENT ⁴			
Source Range	Programming Resolution	Approx. Electrical Resolution	Accuracy ^{1, 6} ±(%rdg. + mA) ^{2, 3}	RMS Noise (typical) (1kHz–20MHz)	Range	Programming Resolution	Approx. Electrical Resolution	Accuracy ¹ ±(%rdg. + mA)
0–500 mA	10 μA	8 μA	0.2 + 0.45	70 μA	0–15 mA	1 μA	7 nA typ.	0.2 + 0.45
0–1.0 A DC 0–5.0 A Pulse	100 μA	80 μA	0.2 + 4.5	800 μA	0–150 mA	10 μA	70 nA typ.	0.2 + 4.5

TEMPERATURE COEFFICIENT (0°–18°C & 28°–50°C): ±(0.15 × accuracy specification)/°C.

PULSE ON TIME¹⁹: 500ns to 5ms, 100ns programming resolution.

PULSE OFF TIME¹⁹: 20μs to 500ms, 10μs programming resolution.

PULSE DUTY CYCLE^{19, 20, 21}: 0 to 99.6% for ≤1.0A; 0 to 4% for >1.0A.

VOLTAGE COMPLIANCE: 3V to 10V, 10mV programming resolution⁵.

POLARITY: 1 quadrant source, polarity reversal available through internal relay inversion.

OUTPUT OFF: <200mΩ short across laser diode; measured at Remote Test Head connector.

LASER DIODE VOLTAGE MEASURE SPECIFICATIONS

Range	Minimum Resolution	Accuracy ±(%rdg. + volts) ^{1, 12}	RMS Noise (typical) ¹³
5.00 V	0.33 mV	0.3% + 6.5 mV	60 μV
10.00 V	0.66 mV	0.3% + 8 mV	120 μV

TEMPERATURE COEFFICIENT (0°–18°C & 28°–50°C): ±(0.15 × accuracy specification)/°C.

MAX. LEAD RESOLUTION: 100Ω for rated accuracy.

INPUT IMPEDANCE: 2MΩ differential, 1MΩ from each input to common.

Input bias current ±7.5μA max.

PHOTODIODE VOLTAGE BIAS SOURCE SPECIFICATIONS (each channel)

RANGE: 0 to ±20VDC.

PROGRAMMING RESOLUTION: 10mV.

ACCURACY: ±(1% + 50mV).

CURRENT: 160mA max. with V-Bias shorted to I-Measure.

RMS NOISE (1kHz to 5MHz): 1mV typical.

PHOTODIODE CURRENT MEASURE SPECIFICATIONS (each channel)

Range	Minimum Resolution ⁴	DC Input Impedance	Accuracy ±(%rdg. + current) ^{1, 2}	RMS Noise (typical) ³
10.00 mA	0.7 μA	< 10 Ω	0.3% + 20 μA	90 nA
20.00 mA	1.4 μA	< 6 Ω	0.3% + 65 μA	180 nA
50.00 mA	3.4 μA	< 3 Ω	0.3% + 90 μA	420 nA
100.00 mA	6.8 μA	<2.5 Ω	0.3% + 175 μA	840 nA

TEMPERATURE COEFFICIENT (0°–18°C & 28°–50°C): ±(0.15 × accuracy specification)/°C.

INPUT PROTECTION: The input is protected against shorting to the associated channel's internal bias supply. The input is protected for shorts to external supplies up to 20V for up to 1 second with no damage, although calibration may be affected.

SYSTEM SPEEDS

READING RATES (ms)^{15, 16}

Number of Source Points ¹⁷	To Memory	To GPIB
1	5.3	6.8
10 ¹⁸	9.5	18
100 ¹⁸	48	120
1000 ¹⁸	431	1170

Setting and Range	Load ⁷	Pulse Mode	Pulse Overshoot Max. ^{6, 8, 9}	Rise/Fall Time ^{6, 8, 9, 10}	
				Typical	Max.
500 mA	10 Ω ¼ Watt	Fast	1.0%	55 ns	80 ns
500 mA	10 Ω ¼ Watt	Slow	0.1%	1 μs	1.3 μs
5.00 A	1.5 Ω 1 Watt	Fast	1.0%	100 ns	130 ns
5.00 A	1.5 Ω 1 Watt	Slow	0.1%	1 μs	1.3 μs

GENERAL

DC FLOATING VOLTAGE: User may float common ground up to ±10VDC from chassis ground.

COMMON MODE ISOLATION: >10⁹Ω.

OVERRANGE: 105% of range on all measurements and voltage compliance.

SOURCE OUTPUT MODES:

- Fixed DC Level
- Fixed Pulse Level
- DC Sweep (linear, log, and list)
- Pulse Sweep (linear, log, and list)
- Continuous Pulse (continuous – low jitter)

PROGRAMMABILITY: IEEE-488 (SCPI-1995.0), RS-232, 5 user-definable power-up states plus factory default and *RST.

DIGITAL INTERFACE:

Safety Interlock: External mechanical contact connector and removable key switch.

Aux. Supply: +5V @ 300mA supply.

Digital I/O: 2 trigger input, 4 TTL/Relay Drive outputs (33V @ 500mA max., diode clamped).

Trigger Link: 6 programmable trigger input/outputs.

Pulse Trigger Out BNC: +5V, 50Ω output impedance, output trigger corresponding to current source pulse; pulse to trigger delay <100ns. See Figure 3.

MAINS INPUT: 100V to 240V rms, 50–60Hz, 140VA.

EMC: Conforms to European Union Directive 89/336/EEC (EN61326-1).

SAFETY: Conforms to European Union Directive 73/23/EEC (EN61010-1) CAT 1.

VIBRATION: MIL-PRF-28800F Class 3, Random.

WARM-UP: 1 hour to rated accuracy.

DIMENSIONS, WEIGHT:

Main Chassis, bench configuration (with handle & feet): 105mm high × 238mm wide × 416mm deep (4¼ in. × 9¼ in. × 16¼ in.). 2.67kg (5.90 lbs).

Remote Test Head: 95mm high × 178mm deep (with interlock key installed) × 216mm wide (3½ in. × 7 in. × 8½ in.). 1.23kg (2.70 lbs).

ENVIRONMENT:

Operating: 0°–50°C, 70% R.H. up to 35°C. Derate 3% R.H./°C, 35°–50°C.

Storage: –25° to 65°C.

1.888.KEITHLEY (U.S. only)

www.keithley.com

KEITHLEY

A Greater Measure of Confidence

A Tektronix Company

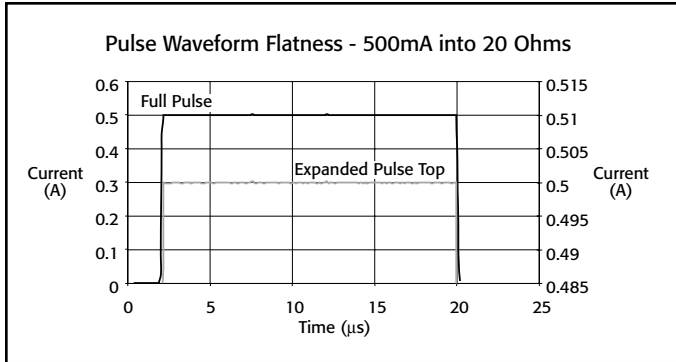

Figure 1

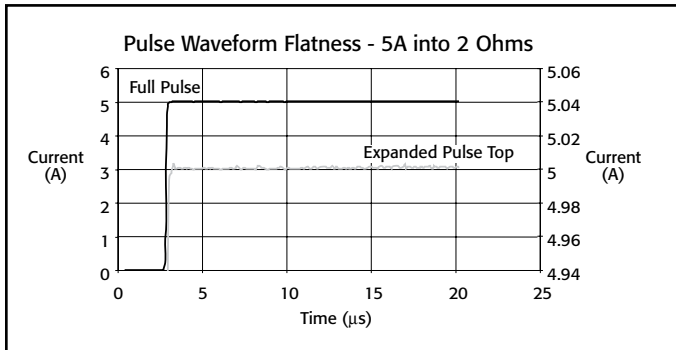

Figure 2

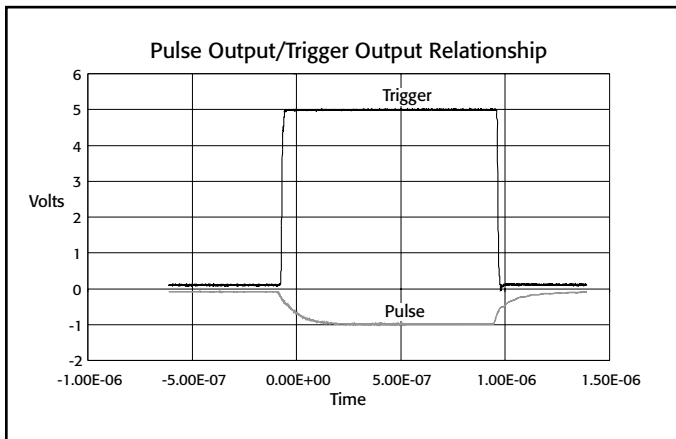

Figure 3

NOTES

- 1 year, 23°C ±5°C.
- If $\sqrt{\text{Duty Cycle}} \cdot I$ exceeds 0.2, accuracy specifications must be derated with an additional error term as follows:
 500mA Range: $\pm 0.1\% \text{ rdg.} \cdot \sqrt{D} \cdot I$
 5A Range: $\pm 0.3\% \text{ rdg.} \cdot \sqrt{D} \cdot I$
 where: I = current setting
 D = duty cycle
 This derating must also be applied for a period equal to the time that $\sqrt{D} \cdot I$ was ≥ 0.2 .
- Not including overshoot and setting time.
- Pulse mode only.
- Output: 500mA DC on 500mA range and 1A DC on 5A range.
- Refer to Model 2520 Service Manual for test setup of current accuracy.
- Figures 1 and 2 are typical pulse outputs into resistive loads.
- Typical.
- Per ANSI/IEEE Std 181-1977.
- Per ANSI/IEEE Std 181-1977 10% to 90%.
- DC accuracy $\pm 700\text{mV}$ @ output terminal. 0.2Ω typical output impedance.
- At DC, 10µs measurement pulse width, filter off.
- Standard deviation of 10,000 readings with 10µs pulse width, filter off, with I source set to 0A DC.
- The A/D converter has 14 bit resolution. The useful resolution is improved by reading averaging. The useful resolution is:

$$\text{Useful Resolution} = \frac{\text{Range}}{2^{14}} \cdot \frac{1}{\sqrt{\frac{\text{Pulse Width (ns)} - 400\text{ns}}{100\text{ns}} \cdot \text{Averaging Filter Setting}}}$$
- Excluding total programmed (Pulse ON time + Pulse OFF time).
- Front panel off, calc off, filter off, duty cycle <10%, binary communications.
- Returning 1 voltage and 2 current measurements for each source point.
- Sweep mode.
- Valid for both continuous pulse and sweep modes.
- Shown is the Power Distribution % based on current settings.
- Timing Cycle ($P\%/(pw + pd)$): 4% max.

2520INT

Integrating Sphere for Pulsed Measurements



- **Optimized for laser diode pulse testing**
- **Suitable for production and laboratory environments**
- **Built-in germanium detector**
- **Works seamlessly with the Model 2520 Pulsed Laser Diode Test System**

interior is highly reflective Spectralon, which scatters, reflects, and diffuses the source beam the DUT produces. This spreads the light from the DUT uniformly over the sphere's interior surface with minimal absorption loss. The detector, which reads the amount of optical power produced by the DUT, is mounted on the interior surface. Due to the multiple diffuse reflections within the sphere, the amount of optical radiation that strikes the detector is the same as that which falls on any other point on the sphere's interior. To convert the attenuated signal measured by the detector into an accurate optical power measurement, the sphere and detector are calibrated as a unit.

Simplifies Beam Alignment

In a typical laser diode manufacturing line, the laser diode is not coupled to an optical fiber until the final stages of the packaging process. Therefore, any pulse testing performed on a laser diode at the bar- or chip-level would require a difficult and time-consuming beam alignment process in order to focus all of the diode's output on the optical detector.

To ensure acceptance of the complete beam with maximum divergence angles, the sphere can be located up to 3 millimeters from the DUT, positioned so the diode's light output enters the ¼-inch port on the sphere's side. Any light that enters the sphere is captured in the measurement taken by the Model 2520.

The Model 2520INT Integrating Sphere is designed to optimize the Model 2520 Pulsed Laser Diode Test System's optical power measurement capabilities. It allows the testing of devices with pulse widths as short as 500ns. The short pulses of the Model 2520 combined with the speed of the Model 2520INT make them ideal for measuring the optical power of laser diodes at the bar or chip level, before these devices are integrated into temperature-controlled modules. When connected to the Model 2520 via a low noise triax cable, the Model 2520INT allows the Model 2520 to make direct, high accuracy measurements of a laser diode's optical power. The results are expressed in milliwatts.

Designed Specifically for Pulsed Laser Diode Testing

Keithley developed the Model 2520INT to address the challenges specific to pulse testing laser diodes, which include short pulse periods and fast rise times. For example, when testing laser diodes in pulse mode, the optical head used must provide a response that's fast enough to measure light pulses as short as 500ns. Many optical power detectors are hampered by long rise times, so they can only measure a portion of the laser diode's light output. Even when using a "fast" detector, many detectors are not good for analog signal measurement. By linking the Model 2520 with the optimum combination of sphere and detector characteristics, Keithley provides the low-level sensitivity needed to ensure accurate pulse measurements.

Easier Laser Diode Power Measurements

An integrating sphere is inherently insensitive to variations in the beam profile produced by a device under test (DUT). The Model 2520INT's

APPLICATIONS

Bar- or chip-level LIV production testing of:

- **980 or 1480 EDFA pump lasers**
- **Raman amplifiers**
- **Telecommunication laser diodes**
- **High power telecommunication VCSELs**

ACCESSORIES REQUIRED

2520	Pulsed Laser Diode Test System
7078-TRX	Low Noise Triax Cable

1.888.KEITHLEY (U.S. only)

www.keithley.com

KEITHLEY

A Greater Measure of Confidence

A Tektronix Company

2520INT

Ordering Information

2520INT-1-Ge

1 inch Integrating Sphere with Germanium Detector

2520/KIT1

Pulsed Laser Diode Measurement Package (Includes 2520, 2520INT, and 3-foot triax cable)

Accessories Supplied

Quick Start Guide, calibration data (supplied as a printed chart and in CSV format on a floppy diskette), base and 1/4–20 post for mounting

Integrating Sphere for Pulsed Measurements

Attenuation of Laser Diode Output

Detectors usually have a maximum power limit of a few milliwatts before the detector is over-saturated. The Model 2520INT Integrating Sphere's highly reflective Spectralon interior surface eliminates the problem of detector saturation. This coating reflects and diffuses the light output from the DUT uniformly over the interior surface of the sphere, which inherently attenuates the level of power read by the built-in detector. The power level at any point on the sphere's interior surface is far less than the power level of a beam that falls directly on the detector. This allows testing much higher power devices without risking detector damage. The Model 2520INT's design attenuates the power output of a laser diode by approximately 100:1.

Optimized for Telecommunications Wavelengths

The Model 2520INT's germanium detector is capable of detecting wavelengths from 800–1700nm. The detector and the sphere are calibrated as a unit in 10nm increments at wavelengths that are of particular interest for laser diode testing (950–1010nm and 1280–1620nm). Calibration constants are provided in printed form as well as in CSV format on a floppy diskette to simplify programming them into a test system. When combined with the Model 2520 Pulsed Laser Diode Test system is capable of measuring power ranging from 14.5mW to 7W, depending on the wavelength (see the specifications for power ranges by wavelengths of interest).

Fiber Tap for Additional Measurements

The Model 2520INT offers production test engineers the flexibility to decrease overall testing time by supporting multiple optical measurements simultaneously. An additional port on the sphere is compatible with an SMA connector; together, the port and fiber tap can be used to output a fraction of the measured light to an external instrument (such as a spectrometer) via a multimode fiber for additional optical measurements.

Eliminates Back Reflections

During testing, the stability of a laser diode can be significantly affected by back reflections from objects in the optical path. The geometry of the Model 2520INT and the diffusing properties of its reflective interior help prevent back reflection and ensure greater device stability during testing.

Production or Laboratory Environments

A slight curvature on the face of the sphere makes Model 2520INT easier to integrate into an automated test system. This curvature allows additional room to connect the sphere to the DUT electrically and simplifies integration with other system components.

The Model 2520INT is designed with four strategically located mounting holes for flexible mounting on laboratory tables or in automated test fixtures. Two of the holes are sized to accommodate metric fixtures, while the other two are designed for use with English fixtures. The Model 2520INT comes with a 1/4–20 base and post.

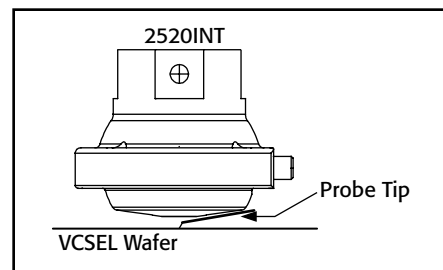

A slight curvature on the face of the sphere allows additional room to connect the DUT electrically in close quarters, such as in wafer probing.

1.888.KEITHLEY (U.S. only)

www.keithley.com

A Greater Measure of Confidence

KEITHLEY

A Tektronix Company

Simplifies pulsed measurements of optical power

SEMICONDUCTOR

2520INT

Integrating Sphere for Pulsed Measurements

Specifications

FULL ACCEPTANCE ANGLE¹: 90° vertical, 50° horizontal (max.).

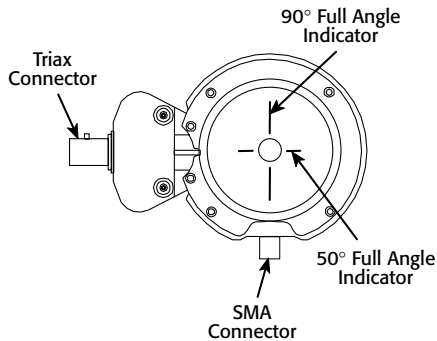

Frontal View of Integrating Sphere Showing Full Acceptance Angle Indicators

OPERATING WAVELENGTH RANGE: 800–1700nm.

CONTINUOUS WAVE (CW) CALIBRATION WAVELENGTH RANGE²: 950–1010nm and 1280–1620nm.

Wavelength (nm)	Measurable Optical Power Range ³	Typical Responsivity ⁴ (mA/W)	Resolution ⁵ (mW)
980	29mW–7W	3.5	0.2
1310	17mW–4W	6.0	0.1
1480	14.5mW–3.5W	7.0	0.1
1550	13.5mW–3W	7.5	0.1

MAXIMUM REVERSE BIAS: 5V (recommended).

DARK CURRENT AT MAX REVERSE BIAS: 4μA (typ.); 10μA (max.).

PHOTODIODE ELECTRICAL CONNECTIONS ON 3 LUG TRIAX⁶:

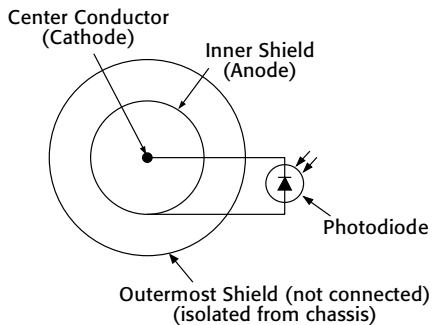

PULSED OPERATION: The 2520INT supports the pulse capabilities of the 2520 Pulsed Laser Diode Test System.

FIBER TAP PORT: Connector Type: SMA. Numerical Aperature (NA): 0.22 (typ.).

Multi-Mode Patch Cord Core Diameter (μm)	Typical Attenuation (dB)
400	39.5
100	53
62.5	58.2
50	63

GENERAL

INPUT PORT DIAMETER: 0.25 in (6.35mm).

RECOMMENDED CALIBRATION CYCLE: 1 year.

OPERATING TEMPERATURE: 0°–50°C.

STORAGE TEMPERATURE: –25°C–65°C.

DIMENSIONS⁸: 60.0mm long × 86.4mm high × 45.7mm deep (2.36 in × 3.40 in × 1.80 in).

WEIGHT⁸: 0.15kg (0.33 lbs).

NOTES

- Maximum distance from input port to accept at full maximum acceptance angle: 3.1mm (0.12 in).
- Calibration performed at 10nm wavelength intervals.
- Based on detector being linear to up to 25mA photocurrent and on a signal to noise ratio (SNR) ≥ 100:1.
- Calibration of the 2520INT is performed with an open fiber tap port. The power measurement will increase by approximately 1% with an SMA patch cord attached to the port.
- Based on resolution of Model 2520 at 10mA (lowest) current measurement range.
- This configuration MUST have a NEGATIVE (reverse) bias voltage applied. If a positive (forward) bias is applied, the detector (photodiode) will become damaged.
- Use of single mode fiber is not recommended.
- Only for integrating head, does not include post and base.

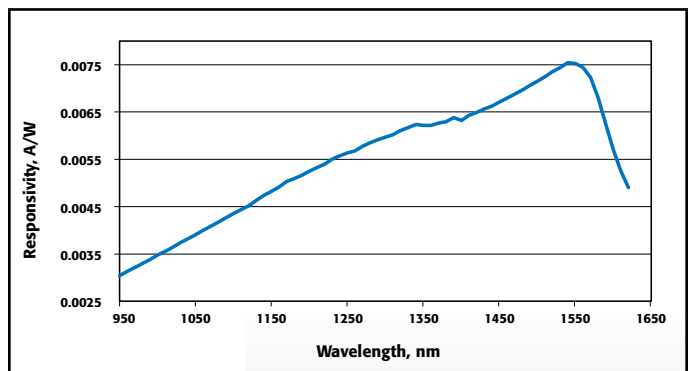

Typical responsivity of the Model 2520INT

System 25

Laser Diode Test System Kit



- Programmable LIV test system for laser diode modules
- Sweep and measure 400 points in <8s
- Very low noise current source (50 μ A) for laser diode drive
- Up to 5A laser diode drive current
- Measures optical power directly
- 1fA resolution for dark current measurements
- Fully digital P-I-D loop for temperature control
- $\pm 0.005^{\circ}\text{C}$ temperature stability, $\pm 0.001^{\circ}\text{C}$ setpoint resolution
- Trigger Link, source memory, and buffer memory support automatic test sequencing, which greatly reduces GPIB bus traffic to improve test throughput
- Expandable and flexible for future requirements

Complete DC Test System with Temperature Control

Keithley's LIV (light-current-voltage) Test System Kit is designed to help manufacturers of laser diode modules (LDMs) keep pace with production demands by allowing them to boost yield and throughput. The LIV test system combines all the DC measurement capabilities required to test these modules with optical power measurement and tight temperature control over the device under test in an integrated instrument package. The LIV test system is configured from proven Keithley instrumentation; the basic configuration can be easily modified to add new measurement functions or to allow for new connections.

Tight Integration Ensures Higher Test Speeds

The LIV test system allows for fast, easy integration and high test speeds because all the building blocks come from the same supplier. All newer Keithley instruments include the Trigger Link feature and digital I/O lines, as well as standard IEEE-488 (GPIB) and RS-232 interfaces, to speed and simplify system integration and control. The Trigger Link feature combines independent software selectable trigger lines on a single connector for simple, direct control over all instruments in a system without the need for constant traffic over the GPIB. This feature is particularly useful for reducing total test time if the test involves a sweep. The digital I/O lines simplify external handler control and binning operations.

Source memory and buffer memory, provided by Models 2400-LV, 2420, 2440, and 2502, enable elimination of GPIB traffic during sweep testing. Source memory is a built-in "programmable test sequencer" for configuring up to 100 different tests. The buffer memory stores data that can be downloaded to the PC via the GPIB after an LIV test sweep is complete. Source memory, buffer memory, and Trigger Link work in concert to form an autonomous test system—all it takes to begin the test sequence is a "start of test" command from the PC. Benchmark testing has demonstrated that these features allow the system to complete a 400-point LIV test sweep with data transfer to the PC in less than eight seconds.

Source memory and buffer memory, provided by Models 2400-LV, 2420, 2440, and 2502, enable elimination of GPIB traffic during sweep testing. Source memory is a built-in "programmable test sequencer" for configuring up to 100 different tests. The buffer memory stores data that can be downloaded to the PC via the GPIB after an LIV test sweep is complete. Source memory, buffer memory, and Trigger Link work in concert to form an autonomous test system—all it takes to begin the test sequence is a "start of test" command from the PC. Benchmark testing has demonstrated that these features allow the system to complete a 400-point LIV test sweep with data transfer to the PC in less than eight seconds.

Easy to Program, Easy to Use

Each kit comes complete with the necessary cables and hardware to use the system. Having all the instrumentation supplied by the same vendor simplifies system programming and improves ease of use. All instruments in the standard system respond to the same SCPI command structure. LabVIEW[®] and Visual Instrument drivers and demonstration software are also available to simplify application development.

Flexible System Configuration Options

In addition to the standard system configurations, LIV test systems can be customized to accommodate virtually any test sequence or setup requirement. Adding new capabilities or expanding existing ones is as simple as adding a new Keithley instrument or switch system. For example, to add isolation resistance measurements, just include any of Keithley's Series 2000 Digital Multimeters in the configuration.

To accommodate multiple pin-out schemes, choose a Series 7000 Switch Mainframe and plug in one or more switch cards, such as the Model 7012 4 \times 10 Matrix Card or the Model 7053 High Current Scanner Card for switching up to 5A. Automated switching makes it simple to accommodate future pin-out configuration changes.

1.888.KEITHLEY (U.S. only)

www.keithley.com

A Greater Measure of Confidence

KEITHLEY

A Tektronix Company

Complete test solutions for individual application needs

SEMICONDUCTOR

System 25

Laser Diode LIV Test System Kit

A custom configuration and ordering guide is available to simplify selecting all the critical items needed to complete a system.

Single Vendor Solution

In addition to the assurance of hardware and software compatibility, systems integrators can be confident they'll get all the technical support they need to complete and maintain their systems from a single source. Keithley's applications engineers can help systems integrators optimize the performance of each instrument in the system to ensure high speed and accuracy from the system as a whole.

High Accuracy Building Blocks

The standard LIV test system provides a fast, flexible solution for testing LDMs by combining the functions of several high speed, high accuracy Keithley instruments:

- **Model 2400-LV, 2401, 2420, or 2440 SourceMeter® SMU instrument.** During LIV testing, the SourceMeter SMU instrument provides a current sweep to drive the laser diode. It also synchronizes the measurements made by other instruments in the system. The Models 2400-LV, 2420, and 2440 SourceMeter SMU instruments are part of Keithley's SourceMeter family and were developed specifically for test applications that demand tightly coupled precision voltage and current sourcing and measurement. Selecting the instrument's high current range eliminates the potential for range change glitches if currents higher than 1A are needed during the LIV sweep. The Model 2420 offers drive current of up to 3A. The Model 2440 offers up to 5A of drive current for demanding pump laser control.
- **Model 2502 Dual Photodiode Meter.** The Model 2502 measures the current flow in the back facet photo detector and combines with the Model 2500INT Integrating Sphere to directly measure optical power. Both optical power measurement channels are fully independent. The measurement timing circuitry is shared between both channels to provide simultaneous measurements to optimize LIV performance. Each channel has eight measurement ranges and provides a resolution high enough to measure dark currents of the photodiode. The isolated bias sources provide up to 100V of bias. The Model 2502 has a high speed analog output that allows the LIV system to be combined with a fiber alignment system.
- **Model 2510-AT TEC SourceMeter SMU instrument.** The Model 2510-AT is a 50W bipolar instrument that controls the operation of an LDM's Thermo-Electric Cooler or TEC (sometimes called a "Peltier device") during LIV testing. During testing, the Model 2510-AT measures the internal temperature of the LDM from any of a variety of temperature sensors, then drives power through the TEC in order to maintain the LDM's temperature at the desired setpoint.

The Model 2510-AT's software-based, fully digital P-I-D (proportional-integral-differential) control provides excellent temperature stability. This high stability allows for very fine control over the output wavelength and over the optical power of the LDM during testing. Another Model 2510-AT can be added to include ambient fixture control, if the test will be done under a variety of ambient conditions. The instrument includes a low-level TEC resistance measurement function to check TECs for mechanical damage during module assembly.

The Model 2510-AT offers autotuning capability. P, I, and D (proportional, integral, and derivative) values for closed loop temperature control are determined by the instrument using a modified Zeigler-Nichols algorithm. This eliminates the need for users to experiment by inputting various P, I, and D coefficients repeatedly in order to determine the optimal values.

- **Model 2500INT Integrating Sphere.** This accessory for the Model 2502 accepts direct optical input and provides for accurate L measurement without being sensitive to polarization mode or beam profile at the end of the fiber. The integrating sphere is available with a silicon, germanium, or cooled indium gallium arsenide detector to ensure accurate optical power measurements at any wavelength.
- **Model 854x.** The 854x Laser Diode Mount Series makes it easier than ever to configure a complete laser diode LIV test system for continuous wave test applications. These fixtures provide highly stable temperature control for all telecommunications laser diodes. They offer an easy-to-use platform for testing laser diodes used in telecommunications. They are designed to speed and simplify setting up test systems for all laser diode/photodiode/thermoelectric cooler/thermistor configurations.

For additional information on any of the building blocks of the LIV test system, refer to the data sheet for that instrument.

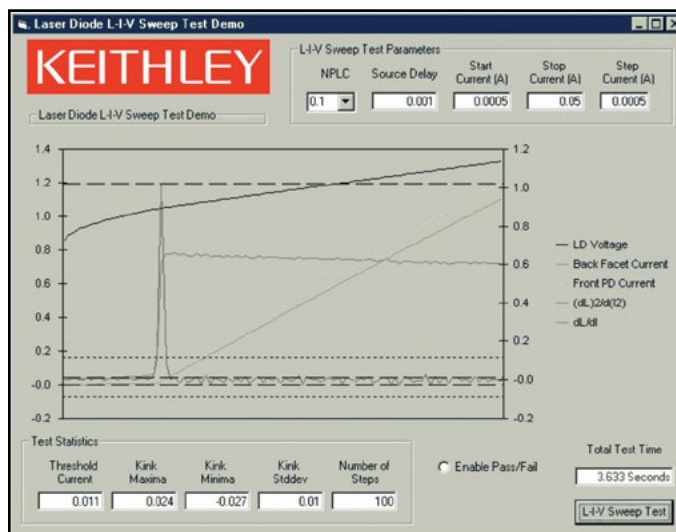

A demonstration software package, written in Visual Basic, is available with the LIV test system to give programmers a head start on creating their own applications. Using the demonstration package, users can set a variety of test parameters, including NPLC (integration time), Source Delay (settling time before measurement), Start Current, Stop Current, and Step Current. These parameters allow users to define the current sweep range and make speed and accuracy trade-offs by adjusting Source Delay and NPLC. The resulting data can be analyzed to determine threshold current and kink statistics. The total test time includes the instrument setup, LIV sweep, and data transfer times (but not the computation times).

1.888.KEITHLEY (U.S. only)

www.keithley.com

KEITHLEY

A Greater Measure of Confidence

A Tektronix Company

Ordering Information

S25-

Source/Measure

- 0 2400-LV or 2401/2502 General Purpose
- 2 2420/2502 Transmitter/Pump
- 4 2440/2502 Pump Laser

Temperature Control

- 0 None
- 1 2510-AT Single Temp. Control
- 2 2510-AT/2510-AT Dual Temp. Control

Integrating Spheres

- 00 None
- 21 2500INT-2-SI 2" Sphere, Silicon
- 22 2500INT-2-GE 2" Sphere, Germanium
- 23 2500INT-2-IGAC 2" Sphere, Cooled InGaAs

Laser Diode Mounts

- 0 None
- 4 8544 14-Pin Butterfly Mount
- 4t 8544-TEC 14-Pin Butterfly w/TEC Control

Select the instrument and accessory for your application. Review the detailed specifications of each instrument in individual catalog sections.

ACCESSORIES INCLUDED IN EACH OPTION

SOURCE/MEASURE

- Includes: 2400-LV, 2401, 2420, or 2440 SourceMeter SMU Instrument
- 2502 Photodiode Meter
- (2) GPIB Interface Cables
- Trigger Link Cable
- Integrating Sphere Cable and adapter (Triax, 6172 adapter)
- DUT Cables (terminated in Alligator clips)
- Rackmount Conversion Kit

TEMPERATURE CONTROL

- Includes: 2510-AT SourceMeter SMU Instrument(s)
- GPIB Interface Cable(s)
- DUT Cables
- Rackmount Conversion Kit

INTEGRATING SPHERE

- Includes: 2500INT Integrating Sphere
- ½" open input port
- Post Stand

LASER DIODE MOUNT

- Includes: 854x Laser Diode Mount
- Easy Connect Multi Terminated Laser Diode Cables
- Easy Connect Multi Terminated Temperature Cables

CUSTOM SYSTEMS

Custom systems are available. Contact your local Keithley sales person.

ASSEMBLY SERVICES

The S25 Systems are not assembled. If you would like assembly service, contact your local Keithley salesperson.

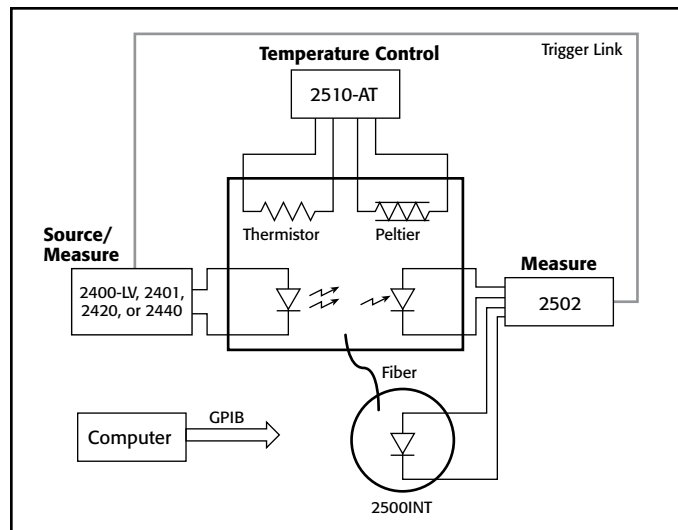

Figure 1. The standard LIV test system is designed for applications that require the highest measurement accuracy. The Model 2420 SourceMeter SMU instrument drives the laser diode, sweeping the drive current from 0A up to 3A in programmable steps. At each step in the sweep, the Model 2420 records the current and voltage measurements, while the Model 2502 measures and records the current flow in the photodiodes. When the sweep is complete, the raw measurement data from the Model 2420 and the Model 2502 is uploaded to the PC for analysis. The LIV Demo Software can calculate first and second derivatives of the back facet monitor diode or the external photo detector.

ACCESSORIES AVAILABLE

CABLES

- 7007-1 Double Shielded GPIB Cable, 1m (3.3 ft.)
- 7007-2 Double Shielded GPIB Cable, 2m (6.6 ft.)

CABINETS

(System kit is supplied with all necessary rack mount hardware. Purchase appropriate cabinet and assembly services separately.)

- 8000-10 Equipment Cabinet 10" high (holds 4 instruments)
- 8000-14A Equipment Cabinet 14" high
- 8000-17A Equipment Cabinet 17.5" high

GPIB CARDS

(GPIB communication required for complete LIV capabilities.)

- KPCI-488LPA IEEE-488 Interface/Controller for the PCI Bus
- KUSB-488B IEEE-488 USB-to-GPIB Adapter for USB Port

**2400-LV, 2400-C,
2401, 2420, 2420-C,
2440, 2440-C**

SourceMeter® SMU Instruments for Optoelectronic I-V Testing



- **Designed for production testing of VCSELs, transmitter, high power pump lasers, and other high current electronic components**
- **Key building block for programmable LIV test system for laser diode modules**
- **Very low noise current source (50 μ A) for laser diode drive**
- **Up to 5A laser diode drive current**
- **Trigger Link, Source Memory, and buffer memory support automatic test sequencing**
- **Reduced GPIB bus traffic improves test throughput**
- **Expandable and flexible for future requirements**
- **Built-in comparator for fast pass/fail testing**
- **Digital I/O handler interface**
- **1000 readings/second at 4½ digits**
- **Optional contact check function**

The SourceMeter family was developed specifically for test applications that demand tightly coupled precision voltage and current sourcing and concurrent measurement, including source read back. This family of instruments can be easily programmed to drive laser diodes throughout the characterization process. Any of them can also be programmed to act as a synchronization controller to ensure simultaneous measurements during the test sequence. Selecting a fixed current range eliminates the potential for range offsets that appear as kinks during the LIV sweep testing. The Models 2400-LV and 2401 offer a drive current of up to 1A, ideal for testing VCSEL devices.

The Model 2420 offers a tighter accuracy specification that allows for precise control of transmitter laser devices. In addition to higher accuracy, the Model 2420 offers a drive current of up to 3A for devices that need drive currents greater than 1A, such as pump lasers used in EDFA amplifiers.

The Model 2440 5A SourceMeter SMU Instrument further broadens the capabilities offered by the popular SourceMeter line. The dynamic range and functionality of the Model 2440 makes it ideal for applications such as testing high power pump lasers for use in optical amplifiers, laser bar tests, and testing other higher power components. Manufacturers of Raman pump laser modules and optical amplifiers will find it invaluable for a wide range of design and production test applications.

A Keithley SourceMeter SMU instrument provides a complete, economical, high throughput solution for component production testing, all in one compact, half-rack box. It combines source, measure, and control capabilities in a form factor that's unique to the industry. The SourceMeter is also suitable for making a wide range of low power DC measurements, including resistance at a specified current or voltage, breakdown voltage, leakage current, and insulation resistance.

Single Box Solution

By linking source and measurement circuitry in a single unit, a SourceMeter SMU instrument offers a variety of advantages over systems configured with separate source and measurement instruments. For example, it minimizes the time required for test station development, setup, and maintenance, while lowering the overall cost of system ownership. It simplifies the test process itself by eliminating many of the complex synchronization and connection issues associated with using multiple instruments. Its compact, half-rack size conserves "real estate" in the test rack or bench.

ACCESSORIES AVAILABLE

LASER DIODE MOUNTS

8542	Dual In-Line Telecom Laser Diode Mount Bundle
8544	Butterfly Telecom Laser Diode Mount Bundle
8544-TEC	Butterfly Telecom Laser Diode Mount Bundle with TEC, thermistor, and AD592CN temperature sensor

COMMUNICATION INTERFACE

KPCI-488LPA	IEEE-488 Interface/Controller for the PCI Bus
KUSB-488B	IEEE-488 USB-to-GPIB Adapter for USB Port

SWITCHING HARDWARE

7001	Two-Slot Switch System
7002	Ten-Slot Switch System
7053	High-Current Switch Card

TEST LEADS AND PROBES

5806	Kelvin Clip Lead Set
------	----------------------

CABLES/ADAPTERS

2499-DIGIO	Digital I/O Expansion Assembly
7007-1	Shielded GPIB Cable, 1m (3.3 ft)
7007-2	Shielded GPIB Cable, 2m (6.6 ft)
7009-5	RS-232 Cable
8501-1	Trigger Link Cable, 1m (3.3 ft)
8501-2	Trigger Link Cable, 2m (6.6 ft)
8502	Trigger Link Adapter Box

RACK MOUNT KITS

4288-1	Single Fixed Rack Mount Kit
4288-2	Dual Fixed Rack Mount Kit

1.888.KEITHLEY (U.S. only)

www.keithley.com

KEITHLEY

A Greater Measure of Confidence

A Tektronix Company

2400-LV, 2400-C, 2401, 2420, 2420-C, 2440, 2440-C

Ordering Information

2400-LV Low Voltage SourceMeter

Measurements up to 20V and 1A, 20W Power Output

2400-C General-Purpose SourceMeter

Contact Check, Measurements up to 200V and 1A, 20W Power Output

2401 Low Voltage SourceMeter

Measurements up to 20V and 1A, 20W Power Output

2420 High-Current SourceMeter

Measurements up to 60V and 3A, 60W Power Output

2420-C High-Current SourceMeter

Contact Check, Measurements up to 60V and 3A, 60W Power Output

2440 5A SourceMeter

Measurements up to 40V and 5A, 50W Power Output

2440-C 5A SourceMeter

Contact Check, Measurements up to 40V and 5A, 50W Power Output

Accessories Supplied

Test Leads, User's Manual, Service Manual, and LabVIEW® Drivers

SourceMeter® SMU Instruments for Optoelectronic I-V Testing

High Throughput to Meet Demanding Production Test Schedules

A SourceMeter SMU instrument's highly integrated architecture offers significant throughput advantages. Many features of this family enable them to "take control" of the test process, eliminating additional system bus traffic and maximizing total throughput. Built-in features that make this possible include:

- Source Memory List test sequencer with conditional branching
- Handler/prober interface
- Trigger Link compatibility with switching hardware and other instruments from Keithley
- High speed comparator, pass/fail limits, mathematical scaling
- Deep memory buffer

The SourceMeter SMU instruments also offer standard RS-232 and GPIB interfaces for integration with a PC. Adding one of Keithley's versatile switch systems enables fast, synchronized multi-point testing.

Testing Optoelectronic Components

Use a SourceMeter SMU instrument to measure a component's electrical performance characteristics and to drive laser diodes and other components.

Types of Optoelectronic Components

- Laser diodes
- Laser diode modules
- Photodetectors
- Light-emitting diodes (LEDs)
- Photovoltaic cells

Typical Tests

- LIV test (laser diodes and LEDs)
- Kink test (laser diode)
- I-V characterization

Model	2400-LV/2400-C/2401	2420/2420-C	2440/2440-C
Description	General Purpose	3 A	5 A
Power Output	20 W	60 W	50 W
Voltage Range	$\pm 1 \mu\text{V}$ to $\pm 20 \text{ V}$	$\pm 1 \mu\text{V}$ to $\pm 63 \text{ V}$	$\pm 1 \mu\text{V}$ to $\pm 42 \text{ V}$
Current Range	$\pm 50 \text{ pA}$ to $\pm 1.05 \text{ A}$	$\pm 500 \text{ pA}$ to $\pm 3.15 \text{ A}$	$\pm 500 \text{ pA}$ to $\pm 5.25 \text{ A}$
Ohms Range	$< 0.2 \Omega$ to $> 200 \Omega$	$< 0.2 \Omega$ to $> 200 \text{ M}\Omega$	$< 2.0 \Omega$ to $> 200 \text{ M}\Omega$
Applications	Optoelectronic components. VCSELs.	Transmitter modules. EDFA pumps.	5A pump laser diodes. Raman amplifiers.

Models 2400-LV/2401
SourceMeter
Instruments

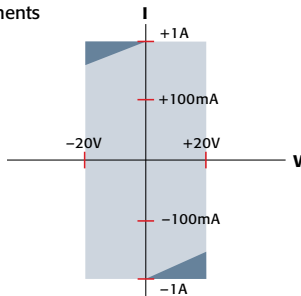

The Models 2400-LV and 2401 are ideal for testing a wide variety of devices, including diodes, resistors, resistor networks, active circuit protection devices, and portable battery-powered devices and components.

Model 2420
3A SourceMeter
Instrument

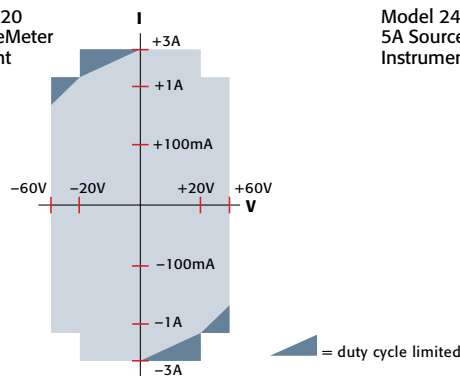

Choose the Model 2420 for testing higher power resistors, thermistors, I_{DDQ} , solar cells, batteries, and high-current or medium power diodes, including switching and Schottky diodes.

Model 2440
5A SourceMeter
Instrument

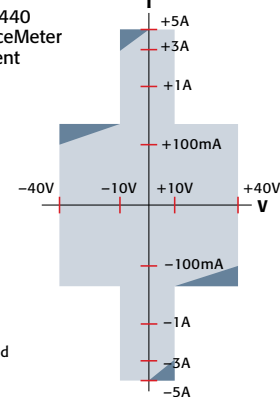

The Model 2440's wide dynamic range is well-suited for applications such as testing high-power pump lasers for use in optical amplifiers and laser bar tests, as well as testing other higher power components.

1.888.KEITHLEY (U.S. only)

www.keithley.com

A Greater Measure of Confidence

KEITHLEY

A Tektronix Company

Tightly coupled source and measure for active component testing

SEMICONDUCTOR

2400-LV, 2400-C, 2401, 2420, 2420-C, 2440, 2440-C

SourceMeter® SMU Instruments for Optoelectronic I-V Testing

Faster, Easier, and More Efficient Testing and Automation

Coupled Source and Measure Capabilities

The tightly coupled nature of a SourceMeter SMU instrument provides many advantages over separate instruments. The ability to fit a source and a meter in a single half-rack enclosure saves valuable rack space and simplifies the remote programming interface. Also, the tight control and a single GPIB address inherent in a single instrument result in faster test times for ATE applications due to reduced GPIB traffic.

Standard and Custom Sweeps

SourceMeter SMU instruments provide sweep solutions that greatly accelerate testing with automation hooks for additional throughput improvement.

Optional Contact Check

The Contact Check option available on all Series 2400 SourceMeter SMU instruments allows quick verification of a good connection to the DUT before functional testing proceeds. This feature helps prevent the loss of precious test time due to damaged, corroded, or otherwise faulty contacts in a test fixture. The innovative contact check design completes the verification and notification process in less than 350µs; comparable capabilities in other test equipment can require up to 5ms to perform the same function. Contact check failure is indicated on the instrument's front panel and over the GPIB bus. The digital I/O interface can also be used to communicate contact failure to the component handler in automated applications.

SOURCEMETER SMU INSTRUMENT SPECIFICATIONS

The following tables summarize the capabilities of the Models 2400-LV, 2420, and 2440.

2400-LV SOURCEMETER (I-V MEASUREMENTS)

Current Programming Accuracy

Range	Programming Resolution	Accuracy (1 Year) 23°C ± 5°C ± (% rdg. + amps)
1.00000 µA	50 pA	0.035% + 600 pA
10.0000 µA	500 pA	0.033% + 2 nA
100.000 µA	5 nA	0.031% + 20 nA
1.00000 mA	50 nA	0.034% + 200 nA
10.0000 mA	500 nA	0.045% + 2 µA
100.000 mA	5 µA	0.066% + 20 µA
1.00000 A	50 µA	0.27 % + 900 µA

Voltage Measurement Accuracy

Range	Default Resolution	Input Resistance	Accuracy (1 Year) 23°C ± 5°C ± (% rdg. + volts)
200.000 mV	1 µV	> 10 GΩ	0.01 % + 300 µV
2.00000 V	10 µV	> 10 GΩ	0.012% + 300 µV
20.0000 V	100 µV	> 10 GΩ	0.015% + 1.5 mV

2420 SOURCEMETER (I-V MEASUREMENTS)

Current Programming Accuracy

Range	Programming Resolution	Accuracy (1 Year) 23°C ± 5°C ± (% rdg. + amps)
10.0000 µA	500 pA	0.033% + 2 nA
100.000 µA	5 nA	0.031% + 20 nA
1.00000 mA	50 nA	0.034% + 200 nA
10.0000 mA	500 nA	0.045% + 2 µA
100.000 mA	5 µA	0.066% + 20 µA
1.00000 A	50 µA	0.067% + 900 µA
3.00000 A	50 µA	0.059% + 2.7 mA

Voltage Measurement Accuracy

Range	Default Resolution	Input Resistance	Accuracy (1 Year) 23°C ± 5°C ± (% rdg. + volts)
200.000 mV	1 µV	> 10 GΩ	0.012% + 300 µV
2.00000 V	10 µV	> 10 GΩ	0.012% + 300 µV
20.0000 V	100 µV	> 10 GΩ	0.015% + 1 mV
60.0000 V	1 mV	> 10 GΩ	0.015% + 3 mV

2440 SOURCEMETER (I-V MEASUREMENTS)

Current Programming Accuracy

Range	Programming Resolution	Accuracy (1 Year) ³ 23°C ± 5°C ± (% rdg. + amps)
10.0000 µA	500 pA	0.033% + 2 nA
100.000 µA	5 nA	0.031% + 20 nA
1.00000 mA	50 nA	0.034% + 200 nA
10.0000 mA	500 nA	0.045% + 2 µA
100.000 mA	5 µA	0.066% + 20 µA
1.00000 A	50 µA	0.067% + 900 µA
5.00000 A	50 µA	0.10 % + 5.4 mA

Voltage Measurement Accuracy

Range	Default Resolution	Input Resistance	Accuracy (1 Year) 23°C ± 5°C ± (% rdg. + volts)
200.000 mV	1 µV	> 10 GΩ	0.012% + 300 µV
2.00000 V	10 µV	> 10 GΩ	0.012% + 300 µV
10.0000 V	100 µV	> 10 GΩ	0.015% + 750 µV
40.0000 V	1 mV	> 10 GΩ	0.015% + 3 mV

1.888.KEITHLEY (U.S. only)

www.keithley.com

KEITHLEY

A Greater Measure of Confidence

A Tektronix Company

2502

Dual-Channel Picoammeter for Photodiode Measurements



- Dual-channel instrument for low current measurements
- $\pm 100V$ bias source
- Measure current from 1fA to 20mA
- 1fA current measurement resolution
- 0–10V analog output for high resolution optical power feedback
- 3000-point buffer memory on each channel allows data transfer after test completion
- Digital I/O and Trigger Link for binning and sweep test operations
- IEEE-488 and RS-232 interfaces

Ordering Information

2502 Dual-Channel Picoammeter

Accessories Supplied
User's Manual

SERVICES AVAILABLE

2502-3Y-EW	1-year factory warranty extended to 3 years from date of shipment
C/2502-3Y-DATA	3 (Z540-1 compliant) calibrations within 3 years of purchase*

*Not available in all countries

High Accuracy Dark Current Measurements

The Model 2502's 2nA current measurement range is ideal for measuring dark currents with 1fA resolution. Once the level of dark current has been determined, the instrument's REL function automatically subtracts the dark current as an offset so the measured values are more accurate for optical power measurements.

Voltage Bias Capability

The Model 2502 provides a choice of voltage bias ranges: $\pm 10V$ or $\pm 100V$. This choice gives the system integrator the ability to match the bias range more closely to the type of photodetector being tested, typically $\pm 10V$ for large area photodetectors and $\pm 100V$ for avalanche-type photodetectors. This ability to match the bias to the photodetector ensures improved measurement linearity and accuracy.

Ratio and Delta Measurements

The Model 2502 can provide ratio or delta measurements between the two completely isolated channels, such as the ratio of the back facet monitor detector to the fiber-coupled photodetector at varying levels of input current. These functions can be accessed via the front panel or the GPIB interface. For test setups with multiple detectors, this capability allows for targeted control capabilities for the laser diode module.

Interface Options

To speed and simplify system integration and control, the Model 2502 includes the Trigger Link feature and digital I/O lines, as well as standard IEEE-488 and RS-232 interfaces. The Trigger Link feature combines six independent software selectable trigger lines on a single connector for simple, direct control over all instruments in a system. This feature is especially useful for reducing total test time if the test involves a sweep. The Model 2502 can sweep through a series of measurements based on triggers received from the SourceMeter® SMU Instrument. The digital I/O lines simplify external handler control and binning operations.

For additional information and detailed specifications, see page 141.

The Model 2502 combines Keithley's expertise in low-level current measurements with high speed current measurement capabilities. Each channel of this instrument consists of a voltage source paired with a high speed picoammeter. Each of the two channels has an independent picoammeter and voltage source with measurements made simultaneously across both channels.

Wide Dynamic Measurement Range

The Model 2502 offers current measurement ranges from 2nA to 20mA in decade steps. This provides for all photodetector current measurement ranges for testing laser diodes and LEDs in applications such as LIV testing, LED total radiance measurements, measurements of cross-talk and insertion loss on optical switches, and many others. The Model 2502 meets industry testing requirements for the transmitter as well as pump laser modules.



Model 2502 rear panel

1.888.KEITHLEY (U.S. only)

www.keithley.com

A Greater Measure of Confidence

KEITHLEY

A Tektronix Company

Dual-channel optical power measurement

SEMICONDUCTOR

2500INT

Integrating Sphere

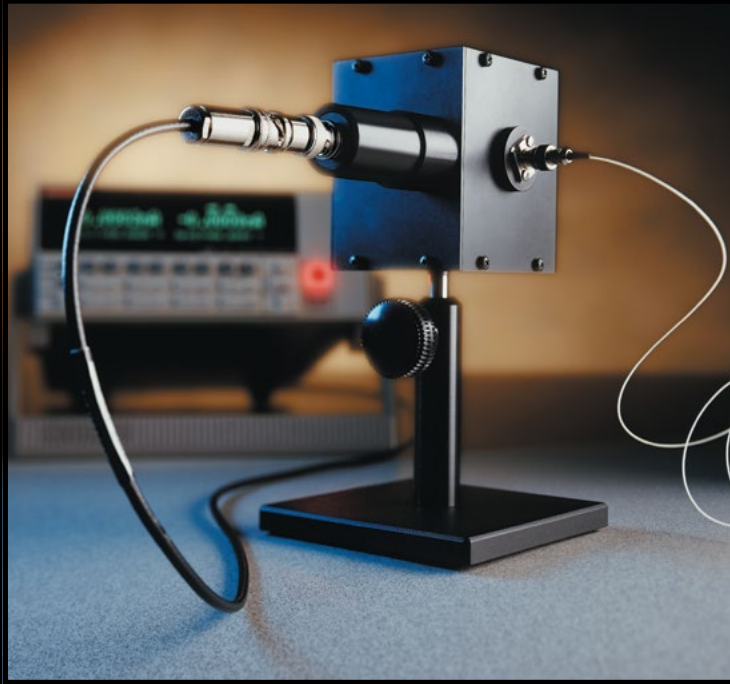

- Choose from silicon, germanium, or cooled indium gallium arsenide detectors
- Spectralon® sphere interior ensures high reflectivity
- Part of Keithley's high throughput system for production testing of laser diodes and LEDs

Ordering Information

2500INT-2-Si

Integrating Sphere
with Silicon Detector

2500INT-2-Ge

Integrating Sphere with
Germanium Detector

2500INT-2-IGAC

Integrating Sphere with
Cooled Indium Gallium
Arsenide Detector

Accessories Supplied

Quick Start Guide, Calibration
Chart for each sphere,
TEC Controller (included with
2500INT-2-IGAC)

The Model 2500INT Integrating Sphere is the latest addition to Keithley's growing line of solutions for LIV (light-current-voltage) testing. When connected via a low noise triax cable to the Model 2502 Dual Photodiode Meter included in Keithley's LIV Test System, the integrating sphere allows the system to make direct measurements of optical power, with results expressed in watts. The integrating sphere simplifies production testing of laser diodes (LDs), light emitting diodes (LEDs), and other optical components by eliminating common optical power measurement problems related to detector alignment, beam profile, polarization, and back reflection.

Choice of Three Detector Types

The Model 2500INT is available with a silicon (2500INT-2-Si), germanium (2500INT-2-Ge), or cooled indium gallium arsenide (InGaAs) detector (2500INT-2-IGAC), each calibrated with the sphere. Spheres equipped with cooled indium gallium arsenide detectors include a controller to regulate the detector's temperature.

Unaffected by DUT Beam Profile

Laser diodes can produce non-gaussian beam profiles, which can lead to inaccurate optical power measurements due to underfill or overfill of the detector. While a number of methods are available to correct for underfill and overfill, these methods can add to the overall inaccuracy of the measurement.

In contrast, an integrating sphere is inherently insensitive to beam profiles. The interior of the Model 2500INT integrating sphere has a highly reflective Spectralon surface, which scatters, reflects, and diffuses the source beam produced by the device under test (DUT). This spreads the light from the DUT uniformly over the interior surface of the sphere with minimal absorption loss. A detector can be placed on the interior surface of the sphere, then the sphere/detector combination can be calibrated. The amount of optical radiation striking the detector is the same as any other point on the sphere interior due to the multiple diffuse reflections within the sphere. Therefore, the calibration and resulting measurement accuracy are independent of beam profile.

The Model 2500INT's Spectralon surface offers a variety of other advantages. It is a nearly perfect diffuse reflector, exhibiting Lambertian reflectance properties, so it reflects equally in all directions, regardless of viewing angle. This eliminates the inaccuracies associated with less diffuse materials by distributing the optical radiation more evenly over the interior of the sphere. In addition, a Spectralon surface offers high reflectance for wavelengths from 250–2500nm, which makes it ideal for laser diode measurement applications. It is also chemically inert, which helps ensure stable measurements in harsh environments.

Eases Beam Alignment

If an integrating sphere is not used in laser diode testing, the entire beam from the laser must shine directly onto the detector in order to measure optical power accurately. However, it is difficult to align a laser and detector with the high degree of precision required, particularly when the laser is operating outside of the visible spectrum. With the use of an integrating sphere, beam alignment is trivial because any light that enters the sphere will be spread evenly across its interior surface. Simply stated, it is easier to direct a laser into a 1/2-inch port than it is to direct a laser onto a 5mm detector. The sphere

APPLICATIONS

Production testing of:

- Laser diode modules
- Chip on submount laser diodes
- Laser diode bars
- LEDs
- Passive optical components

1.888.KEITHLEY (U.S. only)

www.keithley.com

2500INT

Integrating Sphere

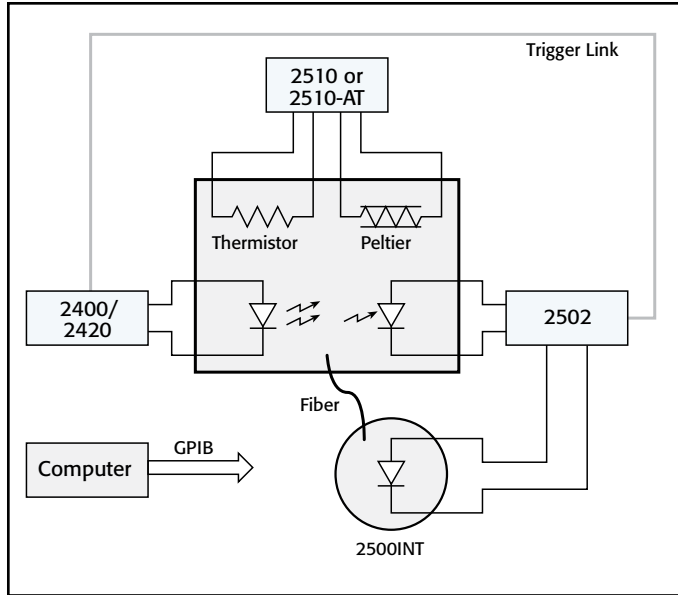

The Model 2500INT allows the LIV Test System to measure optical inputs directly and to display power measurements in watts. Other instruments in the LIV Test System include the Model 2502 Dual Photodiode Meter, the Model 2510 TEC SourceMeter® SMU Instrument, and either the Model 2400 or Model 2420 SourceMeter SMU Instrument. Each integrating sphere is characterized at the factory and provided with a calibration constant for every 25 nanometers in the detector's range. Prior to testing, the user simply enters the constant in the Model 2502 Dual Photodiode Meter to ensure accurate measurements of optical power for that wavelength.

is insensitive to input beam alignment up to 40° off normal or divergences up to 40° half-angle.

Minimizes Polarization Concerns

The randomizing effects of multiple reflections within Keithley's integrating sphere minimize beam polarization problems that can affect optical measurement accuracy when measuring polarized sources. Beam polarization is of particular concern for manufacturers of distributed feedback lasers (DFBs) and Vertical Cavity Surface Emitting Lasers (VCSELs).

Eliminates Back Reflection

The stability of a laser diode is significantly affected by back reflections from objects in the optical path. The geometric nature of the integrating sphere and the diffusing properties of the sphere's reflective material help prevent back reflection and ensure greater device stability during testing.

Attenuates High Power Laser Diode Outputs

Detectors have specified maximum power capability, which is typically just a few milliwatts. By spreading the output power evenly over its interior surface, an integrating sphere automatically attenuates the power from the source; therefore, the power level at any point on the sphere surface is far less than that of a beam that falls directly on the detector. The Model 2500INT sphere is particularly useful for testing high-power laser diodes because it provides calibrated attenuation of the laser diode output, which prevents damage to the detector due to the high density of the output or other problems associated with saturation of the detector.

Designed Specifically for Laser Diode Testing

The design of the Model 2500INT Integrating Sphere is optimized for measuring the optical power of laser diodes. Each sphere is two inches in diameter with a 1/2-inch input port suitable for fiber or direct light (as in chip on submount applications). The port and detector are positioned so there is no need to use a baffle to prevent the input from shining directly onto the detector.

	Silicon Detector	Germanium Detector	Cooled InGaAs Detector
Wavelength Range	190–1100 nm	800–1800 nm	900–1670 nm
Peak Wavelength (λ_p)	960 nm	1550 nm	1550 nm
Sensitivity at Peak Wavelength	Excellent at 960 nm	Good at 1550 nm	Excellent at 1550 nm
Sensitivity at Certain Wavelengths			
Visible	***	N/A	N/A
980 nm	***	**	**
1310 nm	N/A	**	***
1550 nm	N/A	**	***
>1550 nm	N/A	**	***
Speed	***	*	**
Calibration Accuracy/Stability	Spectral response changes rapidly with temperature at wavelengths >1000nm.	Spectral response changes rapidly with temperature and λ above λ_p .	Extremely stable (Spectral response is stable because λ calibration is fixed at constant operating temperatures, i.e., -10°C.)
Cost	\$	\$\$	\$\$\$

* = Good ** = Better *** = Best N/A = not applicable

Detector Selection Criteria

When choosing the most appropriate detector for a specific application, consider the following selection criteria:

- Wavelengths of maximum interest
- Sensitivity at wavelength of interest
- Speed
- Cost
- Calibration accuracy/stability

1.888.KEITHLEY (U.S. only)

www.keithley.com

A Greater Measure of Confidence

KEITHLEY

A Tektronix Company

Enables direct optical power measurement in watts with the Model 2502

SEMICONDUCTOR

2500INT

Integrating Sphere

SPECIFICATIONS

TYPICAL REFLECTANCE DATA FOR SPECTRALON MATERIAL

Wavelength (nm)	Spectralon
500	0.991
600	0.992
700	0.992
800	0.991
900	0.992
1000	0.993
1100	0.992
1200	0.992
1300	0.992
1400	0.991
1500	0.990
1600	0.989
1700	0.986
1800	0.987

PHYSICAL, THERMO-OPTICAL, AND ELECTRONIC PROPERTIES OF SPECTRALON MATERIAL

Property	ASTM Test	Value
Density	N/A	1.25–1.5g/cm ³
Water Permeability	D-570	<0.001% (hydrophobic)
Hardness	D-785	20–30 Shore D
Thermal Stability	N/A	Decomposes at >400°C
Coefficient of Linear Expansion	D-696	5.5–6.5 × 10 ⁻⁵ in/in -°F; 10 ⁻⁴ °C ⁻¹
Vacuum Stability	N/A	No outgassing except for entrained air
Flammability	N/A	Non-flammable (UL rating V-O) Incompatible with non-polar solvents and greases
Yield Stress	D-638	208psi
Ultimate Stress	D-638	891psi
Young's Modulus	N/A	35774psi
Elongation in 2 in.	D-638	42.8%
Elongation at Failure	E-132	91.3%
Poisson's Ratio	D-621	0.296
Deformation under Load	D-621	13.3% @ 250 lbs. 22.6% @ 500 lbs.
Absorbance (ax)	N/A	0.07
Emittance (e)	N/A	0.88
Volume Resistivity	N/A	>10 ¹⁸ Ω/cm
Dielectric Strength	D-149	18V/μm
Refractive Index	D-542	1.35
Flammability Rating	UL-94	V-O

ACCESSORIES AVAILABLE

(Appropriate cables and connectors are required to operate the Model 2500INT Integrating Sphere and must be ordered separately. They are not included with the instrument.)

7078-TRX-1	Low-Noise Triax Cable, 0.3m (1 ft)
7078-TRX-3	Low-Noise Triax Cable, 0.9m (3 ft)
7078-TRX-5	Low-Noise Triax Cable, 1.5m (5 ft)
7078-TRX-10	Low-Noise Triax Cable, 3.0m (10 ft)
7078-TRX-12	Low-Noise Triax Cable, 3.5m (12 ft)
7078-TRX-20	Low-Noise Triax Cable, 6.0m (20 ft)
2500INT-FC/APC	FC/APC Connector for 2500INT
2500INT-FC/PC	FC/PC Connector for 2500INT
2500INT-SMA	SMA Connector for 2500INT
6172	2-Slot Male to 3-Lug Female Triax Adapter

PHOTODIODE SPECIFICATIONS

	Silicon	Germanium	Cooled Indium Gallium Arsenide
Wavelength Range	190–1100nm	800–1800nm	900–1670nm
Peak Sensitivity Wavelength	960nm	1550nm	1550nm
Operating Temperature	-20° to +60°C	-55° to +60°C	-40° to +70°C
Storage Temperature	-55° to +80°C	-55° to +80°C	-55° to +85°C
Active Area	2.4mm × 2.4mm	5.0mm (diameter)	3.0mm (diameter)
Measurement Temperature	—	—	-10°C
Thermistor Allowable Dissipation	—	—	0.2mW
Peltier Element	—	—	1.5A
Allowable Current	—	—	1.0A

1.888.KEITHLEY (U.S. only)

www.keithley.com

KEITHLEY

A Greater Measure of Confidence

A Tektronix Company

2510 2510-AT

TEC SourceMeter® SMU Instrument Autotuning TEC SourceMeter SMU Instrument



The Models 2510 and 2510-AT TEC SourceMeter SMU instruments enhance Keithley's CW (Continuous Wave) test solution for high speed LIV (light-current-voltage) testing of laser diode modules. These 50W bipolar instruments were developed in close cooperation with leading manufacturers of laser diode modules for fiber-optic telecommunications networks. Designed to ensure tight temperature control for the device under test, the Model 2510 was the first in a line of highly specialized instruments created for telecommunications laser diode testing. It brings together Keithley's expertise in high speed DC sourcing and measurement with the ability to control the operation of a laser diode module's Thermo-Electric Cooler or TEC (sometimes called a Peltier device) accurately.

The Model 2510-AT expands the capability of the Model 2510 by offering autotuning capability. P,

I, and D (proportional, integral, and derivative) values for closed loop temperature control are determined by the instrument using a modified Zeigler-Nichols algorithm. This eliminates the need for users to determine the optimal values for these coefficients experimentally. In all other respects, the Model 2510 and Model 2510-AT provide exactly the same set of features and capabilities.

The SourceMeter Concept

The Model 2510 and Model 2510-AT draw upon Keithley's unique SourceMeter concept, which combines precision voltage/current sourcing and measurement functions into a single instrument. SourceMeter SMU instruments provide numerous advantages over the use of separate instruments, including lower acquisition and maintenance costs, the need for less rack space, easier system integration and programming, and a broad dynamic range.

Part of a Comprehensive LIV Test System

In a laser diode CW test stand, the Model 2510 or Model 2510-AT can control the temperature of actively cooled optical components and assemblies (such as laser diode modules) to within $\pm 0.005^\circ\text{C}$ of the user-defined setpoint. During testing, the instrument measures the internal temperature of the laser diode module from any of a variety of temperature sensors, then drives power through the TEC within the laser diode module in order to maintain its temperature at the desired setpoint.

Figure 1. The capabilities of the Models 2510 and 2510-AT are intended to complement those of other Keithley instruments often used in laser diode module LIV testing, including the Model 2400 and 2420 SourceMeter SMU instruments, the Model 2502 Dual Photodiode Meter, and the Model 2500INT Integrating Sphere.

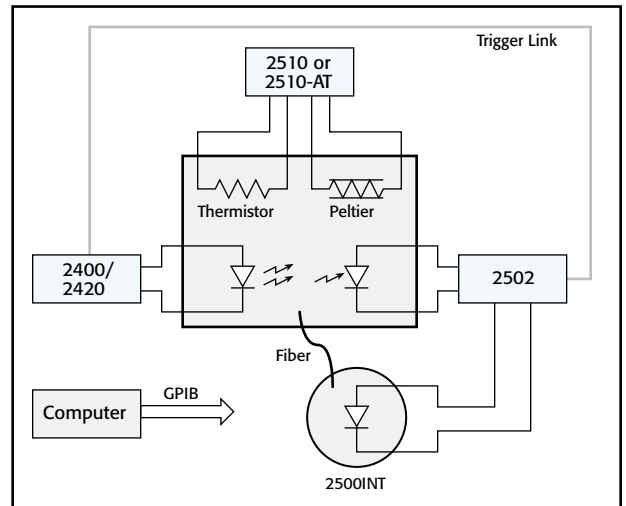

Ordering Information

2510	TEC SourceMeter
2510-AT	Autotuning TEC SourceMeter SMU Instrument

Accessories Supplied

User's Manual, Input/Output Connector

1.888.KEITHLEY (U.S. only)

www.keithley.com

A Greater Measure of Confidence

KEITHLEY

A Tektronix Company

Precision temperature control for TECs with autotuning PID for optimal performance

SEMICONDUCTOR

2510 2510-AT

- 50W TEC Controller combined with DC measurement functions
- Fully digital P-I-D control
- Autotuning capability for the thermal control loop (2510-AT)
- Designed to control temperature during laser diode module testing
- Wide temperature setpoint range (-50°C to $+225^{\circ}\text{C}$) and high setpoint resolution ($\pm 0.001^{\circ}\text{C}$) and stability ($\pm 0.005^{\circ}\text{C}$)
- Compatible with a variety of temperature sensor inputs—thermistors, RTDs, and IC sensors
- Maintains constant temperature, current, voltage, and sensor resistance
- AC Ohms measurement function verifies integrity of TEC
- Measures and displays TEC parameters during the control cycle
- 4-wire open/short lead detection for thermal feedback element
- IEEE-488 and RS-232 interfaces
- Compact, half-rack design

APPLICATIONS

Control and production testing of thermoelectric coolers (Peltier devices) in:

- Laser diode modules
- IR charge-coupled device (CCD) arrays and charge-injection devices (CID)
- Cooled photodetectors
- Thermal-optic switches
- Temperature controlled fixtures

1.888.KEITHLEY (U.S. only)

www.keithley.com

TEC SourceMeter® SMU Instrument Autotuning TEC SourceMeter SMU Instrument

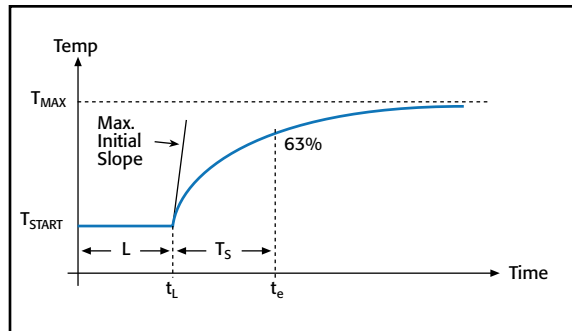

Figure 2.

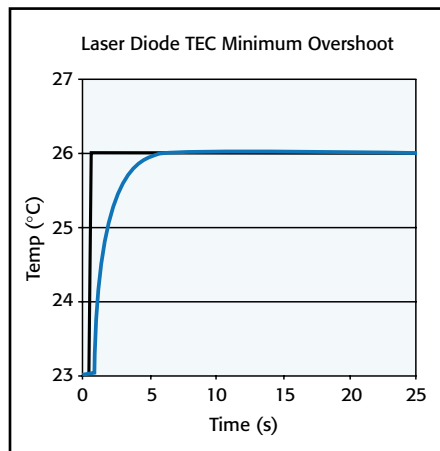

Figure 3.

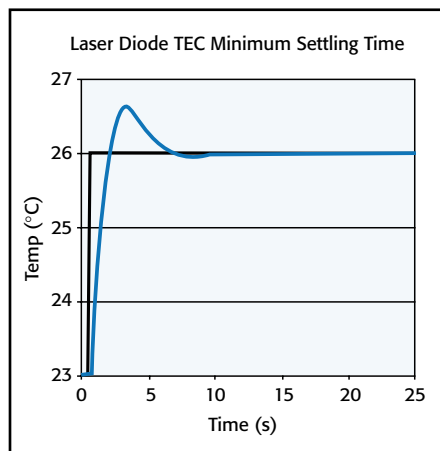

Figure 4.

Active temperature control is very important due to the sensitivity of laser diodes to temperature changes. If the temperature varies, the laser diode's dominant output wavelength may change, leading to signal overlap and crosstalk problems.

Autotuning Function

The Model 2510-AT Autotuning TEC SourceMeter SMU instrument offers manufacturers the ability to automatically tune the

temperature control loop required for CW testing of optoelectronic components such as laser diode modules and thermo-optic switches. This capability eliminates the need for time-consuming experimentation to determine the optimal P-I-D coefficient values.

The Model 2510-AT's P-I-D Auto-Tune software employs a modified Ziegler-Nichols algorithm to determine the coefficients used to control the P-I-D loop. This algorithm ensures that the final settling perturbations are damped by 25% each cycle of the oscillation. The autotuning process begins with applying a voltage step input to the system being tuned (in open loop mode) and measuring several parameters of the system's response to this voltage step function. The system's response to the step function is illustrated in Figure 2. The lag time of the system response, the maximum initial slope, and the TAU [63% (1/e)] response time are measured, then used to generate the Kp (proportional gain constant), Ki (integral gain constant), and Kd (derivative gain constant) coefficients.

The autotuning function offers users a choice of a minimum settling time mode or a minimum overshoot mode, which provides the Model 2510-AT with the flexibility to be used with a variety of load types and devices. For example, when controlling a large area TEC in a test fixture optimized for P, I, and D values, minimum overshoot protects the devices in the fixture from damage (Figure 3). For temperature setpoints that do not approach the maximum specified temperature for the device under test, the minimum settling time mode can be used to speed up the autotuning function (Figure 4).

50W Output

As the complexity of today's laser diode modules increases, higher power levels are needed in temperature controllers to address the module's cooling needs during production test. The 50W

2510 2510-AT

TEC SourceMeter® SMU Instrument Autotuning TEC SourceMeter SMU Instrument

(5A @ 10V) output allows for higher testing speeds and a wider temperature setpoint range than other, lower-power solutions.

High Stability P-I-D Control

When compared with other TEC controllers, which use less sophisticated P-I (proportional-integral) loops and hardware control mechanisms, this instrument's software-based, fully digital P-I-D control provides greater temperature stability and can be easily upgraded with a simple firmware change. The resulting temperature stability ($\pm 0.005^\circ\text{C}$ short term, $\pm 0.01^\circ\text{C}$ long term) allows for very fine control over the output wavelength and optical power of the laser diode module during production testing of DC characteristics. This improved stability gives users higher confidence in measured values, especially for components or sub-assemblies in wavelength multiplexed networks. The derivative component of the instrument's P-I-D control also reduces the required waiting time between making measurements at various temperature setpoints. The temperature setpoint range of -50°C to $+225^\circ\text{C}$ covers most of the test requirements for production testing of cooled optical components and sub-assemblies, with a resolution of $\pm 0.001^\circ\text{C}$.

Before the introduction of the Model 2510-AT, configuring test systems for new module designs and fixtures required the user to determine the best combination of P, I, and D coefficients through trial-and-error experimentation. The Model 2510-AT's autotuning function uses the modified Zeigler-Nichols algorithm to determine the optimal P, I, and D values automatically.

Adaptable to Evolving DUT Requirements

The Model 2510 and Model 2510-AT are well suited for testing a wide range of laser diode modules because they are compatible with the types of temperature sensors most commonly used in these modules. In addition to 100Ω , $1\text{k}\Omega$, $10\text{k}\Omega$, and $100\text{k}\Omega$ thermistors, they can handle inputs from 100Ω or $1\text{k}\Omega$ RTDs, and a variety of solid-state temperature sensors. This input flexibility ensures their adaptability as the modules being tested evolve over time.

Programmable Setpoints and Limits

Users can assign temperature, current, voltage, and thermistor resistance setpoints. The thermistor resistance setpoint feature allows higher correlation of test results with actual performance in the field for laser diode modules because reference resistors are used to control the temperature of the module. Programmable power, current, and temperature limits offer maximum protection against damage to the device under test.

Accurate Real-Time Measurements

Both models can perform real-time measurements on the TEC, including TEC current, voltage drop, power dissipation, and resistance, providing valuable information on the operation of the thermal control system.

Peltier (TEC) Ohms Measurement

TEC devices are easily affected by mechanical damage, such as sheer stress during assembly. The most effective method to test a device for damage after it has been incorporated into a laser diode module is to perform a low-level AC (or reversing DC) ohms measurement. If there is a change in the TEC's resistance value when compared with the manufacturer's specification, mechanical damage is indicated. Unlike a standard DC resistance measurement, where the current passing through the device can produce device heating and affect the measured resistance, the reversing DC ohms method does not and allows more accurate measurements.

Open/Short Lead Detection

Both models of the instrument use a four-wire measurement method to detect open/short leads on the temperature sensor before testing. Four-wire measurements eliminate lead resistance errors on the measured value, reducing the possibility of false failures or device damage.

Interface Options

Like all newer Keithley instruments, both models of the instrument include standard IEEE-488 and RS-232 interfaces to speed and simplify system integration and control.

Optional Resistive Heater Adapter

The Model 2510-RH Resistive Heater Adapter enables either model of the instrument to provide closed loop temperature control for resistive heater elements, rather than for TECs. When the adapter is installed at the instrument's output terminal, current flows through the resistive heater when the P-I-D loop indicates heating. However, no current will flow to the resistive heater when the temperature loop calls for cooling. The resistive element is cooled through radiation, conduction, or convection.

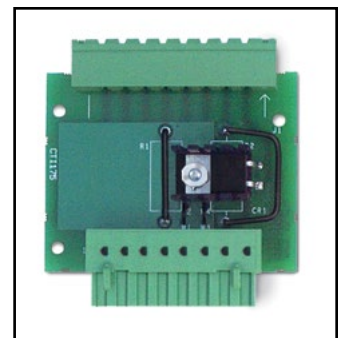

Figure 6. Optional heater adapter

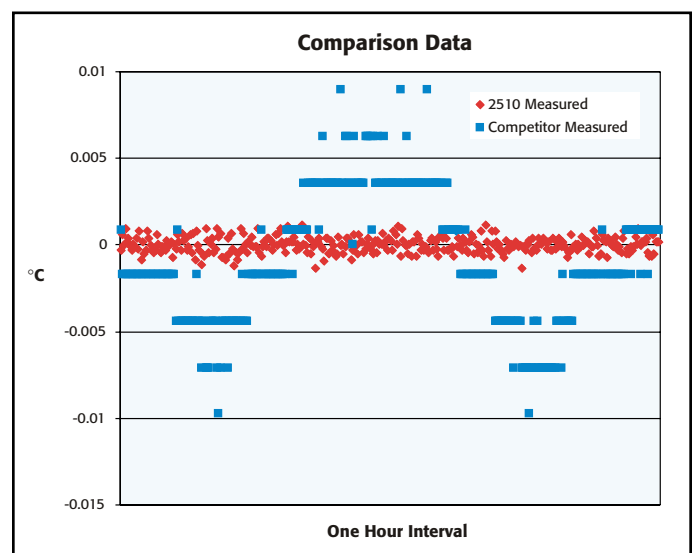

Figure 5. This graph compares the Model 2510/2510-AT's A/D converter resolution and temperature stability with that of a leading competitive instrument. While the competitive instrument uses an analog proportional-integral (P-I) control loop, it displays information in digital format through a low-resolution analog-to-digital converter. In contrast, the Model 2510/2510-AT uses a high-precision digital P-I-D control loop, which provides greater temperature stability, both over the short term ($\pm 0.005^\circ\text{C}$) and the long term ($\pm 0.01^\circ\text{C}$).

1.888.KEITHLEY (U.S. only)

www.keithley.com

KEITHLEY

A Greater Measure of Confidence

A Tektronix Company

2510 2510-AT

TEC SourceMeter® SMU Instrument Autotuning TEC SourceMeter SMU Instrument

SPECIFICATIONS

The Models 2510 and 2510-AT TEC SourceMeter SMU instruments are designed to:
Control the power to the TEC to maintain a constant temperature, current, voltage, or thermistor resistance.
Measure the resistance of the TEC.
Provide greater control and flexibility through a software P-I-D loop.

CONTROL SYSTEM SPECIFICATIONS

SET: Constant Peltier Temperature, Constant Peltier Voltage, Constant Peltier Current. Constant Thermistor Resistance.
CONTROL METHOD: Programmable software PID loop. Proportional, Integral, and Derivative gains independently programmable.
SETPOINT SHORT TERM STABILITY: $\pm 0.005^\circ\text{C rms}^{1,6,7}$.
SETPOINT LONG TERM STABILITY: $\pm 0.01^\circ\text{C}^{1,6,8}$.
SETPOINT RANGE: -50°C to 225°C .
UPPER TEMPERATURE LIMIT: 250°C max .
LOWER TEMPERATURE LIMIT: -50°C max .
SETPOINT RESOLUTION: $\pm 0.001^\circ\text{C}$, $< \pm 400\mu\text{V}$, $< \pm 200\mu\text{A}$ 0.01% of nominal (25°C) thermistor resistance.
HARDWARE CURRENT LIMIT: 1.0A to 5.25A $\pm 5\%$.
SOFTWARE VOLTAGE LIMIT: ± 0.5 to 10.5V $\pm 5\%$.

THERMAL FEEDBACK ELEMENT SPECIFICATIONS³

Sensor Type	RTD		Thermistor				Solid State	
	100 Ω	1 k Ω	100 Ω	1 k Ω	10 k Ω	100 k Ω	Current Output (I_{ss})	Voltage Output (V_{ss})
Excitation ¹³	2.5 mA 4 V max	833 μA	2.5 mA 8 V max	833 μA 8 V max	100 μA 8 V max	33 μA 6.6 V max	+13.5 V 833 μA	2.5 mA 15.75V max
Nominal Resistance Range	0–250 Ω	0–2.50 k Ω	0–1 k Ω	0–10 k Ω	0–80 k Ω	0–200 k Ω		
Excitation Accuracy ^{1,3}	$\pm 1.5\%$	$\pm 2.9\%$	$\pm 2.9\%$	$\pm 2.9\%$	$\pm 2.9\%$	$\pm 2.9\%$	$\pm 12\%$	$\pm 2.9\%$
Nominal Sensor Temperature Range	-50° to $+250^\circ\text{C}$	-50° to $+250^\circ\text{C}$	-50° to $+250^\circ\text{C}$	-50° to $+250^\circ\text{C}$	-50° to $+250^\circ\text{C}$	-50° to $+250^\circ\text{C}$	-40° to $+100^\circ\text{C}$	-40° to $+100^\circ\text{C}$
Calibration	α , β , δ settable	α , β , δ settable	A, B, C settable	A, B, C settable	A, B, C settable	A, B, C settable	Slope & offset	Slope & offset
Measurement Accuracy ^{1,3} \pm (% rdg + offset)	$0.04 + 0.07 \Omega^2$	$0.04 + 0.04 \Omega^2$	$0.04 + 0.07 \Omega^2$	$0.04 + 0.4 \Omega^2$	$0.02 + 3 \Omega$	$0.04 + 21 \Omega$	$0.03 + 100 \text{ nA}$	$0.03 + 500 \mu\text{V}$

THERMISTOR MEASUREMENT ACCURACY¹⁹

Nominal Thermistor Resistance	Accuracy vs. Temperature			
	0 $^\circ\text{C}$	25 $^\circ\text{C}$	50 $^\circ\text{C}$	100 $^\circ\text{C}$
100 Ω	0.021 $^\circ\text{C}$	0.035 $^\circ\text{C}$	0.070 $^\circ\text{C}$	0.27 $^\circ\text{C}$
1 k Ω	0.015 $^\circ\text{C}$	0.023 $^\circ\text{C}$	0.045 $^\circ\text{C}$	0.18 $^\circ\text{C}$
10 k Ω	0.006 $^\circ\text{C}$	0.012 $^\circ\text{C}$	0.026 $^\circ\text{C}$	0.15 $^\circ\text{C}$
100 k Ω	0.009 $^\circ\text{C}$	0.014 $^\circ\text{C}$	0.026 $^\circ\text{C}$	0.13 $^\circ\text{C}$

OPEN/SHORTED ELEMENT DETECTION SOFTWARE LINEARIZATION FOR THERMISTOR AND RTD

Common Mode Voltage: 30VDC.
Common Mode Isolation: $>10^9\Omega$, $<1000\text{pF}$.
Max. Voltage Drop Between Input/Output Sense Terminals: 1V.
Max. Sense Lead Resistance: 100 Ω for rated accuracy.
Sense Input Impedance: $>10^8\Omega$.

TEC OUTPUT SPECIFICATIONS

OUTPUT RANGE: $\pm 10\text{VDC}$ at up to $\pm 5\text{ADC}^{15}$.
OUTPUT RIPPLE: $<5\text{mV rms}^9$.
AC RESISTANCE EXCITATION: $\pm(9.6\text{mA} \pm 90\mu\text{A})^{14}$.

TEC MEASUREMENT SPECIFICATIONS³

Function	1 Year, 23 $^\circ\text{C} \pm 5^\circ\text{C}$
Operating Resistance ^{2, 10, 11, 12}	$\pm(2.0\%$ of rdg + 0.1 Ω)
Operating Voltage ^{2,10}	$\pm(0.1\%$ of rdg + 4mV)
Operating Current ¹⁰	$\pm(0.4\%$ of rdg + 8mA)
AC Resistance ^{2, 18}	$\pm(0.10\%$ of rdg + 0.02 Ω)

OPEN SHORTED THERMOELECTRIC DETECTION

LOAD IMPEDANCE: Stable into 1 μF typical.
COMMON MODE VOLTAGE: 30VDC maximum.
COMMON MODE ISOLATION: $>10^9\Omega$, $<1500\text{pF}$.
MAX. VOLTAGE DROP BETWEEN INPUT/OUTPUT SENSE TERMINALS: 1V.
MAX. SENSE LEAD RESISTANCE: 1 Ω for rated accuracy.
MAX. FORCE LEAD RESISTANCE: 0.1 Ω .
SENSE INPUT IMPEDANCE: $>400\text{k}\Omega$.

GENERAL

NOISE REJECTION:

SPEED	NPLC	NMRR ¹⁶	CMRR ¹⁷
Normal	1.00	60 dB	120 dB ¹

SOURCE OUTPUT MODES: Fixed DC level.
PROGRAMMABILITY: IEEE-488 (SCPI-1995.0), RS-232, 3 user-definable power-up states plus factory default and *RST.
POWER SUPPLY: 90V to 260V rms, 50–60Hz, 75W.
EMC: Complies with European Union Directive 98/336/EEC (CE marking requirements), FCC part 15 class B, CTSPR 11, IEC 801-2, IEC 801-3, IEC 801-4.
VIBRATION: MIL-PRF-28800F Class 3 Random Vibration.
WARM-UP: 1 hour to rated accuracies.
DIMENSIONS, WEIGHT: 89mm high \times 213 mm high \times 370mm deep (3½ in \times 8½ in \times 14½ in). Bench configuration (with handle and feet): 104mm high \times 238mm wide \times 370mm deep (4½ in \times 9½ in \times 14½ in). Net Weight: 3.21kg (7.08 lbs).
ENVIRONMENT: Operating: 0 $^\circ$ –50 $^\circ\text{C}$, 70% R.H. up to 35 $^\circ\text{C}$. Derate 3% R.H./ $^\circ\text{C}$, 35 $^\circ$ –50 $^\circ\text{C}$. **Storage:** -25° to 65 $^\circ\text{C}$.

NOTES

- Model 2510 and device under test in a regulated ambient temperature of 25 $^\circ\text{C}$.
- With remote voltage sense.
- 1 year, 23 $^\circ\text{C} \pm 5^\circ\text{C}$.
- With $I_{load} = 5\text{A}$ and $V_{load} = 0\text{V}$.
- With $I_{load} = 5\text{A}$ and $V_{load} = 10\text{V}$.
- With 10k Ω thermistor as sensor.
- Short term stability is defined as 24 hours with Peltier and Model 2510 at 25 $^\circ\text{C} \pm 0.5^\circ\text{C}$.
- Long term stability is defined as 30 days with Peltier and Model 2510 at 25 $^\circ\text{C} \pm 0.5^\circ\text{C}$.
- 10Hz to 10MHz measured at 5A output into a 2 Ω load.
- Common mode voltage = 0V (meter connect enabled, connects Peltier low output to thermistor measure circuit ground). $\pm(0.1\%$ of rdg. + 0.1 Ω) with meter connect disabled.
- Resistance range 0 Ω to 20 Ω for rated accuracy.
- Current through Peltier $> 0.2\text{A}$.
- Default values shown, selectable values of 3 μA , 10 μA , 33 μA , 100 μA , 833 μA , 2.5mA. Note that temperature control performance will degrade at lower currents.
- AC ohms is a dual pulsed measurement using current reversals available over bus only.
- Settable to $<400\mu\text{V}$ and $<200\mu\text{A}$ in constant V and constant I mode respectively.
- For line frequency $\pm 0.1\%$.
- For 1k Ω unbalance in LO lead.
- Resistance range 0 Ω to 100 Ω for rated accuracy.
- Accuracy figures represent the uncertainty that the Model 2510 may add to the temperature measurement, not including thermistor uncertainty. These accuracy figures are for thermistors with typical A,B,C constants.

1.888.KEITHLEY (U.S. only)

www.keithley.com

KEITHLEY

A Greater Measure of Confidence

A Tektronix Company

8544, 8544-TEC

- Compatible with Keithley laser diode LIV test solutions
- Simplifies configuration of LIV test systems
- Choice of three fixture designs, all with necessary cables
- Cables also available separately
- Ambient temperature control on TEC version

Ordering Information

8544 Butterfly Telecom Laser Diode Mount Bundle with 8542-301 and CA-321-1 cables

8544-TEC Butterfly Telecom Laser Diode Mount Bundle with TEC, thermistor, and AD592CN temperature sensor, with 8542-301 and CA-322-1 cables

Accessories Supplied

8542-301 LIV Cable to connect Model 2500 and 24XX to the fixture, 1.8m (6 ft.) (supplied with 8544 and 8544-TEC)

CA-321-1 Temp Control Cable to connect Model 2510 to fixture, 1.8m (6 ft.) (supplied with 8544)

CA-322-1 Dual Temp Control Cable to connect (2) Model 2510 to fixture, 1.8m (6 ft.) (supplied with 8544-TEC)

Laser Diode Mounts for LIV Test Systems

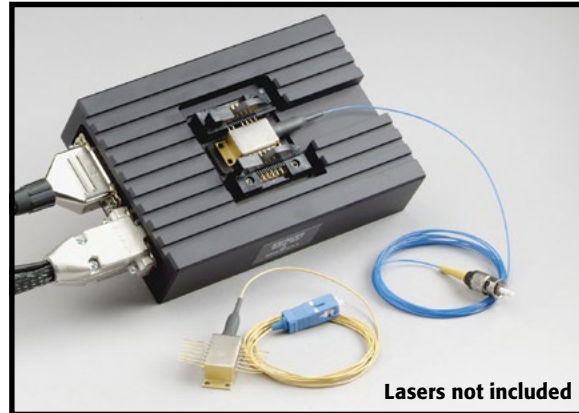

The 8544 Laser Diode Mount Series makes it easier than ever to configure a complete laser diode LIV test system for continuous wave test applications. These fixtures provide highly stable temperature control for all telecommunications laser diodes. They offer an easy-to-use platform for testing laser diodes used in telecommunications. They are designed to speed and simplify setting up test systems for all laser diode/photodiode/thermoelectric cooler/thermistor configurations.

Three different fixture bundle designs are available, all of which are compatible with Keithley's popular laser diode LIV test systems. Each bundle includes all cabling required to connect the test instrumentation to the test fixture. Cables are also available separately.

All 14 pin DIL and butterfly laser packages can be mounted on the 8544 Series. For higher power butterfly packages without integral thermoelectric coolers (TECs), the Model 8544-TEC offers a TEC and both thermistor and AD592CN sensors.

APPLICATIONS

- Continuous wave laser diode LIV characterization

SPECIFICATIONS

This series covers the offering of Laser Diode Mounts (LDM) for use with Continuous LIV Test Solutions. The following products: 2400-LV/2420/2440, 2500/2502, and 2510/2510AT are recommended for use with these products.

LASER TEMPERATURE CONTROL

TEMPERATURE RANGE: 0° to +80°C.

SENSOR TYPE 2 (Model 8544-TEC Only): 10kΩ thermistor, AD592CN.

REFERENCED MOUNT SPECIFICATIONS

LASER DIODE PACKAGE

Model	8544	8544-TEC
Socket	Butterfly 14 pin	Butterfly 14 pin
Base Plate	0.1" centers	0.1" centers

ACCESSORIES AVAILABLE

2400-LV/2420/2440	SourceMeter® SMU Instruments ¹
2502	Dual Photodiode Meter
2510/2510AT	TEC Control Meters (AT: Auto Tune feature)

GENERAL

RECOMMENDED MAXIMUM RATINGS⁵:

Drive Current (Amps): 2.

Measured Voltage (Volts): 3.

WEIGHT⁶: 1.0 lbs (0.45kg).

DIMENSIONS⁶: 32mm high × 95mm wide × 140mm deep (1.2in × 3.75 in × 5.5 in).

NOTES

1. The other SourceMeter offerings from Keithley, Models 2400, 2410, 2425, and 2430, are not recommended for use with the 8542-301 and Laser Diode Mounts unless proper interlock and safety precautions are observed (especially voltage protection).
2. The 8544-TEC unit is shipped with the 10kΩ thermistor wired. This is the more commonly requested configuration. The AD592CN sensor wires are available but not connected.
3. The triax inner shield is available on pin 2 of the 8542-301A. This will allow flexibility for the customer to exchange the wire in the LDM from pin 6 to pin 2.
4. To use the second 2510 (DB-15 pins 9–15), the customer must internally wire the 8544-TEC Mount to the DUT thermocouple. See the Quick Start Guide for wiring configuration.
5. Ratings are based on use of mount with provided cables and average majority of laser diode characteristics.
6. The weight and dimension is the mounting unit without the cables.

1.888.KEITHLEY (U.S. only)

www.keithley.com

A Greater Measure of Confidence

KEITHLEY

A Tektronix Company

1.888.KEITHLEY (U.S. only)

www.keithley.com

A Greater Measure of Confidence

KEITHLEY
A Tektronix Company