

# Rosemount™ 3144P Temperature Transmitter

with Rosemount X-well™ Technology



## NOTICE

Read this manual before working with the product. For personal and system safety, and for optimum product performance, ensure you thoroughly understand the contents before installing, using, or maintaining this product.

Within the United States, Emerson has two toll-free assistance numbers:

Customer Central (Technical support, quoting, and order-related questions): 1-800-999-9307 (7:00 am to 7:00 pm Central Time)

North American Response Center (Equipment service needs): 1-800-654-7768 (24 hours)

International: (952)-906-8888

## ⚠ CAUTION

**The products described in this document are NOT designed for nuclear-qualified applications.**

Using non-nuclear qualified products in applications that require nuclear-qualified hardware or products may cause inaccurate readings.

For information on Rosemount nuclear-qualified products, contact your local Emerson Sales Representative.

## ⚠ WARNING

**Failure to follow these installation guidelines could result in death or serious injury.**

Ensure only qualified personnel perform installation or service.

**Electrical shock could cause death or serious injury.**

Use extreme caution when making contact with the leads and terminals.

**Explosions could result in death or serious injury.**

Do not remove the connection head cover in explosive atmospheres when the circuit is live.

Before powering a FOUNDATION™ Fieldbus segment in an explosive atmosphere, ensure the instruments in the loop are installed in accordance with intrinsically safe or non-incendive field wiring practices.

Verify that the operating atmosphere of the transmitter is consistent with the appropriate hazardous locations certifications.

All connection head covers must be fully engaged to meet explosion-proof requirements.

**Process leaks could result in death or serious injury.**

Do not remove the thermowell while in operation.

Install and tighten thermowells or sensors before applying pressure.

**Physical access**

Unauthorized personnel may potentially cause significant damage to and/or misconfiguration of end users' equipment. This could be intentional or unintentional and needs to be protected against.

Physical security is an important part of any security program and fundamental to protecting your system. Restrict physical access by unauthorized personnel to protect end users' assets. This is true for all systems used within the facility.

# Contents

<b>Chapter 1</b>	<b>Introduction.....</b>	<b>5</b>
	1.1 Using this manual.....	5
	1.2 Rosemount 3144P revisions.....	6
	1.3 Confirm HART revision capability.....	10
<b>Chapter 2</b>	<b>Installation.....</b>	<b>11</b>
	2.1 Installation considerations.....	11
	2.2 Commissioning.....	13
	2.3 Mounting.....	16
	2.4 Installation.....	17
	2.5 Wiring.....	23
	2.6 Foundation Fieldbus.....	27
	2.7 Power supply.....	28
	2.8 Grounding.....	29
	2.9 Wire and apply power.....	32
<b>Chapter 3</b>	<b>HART Commissioning.....</b>	<b>33</b>
	3.1 Overview.....	33
	3.2 Confirm HART revision capability.....	33
	3.3 Safety messages.....	34
	3.4 Field Communicator.....	34
	3.5 Review configuration data.....	44
	3.6 Check output.....	44
	3.7 Configuration.....	44
	3.8 Rosemount X-well Technology configuration.....	99
	3.9 Device output configuration.....	102
	3.10 Device information.....	104
	3.11 Measurement filtering.....	106
	3.12 Diagnostics and service.....	108
	3.13 Multidrop communication.....	109
	3.14 Use with the HART Tri-Loop.....	110
	3.15 Configure Thermocouple Degradation in guided setup.....	113
	3.16 Configure Thermocouple Degradation in manual setup.....	118
	3.17 Active Thermocouple Degradation Alerts.....	123
	3.18 Minimum/maximum tracking diagnostic.....	128
	3.19 Calibration.....	136
	3.20 Trim the transmitter.....	137
	3.21 Output trim or scaled output trim.....	147

	3.22 Troubleshooting.....	148
<b>Chapter 4</b>	<b>FOUNDATION Fieldbus Configuration.....</b>	<b>157</b>
	4.1 Overview.....	157
	4.2 Safety messages.....	157
	4.3 Device description.....	157
	4.4 Node address.....	158
	4.5 Modes.....	158
	4.6 Link Active Scheduler (LAS).....	159
	4.7 Capabilities.....	159
	4.8 FOUNDATION Fieldbus function blocks.....	160
	4.9 Resource block.....	162
	4.10 Analog Input (AI).....	175
	4.11 Operation.....	182
	4.12 Troubleshooting guides.....	188
<b>Chapter 5</b>	<b>Operation and maintenance.....</b>	<b>193</b>
	5.1 Safety messages.....	193
	5.2 Maintenance.....	193
	5.3 Return of materials.....	195
<b>Chapter 6</b>	<b>Safety Instrumented Systems (SIS) requirements.....</b>	<b>197</b>
	6.1 SIS certification.....	197
	6.2 Safety certified identification.....	197
	6.3 Installation.....	197
	6.4 Configuration.....	198
	6.5 Operation and maintenance.....	200
	6.6 Specifications.....	201
	6.7 Spare parts.....	202
<b>Appendix A</b>	<b>Reference data.....</b>	<b>203</b>
	A.1 Product Certifications.....	203
	A.2 Ordering Information, Specifications, and Drawings.....	203

# 1 Introduction

## 1.1 Using this manual

The sections in this manual provide information on installing, operating, and maintaining the Rosemount™ 3144P Temperature Transmitter. The sections are organized as follows:

- [Installation](#) contains mechanical and electrical installation instructions.
- [HART Commissioning](#) contains techniques for properly commissioning the device.
- [FOUNDATION Fieldbus Configuration](#) provides instruction on commissioning and operating the Rosemount 3144P Transmitter. This chapter also includes information on software functions, configuration parameters, and online variables.
- [Operation and maintenance](#) contains operation and maintenance techniques.
- [Safety Instrumented Systems \(SIS\) Requirements](#) provides identification, installation, configuration, operation and maintenance, and inspection information for Safety Instrumented Systems.
- [Reference Data](#) supplies reference and specification data, as well as ordering information and contains intrinsic safety approval information, European ATEX directive information, and approval drawings.

### 1.1.1 Transmitter

Industry-leading temperature transmitter delivers unmatched field reliability and innovative process measurement solutions:

- Rosemount X-Well™ Technology provides a Complete Point Solution™ for accurately measuring process temperature in monitoring applications without the requirement of a thermowell or process penetration
- Superior accuracy and stability
- Dual and single sensor capability with universal sensor inputs (RTD, T/C, mV, ohms)
- Comprehensive sensor and process diagnostics offering
- IEC 61508 safety certification
- Dual-compartment housing
- Large LCD display
- Selectable HART® Revision (5 and 7) or FOUNDATION Fieldbus protocols

Improve efficiency with Best-in-Class product specifications and capabilities:

- Reduce maintenance and improve performance with industry leading accuracy and stability.
- Improve measurement accuracy by 75 percent with Transmitter-Sensor Matching.
- Ensure process health with system alerts and easy-to-use Device Dashboards.

- Easily check device status and values on local LCD display with large percent range graph.
- Achieve high reliability and installation ease with the industry's most rugged dual compartment design.

Optimize measurement reliability with diagnostics designed for any protocol on any host system.

- Thermocouple Degradation Diagnostic monitors the health of a thermocouple loop, enabling preventative maintenance.
- Minimum and Maximum Temperature Tracking tracks and records temperature extremes of the process sensors and the ambient environment.
- Sensor Drift Alert detects sensor drift and alerts you.
- The Hot Backup™ feature provides temperature measurement redundancy.

Refer to the following literature for a full range of compatible connection heads, sensors, and thermowells provided by Emerson:

- Rosemount Volume 1 Temperature Sensors and Accessories [Product Data Sheet](#)
- Rosemount DIN-Style Temperature Sensors and Thermowells (Metric) [Product Data Sheet](#)

## 1.2 Rosemount 3144P revisions

### HART protocol

The initial release of the Rosemount 3144P HART was device revision 3. Each additional revision contains incremental improvements. summarizes these changes.

**Table 1-1: HART Revisions**

Software release date	Identify device			Field device driver		Review instructions
	NAMUR software revision	NAMUR hardware Revision	HART software revision <sup>(1)</sup>	HART universal revision <sup>(2)</sup>	Device revision	Manual document number
April 2017	1.2.1	1.0.0	3	7	7 <sup>(3)</sup>	00809-0100-4021
				5	5 <sup>(4)</sup>	
April 2012	1.1.1	N/A	2	7	6 <sup>(4)</sup>	
				5	5 <sup>(4)</sup>	
Feb 2007	N/A	N/A	1	5	4	
Dec 2003	N/A	N/A	N/A	5	3	

(1) NAMUR software revision is located in the hardware tag of the device. You can read the HART software revision with a HART capable configuration tool.

(2) Device driver file names use device and DD revision (e.g. 10\_07). HART protocol is designed to enable legacy driver revisions to continue to communicate with new HART devices. To access this functionality, download the new device driver. Emerson recommends downloading the new device driver to ensure new functionality.

- (3) Rosemount X-well sensor type.
- (4) HART Revision 5 and 7 selectable, Thermocouple Degradation Diagnostic, Min/Max Tracking.

**FOUNDATION Fieldbus**

The following table summarizes the Rosemount 3144P FOUNDATION™ Fieldbus revision history.

**Table 1-2: FOUNDATION Fieldbus Revisions**

Device revision	Software revision	Hardware revision	NAMUR software revision	NAMUR hardware revision	Description	Date
Rev 1	1.00.011	5	N/A	N/A	Initial release.	Mar. 2004
Rev 1	1.00.024	5	N/A	N/A	Minor product maintenance, software.	Sep. 2004
Rev 1	1.00.024	6	N/A	N/A	Minor product maintenance, hardware.	Dec. 2004
Rev 1	1.01.004	6	N/A	N/A	Software update.	Oct. 2005
Rev 1	1.01.010	7	N/A	N/A	Component obsolescence hardware change and software to support the hardware change.	Feb. 2007
Rev 2	2.02.003	7	N/A	N/A	FF Sensor and Process Diagnostic Release (D01): Thermocouple Degradation Diagnostic and Minimum and Maximum Temperature Tracking.	Nov. 2008

**Table 1-2: FOUNDATION Fieldbus Revisions (continued)**

Device revision	Software revision	Hardware revision	NAMUR software revision	NAMUR hardware revision	Description	Date
Rev 3	3.10.23	7	1.3.1	1.0.0	<p>Device Compliance to ITK 6.0.1. Addition of NE107 device diagnostic information. Ease of use improvements including:</p> <ul style="list-style-type: none"> <li>• Hot Backup functionality has been moved to the transducer block, allowing easier configuration from the DD.</li> <li>• Device is shipped with the simulate switch ON, allowing device alerts simulation without cover removal.</li> <li>• Device has unique block names using the last four digits (XXXX) of the output board serial number, e.g. AI_1400_XXXX</li> <li>• All blocks are instantiated before shipping, including model option code dependent blocks. The product also has all parameters initialized so that its primary measurement is available with no user changes required.</li> <li>• All devices ship will AI block scheduled.</li> <li>• Customer will be able to use old DD files when replacing a device with a newer rev device; this is possible for devices with device</li> </ul>	June 2013



Device revision	Software revision	Hardware revision	NAMUR software revision	NAMUR hardware revision	Description	Date
					<p>revision number 3 and above.</p> <ul style="list-style-type: none"> <li>• Wherever possible, the product ships with parameters initialized to common values. The product shall ship with no uninitialized parameters that will keep the transmitter from providing its primary measurement right out of the box.</li> <li>• The product's default block tags are be less than or equal to 16 characters in length.</li> <li>• Custom function blocks were replaced with enhanced function blocks.</li> <li>• Default block tags include underscores, “_”, instead of white spaces.</li> <li>• The CF file has a better description of the device, including meaningful defaults and example values.</li> <li>• Device provides means to properly range graphs and charts in the device dashboards.</li> </ul>	

## 1.3 Confirm HART revision capability

Confirm the HART capability of the system devices prior to transmitter installation.

### Prerequisites

If using HART based control or asset management systems, confirm the HART capability of those systems prior to transmitter installation. Not all systems are capable of communicating with HART Revision 7 protocol. You can configure the transmitter for either HART Revision 5 or Revision 7.

### Switch HART revision mode

If the HART configuration tool is not capable of communicating with HART Revision 7, the transmitter will load a **Generic Menu** with limited capability. The following procedures will switch the HART revision mode from the **Generic Menu**.

### Procedure

Select **Manual Setup** → **Device Information** → **Identification** → **Message**.

- a) To change to HART Revision 5, enter **HART5** in the Message field.
- b) To change to HART Revision 7, enter **HART7** in the Message field.

## 2 Installation

### 2.1 Installation considerations

#### 2.1.1 General

Electrical temperature sensors, such as resistance temperature detectors (RTDs) and thermocouples (T/Cs), produce low-level signals proportional to temperature. The Rosemount X-well™ 3144P Temperature Transmitter converts low-level signals to HART® or FOUNDATION™ Fieldbus and then transmits the signals to the control system via two power/signal wires.

#### 2.1.2 Electrical

Proper electrical installation is essential to prevent errors due to sensor lead resistance and electrical noise. For HART communications, the current loop must have between 250 and 1100 ohms resistance. Refer to for sensor and current loop connections. Foundation Fieldbus devices must have proper termination and power conditioning for reliable operation. Shielded cables must be used for Foundation Fieldbus and may only be grounded in one place.

#### 2.1.3 Temperature effects

##### Temperature effects

The transmitter will operate within specifications for ambient temperatures between –40 and 185 °F (–40 and 85 °C). Since heat from the process is transferred from the thermowell to the transmitter housing, if the expected process temperature is near or beyond specification limits, consider using additional thermowell lagging, an extension nipple, or a remote mounting configuration to isolate the transmitter from the process. [Figure 2-1](#) details the relationship between housing temperature rise and extension length.

**Figure 2-1: Transmitter Housing Temperature Rise versus Extension Length for a Test Installation**

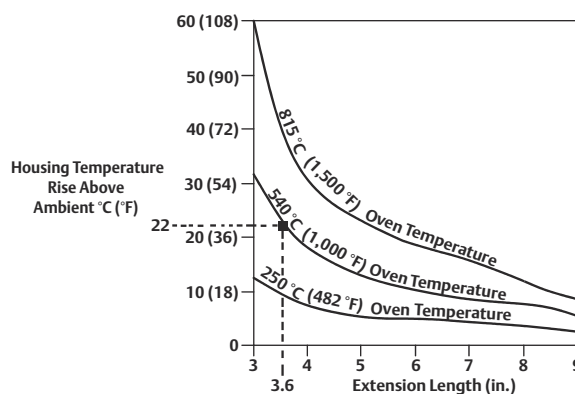

### Example

The maximum permissible housing temperature rise (T) can be calculated by subtracting the maximum ambient temperature (A) from the transmitter's ambient temperature specification limit (S). For instance, if A = 40 °C.

$$T = S - A$$

$$T = 85\text{ °C} - 40\text{ °C}$$

$$T = 45\text{ °C}$$

For a process temperature of 540 °C (1004 °F), an extension length of 3.6-in (91.4 mm) yields a housing temperature rise (R) of 22 °C (72 °F), providing a safety margin of 23 °C (73 °F). A 6.0-in.(152.4 mm) extension length (R = 10 °C [50 °F]) offers a higher safety margin (35 °C [95 °F]) and reduces temperature-effect errors but would probably require extra transmitter support. Gauge the requirements for individual applications along this scale. If a thermowell with lagging is used, the extension length may be reduced by the length of the lagging.

## 2.1.4 Moist or corrosive environments

The Rosemount 3144P Transmitter has a highly reliable dual compartment housing designed to resist moisture and corrosion. The sealed electronics module is mounted in a compartment that is isolated from the terminal side with conduit entries. O-ring seals protect the interior when the covers are properly installed. In humid environments, however, it is possible for moisture to accumulate in conduit lines and drain into the housing.

---

### Note

Each transmitter is marked with a tag indicating the approvals. Install the transmitter according to all applicable installation codes, and approval and installation drawings (see Rosemount 3144P [Product Data Sheet](#)). Verify that the operating atmosphere of the transmitter is consistent with the hazardous locations certifications. Once a device labeled with multiple approval types is installed, it should not be reinstalled using any of the other labeled approval types. To ensure this, the approval label should be permanently marked to distinguish the approval type(s) used.

---

## 2.1.5 Location and position

When choosing an installation location and position, take access to the transmitter into account.

### Terminal side of electronics housing

Mount the transmitter so the terminal side is accessible, allowing adequate clearance for cover removal. Best practice is to mount the transmitter with the conduit entries in a vertical position to allow for moisture drainage.

### Circuit side of electronics housing

Mount the transmitter so the circuit side is accessible, providing adequate clearance for cover removal. Additional room is required for LCD display installation. The transmitter may be mounted directly to or remotely from the sensor. Using optional mounting

brackets, the transmitter may be mounted to a flat surface or a 2.0-in. (50.8 mm) diameter pipe (see [Mounting](#)).

## 2.1.6 Software compatibility

Replacement transmitters may contain revised software that is not fully compatible with the existing software. The latest device descriptors (DD) are available with new Field Communicators or they can be loaded into existing communicators at any Emerson Service Center or via the Easy Upgrade process. For more information on upgrading a Field Communicator, see [HART Commissioning](#).

To download new device drivers, visit [Emerson.com/Rosemount/Device-Install-Kits](http://Emerson.com/Rosemount/Device-Install-Kits).

## 2.2 Commissioning

The transmitter must be configured for certain basic variables to operate. In many cases, these variables are pre-configured at the factory. Configuration may be required if the variables need to be changed.

Commissioning consists of testing the transmitter and verifying transmitter configuration data. Transmitters can be commissioned either before or after installation. Commissioning the transmitter on the bench before installation using a Field Communicator or AMS Device Manager ensures that all transmitter components are in working order.

For more information on using the Field Communicator with the transmitter, see [HART Commissioning](#). For more information on using the Rosemount 3144 with FOUNDATION Fieldbus, see [FOUNDATION Fieldbus Configuration](#).

**Figure 2-2: Installation Flowchart**

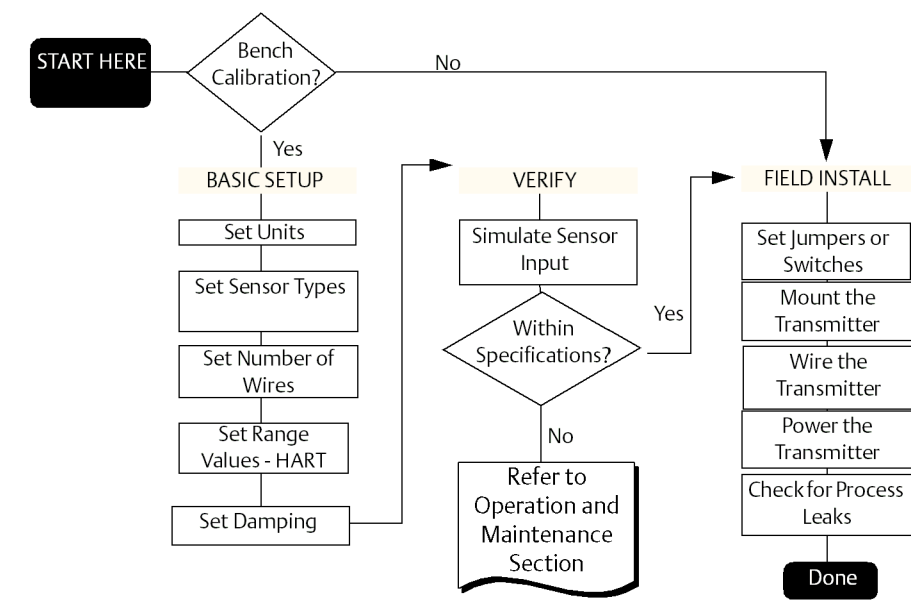

## 2.2.1 Setting the loop to manual

Set the process application loop to manual when sending or requesting data that would disrupt the loop or change the output of the transmitter. The Field Communicator or AMS Device Manager will prompt to set the loop to manual, when necessary. Acknowledging the prompt does not set the loop to manual, it is only a reminder. Setting the loop to manual is a separate operation.

## 2.2.2 Set switches

The security and simulate switches are located on the top center of the electronics module.

---

### Note

The factory ships the simulate switch in the "ON" position.

---

## HART

### Set the switches without an LCD display

#### Procedure

1. If the transmitter is installed in a loop, set the loop to manual mode and disconnect the power.
2. ⚠ Remove the housing cover on the electronics side of the transmitter. Do not remove the transmitter cover in explosive atmospheres with a live circuit.
3. Set the switches to the desired position (see [Figure 2-3](#)).
4. ⚠ Replace the transmitter cover. Both transmitter covers must be fully engaged to meet explosion-proof requirements.
5. Apply power and set the loop to automatic mode.

### Set the switches with an LCD display

#### Procedure

1. If the transmitter is installed in a loop, set the loop to manual mode and disconnect the power.
2. ⚠ Remove the housing cover on the electronics side of the transmitter. Do not remove the transmitter cover in explosive atmospheres with a live circuit.
3. Unscrew the LCD display screws and gently slide the meter straight off.
4. Set the switches to the desired position (see [Figure 2-3](#)).
5. Gently slide the LCD display back into place, taking extra precautions with the 10 pin connection.
6. Replace and tighten the LCD display screws to secure the LCD display.
7. ⚠ Replace the transmitter cover. Both transmitter covers must be fully engaged to meet explosion-proof requirements.
8. Apply power and set the loop to automatic mode.

## FOUNDATION Fieldbus Set switches without LCD display

### Procedure

1. Set the loop to Out-of-Service (OOS) mode (if applicable) and disconnect the power.
2. Remove the electronics housing cover.
3. Set the switches to the desired position.
4. Reattach housing cover.
5. Apply power and set the loop to in-service mode.

## Set switches with LCD display

### Procedure

1. Set the loop to OOS (if applicable) and disconnect the power.
2. Remove the housing cover on the electronics side of the transmitter.
3. Unscrew the LCD display screws and gently pull the meter straight off.
4. Set the switches to the desired position.
5. Replace and tighten the LCD display screws to secure the LCD display.
6. Replace the transmitter cover.
7. Apply power and set the loop to In-service mode.

Figure 2-3: Transmitter Switch Locations

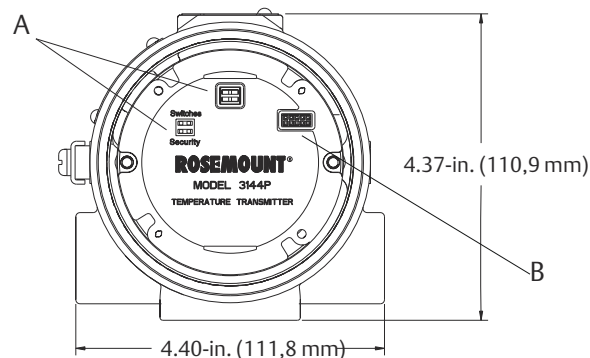

## Write protect switch (HART and FOUNDATION Fieldbus)

The transmitter is equipped with a write-protect switch that can be positioned to prevent accidental or deliberate change of configuration data.

## Alarm switch (HART Protocol)

An automatic diagnostic routine monitors the transmitter during normal operation. If the diagnostic routine detects a sensor failure or an electronics failure, the transmitter goes into alarm (high or low, depending on the position of the failure mode switch).

The analog alarm and saturation values used by the transmitter depend on whether it is configured to standard or NAMUR-compliant operation. These values are also custom-configurable in both the factory and the field using the HART Communications. The limits are:

- $21.0 \leq I \leq 23$  for high alarm
- $20.5 \leq I \leq 20.9$  for high saturation
- $3.70 \leq I \leq 3.90$  for low saturation
- $3.50 \leq I \leq 3.75$  for low alarm

**Note**

A 0.1 mA separation between low saturation and low alarm is required.

**Table 2-1: Values for Standard and NAMUR Operation**

Standard operation (factory default)		NAMUR-compliant operation	
Fail high	$21.75 \text{ mA} \leq I$	Fail high	$21.0 \text{ mA} \leq I$
High saturation	20.5 mA	High saturation	20.5 mA
Low saturation	3.9 mA	Low saturation	3.8 mA
Fail low	$I \leq 3.75 \text{ mA}$	Fail low	$I \leq 3.6 \text{ mA}$

### Simulate switch (FOUNDATION Fieldbus)

Simulate switch is used to replace the channel value coming from the sensor transducer block. For testing purposes, it manually simulates the output of the analog input block to a desired value.

## 2.3 Mounting

If possible, the transmitter should be mounted at a high point in the conduit run so moisture from the conduits will not drain into the housing. The terminal compartment could fill with water if the transmitter is mounted at a low point in the conduit run. In some instances, the installation of a poured conduit seal, such as the one pictured in [Figure 2-5](#), is advisable. Remove the terminal compartment cover periodically and inspect the transmitter for moisture and corrosion.

**Figure 2-4: Incorrect Conduit Installation**

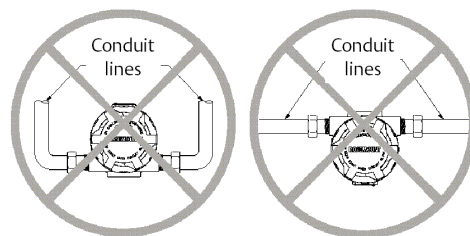



**Figure 2-5: Recommended Mounting with Drain Seal**

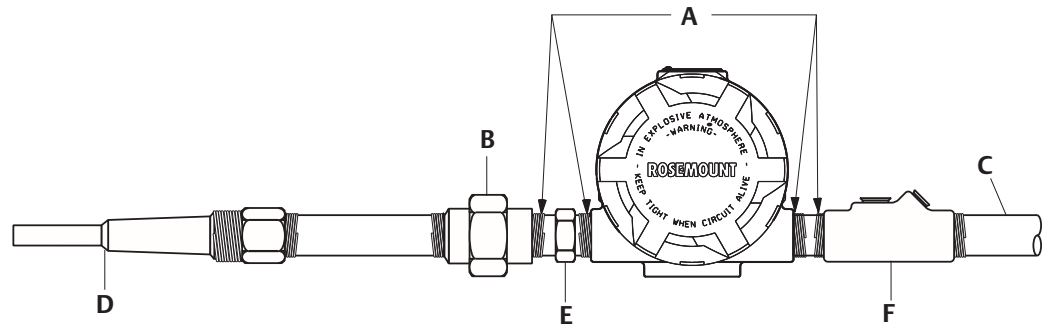

- A. Sealing compound
- B. Union coupling with extension
- C. Conduit for field wiring
- D. Thermowell
- E. Sensor hex
- F. Poured conduit seal (where required)

If mounting the transmitter directly to the sensor assembly, use the process shown in [Figure 2-6](#). If mounting the transmitter apart from the sensor assembly, use conduit between the sensor and transmitter. The transmitter accepts male conduit fittings with  $\frac{1}{2}$  -14 NPT, M20  $\times$  1.5 (CM 20), PG 13.5 (PG 11), or JIS G  $\frac{1}{2}$  threads (M20  $\times$  1.5 (CM 20), PG 13.5 (PG 11), or JIS G  $\frac{1}{2}$  threads are provided by an adapter). Make sure only qualified personnel perform the installation.

The transmitter may require supplementary support under high-vibration conditions, particularly if used with extensive thermowell lagging or long extension fittings. Pipe-stand mounting, using one of the optional mounting brackets, is recommended for use in high-vibration conditions.

## 2.4 Installation

Installation is to be performed by qualified personnel. No special installation is required in addition to the standard installation practices outlined in this document. Always ensure a proper seal by installing the electronics housing cover(s) so that metal contacts metal.

The loop should be designed so the terminal voltage does not drop below 12 Vdc when the transmitter output is 24.5 mA.

Environmental limits are available in the [Rosemount 3144P Temperature Transmitter Product Page](#).

## 2.4.1 Typical North American installation

**Figure 2-6: Typical Direct-Mounted Configuration**

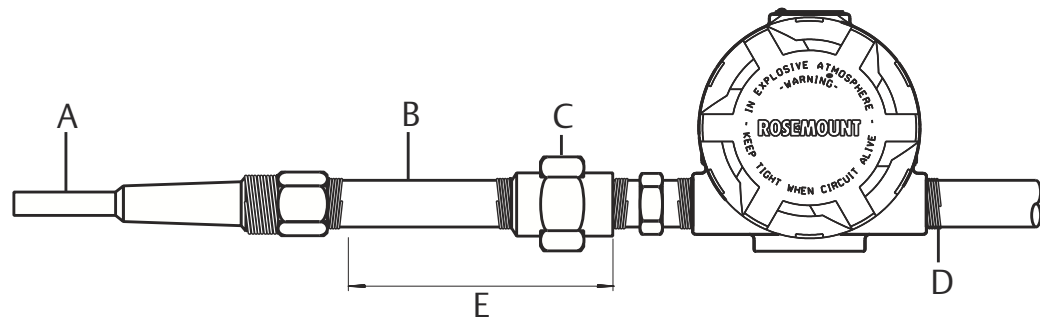

- A. Thermowell
- B. Extension (nipple)
- C. Union or coupling
- D. Conduit for field wiring (dc power)
- E. Extension fitting length

### Procedure

1. Mount the thermowell to the process container wall.
2. Install and tighten thermowells.
3. Perform a leak check.
4. Attach any necessary unions, couplings, and extension fittings. Seal the fitting threads with an approved thread sealant, such as silicone or PTFE tape (if required).
5. Screw the sensor into the thermowell or directly into the process (depending on installation requirements).
6. Verify all sealing requirements.
7. Attach the transmitter to the thermowell/sensor assembly. Seal all threads with an approved thread sealant, such as silicone or PTFE tape (if required).
8. Install field wiring conduit into the open transmitter conduit entry (for remote mounting) and feed wires into the transmitter housing.
9. Pull the field wiring leads into the terminal side of the housing.
10. Attach the sensor leads to the transmitter sensor terminals.  
The wiring diagram is located inside the housing cover.
11. Attach and tighten both transmitter covers.

## 2.4.2 Typical European installation

**Figure 2-7: Typical Remote-Mounted Configuration with Cable Glands**

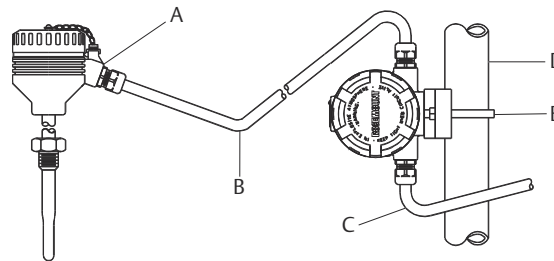

- A. Cable gland
- B. Shielded cable from sensor to transmitter
- C. Shielded cable from transmitter to control room
- D. 2-in. (50 mm) pipe
- E. B4 mounting bracket

### Procedure

1. Mount the thermowell to the process container wall.
2. Install and tighten thermowells.
3. Perform a leak check.
4. Attach a connection head to the thermowell.
5. Insert sensor into the thermowell and wire the sensor to the connection head.  
The wiring diagram is located inside the connection head.
6. Mount the transmitter to a 2-in. (50 mm) pipe or a panel using one of the optional mounting brackets.
7. Attach cable glands to the shielded cable running from the connection head to the transmitter conduit entry.
8. Run the shielded cable from the opposite conduit entry on the transmitter back to the control room.
9. Insert shielded cable leads through the cable entries into the connection head/transmitter. Connect and tighten cable glands.
10. Connect the shielded cable leads to the connection head terminals (located inside the connection head) and to the sensor wiring terminals (located inside the transmitter housing).

## 2.4.3 Rosemount X-well installation

Rosemount X-well™ Technology is for temperature monitoring applications and is not intended for control or safety applications. It is available in the Rosemount 3144P Temperature Transmitter in a factory assembled direct mount configuration with a Rosemount 0085 Pipe Clamp Sensor. It cannot be used in a remote mount configuration. Rosemount X-well Technology will only work as specified with factory supplied and assembled Rosemount 0085 Pipe Clamp silver tipped single element sensor with an 80 mm extension length. It will not work as specified if used with other sensors. Installation

and use of incorrect sensor will result in inaccurate process temperature calculations. **It is extremely important that the above requirements and installation steps below are followed to ensure that Rosemount X-well Technology works as specified.**

In general, pipe clamp sensor installation best practices shall be followed. See Rosemount 0085 Pipe Clamp Sensor [Quick Start Guide](#) with Rosemount X-well Technology specific requirements noted:

1. Mount transmitter directly on pipe clamp sensor in order for Rosemount X-well Technology to properly function.
2. Install assembly away from dynamic external temperature sources such as a boiler or heat tracing.
3. Ensure for the pipe clamp sensor tip to make direct contact with the pipe surface for Rosemount X-well Technology. Moisture build-up between sensor and pipe surface, or sensor hang-up in assembly can cause inaccurate process temperature calculations. Refer to installation best practices in Rosemount 0085 Pipe Clamp Sensor [Quick Start Guide](#) to ensure proper sensor to pipe surface contact.
4. Insulation ½-in. thick minimum with a R-value of  $> 0.42 \text{ m}^2 \times \text{K/W}$  is required over the sensor clamp assembly and sensor extension up to transmitter head to prevent heat loss. Apply a minimum of six inches of insulation on each side of the pipe clamp sensor. Care should be taken to minimize air gaps between insulation and pipe.

---

**Note**

DO NOT apply insulation over transmitter head as it will result in longer response times and may damage transmitter electronics.

---

5. Although it will come factory configured as such, ensure that pipe clamp RTD sensor is assembled in 4-wire configuration.

---

**Figure 2-8: Rosemount 3144P Transmitter with Rosemount X-well Technology Installation**

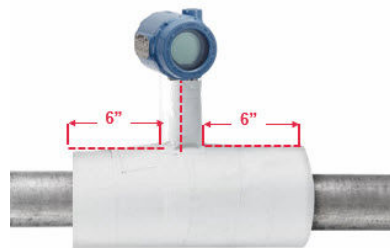

## 2.4.4

### Install Rosemount X-well in conjunction with a Rosemount 333 Tri-Loop (HART/4–20 mA only)

Use the dual-sensor option Rosemount 3144P Transmitter that is operating with two sensors in conjunction with a Rosemount 333 HART Tri-Loop™ HART-to-Analog Signal Converter to acquire an independent 4–20 mA analog output signal for each sensor input.

The transmitter can be configured to output four of the six following digital process variables:

- Sensor 1
- Sensor 2
- Differential temperature
- Average temperature
- First good temperature
- Transmitter terminal temperature
- Surface temperature (Rosemount X-well only)

The HART Tri-Loop reads the digital signal and outputs any or all of these variables into as many as three separate 4–20 mA analog channels.

Refer to [Figure 2-9](#) for basic installation information. Refer to the Rosemount 333 HART-to-Analog [Reference Manual](#) signal converter for complete installation information.

**Figure 2-9: HART Tri-Loop Installation Flowchart <sup>(1)</sup>**

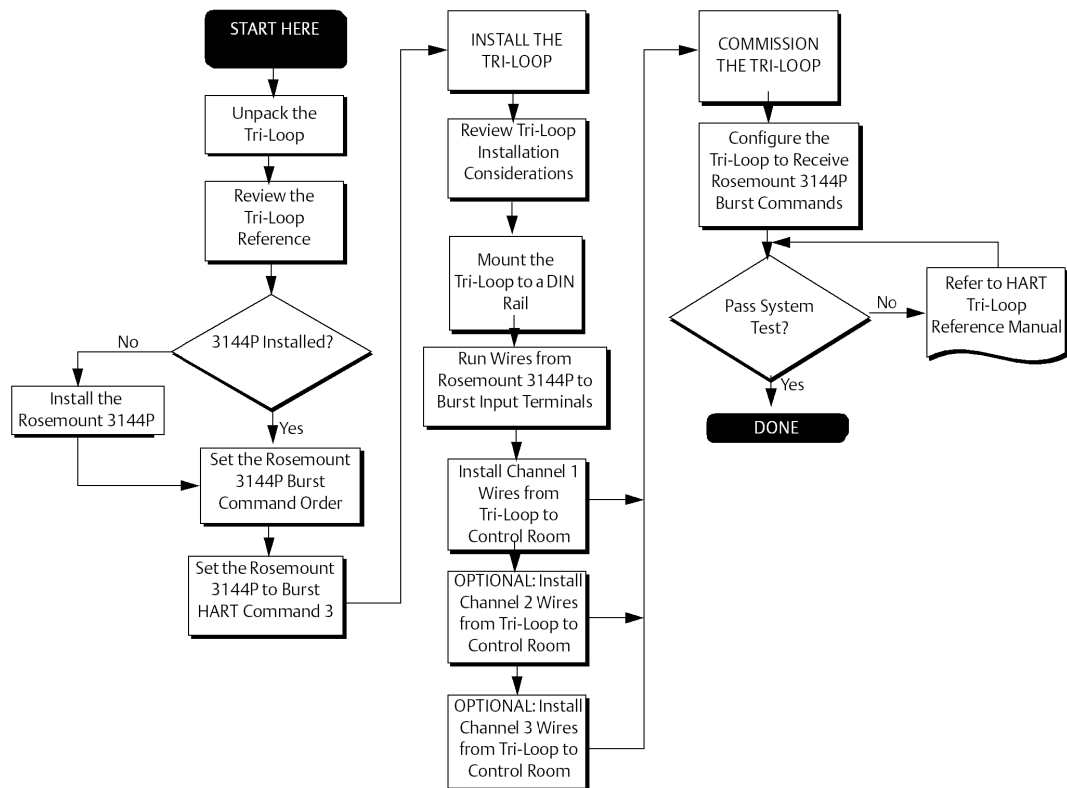

(1) See [Use with the HART Tri-Loop for configuration information](#).

## 2.4.5 LCD display

Transmitters ordered with the LCD display option (code M5) are shipped with the LCD display installed. After-market installation of the LCD display on a conventional transmitter requires a small instrument screwdriver and the LCD display kit, which includes:

- LCD display assembly
- Extended cover with cover O-ring in place
- Captive screws (quantity 2)
- 10-pin interconnection header

To install the LCD display:

### Procedure

1. If the transmitter is installed in a loop, set the loop to manual (HART)/out-of-service (FOUNDATION Fieldbus) mode and disconnect the power.
2. Remove the housing cover from the electronics side of the transmitter. Do not remove the transmitter covers in explosive atmospheres with a live circuit.
3. Ensure that the transmitter write protect switch is set to the Off position. If transmitter security is On, the transmitter cannot be configured to recognize the LCD display. If security On is desired, configure the transmitter for the LCD display, and then install the meter.
4. Insert the interconnection header in the 10-pin socket on the face of the electronics module. Insert the pins into the electronics LCD display interface.
5. The meter can be rotated in 90-degree increments for easy viewing. Position one of the four 10-pin sockets on the back of the meter to accept the interconnection header.
6. Attach the LCD display assembly to the interconnection pins, then thread and tighten the LCD display screws into the holes on the electronics module.
7. Attach the extended cover; tighten at least one-third turn after the O-ring contacts the transmitter housing. Both transmitter covers must be fully engaged to meet explosion proof requirements.
8. Apply power and set the loop to automatic (HART)/in-service (FOUNDATION Fieldbus) mode.

Once the LCD display is installed, configure the transmitter to recognize the meter option. Refer to [LCD display options](#) or [LCD display transducer block \(index number 1200\)](#) (FOUNDATION Fieldbus).

---

### Note

Observe the following LCD display temperature limits:

Operating: -40 to 185 °F (-40 to 85 °C)

Storage: -76 to 185 °F (-60 to 85 °C)

---

## 2.4.6 Multichannel installation (HART/4–20 mA only)

Several transmitters can be connected to a single master power supply (see figure below). In this case, the system may be grounded only at the negative power supply terminal. In multichannel installations, where several transmitters depend on one power supply and the loss of all transmitters would cause operational problems, consider an uninterrupted power supply or a back-up battery. The diodes shown in Figure 2-10 prevent unwanted charging or discharging of the back-up battery.

**Figure 2-10: Multichannel Installations**

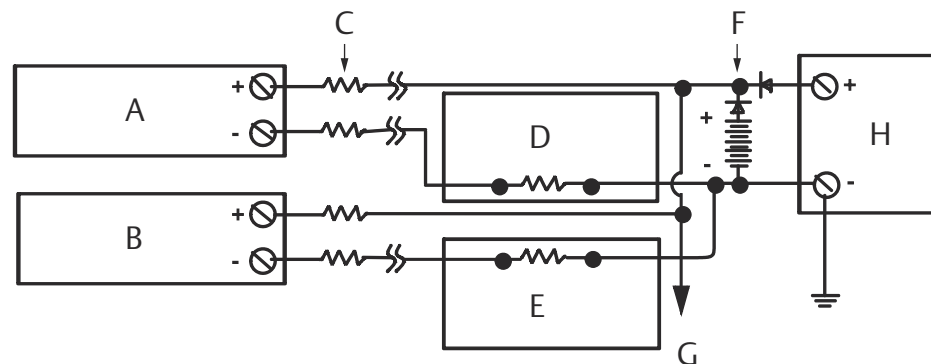

Between 250 and 1100  $\Omega$  If no load resistor

- A. Transmitter 1
- B. Transmitter 2
- C.  $R_{Lead}$
- D. Readout or controller 1
- E. Readout or controller 2
- F. Battery backup
- G. Power supply dc

## 2.5 Wiring

### 2.5.1 HART/4–20 mA

#### Field wiring

The power to the transmitter is supplied over the signal wiring. Signal wiring does not need to be shielded, but twisted pairs should be used for best results. Do not run unshielded signal wiring in conduit or open trays with power wiring or near heavy electrical equipment because high voltage may be present on the leads and may cause an electrical shock.

#### Note

Do not apply high voltage (e.g., AC line voltage) to the power or sensor terminals, since high voltage can damage the unit.

To wire the transmitter for power:

**Figure 2-11: Transmitter Terminal Block Wiring Connection**

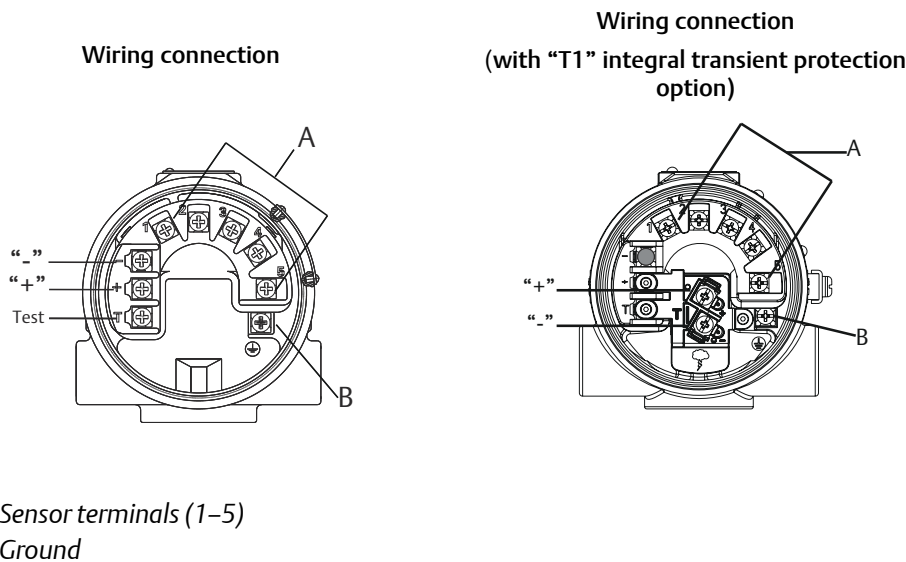

**Figure 2-12: Sensor Wiring Diagram for HART/4-20 mA**

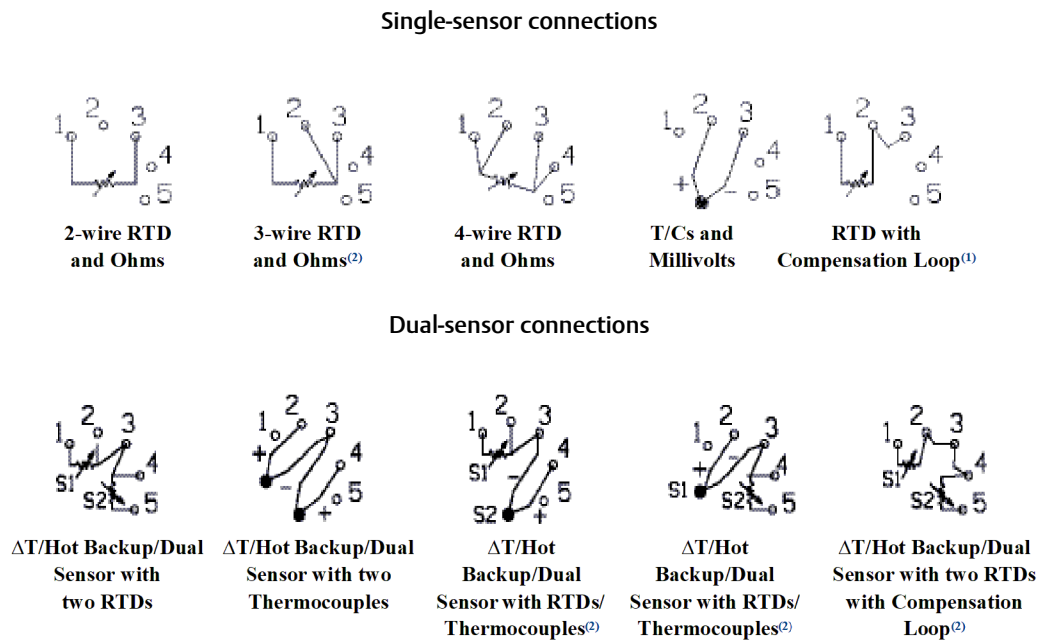

(1) (2)

- (1) Transmitter must be configured for a 3-wire RTD in order to recognize an RTD with a compensation loop.
- (2) Emerson provides 4-wire sensors for all single-element RTDs. Use these RTDs in 2- or 3-wire configurations by leaving the unneeded leads disconnected and insulated with electrical tape.



### Procedure

1. Remove the transmitter covers.  
Do not remove the transmitter covers in an explosive atmosphere when the circuit is live.
2. Connect the positive power lead to the terminal marked “+” and the negative power lead to the terminal marked “-” as shown in [Figure 2-11](#).  
Crimped lugs are recommended when wiring to screw terminals.
3. Tighten the terminal screws to ensure good contact is made. No additional power wiring is required.
4. Replace the transmitter covers making sure both transmitter covers are fully engaged to meet explosion-proof requirements.

### Power/current loop connections

Use copper wire of a sufficient size to ensure that the voltage across the transmitter power terminals does not go below 12.0 Vdc.

1. Connect the current signal leads as shown in [Figure 2-13](#).
2. Recheck the polarity and connections.
3. Turn the power ON.

For information about multichannel installations, refer to [Multichannel installation \(HART/4–20 mA only\)](#).

---

#### Note

Do not connect the power/signal wiring to the test terminal. The voltage present on the power/signal leads may burn out the reverse-polarity protection diode built into the test terminal. If the test terminal’s reverse polarity protection diode is burned out by the incorrect power/signal wiring, the transmitter can still be operated by jumping the current from the test terminal to the “-” terminal. See Test terminal (HART/4–20 mA only) for use of the terminal.

---

**Figure 2-13: Connecting a Field Communicator to a Transmitter Loop (HART/4–20 mA)**

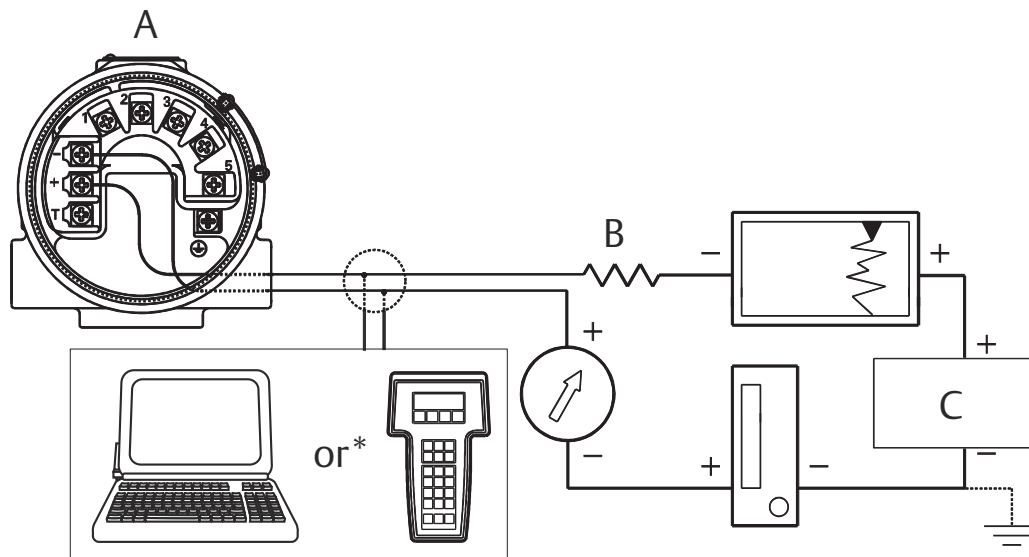

- A. Power/signal terminals
- B.  $250 \leq R_L \leq 1100$
- C. Power supply

**Note**

The signal wire may be grounded at any point or left ungrounded.

**Note**

AMS Device Manager software or a Field Communicator can be connected at any termination point in the signal loop. The signal loop must have between 250 and 1100 ohms load for communications.

## 2.6 Foundation Fieldbus

**Figure 2-14: Transmitter Terminal Block**

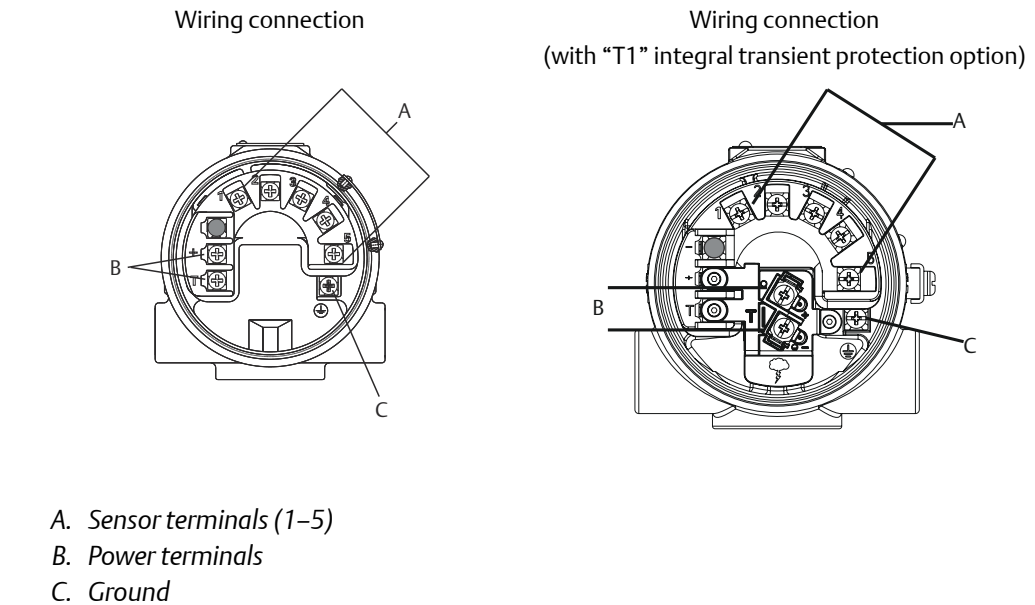

**Figure 2-15: Sensor Wiring Diagram for FOUNDATION Fieldbus**

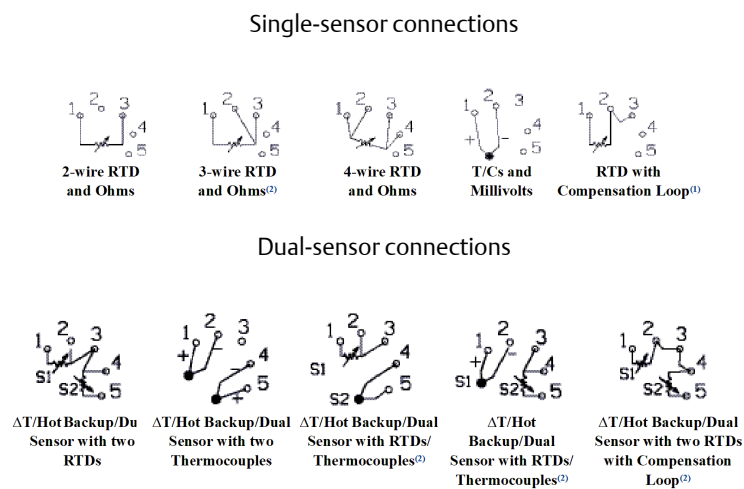

(1) (2)

- (1) Transmitter must be configured for a 3-wire RTD in order to recognize an RTD with a compensation loop.
- (2) Emerson provides 4-wire sensors for all single-element RTDs. Use these RTDs in 2- or 3-wire configurations by leaving the unneeded leads disconnected and insulated with electrical tape.

### RTD or ohm inputs

If the transmitter is mounted remotely from a 3- or 4-wire RTD, it will operate within specifications, without recalibration, for lead wire resistances of up to 60 ohms per lead (equivalent to 1,000 ft. of 20 AWG wire). In this case, the leads between the RTD and transmitter should be shielded. If using only two leads (or a compensation loop lead wire configuration), both RTD leads are in series with the sensor element, so significant errors can occur if the lead lengths exceed one foot of 20 AWG wire. For longer runs, attach a third or fourth lead as described above. To eliminate 2-wire lead resistance error, the 2-wire offset command can be used. This allows the user to input the measured lead wire resistance, resulting in the transmitter adjusting the temperature to correct the error.

When using Rosemount X-well Technology, the Rosemount 3144P Temperature Transmitter is required to be assembled to a Rosemount 0085 Pipe Clamp RTD Sensor in a direct mount 4-wire configuration. It can be changed to 3- or 2-wired configuration, if required, in the field.

### Thermocouple or millivolt inputs

For direct-mount applications, connect the thermocouple directly to the transmitter. If mounting the transmitter remotely from the sensor, use appropriate thermocouple extension wire. Make connections for millivolt inputs with copper wire. Use shielding for long runs of wire.

---

#### Note

For HART transmitters, the use of two grounded thermocouples with a dual option transmitter is not recommended. For applications in which the use of two thermocouples is desired, connect either two ungrounded thermocouples, one grounded and one ungrounded thermocouple, or one dual element thermocouple.

---

## 2.7 Power supply

### HART

An external power supply is required to operate the transmitter (not included). The input voltage range of the transmitter is 12 to 42.4 Vdc. This is the power required across the transmitter power terminals. The power terminals are rated to 42.4 Vdc. With 250 ohms of resistance in the loop, the transmitter requires a minimum of 18.1 Vdc for communication.

The power supplied to the transmitter is determined by the total loop resistance and should not drop below the lift-off voltage. The lift-off voltage is the minimum supply voltage required for any given total loop resistance. See [Figure 2-16](#) to determine the required supply voltage. If the power drops below the lift-off voltage while the transmitter is being configured, the transmitter may output incorrect information.

The dc power supply should provide power with less than two percent ripple. The total resistance load is the sum of the resistance of the signal leads and the load resistance of any controller, indicator, or related piece of equipment in the loop. Note that the resistance of intrinsic safety barriers, if used, must be included.

---

#### Note

Permanent damage to the transmitter could result if the voltage drops below 12.0 Vdc at the power terminals, when changing transmitter configuration parameters.

---

**Figure 2-16: Load Limits**

Maximum load =  $40.8 \times (\text{Supply voltage} - 12.0)$

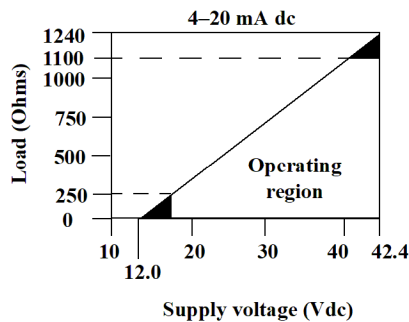

### FOUNDATION Fieldbus

Powered over FOUNDATION Fieldbus with standard Fieldbus power supplies, the transmitter operates between 9.0 and 32.0 Vdc, 11 mA maximum. Transmitter power terminals are rated to 42.4 Vdc.

The power terminals on the transmitter are polarity insensitive.

## 2.7.1 Surges/transients

The transmitter will withstand electrical transients of the energy level usually encountered in static discharges or induced switching; however, high-voltage transients, such as those induced in wiring from nearby lightning strikes, can damage both the transmitter and the sensor.

The integral transient protection terminal block (option code T1) protects against high-voltage transients. The integral transient protection terminal block is available as an ordered option, or as an accessory.

## 2.8 Grounding

### Sensor shielding

The currents in the leads induced by electromagnetic interference can be reduced by shielding. Shielding carries the current to ground and away from the leads and electronics. If the ends of the shields are adequately grounded, only a small amount of current will actually enter the transmitter.

If the ends of the shield are left ungrounded, voltage is created between the shield and the transmitter housing and also between the shield and earth at the element end. The transmitter may not be able to compensate for this voltage, causing it to lose communication and/or go into alarm. Instead of the shield carrying the currents away from the transmitter, the currents will now flow through the sensor leads into the transmitter circuitry where it will interfere with the circuit operation.

## 2.8.1 Ungrounded thermocouple, mV, and RTD/ohm inputs

### Option 1: Recommended for ungrounded transmitter housing

1. Connect the signal wiring shield to the sensor wiring shield.
  2. Ensure the two shields are tied together and electrically isolated from the transmitter housing.
  3. Ground the shield at the power supply end only.
  4. Ensure the shield at the sensor is electrically isolated from the surrounding fixtures that may be grounded.
    - a. Connect shields together, electrically isolated from the transmitter.
- 

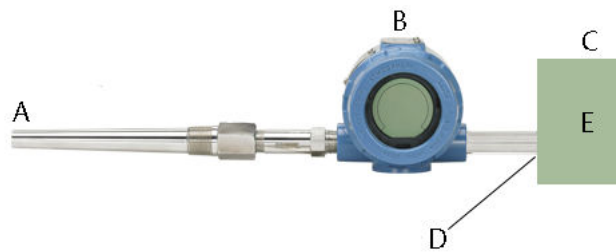

- A. Sensor wires
  - B. Transmitter
  - C. 4-20 mA loop
  - D. Shield ground point
  - E. DCS
- 

### Option 2: Recommended for grounded transmitter housing

1. Ground the transmitter housing then connect the sensor wiring shield to the transmitter housing (see [Transmitter housing](#)).
2. Ensure the shield at the sensor end is electrically isolated from surrounding fixtures that may be grounded.
3. Ground the signal wiring shield at the power supply end.

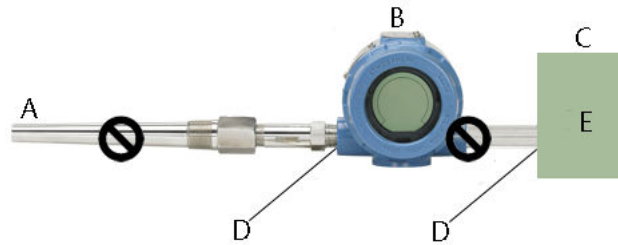

- A. Sensor wires
- B. Transmitter
- C. 4-20 mA loop
- D. Shield ground point
- E. DCS

### Option 3

1. Ground the sensor wiring shield at the sensor, if possible.
2. Ensure the sensor wiring and signal wiring shields are electrically isolated from the transmitter housing and other fixtures that may be grounded.
3. Ground the signal wiring shield at the power supply end.

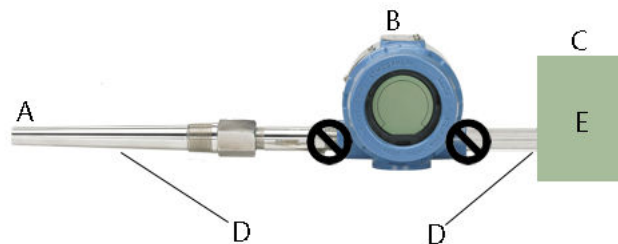

- A. Sensor wires
- B. Transmitter
- C. 4-20 mA loop
- D. Shield ground point
- E. DCS

## 2.8.2 Grounded thermocouple inputs

### Procedure

1. Ground the sensor wiring shield at the sensor.
2. Ensure the sensor wiring and signal wiring shields are electrically isolated from the transmitter housing and other fixtures that may be grounded.

3. Ground the signal wiring shield at the power supply end.
- 

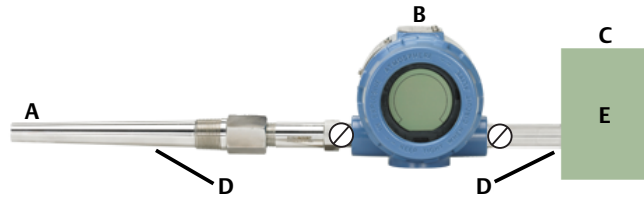

- A. Sensor wires
  - B. Transmitter
  - C. 4–20 mA loop
  - D. Shield ground point
  - E. DCS
- 

### 2.8.3 Transmitter housing

Ground the transmitter housing according to local or site electrical requirements. An internal ground terminal is standard. An optional external ground lug assembly (option code G1) can also be ordered, if needed. Ordering certain hazardous approvals automatically includes an external ground lug.

## 2.9 Wire and apply power

Connect the transmitter to a FOUNDATION Fieldbus network. Two terminators and a power conditioner are required. The voltage at the transmitter terminal must be between nine and 32 Vdc to operate properly.



## 3 HART Commissioning

### 3.1 Overview

This section contains information on commissioning and tasks that should be performed on the bench prior to installation. This section contains Rosemount™ 3144P HART® Configuration information only. The Field Communicator and instructions are given to perform configuration functions.

For convenience, Field Communicator Fast Key sequences are labeled “Fast Keys” for each software function below the appropriate headings.

HART 7 Fast Keys	1, 2, 3, etc.
------------------	---------------

AMS Device Manager help can be found in the AMS Device Manager on-line guides within the AMS Device Manager system.

### 3.2 Confirm HART revision capability

If using HART based control or asset management systems, confirm the HART Protocol capability of those systems prior to transmitter installation. Not all systems are capable of communicating with HART Revision 7. This transmitter can be configured for either HART Revision 5 or Revision 7.

#### 3.2.1 Switch HART revision mode

If the HART Protocol configuration tool is not capable of communicating with HART Revision 7, the transmitter will load a generic menu with limited capability. The following procedures will switch the HART Revision mode from the generic menu:

##### Procedure

Select **Manual Setup > Device Information > Identification > Message**.

- a. To change to HART Revision 5, Enter “HART5” in the **Message** field.
- b. To change to HART Revision 7, Enter “HART7” in the **Message** field.

## 3.3 Safety messages

Instructions and procedures in this section may require special precautions to ensure the safety of the personnel performing the operations. Information that potentially raises safety issues is indicated by a warning symbol (⚠). Refer to the following safety messages before performing an operation preceded by this symbol.

### ⚠ WARNING

#### Explosions could result in death or serious injury.

- Do not remove the instrument cover in explosive atmospheres when the circuit is live.
- Before connecting a handheld communicator in an explosive atmosphere, ensure that the instruments in the loop are installed in accordance with intrinsically safe or non-incendive field wiring practices.
- Both transmitter covers must be fully engaged to meet explosion-proof requirements.

#### Electrical shock could cause death or serious injury.

- If the sensor is installed in a high-voltage environment and a fault or installation error occurs, high voltage may be present on transmitter leads and terminals.
- Use extreme caution when making contact with the leads and terminals.

#### Process leaks could result in death or serious injury.

- Do not remove the thermowell while in operation.
- Install and tighten thermowells and sensors before applying pressure.

---

## 3.4 Field Communicator

The menu tree and Fast Key sequences use the following device revisions:

- Device dashboard: Device revision 5 and 7, DD v1

The Field Communicator exchanges information with the transmitter from the control room, the instrument site, or any wiring termination point in the loop. To facilitate communication, connect the Field Communicator in parallel with the transmitter (see [Figure 2-16](#)) using the loop connection ports on the top of the field communicator. The connections are non-polarized. Do not make connections to the nickel-cadmium (NiCad) recharger jack in explosive atmospheres. Before connecting the Field Communicator in an explosive atmosphere, make sure the instruments in the loop are installed according to intrinsically safe or non-incendive field wiring practices.

## 3.4.1 Updating the HART communication software

The Field Communicator software may need to be updated to take advantage of the additional features available in the latest Rosemount 3144P Transmitter. Perform the following steps to determine if an upgrade is necessary.

### Procedure

1. Select **Rosemount** from the list of manufacturers 5 and 6 and **3144 Temp** from the list of models
2. If the Field Device Rev choices include “Dev v1”, “Dev v2”, “Dev v3”, or “Dev v4” (with any DD version), then the user will be able to connect to the device with reduced functionality. To unlock full functionality, download and install the new DD.

---

### Note

The original release of the safety-certified Rosemount 3144P uses the name “3144P SIS” from the model list and requires “Dev v2, DD v1.”

---

### Note

If communication is initiated with an improved Rosemount 3144P using a communicator that only has a previous version of the transmitter device descriptors (DDs), the communicator will display the following message:

*NOTICE: Upgrade to the field communicator software to access new XMTR functions. Continue with old description?*

YES: The communicator will communicate properly with the transmitter using the existing transmitter

DDs. However, new software features of the DD in the communicator will not be accessible.

NO: The communicator will default to a generic transmitter functionality.

If YES is selected after the transmitter is configured to utilize the new features of the improved transmitters (such as Dual Input configuration or one of the added sensor input types—DIN Type L or DIN Type U), the user will experience trouble communicating with the transmitter and will be prompted to turn the communicator off. To prevent this from happening, either upgrade the communicator to the latest DD or answer NO to the above question and default to the generic transmitter functionality.

---

### 3.4.2 Device Dashboard menu tree

Figure 3-1: HART 5- Overview

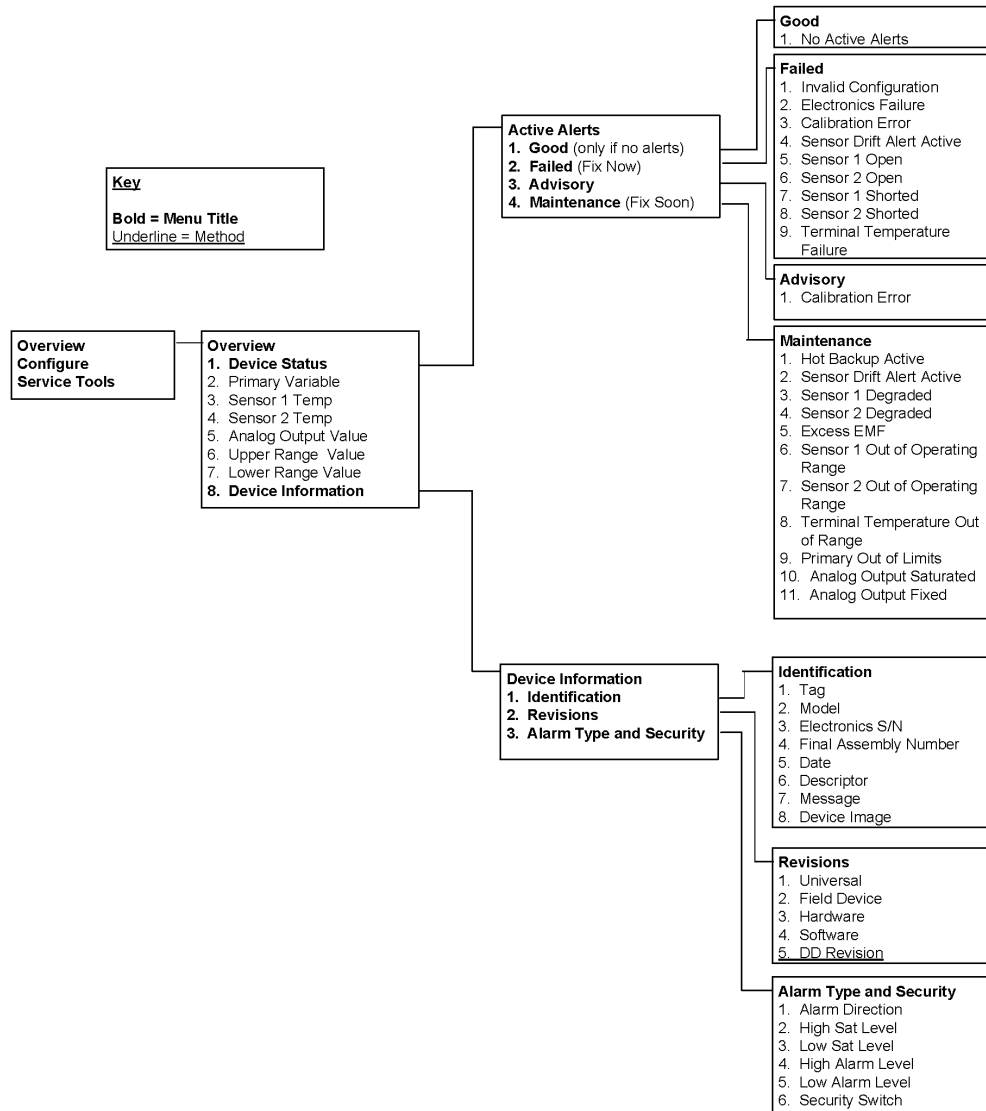

Figure 3-2: HART 5 - Configure

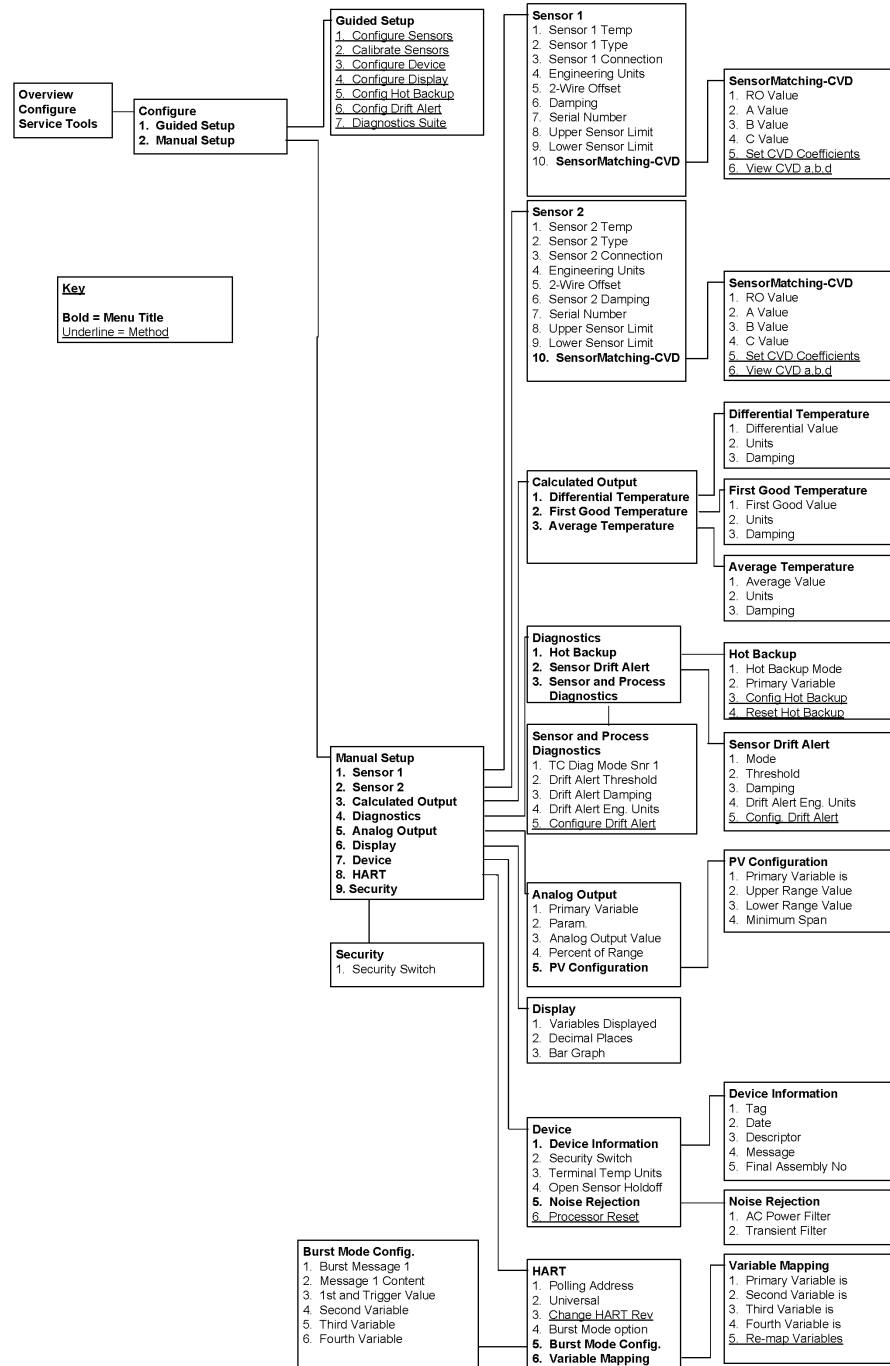

Figure 3-3: HART 5- Service Tools

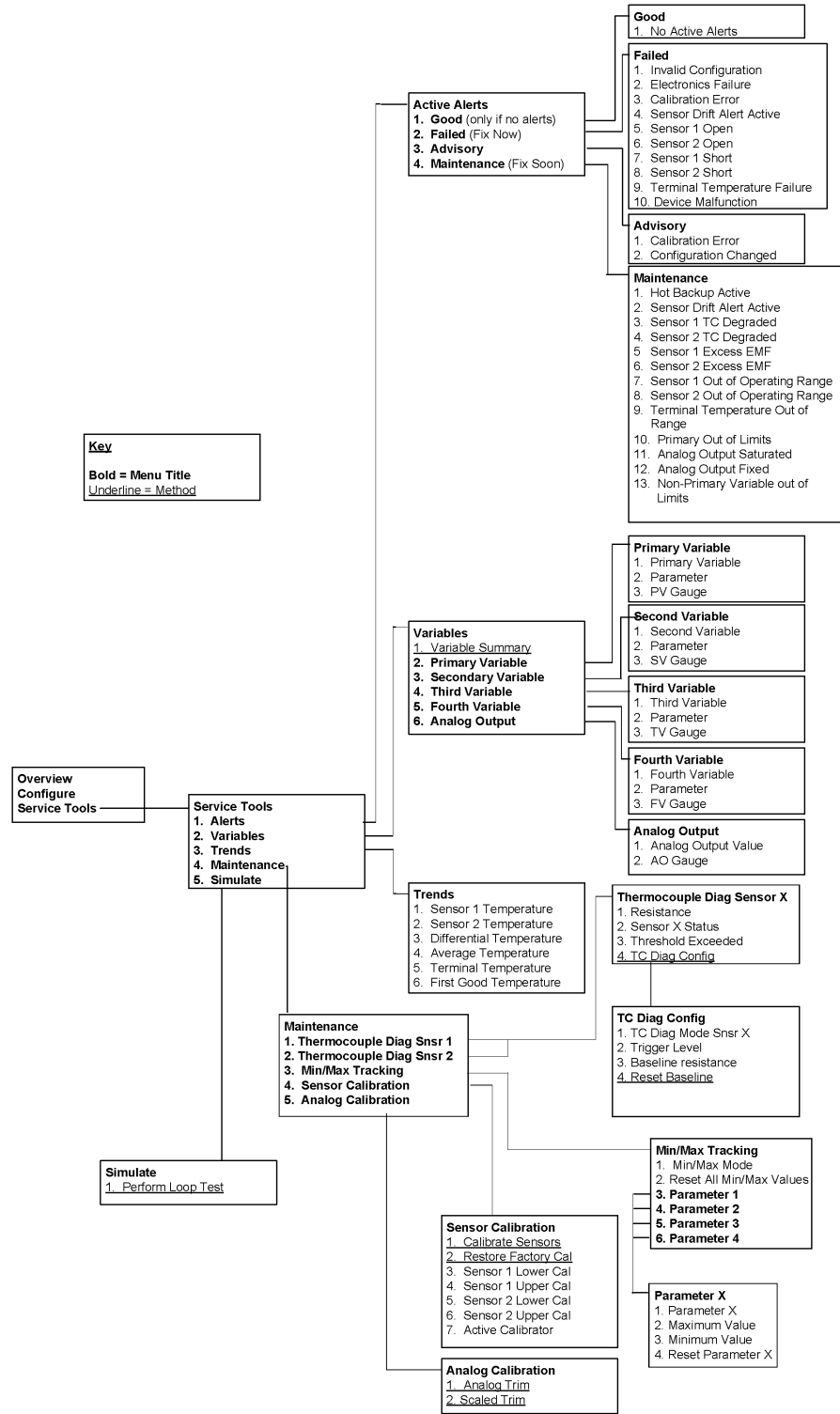

Figure 3-4: HART 7- Overview

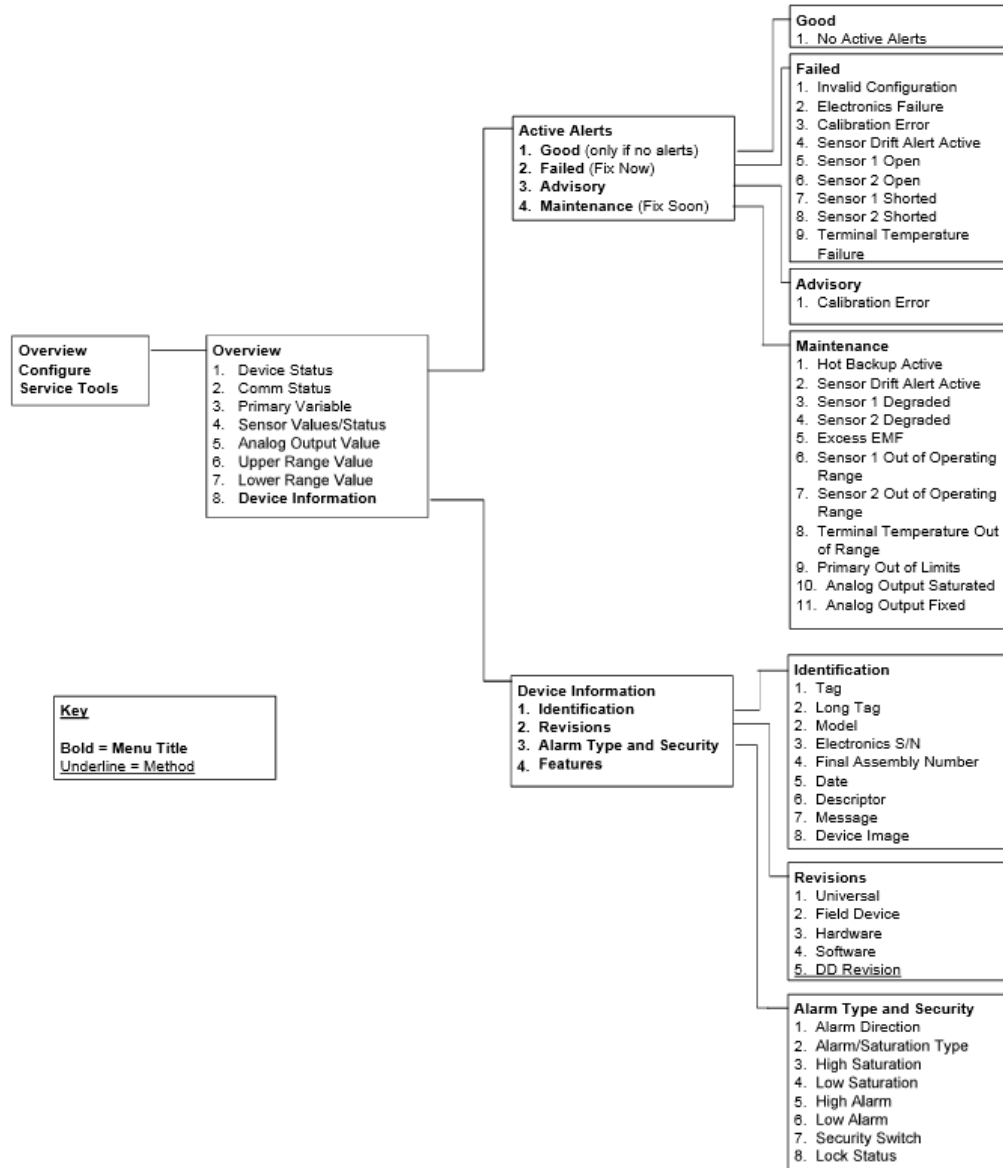

Figure 3-5: HART 7- Configure

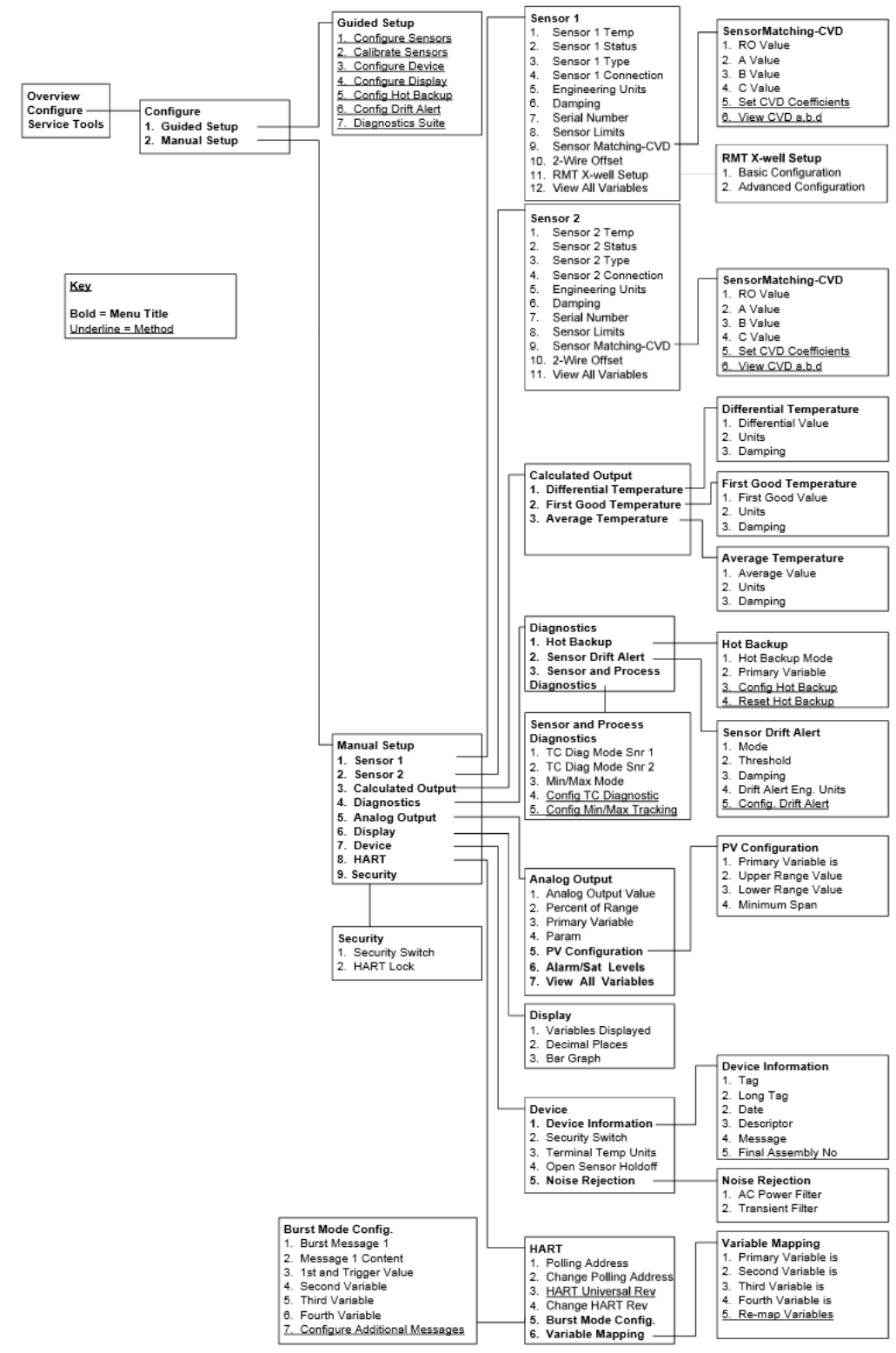
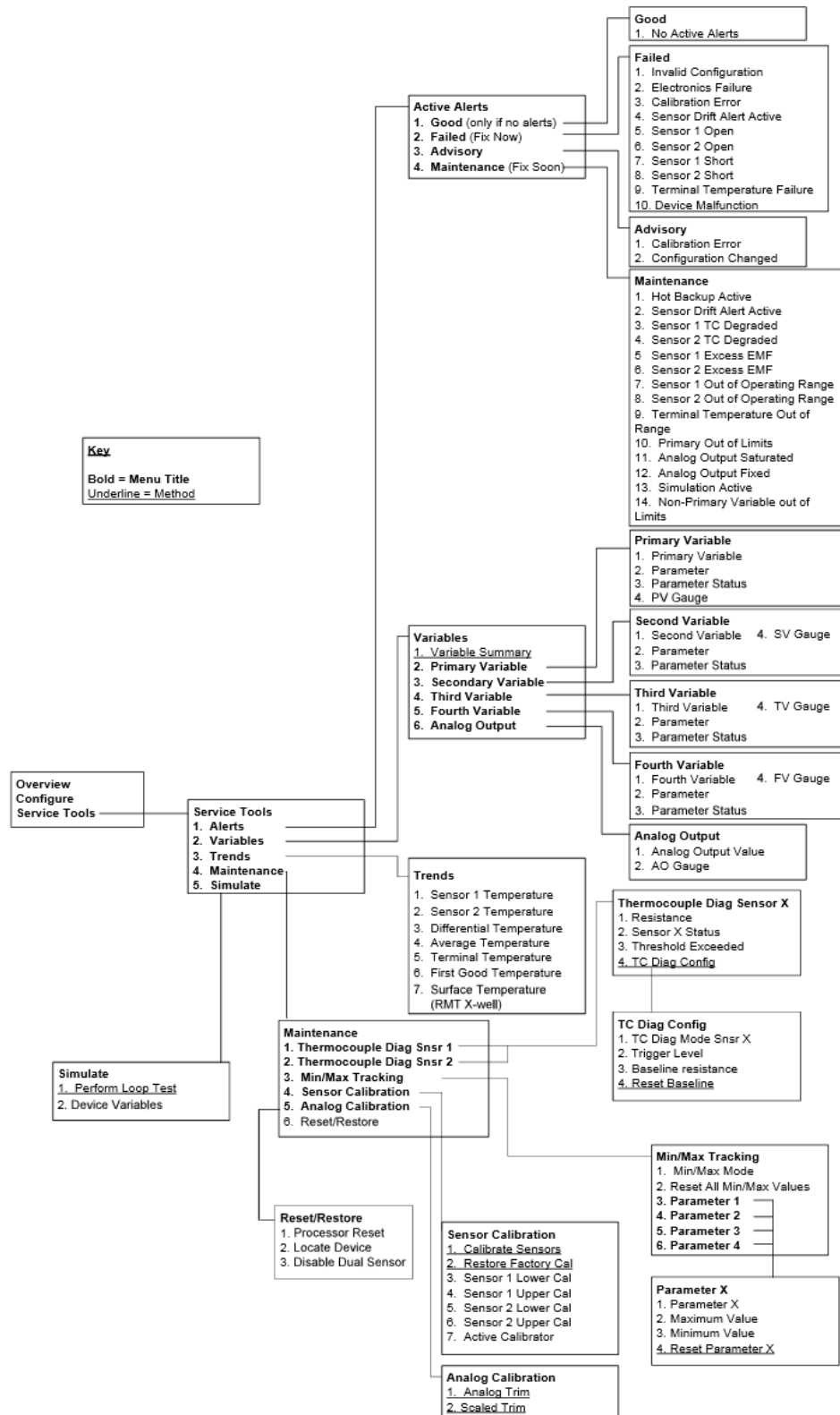



Figure 3-6: HART 7- Service Tools



### 3.4.3 Device dashboard Fast Key sequence

Fast Key sequences are listed below for common Rosemount 3144P Transmitter functions.

**Note**

The Fast Key sequences assume that “Device Revision Dev 5 (HART 5) or v7 (HART 7), DD v1” is being used. [Table 3-1](#) provides alphabetical function lists for all Field Communicator tasks as well as their corresponding Fast Key sequences.

**Table 3-1: Fast Key Sequences**

Function	HART 5 Fast Keys	HART 7 Fast Keys
2-wire offset Sensor 1	2, 2, 1, 5	2, 2, 1, 6
2-wire offset Sensor 2	2, 2, 2, 5	2, 2, 2, 6
Alarm values	2, 2, 5, 6	2, 2, 5, 6
Analog calibration	3, 4, 5	3, 4, 5
Analog output	2, 2, 5	2, 2, 5
Average temperature setup	2, 2, 3, 3	2, 2, 3, 3
Burst mode	N/A	2, 2, 8, 4
Comm status	N/A	1, 2
Configure additional messages	N/A	2, 2, 8, 4, 7
Configure Hot Backup™	2, 2, 4, 1, 3	2, 2, 4, 1, 3
Date	2, 2, 7, 1, 2	2, 2, 7, 1, 3
Descriptor	2, 2, 7, 1, 3	2, 2, 7, 1, 4
Device information	2, 2, 7, 1	2, 2, 7, 1
Differential temperature setup	2, 2, 3, 1	2, 2, 3, 1
Filter 50/60 Hz	2, 2, 7, 5, 1	2, 2, 7, 5, 1
Find device	N/A	3, 4, 6, 2
First good temperature setup	2, 2, 3, 2	2, 2, 3, 2
Hardware revision	1, 8, 2, 3	1, 11, 2, 3
HART Lock	N/A	2, 2, 9, 2
Intermittent sensor detect	2, 2, 7, 5, 2	2, 2, 7, 5, 2
Lock status	N/A	1, 11, 3, 7
Long tag	N/A	2, 2, 7, 2
Loop test	3, 5, 1	3, 5, 1
LRV (Lower Range Value)	2, 2, 5, 5, 3	2, 2, 5, 5, 3
Message	2, 2, 7, 1, 4	2, 2, 7, 1, 5
Open sensor holdoff	2, 2, 7, 4	2, 2, 7, 4
Percent range	2, 2, 5, 4	2, 2, 5, 4

**Table 3-1: Fast Key Sequences (continued)**

Function	HART 5 Fast Keys	HART 7 Fast Keys
Sensor 1 configuration	2, 2, 1	2, 2, 2
Sensor 1 serial number	2, 2, 1, 7	2, 2, 1, 8
Sensor 1 setup	2, 2, 1	2, 2, 1
Sensor 1 status	N/A	2, 2, 1, 2
Sensor 1 type	2, 2, 1, 2	2, 2, 1, 3
Sensor 1 unit	2, 2, 1, 4	2, 2, 1, 5
Sensor 2 configuration	2, 2, 2	2, 2, 2
Sensor 2 serial number	2, 2, 2, 7	2, 2, 2, 8
Sensor 2 setup	2, 2, 2	2, 2, 2
Sensor 2 status	N/A	2, 2, 2, 2
Sensor 2 type	2, 2, 2, 2	2, 2, 2, 3
Sensor 2 unit	2, 2, 2, 4	2, 2, 2, 5
Sensor drift alert	2, 2, 4, 2	2, 2, 4, 2
Simulate device variables	N/A	3, 5, 2
Software revision	1, 8, 2, 4	1, 11, 2, 4
Tag	2, 2, 7, 1, 1	2, 2, 7, 1, 1
Terminal temperature units	2, 2, 7, 3	2, 2, 7, 3
URV (Upper Range Value)	2, 2, 5, 5, 2	2, 2, 5, 5, 2
Variable mapping	2, 2, 8, 5	2, 2, 8, 5
Thermocouple diagnostic	2, 1, 7, 1	2, 1, 7, 1
Min/max tracking	2, 1, 7, 2	2, 1, 7, 2
Rosemount X-well™ setup	N/A	2, 2, 1, 11

## 3.5 Review configuration data

Before operating the transmitter in an actual installation, review all of the factory-set configuration data to ensure that it reflects the current application.

### 3.5.1 Review

HART 5 Fast Keys	1, 4
HART 7 Fast keys	2, 2

#### Field Communicator

Review the transmitter configuration parameters set at the factory to ensure accuracy and compatibility with the particular application. After activating the Review function, scroll through the data list and check each variable. If changes to the transmitter configuration data are necessary, refer to [Configuration](#).

## 3.6 Check output

Before performing other transmitter online operations, review the configuration of the Rosemount 3144P Transmitter digital output parameters to ensure that the transmitter is operating properly.

### 3.6.1 Analog output

HART 5 Fast Keys	2, 2, 5
HART 7 Fast Keys	2, 2, 5

#### Field Communicator

The Rosemount 3144P process variables provide the transmitter output. The PROCESS VARIABLE menu displays the process variables, including sensed temperature, percent range, and analog output. These process variables are continuously updated. The primary variable is 4–20 mA analog signal.

## 3.7 Configuration

The Rosemount 3144P must have certain basic variables configured to operate. In many cases, these variables are pre-configured at the factory. Configuration may be required if the configuration variables need revision.

### 3.7.1 Variable mapping

HART 5 Fast Keys	2, 2, 8, 5
HART 7 Fast Keys	2, 2, 8, 5

### Field Communicator

The Variable Mapping menu displays the sequence of the process variables. Select 5 Variable Re-Map to change this configuration. The Rosemount 3144P single sensor input configuration screens allow selection of the primary variable (PV) and the secondary variable (SV). When the Select PV screen appears **Snsr 1** or **Terminal Temperature** must be selected.

The Rosemount 3144P dual-sensor option configuration screens allow selection of the primary variable (PV), secondary variable (SV), tertiary variable (TV), and quaternary variable (QV). Variable choices are *Sensor 1*, *Sensor 2*, *Differential Temperature*, *Average Temperature*, *First-Good Temperature*, *Terminal Temperature*, and *Not Used*. The primary variable is the 4–20 mA analog signal.

## 3.7.2 Sensor configuration

HART 5 Fast Keys	2, 1, 1
HART 7 Fast Keys	2, 1, 1

### Field Communicator

Sensor configuration contains information for updating the sensor type, connections, units, and damping.

## 3.7.3 Change type and connections

HART 5 Fast Keys	Sensor 1: 2, 2, 1 Sensor 2: 2, 2, 2
HART 7 Fast Keys	Sensor 1: 2, 2, 1 Sensor 2: 2, 2, 2

The connections command allows the user to select the sensor type and the number of sensor wires to be connected from the following list:

- 2-, 3-, or 4-wire Pt 100, Rosemount X-well, Pt 200, Pt 500, Pt 1000 (platinum) RTDs ( $\alpha = 0.00385 \Omega/\Omega/^\circ\text{C}$ )
- 2-, 3-, or 4-wire Pt 100, Pt 200 (platinum) RTDs ( $\alpha = 0.003916 \Omega/\Omega/^\circ\text{C}$ )
- 2-, 3-, or 4-wire Ni 120 (nickel) RTDs
- 2-, 3-, or 4-wire Cu 10 (copper) RTDs
- IEC/NIST/DIN Type B, E, J, K, R, S, T thermocouples
- DIN type L, U thermocouples
- ASTM Type W5Re/W26Re thermocouple
- GOST Type L thermocouples
- –10 to 100 millivolts
- 2-, 3-, or 4-wire 0 to 2000 ohms

Contact an Emerson representative for information on temperature sensors, thermowells, and accessory mounting hardware that is available through Emerson.

### 3.7.4 Output units

HART 5 Fast Keys	Sensor 1: 2, 2, 1, 4 Sensor 2: 2, 2, 2, 4
HART 7 Fast Keys	Sensor 1: 2, 2, 1, 5 Sensor 2: 2, 2, 2, 5

The Sensor 1 unit and Sensor 2 unit commands set the desired primary variable units. The transmitter output can be set to one of the following engineering units:

- Degrees Celsius
- Degrees Fahrenheit
- Degrees Rankine
- Kelvin
- Ohms
- Millivolts

### 3.7.5 Sensor 1 serial number

HART 5 Fast Keys	2, 2, 1, 7
HART 7 Fast Keys	2, 2, 1, 8

The serial number of the attached sensor can be listed in the sensor 1 S/N variable. It is useful for identifying sensors and tracking sensor calibration information.

### 3.7.6 Sensor 2 serial number

HART 5 Fast Keys	2, 2, 2, 7
HART 7 Fast Keys	2, 2, 2, 8

The serial number of a second sensor can be listed in the sensor 2 S/N variable.

### 3.7.7 2-wire RTD offset

HART 5 Fast Keys	Sensor 1: 2, 2, 1, 5 Sensor 2: 2, 2, 2, 5
HART 7 Fast Keys	Sensor 1: 2, 2, 1, 6 Sensor 2: 2, 2, 2, 6

The 2-wire offset command allows the measured lead wire resistance to be input, which results in the transmitter adjusting its temperature measurement to correct the error caused by this resistance. Because of a lack of lead wire compensation within the RTD, temperature measurements made with a 2-wire RTD are often inaccurate.

### 3.7.8 Terminal (body) temperature

HART 5 Fast Keys	2, 2, 7, 3
HART 7 Fast Keys	2, 2, 7, 3

The **Terminal Temp** command sets the terminal temperature units to indicate the temperature at the transmitter terminals.

### 3.7.9 Dual-sensor configuration

HART 5 Fast Keys	2, 2, 3
HART 7 Fast Keys	2, 2, 3

Dual-sensor configuration sets the functions that can be used with a dual-sensor configured transmitter, including differential temperature, average temperature, first good temperature.

#### Differential pressure

HART 5 Fast Keys	2, 2, 3, 1
HART 7 Fast Keys	2, 2, 3, 1

#### Field Communicator

The transmitter configured for a dual-sensor can accept any two inputs then display the differential temperature between them. Use the following procedure with traditional Fast Keys to configure the transmitter to measure differential temperature:

---

#### Note

This procedure reports the differential temperature as the primary variable analog signal. If this is not needed, assign differential temperature to the secondary, tertiary, or quaternary variable.

---

#### Note

The transmitter determines the differential temperature by subtracting the reading of Sensor 2 from Sensor 1 (S1 – S2). Ensure this order of subtraction is consistent with the

desired reading for the application. Refer to [Figure 2-4](#), or inside the transmitter terminal-side cover for sensor wiring diagrams.

If using an LCD display for local indication, configure the meter to read the appropriate variables by using [LCD display options](#).

## Average temperature

HART 5 Fast Keys	2, 2, 3, 3
HART 7 Fast Keys	2, 2, 3, 3

### Field Communicator

The transmitter configured for dual-sensors can output and display the average temperature of any two inputs. Use the following procedure with Traditional Fast Keys to configure the transmitter to measure the average temperature:

Configure sensor 1 and sensor 2 appropriately. Select *1 Device Setup, 3 Configuration, 2 Sensor Configuration, 1 Change Type and Conn.* to set the sensor type and number of wires for sensor 1. Repeat for Sensor 2.

#### Note

This procedure configures the average temperature as the primary variable analog signal. If this is not needed, assign the average temperature to the secondary, tertiary, or quaternary variable.

If using an LCD display, configure it to read the appropriate variables using [LCD display options](#).

#### Note

If Sensor 1 and/or sensor 2 should fail while PV is configured for average temperature and the Hot Backup feature is not enabled, the transmitter will go into alarm. For this reason, it is recommended when PV is sensor average, that the Hot Backup feature be enabled when dual-element sensors are used, or when two temperature measurements are taken from the same point in the process. If a sensor failure occurs when the Hot Backup feature is enabled, while PV is sensor average, three scenarios could result:

- If sensor 1 fails, the average will only be reading from sensor 2, the working sensor.
- If sensor 2 fails, the average will only be reading from sensor 1, the working sensor.
- If both sensors fail simultaneously, the transmitter will go into alarm and the status available (via HART) states that both sensor 1 and sensor 2 have failed.

In the first two scenarios, the 4–20 mA signal is not disrupted and the status available to the control system (via HART Protocol) specifies which sensor has failed.

## First good configuration

HART 5 Fast Keys	2, 2, 3, 2
HART 7 Fast Keys	2, 2, 3, 2



### Field Communicator

The first good device variable is useful for applications where dual-sensors (or a single dual element sensor) are used in a single process. The first good variable will report the sensor 1 value, unless sensor 1 fails. When sensor 1 fails, the sensor 2 value will be reported as the first good variable. Once the first good variable has switched to sensor 2, it will not revert back to sensor 1 until a master reset occurs or “Suspend Non-PV alarms” is disabled. When the PV is mapped to first good variable and either sensor 1 or sensor 2 fails, the analog output will go to the alarm level, but the digital PV value read through the HART Protocol interface will still report the proper first good sensor value.

If the user does not want the transmitter to go into analog output alarm when the PV is mapped to first good and Sensor 1 fails, enable “Suspend Non-PV Alarm” mode. This combination prevents the analog output from going to the alarm level unless BOTH sensors fail.

### Hot Backup feature configuration

HART 5 Fast Keys	2, 2, 4, 1, 3
HART 7 Fast Keys	2, 2, 4, 1, 3

### Field Communicator

The config hot BU command configures the transmitter to automatically use sensor 2 as the primary sensor if sensor 1 fails. With the Hot Backup feature enabled, the primary variable (PV) must either be first good or sensor average. See [Average temperature](#) for details on using the Hot Backup feature when PV is sensor average. Sensors 1 or 2 can be mapped as the secondary variable (SV), tertiary variable (TV), or quaternary variable (QV). In the event of a primary variable (Sensor 1) failure, the transmitter enters the Hot Backup feature mode and sensor 2 becomes the PV. The 4–20 mA signal is not disrupted, and a status is available to the control system through HART Protocol that sensor 1 has failed. An LCD display, if attached, displays the failed sensor status.

While configured to the Hot Backup feature, if sensor 2 fails but sensor 1 is still operating properly, the transmitter continues to report the PV 4–20 mA analog output signal, while a status is available to the control system through HART Protocol that sensor 2 has failed. In the Hot Backup feature mode, the transmitter will not revert back to sensor 1 to control the 4–20 mA analog output, until the Hot Backup feature mode is reset by either re-enabling through HART Protocol or by briefly powering down the transmitter.

For information on using the Hot Backup feature in conjunction with the HART Tri-Loop see [Use with the HART Tri-Loop](#).

<b>Problem description:</b>	The unexpected failure of a critical temperature measurement can cause safety issues, environmental or regulatory concerns, and process shutdowns.
<b>Our solution:</b>	The Hot Backup feature allows the transmitter to automatically switch the transmitter input from the primary sensor to the secondary sensor should the primary sensor fail. This prevents a process disruption due to the failure of the primary sensor. A maintenance alert is also generated to notify operators that a sensor has failed and the Hot Backup feature is active.

**How it works:** Two sensors are wired to a dual-input transmitter. The two sensors are measured in alternating fashion, so when sensor 1 failure is detected, the transmitter can immediately switch the output to reflect the sensor 2 value. The switch is automatic with no disruption to the analog output. The transmitter sends a digital alert to inform the users that the Hot Backup feature is active and the primary sensor needs investigation.

**Take away:** “The Hot Backup feature prevents primary sensor failure from disrupting process control.”

**Target applications:** Redundant measurements, critical measurements, trouble spots.

## Configure Hot Backup in guided setup

*Enable Hot Backup in guided setup: Fast Keys 2-1-5*

### Procedure

1. From the *Home* Screen, select **2 Configure**.

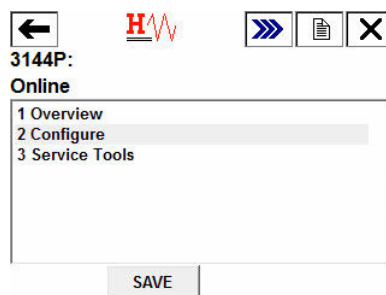

2. Select **1 Guided Setup**.

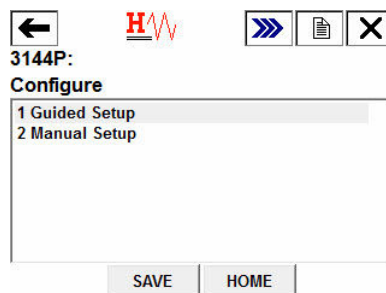

3. Select **5 Config Hot Backup**.

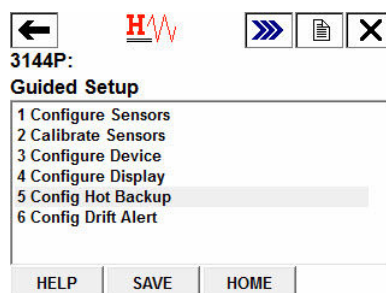

- When prompted, select **1 Yes** to disable Hot Backup. To reconfigure Hot Backup, select **2 No**.

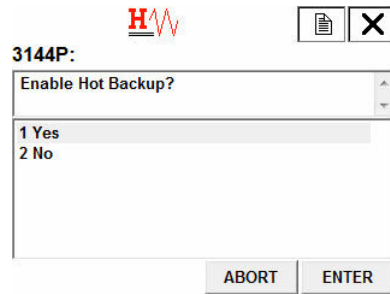

- When prompted, choose which variable you would like as your primary variable (PV) and select **ENTER**. With Hot Backup disabled, the PV may be *Sensor 1 Temperature*, *Sensor 2 Temperature*, *Differential Temperature*, *Average Temperature*, or *First Good Temperature*.

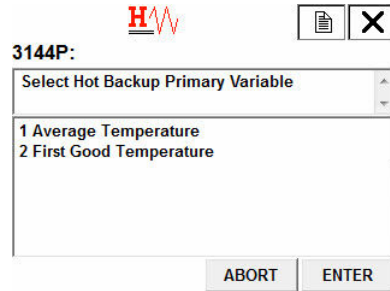

### Disable Hot Backup in guided setup: Fast Keys 2-1-5

#### Procedure

- From the *Home Screen*, select **2 Configure**.

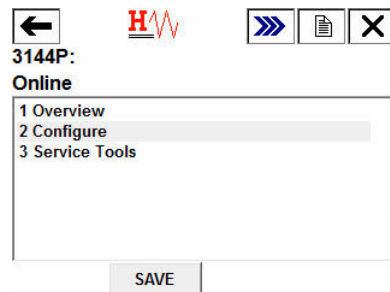

2. Select 1 Guided Setup.

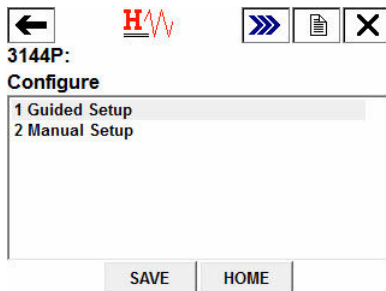

3. Select 5 Config Hot Backup.

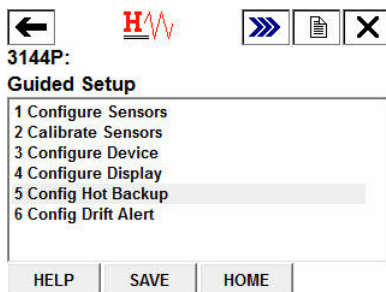

4. When prompted, select 1 Yes to disable Hot Backup. To reconfigure Hot Backup, select 2 No.



5. When prompted, choose which variable you would like as your primary variable (PV) and select ENTER. With Hot Backup disabled, the PV may be *Sensor 1 Temperature*, *Sensor 2 Temperature*, *Differential Temperature*, *Average Temperature*, or *First Good Temperature*.

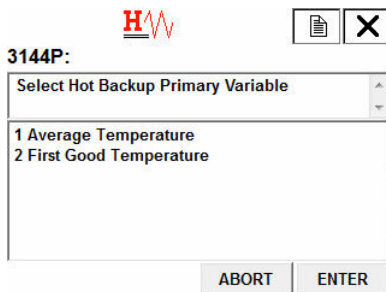

## Configure Hot Backup in manual set up

*Enabling Hot Backup in manual setup: Fast Keys 2-2-4-1-3*

### Procedure

1. From the *Home Screen*, select 2 **Configure**.

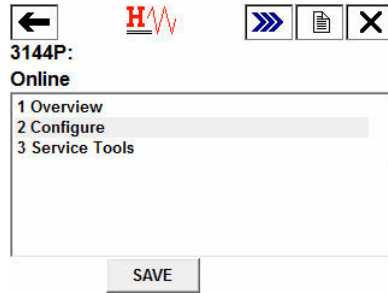

2. Select 2 **Manual Setup**.

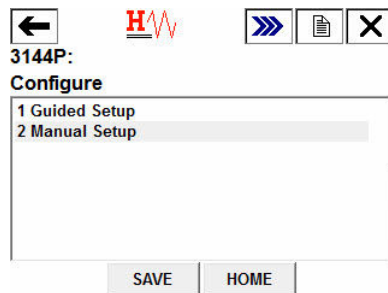

3. Select 4 **Diagnostics**.

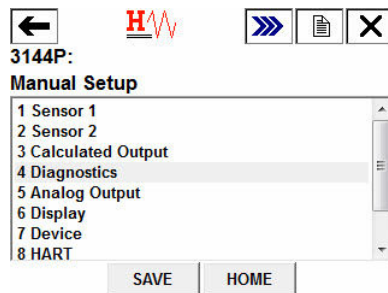

4. Select 1 **Hot Backup**.

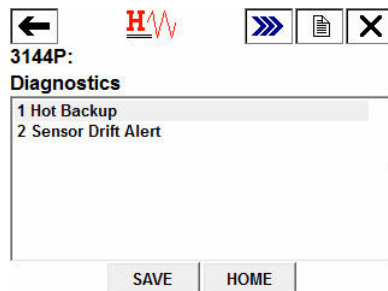

5. Select 3 Config Hot Backup.

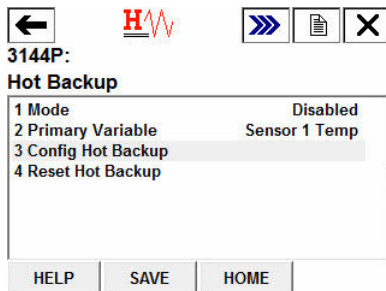

6. When prompted, select 1 Yes to enable Hot Backup. To exit, select 2 No.

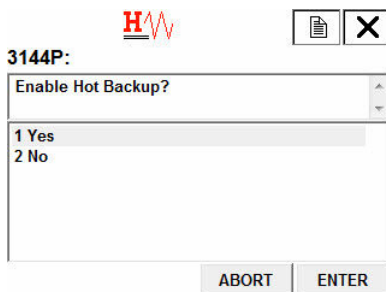

7. When prompted, choose which variable you would like as your primary variable (PV) and select ENTER. With Hot Backup enabled, the PV must either be *First Good Temperature* or *Average Temperature*.

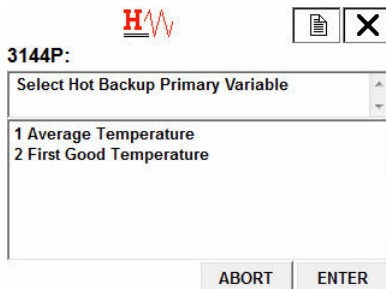

### Disabling Hot Backup in manual setup: Fast Keys 2-2-4-1-3

#### Procedure

1. From the *Home Screen*, select 2 Configure.

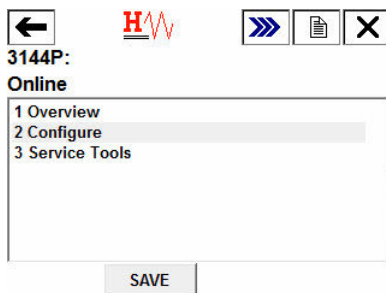

2. Select 2 Manual Setup.

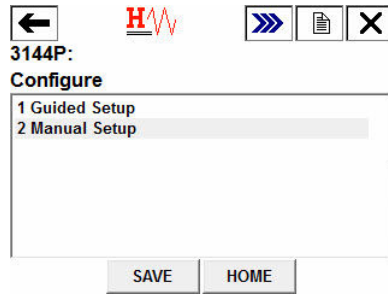

3. Select 4 Diagnostics.

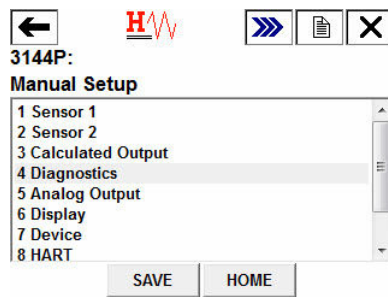

4. Select 1 Hot Backup.

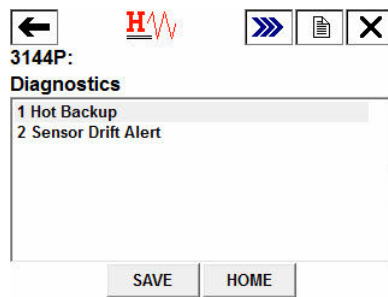

5. Select 3 Config Hot Backup.

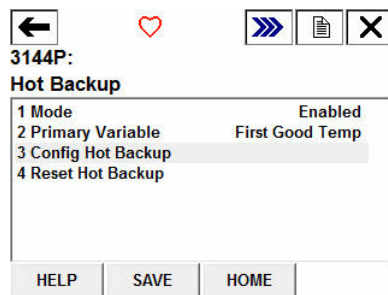

- When prompted, select **1 Yes** to disable Hot Backup. To reconfigure Hot Backup, select **2 No**.

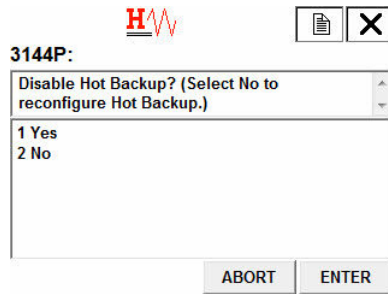

- When prompted, choose which variable you would like as your primary variable (PV) and select **ENTER**. With Hot Backup disabled, the PV may be *Sensor 1 Temperature*, *Sensor 2 Temperature*, *Differential Temperature*, *Average Temperature*, or *First Good Temperature*.

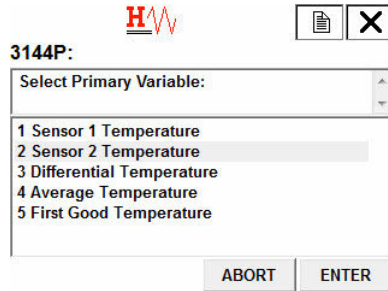

## Verify Hot Backup is enabled: Fast Keys 2-2-4-1

### Procedure

- From the *Home Screen*, select **2 Configure**.

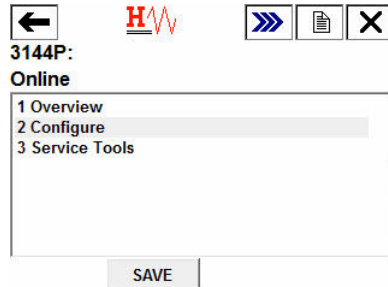



2. Select 2 Manual Setup.

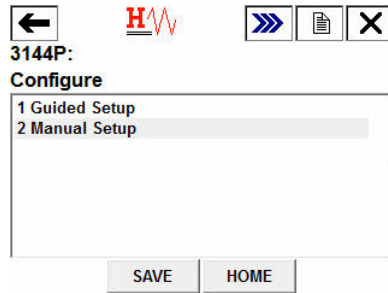

3. Select 4 Diagnostics.

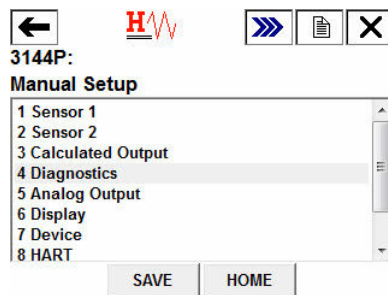

4. Select 1 Hot Backup.

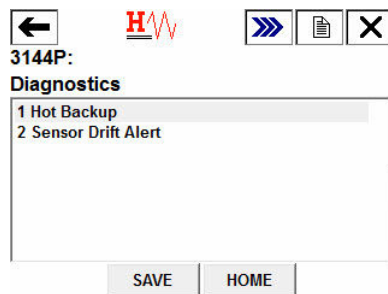

5. You will see this screen. Under 1 Mode, it will say either Enabled or Disabled, as well as indicate what your primary variable is.

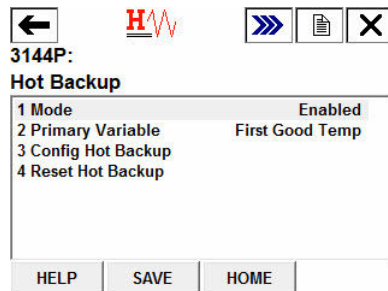

## Alerts configuration for Hot Backup

### Alerts for Hot Backup when configured with first good temperature

#### Primary sensor failure

#### Communicator message

If your primary sensor fails, the second sensor immediately takes over. The transmitter will report a failed device status, indicating Sensor 1 is open and Hot Backup is active. This is shown in the Field Communicator in the Overview section.

Select **1 Device Status** to view the active alerts.

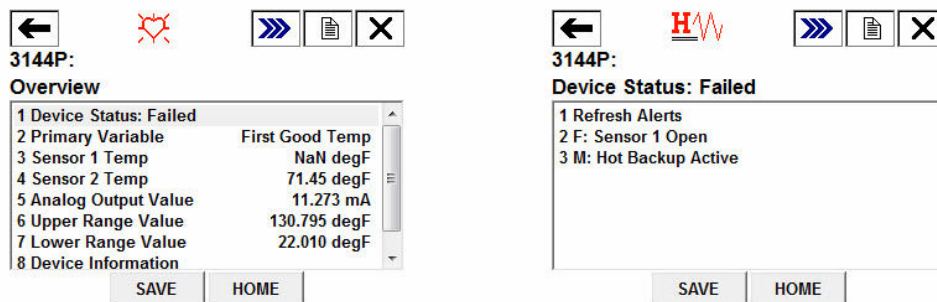

After the sensor has been repaired or replaced, the Field Communicator will display a maintenance device status, indicating Hot Backup is still active. This is shown in the Field Communicator in the Overview section.

Select **1 Device Status** to view the active alerts. Hot Backup is still active even though sensor 1 is repaired.

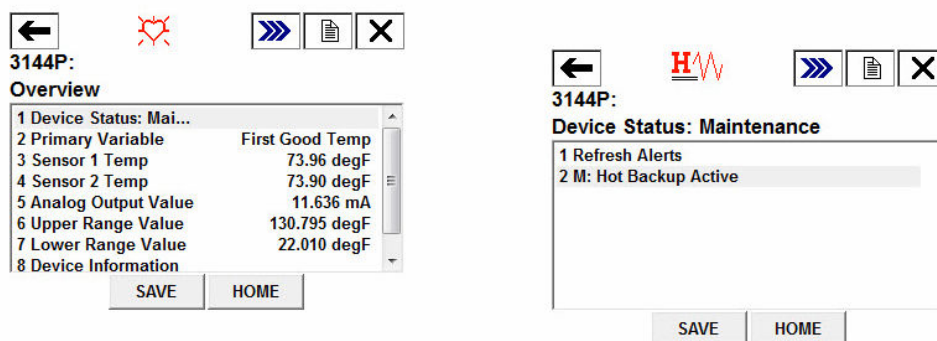

It is recommended Hot Backup be reset immediately after repairing or replacing the affected sensor. See [Reset Hot Backup: Fast Keys 2-2-4-1-4](#). After resetting Hot Backup, the Field Communicator will display an Advisory Device Status, indicating that the configuration has changed. This is shown in the *Overview* section. To clear this advisory, clear the configuration changed flag, as shown below:

1. Select **1 Device Status** to view the active alerts.

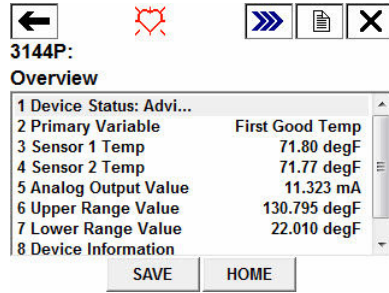

2. Select 2 A: Configuration Changed.

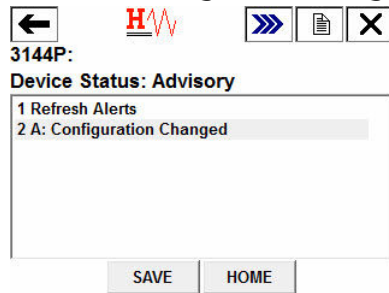

3. Select 2 Clear Config Changed Flag.

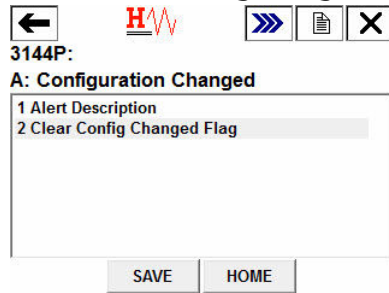

### LCD display message

The LCD display on the transmitter will display a message HOT BU SNSR 1 FAIL as well as the output of the secondary sensor that has taken over the process.



After the sensor has been repaired or replaced, the LCD display on the transmitter will display a message *WARN HOTBU* as well as the output of the secondary sensor that has taken over the process.



It is recommended that Hot Backup be reset immediately after repairing or replacing the affected sensor. See [Reset Hot Backup: Fast Keys 2-2-4-1-4](#). After repairing or replacing the bad sensor, the LCD display on the transmitter will now display the value of Sensor 1.

### DeltaV™ message

Alarms will show up on the bottom toolbar, as shown below:

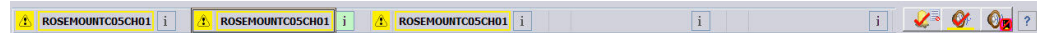

To view the alarm, simply click on the device on the toolbar. A faceplate with further information on the active alarms will appear. It will show an *ADVISE Sensor Summary*, a *FAILED Sensor 1 Open*, and a *MAINTENANCE Hot Backup Active*.

### Note

For all of these alarms to appear in DeltaV, all alarms in DeltaV must be configured to WARNING status.

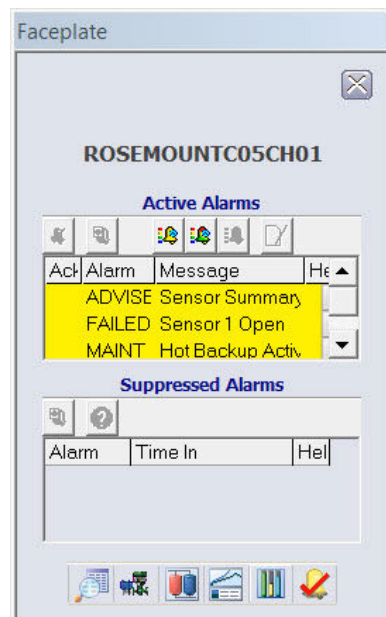

After the sensor has been repaired or replaced, the Faceplate window in DeltaV will display boxes next to each alarm that has been addressed. You must acknowledge each alarm to clear it by checking the ACK box to the left of the alarm.

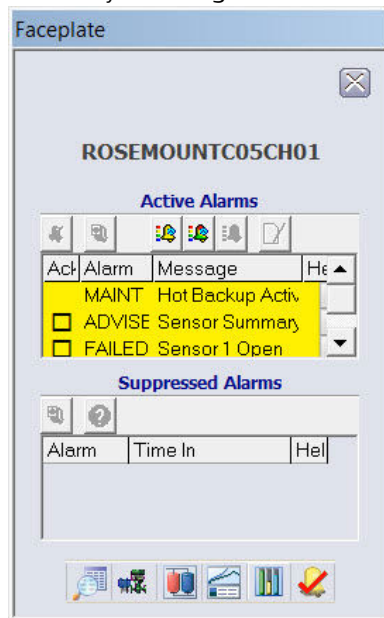

It is recommended Hot Backup be reset immediately after repairing or replacing the affected sensor. See “Reset Hot Backup: Fast Keys 2-2-4-1-4” on page 76. After resetting Hot Backup, the DeltaV Faceplate window indicates the alarms *ADVISE Configuration Change* and *MAINTENANCE Hot Backup Active*. You must acknowledge these alarms in order to clear them by checking the *ACK* boxes next to each alarm.

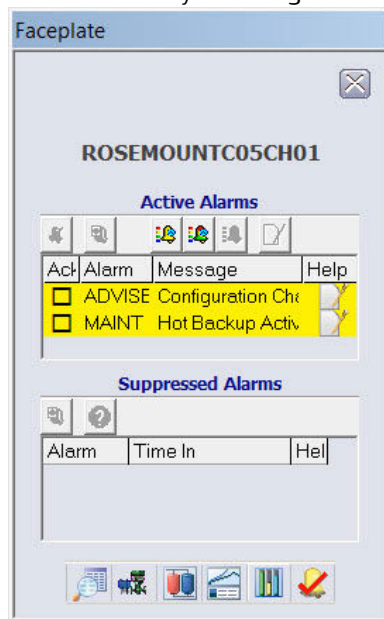

### Yokogawa's Centum PRM/DTM™ messages

When the primary sensor fails, alarms will be displayed in the Plant Resource Manager (PRM) via yellow circles next to the device, as shown below. These yellow circles indicate that something in your process needs attention. To investigate this further, right click on the affected device, and select **DTM Works...** This will open the Device Task Manager (DTM).

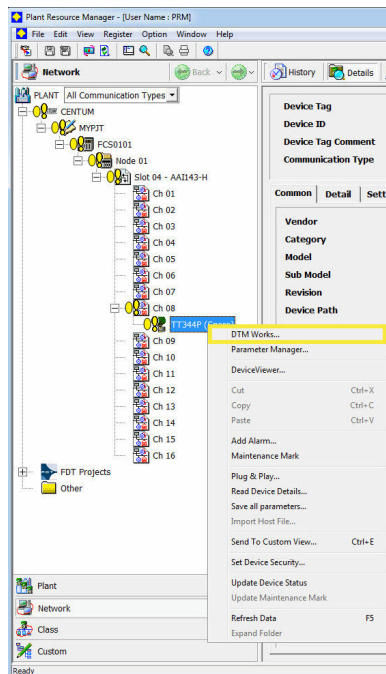

In the DTM, the device status will indicate a Failed status in the Process Variable Overview section, shown below:

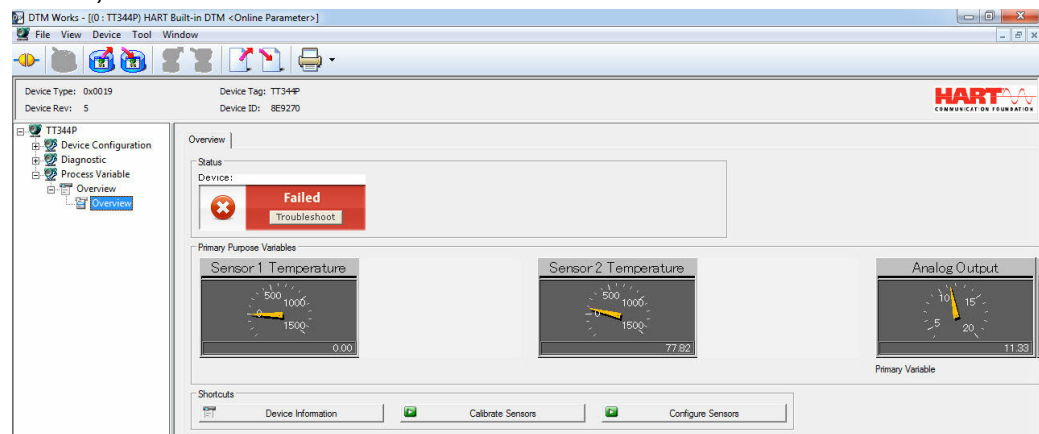

To investigate why the device displays a Failed status, Select **Troubleshoot** in the red device status box. Another screen will display the active alerts indicating *FAILED Sensor 1 Open*, and *MAINTENANCE Hot Backup Active*, as shown below:

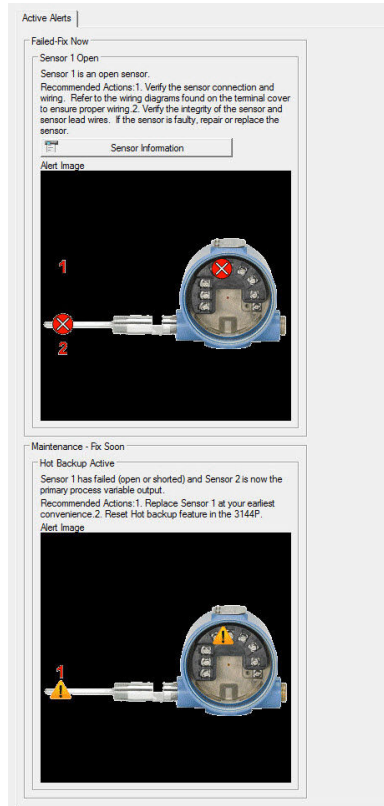

After the sensor has been repaired or replaced, the device status in the Process Variable Overview section of the DTM will change from Failed to Maintenance.

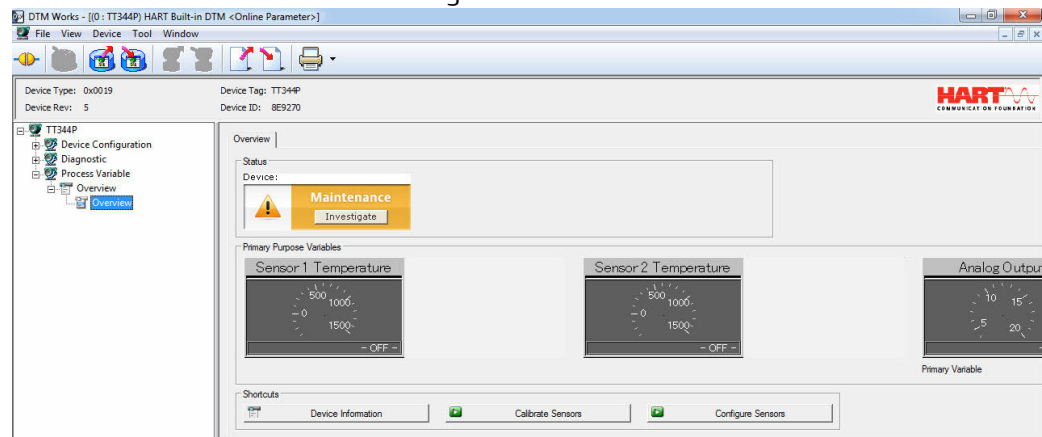

Investigate this Maintenance alert by selecting Troubleshoot in the yellow device status box. Another screen will display the active alerts, indicating MAINTENANCE Hot Backup Active, as shown below:

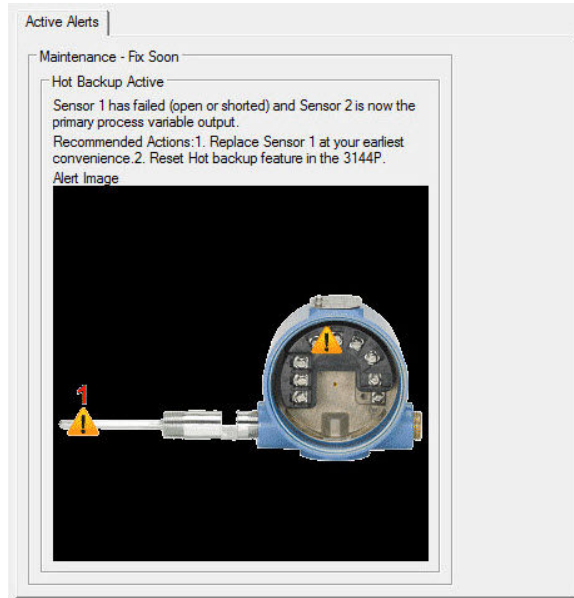

It is recommended that Hot Backup be reset immediately after repairing or replacing the affected sensor. See [Reset Hot Backup: Fast Keys 2-2-4-1-4](#) with a Field Communicator or reset it directly in the DTM by going to the Diagnostics tab of the Manual Setup section and selecting **Reset Hot Backup**, as shown below:

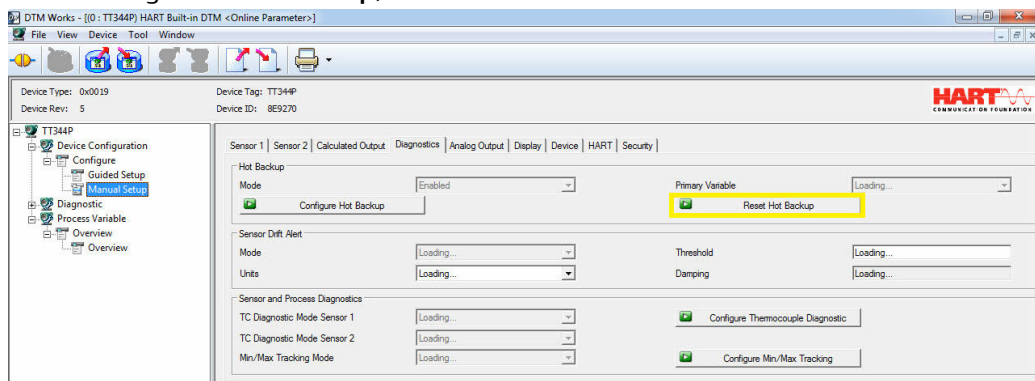

After resetting Hot Backup, the device status in the Process Variable Overview section of the DTM will change from Maintenance to Advisory, as shown below:



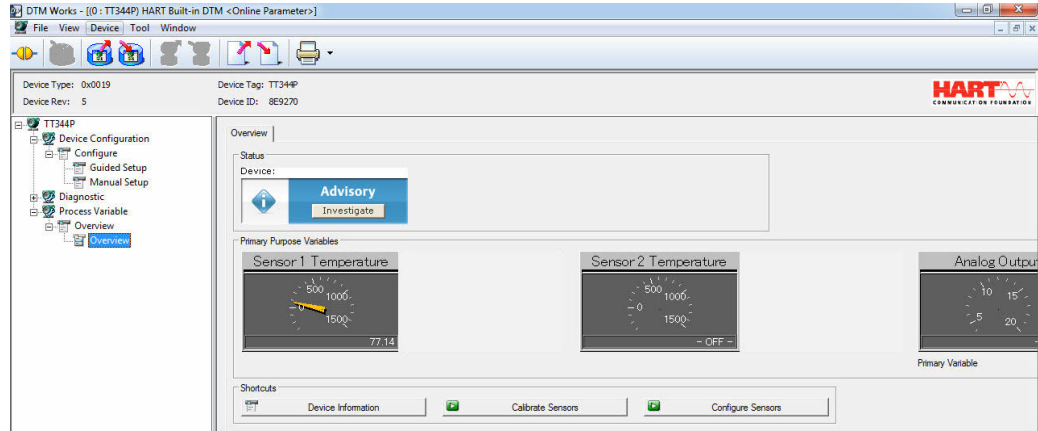

Investigate this advisory alert by clicking Investigate in the blue device status box. Another screen will display the active alerts, indicating ADVISORY Configuration Changed, as shown below. To clear this advisory, Select **Clear Config Changed Flag** and follow the steps.

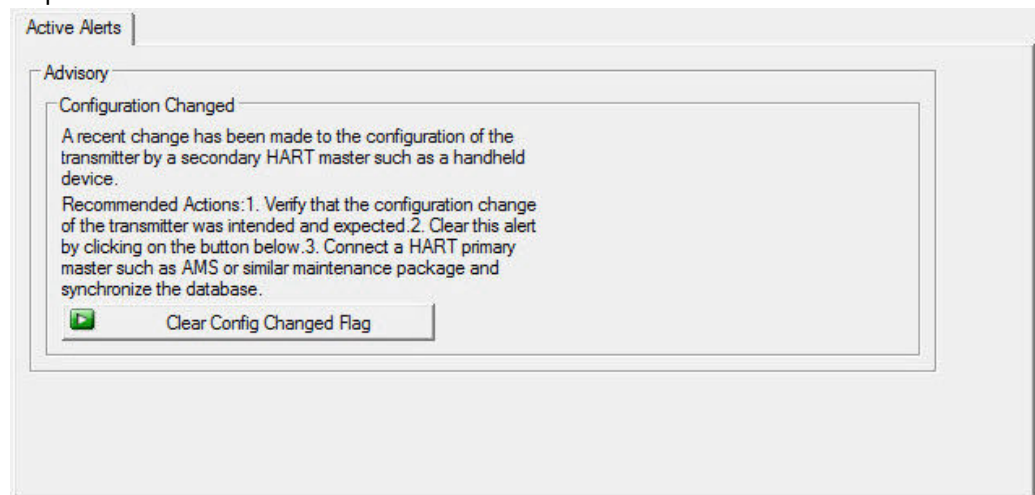

When all of the alerts for this device have been addressed, the yellow circles in the PRM change to green, indicating that everything is operating correctly.

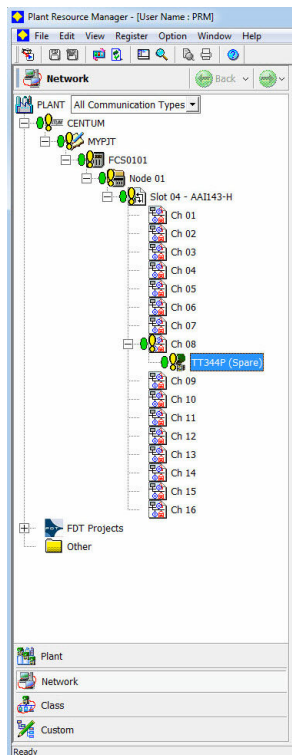

### Secondary sensor failure

#### Communicator message

If Hot Backup is enabled and your secondary sensor fails, your transmitter will report a Failed device status. The alerts show that Sensor 2 is open, but Hot Backup is not active, as shown below on the Field Communicator in the Overview section:

Select **1 Device Status** to view the active alerts.

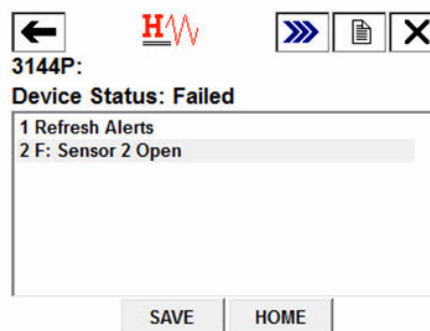
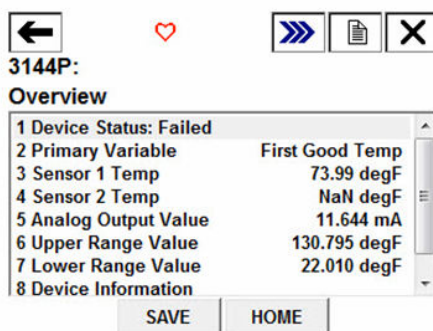

After the sensor has been repaired or replaced, the Field Communicator will display a Good Device Status, indicating the problem is solved.

#### LCD display message

The LCD display on the transmitter will display a message WARN SNSR 2 FAIL. It will also continue to display the output of your primary sensor:



After the sensor has been repaired or replaced, the LCD display warning message will clear and display the output of the primary variable.

### DeltaV message

Alarms will show up on the bottom toolbar, as shown below:



To view the alarm, simply click on the device on the toolbar. A Faceplate with further information on the active alarms will appear. It will show an *ADVISE Sensor Summary*, *FAILED Sensor 2 Open*, and *MAINTENANCE Hot Backup Active*.

### Note

For all of these alarms to appear in DeltaV, all alarms in DeltaV must be configured to WARNING status.

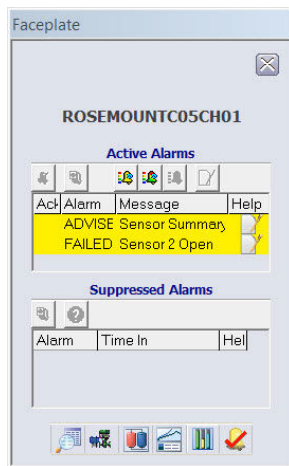

After the sensor has been repaired or replaced, the faceplate in DeltaV will display boxes next to the alarms, shown below. You must acknowledge these alarms by clicking on the boxes in order to clear them.

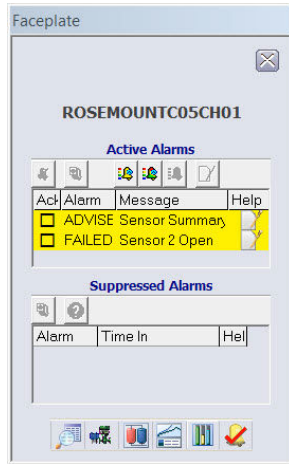

### Yokogawa's Centum PRM/DTM messages

When the secondary sensor fails, alarms will be displayed in the PRM via yellow circles next to the device, as shown below. These yellow circles indicate that something in your process needs attention. To investigate this further, right click on the affected device, and select **DTM Works...** This will open the DTM.

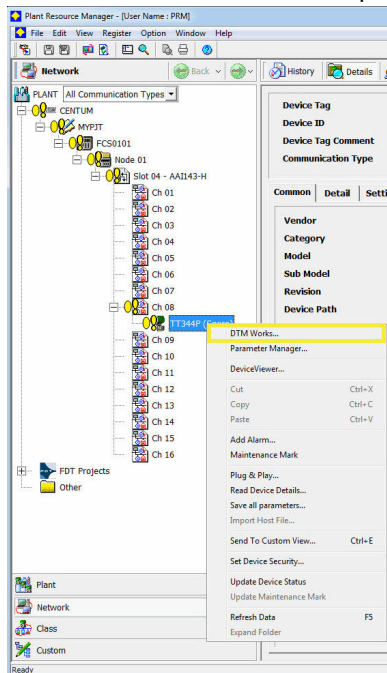

In the DTM, the device status will indicate a Failed status in the Process Variable Overview section, shown below:

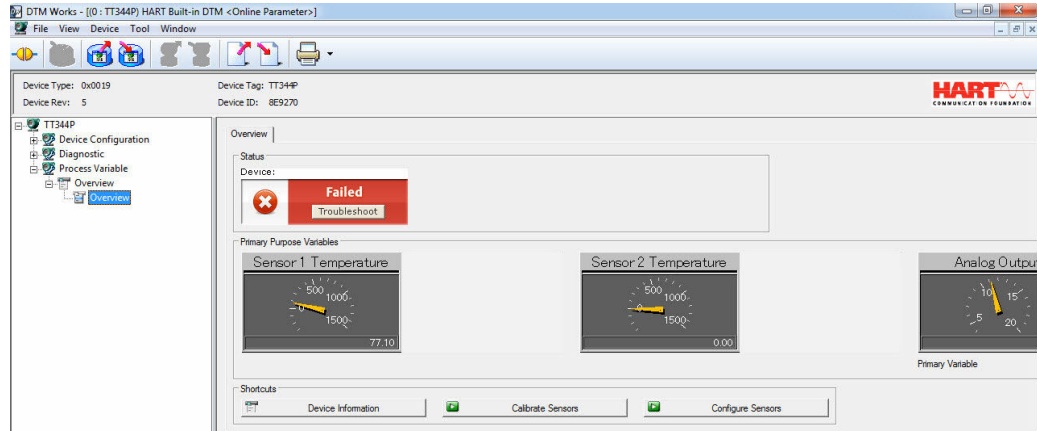

To investigate why the device displays a Failed status, select **Troubleshoot** in the red device status box. Another screen will display the active alerts indicating **FAILED Sensor 2** Open, as shown below:

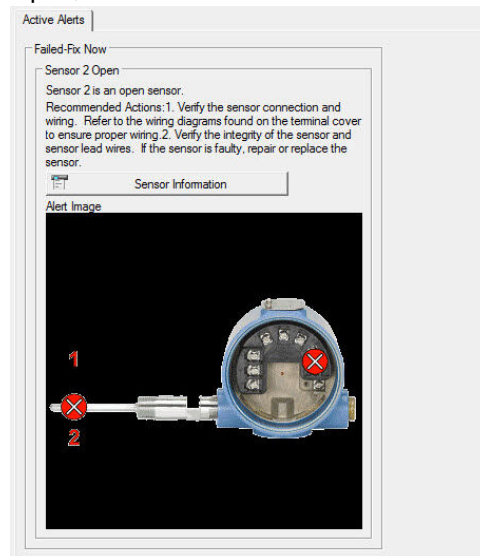

After the sensor has been repaired or replaced, the alerts will clear, and the yellow circles in the PRM change to green, indicating that everything is operating correctly. Hot Backup does not need to be reset in this case.

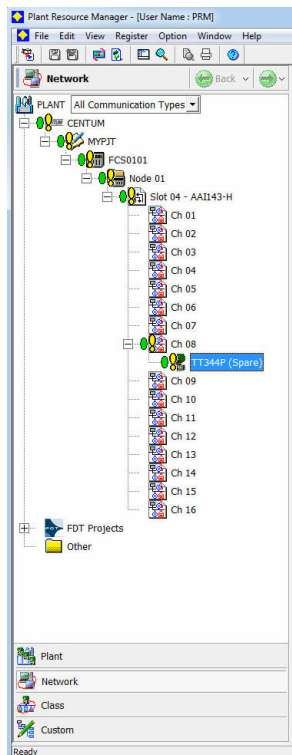

## Alerts for Hot Backup when configured with average temperature *Primary sensor failure*

### Communicator message

If your primary sensor fails, there will be a seamless transition where the second sensor immediately takes over the process. The transmitter will report a Failed status, indicating Sensor 1 is open and Hot Backup is active. This alert is shown on the Field Communicator in the *Overview* section.

Select **1 Device Status** to view the active alerts.

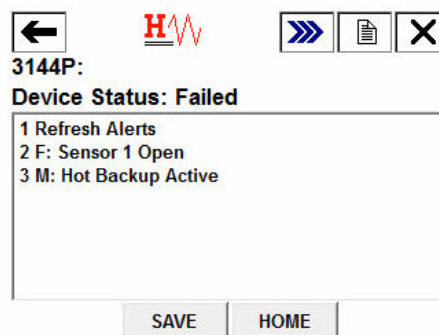
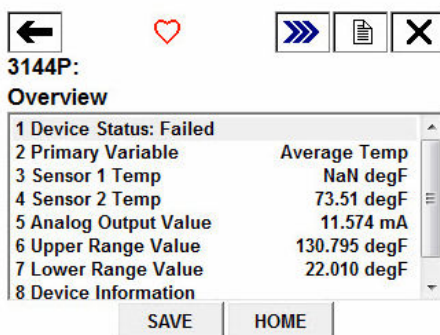

After the sensor has been repaired or replaced, the Field Communicator will display a Maintenance Device Status, indicating Hot Backup is still active. This is shown on the Field Communicator in the *Overview* section.

Hot Backup is still active even though Sensor 1 is repaired. Hot Backup is still active even though Sensor 1 is repaired.

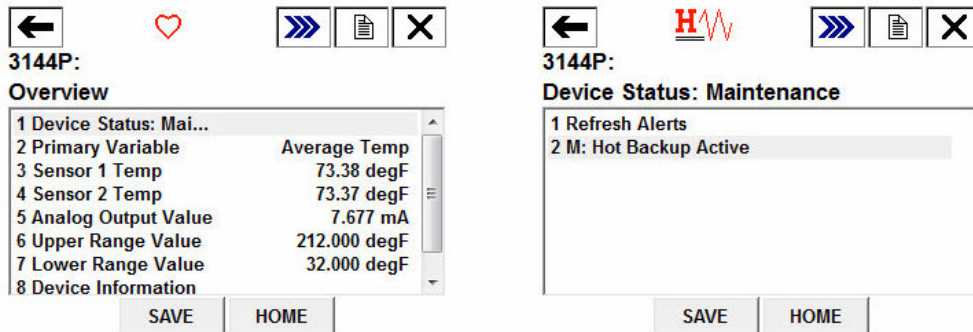

It is recommended that Hot Backup be reset immediately after repairing or replacing the affected sensor. See [Reset Hot Backup: Fast Keys 2-2-4-1-4](#). After resetting Hot Backup, the Field Communicator will display an Advisory Device Status, indicating that the configuration has changed. This is shown in the Overview section. To clear this advisory, simply clear the configuration changed flag, as shown below:

1. Select **1 Device Status** to view the active alerts.

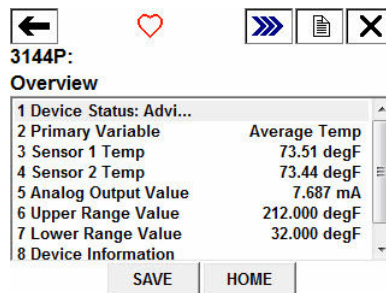

2. Select **2 A: Configuration Changed**.

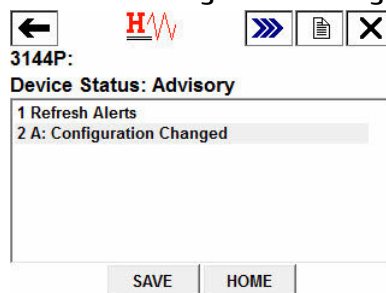

3. Select **2 Clear Config Changed Flag**.

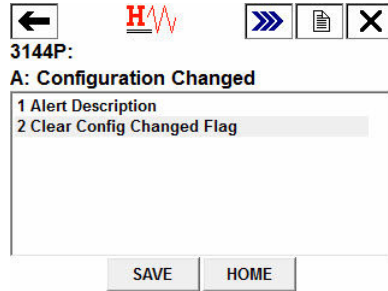

### LCD display message

The LCD display on the transmitter will display a message HOT BU SNSR 1 FAIL; WARN AV DEGRA as well as the output of the average temperature. Because Sensor 1 has failed, this average temperature output is the value of Sensor 2 only.



After the sensor has been repaired or replaced, the LCD display on the transmitter will display a message WARN HOT BU, reminding you that Hot Backup is still active, as well as the normal output of the average temperature. The warning message will clear after you have reset Hot Backup. It is recommended that Hot Backup be reset immediately after repairing or replacing the damaged sensor. See [Reset Hot Backup: Fast Keys 2-2-4-1-4](#).





### DeltaV message

Alarms will show up on the bottom toolbar, as shown below:

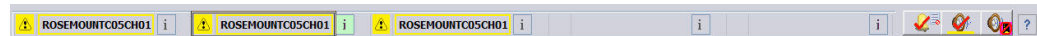

To view the alarm, simply click on the device on the toolbar. A faceplate with further information on the active alarms will appear. It will show an *ADVISE Sensor Summary*, a *FAILED Sensor 1 Open*, and a *MAINTENANCE Hot Backup Active*.

### Note

For all of these alarms to appear in DeltaV, all alarms in DeltaV must be configured to WARNING status.

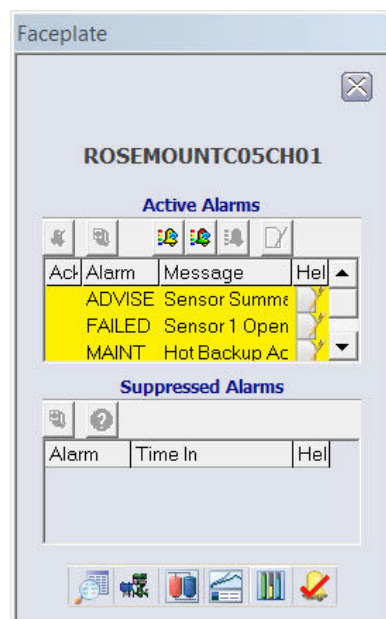

After the sensor has been repaired or replaced, the faceplate window in DeltaV will display boxes next to each alarm that has been addressed. You must acknowledge each alarm to clear it by checking the ACK box to the left of the alarm.

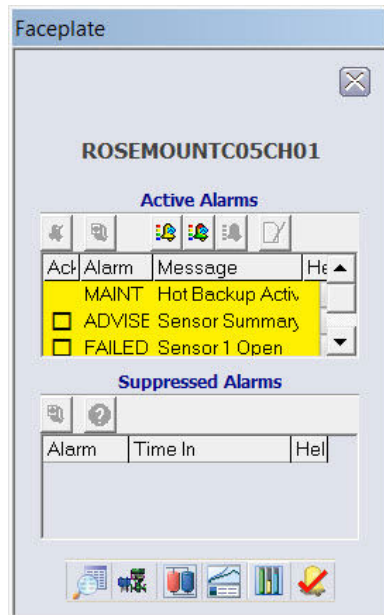

It is recommended that Hot Backup be reset immediately after repairing or replacing the affected sensor. See [Reset Hot Backup: Fast Keys 2-2-4-1-4](#). After resetting Hot Backup, the DeltaV Faceplate window indicates the alarms ADVISE Configuration Change and MAINTENANCE Hot Backup Active. You must acknowledge these alarms in order to clear them by checking the ACK boxes next to each alarm.

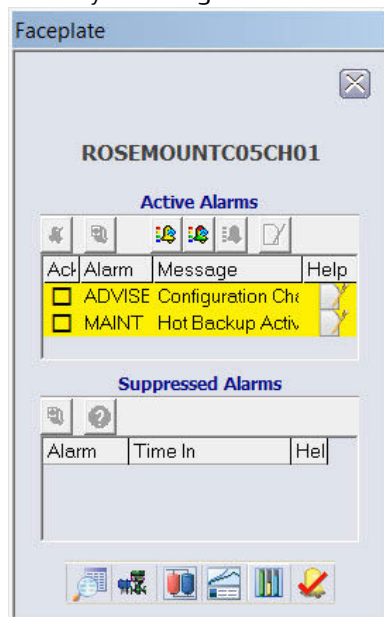

### Yokogawa's Centum PRM/DTM messages

When the primary sensor fails, alarms will be displayed in the PRM via yellow circles next to the device, as shown below. These yellow circles indicate that something in your process needs attention. To investigate this further, right click on the affected device, and select **DTM Works...** This will open the DTM.

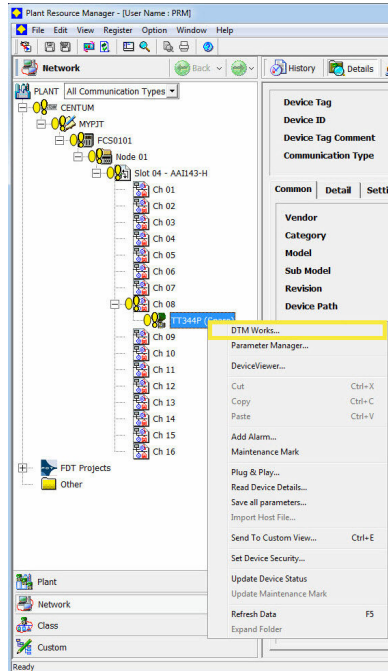

In the DTM, the device status will indicate a Failed status in the Process Variable Overview section, shown below:

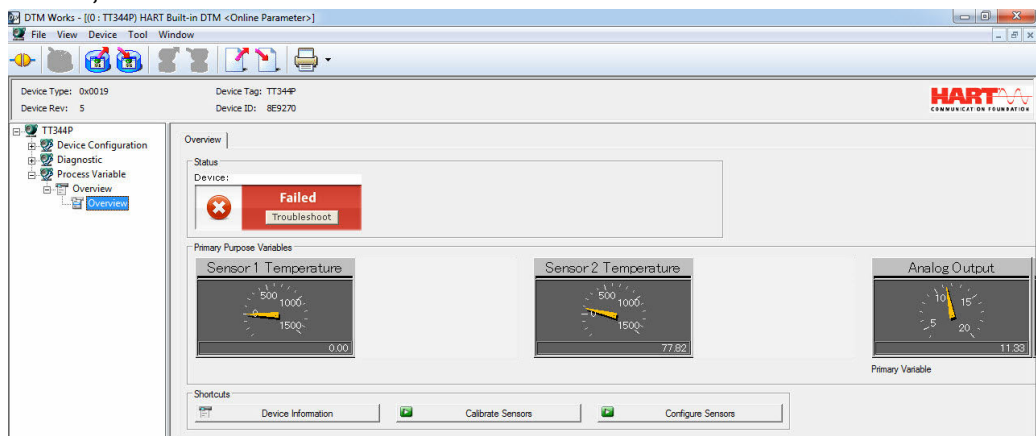

To investigate why the device displays a Failed status, select **Troubleshoot** in the red device status box. Another screen will display the active alerts indicating FAILED Sensor 1 Open, and MAINTENANCE Hot Backup Active, as shown below:

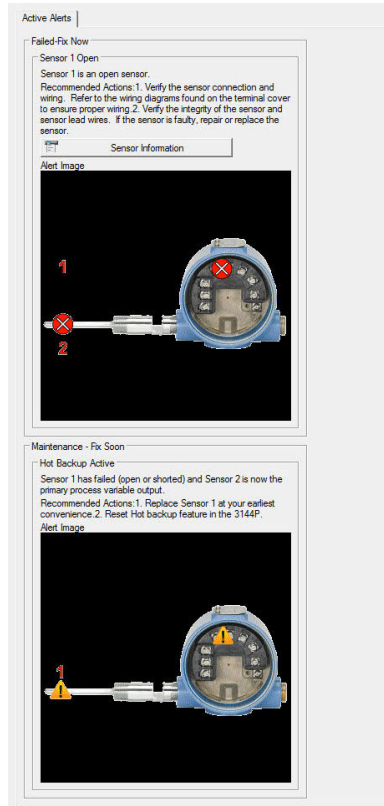

After the sensor has been repaired or replaced, the device status in the Process Variable Overview section of the DTM will change from Failed to Maintenance.



Investigate this Maintenance alert by selecting Troubleshoot in the yellow device status box. Another screen will display the active alerts, indicating MAINTENANCE Hot Backup Active, as shown below:

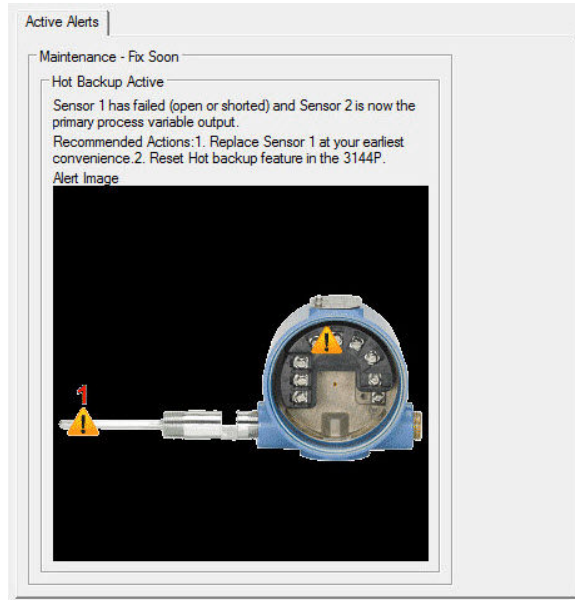

It is recommended that Hot Backup be reset immediately after repairing or replacing the affected sensor. See [Reset Hot Backup: Fast Keys 2-2-4-1-4](#) with a Field Communicator or reset it directly in the DTM by going to the Diagnostics tab of the Manual Setup section and selecting **Reset Hot Backup**, as shown below:

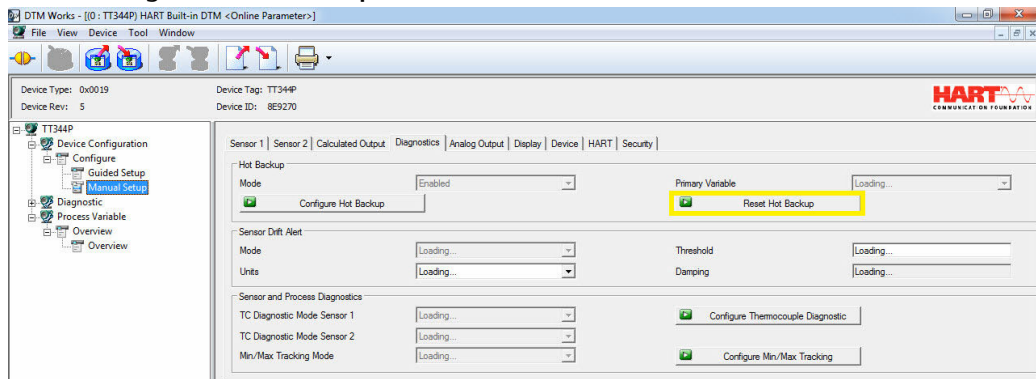

After resetting Hot Backup, the device status in the Process Variable Overview section of the DTM will change from Maintenance to Advisory, as shown below:

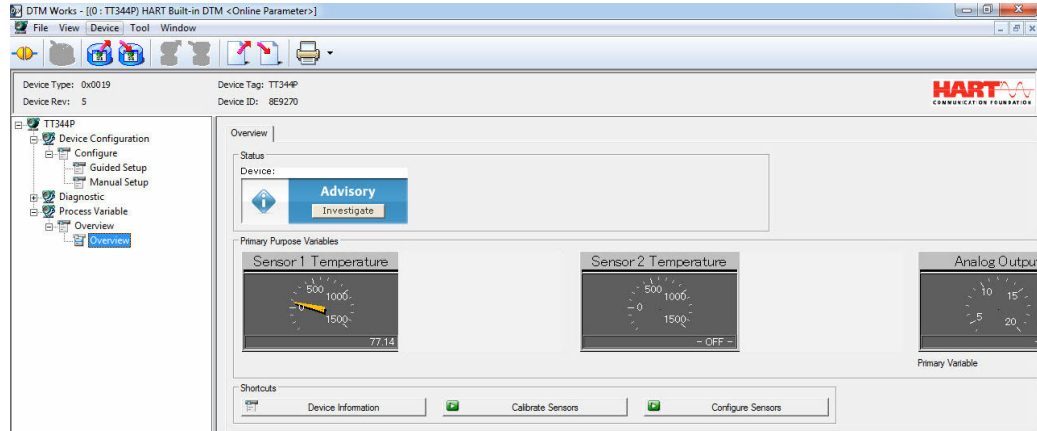

Investigate this advisory alert by choosing **Investigate** in the blue device status box. Another screen will display the active alerts, indicating **ADVISORY Configuration Changed**, as shown below. To clear this advisory, select **Clear Config Changed Flag** and follow the steps.

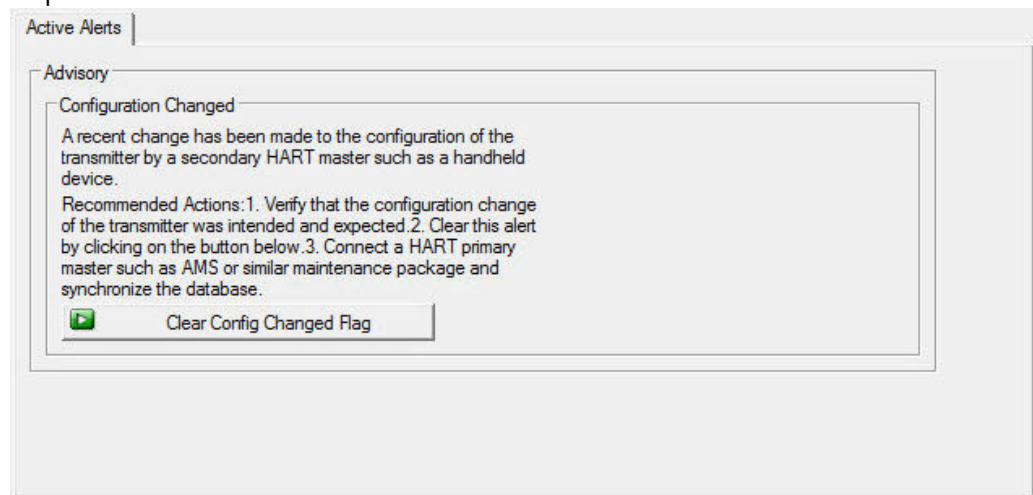

When all of the alerts for this device have been addressed, the yellow circles in the PRM change to green, indicating that everything is operating correctly.

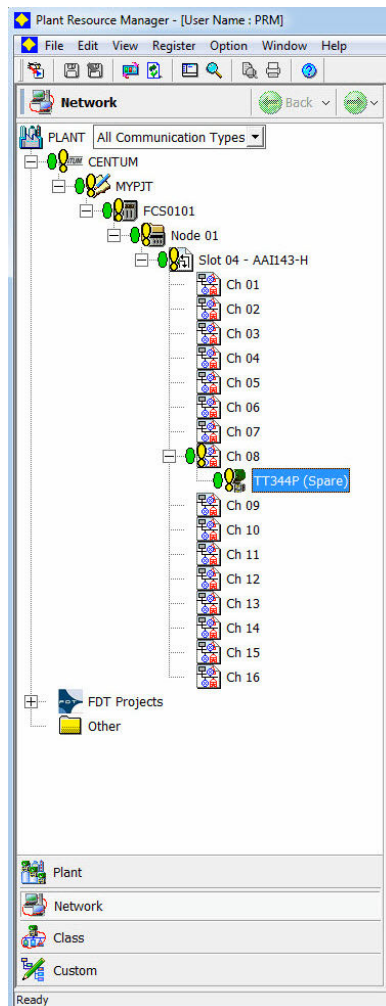

### Secondary sensor failure

#### Communicator message

If Hot Backup is enabled and your secondary sensor fails, your transmitter will report a Failed device status. The alerts show that Sensor 2 is open, but Hot Backup is not active, as shown below on the Field Communicator in the Overview section:

Select **1 Device Status** to view the active alerts.

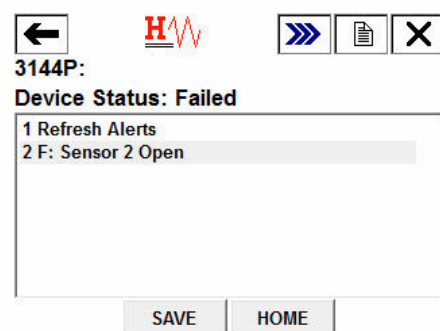
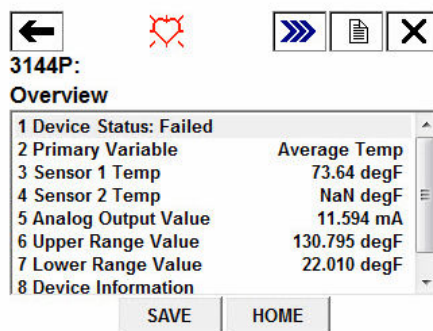

After the sensor has been repaired or replaced, the Field Communicator will display a Good Device Status, indicating the problem is solved.

### LCD display message

The LCD display on the transmitter will display a message WARN SNSR 2 FAIL; WARN AV DEGRA as well as the output of the average temperature. Because Sensor 2 has failed, this average temperature output is the value of Sensor 1 only.



After the sensor has been repaired or replaced, the LCD display warning message will clear and display the output of the primary variable.

### DeltaV message

Alarms will show up on the bottom toolbar, as shown below:



To view the alarm, simply click on the device on the toolbar. A faceplate with further information on the active alarms will appear. It will show an *ADVISE Sensor Summary*, and a *FAILED Sensor 2 Open*.

### Note

For all of these alarms to appear in DeltaV, all alarms in DeltaV must be configured to WARNING status.



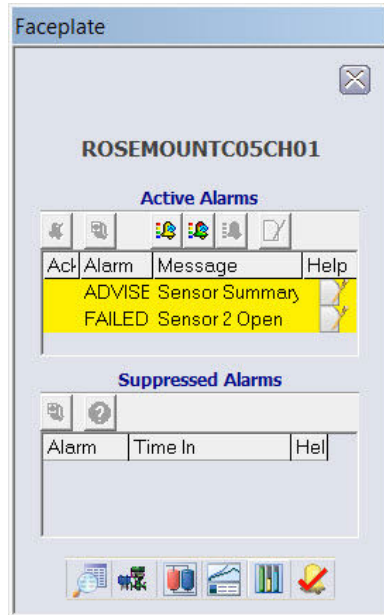

After the sensor has been repaired or replaced, the faceplate in DeltaV will display boxes next to the alarms, shown below. You must acknowledge these alarms by clicking on the boxes in order to clear them.

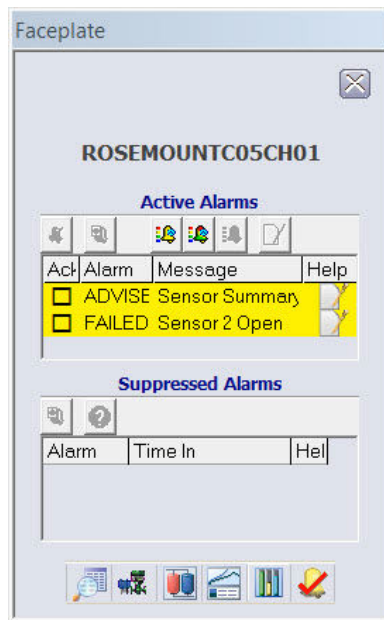

### Yokogawa's Centum PRM/DTM messages

When the secondary sensor fails, alarms will be displayed in the PRM via yellow circles next to the device, as shown below. These yellow circles indicate that something in your process needs attention. To investigate this further, right click on the affected device, and select **DTM Works...** This will open the DTM.

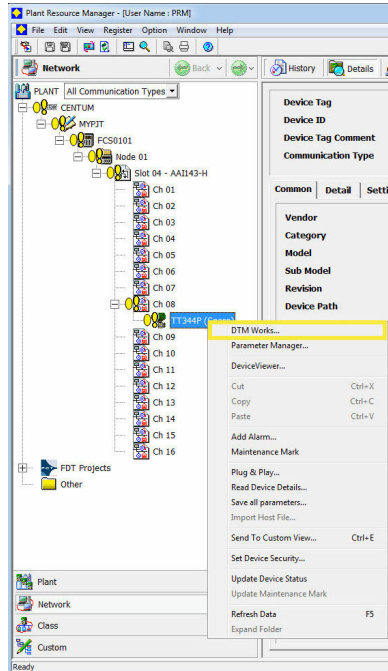

In the DTM, the device status will indicate a Failed status in the *Process Variable Overview* section, shown below:



To investigate why the device displays a Failed status, select **Troubleshoot** in the red device status box. Another screen will display the active alerts indicating FAILED Sensor 2 Open, as shown below:

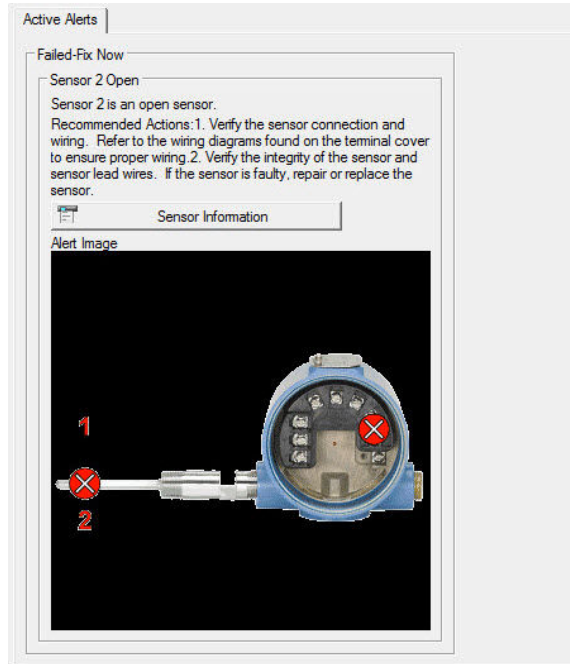

After the sensor has been repaired or replaced, the alerts will clear, and the yellow circles in the PRM change to green, indicating that everything is good. Hot Backup does not need to be reset in this case.

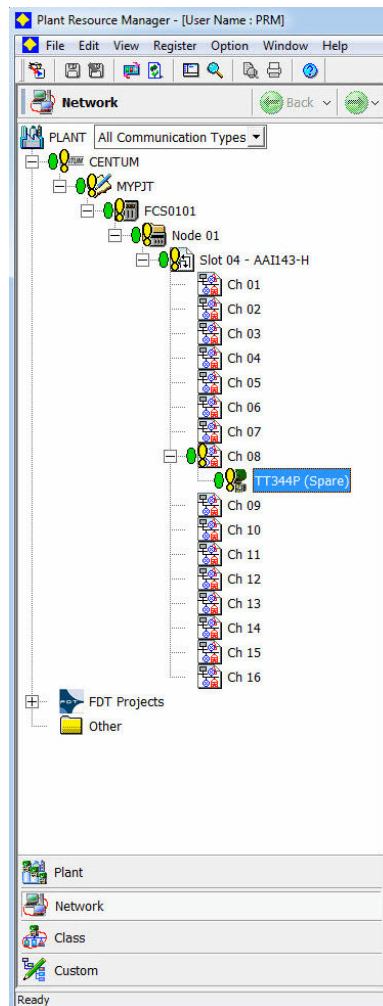

### Reset Hot Backup: Fast Keys 2-2-4-1-4

When the Primary Variable is set to First Good Temperature, the secondary sensor will remain on the 4–20 mA output until Hot Backup is reset, even after Sensor 1 has been replaced. Because of this, it is recommended to reset Hot Backup immediately after Sensor 1 is replaced. If Hot Backup is not reset and Sensor 2 fails, the transmitter will go into alarm. It will not transfer back to Sensor 1 even if sensor one has been repaired.

When the Primary Variable is set to Average Temperature, it is also recommended to reset Hot Backup immediately after Sensor 1 is replaced in order to clear the Hot Backup Active alarm. However, with the PV set to Average Temperature, if Hot Backup is not reset and Sensor 2 fails, the transmitter will simply switch to output the average of only Sensor 1.

1. From the *Home* screen, select **2 Configure**.

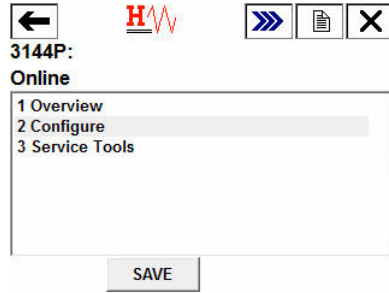

2. Select 2 Manual Setup.

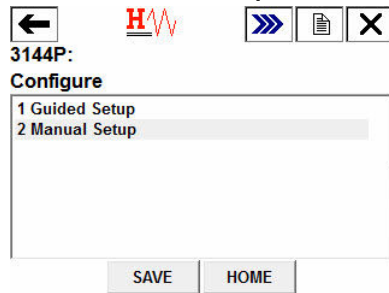

3. Select 4 Diagnostics.

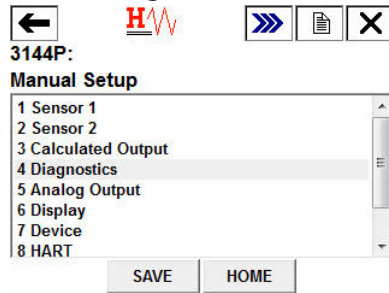

4. Select 1 Hot Backup.

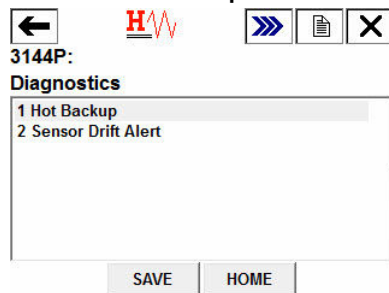

5. Select 4 Reset Hot Backup.

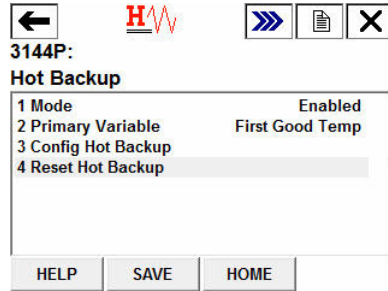

6. Hot Backup has been reset. Select OK.

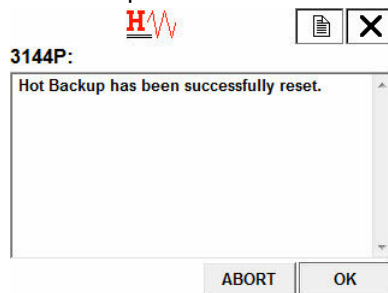

## Sensor Drift Alert configuration

HART 5 Fast Keys	2, 2, 4, 2
HART 7 Fast Keys	2, 2, 4, 2

### Field Communicator

The sensor drift alert command allows the transmitter to set a warning flag (through HART Protocol), or go into analog alarm when the temperature difference between Sensor 1 and Sensor 2 exceeds a user-defined limit. This feature is useful when measuring the same process temperature with two sensors, ideally when using a dual-element sensor. When sensor drift alert mode is enabled, the user sets the maximum allowable difference, in engineering units, between Sensor 1 and Sensor 2. If this maximum difference is exceeded, a sensor drift alert warning flag will be set.

When configuring the transmitter for sensor drift alert, the user also has the option of specifying that the analog output of the transmitter go into alarm when sensor drifting is detected.

#### Note

Using dual sensor configuration in the transmitter supports the configuration and simultaneous use of the Hot Backup feature and sensor drift alert. If one sensor fails, the transmitter switches output to use the remaining good sensor. Should the difference between the two sensor readings exceed the configured threshold, the AO will go to alarm indicating the sensor drift condition. The combination of sensor drift alert and the Hot Backup feature improves sensor diagnostic coverage while maintaining a high level of availability. Refer to the Rosemount 3144P FMEDA report for the impact on safety.

**Problem description:** Sensors often drift before they fail. This causes issues because during the drift period, the sensor is not reporting as accurate measurement.

In control loops, and especially safety loops this can lead to improper process control and potential safety hazards.

**Our solution:** The sensor drift alert continuously monitors two sensor readings to detect a drifting sensor. The diagnostic monitors the difference between the two sensors, and when the difference becomes greater than a value entered by the user, the transmitter sends an alert to indicate a sensor drift condition.

**How it works:** Two sensors are connected to a dual-input transmitter where the difference in sensor readings is continuously being measured. A threshold is set by the user to determine when an excessive drift (i.e. a significant delta) occurs between the two sensors. The temperature delta between the two sensors is calculated by taking the absolute value of the difference between Sensor 1 and Sensor 2. The user configures the transmitter to send a digital alert or analog alarm when the alert has been triggered. The Sensor Drift Alert does not indicate which sensor is failing. Rather the diagnostic provides an indication of a sensor drifting. The user should view the individual sensor output trends on the host to determine which sensor is drifting.

**Take away:** “Sensor Drift Alert detects a degrading sensor.”

**Target applications:** Redundant measurements, critical measurements, severe applications.

---

#### Note

Enabling drift alert option warning only will set a flag (through HART Protocol) whenever the maximum acceptable difference between Sensor 1 and Sensor 2 has been exceeded. For the transmitter’s analog signal to go into alarm when drift alert is detected, select **Alarm** in [Alarm switch \(HART Protocol\)](#).

---

## Configure Sensor Drift in guided setup

*Enable Sensor Drift Alert in guided setup: Fast Keys 2-1-6*

### Procedure

1. From the *Home Screen*, select **2 Configure**.

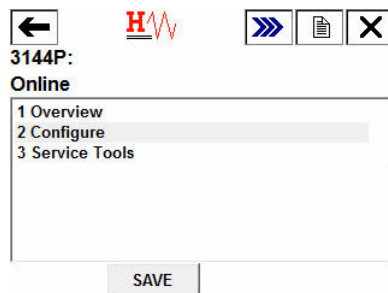

2. Select 1 Guided Setup.

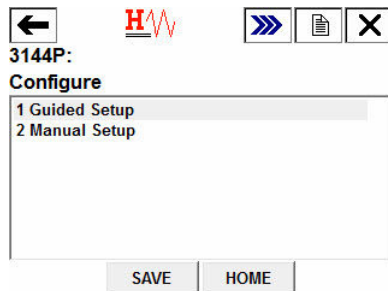

3. Select 6 Config Drift Alert.

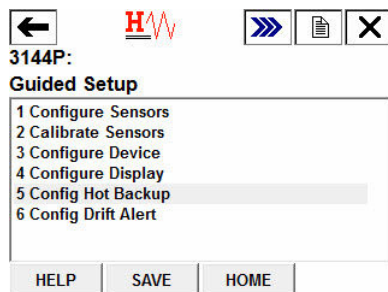

4. Select 1 Enable to activate Sensor Drift Alert and select ENTER.

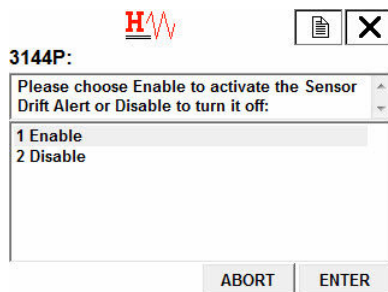

5. When prompted, select whether you want Sensor Drift Alert to put the transmitter into “Alarm” or “Warning”, and select ENTER. Enabling drift alert option warning only will set a flag (through HART Protocol) whenever the maximum acceptable difference between Sensor 1 and Sensor 2 has been exceeded. Enabling drift alert option alarm will send the transmitter's analog signal into alarm when drift alert is detected.

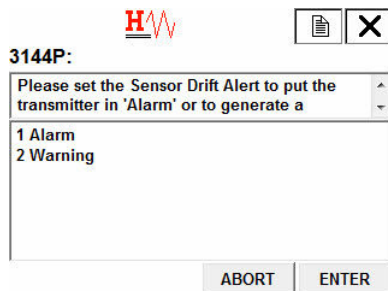



6. Select the engineering units you would like to use and select **ENTER**. Select from *degC*, *degF*, *degR*, *Kelvin*, *mV*, *Ohms*.

The screenshot shows the HART configuration interface. At the top, there is a red 'H' logo with a waveform and two icons: a document and a close 'X' button. Below this, the screen is labeled '3144P:'. A dropdown menu is open, showing 'Engineering Units: (degC)'. The list of options includes: degC, degF, degR, Kelvin, mV, and Ohms. At the bottom of the screen, there are two buttons: 'ABORT' and 'ENTER'.

7. Enter the sensor drift Alert threshold value and select **ENTER**. This is a digital value that triggers the drift alert feature. When this limit is exceeded, the transmitter will go into alarm or generate a warning (depending on the alert mode chosen previously).

The screenshot shows the HART configuration interface. At the top, there is a red 'H' logo with a waveform and two icons: a document and a close 'X' button. Below this, the screen is labeled '3144P:'. A dropdown menu is open, showing 'Enter the Sensor Drift Alert threshold value: (0.93 degC)'. A text input field contains the value '0.93'. Below the input field is a standard QWERTY keyboard layout. At the bottom of the screen, there are four buttons: 'HELP', 'DEL', 'ABORT', and 'ENTER'.

8. Enter a damping value between 0 and 32 and select **ENTER**. This damping value is additional damping applied to the result of (S1–S2) after each sensor's individual damping value has already been applied.

The screenshot shows the HART configuration interface. At the top, there is a red 'H' logo with a waveform and two icons: a document and a close 'X' button. Below this, the screen is labeled '3144P:'. A dropdown menu is open, showing 'Please enter a damping value for Sensor Drift Alert. Valid range is between 0 and 32.'. A text input field contains the value '5.0'. Below the input field is a standard QWERTY keyboard layout. At the bottom of the screen, there are four buttons: 'HELP', 'DEL', 'ABORT', and 'ENTER'.

9. Configuration is complete. Select **OK**.

The screenshot shows the HART configuration interface. At the top, there is a red 'H' logo with a waveform and two icons: a document and a close 'X' button. Below this, the screen is labeled '3144P:'. A text area displays the message 'Configure Sensor Drift Alert method is complete.'. At the bottom of the screen, there are two buttons: 'ABORT' and 'OK'.

### Disable Sensor Drift Alert in guided setup: Fast Keys 2-1-6

#### Procedure

1. From the *Home Screen*, select **2 Configure**.

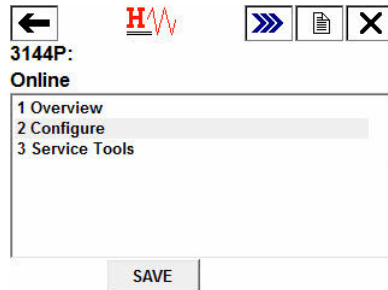

2. Select **1 Guided Setup**.

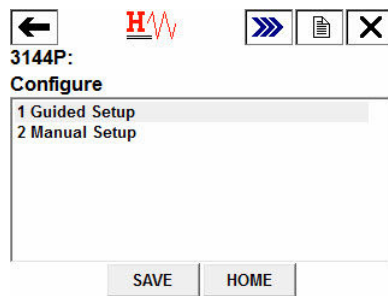

3. Select **6 Config Drift Alert**.

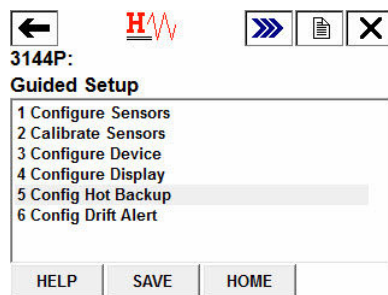

4. Select **2 Disable** to disable Sensor Drift alert and select **ENTER**.

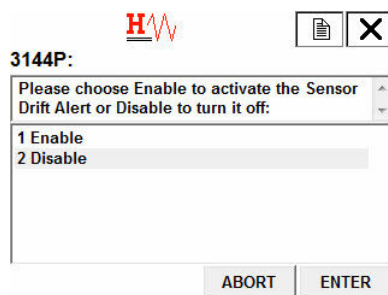

- Sensor Drift Alert has been disabled. Select OK.

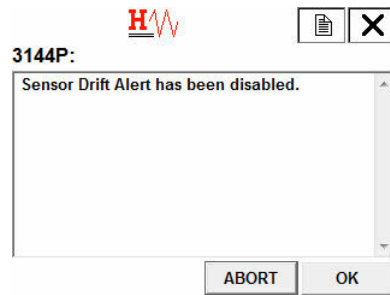

## Configure Sensor Drift in manual setup

Enable Sensor Drift Alert in manual setup: Fast Keys 2-2-4-2-5

### Procedure

- From the *Home* screen, select 2 Configure.

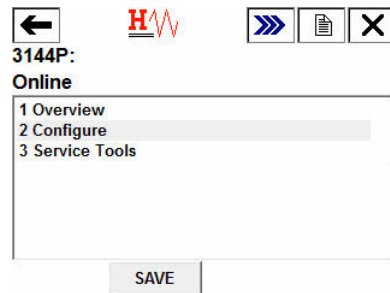

- Select 2 Manual Setup.

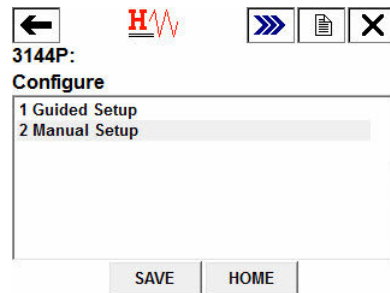

- Select 4 Diagnostics.

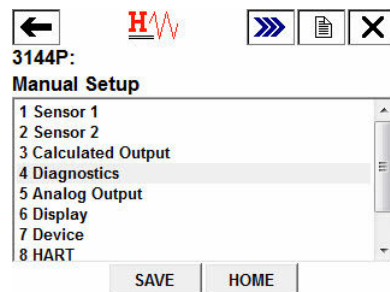

4. Select 2 Sensor Drift Alert.

3144P:  
**Diagnostics**

1 Hot Backup
2 Sensor Drift Alert

SAVE HOME

5. Select 5 Config Drift Alert.

3144P:  
**Sensor Drift Alert**

1 Mode	Disable
2 Threshold	0.93 degC
3 Damping	5.0 sec
4 Drift Alert Engg Units	degC
5 Config Drift Alert	

HELP SAVE HOME

6. Select 1 Enable to activate Sensor Drift Alert and select ENTER.

3144P:  
Please choose Enable to activate the Sensor Drift Alert or Disable to turn it off:

1 Enable
2 Disable

ABORT ENTER

7. When prompted, select whether you want Sensor Drift Alert to put the transmitter into “Alarm” or “Warning”, and select ENTER. Enabling Drift Alert Option Warning only will set a flag (through HART Protocol) whenever the maximum acceptable difference between Sensor 1 and Sensor 2 has been exceeded. Enabling Drift Alert Option Alarm will send the transmitter's analog signal into alarm when Drift Alert is detected.

3144P:  
Please set the Sensor Drift Alert to put the transmitter in 'Alarm' or to generate a

1 Alarm
2 Warning

ABORT ENTER

- Select the engineering units you would like to use and select **ENTER**. Choose from degC, degF, degR, Kelvin, mV, Ohms.

- Enter the Sensor Drift Alert threshold value and select **ENTER**. This is a digital value that triggers the Drift Alert feature. When this limit is exceeded, the transmitter will go into alarm or generate a warning (depending on the alert mode chosen previously).

- Enter a damping value between 0 and 32 and select **ENTER**. This damping value is additional damping applied to the result of (S1–S2) after each sensor's individual damping value has already been applied.

- Configuration is complete. Select **OK**.

### Disable Sensor Drift Alert in manual setup: Fast Keys 2-2-4-2-5

#### Procedure

1. From the *Home Screen*, select **2 Configure**.

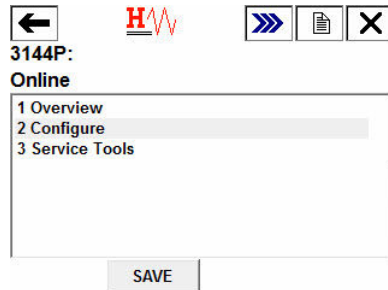

2. Select **2 Manual Setup**.

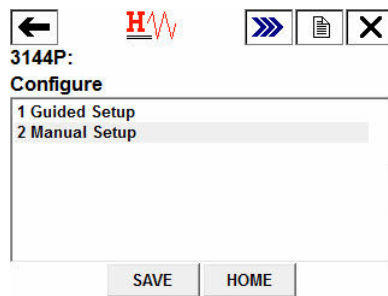

3. Select **4 Diagnostics**.

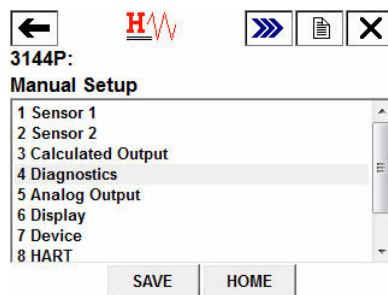

4. Select **1 Hot Backup**.

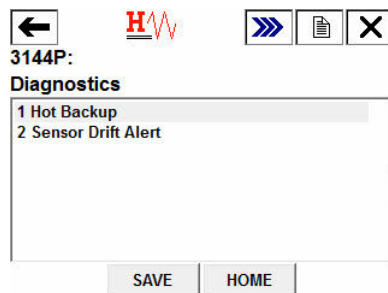

5. Select 3 Config Hot Backup.

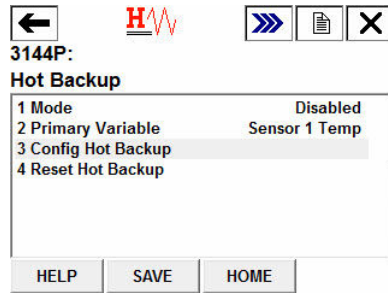

6. Select 2 Disable to disable Sensor Drift alert and select ENTER.

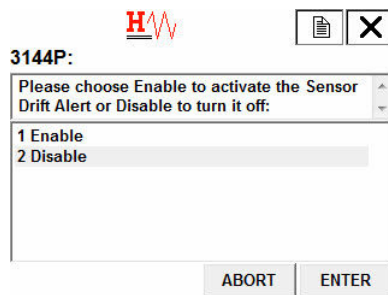

7. Sensor Drift Alert has been disabled. Select OK.

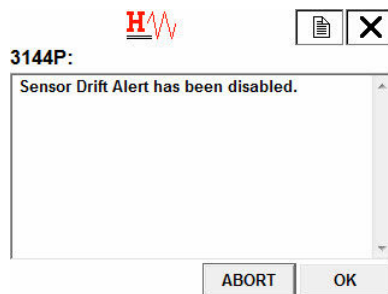

### Verify Sensor Drift Alert is enabled: Fast Keys 2-2-4-2

#### Procedure

1. From the Home Screen, select 2 Configure.

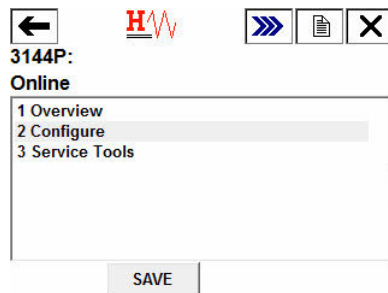

2. Select 2 Manual Setup.

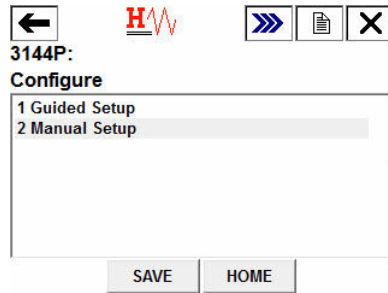

3. Select 4 Diagnostics.

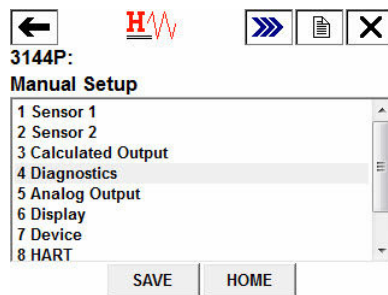

4. Select 2 Sensor Drift Alert.

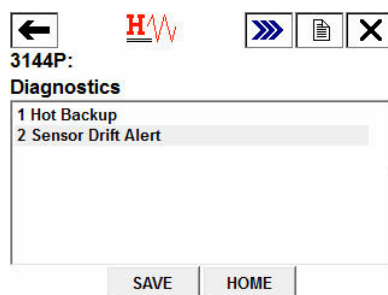

5. You will see this screen. Under 1 Mode, it will say either Alarm or Warning if enabled, or Disable. If enabled, it will also display the current diagnostic values.

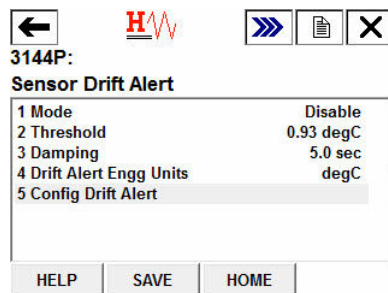



## Active Sensor Drift Alerts

### Viewing active sensor drift alerts: Fast Keys 1-1-2

When the Sensor Drift Alert diagnostic detects a drifting sensor, the LCD display will display a message; “ALARM DRIFT ALERT” if configured in Alarm Mode and “WARN DRIFT ALERT” if configured in Warning Mode.

#### Procedure

1. Select 1 Overview.

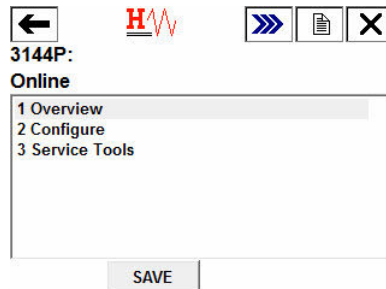

2. If Sensor Drift Alert is configured in Alarm Mode, select 1 Device Status: Failed.

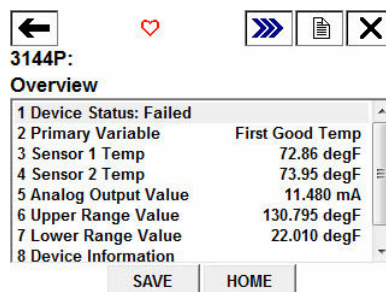

If Sensor Drift Alert is configured in Warning Mode, select 1 Device Status: Maintenance.

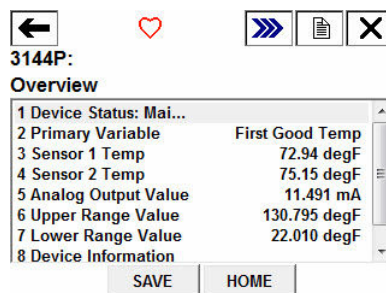

3. Select 2 Sensor Drift Alert Active.

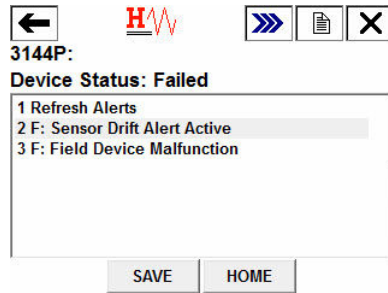

## Resetting active sensor drift alerts: Fast Keys 1-1-1

### Procedure

1. Select 1 Overview.

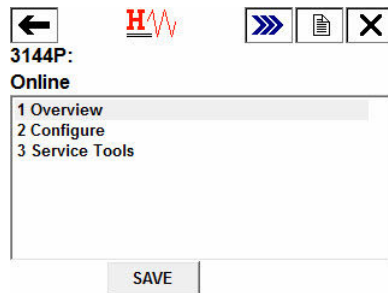

2. Select 1 Device Status: (Maintenance or Failed).

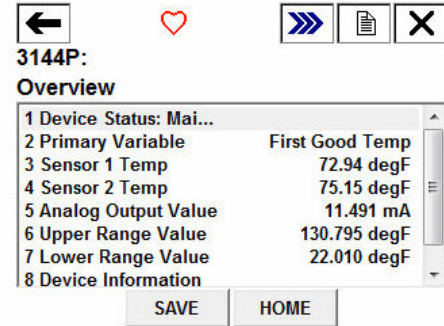
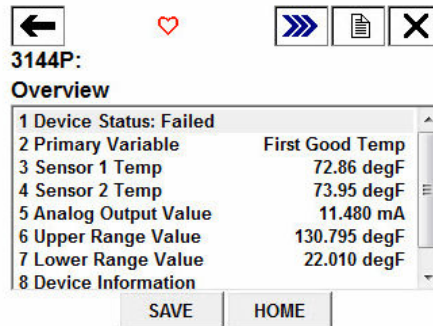

3. Select 1 Refresh Alerts.

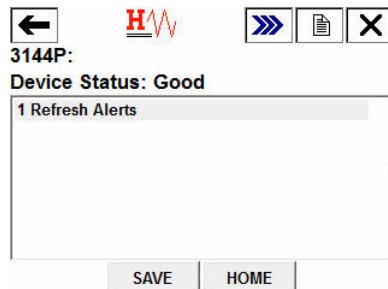

## 3.8 Rosemount X-well Technology configuration

Rosemount X-well functionality can easily be enabled and configured via a field communicator or asset management system. The Rosemount 3144P Temperature Transmitter can be ordered with Rosemount X-well technology via the “PT” model option code. The “C1” model option code must be ordered if the “PT” option code is specified. The “C1” option code requires user supplied information of process pipe material and pipe schedule. Rosemount X-well technology can be configured with any asset management software that supports Electronic Device Description Language (EDDL). The Device Dashboard interface with DD revision 3144P Dev. 7 Rev. 1 or higher is required to view Rosemount X-well functionality. The “Rosemount X-well Process” sensor/type option should be selected as the sensor type in most cases. Once selected, pipe material, line size, and pipe schedule information is required when configuring Rosemount X-well technology. This section is referring to the process pipe properties that Rosemount 3144P and 0085 Pipe Clamp Sensor with Rosemount X-well technology is going to be installed in. This information is required for the in-transmitter algorithm to accurately calculate process temperature. In the rare case that the process pipe is not available, a custom value for the pipe conduction coefficient can be entered. This field becomes available when the “Rosemount X-well Custom” sensor/type option is selected.

### 3.8.1 Configure Rosemount X-well technology with a Field Communicator

#### Procedure

1. From the *Home* screen, select **2: Configure**.
2. Select **1: Guided Setup**.
3. Select **1: Configure Sensor**.
4. Select **1: Configure Sensor Type and Units**.
5. Select either **Rosemount X-well Process** or **Rosemount X-well Custom**.
6. Select desired configurations and select **Enter**.

### Configure Rosemount X-well Technology in manual setup: Fast Keys 2-2-1-11

#### Procedure

1. Under *Configure Sensors*, select **Rosemount X-well Process** sensor type.

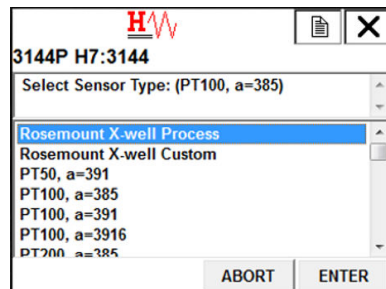

2. Select pipe material.

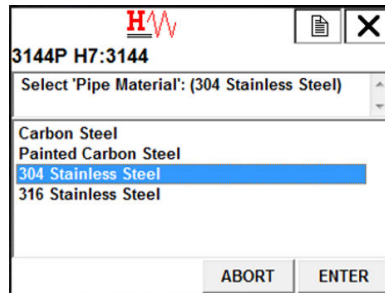

3. Select line size.

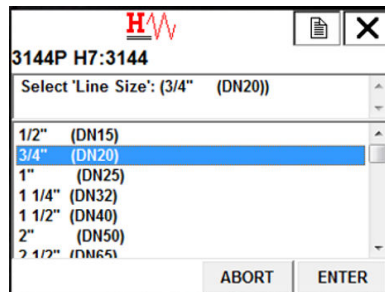

4. Select pipe schedule.

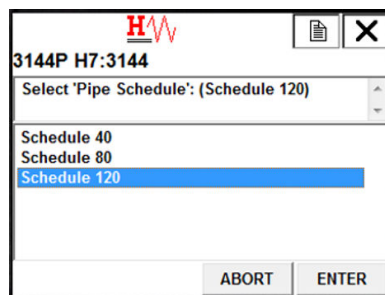

5. If process *Pipe Material*, *Line Size*, or *Pipe Schedule* is not available under Rosemount X-well Process selection, select **Rosemount X-well Custom** sensor type.

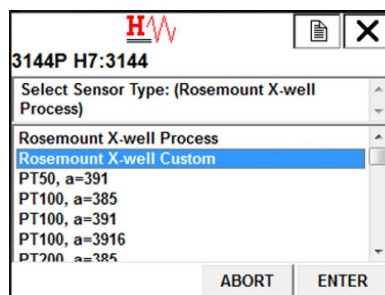

6. Enter *Pipe Conduction Coefficient*. If coefficient is not known, contact factory with pipe material and pipe wall thickness of application. A custom pipe coefficient will be provided to input into transmitter.

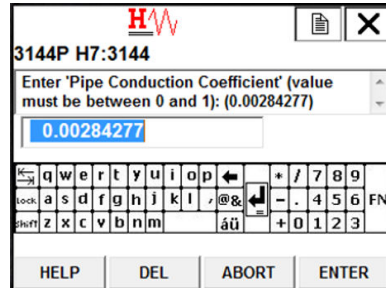

7. Confirm Rosemount X-well Technology Configuration: Fast Keys 2-2-1-11-3

## Configure Rosemount X-well technology with AMS Device Manager

### Procedure

1. Right click on the device and select **Configure**.
2. In the menu tree, select **Manual Setup**.
3. Select the **Sensor** tab.
4. Select either **Rosemount X-well Process** or **Rosemount X-well Custom**.
5. Select desired configurations via Basic Configuration and select **Send**.

Figure 3-7: Manual Setup - Sensor Screen

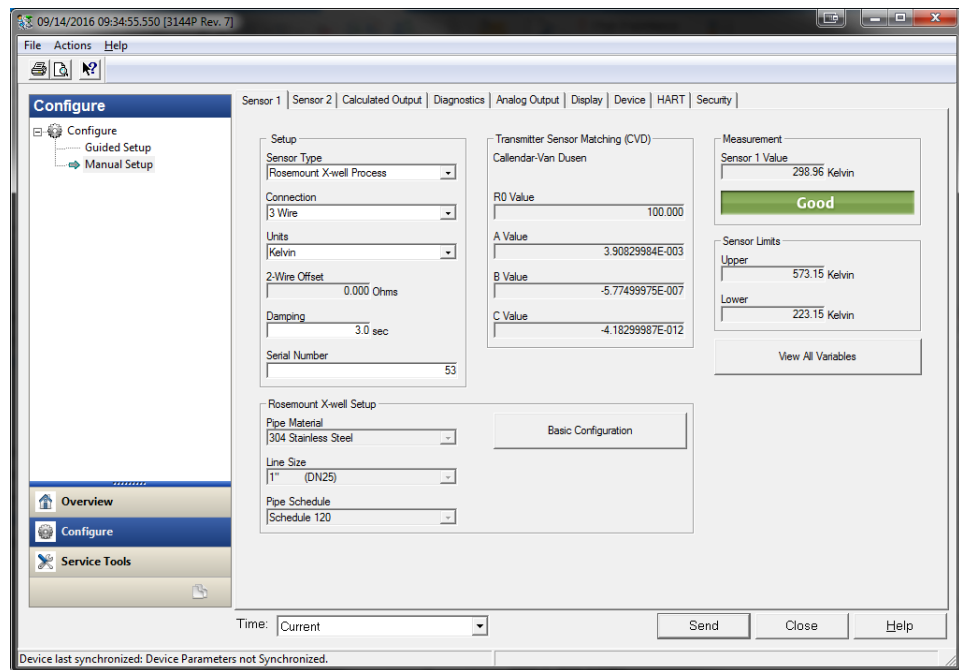

## 3.9 Device output configuration

Device output configuration contains PV range values, alarm and saturation, HART output, and LCD display options. PV range values;

HART 5 Fast Keys	2, 2, 5, 5
HART 7 Fast Keys	2, 2, 5, 5

### Field Communicator

The PV URV and PV LRV commands, found in the PV Range Values menu screen, allow the user to set the transmitter's lower and upper range values using limits of expected readings. The range of expected readings is defined by the Lower Range Value (LRV) and Upper Range Value (URV). The transmitter range values may be reset as often as necessary to reflect changing process conditions. From the PV Range Values screen select **1 PV LRV** to change the lower range value and **2 PV URV** to change the upper range value.

Reranging the transmitter sets the measurement range to the limits of the expected readings, which maximizes transmitter performance; the transmitter is most accurate when operated within the expected temperature range for the application.

The rerange functions should not be confused with the trim function. Although re-ranging the transmitter matches a sensor input to a 4–20 mA output, as in conventional calibration, it does not affect the transmitter's interpretation of the input.

### 3.9.1 Process variable damping

HART 5 Fast Keys	Sensor 1: 2, 2, 1, 6 Sensor 2: 2, 2, 2, 6
HART 7 Fast Keys	Sensor 1: 2, 2, 1, 7 Sensor 1: 2, 2, 2, 7

### Field Communicator

The PV Damp command changes the response time of the transmitter to smooth variations in output readings caused by rapid changes in input. Determine the appropriate damping setting based on the necessary response time, signal stability, and other requirements of the loop dynamics of the system. The default damping value is 5.0 seconds and can be reset to any value between 1 and 32 seconds.

The value chosen for damping affects the response time of the transmitter. When set to zero (disabled), the damping function is off and the transmitter output reacts to changes in input as quickly as the intermittent sensor algorithm allows. Increasing the damping value increases transmitter response time.

### Damping

Damping values may be used for, and should equal, the update rate for Sensor 1, Sensor 2, and sensor differential. Sensor configuration automatically calculates a damping value. The default damping value is five seconds. Damping may be disabled by setting the

parameter damping value to 0 seconds. The maximum damping value allowed is 32 seconds.

An alternate damping value may be entered with the following restrictions:

1. Single sensor configuration:
  - 50 or 60 Hz Line Voltage Filters have a minimum user-configurable damping value of 0.5 seconds
2. Dual sensor configuration:
  - 50 Hz Line Voltage Filter a minimum user-configurable damping value of 0.9 seconds
  - 60 Hz Line Voltage Filter a minimum user-configurable damping value of 0.7 seconds

**Figure 3-8: Change in Input versus Change in Output with Damping Enabled**

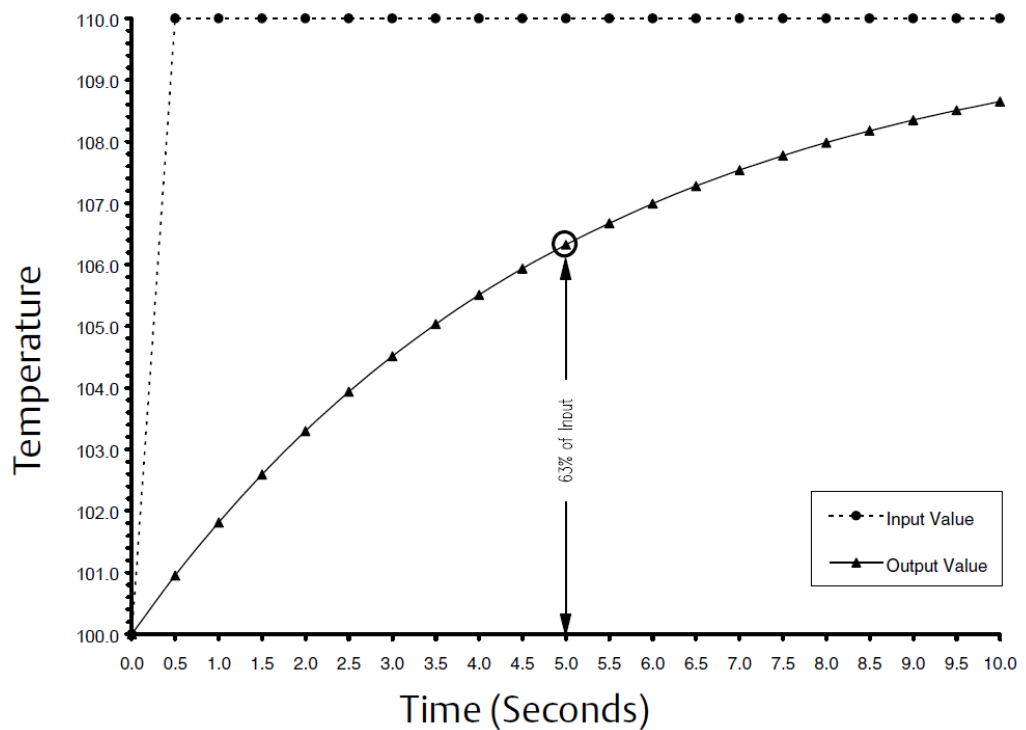

### 3.9.2 Alarm and saturation

HART 5 Fast Keys	2, 2, 5, 6
HART 7 Fast Keys	2, 2, 5, 6

The Alarm/Saturation command allows the user to view the alarm settings (Hi or Low). This command can change the alarm and saturation values. To change the alarm and saturation values, select the value to be changed, either 1 Low Alarm, 2 High Alarm, 3 Low

*Sat*, *4 High Sat*, or *5 Preset Alarms* and enter the desired new value which must fall within the guidelines below:

- The low alarm value must be between 3.50 and 3.75 mA
- The high alarm value must be between 21.0 and 23.0 mA

The low saturation level must be between the low alarm value plus 0.1 mA and 3.9 mA for the standard HART transmitter. For the safety certified transmitter, the lowest saturation setting is 3.7 mA and the highest is 20.9 mA.

Example: The low alarm value has been set to 3.7 mA. Therefore, the low saturation level, *S*, must be  $3.8 \leq S \leq 3.9$  mA.

The high saturation level must be between 20.5 and 20.9 mA.

Preset alarms can either be *1 Rosemount* or *2 NAMUR-compliant*. Use the failure mode switch on the front side of the electronics to set whether the output will be driven to high or low alarm in the case of failure.

### 3.9.3 HART output

HART 5 Fast Keys	2, 2, 8
HART 7 Fast Keys	2, 2, 8

The **HART Output** command allows the user to make changes to the multidrop address, initiate burst mode, or make changes to the burst options.

### 3.9.4 LCD display options

HART 5 Fast Keys	2, 2, 6
HART 7 Fast Keys	2, 2, 6

The LCD display option command sets the meter options, including engineering units and decimal point. Change the LCD display settings to reflect necessary configuration parameters when adding a LCD display or reconfiguring the transmitter. Transmitters without LCD displays are shipped with the meter configuration set to “Not Used.”

## 3.10 Device information

Access the transmitter information variables online using the Field Communicator or other suitable communications device. The following is a list of transmitter information variables, including device identifiers, factory-set configuration variables, and other information. A description of each variable, the corresponding fast key sequence, and a review are provided.

### 3.10.1 Tag

HART 5 Fast Keys	2, 2, 7, 1, 1
HART 7 Fast Keys	2, 2, 7, 1, 1



The Tag variable is the easiest way to identify and distinguish between transmitters in multi-transmitter environments. Use it to label transmitters electronically according to the requirements of the application. The tag defined is automatically displayed when a HART-based Communicator establishes contact with the transmitter at power-up. The tag may be up to eight characters long and has no impact on the primary variable readings of the transmitter.

### 3.10.2 Long Tag

HART 5 Fast Key	HART 7 only
HART 7 Fast Key	2, 2, 7, 1, 2

The Long Tag is similar to Tag. The long tag is different in that the Long tag can be up to 32 Characters instead of the eight characters in traditional Tag.

### 3.10.3 Date

HART 5 Fast Keys	2, 2, 7, 1, 2
HART 7 Fast Keys	2, 2, 7, 1, 3

The Date command is a user-defined variable that provides a place to save the date of the last revision of configuration information. It has no impact on the operation of the transmitter or the Field Communicator.

### 3.10.4 Descriptor

HART 5 Fast Keys	2, 2, 7, 1, 3
HART 7 Fast Keys	2, 2, 7, 1, 4

The Descriptor variable provides a longer user-defined electronic label to assist with more specific transmitter identification than is available with the tag variable. The descriptor may be up to 16 characters long and has no impact on the operation of the transmitter or the Field Communicator.

### 3.10.5 Message

HART 5 Fast Keys	2, 2, 7, 1, 4
HART 7 Fast Keys	2, 2, 7, 1, 5

The Message variable provides the most specific user-defined means for identifying individual transmitters in multi-transmitter environments. It allows for 32 characters of information and is stored with the other configuration data. The message variable has no impact on the operation of the transmitter or the Field Communicator.

## 3.11 Measurement filtering

### 3.11.1 50/60 Hz Filter

HART 5 Fast Keys	2, 2, 7, 5, 1
HART 7 Fast Keys	2, 2, 7, 5, 1

The 50/60 Hz Filter (also known as Line Voltage Filter or AC Power Filter) variable sets the transmitter electronic filter to reject the AC power supply frequency in the plant. The 60 or 50 Hz mode can be chosen. The factory default for this setting is 60 Hz.

---

**Note**

In high noise environments, normal mode is recommended.

---

### 3.11.2 Master Reset

HART 5 Fast Keys	2, 2, 7, 6
HART 7 Fast Keys	2, 2, 7, 6

Master Reset resets the electronics without actually powering down the unit. It does not return the transmitter to the original factory configuration.

### 3.11.3 Intermittent Sensor Detect

HART 5 Fast Keys	2, 2, 7, 5, 2
HART 7 Fast Keys	2, 2, 7, 5, 2

The following steps indicate how to turn the Intermittent Sensor Detect (also known as Transient Filter) feature ON or OFF. When the transmitter is connected to a Field Communicator, use the Fast Key sequence and select **ON** (normal setting) or **OFF**.

### 3.11.4 Intermittent threshold

The threshold value can be changed from the default value of 0.2 percent. Turning the Intermittent Sensor Detect feature OFF or leaving it ON and increasing the threshold value above the default does not affect the time needed for the transmitter to output the correct alarm signal after detecting a true open sensor condition. However, the transmitter may briefly output a false temperature reading for up to one update in either direction (see [Figure 3-10](#)) up to the threshold value (100 percent of sensor limits if Intermittent Sensor Detect is OFF). Unless rapid response rate is necessary, the suggested setting of the Intermittent Sensor Detect mechanism is ON with 0.2 percent threshold.

**Figure 3-9: Open Sensor Response**

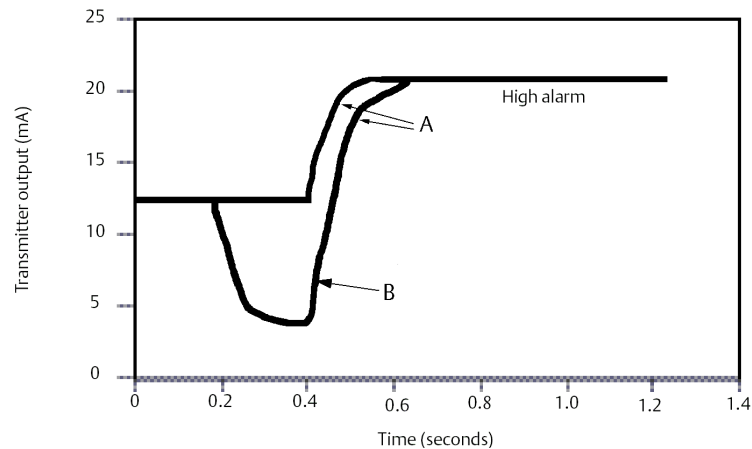

- A. Normal open sensor responses.
- B. When Intermittent Sensor Detect is OFF, a false temperature output is possible when an open sensor condition is detected. A false temperature output in either direction up to the threshold value (100 percent of sensor limits if Intermittent Sensor Detect is OFF) is possible when an open sensor condition is detected.

## Intermittent Sensor Detect (advanced feature)

The Intermittent Sensor Detect feature guards against process temperature readings caused by intermittent open sensor conditions (an intermittent sensor condition is an open sensor condition that lasts less than one update). By default, the transmitter is shipped with the Intermittent Sensor Detect feature switched ON and the threshold value set to 0.2 percent of sensor limits. The Intermittent Sensor Detect feature can be switched ON or OFF and the threshold value can be changed to any value between 0 and 100 percent of the sensor limits with a Field Communicator.

### Transmitter behavior with Intermittent Sensor Detect ON

When the Intermittent Sensor Detect feature is switched ON, the transmitter can eliminate the output pulse caused by intermittent open sensor conditions. Process temperature changes ( $\Delta T$ ) within the threshold value are tracked normally by the transmitter's output. A  $\Delta T$  greater than the threshold value activates the intermittent sensor algorithm. True open sensor conditions cause the transmitter to go into alarm.

The threshold value of the transmitter should be set at a level that allows the normal range of process temperature fluctuations; too high and the algorithm will not be able to filter out intermittent conditions; too low and the algorithm will be activated unnecessarily. The default threshold value is 0.2 percent of the sensor limits

### Transmitter behavior with Intermittent Sensor Detect OFF

When the Intermittent Sensor Detect feature is switched OFF, the transmitter tracks all process temperature changes, even if they are the result of an intermittent sensor. (The

transmitter behaves as though the threshold value had been set at 100 percent.)  
The output delay because of the intermittent sensor algorithm will be eliminated.

### 3.11.5 Open Sensor Holdoff

HART 5 Fast Keys	2, 2, 7, 4
HART 7 Fast Keys	2, 2, 7, 4

The Open Sensor Holdoff option, at the normal setting, enables the Rosemount 248 to tolerate heavy EMI disturbances without producing brief periods of alarm. This is accomplished through the software by having the transmitter perform additional verification of the open sensor status prior to activating the transmitter alarm. If the additional verification shows that the open sensor condition is not valid, the transmitter will not go into alarm.

For users of the transmitter that desire a more immediate open sensor detection, the Open Sensor Holdoff option can be changed to a fast setting. On this setting, the transmitter reports an open sensor condition without additional verification of the open condition.

## 3.12 Diagnostics and service

Diagnostics and service functions listed below are primarily for use after field installation. The Transmitter Test feature is designed to verify that the transmitter is operating properly, and can be performed either on the bench or in the field. The Loop Test feature is designed to verify proper loop wiring and transmitter output, and should only be performed after you install the transmitter.

### 3.12.1 Loop test

HART 5 Fast Keys	3, 5, 1
HART 7 Fast Keys	3, 5, 1

The Loop test variable verifies the output of the transmitter, the integrity of the loop, and the operations of any recorders or similar devices installed in the loop.

## 3.13 Multidrop communication

Multidropping refers to the connection of several transmitters to a single communications transmission line. Communication between the host and the transmitters takes place digitally with the analog output of the transmitters deactivated. Many Rosemount transmitters can be multidropped. With the HART Communications protocol, up to 15 transmitters can be connected on a single twisted pair of wires or over leased phone lines.

Multidrop installation requires consideration of the update rate necessary from each transmitter, the combination of transmitter models, and the length of the transmission line. Communication with transmitters can be accomplished with Bell 202 modems and a host implementing HART Protocol. Each transmitter is identified by a unique address (1–15) and responds to the commands defined in the HART Protocol. Field Communicators and AMS Device Manager can test, configure, and format a multidropped transmitter the same way as a transmitter in a standard point-to-point installation.

**Figure 3-10: Typical Multidropped Network**

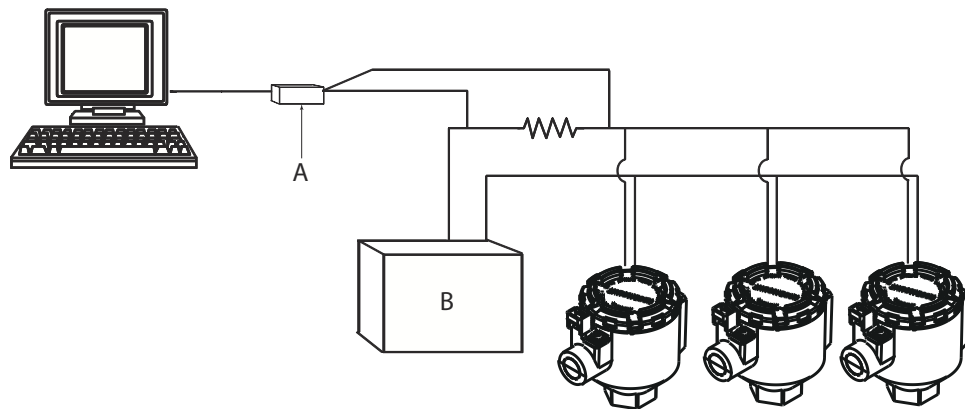

- A. Rosemount 248 HART transmitter
- B. Power supply

Figure 3-10 shows a typical multidropped network. Do not use this figure as an installation diagram. Contact Emerson product support with specific requirements for multidrop applications. Note that multidrop is not suitable for safety-certified applications and installations.

A HART Communicator can test, configure, and format a multidropped Rosemount 3144P Transmitter the same as in a standard point-to-point installation.

### Note

The Rosemount 3144P is set to address 0 at the factory, allowing it to operate in the standard point-to-point manner with a 4–20 mA output signal. To activate multidrop communication, the transmitter address must be changed to a number between 1 and 15, which deactivates the 4–20 mA analog output, sending it to a fixed 4mA output. The failure mode current is also disabled. It also disables the failure mode alarm signal, which is controlled by the upscale/downscale switch/jumper position. Failure signals in multidropped transmitters are communicated through HART messages.

## 3.14 Use with the HART Tri-Loop

To prepare the Rosemount 3144P Transmitter with dual-sensor option for use with a Rosemount 333 HART Tri-Loop, the transmitter must be configured to Burst Mode and the process variable output order must be set. In Burst Mode, the transmitter provides digital information for the four process variables to the HART Tri-Loop. The HART Tri-Loop divides the signal into separate 4–20 mA loops for up to three of the following choices:

- Primary Variable (PV)
- Secondary Variable (SV)
- Tertiary Variable (TV)
- Quaternary Variable (QV)

When using the Rosemount 3144P Transmitter with dual-sensor option in conjunction with the HART Tri-Loop, consider the configuration of the differential, average, first good temperatures, Sensor Drift Alert, and Hot Backup features (if applicable).

---

### Note

The procedures are to be used when the sensors and transmitters are connected, powered, and functioning properly. Also, Field Communicator must be connected and communicating to the transmitter control loop. .

---

### 3.14.1 Set the transmitter to Burst Mode

HART 5 Fast Keys	2, 2, 8, 4
HART 7 Fast Keys	2, 2, 8, 4

### 3.14.2 Set process variable output order

HART 5 Fast Keys	2, 2, 8, 5
HART 7 Fast Keys	2, 2, 8, 5

---

### Note

Take careful note of the process variable output order. The HART Tri-Loop must be configured to read the variables in the same order.

---

### Special considerations

To initiate operation between a transmitter with dual-sensor option and the HART Tri-Loop, consider the configuration of both the differential, average and first good temperatures, sensor drift alert, and Hot Backup features (if applicable).

### Differential temperature measurement

To enable the differential temperature measurement feature of a dual-sensor operating in conjunction with the HART Tri-Loop, adjust the range end points of the corresponding channel on the HART Tri-Loop to include zero. For example, if the secondary variable is to report the differential temperature, configure the transmitter accordingly (see [Set process variable output order](#)) and adjust the corresponding channel of the HART Tri-Loop so one range end point is negative and the other is positive.

### Hot Backup

To enable the Hot Backup feature of a transmitter with dual-sensor option operating in conjunction with the HART Tri-Loop, ensure that the output units of the sensors are the same as the units of the HART Tri-Loop. Use any combination of RTDs or thermocouples as long as the units of both match the units of the HART Tri-Loop.

## 3.14.3 Using the Tri-Loop to detect sensor drift alert

The dual-sensor transmitter sets a failure flag (through HART) whenever a sensor failure occurs. If an analog warning is required, the HART Tri-Loop can be configured to produce an analog signal that can be interpreted by the control system as a sensor failure.

Use these steps to set up the HART Tri-Loop to transmit sensor failure alerts.

### Procedure

1. Configure the dual-sensor Rosemount 3144P Transmitter variable map as shown:

Variable	Mapping
PV	Sensor 1 or sensor average
SV	Sensor 2
TV	Differential temperature
QV	As desired

2. Configure Channel 1 of the HART Tri-Loop as TV (differential temperature). If either sensor should fail, the differential temperature output will be +9999 or -9999 (high or low saturation), depending on the position of the Failure Mode Switch (see [Alarm switch \(HART Protocol\)](#)).
3. Select temperature units for Channel 1 that match the differential temperature units of the transmitter.
4. Specify a range for the TV such as -100 to 100 °C. If the range is large, then a sensor drift of a few degrees will represent only a small percent of range. If Sensor 1 or Sensor 2 fails, the TV will be +9999 (high saturation) or -9999 (low saturation). In this example, zero is the midpoint of the TV range. If a  $\Delta T$  of zero is set as the lower range limit (4 mA), then the output could saturate low if the reading from Sensor 2 exceeds the reading from Sensor 1. By placing a zero in the middle of the range, the output will normally stay near 12 mA, and the problem will be avoided.
5. Configure the DCS so that  $TV < -100\text{ }^{\circ}\text{C}$  or  $TV > 100\text{ }^{\circ}\text{C}$  indicates a sensor failure and, for example,  $TV \leq -3\text{ }^{\circ}\text{C}$  or  $TV \geq 3\text{ }^{\circ}\text{C}$  indicates a drift alert. See [Figure 3-11](#).

**Figure 3-11: Tracking Sensor Drift and Sensor Failure with Differential Temperature**

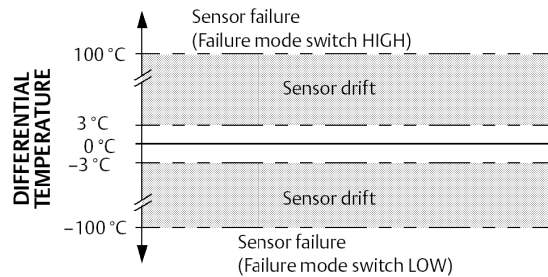

## 3.14.4 Advanced diagnostic

### Thermocouple degradation

- Problem description:** Thermocouples can fail unexpectedly, potentially causing lost production and increased maintenance costs when unplanned service is performed.
- Our solution:** Thermocouple Degradation Diagnostic acts as a gauge of general thermocouple health and is indicative of any major changes in the status of the thermocouple or the thermocouple loop. The transmitter monitors for increasing resistance of the thermocouple loop to detect drift conditions or wiring condition changes. The degrading thermocouple can be caused by wire thinning, sensor breakdown, moisture intrusion or corrosion, and can be an indication of an eventual sensor failure.
- How it works:** The thermocouple degradation diagnostic measures the amount of resistance on a thermocouple sensor path. Ideally a thermocouple would have zero resistance, but in reality it has some resistance especially for long thermocouple extension wires. As the sensor loop degrades (including sensor degradation and wire or junctions degradation), the resistance of the loop increases. First, the transmitter is configured to a baseline by the user. Then, at least once per second, the degradation diagnostic monitors the resistance in the loop by sending a pulsed current (in microamps) on the loop, measuring the voltage induced and calculating the effective resistance. As the resistance increases, the diagnostic can detect when the resistance exceeds the threshold set by the user at which the diagnostic will provide a digital alert. This feature is not intended to be a precise measurement of thermocouple status, but is a general indicator of thermocouple and thermocouple loop health by providing trending over time. The thermocouple degradation diagnostic does not detect shorted thermocouple conditions.
- Take away:** “Thermocouple Diagnostic monitors the health of a thermocouple loop”



**Target applications:** Control loops, safety loops, “problem thermocouples”

## 3.15 Configure Thermocouple Degradation in guided setup

### 3.15.1 Enable Thermocouple Degradation in guided setup: Fast Keys 2-1-7-1

#### Procedure

1. From the *Home Screen*, select **2 Configure**.

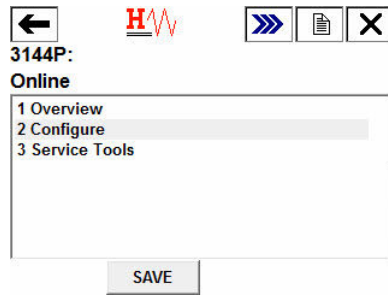

2. Select **1 Guided Setup**.

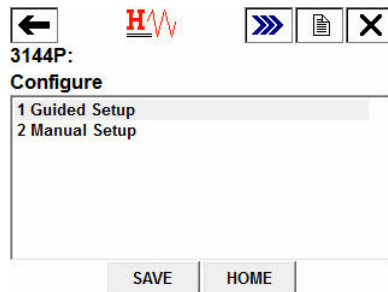

3. Select **7 Diagnostics Suite**.

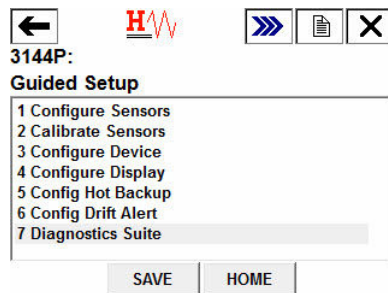

4. Select 1 Config TC Diagnostic.

The screenshot shows the top navigation bar with a back arrow, a red 'H' logo with a waveform, and forward, print, and close icons. Below the bar, the text '3144P:' is followed by the title 'Diagnostics Suite'. A scrollable menu contains two options: '1 Config TC Diagnostic' (highlighted) and '2 Config Min/Max Tracking'. At the bottom are three buttons: 'HELP', 'SAVE', and 'HOME'.

5. Select the sensor for which Thermocouple Diagnostic will be configured. Select from 1 Sensor 1 or 2 Sensor 2 and select ENTER.

The screenshot shows the top navigation bar with the red 'H' logo and print/close icons. Below the bar, the text '3144P:' is followed by a prompt: 'Please select the sensor for which Thermocouple Diagnostic will be configured:'. A scrollable menu contains three options: '1 Sensor 1' (highlighted), '2 Sensor 2', and '3 Exit'. At the bottom are two buttons: 'ABORT' and 'ENTER'.

6. Select 1 Enable to enable Thermocouple Diagnostic and select ENTER.

The screenshot shows the top navigation bar with the red 'H' logo and print/close icons. Below the bar, the text '3144P:' is followed by a prompt: 'Please choose to Enable or Disable Thermocouple Diagnostic for Sensor 1.'. A scrollable menu contains two options: '1 Enable' (highlighted) and '2 Disable'. At the bottom are two buttons: 'ABORT' and 'ENTER'.

7. Decide if you would like to change the trigger level or the sensor you are configuring. If so, select 1 Yes. If not, select 2 No. Return to Main Screen.

The screenshot shows the top navigation bar with the red 'H' logo and print/close icons. Below the bar, the text '3144P:' is followed by a prompt: 'Would you like to change the Trigger Level of Sensor 1?'. A scrollable menu contains two options: '1 Yes' (highlighted) and '2 No. Return to Main Screen'. At the bottom are two buttons: 'ABORT' and 'ENTER'.

8. If **YES**: Select a trigger level for the sensor you are configuring and select **ENTER**. Choose between a fixed *5K Ohms*, *Baseline x 2*, *Baseline x 3*, and *Baseline x 4*.

The screenshot shows a HART communicator screen with a red 'H' logo and a waveform icon. The screen title is '3144P:'. Below the title is a scrollable list box containing the following options: 'Fixed - 5K Ohms', 'Baseline x 2', 'Baseline x 3', and 'Baseline x 4'. At the bottom of the screen are two buttons: 'ABORT' and 'ENTER'.

9. Review the summary provided on the communicator and select **OK** when satisfied or **ABORT** to exit.

The screenshot shows a HART communicator screen with a red 'H' logo and a waveform icon. The screen title is '3144P:'. Below the title is a scrollable text area containing the following summary: 'The Trigger Level for Sensor 1 is 300.000 Ohms.', 'The Baseline Value for Sensor 1 is 150.000 Ohms.', and 'The real-time Sensor 1 Resistance Value is 146.840 Ohms.'. At the bottom of the screen are two buttons: 'ABORT' and 'OK'.

10. Decide if you would like to reset the baseline resistance of the thermocouple you are configuring. If so, select **1 Yes**. If not, select **2 No. Return to Main Screen**. **Return to Main Screen**.

The screenshot shows a HART communicator screen with a red 'H' logo and a waveform icon. The screen title is '3144P:'. Below the title is a scrollable list box containing the following options: '1 Yes' and '2 No. Return to Main Screen'. At the bottom of the screen are two buttons: 'ABORT' and 'ENTER'.

11. If **YES**: Review the summary provided on the communicator and select **OK** when satisfied or **ABORT** to exit.

The screenshot shows a HART communicator screen with a red 'H' logo and a waveform icon. The screen title is '3144P:'. Below the title is a scrollable text area containing the following summary: 'The Trigger Level for Sensor 1 is 300.000 Ohms.', 'The Baseline Value for Sensor 1 is 150.000 Ohms.', and 'The real-time Sensor 1 Resistance Value is 146.840 Ohms.'. At the bottom of the screen are two buttons: 'ABORT' and 'OK'.

## 3.15.2 Disable Thermocouple Degradation in guided setup: Fast Keys 2-1-7-1

### Procedure

1. From the *Home Screen*, select **2 Configure**.

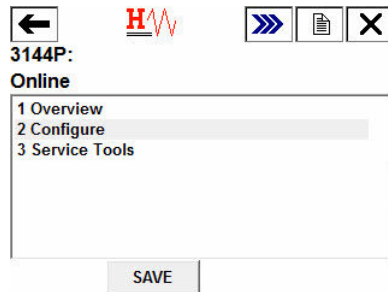

2. Select **1 Guided Setup**.

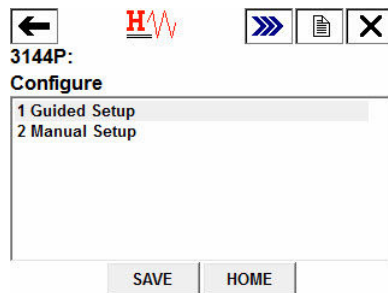

3. Select **7 Diagnostics Suite**.

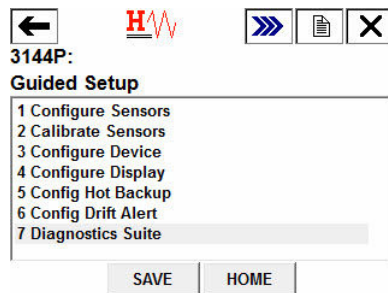

4. Select **1 Config TC Diagnostics**.

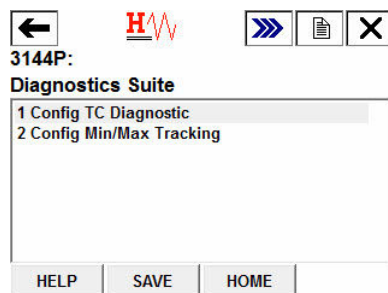

5. Select the sensor for which Thermocouple Diagnostic will be disabled. Select from 1 **Sensor 1** or 2 **Sensor 2** and select **ENTER**.

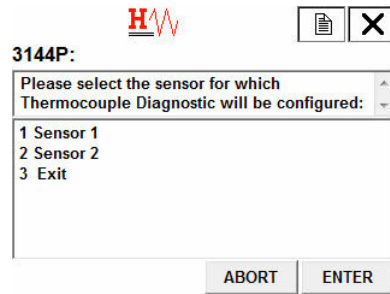

6. Select 2 **Disable** to disable Thermocouple Diagnostic and select **ENTER**.

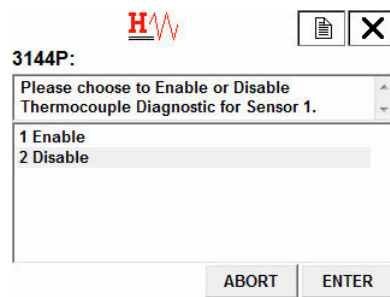

7. Thermocouple Degradation has been disabled for the selected sensor. Select **OK**.



## 3.16 Configure Thermocouple Degradation in manual setup

### 3.16.1 Enable Thermocouple Degradation in manual setup: Fast Keys 2-2-4-3-4

#### Procedure

1. From the *Home Screen*, select **2 Configure**.

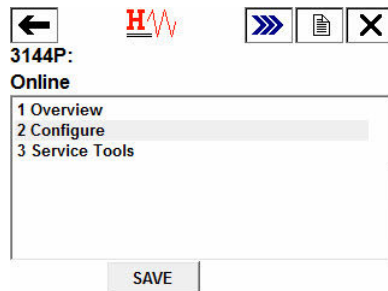

2. Select **2 Manual Setup**.

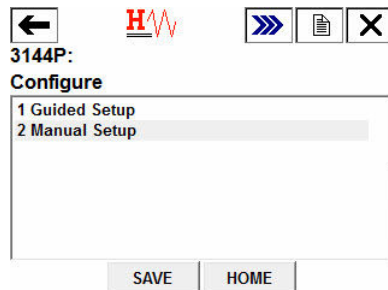

3. Select **4 Diagnostics**.

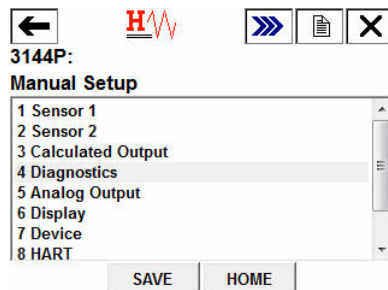

4. Select 3 Sensor and Process Diagnostics.

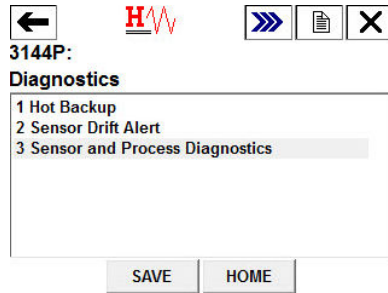

5. Select 4 Config TC Diagnostic.

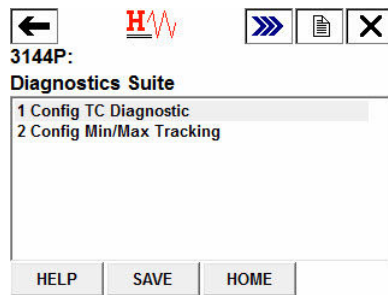

6. Select the sensor for which Thermocouple Diagnostic will be configured. Select from 1 Sensor 1 or 2 Sensor 2 and select ENTER. Select 3 Exit to exit the setup.

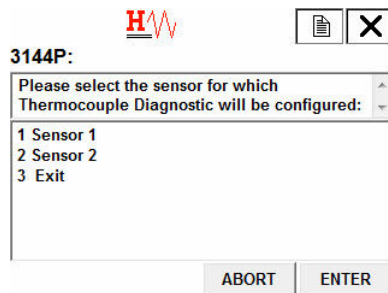

7. Select 1 Enable to enable Thermocouple Diagnostic and select ENTER.

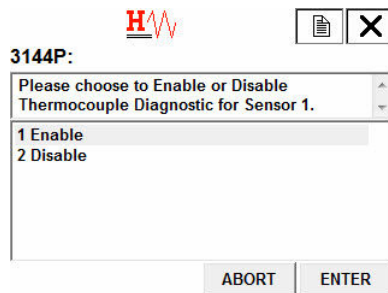

8. Decide if you would like to change the trigger level or the sensor you are configuring. If so, choose 1 Yes. If not, select 2 No. Return to Main Screen.

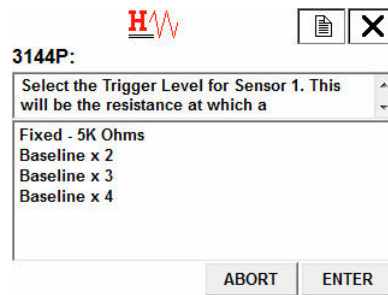

The screenshot shows the HART communicator interface for screen 3144P. At the top, there is a red 'H' logo with a waveform and two icons: a document and a close 'X' button. Below the logo, the screen title '3144P:' is displayed. The main content area contains a scrollable list with the following items: 'Fixed - 5K Ohms', 'Baseline x 2', 'Baseline x 3', and 'Baseline x 4'. At the bottom of the screen, there are two buttons: 'ABORT' and 'ENTER'.

9. If YES: Select a trigger level for the sensor you are configuring and select ENTER. Select between a *fixed 5K Ohms*, *Baseline x 2*, *Baseline x 3*, and *Baseline x 4*.

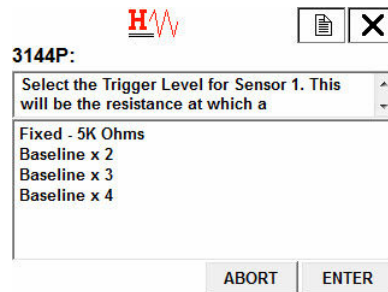

This screenshot is identical to the previous one, showing the HART communicator interface for screen 3144P with the same list of trigger level options: 'Fixed - 5K Ohms', 'Baseline x 2', 'Baseline x 3', and 'Baseline x 4'. The 'ABORT' and 'ENTER' buttons are visible at the bottom.

10. Review the summary provided on the communicator and select OK when satisfied or ABORT to exit.

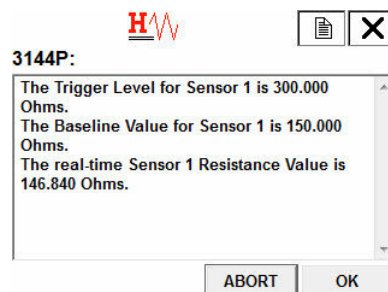

The screenshot shows the HART communicator interface for screen 3144P. At the top, there is a red 'H' logo with a waveform and two icons: a document and a close 'X' button. Below the logo, the screen title '3144P:' is displayed. The main content area contains a scrollable list with the following summary text: 'The Trigger Level for Sensor 1 is 300.000 Ohms.', 'The Baseline Value for Sensor 1 is 150.000 Ohms.', and 'The real-time Sensor 1 Resistance Value is 146.840 Ohms.'. At the bottom of the screen, there are two buttons: 'ABORT' and 'OK'.

11. Decide if you would like to reset the baseline resistance of the thermocouple you are configuring. If so, select 1 Yes. If not, select 2 No. Return to Main Screen.

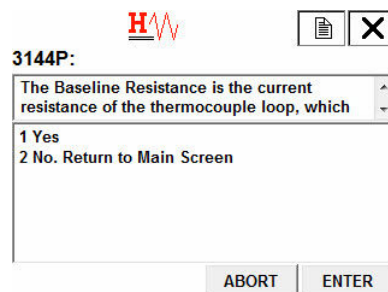

The screenshot shows the HART communicator interface for screen 3144P. At the top, there is a red 'H' logo with a waveform and two icons: a document and a close 'X' button. Below the logo, the screen title '3144P:' is displayed. The main content area contains a scrollable list with the following text: 'The Baseline Resistance is the current resistance of the thermocouple loop, which', '1 Yes', and '2 No. Return to Main Screen'. At the bottom of the screen, there are two buttons: 'ABORT' and 'ENTER'.

12. If YES: Review the summary provided on the communicator and select OK when satisfied or ABORT to exit.



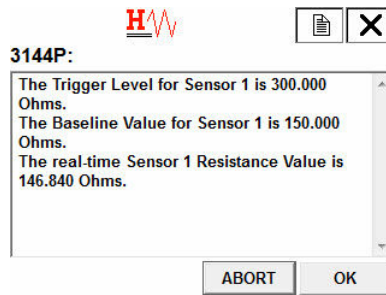

### 3.16.2 Disable Thermocouple Degradation in manual setup: Fast Keys 2-2-4-3-4

#### Procedure

1. From the Home Screen, select **2 Configure**.

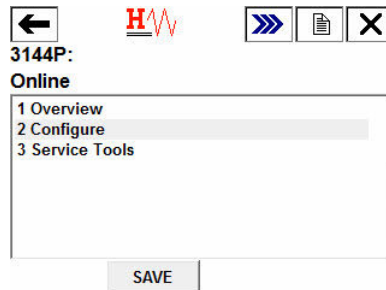

2. Select **2 Manual Setup**.

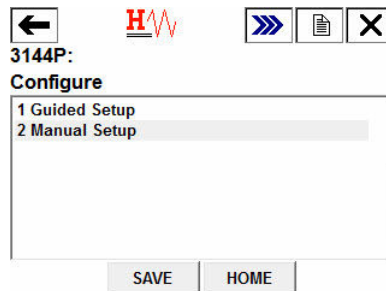

3. Select **4 Diagnostics**.

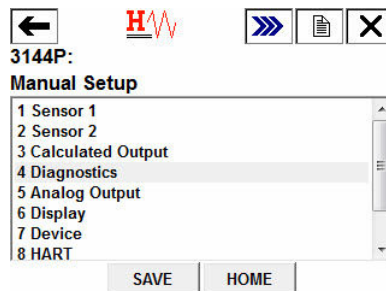

4. Select 3 Sensor and Process Diagnostics.

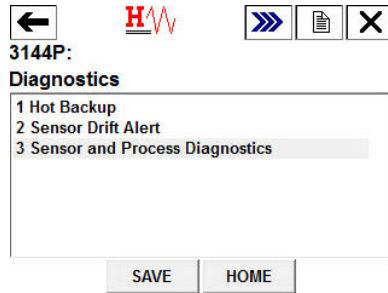

The screenshot shows the top navigation bar with a back arrow, a red 'H' with a waveform, and forward arrows. Below the bar, the text '3144P:' is followed by the title 'Diagnostics'. A list contains three items: '1 Hot Backup', '2 Sensor Drift Alert', and '3 Sensor and Process Diagnostics', with the third item highlighted. At the bottom are 'SAVE' and 'HOME' buttons.

5. Select 4 Config TC Diagnostic.

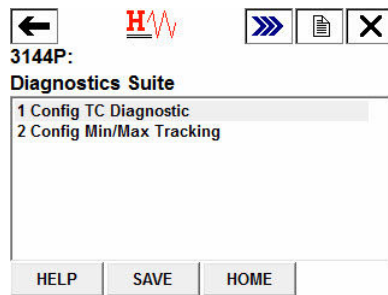

The screenshot shows the top navigation bar with a back arrow, a red 'H' with a waveform, and forward arrows. Below the bar, the text '3144P:' is followed by the title 'Diagnostics Suite'. A list contains two items: '1 Config TC Diagnostic' and '2 Config Min/Max Tracking', with the first item highlighted. At the bottom are 'HELP', 'SAVE', and 'HOME' buttons.

6. Select the sensor for which Thermocouple Diagnostic will be disabled. Select from 1 Sensor 1 or 2 Sensor 2 and select ENTER.

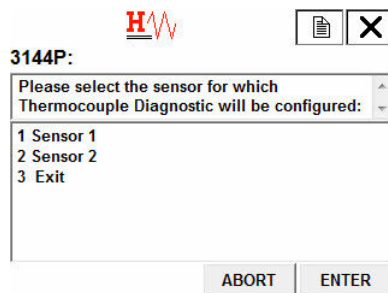

The screenshot shows the top navigation bar with a red 'H' with a waveform and forward arrows. Below the bar, the text '3144P:' is followed by a prompt: 'Please select the sensor for which Thermocouple Diagnostic will be configured:'. A list contains three items: '1 Sensor 1', '2 Sensor 2', and '3 Exit', with the first item highlighted. At the bottom are 'ABORT' and 'ENTER' buttons.

7. Select 2 Disable to disable Thermocouple Diagnostic and select ENTER.

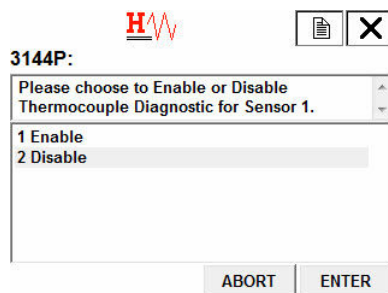

The screenshot shows the top navigation bar with a red 'H' with a waveform and forward arrows. Below the bar, the text '3144P:' is followed by a prompt: 'Please choose to Enable or Disable Thermocouple Diagnostic for Sensor 1.'. A list contains two items: '1 Enable' and '2 Disable', with the second item highlighted. At the bottom are 'ABORT' and 'ENTER' buttons.

8. Thermocouple Degradation has been disabled for the selected sensor. Select **OK**.



## 3.17 Active Thermocouple Degradation Alerts

### 3.17.1 Verify Thermocouple Degradation is enabled: Fast Keys 2-2-4

#### Procedure

1. From the *Home* screen, select **2 Configure**.

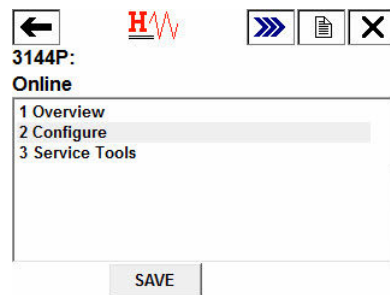

2. Select **2 Manual Setup**.

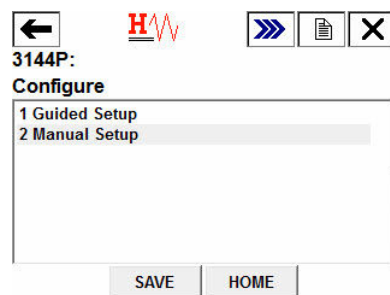

3. Select **4 Diagnostics**.

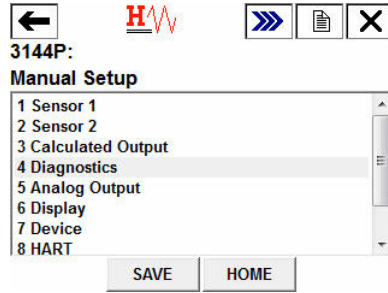

4. Select 3 Sensor and Process Diagnostics.

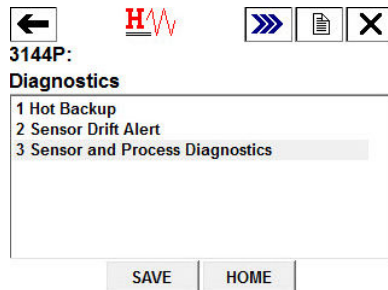

5. 1 TC Diag Mode Snr 1 will show Enabled if Thermocouple Diagnostic is enabled for Sensor 1, and Disabled if Thermocouple Diagnostic is disabled.

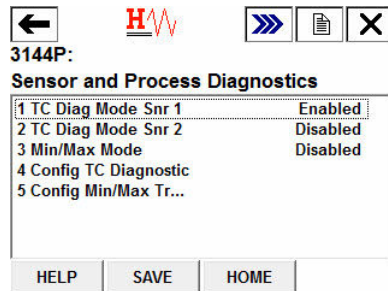

- 2 TC Diag Mode Snr 2 will show Enabled if Thermocouple Diagnostic is enabled for Sensor 2, and Disabled if Thermocouple Diagnostic is disabled.

## 3.17.2 Review configuration of the Thermocouple Diagnostic: Fast Keys 2-2-4

### Procedure

1. From the *Home Screen*, select 3 **Service Tools**.

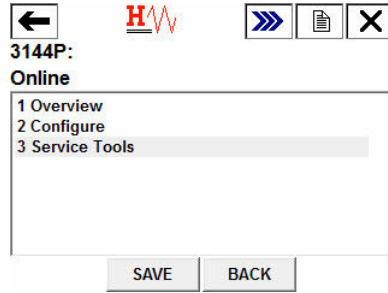

2. Select 4 Maintenance.

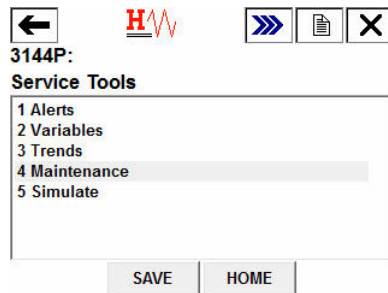

3. Select 1 T/C Diag Snsr 1 or 2 T/C Diag Snsr 2 depending on which sensor you are interested in.

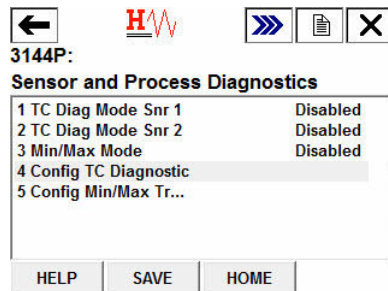

4. Select 3 TC Diag Config to view the configuration information of your sensor.

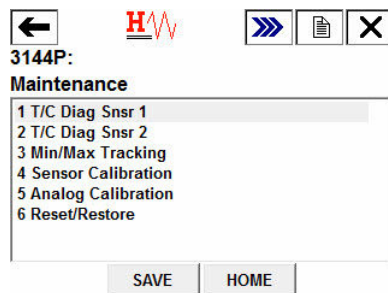

- To Reset Baseline Value: If you wish to reset the baseline value of your sensor, select **4 Reset Baseline** and select **OK**.



### 3.17.3 Viewing Thermocouple Diagnostic Alerts: Fast Keys 1-1-2

When the Thermocouple Degradation diagnostic detects a degraded sensor, the LCD display will display a message; “ALARM SNSR 1 FAIL AO”.



#### Procedure

- Select **1 Overview**.

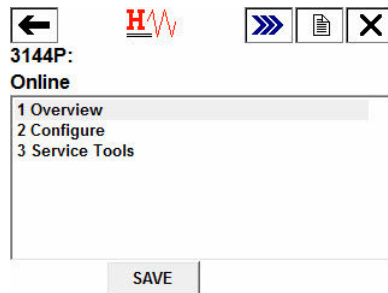

2. Select 1 Device Status: Maintenance.

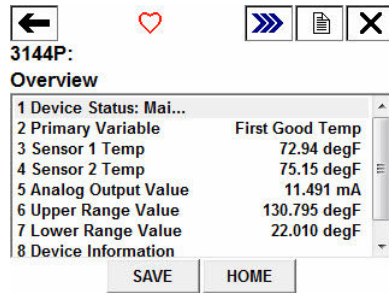

3. If Sensor 1 has degraded, select 2 M: Sensor 1 Degraded.

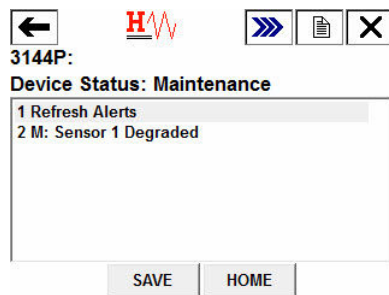

If Sensor 2 has degraded, select 2 M: Sensor 2 Degraded.

## 3.17.4 Resetting Thermocouple Degradation alerts: Fast Keys 1-1-1

### Procedure

1. Select 1 Overview.

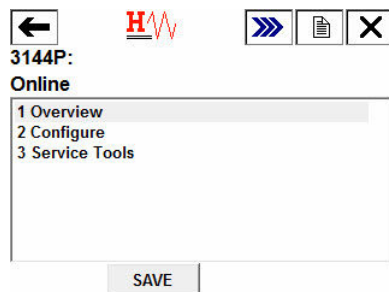

2. Select 1 Device Status: Maintenance.

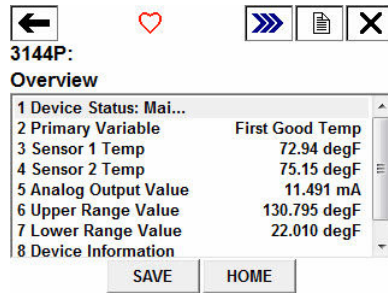

3. Select 1 Refresh Alerts.

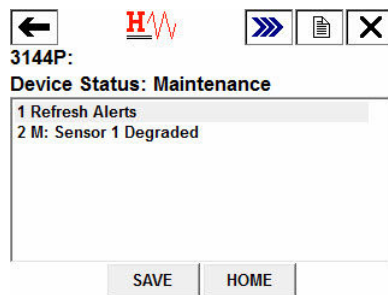

## 3.18 Minimum/maximum tracking diagnostic

Minimum and maximum temperature tracking (min/max tracking) when enabled records minimum and maximum temperatures with date and time stamps on Rosemount 3144P Temperature Transmitters. This feature records values for Sensor 1, Sensor 2, differential and terminal (body) temperatures. Min/Max Tracking only records temperature maxima and minima obtained since the last reset, and is not a logging function.

To track maximum and minimum temperatures, min/max tracking must be enabled using a Field Communicator, AMS Device Manager, or other communicator. While enabled, this feature allows for a reset of information at any time, and all variables can be reset simultaneously. Additionally, each of the individual parameter's minimum and maximum values may be reset individually. Once a particular field has been reset, the previous values are overwritten.

- Equipment:** 3144PD1A2NAM5U1DA1, T/C Type K
- Problem description:** Sometimes it can be difficult to troubleshoot quality issues, or prove compliance. If your plant historian doesn't capture historical data from every temperature point, extreme process or ambient temperature fluctuations cannot be tracked.
- Our solution:** By utilizing min/max tracking, you can be confident that you will have an easily accessible record of all important temperature extremes. Proving compliance and troubleshooting quality issues become that much easier.
- Take away:** "Use Min/Max Tracking to verify installation temperature or to troubleshoot quality issues."



### 3.18.1 Configure Min/Max Tracking in guided setup

#### Enable Min/Max Tracking in guided setup: Fast Keys 2-1-7-2

##### Procedure

1. From the *Home* screen, select 2 *Configure*.

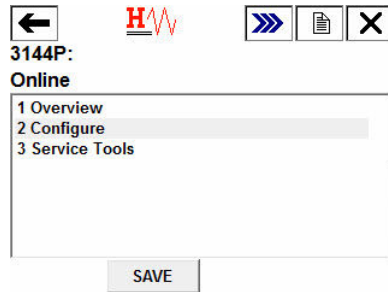

2. Select 1 *Guided Setup*.

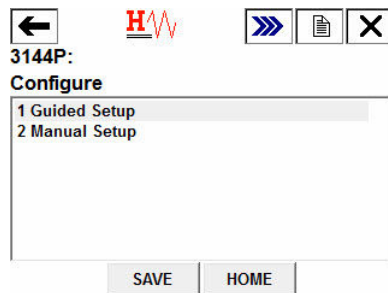

3. Select 7 *Diagnostics Suite*.

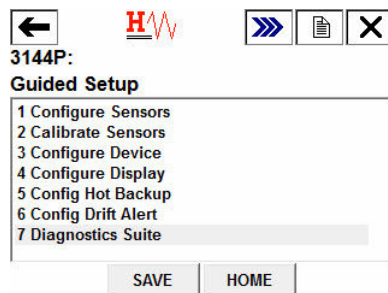

4. Select 2 *Config Min/Max Tracking*.

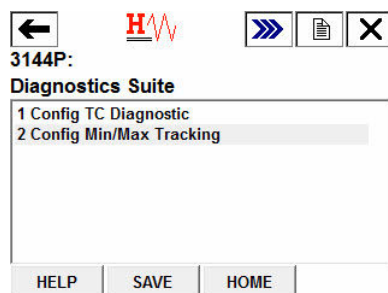

5. Select **1 Enable** to enable the Min/Max Tracking feature and select **ENTER**.

The screenshot shows the HART 3144P configuration interface. At the top, there is a red 'H' logo with a waveform and two icons: a document and a close 'X'. Below this, the text '3144P:' is followed by a menu titled 'The Configure Min/Max Tracking method allows you to Enable or Disable the Minimum'. The menu lists two options: '1 Enable' and '2 Disable'. At the bottom of the screen are two buttons: 'ABORT' and 'ENTER'.

6. Select which parameters you would like to track the minimum and maximum temperatures for. Select between *Parameter 1*, *Parameter 2*, *Parameter 3*, *Parameter 4*, or *all Parameters*.

The screenshot shows the HART 3144P configuration interface. At the top, there is a red 'H' logo with a waveform and two icons: a document and a close 'X'. Below this, the text '3144P:' is followed by a menu titled 'Please select the parameters which require Minimum and Maximum Temperature'. The menu lists six options: '1 Configure Min/Max Parameter 1', '2 Configure Min/Max Parameter 2', '3 Configure Min/Max Parameter 3', '4 Configure Min/Max Parameter 4', '5 Configure All Min/Max Parameters', and '6 Exit'. At the bottom of the screen are two buttons: 'ABORT' and 'ENTER'.

7. Select which variable to track with the selected parameter. Select between *Sensor 1*, *Sensor 2*, *Average Temperature*, *First Good Temperature*, *Differential Temperature*, and *Terminal Temperature*. Select **ENTER**.

The screenshot shows the HART 3144P configuration interface. At the top, there is a red 'H' logo with a waveform and two icons: a document and a close 'X'. Below this, the text '3144P:' is followed by a menu titled 'Select which variable to track with Min/Max Parameter 1:'. The menu lists six options: '1 Sensor 1', '2 Sensor 2', '3 Average Temperature', '4 First Good Temperature', '5 Differential Temperature', and '6 Terminal Temperature'. At the bottom of the screen are two buttons: 'ABORT' and 'ENTER'.

8. Repeat Step 6-7 until all desired parameters have been assigned a variable to track. Select **6 Exit** when finished.

## 3.18.2 Configure Min/Max Tracking in manual setup

### Enable Min/Max Tracking in manual setup: Fast Keys 2-2-4-3-5

#### Procedure

1. From the *Home* screen, select **2 Configure**.

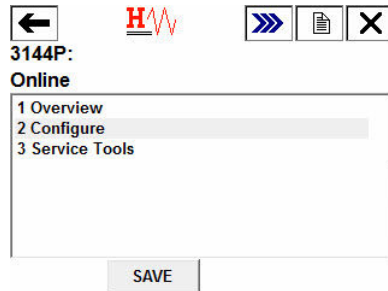

2. Select **2 Manual Setup**.

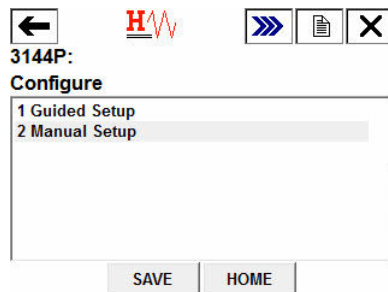

3. Select **4 Diagnostics**.

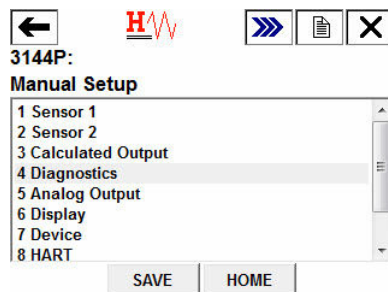

4. Select **3 Sensor and Process Diagnostics**.

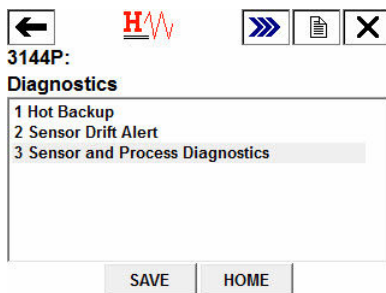

5. Select 5 Config Min/Max Tracking.



6. Select 1 Enable to enable the Min/Max Tracking feature and select ENTER.

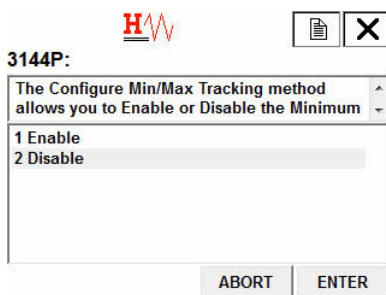

7. Select which parameters you would like to track the minimum and maximum temperatures for. Choose between *Parameter 1*, *Parameter 2*, *Parameter 3*, *Parameter 4*, or *all Parameters*.

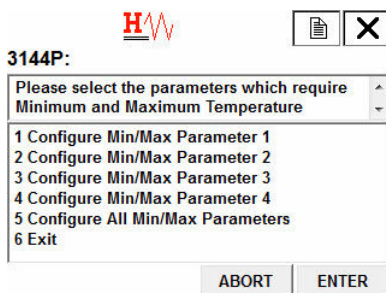

8. Select which variable to track with the selected parameter. Select between *Sensor 1*, *Sensor 2*, *Average Temperature*, *First Good Temperature*, *Differential Temperature*, and *Terminal Temperature*. Select ENTER.

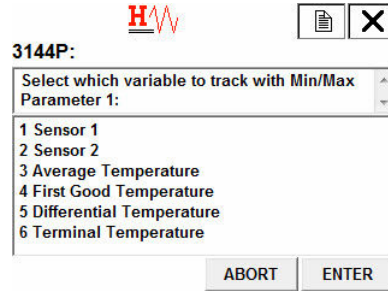

- Repeat Step 7-8 until all desired parameters have been assigned a variable to track. Select 6 Exit when finished.

## Locate the minimum and maximum temperatures and reset values: Fast Keys 3-4-3

### Procedure

- From the *Home* screen, select 3 Service Tools.

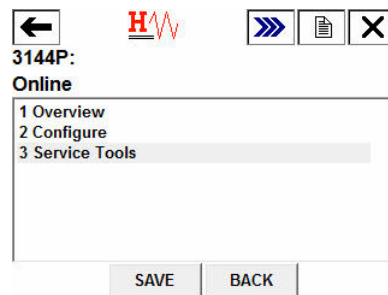

- Select 4 Maintenance.

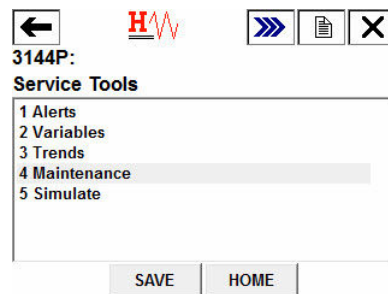

- Select 3 Min/Max Tracking.

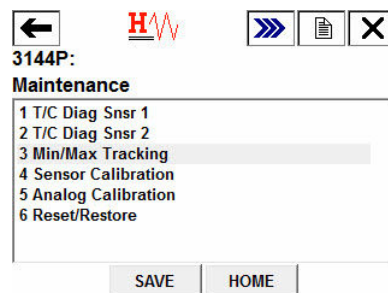

- To view the minimum and maximum recorded temperatures of a parameter, select the parameter you wish to view.

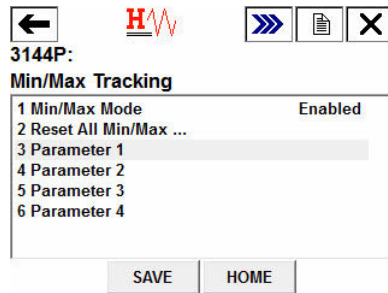

- To reset all of the minimum and maximum recorded temperature values for all parameters, select 2 Reset All Min/Max.

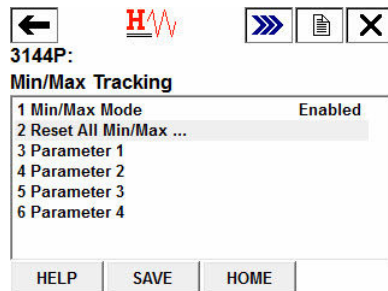

- To reset the minimum and maximum recorded temperature values for a single parameter, select the parameter you wish to reset, and then select 4 Reset Parameter X.

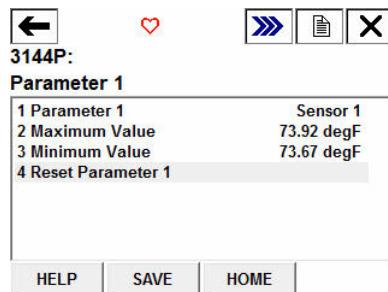

## Disable Min/Max Tracking

### Procedure

- From the *Home Screen*, select 2 **Configure**.

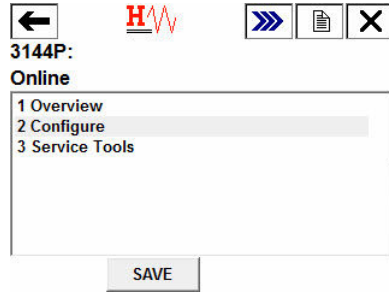

2. Select 1 Guided Setup.

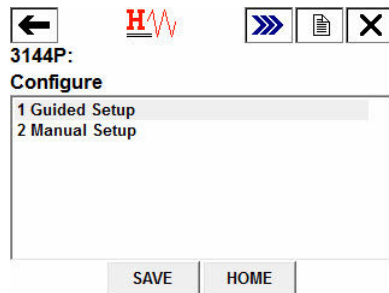

3. Select 7 Diagnostics Suite.

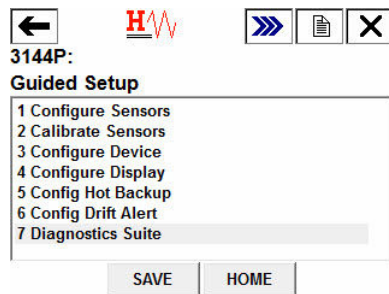

4. Select 2 Config Min/Max Tracking.

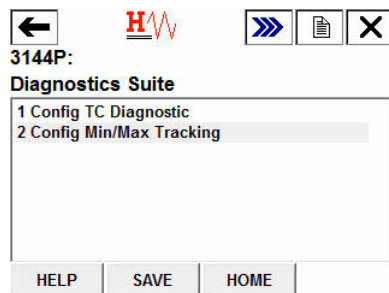

5. Select 2 **Disable** to disable the Min/Max Tracking feature and select ENTER.

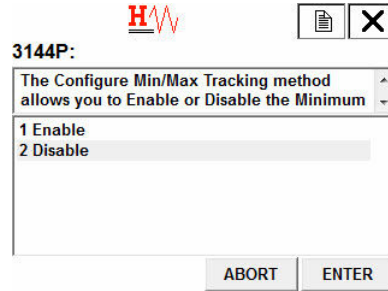

## 3.19 Calibration

Calibrating the transmitter increases the precision of the measurement system. The user may use one or more of a number of trim functions when calibrating. To understand the trim functions, it is necessary to realize that HART Protocol transmitters operate differently from analog transmitters. An important difference is that smart transmitters are factory-characterized; they are shipped with a standard sensor curve stored in the transmitter firmware. In operation, the transmitter uses this information to produce a process variable output, dependent on the sensor input. The trim functions allow the user to make adjustments to the factory-stored characterization curve by digitally altering the transmitter's interpretation of the sensor input.

Calibration of the Rosemount 3144P Transmitter may include:

- Sensor input trim: Digitally alter the transmitter's interpretation of the input signal
- Transmitter-sensor matching: generates a special custom curve to match that specific sensor curve, as derived from the Callendar-Van Dusen (CVD) constants
- Output trim: Calibrates the transmitter to a 4–20 mA reference scale
- Scaled output trim: Calibrates the transmitter to a user-selectable reference scale

### 3.19.1 Calibration frequency

Calibration frequency can vary greatly depending on the application, performance requirements, and process conditions. Use the following procedure to determine calibration frequency that meets the needs of your application.

1. Determine the required performance.
2. Calculate total probable error.
  - a. Digital accuracy = °C
  - b. D/A accuracy = (% of transmitter span)  $\times$  (ambient temperature change) °C
  - c. Digital temp effects = (°C per 1.0 °C change in ambient temperature)  $\times$  (ambient temperature change)
  - d. D/A effects = (% of span per 1.0 °C)  $\times$  (ambient temperature change)  $\times$  (Process temperature range)
  - e. Sensor accuracy = °C



$$f. \text{ TPE} = \sqrt{(\text{DigitalAccuracy})^2 + (\text{D/A})^2 + (\text{DigitalTempEffects})^2 + (\text{D/AEffects})^2 + (\text{SensorAccuracy})^2}$$

3. Calculate stability per month.
  - (% per months)  $\div$  (process temperature range)
4. Calculate Calibration Frequency.
  - $\text{CalFreq} = \frac{(\text{RequiredPerformance} - \text{TPE})}{\text{StabilityPerMonth}}$

### Example for Rosemount 3144P Pt 100 (a = 0.00385)

Reference temperature is 20 °F

Process temperature change is 0–100 °C

Ambient temperature is 30 °C

1. Required performance:  $\pm 0.35$  °C
2. TPE = 0.102 °C
  - a. Digital Accuracy = 0.10 °C
  - b. D/A Accuracy = (0.02%)  $\div$  (30 – 20) °C =  $\pm 0.002$  °C
  - c. Digital Temperature Effects = (0.0015 °C/°C)  $\div$  (30–20) °C = 0.015 °C
  - d. D/A effect = (0.001%/°C)  $\div$  (100 °C)  $\times$  (30–20) °C = 0.01 °C
  - e. Sensor accuracy =  $\pm 0.420$  °C at 400 °C for a class A RTD sensor with CVD constants
- f.  $\text{TPE} = \sqrt{(0.102)^2 + 0.0022^2 + 0.0152^2 + 0.012^2 + 0.4202^2} = 0.102$  °C
3. Stability per month: (0.25%/60 months)  $\div$  (100 °C) = 0.00416 °C
4. Calibration frequency:  $\frac{0.35 - 0.102}{0.00416} = 60$  months (5 years)

## 3.20 Trim the transmitter

The trim functions should not be confused with the rerange functions. Although the rerange command matches a sensor input to a 4–20 mA output—as in conventional calibration—it does not affect the transmitter’s interpretation of the input.

One or more of the trim functions may be used when calibrating. The trim functions are as follows:

- Sensor input trim
- Transmitter-sensor matching
- Output trim
- Output scaled trim

**Figure 3-12: Trim**

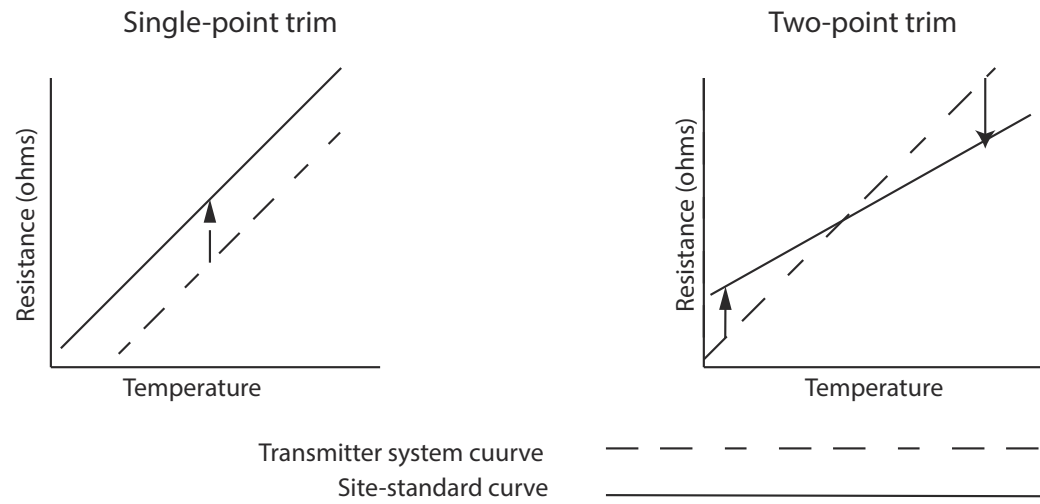

**Application: Linear offset (single-point trim solution)**

1. Connect sensor to transmitter. Place sensor in bath between range points.
2. Enter known bath temperature using the Field Communicator.

**Application: Linear offset and slope correction (two-point trim solution)**

1. Connect sensor to transmitter. Place sensor in bath at low range point.
2. Enter known bath temperature using the Field Communicator.
3. Repeat at high range point.

### 3.20.1 Sensor input trim

HART 5 Fast Keys	3, 4, 4
HART 7 Fast Keys	3, 4, 4

The Sensor Trim command allows for alteration of the transmitter’s interpretation of the input signal as shown in [Figure 3-12](#). The sensor trim command trims, in engineering (°F, °C, °R, K) or raw (W, mV) units, the combined sensor and transmitter system to a site standard using a known temperature source. Sensor trim is suitable for validation procedures or for applications that require profiling the sensor and transmitter together.

Perform a sensor trim if the transmitter’s digital value for the primary variable does not match the plant’s standard calibration equipment. The sensor trim function calibrates the sensor to the transmitter in temperature units or raw units. Unless the site-standard input source is National Institute of Standards and Technology (NIST)-traceable, the trim functions will not maintain the NIST-traceability of your system.

The trim functions should not be confused with the rerange functions. Although the rerange command matches a sensor input to a 4–20 mA output—as in conventional calibration—it does not affect the transmitter’s interpretation of the input.

**Note**

A warning will appear [Setting the loop to manual](#).

### 3.20.2 Active calibrator and Electric and Magnetic Field (EMF) compensation

HART 5 Fast Keys	3, 4, 4, 4
HART 7 Fast Keys	3, 4, 4, 4

The transmitter operates with a pulsating sensor current to allow EMF compensation and detection of open sensor conditions. Because some calibration equipment requires a steady sensor current to function properly, the “Active Calibrator Mode” feature should be used when an active calibrator is connected. Enabling this mode temporarily sets the transmitter to provide steady sensor current unless two sensor inputs are configured. Disable this mode before putting the transmitter back into the process to set the transmitter back to pulsating current. “Active Calibrator Mode” is volatile and will automatically be disabled when a master reset is performed (through HART Protocol) or when the power is cycled.

EMF compensation allows the transmitter to provide sensor measurements that are unaffected by unwanted voltages, typically due to thermal EMFs in the equipment connected to the transmitter, or by some types of calibration equipment. If this equipment also requires steady sensor current, the transmitter must be set to “Active Calibrator Mode.” However, the steady current does not allow the transmitter to perform EMF compensation and as a result, a difference in readings between the active calibrator and actual sensor may exist.

If a reading difference is experienced and is greater than the plant’s accuracy specification allows, perform a sensor trim with “Active Calibrator Mode” disabled. In this case, an active calibrator capable of tolerating pulsating sensor current must be used or the actual sensors must be connected to the transmitter. When the field communicator or AMS Device Manager asks if an Active Calibrator is being used when the sensor trim routine is entered, select No to leave the “Active Calibrator Mode” disabled.

In temperature measurement loops using RTDs, small voltages, called EMFs, can be induced on the sensor wires, increasing the effective resistance and causing false temperature readings. For example, a 12 mV reading equates to 390 °F or 60 W error for a PT100 385 RTD.

The Emerson EMF Compensation detects these externally induced voltages and eliminates the erroneous voltages from the calculations performed by the transmitters. Externally induced voltages come from motors, calibration devices (dry block calibrator), etc.

**How it works:** Our transmitter provides RTD measurement updates at a rate of less than one second for a single sensor. This measurement update consists of a series of smaller measurement scans. A part of these smaller measurement scans is a check for EMF induced voltage, up to 12 mV, on the sensor loop. The transmitter is designed to compensate out the induced voltage up to 12 mV and provide a corrected temperature value. Beyond 12 mV, the transmitter will notify the user that “Excess EMF” is present and warn them of possible inaccuracies in the temperature measurement due to excessive induced

voltage on the RTD sensor loop. In the case of excessive EMF in the transmitter, it is recommended that the user identify the external sources of electromagnetic interference and isolate them from the transmitter and RTD sensor wiring.

### 3.20.3 Transmitter-sensor matching

HART 5 Fast Keys	Sensor 1 - 2, 2, 1, 11
HART 7 Fast Keys	Sensor 1 - 2, 2, 1, 11

The transmitter accepts CVD constants from a calibrated RTD schedule and generates a special custom curve to match that specific sensor Resistance vs. Temperature performance. Matching the specific sensor curve with the transmitter significantly enhances the temperature measurement accuracy. See the comparison below:

System Accuracy Comparison at 150 °C Using a PT 100 (a=0.00385) RTD with a Span of 0 to 200 °C			
Standard RTD		Matched RTD	
Rosemount 3144P	±0.08 °C	Rosemount 3144P	±0.08 °C
Standard RTD	±1.05 °C	Matched RTD	±0.18 °C
Total System <sup>(1)</sup>	±1.05 °C	Total System <sup>(1)</sup>	±0.21 °C

(1) Calculated using root-summed-squared (RSS) statistical method.

**Problem description:** Depending on the process being measured, a certain amount of accuracy may be needed from the sensor.

**Our solution:** A more precise compensation for RTD inaccuracies is provided by Transmitter-Sensor Matching using the transmitter's factory programmed CVD equation. This equation describes the relationship between resistance and temperature of platinum resistance thermometers (RTDs). The matching process allows the user to enter the four sensor specific CVD constants into the transmitter. The transmitter uses these sensor-specific constants in solving the CVD equation to match the transmitter to that specific sensor thus providing outstanding accuracy.

**Take away:** “Transmitter-Sensor Matching customizes sensor curves to minimize sensor inaccuracy”

---

#### Note

In order to use this diagnostic, the RTD must be set as type **Cal VanDusen**.

---

## Configure Transmitter Sensor Matching in guided setup

The guided setup will take you through the complete sensor configuration. This document will guide you through the specific Transmitter Sensor Matching section.

### Procedure

1. From the *Home* screen, select **2 Configure**.

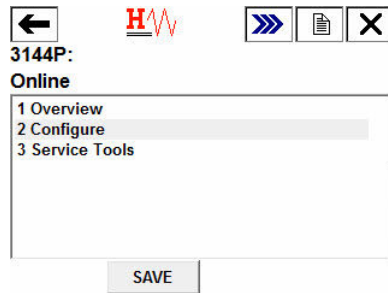

2. Select **1 Guided Setup**.

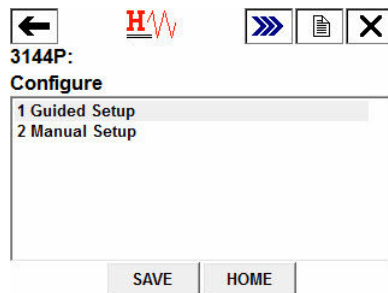

3. Select **1 Configure Sensors**.

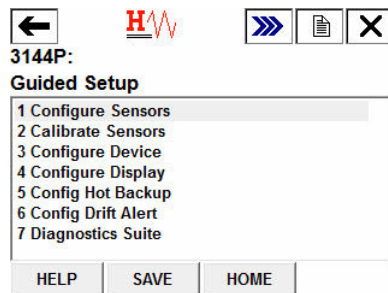

4. When prompted, select **1 Configure Sensor 1**. If you are using dual RTDs, you may also select **2 Configure Sensor 2**, or **3 Configure Both Sensors the Same**.

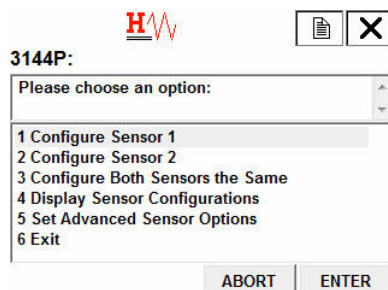

- When prompted, select the sensor type. This must be **Cal VanDusen** for this option. Select **Enter**.

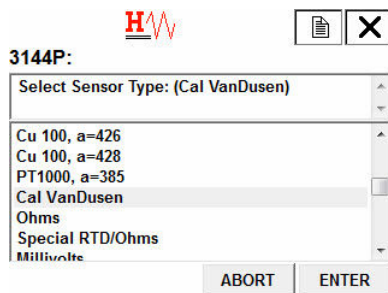

- This will reset any Min/Max values tracking this sensor and any Min/Max values tracking Differential, Average, or First Good. Select **OK**.



- It will now display the current CVD coefficients for the sensor (Alpha, beta, Delta, R0, A, B, C). Select **OK**.

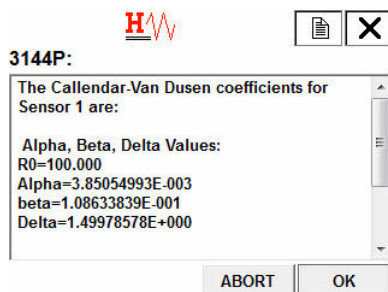

- Select which set of CVD coefficients you would like to enter for that sensor. Select between **1 R0, A, B, C**, and **2 R0, Alpha, Beta, Delta (R0, a, B, d)**.

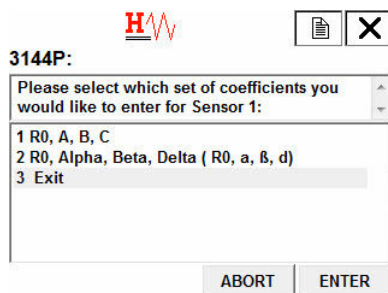

- When prompted, enter in each constant and select **Enter**.

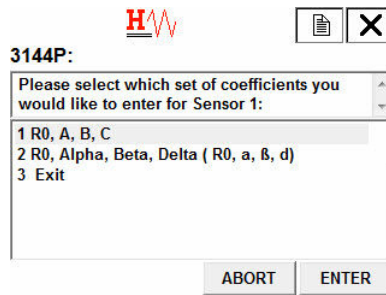

- After you have completed this, it will display a summary screen with all the coefficient values needed for the CVD equation. Review this information and select OK.



- Finish the remaining steps of the sensor configuration according to the Communicator. When you are satisfied with your selection, select **6 Exit** from the main screen, or select **Abort**.

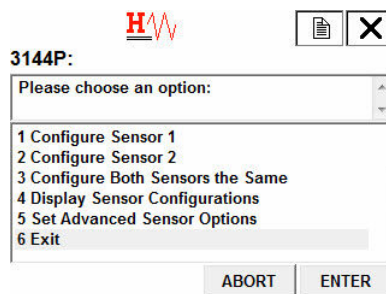

## Configure transmitter sensor matching in manual setup

### Procedure

- From the *Home Screen*, select **2 Configure**.

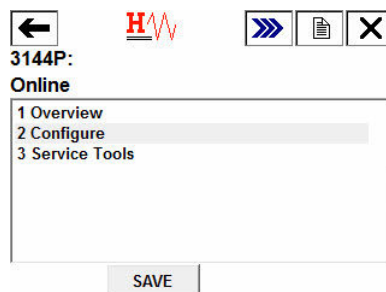

2. Select 2 Manual Setup.

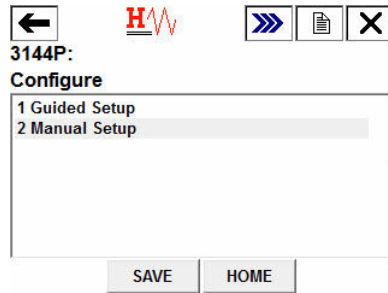

3. Select the sensor you would like to configure.

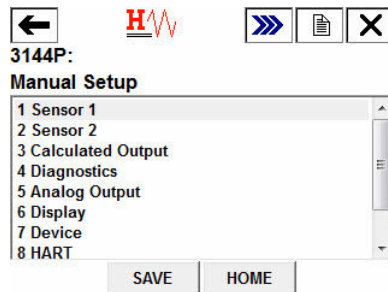

4. Select 9 Sensor Matching-CVD.

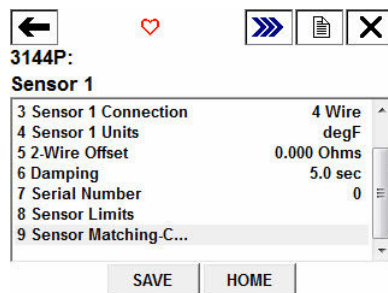

5. The screen would display a summary screen of the coefficients R0, A, B, and C. Select 5 Set CVD Coefficients to set these coefficients.

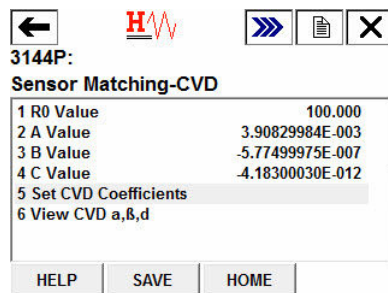

6. When prompted, select which set of coefficients you would like to enter for that sensor. Select between 1 R0, A, B, C and 2 R0, Alpha, Beta, Delta.



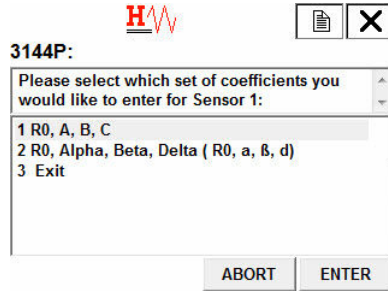

7. When prompted, enter the desired values for each coefficient.

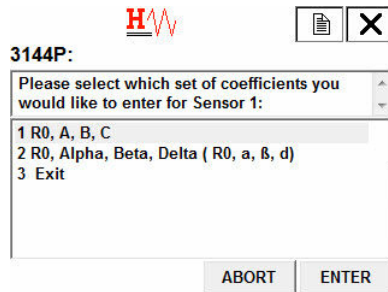

8. When you are done entering in these coefficients, another summary screen will appear. Review this information, and when you are satisfied, select **OK**.

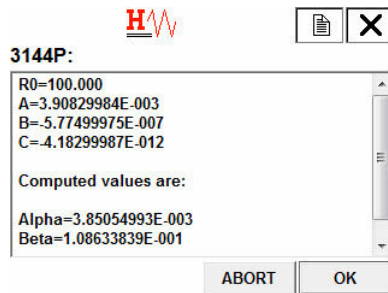

9. The method is complete, select **3 Exit** to exit the method if you are satisfied.

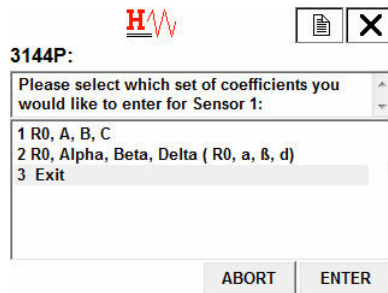

## View the set CVD coefficients

### Procedure

1. From the *Home Screen*, select **2 Configure**.

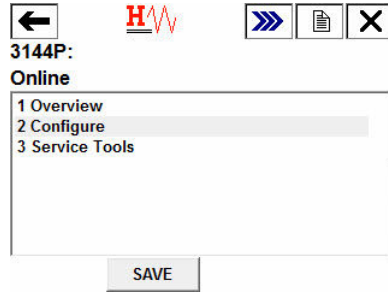

2. Select 2 Manual Setup.

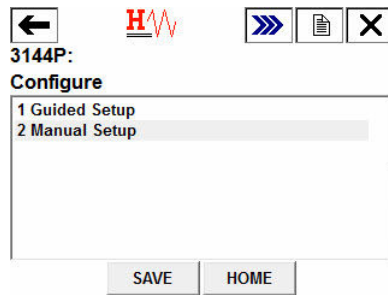

3. Select the sensor you would like to configure.

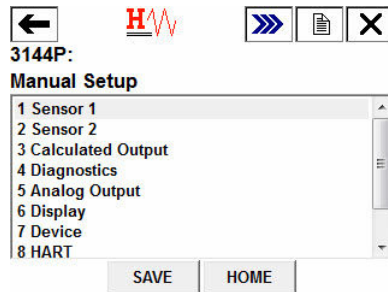

4. Select 9 Sensor Matching-CVD.

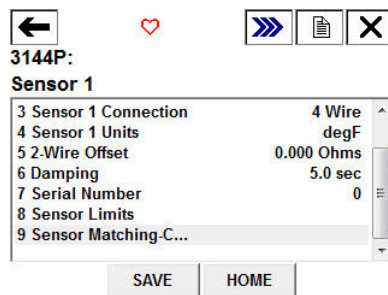

5. The screen would display a summary screen of the coefficients  $R_0$ ,  $A$ ,  $B$ , and  $C$ .  
Select 6 View CVD  $\alpha$ ,  $\beta$ ,  $\delta$  to view those.



The following input constants, included with specially-ordered Rosemount temperature sensors, are required:

$R_0$  = Resistance at Ice Point

Alpha = Sensor Specific Constant

Beta = Sensor Specific Constant

Delta = Sensor Specific Constant

Other sensor may have "A, B, or C" values for constants.

**Note**

When the Transmitter-Sensor Matching is disabled, the transmitter reverts to factory trim input. Make certain the transmitter engineering units default correctly before placing the transmitter into service.

## 3.21 Output trim or scaled output trim

Perform a D/A output trim (scaled output trim) if the digital value for the primary variable matches the plant standard, but the transmitter's analog output does not match the digital value on the output device (such as the ampmeter). The output trim function calibrates the transmitter analog output to a 4–20 mA reference scale; the scaled output trim function calibrates to a user-selectable reference scale. To determine the need for an output trim or a scaled output trim, perform a loop test (see [Loop test](#)).

**Figure 3-13: Dynamics of Temperature Measurement**

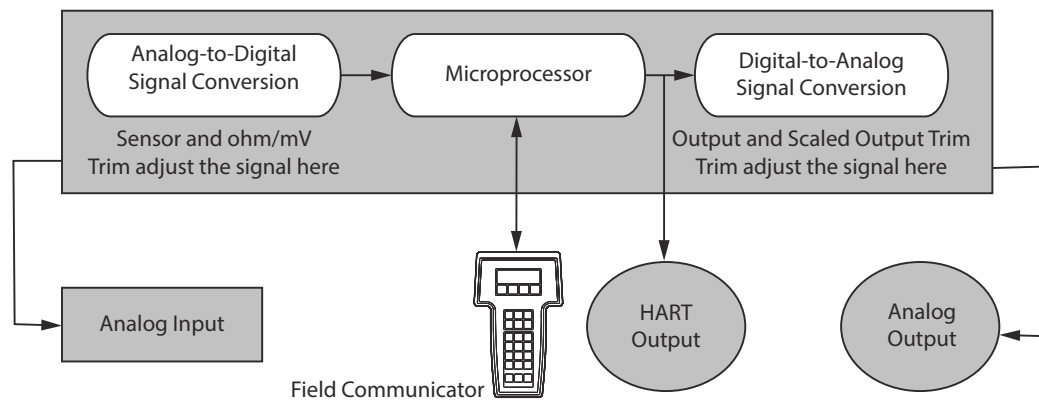

## 3.21.1 Output trim

HART 5 Fast Keys	3, 4, 5, 1
HART 7 Fast Keys	3, 4, 5, 1

The D/A Trim command allows the user to alter the transmitter's conversion of the input signal to a 4–20 mA output (see [Output trim or scaled output trim](#)). Calibrate the analog output signal at regular intervals to maintain measurement precision. To perform a digital-to-analog trim, perform the following procedure with the traditional Fast Key sequence.

## 3.21.2 Scaled output trim

HART 5 Fast Keys	3, 4, 5, 2
HART 7 Fast Keys	3, 4, 5, 2

The Scaled D/A trim command matches the 4 and 20 mA points to a user-selectable reference scale other than 4 and 20 mA (2–10 volts, for example). To perform a scaled D/A trim, connect an accurate reference meter to the transmitter and trim the output signal to scale as outlined in the Output trim procedure.

# 3.22 Troubleshooting

## 3.22.1 Overview

If a malfunction is suspected despite the absence of a diagnostics message on the Field Communicator display, follow the procedures described in [Table 3-2](#) to verify that transmitter hardware and process connections are in good working order. Under each of four major symptoms, specific suggestions are offered for solving problems. Always deal with the most likely and easiest-to-check conditions first.

Advanced troubleshooting information for use with Field Communicators is available in [Table 3-3](#).

**Table 3-2: HART/4–20 mA Basic Troubleshooting**

Symptom	Potential source	Corrective action
Transmitter does not communicate with Field Communicator	Loop wiring	<ul style="list-style-type: none"> <li>• Check the revision level of the transmitter device descriptors (DDs) stored in your communicator. The communicator should report Dev v4, DD v1 (improved), or reference <a href="#">Field Communicator</a> for previous versions. Contact Emerson Customer Central for assistance.</li> <li>• Check for a minimum of 250 ohms resistance between the power supply and Field Communicator connection.</li> <li>• Check for adequate voltage to the transmitter. If a Field Communicator is connected and 250 ohms resistance is properly in the loop, then the transmitter requires a minimum of 12.0 V at the terminals to operate (over entire 3.5 to 23.0 mA operating range), and 12.5 V minimum to communicate digitally</li> <li>• Check for intermittent shorts, open circuits, and multiple grounds..</li> </ul>
High output	Sensor input failure or connection	<ul style="list-style-type: none"> <li>• Connect a Field Communicator and enter the transmitter test mode to isolate a sensor failure.</li> <li>• Check for a sensor open circuit.</li> <li>• Check if the process variable is out of range.</li> </ul>
	Loop wiring	<ul style="list-style-type: none"> <li>• Check for dirty or defective terminals, interconnecting pins, or receptacles.</li> </ul>
	Power supply	<ul style="list-style-type: none"> <li>• Check the output voltage of the power supply at the transmitter terminals. It should be 12.0 to 42.4 Vdc (over entire 3.5 to 23.0 mA operating range).</li> </ul>
	Electronics module	<ul style="list-style-type: none"> <li>• Connect a Field Communicator and enter the transmitter test mode to isolate module failure.</li> <li>• Connect a Field Communicator and check the sensor limits to ensure calibration adjustments are within the sensor range.</li> </ul>

**Table 3-2: HART/4–20 mA Basic Troubleshooting (continued)**

Symptom	Potential source	Corrective action
Erratic output	Loop wiring	<ul style="list-style-type: none"> <li>Check for adequate voltage to the transmitter. It should be 12.0 to 42.4 Vdc at the transmitter terminals (over entire 3.5 to 23.0 mA operating range).</li> <li>Check for intermittent shorts, open circuits, and multiple grounds.</li> <li>Connect a Field Communicator and enter the loop test mode to generate signals of 4 mA, 20 mA, and user-selected values.</li> </ul>
	Electronics module	<ul style="list-style-type: none"> <li>Connect a Field Communicator and enter the transmitter test mode to isolate module failure.</li> </ul>
Low output or No output	Sensor element	<ul style="list-style-type: none"> <li>Connect a Field Communicator and enter the transmitter test mode to isolate a sensor failure.</li> <li>Check if the process variable is out of range.</li> </ul>
	Loop wiring	<ul style="list-style-type: none"> <li>Check for adequate voltage to the transmitter. It should be 12.0 to 42.4 Vdc (over entire 3.5 to 23.0 mA operating range).</li> <li>Check for shorts and multiple grounds.</li> <li>Check for proper polarity at the signal terminal.</li> <li>Check the loop impedance.</li> <li>Connect a Field Communicator and enter the loop test mode.</li> <li>Check wire insulation to detect possible shorts to ground.</li> </ul>
	Electronics module	<ul style="list-style-type: none"> <li>Connect a Field Communicator and check the sensor limits to ensure calibration adjustments are within the sensor range.</li> <li>Connect a Field Communicator and enter the transmitter test mode to isolate an electronic module failure.</li> </ul>

**Table 3-3: Field Communicator Error Warning Descriptions – HART**

Variable parameters within the text of a message are indicated with <variable parameter>. Reference to the name of another message is identified by [another message].

Message	Description
Add item for ALL device types or only for this ONE device type	Asks the user whether the hot key item being added should be added for all device types or only for the type of device that is connected.

**Table 3-3: Field Communicator Error Warning Descriptions – HART (continued)**

Message	Description
Command not implemented	The connected device does not support this function.
Communication error	Either a device sends back a response indicating that the message it received was unintelligible, or the Field Communicator cannot understand the response from the device.
Configuration memory not compatible with connected device	The configuration stored in memory is incompatible with the device to which a transfer has been requested.
Device busy	The connected device is busy performing another task.
Device disconnected	Device fails to respond to a command.
Device write protected	Device is in write-protect mode. Data can not be written.
Device write protected. Do you still want to shut off?	Device is in write-protect mode. Press YES to turn the Field Communicator off and lose the unspent data.
Display value of variable on hot key menu?	Asks whether the value of the variable should be displayed adjacent to its label on the hot key menu if the item being added to the hot key menu is a variable.
Download data from configuration memory to device	Prompts user to press SEND softkey to initiate a memory to device transfer.
EEPROM Error	Reset the Device. If the error persists, the device has failed. Contact a Rosemount Service Center.
EEPROM Write Error	Reset the Device. If the error persists, the device has failed. Contact a Rosemount Service Center.
Exceed field width	Indicates that the field width for the current arithmetic variable exceeds the device-specified description edit format.
Exceed precision	Indicates that the precision for the current arithmetic variable exceeds the device-specified description edit format.
Ignore next 50 occurrences of status?	Asked after displaying device status. Softkey answer determines whether next 50 occurrences of device status will be ignored or displayed.
Illegal character	An invalid character for the variable type was entered.
Illegal date	The day portion of the date is invalid.
Illegal month	The month portion of the date is invalid.
Illegal year	The year portion of the date is invalid.

**Table 3-3: Field Communicator Error Warning Descriptions – HART (continued)**

Message	Description
Incomplete exponent	The exponent of a scientific notation floating point variable is incomplete.
Incomplete field	The value entered is not complete for the variable type.
Looking for a device	Polling for multidropped devices at addresses 1–15.
Mark as read only variable on hotkey menu?	Asks whether the user should be allowed to edit the variable from the hotkey menu if the item being added to the hotkey menu is a variable.
No device configuration in configuration memory	There is no configuration saved in memory available to re-configure off-line or transfer to a device.
No device found	Poll of address zero fails to find a device, or poll of all addresses fails to find a device if auto-poll is enabled.
No hotkey menu available for this device.	There is no menu named “hotkey” defined in the device description for this device.
No offline devices available	There are no device descriptions available to be used to configure a device offline.
No simulation devices available	There are no device descriptions available to simulate a device.
No UPLOAD_VARIABLES in ddl for this device	There is no menu named “upload_variables” defined in the device description for this device. This menu is required for offline configuration
No valid items	The selected menu or edit display contains no valid items.
OFF KEY DISABLED	Appears when the user attempts to turn the Field Communicator off before sending modified data or before completing a method.
Online device disconnected with unsent data. RETRY or OK to lose data.	There is unsent data for a previously connected device. Press <b>RETRY</b> to send data, or press <b>OK</b> to disconnect and lose unsent data.
Out of memory for hotkey configuration. Delete unnecessary items.	There is no more memory available to store additional hotkey items. Unnecessary items should be deleted to make space available.
Overwrite existing configuration memory	Requests permission to overwrite existing configuration either by a device-to-memory transfer or by an offline configuration. User answers using the softkeys.
Press OK	Press the <b>OK</b> softkey. This message usually appears after an error message from the application or as a result of HART communications.



**Table 3-3: Field Communicator Error Warning Descriptions – HART (continued)**

Message	Description
Restore device value?	The edited value that was sent to a device was not properly implemented. Restoring the device value returns the variable to its original value.
Save data from device to configuration memory	Prompts user to press <b>SAVE</b> softkey to initiate a device-to-memory transfer.
Saving data to configuration memory	Data is being transferred from a device to configuration memory.
Sending data to device	Data is being transferred from configuration memory to a device.
There are write only variables which have not been edited. Please edit them.	There are write-only variables that have not been set by the user. These variables should be set or invalid values may be sent to the device.
There is unsent data. Send it before shutting off?	Press YES to send unsent data and turn the Field Communicator off. Press NO to turn the Field Communicator off and lose the unsent data.
Too few data bytes received	Command returns fewer data bytes than expected as determined by the device description.
Transmitter fault	Device returns a command response indicating a fault with the connected device.
Units for <variable label> has changed. Unit must be sent before editing, or invalid data will be sent.	The engineering units for this variable have been edited. Send engineering units to the device before editing this variable.
Unsent data to online device. SEND or LOSE data	There is unsent data for a previously connected device which must be sent or thrown away before connecting to another device.
Use up/down arrows to change contrast. Press DONE when done.	Gives direction to change the contrast of the Field Communicator display.
Value out of range	The user-entered value is either not within the range for the given type and size of variable or not within the min/max specified by the device.
<message> occurred reading/writing <variable label>	Either a read/write command indicates too few data bytes received, transmitter fault, invalid response code, invalid response command, invalid reply data field, or failed pre- or post-read method; or a response code of any class other than SUCCESS is returned reading a particular variable.
<variable label> has an unknown value. Unit must be sent before editing, or invalid data will be sent.	A variable related to this variable has been edited. Send related variable to the device before editing this variable.

### 3.22.2 LCD display

The LCD displays abbreviated diagnostic messages for troubleshooting the transmitter. To accommodate two-word messages, the display alternates between the first and second word. Some diagnostic messages have a higher priority than others, so messages appear according to priority, with normal operating messages appearing last. Messages on the Process Variable line refer to general device conditions, while messages on the Process Variable Unit line refer to specific causes for these conditions. A description of each diagnostic message follows.

**Table 3-4: LCD Display Error Warning Descriptions**

Message	Description
[BLANK]	If the meter does not appear to function, make sure the transmitter is configured for the meter option you desire. The meter will not function if the LCD display option is set to Not Used.
FAIL -or- HDWR FAIL	This message indicates one of several conditions including: <ul style="list-style-type: none"> <li>The transmitter has experienced an electronics module failure.</li> <li>The transmitter self-test has failed.</li> <li>If diagnostics indicate a failure of the electronics module, replace the electronics module with a new one.</li> </ul> Contact the nearest Emerson Field Service Center if necessary.
SNSR 1 FAIL -or- SNSR 2 FAIL	The transmitter has detected an open or shorted sensor condition. The sensor(s) might be disconnected, connected improperly, or malfunctioning. Check the sensor connections and sensor continuity.
SNSR 1 SAT -or- SNSR 2 SAT	The temperature sensed by the transmitter exceeds the sensor limits for this particular sensor type.
HOUSG SAT	The transmitter operating temperature limits (–40 to 185 °F [–40 to 85 °C]) have been exceeded.
LOOP FIXED	During a loop test or a 4–20 mA output trim, the analog output defaults to a fixed value. The <i>Process Variable line</i> of the display alternates between the amount of current selected in milliamperes and “WARN.” The <i>Process Variable Unit</i> line toggles between “LOOP,” “FIXED,” and the amount of current selected in milliamperes.e
OFLOW	The location of the decimal point, as configured in the meter setup, is not compatible with the value to be displayed by the meter. For example, if the meter is measuring a process temperature greater than 9.9999 degrees, and the meter decimal point is set to 4 digit precision, the meter will display an “OFLOW” message because it is only capable of displaying a maximum value of 9.9999 when set to 4-digit precision.

**Table 3-4: LCD Display Error Warning Descriptions (continued)**

Message	Description
HOT BU	Hot Backup is enabled and Sensor 1 has failed. This message is displayed on the <i>Process Variable</i> line and is always accompanied by a more descriptive message on the <i>Process Variable Unit</i> line. In the case of a Sensor 1 failure with Hot Backup enabled, for example, the <i>Process Variable</i> line displays "HOT BU," and the <i>Process Variable Unit</i> line alternates between "SNSR 1" and "FAIL".
WARN DRIFT ALERT	Drift Alert warning is enabled and the difference between Sensor 1 and Sensor 2 has exceeded the user-specified limit. One of the sensors may be malfunctioning. The <i>Process Variable</i> line displays "WARN" and the <i>Process Variable Unit</i> line alternates between "DRIFT" and "ALERT."
ALARM DRIFT ALERT	The analog output is in alarm. Drift Alert alarm is enabled and the difference between Sensor 1 and Sensor 2 has exceeded the user-specified limit. The transmitter is still operating, but one of the sensors may be malfunctioning. The <i>Process Variable</i> line displays "ALARM" and the <i>Process Variable Unit</i> line alternates between "DRIFT" and "ALERT."
ALARM	The digital and analog outputs are in alarm. Possible causes of this condition include, but are not limited to, an electronics failure or an open sensor. This message is displayed on the <i>Process Variable</i> line and is always accompanied by a more descriptive message on the <i>Process Variable Unit</i> line. In the case of a Sensor 1 failure, for example, the <i>Process Variable</i> line displays "ALARM," and the <i>Process Variable Unit</i> line alternates between "SNSR 1" and "FAIL."
WARN	The transmitter is still operating, but something is not correct. Possible causes of this condition include, but are not limited to, an out-of-range sensor, a fixed loop, or an open sensor condition. In the case of a Sensor 2 failure with Hot Backup enabled, the <i>Process Variable</i> line displays "WARN," and the <i>Process Variable Unit</i> line alternates between "SNSR 2" and "RANGE."



## 4 FOUNDATION Fieldbus Configuration

### 4.1 Overview

This section provides information on configuring, troubleshooting, operating, and maintaining the Rosemount™ 3144P Temperature Transmitter using FOUNDATION™ Fieldbus Protocol. There are many common attributes with the HART® transmitter, and if the information cannot be found in this section, refer to [HART Commissioning](#).

### 4.2 Safety messages

Instructions and procedures in this section may require special precautions to ensure the safety of the personnel performing the operations. Information that potentially raises safety issues is indicated by a warning symbol (⚠). Refer to the following safety messages before performing an operation preceded by this symbol.

#### **⚠ WARNING**

**Explosions could result in death or serious injury.**

- Do not remove the instrument cover in explosive atmospheres when the circuit is live.
- Before connecting a handheld communicator in an explosive atmosphere, ensure that the instruments in the loop are installed in accordance with intrinsically safe or non-incendive field wiring practices.
- Both transmitter covers must be fully engaged to meet explosion-proof requirements.

**Electrical shock could cause death or serious injury.**

- If the sensor is installed in a high-voltage environment and a fault or installation error occurs, high voltage may be present on transmitter leads and terminals.
- Use extreme caution when making contact with the leads and terminals.

**Process leaks could result in death or serious injury.**

- Do not remove the thermowell while in operation.
- Install and tighten thermowells and sensors before applying pressure.

### 4.3 Device description

Before configuring the device, ensure the host has the appropriate Device Description file revision for this device. The device descriptor can be found on [Emerson.com/Rosemount](http://Emerson.com/Rosemount).

As of February 2011, the current revision of the Rosemount 3144P with FOUNDATION Fieldbus Protocol is device revision 3.

## 4.4 Node address

The transmitter is shipped at a temporary (248) address. This will enable FOUNDATION Fieldbus host systems to automatically recognize the device and move it to a permanent address.

## 4.5 Modes

The resource, transducer, and all function blocks in the device have modes of operation. These modes govern the operation of the block. Every block supports both automatic (AUTO) and out of service (OOS) modes. Other modes may also be supported.

### 4.5.1 Changing modes

To change the operating mode, set the `MODE_BLK.TARGET` to the desired mode. After a short delay, the parameter `MODE_BLOCK.ACTUAL` should reflect the mode change if the block is operating properly.

### 4.5.2 Permitted modes

It is possible to prevent unauthorized changes to the operating mode of a block. To do this, configure `MODE_BLOCK.PERMITTED` to allow only the desired operating modes. It is recommended to always select OOS as one of the permitted modes.

### 4.5.3 Types of modes

For the procedures described in this manual, it will be helpful to understand the following modes:

#### **AUTO**

The functions performed by the block will execute. If the block has any outputs, these will continue to update. This is typically the normal operating mode.

#### **Out of service (OOS)**

The functions performed by the block will not execute. If the block has any outputs, these will typically not update and the status of any values passed to downstream blocks will be "BAD." To make some changes to the configuration of the block, change the mode of the block to OOS. When the changes are complete, change the mode back to AUTO.

#### **MAN**

In this mode, variables that are passed out of the block can be manually set for testing or override purposes.

### Other types of modes

Other types of modes are Cas, RCas, ROut, IMan, and LO. Some of these may be supported by different function blocks in the 644. For more information, see the [Function Block Reference Manual](#).

#### Note

When an upstream block is set to OOS, this will impact the output status of all downstream blocks. The figure below depicts the hierarchy of blocks:

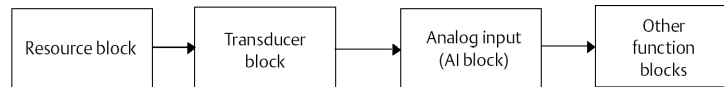

## 4.6 Link Active Scheduler (LAS)

The Rosemount 3144P can be designated to act as the backup LAS in the event that the designated LAS is disconnected from the segment. As the backup LAS, the transmitter will take over the management of communications until the host is restored.

The host system may provide a configuration tool specifically designed to designate a particular device as a backup LAS. Otherwise, this can be configured manually as follows:

#### Procedure

1. Access the Management Information Base (MIB) for the transmitter. To activate the LAS capability, write 0x02 to the BOOT\_OPERAT\_FUNCTIONAL\_CLASS object (Index 605). To deactivate, write 0x01.
2. Restart the device.

## 4.7 Capabilities

### 4.7.1 Virtual Communication Relationship (VCRs)

There are 20 VCRs, where one is permanent and 19 are fully configurable by the host system. Also, 30 link objects are available.

Network parameter	Value
Slot Time	8
Maximum Response Delay	2
Maximum Inactivity to Claim LAS Delay	32
Minimum Inter DLPDU Delay	8
Time Sync class	4 (1 ms)
Maximum Scheduling Overhead	10
Per CLPDU PhL Overhead	4
Maximum Inter-channel Signal Skew	0

Network parameter	Value
Required Number of Post-transmission-gab-ext Units	0
Required Number of Preamble-extension Units	1

### Block Execution times

Block	Execution time
Resource	N/A
Transducer	N/A
LCD display Block	N/A
Advanced Diagnostics	N/A
Analog Input 1, 2, 3	60 ms
PID 1 and 2 with Autotune	90 ms
Input Selector	65 ms
Signal Characterizer	60 ms
Arithmetic	60 ms
Output Splitter	60 ms

## 4.8 FOUNDATION Fieldbus function blocks

For reference information on the resource, sensor transducer, AI, LCD display transducer blocks refer to Rosemount 3144P Temperature Transmitter [Product Data Sheet](#). Reference information on the PID block can be found in the Function Block [Reference Manual](#).

### 4.8.1 Resource block (index number 1000)

The resource function block (RB) contains diagnostic, hardware, and electronics information. There are no linkable inputs or outputs to the resource block.

### 4.8.2 Sensor transducer block (index number 1100)

The Sensor Transducer Function Block (STB) temperature measurement data, includes sensor and terminal (body) temperature. The STB also includes information about sensor type, engineering units, linearization, reranging, damping, temperature compensation, and diagnostics. Transmitter Revision 3 and above also contain Hot Backup™ functionality in the STB.



### 4.8.3 LCD display transducer block (index number 1200)

The LCD display transducer block is used to configure the LCD display.

### 4.8.4 Analog input block (index number 1400, 1500, 1600, and 1700)

The Analog Input Function Block (AI) processes the measurements from the sensor and makes them available to other function blocks. The output value from the AI block is in engineering units and contains a status indicating the quality of the measurement. The AI block is used for scaling functionality.

### 4.8.5 PID block (index number 1800 and 1900)

The PID function block combines all of the necessary logic to perform proportional/integral/derivative (PID) control. The block supports mode control, signal scaling and limiting, feed forward control, override tracking, alarm limit detection, and signal status propagation.

The block supports two forms of the PID equation: Standard and Series. Choose the appropriate equation using the MATHFORM parameter. The Standard ISA PID equation is the default selection and autotune.

### 4.8.6 Input selector (index number 2000)

The signal selector block provides selection of up to four inputs and generates an output based on the configured action. This block normally receives its inputs from AI blocks. The block performs maximum, minimum, middle, average, and 'first good' signal selection.

### 4.8.7 Output splitter (index number OSPL 2300)

The output splitter block provides the capability to drive two control outputs from a single input. Each output is a linear function of some portion of the input.

### 4.8.8 Arithmetic (index number 2200)

This block is designed to permit simple use of popular measurement math functions. The user does not have to know how to write equations. The math algorithm is selected by name, chosen by the user for the function to be done.

### 4.8.9 Signal characterizer (index number 2100)

The signal characterizer block has two sections, each with an output that is a non-linear function of the respective input. The non-linear function is determined by a single look-up

table with 21 arbitrary x-y pairs. The status of an input is copied to the corresponding output, so the block may be used in the control or process signal path.

## 4.9 Resource block

### 4.9.1 Features and Features\_Sel

The FEATURES and FEATURE\_SEL parameters determine optional behavior of the transmitter.

#### FEATURES

The FEATURES parameter is read only and defines which features are supported by the transmitter. Below is a list of the FEATURES the transmitter supports.

#### UNICODE

All configurable string variables in the transmitter, except tag names, are octet strings. Either ASCII or Unicode may be used. If the configuration device is generating Unicode octet strings, you must set the Unicode option bit.

#### REPORTS

The transmitter supports alert reports. The Reports option bit must be set in the features bit string to use this feature. If it is not set, the host must poll for alerts.

#### SOFT W LOCK

Inputs to the security and write lock functions include the software write lock bits of the FEATURE\_SEL parameter, the WRITE\_LOCK parameter, and the DEFINE\_WRITE\_LOCK parameter.

The WRITE\_LOCK parameter prevents modification of parameters within the device except to clear the WRITE\_LOCK parameter. During this time, the block will function normally updating inputs and outputs and executing algorithms. When the WRITE\_LOCK condition is cleared, a WRITE\_ALM alert is generated with a priority that corresponds to the WRITE\_PRI parameter.

The FEATURE\_SEL parameter enables the user to select the software write lock or no write lock capability. In order to enable the software write lock, the SOFT\_W\_LOCK bit must be set in the FEATURE\_SEL parameter. Once this bit is set, the WRITE\_LOCK parameter may be set to "Locked" or "Unlocked." Once the WRITE\_LOCK parameter is set to "Locked" by the software, all user requested writes as determined by the DEFINE\_WRITE\_LOCK parameter shall be rejected.

The DEFINE\_WRITE\_LOCK parameter allows the user to configure whether the write lock function will control writing to all blocks, or only to the resource and transducer blocks. Internally updated data such as process variables and diagnostics will not be restricted. N/A = No blocks are blocked Physical = Locks resource and transducer block Everything = Locks every block.

The following table displays all possible configurations of the WRITE\_LOCK parameter.

FEATURE_SEL HW_SEL bit	FEATURE_SEL SW_SEL bit	SECURITY SWITCH	WRITE_LOCK	WRITE_LOCK Read/Writee	DEFINE_WRITE_LOCK	Write access to blocks
0 (off)	0 (off)	N/A	1 (unlocked)	Read only	N/A	All
0 (off)	1 (on)	N/A	1 (unlocked)	Read/write	N/A	All
0 (off)	1 (on)	N/A	2 (locked)	Read/write	Physical	Function Blocks only
0 (off)	1 (on)	N/A	2 (locked)	Read/write	Everything	None
1 (on)	0 (off) <sup>(1)</sup>	0 (unlocked)	1 (unlocked)	Read only	N/A	All
1 (on)	0 (off)	1 (locked)	2 (locked)	Read only	Physical	Function Blocks only
1 (on)	0 (off)	1 (locked)	2 (locked)	Read only	Everything	None

(1) The hardware and software write lock select bits are mutually exclusive and the hardware select has the highest priority. When the HW\_SEL bit is set to 1 (on), the SW\_SEL bit is automatically set to 0 (off) and is read only.

### FEATURES\_SEL

FEATURES\_SEL is used to turn on any of the supported features. The default setting of the Rosemount 644 does not select any of these features. Choose one of the supported features if any.

### MAX\_NOTIFY

The MAX\_NOTIFY parameter value is the maximum number of alert reports that the resource can have sent without getting a confirmation, corresponding to the amount of buffer space available for alert messages. The number can be set lower, to control alert flooding, by adjusting the LIM\_NOTIFY parameter value. If LIM\_NOTIFY is set to zero, then no alerts are reported.

## 4.9.2 Plantweb alerts

The alerts and recommended actions should be used in conjunction with [Operation](#).

The Resource Block acts as a coordinator for Plantweb™ alerts. There will be three alarm parameters (FAILED\_ALARM, MAINT\_ALARM, and ADVISE\_ALARM) which contain information regarding some of the device errors detected by the transmitter software. There will be a RECOMMENDED\_ACTION parameter used to display the recommended action text for the highest priority alarm and a HEALTH\_INDEX parameters (0–100) indicating the overall health of the transmitter. FAILED\_ALARM has the highest priority, followed by MAINT\_ALARM, and ADVISE\_ALARM is the lowest priority.

### FAILED\_ALARMS

A failure alarm indicates a failure within a device that will make the device or some part of the device non-operational. This implies that the device is in need of repair and must be fixed immediately. There are five parameters associated with FAILED\_ALARMS specifically, they are described below.

### **FAILED\_ENABLED**

This parameter contains a list of failures in the device which makes the device non-operational that will cause an alert to be sent. Below is a list of the failures with the highest priority first.

1. Electronics
2. NV memory
3. HW/SW incompatible
4. Primary value
5. Secondary value

### **FAILED\_MASK**

This parameter will mask any of the failed conditions listed in FAILED\_ENABLED. A bit on means that the condition is masked out from alarming and will not be reported.

### **FAILED\_PRI**

Designates the alerting priority of the FAILED\_ALM, see [Process alarms](#). The default is 0 and the recommended values are between 8 and 15.

### **FAILED\_ACTIVE**

This parameter displays which of the alarms is active. Only the alarm with the highest priority will be displayed. This priority is not the same as the FAILED\_PRI parameter described above. This priority is hard coded within the device and is not user configurable.

### **FAILED\_ALM**

Alarm indicating a failure within a device which makes the device non-operational.

### **MAINT\_ALARMS**

A maintenance alarm indicates the device or some part of the device needs maintenance soon. If the condition is ignored, the device will eventually fail. There are five parameters associated with MAINT\_ALARMS, they are described below.

### **MAINT\_ENABLED**

The MAINT\_ENABLED parameter contains a list of conditions indicating the device or some part of the device needs maintenance soon.

Below is a list of the conditions with the highest priority first.

1. Primary value degraded
2. Secondary value degraded
3. Diagnostic
4. Configuration error
5. Calibration error

### **MAINT\_MASK**

The MAINT\_MASK parameter will mask any of the failed conditions listed in MAINT\_ENABLED. A bit on means that the condition is masked out from alarming and will not be reported.

### **MAINT\_PRI**

MAINT\_PRI designates the alarming priority of the MAINT\_ALM, [Process alarms](#). The default is 0 and the recommended values is 3 to 7.

### **MAINT\_ACTIVE**

The MAINT\_ACTIVE parameter displays which of the alarms is active. Only the condition with the highest priority will be displayed. This priority is not the same as the MAINT\_PRI parameter described above. This priority is hard coded within the device and is not user configurable.

### **MAINT\_ALM**

An alarm indicating the device needs maintenance soon. If the condition is ignored, the device will eventually fail.

### **Advisory alarms**

An advisory alarm indicates informative conditions that do not have a direct impact on the device's primary functions. There are five parameters associated with ADVISE\_ALARMS. They are described below.

### **ADVISE\_ENABLED**

The ADVISE\_ENABLED parameter contains a list of informative conditions that do not have a direct impact on the device's primary functions. Below is a list of the advisories with the highest priority first.

1. NV writes deferred
2. SPM process anomaly detected

### **ADVISE\_MASK**

The ADVISE\_MASK parameter will mask any of the failed conditions listed in ADVISE\_ENABLED. A bit on means the condition is masked out from alarming and will not be reported.

### **ADVISE\_PRI**

ADVISE\_PRI designates the alarming priority of the ADVISE\_ALM, see [Process alarms](#). The default is 0 and the recommended values are 1 or 2.

### **ADVISE\_ACTIVE**

The ADVISE\_ACTIVE parameter displays which of the advisories is active. Only the advisory with the highest priority will be displayed. This priority is not the same as the ADVISE\_PRI parameter described above. This priority is hard coded within the device and is not user configurable.

### 4.9.3 Recommended actions for Plantweb alerts (RECOMMENDED\_ACTION)

The RECOMMENDED\_ACTION parameter displays a text string that will give a recommended course of action to take based on which type and which specific event of the Plantweb alerts are active.

**Table 4-1: Plantweb alerts (RB.RECOMMENDED\_ACTION)**

Alarm type	Failed/Maint/Advise Active Event	Recommended action text string
None	None	No action required
Advisory	NV Writes Deferred	Non-volatile writes have been deferred, leave the device powered until the advisory goes away
Maintenance	Configuration Error	Re-write the Sensor Configuration
	Primary Value Degraded	Confirm the operating range of the applied sensor and/or verify the sensor connection and device environment
	Calibration Error	Retrim the device
	Secondary Value Degraded	Verify the ambient temperature is within operating limits
Failed	Electronics Failure	Replace the Device
	HW / SW Incompatible	Verify the Hardware Revision is compatible with the Software Revision
	NV Memory Failure	Reset the device then download the Device Configuration
	Primary Value Failure	Verify the instrument process is within the Sensor range and / or confirm sensor configuration and wiring.
	Secondary Value Failure	Verify the ambient temperature is within operating limits
Diagnostic Error	Sensor Drift Alert or Hot BU active	Confirm the operating range of the supplied sensor and/or verify the sensor connection and device environment.
	Primary Value Degraded	Confirm the operating range of the supplied sensor and/or verify the sensor connection and device environment.

### 4.9.4 Recommended actions for field diagnostics per NE107

Alarm type	Active event name	Recommended action text string
Maintenance required	Diagnostic error	Device sensor diagnostic has been triggered.
	Process anomaly detected	N/A

Alarm type	Active event name	Recommended action text string
Out of specification	Configuration error	Re-write the sensor configuration.
	Primary value degraded	Confirm the operating range of the applied sensor and/or verify the sensor connection and device environment.e
	Calibration error	Retrim the device.
	Secondary value degraded	Verify the ambient temperature is within operating limits.
Failed	Electronics failure	Replace the device.
	Asic failure	Replace the device.
	HW/SW incompatible	Verify the hardware revision is compatible with the software revision.
	NV memory failure	Reset the device then download the device configuration.
	Primary value failure	Verify the instrument process is within the sensor range and/or confirm sensor configuration and wiring.
	Secondary value failure	Verify sensor range and/or confirm sensor configuration and wiring.
Function check	Check	Transducer Block is under maintenance.

## 4.9.5 Resource block diagnostics

### Block errors

Table 4-2 lists conditions reported in the BLOCK\_ERR parameter.

**Table 4-2: Resource Block BLOCK\_ERR Messages**

Condition name and description	Description
Other	N/A
Device Needs Maintenance Now	N/A
Memory Failure	A memory failure has occurred in FLASH, RAM, or EEPROM memory.
Lost NV Data	Non-volatile data that is stored in non-volatile memory has been lost.
Device Needs Maintenance Now.	N/A
Out of Service	The actual mode is out of service.

**Table 4-3: Resource Block RB.DETAILED\_STATUS**

RB.DETAILED_STATUS	Description
Sensor Transducer block error	Active when any SENSOR_DETAILED_STAUS bit is on.

**Table 4-3: Resource Block RB.DETAILED\_STATUS (continued)**

RB.DETAILED_STATUS	Description
Manufacturing Block integrity error	The manufacturing block size, revision, or checksum is wrong.
Hardware/software incompatible	Verify the manufacturing block revision and the hardware revision are correct/compatible with the software revision.
Non-volatile memory integrity error	Invalid checksum on a block of NV data.

## 4.9.6 Sensor transducer block

### Note

When the engineering units of the XD\_SCALE are selected, the engineering units in the Transducer Block change to the same units. This is the only way to change the engineering units in the sensor transducer block.

### Damping

Damping values may be used for, and should equal, the update rate for Sensor 1, Sensor 2, and sensor differential. Sensor configuration automatically calculates a damping value. The default damping value is five seconds. Damping may be disabled by setting the parameter damping value to zero seconds. The maximum damping value allowed is 32 seconds.

An alternate damping value may be entered with the following restrictions.

1. Single sensor configuration
  - 50 or 60 Hz line voltage filters have a minimum user-configurable damping value of 0.5 seconds.
2. Dual sensor configuration
  - 50 Hz line voltage filter a minimum user-configurable damping value of 0.9 seconds.
  - 60 Hz line voltage filter a minimum user-configurable damping value of 0.7 seconds.

 The damping parameter in the transducer block may be used to filter measurement noise. By increasing the damping time, the transmitter will have a slower response time, but will decrease the amount of process noise that is translated to the transducer block primary value. Because both the LCD display and AI Block get input from the transducer block, adjusting the damping parameter affects the values passed to both blocks.

### Note

The AI block has its own filtering parameter called PV\_FTIME. For simplicity, it is better to do filtering in the transducer block as damping will be applied to primary value on every sensor update. If filtering is done in AI block, damping will be applied to output every macrocycle. The LCD display will display value from transducer block.



## Sensor transducer block diagnostics

**Table 4-4: Sensor Transducer Block BLOCK\_ERR Messages**

Condition name	Description
Other	N/A
Out of Service	The actual mode is out of service.

**Table 4-5: Sensor Transducer Block XD\_ERR Messages**

Condition name	Description
Electronics Failure	An electrical component failed.
I/O Failure	An I/O failure occurred.
Software Error	The software has detected an internal error.
Calibration Error	An error occurred during calibration of the device.
Algorithm Error	The algorithm used in the transducer block produced an error due to overflow, data reasonableness failure, etc.

Table 4-7 lists the potential errors and the possible corrective actions for the given values. The corrective actions are in order of increasing system level compromises. The first step should always be to reset the transmitter and then if the error persists, try the steps in Table 4-7. Start with the first corrective action and then try the second.

**Table 4-6: Sensor Transducer Block STB.SENSOR\_DETAILED\_STATUS Messages**

STB.SENSOR_DETAILED_STATUS	Description
Invalid Configuration	Wrong sensor connection with wrong sensor type.
ASIC RCV Error	The micro detected a checksum or start/stop bit failure with ASIC communication.
ASIC TX Error	The ASIC detected a communication error.
ASIC Interrupt Error	ASIC interrupts are too fast or slow.
Reference Error	Reference resistors are greater than 25% of known value.
ASIC Configuration Error	ASIC registers were not written correctly. (Also CALIBRATION_ERR)
Drift Alert	Difference between sensor values has exceeded user specified limit.
Hot Backup Active	The device is currently operating in Hot Backup mode, meaning the primary sensor has failed.
Sensor Open	Open sensor detected.
Sensor Shorted	Shorted sensor detected.
Terminal (Body) Temperature Failure	Open or shorted PRT detected.
Sensor Out of Operating Range	Sensor readings have gone beyond PRIMARY_VALUE_RANGE values.

**Table 4-6: Sensor Transducer Block STB.SENSOR\_DETAILED\_STATUS Messages (continued)**

STB.SENSOR_DETAILED_STATUS	Description
Sensor beyond operating limits	Sensor readings have gone below 2% of lower range or above 6% of upper range of sensor.
Terminal (Body) Temperature Out of Operating Range	PRT readings have gone beyond SECONDARY_VALUE_RANGE values.
Terminal (Body) Temperature Beyond Operating Limits	PRT readings have gone below 2% of lower range or above 6% of upper range of PRT. (These ranges are calculated and are not the actual range of the PRT which is a PT100 A385).
Sensor Degraded	For RTDs, this is excessive EMF detected. For Thermocouples, the loop resistance has drifted beyond the user-configured threshold limit.
Calibration Error	The user trim has failed due to excessive correction or sensor failure during the trim method.

## 4.9.7 LCD display transducer block

The LCD display meter connects directly to the transmitter electronics FOUNDATION Fieldbus output board. The meter indicates output and abbreviated diagnostic messages.

The first line of five characters displays the sensor being measured.

If the measurement is in error, "Error" appears on the first line. The second line indicates if the device or the sensor is causing the error.

Each parameter configured for display will appear on the LCD display for a brief period before the next parameter is displayed. If the status of the parameter goes bad, the LCD display will also cycle diagnostics following the displayed variable.

### Custom meter configuration

Parameter #1 (Sensor 1) is factory configured to display the primary variable (temperature) from the LCD display transducer block. When shipping with dual sensors, sensor 2 will be configured not to display. To change the configuration of parameter #1, #2, or to configure additional parameters use the configuration parameters below.

The LCD transducer block can be configured to sequence four different process variables as long as the parameters are sourced from a function block that is scheduled to execute within the transmitter. If a function block is scheduled in the transmitter that links a process variable from another device on the segment, that process variable can be displayed on the LCD display.

#### DISPLAY\_PARAM\_SEL

The DISPLAY\_PARAM\_SEL parameter specifies how many process variables will be displayed. Select up to four display parameters.

---

### BLK\_TAG\_#

---

#### Note

“#” represents the specified parameter number.

---

Enter the Block Tag of the function block that contains the parameter to be displayed. The default function block tags from the factory are:

TRANSDUCER

AI 1400, 1500, 1600, 1700

PID 1800 and 1900

ISEL 2000

CHAR 2100

ARTH 2200

Output Splitter OSPL 2300

---

### BLK\_TYPE\_#

---

#### Note

“#” represents the specified parameter number.

---

Enter the block type of the function block that contains the parameter to be displayed. This parameter is generally selected via a drop-down menu with a list of possible function block type (e.g. Transducer, PID, AI, etc.).

---

### PARAM\_INDEX\_#

---

#### Note

“#” represents the specified parameter number.

---

The PARAM\_INDEX\_# parameter is generally selected via a dropdown menu with a list of possible parameter names based upon what is available in the function block type selected. Choose the parameter to be displayed.

---

### CUSTOM\_TAG\_#

---

#### Note

“#” represents the specified parameter number.

---

The CUSTOM\_TAG\_# is an optional user-specified tag identifier that can be configured to be displayed with the parameter in place of the block tag. Enter a tag of up to five characters.

---

### UNITS\_TYPE\_#

---

#### Note

“#” represents the specified parameter number.

---

The UNITS\_TYPE\_# parameter is generally selected via a dropdown menu with three options: AUTO, CUSTOM, or NONE. Select AUTO only when the parameter to be displayed is pressure, temperature, or percent. For other parameters, select CUSTOM and be sure to configure the CUSTOM\_UNITS\_# parameter. Select NONE if the parameter is to be displayed without associated units.

## CUSTOM\_UNITS\_#

### Note

“#” represents the specified parameter number.

Specify custom units to be displayed with the parameter. Enter up to 6 characters. To display Custom Units the UNITS\_TYPE\_# must be set to CUSTOM.

## LCD display transducer block diagnostics

Table 4-7: LCD Display Transducer Block BLOCK\_ERR Messages

Condition name	Description
Other	N/A
Out of Service	The actual mode is out of service.

Symptom	Possible causes	Recommended action
The LCD display displays “DSPLY#INVALID.” Read the BLOCK_ERR and if it says “BLOCK CONFIGURATION” perform the Recommended Action	One or more of the display parameters are not configured properly.	See <a href="#">LCD display transducer block</a> .
The Bar Graph and the AI.OUT readings do not match	The OUT_SCALE of the AI block is not configured properly.	See <a href="#">Analog Input (AI)</a> and <a href="#">Field Communicator</a> .
“3144P” is being displayed or not all of the values are being displayed	The LCD display block parameter “DISPLAY_PARAMETER_SELECT” is not properly configured.	See <a href="#">LCD display transducer block</a> .
The display reads OOS	The resource and or the LCD display Transducer block are OOS.	Verify that both blocks are in “AUTO”.
The display is hard to read	Some of the LCD display segments may have gone bad.	See <a href="#">LCD display transducer block diagnostics</a> ; if some of the segment is bad, replace the LCD display.
	Device is out of the temperature limit for the LCD display. -4 to 185 °F (-20 to 85 °C)	Check ambient temperature of the device.

## 4.9.8 Hot Backup transducer

Hot Backup parameterse	Sub parameter	Description	Values to be set
FEATURE_CONFIG	FEATURE_ENABLE	Select the feature.	Hot Backup

Hot Backup parameterse	Sub parameter	Description	Values to be set
	DEFAULT_SENSOR	Set default sensor, either Sensor 1 or Sensor 2.	Sensor 1
	UNIT_INDEX	Set unit of measurement.	Deg C
FEATURE_VALUE	FEATURE_STATUS	This value changes dynamically.	N/A
	FEATURE_VAL	This value changes dynamically.	N/A

**Note**

Primary value 1 indicates sensor 1 value and primary value 2 indicates sensor 2 value.

**Sensor 1 as a default sensor**

Primary value 1 status	Primary value 2 status	FEATURE_VAL/ FEATURE_STATUS	Recommended action
Good	Good	Primary Value 1/ Good	No error
Good	Uncertain	Primary Value 1/ Good	Sensor 2 out of operating range or Sensor 2 Degraded.
Good	Bad	Primary Value 1/ Good	Sensor 2 Open or short or Beyond operating range.
Uncertain	Good	Primary Value 2/ Goode	Hot Backup Active and (Sensor 1 out of operating range or Sensor 1 Degraded).
Uncertain	Uncertain	Primary Value 1/ Uncertain	([Sensor 1 out of operating range or Sensor 1 Degraded] and [Sensor 2 out of operating range or Sensor 2 Degraded]) or Drift Alert.
Uncertain	Bad	Primary Value 1/ Uncertain	([Sensor 1 out of operating range or Sensor1 Degraded] and [Sensor 2 Open or short or Beyond operating range]).
Bad	Good	Primary Value 2/ Good	Hot Backup Active and Sensor 1 open or short or Beyond operating range.
Bad	Uncertain	Primary Value 2/ Uncertain	Hot Backup Active and Sensor 1 open or short or Beyond operating range and (Sensor 2 out of operating range or Sensor 2 Degraded).

Primary value 1 status	Primary value 2 status	FEATURE_VAL/ FEATURE_STATUS	Recommended action
Bad	Bad	None (Last good value)/Bad	Hot Backup Active and (Sensor 1 open or short or beyond operating range) and (Sensor 2 open or short or beyond operating range).

**Sensor 2 as a default sensor**

Primary value 1 status	Primary value 2 status	FEATURE_VAL/ FEATURE_STATUS	Recommended action
Good	Good	Primary Value 2/ Good	No error
Good	Uncertain	Primary Value 1/ Good	Hot Backup Active and Sensor 2 out of operating range or Sensor2 Degraded.e
Good	Bad	Primary Value 1/ Good	Hot Backup Active and Sensor 2 Open or short or Beyond Operating range.
Uncertain	Good	Primary Value 2/ Good	Sensor 1 out of operating range or Sensor 1 Degraded.
Uncertain	Uncertain	Primary Value 2/ Uncertain	([Sensor 1 out of operating range or Sensor 1 Degraded] and [Sensor 2 out of operating range or Sensor 2 Degraded]) or Drift Alert.
Uncertain	Bad	Primary Value 1/ Uncertain	Hot Backup Active and (Sensor 1 out of operating range or Sensor 1 Degraded) and (Sensor 2 Open or short or Beyond operating range).
Bad	Good	Primary Value 2/ Goode	Sensor 1 open or short or Beyond operating range.
Bad	Uncertain	Primary Value 2/ Uncertain	Sensor 1 open or short or Beyond operating range and (Sensor 2 out of operating range or Sensor 2 Degraded).
Bad	Bad	None (Last good value)/Bad	Hot Backup Active and (Sensor 1 open or short or beyond operating range) and (Sensor 2 open or short or beyond operating range).

## 4.10 Analog Input (AI)

### 4.10.1 Simulation

Simulate replaces the channel value coming from the sensor transducer block. For testing purposes, it is possible to manually drive the output of the analog input block to a desired value. There are two ways to do this.

#### Manual mode

To change only the OUT\_VALUE and not the OUT\_STATUS of the AI Block, place the TARGET MODE of the block to MANUAL. Then, change the OUT\_VALUE to the desired value.

### Simulate

#### Procedure

1. If the SIMULATE switch is in the OFF position, move it to the ON position. If the SIMULATE jumper is already in the ON position, you must move it to off and place it back in the ON position.

---

#### Note

As a safety measure, the switch must be reset every time power is interrupted to the device in order to enable SIMULATE. This prevents a device that is tested on the bench from getting installed in the process with SIMULATE still active.

---

2. To change both the OUT\_VALUE and OUT\_STATUS of the AI Block, set the TARGET MODE to AUTO.
3. Set SIMULATE\_ENABLE\_DISABLE to 'Active.'
4. Enter the desired SIMULATE\_VALUE to change the OUT\_VALUE and SIMULATE\_STATUS\_QUALITY to change the OUT\_STATUS. If errors occur when performing the above steps, be sure that the SIMULATE jumper has been reset after powering up the device.

### 4.10.2 Configure the AI block

 A minimum of four parameters are required to configure the AI block. The parameters are described below, with example configurations shown at the end of this section.

#### CHANNEL

Select the channel that corresponds to the desired sensor measurement .

Channel	Measurement
1	Input 1
2	Input 2
3	Differential
4	Terminal (body) temperature

Channel	Measurement
5	Input 1 minimum value
6	Input 1 maximum value
7	Input 2 minimum values
8	Input 2 maximum values
9	Differential minimum value
10	Differential maximum value
11	Terminal (body) minimum value
12	Terminal (body) maximum value
13	Hot Backup value

### L\_TYPE

The L\_TYPE parameter defines the relationship of the sensor measurement (sensor temperature) to the desired output temperature of the AI block. The relationship can be direct or indirect.

#### Direct

Select direct when the desired output will be the same as the sensor measurement (sensor temperature).

#### Indirect

Select indirect when the desired output is a calculated measurement based on the sensor measurement (e.g. ohm or mV). The relationship between the sensor measurement and the calculated measurement will be linear.

### XD\_SCALE and OUT\_SCALE

The XD\_SCALE and OUT\_SCALE each include four parameters: 0%, 100%, engineering units, and precision (decimal point). Set these based on the L\_TYPE:

#### L\_TYPE is Direct

When the desired output is the measured variable, set the XD\_SCALE to represent the operating range of the process. Set OUT\_SCALE to match XD\_SCALE.

#### L\_TYPE is Indirect

When an inferred measurement is made based on the sensor measurement, set the XD\_SCALE to represent the operating range that the sensor will see in the process. Determine the inferred measurement values that correspond to the XD\_SCALE 0 and 100% points and set these for the OUT\_SCALE.

#### Note

To avoid configuration errors, only select Engineering Units for XD\_SCALE and OUT\_SCALE that are supported by the device. The supported units are:

Temperature (channel 1 and 2)	Terminal (body) temperature
°C	°C



Temperature (channel 1 and 2)	Terminal (body) temperature
°F	°F
K	K
°R	°R
W	N/A
mV	N/A

When the engineering units of the XD\_SCALE are selected, this changes the engineering units of the PRIMARY\_VALUE\_RANGE in the transducer block to the same units.

This is the only way to change the engineering units in the sensor transducer block, PRIMARY\_VALUE\_RANGE PARAMETER.

### Configuration examples

Sensor type: 4-wire, Pt 100  $\alpha = 385$ .

Desired measurement process temperature in the –200 to 500 °F range. Monitor the transmitter electronics temperature in the –40 to 185 °F range.

### Transducer block

If host system supports methods:

1. Select **Methods**.
2. Select **Sensor Connections**<sup>(2)</sup>.
3. Follow on-screen instruction to setup sensor 1 as a 4-wire, Pt 100  $\alpha = 385$ .

If host system does not support methods:

1. Put transducer block into OOS mode.
  - a. Go to *MODE\_BLK.TARGET*.
  - b. Select **OOS (0 x 80)**.
2. Go to *SENSOR\_CONNECTION*.
  - a. Select **4-wire (0 x 4)**.
3. Go to *SENSOR\_TYPE*.
  - a. Select **PT100A385**.

(2) Some choices may not be available due to the current configuration of the device.

Examples:

- a) Sensor 2 cannot be configured at all if sensor 1 is set up as a 4-wire sensor.
- b) If sensor 2 is configured, Sensor 1 can not be set up as a 4-wire sensor (and vice-versa).
- c) When selecting a thermocouple as the sensor type, a 3- or 4-wire connection cannot be selected.

In this situation, configure the other sensor as “Not used.” This will clear the dependencies that are preventing the configuration of the desired sensor.

4. Put the transducer block back into auto mode.

### AI blocks (basic configuration)

AI1 as process temperature

1. Put the AI Block into OOS mode.
  - a. Go to *MODE\_BLK.TARGET*.
  - b. Select **OOS (0 x 80)**.
2. Go to *CHANNEL*.
  - a. Select **Sensor 1**.
3. Go to *L\_TYPE*.
  - a. Select **Direct**.
4. Go to *XD\_Scale*.
  - a. Select **UNITS\_INDEX** to be °F.
  - b. Set 0% = -200, set 100% = 500.
5. Go to *OUT\_SCALE*.
  - a. Select **UNITS\_INDEX** to be °F.
  - b. Set the 0 and 100 scale to be the same as in step [4.b](#).
6. Put the AI block back into auto mode.
7. Follow host procedure to download schedule into block AI2 as terminal temperature (body temperature).
8. Put the AI block into OOS mode.
  - a. Go to *MODE\_BLK.TARGET*.
  - b. Select **OOS (0 x 80)**.
9. Go to *CHANNEL*.
  - a. Select **Terminal (Body) Temperature**.
10. Go to *L\_TYPE*.
  - a. Select **Direct**.
11. Go to *XD\_Scale*.
  - a. Select **UNITS\_INDEX** to be °F.
  - b. Set 0% = -40, set 100% = 185.
12. Go to *OUT\_SCALE*.
  - a. Select **UNITS\_INDEX** to be °F.
  - b. Set the 0 and 100 scale to be the same as in step [4.b](#).

13. Put the AI block back into Auto mode.
14. Follow host procedure to download schedule into block.

### 4.10.3 Filtering

**Note**

If damping has already been configured in the transducer block, setting a non-zero value for PV\_FTME will add to that damping.

 The filtering feature changes the response time of the device to smooth variations in output readings caused by rapid changes in input. Adjust the filter time constant (in seconds) using the PV\_FTME parameter. To disable the filter feature, set the filter time constant to zero.

### 4.10.4 Process alarms

Process alarm detection is based on the OUT value. Configure the alarm limits of the following standard alarms:

- High (HIGH\_LIM)
- High high (HIGH\_HIGH\_LIM)
- Low (LOW\_LIM)
- Low low (LOW\_LOW\_LIM)

To avoid alarm chattering when the variable is oscillating around the alarm limit, an alarm hysteresis in percent of the PV span can be set using the ALARM\_HYS parameter. The priority of each alarm is set in the following parameters:

- HIGH\_PRI
- HIGH\_HIGH\_PRI
- LOW\_PRI
- LOW\_LOW\_PRI

**Alarm priority**

Alarms are grouped into five levels of priority.

Priority number	Priority description
0	The alarm condition is not used.
1	An alarm condition with a priority of 1 is recognized by the system, but is not reported to the operator.
2	An alarm condition with a priority of 2 is reported to the operator.
3–7	Alarm conditions of priority 3 to 7 are advisory alarms of increasing priority.
8–15	Alarm conditions of priority 8 to 15 are critical alarms of increasing priority.

## 4.10.5 Status

When a PV is passed from one function block to another, it passes a STATUS along with the PV. The STATUS can be: GOOD, BAD, or UNCERTAIN. When a fault occurs in the device, the PV will look at the last value with a STATUS of GOOD and the STATUS will change from GOOD to BAD, or from GOOD to UNCERTAIN. It is important that the control strategy that uses the PV also monitors the STATUS to take appropriate action when the STATUS changes from GOOD to either BAD or UNCERTAIN.

### Status options

Status options (status\_opts) supported by the AI block are shown below:

#### Propagate fault forward

If the status from the sensor is Bad, Device failure, or Bad, Sensor failure, propagate it to OUT without generating an alarm. The use of these sub-status in OUT is determined by this option. Through this option, the user determines whether alarming (sending of an alert) will be done by the block or propagated downstream for alarming.

#### Uncertain if limited

Set the output status of the Analog Input block to uncertain if the measured or calculated value is limited.

#### BAD

Set the output status to Bad if the sensor is violating a high or low limit.

#### Uncertain if man mode

Set the output status of the analog Input block to uncertain if the actual mode of the block is Man.

---

#### Note

The instrument must be in out of service mode to set the status option.

---

## 4.10.6 Advanced features

The following parameters provide the capabilities to drive a discrete output alarm in the event that a process alarm (HI\_HI\_LIM, HI\_LIM, LO\_LO\_LIM, LO\_LIM) has been exceeded.

#### ALARM\_TYPE

ALARM\_TYPE allows one or more of the process alarm conditions (HI\_HI\_LIM, HI\_LIM, LO\_LO\_LIM, LO\_LIM) detected by the AI function block to be used in setting its OUT\_D parameter.

#### OUT\_D

OUT\_D is the discrete output of the AI function block based on the detection of process alarm condition(s). This parameter may be linked to other function blocks that require a discrete input based on the detected alarm condition.

## 4.10.7 Analog input diagnostics

**Table 4-8: AI BLOCK\_ERR Conditions**

Condition number	Condition name and description
0	Other
1	Block Configuration Error: the selected channel carries a measurement that is incompatible with the engineering units selected in XD_SCALE, the L_TYPE parameter is not configured, or CHANNEL = zero.
3	Simulate Active: Simulation is enabled and the block is using a simulated value in its execution.
7	Input Failure/Process Variable has Bad Status: The hardware is bad, or a bad status is being simulated.
14	Power Up: Block is not scheduled.
15	Out of Service: The actual mode is out of service.

**Table 4-9: Troubleshooting the AI block**

Symptom	Possible causes	Recommended actions
Bad or no temperature readings (Read the AI "BLOCK_ERR" parameter)	BLOCK_ERR reads OUT OF SERVICE (OOS)	<ol style="list-style-type: none"> <li>AI Block target mode target mode set to OOS.</li> <li>Resource Block OUT OF SERVICE.</li> </ol>
	BLOCK_ERR reads CONFIGURATION ERROR	<ol style="list-style-type: none"> <li>Check CHANNEL parameter (see <a href="#">CHANNEL</a>).</li> <li>Check L_TYPE parameter (see <a href="#">L_TYPE</a>)</li> <li>Check XD_SCALE engineering units. (see <a href="#">XD_SCALE</a> and <a href="#">OUT_SCALE</a>)</li> </ol>
	BLOCK_ERR reads POWERUP	Download schedule into block. Refer to host for downloading procedure.
	BLOCK_ERR reads BAD INPUT	<ol style="list-style-type: none"> <li>Sensor Transducer Block Out Of Service (OOS)</li> <li>Resource Block Out of Service (OOS)</li> </ol>
	No BLOCK_ERR but readings are not correct. If using Indirect mode, scaling could be wrong.	<ol style="list-style-type: none"> <li>Check XD_SCALE parameter.</li> <li>Check OUT_SCALE parameter. (see <a href="#">XD_SCALE</a> and <a href="#">OUT_SCALE</a>)</li> </ol>
	No BLOCK_ERR. Sensor needs to be calibrated or Zero trimmed.	See <a href="#">HART Commissioning</a> to determine the appropriate trimming or calibration procedure.
OUT parameter status reads UNCERTAIN and substatus reads EngUnitRangViolation.	Out_ScaleEU_0 and EU_100 settings are incorrect.	See <a href="#">XD_SCALE</a> and <a href="#">OUT_SCALE</a> .

## 4.11 Operation

This section contains information on operation and maintenance procedures.

### 4.11.1 Methods and manual operation

Each FOUNDATION Fieldbus host or configuration tool has different ways of displaying and performing operations. Some hosts use DD Methods to complete device configuration and display data consistently across platforms. There is no requirement that a host or configuration tool support these features.

In addition, if your host or configuration tool does not support methods, this section covers manually configuring the parameters involved with each method operation. For more detailed information on the use of methods, see the host or configuration tool manual.

### 4.11.2 Trim the transmitter

Calibrating the transmitter increases the precision of the measurement system. The user may use one or more of a number of trim functions when calibrating. The trim functions allow the user to make adjustments to the factory-stored characterization curve by digitally altering the transmitter's interpretation of the sensor input.

**Figure 4-1: Trim**

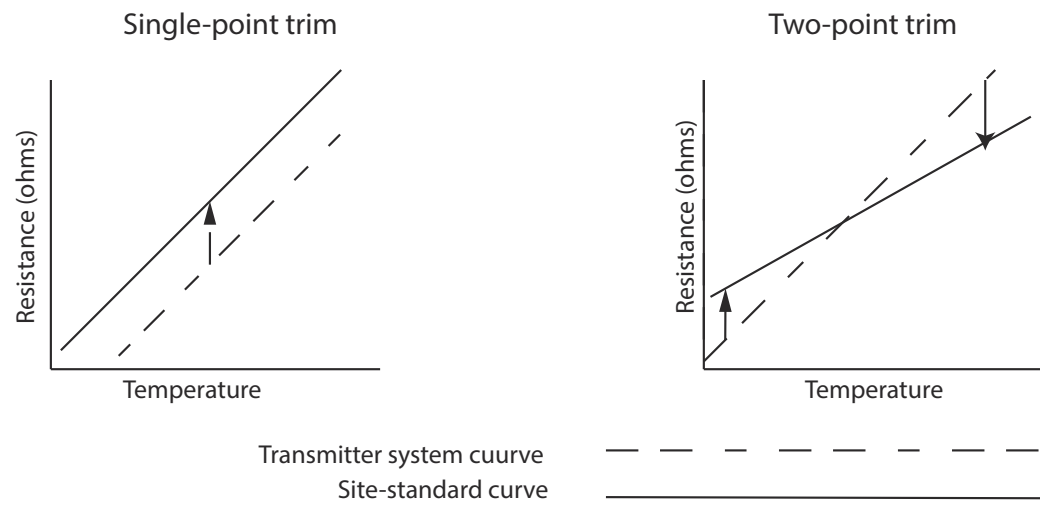

**Application: Linear offset (single-point trim solution)**

1. Connect sensor to transmitter. Place sensor in bath between range points.
2. Enter known bath temperature using the Field Communicator.

**Application: Linear offset and slope correction (two-point trim solution)**

1. Connect sensor to transmitter. Place sensor in bath at low range point.
2. Enter known bath temperature using the Field Communicator.

3. Repeat at high range point.

## Sensor calibration, lower and upper trim methods

In order to calibrate the transmitter, run the lower and upper trim methods. If your system does not support methods, manually configure the transducer block parameters listed below.

### Procedure

1. Set MODE\_BLK.TARGET\_X to OOS.
2. Set SENSOR\_CAL\_METHOD\_X to User Trim.
3. Set CAL\_UNIT\_X to supported engineering units in the transducer block.
4. Apply temperature that corresponds to the lower calibration point and allow the temperature to stabilize. The temperature must be between the range limits defined in PRIMARY\_VALUE\_RANGE\_X.
5. Set values of CAL\_POINT\_LO\_X to correspond to the temperature applied by the sensor.
6. Apply temperature, temperature corresponding to the upper calibration.
7. Allow temperature to stabilize.
8. Set CAL\_POINT\_HI\_X.

---

#### Note

CAL\_POINT\_HI\_X must be within PRIMARY\_VALUE\_RANGE\_X and greater than CAL\_POINT\_LO\_X + CAL\_MIN\_SPAN\_X.

---

9. Set SENSOR\_CAL\_DATE\_X to the current date.
10. Set SENSOR\_CAL\_WHO\_X to the person responsible for the calibration.
11. Set SENSOR\_CAL\_LOC\_X to the calibration location.
12. Set MODE\_BLK.TARGET\_X to AUTO.

If trim fails the transmitter will automatically revert to factory trim. Excessive correction or sensor failure could cause device status to read “calibration error.” To clear this, trim the transmitter.

## Recall factory trim

To recall a factory trim on the transmitter, run the Recall Factory Trim.

---

#### Note

When sensor type is changed, the transmitter reverts to the factory trim. Changing sensor type causes you to lose any trim performed on the transmitter.

---

If your system does not support methods, manually configure the Transducer Block parameters.

### Procedure

1. Set TARGET\_MODE to OOS
2. Set SENSOR\_CAL\_METHOD to Factory Trim.
3. Set SENSOR\_CAL\_DATE to the current date.

4. Set SENSOR\_CAL\_WHO to the person responsible for the calibration.
5. Set SENSOR\_CAL\_LOC to the calibration location.
6. Set TARGET\_MODE to AUTO.

## 4.11.3 Advanced diagnostics

### Thermocouple degradation diagnostic

Thermocouple degradation diagnostic acts as a gauge of general thermocouple health and is indicative of any major changes in the status of the thermocouple or the thermocouple loop. The transmitter monitors for increasing resistance of the thermocouple loop to detect drift conditions or wiring condition changes. The degrading thermocouple can be caused by wire thinning, sensor breakdown, moisture intrusion or corrosion and can be an indication of an eventual sensor failure.

**How it works:** The thermocouple degradation diagnostic measures the amount of resistance on a thermocouple sensor path. Ideally a thermocouple would have zero resistance, but in reality it has some resistance especially for long thermocouple extension wires. As the sensor loop degrades (including sensor degradation and wire or junctions degradation), the resistance of the loop increases. First, the transmitter is configured to a baseline by the user. Then, at least once per second, the degradation diagnostic monitors the resistance in the loop by sending a pulsed current (in microamps) on the loop, measuring the voltage induced and calculating the effective resistance. As the resistance increases, the diagnostic can detect when the resistance exceeds the threshold set by the user at which the diagnostic will provide a digital alert. This feature is not intended to be a precise measurement of thermocouple status, but is a general indicator of thermocouple and thermocouple loop health by providing trending over time.

The thermocouple degradation diagnostic does not detect shorted thermocouple conditions.

Thermocouple diagnostic must be connected, configured, and enabled to read a thermocouple. Once the diagnostic has been activated, a Baseline resistance value is calculated. Then a threshold Trigger must be selected, which can be two, three, or four times the Baseline resistance, or the default of 5000 ohms. If the thermocouple loop resistance reaches the trigger level, a maintenance alert is generated.

---

#### Important

The thermocouple degradation diagnostic monitors the health of the entire thermocouple loop, including wiring, terminations, junctions, and the sensor itself. Therefore, it is imperative that the diagnostic baseline resistance be measured with the sensor fully installed and wired in the process, and not on the bench.

---

#### Note

The thermocouple resistance algorithm does not calculate resistance values while the active calibrator mode is enabled.

---



**Table 4-10: AMS Device Manager terms**

Term	Definition
Trigger level	Threshold resistance value for the thermocouple loop. The Trigger Level may be set for 2, 3, or 4 3 Baseline or the default of 5000 Ohms. If the resistance of the thermocouple loop surpasses the trigger level, a Plantweb maintenance alert will be generated.
Resistance	This is the existing resistance reading of the thermocouple loop.
Baseline value	The resistance of the thermocouple loop obtained after installation, or after resetting the Baseline value. The Trigger Level may be calculated from the baseline value.
Trigger setting	May be set for 2, 3, or 4 3 baseline or the default of 5000 ohms.
Sensor 1 degraded	A Plantweb maintenance alert generated when the thermocouple degradation diagnostic is enabled and the resistance in the loop exceeds the user-configured trigger level. This alert indicates maintenance may be necessary or that the thermocouple may have degraded.
Configure	Launches a method so the user can enable or disable the thermocouple degradation diagnostic, select the trigger level, and automatically calculates the baseline value (which may take several seconds).
Reset baseline value	Launches a method to recalculate the baseline value (which may take several seconds).
Enabled	Indicates when the thermocouple degradation diagnostic is enabled for the sensor.
Learning	Indicates when checked that the baseline value is being calculated.
Licensed	The check box indicates if thermocouple degradation diagnostic is available for the specific transmitter.

## Minimum and maximum temperature tracking

Minimum and maximum temperature tracking (Min/Max Tracking) when enabled, records minimum and maximum temperatures with date and time stamps on Rosemount 3144P Temperature Transmitters. This feature records values for Sensor 1, Sensor 2, differential and terminal (body) temperatures. Min/Max Tracking only records temperature maxima and minima obtained since the last reset, and is not a logging function.

To track maximum and minimum temperatures, Min/Max Tracking must be enabled in the transducer function block using a Field Communicator, AMS Device Manager, or other communicator. While enabled, this feature allows for a reset of information at any time, and all variables can be reset simultaneously. Additionally, sensor 1, sensor 2, differential, and terminal (body) temperature minimum and maximum values may be reset individually. Once a particular field has been reset, the previous values are overwritten.

### 4.11.4 Statistical process monitoring (SPM)

SPM algorithm provides basic information regarding the behavior of process measurements such as PID control block and actual valve position. The algorithm can monitor up to four user selected variables. All variables must reside in a scheduled function block contained in the device. This algorithm can perform higher levels of

diagnostics by distribution of computational power to field devices. The two statistical parameters monitored by the SPM are mean and standard deviation. By using the mean and standard deviation, the process or control levels and dynamics can be monitored for change over time. The algorithm also provides:

- Configurable limits/alarms for high variation, low dynamics, and mean changes with respect to the learned levels
- Necessary statistical information for regulatory control loop diagnostics, root cause diagnostics, and operations diagnostics

---

#### Note

FOUNDATION Fieldbus devices offer a wealth of information to the user. Both process measurement and control is feasible at the device level. The devices contain both the process measurements and control signals that are necessary to not only control the process, but to determine if the process and control is healthy. By looking at the process measurement data and control output over time, additional insight into the process can be gained. Under some load conditions and process demands, changes could be interpreted as degradation of instruments, valves, or major components such as pumps, compressors, heat exchangers, etc. This degradation may indicate that the loop control scheme should be re-tuned or re-evaluated. By learning a healthy process and continually comparing current information to the known healthy information, problems from degradation and eventual failure can be remedied ahead of time. These diagnostics aid in the engineering and maintenance of the devices. False alarms and missed detections may occur. If a reoccurring problem in the process exists, contact Emerson for assistance.

---

## Configuration phase

The configuration phase is an inactive state when the SPM algorithm can be configured. In this phase, the block tags, block type, parameter, limits for high variation, low dynamics, and mean change detection can be set by the user. The “Statistical Process Monitoring Activation” parameter must be set to “disabled” to configure any SPM parameter. SPM can monitor any linkable input or output parameter of a scheduled function block that resides in the device.

## Learning phase

In the learning phase of SPM, the algorithm establishes a baseline of the mean and dynamics of a SPM variable. The baseline data is compared to current data for calculating any changes in mean or dynamics of the SPM variables.

## Monitoring phase

The monitoring phase starts once the learning process is complete. The algorithm compares the current values to the baseline values of the mean and standard deviation.

During this phase the algorithm computes the percent change in mean and standard deviation to determine if the defined limits are violated.

## 4.11.5 SPM configuration

### **SPM\_Bypass\_Verification**

“Yes” means that the verification of the baseline is turned off while “No” indicates the learned baseline is compared to the next current calculated value to ensure a good baseline value. The recommended value is NO.

### **SPM\_Monitoring\_Cycle**

SPM\_Monitoring\_Cycle is the length of time the process values are taken and used in each calculation. A longer monitoring cycle may provide a more stable mean value with the default set at 15 minutes.

### **SPM#\_Block\_Tag**

Enter the Block Tag of the function block containing the parameter to be monitored. Block tag must be entered, since there is no pull-down menu to select the tag. The tag must be a valid “Block Tag” in the device. The default block tags from the factory are:

- AI 1400
- AI 1500
- PID 1600
- ISEL 1700
- CHAR 1800
- ARITH 1900

SPM can also monitor “out” parameters from other devices. Link the “out” parameter to an input parameter of a function block residing in the device, and set up SPM to monitor the input parameter.

### **SPM#\_Block Type**

Enter the Block Type of the function block containing the parameter to be monitored.

### **SPM#\_Parameter Index**

Enter the Parameter Index of the parameter to be monitored.

### **SPM#\_Thresholds**

The SPM#\_Thresholds allow alerts to be sent when the values are beyond the threshold values that set for each parameter.

### **Mean limit**

Alert Limit value in percent change of the Mean compared with the baseline mean value.

### **High variation**

Alert Limit value in percent change of the Stdev compared with the baseline Stdev value.

### Low dynamics

Alert Limit value in percent change of the Stdev compared with the baseline Stdev value.

### SPM\_Active

SPM\_Active parameter that starts the SPM when “Enabled”. “Disabled” turns the diagnostic monitoring off. It must be set to “Disabled” for configuration, and only set to “Enabled” after fully configuring the SPM.

### SPM#\_User command

Select “Learn” after all of the parameters have been configured to begin the Learning Phase. The monitoring phase starts after the learning process is complete. Select “Quit” to stop the SPM. “Detect” may be selected to return to the monitoring phase.

### Baseline values

The baseline values are the calculated values from the process over the learning cycle.

### SPM#\_Baseline\_Mean

SPM#\_Baseline\_Mean is the calculated average of the process variable over the learning cycle.

### SPM#\_Baseline\_Standard\_Deviation

SPM#\_Baseline\_Standard\_Deviation is the square root of the variance of the process variable over the learning cycle.

## 4.12 Troubleshooting guides

Table 4-11: Troubleshooting Guide

Symptom <sup>(1)</sup>	Cause	Recommended actions
Device does not show up on segment	Unknown	Recycle power to device.
	No power to device	<ol style="list-style-type: none"> <li>1. Ensure the device is connected to the segment.</li> <li>2. Check voltage at terminals. There should be 9–32 Vdc.</li> <li>3. Check to ensure the device is drawing current. There should be approximately 11 mA.</li> </ol>
	Segment problems	1. Check wiring
	Electronics failing	1. Replace device.
	Incompatible network settings	1. Change host network parameters (refer to host documentation for procedure).

**Table 4-11: Troubleshooting Guide (continued)**

Symptom <sup>(1)</sup>	Cause	Recommended actions
Device does not stay on segment <sup>(2)</sup>	Incorrect signal levels. Refer to host documentation for procedure.	<ol style="list-style-type: none"> <li>1. Check for two terminators.</li> <li>2. Excess cable length.</li> <li>3. Bad Power supply or conditioner</li> </ol>
	Excess noise on segment. Refer to host documentation for procedure.	<ol style="list-style-type: none"> <li>1. Check for incorrect grounding.</li> <li>2. Check for correct shielded wire.</li> <li>3. Tighten wire connections.</li> <li>4. Check for corrosion or moisture on terminals.</li> <li>5. Check for Bad power supply.</li> </ol>
	Electronics failing	<ol style="list-style-type: none"> <li>1. Replace device.</li> </ol>
	Other	<ol style="list-style-type: none"> <li>1. Check for water around the transmitter.</li> </ol>

(1) The corrective actions should be done with consultation of your system integrator.

(2) Wiring and installation 31.25 kbit/s, voltage mode, wire medium application guide AG-140 available from the FOUNDATION Fieldbus.

## 4.12.1 FOUNDATION Fieldbus

If a malfunction is suspected despite the absence of a diagnostics message, follow the procedures described in Table 4-13 to verify that transmitter hardware and process connections are in good working order. Under each of the symptoms, specific suggestions for solving problems are offered. Always deal with the most likely and easiest-to-check conditions first.

**Table 4-12: FOUNDATION Fieldbus Troubleshooting**

Symptom	Potential source	Corrective action
Transmitter does not Communicate with the Configuration Interface	Loop wiring	<ul style="list-style-type: none"> <li>• Check for adequate voltage to the transmitter. The transmitter requires between 9.0 and 32.0 V at the terminals to operate and provide complete functionality.</li> <li>• Check for intermittent wire shorts, open circuits, and multiple grounds.</li> </ul>
High output	Sensor input failure or connection	<ul style="list-style-type: none"> <li>• Enter the transmitter test mode to isolate a sensor failure.</li> <li>• Check for a sensor open circuit.</li> <li>• Check the process variable to see if it is out of range.</li> </ul>
	Loop wiring	<ul style="list-style-type: none"> <li>• Check for dirty or defective terminals, interconnecting pins, or receptacles.</li> </ul>

**Table 4-12: FOUNDATION Fieldbus Troubleshooting (continued)**

Symptom	Potential source	Corrective action
	Electronics module	<ul style="list-style-type: none"> <li>Enter the transmitter test mode to isolate a module failure.</li> <li>Check the sensor limits to ensure calibration adjustments are within the sensor range.</li> </ul>
Erratic output	Loop wiring	<ul style="list-style-type: none"> <li>Check for adequate voltage to the transmitter. The transmitter requires between 9.0 and 32.0 V at the terminals to operate and provide complete functionality.</li> <li>Check for intermittent wire shorts, open circuits, and multiple grounds.</li> </ul>
	Electronics module	<ul style="list-style-type: none"> <li>Enter the transmitter test mode to isolate module failure.</li> </ul>
Low output or no output	Sensor element	<ul style="list-style-type: none"> <li>Enter the transmitter test mode to isolate a sensor failure.</li> <li>Check the process variable to see if it is out of range.</li> </ul>
	Loop wiring	<ul style="list-style-type: none"> <li>Check for adequate voltage to the transmitter. The transmitter requires between 9.0 and 32.0 V at the terminals to operate and provide complete functionality.</li> <li>Check for wire shorts and multiple grounds.</li> <li>Check the loop impedance.</li> <li>Check wire insulation to detect possible shorts to ground.</li> </ul>
	Electronics module	<ul style="list-style-type: none"> <li>Check the sensor limits to ensure calibration adjustments are within the sensor range.</li> <li>Enter the transmitter test mode to isolate an electronics module failure.</li> </ul>

## 4.12.2 LCD display

### Note

For Rosemount 3144P Transmitters with FOUNDATION Fieldbus, the following LCD display options are not used: Bar graph, Sensor 1, Sensor 2, Differential, Multidrop, and Burst mode.

Message	LCD display top line	LCD display bottom line
RB.DETAILED_STATUS		
Sensor Transducer Block Error	"Error"	"DVICE"
Manufacturing Block Integrity Error	"Error"	"DVICE"

Message	LCD display top line	LCD display bottom line
Hardware/Software Incompatible	"Error"	"DVICE"
Non-volatile Memory Integrity Error	"Error"	"DVICE"
ROM Integrity Error	"Error"	"DVICE"
Lost Deferred NV Data	"Error"	"DVICE"
NV Writes Deferred	No errors displayed	
ADB Transducer Block Error	No errors displayed	
<b>STB.SENSR_DETAILED_STATUS</b>		
Invalid Configuration	"Error"	"SNSOR"
ASIC RCV Error	"Error"	"SNSOR"
ASIC TX Error	"Error"	"SNSOR"
ASIC Interrupt Error	"Error"	"SNSOR"
ASIC Configuration Error	"Error"	"SNSOR"
Sensor 1 Open	"Error"	"SNSOR"
Sensor 1 Shorted	"Error"	"SNSOR"
Terminal (Body) Temperature Failure	"Error"	"SNSOR"
Sensor 1 Out of Operating Range	No errors displayed	
Sensor 1 Beyond Operating Limits	"Error"	"SNSOR"
Terminal (Body) Temperature Out of Operating Range	No errors displayed	
Terminal (Body) Temperature Beyond Operating Limits	"Error"	"SNSOR"
Sensor 1 Degraded	"Error"	"SNSOR"
Calibration Error	"Error"	"SNSOR"
Sensor 2 Open	"Error"	"SNSOR"
Sensor 2 Shorted	"Error"	"SNSOR"
Sensor 2 Out of Operating Range	No errors displayed	
Sensor 2 Beyond Operating Limits	"Error"	"SNSOR"
Sensor 2 Degraded	"Error"	"SNSOR"
Sensor Drift Alert	"Error"	"SNSOR"
Hot Backup Active	"Error"	"SNSOR"
Thermocouple Degradation Alert	"Error"	"SNSOR"

The following are the default tags for each of the possible Function blocks which display data on the LCD display:

Block name	LCD display bottom line
Transducer	"TRANS"

Block name	LCD display bottom line
AI 1400	"AI 14"
AI 1500	"AI 15"
AI 1600	"AI 16"
PID 1700	"PID 1"
PID 1800	"PID 1"
ISEL 1900	"ISEL"
CHAR 2000	"CHAR"
ARITH 2100	"ARITH"
OSPL 2200	"OSPL"

All other custom tags that are entered must be: numbers 0–9, letters A–Z, and/or spaces.

The following are the standard temperature units codes displayed on the LCD display:

Units	LCD display bottom line
Degrees C	"DEG C"
Degrees F	"DEG F"
Degrees K	"DEG K"
Degrees R	"DEG R"
Ohms	"OHMS"
Millivolts	"MV"
Percent (%)	Uses the percent symbol

All other custom units that are entered must be: numbers 0–9, letters A–Z, and/or spaces.

If the value of the process variable displayed has a bad or uncertain status, the following is shown:

Status	LCD display bottom line
Bad	"BAD"
Uncertain	"UNCTN"

When power is first applied, the LCD display will display the following:

LCD display top line	LCD display bottom line
"3144"	blank

If the device goes from "Auto" mode to Out-of-Service (OOS) mode, the LCD display will display the following:

LCD display top line	LCD display bottom line
"OOS"	blank



# 5 Operation and maintenance

## 5.1 Safety messages

Instructions and procedures in this section may require special precautions to ensure the safety of the personnel performing the operations. Information that raises potential safety issues is indicated by a warning symbol ( $\triangle$ ). Refer to the following safety messages before performing an operation preceded by this symbol.

## 5.2 Maintenance

The transmitter has no moving parts and requires a minimum amount of scheduled maintenance and features a modular design for easy maintenance. If a malfunction is suspected, check for an external cause before performing the diagnostics discussed in this section.

### 5.2.1 Test terminal (HART<sup>®</sup>/4–20 mA only)

The test terminal, marked as TEST or (“T”) on the terminal block, and the negative (–) terminal accept MINIGRABBER<sup>™</sup>, or alligator clips, facilitate in-process checks (see [Figure 2-14](#)). The test and the negative terminals are connected across a diode through the loop signal current. The current measuring equipment shunts the diode when connected across the test (T) and negative (–) terminals; so as long as the voltage across the terminals is kept below the diode threshold voltage, no current passes through the diode. To ensure there is no leakage current through the diode while making a test reading, or while an indicating meter is connected, the resistance of the test connection or meter should not exceed 10 ohms. A resistance value of 30 ohms will cause an error of approximately 1.0 percent of reading.

### 5.2.2 Sensor checkout

If the sensor is installed in a high-voltage environment and a fault condition or installation error occurs, the sensor leads and transmitter terminals could carry lethal voltages. Use extreme caution when making contact with the leads and terminals.

To determine whether the sensor is at fault, replace it with another sensor or connect a test sensor locally at the transmitter to test remote sensor wiring. Transmitters with option code C7 (trim to special sensor), are matched to a specific sensor. Select a standard, off-the-shelf sensor for use with the transmitter, or consult the factory for a replacement special sensor/transmitter combination.

### 5.2.3 Electronics housing

The transmitter is designed with a dual-compartment housing. One compartment contains the electronics module, and the other contains all wiring terminals and communication receptacles.

## Removing the electronics module

---

### Note

The electronics are sealed in a moisture-resistant plastic enclosure referred to as the electronics module. This module is a non-repairable unit and the entire unit must be replaced if a malfunction occurs.

---

The transmitter electronics module is located in the compartment opposite the wiring terminals.

Use the following procedure to remove the electronics module:

### Procedure

1. Disconnect the power to the transmitter.
2. Remove the cover from the electronics side of the transmitter housing. Do not remove the covers in explosive atmospheres with a live circuit. Remove the LCD display, if applicable.
3. Loosen the two screws anchoring the electronics module assembly to the transmitter housing.
4. Firmly grasp the screws and assembly and pull straight out of the housing, taking care not to damage the interconnecting pins.

If you are replacing the electronics module with a new one, make sure that the alarm switches are set in the same positions.

## Replacing the electronics module

Use the following procedure to reassemble the electronics housing for the transmitter:

### Procedure

1. Examine the electronics module to ensure that the failure mode and transmitter security switches are in the desired positions.
2. Carefully insert the electronics module lining up the interconnecting pins with the necessary receptacles on the electronics board.
3. Tighten the two mounting screws. Replace the LCD display, if applicable.
4. Replace the cover. Tighten of a revolution after the cover begins to compress the O-ring. Both transmitter covers must be fully engaged to meet explosion proof requirements.

## 5.2.4 Transmitter diagnostics logging

The Transmitter Diagnostics Logging feature stores advanced diagnostic information between device resets, such as what caused the transmitter to go into alarm, even if that event has disappeared. For example, if the transmitter detects an open sensor from a loose terminal connection, the transmitter will go into alarm. If wire vibration causes that wire to begin making a good connection, the transmitter will come out of alarm. This jumping in and out of alarm is frustrating when trying to determine what is causing the problem. However, the Transmitter Diagnostics Logging feature keeps track of what caused the transmitter to go into alarm and saves valuable debugging time. The log may be viewed using an asset management software, such as AMS Device Manager.

## 5.3 Return of materials

To expedite the return process in North America, call the Emerson National Response Center (1-800-654-7768) for assistance with any needed information or materials.

The center will ask for the following information:

- Product model
- Serial numbers
- The last process material to which the product was exposed

The center will provide

- A Return Material Authorization (RMA) number
- Instructions and procedures to return goods that were exposed to hazardous substances

For other locations, contact an Emerson representative.

---

### Note

If a hazardous substance is identified, a Safety Data Sheet (SDS), required by law to be available to people exposed to specific hazardous substances, must be included with the returned materials.

---



# 6 Safety Instrumented Systems (SIS) requirements

## 6.1 SIS certification

The safety-critical output of the Rosemount™ 3144P Temperature Transmitter is provided through a two-wire, 4–20 mA signal representing temperature. The Rosemount 3144P Transmitter can be equipped with or without a display. The Rosemount 3144P Safety Certified Safety Transmitter is certified to: Low demand; Type B.

- SIL 2 for random integrity at HFT=0
- SIL 3 for random integrity at HFT=1
- SIL 3 for systematic integrity

## 6.2 Safety certified identification

All Rosemount 3144P HART® Transmitters must be identified as safety certified before installing into SIS systems.

To identify a safety certified Rosemount 3144P Transmitter, make sure the device satisfies the requirements below:

1. Verify the transmitter was ordered with output option code “A” and option code “QT”. This signifies that it is a 4–20mA/HART safety certified device. For example: MODEL 3144PDxA.....QT....
2. Devices used in safety applications with ambient temperature below –40 °F (–40 °C) requires option code QT and BR6
3. Check the Namur Software Revision located on the adhesive transmitter tag. “SW Rev \_.\_.”. If the Device label software revision is 1.1.1 or higher, the device is safety certified.

## 6.3 Installation

Installation is to be performed by qualified personnel. No special installation is required in addition to the standard installation practices outlined in this document. Always ensure a proper seal by installing the electronics housing cover(s) so that metal contacts metal.

The loop should be designed so the terminal voltage does not drop below 12 Vdc when the transmitter output is 24.5 mA.

Environmental limits are available in the Rosemount 3144P Temperature Transmitter [Product Page](#).

## 6.4 Configuration

Use any HART Protocol capable configuration tool to communicate with and verify the initial configuration or any configuration changes made to the transmitter prior to operating in Safety Mode. All configuration methods outlined in are the same for the safety certified transmitter with any differences noted.

Software or hardware lock must be used in order to prevent unwanted changes to the transmitter configuration.

---

### Note

Transmitter output is not safety-rated during the following: Configuration changes, Multidrop operation, Simulation, Active Calibrator mode, and loop tests. Alternative means should be used to ensure process safety during transmitter configuration and maintenance activities.

---

## 6.4.1 Alarm and saturation levels

DCS or safety logic solver should be configured to match transmitter configuration. Figure 6-1 identifies the three alarm levels available and their operations values.

**Figure 6-1: Alarm Levels**

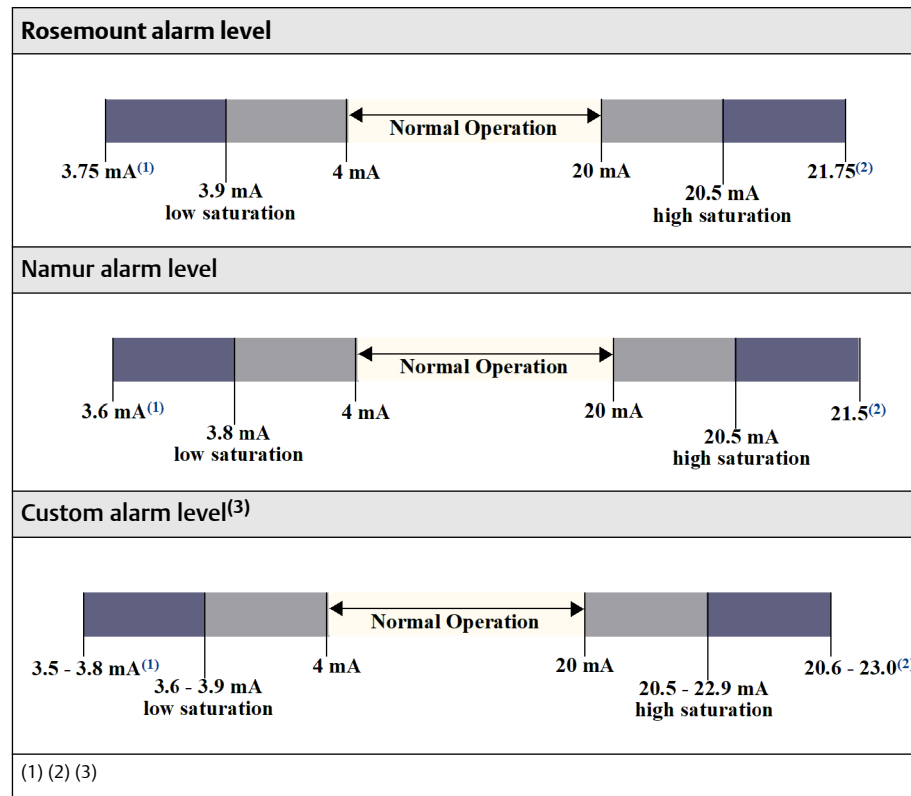

- (1) 1. Transmitter Failure, hardware or software alarm in LO position.  
 (2) 2. Transmitter Failure, hardware or software alarm in HI position.  
 (3) 3. Low alarm must be at least 0.1 mA lower than the low saturation value.

### Security switch

Position the security switch to the “ON” position to prevent accidental or deliberate change of configuration data during normal operation. Be sure to take transmitter out of fixed current (loop test) and simulation before setting security switch to “ON”. Alternatively, the Processor Reset function may be used to restore normal operation while security switch is “ON”.

## 6.4.2 Damping

User-adjustable damping affects the transmitter's ability to respond to changes in the applied process. The damping value + response time should not exceed the loop requirements.

If using a thermowell assembly, make sure to also take into account the added response due to thermowell material.

## 6.5 Operation and maintenance

### Proof test

The following proof tests are recommended. In the event that an error is found in the safety functionality, proof test results and corrective actions taken must be documented at [Emerson.com/Rosemount/Safety](https://www.emerson.com/Rosemount/Safety).

All proof test procedures must be carried out by qualified personnel.

### 6.5.1 Partial proof test 1

The partial proof test 1 consists of a power cycle plus reasonability checks of the transmitter output. Reference the FMEDA Report for percent of possible DU failures in the device.

FMEDA report can be found at Rosemount 3144P Temperature Transmitter [Product Page](#).

Required tools: Field Communicator, mA meter

#### Procedure

1. Bypass the safety PLC or take other appropriate action to avoid a false trip.
2. Send a HART command to the transmitter to go to high alarm current output and verify that the analog current reaches that value. This tests for compliance voltage problems such as low loop power supply voltage or increased wiring resistance. This also tests for other possible failures.
3. Send a HART command to the transmitter to go to the low alarm current output and verify that the analog current reaches that value. This tests for possible quiescent current related failures.
4. Use the HART communicator to view detailed device status to ensure no alarms or warnings are present in the transmitter.
5. Perform reasonability check on the sensor value(s) versus an independent estimate (i.e. from direct monitoring of BPCS value) to show current reading is good.
6. Restore the loop to full operation.
7. Remove the bypass from the safety PLC or otherwise restore to normal operation.

### 6.5.2 Comprehensive proof test 2

The comprehensive proof test 2 consists of performing the same steps as the partial proof test but with a 2-point calibration of the temperature sensor in place of the reasonability check. Reference the FMEDA report for percent of possible DU failures in the device.

Required tools: Field Communicator, temperature calibration equipment

#### Procedure

1. Bypass the safety PLC or take other appropriate action to avoid a false trip.



2. Perform partial proof test 1.
3. Verify the measurement for two temperature points for Sensor 1. Verify the measurement for two temperature points for Sensor 2, if second sensor is present.
4. Perform reasonability check of the housing temperature.
5. Restore the loop to full operation.
6. Remove the bypass from the safety PLC or otherwise restore to normal operation.

### 6.5.3 Comprehensive proof test 3

The comprehensive proof test 3 includes a comprehensive proof test along with a simple sensor proof test. Reference the FMEDA report for percent of possible DU failures in the device.

#### Procedure

1. Bypass the safety PLC or take other appropriate action to avoid a false trip.
2. Perform simple proof test 1.
3. Connect calibrated sensor simulator in place of sensor 1.
4. Verify safety accuracy of 2 temperature points inputs to transmitter.
5. If sensor 2 is used, repeat [Step 3](#) and [Step 4](#).
6. Restore sensor connections to transmitter.
7. Perform reasonability check of transmitter housing temperature.
8. Perform reasonability check on the sensor(s) values versus an independent estimate (i.e. from direct monitoring of BPCS value) to show current reading is acceptable.
9. Restore loop to full operation.
10. Remove the bypass from the safety PLC or otherwise restore to normal operation.

### 6.5.4 Inspection

<b>Visual inspection</b>	Not required.
<b>Special tools</b>	Not required.

#### Product repair

The transmitter is repairable by major component replacement.

All failures detected by the transmitter diagnostics or by the proof-test must be reported. Feedback can be submitted electronically at [Emerson.com/Rosemount/Contact-Us](https://www.emerson.com/Rosemount/Contact-Us).

## 6.6 Specifications

The transmitter must be operated according to the functional and performance specifications provided in the Rosemount 3144P [Product Data Sheet](#).

#### Failure rate data

The FMEDA report includes failure rates and independent information on generic sensor models.

The report is available at Rosemount 3144P Temperature Transmitter [Product Page](#).

#### Failure values

Safety Deviation (defines what is dangerous in a FMEDA):

- Span  $\geq 100\text{ }^{\circ}\text{C} \pm 2\%$  of process variable span
- Span  $< 100\text{ }^{\circ}\text{C} \pm 2\text{ }^{\circ}\text{C}$

Safety response time: 5 seconds

#### Product life

50 years – based on worst case component wear-out mechanisms – not based on wear-out of process sensors.

Report any safety related product information at [Emerson.com/Rosemount/Safety/Report-A-Failure](https://emerson.com/Rosemount/Safety/Report-A-Failure).

## 6.7 Spare parts

This spare part is available for the Rosemount 3144P.

Description	Part Number
Safety Certified electronics module assembly	03144-3111-1007

# A Reference data

## A.1 Product Certifications

To view current Rosemount™ 3144P Temperature Transmitter Product Certifications, follow these steps:

### Procedure

1. Go to [Emerson.com/Rosemount/Rosemount-3144](http://Emerson.com/Rosemount/Rosemount-3144).
2. Scroll as needed to the green menu bar and click Documents & Drawings.
3. Click Manuals & Guides.
4. Select the appropriate Quick Start Guide.

## A.2 Ordering Information, Specifications, and Drawings

To view current Rosemount 3144P Temperature Transmitter Ordering Information, Specifications, and Drawings, follow these steps:

### Procedure

1. Go to [Emerson.com/Rosemount/Rosemount-3144](http://Emerson.com/Rosemount/Rosemount-3144).
2. Scroll as needed to the green menu bar and click Documents & Drawings.
3. For installation drawings, click Drawings & Schematics.
4. Select the appropriate document.

For ordering information, specifications, and dimensional drawings, click Data Sheets & Bulletins and select the appropriate Product Data Sheet.

#### Global Headquarters

Emerson Automation Solutions  
6021 Innovation Blvd.  
Shakopee, MN 55379, USA

+1 800 999 9307 or +1 952 906 8888

+1 952 204 8889

RFQ.RMD-RCC@Emerson.com

#### North America Regional Office

Emerson Automation Solutions  
8200 Market Blvd.  
Chanhassen, MN 55317, USA

+1 800 999 9307 or +1 952 906 8888

+1 952 204 8889

RMT-NA.RCCRFQ@Emerson.com

#### Latin America Regional Office

Emerson Automation Solutions  
1300 Concord Terrace, Suite 400  
Sunrise, FL 33323, USA

+1 954 846 5030

+1 954 846 5121

RFQ.RMD-RCC@Emerson.com

#### Europe Regional Office

Emerson Automation Solutions Europe  
GmbH  
Neuhofstrasse 19a P.O. Box 1046  
CH 6340 Baar  
Switzerland

+41 (0) 41 768 6111

+41 (0) 41 768 6300

RFQ.RMD-RCC@Emerson.com

#### Asia Pacific Regional Office

Emerson Automation Solutions  
1 Pandan Crescent  
Singapore 128461

+65 6777 8211

+65 6777 0947

Enquiries@AP.Emerson.com

#### Middle East and Africa Regional Office

Emerson Automation Solutions  
Emerson FZE P.O. Box 17033  
Jebel Ali Free Zone - South 2  
Dubai, United Arab Emirates

+971 4 8118100

+971 4 8865465

RFQ.RMTMEA@Emerson.com

 [Linkedin.com/company/Emerson-Automation-Solutions](https://www.linkedin.com/company/Emerson-Automation-Solutions)

 [Twitter.com/Rosemount\\_News](https://twitter.com/Rosemount_News)

 [Facebook.com/Rosemount](https://www.facebook.com/Rosemount)

 [Youtube.com/user/RosemountMeasurement](https://www.youtube.com/user/RosemountMeasurement)

©2019 Emerson. All rights reserved.

Emerson Terms and Conditions of Sale are available upon request. The Emerson logo is a trademark and service mark of Emerson Electric Co. Rosemount is a mark of one of the Emerson family of companies. All other marks are the property of their respective owners.