



LH-MPL0915
EFFECTIVE DATE SEPTEMBER 11, 2015
SUPERSEDES APRIL 8, 2013 PRICE LIST



Guaranteed Performance

100% 24 hour order processing, or 5% off the order; 100% line item fill rate, or 5% off the back-order; 100% line item order accuracy, or 5% off the error; the Legendary 5/25 product warranty; no minimum order; no case pack quantity requirement; and material may be returned with no re-stocking fees.

Legendary Customer Service

Always a human, no voice mail or automated assistance, trained customer service representatives to support you and your business always striving to achieve 100% problem resolution in one call.

Expert Engineering

A fully-functioning and staffed laboratory for product development and design; quality assurance; and product testing assuring you and your customers the best quality products.

On Demand Technical Support

Degreed engineers, master plumbers and technical advisers with decades of PVF and Hydronic experience on demand to support your business.

Comprehensive Training

Expert staff as course instructors for distributor and contractor training classes scheduled throughout the year.



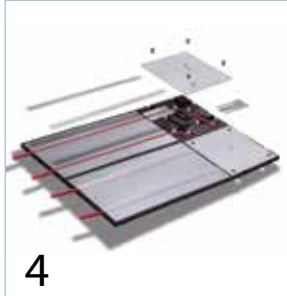

4



24



44



46



53

CONTENTS

Terms and Conditions of Sale 2

Radiant Panel Systems 3

VersaTherm™ Floor System 4

QuickTherm™ Floor System 6

Tubing Installation Accessories 7

LegendFlex™ Tubing 12

Manifolds 13

Modular Manifolds 14

Modular Manifold Components 17

Plastic Manifolds 20

Plastic Manifold Accessories 22

Precision Brass Manifolds 24

Brass Manifold Accessories 27

High Capacity Manifolds 30

High Capacity Manifold Accessories 32

Stainless Steel Manifolds 34

Stainless Steel Manifold Accessories 36

Hydronic System Components 39

Legend Connect System 40

Air & Debris Eliminator 42

Air & Debris Eliminator Accessories 43

Hydraulic Separator 44

Hydraulic Separator Accessories 45

Three-Way Mixing Valve 46

Auto-Fill Back Flow Preventor 47

Heat Exchangers 48

Zone Valves 49

Gauges 50

Solar & Geothermal 53

Geothermal Manifolds 54

Geothermal Manifold Accessories 56

Solar Pumping Stations 58

Valves & Fittings 60

Custom-Built Mechanical Panels 64

Ambiance™ Ceiling Panels 65

Radiant Panel Ordering Guide 66

Legendary 5/25 Warranty 67

TERMS AND CONDITIONS OF SALE

TERMS OF PAYMENT

2% 30 Days, Net 45

Cash discount is to be calculated on the total amount of the invoice before additions for transportation. A 1-1/2% service charge per month will be added to past due balances.

FREIGHT POLICY

Freight charges will be prepaid on orders of **\$1,500.00 net** or more (excluding radiant floor panels) to one destination in the Continental United States. All Legend products can be combined to reach freight minimum. Otherwise, freight terms are F.O.B. Auburn Hills, Michigan or Reno, Nevada. Call Legend Customer Service at 1-800-752-2082 for shipments to Alaska and Hawaii.

VersaTherm & QuickTherm FREIGHT POLICY

Freight charges will be prepaid on all orders for VersaTherm/QuickTherm of **\$2,500.00 net** or more to one destination in the Continental United States. All Legend products may be combined with the VersaTherm/QuickTherm Panels to reach the **\$2,500.00 net**. Otherwise, freight terms are F.O.B. Auburn Hills, Michigan or Reno, Nevada.

MINIMUM ORDER

Legend has no minimum order requirement.

ORDER ACCEPTANCE

All orders are subject to acceptance by Legend Valve & Fitting, Inc. Possession of our catalog or price list by any person is not to be construed as an offer to sell to that person. All prices are subject to change without notice.

Did you know?

- Legend does not have a minimum order.
- Legend ships every order in 24 hours, guaranteed or you get 5% off the order.
- Legend ships every order complete or you get 5% off the back-order.
- Legend guarantees error-free transactions or you get 5% off the error.
- Legend allows you to return non-obsolete materials without a restocking charge.
- Legend guarantees our products for 5 years or \$25.00 back.

This legendary performance can result in as many as three to four more additional inventory turns annually, significantly increasing your I.R.O.I.!



Radiant Panel Systems



**Downstream
Thinking.**

It's all about Performance.

VersaTherm™ installation in the main office area of Legends' corporate headquarters.

VersaTherm™

snap-fit floor system

The innovative VersaTherm™ floor system is unlike any dry radiant system on the market. The panels snap together in minutes saving significant labor costs. Basement and 2nd floor retrofits are easy because the panels are pre-insulated and naturally water resistant. The use of 1/2" pipe allows for greater circuit lengths and is 100% protected by metal, unlike many other dry systems. Thus, the entire surface transfers heat, reducing temperature stratification common in some systems. The panels are only 3/4" thick, minimizing construction problems common in over-pour installations.

- Labor saving – snaps together
- 1/2" pipe – for longer circuit lengths
- Tubing is protected against damage
- Return Panels are pre-insulated – great for retrofits and basements
- Naturally water resistant
- Entire surface transfers heat
- Return Panels are easily cut for tight installations
- Tube spacing is 8" on center

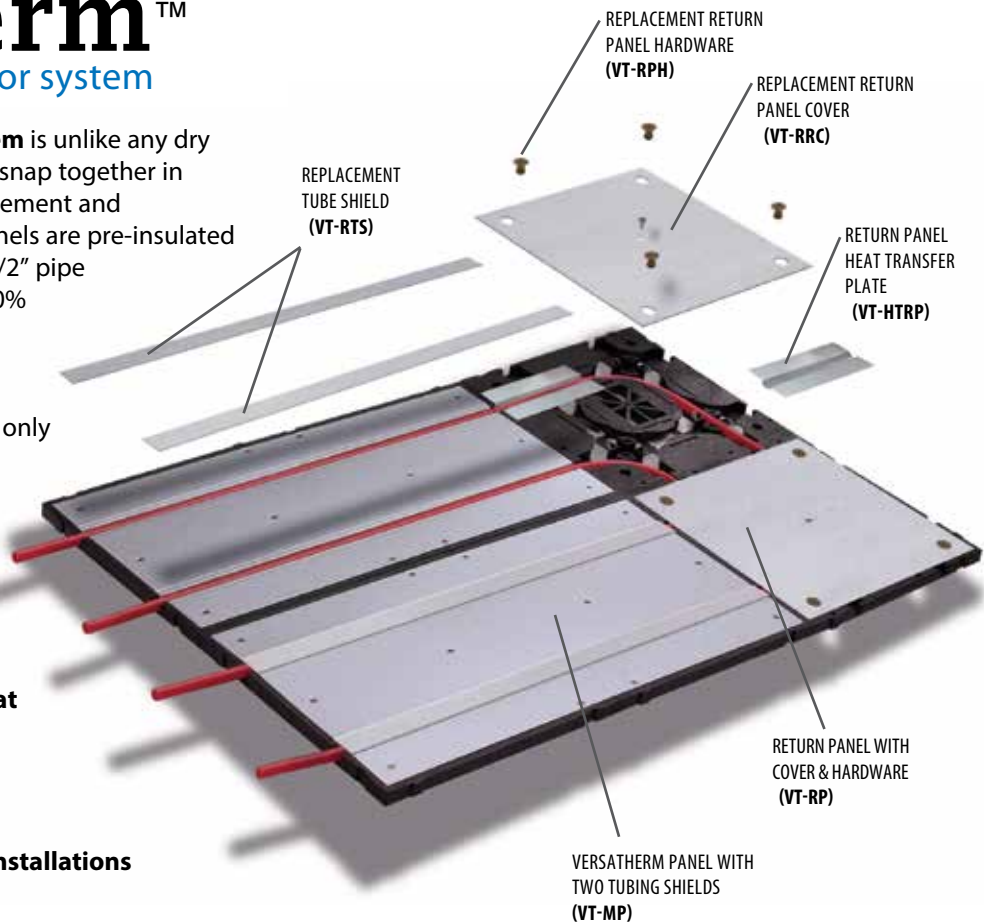

VersaTherm™ Panels

[Material worksheet on page 66](#)

Main Panels

Main Panel – Includes two Tube Shields (VT-RTS).



MAIN PANEL WITH TUBE SHIELDS*

*Actual dimensions are 31-1/2" x 15-3/4" x 3/4"

Item Number	Price	Quantity	Case
VT-MP	40.95	1	10

Return Panels

Return Panel – Includes Return Panel Cover (VT-RRC), Return Panel Hardware (VT-RPH) and Return Panel Heat Transfer Plate(s) (VT-HTRP).



RETURN PANEL WITH COVER*

*Actual dimensions are 15-3/4" x 15-3/4" x 3/4"

Item Number	Price	Quantity	Case
VT-RP	20.48	1	20

VersaTherm™ Replacement Parts and Accessories

Tube Shield

Replacement Tube Shield – Used with Main Panel to protect tubing from damage.



	Item Number	List Price	Quantity
REPLACEMENT TUBE SHIELD	VT-RTS	3.00	1

Return Panel Cover

Replacement Return Panel Cover – Used with Return Panel to protect tubing from damage.



	Item Number	List Price	Quantity
REPLACEMENT RETURN PANEL COVER	VT-RRC	16.00	1

Return Panel Hardware

Replacement Return Panel Hardware – Used to fasten Return Panel Cover.



	Item Number	List Price	Quantity
RETURN PANEL HARDWARE	VT-RPH	3.00	1

Includes 4 plastic snap rivets and 1 screw

Filler Panels

Filler Panels – Used to fill non-active space along floor edges and around obstructions.



	Item Number	List Price	Quantity
2" x 15-3/4" SMALL FILLER	VT-SM	4.00	1
7-7/8" x 15-3/4" LARGE FILLER	VT-LF	6.00	1

Non- active space can also be filled with standard 3/4" plywood

Return Panel Heat Transfer Plate

Return Panel Heat Transfer Plate – Optional plate increases heat output on Return Panel.

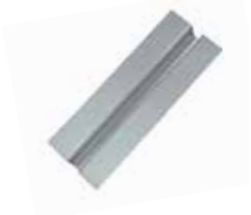

	Item Number	List Price	Quantity
RETURN PANEL HEAT TRANSFER PLATE - PAIR	VT-HTRP	3.00	2

QuickTherm™

radiant installation panels

**Lay down the QuickTherm panels,
snap in the tubing and IT'S DONE!**

QuickTherm™ panels reduce labor costs by making it easy to properly install radiant tubing. There's no need to tie, clip, or staple tubing to the substrate.

- **One person can quickly put down the panels, and install the tubing ... while walking upright!**
- **The tube is better protected than in a wire mesh install**
- **Labor saving - installs 75% faster**
- **No bending or crawling**
- **Available in R-5, R-10 or R-11 thicknesses**
- **Eliminates stapling and cable ties**
- **2' x 4' panels are more accommodating to uneven gravel base and subbase surfaces**
- **1/2", 5/8" or 3/4" radiant tubing can be used with QuickTherm**

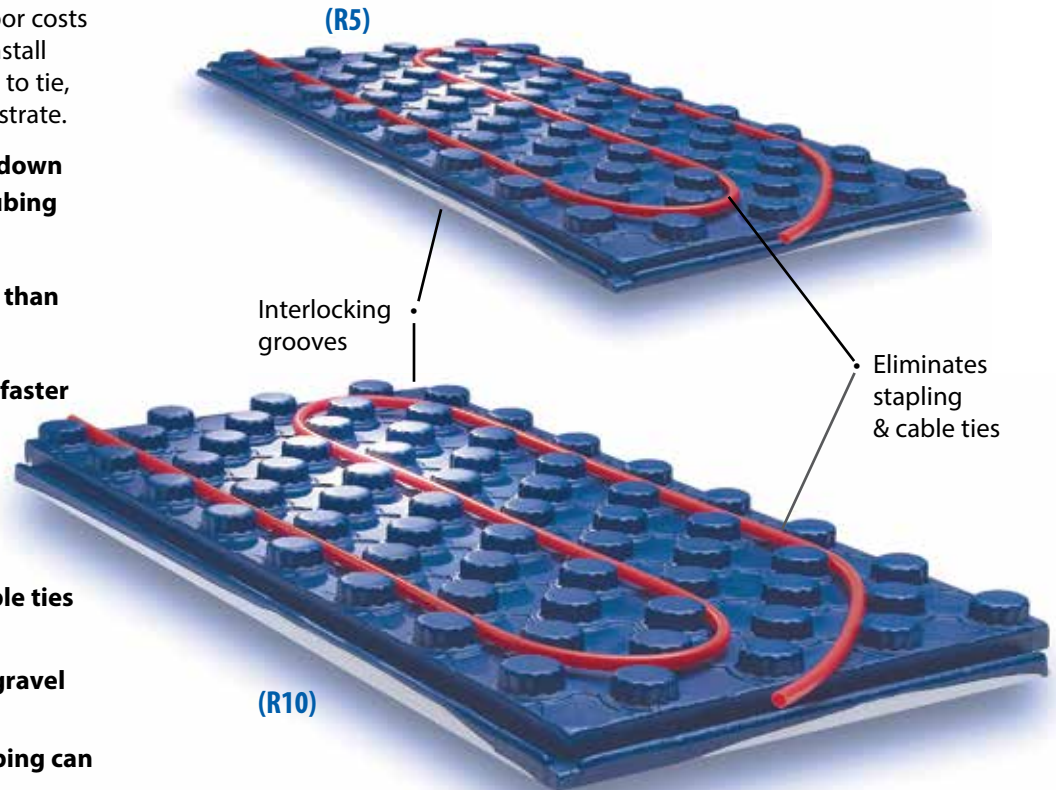

QuickTherm panels can reduce installation time by up to 75%! Install 1,000's of feet of tubing in just a few hours!

QuickTherm Panels can be drop shipped directly to the job site. Call for LTL or truck-load discount. Allow up to 3 weeks for delivery.

QuickTherm Panels

ISO-9002

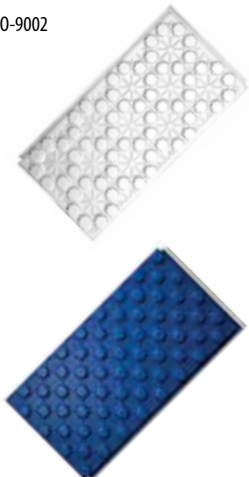

QuickTherm Radiant Installation Panels – Are 2' x 4', can be used with, 1/2", 5/8" or 3/4" radiant tubing and feature snap-tight grids with 3" on-center points for easy bends and optimal spacing of tubing.

	Item Number	List Price	Quantity	Bundle
QUICKTHERM 100 - RESIDENTIAL 1" THICK (R5) - 6" & 12" TUBE SPACING <i>Note: QuickTherm 100 is for use with 1/2" and 5/8" radiant tubing only</i>	800-QT100R			
			SPECIAL ORDER ONLY CALL FOR QUOTE	
QUICKTHERM 100 1" THICK (R5) - 6", 9", 12" TUBE SPACING	800-QT100	32.55	1	18
QUICKTHERM 200 2" THICK (R10) - 6", 9", 12" TUBE SPACING	800-QT200	38.85	1	10
QUICKTHERM 300 3" THICK (R11) - 6", 9", 12" TUBE SPACING	800-QT300			
			SPECIAL ORDER ONLY CALL FOR QUOTE	

Tubing Installation Accessories

Tube Holding Pins

Large Diameter Tube Holder Pins – Designed to be manually inserted into QuickTherm “knobs” to hold down large diameter tube (typ. 3/4”) in tough spots where additional support may be needed. Works on all sizes of tube and all models (thicknesses) of QuickTherm.

ISO-9002



TUBE HOLDER PIN - ALL TUBE SIZES FOR QT-100, QT-200 & QT-300

Item Number	List Price	Quantity / Bag
800-349	46.00	100

Tube Holding Pins

Heavy Duty Tube Holder Pins – Sturdy, high grip pins manually inserted to hold down up to 5/8” tubing in rigid foam board installations. May also be used with Tube Track, Tube Track Duo and Mounting Rail (see below).

ISO-9002



TUBE HOLDER PIN (1-1/2” LONG) - FOR PANELS 1” OR THICKER

TUBE HOLDER PIN (2” LONG) - FOR PANELS 1-1/2” OR THICKER

Item Number	List Price	Quantity / Bag
800-345	27.90	100
800-348	32.02	100

Tube Bend Support

Tube Bend Support 90° – Holds tube in a tight radius 90° bend without a fitting elbow and without fear of “kinking”. Slide support easily around 1/2” tube while straight, then make bend by clicking tabs together.



TUBE BEND SUPPORT 90° - FOR 1/2” TUBING

Item Number	List Price	Quantity
800-503	5.25	1

Tube Bend Support

Tube Bend Support 90° – Used to hold flexible tubing in a 90° bend without a fitting elbow and creates a neat, professional appearance.

ISO-9002



TUBE BEND SUPPORT 90° – FITS UP TO 1/2” TUBING

TUBE BEND SUPPORT 90° – FITS UP TO 3/4” TUBING

Item Number	List Price	Quantity
800-305	7.16	1
800-304	8.78	1

Ideal for transitioning tubing to and from wall mounted manifolds. Protects tubing at this vulnerable location.

Protection Sleeve

Tube Protection Sleeve – Used to protect tubing in a concrete slab at expansion joints. Pre-slit 12” lengths allow for rapid installation after tubing has been installed and before concrete pour.



TUBE PROTECTION SLEEVE 12” – FITS UP TO 1/2” TUBING

TUBE PROTECTION SLEEVE 12” – FITS UP TO 3/4” TUBING

Item Number	List Price	Quantity
800-313	1.54	1
800-314	1.82	1

Tubing Installation Accessories (continued)

Heat Transfer Plates - Joist Space



Extruded Aluminum Heat Transfer Plates – For use in radiant floor heating via joist space applications (under sub-floor) with 3/8" or 1/2" PEX tubing. Plates are 3-1/2" x 4' long and pre-drilled for wood screws to attach underneath sub-floor. PEX tubing is held securely in tube channel on under side of plate.

	Item Number	List Price	Quantity	Case
HEAT TRANSFER PLATE – 3/8" PEX TUBING	800-362	16.50	1	20
HEAT TRANSFER PLATE – 1/2" PEX TUBING	800-364	17.50	1	20

Maximize floor output and simplify normally labor intensive joist space installations (3-1/2" x 4' long).

Tube Track



Tube Track & Tube Track Duo – Used to hold tubing to rigid foam, wood or concrete. Mounting holes are provided for appropriate fasteners. Clips at end of each piece allow 3-1/4' (39") sections to snap together. Use tube holding pins (top) in rigid foam board installations.

	Item Number	List Price	Quantity
TUBE TRACK – 39" LENGTH <i>Holding tabs for 3/8" or 1/2" tubing are spaced every 2".</i>	800-323	7.87	1
TUBE TRACK DUO – 39" LENGTH <i>Holding tabs for 3/8" or 1/2" and for 5/8" or 3/4" tubing alternate every 4".</i>	800-324	9.14	1

Mounting Rail



Tube Mounting Rail – Used to hold tubing to rigid foam, wood or concrete. Mounting holes are provided for appropriate fasteners. 6-1/2' (78") rails have prescored "break" lines should shorter lengths be needed.

	Item Number	List Price	Quantity
1/2" TUBE MOUNTING RAIL – 78" LENGTH	800-333	12.39	1
3/4" TUBE MOUNTING RAIL – 78" LENGTH <i>Holding slots are spaced every 2". Note: Use tube holding pins (top) in rigid foam board installations.</i>	800-334	14.14	1

Tube Cutters



Tube Cutters - High quality plastic tube cutters for PEX, CPVC and PVC tubing. Includes 1 replacement blade.

	Item Number	List Price	Quantity
TUBE CUTTER - PEX TUBING UP TO 2"	800-250	30.00	1
REPLACEMENT BLADE FOR TUBE CUTTER	800-252	15.00	1
TUBE CUTTER (RATCHETING) - CPVC & PVC TUBING UP TO 1-1/2"	800-251	70.00	1
REPLACEMENT BLADE FOR TUBE CUTTER RATCHETING	800-253	20.00	1

SnappRAIL™



SnappRAIL™ Clip Holders can be attached to the surface individually with a screw or nail (not included); or attach several in a row to clip holder Rail (**800-500**) with adapter (**800-501**). Clip holders can quickly and easily secure either flexible tubing (PEX or PERT) or rigid copper tubing by pushing the tube into the mounted clip holder Rail. Removal of the tubing, if necessary, is easy without damage to either the tubing or the clip holder.

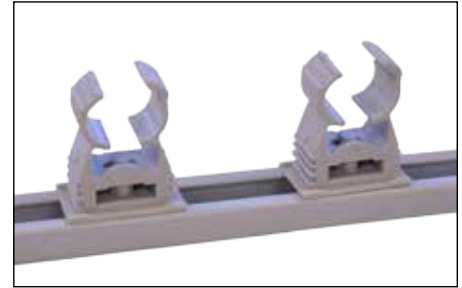

Clip Tube Holders

SnappRAIL™ Clip Holders attach to clip holder rail with adapter (**800-501**). May also be fastened to joist or stud individually without rail.

ISO-9002



	Item Number	List Price	Quantity/Bag
CLIP TUBE HOLDER (3/8" TUBING)	800-352	1.09	1
CLIP TUBE HOLDER (1/2" TUBING)	800-353	1.09	1
CLIP TUBE HOLDER (5/8" TUBING)	800-351	1.21	1
CLIP TUBE HOLDER (3/4" TUBING)	800-354	1.52	1
CLIP TUBE HOLDER (1" TUBING)	800-355	1.93	1
CLIP TUBE HOLDER (1-1/4" TUBING)	800-356	3.39	1

Clip Holder Rail

Clip Holder Rail

ISO-9002



	Item Number	List Price	Quantity/Bag
CLIP HOLDER RAIL (3-1/4")	800-500	17.00	1

Clip Holder Adapter

Clip Holder Rail Adapters

ISO-9002



	Item Number	List Price	Quantity/Bag
CLIP HOLDER RAIL ADAPTER <i>Holds Clip Tube Holders</i>	800-501	2.30	1

Tubing Installation Accessories (continued)

Tube Talon Fasteners

Tube Talon Fasteners – Plastic talon hook with nail included; secures tubing to wood surfaces. Ideal for neatly routing and attaching PEX manifold distribution tubing to floor joist or wall studs. Designed for copper tube sized (CTS) 1/2", 3/4" or 1" tubing.



	Item Number	List Price	Quantity /Bag
1/2" TUBE TALON	800-373	14.00	100
3/4" TUBE TALON	800-374	18.00	100
1" TUBE TALON	800-375	27.00	100

New

Tube Isolation Clamps

Tube Isolation Clamps - Plastic tube fastener for isolating flexible tube as it passes through building floor joists and wall studs. Protects the tubing from coming in contact with sharp or hard surfaces that may damage or prematurely wear against the outer diameter. Ideal for routing tube used in plumbing, hydronic distribution and joist space radiant heating applications. Includes two pre-drilled screw holes and available for CTS 1/2", 3/4" or 1" tubing.



	Item Number	List Price	Quantity/Bag
1/2" TUBE ISOLATION CLAMP	800-513	18.00	100
3/4" TUBE ISOLATION CLAMP	800-514	20.00	100
1" TUBE ISOLATION CLAMP	800-515	32.00	100

New

Standard Tube Clamps

Standard Tube Clamps – Plastic tube fastener for securing flexible tube to solid surfaces, typically building floor joists or wall studs. Protects and helps keep tubing straight when routing in plumbing and hydronic distribution applications. Split design allows clamp to be wrapped around tube, in place and secured with two pre-drilled screw holes. Available for CTS 1/2", 3/4" or 1" tubing.



	Item Number	List Price	Quantity /Bag
1/2" STANDARD TUBE CLAMP	800-523	18.00	100
3/4" STANDARD TUBE CLAMP	800-524	20.00	100
1" STANDARD TUBE CLAMP	800-525	27.00	100

ST-100 Up-Right Tube Installation Staple Tool

The ST-100 Up-Right Hand Staple Tool is for installing radiant tube in concrete slab applications.

Long handle allows installer to easily staple down flexible radiant tube to rigid foam insulation while walking up-right. Very easy to use tool minimizes installation time and uses very few working mechanisms so that staple jams are virtually eliminated. Extruded polystyrene foam board insulation used under concrete slabs is recommended. Magazines of 30 staples (25 staples for 1-1/2" length) easily load and feed through staple tool via gravity with metal weight. Staples are available in 3 lengths to accommodate combinations of different size tubing (3/8", 1/2", 5/8" and 3/4") and thicknesses of ridged foam board insulation as noted.



KEY FEATURES AT A GLANCE

- Easy to use & reduces labor
- New & simple design virtually eliminates staple jams
- Easy to load staple magazines
- Staples available in three sizes

New Tube Installation Stapler Tool

Tube installation Staple tool- upright hand Staple tool for installing different sizes of tubing into EPS foam board.



PLASTIC STAPLE FOR RIGID FOAM (1-3/8" LONG) – HOLDS UP TO 1/2" TUBE WITH MIN 1/2" THICK BOARD

Item number	List Price	Quantity / Bag
800-340	819.45	1



PLASTIC STAPLE FOR RIGID FOAM (1-1/2" LONG) – HOLDS UP TO 5/8" TUBE WITH MIN 1" THICK BOARD

800-340-34	8.20	30 PER MAGAZINE
------------	------	-----------------

800-340-40	5.84	25 PER MAGAZINE
------------	------	-----------------



PLASTIC STAPLE FOR RIGID FOAM (2-1/8" LONG) – HOLDS UP TO 3/4" TUBE WITH MIN 2" THICK BOARD

800-340-55	8.48	30 PER MAGAZINE
------------	------	-----------------

LEGEND Flex™ Highly flexible PEX heating tube with oxygen barrier

Manufactured from a proprietary polymer formulation which dramatically increases flexibility and maintains high strength.

Available in 3/8", 1/2", 5/8", 3/4" and 1" tube sizes. LegendFlex™ delivers greater performance and flexibility than standard PEX. We are so confident in its performance we back it with a **30 year warranty**.

LegendFlex is extremely flexible and very difficult to kink. In the unlikely event one should occur, simply repair it with a heat gun. No need to cut and use a coupling or replace the tubing.

LegendFlex tubing is also compatible with cold expansion type fitting systems (compliant with standards ASTM F2080 & ASTM F1960). Its strength, durability and thermal memory enables proper seal with crimp or expansion style connections.

Residential, commercial and industrial applications include:

- Radiant Heating and Cooling
- Snow & Ice Melt
- GeoThermal
- Turf Conditioning

PROPERTY:	VALUE:
Density	58.6 lb/ft ³
Thermal conductivity	0.22 Btu ft/h ft ² °F
Coefficient of linear expansion	1.2 in. per 100 ft. per 10 °F
Modulus of elasticity	78,300 PSI
Oxygen permeation	< 0.1 grams/m ³ /day
Bend radius	< 5x tubing outside diameter

Meets the requirements of ASTM F876 and F877



The externally-extruded EVOH oxygen barrier reduces oxygen molecule permeation into the water. Compliant with standard DIN4726(<0.1 grams/m³/day)

Heating Tube LegendFlex™ Heating Tube – Highly flexible PEX with oxygen barrier. Provides excellent flexibility and thermal memory for easy installation.



Size	Description	Weight (lbs)	Capacity (size –gal./ft.)	Item Number	List Price
3/8"	PEX TUBING WITH OXYGEN BARRIER - 500 FEET	20	3/8" – 0.0051	850-125	375.00
3/8"	PEX TUBING WITH OXYGEN BARRIER - 1000 FEET	40		850-129	750.00
1/2"	PEX TUBING WITH OXYGEN BARRIER - 300 FEET	15	1/2" – 0.0096	850-133	240.00
1/2"	PEX TUBING WITH OXYGEN BARRIER - 500 FEET	25		850-135	400.00
1/2"	PEX TUBING WITH OXYGEN BARRIER - 1000 FEET	50		850-139	800.00
5/8"	PEX TUBING WITH OXYGEN BARRIER - 400 FEET	28	5/8" – 0.0138	850-144	400.00
5/8"	PEX TUBING WITH OXYGEN BARRIER - 1000 FEET	70		850-149	1000.00
3/4"	PEX TUBING WITH OXYGEN BARRIER - 100 FEET	10	3/4" – 0.0189	850-151	131.84
3/4"	PEX TUBING WITH OXYGEN BARRIER - 500 FEET	50		850-155	659.20
3/4"	PEX TUBING WITH OXYGEN BARRIER - 1000 FEET	100		850-159	1280.00
1"	PEX TUBING WITH OXYGEN BARRIER - 100 FEET	16	1" – 0.0312	850-161	253.00
1"	PEX TUBING WITH OXYGEN BARRIER - 500 FEET	80		850-165	1265.00

Manifolds

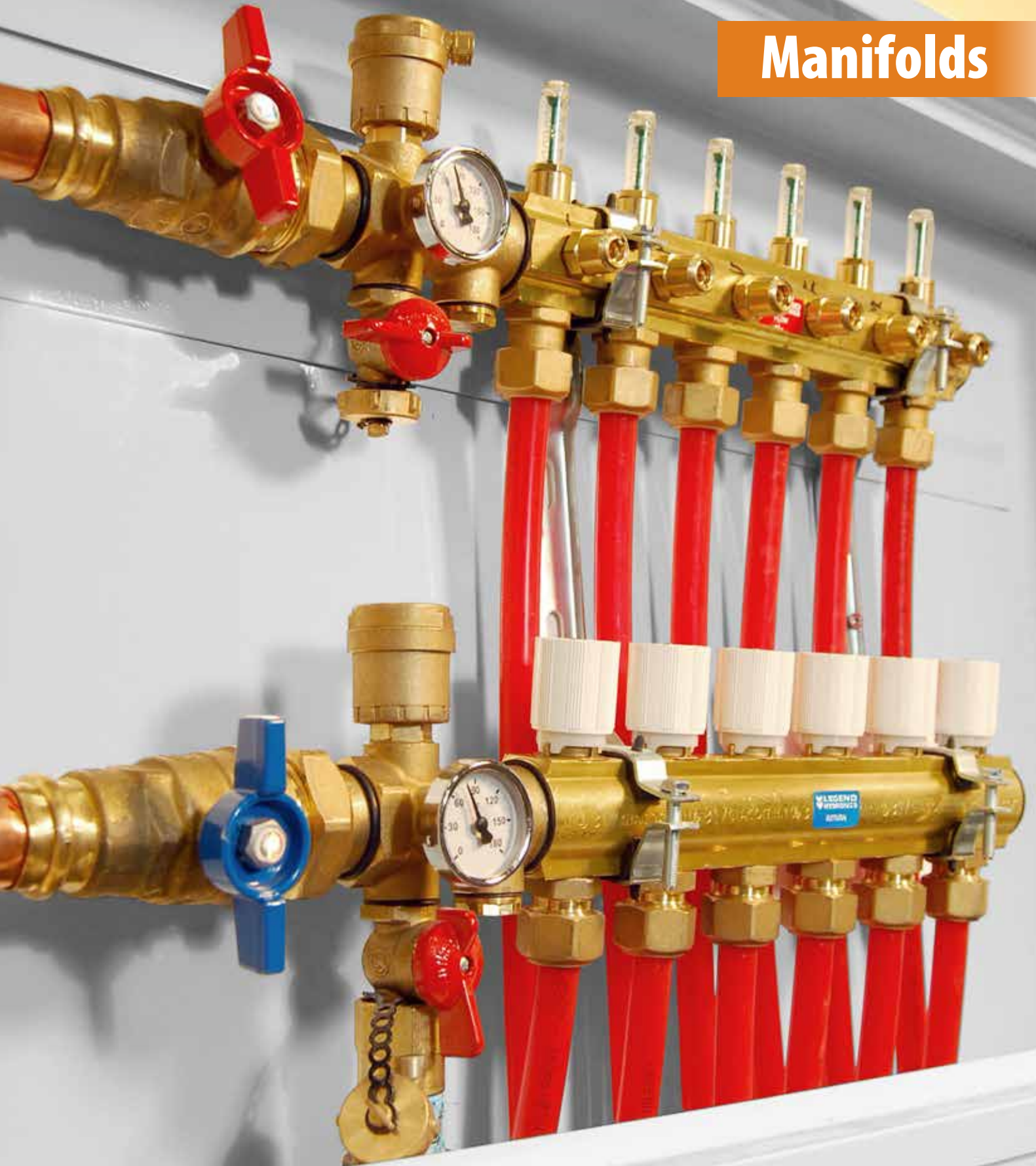

**Downstream
Thinking.**

It's all about Performance®

Legend's M-8200SP "LegendPress™" Manifold System installed in our Auburn Hills, MI headquarters.

M-8000

MODULAR™

2 ends can be combined with as many as 12 additional Expansions for up to 14 circuits

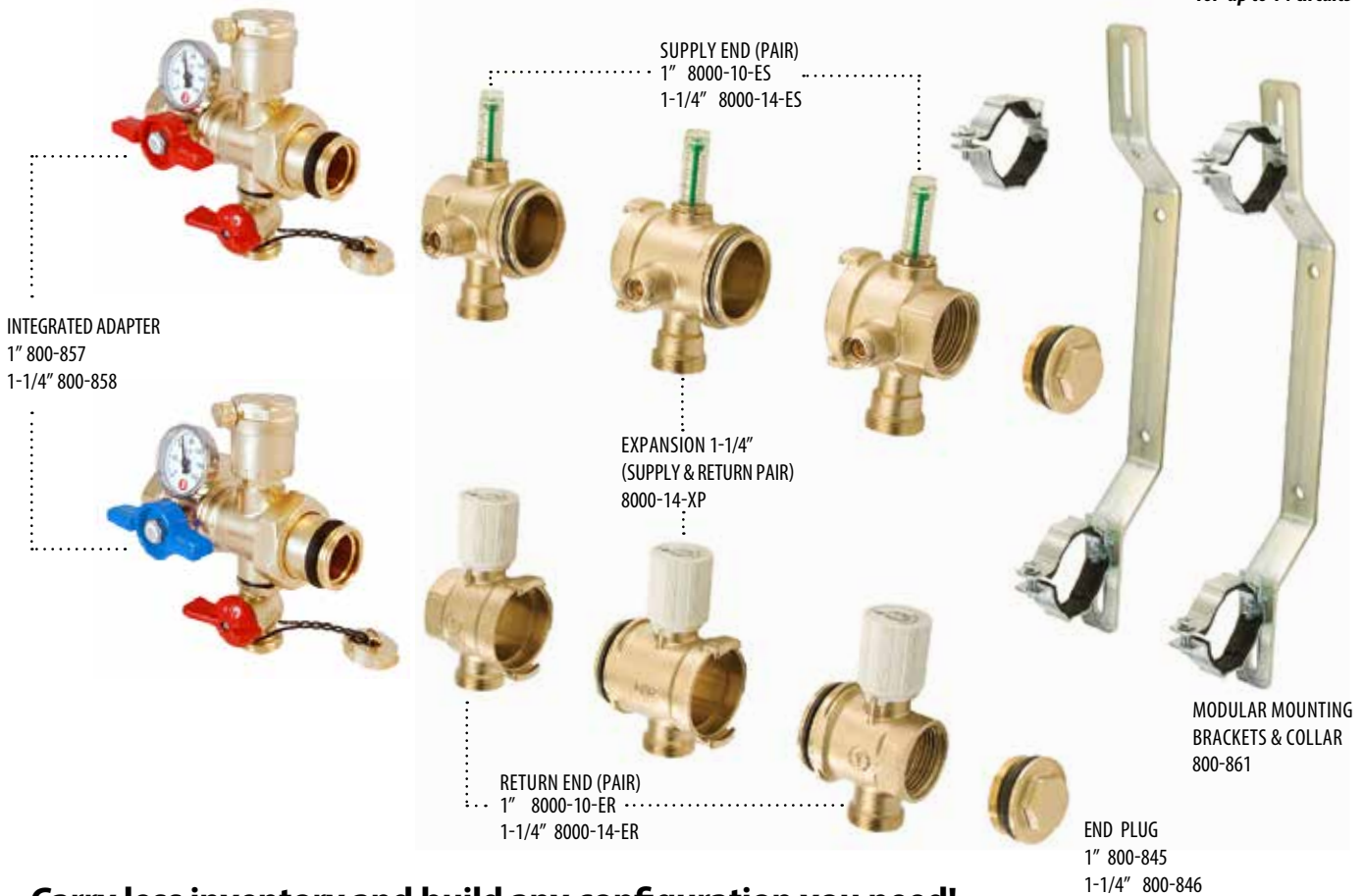

Carry less inventory and build any configuration you need!

The M-8000 Modular™ manifold series guarantees you'll always have the manifold you need when you need it. Precision-designed individual components can be easily customized to any solution a project requires. EPDM O-rings and CNC machining ensure **a perfect seal... guaranteed.** The M-8000 system makes on-site customization, configuration and installation a snap. By stocking a handful of interchangeable components, any manifold from 1" to 1-1/4", from 2 to 14 ports, with or without fill/purge valves can be built in minutes. Our modular system allows you to carry less inventory, yet stock exactly what you need to get the job done... **especially when requirements change on the job site.** Many components are compatible with our M-8100, M-8200 and M-8220 manifolds – making the Legend manifold family the most flexible manifold system on the market.

KEY FEATURES AT A GLANCE

- Perfect Seal – Guaranteed
- Easy to assemble – twist & turn
- Flexible circuit orientation – service loops above and below manifold
- 2 GPM flow meters
- Balancing valves with memory stop
- Optional angle isolation valves for tight installations
- Can be mounted in any orientation
- Available in 1" and 1-1/4" configurations



Manifold sections rotate 180° allowing tubing to be routed both above or below the same manifold.

M-8000 Modular™ Manifold Series Kits

1" M-8000 as Kit

ISO-9002



M-8000 Modular Basic – includes all required pieces to create basic 2-port 1" modular manifold.

KIT

1" SUPPLY END-PAIR

1" RETURN END-PAIR

1" MANIFOLD END PLUG

1" MANIFOLD ISOLATION VALVE-PAIR

MODULAR MANIFOLD MOUNTING BRACKET & COLLAR-PAIR

*MODULAR EXPANSIONS

Quantity	Item Number	List Price
	8000-10-2	303.36
1	8000-10-ES	
1	8000-10-ER	
2	800-845	
1	800-855	
1	800-861	
Order as needed (page 17)	8000-14-XP	

1" M-8000A as Kit

ISO-9002



M-8000A Modular Angle – includes all required pieces to create basic 2-port 1" modular manifold with angle isolation valve.

KIT

1" SUPPLY END-PAIR

1" RETURN END-PAIR

1" MANIFOLD END PLUG

1" MANIFOLD ANGLE ISOLATION VALVE-PAIR

MODULAR MANIFOLD MOUNTING BRACKET & COLLAR-PAIR

*MODULAR EXPANSIONS

Quantity	Item Number	List Price
	8000A-10-2	360.68
1	8000-10-ES	
1	8000-10-ER	
2	800-845	
1	800-825	
1	800-861	
Order as needed (page 17)	8000-14-XP	

1" M-8000S as Kit

ISO-9002



M-8000S Modular Press – includes all required pieces to create basic 2-port 1" modular manifold with LegendPress isolation valve.

KIT

1" SUPPLY END-PAIR

1" RETURN END-PAIR

1" MANIFOLD END PLUG

1" LEGENDPRESS MANIFOLD ISOLATION VALVE-PAIR

MODULAR MANIFOLD MOUNTING BRACKET & COLLAR-PAIR

*MODULAR EXPANSIONS

Quantity	Item Number	List Price
	8000S-10-2	331.88
1	8000-10-ES	
1	8000-10-ER	
2	800-845	
1	800-865	
1	800-861	
Order as needed (page 17)	8000-14-XP	

1" M-8000T as Kit

ISO-9002



M-8000T Modular-T – includes all required pieces to create basic 2-port 1" modular manifold with thermometer.

KIT

1" SUPPLY END-PAIR

1" RETURN END-PAIR

1" MANIFOLD END PLUG

1" MANIFOLD ISOLATION VALVE WITH THERMOMETER-PAIR

MODULAR MANIFOLD MOUNTING BRACKET & COLLAR-PAIR

*MODULAR EXPANSIONS

Quantity	Item Number	List Price
	8000T-10-2	360.68
1	8000-10-ES	
1	8000-10-ER	
2	800-845	
1	800-855T	
1	800-861	
Order as needed (page 17)	8000-14-XP	

M-8000 Modular™ Manifold Series Kits (cont.)

1" M-8000P as Kit

ISO-9002



M-8000P Modular Pro – includes all required pieces to create basic 2-port 1" modular manifold with integrated adapter valve.

	Quantity	Item Number	List Price
KIT		8000P-10-2	466.68
1" SUPPLY END-PAIR	1	8000-10-ES	
1" RETURN END-PAIR	1	8000-10-ER	
1" MANIFOLD END PLUG	2	800-845	
1" INTEGRATED MANIFOLD ADAPTER VALVE-PAIR	1	800-857	
MODULAR MANIFOLD MOUNTING BRACKET & COLLAR-PAIR	1	800-861	
*MODULAR EXPANSIONS	Order as needed (page 17)	8000-14-XP	

1" M-8000AP as Kit

ISO-9002



M-8000AP Modular Angle-Pro – includes all required pieces to create basic 2-port 1" modular manifold.

	Quantity	Item Number	List Price
KIT		8000AP-10-2	459.90
1" SUPPLY END-PAIR	1	8000-10-ES	
1" RETURN END-PAIR	1	8000-10-ER	
1" MANIFOLD END PLUG	2	800-845	
1" MANIFOLD ISOLATION VALVE-PAIR	1	800-855	
1" PRECISION ADAPTER	1	800-805	
MODULAR MANIFOLD MOUNTING BRACKET & COLLAR-PAIR	1	800-861	
*MODULAR EXPANSIONS	Order as needed (page 17)	8000-10-XP	

1" M-8000SP as Kit

ISO-9002



M-8000SP Modular Press-Pro – includes all required pieces to create basic 2-port 1" modular manifold with LegendPress isolation valve.

	Quantity	Item Number	List Price
KIT		8000SP-10-2	488.42
1" SUPPLY END-PAIR	1	8000-10-ES	
1" RETURN END-PAIR	1	8000-10-ER	
1" MANIFOLD END PLUG	2	800-845	
1" LEGEND PRESS MANIFOLD ISOLATION VALVE-PAIR	1	800-865	
1" PRECISION ADAPTER	1	800-805	
MODULAR MANIFOLD MOUNTING BRACKET & COLLAR-PAIR	1	800-861	
*MODULAR EXPANSIONS	Order as needed (page 17)	8000-10-XP	

1-1/4" M-8000P as Kit

ISO-9002



M-8000P 1-1/4" Modular Pro – includes all required pieces to create basic 2-port 1-1/4" modular manifold with thermometer.

	Quantity	Item Number	List Price
KIT		8000P-14-2	545.24
1-1/4" SUPPLY END-PAIR	1	8000-14-ES	
1-1/4" RETURN END-PAIR	1	8000-14-ER	
1-1/4" MANIFOLD END PLUG	2	800-846	
1-1/4" INTEGRATED ADAPTER	1	800-858	
MODULAR MANIFOLD MOUNTING BRACKET & COLLAR-PAIR	1	800-861	
*MODULAR EXPANSIONS	Order as needed (page 17)	8000-14-XP	

M-8000 Modular™ Components

M-8000 Supply & Return Expansions

Supply and Return Expansion Pair – Order expansion quantities as required for headers with more than 2 circuits

SUPPLY & RETURN EXPANSION-PAIR	8000-14-XP	66.86
--------------------------------	------------	-------

M-8000 Components

Supply and Return Expansions

ISO-9002



	Item Number	List Price
1" MODULAR SUPPLY END - MATCHING PAIR	8000-10-ES	66.85
1-1/4" MODULAR SUPPLY END - MATCHING PAIR	8000-14-ES	71.10
1" MODULAR RETURN END - MATCHING PAIR	8000-10-ER	66.85
1-1/4" MODULAR RETURN END - MATCHING PAIR	8000-14-ER	71.10
*1-1/4" MODULAR SUPPLY AND RETURN EXPANSION - MATCHING PAIR ¹	8000-14-XP	66.86
1-1/4" MODULAR RETURN EXPANSION ¹	8000-14-MR	33.43
1-1/4" MODULAR SUPPLY EXPANSION ¹	8000-14-MS	33.43

Note: End sections ship in matching right and left pairs. Request both Supply & Return End pairs when completing a modular manifold. Order expansion quantities as required for headers with more than 2 circuits.

End Plug w/Gasket

Brass Manifold End Plug – To close and seal manifold end.

ISO-9002



	Item Number	List Price
1" MANIFOLD END PLUG	800-845	6.49
1-1/4" MANIFOLD END PLUG	800-846	9.02

Note: Plugs do not ship in pairs. Order 2 to complete a modular manifold.

Isolation Valve

Isolation Valves

ISO-9002



	Item Number	List Price
1" MANIFOLD ISOLATION VALVE - MATCHING PAIR	800-855	116.88
1" MANIFOLD ISOLATION VALVE - BLUE HANDLE	800-855B	58.34
1" MANIFOLD ISOLATION VALVE - RED HANDLE	800-855R	58.34
1-1/4" MANIFOLD ISOLATION VALVE - MATCHING PAIR	800-856	164.88
1-1/4" MANIFOLD ISOLATION VALVE - BLUE HANDLE	800-856B	82.44
1-1/4" MANIFOLD ISOLATION VALVE - RED HANDLE	800-856R	82.44

Note: Also used as loop isolation valve on M-8220 High Capacity™ and GeoGreen™ series manifolds.

M-8000 Modular™ Components

Mounting Brackets

Mounting brackets – For M-8000 Manifolds.

ISO-9002



MODULAR MANIFOLD MOUNTING BRACKET & COLLAR - PAIR

Item Number
800-861

List Price
40.00

Isolation Valve

Isolation Valves with Thermometer – For M-8000, M-8100 and M-8200 manifolds, also used as loop isolation valve on M-8220 high capacity manifolds. Sold as red and blue handled pairs.

ISO-9002



1" MANIFOLD ISOLATION VALVE WITH THERMOMETER-PAIR

Item Number
800-855T

List Price
174.00

1-1/4" MANIFOLD ISOLATION VALVE WITH THERMOMETER-PAIR

800-856T

216.30

Notes: Also used as loop isolation valve on M-8220 High Capacity™ and GeoGreen™ series manifolds.

Integrated Adapter Valve

Integrated Adapter Valves – Includes garden hose thread fill & purge, air vent, thermometer, isolation valve and sensor port, all in one unit.



1" INTEGRATED MANIFOLD ADAPTER VALVE – PAIR

Item Number
800-857

List Price
280.00

1-1/4" INTEGRATED MANIFOLD ADAPTER VALVE – PAIR

800-858

345.00

Precision Adapter

Precision Adapters – Includes garden hose thread fill & purge, air vent and thermometer.

ISO-9002



1" MANIFOLD PRECISION ADAPTER-PAIR

Item Number
800-805

List Price
156.54

1-1/4" MANIFOLD PRECISION ADAPTER-PAIR

800-806

171.42

Angle Isolation Valve

ISO-9002



Angle Isolation Valves – For M-8000, M-8100 and M-8200 manifolds. Used for low profile installations when supply & return piping feeds from the ceiling or floor. Includes offset adapter to properly align vertical piping.

1" MANIFOLD ANGLE ISOLATION VALVE-PAIR

Item Number	List Price
800-825	174.00

**LegendPress™
 Isolation Valve**

ISO-9002



LegendPress Isolation Valves –LegendPress style isolation valves feature two EPDM O-Rings and deep sockets to ensure a perfect seal with every press.

1" LEGENDPRESS MANIFOLD ISOLATION VALVE-PAIR

1-1/4" LEGENDPRESS MANIFOLD ISOLATION VALVE-PAIR

Item Number	List Price
800-865	145.20
800-866	207.50

M-8100

ENGINEERED PLASTIC



KEY FEATURES AT A GLANCE

- Manufactured from advanced & polymer – strong and very durable yet lightweight
- Pre-assembled for easy installation
- Field expandable allowing easy adaptability to project changes
- Variety of connection options—threaded, LegendPress™, angle, built-in thermometers, compression and F1960 cold expansion style
- Built-in loop isolation, balancing and flow meters (0 to 2 GPM) for easy set-up and optimization

The “all-in-one” manifold - light weight, yet durable. Pre-assembled, yet easily adaptable!

The M-8100 Engineered Plastic manifold provides many solutions in this superbly designed series. It is manufactured from a high-performance, lightweight polymer that is durable and strong. It can withstand pressures and temperatures well beyond what is needed for even the most demanding radiant heating or cooling project. The M-8100 manifold is shipped pre-assembled and mounted on brackets so it's ready to be installed out of the box. Plus, its circuit loop "add-on" capability allows for convenient adaptability to accommodate project changes. The variety of available kits, accessories, and options provide for optimal flexibility.



M-8100 Engineered Plastic Pro Manifold

M-8100P

ISO-9002



M-8100P EP Pro – Includes integrated adapter valve with garden hose thread fill & purge valve, automatic air vent, thermometer, isolation valve and sensor port all in one unit.

	Item Number	List Price
2 PORT – 1" EP PRO MANIFOLD WITH INTEGRATED ADAPTER VALVE	8100P-10-2	350.00
3 PORT – 1" EP PRO MANIFOLD WITH INTEGRATED ADAPTER VALVE	8100P-10-3	392.00
4 PORT – 1" EP PRO MANIFOLD WITH INTEGRATED ADAPTER VALVE	8100P-10-4	448.00
5 PORT – 1" EP PRO MANIFOLD WITH INTEGRATED ADAPTER VALVE	8100P-10-5	504.00
6 PORT – 1" EP PRO MANIFOLD WITH INTEGRATED ADAPTER VALVE	8100P-10-6	561.00
7 PORT – 1" EP PRO MANIFOLD WITH INTEGRATED ADAPTER VALVE	8100P-10-7	619.00
8 PORT – 1" EP PRO MANIFOLD WITH INTEGRATED ADAPTER VALVE	8100P-10-8	681.00
9 PORT – 1" EP PRO MANIFOLD WITH INTEGRATED ADAPTER VALVE	8100P-10-9	752.00
10 PORT – 1" EP PRO MANIFOLD WITH INTEGRATED ADAPTER VALVE	8100P-10-10	769.00
11 PORT – 1" EP PRO MANIFOLD WITH INTEGRATED ADAPTER VALVE	8100P-10-11	841.00
12 PORT – 1" EP PRO MANIFOLD WITH INTEGRATED ADAPTER VALVE	8100P-10-12	911.00

M-8100 Engineered Plastic Angle Manifold

M-8100A

ISO-9002



M-8100A EP Angle – Includes angle isolation valves with offset adapter for vertical piping applications, and ships loosely pre-assembled ready to install.

	Item Number	List Price
2 PORT – 1" EP ANGLE MANIFOLD WITH ANGLE ISOLATION VALVE	8100A-10-2	280.00
3 PORT – 1" EP ANGLE MANIFOLD WITH ANGLE ISOLATION VALVE	8100A-10-3	325.00
4 PORT – 1" EP ANGLE MANIFOLD WITH ANGLE ISOLATION VALVE	8100A-10-4	372.00
5 PORT – 1" EP ANGLE MANIFOLD WITH ANGLE ISOLATION VALVE	8100A-10-5	422.00
6 PORT – 1" EP ANGLE MANIFOLD WITH ANGLE ISOLATION VALVE	8100A-10-6	480.00
7 PORT – 1" EP ANGLE MANIFOLD WITH ANGLE ISOLATION VALVE	8100A-10-7	535.00
8 PORT – 1" EP ANGLE MANIFOLD WITH ANGLE ISOLATION VALVE	8100A-10-8	589.00
9 PORT – 1" EP ANGLE MANIFOLD WITH ANGLE ISOLATION VALVE	8100A-10-9	659.00
10 PORT – 1" EP ANGLE MANIFOLD WITH ANGLE ISOLATION VALVE	8100A-10-10	735.00
11 PORT – 1" EP ANGLE MANIFOLD WITH ANGLE ISOLATION VALVE	8100A-10-11	802.00
12 PORT – 1" EP ANGLE MANIFOLD WITH ANGLE ISOLATION VALVE	8100A-10-12	870.00

M-8100 Engineered Plastic Basic Manifold

M-8100

ISO-9002



M-8100 EP Basic Manifold – Includes threaded (FNPT) isolation valves, and ships loosely pre-assembled ready to install.

	Item Number	List Price
2 PORT – 1" EP BASIC MANIFOLD WITH ISOLATION VALVE	8100-10-2	245.00
3 PORT – 1" EP BASIC MANIFOLD WITH ISOLATION VALVE	8100-10-3	295.00
4 PORT – 1" EP BASIC MANIFOLD WITH ISOLATION VALVE	8100-10-4	344.00
5 PORT – 1" EP BASIC MANIFOLD WITH ISOLATION VALVE	8100-10-5	390.00
6 PORT – 1" EP BASIC MANIFOLD WITH ISOLATION VALVE	8100-10-6	444.00
7 PORT – 1" EP BASIC MANIFOLD WITH ISOLATION VALVE	8100-10-7	495.00
8 PORT – 1" EP BASIC MANIFOLD WITH ISOLATION VALVE	8100-10-8	545.00
9 PORT – 1" EP BASIC MANIFOLD WITH ISOLATION VALVE	8100-10-9	610.00
10 PORT – 1" EP BASIC MANIFOLD WITH ISOLATION VALVE	8100-10-10	680.00
11 PORT – 1" EP BASIC MANIFOLD WITH ISOLATION VALVE	8100-10-11	742.00
12 PORT – 1" EP BASIC MANIFOLD WITH ISOLATION VALVE	8100-10-12	805.00

M-8100 Engineered Plastic Components

Header Isolation Valve Connector

EP Header Isolation Valve Connector – For both supply and return to allow connection of header isolation valves. Includes large header C-clip, double O-ring and spacer ring.



EP HEADER ISOLATION VALVE CONNECTOR – PAIR

Item Number
810-105

List Price
40.00

End Plug

EP End Plug – For both supply and return, to close and seal manifold headers. Includes large header C-clip, double O-ring and spacer ring.



EP END PLUG – PAIR

Item Number
810-102

List Price
35.00

Expansion

EP Expansion – Includes one each for both supply and return. Add as necessary to End Plug and Header Isolation Valve Connector to provide circuit loops to the manifold assembly. Includes large C-clip, double O-ring and spacer ring.



EP EXPANSION - PAIR

Item Number
8100-10-XP

List Price
75.00

Manifold Mounting Bracket & Collar

Manifold Mounting Bracket & Collar – For M-8100 Manifolds, adjustable height / distance between headers.



EP MANIFOLD MOUNTING BRACKET & COLLAR - PAIR

Item Number
810-100

List Price
35.00

M-8100 Engineered Plastic Components

PTFE Header Connector

EP PTFE Header Connector – Allows connection of brass isolation valves to manifold headers, both supply and return. Required for isolation valves with or without thermometers, Angle and LegendPress™ configurations.



	Item Number	List Price
EP PTFE HEADER CONNECTOR – PAIR	810-106	30.28

Brass Bushing

EP Brass Bushing – Allows connection of brass Angle Isolation Valve Offset Adapter and Precision Adapter to manifold headers, as needed.



	Item Number	List Price
EP BRASS BUSHING - EACH	810-107	8.34

Large Header C-Clip

EP Large Header C-Clip– Replacement C-clips for securing Header Isolation Valve Connectors, End Plugs and expansion pieces together.



	Item Number	List Price	Quantity / Bag
EP LARGE HEADER C-CLIP - PAIR	810-103	45.00	10

Tube Connector C-Clip

EP Tube Connector C-Clip – Replacement C-clips for securing brass port connections to manifold headers, both supply and return.



	Item Number	List Price	Quantity / Bag
EP TUBE CONNECTOR C-CLIP - PAIR	810-104	20.00	10

PEX Connectors

PEX Tube Connectors – for M-8100EP Manifold only.



	Item Number	List Price
3/8" PEX TO EP MANIFOLD CONNECTOR-PAIR	810-142EP	28.00
1/2" PEX TO EP MANIFOLD CONNECTOR-PAIR	810-143EP	20.00
5/8" PEX TO EP MANIFOLD CONNECTOR-PAIR	810-144EP	21.00
3/4" PEX TO EP MANIFOLD CONNECTOR-PAIR	810-145EP	45.00

Not for use with PEX-AL-PEX Tube

3/4" CONNECTOR

M-8200

PRECISION™



The M-8200 Precision™ manifold is fully loaded with the features and benefits required for high performance. Flow metering and balancing are built-in, and there is unlimited flexibility in positioning the manifold in any direction. The unique “Integrated Adapter” combines isolation, temperature, air vent and fill & purge valves into one compact unit. Only Legend places the air vent in-line with the water flow removing more air than typical end mount installations. Many components are compatible with our M-8000, M-8100 and M-8220 manifolds – making the Legend manifold series the most flexible manifold system on the market.

KEY FEATURES AT A GLANCE

- 2 GPM flow meters
- Balancing valves with memory stop
- Optional 4-wire actuators
- Manifold union available for easy circuit expansion
- Optional LegendPress™ and angle isolation valves available
- Optional compact “integrated adapter” removes more air

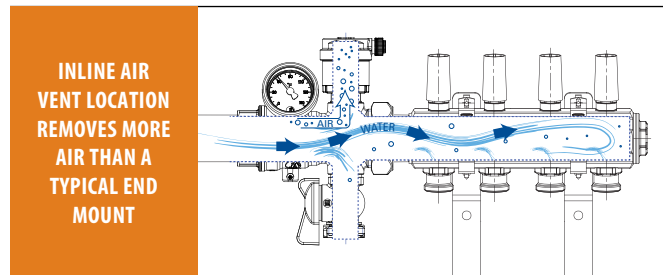

M-8200P Precision-Pro Manifold

M-8200P

M-8200P Precision-Pro Manifold – Includes integrated adapter valve with garden hose thread fill & purge valve, automatic air vent, thermometer, isolation valve and sensor port all in one unit.



1" BRASS BAR

	Item Number	List Price
2 PORT	8200P-10-2	460.00
3 PORT	8200P-10-3	546.00
4 PORT	8200P-10-4	622.00
5 PORT	8200P-10-5	673.00
6 PORT	8200P-10-6	745.00
7 PORT	8200P-10-7	821.00
8 PORT	8200P-10-8	888.00
9 PORT	8200P-10-9	966.00
10 PORT	8200P-10-10	1069.00
11 PORT	8200P-10-11	1130.00
12 PORT	8200P-10-12	1205.00

1-1/4" BRASS BAR

	Item Number	List Price
	-	-
	-	-
	8200P-14-4	710.00
	8200P-14-5	791.00
	8200P-14-6	869.00
	8200P-14-7	952.00
	8200P-14-8	1032.00
	8200P-14-9	1109.00
	8200P-14-10	1216.00
	8200P-14-11	1303.00
	8200P-14-12	1394.00

M-8200AP Precision Angle-Pro Manifold

M-8200AP

M-8200AP Precision Manifold with Angle Isolation Valve – Angle connection and isolation valve in one body allows connection of supply and distribution piping from above or below in a tight configuration.

ISO-9002



2 PORT – 1" PRECISION MANIFOLD WITH ANGLE ISOLATION VALVE	8200AP-10-2	520.00
3 PORT – 1" PRECISION MANIFOLD WITH ANGLE ISOLATION VALVE	8200AP-10-3	606.00
4 PORT – 1" PRECISION MANIFOLD WITH ANGLE ISOLATION VALVE	8200AP-10-4	671.00
5 PORT – 1" PRECISION MANIFOLD WITH ANGLE ISOLATION VALVE	8200AP-10-5	733.00
6 PORT – 1" PRECISION MANIFOLD WITH ANGLE ISOLATION VALVE	8200AP-10-6	806.00
7 PORT – 1" PRECISION MANIFOLD WITH ANGLE ISOLATION VALVE	8200AP-10-7	881.00
8 PORT – 1" PRECISION MANIFOLD WITH ANGLE ISOLATION VALVE	8200AP-10-8	948.00
9 PORT – 1" PRECISION MANIFOLD WITH ANGLE ISOLATION VALVE	8200AP-10-9	1026.00
10 PORT – 1" PRECISION MANIFOLD WITH ANGLE ISOLATION VALVE	8200AP-10-10	1120.00
11 PORT – 1" PRECISION MANIFOLD WITH ANGLE ISOLATION VALVE	8200AP-10-11	1180.00
12 PORT – 1" PRECISION MANIFOLD WITH ANGLE ISOLATION VALVE	8200AP-10-12	1266.00

Item Number	List Price
8200AP-10-2	520.00
8200AP-10-3	606.00
8200AP-10-4	671.00
8200AP-10-5	733.00
8200AP-10-6	806.00
8200AP-10-7	881.00
8200AP-10-8	948.00
8200AP-10-9	1026.00
8200AP-10-10	1120.00
8200AP-10-11	1180.00
8200AP-10-12	1266.00

M-8200SP Precision Press-Pro Manifold

M-8200SP

M-8200SP Precision Manifold with LegendPress™ – Press style isolation valves featuring two EPDM O-rings and deep sockets to ensure a perfect seal without the need for either solder or thread sealant.

ISO-9002



	1" BRASS BAR	
	Item Number	List Price
2 PORT	8200SP-10-2	490.00
3 PORT	8200SP-10-3	576.00
4 PORT	8200SP-10-4	640.00
5 PORT	8200SP-10-5	703.00
6 PORT	8200SP-10-6	775.00
7 PORT	8200SP-10-7	851.00
8 PORT	8200SP-10-8	918.00
9 PORT	8200SP-10-9	996.00
10 PORT	8200SP-10-10	1079.00
11 PORT	8200SP-10-11	1139.00
12 PORT	8200SP-10-12	1212.00

	1-1/4" BRASS BAR	
	Item Number	List Price
	-	-
	-	-
	8200SP-14-4	734.00
	8200SP-14-5	813.00
	8200SP-14-6	889.00
	8200SP-14-7	969.00
	8200SP-14-8	1047.00
	8200SP-14-9	1122.00
	8200SP-14-10	1204.00
	8200SP-14-11	1286.00
	8200SP-14-12	1372.00

M-8200T Precision-T Manifold

M-8200T

ISO-9002



M-8200T Precision-T Manifold with Thermometer – Includes isolation valves with thermometer for supply and return temperature measurement. Ships loosely assembled and ready to install.

1" BRASS BAR

	Item Number	List Price
2 PORT	8200T-10-2	369.00
3 PORT	8200T-10-3	448.00
4 PORT	8200T-10-4	505.00
5 PORT	8200T-10-5	573.00
6 PORT	8200T-10-6	638.00
7 PORT	8200T-10-7	719.00
8 PORT	8200T-10-8	791.00
9 PORT	8200T-10-9	866.00
10 PORT	8200T-10-10	977.00
11 PORT	8200T-10-11	1042.00
12 PORT	8200T-10-12	1125.00

1-1/4" BRASS BAR

Item Number	List Price
-	-
-	-
8200T-14-4	613.00
8200T-14-5	685.00
8200T-14-6	748.00
8200T-14-7	835.00
8200T-14-8	910.00
8200T-14-9	991.00
8200T-14-10	1079.00
8200T-14-11	1168.00
8200T-14-12	1261.00

M-8200 Precision Basic Manifold

M-8200

ISO-9002



M-8200 Precision Basic Manifold – ships loosely assembled and ready to install.

1" BRASS BAR

	Item Number	List Price
2 PORT	8200-10-2	320.00
3 PORT	8200-10-3	397.00
4 PORT	8200-10-4	462.00
5 PORT	8200-10-5	524.00
6 PORT	8200-10-6	597.00
7 PORT	8200-10-7	672.00
8 PORT	8200-10-8	739.00
9 PORT	8200-10-9	809.00
10 PORT	8200-10-10	910.00
11 PORT	8200-10-11	980.00
12 PORT	8200-10-12	1051.00

1-1/4" BRASS BAR

Item Number	List Price
-	-
-	-
8200-14-4	547.00
8200-14-5	629.00
8200-14-6	706.00
8200-14-7	797.00
8200-14-8	870.00
8200-14-9	947.00
8200-14-10	1051.00
8200-14-11	1137.00
8200-14-12	1228.00

Brass Manifold Accessories

Integrated Adapter Valve



Integrated Adapter Valves – Includes garden hose thread fill & purge, air vent, thermometer, isolation valve and sensor port, all in one unit. Converts the M-8200 to the M-8200P.

	Item Number	List Price
1" INTEGRATED MANIFOLD ADAPTER VALVE – PAIR	800-857	280.00
1-1/4" INTEGRATED MANIFOLD ADAPTER VALVE – PAIR	800-858	345.00
REPLACEMENT THERMOMETER	800-853	37.94

Precision Adapter

ISO-9002



Precision Adapters – Includes garden hose thread fill & purge, air vent and press. Converts the M-8200 to the M-8200P.

	Item Number	List Price
1" MANIFOLD PRECISION ADAPTER – PAIR	800-805	156.54
1-1/4" MANIFOLD PRECISION ADAPTER – PAIR	800-806	171.42
REPLACEMENT THERMOMETER WITH THERMOWELL	800-803	37.94

Air Vent

ISO-9002



Automatic Air Vent – Replacement air vent for precision adapter & integrated adapter valve.

	Item Number	List Price
REPLACEMENT AUTOMATIC AIR VENT	800-332	14.09

Fill & Purge Valve

ISO-9002



Replacement Fill & Purge Valve – Replacement fill & purge valve for precision adapter and integrated adapter valve. Quarter-turn ball valve with tethered cap, garden hose thread (GHT) connection and EPDM gasket / O-ring seals.

	Item Number	List Price
REPLACEMENT FILL & PURGE VALVE	800-802	24.00

Isolation Valve

ISO-9002



Isolation Valves – for M-8000, M-8100 and M-8200 manifolds.

	Item Number	List Price
1" MANIFOLD ISOLATION VALVE - MATCHING PAIR	800-855	116.68
1" MANIFOLD ISOLATION VALVE - BLUE HANDLE	800-855B	58.34
1" MANIFOLD ISOLATION VALVE - RED HANDLE	800-855R	58.34
1-1/4" MANIFOLD ISOLATION VALVE - MATCHING PAIR	800-856	164.88
1-1/4" MANIFOLD ISOLATION VALVE - BLUE HANDLE	800-856B	82.44
1-1/4" MANIFOLD ISOLATION VALVE - RED HANDLE	800-856R	82.44

Note: Also used as loop isolation valve on M-8220 High Capacity™ and GeoGreen™ series manifolds.

Brass Manifold Accessories

Isolation Valve

Isolation Valves with Thermometer – For M-8000, M-8100 and M-8200 manifolds. Converts the M-8200 to the M-8200T.

ISO-9002



1" MANIFOLD ISOLATION VALVE WITH THERMOMETER-PAIR

1-1/4" MANIFOLD ISOLATION VALVE WITH THERMOMETER-PAIR

Converts M-8200 to the M-8200T

Note: Also used as loop isolation valve on M-8220 High Capacity™ and GeoGreen™ series manifolds.

Item Number	List Price
800-855T	174.00
800-856T	216.30

Angle Isolation Valve

Angle Isolation Valves – For M-8000, M-8100 and M-8200 manifolds. Used for low profile installations when supply & return piping feeds from the ceiling or floor. Includes offset adapter to properly align vertical piping.

ISO-9002



1" MANIFOLD ANGLE ISOLATION VALVE-PAIR

Item Number	List Price
800-825	174.00

LegendPress™ Isolation Valve

LegendPress™ Isolation Valves – For M-8000, M-8100 and M-8200 manifolds. Press style isolation valves feature two EPDM O-Rings and deep sockets to ensure a perfect seal with every press.

ISO-9002



1" LEGENDPRESS™ MANIFOLD ISOLATION VALVE-PAIR

1-1/4" LEGENDPRESS™ MANIFOLD ISOLATION VALVE-PAIR

Item Number	List Price
800-865	145.20
800-866	207.50

Mounting Brackets

Mounting brackets – For M-8000 and M-8200 Manifolds.

ISO-9002



M-8000 MODULAR-MANIFOLD MOUNTING BRACKET & COLLAR-PAIR

M-8200 PRECISION-MANIFOLD MOUNTING BRACKET & COLLAR-PAIR

Item Number	List Price
800-861	40.00
800-860	30.53

Circuit Actuator

4-Wire Circuit Actuator – For M-8000, M-8100 and M-8200 series manifolds. 24 volt AC actuator with 36" leads. Includes end-switch that closes when valve is fully open.

ISO-9002



4-WIRE CIRCUIT ACTUATOR WITH END SWITCH

Item Number	List Price
800-200	77.02

Brass Manifold Accessories

Manifold Union

ISO-9002



Manifold Union – Connects any two M-8200 series manifolds to increase circuit capacity.

1" MANIFOLD UNION
1-1/4" MANIFOLD UNION

Item Number	List Price
800-815	10.82
800-816	17.14

End Plug With Gasket

ISO-9002



Brass Manifold End Plug – With EPDM O-ring. Used on all M-8000 and M-8200 series manifolds to close and seal manifold end.

1" MANIFOLD END PLUG
1-1/4" MANIFOLD END PLUG

Item Number	List Price
800-845	6.49
800-846	9.02

Port Cap

ISO-9002



Manifold Port Cap – Used to close and seal unused ports on M-8000, M-8100 and M-8200 manifolds. Includes EPDM O-ring.

MANIFOLD PORT CAP

Item Number	List Price
800-141	3.10

PEX Connectors



3/4" CONNECTOR

PEX Tube Connectors – for M-8000 and M-8200 series manifolds.

5/16" PEX TO MANIFOLD CONNECTOR-PAIR
3/8" PEX TO MANIFOLD CONNECTOR-PAIR
1/2" PEX TO MANIFOLD CONNECTOR-PAIR
5/8" PEX TO MANIFOLD CONNECTOR-PAIR
3/4" PEX TO MANIFOLD CONNECTOR-PAIR

Item Number	List Price
800-140	19.16
800-142	15.77
800-143	15.98
800-144	15.98
800-145	25.47

Not for use with PEX-AL-PEX Tube

Composite Connectors



3/4" CONNECTOR

Composite Tube Connectors – for all M-8000 and M-8200 series manifolds.

1/2" COMPOSITE TUBE TO MANIFOLD CONNECTOR-PAIR
5/8" COMPOSITE TUBE TO MANIFOLD CONNECTOR-PAIR
3/4" COMPOSITE TUBE TO MANIFOLD CONNECTOR-PAIR

Item Number	List Price
800-143C	16.80
800-144C	18.69
800-145C	47.36

For use with PEX-AL-PEX Tube

New F1960 Connectors



Cold Expansion Tube Connectors – ASTM F1960 cold expansion tube connectors – for all M-8000 and M-8200 series manifolds. Installer must verify with tube manufacturer that the tubing is compatible with expansion type fitting systems.

1/2" EXPANSION PEX TO MANIFOLD CONNECTOR - PAIR
5/8" EXPANSION PEX TO MANIFOLD CONNECTOR - PAIR
3/4" EXPANSION PEX TO MANIFOLD CONNECTOR - PAIR

Item Number	List Price
800-143P	26.20
800-144P	30.50
800-145P	42.00

M-8220

HIGH CAPACITY™

The M-8220 high capacity manifold is ideal for hydronic radiant applications that require high flow rates such as snow & ice melt systems or projects with large floor areas (warehouses, commercial garages, airplane hangers, manufacturing facilities, etc...). This versatile manifold can also be used in the mechanical room for flow distribution in hydronic systems where each branch is supplying one or more zones of radiant panel manifolds, radiator panels, baseboard, fan coil units, etc...

The M-8220 provides full isolation at each header and circuit loop with color coded handles. The header valves are available with standard pipe thread or press style connections. The circuit loop isolation valves are available with or without press, depending upon circuit balancing requirements, and offer standard female pipe threads for connecting to any NPT pipe adapter or connector. Many components are compatible with our M-8000, M-8100 and M-8200 manifolds – making the Legend manifold series the most flexible manifold system on the market.



- Extruded from high-strength OT63 alloy—63% copper content
- Header isolation valves with threaded or LegendPress™ connections
- High flow capacity
- Manifold unions available to expand number of circuit loops
- Includes strong and versatile mounting brackets
- Automatic air vent and GHT fill/purge assemblies included



Thermal insulation jackets available
ITEM 822-867 & 822-868

M-8220 High Capacity Manifold Base Kit

M-8220 Base Kit

ISO-9002

M-8220 High Capacity Manifold Base Kit – Base includes supply and return headers, 1-1/2" FNPT isolation valves for headers, 1" NPT circuit loop isolation valves for supply and return, mounting brackets, and fill & air purger.



2 PORT – 1-1/2" HI-CAP MANIFOLD BASE – 2 BRACKETS	8220-15-2	1047.00
3 PORT – 1-1/2" HI-CAP MANIFOLD BASE – 4 BRACKETS	8220-15-3	1418.00
4 PORT – 1-1/2" HI-CAP MANIFOLD BASE – 4 BRACKETS	8220-15-4	1671.00
5 PORT – 1-1/2" HI-CAP MANIFOLD BASE – 4 BRACKETS	8220-15-5	1898.00
6 PORT – 1-1/2" HI-CAP MANIFOLD BASE – 4 BRACKETS	8220-15-6	2147.00
7 PORT – 1-1/2" HI-CAP MANIFOLD BASE – 4 BRACKETS	8220-15-7	2378.00
8 PORT – 1-1/2" HI-CAP MANIFOLD BASE – 4 BRACKETS	8220-15-8	2618.00
2 PORT – 2" HI-CAP MANIFOLD BASE – 2 BRACKETS	8220-20-2	1196.00
3 PORT – 2" HI-CAP MANIFOLD BASE – 4 BRACKETS	8220-20-3	1593.00
4 PORT – 2" HI-CAP MANIFOLD BASE – 4 BRACKETS	8220-20-4	1856.00
5 PORT – 2" HI-CAP MANIFOLD BASE – 4 BRACKETS	8220-20-5	2123.00
6 PORT – 2" HI-CAP MANIFOLD BASE – 4 BRACKETS	8220-20-6	2385.00

Item Number	List Price
8220-15-2	1047.00
8220-15-3	1418.00
8220-15-4	1671.00
8220-15-5	1898.00
8220-15-6	2147.00
8220-15-7	2378.00
8220-15-8	2618.00
8220-20-2	1196.00
8220-20-3	1593.00
8220-20-4	1856.00
8220-20-5	2123.00
8220-20-6	2385.00

Note: 2" manifold isolation valve adapters provided with 2" M-8220

M-8220 High Capacity Manifold Press Kit

M-8220P Press Kit

ISO-9002



M-8220P High Capacity Manifold Press Kit – Base includes supply and return headers, 1-1/2" LegendPress™ isolation valves for headers, 1" NPT circuit loop isolation valves for supply and return, mounting brackets, and fill & air purger.

	Item Number	List Price
2 PORT – 1-1/2" HI-CAP LEGENDPRESS™ MANIFOLD – 2 BRACKETS	8220S-15-2	1113.00
3 PORT – 1-1/2" HI-CAP LEGENDPRESS™ MANIFOLD – 4 BRACKETS	8220S-15-3	1484.00
4 PORT – 1-1/2" HI-CAP LEGENDPRESS™ MANIFOLD – 4 BRACKETS	8220S-15-4	1737.00
5 PORT – 1-1/2" HI-CAP LEGENDPRESS™ MANIFOLD – 4 BRACKETS	8220S-15-5	1964.00
6 PORT – 1-1/2" HI-CAP LEGENDPRESS™ MANIFOLD – 4 BRACKETS	8220S-15-6	2213.00
7 PORT – 1-1/2" HI-CAP LEGENDPRESS™ MANIFOLD – 4 BRACKETS	8220S-15-7	2444.00
8 PORT – 1-1/2" HI-CAP LEGENDPRESS™ MANIFOLD – 4 BRACKETS	8220S-15-8	2684.00
2 PORT – 2" HI-CAP LEGENDPRESS™ MANIFOLD – 2 BRACKETS	8220S-20-2	1262.00
3 PORT – 2" HI-CAP LEGENDPRESS™ MANIFOLD – 4 BRACKETS	8220S-20-3	1659.00
4 PORT – 2" HI-CAP LEGENDPRESS™ MANIFOLD – 4 BRACKETS	8220S-20-4	1922.00
5 PORT – 2" HI-CAP LEGENDPRESS™ MANIFOLD – 4 BRACKETS	8220S-20-5	2189.00
6 PORT – 2" HI-CAP LEGENDPRESS™ MANIFOLD – 4 BRACKETS	8220S-20-6	2451.00

Note: 2" manifold isolation valve adapters provided with 2" M-8220

M-8220 High Capacity Manifold Expansion Kit

M-8220X Expansion Kit

ISO-9002



M-8220X High Capacity Manifold Expansion Kit – Base includes supply and return headers, 1" NPT circuit loop isolation valves for supply and return, mounting brackets, and 2 manifold unions.

	Item Number	List Price
2 PORT – 1-1/2" HI-CAP EXPANSION KIT – 2 BRACKETS	8220-15-2X	722.00
3 PORT – 1-1/2" HI-CAP EXPANSION KIT – 4 BRACKETS	8220-15-3X	1093.00
4 PORT – 1-1/2" HI-CAP EXPANSION KIT – 4 BRACKETS	8220-15-4X	1346.00
5 PORT – 1-1/2" HI-CAP EXPANSION KIT – 4 BRACKETS	8220-15-5X	1573.00
6 PORT – 1-1/2" HI-CAP EXPANSION KIT – 4 BRACKETS	8220-15-6X	1822.00
7 PORT – 1-1/2" HI-CAP EXPANSION KIT – 4 BRACKETS	8220-15-7X	2053.00
8 PORT – 1-1/2" HI-CAP EXPANSION KIT – 4 BRACKETS	8220-15-8X	2293.00
2 PORT – 2" HI-CAP EXPANSION KIT – 2 BRACKETS	8220-20-2X	871.00
3 PORT – 2" HI-CAP EXPANSION KIT – 4 BRACKETS	8220-20-3X	1268.00
4 PORT – 2" HI-CAP EXPANSION KIT – 4 BRACKETS	8220-20-4X	1531.00
5 PORT – 2" HI-CAP EXPANSION KIT – 4 BRACKETS	8220-20-5X	1798.00
6 PORT – 2" HI-CAP EXPANSION KIT – 4 BRACKETS	8220-20-6X	2060.00

Note: 2" manifold isolation valve adapters provided with 2" M-8220

M-8220X

M-8220 Expansion Kit—Order expansion kits as required to build manifolds with more than 8 ports in 1"-1/2" and 6 ports in 2" sizes. Expansion kit includes **2 manifold unions** in place of the 2 fill & purge assemblies.



Substitute one or more multiple pairs of Loop Isolation Valves with Thermometer, in place of the Standard Loop Isolation Valves included with the manifold kits. The supply and return thermometer can provide means to determine delta T and help balance flow rates. Call customer service to make application adjustments. (800) 752-2082

High-Capacity Manifold Accessories

Hi-Cap Isolation Valve

ISO-9002



High Capacity Header Isolation Valves – for **M-8220** and **GeoGreen™** manifolds.

1-1/2" MANIFOLD HEADER ISOLATION VALVE-PAIR

Note: 2" x 1-1/2" Manifold Isolation Valve Adapter provided with 2" Base Kits.

Item Number

822-857

List Price

325.00

LegendPress™ Isolation Valve

ISO-9002



High Capacity Header Isolation Valves with LegendPress™ Connection – for **M-8220** and **GeoGreen™** manifolds. Legend's press connection isolation valves feature two EPDM O-rings and deep sockets to ensure a perfect seal with every press.

1-1/2" LEGENDPRESS™ MANIFOLD HEADER ISOLATION VALVE-PAIR

Note: 2" x 1-1/2" Manifold Isolation Valve Adapter provided with 2" Base Kits.

Item Number

800-867

List Price

398.48

Loop Isolation Valve

ISO-9002



Loop Isolation Valves – for **M-8220** and **GeoGreen™** manifolds.

1" LOOP ISOLATION VALVE-PAIR

May be used with 3/4" or 1" High Capacity Tubing Connectors.

Note: Also used as header isolation valve on M-8000 and M-8200 series manifolds.

Item Number

800-855

List Price

116.68

Loop Isolation Valve W/Thermometer

ISO-9002



Loop Isolation Valves with Thermometer – for **M-8220** and **GeoGreen™** manifolds. Two press ports (left or right) add flexibility in mounting.

1" LOOP ISOLATION VALVE WITH THERMOMETER-PAIR

May be used with 3/4" or 1" High Capacity Tubing Connectors.

Note: Also used as header isolation valve on M-8000 and M-8200 series manifolds.

Item Number

800-855T

List Price

174.00

Manifold Union

ISO-9002



High Capacity Manifold Union – Connects any two **M-8220** series manifolds to increase circuit capacity.

1-1/2" HI -CAP MANIFOLD UNION-PAIR

2" HI -CAP MANIFOLD UNION-PAIR

Note: When ordering expansion kit, add "x" after the item number. Includes 2 manifold unions in place of the 2 Fill & Purge Assemblies.

Item Number

822-817

List Price

31.00

Item Number

822-818

List Price

42.00

High-Capacity Manifold Accessories

Compression Connectors

High Capacity Compression Tube Connectors – for M-8220 manifolds.
1" male MPT x copper tube size.

ISO-9002



3/4" HIGH-CAPACITY COMPRESSION CONNECTOR-PAIR
1" HIGH-CAPACITY COMPRESSION CONNECTOR-PAIR

Item Number	List Price
800-134	42.00
800-135	46.20

For use with copper tube.

PEX Connectors

High Capacity Pex Tube Connectors – for M-8220 and GeoGreen™ manifolds.
1" male NPT x PEX

ISO-9002



3/4" HIGH-CAPACITY PEX CONNECTOR-PAIR
1" HIGH-CAPACITY PEX CONNECTOR-PAIR

Item Number	List Price
800-234	62.83
800-235	77.00

Not for use with PEX-AL-PEX.

Hi-Cap Manifold Brackets

High Capacity Manifold Mounting Brackets – Replacement brackets and collars for M-8220 and GeoGreen™ manifolds. Replacement collars for M-8220 with insulation jackets.

ISO-9002



HI-CAP MANIFOLD MOUNTING BRACKET & COLLAR-PAIR

LARGE COLLAR FOR 1-1/2" HI-CAP MANIFOLD WITH INSULATION JACKET (822-867)-PAIR

LARGE COLLAR FOR 2" HI-CAP MANIFOLD WITH INSULATION JACKET (822-868)-PAIR

Note: Order Large Collars when using Insulation Jackets (822-867 and 822-868)

Item Number	List Price
822-861	50.00
822-862	38.00
822-863	52.00

Insulation Jacket

6 Port Insulation Jacket – for M-8220 series manifolds. Easily cuts to size for manifolds with fewer loops.

ISO-9002



1-1/2" HIGH CAPACITY 6-PORT INSULATION JACKET - 1 HEADER

2" HIGH CAPACITY 6-PORT INSULATION JACKET - 1 HEADER

Note: Order Insulation Jackets and Large Collars (822-862 for 1-1/2" manifolds & 822-863 for 2" manifolds) individually for each Header.

Item Number	List Price
822-867	39.00
822-868	42.00

Hi-Cap Air Vent

High Capacity Air Vent – Replacement air vent for fill and purge module M-8220.
Vent can be serviced by unthreading the cap.

ISO-9002



HIGH CAPACITY AIR VENT

Item Number	List Price
800-244	34.00

M-8300

STAINLESS Manifold Series



M-8300

M-8300P

Simple Installation - right out of the box.

The M-8300 manifold is manufactured from quality **304 Stainless Steel** in our ISO-9001 facilities. Each and every manifold component is pressure tested before being loosely assembled, attached to mounting brackets, packed and shipped. The M-8300 manifold is virtually ready for installation right out of the box upon receipt at the job site.

Union nut configuration allows air vent and purge to be orientated in any direction.



KEY FEATURES AT A GLANCE

- **Manufactured from 304 stainless steel**
- **Ships pre-assembled and ready for installation right out of the box**
- **Versatile and easily adaptable to a variety of mounting configurations**
- **EPDM O-rings and seals**
- **Built-in visual flow gauges for quick circuit performance verification**
- **Optional 4-wire actuators**
- **Angle isolation valve for tight installations**

M-8300P Stainless Steel Manifold

M-8300P

M-8300P Stainless Pro – Includes adapter with automatic air vent and fill & purge – Ships loosely assembled and ready to install.

ISO-9001



	Item Number	List Price
2 PORT – 1" STAINLESS STEEL PRECISION MANIFOLD WITH ADAPTER	8300P-10-2	319.84
3 PORT – 1" STAINLESS STEEL PRECISION MANIFOLD WITH ADAPTER	8300P-10-3	372.09
4 PORT – 1" STAINLESS STEEL PRECISION MANIFOLD WITH ADAPTER	8300P-10-4	425.24
5 PORT – 1" STAINLESS STEEL PRECISION MANIFOLD WITH ADAPTER	8300P-10-5	477.75
6 PORT – 1" STAINLESS STEEL PRECISION MANIFOLD WITH ADAPTER	8300P-10-6	532.14
7 PORT – 1" STAINLESS STEEL PRECISION MANIFOLD WITH ADAPTER	8300P-10-7	586.94
8 PORT – 1" STAINLESS STEEL PRECISION MANIFOLD WITH ADAPTER	8300P-10-8	646.21
9 PORT – 1" STAINLESS STEEL PRECISION MANIFOLD WITH ADAPTER	8300P-10-9	713.01
10 PORT – 1" STAINLESS STEEL PRECISION MANIFOLD WITH ADAPTER	8300P-10-10	779.45
11 PORT – 1" STAINLESS STEEL PRECISION MANIFOLD WITH ADAPTER	8300P-10-11	846.48
12 PORT – 1" STAINLESS STEEL PRECISION MANIFOLD WITH ADAPTER	8300P-10-12	912.63

M-8300AP Stainless Steel Manifold

M-8300AP

M-8300AP Stainless Angle Pro – Includes angle isolation valve and adapter with automatic air vent, and fill & purge.

ISO-9001



	Item Number	List Price
2 PORT – 1" STAINLESS STEEL PRECISION MANIFOLD WITH ANGLE	8300AP-10-2	340.56
3 PORT – 1" STAINLESS STEEL PRECISION MANIFOLD WITH ANGLE	8300AP-10-3	392.81
4 PORT – 1" STAINLESS STEEL PRECISION MANIFOLD WITH ANGLE	8300AP-10-4	445.96
5 PORT – 1" STAINLESS STEEL PRECISION MANIFOLD WITH ANGLE	8300AP-10-5	498.47
6 PORT – 1" STAINLESS STEEL PRECISION MANIFOLD WITH ANGLE	8300AP-10-6	552.86
7 PORT – 1" STAINLESS STEEL PRECISION MANIFOLD WITH ANGLE	8300AP-10-7	607.66
8 PORT – 1" STAINLESS STEEL PRECISION MANIFOLD WITH ANGLE	8300AP-10-8	666.93
9 PORT – 1" STAINLESS STEEL PRECISION MANIFOLD WITH ANGLE	8300AP-10-9	733.73
10 PORT – 1" STAINLESS STEEL PRECISION MANIFOLD WITH ANGLE	8300AP-10-10	800.17
11 PORT – 1" STAINLESS STEEL PRECISION MANIFOLD WITH ANGLE	8300AP-10-11	867.20
12 PORT – 1" STAINLESS STEEL PRECISION MANIFOLD WITH ANGLE	8300AP-10-12	933.55

M-8300 Stainless Steel Manifold

M-8300

M-8300 Stainless Basic – Ships loosely assembled and ready to install.

ISO-9001



	Item Number	List Price
2 PORT – 1" STAINLESS STEEL PRECISION MANIFOLD	8300-10-2	264.78
3 PORT – 1" STAINLESS STEEL PRECISION MANIFOLD	8300-10-3	319.17
4 PORT – 1" STAINLESS STEEL PRECISION MANIFOLD	8300-10-4	372.73
5 PORT – 1" STAINLESS STEEL PRECISION MANIFOLD	8300-10-5	425.65
6 PORT – 1" STAINLESS STEEL PRECISION MANIFOLD	8300-10-6	480.51
7 PORT – 1" STAINLESS STEEL PRECISION MANIFOLD	8300-10-7	535.72
8 PORT – 1" STAINLESS STEEL PRECISION MANIFOLD	8300-10-8	595.53
9 PORT – 1" STAINLESS STEEL PRECISION MANIFOLD	8300-10-9	662.80
10 PORT – 1" STAINLESS STEEL PRECISION MANIFOLD	8300-10-10	729.76
11 PORT – 1" STAINLESS STEEL PRECISION MANIFOLD	8300-10-11	797.38
12 PORT – 1" STAINLESS STEEL PRECISION MANIFOLD	8300-10-12	864.01

Stainless Steel Manifold Accessories

Isolation Valve

Isolation Valve with Thermometer – For M-8300 Stainless manifolds.

ISO-9001



- 1" ISOLATION VALVE WITH THERMOMETER-PAIR
- 1" ISOLATION VALVE WITH THERMOMETER - BLUE HANDLE
- 1" ISOLATION VALVE WITH THERMOMETER - RED HANDLE

Item Number	List Price
830-855	133.62
830-855B	66.81
830-855R	66.81

Angle Isolation Valve

Angle Isolation Valve with Thermometer – For M-8300 Stainless manifolds.
Used for low profile installations.

ISO-9001



- 1" ANGLE ISOLATION VALVE WITH THERMOMETER-PAIR
- 1" ANGLE ISOLATION VALVE WITH THERMOMETER - BLUE HANDLE
- 1" ANGLE ISOLATION VALVE WITH THERMOMETER - RED HANDLE

Item Number	List Price
830-825	154.34
830-825B	77.17
830-825R	77.17

Isolation Valve w/Strainer

Isolation Valve with Thermometer and Y-Strainer – For M-8300 Stainless manifolds.

ISO-9001



- 1" ISOLATION VALVE WITH THERMOMETER & Y-STRAINER- RED HANDLE

Item Number	List Price
830-835R	105.33

Purge Adapter

Air & Water Purge Adapter – For M-8300 Stainless manifolds. Includes automatic air vent and fill & purge valve. Converts the M-8300 to the M-8300P.

ISO-9001



- STAINLESS AIR & WATER PURGE ADAPTER

Item Number	List Price
830-805	53.00

Circuit Actuator

4-Wire Circuit Actuator – For M-8300 Stainless manifolds. 24 volt AC actuator with 36" leads.

ISO-9000



- 4-WIRE CIRCUIT ACTUATOR WITH END SWITCH
- REPLACEMENT ACTUATOR ADAPTER FOR STAINLESS MANIFOLDS

Item Number	List Price
830-201	89.00
830-201S	5.00

Stainless Steel Manifold Accessories

Manifold Union

ISO-9001



Manifold Union – Connects any two M-8300 Stainless manifolds to increase circuit capacity.

1" M-8300 MANIFOLD UNION

Sold as a single item

Item Number
830-815

List Price
8.00

Port Cap

ISO-9001



Manifold Port Cap – Used to close and seal unused ports on M-8300 Stainless manifolds. Includes EPDM O-ring.

M-8300 MANIFOLD PORT CAP

Item Number
830-141

List Price
6.00

Tube Connector

ISO-9001



Tube Connectors – Used on all M-8300 Stainless manifolds.

- 5/16" M-8300 TUBE TO MANIFOLD CONNECTOR-PAIR
- 3/8" M-8300 TUBE TO MANIFOLD CONNECTOR-PAIR
- 1/2" M-8300 TUBE TO MANIFOLD CONNECTOR-PAIR
- 5/8" M-8300 TUBE TO MANIFOLD CONNECTOR-PAIR
- 3/4" M-8300 TUBE TO MANIFOLD CONNECTOR-PAIR

Item Number
830-140
830-142
830-143
830-144
830-145

List Price
10.19
10.68
10.71
11.20
24.64

3/4" CONNECTOR

Not for use with PEX-AL-PEX

Composite Connectors

ISO-9001



Composite Tube Connectors – Used on all M-8300 Stainless manifolds.

- 3/8" M-8300 COMPOSITE TUBING TO MANIFOLD CONNECTOR-PAIR
- 1/2" M-8300 COMPOSITE TUBING TO MANIFOLD CONNECTOR-PAIR
- 5/8" M-8300 COMPOSITE TUBING TO MANIFOLD CONNECTOR-PAIR
- 3/4" M-8300 COMPOSITE TUBING TO MANIFOLD CONNECTOR-PAIR

Item Number
830-142C
830-143C
830-144C
830-145C

List Price
10.92
11.20
11.76
22.00

3/4" CONNECTOR

For use with PEX-AL-PEX

New F1960 Connectors



Cold Expansion Tube Connectors – ASTM F1960 cold expansion tube connectors – for M-8300 series manifolds. Installer must verify with tube manufacturer that the tubing is compatible with expansion type fitting systems.

1/2" EXPANSION PEX TO MANIFOLD CONNECTOR - PAIR

Item Number
830-143P

List Price
26.20

Stainless Steel Manifold Accessories

Mounting Brackets

Mounting brackets – For M-8300 Stainless manifolds.

ISO-9001



M-8300 MANIFOLD MOUNTING BRACKET & COLLAR-PAIR

Item Number
830-861

List Price
28.00

End Plug With Gasket

Manifold End Plug – Used on all M-8300 Stainless manifolds to close and seal manifold end.

ISO-9001



1" M-8300 MANIFOLD END PLUG

Item Number
830-845

List Price
6.50

New Flow Meter

Replacement Flow Meter – for M-8300 Stainless manifolds. Threads into top of supply header.

ISO-9001



REPLACEMENT FLOW METER

Item Number
830-862

List Price
20.25

Hydronic System Components



**Downstream
Thinking.**

It's all about Performance®

The M-8220 High Capacity manifold and other hydronic products under test in Legend's Auburn Hills, MI laboratory.

LEGENDConnect™



Ordering Guide for LEGENDConnect™ System

EXAMPLE

1

Select your tube size and connector type. Note the body type (ie. A, B, C, etc.)

2

Choose your product with the matching body type on page 41.

Example:

A 1" FNPT would need a B body style component and Connector Item # 800-875F

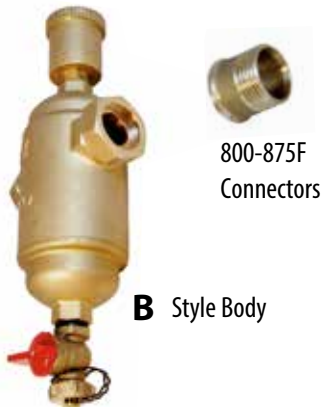

Piping/Tube Size	Connector Type	Body	Connector Item	Qty	List Price
3/4"	MNPT		800-874M	PAIR	20.00
3/4"	FNPT		800-874F	PAIR	20.00
3/4"	Sweat		800-874S	PAIR	17.00
3/4"	LegendPress		800-874LP	PAIR	38.00
3/4"	Iso Valve Comp*	A	800-874VC	PAIR	52.00
3/4"	Iso Valve FNPT*		800-874VF	PAIR	50.00
1"	MNPT		800-875M	PAIR	20.00
1"	Sweat		800-875S	PAIR	17.00
1"	FNPT		800-875F	PAIR	21.00
1"	LegendPress		800-875LP	PAIR	50.00
1"	Iso Valve Comp		800-875VC	PAIR	74.00
1"	Iso Valve FNPT	B	800-875VF	PAIR	56.00
1-1/4"	MNPT		800-876M	PAIR	33.00
1-1/4"	FNPT		800-876F	PAIR	43.00
1-1/4"	Sweat		800-876S	PAIR	28.00
1-1/4"	LegendPress		800-876LP	PAIR	68.00
1-1/4"	Iso Valve FNPT		800-876VF	PAIR	60.00
1-1/2"	MNPT	C	800-877M	PAIR	51.00
1-1/2"	Sweat		800-877S	PAIR	45.00

*These connectors include two connector nuts that should be used in place of the nuts included with the component bodies. Connectors are sold in pairs. **The HS-808 Hydraulic Separator requires 2 pair (4 total connectors).**

The **LEGENDConnect™** system is the ultimate in flexibility and convenience. The connectors are interchangeable with the T-88 Air & Dirt Separator, HS-808 Hydraulic Separator and LMV-3 Three-way Mixing Valve. Stock the bodies of any of these three models, then choose from a variety of connection types and sizes to meet the requirements of the project. From threaded and solder (sweat) to compact connections with built-in isolation valves; reduce inventory, improve service and handle all project requirements and installer preferences with one connection system - **LEGENDConnect™**

Component Bodies for use with LEGENDConnect™

Components are to be used with the **LEGENDConnect™** system. All component bodies listed here are sold without connectors. Choose the connector type and size on page 40 to match these bodies. To purchase kits that include the component body and specific connector type and size, see pages 42, 44 and 45.

High-Performance Air Purger



T-88 High Performance Air and Debris Eliminator (Body Only) – Includes serviceable, automatic air vent w/ check valve adapter, purge valve and serviceable stainless steel screen. Connectors NOT included. See page 40 to order connectors separately.

Description	Item Number	Body	List Price (body only)
T-88 W/ AIR VENT, CHECK, FILL & PURGE VALVE, CONNECTOR NUTS & WASHER	800-875	A	240.00
T-88 W/ AIR VENT, CHECK, FILL & PURGE VALVE, CONNECTOR NUTS & WASHER	800-876	B	305.00
T-88 W/ AIR VENT, CHECK, FILL & PURGE VALVE, CONNECTOR NUTS & WASHER	800-877	C	375.00

Hydro-Separator



HS-808 Hydraulic Separator (Body Only) – Includes serviceable, automatic air vent w/ check valve adapter, purge valve and insulation jacket. Connectors NOT included. See page 40 to order connectors separately. NOTE: Requires 2 pair of connectors (4 total).

Description	Item Number	Body	List Price (body only)
HS-808 W/ AIR VENT, CHECK, FILL & PURGE VALVE, CONNECTOR NUTS & WASHERS	800-835	A	616.00
HS-808 W/ AIR VENT, CHECK, FILL & PURGE VALVE, CONNECTOR NUTS & WASHERS	800-836	B	700.00
HS-808 W/ AIR VENT, CHECK, FILL & PURGE VALVE, CONNECTOR NUTS & WASHERS	800-837	C	930.00

New Three-Way Mixing Valve



LMV-3 Three-Way Mixing Valve (Body Only) – Includes plastic cover for mixing actuator mounting threads and 1" compression nut for return port connection. Requires mixing valve actuator for proper system operation. Connectors NOT included. See page 40 to order connectors separately.

Description	Item Number	Body	List Price (body only)
LMV-3 W/ CONNECTOR NUTS & WASHERS	800-766	B	187.50

T-88 High Performance Air and Debris Eliminator

The T-88 provides superior air and dirt elimination to help maximize efficiency and reduce noise in hydronic systems. The large bowl design combines with the internal stainless steel screen to separate entrained air, micro-bubbles and debris from the system fluid. The fluid velocity slows as it enters the larger volume of the T-88 bowl which allows the micro-bubbles and entrained air to separate from fluid, collect on the screen and/or float to the top of the bowl where it is eliminated from the system through the float type air vent. Also at this slower fluid velocity, the heavier dirt and debris particles separate and fall to the bottom of the bowl where it can later be blown out of the system through the purge valve.



The T-88 is fully serviceable with a two piece bowl design which allows for cleaning and/or replacement of the stainless steel screen.



The automatic High Capacity Air Vent attaches to the T-88 through a check valve to allow removal without system pressure loss.

The body of the T-88 is also bi-directional for adaptability in maximizing performance of the more critical function required by the particular system.



To maximize air removal, the larger half of the bowl should be on top.



To maximize debris removal, the larger half of the bowl should be on bottom.

High-Performance Air Purger - Kit

T-88 High Performance Air and Debris Eliminator KITS – Maximum performance, serviceability, and flexibility. Includes serviceable, automatic air vent w/ check valve adapter, purge valve and serviceable stainless steel screen. Connectors included in ALL kits listed below.



	Connection	Item Number	List Price
3/4" FNPT (FEMALE) HI-PERFORMANCE AIR PURGER - KIT*	FNPT	800-884F	260.00
3/4" MNPT (MALE) HI-PERFORMANCE AIR PURGER - KIT*	MNPT	800-884M	260.00
3/4" SWT (SOLDER) HI-PERFORMANCE AIR PURGER - KIT*	SWT	800-884S	257.00
3/4" LEGENDPRESS™ HI-PERFORMANCE AIR PURGER - KIT*	PRESS	800-884P	278.00
3/4" ISO VALVE COMPRESSION HI-PERFORMANCE AIR PURGER - KIT*	COMP	800-884VC	292.00
3/4" ISO VALVE FNPT (FEMALE) HI-PERFORMANCE AIR PURGER - KIT*	FNPT	800-884VF	290.00
1" FNPT (FEMALE) HI-PERFORMANCE AIR PURGER - KIT*	FNPT	800-885F	326.00
1" MNPT (MALE) HI-PERFORMANCE AIR PURGER - KIT	MNPT	800-885M	260.00
1" SWT (SOLDER) HI-PERFORMANCE AIR PURGER - KIT	SWT	800-885S	257.00
1" LEGENDPRESS™ HI-PERFORMANCE AIR PURGER - KIT*	PRESS	800-885P	355.00
1" ISO VALVE COMPRESSION HI-PERFORMANCE AIR PURGER - KIT*	COMP	800-885VC	379.00
1" ISO VALVE FNPT (FEMALE) HI-PERFORMANCE AIR PURGER - KIT*	FNPT	800-885VF	361.00
1-1/4" FNPT (FEMALE) HI-PERFORMANCE AIR PURGER - KIT	FNPT	800-886F	348.00
1-1/4" MNPT (MALE) HI-PERFORMANCE AIR PURGER - KIT	MNPT	800-886M	338.00
1-1/4" SWT (SOLDER) HI-PERFORMANCE AIR PURGER - KIT	SWT	800-886S	333.00
1-1/4" LEGENDPRESS HI-PERFORMANCE AIR PURGER - KIT	PRESS	800-886P	373.00
1-1/4" ISO VALVE FNPT (FEMALE) HI-PERFORMANCE AIR PURGER - KIT	FNPT	800-886VF	365.00
1-1/2" MNPT (MALE) HI-PERFORMANCE AIR PURGER - KIT	MNPT	800-887M	426.00
1-1/2" SWT (SOLDER) HI-PERFORMANCE AIR PURGER - KIT	SWT	800-887S	420.00

*Uses next larger size body style

T-88 High Performance Air and Debris Eliminator Accessories

New T-88 Magnetic Debris Remover



T-88 Magnetic Debris Remover – The magnet and housing replaces the automatic air vent on the top port of the bowl and slides down through the center of the internal stainless steel screen. During operation of the Hydronic system, the magnet generates a powerful magnetic field that attracts ferrous debris out of the fluid stream as it passes through the body of the T-88. This is especially effective in older hydronic systems that contain steel or iron piping, cast iron radiators and/or cast iron boilers where ferrous oxide corrosion may have built up within system components over time. The magnet can be removed from the housing. Debris adhering to the housing is then released and is cleaned.

	Item Number	List Price
T-88 MAGNETIC DEBRIS REMOVER W/ HOUSING	800-881	85.00

New Expansion Tank / Fill Valve Tee Connector



Expansion Tank / Fill Valve System Connection – Designed to allow easy connection of an expansion tank and / or automatic fill valve (make-up water) to the hydronic system. The tee provides a convenient piping attachment point (1/2" MNPT), into the system, attaching to the top port of either the T-88 Air & Debris Eliminator or the HS-808 Hydraulic Separator, automatic air vent check valve attaches to the other end of the tee.

	Item Number	List Price
EXPANSION TANK / FILL VALVE TEE CONNECTOR - 1/2" MNPT	800-246	38.00

Fill & Purge Valve



Replacement Fill & Purge Valve – Replacement fill & purge valve for T-88 and HS-808. Quarter-turn ball valve with tethered cap, garden hose thread (GHT) connection and EPDM gasket / o-ring seals.

	Item Number	List Price
REPLACEMENT FILL & PURGE VALVE	800-802	24.00

Air Vent



High Capacity Air Vent – Replacement air vent for T-88 and HS-808. Vent can be serviced by unthreading the cap.

	Item Number	List Price
REPLACEMENT HIGH CAPACITY AIR VENT WITH CHECK VALVE	800-245	35.00

HS-808 Hydraulic Separator

The HS-808 allows for a simple, efficient and economical method of "hydraulic" separation in hydronic systems. Enjoy all the benefits of "primary/secondary" system piping; eliminate circuit to circuit (zone distribution) and circuit to heating or cooling source flow (hydraulic) interference and simplify system design and analysis; without the complicated and costly "closely spaced tees" piping. In many cases the use of a hydro-separator eliminates the need for a "primary" circulator, not to mention the installation and operating costs that go with it.

Additional benefits of the HS-808 include system air removal via the included automatic high capacity air vent and debris collection and removal via the included purge valve. All sizes feature union connections for ease of installation and maintenance. Attractive, compact and form fitting insulation is provided with each unit.

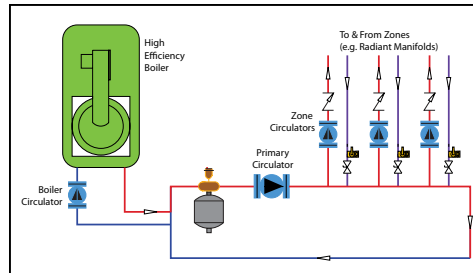
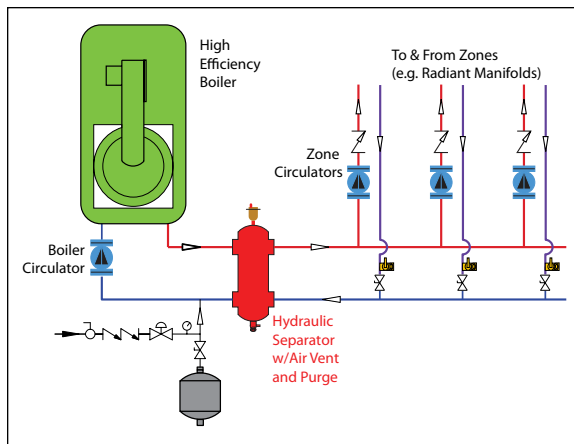

KEY FEATURES AT A GLANCE

- High capacity field-serviceable automatic air vent has built-in check valve
- Garden hose thread clean-out valve
- Union style connections
- Compact insulation jacket
- Uses LegendConnect™ system



The HS-808 simplifies system piping for easier installation, design and analysis. In many cases eliminating the need for a "primary" circulator.

Hydro-Separator Kit

HS-808 Hydraulic Separator KITS – Includes serviceable, automatic air vent w/ check valve adapter, purge valve and insulation jacket. Connectors included in ALL kits listed below.



	Connection	Item Number	List Price
1" MNPT (MALE) HYDRAULIC SEPARATOR - KIT	MNPT	800-835M	656.00
1" FNPT (FEMALE) HYDRAULIC SEPARATOR - KIT*	FNPT	800-835F	742.00
1" SWT (SOLDER) HYDRAULIC SEPARATOR - KIT	SWT	800-835S	650.00
1" LEGENDPRESS™ HYDRAULIC SEPARATOR - KIT*	PRESS	800-835P	800.00
1" ISO VALVE COMPRESSION HYDRAULIC SEPARATOR - KIT*	COMP	800-835VC	848.00
1" ISO VALVE FNPT (FEMALE) HYDRAULIC SEPARATOR - KIT*	FNPT	800-835VF	812.00
1-1/4" MNPT (MALE) HYDRAULIC SEPARATOR - KIT	MNPT	800-836M	766.00
1-1/4" FNPT (FEMALE) HYDRAULIC SEPARATOR - KIT	FNPT	800-836F	786.00
1-1/4" SWT (SOLDER) HYDRAULIC SEPARATOR - KIT	SWT	800-836S	756.00
1-1/4" LEGENDPRESS™ HYDRAULIC SEPARATOR - KIT	PRESS	800-836P	836.00
1-1/4" ISO VALVE FNPT (FEMALE) HYDRAULIC SEPARATOR - KIT	FNPT	800-836VF	820.00
1-1/2" MNPT (MALE) HYDRAULIC SEPARATOR - KIT	MNPT	800-837M	1032.00
1-1/2" SWT (SOLDER) HYDRAULIC SEPARATOR - KIT	SWT	800-837S	1020.00
1-1/2" UNION FNPT (FEMALE) HYDRAULIC SEPARATOR - KIT**	UNION	800-837U	990.00
2" UNION FNPT (FEMALE) HYDRAULIC SEPARATOR - KIT**	UNION	800-838U	1250.00

*Uses next larger size body style

**Not part of the Legend Connect system

HS-808 Hydraulic Separator Accessories

New Expansion Tank / Fill Valve Tee Connector

ISO-9002



Expansion Tank / Fill Valve System Connection – Designed to allow easy connection of an expansion tank and / or automatic fill valve (make-up water) to the Hydronic system. The tee provides a convenient piping attachment point (1/2" MNPT), into the system attaching to the top port of either the T-88 Air & Debris Eliminator or the HS-808 Hydraulic Separator, automatic air vent check valve attaches to the other end of the tee.

	Item Number	List Price
EXPANSION TANK / FILL VALVE TEE CONNECTOR - 1/2" MNPT	800-246	38.00

Fill & Purge Valve

ISO-9002



Replacement Fill & Purge Valve – Replacement fill & purge valve for T-88 and HS-808. Quarter-turn ball valve with tethered cap, garden hose thread (GHT) connection and EPDM gasket / o-ring seals.

	Item Number	List Price
REPLACEMENT FILL & PURGE VALVE	800-802	24.00

Air Vent

ISO-9002



High Capacity Air Vent – Replacement air vent for T-88 and HS-808. Vent can be serviced by unthreading the cap.

	Item Number	List Price
REPLACEMENT HIGH CAPACITY AIR VENT WITH CHECK VALVE	800-245	35.00

LMV-3 Three-Way Mixing Valve

The LMV-3, is designed for use in hydronic heating and cooling systems. This valve is designed to provide a desired system fluid temperature by mixing fluid at a higher temperature from the heat source (typically a boiler) with fluid at a lower temperature returning from the heating zone. For cooling applications it can be installed to mix cooler fluid from the chiller (or other cooling water sources) with warmer fluid returning from the zones to achieve the desired system chilled fluid temperature.



KEY FEATURES AT A GLANCE

- “Stand alone” option available
- Compatible with most popular mixing controllers
- Capable of “outdoor reset” or “set point” mixing strategies
- Economical method to employ multiple water temperatures on same project
- Utilizes LegendConnect™ system for variety of installation options

New Three-Way Mixing Valve



LMV-3 Three-Way Mixing Valve Kit – Requires mixing valve actuator for proper system operations. Connector included in all kits listed below.

	Connection	Item Number	List Price
1" FNPT (FEMALE) 3-WAY MIXING VALVE - KIT	FNPT	800-765F	208.50
1" LEGENDPRESS™ 3-WAY MIXING VALVE - KIT	PRESS	800-765P	237.50
1" ISO VALVE COMPRESSION 3-WAY MIXING VALVE - KIT	COMP	800-765VC	261.50
1" ISO VALVE FNPT (FEMALE) 3-WAY MIXING VALVE - KIT	FNPT	800-765VF	243.50
1-1/4" MNPT (MALE) 3-WAY MIXING VALVE - KIT	MNPT	800-766M	220.50
1-1/4" SWT (SOLDER) 3-WAY MIXING VALVE - KIT	SWT	800-766S	215.50
1-1/4" FNPT (FEMALE) 3-WAY MIXING VALVE - KIT	FNPT	800-766F	230.50
1-1/4" LEGENDPRESS™ 3-WAY MIXING VALVE - KIT	PRESS	800-766P	255.50
1-1/4" ISO VALVE FNPT (FEMALE) 3-WAY MIXING VALVE - KIT	FNPT	800-766VF	247.50

New Mixing Valve Actuators



Mixing Valve Actuators are compact and very reliable design for use with the LMV-3 mixing valve. Two control options are available to utilize either “set point” or “outdoor reset” mixing strategies. Utilizes knurled brass nut for easy connection to the 3-way valve and colored LED lights to visually indicate movement and direction of actuator.

24V Floating Actuator – for use with the LMV-3 Mixing Valve. Must be paired with separate controller that can provide a 24V output signal (sold separately).

	Item Number	List Price
MIXING VALVE ACTUATOR – 24V FLOATING	800-761	254.16



Stand-Alone Actuator – for use with the LMV-3 Mixing Valve. Contains built-in, proportional –integral (PI) control that uses feedback from the pre-wired temperature probe (included) to control position of 3-way mixing valve for desired output temperature. No need to connect to separate control box or system.

	Item Number	List Price
MIXING VALVE ACTUATOR - STAND ALONE	800-762	436.66

AF-480 Auto Fill With Backflow Preventer

The AF-480 reduces the feed pressure from the make-up system to the lower operating pressure of the hydronic system. The backflow preventer allows for a safe connection between the two systems by preventing any possibility of back flow from the hydronic system into the potable water system.

Set up is simple with the built-in pressure gauge; just dial in the desired system pressure to be maintained; from 7 to 45 PSI. The gauge can be mounted on either side of the assembly for easy viewing in any mounting direction. The pressure reducing valve is fully serviceable with removable filter cartridge for easy cleaning or replacement.



KEY FEATURES AT A GLANCE

- Built-In system pressure gauge
- Adjustable from 7 to 45 PSI (pre-set to 12 PSI)
- Fully serviceable with removable filter cartridge
- ASSE 1012 certified to meet local codes

Autofill W/Backflow & Gauge

AF-480 Auto Fill with Backflow Preventer & Gauge – Compact, safe and easy to install automatic make-up water assembly.



AUTO FILL WITH BACKFLOW & GAUGE - 1/2" FNPT
 AUTO FILL WITH GAUGE ONLY - 1/2" FNPT

Item Number	List Price
800-841	190.00
800-842	121.00

Heat Exchangers

Legend's HX Series Brazed Plate Heat Exchangers (BPHE) consist of acid-resistant stainless steel plates with a herringbone ridge pattern. The plates are arranged so that this pattern is in the opposite direction on each adjacent plate and, at every point where the ridges intersect a copper vacuum brazed joint exists forming a separate flow path for the two media exchanging heat energy. The counter-current flow paths of the media and the vigorous turbulence caused by the ridges ensure maximum heat transfer.

Legend's BPHE is designed to be used in a variety of applications; to include, but not limited to:

- *Hydronic heating and cooling (E.g. Radiant Floor, Snow & Ice Melt)*
- *Domestic water heating*
- *Industrial fluid processing*
- *Solar/Geothermal applications*

Legend's BPHE is compatible with a variety of media:

- *Water*
- *Oil*
- *Organic solvents*
- *Various antifreeze solutions (glycol mixtures, alcohols, etc...)*

KEY FEATURES AT A GLANCE

- **U.L. Listed**
- **High thermal efficiency**
- **High temperature (302° F) and pressure (435 PSI) resistance**
- **Excellent flow characteristics**
- **High corrosion resistance**
- **No gasket seals**
- **Compact size and low weight**
- **Easy installation and less maintenance**
- **Very durable**



Heat Exchanger

UL Listed



HX series Heat Exchangers – Brazed Plate Heat Exchanger (BPHE) 5" x 12" with MIP connections and acid-resistant stainless steel plates.

3/4" HX-100 HEAT EXCHANGER – 10 PLATE; 50M BTU/H	807-001	363.80
1" HX-100 HEAT EXCHANGER – 10 PLATE; 50M BTU/H	807-071	380.00
3/4" HX-200 HEAT EXCHANGER – 20 PLATE; 100M BTU/H	807-002	562.28
1" HX-200 HEAT EXCHANGER – 20 PLATE; 100M BTU/H	807-072	575.00
3/4" HX-300 HEAT EXCHANGER – 30 PLATE; 150M BTU/H	807-003	811.80
1" HX-300 HEAT EXCHANGER – 30 PLATE; 150M BTU/H	807-073	831.00

Item Number	List Price
807-001	363.80
807-071	380.00
807-002	562.28
807-072	575.00
807-003	811.80
807-073	831.00

Compact Heat Exchanger

UL Listed



HX series Compact Heat Exchangers – Brazed Plate Heat Exchanger (BPHE) 3" x 7-1/2" with 3/4" MIP connections and acid-resistant stainless steel plates.

HX-100B HEAT EXCHANGER – 10 PLATE; 40M BTU/H	807-031	230.00
HX-160B HEAT EXCHANGER – 16 PLATE; 70M BTU/H	807-032	295.00
HX-200B HEAT EXCHANGER – 20 PLATE; 90M BTU/H	807-033	350.00

Item Number	List Price
807-031	230.00
807-032	295.00
807-033	350.00

Zone Valves

LZV-2 and LZV-3 series motorized valves are used to control flow in chilled or hot water systems and low pressure steam systems up to 15 PSI. The valve is driven by a hysteresis synchronous motor with spring return. Normally open actuator models are available upon request.

KEY FEATURES AT A GLANCE

- Suitable for heating/cooling or low pressure steam systems
- Long life synchronous motor
- Stainless steel shaft with EPDM ball and seals
- Can be used on applications with high make up water
- Locking connection between valve body and actuator
- High differential pressure close-off, low noise



2-Way Zone Valve

ISO-9002



LZV-2 Series Motorized Valves – 2-Way Zone Valve, normally closed

	CV Factor	Item Number	List Price
2-WAY - 1/2" SWEAT CONNECTION WITH END SWITCH	3.8	800-703	126.36
2-WAY - 3/4" SWEAT CONNECTION WITHOUT END SWITCH	5.4	800-704NE	115.50
2-WAY - 3/4" SWEAT CONNECTION WITH END SWITCH	5.4	800-704	124.95
2-WAY - 1" SWEAT CONNECTION WITH END SWITCH	8.0	800-705	137.55
2-WAY - 1-1/4" SWEAT CONNECTION WITH END SWITCH	11.7	800-706	208.95
NORMALLY OPEN ACTUATOR		800-710	78.75
REPLACEMENT 4-WIRE ACTUATOR		800-709	78.75

Order as replacement part for LZV-2 Series

3-Way Zone Valve

ISO-9002



LZV-3 Series Motorized Valves – 3-Way Zone Valve

	CV Factor	Item Number	List Price
3-WAY - 1/2" SWEAT CONNECTION,	3.8	800-713	127.05
3-WAY - 3/4" SWEAT CONNECTION	5.4	800-714	131.25
3-WAY - 1" SWEAT CONNECTION	6.7	800-715	152.25
3-WAY - 1-1/4" SWEAT CONNECTION	9.8	800-716	241.50
REPLACEMENT 2 WIRE ACTUATOR		800-719	78.75

Order as replacement part for LZV-3 Series

Gauges

KEY FEATURES AT A GLANCE

- Adjustable reference temperature
- 0-75 PSI
- 0-170 Feet of Head
- 40-200 °F range option optimized for hydronic heating and cooling applications or 60-280 °F temperature range standard option



Rear Mount Gauge

ISO-9001



T-825 Rear Mount Temperature and Pressure Gauge

	Range	Item Number	List Price
TEMPERATURE AND PRESSURE GAUGE 1/4" MPT - REAR MOUNT	40-200 °F	800-662	29.00
TEMPERATURE AND PRESSURE GAUGE 1/2" MPT - REAR MOUNT	40-200 °F	800-663	30.00
TEMPERATURE AND PRESSURE GAUGE 1/2" MPT - REAR MOUNT	60-280 °F	800-673	31.00

Bottom Mount Gauge

ISO-9001



T-825 Bottom Mount Temperature and Pressure Gauge

	Range	Item Number	List Price
TEMPERATURE AND PRESSURE GAUGE 1/4" MPT - BOTTOM MOUNT	40-200 °F	800-664	29.00
TEMPERATURE AND PRESSURE GAUGE 1/2" MPT - BOTTOM MOUNT	40-200 °F	800-665	31.50
TEMPERATURE AND PRESSURE GAUGE 1/2" MPT - BOTTOM MOUNT	60-280 °F	800-675	31.00

Extended Probe Rear Mount

ISO-9001



T-825 Rear Mount Extended Probe Temperature and Pressure Gauge

1/2" MPT, 3" Probe.

	Range	Item Number	List Price
3" PROBE TEMPERATURE AND PRESSURE GAUGE 1/2" MPT - REAR MOUNT	60-280 °F	800-683	31.00

Extended Probe Bottom Mount

ISO-9001



T-825 Bottom Mount Extended Probe Temperature and Pressure Gauge

1/2" MPT, 3" Probe.

	Range	Item Number	List Price
3" PROBE TEMPERATURE AND PRESSURE GAUGE 1/2" MPT - BOTTOM MOUNT	60-280 °F	800-684	31.00

2-1/2" Rear Mount Gauges

T-825 2-1/2" Rear Mount Temperature and Pressure Gauge

2-1/2" Gauge ideal for boiler replacements.



	Range	Item Number	List Price
2-1/2" TEMPERATURE AND PRESSURE GAUGE 1/4" MPT - REAR MOUNT	60-280 °F	800-692	23.00
2-1/2" TEMPERATURE AND PRESSURE GAUGE 1/2" MPT - REAR MOUNT	60-280 °F	800-693	25.00

T-820 Test Gauges

KEY FEATURES AT A GLANCE

- High quality 1 piece 0-100 PSI test gauge
- Available in 1" MPT – threads directly to 1" manifold without fittings
- Built in Schraeder valve
- End mount design perfect for low profile test applications



1" Thread allows direct attachment to the manifold without fittings (800-668).

Side Mount Tester

ISO-9001



T-820 Air Pressure Tester FPT – 3/4" female threads

AIR PRESSURE TESTER 3/4" FPT - SIDE MOUNT

Item Number

List Price

800-669

36.00

Side Mount Tester

ISO-9001



T-820 Air Pressure Tester MPT – 1" male thread allows direct connection to manifold.

AIR PRESSURE TESTER 1" MPT - SIDE MOUNT

Item Number

List Price

800-668

30.75

End Mount Tester

ISO-9001



T-820 Air Pressure Tester MPT – End mount style is great for low profile applications. 1" male thread allows direct connection to manifold.

AIR PRESSURE TESTER 1" MPT - END MOUNT

Item Number

List Price

800-667

30.75

New Water Pressure Tester

ISO-9001



T-820 Water Pressure Tester GHT – GHT connection to allow for easy plumbing system pressure testing.

WATER PRESSURE TESTER 3/4" GHT

Item Number

List Price

800-660

14.00

Temperature Gauge with Thermowell

KEY FEATURES AT A GLANCE

- Rear Mount - 2" or 3" Gauges
- Solder or threaded thermowell options
- Gauge is easily removable without loss of system pressure
- 60° F-280° F



Temp Gauge W/ Thermowell

Temperature Gauge with Thermowell – 1" probe

ISO-9001



2" TEMPERATURE GAUGE WITH 1/2" MPT THERMOWELL

Range

60° F – 280° F

Item Number

800-653

List Price

18.90

3" TEMPERATURE GAUGE WITH 1/2" MPT THERMOWELL

60° F – 280° F

800-652

21.00

2" TEMPERATURE GAUGE WITH 3/4" SOLDER THERMOWELL

60° F – 280° F

800-655

21.00

3" TEMPERATURE GAUGE WITH 3/4" SOLDER THERMOWELL

60° F – 280° F

800-654

21.99

Solar & Geothermal



**Downstream
Thinking.**

It's all about Performance.

Legend offers a wide range of Solar and Geothermal products.

M-8400

GeoGreen™

GEO THERMAL Manifold System

The Legend GeoGreen™ M-8400 Geothermal™ Manifold System offers the ultimate in lightweight durability, labor savings and installation flexibility for commercial and residential geothermal applications.



M-8400 GeoGreen™ mounted ground vault.

This easy to install and maintain, custom manifold for ground-source geothermal loops offers the ultimate in labor savings and installation flexibility. It reduces labor due to its low number of parts and connections and saves space because of its compact design. The unit is lightweight, made of chemical and corrosion resistant PPR Type 3 engineered plastic, and is visually appealing. Most common configurations are available from stock, but Legend Hydronics will custom build to suit any application from 2-1/2" to 3-1/2" diameter and 4 to 26 loops for larger industrial and commercial applications. Header connections are available in threaded or new LegendPress™ style connections.

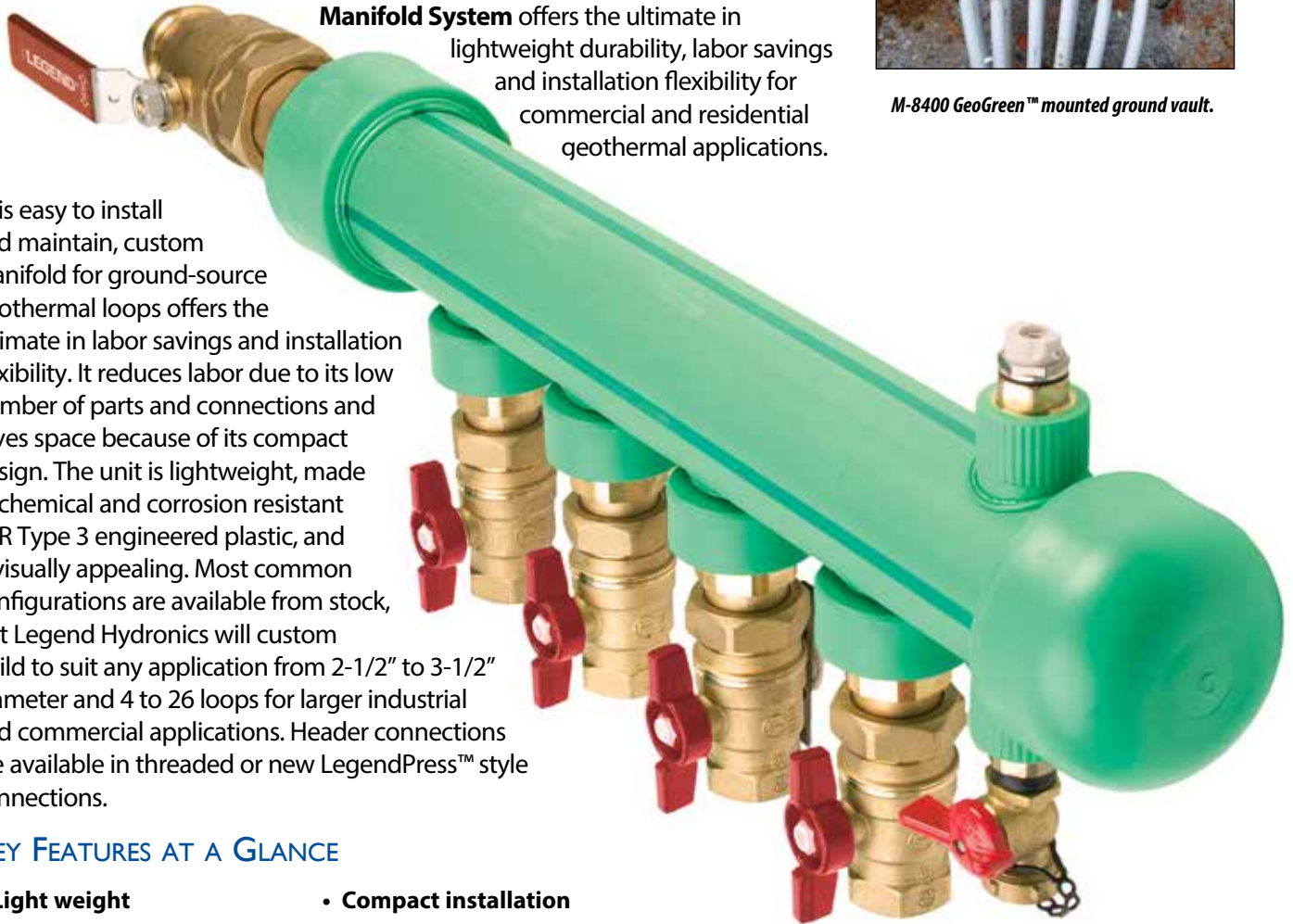

KEY FEATURES AT A GLANCE

- Light weight
- Labor saving
- Easy to install
- Compact installation
- Custom configurations available

GeoGreen™ **GeoGreen M-8400 Geothermal™ Manifold Base Kit** – Durable lightweight 2-1/2" geothermal manifolds. Contact Legend Customer Service for additional configurations.



ISO-9002

- 75mm 2-1/2" 4-PORT MANIFOLD BASE KIT
- 75mm 2-1/2" 6-PORT MANIFOLD BASE KIT
- 75mm 2-1/2" 8-PORT MANIFOLD BASE KIT **NEW**

Item Number	Price
8400-25-4	CALL FOR QUOTE
8400-25-6	CALL FOR QUOTE
8400-25-8	CALL FOR QUOTE

GeoGreen™ M-8400 Geothermal™ Manifold System

Custom GeoGreen™ Manifolds
are available in configurations of
10 to 26 ports, up to 3-1/2" sizes.



**GEOGREEN MANIFOLD BASE: SUPPLY & RETURN HEADERS,
2 SETS OF BRACKETS, AND FILL VALVE & AIR PURGER**



HEADER ISOLATION
VALVES (RED & BLUE PAIR)
FIP – 1-1/2" 822-857



Contact Legend Customer Service
for assistance in specifying and
ordering accessories for the
GeoGreen™ M-8400 Geothermal™
Manifold. 1-866-752-2055

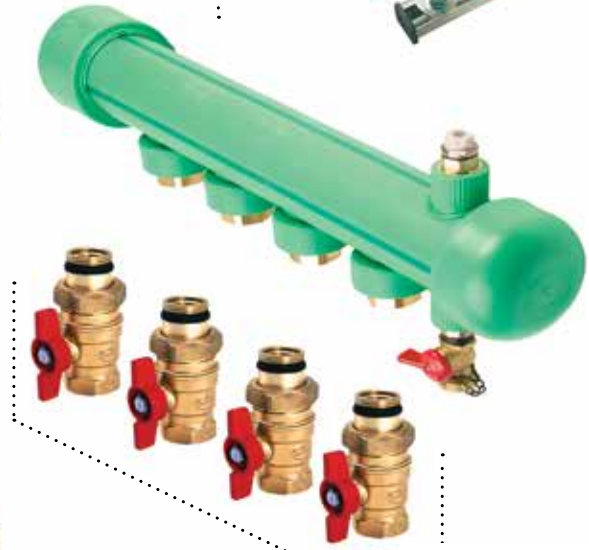

LOOP ISOLATION
VALVES
(RED & BLUE PAIR)
1" 800-855

HEADER ISOLATION
VALVES (RED & BLUE PAIR)
LEGENDPRESS™
1-1/2" 800-867



LOOP ISOLATION VALVES
WITH THERMOMETERS
(RED & BLUE PAIR)
1" 800-855T

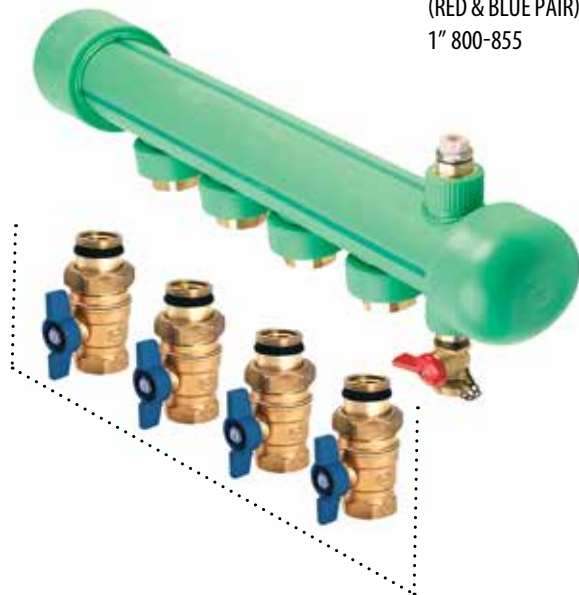

GeoGreen™ M-8400 Geothermal™ Manifold Accessories

Contact Legend Customer Service at 1-866-752-2055 for assistance in specifying and ordering accessories for GeoGreen™ M-8400 Geothermal™ Manifolds.

Hi-Cap Isolation Valve

High Capacity Header Isolation Valves – for GeoGreen™ and M-8220 Manifolds.

ISO-9002



1-1/2" MANIFOLD HEADER ISOLATION VALVE-PAIR

Item Number

822-857

List Price

325.00

LegendPress™ Isolation Valve

High Capacity Header Isolation Valves with LegendPress™ Connection – for GeoGreen™ and M-8220 Manifolds. Legend's Press-Style isolation valves feature two EPDM O-rings and deep sockets to ensure a perfect seal with every press.

ISO-9002



1-1/2" LEGENDPRESS™ MANIFOLD HEADER ISOLATION VALVE -PAIR

Item Number

800-867

List Price

379.50

Loop Isolation Valve

Loop Isolation Valves – for GeoGreen™ and M-8220 Manifolds.

ISO-9002



1" LOOP ISOLATION VALVE-PAIR

Item Number

800-855

List Price

116.68

May be used with 3/4" or 1" high capacity tubing connectors

Note: Also used as header isolation valve on M-8000 and M-8200 series manifolds

Loop Isolation Valve W/Thermometer

Loop Isolation Valves with Thermometer – for GeoGreen™ and M-8220 Manifolds. Two Thermometer ports (left or right) add flexibility in mounting.

ISO-9002



1" LOOP ISOLATION VALVE WITH PRESS-PAIR

Item Number

800-855T

List Price

174.00

May be used with 3/4" or 1" high capacity tubing connectors

Note: Also used as header isolation valve on M-8000 and M-8200 series manifolds

GeoGreen™ M-8400 Geothermal™ Manifold Accessories

PEX Connectors

ISO-9002



High Capacity PEX Tube Connectors – for GeoGreen™ and M-8220 Manifolds.
1" male NPT x PEX

3/4" HI-CAP PEX CONNECTOR-PAIR

1" HI-CAP PEX CONNECTOR-PAIR

Item Number

800-234

List Price

62.83

800-235

77.00

Not for use with PEX-AL-PEX.

Note: Both 3/4" and 1" for use with 1" loop isolation valve

Hi-Cap Manifold Brackets

ISO-9002



High Capacity Manifold Mounting Brackets – Replacement for GeoGreen™ and M-8220 Manifolds.

HI-CAP MANIFOLD MOUNTING BRACKET & COLLAR-PAIR

Item Number

822-861

List Price

50.00

NEW!

SUNSTATION™

Legend Hydronics' space and labor saving SP-20 SunStation™ Pump System is state of the art. The "heart" of any solar thermal heating system is its pump system and SunStation's compact, lightweight design makes it easy to install and maintain. The insulation shell ensures effective thermal insulation, easy access and an attractive appearance. Proven for many years in European applications, the cost-effective SunStation™ Pump includes flow gauge, fill & purge valves, circulator, balancing valve, supply & return isolation valves with built-in check, manual air vent, supply & return temperature gauges, pressure gauge and pressure relief valve with drain port.

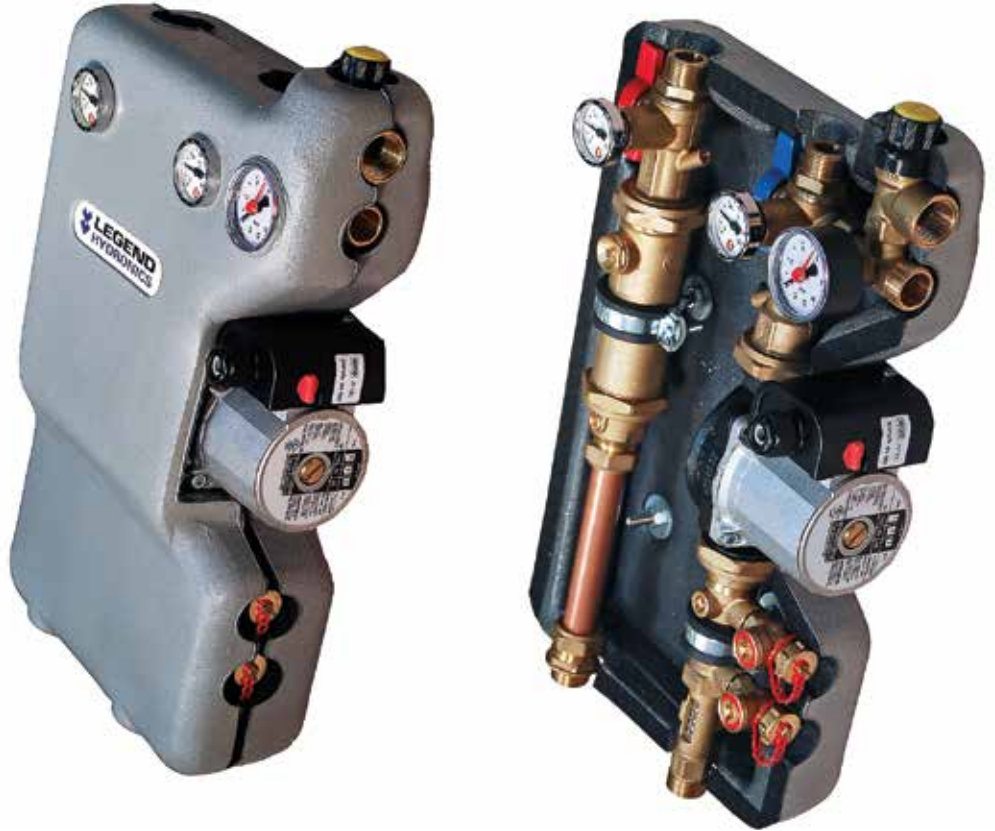

KEY FEATURES AT A GLANCE

- Isolation valves with integrated thermometers
- 2 piece insulation shell included
- Electronic Control Unit (ordered separately)
- Built-in flow meter
- Fill and purge valves
- Pressure relief with drain port



The SP-20 Unit provides automatic control of the solar pumping station. The unit monitors temperature sensors mounted on the solar panels and in the storage tank. When the solar panel temperature is greater than the storage tank, the pump operates, heating the water in the tank. At night or in cold conditions the pump remains off, preserving the heat accumulated in the tank. The controller also logs operating parameters providing information on the amount of energy saved and collected over time.

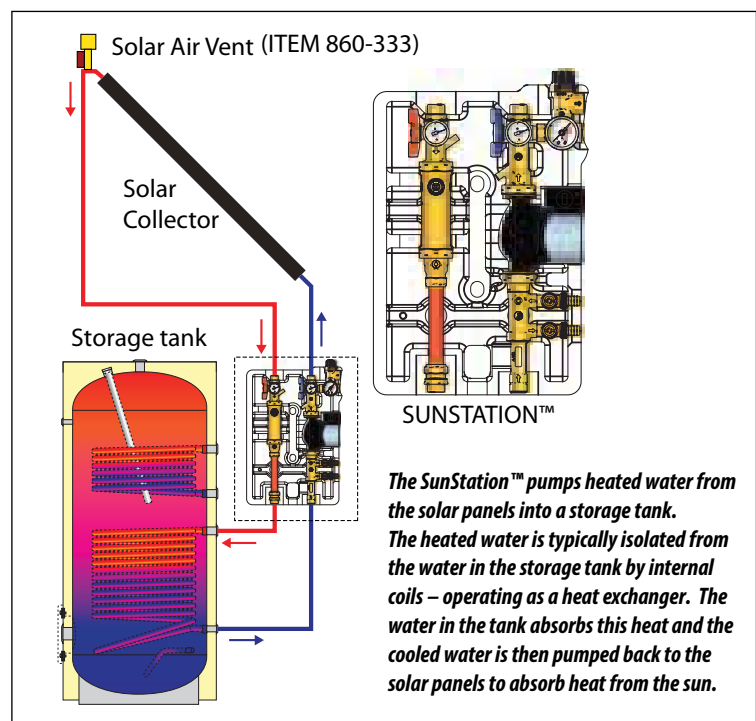

Compact Solar Pumping Stations

SP-20 SunStation

ISO 9002



SunStation™ Compact Solar Pumping Station – Includes flow gauge, fill & purge valves, circulator, balancing valve, supply & return isolation valves with built-in check, manual air vent, supply & return temperature gauges, pressure gauge and pressure relief valve with drain port.

SP-20 DUAL LINE SOLAR PUMP

Item Number	List Price
860-020	1575.00

Connection Kit

ISO 9002



Connection Kit for SP-20 SunStation™ – Contains 6 adapters for panel supply & return, tank supply/return, expansion tank, and overpressure blow-off.

1/2" COMPRESSION CONNECTION KIT

Item Number	List Price
860-023	90.00

3/4" COMPRESSION CONNECTION KIT

860-024	115.00
---------	--------

1" COMPRESSION CONNECTION KIT

860-025	165.00
---------	--------

Electronic Control Unit

ISO 9002



Control Unit for SP-20 SunStation™ – The SP-20 Electronic Control provides automatic control of the SP-20 SunStation™ .

SP-20 ELECTRONIC CONTROL UNIT

Item Number	List Price
860-100	625.00

Solar Air Vent

ISO 9002



Air Vent – High temperature (356° F) and high capacity air vent for solar applications. Includes isolation ball valve for servicing air vent.

SOLAR AIR VENT AND VALVE KIT

Item Number	List Price
860-333	105.45

Valves & Fittings



**Downstream
Thinking.**

It's all about Performance

Legend offers a broad range of valves and fittings for steam, hot water and mechanical room applications.

VALVES & FITTINGS

T/S-1002FLG & T/S-2011RFLG FORGED BRASS ISOLATION VALVES

ISO 9002

Full Port Flanged Isolation Valve
Gland Follower Design

MSS SP-110
600 CWP

Blow-out proof stem
PTFE seats
Bolt set included

Rotating flange (T/S-2011) allows
infinite valve positioning in confined
piping installations

Permits circulator pump isolation and
removal without complete system
drain-down

Sizes: Threaded 3/4" to 1-1/4"
Sweat 3/4" to 1-1/4"



T-2011RFLG



T/S-2012 FORGED BRASS ISOLATION VALVES W/ PURGE

ISO 9002

Full Port Flanged Isolation Valve
Gland Follower Design

MSS SP-110
600 CWP

Blow-out proof stem
PTFE seats
Bolt set included

Rotating flange allows infinite valve
positioning for better access to the
handle and purge valve

Integral drain valve allows air purging,
balancing and flushing operations

Sizes: Threaded 3/4" to 1-1/4"
Sweat 3/4" to 1-1/4"



T-2012RFLG

T-80 CAST IRON AIR PURGER & T-70 HOT WATER AIR VENT

ISO 9002

Air Purger & Hot Water Air Vent

T-80's top and bottom tapings accept
T-70 air vent and expansion tank (each
sold separately)

T-70 automatically vents trapped air
from hot water heating systems

Sizes: T-80 1", 1-1/4", 1-1/2" & 2"
T-70 1/8" & 1/4"



T-80



T-70

T-457 AND T/S-459 FORGED BRASS BACKFLOW PREVENTERS

ISO 9002

Dual Check / with or without atmospheric
vent

T-457: A dual check non-vented design for
residential or commercial potable water
containment, downstream of the water
meter

T/S-459: A dual check design with
atmospheric vent for continuous pressure
boiler feed water lines

Sizes: T/S-459 1/2" & 3/4"
T-457 1/2" to 1"



T-459



T-457

Certified to ASSE
Standards 1012 and 1024

T/S-456 BRONZE CONICAL-BALL CHECK

ISO 9002

In-line Spring Check

250 CWP
125 WSP
Max Temp: 300° F @ 20 PSI

Bronze body
PTFE Conical-ball

Spring loaded high-flow design is ideal
for hydronic heating applications

Sizes: Threaded 1/2" to 2"
Sweat 1/2" to 2"



T-456

Conforms to MSS SP-80

Not for reciprocating air
compressor service.

T/S-455 BRONZE INLINE CHECK VALVES

ISO 9002

In-line Spring Check Valves

250 CWP

Durable cast bronze body

Fast, reliable spring loaded piston
assures positive sealing and silent
operation

Buna-N seat

Sizes: Threaded 1/2" to 2"
Sweat 1/2" to 2"



T-455



S-455

Conforms to MSS SP-80

Not for reciprocating air
compressor service.

VALVES & FITTINGS

CARBON STEEL MANIFOLD HEADER

ISO 9002

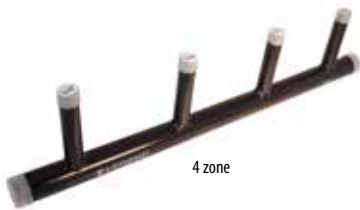

Boiler Manifold Header

Forged steel Schedule 40 pipe construction

Labor-saving one-piece design eliminates leak paths associated with nipple and fitting joints

Sizes: Available in 2, 3 & 4-zones, main run sizes 1", 1/4" & 1-1/2" and zone leg sizes 3/4" & 1"

1" x 3/4"
 1-1/4" x 3/4"
 1-1/4" x 1"
 1-1/4" x 3/4" x 1"
 1-1/2" x 3/4"
 1-1/2" x 1"

T/S-15 BRONZE Y-STRAINERS

ISO 9002



S-15

T-15
 Optional 40 and 80 mesh screens available

Y-Strainer

150 WSP
300 CWP

304 stainless steel 20 mesh screen*

Closure plug furnished

Can be installed vertically (downward flow only) or horizontally

Sizes: Threaded 1/4" to 3"
 Sweat 1/2" to 3"

*Sizes 2-1/2" & 3" are equipped with a 304 SS 1/16" perforated strainer

T-60, T-60A, T-61, T-63 AND T-65 CHROME PLATED AIR VENTS

ISO 9002



Steam Air Vents

Durable chrome finish

Automatically vents trapped air from steam heating systems

Available in straight and angle patterns

Sizes: 1/8" & 1/4"
 1/2" & 3/4"

T-90, T-90A, T-91, T-93 AND T-95 CHROME PLATED ECONOMY AIR VENTS

ISO 9002



Steam Air Vents

Chrome finish resists corrosion and pitting

Automatically vents trapped air from steam heating systems

Available in straight and angle patterns

Sizes: 1/8" & 1/4"
 1/2" & 3/4"

T/S-437 BRONZE HOT WATER ANGLE VALVES

ISO 9002



T-437

Hot Water Angle Valves

60 PSI Hot Water

Ideal for hot water baseboard heating systems

Heavy-duty bronze and forged brass construction

Sizes: Threaded 1/2" to 1-1/2"*
 Sweat 1/2" & 3/4"

*1", 1-1/4" and 1-1/2" are our T-431 steam angle valves drilled for hot water use

T-431 & T-435 BRONZE RADIATOR VALVES

ISO 9002



Angle and Straight Steam Radiator Valves

T-431: 15 WSP
60 PSI Hot WaterT-435: 125 WSP
200 PSI

Phenolic handle protects the operator's hand from burns

Complete closure design for steam radiator heating systems

Heavy-duty bronze or brass* construction

Sizes: T-431: 1/2" to 2"
 T-435: 1/2" to 1-1/2"

*Both models are also available in yellow brass

VALVES & FITTINGS

S-439 AND S-464 BRONZE PURGE & BALANCING VALVES

ISO 9002



S-439

Balancing and Purge Valves

S-464: 60 CWP

S-439: 150 WSP
400 CWP



S-464

S-439 balancing valve features ball-type screwdriver slot 100% shut-off operation

S-464 purge and balancing valve features 1/2" FNPT purge valve connection (valve not included) and screwdriver slot balancing-only disc (not 100% shut-off).

Sizes: S-464 Sweat 3/4" to 1-1/4"
S-439 Sweat 1/2" to 1"

FORGED BRASS TANKLESS WATER HEATER VALVES

ISO 9002



Tankless Water Heater Isolation Valve Kit (Pair)

600 CWP

Full port ball valve design

Integral drain valve w/ tethered cap

Heater union connections permit servicing

Pressure relief valve included

Sizes: Threaded 3/4"
Sweat 3/4"

Pressure relief valve is ASME listed and ANSI Z21.22 / CSA 4.4 compliant

BRASS CAST PRESSURE FITTINGS

ISO 9002



Cast Pressure Fittings

125 CWP

Baseboard Tees
Drain Couplings
Copper x FNPT Cast Tee's

Sizes: 3/8" to 2"



P-200 LEGENDPRESS™ FORGED BRASS

ISO 9002



P-200

Press-to-connect ball valves

MSS SP-110

1/2" & 3/4" 600 CWP

1" & 1-1/4" 500 CWP

1-1/2" to 4" 400 CWP

230° F Maximum Temperature

Full Port

Deep tubing sockets provide extra pressing stability

Blow-out proof, dual O-ring stem design

Sizes: 1/2" to 4"

T-40, T40UE & T-41 FORGED BRASS THERMOSTATIC MIXING VALVES

ISO 9002



T-40

Thermostatic Mixing Valves

230 PSI Maximum Working Pressure

185° F Maximum Working Temperature

Adjustable temperature actuated mixing function

Automatic anti-scald protection

Can be used in hydronic heating applications (T-41)

Sizes: Threaded 1/2" to 1"
Sweat (T-40UE) 1/2" to 1"

ASSE 1017 certified

T-3000 FORGED BRASS GAS BALL VALVES

ISO 9002



T-3000

One-piece Gas Ball Valve

175 CWP

Superior one-piece forging eliminates body-to-end adapter leak path

Available in eight different configurations

Sizes: 3/8" to 3/4"

CSA certified for residential and commercial gas piping and gas appliance installations

Custom-Built Mechanical Panels

MECHPanels™

Designed and manufactured to fit your project specifications, the Legend Hydronics MechPanels™ are assembled and tested in our factory and shipped direct to the project ready for installation. All Legend Hydronics MechPanels are temperature and pressure tested to ensure leak free, quality connections. All wiring and electrical connections & circuits are also 100% tested*.

Why spend unnecessary time at the jobsite when you can simply hang the MechPanel on the wall, make the major connections, commission the project and leave. The Legend Hydronics MechPanels will save you time and money.

Our MechPanels™ offer a "just right" solution for every project whatever the scale.

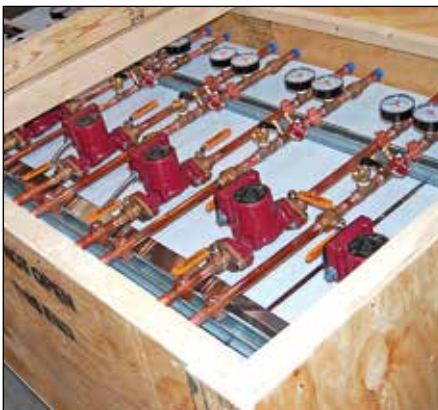

MechPanels™ use stainless steel backing for an attractive, clean, professional appearance.

Call your Legend Representative for a quotation to your projects specifications.

KEY FEATURES AT A GLANCE

- **Zone Distribution – with Circulators and/or Valves**
- **Primary Piping - Heating/Cooling Source included**
- **Residential Projects**
- **Commercial Skids – Snow & Ice Melt Systems**
- **Controls included and pre-wired**

** Service manual included – wiring and piping schematics, equipment specifications, unpacking, installation, and operation instructions.*

AMBIANCE™

radiant heating and cooling ceiling panels



Ambiance™ is available in elegant colors & designs

AMBIANCE™ panels can be used for commercial environments supplying zoned heating and cooling efficiently. In multi-floor buildings, AMBIANCE™ can reduce plenum space and result in 5-10% more usable building space.

AMBIANCE™ panels can be used to provide supplemental heat in small spaces where design constraints do not allow for sufficient heat. Entry ways, foyers, bathrooms, and windowed areas are common applications where supplemental heat is needed to provide comfort.

Call your Legend Representative for a quotation to your project specifications.

KEY FEATURES AT A GLANCE

- Fits in standard 2x2 and 2x4 ceiling grid systems
- Works for heating and cooling applications
- Great for new construction or existing ceiling retrofits
- Great for large, multi-level buildings or smaller residential spaces
- Excellent supplemental heat for foyers, basements, entry ways, etc.

AMBIANCE™ is a ceiling based radiant panel system that can be used for heating or cooling applications.

AMBIANCE™ consists of 2x2 or 2x4 steel panels that fit in standard suspended ceiling grid systems. The panels incorporate aluminum heat transfer plates that conduct heat to or from the panel surface. Copper or PEX tube is connected to the heat transfer plates via flexible braided connectors. The panels are then connected in series to a manifold supplying heated or chilled water.

An AMBIANCE™ system can easily accommodate as many temperature zones and controls as needed.



Floor Systems Material Estimate Work Sheet

To estimate the number of panels required for your project enter the project square footage in the formulas below.

VersaTherm™



Main Panels (VT-MP) Panel Size = 31-1/2 in. x 15-3/4 in. = (496) 3.44 ft² (10 panels per box)

NUMBER OF PANELS:

$$\frac{\text{Project square footage}}{\text{Number of Main Panels needed}^*} \times 0.233 = \text{Number of Main Panels needed}^* \text{ (Round Up)}$$

EXAMPLE: 400 ft² x 0.233 = 93.2 or (94)

NUMBER OF CASES:

$$\frac{\text{Number of Main Panels needed}}{\text{Number of Cases of needed}^*} \div 10 = \text{Number of Cases of needed}^* \text{ (Round Up)}$$

EXAMPLE: 94 panels ÷ 10 = 9.4 or (10) boxes *Use to calculate Number of Cases



Return Panels (VT-RP) Panel Size = 15-3/4 in. x 15-3/4 in. = (248) 1.72 ft² (20 panels per box)

NUMBER OF PANELS:

$$\frac{\text{Project square footage}}{\text{Number of Return Panels needed}^*} \times 0.117 = \text{Number of Return Panels needed}^* \text{ (Round Up)}$$

EXAMPLE: 400 ft² x 0.117 = 46.8 or (47)

NUMBER OF CASES:

$$\frac{\text{Number of Return Panels needed}}{\text{Number of Cases needed}^*} \div 20 = \text{Number of Cases needed}^* \text{ (Round Up)}$$

EXAMPLE: 47 panels ÷ 20 = 2.35 or (3) boxes *Use to calculate Number of Cases



QuickTherm™

QT100 (1") Panel Size = 2' x 4' = 8 ft² (18 panels per bundle)

QT200 (2") Panel Size = 2' x 4' = 8 ft² (10 panels per bundle)

NUMBER OF PANELS:

$$\frac{\text{Project square footage}}{\text{Number of QT Panels needed}^*} \div 8 = \text{Number of QT Panels needed}^* \text{ (Round Up)}$$

EXAMPLE: 3500 ft² ÷ 8 = 437.5 or (438) panels

NUMBER OF BUNDLES:

$$\frac{\text{Number of QT Panels needed}}{\text{Number of Bundles needed}^*} \div (18 \text{ or } 10) = \text{Number of Bundles needed}^* \text{ (Round Up)}$$

EXAMPLE: 438 ÷ 10 (QT200) = 43.8 or (44) bundles *Use to calculate Number of Bundles

Notes: The project square footage includes only the area of the room or project space that is to be covered by tubing. Do not include areas under cabinets or any areas that will not receive tubing.

PROJECT DESIGN IS HIGHLY RECOMMENDED WITH VERSATHERM.

LIMITED WARRANTY (NON-CONSUMER PRODUCTS)

Legend Valve and Fitting's limited warranty warrants each valve to be free of defects in materials and workmanship for a period of 5 years from the date of purchase when properly installed and operated under normal use and service. Should one of these valves be proven defective, Legend will replace the defective valve free of charge and pay directly to the installing contractor \$25 for the cost of installation, which shall be the sole and exclusive remedy. This limited warranty is in lieu of all other warranties, express or implied, including the any warranty of MERCHANTABILITY OR FITNESS FOR A PARTICULAR PURPOSE, SAID WARRANTIES BEING EXPRESSLY DISCLAIMED. Legend will not be liable to any buyer for any incidental, consequential, or special damages including, without limitation, lost revenues and profits, mold intrusion, or water damage.

Legend Valve does NOT warrant against failure of any valve for any valve used for any purpose other than a purpose authorized by Legend Valve or damage to the valve caused by abuse, misuse, tampering, neglect, or natural disasters. Legend does NOT warrant against failure of any valve due to external causes where external, physical or chemical qualities produce damage to the product such as, without limitation, variations in water quality, aggressive water, or an unsuitable or hostile environment.

In the event a defect occurs that is believed to be covered by this warranty, Legend Valve Customer Services should be contacted immediately, either in writing or by telephone at 800-752-2082. Instructions will be given to return the valve, at the owner's expense, to Legend Valve or an authorized representative for inspection. In the event inspection of the valve discloses that it is defective, a replacement shall be mailed free of charge to the installing contractor together with payment of \$25 for the cost of installation, which shall be the sole and exclusive remedy. Some states or countries do not allow for the exclusion or limitation of incidental or consequential damages so these limitations may not apply to you. This warranty gives you specific legal rights, and you may also have other rights which vary from state to state and country to country. This warranty is applicable to Non-Consumer products only.





PLUMBING • INDUSTRIAL • COMMERCIAL • HYDRONICS

It takes a commitment to exceed the expectations of our customers in every way possible. It takes unparalleled performance in everything we do. From 24 hour shipping, to industry leading fill rates, we guarantee to do everything it takes to help you succeed. Legend is here to meet the rapidly growing demand for innovative radiant, solar, and geothermal systems with a full line of high-quality, high-performing products. As you would expect, every Legend product is backed by the same suite of services the industry has become accustomed to from Legend Valve.

300 N. Opdyke Rd.
Auburn Hills, MI 48326

Tel:1-866-752-2055
Fax:1-866-752-2054

www.legendhydronics.com



**Downstream
Thinking**

It's all about Performance



LH-MPL0915