

ShockLine™

MS46522A/MS46524A Series

Vector Network Analyzers

MS46522A-004 VNA, 50 kHz to 4.5 GHz, 2-Port

MS46522A-010 VNA, 50 kHz to 8.5 GHz, 2-Port

MS46524A-004 VNA, 50 kHz to 4.5 GHz, 4-Port

MS46524A-010 VNA, 50 kHz to 8.5 GHz, 4-Port



Anritsu

TRADEMARK ACKNOWLEDGMENTS

Anritsu, Advanced-LRM, K-Connector, Lightning, V-Connector, ShockLine™, and W1-Connector are registered trademarks of the Anritsu Company, Morgan Hill, California, USA.

Acrobat Reader is a registered trademark of Adobe Corporation of San Jose, California, USA.

Duro microprocessors are registered trademarks of AMD Corporation,

Smith (Smith Chart) is a registered trademark of Analog Instruments Company, New Providence, New Jersey, USA.

Teflon is a registered trademark and brand name of the DuPont Company.

i5, Pentium and Celeron microprocessors are registered trademarks of Intel Corporation, Santa Clara, California, USA.

LabView, LabWindows, NI, NI-VISA, are registered trademarks of the National Instruments Corporation, Austin, Texas, USA.

Norton and Norton Ghost are registered trademarks of the Symantec Corporation, Cupertino, California, USA.

ActiveX, Excel, NotePad, ToolTips, Visual Basic, Visual C++, Windows, Windows 2000, Windows CE/Mobile, Windows XP, Windows 7, and Windows 8 are registered trademarks of Microsoft Corporation, Redmond, Washington, USA.

All other trademarks or trade names mentioned in this document are the property of their respective owners.

NOTICE

Anritsu Company has prepared this manual for use by Anritsu Company personnel and customers as a guide for the proper installation, operation and maintenance of Anritsu Company equipment and computer programs. The drawings, specifications, and information contained herein are the property of Anritsu Company, and any unauthorized use or disclosure of these drawings, specifications, and information is prohibited; they shall not be reproduced, copied, or used in whole or in part as the basis for manufacture or sale of the equipment or software programs without the prior written consent of Anritsu Company.

UPDATES

Updates, if any, can be downloaded from the Documents area of the Anritsu Website at:

<http://www.anritsu.com>

For the latest service and sales contact information in your area, please visit:

<http://www.anritsu.com/contact.asp>

Notes On Export Management

This product and its manuals may require an Export License or approval by the government of the product country of origin for re-export from your country.

Before you export this product or any of its manuals, please contact Anritsu Company to confirm whether or not these items are export-controlled.

When disposing of export-controlled items, the products and manuals need to be broken or shredded to such a degree that they cannot be unlawfully used for military purposes.

Safety Symbols

To prevent the risk of personal injury or loss related to equipment malfunction, Anritsu Company uses the following symbols to indicate safety-related information. For your own safety, please read the information carefully *before* operating the equipment.

Symbols Used in Manuals

Danger



This indicates a risk from a very dangerous condition or procedure that could result in serious injury or death and possible loss related to equipment malfunction. Follow all precautions and procedures to minimize this risk.

Warning



This indicates a risk from a hazardous condition or procedure that could result in light-to-severe injury or loss related to equipment malfunction. Follow all precautions and procedures to minimize this risk.

Caution



This indicates a risk from a hazardous procedure that could result in loss related to equipment malfunction. Follow all precautions and procedures to minimize this risk.

Safety Symbols Used on Equipment and in Manuals

The following safety symbols are used inside or on the equipment near operation locations to provide information about safety items and operation precautions. Ensure that you clearly understand the meanings of the symbols and take the necessary precautions *before* operating the equipment. Some or all of the following five symbols may or may not be used on all Anritsu equipment. In addition, there may be other labels attached to products that are not shown in the diagrams in this manual.



This indicates a prohibited operation. The prohibited operation is indicated symbolically in or near the barred circle.



This indicates a compulsory safety precaution. The required operation is indicated symbolically in or near the circle.



This indicates a warning or caution. The contents are indicated symbolically in or near the triangle.



This indicates a note. The contents are described in the box.



These indicate that the marked part should be recycled.

For Safety

Warning



Always refer to the operation manual when working near locations at which the alert mark, shown on the left, is attached. If the operation, etc., is performed without heeding the advice in the operation manual, there is a risk of personal injury. In addition, the equipment performance may be reduced.

Moreover, this alert mark is sometimes used with other marks and descriptions indicating other dangers.

Warning



or

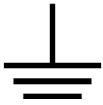

When supplying power to this equipment, connect the accessory 3-pin power cord to a 3-pin grounded power outlet. If a grounded 3-pin outlet is not available, use a conversion adapter and ground the green wire, or connect the frame ground on the rear panel of the equipment to ground. If power is supplied without grounding the equipment, there is a risk of receiving a severe or fatal electric shock.

Warning



This equipment can not be repaired by the operator. Do not attempt to remove the equipment covers or to disassemble internal components. Only qualified service technicians with a knowledge of electrical fire and shock hazards should service this equipment. There are high-voltage parts in this equipment presenting a risk of severe injury or fatal electric shock to untrained personnel. In addition, there is a risk of damage to precision components.

Caution



Electrostatic Discharge (ESD) can damage the highly sensitive circuits in the instrument. ESD is most likely to occur as test devices are being connected to, or disconnected from, the instrument's front and rear panel ports and connectors. You can protect the instrument and test devices by wearing a static-discharge wristband. Alternatively, you can ground yourself to discharge any static charge by touching the outer chassis of the grounded instrument before touching the instrument's front and rear panel ports and connectors. Avoid touching the test port center conductors unless you are properly grounded and have eliminated the possibility of static discharge.

Repair of damage that is found to be caused by electrostatic discharge is not covered under warranty.

Chapter Descriptions

Chapter 1 — Overview

This manual is a reference document for the Anritsu ShockLine™ VNA user interface (UI) menus and dialog boxes. This chapter describes the document conventions used in this manual and lists related ShockLine™ VNA documentation.

Chapter 2 — Menu Bar, Icon Bar, and Main Menu

This chapter describes the user interface screen layout, and navigation tools including the Menu Bar, Icon Bar, and MAIN MENU.

Chapter 3 — Channel Menus

This chapter describes how to set the number of channels used and how they are displayed on the instrument. Up to 16 channels can be configured, each with up to 16 traces per channel. For the MS46121A only, each channel is dedicated to an individual 1-port VNA. Only those channels associated with VNA hardware will have active trace displays.

Chapter 4 — Frequency Menus

This chapter covers the FREQUENCY menu which allows the user to set frequency start, stop, span, number of points, and CW mode parameters for the currently active (selected) channel. The FREQUENCY menu has several variants; the one that is displayed depends on the SWEEP TYPES setting for the current channel. The sweep type is set on the SWEEP SETUP menu.

Chapter 5 — Power Menus: 2-Port VNAs

This chapter provides information on port power control in 2-port VNAs. Power conditions for sweeps are set in different places in the ShockLine application, depending on the sweep type: 1) for frequency-based sweeps and for power-based sweeps, the Power menu is used to set power parameters, and 2) for segmented and indexed sweeps, the power setup controls are in segment or index setup characteristics areas of the sweep tableaus (see Sweep chapter for details).

Chapter 6 — Power Menus: 4-Port VNAs

This chapter provides information on port power control in 4-port VNAs. Power conditions for sweeps are set in different places in the ShockLine application, depending on the sweep type: 1) for frequency-based sweeps and for power-based sweeps, the Power menu is used to set power parameters, and 2) for segmented and indexed sweeps, the power setup controls are in segment or index setup characteristics areas of the sweep tableaus. (See Sweep chapter for details.)

Chapter 7 — Sweep Menus

This chapter describes sweep types supported by the VNA and how to set and configure them.

Chapter 8 — Averaging Menu

The AVERAGING menu allows users to turn averaging on or off, set the averaging factor, and select whether the averaging type is per point or per sweep. Control is also provided for IFBW and trace smoothing.

Chapter 9 — Calibration Menus: 1-Port and 2-Port VNAs

This chapter describes the menus used when calibrating 1- and 2-Port ShockLine™ VNAs. It is organized to follow the flows in the progressions of menus and dialog boxes for calibration control. Though it provides representative examples of dialogs, it does not show all the possible dialog contents. This is because their appearance changes dynamically based on combination of instrument calibration ports, AutoCal, manual calibration, calibration methods, line types, and connectors. However, basic elements in the combinations are explained. Only 1-port menus, dialogs, and calibrations are valid for the MS46121A.

Chapter 10 — Calibration Menus: 4-Port VNAs

This chapter describes the menus used when calibrating 4-Port ShockLine™ VNAs. Chapter organization follows the flows in the progressions of menus and dialog boxes for calibration control. Representative examples of dialogs are shown. Dialog appearance changes dynamically depending on based on the combination of instrument calibration ports, AutoCal, manual calibration, calibration methods, line types, and connectors.

Chapter 11 — Measurement Menus

This chapter provides information for the measurement menu system which controls the embed/de-embed functions, the impedance transformations, reference plane location, post-processing order functions, and dielectric parameters along with their related configuration dialog boxes. Impedance transformation and post-processing order functions do not apply to the MS46121A.

Chapter 12 — Time Domain Menu

The Time Domain (TDOMAIN) menu provides a convenient way to access all time domain-related parameter setup items. Although these parameters are also accessible in other places throughout the ShockLine application, the user must shift among menus to reach them. Here, the Measurement Setup dialog collects all of them for access on one screen.

Chapter 13 — Application Menu

This chapter provides information for the APPLICATION menu that is used for Receiver Configuration. The default measurement mode setting is for Standard S-Parameters.

Chapter 14 — Trace Menus

This chapter provides information on traces. You can set the number of traces that appear for each channel and how those traces are arranged on the main display. Up to 16 traces can be defined and there are 22 available trace layouts. Traces can be detached as free-floating windows.

Chapter 15 — Response Menus: 1-Port and 2-Port VNAs: 1-Port and 2-Port VNAs

This chapter provides information on the 1- and 2-port VNA Response menus used to configure S-Parameters using standard options, or to configure user-defined parameters. Only 1-port related response menu items apply to the MS46121A.

Chapter 16 — Response Menus: 4-Port VNAs

This chapter provides information about the 4-Port VNA Response menus for configuration of standard S-Parameters or user-definition of a unique parameter. The MIXED MODE dialog box variants provide mixed-mode response setup on a trace-by-trace basis with multiple response options for each trace.

Chapter 17 — Display Menus

This chapter provides information for setup and configuration for the instrument displays. Selections provide control over the trace formats, with over nine different major display types. Each display type can be further modified with parameters applicable to that display format. The control also provides control for trace memory and trace math modifications. The trace limit functions allow maximum/minimum parameters to be set for each trace and provide visual and/or programmatic indications of pass/fail.

Chapter 18 — Scale Menus

This chapter provides information about the button controls for the SCALE menu variants. SCALE menus provide trace display control of settings such as resolution, reference value, and the scale of units. The number of buttons on a SCALE menu depends on the settings on the TRACE FORMAT menu.

Chapter 19 — Marker Menus

This chapter provides information for configuring and controlling the marker functions. The instrument provides up to thirteen markers per trace of which twelve can be direct markers and one a reference marker. Each marker can be individually controlled on/off and positioned as required. If the reference marker is off, each marker provides measurement data based on its display position. If the reference marker is on, each marker provides differential measurement data based on its position relative the reference. Other functions for display options and various types of single-peak search are available.

Chapter 20 — System Menus

This chapter provides information for various system and instrument management and configuration functions including initial setup, power-on options, preset options, network interface, self-test, and diagnostics.

Chapter 21 — File Management Menus

This chapter provides information for management of various system output and configuration files including Active channel TXT files, Active channel S2P files, Active channel CSV files, Active trace data (Formatted), and Active trace data (Unformatted).

Appendix A — File Specifications

This appendix defines the file directory structure used on default-configuration ShockLine Series VNAs and provides the general file extensions and specifications used in the instrument.

Appendix B — Error Messages

This appendix lists, describes, and provides corrective action for error messages that appear on the instrument display. Any error messages that require action by a qualified service representative are also listed. The tables herein describe the name of the message, the typical reason for its occurrence, and recommended error correction methods. In many cases, the remedial action for the error message is described with applicable cross-references to documented procedures.

Appendix C — Anritsu easyTest

This appendix outlines using easyTest with ShockLine VNAs. The easyTest Tools application is used to create easyTest .ett files having step sequences that can be run (displayed) on the instrument.

Table of Contents

Chapter 1 — Overview

1-1 Introduction	1-1
1-2 Documentation Conventions	1-1
Instrument Identification	1-1
User Interface	1-1
User Interface Navigation	1-1
User Input	1-2
1-3 User Documentation	1-2
Updates to Manuals	1-2

Chapter 2 — Menu Bar, Icon Bar, and Main Menu

2-1 Chapter Overview	2-1
2-2 Menu Bar	2-1
2-3 Icon Bar	2-1
2-4 Main Menu	2-2

Chapter 3 — Channel Menus

3-1 Chapter Overview	3-1
3-2 Overview of Channel Menus	3-1
3-3 Channel Menus	3-2
CHANNEL Menu	3-2
CHAN. LAYOUT Menu	3-3

Chapter 4 — Frequency Menus

4-1 Chapter Overview	4-1
4-2 Overview of Frequency Menus	4-1
4-3 FREQUENCY Menu for Frequency-Based Linear Sweep Mode	4-2
4-4 FREQUENCY Menu for Frequency-Based Logarithmic Sweep Mode	4-4
4-5 FREQUENCY Menu for Frequency-Based Segmented Sweep Mode	4-5
4-6 FREQUENCY Menu for Segmented Sweep (Index-Based)Mode	4-6
4-7 FREQUENCY Power Sweep CW-Based Menu	4-7

Chapter 5 — Power Menus: 2-Port VNAs

5-1 Chapter Overview	5-1
Maximum and Minimum Power Settings	5-1
5-2 Overview - Power Menus - 2-Port VNAs	5-2
Locations of Power Settings	5-2
Power Coupling State Is Shown in Power Menu Titles	5-2
5-3 POWER Menu for Frequency-Based Sweeps (Linear or Log)	5-3
Power Setup Menu	5-3
5-4 POWER Menu for Segment-Based Sweeps - 2-Port VNAs	5-4
5-5 POWER Menu for Power-Based Sweeps (CW)	5-5
POWER Menu - Power-Based Sweeps - 2-Port VNAs	5-6

Table of Contents (Continued)

POWER SETUP Menu - Power-Based Sweep Menu - 2-Port VNAs	5-8
Receiver Setup	5-9
Chapter 6 — Power Menus: 4-Port VNAs	
6-1 Chapter Overview	6-1
Maximum and Minimum Power Settings	6-1
6-2 Overview - Power Menus - 2-Port VNAs	6-2
Locations of Power Settings	6-2
Power Coupling State Is Shown in Power Menu Titles	6-2
6-3 POWER Menu for Frequency-Based Sweep (Linear and Log)	6-3
POWER SETUP Menu for Frequency-Based Sweep	6-4
6-4 POWER Menu for Segment-Based Sweeps	6-5
6-5 POWER Menu for Power-Based Sweep (CW)	6-6
POWER Menu - Power-Based Sweep - 4-Port VNAs	6-7
POWER SETUP Menu - Power-Based Sweep Menu - 4-Port VNAs	6-9
Receiver Setup	6-10
Chapter 7 — Sweep Menus	
7-1 Chapter Overview	7-1
7-2 Sweep on the ShockLine VNA	7-1
7-3 Overview of Sweep Menus	7-1
7-4 Sweep Setup Menu	7-2
SWEEP SETUP Menu	7-2
SWEEP CONFIG Menu	7-4
SWEEP TYPES Menu	7-5
7-5 Frequency-Based Segmented Sweep Setup	7-7
FREQ BASE SETUP Menu	7-7
7-6 Index-Based Segmented Sweep Setup	7-13
INDEX BASE SETUP Menu	7-13
7-7 FREQUENCY Power Sweep CW-Based Menu	7-15
7-8 Sweep Hold and Trigger Functions	7-16
HOLD FUNCTIONS Menu	7-16
HOLD CONDITIONS Menu	7-17
TRIGGER Menu	7-18
TRIGGER SOURCE Source Menu	7-19
SWEEP TIME SETUP Menu	7-19
Chapter 8 — Averaging Menu	
8-1 Chapter Overview	8-1
8-2 Overview of the Averaging Menu	8-1
8-3 Averaging Menu Functions	8-2
AVERAGING Menu	8-2
Chapter 9 — Calibration Menus: 1-Port and 2-Port VNAs	
9-1 Chapter Overview	9-1
9-2 Listing of Calibration Menus	9-1

Table of Contents (Continued)

9-3 Primary Menus for VNA Calibration	9-4
CALIBRATION [TR] Menu	9-5
CALIBRATE Menu	9-6
THRU (Update) Menu - 2-Port VNAs	9-8
9-4 Calibration Utility Functions	9-9
CAL KIT Menu	9-10
CAL OPTIONS Menu	9-17
9-5 AutoCal Port Selection Setup	9-21
AUTOCAL (Port Selection) Menu	9-21
9-6 AutoCal 2-Port Cal Setup	9-22
AUTOCAL SETUP Menu - 2-Port Cal	9-22
9-7 AutoCal 1-Port Cal Setup	9-28
AUTOCAL SETUP Menu - 1-Port Cal	9-28
9-8 Manual Calibration Menus and Dialog Boxes	9-31
Manual Calibration Types	9-33
Manual Calibration Methods	9-33
Calibration Line Types	9-33
Manual Calibration Dialog Box Settings	9-33
MANUAL CAL Menu	9-34
CAL SETUP Menu	9-35
CAL METHOD Menu	9-37
LINE TYPE Menu	9-38
9-9 Manual 2-Port Cal Setup	9-39
TWO PORT CAL Menu	9-39
Manual 2-Port Cal Setup Dialog Boxes	9-42
Manual 2-Port Cal Dialog Box Summary	9-55
9-10 Typical Calibration Sub-Menus	9-59
REFL. DEVICE(S) Menu	9-59
THRU/RECIP Menu	9-61
ISOLATION(S) Menu - 2-Port VNA	9-62
9-11 Manual 1-Port Cal Setup	9-63
ONE PORT CAL Menu (SOLT/R - Coaxial) 2-Port VNAs	9-63
9-12 Manual Cal - Trans. Freq. Resp. Cal	9-77
TRANS. RESPONSE Menu	9-77
Transmission Frequency Response Calibration Setup Dialog Boxes	9-81
9-13 Manual Cal - Refl. Freq. Resp. Cal	9-83
REFL. RESPONSE Menu	9-83
Refl. Freq. Resp. Calibration Setup Dialog Box Summary	9-88
9-14 Manual Calibration General Dialog Boxes	9-91
Chapter 10 — Calibration Menus: 4-Port VNAs	
10-1 Chapter Overview	10-1
10-2 Listing of Calibration Menus (4-Port VNA)	10-1
Primary Calibration Menus	10-1
Calibration Utility Functions	10-1

Table of Contents (Continued)

AutoCal Setup Menu	10-1
AutoCal 4-Port Calibration on 4-Port VNA	10-1
AutoCal 2-Port Calibration on 4-Port VNA	10-1
AutoCal 1-Port Calibration on 4-Port VNA	10-2
Manual Calibration Configuration on 4-Port VNA	10-2
Manual 4-Port Calibration on 4-Port VNA	10-2
Manual 3-Port Calibration on 4-Port VNA	10-2
Manual 2-Port Calibration on 4-Port VNA	10-2
Manual 1-Port Calibration on 4-Port VNA	10-3
Manual Transmission Frequency Response on 4-Port VNA	10-3
Manual Reflection Frequency Response Calibration on 4-Port VNA	10-3
Manual Calibration General Dialog Boxes on 4-Port VNA	10-3
10-3 Primary Menus for 4-Port VNA Calibration	10-4
CALIBRATION [TR] Menu - 4-Port VNAs	10-5
CALIBRATE Menu - 4-Port VNAs	10-6
THRU UPDATE Menu - 4-Port VNAs	10-8
10-4 Calibration Utility Functions	10-10
CAL OPTIONS Menu - 4-Port VNAs	10-11
CAL KIT (and AutoCal Kit) Menu - 4-Port VNAs	10-14
10-5 AutoCal Port Selection Setup - 4-Port VNAs	10-22
AUTOCAL (Port Selection) Menu - 4-Port VNAs	10-22
AUTOCAL SETUP Menu - 4-Port Cal - 4-Port VNAs	10-23
10-6 SmartCal 2-Port Cal Setup - 4-Port VNAs	10-28
SMARTCAL SETUP Menu - 2-Port Cal - 4-Port VNAs	10-28
AUTOCAL SETUP Menu - 2-Port Cal - 4-Port VNAs	10-29
10-7 SMARTCal 1-Port Cal Setup - 4-Port VNAs	10-35
SMARTCAL SETUP Menu - 1-Port Cal - 4-Port VNAs	10-35
AUTOCAL SETUP Menu - 1-Port Cal - 4-Port VNAs	10-36
10-8 Manual Calibration Menus and Dialog Boxes - 4-Port VNAs	10-39
Manual Cal Dialog Box Settings	10-41
MANUAL CAL Menu - 4-Port VNAs	10-42
CAL SETUP Menu - 4-Port VNAs	10-43
CAL METHOD Menu - 4-Port VNA	10-45
LINE TYPE Menu - 4-Port VNA	10-46
10-9 Manual 4-Port Cal Setup - 4-Port VNAs	10-47
FOUR PORT CAL Menu - 4-Port VNAs	10-47
Manual 4-Port Cal Setup Dialog Boxes - 4-Port VNAs	10-50
Manual 4-Port Cal Dialog Box Summary	10-66
10-10 Typical Calibration Sub-Menus	10-70
REFL. DEVICE(S) Menu - 4-Port VNAs	10-70
SLIDING LOADS Menu - 4-Port VNAs	10-72
THRU Menu - 4-Port VNAs	10-74
ISOLATION(S) Menu	10-76
10-11 Manual 3-Port Cal Setup - 4-Port VNAs	10-78
THREE PORT CAL Menu - 4-Port VNAs	10-78

Table of Contents (Continued)

Summary of 3-Port Calibration Setup Dialog Boxes	10-92
10-12 Manual 2-Port Cal Setup - 4-Port VNAs	10-97
TWO PORT CAL Menu - 4-Port VNAs	10-97
Summary of 2-Port Calibration Setup Dialog Boxes	10-109
10-13 Manual 1-Port Cal Setup	10-114
ONE PORT CAL/S Menu - 4-Port VNAs	10-114
Summary of 1-Port Calibration Setup Dialog Boxes	10-124
10-14 Manual Trans. Freq. Response Cal Menus and Dialog Boxes	10-127
TRANS. RESPONSE Menu - 4-Port VNAs	10-127
Summary of Trans. Freq. Resp. Cal Setup Dialog Boxes	10-135
10-15 Manual Refl. Freq. Response Menus and Dialog Boxes	10-136
REFL. RESPONSE Menu - 4-Port VNAs	10-136
Summary of Reflection Freq. Response Calibration Setup Dialog Boxes	10-144
10-16 Manual Calibration General Dialog Boxes	10-145

Chapter 11 — Measurement Menus

11-1 Chapter Overview	11-1
11-2 Overview of Measurement Menus	11-1
MEASUREMENT Menu	11-3
IMPED. TRANSF. Menu	11-4
REFERENCE PLANE Menu	11-5
PROCESSING ORDER Menu	11-6
EMBEDDING Menu	11-7
DIELECTRIC Menu	11-13

Chapter 12 — Time Domain Menu

12-1 Chapter Overview	12-1
12-2 Overview of the Time Domain Menu	12-1
12-3 Time Domain Icon on Icon Bar	12-1
12-4 Time Domain Menu	12-2
12-5 Low Pass Time Domain Cal Dialog	12-3
12-6 Time Domain Measurement Setup Dialog	12-4

Chapter 13 — Application Menu

13-1 Chapter Overview	13-1
APPLICATION Menu	13-1
APPLICATION Menu (for Receiver Configuration)	13-1
MULTIPLE SOURCE Menu	13-2
INT. SRC CONTROL Menu	13-3

Chapter 14 — Trace Menus

14-1 Chapter Overview	14-1
14-2 Overview of Trace Menus	14-1
14-3 Trace Configuration	14-2
TRACE Menu	14-2
14-4 Trace Display Layout	14-3

Table of Contents (Continued)

TRACE LAYOUT Menu	14-3
Chapter 15 — Response Menus: 1-Port and 2-Port VNAs: 1-Port and 2-Port VNAs	
15-1 Chapter Overview	15-1
15-2 Overview of Response Menus - 1-Port and 2-Port VNAs	15-1
15-3 RESPONSE Menu Set	15-2
15-4 RESPONSE Menu	15-3
RESPONSE Menu	15-3
15-5 USER-DEFINED Menu	15-5
USER-DEFINED Menu	15-5
NUMERATOR Menu	15-7
DENOMINATOR Menu	15-8
MIXED-MODE Menu	15-9
Chapter 16 — Response Menus: 4-Port VNAs	
16-1 Chapter Overview	16-1
16-2 Overview of 4-Port Response Menus and Dialog Boxes	16-1
16-3 RESPONSE Menu Set - 4-Port VNAs	16-2
RESPONSE Menu - 4-Port VNAs	16-2
RESPONSE and SINGLE-MODE Menus	16-4
RESPONSE and USER-DEFINED Menus	16-5
RESPONSE Menu and MIXED MODE Dialog Box Variants	16-6
16-4 SINGLE-MODE Menu - 4-Port VNAs	16-7
16-5 USER-DEFINED Menu Set- 4-Port VNAs	16-9
USER-DEFINED Menu - 4-Port VNAs	16-9
NUMERATOR Menu - 4-Port VNAs	16-11
DENOMINATOR Menu - 4-Port VNAs	16-13
16-6 MIXED MODE Dialog Box Variants- 4-Port VNAs	16-15
Chapter 17 — Display Menus	
17-1 Chapter Overview	17-1
17-2 Overview of Display Menus and Dialog Boxes	17-1
17-3 Display Main Menu	17-2
DISPLAY Menu	17-2
17-4 Trace Format and Parameter Menus	17-4
TRACE FORMAT Menu	17-4
IMPEDANCE Menu	17-6
SMITH IMPEDANCE Menu	17-8
SMITH ADMITTANCE Menu	17-9
VIEW TRACE Menu	17-10
DATA-MEM. OP. Menu	17-12
17-5 Trace Limit Line Control Menus and Dialog Boxes	17-13
LIMIT Menu	17-13
EDIT LIMIT LINE Menu	17-14
17-6 DOMAIN Menu Appearance and Button Availability	17-22
DOMAIN Menu Button Selection Group	17-22

Table of Contents (Continued)

DOMAIN Menu Variants	17-22
DOMAIN Frequency with No Time Gate Menu	17-23
DOMAIN Frequency with Time Gate	17-23
DOMAIN Time Gate Low Pass Menu	17-23
DOMAIN Time Gate Band Pass Menu	17-24
DOMAIN Frequency with No Time Gate Menu	17-25
DOMAIN Frequency with Time Gate Menu	17-26
DOMAIN Time Low Pass Menu	17-27
DOMAIN Time Band Pass Menu	17-29
17-7 Domain Time Definition Menu	17-30
TIME DEFINITION Menu	17-30
17-8 Range Setup Menus and Dialog Boxes	17-31
Range Setup Button Unavailable	17-31
RANGE SETUP Menu Availability	17-31
RANGE SETUP Menu Variants	17-31
RANGE SETUP Menu When Time Domain is Set to Frequency with Time Gate	17-31
RANGE SETUP Menu When Time Domain is Set to Time Band Pass	17-31
RANGE SETUP Menu When Time Domain is Set to Time Low Pass	17-31
The Display Unit Button Changes the Range Setup Menu Button Units	17-32
RANGE SETUP Frequency with Time Gate Menu	17-33
RANGE SETUP Time Band Pass Menu	17-35
RANGE SETUP Time Low Pass Menu	17-37
DC TERM Menu	17-39
EXTRAPOLATION Menu	17-41
17-9 Time Domain Window Shape and Gate Setup Menus	17-42
WINDOW SHAPE Menu	17-42
GATE SETUP Menu	17-45
GATE FUNCTION Menu	17-47
17-10 Inter- and Intra-Trace Math and Operand Setup Menus	17-51
INTER-TRACE MATH Menu	17-51
INTRA TRACE OP. Menu	17-53
17-11 Display Area Setup Menu	17-54
DISPLAY AREA SETUP Menu	17-54

Chapter 18 — Scale Menus

18-1 Chapter Overview	18-1
18-2 Scale Menus Appearance, Common Buttons, and Units	18-1
Appearance	18-1
Common SCALE Menu Buttons	18-1
SCALE Menu Units	18-2
18-3 Overview of SCALE Menu Variants	18-4
18-4 SCALE Magnitude Menus	18-5
SCALE Log Magnitude Menu	18-5
SCALE Linear Magnitude Menu	18-6
18-5 SCALE Phase Menu	18-7
SCALE Phase Menu	18-7

Table of Contents (Continued)

18-6 SCALE Real or Imaginary Menus	18-9
SCALE Real Magnitude Menu	18-9
SCALE Imaginary Menu	18-10
18-7 SCALE SWR Menu	18-11
SCALE Standing Wave Ratio Menu	18-11
18-8 SCALE Smith Chart Menus	18-12
SCALE Smith Chart Impedance Menu	18-12
SCALE Smith Chart Admittance Menu	18-14
SMITH SCALING Menu	18-15
18-9 SCALE Polar Chart Menus	18-16
SCALE Linear Polar Chart Menu	18-16
SCALE Log Polar Chart Menu	18-17
WRAP Setup Menu	18-18
18-10 SCALE Dual-Trace Display Menus	18-19
SCALE Impedance Real and Imaginary Menu	18-19
SCALE Log Magnitude and Phase Menu	18-21
SCALE Linear Magnitude and Phase Menu	18-24
SCALE Real and Imaginary Menu	18-27
18-11 GROUP DELAY Menu	18-29
SCALE Group Delay Menu	18-29
18-12 SCALE Menu Common Buttons	18-30

Chapter 19 — Marker Menus

19-1 Chapter Overview	19-1
19-2 Overview of Marker Menus, Dialog Boxes, and Toolbars	19-1
19-3 Marker Menu Overview	19-2
Marker Button Label Changes	19-2
Marker Unit Changes	19-2
Reference Marker OFF or On	19-2
Turning Individual Markers Off and On	19-2
Turning All Markers On	19-2
Turning All Markers Off	19-3
Naming Conventions for Marker Buttons and Toolbars	19-3
19-4 Primary Marker Menus	19-4
MARKERS [1] Menu	19-4
MARKERS [2] Menu	19-6
MARKER SETUP Menu	19-7
MRK. POSITION Menu	19-8
Marker Labels	19-9
19-5 Marker Search Menus	19-10
MARKER SEARCH Menu	19-10
PEAK (Marker) Menu	19-11
TARGET (Marker) Menu	19-12
ADVANCED SEARCH Markers Menu	19-13
MULTI PEAK Marker Search Menu	19-14
MULTI TARGET Marker Search Menu	19-15

SEARCH RANGE Marker Menu	19-16
BANDWIDTH Marker Search Menu	19-17
NOTCH Marker Search Menu	19-18
Marker Function Menu.	19-19

Chapter 20 — System Menus

20-1 Chapter Overview	20-1
20-2 System Menus, Buttons, and Dialog Boxes	20-1
20-3 SYSTEM Menu	20-2
SETUP Menu.	20-3
PRESET SETUP Menu	20-4
POWER-ON SETUP Menu	20-5
MISC SETUP Menu.	20-7
MISC SETUP Menu in 4-Port VNAs	20-7
MISC SETUP Menu in 2-Port VNAs	20-8
SNP Files Setup	20-9
SNP FILES SETUP Menu - 2-Port VNAs	20-9
UTILITY Menu	20-14
AUTOCAL CHARAC. Menu	20-15
Network Interface Menu and Dialog Boxes	20-16
NETWORK INTERFACE Menu.	20-16
NETWORK CONNECTIONS Dialog Box	20-17
SELF TEST Dialog Box.	20-18
IO HANDLER Dialog	20-22
DISABLE TIME DOMAIN Dialog Box	20-24
Upgrade FPGA	20-24

Chapter 21 — File Management Menus

21-1 Chapter Overview	21-1
21-2 Overview of File Management Menus and Dialog Boxes	21-1
21-3 File Menus and Dialog Boxes.	21-2
FILE Menu	21-2

Appendix A — File Specifications

A-1 Default File Directory Structure	A-1
A-2 File Extension Definitions	A-1
A-3 Identification of Misc File Types.	A-6

Appendix B — Error Messages

B-1 Appendix Overview	B-1
B-2 System Messages	B-1
B-3 Operational Messages	B-3

Appendix C — Anritsu easyTest

C-1 Introduction	C-1
C-2 Anritsu easyTest Tools and easyTest .ett Scripts	C-1
Introduction	C-1
Capabilities	C-1

C-3 easyTest Tools on the PC C-1
C-4 easyTest on a ShockLine VNA..... C-3

List of Figures

Figure 2-1.	MAIN MENU	2-2
Figure 3-1.	CHANNEL Menu	3-2
Figure 3-2.	CHAN. LAYOUT (CHANNEL LAYOUT) Menu	3-4
Figure 4-1.	FREQUENCY Freq. Based Sweep Menu	4-2
Figure 4-2.	FREQUENCY Freq. Based Segmented Sweep Menu	4-5
Figure 4-3.	INDEX. SEG. SWP (FREQUENCY) Index-Based Segmented Sweep Menu	4-6
Figure 4-4.	FREQUENCY Power Sweep CW Freq. Menu.	4-7
Figure 5-1.	POWER Menu - Frequency-Based Sweep Modes - MS46522A 2-Port VNAs	5-3
Figure 5-2.	POWER Setup Menu - Frequency-Based Sweep Modes - MS46522A 2-Port VNAs	5-3
Figure 5-3.	POWER Menu - Segment-Based Sweep Mode - 2-Port VNAs	5-4
Figure 5-4.	POWER Menu - Power Sweeps (CW).	5-5
Figure 5-5.	POWER Menu - Power-Based Sweep Mode- 2-Port VNAs	5-6
Figure 5-6.	POWER [COUPLED] Menu - Power-Based Sweep Mode - 2-Port VNAs	5-8
Figure 5-7.	Receiver Setup Menu - 2-Port VNAs	5-9
Figure 6-1.	POWER [COUPLED] Menu - Frequency-Based Sweep - 4-Port VNAs	6-3
Figure 6-2.	POWER Setup Menu - Frequency-Based Sweep Modes - 4-Port VNAs	6-4
Figure 6-3.	Power Menu Set - Segmented Sweeps (Frequency- or Index-Based)	6-5
Figure 6-4.	POWER Menus - Power-Based Sweep (CW)	6-6
Figure 6-5.	POWER [COUPLED] Menu - Power-Based Sweep - 4-Port VNAs	6-7
Figure 6-6.	POWER SETUP Menu - Power-Based Sweep - 4-Port VNAs	6-9
Figure 6-7.	Receiver Setup Menu - 2-Port VNAs	6-10
Figure 7-1.	SWEEP SETUP Menu - MS4652xA Series	7-3
Figure 7-2.	SWEEP Config Menu	7-4
Figure 7-3.	SWEEP TYPES Menu - MS4652xA Series VNA	7-6
Figure 7-4.	FREQ BASE SETUP (FREQUENCY-BASED SEGMENTED SWEEP SETUP) Menu	7-8
Figure 7-5.	SAVE AS (SEGMENT SWEEP TABLE SGS FILE) Dialog Box	7-11
Figure 7-6.	RECALL (SEGMENTED SWEEP TABLE SGS FILE) Dialog Box	7-12
Figure 7-7.	INDEX BASE SETUP (INDEX-BASED SEGMENTED SWEEP SETUP) Menu	7-14
Figure 7-8.	FREQUENCY Power Sweep CW Freq. Menu.	7-15
Figure 7-9.	HOLD FUNCTIONS Menu	7-16
Figure 7-10.	HOLD CONDITIONS Menu	7-17
Figure 7-11.	TRIGGER Menu	7-18
Figure 7-12.	TRIGGER SOURCE Menu	7-19
Figure 7-13.	SWEEP Config Menu	7-19
Figure 8-1.	AVERAGING Menu and Field Toobars	8-2
Figure 9-1.	Primary Menus for VNA Calibration	9-4
Figure 9-2.	CALIBRATION Menu	9-5
Figure 9-3.	CALIBRATE Menu	9-6
Figure 9-4.	IF CALIBRATION Dialog Box	9-7
Figure 9-5.	THRU (Update) Calibration Menu - 2-Port VNAs	9-8
Figure 9-6.	CAL KIT Menu	9-10
Figure 9-7.	LOAD (Cal Kit) Dialog Box	9-11
Figure 9-8.	SAVE (AUTOCAL CHARACTERIZATION/CAL) KIT FILE Dialog Box	9-12
Figure 9-9.	CAL KIT INFO Dialog Box	9-13
Figure 9-10.	STANDARD INFO Dialog Box	9-14
Figure 9-11.	RESTORE DEFAULT COEF. (RESTORE DEFAULT COEFFICIENTS) Dialog Box	9-15
Figure 9-12.	CAL OPTIONS (CALIBRATION OPTIONS) Menu	9-17
Figure 9-13.	MANUAL ADAPTER REMOVAL Dialog Box	9-18
Figure 9-14.	NETWORK EXTRACTION Dialog Box	9-19
Figure 9-15.	THRU CHARACTERIZATION Dialog Box	9-20
Figure 9-16.	AUTOCAL (Port Selection) Menu	9-21
Figure 9-17.	AUTOCAL 2-PORT CAL SETUP Menu	9-22
Figure 9-18.	MODIFY 2-PORT SMARTCAL/AUTOCAL SETUP Dialog Box	9-23

Figure 9-19. AUTOCAL SETUP Menu - One-Port Calibration	9-28
Figure 9-20. MODIFY 1-PORT SMARTCAL/AUTOCAL SETUP Dialog Box	9-29
Figure 9-21. Manual Calibration Setup Menus (1 of 2)	9-31
Figure 9-22. Manual Calibration Setup Menus (2 of 2)	9-32
Figure 9-23. MANUAL CAL (MANUAL CALIBRATION) Menu	9-34
Figure 9-24. CAL SETUP (CALIBRATION SETUP) Menu - 2-Port VNAs	9-36
Figure 9-25. CAL METHOD Menu - 2-Port VNAs	9-37
Figure 9-26. LINE TYPE Menu	9-38
Figure 9-27. TWO PORT CAL MENU - Typical Example	9-39
Figure 9-28. REFLECTIVE DEVICES MENU	9-41
Figure 9-29. Edit Cal Params - TWO PORT CAL SETUP (SOLT/R, COAXIAL) Dialog Box	9-43
Figure 9-30. Edit Cal Params - TWO PORT CAL SETUP (LRL/LRM, COAXIAL) Dialog Box	9-46
Figure 9-31. TWO PORT CAL SETUP (SSLT, COAXIAL) Dialog Box	9-49
Figure 9-32. Edit Cal Params - TWO PORT CAL SETUP (SSST, COAXIAL) Dialog Box	9-52
Figure 9-33. REFL. DEVICE(S) (REFLECTIVE DEVICES) Menu - Typical Example	9-60
Figure 9-34. THRU/RECIP Menu - Typical Example	9-61
Figure 9-35. ISOLATION(S) Menu - Typical Example	9-62
Figure 9-36. ONE PORT CAL MENU - Typical Example	9-63
Figure 9-37. ONE-PORT CAL SETUP (SOLT/R, COAXIAL) Dialog Box	9-66
Figure 9-38. ONE-PORT CAL SETUP (SSLT, COAXIAL) Dialog Box	9-69
Figure 9-39. ONE-PORT CAL SETUP (SSST, COAXIAL) Dialog Box	9-72
Figure 9-40. TRANS. RESPONSE Menu - Trans. Freq. Resp. Cal. - Typical Example	9-77
Figure 9-41. TRANSMISSION FREQUENCY RESPONSE CAL SETUP (SOLT/R, COAXIAL) Dialog Box	9-79
Figure 9-42. REFL. RESPONSE Menu - Refl. Freq. Resp. Cal. - Typical Example	9-83
Figure 9-43. REFL. FREQ. RESP. CAL SETUP (SOLT/R, COAXIAL) Dialog Box	9-85
Figure 9-44. AIR EQUIVALENT LENGTH CONVERSION (FROM PS TO MM) Dialog Box	9-92
Figure 9-45. STANDARD INFO (SOLT/R) Dialog Box	9-93
Figure 9-46. THRU INFO Dialog Box - AutoCal Two Port Calibration	9-94
Figure 9-47. USER DEFINED MATCH DEVICES Dialog Box - 2-Port VNAs	9-95
Figure 9-48. USER DEFINED WAVEGUIDE Dialog Box	9-97
Figure 9-49. WAVEGUIDE INFO Dialog Box	9-99
Figure 10-1. Primary Menus for 4-Port VNA Calibration	10-4
Figure 10-2. CALIBRATION Menu - 4-Port VNAs	10-5
Figure 10-3. CALIBRATE Menu - 4-Port VNAs	10-6
Figure 10-4. IF CALIBRATION Dialog Box	10-7
Figure 10-5. THRU UPDATE Calibration Menu – 4-Port VNAs	10-8
Figure 10-6. CAL OPTIONS (CALIBRATION OPTIONS) Menu	10-11
Figure 10-7. MANUAL ADAPTER REMOVAL Dialog Box	10-12
Figure 10-8. Network Extraction Menu	10-13
Figure 10-9. CAL KIT/AUTOCAL Menu - 4-Port VNAs	10-14
Figure 10-10. LOAD (Cal Kit) Dialog Box	10-15
Figure 10-11. SAVE (Cal Kit) Dialog Box	10-16
Figure 10-12. CAL KIT INFO Dialog Box	10-18
Figure 10-13. STANDARD INFO Dialog Box	10-19
Figure 10-14. RESTORE DEFAULT COEF. (RESTORE DEFAULT COEFFICIENTS) Dialog Box	10-20
Figure 10-15. AUTOCAL PORT Menu - 4-Port VNAs	10-22
Figure 10-16. AUTOCAL SETUP Menu - 4-Port Cal - 4-Port VNAs	10-23
Figure 10-17. MODIFY 4-PORT AUTOCAL / SMARTCAL SETUP Dialog Box	10-24
Figure 10-18. AUTOCAL SETUP Menu - 2-Port Cal - 4-Port VNAs	10-28
Figure 10-19. AUTOCAL SETUP Menu - 2-Port Cal - 4-Port VNAs	10-29
Figure 10-20. MODIFY 2-PORT AUTOCAL SETUP Dialog Box - 4-Port VNAs	10-30
Figure 10-21. AUTOCAL PROCEDURE Menu - 1-Port Calibration - 4-Port VNA	10-35
Figure 10-22. AUTOCAL PROCEDURE Menu - 1-Port Calibration - 4-Port VNA	10-36
Figure 10-23. MODIFY 1-PORT AUTOCAL/SMARTCAL SETUP Dialog Box - 4-Port VNAs	10-37
Figure 10-24. Manual Calibration Setup Menus - 4-Port VNAs - Sheet 1	10-39
Figure 10-25. Manual Calibration Setup Menus - 4-Port VNAs - Sheet 2	10-40

Figure 10-26. MANUAL CALIBRATION Menu - 4-Port VNAs	10-42
Figure 10-27. CAL SETUP Menu	10-43
Figure 10-28. CAL METHOD Menu	10-45
Figure 10-29. LINE TYPE Menu	10-46
Figure 10-30. FOUR PORT CAL Menu - 4-Port VNAs - Typical Example	10-48
Figure 10-31. FULL FOUR PORT CAL SETUP (SOLT/R, COAXIAL) Dialog Box	10-51
Figure 10-32. FULL FOUR PORT CAL SETUP (SSLT, COAXIAL) Dialog Box	10-54
Figure 10-33. FULL FOUR PORT CAL SETUP (SSST, COAXIAL) Dialog Box	10-58
Figure 10-34. FULL FOUR PORT CAL SETUP (SSST, WAVEGUIDE) Dialog Box	10-60
Figure 10-35. FOUR PORT CAL SETUP (LRL/LRM, COAXIAL) Dialog Box	10-62
Figure 10-36. REFL. DEVICE(S) Menu - 4-Port VNAs - Typical Example	10-71
Figure 10-37. SLIDING LOADS Menu - 4-Port VNAs - Typical Example	10-73
Figure 10-38. THRU/RECIP Menu - 4-Port VNAs - Typical Example	10-75
Figure 10-39. ISOLATION(S) Menu - 4-Port VNAs - Typical Example	10-77
Figure 10-40. THREE PORT CAL Menu - 4-Port VNAs - Typical example	10-78
Figure 10-41. THREE PORT CAL SETUP (SSLT, MICROSTRIP) Dialog Box	10-81
Figure 10-42. THREE PORT CAL SETUP (SSST, COAXIAL) Dialog Box	10-83
Figure 10-43. THREE PORT CAL SETUP (SOLT/R, COAXIAL) Dialog Box	10-85
Figure 10-44. THREE PORT CAL SETUP (LRL/LRM, COAXIAL) Dialog Box - Cal A Tab	10-88
Figure 10-45. THREE PORT CAL SETUP (LRL/LRM, COAXIAL) Dialog Box - Cal B Tab	10-89
Figure 10-46. TWO PORT CAL Menu - 4-Port VNAs - Typical example	10-98
Figure 10-47. TWO PORT CAL SETUP (SOLT/R, COAXIAL) Dialog Box	10-99
Figure 10-48. TWO PORT CAL SETUP (SOLT/R, MICROSTRIP) Dialog Box	10-102
Figure 10-49. TWO PORT CAL SETUP (LRL/LRM, MICROSTRIP) Dialog Box - Cal A Tab	10-105
Figure 10-50. TWO PORT CAL SETUP (LRL/M, MICROSTRIP) Dialog Box - Cal B Tab	10-106
Figure 10-51. ONE PORT CAL Menu - 4-Port VNAs - Typical example	10-114
Figure 10-52. ONE PORT CAL SETUP (SOLT/R, COAXIAL) Dialog Box	10-115
Figure 10-53. ONE PORT CAL SETUP (SSLT, COAXIAL) Dialog Box	10-118
Figure 10-54. ONE PORT CAL SETUP (SSST, COAXIAL) Dialog Box	10-120
Figure 10-55. ONE PORT CAL SETUP (SSLT, WAVEGUIDE) Dialog Box	10-122
Figure 10-56. TRANS. RESPONSE Menu - 4-Port VNAs - Typical example	10-128
Figure 10-57. TRANSMISSION FREQ. RESPONSE CAL SETUP (SOLT/R, COAXIAL) Dialog Box	10-129
Figure 10-58. TRANS. FREQ. RESP. CAL SETUP (SSLT, WAVEGUIDE) Dialog Box	10-131
Figure 10-59. TRANS. FREQ. RESP. CAL SETUP (SSST, MICROSTRIP) Dialog Box	10-133
Figure 10-60. REFL. RESPONSE Menu - 4-Port VNAs - Typical example	10-137
Figure 10-61. REFLECTION FREQ. RESPONSE. CAL SETUP (SOLT/R, COAXIAL) Dialog Box	10-138
Figure 10-62. REFL. FREQ. RESP. CAL SETUP (SSLT, MICROSTRIP) Dialog Box	10-140
Figure 10-63. REFL. FREQ. RESP. CAL SETUP (SSST, WAVEGUIDE) Dialog Box	10-142
Figure 10-64. AIR EQUIVALENT LENGTH CONVERSION CALCULATOR Dialog Box	10-146
Figure 10-65. MICROSTRIP INFO and USER DEFINED MICROSTRIP Dialog Boxes	10-147
Figure 10-66. STANDARD INFO (OFFSET SHORT) W-1Conn (F)	10-149
Figure 10-67. STANDARD INFO (SOLT/R) N-Conn (M)	10-150
Figure 10-68. STANDARD INFO (SOLT/R) V-Conn (M)	10-152
Figure 10-69. STANDARD INFO (TRIPLE OFFSET SHORT) W1-Conn (M)	10-153
Figure 10-70. THRU INFO (Thru/Reciprocal Ports 1-2 Setup) Dialog Box	10-154
Figure 10-71. USER DEFINED MATCH DEVICES Dialog Box - LRL/LRM	10-155
Figure 10-72. WAVEGUIDE INFO and USER DEFINED WAVEGUIDE Dialog Boxes	10-156
Figure 11-1. MEASUREMENT Menu and Related Submenus	11-2
Figure 11-2. MEASUREMENT Menu	11-3
Figure 11-3. IMPED. TRANSF. (IMPEDANCE TRANSFORMATION) Menu	11-4
Figure 11-4. REFERENCE PLANE Menu	11-5
Figure 11-5. PROCESSING ORDER Menu	11-6
Figure 11-6. EMBEDDING Menu	11-7
Figure 11-7. EDIT EMBEDDING/DE-EMBEDDING (DUT Type) Dialog Box	11-8
Figure 11-8. SAVE AS (EMBED/DE-EMBED EDL FILE) Dialog Box	11-11
Figure 11-9. OPEN (EMBED/DE-EMBED EDL FILE) Dialog Box	11-12

Figure 11-10. DIELECTRIC Menu	11-13
Figure 12-1. TIME DOMAIN Menu	12-2
Figure 12-2. LOW PASS TIME DOMAIN CAL Dialog Box	12-3
Figure 12-3. TIME DOMAIN MEASUREMENT SETUP Dialog Box	12-4
Figure 13-1. APPLICATION Menu for Receiver Configuration	13-1
Figure 13-2. MULTIPLE SOURCE Menu	13-2
Figure 13-3. INT. SRC CONTROL Menu	13-3
Figure 14-1. TRACE Menu	14-2
Figure 14-2. TRACE LAYOUT Menu	14-3
Figure 15-1. RESPONSE and USER-Defined Menu Set	15-2
Figure 15-2. RESPONSE Menu	15-3
Figure 15-3. USER DEFINED Menu	15-5
Figure 15-4. NUMERATOR Menu - 2-Port VNAs	15-7
Figure 15-5. DENOMINATOR Menu	15-8
Figure 15-6. MIXED-MODE	15-9
Figure 16-1. RESPONSE Menu - 4-Port VNAs	16-2
Figure 16-2. RESPONSE and SINGLE-MODE Menus - 4-Port VNAs	16-4
Figure 16-3. Response Menu Set - 4-Port VNAs	16-5
Figure 16-4. RESPONSE Menu and MIXED MODE Dialog Box Variants – 4-Port VNA	16-6
Figure 16-5. SINGLE-MODE Menu - 4-Port VNAs	16-7
Figure 16-6. USER DEFINED Menu - 4-Port VNAs	16-9
Figure 16-7. NUMERATOR Menu - 4-Port VNAs	16-11
Figure 16-8. DENOMINATOR Menu - 4-Port VNAs	16-13
Figure 16-9. MIXED MODE Dialog Box - Two Differential Pairs	16-15
Figure 16-10. MIXED MODE Dialog Box - One Differential Pair and One Singleton - 4-Port VNAs	16-17
Figure 16-11. MIXED MODE Dialog Box - One Differential Pair and Two Singletons - 4-Port VNAs	16-19
Figure 16-12. SELECT TRACE Dialog Box - For Mixed-Mode Trace Assignment	16-21
Figure 17-1. DISPLAY Menu	17-2
Figure 17-2. TRACE FORMAT Menu	17-4
Figure 17-3. IMPEDANCE Menu	17-6
Figure 17-4. SMITH (IMPEDANCE) Menu	17-8
Figure 17-5. SMITH (ADMITTANCE) Menu	17-9
Figure 17-6. VIEW TRACE Menu	17-10
Figure 17-7. DATA-MEM. OP. (DATA-MEMORY OPERATIONS) Menu	17-12
Figure 17-8. LIMIT Menu	17-13
Figure 17-9. EDIT LIMIT LINE Menu	17-14
Figure 17-10. SAVE AS (LIMIT LINE LMT FILE) Dialog Box	17-20
Figure 17-11. OPEN (LIMIT LINE LMT FILE) Dialog Box	17-21
Figure 17-12. DOMAIN Frequency with No Time Gate Menu	17-25
Figure 17-13. DOMAIN Frequency with Time Gate Menu	17-26
Figure 17-14. DOMAIN Time Low Pass Menu	17-27
Figure 17-15. DOMAIN Time Band Pass Menu	17-29
Figure 17-16. TIME DEFINITION Menu	17-30
Figure 17-17. RANGE SETUP Frequency with Time Gate Menu	17-33
Figure 17-18. RANGE SETUP Time Band Pass Menu - 8 Buttons	17-35
Figure 17-19. RANGE SETUP Time Gate Low Pass Menu - Nine Buttons -	17-37
Figure 17-20. DC TERM Menu	17-39
Figure 17-21. EXTRAPOLATION Menu	17-41
Figure 17-22. WINDOW SHAPE Menu	17-42
Figure 17-23. ADVANCED WINDOW SHAPE SETUP Dialog Box	17-43
Figure 17-24. GATE SETUP Menu	17-45
Figure 17-25. GATE FUNCTION Menu	17-48
Figure 17-26. ADVANCED GATE SHAPE SETUP Dialog Box	17-49
Figure 17-27. INTER-TRACE MATH Menu	17-51
Figure 17-28. INTRA-TRACE OP. (INTRA TRACE OPERAND) Menu	17-53
Figure 17-29. DISPLAY SETUP Menu	17-54

Figure 18-1. SCALE Log Magnitude Menu	18-5
Figure 18-2. SCALE Linear Magnitude Menu	18-6
Figure 18-3. SCALE Phase Menu	18-8
Figure 18-4. SCALE Real Menu	18-9
Figure 18-5. SCALE Imaginary Menu	18-10
Figure 18-6. SCALE SWR (Standing Wave Ratio) Menu	18-11
Figure 18-7. SCALE Smith Impedance Menu	18-13
Figure 18-8. SCALE Smith Admittance Menu	18-14
Figure 18-9. SMITH SCALING Menu	18-15
Figure 18-10. SCALE Linear Polar Menu	18-16
Figure 18-11. SCALE Log Polar Menu	18-17
Figure 18-12. WRAP SETUP Menu	18-18
Figure 18-13. SCALE Impedance Real and Impedance Imaginary Menu	18-20
Figure 18-14. SCALE Log Magnitude and Phase Menu	18-22
Figure 18-15. SCALE Linear Magnitude and Phase Menu	18-25
Figure 18-16. SCALE Real and Imaginary Menu	18-28
Figure 18-17. SCALE Group Delay Menu (1 of 2)	18-29
Figure 18-18. SCALE Menu - Common Buttons	18-30
Figure 19-1. MARKERS [1] Menu	19-4
Figure 19-2. MARKERS [2] Menu	19-6
Figure 19-3. MARKER SETUP Menu	19-7
Figure 19-4. MARKER SETUP Menu	19-8
Figure 19-5. MARKER TABLE DISPLAY Tableau	19-9
Figure 19-6. MARKER SEARCH Menu	19-10
Figure 19-7. PEAK (Marker) Menu	19-11
Figure 19-8. TARGET (Marker) Menu	19-12
Figure 19-9. ADVANCED SEARCH (Marker) Menu	19-13
Figure 19-10. MULTI PEAK (Marker) Menu	19-14
Figure 19-11. MULTI TARGET (Marker) Menu	19-15
Figure 19-12. SEARCH RANGE (Marker) Menu	19-16
Figure 19-13. BANDWIDTH (Marker) Menu	19-17
Figure 19-14. NOTCH (Marker) Menu	19-18
Figure 19-15. Markers On/Off	19-19
Figure 20-1. SYSTEM MENU Menu	20-2
Figure 20-2. SETUP Menu	20-3
Figure 20-3. PRESET SETUP Menu	20-4
Figure 20-4. POWER-ON SETUP Menu	20-5
Figure 20-5. COLOR SETUP Menu	20-6
Figure 20-6. MISC SETUP Menu in 4-Port VNAs	20-7
Figure 20-7. MISC SETUP Menu in 2-Port VNAs	20-8
Figure 20-8. SNP FILES SETUP Menu 2-Port VNAs	20-9
Figure 20-9. SNP SETUP Dialog Box - 4-Port VNAs	20-10
Figure 20-10. MXP (MIXED-MODE DUT) SETUP Dialog Box	20-12
Figure 20-11. UTILITY Menu	20-14
Figure 20-12. AUTOCAL CHARAC. (AUTOCAL CHARACTERIZATION) Menu	20-15
Figure 20-13. AUTOCAL CHARAC. (AUTOCAL CHARACTERIZATION) Menu	20-16
Figure 20-14. NETWORK CONNECTIONS Dialog Box	20-17
Figure 20-15. SELF TEST Dialog Box	20-18
Figure 20-16. EVENT VIEWER Dialog Box	20-19
Figure 20-17. DIAGNOSTICS ACCESS Dialog Box	20-21
Figure 20-18. IO HANDLER Dialog Box	20-22
Figure 20-19. DISABLE TIME DOMAIN Dialog Box	20-24
Figure 21-1. FILE Menu – Data Save/Recall Functions – Print Functions	21-2
Figure 21-2. RECALL SETUP Dialog Box	21-4
Figure 21-3. RECALL DATA Dialog Box	21-5
Figure 21-4. SAVE SETUP Dialog Box	21-6

Figure 21-5. SAVE DATA Dialog Box	21-7
Figure C-1. Example of setup in easyTest Tools on the PC.....	C-2
Figure C-2. Resulting easyTest sequence step displayed on a ShockLine VNA	C-3

Alphabetical List of Figures

ADVANCED GATE SHAPE SETUP Dialog Box	17-49
ADVANCED SEARCH (Marker) Menu	19-13
ADVANCED WINDOW SHAPE SETUP Dialog Box	17-43
AIR EQUIVALENT LENGTH CONVERSION (FROM PS TO MM) Dialog Box	9-92
AIR EQUIVALENT LENGTH CONVERSION CALCULATOR Dialog Box	10-146
APPLICATION Menu for Receiver Configuration	13-1
AUTOCAL (Port Selection) Menu	9-21
AUTOCAL 2-PORT CAL SETUP Menu	9-22
AUTOCAL CHARAC. (AUTOCAL CHARACTERIZATION) Menu	20-15
AUTOCAL CHARAC. (AUTOCAL CHARACTERIZATION) Menu	20-16
AUTOCAL PORT Menu - 4-Port VNAs	10-22
AUTOCAL PROCEDURE Menu - 1-Port Calibration - 4-Port VNA	10-35
AUTOCAL PROCEDURE Menu - 1-Port Calibration - 4-Port VNA	10-36
AUTOCAL SETUP Menu - 2-Port Cal - 4-Port VNAs	10-28
AUTOCAL SETUP Menu - 2-Port Cal - 4-Port VNAs	10-29
AUTOCAL SETUP Menu - 4-Port Cal - 4-Port VNAs	10-23
AUTOCAL SETUP Menu - One-Port Calibration	9-28
AVERAGING Menu and Field Toobars	8-2
BANDWIDTH (Marker) Menu	19-17
CAL KIT INFO Dialog Box	10-18
CAL KIT INFO Dialog Box	9-13
CAL KIT Menu	9-10
CAL KIT/AUTOCAL Menu - 4-Port VNAs	10-14
CAL METHOD Menu - 2-Port VNAs	9-37
CAL METHOD Menu	10-45
CAL OPTIONS (CALIBRATION OPTIONS) Menu	10-11
CAL OPTIONS (CALIBRATION OPTIONS) Menu	9-17
CAL SETUP (CALIBRATION SETUP) Menu - 2-Port VNAs	9-36
CAL SETUP Menu	10-43
CALIBRATE Menu - 4-Port VNAs	10-6
CALIBRATE Menu	9-6
CALIBRATION Menu - 4-Port VNAs	10-5
CALIBRATION Menu	9-5
CHAN. LAYOUT (CHANNEL LAYOUT) Menu	3-4
CHANNEL Menu	3-2
COLOR SETUP Menu	20-6
DATA-MEM. OP. (DATA-MEMORY OPERATIONS) Menu	17-12
DC TERM Menu	17-39
DENOMINATOR Menu - 4-Port VNAs	16-13
DENOMINATOR Menu	15-8
DIAGNOSTICS ACCESS Dialog Box	20-21
DIELECTRIC Menu	11-13
DISABLE TIME DOMAIN Dialog Box	20-24
DISPLAY Menu	17-2
DISPLAY SETUP Menu	17-54
DOMAIN Frequency with No Time Gate Menu	17-25
DOMAIN Frequency with Time Gate Menu	17-26
DOMAIN Time Band Pass Menu	17-29
DOMAIN Time Low Pass Menu	17-27
Edit Cal Params - TWO PORT CAL SETUP (LRL/LRM, COAXIAL) Dialog Box	9-46
Edit Cal Params - TWO PORT CAL SETUP (SOLT/R, COAXIAL) Dialog Box	9-43

Edit Cal Params - TWO PORT CAL SETUP (SSST, COAXIAL) Dialog Box	9-52
EDIT EMBEDDING/DE-EMBEDDING (DUT Type) Dialog Box	11-8
EDIT LIMIT LINE Menu	17-14
EMBEDDING Menu	11-7
EVENT VIEWER Dialog Box	20-19
Example of setup in easyTest Tools on the PC	C-2
EXTRAPOLATION Menu	17-41
FILE Menu – Data Save/Recall Functions – Print Functions	21-2
FOUR PORT CAL Menu - 4-Port VNAs - Typical Example	10-48
FOUR PORT CAL SETUP (LRL/LRM, COAXIAL) Dialog Box	10-62
FREQ BASE SETUP (FREQUENCY-BASED SEGMENTED SWEEP SETUP) Menu	7-8
FREQUENCY Freq. Based Segmented Sweep Menu	4-5
FREQUENCY Freq. Based Sweep Menu	4-2
FREQUENCY Power Sweep CW Freq. Menu	4-7
FREQUENCY Power Sweep CW Freq. Menu	7-15
FULL FOUR PORT CAL SETUP (SOLT/R, COAXIAL) Dialog Box	10-51
FULL FOUR PORT CAL SETUP (SSLT, COAXIAL) Dialog Box	10-54
FULL FOUR PORT CAL SETUP (SSST, COAXIAL) Dialog Box	10-58
FULL FOUR PORT CAL SETUP (SSST, WAVEGUIDE) Dialog Box	10-60
GATE FUNCTION Menu	17-48
GATE SETUP Menu	17-45
HOLD CONDITIONS Menu	7-17
HOLD FUNCTIONS Menu	7-16
IF CALIBRATION Dialog Box	10-7
IF CALIBRATION Dialog Box	9-7
IMPED. TRANSF. (IMPEDANCE TRANSFORMATION) Menu	11-4
IMPEDANCE Menu	17-6
INDEX BASE SETUP (INDEX-BASED SEGMENTED SWEEP SETUP) Menu	7-14
INDEX. SEG. SWP (FREQUENCY) Index-Based Segmented Sweep Menu	4-6
INT. SRC CONTROL Menu	13-3
INTER-TRACE MATH Menu	17-51
INTRA-TRACE OP. (INTRA TRACE OPERAND) Menu	17-53
IO HANDLER Dialog Box	20-22
ISOLATION(S) Menu - 4-Port VNAs - Typical Example	10-77
ISOLATION(S) Menu - Typical Example	9-62
LIMIT Menu	17-13
LINE TYPE Menu	10-46
LINE TYPE Menu	9-38
LOAD (Cal Kit) Dialog Box	10-15
LOAD (Cal Kit) Dialog Box	9-11
LOW PASS TIME DOMAIN CAL Dialog Box	12-3
MAIN MENU	2-2
MANUAL ADAPTER REMOVAL Dialog Box	10-12
MANUAL ADAPTER REMOVAL Dialog Box	9-18
MANUAL CAL (MANUAL CALIBRATION) Menu	9-34
MANUAL CALIBRATION Menu - 4-Port VNAs	10-42
Manual Calibration Setup Menus - 4-Port VNAs - Sheet 1	10-39
Manual Calibration Setup Menus - 4-Port VNAs - Sheet 2	10-40
Manual Calibration Setup Menus (1 of 2)	9-31
Manual Calibration Setup Menus (2 of 2)	9-32
MARKER SEARCH Menu	19-10
MARKER SETUP Menu	19-7
MARKER SETUP Menu	19-8
MARKER TABLE DISPLAY Tableau	19-9
MARKERS [1] Menu	19-4
MARKERS [2] Menu	19-6

Markers On/Off	19-19
MEASUREMENT Menu	11-3
MEASUREMENT Menu and Related Submenus	11-2
MICROSTRIP INFO and USER DEFINED MICROSTRIP Dialog Boxes	10-147
MISC SETUP Menu in 2-Port VNAs	20-8
MISC SETUP Menu in 4-Port VNAs	20-7
MIXED MODE Dialog Box - One Differential Pair and One Singleton - 4-Port VNAs	16-17
MIXED MODE Dialog Box - One Differential Pair and Two Singletons - 4-Port VNAs	16-19
MIXED MODE Dialog Box - Two Differential Pairs	16-15
MIXED-MODE	15-9
MODIFY 1-PORT AUTOCAL/SMARTCAL SETUP Dialog Box - 4-Port VNAs	10-37
MODIFY 1-PORT SMARTCAL/AUTOCAL SETUP Dialog Box	9-29
MODIFY 2-PORT AUTOCAL SETUP Dialog Box - 4-Port VNAs	10-30
MODIFY 2-PORT SMARTCAL/AUTOCAL SETUP Dialog Box	9-23
MODIFY 4-PORT AUTOCAL / SMARTCAL SETUP Dialog Box	10-24
MULTI PEAK (Marker) Menu	19-14
MULTI TARGET (Marker) Menu	19-15
MULTIPLE SOURCE Menu	13-2
MXP (MIXED-MODE DUT) SETUP Dialog Box	20-12
NETWORK CONNECTIONS Dialog Box	20-17
NETWORK EXTRACTION Dialog Box	9-19
Network Extraction Menu	10-13
NOTCH (Marker) Menu	19-18
NUMERATOR Menu - 2-Port VNAs	15-7
NUMERATOR Menu - 4-Port VNAs	16-11
ONE PORT CAL Menu - 4-Port VNAs - Typical example	10-114
ONE PORT CAL MENU - Typical Example	9-63
ONE PORT CAL SETUP (SOLT/R, COAXIAL) Dialog Box	10-115
ONE PORT CAL SETUP (SSLT, COAXIAL) Dialog Box	10-118
ONE PORT CAL SETUP (SSLT, WAVEGUIDE) Dialog Box	10-122
ONE PORT CAL SETUP (SSST, COAXIAL) Dialog Box	10-120
ONE-PORT CAL SETUP (SOLT/R, COAXIAL) Dialog Box	9-66
ONE-PORT CAL SETUP (SSLT, COAXIAL) Dialog Box	9-69
ONE-PORT CAL SETUP (SSST, COAXIAL) Dialog Box	9-72
OPEN (EMBED/DE-EMBED EDL FILE) Dialog Box	11-12
OPEN (LIMIT LINE LMT FILE) Dialog Box	17-21
PEAK (Marker) Menu	19-11
POWER [COUPLED] Menu - Frequency-Based Sweep - 4-Port VNAs	6-3
POWER [COUPLED] Menu - Power-Based Sweep - 4-Port VNAs	6-7
POWER [COUPLED] Menu - Power-Based Sweep Mode - 2-Port VNAs	5-8
POWER Menu - Frequency-Based Sweep Modes - MS46522A 2-Port VNAs	5-3
POWER Menu - Power Sweeps (CW)	5-5
POWER Menu - Power-Based Sweep Mode- 2-Port VNAs	5-6
POWER Menu - Segment-Based Sweep Mode - 2-Port VNAs	5-4
Power Menu Set - Segmented Sweeps (Frequency- or Index-Based)	6-5
POWER Menus - Power-Based Sweep (CW)	6-6
POWER Setup Menu - Frequency-Based Sweep Modes - 4-Port VNAs	6-4
POWER Setup Menu - Frequency-Based Sweep Modes - MS46522A 2-Port VNAs	5-3
POWER SETUP Menu - Power-Based Sweep - 4-Port VNAs	6-9
POWER-ON SETUP Menu	20-5
PRESET SETUP Menu	20-4
Primary Menus for 4-Port VNA Calibration	10-4
Primary Menus for VNA Calibration	9-4
PROCESSING ORDER Menu	11-6
RANGE SETUP Frequency with Time Gate Menu	17-33
RANGE SETUP Time Band Pass Menu - 8 Buttons	17-35

RANGE SETUP Time Gate Low Pass Menu - Nine Buttons -	17-37
RECALL (SEGMENTED SWEEP TABLE SGS FILE) Dialog Box	7-12
RECALL DATA Dialog Box	21-5
RECALL SETUP Dialog Box	21-4
Receiver Setup Menu - 2-Port VNAs	5-9
Receiver Setup Menu - 2-Port VNAs	6-10
REFERENCE PLANE Menu	11-5
REFL. DEVICE(S) (REFLECTIVE DEVICES) Menu - Typical Example	9-60
REFL. DEVICE(S) Menu - 4-Port VNAs - Typical Example	10-71
REFL. FREQ. RESP. CAL SETUP (SOLT/R, COAXIAL) Dialog Box	9-85
REFL. FREQ. RESP. CAL SETUP (SSLT, MICROSTRIP) Dialog Box	10-140
REFL. FREQ. RESP. CAL SETUP (SSST, WAVEGUIDE) Dialog Box	10-142
REFL. RESPONSE Menu - 4-Port VNAs - Typical example	10-137
REFL. RESPONSE Menu - Refl. Freq. Resp. Cal. - Typical Example	9-83
REFLECTION FREQ. RESPONSE. CAL SETUP (SOLT/R, COAXIAL) Dialog Box	10-138
REFLECTIVE DEVICES MENU	9-41
RESPONSE and SINGLE-MODE Menus - 4-Port VNAs	16-4
RESPONSE and USER-Defined Menu Set	15-2
RESPONSE Menu - 4-Port VNAs	16-2
RESPONSE Menu	15-3
RESPONSE Menu and MIXED MODE Dialog Box Variants – 4-Port VNA	16-6
Response Menu Set - 4-Port VNAs	16-5
RESTORE DEFAULT COEF. (RESTORE DEFAULT COEFFICIENTS) Dialog Box	10-20
RESTORE DEFAULT COEF. (RESTORE DEFAULT COEFFICIENTS) Dialog Box	9-15
Resulting easyTest sequence step displayed on a ShockLine VNA	C-3
SAVE (AUTOCAL CHARACTERIZATION/CAL) KIT FILE Dialog Box	9-12
SAVE (Cal Kit) Dialog Box	10-16
SAVE AS (EMBED/DE-EMBED EDL FILE) Dialog Box	11-11
SAVE AS (LIMIT LINE LMT FILE) Dialog Box	17-20
SAVE AS (SEGMENT SWEEP TABLE SGS FILE) Dialog Box	7-11
SAVE DATA Dialog Box	21-7
SAVE SETUP Dialog Box	21-6
SCALE Group Delay Menu (1 of 2)	18-29
SCALE Imaginary Menu	18-10
SCALE Impedance Real and Impedance Imaginary Menu	18-20
SCALE Linear Magnitude and Phase Menu	18-25
SCALE Linear Magnitude Menu	18-6
SCALE Linear Polar Menu	18-16
SCALE Log Magnitude and Phase Menu	18-22
SCALE Log Magnitude Menu	18-5
SCALE Log Polar Menu	18-17
SCALE Menu - Common Buttons	18-30
SCALE Phase Menu	18-8
SCALE Real and Imaginary Menu	18-28
SCALE Real Menu	18-9
SCALE Smith Admittance Menu	18-14
SCALE Smith Impedance Menu	18-13
SCALE SWR (Standing Wave Ratio) Menu	18-11
SEARCH RANGE (Marker) Menu	19-16
SELECT TRACE Dialog Box - For Mixed-Mode Trace Assignment	16-21
SELF TEST Dialog Box	20-18
SETUP Menu	20-3
SINGLE-MODE Menu - 4-Port VNAs	16-7
SLIDING LOADS Menu - 4-Port VNAs - Typical Example	10-73
SMITH (ADMITTANCE) Menu	17-9
SMITH (IMPEDANCE) Menu	17-8

SMITH SCALING Menu	18-15
SNP FILES SETUP Menu 2-Port VNAs	20-9
SNP SETUP Dialog Box - 4-Port VNAs	20-10
STANDARD INFO (OFFSET SHORT) W-1Conn (F)	10-149
STANDARD INFO (SOLT/R) Dialog Box	9-93
STANDARD INFO (SOLT/R) N-Conn (M)	10-150
STANDARD INFO (SOLT/R) V-Conn (M)	10-152
STANDARD INFO (TRIPLE OFFSET SHORT) W1-Conn (M)	10-153
STANDARD INFO Dialog Box	10-19
STANDARD INFO Dialog Box	9-14
SWEEP Config Menu	7-19
SWEEP Config Menu	7-4
SWEEP SETUP Menu - MS4652xA Series	7-3
SWEEP TYPES Menu - MS4652xA Series VNA	7-6
SYSTEM MENU Menu	20-2
TARGET (Marker) Menu	19-12
THREE PORT CAL Menu - 4-Port VNAs - Typical example	10-78
THREE PORT CAL SETUP (LRL/LRM, COAXIAL) Dialog Box - Cal A Tab	10-88
THREE PORT CAL SETUP (LRL/LRM, COAXIAL) Dialog Box - Cal B Tab	10-89
THREE PORT CAL SETUP (SOLT/R, COAXIAL) Dialog Box	10-85
THREE PORT CAL SETUP (SSLT, MICROSTRIP) Dialog Box	10-81
THREE PORT CAL SETUP (SSST, COAXIAL) Dialog Box	10-83
THRU (Update) Calibration Menu - 2-Port VNAs	9-8
THRU CHARACTERIZATION Dialog Box	9-20
THRU INFO (Thru/Reciprocal Ports 1-2 Setup) Dialog Box	10-154
THRU INFO Dialog Box - AutoCal Two Port Calibration	9-94
THRU UPDATE Calibration Menu – 4-Port VNAs	10-8
THRU/RECIP Menu - 4-Port VNAs - Typical Example	10-75
THRU/RECIP Menu - Typical Example	9-61
TIME DEFINITION Menu	17-30
TIME DOMAIN MEASUREMENT SETUP Dialog Box	12-4
TIME DOMAIN Menu	12-2
TRACE FORMAT Menu	17-4
TRACE LAYOUT Menu	14-3
TRACE Menu	14-2
TRANS. FREQ. RESP. CAL SETUP (SSLT, WAVEGUIDE) Dialog Box	10-131
TRANS. FREQ. RESP. CAL SETUP (SSST, MICROSTRIP) Dialog Box	10-133
TRANS. RESPONSE Menu - 4-Port VNAs - Typical example	10-128
TRANS. RESPONSE Menu - Trans. Freq. Resp. Cal. - Typical Example	9-77
TRANSMISSION FREQ. RESPONSE CAL SETUP (SOLT/R, COAXIAL) Dialog Box	10-129
TRANSMISSION FREQUENCY RESPONSE CAL SETUP (SOLT/R, COAXIAL) Dialog Box	9-79
TRIGGER Menu	7-18
TRIGGER SOURCE Menu	7-19
TWO PORT CAL Menu - 4-Port VNAs - Typical example	10-98
TWO PORT CAL MENU - Typical Example	9-39
TWO PORT CAL SETUP (LRL/LRM, MICROSTRIP) Dialog Box - Cal A Tab	10-105
TWO PORT CAL SETUP (LRL/M, MICROSTRIP) Dialog Box - Cal B Tab	10-106
TWO PORT CAL SETUP (SOLT/R, COAXIAL) Dialog Box	10-99
TWO PORT CAL SETUP (SOLT/R, MICROSTRIP) Dialog Box	10-102
TWO PORT CAL SETUP (SSLT, COAXIAL) Dialog Box	9-49
USER DEFINED MATCH DEVICES Dialog Box - 2-Port VNAs	9-95
USER DEFINED MATCH DEVICES Dialog Box - LRL/LRM	10-155
USER DEFINED Menu - 4-Port VNAs	16-9
USER DEFINED Menu	15-5
USER DEFINED WAVEGUIDE Dialog Box	9-97
UTILITY Menu	20-14

VIEW TRACE Menu	17-10
WAVEGUIDE INFO and USER DEFINED WAVEGUIDE Dialog Boxes	10-156
WAVEGUIDE INFO Dialog Box	9-99
WINDOW SHAPE Menu	17-42
WRAP SETUP Menu	18-18

Chapter 1 — Overview

1-1 Introduction

This manual is a reference document for the Anritsu ShockLine™ VNA user interface (UI) menus and dialog boxes. This chapter describes the document conventions used in this manual and lists related ShockLine™ VNA documentation.

The full documentation set for the ShockLine™ VNA is listed in “[User Documentation](#)” on page 1-2. All documentation except the maintenance manuals is available from the Anritsu website. Maintenance manuals are available by contacting Anritsu Customer Service. Refer to other MS46121A/MS46522A/MS46524A Series VNA documentation for detailed explanations and procedures.

This document assumes readers have reviewed the introduction to the ShockLine application User Interface presented in the Operation Manual or User Guide.

1-2 Documentation Conventions

The following conventions are used throughout the entire ShockLine VNA Series documentation set.

Instrument Identification

Throughout this manual, the following term definitions are used:

- ShockLine™ VNA refers to any ShockLine™ VNA module or system.
- VNA refers to any ShockLine™ VNA module.

When identifying a frequency option for a VNA model, that option number is appended after the model number; example: MS46522A-010.

Note

Many of the images in this document are used as typical representations of the product, product features, or the user interface. Your instrument and instrument displays may vary slightly from these images.

User Interface

The ShockLine VNA user interface consists of menus, sub-menus, buttons, toolbars, and dialog boxes.

User Interface Navigation

In ShockLine VNA documentation:

- regular text uses a Serif font (example: this is Serif text).
 - All references to UI elements use Sans Serif font (example: this is a Sans Serif font)
 - Menu and dialog box names are formatted in ALL CAPITALS
 - Button names are in Initial Capitals

For example, “on the MAIN MENU, click the Calibration button.”

- Elements in navigation paths are separated with a vertical bar or “pipe” symbol (“|”). For example, the path to the CALIBRATE menu is:

MAIN | Calibration | CALIBRATION [TR] | Calibrate | CALIBRATE |

which means: MAIN menu -> Calibration button -> CALIBRATION [TR] MENU -> Calibrate button -> CALIBRATE Menu

User Input

User input such as entering values or other information is denoted in a mono-spaced font such as:

```
This font denotes a string of user input.
```

1-3 User Documentation

The following ShockLine™ MS46522A/MS46524A Series VNA documentation is provided on the user documentation media, and is also available on the Anritsu website.

- MS46121A Series VNA Technical Data Sheet 11410-00839
- MS46121A Series VNA User Guide 10410-00344
- MS46522A Series VNA Technical Data Sheet – 11410-00750
- MS46524A Series VNA Technical Data Sheet – 11410-00791
- MS46522A/MS46524A Series VNA Operation Manual – 10410-00330
- MS46522A Series VNA Measurement Guide – 10410-00331
- MS46522A/MS46524A Series VNA User Interface Reference Manual – 10410-00332
- MS46522A/MS46524A Series VNA Programming Manual – 10410-00333
- All User Documentation above on a USB device - 2300-559

Updates to Manuals

For updates to any of the MS46522A/MS46524A Series product documentation, visit the Anritsu website at: <http://www.anritsu.com>

Chapter 2 — Menu Bar, Icon Bar, and Main Menu

2-1 Chapter Overview

This chapter describes the user interface screen layout, and navigation tools including the Menu Bar, Icon Bar, and MAIN MENU.

Because the Menu Bar and Icon Bar are fully covered in the Operations Manual, these topics are only summarized here. For full discussions, see the Operation Manual.

2-2 Menu Bar

The menu bar at the top of the screen provides drop-down menus for access to major ShockLine™ VNA functions and dialogs. The bar is shown below.



2-3 Icon Bar

The Icon Toolbar is located immediately below the Menu Bar and allows single-click access to many menus and functions. The icon toolbar is user-configurable and up to 13 icons can be displayed in any configuration.



2-4 Main Menu

The Main Menu allows navigating to all functions of the software application. It is located at the right side of the ShockLine screen. The split/collapsed view in the diagram below shows all of what is seen when the main menu is scrolled down.

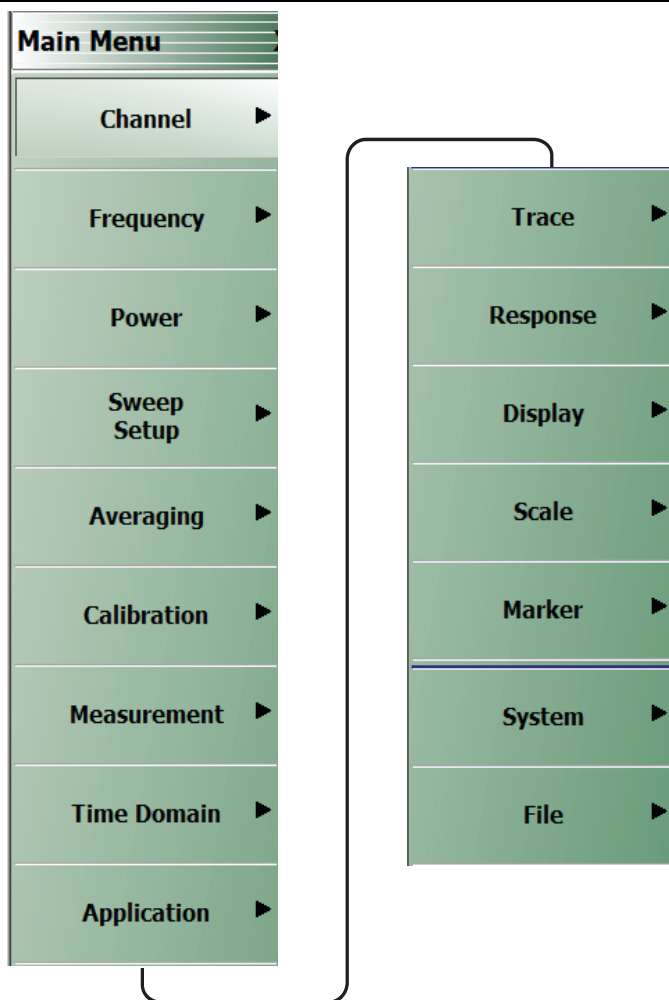

Figure 2-1. MAIN MENU

Channel

Select displays the CHANNEL menu.

- [“Channel Menus” on page 3-2](#)

Frequency

Select displays the FREQUENCY menu.

- [“Overview of Frequency Menus” on page 4-1](#)

Power

Select displays the POWER menu.

- [“Overview - Power Menus - 2-Port VNAs” on page 5-2](#)

- [“Maximum and Minimum Power Settings” on page 6-1](#)

Sweep Setup

Select displays the SWEEP SETUP menu.

- [“Sweep Menus” on page 7-1](#)

Averaging

Select displays the AVERAGING menu.

- [“AVERAGING Menu” on page 8-2](#)

Calibration

Select displays the CALIBRATION menu.

- [“CALIBRATION \[TR\] Menu” on page 9-5](#)
- [“CALIBRATION \[TR\] Menu - 4-Port VNAs” on page 10-5](#)

Measurement

Select displays the MEASUREMENT menu.

- [“MEASUREMENT Menu” on page 11-3](#)

Time Domain

Selection displays the Time Domain menu.

- [Section 12-1 “Chapter Overview” on page 12-1](#)

Application

Select displays the APPLICATION menu.

- [“APPLICATION Menu \(for Receiver Configuration\)” on page 13-1](#)

Trace

Select displays the TRACE menu.

- [“TRACE Menu” on page 14-2](#)

Response

Select displays the RESPONSE menu.

- [“RESPONSE Menu” on page 15-3](#)
- [“RESPONSE Menu - 4-Port VNAs” on page 16-2](#)

Display

Select displays the DISPLAY menu.

- [“DISPLAY Menu” on page 17-2](#)

Scale

Select displays the SCALE menu which allows the user to change the scaling and other attributes of a trace display.

- [“Overview of SCALE Menu Variants” on page 18-4](#)

The available SCALE menu buttons change based on the settings on the DISPLAY Menu’s submenu TRACE FORMAT.

- [“TRACE FORMAT Menu” on page 17-4](#)

Marker

Select displays the MARKERS [1] menu.

- [“MARKERS \[1\] Menu” on page 19-4](#)

System

Select displays the SYSTEM menu.

- [“System Menus, Buttons, and Dialog Boxes” on page 20-1](#)

File

Select displays the FILE menu.

- [“FILE Menu” on page 21-2](#)

Chapter 3 — Channel Menus

3-1 Chapter Overview

This chapter describes how to set the number of channels used and how they are displayed on the instrument. Up to 16 channels can be configured, each with up to 16 traces per channel. For the MS46121A only, each channel is dedicated to an individual 1-port VNA. Only those channels associated with VNA hardware will have active trace displays.

3-2 Overview of Channel Menus

There are two channel menus:

- [“CHANNEL Menu” on page 3-2](#)
- [“CHAN. LAYOUT Menu” on page 3-3](#)

3-3 Channel Menus

The CHANNEL menu and the CHAN. LAYOUT menus are related in that the setting on one menu affects the setting on the other menu.

CHANNEL Menu

Previous

- [“Main Menu” on page 2-2](#)

Navigation

- MAIN | Channel | CHANNEL

You can move between channels either by clicking on a channel on-screen, or from the keyboard by pressing ALT and holding it, and pressing 3 followed by the menu number of the operation you want (such as 1 - Menu, 2 - Max, 3 - Previous, or 4 -Next).

	<p>Chan. Max When multiple channels are displayed, use the Channel Maximum button to maximize the active channel to fill the display area. Clicking a second time returns to the prior multi-channel view.</p> <p>Chan. Next When multiple channels are displayed, the Channel Next button activates the next higher channel number. When the highest channel number is reached, the next click activates channel 1 (one).</p> <p>Chan. Previous When multiple channels are displayed, the Channel Previous button activates the next lower channel number. When channel 1 (one) is reached, the next click activates the highest channel number.</p> <p># of Channels Select displays the Number of Channels field toolbar below the icon toolbar. The toolbar allows the user to set the number of displayed channels in discrete values of 1 (one), 2, 3, 4, 6, 8, 9, 10, 12, or 16 channels. If other channel settings are applied (5, 7, 11, 13, or 14), the instrument applies the next permitted channel setting. The Channel Layout (described below) is automatically set to the number of selected channels.</p> <p># of Channels : <input type="text" value="16"/> <input type="button" value="^"/> <input type="button" value="v"/> <input type="button" value="Enter"/></p> <p>Chan. Layout The Channel Layout button displays the CHAN. LAYOUT menu which defines how multiple channels are displayed on the screen.</p> <ul style="list-style-type: none"> • “CHAN. LAYOUT Menu” on page 3-3
---	---

Figure 3-1. CHANNEL Menu

CHAN. LAYOUT Menu

The CHANNEL LAYOUT menu allows the user to select from 22 selectable channel views. The channel view buttons are not labeled, but instead provide a representative icon of each view configuration. For example, the Single Channel View button provides a channel view where one channel is displayed in one display area. Once the desired view is selected, click the Back button at the bottom of the CHAN. LAYOUT menu to return to the CHANNEL menu. Note that CHAN. LAYOUT menu setting and the # of Channels setting on the CHANNEL menu are linked. Changing the number of channels selects an appropriate channel layout. Changing the channel layout where the number of displayed channels changes, changes the number of channels set on the CHANNEL menu.

Full Name

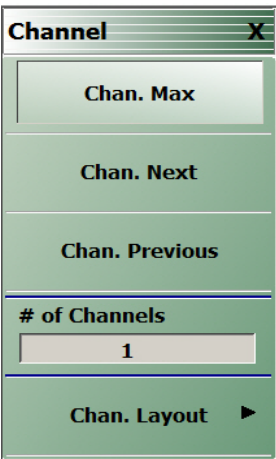
- CHANNEL LAYOUT Menu

Previous

- [“CHANNEL Menu” on page 3-2.](#)

Navigation

- MAIN | Channel | CHANNEL | Chan. Layout | CHAN. LAYOUT

Note

The **Chan. Layout** buttons do not have labels, but do have tool tips that appear if the mouse pointer is hovered over the button. The selected channel layout view is indicated by the button selected icon. For VNA programmatic control, note also that each channel layout is described by the appropriate SCPI parameter. For example, to program a three across channel layout, use the R1C3 parameter.

The long CHAN LAYOUT menu is immediately below. The names of the different channel layout displays are shown in the [Table 3-1, “Channel Layout Options” on page 3-5](#) below.

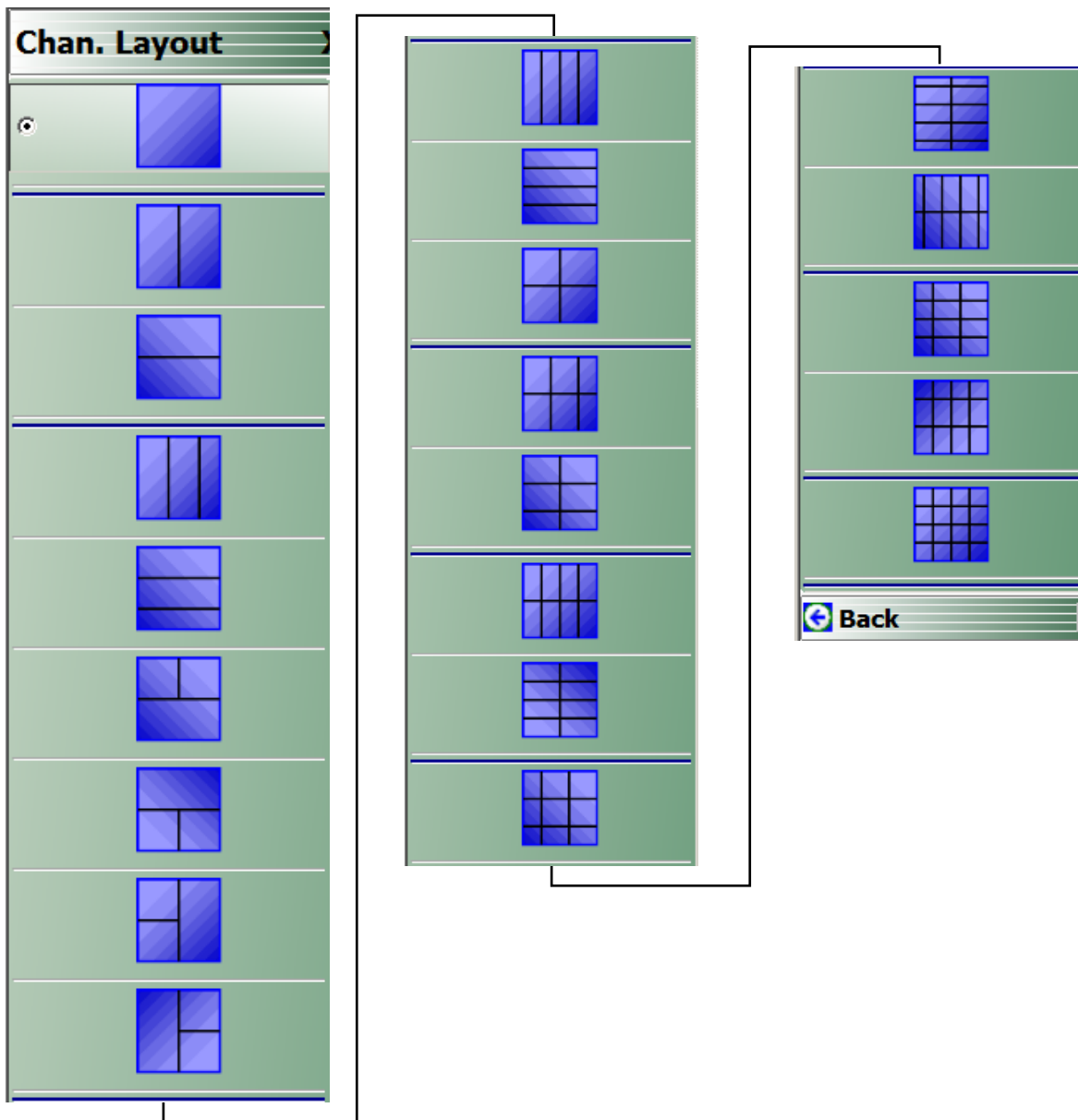

The menu uses the right-side scroll bar to display the entire menu.

Figure 3-2. CHAN. LAYOUT (CHANNEL LAYOUT) Menu

The table below describes each Channel Layout option.

Table 3-1. Channel Layout Options (1 of 2)























Graphic	Description
	Single Channel View Click Back to return to the CHANNEL menu. R1C1 for SCPI programs.
	Two Channel View - 2 Across x 1 Down Click Back to return to the CHANNEL menu. R1C2 for SCPI programs.
	Two Channel View - 1 Across x 2 Down Click Back to return to the CHANNEL menu. R2C1 for SCPI programs.
	Three Channel View - 3 Across Click Back to return to the CHANNEL menu. R1C3 for SCPI programs.
	Three Channel View - 3 Down Click Back to return to the CHANNEL menu. R3C1 for SCPI programs.
	Three Channel View - 2 on Top x 1 on Bottom Click Back to return to the CHANNEL menu. R2C2C1 for SCPI programs.
	Three Channel View - 1 on Top x 2 on Bottom Click Back to return to the CHANNEL menu. R2C1C2 for SCPI programs.
	Three Channel View - 2 on Left x 1 on Right Click Back to return to the CHANNEL menu. C2R2R1 for SCPI programs.
	Three Channel View - 1 on Left x 2 on Right Click Back to return to the CHANNEL menu. C2R1R2 for SCPI programs.
	Four Channel View - 4 Across Click Back to return to the CHANNEL menu. R1C4 for SCPI programs.
	Four Channel View - 4 Down Click Back to return to the CHANNEL menu. R4C1 for SCPI programs.
	Four Channel View - 2 Across x 2 Down Click Back to return to the CHANNEL menu. R2C2 for SCPI programs.

Table 3-1. Channel Layout Options (2 of 2)

Graphic	Description
	Six Channel View - 3 Across x 2 Down Click Back to return to the CHANNEL menu. R2C3 for SCPI programs.
	Six Channel View - 2 Across x 3 Down Click Back to return to the CHANNEL menu. R3C2 for SCPI programs.
	Eight Channel View - 4 Across x 2 Down Click Back to return to the CHANNEL menu. R2C4 for SCPI programs.
	Eight Channel View - 2 Across x 4 Down Click Back to return to the CHANNEL menu. R4C2 for SCPI programs.
	Nine Channel View - 3 Across x 3 Down Click Back to return to the CHANNEL menu. R3C3 for SCPI programs.
	Ten Channel View - 5 Across x 2 Down Click Back to return to the CHANNEL menu. R5C2 for SCPI programs.
	Ten Channel View - 2 Across x 5 Down Click Back to return to the CHANNEL menu. R2C5 for SCPI programs.
	Twelve Channel View - 3 Across x 4 Down Click Back to return to the CHANNEL menu. R4C3 for SCPI programs.
	Twelve Channel View - 4 Across x 3 Down Click Back to return to the CHANNEL menu. R3C4 for SCPI programs.
	Sixteen Channel View - 4 Across x 4 Down Click Back to return to the CHANNEL menu. R4C4 for SCPI programs.

Chapter 4 — Frequency Menus

4-1 Chapter Overview

This chapter covers the FREQUENCY menu which allows the user to set frequency start, stop, span, number of points, and CW mode parameters for the currently active (selected) channel. The FREQUENCY menu has several variants; the one that is displayed depends on the SWEEP TYPES setting for the current channel. The sweep type is set on the SWEEP SETUP menu.

4-2 Overview of Frequency Menus

The appearance and content of the FREQUENCY menu and sub menus depend on the current channel's sweep mode, set by the SWEEP TYPES menu. The settings on the FREQUENCY menu apply to the currently active channel.

The setup sequence is:

1. Select a channel
2. Select a sweep type for the channel.
 - MAIN | Sweep Setup | SWEEP SETUP | Sweep Types | SWEEP TYPES
3. Set the channel's frequency parameters on the FREQUENCY menu variant appropriate for your situation.

This chapter covers the sweep-based variants of the FREQUENCY menu. They are:

- [“FREQUENCY Menu for Frequency-Based Linear Sweep Mode” on page 4-2](#)
- [“FREQUENCY Menu for Frequency-Based Logarithmic Sweep Mode” on page 4-4](#)
- [“FREQUENCY Menu for Frequency-Based Segmented Sweep Mode” on page 4-5](#)
- [“FREQUENCY Menu for Segmented Sweep \(Index-Based \)Mode” on page 4-6](#)
- [“FREQUENCY Power Sweep CW-Based Menu” on page 4-7.](#)

4-3 FREQUENCY Menu for Frequency-Based Linear Sweep Mode

Function(s)

This menu controls linear sweeps.

Displays

- Traces for the channel will show linear axes.

Prerequisites

- User has selected a channel to set up.
- This menu is enabled by selection of Frequency Sweep on the SWEEP TYPES menu.
Menu

Navigation

- MAIN | Frequency | FREQUENCY

Appearance and Controls

	<p>Start (Frequency) Displays the Start (Frequency) field toolbar and allows the user to enter a starting frequency.</p> <p>Start : 300.000 kHz ^ v GHz MHz kHz Hz X</p> <p>Stop (Frequency) Displays the Stop (Frequency) field toolbar and allows the user to enter a stop frequency.</p> <p>Stop : 8.500000000 GHz ^ v GHz MHz kHz Hz X</p> <p>Center (Frequency) The Center (Frequency) button displays the Center (Frequency) field toolbar and allows the user to enter a center frequency.</p> <p>Center : 4.250150000 GHz ^ v GHz MHz kHz Hz X</p> <p>Span (Frequency) The Span (Frequency) button displays the Span (Frequency) field toolbar and allows the user to enter a span frequency.</p> <p>Span : 8.499700000 GHz ^ v GHz MHz kHz Hz X</p> <p># of Points The Number of Points button displays the # of Points field toolbar and allows the user to enter the number of points for the frequency span, allowing separate parameter point settings for CW Mode ON and CW Mode OFF.</p> <p># of Points : 201 ^ v Enter X</p> <p>Step Size (Frequency) This read-only field displays the frequency step-size computed from the requested frequency span and the number of points selected in the buttons above. If the CW Mode (below) is set to ON, the read-only field displays 0 (zero) Hz.</p>
---	---

Figure 4-1. FREQUENCY Freq. Based Sweep Menu (1 of 2)

	<p>CW Mode (Off/On)</p> <p>The Continuous Wave (CW) toggle button toggles the CW function off and on. The default setting is off. If CW Mode is ON, the Step Size (Frequency) display (described above) is set to 0 (zero) Hz and the # of Points setting changes to what has been set for the CW Mode.</p> <p>CW Frequency</p> <p>The CW Frequency button displays the CW Frequency field toolbar and allows the user to set the required CW frequency. Input the required frequency value and select GHz, MHz, kHz, or Hz. If a calibration is active, the VNA will choose the closest CW frequency point from the active calibration points. If the requested CW frequency is a calibrated point, the VNA will assign the entered value. Note that the CW Frequency must fall within the range set by the Start/Stop buttons above.</p> <p>CW Frequency : 300.000 kHz <input type="button" value="^"/> <input type="button" value="v"/> GHz MHz kHz Hz X</p>
--	---

Figure 4-1. FREQUENCY Freq. Based Sweep Menu (2 of 2)

4-4 FREQUENCY Menu for Frequency-Based Logarithmic Sweep Mode

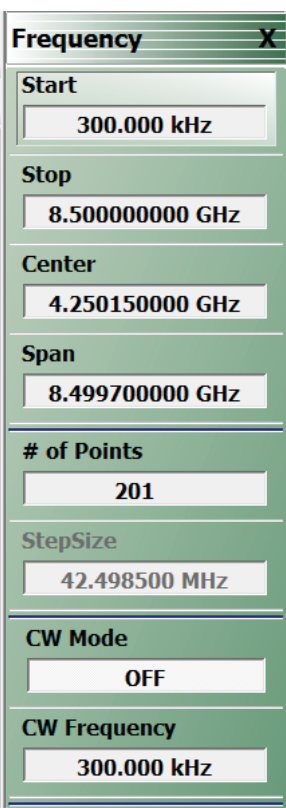
Function(s)

This menu controls logarithmic sweeps.

Displays

- Traces for the channel will show logarithmic axes.

Prerequisites

- User has selected a channel to set up.
- This menu is enabled by selection of Frequency Sweep (Log) on the SWEEP TYPES menu

Navigation

- MAIN | Frequency | FREQUENCY

Appearance and Controls

The menu appearance and controls are exactly the same as for Frequency-Based Linear Sweep shown in [“FREQUENCY Menu for Frequency-Based Linear Sweep Mode” on page 4-2](#). Traces appear the same except that the graph bars are logarithmic.

4-5 FREQUENCY Menu for Frequency-Based Segmented Sweep Mode

Function(s)

This menu controls frequency-based segmented sweeps. (Parameters are also set at the SWEEP Setup Menu’s Freq-based Seg. Sweep Setup button and its menu.)

Displays

- Traces for the channel will show linear axes.

Prerequisites

- User has selected a channel to set up.
- This menu is enabled by selection of Segmented (Freq) sweep type on the Sweep Setup menu’s Sweep Types button.

Navigation

- MAIN | Frequency | FREQUENCY

Appearance and Controls

- The three active buttons are Start Range, Stop Range, and Maximize Range
- The three read-only buttons are Display Start, Display Stop, and DataPoints.

	<p>Start Range (Frequency) Select displays the Start Range (Frequency) toolbar with frequency values and units of GHz, MHz, kHz, and Hz.</p> <p>Start Range : 300.000 kHz ^ v GHz MHz kHz Hz X</p> <p>Stop Range (Frequency) Select displays the Stop Range (Frequency) toolbar with frequency values and units of GHz, MHz, kHz, and Hz.</p> <p>Stop Range : 8.500000000 GHz ^ v GHz MHz kHz Hz X</p> <p>Maximize Range (Frequency) Select maximizes the start and stop value to the maximum of the instrument. Note that when clicked, any previously entered Start and Stop value are overwritten and cannot be recovered unless a preset save was done.</p> <p>Display Start (Frequency) A read-only display of the Start Range frequency.</p> <p>Display Stop (Frequency) A read-only display of the Stop Range frequency.</p> <p>DataPoints (Number) A read-only display of the calculated number of data points in the set frequency range.</p>
--	--

Figure 4-2. FREQUENCY Freq. Based Segmented Sweep Menu

4-6 FREQUENCY Menu for Segmented Sweep (Index-Based)Mode

Function(s)

This menu controls index-based segmented sweeps. (Parameters are also set at the SWEEP Setup Menu's Index-based Seg. Sweep Setup button and its menu.)

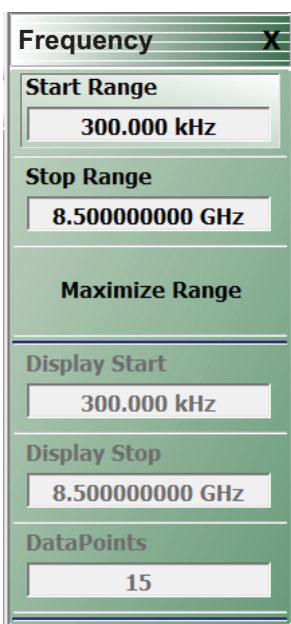
Displays

Sweeps showing index-based data.

Prerequisites

- User has selected a channel to set up.
- This menu is available when Segmented Sweep (Index-based) is selected on the SWEEP TYPES menu's Sweep Types button to produce a linear sweep.

Navigation

- MAIN | Frequency | FREQUENCY

Appearance

- The three (3) active buttons are Start Index, Stop Index, and Maximize Range
- The three read-only buttons are Display Start Index, Display Stop Index, and DataPoints

	<p>Start Index (Number) Select displays the Start (Index Number) toolbar allowing the selection of a starting index number for the sweep.</p> <p>Start Index : 0 ^ v Enter X</p> <p>Stop Index (Number) Select displays the Stop (Index Number) toolbar allowing the selection of an ending index number for the sweep.</p> <p>Stop Index : 14 ^ v Enter X</p> <p>Maximize Range Select maximizes the start and stop value to the maximum of the instrument. Note that when clicked, any previously entered Start and Stop value are overwritten and cannot be recovered unless a preset save was done.</p> <p>Display Start Index (Number) A read-only display of the Start Index number.</p> <p>Display Stop Index (Number) A read-only display of the Stop Index number.</p> <p>DataPoints (Number) A read-only display of the calculated number of data points in the swept frequency range.</p>
--	--

Figure 4-3. INDEX. SEG. SWP (FREQUENCY) Index-Based Segmented Sweep Menu

4-7 FREQUENCY Power Sweep CW-Based Menu

Function(s)

This menu controls (sets) the frequency at which a power-based sweep is performed. The power values for the sweep are set on the Power menu.

Displays

- Traces for the channel will show power values on the horizontal axis.

Prerequisites

- This menu is enabled when SWEEP TYPES is set to Power Sweep (CW Frequency) on the SWEEP TYPES menu.

Navigation

- MAIN | Frequency | FREQUENCY

Appearance

Available control buttons are: CW Frequency.

<p>The screenshot shows a menu titled 'Frequency' with a close button 'X'. It contains two sections: 'CW Mode' with a toggle button set to 'ON', and 'CW Frequency' with a text field containing '300.000 kHz'.</p>	<p>CW Mode (ON/OFF) The CW Mode toggle button is set to a read-only value of ON for a per-channel basis.</p> <p>CW Frequency The CW Frequency button displays the CW Frequency field toolbar and allows the user to set the required CW frequency. Input the required frequency value and select GHz, MHz, kHz, or Hz. Note that the CW Frequency must fall within the range set by the Start/Stop buttons above.</p> <p>CW Frequency : 300.000 kHz ^ v GHz MHz kHz Hz X</p>
---	---

Figure 4-4. FREQUENCY Power Sweep CW Freq. Menu

Chapter 5 — Power Menus: 2-Port VNAs

5-1 Chapter Overview

This chapter provides information on port power control in 2-port VNAs. Power conditions for sweeps are set in different places in the ShockLine application, depending on the sweep type: 1) for frequency-based sweeps and for power-based sweeps, the Power menu is used to set power parameters, and 2) for segmented and indexed sweeps, the power setup controls are in segment or index setup characteristics areas of the sweep tableaus (see Sweep chapter for details).

Note	The MS46121A 1-port VNA has only one default power level so the power menu is not applicable and not available.
-------------	---

Maximum and Minimum Power Settings

The VNA models in this series support using two power levels normally: High, or Low. For all configurations, the maximum power setting is +15 dBm.

Table 5-1 below shows the ranges on the power settings .

Table 5-1. Summary of Maximum and Minimum Power Levels for MS46522A Series 2-Port VNAs

Power Level, and Frequency Range	Power Sweep Type	Power Setting Max/Min ^a
Maximum Power 8 GHz to 8.5 GHz	Any	+10 dBm
Maximum Power 6 GHz to 8 GHz	Any	+12 dBm
Maximum Power 300 KHz to 6 GHz	Any	+15 dBm
Minimum Power at 8.5 GHz	<ul style="list-style-type: none">• Power Sweep CW• Single Power Mode	-30 dBm

a. The default power setting (+5 dBm) applies to the user configurable Start, Stop, and Single Power buttons and their variants.

5-2 Overview - Power Menus - 2-Port VNAs

Locations of Power Settings

There are two main things to know about the VNA power controls:

1. The sweep type determines where the power controls are found. For basic frequency-based sweeps the controls are in the POWER menus. For segment or index sweeps, the controls are both in the POWER menus and in SWEEP menu setup tables.
2. The POWER menu contents such as menu title text, buttons, and available functions, may vary depending on selected sweep type, instrument model (2 or 4 port), and installed options.

This chapter organizes discusses of power menus by sections reflecting the sweep type. The following is a quick reference:

1. POWER Settings for Frequency-Based Sweeps

If SWEEP Menu SWEEP TYPES is set to either Frequency Sweep (for linear sweep) or to Frequency Sweep (Log), the power settings are under the POWER menu and its submenus.

2. POWER Settings for Segment-Based Sweeps

If SWEEP Menu SWEEP TYPES is set to a Segment-Based Sweep type (Frequency or Index), the per-port power and effective power are set on a per-segment basis in the Segmented Sweep Setup Tableau dialog area. To reach that dialog:

How to Navigate to Power Settings for Frequency-Segment-Based Sweeps

- MAIN | Sweep Setup | SWEEP SETUP | Freq-Based Seg Sweep Setup | FREQ BASE SETUP
- For use see [“FREQ BASE SETUP Menu” on page 7-7](#)

How to Navigate to Power Settings for Index-Based Segmented Sweeps

- MAIN | Sweep Setup | SWEEP SETUP | Index-Based Seg Sweep Setup | INDEX BASE SETUP
- For use see [“INDEX BASE SETUP Menu” on page 7-13](#)

3. POWER Settings for Power-Based Sweeps

If SWEEP Menu SWEEP TYPES is set to Power-Based Sweep (CW), power settings for sweeps are set here:

Navigation to Power Settings for Power-Based Sweeps

- MAIN | Power | POWER |
- and also MAIN | Power | POWER | Other Setup | POWER SETUP
- For use see: [“POWER SETUP Menu - Power-Based Sweep Menu - 2-Port VNAs” on page 5-8](#)

Power Coupling State Is Shown in Power Menu Titles

- POWER menu title text of ‘POWER [COUPLED]’ or ‘POWER [C]’ indicates that all port powers are coupled.
- POWER menu title text of ‘POWER’ indicates that the port powers are not coupled.
- To enable/disable port power coupling
 - Navigate to: MAIN | Power | POWER |
 - Click the POWER menu’s Other Setup button to open the POWER SETUP menu.
 - Use the Port Power button to toggle between Not Coupled and Coupled.

5-3 POWER Menu for Frequency-Based Sweeps (Linear or Log)

Navigation

- MAIN | Power | POWER

	<p>Port 1 Power Select displays the Port 1 Power field toolbar and allows setting the port 1 power level in dBm. If Port Power is set to coupled, changes to the Port 1 Power level affect the Port 2 Power level.</p> <p>Port 1 Power : 5.00 dBm [^] [v] dBm [X]</p> <p>Port 2 Power Select displays the Port 2 Power field toolbar and allows setting the port 2 power level in dBm. If Port Power is set to coupled, changes to the Port 2 Power level affect the Port 1 Power level.</p> <p>Port 2 Power : 5.00 dBm [^] [v] dBm [X]</p> <p>Receiver Cal Select opens the Receive Setup menu.</p> <ul style="list-style-type: none"> • “Receiver Setup” on page 5-9 <p>Other Setup Select displays the POWER SETUP menu. The title of the POWER SETUP menu may include [1], [2]], or [C] to show reference to port 1, port 2, coupling of the port powers. This is based on the settings of the Power Selection button and the Port Power button.</p>
--	---

Figure 5-1. POWER Menu - Frequency-Based Sweep Modes - MS46522A 2-Port VNAs

Power Setup Menu

	<p>Port Power Toggles coupling port power levels. When coupled, ports use same power level and menu title include [C] in its text to signal this.</p> <p>Min. Port Power Dialog This dialog has one button for on/off control of minimum power on the ports. When set On, the VNA will use the lowest output power it can achieve. (This is not the same as the Low Power setting, which simply applies the normal Low Power setting in sweeps.</p>
--	---

Figure 5-2. POWER Setup Menu - Frequency-Based Sweep Modes - MS46522A 2-Port VNAs

5-4 POWER Menu for Segment-Based Sweeps - 2-Port VNAs

Previous

- [“Main Menu” on page 2-2](#)

Navigation

- MAIN | Power | POWER

Prerequisites

- SWEEP TYPES = Frequency-Based Segmented Sweep or Index-Based Segmented Sweep
- Segmented Sweep Frequency-Based Setup
 - MAIN | Sweep Setup | SWEEP SETUP | Sweep Type | SWEEP TYPES | Segmented Sweep (Freq-Based)
 - [“Sweep Setup Menu” on page 7-2](#)
- SWEEP TYPES - Segmented Sweep Index-Based Setup
 - MAIN | Sweep Setup | SWEEP SETUP | Sweep Type | SWEEP TYPES | Segmented Sweep (Index-Based)
 - [“Sweep Setup Menu” on page 7-2](#)

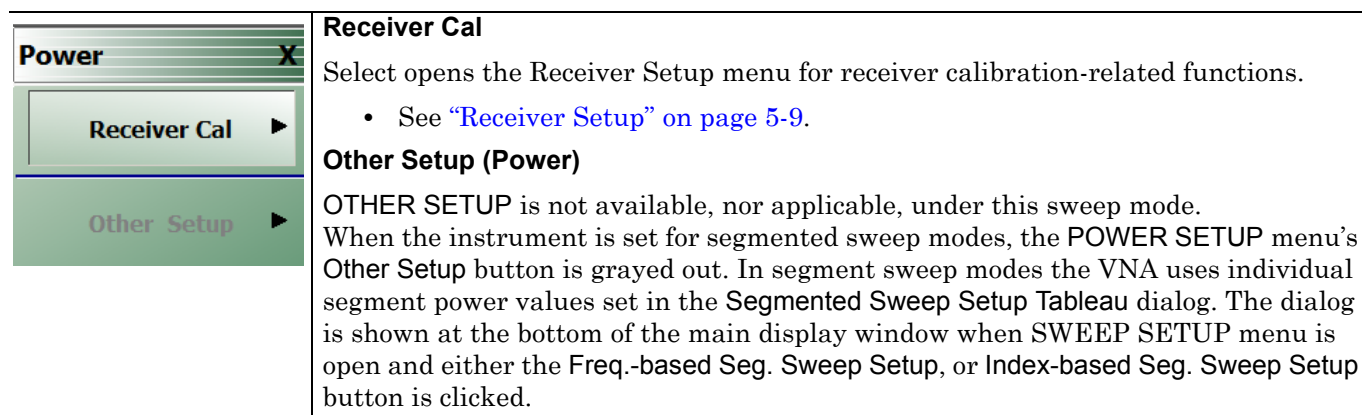

Figure 5-3. POWER Menu - Segment-Based Sweep Mode - 2-Port VNAs

5-5 POWER Menu for Power-Based Sweeps (CW)

Previous

- [“Main Menu” on page 2-2](#)

Navigation

- MAIN | Power | POWER

Prerequisites

- SWEEP TYPES = Power-Based Sweep
- Power-Based Sweep Setup
 - MAIN | Sweep Setup | SWEEP SETUP | Sweep Type | SWEEP TYPES | Power Sweep
 - [“Sweep Setup Menu” on page 7-2](#)

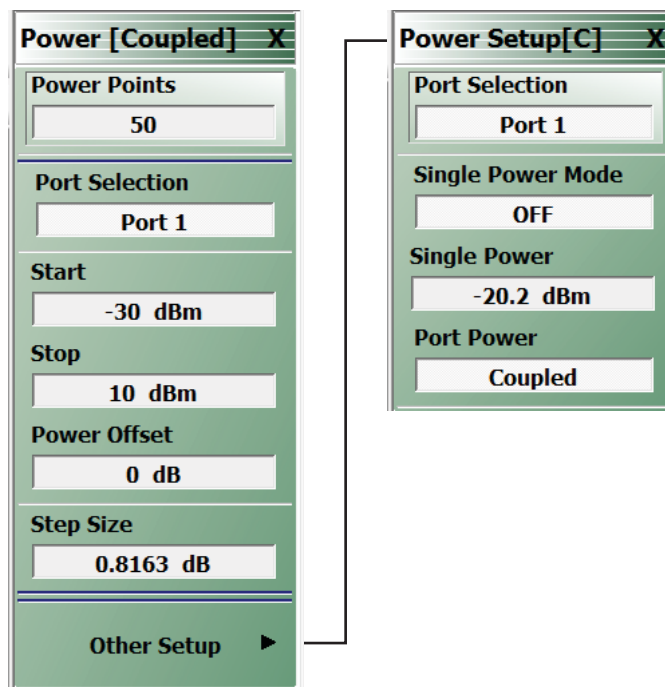

The VNA displays this power menu set if SWEEP TYPES is set to Power Sweep (CW Freq).

The power settings for power sweeps are in the frequency-based or index-based segment power setting input tables: see [“SEGMENTED SWEEP DEFINITION Table” on page 7-9](#).

1. [“POWER Menu - Power-Based Sweeps - 2-Port VNAs” on page 5-6](#)

2. [“POWER SETUP Menu - Power-Based Sweep Menu - 2-Port VNAs” on page 5-8](#).

Figure 5-4. POWER Menu - Power Sweeps (CW)

POWER Menu - Power-Based Sweeps - 2-Port VNAs

The power-based sweep POWER Menu provides controls for port selection and power offset, and interactive controls for adjusting the number of power points, start, stop, and step size values.

Previous

- [“Main Menu” on page 2-2](#)

Navigation

- MAIN | Power | POWER

Prerequisites

- SWEEP TYPES = Power-Based Sweep (CW Frequency)
- Power-Based Sweep (CW Frequency) Setup
 - MAIN | Sweep Setup | SWEEP SETUP | Sweep Types | SWEEP TYPES | Power Sweep (CW Freq)
 - [“Sweep Setup Menu” on page 7-2](#)

	<p>Power Points Select displays Power Points field toolbar for setting total number of power points in the sweep.</p> <p>Power Points : 50 [^] [v] Enter [X]</p> <p>Port Selection The Port Selection button displays the SELECT PORT dialog box. The selected port is shown in the button display field.</p> <p>Start Select displays the Start field toolbar with start power level set in dBm.</p> <p>Start : -30.00 dBm [^] [v] dBm [X]</p> <p>Stop Select displays the Stop field toolbar with stop power level set in dBm.</p> <p>Stop : 10.00 dBm [^] [v] dBm [X]</p> <p>Power Offset Select displays the Power Offset field toolbar with offsets applied in dB.</p> <p>Power Offset : 0.0000 dB [^] [v] dB [X]</p> <p>Step Size Select displays the Step Size field toolbar with step size value set in dB.</p> <p>Step Size : 0.8163 dB [^] [v] dB [X]</p>
--	---

Figure 5-5. POWER Menu - Power-Based Sweep Mode- 2-Port VNAs (1 of 2)

	<p>Other Setup</p> <p>Select displays the POWER SETUP menu which contains the controls for Port Selection, Single Power Mode, Single Power Level, and Port Power Coupling.</p> <ul style="list-style-type: none">• MAIN Power POWER Other Setup POWER SETUP• “POWER SETUP Menu - Power-Based Sweep Menu - 2-Port VNAs” on page 5-8
--	--

Figure 5-5. POWER Menu - Power-Based Sweep Mode- 2-Port VNAs (2 of 2)

POWER SETUP Menu - Power-Based Sweep Menu - 2-Port VNAs

Previous

- “POWER Menu - Power-Based Sweeps - 2-Port VNAs” on page 5-6

Navigation

- MAIN | Power | POWER | Power Setup | POWER SETUP

Prerequisites

- Sweep = Power-Based Sweep (CW Frequency)
- MAIN | Sweep Setup | SWEEP SETUP | SWEEP TYPES | SWEEP TYPES | Power Sweep (CW Freq)
- “Sweep Setup Menu” on page 7-2)

	<p>The menu name suffix changes depending on the state of the Port Power selector: Port Power Coupled -> Power Setup (C) Port Power Uncoupled -> Power Setup (1) for Port 1 or Power Setup (2) for Port 2</p> <p>Port Selection (Port 1/Port 2) The Port Selection button displays the SELECT PORT dialog box to toggle between Port 1 and Port 2. The selected port is shown in the button display field, and the type of coupling between port power level settings.</p> <p>Single Power Mode Selection toggles single power mode ON and OFF.</p> <p>Single Power Selection displays the Single Power (dBm) field toolbar and allows the user to select the single power level.</p> <p>Single Power : -20.20 dBm ^ v dBm X</p> <p>Port Power The Port Power selector toggles whether power adjustments to Ports 1 and 2 are coupled or not coupled. If Not Coupled is selected:</p> <ul style="list-style-type: none"> • The power level of the two port pairs can be adjusted separately on the POWER and POWER SETUP menus. • The Port Selection button (described above) toggles between Port 1 and Port 2 also changing the POWER SETUP menu name between POWER SETUP [1] or [2] and POWER SETUP [C]. <p>If Coupled is selected: An adjustment to one port is also applied to the other port on the POWER and POWER SETUP menus.</p>
--	--

Figure 5-6. POWER [COUPLED] Menu - Power-Based Sweep Mode - 2-Port VNAs

Receiver Setup

The receiver setup and calibration menus are available for frequency sweeps and for both segmented sweep types (frequency and index-based).

Navigation

- MAIN | Power | POWER | Receiver Cal | RECEIVER SETUP

Receiver Setup X	Port 1 Test (Off/On) Select toggles the receiver Port 1 Test Off and On.
Port 1 Test <input type="button" value="OFF"/>	Port 1 Reference (Off/On) This button is unavailable until a Perform Receiver Calibration has been completed. Once enabled, select toggles the Receiver Setup Port 1 Reference between off and on.
Port 1 Reference <input type="button" value="OFF"/>	
Port 2 Test <input type="button" value="OFF"/>	Port 2 Test (Off/On) This button is unavailable until a Perform Receiver Calibration has been completed. Once enabled, select toggles the Receiver Port 2 Test between off and on.
Port 2 Reference <input type="button" value="OFF"/>	
Perform Receiver Cal ▶	Port 2 Reference (Off/On) This button is unavailable until a Perform Receiver Calibration has been completed. Once enabled, select toggles the Receiver Setup Port 2 Reference between off and on.
Save Cal(s)	Perform Receiver Cal Select displays the RECEIVER CAL menu.
Recall Cal(s)	Save Cal(s) Select displays the SAVE RCVR CAL dialog box.
Receiver Cal Utilites ▶	Recall Cal(s) Select displays the RECALL RCVR CAL dialog box.
	Receiver Cal Utilities Select displays the RCVR UTILITIES menu.

Figure 5-7. Receiver Setup Menu - 2-Port VNAs

Chapter 6 — Power Menus: 4-Port VNAs

6-1 Chapter Overview

This chapter provides information on port power control in 4-port VNAs. Power conditions for sweeps are set in different places in the ShockLine application, depending on the sweep type: 1) for frequency-based sweeps and for power-based sweeps, the Power menu is used to set power parameters, and 2) for segmented and indexed sweeps, the power setup controls are in segment or index setup characteristics areas of the sweep tableaux. (See Sweep chapter for details.)

Maximum and Minimum Power Settings

For all configurations, the maximum power setting is +15 dBm.

Table 6-1. Summary of Maximum and Minimum Power Levels for MS46524A Series VNAs

VNA, Power Level, and Frequency Range	Power Sweep Type	Power Setting Max/Min ^a
Maximum Power 8 GHz to 8.5 GHz	Any	+10 dBm
Maximum Power 6 GHz to 8 GHz	Any	+12 dBm
Maximum Power 300 KHz to 6 GHz	Any	+15 dBm
Minimum Power at 8.5 GHz	<ul style="list-style-type: none">• Power Sweep CW• Single Power Mode	-30 dBm

a. The default power setting (+5 dBm) applies to the user configurable Start, Stop, and Single Power buttons and their variants.

6-2 Overview - Power Menus - 2-Port VNAs

Locations of Power Settings

There are two main things to know about the VNA power controls:

1. The sweep type determines where the power controls are found. For basic frequency-based sweeps the controls are in the POWER menus. For segment or index sweeps, the controls are both in the POWER menus and in SWEEP menu setup tables.
2. The POWER menu contents such as menu title text, buttons, and available functions, may vary depending on selected sweep type, instrument model (2 or 4 port), and installed options.

This chapter organizes discusses of power menus by sections reflecting the sweep type. The following is a quick reference:

1. POWER Settings for Frequency-Based Sweeps

If SWEEP Menu SWEEP TYPES is set to either Frequency Sweep (for linear sweep) or to Frequency Sweep (Log), the power settings are under the POWER menu and its submenus.

2. POWER Settings for Segment-Based Sweeps

If SWEEP Menu SWEEP TYPES is set to a Segment-Based Sweep type (Frequency or Index), the per-port power and effective power are set on a per-segment basis in the Segmented Sweep Setup Tableau dialog area. To reach that dialog:

How to Navigate to Power Settings for Frequency-Segment-Based Sweeps

- MAIN | Sweep Setup | SWEEP SETUP | Freq-Based Seg Sweep Setup | FREQ BASE SETUP
- For use see [“FREQ BASE SETUP Menu” on page 7-7](#)

How to Navigate to Power Settings for Index-Based Segmented Sweeps

- MAIN | Sweep Setup | SWEEP SETUP | Index-Based Seg Sweep Setup | INDEX BASE SETUP
- For use see [“INDEX BASE SETUP Menu” on page 7-13](#)

3. POWER Settings for Power-Based Sweeps

If SWEEP Menu SWEEP TYPES is set to Power-Based Sweep (CW), power settings for sweeps are set here:

Navigation to Power Settings for Power-Based Sweeps

- MAIN | Power | POWER |
- and also MAIN | Power | POWER | Other Setup | POWER SETUP
- UPDATE THE BELOW ITEMS
-
- For use see: [“POWER SETUP Menu - Power-Based Sweep Menu - 4-Port VNAs” on page 6-9](#)

Power Coupling State Is Shown in Power Menu Titles

- POWER menu title text of ‘POWER [COUPLED]’ or ‘POWER [C]’ indicates that all port powers are coupled.
- POWER menu title text of ‘POWER’ indicates that the port powers are not coupled.
- To enable/disable port power coupling
 - Navigate to: MAIN | Power | POWER |
 - Click the POWER menu’s Other Setup button to open the POWER SETUP menu.
 - Use the Port Power button to toggle between Not Coupled and Coupled.

6-3 POWER Menu for Frequency-Based Sweep (Linear and Log)

If Port Power is set to Coupled, changes to any Port Power level are applied to all other port power levels.

Navigation

- MAIN | Power | POWER

Prerequisites

- Sweep Type = Frequency-Based Sweep (Linear or Log)
- Frequency-Based Sweep (Linear)
 - MAIN | Sweep Setup | SWEEP SETUP | Sweep Type | SWEEP TYPES | Freq Sweep (Linear)
 - [“SWEEP CONFIG Menu” on page 7-4](#)

	<p>Port 1 Power Select displays the Port 1 Power value toolbar which allows setting the port 1 power level in dBm.</p> <p>Port 1 Power : 5.00 dBm [^] [v] dBm [X]</p> <p>Port 2 Power Select displays the Port 2 Power value toolbar which allows setting the port 2 power level in dBm.</p> <p>Port 2 Power : 5.00 dBm [^] [v] dBm [X]</p> <p>Port 3 Power Select displays the Port 3 Power value toolbar which allows setting the port 3 power level in dBm.</p> <p>Port 3 Power : 5.00 dBm [^] [v] dBm [X]</p> <p>Port 4 Power Select displays the Port 4 Power value toolbar which allows setting the port 4 power level in dBm.</p> <p>Port 4 Power : 5.00 dBm [^] [v] dBm [X]</p> <p>Receiver Cal Select opens the Receive Setup menu.</p> <ul style="list-style-type: none"> • “Receiver Setup” on page 6-10 <p>Other Setup Select displays the POWER SETUP menu. The title of the POWER SETUP menu may include [1], [2], or [C] to show reference to port 1, port 2, coupling of the port powers. This is based on the settings of the Power Selection button and the Port Power button</p> <ul style="list-style-type: none"> • “POWER SETUP Menu for Frequency-Based Sweep” on page 6-4
--	---

Figure 6-1. POWER [COUPLED] Menu - Frequency-Based Sweep - 4-Port VNAs

POWER SETUP Menu for Frequency-Based Sweep

	<p>Port Power</p> <p>Toggles coupling port power levels. When coupled, ports use same power level and menu title include [C] in its text to signal this.</p> <p>Min. Port Power Dialog</p> <p>This dialog has one button for on/off control of minimum power on the ports. When set On, the VNA will use the lowest output power it can achieve. (This is not the same as the Low Power setting, which simply applies the normal Low Power setting in sweeps.</p>
--	---

Figure 6-2. POWER Setup Menu - Frequency-Based Sweep Modes - 4-Port VNAs

6-4 POWER Menu for Segment-Based Sweeps

The power menu when instrument is set for segment-based sweep is shown in the figure below..

Navigation

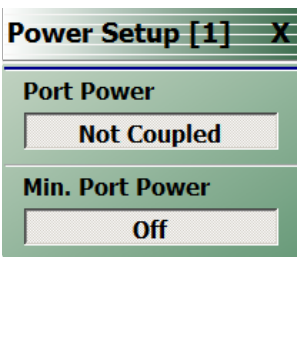
- MAIN | Power | POWER

Prerequisites

- Sweep Type = Segmented Sweep (Freq or Index-based)
- MAIN | Sweep Setup | SWEEP SETUP | Sweep Type | SWEEP TYPES | Segmented Sweep

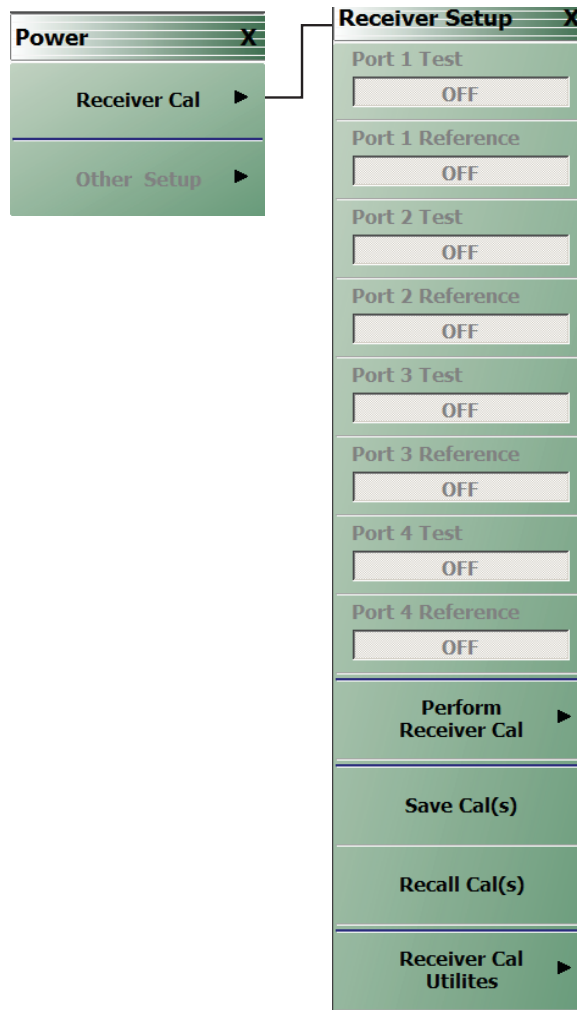

POWER menu when instrument Sweep Type is set to a Segmented sweep type.

Figure 6-3. Power Menu Set - Segmented Sweeps (Frequency- or Index-Based)

Clicking Receiver Cal opens the Receiver Setup menu: see [“Receiver Setup” on page 6-10](#)

6-5 POWER Menu for Power-Based Sweep (CW)

The power menu when instrument is set for power-based sweep is shown in the figure below.

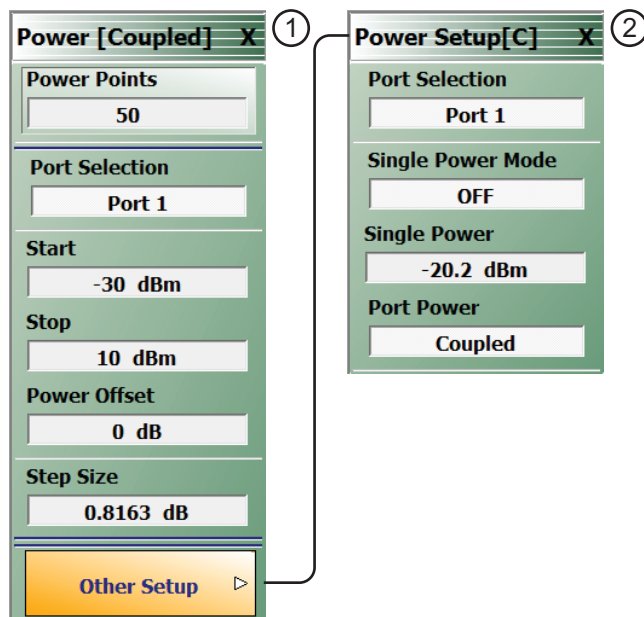

This POWER menu set is available if Sweep Type is set to Power Sweep (CW Freq).

2. [“POWER SETUP Menu - Power-Based Sweep Menu - 4-Port VNAs” on page 6-9](#)

1. [“POWER Menu - Power-Based Sweep - 4-Port VNAs” on page 6-7](#)

Figure 6-4. POWER Menus - Power-Based Sweep (CW)

POWER Menu - Power-Based Sweep - 4-Port VNAs

The power-based sweep POWER Menu provides controls for port selection and power offset, and interactive controls for adjusting the number of power points, start, stop, and step size values.

Previous

- [“Main Menu” on page 2-2](#)

Navigation

- MAIN | Power | POWER

Prerequisites

- Sweep Type = Power-Based Sweep (CW Frequency)
- Power-Based Sweep (CW Frequency)
 - MAIN | Sweep Setup | SWEEP SETUP | Sweep Types | SWEEP TYPES | Power Sweep (CW Freq)
 - [“SWEEP CONFIG Menu” on page 7-4](#)

Power [Coupled] X

Power Points
50

Port Selection
Port 1

Start
-30 dBm

Stop
10 dBm

Power Offset
0 dB

Step Size
0.8163 dB

Other Setup ▶

Power Points
Select displays Power Points field toolbar for setting total number of power points in the sweep.

Power Points : 50 ^ v Enter X

Port Selection
The Port Selection button displays the SELECT PORT dialog box. The selected port is shown in the button display field.

Select Port

Choose a port to use

Port 1 Port 2
Port 3 Port 4

Start
Select displays the Start field toolbar with start power level set in dBm.

Start : -30.00 dBm ^ v dBm X

Stop
Select displays the Stop field toolbar with stop power level set in dBm.

Stop : 10.00 dBm ^ v dBm X

Figure 6-5. POWER [COUPLED] Menu - Power-Based Sweep - 4-Port VNAs (1 of 2)

	<p>Power Offset</p> <p>Select displays the Power Offset field toolbar with offsets applied in dB.</p> <p>Power Offset : 0.0000 dB ^ v dB X</p>
	<p>Step Size (power)</p> <p>Select displays the Step Size (power) field toolbar with step size value set in dB.</p> <p>Step Size : 0.8163 dB ^ v dB X</p>
	<p>Other Setup</p> <p>Select displays the power-based sweep POWER SETUP menu.</p> <ul style="list-style-type: none">• MAIN Power POWER Other Setup POWER SETUP• “POWER SETUP Menu - Power-Based Sweep Menu - 4-Port VNAs” on page 6-9

Figure 6-5. POWER [COUPLED] Menu - Power-Based Sweep - 4-Port VNAs (2 of 2)

POWER SETUP Menu - Power-Based Sweep Menu - 4-Port VNAs

Previous

- [“POWER Menu - Power-Based Sweep - 4-Port VNAs” on page 6-7](#)

Navigation

- MAIN | Power | POWER | Power Setup | POWER SETUP

Prerequisites

- Sweep Type = Power Sweep (CW Frequency)
- [“SWEEP CONFIG Menu” on page 7-4](#)
- MAIN | Sweep Setup | SWEEP SETUP | Sweep Type | SWEEP TYPES | Power Sweep (CW Freq)



	<p>Port Selection</p> <p>Select displays the SELECT PORT dialog box allowing touch screen selection of Port 1, Port 2, Port 3, or Port 4.</p> <ul style="list-style-type: none"> • “Port Selection” on page 6-7 <p>The menu name suffix changes depending on the state of the Port Power (Coupled/Not Coupled) button, and if Not Coupled, to identify the currently selected port.</p> <p>Single Power Mode</p> <p>Select toggles single power mode ON and OFF.</p> <p>Single Power</p> <p>Select displays the Single Power field toolbar and allows the user to set the single power level in dBm.</p>  <p>Port Power</p> <p>The Port Power button toggles whether power adjustments to Ports 1, 2, 3, and 4 are coupled or not coupled</p> <p>Coupled selected: (top figure)</p> <ul style="list-style-type: none"> • Power adjustment to one port is applied to all other ports on the POWER and POWER SETUP menus. • The POWER SETUP menu name changes to POWER SETUP [C]. • The POWER menu name changes to POWER [COUPLED]. <p>Not Coupled selected: (bottom figure)</p> <ul style="list-style-type: none"> • The POWER SETUP menu name changes to include the number of the port. For example, POWER SETUP [1] or POWER SETUP [2] or POWER SETUP [3] or POWER SETUP [4].
--	--

Figure 6-6. POWER SETUP Menu - Power-Based Sweep - 4-Port VNAs

Receiver Setup

The receiver setup and calibration menus are available for frequency sweeps and for both segmented sweep types (frequency and index-based).

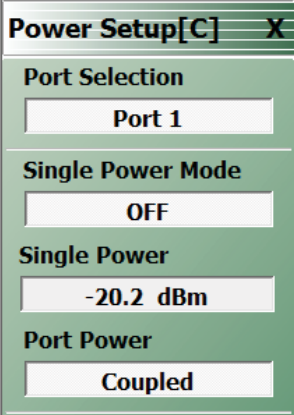
Navigation

- MAIN | Power | POWER | Receiver Cal | RECEIVER SETUP

Receiver Setup X	Port 1 Test (Off/On) Select toggles the receiver Port 1 Test Off and On.
Port 1 Test OFF	Port 1 Reference (Off/On) This button is unavailable until a Perform Receiver Calibration has been completed. Once enabled, select toggles the Receiver Setup Port 1 Reference between off and on.
Port 1 Reference OFF	
Port 2 Test OFF	Port 2 Test (Off/On) This button is unavailable until a Perform Receiver Calibration has been completed. Once enabled, select toggles the Receiver Port 2 Test between off and on.
Port 2 Reference OFF	
Port 3 Test OFF	Port 2 Reference (Off/On) This button is unavailable until a Perform Receiver Calibration has been completed. Once enabled, select toggles the Receiver Setup Port 2 Reference between off and on.
Port 3 Reference OFF	
Port 4 Test OFF	Port 3 Test (Off/On) Select toggles the receiver Port 3 Test Off and On.
Port 4 Reference OFF	Port 3 Reference (Off/On) This button is unavailable until a Perform Receiver Calibration has been completed. Once enabled, select toggles the Receiver Setup Port 3 Reference between off and on.
Perform Receiver Cal ▶	Port 4 Test (Off/On) This button is unavailable until a Perform Receiver Calibration has been completed. Once enabled, select toggles the Receiver Port 4 Test between off and on.
Save Cal(s)	
Recall Cal(s)	Port 4 Reference (Off/On) This button is unavailable until a Perform Receiver Calibration has been completed. Once enabled, select toggles the Receiver Setup Port 4 Reference between off and on.
Receiver Cal Utilites ▶	
	(continued)

Figure 6-7. Receiver Setup Menu - 2-Port VNAs (1 of 2)

<p>Perform Receiver Cal Select displays the RECEIVER CAL menu.</p> <p>Save Cal(s) Select displays the SAVE RCVR CAL dialog box.</p> <p>Recall Cal(s) Select displays the RECALL RCVR CAL dialog box.</p> <p>Receiver Cal Utilities Select displays the RCVR UTILITIES menu.</p>

Figure 6-7. Receiver Setup Menu - 2-Port VNAs (2 of 2)

Chapter 7 — Sweep Menus

7-1 Chapter Overview

This chapter describes sweep types supported by the VNA and how to set and configure them.

7-2 Sweep on the ShockLine VNA

The Sweep menu is used to select sweep type for a channel, and to set key sweep parameters. You can choose from these types:

A. Basic (continuous) frequency sweeps:

- Frequency-based (linear) sweep - you can set start and end frequency values for the sweep. All traces in the display have linear frequency axes.
- Frequency-based (logarithmic) sweep - you can set start and end frequency values for the sweep. All traces in the display have logarithmic frequency axes

This sweep type is configured for frequency on the Frequency menu and port power is set at the Power menu.

B. Segmented frequency sweeps:

- Segmented frequency-based sweep - you can create multiple linear segments each with its own independent start and end frequencies.
- Segmented index-based sweep - you can create a collection of index-based specific frequencies that the instrument steps through. Any index point can have any frequency assigned.

Segments for these sweep types are configured through the Sweep Setup menu. Segment parameters for frequency, power, and number of points are set on the Sweep Setup tableau at the bottom of the display window. You can also set parameters for segments at the Frequency menu.

C. Power sweep:

- Power sweep at a CW frequency - you can set start and end power levels for a sweep at a constant frequency

The power sweep mode is selected on the Sweep menu and the port power levels are set at the Power menu. In all cases, the sweep type selected for a channel applies to all traces of that channel.

All sweep configurations can be saved or recalled individually and/or can be assigned to a user-defined preset setup configuration. The configuration can be recalled at any time. You can configure the hold and trigger conditions for a sweep type.

7-3 Overview of Sweep Menus

These are the sweep control menus and dialog boxes:

- [“SWEEP SETUP Menu” on page 7-2](#)
- [“SWEEP CONFIG Menu” on page 7-4](#)
- [“FREQ BASE SETUP Menu” on page 7-7](#)
- [“SEGMENTED SWEEP DEFINITION Table” on page 7-9](#)
- [“SAVE AS \(SEGMENT SWEEP TABLE SGS FILE\) Dialog Box” on page 7-11](#)
- [“RECALL SEGMENTED SWEEP TABLE SGS FILE Dialog Box” on page 7-12](#)
- [“INDEX BASE SETUP Menu” on page 7-13](#)
- [“HOLD FUNCTIONS Menu” on page 7-16](#)
- [“TRIGGER Menu” on page 7-18](#)
- [“TRIGGER SOURCE Source Menu” on page 7-19](#)

7-4 Sweep Setup Menu

SWEEP SETUP Menu

Purposes

Select sweep type, and set up sweep parameters.

Navigation

MAIN | Sweep Setup | SWEEP SETUP

	<p>Sweep Config Select displays the SWEEP CONFIG menu for selecting frequency sweep options. The display field in the Sweep Config button displays the instrument sweep setting for the active channel. See:</p> <ul style="list-style-type: none"> • “SWEEP CONFIG Menu” on page 7-4 <p>Sweep Types Select displays the SWEEP TYPES menu for selection frequency sweep options. The display field in the Sweep Types button displays the instrument sweep setting for the active channel. See:</p> <ul style="list-style-type: none"> • “SWEEP TYPES Menu” on page 7-5 <p>Freq-based Seg. Sweep Setup The Frequency-Based Segmented Sweep Setup button displays the FREQ BASE SETUP menu and opens the FREQ DEF for F1 & F2 tableau area below the main display area.</p> <ul style="list-style-type: none"> • “FREQ BASE SETUP Menu” on page 7-7 <p>Index-based Seg. Sweep Setup The Index-Based Segmented Sweep Setup button displays the INDEX BASE SETUP menu and opens the FREQ DEF for F1 & F2 table area below the main display area.</p> <ul style="list-style-type: none"> • “INDEX BASE SETUP Menu” on page 7-13 <p>Hold Functions Select displays the HOLD FUNCTIONS menu.</p> <ul style="list-style-type: none"> • “HOLD FUNCTIONS Menu” on page 7-16 <p>Trigger Select displays the TRIGGER menu.</p> <ul style="list-style-type: none"> • “TRIGGER Menu” on page 7-18 <p>Enable Sweep Time Toggles sweep time setup OFF or ON.</p> <p>Sweep Time Setup Select displays the SWP TIME SETUP menu. Sweep Time must first be enabled.</p> <ul style="list-style-type: none"> • “SWEEP TIME SETUP Menu” on page 7-19 <p>Apply Delay? Select toggles delay per point value off and on.</p> <p>Delay Per Point Displays delay per point value. Select enables adjustment of delay per point value.</p>
--	---

Figure 7-1. SWEEP SETUP Menu - MS4652xA Series

SWEEP CONFIG Menu

Simultaneous Sweep: Introduction

The MS46522A/524A VNAs have an independent source for each port that can be programmed to sweep simultaneously. Simultaneous sweep mode automatically programs each port source with a frequency offset that creates a unique IF frequency for each port, enabling all ports to be measured in parallel. Standard sweep does one source at a time sequentially, so simultaneous sweep is capable of faster measurements.

Navigation

MAIN | Sweep Setup | SWEEP SETUP | Sweep Config | CONFIGURATION

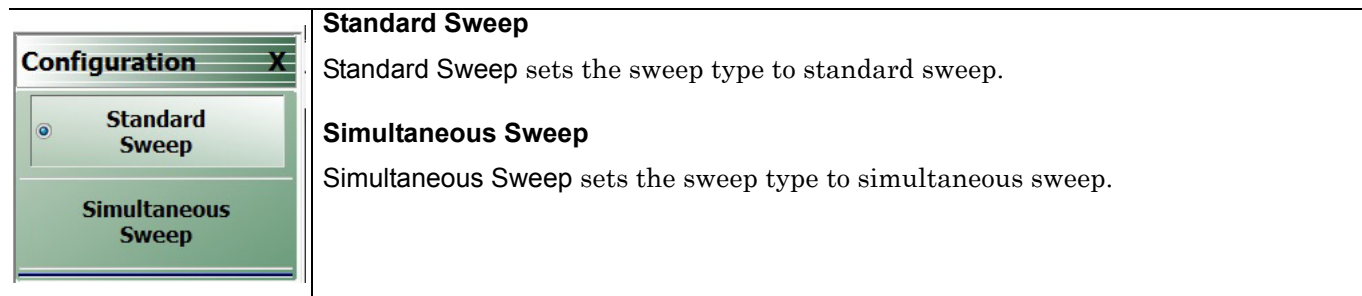

Figure 7-2. SWEEP Config Menu

SWEEP TYPES Menu

Purposes

Select sweep type.

Navigation

MAIN | Sweep Setup | SWEEP SETUP | Sweep Types | SWEEP TYPES

Notes

Several classes of sweep type appear here, invoked by control buttons:

- linear or log frequency sweep
- segmented sweep (either normal segments each with a start and end frequency, or indexed segments each having a start and end frequency)
- power sweep (for CW frequency)

Segmented Sweep: Introduction

Segmented Sweep allows selections of different frequency segments, each monotonic in frequency, and where each segment can have a different number of points, power level, and Averaging. There are two types of segmented sweep. In the frequency-based version, segments can have many points in a short segment or no points within a long segment. In index based, the sweep has all points are plotted with equal spacing, and any point can have any frequency

Sweep Types X	Freq Sweep
Frequency Sweep	Frequency Sweep sets the sweep type to a linear function. The displayed X-axis is linear. Sweep frequency parameters are set at the Frequency menu.
Frequency Sweep (Log)	Freq Sweep (Log)
Segmented Sweep (Freq-based)	Frequency Sweep (Log) sets the sweep type to a log function. Log sweeps have unequal step sizes and the number of points selected are spread equally between the decade divisions, and are displayed on a log scale X-axis. Sweep frequency parameters are set at the Frequency menu.
Segmented Sweep (Index-based)	Segmented Sweep (Freq-Based)
Power Sweep (CW Freq)	The displayed x-axis is linear and the frequencies are plotted where those frequencies lie. Sweep frequency parameters are set using the SEGMENTED SWEEP DEFINITION TABLE dialog that appears below the main display when in this mode.
	Segmented Sweep (Index-Based)
	Sets the sweep type to an index-based segmented sweep and de-selects all other sweep types. Sweep frequency parameters are set using the SEGMENTED SWEEP DEFINITION TABLE dialog that appears below the main display when in this mode. An index-based segmented sweep sweeps over a custom list of frequency points. The indexed frequencies do not have to be in any order. Plotting on the X-axis is index-based and not frequency based, and index points are shown in order on the axis, displayed at equal spacing. The frequencies in each segment do not have to be monotonic. Index-based sweeps are often used when reverse sweeps and a particular frequency order is required. If index-based segmented sweep is selected, the display mode for all traces if the channel is always limited to index-based.
	Power Sweep (CW Freq)
	The Power Sweep (CW Freq) button selects the power sweep mode and de-selects all other sweep types. In this mode, a CW Frequency for the sweep is set on the FREQUENCY menu and power parameters are set an the Power menu, and power is swept linearly on the X-axis between start and end point, based on the number of power steps set.
	<ul style="list-style-type: none"> • “FREQUENCY Power Sweep CW-Based Menu” on page 4-7

Figure 7-3. SWEEP TYPES Menu - MS4652xA Series VNA

7-5 Frequency-Based Segmented Sweep Setup

FREQ BASE SETUP Menu

Purposes

Used to set up frequency-based segment sweep parameters.

Navigation

MAIN | Sweep Setup | SWEEP SETUP | Freq-Based Seg Sweep Setup | FREQ BASE SETUP

Notes:

When the FREQ BASE SETUP menu appears, the companion set of controls, SEGMENTED SWEEP DEFINITION TABLE dialog, also appears. The table display at the bottom of the main display area. allows the configuration of frequency segments for sweep management. See instructions in:

- [“SEGMENTED SWEEP DEFINITION Table” on page 7-9](#)

Freq Base Setup X	Graph Mode (Freq Base/Index Base)
Graph Mode Freq Base	Toggles graph mode between Freq Base and Index Base. When Freq Base is selected, the display status bar shows Freq Base. Display IFBW (Off/On)
Display IFBW ON	Toggles the IFBW column off and on. If on, the IFBW field is added to the Freq Def. for F1 & F2 table header in the SEGMENTED SWEEP DEFINITION table below.
Display Power ON	Display Power (Off/On) Toggles the Power column display off and on. If on, the P1 Src. Pwr (Src. Atten - 0 dB) and P2 Src. Pwr (Src. Atten - 0 dB) columns are added to the Freq Def. for F1 & F2 table header in the SEGMENTED SWEEP DEFINITION table.
Display Averaging ON	Display Averaging (Off/On)
Add	Toggles the Averaging column display off and on. If on, the Averaging field is added to the Freq Def. for F1 & F2 table header in the SEGMENTED SWEEP DEFINITION table
Delete	Add (Freq-Based Segment) Adds a row for a new segment to the Freq Def. for F1 & F2 table information below the currently selected segment.
Clear All Segments	Delete (Freq-Based Segment)
Save Table to File	Deletes the currently selected row/segment from the Freq Def. for F1 & F2 table information.
Recall Table from File	Clear All Segments (Freq-Based Segment) Clears all rows except for Row 1 from the Freq Def. for F1 & F2 table information.
	Save Table to File (Freq-Based Segment) Saves the table data to a Segment Sweep .sgs file. Select displays the Save Segmented Sweep Table (SGS File) dialog box. <ul style="list-style-type: none"> • “SAVE AS (SEGMENT SWEEP TABLE SGS FILE) Dialog Box” on page 7-11
	Recall Table from File (Freq-Based Segment) Recalls table data from a Segment Sweep .sgs file. Select displays the Recall Segmented Sweep Table (Sweep SGS File) dialog box. <ul style="list-style-type: none"> • “RECALL SEGMENTED SWEEP TABLE SGS FILE Dialog Box” on page 7-12

Figure 7-4. FREQ BASE SETUP (FREQUENCY-BASED SEGMENTED SWEEP SETUP) Menu

SEGMENTED SWEEP DEFINITION Table

Purposes

Used to edit frequency-based segment sweep parameters.

Navigation

MAIN | Sweep Setup | SWEEP SETUP | Freq-Based Seg Sweep Setup | FREQ BASE SETUP

Overview

The Freq Def. for F1 and F2 (Segmented Sweep Definition) table information appears below the display area. The number of rows and columns displayed depend on the button settings in the Freq Base Setup menu. The default settings display the following column fields: IFBW, P1 source power, P2 source power, and Averaging.

Default Appearance

The following table displays all fields showing.

	Seg. On	Freq Def. for F1 & F2	F1	F2	# of Pts	Step/Stop Freq	IFBW	P1 Src Pwr	P2 Src Pwr	Averaging
▶ 1	<input checked="" type="checkbox"/>	Start & Stop	300 kHz	8.5 GHz	15	607.1214285...	100 kHz	0	0	1

Freq Def. for F1 & F2 Column, Sweep Segment Options Pull-Down Menu

The Freq Def. for F1 & F2 pull-down menu allows each segments to be set as either a Stop & Start, Start & Step Size, or CW (F2 not used).

	Seg. On	Freq Def. for F1 & F2	F1	F2	# of Pts	Step/Stop Freq	IFBW	P1 Src Pwr	P2 Src Pwr	Averaging
▶ 1	<input checked="" type="checkbox"/>	Start & Stop	300 kHz	8.5 GHz	15	607.1214285...	100 kHz	0	0	1
		Start & Stop								
		Start & Step Size								
		CW (F2 not used)								

Display IFBW Column, Toggle Off/On

The Display IFBW button on the Freq Base Setup menu causes the IFBW column to disappear and appear.

	Seg. On	Freq Def. for F1 & F2	F1	F2	# of Pts	Step/Stop Freq	P1 Src Pwr	P2 Src Pwr	Averaging
▶ 1	<input checked="" type="checkbox"/>	CW (F2 not used)	300 kHz		1	0 kHz	0	0	1

Display Power Column, Toggle Off/On

The Display Power button on the Freq Base Setup menu causes the Power columns to disappear and appear.

	Seg. On	Freq Def. for F1 & F2	F1	F2	# of Pts	Step/Stop Freq	IFBW	Averaging
▶ 1	<input checked="" type="checkbox"/>	CW (F2 not used)	1 MHz		1	0 MHz	100 kHz	1

	Seg. On	Freq Def. for F1 & F2	F1	F2	# of Pts	Step/Stop Freq	IFBW	Averaging
▶ 1	<input checked="" type="checkbox"/>	CW (F2 not used)	300 kHz		1	0 kHz	100 kHz	1

Display Averaging, Toggle Off/On

The Display Averaging button on the Freq Base Setup menu causes the Averaging column to disappear and appear.

	Seg. On	Freq Def. for F1 & F2	F1	F2	# of Pts	Step/Stop Freq	IFBW	P1 Src Pwr	P2 Src Pwr
▶ 1	<input checked="" type="checkbox"/>	Start & Stop	300 kHz	300.01 kHz	2	10 Hz	100 kHz	0	0

Adding Rows

Selecting the Add button on the Freq Base Setup menu adds a row to the tableau so that another frequency segment can be added.

	Seg. On	Freq Def. for F1 & F2	F1	F2	# of Pts	Step/Stop Freq
▶ 1	<input checked="" type="checkbox"/>	Start & Stop	300 kHz	300.01 kHz	2	10 Hz
2	<input checked="" type="checkbox"/>	Start & Stop	300.02 kHz	300.03 kHz	2	10 Hz

To add additional rows, repeat selecting the Add button. Note that the currently selected and editable row is indicated by the left arrow, as shown in Row 3 below.

	Seg. On	Freq Def. for F1 & F2	F1	F2	# of Pts	Step/Stop Freq
1	<input checked="" type="checkbox"/>	Start & Stop	300 kHz	300.01 kHz	2	10 Hz
2	<input checked="" type="checkbox"/>	Start & Stop	300.02 kHz	300.03 kHz	2	10 Hz
▶ 3	<input checked="" type="checkbox"/>	Start & Stop	300.04 kHz	300.05 kHz	2	10 Hz

Deleting Rows

Select a row to delete it. A selected row is indicated by the right-facing arrow icon as shown for Row 2 below:

	Seg. On	Freq Def. for F1 & F2	F1	F2	# of Pts	Step/Stop Freq
1	<input checked="" type="checkbox"/>	Start & Stop	300 kHz	300.01 kHz	2	10 Hz
▶ 2	<input checked="" type="checkbox"/>	Start & Stop	300.02 kHz	300.03 kHz	2	10 Hz
3	<input checked="" type="checkbox"/>	Start & Stop	300.04 kHz	300.05 kHz	2	10 Hz

Click the Delete button on the Freq Base Setup menu to delete the row:

	Seg. On	Freq Def. for F1 & F2	F1	F2	# of Pts	Step/Stop Freq
▶ 1	<input checked="" type="checkbox"/>	Start & Stop	300 kHz	300.01 kHz	2	10 Hz
2	<input checked="" type="checkbox"/>	Start & Stop	300.04 kHz	300.05 kHz	2	10 Hz

Click the Clear All Seg. button on the Freq Base Setup menu to clear all rows.

SAVE AS (SEGMENT SWEEP TABLE SGS FILE) Dialog Box

Purposes

Used to save the frequency-based segment sweep table.

Navigation

MAIN | Sweep Setup | SWEEP SETUP | Freq-Based Seg Sweep Setup | FREQ BASE SETUP | Save Table to File | SAVE SEGMENTED SWEEP TABLE Dialog Box

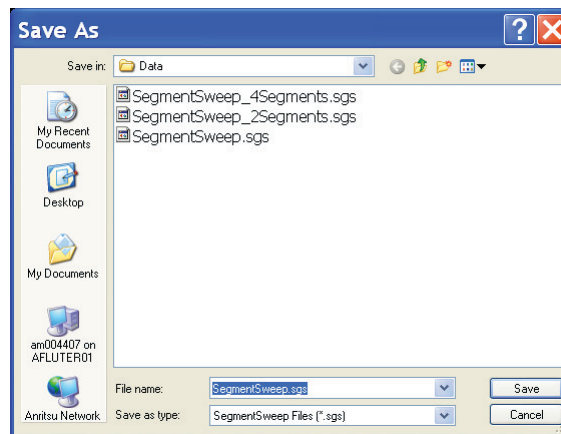

Figure 7-5. SAVE AS (SEGMENT SWEEP TABLE SGS FILE) Dialog Box

Instructions

Navigate to required location, enter unique file name, and click **Save**. Click **Cancel** to return to the Freq Base Setup menu.

RECALL SEGMENTED SWEEP TABLE SGS FILE Dialog Box

Purposes

Used to load and use a frequency-based segment sweep table.

Navigation

MAIN | Sweep Setup | SWEEP SETUP | Freq-Based Seg Sweep Setup | FREQ BASE SETUP | Recall Table from File | RECALL SEGMENTED SWEEP TABLE SGS FILE Dialog Box

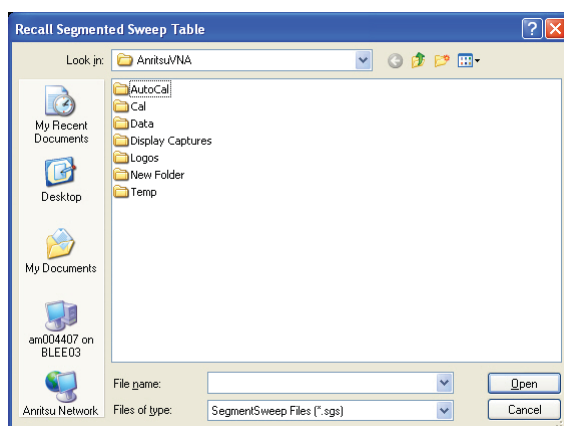

Figure 7-6. RECALL (SEGMENTED SWEEP TABLE SGS FILE) Dialog Box

Instructions

Navigate to required location, select the required SGS file, and click **Open**. Click **Cancel** to return to the Freq Base Setup menu.

7-6 Index-Based Segmented Sweep Setup

INDEX BASE SETUP Menu

Purposes

Used to set up index-based segment sweep parameters.

Navigation

MAIN | Sweep Setup | SWEEP SETUP | Index-Based Seg Sweep Setup | INDEX BASE SETUP

Notes:

When the INDEX BASE SETUP menu appears, the companion set of controls, SEGMENTED SWEEP DEFINITION TABLE dialog, also appears. The table display at the bottom of the main display area. allows the configuration of frequency segments for sweep management. For Add, Delete, and Clear, see instructions in:

- [“SEGMENTED SWEEP DEFINITION Table” on page 7-9](#)

	<p>Display IFBW (Off/On) Toggles the IFBW column off and on in the tableau display. If on, the IFBW column field is added to the Freq Def. for F1 & F2 table header.</p> <p>Display Power (Off/On) Toggles the P1 Src. Pwr and P2 Src. Pwr columns off and on in the tableau display</p> <p>Display Averaging (Off/On) Toggles the Averaging column display off and on in the tableau display. If on, an Averaging column field is added to the Freq Def. for F1 & F2 table header.</p> <p>Add (Index-Based Segment) Adds a row to the Freq Def. for F1 & F2 table information in the tableau area.</p> <p>Delete (Index-Based Segment) To delete a row in the tableau, select a row there so the Right Arrow icon appears. Click Delete to remove the row from the Freq Def. for F1 & F2 table information.</p> <p>Clear All Segments (Index-Based Segment) To clear all rows in the tableau area, select the Clear All Segments button. This clears all rows except for Row 1 from the Freq Def. for F1 & F2 table information.</p> <p>Save Table to File (Index-Based Segment) This displays the Save Segmented Sweep Table (SGS File) dialog box to save the segment table data as a Segment Sweep SGS file.</p> <ul style="list-style-type: none"> • “SAVE AS (SEGMENT SWEEP TABLE SGS FILE) Dialog Box” on page 7-11 <p>Recall Table from File (Index-Based Segment) This displays the Recall Segmented Sweep Table (SGS) dialog box to recall table data from a previously stored Segment Sweep SGS file.</p> <ul style="list-style-type: none"> • “RECALL SEGMENTED SWEEP TABLE SGS FILE Dialog Box” on page 7-12
---	---

Figure 7-7. INDEX BASE SETUP (INDEX-BASED SEGMENTED SWEEP SETUP) Menu

7-7 FREQUENCY Power Sweep CW-Based Menu

Full Name

- Frequency Power Sweep CW-Based Menu

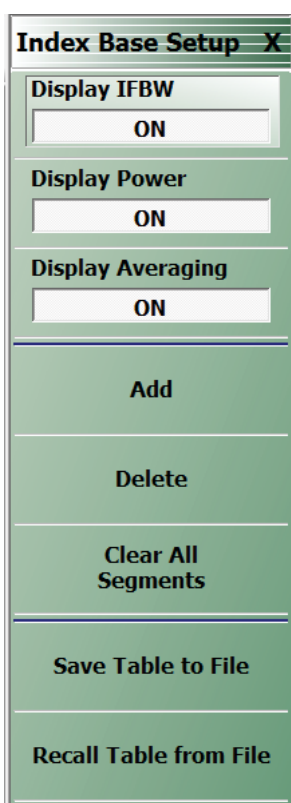
Menu Identification and Variants

- The FREQUENCY menu's appearance and button change when this sweep mode is selected on the SWEEP TYPE menu.

Prerequisites

- When the SWEEP TYPE is set to Power Sweep (CW Frequency), the FREQUENCY menu changes to a two (2) button menu with one active button and one read-only display.

SWEEP TYPES Menu

- [“SWEEP CONFIG Menu” on page 7-4](#)
- MAIN | Sweep Setup | SWEEP SETUP | Sweep Types | SWEEP TYPES

Previous

- [“Main Menu” on page 2-2](#)

Navigation

- MAIN | Frequency | FREQUENCY

 <p>The screenshot shows a menu titled 'Frequency' with a close button 'X'. It contains two buttons: 'CW Mode' with 'ON' displayed below it, and 'CW Frequency' with '300.000 kHz' displayed below it.</p>	<p>CW Mode (ON/OFF) The CW Mode toggle button is set to a read-only value of ON for a per-channel basis.</p> <p>CW Frequency The CW Frequency button displays the CW Frequency field toolbar and allows the user to set the required CW frequency. Input the required frequency value and select GHz, MHz, kHz, or Hz. Note that the CW Frequency must fall within the range set by the Start/Stop buttons above.</p> <p>CW Frequency : 300.000 kHz ^ v GHz MHz kHz Hz X</p>
--	---

Figure 7-8. FREQUENCY Power Sweep CW Freq. Menu

7-8 Sweep Hold and Trigger Functions

HOLD FUNCTIONS Menu

Purposes

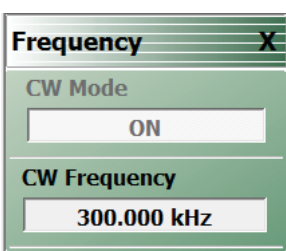
Provides hold control over sweep in the current display channel.

Navigation

MAIN | Sweep Setup | SWEEP SETUP | Hold Functions | HOLD FUNCTIONS

	<p>HOLD FUNCTIONS Menu - Button Selection Group</p> <p>The top three buttons of the HOLD FUNCTIONS menu provide hold control for the active trace.</p> <p>The Hold, Sweep, and Single Sweep & Hold buttons form a three button selection group where the selection of any one button de-selects the other two buttons.</p> <p>The fourth button, Hold Conditions, opens the menu for setting hold conditions.</p> <p>Hold</p> <p>The Hold button pauses the display and stops the channel signal processing.</p> <p>Sweep</p> <p>The Sweep button starts signal processing and resumes the active channel display.</p> <p>Single Sweep & Hold</p> <p>For the active channel, the Single Sweep & Hold button performs a single sweep signal processing, and then holds the display, stops signal processing, and returns the button selection to the Hold button.</p> <p>Hold All Channels</p> <p>The Hold All Channels button pauses the display and stops the signal processing on all channels.</p> <p>Sweep All Channels</p> <p>The Sweep All Channels button starts the signal processing and resumes all channel displays.</p> <p>Single Sweep & Hold All Channels</p> <p>For all channels, the single sweep and hold all channels button performs a single sweep signal processing, and then holds the display, stops signal processing, and returns the button selection to the Hold button.</p> <p>Hold Conditions</p> <p>Select displays the HOLD CONDITIONS menu with toggle settings for RF, and Hold Power value for Power-based sweep (not applicable to the MS46121A).</p> <p>“HOLD CONDITIONS Menu” on page 7-17</p>
--	---

Figure 7-9. HOLD FUNCTIONS Menu

HOLD CONDITIONS Menu

Previous

- [HOLD FUNCTIONS Menu](#)

Navigation

- MAIN | Sweep Setup | SWEEP SETUP | Hold Functions | HOLD FUNCTIONS| HOLD CONDITIONS

	<p>HOLD CONDITIONS Menu</p> <p>The HOLD CONDITIONS menu sets hold conditions for the active trace.</p> <p>The HOLD POWER field appears only when Power Sweep is the selected sweep mode.</p> <p>RF (Off/On)</p> <p>Select toggles the Radio Frequency (RF) option off and on during Hold mode.</p> <p>Hold Power</p> <p>On a per-system basis, sets the hold power level. Select displays the Hold Power field toolbar.</p> <p>Hold Power : <input type="text" value="-20.00 dBm"/> <input type="button" value="^"/> <input type="button" value="v"/> <input type="text" value="dBm"/></p>
---	---

Figure 7-10. HOLD CONDITIONS Menu

TRIGGER Menu

Purposes

Access to trigger controls for the sweep in the current display channel. The MS46121A is internal trigger only. This menu is not applicable to the MS46121A.

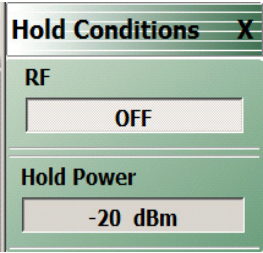
Navigation

MAIN | Sweep Setup | SWEEP SETUP | Trigger | TRIGGER

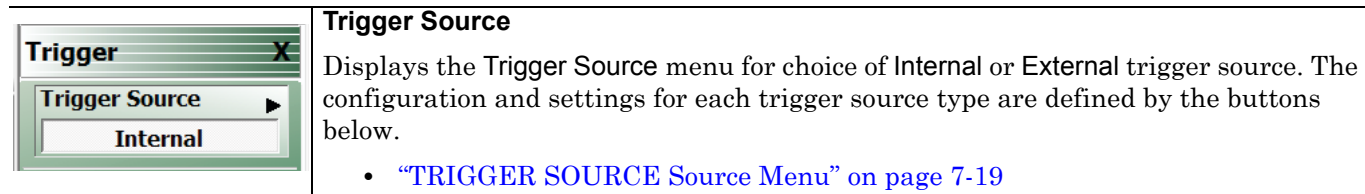

Figure 7-11. TRIGGER Menu

TRIGGER SOURCE Source Menu

Purposes

Set trigger controls for the sweep in the current display channel.

Navigation

- MAIN | Sweep Setup | SWEEP SETUP | Trigger | TRIGGER | Trigger Source | TRIGGER SOURCE

 <p>The screenshot shows the 'Trigger Source' menu with two options: 'Internal' (selected with a radio button) and 'External'.</p>	<p>TRIGGER SOURCE Menu Auto-Return Button Selection Group</p> <p>In the TRIGGER SOURCE menu, the Internal and Triggering buttons are members of a radio button selection group. Selection of either button de-selects the other button and automatically returns to the TRIGGER menu.</p> <p>Internal (Trigger Source)</p> <p>Sets triggering to be automatically initiated within the instrument. Internal triggering mode is an automatically triggered point-by-point measurement that is controlled by the instrument internal software.</p> <p>External (Trigger Source)</p> <p>Sets triggering to be initiated externally by another instrument and sensed through the external port/connector.</p>
---	--

Figure 7-12. TRIGGER SOURCE Menu

SWEEP TIME SETUP Menu

Purposes

Select sweep time configuration.

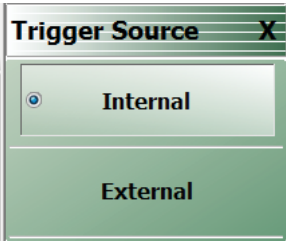
Navigation

MAIN | Sweep Setup | SWEEP SETUP | Sweep Time Setup | SWP TIME SETUP

 <p>The screenshot shows the 'Swp Time Setup' menu with three fields: 'Sweep Time Mode' (set to 'Auto'), 'Sweep Time' (set to '0 s'), and 'Sweep Delay' (set to '0 s').</p>	<p>Sweep Time Mode</p> <p>Selects the sweep time mode of Auto or ?</p> <p>Sweep Time</p> <p>When Sweep Time Mode is set to ?, sets the sweep time.</p> <p>Sweep Delay</p> <p>Sets the sweep delay time.</p>
--	--

Figure 7-13. SWEEP Config Menu

Chapter 8 — Averaging Menu

8-1 Chapter Overview

The AVERAGING menu allows users to turn averaging on or off, set the averaging factor, and select whether the averaging type is per point or per sweep. Control is also provided for IFBW and trace smoothing.

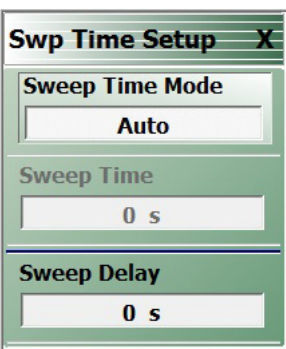
8-2 Overview of the Averaging Menu

There is one averaging menu:

- [“AVERAGING Menu” on page 8-2](#)

8-3 Averaging Menu Functions

AVERAGING Menu

Previous

- “Main Menu” on page 2-2

Navigation

- MAIN | Averaging | AVERAGING

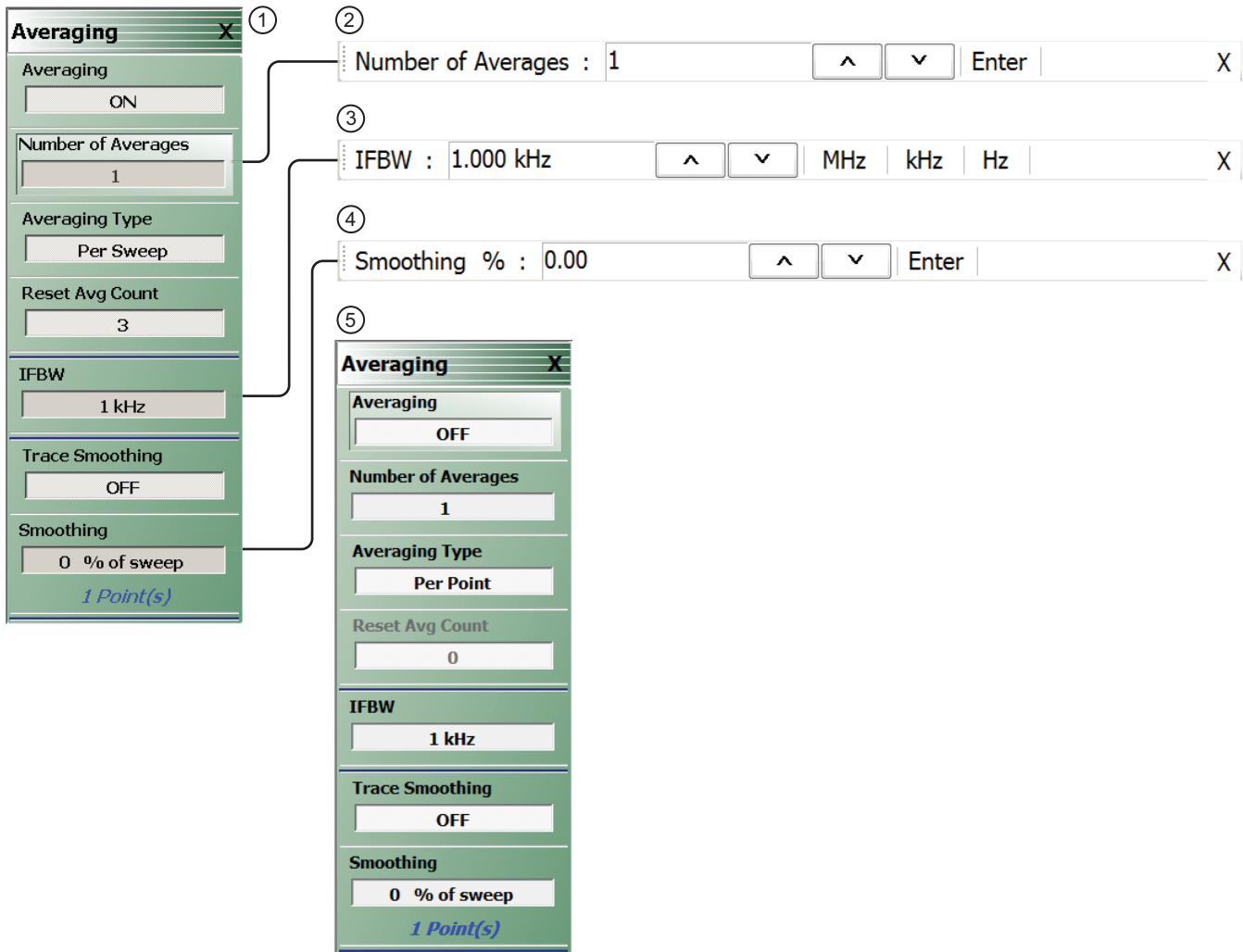

1. AVERAGING Menu – Shown with parameters set and with Averaging ON. When set to ON, the Reset Avg Count and a field in the status bar counts up to the Averaging Factor value setting.

2. Number of Averages Field Toolbar

3. IFBW Frequency Field Toolbar

4. Smoothing % (Smoothing Percentage) Field Toolbar

5. AVERAGING Menu – Example of menu with parameters set, and Averaging OFF.

Figure 8-1. AVERAGING Menu and Field Toolbars

Averaging

Select toggles trace averaging OFF and ON.

Number of Averages

Select displays the Number of Averages field toolbar.

Averaging Type

Select toggles between averaging Per Point and averaging Per Sweep.

Reset Average Count

Read only display field. Counts up to the Averaging Factory value as the averaging session proceeds. Select resets the averaging count to 0 (zero), and the averaging session starts anew.

IFBW

NOTE: for frequencies below 10MHz the maximum IFBW is 100 Hz.

Button only present for frequency-based sweeps. Not present for segment-based sweeps. Select displays the IFBW field toolbar for setting the Intermediate Frequency Bandwidth frequency. The toolbar allows discrete values of :

10 Hz, 20 Hz, 30 Hz, 70 Hz

100 Hz, 200 Hz, 300 Hz, 500 Hz, 700 Hz

1 kHz, 2 kHz, 3 kHz, 5 kHz, 7 kHz,

10 kHz, 20 kHz, 30 kHz, 50 kHz, 70 kHz

100 kHz, 200 kHz, 300 kHz, 500 kHz.

Trace Smoothing

On a per-trace basis, toggles trace smoothing OFF and ON.

Smoothing

On a per-trace basis, select displays the Smoothing % field toolbar. The toolbar allows the user to set the percentage of trace smoothing in use. A display below the button field shows the number of points that are smoothed.

Chapter 9 — Calibration Menus: 1-Port and 2-Port VNAs

9-1 Chapter Overview

This chapter describes the menus used when calibrating 1- and 2-Port ShockLine™ VNAs. It is organized to follow the flows in the progressions of menus and dialog boxes for calibration control. Though it provides representative examples of dialogs, it does not show all the possible dialog contents. This is because their appearance changes dynamically based on combination of instrument calibration ports, AutoCal, manual calibration, calibration methods, line types, and connectors. However, basic elements in the combinations are explained. Only 1-port menus, dialogs, and calibrations are valid for the MS46121A.

9-2 Listing of Calibration Menus

This section lists coverage in this chapter of the calibration menu types for a 2-port VNA, including

Primary Calibration Menus

The primary calibration menus are:

- [“CALIBRATION \[TR\] Menu” on page 9-5](#)
- [“CALIBRATE Menu” on page 9-6](#)
- [“THRU \(Update\) Menu - 2-Port VNAs” on page 9-8](#)

General Setup and Utilities for Calibration

The calibration utility and setup function and management menus, key buttons, and dialog boxes are:

- [“CAL OPTIONS Menu” on page 9-17](#)
 - [“MANUAL ADAPTER REMOVAL Dialog Box” on page 9-18](#)
- [“CAL KIT Menu” on page 9-10](#)
 - Load Kit/Charac. button -- [“Load \(Cal Kit\) Dialog Box” on page 9-11](#)
 - Save Kit/Charac. button -- [“SAVE \(Cal Kit\) Dialog Box” on page 9-12](#)
 - Create/Edit Kit button -- [“CAL KIT INFO Dialog Box” on page 9-13](#)
 - Restore Default Coef. button -- [“RESTORE DEFAULT COEF. Dialog Box” on page 9-15](#)
- [“CAL SETUP Menu” on page 9-35](#)
- [“CAL METHOD Menu” on page 9-37](#)

Auto Calibration on MS4652x Series

- [“AutoCal Port Selection Setup” on page 9-21](#)
- [“AUTOCAL \(Port Selection\) Menu” on page 9-21](#)

Menus for Performing 2-port Auto Cal

- [“AUTOCAL SETUP Menu - 2-Port Cal” on page 9-22](#)
- Modify Cal Setup button -- [“MODIFY 2-PORT AUTOCAL SETUP Dialog Box” on page 9-23](#)

Menus for Performing 1-port Auto Cal

- [“AUTOCAL SETUP Menu - 1-Port Cal” on page 9-28](#)

- [“MODIFY 1-PORT AUTOCAL SETUP Dialog Box”](#) on page 9-29

Manual Calibration on MS46121A/MS46122A/MS4652x Series

Start at CALIBRATION [TR] menu, and do setup as needed with any of:

Setup and Configuration Menus

- [“CAL KIT Menu”](#) on page 9-10
 - [“Load \(Cal Kit\) Dialog Box”](#) on page 9-11
 - [“SAVE \(Cal Kit\) Dialog Box”](#) on page 9-12
 - [“CAL KIT INFO Dialog Box”](#) on page 9-13
- Cal Options

Once a calibration type is selected at the MANUAL CALIBRATION menu, the next menus are used to set up the calibration method and line type. The settings for calibration parameters in these three menus determine which dialog boxes will be available and which procedural menus will appear:

- [“CAL SETUP Menu”](#) on page 9-35
- [“CAL METHOD Menu”](#) on page 9-37
- [“LINE TYPE Menu”](#) on page 9-38

Menus and Dialogs for Performing 2-port Manual Calibration

- [“MANUAL CAL Menu”](#) on page 9-34
- [“Manual 2-Port Cal Setup Dialog Box Summary”](#) on page 9-55
- [“TWO PORT CAL SETUP \(SOLT/R, COAXIAL\) Dialog Box”](#) on page 9-43
- [“TWO PORT CAL SETUP \(LRL/LRM, COAXIAL\) Dialog Box - 2-Port VNA”](#) on page 9-46
- [“TWO PORT CAL SETUP \(SSLT, COAXIAL\) Dialog Box”](#) on page 9-49
- [“TWO PORT CAL SETUP \(SSST, COAXIAL\) Dialog Box - 2-Port VNA”](#) on page 9-52
- [“THRU/RECIP Menu”](#) on page 9-61

Menus for Performing 1-port Manual Calibration

- [“ONE PORT CAL Menu \(SOLT/R - Coaxial\) 2-Port VNAs”](#) on page 9-63
- [“Modify One-Port Cal Setup Dialog Boxes”](#) on page 9-65
- [“ONE-PORT CAL SETUP \(SOLT/R, COAXIAL\) Dialog Box”](#) on page 9-66
- [“ONE-PORT CAL SETUP \(SSLT, COAXIAL\) Dialog Box”](#) on page 9-69
- [“ONE-PORT CAL SETUP \(SSST, COAXIAL\) Dialog Box”](#) on page 9-72
- [“REFL. DEVICE\(S\) Menu”](#) on page 9-59

Additional Menus and Dialogs

- [“TRANS. RESPONSE Menu”](#) on page 9-77
- [“TRANSMISSION FREQUENCY RESPONSE CAL SETUP \(SOLT/R - Coaxial\) Dialog Box”](#) on page 9-79
- [“Manual Cal - Trans. Freq. Resp. Cal”](#) on page 9-77
- [“REFL. RESPONSE Menu”](#) on page 9-83
- [“REFLECTION FREQ. RESPONSE CAL SETUP \(SOLT/R, COAXIAL\) Dialog Box”](#) on page 9-85
- [“Manual Cal - Refl. Freq. Resp. Cal”](#) on page 9-83

General Purpose Manual Calibration Dialog Boxes

These dialog boxes are representative of those that can be linked-to from multiple locations. Not all possible dialog boxes are shown:

- [“AIR EQUIVALENT LENGTH CONVERSION \(FROM PS TO MM\) Dialog Box”](#) on page 9-92
- [“STANDARD INFO Dialog Box”](#) on page 9-93. Exists in different variants from the normal one, with differences in cal type and line type.
- [“THRU INFO Dialog Box”](#) on page 9-94
- [“USER DEFINED MATCH DEVICES Dialog Box - 2-Port VNAs”](#) on page 9-95

9-3 Primary Menus for VNA Calibration

The menus shown in [Figure 9-1](#) provide access to all 2-Port VNA calibration functions. Additional menus and dialog boxes accessed from the MANUAL CAL menu provide configuration and setup for 2-Port, 1-Port, Transmission Frequency Response, and Reflection Frequency Response manual calibration procedures.

This section provides descriptions for each primary menu.

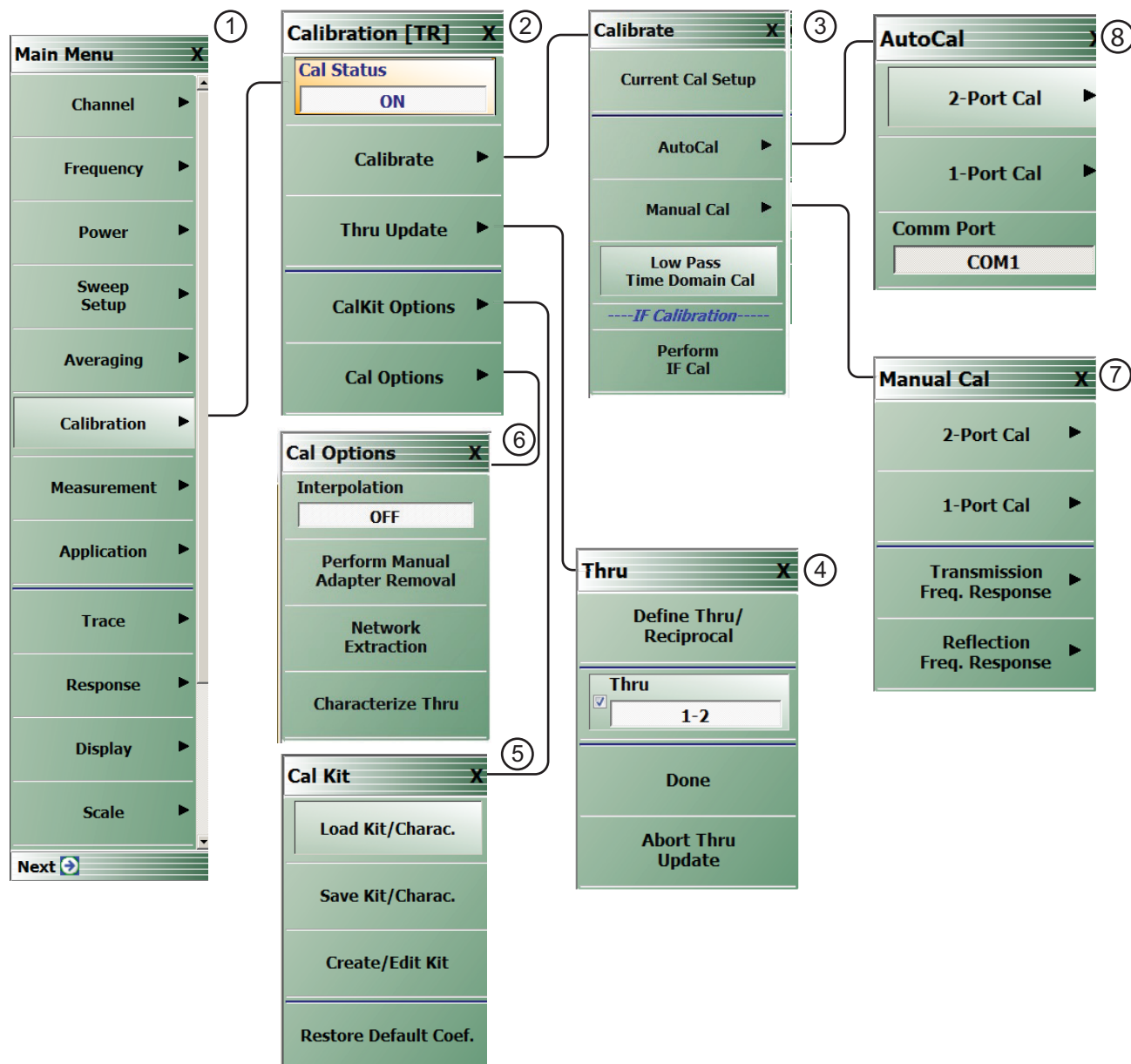

- | | |
|---|---------------------|
| 1. MAIN MENU | 5. CAL KIT Menu |
| 2. CALIBRATION [TR] Menu | 6. CAL OPTIONS Menu |
| 3. CALIBRATE Menu | 7. MANUAL CAL Menu |
| 4. Thru Update button and THRU (Update) Menu (these are available only if a valid calibration has been completed) | 8. AUTOCAL Menu |

Figure 9-1. Primary Menus for VNA Calibration

CALIBRATION [TR] Menu

Full Name

- CALIBRATION [TRANSMISSION-REFLECTION] Menu

Purpose

The CALIBRATION [TR] menu provides options to configure and run calibration routines, to configure cal kit characterization files, to enable /disable interpolation, and to perform manual adapter removal.

Prerequisites

- Availability of the Thru Update button on the CALIBRATION [TR] menu requires successful completion of a full 4-Port, 3-Port, 2-Port, or 1 Path-2 Port calibration.

Navigation

- MAIN | Calibration | CALIBRATION

	<p>Cal Status</p> <p>The Cal Status button toggles display of calibration status between OFF and ON based on the last calibration run. If ON, the Status bar at the bottom of the display area shows a status of CORR in green.</p> <p>If a calibration has not been performed, the Cal Status button is unavailable.</p> <p>Calibrate</p> <p>Use the Calibrate button to start the manual calibration process. Options on sub-menus allow for selection of automatic or manual calibration, calibration type, calibration method, line type and other calibration parameters. Select displays the CALIBRATE menu.</p> <ul style="list-style-type: none"> • “CALIBRATE Menu” on page 9-6 <p>Thru Update</p> <p>Select displays the THRU UPDATE menu. Thru update is a calibration refreshing technique where the user connects a thru line and quickly refreshes the transmission tracking and load match terms without the time and complexity of a full calibration run. The thru update is essentially a one-step refresh calibration for Full 2 Port and 1 Path-2 Port calibrations.</p> <p>The Thru Update button and the THRU (Update) Menu are available only after a valid calibration has been completed.</p> <ul style="list-style-type: none"> • “THRU INFO Dialog Box” on page 9-94 <p>Cal Kit Options</p> <p>Select displays the CAL KIT menu to save, load, and recall characterization files for manual calibration kits.</p> <ul style="list-style-type: none"> • “CAL KIT Menu” on page 9-10. <p>Cal Options</p> <p>Select displays the CAL OPTIONS menu to add interpolated measurement points and perform manual adapter removal after calibration completion.</p> <ul style="list-style-type: none"> • “CAL OPTIONS Menu” on page 9-17
--	---

Figure 9-2. CALIBRATION Menu

CALIBRATE Menu

The CALIBRATE menu initiates the manual calibration process with the selection of calibration parameters, calibration types, calibration methods, line types, and test port connectors.

Previous

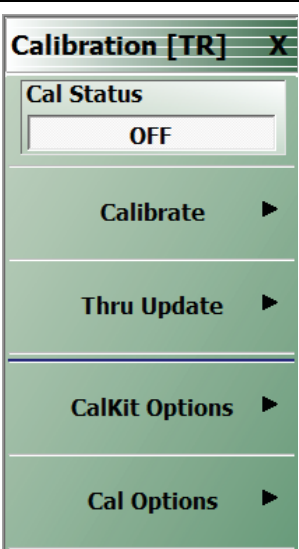
- [“CALIBRATION \[TR\] Menu” on page 9-5](#)

Navigation

- MAIN | Calibration | CALIBRATION [TR] | Calibrate | CALIBRATE

	<p>Current Cal Setup</p> <p>Restores the setup parameters from the last successful calibration procedure. All menu and dialog box settings are returned to their prior settings and the operator can proceed with the calibration procedure as soon as the necessary external device connections are complete.</p> <p>AutoCal</p> <p>Select displays the AutoCal menu.</p> <ul style="list-style-type: none"> • “AutoCal Port Selection Setup” on page 9-21 <p>Manual Cal</p> <p>Select displays the Manual Calibration menu.</p> <ul style="list-style-type: none"> • “MANUAL CAL Menu” on page 9-34 <p>Low Pass Time Domain Cal</p> <p>Select displays the Low Pass Time Domain Cal dialog box.</p> <ul style="list-style-type: none"> • “Low Pass Time Domain Cal Dialog” on page 12-3 <p>Perform IF Cal</p> <p>Select displays the IF CALIBRATION dialog box.</p> <ul style="list-style-type: none"> • “IF CALIBRATION Dialog Box” on page 9-7
---	---

Figure 9-3. CALIBRATE Menu

IF CALIBRATION Dialog Box

Previous

- [“CALIBRATE Menu”](#)

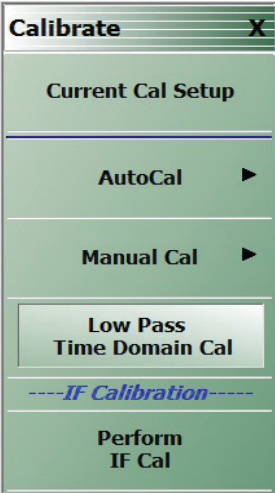
Navigation

- MAIN | Calibration | CALIBRATION [TR] | Calibrate | CALIBRATE | Perform IF Cal | IF CALIBRATION dialog box

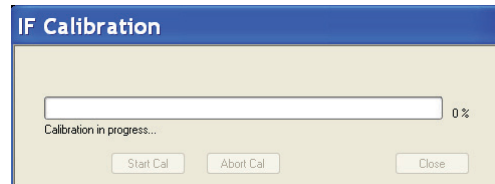

Figure 9-4. IF CALIBRATION Dialog Box

Instructions

Click Start Cal button to begin calibration; click Abort Cal to cancel calibration; click Close to exit the dialog box.

THRU (Update) Menu - 2-Port VNAs

The THRU (Update) menu is a completion button menu. When the through update calibration procedure is complete, the menu's Thru button is annotated with a completion checkmark as shown in the figure below.

Prerequisites

- You must first perform a successful Full 2-Port, or a 1 Path-2 Port calibration (AutoCal or manual) before the Thru Update button on the MANUAL CALIBRATION menu is available. The button will be grayed out before that.

Previous

- [“CALIBRATION \[TR\] Menu” on page 9-5](#)

Navigation

- MAIN | Calibration | CALIBRATION [TR] | Thru Update | THRU (Update)

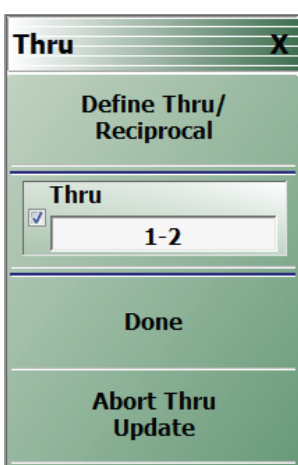
	<p>Define Thru/Reciprocal Displays the THRU INFO dialog box where the through parameters can be changed.</p> <ul style="list-style-type: none"> “THRU INFO Dialog Box” on page 9-94 <p>Thru Select to calibrate Thru connection and update the existing calibration's data.</p> <p>Done Select when all Thru calibrations are completed. Available when all Thru calibrations are completed. Select returns to the CALIBRATION menu, activating Cal Status button.</p> <ul style="list-style-type: none"> “CALIBRATION [TR] Menu” on page 9-5 <p>Abort Thru Update Abort Thru Update stops the current calibration procedure and returns to the CALIBRATION menu.</p> <ul style="list-style-type: none"> “CALIBRATION [TR] Menu” on page 9-5
---	---

Completed THRU UPDATE calibration menu for 2-Port VNA system with completion checkmark and Done button available.

Figure 9-5. THRU (Update) Calibration Menu - 2-Port VNAs

9-4 Calibration Utility Functions

The calibration utility function and management menus and dialog boxes are:

- “CAL OPTIONS Menu” on page 9-17
 - “MANUAL ADAPTER REMOVAL Dialog Box” on page 9-18
- “CAL KIT Menu” on page 9-10
 - Load Kit/Charac. button -- “Load (Cal Kit) Dialog Box” on page 9-11
 - Save Kit/Charac. button -- “SAVE (Cal Kit) Dialog Box” on page 9-12
 - Create/Edit Kit button -- “CAL KIT INFO Dialog Box” on page 9-13
 - Restore Default Coef. button -- “RESTORE DEFAULT COEF. Dialog Box” on page 9-15
- “CAL SETUP Menu” on page 9-35
- “CAL METHOD Menu” on page 9-37

CAL KIT Menu

The CAL KIT menu provides tools to load, save, and create, and edit calibration kit characterization files between an external memory device, the instrument firmware, and a hard drive on the instrument or on a network.

Previous

- [“CALIBRATION \[TR\] Menu” on page 9-5](#)

Navigation [MAIN](#) | [Calibration](#) | [CALIBRATION \[TR\]](#) | [CalKit Options](#) | [CAL KIT](#)

 <p>The screenshot shows a menu titled 'Cal Kit' with a close button (X) in the top right corner. Below the title are four menu items, each in a green button-like box: 'Load Kit/Charac.', 'Save Kit/Charac.', 'Create/Edit Kit', and 'Restore Default Coef.'.</p>	<p>Load Kit/Charac. Select loads the Calibration Kit file or AutoCal Characterization file from the hard drive or external memory device into the VNA firmware through the LOAD (AutoCal Characterization/Cal Kit File) dialog box.</p> <ul style="list-style-type: none"> • “Load (Cal Kit) Dialog Box” on page 9-11 <p>Save Kit/Charac. Select saves the Cal Kit or AutoCal Characterization file from the firmware to the location of choice (typically the instrument hard drive) for later use through the SAVE (AutoCal Characterization/Cal Kit) File dialog box.</p> <ul style="list-style-type: none"> • “SAVE (Cal Kit) Dialog Box” on page 9-12 <p>Create/Edit Kit Select displays the CAL KIT INFO dialog box which shows parametric information about the calibration kit and allows user edits of the values.</p> <ul style="list-style-type: none"> • “CAL KIT INFO Dialog Box” on page 9-13 <p>Restore Default Coef. Select displays the RESTORE DEFAULT COEF dialog box.</p> <ul style="list-style-type: none"> • “RESTORE DEFAULT COEF. Dialog Box” on page 9-15
---	--

Figure 9-6. CAL KIT Menu

Load (Cal Kit) Dialog Box

The LOAD (Cal Kit) dialog box is used to install a calibration kit coefficients file in the instrument for subsequent use. A recommended best practice is to keep the cal kit serial number as part of the file name.

Previous

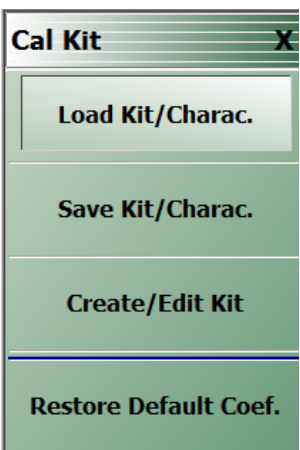
- [“CAL KIT Menu” on page 9-10](#)

Navigation

- MAIN | Calibration | CALIBRATION [TR] | Cal Kit Options| CAL KIT | Load Kit/Charac. | LOAD (Cal Kit) Dialog Box

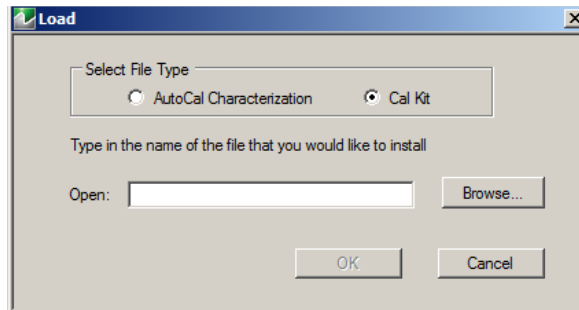

Figure 9-7. LOAD (Cal Kit) Dialog Box

Instructions

1. Cal Kit is the default selection under Select File Type.
2. Enter a file name in the Open field, or click Browse to navigate manually to the appropriate CalKit Coefficient.ccf file.
3. Click Open to load the file or Cancel to return to the menu.

SAVE (Cal Kit) Dialog Box

The SAVE (Cal Kit) dialog is used to save Cal Kit Coefficient Files from the VNA firmware to other locations such as the instrument hard drive, a network drive, or an external memory device, allowing storage of multiple files from available cal kits.

An alternate method is to a Windows program such as File Manager to copy files from the supplied USB flash drive to the recommended internal hard drive location C:\AnritsuVNA\Data.

Previous

- “CAL KIT Menu” on page 9-10

Navigation

- MAIN | Calibration | CALIBRATION [TR] | Cal Kit Options| CAL KIT | Save Kit/Charac | SAVE (Cal Kit) Dialog Box

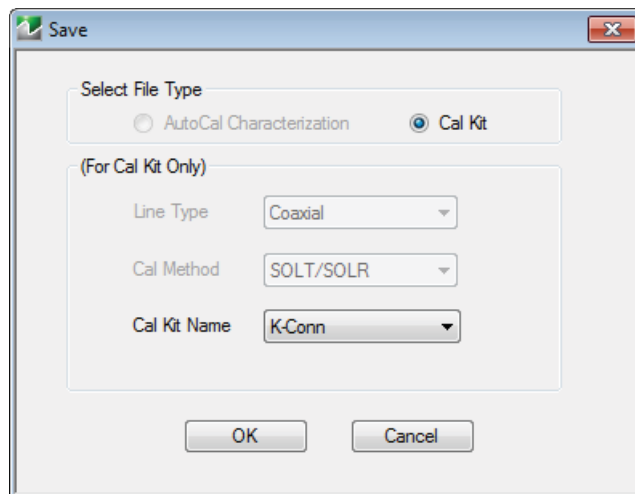

Cal Kit radio button selected

Figure 9-8. SAVE (AUTOCAL CHARACTERIZATION/CAL) KIT FILE Dialog Box

Instructions

1. Cal Kit is the default selection under Select File Type.
2. Select a calibration kit characterization file from the Cal Kit Name drop-down menu:
 - K-Conn
 - GPC-3.5
 - SMA
 - N-Conn
 - other types in the menu
3. Click OK to proceed or Cancel to return to the menu.
4. A SAVE AS dialog box appears with a default Cal Kit Coefficient Files (*.ccf) file name.
5. Navigate to a storage location:
 - C:\AnritsuVNA\Data is recommended.
6. Click Save to save the file or Cancel to return to the menu.

CAL KIT INFO Dialog Box

The CAL KIT INFO dialog box provides access to instrument calibration kit information that is read-only for selections from the Cal Standard drop-down menu, but editable for user-defined cal kits.

Previous

- [“CAL KIT Menu” on page 9-10](#)

Navigation

- MAIN | Calibration | CALIBRATION [TR] | Cal Kit Options| CAL KIT | Create/Edit Kit | CAL KIT INFO Dialog Box

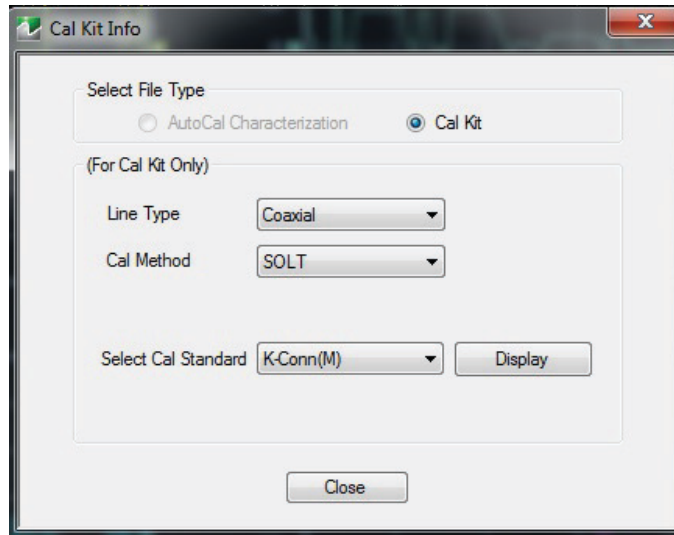

Controls for Cal Kit files.

Figure 9-9. CAL KIT INFO Dialog Box

Instructions

1. Cal Kit is the default selection under Select File Type.
2. Select a connector type from the Select Cal Standard drop-down menu:
 - K-Conn (M)
 - K-Conn (F)
 - GPC-3.5 (M)
 - GPC-3.5 (F)
 - SMA (M)
 - SMA (F)
 - N-Conn (M)
 - N-Conn (F)
 - 2.4 mm (M)
 - 2.4 mm (F)
 - TNC (M)
 - TNC (F)
 - V-conn (M)
 - V-conn (F)

- W1-conn (M)
 - W1-conn (F)
 - 7/16 (M)
 - 7/16 (F)
 - GPC-7
 - N-conn(75) (M)
 - N-conn(75) (F)
 - user defined 1 through 8 (M or F)
3. Click Display.
 4. The STANDARD INFO read-only dialog box opens (Figure 9-10).
 - Note that the dialog box title and content fields reflect selections made in the CAL SETUP menu (“CAL SETUP Menu” on page 9-35).
 5. Click OK to close the STANDARD INFO dialog box.
 6. Click Close to close the CAL KIT INFO dialog box.

Standard Info (SOLT/R)

Cal Kit Label: N-Conn(M)

Serial Number: XXXXXX

Broadband Load

$Z_0, 10^*$

L_0

C_0

R

BB Load 1 (SN XXXXXX)

R (Ω)	Z_0 (Ω)	l0 (mm)	L_0 (e-12)	C_0 (e-15)
50	50	0	0	0

BB Load 2 (SN XXXXXX)

R (Ω)	Z_0 (Ω)	l0 (mm)	L_0 (e-12)	C_0 (e-15)
50	50	0	0	0

l0*: air equivalent length polynomial coef0

Sliding Load BreakPoint Freq (in GHz)

2

Short (SN XXXXXX)

L_0 (e-12)	L_1 (e-24)	L_2 (e-33)	L_3 (e-42)	Offset length (mm)
0	0	0	0	17.83

Open (SN XXXXXX)

C_0 (e-15)	C_1 (e-27)	C_2 (e-36)	C_3 (e-45)	Offset length (mm)
4	200	0	1.1	17.83

Where $L(H) = L_0 + L_1 * f + L_2 * f^2 + L_3 * f^3$ and $C(F) = C_0 + C_1 * f + C_2 * f^2 + C_3 * f^3$

OK

Figure 9-10. STANDARD INFO Dialog Box

RESTORE DEFAULT COEF. Dialog Box

Use the RESTORE DEFAULT COEF. dialog box to restore firmware-stored Cal Kit Coefficients fields back to their default coefficients. For best performance, either install the cal kit coefficients file supplied with your cal kit, or enter your user-defined coefficients before starting this procedure. The restore function is not available to AutoCal kits as they do not have restorable characterization data.

Previous

- [“CAL KIT Menu” on page 9-10](#)

Navigation

- MAIN | Calibration | CALIBRATION [TR] | Cal Kit Options | CAL KIT | Restore Default Coef. | RESTORE DEFAULT COEF. Dialog Box

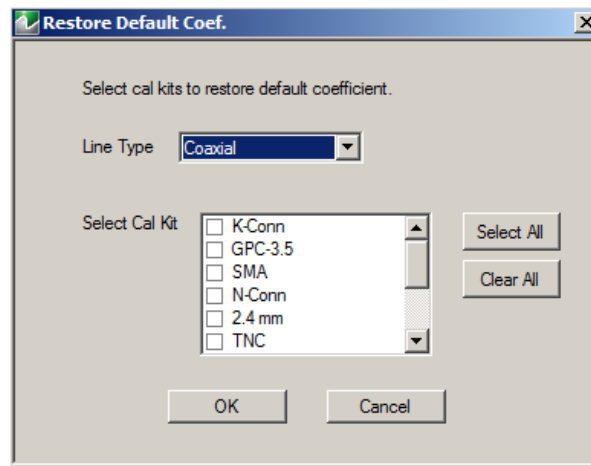

Figure 9-11. RESTORE DEFAULT COEF. (RESTORE DEFAULT COEFFICIENTS) Dialog Box

Instructions Restore Default Calibration Coefficients

Use this dialog to restore factory coefficients to available calibration kits.

1. Select the Line Type as required.
2. Select the Calibration Kits as required to be restored.
3. Click OK.

Available Selections

The table below shows the available calibration kits in the Select Cal Kit field of the RESTORE DEFAULT COEFFICIENTS dialog box. The available kits depend on the input combination selected for Line Type Media and Cal Method

Table 9-1. Calibration Kit Availability in the RESTORE DEFAULT COEF. Dialog Box

LINE TYPE Media Setting	CAL METHOD Setting	Available Calibration Kits
Coaxial	SOLT/SOLR	W1-Conn, V-Conn, K-Conn, 2.4 mm, 2.4 mm V, GPC-3.5, SMA, N-Conn, N-Conn (75), GPC-7, 7/16, TNC
	SSLT	W1-Conn
	SSST	W1-Conn
Non-Dispersive	SOLT/SOLR	W1-Conn, V-Conn, K-Conn, 2.4 mm, GPC-3.5, SMA, N-Conn, N-Conn (75), GPC-7, 7/16, TNC
	SSLT	W1-Conn
	SSST	W1-Conn
Microstrip	SOLT/SOLR	10 Mil Kit, 15 Mil Kit, 25 Mil Kit
	SSLT	10 Mil Kit, 15 Mil Kit, 25 Mil Kit
	SSST	10 Mil Kit, 15 Mil Kit, 25 Mil Kit
Waveguide	SOLT/SOLR	No selections available
	SSLT	WR10, WR12, WR15
	SSST	No selections available

CAL OPTIONS Menu

The CAL OPTIONS menu provides control for use of interpolation and procedure for manual adapter removal.

Previous

- [“CALIBRATION \[TR\] Menu” on page 9-5](#)

Navigation

- MAIN | Calibration | CALIBRATION [TR] | Cal Options | CAL OPTIONS

 <p>The screenshot shows a menu titled 'Cal Options' with a close button (X). Below the title are four menu items: 'Interpolation' with a sub-menu showing 'OFF', 'Perform Manual Adapter Removal', 'Network Extraction', and 'Characterize Thru'.</p>	<p>Interpolation</p> <p>Select toggles interpolation OFF and ON with a default state of OFF.</p> <p>Interpolation allows additional interpolated measurement points between calibrated measurement points. This is useful if the user wants to zoom into a specific area without having to recalibrate the instrument. The interpolated points must lie within the calibration frequency points.</p> <p>Perform Manual Adapter Removal</p> <p>Select displays the MANUAL ADAPTER REMOVAL dialog box.</p> <p>Adapter removal permits accurate measurement of non-insertable devices using an adapter of known electrical length and two full 12-term calibrations. Manual adapter removal extracts the behavior of the adapter from the setup after a successful calibration.</p> <ul style="list-style-type: none"> • “MANUAL ADAPTER REMOVAL Dialog Box” on page 9-18 <p>Network Extraction</p> <p>Use network extraction to generate an S-Parameter (.s2p) file for a set of networks. The file can be embedded or de-embedded as required. Select displays the NETWORK EXTRACTION dialog box.</p> <ul style="list-style-type: none"> • “NETWORK EXTRACTION Dialog Box - 2-Port VNAs” on page 9-19 <p>Characterize Thru</p> <p>Select displays the THRU CHARACTERIZATION dialog box.</p> <p>The THRU CHARACTERIZATION dialog box provides a process to characterize an unknown Thru standard. Two 1-port calibrations are performed, one at the VNA port and one at the end of the unknown Thru. A network extraction is performed to create an s2p file characterizing the unknown thru. This s2p file can then be used in an SOLT calibration.</p> <ul style="list-style-type: none"> • “THRU CHARACTERIZATION Dialog Box” on page 9-20
---	--

Figure 9-12. CAL OPTIONS (CALIBRATION OPTIONS) Menu

MANUAL ADAPTER REMOVAL Dialog Box

The MANUAL ADAPTER REMOVAL dialog box provides a process to extract the electrical behavior of an adapter after completion of a calibration procedure using different connectors at each end that are incompatible with the DUT configuration.

Previous

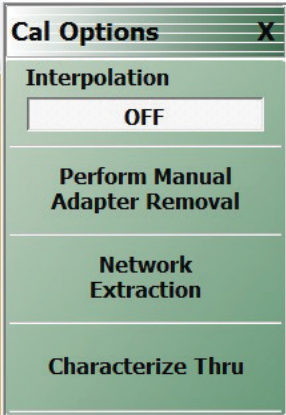
- [“CAL OPTIONS Menu” on page 9-17](#)

Navigation

- MAIN | Calibration | CALIBRATION [TR] | Cal Options | CAL OPTIONS | Perform Manual Adapter Removal | MANUAL ADAPTER REMOVAL Dialog Box

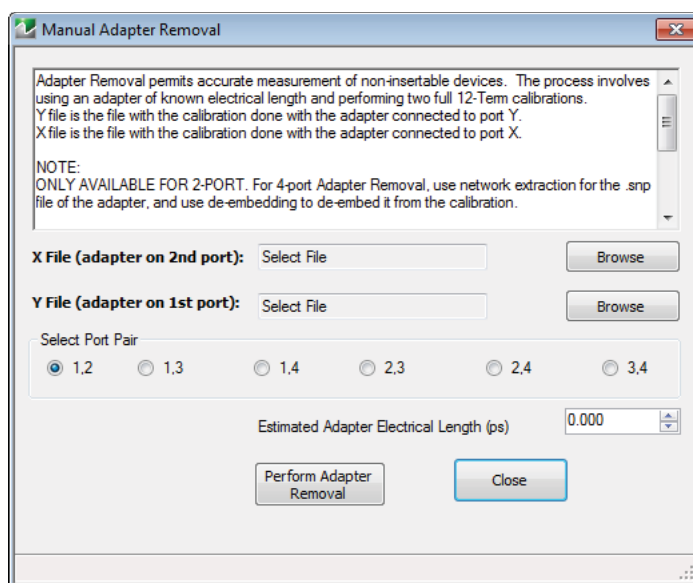

Figure 9-13. MANUAL ADAPTER REMOVAL Dialog Box

Instructions

Adapter removal permits accurate measurement of non-insertable devices. The process involves using an adapter of known electrical length and performing two full 12-term calibrations. In the procedure below:

- The Y file is the file with the calibration when the adapter connected to Port 1.
- The X file is the file with the calibration when the adapter connected to Port 2

Procedure

1. Connect the adapter to port X, where X signifies any port. Perform a full 12-term (Full 2 Port) calibration using Y' and Y as the test ports and store the calibration to disk.
2. Connect the adapter to port Y, where Y signifies any port that is not X. Perform a full 12-term calibration using X and X' as the test ports and store calibration to disk.
3. Call up the X and Y files.
4. Input the estimated adapter electrical length.
5. Select Perform Adapter Removal to remove adapter.

NETWORK EXTRACTION Dialog Box - 2-Port VNAs

The network extraction features provides a method of generating an S-Parameter (.s2p) file for a set of networks. The.s2p file can then be embedded or de-embedded into the error coefficient of the VNA as required. Four extractable network configurations are provided:

- Type A – Adapter Extraction – Extract one 2-port network
- Type B – Two Tier Calibration – Extract one 2-port network
- Type C – Inner and Outer Calibrations Available – Extract two 2-port networks
- Type D – Outer Cal Only – Extract two 2-port networks.

Previous

- “CAL OPTIONS Menu” on page 9-17

Navigation

- MAIN | Calibration | CALIBRATION | Cal Options | CAL OPTIONS | Network Extraction | NETWORK EXTRACTION Dialog Box

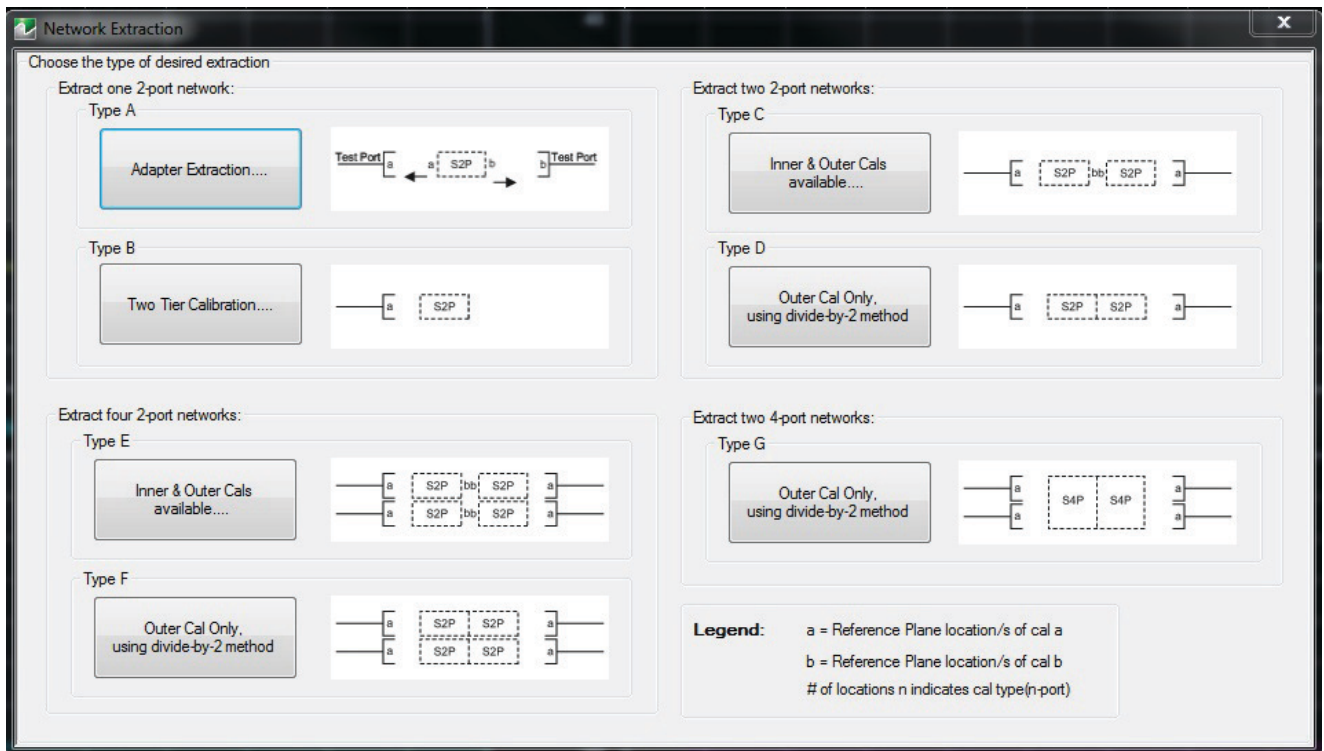

NETWORK EXTRACTION Dialog Box – Choose the type of desired extraction from the buttons below:

- Type A - Extract one (1) 2-Port Network - Adapter Extraction
- Type B - Extract one (1) 2-Port Network - Two Tier Calibration
- Type C - Extract two (2) 2-Port Networks - Inner and Outer Cals Available
- Type D - Extract two (2) 2-Port Networks - Outer Cal Only using divided-by-2 method
- Type E - Extract four (4) 2-Port Networks - Inner and Outer Cals Available
- Type F - Extract four (4) 2-Port Networks - Outer Cal Only using divided-by-2 method
- Type G - Extract two (2) 4-Port Networks - Outer Cal Only using divided-by-2 method

Figure 9-14. NETWORK EXTRACTION Dialog Box

THRU CHARACTERIZATION Dialog Box

The THRU CHARACTERIZATION dialog box provides a process to characterize an unknown Thru standard. Two 1-port calibrations are performed, one at the VNA port and one at the end of the unknown Thru. A network extraction is performed to create an s2p file characterizing the unknown thru. This s2p file can then be used in an SOLT calibration.

Previous

- [“CAL OPTIONS Menu” on page 9-17](#)

Navigation

- MAIN | Calibration | CALIBRATION [TR] | Cal Options | CAL OPTIONS | Thru Chracterization | THRU CHARACTERIZATOIN Dialog Box

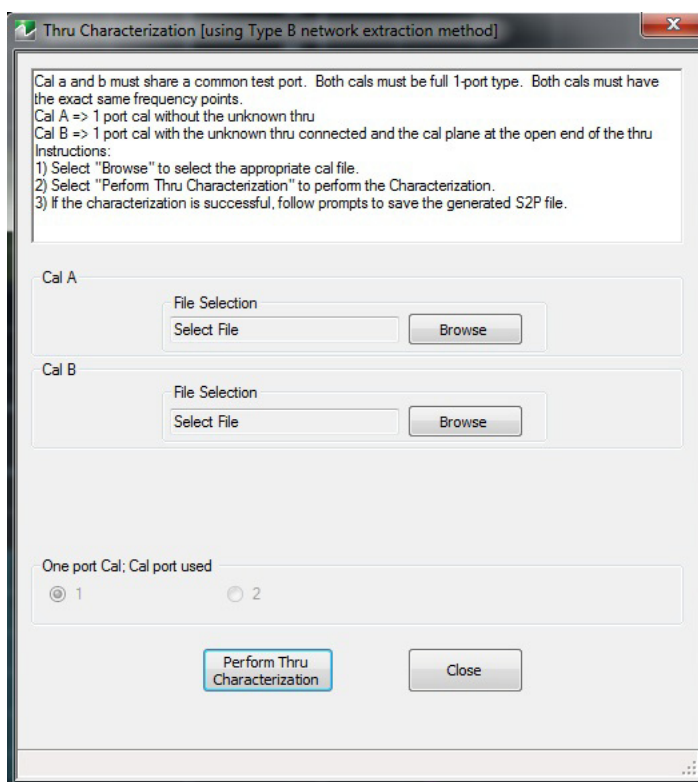

Figure 9-15. THRU CHARACTERIZATION Dialog Box

9-5 AutoCal Port Selection Setup

AUTOCAL (Port Selection) Menu

Use the AUTOCAL menu to define whether the AutoCal procedure will be for two-ports or only for one-port.

NOTE: To use the 36585 Series autocal with ShockLine VNAs, a serial to USB converter (Anritsu part number 2000-1809-R USB to Serial adapter) must be employed to enable communication between the autocal unit and the VNA. The proper comm port will need to be selected once the adapter has been installed.

Previous

- [“CALIBRATE Menu” on page 9-6](#)

Navigation

- MAIN | Calibration | CALIBRATION [TR] | Calibrate | CALIBRATE | AutoCal | AUTOCAL

 <p>The screenshot shows a menu titled 'AutoCal' with a close button (X) in the top right corner. Below the title, there are two menu items: '2-Port Cal' and '1-Port Cal', each with a right-pointing arrow indicating further options.</p>	<p>2-Port Cal (2-Port VNAs) Sets the AutoCal calibration function for 2-Port VNAs to a 2-port method and displays the AUTOCAL PROCEDURE (2-PORT CAL) menu.</p> <ul style="list-style-type: none"> • “AUTOCAL SETUP Menu - 2-Port Cal” on page 9-22 <p>1-Port Cal (2-Port VNAs) Sets the AutoCal calibration function for 2-Port VNAs to a 1-port method and displays the AUTOCAL SETUP (1-PORT CAL) menu.</p> <ul style="list-style-type: none"> • “AUTOCAL SETUP Menu - 1-Port Cal” on page 9-28
---	---

Figure 9-16. AUTOCAL (Port Selection) Menu

9-6 AutoCal 2-Port Cal Setup

AUTOCAL SETUP Menu - 2-Port Cal

Instrument Mode

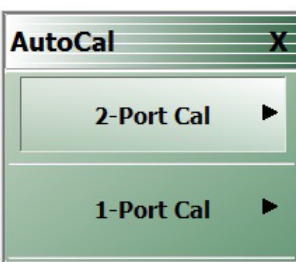
- 2-Port VNA Mode

Previous

- [“AUTOCAL \(Port Selection\) Menu” on page 9-21](#)

Navigation

- MAIN | Calibration | CALIBRATION [TR] | Calibrate | CALIBRATE | AutoCal | AUTOCAL | 2-Port Cal | AUTOCAL SETUP

	<p>Modify Cal Setup</p> <p>Select displays the MODIFY 2-PORT AUTOCAL SETUP dialog box. The dialog box provides control settings for Auto Sense Module Orientation, Select Cal Type, Through Setup, Adapter Removal Port, and links to the THRU INFO and AIR EQUIVALENT LENGTH CALCULATOR dialog boxes.</p> <ul style="list-style-type: none"> • “MODIFY 2-PORT AUTOCAL SETUP Dialog Box” on page 9-23 <p>Port Selection (Read Only)</p> <p>Displays the Ports selected for the AutoCal procedure. The settings are determined in the MODIFY 2-PORT AUTOCAL SETUP dialog box.</p> <p>Cal Type (Read Only)</p> <p>Displays the Cal Type selected for the AutoCal procedure. The settings are determined in the MODIFY 2-PORT AUTOCAL SETUP dialog box.</p> <p>Thru Type (Read Only)</p> <p>Displays the Thru Type selected for the AutoCal procedure as either Internal Thru or True Thru. The settings are determined in the MODIFY 2-PORT AUTOCAL SETUP dialog box.</p> <p>Module Orientation (Read Only)</p> <p>Displays the left/right VNA Port orientation and assignment for the AutoCal procedure. Options are either Left=P1 Right =P1 or Left=P2 and Right=P1. The settings are determined in the MODIFY 2-PORT AUTOCAL SETUP dialog box.</p> <p>Begin Cal (AutoCal 4-Port Cal)</p> <p>Starts the AutoCal procedure. On-screen dialogs and prompts provide user instructions for the selected calibration procedure. When the calibration is complete, the display returns to the CALIBRATION [TR] menu where the Cal Status button is enabled and set to ON.</p>
---	---

Figure 9-17. AUTOCAL 2-PORT CAL SETUP Menu

MODIFY 2-PORT AUTOCAL SETUP Dialog Box

Use the MODIFY 2-PORT SMARTCAL or AUTOCAL SETUP dialog box to change the calibration parameters prior to an AutoCal calibration procedure. Options include the calibration and thru types to be used. If required, an adapter removal calibration can be configured. For production installations, the left/right port sense can be automatically or manually configured.

Previous

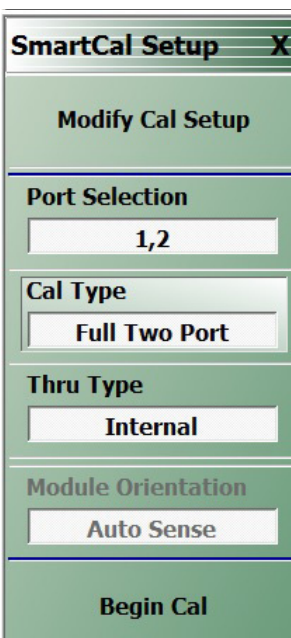
- “AUTOCAL SETUP Menu - 2-Port Cal” on page 9-22

Navigation

- MAIN | Calibration | CALIBRATION [TR] | Calibrate | CALIBRATE | AutoCal | AUTOCAL PORT | 2-Port Cal | SMARTCAL SETUP | Modify Cal Setup | MODIFY 2-Port SMARTCAL SETUP Dialog Box
- MAIN | Calibration | CALIBRATION [TR] | Calibrate | CALIBRATE | AutoCal | AUTOCAL PORT | 2-Port Cal | AUTOCAL SETUP | Modify Cal Setup | MODIFY 2-Port AUTOCAL SETUP Dialog Box

(the dialob box in the image below varies depending on if SmartCal or Autocal is selected)

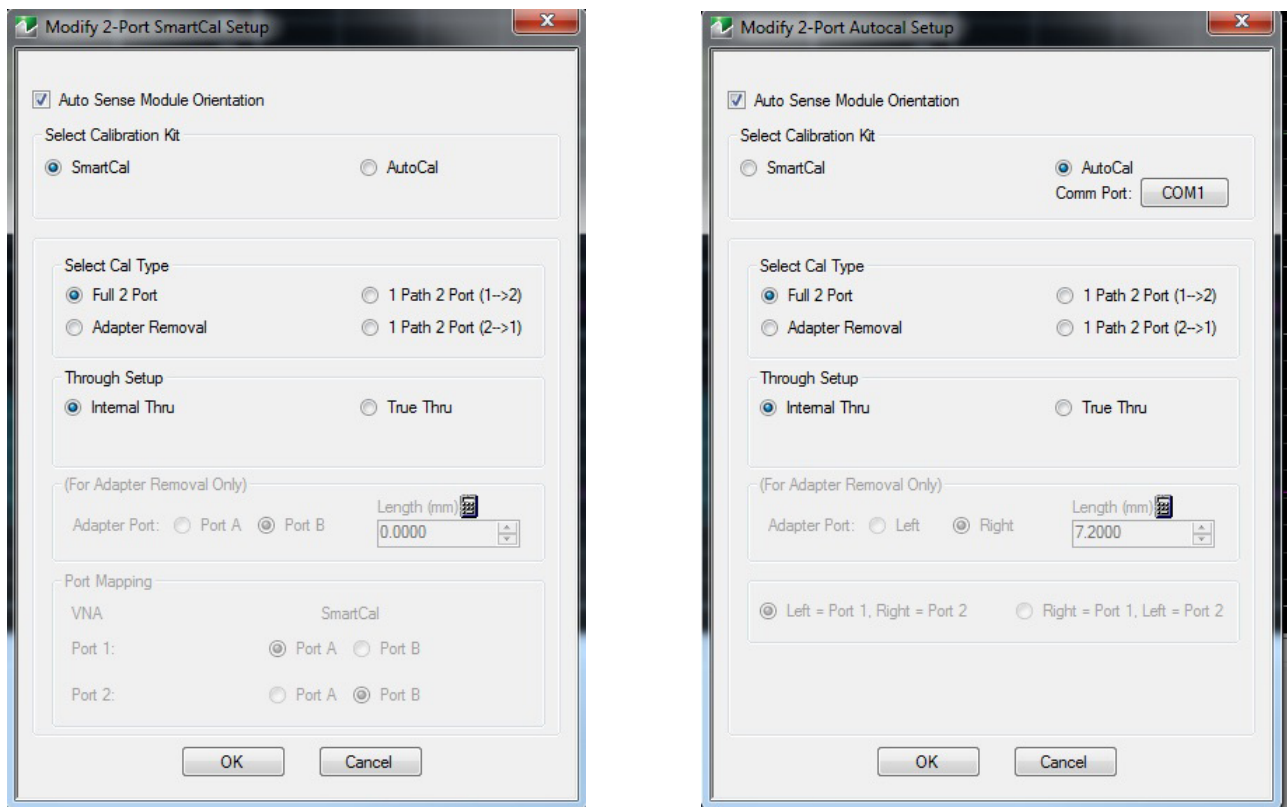

Figure 9-18. MODIFY 2-PORT SMARTCAL/AUTOCAL SETUP Dialog Box

SmartCal Dialog Box Descriptions

Auto Sense Module Orientation Check Box

- If selected, the AutoCal Module determines the Port A / B assignments.
- If not selected, manual port assignment is available in the port mapping section of the dialog box. The user can select a radio button to assign ports A and B

Select Cal Type Area

Select one of the following using the provided radio buttons:

- Full 2 Port
 - When selected, the Thru Select area becomes available.

- When selected, the For Adapter Removal Only area is unavailable.
- Adapter Removal
 - When selected, the Thru Select area becomes available and the Thru Info button appears.
 - Select the Thru Info button to display the THRU INFO dialog box.
 - When selected, the For Adapter Removal Only area becomes available.
 - Select the Calculator icon to display the AIR EQUIVALENT LENGTH CONVERSION dialog box. Use the calculator to convert length in ps to air equivalent length in mm.
- 1 Path 2 Port (1-->2)
 - When selected, the Thru Select area becomes available.
 - When selected, the For Adapter Removal Only area is unavailable.
- 1 Path 2 Port (2-->1)
 - When selected, the Thru Select area becomes available.
 - When selected, the For Adapter Removal Only area is unavailable.

Through Setup Area

This area is available for all AutoCal Types. The button selection options are:

- Internal Thru
 - If selected, the AutoCal module uses internal circuitry to determine the through values.
 - The Thru Info button is unavailable.
- True Thru
 - If selected, the AutoCal module will prompt the user to remove the module and connect the ports with a through line.
 - If selected, the Thru Info button becomes available. When clicked, the THRU INFO dialog box appears and allows input of values for Thru Length, Thru Line Impedance, Thru Line Loss, and Thru Frequency Setting.
 - In the Thru Line Length field, enter the line length in mm. For example, enter a value of 30 mm.
 - In the Line Impedance field, enter the impedance in ohms. For example, use the default value of 50 ohms.
 - In the Line Loss field, enter the loss as dB per mm. For example, enter a value of 0.1 dB/mm.
 - In the @ Frequency field, enter the working frequency in GHz. For example, enter a value of 45 GHz.
 - When all entries are complete, click OK to return to the Modify 2-Port AutoCal Setup dialog box.
 - [“THRU INFO Dialog Box” on page 9-94](#)

For Adapter Removal Only Area

This area is only available if Adapter Removal button was selected in the Select Cal Type area above. The adapter removal controls are:

Adapter Port Select Radio Buttons

- Port A
- Port B

Adapter Length (mm) Field

Available as either a direct entry field or using the dialog box below to calculate the parameters.

- To use the calculator dialog, click the Calculator icon.
- The AIR EQUIVALENT LENGTH CONVERSION CALCULATOR dialog box appears. Entries can be typed in or incremented by clicking the field up/down arrows, or by pressing the keyboard up/down arrow keys.
 - Enter the adapter length in ps. For example, enter a length of 100 ps.

- Enter the adapter dielectric constant. For example, enter a dielectric constant for polyethylene of 2.26.
- Click the Calculate Air Equivalent Length button.
- The air equivalent length in mm is: 9.9778515... or 9.9779.
- Click OK and the result appears in the For Adapter Removal Only Length field.
- [“AIR EQUIVALENT LENGTH CONVERSION \(FROM PS TO MM\) Dialog Box” on page 9-92](#)

Manual Port Orientation Area

This area is only available if the Auto Sense Module Orientation check box at the top of the dialog box is deselected. Refer to [Figure 9-18 on page 9-23](#)

- If the Auto Sense check box is selected, the Port A / Port B buttons at the bottom of the dialog box are unavailable. The instrument identifies the Port A / Port B and directs the user to the appropriate port.
- If the Auto Sense check box is deselected, the Port A / Port B buttons at the bottom of the dialog box are available. The user defines which port is “Port A” and which port is “Port B”. This is especially useful if the instrument is oriented differently from the work environment. Options are:
 - Port 1=Port A, Port 2=Port B
 - Port 1=Port B, Port 2=Port A

Completing AutoCal Setup

When all AutoCal Setup functions are completed, click OK to return to the AutoCal menu. Click Cancel to make no changes and close the dialog box.

AutoCal Dialog Box Descriptions

Auto Sense Module Orientation Check Box

- If selected, the AutoCal Module determines the Port Left/Right assignments.
- If not selected, the Left/Right manual assignment area at the bottom of the dialog box is available. The user can select a radio button for either:
 - Left = Port 1, Right = Port 2
 - Right = Port 1, Left = Port 2

Select Cal Type Area

Select one of the following using the provided radio buttons:

- Full 2 Port
 - When selected, the Thru Select area becomes available.
 - When selected, the For Adapter Removal Only area is unavailable.
- Adapter Removal
 - When selected, the Thru Select area becomes available and the Thru Info button appears.
 - Select the Thru Info button to display the THRU INFO dialog box.
 - When selected, the For Adapter Removal Only area becomes available.
 - Select the Calculator icon to display the AIR EQUIVALENT LENGTH CONVERSION dialog box. Use the calculator to convert length in ps to air equivalent length in mm.
- 1 Path 2 Port (1-->2)
 - When selected, the Thru Select area becomes available.
 - When selected, the For Adapter Removal Only area is unavailable.
- 1 Path 2 Port (2-->1)
 - When selected, the Thru Select area becomes available.
 - When selected, the For Adapter Removal Only area is unavailable.

Through Setup Area

This area is available for all AutoCal Types. The button selection options are:

- Internal Thru
 - If selected, the AutoCal module uses internal circuitry to determine the through values.
 - The Thru Info button is unavailable.
- True Thru
 - If selected, the AutoCal module will prompt the user to remove the module and connect the ports with a through line.
 - If selected, the Thru Info button becomes available. When clicked, the THRU INFO dialog box appears and allows input of values for Thru Length, Thru Line Impedance, Thru Line Loss, and Thru Frequency Setting.
 - In the Thru Line Length field, enter the line length in mm. For example, enter a value of 30 mm.
 - In the Line Impedance field, enter the impedance in ohms. For example, use the default value of 50 ohms.
 - In the Line Loss field, enter the loss as dB per mm. For example, enter a value of 0.1 dB/mm.
 - In the @ Frequency field, enter the working frequency in GHz. For example, enter a value of 45 GHz.
 - When all entries are complete, click OK to return to the Modify 2-Port AutoCal Setup dialog box.
 - [“THRU INFO Dialog Box” on page 9-94](#)

For Adapter Removal Only Area

This area is only available if Adapter Removal button was selected in the Select Cal Type area above. The adapter removal controls are:

Adapter Port Select Radio Buttons

- Left
- Right

Adapter Length (mm) Field

Available as either a direct entry field or using the dialog box below to calculate the parameters.

- To use the calculator dialog, click the Calculator icon.
- The AIR EQUIVALENT LENGTH CONVERSION CALCULATOR dialog box appears. Entries can be typed in or incremented by clicking the field up/down arrows, or by pressing the keyboard up/down arrow keys.
 - Enter the adapter length in ps. For example, enter a length of 100 ps.
 - Enter the adapter dielectric constant. For example, enter a dielectric constant for polyethylene of 2.26.
 - Click the Calculate Air Equivalent Length button.
 - The air equivalent length in mm is: 9.9778515... or 9.9779.
 - Click OK and the result appears in the For Adapter Removal Only Length field.

[“AIR EQUIVALENT LENGTH CONVERSION \(FROM PS TO MM\) Dialog Box” on page 9-92](#)

Manual Port Orientation Area

This area is only available if the Auto Sense Module Orientation check box at the top of the dialog box is deselected.

- If the Auto Sense check box is selected, the Left/Right buttons at the bottom of the dialog box are unavailable. The instrument identifies the left/right ports, and directs the user to the appropriate port.
- If the Auto Sense check box is deselected, the Left/Right buttons (Callout 8) at the bottom of the dialog box are available. The user defines which port is “Left” and which port is “Right”. This is especially useful if the instrument is oriented differently from the work environment. Options are:

- Left = Port 1, Right = Port 2
- Right = Port 1, Left = Port 2

Completing AutoCal Setup

When all AutoCal Setup functions are completed, click OK to return to the AutoCal menu. Click Cancel to make no changes and close the dialog box.

For Adapter Removal Only Area

This area is only available if Adapter Removal button was selected in the Select Cal Type area above. The adapter removal controls are:

Adapter Port Select Radio Buttons

- Left
- Right

Adapter Length (mm) Field

Available as either a direct entry field or using the dialog box below to calculate the parameters.

- To use the calculator dialog, click the Calculator icon.
- The AIR EQUIVALENT LENGTH CONVERSION CALCULATOR dialog box appears. Entries can be typed in or incremented by clicking the field up/down arrows, or by pressing the keyboard up/down arrow keys.
 - Enter the adapter length in ps. For example, enter a length of 100 ps.
 - Enter the adapter dielectric constant. For example, enter a dielectric constant for polyethylene of 2.26.
 - Click the Calculate Air Equivalent Length button.
 - The air equivalent length in mm is: 9.9778515... or 9.9779.
 - Click OK and the result appears in the For Adapter Removal Only Length field.
 - [“AIR EQUIVALENT LENGTH CONVERSION \(FROM PS TO MM\) Dialog Box” on page 9-92](#)

Manual Port Orientation Area

This area is only available if the Auto Sense Module Orientation check box at the top of the dialog box is deselected.

- If the Auto Sense check box is selected, the Left/Right buttons at the bottom of the dialog box are unavailable. The instrument identifies the left/right ports, and directs the user to the appropriate port.
- If the Auto Sense check box is deselected, the Left/Right buttons (Callout 8) at the bottom of the dialog box are available. The user defines which port is “Left” and which port is “Right”. This is especially useful if the instrument is oriented differently from the work environment. Options are:
 - Left = Port 1, Right = Port 2
 - Right = Port 1, Left = Port 2

Completing AutoCal Setup

When all AutoCal Setup functions are completed, click OK to return to the AutoCal menu. Click Cancel to make no changes and close the dialog box.

- [Figure 9-17, “AUTOCAL 2-PORT CAL SETUP Menu” on page 9-22](#)

9-7 AutoCal 1-Port Cal Setup

AUTOCAL SETUP Menu - 1-Port Cal

Previous

- [“AUTOCAL \(Port Selection\) Menu” on page 9-21](#)

Navigation

- MAIN | Calibration | CALIBRATION [TR] | Calibrate | CALIBRATE | AutoCal | AUTOCAL | 1-PORT CAL | 1-Port Cal | SMARTCAL SETUP

	<p>Modify Cal Setup</p> <p>Select displays the MODIFY 1-PORT AUTOCAL SETUP dialog box. The dialog box provides control settings for 1-Port Calibration Ports and Port A / Port B Identification.</p> <ul style="list-style-type: none"> • “MODIFY 1-PORT AUTOCAL SETUP Dialog Box” on page 9-29 <p>Port Selection (Read Only)</p> <p>Displays the Port or Ports selected for the AutoCal procedure. The settings are determined in the MODIFY 1-PORT AUTOCAL SETUP dialog box.</p> <p>Cal Type (Read Only)</p> <p>Displays the Cal Type selected for the AutoCal procedure. The setting is defined in the AUTOCAL PORTS menu.</p> <p>Port 1 Orientation (Read Only)</p> <p>This read-only button only appears if Port 1 was selected in the MODIFY 1-PORT AUTOCAL SETUP dialog box. If available, shows the Port A / Port B assignment for Port 1.</p> <ul style="list-style-type: none"> • “MODIFY 1-PORT AUTOCAL SETUP Dialog Box” on page 9-29 <p>Port 2 Orientation (Read Only)</p> <p>This read-only button only appears if Port 2 was selected in the MODIFY 1-PORT AUTOCAL SETUP dialog box. If available, shows the Port A / Port B assignment for Port 2.</p> <ul style="list-style-type: none"> • “MODIFY 1-PORT AUTOCAL SETUP Dialog Box” on page 9-29 <p>Begin Cal (AutoCal 1-Port Cal)</p> <p>Starts the AutoCal procedure. On-screen dialogs and prompts provide user instructions for the selected calibration procedure. When the calibration is complete, the display returns to the CALIBRATION [TR] menu when the Cal Status button is enabled and set to ON.</p> <ul style="list-style-type: none"> • “CALIBRATION [TR] Menu” on page 9-5
---	---

Figure 9-19. AUTOCAL SETUP Menu - One-Port Calibration

MODIFY 1-PORT AUTOCAL SETUP Dialog Box

Previous

- “AUTOCAL SETUP Menu - 1-Port Cal” on page 9-28

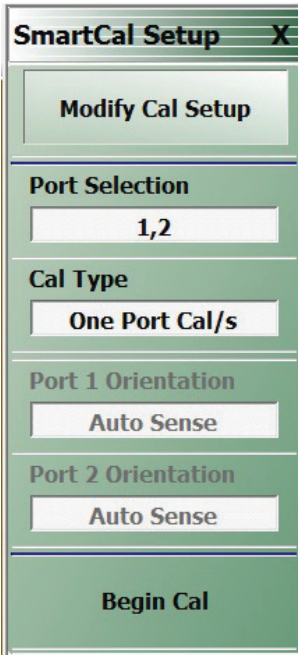
Navigation

- MAIN | Calibration | CALIBRATION [TR] | Calibrate | CALIBRATE | AutoCal | AUTOCAL | 1-Port Cal | AUTOCAL SETUP | Modify Cal Setup | MODIFY 1-PORT AUTOCAL SETUP Dialog Box
- MAIN | Calibration | CALIBRATION [TR] | Calibrate | CALIBRATE | AutoCal | AUTOCAL | 1-Port Cal | SMARTCAL SETUP | Modify Cal Setup | MODIFY 1-PORT AUTOCAL SETUP Dialog Box

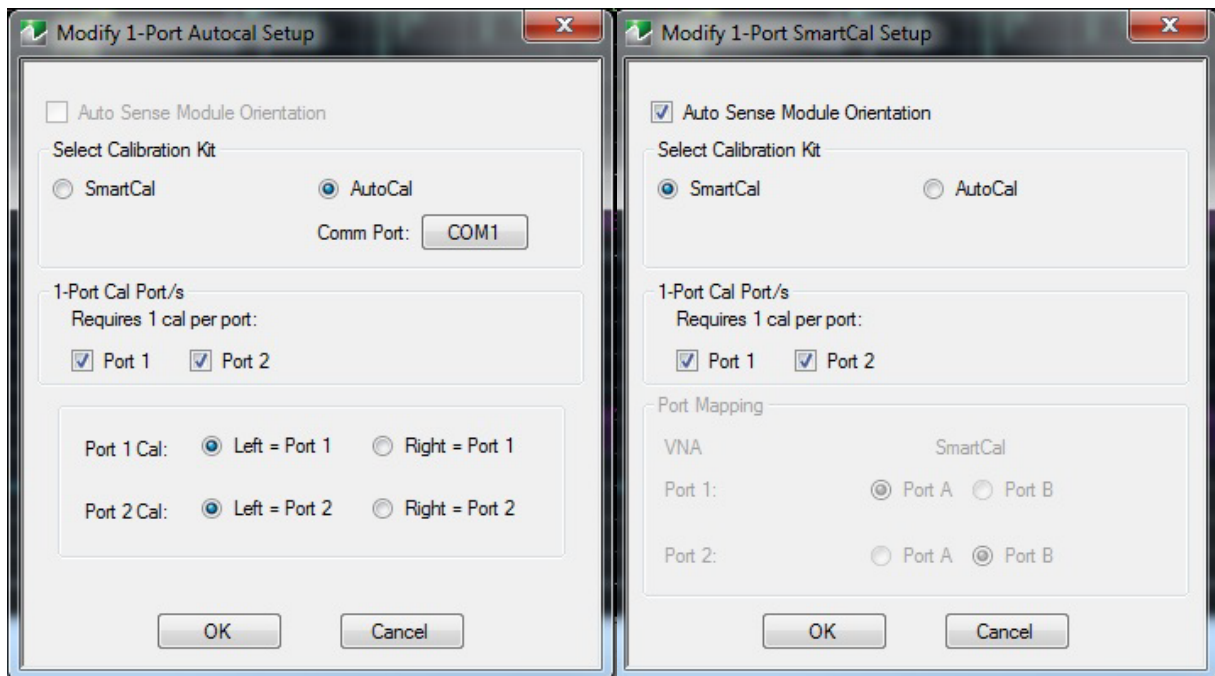

Figure 9-20. MODIFY 1-PORT SMARTCAL/AUTOCAL SETUP Dialog Box

SmartCal Dialog Box Descriptions

Auto Sense Cal Port(s)

The Auto Sense selection check box is on by default in the SmartCal option. Auto sense is not available in the Autocal option.

1-Port Cal Port(s)

Select either one or both of the available ports. Ports will be automatically mapped depending on the choice for one port cal or both.

- Port 1 Only
 - If selected, the Port 1 Cal Left/Right area is available.
- Port 1 and Port 2
 - If selected, the Port 1 Cal Left/Right area is available.
- Port 2 Only
 - If selected, the Port 2 Cal Left/Right area is available.

Port 1 Cal Left/Right Radio Buttons

Port 1 above must be selected to make the radio buttons available. If available, allows the following port left/right options:

- Left = Port 1
- Right = Port 1

Port 2 Cal Left/Right Radio Buttons

Port 2 above must be selected to make the radio buttons available. If available, allows the following port left/right options:

- Left = Port 2
- Right = Port 2

AutoCal Dialog Box Descriptions**Auto Sense Cal Port(s)**

The Auto Sense selection check box is not available in AutoCal 1-Port1

Select either one or both of the available ports.

- Port 1 Only
 - If selected, the Port 1 Cal Left/Right area is available.
- Port 1 and Port 2
 - If selected, the Port 1 Cal Left/Right area is available.
- Port 2 Only
 - If selected, the Port 2 Cal Left/Right area is available.

Port 1 Cal Left/Right Radio Buttons

Port 1 above must be selected to make the radio buttons available. If available, allows the following port left/right options:

- Left = Port 1
- Right = Port 1

Port 2 Cal Left/Right Radio Buttons

Port 2 above must be selected to make the radio buttons available. If available, allows the following port left/right options:

- Left = Port 2
- Right = Port 2

9-8 Manual Calibration Menus and Dialog Boxes

The MANUAL CAL menu buttons select a calibration type and then open the main setup menu for that type.

In main setup menus, the Modify Cal Setup button opens the CAL SETUP menu which has CAL METHOD, LINE TYPE, and Edit Cal Params buttons. Edit Cal Params opens a calibration parameter configuration dialog box showing parameters appropriate to the cal type, cal method, and line type.

The selection of parameters shown on a menu or dialog depends on the configuration set by previous parameter selections higher in the tree.

The figure “Manual Calibration Setup Menus (1 of 2)” on page 9-31 summarizes the configuration menus and dialogs.

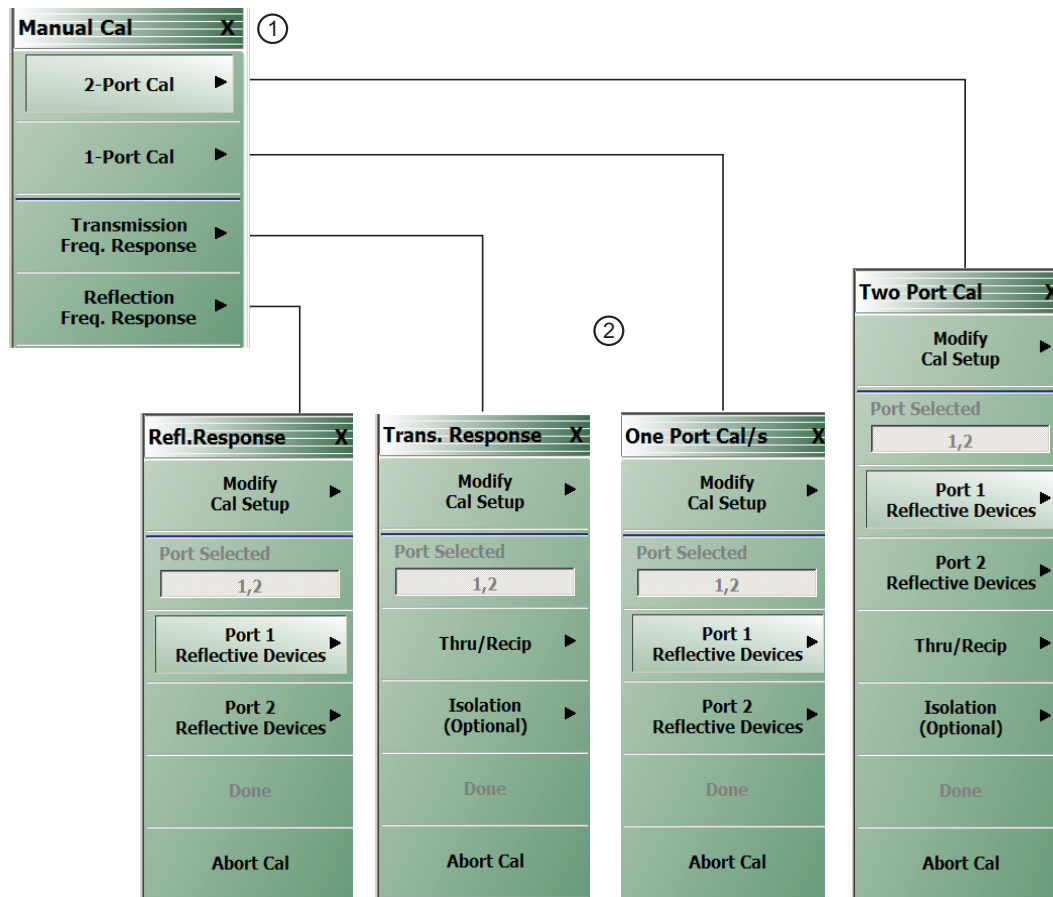

1. MANUAL CAL menu
2. TWO PORT CAL, ONE PORT CAL/S (select cal for a specific single port), TRANSMISSION RESPONSE, REFLECTION RESPONSE menus

Figure 9-21. Manual Calibration Setup Menus (1 of 2)

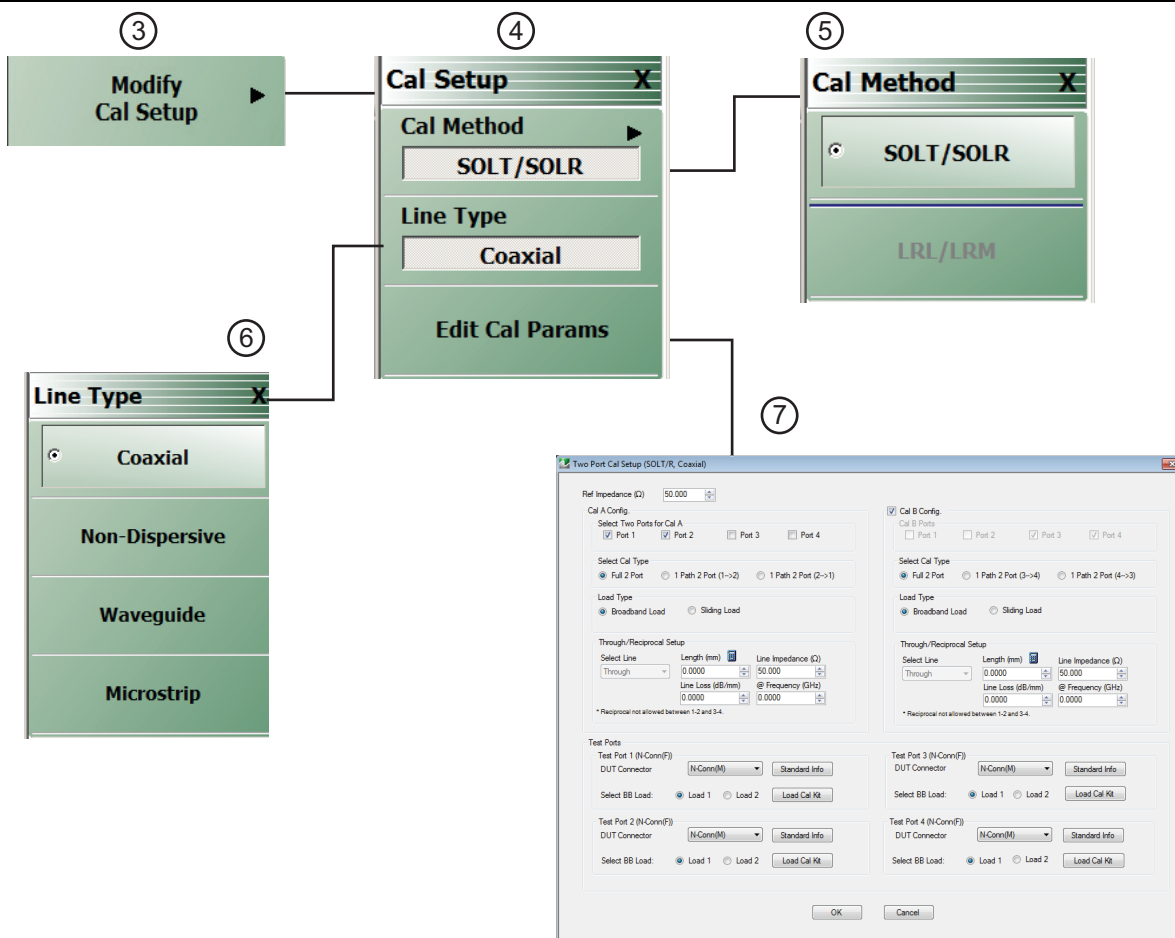

3. MODIFY CAL SETUP menu
4. CAL SETUP menu
5. CAL METHOD menu
6. LINE TYPE menu
7. TWO PORT CAL SETUP (example: SOLT/R, COAXIAL) dialog box

Figure 9-22. Manual Calibration Setup Menus (2 of 2)

Manual Calibration Types

- 2-Port Calibration
- 1-Port Calibration
- Transmission Frequency Response Calibration
- Reflection Frequency Response Calibration

Manual Calibration Methods

- SOLT/SOLR - Short-Open-Load-Thru / Short-Open-Load-Return
- SSLT - Offset Short or Short-Short-Load-Thru
- SSST - Triple Offset Short or Short-Short-Short-Thru
- LRL/LRM - Line-Reflect-Line / Line-Reflect-Match

Calibration Line Types

- Coaxial
- Non-Dispersive - Essentially the same as coaxial
- Waveguide
- Microstrip

Manual Calibration Dialog Box Settings

All permissible combinations of the calibration parameters above can be further modified through a series of dialog boxes that control DUT connectors, load types such as broadband or sliding loads, port selection, through types, reference plane location, number of bands, and similar settings. Many of these dialog boxes are shown in this document and all are summarized in tables.

MANUAL CAL Menu

Previous

- [“CALIBRATE Menu” on page 9-6](#)

Navigation

- MAIN | Calibration | CALIBRATION [TR] | Calibrate | CALIBRATE | Manual Cal | MANUAL CAL

 <p>The screenshot shows a menu titled 'Manual Cal' with a close button (X). Below the title are four menu items, each with a right-pointing arrow: '2-Port Cal', '1-Port Cal', 'Transmission Freq. Response', and 'Reflection Freq. Response'.</p>	<p>2-Port Cal</p> <p>Select displays the Two Port Cal menu where the calibration step-by-step procedure is carried out. Also called 12 Term Calibration. This is the most complete calibration, and fully corrects the four S-parameters (S11, S12, S21, and S22) parameters for both instrument ports.</p> <ul style="list-style-type: none"> • “TWO PORT CAL Menu” on page 9-39 <p>1-Port Cal</p> <p>Select displays the One Port Cal menu. Allows selecting which port is to be corrected, A single reflection parameter, configured in the Edit Cal Params CAL SETUP dialog, is fully corrected (S11 or S22). Both ports can be covered but only reflection measurements are corrected.</p> <ul style="list-style-type: none"> • “ONE PORT CAL Menu (SOLT/R - Coaxial) 2-Port VNAs” on page 9-63 <p>Transmission Freq. Response</p> <p>Selecting the Transmission Frequency Response button displays the Trans Freq menu. During the calibration configuration in the Edit Cal Params CAL SETUP dialog, select forward or reverse or both directions.</p> <ul style="list-style-type: none"> • “TRANS. RESPONSE Menu” on page 9-77 <p>Reflection Freq. Response</p> <p>Select displays the Refl. Response menu.</p> <ul style="list-style-type: none"> • “REFL. RESPONSE Menu” on page 9-83
---	---

Figure 9-23. MANUAL CAL (MANUAL CALIBRATION) Menu

CAL SETUP Menu

Use the CAL SETUP menu to set the calibration method (for example SOLT/R), the calibration line type (such as coaxial or microwave), and additional parameters for ports and connectors shown via the **Edit Cal Parameters** button and the linked CAL SETUP dialogs.

Previous

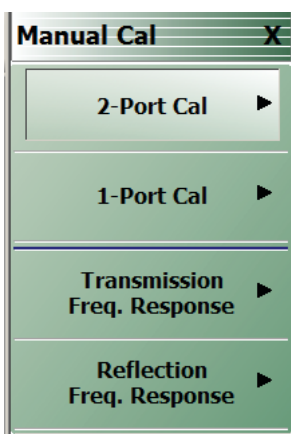
- The CAL SETUP menu can be accessed from multiple menus depending on the manual calibration type selected on the MANUAL CAL menu.
 - [“TWO PORT CAL Menu” on page 9-39](#)
 - [“ONE PORT CAL Menu \(SOLT/R - Coaxial\) 2-Port VNAs” on page 9-63](#)
 - [“TRANS. RESPONSE Menu” on page 9-77](#)
 - [“REFL. RESPONSE Menu” on page 9-83](#)

Navigation Alternatives

- MAIN | Calibration | CALIBRATION [TR] | Calibrate | CALIBRATE | Manual Cal | MANUAL CAL | 2-Port Cal | TWO PORT CAL | Modify Cal Setup | CAL SETUP
- MAIN | Calibration | CALIBRATION [TR] | Calibrate | CALIBRATE | Manual Cal | MANUAL CAL | 1-Port Cal | ONE PORT CAL | Modify Cal Setup | CAL SETUP
- MAIN | Calibration | CALIBRATION [TR] | Calibrate | CALIBRATE | Manual Cal | MANUAL CAL | Transmission Freq, Response | TRANS. RESPONSE | Modify Cal Setup | CAL SETUP
- MAIN | Calibration | CALIBRATION [TR] | Calibrate | CALIBRATE | Manual Cal | MANUAL CAL | Reflection Freq, Response | REFL. RESPONSE | Modify Cal Setup | CAL SETUP

(continued on next page)

 <p>The screenshot shows a menu titled 'Cal Setup' with a close button (X). Below the title are three sections: 'Cal Method' with a right-pointing arrow and a button labeled 'SOLT/SOLR'; 'Line Type' with a button labeled 'Coaxial'; and 'Edit Cal Params' at the bottom.</p>	<p>Cal Method</p> <p>The field displays the currently selected calibration method (either SOLT/SOLR, LRL/LRM, SSLT, or SSST). Clicking the button displays the CAL METHOD menu for selection of the calibration method. Once a selection is made, the display returns to the CAL SETUP menu.</p> <ul style="list-style-type: none"> • “CAL METHOD Menu” on page 9-37 <p>Line Type</p> <p>The field displays the currently selected line type such as Coaxial (the default value) or others. The button opens the LINE TYPE menu which allows selecting a line type. Once a selection is made, the display returns to the CAL SETUP menu.</p> <ul style="list-style-type: none"> • “LINE TYPE Menu” on page 9-38 <p>Edit Cal Params</p> <p>The button opens a calibration setup dialog box with parameters appropriate to the configuration. The displayed name of the dialog box always changes to match the combination of selected calibration type, calibration method, and line type.</p> <ul style="list-style-type: none"> • Dialog box name format: [Cal Type] [Cal Method] Cal Setup [Line Type] • For example, if Full 2 Port, SOLT/SOLR, and Coaxial were selected, the dialog box name is: <ul style="list-style-type: none"> • Full Two Port Cal Setup (SOLT/R, Coaxial) • Examples of Cal Setup dialog boxes using Coaxial line type are available in the links below: <ul style="list-style-type: none"> • “TWO PORT CAL SETUP (SOLT/R, COAXIAL) Dialog Box” on page 9-43 • “TWO PORT CAL SETUP (LRL/LRM, COAXIAL) Dialog Box - 2-Port VNA” on page 9-46 • A summary table lists dialog box contents for all other combinations of method and line type: <ul style="list-style-type: none"> • Table 9-2, “Manual 2-Port Cal Setup Dialog Box Summary” on page 9-55
--	--

Figure 9-24. CAL SETUP (CALIBRATION SETUP) Menu - 2-Port VNAs

CAL METHOD Menu

Use the CAL METHOD menu to select whether the method of SOLT/SOLR,, SSLT, SSST, or LRL/LRM will be used during the calibration.

Previous

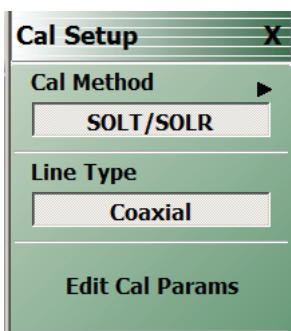
- [“CAL SETUP Menu” on page 9-35](#)

Navigation

- MAIN | Calibration | CALIBRATION [TR] | Calibrate | CALIBRATE | Manual Cal | MANUAL CAL | 2-Port Cal | TWO PORT CAL | Modify Cal Setup | CAL SETUP | Cal Method | CAL METHOD
- The navigation path above assumes that Two Port Cal calibration type was selected on the Manual Cal menu.

 <p>The screenshot shows a menu titled 'Cal Method' with a close button 'X'. There are four buttons: 'SOLT/SOLR' (selected with a radio button), 'Offset Short (SSLT)', 'Triple Offset Short (SSST)', and 'LRL/LRM'.</p>	<p>Selecting any button marks the selection with the select icon, de-selects the other button, and auto-returns to the CAL SETUP menu.</p> <p>SOLT/SOLR Selecting the SOLT/SOLR button sets the calibration method to Short-Open-Load-Thru (or Short-Open-Load-Reciprocal) and then auto-returns to the CAL SETUP menu.</p> <ul style="list-style-type: none"> • “CAL SETUP Menu” on page 9-35 <p>Offset Short (SSLT) Selecting the Offset Short (SSLT) button sets the calibration method to Short-Short-Load-Thru and then auto-returns to the CAL SETUP menu.</p> <ul style="list-style-type: none"> • “CAL SETUP Menu” on page 9-35 <p>Triple Offset Short (SSST) Selecting the Triple Offset Short (SSST) button sets the calibration method to Short-Short-Short-Thru and then auto-returns to the CAL SETUP menu.</p> <ul style="list-style-type: none"> • “CAL SETUP Menu” on page 9-35 <p>LRL/LRM Selecting the LRL/LRM button sets the calibration method to Line-Reflect-Line or Line-Reflect-Match and then auto-returns to the CAL SETUP menu.</p> <ul style="list-style-type: none"> • “CAL SETUP Menu” on page 9-35
--	--

Figure 9-25. CAL METHOD Menu - 2-Port VNAs

LINE TYPE Menu

Use the LINE TYPE menu to select from coaxial, non-dispersive, waveguide, or microstrip line types.

Non-dispersive is for line types such as coplanar waveguide, stripline, or twin-lead and is treated the same as coaxial line.

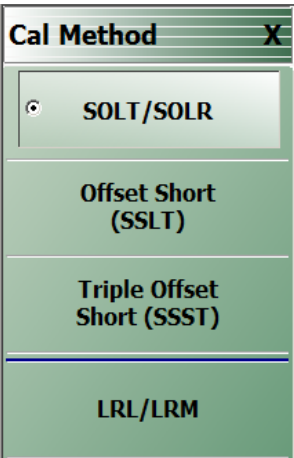
Previous

- [“CAL SETUP Menu” on page 9-35.](#)

Navigation

- MAIN | Calibration | CALIBRATION [TR] | Calibrate | CALIBRATE | Manual Cal | MANUAL CAL | 2-Port Cal | TWO PORT CAL | Modify Cal Setup | CAL SETUP | Line Type | LINE TYPE

 <p>The screenshot shows a menu titled 'Line Type' with a close button 'X'. There are four buttons: 'Coaxial' (with a select icon), 'Non-Dispersive', 'Waveguide', and 'Microstrip'.</p>	<p>Auto-Return Button Selection Group</p> <p>The four buttons of the LINE TYPE menu form an auto-return button selection group. Selecting any one button marks the selection with the select icon, de-selects the other three buttons, and auto-returns to the CAL SETUP menu.</p> <p>Coaxial (Line Type)</p> <p>Select sets the line type to coaxial, marks the button with the select icon, de-selects the Non-Dispersive, Waveguide, and Microstrip buttons, and then auto-returns to the CAL SETUP menu.</p> <ul style="list-style-type: none"> • “CAL SETUP Menu” on page 9-35 <p>Non-Dispersive (Line Type)</p> <p>Non-dispersive line types, such as Coplanar Waveguide, Stripline, or twin-lead, are used on transmissions. The system treats non-dispersive lines the same as coaxial line types.</p> <p>Select sets the line type to non-dispersive, marks the button with the select icon, de-selects the Coaxial, Waveguide, and Microstrip buttons, and then auto-returns to the CAL SETUP menu.</p> <ul style="list-style-type: none"> • “CAL SETUP Menu” on page 9-35 <p>Waveguide (Line Type)</p> <p>Waveguide is transmission media such as rectangular or circular waveguide.</p> <p>Select sets the line type to waveguide, marks the button with the select icon, de-selects the Coaxial, Non-Dispersive, and Microstrip buttons, and then auto-returns to the CAL SETUP menu.</p> <ul style="list-style-type: none"> • “CAL SETUP Menu” on page 9-35 <p>Microstrip (Line Type)</p> <p>Microstrip line is typically used in on-wafer media.</p> <p>Select sets the line type to microstrip, marks the button with the select icon, de-selects the Coaxial, Non-Dispersive, and Waveguide buttons, and then auto-returns to the CAL SETUP menu.</p> <ul style="list-style-type: none"> • “CAL SETUP Menu” on page 9-35
---	--

Figure 9-26. LINE TYPE Menu

9-9 Manual 2-Port Cal Setup

TWO PORT CAL Menu

Button Availability

- The exact composition of the menu depends on the settings made on the CAL SETUP, CAL METHOD, and LINE TYPE menus and on the resultant TWO PORT CAL SETUP dialog box.
- A representative menu is shown below.
- The example procedures at the end of this chapter show examples of various TWO PORT CAL menus.

Previous

- [“MANUAL CAL Menu” on page 9-34](#)

Navigation

- MAIN | Calibration | CALIBRATION [TR] | Calibrate | CALIBRATE | Manual Cal | MANUAL CAL | 2-Port Cal | TWO PORT CAL

	<p>Modify Cal Setup Select displays the CAL SETUP menu.</p> <ul style="list-style-type: none"> • “CAL SETUP Menu” on page 9-35 <p>Here, changes to the calibration method, line type, and associated parameters are made on the CAL METHOD, LINE TYPE and Edit Cal Params submenus.</p> <ul style="list-style-type: none"> • Calibration method options are: SOLT/SOLR or LRL/LRM. • Line Type is Coaxial. <p>A composite view of the CAL SETUP menu set is available in the figure below:</p> <ul style="list-style-type: none"> • Figure 9-21, “Manual Calibration Setup Menus (1 of 2)” on page 9-31 <p>Descriptions of the calibration configuration menus are available at:</p> <ul style="list-style-type: none"> • “CAL SETUP Menu” on page 9-35 • “CAL METHOD Menu” on page 9-37 <p>A summary of 2-port calibration setup dialog box controls and functions is available in the table below:</p> <ul style="list-style-type: none"> • Table 9-2, “Manual 2-Port Cal Setup Dialog Box Summary” on page 9-55 <p>Ports Selected (Read Only) A display button showing the port numbers that are in the calibration.</p>
	<p>(continued)</p>

Figure 9-27. TWO PORT CAL MENU - Typical Example (1 of 2)

Completion Menu Buttons

For this example menu, the Port 1 Reflective Devices to the Isolation (Optional) buttons link to completion submenus where additional calibration procedures are performed.

For example, the Port 1 Reflective Devices button (shown below at #1) links to the REFL. DEVICES PORT 1 submenu. As each procedure is completed, the submenu button is marked with a completion checkmark. When all the procedures on the submenu are completed, use the Back button to return to the TWO PORT CAL menu.



The Port 1 Reflective Devices button (shown above at #2) is now marked with a completion checkmark.

Port 1 Reflective Devices

When selected, provides the REFL. DEVICES PORT 1 menu. Each button represents a completion task. When ready for the task, click the button, and the instrument performs the calibration. When the calibration task is successfully completed, the button is marked with a completion checkmark. When all tasks are completed on the menu, return to the TWO PORT CAL menu.

Port 2 Reflective Devices

When selected, displays the REFL. DEVICES PORT 2 menu. When all tasks are completed, return to the TWO PORT CAL menu.

Thru/Recip

When selected, displays the THRU/RECIP menu. When all tasks are completed, return to the TWO PORT CAL menu.

Isolation (Optional)

When selected, displays the ISOLATION menu. When all tasks are completed, return to the TWO PORT CAL menu.

Done

This button is unavailable until all calibration tasks have been successfully completed. When available, select the button to return to the CALIBRATION menu when the Cal Status is set to ON.

- [“CALIBRATION \[TR\] Menu” on page 9-5](#)

Abort Cal

Select aborts the current calibration and returns to the CALIBRATION menu.

- [“CALIBRATION \[TR\] Menu” on page 9-5](#)

Figure 9-27. TWO PORT CAL MENU - Typical Example (2 of 2)

REFLECTIVE DEVICES Menu

	<p>Port 1 Connector Double-clicking it opens the One-Port Cal Setup Dialog for setup of parameters relevant for the calibration</p> <p>Open Clicking this performs the calibration. When the action is complete, a checkmark appears.</p> <p>Short Clicking this performs the calibration. When the action is complete, a checkmark appears.</p> <p>Load Clicking this performs the calibration. When the action is complete, a checkmark appears.</p>
---	--

Figure 9-28. REFLECTIVE DEVICES MENU

Manual 2-Port Cal Setup Dialog Boxes

From the TWO PORT CAL menu, Modify Cal Setup button links to the CAL SETUP menu, where the Edit Cal Params button displays the appropriate configuration dialog box with that vary depending on the settings made in the MANUAL CAL, CAL SETUP, CAL METHOD, and LINE TYPE menus. Sample dialog boxes are described in the sections below for:

- [“TWO PORT CAL SETUP \(SOLT/R, COAXIAL\) Dialog Box” on page 9-43](#)
- [“TWO PORT CAL SETUP \(LRL/LRM, COAXIAL\) Dialog Box - 2-Port VNA” on page 9-46](#)

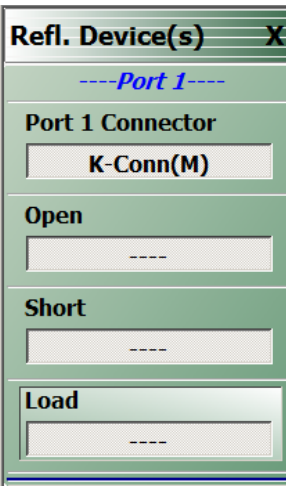
For all other calibration combinations, see the summary table of all dialog boxes and their controls:

- Table: [“Manual 2-Port Cal Setup Dialog Box Summary” on page 9-55.](#)

TWO PORT CAL SETUP (SOLT/R, COAXIAL) Dialog Box

Prerequisites

- Cal Method = SOLT/SOLR
- Line Type = Coaxial

Previous

- “CAL SETUP Menu” on page 9-35

Navigation

- MAIN | Calibration | CALIBRATION [TR] | Calibrate | CALIBRATE | Manual Cal | MANUAL CAL | 2-Port Cal | TWO-PORT CAL | Modify Cal Setup | CAL SETUP | Edit Cal Params | TWO-PORT CAL SETUP (SOLT/R, COAXIAL) Dialog Box

The screenshot shows the 'Two Port Cal Setup (SOLT/R, Coaxial)' dialog box. The interface includes the following elements:

- Ref Impedance (Ω):** A numeric field set to 50.000.
- Select Cal Type:** Three radio buttons: Full 2 Port, 1 Path 2 Port (1 \rightarrow 2), and 1 Path 2 Port (2 \rightarrow 1).
- Load Type:** Two radio buttons: Broadband Load and Sliding Load.
- Test Port 1 (N-Conn(F)):**
 - Cal Kit:** A dropdown menu set to 'N-Conn(M)' with a 'Standard Info' button.
 - Select BB Load:** Two radio buttons: Load 1 and Load 2, with a 'Load Cal Kit' button.
- Test Port 2 (N-Conn(F)):**
 - Cal Kit:** A dropdown menu set to 'N-Conn(M)' with a 'Standard Info' button.
 - Select BB Load:** Two radio buttons: Load 1 and Load 2, with a 'Load Cal Kit' button.
- Through/ Reciprocal:**
 - Select Line:** A dropdown menu set to 'Through'.
 - Length (mm):** A numeric field set to 0.0000 with a calculator icon.
 - Line Impedance (Ω):** A numeric field set to 50.000.
 - UseS2P for Thru:** An unchecked checkbox.
 - Line Loss (dB/mm):** A numeric field set to 0.0000.
 - @ Frequency (GHz):** A numeric field set to 0.0000.
- Buttons:** 'OK' and 'Cancel' buttons at the bottom.

Figure 9-29. Edit Cal Params - TWO PORT CAL SETUP (SOLT/R, COAXIAL) Dialog Box

Reference Impedance

Reference Impedance is 50 ohms.

Select Cal Type

Select from three radio button controlled options:

- Full 2 Port
- 1 Path 2 Port (1 --> 2)
- 1 Path 2 Port (2 --> 1)

Load Type Area

Select from two radio button controlled options:

- Broadband Load
- Sliding Load. If Sliding Load is selected:
 - A message appears in the “Still requires broadband loads below sliding load breakpoint frequency.”
 - A Sliding Load button appears on the PORT 1 REFLECTIVE DEVICES menu and on the PORT 2 REFLECTIVE DEVICES menu.

Test Port 1 Connector Type Area

Select the DUT Connector Type from a drop-down menu list with options of:

- K-Conn (M)
- K-Conn (F)
- GPC-3.5 (M)
- GPC-3.5 (F)
- SMA (M)
- SMA (F)
- N-Conn (M)
- N-Conn (F)
- 2.4 mm (M)
- 2.4 mm (F)
- TNC (M)
- TNC (F)
- V-conn (M)
- V-conn (F)
- W1-conn (M)
- W1-conn (F)
- 7/16 (M)
- 7/16 (F)
- GPC-7
- N-conn(75) (M)
- N-conn(75) (F)
- user defined 1 through 8 (M or F)

Select BB Load for Test Port 1 Area

Select BB Load number for Test Port 1:

- Load 1
- Load 2

Load Cal Kit

Prompts the LOAD dialog box.

Test Port 1 Connector Standard Info Button

Select displays the Standard Info dialog box for the selected connector and calibration method that displays the connector calibration coefficients. The dialog box contents depends on the connector selected above and on the Cal Method selected.

Test Port 2 Connector Type Area

Select the DUT Connector Type from a drop-down menu list with options the same as the Test Port 1 Connector area above.

Test Port 2 Connector Standard Info Button

Select displays the Standard Info dialog box for the selected connector and calibration method that displays the connector calibration coefficients. The dialog box contents depends on the connector selected above and on the Cal Method selected.

Select BB Load for Test Port 2 Area

Select BB Load number for Test Port 2:

- Load 1
- Load 2.

Load Cal Kit

Prompts the LOAD dialog box.

Through/Reciprocal Area

Located on the right side of the dialog box, these controls allow characterization of the through/reciprocal line settings.

- Select Line. Allows options of:
 - Through
 - Reciprocal
- Length (mm)
 - Input line length in mm.
 - Calculator icon displays the AIR EQUIVALENT LENGTH CONVERSION dialog box.
 - [“AIR EQUIVALENT LENGTH CONVERSION \(FROM PS TO MM\) Dialog Box” on page 9-92](#)
- Line Impedance (Ohms)
 - Input defaults to be 50 Ohms. Any numeric value accepted.
- Line Loss (dB/mm)
 - Allows input of a line loss in dB per mm at the frequency specified in the field below.
- @ Frequency (GHz)
 - Allows input of a frequency setting for the Line Loss factor input above.

OK / Cancel

Click OK to accept the changes and return to the CAL SETUP menu.

Click Cancel to abandon any changes and return to the CAL SETUP menu.

TWO PORT CAL SETUP (LRL/LRM, COAXIAL) Dialog Box - 2-Port VNA

Prerequisites

- Cal Method = LRL/LRM
- Line Type = Coaxial

Previous

- [“CAL SETUP Menu” on page 9-35](#)

Navigation

- MAIN | Calibration | CALIBRATION [TR] | Calibrate | CALIBRATE | Manual Cal | MANUAL CAL | 2-Port Cal | TWO-PORT CAL | Modify Cal Setup | CAL SETUP | Edit Cal Params | TWO-PORT CAL SETUP (LRL/LRM, COAXIAL) Dialog Box

Two Port Cal Setup (LRL/LRM, Coaxial)

Ref Impedance (Ω) 50.000

Reference Plane Location

Ends of Line 1 Middle of Line 1

Band Definition

Number of Bands 1

Band 1 standard1 Line Line Length (mm) 0.0000

standard2 Line Line Length (mm) 0.0000

standard3 Reflection Type Use Open-like component

Line Loss (dB/mm) 0.0000 Line Loss Frequency (GHz) 0.0000

Reflection Standards

Open-like Standard Offset Length (mm) 0.0000

OK Cancel

Figure 9-30. Edit Cal Params - TWO PORT CAL SETUP (LRL/LRM, COAXIAL) Dialog Box

Reference Impedance

Reference impedance is 50 Ohms.

Reference Plane Location

Select from two radio button controlled options:

- Ends of Line 1
- Middle of Line 1

Band Definition

Select one or two bands from the pull-down menu.

- Number of Bands = 1. Only the Band 1 Definition Area is present.
- Number of Bands = 2. The Band 1 Definition and the Band Break Point areas appear.

Band 1 Definition

Provides the following fields and controls for Band 1:

- Band 1 Standard 1 = Defaulted to Line.
 - Line Length (mm) for Standard 1. Allows input of the line length in mm.
 - Line Loss (dB/mm). Allows input of a line loss in dB per mm at the frequency specified in the field below.
 - @ Frequency (GHz). Allows input of a frequency setting for the Line Loss factor input above.
- Band 1 Standard 2. Select from Line or Match in pull-down menu.
 - If Line is selected, Standard 3 Reflection Type allows selection of Use Open-like component or Use Short-like component.
 - If Match is selected, standard3 Reflection Type allows selection of Use Open-like component or Use Short-like component, and displays a Match Info button, which opens the User Define Match Devices dialog box

Band 2 Definition

The Number of Bands field above must be set to “2” for this area and the Band Break Point area described below to be displayed. Provides the following fields and controls for Band 2.

Band 2 Standard 4

A pull-down menu with selection of:

- Line Match

Band 2 Standard 5

A pull-down menu with selections of:

- Use device 1
- Use device 2
- Use new line. If selected, additional fields appear as Line Length (mm), Line Loss (dB/mm), and @ Frequency (GHz).

If Line is selected for Standard 4, the Line Length (mm) field is available. The standard6 Reflection Type field choices are limited to:

- Use Short-like component. If selected, the Reflection Component area below has two fields of Open-like Offset Length (mm) and Short-like Offset Length (mm).
- Use Open-like component. If selected, the Reflection Component area below has one field of Open-like Offset Length (mm).

If Match is selected for Standard 4, the Match Info button is available with choices of:

- The Match Info button appears. Select displays the USER DEFINED MATCH DEVICES dialog box appears which allows configuration of the match devices. Per Stan, no match available.

Band Break Point

This area only appears if the Number of Bands in the Band Definition area is set to “2”.

The **Calculate Recommended Value** button calculates the recommended break point value based on the input parameters in the fields above. Clicking the button calculates a break point frequency value and populates the **Use Recommended Frequency (GHz)** field.

A radio button set allows selection of either:

- Use Recommended Frequency (GHz) which was calculated by the button above.
- Define New Frequency (GHz) field which allows direct user input of a break frequency value.

Reflection Standards

Depending on the settings in the fields above, this area provides up to two input fields.

- Open-like Offset Length (mm)
- Short-like Offset Length (mm)

OK / Cancel

Click **OK** to accept the changes and return to the **CAL SETUP** menu.

Click **Cancel** to abandon any changes and return to the **CAL SETUP** menu

TWO PORT CAL SETUP (SSLT, COAXIAL) Dialog Box

Prerequisites

- Cal Method = SSLT
- Line Type = Coaxial

Previous

- [“CAL SETUP Menu” on page 9-35](#)

Navigation

- MAIN | Calibration | CALIBRATION [TR] | Calibrate | CALIBRATE | Manual Cal | MANUAL CAL | 2-Port Cal | TWO-PORT CAL | Modify Cal Setup | CAL SETUP | Edit Cal Params | TWO-PORT CAL SETUP (SSLT, COAXIAL) Dialog Box

Figure 9-31. TWO PORT CAL SETUP (SSLT, COAXIAL) Dialog Box

Reference Impedance

Input the reference impedance.

- Input field defaulted to 50 Ohms.

- Any numerical value accepted although input values <0.01 Ohms are converted to 0.01 Ohms.

Select Cal Type

Select from three radio button controlled options:

- Full 2 Port
- 1 Path 2 Port (1 --> 2)
- 1 Path 2 Port (2 --> 1)

Load Type Area

Select from two radio button controlled options:

- Broadband Load
- Sliding Load. If Sliding Load is selected:
 - A message appears in the “Still requires broadband loads below sliding load breakpoint frequency.”
 - A Sliding Load button appears on the PORT 1 REFLECTIVE DEVICES menu and on the PORT 2 REFLECTIVE DEVICES menu.

Test Port 1 Connector Type Area

Select the DUT Connector Type from a drop-down menu list with options of:

- W1-Conn (M)
- W1-Conn (F)
- User-Defined1 (M) through User-Defined8 (M)
- User-Defined1 (F) through User-Defined8 (F)

Select BB Load for Test Port 1 Area

Select BB Load number for Test Port 1:

- Load 1
- Load 2

Test Port 1 Connector Standard Info Button

Select displays the STANDARD INFO dialog box for the selected connector and calibration method that displays the connector calibration coefficients. The dialog box contents depends on the connector selected above and on the Cal Method selected.

Test Port 2 Connector Type Area

Select the DUT Connector Type from a drop-down menu list with options the same as the Test Port 1 Connector area above.

Test Port 2 Connector Standard Info Button

Select displays the STANDARD INFO dialog box for the selected connector and calibration method that displays the connector calibration coefficients. The dialog box contents depends on the connector selected above and on the Cal Method selected.

Select BB Load for Test Port 2 Area

Select BB Load number for Test Port 2:

- Load 1
- Load 2

Through/Reciprocal Area

Located on the right side of the dialog box, these controls allow characterization of the through/reciprocal line settings.

- Select Line. Allows options of:
 - Reciprocal
 - Through
- Length (mm)
 - Input line length in mm.
 - Calculator icon displays the AIR EQUIVALENT LENGTH CONVERSION dialog box.
- Line Impedance (Ohms)
 - Input defaults to be 50 Ohms. Any numeric value accepted.
- Line Loss (dB/mm)
 - Allows input of a line loss in dB per mm at the frequency specified in the field below.
- @ Frequency (GHz)
 - Allows input of a frequency setting for the Line Loss factor input above.

OK / Cancel

Click OK to accept the changes and return to the CAL SETUP menu.

Click Cancel to abandon any changes and return to the CAL SETUP menu.

TWO PORT CAL SETUP (SSST, COAXIAL) Dialog Box - 2-Port VNA

Prerequisites

- Cal Method = SSST
- Line Type = Coaxial

Previous

- [“CAL SETUP Menu” on page 9-35](#)

Navigation

- MAIN | Calibration | CALIBRATION [TR] | Calibrate | CALIBRATE | Manual Cal | MANUAL CAL | 2-Port Cal | TWO-PORT CAL | Modify Cal Setup | CAL SETUP | Edit Cal Params | TWO-PORT CAL SETUP (SSST, COAXIAL) Dialog Box

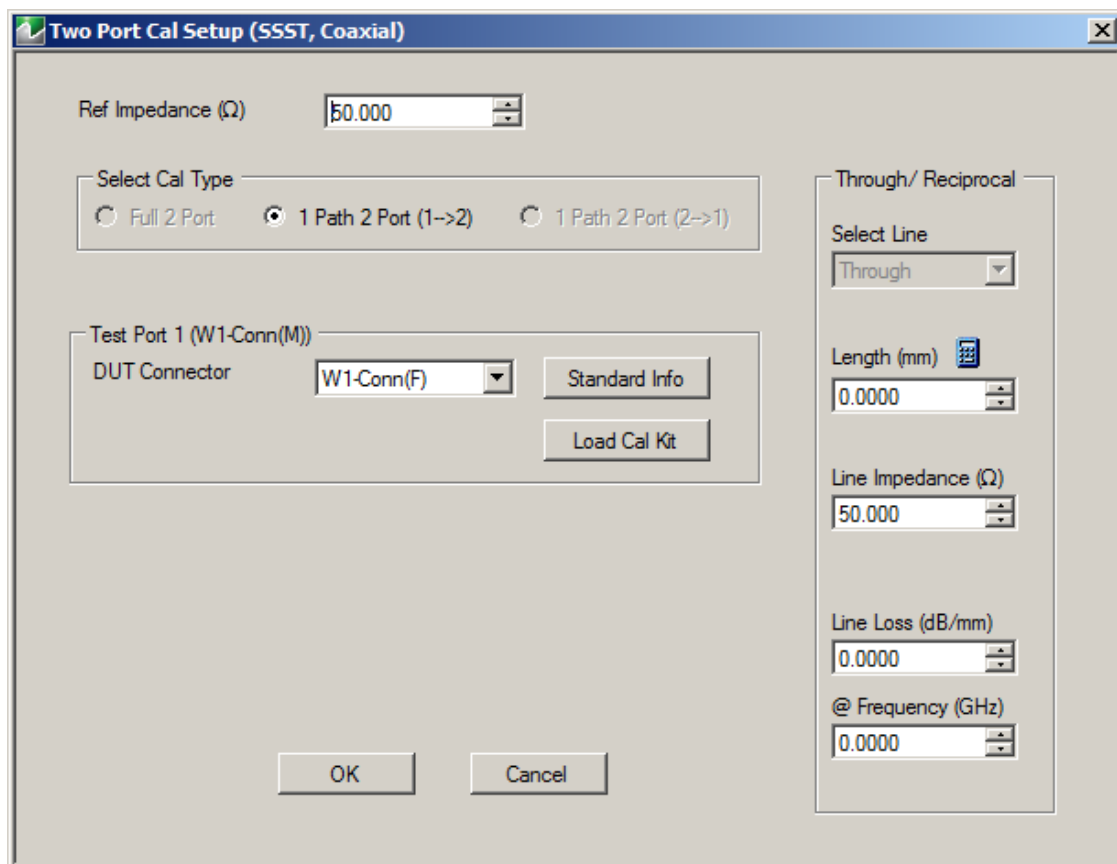

Figure 9-32. Edit Cal Params - TWO PORT CAL SETUP (SSST, COAXIAL) Dialog Box

Reference Impedance

Input the reference impedance.

- Input field defaulted to 50 Ohms.
- Any numerical value accepted although input values <0.01 Ohms are converted to 0.01 Ohms.

Select Cal Type

Select from three radio button controlled options:

- Full 2 Port
- 1 Path 2 Port (1 --> 2)
- 1 Path 2 Port (2 --> 1)

Test Port 1 Connector Type Area

Select the DUT Connector Type from a drop-down menu list with options of:

- W1-Conn (M)
- W1-Conn (F)
- User-Defined1 (M) through User-Defined8 (M)
- User-Defined1 (F) through User-Defined8 (F)

Test Port 1 Connector Standard Info Button

Select displays the STANDARD INFO dialog box for the selected connector and calibration method that displays the connector calibration coefficients. The dialog box contents depends on the connector selected above and on the Cal Method selected.

Test Port 2 Connector Type Area

Select the DUT Connector Type from a drop-down menu list with options the same as the Test Port 1 Connector area above.

Test Port 2 Connector Standard Info Button

Select displays the STANDARD INFO dialog box for the selected connector and calibration method that displays the connector calibration coefficients. The dialog box contents depends on the connector selected above and on the Cal Method selected.

Through/Reciprocal Area

Located on the right side of the dialog box, these controls allow characterization of the through/reciprocal line settings.

- Select Line. Allows options of:
 - Reciprocal
 - Through
- Length (mm)
 - Input line length in mm.
 - Calculator icon displays the AIR EQUIVALENT LENGTH CONVERSION dialog box.
- Line Impedance (Ohms)
 - Input defaults to be 50 Ohms. Any numeric value accepted.
- Line Loss (dB/mm)
 - Allows input of a line loss in dB per mm at the frequency specified in the field below.
- @ Frequency (GHz)
 - Allows input of a frequency setting for the Line Loss factor input above.

OK / Cancel

Click **OK** to accept the changes and return to the **CAL SETUP** menu.

Click **Cancel** to abandon any changes and return to the **CAL SETUP** menu.

Manual 2-Port Cal Dialog Box Summary

The table below summarizes the available fields in all 2-port calibration setup dialog boxes. If the dialog box is described above, a link is provided to that description. To view each dialog box, set the CAL METHOD and LINE TYPE menus to the appropriate settings, and then select the Edit Cal Params button. All dialog boxes are named “Two Port Cal Setup (*Cal Method, Line Type*)”

Table 9-2. Manual 2-Port Cal Setup Dialog Box Summary (1 of 4)

Cal Method Line Type	Dialog Box Controls and Functions
SOLT/R Coaxial	<p>See full description above at “TWO PORT CAL SETUP (SOLT/R, COAXIAL) Dialog Box” on page 9-43</p> <p>Reference Impedance (Ohms)</p> <p>Select Cal Type: Full 2 Port, 1 Path 2 Prt (1-->2), 1 Path 2 Port (2-->1)</p> <p>Load Type: Broadband Load, Sliding Load</p> <p>Test Port 1 and Test Port 2 controls are the same.</p> <p>Test Port DUT Connector: For each selected test port, select one of the following connectors: W1-Conn (M), W1-Conn (F), V-Conn (M), V-Conn (F), K-Conn (M), K-Conn (F), 2.4 mm (M), 2.4 mm (F), GPC-3.5 (M), GPC-3.5 (F), SMA (M), SMA (F), N-Conn (M), N-Conn (F), N-Conn (75) (M), N-Conn (75) (F), GPC-7, 7/16 (M), 7/16 (F), TNC (M), TNC (F), User-Defined 1 (M) through User-Defined 8 (M), User-Defined 1 (F) through User-Defined 8 (F)</p> <p>Test Port Connector Standard Info Button: For each DUT port connector, displays the STANDARD INFORMATION or USER-DEFINED dialog box for the selected connector.</p> <ul style="list-style-type: none"> • Typical “STANDARD INFO Dialog Box” on page 9-93 <p>Use S2P for Thru: Allows user to define a Thru using an S2P file. S2P file can be loaded from memory or characterized before use.</p> <p>Test Port Select BB Load: Load 1, Load 2</p> <p>Through/Reciprocal Select Line: Through, Reciprocal</p> <p>Through/Reciprocal Length (mm): Input field</p> <p>Through/Reciprocal Line Impedance (Ohms): Input field</p> <p>Through/Reciprocal Line Loss (dB/mm): Input field</p> <p>Through/Reciprocal @ Frequency (GHz): Input field</p>

Table 9-2. Manual 2-Port Cal Setup Dialog Box Summary (2 of 4)

Cal Method Line Type	Dialog Box Controls and Functions
SSLT Coaxial	<p>See full description above at “TWO PORT CAL SETUP (SSLT, COAXIAL) Dialog Box” on page 9-49</p> <p>Reference Impedance (Ohms)</p> <p>Select Cal Type: Full 2 Port, 1 Path 2 Prt (1-->2), 1 Path 2 Port (2-->1)</p> <p>Load Type: Broadband Load, Sliding Load</p> <p>Test Port 1 and Test Port 2 controls are the same.</p> <p>Test Port DUT Connector: For each selected test port, select one of the following connectors: W1-Conn (M), W1-Conn (F), V-Conn (M), V-Conn (F), K-Conn (M), K-Conn (F), 2.4 mm (M), 2.4 mm (F), GPC-3.5 (M), GPC-3.5 (F), SMA (M), SMA (F), N-Conn (M), N-Conn (F), N-Conn (75) (M), N-Conn (75) (F), GPC-7, 7/16 (M), 7/16 (F), TNC (M), TNC (F), User-Defined 1 (M) through User-Defined 8 (M), User-Defined 1 (F) through User-Defined 8 (F)</p> <p>Test Port Connector Standard Info Button: For each DUT port connector, displays the STANDARD INFORMATION or USER-DEFINED dialog box for the selected connector.</p> <ul style="list-style-type: none"> • Typical “STANDARD INFO Dialog Box” on page 9-93 <p>Use S2P for Thru: Allows user to define a Thru using an S2P file. S2P file can be loaded from memory or characterized before use.</p> <p>Test Port Select BB Load: Load 1, Load 2</p> <p>Through/Reciprocal Select Line: Through, Reciprocal</p> <p>Through/Reciprocal Length (mm): Input field</p> <p>Through/Reciprocal Line Impedance (Ohms): Input field</p> <p>Through/Reciprocal Line Loss (dB/mm): Input field</p> <p>Through/Reciprocal @ Frequency (GHz): Input field</p>
SSLT Non-Dispersive	Same controls and functions as SSLT Coax above.
SSLT Waveguide	<p>Same controls and functions as SSLT Coax above with the following changes:</p> <p>Waveguide Kit: WR10, WR12, WR15, User-Defined 1 to User-Defined 8</p> <p>Waveguide Info button: Displays USER DEFINED WAVEGUIDE dialog box.</p> <ul style="list-style-type: none"> • Typical “USER DEFINED WAVEGUIDE Dialog Box” on page 9-97
SSLT Microstrip	<p>Same controls and functions as SSLT Coax above with the following changes:</p> <p>Microstrip Kit: 10 Mil Kit, 15 Mil Kit, 25 Mil Kit, User-Defined 1 to User-Defined 8</p> <p>Microstrip Info button: Displays a dialog box for selected calibration method and kit.</p> <ul style="list-style-type: none"> • Typical “STANDARD INFO Dialog Box” on page 9-93 <p>Test Port DUT Connector Type: User-Defined 1 to User-Defined 8</p> <p>Test Port DUT Connector Standard Info button: Displays USER DEFINED STANDARD dialog box for selected calibration method and kit.</p>

Table 9-2. Manual 2-Port Cal Setup Dialog Box Summary (3 of 4)

Cal Method Line Type	Dialog Box Controls and Functions
SSST Coaxial	<p>See full description above at “TWO PORT CAL SETUP (SSST, COAXIAL) Dialog Box - 2-Port VNA” on page 9-52.</p> <p>Reference Impedance (Ohms)</p> <p>Select Cal Type: Full 2 Port, 1 Path 2 Prt (1-->2), 1 Path 2 Port (2-->1)</p> <p>Load Type: Broadband Load, Sliding Load</p> <p>Test Port 1 and Test Port 2 controls are the same.</p> <p>Test Port DUT Connector: For each selected test port, select one of the following connectors: W1-Conn (M), W1-Conn (F), V-Conn (M), V-Conn (F), K-Conn (M), K-Conn (F), 2.4 mm (M), 2.4 mm (F), GPC-3.5 (M), GPC-3.5 (F), SMA (M), SMA (F), N-Conn (M), N-Conn (F), N-Conn (75) (M), N-Conn (75) (F), GPC-7, 7/16 (M), 7/16 (F), TNC (M), TNC (F), User-Defined 1 (M) through User-Defined 8 (M), User-Defined 1 (F) through User-Defined 8 (F)</p> <p>Test Port Connector Standard Info Button: For each DUT port connector, displays the STANDARD INFORMATION or USER-DEFINED dialog box for the selected connector.</p> <ul style="list-style-type: none"> • Typical “STANDARD INFO Dialog Box” on page 9-93 <p>Through/Reciprocal Select Line: Through, Reciprocal</p> <p>Through/Reciprocal Length (mm): Input field</p> <p>Through/Reciprocal Line Impedance (Ohms): Input field</p> <p>Through/Reciprocal Line Loss (dB/mm): Input field</p> <p>Through/Reciprocal @ Frequency (GHz): Input field</p>
SSST Non-Dispersive	Same controls and functions as SSST Coaxial above.
SSST Waveguide	<p>Same controls and functions as SSLT Coax above with the following changes:</p> <p>Waveguide Kit: User-Defined 1 to User-Defined 8</p> <p>Waveguide Info button: Displays USER DEFINED WAVEGUIDE dialog box.</p> <ul style="list-style-type: none"> • Typical “USER DEFINED WAVEGUIDE Dialog Box” on page 9-97
SSST Microstrip	<p>Same controls and functions as SSST Coax above with the following changes:</p> <p>Microstrip Kit: 10 Mil Kit, 15 Mil Kit, 25 Mil Kit, User-Defined 1 to User-Defined 8</p> <p>Microstrip Info button: Displays a dialog box for selected calibration method and kit.</p> <ul style="list-style-type: none"> • Typical “STANDARD INFO Dialog Box” on page 9-93 <p>Test Port DUT Connector Type: User-Defined 1 to User-Defined 8</p> <p>Test Port DUT Connector Standard Info button: Displays USER DEFINED STANDARD dialog box for selected calibration method and kit.</p>

Table 9-2. Manual 2-Port Cal Setup Dialog Box Summary (4 of 4)

Cal Method Line Type	Dialog Box Controls and Functions
LRL/LRM Coaxial	<p>See full description above display logic and controls at “TWO PORT CAL SETUP (LRL/LRM, COAXIAL) Dialog Box - 2-Port VNA” on page 9-46.</p> <p>Reference Impedance (Ohms)</p> <p>Reference Plane Location: Ends of Line 1 or Middle of Line 1</p> <p>Number of Bands: 1 or 2</p> <p>Band 1 Device 1: Type defaults to Line, Line Length (mm), Line Loss (dB/mm), @ Frequency (GHz)</p> <p>Band 1 Device 2 Type: Line or Match</p> <ul style="list-style-type: none"> • If Device 2 = Match, Match Info button appears. Select displays USER DEFINED MATCH DEVICES dialog box for selected calibration method and kit. • Typical “USER DEFINED MATCH DEVICES Dialog Box - 2-Port VNAs” on page 9-95 <p>Band 1 Device 2 Type of Reflection: Use Short-like component, Use Open-like component, Use both</p> <ul style="list-style-type: none"> • If Use Short-like component selected: Reflection Component = Short-like Offset Length (mm) • If Use Open-like component selected: Reflection Component = Open-like Offset Length (mm) • If Use both selected: Reflection Component = Short-like Offset Length (mm) and Open-like Offset Length (mm) <p>If Number of Bands = 2, Band 2 Device 3 and Band 2 Device 4 areas appear:</p> <p>Band 2 Device 3: Use device 1, Use new line</p> <ul style="list-style-type: none"> • If Use new line selected: Line Length (mm), Line Loss (dB/mm), and @ Frequency (GHz) fields appear <p>Band 2 Device 4: Line or Match</p> <ul style="list-style-type: none"> • If Line selected: Line Length (mm) field appears. • If Match selected: Match Info button appears. Select displays USER DEFINED MATCH DEVICES dialog box for selected calibration method and kit. • Typical “USER DEFINED MATCH DEVICES Dialog Box - 2-Port VNAs” on page 9-95 <p>Band 2 Device 4 Type of Reflection: Use Short-like component, Use Open-like component</p> <p>Band Break Point: Calculate Recommended Value, Use Recommended Frequency (GHz) or Define New Frequency (GHz).</p> <p>Reflection Component: Open-like Length (mm) and/or Short-like Offset Length (mm)</p>

9-10 Typical Calibration Sub-Menus

The menus in this section are example menus for the calibration step procedures. The exact content and presence of each menu is dependent on the settings for each calibration run.

REFL. DEVICE(S) Menu

This example is a representative menu based on the following configuration:

- VNA is in 2-port mode
- A 2-port calibration
- A SOLT/SOLR calibration method
- A coaxial line type
- Connector

Using a different configuration set can change the appearance of the REFL. DEVICE(S) menu.

Full Name

- REFLECTIVE DEVICE(S) Menu

Previous

- The previous menu can be any of the following manual calibration menus and their associated configuration dialog boxes.
 - [“TWO PORT CAL Menu” on page 9-39](#)
 - [“ONE PORT CAL Menu \(SOLT/R - Coaxial\) 2-Port VNAs” on page 9-63](#)
 - [“TRANS. RESPONSE Menu” on page 9-77](#)
 - [“REFL. RESPONSE Menu” on page 9-83](#)
- The REFL. DEVICE(s) menu controls and functions are also subject to the settings in the following:
 - [“CAL SETUP Menu” on page 9-35](#)
 - [“CAL METHOD Menu” on page 9-37](#)
 - [“LINE TYPE Menu” on page 9-38](#)

Similar Menus

- The REFL. DEVICE(S) Port 1 menu is nearly identical to the typical REFL. DEVICE(S) Port 2 menu (not shown).

 <p>The screenshot shows a menu titled "Refl. Device(s)" with a close button (X). Below the title is a sub-header "----Port 1----". The menu contains four main sections, each with a button and a status indicator (a box with "----" inside):</p> <ul style="list-style-type: none"> Port 1 Connector: N-Conn(F) Open Short Load 	<p>A typical REFL. DEVICE(S) menu.</p> <p>Each button is a completion task button and marked with a checkmark when the calibration task is complete.</p> <p>Port 1 Connector</p> <p>This button returns user to the Two Port Cal Setup dialog box, allowing changes to the connector type.</p> <p>Open</p> <p>In general, prepare the indicated connections and components and then select the button. Starts the open calibration procedure for the indicated port. When the calibration task is completed, the button is marked with a checkmark.</p> <p>Short</p> <p>Starts the short calibration procedure for the indicated port. When the calibration task is completed, the button is marked with a checkmark.</p> <p>Load</p> <p>Starts the load calibration procedure for the indicated port. When the calibration task is completed, the button is marked with a checkmark.</p> <p>Sliding Load</p> <p>If present, selecting this button displays the SLIDING LOADS menu which is described in the section below.</p>
--	---

Figure 9-33. REFL. DEVICE(S) (REFLECTIVE DEVICES) Menu - Typical Example

THRU/RECIP Menu

This menu example is a representative menu based on the following configuration:

- VNA is in 2-port mode
- A 2-port calibration
- A SOLT/SOLR calibration method
- Sliding loads selected
- A coaxial line type
- Connector

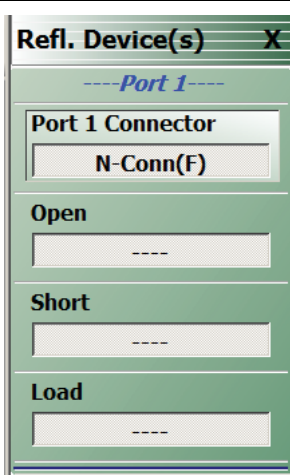
Using a different configuration set can change the appearance of the THRU/RECIP menu.

Previous

- The previous menu can be any of the following manual calibration menus and their associated configuration dialog boxes.
 - [“TWO PORT CAL Menu” on page 9-39](#)
 - [“ONE PORT CAL Menu \(SOLT/R - Coaxial\) 2-Port VNAs” on page 9-63](#)
 - [“TRANS. RESPONSE Menu” on page 9-77](#)
 - [“REFL. RESPONSE Menu” on page 9-83](#)
- The THRU/RECIP menu controls and functions are also subject to the settings in the following:
 - [“CAL SETUP Menu” on page 9-35](#)
 - [“CAL METHOD Menu” on page 9-37](#)

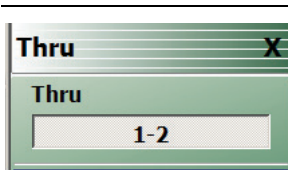

A typical THRU/RECIP menu.

Each button is a completion task button and marked with a checkmark when the calibration task is complete.

Thru (Port Pair 1-2)

In general, prepare the indicated connections and components and then select the button. Starts the through calibration procedure for the indicated port pair. When the calibration task is completed, the button is marked with a checkmark.

When all calibration procedures are complete, use the Back button to return to the REFL DEVICE menu.

- [“REFL. DEVICE\(S\) Menu” on page 9-59](#)

Figure 9-34. THRU/RECIP Menu - Typical Example

ISOLATION(S) Menu - 2-Port VNA

This menu example is a representative menu based on the following configuration:

- VNA is in 2-port mode
- A 2-port calibration
- A SOLT/SOLR calibration method
- A coaxial line type
- A K (f) Connector

Using a different configuration set can change the appearance of the THRU/RECIP menu.

Previous

- The previous menu can be any of the following manual calibration menus and their associated configuration dialog boxes.
 - [“TWO PORT CAL Menu” on page 9-39](#)
 - [“ONE PORT CAL Menu \(SOLT/R - Coaxial\) 2-Port VNAs” on page 9-63](#)
 - [“TRANS. RESPONSE Menu” on page 9-77](#)
 - [“REFL. RESPONSE Menu” on page 9-83](#)
- The THRU/RECIP menu controls and functions are also subject to the settings in the following:
 - [“CAL SETUP Menu” on page 9-35](#)
 - [“CAL METHOD Menu” on page 9-37](#)

	<p>A typical ISOLATION(S) menu.</p> <p>Each button is a completion task button and marked with a checkmark when the calibration task is complete.</p> <p>Isolation (Port Pair 1-2)</p> <p>In general, prepare the indicated connections and components and then select the button. Starts the optional isolation calibration procedure for the indicated port pair. When the calibration task is completed, the button is marked with a checkmark.</p> <p>When all calibration procedures are complete, use the Back button to return to the REFL DEVICE menu.</p> <ul style="list-style-type: none"> • “REFL. DEVICE(S) Menu” on page 9-59
---	---

Figure 9-35. ISOLATION(S) Menu - Typical Example

9-11 Manual 1-Port Cal Setup

Note The appearance and button availability of the calibration menus depends on the settings established in the CAL SETUP, CAL METHOD, LINE TYPE menus and in the associated dialog boxes that appear from the Edit Cal Params button.

ONE PORT CAL Menu (SOLT/R - Coaxial) 2-Port VNAs

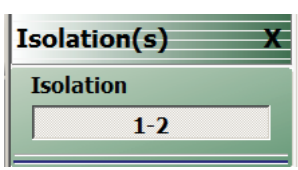
Previous

- [“MANUAL CAL Menu” on page 9-34](#)

Navigation

- MAIN | Calibration | CALIBRATION [TR] | Calibrate | CALIBRATE | Manual Cal | MANUAL CAL | 1-Port Cal | ONE PORT CAL/S menu

	<p>Modify Cal Setup</p> <p>Select displays the CAL SETUP menu where changes to the calibration method, line type, and associated parameters are made on the CAL METHOD and LINE TYPE submenus.</p> <ul style="list-style-type: none"> • “CAL SETUP Menu” on page 9-35. • “CAL METHOD Menu” on page 9-37. <ul style="list-style-type: none"> • Calibration method option: SOLT/SOLR or LRL/LRM. • Line Type option is Coaxial. • “LINE TYPE Menu” on page 9-38 <ul style="list-style-type: none"> • Line Type options are Coaxial, Non-Dispersive, Waveguide, or Microstrip. <p>A composite view of the CAL SETUP menu set and is available in:</p> <ul style="list-style-type: none"> • Figure 9-21 on page 9-31 <p>Ports Selected (Read Only)</p> <p>A display button showing the port numbers that are in the calibration.</p>
--	---

Figure 9-36. ONE PORT CAL MENU - Typical Example (1 of 2)

Completion Menu Buttons

For this example menu, the Port 1 Reflective Devices to the Isolation (Optional) buttons link to completion submenus where additional calibration procedures are performed.

For example, the Port 1 Reflective Devices button (shown below at #1) links to the REFL. DEVICES PORT 1 submenu. As each procedure is completed, the submenu button is marked with a completion checkmark. When all the procedures on the submenu are completed, use the Back button to return to the FOUR PORT CAL menu.



The Port 1 Reflective Devices button (shown above at #2) is now marked with a completion checkmark.

Port 1 Reflective Devices

When selected, provides the PORT 1 REFLECTIVE DEVICES menu. Each button represents a completion task. When ready for the task, click the button, and the instrument performs the calibration. When the calibration task is successfully completed, the button is marked with a completion checkmark. When all tasks are completed on the menu, return to the ONE PORT CAL menu.

Done

This button is unavailable until all calibration tasks have been successfully completed. When available, select the button to return to the CALIBRATION menu when the Cal Status is set to ON.

- [“CALIBRATION \[TR\] Menu” on page 9-5](#)

Abort Cal

Select aborts the current calibration and returns to the CALIBRATION menu.

- [“CALIBRATION \[TR\] Menu” on page 9-5](#)

Figure 9-36. ONE PORT CAL MENU - Typical Example (2 of 2)

Modify One-Port Cal Setup Dialog Boxes

The controls and fields in Edit Cal Params dialog boxes depend on the settings made in the MANUAL CAL, CAL SETUP, CAL METHOD, and LINE TYPE menus. Dialog box examples are:

- [“ONE-PORT CAL SETUP \(SOLT/R, COAXIAL\) Dialog Box”](#) on page 9-66

For all other combinations of calibration methods and line types, see the summary in [Table 9-3 on page 9-74](#) for a listing of dialog box controls and functions.

Note Note that the LRL/LRM calibration method is not available for One-Port Calibrations.
--

ONE-PORT CAL SETUP (SOLT/R, COAXIAL) Dialog Box

Prerequisites

- Calibration Method = SOLT/SOLR
- Line Type = Coaxial

Previous

- “ONE PORT CAL Menu (SOLT/R - Coaxial) 2-Port VNAs” on page 9-63

Navigation

- MAIN | Calibration | CALIBRATION [TR] | Calibrate | CALIBRATE | Manual Cal | MANUAL CAL | 1-Port Cal | ONE-PORT CAL(S) | Modify Cal Setup | CAL SETUP | Edit Cal Params | ONE-PORT CAL SETUP (SOLT/R, COAXIAL) Dialog Box

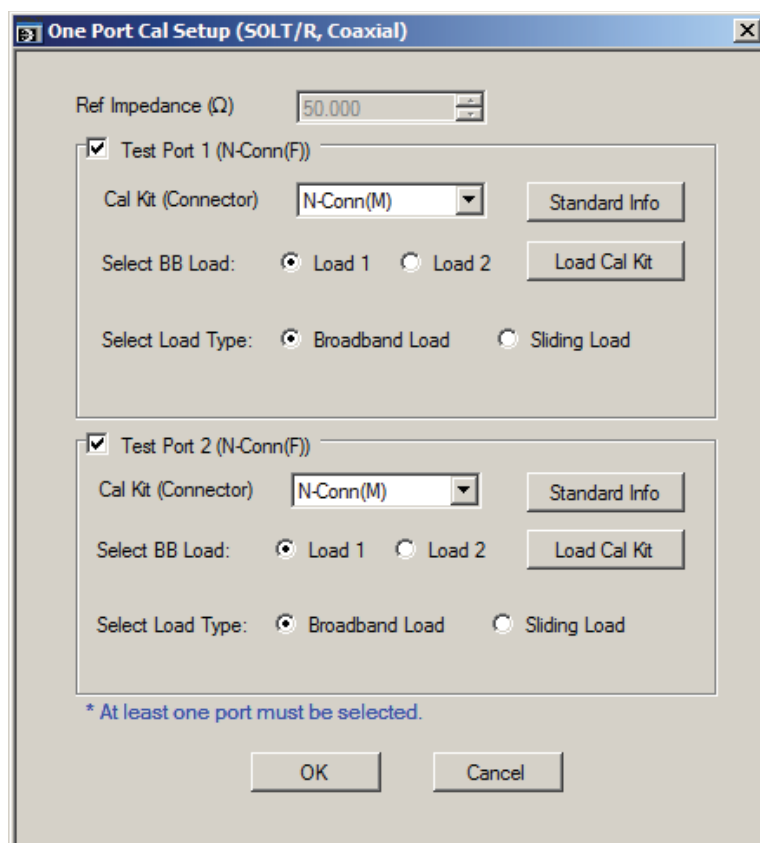

Figure 9-37. ONE-PORT CAL SETUP (SOLT/R, COAXIAL) Dialog Box

Reference Impedance

Read-only field displays 50 Ohms reference impedance.

Test Port 1

At least one test port (Test Port 1 or Test Port 2) must be selected. Both test ports may be selected.

Use the check box to select Test Port 1. If the check box is not selected, all Test Port 1 fields and controls are unavailable. If selected, the following controls are available:

Cal Kit (Connector) Type Field

Select the DUT Connector Type from a drop-down menu list with options of:

- K-Conn (M)
- K-Conn (F)
- GPC-3.5 (M)
- GPC-3.5 (F)
- SMA (M)
- SMA (F)
- N-Conn (M)
- N-Conn (F)
- 2.4 mm (M)
- 2.4 mm (F)
- TNC (M)
- TNC (F)
- V-conn (M)
- V-conn (F)
- W1-conn (M)
- W1-conn (F)
- 7/16 (M)
- 7/16 (F)
- GPC-7
- N-conn(75) (M)
- N-conn(75) (F)
- user defined 1 through 8 (M or F)

Test Port 1 Connector Standard Info Button

Select displays the Standard Info dialog box for the selected connector and calibration method that displays the connector calibration coefficients. The dialog box contents depends on the connector selected above and on the Cal Method selected.

Select BB Load for Test Port 1

Select BB Load number for Test Port 1:

- Load 1
- Load 2

Load Cal Kit

Prompts the LOAD dialog box.

Select Load Type for Test Port 1

Select the load type for Test Port 1:

- Broadband Load
- Sliding Load. If Sliding Load is selected:
 - A message appears in the “Still requires broadband loads below sliding load breakpoint frequency.”
 - A Sliding Load button appears on the PORT 1 REFLECTIVE DEVICES menu.

Test Port 2 Area

Use the check box to select Test Port 2. If the check box is not selected, all Test Port 2 fields and controls are unavailable. If selected, the following controls are available:

DUT Connector Type Field:

Select the DUT Connector Type from a drop-down menu list with the same options as in Test Port 1 above.

Test Port 2 Connector Standard Info Button

Select displays the Standard Info dialog box for the selected connector and calibration method that displays the connector calibration coefficients. The dialog box contents depends on the connector selected above and on the Cal Method selected.

Select BB Load for Test Port 2

Select BB Load number for Test Port 2:

- Load 1
- Load 2

Load Cal Kit

Prompts the LOAD dialog box.

Select Load Type for Test Port 2

Select the load type for Test Port 2:

- Broadband Load
- Sliding Load. If Sliding Load is selected:
 - A message appears in the “Still requires broadband loads below sliding load breakpoint frequency.”
 - A Sliding Load button appears on the PORT 2 REFLECTIVE DEVICES menu.

OK / Cancel

Click OK to accept the changes and return to the CAL SETUP menu.

Click Cancel to abandon any changes and return to the CAL SETUP menu.

ONE-PORT CAL SETUP (SSLT, COAXIAL) Dialog Box

Prerequisites

- Calibration Method = SSLT
- Line Type = Coaxial

Previous

- [“ONE PORT CAL Menu \(SOLT/R - Coaxial\) 2-Port VNAs”](#) on page 9-63

Navigation

- MAIN | Calibration | CALIBRATION [TR] | Calibrate | CALIBRATE | Manual Cal | MANUAL CAL | 1-Port Cal | ONE-PORT CAL | Modify Cal Setup | CAL SETUP | Edit Cal Params | ONE-PORT CAL SETUP (SSLT, COAXIAL) Dialog Box

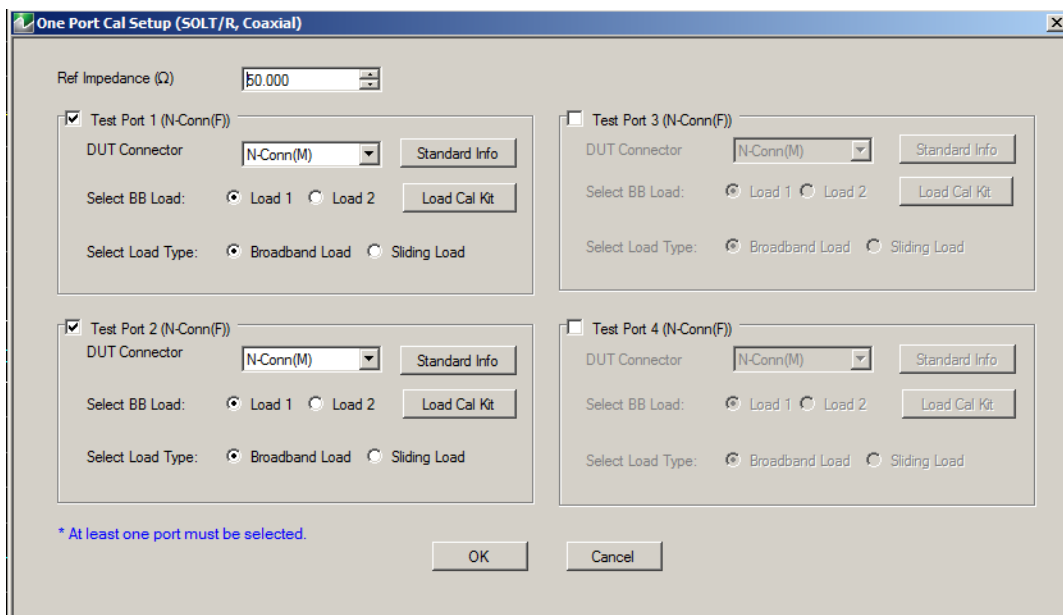

Figure 9-38. ONE-PORT CAL SETUP (SSLT, COAXIAL) Dialog Box

Reference Impedance

Input the reference impedance.

- Input field defaulted to 50 Ohms.
- Any numerical value accepted although input values <0.01 Ohms are converted to 0.01 Ohms.

Test Port 1

At least one test port (Test Port 1 or Test Port 2) must be selected. Both test ports may be selected.

Use the check box to select Test Port 1. If the check box is not selected, all Test Port 1 fields and controls are unavailable. If selected, the following controls are available:

Test Port 1 DUT Connector Type Field

Select the DUT Connector Type from a drop-down menu list with options of:

- W1-Conn (M)
- W1-Conn (F)
- User-Defined1 (M) through User-Defined8 (M)
- User-Defined1 (F) through User-Defined8 (F)

Test Port 1 Connector Standard Info Button

Select displays the Standard Info dialog box for the selected connector and calibration method that displays the connector calibration coefficients. The dialog box contents depends on the selected connector and Cal Method selected.

Select BB Load for Test Port 1

Select BB Load number for Test Port 1:

- Load 1
- Load 2

Select Load Type for Test Port 1

Select the load type for Test Port 1:

- Broadband Load
- Sliding Load. If Sliding Load is selected:
 - A message appears in the “Still requires broadband loads below sliding load breakpoint frequency.”
 - A Sliding Load button appears on the PORT 1 REFLECTIVE DEVICES menu.

Test Port 2 Area

Use the check box to select Test Port 2. If the check box is not selected, all Test Port 2 fields and controls are unavailable. If selected, the following controls are available:

Test Port 2 DUT Connector Type Field:

Select the DUT Connector Type from a drop-down menu list with the same options as in Test Port 1 above.

Test Port 1 Connector Standard Info Button

Select displays the Standard Info dialog box for the selected connector and calibration method that displays the connector calibration coefficients. The dialog box contents depends on the connector selected above and on the Cal Method selected.

Select BB Load for Test Port 2

Select BB Load number for Test Port 2:

- Load 1
- Load 2

Select Load Type for Test Port 2

Select the load type for Test Port 2:

- Broadband Load
- Sliding Load. If Sliding Load is selected:
 - A message appears in the “Still requires broadband loads below sliding load breakpoint frequency.”
 - A Sliding Load button appears on the PORT 2 REFLECTIVE DEVICES menu.

OK / Cancel

Click OK to accept the changes and return to the CAL SETUP menu.

Click Cancel to abandon any changes and return to the CAL SETUP menu.

ONE-PORT CAL SETUP (SSST, COAXIAL) Dialog Box

Prerequisites

- Calibration Method = SSST
- Line Type = Coaxial

Previous

- [“ONE PORT CAL Menu \(SOLT/R - Coaxial\) 2-Port VNAs” on page 9-63](#)

Navigation

- MAIN | Calibration | CALIBRATION [TR] | Calibrate | CALIBRATE | Manual Cal | MANUAL CAL | 1-Port Cal | ONE-PORT CAL(S) | Modify Cal Setup | CAL SETUP | Edit Cal Params | ONE-PORT CAL SETUP (SSST, COAXIAL) Dialog Box

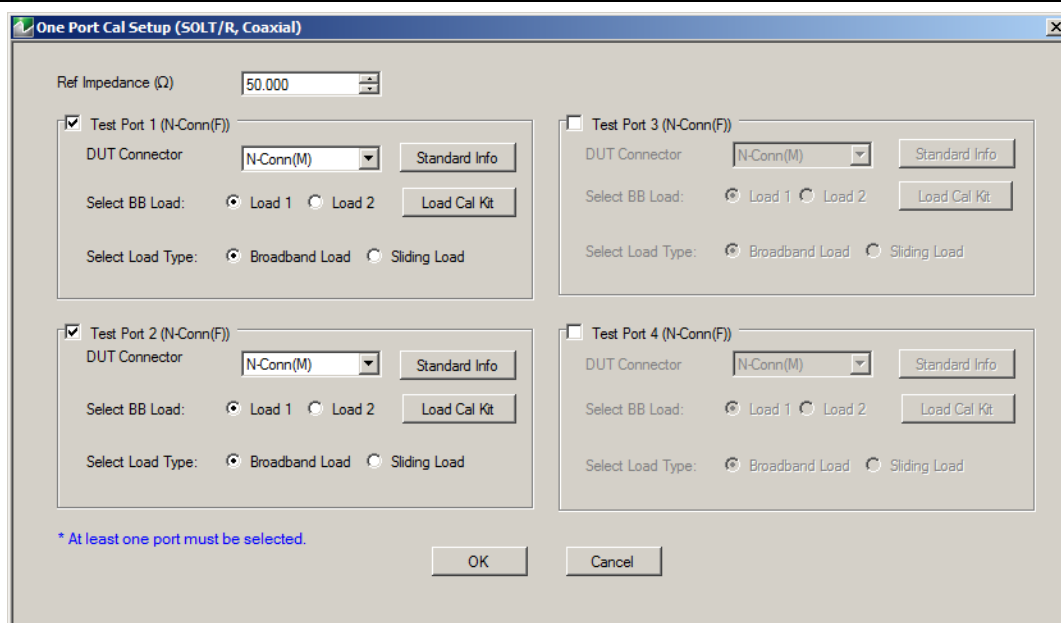

Figure 9-39. ONE-PORT CAL SETUP (SSST, COAXIAL) Dialog Box

Reference Impedance

Input the reference impedance.

- Input field defaulted to 50 Ohms.
- Any numerical value accepted although input values <0.01 Ohms are converted to 0.01 Ohms.

Test Port 1

At least one test port (Test Port 1 or Test Port 2) must be selected. Both test ports may be selected.

Use the check box to select Test Port 1. If the check box is not selected, all Test Port 1 fields and controls are unavailable. If selected, the following controls are available:

Test Port 1 DUT Connector Type

Select the DUT Connector Type from a drop-down menu list with options of:

- W1-Conn (M)
- W1-Conn (F)
- User-Defined1 (M) through User-Defined8 (M)
- User-Defined1 (F) through User-Defined8 (F)

Test Port 1 Connector Standard Info Button

Select displays the Standard Info dialog box for the selected connector and calibration method that displays the connector calibration coefficients. The dialog box contents depends on the connector selected above and on the Cal Method selected.

Test Port 2 Area

Use the check box to select Test Port 2. If the check box is not selected, all Test Port 2 fields and controls are unavailable. If selected, the following controls are available:

Test Port 2 DUT Connector Type Field:

Select the DUT Connector Type from a drop-down menu list with the same options as in Test Port 1 above.

Test Port 1 Connector Standard Info Button

Select displays the Standard Info dialog box for the selected connector and calibration method that displays the connector calibration coefficients. The dialog box contents depends on the connector selected above and on the Cal Method selected.

OK / Cancel

Click OK to accept the changes and return to the CAL SETUP menu.

Click Cancel to abandon any changes and return to the CAL SETUP menu.

Summary of 1-Port Calibration Setup Dialog Boxes

The table below summarizes the available fields in other one-port calibration setup dialog boxes. To view each dialog box, set the CAL METHOD and LINE TYPE menus to the appropriate settings, and then select the Edit Cal Params button. All dialog boxes are named “One Port Cal Setup (*Cal Method, Line Type*)”.

Table 9-3. Manual Calibration - 1-Port Calibration Setup Dialog Box Contents (1 of 3)

Cal Method Line Type	Dialog Box Input Selections and Controls
SOLT/R Coaxial	<p>See full description above at “ONE-PORT CAL SETUP (SOLT/R, COAXIAL) Dialog Box” on page 9-66.</p> <p>Reference Impedance (Ohms) Select Test Port: Port 1 and/or Port 2 Test Port 1 and Test Port 2 controls are the same. Port must be selected to enable controls. Test Port DUT Connector: For each selected test port, select one of the connector types. Test Port Connector Standard Info Button: For each DUT port connector, displays the info dialog box for the selected connector. • Typical “STANDARD INFO Dialog Box” on page 9-93 Test Port BB Load: Load 1, Load 2 Test Port Load Type: Broadband Load, Sliding Load</p>
SOLT/R Non-Dispersive	<p>Same controls and functions as SOLT/R Coaxial above.</p>
SOLT/R Waveguide	<p>SOLT/R is not recommended for Waveguide calibrations.</p> <p>Same controls and functions as SOLT/R Coaxial above with the following changes: Reference Impedance (Ohms) Waveguide Kit: User-Defined 1 to User-Defined8 Waveguide Info button: Displays USER DEFINED WAVEGUIDE dialog box. • Typical “USER DEFINED WAVEGUIDE Dialog Box” on page 9-97</p>
SOLT/R Microstrip	<p>Same controls and functions as SOLT/R Coaxial above with the following changes: Microstrip Kit: 10 Mil Kit, 15 Mil Kit, 25 Mil Kit, User-Defined 1 to User-Defined8 Microstrip Info button: Displays dialog box for selected calibration method and kit. • Typical “STANDARD INFO Dialog Box” on page 9-93 Test Port DUT Connector Type: User-Defined1 to User-Defined8 Test Port Standard Info button: Displays info dialog box for selected calibration method and kit. • Typical “STANDARD INFO Dialog Box” on page 9-93</p>

Table 9-3. Manual Calibration - 1-Port Calibration Setup Dialog Box Contents (2 of 3)

Cal Method Line Type	Dialog Box Input Selections and Controls
SSLT Coaxial	<p>See full description above at “ONE-PORT CAL SETUP (SSLT, COAXIAL) Dialog Box” on page 9-69.</p> <p>Reference Impedance (Ohms)</p> <p>Select Test Port: Port 1 and/or Port 2</p> <p>Test Port 1 and Test Port 2 controls are the same. Port must be selected to enable controls.</p> <p>Test Port DUT Connector: For each selected test port, select one of the following connectors: , W1-Conn (M), W1-Conn (F), User-Defined 1 (M) through User-Defined8 (M), User-Defined 1 (F) through User-Defined8 (F)</p> <p>Test Port Connector Standard Info Button: For each DUT port connector, displays the info dialog box for the selected connector.</p> <ul style="list-style-type: none"> • Typical “STANDARD INFO Dialog Box” on page 9-93 <p>Test Port BB Load: Load 1, Load 2</p> <p>Test Port Load Type: Broadband Load, Sliding Load</p>
SSLT Non-Dispersive	Same controls and functions as SSLT Coax.
SSLT Waveguide	<p>Same controls and functions as SSLT Coax with the following changes:</p> <p>Waveguide Kit: WR10, WR12, WR15, User-Defined 1 to User-Defined8</p> <p>Waveguide Info button: Displays info dialog box for selected calibration method and kit.</p> <ul style="list-style-type: none"> • Typical “STANDARD INFO Dialog Box” on page 9-93 • Typical “USER DEFINED WAVEGUIDE Dialog Box” on page 9-97
SSLT Microstrip	<p>Same controls and functions as SSLT Coax with the following changes:</p> <p>Microstrip Kit: 10 Mil Kit, 15 Mil Kit, 25 Mil Kit, User-Defined 1 to User-Defined8</p> <p>Microstrip Info button: Displays info dialog box for selected calibration method and kit.</p> <ul style="list-style-type: none"> • Typical “STANDARD INFO Dialog Box” on page 9-93 <p>Test Port Standard Info button: Displays USER DEFINED STANDARD dialog box for selected calibration method and kit.</p> <ul style="list-style-type: none"> • Typical “USER DEFINED MATCH DEVICES Dialog Box - 2-Port VNAs” on page 9-95

Table 9-3. Manual Calibration - 1-Port Calibration Setup Dialog Box Contents (3 of 3)

Cal Method Line Type	Dialog Box Input Selections and Controls
SSST Coaxial	<p>See the full description above at “ONE-PORT CAL SETUP (SSST, COAXIAL) Dialog Box” on page 9-72.</p> <p>Reference Impedance (Ohms)</p> <p>Select Test Port: Port 1 and/or Port 2</p> <p>Test Port 1 and Test Port 2 controls are the same. Port must be selected to enable controls.</p> <p>Test Port DUT Connector: For each selected test port, select one of the following connectors: W1-Conn (M), W1-Conn (F), User-Defined 1 (M) through User-Defined8 (M), User-Defined 1 (F) through User-Defined8 (F)</p> <p>Test Port Connector Standard Info Button: For each DUT port connector, displays the info dialog box for the selected connector.</p> <ul style="list-style-type: none"> • Typical “STANDARD INFO Dialog Box” on page 9-93
SSST Non-Dispersive	Same controls and functions as SSST Coaxial.
SSST Waveguide	<p>Same controls and functions as SSST Coaxial above with the following changes:</p> <p>Waveguide Kit: User-Defined 1 to User-Defined8</p> <p>Waveguide Info button: Displays WAVEGUIDE INFO dialog box for selected calibration method and kit.</p> <ul style="list-style-type: none"> • Typical “USER DEFINED MATCH DEVICES Dialog Box - 2-Port VNAs” on page 9-95
SSST Microstrip	<p>Same controls and functions as SSST Coaxial above with the following changes:</p> <p>Microstrip Kit: 10 Mil Kit, 15 Mil Kit, 25 Mil Kit, User-Defined 1 to User-Defined8</p> <p>Microstrip Info button: Displays MICROSTRIP INFO dialog box for selected calibration method and kit.</p> <ul style="list-style-type: none"> • Typical “STANDARD INFO Dialog Box” on page 9-93
LRL/LRM Non-Dispersive	The LRL/LRM calibration method is not available for one-port calibrations.
LRL/LRM Waveguide	The LRL/LRM calibration method is not available for one-port calibrations.
LRL/LRM Microstrip	The LRL/LRM calibration method is not available for one-port calibrations.

9-12 Manual Cal - Trans. Freq. Resp. Cal

Note The appearance and button availability of the calibration menus depends on the settings established in the CAL SETUP, CAL METHOD, LINE TYPE menus and in the associated dialog boxes that appear from the Edit Cal Params button.

Full Name

- Transmission Frequency Response Calibration

Menu Name

- TRANS. RESPONSE

Button Name

- Transmission Freq. Response

TRANS. RESPONSE Menu

Full Name

- TRANSMISSION FREQUENCY RESPONSE CALIBRATION SETUP Menu

The exact composition of the menu depends on the settings made on the CAL SETUP, CAL METHOD, and LINE TYPE menus and on the resultant TRANSMISSION FREQUENCY RESPONSE CAL SETUP dialog box. A representative menu is shown below. There is one example procedure of a TRANS. RESPONSE calibration in this chapter.

Previous

- [“MANUAL CAL Menu” on page 9-34](#)

Navigation

- MAIN | Calibration | CALIBRATION [TR] | Calibrate | CALIBRATE | Manual Cal | MANUAL CAL | Transmission Freq. Response | TRANS. RESPONSE

	<p>Modify Cal Setup</p> <p>Select displays the CAL SETUP menu where the Edit Cal Params button provides access to the TRANSMISSION FREQUENCY RESPONSE CAL SETUP dialog box for the selected calibration method and line type.</p> <ul style="list-style-type: none"> • “CAL SETUP Menu” on page 9-35 <p>Example transmission frequency response calibration dialog boxes are available below:</p> <ul style="list-style-type: none"> • “TRANSMISSION FREQUENCY RESPONSE CAL SETUP (SOLT/R - Coaxial) Dialog Box” on page 9-79 <p>A summary table of all transmission frequency response calibration configuration dialog boxes is available here:</p> <ul style="list-style-type: none"> • Table 9-4, “Manual Calibration - Trans. Freq. Resp. Cal. Setup Dialog Box Contents” on page 9-81
---	---

Figure 9-40. TRANS. RESPONSE Menu - Trans. Freq. Resp. Cal. - Typical Example (1 of 2)

Port Selected

Read-only display of the ports selected for the pending calibration.

Completion Menu Buttons

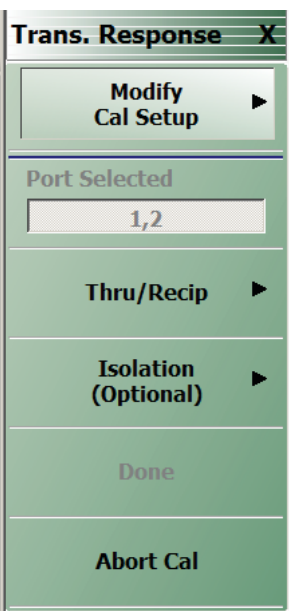
For this example menu, the Thru/Recip and Isolation (Optional) buttons link to completion submenus where additional calibration procedures are performed.

For example, the Thru/Recip button (shown below at #1) links to the THRU/RECIP submenu. As each procedure is completed, the submenu button is marked with a completion checkmark. When all the procedures on the submenu are completed, use the Back button to return to the TRANS. RESPONSE menu.



The Thru/Recip button (shown above at #2) is now marked with a completion checkmark.

Thru/Recip

When selected, displays the THRU/RECIP menu. When all tasks are complete, return to the TRANS. RESPONSE menu.

Isolation (Optional)

When selected, displays the ISOLATION menu. When all tasks are completed, return to the TRANS. RESPONSE menu.

Done

This button is unavailable until all calibration tasks have been successfully completed. When available, select the button to return to the CALIBRATION menu when the Cal Status is set to ON.

- [“CALIBRATION \[TR\] Menu” on page 9-5](#)

Abort Cal

Select aborts the current calibration and returns to the CALIBRATION menu.

- [“CALIBRATION \[TR\] Menu” on page 9-5](#)

Figure 9-40. TRANS. RESPONSE Menu - Trans. Freq. Resp. Cal. - Typical Example (2 of 2)

TRANSMISSION FREQUENCY RESPONSE CAL SETUP (SOLT/R - Coaxial) Dialog Box

Full Name

- Transmission Frequency Response Calibration Setup Dialog Box

Prerequisites

- Cal Method = SOLT/SOLR
- Line Type = Coaxial

Previous

- “[TRANS. RESPONSE Menu](#)” on page 9-77
- “[CAL SETUP Menu](#)” on page 9-35

Navigation

- MAIN | Calibration | CALIBRATION [TR] | Calibrate | CALIBRATE | Manual Cal | MANUAL CAL | Transmission Freq Response | TRANS FREQ (TRANSMISSION FREQUENCY RESPONSE) | Modify Cal Setup | CAL SETUP | Edit Cal Params | TRANSMISSION FREQUENCY RESPONSE CAL SETUP (SOLT/R, COAXIAL) Dialog Box

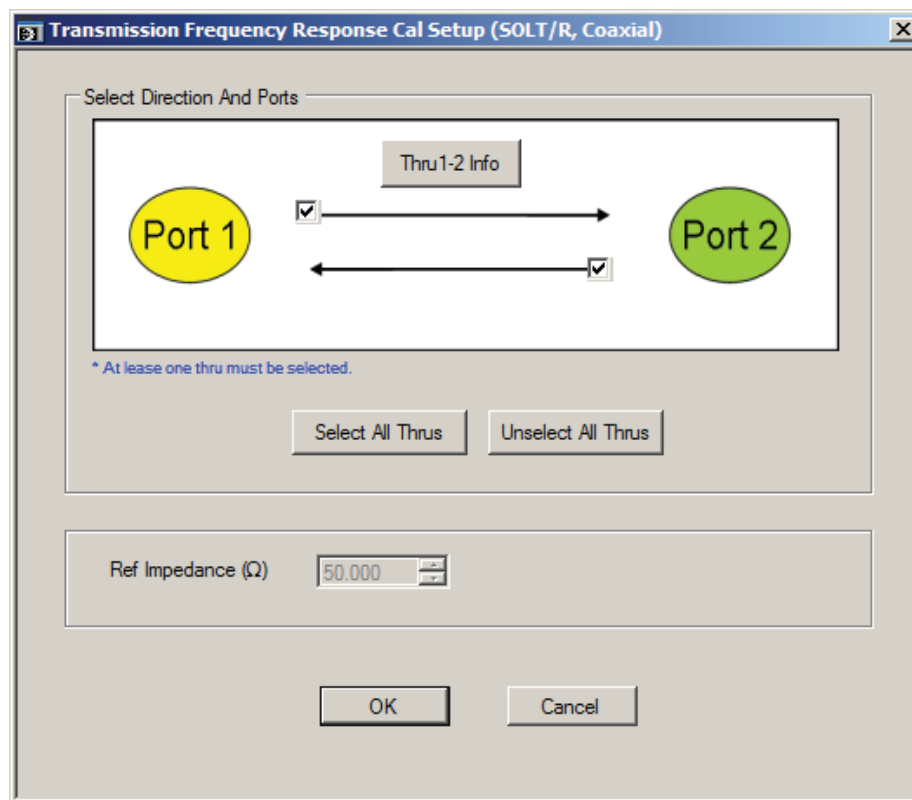

Figure 9-41. TRANSMISSION FREQUENCY RESPONSE CAL SETUP (SOLT/R, COAXIAL) Dialog Box

Select Direction And Ports

Select any combination of the two available thrus. At least one thru must be selected. Both the Thru Port 1 to Port 2 and the Thru Port 2 to Port 1 may be selected.

Thru 1-2 Info Button

Select the Thru 1-2 to display the THRU INFO dialog box.

- The THRU INFO dialog box is described above in [“THRU INFO Dialog Box”](#) on page 9-94

The Calculator icon is available on the THRU INFO dialog box. Select displays the AIR EQUIVALENT LENGTH CONVERSION dialog box.

- The AIR EQUIVALENT LENGTH CONVERSION dialog box is described above in [“AIR EQUIVALENT LENGTH CONVERSION \(FROM PS TO MM\) Dialog Box”](#) on page 9-92.

Reference Impedance

The reference impedance is 50 Ohms. This field is read only.

Transmission Frequency Response Calibration Setup Dialog Boxes

The table below summarizes the available fields and controls in other transmission frequency response calibration setup dialog boxes (abbreviated in this section as Trans. Freq. Resp. Cal.). To view each dialog box, set the CAL METHOD and LINE TYPE menus to the appropriate settings, and then select the Edit Cal Params button.

Table 9-4. Manual Calibration - Trans. Freq. Resp. Cal. Setup Dialog Box Contents (1 of 2)

Cal Method Line Type	Dialog Box Input Selections and Controls
SOLT/R Coaxial	See full description above at “TRANSMISSION FREQUENCY RESPONSE CAL SETUP (SOLT/R - Coaxial) Dialog Box” on page 9-79. Select Direction and Ports: Port 1, Port 2, Port 1 and Port 2 Reference Impedance (Ohms)
SOLT/R Non-Dispersive	Same controls and functions as SOLT/R Coaxial.
SOLT/R Waveguide	Same controls and functions as SOLT/R Coaxial with the following changes: Waveguide Kit: User-Defined 1 to User-Defined8 Waveguide Info button: Displays USER DEFINED WAVEGUIDE dialog box.
SOLT/R Microstrip	Same controls and functions as SOLT/R Coaxial with the following changes: Microstrip Kit: 10 Mil Kit, 15 Mil Kit, 25 Mil Kit, User-Defined 1 to User-Defined8 Microstrip Info button: Displays info dialog box for selected calibration method and kit. • Typical “STANDARD INFO Dialog Box” on page 9-93
SSLT Coaxial	Same controls and functions as SOLT/R Coaxial above.
SSLT Non-Dispersive	Same controls and functions as SOLT/R Coaxial above.
SSLT Waveguide	Same controls and functions as SOLT/R Coaxial with the following changes: Waveguide Kit: User-Defined 1 to User-Defined8 Waveguide Info button: Displays USER DEFINED WAVEGUIDE dialog box. • Typical “STANDARD INFO Dialog Box” on page 9-93
SSLT Microstrip	Same controls and functions as SOLT/R Coaxial with the following changes: Microstrip Kit: 10 Mil Kit, 15 Mil Kit, 25 Mil Kit, User-Defined 1 to User-Defined8 Microstrip Info button: Displays info dialog box for selected calibration method and kit. • Typical “STANDARD INFO Dialog Box” on page 9-93
SSST Coaxial	Same controls and functions as SOLT/R Coaxial above.
SSST Non-Dispersive	Same controls and functions as SOLT/R Coaxial above.

Table 9-4. Manual Calibration - Trans. Freq. Resp. Cal. Setup Dialog Box Contents (2 of 2)

Cal Method Line Type	Dialog Box Input Selections and Controls
SSST Waveguide	Same controls and functions as SOLT/R Coaxial with the following changes: Waveguide Kit: User-Defined 1 to User-Defined8 Waveguide Info button: Displays USER DEFINED WAVEGUIDE dialog box.
SSST Microstrip	Same controls and functions as SOLT/R Coaxial with the following changes: Microstrip Kit: 10 Mil Kit, 15 Mil Kit, 25 Mil Kit, User-Defined 1 to User-Defined8 Microstrip Info button: Displays info dialog box for selected calibration method and kit. • Typical “STANDARD INFO Dialog Box” on page 9-93
LRL/LRM Coaxial	The LRL/LRM calibration method is not available for transmission frequency response calibrations.
LRL/LRM Non-Dispersive	
LRL/LRM Waveguide	
LRL/LRM Microstrip	

9-13 Manual Cal - Refl. Freq. Resp. Cal

Purpose

Setup and configuration of reflection frequency response manual calibration for a 2-port VNA.

Note The appearance and button availability of the calibration menus depends on the settings established in the CAL SETUP, CAL METHOD, LINE TYPE menus and in the associated dialog boxes that appear from the Edit Cal Params button.

Full Name

- Reflection Frequency Response Calibration

Menu Name

- REFL. RESPONSE

Button Name

- Reflection Freq. Response

REFL. RESPONSE Menu

Full Name

- REFLECTION RESPONSE Menu

The exact composition of the menu depends on the settings made on the CAL SETUP, CAL METHOD, and LINE TYPE menus and on the resultant REFLECTION FREQUENCY RESPONSE CAL SETUP dialog box. A representative menu is shown below. There is one example procedure of a REFL. RESPONSE calibration in this chapter.

Previous

- [“MANUAL CAL Menu” on page 9-34](#)

Navigation

- MAIN | Calibration | CALIBRATION [TR] | Calibrate | CALIBRATE | Manual Cal | MANUAL CAL | Reflection Freq. Response | REFL. RESPONSE

	<h3>Modify Cal Setup</h3> <p>Select displays the CAL SETUP menu where the Edit Cal Params button provides access to the REFLECTION FREQ. RESPONSE CAL SETUP dialog box for the selected calibration method and line type.</p> <ul style="list-style-type: none"> • “CAL SETUP Menu” on page 9-35 <p>A typical reflection frequency response calibration dialog box is available at:</p> <ul style="list-style-type: none"> • “REFLECTION FREQ. RESPONSE CAL SETUP (SOLT/R, COAXIAL) Dialog Box” on page 9-85 <p>A summary table of all reflection frequency response calibration configuration dialog boxes is available at:</p> <ul style="list-style-type: none"> • Table: “Manual Calibration - Reflection Frequency Response Cal Setup” on page 9-88
---	---

Figure 9-42. REFL. RESPONSE Menu - Refl. Freq. Resp. Cal. - Typical Example (1 of 2)

Port Selected

Read-only display of the ports selected for the pending calibration.

Completion Menu Buttons

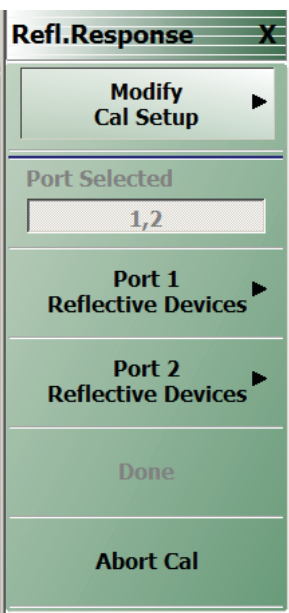
For this example menu, the Port 1 Reflective Devices, Port 2 Reflective Devices, Thru/Recip, and Isolation (Optional) buttons link to completion submenus where additional calibration procedures are performed.

For example, the Port 1 Reflective Devices button (shown below at #1) links to the REFL. DEVICES PORT 1 submenu. As each procedure is completed, the submenu button is marked with a completion checkmark. When all the procedures on the submenu are completed, use the Back button to return to the REFL. RESPONSE menu.



The Port 1 Reflective Devices button (shown above at #2) is now marked with a completion checkmark.

Port 1 Reflective Devices

When selected, the REFL. DEVICES PORT 1 menu appears where each button represents a completion task. When ready for the task, click the button, and the instrument performs the calibration. When the calibration task is successfully completed, the button is marked with a completion checkmark. When all tasks are completed on the menu, return to the REFL. RESPONSE menu.

Port 2 Reflective Devices

When selected, displays the REFL. DEVICES PORT 2 menu where each button represents a completion task. When ready for the task, click the button, and the instrument performs the calibration. When the calibration task is successfully completed, the button is marked with a completion checkmark. When all tasks are completed on the menu, return to the REFL. RESPONSE menu.

Done

This button is unavailable until all calibration tasks have been successfully completed. When available, select the button to return to the CALIBRATION menu when the Cal Status is set to ON.

- [“CALIBRATION \[TR\] Menu” on page 9-5](#)

Abort Cal

Select aborts the current calibration and returns to the CALIBRATION menu.

- [“CALIBRATION \[TR\] Menu” on page 9-5](#)

Figure 9-42. REFL. RESPONSE Menu - Refl. Freq. Resp. Cal. - Typical Example (2 of 2)

REFLECTION FREQ. RESPONSE CAL SETUP (SOLT/R, COAXIAL) Dialog Box

Prerequisites

- Cal Method = SOLT/SOLR
- Line Type = Coaxial

Previous

- “REFL. RESPONSE Menu” on page 9-83
- “CAL SETUP Menu” on page 9-35

Navigation

- MAIN | Calibration | CALIBRATION [TR] | Calibrate | CALIBRATE | Manual Cal | MANUAL CAL | Reflection Freq Response | REFL. RESPONSE | Modify Cal Setup | CAL SETUP | Edit Cal Params | REFLECTION FREQ REPOSE CAL SETUP (SOLT/R, COAXIAL) Dialog Box

Reflection Freq. Response Cal Setup (SOLT/R, Coaxial)

Ref Impedance (Ω) 50.000

Test Port 1 (N-Conn(F))

Select Cal Component Open

Cal Kit (Connector) N-Conn(M)

Standard Info Load Cal Kit

Test Port 2 (N-Conn(F))

Select Cal Component Open

Cal Kit (Connector) N-Conn(M)

Standard Info Load Cal Kit

* At least one port must be selected.

OK Cancel

REFLECTION FREQUENCY RESPONSE CALIBRATION SETUP Dialog Box

Figure 9-43. REFL. FREQ. RESP. CAL SETUP (SOLT/R, COAXIAL) Dialog Box

Reference Impedance

The reference impedance is 50 Ohms. This field is read only.

Test Port Selection

Select any combination:

- Test Port 1
- Test Port 2
- Test Port 1 and Test Port 2

Test Port 1 Select Cal Component

Select either:

- Open
- Short

Test Port 1 Cal Kit (Connector)

Select the Test Port 1 Connector type from the pull down menu with options of:

- K-Conn (M)
- K-Conn (F)
- GPC-3.5 (M)
- GPC-3.5 (F)
- SMA (M)
- SMA (F)
- N-Conn (M)
- N-Conn (F)
- 2.4 mm (M)
- 2.4 mm (F)
- TNC (M)
- TNC (F)
- V-conn (M)
- V-conn (F)
- W1-conn (M)
- W1-conn (F)
- 7/16 (M)
- 7/16 (F)
- GPC-7
- N-conn(75) (M)
- N-conn(75) (F)
- user defined 1 through 8 (M or F)

Test Port 1 Connector Standard Info Button

Select displays the STANDARD INFO (SOLT/R) Dialog Box. Note that the name of this dialog changes depending on the selected Cal Method.

Load Cal Kit

Prompts the LOAD dialog box.

Test Port 2 Select Cal Component

Select either:

- Open
- Short

Test Port 2 Cal Kit (Connector)

Select the Test Port 2 Connector type from the pull down menu. The options are the same as those for Test Port 1 above.

Test Port 2 Connector Standard Info Button

Select displays the STANDARD INFO (SOLT/R) STANDARD LABEL (V-Conn M) Dialog Box. Note that the name of this dialog changes depending on the selected Cal Method and DUT Connector.

- Test Port 1 Connector Load Cal Kit Button Select displays the LOAD dialog box. The cal kit file can be loaded into memory from this menu.

Load Cal Kit

Prompts the LOAD dialog box.

Refl. Freq. Resp. Calibration Setup Dialog Box Summary

The table below summarizes the available fields and controls in other reflection frequency response calibration setup dialog boxes. To view each dialog box, set the CAL METHOD and LINE TYPE menus to the appropriate settings, and then select the Edit Cal Params button.

Table 9-5. Manual Calibration - Reflection Frequency Response Cal Setup (1 of 3)

Cal Method Line Type	Dialog Box Input Selections and Controls
SOLT/R Coaxial	<p>See the full description above “REFLECTION FREQ. RESPONSE CAL SETUP (SOLT/R, COAXIAL) Dialog Box” on page 9-85</p> <p>Reference Impedance (Ohms)</p> <p>Select Test Port: Port 1 and/or Port 2</p> <p>Test Port 1 and Test Port 2 controls are the same. Port must be selected to enable controls.</p> <p>Test Port Cal Component: Open, Short</p> <p>Test Port DUT Connector: For each selected test port, select one of the following connectors: W1-Conn (M), W1-Conn (F), V-Conn (M), V-Conn (F), K-Conn (M), K-Conn (F), 2.4 mm (M), 2.4 mm (F), GPC-3.5 (M), GPC-3.5 (F), SMA (M), SMA (F), N-Conn (M), N-Conn (F), N-Conn (75) (M), N-Conn (75) (F), GPC-7, 7/16 (M), 7/16 (F), TNC (M), TNC (F), User-Defined 1 (M) through User-Defined 8 (M), User-Defined 1 (F) through User-Defined 8 (F)</p> <p>Test Port Connector Standard Info Button: For each DUT port connector, displays the info dialog box for the selected connector.</p> <ul style="list-style-type: none"> • Typical “STANDARD INFO Dialog Box” on page 9-93\
SOLT/R Non-Dispersive	Same controls and functions as SOLT/R Coaxial above.
SOLT/R Waveguide	<p>Same controls and functions as SOLT/R Coaxial above with the following changes:</p> <p>Waveguide Kit: User-Defined 1 to User-Defined8</p> <p>Waveguide Info button: Displays USER DEFINED WAVEGUIDE dialog box.</p> <ul style="list-style-type: none"> • Typical “USER DEFINED WAVEGUIDE Dialog Box” on page 9-97
SOLT/R Microstrip	<p>Same controls and functions as SOLT/R Coaxial above with the following changes:</p> <p>Microstrip Kit: 10 Mil Kit, 15 Mil Kit, 25 Mil Kit, User-Defined 1 to User-Defined8</p> <p>Microstrip Info button: Displays appropriate information dialog box for selected microstrip kit.</p> <ul style="list-style-type: none"> • Typical “STANDARD INFO Dialog Box” on page 9-93
SSLT Coaxial	<p>Reference Impedance (Ohms)</p> <p>Select Test Port: Port 1 and/or Port 2</p> <p>Test Port 1 and Test Port 2 controls are the same. Port must be selected to enable controls.</p> <p>Test Port Cal Component: Offset Short 1, Offset Short 2</p> <p>Test Port DUT Connector: For each selected test port, select one of the following connectors: , W1-Conn (M), W1-Conn (F), User-Defined 1 (M) through User-Defined8 (M), User-Defined 1 (F) through User-Defined8 (F)</p> <p>Test Port Connector Standard Info Button: For each DUT port connector, displays the info dialog box for the selected connector.</p> <ul style="list-style-type: none"> • Typical “STANDARD INFO Dialog Box” on page 9-93

Table 9-5. Manual Calibration - Reflection Frequency Response Cal Setup (2 of 3)

Cal Method Line Type	Dialog Box Input Selections and Controls
SSLT Non-Dispersive	Same controls and functions as SSLT Coaxial above.
SSLT Waveguide	<p>See the full description above</p> <p>Same controls and functions as SSLT Coaxial above with the following changes:</p> <p>Waveguide Kit: WR10, WR12, WR15, User-Defined 1 to User-Defined8</p> <p>Waveguide Info button: Display the appropriate information dialog box for the selected waveguide.</p> <ul style="list-style-type: none"> • Typical “WAVEGUIDE INFO Dialog Box” on page 9-99
SSLT Microstrip	<p>Same controls and functions as SSLT Coaxial above with the following changes:</p> <p>Microstrip Kit: 10 Mil Kit, 15 Mil Kit, 25 Mil Kit, User-Defined 1 to User-Defined8</p> <p>Microstrip Info button: Displays appropriate information dialog box for the selected microstrip.</p> <ul style="list-style-type: none"> • Typical “STANDARD INFO Dialog Box” on page 9-93
SSST Coaxial	<p>Reference Impedance (Ohms)</p> <p>Select Test Port: Port 1 and/or Port 2</p> <p>Test Port 1 and Test Port 2 controls are the same. Port must be selected to enable controls.</p> <p>Test Port Cal Component: Offset Short 1, Offset Short 2, Offset Short 2</p> <p>Test Port DUT Connector: For each selected test port, select one of the following connectors: W1-Conn (M), W1-Conn (F), User-Defined 1 (M) through User-Defined8 (M), User-Defined 1 (F) through User-Defined8 (F)</p> <p>Test Port Connector Standard Info Button: For each DUT port connector, displays the appropriate information dialog box for the selected connector.</p> <ul style="list-style-type: none"> • Typical “STANDARD INFO Dialog Box” on page 9-93
SSST Non-Dispersive	Same controls and functions as SSST Coaxial above.
SSST Waveguide	<p>Same controls and functions as SSST Coaxial above with the following changes:</p> <p>Waveguide Kit: User-Defined 1 to User-Defined8</p> <p>Waveguide Info button: Display the appropriate information dialog box for the selected waveguide.</p>
SSST Microstrip	<p>Same controls and functions as SSST Coaxial above with the following changes:</p> <p>Microstrip Kit: 10 Mil Kit, 15 Mil Kit, 25 Mil Kit, User-Defined 1 to User-Defined8</p> <p>Microstrip Info button: Displays appropriate information dialog box for the selected microstrip.</p> <ul style="list-style-type: none"> • Typical “STANDARD INFO Dialog Box” on page 9-93

Table 9-5. Manual Calibration - Reflection Frequency Response Cal Setup (3 of 3)

Cal Method Line Type	Dialog Box Input Selections and Controls
LRL/LRM Coaxial	The LRL/LRM calibration method is not available for reflection frequency response calibrations.
LRL/LRM Non-Dispersive	
LRL/LRM Waveguide	
LRL/LRM Microstrip	

9-14 Manual Calibration General Dialog Boxes

The dialog boxes displayed below are representative of standard and user-defined dialog boxes associated with the calibration function. Most of these dialog boxes can be called from multiple locations.

- [“AIR EQUIVALENT LENGTH CONVERSION \(FROM PS TO MM\) Dialog Box” on page 9-92](#)
- [“STANDARD INFO Dialog Box” on page 9-93](#)
- [“THRU INFO Dialog Box” on page 9-94](#)
- [“USER DEFINED MATCH DEVICES Dialog Box - 2-Port VNAs” on page 9-95](#)

AIR EQUIVALENT LENGTH CONVERSION (FROM PS TO MM) Dialog Box

Use the AIR EQUIVALENT LENGTH calculator dialog box to speed configuration of a thru line by entering its length in picoseconds (ps) and its dielectric constant. The calculator returns the air equivalent length in millimeters (mm).

Previous

- The AIR EQUIVALENT LENGTH dialog box can be accessed from multiple locations.
- [“TWO PORT CAL SETUP \(SOLT/R, COAXIAL\) Dialog Box”](#) on page 9-43
- [“TWO PORT CAL SETUP \(LRL/LRM, COAXIAL\) Dialog Box - 2-Port VNA”](#) on page 9-46
- [“ONE-PORT CAL SETUP \(SOLT/R, COAXIAL\) Dialog Box”](#) on page 9-66

Navigation

- MAIN | Calibration | CALIBRATION [TR] | Calibrate | CALIBRATE | Manual Cal | MANUAL CAL | 2-Port Cal | TWO PORT CAL | Modify Cal Setup | CAL SETUP | Edit Cal Params | TWO PORT CAL SETUP dialog | Through/Reciprocal Length Calculator Icon | AIR EQUIVALENT LENGTH Dialog Box

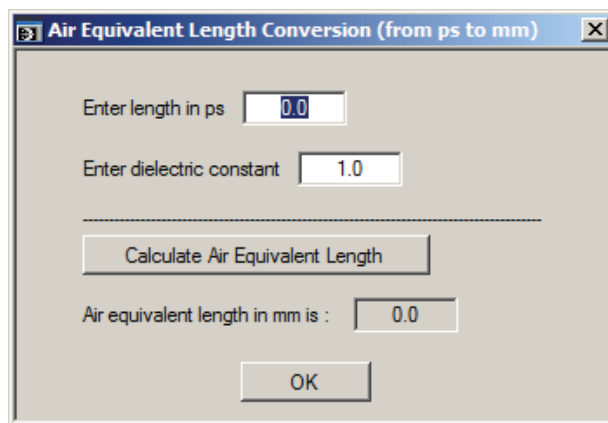

Figure 9-44. AIR EQUIVALENT LENGTH CONVERSION (FROM PS TO MM) Dialog Box

Using the Calculator

1. Use the Enter length in ps (picoseconds) to input a length.
 - For example, enter a value of 250 ps.
2. Use the Enter constant to change the dielectric constant as required.
 - For example, change the dielectric constant to 1.2.
3. Click the Calculate Air Equivalent Length button.
4. The required value appears in the Air Equivalent Length in mm field.
 - Using the examples above, an air equivalent length of 68.465319... appears in the field.
5. Click OK.
6. The Thru Info dialog box reappears with the calculated value in the Length (mm) field.
7. Using the examples above, the Length (mm) field displays 68.4653 mm.
 - [“THRU INFO Dialog Box”](#) on page 9-94
8. Click OK on the Thru Info dialog box.
9. The Modify AutoCal Setup dialog box reappears.

STANDARD INFO Dialog Box

The exact title and contents of the dialog box depend on the calibration method and connector types selected. This dialog box displays parametric information for the standard connector selected previously.

Prerequisites

- Line Type = Coaxial
- DUT Connector Type = N-Conn (M)

Previous

- The STANDARD INFO dialog box can be accessed from multiple locations.
- [“ONE-PORT CAL SETUP \(SOLT/R, COAXIAL\) Dialog Box”](#) on page 9-66
- [“TWO PORT CAL SETUP \(SOLT/R, COAXIAL\) Dialog Box”](#) on page 9-43

Navigation

- MAIN | Calibration | CALIBRATION [TR] | Calibrate | CALIBRATE | Manual Cal | MANUAL CAL | 2-Port Cal | TWO PORT CAL | Modify Cal Setup | CAL SETUP | Cal Method = SOLT/SOLR | Line Type = Coaxial | Edit Cal Params | TWO PORT CAL SETUP (SOLT/R, COAXIAL) | DUT Connector = N-Conn(M) | Standard Info button | STANDARD INFO (SOLT/R) Dialog Box

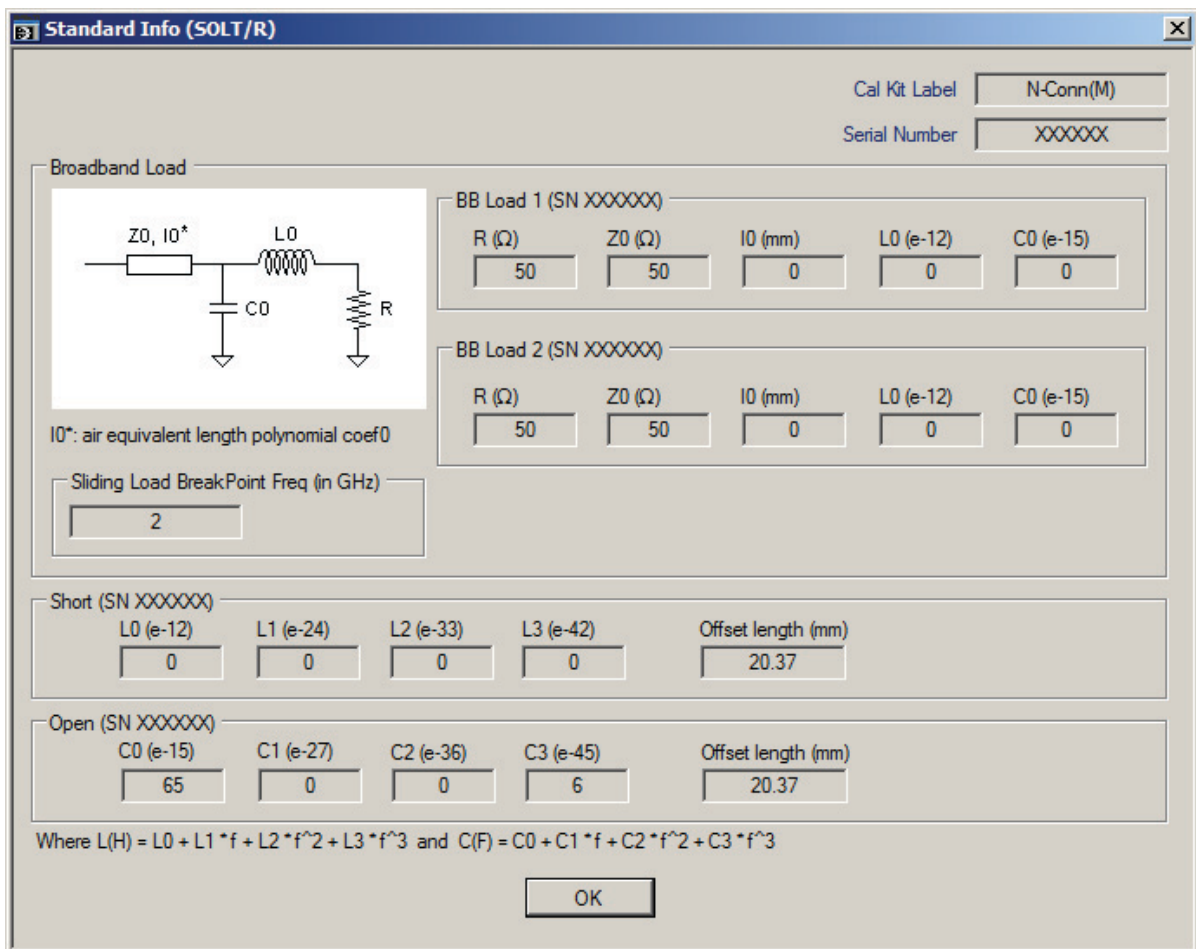

Figure 9-45. STANDARD INFO (SOLT/R) Dialog Box

The read-only dialog box provides the calibration parameters for the selected connector and calibration method.

THRU INFO Dialog Box

Use the THRU INFO dialog to update the thru information for most calibration types. The dialog includes access to the AIR EQUIVALENT LENGTH calculator function dialog box to speed configuration.

Previous

- The THRU INFO dialog box can be accessed from multiple locations.
- “MODIFY 2-PORT AUTOCAL SETUP Dialog Box” on page 9-46

Navigation

- MAIN | Calibration | CALIBRATION [TR] | Thru Update | THRU | Define Thru/Reciprocal | THRU INFO Dialog Box

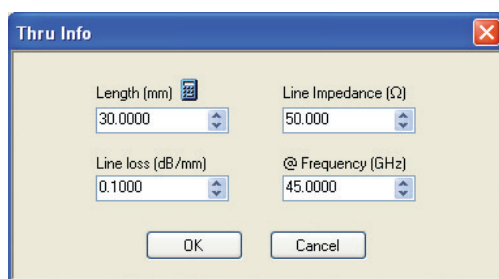

Figure 9-46. THRU INFO Dialog Box - AutoCal Two Port Calibration

Thru Information Parameters and Calculator

The Thru Info dialog box allows user input field for the thru connection parameters of:

- Length (mm). If needed, click the Calculator icon to display the Air Equivalent Length Conversion Calculator dialog box.
 - [“AIR EQUIVALENT LENGTH CONVERSION \(FROM PS TO MM\) Dialog Box”](#) on page 9-92
- Line Loss (dB/mm)
- Line Impedance (Ω or Ohms)
- @ Frequency (GHz)

USER DEFINED MATCH DEVICES Dialog Box - 2-Port VNAs

Prerequisites

- Calibration Method = LRL/LRM
- Line Type = Coaxial
- Band 1 Device 2 = Match

Previous

- The STANDARD INFO dialog box can be accessed from multiple locations.
- [“TWO PORT CAL SETUP \(LRL/LRM, COAXIAL\) Dialog Box - 2-Port VNA”](#) on page 9-46

Navigation

- MAIN | Calibration | CALIBRATION [TR] | Calibrate | CALIBRATE | Manual Cal | MANUAL CAL | 2-Port Cal | TWO PORT CAL | Modify Cal Setup | CAL SETUP | Cal Method = LRL\LRM | Edit Cal Params | TWO PORT CAL SETUP (LRL/LRM, COAXIAL) | Band 1 Device 2 = Match | Match button | USER DEFINED MATCH DEVICES Dialog Box

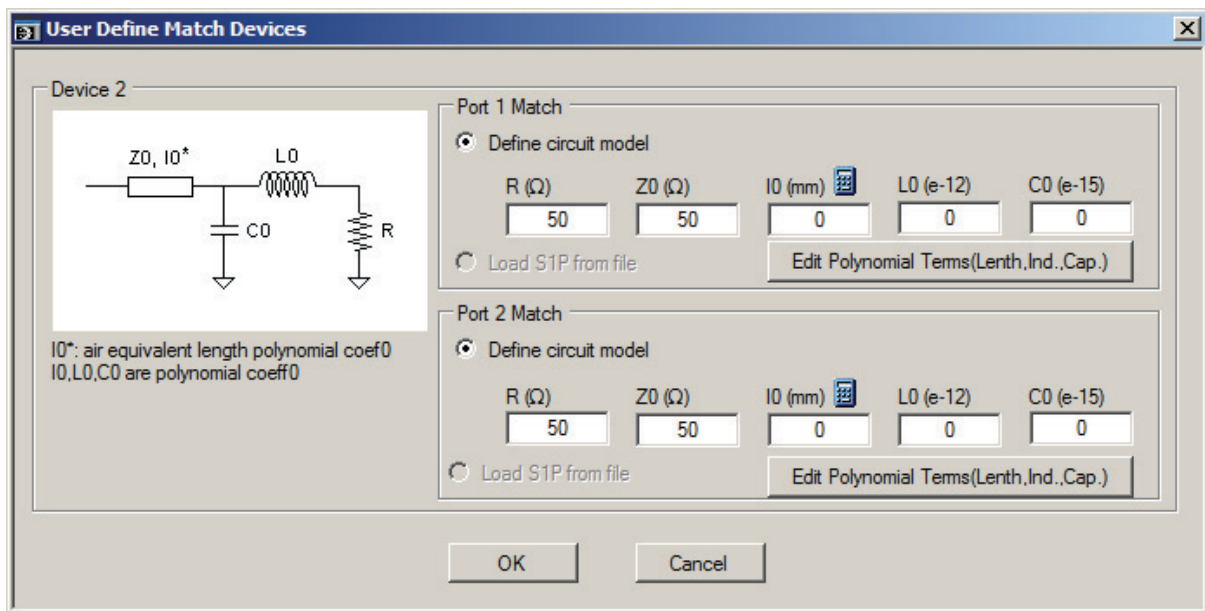

Figure 9-47. USER DEFINED MATCH DEVICES Dialog Box - 2-Port VNAs

Description

The dialog box allows the definition of a user-provided match device.

Port 1 Match

Define the Port 1 Match device by entering the following parameters:

- R (Ohms)
- Z0 (Ohms)
- IO (mm)
 - If required, a link is available to the AIR EQUIVALENT LENGTH dialog box.
 - [“AIR EQUIVALENT LENGTH CONVERSION \(FROM PS TO MM\) Dialog Box”](#) on page 9-92
- L0 (e-12)
- C0(e-15)
- Provides the calibration parameters for the selected connector and calibration method.

- Edit Polynomial Terms (Length, Ind., Cap) button opens a window for editing the polynomial terms.

Port 2 Match

The Port 2 Match parameters and controls are the same as the Port 1 Match.

USER DEFINED WAVEGUIDE Dialog Box

This dialog box displays parametric information for a user-defined waveguide. For the equivalent dialog box for a standard waveguide kit, see “[WAVEGUIDE INFO Dialog Box](#)” on page 9-99.

Prerequisites

- Line Type = Waveguide
- DUT Connector Type = User-Defined1 to User-Defined8

Previous

- Item 1 shows TWO PORT CAL SETUP (SSLT, WAVEGUIDE) Dialog Box
- Item 2 in figure is the User Defined Waveguide dialog box titled WAVEGUIDE INFO, which is invoked by the Waveguide Info button in the TWO PORT CAL SETUP dialog box.

Navigation

- MAIN | Calibration | CALIBRATION [TR] | Calibrate | CALIBRATE | Manual Cal | MANUAL CAL | 2-Port Cal | TWO PORT CAL | Modify Cal Setup | CAL SETUP | Cal Method = SSLT | Line Type = Waveguide | Edit Cal Params | TWO PORT CAL SETUP (SSLT, WAVEGUIDE) | Waveguide Kit = User-Defined 1 | Waveguide Info button | USER DEFINED WAVEGUIDE Dialog Box

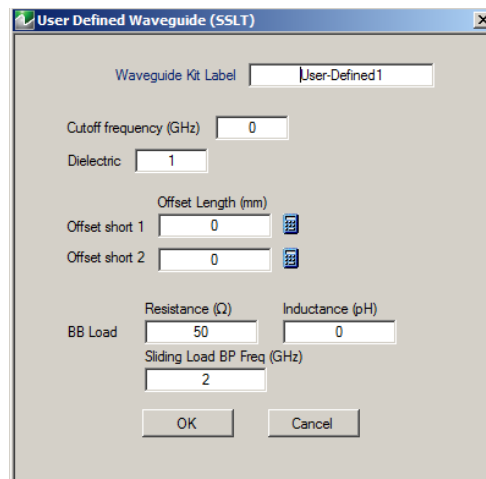

Figure 9-48. USER DEFINED WAVEGUIDE Dialog Box

Description

The USER DEFINED WAVEGUIDE dialog box allows the input of the calibration parameters for a user-defined device.

Standard Label

Either leave as the pre-defined label or input a new label for the device.

Cutoff Frequency and Dielectric

- Cutoff frequency (GHz)
- Dielectric value

Broadband Load Definition

Define the broadband load with the following parameters:

- Resistance (Ohms)
- Inductance (pH)

- Sliding Load Break Point Frequency (GHz)

Short Definition

- Offset length (mm)
 - If required, a link is available to the AIR EQUIVALENT LENGTH dialog box.
 - [“AIR EQUIVALENT LENGTH CONVERSION \(FROM PS TO MM\) Dialog Box”](#) on page 9-92

Open Circuit Model

Define the Open Circuit Model with the following parameters:

- C0 (e-15)
- C1 (e-27)
- C2 (e-36)
- C3 (e-45)
- Offset length (mm)
 - If required, a link is available to the AIR EQUIVALENT LENGTH dialog box.
 - [“AIR EQUIVALENT LENGTH CONVERSION \(FROM PS TO MM\) Dialog Box”](#) on page 9-92

WAVEGUIDE INFO Dialog Box

This read-only dialog box displays parametric information for a standard waveguide kit. For the equivalent dialog box for a user-defined waveguide, see [“USER DEFINED WAVEGUIDE Dialog Box”](#) on page 9-97.

Prerequisites

- Line Type = Waveguide
- DUT Connector Type = User-Defined1 to User-Defined8

Previous

- The WAVEGUIDE INFO dialog box can be accessed from multiple locations when Line Type is set to Waveguide.
- TWO PORT CAL SETUP (SSLT, WAVEGUIDE) Dialog Box

Navigation

- MAIN | Calibration | CALIBRATION [TR] | Calibrate | CALIBRATE | Manual Cal | MANUAL CAL | 2-Port Cal | TWO PORT CAL | Modify Cal Setup | CAL SETUP | Cal Method = SSLT | Line Type = Waveguide | Edit Cal Params | TWO PORT CAL SETUP (SSLT, WAVEGUIDE) | Waveguide Kit = WR10, WR12, or WR15 | Waveguide Info button | WAVEGUIDE Dialog Box

The screenshot shows a dialog box titled "Waveguide Info (SSLT)". It contains the following fields and values:

- Waveguide Kit Label: WR10
- Serial Number: XXXXXX
- Cutoff frequency (GHz): 59.0143
- Dielectric: 1
- Offset Length (mm): 2.537
- Offset short 1: 3.612
- Offset short 2: 3.612
- Resistance (Ω): 50
- Inductance (pH): 0
- Sliding Load BP Freq (GHz): 2

An "OK" button is located at the bottom center of the dialog box.

Figure 9-49. WAVEGUIDE INFO Dialog Box

Description

The read-only WAVEGUIDE INFO dialog box provides the calibration parameters for the WR10, WR12, and WR15 waveguide kits.

Instructions

The parameters are:

- Waveguide Kit Label
- Cutoff Frequency (GHz)
- Dielectric value
- Cutoff frequency (GHz)
- Offset short 1 length (mm)
- Offset short 2 length (mm)
- Broadband Load Resistance (Ohms)
- Broadband Load Inductance (pH)
- Sliding Load Break Point Frequency (GHz)

Chapter 10 — Calibration Menus: 4-Port VNAs

10-1 Chapter Overview

This chapter describes the menus used when calibrating 4-Port ShockLine™ VNAs. Chapter organization follows the flows in the progressions of menus and dialog boxes for calibration control. Representative examples of dialogs are shown. Dialog appearance changes dynamically depending on based on the combination of instrument calibration ports, AutoCal, manual calibration, calibration methods, line types, and connectors.

10-2 Listing of Calibration Menus (4-Port VNA)

This section covers all calibration menu types for a 4-port VNA, including

- 1-port, 2-port, 3-port, and 4-port
- Auto Cal and Manual cal
- Calibration utilities and support menus

These links connect to the calibration menus organized by function and type of calibration:

Primary Calibration Menus

- [“CALIBRATION \[TR\] Menu - 4-Port VNAs” on page 10-5](#)
- [“CALIBRATE Menu - 4-Port VNAs” on page 10-6](#)
- [“THRU UPDATE Menu - 4-Port VNAs” on page 10-8](#)

Calibration Utility Functions

The calibration utility function and management menus and dialog boxes are:

- [“CAL OPTIONS Menu - 4-Port VNAs” on page 10-11](#)
 - [“MANUAL ADAPTER REMOVAL Dialog Box - 4-Port VNAs” on page 10-12](#)
- [“CAL KIT \(and AutoCal Kit\) Menu - 4-Port VNAs” on page 10-14](#)
 - [“SAVE \(Cal Kit\) Dialog Box - 4-Port VNAs” on page 10-16](#)
 - [“CAL KIT INFO Dialog Box - 4-Port VNAs” on page 10-18](#)
 - [“RESTORE DEFAULT COEF. Dialog Box - 4-Port VNAs” on page 10-20](#)

AutoCal Setup Menu

The main AutoCal setup menu is:

- [“AutoCal Port Selection Setup - 4-Port VNAs” on page 10-22](#)

AutoCal 4-Port Calibration on 4-Port VNA

- [“AutoCal Port Selection Setup - 4-Port VNAs” on page 10-22](#)
 - [“MODIFY 4-PORT AUTOCAL SETUP Dialog Box” on page 10-24](#)

AutoCal 2-Port Calibration on 4-Port VNA

- [“SMARTCAL SETUP Menu - 2-Port Cal - 4-Port VNAs” on page 10-28](#)

- “MODIFY 2-PORT AUTOCAL SETUP Dialog Box - 4-Port VNAs” on page 10-30

AutoCal 1-Port Calibration on 4-Port VNA

- “AUTOCAL SETUP Menu - 1-Port Cal - 4-Port VNAs” on page 10-36
- “MODIFY 1-PORT AUTOCAL SETUP Dialog Box - 4-Port VNAs” on page 10-37

Manual Calibration Configuration on 4-Port VNA

Basic method: Once a calibration type is selected in the MANUAL CALIBRATION menus, the following menus are used to set up the calibration method and line type. The settings in these menus define which dialog boxes will be available and the procedural menus that will appear for the specified calibration parameters:

- “MANUAL CAL Menu - 4-Port VNAs” on page 10-42
- “CAL SETUP Menu - 4-Port VNAs” on page 10-43
- “CAL METHOD Menu - 4-Port VNA” on page 10-45
- “LINE TYPE Menu - 4-Port VNA” on page 10-46

Manual 4-Port Calibration on 4-Port VNA

- “FOUR PORT CAL Menu - 4-Port VNAs” on page 10-47
 - “FULL FOUR PORT CAL SETUP (SOLT/R, COAXIAL) Dialog Box” on page 10-51
 - “FULL FOUR PORT CAL SETUP (SSLT, COAXIAL) Dialog Box” on page 10-54
 - “FULL FOUR PORT CAL SETUP (SSST, COAXIAL) Dialog Box” on page 10-58
 - “FULL FOUR PORT CAL SETUP (SSST, WAVEGUIDE) Dialog Box” on page 10-60
 - “FULL FOUR PORT CAL SETUP (LRL/LRM, COAXIAL) Dialog Box” on page 10-62
 - “THRU Menu - 4-Port VNAs” on page 10-74
 - Summary Table:
 - Table 10-2, “Manual 4-Port Cal Setup Dialog Box Summary” on page 10-66

Manual 3-Port Calibration on 4-Port VNA

- “THREE PORT CAL Menu - 4-Port VNAs” on page 10-78
 - “THREE PORT CAL SETUP (SOLT/R, COAXIAL) Dialog Box” on page 10-85
 - “THREE PORT CAL SETUP (SSLT, MICROSTRIP) Dialog Box” on page 10-81
 - “THREE PORT CAL SETUP (SSST, COAXIAL) Dialog Box” on page 10-83
 - “THREE PORT CAL SETUP (LRL/LRM, COAXIAL) Dialog Box” on page 10-88
 - Summary Table:
 - Table 10-3, “Manual Calibration - 3-Port Calibration Setup Dialog Box Contents - 4-Port VNAs” on page 10-92

Manual 2-Port Calibration on 4-Port VNA

- “TWO PORT CAL Menu - 4-Port VNAs” on page 10-97
 - “TWO PORT CAL SETUP (SOLT/R, COAXIAL) Dialog Box” on page 10-99
 - “TWO PORT CAL SETUP (SOLT/SOLR, MICROSTRIP) Dialog Box” on page 10-102
 - “TWO PORT CAL SETUP (LRL/LRM, MICROSTRIP) Dialog Box” on page 10-105
 - Summary Table:
 - Table 10-4, “Manual Calibration - 2-Port Calibration Setup Dialog Box Contents - 4-Port VNAs” on page 10-109

Manual 1-Port Calibration on 4-Port VNA

- “ONE PORT CAL/S Menu - 4-Port VNAs” on page 10-114
 - “ONE PORT CAL SETUP (SOLT/R, COAXIAL) Dialog Box” on page 10-115
 - “ONE PORT CAL SETUP (SSST, COAXIAL) Dialog Box” on page 10-120
 - “ONE PORT CAL SETUP (SSLT, WAVEGUIDE) Dialog Box” on page 10-122
- Summary Table:
 - Table 10-5, “Manual Calibration - 1-Port Calibration Setup Dialog Box Contents - 4-Port VNAs” on page 10-124

Manual Transmission Frequency Response on 4-Port VNA

- “TRANS. RESPONSE Menu - 4-Port VNAs” on page 10-127
 - “TRANSMISSION FREQ. RESPONSE CAL SETUP (SOLT/SOLR, COAXIAL) Dialog Box” on page 10-129
 - “TRANS. FREQ. RESP. CAL SETUP (SSLT, WAVEGUIDE) Dialog Box” on page 10-131
 - “TRANS. FREQ. RESP. CAL SETUP (SSST, MICROSTRIP) Dialog Box” on page 10-133
- Summary Table: “Trans. Freq. Resp. Manual Cal Setup Dialog Box Contents - 4-Port VNAs” on page 10-135

Manual Reflection Frequency Response Calibration on 4-Port VNA

- “REFL. RESPONSE Menu - 4-Port VNAs” on page 10-136
 - “REFLECTION FREQ. RESPONSE CAL SETUP (SOLT/R, COAXIAL) Dialog Box” on page 10-138
 - “REFL. FREQ. RESP. CAL SETUP (SSLT, MICROSTRIP) Dialog Box” on page 10-140
 - “REFL. FREQ. RESP. CAL SETUP (SSST, WAVEGUIDE) Dialog Box” on page 10-142
- Summary Table:
 - Table 10-7, “Refl. Freq. Resp. Manual Cal. Setup Dialog Box Contents - 4-Port VNAs” on page 10-144

Manual Calibration General Dialog Boxes on 4-Port VNA

These dialog boxes are representative of those that can be linked to from multiple locations. Not all possible dialog boxes are shown:

- “AIR EQUIVALENT LENGTH Calculator Dialog Box” on page 10-146
- “MICROSTRIP KIT INFO and USER DEFINED MICROSTRIP Dialog Boxes” on page 10-147
- “STANDARD INFO (OFFSET SHORT) W1-Connector (F) Dialog Box” on page 10-148
- “THRU INFO Dialog Box - 4-Port VNAs” on page 10-154
- “USER DEFINED MATCH DEVICES Dialog Box - LRL/LRM” on page 10-155
- “WAVEGUIDE INFO and USER DEFINED WAVEGUIDE Dialog Boxes” on page 10-156

10-3 Primary Menus for 4-Port VNA Calibration

The menus shown below provide access to all 4-Port VNA calibration functions. From the AUTOCAL menu (below at #6), additional menus and dialog boxes provide configuration and setup for the 4-Port, 2-Port, and 1-Port AutoCal calibration procedures. From the MANUAL CAL menu (below at #7), additional menus and dialog boxes provide configuration and setup for the manual calibration 4-Port, 3-Port, 2-Port, 1-Port, Transmission Frequency Response, and Reflection Frequency Response procedures

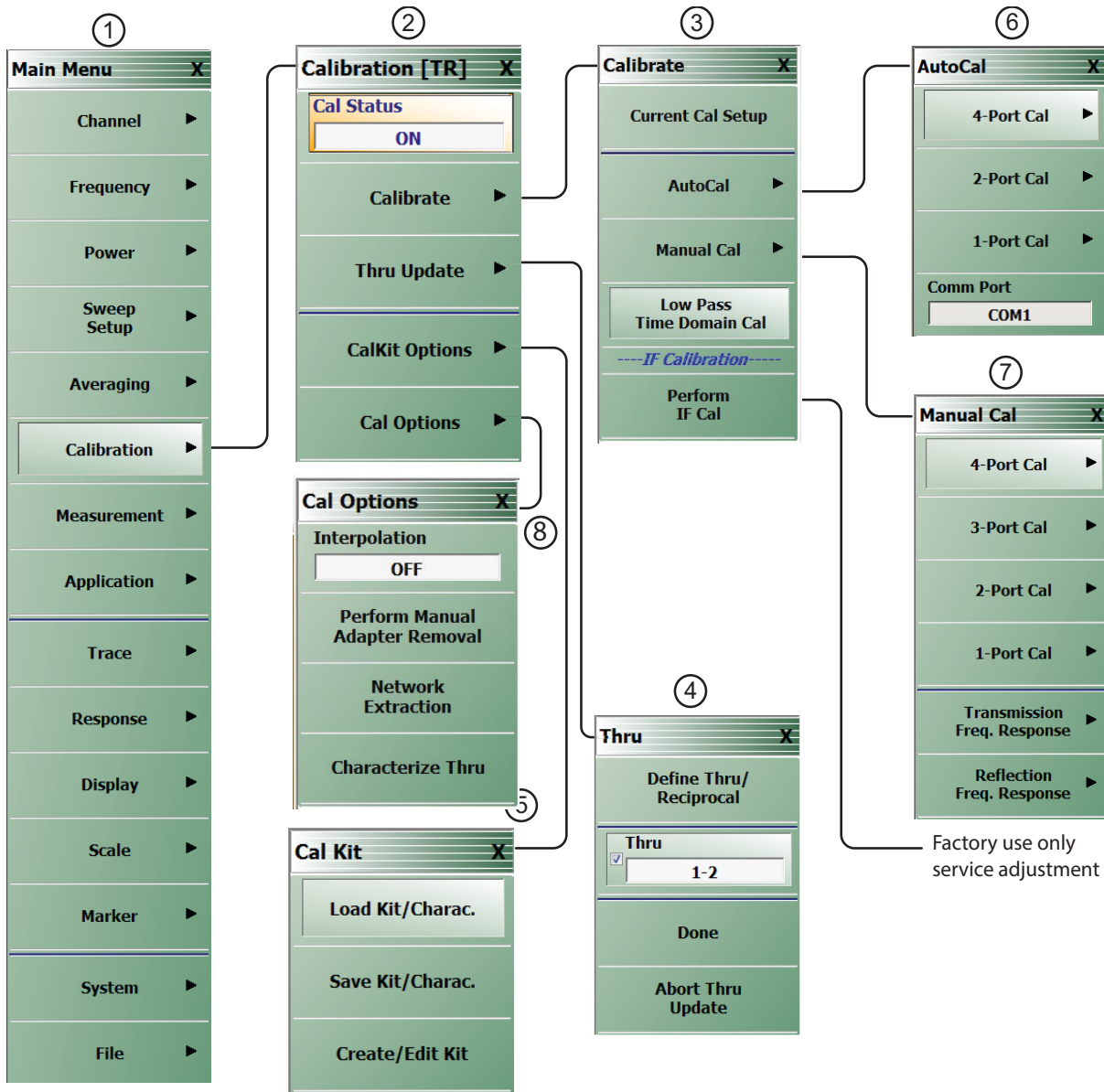

- | | |
|---|---------------------|
| 1. MAIN MENU | 5. CAL KIT Menu |
| 2. CALIBRATION [TR] Menu | 6. AUTOCAL Menu |
| 3. CALIBRATE Menu | 7. MANUAL CAL Menu |
| 4. THRU Menu (available only if a valid calibration has been completed) | 8. CAL OPTIONS Menu |

Figure 10-1. Primary Menus for 4-Port VNA Calibration

CALIBRATION [TR] Menu - 4-Port VNAs

The CALIBRATION [TR] menu provides options to configure and run calibration routines, to configure cal kit characterization files, and to enable /disable interpolation.

Full Name

- CALIBRATION [TRANSMISSION-RESPONSE] Menu

The name of the CALIBRATION menu is appended with [TR] for transmission/reflection operational mode.

Prerequisites

- The VNA is in 4-Port mode.
- The VNA is equipped with a Multiport Test Set.
- Availability of the Thru Update button on the CALIBRATION [TR] menu requires successful completion of a full 4-Port, 3-Port, 2-Port, or 1 Path-2 Port calibration.

Previous

- [“Main Menu” on page 2-2](#)

Navigation

- MAIN | Calibration | CALIBRATION

	<p>Cal Status</p> <p>Select toggles display of calibration status between OFF and ON based on the last calibration run. If ON, the Status bar at the bottom of the display area shows a status of CORR in green.</p> <p>Availability of the Cal Status button results from selecting the Done button following completion of Thru calibrations on the THRU UPDATE menu. If the calibrations have not been performed, the Cal Status button is unavailable.</p> <p>Calibrate</p> <p>Select displays the CALIBRATE menu to begin the manual calibration process. Options on sub-menus allow for selection of automatic or manual calibration, calibration type, calibration method, line type and other calibration parameters.</p> <ul style="list-style-type: none"> • “CALIBRATE Menu - 4-Port VNAs” on page 10-6 <p>Thru Update</p> <p>Select displays the THRU UPDATE menu to perform Thru calibrations.</p> <ul style="list-style-type: none"> • “THRU UPDATE Menu - 4-Port VNAs” on page 10-8 <p>Cal Kit Options</p> <p>Select displays the CAL KIT menu to save, load, and recall characterization files for manual calibration kits.</p> <ul style="list-style-type: none"> • “CAL KIT (and AutoCal Kit) Menu - 4-Port VNAs” on page 10-14 <p>Cal Options</p> <p>Select displays the CAL OPTIONS menu to add interpolated measurement points and perform manual adapter removal after calibration completion.</p> <ul style="list-style-type: none"> • “CAL OPTIONS Menu - 4-Port VNAs” on page 10-11
--	---

Figure 10-2. CALIBRATION Menu - 4-Port VNAs

CALIBRATE Menu - 4-Port VNAs

The CALIBRATE menu initiates the manual calibration process with the selection of calibration parameters, calibration types, calibration methods, line types, and test port connectors.

Previous

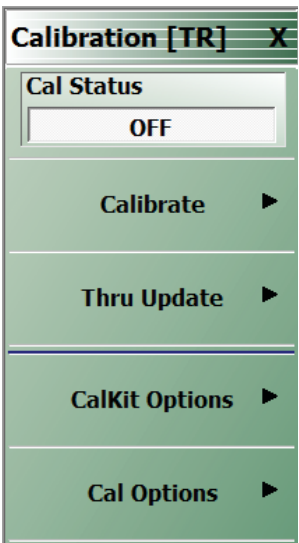
- [“MANUAL CAL Menu - 4-Port VNAs” on page 10-42](#)

Navigation

- MAIN | Calibration | CALIBRATION [TR] | Calibrate | CALIBRATE

	<p>Current Cal Setup Restores the setup parameters from the last successful calibration procedure, whether an AutoCal or manual calibration. All menu and dialog box settings are returned to their prior settings and the operator can proceed with the calibration procedure as soon as the necessary external device connections are complete.</p> <p>AutoCal Select displays the AutoCal menu.</p> <ul style="list-style-type: none"> • “AutoCal Port Selection Setup - 4-Port VNAs” on page 10-22 <p>Manual Cal Select displays the Manual Cal menu.</p> <ul style="list-style-type: none"> • “MANUAL CAL Menu - 4-Port VNAs” on page 10-42 <p>----IF Calibration----</p> <p>Perform IF Cal Select displays the IF CALIBRATION dialog box.</p>
--	---

Figure 10-3. CALIBRATE Menu - 4-Port VNAs

IF CALIBRATION Dialog Box

Previous

- [“CALIBRATE Menu - 4-Port VNAs”](#)

Navigation

- MAIN | Calibration | CALIBRATION [TR] | Calibrate | CALIBRATE | Perform IF Cal | IF CALIBRATION dialog box

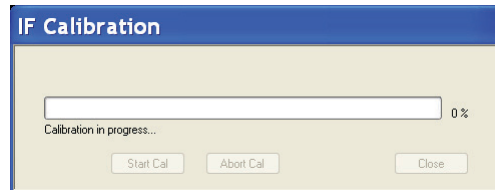

Figure 10-4. IF CALIBRATION Dialog Box

Instructions

Click **Start Cal** button to begin calibration; click **Abort Cal** to cancel calibration; click **Close** to exit the dialog box.

THRU UPDATE Menu - 4-Port VNAs

The THRU UPDATE menu provides completion buttons for Thru calibrations. When a Thru calibration is complete, the button displays a completion checkmark.

Prerequisites

- To enable the Thru Update button on the MANUAL CALIBRATION menu, a Full 4-Port, Full 3-Port, Full 2-Port, or a 1 Path-2 Port calibration must first be successfully completed .

Previous

- “MANUAL CAL Menu - 4-Port VNAs” on page 10-42

Navigation

- MAIN | Calibration | CALIBRATION [TR] | Thru Update | THRU UPDATE

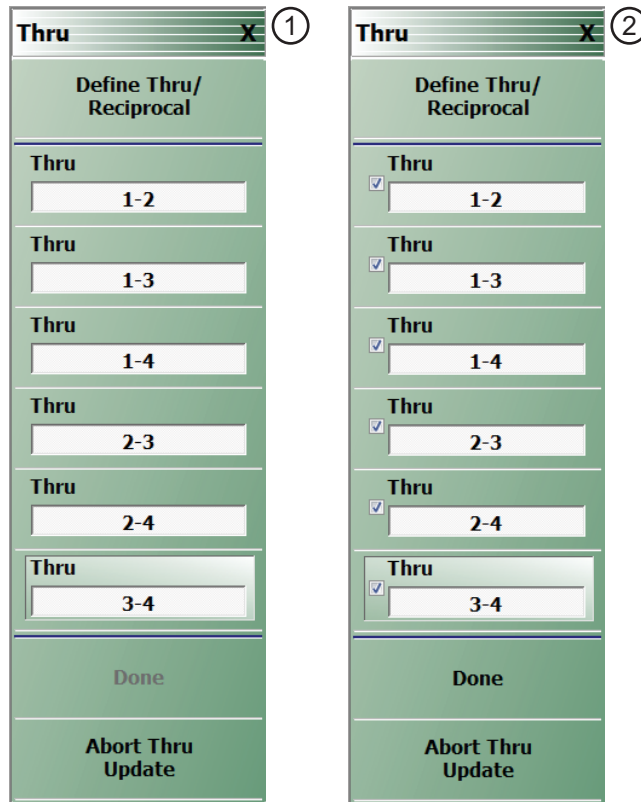

1. Initial display of THRU UPDATE calibration menu with Done button unavailable.	2. All THRU calibrations completed with Done button available.
--	--

Figure 10-5. THRU UPDATE Calibration Menu – 4-Port VNAs

Define Thru/Reciprocal

Displays the THRU INFO dialog box where the through parameters can be changed.

- “THRU INFO Dialog Box - 4-Port VNAs” on page 10-154

Thru

Select to calibrate Thru connection. The number of Thru connection buttons displayed on the menu corresponds to the number of ports selected during setup. A 4-Port calibration requires calibrating all possible thru connections (1-2, 1-3, 1-4, 2-3, 2-4, and 3-4) as illustrated in [Figure 10-5](#).

Done

Select when all Thru calibrations are completed. Select returns to the CALIBRATION menu, activating the Cal Status button.

- [“CALIBRATION \[TR\] Menu - 4-Port VNAs” on page 10-5](#)

Abort Thru Update

Abort Thru Update stops the current calibration procedure and returns to the CALIBRATION menu.

- [“CALIBRATION \[TR\] Menu - 4-Port VNAs” on page 10-5](#)

10-4 Calibration Utility Functions

The calibration utility functions and management menus and dialog boxes are:

- “CAL OPTIONS Menu - 4-Port VNAs” on page 10-11
 - “MANUAL ADAPTER REMOVAL Dialog Box - 4-Port VNAs” on page 10-12
- “CAL KIT (and AutoCal Kit) Menu - 4-Port VNAs” on page 10-14
 - “LOAD (Cal Kit) Dialog Box - 4-Port VNAs” on page 10-15
 - “SAVE (Cal Kit) Dialog Box - 4-Port VNAs” on page 10-16
 - CREATE/EDIT KIT: “CAL KIT INFO Dialog Box - 4-Port VNAs” on page 10-18
 - “RESTORE DEFAULT COEF. Dialog Box - 4-Port VNAs” on page 10-20

CAL OPTIONS Menu - 4-Port VNAs

The CAL OPTIONS menu provides control for use of interpolation and procedure for manual adapter removal.

Previous

- [“CALIBRATION \[TR\] Menu - 4-Port VNAs” on page 10-5](#)

Navigation

- MAIN | Calibration | CALIBRATION [TR] | Cal Options | CAL OPTIONS

	<p>Interpolation</p> <p>Select toggles interpolation OFF and ON with a default OFF state.</p> <p>Interpolation allows additional interpolated measurement points between calibrated measurement points. This is useful if the user wants to zoom into a specific area without having to recalibrate the instrument. The interpolated points must lie within the calibration frequency points.</p> <p>Perform Manual Adapter Removal</p> <p>Select displays the MANUAL ADAPTER REMOVAL dialog box.</p> <p>Adapter removal permits accurate measurement of non-insertable devices using an adapter of known electrical length and two full 12-term calibrations. Manual adapter removal extracts the behavior of the adapter from the setup after a successful calibration.</p> <ul style="list-style-type: none"> • “MANUAL ADAPTER REMOVAL Dialog Box - 4-Port VNAs” on page 10-12 <p>Characterize Thru</p> <p>Select displays the THRU CHARACTERIZATION dialog box.</p> <p>The THRU CHARACTERIZATION dialog box provides a process to characterize an unknown Thru standard. Two 1-port calibrations are performed, one at the VNA port and one at the end of the unknown Thru. A network extraction is performed to create an s2p file characterizing the unknown thru. This s2p file can then be used in an SOLT calibration.</p> <ul style="list-style-type: none"> • “THRU CHARACTERIZATION Dialog Box” on page 9-20 <p>Network Extraction</p> <p>Use network extraction to generate an S-Parameter (.s2p) file for a set of networks. The file can be embedded or de-embedded as required. Select displays the NETWORK EXTRACTION dialog box.</p>
---	---

Figure 10-6. CAL OPTIONS (CALIBRATION OPTIONS) Menu

MANUAL ADAPTER REMOVAL Dialog Box - 4-Port VNAs

The MANUAL ADAPTER REMOVAL dialog box provides a process to extract the electrical behavior of an adapter after completion of a calibration procedure using different connectors at each end that are incompatible with the DUT configuration.

Previous

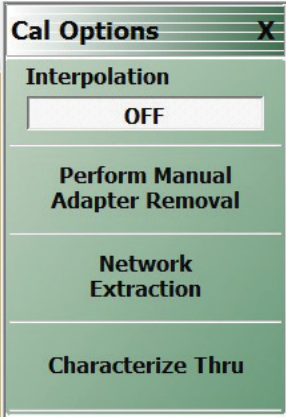
- [“CAL OPTIONS Menu - 4-Port VNAs” on page 10-11](#)

Navigation

- MAIN | Calibration | CALIBRATION [TR] | Cal Options | CAL OPTIONS | Perform Manual Adapter Removal | MANUAL ADAPTER REMOVAL Dialog Box

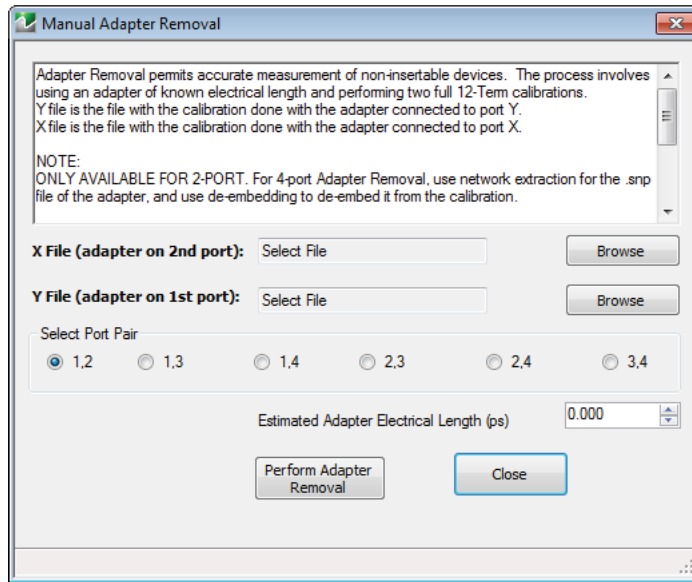

Figure 10-7. MANUAL ADAPTER REMOVAL Dialog Box

Instructions

Adapter removal permits accurate measurement of non-insertable devices. The process involves using an adapter of known electrical length and performing two full 12-term calibrations. In the procedure below:

- The Y file is the file with the calibration when the adapter connected to Port 1.
- The X file is the file with the calibration when the adapter connected to Port 2.

Note ONLY AVAILABLE FOR 2-PORT. For 4-port Adapter Removal, use network extraction for the SNP file of the adapter, and use de-embedding to de-embed it from the calibration.

Procedure

Select the port pair to be used from the following port combinations: 1,2; 1,3; 1,4; 2,3; 2,4; or 3,4.

1. Connect the adapter to Port X where X signifies any port. Perform a full 12-term calibration using Y' and Y as the test ports and store calibration to disk.
2. Connect the adapter to Port Y where Y signifies any port that is not X. Perform a full 12-term calibration using X and X' as the test ports and store calibration to disk.
3. Call up the X and Y files.
4. Input the estimated adapter electrical length in picoseconds (ps).
5. Select Perform Adapter Removal to remove adapter.

Network Extraction

Use network extraction to generate an S-Parameter (.s2p) file for a set of networks. The file can be embedded or de-embedded as required. Select displays the NETWORK EXTRACTION dialog box.

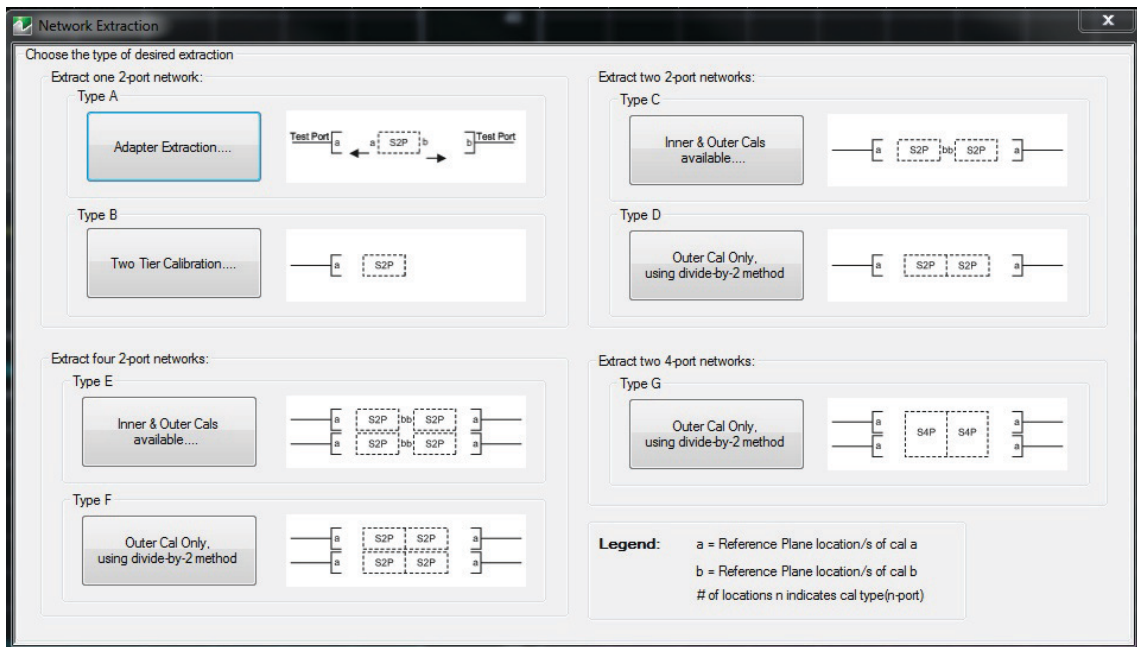

Figure 10-8. Network Extraction Menu

CAL KIT (and AutoCal Kit) Menu - 4-Port VNAs

Use the CAL KIT menu to install, save, and restore calibration kit characterization files between an external memory device, the instrument firmware, and a hard drive on the instrument or on a network. This menu is also used for working with AutoCal kit characterization files.

Full Name

- FULL MANUAL CALIBRATION KIT / AUTOMATIC CALIBRATOR (AUTOCAL) Menu

Previous

- [“CALIBRATION \[TR\] Menu - 4-Port VNAs” on page 10-5](#)

Navigation

- MAIN | Calibration | CALIBRATION [TR] | Cal Kit Options | CAL KIT

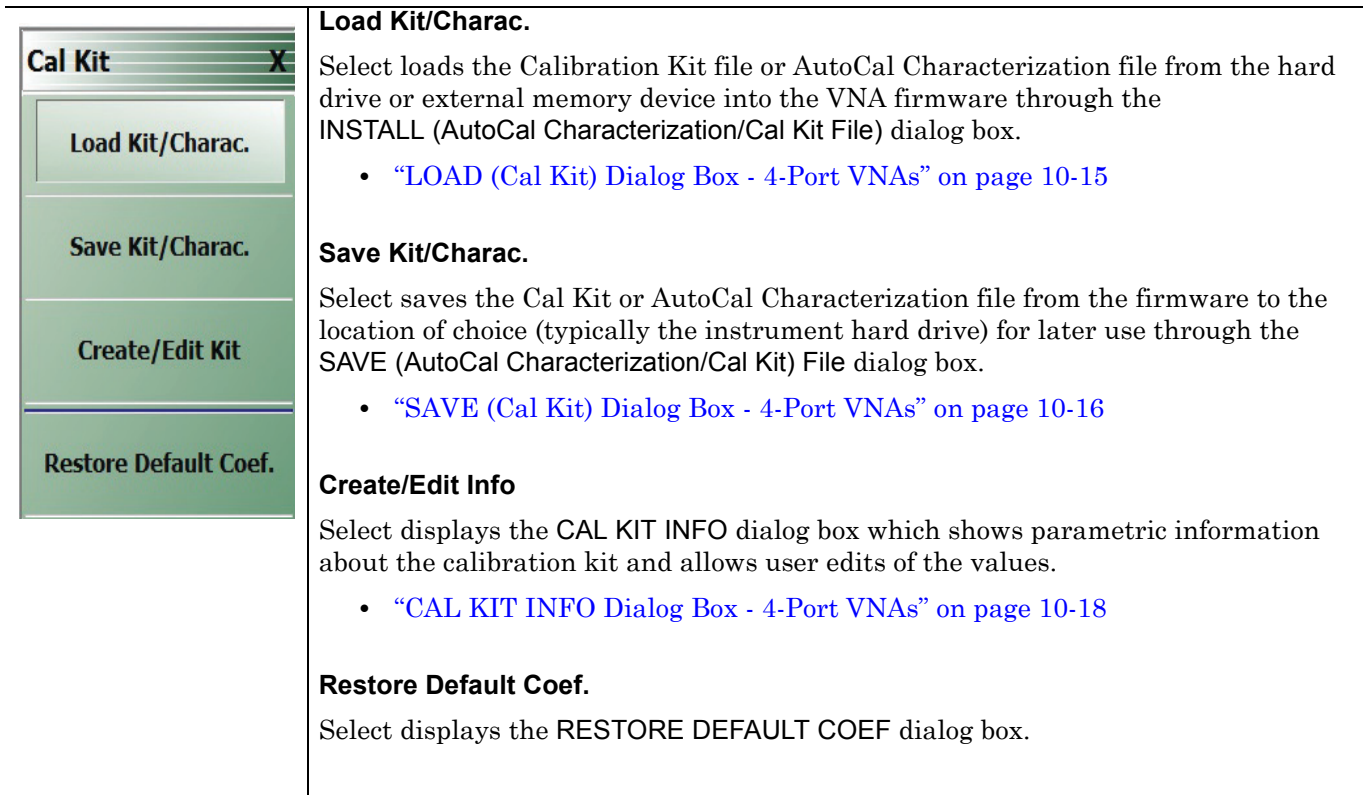

Figure 10-9. CAL KIT/AUTOCAL Menu - 4-Port VNAs

LOAD (Cal Kit) Dialog Box - 4-Port VNAs

The LOAD (Cal Kit) dialog box is used to install a calibration kit coefficients file in the instrument firmware for subsequent use. A recommended best practice is to keep the cal kit serial number as part of the file name.

Full Name

- LOAD (CAL KIT PARAMETERS FILES) Dialog Box

Previous

- [“CAL KIT \(and AutoCal Kit\) Menu - 4-Port VNAs” on page 10-14](#)

Navigation

- MAIN | Calibration | CALIBRATION [TR] | Cal Kit Options | CAL KIT | Load Kit/Charac. | LOAD (Cal Kit) Dialog Box

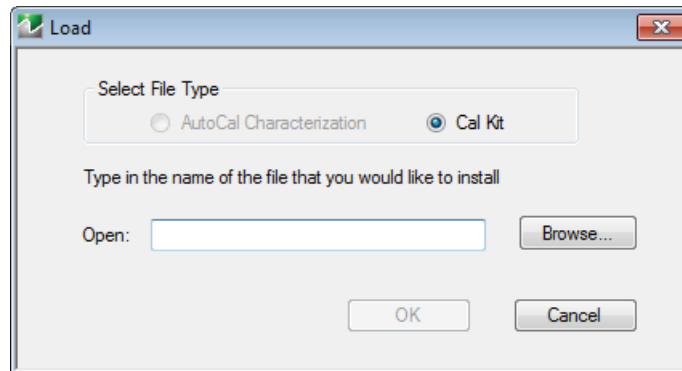

Figure 10-10. LOAD (Cal Kit) Dialog Box

Instructions

1. Cal Kit is the default selection under Select File Type.
2. Enter a file name in the Open field, or click Browse to navigate manually to the appropriate CalKit Coefficient.ccf file.
3. Click Open to load the file or Cancel to return to the menu.

SAVE (Cal Kit) Dialog Box - 4-Port VNAs

The SAVE (Cal Kit) dialog is used to save CalKitCoefficient Files from the VNA firmware to other locations such as the instrument hard drive, a network drive, or an external memory device, allowing storage of multiple files from available cal kits.

An alternate method is to a Windows program such as File Manager to copy files from the supplied USB flash drive to the recommended internal hard drive location C:\AnritsuVNA\Data.

Previous

- [“CAL KIT \(and AutoCal Kit\) Menu - 4-Port VNAs” on page 10-14](#)

Navigation

- MAIN | Calibration | CALIBRATION [TR] | Cal Kit Options | CAL KIT | Save Kit/Charac | SAVE (Cal Kit) Dialog Box

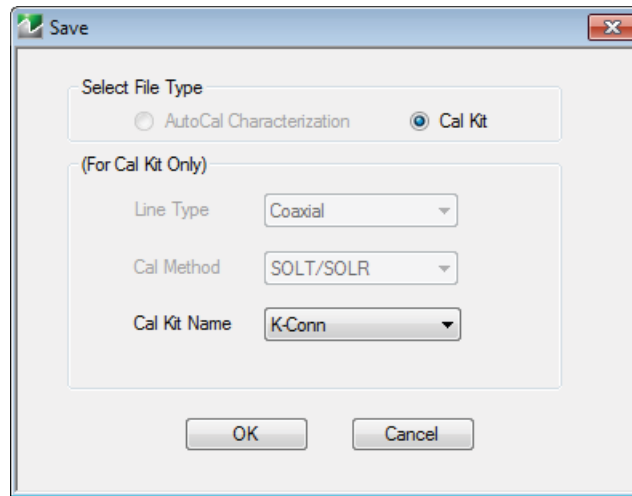

Figure 10-11. SAVE (Cal Kit) Dialog Box

Instructions for Cal Kit File Types

1. Under Select File Type, Cal Kit is the default selection. If Cal Kit is selected, the fields of Line Type, Cal Method, and Cal Kit Name are available (shown at right in [Figure 10-11 on page 10-16](#) above) with the values in drop-down menus. For AutoCal these are no active.
2. For a Cal Kit but not with AutoCal, select a line type
3. For a Cal Kit but not with AutoCal, select a calibration method
4. Select a calibration kit characterization file type from the Cal Kit Name drop-down menu
 - K-Conn (M)
 - K-Conn (F)
 - GPC-3.5 (M)
 - GPC-3.5 (F)
 - SMA (M)
 - SMA (F)
 - N-Conn (M)
 - N-Conn (F)
 - 2.4 mm (M)
 - 2.4 mm (F)

- TNC (M)
- TNC (F)
- V-conn (M)
- V-conn (F)
- W1-conn (M)
- W1-conn (F)
- 7/16 (M)
- 7/16 (F)
- GPC-7
- N-conn(75) (M)
- N-conn(75) (F)
- user defined 1 through 8 (M or F)

5. Click **OK** to proceed or **Cancel** to return to the menu.

6. A **SAVE AS** dialog box appears with a default CalKitCoefficient Files (*.ccf) file name.

7. Navigate to a storage location:

- C:\AnritsuVNA\Data is recommended.

8. Click **Save** to save the file or **Cancel** to return to the menu.

CAL KIT INFO Dialog Box - 4-Port VNAs

The CAL KIT INFO dialog box provides access to instrument calibration kit information that is read-only for selections from the Cal Standard drop-down menu, but editable for user-defined cal kits.

Previous

- [“CAL KIT \(and AutoCal Kit\) Menu - 4-Port VNAs” on page 10-14](#)

Navigation

- MAIN | Calibration | CALIBRATION [TR] | Cal Kit Options | CAL KIT | Create/Edit Info | CAL KIT INFO Dialog Box

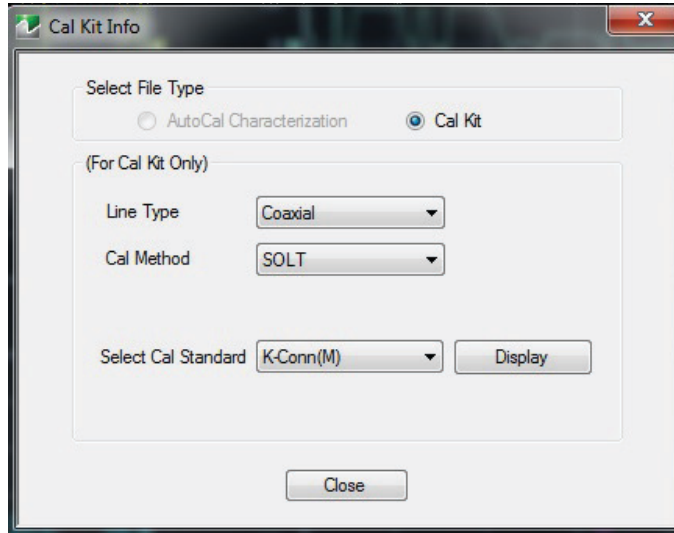

Figure 10-12. CAL KIT INFO Dialog Box

Instructions

1. Cal Kit is the default selection under Select File Type.
2. Select a connector type from the Select Cal Standard drop-down menu:
3. Click Display.
4. The STANDARD INFO read-only dialog box opens ([Figure 10-13](#)).
 - Dialog box title and content fields reflect selections made in the CAL SETUP menu ([“CAL SETUP Menu - 4-Port VNAs” on page 10-43](#)).
5. Click OK to close the STANDARD INFO dialog box.
6. Click Close to close the CAL KIT INFO dialog box.

STANDARD INFO Dialog Box - 4-Port VNAs

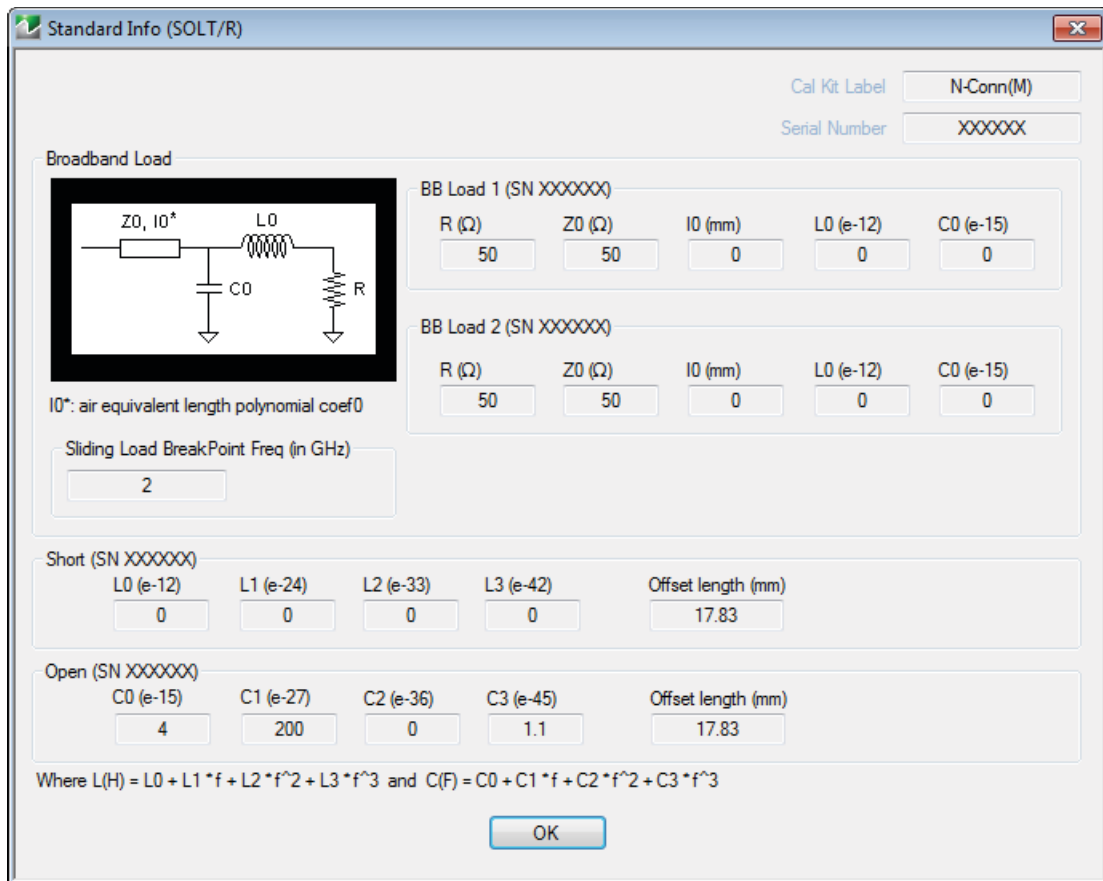

Figure 10-13. STANDARD INFO Dialog Box

RESTORE DEFAULT COEF. Dialog Box - 4-Port VNAs

Use the RESTORE DEFAULT COEF. dialog box to restore firmware-stored Cal Kit Coefficients fields back to their default coefficients. For best performance, either install the cal kit coefficients file supplied with your cal kit, or enter your user-defined coefficients before starting this procedure. The restore function is not available to AutoCal kits as they do not have restorable characterization data.

Full Name

- FULL RESTORE DEFAULT COEFFICIENTS Dialog Box

Previous

- [“CAL KIT \(and AutoCal Kit\) Menu - 4-Port VNAs” on page 10-14](#)

Navigation

- MAIN | Calibration | CALIBRATION [TR] | Cal Kit Options | CAL KIT | Restore Default Coef | RESTORE DEFAULT COEF Dialog Box

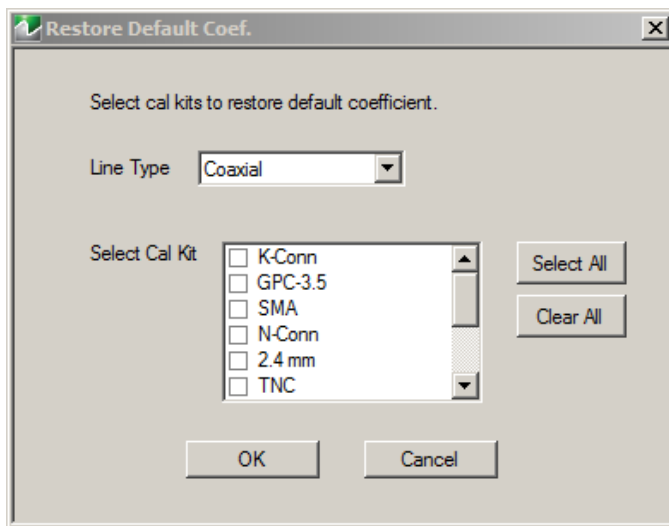

Figure 10-14. RESTORE DEFAULT COEF. (RESTORE DEFAULT COEFFICIENTS) Dialog Box

Instructions Restore Default Calibration Coefficients

Use this dialog to restore factory coefficients to available calibration kits.

1. Select the Line Type as required.
2. Select the Calibration Kits as required to be restored.
3. Click OK.

Available Selections

The table below shows the available calibration kits in the **Select Cal Kit** field of the **RESTORE DEFAULT COEFFICIENTS** dialog box. The available kits depend on the input combination selected for **Line Type Media** and **Cal Method**.

Table 10-1. Calibration Kit Availability in the RESTORE DEFAULT COEF. Dialog Box

LINE TYPE Media Setting	CAL METHOD Setting	Available Calibration Kits
Coaxial	SOLT/SOLR	W1-Conn, V-Conn, K-Conn, 2.4 mm, 2.4 mm V, GPC-3.5, SMA, N-Conn, N-Conn (75), GPC-7, 7/16, TNC
	SSLT	W1-Conn
	SSST	W1-Conn
Non-Dispersive	SOLT/SOLR	W1-Conn, V-Conn, K-Conn, 2.4 mm, GPC-3.5, SMA, N-Conn, N-Conn (75), GPC-7, 7/16, TNC
	SSLT	W1-Conn
	SSST	W1-Conn
Microstrip	SOLT/SOLR	10 Mil Kit, 15 Mil Kit, 25 Mil Kit
	SSLT	10 Mil Kit, 15 Mil Kit, 25 Mil Kit
	SSST	10 Mil Kit, 15 Mil Kit, 25 Mil Kit
Waveguide	SOLT/SOLR	No selections available
	SSLT	WR10, WR12, WR15
	SSST	No selections available

10-5 AutoCal Port Selection Setup - 4-Port VNAs

AUTOCAL (Port Selection) Menu - 4-Port VNAs

Use the AUTOCAL (Port Selection) menu to select whether the AutoCal procedure will be for 4-port, 2-port, or 1-port calibration. Menu is also used to identify COMM port number targeted by the adapter.

Prerequisites

- 4-Port VNA Mode

Previous

- [“CALIBRATE Menu - 4-Port VNAs” on page 10-6](#)

Navigation

- MAIN | Calibration | CALIBRATION [TR] | Calibrate | CALIBRATE | AutoCal | AUTOCAL

 <p>The screenshot shows a menu titled 'AutoCal' with a close button 'X' in the top right corner. Below the title are three menu items, each with a right-pointing arrow: '4-Port Cal', '2-Port Cal', and '1-Port Cal'. The '2-Port Cal' option is highlighted with a white background.</p>	<p>4-Port Cal (4-Port VNAs) Sets the AutoCal calibration function for 4-Port VNAs to a 4-port method and displays the AUTOCAL PROCEDURE (4-PORT CAL) menu.</p> <ul style="list-style-type: none"> • “AUTOCAL (Port Selection) Menu - 4-Port VNAs” on page 10-22 <p>2-Port Cal (4-Port VNAs) Sets the AutoCal calibration function for 4-Port VNAs to a 2-port method and displays the AUTOCAL PROCEDURE (2-PORT CAL) menu.</p> <ul style="list-style-type: none"> • “SMARTCAL SETUP Menu - 2-Port Cal - 4-Port VNAs” on page 10-28 <p>1-Port Cal (4-Port VNAs) Sets the AutoCal calibration function for 4-Port VNAs to a 1-port method and displays the AUTOCAL PROCEDURE (1-PORT CAL) menu.</p> <ul style="list-style-type: none"> • “AUTOCAL SETUP Menu - 1-Port Cal - 4-Port VNAs” on page 10-36 <p>COMM PORT Shows/sets the Comm Port number for the AutoCal adapter.</p>
--	---

Figure 10-15. AUTOCAL PORT Menu - 4-Port VNAs

AUTOCAL SETUP Menu - 4-Port Cal - 4-Port VNAs

Prerequisites

- 4-Port Mode

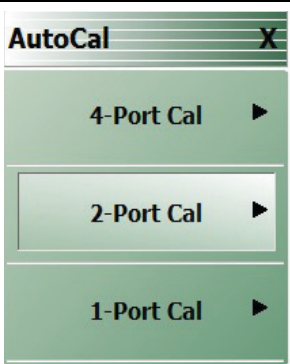
Previous

- [“AUTOCAL \(Port Selection\) Menu - 4-Port VNAs” on page 10-22](#)

Navigation

MAIN | Calibration | CALIBRATION [TR] | Calibrate | CALIBRATE | AutoCal | AUTOCAL PORT | 4-Port Cal | AUTOCAL

	<p>Modify Cal Setup</p> <p>Select displays the MODIFY 4-PORT AUTOCAL SETUP dialog box. The dialog box provides control settings for Auto Sense Module Orientation, Select Cal Type, Through Setup, Adapter Removal Port, and links to the THRU INFO and AIR EQUIVALENT LENGTH CALCULATOR dialog boxes.</p> <ul style="list-style-type: none"> • “MODIFY 4-PORT AUTOCAL SETUP Dialog Box” on page 10-24 <p>Port Selection (Read Only)</p> <p>Displays the Ports selected for the AutoCal procedure. The settings are determined in the MODIFY 4-PORT AUTOCAL SETUP dialog box.</p> <p>Cal Type (Read Only)</p> <p>Displays the Cal Type selected for the AutoCal procedure. The settings are determined in the MODIFY 4-PORT AUTOCAL SETUP dialog box.</p> <p>Thru Type (Read Only)</p> <p>Displays the Thru Type selected for the AutoCal procedure as either Internal Thru or True Thru. The settings are determined in the MODIFY 4-PORT AUTOCAL SETUP dialog box.</p> <p>Cal A Orientation</p> <p>Displays the left/right VNA Port orientation and assignment for the Cal A configuration, Opens the MODIFY 4-PORT AUTOCAL SETUP dialog box. Orientation options are either Left=P1 Right =P1 or Left=P2 and Right=P1.</p> <p>Cal B Orientation</p> <p>Displays the Port A / Port B VNA Port orientation and assignment for the Cal B configuration. Opens the MODIFY 4-PORT AUTOCAL SETUP dialog box. Manual orientation options are either Port 1=A Port 2=B or Port 1=B Port 2=A.</p> <p>Begin Cal (AutoCal 4-Port Cal)</p> <p>Starts the AutoCal procedure. On-screen dialogs and prompts provide user instructions for the selected calibration procedure. When the calibration is complete, the display returns to the CALIBRATION [TR] menu where the Cal Status button is enabled and set to ON.</p> <ul style="list-style-type: none"> • “CALIBRATION [TR] Menu - 4-Port VNAs” on page 10-5
--	--

Figure 10-16. AUTOCAL SETUP Menu - 4-Port Cal - 4-Port VNAs

MODIFY 4-PORT AUTOCAL SETUP Dialog Box

Use the MODIFY 4-PORT SMARTCAL orAUTOCAL SETUP dialog box to change the calibration parameters prior to an AutoCal calibration procedure. Options include the calibration and thru types to be used. The Port A / Port B port sense is configured.

Previous

- [“AutoCal Port Selection Setup - 4-Port VNAs” on page 10-22](#)

Navigation

- MAIN | Calibration | CALIBRATION [TR] | Calibrate | CALIBRATE | AutoCal | AUTOCAL | 4-Port Cal | AUTOCAL SETUP | Modify Cal Setup | MODIFY 4-PORT AUTOCAL SETUP Dialog Box
- MAIN | Calibration | CALIBRATION [TR] | Calibrate | CALIBRATE | AutoCal | AUTOCAL | 4-Port Cal | AUTOCAL SETUP | Modify Cal Setup | MODIFY 4-PORT AUTOCAL SETUP Dialog Box



Figure 10-17. MODIFY 4-PORT AUTOCAL / SMARTCAL SETUP Dialog Box

SmartCal Dialog Box Description

General

The calibration requires two 2-Port calibrations: Cal A and Cal B.

Auto Sense Module Orientation

Auto Sense Module Orientation is default. Check for manual port assignment.

[Figure 10-17, “MODIFY 4-PORT AUTOCAL / SMARTCAL SETUP Dialog Box”](#)

10-5 AutoCal Port Selection Setup - 4-Port VNAs Calibration Menus: 4-Port VNAs

10-24 PN: 10410-00332 Rev. H MS46522A/MS46524A Series UIRM

Cal A Configuration

Select two ports for the Cal A configuration. choose from Port 1, Port 2, Port 3, or Port 4.

Cal A Configuration - Select Cal Type

Only the Full 2 Port selection is available.

Cal A Configuration - Through Setup

Select either Internal Through or True Thru. If True Thru is selected, the Thru Info button is available. Select displays the THRU INFO dialog box.

For Adapter Removal

The For Adapter Removal area and its controls are not available in 4-Port AutoCal Setup.

Cal A Manual Port Sense Configuration

The selections available are dependent on the ports selected above in Cal A Configuration. For example: If Port 1 and Port 2 were selected above, your choices are:

- Port 1 = Port A and Port 2 = Port B
- Port 1 = Port B and Port 2 = Port A

If Port 1 and Port 3 were selected above, your choices are:

- Port 1 = Port A and Port 3 = Port B
- Port 1 = Port B and Port 3 = Port A

Cal B Configuration

Auto selects whichever ports were not selected in Cal A Configuration.

Cal B Configuration - Select Cal Type

Only the Full 2 Port selection is available.

Cal B Configuration - Through Setup

Select either Internal Through or True Thru. If True Thru is selected, the Thru Info button is available. Select displays the THRU INFO dialog box.

Cal B Manual Port Sense Configuration

The selections available are dependent on the ports selected above in Cal A Configuration. For example: If Port 1 and Port 2 were selected for Cal A above, your choices are:

- • Port 3 = Port A and Port 4 = Port B
- • Port 3 = Port B and Port 4 = Port A
- If Port 1 and Port 3 were selected for Cal A above, your choices are:
 - • Port 1 = Port A and Port 3 = Port B
 - • Port 1 = Port B and Port 3 = Port A

Calibration Menus: 4-Port VNAs 10-5 AutoCal Port Selection Setup - 4-Port VNAs

MS46522A/MS46524A Series UIRM PN: 10410-00332 Rev. H 10-25

Additional Throughs

Choose at least one additional external thru from the check boxes in the port diagrams. More than one selection may be made. Select from:

- • Thru 1-2
- • Thru 1-4
- • Thru 2-3
- • Thru 3-4

Completing AutoCal Setup

When all AutoCal Setup functions are completed, click OK to return to the AutoCal menu. Click Cancel to make no changes and close the dialog box.

AutoCal Dialog Box Description

General

The calibration requires two 2-Port calibrations: Cal A and Cal B.

Auto Sense Module Orientation

Check to use Auto Sense Module Orientation.

Cal A Configuration

Select two ports for the Cal A configuration. choose from Port 1, Port 2, Port 3, or Port 4.

Cal A Configuration - Select Cal Type

Only the Full 2 Port selection is available.

Cal A Configuration - Through Setup

Select either Internal Through or True Thru.

If True Thru is selected, the Thru Info button is available. Select displays the THRU INFO dialog box.

For Adapter Removal

The For Adapter Removal area and its controls are not available in 4-Port AutoCal Setup.

Cal A Manual Port Sense Configuration

The selections available are dependent on the ports selected above in Cal A Configuration. For example:

- If Port 1 and Port 2 were selected above, your choices are:
 - Left = Port 1 and Right = Port 2
 - Left = Port 2 and Right = Port 1
- If Port 1 and Port 3 were selected above, your choices are:
 - Left = Port 1 and Right = Port 3
 - Left = Port 3 and Right = Port 1

Cal B Configuration

Auto selects whichever ports were not selected in Cal A Configuration.

Cal B Configuration - Select Cal Type

Only the Full 2 Port selection is available.

Cal B Configuration - Through Setup

Select either Internal Through or True Thru.

If True Thru is selected, the Thru Info button is available. Select displays the THRU INFO dialog box.

Cal B Manual Port Sense Configuration

The selections available are dependent on the ports selected above in Cal A Configuration. For example:

- If Port 1 and Port 2 were selected for Cal A above, your choices are:
 - Left = Port 3 and Right = Port 4
 - Left = Port 4 and Right = Port 3
- If Port 1 and Port 3 were selected for Cal A above, your choices are:
 - Left = Port 2 and Right = Port 4
 - Left = Port 4 and Right = Port 2

Additional Througths

Choose at least one additional external thru from the check boxes in the port diagrams. More than one selection may be made. Select from:

- Thru 1-2
- Thru 1-4
- Thru 2-3
- Thru 3-4

Completing AutoCal Setup

When all AutoCal Setup functions are completed, click **OK** to return to the AutoCal menu. Click **Cancel** to make no changes and close the dialog box.

10-6 SmartCal 2-Port Cal Setup - 4-Port VNAs

SMARTCAL SETUP Menu - 2-Port Cal - 4-Port VNAs

Instrument Mode:

- 4-Port Mode

Previous

- [“AutoCal Port Selection Setup - 4-Port VNAs” on page 10-22](#)

Navigation

- MAIN | Calibration | CALIBRATION [TR] | Calibrate | CALIBRATE | AutoCal | SMARTCAL| 2-Port Cal | SMARTCAL SETUP

	<p>Modify Cal Setup</p> <p>Select displays the MODIFY 2-PORT SMARTCAL SETUP dialog box. The dialog box provides control settings for Auto Sense Module Orientation, Select Cal Type, Thru Setup, Adapter Removal Port, and links to the THRU INFO and AIR EQUIVALENT LENGTH CALCULATOR dialog boxes.</p> <ul style="list-style-type: none"> • “MODIFY 2-PORT AUTOLOCAL SETUP Dialog Box - 4-Port VNAs” on page 10-30 • “THRU INFO Dialog Box - 4-Port VNAs” on page 10-154 • “AIR EQUIVALENT LENGTH Calculator Dialog Box” on page 10-146 <p>Port Selection (Read Only)</p> <p>Displays the Ports selected for the AutoCal procedure. The settings are determined in the MODIFY 2-PORT SMARTCAL SETUP dialog box.</p> <p>Cal Type (Read Only)</p> <p>Displays the Cal Type selected for the AutoCal procedure. The settings are determined in the MODIFY 2-PORT SMARTCAL SETUP dialog box.</p> <p>Thru Type (Read Only)</p> <p>Displays the Thru Type selected for the AutoCal procedure as either Internal Thru or True Thru. The settings are determined in the MODIFY 2-PORT AUTOLOCAL SETUP dialog box.</p> <p>Thru Type (Cal B)</p> <p>Cal A Orientation</p> <p>Cal B Orientation</p> <p>Begin Cal (AutoCal 2-Port Cal) (2-Port VNAs)</p> <p>Starts the AutoCal procedure. On-screen dialogs and prompts provide user instructions for the selected calibration procedure. When the calibration is complete, the display returns to the CALIBRATION [TR] menu when the Cal Status button is enabled and set to ON.</p> <ul style="list-style-type: none"> • “CALIBRATION [TR] Menu - 4-Port VNAs” on page 10-5
--	---

Figure 10-18. AUTOCAL SETUP Menu - 2-Port Cal - 4-Port VNAs

AUTOCAL SETUP Menu - 2-Port Cal - 4-Port VNAs

Instrument Mode:

- 4-Port Mode

Previous

- [“AutoCal Port Selection Setup - 4-Port VNAs” on page 10-22](#)

Navigation

- MAIN | Calibration | CALIBRATION [TR] | Calibrate | CALIBRATE | AutoCal | AUTOCAL | 2-Port Cal | AUTOCAL SETUP

<p>The screenshot shows the AUTOCAL SETUP menu with the following options and their current values:</p> <ul style="list-style-type: none"> AutoCal Setup (with an 'X' icon) Modify Cal Setup (highlighted) Port Selection: 1,2,3,4 Cal Type: Two Port Cal/s Thru Type: Internal Thru Type[Cal B]: Internal Cal A Orientation: Auto Sense Cal B Orientation: Auto Sense Begin Cal 	<p>Modify Cal Setup</p> <p>Select displays the MODIFY 2-PORT AUTOCAL SETUP dialog box. The dialog box provides control settings for Auto Sense Module Orientation, Select Cal Type, Through Setup, Adapter Removal Port, and links to the THRU INFO and AIR EQUIVALENT LENGTH CALCULATOR dialog boxes.</p> <ul style="list-style-type: none"> • “MODIFY 2-PORT AUTOCAL SETUP Dialog Box - 4-Port VNAs” on page 10-30 • “THRU INFO Dialog Box - 4-Port VNAs” on page 10-154 • “AIR EQUIVALENT LENGTH Calculator Dialog Box” on page 10-146 <p>Port Selection (Read Only)</p> <p>Displays the Ports selected for the AutoCal procedure. The settings are determined in the MODIFY 2-PORT AUTOCAL SETUP dialog box.</p> <p>Cal Type (Read Only)</p> <p>Displays the Cal Type selected for the AutoCal procedure. The settings are determined in the MODIFY 2-PORT AUTOCAL SETUP dialog box.</p> <p>Thru Type (Read Only)</p> <p>Displays the Thru Type selected for the AutoCal procedure as either Internal Thru or True Thru. The settings are determined in the MODIFY 2-PORT AUTOCAL SETUP dialog box.</p> <p>Thru Type (Cal B)</p> <p>Cal A Orientation</p> <p>Cal B Orientation</p> <p>Begin Cal (AutoCal 2-Port Cal) (2-Port VNAs)</p> <p>Starts the AutoCal procedure. On-screen dialogs and prompts provide user instructions for the selected calibration procedure. When the calibration is complete, the display returns to the CALIBRATION [TR] menu when the Cal Status button is enabled and set to ON.</p> <ul style="list-style-type: none"> • “CALIBRATION [TR] Menu - 4-Port VNAs” on page 10-5
--	---

Figure 10-19. AUTOCAL SETUP Menu - 2-Port Cal - 4-Port VNAs

MODIFY 2-PORT AUTOLOCAL SETUP Dialog Box - 4-Port VNAs

Use the MODIFY 2-PORT AUTOLOCAL SETUP dialog box to change the calibration parameters prior to an AutoCal calibration procedure. Options include the calibration and thru types to be used. If required, an adapter removal calibration can be configured. For production installations, the left/right port sense can be automatically or manually configured.

Previous

- “SMARTCAL SETUP Menu - 2-Port Cal - 4-Port VNAs” on page 10-28

Navigation

- MAIN | Calibration | CALIBRATION [TR] | Calibrate | CALIBRATE | AutoCal | AUTOLOCAL | 2-Port Cal | AUTOLOCAL SETUP | Modify Cal Setup | MODIFY 2-PORT AUTOLOCAL SETUP Dialog Box

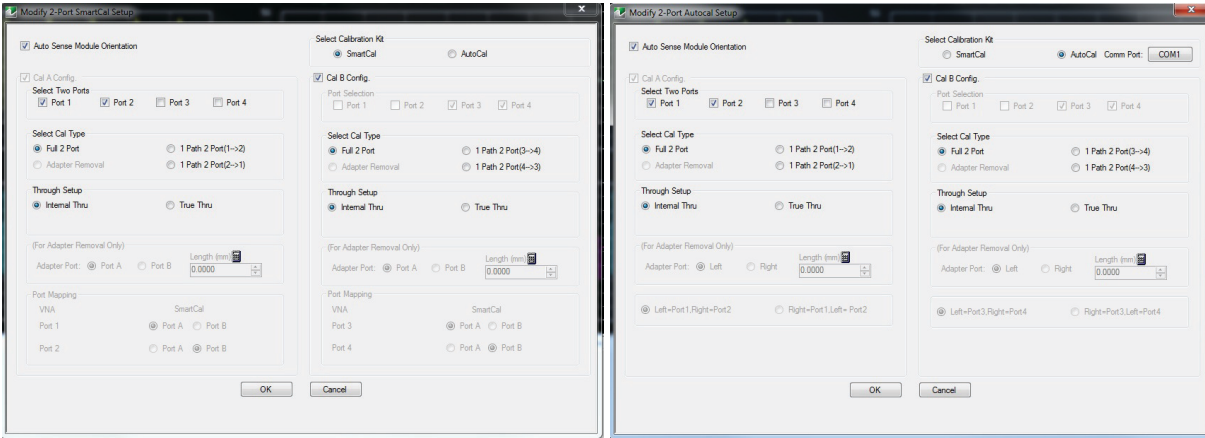

Figure 10-20. MODIFY 2-PORT AUTOLOCAL SETUP Dialog Box - 4-Port VNAs

SmartCal Dialog Box Description

Auto Sense Module Orientation

Auto Sense Module Orientation is checked by default. Check to use Manual Module Orientation.

Cal A Configuration

The Cal A Configuration is auto-selected.

Select two ports for the Cal A configuration from either:

- Port 1
- Port 2
- Port 3
- Port 4

Whichever two ports are not selected are auto selected for Cal B Configuration.

Cal A Configuration - Select Cal Type

Select calibration types from the following choices. Note that the 1 Path 2 Port choices depend on the ports selected above in Cal A Configuration. The examples below assume that Port 1 and Port 3 were selected above.

- Full 2 Port
- 1 Path 2 Port (1-->3)
- 1 Path 2 Port (3-->1)

Cal A Configuration - Through Setup

Select either:

- Internal Through
- True Thru
 - If True Thru is selected, the Thru Info button is available. Select displays the THRU INFO dialog box which is described in the section above.
 - [“THRU INFO Dialog Box - 4-Port VNAs” on page 10-154](#)

For Adapter Removal

The For Adapter Removal area and its controls are not available in 2-Port AutoCal Setup.

Cal A Manual Port Sense Configuration

The port sense configuration options are dependent on the ports selected above in Cal A Configuration. For example:

- If Port 1 and Port 3 were selected above, your choices are:
 - Port 1 = Port A and Port 3 = Port B
 - Port 1 = Port B and Port 3 = Port A

Cal B Configuration

The configuration auto selects whichever ports were not selected in Cal A Configuration.

Cal B Configuration - Select Cal Type

Select calibration types from the following choices. Note that the 1 Path 2 Port choices depend on the ports selected above in Cal A Configuration. The examples below assume that Port 1 and Port 3 were selected above and that the Cal B ports are Port 2 and Port 4.

- Full 2 Port
- 1 Path 2 Port (2-->4)
- 1 Path 2 Port (4-->2)

Calibration Menus: 4-Port VNAs 10-6 AutoCal 2-Port Cal Setup - 4-Port VNAs

MS46522A/MS46524A Series UIRM PN: 10410-00332 Rev. H 10-29

Cal B Configuration - Through Setup

Select either:

- Internal Through
- True Thru
 - If True Thru is selected, the Thru Info button is available. Select displays the THRU INFO dialog box.
 - [“THRU INFO Dialog Box - 4-Port VNAs” on page 10-154](#)

Cal B Manual Port Sense Configuration

The selections available are dependent on the ports selected above in Cal A Configuration. For example:

- If Port 1 and Port 3 were selected for Cal A above, your choices are:
 - Port 1 = Port A and Port 3 = Port B
 - Port 1 = Port B and Port 3 = Port A

Completing AutoCal Setup

When all AutoCal Setup functions are completed, click OK to return to the AutoCal menu. Click Cancel to make no changes and close the dialog box.

- [“SMARTCAL SETUP Menu - 2-Port Cal - 4-Port VNAs” on page 10-28](#)

AutoCal Dialog Box Description**Auto Sense Module Orientation**

Check to use Auto Sense Module Orientation.

Cal A Configuration

The Cal A Configuration is auto-selected.

Select two ports for the Cal A configuration from either:

- Port 1
- Port 2
- Port 3
- Port 4

Whichever two ports are not selected are auto selected for Cal B Configuration.

Cal A Configuration - Select Cal Type

Select calibration types from the following choices. Note that the 1 Path 2 Port choices depend on the ports selected above in Cal A Configuration. The examples below assume that Port 1 and Port 3 were selected above.

- Full 2 Port
- 1 Path 2 Port (1-->3)
- 1 Path 2 Port (3-->1)

Cal A Configuration - Through Setup

Select either:

- Internal Through
- True Thru
 - If True Thru is selected, the Thru Info button is available. Select displays the THRU INFO dialog box which is described in the section above.
 - [“THRU INFO Dialog Box - 4-Port VNAs” on page 10-154](#)

For Adapter Removal

The For Adapter Removal area and its controls are not available in 2-Port AutoCal Setup.

Cal A Manual Port Sense Configuration

The port sense configuration options are dependent on the ports selected above in Cal A Configuration. For example:

- If Port 1 and Port 3 were selected above, your choices are:
 - Left = Port 1 and Right = Port 3
 - Left = Port 3 and Right = Port 1

Cal B Configuration

The configuration auto selects whichever ports were not selected in Cal A Configuration.

Cal B Configuration - Select Cal Type

Select calibration types from the following choices. Note that the 1 Path 2 Port choices depend on the ports selected above in Cal A Configuration. The examples below assume that Port 1 and Port 3 were selected above and that the Cal B ports are Port 2 and Port 4.

- Full 2 Port
- 1 Path 2 Port (2-->4)
- 1 Path 2 Port (4-->2)

Cal B Configuration - Through Setup

Select either:

- Internal Through
- True Thru
 - If True Thru is selected, the Thru Info button is available. Select displays the THRU INFO dialog box.
 - [“THRU INFO Dialog Box - 4-Port VNAs” on page 10-154](#)

Cal B Manual Port Sense Configuration

The selections available are dependent on the ports selected above in Cal A Configuration. For example:

- If Port 1 and Port 3 were selected for Cal A above, your choices are:
 - Left = Port 2 and Right = Port 4
 - Left = Port 4 and Right = Port 2

Completing AutoCal Setup

When all AutoCal Setup functions are completed, click OK to return to the AutoCal menu. Click Cancel to make no changes and close the dialog box.

[“SMARTCAL SETUP Menu - 2-Port Cal - 4-Port VNAs” on page 10-28](#)

10-7 SMARTCal 1-Port Cal Setup - 4-Port VNAs

SMARTCAL SETUP Menu - 1-Port Cal - 4-Port VNAs

Prerequisites

- 4-Port Mode

Previous

- [“AutoCal Port Selection Setup - 4-Port VNAs” on page 10-22](#)

Navigation

- MAIN | Calibration | CALIBRATION [TR] | Calibrate | CALIBRATE | AutoCal | SMARTCAL | 1-Port Cal | SMARTCAL SETUP

	<h4>Modify Cal Setup</h4> <p>Select displays the MODIFY 1-PORT SMARTCAL SETUP dialog box. The dialog box provides control settings for 1-Port Calibration Ports and Port A / Port B Identification.</p> <ul style="list-style-type: none"> • “MODIFY 1-PORT AUTOLOCAL SETUP Dialog Box - 4-Port VNAs” on page 10-37 <h4>Port Selection (Read Only)</h4> <p>Displays the Port or Ports selected for the AutoCal procedure. The settings are determined in the MODIFY 1-PORT SMARTCAL SETUP dialog box.</p> <h4>Cal Type (Read Only)</h4> <p>Displays the Cal Type selected for the AutoCal procedure. The setting is defined by the selectin of a button on the SMARTCAL menu.</p> <ul style="list-style-type: none"> • “AutoCal Port Selection Setup - 4-Port VNAs” on page 10-22 <h4>Port 1 Orientation (Read Only)</h4> <p>This read-only button only appears if Port 1 was selected in the MODIFY 1-PORT SMARTCAL SETUP dialog box. If available, shows the Port 1 / Port 2 assignment.</p> <ul style="list-style-type: none"> • “MODIFY 1-PORT AUTOLOCAL SETUP Dialog Box - 4-Port VNAs” on page 10-37 <h4>Port 2 Orientation (Read Only)</h4> <p>This read-only button only appears if Port 2 was selected in the MODIFY 1-PORT SMARTCAL SETUP dialog box. If available, shows the Port 1 / Port 2 assignment for Port 2.</p> <ul style="list-style-type: none"> • “MODIFY 1-PORT AUTOLOCAL SETUP Dialog Box - 4-Port VNAs” on page 10-37 <h4>Begin Cal (AutoCal 1-Port Cal)</h4> <p>Starts the AutoCal procedure. On-screen dialogs and prompts provide user instructions for the selected calibration procedure. When the calibration is complete, the display returns to the CALIBRATION [TR] menu where the Cal Status button is now enabled and set to ON.</p> <ul style="list-style-type: none"> • “CALIBRATION [TR] Menu - 4-Port VNAs” on page 10-5
--	---

Figure 10-21. AUTOLOCAL PROCEDURE Menu - 1-Port Calibration - 4-Port VNA

AUTOCAL SETUP Menu - 1-Port Cal - 4-Port VNAs

Prerequisites

- 4-Port Mode

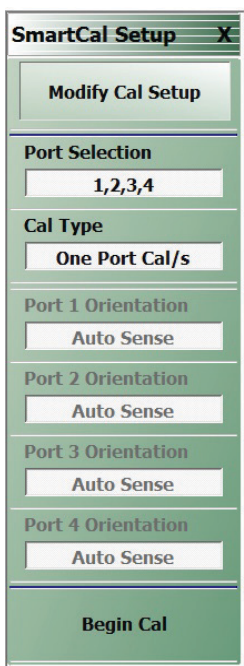
Previous

- [“AutoCal Port Selection Setup - 4-Port VNAs” on page 10-22](#)

Navigation

- MAIN | Calibration | CALIBRATION [TR] | Calibrate | CALIBRATE | AutoCal | AUTOCAL | 1-Port Cal | AUTOCAL SETUP

 <p>The screenshot shows the AUTOCAL SETUP menu with the following items: AutoCal Setup (with a close button), Modify Cal Setup, Port Selection (1,2,3,4), Cal Type (One Port Cal/s), Port 1 Orientation (Left), Port 2 Orientation (Left), Port 3 Orientation (Left), Port 4 Orientation (Left), and Begin Cal.</p>	<p>Modify Cal Setup</p> <p>Select displays the MODIFY 1-PORT AUTOCAL SETUP dialog box. The dialog box provides control settings for 1-Port Calibration Ports and Port Left/Right Identification.</p> <ul style="list-style-type: none"> • “MODIFY 1-PORT AUTOCAL SETUP Dialog Box - 4-Port VNAs” on page 10-37 <p>Port Selection (Read Only)</p> <p>Displays the Port or Ports selected for the AutoCal procedure. The settings are determined in the MODIFY 1-PORT AUTOCAL SETUP dialog box.</p> <p>Cal Type (Read Only)</p> <p>Displays the Cal Type selected for the AutoCal procedure. The setting is defined by the selectin of a button on the AUTOCAL menu.</p> <ul style="list-style-type: none"> • “AutoCal Port Selection Setup - 4-Port VNAs” on page 10-22 <p>Port 1 Orientation (Read Only)</p> <p>This read-only button only appears if Port 1 was selected in the MODIFY 1-PORT AUTOCAL SETUP dialog box. If available, shows the left/right assignment for Port 1.</p> <ul style="list-style-type: none"> • “MODIFY 1-PORT AUTOCAL SETUP Dialog Box - 4-Port VNAs” on page 10-37 <p>Port 2 Orientation (Read Only)</p> <p>This read-only button only appears if Port 2 was selected in the MODIFY 1-PORT AUTOCAL SETUP dialog box. If available, shows the left/right assignment for Port 2.</p> <ul style="list-style-type: none"> • “MODIFY 1-PORT AUTOCAL SETUP Dialog Box - 4-Port VNAs” on page 10-37 <p>Begin Cal (AutoCal 1-Port Cal)</p> <p>Starts the AutoCal procedure. On-screen dialogs and prompts provide user instructions for the selected calibration procedure. When the calibration is complete, the display returns to the CALIBRATION [TR] menu where the Cal Status button is now enabled and set to ON.</p> <ul style="list-style-type: none"> • “CALIBRATION [TR] Menu - 4-Port VNAs” on page 10-5
--	---

Figure 10-22. AUTOCAL PROCEDURE Menu - 1-Port Calibration - 4-Port VNA

MODIFY 1-PORT AUTOCAL SETUP Dialog Box - 4-Port VNAs

Previous

- [“AUTOCAL SETUP Menu - 1-Port Cal - 4-Port VNAs” on page 10-36](#)

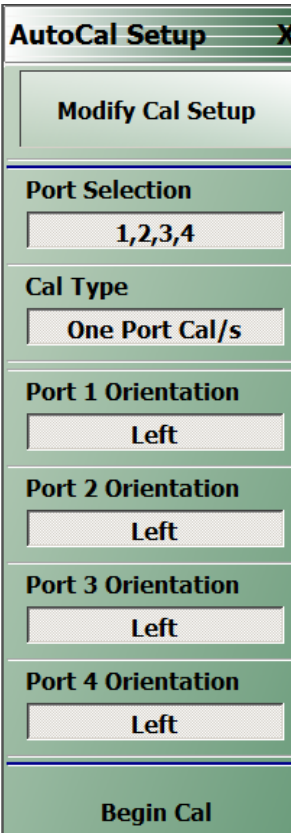
Navigation

- MAIN | Calibration | CALIBRATION [TR] | Calibrate | CALIBRATE | AutoCal | SMARTCAL PORT | 1-Port Cal | SMARTCAL SETUP | Modify Cal Setup | MODIFY 1-PORT AUTOCAL SETUP Dialog Box
- MAIN | Calibration | CALIBRATION [TR] | Calibrate | CALIBRATE | AutoCal | AUTOCAL PORT | 1-Port Cal | AUTOCAL SETUP | Modify Cal Setup | MODIFY 1-PORT AUTOCAL SETUP Dialog Box

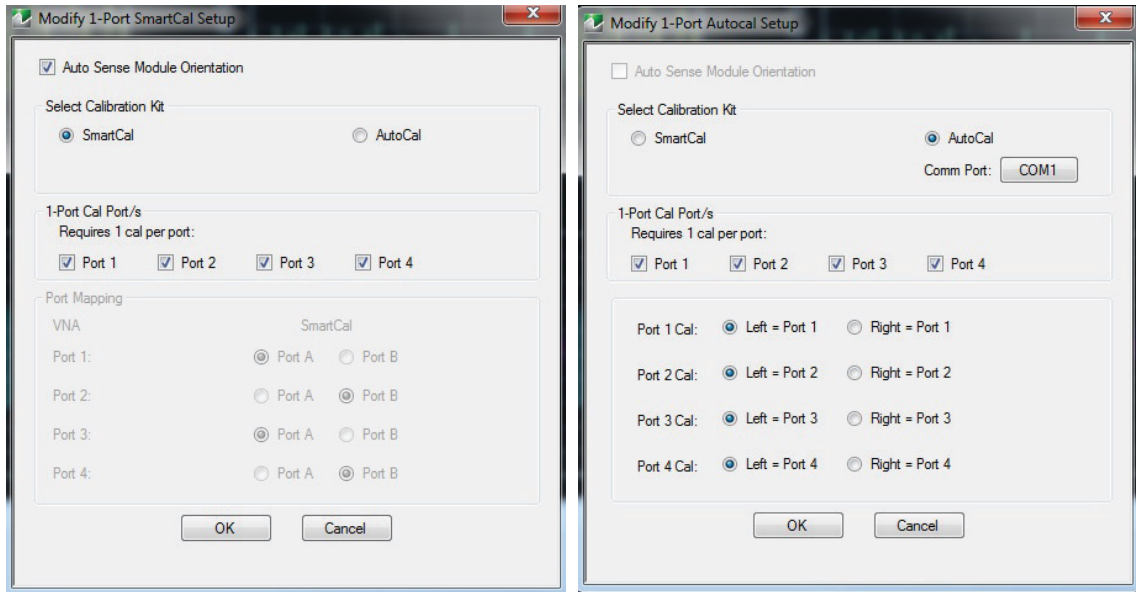

Figure 10-23. MODIFY 1-PORT AUTOCAL/SMARTCAL SETUP Dialog Box - 4-Port VNAs

SmartCal Dialog Box Description

Auto Sense Module Orientation

Auto Sense Module Orientation is checked by default. Check to use manual Module Orientation.

1-Port Cal Port(2)

Select any combination of ports from Port 1, Port 2, Port 3, or Port 4.

For each port selected above, a Port A / Port B configuration radio button becomes available below.

Port Sense Left/Right Configuration

For each selected port above, select the left/right assignment:

- Port 1 Cal: Port 1 = Port A or Port 1 = Port B
- Port 2 Cal: Port 1 = Port A or Port 1 = Port B
- Port 3 Cal: Port 1 = Port A or Port 1 = Port B
- Port 4 Cal: Port 1 = Port A or Port 1 = Port B

Completing AutoCal Setup

When all AutoCal Setup functions are completed, click OK to return to the SmartCal menu. Click Cancel to make no changes and close the dialog box.

- [“AUTOCAL SETUP Menu - 1-Port Cal - 4-Port VNAs” on page 10-36](#)

AutoCal Dialog Box Description**Auto Sense Module Orientation**

Check to use Auto Sense Module Orientation.

1-Port Cal Port(2)

Select any combination of ports from Port 1, Port 2, Port 3, or Port 4.

For each port selected above, a left/right configuration radio button becomes available below.

Port Sense Left/Right Configuration

For each selected port above, select the left/right assignment:

- Port 1 Cal: Left = Port 1 or Right = Port 1
- Port 2 Cal: Left = Port 2 or Right = Port 2
- Port 3 Cal: Left = Port 3 or Right = Port 3
- Port 4 Cal: Left = Port 4 or Right = Port 4

Completing AutoCal Setup

When all AutoCal Setup functions are completed, click OK to return to the AutoCal menu. Click Cancel to make no changes and close the dialog box.

- [“AUTOCAL SETUP Menu - 1-Port Cal - 4-Port VNAs” on page 10-36](#)

10-8 Manual Calibration Menus and Dialog Boxes - 4-Port VNAs

The MANUAL CAL menu buttons allow selection of the calibration type. The Modify Cal Setup button on the setup menus provides access to the CAL SETUP menu, which allows selection of either SOLT/SOLR or LRL/LRM calibration methods, and access with the Edit Cal Params button to the corresponding configuration dialog box.



<p>1. MANUAL CAL menu.</p> <p>2. FOUR PORT CAL menus</p> <p>3. THREE PORT CAL menu.</p> <p>4. TWO PORT CAL menu</p>	<p>5. ONE PORT CAL menu</p> <p>6. TRANS. RESPONSE menu</p> <p>7. REFL. RESPONSE menu</p>
---	--

Figure 10-24. Manual Calibration Setup Menus - 4-Port VNAs - Sheet 1

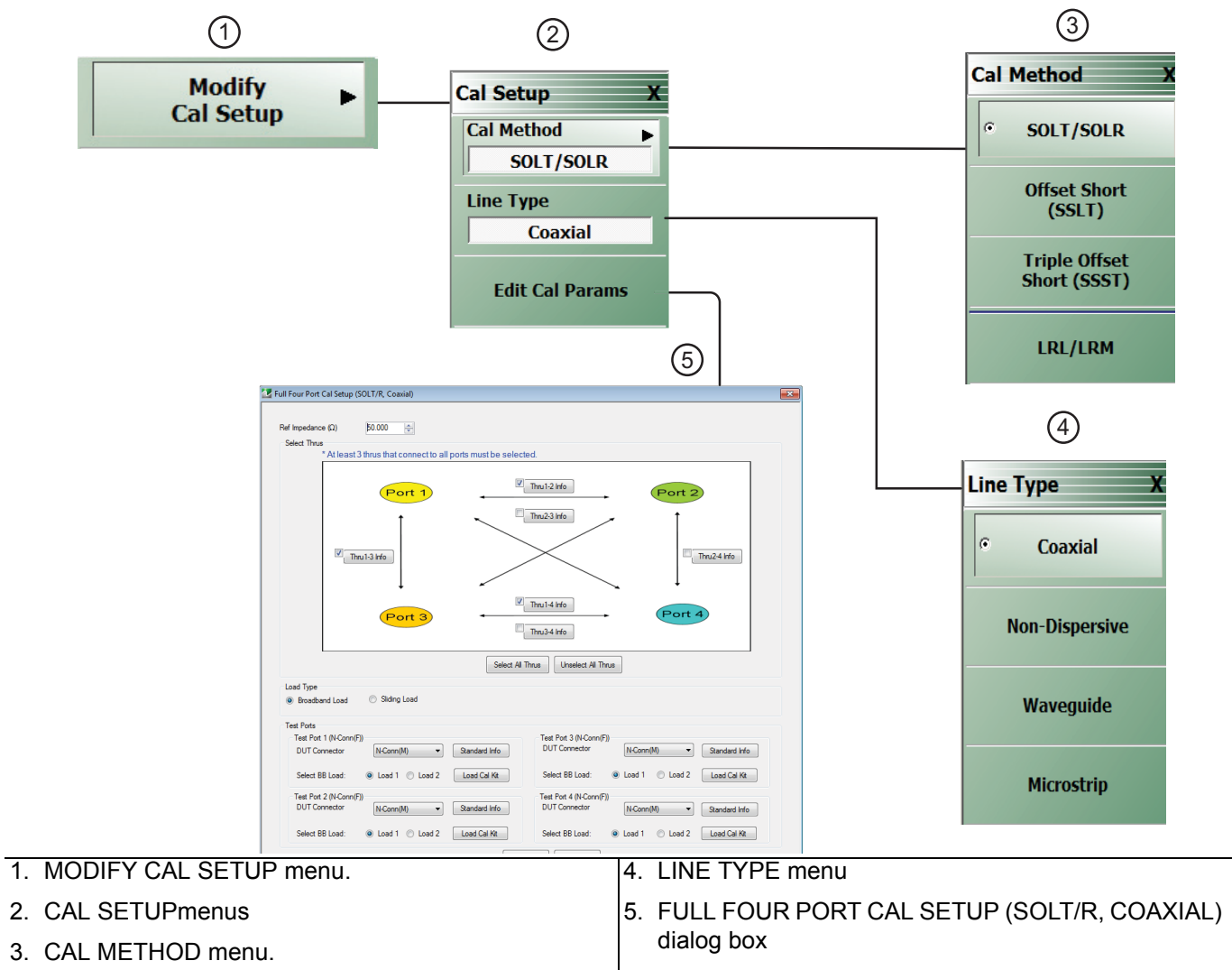

Figure 10-25. Manual Calibration Setup Menus - 4-Port VNAs - Sheet 2

Manual Cal Combinations

The manual calibration setup menus and dialog boxes provide the following port configurations, calibration types, and calibration methods, and line types:

- Manual Calibration Types
 - 4-Port Calibration
 - 3-Port Calibration
 - 2-Port Calibration
 - 1-Port Calibration
 - Transmission Frequency Response Calibration
 - Reflection Frequency Response Calibration
- Calibration Methods
 - SOLT/SOLR - Short-Open-Load-Thru / Short-Open-Load-Return
- Line Types
 - Coaxial

Manual Cal Dialog Box Settings

Most combinations of the calibration parameters above can be further modified through a series of dialog boxes that control DUT connectors, load types such as broadband or sliding loads, port selection, through types, reference plane location, number of bands, and similar settings. Many of these dialog boxes are shown in this document and all are summarized in tables.

MANUAL CAL Menu - 4-Port VNAs

Full Name

- Manual Calibration Menu

Prerequisites

- 4-Port Mode

Previous

- [“CALIBRATE Menu - 4-Port VNAs” on page 10-6](#)

Navigation

- MAIN | Calibration | CALIBRATION [TR] | Calibrate | CALIBRATE | Manual Cal | MANUAL CAL

	<p>4-Port Cal Select displays the Four Port Cal menu where the calibration step-by-step procedure is carried out. This is the most complete calibration and fully corrects all S11, S12, S13, S14, S21, S22, S23, S24, S31, S32, S33, S34, S41, S42, S43, S44 four-port S-parameters:</p> <ul style="list-style-type: none"> • “FOUR PORT CAL Menu - 4-Port VNAs” on page 10-47 <p>3-Port Cal Select displays the THREE PORT CAL menu where the calibration step-by-step procedure is carried out.</p> <ul style="list-style-type: none"> • “THREE PORT CAL Menu - 4-Port VNAs” on page 10-78 <p>2-Port Cal Select displays the TWO PORT CAL menu where the calibration step-by-step procedure is carried out.</p> <ul style="list-style-type: none"> • “TWO PORT CAL Menu - 4-Port VNAs” on page 10-97 <p>1-Port Cal Select displays the One Port Cal menu. The menu below is representative of a typical 1-port calibration.</p> <ul style="list-style-type: none"> • “ONE PORT CAL/S Menu - 4-Port VNAs” on page 10-114 <p>Transmission Freq. Response Selecting the Transmission Frequency Response button displays the TRANS. RESPONSE menu. During the calibration configuration in the Edit Cal Params CAL SETUP dialog, select forward or reverse or both directions.</p> <ul style="list-style-type: none"> • “TRANS. RESPONSE Menu - 4-Port VNAs” on page 10-127 <p>Reflection Freq. Response Selecting the Reflection Frequency Response button displays the Refl. Response menu. During the calibration configuration in the Edit Cal Params CAL SETUP dialog, select an Open or Short cal component.</p> <ul style="list-style-type: none"> • “REFL. RESPONSE Menu - 4-Port VNAs” on page 10-136
---	---

Figure 10-26. MANUAL CALIBRATION Menu - 4-Port VNAs

CAL SETUP Menu - 4-Port VNAs

Use the CAL SETUP menu to set the calibration method (SOLT/R, SSLT, SSST, or LRL/M), the calibration line type (default coaxial), and more detailed parameters for ports and connectors through the Edit Cal Parameters button and corresponding CAL SETUP dialogs.

Previous

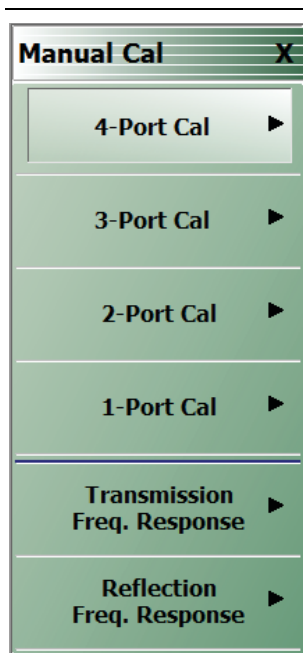
The CAL SETUP menu can be accessed from multiple menus depending on the manual calibration type selected on the MANUAL CAL menu.

- [“FOUR PORT CAL Menu - 4-Port VNAs” on page 10-47](#)
- [“THREE PORT CAL Menu - 4-Port VNAs” on page 10-78](#)
- [“TWO PORT CAL Menu - 4-Port VNAs” on page 10-97](#)
- [“ONE PORT CAL/S Menu - 4-Port VNAs” on page 10-114](#)
- [“TRANS. RESPONSE Menu - 4-Port VNAs” on page 10-127](#)
- [“REFL. RESPONSE Menu - 4-Port VNAs” on page 10-136](#)

Navigation

The navigation path below assumes that 4-Port Cal manual calibration type was selected on the MANUAL CAL menu.

- MAIN | Calibration | CALIBRATION [TR] | Calibrate | CALIBRATE | Manual Cal | MANUAL CAL | 4-Port Cal | FOUR PORT CAL | Modify Cal Setup | CAL SETUP
- The general navigation path is:
- MAIN | Calibration | CALIBRATION [TR] | Calibrate | CALIBRATE | Manual Cal | MANUAL CAL | [# of Ports] Cal | [NUM OF PORTS] CAL | Modify Cal Setup | CAL SETUP

	<p>Cal Method</p> <p>Select displays the CAL METHOD menu where the calibration method is selected.</p> <p>The field displays either SOLT/SOLR or LRL/LRM as the currently selected calibration method.</p> <ul style="list-style-type: none"> • “CAL METHOD Menu - 4-Port VNA” on page 10-45 <p>Line Type</p> <p>Displays the default Coaxial line type.</p>
---	---

Figure 10-27. CAL SETUP Menu (1 of 2)

Edit Cal Params

Select displays the appropriate calibration setup dialog box. The exact name of the dialog box varies depending on the calibration type, calibration method, and line type selected.

Dialog box name format: [Cal Type] [Cal Method] Cal Setup [Line Type]

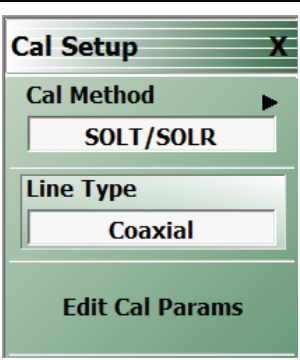
- For example, if Full 2 Port, SOLT/SOLR, and Coaxial were selected, the dialog box name is:

Full Two Port Cal Setup (SOLT/R, Coaxial)

Examples of Cal Setup dialog boxes using Coaxial line type are available in the links below:

- [“FULL FOUR PORT CAL SETUP \(SOLT/R, COAXIAL\) Dialog Box” on page 10-51](#)
- [“THREE PORT CAL SETUP \(SOLT/R, COAXIAL\) Dialog Box” on page 10-85](#)
- [“TWO PORT CAL SETUP \(SOLT/R, COAXIAL\) Dialog Box” on page 10-99](#)
- [“ONE PORT CAL SETUP \(SOLT/R, COAXIAL\) Dialog Box” on page 10-115](#)
- [“TRANSMISSION FREQ. RESPONSE CAL SETUP \(SOLT/SOLR, COAXIAL\) Dialog Box” on page 10-129](#)
- [“REFLECTION FREQ. RESPONSE CAL SETUP \(SOLT/R, COAXIAL\) Dialog Box” on page 10-138](#)

The summary tables below list the contents of all calibration setup dialog boxes based on the number of ports involved in the calibration:

- [Table: “Manual 4-Port Cal Setup Dialog Box Summary” on page 10-66](#)
- [Table: “Manual Calibration - 3-Port Calibration Setup Dialog Box Contents - 4-Port VNAs” on page 10-92](#)
- [Table: “Manual Calibration - 2-Port Calibration Setup Dialog Box Contents - 4-Port VNAs” on page 10-109](#)
- [Table: “Manual Calibration - 1-Port Calibration Setup Dialog Box Contents - 4-Port VNAs” on page 10-124](#)
- [Table: “Trans. Freq. Resp. Manual Cal Setup Dialog Box Contents - 4-Port VNAs” on page 10-135](#)
- [Table: “Refl. Freq. Resp. Manual Cal. Setup Dialog Box Contents - 4-Port VNAs” on page 10-144](#)

Figure 10-27. CAL SETUP Menu (2 of 2)

CAL METHOD Menu - 4-Port VNA

Use the CAL METHOD menu to select whether the method of SOLT/SOLR, SSLT, SSST, or LRL/LRM will be used during the calibration.

Procedure Reference

- [Figure 10-28, “CAL METHOD Menu” on page 10-45](#)

Auto-Return Button Selection Group

- The four (4) buttons of the CAL METHOD menu form an auto-return button selection group. Selecting any one button marks the selection with the select icon, de-selects the other three (3) buttons, and auto-returns to the CAL SETUP menu.

Previous

- [“CAL SETUP Menu - 4-Port VNAs” on page 10-43](#)

Navigation

- The navigation path below assumes that Full 2 Port calibration type was selected on the Manual Cal menu.
- MAIN | Calibration | CALIBRATION [TR] | Calibrate | CALIBRATE | Manual Cal | MANUAL CAL | 2-Port Cal | TWO PORT CAL | Modify Cal Setup | CAL SETUP | Cal Method | CAL METHOD

 <p>The screenshot shows a menu titled 'Cal Method' with a close button 'X'. There are four buttons: 'SOLT/SOLR' (selected with a radio button), 'Offset Short (SSLT)', 'Triple Offset Short (SSST)', and 'LRL/LRM'.</p>	<p>SOLT/SOLR</p> <p>Selecting the SOLT/SOLR button sets the calibration method to Short-Open-Load-Thru (or Short-Open-Load-Reciprocal) and then auto-returns to the CAL SETUP menu.</p> <ul style="list-style-type: none"> • “CAL SETUP Menu - 4-Port VNAs” on page 10-43 <p>Offset Short (SSLT)</p> <p>Selecting the Offset Short (SSLT) button sets the calibration method to Short-Short-Load-Thru and then auto-returns to the CAL SETUP menu.</p> <ul style="list-style-type: none"> • “CAL SETUP Menu - 4-Port VNAs” on page 10-43 <p>Triple Offset Short (SSST)</p> <p>Selecting the Triple Offset Short (SSST) button sets the calibration method to Short-Short-Short-Thru and then auto-returns to the CAL SETUP menu.</p> <ul style="list-style-type: none"> • “CAL SETUP Menu - 4-Port VNAs” on page 10-43 <p>LRL/LRM</p> <p>Selecting the LRL/LRM button sets the calibration method to Line-Reflect-Line or Line-Reflect-Match and then auto-returns to the CAL SETUP menu.</p> <ul style="list-style-type: none"> • “CAL SETUP Menu - 4-Port VNAs” on page 10-43
--	---

Figure 10-28. CAL METHOD Menu

LINE TYPE Menu - 4-Port VNA

Use the LINE TYPE menu to select from coaxial, non-dispersive, waveguide, or microstrip line types. Non-dispersive is for line types such as coplanar waveguide, stripline, or twin-lead and is treated the same as coaxial line.

Procedure Reference

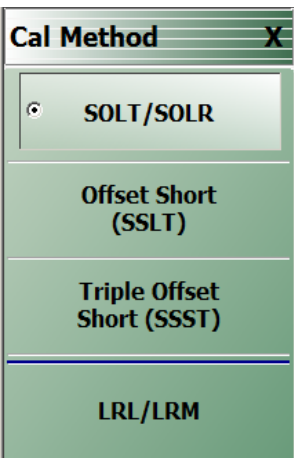
- [Figure 10-29, “LINE TYPE Menu” on page 10-46](#) Callout #4

Auto-Return Button Selection Group

- The four (4) buttons of the LINE TYPE menu form an auto-return button selection group.
- Selecting any one button marks the selection with the select icon, de-selects the other three (3) buttons, and auto-returns to the CAL SETUP menu.

Previous

- [“CAL SETUP Menu - 4-Port VNAs” on page 10-43.](#)

Navigation

- The navigation path below assumes that Full 2 Port calibration type was selected on the Manual Cal menu.
- MAIN | Calibration | CALIBRATION [TR] | Calibrate | CALIBRATE | Manual Cal | MANUAL CAL | 2-Port Cal | TWO PORT CAL | Modify Cal Setup | CAL SETUP | Line Type | LINE TYPE

	<p>Coaxial (Line Type)</p> <p>Select sets the line type to coaxial, marks the button with the select icon, de-selects the Non-Dispersive, Waveguide, and Microstrip buttons, and then auto-returns to the CAL SETUP menu.</p> <ul style="list-style-type: none"> • “CAL SETUP Menu - 4-Port VNAs” on page 10-43 <p>Non-Dispersive (Line Type)</p> <p>Non-dispersive line types, such as Coplanar Waveguide, Stripline, or twin-lead, are used on transmissions. The system treats non-dispersive lines the same as coaxial line types. Select sets the line type to non-dispersive, marks the button with the select icon, de-selects the Coaxial, Waveguide, and Microstrip buttons, and then auto-returns to the CAL SETUP menu.</p> <ul style="list-style-type: none"> • “CAL SETUP Menu - 4-Port VNAs” on page 10-43 <p>Waveguide (Line Type)</p> <p>Waveguide is transmission media such as rectangular or circular waveguide. Select sets the line type to waveguide, marks the button with the select icon, de-selects the Coaxial, Non-Dispersive, and Microstrip buttons, and then auto-returns to the CAL SETUP menu.</p> <ul style="list-style-type: none"> • “CAL SETUP Menu - 4-Port VNAs” on page 10-43 <p>Microstrip (Line Type)</p> <p>Microstrip line is typically used in on-wafer media. Select sets the line type to microstrip, marks the button with the select icon, de-selects the Coaxial, Non-Dispersive, and Waveguide buttons, and then auto-returns to the CAL SETUP menu.</p> <ul style="list-style-type: none"> • “CAL SETUP Menu - 4-Port VNAs” on page 10-43
--	---

Figure 10-29. LINE TYPE Menu

10-9 Manual 4-Port Cal Setup - 4-Port VNAs

The FOUR PORT CAL Setup menu and its related dialog boxes is used to set the calibration parameters for the four port calibration. Dialog boxes for all Cal Method/Line Type combinations are summarized in the table:

- Table: [“Manual 4-Port Cal Dialog Box Summary” on page 10-66](#)

FOUR PORT CAL Menu - 4-Port VNAs

Button Availability

- The exact composition of the menu depends on the settings made on the CAL SETUP, CAL METHOD, and LINE TYPE menus and on the resultant FULL FOUR PORT CAL SETUP dialog box.
- A representative menu is shown below.
- The example procedures at the end of this chapter show examples of various FOUR PORT CAL menus.

Previous

- [“MANUAL CAL Menu - 4-Port VNAs” on page 10-42](#)

Navigation

- MAIN | Calibration | CALIBRATION [TR] | Calibrate | CALIBRATE | Manual Cal | MANUAL CAL | 4-Port Cal | FOUR PORT CAL

	<p>Modify Cal Setup</p> <p>Select opens the CAL SETUP menu .</p> <ul style="list-style-type: none"> • “CAL SETUP Menu - 4-Port VNAs” on page 10-43 <p>The following Cal Method/Line Type combinations are represented with a figure and complete description:</p> <ul style="list-style-type: none"> • “FULL FOUR PORT CAL SETUP (SOLT/R, COAXIAL) Dialog Box” on page 10-51 • • “FULL FOUR PORT CAL SETUP (LRL/LRM, COAXIAL) Dialog Box” on page 10-62 <p>Port Selected</p> <p>Read-only display of the ports selected for the pending calibration.</p> <p>Port 1 Reflective Devices</p> <p>Select displays the REFL. DEVICES PORT 1 submenu. When all procedures are complete, select the Back button to return to the FOUR PORT CAL menu where this button is now marked with a completion checkmark.</p> <p>Port 2 Reflective Devices</p> <p>Select displays the REFL. DEVICES PORT 2 submenu. When all procedures are complete, select the Back button to return to the FOUR PORT CAL menu where this button is now marked with a completion checkmark.</p>
--	--

Figure 10-30. FOUR PORT CAL Menu - 4-Port VNAs - Typical Example (1 of 2)

	<p>Port 3 Reflective Devices</p> <p>Select displays the REFL. DEVICES PORT 3 submenu. When all procedures are complete, select the Back button to return to the FOUR PORT CAL menu where this button is now marked with a completion checkmark.</p> <p>Port 4 Reflective Devices</p> <p>Select displays the REFL. DEVICES PORT 3 submenu. When all procedures are complete, select the Back button to return to the FOUR PORT CAL menu where this button is now marked with a completion checkmark.</p> <p>Thru/Recip</p> <p>Select displays the THRU/RECIP submenu. When all procedures are complete, select the Back button to return to the FOUR PORT CAL menu where this button is now marked with a completion checkmark.</p> <p>Isolation (Optional)</p> <p>If required, select displays the ISOLATION submenu. When all procedures are complete, select the Back button to return to the FOUR PORT CAL menu where this button is now marked with a completion checkmark.</p> <p>Done</p> <p>This button is unavailable until the calibration procedure has been completed. When available, it returns to the CALIBRATION menu where the Cal Status button is set to ON.</p> <ul style="list-style-type: none"> • “CALIBRATION [TR] Menu - 4-Port VNAs” on page 10-5 <p>Abort Cal</p> <p>Select stops the current calibration procedure and returns to the CALIBRATION menu.</p> <ul style="list-style-type: none"> • “CALIBRATION [TR] Menu - 4-Port VNAs” on page 10-5
--	--

Figure 10-30. FOUR PORT CAL Menu - 4-Port VNAs - Typical Example (2 of 2)

Completion Menu Button Example

The Port 1 Reflective Devices button (#1) links to the REFL. DEVICES PORT 1 submenu. As each procedure is completed, the submenu button is marked with a completion checkmark. When all the procedures on the submenu are completed, use the **Back** button to return to the FOUR PORT CAL menu.



The Port 1 Reflective Devices button (#2) is now marked with a completion checkmark.

Manual 4-Port Cal Setup Dialog Boxes - 4-Port VNAs

The instrument supports all combinations of 4-port calibration method and line types with configuration dialog boxes. In the interest of document length, not all combinations are described in detail. However, all combinations are summarized in the table at the end of this section.

- [“FULL FOUR PORT CAL SETUP \(SOLT/R, COAXIAL\) Dialog Box”](#) on page 10-51
- [“FULL FOUR PORT CAL SETUP \(SSLT, COAXIAL\) Dialog Box”](#) on page 10-54
- [“FULL FOUR PORT CAL SETUP \(SSST, COAXIAL\) Dialog Box”](#) on page 10-58
- [“FULL FOUR PORT CAL SETUP \(LRL/LRM, COAXIAL\) Dialog Box”](#) on page 10-62
- Table: [“Manual 4-Port Cal Setup Dialog Box Summary”](#) on page 10-66

FULL FOUR PORT CAL SETUP (SOLT/R, COAXIAL) Dialog Box

Prerequisites

- VNA Mode = 4-Port Mode
- Cal Method = SOLT/SOLR
- Line Type = Coaxial

Previous

- [“FOUR PORT CAL Menu - 4-Port VNAs”](#) on page 10-47
- [“CAL SETUP Menu - 4-Port VNAs”](#) on page 10-43

Navigation

- MAIN | Calibration | CALIBRATION [TR] | Calibrate | CALIBRATE | Manual Cal | MANUAL CAL | 4-Port Cal | FOUR PORT CAL | Modify Cal Setup | CAL SETUP | Cal Method = SOLT/SOLR | Line Type = Coaxial | Edit Cal Params | FULL FOUR PORT CAL SETUP (SOLT/R, COAXIAL) Dialog Box

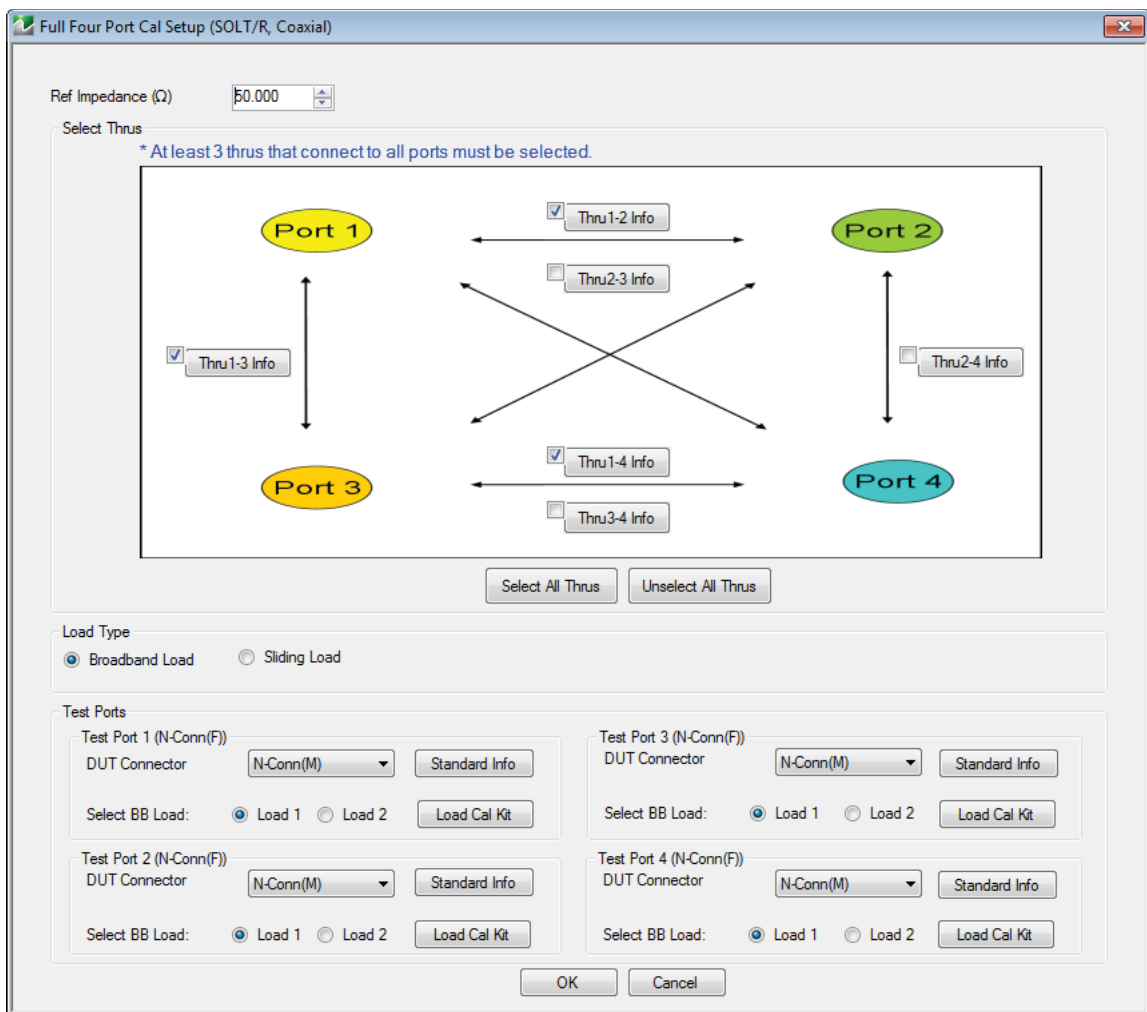

Figure 10-31. FULL FOUR PORT CAL SETUP (SOLT/R, COAXIAL) Dialog Box

Reference Impedance

Input the reference impedance.

- Input field defaulted to 50 Ohms.
- Any numerical value accepted although input values <0.01 Ohms are converted to 0.01 Ohms.

Select Through Area

Select any combination of throughs as long as three are selected. For a 4-port calibration, the following port pairs are available:

- Thru 1-2
- Thru 1-3
- Thru 1-4
- Thru 2-3
- Thru 2-4
- Thru 3-4

Thru Buttons

Each of the throughs above enables a Thru Info button that displays the THRU INFO dialog box allowing configuration of each through. A calculator icon in the THRU INFO dialog box allows access to the AIR EQUIVALENT LENGTH CALCULATOR dialog box.

- [“THRU INFO Dialog Box - 4-Port VNAs” on page 10-154](#)
- [“AIR EQUIVALENT LENGTH Calculator Dialog Box” on page 10-146](#)

Load Type Area

Select from two options:

- Broadband Load
- Sliding Load (Requires broadband loads below sliding load breakpoint frequency)

Test Port 1 Connector Type Area

Select the **DUT Connector Type** from a drop-down menu list with options of:

- K-Conn (M)
- K-Conn (F)
- GPC-3.5 (M)
- GPC-3.5 (F)
- SMA (M)
- SMA (F)
- N-Conn (M)
- N-Conn (F)
- 2.4 mm (M)
- 2.4 mm (F)
- TNC (M)
- TNC (F)
- V-conn (M)
- V-conn (F)
- W1-conn (M)
- W1-conn (F)
- 7/16 (M)

- 7/16 (F)
- GPC-7
- N-conn(75) (M)
- N-conn(75) (F)
- user defined 1 through 8 (M or F)

Test Port 1 Connector Standard Info Button

Select displays the Standard Info dialog box for the selected connector and calibration method that displays the connector calibration coefficients. The dialog box contents depend on the selected connector, Cal Method, and Line Type. The example here shows a typical standard information dialog box.

- [“MICROSTRIP KIT INFO and USER DEFINED MICROSTRIP Dialog Boxes” on page 10-147](#)

Test Port 1 Select BB Load Area

Select BB Load number for Test Port 1:

- Load 1
- Load 2

Test Port 2, Test Port 3, and Test Port 4 Connector Type Area

Identical function as with the Test Port 1 Connector Area above. Select the DUT Connector Type from a drop-down menu list.

Test Port 2, Test Port 3, and Test Port 4 Connector Standard Info Button

Identical function as with the Test Port 1 Connector Standard Info Button above. Select displays the Standard Info dialog box for the selected DUT Connector.

Test Port 2, Test Port 3, and Test Port 4 Select BB Load Area

Identical function as with the Test Port 1 Select BB Load Area above. Select between Load 1 and Load 2.

OK / Cancel

Click OK to accept the changes and return to the CAL SETUP menu or click Cancel.

FULL FOUR PORT CAL SETUP (SSLT, COAXIAL) Dialog Box

Prerequisites

- VNA Mode = 4-Port Mode
- Cal Method = SSLT
- Line Type = Coaxial

Previous

- [“FOUR PORT CAL Menu - 4-Port VNAs”](#) on page 10-47
- [“CAL SETUP Menu - 4-Port VNAs”](#) on page 10-43

Navigation

- MAIN | Calibration | CALIBRATION [TR] | Calibrate | CALIBRATE | Manual Cal | MANUAL CAL | 4-Port Cal | FOUR PORT CAL | Modify Cal Setup | CAL SETUP | Cal Method = SSLT | Line Type = Coaxial | Edit Cal Params | FULL FOUR PORT CAL SETUP (SSLT, COAXIAL) Dialog Box

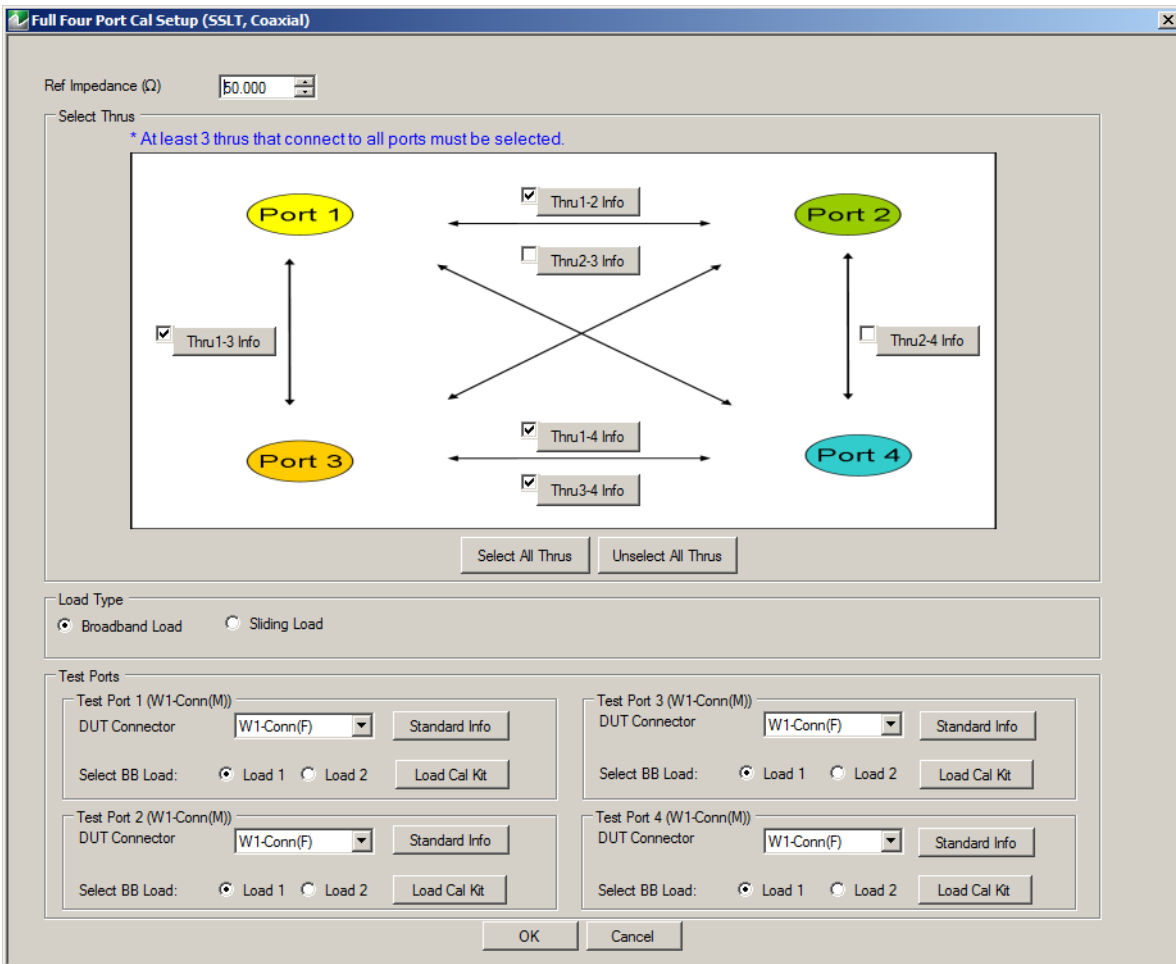

Figure 10-32. FULL FOUR PORT CAL SETUP (SSLT, COAXIAL) Dialog Box

Reference Impedance

Input the reference impedance.

- Input field defaulted to 50 Ohms.
- Any numerical value accepted although input values <0.01 Ohms are converted to 0.01 Ohms.

Select Throughs

Select any combination of throughs as long as three are selected. For a 4-port calibration, the following port pairs are available:

- Thru 1-2
- Thru 1-3
- Thru 1-4
- Thru 2-3
- Thru 2-4
- Thru 3.4

Thru Buttons

Each of the throughs above enables a Thru Info button that displays the THRU INFO dialog box allowing configuration of each through. A calculator icon in the THRU INFO dialog box allows access to the AIR EQUIVALENT LENGTH CALCULATOR dialog box.

- [“THRU INFO Dialog Box - 4-Port VNAs” on page 10-154](#)
- [“AIR EQUIVALENT LENGTH Calculator Dialog Box” on page 10-146](#)

Load Type

Select from two radio button controlled options:

- Broadband Load
- Sliding Load. If Sliding Load is selected, a message appears in the “Still requires broadband loads below sliding load breakpoint frequency.”

Test Port 1 Connector Type

Select the **DUT Connector Type** from a drop-down menu list with options of:

- K-Conn (M)
- K-Conn (F)
- GPC-3.5 (M)
- GPC-3.5 (F)
- SMA (M)
- SMA (F)
- N-Conn (M)
- N-Conn (F)
- 2.4 mm (M)
- 2.4 mm (F)
- TNC (M)
- TNC (F)
- V-conn (M)
- V-conn (F)
- W1-conn (M)
- W1-conn (F)
- 7/16 (M)

- 7/16 (F)
- GPC-7
- N-conn(75) (M)
- N-conn(75) (F)
- user defined 1 through 8 (M or F)

Test Port 1 Connector Standard Info Button

Select displays the Standard Info dialog box for the selected connector and calibration method that displays the connector calibration coefficients. The dialog box contents depend on the selected connector, Cal Method, and Line Type. The example here shows a typical standard information dialog box.

- [“MICROSTRIP KIT INFO and USER DEFINED MICROSTRIP Dialog Boxes”](#) on page 10-147

Test Port 1 Select BB Load

Select BB Load number for Test Port 1:

- Load 1
- Load 2

Test Port 2, Test Port 3, and Test Port 4 Connector Type

Identical function as with the Test Port 1 Connector above. Select the DUT Connector Type from a drop-down menu list.

Test Port 2, Test Port 3, and Test Port 4 Connector Standard Info Button

Identical function as with the Test Port 1 Connector Standard Info Button above. Select displays the Standard Info dialog box for the selected DUT Connector.

Test Port 2, Test Port 3, and Test Port 4 Select BB Load

Identical function as with the Test Port 1 Select BB Load above. Select between Load 1 and Load 2.

OK / Cancel

Click OK to accept the changes and return to the CAL SETUP menu.

Click Cancel to abandon any changes and return to the CAL SETUP menu.

FULL FOUR PORT CAL SETUP (SSST, COAXIAL) Dialog Box

Prerequisites

- VNA Mode = 4-Port Mode
- Cal Method = SSST
- Line Type = Coaxial

Previous

- [“FOUR PORT CAL Menu - 4-Port VNAs” on page 10-47](#)
- [“CAL SETUP Menu - 4-Port VNAs” on page 10-43](#)

Navigation

- This dialog box is available from multiple menus.
- MAIN | Calibration | CALIBRATION [TR] | Calibrate | CALIBRATE | Manual Cal | MANUAL CAL | 4-Port Cal | FOUR PORT CAL | Modify Cal Setup | CAL SETUP | Cal Method = SSST | Line Type = Coaxial | Edit Cal Params | FULL FOUR PORT CAL SETUP (SSST, COAXIAL) Dialog Box

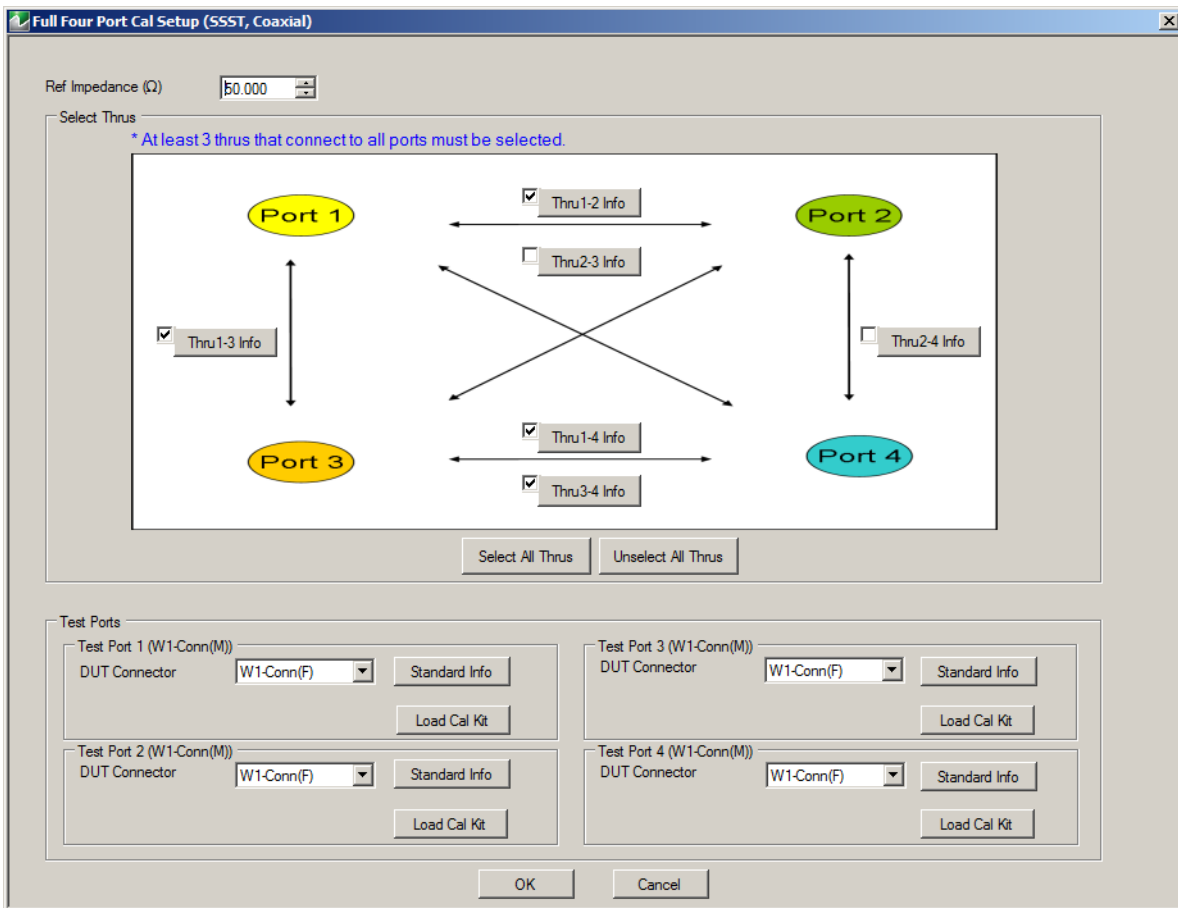

Figure 10-33. FULL FOUR PORT CAL SETUP (SSST, COAXIAL) Dialog Box

Reference Impedance

Input the reference impedance.

- Input field defaulted to 50 Ohms.
- Any numerical value accepted although input values <0.01 Ohms are converted to 0.01 Ohms.

Select Throughs

Select any combination of throughs as long as three are selected. For a 4-port calibration, the following port pairs are available:

- Thru 1-2
- Thru 1-3
- Thru 1-4
- Thru 2-3
- Thru 2-4
- Thru 3.4

Thru Info Buttons

Each of the throughs above enables a Thru Info button that displays the THRU INFO dialog box allowing configuration of each through. A calculator icon in the THRU INFO dialog box allows access to the AIR EQUIVALENT LENGTH CALCULATOR dialog box.

- [“THRU INFO Dialog Box - 4-Port VNAs” on page 10-154](#)
- [“AIR EQUIVALENT LENGTH Calculator Dialog Box” on page 10-146](#)

Test Port 1 Connector Type

Select the **DUT Connector Type** from a drop-down menu list with options of:

- W1-Conn (M)
- W1-Conn (F)
- User-Defined1 (M) through User-Defined8 (M)
- User-Defined1 (F) through User-Defined8 (F)

Test Port 1 Connector Standard Info Button

Select displays the Standard Info dialog box for the selected connector and calibration method that displays the connector calibration coefficients. The dialog box contents depend on the selected connector, Cal Method, and Line Type. The example here shows a typical standard information dialog box.

- [“MICROSTRIP KIT INFO and USER DEFINED MICROSTRIP Dialog Boxes” on page 10-147](#)

Test Port 2, Test Port 3, and Test Port 4 Connector Type

Identical function as with the Test Port 1 Connector above. Select the DUT Connector Type from a drop-down menu list.

Test Port 2, Test Port 3, and Test Port 4 Connector Standard Info Button

Identical function as with the Test Port 1 Connector Standard Info Button above. Select displays the Standard Info dialog box for the selected DUT Connector.

OK / Cancel

Click OK to accept the changes and return to the CAL SETUP menu.

Click Cancel to abandon any changes and return to the CAL SETUP menu.

FULL FOUR PORT CAL SETUP (SSST, WAVEGUIDE) Dialog Box

Prerequisites

- VNA Mode = 4-Port Mode
- Cal Method = SSST
- Line Type = Waveguide

Previous

- “FOUR PORT CAL Menu - 4-Port VNAs” on page 10-47
- “CAL SETUP Menu - 4-Port VNAs” on page 10-43

Navigation

- This dialog box is available from multiple menus.
- MAIN | Calibration | CALIBRATION [TR] | Calibrate | CALIBRATE | Manual Cal | MANUAL CAL | 4-Port Cal | FOUR PORT CAL | Modify Cal Setup | CAL SETUP | Cal Method = SSST | Line Type = Waveguide | Edit Cal Params | FULL FOUR PORT CAL SETUP (SSST, WAVEGUIDE) Dialog Box

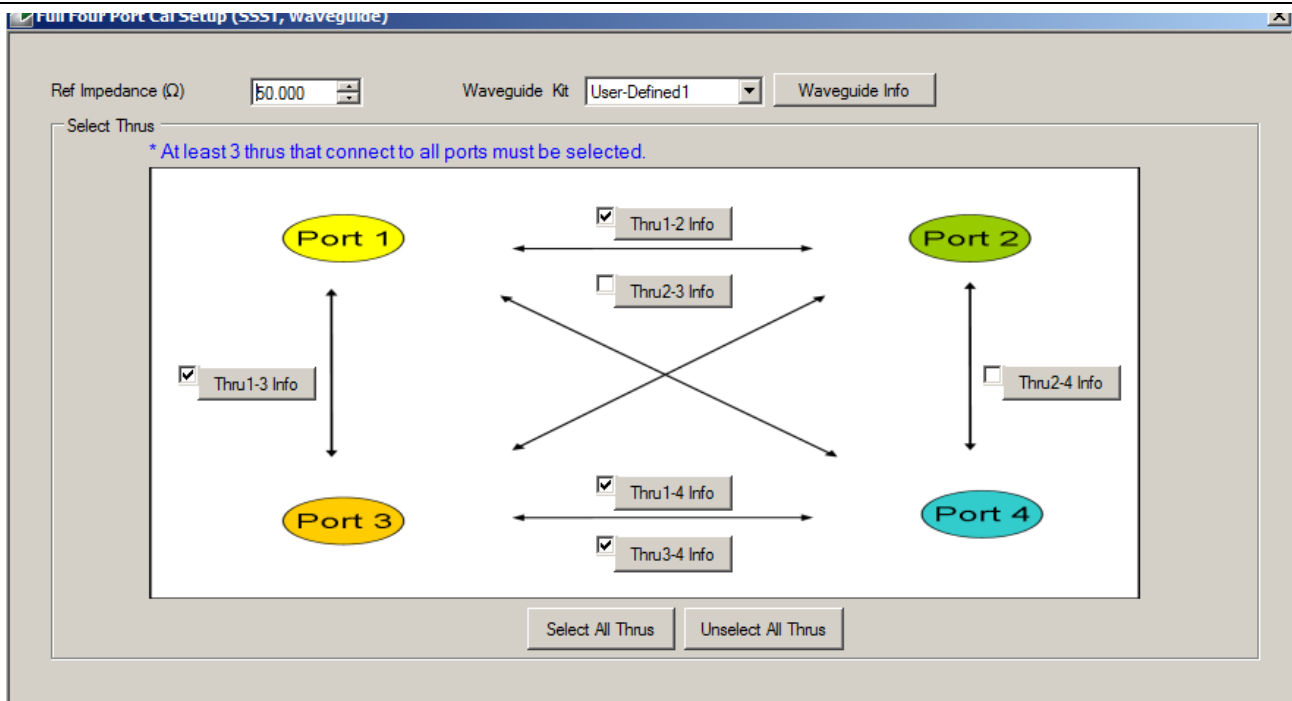

Figure 10-34. FULL FOUR PORT CAL SETUP (SSST, WAVEGUIDE) Dialog Box

Reference Impedance

Input the reference impedance.

- Input field defaulted to 50 Ohms.
- Any numerical value accepted although input values <0.01 Ohms are converted to 0.01 Ohms.

Waveguide Kit

Select the **Waveguide Kit** from a drop-down menu list with options of:

- User-Defined1 through User-Defined8

Select Throughs

Select any combination of throughs as long as three are selected that connect to all ports. For a 4-port calibration, the following port pairs are available:

- Thru 1-2
- Thru 1-3
- Thru 1-4
- Thru 2-3
- Thru 2-4
- Thru 3,4

Thru Buttons

As each through is selected, it enables a Thru Info button that displays the THRU INFO configuration dialog box for the selected port pair. A calculator icon in the THRU INFO dialog box allows access to the AIR EQUIVALENT LENGTH CALCULATOR dialog box.

- [“THRU INFO Dialog Box - 4-Port VNAs” on page 10-154](#)
- [“AIR EQUIVALENT LENGTH Calculator Dialog Box” on page 10-146](#)

OK / Cancel

Click OK to accept the changes and return to the CAL SETUP menu.

Click Cancel to abandon any changes and return to the CAL SETUP menu.

FULL FOUR PORT CAL SETUP (LRL/LRM, COAXIAL) Dialog Box

Prerequisites

- VNA Mode = 4-Port Mode
- Cal Method = LRL/LRM
- Line Type = Coaxial

Previous

- [“FOUR PORT CAL Menu - 4-Port VNAs”](#) on page 10-47
- [“CAL SETUP Menu - 4-Port VNAs”](#) on page 10-43

Navigation

- MAIN | Calibration | CALIBRATION [TR] | Calibrate | CALIBRATE | Manual Cal | MANUAL CAL | 4-Port Cal | FOUR PORT CAL | Modify Cal Setup | CAL SETUP | Cal Method = LRL/LRM | Line Type = Coaxial | Edit Cal Params | FULL FOUR PORT CAL SETUP (LRL/LRM, COAXIAL) Dialog Box

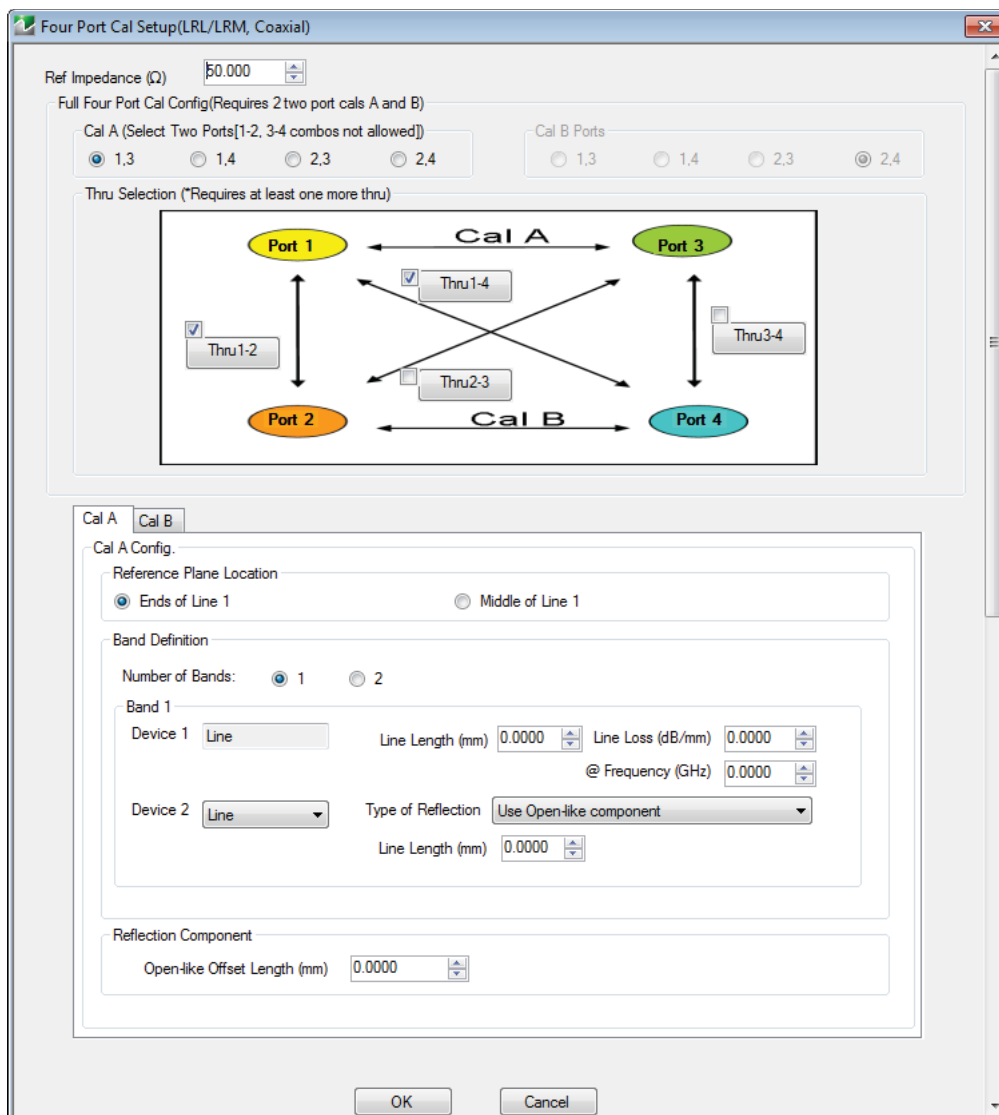

Figure 10-35. FOUR PORT CAL SETUP (LRL/LRM, COAXIAL) Dialog Box

Overview

The dialog box provides common areas for Reference Impedance, Full Four Port Calibration Configuration, and Thru Selection. Below this common section are two tabbed dialog areas for Cal A and Cal B.

Reference Impedance

Input the reference impedance.

- Input field defaulted to 50 Ohms.
- Any numerical value accepted although input values <0.01 Ohms are converted to 0.01 Ohms.

Full Four Port Cal Configuration

Requires two 2-port calibrations as Cal A and Cal B, configured below.

Cal A Ports

Allows selection of the calibration A port pair. Combinations of ports 1-2 and ports 3-4 are not allowed. Select from:

- Port 1, 3
- Port 1, 4
- Port 2, 3
- Port 2, 4

Cal B Ports

This area is read-only and defined by the port pair choice for Cal A.

- If Cal A = Ports 1, 3, then Cal B = Ports 2, 4
- If Cal A = Ports 1, 4, then Cal B = Ports 2, 3
- If Cal A = Ports 2, 3, then Cal B = Ports 1, 4
- If Cal A = Ports 2, 4, then Cal B = Ports 1, 3

Thru Selection

Any combination of throughs may be selected as long as least one additional through is selected from:

- Thru 1-2
- Thru 1-3
- Thru 1-4
- Thru 3-4

Cal A Tab

Access the Cal A functions and controls by selecting the Cal A tab.

Cal A - Reference Plane Location

Select from two options:

- Ends of Line 1
- Middle of Line 1

Cal A - Band Definition

Select one or two bands from the pull-down menu.

- Number of Bands = 1. Only the **Band 1 Definition** area is present.
- Number of Bands = 2. The **Band 1 Definition** area remains, and the **Band 2 Definition** and the **Band Break Point** areas appear.

Cal A - Band 1 Device 1 Definition

Provides the following fields and controls for Band 1:

- Band 1 Device 1 = Defaulted to Line.
- Line Length (mm) for Device 1. Allows input of the line length in mm.

- Line Loss (dB/mm). Allows input of a line loss in dB per mm at the frequency specified in the field below.
- @ Frequency (GHz). Allows input of a frequency setting for the Line Loss factor input above.

Cal A - Band 1 Device 2 Definition

- Band 1 Device 2. Select from Line or Match in pull-down menu.
- If Line is selected, the Type of Reflection allows selection of Use Open-like component or Use Short-like component.
 - If Use Open-line component is selected, the Reflection Component area at bottom of dialog box displays the Open-like Offset Length (mm) field.
 - If Use Short-like component is selected, the Reflection Component area at bottom of dialog box displays Short-line Offset Length (mm) field.

Cal A - Band 2 Definition

The Number of Bands field above must be set to “2” for this area and the Band Break Point area described below to be displayed. Provides the following fields and controls for Band 2.

Cal A - Band 2 Device 3 Definition

A pull-down menu with selections of:

- Use device 1
- Use device 2
- Use new line. If selected, additional fields appear as Line Length (mm), Line Loss (dB/mm), and @ Frequency (GHz).

Cal A - Band 2 Device 4 Definition

A pull-down menu with selections of:

- Line
- Match

If Line is selected for Band 2 Device 4, the Type of Reflection and Line Length (mm) fields are available.

The Type of Reflection field choices are limited to:

- Use Short-like component. If selected, the Reflection Component area below has one field for Short-like Offset Length (mm).
- Use Open-like component. If selected, the Reflection Component area below has two fields of Open-like Offset Length (mm) and Short-like Offset Length (mm).

If Match is selected for Band 2 Device 4, the Match Info button and the Type of Reflection fields appear with choices of:

- The Match Info button appears. Select displays the USER DEFINED MATCH DEVICES dialog box appears which allows configuration of the match devices.
 - [“USER DEFINED MATCH DEVICES Dialog Box - LRL/LRM” on page 10-155](#)
- The Type of Reflection field has the following choices:
 - Use Short-like component. If selected, the Reflection Component area below has one field of Short-like Offset Length (mm) field.
 - Use Open-like component. If selected, the Reflection Component area below has two fields of Open-like Offset Length (mm) and Short-like Offset Length (mm).
 - Use both. If selected, pair of radio button fields appear and allow selection of either Use Port 1 Match or Use Port 2 Match. Also, if selected, the Reflection Component area below has two fields of Open-like Offset Length (mm) and Short-like Offset Length (mm).

Cal A - Band Break Point

This area appears if the Number of Bands in the Band Definition area is set to “2”.

The Calculate Recommended Value button calculates the recommended break point value based on the input parameters in the fields above. Clicking the button calculates a break point frequency value and populates the Use Recommended Frequency (GHz) field.

A radio button set allows selection of either:

- Use Recommended Frequency (GHz) which was calculated by the button above.
- Define New Frequency (GHz) field which allows direct user input of a break frequency value.

Cal A - Reflection Component

Depending on the settings in the fields above, this area one or two input fields from:

- Open-like Offset Length (mm)
- Short-like Offset Length (mm)

Cal B Tab and Controls

Access the Cal B functions and controls by selecting the Cal B tab.

Cal B - Reference Plane Location

Select from two options:

- Ends of Line 1
- Middle of Line 1

Cal B - Band Definition

Select one or two bands from the pull-down menu. The function is the same as the Cal A - Band Definition described above.

Cal B - Band 1 Device 1 Definition

Provides fields and controls for Cal B - Band 1 Device 1. The functions are the same as the Cal B - Band 1 Device 1 Definition area described above.

Cal B - Band 1 Device 2 Definition

Provides fields and controls for Cal B - Band 1 Device 2. The functions are the same as the Cal A - Band 1 Device 2 Definition area described above.

Cal B - Band 2 Definition

The Number of Bands field above must be set to “2” for this area and the Band Break Point area described below to be displayed. The functions are the same as the Cal B - Band 2 Definition area described above.

Cal B - Band 2 Device 3 Definition

A pull-down menu with selections of Use device 1, Use device 2, or Use new line. The functions and controls are the same as the Cal A - Band 2 Device 3 Definition area described above.

Cal B - Band 2 Device 4 Definition

A pull-down menu with selections of Line or Match. The functions and controls are the same as the Cal A - Band 2 Device 4 Definition area described above.

Cal B - Band Break Point

This area only appears if the Number of Bands in the Band Definition area is set to “2”. The functions and controls are the same as the Cal A - Band Break Point area described above.

Cal B - Reflection Component

Depending on the settings in the fields above, this area has one or two input fields. The functions and controls are the same as the Cal A - Reflection Component area described above.

OK / Cancel

Click OK to accept the changes and return to the CAL SETUP menu or click Cancel.

Manual 4-Port Cal Dialog Box Summary

The table below summarizes the available fields in all available 4-port calibration setup dialog boxes. If the dialog box is described above, a link is provided to that description. To view each dialog box, set the CAL METHOD and LINE TYPE menus to the appropriate settings, and then select the Edit Cal Params button. All dialog boxes are named either “Full Four Port Cal Setup (Cal Method, Line Type)” or “Four Port Cal Setup (Cal Method, Line Type)

Table 10-2. Manual 4-Port Cal Setup Dialog Box Summary (1 of 4)

Cal Method Line Type	Dialog Box Controls and Functions
<p>SOLT/R Coaxial</p>	<p>See full description at “FULL FOUR PORT CAL SETUP (SOLT/R, COAXIAL) Dialog Box” on page 10-51</p> <p>Reference Impedance (Ohms)</p> <p>Select Throughs: At least 3 throughs that connect to all ports must be selected. Select from Thru 1-2, Thru 1-3, Thru 1-4, Thru 2-3, Thru 2-4, Thru 3-4.</p> <p>Thru Info buttons: Displays the THRU INFO dialog box for the selected through.</p> <ul style="list-style-type: none"> • “THRU INFO Dialog Box - 4-Port VNAs” on page 10-154 <p>Load Type: Select from Broadband Load or Sliding Load</p> <p>Test Ports: Port 1, Port 2, Port 3, Port 4.</p> <p>Test Port DUT Connector: Select from K-Conn (M), K-Conn (F); GPC-3.5 (M), GPC-3.5 (F); SMA (M), SMA (F); N-Conn (M), N-Conn (F); User-Defined1 (M) to User-Defined8 (M), User-Defined1 (F) to User-Defined8 (F)</p> <p>Test Port Connector Standard Info Button: For each DUT port connector, displays the STANDARD INFORMATION or USER-DEFINED dialog box for the selected connector.</p> <ul style="list-style-type: none"> • “MICROSTRIP KIT INFO and USER DEFINED MICROSTRIP Dialog Boxes” on page 10-147 <p>Test Port Select BB Load: Load 1, Load 2.</p> <p>Test Port 1, Test Port 2, Test Port 3, and Test Port 4 controls are the same.</p>
<p>SOLT/R Non-Dispersive</p>	<p>Same controls and functions as SOLT/R Coaxial above.</p>
<p>SOLT/R Waveguide</p>	<p>SOLT/R is not recommended for Waveguide calibrations.</p> <p>Same controls as SOLT/R Coaxial with the following changes:</p> <p>Waveguide Kit: User-Defined 1 to User-Defined8</p> <p>Waveguide Info button: Displays USER DEFINED WAVEGUIDE dialog box for the waveguide kit selected above.</p> <ul style="list-style-type: none"> • “WAVEGUIDE INFO and USER DEFINED WAVEGUIDE Dialog Boxes” on page 10-156

Table 10-2. Manual 4-Port Cal Setup Dialog Box Summary (2 of 4)

Cal Method Line Type	Dialog Box Controls and Functions
SOLT/R Microstrip	<p>Same controls as SOLT/R Coaxial with the following changes:</p> <p>Microstrip Kit: 10 Mil Kit, 15 Mil Kit, 25 Mil Kit, User-Defined 1 to User-Defined8</p> <p>Microstrip Info button: Displays either the MICROSTRIP INFO or the USER DEFINED MICROSTRIP dialog box for the microstrip kit selected above.</p> <ul style="list-style-type: none"> • “MICROSTRIP KIT INFO and USER DEFINED MICROSTRIP Dialog Boxes” on page 10-147 <p>Test Port DUT Connector: User-Defined 1 through User Defined 32.</p> <p>Test Port DUT Connector Standard Info Button: For each port, displays the USER DEFINED STANDARD dialog box for the selected connector:</p>
SSLT Coaxial	<p>See full description at “FULL FOUR PORT CAL SETUP (SSLT, COAXIAL) Dialog Box” on page 10-54</p> <p>Reference Impedance (Ohms)</p> <p>Select Throughs:</p> <ul style="list-style-type: none"> • At least 3 throughs that connect to all ports must be selected. • Thru 1-2, Thru 1-3, Thru 1-4, Thru 2-3, Thru 2-4, Thru 3-4 <p>Thru Info buttons:</p> <ul style="list-style-type: none"> • Displays the THRU INFO dialog box for the selected through. • “THRU INFO Dialog Box - 4-Port VNAs” on page 10-154 <p>Load Type: Broadband Load, Sliding Load</p> <p>Test Ports: Port 1, Port 2, Port 3, Port 4</p> <p>Test Port 1 DUT Connector: , W1-Conn (M), W1-Conn (F), User-Defined1 (M) through User-Defined8 (M), User-Defined1 (F) through User-Defined8 (F)</p> <p>Test Port 1 Connector Standard Info Button:</p> <ul style="list-style-type: none"> • Displays the STANDARD INFORMATION dialog box for the selected connector. • “MICROSTRIP KIT INFO and USER DEFINED MICROSTRIP Dialog Boxes” on page 10-147 <p>Test Port 1 BB Load: Load 1, Load 2.</p> <p>Test Port 2, Test Port 3, and Test Port 4 controls are the same as Test Port 1.</p>
SSLT Non-Dispersive	<p>Same controls and functions as SSLT Coax above.</p>
SSLT Waveguide	<p>Same controls as SSLT Coaxial with the following changes:</p> <p>Waveguide Kit: WR10, WR12, WR15, User-Defined 1 to User-Defined8</p> <p>Waveguide Info button:</p> <ul style="list-style-type: none"> • Displays WAVEGUIDE INFO dialog box for selected calibration method and kit. • “WAVEGUIDE INFO and USER DEFINED WAVEGUIDE Dialog Boxes” on page 10-156

Table 10-2. Manual 4-Port Cal Setup Dialog Box Summary (3 of 4)

Cal Method Line Type	Dialog Box Controls and Functions
SSLT Microstrip	<p>Same controls as SSLT Coaxial with the following changes:</p> <p>Microstrip Kit: 10 Mil Kit, 15 Mil Kit, 25 Mil Kit, User-Defined 1 to User-Defined8</p> <p>Microstrip Info button:</p> <ul style="list-style-type: none"> • Displays MICROSTRIP INFO dialog box for selected calibration method and kit. • “MICROSTRIP KIT INFO and USER DEFINED MICROSTRIP Dialog Boxes” on page 10-147 <p>Test Port DUT Connector: User-Defined 1 through User Defined 32.</p> <p>Test Port DUT Connector Standard Info Button:</p> <ul style="list-style-type: none"> • Select displays the USER DEFINED STANDARD dialog box for the selected connector.
SSST Coaxial	<p>See full description at “FULL FOUR PORT CAL SETUP (SSST, COAXIAL) Dialog Box” on page 10-58</p> <p>Reference Impedance (Ohms)</p> <p>Select Throughs: At least 3 throughs that connect to all ports must be selected. Select from Thru 1-2, Thru 1-3, Thru 1-4, Thru 2-3, Thru 2-4, Thru 3-4</p> <p>Thru Info buttons: Displays the THRU INFO dialog box for the selected through.</p> <ul style="list-style-type: none"> • “THRU INFO Dialog Box - 4-Port VNAs” on page 10-154 <p>Test Ports: Port 1, Port 2, Port 3, Port 4</p> <p>Test Port DUT Connector: W1-Conn (M), W1-Conn (F), User-Defined1 (M) through User-Defined8 (M), User-Defined1 (F) through User-Defined8 (F)</p> <p>Test Port Connector Standard Info Button: Displays the STANDARD INFORMATION dialog box for the selected connector.</p> <ul style="list-style-type: none"> • “STANDARD INFO (OFFSET SHORT) W1-Connector (F) Dialog Box” on page 10-148 <p>Test Port 1, Test Port 2, Test Port 3, and Test Port 4 controls are the same.</p>
SSST Non-Dispersive	<p>Same controls as SSST Coaxial above.</p>
SSST Waveguide	<p>See full description at “FULL FOUR PORT CAL SETUP (SSST, WAVEGUIDE) Dialog Box” on page 10-60</p> <p>Same controls as SSST Coaxial with the following changes:</p> <p>Waveguide Kit: User-Defined 1 to User-Defined8</p> <p>Waveguide Info button:</p> <ul style="list-style-type: none"> • Displays WAVEGUIDE INFO dialog box for selected calibration method and kit. • “WAVEGUIDE INFO and USER DEFINED WAVEGUIDE Dialog Boxes” on page 10-156

Table 10-2. Manual 4-Port Cal Setup Dialog Box Summary (4 of 4)

Cal Method Line Type	Dialog Box Controls and Functions
SSST Microstrip	<p>Same controls as SSST Coaxial with the following changes:</p> <p>Microstrip Kit: 10 Mil Kit, 15 Mil Kit, 25 Mil Kit, User-Defined 1 to User-Defined8</p> <p>Microstrip Info button:</p> <ul style="list-style-type: none"> • Displays MICROSTRIP INFO dialog box for selected calibration method and kit. • “MICROSTRIP KIT INFO and USER DEFINED MICROSTRIP Dialog Boxes” on page 10-147 <p>Test Port DUT Connector: User-Defined 1 through User Defined 32.</p> <p>Test Port DUT Connector Standard Info Button:</p> <ul style="list-style-type: none"> • Select displays the USER DEFINED STANDARD dialog box for the selected connector.
LRL/LRM Coaxial	<p>See full description of controls and display logic at “FULL FOUR PORT CAL SETUP (LRL/LRM, COAXIAL) Dialog Box” on page 10-62.</p> <p>Reference Impedance (Ohms)</p> <p>Cal A Ports - Select two from 1-3, 1-4, 2-3, 2-4</p> <p>Cal B Ports - Auto-selected non-Cal A Ports of 1-3, 1-4, 2-3, 2-4</p> <p>Select Throughs:</p> <ul style="list-style-type: none"> • Requires at least one additional through. • Four through combinations of Cal A and Cal B Ports are displayed. • Only four of Thru 1-2, Thru 1-3, Thru 1-4, Thru 2-3, Thru 2-4, Thru 3-4 are shown • “THRU INFO Dialog Box - 4-Port VNAs” on page 10-154 <p>Cal A and Cal B tabs: The “A” and “B” calibration parameters are selected via a tabbed menu within the dialog box.</p> <p>Number of Bands: 1, 2</p> <ul style="list-style-type: none"> • If 1, only Band 1 Device 1 and Band 1 Device 2 controls appear. • If 2, the above plus Band 2 Device 3 and Band 2 Device 4 controls appear. <p>Cal A Configuration Parameters:</p> <ul style="list-style-type: none"> • Cal A Reference Plane Location: Ends of Line, Middle of Line 1 • Cal A Number of Bands: 1 or 2 • Cal A Band 1 Device 1 Line: Line Length (mm), Line Loss (dB/mm), @ Frequency (GHz) • Cal A Band 1 Device 2 Type: Line, Match; Use Short-like component, Use Open-like component, Use both; If Device 2 = Match, Match Info button displays USER DEFINED MATCH DEVICES dialog box for selected calibration kit. • “USER DEFINED MATCH DEVICES Dialog Box - LRL/LRM” on page 10-155 • Cal A Band 2 Device 3: Use device 1, Use new line • Cal A Band 2 Device 4: Line, Match, Type of Reflection (Use Open-like component, Use Short-like component), Line Length (mm) • Cal A Band Break Point: Calculate Recommended Value, Use Recommended Frequency (GHz), Define New Frequency (GHz). • Cal A Reflection Component: Open-like Length (mm), Short-like Offset Length (mm) <p>Cal B Configuration Parameters</p> <ul style="list-style-type: none"> • Cal B parameters are the same as those for Cal A.
LRL/LRM Non-Dispersive	<p>Same controls as LRL/LRM Coaxial.</p>

10-10 Typical Calibration Sub-Menus

The menus in this section are example menus for the calibration step procedures. The exact content and presence of each menu is dependent on the settings for each calibration run.

REFL. DEVICE(S) Menu - 4-Port VNAs

Full Name

- REFLECTIVE DEVICE(S) Menu

Typical Configuration

This menu example is a representative menu based on the following configuration:

- VNA is in 4-port mode
- A 4-port calibration
- A SOLT/SOLR calibration method
- A coaxial line type
- An N(f) Connector

Using a different configuration set can change the appearance of the REFL. DEVICE(S) menu.

Previous

- The previous menu can be any of the following manual calibration menus and their associated configuration dialog boxes.
 - [“FOUR PORT CAL Menu - 4-Port VNAs” on page 10-47](#)
 - [“THREE PORT CAL Menu - 4-Port VNAs” on page 10-78](#)
 - [“TWO PORT CAL Menu - 4-Port VNAs” on page 10-97](#)
 - [“ONE PORT CAL/S Menu - 4-Port VNAs” on page 10-114](#)
 - [“TRANS. RESPONSE Menu - 4-Port VNAs” on page 10-127](#)
 - [“REFL. RESPONSE Menu - 4-Port VNAs” on page 10-136](#)
- The REFL. DEVICE(s) menu controls and functions are also subject to the settings in the following:
 - [“CAL SETUP Menu - 4-Port VNAs” on page 10-43](#)
 - [“CAL METHOD Menu - 4-Port VNA” on page 10-45](#)
 - [“LINE TYPE Menu - 4-Port VNA” on page 10-46](#)
 - [“CAL SETUP Menu - 4-Port VNAs” on page 10-43](#)

Similar Menus

- The REFL. DEVICE(S) Port 1 menu is nearly identical to typical REFL. DEVICE(S) Port 2, REFL. DEVICE(S) Port 3, and REFL. DEVICE(S) Port 4 menus.

 <p>Refl. Device(s) X ----Port 1---- Port 1 Connector N-Conn(F) Open ---- Short ---- Load ---- Sliding Load ▶</p>	<p>REFL. DEVICE(S) menu (typical)</p> <p>REFLECTIVE DEVICE(S) menu. The Open, Short, and Load buttons display a checkmark on completion of the calibration task.</p> <p>Port 1 Connector Displays designated connector for the indicated port. Select opens the Full Four Port Cal Setup (SOLT/R, Coaxial) dialog box.</p> <ul style="list-style-type: none"> • “FULL FOUR PORT CAL SETUP (SOLT/R, COAXIAL) Dialog Box” on page 10-51 <p>Open Select starts open calibration procedure for the indicated port.</p> <p>Short Select starts the short calibration procedure for the indicated port.</p> <p>Load Select starts the load calibration procedure for the indicated port.</p> <p>Sliding Load Select opens the SLIDING LOADS configuration menu. Availability requires selection of Sliding Load as Load Type in the Full Four Port Cal Setup (SOLT/R, Coaxial) menu.</p> <ul style="list-style-type: none"> • “SLIDING LOADS Menu - 4-Port VNAs” on page 10-72
---	--

Figure 10-36. REFL. DEVICE(S) Menu - 4-Port VNAs - Typical Example

SLIDING LOADS Menu - 4-Port VNAs

Typical Configuration

This menu example is a representative menu based on the following configuration:

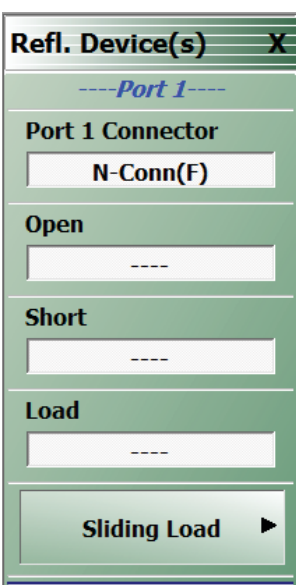
- VNA is in 4-port mode
- A 4-port calibration
- A SOLT/SOLR calibration method
- Sliding loads selected
- A coaxial line type
- An N(f) Connector

Using a different configuration set can change the appearance of the SLIDING LOADS menu.

Previous

- The previous menu can be any of the following manual calibration menus and their associated configuration dialog boxes.
 - [“REFL. DEVICE\(S\) Menu - 4-Port VNAs” on page 10-70](#)
 - [“FOUR PORT CAL Menu - 4-Port VNAs” on page 10-47](#)
 - [“THREE PORT CAL Menu - 4-Port VNAs” on page 10-78](#)
 - [“TWO PORT CAL Menu - 4-Port VNAs” on page 10-97](#)
 - [“ONE PORT CAL/S Menu - 4-Port VNAs” on page 10-114](#)
 - [“TRANS. RESPONSE Menu - 4-Port VNAs” on page 10-127](#)
 - [“REFL. RESPONSE Menu - 4-Port VNAs” on page 10-136](#)
- The SLIDING LOADREFL. DEVICE(s) menu controls and functions are also subject to the settings in the following:
 - [“CAL SETUP Menu - 4-Port VNAs” on page 10-43](#)
 - [“CAL METHOD Menu - 4-Port VNA” on page 10-45](#)
 - [“LINE TYPE Menu - 4-Port VNA” on page 10-46](#)

	<p>Typical SLIDING LOADS menu</p> <p>Each button is a completion task button and marked with a checkmark when the calibration task is complete. The number of buttons appearing on the menu is dependent on the calibration settings.</p> <p>Connector Type Read only button showing the designated connector type for the indicated port.</p> <p>Sliding Load (Position 1) Select starts the sliding load calibration procedure at position 1.</p> <p>Sliding Load (Position 2) Select starts the sliding load calibration procedure at position 2.</p> <p>Sliding Load (Position 3) Select starts the sliding load calibration procedure at position 3.</p> <p>Sliding Load (Position 4) Select starts the sliding load calibration procedure at position 4.</p> <p>Sliding Load (Position 5) Select starts the sliding load calibration procedure at position 5.</p> <p>Sliding Load (Position 6) Select starts the sliding load calibration procedure at position 6.</p> <p>When all calibration procedures are complete, use the Back button to return to the REFL DEVICE menu.</p> <ul style="list-style-type: none"> • “REFL. DEVICE(S) Menu - 4-Port VNAs” on page 10-70
---	--

Figure 10-37. SLIDING LOADS Menu - 4-Port VNAs - Typical Example

THRU Menu - 4-Port VNAs

Typical Configuration

This menu example is a representative menu based on the following configuration:

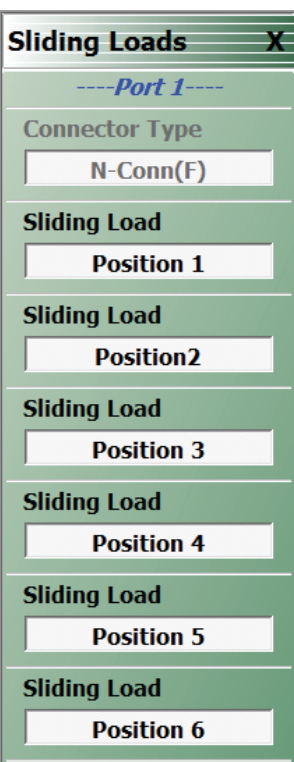
- VNA in 4-port mode
- 4-port calibration
- SOLT/SOLR calibration method
- Sliding loads selected
- Coaxial line type
- N (f) Connector

Using a different configuration set can change the appearance of the THRU/RECIP menu.

Previous

- The previous menu can be any of the following manual calibration menus and their associated configuration dialog boxes.
 - [“FOUR PORT CAL Menu - 4-Port VNAs” on page 10-47](#)
 - [“THREE PORT CAL Menu - 4-Port VNAs” on page 10-78](#)
 - [“TWO PORT CAL Menu - 4-Port VNAs” on page 10-97](#)
 - [“ONE PORT CAL/S Menu - 4-Port VNAs” on page 10-114](#)
 - [“TRANS. RESPONSE Menu - 4-Port VNAs” on page 10-127](#)
 - [“REFL. RESPONSE Menu - 4-Port VNAs” on page 10-136](#)
- The THRU/RECIP menu controls and functions are also subject to the settings in the following:
 - [“CAL SETUP Menu - 4-Port VNAs” on page 10-43](#)
 - [“CAL METHOD Menu - 4-Port VNA” on page 10-45](#)
 - [“LINE TYPE Menu - 4-Port VNA” on page 10-46](#)

	<p>THRU menu (typical)</p> <p>Select a Thru port pair button to start the thru/reciprocal calibration procedure for the indicated port pair. Completion of calibration steps is signified by completion checkmarks on the button.</p> <p>Thru Select initiates thru/reciprocal calibration at port pair 1-2.</p> <p>Thru Select initiates thru/reciprocal calibration at port pair 1-3.</p> <p>Thru Select initiates thru/reciprocal calibration at port pair 1-4.</p> <p>Thru Select initiates thru/reciprocal calibration at port pair 2-3.</p> <p>Thru Select initiates thru/reciprocal calibration at port pair 2-4.</p> <p>Thru Select initiates thru/reciprocal calibration at port pair 3-4.</p> <p>When all calibration procedures are complete, use the Back button to return to the REFL DEVICE menu.</p> <p>“REFL. DEVICE(S) Menu - 4-Port VNAs” on page 10-70</p>
--	---

Figure 10-38. THRU/RECIP Menu - 4-Port VNAs - Typical Example

ISOLATION(S) Menu

Typical Configuration

This menu example is a representative menu based on the following configuration:

- VNA in 4-port mode
- 4-port calibration
- SOLT/SOLR calibration method
- Coaxial line type
- N (f) Connector

Previous

- The previous menu can be any of the following manual calibration menus and their associated configuration dialog boxes.
 - [“FOUR PORT CAL Menu - 4-Port VNAs” on page 10-47](#)
 - [“THREE PORT CAL Menu - 4-Port VNAs” on page 10-78](#)
 - [“TWO PORT CAL Menu - 4-Port VNAs” on page 10-97](#)
 - [“ONE PORT CAL/S Menu - 4-Port VNAs” on page 10-114](#)
 - [“TRANS. RESPONSE Menu - 4-Port VNAs” on page 10-127](#)
 - [“REFL. RESPONSE Menu - 4-Port VNAs” on page 10-136](#)
- The THRU/RECIP menu controls and functions are also subject to the settings in the following:
 - [“CAL SETUP Menu - 4-Port VNAs” on page 10-43](#)
 - [“CAL METHOD Menu - 4-Port VNA” on page 10-45](#)
 - [“LINE TYPE Menu - 4-Port VNA” on page 10-46](#)

 <p>The screenshot shows a menu titled "Isolation(s)" with a close button (X). Below the title are six buttons, each labeled "Isolation" and containing a port pair: "1-2", "1-3", "1-4", "2-3", "2-4", and "3-4".</p>	<p>ISOLATION(S) menu (typical)</p> <p>Select Isolation port pair button to start isolation calibration procedure for the indicated port pair. Completion of calibration steps is signified by completion checkmarks on the button.</p> <p>Isolation Select initiates isolation calibration at port pair 1-2.</p> <p>Isolation Select initiates isolation calibration at port pair 1-3.</p> <p>Isolation Select initiates isolation calibration at port pair 1-4.</p> <p>Isolation Select initiates isolation calibration at port pair 2-3.</p> <p>Isolation Select initiates isolation calibration at port pair 2-4.</p> <p>Isolation Select initiates isolation calibration at port pair 3-4.</p> <p>When calibration procedures are complete, use the Back button to return to the REFL DEVICE menu.</p>
---	--

Figure 10-39. ISOLATION(S) Menu - 4-Port VNAs - Typical Example

10-11 Manual 3-Port Cal Setup - 4-Port VNAs

This sections described the menus and dialog boxes uses for manual 3-port calibration on a ShockLine 4-Port VNA.

THREE PORT CAL Menu - 4-Port VNAs

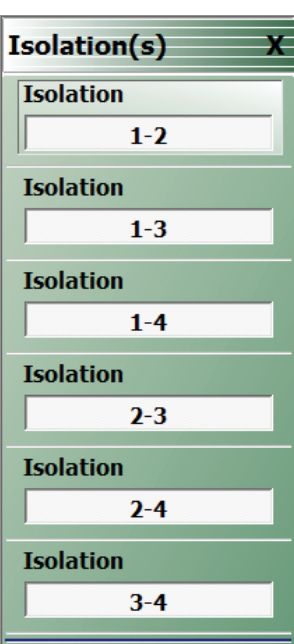
Button Availability

- The exact composition of the menu depends on the settings made on the CAL SETUP, CAL METHOD, and LINE TYPE menus and on the resultant THREE PORT CAL SETUP dialog box.
- A representative menu is shown below.
- The example procedures at the end of this chapter show examples of various THREE PORT CAL menus.

Previous

- [“MANUAL CAL Menu - 4-Port VNAs” on page 10-42](#)

Navigation

- MAIN | Calibration | CALIBRATION [TR] | Calibrate | CALIBRATE | Manual Cal | MANUAL CAL | 3-Port Cal | THREE PORT CAL

	<p>Modify Cal Setup</p> <p>Select displays the CAL SETUP menu where the Edit Cal Params button provides access to the THREE PORT CAL SETUP dialog box for the selected calibration method and line type.</p> <ul style="list-style-type: none"> • “CAL SETUP Menu - 4-Port VNAs” on page 10-43 <p>The following Cal Method/Line Type combinations and their dialog boxes are represented with a figure and complete description:</p> <ul style="list-style-type: none"> • “THREE PORT CAL SETUP (SOLT/R, COAXIAL) Dialog Box” on page 10-85 • “THREE PORT CAL SETUP (LRL/LRM, COAXIAL) Dialog Box” on page 10-88 <p>This table summarizes the dialog boxes for all Cal Method/Line Type combinations:</p> <ul style="list-style-type: none"> • Table 10-3, “Manual Calibration - 3-Port Calibration Setup Dialog Box Contents - 4-Port VNAs” on page 10-92 <p>Port Selected</p> <p>Read-only display of the ports selected for the pending calibration.</p>
---	---

Figure 10-40. THREE PORT CAL Menu - 4-Port VNAs - Typical example (1 of 3)

Completion Menu Buttons

For this example menu, the Port 1 Reflective Devices to the Isolation (Optional) buttons link to completion submenus where additional calibration procedures are performed.

For example, the Port 1 Reflective Devices button (shown below at #1) links to the REFL. DEVICES PORT 1 submenu. As each procedure is completed, the submenu button is marked with a completion checkmark. When all the procedures on the submenu are completed, use the Back button to return to the THREE PORT CAL menu.

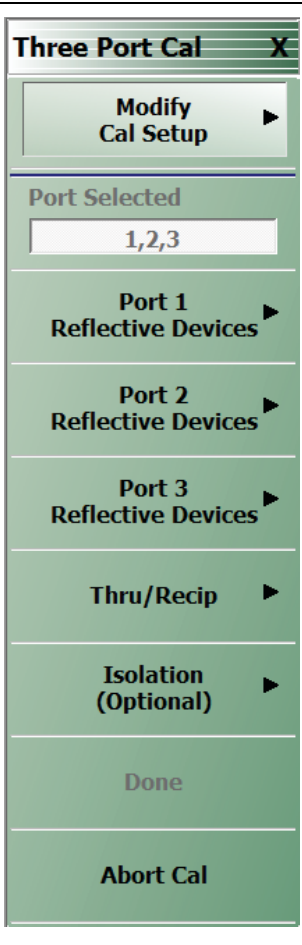

The Port 1 Reflective Devices button (shown above at #2) is now marked with a completion checkmark.

Port 1 Reflective Devices

Select displays the REFL. DEVICES PORT 1 submenu. When all procedures are complete, select the Back button to return to the THREE PORT CAL menu where this button is now marked with a completion checkmark.

- Example: [“REFL. DEVICE\(S\) Menu - 4-Port VNAs” on page 10-70](#)

Port 2 Reflective Devices

Select displays the REFL. DEVICES PORT 2 submenu. When all procedures are complete, select the Back button to return to the THREE PORT CAL menu where this button is now marked with a completion checkmark.

Port 3 Reflective Devices

Select displays the REFL. DEVICES PORT 3 submenu. When all procedures are complete, select the Back button to return to the THREE PORT CAL menu where this button is now marked with a completion checkmark.

Port 4 Reflective Devices

Select displays the REFL. DEVICES PORT 3 submenu. When all procedures are complete, select the Back button to return to the THREE PORT CAL menu where this button is now marked with a completion checkmark.

Figure 10-40. THREE PORT CAL Menu - 4-Port VNAs - Typical example (2 of 3)

Thru/Recip

Select displays the THRU/RECIP submenu. When all procedures are complete, select the **Back** button to return to the THREE PORT CAL menu where this button is now marked with a completion checkmark.

- [“THRU Menu - 4-Port VNAs” on page 10-74](#)

Isolation (Optional)

If required, select displays the ISOLATION submenu. When all procedures are complete, select the **Back** button to return to the THREE PORT CAL menu where this button is now marked with a completion checkmark.

- [“ISOLATION\(S\) Menu” on page 10-76](#)

Done

This button is unavailable until a successful calibration procedure has been completed. When available, it returns to the CALIBRATION menu where the **Cal Status** button is set to ON.

- [“CALIBRATION \[TR\] Menu - 4-Port VNAs” on page 10-5](#)

Abort Cal

This button stops the current calibration procedure and returns to the CALIBRATION menu.

- [“CALIBRATION \[TR\] Menu - 4-Port VNAs” on page 10-5](#)

Figure 10-40. THREE PORT CAL Menu - 4-Port VNAs - Typical example (3 of 3)

THREE PORT CAL SETUP (SSLT, MICROSTRIP) Dialog Box

Prerequisites

- VNA Mode = 4-Port Mode
- Cal Method = SSLT
- Line Type = Microstrip

Previous

- [“CAL SETUP Menu - 4-Port VNAs” on page 10-43](#)
- [“THREE PORT CAL Menu - 4-Port VNAs” on page 10-78](#)

Navigation

- MAIN | Calibration | CALIBRATION [TR] | Calibrate | CALIBRATE | Manual Cal | MANUAL CAL | 3-Port Cal | THREE PORT CAL | Modify Cal Setup | CAL SETUP | Cal Method = SSLT | Line Type = Microstrip | Edit Cal Params | THREE PORT CAL SETUP (SSLT, MICROSTRIP) Dialog Box

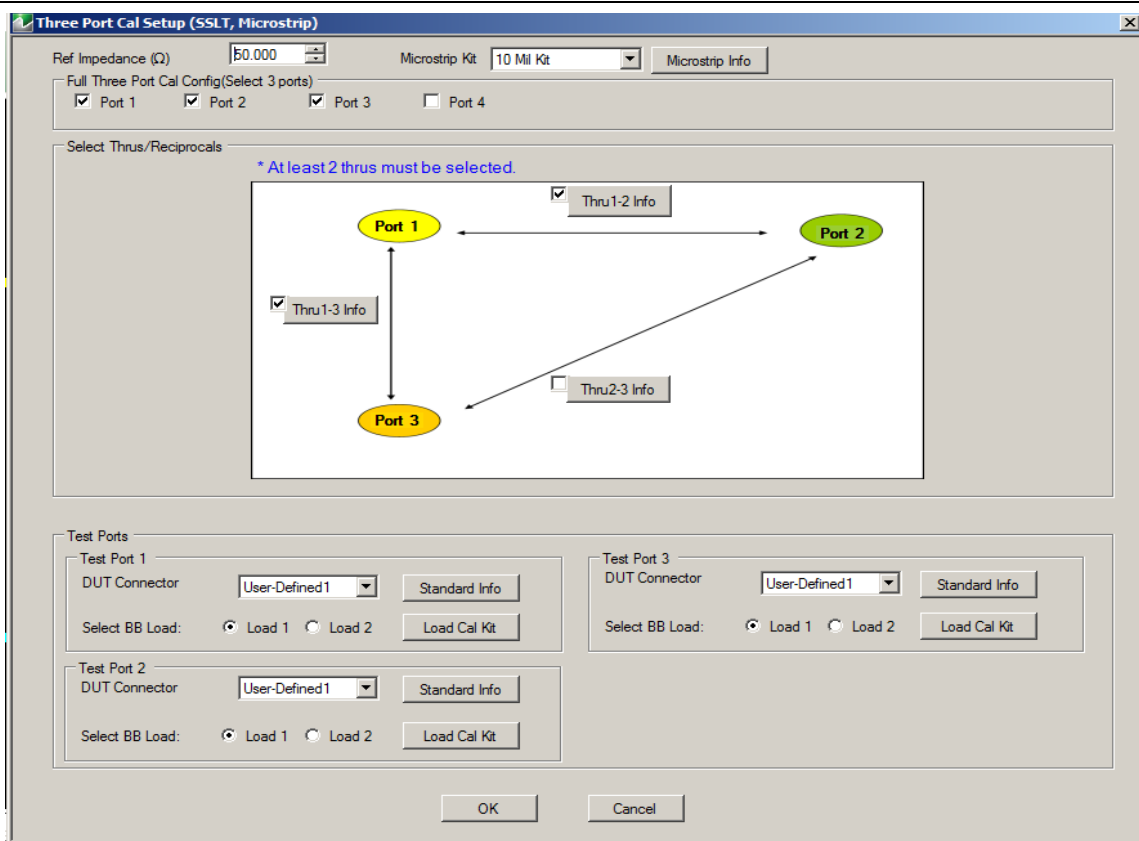

Figure 10-41. THREE PORT CAL SETUP (SSLT, MICROSTRIP) Dialog Box

Reference Impedance

Input the reference impedance.

- Input field defaulted to 50 Ohms.
- Any numerical value accepted although input values <0.01 Ohms are converted to 0.01 Ohms.

OK / Cancel

- Click OK to accept the changes and return to the CAL SETUP menu. Click Cancel to abandon any changes and return to the CAL SETUP menu.

Full Three Port Calibration Configuration

Select three ports from the list below. If a fourth port selection is attempted, an earlier port is discarded:

- Port 1
- Port 2
- Port 3
- Port 4

Select Throughs

Select any combination of three possible throughs as long as two are selected. The available port pair throughs are based on the ports selected above. For a 3-port calibration, only three of the following port pairs are available:

- Thru 1-2
- Thru 1-3
- Thru 1-4
- Thru 2-3
- Thru 2-4
- Thru 3,4

Thru Buttons

Each of the throughs above enables a Thru Info button that displays the THRU INFO dialog box allowing configuration of each through. A calculator icon in the THRU INFO dialog box allows access to the AIR EQUIVALENT LENGTH CALCULATOR dialog box.

- [“THRU INFO Dialog Box - 4-Port VNAs” on page 10-154](#)
- [“AIR EQUIVALENT LENGTH Calculator Dialog Box” on page 10-146](#)

Only three of the Test Port configuration areas are available based on the port selection above.

Test Port 1 DUT Connector

If Port 1 was selected above, select the **DUT Connector Type** from a drop-down menu list with options of:

- User-Defined1 through User-Defined8

Test Port 1 DUT Connector Standard Info Button

If Port 1 was selected above, select displays the Standard Info dialog box for the selected connector and calibration method that displays the connector calibration coefficients. The dialog box contents depend on the selected connector, Cal Method, and Line Type. The example here shows a typical standard information dialog box.

- [“MICROSTRIP KIT INFO and USER DEFINED MICROSTRIP Dialog Boxes” on page 10-147](#)

Test Port 1 Select BB Load

If Port 1 was selected above, select BB Load number for Test Port 1:

- Load 1
- Load 2

Test Port 2 Configuration

If Port 2 was selected above, provides the same controls as Test Port 1 Connector above.

Test Port 3 Configuration

If Port 3 was selected above, provides the same controls as Test Port 3 Connector above.

Test Port 4 Configuration

If Port 4 was selected above, provides the same controls as Test Port 4 Connector above.

THREE PORT CAL SETUP (SSST, COAXIAL) Dialog Box

Prerequisites

- VNA Mode = 4-Port Mode
- Cal Method = SSST
- Line Type = Coaxial

Previous

- [“CAL SETUP Menu - 4-Port VNAs” on page 10-43](#)
- [“THREE PORT CAL Menu - 4-Port VNAs” on page 10-78](#)

Navigation

- MAIN | Calibration | CALIBRATION [TR] | Calibrate | CALIBRATE | Manual Cal | MANUAL CAL | 3-Port Cal | THREE PORT CAL | Modify Cal Setup | CAL SETUP | Cal Method = SSST | Line Type = Coaxial | Edit Cal Params | THREE PORT CAL SETUP (SSST, COAXIAL) Dialog Box

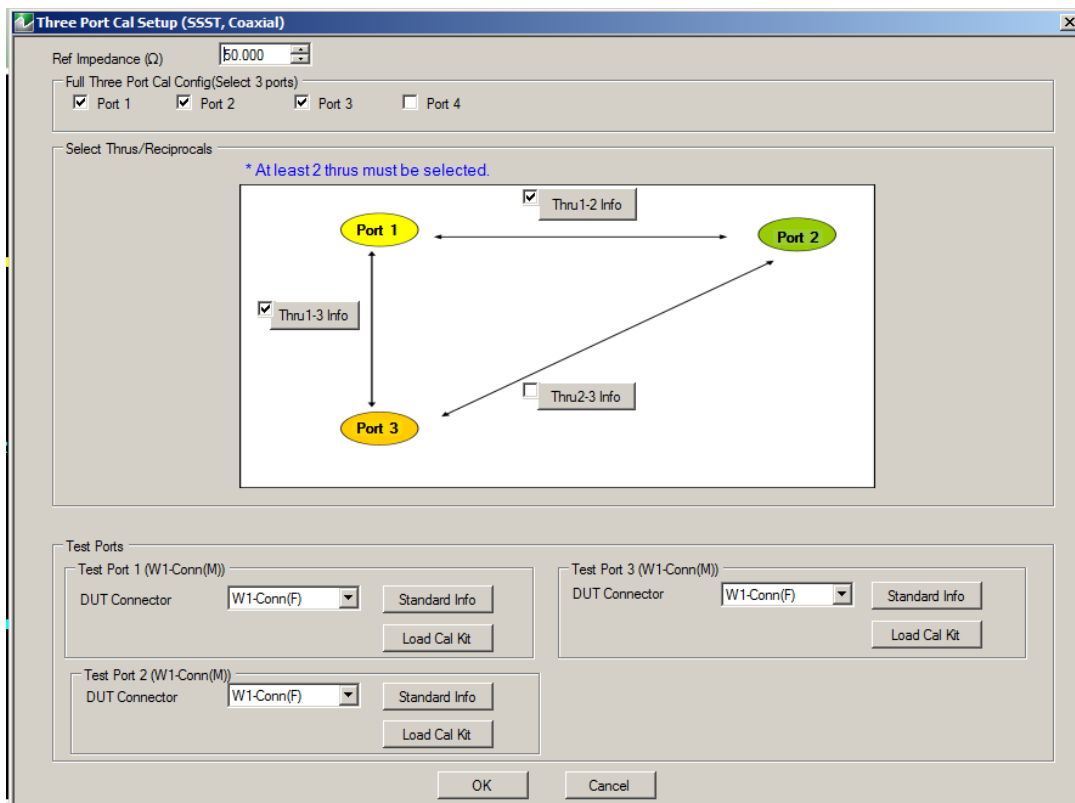

Figure 10-42. THREE PORT CAL SETUP (SSST, COAXIAL) Dialog Box

Reference Impedance

Input the reference impedance.

- Input field defaulted to 50 Ohms.
- Any numerical value accepted although input values <0.01 Ohms are converted to 0.01 Ohms.

Full Three Port Calibration Configuration

Select three (3) ports from the list below. If a fourth port selection is attempted, an earlier port is discarded:

- Port 1
- Port 2

- Port 3
- Port 4

Select Throughs/Reciprocals

Select any combination of three possible throughs as long as two (2) are selected. The available port pair throughs are based on the ports selected above. For a 3-port calibration, only three of the following port pairs are available:

- Thru 1-2
- Thru 1-3
- Thru 1-4
- Thru 2-3
- Thru 2-4
- Thru 3-4

Thru Info Buttons

Each of the throughs above enables a Thru Info button that displays the THRU INFO dialog box allowing configuration of each through. A calculator icon in the THRU INFO dialog box accesses the AIR EQUIVALENT LENGTH CALCULATOR dialog box.

- [“THRU INFO Dialog Box - 4-Port VNAs” on page 10-154](#)
- [“AIR EQUIVALENT LENGTH Calculator Dialog Box” on page 10-146](#)

Only three of the Test Port Configuration areas are available based on the port selection above.

Test Port 1 DUT Connector

If Port 1 was selected above, select the **DUT Connector Type** from a drop-down menu list with options of:

- W1-Conn (M)
- W1-Conn (F)
- User-Defined1 (M) through User-Defined8 (M)
- User-Defined1 (F) through User-Defined8 (F)

Test Port 1 DUT Connector Standard Info Button

If Port 1 was selected above, select displays the STANDARD INFO dialog box for the selected connector and calibration method that displays the connector calibration coefficients. The dialog box contents depend on the selected connector, Cal Method, and Line Type. The example here shows a typical standard information dialog box.

- [“MICROSTRIP KIT INFO and USER DEFINED MICROSTRIP Dialog Boxes” on page 10-147](#)

Test Port 2 Configuration

If Port 2 was selected above, provides the same controls as Test Port 1 Connector above.

Test Port 3 Configuration

If Port 3 was selected above, provides the same controls as Test Port 3 Connector above.

Test Port 4 Configuration

If Port 4 was selected above, provides the same controls as Test Port 4 Connector above.

OK / Cancel

Click OK to accept the changes and return to the CAL SETUP menu.

Click Cancel to abandon any changes and return to the CAL SETUP menu.

THREE PORT CAL SETUP (SOLT/R, COAXIAL) Dialog Box

Previous

- “CAL SETUP Menu - 4-Port VNAs” on page 10-43
- “THREE PORT CAL Menu - 4-Port VNAs” on page 10-78

Navigation

- MAIN | Calibration | CALIBRATION [TR] | Calibrate | CALIBRATE | Manual Cal | MANUAL CAL | 3-Port Cal | THREE PORT CAL | Modify Cal Setup | CAL SETUP | Cal Method = SOLT/SOLR | Line Type = Coaxial | Edit Cal Params | THREE PORT CAL SETUP (SOLT/R, COAXIAL) Dialog Box

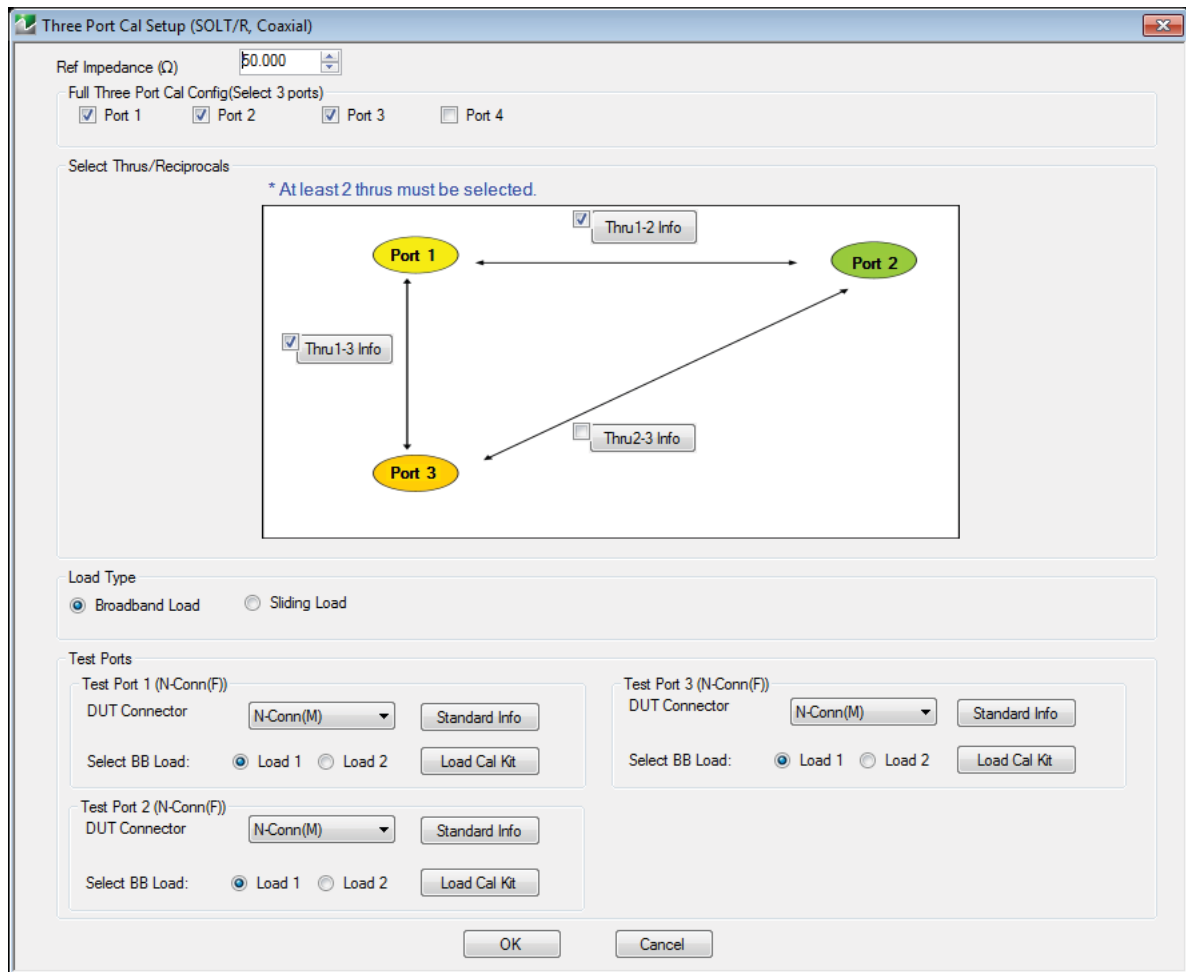

Figure 10-43. THREE PORT CAL SETUP (SOLT/R, COAXIAL) Dialog Box

Reference Impedance

Input the reference impedance.

- Input field defaulted to 50 Ohms.
- Any numerical value accepted although input values <0.01 Ohms are converted to 0.01 Ohms.

Full Three Port Calibration Configuration

Select three of the four available ports. Selection of an additional port deselects one of the previously selected ports.

- Port 1
- Port 2
- Port 3
- Port 4

Select Thrus/Reciprocals

Select a minimum two of the three available port pairs determined by the ports selected above. Three of the following port pairs are available for a 3-port calibration:

- Thru 1-2
- Thru 1-3
- Thru 1-4
- Thru 2-3
- Thru 2-4
- Thru 3-4

Thru Buttons

Each selected through enables a corresponding Thru Info button that displays the THRU INFO dialog box, allowing configuration of the selected through, including a Length calculator icon that opens the AIR EQUIVALENT LENGTH CONVERSION dialog box.

- [“THRU INFO Dialog Box - 4-Port VNAs” on page 10-154](#)
- [“AIR EQUIVALENT LENGTH Calculator Dialog Box” on page 10-146](#)

Load Type

Select from two options:

- Broadband Load
- Sliding Load (requires broadband loads below sliding load breakpoint frequency).

Test Port 1 DUT Connector

If Port 1 was selected above, select the **DUT Connector Type** from a drop-down menu list with options of:

- K-Conn (M)
- K-Conn (F)
- GPC-3.5 (M)
- GPC-3.5 (F)
- SMA (M)
- SMA (F)
- N-Conn (M)
- N-Conn (F)
- 2.4 mm (M)
- 2.4 mm (F)
- TNC (M)
- TNC (F)
- V-conn (M)
- V-conn (F)
- W1-conn (M)

- W1-conn (F)
- 7/16 (M)
- 7/16 (F)
- GPC-7
- N-conn(75) (M)
- N-conn(75) (F)
- user defined 1 through 8 (M or F)

Test Port 1 DUT Connector Standard Info Button

If Port 1 was selected above, select displays the Standard Info dialog box for the selected connector and calibration method that displays the connector calibration coefficients. The dialog box contents depend on the selected connector, Cal Method, and Line Type. The example here shows a typical standard information dialog box.

- [“MICROSTRIP KIT INFO and USER DEFINED MICROSTRIP Dialog Boxes” on page 10-147](#)

Test Port 1 Select BB Load

If Port 1 was selected above, select BB Load number for Test Port 1:

- Load 1
- Load 2

Test Port 2 Configuration

If Port 2 was selected above, provides the same controls as Test Port 1 Connector above.

Test Port 3 Configuration

If Port 3 was selected above, provides the same controls as Test Port 3 Connector above.

Test Port 4 Configuration

If Port 4 was selected above, provides the same controls as Test Port 4 Connector above.

OK / Cancel

Click OK to accept the changes and return to the CAL SETUP menu, or click Cancel.

THREE PORT CAL SETUP (LRL/LRM, COAXIAL) Dialog Box

Previous

- “CAL SETUP Menu - 4-Port VNAs” on page 10-43
- “THREE PORT CAL Menu - 4-Port VNAs” on page 10-78

Navigation

- MAIN | Calibration | CALIBRATION [TR] | Calibrate | CALIBRATE | Manual Cal | MANUAL CAL | 3-Port Cal | THREE PORT CAL | Modify Cal Setup | CAL SETUP | Cal Method = LRL/LRM | Line Type = Coaxial | Edit Cal Params | THREE PORT CAL SETUP (LRL/LRM, COAXIAL)

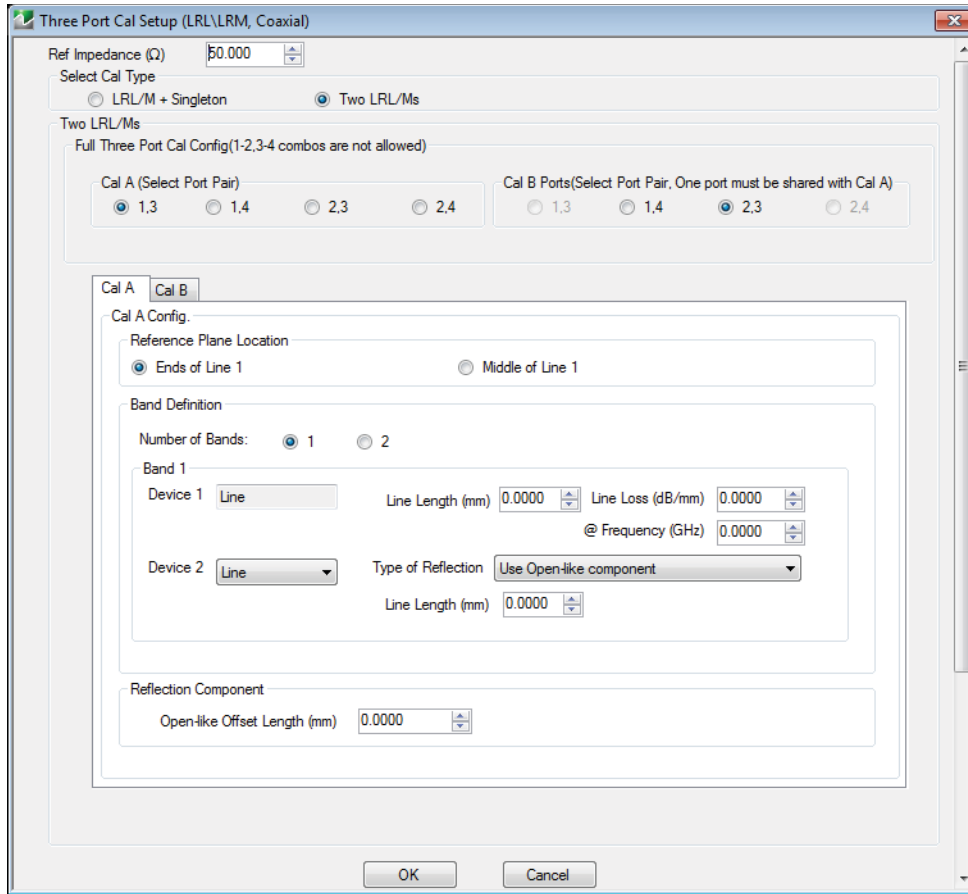

Figure 10-44. THREE PORT CAL SETUP (LRL/LRM, COAXIAL) Dialog Box - Cal A Tab

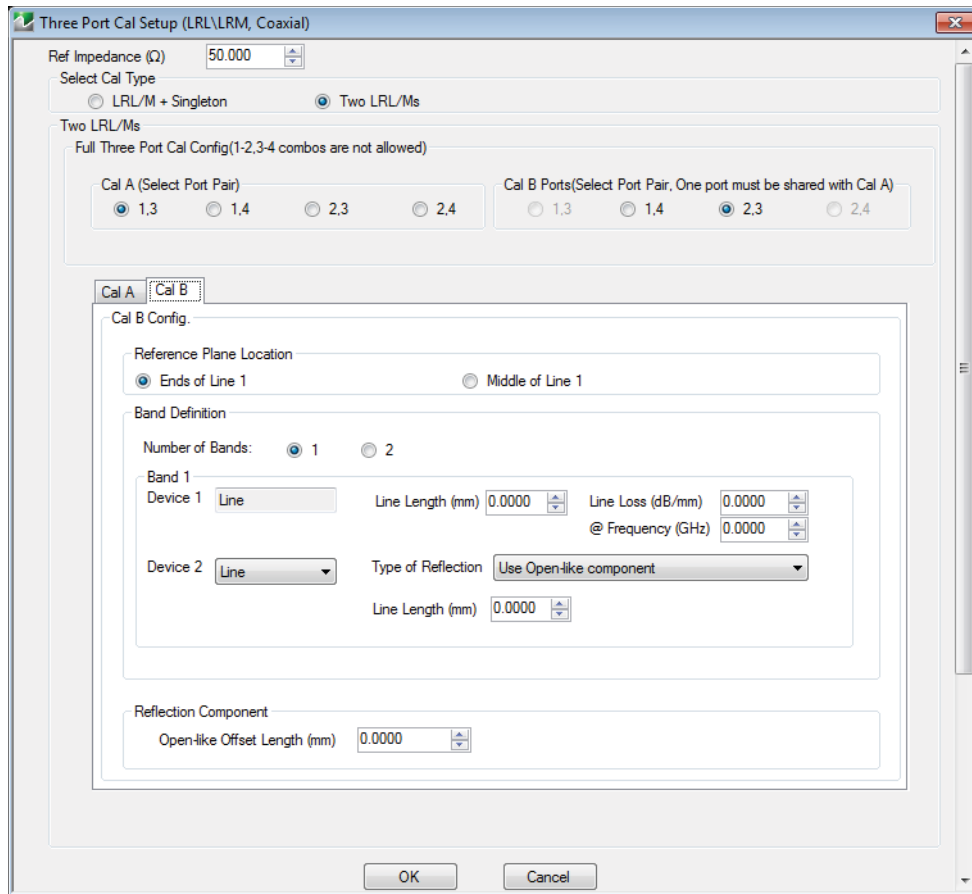

Figure 10-45. THREE PORT CAL SETUP (LRL/LRM, COAXIAL) Dialog Box - Cal B Tab

Overview

The dialog box provides common areas at the top for Reference Impedance, Three Port Calibration Configuration, and Thru Selection, and tabbed Cal A and Cal B dialog areas.

Reference Impedance

Input the reference impedance.

- Input field defaulted to 50 Ohms.
- Any numerical value accepted although input values <0.01 Ohms are converted to 0.01 Ohms.

Select Cal Type

Select a calibration type:

- LRL/M + Singleton
- Two LRL/Ms

Cal A (Select Port Pair)

Select Calibration A Port Pair (Port Pair 1-2 and Port Pair 3-4 combinations not allowed):

- Port 1-3
- Port 1-4
- Port 2-3
- Port 2-4

Cal B (Select Port Pair, One port must be shared with Cal A)

Select one (1) Calibration B Port Pair from the remaining unused port pairs from the Cal A Ports:

- If Cal A = Ports 1-3, then select Cal B from Ports 1-4 or 2-3
- If Cal A = Ports 1-4, then select Cal B from Ports 1-3 or 2-4.
- If Cal A = Ports 2-3, then select Cal B from Ports 1-3 or 2-4.
- If Cal A = Ports 2-4, then select Cal B from Ports 1-4 or 2-3.

Cal A Configuration Tab**Cal A - Reference Plane Location**

Select either:

- Ends of Line 1
- Middle of Line 1

Cal A - Band Definition

Number of Bands:

- 1: Specify settings for Band 1.
- 2: Specify settings for Band 1, Band 2, and Band Break Point.

Cal A - Band 1 Device 1 Definition

- Device 1: Line (default)
 - Line Length (mm): Input line length in mm.
 - Line Loss (dB/mm): Input line loss in dB per mm at frequency specified in GHz.
 - @ Frequency (GHz): Input frequency setting for line loss factor input above.

Cal A - Band 1 Device 2 Definition

Select either:

- Line
 - Requires input for Line Length (mm), Line Loss (dB/mm), and @ Frequency (GHz) settings.
 - Type of Reflection settings:
 - Use Short-like component: select displays Short-like Offset Length (mm) Reflection Component field.
 - Use Open-like component: select displays Open-like Offset Length (mm) Reflection Component field.
- Match
 - Match Info button: Select displays the USER DEFINED MATCH DEVICES dialog box for configuration of the match devices.
[“USER DEFINED MATCH DEVICES Dialog Box - LRL/LRM” on page 10-155](#)
 - Type of Reflection settings:
 - Use Short-like component: select displays Short-like Offset Length (mm) Reflection Component field.
 - Use Open-like component: select displays Open-like Offset Length (mm) Reflection Component field.
 - Use both: select displays both Open-like Offset Length (mm) and Short-like Offset Length (mm) Reflection Component fields, and Use Port 1 Match or Use Port 2 Match options.

Cal A - Band 2 Definition

The Number of Bands field above must be set to 2 for this area and the Band Break Point area described below to be displayed. Provides the following fields and controls for Band 2.

Cal A - Band 2 Device 3 Definition

Select either:

- Use new line
 - Requires input for Line Length (mm), Line Loss (dB/mm), and @ Frequency (GHz) settings.
- Use device 1
- Use device 2

Cal A - Band 2 Device 4 Definition

Select either:

- Line
 - Requires input for Line Length (mm) setting.
 - Type of Reflection settings:
 - Use Short-like component: select displays Short-like Offset Length (mm) Reflection Component field.
 - Use Open-like component: select displays Open-like Offset Length (mm) Reflection Component field.
- Match
 - Match Info button: Select displays the USER DEFINED MATCH DEVICES dialog box for configuration of the match devices.
[“USER DEFINED MATCH DEVICES Dialog Box - LRL/LRM” on page 10-155](#)
 - Type of Reflection settings:
 - Use Short-like component: select displays Short-like Offset Length (mm) Reflection Component field.
 - Use Open-like component: select displays Open-like Offset Length (mm) Reflection Component field.
 - Use both: select displays both Open-like Offset Length (mm) and Short-like Offset Length (mm) Reflection Component fields, and Use Port 1 Match or Use Port 2 Match options.

Cal A - Band Break Point

This area only appears if the Number of Bands in the Band Definition area is set to 2.

The Calculate Recommended Value button calculates the recommended break point value based on the input parameters in the fields above. Clicking the button calculates a break point frequency value and populates the Use Recommended Frequency (GHz) field.

Select either:

- Use Recommended Frequency (GHz): Infinity (default)
- Define New Frequency (GHz): Input break frequency value

Cal A - Reflection Component

Display based on Type of Reflection setting:

- Short-like Offset Length (mm)
- Open-like Offset Length (mm)

OK / Cancel

Click OK to accept the changes, or click Cancel.

Cal B Configuration Tab

Select the Cal B tab to access the same controls and functions as those in the Cal A tab.

Summary of 3-Port Calibration Setup Dialog Boxes

The table below summarizes the available fields in all available 3-port calibration setup dialog boxes. If the dialog box is described in greater detail above, a link is provided to that description. To view each dialog box, set the CAL METHOD and LINE TYPE menus to the appropriate settings, and then select the Edit Cal Params button. All three-port dialog boxes are named “Three Port Cal Setup (Cal Method, Line Type)”

Table 10-3. Manual Calibration - 3-Port Calibration Setup Dialog Box Contents - 4-Port VNAs (1 of 5)

Cal Method Line Type	Dialog Box Controls and Functions
<p>SOLT/R Coaxial</p>	<p>See full description at “THREE PORT CAL SETUP (SOLT/R, COAXIAL) Dialog Box” on page 10-85</p> <p>Reference Impedance (Ohms)</p> <p>Test Ports: Select 3 ports from Port 1, Port 2, Port 3, Port 4.</p> <p>Select Throughs:</p> <ul style="list-style-type: none"> • At least 2 throughs that connect to all ports must be selected. Only three throughs are available from the ports selected above. • Thru 1-2, Thru 1-3, Thru 1-4, Thru 2-3, Thru 2-4, Thru 3-4 <p>Thru Info buttons: Displays the THRU INFO dialog box for the selected through.</p> <ul style="list-style-type: none"> • “THRU INFO Dialog Box - 4-Port VNAs” on page 10-154 <p>Load Type: Broadband Load, Sliding Load</p> <p>The Test Port Configuration areas below are only available if the port was selected above.</p> <p>Test Port 1 DUT Connector: W1-Conn (M), W1-Conn (F), V-Conn (M), V-Conn (F), K-Conn (M), K-Conn (F), 2.4 mm (M), 2.4 mm (F), 2.4 mm V (M), 2.4 mm V (F), GPC-3.5 (M), GPC-3.5 (F), SMA (M), SMA (F), N-Conn (M), N-Conn (F), N-Conn (75) (M), N-Conn (75) (F), GPC-7, 7/16 (M), 7/16 (F), TNC (M), TNC (F), User-Defined1 (M) to User-Defined 8 (M), User-Defined1 (F) to User-Defined 8 (F)</p> <p>Test Port 1 Connector Standard Info Button: For each DUT port connector, displays the STANDARD INFORMATION dialog box for the selected connector.</p> <ul style="list-style-type: none"> • “MICROSTRIP KIT INFO and USER DEFINED MICROSTRIP Dialog Boxes” on page 10-147 <p>Test Port 1 Select BB Load: Load 1, Load 2.</p> <p>Test Port 2, Test Port 3, and Test Port 4 controls are the same as Test Port 1, but only available if that test port was selected.</p>
<p>SOLT/R Non-Dispersive</p>	<p>Same controls and functions as SOLT/R Coaxial above.</p>
<p>SOLT/R Waveguide</p>	<p>SOLT/R is not recommended for Waveguide calibrations.</p> <p>Same controls as SOLT/R Coaxial with the following changes:</p> <p>Waveguide Kit: User-Defined 1 to User-Defined 8</p> <p>Waveguide Info button: Displays USER DEFINED WAVEGUIDE dialog box for the waveguide kit selected above.</p> <ul style="list-style-type: none"> • “WAVEGUIDE INFO and USER DEFINED WAVEGUIDE Dialog Boxes” on page 10-156

Table 10-3. Manual Calibration - 3-Port Calibration Setup Dialog Box Contents - 4-Port VNAs (2 of 5)

Cal Method Line Type	Dialog Box Controls and Functions
SOLT/R Microstrip	<p>Same controls as SOLT/R Coaxial with the following changes:</p> <p>Microstrip Kit: 10 Mil Kit, 15 Mil Kit, 25 Mil Kit, User-Defined 1 to User-Defined 8</p> <p>Microstrip Info button: Displays either the MICROSTRIP INFO or the USER DEFINED MICROSTRIP dialog box for the microstrip kit selected above.</p> <ul style="list-style-type: none"> • “MICROSTRIP KIT INFO and USER DEFINED MICROSTRIP Dialog Boxes” on page 10-147 <p>Test Port DUT Connector: User-Defined1 to User-Defined 8</p> <p>Test Port 1 Connector Standard Info Button: Select displays the STANDARD INFORMATION dialog box for the selected connector.</p>
SSLT Coaxial	<p>See full description at “THREE PORT CAL SETUP (SSLT, MICROSTRIP) Dialog Box” on page 10-81 above.</p> <p>Reference Impedance (Ohms)</p> <p>Test Ports: Select 3 ports from Port 1, Port 2, Port 3, Port 4.</p> <p>Select Throughs:</p> <ul style="list-style-type: none"> • At least 2 throughs that connect to all ports must be selected. Only three throughs are available from the ports selected above. • Thru 1-2, Thru 1-3, Thru 1-4, Thru 2-3, Thru 2-4, Thru 3-4 <p>Thru Info buttons: Displays the THRU INFO dialog box for the selected through.</p> <ul style="list-style-type: none"> • “THRU INFO Dialog Box - 4-Port VNAs” on page 10-154 <p>Load Type: Broadband Load, Sliding Load</p> <p>The Test Port Configuration areas below are only available if the port was selected above.</p> <p>Test Port DUT Connector: W1-Conn (M), W1-Conn (F), User-Defined1 (M) to User-Defined 8 (M), User-Defined1 (F) to User-Defined 8 (F)</p> <p>Test Port Connector Standard Info Button: Select displays the STANDARD INFORMATION dialog box for the selected connector.</p> <ul style="list-style-type: none"> • “MICROSTRIP KIT INFO and USER DEFINED MICROSTRIP Dialog Boxes” on page 10-147 <p>Test Port Select BB Load: Load 1, Load 2.</p> <p>Test Port 1, Test Port 2, Test Port 3, and Test Port 4 controls are the same.</p>
SSLT Non-Dispersive	<p>Same controls SSLT Coaxial above.</p>
SSLT Waveguide	<p>Warning: Not recommended to perform waveguide cal with SOLT/R method.</p> <p>Same controls as SSLT Coaxial with the following changes:</p> <p>Waveguide Kit: Select from WR10, WR12, WR15, User-Defined 1 to User-Defined 8</p> <p>Waveguide Info button: Displays WAVEGUIDE INFO dialog box for selected calibration method and kit.</p> <ul style="list-style-type: none"> • “WAVEGUIDE INFO and USER DEFINED WAVEGUIDE Dialog Boxes” on page 10-156

Table 10-3. Manual Calibration - 3-Port Calibration Setup Dialog Box Contents - 4-Port VNAs (3 of 5)

Cal Method Line Type	Dialog Box Controls and Functions
<p>SSLT Microstrip</p>	<p>See full description at “THREE PORT CAL SETUP (SSLT, MICROSTRIP) Dialog Box” on page 10-81</p> <p>Same controls as SSLT Coaxial with the following changes:</p> <p>Microstrip Kit: Select from 10 Mil Kit, 15 Mil Kit, 25 Mil Kit, User-Defined 1 to User-Defined 8</p> <p>Microstrip Info button: Displays MICROSTRIP INFO dialog box for selected calibration method and kit.</p> <ul style="list-style-type: none"> • “MICROSTRIP KIT INFO and USER DEFINED MICROSTRIP Dialog Boxes” on page 10-147 <p>Test Port DUT Connector: User-Defined1 to User-Defined 8</p> <p>Test Port Connector Standard Info Button: Select displays the STANDARD INFORMATION dialog box for the selected connector.</p>
<p>SSST Coaxial</p>	<p>See full description at “THREE PORT CAL SETUP (SSST, COAXIAL) Dialog Box” on page 10-83 above.</p> <p>Reference Impedance (Ohms)</p> <p>Test Ports: Select 3 ports from Port 1, Port 2, Port 3, Port 4.</p> <p>Select Throughs:</p> <ul style="list-style-type: none"> • At least 2 throughs that connect to all ports must be selected. Only three throughs are available from the ports selected above. • Thru 1-2, Thru 1-3, Thru 1-4, Thru 2-3, Thru 2-4, Thru 3-4 <p>Thru Info buttons: Displays the THRU INFO dialog box for the selected through.</p> <ul style="list-style-type: none"> • “THRU INFO Dialog Box - 4-Port VNAs” on page 10-154 <p>The Test Port Configuration areas below are only available if the port was selected above.</p> <p>Test Port DUT Connector: W1-Conn (M), W1-Conn (F), User-Defined 1 (M) to User-Defined 8 (M), User-Defined 1 (F) to User-Defined 8 (F)</p> <p>Test Port Connector Standard Info Button: Select displays the STANDARD INFORMATION dialog box for the selected connector.</p> <ul style="list-style-type: none"> • “MICROSTRIP KIT INFO and USER DEFINED MICROSTRIP Dialog Boxes” on page 10-147 <p>Test Port 1, Test Port 2, Test Port 3, and Test Port 4 controls are the same.</p>
<p>SSST Non-Dispersive</p>	<p>Same controls as SSST Coaxial.</p>
<p>SSST Waveguide</p>	<p>Same controls as SSST Coaxial with the following changes:</p> <p>Waveguide Kit: User-Defined 1 to User-Defined 8</p> <p>Waveguide Info button: Displays WAVEGUIDE INFO dialog box for selected calibration method and kit.</p> <ul style="list-style-type: none"> • “WAVEGUIDE INFO and USER DEFINED WAVEGUIDE Dialog Boxes” on page 10-156

Table 10-3. Manual Calibration - 3-Port Calibration Setup Dialog Box Contents - 4-Port VNAs (4 of 5)

Cal Method Line Type	Dialog Box Controls and Functions
<p>SSST Microstrip</p>	<p>Same controls as SSST Coaxial with the following changes:</p> <p>Microstrip Kit: 10 Mil Kit, 15 Mil Kit, 25 Mil Kit, User-Defined 1 to User-Defined 8</p> <p>Microstrip Info button: Displays MICROSTRIP INFO dialog box for selected calibration method and kit.</p> <ul style="list-style-type: none"> • “MICROSTRIP KIT INFO and USER DEFINED MICROSTRIP Dialog Boxes” on page 10-147 <p>Test Port DUT Connector: User-Defined1 to User-Defined 8</p> <p>Test Port Connector Standard Info Button: Select displays the STANDARD INFORMATION dialog box for the selected connector.</p>
<p>LRL/LRM Coaxial</p>	<p>See full description of controls and display logic at “THREE PORT CAL SETUP (LRL/LRM, COAXIAL) Dialog Box” on page 10-88.</p> <p>Reference Impedance (Ohms)</p> <p>Select Cal Type: LRL/M + Singleton, Two LRL/Ms</p> <p>Cal A Ports: Select two port pairs from 1-3, 1-4, 2-3, 2-4</p> <p>Cal B Ports: Auto-selected non-Cal A Port Pairs: 1-3, 1-4, 2-3, 2-4</p> <p>Cal A and Cal B tabs: The “A” and “B” calibration parameters are selected via a tabbed menu within the dialog box.</p> <p>Reference Plane Location: Ends of Line 1, Middle of Line 1</p> <p>Number of Bands: 1, 2</p> <ul style="list-style-type: none"> • If 1, only Band 1 Device 1 and Band 1 Device 2 controls appear. • If 2, the above plus Band 2 Device 3 and Band 2 Device 4 controls appear. <p>Cal A Configuration Parameters:</p> <ul style="list-style-type: none"> • Cal A Reference Plane Location: Ends of Line, Middle of Line 1 • Cal A Number of Bands: 1 or 2 • Cal A Band 1 Device 1 Line: Line Length (mm), Line Loss (dB/mm), @ Frequency (GHz) • Cal A Band 1 Device 2 Type: Line, Match; Use Short-like component, Use Open-like component, Use both; If Device 2 = Match, Match Info button displays USER DEFINED MATCH DEVICES dialog box for selected calibration kit. • “USER DEFINED MATCH DEVICES Dialog Box - LRL/LRM” on page 10-155 • Cal A Band 2 Device 3: Use device 1, Use new line • Cal A Band 2 Device 4: Line, Match, Type of Reflection (Use Open-like component, Use Short-like component), Line Length (mm) • Cal A Band Break Point: Calculate Recommended Value, Use Recommended Frequency (GHz), Define New Frequency (GHz). • Cal A Reflection Component: Open-like Length (mm), Short-like Offset Length (mm) <p>Cal B Configuration Parameters</p> <ul style="list-style-type: none"> • Cal B parameters are the same as those for Cal A.
<p>LRL/LRM Non-Dispersive</p>	<p>Same controls as LRL/LRM Coaxial above.</p>

Table 10-3. Manual Calibration - 3-Port Calibration Setup Dialog Box Contents - 4-Port VNAs (5 of 5)

Cal Method Line Type	Dialog Box Controls and Functions
LRL/LRM Waveguide	Same controls as LRL/LRM Coaxial above with the following changes: Cutoff Frequency (GHz) Dielectric Value
LRL/LRM Microstrip	Same controls as LRL/LRM Coaxial above with the following changes: Microstrip Kit: 10 Mil Kit, 15 Mil Kit, 25 Mil Kit, User-Defined 1 to User-Defined 8 Microstrip Info button: Displays MICROSTRIP INFO dialog box for selected calibration kit. • “MICROSTRIP KIT INFO and USER DEFINED MICROSTRIP Dialog Boxes” on page 10-147

10-12 Manual 2-Port Cal Setup - 4-Port VNAs

TWO PORT CAL Menu - 4-Port VNAs

Summary of all 2-Port Cal Method and Line Type combinations is available at:

- [Table 10-4, “Manual Calibration - 2-Port Calibration Setup Dialog Box Contents - 4-Port VNAs” on page 10-109](#)

Button Availability:

- The exact composition of the menu depends on the settings made on the CAL SETUP, CAL METHOD, and LINE TYPE menus and on the resultant TWO PORT CAL SETUP dialog box.
- A representative menu is shown below.
- The example procedures at the end of this chapter show examples of various TWO PORT CAL menus.

Previous

- [“MANUAL CAL Menu - 4-Port VNAs” on page 10-42](#)

Navigation

- MAIN | Calibration | CALIBRATION [TR] | Calibrate | CALIBRATE | Manual Cal | MANUAL CAL | 2-Port Cal | TWO PORT CAL

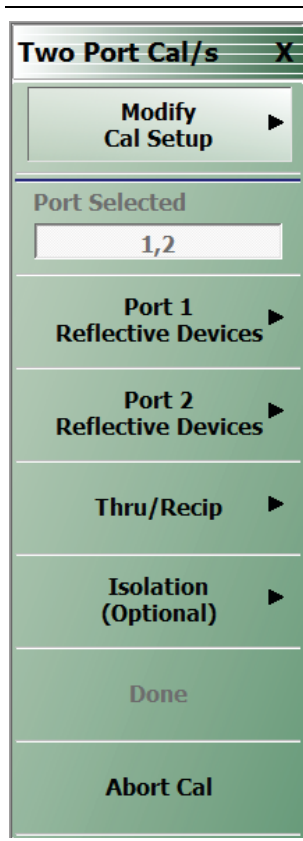
	<p>Modify Cal Setup</p> <p>Select displays the CAL SETUP menu with access to the THREE PORT CAL SETUP dialog box for the selected calibration method and line type.</p> <p>Select displays the CAL SETUP menu where the Edit Cal Params button provides access to the THREE PORT CAL SETUP dialog box for the selected calibration method and line type.</p> <ul style="list-style-type: none"> • “CAL SETUP Menu - 4-Port VNAs” on page 10-43 • “TWO PORT CAL SETUP (SOLT/R, COAXIAL) Dialog Box” on page 10-99 <p>Port Selected</p> <p>Read-only display of the ports selected for the pending calibration.</p> <p>Port 1 / Port 2 Reflective Devices</p> <p>Select Port 1 Reflective Devices and Port 2 Reflective Devices buttons to display REFL. DEVICE(S) ----<i>Port 1</i>---- and REFL. DEVICE(S) ----<i>Port 2</i>---- calibration submenus. Completion of submenu calibration steps is signified by completion checkmarks on the Port 1 Reflective Devices and Port 2 Reflective Devices buttons.</p> <ul style="list-style-type: none"> • “REFL. DEVICE(S) Menu - 4-Port VNAs” on page 10-70 <p>Thru/Recip / Isolation (Optional)</p> <p>Select Thru/Recip and Isolation (OPTIONAL) buttons to display THRU and ISOLATION(S) calibration submenus. Completion of submenu calibration steps is signified by completion checkmarks on the Thru/Recip and Isolation (OPTIONAL) buttons.</p> <ul style="list-style-type: none"> • “THRU Menu - 4-Port VNAs” on page 10-74 • “ISOLATION(S) Menu” on page 10-76 <p>Done</p> <p>Available after completion of calibration procedures. Select returns to CALIBRATION menu with Cal Status button set to ON.</p> <p>Abort Cal</p> <p>Select stops calibration procedure and returns to the CALIBRATION menu.</p>
---	--

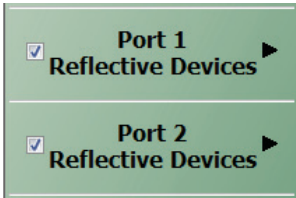

Figure 10-46. TWO PORT CAL Menu - 4-Port VNAs - Typical example

TWO PORT CAL SETUP (SOLT/R, COAXIAL) Dialog Box

Previous

- “CAL SETUP Menu - 4-Port VNAs” on page 10-43
- “TWO PORT CAL Menu - 4-Port VNAs” on page 10-97

Navigation

- MAIN | Calibration | CALIBRATION [TR] | Calibrate | CALIBRATE | Manual Cal | MANUAL CAL | 2-Port Cal | TWO PORT CAL | Modify Cal Setup | CAL SETUP | Edit Cal Params | TWO PORT CAL SETUP (SOLT/R, COAXIAL)

The dialog box, titled "Two Port Cal Setup (SOLT/R, Coaxial)", contains the following elements:

- Ref Impedance (Ω):** A numeric field set to 50.000.
- Cal A Config:**
 - Select Two Ports for Cal A:** Checkboxes for Port 1 (checked), Port 2 (checked), Port 3, and Port 4.
 - Select Cal Type:** Radio buttons for Full 2 Port (selected), 1 Path 2 Port (1->2), and 1 Path 2 Port (2->1).
 - Load Type:** Radio buttons for Broadband Load (selected) and Sliding Load.
 - Through/Reciprocal Setup:**
 - Select Line:** A dropdown menu set to "Through".
 - Length (mm):** A numeric field set to 0.0000.
 - Line Impedance (Ω):** A numeric field set to 50.000.
 - Line Loss (dB/mm):** A numeric field set to 0.0000.
 - @ Frequency (GHz):** A numeric field set to 0.0000.
- Cal B Config:**
 - Cal B Ports:** Checkboxes for Port 1, Port 2, Port 3 (checked), and Port 4 (checked).
 - Select Cal Type:** Radio buttons for Full 2 Port (selected), 1 Path 2 Port (3->4), and 1 Path 2 Port (4->3).
 - Load Type:** Radio buttons for Broadband Load (selected) and Sliding Load.
 - Through/Reciprocal Setup:** Identical to the Cal A section.
- Test Ports:** Four sections for Test Port 1, 2, 3, and 4. Each section includes:
 - Test Port (N-Conn(F)):** A label.
 - DUT Connector:** A dropdown menu set to "N-Conn(M)".
 - Standard Info:** A button.
 - Select BB Load:** Radio buttons for Load 1 (selected) and Load 2.
 - Load Cal Kit:** A button.
- Buttons:** "OK" and "Cancel" buttons at the bottom center.

Figure 10-47. TWO PORT CAL SETUP (SOLT/R, COAXIAL) Dialog Box

Reference Impedance

Input the reference impedance.

- Input field defaulted to 50 Ohms.
- Any numerical value accepted although input values <0.01 Ohms are converted to 0.01 Ohms.

Cal A and Cal B Configuration

The dialog box is divided into two calibration areas for Calibration A and Calibration B. Of the four test ports, the user selects two ports for the Cal A procedure. The instrument autoselects the remaining two test ports for the Cal B procedure.

Cal A Test Ports

Select two test ports from Port 1, Port 2, Port 3, and Port 4. The non-selected ports are autoselected for Cal B.

Cal A Cal Type

Select the calibration type from the following options:

- Full 2 Port
- 1 Path 2 Port forward. If port 1 and port 2 are selected, this is labeled as 1 Path 2 Port (1-->2).
- 1 Path 2 Port reverse. If port 1 and port 2 are selected, this is labeled as 1 Path 2 Port (2-->1).

Cal A Load Type

Select from:

- Broadband Load
- Sliding Load. If selected, a message appears: "Still required broadband loads below sliding load breakpoint frequency."

Cal A Through/Reciprocal Setup

- Select Line:
 - Through
 - Reciprocal. Reciprocal is not allowed between 1-2 and 3-4.
- Length (mm).
 - Select the Calculator icon to convert time to length:
 - ["AIR EQUIVALENT LENGTH Calculator Dialog Box" on page 10-146](#)
- Line Impedance (Ohms)
- Line Loss (dB/mm)
- @ Frequency (GHz)

Cal B Setup Areas

The Cal B functions and controls are the same as Cal A above.

Test Port 1 DUT Connector

If Port 1 was selected above, select the **DUT Connector Type** from a drop-down menu list with options of:

- K-Conn (M)
- K-Conn (F)
- GPC-3.5 (M)
- GPC-3.5 (F)
- SMA (M)
- SMA (F)
- N-Conn (M)
- N-Conn (F)
- 2.4 mm (M)
- 2.4 mm (F)
- TNC (M)
- TNC (F)
- V-conn (M)
- V-conn (F)
- W1-conn (M)
- W1-conn (F)
- 7/16 (M)

- 7/16 (F)
- GPC-7
- N-conn(75) (M)
- N-conn(75) (F)
- user defined 1 through 8 (M or F)

Test Port 1 DUT Connector Standard Info Button

Select displays the STANDARD INFO dialog box for the selected connector with its calibration coefficients. The dialog box contents depend on the selected connector, Cal Method, and Line Type. The example here shows a typical standard information dialog box.

- [“WAVEGUIDE INFO and USER DEFINED WAVEGUIDE Dialog Boxes” on page 10-156](#)

Test Port 1 Select BB Load

Select BB Load:

- Load 1
- Load 2

Test Port 2 Configuration

Provides the same controls as Test Port 1 Connector above.

Test Port 3 Configuration

Provides the same controls as Test Port 1 Connector above.

Test Port 4 Configuration

Provides the same controls as Test Port 1 Connector above.

OK / Cancel

Click OK to accept the changes or click Cancel.

TWO PORT CAL SETUP (SOLT/SOLR, MICROSTRIP) Dialog Box

Previous

- “CAL SETUP Menu - 4-Port VNAs” on page 10-43
- “TWO PORT CAL Menu - 4-Port VNAs” on page 10-97

Navigation

- MAIN | Calibration | CALIBRATION [TR] | Calibrate | CALIBRATE | Manual Cal | MANUAL CAL | 2-Port Cal | TWO PORT CAL | Modify Cal Setup | CAL SETUP | Cal Method = SOLT/SOLR; Line Type = Microstrip | Edit Cal Params | TWO PORT CAL SETUP (SOLT/R, MICROSTRIP) Dialog Box

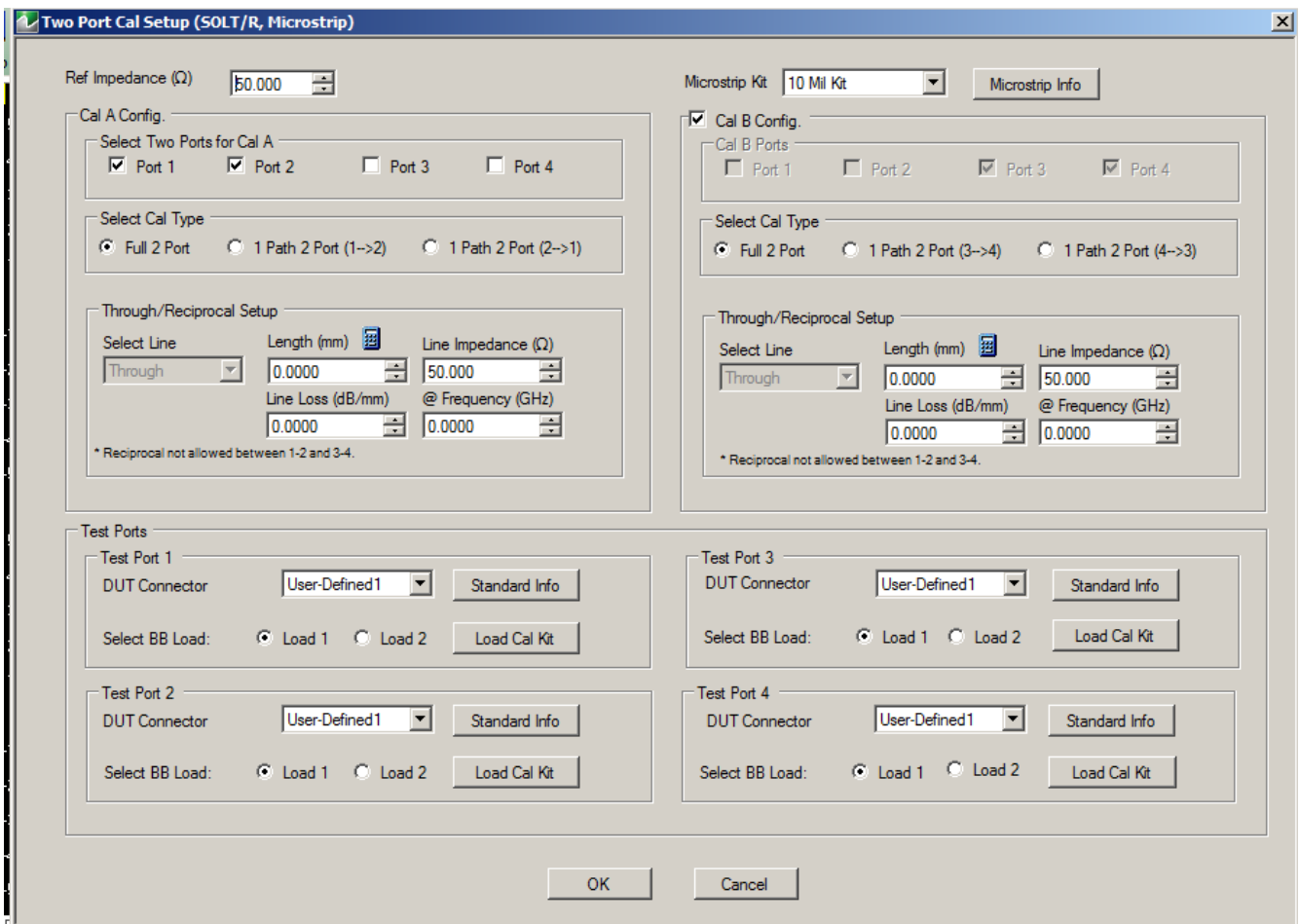

Figure 10-48. TWO PORT CAL SETUP (SOLT/R, MICROSTRIP) Dialog Box

Reference Impedance

Input the reference impedance.

- Input field defaulted to 50 Ohms.
- Any numerical value accepted.

Cal A and Cal B Configuration

The dialog box is divided into two calibration areas for Calibration A and Calibration B. Of the four test ports, the user selects two ports for the Cal A procedure. The instrument autoselects the remaining two test ports for the Cal B procedure.

Cal A Test Ports

Select any two test ports from Port 1, Port 2, Port 3, and Port 4. The non-selected ports are autoselected for Cal B.

Cal A Cal Type

Select the calibration type from the following options:

- Full 2 Port
- 1 Path 2 Port forward. If port 1 and port 2 are selected, this is labeled as 1 Path 2 Port (1-->2).
- 1 Path 2 Port reverse. If port 1 and port 2 are selected, this is labeled as 1 Path 2 Port (2-->1).

Cal A Load Type

Select from:

- Broadband Load
- Sliding Load. If selected, a message appears: "Still required broadband loads below sliding load breakpoint frequency."

Cal A Through/Reciprocal Setup

- Select Line:
 - Through
 - Reciprocal. Reciprocal is not allowed between 1-2 and 3-4.
- Length (mm).
 - Select the Calculator icon to convert time to length:
 - ["AIR EQUIVALENT LENGTH Calculator Dialog Box" on page 10-146](#)
- Line Impedance (Ohms)
- Line Loss (dB/mm)
- @ Frequency (GHz)

Cal B Setup Areas

The functions of the Cal B areas is the same as the Cal A above.

Test Port 1 DUT Connector

If Port 1 was selected above, select the **DUT Connector Type** from a drop-down menu list with options of:

- User-Defined1 through User-Defined8

Test Port 1 DUT Connector Standard Info Button

Select displays the STANDARD INFO dialog box for the selected connector with its calibration coefficients. The dialog box contents depend on the selected connector, Cal Method, and Line Type. The example here shows a typical standard information dialog box.

- ["MICROSTRIP KIT INFO and USER DEFINED MICROSTRIP Dialog Boxes" on page 10-147](#)

Test Port 1 Select BB Load

Select BB Load number for Test Port 1:

- Load 1
- Load 2

Test Port 2 Configuration

Provides the same controls as Test Port 1 Connector above.

Test Port 3 Configuration

Provides the same controls as Test Port 1 Connector above.

Test Port 4 Configuration

Provides the same controls as Test Port 1 Connector above.

OK / Cancel

Click OK to accept the changes and return to the CAL SETUP menu.

Click Cancel to abandon any changes and return to the CAL SETUP menu.

TWO PORT CAL SETUP (LRL/LRM, MICROSTRIP) Dialog Box

Previous

- “CAL SETUP Menu - 4-Port VNAs” on page 10-43
- “TWO PORT CAL Menu - 4-Port VNAs” on page 10-97

Navigation

- MAIN | Calibration | CALIBRATION [TR] | Calibrate | CALIBRATE | Manual Cal | MANUAL CAL | 2-Port Cal | TWO PORT CAL | Modify Cal Setup | CAL SETUP | Cal Mthod = LRL/LRM; Line Type = Microstrip | Edit Cal Parameters | TWO PORT CAL SETUP (LRL/M, Microstrip) Dialog Box

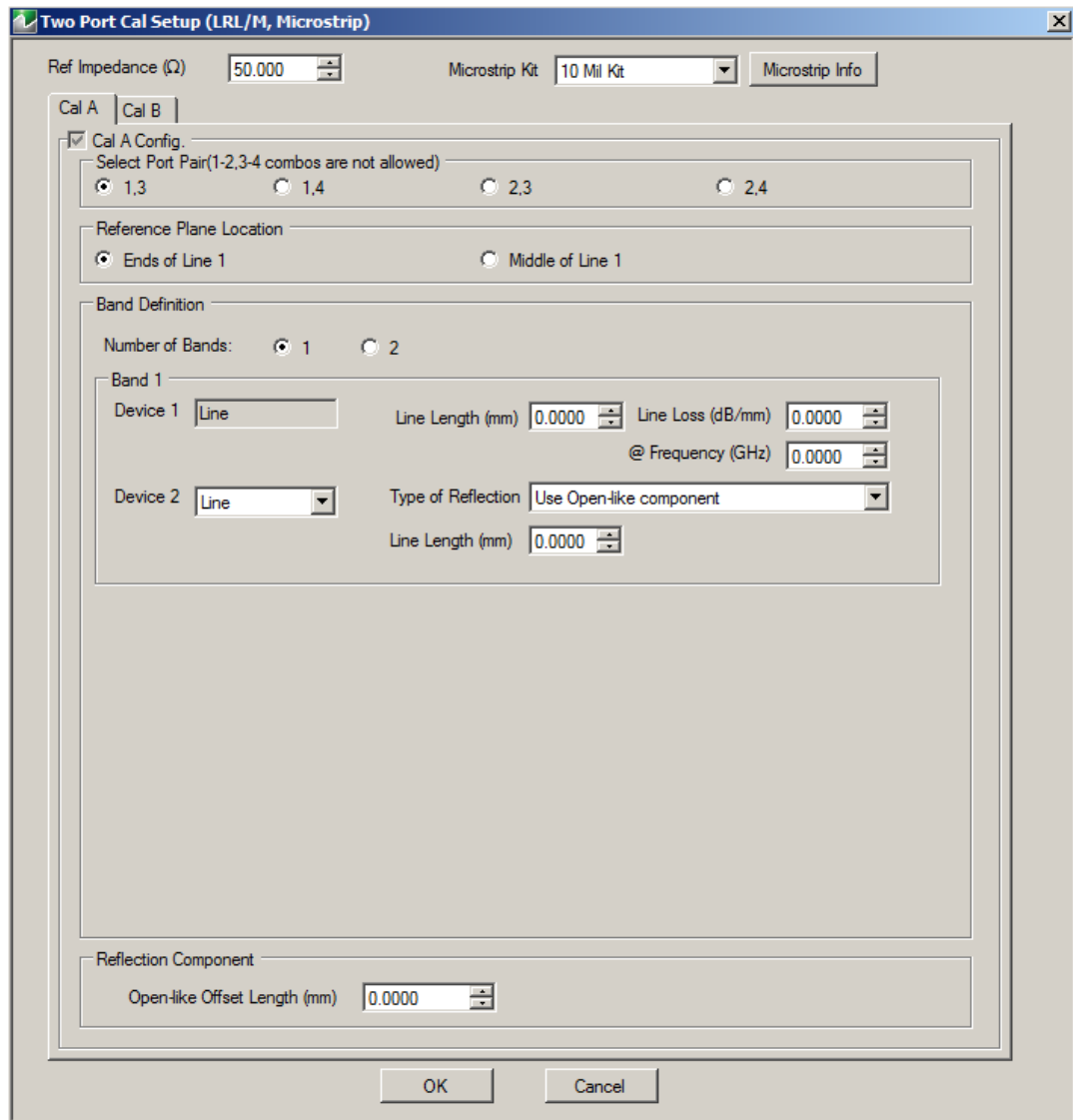

Figure 10-49. TWO PORT CAL SETUP (LRL/LRM, MICROSTRIP) Dialog Box - Cal A Tab

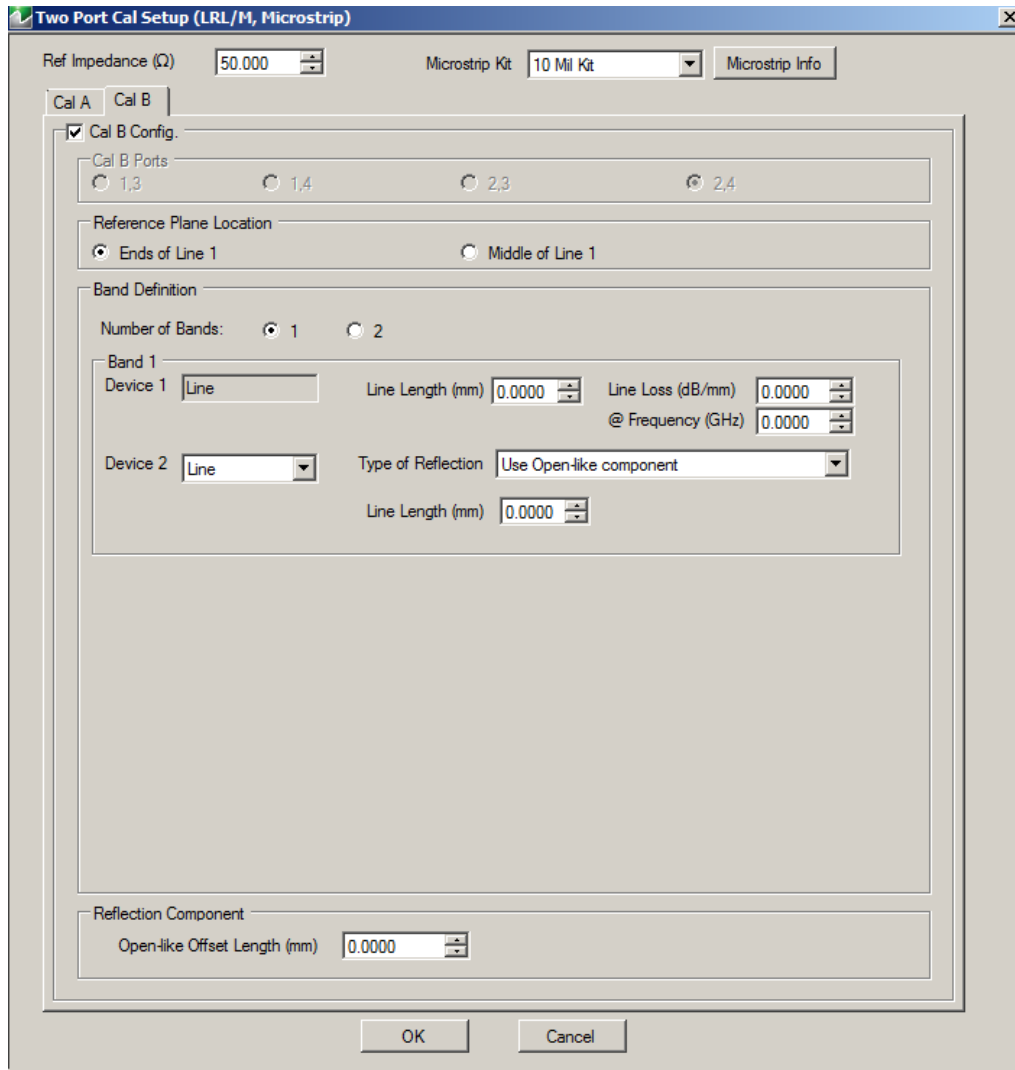

Figure 10-50. TWO PORT CAL SETUP (LRL/M, MICROSTRIP) Dialog Box - Cal B Tab

Reference Impedance

Input the reference impedance.

- Input field defaulted to 50 Ohms.
- Any numerical value accepted.

Microstrip Kit

Select from:

- 10 Mil Kit
- 15 Mil Kit
- 25 Mil Kit
- User-Defined1 to User-Defined8

Microstrip Info Button

Select the Microstrip Info button to display the parameter information dialog box for the selected kit. The contents of the box vary depending on the selected Cal Method, Line Type, and connector type.

- [“MICROSTRIP KIT INFO and USER DEFINED MICROSTRIP Dialog Boxes” on page 10-147](#)

Cal A Ports

Select one (1) Calibration A Port Pair noting that combinations of **Port Pair 1-2** and **Port Pair 3-4** are not allowed.

- Select one (1) from: Port 1-3, Port 1-4, Port 2-3, Port 2-4

Access the **Cal A** functions and controls by selecting the Cal A tab.

Cal A - Reference Plane Location

Select from two radio button controlled options:

- Ends of Line 1
- Middle of Line 1

Cal A - Band Definition

Select one or two bands from the pull-down menu.

- Number of Bands = 1. Only the **Band 1 Definition** area is present.
- Number of Bands = 2. The **Band 1 Definition** area remains, and the **Band 2 Definition** and the **Band Break Point** areas appear.

Cal A - Band 1 Device 1 Definition

Provides the following fields and controls for Band 1:

- Band 1 Device 1 = Defaulted to Line.
- Line Length (mm) for Device 1. Allows input of the line length in mm.
- Line Loss (dB/mm). Allows input of a line loss in dB per mm at the frequency specified in the field below.
- @ Frequency (GHz). Allows input of a frequency setting for the Line Loss factor input above.

Cal A - Band 1 Device 2 Definition

- Band 1 Device 2. Select from Line or Match in pull-down menu.
- If Line is selected, the Type of Reflection allows selection of Use Open-like component or Use Short-like component.
 - If Use Open-line component is selected, the Reflection Component area at bottom of dialog box displays the Open-like Offset Length (mm) field.
 - If Use Short-like component is selected, the Reflection Component area at bottom of dialog box displays Short-line Offset Length (mm) field.

Cal A - Band 2 Definition

The Number of Bands field above must be set to “2” for this area and the Band Break Point area described below to be displayed. Provides the following fields and controls for Band 2.

Cal A - Band 2 Device 3 Definition

A pull-down menu with selections of:

- Use device 1
- Use device 2
- Use new line. If selected, additional fields appear as Line Length (mm), Line Loss (dB/mm), and @ Frequency (GHz).

Cal A - Band 2 Device 4 Definition

A pull-down menu with selections of:

- Line
- Match

If Line is selected for Band 2 Device 4, the Type of Reflection and Line Length (mm) fields are available.

The Type of Reflection field choices are limited to:

- Use Short-like component. If selected, the Reflection Component area below has one field for Short-like Offset Length (mm).

- Use Open-like component. If selected, the Reflection Component area below has two fields of Open-like Offset Length (mm) and Short-like Offset Length (mm).

If Match is selected for Band 2 Device 4, the Match Info button and the Type of Reflection fields appear with choices of:

- The Match Info button appears. Select displays the USER DEFINED MATCH DEVICES dialog box appears which allows configuration of the match devices.
 - [“USER DEFINED MATCH DEVICES Dialog Box - LRL/LRM” on page 10-155](#)
- The Type of Reflection field has the following choices:
 - Use Short-like component. If selected, the Reflection Component area below has one field of Short-like Offset Length (mm) field.
 - Use Open-like component. If selected, the Reflection Component area below has two fields of Open-like Offset Length (mm) and Short-like Offset Length (mm).
 - Use both. If selected, pair of radio button fields appear and allow selection of either Use Port 1 Match or Use Port 2 Match. Also, if selected, the Reflection Component area below has two fields of Open-like Offset Length (mm) and Short-like Offset Length (mm).

Cal A - Band Break Point

This area only appears if the Number of Bands in the Band Definition area is set to “2”.

The Calculate Recommended Value button calculates the recommended break point value based on the input parameters in the fields above. Clicking the button calculates a break point frequency value and populates the Use Recommended Frequency (GHz) field.

A radio button set allows selection of either:

- Use Recommended Frequency (GHz) which was calculated by the button above.
- Define New Frequency (GHz) field which allows direct user input of a break frequency value.

Cal A - Reflection Component

Depending on the settings in the fields above, this area has one or two input fields as:

- Open-like Offset Length (mm)
- Short-like Offset Length (mm)

Access the **Cal B** functions and controls by selecting the Cal B tab where the controls and functions are the same as the Cal A tab above.

Cal B Ports

The Calibration B Port Pair is autoselected from the remaining unused port pairs:

- If Cal A = Ports 1-3, then Cal B = Ports 2-4
- If Cal A = Ports 1-4, then Cal B = Ports 2-3
- If Cal A = Ports 2-3, then Cal B = Ports 1-4
- If Cal A = Ports 2-4, then Cal B = Ports 1-3

OK / Cancel

Click OK to accept the changes and return to the CAL SETUP menu.

Click Cancel to abandon any changes and return to the CAL SETUP menu.

Summary of 2-Port Calibration Setup Dialog Boxes

The table below summarizes the available fields in all available 3-port calibration setup dialog boxes. If the dialog box is described in greater detail above, a link is provided to that description. To view each dialog box, set the CAL METHOD and LINE TYPE menus to the appropriate settings, and then select the Edit Cal Params button. All three-port dialog boxes are named “Three Port Cal Setup (Cal Method, Line Type)”

Table 10-4. Manual Calibration - 2-Port Calibration Setup Dialog Box Contents - 4-Port VNAs (1 of 5)

Cal Method Line Type	Input Selections
<p>SOLT/R Coaxial</p>	<p>See full description at “TWO PORT CAL SETUP (SOLT/R, COAXIAL) Dialog Box” on page 10-99</p> <p>Reference Impedance (Ohms)</p> <p>Cal A Test Ports: Select 2 ports from Port 1, Port 2, Port 3, Port 4. Ports not selected are assigned to Cal B</p> <p>Cal A Cal Type: Select Full 2 Port, 1 Path 2 Port Forward, or 1 Path 2 Port Reverse</p> <p>Cal A Load Type: Select Broadband Load or Sliding Load</p> <p>Cal A Through/Reciprocal: Select Through or Reciprocal</p> <ul style="list-style-type: none"> • Length (mm). Use the Calculator icon to display the AIR EQUIVALENT LENGTH dialog box at “AIR EQUIVALENT LENGTH Calculator Dialog Box” on page 10-146. • Line Impedance (Ohms) • Line Loss (dB/mm) • @ Frequency (GHz) <p>Cal B Test Ports: Test Ports are autoselected the remaining non-Cal A Ports</p> <ul style="list-style-type: none"> • All other controls and functions are the same as Cal A. <p>Test Port DUT Connector: Select from W1-Conn (M), W1-Conn (F), V-Conn (M), V-Conn (F), K-Conn (M), K-Conn (F), 2.4 mm (M), 2.4 mm (F), 2.4 mm V (M), 2.4 mm V (F), GPC-3.5 (M), GPC-3.5 (F), SMA (M), SMA (F), N-Conn (M), N-Conn (F), N-Conn (75) (M), N-Conn (75) (F), GPC-7, 7/16 (M), 7/16 (F), TNC (M), TNC (F), User-Defined1 (M) to User-Defined 8 (M), User-Defined1 (F) to User-Defined 8 (F)</p> <p>Test Port Connector Standard Info Button: Select displays the STANDARD INFORMATION dialog box for the selected connector.</p> <ul style="list-style-type: none"> • “MICROSTRIP KIT INFO and USER DEFINED MICROSTRIP Dialog Boxes” on page 10-147 <p>Test Port Select BB Load: Select Load 1 or Load 2.</p> <p>Test Port 1, Test Port 2, Test Port 3, and Test Port 4 controls are the same.</p>
<p>SOLT/R Non-Dispersive</p>	<p>Same controls as SOLT/R Coaxial above.</p>
<p>SOLT/R Waveguide</p>	<p>SOLT/R is not recommended for Waveguide calibrations.</p> <p>Same controls as SOLT/R Coaxial with the following changes:</p> <p>Waveguide Kit: User-Defined 1 to User-Defined 8</p> <p>Waveguide Info button: Displays USER DEFINED WAVEGUIDE dialog box for the waveguide kit selected above.</p> <ul style="list-style-type: none"> • “WAVEGUIDE INFO and USER DEFINED WAVEGUIDE Dialog Boxes” on page 10-156

Table 10-4. Manual Calibration - 2-Port Calibration Setup Dialog Box Contents - 4-Port VNAs (2 of 5)

Cal Method Line Type	Input Selections
SOLT/R Microstrip	<p>See full description at “TWO PORT CAL SETUP (SOLT/SOLR, MICROSTRIP) Dialog Box” on page 10-102</p> <p>Same controls as SOLT/R Coaxial with the following changes:</p> <p>Microstrip Kit: 10 Mil Kit, 15 Mil Kit, 25 Mil Kit, User-Defined 1 to User-Defined 8</p> <p>Microstrip Info button: Displays either the MICROSTRIP INFO or the USER DEFINED MICROSTRIP dialog box for the microstrip kit selected above.</p> <ul style="list-style-type: none"> • “MICROSTRIP KIT INFO and USER DEFINED MICROSTRIP Dialog Boxes” on page 10-147 <p>Test Port 1, 2, 3, and 4 Connector Standard Info Button: Select displays the USER DEFINED STANDARD dialog box for the selected connector.</p>
SSLT Coaxial	<p>See full description at “TWO PORT CAL SETUP (SOLT/R, COAXIAL) Dialog Box” on page 10-99</p> <p>Same controls as SOLT/R Coaxial with the following exception:</p> <p>Test Port DUT Connector: W1-Conn (M), W1-Conn(F), User-Defined1(M) to User-Defined 8 (M), User-Defined1(F) to User-Defined 8 (F)</p> <p>Test Port Connector Standard Info Button: Select displays either the STANDARD INFORMATION or the USER DEFINED dialog box for the selected connector.</p> <ul style="list-style-type: none"> • “STANDARD INFO (OFFSET SHORT) W1-Connector (F) Dialog Box” on page 10-148
SSLT Non-Dispersive	<p>Same controls as SSLT Coaxial.</p>
SSLT Waveguide	<p>Same controls as SSLT Coaxial with the following changes:</p> <p>Waveguide Kit: WR10, WR12, WR15, User-Defined 1 to User-Defined 8</p> <p>Waveguide Info button: Displays WAVEGUIDE INFO dialog box for selected calibration method and kit.</p> <ul style="list-style-type: none"> • “WAVEGUIDE INFO and USER DEFINED WAVEGUIDE Dialog Boxes” on page 10-156
SSLT Microstrip	<p>Same controls as SSLT Coaxial with the following changes:</p> <p>Microstrip Kit: 10 Mil Kit, 15 Mil Kit, 25 Mil Kit, User-Defined 1 to User-Defined 8</p> <p>Microstrip Info button: Displays MICROSTRIP INFO dialog box for selected calibration method and kit.</p> <ul style="list-style-type: none"> • “MICROSTRIP KIT INFO and USER DEFINED MICROSTRIP Dialog Boxes” on page 10-147

Table 10-4. Manual Calibration - 2-Port Calibration Setup Dialog Box Contents - 4-Port VNAs (3 of 5)

Cal Method Line Type	Input Selections
<p>SSST Coaxial</p>	<p>See full description at above.</p> <p>Reference Impedance (Ohms)</p> <p>Cal A Test Ports: Select 2 ports from Port 1, Port 2, Port 3, Port 4.</p> <p>Cal A Cal Type: Select from Full 2 Port, 1 Path 2 Port Forward, or 1 Path 2 Port Reverse</p> <p>Cal A Through/Reciprocal: Through, Reciprocal</p> <ul style="list-style-type: none"> • Length (mm). Use the Calculator icon to display the AIR EQUIVALENT LENGTH dialog box at “AIR EQUIVALENT LENGTH Calculator Dialog Box” on page 10-146. • Line Impedance (Ohms) • Line Loss (dB/mm) • @ Frequency (GHz) <p>Cal B Configuration</p> <ul style="list-style-type: none"> • Cal B can be included or not in the calibration. • If included, Test Ports are autoselected from the remaining non-Cal A Ports • All other controls and functions are the same <p>Test Port 1, Test Port 2, Test Port 3, and Test Port 4 Controls are the same.</p> <p>Test Port DUT Connector: W1-Conn (M), W1-Conn(F), User-Defined1(M) to User-Defined 8 (M), User-Defined1(F) to User-Defined 8 (F)</p> <p>Test Port DUT Connector Standard Info Button: Select displays the USER DEFINED STANDARD dialog box for the selected connector.</p> <ul style="list-style-type: none"> • “MICROSTRIP KIT INFO and USER DEFINED MICROSTRIP Dialog Boxes” on page 10-147 • “THRU INFO Dialog Box - 4-Port VNAs” on page 10-154
<p>SSST Non-Dispersive</p>	<p>Same controls as SSST Coaxial.</p>
<p>SSST Waveguide</p>	<p>Same controls as SSST Coaxial with the following changes:</p> <p>Waveguide Kit: User-Defined 1 to User-Defined 8</p> <p>Waveguide Info button: Displays WAVEGUIDE INFO dialog box for selected kit.</p> <ul style="list-style-type: none"> • “WAVEGUIDE INFO and USER DEFINED WAVEGUIDE Dialog Boxes” on page 10-156 <p>Test Port DUT Connector: User-Defined1 to User-Defined 8</p>
<p>SSST Microstrip</p>	<p>Same controls as SSST Coaxial with the following exception:</p> <p>Microstrip Kit: 10 Mil Kit, 15 Mil Kit, 25 Mil Kit, User-Defined 1 to User-Defined 8</p> <p>Microstrip Info button: Displays MICROSTRIP INFO dialog box for selected calibration method and kit.</p> <ul style="list-style-type: none"> • “MICROSTRIP KIT INFO and USER DEFINED MICROSTRIP Dialog Boxes” on page 10-147 <p>Test Port DUT Connector Standard Info Button: Select displays the USER DEFINED STANDARD dialog box for the selected connector.</p>

Table 10-4. Manual Calibration - 2-Port Calibration Setup Dialog Box Contents - 4-Port VNAs (4 of 5)

Cal Method Line Type	Input Selections
LRL/LRM Coaxial	<p>See full description at “TWO PORT CAL SETUP (LRL/LRM, MICROSTRIP) Dialog Box” on page 10-105 above.</p> <p>Reference Impedance (Ohms)</p> <p>Cal A Ports - Select two port pairs from 1-3, 1-4, 2-3, 2-4</p> <p>Cal B Ports - Autoselected non-Cal A Port Pairs: 1-3, 1-4, 2-3, 2-4</p> <p>Cal A and Cal B tabs: The “A” and “B” calibration parameters are selected via a tabbed menu within the dialog box.</p> <p>Reference Plane Location: Ends of Line 1, Middle of Line 1</p> <p>Number of Bands: 1, 2</p> <ul style="list-style-type: none"> • If 1, only Band 1 Device 1 and Band 1 Device 2 controls appear. • If 2, the above plus Band 2 Device 3 and Band 2 Device 4 controls appear. <p>Cal A Configuration Parameters:</p> <ul style="list-style-type: none"> • Cal A Reference Plane Location: Ends of Line, Middle of Line 1 • Cal A Number of Bands: 1 or 2 • Cal A Band 1 Device 1 Line: Line Length (mm), Line Loss (dB/mm), @ Frequency (GHz) • Cal A Band 1 Device 2 Type: Line, Match; Use Short-like component, Use Open-like component, Use both; If Device 2 = Match, Match Info button displays USER DEFINED MATCH DEVICES dialog box for selected calibration kit. • “USER DEFINED MATCH DEVICES Dialog Box - LRL/LRM” on page 10-155 • Cal A Band 2 Device 3: Use device 1, Use new line • Cal A Band 2 Device 4: Line, Match, Type of Reflection (Use Open-like component, Use Short-like component), Line Length (mm) • Cal A Band Break Point: Calculate Recommended Value, Use Recommended Frequency (GHz), Define New Frequency (GHz). • Cal A Reflection Component: Open-like Length (mm), Short-like Offset Length (mm) <p>Cal B Configuration Parameters</p> <ul style="list-style-type: none"> • Cal B parameters are the same as those for Cal A.
LRL/LRM Non-Dispersive	Same controls as LRL/LRM Coaxial.

Table 10-4. Manual Calibration - 2-Port Calibration Setup Dialog Box Contents - 4-Port VNAs (5 of 5)

Cal Method Line Type	Input Selections
LRL/LRM Waveguide	Same controls as LRL/LRM Coaxial above with the following changes: Cutoff Frequency (GHz) Dielectric Value
LRL/LRM Microstrip	See full description at “TWO PORT CAL SETUP (LRL/LRM, MICROSTRIP) Dialog Box” on page 10-105 above. Same controls as LRL/LRM Coaxial with the following changes: Microstrip Kit: 10 Mil Kit, 15 Mil Kit, 25 Mil Kit, User-Defined 1 to User-Defined 8 Microstrip Info button: Displays MICROSTRIP INFO dialog box for selected calibration method and kit. • “MICROSTRIP KIT INFO and USER DEFINED MICROSTRIP Dialog Boxes” on page 10-147

10-13 Manual 1-Port Cal Setup

ONE PORT CAL/S Menu - 4-Port VNAs

Button Availability:

- The exact composition of the menu depends on the settings made on the CAL SETUP, CAL METHOD, and LINE TYPE menus, and on the resultant ONE PORT CAL SETUP dialog box.
- A representative menu is shown below.
- The example procedures at the end of this chapter show examples of various TWO PORT CAL menus.

Previous

- [“MANUAL CAL Menu - 4-Port VNAs” on page 10-42](#)

Navigation

- MAIN | Calibration | CALIBRATION [TR] | Calibrate | CALIBRATE | Manual Cal | MANUAL CAL | 1-Port Cal | ONE PORT CAL

	<p>Modify Cal Setup</p> <p>Select displays the CAL SETUP menu with access to the FULL ONE PORT CAL SETUP dialog box for the selected calibration method and line type.</p> <ul style="list-style-type: none"> • “CAL SETUP Menu - 4-Port VNAs” on page 10-43 • “ONE PORT CAL SETUP (SOLT/R, COAXIAL) Dialog Box” on page 10-115 <p>Port Selected</p> <p>Read-only display of ports selected for the calibration.</p> <p>Port 1 / Port 2 / Port 3 / Port 4 Reflective Devices</p> <p>Select Port 1 Reflective Devices, Port 2 Reflective Devices, Port 3 Reflective Devices, and Port 4 Reflective Devices buttons to display REFL. DEVICE(S) ----Port 1----, REFL. DEVICE(S) ----Port 2----, REFL. DEVICE(S) ----Port 3----, and REFL. DEVICE(S) ----Port 4---- calibration submenus. Completion of submenu calibration steps is signified by completion checkmarks on the button.</p> <ul style="list-style-type: none"> • “REFL. DEVICE(S) Menu - 4-Port VNAs” on page 10-70 <p>Done</p> <p>Available after completion of calibration procedures. Select returns to CALIBRATION menu with Cal Status button set to ON.</p> <p>Abort Cal</p> <p>Select stops calibration procedure and returns to the CALIBRATION menu.</p>
--	--

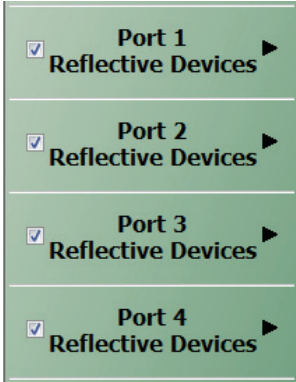

Figure 10-51. ONE PORT CAL Menu - 4-Port VNAs - Typical example

ONE PORT CAL SETUP (SOLT/R, COAXIAL) Dialog Box

Previous

- “CAL SETUP Menu - 4-Port VNAs” on page 10-43
- “ONE PORT CAL/S Menu - 4-Port VNAs” on page 10-114

Navigation

- MAIN | Calibration | CALIBRATION [TR] | Calibrate | CALIBRATE | Manual Cal | MANUAL CAL | 1-Port Cal | ONE PORT CAL | Modify Cal Setup | CAL SETUP | Edit Cal Params | ONE PORT CAL SETUP (SOLT/R, COAXIAL) Dialog Box

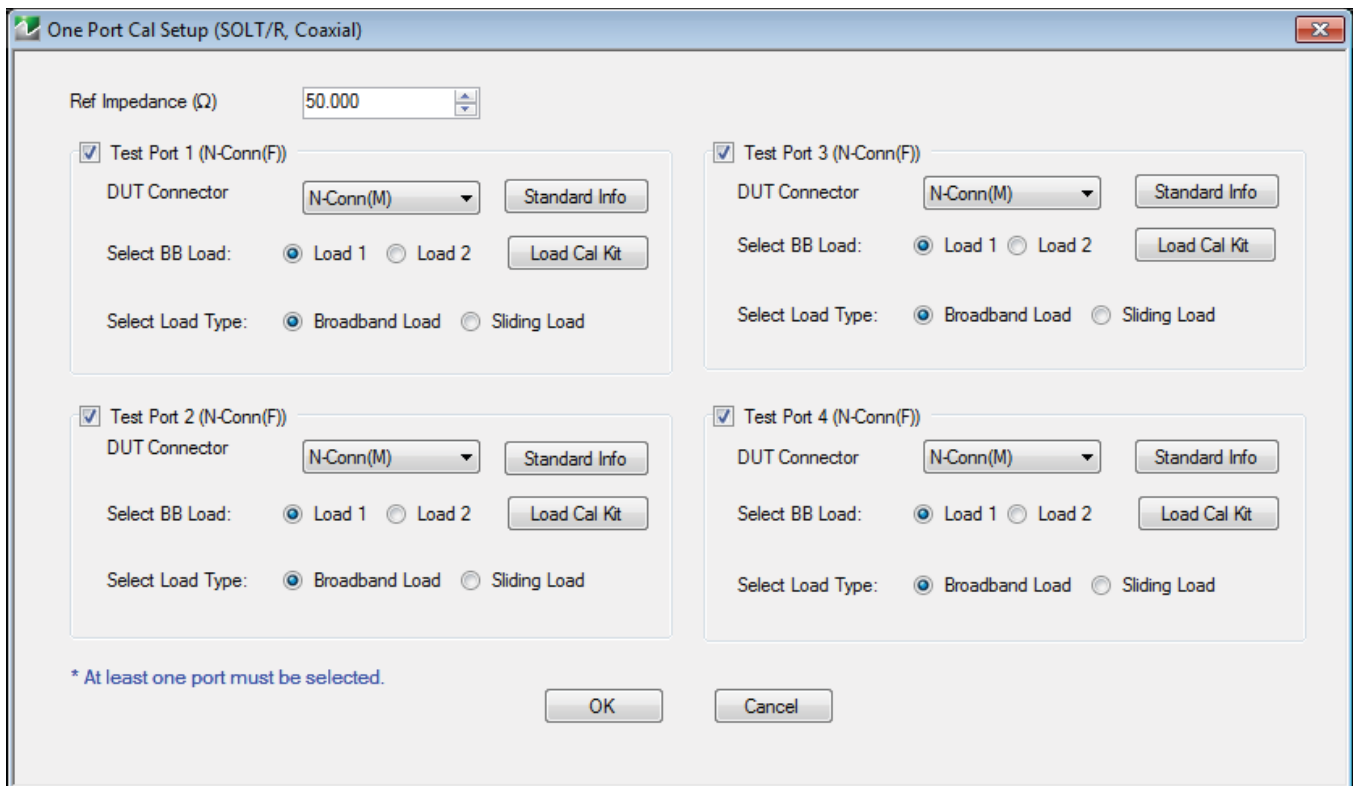

Figure 10-52. ONE PORT CAL SETUP (SOLT/R, COAXIAL) Dialog Box

Reference Impedance

Input the reference impedance.

- Input field defaulted to 50 Ohms.
- Any numerical value accepted although input values <0.01 Ohms are converted to 0.01 Ohms.

Test Port Selection Boxes

Allows selection of any combination of Test Port 1, Test Port 2, Test Port 3, or Test Port 4 as long as one port is selected.

If a port is not selected, its buttons and controls are not available.

Test Port 1 DUT Connector

Select the **DUT Connector Type** from a drop-down menu list with options of:

- K-Conn (M)
- K-Conn (F)
- GPC-3.5 (M)
- GPC-3.5 (F)
- SMA (M)
- SMA (F)
- N-Conn (M)
- N-Conn (F)
- 2.4 mm (M)
- 2.4 mm (F)
- TNC (M)
- TNC (F)
- V-conn (M)
- V-conn (F)
- W1-conn (M)
- W1-conn (F)
- 7/16 (M)
- 7/16 (F)
- GPC-7
- N-conn(75) (M)
- N-conn(75) (F)
- user defined 1 through 8 (M or F)

Test Port 1 Connector Standard Info Button

Select displays the STANDARD INFO dialog box with connector calibration coefficients for the selected connector and calibration method. The dialog box contents depend on the selected connector, calibration method, and line type. The example in the link below shows a typical standard information dialog box.

- [“MICROSTRIP KIT INFO and USER DEFINED MICROSTRIP Dialog Boxes” on page 10-147](#)

Test Port 1 Load Type

Select the load for Test Port 1:

- Broadband Load
- Sliding Load
 - If sliding load is selected, a message appears: “Still required broadband loads below sliding load breakpoint frequency.”

Test Port 2, Test Port 3, and Test Port 4 DUT Connector

Select the **DUT Connector Type** from a drop-down menu list as shown above in Test Port 1.

Test Port 2, Test Port 3, and Test Port 4 Connector Standard Info Button

Select displays the STANDARD INFO dialog box with connector calibration coefficients for the selected connector and calibration method as described above in Test Port 1.

Test Port 2, Test Port 3, and Test Port 4 Load Type

Select the load as either Broadband Load or Sliding Load as describe above in Test Port 1.

OK / Cancel

Click **OK** to accept the changes and return to the **CAL SETUP** menu.

Click **Cancel** to abandon any changes and return to the **CAL SETUP** menu.

ONE PORT CAL SETUP (SSLT, COAXIAL) Dialog Box

Previous

- “CAL SETUP Menu - 4-Port VNAs” on page 10-43
- “ONE PORT CAL/S Menu - 4-Port VNAs” on page 10-114

Navigation

- MAIN | Calibration | CALIBRATION [TR] | Calibrate | CALIBRATE | Manual Cal | MANUAL CAL | 1-Port Cal | ONE PORT CAL | Modify Cal Setup | CAL SETUP | Edit Cal Params | ONE PORT CAL SETUP (SSLT, COAXIAL) Dialog Box

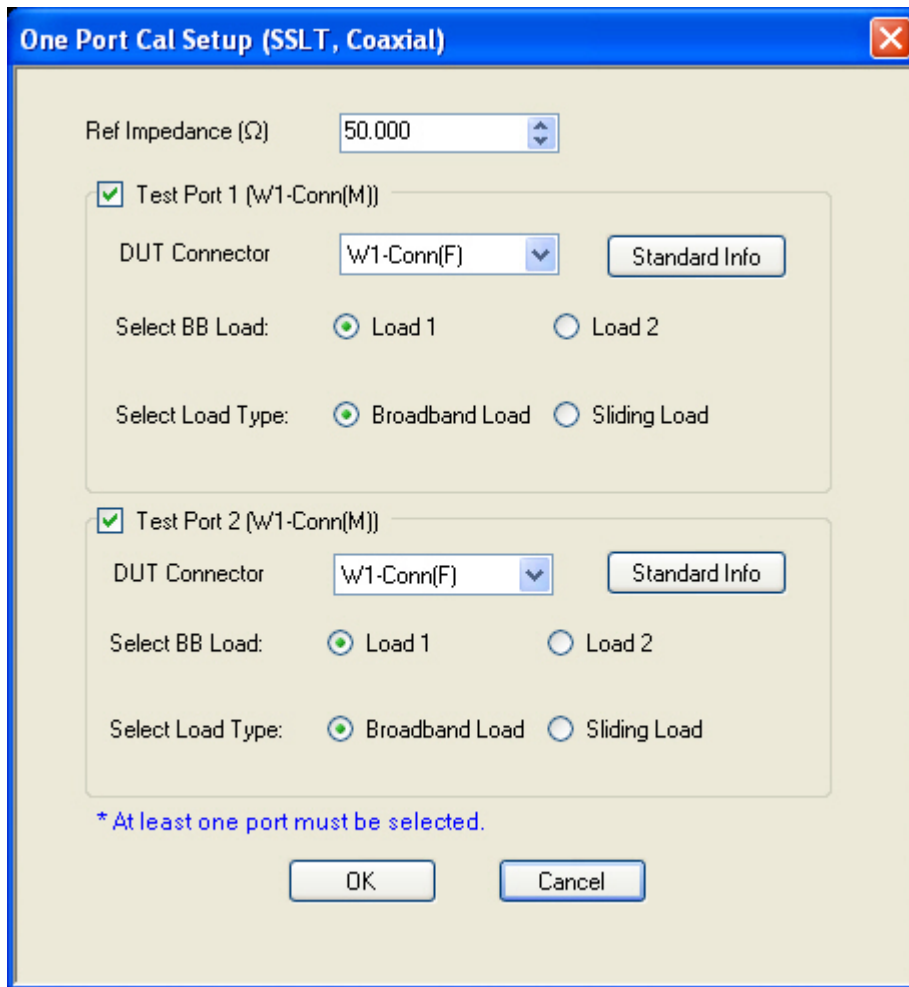

Figure 10-53. ONE PORT CAL SETUP (SSLT, COAXIAL) Dialog Box

Reference Impedance

Input the reference impedance.

- Input field defaulted to 50 Ohms.
- Any numerical value accepted although input values <0.01 Ohms are converted to 0.01 Ohms.

Test Port Selection Boxes

Allows selection of any combination of Test Port 1, Test Port 2, Test Port 3, or Test Port 4 as long as one port is selected.

If a port is not selected, its buttons and controls are not available.

Test Port 1 DUT Connector

Select the **DUT Connector Type** from a drop-down menu list with options of:

- W1-Conn (M)
- W1-Conn (F)
- User-Defined1 (M) through User-Defined8 (M)
- User-Defined1 (F) through User-Defined8 (F)

Test Port 1 Connector Standard Info Button

Select displays the STANDARD INFO dialog box with connector calibration coefficients for the selected connector and calibration method. The dialog box contents depend on the selected connector, calibration method, and line type. The examples in the link below shows a typical standard information dialog box.

- [“MICROSTRIP KIT INFO and USER DEFINED MICROSTRIP Dialog Boxes” on page 10-147](#)
- [“STANDARD INFO \(OFFSET SHORT\) W1-Connector \(F\) Dialog Box” on page 10-148](#)

Test Port 1 BB Load

Select the broadband load for Test Port 1:

- Load 1
- Load 2

Test Port 1 Load Type

Select the load for Test Port 1:

- Broadband Load
- Sliding Load
 - If sliding load is selected, a message appears: “Still required broadband loads below sliding load breakpoint frequency.”

Test Port 2, Test Port 3, and Test Port 4 DUT Connector

Select the **DUT Connector Type** from a drop-down menu list as shown above in Test Port 1.

Test Port 2, Test Port 3, and Test Port 4 Connector Standard Info Button

Select displays the STANDARD INFO dialog box with connector calibration coefficients for the selected connector and calibration method as described above in Test Port 1.

Test Port 2, Test Port 3, and Test Port 4 BB Load

Select the broadband load as either Load 1 or Load 2 as describe above in Test Port 1.

Test Port 2, Test Port 3, and Test Port 4 Load Type

Select the load as either Broadband Load or Sliding Load as describe above in Test Port 1.

OK / Cancel

Click OK to accept the changes and return to the CAL SETUP menu.

Click Cancel to abandon any changes and return to the CAL SETUP menu.

ONE PORT CAL SETUP (SSST, COAXIAL) Dialog Box

Previous

- “CAL SETUP Menu - 4-Port VNAs” on page 10-43
- “ONE PORT CAL/S Menu - 4-Port VNAs” on page 10-114

Navigation

- MAIN | Calibration | CALIBRATION [TR] | Calibrate | CALIBRATE | Manual Cal | MANUAL CAL | 1-Port Cal | ONE PORT CAL/S | Modify Cal Setup | CAL SETUP | Cal Method = SSST; Line Type = Coaxial | Edit Cal Params | ONE PORT CAL SETUP (SSST, COAXIAL) Dialog Box

One Port Cal Setup (SOLT/R, Microstrip)

Ref Impedance (Ω)

Microstrip Kit

Test Port 1

DUT Connector

Select BB Load: Load 1 Load 2

Test Port 2

DUT Connector

Select BB Load: Load 1 Load 2

Test Port 3

DUT Connector

Select BB Load: Load 1 Load 2

Test Port 4

DUT Connector

Select BB Load: Load 1 Load 2

* At least one port must be selected.

Figure 10-54. ONE PORT CAL SETUP (SSST, COAXIAL) Dialog Box

Reference Impedance

Input the reference impedance.

- Input field defaulted to 50 Ohms.
- Any numerical value accepted although input values <0.01 Ohms are converted to 0.01 Ohms.

Test Port Selection Boxes

Allows selection of any combination of Test Port 1, Test Port 2, Test Port 3, or Test Port 4 as long as one port is selected.

If a port is not selected, its buttons and controls are not available.

Test Port 1 DUT Connector

Select the **DUT Connector Type** from a drop-down menu list with options of:

- W1-Conn (M)
- W1-Conn (F)
- User-Defined1 (M) through User-Defined8 (M)
- User-Defined1 (F) through User-Defined8 (F)

Test Port 1 Connector Standard Info Button

Select displays the STANDARD INFO dialog box with connector calibration coefficients for the selected connector and calibration method. The dialog box contents depend on the selected connector, calibration method, and line type. The examples in the link below shows a typical standard information dialog box.

- [“MICROSTRIP KIT INFO and USER DEFINED MICROSTRIP Dialog Boxes” on page 10-147](#)
- [“STANDARD INFO \(OFFSET SHORT\) W1-Connector \(F\) Dialog Box” on page 10-148](#)

OK / Cancel

Click OK to accept the changes and return to the CAL SETUP menu.

Click Cancel to abandon any changes and return to the CAL SETUP menu.

ONE PORT CAL SETUP (SSLT, WAVEGUIDE) Dialog Box

Previous

- “CAL SETUP Menu - 4-Port VNAs” on page 10-43
- “ONE PORT CAL/S Menu - 4-Port VNAs” on page 10-114

Navigation

- MAIN | Calibration | CALIBRATION [TR] | Calibrate | CALIBRATE | Manual Cal | MANUAL CAL | 1-Port Cal | ONE PORT CAL | Modify Cal Setup | Cal Mthod = SSLT; Line Type = Waveguide | Edit Cal Params | ONE PORT CAL (SSLT, WAVEGUIDE) Dialog Box

Full One Port Cal (SSLT, Waveguide)

Ref Impedance (Ω)

Waveguide Kit

Test Port 1
Select Load Type: Broadband Load Sliding Load

Test Port 2
Select Load Type: Broadband Load Sliding Load

Test Port 3
Select Load Type: Broadband Load Sliding Load

Test Port 4
Select Load Type: Broadband Load Sliding Load

* At least one port must be selected.

Figure 10-55. ONE PORT CAL SETUP (SSLT, WAVEGUIDE) Dialog Box

Reference Impedance

Input the reference impedance.

- Input field defaulted to 50 Ohms.
- Any numerical value accepted although input values <0.01 Ohms are converted to 0.01 Ohms.

Waveguide Kit Selection

Select the **Waveguide Kit Type** from a drop-down menu list with options of:

- User-Defined 1 through User-Defined8

Waveguide Info Button

Select displays the USER DEFINED WAVEGUIDE (SSST) parameters dialog box. The dialog box allows user input of waveguide calibration parameters of:

- Waveguide kit label. A user-defined kit label can be input here.
- Cutoff frequency (GHz)
- Dielectric
- Offset short 1 length (mm)
- Offset short 2 length (mm)
- Offset short 3 length (mm)
- A calculator icon provides access to the AIR EQUIVALENT LENGTH CALCULATOR dialog box described in the AutoCal sections above.
 - [“AIR EQUIVALENT LENGTH Calculator Dialog Box” on page 10-146](#)

The dialog box contents depend on the selected connector, calibration method, and line type. The example in the link below shows a typical standard information dialog box.

- [“WAVEGUIDE INFO and USER DEFINED WAVEGUIDE Dialog Boxes” on page 10-156](#)

OK / Cancel

Click OK to accept the changes and return to the CAL SETUP menu.

Click Cancel to abandon any changes and return to the CAL SETUP menu.

Summary of 1-Port Calibration Setup Dialog Boxes

The table below summarizes the fields and controls in all 1-port calibration setup dialog boxes. If the dialog box is described in greater detail above, a link is provided to that description. To view each dialog box, set the CAL METHOD and LINE TYPE menus to the appropriate settings, and then select the Edit Cal Params button. All three-port dialog boxes are named “Three Port Cal Setup (Cal Method, Line Type)”

Table 10-5. Manual Calibration - 1-Port Calibration Setup Dialog Box Contents - 4-Port VNAs (1 of 3)

Cal Method Line Type	Dialog Box Input Selections and Controls
SOLT/R Coaxial	<p>See full description above at “ONE PORT CAL SETUP (SOLT/R, COAXIAL) Dialog Box” on page 10-115</p> <p>Reference Impedance (Ohms)</p> <p>Select Test Ports: Select any combination of Test Port 1, Test Port 2, Test Port 3, and/or Test Port 4 as long as one port is selected.</p> <p>Test Port DUT Connector: For each test port, select one of the following connectors from a drop-down list: W1-Conn (M), W1-Conn (F), V-Conn (M), V-Conn (F), K-Conn (M), K-Conn (F), 2.4 mm (M), 2.4 mm (F), 2.4 mm V (M), 2.4 mm V (F), GPC-3.5 (M), GPC-3.5 (F), SMA (M), SMA (F), N-Conn (M), N-Conn (F), N-Conn (75) (M), N-Conn (75) (F), GPC-7, 7/16 (M), 7/16 (F), TNC (M), TNC (F), User-Defined1 (M) through User-Defined8 (M), User-Defined1 (F) through User-Defined8 (F)</p> <p>Test Port DUT Connector Standard Info Button: Select displays the STANDARD INFO dialog box for the selected connector above.</p> <ul style="list-style-type: none"> • “MICROSTRIP KIT INFO and USER DEFINED MICROSTRIP Dialog Boxes” on page 10-147 <p>Test Port BB Load: For each Test Port selected above, select either Load 1 or Load 2</p> <p>Test Port Load Type: For each Test Port selected above, select either Broadband Load, Sidling Load</p>
SOLT/R Non-Dispersive	Same controls as SOLT/R Coaxial.
SOLT/R Waveguide	<p>SOLT/R is not recommended for Waveguide calibrations.</p> <p>The same controls as SOLT/R Coaxial with the following changes:</p> <p>Waveguide Kit: User-Defined 1 to User-Defined 8</p> <p>Waveguide Info button: Displays USER DEFINED WAVEGUIDE dialog box for the waveguide kit selected above.</p> <ul style="list-style-type: none"> • “WAVEGUIDE INFO and USER DEFINED WAVEGUIDE Dialog Boxes” on page 10-156
SOLT/R Microstrip	<p>Same controls as SOLT/R Coaxial with the following changes:</p> <p>Microstrip Kit: Select from 10 Mil Kit, 15 Mil Kit, 25 Mil Kit, or User-Defined 1 to User-Defined 8</p> <p>Microstrip Info button: Displays either the MICROSTRIP INFO or the USER DEFINED MICROSTRIP dialog box for the microstrip kit selected above.</p> <ul style="list-style-type: none"> • “MICROSTRIP KIT INFO and USER DEFINED MICROSTRIP Dialog Boxes” on page 10-147

Table 10-5. Manual Calibration - 1-Port Calibration Setup Dialog Box Contents - 4-Port VNAs (2 of 3)

Cal Method Line Type	Dialog Box Input Selections and Controls
<p>SSLT Coaxial</p>	<p>See full description above at “ONE PORT CAL SETUP (SSLT, COAXIAL) Dialog Box” on page 10-118</p> <p>Reference Impedance (Ohms).</p> <p>Select Test Ports: Select any combination of Test Port 1, Test Port 2, Test Port 3, and/or Test Port 4 as long as one port is selected.</p> <p>Test Port DUT Connector: For each test port, select one of the following connectors from a drop-down list: W1-Conn (M), W1-Conn (F), V-Conn (M), V-Conn (F), K-Conn (M), K-Conn (F), 2.4 mm (M), 2.4 mm (F), 2.4 mm V (M), 2.4 mm V (F), GPC-3.5 (M), GPC-3.5 (F), SMA (M), SMA (F), N-Conn (M), N-Conn (F), N-Conn (75) (M), N-Conn (75) (F), GPC-7, 7/16 (M), 7/16 (F), TNC (M), TNC (F), User-Defined1 (M) through User-Defined8 (M), User-Defined1 (F) through User-Defined8 (F)</p> <p>Test Port DUT Connector Standard Info Button: Select displays the STANDARD INFO dialog box for the selected connector above.</p> <ul style="list-style-type: none"> • “MICROSTRIP KIT INFO and USER DEFINED MICROSTRIP Dialog Boxes” on page 10-147 • “STANDARD INFO (OFFSET SHORT) W1-Connector (F) Dialog Box” on page 10-148 <p>Test Port BB Load: For each Test Port selected above, select either Load 1 or Load 2</p> <p>Test Port Load Type: For each Test Port selected above, select either Broadband Load, Sidling Load</p>
<p>SSLT Non-Dispersive</p>	<p>Same controls and functions options as SSLT Coax.</p>
<p>SSLT Waveguide</p>	<p>See full description above at “ONE PORT CAL SETUP (SSLT, WAVEGUIDE) Dialog Box” on page 10-122</p> <p>Same controls and functions as SSLT Coaxial with the following changes:</p> <p>Waveguide Kit: WR10, WR12, WR15, User-Defined 1 to User-Defined 8</p> <p>Waveguide Info button: Displays WAVEGUIDE INFO dialog box for selected calibration method and kit.</p> <ul style="list-style-type: none"> • “WAVEGUIDE INFO and USER DEFINED WAVEGUIDE Dialog Boxes” on page 10-156
<p>SSLT Microstrip</p>	<p>Same controls and functions as SSLT Coaxial with the following changes:</p> <p>Microstrip Kit: 10 Mil Kit, 15 Mil Kit, 25 Mil Kit, User-Defined 1 to User-Defined 8</p> <p>Microstrip Info button: Displays the MICROSTRIP INFO or USER DEFINED dialog box for selected calibration method and kit.</p> <ul style="list-style-type: none"> • “MICROSTRIP KIT INFO and USER DEFINED MICROSTRIP Dialog Boxes” on page 10-147 <p>Test Port Connector Standard Info Button: For each port selected, displays the USER DEFINED STANDARD dialog box for the selected calibration method and connector. See the following links for typical examples:</p> <ul style="list-style-type: none"> • “STANDARD INFO (OFFSET SHORT) W1-Connector (F) Dialog Box” on page 10-148

Table 10-5. Manual Calibration - 1-Port Calibration Setup Dialog Box Contents - 4-Port VNAs (3 of 3)

Cal Method Line Type	Dialog Box Input Selections and Controls
SSST Coaxial	<p>See full description above at “ONE PORT CAL SETUP (SSST, COAXIAL) Dialog Box” on page 10-120</p> <p>Reference Impedance (Ohms)</p> <p>Test Ports: Select any combination of Test Port 1, Test Port 2, Test Port 3, Test Port 3 as long a one port is selected.</p> <p>Test Port DUT Connector: W1-Conn (M), W1-Conn (F), User-Defined 1 (M) to User-Defined 8 (M), User-Defined 1 (F) to User-Defined 8 (F)</p> <p>Test Port DUT Connector Standard Info button: Displays the STANDARD INFO (Triple Offset Short) dialog box for selected connector.</p> <ul style="list-style-type: none"> • “THRU INFO Dialog Box - 4-Port VNAs” on page 10-154
SSST Non-Dispersive	<p>Same controls and functions as SSST Coaxial.</p>
SSST Waveguide	<p>Same controls and functions as SSST Coaxial with the following changes</p> <p>Waveguide Kit: User-Defined 1 to User-Defined 8</p> <p>Waveguide Info button: Displays WAVEGUIDE INFO dialog box for selected calibration method and kit.</p> <ul style="list-style-type: none"> • “WAVEGUIDE INFO and USER DEFINED WAVEGUIDE Dialog Boxes” on page 10-156
SSST Microstrip	<p>Same controls and functions as SSST Coaxial with the following changes</p> <p>Microstrip Kit: 10 Mil Kit, 15 Mil Kit, 25 Mil Kit, User-Defined 1 to User-Defined 8</p> <p>Microstrip Info button: Displays MICROSTRIP INFO dialog box for selected calibration method and kit.</p> <ul style="list-style-type: none"> • “MICROSTRIP KIT INFO and USER DEFINED MICROSTRIP Dialog Boxes” on page 10-147
LRL/LRM	<p>LRL/LRM calibration method is not available for 1-port calibrations.</p>

10-14 Manual Trans. Freq. Response Cal Menus and Dialog Boxes

- [“TRANS. FREQ. RESP. CAL SETUP \(SSLT, WAVEGUIDE\) Dialog Box” on page 10-131](#)
- [“TRANS. FREQ. RESP. CAL SETUP \(SSST, MICROSTRIP\) Dialog Box” on page 10-133](#)

Summary table of all transmission frequency response calibration configuration dialog boxes:

- [Table 10-6, “Trans. Freq. Resp. Manual Cal Setup Dialog Box Contents - 4-Port VNAs” on page 10-135](#)

Full Name

- Transmission Frequency Response Calibration

Menu Name

- TRANS. RESPONSE

Button Name

- Transmission Freq. Response

TRANS. RESPONSE Menu - 4-Port VNAs

Composition of menu depends on settings made on the CAL SETUP, CAL METHOD, and LINE TYPE menus and on the resultant TRANSMISSION FREQUENCY REPOSENSE CAL SETUP dialog box.

Full Name

- Transmission Frequency Response Menu

Previous

- [“MANUAL CAL Menu - 4-Port VNAs” on page 10-42](#)

Navigation

- MAIN | Calibration | CALIBRATION [TR] | Calibrate | CALIBRATE | Manual Cal | MANUAL CAL | Transmission Freq. Response | TRANS. RESPONSE

	<p>Modify Cal Setup</p> <p>Select displays the CAL SETUP menu where the Edit Cal Params button provides access to the TRANSMISSION FREQUENCY RESPONSE CAL SETUP dialog box for the selected calibration method and line type.</p> <ul style="list-style-type: none"> • “TRANSMISSION FREQ. RESPONSE CAL SETUP (SOLT/SOLR, COAXIAL) Dialog Box” on page 10-129 <p>Port Selected</p> <p>Read-only display of the ports selected for the pending calibration.</p> <p>Thru/Recip / Isolation (Optional)</p> <p>Select Thru/Recip and Isolation (OPTIONAL) buttons to display THRU and ISOLATION(S) calibration submenus. Completion of submenu calibration steps is signified by completion checkmarks on the buttons.</p> <ul style="list-style-type: none"> • “THRU Menu - 4-Port VNAs” on page 10-74 • “ISOLATION(S) Menu” on page 10-76 <p>Done</p> <p>Available after completion of calibration procedures. Select returns to CALIBRATION menu with Cal Status button set to ON.</p> <p>Abort Cal</p> <p>Select stops calibration procedure and returns to the CALIBRATION menu.</p>
--	---

Figure 10-56. TRANS. RESPONSE Menu - 4-Port VNAs - Typical example

TRANSMISSION FREQ. RESPONSE CAL SETUP (SOLT/SOLR, COAXIAL) Dialog Box

Full Name

- Transmission Frequency Response Calibration Setup

Previous

- [“TRANS. RESPONSE Menu - 4-Port VNAs” on page 10-127](#)

Navigation

- MAIN | Calibration | CALIBRATION [TR] | Calibrate | CALIBRATE | Manual Cal | MANUAL CAL | Transmission Freq. Response | TRANS. RESPONSE | Modify Cal Setup | CAL SETUP | Cal Method = SOLT/SOLR; Line Type = Coaxial | Edit Cal Params | TRANSMISSION FREQUENCY RESPONSE CAL SETUP (SOLT/R, COAXIAL) Dialog Box

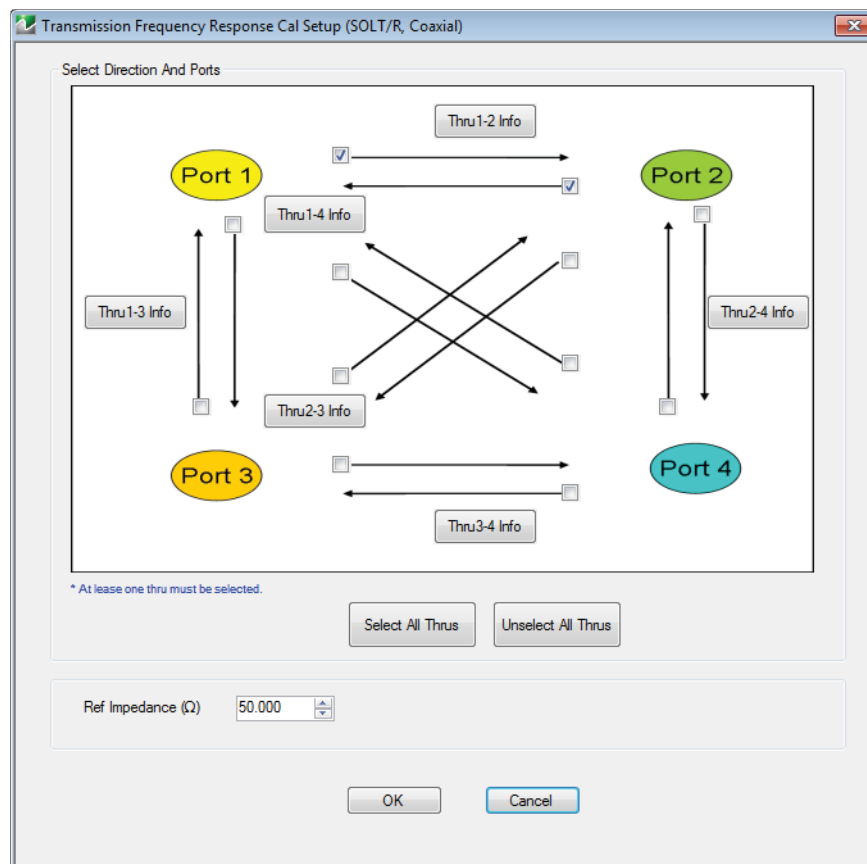

Figure 10-57. TRANSMISSION FREQ. RESPONSE CAL SETUP (SOLT/R, COAXIAL) Dialog Box

Test Port Thru Selection Boxes

Allows selection of any combination of the test port throughs for the available port pairs:

- Thru 1-2
- Thru 1-3
- Thru 1-4
- Thru 2-3
- Thru 2-4
- Thru 3-4

Test Port Pair Thru Info Buttons

A Thru Info button becomes available for each port pair through selected above. Select displays the THRU INFO configuration dialog box for the selected port pair. A calculator icon in the THRU INFO dialog box allows access to the AIR EQUIVALENT LENGTH CALCULATOR dialog box.

- [“THRU INFO Dialog Box - 4-Port VNAs” on page 10-154](#)
- [“AIR EQUIVALENT LENGTH Calculator Dialog Box” on page 10-146](#)

Reference Impedance

Input the reference impedance.

- Input field defaulted to 50 Ohms.
- Any numerical value accepted although input values <0.01 Ohms are converted to 0.01 Ohms.

OK / Cancel

Click OK to accept the changes, or click Cancel.

TRANS. FREQ. RESP. CAL SETUP (SSLT, WAVEGUIDE) Dialog Box

Full Name

- Transmission Frequency Response Calibration Setup

Previous

- [“TRANS. RESPONSE Menu - 4-Port VNAs”](#) on page 10-127

Navigation

- MAIN | Calibration | CALIBRATION [TR] | Calibrate | CALIBRATE | Manual Cal | MANUAL CAL | Transmission Freq. Response | TRANS. RESPONSE | Modify Cal Setup | CAL SETUP | Edit Cal Params | TRANSMISSION FREQUENCY RESPONSE | Modify Cal Setup | CAL SETUP | Cal Method = SSLT; Line Type = Waveguide) Dialog Box

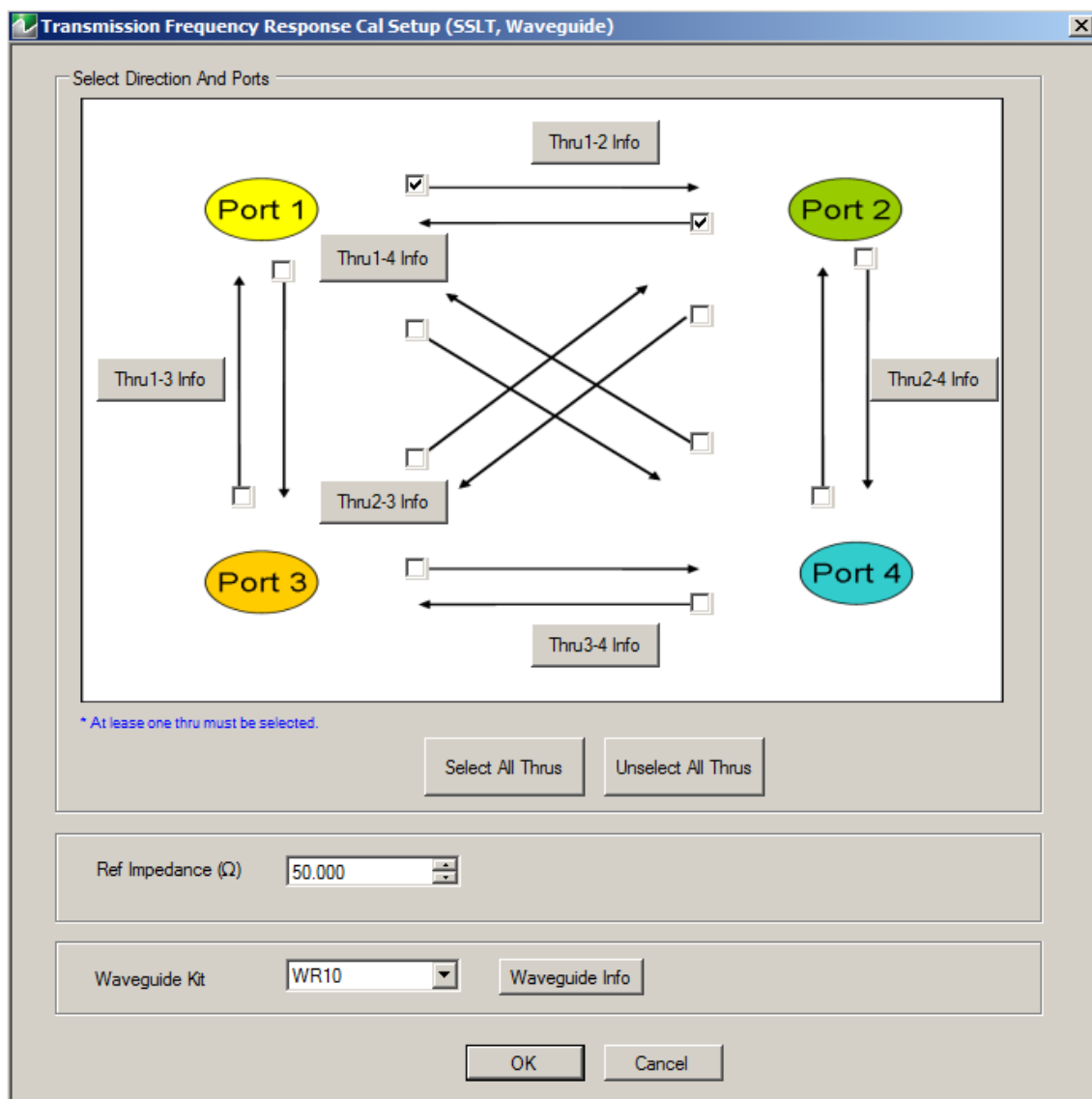

TRANSMISSION FREQUENCY RESPONSE CALIBRATION SETUP

Figure 10-58. TRANS. FREQ. RESP. CAL SETUP (SSLT, WAVEGUIDE) Dialog Box

Reference Impedance

Input the reference impedance.

- Input field defaulted to 50 Ohms.
- Any numerical value accepted although input values <0.01 Ohms are converted to 0.01 Ohms.

Waveguide Kit Selection

Select the **Waveguide Kit Type** from a drop-down menu list with options of:

- User-Defined1 through User-Defined8

Waveguide Info Button

Select displays the USER DEFINED WAVEGUIDE (SSST) parameters dialog box. The dialog box allows user input of waveguide calibration parameters of:

- Waveguide kit label. A user-defined kit label can be input here.
- Cutoff frequency (GHz)
- Dielectric
- Offset short 1 length (mm)
- Offset short 2 length (mm)
- Offset short 3 length (mm)
- A calculator icon provides access to the AIR EQUIVALENT LENGTH CALCULATOR dialog box described in the AutoCal sections above.
 - [“AIR EQUIVALENT LENGTH Calculator Dialog Box” on page 10-146](#)

The dialog box contents depend on the selected connector, calibration method, and line type. The example in the link below shows a typical standard information dialog box.

- [“WAVEGUIDE INFO and USER DEFINED WAVEGUIDE Dialog Boxes” on page 10-156](#)

OK / Cancel

Click OK to accept the changes and return to the CAL SETUP menu.

Click Cancel to abandon any changes and return to the CAL SETUP menu.

TRANS. FREQ. RESP. CAL SETUP (SSST, MICROSTRIP) Dialog Box

Full Name

- Transmission Frequency Response Calibration Setup

Previous

- [“TRANS. RESPONSE Menu - 4-Port VNAs” on page 10-127](#)

Navigation

- MAIN | Calibration | CALIBRATION [TR] | Calibrate | CALIBRATE | Manual Cal | MANUAL CAL | Transmission Freq. Response | TRANS. RESPONSE | Modify Cal Setup | CAL SETUP | Cal Method = SSST; Line Type = Microstrip | Edit Cal Params | TRANSMISSION FREQUENCY RESPONSE CAL SETUP (SSST, COAXIAL) Dialog Box

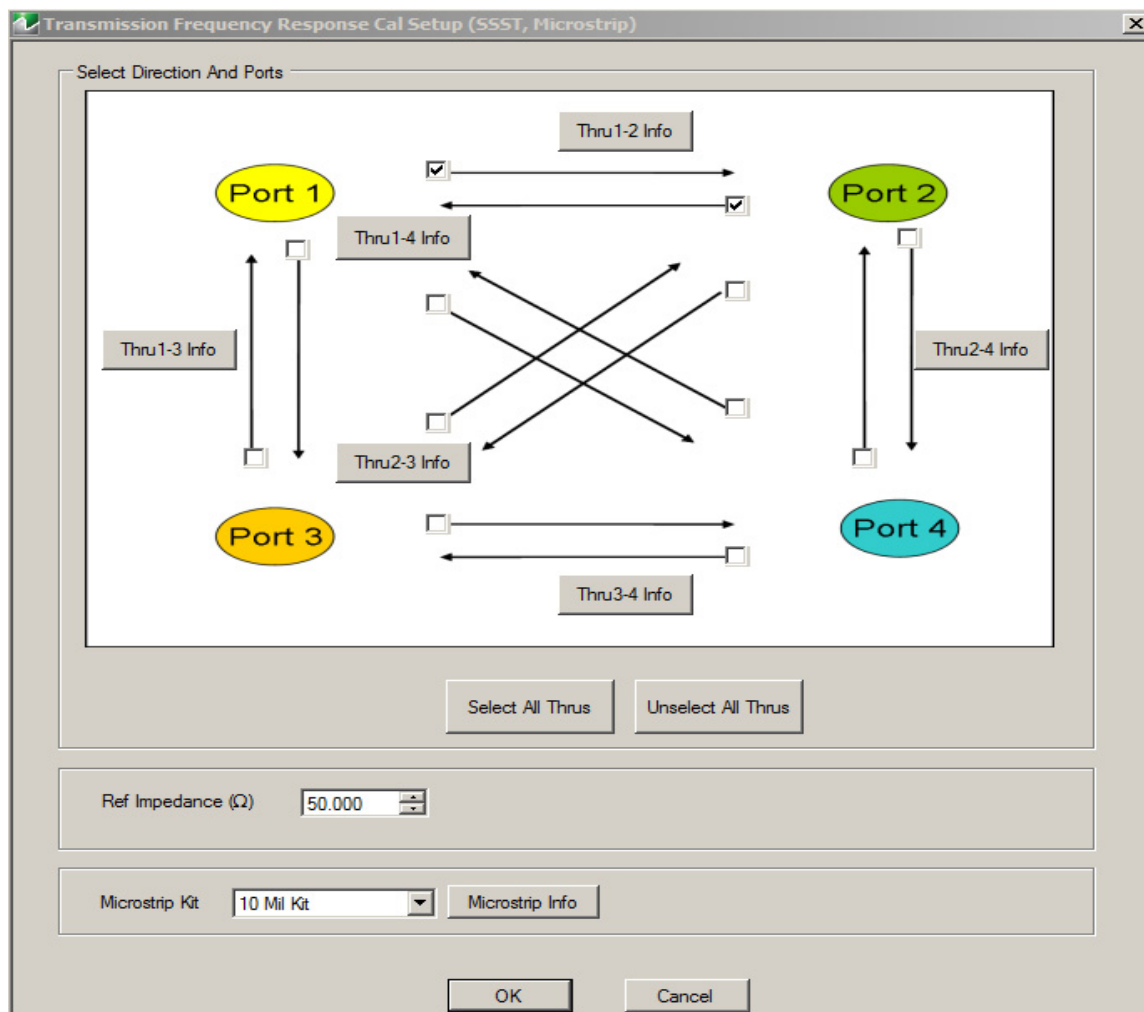

Figure 10-59. TRANS. FREQ. RESP. CAL SETUP (SSST, MICROSTRIP) Dialog Box

Reference Impedance

Input the reference impedance.

- Input field defaulted to 50 Ohms.
- Any numerical value accepted although input values <0.01 Ohms are converted to 0.01 Ohms.

Test Port Selection Boxes

Allows selection of any combination of Test Port 1, Test Port 2, Test Port 3, or Test Port 4 as long as one port is selected.

If a port is not selected, its buttons and controls are not available.

Test Port 1 Select Cal Component

Select from Offset Short 1, Offset Short 2, or Offset Short 3

Test Port 1 DUT Connector

Select the **DUT Connector Type** from a drop-down menu list with options of:

- User-Defined1 through User-Defined8

Test Port 1 Connector Standard Info Button

Select displays the USER DEFINED OFFSET SHORT INFO dialog box with connector calibration coefficients for the selected connector and calibration method. The dialog box contents depend on the selected connector, calibration method, and line type. See the following links for typical examples:

- [“WAVEGUIDE INFO and USER DEFINED WAVEGUIDE Dialog Boxes” on page 10-156](#)
- [“USER DEFINED MATCH DEVICES Dialog Box - LRL/LRM” on page 10-155](#)

Test Port 2, Test Port 3, and Test Port 4 DUT Connector

Select the **DUT Connector Type** from a drop-down menu list as shown above in Test Port 1.

Test Port 2, Test Port 3, and Test Port 4 Connector Standard Info Button

Select displays the USER DEFINED SHORT INFO dialog box with connector calibration coefficients for the selected connector and calibration method as described above in Test Port 1.

OK / Cancel

Click OK to accept the changes and return to the CAL SETUP menu.

Click Cancel to abandon any changes and return to the CAL SETUP menu.

Summary of Trans. Freq. Resp. Cal Setup Dialog Boxes

The table below summarizes the fields and controls in all transmission frequency response calibration setup dialog boxes. If the dialog box is described in greater detail above, a link is provided to that description. To view each dialog box, set the CAL METHOD and LINE TYPE menus to the appropriate settings, and then select the Edit Cal Params button. All transmission frequency response dialog boxes are named “Transmission Frequency Response Cal Setup (Cal Method, Line Type)”

Table 10-6. Trans. Freq. Resp. Manual Cal Setup Dialog Box Contents - 4-Port VNAs

Cal Method Line Type	Dialog Box Input Selections and Controls
SOLT/R Coaxial	<p>See full description above at “TRANSMISSION FREQ. RESPONSE CAL SETUP (SOLT/SOLR, COAXIAL) Dialog Box” on page 10-129</p> <p>Select Test Port Throughs: Select any combination of port pair throughs from Thru 1-2, Thru 1-3, Thru 1-4, Thru 2-3, Thru 2-4, and/or Thru 1-3. At least one through must be selected.</p> <p>Thru Info Button: For each through selected above, the Thru Info [Port Pair] button is enabled. Select Thru Info button to display corresponding THRU INFO dialog box.</p> <ul style="list-style-type: none"> • “THRU INFO Dialog Box - 4-Port VNAs” on page 10-154 • In the Thru Info dialog box, select the Calculator icon to display the AIR EQUIVALENT LENGTH CONVERSION dialog box to change units. • “AIR EQUIVALENT LENGTH Calculator Dialog Box” on page 10-146 <p>Reference Impedance (Ohms)</p>
SOLT/R Non-Dispersive	Same controls and functions as SOLT/R Coaxial above.
LRL/LRM	LRL/LRM calibration method is not available for the Transmission Frequency Response calibration type.

10-15 Manual Refl. Freq. Response Menus and Dialog Boxes

- [“REFL. FREQ. RESP. CAL SETUP \(SSLT, MICROSTRIP\) Dialog Box” on page 10-140](#)
- [“REFL. FREQ. RESP. CAL SETUP \(SSST, WAVEGUIDE\) Dialog Box” on page 10-142](#)

Summary table of reflection frequency response calibration dialog boxes is at:

- [Table 10-7, “Refl. Freq. Resp. Manual Cal. Setup Dialog Box Contents - 4-Port VNAs” on page 10-144](#)

Calibration Full Name

- Reflection Frequency Response Calibration

Menu Full Name

- REFLECTION FREQUENCY RESPONSE Menu

Button Name

- Reflection Freq. Response

REFL. RESPONSE Menu - 4-Port VNAs

The exact composition of the menu depends on the settings made on the CAL SETUP, CAL METHOD, and LINE TYPE menus and on the resultant TRANSMISSION FREQUENCY RESPONSE CAL SETUP dialog box. A representative menu is shown below. The example procedures in this chapter show one example of a TRANS. RESPONSE menu.

Previous

- [“MANUAL CAL Menu - 4-Port VNAs” on page 10-42](#)

Navigation

- MAIN | Calibration | CALIBRATION [TR] | Calibrate | CALIBRATE | Manual Cal | MANUAL CAL | Reflection Freq. Response | REFL. RESPONSE

	<p>Modify Cal Setup</p> <p>Select displays the CAL SETUP menu where the Edit Cal Params button provides access to the REFLECTION FREQ. RESPONSE CAL SETUP dialog box for the selected calibration method and line type.</p> <ul style="list-style-type: none"> • “REFLECTION FREQ. RESPONSE CAL SETUP (SOLT/R, COAXIAL) Dialog Box” on page 10-138 <p>Port Selected</p> <p>Read-only display of ports selected for the calibration.</p> <p>Port 1 / Port 2 Reflective Devices</p> <p>Select Port 1 Reflective Devices and Port 2 Reflective Devices buttons to display REFL. DEVICE(S) ----Port 1---- and REFL. DEVICE(S) ----Port 2---- calibration submenus. Completion of submenu calibration steps is signified by completion checkmarks on the Port 1 Reflective Devices and Port 2 Reflective Devices buttons.</p> <ul style="list-style-type: none"> • “REFL. DEVICE(S) Menu - 4-Port VNAs” on page 10-70 <p>Done</p> <p>Available after completion of calibration procedures. Select returns to CALIBRATION menu with Cal Status button set to ON.</p> <p>Abort Cal</p> <p>Select stops calibration procedure and returns to the CALIBRATION menu.</p>
--	---

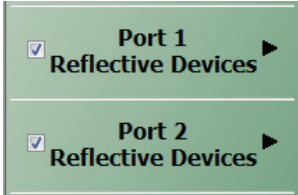

Figure 10-60. REFL. RESPONSE Menu - 4-Port VNAs - Typical example

REFLECTION FREQ. RESPONSE CAL SETUP (SOLT/R, COAXIAL) Dialog Box

Full Name

- REFLECTION FREQUENCY RESPONSE CALIBRATION SETUP (SOLT/R, COAXIAL) Dialog Box

Previous

- [“REFL. RESPONSE Menu - 4-Port VNAs” on page 10-136](#)

Navigation

- MAIN | Calibration | CALIBRATION [TR] | Calibrate | CALIBRATE | Manual Cal | MANUAL CAL | Reflection Freq. Response | REFL. RESPONSE | Modify Cal Setup | CAL SETUP | Edit Cal Params | REFLECTION FREQ. RESPONSE CAL SETUP (SOLT/R, COAXIAL) Dialog Box
- CAL SETUP must be set to Cal Method = SOLT/R and Line Type = Coaxial.

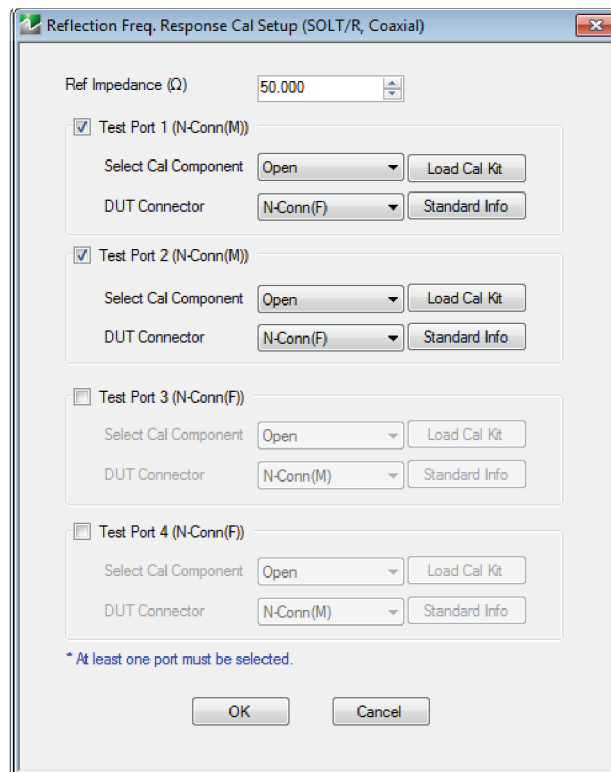

Figure 10-61. REFLECTION FREQ. RESPONSE. CAL SETUP (SOLT/R, COAXIAL) Dialog Box

Reference Impedance

Input the reference impedance.

- Input field defaulted to 50 Ohms.
- Any numerical value accepted although input values <0.01 Ohms are converted to 0.01 Ohms.

Test Port Selection Boxes

Allows selection of any combination of Test Port 1, Test Port 2, Test Port 3, or Test Port 4, with minimum one selected port required.

Test Port 1 Select Cal Component and Load Cal Kit Button

Select Open or Short from the drop-down menu, or click Load Cal Kit to install a custom Cal Kit file.

Test Port 1 DUT Connector

Select the **DUT Connector Type** from the drop-down menu:

- K-Conn (M)
- K-Conn (F)
- GPC-3.5 (M)
- GPC-3.5 (F)
- SMA (M)
- SMA (F)
- N-Conn (M)
- N-Conn (F)
- 2.4 mm (M)
- 2.4 mm (F)
- TNC (M)
- TNC (F)
- V-conn (M)
- V-conn (F)
- W1-conn (M)
- W1-conn (F)
- 7/16 (M)
- 7/16 (F)
- GPC-7
- N-conn(75) (M)
- N-conn(75) (F)
- user defined 1 through 8 (M or F)

Test Port 1 Connector Standard Info Button

Select displays the STANDARD INFO dialog box with connector calibration coefficients for the selected connector and calibration method, as in the following example:

- [“MICROSTRIP KIT INFO and USER DEFINED MICROSTRIP Dialog Boxes” on page 10-147](#)

Test Port 2, Test Port 3, and Test Port 4 Select Cal Component and Load Cal Kit Button

Select Open or Short from the drop-down menu, or click Load Cal Kit to install a custom Cal Kit file, as described above for Test Port 1.

Test Port 2, Test Port 3, and Test Port 4 DUT Connectors

Select the **DUT Connector Type** from the drop-down menu list as described above for Test Port 1.

Test Port 2, Test Port 3, and Test Port 4 Connector Standard Info Buttons

Select displays the STANDARD INFO dialog box with connector calibration coefficients for the selected connector and calibration method as described above for Test Port 1.

OK / Cancel

- Click OK to accept the changes and return to the CAL SETUP menu, or click Cancel.

REFL. FREQ. RESP. CAL SETUP (SSLT, MICROSTRIP) Dialog Box

Full Name

- REFLECTION FREQUENCY RESPONSE CALIBRATION SETUP (SSLT, MICROSTRIP) Dialog Box

Previous

- “REFL. RESPONSE Menu - 4-Port VNAs” on page 10-136

Navigation

- MAIN | Calibration | CALIBRATION [TR] | Calibrate | CALIBRATE | Manual Cal | MANUAL CAL | Reflection Freq. Response | REFL. RESPONSE | Modify Cal Setup | CAL SETUP | Cal Method = SSLT; Line Type = Microstrip | Edit Cal Params | REFLECTION FREQ. RESPONSE CAL SETUP (SSLT, MICROSTRIP) Dialog Box
- CAL SETUP must be set to Cal Method = SSLT and Line Type = Microstrip.

Reflection Freq. Response Cal Setup (SSST, Microstrip)

Ref Impedance (Ω)

Microstrip Kit

Test Port 1

Select Cal Component

DUT Connector

Test Port 2

Select Cal Component

DUT Connector

Test Port 3

Select Cal Component

DUT Connector

Test Port 4

Select Cal Component

DUT Connector

* At least one port must be selected.

REFLECTION FREQUENCY RESPONSE CALIBRATION SETUP

Figure 10-62. REFL. FREQ. RESP. CAL SETUP (SSLT, MICROSTRIP) Dialog Box

Reference Impedance

Input the reference impedance.

- Input field defaulted to 50 Ohms.
- Any numerical value accepted although input values <0.01 Ohms are converted to 0.01 Ohms.

Test Port Selection Boxes

Allows selection of any combination of Test Port 1, Test Port 2, Test Port 3, or Test Port 4 as long as one port is selected.

If a port is not selected, its buttons and controls are not available.

Test Port 1 Select Cal Component

Select from Offset Short 1 or Offset Short 2

Test Port 1 DUT Connector

Select the **DUT Connector Type** from a drop-down menu list with options of:

- User-Defined1 through User-Defined8

Test Port 1 Connector Standard Info Button

Select displays the USER DEFINED SHORT INFO dialog box with connector calibration coefficients for the selected connector and calibration method. The dialog box contents depend on the selected connector, calibration method, and line type. See the following links for typical examples:

- [“WAVEGUIDE INFO and USER DEFINED WAVEGUIDE Dialog Boxes” on page 10-156](#)
- [“USER DEFINED MATCH DEVICES Dialog Box - LRL/LRM” on page 10-155](#)

Test Port 2, Test Port 3, and Test Port 4 DUT Connector

Select the **DUT Connector Type** from a drop-down menu list as shown above in Test Port 1.

Test Port 2, Test Port 3, and Test Port 4 Connector Standard Info Button

Select displays the USER DEFINED SHORT INFO dialog box with connector calibration coefficients for the selected connector and calibration method as described above in Test Port 1.

OK / Cancel

Click OK to accept the changes and return to the CAL SETUP menu.

Click Cancel to abandon any changes and return to the CAL SETUP menu.

REFL. FREQ. RESP. CAL SETUP (SSST, WAVEGUIDE) Dialog Box

Full Name

- REFLECTION FREQUENCY RESPONSE CALIBRATION SETUP (SSST, WAVEGUIDE) Dialog Box

Previous

- “REFL. RESPONSE Menu - 4-Port VNAs” on page 10-136

Navigation

- MAIN | Calibration | CALIBRATION [TR] | Calibrate | CALIBRATE | Manual Cal | MANUAL CAL | Reflection Freq. Response | REFL. RESPONSE | Modify Cal Setup | CAL SETUP | Cal Method = SSST; Line Type = Waveguide | Edit Cal Params | REFLECTION FREQ. RESPONSE CAL SETUP (SSST, WAVEGUIDE) Dialog Box

REFLECTION FREQUENCY RESPONSE CALIBRATION SETUP

Figure 10-63. REFL. FREQ. RESP. CAL SETUP (SSST, WAVEGUIDE) Dialog Box

Reference Impedance

Input the reference impedance.

- Input field defaulted to 50 Ohms.
- Any numerical value accepted although input values <0.01 Ohms are converted to 0.01 Ohms.

Waveguide Kit Selection

Select the **Waveguide Kit Type** from a drop-down menu list with options of:

- User-Defined1 through User-Defined8

Test Port Selection Boxes

Allows selection of any combination of Test Port 1, Test Port 2, Test Port 3, or Test Port 4 as long as one port is selected.

If a port is not selected, its buttons and controls are not available.

Select Test Port 1 Cal Component

Select a cal component from:

- Offset short 1
- Offset short 2
- Offset short 3

Test Port 1 Waveguide Info Button

Select displays the USER DEFINED WAVEGUIDE (SSST) parameters dialog box. The dialog box allows user input of waveguide calibration parameters of:

- Waveguide kit label. A user-defined kit label can be input here.
- Cutoff frequency (GHz)
- Dielectric
- Offset short 1 length (mm)
- Offset short 2 length (mm)
- Offset short 3 length (mm)
- A calculator icon provides access to the AIR EQUIVALENT LENGTH CALCULATOR dialog box described in the AutoCal sections above.
 - [“AIR EQUIVALENT LENGTH Calculator Dialog Box” on page 10-146](#)

The dialog box contents depend on the selected connector, calibration method, and line type. The example in the link below shows a typical standard information dialog box.

- [“WAVEGUIDE INFO and USER DEFINED WAVEGUIDE Dialog Boxes” on page 10-156](#)

Test Port 2, Test Port 3, and Test Port 4 Controls

The controls for these test ports are the same as those for Test Port 1.

OK / Cancel

Click OK to accept the changes and return to the CAL SETUP menu.

Click Cancel to abandon any changes and return to the CAL SETUP menu.

Summary of Reflection Freq. Response Calibration Setup Dialog Boxes

The table below summarizes the fields and controls in all Reflection Frequency Response calibration setup dialog boxes. If the dialog box is described in greater detail above, a link is provided to that description. To view each dialog box, set the CAL METHOD and LINE TYPE menus to the appropriate settings, and then select the Edit Cal Params button.

Table 10-7. Refl. Freq. Resp. Manual Cal. Setup Dialog Box Contents - 4-Port VNAs

Cal Method Line Type	Dialog Box Input Selections and Controls
SOLT/R Coaxial	See full description above at “REFLECTION FREQ. RESPONSE CAL SETUP (SOLT/R, COAXIAL) Dialog Box” on page 10-138 Reference Impedance (Ohms) Select Test Ports: Select any combination of Test Port 1, Test Port 2, Test Port 3, and/or Test Port 4 as long as one port is selected. Select Test Port Cal Component: For each selected test port, select Open or Short. Test Port DUT Connector: Select from K-Conn (M), K-Conn (F); GPC-3.5 (M), GPC-3.5 (F); SMA (M), SMA (F); N-Conn (M), N-Conn (F). DUT Connector Standard Info Button: Select displays the STANDARD INFO dialog box for the selected connector. • “MICROSTRIP KIT INFO and USER DEFINED MICROSTRIP Dialog Boxes” on page 10-147
SOLT/R Non-Dispersive	Same controls and functions as SOLT/R Coaxial
LRL/LRM	LRL/LRM calibration method is not available for the Reflection Frequency Response calibration type.

10-16 Manual Calibration General Dialog Boxes

These are general information dialog boxes that can be linked to from most manual calibration procedures. A representative typical of dialog box contents are shown below:

- [“AIR EQUIVALENT LENGTH Calculator Dialog Box”](#) on page 10-146
- [“MICROSTRIP KIT INFO and USER DEFINED MICROSTRIP Dialog Boxes”](#) on page 10-147
- [“STANDARD INFO \(OFFSET SHORT\) W1-Connector \(F\) Dialog Box”](#) on page 10-148
- [“THRU INFO Dialog Box - 4-Port VNAs”](#) on page 10-154
- [“USER DEFINED MATCH DEVICES Dialog Box - LRL/LRM”](#) on page 10-155
- [“WAVEGUIDE INFO and USER DEFINED WAVEGUIDE Dialog Boxes”](#) on page 10-156

AIR EQUIVALENT LENGTH Calculator Dialog Box

Use the AIR EQUIVALENT LENGTH calculator dialog box to speed configuration of a through line by entering its length in picoseconds (ps) and its dielectric constant. The calculator returns the air equivalent length in millimeters (mm).

Previous

- The AIR EQUIVALENT LENGTH dialog box can be accessed from multiple locations.
- [“THRU INFO Dialog Box - 4-Port VNAs” on page 10-154](#)

Navigation

- MAIN | Calibration | CALIBRATION [TR] | Thru Update| THRU | Define Thru/Reciprocal | DEFINE THRU RECIPROCAL Dialog Box | Thru Info | THRU INFO Dialog Box | Calculator Icon | AIR EQUIVALENT LENGTH CONVERSION Dialog Box

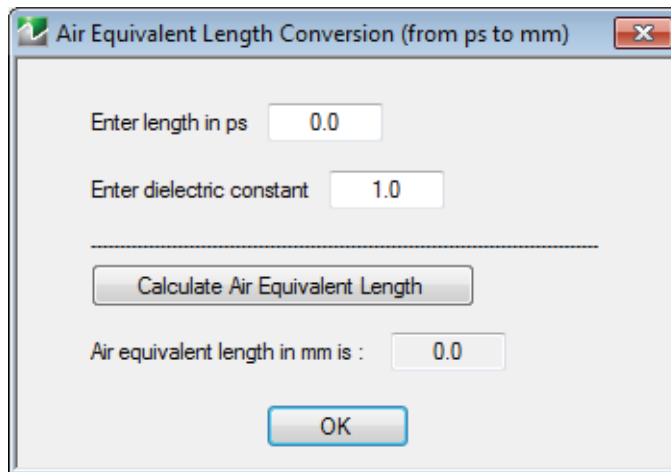

Figure 10-64. AIR EQUIVALENT LENGTH CONVERSION CALCULATOR Dialog Box

Using the Calculator

1. Use the Enter length in ps (picoseconds) to input a length.
 - For example, enter a value of 250 ps.
2. Use the Enter constant to change the dielectric constant as required.
 - For example, change the dielectric constant to 1.2.
3. Click the Calculate Air Equivalent Length button.
4. The required value appears in the Air Equivalent Length in mm field.
 - Using the examples above, an air equivalent length of 68.465319... appears in the field.
5. Click OK.
6. The Thru Info dialog box reappears with the calculated value in the Length (mm) field.
7. Using the examples above, the Length (mm) field displays 68.4653 mm.
 - [“THRU INFO Dialog Box - 4-Port VNAs” on page 10-154](#)
8. Click OK on the Thru Info dialog box.
9. The Modify AutoCal Setup dialog box reappears.
 - [“MODIFY 4-PORT AUTOCAL SETUP Dialog Box” on page 10-24](#)
 - [“MODIFY 2-PORT AUTOCAL SETUP Dialog Box - 4-Port VNAs” on page 10-30](#)
 - [“MODIFY 1-PORT AUTOCAL SETUP Dialog Box - 4-Port VNAs” on page 10-37](#)

MICROSTRIP KIT INFO and USER DEFINED MICROSTRIP Dialog Boxes

Dialog Box Name Changes

The exact names of these dialog boxes change depending on the calibration method and connector type selected.

- This dialog box can be linked to from a multiple dialog sources. The links below are for dialogs that appear in this chapter.
- [“TWO PORT CAL SETUP \(SOLT/SOLR, MICROSTRIP\) Dialog Box”](#) on page 10-102.
- [“TWO PORT CAL SETUP \(LRL/LRM, MICROSTRIP\) Dialog Box”](#) on page 10-105.
- [“TRANS. FREQ. RESP. CAL SETUP \(SSST, MICROSTRIP\) Dialog Box”](#) on page 10-133.
- [“REFL. FREQ. RESP. CAL SETUP \(SSLT, MICROSTRIP\) Dialog Box”](#) on page 10-140.

Navigation

- This dialog box can be linked to from a multiple dialog sources. The links below are for dialogs that appear in this chapter.
- MAIN | Calibration | CALIBRATION [TR] | Calibrate | CALIBRATE | Manual Cal | MANUAL CAL | 3-Port Cal | THREE PORT CAL | Modify Cal Setup | CAL SETUP | Cal Method = SSLT | Line Type = Microstrip | Edit Cal Params | THREE PORT CAL SETUP (SSLT, MICROSTRIP) Dialog Box
- MAIN | Calibration | CALIBRATION [TR] | Calibrate | CALIBRATE | Manual Cal | MANUAL CAL | 2-Port Cal | TWO PORT CAL | Modify Cal Setup | CAL SETUP | Cal Method = SOLT/R | Line Type = Microstrip | Edit Cal Params | TWO PORT CAL SETUP (SOLT/R, MICROSTRIP) Dialog Box
- MAIN | Calibration | CALIBRATION [TR] | Calibrate | CALIBRATE | Manual Cal | MANUAL CAL | 2-Port Cal | TWO PORT CAL | Modify Cal Setup | CAL SETUP | Cal Method = LRL/LRM | Line Type = Microstrip | Edit Cal Params | TWO PORT CAL SETUP (LRL/LRM, MICROSTRIP) Dialog Box
- MAIN | Calibration | CALIBRATION [TR] | Calibrate | CALIBRATE | Manual Cal | MANUAL CAL | Trans. Freq. Resp. | TRANS. RESP. | Modify Cal Setup | CAL SETUP | Cal Method = SSST | Line Type = Microstrip | Edit Cal Params | TRANSMISSION REFLECTION RESPONSE SETUP (SSST, MICROSTRIP) Dialog Box
- MAIN | Calibration | CALIBRATION [TR] | Calibrate | CALIBRATE | Manual Cal | MANUAL CAL | Refl. Freq. Resp. | REFL. RESP. | Modify Cal Setup | CAL SETUP | Cal Method = SSLT | Line Type = Microstrip | Edit Cal Params | REFLECTION RESPONSE SETUP (SSLT, MICROSTRIP) Dialog Box

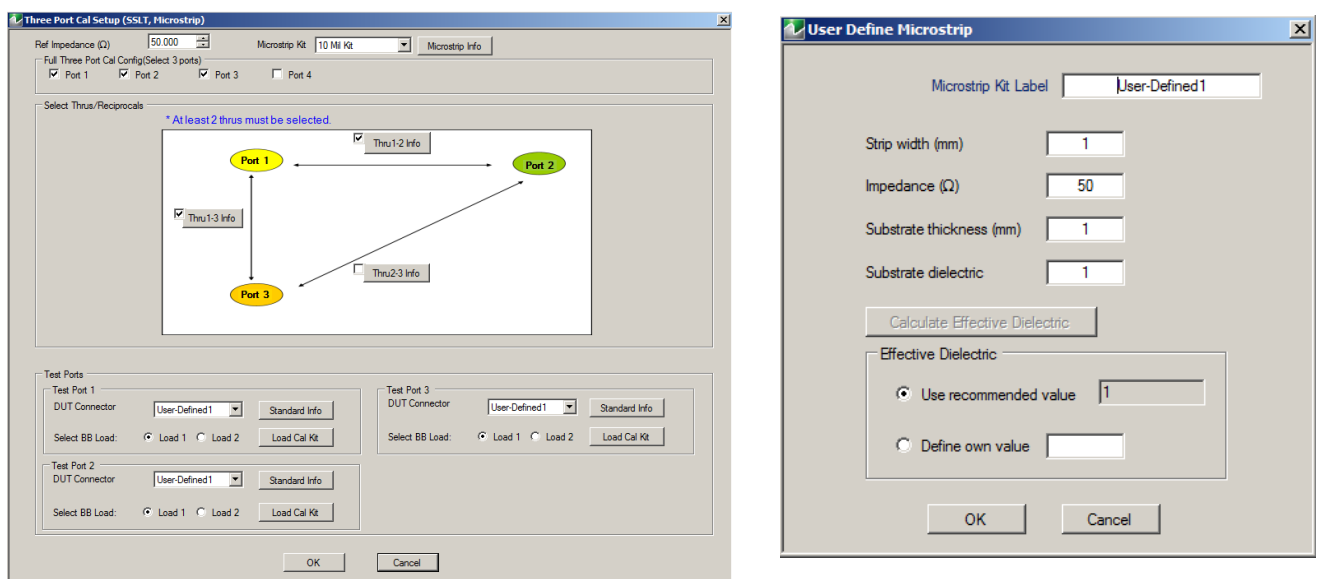

1. At left MICROSTRIP INFO for 10 Mil Kit.
2. At right USER DEFINED MICROSTRIP Input Dialog Box, Microstrip Kit = User Defined1 then click Microstrip Info

Figure 10-65. MICROSTRIP INFO and USER DEFINED MICROSTRIP Dialog Boxes

STANDARD INFO (OFFSET SHORT) W1-Connector (F) Dialog Box

The figure below shows a typical connector standard information dialog box. The box format and contents depending on the calibration method, the calibration line type, and the calibration connectors and genders used. Anritsu-provided dialogs provide read-only information. User-defined dialogs allow user input of parameters and names.

Previous

- This dialog box can be linked to from a multiple dialog sources. The links below are for dialogs that appear in this chapter.
- [“FULL FOUR PORT CAL SETUP \(SSLT, COAXIAL\) Dialog Box” on page 10-54.](#)
- [“FULL FOUR PORT CAL SETUP \(SSLT, COAXIAL\) Dialog Box” on page 10-54.](#)
- [“FULL FOUR PORT CAL SETUP \(LRL/LRM, COAXIAL\) Dialog Box” on page 10-62.](#)

Navigation

- This dialog box can be linked to from a multiple dialog sources. The links below are for dialogs that appear in this chapter.
- [MAIN | Calibration | CALIBRATION \[TR\] | Calibrate | CALIBRATE | Manual Cal | MANUAL CAL | 4-Port Cal | FOUR PORT CAL | Modify Cal Setup | CAL SETUP | Cal Method = SSLT | Line Type = Coaxial | Edit Cal Params | FULL FOUR PORT CAL SETUP \(SSLT, COAXIAL\) Dialog Box | DUT Connector = W1-Conn \(F\) | Standard Info | STANDARD INFO \(OFFSET SHORT, W1-CONN \(F\)\) Dialog Box](#)

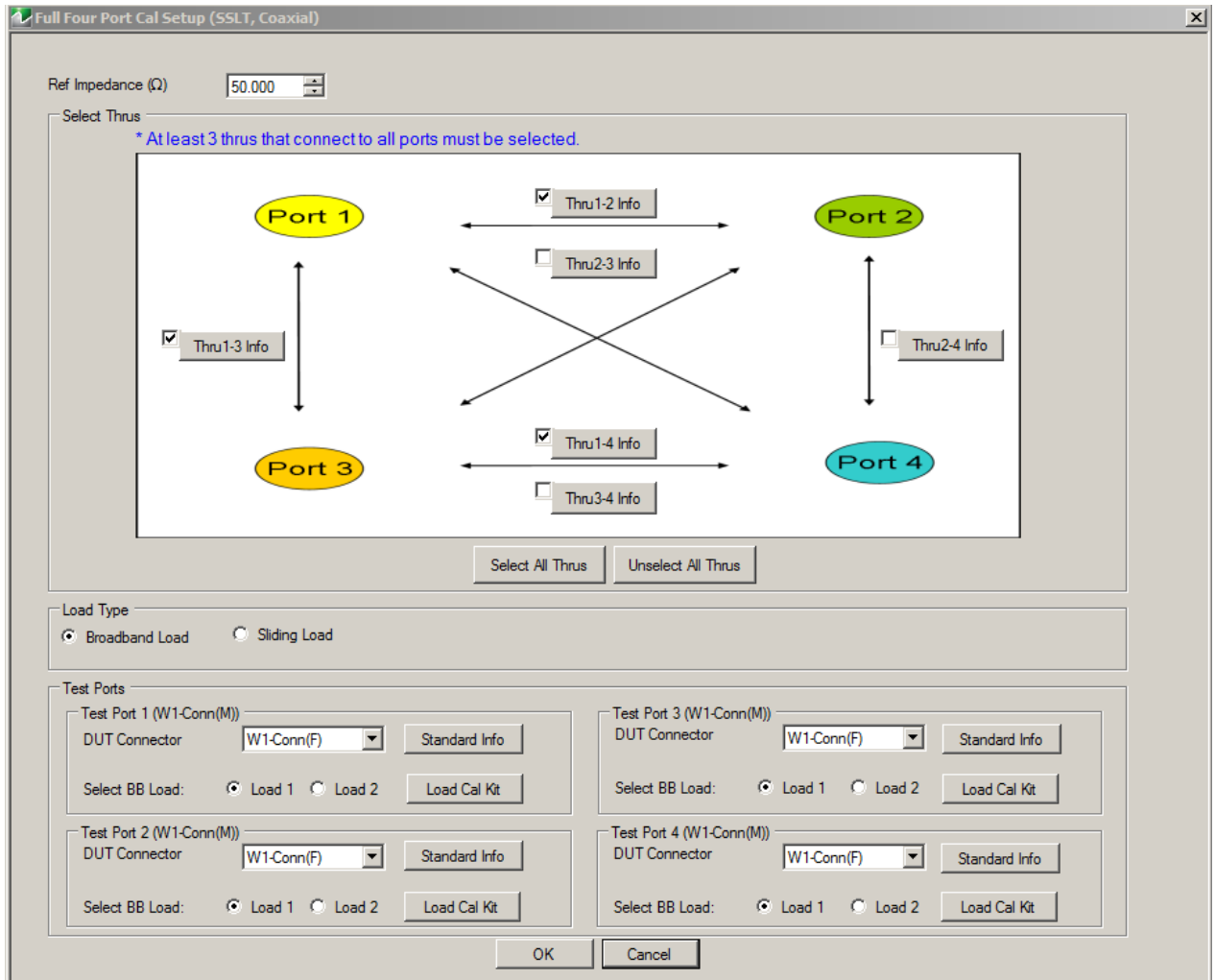

Representative Standard Information Dialog Box

Figure 10-66. STANDARD INFO (OFFSET SHORT) W-1Conn (F)

STANDARD INFO (SOLT/R) N-Connector (M) Dialog Box

The figure below shows a typical connector standard information dialog box. The box format and contents depending on the calibration method, the calibration line type, and the calibration connectors and genders used. Anritsu-provided dialogs provide read-only information. User-defined dialogs allow user input of parameters and names.

Previous

- This dialog box can be linked from multiple dialog sources. The links below are for dialogs that appear in this chapter.
- [“FULL FOUR PORT CAL SETUP \(SOLT/R, COAXIAL\) Dialog Box”](#) on page 10-51.
- [“FULL FOUR PORT CAL SETUP \(LRL/LRM, COAXIAL\) Dialog Box”](#) on page 10-62.

Navigation

- This dialog box can be linked to from a multiple dialog sources. The links below are for dialogs that appear in this chapter.
- MAIN | Calibration | CALIBRATION [TR] | Calibrate | CALIBRATE | Manual Cal | MANUAL CAL | 4-Port Cal | FOUR PORT CAL | Modify Cal Setup | CAL SETUP | Edit Cal Params | FULL FOUR PORT CAL SETUP (SOLT/R, COAXIAL) Dialog Box | DUT Connector = N-Conn (M) | Standard Info | STANDARD INFO (SOLT/R, N-CONN(M))

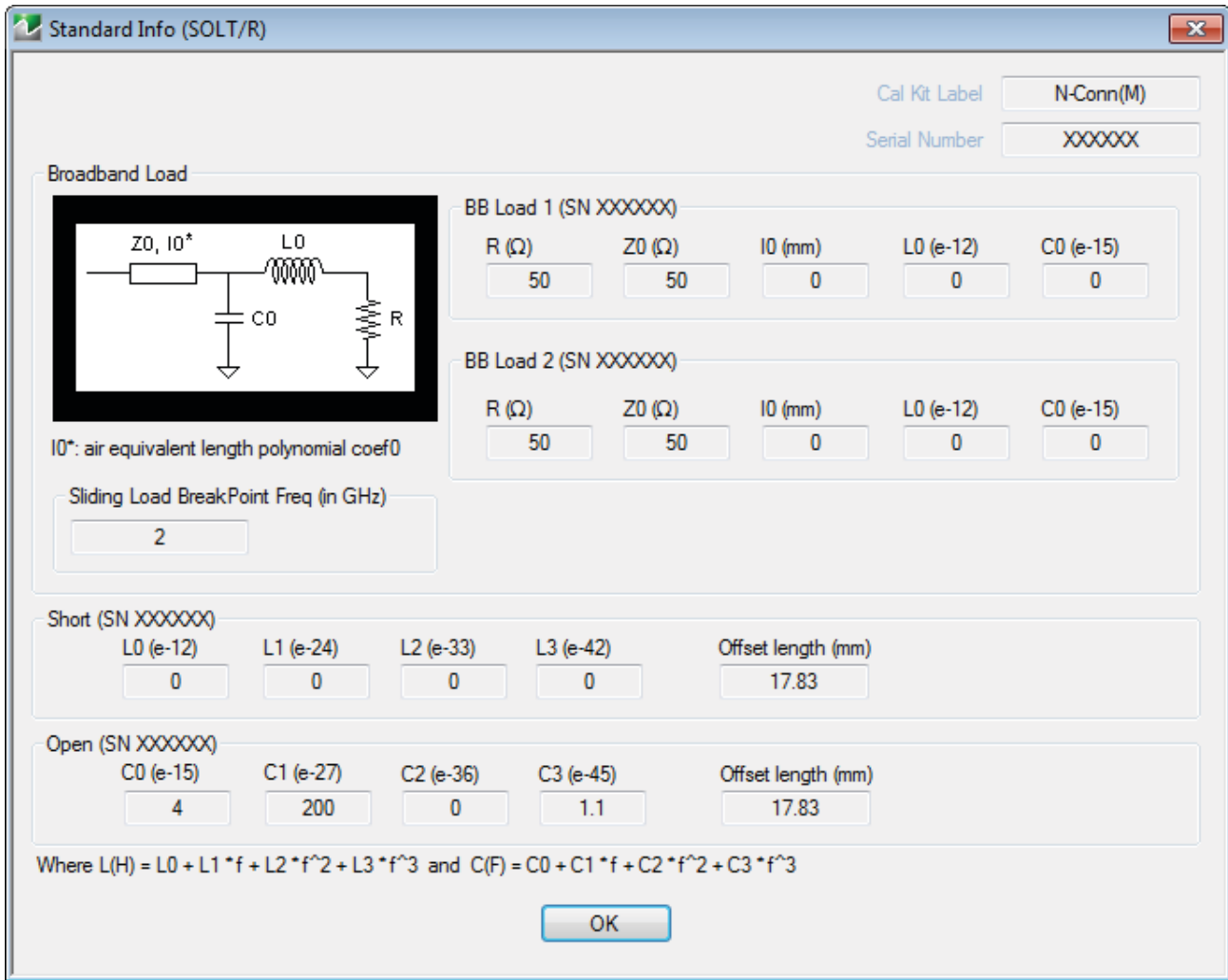

Representative Standard Information Dialog Box

Figure 10-67. STANDARD INFO (SOLT/R) N-Conn (M)

STANDARD INFO (SOLT/R) V-Connector (M) Dialog Box

The figure below shows a typical connector standard information dialog box. The box format and contents depending on the calibration method, the calibration line type, and the calibration connectors and genders used. Anritsu-provided dialogs provide read-only information. User-defined dialogs allow user input of parameters and names.

Previous

- This dialog box can be linked from multiple dialog sources. The links below are for dialogs that appear in this chapter.
- [“FULL FOUR PORT CAL SETUP \(SOLT/R, COAXIAL\) Dialog Box”](#) on page 10-51.
- [“FULL FOUR PORT CAL SETUP \(SSLT, COAXIAL\) Dialog Box”](#) on page 10-54.
- [“FULL FOUR PORT CAL SETUP \(SSST, COAXIAL\) Dialog Box”](#) on page 10-58.
- [“FULL FOUR PORT CAL SETUP \(LRL/LRM, COAXIAL\) Dialog Box”](#) on page 10-62.

Navigation

- This dialog box can be linked to from a multiple dialog sources. The links below are for dialogs that appear in this chapter.
- MAIN | Calibration | CALIBRATION [TR] | Calibrate | CALIBRATE | Manual Cal | MANUAL CAL | 4-Port Cal | FOUR PORT CAL | Modify Cal Setup | CAL SETUP | Cal Method = SOLT/SOLR | Line Type = Coaxial | Edit Cal Params | FULL FOUR PORT CAL SETUP (SOLT/R, COAXIAL) Dialog Box | DUT Connector = V-Conn (M) | Standard Info | STANDARD INFO (SOLT/R, V-CONN(M))

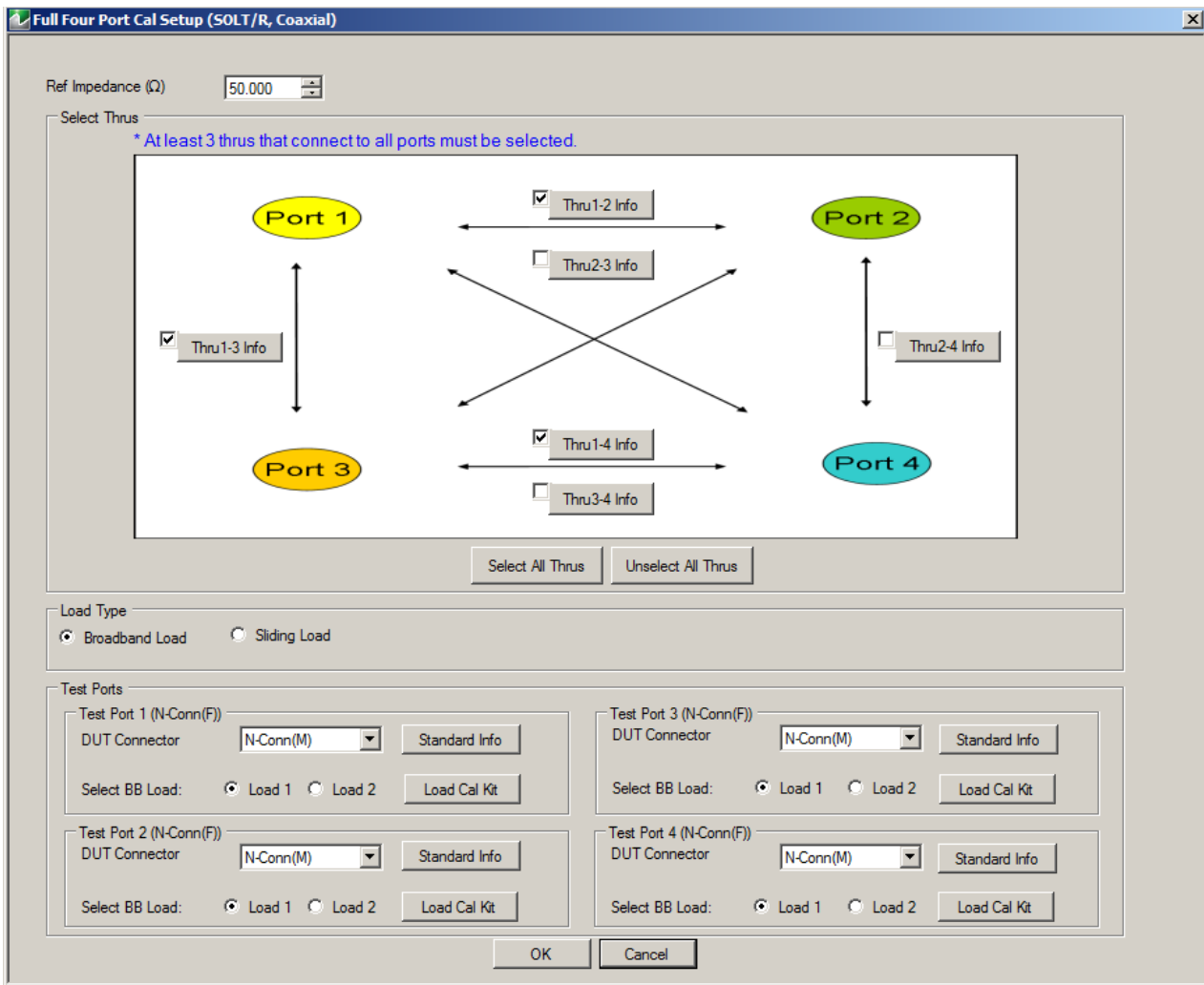

Representative Standard Information Dialog Box

Figure 10-68. STANDARD INFO (SOLT/R) V-Conn (M)

STANDARD INFO (TRIPLE OFFSET SHORT) W1-Connector (M) Dialog Box

The figure below shows a typical connector standard information dialog box. The box format and contents depending on the calibration method, the calibration line type, and the calibration connectors and genders used. Anritsu-provided dialogs provide read-only information. User-defined dialogs allow user input of parameters and names.

Previous

- This dialog box can be linked from multiple dialog sources. The links below are for dialogs that appear in this chapter.

Navigation

- This dialog box can be linked to from a multiple dialog sources. The links below are for dialogs that appear in this chapter.
- MAIN | Calibration | CALIBRATION [TR] | Calibrate | CALIBRATE | Manual Cal | MANUAL CAL | 4-Port Cal | FOUR PORT CAL | Modify Cal Setup | CAL SETUP | Cal Method = SSST | Line Type = Coaxial | Edit Cal Params | FULL FOUR PORT CAL SETUP (SSST, COAXIAL) Dialog Box | DUT Connector = W1-Conn (M) | Standard Info | STANDARD INFO (TRIPLE OFFSET SHORT, W1-CONN(M))

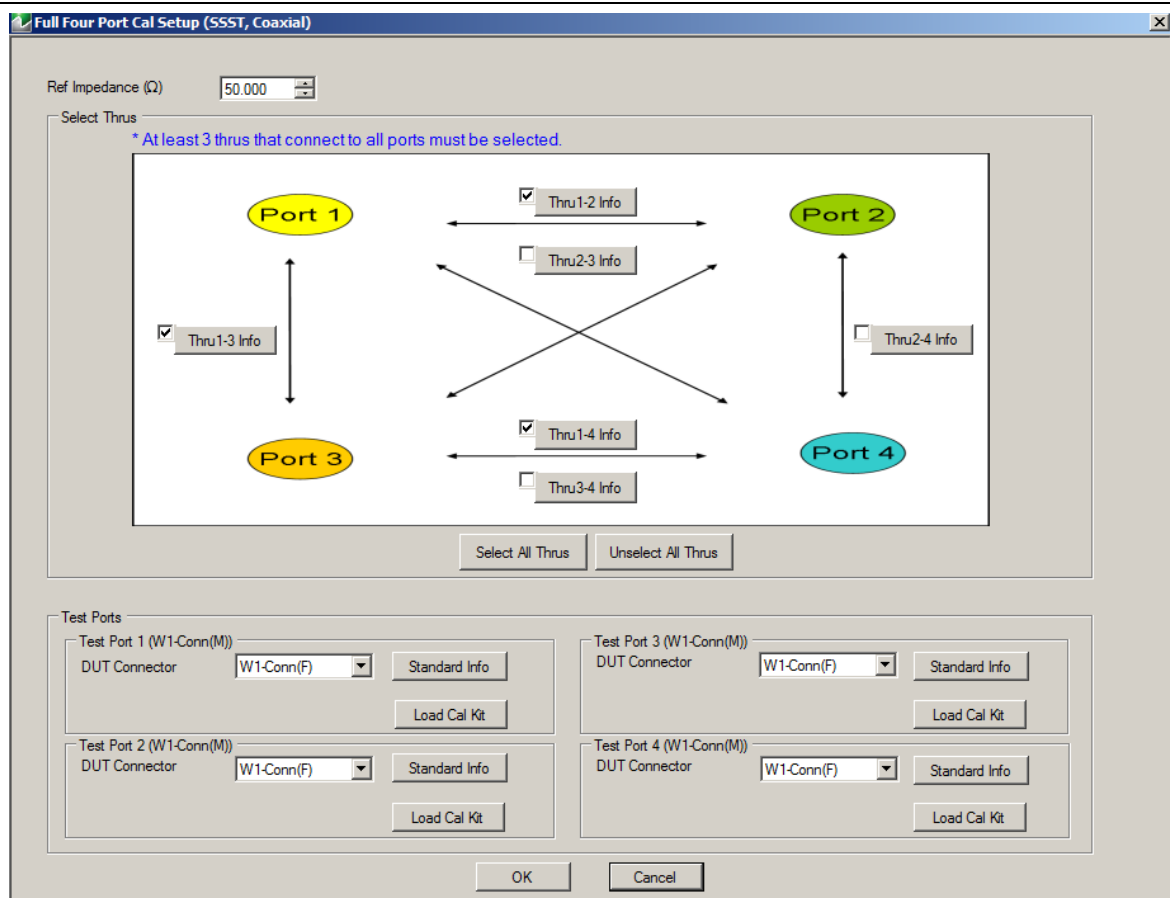

Representative Standard Information Dialog Box

Figure 10-69. STANDARD INFO (TRIPLE OFFSET SHORT) W1-Conn (M)

THRU INFO Dialog Box - 4-Port VNAs

The THRU INFO dialog provides controls to update thru information. The dialog title includes the port-pair being configured.

Previous

- The THRU INFO dialog box can be accessed from multiple locations.

Navigation

- MAIN | Calibration | CALIBRATION [TR] | Thru Update| THRU | Define Thru/Reciprocal | DEFINE THRU RECIPROCAL Dialog Box | Thru Info | THRU INFO Dialog Box

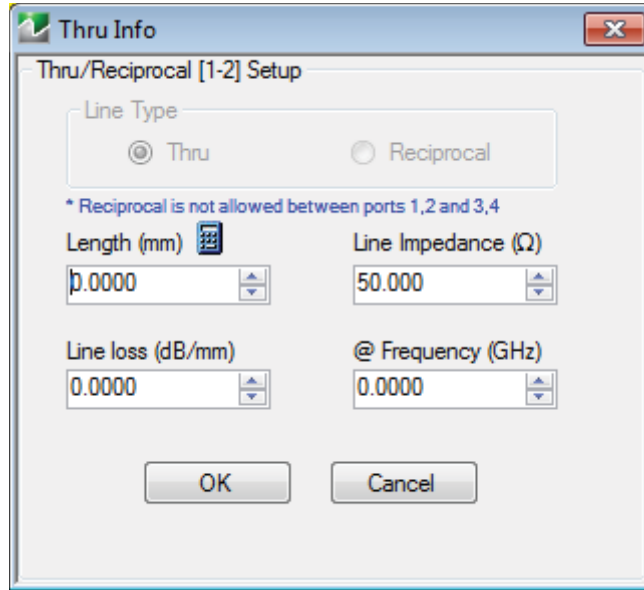

Figure 10-70. THRU INFO (Thru/Reciprocal Ports 1-2 Setup) Dialog Box

Overview

The THRU INFO dialog box is available for all possible through combinations for all 4-port, 3-port, and 2-port calibrations. Each box is labeled with the port pair it represents.

Thru Information Parameters and Calculator

The Thru Info dialog box allows user input field for the thru connection parameters of:

- Length (mm). If needed, click the Calculator icon to display the Air Equivalent Length Conversion Calculator dialog box.
 - [“AIR EQUIVALENT LENGTH Calculator Dialog Box”](#) on page 10-146
- Line Loss (dB/mm)
- Line Impedance (Ω)
- @ Frequency (GHz)

USER DEFINED MATCH DEVICES Dialog Box - LRL/LRM

Previous

- This dialog box can be linked to from multiple dialog sources. The links below are for dialogs that appear in this chapter.
- [“FULL FOUR PORT CAL SETUP \(LRL/LRM, COAXIAL\) Dialog Box”](#) on page 10-62.
- [“THREE PORT CAL SETUP \(LRL/LRM, COAXIAL\) Dialog Box”](#) on page 10-88.

Navigation

- This dialog box can be linked to from a multiple dialog sources. The links below are for dialogs that appear in this chapter.
- MAIN | Calibration | CALIBRATION [TR] | Calibrate | CALIBRATE | Manual Cal | MANUAL CAL | 4-Port Cal | FOUR PORT CAL | Modify Cal Setup | CAL SETUP | Cal Method = LRL/LRM | Line Type = Coaxial | Edit Cal Params | FULL FOUR PORT CAL SETUP (LRL/LRM, COAXIAL) | Band 1, Device 2 (Match) | Match Info | USER DEFINE MATCH DEVICES Dialog Box
- MAIN | Calibration | CALIBRATION [TR] | Calibrate | CALIBRATE | Manual Cal | MANUAL CAL | 3-Port Cal | THREE PORT CAL | Modify Cal Setup | CAL SETUP | Cal Method = LRL/LRM | Line Type = Coaxial | Edit Cal Params | THREE PORT CAL SETUP (LRL/LRM, COAXIAL) | Band 1, Device 2 (Match) | Match Info | USER DEFINE MATCH DEVICES Dialog Box
- MAIN | Calibration | CALIBRATION [TR] | Calibrate | CALIBRATE | Manual Cal | MANUAL CAL | 2-Port Cal | TWO PORT CAL | Modify Cal Setup | CAL SETUP | Cal Method = LRL/LRM | Line Type = Coaxial | Edit Cal Params | THREE PORT CAL SETUP (LRL/LRM, COAXIAL) | Band 1, Device 2 (Match) | Match Info | USER DEFINE MATCH DEVICES Dialog Box

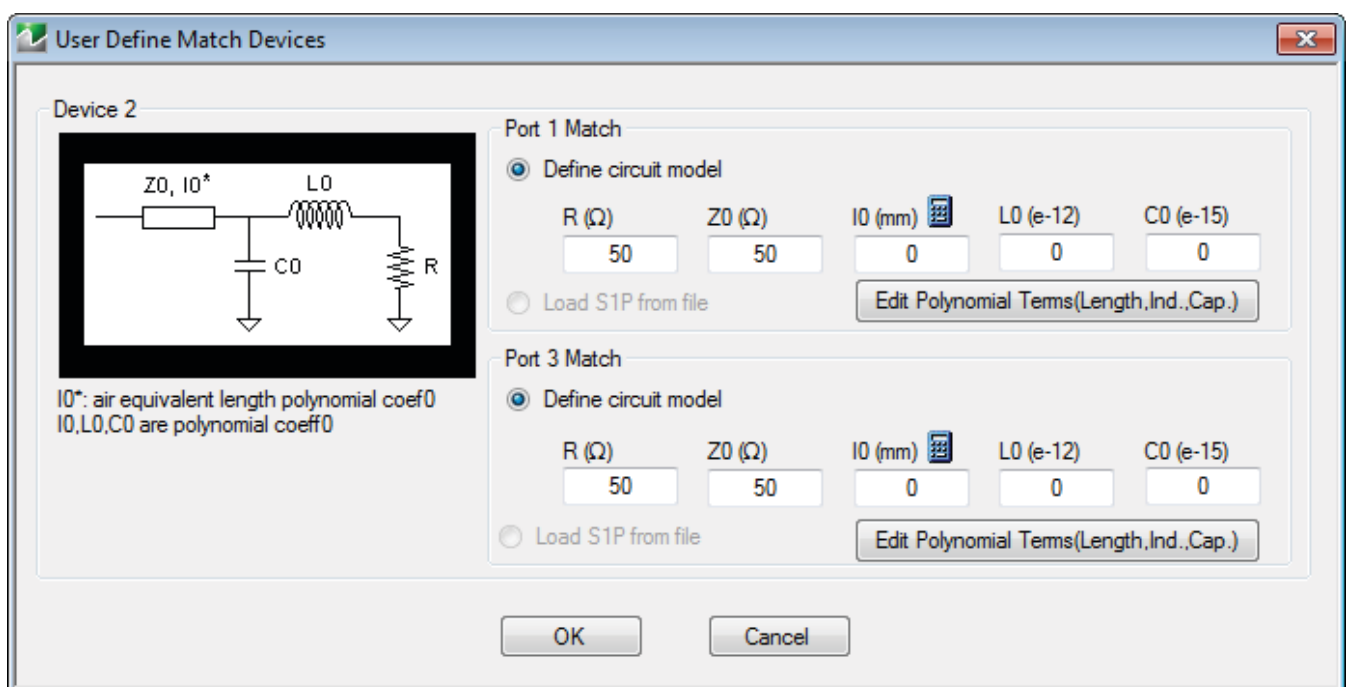

Figure 10-71. USER DEFINED MATCH DEVICES Dialog Box - LRL/LRM

WAVEGUIDE INFO and USER DEFINED WAVEGUIDE Dialog Boxes

Dialog Box Name Changes

- The exact title of this dialog box varies depending on the selected calibration method and waveguide kit. See section immediately below.

Previous

- This dialog box can be linked to from a multiple dialog sources. The links below are for dialogs that appear in this chapter.
- [“FULL FOUR PORT CAL SETUP \(SSST, WAVEGUIDE\) Dialog Box”](#) on page 10-60.
- [“ONE PORT CAL SETUP \(SSLT, WAVEGUIDE\) Dialog Box”](#) on page 10-122.

Navigation

- This dialog box can be linked to from a multiple dialog sources. The links below are for dialogs that appear in this chapter.
- MAIN | Calibration | CALIBRATION [TR] | Calibrate | CALIBRATE | Manual Cal | MANUAL CAL | 4-Port Cal | FOUR PORT CAL | Modify Cal Setup | CAL SETUP | Cal Method = SSST | Line Type = Waveguide | Edit Cal Params | FULL FOUR PORT CAL SETUP (SSST, WAVEGUIDE) Dialog Box
- MAIN | Calibration | CALIBRATION [TR] | Calibrate | CALIBRATE | Manual Cal | MANUAL CAL | 1-Port Cal | ONE PORT CAL | Modify Cal Setup | CAL SETUP | Cal Method = SSLT | Line Type = Waveguide | Edit Cal Params | FULL ONE PORT CAL (SSLT, WAVEGUIDE) | Waveguide Info Button | WAVEGUIDE INFO (SSLT) Dialog Box

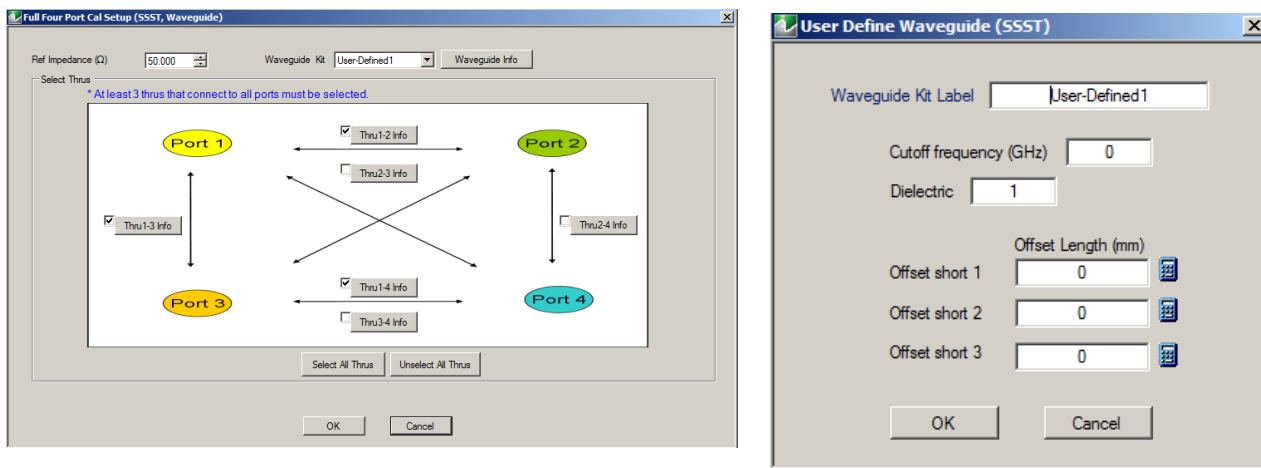

- At left, USER DEFINED WAVEGUIDE Input Dialog Box.
- At right WAVEGUIDE INFO for WR10 Connector.

Figure 10-72. WAVEGUIDE INFO and USER DEFINED WAVEGUIDE Dialog Boxes

Chapter 11 — Measurement Menus

11-1 Chapter Overview

This chapter provides information for the measurement menu system which controls the embed/de-embed functions, the impedance transformations, reference plane location, post-processing order functions, and dielectric parameters along with their related configuration dialog boxes. Impedance transformation and post-processing order functions do not apply to the MS46121A.

11-2 Overview of Measurement Menus

There are six menus in the measurement menus:

- [“MEASUREMENT Menu” on page 11-3](#)
- [“IMPED. TRANSF. Menu” on page 11-4](#)
- [“REFERENCE PLANE Menu” on page 11-5](#)
- [“PROCESSING ORDER Menu” on page 11-6](#)
- [“EMBEDDING Menu” on page 11-7](#)
- [“DIELECTRIC Menu” on page 11-13](#)

The Measurement Menu Set is shown in the figure below.

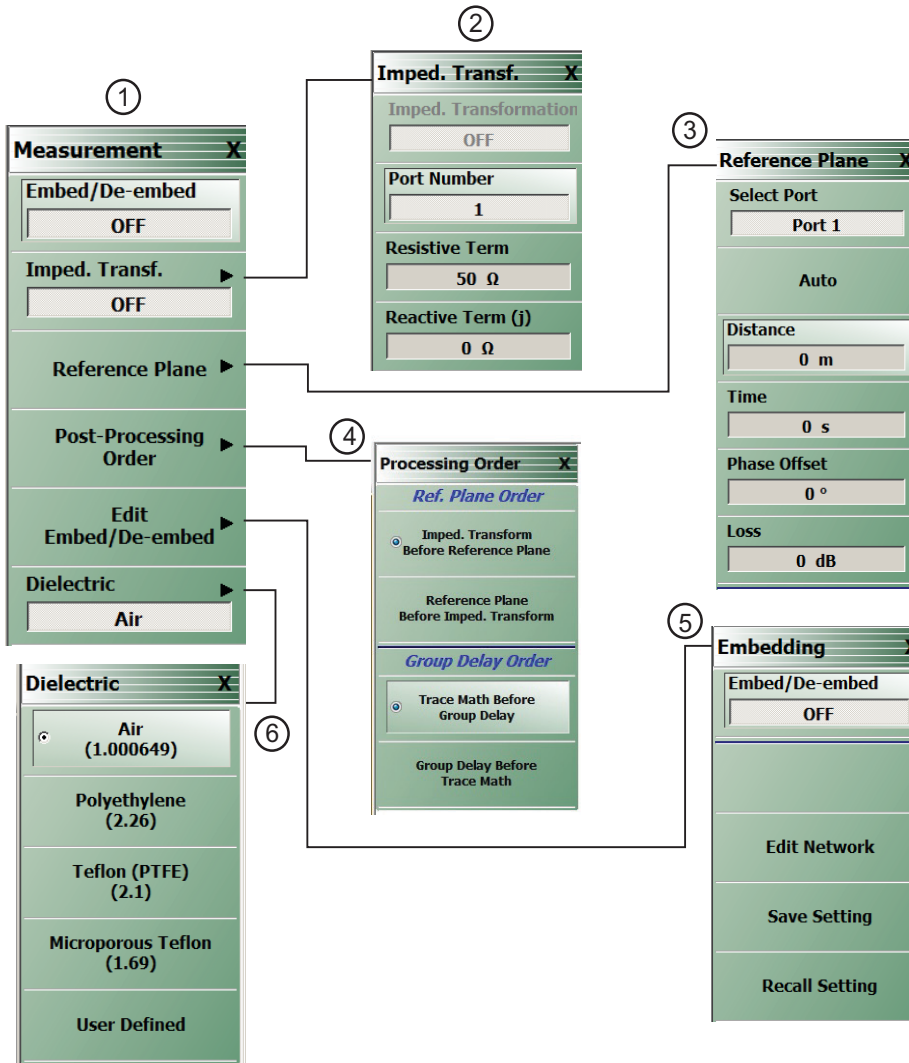

- | | |
|--|---|
| 1. MEASUREMENT Menu | 4. PROCESSING ORDER Menu |
| 2. IMPED. TRANSF.(Impedance Transformation) Menu | 5. EMBEDDING Menu |
| 3. REFERENCE PLANE Adjustment Menu | 6. DIELECTRIC Selection Menu – If User Defined is selected, Value field is available for input. |

Figure 11-1. MEASUREMENT Menu and Related Submenus

MEASUREMENT Menu

Previous

- [“Main Menu” on page 2-2](#)

Navigation

- MAIN | Measurement | MEASUREMENT

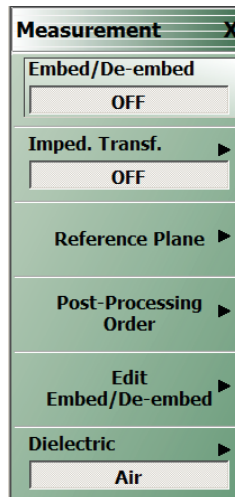

Figure 11-2. MEASUREMENT Menu

Embed/De-embed (Off/On)

Select toggles the embedding/de-embedding function off and on.

If no successful calibration has been performed, select displays a warning message. Click OK to clear.

Imped Transf (Impedance Transformation)

Select Impedance Transfer displays the IMPED TRANSF menu.

- [“IMPED. TRANSF. Menu” on page 11-4](#)

Reference Plane

Select displays the REFERENCE PLANE menu.

- [“REFERENCE PLANE Menu” on page 11-5](#)

Post-Processing Order

Select displays the PROCESSING ORDER menu.

- [“PROCESSING ORDER Menu” on page 11-6](#)

Edit Embed/De-embed

Select displays the EMBEDDING menu.

- [“EMBEDDING Menu” on page 11-7](#)

Dielectric

Select displays the DIELECTRIC menu and allows the user to select from pre-defined dielectric materials or create the value for a user-defined material.

- [“DIELECTRIC Menu” on page 11-13](#)

IMPED. TRANSF. Menu

Full Name

- IMPEDANCE TRANSFORMATION Menu

Previous

- [“MEASUREMENT Menu” on page 11-3](#)

Navigation

- MAIN | Measurement | MEASUREMENT | Imped Transf | IMPED TRANSF (IMPEDANCE TRANSFORMATION)

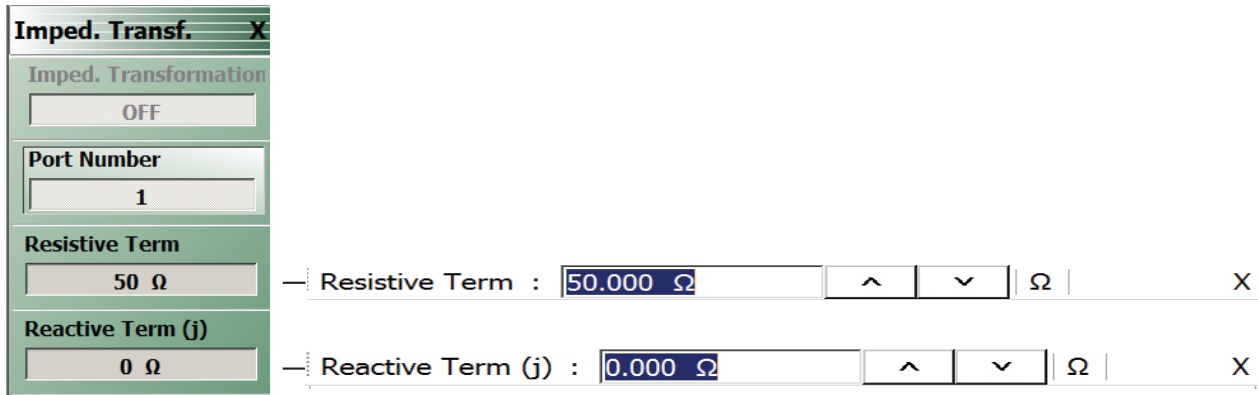

Figure 11-3. IMPED. TRANSF. (IMPEDANCE TRANSFORMATION) Menu

Impedance Trans

Select toggles impedance transformation off and on.

Port Number

When the VNA is in 2-Port Mode, select toggles between Port 1 or Port 2.

When the VNA is in 4-Port Mode, select displays the SELECT PORT dialog box with large easy-to-select buttons. Selecting a port auto-returns to the IMPED. TRANSF. menu.

Resistive Term

Select displays the Resistive Term field toolbar and allows the user to define the resistive term in Ohms. The default value is 50.000 ohms.

Reactive Term (j) (Ohms)

Select displays the Reactive Term field toolbar and allows the user to define the reactive (j) term in Ohms.

REFERENCE PLANE Menu

Previous

- [“MEASUREMENT Menu” on page 11-3](#)

Navigation

- MAIN | Measurement | MEASUREMENT | Reference Plane | REFERENCE PLANE

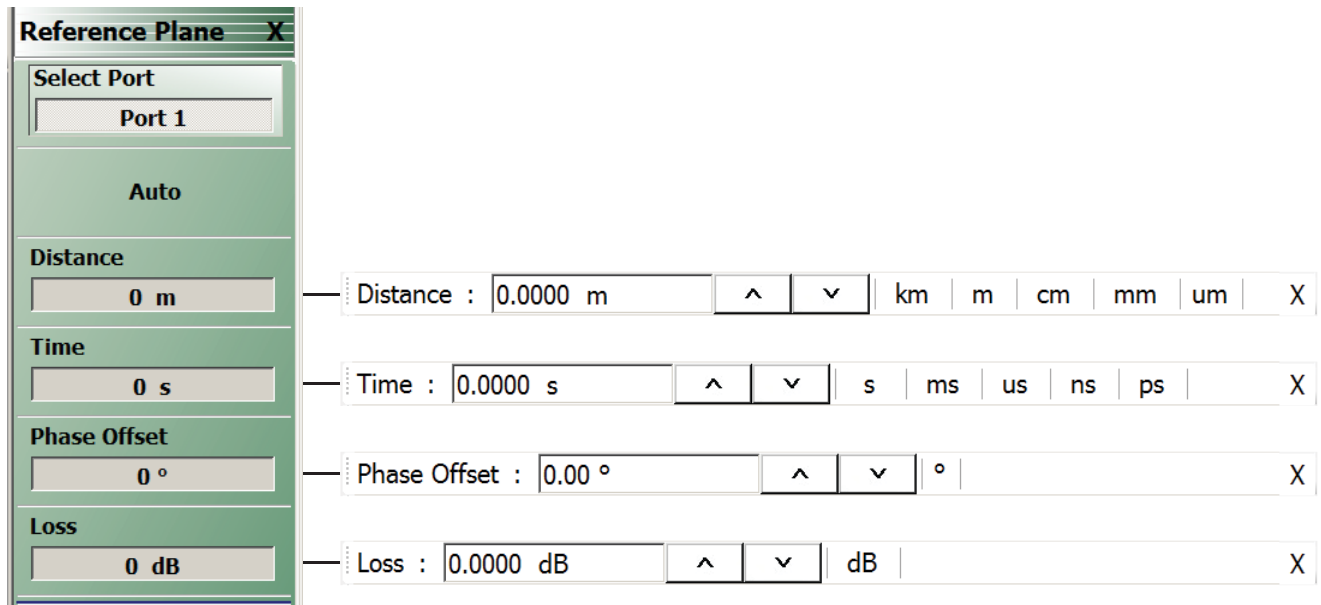

Figure 11-4. REFERENCE PLANE Menu

Select Port

When the VNA is in 2-Port Mode, select toggles between Port 1 or Port 2. When the VNA is in 4-Port Mode, select displays the SELECT PORT (REFERENCE PLANE) dialog box with large easy-to-select buttons. Selecting a port auto-returns to the REFERENCE PLANE menu.

Auto (Reference Plane)

The Auto button automatically extends the test port location by removing the effects of the electrical delay of a device. If selected, the button dims until the calibration step is complete, when the button returns to normal appearance.

Distance (Reference Plane)

Select displays the Distance field toolbar. Allows the user to enter a distance in units of km (kilometers), m (meters), cm (centimeters), mm (millimeters), or μm (micrometers).

Time (Reference Plane)

Select displays the Time field toolbar. Allows the user to enter a reference time in units of s (seconds), ms (milliseconds), us (microseconds), ns (nanoseconds), or ps (picoseconds).

Phase Offset (Degrees) (Reference Plane)

Select displays the Phase Offset field toolbar. Allows the user to enter a phase offset in degrees from -360° (degrees) to $+360^\circ$ in 0.01° increments.

Loss (dB) (Reference Plane)

Displays the Loss (dB) field toolbar. Allows the user to enter a loss factor in dB.

PROCESSING ORDER Menu

Previous

- [“MEASUREMENT Menu” on page 11-3](#)

Navigation

- MAIN | Measurement | MEASUREMENT | Post-Processing Order | PROCESSING ORDER

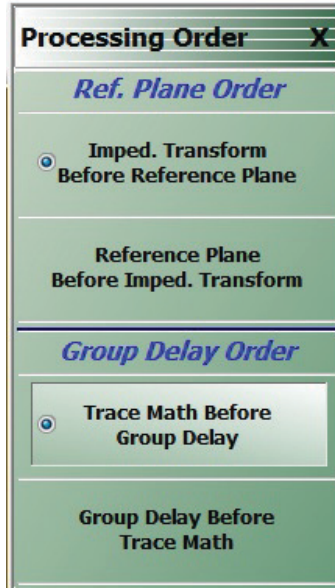

Figure 11-5. PROCESSING ORDER Menu

Imped. Transform Before Reference Plane

Select sets the processing order to first process the impedance transformation and then process the reference plane data. Click **Back** to return to the MEASUREMENT menu.

Reference Plane Before Imped. Transform

Select sets the processing order to first process the reference plane data and then process the impedance transformation. Click **Back** to return to the MEASUREMENT menu.

Trace Math Before Group Delay

Select sets the processing order to first process trace math and then process group delay. Click **Back** to return to the MEASUREMENT menu.

Group Delay Before Trace Math

Select sets the processing order to first process group delay and then process trace math. Click **Back** to return to the MEASUREMENT menu.

EMBEDDING Menu

Previous

- [“MEASUREMENT Menu” on page 11-3](#)

Navigation

- MAIN | Measurement | MEASUREMENT | Edit Embed/De-embed | EMBEDDING

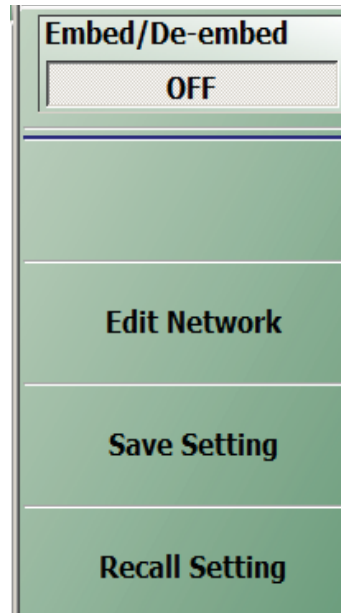

Figure 11-6. EMBEDDING Menu

Embed/De-Embed (Off/On)

Toggles embedding/de-embedding off and on.

If calibration has not been applied, and a toggle to ON is attempted, a **Not Allowed** warning message is displayed.

Edit Network (Embedding)

Select displays the EDIT EMBEDDING/DE-EMBEDDING (2 Port DUT) dialog box.

- [“EDIT EMBEDDING/DE-EMBEDDING \(2 Port DUT\) Dialog Box” on page 11-8](#)

Save Setting (Embedding)

Select displays the SAVE AS (Embed/De-Embed EDL File) dialog box.

- [“SAVE AS \(EMBED/DE-EMBED EDL FILE\) Dialog Box” on page 11-11](#)

Recall Setting (Embedding)

Select displays the OPEN (Embed/De-Embed EDL File) dialog box.

- [“OPEN \(EMBED/DE-EMBED EDL File\) Dialog Box” on page 11-12](#)

EDIT EMBEDDING/DE-EMBEDDING (2 Port DUT) Dialog Box

Previous

- “[EMBEDDING Menu](#)” on page 11-7

Navigation

- MAIN | Measurement | MEASUREMENT | Edit Embed/De-embed | EMBEDDING | Edit Network | EDIT EMBEDDING/DE-EMBEDDING (DUT TYPE) Dialog Box

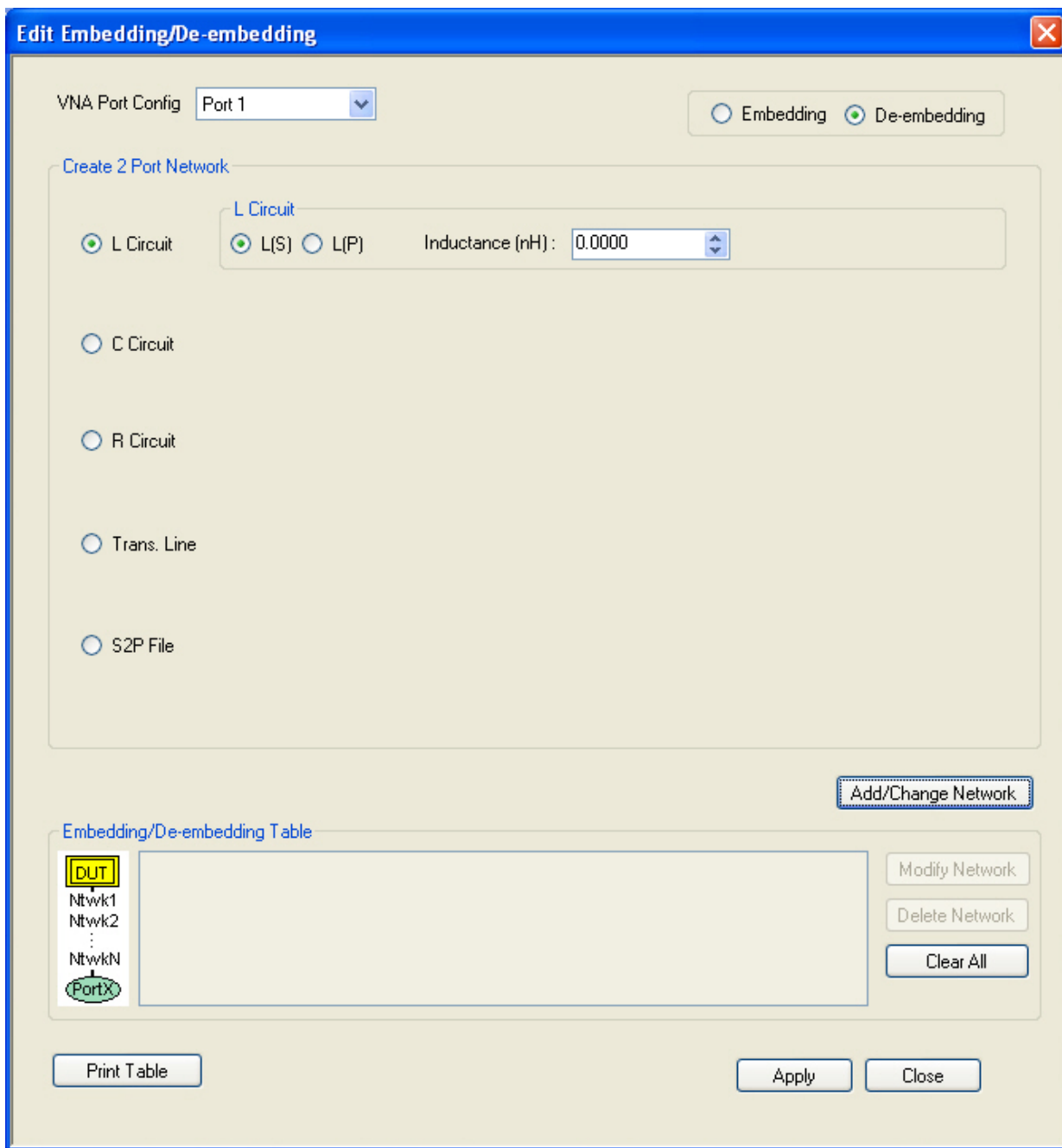

Figure 11-7. EDIT EMBEDDING/DE-EMBEDDING (DUT Type) Dialog Box

Overview

The dialog box allows user setup of the embedding/de-embedding for the DUT. The available parameters for each dialog box area are described below.

VNA Port Configuration

The available port list depends on whether the VNA is in 2-Port Mode or in 4-Port Mode. Port 3 and/or Port 4 are only available if the VNA is in 4-Port Mode:

- Port 1
- Port 2
- Port 3
- Port 4
- Ports 1,2
- Ports 1,3
- Ports 1,4
- Ports 2,3
- Ports 3,4

Embedding/De-embedding Radio Buttons

The configuration can be set to either embedding or de-embedding.

- Embedding
- De-embedding

Create 2 Port Network

Allows user selection of a specific type of 2-Port Networks:

- L Circuit
- C Circuit
- R Circuit
- Trans. (Transmission) Line
- S2P File

Once an option above has been selected, other sub-options, described in the sections below, are available.

L Circuit Selected in Create 2 Port Network

If L Circuit is selected above in Create 2 Port Network, the L Circuit area appears with the following options:

- Radio button selections for L(S) or L(P)
- Input field for Inductance (nH)

C Circuit Selected in Create 2 Port Network

If C Circuit is selected above in Create 2 Port Network, the C Circuit area appears with the following options:

- Radio button selections for C(S) or C(P)
- Input field for Capacitance (pF)

R Circuit Selected in Create 2 Port Network

If R Circuit is selected above in Create 2 Port Network, the R Circuit area appears with the following options:

- Radio button selections for R(S) or R(P)
- Input field for Resistance (Ohms)

Trans. Line Circuit Selected in Create 2 Port Network

If Trans. Line is selected above in Create 2 Port Network, the Transmission Line area appears with the following options:

- Input field for Impedance (Ohms)
- Input field for Length (mm) or Calculator icon
 - The transmission line length can be directly input in millimeters.
 - If the Calculator icon is selected, the AIR EQUIVALENT LENGTH CONVERSION (from ps to mm) dialog appears. Enter the length in ps, enter dielectric constant, calculate equivalent air equivalent length, obtain the air equivalent length in millimeters. Click OK. The calculated value is entered into the Length field.
- Input field for Loss (dB/mm)
- Input field for @ Frequency (GHz)
- Input field for Dielectric constant:
 - Provides menu selections for Air (1.000649), Polyethylene (2.26), Teflon (2.10), Microporous Teflon (1.69), Other.
 - If other is selected, an Other input field is provided for a user-defined dielectric constant.

S2P File Selected in Create 2 Port Network

If S2P File is selected above in Create 2 Port Network, the following options are available:

- The Load S2P file button appears. Select displays the OPEN (Display S2P File) dialog box to allow the user to navigate to a previously saved S2P file. Once a file is selected, its path and file names appears in the field next to the button.
- Swap Port Assignment Check Box. Normally, the network's Port 2 will be nearer the DUT. If the Swap Port check box is selected, the port assignments are swapped.

Add/Change Network

As each network is configured, select the Add/Change Network button to add it to the Embedding/De-embedding Table. The newest configured networks are entered closest to the Test Port.

To modify or delete a network, delete the network in the Embedding/De-embedding Table. The Modify Network and Delete Network buttons become available. Use the Clear All button to clear all entries. Use the Print Table button to output a network table to a connected printer.

When all network changes are made, select Apply and then Close. On the EMBEDDING menu, select Save Setting to store the network configuration.

SAVE AS (EMBED/DE-EMBED EDL FILE) Dialog Box

Previous

- “[EMBEDDING Menu](#)” on page 11-7

Navigation

- MAIN | Measurement | MEASUREMENT | Edit Embed/De-embed | EMBEDDING | Save Setting | SAVE AS (EMBED/DE-EMBED EDL FILE) Dialog Box

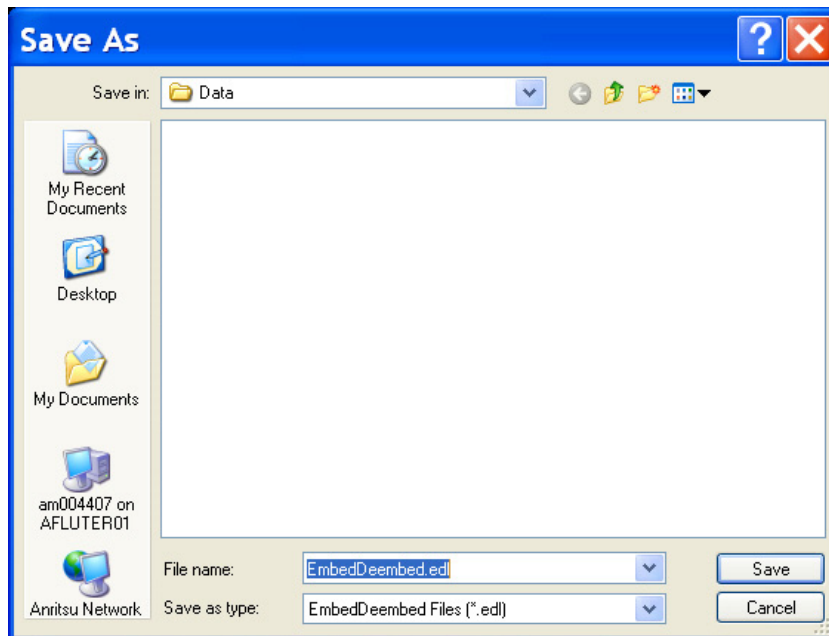

Figure 11-8. SAVE AS (EMBED/DE-EMBED EDL FILE) Dialog Box

OPEN (EMBED/DE-EMBED EDL File) Dialog Box

Previous

- “[EMBEDDING Menu](#)” on page 11-7

Navigation

- MAIN | Measurement | MEASUREMENT | Edit Embed/De-embed | EMBEDDING | Recall Setting | OPEN (EMBED/DE-EMBED EDL FILE) Dialog Box

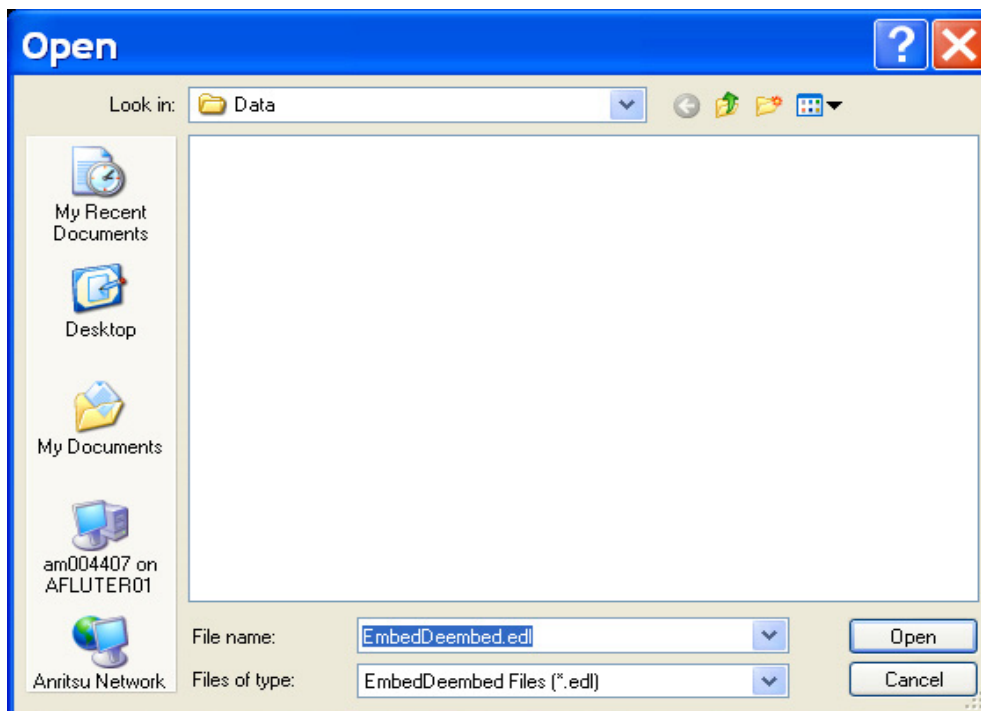

Figure 11-9. OPEN (EMBED/DE-EMBED EDL FILE) Dialog Box

DIELECTRIC Menu

Previous

- [“MEASUREMENT Menu” on page 11-3](#)

Navigation

- MAIN | Measurement | MEASUREMENT | Dielectric | DIELECTRIC

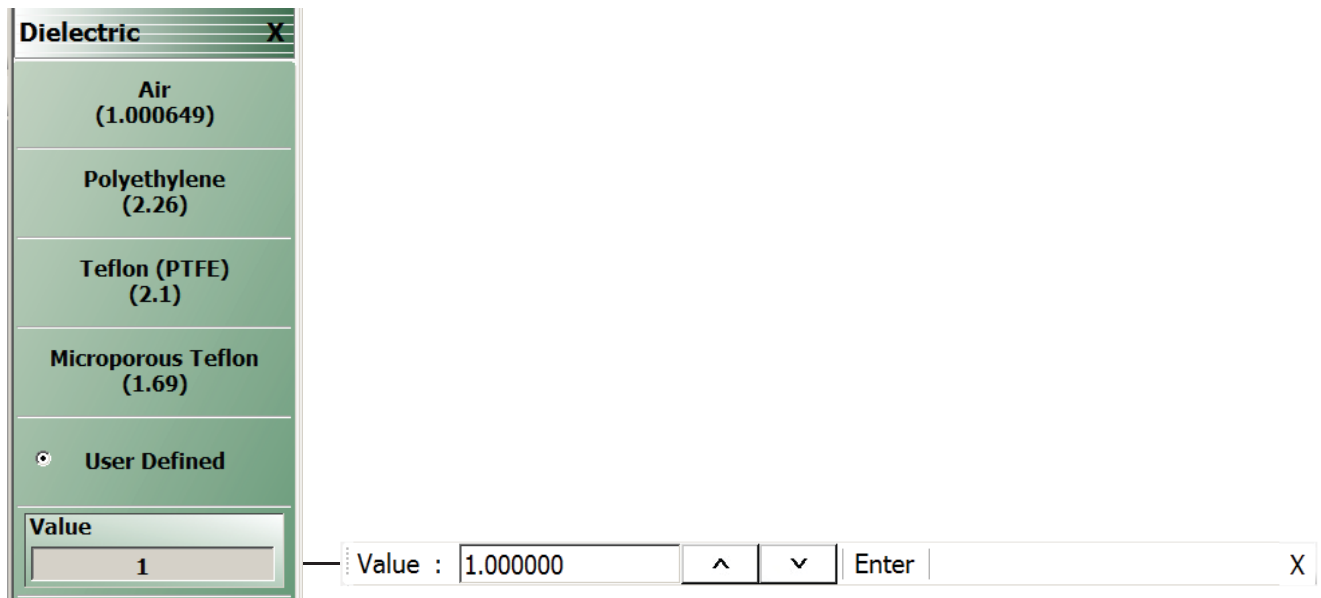

Select the User Defined button to access the Value button and related Field Toolbar.

Figure 11-10. DIELECTRIC Menu

DIELECTRIC Menu Button Selection Group

The DIELECTRIC menu variably displays either five (5) or six (6) buttons that are all members of a button selection group. If any single button is selected, the other buttons are deselected.

If the User Defined (Dielectric) button is selected, a sixth button, Value (Dielectric) appears at the bottom of the menu and allows the user to enter a user-defined dielectric constant.

The dielectric material selected here is displayed in the MEASUREMENT menu in the read-only Dielectric button field.

- [“MEASUREMENT Menu” on page 11-3](#)
- MAIN | Measurement | MEASUREMENT

After selecting a dielectric value, click Back to return to the MEASUREMENT menu.

Air (1.000649) (Dielectric)

Select sets the dielectric as air (1.000649) and de-selects Polyethylene, Teflon, Micr. Teflon, and User Defined.

Polyethylene (2.26) (Dielectric)

Select sets the dielectric as polyethylene (2.26) and de-selects Air, Teflon, Micr. Teflon, and User Defined.

Teflon (2.1) (Dielectric)

Select sets the dielectric as Teflon (2.1) and de-selects Air, Polyethylene, Micr. Teflon, and User Defined.

Micr. Teflon (1.69) (Dielectric)

Select sets the dielectric as Microporous Teflon (1.69) and de-selects Air, Polyethylene, Teflon, and User Defined.

User Defined (Dielectric)

Select sets the dielectric as User Defined (Dielectric) and de-selects Air, Polyethylene, Teflon, and Micr. Teflon. Select also displays the Value (Dielectric) button at the bottom of the menu.

Value (Dielectric)

The Value (Dielectric) button only appears if the User Defined button (above) has been selected. Once the Value (Dielectric) button is available, select displays the Value (Dielectric) field toolbar for entry of a user-defined dielectric constant.

Chapter 12 — Time Domain Menu

12-1 Chapter Overview

The Time Domain (TDOMAIN) menu provides a convenient way to access all time domain-related parameter setup items. Although these parameters are also accessible in other places throughout the ShockLine application, the user must shift among menus to reach them. Here, the Measurement Setup dialog collects all of them for access on one screen.

Note The Time Domain option must be installed for the TDOMAIN menu to be available.
--

12-2 Overview of the Time Domain Menu

The Time Domain menu offers the following selection buttons:

- [“Low Pass Time Domain Cal Dialog” on page 12-3](#)
- [“Time Domain Measurement Setup Dialog” on page 12-4](#)

12-3 Time Domain Icon on Icon Bar

Although Time Domain is an item on the Main Menu, it does not appear on the Icon Bar unless placed there manually. To do that:

1. Select Utilities menu.
2. Select Customize Toolbar.
3. In the Customize Toolbar dialog box, locate the Time Domain icon in the Available Buttons scroll list then click the center-located Add button to add it to the displayed icons list on the right.
4. If desired, use the Up/Down buttons to adjust icon position on toolbar.
5. Click Close to exit the dialog.

12-4 Time Domain Menu

Previous

- [“Main Menu” on page 2-2](#)

Navigation

- MAIN | Time Domain | TDOMAIN

 <p>The screenshot shows a menu titled 'TDomain' with a close button 'X'. It contains two main items: 'Low Pass Time Domain Cal' and 'Measurement Setup'. The 'Low Pass Time Domain Cal' item is highlighted with a light green background.</p>	<p>Low Pass Time Domain Cal</p> <p>Selection opens the Note Dialog used to open the Low Pass Time Domain Cal Setup Dialog.</p> <ul style="list-style-type: none">• “Low Pass Time Domain Cal Dialog” on page 12-3 <p>Measurement Setup</p> <p>Selection opens the dialog used to set up parameters for measurements supporting time domain results.</p> <ul style="list-style-type: none">• “Time Domain Measurement Setup Dialog” on page 12-4
---	---

Figure 12-1. TIME DOMAIN Menu

12-5 Low Pass Time Domain Cal Dialog

Navigation

- MAIN | Time Domain | TDOMAIN | Low Pass Time Domain Cal | LOW PASS TIME DOMAIN CAL Dialog

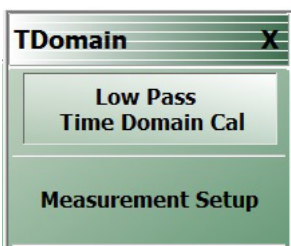
Low Pass Time Domain Cal Dialog

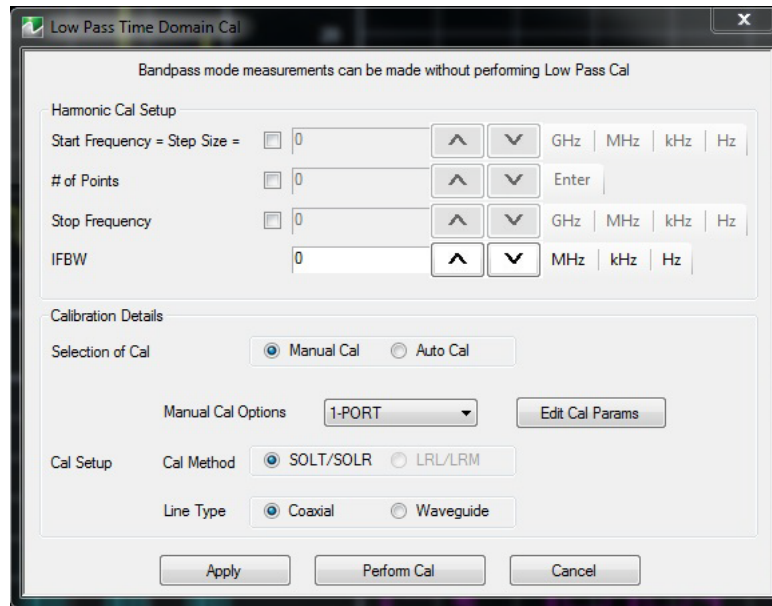

Figure 12-2. LOW PASS TIME DOMAIN CAL Dialog Box

The main sections of this dialog are:

Harmonic Cal Setup

This frame calculates the frequency sweep plan that satisfies the requirements for a low pass time domain measurement. The user sets two of the three sweep parameters and the calculator sets the third parameter such that the following equations are satisfied:

Stop frequency = start frequency * number of points

Start frequency = sweep step size

Also note that when any parameter hits its range limit, the adjustment of the other parameters may then be limited according to the constraints of the equation.

In this frame you can also set the IF measurement bandwidth.

Calibration Details

This sets the calibration parameters: Measurement type (Manual or Auto), number of ports, calibration method and line type).

Edit Cal Params - This button opens the same dynamically composed dialog that appears through this Calibrate menu path:

Calibrate | Manual Cal | X-Port Cal (where X is the number of ports) | Modify Cal Setup | Edit Cal Params

Perform Cal - This button invokes a calibration; the application then asks you to complete the calibration using appropriate selections from the Manual Cal menu and its submenus.

12-6 Time Domain Measurement Setup Dialog

This dialog contains setup parameters for time domain measurements. It replicates and gathers in one place a number of parameters occurring under various ShockLine menus. For explanations of some items, this chapter refers to other chapters where the topic is already covered under a particular menu. For example, many functions invoked by Time Domain controls in this dialog are discussed in the Display chapter under DOMAIN. Also, visual behavior of controls that are dependent on other settings matches the behavior in the menus. For example, Range Setup and Gate Setup are grayed out if Domain Mode Frequency with No Time Gate is active.

Navigation

- MAIN | Time Domain | TIME DOMAIN | Measurement Setup | TIME DOMAIN MEASUREMENT SETUP

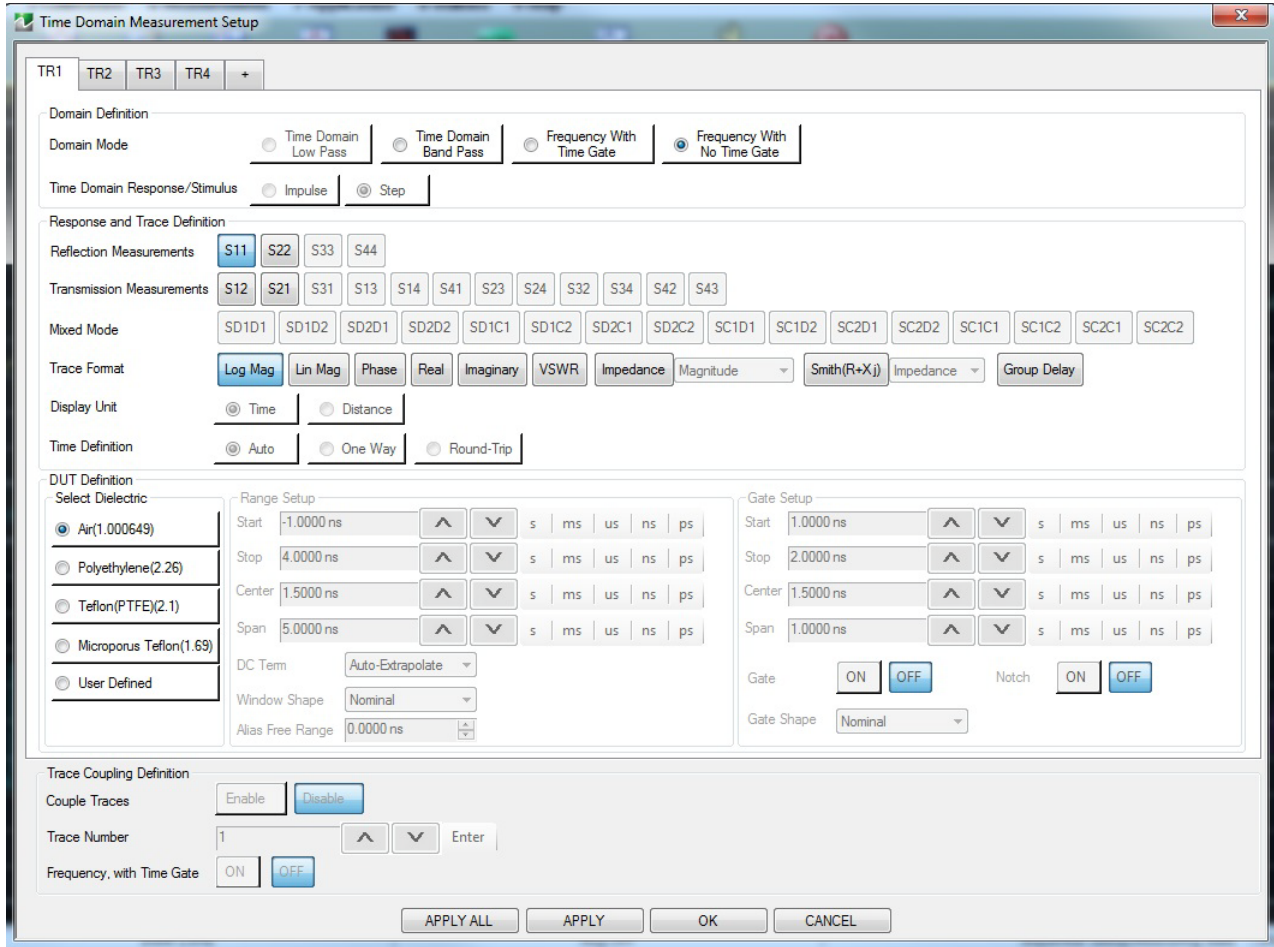

Figure 12-3. TIME DOMAIN MEASUREMENT SETUP Dialog Box

This dialog shows a tab for each trace in the current channel. There can be from one to sixteen tabs depending on how many traces have been set up for the channel.

There are four main controls frames on each tab.

- *Domain Definition* contains controls for selecting domain qualities.
- *Response and Trace Definition* controls are used to set up type of measurement and output formats.
- *DUT Definition* allows characterizing parameters for the device under test.
- *Trace Couple Definition* controls the appearance of the displayed trace measurement data.

The Apply All, Apply, Okay, and Cancel buttons at the dialog bottom provide control over dialog application and exit

Domain Definition

To set the time domain type, select one of the four types (Time Domain - Low Pass; Time Domain - Band Pass; Frequency with Time Gate; or Frequency with No Time Gate). (Time Domain - Low Pass will not be enabled for selection until you have performed a Low Pass Time Domain calibration.)

Next, set Time Domain Response/Stimulus as needed.

Response and Trace Definition

The available choices here depend on the instrument model.

For 1-port model: MS46121A, parameter S11 is selectable.

For 2-port models: MS46122A, MS46322A, and MS46522A, parameters S11, S12, S21, and S22 are selectable.

For 4-port models: MS46524A, all parameters shown are selectable.

Trace Format controls the display format for a trace. For information on all formats listed here, see [Chapter 17 — Display Menus](#).

Display Unit button choices depend on the Domain Mode setting.

Time Definition button choices depend on the Domain Mode setting.

DUT Definition

This frame's controls are:

Select Dielectric: These five radio buttons allow selecting the type of dielectric.

There are four standard choices of dielectric and one button allowing entry of a user defined dielectric constant value.

Range Setup: These parameters are grayed out if Domain Mode is set to Frequency With No Time Gate.

Gate Setup: These parameters are grayed out if Domain Mode is set to Frequency With No Time Gate.

Trace Coupling Definition

This frame's controls are:

Couple Traces: This feature allows the selected number of traces to be plotted on the same channel.

Trace Number: This parameter allows the user to select the number of traces used to display data. There is a maximum number of traces defined by the type of trace layout displayed.

Frequency with

Time Gating: This tab turns on the time gating feature.

Apply All, Apply, Okay, and Cancel buttons

Apply All: Applies all parameter settings here across all areas of the instrument.

Apply: Applies the selected parameter values but leaves the dialog open.

Okay: Applies the selected parameter values then closes the dialog and returns to the Time Domain menu.

Cancel: Closes the dialog without saving the settings, and returns to the Time Domain menu.

Chapter 13 — Application Menu

13-1 Chapter Overview

This chapter provides information for the APPLICATION menu that is used for Receiver Configuration. The default measurement mode setting is for Standard S-Parameters.

APPLICATION Menu

APPLICATION Menu (for Receiver Configuration)

Previous

- [“Main Menu” on page 2-2](#)

Navigation

- MAIN | Application | APPLICATION

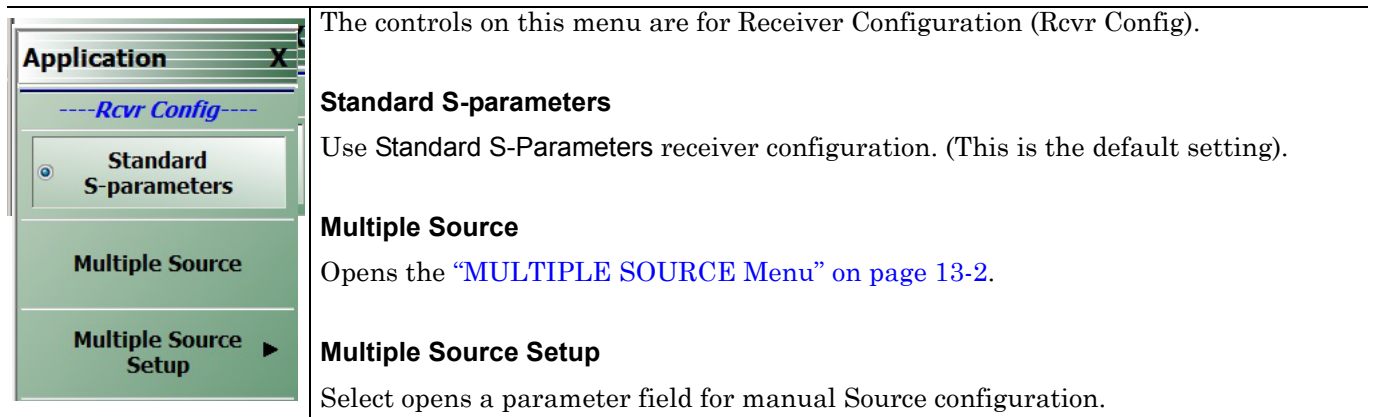

Figure 13-1. APPLICATION Menu for Receiver Configuration

MULTIPLE SOURCE Menu

Previous

- [“APPLICATION Menu \(for Receiver Configuration\)” on page 13-1](#)

Navigation

- MAIN | Application | APPLICATION | Multiple Source Setup | MULTIPLE SOURCE

	<p>The controls on this menu are for Multiple Source Configuration.</p> <p>Multiple Source Button turns multiple sources on or off</p> <p>Done Editing When selected, enables parameters for manual Source control. Button will be grayed out until parameters updated</p> <p>Int. Src Control Opens the “INT. SRC CONTROL Menu” on page 13-3.</p> <p>Phase Inversion Toggles phase inversion ON or OFF.</p>
--	--

Figure 13-2. MULTIPLE SOURCE Menu

INT. SRC CONTROL Menu

Previous

- “MULTIPLE SOURCE Menu” on page 13-2

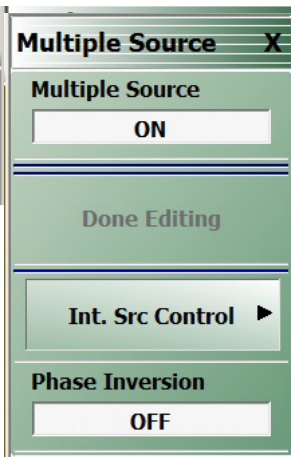
Navigation

- MAIN | Application | APPLICATION | Multiple Source Setup | MULTIPLE SOURCE | Int. Src Control | INT. SRC CONTROL

	<p>The controls on this menu are for Internal Source Control.</p> <p>Int. Src1, 2, 3, 4</p> <p>Radio buttons that allow each of two to four sources to be Auto controlled, Active, or Inactive. The number of sources is dependent on VNA model.</p> <p>Note that Int. Src 3 and Int. Src 4 are only available on 4-port instruments.</p>
--	--

Figure 13-3. INT. SRC CONTROL Menu

Chapter 14 — Trace Menu

14-1 Chapter Overview

This chapter provides information on traces. You can set the number of traces that appear for each channel and how those traces are arranged on the main display. Up to 16 traces can be defined and there are 22 available trace layouts. Traces can be detached as free-floating windows.

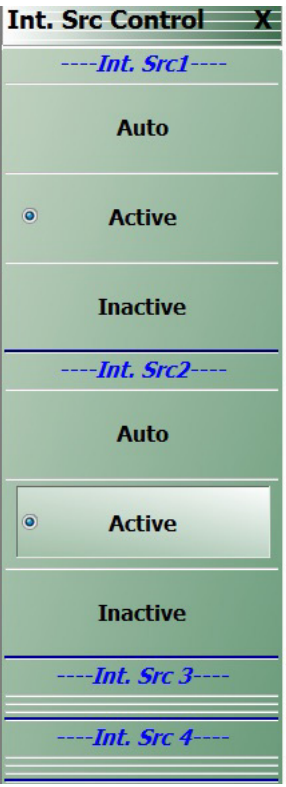
Trace memory and trace format are controlled under Display controls (see [“DISPLAY Menu” on page 17-2](#)).

14-2 Overview of Trace Menu

There are two (2) trace menus:

- [“TRACE Menu” on page 14-2](#)
- [“TRACE LAYOUT Menu” on page 14-3](#)

14-3 Trace Configuration

TRACE Menu

Previous

- [“Main Menu” on page 2-2](#)

Navigation

- MAIN | Trace | TRACE

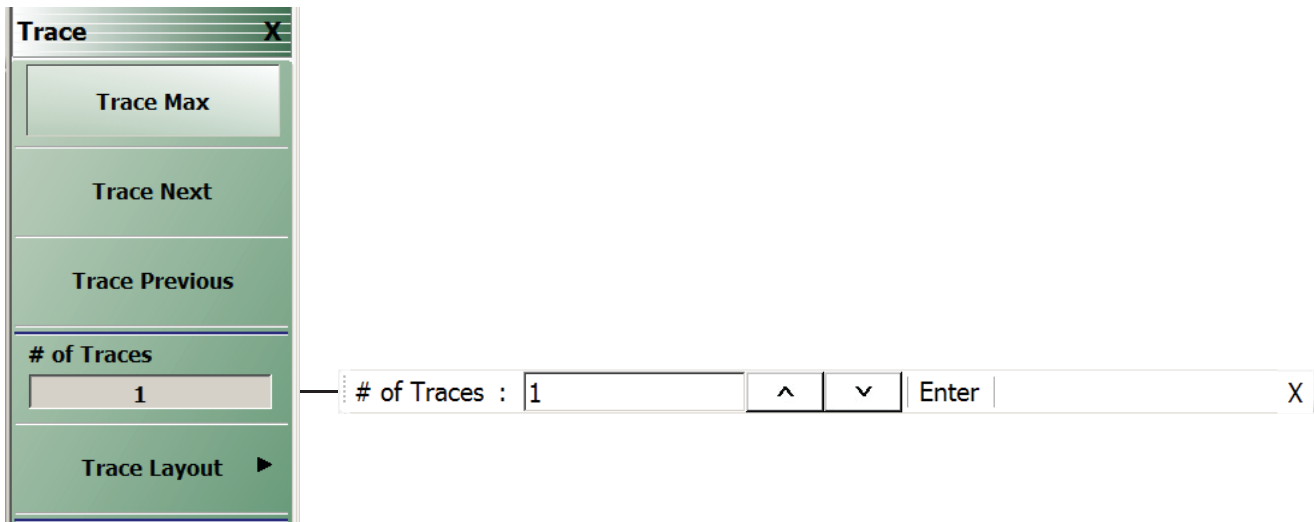

1. TRACE Menu

2. # of Traces (Number of Traces) Field Toolbar

Figure 14-1. TRACE Menu

Trace Max

Select toggles between original trace layout and full screen display of the active trace.

Trace Next

Select activates adjacent traces in ascending order, looping to trace 1 from the highest trace number.

Trace Previous

Select activates adjacent traces in descending order, looping to the highest trace number from trace 1.

of Traces

Select activates the # of Traces (Number of Traces) field toolbar, allowing the user to specify the number of traces displayed, to a maximum of 16.

- When the number of traces specified is more than the number of trace displays in the layout, traces are overlaid sequentially with priority to the first display.
- If the number of traces specified is less than the number of displays in the current layout, the remainder of display areas are blank.

Trace Layout

Select displays the TRACE LAYOUT menu to change how the traces are displays on the screen.

- [“TRACE LAYOUT Menu” on page 14-3](#)

14-4 Trace Display Layout

TRACE LAYOUT Menu

The trace view buttons are not labeled but instead provide a representation icon of the available view. Click the required view to select it. Click the **Back** button at the bottom of the TRACE LAYOUT menu to return to the TRACE menu. If more traces than trace layouts are specified, some or all of the trace layouts will show multiple overlaid trace displays. If more trace layouts than trace are specified, some trace layout positions will be empty.

Previous

- [“TRACE Menu” on page 14-2](#)

Navigation

- MAIN | Trace | TRACE | Trace Layout | TRACE LAYOUT



Figure 14-2. TRACE LAYOUT Menu (1 of 3)

	<p>Single Trace View</p> <p>Click Back to return to the Trace menu.</p> <p>If SCPI programming is used to control the VNA, the command parameter for this trace view is R1C1. The command parameters for the other trace layout views are listed with each trace view type below.</p>
	<p>Two Trace View - 2 Across x 1 Down</p> <p>Click Back to return to the Trace menu.</p> <p>R1C2 for SCPI programs.</p>
	<p>Two Trace View - 1 Across x 2 Down</p> <p>Click Back to return to the Trace menu.</p> <p>R2C1 for SCPI programs.</p>
	<p>Three Trace View - 3 Across</p> <p>Click Back to return to the Trace menu.</p> <p>R1C3 for SCPI programs.</p>
	<p>Three Trace View - 3 Down</p> <p>Click Back to return to the Trace menu.</p> <p>R3C1 for SCPI programs.</p>
	<p>Three Trace View - 2 on Top x 1 on Bottom</p> <p>Click Back to return to the Trace menu.</p> <p>R2C2C1 for SCPI programs.</p>
	<p>Three Trace View - 1 on Top x 2 on Bottom</p> <p>Click Back to return to the Trace menu.</p> <p>R2C1C2 for SCPI programs.</p>
	<p>Three Trace View - 2 on Left x 1 on Right</p> <p>Click Back to return to the Trace menu.</p> <p>C2R2R1 for SCPI programs.</p>
	<p>Three Trace View - 1 on Left x 2 on Right</p> <p>Click Back to return to the Trace menu.</p> <p>C2R1R2 for SCPI programs.</p>
	<p>Four Trace View - 4 Across</p> <p>Click Back to return to the Trace menu.</p> <p>R1C4 for SCPI programs.</p>
	<p>Four Trace View - 4 Down</p> <p>Click Back to return to the Trace menu.</p> <p>R4C1 for SCPI programs.</p>
	<p>Four Trace View - 2 Across x 2 Down</p> <p>Click Back to return to the Trace menu.</p> <p>R2C2 for SCPI programs.</p>
	<p>Six Trace View - 3 Across x 2 Down</p> <p>Click Back to return to the Trace menu.</p> <p>C2R1R2 for SCPI programs.</p>

Figure 14-2. TRACE LAYOUT Menu (2 of 3)

	<p>Six Trace View - 2 Across x 3 Down</p> <p>Click Back to return to the Trace menu. R1C4 for SCPI programs.</p>
	<p>Eight Trace View - 4 Across x 2 Down</p> <p>Click Back to return to the Trace menu. R4C1 for SCPI programs.</p>
	<p>Eight Trace View - 2 Across x 4 Down</p> <p>Click Back to return to the Trace menu. R2C2 for SCPI programs.</p>
	<p>Nine Trace View - 3 Across x 3 Down</p> <p>Click Back to return to the Trace menu. R2C2 for SCPI programs.</p>
	<p>Ten Trace View - 2 Across x 5 Down</p> <p>Click Back to return to the Trace menu. R2C2 for SCPI programs.</p>
	<p>Ten Trace View - 5 Across x 2 Down</p> <p>Click Back to return to the Trace menu. R2C2 for SCPI programs.</p>
	<p>Twelve Trace View - 3 Across x 4 Down</p> <p>Click Back to return to the Trace menu. R2C2 for SCPI programs.</p>
	<p>Twelve Trace View - 4 Across x 3 Down</p> <p>Click Back to return to the Trace menu. R2C2 for SCPI programs.</p>
	<p>Sixteen Trace View - 4 Across x 4 Down</p> <p>Click Back to return to the Trace menu. R2C2 for SCPI programs.</p>

Figure 14-2. TRACE LAYOUT Menu (3 of 3)

Chapter 15 — Response Menus: 1-Port and 2-Port VNAs: 1-Port and 2-Port VNAs

15-1 Chapter Overview

This chapter provides information on the 1- and 2-port VNA Response menus used to configure S-Parameters using standard options, or to configure user-defined parameters. Only 1-port related response menu items apply to the MS46121A.

15-2 Overview of Response Menus - 1-Port and 2-Port VNAs

The available 2-port Response menus are:

- [“RESPONSE Menu” on page 15-3](#)
- [“USER-DEFINED Menu” on page 15-5](#)
 - [“NUMERATOR Menu” on page 15-7](#)
 - [“DENOMINATOR Menu” on page 15-8](#)
- [“MIXED-MODE Menu” on page 15-9](#)

15-3 RESPONSE Menu Set

The USER-DEFINED menu provides options to select numerator and denominator values of a user-defined parameter, and to select a driver port.

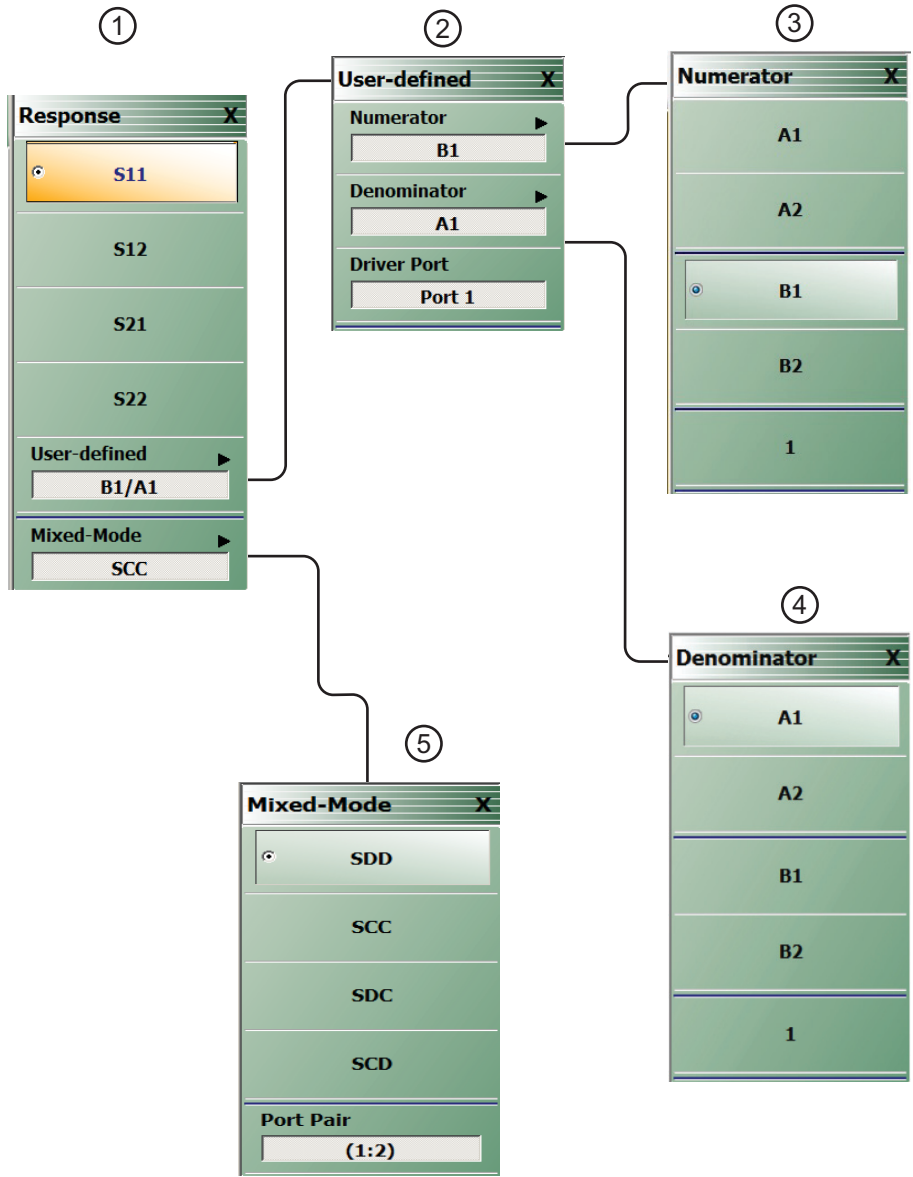

- | | |
|----------------------|---------------------|
| 1. RESPONSE Menu | 3. NUMERATOR Menu |
| 2. USER-DEFINED Menu | 4. DENOMINATOR Menu |
| | 5. MIXED MODE Menu |

Figure 15-1. RESPONSE and USER-Defined Menu Set

15-4 RESPONSE Menu

RESPONSE Menu

Previous

- [“Main Menu” on page 2-2](#)

Navigation

- MAIN | Response | RESPONSE



Figure 15-2. RESPONSE Menu

The RESPONSE menu provides access for setting S11, S12, S21, or S22 parameters to the active trace.

S11

Select sets the response to the input reflection coefficient (or S11 Forward Reflection).

S12

Select sets the response to the reverse transmission coefficient (or S12 Reverse Transmission).

S21

Select sets the response to the forward transmission coefficient (or S21 Forward Transmission).

S22

Select sets the response to the output reflection coefficient (or S22 Reverse Reflection).

User-defined

Select displays the USER-DEFINED menu.

- [“USER-DEFINED Menu” on page 15-5](#)

Mixed-Mode (Response 2-Port)

Select displays the MIXED-MODE menu where mixed-mode response options of SDD, SCC, SDC, and SCD are available with a Port Pair assignment of either 1:2 or 2:1. Select also de-selects S12, S21, S22, and User-Defined,

- [“MIXED-MODE Menu” on page 15-9](#)

15-5 USER-DEFINED Menu

USER-DEFINED Menu

The USER DEFINED menu is used to establish various mathematical combinations of incident and reflected power values. See [Table 15-1, “User-Defined Numerator/Denominator Combinations”](#) for all possible combinations and definitions of common 2-port parameters.

Previous

- [“RESPONSE Menu” on page 15-3](#)

Navigation

- MAIN | Response | RESPONSE | User Defined | USER DEFINED

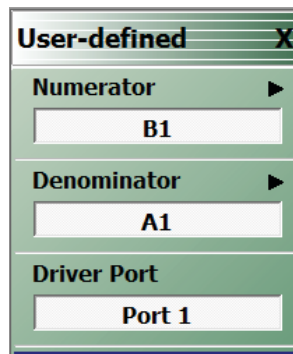

Figure 15-3. USER DEFINED Menu

Numerator

Select displays the NUMERATOR menu.

- [“NUMERATOR Menu” on page 15-7](#)

Denominator

Select displays the DENOMINATOR menu.

- [“DENOMINATOR Menu” on page 15-8](#)

Driver Port (Port 1/Port 2)

Select toggles the driver port setting between Port 1 and Port 2.

Table 15-1. User-Defined Numerator/Denominator Combinations

Denominator	Numerator				
	A1	A2	B1	B2	1
A1	$\frac{A1}{A1} = 1$	$\frac{A2}{A1}$	$\frac{B1}{A1}$ S11 Forward Reflection	$\frac{B2}{A1}$ S21 Forward Transmission	$\frac{1}{A1}$
A2	$\frac{A1}{A2}$	$\frac{A2}{A2} = 1$	$\frac{B1}{A2}$ S12 Reverse Transmission	$\frac{B2}{A2}$ S22 Reverse Reflection	$\frac{1}{A2}$
B1	$\frac{A1}{B1}$	$\frac{A2}{B1}$	$\frac{B1}{B1} = 1$	$\frac{B2}{B1}$	$\frac{1}{B1}$
B2	$\frac{A1}{B2}$	$\frac{A2}{B2}$	$\frac{B1}{B2}$	$\frac{B2}{B2} = 1$	$\frac{1}{B2}$
1	$\frac{A1}{1} = A1$	$\frac{A2}{1} = A2$	$\frac{B1}{1} = B1$	$\frac{B2}{1} = B2$	$\frac{1}{1} = 1$

NUMERATOR Menu

Sets the response to a user-defined mathematical fraction using the USER DEFINED menu to select S11, S12, S21, S22, or 1 (one) as a numerator over S11, S12, S21, S22, or 1 as the denominator.

Previous

- [“USER-DEFINED Menu” on page 15-5](#)

Navigation

- MAIN | Response | RESPONSE | User Defined | USER DEFINED | Numerator | NUMERATOR

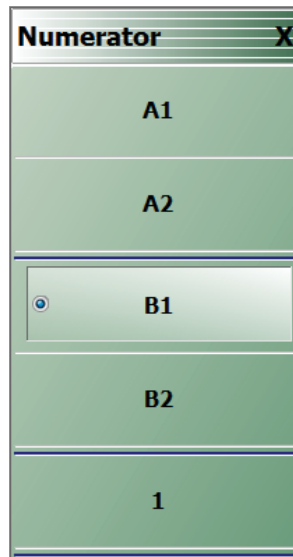

Figure 15-4. NUMERATOR Menu - 2-Port VNAs

A1

Select sets A1 incident power on port 1 as the numerator value.

A2

Select sets A2 incident power on port 2 as the numerator value.

B1

Select sets B1 received power on port 1 as the numerator value.

B2

Select sets B2 received power on port 2 as the numerator value.

1

Select sets 1 (one) as the numerator value.

DENOMINATOR Menu

Previous

- [“USER-DEFINED Menu” on page 15-5](#)

Navigation

- MAIN | Response | RESPONSE | User Defined | USER DEFINED | Denominator | DENOMINATOR

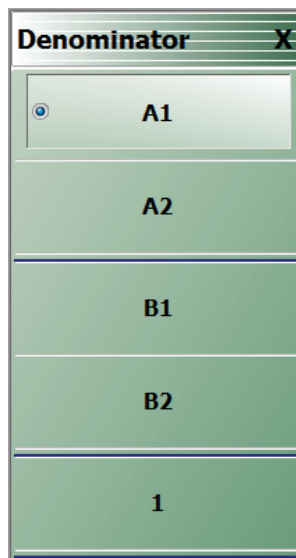

Figure 15-5. DENOMINATOR Menu

A1

Select sets A1 incident power on port 1 as the denominator value.

A2

Select sets A2 incident power on port 2 as the denominator value.

B1

Select sets B1 received power on port 1 as the denominator value.

B2

Select sets B2 received power on port 2 as the denominator value.

1

Select sets 1 (one) as the denominator value.

MIXED-MODE Menu

Previous

- [“RESPONSE Menu” on page 15-3](#)

Navigation

- MAIN | Response | RESPONSE |Mixed-Mode | MIXED-MODE

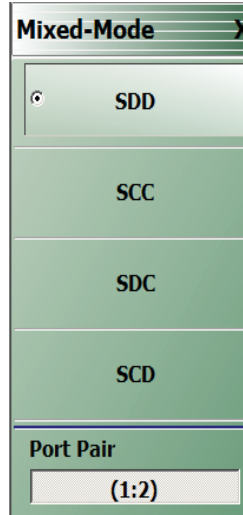

Figure 15-6. MIXED-MODE

SDD

Select sets the S-Parameter to differential reception with differential drive where the reception/driver ports are determined by the Port Pair button below.

SCC

Select sets the S-Parameter to common-mode reception with common-mode drive where the reception/driver ports are determined by the Port Pair button below.

SDC

Select sets the S-Parameter to differential reception with common-mode drive where the reception/driver ports are determined by the Port Pair button below.

SCD

Select sets the S-Parameter to common-mode reception with differential drive where the reception/driver ports are determined by the Port Pair button below.

Port Pair

Toggles the reception/driver port pair between 1:2 and 2:1.

Chapter 16 — Response Menus: 4-Port VNAs

16-1 Chapter Overview

This chapter provides information about the 4-Port VNA Response menus for configuration of standard S-Parameters or user-definition of a unique parameter. The MIXED MODE dialog box variants provide mixed-mode response setup on a trace-by-trace basis with multiple response options for each trace.

For information on Response menus for 2-Port VNAs, consult [Chapter 15, “Response Menus: 1-Port and 2-Port VNAs: 1-Port and 2-Port VNAs”](#)

16-2 Overview of 4-Port Response Menus and Dialog Boxes

The available 4-port Response menus and dialog boxes are:

- [“RESPONSE Menu - 4-Port VNAs” on page 16-2](#)
- [“SINGLE-MODE Menu - 4-Port VNAs” on page 16-7](#)
- [“USER-DEFINED Menu Set- 4-Port VNAs” on page 16-9](#)
 - [“NUMERATOR Menu - 4-Port VNAs” on page 16-11](#)
 - [“DENOMINATOR Menu - 4-Port VNAs” on page 16-13](#)
- [“MIXED MODE Dialog Box Variants- 4-Port VNAs” on page 16-15](#)
 - [“MIXED MODE Dialog Box - Two Differential Pairs - 4-Port VNAs” on page 16-15](#)
 - [“MIXED MODE Dialog Box - One Differential Pair - One Singleton - 4-Port VNAs” on page 16-17](#)
 - [“MIXED MODE Dialog Box - One Differential Pair - Two Singletons - 4-Port VNAs” on page 16-19](#)
 - [“SELECT TRACE Dialog Box - 4-Port VNAs” on page 16-21](#)

16-3 RESPONSE Menu Set - 4-Port VNAs

RESPONSE Menu - 4-Port VNAs

Prerequisites

- The VNA must be in 4-Port Mode

Previous

- [“Main Menu” on page 2-2](#)

Navigation

- MAIN | Response | RESPONSE

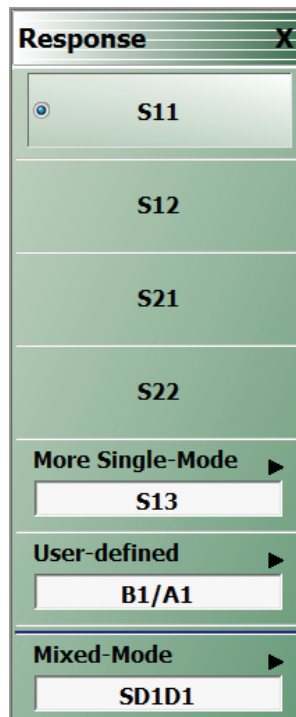

Figure 16-1. RESPONSE Menu - 4-Port VNAs

The RESPONSE menu provides access for setting S11, S12, S21, or S22 parameters to the active trace.

S11

Select sets the response to the input reflection coefficient (or S11 Forward Reflection).

S12

Select sets the response to the reverse transmission coefficient (or S12 Reverse Transmission).

S21

Select sets the response to the forward transmission coefficient (or S21 Forward Transmission).

S22

Select sets the response to the output reflection coefficient (or S22 Reverse Reflection).

More Single-Mode

Select displays the SINGLE-MODE menu where 4-Port S-Parameters are selected from the following selections: S13, S14, S23, S24, S31, S32, S33, S34, S41, S42, S43, S44.

- [“RESPONSE and SINGLE-MODE Menus” on page 16-4](#)
- [“SINGLE-MODE Menu - 4-Port VNAs” on page 16-7](#)

User-Defined

Select sets the response to a user-defined mathematical fraction, and displays the USER DEFINED menu to select S11, S12, S21, S22, or 1 (one) as a numerator over S11, S12, S21, S22, or 1 as the denominator.

- [“RESPONSE and USER-DEFINED Menus” on page 16-5](#)
- [“USER-DEFINED Menu Set- 4-Port VNAs” on page 16-9](#)

Mixed-Mode

Select de-selects all other menu buttons and displays the MIXED MODE dialog box for three general mixed-mode configurations of:

- Two differential pairs
- One differential pair and one singleton
- One differential pair and two singletons

The button field displays the currently selected mixed-mode settings where SXX is the selected response type and numbers are the assigned port number.

- [“RESPONSE Menu and MIXED MODE Dialog Box Variants” on page 16-6](#)
- [“MIXED MODE Dialog Box Variants- 4-Port VNAs” on page 16-15](#)

RESPONSE and SINGLE-MODE Menus

The RESPONSE menu provides direct access to the standard S-Parameters S11, S12, S21, and S22, and also access to additional S-parameters through the SINGLE-MODE menu.

- [“SINGLE-MODE Menu - 4-Port VNAs” on page 16-7](#)

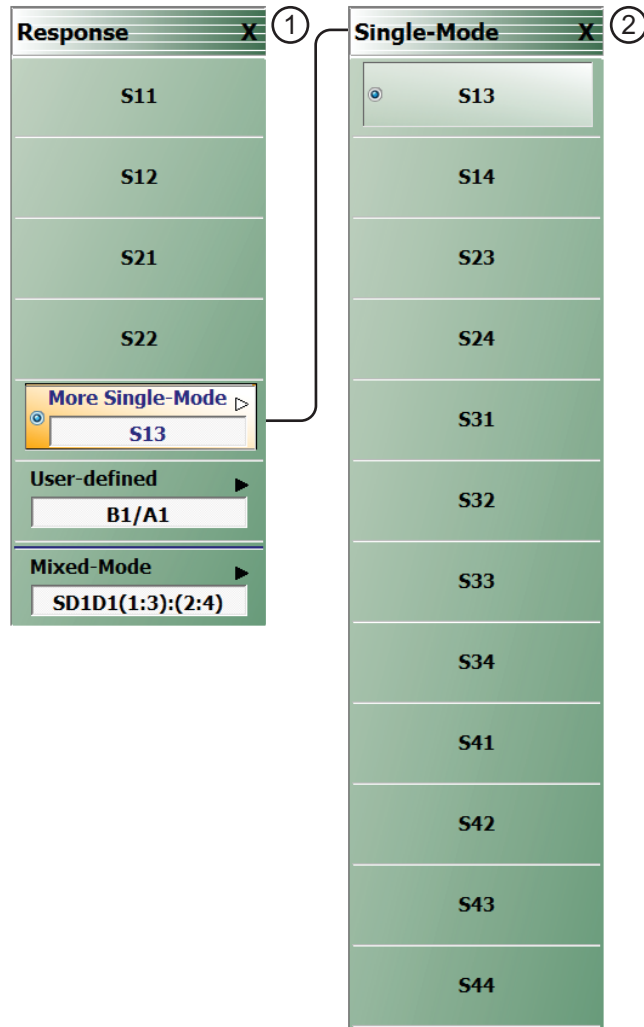

1. RESPONSE Menu - 4-Port VNAs	2. SINGLE-MODE Menu - 4-Port VNAs
--------------------------------	-----------------------------------

Figure 16-2. RESPONSE and SINGLE-MODE Menus - 4-Port VNAs

The SINGLE-MODE menu provides access for setting S13 through S44 parameters to the active trace.

RESPONSE and USER-DEFINED Menu

The RESPONSE menu provides access to create user-defined parameters as shown in [Figure 16-3](#).

Note that all parameters listed on the NUMERATOR and DENOMINATOR menus are available regardless of the calibration in place. Some parameters selected for a user-defined parameter could be uncorrected if they were not included in the original calibration.

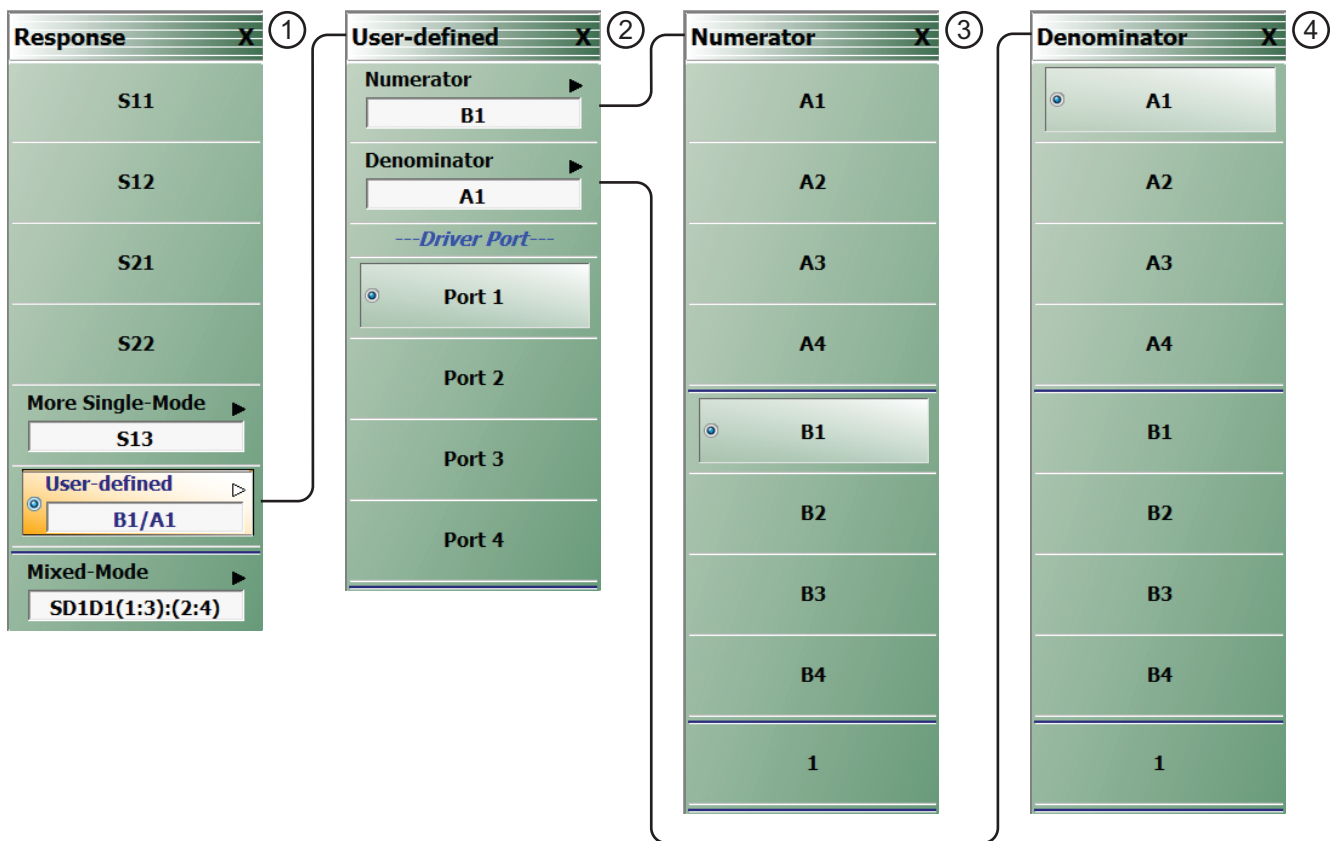

- | | |
|------------------------------------|-----------------------------------|
| 1. RESPONSE Menu - 4-Port VNAs | 3. NUMERATOR Menu - 4-Port VNAs |
| 2. USER-DEFINED Menu - 4-Port VNAs | 4. DENOMINATOR Menu - 4-Port VNAs |

Figure 16-3. Response Menu Set - 4-Port VNAs

The USER-DEFINED menu provides access to the NUMERATOR and DENOMINATOR menus to assign numerator and denominator values of a user-defined parameter, and also provides a control for specifying the driver port.

RESPONSE Menu and MIXED MODE Dialog Box Variants

The MIXED MODE dialog box provides setup for using any of three mixed-mode configurations:

- Two differential pairs
- One differential pair and one singleton
- One differential pair and two singletons

Each mixed-mode configuration dialog box provides control of all response measurement parameters.

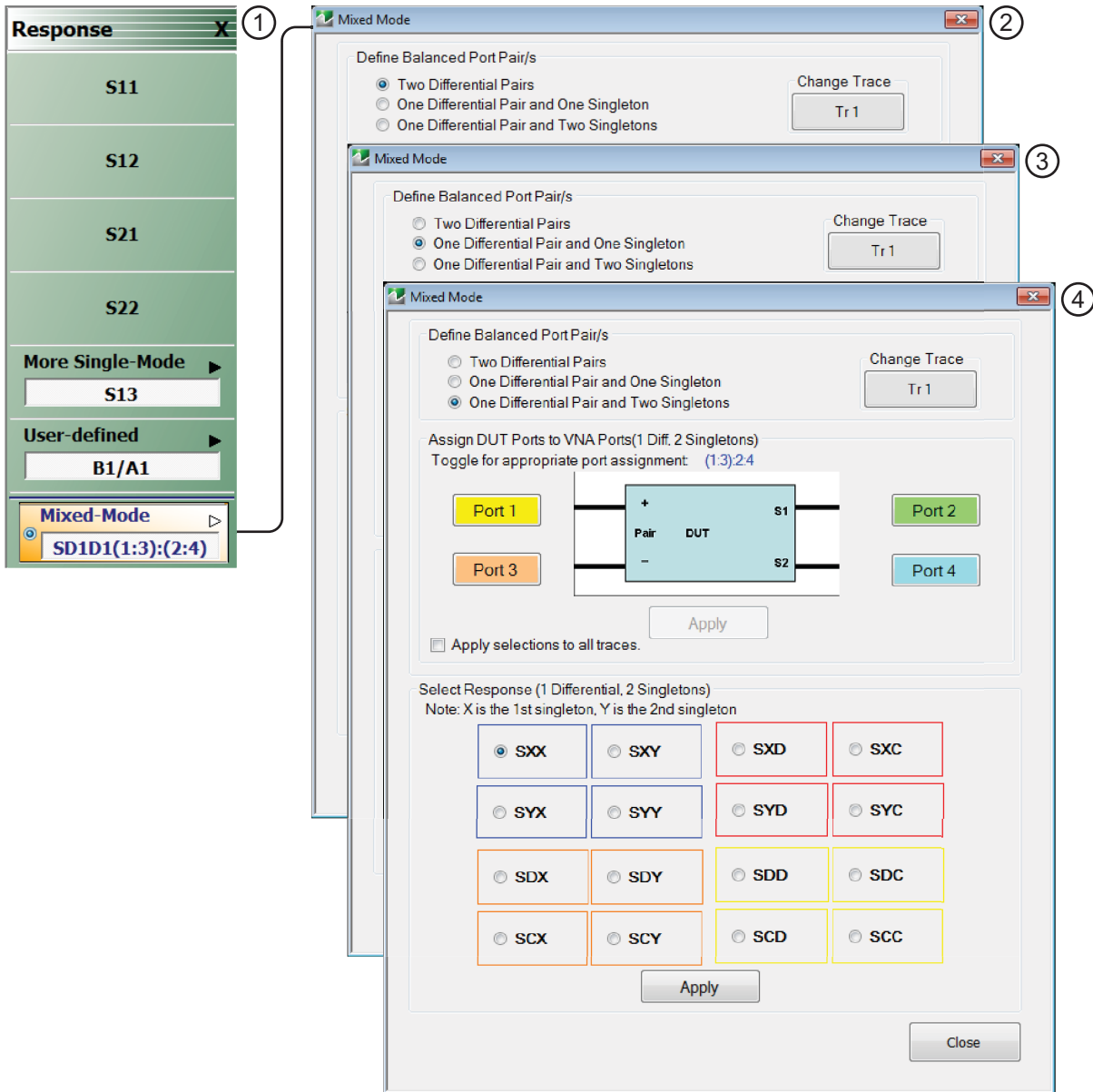

- | | |
|--|--|
| 1. RESPONSE Menu and Mixed Mode button. | 3. MIXED MODE Dialog Box for One Differential Pair and One Singleton. |
| 2. MIXED MODE Dialog Box for Two Differential Pairs. | |
| | 4. MIXED MODE Dialog Box for One Differential Pair and Two Singletons. |

Figure 16-4. RESPONSE Menu and MIXED MODE Dialog Box Variants – 4-Port VNA

16-4 SINGLE-MODE Menu - 4-Port VNAs

Prerequisites

- The VNA must be in 4-Port Mode

Previous

- [“RESPONSE Menu - 4-Port VNAs” on page 16-2](#)

Navigation

- MAIN | Response | RESPONSE | More Single-Mode | SINGLE-MODE



Figure 16-5. SINGLE-MODE Menu - 4-Port VNAs

S13

Select sets S-Parameter to S13.

S14

Select sets S-Parameter to S14.

S23

Select sets S-Parameter to S23.

S24

Select sets S-Parameter to S24.

S31

Select sets S-Parameter to S31.

S32

Select sets S-Parameter to S32.

S33

Select sets S-Parameter to S33.

S34

Select sets S-Parameter to S34.

S41

Select sets S-Parameter to S41.

S42

Select sets S-Parameter to S42.

S43

Select sets S-Parameter to S43.

S44

Select sets S-Parameter to S44.

16-5 USER-DEFINED Menu Set- 4-Port VNAs

USER-DEFINED Menu - 4-Port VNAs

The USER DEFINED menu is used to establish various mathematical combinations of incident and reflected power values. See [Table 16-1, “User-Defined 4-Port Mathematical Combinations” on page 16-10](#) below for a listing of all possible parameter combinations.

Prerequisites

- The VNA must be in 4-Port Mode

Previous

- [“RESPONSE Menu - 4-Port VNAs” on page 16-2](#)

Navigation

- MAIN | Response | RESPONSE | User Defined | USER DEFINED

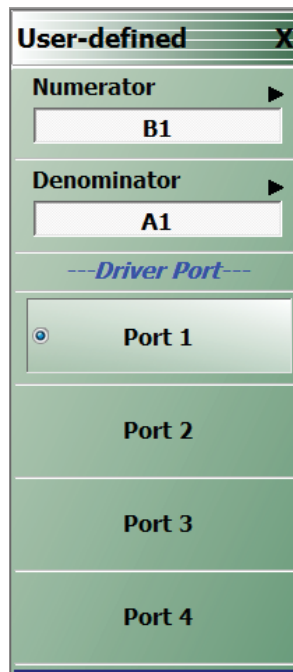

Figure 16-6. USER DEFINED Menu - 4-Port VNAs

Numerator

Select displays the NUMERATOR menu.

- [“NUMERATOR Menu - 4-Port VNAs” on page 16-11](#)

Denominator

Select displays the DENOMINATOR menu.

- [“DENOMINATOR Menu - 4-Port VNAs” on page 16-13](#)

---Driver Port---

Select Port 1, Port 2, Port 3, or Port 4 to set the driving port.

Table 16-1. User-Defined 4-Port Mathematical Combinations

Denominator	Numerator								
	A1	A2	A3	A4	B1	B2	B3	B4	1
A1	$\frac{A1}{A1} = 1$ Unity	$\frac{A2}{A1}$	$\frac{A3}{A1}$	$\frac{A4}{A1}$	$\frac{B1}{A1}$ S11	$\frac{B2}{A1}$ S21	$\frac{B3}{A1}$ S31	$\frac{B4}{A1}$ S41	$\frac{1}{A1}$
A2	$\frac{A1}{A2}$	$\frac{A2}{A2} = 1$ Unity	$\frac{A3}{A2}$	$\frac{A4}{A2}$	$\frac{B1}{A2}$ S12	$\frac{B2}{A2}$ S22	$\frac{B3}{A2}$ S32	$\frac{B4}{A2}$ S42	$\frac{1}{A2}$
A3	$\frac{A1}{A3}$	$\frac{A2}{A3}$	$\frac{A3}{A3} = 1$ Unity	$\frac{A4}{A3}$	$\frac{B1}{A3}$ S13	$\frac{B2}{A3}$ S23	$\frac{B3}{A3}$ S33	$\frac{B4}{A3}$ S43	$\frac{1}{A3}$
A4	$\frac{A1}{A4}$	$\frac{A2}{A4}$	$\frac{A3}{A4}$	$\frac{A4}{A4} = 1$ Unity	$\frac{B1}{A4}$ S14	$\frac{B2}{A4}$ S24	$\frac{B3}{A4}$ S34	$\frac{B4}{A4}$ S44	$\frac{1}{A4}$
B1	$\frac{A1}{B1}$	$\frac{A2}{B1}$	$\frac{A3}{B1}$	$\frac{A4}{B1}$	$\frac{B1}{B1} = 1$ Unity	$\frac{B2}{B1}$	$\frac{B3}{B1}$	$\frac{B4}{B1}$	$\frac{1}{B1}$
B2	$\frac{A1}{B2}$	$\frac{A2}{B2}$	$\frac{A3}{B2}$	$\frac{A4}{B2}$	$\frac{B1}{B2}$	$\frac{B2}{B2} = 1$ Unity	$\frac{B3}{B2}$	$\frac{B4}{B2}$	$\frac{1}{B2}$
B3	$\frac{A1}{B3}$	$\frac{A2}{B3}$	$\frac{A3}{B3}$	$\frac{A4}{B3}$	$\frac{B1}{B3}$	$\frac{B1}{B3}$	$\frac{B3}{B3} = 1$ Unity	$\frac{B4}{B3}$	$\frac{1}{B3}$
B4	$\frac{A1}{B4}$	$\frac{A2}{B4}$	$\frac{A3}{B4}$	$\frac{A4}{B4}$	$\frac{B1}{B4}$	$\frac{B2}{B4}$	$\frac{B3}{B4}$	$\frac{B4}{B4} = 1$ Unity	$\frac{1}{B4}$
1	$\frac{A1}{1} = A1$ A1	$\frac{A2}{1} = A2$ A2	$\frac{A3}{1} = A3$ A3	$\frac{A4}{1} = A4$ A4	$\frac{B1}{1} = B1$ B1	$\frac{B2}{1} = B2$ B2	$\frac{B3}{1} = B3$ B3	$\frac{B4}{1} = B4$ B4	$\frac{1}{1} = 1$ Unity

NUMERATOR Menu - 4-Port VNAs

Possible combinations of the NUMERATOR and DENOMINATOR functions are summarized above in [Table 16-1](#), “User-Defined 4-Port Mathematical Combinations” on page 16-10.

Prerequisites

- The VNA must be in 4-Port Mode

Previous

- “USER-DEFINED Menu Set- 4-Port VNAs” on page 16-9

Navigation

- MAIN | Response | RESPONSE | User Defined | USER DEFINED | Numerator | NUMERATOR

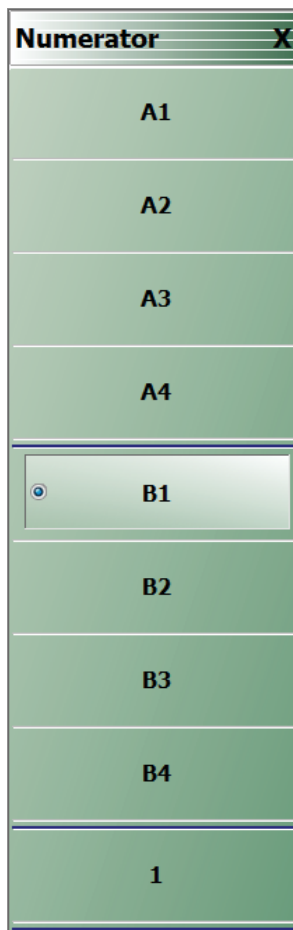

Figure 16-7. NUMERATOR Menu - 4-Port VNAs

A1

Select sets A1 incident power on port 1 as the numerator value.

A2

Select sets A2 incident power on port 2 as the numerator value.

A3

Select sets A3 incident power on port 3 as the numerator value.

A4

Select sets A4 incident power on port 4 as the numerator value.

B1

Select sets B1 received power on port 1 as the numerator value.

B2

Select sets B2 received power on port 2 as the numerator value.

B3

Select sets B3 received power on port 3 as the numerator value.

B4

Select sets B4 received power on port 4 as the numerator value.

1

Select specifies that 1 (one) will be the numerator value.

DENOMINATOR Menu - 4-Port VNAs

Possible combinations of the NUMERATOR and DENOMINATOR functions are summarized above in [Table 16-1](#), “User-Defined 4-Port Mathematical Combinations” on page 16-10.

Prerequisites

- The VNA must be in 4-Port Mode

Previous

- “USER-DEFINED Menu Set- 4-Port VNAs” on page 16-9

Navigation

- MAIN | Response | RESPONSE | User Defined | USER DEFINED | Denominator | DENOMINATOR

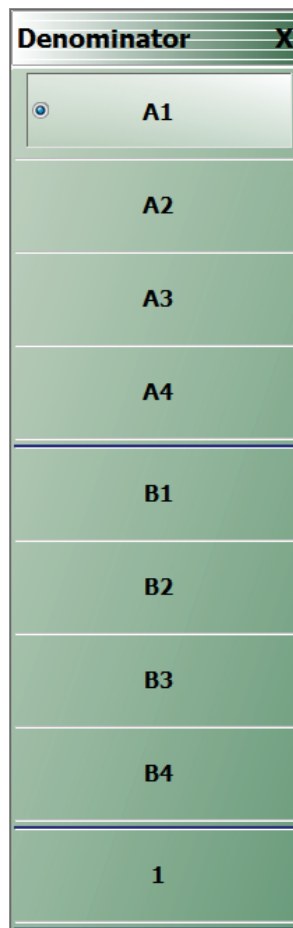

Figure 16-8. DENOMINATOR Menu - 4-Port VNAs

A1

Select sets A1 incident power on port 1 as the denominator value

A2

Select sets A2 incident power on port 2 as the denominator value.

A3

Select sets A3 incident power on port 3 as the denominator value.

A4

Select sets A4 incident power on port 4 as the denominator value.

B1

Select sets B1 received power on port 1 as the denominator value.

B2

Select sets B2 received power on port 2 as the denominator value.

B3

Select sets B3 received power on port 3 as the denominator value.

B4

Select sets B4 received power on port 4 as the denominator value.

1

Select sets 1 (one) as the denominator value.

16-6 MIXED MODE Dialog Box Variants- 4-Port VNAs

MIXED MODE Dialog Box - Two Differential Pairs - 4-Port VNAs

Prerequisites

- Balanced Port Pair Setting = Two Differential Pairs

Previous

- [“RESPONSE Menu - 4-Port VNAs” on page 16-2](#)

Navigation

- MAIN | Response | RESPONSE | Mixed Mode | MIXED MODE Dialog Box | Two Differential Pairs

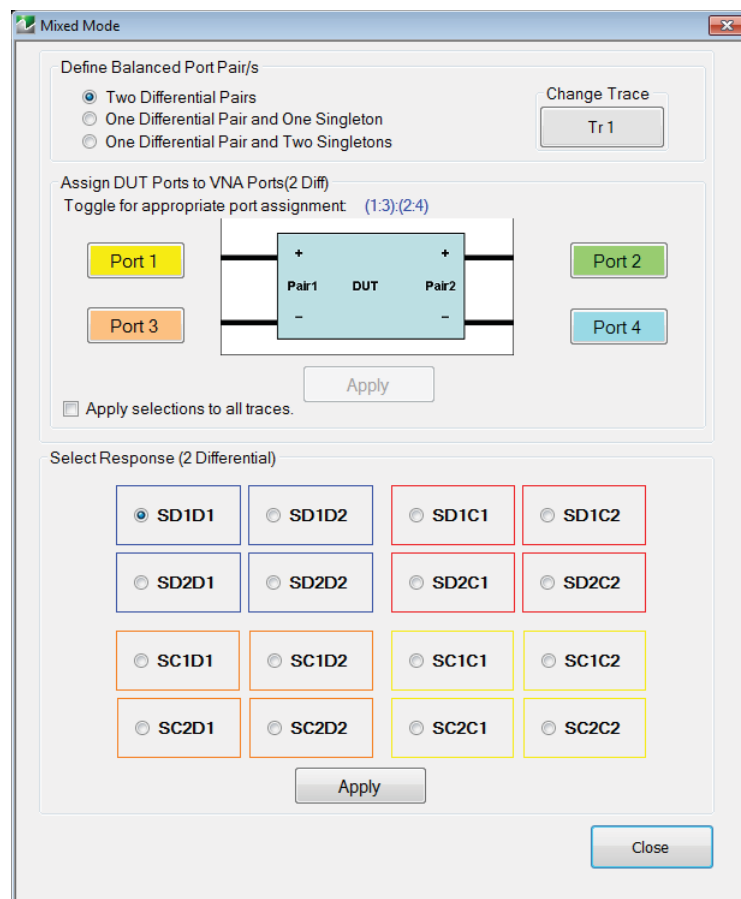

Figure 16-9. MIXED MODE Dialog Box - Two Differential Pairs

Define Balanced Port Pair(s)

Option selected:

- Two Differential Pairs

Change Trace

Change Trace button displays currently active trace number. Select opens the SELECT TRACE dialog box with options for trace selection.

- [“SELECT TRACE Dialog Box - 4-Port VNAs” on page 16-21](#)

Assign DUT Ports to VNA Ports (2 Diff)

For each DUT connection, click the Port button to select the appropriate VNA Port Number. Each port assignment must be unique.

- DUT Port Pair 1
 - Pair 1 (+): Select positive polarity port from VNA Ports 1, 2, 3, or 4
 - Pair 1 (-): Select negative polarity port from VNA Ports 1, 2, 3, or 4
- DUT Port Pair 2:
 - Pair 2 (+): Select positive polarity port from VNA Ports 1, 2, 3, or 4
 - Pair 2 (-): Select negative polarity port from VNA Ports 1, 2, 3, or 4

Apply

Select applies the port assignments, displayed above the DUT Ports/VNA Ports diagram. For example:

- (1:2):(3:4) = First port pair measured from ports 1 to 2: second port pair measured from ports 3 to 4

Apply selections to all traces

Select check box to apply the port pair selections to all traces.

Select Response

Select the required 2-differential response characteristic from the available 16 combinations of pure differential (D) and common-mode (C) parameters. Only one response may be selected:

- Differential Reception with Differential Drive S-Parameters
 - SD1D1 - S-parameter for differential reception at Pair 1 and differential drive at Pair 1.
 - SD1D2 - S-parameter for differential reception at Pair 1 and differential drive at Pair 2
 - SD2D1 - S-parameter for differential reception at Pair 2 and differential drive at Pair 1
 - SD2D2 - S-parameter for differential reception at Pair 2 and differential drive at Pair 2
- Common-Mode Reception with Differential Drive S-Parameters
 - SC1D1 - S-parameter for common-mode reception at Pair 1 and differential drive at Pair 1
 - SC1D2 - S-parameter for common-mode reception at Pair 1 and differential drive at Pair 2
 - SC2D1 - S-parameter for common-mode reception at Pair 2 and differential drive at Pair 1
 - SC2D2 - S-parameter for common-mode reception at Pair 2 and differential drive at Pair 2
- Differential Reception with Common-Mode Drive S-Parameters
 - SD1C1 - S-parameter for differential reception at Pair 1 and common-mode drive at Pair 2
 - SD1C2 - S-parameter for differential reception at Pair 1 and common-mode drive at Pair 2
 - SD2C1 - S-parameter for differential reception at Pair 2 and common-mode drive at Pair 1
 - SD2C2 - S-parameter for differential reception at Pair 2 and common-mode drive at Pair 2
- Common-Mode Reception with Common-Mode Drive S-Parameters
 - SC1C1 - S-parameter for common-mode reception at Pair 1 and common-mode drive at Pair 1
 - SC1C2 - S-parameter for common-mode reception at Pair 1 and common-mode drive at Pair 2
 - SC2C1 - S-parameter for common-mode reception at Pair 2 and common-mode drive at Pair 1
 - SC2C2 - S-parameter for common-mode reception at Pair 2 and common-mode drive at Pair 2

Apply

Select applies the designated response characteristic.

Close

Select closes the dialog box.

MIXED MODE Dialog Box - One Differential Pair - One Singleton - 4-Port VNAs

Prerequisites

- Balanced Port Pair Setting = One Differential Pair and One Singleton

Previous

- [“RESPONSE Menu - 4-Port VNAs” on page 16-2](#)

Navigation

- MAIN | Response | RESPONSE | Mixed Mode | MIXED MODE Dialog Box | One Differential Pair and One Singleton

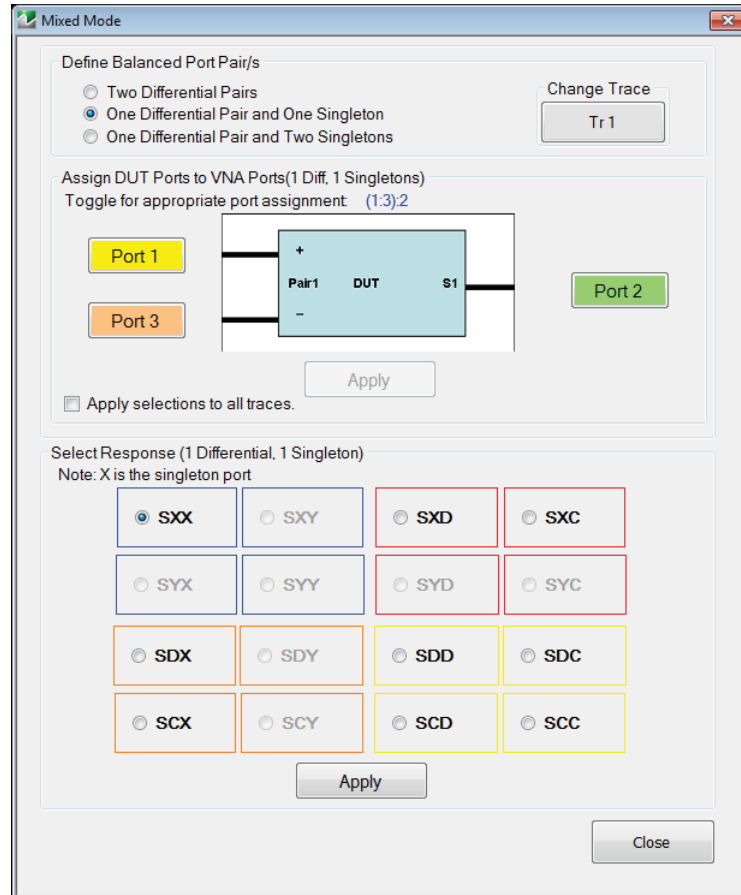

Figure 16-10. MIXED MODE Dialog Box - One Differential Pair and One Singleton - 4-Port VNAs

Define Balanced Port Pair(s)

Option selected:

- One Differential Pair and One Singleton

Change Trace

Change Trace button displays currently active trace number. Select opens the SELECT TRACE dialog box with options for trace selection.

- [“SELECT TRACE Dialog Box - 4-Port VNAs” on page 16-21](#)

Assign DUT Ports to VNA Ports (1 Diff, 1 Singleton)

For each DUT connection, click the **Port** button to select the appropriate VNA Port Number. Each port assignment must be unique.

- DUT Port Pair 1
 - Pair 1 (+): Select positive polarity port from VNA Ports 1, 2, 3, or 4
 - Pair 1 (-): Select negative polarity port from VNA Ports 1, 2, 3, or 4
- DUT S1 Singleton:
 - S1: Select from VNA Ports 1, 2, 3, or 4

Apply

Select applies the port assignments, displayed above the DUT Ports/VNA Ports diagram. For example:

- (1:2):3 = DUT port differential measured from ports 1 to 2: port 3 is the singleton

Apply selections to all traces

Select check box to apply the port pair selections to all traces.

Select Response

Select the required differential or common-mode response characteristic from the available 9 combinations of pure differential (D), common-mode (C), or singleton (X) parameters. Only one response may be selected:

- Reception at Singleton and Drive at Singleton
 - SXX - S-Parameter for singleton reception and singleton drive
- Reception at Singleton and Drive at Pair 1
 - SXD - S-Parameter for singleton reception and differential drive at Pair 1
 - SXC - S-Parameter for singleton reception and common-mode drive at Pair 1
- Reception at Pair 1 and Drive at Singleton
 - SDX - S-Parameter for differential reception at Pair 1 and singleton drive
 - SCX - S-Parameter for common-mode reception at Pair 1 and singleton drive
- Reception at Pair 1 and Drive at Pair 1
 - SDD - S-Parameter for differential reception at the Pair 1 and differential drive at the port pair
 - SDC - S-Parameter for differential reception at Pair 1 and common-mode drive at the port pair
 - SCD - S-Parameter for common-mode reception at Pair 1 and differential drive at the port pair
 - SCC - S-Parameter for common-mode reception at Pair 1 and common-mode drive at the port pair

Apply

Select applies the designated response characteristic.

Close

Select closes the dialog box.

MIXED MODE Dialog Box - One Differential Pair - Two Singletons - 4-Port VNAs

Prerequisites

- Balanced Port Pair Setting = One Differential Pair and Two Singletons

Previous

- [“RESPONSE Menu - 4-Port VNAs” on page 16-2](#)

Navigation

- MAIN | Response | RESPONSE | Mixed Mode | MIXED MODE Dialog Box | One Differential Pair and Two Singletons

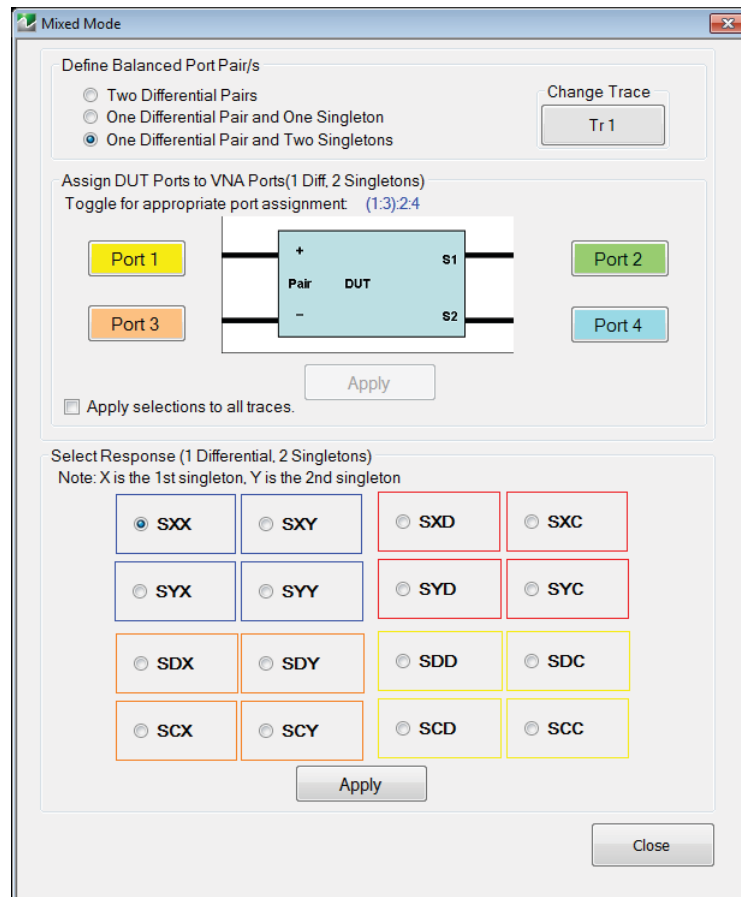

Figure 16-11. MIXED MODE Dialog Box - One Differential Pair and Two Singletons - 4-Port VNAs

Define Balanced Port Pair(s)

Option selected:

- One Differential Pair and Two Singletons

Change Trace

Change Trace button displays currently active trace number. Select opens the SELECT TRACE dialog box with options for trace selection.

- [“SELECT TRACE Dialog Box - 4-Port VNAs” on page 16-21](#)

Assign DUT Ports to VNA Ports (1 Diff, 1 Singleton)

For each DUT connection, click the Port button to assign a unique VNA port number.

- DUT Port Pair 1
 - Pair 1 (+): Select positive polarity port from VNA Ports 1, 2, 3, or 4
 - Pair 1 (-): Select negative polarity port from VNA Ports 1, 2, 3, or 4
- DUT S1 Singleton:
 - S1: Select from VNA Port 1, Port 2, Port 3, or Port 4
- DUT S2 Singleton:
 - S2: Select from VNA Port 1, Port 2, Port 3, or Port 4

Apply

Select applies the port assignments, displayed above the DUT Ports/VNA Ports diagram. For example:

- (1:2):3:4 = DUT port differential measured from ports 1 to 2; ports 3 and 4 are the singletons

Apply selections to all traces

Select check box to apply the port pair selections to all traces.

Select Response

Select the required differential or common-mode response characteristic from the available 16 combinations of pure differential (D), common-mode (C), first singleton (X), or second singleton (Y) parameters. Only one response may be selected:

- Reception at Singleton and Drive at Singleton
 - SXX - S-Parameter for first singleton reception and first singleton drive
 - SXY - S-Parameter for first singleton reception and second singleton drive
 - SYX - S-Parameter for second singleton reception and first singleton drive
 - SYY - S-Parameter for second singleton reception and second singleton drive
- Reception at Singleton and Drive at Pair 1
 - SXD - S-Parameter for first singleton reception and differential drive at Pair 1
 - SXC - S-Parameter for first singleton reception and common-mode drive at Pair 1
 - SYD - S-Parameter for second singleton reception and differential drive at Pair 1
 - SYC - S-Parameter for second singleton reception and common-mode drive at Pair 1
- Reception at Pair 1 and Drive at Singleton
 - SDX - S-Parameter for differential reception at Pair 1 and first singleton drive
 - SDY - S-Parameter for differential reception at Pair 1 and second singleton drive
 - SCX - S-Parameter for common-mode reception at Pair 1 and first singleton drive
 - SCY - S-Parameter for common-mode reception at Pair 1 and second singleton drive
- Reception at Pair 1 and Drive at Pair 1
 - SDD - S-Parameter for differential reception at Pair 1 and differential drive at the port pair.
 - SDC - S-Parameter for differential reception at Pair 1 and common-mode drive at the port pair.
 - SCD - S-Parameter for common-mode reception at Pair 1 and differential drive at the port pair.
 - SCC - S-Parameter for common-mode reception at Pair 1 and common-mode drive at the port pair.

Apply

Select applies the designated response characteristic.

Close

Select closes the dialog box.

SELECT TRACE Dialog Box - 4-Port VNAs

Prerequisites

- One of the three MIXED MODE dialog box configurations must be selected.

Previous

- “MIXED MODE Dialog Box - Two Differential Pairs - 4-Port VNAs” on page 16-15
 - Figure 16-9, “MIXED MODE Dialog Box - Two Differential Pairs” on page 16-15
- “MIXED MODE Dialog Box - One Differential Pair - One Singleton - 4-Port VNAs” on page 16-17
 - Figure 16-10, “MIXED MODE Dialog Box - One Differential Pair and One Singleton - 4-Port VNAs” on page 16-17
- “MIXED MODE Dialog Box - One Differential Pair - Two Singletons - 4-Port VNAs” on page 16-19
 - Figure 16-11, “MIXED MODE Dialog Box - One Differential Pair and Two Singletons - 4-Port VNAs” on page 16-19

Navigation

- MAIN | Response | RESPONSE | Mixed Mode | MIXED MODE Dialog Box | Change Trace | SELECT TRACE Dialog Box



Figure 16-12. SELECT TRACE Dialog Box - For Mixed-Mode Trace Assignment

Choose a trace to update

Select applies current mixed-mode settings to the designated trace, and closes the dialog box.

Chapter 17 — Display Menus

17-1 Chapter Overview

This chapter provides information for setup and configuration for the instrument displays. Selections provide control over the trace formats, with over nine different major display types. Each display type can be further modified with parameters applicable to that display format. The control also provides control for trace memory and trace math modifications. The trace limit functions allow maximum/minimum parameters to be set for each trace and provide visual and/or programmatic indications of pass/fail.

17-2 Overview of Display Menus and Dialog Boxes

The available display menus and dialog boxes are:

- [“DISPLAY Menu” on page 17-2](#)
- [“TRACE FORMAT Menu” on page 17-4](#)
- [“IMPEDANCE Menu” on page 17-6](#)
- [“SMITH IMPEDANCE Menu” on page 17-8](#)
- [“VIEW TRACE Menu” on page 17-10](#)
- [“DATA-MEM. OP. Menu” on page 17-12](#)
- [“EDIT LIMIT LINE Menu” on page 17-14](#)
 - [“LIMIT LINE TYPE SETUP Tableau Dialog” on page 17-16](#)
 - [“SAVE AS \(LIMIT LINE LMT FILE\) Dialog Box” on page 17-20](#)
 - [“OPEN \(LIMIT LINE LMT FILE\) Dialog Box” on page 17-21](#)
- [“DOMAIN Frequency with No Time Gate Menu” on page 17-25](#)
- [“DOMAIN Frequency with Time Gate Menu” on page 17-26](#)
- [“DOMAIN Time Low Pass Menu” on page 17-27](#)
- [“DOMAIN Time Band Pass Menu” on page 17-29](#)
- [“TIME DEFINITION Menu” on page 17-30](#)
- [“RANGE SETUP Frequency with Time Gate Menu” on page 17-33](#)
- [“RANGE SETUP Time Band Pass Menu” on page 17-35](#)
- [“RANGE SETUP Time Low Pass Menu” on page 17-37](#)
- [“DC TERM Menu” on page 17-39](#)
- [“EXTRAPOLATION Menu” on page 17-41](#)
- [“WINDOW SHAPE Menu” on page 17-42](#)
 - [“ADVANCED WINDOW SHAPE SETUP Dialog Box” on page 17-43](#)
- [“GATE SETUP Menu” on page 17-45](#)
- [“GATE FUNCTION Menu” on page 17-47](#)
 - [“ADVANCED GATE SHAPE SETUP Dialog Box” on page 17-49](#)

17-3 Display Main Menu

DISPLAY Menu

Previous

- [“Main Menu” on page 2-2](#)

Navigation

- MAIN | Display | DISPLAY

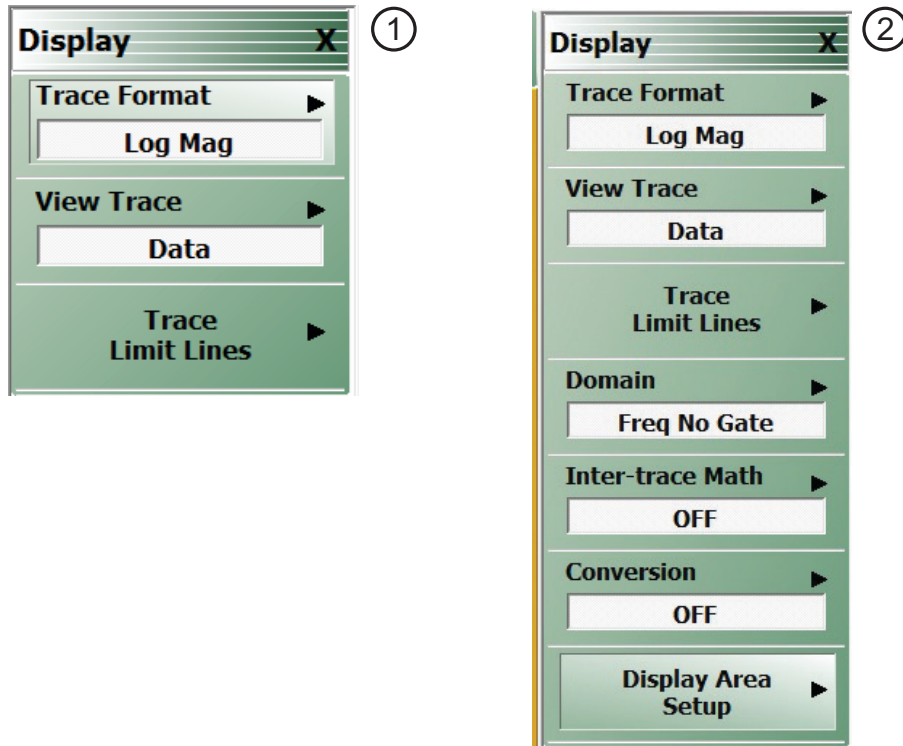

1. DISPLAY menu without Time Domain option.

2. DISPLAY menu with Time Domain option.

Figure 17-1. DISPLAY Menu

Trace Format

Select displays the current trace format setting. Select displays the TRACE FORMAT menu.

- [“TRACE FORMAT Menu” on page 17-4](#)

View Trace

Select displays the VIEW TRACE menu.

- [“VIEW TRACE Menu” on page 17-10](#)

Trace Limit Lines

Select displays the LIMIT menu.

- [“LIMIT Menu” on page 17-13](#)
- [DOMAIN Menu Appearance and Button Availability on page 17-22](#)

Domain

Select displays the DOMAIN menu. The appearance and button availability of the DOMAIN menu depends on settings on other menus.

- [“DOMAIN Menu Appearance and Button Availability” on page 17-22](#)
- [“DOMAIN Frequency with No Time Gate Menu” on page 17-25](#)
- [“DOMAIN Frequency with Time Gate Menu” on page 17-26](#)
- [“DOMAIN Time Low Pass Menu” on page 17-27](#)
- [“DOMAIN Time Band Pass Menu” on page 17-29](#)

Inter-Trace Math

Select displays the INTER-TRACE MATH menu.

- [“INTER-TRACE MATH Menu” on page 17-51](#)

Conversion

Select toggles conversion ON or OFF.

Display Area Setup

Select displays the DISPLAY SETUP menu.

- [“DISPLAY AREA SETUP Menu” on page 17-54](#)

17-4 Trace Format and Parameter Menus

TRACE FORMAT Menu

Active Trace on Active Channel

- The trace format selections below apply only to the currently active trace.

Previous

- [“Main Menu” on page 2-2](#)

Navigation

- MAIN | Display | DISPLAY | Trace Format | TRACE FORMAT

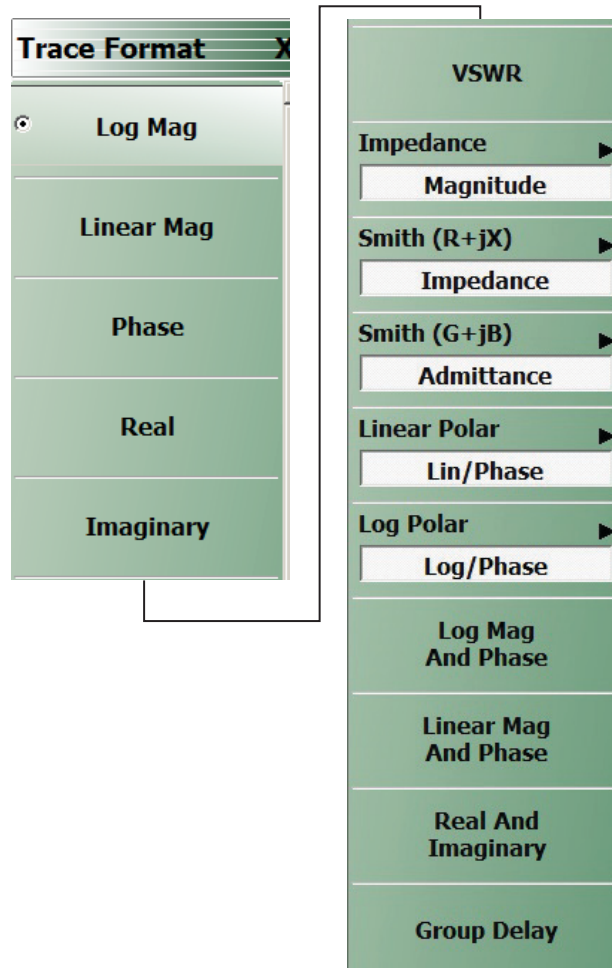

Figure 17-2. TRACE FORMAT Menu

Log Mag

Select sets a single rectilinear display. All other trace display graph types are deselected.

Linear Mag

Select sets a single rectilinear display.

Phase

Select sets a single rectilinear display.

Real

Select sets a single rectilinear display.

Imaginary

Select sets a single rectilinear display.

VSWR

Select sets a single rectilinear display.

Impedance

Select displays the Impedance submenu.

- [“IMPEDANCE Menu” on page 17-6](#)

Smith (R+jX)

Select displays the SMITH (with Impedance) submenu to configure the display of Smith Impedance charts.

- [“SMITH IMPEDANCE Menu” on page 17-8](#)

Smith (G+jB)

Select displays the SMITH (with Admittance) submenu to configure the display of Smith Impedance charts.

- [“SMITH IMPEDANCE Menu” on page 17-8](#)

Linear Polar

Select sets a linear polar display.

Log Polar

Select sets a logarithmic polar display.

Log Mag And Phase

Selects sets a dual Refl Log Mag and Phase Ref Level display.

Linear Mag And Phase

Select sets a dual Refl Linear Mag and Phase Ref Level display.

Real And Imaginary

Select sets a dual Refl Real and Imaginary Ref Level display.

Group Delay

Selects sets a single group delay display. Group Delay not applicable to the MS46121A.

IMPEDANCE Menu

Previous

- “TRACE FORMAT Menu” on page 17-4

Navigation

- MAIN | Display | DISPLAY | Trace Format | TRACE FORMAT | Impedance | IMPEDANCE

Auto-Return Button Selection Group

- The first four (4) buttons (Real, Imaginary, Magnitude, and Real & Imaginary) on the IMPEDANCE menu are configured as a button selection group with an auto-return function, where selection of any one button de-selects the other three (3) buttons, and then auto-returns to the TRACE FORMAT menu.

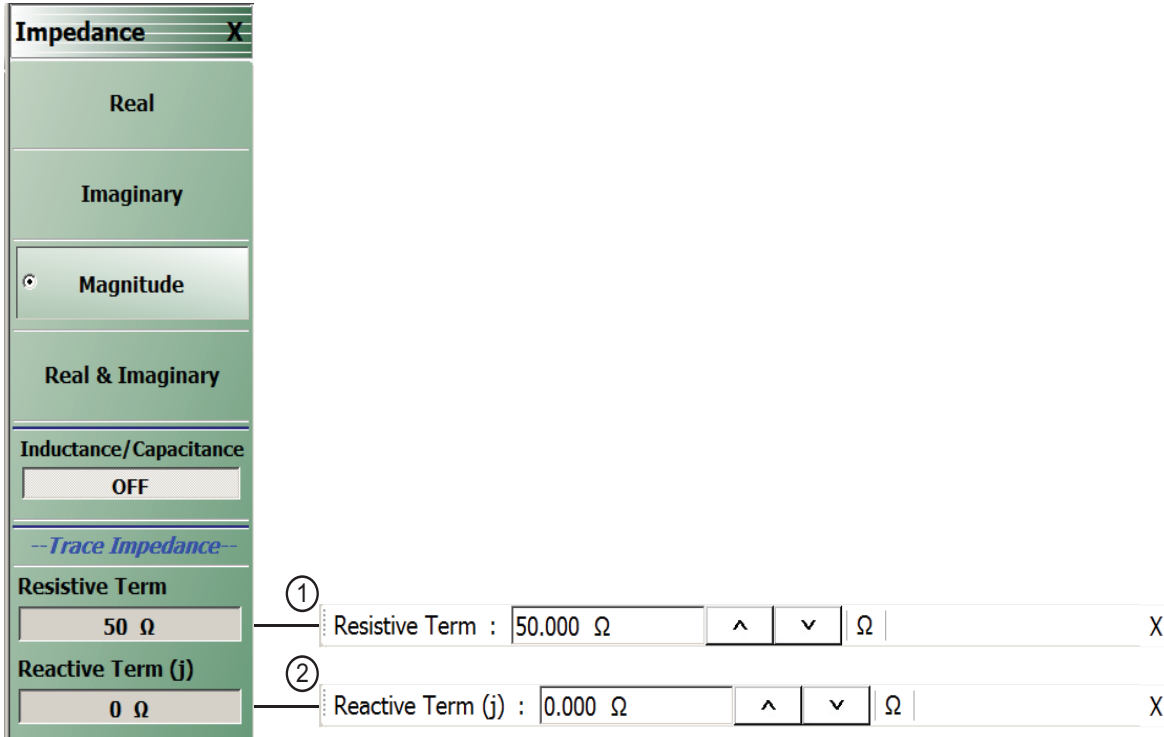

1. Resistive Term Field Toolbar in Ohms.

2. Reactive (j) Term Field Toolbar in Ohms.

Figure 17-3. IMPEDANCE Menu

Real

Select sets a rectilinear display, and de-selects Imaginary, Magnitude, and Real & Imaginary and auto-returns to TRACE FORMAT menu.

Imaginary

Select sets a rectilinear display, and de-selects Real, Magnitude, and Real & Imaginary and auto-returns to TRACE FORMAT menu.

Magnitude

Select sets a rectilinear display, and de-selects Real, Imaginary, and Real & Imaginary and auto-returns to TRACE FORMAT menu.

Real & Imaginary

Select sets a dual rectilinear display with Real data in the upper graph and Imaginary data in the lower graph. Select also de-selects Real, Imaginary, and Magnitude and auto-returns to TRACE FORMAT menu.

Inductance/Capacitance

Select enables marker Inductance or Capacitance measurement readout.

Resistive Term

Select allows the user to enter the trace impedance in Ohms and displays the **Resistive Term** toolbar. Use the toolbar to enter the required impedance for the currently active trace. The default value is 50.000 Ohms.

Reactive (j)

Select allows the user to enter trace reactive term in Ohms and displays the **Reactive (j)** toolbar.

SMITH IMPEDANCE Menu

Previous

- [“TRACE FORMAT Menu” on page 17-4](#)

Navigation

- MAIN | Display | DISPLAY | Trace Format | TRACE FORMAT | Smith (R+jX) | SMITH (IMPEDANCE)

Scaling

- Once the Smith Impedance display is selected, the scale of the display can be adjusted by using the SCALE menu.
- [“SCALE Smith Chart Impedance Menu” on page 18-12](#)
- MAIN | Scale | SCALE | Scale Selection | SMITH SCALING

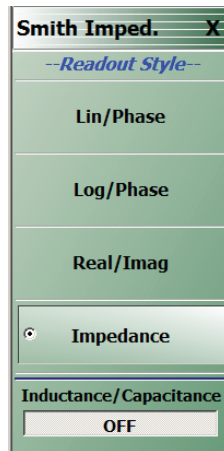

Figure 17-4. SMITH (IMPEDANCE) Menu

Lin/Phase

Select creates a Smith Chart (Impedance) that plots with linear values and phase.

Log/Phase

Select creates a Smith Chart (Impedance) that plots with log values and phase.

Real/Imag

Select creates a Smith Chart (Impedance) that plots with real and imaginary values.

Impedance

Select creates a Smith Chart (Impedance) that plots only impedance.

Inductance/Capacitance

Select enables marker Inductance or Capacitance measurement readout

SMITH ADMITTANCE Menu

Previous

- “TRACE FORMAT Menu” on page 17-4

Navigation

- MAIN | Display | DISPLAY | Trace Format | TRACE FORMAT | Smith (G+jB) | SMITH (ADMITTANCE)

Scaling

- Once the Smith Admittance display is selected, the scale of the display can be adjusted by using the SCALE menu.
- “SCALE Smith Chart Impedance Menu” on page 18-12
- MAIN | Scale | SCALE | Scale Selection | SMITH SCALING

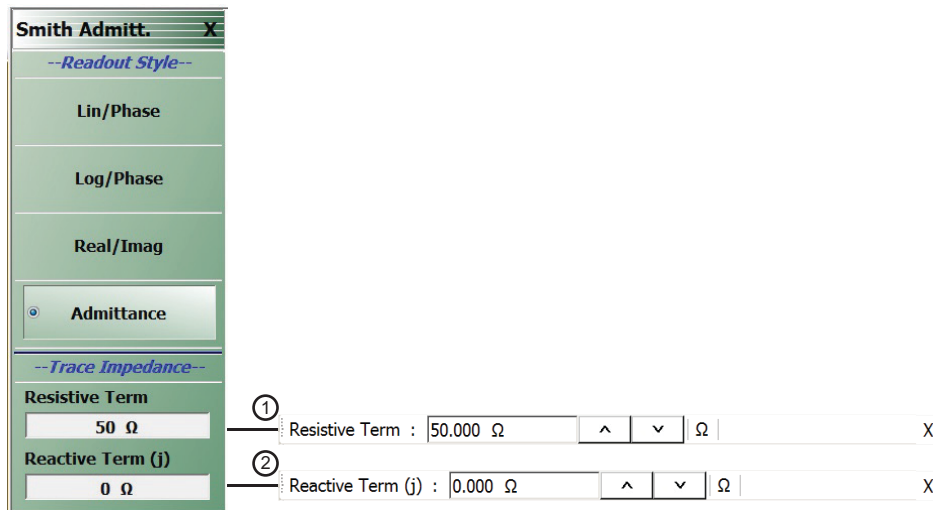

Figure 17-5. SMITH (ADMITTANCE) Menu

Lin/Phase

Select creates a Smith Chart (Admittance) that plots with linear values and phase.

Log/Phase

Select creates a Smith Chart (Admittance) that plots with log values and phase.

Real/Imag

Select creates a Smith Chart (Admittance) that plots with real and imaginary values.

Admittance

Select creates a Smith Chart (Admittance) that plots only admittance.

Resistive Term

Select allows the user to enter the trace impedance in Ohms and displays the Resistive Term toolbar. Use the toolbar to enter the required impedance for the currently active trace. The default value is 50.000 Ohms.

Reactive (j)

Select allows the user to enter trace reactive term in Ohms and displays the Reactive (j) toolbar.

VIEW TRACE Menu

Previous

- “TRACE FORMAT Menu” on page 17-4

Navigation

- MAIN | Display | DISPLAY | View Trace | VIEW TRACE

Button Availability

- If trace data has not previously been stored to memory, only the Data, Off, Store Data to Memory, and Data Mem Op buttons (all described below) are available as shown left side of Figure 17-6 below.
- The Memory, Data & Memory, and Data, Memory Math buttons are unavailable.
- After one or more sweeps, select the Store Data to Memory button to enable the Memory, Data & Memory, Data Memory Math buttons.

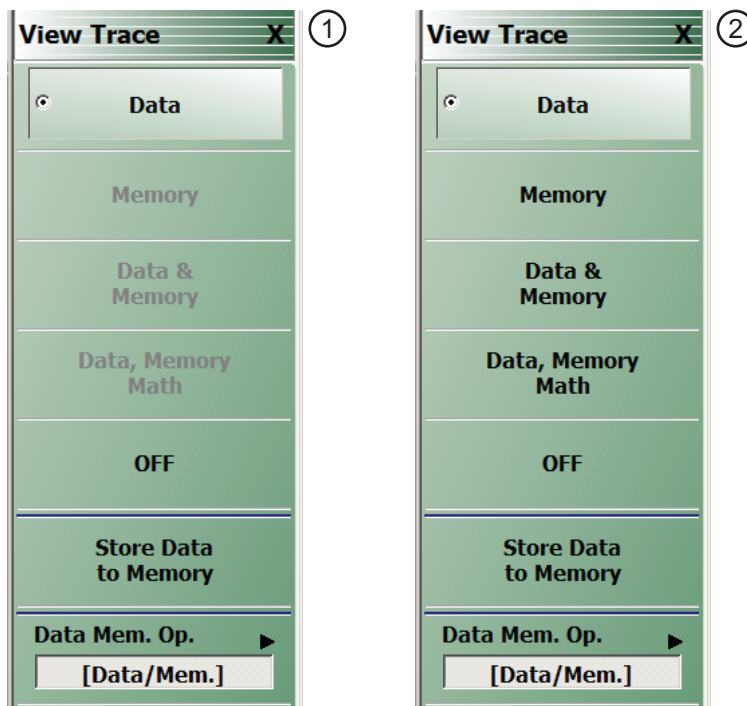

1. VIEW TRACE menu button availability with no data stored to memory.

2. VIEW TRACE menu after one or more sweeps and Store Data to Memory has been selected.

Figure 17-6. VIEW TRACE Menu

View Trace Button Availability

If trace data has not previously been stored to memory, only the Data, Off, Store Data to Memory, and Data Mem Op buttons are available.

Data

The button is available but has no function until data has been stored as described below.

OFF (View Trace)

If OFF (View Trace) is selected, the active trace on the active channel is removed from the trace graph display.

Store Data to Memory

Select causes data to be stored to memory.

Data Mem. Op.

Select displays the Data Mem Op menu.

- [“DATA-MEM. OP. Menu” on page 17-12](#)

After one or more sweeps, select the Store Data to Memory button to enable the Memory, Data & Memory, Data Memory Math buttons described below.

View Trace Menu Buttons

The Data, Memory, Data and Memory, Data, Memory Math, and OFF buttons become available when data has been saved to memory.

Data

Select records data to memory where it can be stored or further manipulated. The Store Data MemMath to Memory button (below) is unavailable.

Memory

Memory recalls data from memory where it is displayed or further manipulated. The Store Data MemMath to Memory button (below) is unavailable.

Data & Memory

Data & Memory recalls data and uses the active memory for display and/or further manipulation. The Store Data MemMath to Memory button (below) is unavailable.

Data Memory Math

The Data Memory Math button enabled the Store Data MemMath to Memory button (below) is available where the selected math operation is applied to the stored data.

OFF (View Trace)

If OFF (View Trace) is selected, the active trace on the active channel is removed from the trace graph display. The Store Data MemMath to Memory button (below) is unavailable.

Store Data to Memory

Select causes data to be stored to memory.

Data Mem. Op.

Select displays the Data Mem Op menu.

- [“DATA-MEM. OP. Menu” on page 17-12](#)

DATA-MEM. OP. Menu

Full Name

- DATA-MEMORY OPERATIONS Setup Menu

Previous

- [“VIEW TRACE Menu” on page 17-10](#)

Navigation

- MAIN | Display | DISPLAY | View Trace | VIEW TRACE | Data Mem Op | DATA MEM OP

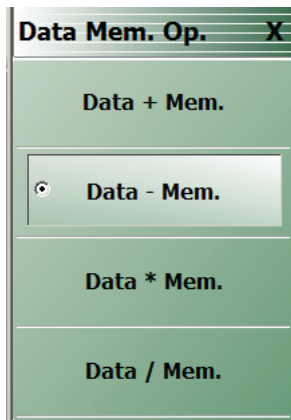

Figure 17-7. DATA-MEM. OP. (DATA-MEMORY OPERATIONS) Menu

Data + Mem.

Select adds data value to the memory value.

Data – Mem.

Select subtracts memory value from the data value.

Data * Mem.

Select multiplies data value times the memory value.

Data / Mem.

Select divides data value by the memory value.

17-5 Trace Limit Line Control Menus and Dialog Boxes

LIMIT Menu

Previous

- [“DISPLAY Menu” on page 17-2](#)

Navigation

- MAIN | Display | DISPLAY | Trace Limit Lines | LIMIT

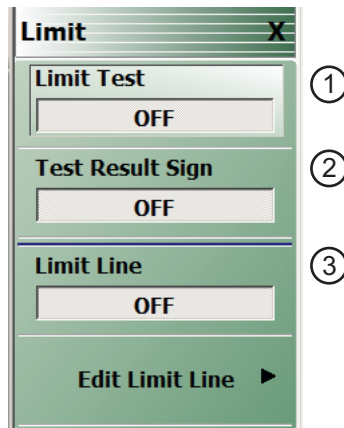

1. Limit Test Toggle Button – Toggles limit tests ON or OFF.
2. Limit Test Results Sign Button – Toggles limit test results as screen message as shown in #5 ON and OFF.
3. Limit Line Toggle Button – Toggles existing limit lines ON or OFF.

Figure 17-8. LIMIT Menu

Limit Test

On a per-system basis, select toggles Limit Test on and off.

Test Result Sign

On a per-system basis, toggles the Test Result Sign on and off. If the Test Result Sign is enabled, a failed test icon appears. If the Test Result Sign is enabled, a passed test icon appears.

Limit Line

On a per-trace basis, toggles Limit Lines off and on.

Edit Limit Line

On a per-trace basis, displays the Edit Limit Line menu.

- [“EDIT LIMIT LINE Menu” on page 17-14](#)

EDIT LIMIT LINE Menu

When this menu is selected, the bottom of the display moves up and the [“LIMIT LINE TYPE SETUP Tableau Dialog”](#) is displayed. The number of limit lines that can be added depend on the type of display:

- Single rectangular trace displays can have up to 50 limit line segments per trace.
- Dual rectangular trace displays can have up to 50 limit line segments where each segment is the same on both trace displays.

Previous

- [“LIMIT Menu” on page 17-13](#)

Navigation

- MAIN | Display | DISPLAY | Trace Limit Lines | LIMIT | Edit Limit Line | EDIT LIMIT LINE

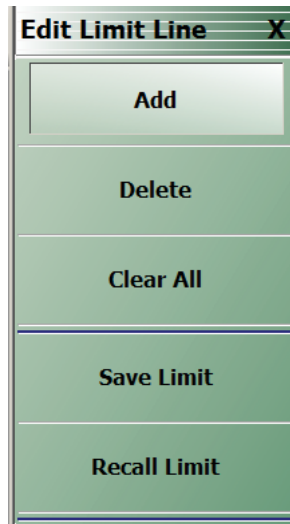

Figure 17-9. EDIT LIMIT LINE Menu

EDIT LIMIT LINE Menu Button Availability

The EDIT LIMIT LINE menu buttons are available to all rectangular displays.

Rectangular displays can have up to 50 limit line segments per trace.

Add

Select adds a new row of limit line information to the [“LIMIT LINE TYPE SETUP Tableau Dialog”](#) at the bottom of the display. For example, if four (4) limit lines are displayed, selecting **Add** creates a new limit line at position five (5).

- [“LIMIT LINE TYPE SETUP Tableau Dialog” on page 17-16](#)

Delete

After selecting a limit line row in the EDIT LIMIT LINE TABLEAU dialog, selecting the **Delete** button removes the limit line.

- [“LIMIT LINE TYPE SETUP Tableau Dialog” on page 17-16](#)

Clear All

Select deletes all recorded limit lint rows in the EDIT LIMIT LINE TABLEAU dialog.

- [“LIMIT LINE TYPE SETUP Tableau Dialog” on page 17-16](#)

Save Limit

Select displays the SAVE AS (LIMIT LINE LMT FILE) dialog box.

- [“SAVE AS \(LIMIT LINE LMT FILE\) Dialog Box” on page 17-20](#)

Recall Limit

Select displays the OPEN (LIMIT LINE LMT FILE) dialog box.

- [“OPEN \(LIMIT LINE LMT FILE\) Dialog Box” on page 17-21](#)

LIMIT LINE TYPE SETUP Tableau Dialog

When the EDIT LIMIT LINE menu is selected, the “LIMIT LINE TYPE SETUP Tableau Dialog” appears at the bottom of the display allowing creation of limit lines for each trace display. Both upper- and lower-segmented limits can be created by using the buttons in the EDIT LIMIT LINE menu and the segment controls in the tableau dialog.

Previous

- “EDIT LIMIT LINE Menu” on page 17-14

Navigation

- MAIN | Display | DISPLAY | Trace Limit Lines | LIMIT | Edit Limit Line | EDIT LIMIT LINE

Limit Line Parameters

The following eight parameters are used to define each limit line:

- Limit line segment number
- Limit line type. Each segment can be defined as an Upper limit, a Lower limit, or turned off.
- X1 = The X-axis segment start frequency.
- X2 = The X-axis segment stop frequency.
- Y1 = The Y-axis starting constraint for the segment. The units for Y1 change depending on the trace display type. For example, if the display is set Log Magnitude, the Y1 units are in dB. If the display is set to Power Out, the Y1 units are in dBm.
- Y2 = The Y-axis stopping constraint for the segment. As above, the Y2 units change depending on the trace display type.
- X Offset = The offset from the X1 value. This is useful if copying existing limit line segments where an incremental offset can be applied to a fundamental X1 value. Any offset is applied to both the X1 and X2 values.
- Y Offset = The offset from the Y1 value. As above, the offset is applied to both the Y1 and Y2 values.

Adding the First Limit Line

Assuming that no limit lines have been added during the current session, the dialog area appears as just a title bar. If unwanted limit lines from a previous configuration appear, on the EDIT LIMIT LINE menu, click the Clear All button.

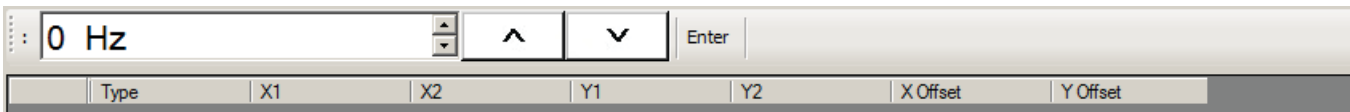

Adding a Limit Line Row

On the EDIT LIMIT LINE menu, click Add. A default limit line appears in the tableau at row 1.

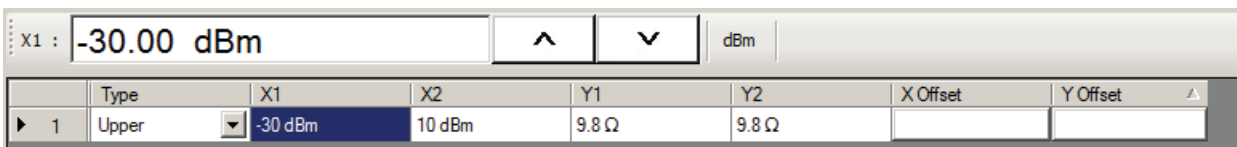

Type Selection Field

In the Type field, click the down button icon to select whether the limit will be an Upper or Lower limit line or if it will be OFF.

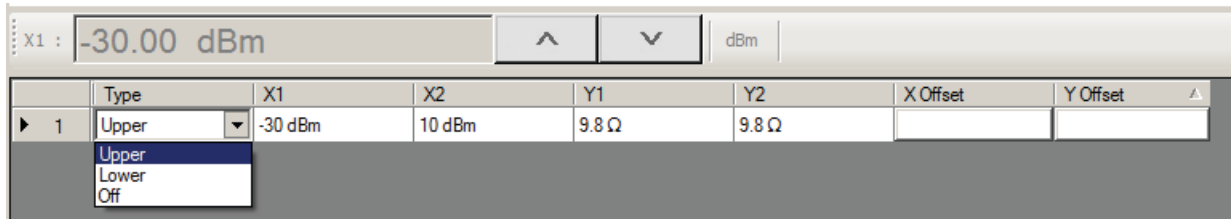

The OFF function is useful if you use a saved limit line file and want to temporarily disable some limits.

X1 Field

In X1 column, click the X1 field which constrains the start point for the X-axis segment. Usually this will be frequency for linear, log, or segmented frequency-based sweeps. Alternatively, the units can be time (time domain) or power (CW power sweeps).

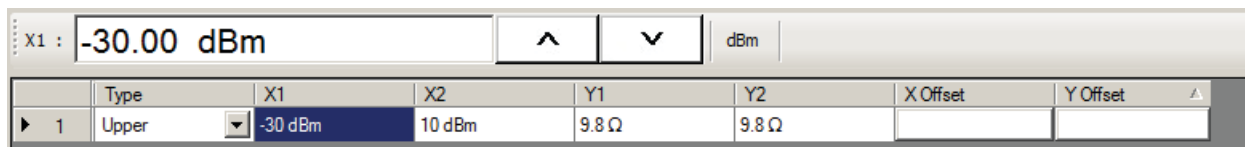

X1 Field Toolbar

As shown above, the X1 field toolbar appears immediately above the tableau header row. If the units are frequency, enter the required X1 frequency, using the field toolbar buttons to select the required units of GHz, MHz, kHz, or Hz. If the units are time or power, the general operation is the same.

X2 Field

In the X2 column, click the X2 field which constrains the end point for the X-axis segment. As above, the X2 field toolbar appears immediately above the tableau header row with units of frequency, time, or power.

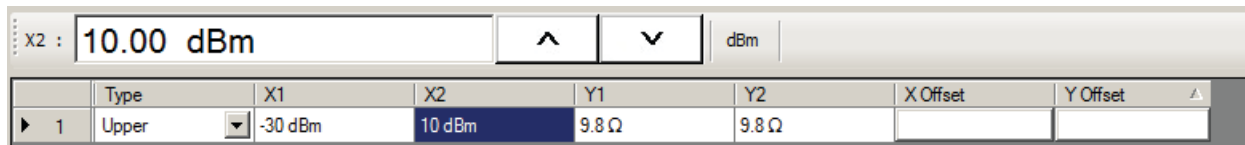

X2 Field Toolbar

As shown above, use the toolbar to enter the required X2 value and units.

Y1 Field

The Y1 and Y2 fields constrain the limit segment in the trace display Y-axis. The units used will match those of the selected trace display. In the Y1 column, click the Y1 field. The Y1 field toolbar appears immediately above the header row.

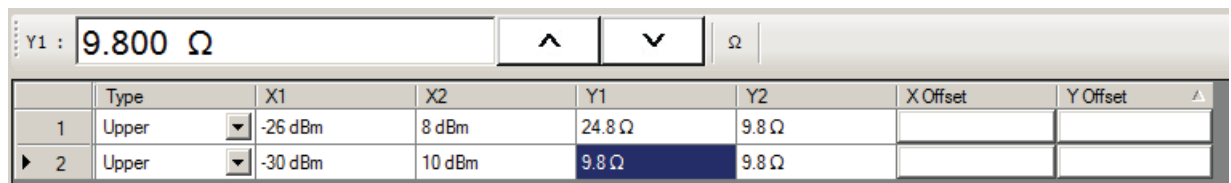

Y1 Field Toolbar

As shown above, use the toolbar to enter the Y1 value and units.

Y2 Field

In the Y2 column, click the Y2 field. As above in the Y1 field, the Y2 field toolbar appears immediately above the header row.

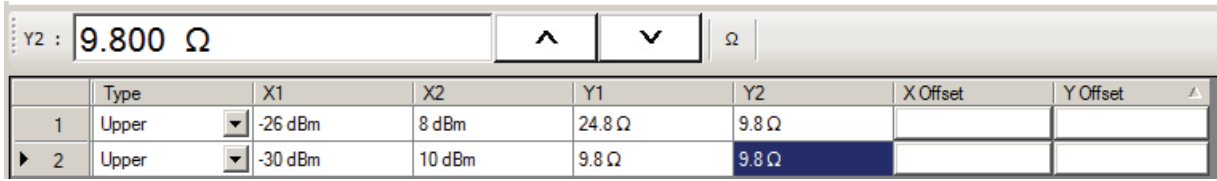

Y2 Field Toolbar

As shown above, use the field toolbar to enter the required Y2 value and units.

X Offset Button

On a per-row basis, the X Offset and Y Offset buttons allow the user to offset indices by a constant amount. This is useful for copying multiple rows and incrementing by a fixed frequency offset. In the X Offset column, click the X Offset button for the appropriate row. The X Offset field toolbar appears immediately above the tableau header row. Use the toolbar to enter the required value and units. When the units button is selected, the offset is applied to the X1 and X2 values. In the example in row 2 below, a lower limit line has already been established for X1 = 2.0 GHz and X2 = 2.99 GHz. To offset these by the same amount, select row 2, and then click the X Offset button. In the example, the offset required is -0.5 GHz. With row 2 selected, click the X Offset button and the X Offset field toolbar appears. Enter the required value and units.

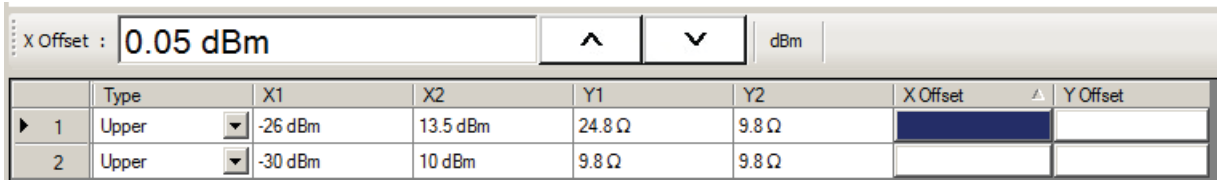

X Offset Field Toolbar

As shown above, use the field toolbar to enter the required X Offset value and units.

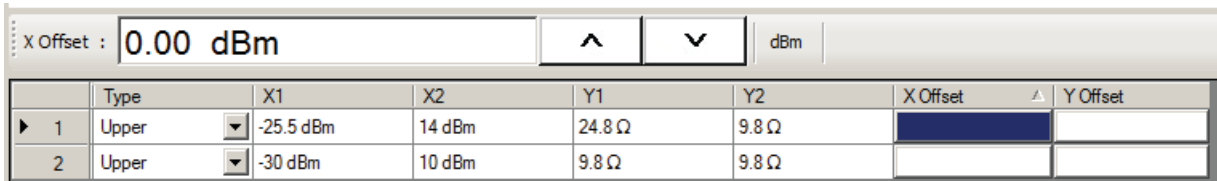

Y Offset Button

The Y Offset button and field toolbar function the same as the X Offset button described above. Under the Y Offset column heading, click the Y Offset button. The Y Offset field toolbar appears immediately above the tableau header row.

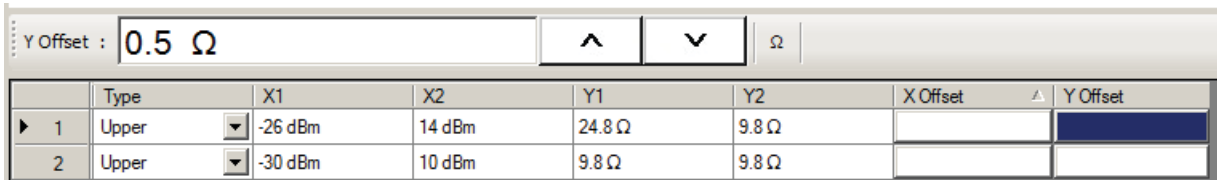

Y Offset Field Toolbar

As shown above, use the field toolbar to enter the required Y Offset value and units. Once the units button has been selected, the Y1 and Y2 fields for row 1 are changed as shown below.

Y Offset :		0.000 Ω		^	v	Ω	
	Type	X1	X2	Y1	Y2	X Offset	Y Offset
▶ 1	Upper	-26 dBm	14 dBm	25.3 Ω	10.3 Ω		
2	Upper	-30 dBm	10 dBm	9.8 Ω	9.8 Ω		

Adding a Limit Line Row

To add more rows to the bottom of the “LIMIT LINE TYPE SETUP Tableau Dialog” area, use the Add button on the EDIT LIMIT LINE menu and then complete the X1, X2, Y1, Y2, and offset parameters as described above.

If no rows are present, Add creates a new row 1 at the top of the tableau using the trace settings for X1 start and X2 stop values.

- If one or more rows are present, the Add button places each new row at the bottom of the tableau.
- If no rows are present or the field of an existing row is selected, the Insert does not function.
- If one or more rows are present and the entire row is selected by selecting the row number, Insert adds a row at the cursor position and pushes the current row and all those below down.

Deleting a Limit Line

To delete a limit line, select it as above, and then on the EDIT LIMIT LINE menu, select the Delete button on the EDIT LIMIT LINE menu. In the example below, row 1 is selected and ready to be deleted.

X1 :		-30.00 dBm		^	v	dBm	
	Type	X1	X2	Y1	Y2	X Offset	Y Offset
1	Upper	-26 dBm	14 dBm	25.3 Ω	10.3 Ω		
▶ 2	Upper	-30 dBm	10 dBm	9.8 Ω	9.8 Ω		
3	Upper	-30 dBm	10 dBm	9.8 Ω	9.8 Ω		

After the Delete button is selected, the row is removed and all rows below move up as shown below.

X1 :		-26.00 dBm		^	v	dBm	
	Type	X1	X2	Y1	Y2	X Offset	Y Offset
▶ 1	Upper	-26 dBm	14 dBm	25.3 Ω	10.3 Ω		
2	Upper	-30 dBm	10 dBm	9.8 Ω	9.8 Ω		

SAVE AS (LIMIT LINE LMT FILE) Dialog Box

Previous

- [“EDIT LIMIT LINE Menu” on page 17-14](#)

Navigation

- MAIN | Display | DISPLAY | Trace Limit Lines | LIMIT | Edit Limit Line | EDIT LIMIT LINE | Save Limit | SAVE AS (LIMIT LINE LMT FILE) Dialog Box

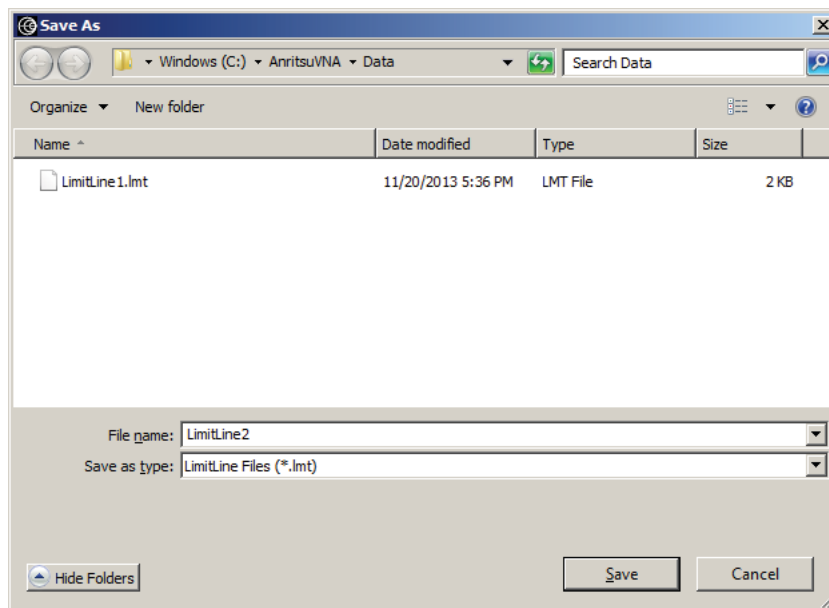

Figure 17-10. SAVE AS (LIMIT LINE LMT FILE) Dialog Box

Instructions

Use the **Save As** dialog box to save the limit line settings as a Limit Line (LMT) file.

OPEN (LIMIT LINE LMT FILE) Dialog Box

Previous

- [“EDIT LIMIT LINE Menu” on page 17-14](#)

Navigation

- MAIN | Display | DISPLAY | Trace Limit Lines | LIMIT | Edit Limit Line | EDIT LIMIT LINE | Recall Limit | OPEN (LIMIT LINE LMT FILE) Dialog Box

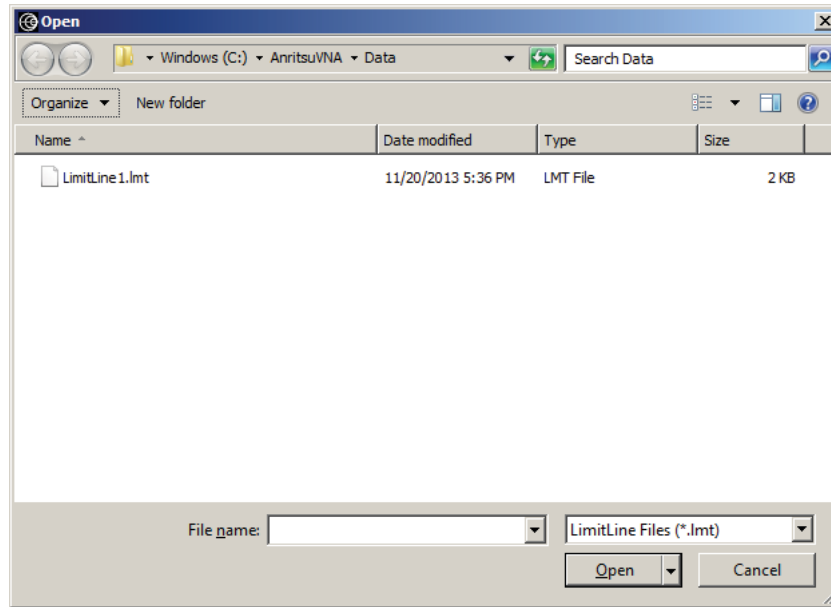

Figure 17-11. OPEN (LIMIT LINE LMT FILE) Dialog Box

Instructions

Select the required LMT file and then click Open.

17-6 DOMAIN Menu Appearance and Button Availability

The presence and availability of the DOMAIN menu buttons depends on whether or not the Time Domain option (-002) is installed on the VNA. The selections on the SWEEP TYPE and FREQUENCY menus also affect the DOMAIN menu display. Use the descriptions below to determine which menu is currently present and then use the link to navigate to the correct menu description. The Domain menu is not available when using the MS46121A. All domain menu features must be accessed through the Time Domain Menu.

DOMAIN Menu Button Selection Group

The top four (4) buttons on the DOMAIN menu form a button selection group where the selection of one (1) button de-selects the other three (3) buttons.

- Frequency, with No Time Gate
- Frequency, with Time Gate
- Time, Low Pass
- Time, Band Pass

DOMAIN Menu Variants

Each DOMAIN menu variant is shown in the sections below.

- Time Domain, Frequency with No Time Gate
- Time Domain, Frequency with Time Gate
- Time Domain, Time Gate Low Pass
- Time Domain, Time Gate Band Pass

DOMAIN Frequency with No Time Gate Menu

The DOMAIN Frequency with No Time Gate menu has only the Frequency with No Time Gate button available. No other menu options are available.

Menu Description

- [“DOMAIN Frequency with No Time Gate Menu” on page 17-25](#)

Prerequisites

- SWEEP TYPES = Power (CW Freq).
- [“SWEEP TYPES Menu” on page 7-5](#)
- MAIN | Sweep Setup | SWEEP SETUP | Sweep Types | SWEEP TYPES | Power (CW Freq)

DOMAIN Frequency with Time Gate

The DOMAIN Frequency with Time Gate menu has the Frequency with Time Gate button available.

Menu Description

- [“DOMAIN Frequency with Time Gate Menu” on page 17-26](#)

Prerequisites

- SWEEP TYPES = Freq Sweep (Linear) or Segmented Sweep (Freq-based)
- [“SWEEP TYPES Menu” on page 7-5](#)
- MAIN | Sweep Setup | SWEEP SETUP | Sweep Types | SWEEP TYPES | Freq Sweep (Linear)
- MAIN | Sweep Setup | SWEEP SETUP | Sweep Types | SWEEP TYPES | Segmented Sweep (Freq-based)

DOMAIN Time Gate Low Pass Menu

The DOMAIN Time Gate Low Pass menu and the Time, Low Pass button is only available as a selection under certain conditions when a harmonic sweep condition is established. Sweep must be set to a frequency-based sweep: Frequency Sweep (Linear) or Segmented sweep (Frequency-based).

Menu Unavailable

- The Time, Low Pass button is unavailable if:
 - A power-based sweep of Power Sweep (CW Frequency) is set.
 - A Segmented Sweep (Index-Based) is set.

Menu Description

- [“DOMAIN Time Low Pass Menu” on page 17-27](#)

Prerequisites

- SWEEP TYPES Menu = Freq Sweep (Linear) or Segmented Sweep (Freq-based)
 - [“SWEEP TYPES Menu” on page 7-5](#)
 - MAIN | Sweep Setup | SWEEP SETUP | Sweep Types | SWEEP TYPES | Freq Sweep (Linear)
 - MAIN | Sweep Setup | SWEEP SETUP | Sweep Types | SWEEP TYPES | Segmented Sweep (Freq-based)
- For example, at the FREQUENCY menu, set the following:
 - Start point of 1 GHz
 - Stop point of 10 GHz
 - # of Points set to 10
 - The Time, Low Pass button available.
 - [“FREQUENCY Menu for Frequency-Based Segmented Sweep Mode” on page 4-5](#)
 - MAIN | Frequency | FREQUENCY

DOMAIN Time Gate Band Pass Menu

The DOMAIN Time Gate Band Pass menu and the Time, Band Pass button is only available as a selection when a frequency-based sweep: Frequency Sweep (Linear) or Segmented sweep (Frequency-based).

Menu Unavailable

- The Time, Band Pass button is unavailable if:
 - A power-based sweep of Power Sweep (CW Frequency) is set.
 - A Segmented Sweep (Index-Based) is set.

Menu Description

- [“DOMAIN Time Band Pass Menu” on page 17-29](#)

Prerequisites

- SWEEP TYPES Menu = Freq Sweep (Linear), or Segmented Sweep (Freq-based)
 - [“SWEEP TYPES Menu” on page 7-5](#)
 - MAIN | Sweep Setup | SWEEP SETUP | Sweep Types | SWEEP TYPES

DOMAIN Frequency with No Time Gate Menu

Menu Identification and Variants

- The appearance and button availability of the DOMAIN menu depends on settings on the SWEEP menu.
- Consult the section above for menu identification and prerequisites.
- [“DOMAIN Menu Appearance and Button Availability” on page 17-22](#)

Previous

- [“DISPLAY Menu” on page 17-2](#)

Navigation

- MAIN | Display | DISPLAY | Domain | DOMAIN Frequency with No Time Gate

 <p>The screenshot shows a menu titled 'Domain' with a close button 'X'. The menu items are: 'Frequency, with No Time Gate' (selected with a radio button), 'Frequency, with Time Gate', 'Time, Low Pass', 'Time, Band Pass', 'Display Unit' (with a dropdown showing 'Time'), 'Time Definition' (with a dropdown showing 'Auto'), 'Range Setup', and 'Gate Setup'.</p>	<h3>Frequency, with No Time Gate</h3> <p>If the Frequency, with No Time Gate button is selected:</p> <ul style="list-style-type: none"> • The following time domain options are deselected and unavailable: <ul style="list-style-type: none"> • Frequency, with Time Gate • Time, Low Pass • Time, Band Pass • No other menu buttons are available.
---	--

Figure 17-12. DOMAIN Frequency with No Time Gate Menu

DOMAIN Frequency with Time Gate Menu

Menu Identification and Variants

- The appearance and button availability of the DOMAIN menu depends on settings on the SWEEP menu.
- Consult the section above for menu identification and prerequisites.
- [“DOMAIN Menu Appearance and Button Availability” on page 17-22](#)

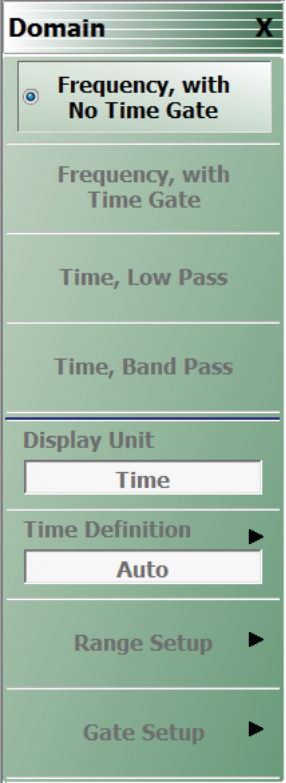
Previous

- [“DISPLAY Menu” on page 17-2](#)

Navigation

- MAIN | Display | DISPLAY | Domain | DOMAIN

	<h3>Frequency with Time Gate</h3> <p>If the Frequency, with Time Gate button is selected:</p> <ul style="list-style-type: none"> • The following time domain options are deselected and unavailable: <ul style="list-style-type: none"> • Frequency, with No Time Gate • Time, Low Pass • Time, Band Pass • The following time domain options are available below: <ul style="list-style-type: none"> • The Display Unit, Time Definition, Range Setup, and Gate Setup buttons are available. <h3>Display Unit</h3> <p>This button is available if the Frequency, with Time Gate button (above) has been selected. Select toggles the display units between time and distance.</p> <h3>Time Definition</h3> <p>This button is available if the Frequency, with Time Gate button (above) has been selected. Select displays the TIME DEFINITION menu.</p> <ul style="list-style-type: none"> • “TIME DEFINITION Menu” on page 17-30 <h3>Range Setup</h3> <p>This button is available if the Frequency, with Time Gate button (above) has been selected. Select displays the RANGE SETUP menu.</p> <ul style="list-style-type: none"> • “RANGE SETUP Frequency with Time Gate Menu” on page 17-33 <h3>Gate Setup</h3> <p>This button is available if the Frequency, with Time Gate button (above) has been selected. Select displays the GATE SETUP menu.</p> <ul style="list-style-type: none"> • “GATE SETUP Menu” on page 17-45
---	---

Figure 17-13. DOMAIN Frequency with Time Gate Menu

DOMAIN Time Low Pass Menu

The appearance and button availability of the DOMAIN menu depends on settings on the SWEEP and FREQUENCY menus. Consult the section above at [“DOMAIN Menu Appearance and Button Availability” on page 17-22](#) for menu identification and prerequisites.

Prerequisites

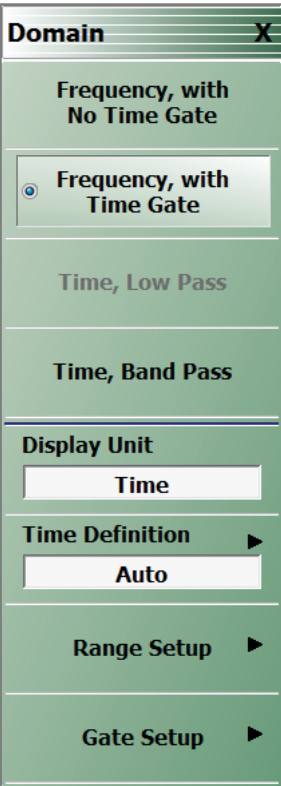
- The Time, Low Pass button is only available as a selection under certain conditions when a harmonic sweep condition is established.
- For example, at the FREQUENCY menu, a Start point of 1 GHz, a Stop point of 10 GHz, and the # of Points set to 10 makes the Time, Low Pass button available.
 - [“FREQUENCY Menu for Frequency-Based Segmented Sweep Mode” on page 4-5](#)
 - MAIN | Frequency | FREQUENCY

Previous

- [“DISPLAY Menu” on page 17-2](#)

Navigation

- MAIN | Display | DISPLAY | Domain | DOMAIN Time Low Pass

	<p>Time, Low Pass</p> <p>If the Time, Low Pass button is selected:</p> <ul style="list-style-type: none"> • The following time domain options are deselected and unavailable: <ul style="list-style-type: none"> • Frequency, with No Time Gate • Frequency, with Time Gate • Time, Band Pass • If the Time Band Pass button is selected: <ul style="list-style-type: none"> • The read-only Impulse Width [3dB] display button appears. • The Display Unit, Time Definition, Range Setup, and Gate Setup buttons are available. <p>Impulse Width [3dB]</p> <p>The read-only display button is only available if the Time, Low Pass button (above) has been selected. The units in the Impulse Width display change to match the setting on the Display Units button.</p> <p>Display Unit</p> <p>This button is available if the Time, Low Pass button (above) has been selected. Select toggles the display units between time and distance.</p> <p>Time Definition</p> <p>This button is available if the Time, Low Pass button (above) has been selected. Select displays the TIME DEFINITION menu.</p> <ul style="list-style-type: none"> • “TIME DEFINITION Menu” on page 17-30
--	--

Figure 17-14. DOMAIN Time Low Pass Menu (1 of 2)

Range Setup

This button is available if the Time, Low Pass button (above) has been selected. Select displays the RANGE SETUP menu.

- [“RANGE SETUP Time Low Pass Menu” on page 17-37](#)

Gate Setup

This button is available if the Time, Low Pass button (above) has been selected. Select displays the GATE SETUP menu.

- [“GATE SETUP Menu” on page 17-45](#)
-

Figure 17-14. DOMAIN Time Low Pass Menu (2 of 2)

DOMAIN Time Band Pass Menu

Menu Identification and Variants

- The appearance and button availability of the DOMAIN menu depends on settings on the SWEEP menu.
- Consult the section above for menu identification and prerequisites.
- [“DOMAIN Menu Appearance and Button Availability” on page 17-22](#)

Previous

- [“DISPLAY Menu” on page 17-2](#)

Navigation

- MAIN | Display | DISPLAY | Domain | DOMAIN Time Band Pass

	<p>Time, Band Pass</p> <p>If the Time, Band Pass button is selected:</p> <ul style="list-style-type: none"> • The following time domain options are deselected and unavailable: <ul style="list-style-type: none"> • Frequency, with No Time Gate • Frequency, with Time Gate • Time, Low Pass • These options are available: <ul style="list-style-type: none"> • The read-only Impulse Width [3dB] display button appears. • The Display Unit, Time Definition, Range Setup, and Gate Setup buttons are available. <p>Impulse Width [3dB]</p> <p>This display button is only available if the Time Band Pass button (above) has been selected. The units in the Impulse Width display changes to match the setting on the Display Units button.</p> <p>Display Unit</p> <p>This button is available if the Time Band Pass button (above) has been selected. Select toggles the display units between time and distance.</p> <p>Time Definition</p> <p>This button is available if the Time Band Pass button (above) has been selected. Select displays the TIME DEFINITION menu.</p> <ul style="list-style-type: none"> • “TIME DEFINITION Menu” on page 17-30 <p>Range Setup</p> <p>This button is available if the Time Band Pass button (above) has been selected. Select displays the RANGE SETUP menu.</p> <ul style="list-style-type: none"> • “RANGE SETUP Frequency with Time Gate Menu” on page 17-33 <p>Gate Setup</p> <p>This button is available if the Time Band Pass button (above) has been selected. Select displays the GATE SETUP menu.</p> <ul style="list-style-type: none"> • “GATE SETUP Menu” on page 17-45
--	--

Figure 17-15. DOMAIN Time Band Pass Menu

17-7 Domain Time Definition Menu

TIME DEFINITION Menu

Prerequisites

- The DOMAIN menu must be set to one of the following: Frequency, with Time Gate; Time, Low Pass; Time, Band Pass.

Previous

- [“DOMAIN Frequency with Time Gate Menu” on page 17-26](#)
- [“DOMAIN Time Low Pass Menu” on page 17-27](#)
- [“DOMAIN Time Band Pass Menu” on page 17-29](#)

Navigation

- MAIN | Display | DISPLAY | Domain | DOMAIN Frequency with Time Gate | Time Definition | TIME DEFINITION
- MAIN | Display | DISPLAY | Domain | DOMAIN Time Low Pass | Time Definition | TIME DEFINITION
- MAIN | Display | DISPLAY | Domain | DOMAIN Time Band Pass | Time Definition | TIME DEFINITION

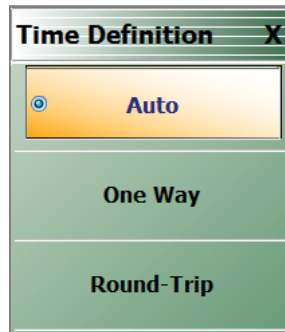

Figure 17-16. TIME DEFINITION Menu

Auto

Selecting the Auto button de-selects the One Way and the Round-Trip buttons and auto-returns to the DOMAIN menu.

One Way

Selecting the One Way button de-selects the Auto and the Round-Trip buttons and auto-returns to the DOMAIN menu.

Round-Trip

Selecting the Round-Trip button de-selects the Auto and the One Way buttons and auto-returns to the DOMAIN menu.

17-8 Range Setup Menus and Dialog Boxes

Range Setup Button Unavailable

If the Domain Type on the DOMAIN menu is set to Frequency, with No Time Gate, the Range Setup button and the underlying RANGE SETUP menu are unavailable.

- [“DOMAIN Frequency with No Time Gate Menu” on page 17-25](#)
- MAIN | Display | DISPLAY | Domain | DOMAIN

RANGE SETUP Menu Availability

In order to view the RANGE SETUP menu, the Domain Type on the DOMAIN menu must be set to one of the following: Frequency, with Time Gate; Time, Low Pass; Time, Band Pass.

The Time, Low Pass button on the DOMAIN menu is only available if a harmonic sweep is set on the FREQUENCY menu such as: Start Frequency = 10 MHz; Stop Frequency = 50 MHz; # of Points = 5 points.

- [“FREQUENCY Menu for Frequency-Based Segmented Sweep Mode” on page 4-5](#)
- MAIN | Frequency | FREQUENCY

RANGE SETUP Menu Variants

The Time Domain type set in the DOMAIN menu affects which functions are displayed in buttons on the RANGE SETUP menu:

RANGE SETUP Menu When Time Domain is Set to Frequency with Time Gate

If the Domain Type is set to Frequency, with Time Gate, the RANGE SETUP menu has these seven buttons: Display Unit, Start, Stop, Center, Span, Window Shape, and Alias Free Range.

Menu Description

- [“RANGE SETUP Frequency with Time Gate Menu” on page 17-33](#)

Prerequisites

- Domain Type = Frequency with Time Gate

RANGE SETUP Menu When Time Domain is Set to Time Band Pass

If the Domain Type is set to Time, Band Pass, the RANGE SETUP menu has these eight buttons: Display Unit, Start, Stop, Center, Span, Phasor Impulse, Window Shape, and Alias Free Range.

Menu Description

- [“RANGE SETUP Time Band Pass Menu” on page 17-35](#)

Prerequisites

- Domain Type = Time Band Pass

RANGE SETUP Menu When Time Domain is Set to Time Low Pass

If the Domain Type is set to Time, Low Pass, the RANGE SETUP menu has these nine buttons: Display Unit, Start, Stop, Center, Span, Response, DC Term, Window Shape, and Alias Free Range.

Menu Description

- [“RANGE SETUP Time Low Pass Menu” on page 17-37](#)

Prerequisites

- Domain Type = Time Low Pass

The Display Unit Button Changes the Range Setup Menu Button Units

The setting of the Display Unit toggle button on each RANGE SETUP menu changes the units of the RANGE SETUP menu. It changes the Start, Stop, Center, and Span buttons between Distance or Time. The RANGE SETUP (DISTANCE) menu is shown in the following section.

- See also the GATE SETUP menu, [“GATE SETUP Menu” on page 17-45](#), for an example of time setup values in a menu.
- MAIN | Display | DISPLAY | Domain | DOMAIN | Gate Setup | GATE SETUP

RANGE SETUP Frequency with Time Gate Menu

Menu Identification and Variants

- The appearance and button availability of the RANGE SETUP (Frequency with Time Gate) menu depends on settings on DOMAIN menu.
- The RANGE SETUP Frequency with Time Gate menu has seven (7) buttons.
- [“Range Setup Menus and Dialog Boxes” on page 17-31](#)

Prerequisites

- On the DOMAIN menu, Domain Type is set to Frequency, with Time Gate

Previous

- [“DOMAIN Frequency with Time Gate Menu” on page 17-26](#)

Navigation

- MAIN | Display | DISPLAY | Domain | DOMAIN Frequency with Time Gate | Range Setup | RANGE SETUP Frequency with Time Gate

	<h3>Display Unit</h3> <p>The RANGE SETUP and the GATE SETUP menus use the same Display Unit toggle button setting. Changing the Display Unit setting on one menu changes the other menu setting to an identical setting.</p> <p>Select toggles between distance and time.</p> <ul style="list-style-type: none"> • When toggled to Distance, the Start, Stop, Center, and Span button fields show distance values as described in the buttons below. • When toggled to Time, the Start, Stop, Center, and Span button fields show time values as described in the buttons below. <h3>Start</h3> <p>If the Display Unit toggle button is set to distance, select displays the Start (Distance) toolbar.</p> <div data-bbox="459 1260 1527 1312" style="border: 1px solid gray; padding: 2px;"> Start : 29.9695 cm ^ v km m cm mm um X </div> <p>If the Display Unit toggle button is set to time, select displays the Start (Time) toolbar.</p> <div data-bbox="459 1407 1527 1459" style="border: 1px solid gray; padding: 2px;"> Start : 1.0000 ns ^ v s ms us ns ps X </div> <h3>Stop</h3> <p>Select either displays the Stop (Distance) or Stop (Time) toolbar.</p> <div data-bbox="459 1575 1527 1627" style="border: 1px solid gray; padding: 2px;"> Stop : 1.1988 m ^ v km m cm mm um X </div> <div data-bbox="459 1638 1527 1690" style="border: 1px solid gray; padding: 2px;"> Stop : 4.0000 ns ^ v s ms us ns ps X </div>
--	---

Figure 17-17. RANGE SETUP Frequency with Time Gate Menu (1 of 2)

Center

Select either displays the Center (Distance) or Center (Time) toolbar.

Center :	74.9238 cm	^	v	km	m	cm	mm	um	X
Center :	2.5000 ns	^	v	s	ms	us	ns	ps	X

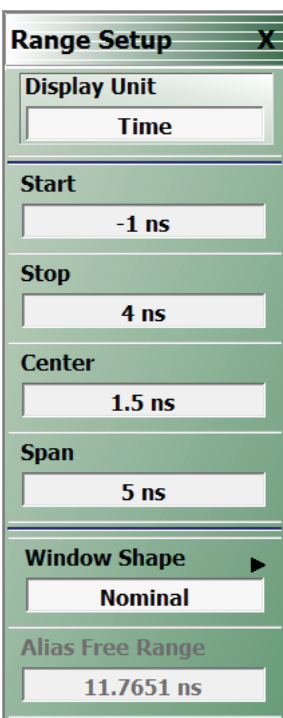
Span

Select either displays the Span (Distance) or Span (Time) toolbar.

Span :	89.9086 cm	^	v	km	m	cm	mm	um	X
Span :	3.0000 ns	^	v	s	ms	us	ns	ps	X

Window Shape

Select displays the WINDOW SHAPE menu where four (4) standard shapes of Rectangular, Nominal, Low Side Lobe, and Min Side Lobe can be selected. A fifth advanced selection provides an additional menu where configurable Kaiser-Bessel or Dolph-Chebyshev window types are available.

- [“WINDOW SHAPE Menu” on page 17-42](#)

Alias Free Range

Read-only display button. The units are the same as those set by the Display Unit button above. Displays the length or time period that can be measured without repeating a discontinuity response. This is a function of the inverse of the frequency sweep step size.

Figure 17-17. RANGE SETUP Frequency with Time Gate Menu (2 of 2)

RANGE SETUP Time Band Pass Menu

Menu Identification and Variants

- The appearance and button availability of the RANGE SETUP (Time Band Pass) menu depends on settings on DOMAIN menu.
- This RANGE SETUP (Time Band Pass) menu has eight (8) buttons.
- [“Range Setup Menus and Dialog Boxes” on page 17-31](#)

Prerequisites

- On the DOMAIN menu, Domain Type is set to Time, Band Pass

Previous

- [“DOMAIN Time Band Pass Menu” on page 17-29](#)

Navigation

- MAIN | Display | DISPLAY | Domain | DOMAIN Time, Band Pass | Range Setup | RANGE SETUP Time Band Pass

	<h3>Display Unit</h3> <p>The RANGE SETUP and the GATE SETUP menus use the same Display Unit toggle button setting. Changing the Display Unit setting on one menu changes the other menu setting to an identical setting.</p> <p>Select toggles between distance and time.</p> <ul style="list-style-type: none"> • When toggled to Distance, the Start, Stop, Center, and Span button fields show distance values as described in the buttons below. • When toggled to Time, the Start, Stop, Center, and Span button fields show time values as described in the buttons below. <h3>Start</h3> <p>If the Display Unit toggle button is set to distance, select displays the Start (Distance) toolbar.</p> <p>Start : 29.9695 cm ^ v km m cm mm um X</p> <p>If the Display Unit toggle button is set to time, select displays the Start (Time) toolbar.</p> <p>Start : 1.0000 ns ^ v s ms us ns ps X</p>
--	--

Figure 17-18. RANGE SETUP Time Band Pass Menu - 8 Buttons (1 of 2)

Stop
 Select either displays the Stop (Distance) or Stop (Time) toolbar.

Stop :	1.1988 m	^	v	km	m	cm	mm	um	X
Stop :	4.0000 ns	^	v	s	ms	us	ns	ps	X

Center
 Select either displays the Center (Distance) or Center (Time) toolbar.

Center :	74.9238 cm	^	v	km	m	cm	mm	um	X
Center :	2.5000 ns	^	v	s	ms	us	ns	ps	X

Span
 Select either displays the Span (Distance) or Span (Time) toolbar.

Span :	89.9086 cm	^	v	km	m	cm	mm	um	X
Span :	3.0000 ns	^	v	s	ms	us	ns	ps	X

Phasor Impulse
 Select toggles the phasor impulse OFF or ON.

Window Shape
 Select displays the WINDOW SHAPE menu to allow changing the window shape between rectangular, nominal, low side lobe, minimum side load, or addition advanced selections.

- [“WINDOW SHAPE Menu” on page 17-42](#)

Alias Free Range
 Read-only display button. The units are the same as those set by the Display Unit button above. Displays the length or time period that can be measured without repeating a discontinuity response. This is a function of the inverse of the frequency sweep step size

Figure 17-18. RANGE SETUP Time Band Pass Menu - 8 Buttons (2 of 2)

RANGE SETUP Time Low Pass Menu

Menu Identification and Variants

- The appearance and button availability of the RANGE SETUP (Time Band Pass) menu depends on settings on DOMAIN menu.
- This RANGE SETUP (Time Low Pass) menu has nine (9) buttons.
- [“Range Setup Menus and Dialog Boxes” on page 17-31](#)

Prerequisites

- On the FREQUENCY menu, a harmonic sweep must be set such as: Start Frequency = 10 MHz; Stop Frequency = 50 MHz; # of Points = 5 points
 - [“FREQUENCY Menu for Frequency-Based Segmented Sweep Mode” on page 4-5](#)
 - MAIN | Frequency | FREQUENCY
- On the DOMAIN menu, Domain Type is set to Time, Low Pass

Previous

- [“DOMAIN Time Low Pass Menu” on page 17-27](#)

Navigation

- MAIN | Display | DISPLAY | Domain | DOMAIN Time, Low Pass | Range Setup | RANGE SETUP Time Low Pass

	<h3>Display Unit</h3> <p>The RANGE SETUP and the GATE SETUP menus use the same Display Unit toggle button setting. Changing the Display Unit setting on one menu changes the other menu setting to an identical setting.</p> <p>Select toggles between distance and time.</p> <ul style="list-style-type: none"> • When toggled to Distance, the Start, Stop, Center, and Span button fields show distance values as described in the buttons below. • When toggled to Time, the Start, Stop, Center, and Span button fields show time values as described in the buttons below. <h3>Start</h3> <p>If the Display Unit toggle button is set to distance, select displays the Start (Distance) toolbar.</p> <div data-bbox="462 1396 1508 1438"> <p>Start : 29.9695 cm ^ v km m cm mm um X</p> </div> <p>If the Display Unit toggle button is set to time, select displays the Start (Time) toolbar.</p> <div data-bbox="462 1543 1508 1585"> <p>Start : 1.0000 ns ^ v s ms us ns ps X</p> </div>
--	--

Figure 17-19. RANGE SETUP Time Gate Low Pass Menu - Nine Buttons - (1 of 2)

Stop
 Select either displays the Stop (Distance) or Stop (Time) toolbar.

Stop :	1.1988 m	^	v	km	m	cm	mm	um	X
Stop :	4.0000 ns	^	v	s	ms	us	ns	ps	X

Center
 Select either displays the Center (Distance) or Center (Time) toolbar.

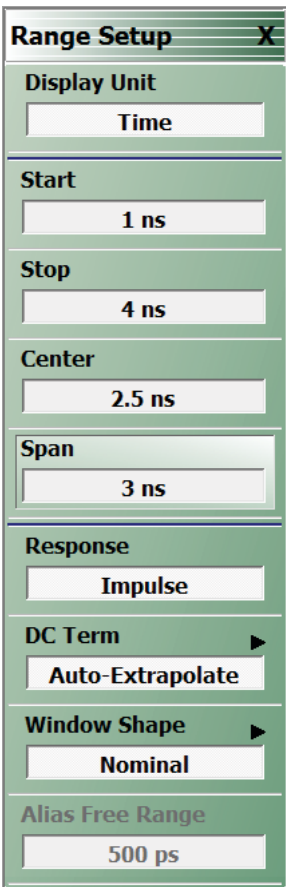
Center :	74.9238 cm	^	v	km	m	cm	mm	um	X
Center :	2.5000 ns	^	v	s	ms	us	ns	ps	X

Span
 Select either displays the Span (Distance) or Span (Time) toolbar.

Span :	89.9086 cm	^	v	km	m	cm	mm	um	X
Span :	3.0000 ns	^	v	s	ms	us	ns	ps	X

Response
 Select toggles response between Impulse and Step.

DC Term
 Select displays the DC TERM menu where Auto-Extrapolate or other extrapolation methods can be selected.

- [“DC TERM Menu” on page 17-39](#)

Window Shape
 Select displays the WINDOW SHAPE menu to allow changing the window shape between rectangular, nominal, low side lobe, minimum side load, or addition advanced selections.

- [“WINDOW SHAPE Menu” on page 17-42](#)

Alias Free Range
 Read-only display button. The units are the same as those set by the Display Unit button above. Displays the length or time period that can be measured without repeating a discontinuity response. This is a function of the inverse of the frequency sweep step size.

Figure 17-19. RANGE SETUP Time Gate Low Pass Menu - Nine Buttons - (2 of 2)

DC TERM Menu

Prerequisites

- On the FREQUENCY menu, a harmonic sweep must be set such as:
 - Start Frequency = 10 MHz
 - Stop Frequency = 50 MHz
 - # of Points = 5 points
- FREQUENCY Menus
 - “FREQUENCY Menu for Frequency-Based Segmented Sweep Mode” on page 4-5
 - MAIN | Frequency | FREQUENCY
- On the DOMAIN menu, Domain Type is set to Time, Low Pass

Previous

- “RANGE SETUP Time Low Pass Menu” on page 17-37

Navigation

- MAIN | Display | DISPLAY | Domain | DOMAIN Time, Low Pass | Range Setup | RANGE SETUP Time Low Pass | DC Term | DC TERM

Menu Button Availability

The availability of buttons on the DC TERM menu change based on the setting on the Auto-Extrapolate and Other buttons. These two buttons also form a button selection group where the selection of one button de-selects the other button.

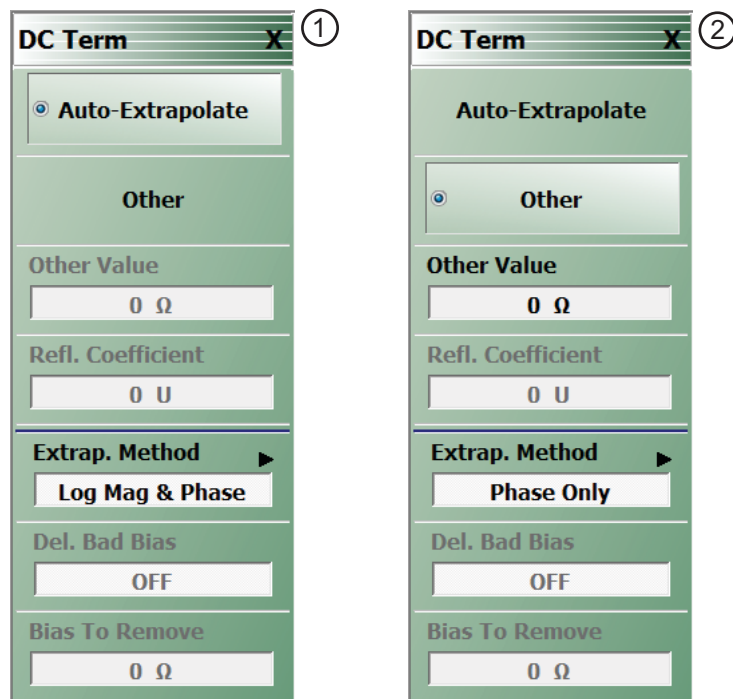

1. DC TERM menu with Auto-Extrapolate option selected. See below for button function descriptions.

2. DC TERM menu with Other option selected and Other Value field button now available. See below for button function descriptions.

Figure 17-20. DC TERM Menu

Auto-Extrapolate

Selection of the Auto-Extrapolate button de-selects the Other button (below) and sets the DC Term extrapolation to the method currently set in the Extrap Method button (described below).

Other

Selection of the Other button de-selects the Auto-Extrapolate button and enables the Other Value button below for input of a user-defined DC Term.

Other Value

This button is only available if the Other button above is selected. Displays the currently user-defined Other Value DC Term in Ohms. Select displays the Other Value (Ohms) field toolbar which allows user input of a custom user-defined DC Term in Ohms.

Other Value : 0.000 Ω [^] [v] [Ω] [X]

Refl. Coefficient

Reflection Coefficient button. Read-only display. The Reflection Coefficient display shows the calculated coefficient in Units.

Extrap Method

Extrapolation Method button. The Extrapolation Method button displays the currently selection DC term extrapolation method. Available options on the displayed EXTRAPOLATION menu are Log Mag & Phase, Phase Only, and User Defined.

- [“EXTRAPOLATION Menu” on page 17-41](#)

Del. Bad Bias

The Delete Bad Bias toggle button is not available.

Bias To Remove

The Bias to Remove button and the related Bias to Remove (Ohms) field toolbar are not available.

EXTRAPOLATION Menu

Prerequisites

- On the FREQUENCY menu, a harmonic sweep must be set such as:
 - Start Frequency = 10 MHz
 - Stop Frequency = 50 MHz
 - # of Points = 5 points
- FREQUENCY Menus
 - [“FREQUENCY Menu for Frequency-Based Segmented Sweep Mode” on page 4-5](#)
 - MAIN | Frequency | FREQUENCY
- On the DOMAIN menu, Domain Type is set to Time, Low Pass

Previous

- [“DC TERM Menu” on page 17-39](#)

Navigation

- MAIN | Display | DISPLAY | Domain | DOMAIN Time, Low Pass | Range Setup | RANGE SETUP Time Low Pass | DC Term | DC TERM | Extrap Method | EXTRAPOLATION

	<p>Log Mag & Phase Selection sets the method as Log Mag & Phase.</p> <p>Phase Only Selection sets the method as Phase Only.</p> <p>User Defined Option unavailable.</p>
--	--

Figure 17-21. EXTRAPOLATION Menu

17-9 Time Domain Window Shape and Gate Setup Menus

WINDOW SHAPE Menu

Prerequisites

- On the DOMAIN menu, Domain Type is set to one of the following: Frequency, with Time Gate; Time, Band Pass; Time, Low Pass.
- Time Low Pass requires on the FREQUENCY menu, a harmonic sweep such as: Start Frequency = 10 MHz; Stop Frequency = 50 MHz; # of Points = 5 points
 - [“FREQUENCY Menu for Frequency-Based Segmented Sweep Mode” on page 4-5](#)
 - MAIN | Frequency | FREQUENCY

Previous

- [“RANGE SETUP Frequency with Time Gate Menu” on page 17-33](#)
- [“RANGE SETUP Time Band Pass Menu” on page 17-35](#)
- [“RANGE SETUP Time Low Pass Menu” on page 17-37](#)

Navigation

- MAIN | Display | DISPLAY | Domain | DOMAIN Frequency with Time Gate | Range Setup | RANGE SETUP Frequency with Time Gate | Window Shape | WINDOW SHAPE
- MAIN | Display | DISPLAY | Domain | DOMAIN Time Band Pass | Range Setup | RANGE SETUP Time Band Pass | Window Shape | WINDOW SHAPE
- MAIN | Display | DISPLAY | Domain | DOMAIN Time Low Pass | Range Setup | RANGE SETUP Time Low Pass

	<p>Rectangular Select sets the window shape to rectangular.</p> <p>Nominal Select sets the window shape to nominal.</p> <p>Low Side Lobe Select sets the window shape to low side lobe.</p> <p>Min Side Lobe Select sets the window shape to the minimum side lobe.</p> <p>Advanced Selection Selects displays the ADVANCED WINDOW SETUP dialog box that allows selection of configurable Kaiser-Bessel or Dolph-Chebyshev window types. <ul style="list-style-type: none"> • “ADVANCED WINDOW SHAPE SETUP Dialog Box” on page 17-43 </p> <p>Impulse Width [3dB] Read-only display. Shows the calculated width of the window at 3 dB.</p>
--	---

Figure 17-22. WINDOW SHAPE Menu

ADVANCED WINDOW SHAPE SETUP Dialog Box

Prerequisites

- On the DOMAIN menu, Domain Type is set to one of the following: Frequency, with Time Gate; Time, Band Pass; Time, Low Pass
- Time Low Pass requires on the FREQUENCY menu, a harmonic sweep set such as: Start Frequency = 10 MHz; Stop Frequency = 50 MHz; # of Points = 5 points
 - “FREQUENCY Menu for Frequency-Based Segmented Sweep Mode” on page 4-5
 - MAIN | Frequency | FREQUENCY

Previous

- “WINDOW SHAPE Menu” on page 17-42

Navigation

- MAIN | Display | DISPLAY | Domain | DOMAIN Frequency with Time Gate | Range Setup | RANGE SETUP Frequency with Time Gate | Window Shape | WINDOW SHAPE | Advanced Selection | ADVANCED WINDOW SHAPE SETUP Dialog Box
- MAIN | Display | DISPLAY | Domain | DOMAIN Time Band Pass | Range Setup | RANGE SETUP Time Band Pass | Window Shape | WINDOW SHAPE | Advanced Selection | ADVANCED WINDOW SHAPE SETUP Dialog Box
- MAIN | Display | DISPLAY | Domain | DOMAIN Time Low Pass | Range Setup | RANGE SETUP Time Low Pass | Window Shape | WINDOW SHAPE | Advanced Selection | ADVANCED WINDOW SHAPE SETUP Dialog Box

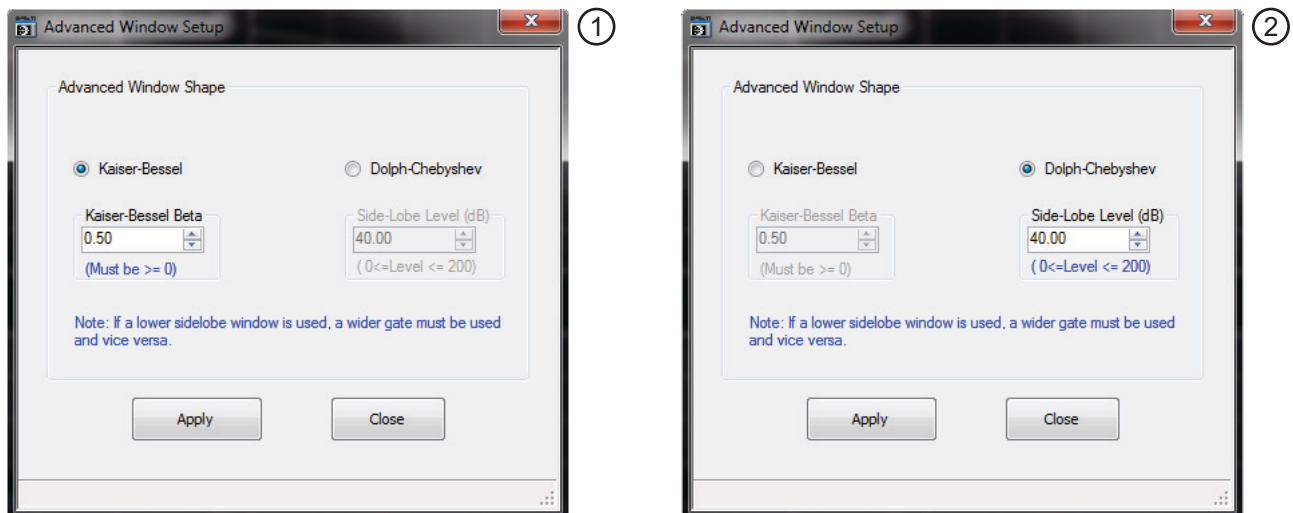

1. ADVANCED WINDOW SETUP – Advanced Window Shape dialog box for Kaiser-Bessel at left.

2. ADVANCED WINDOW SETUP – Advanced Window Shape dialog box for Dolph-Chebyshev at right.

Figure 17-23. ADVANCED WINDOW SHAPE SETUP Dialog Box

Instructions

The Advanced Window Shape area provides the option to select Kaiser-Bessel or Dolph-Chebyshev window shapes.

Note

If a lower side-lobe window is used, a wider gate must be used. If a higher side-lobe window is used, a narrower gate must be used.

1. Select Kaiser-Bessel to enter a Kaiser-Bessel Beta value:
 - Use the up/down arrows to select a pre-defined value, or enter a custom value.
 - Note that the input value must be ≥ 0 (greater than or equal to zero).
2. Select Dolph-Chebyshev to enter a Side-Lobe Level (dB) value:
 - Use the up/down arrows to select a pre-defined value, or enter a custom value.
 - Note that the input value must be $0 \geq \text{Level} \geq 200$ (greater than or equal to zero and less than or equal to 200).
3. Click Apply to set the changes.
 - If you click Close without clicking the Apply button, any dialog box changes are discarded and the prior window shape state is retained.
4. Click Close to close the dialog box and return to the ADVANCED WINDOW SHAPE SETUP dialog box.
 - [“ADVANCED WINDOW SHAPE SETUP Dialog Box” on page 17-43](#)

GATE SETUP Menu

Prerequisites

- On the DOMAIN menu, Domain Type is set to one of the following: Frequency, with Time Gate; Time, Band Pass; Time, Low Pass.
- Time Low Pass requires on the FREQUENCY menu, a harmonic sweep set such as: Start Frequency = 10 MHz; Stop Frequency = 50 MHz; # of Points = 5 points
 - [“FREQUENCY Menu for Frequency-Based Segmented Sweep Mode” on page 4-5](#)
 - MAIN | Frequency | FREQUENCY

Previous

- [“DOMAIN Frequency with Time Gate Menu” on page 17-26](#)
- [“DOMAIN Time Low Pass Menu” on page 17-27](#)
- [“DOMAIN Time Band Pass Menu” on page 17-29](#)

Navigation

- MAIN | Display | DISPLAY | Domain | DOMAIN Frequency with Time Gate | Gate Setup | GATE SETUP
- MAIN | Display | DISPLAY | Domain | DOMAIN Time Band Pass | Gate Setup | GATE SETUP
- MAIN | Display | DISPLAY | Domain | DOMAIN Time Low Pass | Gate Setup | GATE SETUP

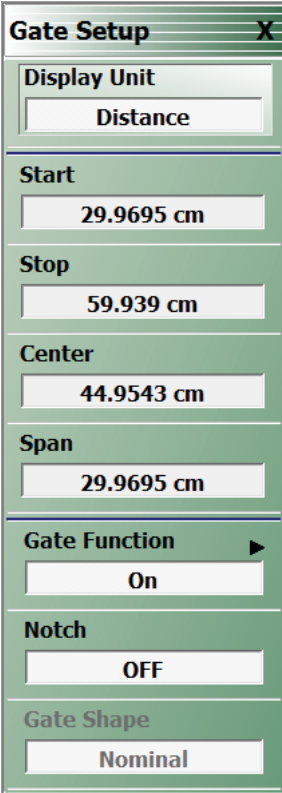

The screenshot shows a vertical menu titled "Gate Setup" with a close button (X) in the top right corner. The menu contains several sections, each with a label and a corresponding value in a text box:

- Display Unit:** Distance
- Start:** 29.9695 cm
- Stop:** 59.939 cm
- Center:** 44.9543 cm
- Span:** 29.9695 cm
- Gate Function:** On (with a right-pointing arrow)
- Notch:** OFF
- Gate Shape:** Nominal

Figure 17-24. GATE SETUP Menu

GATE SETUP Menu Button Units

The units of the GATE SETUP menu and its Start, Stop, Center, and Span buttons change between Distance or Time, depending on the setting of the Display Unit toggle button. This button is shared by the GATE SETUP and the RANGE SETUP menus. The GATE SETUP (Distance) menu is shown at left.

- See the RANGE SETUP menu above for an example of time setup values in a menu.
- [“RANGE SETUP Frequency with Time Gate Menu” on page 17-33](#)

Display Unit

The RANGE SETUP and the GATE SETUP menus use the same Display Unit button setting. Changing the Display Unit setting on one menu changes the other menu setting to an identical setting.

Select toggles between distance and time. When toggled to Distance, the Start, Stop, Center, and Span button fields show distance values as described in the buttons below.

Start

If the Display Unit toggle button is set to distance, select displays the Start (Distance) toolbar.



If the Display Unit toggle button is set to time, select displays the Start (Time) toolbar.



Stop

Select either displays the Stop (Distance) or Stop (Time) toolbar.



Center

Select either displays the Center (Distance) or Center (Time) toolbar.



Span

Select either the Span (Distance) or Span (Time) toolbar.



Gate Function (Off/On)

Select displays the Gate Function menu.

- [“GATE FUNCTION Menu” on page 17-47](#)

Notch (Off/On)

Select toggles notch between off and on.

Gate Slope

Read-only display of the Gate Slope setting.

GATE FUNCTION Menu

Prerequisites

- On the DOMAIN menu, Domain Type is set to one of the following: Frequency, with Time Gate; Time, Band Pass; Time, Low Pass.
- Time Low Pass requires on the FREQUENCY menu, a harmonic sweep set such as:
 - Start Frequency = 10 MHz
 - Stop Frequency = 50 MHz
 - # of Points = 5 points
- FREQUENCY Menus
 - [“FREQUENCY Menu for Frequency-Based Segmented Sweep Mode” on page 4-5](#)
 - MAIN | Frequency | FREQUENCY

Previous

- [“GATE SETUP Menu” on page 17-45](#)

Navigation

- MAIN | Display | DISPLAY | Domain | DOMAIN Frequency with Time Gate | Gate Setup | GATE SETUP | Gate Function | GATE FUNCTION
- MAIN | Display | DISPLAY | Domain | DOMAIN Time Band Pass | Gate Setup | GATE SETUP | Gate Function | GATE FUNCTION
- MAIN | Display | DISPLAY | Domain | DOMAIN Time Low Pass | Gate Setup | GATE SETUP | Gate Function | GATE FUNCTION

	<p>----Function----</p> <p>Off Select turns OFF gate function on the active trace.</p> <p>Display Select displays gate function on the active trace</p> <p>On Select turns ON gate function on the active trace.</p> <p>----Gate Shape----</p> <p>Minimum Select sets gate function to its minimum setting.</p> <p>Nominal Select sets gate function to its nominal setting.</p> <p>Wide Select sets gate function to its widest setting.</p> <p>Maximum Select sets gate function to its maximum setting.</p> <p>Advanced Selection Select displays the Advanced Gate (Shape) Setup dialog box which allows selection either of a Kaiser-Bessel or Dolph-Chebyshev shaped gate. Each gate option allows selectable parameters.</p> <ul style="list-style-type: none"> • “ADVANCED GATE SHAPE SETUP Dialog Box” on page 17-49
--	--

Figure 17-25. GATE FUNCTION Menu

ADVANCED GATE SHAPE SETUP Dialog Box

Previous

- “GATE FUNCTION Menu” on page 17-47

Navigation

- MAIN | Display | DISPLAY | Domain | TIME DOMAIN | Gate Setup | GATE SETUP | Gate Function | GATE FUNCTION | Advanced Selection | ADVANCED GATE (SHAPE) SETUP Dialog Box

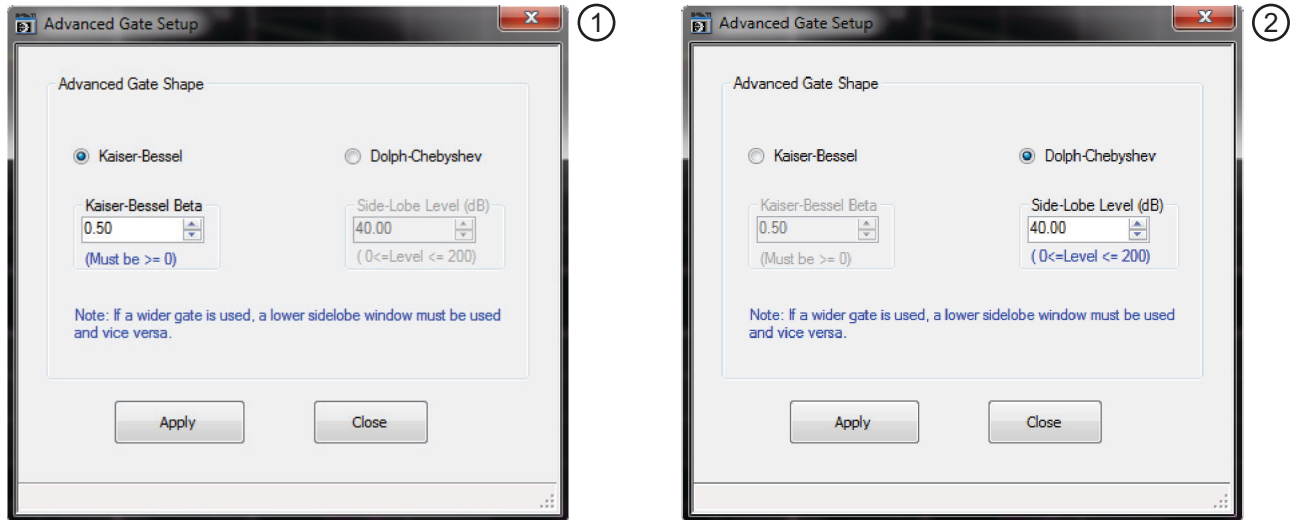

1. ADVANCED WINDOW SETUP – Advanced Gate Shape dialog box for Kaiser-Bessel at left.

2. ADVANCED WINDOW SETUP – Advanced Gate Shape dialog box for Dolph-Chebyshev at right.

Figure 17-26. ADVANCED GATE SHAPE SETUP Dialog Box

Instructions

The Advanced Gate Shape area provides a two-button selection group (Kaiser-Bessel or Dolph-Chebyshev) where the selection of one button deselects the other button. If selected, each button provides an additional configuration parameter.

Note If a lower side-lobe window is used, a wider gate must be used. If a higher side-lobe window is used, a narrower gate must be used.

1. Make a selection of one of the two available choices.
 - Kaiser-Bessel, shown at left at #1 in [Figure 17-26](#) above.
 - Dolph-Chebyshev, shown at right at #2 in [Figure 17-26](#) above.
2. If Kaiser-Bessel is selected, the Kaiser-Bessel Beta area below the button becomes available.
 - Either use the up/down arrows to select a pre-defined value, or enter a value from the keyboard.
 - Note that the input value must be ≥ 0 (greater than or equal to zero).

3. If Dolph-Chebyshev is selected, the Side-Lobe Level (dB) area button becomes available.
 - Either use the up/down arrows to select a pre-defined value, or enter a value from the keyboard.
 - Note that the input value must be $0 \geq \text{Level} \geq 200$ (greater than or equal to zero and less than or equal to 200).
4. Click **Apply** to set the changes.
 - If you click **Close** without clicking the **Apply** button, any dialog box changes are discarded and the prior window shape state is retained.
5. Click **Close** to close the dialog box and return to the **ADVANCED GATE (SHAPE) SETUP** dialog box.

17-10 Inter- and Intra-Trace Math and Operand Setup Menus

INTER-TRACE MATH Menu

This menu allows operand setting and then mathematical comparisons between a user-defined trace 1 (one) and trace 2 (two). The two traces' values can be added together, subtracted from each other, multiplied, or divided. This is useful in such ways as subtracting results from each other to see small differences.

Previous

- [“DISPLAY Menu” on page 17-2](#)

Navigation

- MAIN | Display | DISPLAY | Inter-Trace Math | INTER-TRACE MATH

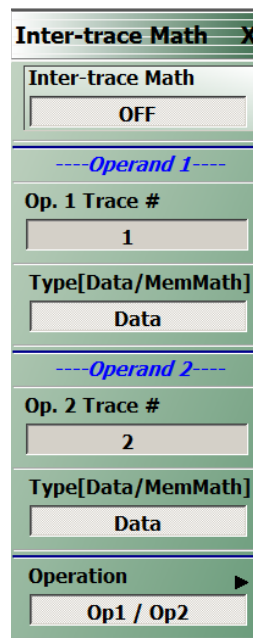

Figure 17-27. INTER-TRACE MATH Menu

Inter-Trace Math (Off/On)

Toggles Inter-Trace Math off and on.

Operand 1 Area

Op. 1 Trace

Operand One Trace Number. Select displays the Op 1 Trace # field toolbar which allows selection of the trace number of trace math operand 1 (one).



(Op. 1) Type (Data/MemMath)

The Operand 1 Type toggle button switches between DataMemMath and Data for Operand 1.

Operand 2 Area**Op. 2 Trace #**

Operand Two Trace Number. Select displays the Op 2 Trace # field toolbar which allows selection of the trace number of trace math operand 2 (two).

Op. 2 Trace # : ^ v | Enter |

(Op. 2) Type (Data/MemMath)

The Operand 2 Type toggle button switches between DataMemMath and Data for Operand 2.

Operation Area**Operation**

Select displays the INTRA TRACE OP. menu.

- [“INTRA TRACE OP. Menu” on page 17-53](#)

INTRA TRACE OP. Menu

Full Name

- INTRA-TRACE OPERAND Menu

The menu provides mathematical operations between the values on two separate traces.

Previous

- [“INTER-TRACE MATH Menu” on page 17-51](#)

Navigation

- MAIN | Display | DISPLAY | Inter-trace Math | INTER-TRACE MATH | Operation | INTRA-TRACE OP

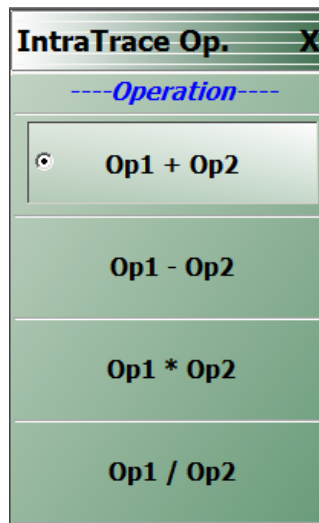

See below for button function descriptions.

Figure 17-28. INTRA-TRACE OP. (INTRA TRACE OPERAND) Menu

INTRA TRACE OP. Menu Button Selection Group

The four (4) buttons of the INTRA TRACE OPERATIONS menu form a button selection group where the selection of any one (1) button de-selects the other three (3) buttons.

Operation Area

Op1 + Op2 (Operand Plus)

The trace value assigned to Operand 1 is added to the trace value assigned to Operand 2.

Op1 – Op2 (Operand Subtraction)

The trace value assigned to Operand 2 is subtracted from the trace value assigned to Operand 1.

Op1 * Op2 (Operand Multiplication)

The trace value assigned to Operand 1 is multiplied times the trace value assigned to Operand 2.

Op1 / Op2 (Operand Division)

The trace value assigned to Operand 1 is divided by the trace value assigned to Operand 2.

17-11 Display Area Setup Menu

DISPLAY AREA SETUP Menu

This menu allows the display area to be customized.

Previous

- [“DISPLAY Menu” on page 17-2](#)

Navigation

- MAIN | Display | DISPLAY | Display Area Setup | DISPLAY SETUP



Figure 17-29. DISPLAY SETUP Menu

Edit Chan. Title

Select displays the channel title field toolbar which allows entry of a custom title.

Channel Title

Toggles the channel title display ON or OFF.

All Chan. Freq Label

Toggles the channel frequency labels ON or OFF.

Edit Alternate Trace Name

Select displays the alternate trace name field toolbar which allows entry of a custom trace name.

Alternate Trace Name

Toggles the alternate trace name display ON or OFF.

Chapter 18 — Scale Menus

18-1 Chapter Overview

This chapter provides information about the button controls for the SCALE menu variants. SCALE menus provide trace display control of settings such as resolution, reference value, and the scale of units. The number of buttons on a SCALE menu depends on the settings on the TRACE FORMAT menu.

The bottom three (3) buttons on the SCALE menu, always the same, apply settings to the active trace, and also control of the number of display vertical divisions.

18-2 Scale Menu Appearance, Common Buttons, and Units

Appearance

The appearance of the SCALE menu label buttons, their units, and the menu area names change depending on the trace type selected in the TRACE FORMAT menu.

- [“Trace Display Layout” on page 14-3](#)
- MAIN | Display | DISPLAY | Trace Format | TRACE FORMAT

Common SCALE Menu Buttons

In all SCALE menus, the bottom three (3) buttons on the SCALE menu are always the same and described at the end of this section. The five common buttons are:

- Auto Scale Active Trace
- Auto Scale All Traces
- # of Vert. Divisions

The description of these buttons is found at:

- [Section 18-12 “SCALE Menu Common Buttons” on page 18-30](#)

SCALE Menu Units

The table below summarizes the displayed fields and units available in the SCALE menu variants.

Table 18-1. SCALE Menu Parameter Buttons (1 of 2)

Scale	Resolution Button and Field Toolbar	Reference Value Button and Field Toolbar	Reference Position Button and Field Toolbar	Wrap Offset Button and Field Toolbar	Aperture Button and Field Toolbar	Auto Scale Active Trace Button	Auto Scale All Traces Button	# of Vert Div. Button and Field Toolbar
Notes	<p>YES – The button or link to submenu APPEARS on the menu. NO – The button DOES NOT APPEAR on the menu # – A number without units is entered. NA – The button appears on the menu but is not available (is grayed out). Time Units – The available time units are s (seconds), ms (milliseconds), us (microseconds), ns (nanoseconds, and ps (picoseconds). Dual Entries – Table cells with dual entries are for SCALE menus that have separate controls for dual displays with upper and lower traces. For example, the SCALE menu for Log Mag and Phase, a dual display, has an upper menu area titled Log Mag with these buttons: Resolution (dB/Division), Reference Value (dB), and Reference Position (Number). The lower menu area is titled Phase with these buttons: Resolution (Deg/Division), Reference Value (dB), Reference Position (Number), and Wrap Offset (Deg)</p>							
Log Mag	dB/Division	# dB	#	NO	NO	YES	YES	#
Lin Mag	Units/Division	# Units	#	NO	NO	YES	YES	#
Phase	Deg/Division	# Deg	#	NO	NO	YES	YES	#
Real	Units/Division	# Units	#	NO	NO	YES	YES	#
Imaginary	Units/Division	# Units	#	NO	NO	YES	YES	#
VSWR	Units/Division	# Units	#	NO	NO	YES	YES	#
Impedance: Real	Ohms/Division	# Ohms	#	NO	NO	YES	YES	#
Impedance: Imaginary	Ohms/Division	# Ohms	#	NO	NO	YES	YES	#
Impedance: Magnitude	Ohms/Division	# Ohms	#	NO	NO	YES	YES	#
Impedance: Real & Imaginary (dual display)	Ohms/Division	# Ohms	#	NO	NO	YES	YES	#
	Ohms/Division	# Ohms	#	NO	NO			
Smith Chart Impedance: Lin/Phase, Log/Phase, Real/Imaginary, Impedance	NA	NA	NA	# Deg	NO	YES	YES	#
Linear Polar: Lin/Phase, Real/Imag	Units/Division	# Units	NA	Deg	NO	YES	YES	#
Log Polar: Log/Phase and Real/Imag	Units/Division	# Units	NA	Deg	NO	YES	YES	#
Log Mag and Phase (dual display)	dB/Division	# dB	#	NO	NO	YES	YES	#
	Deg/Division	# Deg	#	# Deg				

Table 18-1. SCALE Menu Parameter Buttons (2 of 2)

Scale	Resolution Button and Field Toolbar	Reference Value Button and Field Toolbar	Reference Position Button and Field Toolbar	Wrap Offset Button and Field Toolbar	Aperture Button and Field Toolbar	Auto Scale Active Trace Button	Auto Scale All Traces Button	# of Vert Div. Button and Field Toolbar
Notes	<p>YES – The button or link to submenu APPEARS on the menu. NO – The button DOES NOT APPEAR on the menu # – A number without units is entered. NA – The button appears on the menu but is not available (is grayed out). Time Units – The available time units are s (seconds), ms (milliseconds), us (microseconds), ns (nanoseconds, and ps (picoseconds). Dual Entries – Table cells with dual entries are for SCALE menus that have separate controls for dual displays with upper and lower traces. For example, the SCALE menu for Log Mag and Phase, a dual display, has an upper menu area titled Log Mag with these buttons: Resolution (dB/Division), Reference Value (dB), and Reference Position (Number). The lower menu area is titled Phase with these buttons: Resolution (Deg/Division), Reference Value (dB), Reference Position (Number), and Wrap Offset (Deg)</p>							
Linear Mag and Phase (dual display)	dB/Division	# dB	#	NO	NO	YES	YES	#
	Deg/Division	# Deg	#	# Deg				
Real and Imaginary (dual display)	Units/Division	# Units	#	NO	NO	YES	YES	#
	Units/Division	# Units	#					
Group Delay	Time/Division	Time Units	#	NO	% of Sweep	YES	YES	#

18-3 Overview of SCALE Menu Variants

All SCALE menu variants are shown in the sections and links below:

- [“SCALE Magnitude Menus” on page 18-5](#)
 - [“SCALE Log Magnitude Menu” on page 18-5](#)
 - [“SCALE Linear Magnitude Menu” on page 18-6](#)
- [“SCALE Phase Menu” on page 18-7](#)
 - [“SCALE Phase Menu” on page 18-7](#)
- [“SCALE Real or Imaginary Menus” on page 18-9](#)
 - [“SCALE Real Magnitude Menu” on page 18-9](#)
 - [“SCALE Imaginary Menu” on page 18-10](#)
- [“SCALE SWR Menu” on page 18-11](#)
 - [“SCALE Standing Wave Ratio Menu” on page 18-11](#)
- [“SCALE Smith Chart Menus” on page 18-12](#)
 - [“SCALE Smith Chart Impedance Menu” on page 18-12](#)
- [“SCALE Smith Chart Menus” on page 18-12](#)
 - [“SCALE Smith Chart Impedance Menu” on page 18-12](#)
- [“SCALE Menu Common Buttons” on page 18-30](#)

18-4 SCALE Magnitude Menus

SCALE Log Magnitude Menu

Prerequisite

- TRACE FORMAT is set to Log Mag
- MAIN | Display | DISPLAY | Trace Format | TRACE FORMAT | Log Mag

Previous

- [“Main Menu” on page 2-2](#)

Navigation

- MAIN | Scale | SCALE

Scale X <hr/> <i>---Log Mag---</i> Resolution <input type="text" value="10 dB/Div"/> Reference Value <input type="text" value="0 dB"/> Reference Position <input type="text" value="5"/> <hr/> Auto Scale Active Trace <hr/> Auto Scale All Traces <hr/> Auto Scale All Channels <hr/> # of Vert. Divisions <input type="text" value="10"/> <hr/> <input type="button" value="Apply # of Div. to All Channels"/>	<h4>SCALE (Log Magnitude) Menu</h4> <p>---Log Magnitude---</p> <p>Resolution Select displays the Resolution (dB) toolbar with units in dB per division.</p> <p>Resolution : <input type="text" value="10.0000 dB"/> <input type="button" value="^"/> <input type="button" value="v"/> <input type="button" value="Enter"/> <input type="button" value="X"/></p> <p>Reference Value Select displays the Reference Value toolbar.</p> <p>Reference Value : <input type="text" value="0.0000 dB"/> <input type="button" value="^"/> <input type="button" value="v"/> <input type="text" value="dB"/> <input type="button" value="X"/></p> <p>Reference Position Select displays the Reference Position toolbar.</p> <p>Reference Position : <input type="text" value="5"/> <input type="button" value="^"/> <input type="button" value="v"/> <input type="button" value="Enter"/> <input type="button" value="X"/></p> <p>Additional Common Buttons</p> <ul style="list-style-type: none"> • “SCALE Menu Common Buttons” on page 18-30
--	---

Figure 18-1. SCALE Log Magnitude Menu

SCALE Linear Magnitude Menu

Prerequisite

- TRACE FORMAT is set to Lin Mag
- MAIN | Display | DISPLAY | Trace Format | TRACE FORMAT | Lin Mag

Previous

- [“Main Menu” on page 2-2](#)

Navigation

- MAIN | Scale | SCALE

	<p>SCALE Menu ----Linear Magnitude----</p> <p>Resolution Select displays the Resolution (Units/Division) toolbar with units of units per division.</p> <p>Resolution : 10.000 U ^ v nU uU mU U X</p> <p>Reference Value Select displays the Reference Value (Units) toolbar.</p> <p>Reference Value : 0.000 U ^ v nU uU mU U X</p> <p>Reference Position (Number) Select displays the Reference Position toolbar.</p> <p>Reference Position : 5 ^ v Enter X</p> <p>Additional Common Buttons</p> <ul style="list-style-type: none"> • “SCALE Menu Common Buttons” on page 18-30
--	---

Figure 18-2. SCALE Linear Magnitude Menu

18-5 SCALE Phase Menu

SCALE Phase Menu

Prerequisite

- TRACE FORMAT is set to Phase
- MAIN | Display | DISPLAY | Trace Format | TRACE FORMAT | Phase

Previous

- [“Main Menu” on page 2-2](#)

Navigation

- MAIN | Scale | SCALE

<p>Scale</p> <p>----Phase----</p> <p>Resolution 45 °/Div</p> <p>Reference Value 0.00000000 °</p> <p>Reference Position 5</p> <p>Wrap Setup ▶</p> <p>Wrap Offset 0 °</p> <hr/> <p>Auto Scale Active Trace</p> <p>Auto Scale All Traces</p> <p>Auto Scale All Channels</p> <hr/> <p># of Vert. Divisions 10</p> <p>Apply # of Div. to All Channels</p>	<p>SCALE Menu</p> <p>----Phase----</p> <p>Resolution Select displays the Resolution (Degrees/Division) toolbar with units in degrees per division. Resolution : 45.00 ° ^ v ° X</p> <p>Reference Value (Degrees) Select displays the Reference Value (Degrees) toolbar. Reference Value : 0.00 ° ^ v ° X</p> <p>Reference Position (Number) Select displays the Reference Position toolbar. Reference Position : 5 ^ v Enter X</p> <p>Wrap Setup Select opens the WRAP SETUP menu. </p> <p>Wrap Offset Select displays the Wrap Offset field toolbar with units in degrees. Reference Value : 0.00 ° ^ v ° X</p> <p>Additional Common Buttons</p> <ul style="list-style-type: none"> • “SCALE Menu Common Buttons” on page 18-30
---	--

Figure 18-3. SCALE Phase Menu

18-6 SCALE Real or Imaginary Menus

SCALE Real Magnitude Menu

Prerequisite

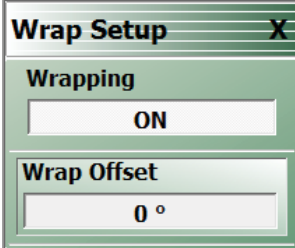
- TRACE FORMAT is set to Real
- MAIN | Display | DISPLAY | Trace Format | TRACE FORMAT | Real

Previous

- [“Main Menu” on page 2-2](#)

Navigation

- MAIN | Scale | SCALE

	<p>SCALE Menu ---Real---</p> <p>Resolution Select displays the Resolution (Units/Division) toolbar with units of units per division. Reference Position : 5 ^ v Enter X</p> <p>Reference Value (Units) Select displays the Reference Value (Units) toolbar. Reference Value : 0.000 U ^ v nU uU mU U X</p> <p>Reference Position (Number) Select displays the Reference Position toolbar. Reference Position : 5 ^ v Enter X</p> <p>Additional Common Buttons</p> <ul style="list-style-type: none"> • “SCALE Menu Common Buttons” on page 18-30
--	---

Figure 18-4. SCALE Real Menu

SCALE Imaginary Menu

Prerequisite

- TRACE FORMAT is set to Imaginary
- MAIN | Display | DISPLAY | Trace Format | TRACE FORMAT | Imaginary

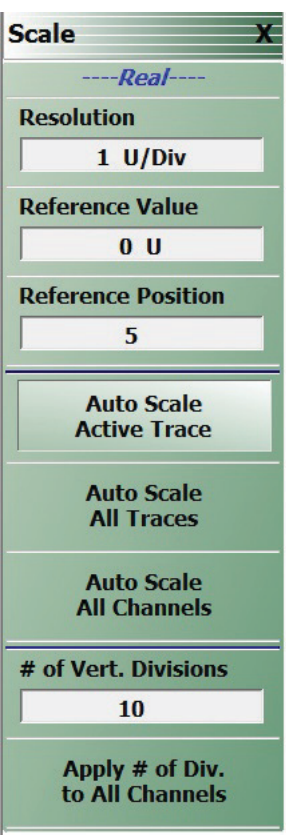
Previous

- [“Main Menu” on page 2-2](#)

Navigation

- MAIN | Scale | SCALE

	<p>SCALE Menu ----Imaginary----</p> <p>Resolution Select displays the Resolution toolbar with units of nU, uU, mU, or U units per division.</p> <p>Resolution : 1.000 U ^ v nU uU mU U X</p> <p>Reference Value (Units) Select displays the Reference Value toolbar units of nU, uU, mU, or U.</p> <p>Reference Value : 0.000 U ^ v nU uU mU U X</p> <p>Reference Position (Number) Select displays the Reference Position toolbar.</p> <p>Reference Position : 5 ^ v Enter X</p> <p>Additional Common Buttons</p> <ul style="list-style-type: none"> • “SCALE Menu Common Buttons” on page 18-30
--	---

Figure 18-5. SCALE Imaginary Menu

18-7 SCALE SWR Menu

SCALE Standing Wave Ratio Menu

Prerequisite

- TRACE FORMAT is set to VSWR
- MAIN | Display | DISPLAY | Trace Format | TRACE FORMAT | VSWR

Previous

- [“Main Menu” on page 2-2](#)

Navigation

- MAIN | Scale | SCALE

<div style="border: 1px solid black; padding: 5px;"> <p>Scale X</p> <p style="text-align: center;">---SWR---</p> <p>Resolution</p> <p style="text-align: center;">10 U/Div</p> <p>Reference Value</p> <p style="text-align: center;">0 U</p> <p>Reference Position</p> <p style="text-align: center;">5</p> <hr/> <p style="text-align: center;">Auto Scale Active Trace</p> <p style="text-align: center;">Auto Scale All Traces</p> <p style="text-align: center;">Auto Scale All Channels</p> <hr/> <p># of Vert. Divisions</p> <p style="text-align: center;">10</p> <p style="text-align: center;">Apply # of Div. to All Channels</p> </div>	<p>SCALE Menu</p> <p>---SWR---</p> <p>Resolution</p> <p>Select displays the Resolution (Units/Division) toolbar with units of nU, uU, mU, or U per division.</p> <p>Resolution : 10.000 U ^ v nU uU mU U X</p> <p>Reference Value (Units)</p> <p>Select displays the Reference Value (Units) toolbar with units of nU, uU, mU, or U.</p> <p>Reference Value : 0.000 U ^ v nU uU mU U X</p> <p>Reference Position (Number)</p> <p>Select displays the Reference Position toolbar.</p> <p>Reference Position : 5 ^ v Enter X</p> <p>Additional Common Buttons</p> <ul style="list-style-type: none"> • “SCALE Menu Common Buttons” on page 18-30
--	--

Figure 18-6. SCALE SWR (Standing Wave Ratio) Menu

18-8 SCALE Smith Chart Menus

SCALE Smith Chart Impedance Menu

Prerequisites

- TRACE FORMAT is set to Smith (R+jX Impedance)
 - [“Display Main Menu” on page 17-2](#)
 - MAIN | Display | DISPLAY | Trace Format | TRACE FORMAT | Smith (R+jX)
- SMITH readout style is set to Linear/Phase, Log/Phase, Real/Imaginary, or Impedance
 - [“SMITH IMPEDANCE Menu” on page 17-8](#)
 - MAIN | Display | DISPLAY | Trace Format | TRACE FORMAT | Smith (R+jX) | SMITH IMPED.

Previous

- [“Main Menu” on page 2-2](#)

Navigation

- MAIN | Scale | SCALE

	<p>SCALE Menu ----Smith Impedance----</p> <p>Reference Value Reference Value button is unavailable.</p> <p>Reference Position Reference Position button is unavailable.</p> <p>Scale Selection Opens the “SMITH SCALING Menu” on page 18-15.</p> <p>Wrap Setup Select opens the WRAP SETUP menu.</p> <div data-bbox="837 808 1133 1050" style="border: 1px solid gray; padding: 5px; margin: 10px 0;"> </div> <p>Wrap Offset Select displays the Wrap Offset field toolbar with units in degrees.</p> <div data-bbox="462 1186 1508 1228" style="border: 1px solid gray; padding: 2px;"> Reference Value : 0.00 ° ^ v ° X </div> <p>Additional Common Buttons</p> <ul style="list-style-type: none"> • “SCALE Menu Common Buttons” on page 18-30
--	---

Figure 18-7. SCALE Smith Impedance Menu

SCALE Smith Chart Admittance Menu

Prerequisites

- TRACE FORMAT is set to Smith (G+jB Admittance)
 - [“Display Main Menu” on page 17-2](#)
 - MAIN | Display | DISPLAY | Trace Format | TRACE FORMAT | Smith (G+jB)
- SMITH readout style is set to Linear/Phase, Log/Phase, Real/Imaginary, or Admittance
 - [“SMITH IMPEDANCE Menu” on page 17-8](#)
 - MAIN | Display | DISPLAY | Trace Format | TRACE FORMAT | Smith (G+jB) | SMITH ADMITT.

Previous

- [“Main Menu” on page 2-2](#)

Navigation

- MAIN | Scale | SCALE

	<p>SCALE Menu ----Smith Admittance----</p> <p>Reference Value Reference Value button is unavailable.</p> <p>Reference Position Reference Position button is unavailable.</p> <p>Scale Selection Opens the “SMITH SCALING Menu” on page 18-15.</p> <p>Wrap Setup Select opens the WRAP SETUP menu.</p> <div data-bbox="762 1325 1059 1570" style="border: 1px solid black; padding: 5px; margin: 10px 0;"> </div> <p>Wrap Offset Select displays the Wrap Offset field toolbar with units in degrees.</p> <div data-bbox="391 1711 1436 1753" style="border: 1px solid gray; padding: 2px;"> Reference Value : 0.00 ° ^ v ° X </div> <p>Additional Common Buttons</p> <ul style="list-style-type: none"> • “SCALE Menu Common Buttons” on page 18-30
--	--

Figure 18-8. SCALE Smith Admittance Menu

SMITH SCALING Menu

Prerequisites

- TRACE FORMAT is set to Smith (R+jX Impedance) or Smith (G+jB Admittance)
 - “Display Main Menu” on page 17-2
 - MAIN | Display | DISPLAY | Trace Format | TRACE FORMAT | Smith (R+jX)
 - MAIN | Display | DISPLAY | Trace Format | TRACE FORMAT | Smith (G+jB)
- SMITH readout style is set to Linear/Phase, Log/Phase, Real/Imaginary, Impedance or Admittance
 - “SMITH IMPEDANCE Menu” on page 17-8
 - MAIN | Display | DISPLAY | Trace Format | TRACE FORMAT | Smith (R+jX) | SMITH IMPED.
 - MAIN | Display | DISPLAY | Trace Format | TRACE FORMAT | Smith (G+jB) | SMITH ADMITT.

Previous

- “SCALE Smith Chart Impedance Menu” on page 18-12
- “SCALE Smith Chart Admittance Menu” on page 18-14

Navigation

- MAIN | Scale | SCALE

	<p>SCALE Menu</p> <p>---Smith Scaling---</p> <p>The Smith Scaling menu allows selection of the following scaling options:</p> <p>0 dB (Refl 1.0)</p> <p>-10 dB (Refl 0.3162278)</p> <p>-20 dB (Refl 0.10)</p> <p>-30 dB (Refl 0.0316228)</p> <p>3 dB (Refl 1.4125375)</p>
--	---

Figure 18-9. SMITH SCALING Menu

18-9 SCALE Polar Chart Menus

SCALE Linear Polar Chart Menu

Menu Identification

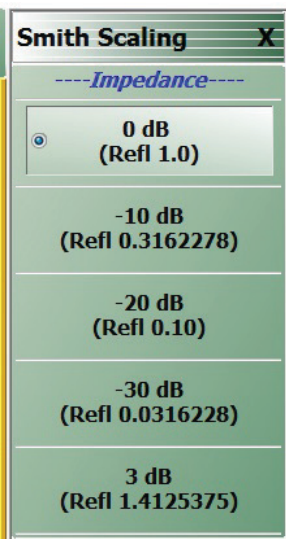
- The appearance and button availability of the SCALE menu depends on the settings on the DISPLAY menu.
- [“Scale Menus Appearance, Common Buttons, and Units” on page 18-1](#)

Prerequisites

- The SCALE (Linear Polar) menu is available when TRACE FORMAT on the Display menu is set to either Linear Polar (Linear/Phase) or Linear Polar (Real/Imaginary).
- Button Units: U (Units)
- Button Units: ° (Degrees)
- The Reference Position button is unavailable.

Previous

- [“Main Menu” on page 2-2](#)

Navigation

- MAIN | Scale | SCALE

	<p>Resolution (Units/Div) Select displays the Resolution (Units/Division) toolbar with units of units per division.</p> <p>Resolution (Units/Division) Field Toolbar Resolution : 1.000 U ^ v nU uU mU U X</p> <p>Reference Value (Units) Select displays the Reference Value (Units) toolbar.</p> <p>Reference Value (Units) Field Toolbar Reference Value : 5.000 U ^ v nU uU mU U X</p> <p>Reference Position (Number) The Reference Position button is unavailable.</p> <p>Wrap Offset (Degrees) Select allows the user to define the phase offset in degrees and displays the Wrap Offset field toolbar.</p> <p>Wrap Offset (Degrees) Field Toolbar Wrap Offset : 0.00 ° ^ v ° X</p> <p>Additional Common Buttons</p> <ul style="list-style-type: none"> • “SCALE Menu Common Buttons” on page 18-30
--	--

Figure 18-10. SCALE Linear Polar Menu

SCALE Log Polar Chart Menu

Menu Identification

- The appearance and button availability of the SCALE menu depends on the settings on the DISPLAY menu. Consult the section above for SCALE menu identification and prerequisites.
- [“Scale Menus Appearance, Common Buttons, and Units” on page 18-1](#)

Prerequisites

- The SCALE (Log Polar) menu is available when TRACE FORMAT is set to either Log Polar (Linear/Phase) or Log Polar (Real/Imaginary).
- Button Units: dB
- Button Units: ° (Degrees)

Previous

- [“Main Menu” on page 2-2](#)

Navigation

- MAIN | Scale | SCALE

	<p>Resolution (dB/Div) Select displays the Resolution (dB) toolbar with units in dB per division.</p> <p>Resolution (dB/Division) Field Toolbar Resolution : 10.0000 dB ^ v Enter</p> <p>Reference Value (dB) Select displays the Reference Value (dB) toolbar.</p> <p>Reference Value (dB) Field Toolbar Reference Value : 0.0000 dB ^ v dB</p> <p>Reference Position (Number) The Reference Position button is unavailable.</p> <p>Wrap Setup Select opens the WRAP SETUP menu. See menu description following</p> <p>Additional Common Buttons</p> <ul style="list-style-type: none"> • “SCALE Menu Common Buttons” on page 18-30
--	--

Figure 18-11. SCALE Log Polar Menu

WRAP Setup Menu

Prerequisites

- The WRAP SETUP submenu appears on the SCALE (Log Polar) menu
(continued)

 <p>The screenshot shows a menu titled 'Wrap Setup' with a close button 'X'. Underneath, there are two sections: 'Wrapping' with a button labeled 'ON', and 'Wrap Offset' with a button labeled '0 °'.</p>	<p>Wrapping (On/Off) Select toggles Smith chart phase wrapping on and off, with the current state displayed in the button field.</p> <p>Wrap Offset (Degrees) Select displays the Wrap Offset field toolbar where the user can define the phase offset in degrees from 0 degrees to 360 degrees.</p> <p>Wrap Offset (Degrees) Field Toolbar</p> <p>Wrap Offset : 0.00 ° <input type="button" value="^"/> <input type="button" value="v"/> °</p>
--	--

Figure 18-12. WRAP SETUP Menu

18-10 SCALE Dual-Trace Display Menus

SCALE Impedance Real and Imaginary Menu

Prerequisite

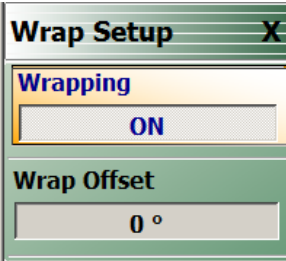
- TRACE FORMAT is set to Real & Imaginary
- MAIN | Display | DISPLAY | Trace Format | TRACE FORMAT | Impedance | IMPEDANCE | Real&Imaginary

Previous

- [“Main Menu” on page 2-2](#)

Navigation

- MAIN | Scale | SCALE

<p>Scale</p> <p>---Real---</p> <p>Resolution 1 U/Div</p> <p>Reference Value 0 U</p> <p>Reference Position 5</p> <hr/> <p>---Imaginary---</p> <p>Resolution 1 U/Div</p> <p>Reference Value 0 U</p> <p>Reference Position 5</p> <hr/> <p>Auto Scale Active Trace</p> <p>Auto Scale All Traces</p> <p>Auto Scale All Channels</p> <hr/> <p># of Vert. Divisions 10</p> <p>Apply # of Div. to All Channels</p>	<p>SCALE Menu</p> <p>----Impedance Real----</p> <p>Resolution Select displays the Resolution toolbar with units in Ω (Ohms) per division. Resolution : 1.000 U ^ v nU uU mU U X</p> <p>Reference Value Select displays the Reference Value toolbar with units in Ω (Ohms). Resolution : 1.000 U ^ v nU uU mU U X</p> <p>Reference Position Select allows the user to define a reference position and displays the Reference Position field toolbar. Reference Position : 5 ^ v Enter X</p> <p>----Impedance Imaginary----</p> <p>Resolution Select displays the Resolution toolbar with units in Ω (Ohms) per division. Resolution : 1.000 U ^ v nU uU mU U X</p> <p>Reference Value Select displays the Reference Value toolbar with units in Ω (Ohms). Resolution : 1.000 U ^ v nU uU mU U X</p> <p>Reference Position Select allows the user to define a reference position and displays the Reference Position field toolbar. Reference Position : 5 ^ v Enter X</p> <p>Additional Common Buttons: “SCALE Menu Common Buttons” on page 18-30</p>
--	--

Figure 18-13. SCALE Impedance Real and Impedance Imaginary Menu

SCALE Log Magnitude and Phase Menu

Prerequisite

- TRACE FORMAT is set to Log Mag And Phase
- MAIN | Display | DISPLAY | Trace Format | TRACE FORMAT | Log Mag And Phase

Previous

- [“Main Menu” on page 2-2](#)

Navigation

- MAIN | Scale | SCALE

Scale Resolution 10 dB/Div Reference Value 0 dB Reference Position 5 <hr/> <i>---Phase---</i> Resolution 45 °/Div Reference Value 0 ° Reference Position 5 Wrap Setup ▶ Wrap Offset 0 ° <hr/> Auto Scale Active Trace Auto Scale All Traces Auto Scale All Channels <hr/> # of Vert. Divisions 10 Apply # of Div. to All Channels	<p>SCALE Menu</p> <p>----Log Magnitude-----</p> <p>Resolution Select displays the Resolution toolbar with units in dB per division. Resolution : 10.0000 dB ^ v Enter X</p> <p>Reference Value Select displays the Reference Value toolbar with units in dB. Reference Value : 0.0000 dB ^ v dB X</p> <p>Reference Position Select displays the Reference Position toolbar. Reference Position : 5 ^ v Enter X</p> <p>----Phase -----</p> <p>Resolution Select displays the Resolution toolbar with units in degrees per division. Resolution : 45.00 ° ^ v ° X</p> <p>Reference Value Select displays the Reference Value toolbar with units in degrees. Reference Value : 0.00 ° ^ v ° X</p> <p>Reference Position Select displays the Reference Position toolbar. Reference Position : 5 ^ v Enter X</p>
--	--

Figure 18-14. SCALE Log Magnitude and Phase Menu (1 of 2)

Wrap Setup

Select opens the WRAP SETUP menu.

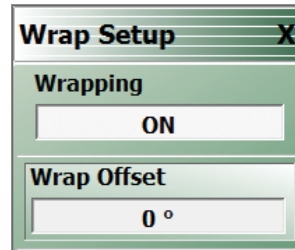
**Wrap Offset**

Select displays the Wrap Offset field toolbar with units in degrees.

**Additional Common Buttons**

- [“SCALE Menu Common Buttons” on page 18-30](#)

Figure 18-14. SCALE Log Magnitude and Phase Menu (2 of 2)

SCALE Linear Magnitude and Phase Menu

Prerequisite

- TRACE FORMAT is set to Lin Mag And Phase
- MAIN | Display | DISPLAY | Trace Format | TRACE FORMAT | Lin Mag And Phase

Previous

- [“Main Menu” on page 2-2](#)

Navigation

- MAIN | Scale | SCALE

Scale ----Lin Mag---- Resolution 10 U/Div Reference Value 0 U Reference Position 5 ----Phase---- Resolution 45 °/Div Reference Value 0 ° Reference Position 5 Wrap Setup ▶ Wrap Offset 0 ° Auto Scale Active Trace Auto Scale All Traces Auto Scale All Channels # of Vert. Divisions 10 Apply # of Div. to All Channels	<p>SCALE Menu</p> <p>----Linear Magnitude----</p> <p>Resolution Select displays the Resolution toolbar with units in dB per division. Resolution : 10.0000 dB ^ v Enter X</p> <p>Reference Value Select displays the Reference Value toolbar with units in dB. Reference Value : 0.0000 dB ^ v dB X</p> <p>Reference Position Select displays the Reference Position toolbar. Reference Position : 5 ^ v Enter X</p> <p>----Phase ----</p> <p>Resolution Select displays the Resolution toolbar with units in degrees per division. Resolution : 45.00 ° ^ v ° X</p> <p>Reference Value Select displays the Reference Value toolbar with units in degrees. Reference Value : 0.00 ° ^ v ° X</p> <p>Reference Position Select displays the Reference Position toolbar. Reference Position : 5 ^ v Enter X</p>
---	---

Figure 18-15. SCALE Linear Magnitude and Phase Menu (1 of 2)

Wrap Setup

Select opens the WRAP SETUP menu.

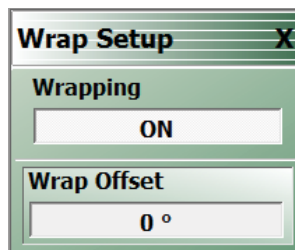
**Wrap Offset**

Select displays the Wrap Offset field toolbar with units in degrees.

**Additional Common Buttons**

- [“SCALE Menu Common Buttons” on page 18-30](#)

Figure 18-15. SCALE Linear Magnitude and Phase Menu (2 of 2)

SCALE Real and Imaginary Menu

Prerequisite

- TRACE FORMAT is set to Real And Imaginary
- MAIN | Display | DISPLAY | Trace Format | TRACE FORMAT | Real And Imaginary

Previous

- [“Main Menu” on page 2-2](#)

Navigation

- MAIN | Scale | SCALE

<div style="border: 1px solid black; padding: 5px;"> <p>Scale</p> <p>----Real----</p> <p>Resolution 1 U/Div</p> <p>Reference Value 0 U</p> <p>Reference Position 5</p> <p>----Imaginary----</p> <p>Resolution 1 U/Div</p> <p>Reference Value 0 U</p> <p>Reference Position 5</p> <hr/> <p>Auto Scale Active Trace</p> <p>Auto Scale All Traces</p> <p>Auto Scale All Channels</p> <hr/> <p># of Vert. Divisions 10</p> <p>Apply # of Div. to All Channels</p> </div>	<p>SCALE (Real & Imaginary) Menu</p> <p>----Real----</p> <p>Resolution Select displays the Resolution toolbar with units in Ω (Ohms) per division. Resolution : 1.000 U ^ v nU uU mU U X</p> <p>Reference Value Select displays the Reference Value toolbar with units in Ω (Ohms). Resolution : 1.000 U ^ v nU uU mU U X</p> <p>Reference Position Select allows the user to define a reference position and displays the Reference Position field toolbar. Reference Position : 5 ^ v Enter X</p> <p>----Imaginary----</p> <p>Resolution Select displays the Resolution toolbar with units in Ω (Ohms) per division. Resolution : 1.000 U ^ v nU uU mU U X</p> <p>Reference Value Select displays the Reference Value toolbar with units in Ω (Ohms). Resolution : 1.000 U ^ v nU uU mU U X</p> <p>Reference Position Select allows the user to define a reference position and displays the Reference Position field toolbar. Reference Position : 5 ^ v Enter X</p> <p>Additional Common Buttons "SCALE Menu Common Buttons" on page 18-30</p>
---	--

Figure 18-16. SCALE Real and Imaginary Menu

18-11 GROUP DELAY Menu

SCALE Group Delay Menu

Prerequisite

- TRACE FORMAT is set to Group Delay
- MAIN | Display | DISPLAY | Trace Format | TRACE FORMAT | Group Delay

Previous

- [“Main Menu” on page 2-2](#)

Navigation

- MAIN | Scale | SCALE

	<p>SCALE Menu ----Group Delay----</p> <p>Resolution Select displays the Resolution toolbar with with available units of s (seconds), ms (milliseconds), us (microseconds), ns (nanoseconds), or ps (picoseconds) per division. Resolution : 1.0000 us ^ v ms us ns ps X</p> <p>Reference Value Select displays the Reference Value toolbar with available units of s (seconds), ms (milliseconds), us (microseconds), ns (nanoseconds), or ps (picoseconds) per division. Reference Value : 0.0000 s ^ v ms us ns ps X</p> <p>Reference Position Select displays the Reference Position toolbar. Reference Position : 5 ^ v Enter X</p> <p>Aperture Select displays the Aperture % toolbar that provides control of the width of sweep frequency used in the group delay calculation, where group delay is the integrated slope of the signal measurement. Aperture % : 1.00 ^ v Enter X</p> <p>Additional Common Buttons</p> <ul style="list-style-type: none"> • “SCALE Menu Common Buttons” on page 18-30
--	---

Figure 18-17. SCALE Group Delay Menu (1 of 2)

18-12 SCALE Menu Common Buttons

The button descriptions below apply to all SCALE menus.

Prerequisite

- MAIN | Scale | SCALE

Previous

- [“Main Menu” on page 2-2](#)

Navigation

- MAIN | Scale | SCALE

	<p>SCALE Menu Common Buttons</p> <p>Auto Scale Active Trace Select applies the auto scale function to the active trace only.</p> <p>Auto Scale All Traces Select applies the auto scale function to all traces.</p> <p>Auto Scale All Channels Select applies the auto scale function to all channels.</p> <p># of Vert. Divisions (Number) Select displays the Number of Vertical Divisions field toolbar.</p> <p># of Vert. Divisions : 10 <input type="button" value="^"/> <input type="button" value="v"/> Enter X</p>
--	---

Figure 18-18. SCALE Menu - Common Buttons

Chapter 19 — Marker Menus

19-1 Chapter Overview

This chapter provides information for configuring and controlling the marker functions. The instrument provides up to thirteen markers per trace of which twelve can be direct markers and one a reference marker. Each marker can be individually controlled on/off and positioned as required. If the reference marker is off, each marker provides measurement data based on its display position. If the reference marker is on, each marker provides differential measurement data based on its position relative the reference. Other functions for display options and various types of single-peak search are available.

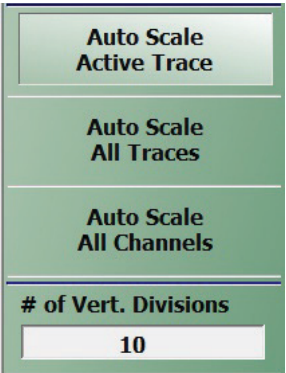
19-2 Overview of Marker Menus, Dialog Boxes, and Toolbars

The available menus and dialog boxes are:

- “[MARKERS \[1\] Menu](#)” on page 19-4
- “[MARKERS \[2\] Menu](#)” on page 19-6
- “[MARKER SETUP Menu](#)” on page 19-7
 - “[MARKER TABLE DISPLAY Tableau](#)” on page 19-9
- “[MARKER SEARCH Menu](#)” on page 19-10
- “[PEAK \(Marker\) Menu](#)” on page 19-11
- “[TARGET \(Marker\) Menu](#)” on page 19-12

19-3 Marker Menu Overview

Marker Button Label Changes

The labels for marker buttons 1 through 12 change depending on whether they are on or off and whether the Ref. Mkr function (described below) is on or off.

Marker Unit Changes

The marker units change depending on the selected instrument sweep setting on the SWEEP TYPES menu and settings on the DOMAIN and RANGE menus:

- Frequency Sweep:
 - Marker units set to frequency (GHz, MHz, kHz, Hz)
- Segmented Sweep (Frequency-Based):
 - Marker units set to frequency (GHz, MHz, kHz, Hz)
- Segmented Sweep (Index-Based):
 - Marker units set to Index number.
- Power Sweep (CW Frequency):
 - Marker units set to power (dBm)

Reference Marker OFF or On

If Ref. Mkr is set to OFF, the label is formatted as:

- Mkr # [OFF] if the marker is off (where # is the marker number).
- Mkr # [ON] if the marker is on.
- For example, Marker 1 would be labeled either Mkr #1 [OFF] or Mkr #1 [ON].

If Ref. Mkr. is set to ON, the label is formatted as:

- Mkr#-Ref [OFF] if the marker is off.
- Mkr#-Ref [ON] if the marker is on.
- For example, Marker 1 would be labeled either Mkr#1-Ref [OFF] or Mkr#1-Ref [ON].

Turning Individual Markers Off and On

The MARKERS [1] menu described below is shown with Marker 1 (Mkr 1) through Marker 4 (Mkr 4) turned off. Individual markers can be turned off manually by clicking their buttons.

Turning All Markers On

All markers can be turned on either manually one-by-one (as above) or at the MARKERS [2] menu, by clicking the All Markers On button.

Note that selecting Inductance/Capacitance on the Smith (Impedance) menu enables marker Inductance or Capacitance measurement readout

The location of that is:

MAIN | Display | DISPLAY | Trace Format | TRACE FORMAT | Smith (R+jX) | SMITH (IMPEDANCE)

Navigation

- MAIN | Markers | MARKERS | More Markers | MARKERS [2] | All Markers On

Turning All Markers Off

All markers can be turned off either manually one-by-one or at the MARKERS [2] menu, by clicking the All Markers Off button.

Navigation

- MAIN | Markers | MARKERS [1] | More Markers | MARKERS [2] | All Markers Off

Naming Conventions for Marker Buttons and Toolbars

The following conventions are used to label the marker buttons and toolbars in this section.

Marker Buttons

- Mkr # [Ref] [OFF/ON] is used for all button names (where # is the number of the marker).
- For example, Mkr1 [Ref] [OFF/ON] is used for the Marker 1 button when it is labeled Mkr 1 [OFF], Mkr 1 [ON], Mkr1-Ref [OFF], or Mkr1-Ref [ON].

Marker Toolbars

- Mkr # [Ref] [ON] is used for all marker toolbars (where # is the number of the marker).
- For example, Mkr1-[Ref] [ON] is used for the Marker 1 toolbar when it is labeled Mkr 1 [ON] or Mkr1-Ref [ON].
- Note the marker must be on for the toolbar to be available.

19-4 Primary Marker Menus

MARKERS [1] Menu

Previous

- [“Main Menu” on page 2-2](#)

Navigation

- MAIN | Marker | MARKERS [1]

<div style="border: 1px solid black; padding: 5px;"> <p>Markers [1] X</p> <p>Marker 1 [ON]</p> <p style="text-align: center;">50.000 kHz</p> <hr/> <p>Marker 2 [OFF]</p> <hr/> <p>Marker 3 [OFF]</p> <hr/> <p>Marker 4 [OFF]</p> <hr/> <p>Ref. Marker [OFF]</p> <hr/> <p>More Markers ▶</p> <hr/> <p>Marker Setup ▶</p> <hr/> <p>Marker Search ▶</p> <hr/> <p>Marker Functions ▶</p> </div>	<p>Mkr 1 [Ref] [OFF/ON]</p> <p>The Marker 1 Button appearance depends on instrument settings:</p> <ul style="list-style-type: none"> • If the label reads Mkr 1 [OFF], Marker 1 is set to off. • If the label reads Mkr 1 [ON], Marker 1 is set to on. • If the label reads Mkr1-Ref [OFF], the Ref. Mkr button (described below) is set to on, and Marker 1 is set to off. • If the label reads Mkr1-Ref [ON], the Ref. Mkr button is set to on, and Marker 1 is set to on. • If the marker button reads Mkr1-Ref1[ON], the Mkr1-Ref [ON] Toolbar is available. Allows input of frequency value (dBm). <p>Mkr 2 [Ref] [OFF/ON]</p> <p>Used to control Marker 2.</p> <ul style="list-style-type: none"> • “Mkr 1 [Ref] [OFF/ON]” on page 19-4 <p>Mkr 3 [Ref] [OFF/ON]</p> <p>Used to control Marker 3.</p> <ul style="list-style-type: none"> • “Mkr 1 [Ref] [OFF/ON]” on page 19-4 <p>Mkr 4 [Ref] [OFF/ON]</p> <p>Used to control Marker 4.</p> <ul style="list-style-type: none"> • “Mkr 1 [Ref] [OFF/ON]” on page 19-4
--	---

Figure 19-1. MARKERS [1] Menu (1 of 2)

Ref. Mkr [OFF/ON]

Select toggles the reference marker off and on.

Ref. Mkr ON

If toggled to ON, a user-defined reference value can be entered and:

- The labels for the Mkr 1, Mkr 2, Mkr 3, and Mkr 4 buttons (described above) change to Mkr1-Ref, Mkr2-Ref, Mkr3-Ref, and Mkr4-Ref.
- The labels for Mkr 5 and Mkr 6 on the Markers [2] menu (described below) are changed to Mkr5-Ref and Mkr6-Ref.
- The Ref. Mkr [ON] toolbar appears below the icon toolbar.
- The units in the reference marker toolbar depend on the sweep, domain, and time/distance settings.

Ref. Mkr OFF

If toggled to OFF:

- The labels for the Mkr1-Ref, Mkr2-Ref, Mkr3-Ref, and Mkr4-Ref buttons change to Mkr 1, Mkr 2, Mkr 3, and Mkr 4.
- The labels for Mkr5-Ref and Mkr6-Ref. on the Markers [2] menu change to Mkr 5 and Mkr 6.

More Markers

Select displays the MARKERS [2] menu and the controls for Marker 5 and Marker 6. The button labels for these markers are the same as Marker 1 through Marker 4.

- [“MARKERS \[2\] Menu” on page 19-6](#)

Markers Setup

Select displays the MARKER SETUP menu.

- [“MARKER SETUP Menu” on page 19-7](#)

Markers Search

Select displays the MARKER SEARCH button.

- [“MARKER SEARCH Menu” on page 19-10](#)

Markers Functions

Select displays the MARKER FUNCTIONS menu

Figure 19-1. MARKERS [1] Menu (2 of 2)

MARKERS [2] Menu

Previous

- [“MARKERS \[1\] Menu” on page 19-4](#)

Navigation

- MAIN | Marker | MARKERS [1] | More Markers | MARKERS [2]

	<p>All Markers Off Select toggles all 12 regular markers off. If on, Reference Marker is turned off.</p> <p>All Markers On Select toggles all 12 regular markers on. If OFF, the Reference Marker is not turned on. If ON, the Reference Marker is not affected.</p> <p>Mkr 5 [Ref] [OFF/ON] Used to control Marker 5. <ul style="list-style-type: none"> • “Mkr 1 [Ref] [OFF/ON]” on page 19-4 </p> <p>Mkr 6 [Ref] [OFF/ON] Used to control Marker 6. <ul style="list-style-type: none"> • “Mkr 1 [Ref] [OFF/ON]” on page 19-4 </p>
--	--

Figure 19-2. MARKERS [2] Menu

MARKER SETUP Menu

Previous

- [“MARKERS \[1\] Menu” on page 19-4](#)

Navigation

- MAIN | Marker | MARKERS [1] | Marker Setup | MARKER SETUP

	<p>Marker Table</p> <p>Select toggles the marker table off and on. When OFF is selected, the Marker Table display area is not visible. When ON is selected, the display area is shortened, and the marker table appears below the main display.</p> <ul style="list-style-type: none"> • “MARKER TABLE DISPLAY Tableau” on page 19-9 <p>Coupled Markers (Off/On)</p> <p>Select toggles the marker coupling off and on for a per channel basis.</p> <ul style="list-style-type: none"> • In Coupled Markers ON mode, moving a specific marker in one trace display moves the same numbered marker in all other trace displays in that channel. • In Coupled Markers OFF mode, markers can be moved independently in each trace without affecting the position of other markers in other traces. <p>Display Markers (Off/On)</p> <p>Select toggles the markers display off and on. The number and position of displayed markers is not changed when the display is turned back on.</p> <p>All Markers Off</p> <p>Select toggles all markers OFF. If on, the Reference Marker is also turned OFF.</p> <p>All Markers On</p> <p>Select toggles all 6 regular markers ON. If OFF, the Reference Marker is not turned on. If ON, the Reference Marker is not affected.</p> <p>Marker Mode</p> <p>Select toggles between Discrete Marker Mode and Continuous Marker Mode.</p> <ul style="list-style-type: none"> • In Discrete Mode, markers can only be moved from measured point to measured point and cannot be set between measured points. • In Continuous Mode, markers can be moved between measured points. If a non-measured position is selected, the instrument interpolates the measurement value. <p>Statistics Display</p> <p>Select toggles the statistics display off and on.</p> <p>Mrk Location</p> <p>Select opens the “MRK. POSITION Menu” on page 19-8</p>
--	---

Figure 19-3. MARKER SETUP Menu

MRK. POSITION Menu

Previous

- [“MARKER SETUP Menu” on page 19-7](#)

Navigation

- MAIN | Marker | MARKERS [1] | Marker Setup | MARKER SETUP | Mrk Location | MRK. POSITION

Mrk. Position X	Marker Position
<input checked="" type="radio"/> Upper Left	Selects the location of the marker display data to one of the following locations:
Upper Right	Upper Left
Lower Left	Upper Right
Lower Right	Lower Left
	Lower Right

Figure 19-4. MARKER SETUP Menu

MARKER TABLE DISPLAY Tableau

Previous

- “MARKER SETUP Menu” on page 19-7

Navigation

- MAIN | Marker | MARKERS [1] | Marker Setup | MARKER SETUP | Marker Table Display

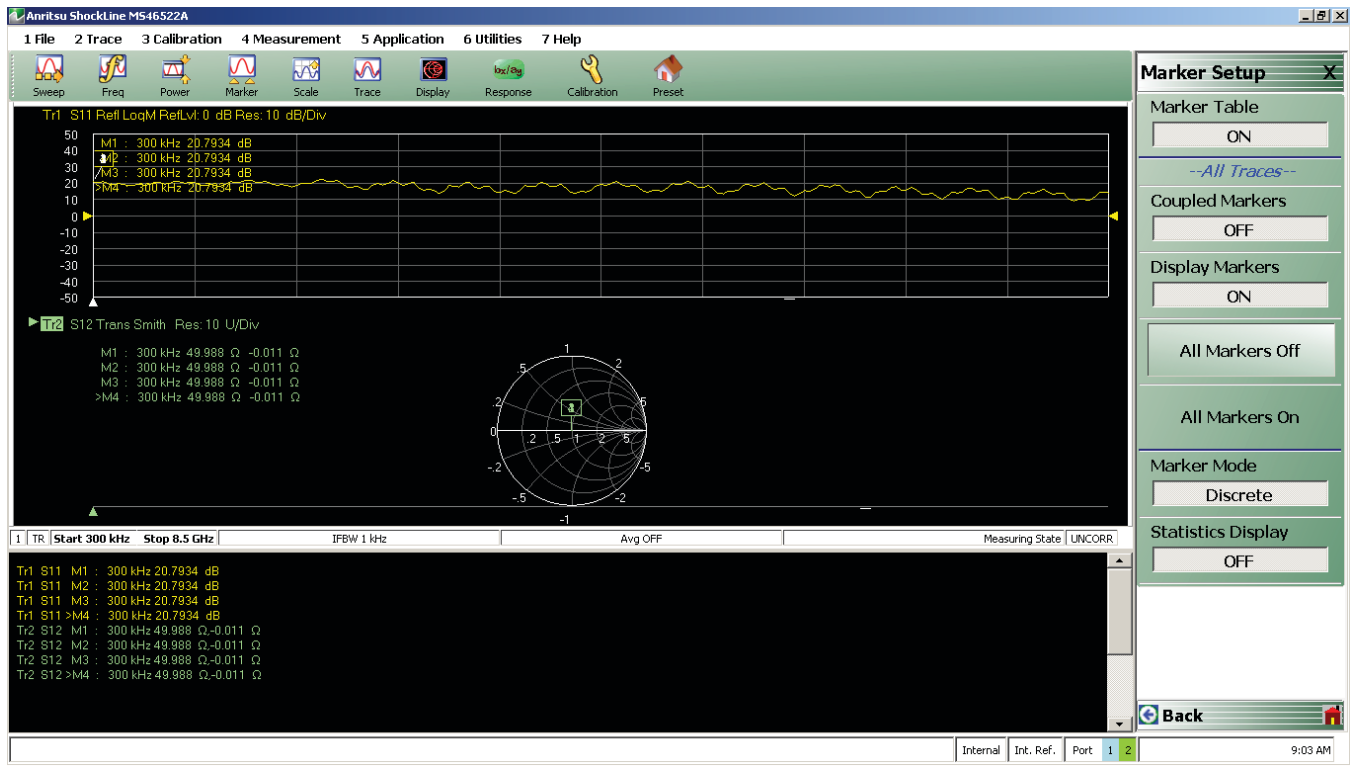

Figure 19-5. MARKER TABLE DISPLAY Tableau

Marker Labels

Marker labels in the Marker Table Display show the response type set for the Trace. For example, if S11 is selected in the Response Menus, the Marker Table listing starts with S11.

19-5 Marker Search Menus

MARKER SEARCH Menu

Previous

- [“MARKERS \[1\] Menu” on page 19-4](#)

Navigation

- MAIN | Marker | MARKERS [1] | Marker Search | MARKER SEARCH

	<p>MARKER SEARCH Menu Button Selection Group</p> <p>The Max, Min, Peak, and Target buttons form a four (4) button selection group where the selection of any one button de-selects the other three (3) buttons.</p> <p>Max (Marker) Select sets marker search to Maximum values and de-selects Min, Peak, and Target.</p> <p>Min (Marker) Select sets marker search to Minimum values and de-selects Max, Peak, and Target.</p> <p>Peak (Marker) Select sets marker search to Peak values, de-selects Max, Min, and Target, and then displays the PEAK menu.</p> <ul style="list-style-type: none"> • “PEAK (Marker) Menu” on page 19-11 <p>Target (Marker) Select sets marker search to Target values, de-selects Max, Min, and Peak, and then displays the TARGET menu.</p> <ul style="list-style-type: none"> • “TARGET (Marker) Menu” on page 19-12 <p>Tracking Select retains marker at the current location based on selection of Max, Min, or Peak. Operates on a per marker basis.</p> <p>Advanced Search Select displays the ADVANCED SEARCH menu.</p> <ul style="list-style-type: none"> • “ADVANCED SEARCH Markers Menu” on page 19-13
---	---

Figure 19-6. MARKER SEARCH Menu

PEAK (Marker) Menu

Previous

- [“MARKER SEARCH Menu” on page 19-10](#)

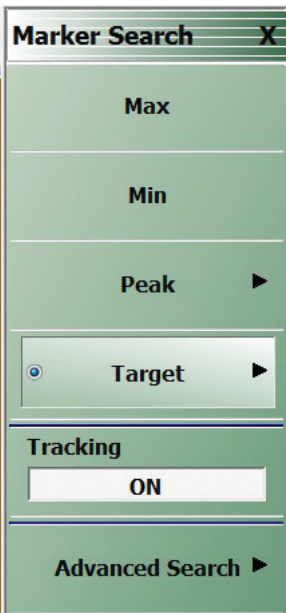
Navigation

- MAIN | Marker | MARKERS [1] | Marker Search | MARKER SEARCH | Peak | PEAK

	<p>Search Peak Select moves the active marker to the peak with the highest absolute value that matches the selected Peak Excursion, Threshold, and Polarity values.</p> <p>Search Left Select moves the active marker to the target that is nearest on its left to the peak value that matches the selected Peak Excursion, Threshold, and Polarity values.</p> <p>Search Right Select moves the active marker to the target that is nearest on its right to the peak value that matches the selected Peak Excursion, Threshold, and Polarity values.</p> <p>Peak Excursion Select displays the Peak Excursion field toolbar and allows the user to enter the peak excursion value in dB, dBm, Degrees, or Units, depends on trace display settings and instrument settings.</p> <p>Peak Excursion : 0.0000 dB ^ v dB X</p> <p>Threshold Select displays the Threshold field toolbar and allows the user to enter the peak threshold value in dB, dBm, Degrees, or Units (U) depending on instrument settings.</p> <p>Threshold : 0.0000 dB ^ v dB X</p> <p>----Peak Polarity----</p> <p>Positive Sets the peak search object polarity to positive.</p> <p>Negative Sets the peak search object polarity to negative.</p> <p>Both Sets the peak search object polarity to either positive or negative.</p>
--	--

Figure 19-7. PEAK (Marker) Menu

TARGET (Marker) Menu

Previous

- [“MARKER SEARCH Menu” on page 19-10](#)

Navigation

- MAIN | Marker | MARKERS [1] | Marker Search | MARKER SEARCH | Target | TARGET

	<p>TARGET Search Button Selection Group</p> <p>The Search Target, Search Left, and the Search Right buttons form a button selection group where selection of any one button de-selects the other two (2) buttons.</p> <p>Search Target (Marker)</p> <p>Select moves the active marker to the marker that matches the target value and polarity.</p> <p>Search Left (Marker)</p> <p>Select moves the active marker to the marker that is nearest on its left that matches the target value and polarity.</p> <p>Search Right (Marker)</p> <p>Select moves the active marker to the marker that is nearest on its right that matches the target value and polarity.</p> <p>Target Value (Marker)</p> <p>Select displays the Target Value field toolbar and allows the user to enter the target value in dB, dBm, Degrees, or Units (U), depends on trace display and instrument settings.</p> <p>Target Value : 0.0000 dB ^ v dB X</p> <p>---Target Transition---</p> <p>Positive (Marker Target)</p> <p>Sets the target transition to search for a positive transition.</p> <p>Negative (Marker Target)</p> <p>Sets the target transition to search for a negative transition.</p> <p>Both (Marker Target)</p> <p>Sets the target transition to search for either a positive or negative transition.</p>
--	--

Figure 19-8. TARGET (Marker) Menu

ADVANCED SEARCH Markers Menu

Previous

- [MARKER SEARCH Menu](#) on page 19-10

Navigation

- MAIN | Marker | MARKERS [1] | Marker Search | MARKER SEARCH | Advanced Search | ADVANCED SEARCH

	<p>Multi Peak Select displays the Multi Peak menu.</p> <ul style="list-style-type: none"> • “MULTI PEAK Marker Search Menu” on page 19-14 <p>Multi Target Select displays the Multi Target menu.</p> <ul style="list-style-type: none"> • “MULTI TARGET Marker Search Menu” on page 19-15 <p>Search Range Select displays the Search Range menu.</p> <ul style="list-style-type: none"> • “SEARCH RANGE Marker Menu” on page 19-16 <p>Bandwidth Select displays the Bandwidth menu.</p> <ul style="list-style-type: none"> • “BANDWIDTH Marker Search Menu” on page 19-17 <p>Notch Select displays the Notch menu.</p> <ul style="list-style-type: none"> • “NOTCH Marker Search Menu” on page 19-18
---	--

Figure 19-9. ADVANCED SEARCH (Marker) Menu

MULTI PEAK Marker Search Menu

Previous

- “ADVANCED SEARCH Markers Menu” on page 19-13

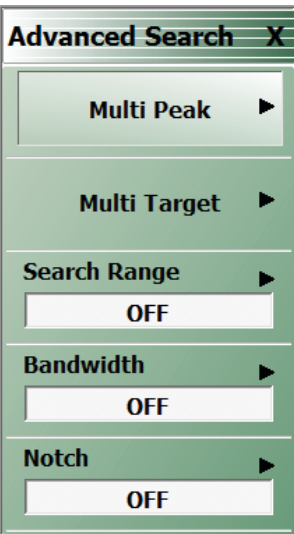
Navigation

- MAIN | Marker | MARKERS [1] | Marker Search | MARKER SEARCH | Advanced Search | ADVANCED SEARCH | Multi Peak | MULTI PEAK

Multi Peak X	All Markers Off Select turns all markers off.
All Markers Off	Search Select starts the defined marker search.
Search Multi Peak	Peak Excursion Select displays the Peak Excursion toolbar and allows entry of the peak excursion value in dB, dBm, Degrees, or Units (U) depending on instrument settings.
Peak Excursion 0 dB	Peak Excursion : 0.0000 dB ^ v dB X
Threshold 0 dB	Threshold Select displays the Threshold field toolbar and allows the user to enter the peak excursion value in dB, dBm, Degrees, or Units (U) depending on instrument settings.
----Peak Polarity----	Threshold : 0.0000 dB ^ v dB X
<input checked="" type="radio"/> Positive	----Peak Polarity---- Positive Polarity Sets the peak search object polarity to positive.
<input type="radio"/> Negative	Negative Polarity Sets the peak search object polarity to negative.
<input type="radio"/> Both	Both Polarity Sets the peak search object polarity to either positive or negative.

Figure 19-10. MULTI PEAK (Marker) Menu

MULTI TARGET Marker Search Menu

Previous

- “ADVANCED SEARCH Markers Menu” on page 19-13

Navigation

- MAIN | Marker | MARKERS [1] | Marker Search | MARKER SEARCH | Advanced Search | ADVANCED SEARCH | Multi Target | MULTI TARGET

Multi Target X	All Markers Off
All Markers Off	Select turns all markers off.
Search Multi Target	Search Multi Target Select starts the defined multi peak marker search with search units in dB, dBm, Degrees, or Units depending on the instrument settings.
Target Value	Target Value : 0.0000 dB ^ v dB X
0 dB	
<i>--Target Transition--</i>	----Target Transition----
Positive	Positive Sets the target transition to search for a positive transition.
Negative	Negative Sets the target transition to search for a negative transition.
<input checked="" type="radio"/> Both	Both Sets the target transition to search for either a positive or negative transition.

Figure 19-11. MULTI TARGET (Marker) Menu

SEARCH RANGE Marker Menu

Previous

- [“ADVANCED SEARCH Markers Menu” on page 19-13](#)

Navigation

- MAIN | Marker | MARKERS [1] | Marker Search | MARKER SEARCH | Advanced Search | ADVANCED SEARCH | Search Range | SEARCH RANGE

	<p>Search Range Select toggles the search range OFF and ON.</p> <p>Marker Search Range Units The marker search range units can vary depending on the settings in the SWEEP TYPES menu and in the DOMAIN menu. The button descriptions below and their related field toolbars reflect a marker units setting of frequency in Hertz. Marker units can also be set in:</p> <ul style="list-style-type: none"> • dBm • Distance (km to um) • Frequency (GHz to Hz) • Number (Index Number) • Time (s to ps) <p>Start Range Select displays the Start Range field toolbar and allows entry of a starting search point in the appropriate units.</p> <p>Start Range : 0 Hz ^ v GHz MHz kHz Hz X</p> <p>Stop Range Select displays the Stop Range field toolbar and allows entry of a stop search point in the appropriate units.</p> <p>Stop Range : 0 Hz ^ v GHz MHz kHz Hz X</p> <p>Apply to All Traces? Select toggles Apply to All Traces NO and YES.</p> <ul style="list-style-type: none"> • If YES, the search range is applied to all traces. • If NO, the search range applies to the active trace.
--	--

Figure 19-12. SEARCH RANGE (Marker) Menu

BANDWIDTH Marker Search Menu

Previous

- [“ADVANCED SEARCH Markers Menu” on page 19-13](#)

Navigation

- MAIN | Marker | MARKERS [1] | Marker Search | MARKER SEARCH | Advanced Search | ADVANCED SEARCH | Bandwidth | BANDWIDTH

Bandwidth X	Bandwidth Select toggles the bandwidth marker search OFF and ON.
Bandwidth <input type="button" value="ON"/>	Bandwidth Loss Value Select displays the Bandwidth Loss Value field toolbar and allows entry of a loss value in dB (shown below), dBm, or Units (U).
Bandwidth Loss Value <input type="button" value="0 dB"/>	Bandwidth Loss Value : 0.0000 dB <input type="button" value="^"/> <input type="button" value="v"/> dB <input type="button" value="X"/>
----Shape Factor----	----Shape Factor----
Include In Search? <input type="button" value="YES"/>	Include in Search? Select toggles YES or NO to specify whether the shape factor will be included in the marker search.
High(Rel. To Loss) <input type="button" value="0 dB"/>	High (Rel. To Loss) Select displays the High (Relative to Loss) field toolbar and allows entry of a high loss value in dB. Depending on instrument settings, this search function can be in units of dB, dBm (not shown), Degrees, or Units.
Low(Rel. To Loss) <input type="button" value="0 dB"/>	Low (Rel. To Loss) Select displays the Low (Relative to Loss) field toolbar and allows entry of a low loss value in dB. Depending on instrument settings, this search function can be in units of dB, dBm (not shown), Degrees, or Units.
	Low(Rel. To Loss) : 0.0000 dB <input type="button" value="^"/> <input type="button" value="v"/> dB <input type="button" value="X"/>

Figure 19-13. BANDWIDTH (Marker) Menu

NOTCH Marker Search Menu

Previous

- [“ADVANCED SEARCH Markers Menu” on page 19-13](#)

Navigation

- MAIN | Marker | MARKERS [1] | Marker Search | MARKER SEARCH | Advanced Search | ADVANCED SEARCH | Notch | NOTCH

	<p>Notch Select toggles the bandwidth marker search OFF and ON.</p> <p>Notch Loss Value Select displays the Notch Loss Value field toolbar and allows entry of a loss value in dB, Degrees, or Units.</p> <p>Notch Loss Value : 0.0000 dB [^] [v] dB [X]</p> <p>----Shape Factor----</p> <p>Include in Search? Select toggles YES or NO to specify whether the notch factor will be included in the search.</p> <p>High (Rel. To Loss) (dB) (Marker) Select displays the High (Relative to Loss) (Notch) field toolbar and allows entry of a high loss value in dB, dBm (not shown), Degrees, or Units.</p> <p>High(Rel. To Loss) : 0.0000 dB [^] [v] dB [X]</p> <p>Low (Rel. To Loss) Select displays the Low (Relative to Loss) (Notch) field toolbar and allows entry of a high loss value in dB, dBm (not shown), Degrees, or Units.</p> <p>Low(Rel. To Loss) : 0.0000 dB [^] [v] dB [X]</p>
---	---

Figure 19-14. NOTCH (Marker) Menu

Marker Function Menu

Previous

- “ADVANCED SEARCH Markers Menu” on page 19-13

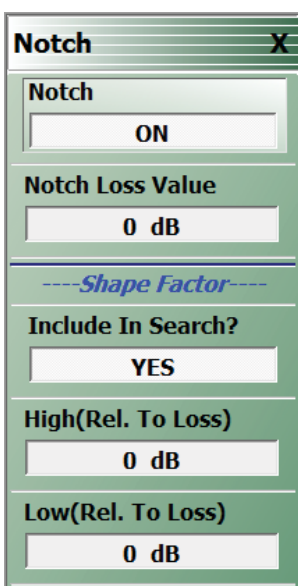
Navigation

- MAIN | Marker | MARKERS [1] | Marker Search | MARKER SEARCH | Advanced Search | ADVANCED SEARCH | MKR Functions | MKR FUNCTIONS

<p>Mkr Functions</p> <p>All Markers Off</p> <p>All Markers On</p> <p>---Mkr = X value---</p> <p>Actv Mkr-->Start</p> <p>Actv Mkr-->Stop</p> <p>Actv Mkr-->Center</p> <p>Actv Mkr-->Ref. Mkr</p> <p>---X = Mkr Value---</p> <p>Start-->Actv Mkr</p> <p>Stop-->Actv Mkr</p> <p>Center-->Actv Mkr</p>	<p>All Markers Off</p> <p>All Markers On</p> <p>---Mkr = X value---</p> <p>Actv Mkr-->Start</p> <p>Actv Mkr-->Stop</p> <p>Actv Mkr-->Center</p> <p>Actv Mkr-->Ref. Mkr</p> <p>---X = Mkr Value---</p> <p>Start-->Actv Mkr</p> <p>Stop-->Actv Mkr</p> <p>Center-->Actv Mkr</p>	<p>MKR Functions</p> <p>Two choices within this menu</p> <p>All Markers Off</p> <p>Select displays all Markers turned off</p> <p>All Markers On</p> <p>Select displays all markers on. All buttons below it are active. The buttons below it are Active marker to Start, Stop, Center and Ref. Marker</p>
--	--	--

Figure 19-15. Markers On/Off

Chapter 20 — System Menus

20-1 Chapter Overview

This chapter provides information for various system and instrument management and configuration functions including initial setup, power-on options, preset options, network interface, self-test, and diagnostics.

20-2 System Menus, Buttons, and Dialog Boxes

- “SYSTEM Menu” on page 20-2
- “SETUP Menu” on page 20-3
 - “Clock Setup” on page 20-3
 - “COLOR SETUP Dialog Box” on page 20-6
 - “MISC SETUP Menu” on page 20-7
 - “MISC SETUP Menu in 4-Port VNAs” on page 20-7
 - “SNP FILES SETUP Menu - 2-Port VNAs” on page 20-9
 - “MXP SETUP Dialog Box - 4-Port VNAs” on page 20-12
 - “AUTOCAL CHARAC. Menu” on page 20-15
- “UTILITY Menu” on page 20-14
- “NETWORK INTERFACE Menu” on page 20-16
 - “NETWORK CONNECTIONS Dialog Box” on page 20-17
- “SELF TEST Dialog Box” on page 20-18
- “EVENT VIEWER Dialog Box” on page 20-19
- “DIAGNOSTICS ACCESS Dialog Box” on page 20-21
- “IO HANDLER Dialog” on page 20-22
- “DISABLE TIME DOMAIN Dialog Box” on page 20-24
- “Upgrade FPGA” on page 20-24

20-3 SYSTEM Menu

Previous

- [“Main Menu” on page 2-2](#)

Navigation

- MAIN | System | SYSTEM

<div style="background-color: #4F81BD; color: white; padding: 5px; font-weight: bold;">System</div> <div style="background-color: #4F81BD; color: white; padding: 5px; font-weight: bold;">Setup</div> <div style="background-color: #4F81BD; color: white; padding: 5px; font-weight: bold;">Utility</div> <div style="background-color: #4F81BD; color: white; padding: 5px; font-weight: bold;">Network Interface</div> <div style="background-color: #4F81BD; color: white; padding: 5px; font-weight: bold;">Self-Test</div> <div style="background-color: #4F81BD; color: white; padding: 5px; font-weight: bold;">Event Log</div> <div style="background-color: #4F81BD; color: white; padding: 5px; font-weight: bold;">Diagnostics</div> <div style="background-color: #4F81BD; color: white; padding: 5px; font-weight: bold;">IO Handler</div> <div style="background-color: #4F81BD; color: white; padding: 5px; font-weight: bold;">Disable Time Domain</div> <div style="background-color: #4F81BD; color: white; padding: 5px; font-weight: bold;">Upgrade FPGA</div>	<p>Setup Select displays the SETUP menu.</p> <ul style="list-style-type: none"> • “SETUP Menu” on page 20-3 <p>Utility Select displays the UTILITY menu.</p> <ul style="list-style-type: none"> • “UTILITY Menu” on page 20-14 <p>Network Interface Select displays the NETWORK INTERFACE menu.</p> <ul style="list-style-type: none"> • “NETWORK INTERFACE Menu” on page 20-16 <p>Self-Test Select displays the SELF TEST dialog box.</p> <ul style="list-style-type: none"> • “SELF TEST Dialog Box” on page 20-18 <p>Event Log Select displays the EVENT VIEWER dialog box.</p> <ul style="list-style-type: none"> • “EVENT VIEWER Dialog Box” on page 20-19 <p>Diagnostics Select displays the DIAGNOSTICS ACCESS dialog box.</p> <ul style="list-style-type: none"> • “DIAGNOSTICS ACCESS Dialog Box” on page 20-21 <p>IO Handler Select displays the IO Handler dialog for IO debug. IO Handler is only applicable for MS46522A and MS46524A models equipped with Option 5.</p> <ul style="list-style-type: none"> • “IO HANDLER Dialog” on page 20-22 <p>Disable Time Domain Opens a Dialog Box to disable the Time Domain Option. WARNING: Once it is disabled, this is not reversible without re-licensing the option.</p> <ul style="list-style-type: none"> • “DISABLE TIME DOMAIN Dialog Box” on page 20-24 <p>Upgrade FPGA Select initiates a firmware update. FOR FACTORY SERVICE USE ONLY.</p>
--	--

Figure 20-1. SYSTEM MENU Menu

SETUP Menu

Provides a variety of setup functions.

Previous

- [“SYSTEM Menu” on page 20-2](#)

Navigation

- MAIN | System | SYSTEM | Setup | SETUP

	<p>Preset Setup Opens the “PRESET SETUP Menu” on page 20-4.</p> <p>Power-On Setup Opens the “POWER-ON SETUP Menu” on page 20-5.</p> <p>Clock Setup Opens standard Windows 7 DATE AND TIME control panel.</p> <p>Invert Colors Toggles inversion of display colors ON and OFF.</p> <p>Colors Setup Opens COLOR SETUP dialog box for options to change trace and background colors.</p> <ul style="list-style-type: none"> • “COLOR SETUP Dialog Box” on page 20-6 <p>Reset Colors Opens RESET COLORS dialog box for option to reset color changes made in COLOR SETUP dialog box.</p> <p>Misc. Setup Opens MISC SETUP dialog box for options for SnP, MnP, and data file setup options.</p> <ul style="list-style-type: none"> • “MISC SETUP Menu” on page 20-7
--	---

Figure 20-2. SETUP Menu

PRESET SETUP Menu

Provides a variety of setup functions.

Previous

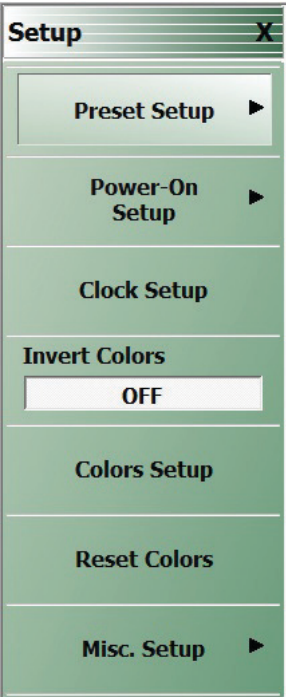
- [“SETUP Menu” on page 20-3](#)

Navigation

- MAIN | System | SYSTEM | Setup | SETUP | Preset Setup | PRESET SETUP

 <p>The screenshot shows a menu titled 'Preset Setup' with a close button 'X'. Below the title are four menu items: 'Default', 'Default 0' (which is selected with a radio button), 'Saved Setup', and 'Select Saved Setup File'.</p>	<p>Default</p> <p>If selected, Default selection loads the factory as-shipped preset configuration, which is one channel with four traces displayed on a two-row and two-column trace display.</p> <p>Default 0</p> <p>The Default 0 button operates identical to the Default button (above) with the addition of removing any Cal Kits and/or Characterization Coefficient files from instrument memory. Once used, all connector coefficients are then returned to the factory as-shipped default values. Note that any Cal Kit and/or Characterization Coefficient files resident on the instrument hard drive are not deleted and remain in place. If this command is used, the user must re-load into memory all required Cal Kit and other Characterization Coefficient files.</p> <p>Saved Setup</p> <p>If selected, the Saved Setup selection loads the setup file selected in the resulting dialog box below. If the Saved Setup button is clicked when no prior Setup File has been saved, a NO FILE SELECTED dialog box appears with the message: “There is currently no saved setup selected. This selection requires a file selection. Would you like to select the file now?”</p> <p>Select Saved Setup File</p> <p>Use this button to display a dialog to recall a previously saved setup file. Once recalled, the file settings can be implemented by selecting the Saved Setup button above.</p>
---	---

Figure 20-3. PRESET SETUP Menu

POWER-ON SETUP Menu

Provides a variety of setup functions.

Previous

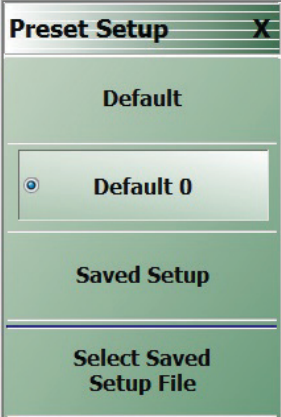
- [“SETUP Menu” on page 20-3](#)

Navigation

- MAIN | System | SYSTEM | Setup | SETUP | Power-On Setup | POWER-ON SETUP

	<p>Default</p> <p>Select sets the factory default as-shipped power-on setup settings. This setting is always available.</p> <p>Last Setup</p> <p>For many users in general purpose work, this setting is the user-selected default. Select sets the power-on setup to be from the last operational state including frequencies, channels, traces, markers, and limit lines.</p> <p>Saved Setup</p> <p>Select sets the power-on settings to a previously saved user-defined setup file, useful for repeated identical settings in a line production mode. If the Saved Setup button is selected when no prior Setup File has been saved, a NO FILE SELECTED dialog box appears with the message: “There is currently no saved setup selected. This selection requires a file selection. Would you like to select the file now?”</p> <p>Select Saved Setup File</p> <p>Use this button to display a dialog to recall a previously saved setup file. Once recalled, the file settings can be implemented by selecting the Saved Setup button above.</p>
---	--

Figure 20-4. POWER-ON SETUP Menu

COLOR SETUP Dialog Box

Previous

- “[SETUP Menu](#)” on page 20-3

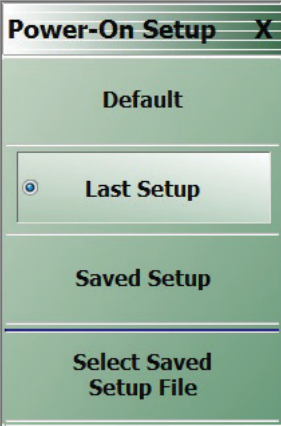
Navigation

- MAIN | System | SYSTEM | Setup | SETUP | Colors Setup | COLOR SETUP

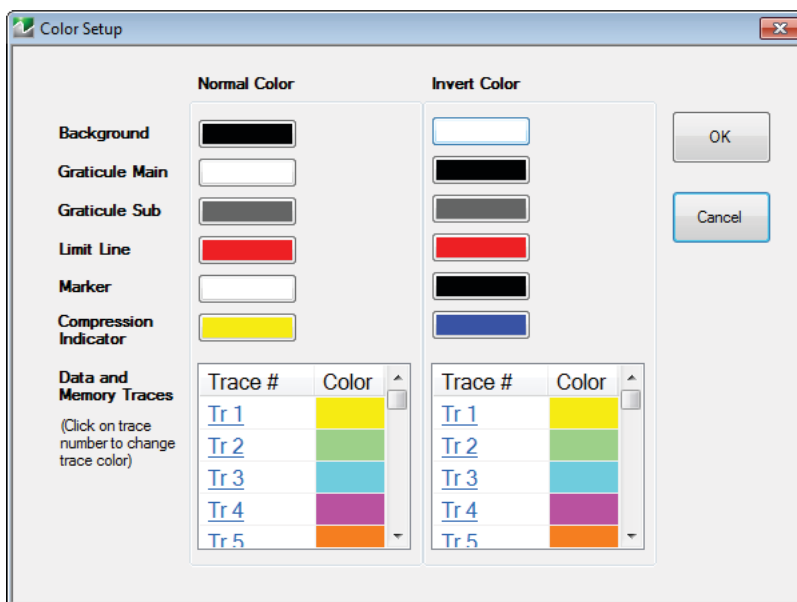

Figure 20-5. COLOR SETUP Menu

Normal Color

Provides controls for changing default colors of display elements.

Invert Color

Provides controls for changing default colors of display element colors inverted using the Invert Colors button.

MISC SETUP Menu

Previous

- [“Main Menu” on page 2-2](#)

Navigation

- MAIN | System | SYSTEM

MISC SETUP Menu in 4-Port VNAs

Misc. Setup X	SnP Files Setup
SnP Files Setup	Select displays the SNP FILES SETUP Dialog Box where the frequency units and output format of the SnP files is set. <ul style="list-style-type: none"> • “SNP SETUP Dialog Box - 4-Port VNAs” on page 20-10
MnP Files Setup	MnP Files Setup
Data File Setup	Select displays the MXP SETUP dialog box. The dialog box allows mixed-mode DUT configuration as:
Include Header	<ul style="list-style-type: none"> • M4P DUT with two differential pairs and no singletons • M4P DUT with one differential pair and two singletons • M3P DUT with one differential pair and one singleton • M2P DUT with one differential pair and no singletons
<input type="button" value="ON"/>	Each configuration allows any VNA port to be assigned to any DUT port. <ul style="list-style-type: none"> • “MXP SETUP Dialog Box - 4-Port VNAs” on page 20-12
	--- Data File Setup ---
	Include Header
	Toggle ON to include header information in the data file.

Figure 20-6. MISC SETUP Menu in 4-Port VNAs

MISC SETUP Menu in 2-Port VNAs

Misc. Setup X	SnP Files Setup
SnP Files Setup ▶	Select displays the SNP FILES SETUP Menu where the frequency units and output format of the SnP files is set. <ul style="list-style-type: none"> • “SNP FILES SETUP Menu - 2-Port VNAs” on page 20-9
S1P Port Setup Port 1	S1P Port Setup Toggles between Port 1 and Port 2.
<i>Data File Setup</i>	--- Data File Setup ---
Include Header ON	Include Header Toggle ON to include header information in the data file.

Figure 20-7. MISC SETUP Menu in 2-Port VNAs

SNP Files Setup

The SnP files setup configuration user interface varies depending on the VNA model's maximum number of ports. The following presents information for the model series covered by this manual.

SNP FILES SETUP Menu - 2-Port VNAs

Frequency Units Area Button Selection Group

In the Freq Units area, the four frequency units buttons (GHz, MHz, kHz, and Hz) form a button selection group where the selection of one button de-selects the other three buttons.

Prerequisites

- The VNA is in 2-Port Mode

Previous

- [“MISC SETUP Menu” on page 20-7](#)

Navigation

- MAIN | System | SYSTEM | Setup | SETUP | Misc. Setup | MISC. SETUP | SnP Files Setup | SNP FILES SETUP

SnP Files Setup	GHz Select sets the units for the SnP file output to GHz.
<i>Freq Units</i>	
<input type="radio"/> GHz	MHz Select sets the units for the SnP file output to MHz.
MHz	kHz Select sets the units for the SnP file output to kHz.
kHz	Hz Select sets the units for the SnP file output to Hz.
Hz	Output Format Area Button Selection Group In the Output Format area of the menu, the three buttons form a button selection group where the selection of one button de-selects the other two (2) buttons.
<i>Output Format</i>	
Linear Magnitude & Phase	Linear Magnitude & Phase Select sets the data file output format to record linear magnitude and phase information.
Log Magnitude & Phase	Log Magnitude & Phase Select sets the data file output format to record log magnitude and phase information.
<input checked="" type="radio"/> Real & Imaginary	Real & Imaginary Select sets the data file output format to real and imaginary information.

Figure 20-8. SNP FILES SETUP Menu 2-Port VNAs

SNP SETUP Dialog Box - 4-Port VNAs

Prerequisites

- The VNA is in 4-Port Mode

Previous

- [“MISC SETUP Menu” on page 20-7](#)

Navigation

- MAIN | System | SYSTEM | Setup | SETUP | Misc. Setup | MISC. SETUP | SnP Files Setup | SNP SETUP Dialog Box

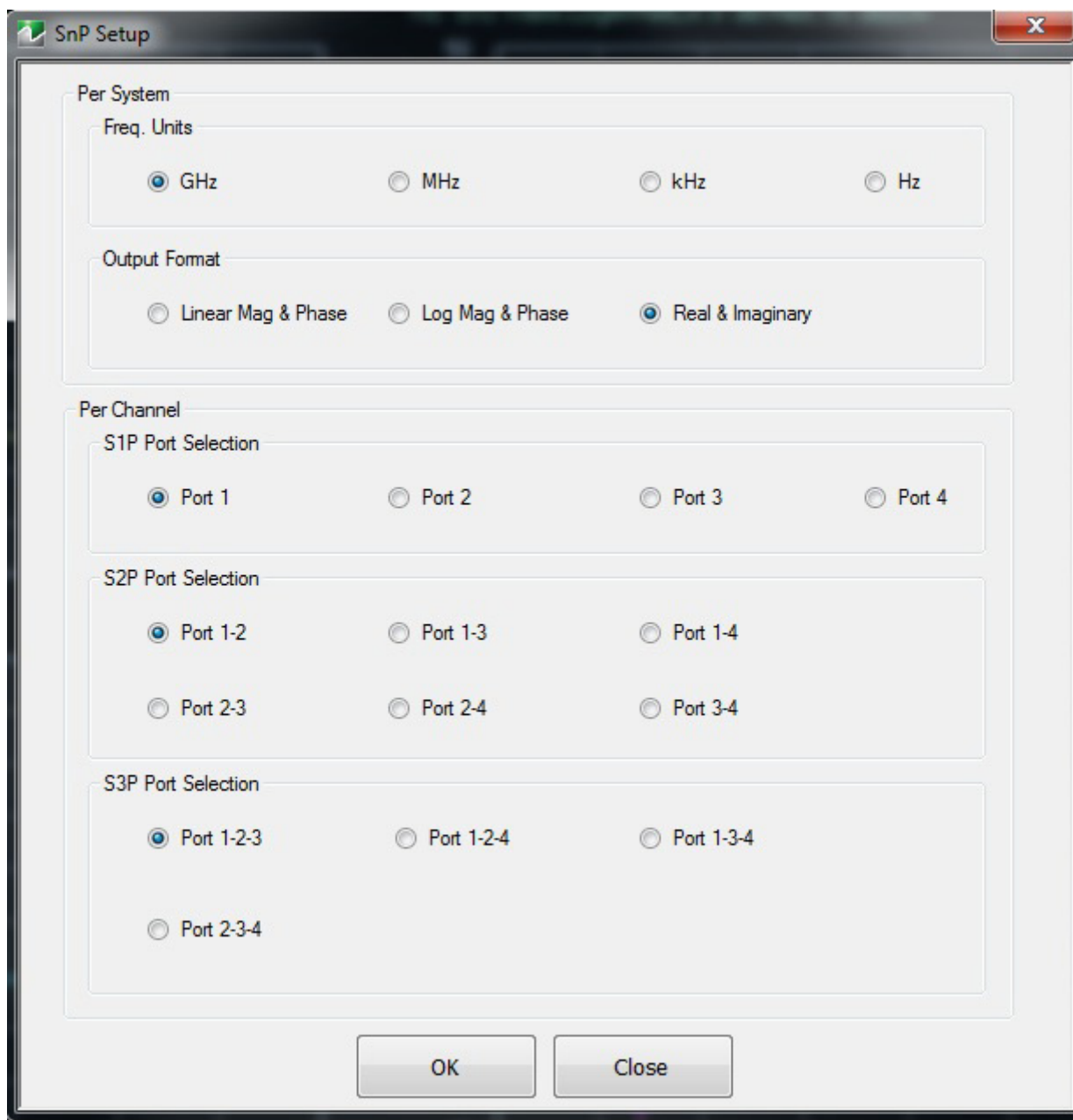

Figure 20-9. SNP SETUP Dialog Box - 4-Port VNAs

Instructions

The controls in the SNP SETUP dialog box allow for configuration of file output for all SnP file types.

Per System - Frequency Units

On a per-system basis, allows the frequency units to be set as:

- GHz
- MHz
- kHz
- Hz

Per System - Output Format

On a per-system basis, allows the output format to be set as:

- Linear magnitude and phase
- Log magnitude and phase
- Real and imaginary numbers

Per Channel - S1P Port Selection

On a per-channel basis, allows the S1P single port to be selected as:

- Port 1
- Port 2
- Port 3
- Port 4

Per Channel - S2P Port Selection

On a per-channel basis, allows the S2P port pair to be selected as:

- Port 1-2
- Port 1-3
- Port 1-4
- Port 2-3
- Port 2-4
- Port 3-4

Per Channel - S3P Port Selection

On a per-channel basis, allows the S2P port triad to be selected as:

- Port 1-2-3
- Port 1-2-4
- Port 1-3-4
- Port 2-3-4

MXP SETUP Dialog Box - 4-Port VNAs

Full Name

- MIXED-MODE DUT SETUP Dialog Box - 4-Port VNAs

Prerequisites

- VNA is in 4-Port Mode

Previous

- [“MISC SETUP Menu” on page 20-7](#)

Navigation

- MAIN | System | SYSTEM | Setup | SETUP | Misc. Setup | MISC. SETUP | MnP Files Setup | MXP SETUP Dialog Box

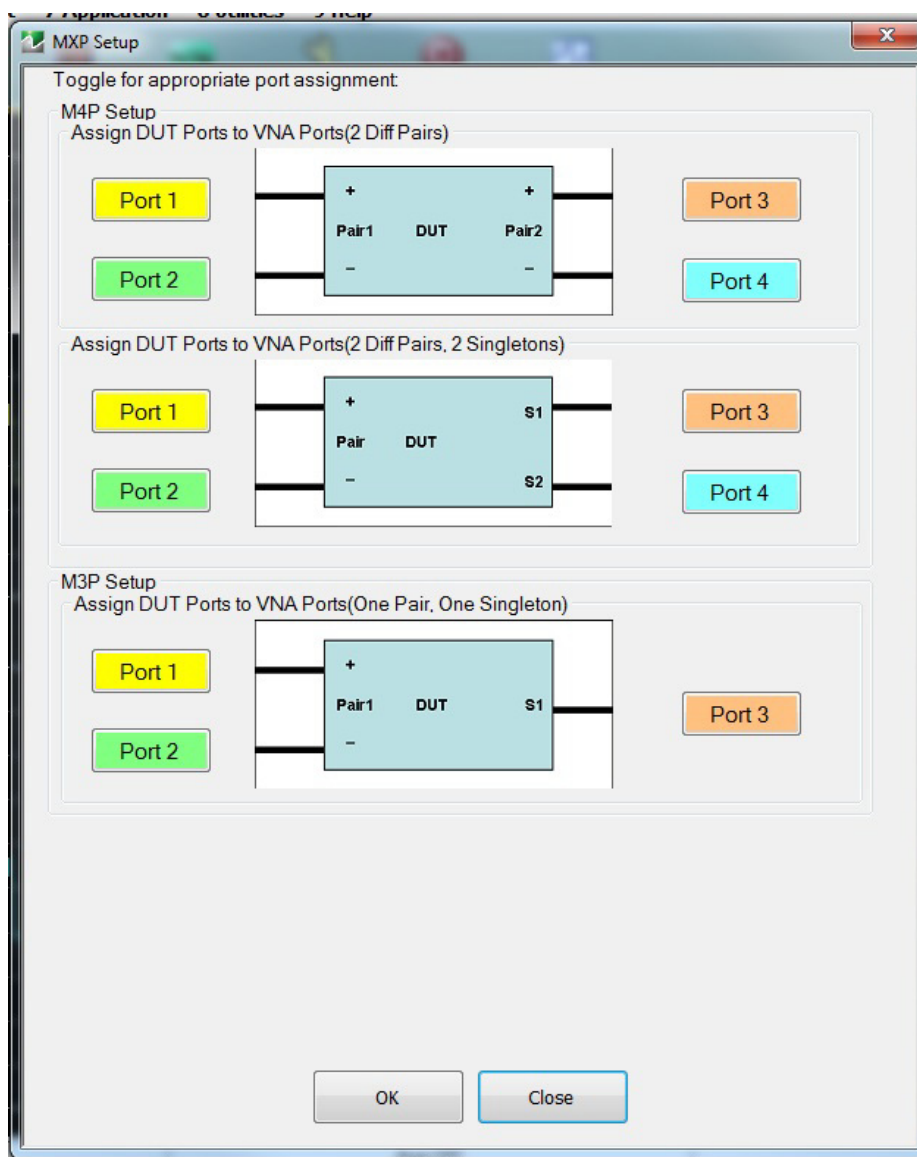

Figure 20-10. MXP (MIXED-MODE DUT) SETUP Dialog Box

Instructions

Select displays the MXP SETUP dialog box. The dialog box provides VNA-port to DUT-port configuration for output files for four mixed-mode DUT types:

- M4P Setup - Assign DUT ports with two differential pairs. For remote GPIB control, this is defined as D2S0.
- M4P Setup - Assign DUT ports with one differential pair and two singletons. For remote GPIB control, this is defined as D1S2
- M3P Setup - Assign DUT ports with one differential pair and one singleton. For remote GPIB control, this is defined as D2S1.

M2P Setup - Assign DUT ports with one differential pair and no singletons. For remote GPIB control, this is defined as D1S0.

UTILITY Menu

Previous

- [“SYSTEM Menu” on page 20-2](#)

Navigation

- MAIN | System | SYSTEM | Utility | UTILITY

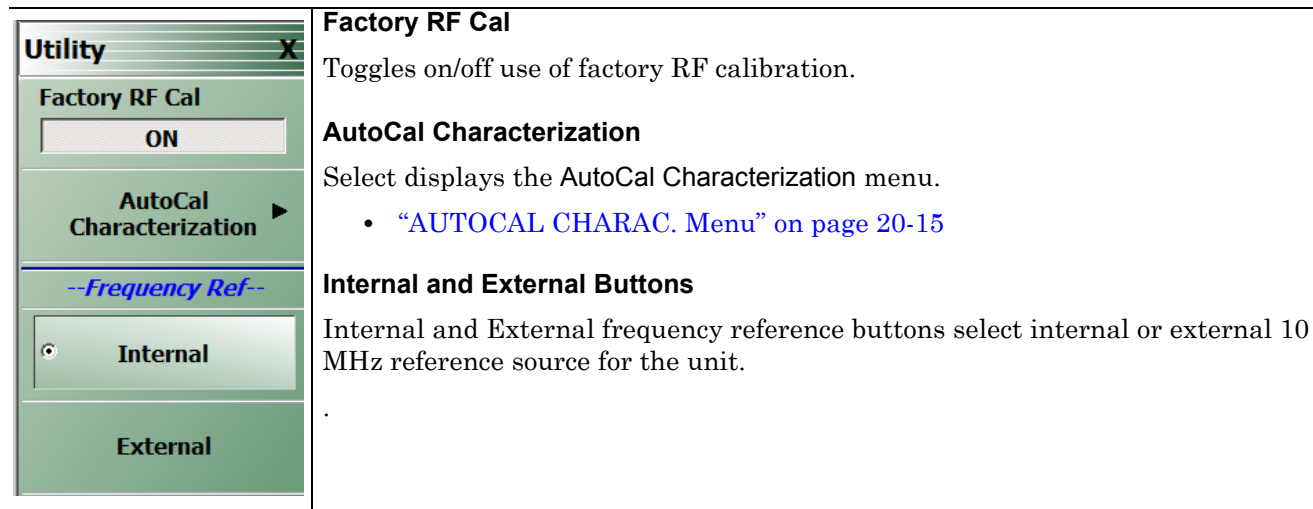

Figure 20-11. UTILITY Menu

AUTOCAL CHARAC. Menu

The best practice recommendation is to return the AutoCal module to Anritsu annually for an in-factory characterization. If a factory re-characterization is not possible, you can use this menu to re-characterize the module. Note that the re-characterization will be only as good as the prior instrument manual full calibration procedure. The recommended manual calibration is a Full Two Port calibration (12 Term Cal). For more information, contact Anritsu Customer Service.

Full Name

- AUTOMATIC CALIBRATOR (AUTOCAL) CHARACTERIZATION Menu

Previous

- [“UTILITY Menu” on page 20-14](#)

Navigation

- MAIN | System | SYSTEM | Utility | UTILITY | AutoCal Characterization | AUTOCAL CHARAC.

	<p>Load Charac. File Selecting the Load Characterization File button displays a Windows file open dialog. Use it to select a file, then click Okay in the dialog.</p> <p>Save Charac. File Select displays a Windows file save dialog. In it, enter a file name, then click Okay in the dialog..</p>
---	--

Figure 20-12. AUTOCAL CHARAC. (AUTOCAL CHARACTERIZATION) Menu

Network Interface Menu and Dialog Boxes

NETWORK INTERFACE Menu

Previous

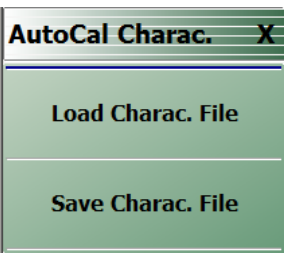
- [“SYSTEM Menu” on page 20-2](#)

Navigation

- MAIN | System | SYSTEM | Network Interface | NETWORK INTERF.

	<p>IP Address A read-only display. Shows the IP address of the instrument.</p> <p>Hardware Address A read-only display. Shows the internal network interface card hardware address.</p> <p>Subnet Mask A read-only display. Shows the network subnet mask value.</p> <p>Default Gateway A read-only display. Shows the network default gateway address.</p> <p>TCP Port Number A read-only display. Shows the network TCP port number.</p> <p>Network Connections Select displays the Network Connections dialog box which is part of the Microsoft XP Operating System.</p> <ul style="list-style-type: none"> • “NETWORK CONNECTIONS Dialog Box” on page 20-17
---	---

Figure 20-13. AUTOCAL CHARAC. (AUTOCAL CHARACTERIZATION) Menu

NETWORK CONNECTIONS Dialog Box

Previous

- [“NETWORK INTERFACE Menu” on page 20-16](#)

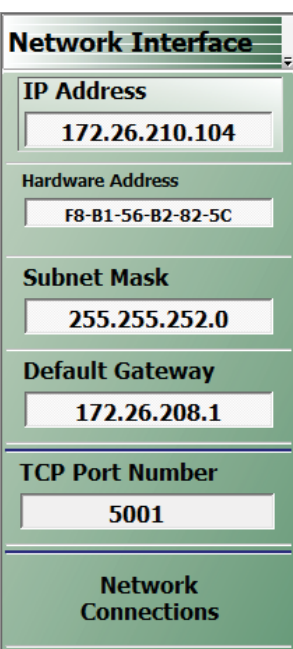
Navigation

- MAIN | System | SYSTEM | Network Interface | NETWORK INTERF. | Network Connections | NETWORK CONNECTIONS Dialog Box

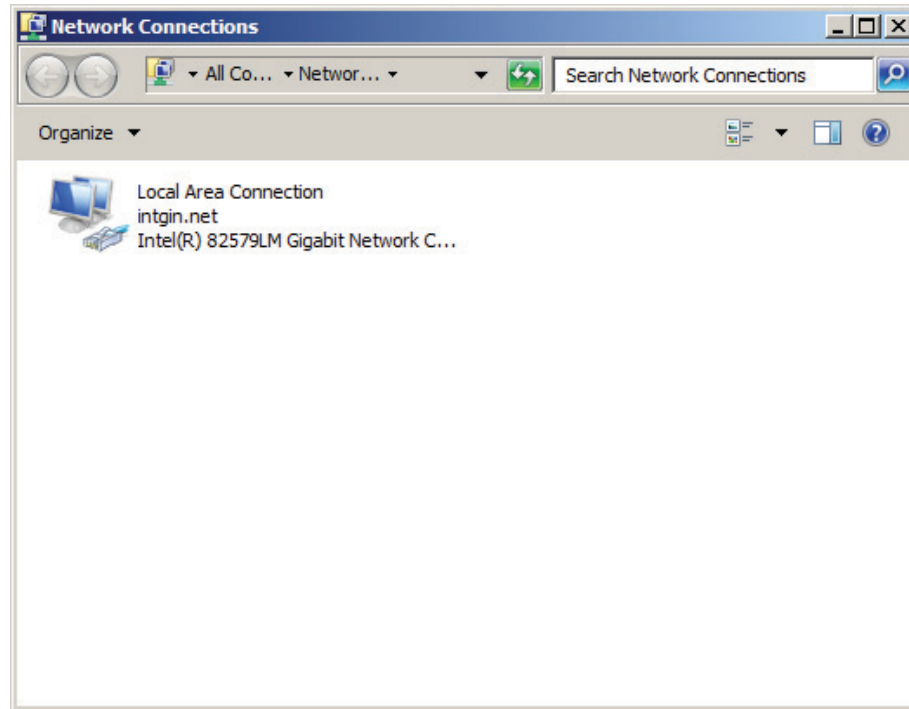

Figure 20-14. NETWORK CONNECTIONS Dialog Box

SELF TEST Dialog Box

Previous

- “SYSTEM Menu” on page 20-2

Navigation

- MAIN | System | SYSTEM | Diagnostics | DIAGNOSTICS | Self-Test | SELF TEST Dialog Box

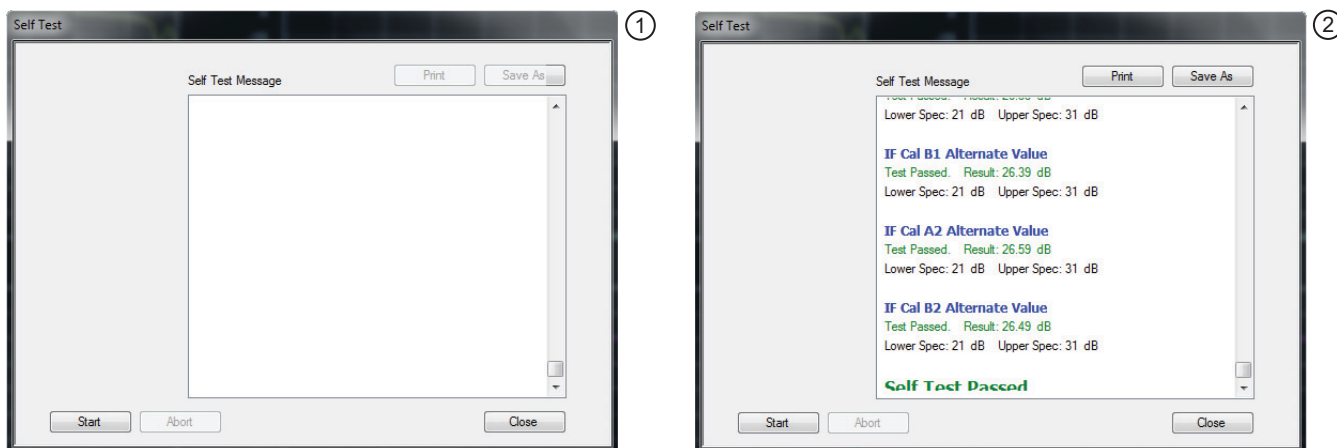

1. SELF TEST Dialog Box – Test Not Started.

2. SELF TEST Dialog Box – Test Passed.

Figure 20-15. SELF TEST Dialog Box

Instructions

1. Select any combination of tests from the available check boxes:
 - Source
 - Analog IF
 - RF Deck Ctrl
 - DSP/PV
2. The Select All button selects all tests. The Clear All button de-selects all tests.
3. Once selections are made, click Start to run the tests. Click Abort to cancel in-process tests.
4. Test results are displayed in the Self Test Message area.
5. A normal message is Self Test Passed.
6. Click Print to print to the local printer through an open Print dialog box. Click Save As to save as a Self Test Result TXT file typically located in C:\AnritsuVNA\Data. Click Close to close the dialog box.

EVENT VIEWER Dialog Box

Previous

- “SYSTEM Menu” on page 20-2

Navigation

- MAIN | System | SYSTEM | Event Log | EVENT VIEWER Dialog Box

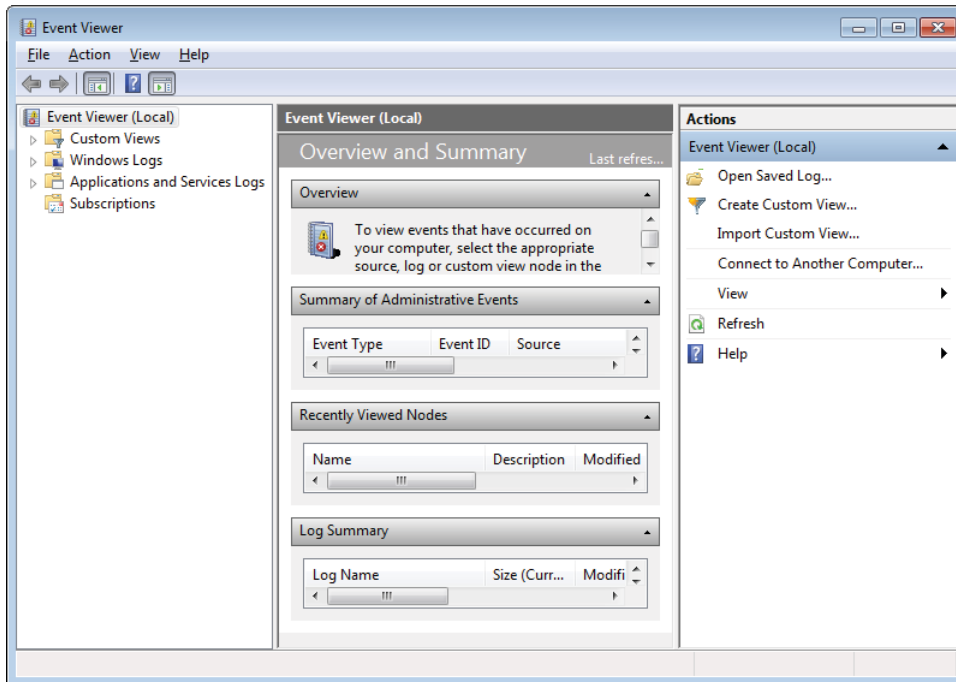

Figure 20-16. EVENT VIEWER Dialog Box

Instructions

Options on the menu bar are:

- File
 - Options: Displays the Options dialog box with additional system functions.
 - Exit: Closes the dialog box and returns to the Diagnostics menu
- Action
 - Connect to another computer
 - Open saved log
 - Create Custom View
 - Import Custom View
 - Refresh
 - Help
- View
 - Show Analytic and Debug Logs
 - Customize

- Help
 - Help Topics
 - TechCenter Web Site
 - About Microsoft Management Console
 - About Event Viewer

DIAGNOSTICS ACCESS Dialog Box

Previous

- [“SYSTEM Menu” on page 20-2](#)

Navigation

- MAIN | System | SYSTEM | Diagnostics | DIAGNOSTICS ACCESS Dialog Box

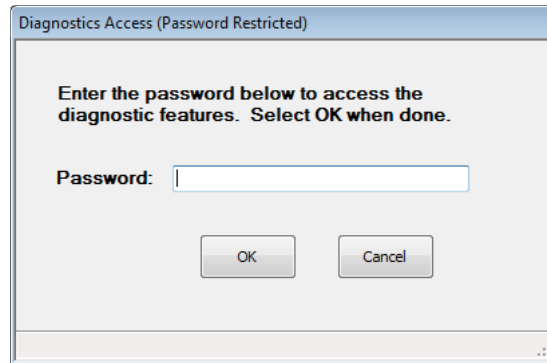

Figure 20-17. DIAGNOSTICS ACCESS Dialog Box

Instructions

An instrument-specific password is required to enter the DIAGNOSTICS ACCESS dialog box.

IO HANDLER Dialog

This function is accessible in ShockLine on all models but functions only with the MS4652xA series when these are equipped with the Centronics connector for I/O with handlers. It is not functional on MS46322A nor MS46122A series VNAs.

The optional IO Handler functionality in the VNA provides a parallel interface for communication with external equipment such as device handlers, switch boxes, status lights, foot pedal switches, and so on. This function is active only in the model MS4652xA series VNAs which are equipped with the handler interface option which provides a Centronics 36 pin female connector on the instrument back panel. The signal lines can be manipulated either programmatically through commands to the VNA as described in the VNA Programming Manual) or manually through this ShockLine dialog. The following material describes the screen dialog.

Previous

- “SYSTEM Menu” on page 20-2

Navigation

- MAIN | System | SYSTEM | IO Handler | IO HANDLER Dialog Box

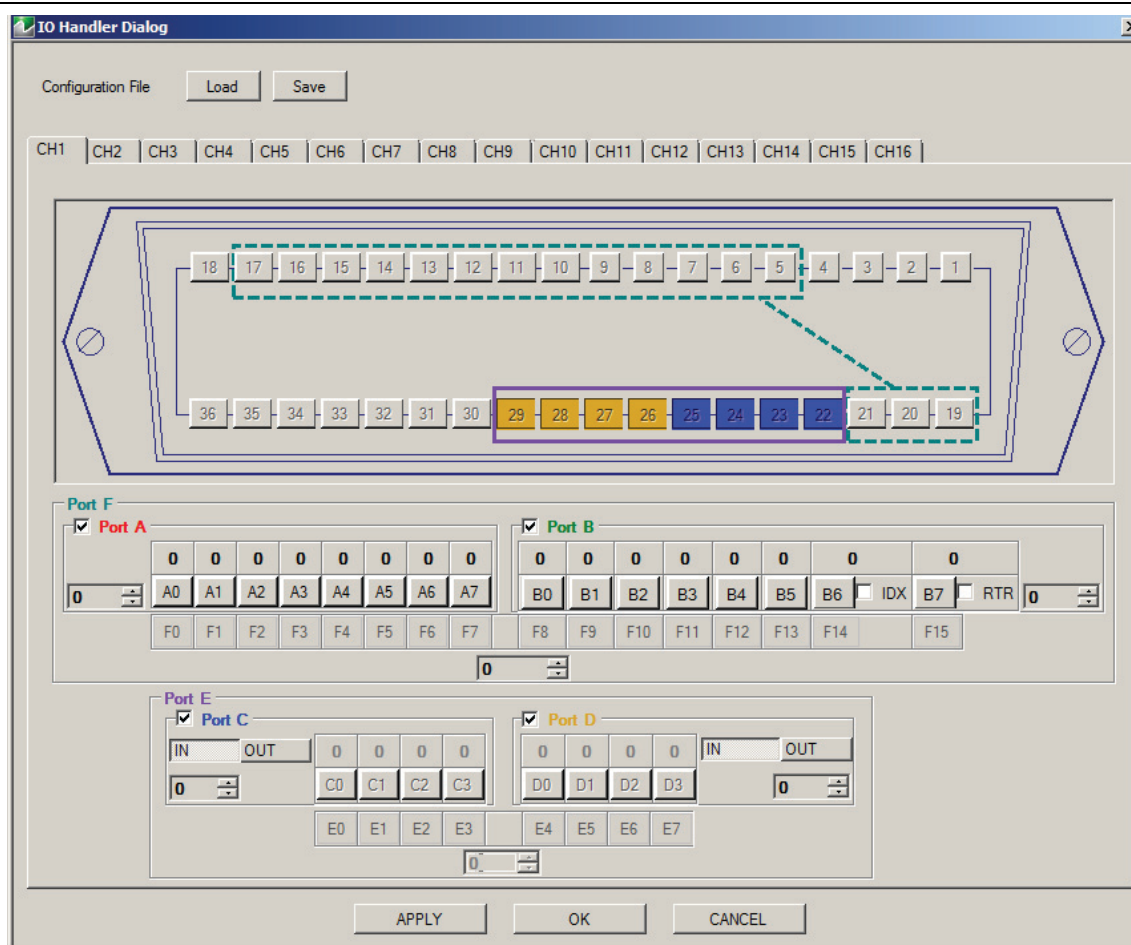

Figure 20-18. IO HANDLER Dialog Box

Main parts of the IO Handler Dialog Box

A. Configuration File Controls

B. Channel tabs with Port Bit Controls

These are discussed below:

Configuration File Controls

You can load or save IO Handler port configurations using these controls.

Load loads a previously saved configuration that was stored into a file of type .ioh

Save saves the entire current IO configuration that was set up in this dialog.

Channel Tabs

Selecting a channel tab determines the channel for which the I/O signals will be operative during any debug activities. Each channel tab has two main areas, an upper diagram, and a lower bit function selector.

The upper diagram on a tab is a map of the Centronics connector, showing port and bit assignments. The green dashed line area is all bits in Port F, the combination of Ports A and B. The blue outlined area shows Port E, the combination of Port C and D. The image of a signal line is grayed out when the bit is inactive and changes either when its state changes due to external signal coming in, or when the bit's button is clicked in the lower area of the diagram.

The lower diagram area on a tab allows you to turn port bits on or off, or observe static status of an input bit.

Ports A and B are each eight-bit output ports. Their bits can be programmatically controlled or manually set in this dialog. They also can be grouped together to form combined Port F which also can be either programmatically or manually controlled. In the dialog, clicking a bit turns it on or toggles it off. Note that Port B bit 6 is dual purpose; it can be either B6 or function as Index (out). Port B bit B7 is dual purpose and can be either B7 or RTR. Both these bits can be programmatically controlled or manually controlled in the diagram.

The numeric scrollers allow you to see the numeric representation of the port values (or combined port values) or to set the bits - entering a decimal value sets up all the port bits according to the binary value of the setting.

DISABLE TIME DOMAIN Dialog Box

This dialog is used to remove the license for Time Domain operation of the VNA. It is a factory service control that should not be used by the instrument owner. If you activate it, you will deactivate any license to use the Time Domain option and will have to re-license the instrument to use the option again.

Previous

- [“SYSTEM Menu” on page 20-2](#)

Navigation

- MAIN | System | SYSTEM | Disable Time Domain | DISABLE TIME DOMAIN Dialog Box

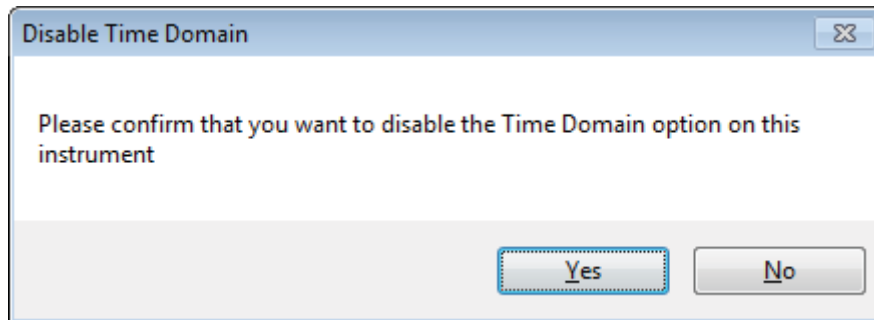

Figure 20-19. DISABLE TIME DOMAIN Dialog Box

Instructions

To confirm that you want to disable the Time Domain option:

- Click **Yes** to disable the Time Domain option, or click **No** to cancel.

Upgrade FPGA

This is a factory service control and is not supported for customer use.

Chapter 21 — File Management Menus

21-1 Chapter Overview

This chapter provides information for management of various system output and configuration files including Active channel TXT files, Active channel S2P files, Active channel CSV files, Active trace data (Formatted), and Active trace data (Unformatted).

21-2 Overview of File Management Menus and Dialog Boxes

There is one available menu with multiple related dialog boxes:

- [“FILE Menu” on page 21-2](#)
 - [“RECALL SETUP Dialog Box” on page 21-4](#)
 - [“RECALL DATA Dialog Box” on page 21-5](#)
 - [“SAVE SETUP Dialog Box” on page 21-6](#)
 - [“SAVE DATA Dialog Box” on page 21-7](#)

21-3 File Menus and Dialog Boxes

FILE Menu

Previous

- [“Main Menu” on page 2-2](#)

Navigation

- MAIN | File | FILE

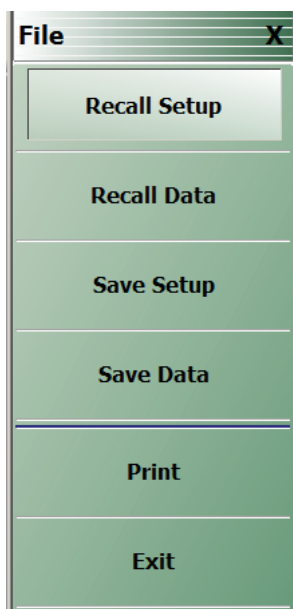

Figure 21-1. FILE Menu – Data Save/Recall Functions – Print Functions

Recall Setup

Select displays the Recall Setup dialog box which allows recalling of previously saved setup files.

- [“RECALL SETUP Dialog Box” on page 21-4](#)

Recall Data

Select displays the Recall Data dialog box.

- [“RECALL DATA Dialog Box” on page 21-5](#)

Save Setup

Use the Save Setup button to save variations of the current instrument setup. The configurations that can be saved are of the following types:

- Active Channel Setup and Calibration CHX files
- Active Channel Setup STX files

Select displays the Save Setup dialog box.

- [“SAVE SETUP Dialog Box” on page 21-6](#)

Save Data

Use the **Save Data** button to save the active channel data in several different formats and different purposes. For example, save data as a TXT file for use in another application such as a spreadsheet or word processor. Note the TXT data cannot be imported back into the instrument. Available formats are:

- Active Channel TXT files
- Active Channel S1P files
- Active Channel S2P files
- Active Channel S3P files
- Active Channel S4P files
- Active Channel CSV files
- Active Channel BMP files
- Active Channel PNG files
- Active Channel JPEG files
- Active Trace Data (Formatted) TDF files
- Active Trace Data (Unformatted) TDU files

Select displays the **Save Data** dialog box.

- [“SAVE DATA Dialog Box” on page 21-7](#)

Print

Select prints the current main display to the default printer using a standard Windows PRINT dialog box. Print confirmation dialogs appear as the print job is spooled to the default printer. Note that the default printer and its configuration is set from the Windows Desktop using the PRINTERS AND FAX dialog box. If the VNA is standalone and not on a network, the attached printer is used. If the VNA is networked, any network printer can be used.

Exit

Select displays an exit warning, and if confirmed, ends all ShockLine application processes, and exits the VNA application to the Windows 7 operating system desktop.

RECALL SETUP Dialog Box

Use the Recall Setup dialog to recall one of several types of previously saved setup for general instrument configuration.

Power-On Configuration Setup

- Note that this dialog does not set the power-on configuration setting.
- Power-on settings are configured in the POWER-ON SETUP menu located within the SYSTEM menus.
- MAIN | System | SYSTEM | Power-On Setup | POWER-ON SETUP

Previous

- [“FILE Menu” on page 21-2](#)

Navigation

- MAIN | File | FILE | Recall Setup | RECALL SETUP Dialog Box

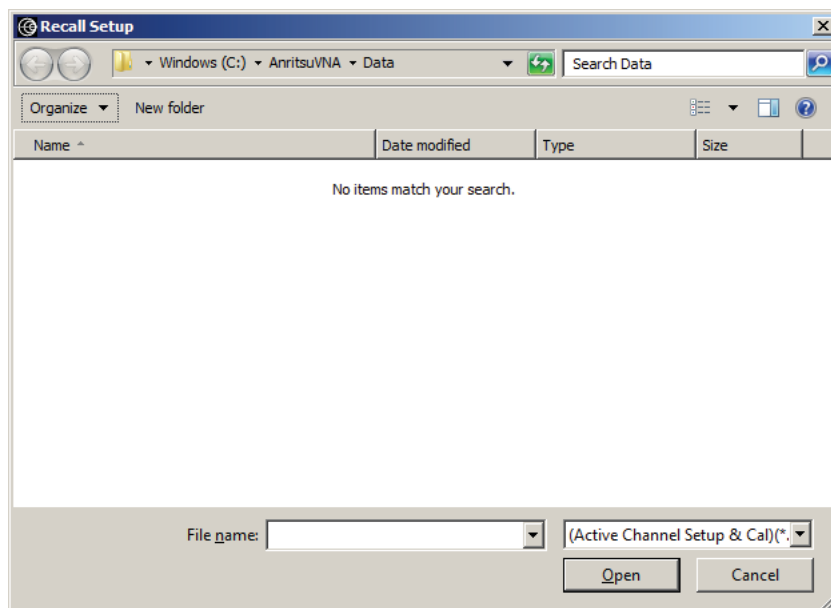

Figure 21-2. RECALL SETUP Dialog Box

Instructions

Use this dialog to select a previously stored setup configuration file.

1. Navigate to the File menu and the Power-On Setup dialog box.
 - MAIN | File | FILE | Recall Setup | RECALL SETUP Dialog Box
2. The Recall Setup dialog box appears.
3. Navigate to the required folder (recommend C:\AnritsuVNA folder) and locate the required setup file:
 - Active Channel Setup and Calibration CHX files
 - Active Channel Setup STX files
4. Once the appropriate file is selected, click Open.
5. The selected setup file is now available for use on the PRESET SETUP menu if the Saved Setup button is selected.
 - MAIN | System | SYSTEM | Preset Setup | PRESET SETUP

RECALL DATA Dialog Box

Previous

- “FILE Menu” on page 21-2

Navigation

- MAIN | File | FILE | Recall Data | RECALL DATA Dialog Box

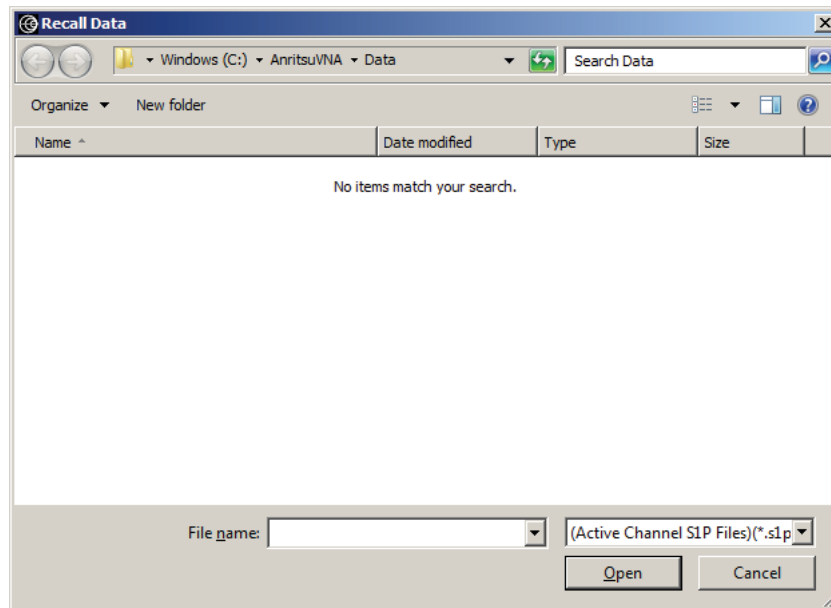

Figure 21-3. RECALL DATA Dialog Box

Instructions

Use this dialog to select a previously stored data configuration file. If the system is on hold, recall a TBF formatted file to overwrite the active trace memory. If system is not on hold, recall a TBF or TBU formatted file to overwrite the active trace memory. Note that the Active Channel TXT file cannot be imported back into the instrument.

Procedure

1. Navigate to the required folder and locate the required data file:
 - Active Channel S1P files
 - Active Channel S2P files
 - Active Channel S3P files
 - Active Channel S4P files
 - Active Trace Data (Formatted) TDF files
 - Active Trace Data (Unformatted) TDU files
 - Active Trace Memory (Formatted) TDF files
 - Active Trace Memory (Unformatted) TDU files
2. Best practices recommend the C:\AnritsuVNA folder.
3. Once the appropriate file is selected, click Open.
4. The selected data file is applied depending on the file type.

SAVE SETUP Dialog Box

Previous

- “FILE Menu” on page 21-2

Navigation

- MAIN | File | FILE | Save Setup | SAVE SETUP Dialog Box

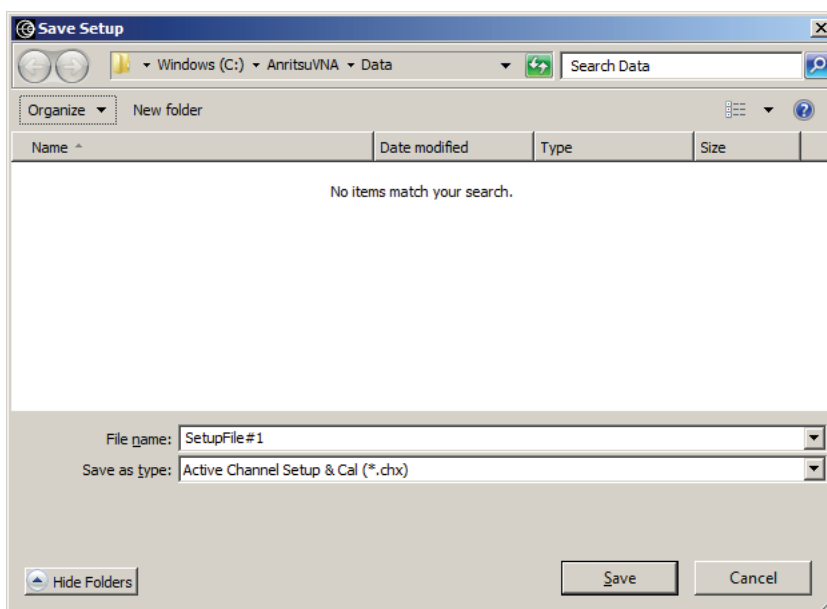

Figure 21-4. SAVE SETUP Dialog Box

Instructions

Use this dialog to select a previously stored setup configuration file.

1. Navigate to the required folder to save the setup file.
 - Best practices recommend the C:\AnritsuVNA folder.
2. Select the file type from the pull-down menu in the dialog box:
 - Active Channel CHX files
 - Active Channel STX files
3. Once the appropriate file type and location is selected, click **Save**.

SAVE DATA Dialog Box

Previous

- “FILE Menu” on page 21-2

Navigation

- MAIN | File | FILE | Save Data | SAVE DATA Dialog Box

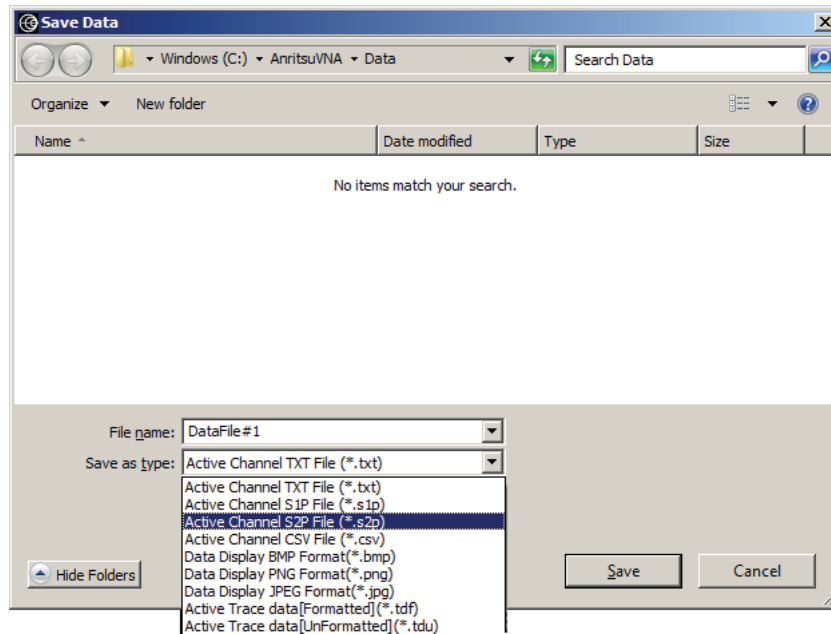

Figure 21-5. SAVE DATA Dialog Box

Note

Not all file data types are available in all application modes. For example, the S2P file type is not available for saving Pulse Profile or Pulse-to-Pulse data. The “Save as type” selection list automatically limits the available selections as appropriate for the current operating mode and data being saved.

Instructions

Use this dialog to save a data configuration file.

1. Navigate to the required folder.
 - Best practices recommend the C:\AnritsuVNA folder.
2. Select the data file type from the pull-down menu:
 - Active Channel TXT files
 - Active Channel S1P files
 - Active Channel S2P files
 - Active Channel S3P files
 - Active Channel S4P files
 - Active Channel CSV files
 - Active Channel BMP files
 - Active Channel PNG files
 - Active Channel JPEG files
 - Active Trace Data (Formatted) TDF files

- Active Trace Data (Unformatted) TDU files
3. Once the appropriate file type is selected, click **Save**.
 4. The selected data file is saved.

Appendix A — File Specifications

A-1 Default File Directory Structure

This appendix defines the file directory structure used on default-configuration ShockLine Series VNAs and provides the general file extensions and specifications used in the instrument.

The following is the standard directory structure:

```
C:\AnritsuVNA
    \AutoCal
    \Cal
    \Data
    \Temp
```

A-2 File Extension Definitions

The following file types are used to support the instrument. The typical location provided is the default installation location.

Table A-1. File Extension Definitions (1 of 5)

Extension	Name	Definition
.acd	Precision Automatic Calibrator (AutoCal) Module Characterization File AutoCal Characterization File	Each AutoCal module has an associated characterization file that contains parametric data about the module. When AutoCal starts up, it looks for any files in the current directory with the extension .acd. If more than one file is found, the user is prompted for which file to use.
.ahc	All Hardware Calibration File	Saves all hardware calibration data on a per-system basis.
.aic	AIC Analog-In Calibration File	Saves analog-in calibration data on a per-system basis.
.alc	ALC Calibration File	Saves all available ALC calibration for all ports, per system.
.bmp	Bit-mapped Graphics File	A Windows-compatible graphic file. In the ShockLine Series VNAs, the graphic capture of the main display results in a .bmp file that includes the running graphics display,
.ccf	Calibration Kit Coefficients File	For ShockLine Series VNA. A calibration kit coefficients file comes with each calibration kit, usually on a USB memory device. These files can be loaded onto the VNA hard disk and then recalled to active memory as required. See also .kit files.
.cha	All Channels Setup and Calibrations File	For saving and recalling all channel setup parameters and calibration data. Upon recall, restores all configuration settings to all channels. Similar to the .sta file. The .sta file does not save calibration data.

Table A-1. File Extension Definitions (2 of 5)

Extension	Name	Definition
.chx	Active Channel Setup and Calibration File	<p>For the active channel, saves the active channel setup and calibration parameters.</p> <p>Upon recall, restores the channel configuration settings and calibration data to the active channel.</p> <p>The .chx and .stx file formats are very convenient for copying the setup of one channel into another channel. Save the setup from the active channel, open an additional channel, and recall the saved .chx or .stx file into the new channel.</p> <p>Similar to the .stx file. The .stx file type does not save calibration data.</p>
.csv	Active Channel Information CSV File	<p>An exportable trace data file in a spreadsheet compatible comma-separated-value (CSV) format.</p> <p>Includes an optional descriptive heading in which the data for every trace is saved to a defined location folder.</p> <p>The data for each trace is saved as an X and a Y column to accommodate multiple parameters such as mixed frequency and time domain.</p> <p>Subsequent traces are added as additional columns.</p> <p>Instrument data can be saved to the .csv but the .csv file cannot be recalled into the VNA memory.</p> <p>Similar to the .txt file format.</p>
.edl	Embedding/De-embedding Configuration File	Default file name is EmbedDeembed.edl.
.fpc	Frequency Sweep Power Calibration File	<p>On a per-channel, per-port basis, saves the active channel and port data.</p> <p>Upon recall, restores the saved port data to the active channel.</p> <p>File extension for frequency sweep calibrations using Frequency Sweep (Linear), Segmented Sweep (Frequency-based), and Segmented Sweep (Index-based).</p> <p>Compare with .ppc file types below for power sweeps.</p>
.ini	AutoCal Default Setup File	<p>The default setup file for AutoCal. The default file name is auto_cal.ini.</p> <p>If another file is required, another AutoCal setup file should be loaded by selecting File Open Setup File.</p>
.ini	Source Initialization Table	For troubleshooting only. Saves the source initialization table data. Upon recall, restores the source initialization table data.
.ini	Frequency Initialization Table file	Default name is FreqIniTable.ini
.jpg .jpeg	Joint Photographic Experts Group Image File	User-initiated capture of the data display area of the VNA.

Table A-1. File Extension Definitions (3 of 5)

Extension	Name	Definition
.kit	Calibration Kit Coefficients File	From Anritsu Lightning 37000D Series VNA. ShockLine VNAs will read .kit files but not save them. The ShockLine VNA will convert a .kit file to a .ccf file format.
.lmt	Limit Line Configuration File	For the active trace on the active channel, saves all limit line data including number of segments, frequency range or CW, test result signs, limit fail signals, and limit external output. Upon recall, restores the limit line configuration to the active trace on the active channel
.log	Microsoft Windows Event Viewer Log File	These are operating system files logging events for the Application, Security, System, and Vector. The files are viewable by navigating to: MAIN System SYSTEM Event Log EVENT VIEWER Dialog Box
.mft	Multiple Frequency Table configuration file.	Provides the entire frequency table and is used for troubleshooting. Default file name is FreqTable.mft.
.ppc	Power Sweep Power Calibration File	On a per-channel basis, saved the active channel and port. Upon recall, restores the saved port data to the active channel. File extension for power sweep calibration files using Power Sweep (CW Frequency) or Power Sweep (Swept Frequency). Compare with .fpc file types above for frequency-based sweeps.
.ptc	Pretune Calibration File	Per system
.rcvr	Receiver Calibration File	On a per-channel basis, saves all available user receiver calibration data. Upon recall, restored the user receiver calibration data to the active channel.

Table A-1. File Extension Definitions (4 of 5)

Extension	Name	Definition
.s1p	Active Channel S1P file	Generically, an .sNp file is in standard microwave simulator text format and is similar to the .txt file described below.
.s2p	Active Channel S2P file	Includes a controlled header and only one or four S-parameters are saved.
.s3p	Active Channel S3P file	An .s1p file type holds the characteristics of a reflective calibration components. These files are loaded as needed during calibration if the calibration components is characterized by this file type.
.s4p	Active Channel S4P file	An .s2p file type holds the characteristics of a 2-port microwave device. If a full two-port calibration is applied, all of the S-parameters are always measured, even if they do not need to be displayed. The resultant .s2p file is complete with all S-parameter information. Upon recall, the .sNp file can be recalled and displayed as trace memory when they are loaded into the active channel.
.sft	Single Frequency Table File	For troubleshooting, saves the frequency table for a single frequency. Upon recall, restores the saved single frequency table.
.sgs	Segmented Sweep File	On a per-channel basis, saves the segmented sweep definition configuration data. Use Segmented sweep definition file. Used for frequency-based sweep and index-based sweep.
.slc	Source Low Level Calibration (Src LO) calibration file	On a per-system basis, saves the hardware calibration file for each VNA internal source. There is a separate .slc file for each internal source. Upon recall, restores the internal source settings.
.sqm	Source Quadrupler hardware calibration file	
.sta	All Channels Setup File	Same as .cha file but without calibration information. The file can be saved and recalled.
.stx	Active Channel Setup File	For saving and recalling active channel setup parameters. Includes all setup details for the active channel without any calibration data. Upon recall, restores the channel configuration settings to the active channel. The .chx and .stx file formats are very convenient for copying the setup of one channel into another channel. Save the setup from the active channel, open an additional channel, and recall the saved .chx or .stx file into the new channel. Similar to the .chx file. The .chx file includes channel calibration data.

Table A-1. File Extension Definitions (5 of 5)

Extension	Name	Definition
.tdf	Active Trace Data Memory Formatted File - After Post Processing	<p>The .tdf file stores trace data or trace memory data after all post processing using an XML format.</p> <p>This is useful for comparing a DUT against a “golden device” or seeing if the performance of a DUT has changed over time.</p> <p>The file can be saved and recalled. The file will recalled into the same part of the chain that it was saved from and after any post-processing steps.</p>
.tdu	Active Trace Data Memory Unformatted File - Before Post Processing	<p>The .tdf file stores trace data or trace memory data using an XML format.</p> <p>The file saves the active trace’s memory before most post processing such as time domain, smoothing, and group delay calculations.</p> <p>The file can save data from the current trace or from the trace memory.</p> <p>A previously saved file can be recalled and loaded, and then either displayed on the current trace or displayed on the trace memory.</p> <p>This file can be recalled into either the active trace (normally in hold or sweeping very slowly) or into the active trace’s memory.</p> <p>The file will recalled into the same part of the chain that it was saved from and before any post-processing steps.</p>
.tmz	Ten (10) MHz Calibration File	Per system
.txt	Active channel trace data text file	<p>An exportable trace data file in a spreadsheet or word processor compatible format that uses tabs to delimit the output fields.</p> <p>Includes an optional descriptive heading in which the data for every trace is saved to a defined location folder.</p> <p>The data for each trace is saved as an X and Y column to accomodate multiple parameters such as mixed frequency and time domain.</p> <p>Subsequent traces are added as additional columns.</p> <p>Instrument data can be saved to the .txt file but the .txt file cannot be recalled into the VNA memory.</p> <p>Similar to the .csv file format.</p>
.xml	VNA configuration file in XML	<p>XML or eXtensible Markup Language file</p> <p>Used for the VNA configuration state when the instrument is shut down and subsequently powered back up.</p>
KIT_INFO.xyz	Calibration kit file for an Anritsu Lightning 37xxD/37xxE Series VNA.	<p>The .xyz file extension varies with the connector geometry and gender.</p> <p>A ShockLine Series VNA can read Lightning calibration kit files and convert them to a .ccf format.</p>

A-3 Identification of Misc File Types

The table below identifies specific file type names.

Table A-2. File Definitions

File	Name
EmbedDeembed.edl	
FreqIniTable.ini	Frequency Initialization Table file
FreqIniTable.ini	Frequency Initialization Table files.
FreqTable.mft	Multiple Frequency Table configuration file
FreqTable.sft.	Single Frequency Table configuration files

Appendix B — Error Messages

B-1 Appendix Overview

This appendix lists, describes, and provides corrective action for error messages that appear on the instrument display. Any error messages that require action by a qualified service representative are also listed. The tables herein describe the name of the message, the typical reason for its occurrence, and recommended error correction methods. In many cases, the remedial action for the error message is described with applicable cross-references to documented procedures.

B-2 System Messages

System messages are displayed in the status bar or a pop-up dialog box. They indicate that the system may be malfunctioning. System messages are recorded into the event log. Contact Anritsu Customer service if problems are not resolved with instrument re-boot.

Table B-1. Status Bar Messages

Message	Description	Display Location
Lock Error "A"	Direct Digital Synthesis Reference Unlocked	Status Bar
Lock Error "B"	Local Oscillator 1 Heterodyne Unlocked	Status Bar
Lock Error "C"	Local Oscillator 1 Offset Unlocked	Status Bar
Lock Error "D"	Source 1 Offset Unlocked	Status Bar
Lock Error "E"	Local Oscillator 1 Main Unlocked	Status Bar
Lock Error "F"	Source 1 Main Unlocked	Status Bar
Lock Error "H"	Source 1 Heterodyne Unlocked	Status Bar
Lock Error "I"	Source 2 Offset Unlocked	Status Bar
Lock Error "J"	Source 2 Main Unlocked	Status Bar
Level Error "K"	Source 2 Unleveled (Automatic Level Control Loop Failed)	Status Bar
Lock Error "L"	Source 2 Heterodyne Unlocked	Status Bar
RF Power Unlevel	Automatic Level Control Loop Failed	Status Bar
Auto IF Cal Failed	Intermediate Frequency Power Level Failed	Status Bar
Trigger IF Cal Failed	Intermediate Frequency Power Level Failed	Dialog Box
Power Up Self Test Failed	Self Test Failed	Status Bar
Trigger Self Test Failed	Self Test Failed	Dialog Box
Source Pretune Cal Failed	Source Pretune Calibration Failed to Complete	Dialog Box
LO Level Cal Failed	Local Oscillator Calibration Failed to Complete	Dialog Box
ALC Cal Failed	Automatic Level Control Calibration Failed to Complete	Dialog Box
Memory Location Corrupted		Status Bar/ Dialog Box

Table B-1. Status Bar Messages

Message	Description	Display Location
System Out of Memory		Status Bar/dialog Box

B-3 Operational Messages

Operational messages are displayed in the status bar, a pop-up dialog box, or in a table. They indicate an operation error. A system malfunction does not typically cause operational messages. Operational messages are not recorded to the event log unless specified below.

Table B-2. Multiple Source Operational Messages

Message	Display Location	Corrective Action
Equation out of range	Table, Dialog Box	Enter values for the source equation that are within the operational range of the instrument.
Start must be less than stop	Table, Dialog Box	Enter a correct start or stop frequency for the current band.
Frequency range overlaps between bands	Table, Dialog Box	Enter a correct start or stop frequency for the current band.
Undefined divide by zero	Table, Dialog Box	Enter a correct divisor value.
Invalid data entries in band x	Table, Dialog Box	Enter an in band x value

Table B-3. LO Level Cal/ALC Cal Operational Messages

Message	Display Location	Corrective Action
Incorrect sensor detected	Dialog Box	Reconnect the sensors or change the port configuration.
Power cal in frequency sweep	Dialog Box	Change the sweep to a power sweep.
Power cal in power sweep	Dialog Box	Change the sweep to a frequency sweep
Power meter not detected	Dialog Box	Verify that the power meter is properly connected and communicating with the instrument.
Power sensor out of range	Dialog Box	Change the power range.
Wrong power meter detected	Dialog Box	Restart the calibration with the connected power meter or change the power meter.

Table B-4. AutoCal/AutoCal Characterization Operational Messages

Message	Display Location	Corrective Action
Characterization file not found	Dialog Box	Load the AutoCal module characterization file.
AutoCal module not detected	Dialog Box	Check the serial cable connection.
AutoCal module orientation not detected	Dialog Box	Select the module orientation on the next dialog.
AutoCal assurance failed	Dialog Box, Event Log	Rerun AutoCal. If the problem reoccurs, there might be a problem with the AutoCal Module.
12 term cal not applied	Dialog Box	Apply the 12-term calibration.

Table B-5. RF Calibration Operational Messages

Message	Display Location	Corrective Action
Label name already exist	Dialog Box	Enter a new label name.
Blank label name not allowed	Dialog Box	Enter a valid label name.

Table B-6. Operational Messages

Message	Display Location	Corrective Action
File read error		
File write error		
External drive has no room		Delete unneeded files from the external drive.
External drive unavailable		
Hard disk has no room		Delete unneeded files from the internal drive.
Hard disk unavailable		

Appendix C — Anritsu easyTest

C-1 Introduction

This appendix outlines using easyTest with ShockLine VNAs. The easyTest Tools application is used to create easyTest .ett files having step sequences that can be run (displayed) on the instrument.

easyTest Tools is available for download from the Anritsu web site.

This appendix contains the following sections:

- [“easyTest Tools on the PC” on page C-1](#)
- [“easyTest on a ShockLine VNA” on page C-3](#)

Screen images in this chapter are illustrations of typical instrument features. Because easyTest supports multiple products, some images may include Anritsu instruments other than a ShockLine VNA.

C-2 Anritsu easyTest Tools and easyTest .ett Scripts

Introduction

easyTest Tools allows you to create a test sequence (.ett) file on a PC. The file can be copied to the ShockLine VNA via a USB memory stick. The ShockLine software application provides the instrument interface and is used for invoking easyTest scripts. When users select the Utilities menu on its Menu Toolbar and then choose submenu easyTest, the application asks for the .ett file to run. After it loads the file, it then runs (displays) the test sequence steps.

Capabilities

easyTest Tools files can:

- Display custom user images on the screen showing the ShockLine application. Images may include connection diagrams or procedure steps. easyTest supports a variety of image types including .jpg, .bmp, and .png.
- Set instrument parameters to a specific state including measurement type, frequency and amplitude settings, limit lines, and markers. This is accomplished by including a previously-saved instrument setup in the easyTest Tool file.
- Prompt you with a message at the top of the display. While the message is displayed, the instrument can be unlocked for prompts that require user action. An example message is “Press the Autoscale button to zoom in on the trace”.
- Include automatic or manual saving and naming of measurements or screen shots.

C-3 easyTest Tools on the PC

The software is available from the Anritsu web site and is compatible with Windows XP, Windows Vista, and Windows 7. To create an easyTest (.ett) file on the PC that can be opened on the ShockLine VNA, install and launch easyTest Tools, then perform the actions covered in the easyTest documentation.

The following illustrates a test step being created on a PC ([“Example of setup in easyTest Tools on the PC” on page C-2](#)), and shows the resulting material displayed on the VNA ([“Resulting easyTest sequence step displayed on a ShockLine VNA” on page C-3](#)).

Refer to the easyTest Tools Help menu for additional information.

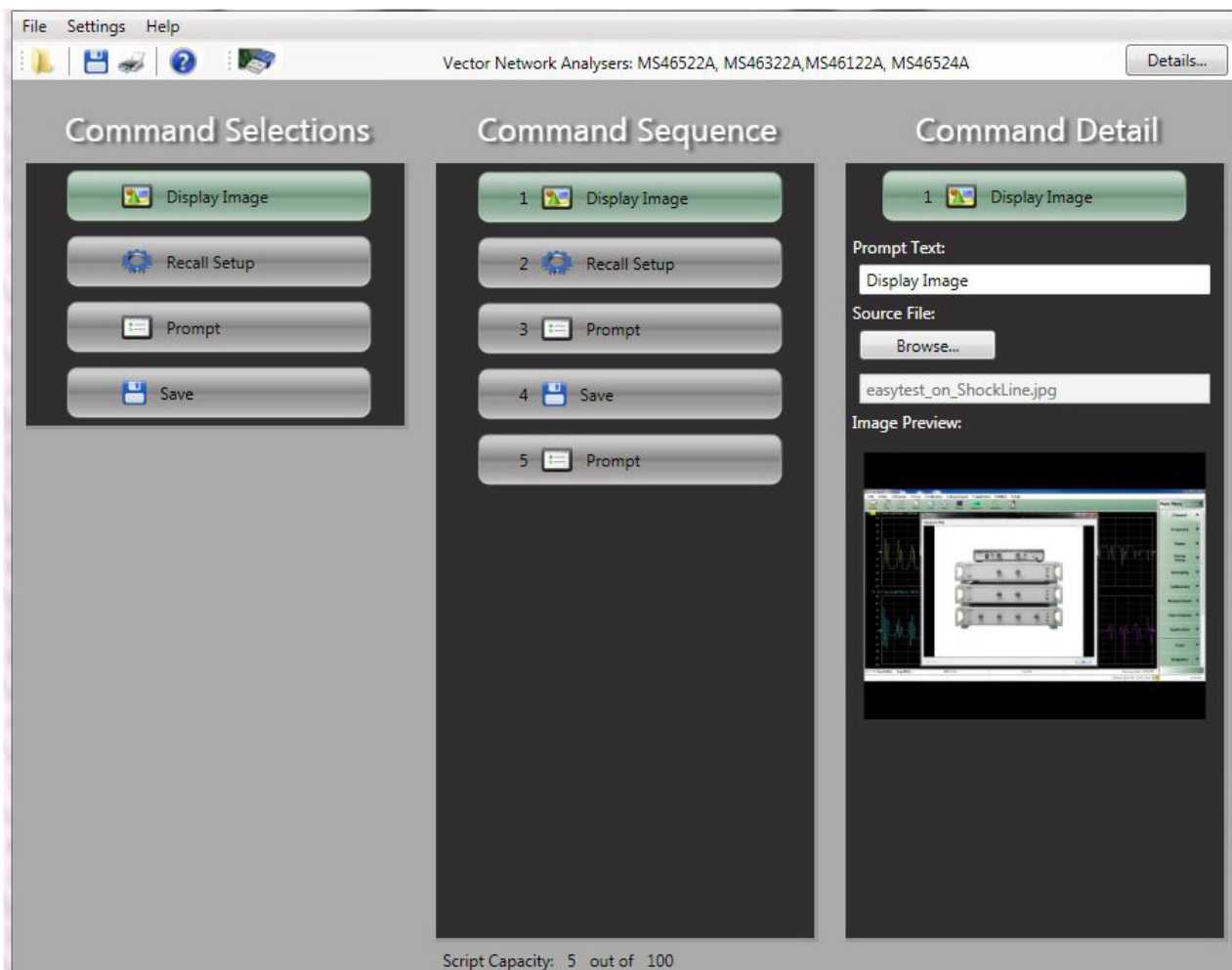

Figure C-1. Example of setup in easyTest Tools on the PC



Figure C-2. Resulting easyTest sequence step displayed on a ShockLine VNA

C-4 easyTest on a ShockLine VNA

After an easyTest Tool test sequence has been created on a PC, you can transfer the project file to the VNA's hard drive for use. This can be done over the Ethernet port on the instrument, or through a USB port.

For Ethernet, if the VNA is visible and accessible on your network, copy the .ett file to a suitable place on the VNA's drive. After that, follow Steps 2 through 5 below to load and run the file.

For transfer from data on a USB memory device:

1. Insert the USB memory device with the easyTest (.ett) file in a ShockLine VNA USB port.
2. On the ShockLine application's Menu Bar, select the Utilities menu then subitem easyTest

1 File 2 Main 3 Channels 4 Trace 5 Calibration 6 Measurement 7 Application 8 Utilities 9 Help

3. In the File Open dialog that appears, select an easyTest .ett file on the USB memory device then click Open.
4. The .ett file will then be loaded and run, displaying the scripted test sequence steps.
5. After the last sequence step is completed, the easyTest window will show an Exit button; click the button to close the window.

Anritsu



 Anritsu utilizes recycled paper and environmentally conscious inks and toner.

Anritsu Company
490 Jarvis Drive
Morgan Hill, CA 95037-2809
USA
<http://www.anritsu.com>