



**Dual Rail LCD KVM Switch
KL9108 / KL9116
User Manual**



FCC, CE Information

FEDERAL COMMUNICATIONS COMMISSION INTERFERENCE STATEMENT: This equipment has been tested and found to comply with the limits for a Class A digital device, pursuant to Part 15 of the FCC Rules. These limits are designed to provide reasonable protection against harmful interference when the equipment is operated in a commercial environment. This equipment generates, uses, and can radiate radio frequency energy and, if not installed and used in accordance with the instruction manual, may cause harmful interference to radio communications. Operation of this equipment in a residential area is likely to cause harmful interference in which case the user will be required to correct the interference at his own expense.

FCC Caution: Any changes or modifications not expressly approved by the party responsible for compliance could void the user's authority to operate this equipment.

CE Warning: This is a class A product. In a domestic environment this product may cause radio interference in which case the user may be required to take adequate measures.

RoHS

This product is RoHS compliant.

SJ/T 11364-2006

The following contains information that relates to China.

部件名称	有毒有害物质或元素					
	铅	汞	镉	六价铬	多溴联苯	多溴二苯醚
电器部件	●	○	○	○	○	○
机构部件	○	○	○	○	○	○

- : 表示该有毒有害物质在该部件所有均质材料中的含量均在SJ/T 11363-2006规定的限量要求之下。
- : 表示符合欧盟的豁免条款, 但该有毒有害物质至少在该部件的某一均质材料中的含量超出SJ/T 11363-2006的限量要求。
- ×: 表示该有毒有害物质至少在该部件的某一均质材料中的含量超出SJ/T 11363-2006的限量要求。



User Information

Online Registration

Be sure to register your product at our online support center:

International	http://eservice.aten.com
---------------	---

Telephone Support

For telephone support, call this number:

International	886-2-8692-6959
China	86-10-5255-0110
Japan	81-3-5615-5811
Korea	82-2-467-6789
North America	1-888-999-ATEN ext 4988
United Kingdom	44-8-4481-58923

User Notice

All information, documentation, and specifications contained in this manual are subject to change without prior notification by the manufacturer. The manufacturer makes no representations or warranties, either expressed or implied, with respect to the contents hereof and specifically disclaims any warranties as to merchantability or fitness for any particular purpose. Any of the manufacturer's software described in this manual is sold or licensed *as is*. Should the programs prove defective following their purchase, the buyer (and not the manufacturer, its distributor, or its dealer), assumes the entire cost of all necessary servicing, repair and any incidental or consequential damages resulting from any defect in the software.

The manufacturer of this system is not responsible for any radio and/or TV interference caused by unauthorized modifications to this device. It is the responsibility of the user to correct such interference.

The manufacturer is not responsible for any damage incurred in the operation of this system if the correct operational voltage setting was not selected prior to operation. PLEASE VERIFY THAT THE VOLTAGE SETTING IS CORRECT BEFORE USE.

Package Contents

Basic Package

The basic KL9108 / KL9116 package consists of:

- 1 KL9108 or KL9116 Dual Rail LCD KVM Switch with Standard Rack Mount Kit
- 2 Custom KVM Cable Sets
- 1 Power Cord
- 1 User Instructions*
- 1 Quick Start Guide

Optional Equipment

Depending on any optional equipment that you may have purchased, one of the following may be included in your package:

- ◆ Standard Rack Mounting Kit - Long
- ◆ Easy-Installation Rack Mounting Kit - Short
- ◆ Easy-Installation Rack Mounting Kit - Long

Check to make sure that all of the components are present and in good order. If anything is missing, or was damaged in shipping, contact your dealer.

Read this manual thoroughly and follow the installation and operation procedures carefully to prevent any damage to the switch or to any other devices on the KL9108 / KL9116 installation.

* Changes may have been made to the manual since it was published. Please visit our Website to check for the most up-to-date version.

Copyright © 2014 ATEN® International Co., Ltd.
Manual Part No. PAPE-0267-3AXG
Manual Date: 2014-10-01

Altusen and the Altusen logo are registered trademarks of ATEN International Co., Ltd. All rights reserved.
All other brand names and trademarks are the registered property of their respective owners.

Contents

FCC, CE Information	ii
SJ/T 11364-2006	ii
User Information	iii
Online Registration	iii
Telephone Support	iii
User Notice	iii
Package Contents	iv
Basic Package	iv
Optional Equipment	iv
About This Manual	x
Overview	x
Conventions	xi
Product Information	xi

Chapter 1.

Introduction

Overview	1
Features	3
Requirements	5
External Console	5
Computers	5
Remote Computers	5
Cables	6
Converters and Adapters	6
Operating Systems	7
Components	8
Front View	8
Keyboard Module	9
LCD Module	10
Rear View	11

Chapter 2.

Hardware Setup

Before You Begin	13
Standard Rack Mounting	14
Single Stage Installation	16
Two Stage Installation	18

Chapter 3.

Basic Operation

Opening the Console	21
Opening Separately	21
Opening Together	23

Operating Precautions	24
Closing the Console	25
LCD OSD Configuration	27
The LCD Buttons.	27
The Adjustment Settings.	28
Port Selection	29
Manual Port Switching	29
Hot Plugging	29
Powering Off and Restarting.	29
Port ID Numbering	29

Chapter 4.

Administration

Overview	31
The Local Console	31
The Main Page	33
Quick View Ports.	33
The List Function.	34
Port Names	36
Port Operation	38
The Configuration Page	39
The Administration Page	41
General	41
User Management.	42
Service Configuration	45
Network	47
ANMS	48
Security	53
Customization	55
Date/Time	59
The Log Page	60
Upgrading the Firmware	61

Chapter 5.

Browser Operation

Overview	63
Logging In	63
Webpage Layout.	65
Webpage Icons	65
The General Dialog Box	66
Webpage Buttons	67

Chapter 6.

Windows Client Port Operation

Activating the OSD	69
Before you Begin.	71

Graphics Configuration Dialog Box	72
The Windows Client OSD	74
Windows Client Control Panel.	75
Hotkey Setup.	76
Video Adjustment	78
The Message Board	81
The Main Page	84
Port Operation.	85
The OSD Toolbar	85
Recalling the OSD.	85
OSD Hotkey Summary Table	86
OSD Toolbar Icons	86
Panel Array Mode	87
Multiuuser Operation.	89
Keyboard Hotkey Operation	90
Auto Scanning.	90
Setting the Scan Interval	90
Invoking Auto Scan	90
Pausing Auto Scan	91
Exiting Auto Scan	91
Skip Mode	91
Keyboard and Mouse Considerations.	92
Keystrokes.	92
Mouse Synchronization	93

Chapter 7.

Java Client Port Operation

Activating the OSD	95
The Java Client OSD	96
The Java Client Control Panel	96
Set Video Parameters	97
Keypad	97
Mouse Synchronization	98
Message Board	98
Lock Key LEDs and Resolution.	101
Switch Screen Mode	101
About.	101
Send Ctrl+Alt+Del	101
Help	101
Exit	101
Port Operation.	102
Panel Array Mode	102
Keyboard Hotkey Operation	102

Chapter 8.

The Log File

The Main Screen 103

Chapter 9.

The Log Server

Installation..... 105
 Starting Up 106
 The Menu Bar..... 107
 Configure..... 107
 Events 108
 Options 110
 Help..... 110
 The Log Server Main Screen 111
 Overview 111
 The List Panel..... 112
 The Event Panel..... 112

Chapter 10.

AP Operation

Overview..... 113
 The Windows Client 113
 Installation..... 113
 Starting Up 114
 The File Menu..... 116
 The Tools Menu 116
 Connecting 118
 Operation 119
 Ending the Session..... 119
 The Java Client..... 119
 Installation..... 119
 Starting Up 120
 Operation 121

Chapter 11.

LDAP Server Configuration

Introduction..... 123
 Install the Windows 2003 Support Tools 123
 Install the Active Directory Schema Snap-in..... 124
 Create a Start Menu Shortcut Entry 124
 Extend and Update the Active Directory Schema..... 125
 Creating a New Attribute..... 125
 Extending the Object Class With the New Attribute 127
 Editing Active Directory Users..... 129
 OpenLDAP 132

OpenLDAP Server Installation	132
OpenLDAP Server Configuration	133
Starting the OpenLDAP Server	134
Customizing the OpenLDAP Schema	135
LDAP DIT Design and LDIF File	136
Using the New Schema	138

Appendix

Safety Instructions	139
General	139
Rack Mounting	141
Consignes de sécurité	142
Général	142
Montage sur bâti	145
Technical Support	146
International	146
North America	146
Specifications	147
OSD Factory Default Settings	148
Trusted Certificates	149
Overview	149
Installing the Certificate	150
Certificate Trusted	151
Troubleshooting	152
Overview	152
Administration	152
General Operation	153
The Java Client	154
The Log Server	154
Panel Array Mode	155
The Windows Client	155
Sun Systems	156
Screen Resolutions Higher than 1280 x 1024	156
Additional Mouse Synchronization Procedures	158
Windows:	158
Administrator Login Failure	160
Optional Rack Mounting	161
Dedicated Invocation Keys	164
About SPHD Connectors	165
Supported KVM Switches	165
Limited Warranty	166

About This Manual

This User Manual is provided to help you get the most from your KL9108 / KL9116 system. An overview of the information found in the manual is provided below.

Overview

Chapter 1, Introduction, introduces you to the KL9108 / KL9116 System. Its purpose, features and benefits are presented, and its front and back panel components are described.

Chapter 2, Hardware Setup, provides step-by-step instructions for setting up your installation, and explains some basic operating procedures.

Chapter 3, Basic Operation, explains the fundamental concepts involved in operating the KL9108 / KL9116.

Chapter 4, Administration, explains the administrative procedures that are employed to configure the KL9108 / KL9116's working environment, as well as how to operate the KL9108 / KL9116 from the local console.

Chapter 5, Browser Operation, describes how to log into the KL9108 / KL9116 with your browser, and explains the functions of the icons and buttons on the KL9108 / KL9116 web page.

Chapter 6, Windows Client Port Operation, explains how to use the Windows Client to access and control the computers connected to the switch.

Chapter 7, Java Client Port Operation, describes how to use the Java Client to access and control the computers connected to the switch.

Chapter 8, The Log File, shows how to use the log file utility to view all the events that take place on the KL9108 / KL9116.

Chapter 9, The Log Server, explains how to install and configure the Log Server.

Chapter 10, AP Operation, describes how to operate the KL9108 / KL9116 using Windows and Java Client application programs, rather than with the browser method.

Chapter 11, LDAP Server Configuration, explains how to configure the KL9108 / KL9116 for LDAP / LDAPS authentication and authorization with Active Directory or OpenLDAP.

An Appendix at the end of the manual provides technical and troubleshooting information.

Conventions

This manual uses the following conventions:

- Monospaced Indicates text that you should key in.

- [] Indicates keys you should press. For example, [Enter] means to press the **Enter** key. If keys need to be chorded, they appear together in the same bracket with a plus sign between them: [Ctrl+Alt].

- 1. Numbered lists represent procedures with sequential steps.

- ◆ Bullet lists provide information, but do not involve sequential steps.

- Indicates selecting the option (on a menu or dialog box, for example), that comes next. For example, Start → Run means to open the *Start* menu, and then select *Run*.

-  Indicates critical information.

Product Information

For information about all ATEN products and how they can help you connect without limits, visit ATEN on the Web or contact an ATEN Authorized Reseller. Visit ATEN on the Web for a list of locations and telephone numbers:

International	http://www.aten.com
North America	http://www.aten-usa.com

This Page Intentionally Left Blank

Chapter 1

Introduction

Overview

The KL9108 and KL9116 Dual Rail LCD KVM Switches are control units that allow secure access to multiple computers from a single KVM (keyboard, video, and mouse), console. A single KL9108 or KL9116 can control up to 8 or 16 computers, respectively. They consist of an integrated LCD monitor, keyboard, and touchpad in a in a 1U rack-mountable retractable sliding housing.

The LCD and keyboard/touchpad modules slide independently of each other. To maximize space in your data center, the keyboard/touchpad module slides back to "hide away" when not in use, while the thin profile LCD monitor rotates back – flush against the rack – allowing convenient monitoring of computer activity.

The KL9108 / KL9116 features IP-based connectivity that allows one local operator and multiple remote operators to concurrently monitor and access the computers on your installation. Because the it uses TCP/IP for its communications protocol, the KL9108 / KL9116 can be accessed from any computer on the LAN, WAN, or Internet – whether that computer is located down the hall, down the street, or halfway around the world.

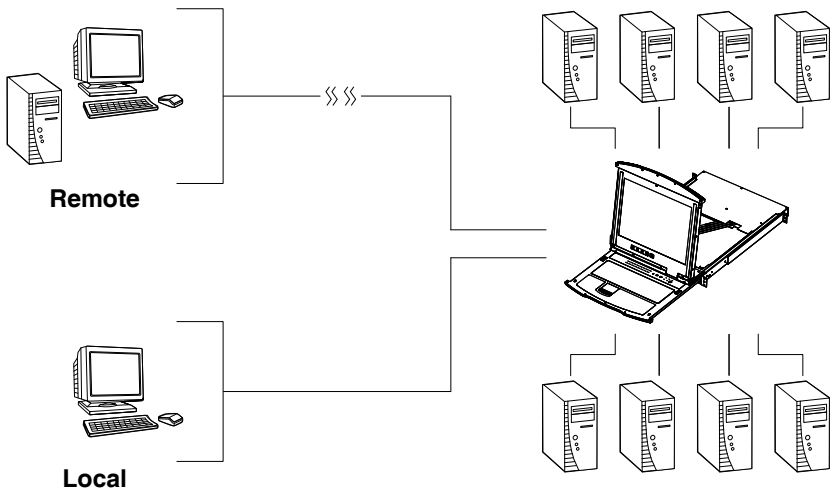

For added convenience, ports for an external keyboard, monitor, and mouse are provided on the rear panel – permitting you to manage the switch from a local console up to 20 meters away. There is also an external PS/2 mouse port on the keyboard module, allowing you to use an external mouse, rather than the touchpad.

Access to any computer connected to the installation from the local console is easily accomplished by means of a powerful mouse driven graphical OSD (On Screen Display) menu system. A convenient *Auto Scan* feature also permits automatic scanning and monitoring of the activities of all computers running on the installation one by one.

Remote operators connect to the KL9108 / KL9116 via its IP address from anywhere on the LAN, WAN, or Internet via their browsers. Once they successfully log in, they can take control using either the *Windows Client* or *Java Client* utility. Inclusion of a Java-based client ensures that the KL9108 / KL9116 is platform independent, and is able to work with most operating systems.

System administrators can handle a multitude of maintenance tasks smoothly and efficiently – from installing and running GUI applications, to BIOS level troubleshooting, routine monitoring, concurrent maintenance, system administration, rebooting and even pre-booting functions – all from a remote connection.

Remote operators can exchange keyboard, video and mouse signals with the computers attached to the KL9108 / KL9116 just as if they were present locally and working on the equipment directly.

Enhanced features include a *Panel Array Mode* that displays the video output of up to 8 (KL9108) or 16 (KL9116) computers at the same time, and a *Message Board* that allows logged in users to conveniently and instantly communicate with one other – no matter where in the world they actually are.

The KL9108 / KL9116 utilizes high density 15-pin KVM port connectors instead of the usual 25-pin connectors. This space-saving innovation allows a full 8 / 16 port switch to be conveniently installed in one unit of system rack space.

Setup is fast and easy - plugging cables into their appropriate ports is all that is entailed. Because the KL9108 / KL9116 intercepts keyboard input directly, there is no need to get involved in complex installation routines or to be concerned with incompatibility problems.

Since the KL9108 / KL9116's firmware is upgradable over the Internet, you can stay current with the latest functionality improvements simply by downloading firmware updates from our website as they become available.

With its advanced security features, the KL9108 / KL9116 is the fastest, most reliable, most cost effective way to remotely access and manage widely distributed multiple computer installations.

Features

- ◆ 8 (KL9108) / 16 (KL9116) port remote access KVM switch in a sliding dual rail housing with top and bottom clearance for smooth operation in a 1U high rack
- ◆ Integrated KVM console with 17" LCD monitor, keyboard, and touchpad
- ◆ Dual slide – LCD Monitor module can slide independently of the keyboard/touchpad module
- ◆ Dual bus support – one local and one remote user can simultaneously control up to 8 (KL9108) or 16 (KL9116) computers
- ◆ A single console controls up to 8 (KL9108) or 16 (KL9116) computers – cascade additional units to control up to 128 computers
- ◆ Remotely access computers via the LAN, WAN, or Internet – control your installation when and where you want
- ◆ Grayscale option to improve transfer speed in low bandwidth situations
- ◆ User-selectable network transfer rate
- ◆ External console ports – manage computers in the LCD KVM switch from an external console (PS/2 keyboard, monitor, and PS/2 mouse)
- ◆ Supports external PS/2 mouse
- ◆ Supports dedicated OSD and OSD Toolbar invocation keys
- ◆ Console lock – enables the console modules to remain securely locked away in position when not in use
- ◆ Internet browser access – Windows Client and Java Client provided, Java Client works with most operating systems*
- ◆ Graphical OSD and graphical toolbars for convenient, user-friendly operation
- ◆ Up to 64 user accounts – up to 32 concurrent remote logins
- ◆ Panel Array Mode – view all 8 (KL9108) or 16 (KL9116) ports at the same time

- ◆ Message board feature allows logged in users to communicate with each other and allows a remote user to take exclusive control of the KVM functions
- ◆ Windows-based Log Server
- ◆ Remote power control for attached Power over the Net™ devices
- ◆ Three user account types: Administrator, User, and Select
- ◆ Advanced security features include password protection and advanced encryption technologies: 1024-bit RSA, 256-bit AES, 56-bit DES, and 128-bit SSL
- ◆ Supports RADIUS server authentication
- ◆ Supports CC1000 management
- ◆ Flash firmware upgradable over a network connection
- ◆ Ports can be set to Exclusive, Occupy and Share
- ◆ Network Interfaces: TCP/IP, HTTP, HTTPS, UDP, RADIUS, DHCP, SSL, ARP, DNS, 10Base-T/100Base-TX, Auto Sense, and Ping
- ◆ High video resolution: up to 1280 x 1024 @ 75Hz (17" LCD monitor); 1600 x 1200 @ 60Hz (remote computer)
- ◆ Keyboard Language support: English (US); English (UK); German; German (Swiss); French; Spanish; Traditional Chinese; Japanese; Korean; Swedish; Italian; Russian; Hungarian and Greek

* Browsers must support 128-bit SSL encryption.

Requirements

External Console

- ◆ A VGA, SVGA, or MultiSync monitor capable of displaying the highest resolution provided by any computer in the installation
- ◆ PS/2 keyboard and mouse

Computers

The following equipment must be installed on each computer:

- ◆ A VGA, SVGA or MultiSync video graphics card with an HDB-15 port

Note: The integrated LCD monitor's maximum screen resolution is 1280 x 1024 @ 75 Hz. If you want to use a higher setting for the screen resolutions of the attached computers, see *Screen Resolutions Higher than 1280 x 1024*, page 156.

- ◆ PS/2 mouse and keyboard ports (6-pin Mini-DIN)

Remote Computers

- ◆ For best results, computers that remotely access the KL9108 / KL9116 should have at least a P III 1 GHz processor, with their screen resolution set to 1024 x 768.
- ◆ Users who want to access the KL9108 / KL9116 with the Windows Client must have DirectX 7.0 or higher installed.
If you don't already have it, DirectX is available for free download from Microsoft's Website: <http://www.microsoft.com/downloads>.
- ◆ Users who want to access the KL9108 / KL9116 with the Java Client must have Sun's Java 2 (1.4.2 or higher) runtime environment installed. Java is available for free download from the Sun Java Website: <http://java.sun.com>.
- ◆ Browsers must support 128-bit SSL encryption.
- ◆ For best results, a network transfer speed of at least 128 Kbps is recommended.

Cables

Substandard cables may degrade system performance or damage your installation. For optimum signal integrity and reliability, we strongly recommend that you use ATEN's high-quality, custom cable sets. To purchase cable sets contact your dealer. Lengths and part numbers are provided in the following table.

Length (m)	Part Number
1.2	2L-5201P
1.8	2L-5202P 2L-5702P*
3.0	2L-5203P
6.0	2L-5206P

* These two are functionally the same – they differ slightly in appearance only.

Converters and Adapters

Adapters and converters are used to connect Mac or Sun computers to the KL9108 / KL9116. To purchase adapters and converters contact your dealer. The type, model number, and purpose of each provided in the following table:

Purpose	Type	Model Number
Connecting USB port computers	PS/2 to USB Adapter	UC100KMA
Connecting Sun legacy computers	Sun Console Converter	CV130A
Connecting Sun USB computers	Sun Console Converter	CV131A

Operating Systems

Supported operating systems are shown in the table, below:

OS	Version	
Windows		2000 and higher
Linux	RedHat	6.0 and higher
	SuSE	8.2 and higher
	Mandriva (Mandrake)	9.0 and higher
UNIX	AIX	4.3 and higher
	FreeBSD	3.51 and higher
	Sun	Solaris 8 and higher
Novell	Netware	5.0 and higher
Mac		8.6 and higher
OS/2		Warp and higher
DOS		6.2 and higher

Components

Front View

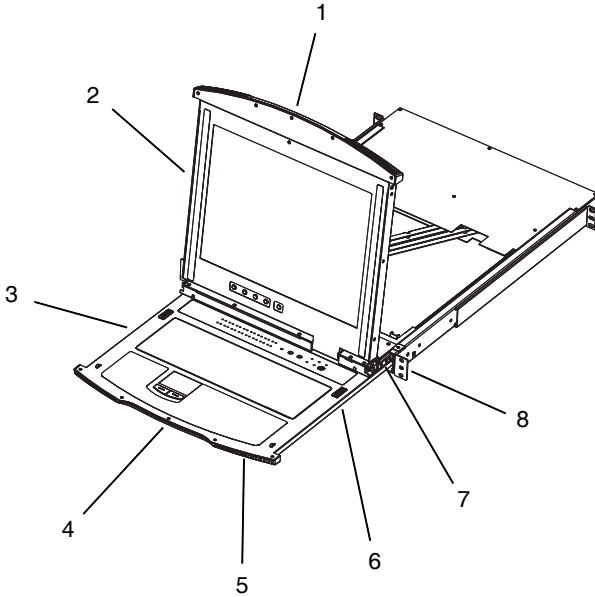

No.	Component	Description
1	Upper Handle	Pull to slide the LCD module out; push to slide the module in. See <i>Opening the Console</i> , page 21, for details on sliding the console in and out.
2	LCD Module	See <i>LCD Module</i> , page 10.
3	Keyboard Module	See <i>Keyboard Module</i> , page 9.
4	Lower Handle	Pull to slide the keyboard module out. See <i>Opening the Console</i> , page 21, for more details on sliding the console in and out.
5	Power LED	Lights (blue) to indicate that the unit is receiving power.
6	Keyboard Release Catch	These catches (one on each side) release the keyboard module so you can slide it away.
7	LCD Release Catch	These catches (one on each side) release the LCD module so you can slide it away.
8	Rack Mounting Tabs	The rack mounting tabs located at each corner of the unit secure the chassis to a system rack. See <i>Standard Rack Mounting</i> , page 14, for details.

Keyboard Module

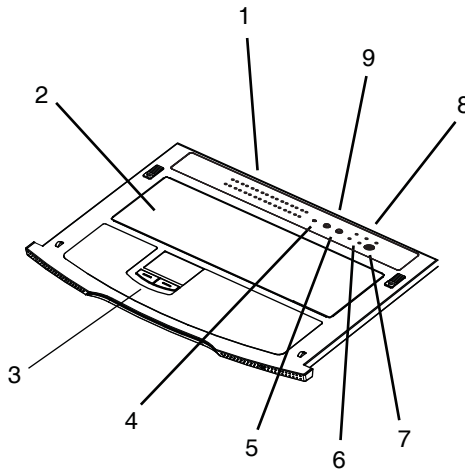

No.	Component	Description
1	Port LEDs	<ul style="list-style-type: none"> ◆ An <i>On Line</i> LED lights to indicate that the device attached to its corresponding port is up and running. ◆ A Selected LED lights to indicate that the computer attached to its corresponding port has the KVM focus.
2	Keyboard	Standard 105-key keyboard
2	Touchpad	Standard mouse touchpad
4	Reset Switch	<ul style="list-style-type: none"> ◆ Pressing and holding this switch in while powering on the unit causes the KL9108 / KL9116 to revert to the original factory installed firmware version – allowing you to recover from a failed firmware upgrade. ◆ Pressing and holding this switch in for more than three seconds performs a system reset. <p>Note: The switch is recessed and must be pushed with a thin object - such as the end of a paper clip or a ballpoint pen.</p>
5	Port Selection Switches	<ul style="list-style-type: none"> ◆ The left button (DOWN), shifts the KVM focus down through the ports (Port 7 → Port 6, etc.). After Port 1, it cycles back to the last port. ◆ The right button (UP), shifts the KVM focus up through the ports. After the last port, it cycles to Port 1.

(Continues on next page.)

(Continued from previous page.)

No.	Component	Description
6	Connection LEDs	<ul style="list-style-type: none"> ◆ The <i>LINK</i> LED flashes when a remote client connects to the KVM switch. ◆ The <i>10/100 Mbps</i> LED lights orange to indicate 10 Mbps data transmission speed. It lights green for 100 Mbps.
7	External Mouse Port	This PS/2-type mouse port is provided for users who prefer to use an external mouse.
5	Lock LEDs	The Num Lock, Caps Lock, Scroll Lock LEDs are located here.

LCD Module

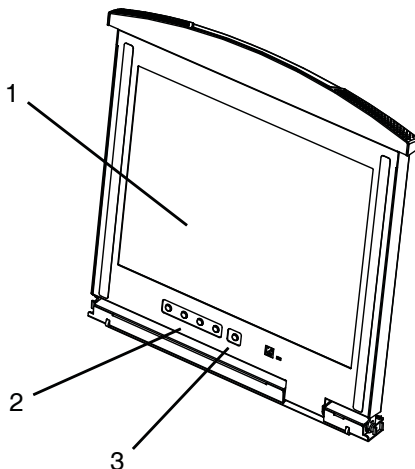

No.	Component	Description
1	LCD Display	To access the LCD monitor, slide the LCD module out and flip up the cover. See <i>Opening the Console</i> , page 21, for details on sliding the LCD module out.
2	LCD Controls	These buttons control the position and picture settings of the LCD display. See <i>LCD OSD Configuration</i> , page 27, for details.
3	LCD On/Off Button	Push this button to turn the LCD monitor on and off. The button lights when the LCD monitor is off to indicate that only the monitor is off – not the KVM switch itself.)

Rear View

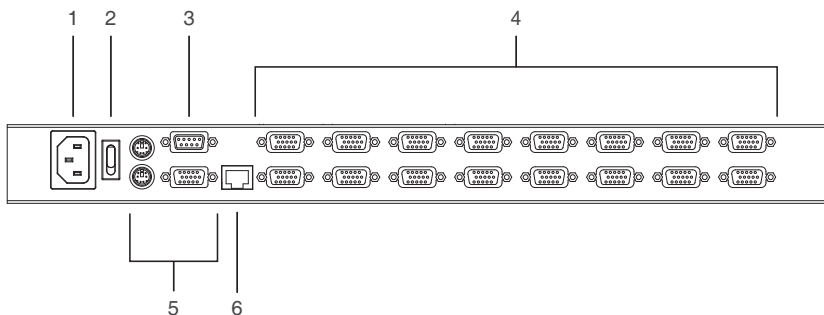

No.	Component	Description
1	Power Socket	This is a standard 3-pin AC power socket. The power cord from an AC source plugs in here.
2	Power Switch	This is a standard rocker switch that powers the unit on and off.
3	PON Port	This connector is provided for a Power over the Net™ (PON) unit to plug into. A PON device allows computers attached to the KL9108 / KL9116 to be booted remotely over the LAN, WAN, or Internet. Contact your dealer for more details.
4	KVM Ports	The cables that link to the computers plug in here. Note: The shape of these 15-pin connectors has been specifically modified so that only custom KVM cables designed to work with this switch can plug in. (See <i>Cables</i> , page 6, for details.) Do NOT attempt to use ordinary 15-pin VGA connector cables to link these ports to the computers.
5	External Console Ports	For flexibility and convenience, the KL9108 / KL9116 supports an external KVM console. A custom console cable set is provided to attach the external console's monitor, keyboard, and mouse.
6	LAN Port	The cable that connects the KL9108 / KL9116 to a LAN, WAN, or Internet plugs in here.

* The KL9116 is pictured above. The KL9108 rear panel is the same as that of the KL9116, except that it has 8 KVM ports instead of 16.

This Page Intentionally Left Blank

Chapter 2

Hardware Setup

Before You Begin



1. Important safety information regarding the placement of this device is provided on page 139. Please review it before proceeding.
2. Make sure that power to all the devices you will be connecting up has been turned off. You must unplug the power cords of any computers that have the Keyboard Power On function.
3. Packing material has been inserted to protect the KL9108 / KL9116 during shipping. Slide the LCD module out (see *Opening the Console*, page 21), until the packing material is visible. Remove the packing material before installing the unit, as shown in the diagram below.

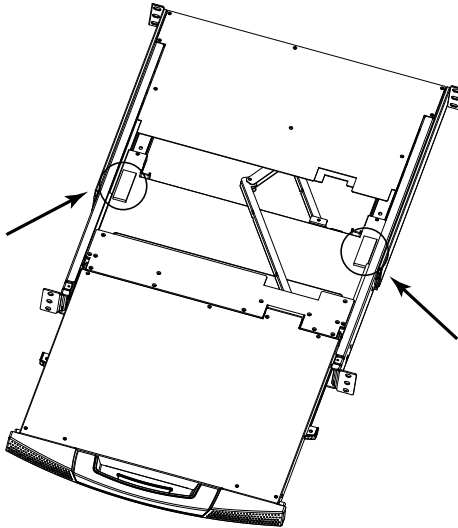

Standard Rack Mounting

A standard rack mounting kit is provided with your KL9108 / KL9116. The kit enables the switch to be mounted in a rack with a depth of 42–77 cm.

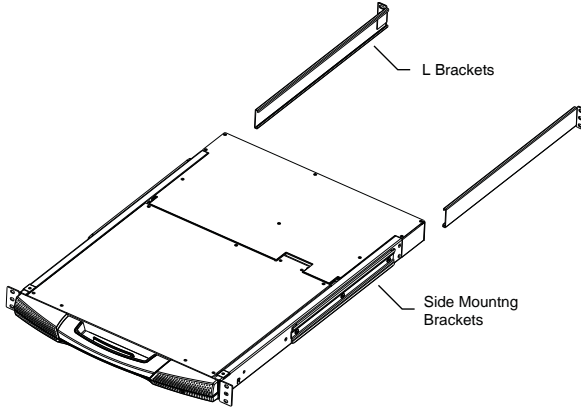

-
- Note:**
1. It takes two people to mount the switch: one to hold it in place, the other to screw it in.
 2. The standard rack mounting kit does not include screws or cage nuts. If you need additional screws or cage nuts, contact your rack dealer.
 3. Optional mounting kits – including single person *Easy Installation* kits – are available with a separate purchase. See *Optional Rack Mounting*, page 161, for details.
-

To rack mount the switch, do the following:

1. While one person positions the switch in the rack and holds it in place, the second person loosely screws the front brackets to the rack.

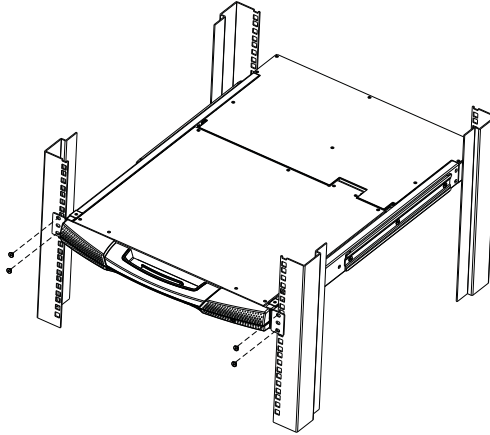

2. While the first person still holds the switch in place, the second person slides the L brackets into the switch's side mounting brackets, from the rear until the bracket flanges contact the rack, then screws the L brackets to the rack.

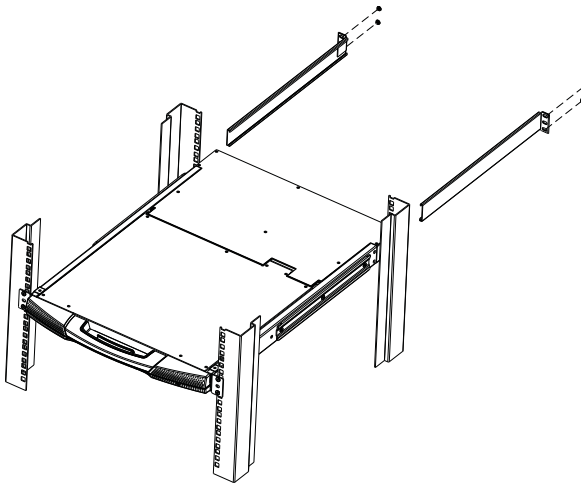

3. After the L brackets have been secured, tighten the front bracket screws.

Note: Allow at least 5.1 cm on each side for proper ventilation, and at least 12.7 cm at the back for the power cord and cable clearance.

Single Stage Installation

In a Single Stage installation, there are no additional switches daisy chained down from the first unit. To set up a single stage installation, refer to the installation diagram on the following page (the numbers in the diagram correspond to the numbers of the installation steps) and do the following:

1. (*Optional*) If you choose to install an external console, plug your keyboard, monitor, and mouse into the *Console Ports* located on the KL9108 / KL9116's rear panel. The ports are color coded and marked with an icon to identify themselves.
2. Using a KVM cable set (see *Cables*, page 6), plug the custom SPHD (yellow) connector into any available KVM port on the switch.
3. At the other end of the cable, plug the keyboard, video (blue), and mouse connectors into their respective ports on the computer.
4. Plug the cable from the LAN into the LAN port on the KL9108 / KL9116's rear panel.
5. Connect the power cord provided with this package to an AC source and the KL9108 / KL9116's power socket.

Repeat steps 2 – 5 for any other computers you wish to install.

After you are all cabled up, you can power on the switch. After the switch is powered on, power on the computers.

Note: Although the KL9116 is pictured in the diagram, the installation process is the same for the KL9108.

Single Stage Installation Diagram

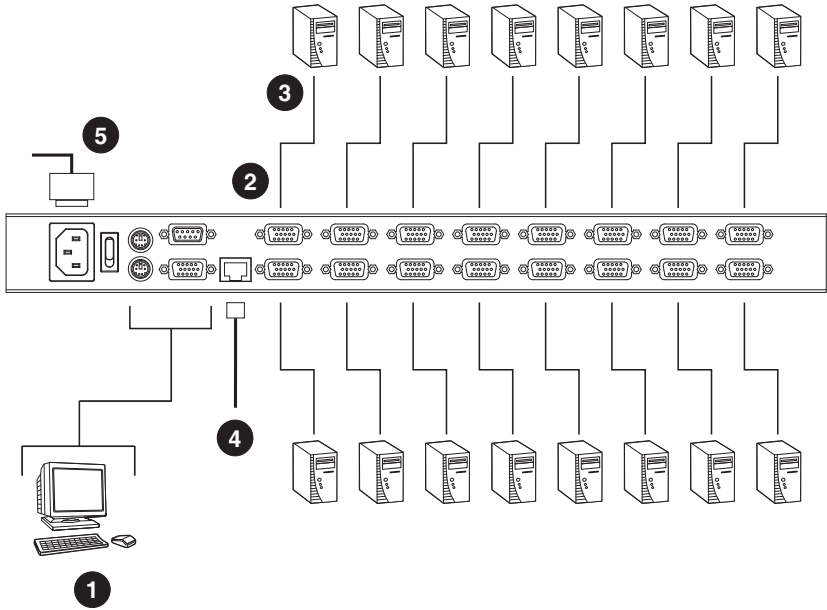

Two Stage Installation

To expand the number of computers that can be controlled in your KVM installation, up to 8 (KL9108), or 16 (KL9116) additional KVM switches can be cascaded from the KL9108 / KL9116's KVM ports. As many as 64 (KL9108) or 128 (KL9116) computers can be controlled in a complete two stage installation.

In a two stage installation, the KL9108 / KL9116 is considered the *first stage* unit; the cascaded switches are considered *second stage* units.

Note: The KVM switch shown in the installation example is the KH98. See *Supported KVM Switches*, page 165, for a complete list of switches that can be cascaded from the KL9108 / KL9116.

To set up a two stage installation, refer to the Two Stage Installation diagram on the next page, and do the following:

1. Make sure that power to all the devices you will be connecting up, including all preexisting devices on the installation, have been turned off.
2. Use a KVM cable set (see *Cables*, page 6), to connect any available KVM Port on the First Stage unit to the Console ports of the Second Stage unit.
3. Use KVM cable sets (as described in the *Cables* section of the user manual for the cascaded KVM switch) to connect any available KVM port on the cascaded KVM switch to the keyboard, video, and mouse ports of the computers you are installing.
4. Plug the power cord that came with the cascaded KVM switch into its power socket, and then into an AC power source.
(Repeat Steps 2–4 for any additional KVM switches that you wish to cascade from the KL9108 / KL9116.)
5. Power on the KL9108 / KL9116.
6. Power on the cascaded KVM switches.
7. Power on the computers.

Two Stage Installation Diagram

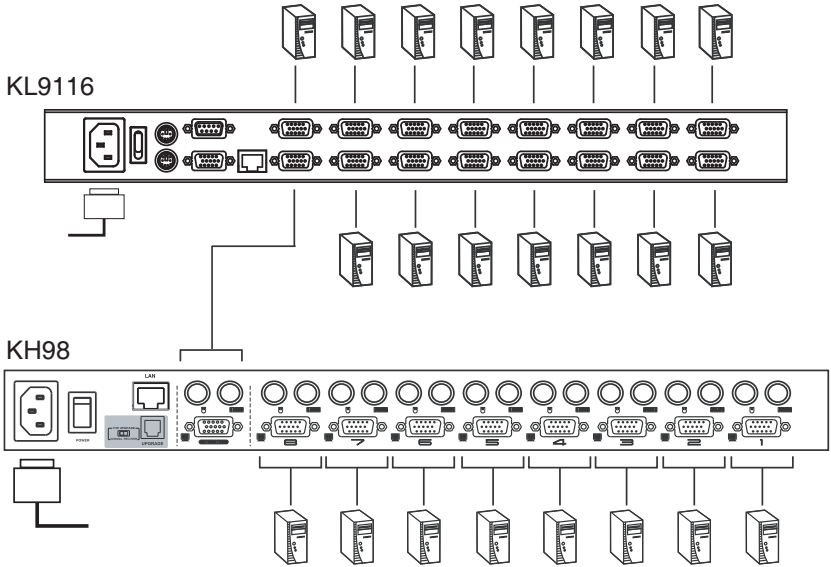

This Page Intentionally Left Blank

Chapter 3

Basic Operation

Opening the Console

The KL9108 / KL9116's console consists of two modules: an LCD display module located under the top cover; and a keyboard/touchpad module below the LCD module.

The modules can either slide together, or independently. This allows you to have the LCD display available for viewing while the keyboard/touchpad module is conveniently out of the way when not in use.

Opening Separately

1. Pull the release catch to release the console, and pull the top panel a few centimeters toward you. Once the console has been released, you can let go of the catch.

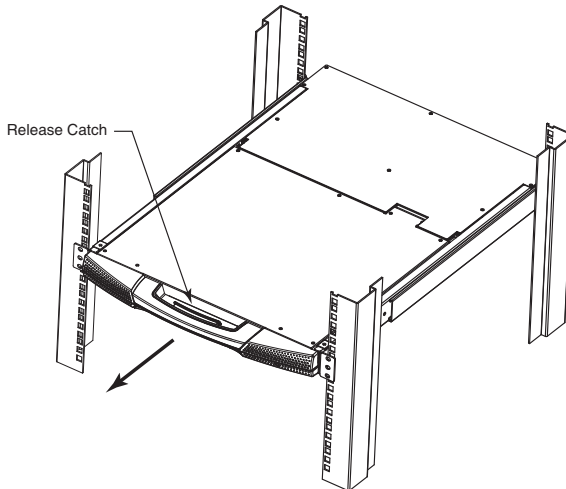

(Continues on next page.)

(Continued from previous page.)

2. Pull the top panel all the way out until it clicks into place.

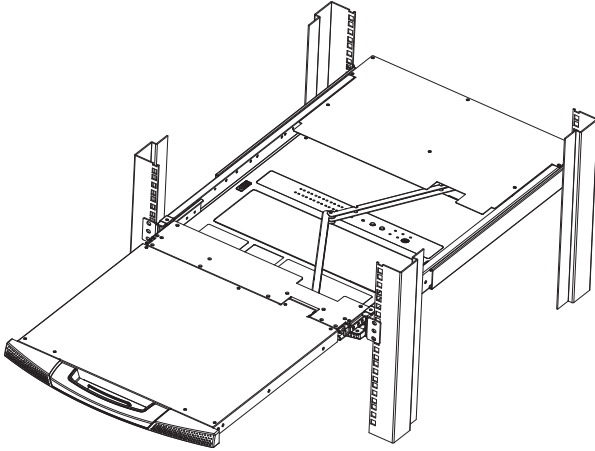

3. Rotate the top panel all the way back to expose the LCD screen.

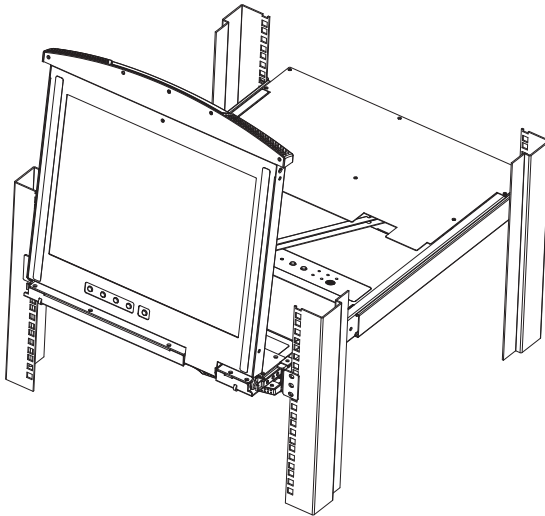

4. Reach underneath and pull the keyboard module all the way out until it clicks into place.

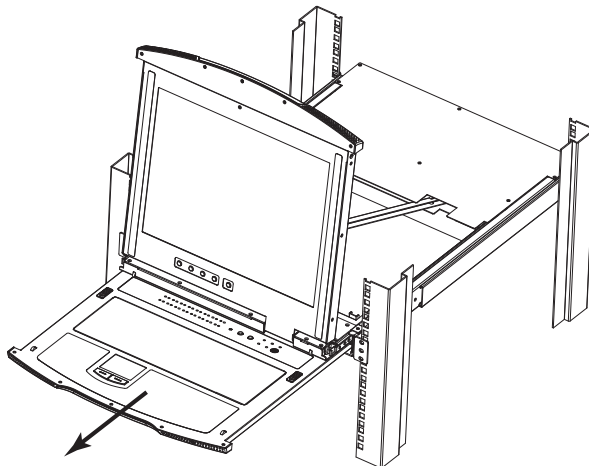

Opening Together

Refer to the diagrams in the *Opening Separately* section as you do the following:

1. Pull the release catch and pull the top and bottom panels out until the keyboard module clicks into place.

Note: Once the console has been released, you can let go of the catch.

2. Pull the top panel the rest of the way out until it clicks into place.
3. Rotate the top panel all the way back to expose the LCD screen.

Note: Refer to the warning regarding placing excessive weight on the keyboard module on the following page.

Operating Precautions

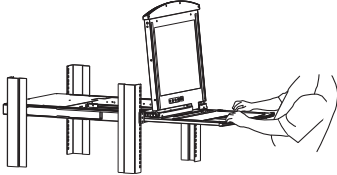
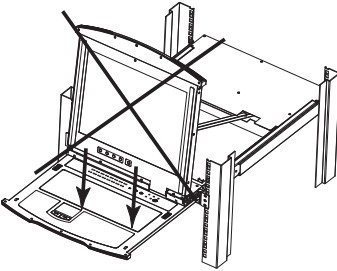

The maximum load bearing capacity of the keyboard module is 30kg. Failure to heed the information below can result in damage to the keyboard module.

	<p>RIGHT</p> <p>Rest your hands and arms lightly on the keyboard module as you work.</p>
	<p>WRONG!</p> <ul style="list-style-type: none">◆ DO NOT lean your body weight on the keyboard module.◆ DO NOT place heavy objects on the keyboard module.

Closing the Console

1. Pull the release catches located on either side of the keyboard toward you to release the keyboard module, then slide the module slightly in.

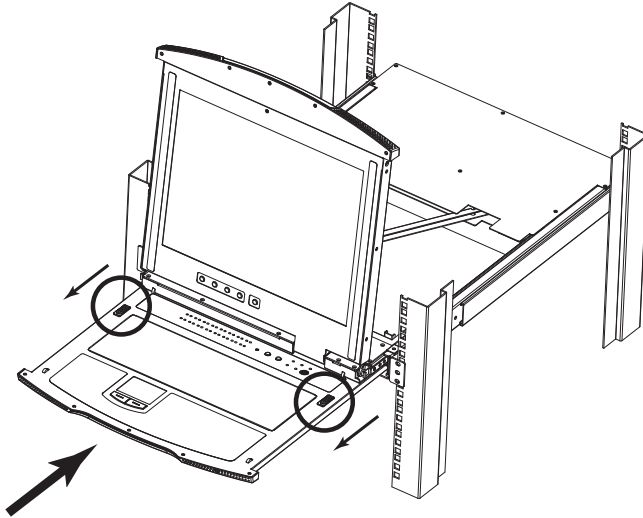

2. Let go of the catches. Using the front handle, push the keyboard module all the way in.

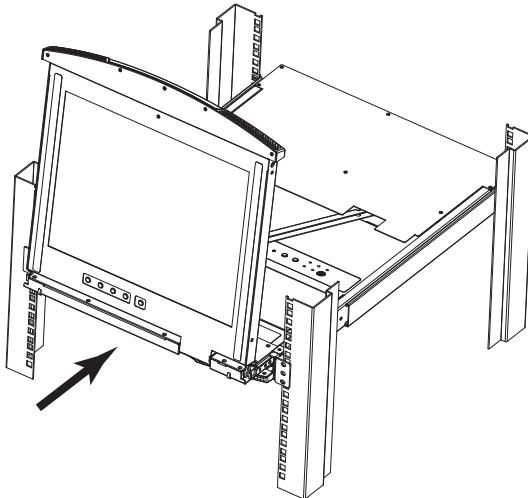

3. Rotate the LCD module all the way down, then pull the rear catches to release the LCD module.

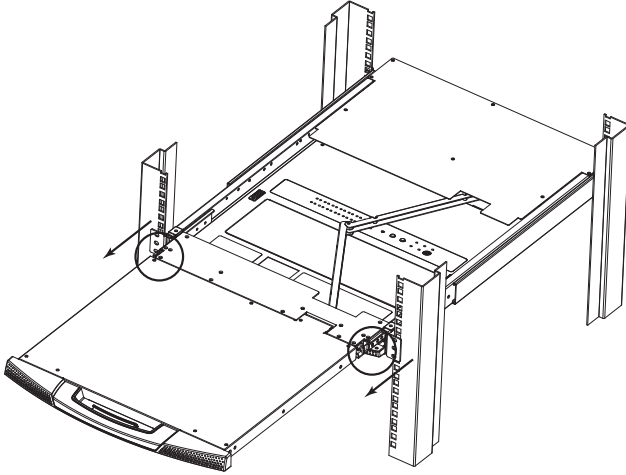

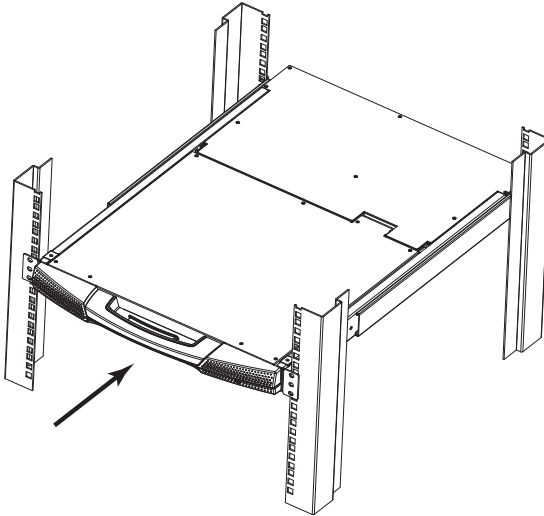

4. Using the front handle, push the module all the way in.



LCD OSD Configuration

The LCD Buttons

The LCD OSD allows you to set up and configure the LCD display. Four buttons (see *LCD Controls*, page 10), are used to perform the configuration, as described in the table below:

Button	Function
MENU	When you have not entered the LCD OSD Menu function, pressing this button invokes the Menu function and brings up the Main Menu.
	When navigating through the menus, this button moves you right or up. When making an adjustment, it increases the value.
	When navigating through the menus, this button moves you left or down. When making an adjustment, it decreases the value.
EXIT	<ul style="list-style-type: none"> ◆ When you have not entered the LCD OSD Menu function, pressing this button performs an auto adjustment. An auto adjustment automatically configures all the settings for the LCD panel to what the OSD considers their optimum values to be. ◆ When you have entered the LCD OSD Menu function, pressing this button exits the current menu and returns you to the previous menu. Use it to leave an adjustment menu when you are satisfied with the adjustment you have made. ◆ When you are at the Main Menu, pressing this button exits the LCD OSD.

The Adjustment Settings

An explanation of the LCD OSD adjustment settings is given in the table below:

Setting	Explanation
Brightness	Adjusts the background black level of the screen image.
Contrast	Adjusts the foreground white level of the screen image.
Phase	If pixel jitter or horizontal line noise is visible on the display, your LCD may have the wrong phase setting. Adjust the phase setting to eliminate these problems.
Clock	If vertical banding is visible on the display, your LCD may have the wrong clock setting. Adjust the clock setting to eliminate vertical banding.
H-Position	Positions the display area on the LCD panel horizontally (moves the display area left or right).
V-Position	Positions the display area on the LCD panel vertically (moves the display area up or down).
Color Temperature	Adjusts the color quality of the display. You can adjust the "warmth" value, color balance, etc. The <i>Adjust Color</i> selection has a further submenu that lets you fine tune the RGB values.
Language	Selects the language that the OSD displays its menus in.
OSD Duration	Lets you set the amount of time that the OSD displays on the screen. If there is no input for the amount of time you choose, the OSD display turns off.
Reset	Resets the menu and submenu adjustments (except for language settings) to the original factory default settings.

Port Selection

The KL9108 / KL9116 provides three port selection methods to access the computers on the installation: Manual, an OSD (On Screen Display) menu system, and Hotkeys. OSD Operation and Hotkey Port Selection are discussed in the *Windows Client Port Operation* and *Java Client Port Operation* Chapters.

Manual Port Switching

Use the *Port Selection Switches* on the keyboard to manually switch to a port.

Hot Plugging

The KL9108 / KL9116 supports *hot plugging* - components can be removed and added back into the installation by unplugging and replugging their cables from the ports without the need to shut the unit down.

If you change computer positions, in order for the OSD menus to correspond to the KVM port changes, you must manually edit the Port Names for the OSD to reflect the new port information. See *Port Names*, page 36, for details.

Note: If the computer's operating system does not support hot plugging, this function may not work properly.

Powering Off and Restarting

If it becomes necessary to power off the KL9108 / KL9116, or if the switch loses power and needs to be restarted, wait 10 seconds before powering it back on. The computers should not be affected by this, but if any of them should fail, simply restart the affected computers.

Port ID Numbering

Each of the KL9108 / KL9116's KVM ports is assigned a two-digit Port ID number. You can access any device by specifying the Port ID of the port that it is connected to. Port numbers from 1 - 9 are padded with a preceding zero, so they become 01 - 09.

For example, a computer attached to **Port 6** would have a Port ID of: **06**.

This Page Intentionally Left Blank

Chapter 4

Administration

Overview

The OSD's *Administration* page lets the Administrator (and users with administration permission - see *User Management*, page 42) configure and control the overall operations of the KL9108 / KL9116. The *Administration* tab is disabled (grayed out) for users who do not have administration permission.

The Local Console

Once the KL9108 / KL9116 has been installed, the next step that the Administrator needs to perform is to set up the unit for user operation. The most convenient way to do this for the first time is from the local console.

After turning on the KL9108 / KL9116, a login prompt appears:

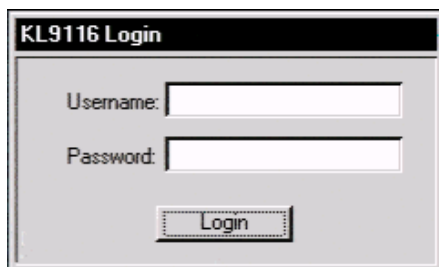

The image shows a login dialog box titled "KL9116 Login". It contains two input fields: "Username:" and "Password:". Below the fields is a "Login" button. The dialog box has a black title bar and a gray background.



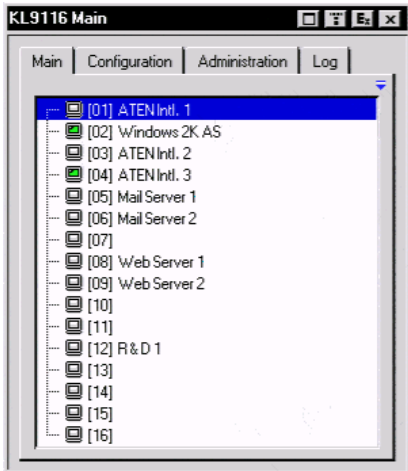

Since this is the first time you are logging in, use the default Username: *administrator*; and the default Password: *password*. For security purposes, we strongly recommend that you use the User Management function (see page 42) to remove these and give yourself a unique Username and Password with the appropriate permissions.

After you successfully log in, the Local Console OSD appears:



The OSD consists of four pages, each with a specific set of functions: Main, Configuration, Administration, and Log. Each of page is discussed in the sections that follow.

The functions of the four buttons at the right of the title bar are described in the table below. Functions can be invoked by clicking the icon, or by pressing its associated function key.

Button	Key	Function
	F6	Screen View: Depending on the display resolution of the port you are viewing, the OSD it may appear smaller than normal. Use this function to return the OSD to its original size and blank the background. Click again to recover the background.
	F7	Transparency: Makes the OSD semi transparent, allowing the background to show through. Clicking again, returns the OSD to normal. Note: 1. We recommend setting your monitor refresh rate to a value greater than 75Hz before using this feature. 2. If you switch to a null port when Transparency is enabled, the feature becomes disabled.
	F8	Log Out: Closes the OSD display and logs you out of the session.
	Esc	Close: Closes the OSD display but does not log you out of the session. You can bring the display back with the OSD hotkeys (see <i>OSD Hotkey</i> , page 40).

The Main Page

The Main page governs port access. Selecting a port and double-clicking it switches you to the device on that port.

- ♦ A *monitor* icon is in front of the port number. The monitor icon is green for ports that have devices connected to them that are powered on; otherwise, it is gray.
- ♦ If a port has been specified as a Quick View port (see below), a red *eye* icon is displayed along with the monitor icon to indicate so.

In addition to using this page to select ports to switch to, the administrator can also use this page to enable/disable *Quick View* status for selected ports, and to create, modify, or delete names for each of the ports. The following sections describe how to enable Quick View status and how to create, modify, or delete port names.

Quick View Ports

Selecting certain ports as Quick View ports is a way of limiting which ports are included when the KL9108 / KL9116 is in Auto Scan mode. If the KL9108 / KL9116 is configured to only auto scan ports that have Quick View status (see *Scan Select*, page 40), designating a port as a Quick View port in this dialog box means that it will be included when auto scanning is in effect.

The spacebar toggles a port's Quick View status. To select/deselect a port, highlight it and press the **spacebar**. When a port has been selected as a Quick View port, a red *eye* icon displays in the port icon column to indicate so. When a port isn't selected, there is no red eye icon.

The List Function

The List Function lets you broaden or narrow the scope of which ports the OSD displays (lists) in the Main Screen. To invoke the List Function, click the arrow at the upper right corner of the screen, or press [F3]:

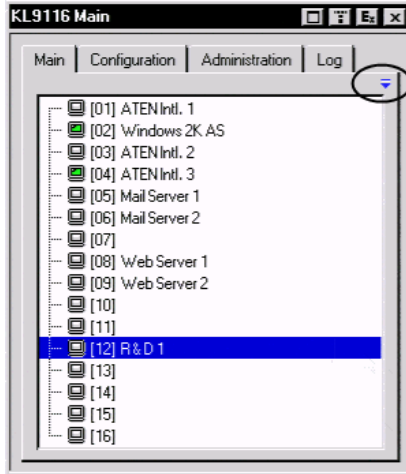

The screen changes to allow you to choose the ports that will be listed:

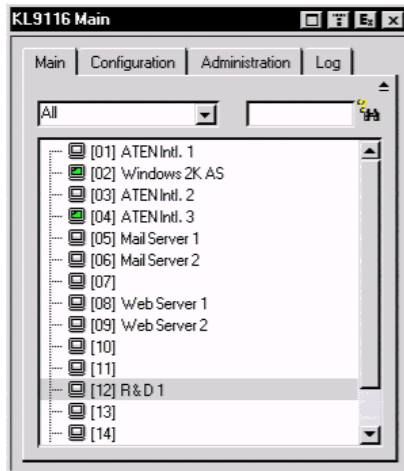

The drop down list on the left offers four fixed choices as shown in the table, below:

Choice	Meaning
All	Lists all of the ports on the installation.
Powered On	Lists only the ports that have their attached devices powered on.
Quick View	Lists only the ports that have been selected as Quick View ports (see <i>Quick View Ports</i> , page 33).
Quick View + Powered On	Lists only the ports that have been selected as Quick View Ports (see <i>Quick View Ports</i> , page 33), and that have their attached devices Powered On.

The text input box on the right allows you to key in a port name so that only port names that match what you key in show up in the List. Wildcards (? and *) are acceptable, so that more than one port can show up in the list. For example, if you key in **Web***, both Web Server 1 and Web Server 2 would show up in the list, as shown in the screen shot below:

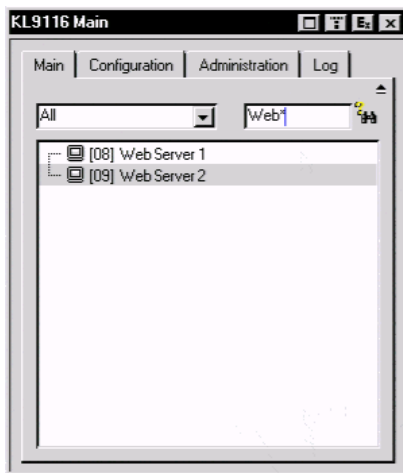

- ◆ After you key in your string, either click the binoculars to the right of the box, or press **[Enter]**.
- ◆ To go back to the default view, erase the string and either click the binoculars to the right of the box, or press **[Enter]**.
- ◆ To dismiss the List function, click the arrow or press **[F3]**.

Port Names

To help remember which computer is attached to a particular port, every port can be given a name. This field allows the Administrator to create, modify, or delete port names. To configure a port name:

1. Click once on the port you want to edit, wait one second and then click again. (Alternately, use the up and down arrow keys to move the highlight bar to the port, and then press the F2 function key.)

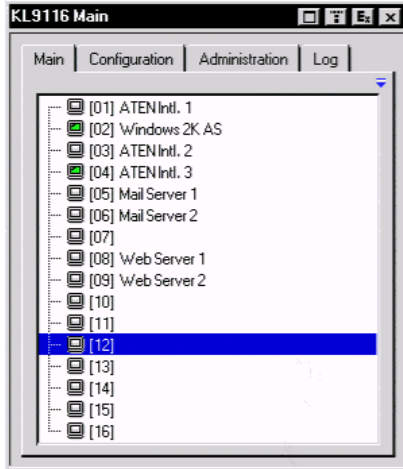

Note: This is not a double-click. It involves two separate clicks. A double-click will switch you to the device attached to the port.

After a second or two, the bar changes to provide you with a text input box:

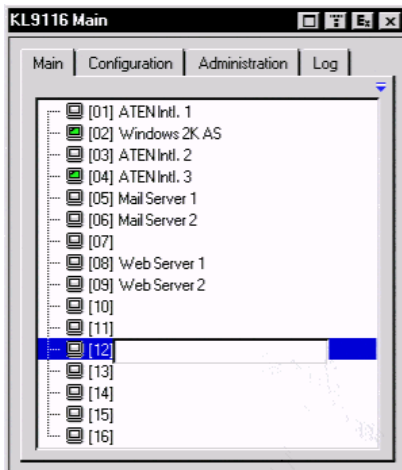

2. Key in the new Port Name, or modify/delete the old one.

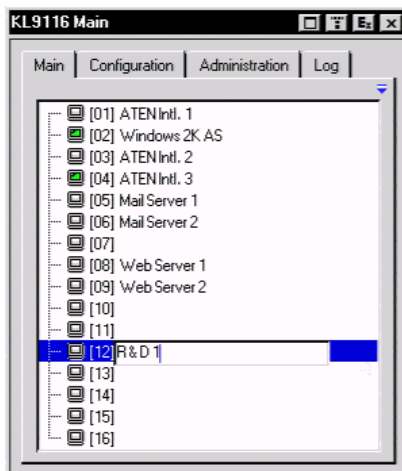

The maximum number of characters allowed for a Port Name is 19. You can use all letters, numbers, and symbols on the typewriter keys of keyboards with PC US English layout.

3. When you have finished editing the port name, press [Enter] or click anywhere outside of the input box to complete the operation.

Port Operation

Because the methods used to access the target device(s) are the same for the local console as for the Windows Client, the procedures are discussed in *Windows Client Port Operation* and *Java Client Port Operation* Chapters on pages 85 and 102, respectively.

Note: If you invoke the OSD while accessing a target device from the local console, press [F6] to hide the background and enlarge the OSD. Press [F6] again to show the background.

The Configuration Page

The OSD *Configuration* page allows users to set up their own, individual, working environments. The KL9108 / KL9116 stores a separate configuration record for each user profile, and sets up the working configuration according to the *Username* that is used to log in.

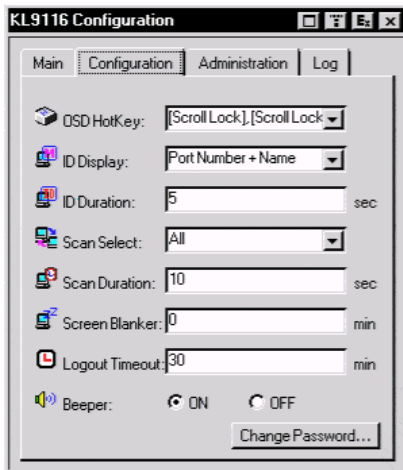

The Configuration page settings are explained in the table on the following page.

(Continues on next page.)

(Continued from previous page.)

Setting	Function
OSD Hotkey	Selects which Hotkey controls the OSD function: [Scroll Lock] [Scroll Lock] or [Ctrl] [Ctrl] . Since the Ctrl key combination may conflict with programs running on the computers, the default is the Scroll Lock combination.
ID Display	Selects how the Port ID is displayed: the Port Number alone (PORT NUMBER); the Port Name alone (PORT NAME); or the Port Number plus the Port Name (PORT NUMBER + PORT NAME). The default is PORT NUMBER + PORT NAME.
ID Duration	Determines how long a Port ID displays on the monitor after a port change has taken place. You can choose an amount from 0 - 255 seconds. The default is 5 Seconds. 0 is Always On.
Scan Select	Selects which computers will be accessed under Auto Scan Mode (see <i>Auto Scanning</i> , page 90). Choices are: ALL - All the Ports which have been set Accessible (see <i>Port Access</i> , page 44); POWERED ON - Only those Ports which have been set Accessible and are Powered On; QUICK VIEW - Only those Ports which have been set Accessible and have been selected as Quick View Ports (see <i>Quick View Ports</i> , page 33); QUICK VIEW + POWERED ON - Only those Ports which have been set Accessible and have been selected as Quick View Ports and are Powered On. The default is ALL.
Scan Duration	Determines how long the focus dwells on each port as it cycles through the selected ports in Auto Scan Mode (see <i>Auto Scanning</i> , page 90). Key in a value from 0 - 255 seconds. The default is 10 seconds; a setting of 0 disables the Scan function.
Screen Blanker	If there is no input from the console for the amount of time set with this function, the screen is blanked. Key in a value from 1 - 30 minutes. A setting of 0 disables this function. The default is 0 (disabled).
Logout Timeout	If there is no Operator input for the amount of time set with this function, the Operator is automatically logged out. A login is necessary before the KL9108 / KL9116 can be accessed again. Enter a value from 0 - 180 minutes. The default is 30 minutes. 0 disables the function.
Beeper	When set to ON , the beeper sounds whenever the port is switched, when activating the Auto Scan function (see <i>Auto Scanning</i> , page 90), or when an invalid entry is made on an OSD menu. The default is ON.
Change Password	Allows a user to change the account password. After clicking the Change Password button, a dialog box appears. Enter the old password. Then, enter a new password and confirm it by entering it again. Press OK to save changes, or press Cancel to discard changes.

The Administration Page

When you click the Administration tab, the Administration page comes up. Each of the administrative functions is represented by an icon at the left of the page. Clicking the icon brings up its associated dialog box. When the Administration page first comes up the *General* dialog box appears:

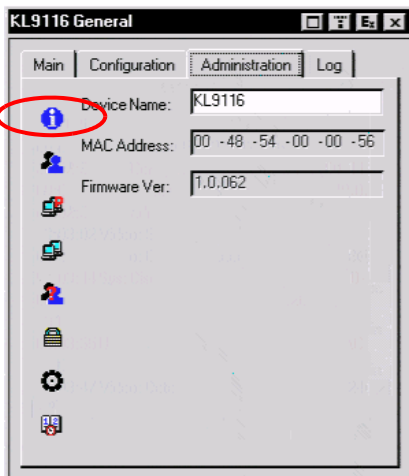

General

The General Page presents four items of information. This is the same information that displays after you log in from a browser, or when you click the *General* icon at the top left of the browser main page. The meaning of these items is described in the table below:

Item	Description
Device Name	This field lets you give the switch a unique name. This can be convenient when you need to differentiate among several devices in multi-station installations.
MAC Address	This item displays the KL9108 / KL9116's MAC address.
Firmware Ver	This item displays the current firmware version number. You can reference it to see if there are newer versions available on the Altusen Website.
Last IP from DHCP Server	If the switch is on a network that uses DHCP assigned IP addresses, this item is a convenient way of ascertaining what its IP address is, to inform the Users which IP to use when they want to log in to the KL9108 / KL9116.

User Management

The User Management dialog box is used to create and manage user profiles. Up to 64 user profiles can be established.

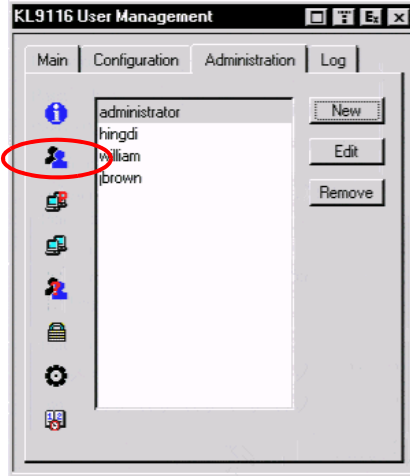

- ◆ To delete a user profile, select it in the list box, and Click **Remove**.
- ◆ To modify a user profile, select it and Click **Edit**.
- ◆ To add a user, Click **New**.

If you choose *Edit* or *New*, a dialog box similar to the one below appears:

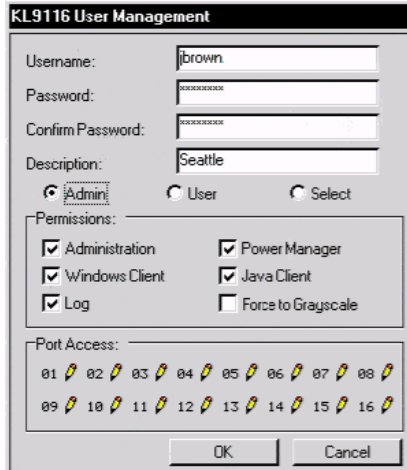

Fill in the required information for a new profile, or modify the existing information to edit a previous profile. A description of the field headings is given in the table below:

Heading	Description
Username	A minimum of 6 and a maximum of 15 characters is allowed.
Password	A minimum of 8 and a maximum of 15 characters is allowed.
Confirm Password	To be sure there is no mistake in the password, you are asked to enter it again. The two entries must match.
Description	Additional information about the user that you may wish to include.
Admin	Enabling this gives the user Administrator level access to the KL9108 / KL9116. All permissions are granted. (See <i>Permissions</i> , in this table.)
User	Enabling this gives the user User level access to the KL9108 / KL9116. Windows Client, Power Manager, and Java Client permissions are granted. (See <i>Permissions</i> , in this table.)
Select	This button is automatically enabled if the permission choices selected by the Administrator (in the panel just below) do not match the default access level choices for Admin or User.
Permissions	<p>These are used together with the <i>Select</i> radio button to set up permissions that differ from the defaults for Admin and User.</p> <ol style="list-style-type: none"> 1. Checking <i>Administration</i> gives a User administration privileges, which allows him to set up and modify the KL9108 / KL9116's Administration page settings. 2. Checking <i>Windows Client</i> allows a user to access the KL9108 / KL9116 via the Windows Client software. By default, all users may access the KL9108 / KL9116 via the Windows Client software. 3. Checking <i>Log</i> allows a User to view and query the log file. The <i>Log</i> and <i>Log Server</i> buttons appear on the Main web page of Users who have Log permission (see <i>Webpage Buttons</i>, page 67). 4. Checking <i>Power Manager</i> allows a User to connect to Power on the Net™ devices. The <i>PON</i> button appears on the Main web page of Users who have Power Manager permission (see <i>Webpage Buttons</i>, page 67). 5. Checking <i>Java client</i> allows a User to access the KL9108 / KL9116 via the Java Client software. 6. Checking <i>Force to Grayscale</i>, forces the user's view of the remote display to be in grayscale. This can speed up I/O transfer in low bandwidth situations.

(Continues on next page.)

(Continued from previous page.)

Heading	Description
Port Access	<p>This function allows the Administrator or a User with <i>Administration</i> permission to define the selected User's access to the computers on a Port-by-Port basis. (See the screen, below.)</p> <p>For each User profile, select a port and click it to cycle through the choices:</p> <p>Full - The user can view the screen and can perform operations on the system from the keyboard and mouse.</p> <p>View - A diagonal line through the port icon indicates the port access is View. The user can view the screen, but cannot perform operations on the system.</p> <p>Null (no access rights) - An X through the port icon indicates no port access. The Port will not show up on the User's list on the Main Screen.</p> <p>Repeat until access rights have been set for all ports. The default is Full for all users on all Ports.</p>

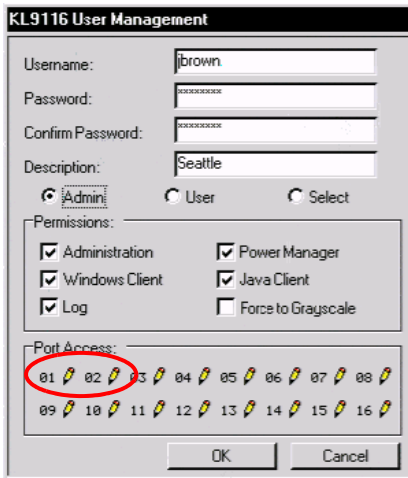

Service Configuration

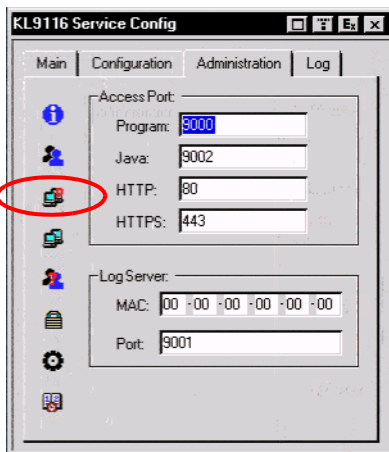

Access Port

As a security measure, if a firewall is being used, the Administrator can specify the port numbers that the firewall will allow, and set the firewall accordingly. Users must specify the port number when they log in to the KL9108 / KL9116. If an invalid port number (or no port number) is specified, the KL9108 / KL9116 will not be found.

An explanation of the fields is given in the table below:

Field	Explanation
Program	This is the port number that must be specified when connecting from the Windows Client software program. Valid entries are from 1024-60,000. The default is 9000.
Java	This is the port number used for Java Client connections. Valid entries are from 0-65535. The default is 9002.
HTTP	The port number for a browser login. The default is 80.
HTTPS	The port number for a secure browser login. The default is 443.

Note: 1. If there is no firewall (on an intranet, for example), it doesn't matter what these numbers are set to, since they have no effect.

2. You must set different values for each of the service ports.

Log Server

Important transactions that occur on the KL9108 / KL9116, such as logins and internal status messages, are kept in an automatically generated log file. In this panel, you specify the MAC address and a port number for the computer that the Log Server resides on.

Installation and operation of the Log Server is discussed in Chapter 9. The Log File is discussed in Chapter 8.

Network

The Network dialog is used to specify the KL9108 / KL9116's network environment.

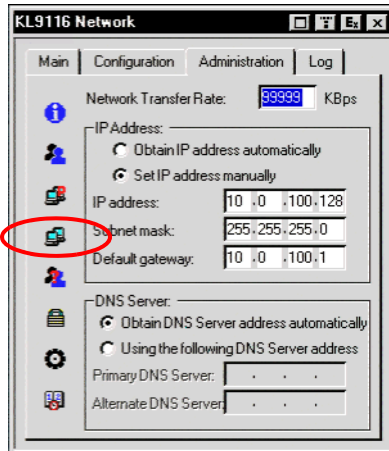

Network Transfer Rate

Set the rate at which the KL9108 / KL9116 transfers data to remote computers. The range is from 8 to 99999 Kilobytes per second (KBps).

IP Address

The KL9108 / KL9116 can either have its IP address assigned dynamically (DHCP), or it can be given a fixed IP address.

- ◆ For dynamic IP address assignment, select the *Obtain IP address automatically* radio button.
- ◆ To specify a fixed IP address, select the *Set IP address manually* radio button and fill in the IP address, subnet mask and default gateway.

DNS Server

- ◆ For automatic DNS Server address assignment, select the *Obtain DNS Server address automatically*, radio button.
- ◆ To specify the DNS Server address manually, select the *Use the following DNS Server* radio button, and fill in the addresses for the Primary and Alternate DNS servers.

Note: Specifying at the primary DNS Server address is mandatory. The alternate DNS Server address is optional.

ANMS

The Advanced Network Management Settings page is used to set up login authentication and authorization management from external sources. Click on the ANMS icon to select RADIUS, LDAP, or CC Management.

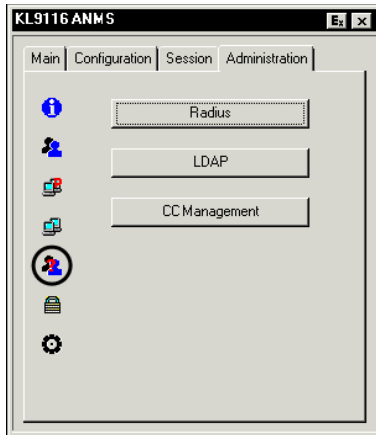

RADIUS

If you are using a RADIUS server, set up its parameters as follows:

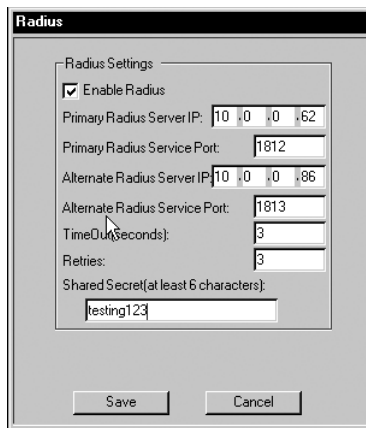

1. Check Enable.
2. Fill in the IP addresses and Service Ports for the Primary and Alternate RADIUS servers.

(Continues on next page.)

(Continued from previous page.)

3. Set the time in seconds that the KL9108 / KL9116 waits for a RADIUS server reply before it times out in the Timeout field.
4. Set the number of RADIUS retries allowed in the Retries field.
5. Key the *Shared Security* character string for authentication between the KL9108 / KL9116 and the RADIUS Server in this field.
6. On the RADIUS server, set the access rights for each user according to the information in the table on page 50.

Note: 1. The characters are not case sensitive. Capitals or lower case work equally well.

2. Characters are comma delimited.

3. An invalid character in the configuration string will prohibit access to the KL9108 / KL9116 for the user.

Examples:

String	Meaning
c,w,p	User has administrator privileges; user can access the system via the WinClient ActiveX Viewer; user can access the attached PN0108.
w,j,l	User can access the system via the WinClient ActiveX Viewer; user can access the system via the Java Client; user can access log information via the user's browser.

Character	Meaning
C	Grants the user administrator privileges, allowing the user to configure the system.
W	Allows the user to access the system via the WinClient ActiveX Viewer program.
J	Allows the user to access the system via the Java Client program.
P	Allows the user to access an attached Power Over the Net™ device.
L	Allows the user to access log information via the user's browser.
PN	Restricts the user from accessing the OSD port list. Syntax: pn/1/2/3/4
PV	Limits the user's access to viewing of the OSD port list only. Syntax: pv/1/2/3/4
UHK	Defines the OSD Hotkey (see <i>OSD Hotkey</i> , page 40). (uhk0: Scroll Lock + Scroll Lock; uhk1: Ctrl + Ctrl) Syntax: uhk0
UOL	Defines the OSD List Function (see page 34). (uol0: All; uol1: Powered On; uol2: Quick View; uol3: Quick View + Powered On) Syntax: uol0
UODM	Selects how the Port ID displays (see <i>ID Display</i> , page 40). (uodm0: Port Number + Port Name; uodm1: Port Number; uodm2: Port Name) Syntax: uodm0
UODT	Determines the length of time in seconds that the Port ID displays on the monitor after a port change (see <i>ID Duration</i> , page 40). Syntax: uodtn (where <i>n</i> represents a number from 0-255)
UBUZ	Turns the beeper on or off (see <i>Beeper</i> , page 40). (ubuz0: Beeper Off; ubuz1: Beeper On) Syntax: ubuz0
ULT	When there is no input from the user for the amount of time set with this function, the user is automatically logged out. The user will need to log in again. Set the Logout Timeout from 0-180 minutes. Syntax: ultn (where <i>n</i> represents a number from 0-180)
USM	Selects which computers are accessed under Auto Scan Mode (see <i>Scan Select</i> , page 40). (usm0: All; usm1: Powered On; usm2: Quick View; usm3: Quick View + Powered On) Syntax: usm0
UST	Determines the length of time in seconds the KVM focus dwells on each port in Auto Scan Mode (see <i>Scan Select</i> , page 40). Syntax: ustn (where <i>n</i> represents a number from 0-255)

LDAP / LDAPS

To allow authentication and authorization for the KL9108 / KL9116 via LDAP / LDAPS, set the parameters as follows:

1. Check the box to enable LDAP / LDAPS authentication and authorization.
2. Click a radio button to specify whether to use LDAP or LDAPS
3. Fill in the IP address and port number for the LDAP or LDAPS server. For LDAP, the default port number is 389; for LDAPS, the default port number is 636.
4. Set the time in seconds that the KL9108 / KL9116 waits for an LDAP or LDAPS server reply before it times out.
5. Consult the LDAP / LDAPS administrator to ascertain the appropriate entry for this field. For example, the entry might look like this:
ou=kn4132,dc=aten,dc=com
6. Key in the LDAP administrator's username.
7. Key in the LDAP administrator's password.
8. Set the distinguished name of the search base. This is the domain name where the search starts for user names.

Note: If *LDAP Settings* is enabled, the LDAP schema for MS Active Directory must be extended. See *LDAP Server Configuration*, page 123, for details.

CC Management Settings

To allow authorization for the KL9108 / KL9116 through a CC (Control Center) server, check *Enable* and fill in the CC Server's IP address and the port that it listens on in the appropriate fields.

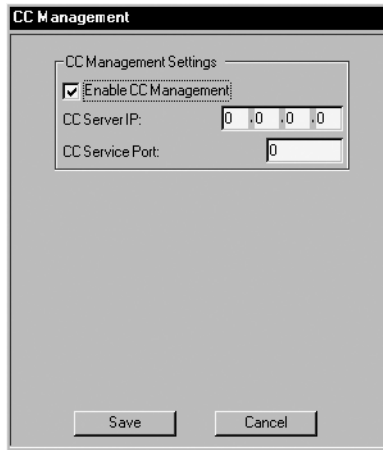

The image shows a dialog box titled "CC Management". Inside the dialog, there is a section titled "CC Management Settings" which contains a checked checkbox labeled "Enable CC Management". Below this, there are two input fields: "CC Server IP:" with a text box containing "0 . 0 . 0 . 0" and "CC Service Port:" with a text box containing "0". At the bottom of the dialog, there are two buttons: "Save" and "Cancel".

Note: The current firmware (insert firmware version) supports CC1000 only. Future firmware upgrades will provide support for CC2000. Please visit our website to download the most up-to-date version of the firmware.

Security

The Security page controls access to the KL9108 / KL9116.

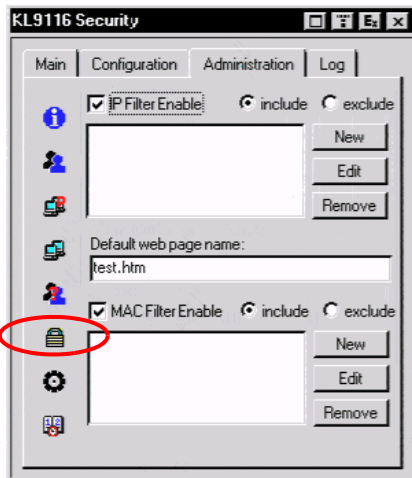

IP and MAC Filtering

- ◆ If any filters have been configured, they appear in the IP Filter and/or MAC Filter list boxes.
- ◆ IP and MAC Filters control access to the KL9108 / KL9116 based on the IP and/or MAC addresses of the computers attempting to connect. A maximum of 100 IP filters and 100 MAC filters are allowed. To enable IP and/or MAC filtering, **Click** to put a check mark in the *IP Filter Enable* and/or *MAC Filter Enable* checkbox.
 - ◆ If the include button is checked, all the addresses within the filter range are allowed access; all other addresses are denied access.
 - ◆ If the exclude button is checked, all the addresses within the filter range are denied access; all other addresses are allowed access.
- ◆ To add a filter, click **New**. A dialog box similar to the ones below appears:

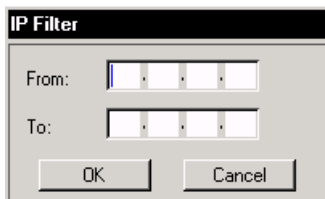

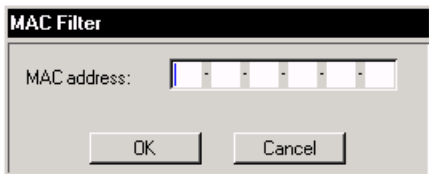

Note: Each IP filter can consist of a single address, or a range of addresses. To filter a single IP address, key in the same address in both the From and To fields. To filter a continuous range of IP addresses, key in the start of the range in the From field; key in the end of the range in the To field.

After you specify the filter addresses, click OK.

- ◆ To delete a filter, select it in the IP Filter and/or MAC Filter list boxes and click **Remove**.
- ◆ To modify a filter, select it in the IP Filter and/or MAC Filter list boxes and click **Edit**. The Edit dialog box is similar to the New dialog box. When it comes up, simply delete the old address and replace it with the new one.

Default Webpage Name

- ◆ The Default web page name entry field lets the Administrator specify a login string (in addition to the IP address) that the user must include when accessing the KL9108 / KL9116 with a browser. For example:
`192.168.0.126/abcdefg`
- ◆ The user must include the forward slash and the string along with the IP address. For security purposes, we recommend that you change this string from time to time.

Note: If no string is specified here, anyone will be able to access the KL9108 / KL9116 with the Web browser using the IP address alone. This makes your installation less secure.

Customization

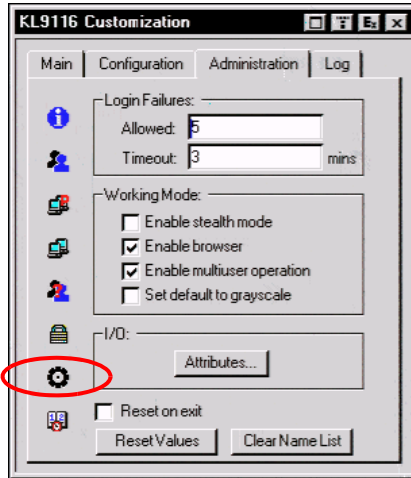

The Customization dialog box is arranged in four major sections: Login Failures; Working Mode; I/O; and untitled miscellaneous functions at the bottom. The functions of each of the Customization items are described in the sections that follow:

Login Failures

- ◆ **Allowed:** sets the number of consecutive failed login attempts that are permitted from a remote computer.
- ◆ **Timeout:** sets the amount of time a remote computer must wait before attempting to login again after it has exceeded the number of allowed failures.

Working Mode

- ◆ If *Stealth Mode* is enabled, the KL9108 / KL9116 cannot be pinged.
- ◆ To permit browser access to the KL9108 / KL9116, click to put a check mark in the *Enable Browser* checkbox. If browser access is not enabled, users will not be able to log into the unit via their browsers.
- ◆ If *Multiuser Operation* is enabled, up to 32 users can simultaneously access the KL9108 / KL9116.
- ◆ If *Set default to grayscale* is enabled, the remote display is changed to grayscale. This can speed up I/O transfer in low bandwidth situations.

Note: Although enabling this option sets the default to grayscale, users can change their sessions to color – unless the administrator enabled the *Force to Grayscale* option, when the user was created (see page 42 for details).

I/O

- ◆ Attributes

Clicking the *Attributes* button brings up a dialog box that allows you to set *Share mode* and *Timeout* threshold for each of the ports:

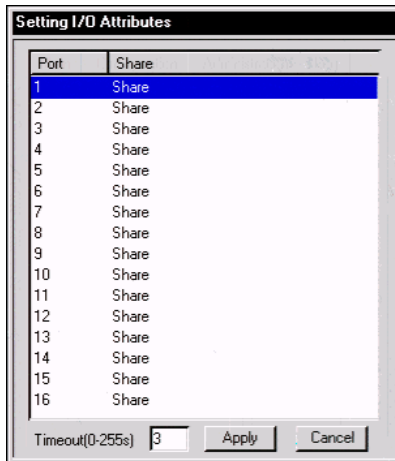

- ◆ To set a port's Share mode, double click it to bring up the I/O attributes dialog box:

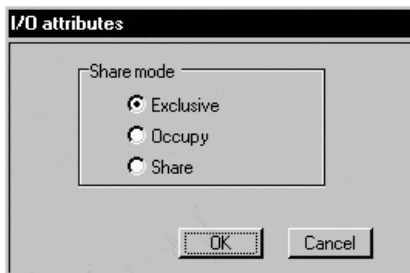

Set the port's Share mode according to the information in the following table:

Attribute	Action
Exclusive:	The first user to occupy the port has exclusive control over it. No other user can view or access it.
Occupy:	The first user to occupy the port has control over it. Up to 31 additional users can view its video output, however. The <i>Timeout</i> function discussed on page 57 applies to ports that have this setting.
Share:	Allows up to 32 users to simultaneously share control over the port. User input is placed in a queue and executed on a first sequentially. In addition, a user can access the KL9108 / KL9116's <i>Message Board</i> function to gain control of the keyboard and mouse, or keyboard, video, and mouse of a Share designated port. See <i>The Message Board</i> , page 81.

- ◆ The *Timeout* field sets a time threshold for users on ports whose Share Mode has been set to *Occupy* (see *Occupy*., page 57). If there is no activity from the user occupying the port for the amount of time set here, the user is timed out and the port is released. The first user to send keyboard or mouse input after the port has been released gets to occupy the port. Input a value from 0 to 255 seconds. The default is 3 seconds. A setting of 0 causes the port to be released the instant there is no input.

Miscellaneous

The functions performed by the remaining elements at the bottom of the screen are described in the table below:

Parameter	Explanation
Reset on exit	Place a check here to have the KL9108 / KL9116 reset itself and implement all the new settings when you log out. Following the reset, wait one to two minutes before logging back in. Note: For some changes the <i>Reset on exit</i> check box is automatically selected and the KVM switch will reset when you log out. Clearing the check mark before logging out will cause the new settings to be discarded.
Reset Values	Clicking this button undoes all changes that have been made to the Configuration and Administration pages (except for port names, usernames, and passwords) and returns the parameters to the original factory default settings (see <i>OSD Factory Default Settings</i> , page 148).
Clear Name List	This function clears the Port Names on the Main page.

Date/Time

The Date/Time dialog box lets the Administrator set up the KL9108 / KL9116's time parameters:

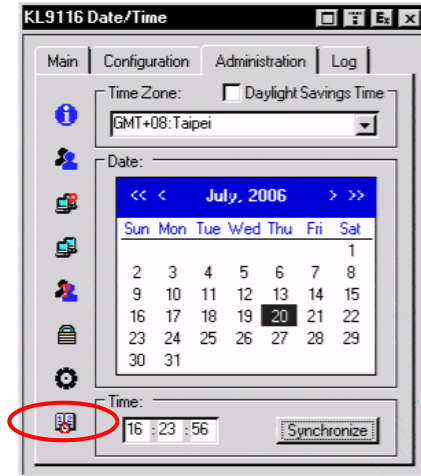

- ◆ If your country or region employs Daylight Saving Time (Summer Time), check the corresponding box.
- ◆ To establish the time zone that the KL9108 / KL9116 is located in, drop down the *Time Zone* list and choose the city that most closely corresponds to where it is at.
- ◆ To set the year and day, use the Calendar graphic.
 - ◆ Clicking < or > moves you backward or forward by one month increments.
 - ◆ Clicking << or >> moves you backward or forward by one year increments.
 - ◆ In the calendar, click on the day.
- ◆ To set the time, use the 24 hour HH:MM:SS format.
- ◆ Click **Synchronize** to save your settings.

The Log Page

Clicking the Log tab brings up the contents of the log file. The log file is discussed in Chapter 8.

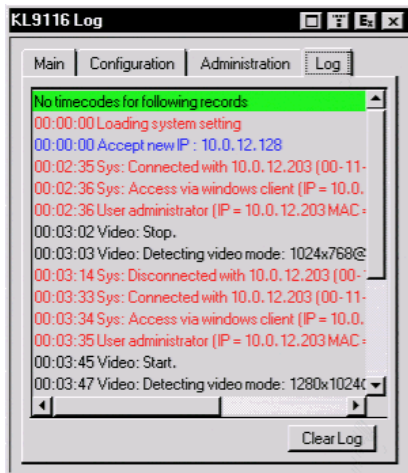

Upgrading the Firmware

As new versions of the KL9108 / KL9116 firmware become available, they can be downloaded from our Website.

Note: Although upgrading the firmware isn't on the OSD Administration page, it is an administrative function, so we chose to discuss it in this chapter.

To upgrade the firmware, do the following:

1. Download the new firmware file to a computer that is not part of your KL9108 / KL9116 installation.
2. From that computer, open your browser and log in to the KL9108 / KL9116 (see *Logging In*, page 63).
3. Click the **Firmware** icon (see *Webpage Icons*, page 65) to open the *Firmware configuration* dialog box:

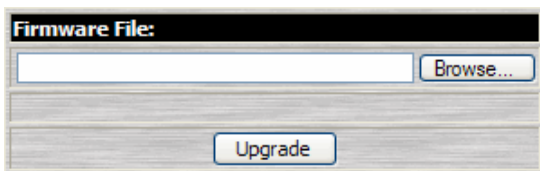

4. Click **Browse**; navigate to the directory that the new firmware file is in and select the file.
5. Click **Upgrade**.
6. After the upload completes, click the **Logout** icon to exit and reset the KL9108 / KL9116.

This Page Intentionally Left Blank

Chapter 5

Browser Operation

Overview

An On Screen Display (OSD) interface governs KL9108 / KL9116 computer control and switching operations. The OSD can be accessed remotely with a Windows-based client or a Java-based client. You must log in via an Internet browser to connect to the KL9108 / KL9116 and to invoke the OSD.

Logging In

To log in from an Internet browser:

1. Open the browser and specify the IP address and Default Webpage name (if one has been specified) for the KL9108 / KL9116 in the URL bar.

Note: If you don't know the IP address and Default Webpage name, get it from the KL9108 / KL9116 administrator.

2. When the *Security Alert* dialog box appears, accept the certificate – it can be trusted. (See *Trusted Certificates*, page 149, for details.) A login page appears:

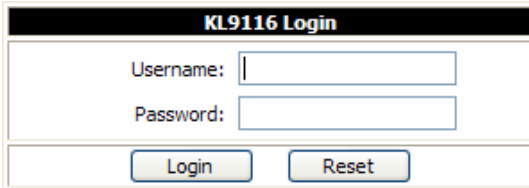

The image shows a web browser window displaying a login page for the KL9116 device. The page has a black header bar with the text "KL9116 Login" in white. Below the header, there are two text input fields. The first is labeled "Username:" and the second is labeled "Password:". At the bottom of the form, there are two buttons: "Login" and "Reset".

3. Provide a valid Username and Password (set up by the KL9108 / KL9116 administrator), then Click **Login** to continue.

Note: 1. If you supply an invalid login, the authentication routine will return a message stating, *Invalid Username or Password. Please try again.* If you exceed the number of login failures set by the administrator, a message stating that *The page cannot be displayed,* appears. This is done to confuse and discourage hackers from trying to discover a valid Username and Password. If you see this message, try logging in again being careful with the Username and Password.

2. If you are the Administrator and are logging in for the first time, use the default Username: *administrator*; and the default Password: *password*. For security purposes, we strongly recommend you remove these and give yourself a unique Username and Password (see *User Management*, page 42).
-

After you have successfully logged in, the KL9108 / KL9116 Main webpage appears with the *General* dialog box displayed:







Note: This is the same dialog box that appears whenever you click the *General* icon at the top left of the page.

Webpage Layout

Webpage Icons

The functions of the icons at the top of the Webpage are explained in the table below:

Icon	Function
	<p>Click this icon to display the General dialog box. See <i>The General Dialog Box</i>, page 66, for an explanation of the dialog box fields.</p>
	<p>Click this icon to synchronize the KL9108 / KL9116's time with your computer's time.</p> <ul style="list-style-type: none"> ◆ If both are in the same time zone, the device's time is changed to match the computer's time. ◆ If they are in different time zones, the device's time is changed to match the computer's time, except that the time zone difference is still maintained.
	<p>Click this icon to install new versions of the KL9108 / KL9116's firmware. See page 61 for details.</p> <p>Note: The Firmware icon only displays for users with administrative permission. It doesn't appear on the Webpages of users who don't have the proper permission.</p>
	<p>You should always click this icon to log out and end your KL9108 / KL9116 session. If you close the browser without first logging out, you will have to wait approximately one minute before logging in again unless multiuser operation is enabled (see <i>Customization</i>, page 55).</p>

The General Dialog Box







The General dialog box is the default Webpage. An explanation of the dialog box fields is given in the table below:

Field	Purpose
Device Name	To make it easier to manage installations that have more than one KL9108 / KL9116.
MAC Address	The KL9108 / KL9116's MAC Address displays here.
Firmware Version	Indicates the KL9108 / KL9116's current firmware version level.
Network Transfer Rate	Displays the currently selected rate for data transmission. The network transfer rate is administrator selectable – see <i>Network Transfer Rate</i> , page 47.
Reset on exit	Select this check box to reset the KL9108 / KL9116 and implement new settings when you log out. Following a reset, wait one to two minutes before logging back in. (This check box is only enabled for users who have administration privileges.) Note: For some changes the <i>Reset on exit</i> check box is automatically selected and the KVM switch will reset when you log out. Clearing the check mark before logging out will cause the new settings to be discarded.
Last IP from DHCP server	Displays the current IP address of the KL9108 / KL9116.

Note: New versions of the KL9108 / KL9116's firmware can be downloaded from our Website as they become available. See page 61 for details.

Webpage Buttons

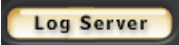
The purpose of the buttons at the left of the Webpage are explained in the table below:

Icon	Purpose
	<p>Click this button to download the Windows Client software to remotely control the connected computer(s).</p> <p>Note: You must download a new Windows Client each time you log in from your browser.</p>
	<p>For platform independence, the Java client allows users that have Java installed to connect to the KL9108 / KL9116. Click this button to download the Java Client software to remotely control the connected server(s).</p> <p>Note: You must download a new Java Client each time you log in from your browser.</p>
	<p>In some instances, administrators don't want the KL9108 / KL9116 to be accessible by browser. Clicking this button allows the user to download the API version of the Windows Client. Once a user has downloaded the API program, the administrator can turn off browser access. API operation is discussed in Chapter 9.</p>
	<p>In some instances, administrators don't want the KL9108 / KL9116 to be accessible by browser. Clicking this button allows the user to download the API version of the Java Client. Once a user has downloaded the API program, the administrator can turn off browser access. API operation is discussed in Chapter 9.</p>
	<p>Clicking this button allows the administrator to download and install the Log Server application. See Chapter 9 for Log Server details.</p>
	<p>If a Power on the NET™ (PON) module is connected to the KL9108 / KL9116, clicking this button brings up it's interface.</p>
	<p>All the events that take place on the KL9108 / KL9116 are recorded in a log file. Clicking this icon displays the contents of the log file.</p>

This Page Intentionally Left Blank

Chapter 6

Windows Client Port Operation

Activating the OSD

After you have successfully logged in (see page 63), to activate the browser-based Windows Client OSD do the following:

1. Click the *Windows Client* button (the one without the arrow) at the left of the Webpage.

Note: 1. You must have DirectX 7.0 or higher installed on your computer. If not, the Windows Client will not load. If you don't already have it, DirectX is available for free download from Microsoft's Website: <http://www.microsoft.com/downloads>.

2. The Windows Client button with the arrow is for running the AP version of the Windows Client (see page 113 for details).
-

2. When the file download security warning dialog box appears, click **Run**.
3. If a second security warning dialog box appears, click **Run** again.

Note: 1. If the browser cannot run the file, save it to disk, instead. Then, with your browser still open to the KL9108 / KL9116 Webpage, run the file from your disk.

2. If you use the *save to disk* method, for security purposes, you cannot simply run a previously downloaded version of the program. Each time you want to access the KL9108 / KL9116, you must log in to the Webpage with a valid username and password to download a fresh copy of the program.
-

(Continues on next page.)

(Continued from previous page.)

4. When a connection to the KL9108 / KL9116 has been established, the screen opens to the Windows Client OSD with the *Main* page and *Windows Client Control Panel* displayed:

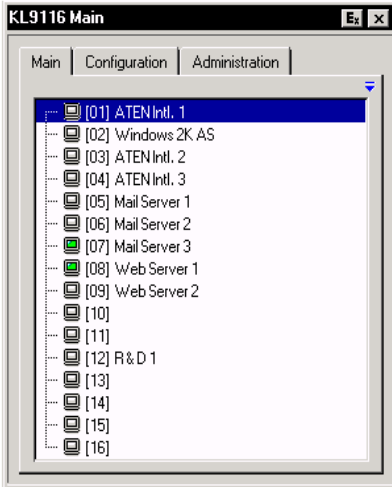

Before you Begin

Discussion of the Windows Client OSD begins on page 74, but the first time you run the program, you may want to make some display configuration changes. To do so, Click the curved Arrow icon on the Control Panel at the lower right of the remote display. a screen similar to the one below appears

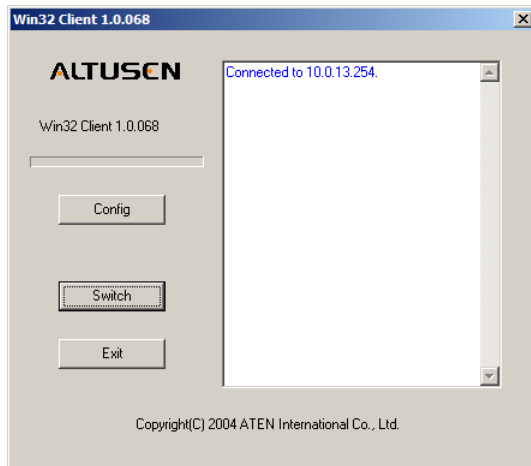

There are three buttons: Config, Switch, and Exit. Their actions are described in the table, below:

Button	Action
Config	Brings up the <i>Graphics Configuration</i> dialog box, which allows you to set up the graphical environment. The Graphics Configuration dialog box is discussed in the next section.
Switch	Switches you to the <i>Windows Client OSD</i> . The Windows Client OSD is discussed on page 74.
Exit	Ends the program and closes the application.

Graphics Configuration Dialog Box

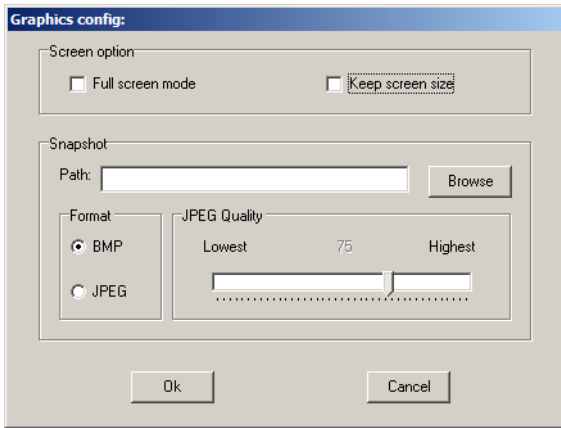

The dialog box is organized into two main parts: Screen Options, and Snapshot

Screen Options

Screen options lets you set up the way the remote display appears on the local monitor:

- ◆ If *Full Screen Mode* is enabled (the box is checked), the remote display fills the entire screen.
- ◆ If *Full Screen Mode* is not enabled (the box is not checked), the remote display appears as a window on the local desktop. If the remote screen is larger than what is able to fit in the window, move the mouse pointer to the screen border that is closest to the area you want to view and the screen will scroll.
- ◆ If *Keep Screen Size* is enabled (the box is checked), the remote screen is not resized.
 - ◆ If the remote resolution is smaller than that of the local monitor, its display appears like a window centered on the screen.
 - ◆ If the remote resolution is larger than that of the local monitor, its display is centered on the screen. To access the areas that are off screen, move the mouse to the corner of the screen that is closest to the area you want to view and the screen will scroll.
- ◆ If *Keep Screen Size* is not enabled (the box is not checked), the remote screen is resized to fit the local monitor's resolution.

Snapshot

These settings let the user configure the KL9108 / KL9116's screen capture parameters (see *Windows Client Control Panel*, page 75):

- ◆ Path lets you select a directory that the captured screens automatically get saved to. Click **Browse**; navigate to the directory of your choice; then click **OK**.
- ◆ Click a radio button to choose whether you want the captured screen to be saved as a BMP or a JPEG (JPG) file.
- ◆ If you choose JPEG, you can select the quality of the captured file with the slider bar. The higher the quality, the better looking the image, but the larger the file size.

Finishing Up

After you have finished making your configuration settings:

1. Click **OK** to close the dialog box.
2. Click **Switch** to go back to the Windows Client OSD *Main* page.

The Windows Client OSD

After you switch to the KL9108 / KL9116 the OSD comes up with the *Main* page and *Windows Client Control Panel* displayed:

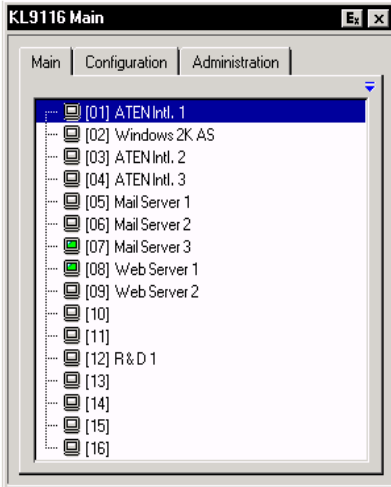

The OSD consists of three pages – Main, Configuration, and Administration.









- ◆ The Configuration and Administration pages are discussed in Chapter 4.
- ◆ The Main page is introduced later in this chapter, on page 84.

Note: The *Administration* tab is disabled for users who don't have administration privileges.

Windows Client Control Panel

The Windows Client Control Panel consists of an icon bar at the top, with two text bars below it. Ordinarily, the text bars display the video resolution and IP address of the device at the remote location. As the mouse pointer moves over the icons in the icon bar, however, the text bar information changes to describe the icon's function.

The functions that the icons perform are described in the table below.

Icon	Function
	Click and drag to move the control panel to another position on the screen.
	Click to bring up the Hotkey Setup dialog box (see <i>Hotkey Setup</i> , page 76 for details).
	Click to bring up the Video Options dialog box. Right-click to perform a quick Auto Sync (see <i>Video Adjustment</i> , page 78).
	Left click this icon to toggle <i>Full Screen Mode</i> on and off. Right click this icon to toggle <i>Keep Screen Size</i> on and off. See <i>Graphics Configuration Dialog Box</i> , page 72, for details.
	Click to take a snapshot of the remote screen. The captured screen is saved in the directory you set up in the <i>Graphics Configuration</i> dialog box. See <i>Graphics Configuration Dialog Box</i> , page 72, for details.
	Click to bring up the Message Board (see <i>The Message Board</i> , page 81, for details).
	Click to send a Ctrl+Alt+Del signal to the remote system.
	Click to exit the remote view.
	These Lock Key LEDs show the Num Lock, Caps Lock, and Scroll Lock status of the remote computer. Click on the icon to toggle the status. Note: When you first connect, the LED display may not be accurate. To be sure, click on the LEDs to set them.



Hotkey Setup

Various actions related to manipulating the remote server can be accomplished with hotkeys. The *Hotkey Setup* utility (accessed by clicking the *Keyboard* icon on the Control Panel), lets you configure which hotkeys perform the actions. The actions are listed in the left panel; the hotkeys that invoke them are shown in the panel at the right.

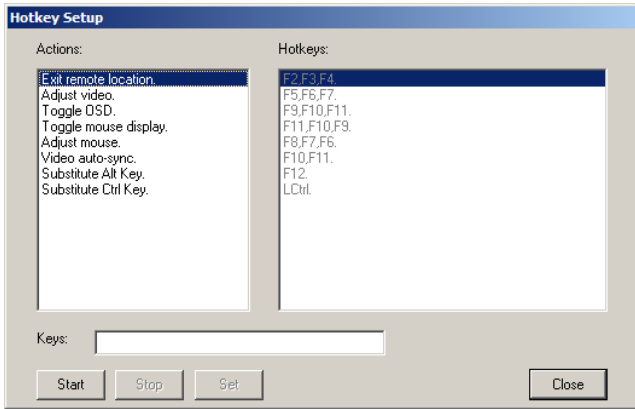

If you find the default Hotkey combinations inconvenient, you can reconfigure them as follows:

1. Highlight the *Action*, then click **Start**.
2. Key in the Function keys (one at a time). The key names appear in the *Key* field as you press them.
3. When you have finished keying in your sequence, click **Stop**.
4. Click **Set**.
5. Click **Close**.

Note: You can use the same function keys for more than one action, *as long as the first key is not the same*. For example, you can use **F1 F2 F3** for one action; **F2 F1 F3** for another; **F3 F2 F1** for a third, etc.

An explanation of the Hotkey actions is given in the table below:

Action	Explanation
Exit remote location	Breaks the connection to the KL9108 / KL9116 and returns you to local operation.
Adjust Video	Brings up the video adjustment utility.
Toggle OSD	Toggles the OSD display Off and On.
Toggle mouse display	If you find the display of the two mouse pointers (local and remote) to be confusing or annoying, you can use this function to shrink the non-functioning pointer down to a barely-noticeable tiny circle - which can be ignored. Since this function is a toggle - use the hotkeys again to bring the mouse display back to its original configuration.
Adjust mouse	This utility synchronizes the local and remote mouse movements following a video resolution change. After invoking this utility, simply click the local mouse pointer on top of the remote mouse pointer.
Video Auto-sync	This combination performs an auto-sync operation. It is the same as clicking the Auto-sync button in the <i>Video Options</i> dialog box (see <i>Video Adjustment</i> , page 78).
Substitute Alt key	Although all other keyboard input is captured and sent to the KL9108 / KL9116, [Alt + Tab] and [Ctrl + Alt + Del] work on your local computer. In order to implement their effects on the remote system, another key may be substituted for the Alt key. If you substitute the F12 key, for example, you would use [F12 + Tab] and [Ctrl + F12 + Del].
Substitute Ctrl key	If your local computer captures Ctrl key combinations, preventing them from being sent to the remote system, you can implement their effects on the remote system by specifying a function key to substitute for the Ctrl key. If you substitute the F11 key, for example, pressing [F11 + 5] would appear to the remote system as [Ctrl + 5].

Note: To invoke an action, you must press and release the keys one key at a time.



Video Adjustment

The *Video options* dialog box allows you to adjust the placement and picture quality of the remote screen (as displayed on your monitor). To bring up the dialog box, either click on the Hammer icon on the Control Panel, or use the *Adjust Video* and *Video Auto-sync* hotkeys (see *Hotkey Setup*, page 76).

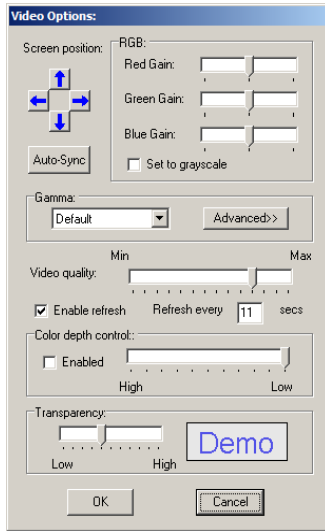

The meanings of the video adjustment options are given in the table below:

Option	Usage
Screen Position	Adjust the horizontal and vertical position of the remote computer window by Clicking the Arrow buttons.
Auto-Sync	<p>Click Auto-Sync to have the function detect the vertical and horizontal offset values of the remote screen and automatically synchronize it with the local screen.</p> <p>If the local and remote mouse pointers are out of sync, in most cases, performing this function will bring them back into sync.</p> <p>Note: This function works best with a bright screen.</p> <p>If you are not satisfied with the results, use the Screen Position arrows to position the remote display manually.</p>
RGB	<p>Drag the slider bars to adjust the RGB (Red, Green, Blue) values. When an RGB value is increased, the RGB component of the image is correspondingly increased.</p> <p>If you enable <i>Set to Grayscale</i>, the remote video display is changed to grayscale.</p>
Gamma	This section allows you to adjust the video display's gamma level. This function is discussed in detail in the next section, <i>Gamma Adjustment</i> .
Video Quality	Drag the slider bar to adjust the overall Video Quality. Values can be from 20 to 100. The larger the value, the clearer the picture and the more video data goes through the network. Depending on the network bandwidth, a high value may adversely effect response time.
Enable Refresh	The KL9108 / KL9116 can redraw the screen every 1 to 99 seconds, eliminating unwanted artifacts from the screen. Select Enable Refresh and enter a number from 1 through 99. The KL9108 / KL9116 will redraw the screen at the interval you specify. This feature is disabled by default. Click to put a check mark in the box next to <i>Enable Refresh</i> to enable this feature.
Color Depth Control	This setting adjusts the amount of color information for the video data sent over the network. The richer the color, the greater the data. For slow data connections, drag the slider bar to a lower setting to decrease the amount of video data transferred. This ensures screen refresh at workable speeds.
Transparency	Adjusts the transparency of the toolbars displayed by the Windows and Java Client applications. Slide the bar until the display in the <i>Demo</i> window is to your liking.

Gamma Adjustment

If it is necessary to correct the gamma level for the remote video display, use the *Gamma* function of the Video Adjustment dialog box.

- ◆ Under *Basic* configuration, there are ten preset and four user-defined levels to choose from. Drop down the list box and choose the most suitable one.
- ◆ For greater control, clicking the *Advanced* button brings up the following dialog box:

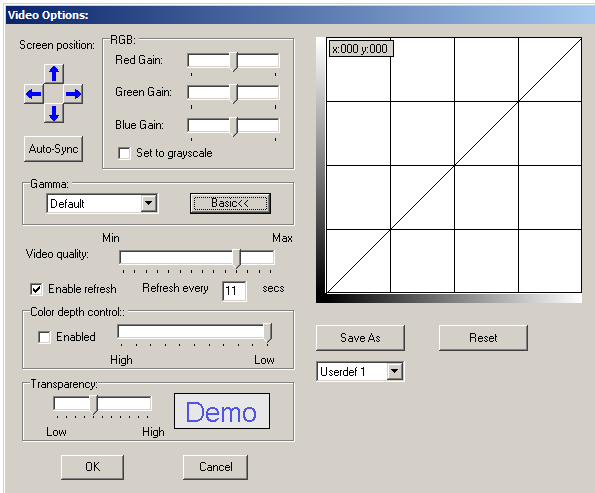

- ◆ Click and drag the diagonal line at as many points as you wish to achieve the display output you desire.
- ◆ Click **Save As** to save up to four user-defined configurations derived from this method. Saved configurations can be recalled from the list box at a future time.
- ◆ Click **Reset** to abandon any changes and return the gamma line to its original diagonal position.
- ◆ Click **OK** to save your changes and close the dialog box.
- ◆ Click **Cancel** to abandon your changes and close the dialog box.

Note: For best results, change the gamma while viewing a remote computer.



The Message Board



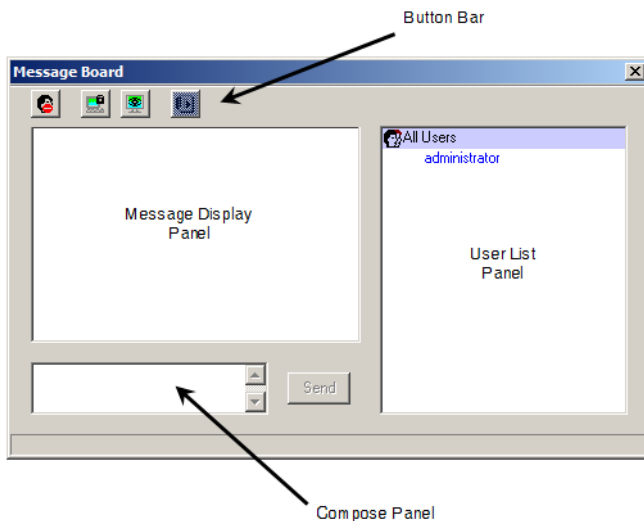

The KL9108 / KL9116 supports multiple user logins, which can possibly give rise to access conflicts. To alleviate this problem, a message board feature has been provided, allowing users to communicate with each other.

The message board functions much like an Internet chat program does. When you click the Message Board icon on the Windows Client Control Panel (see page 75), a screen similar to the one below appears:



The Button Bar

The buttons on the Button Bar are toggles. Their actions are described in the table below:

Button	Action
	<p>Enable/Disable Chat. When disabled, messages posted to the board are not displayed. The button is shadowed when Chat is disabled. The icon displays next to the user's name in the User List panel when the user has disabled Chat.</p>
	<p>Occupy/Release Keyboard/Video/Mouse. When you Occupy the KVM, other users cannot see the video, and cannot input keyboard or mouse data. The button is shadowed when the KVM is occupied. The icon displays next to the user's name in the User List panel when the user has occupied the KVM.</p>
	<p>Occupy/Release Keyboard/Mouse. When you Occupy the KM, other users can see the video, but cannot input keyboard or mouse data. The button is shadowed when the KM is occupied. The icon displays next to the user's name in the User List panel when the user has occupied the KM.</p>
	<p>Show/Hide User List. When you Hide the User List, the User List panel closes. The button is shadowed when the User List is open.</p>

Message Display Panel

Messages that users post to the board - as well as system messages - display in this panel. If you disable Chat, however, messages that get posted to the board won't appear.

Compose Panel

Key in the messages that you want to post to the board in this panel. Click **Send**, or press **[Enter]** to post the message to the board.

User List Panel

The names of all the logged in users are listed in this panel.

- ◆ Your name appears in blue; other users' names appear in black.
- ◆ By default, messages are posted to all users. To post a message to one individual user, select the user's name before sending your message.
- ◆ If a user's name is selected, and you want to post a message to all users, select All Users before sending your message.
- ◆ If a user has disabled Chat, its icon displays before the user's name to indicate so.
- ◆ If a user has occupied the KVM or the KM, its icon displays before the user's name to indicate so.

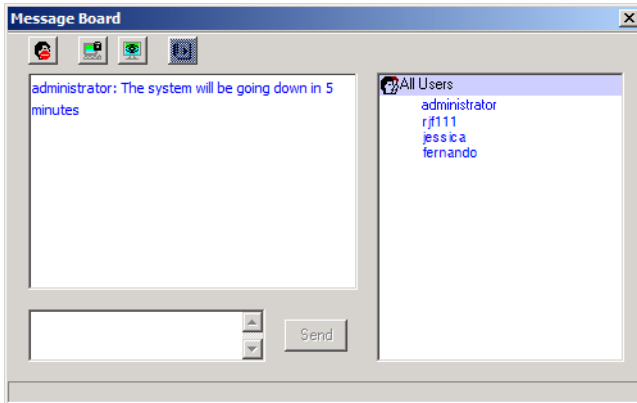

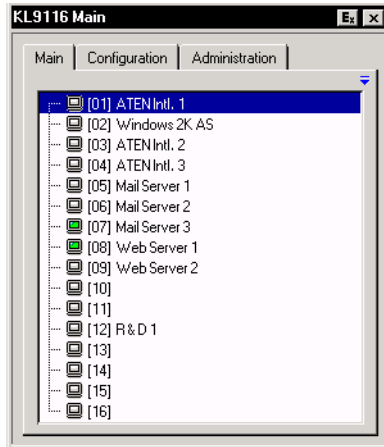

The Main Page



The Main Page lists all of the KL9108 / KL9116's ports and governs port access. Double clicking a port switches you to the device on that port.

Note: The administrator selects which ports are accessible to each user (see *User Management*, page 42).

- ◆ The Main Page uses a tree view to organize the port display. To see the ports for a particular station, click the plus sign [+] in front of the Station Number. The Port Number List drops down. To dismiss the list, click the minus sign [-] in front of the Station Number.
- ◆ A *port icon* in the shape of a monitor displays in front of the port number. Ports that have devices connected to them that are up and running have the port icon lit in green.
- ◆ Ports that have been selected as Quick View ports (see below), have a red *eye icon* displayed with the monitor in the port icon column to indicate so.
- ◆ There are two buttons on the title bar at the top right:

Button	Function
	<i>Log out:</i> clicking this button (or pressing F8) closes the OSD display and logs you out of the KL9108 / KL9116 session.
	<i>Close:</i> clicking this button (or pressing [Esc]) closes the OSD display but does not log you out of the session. You can bring the display back with the OSD hotkeys (see <i>OSD Hotkey</i> , page 40).

Port Operation

Select a port on the OSD Main Screen either by moving the highlight bar to it with the Up and Down Arrow keys and pressing **Enter**, or by **double-clicking** it. Once you select a port, its screen displays on your monitor, and your keyboard and mouse input affects the remote system.

The OSD Toolbar

The OSD provides a toolbar to help you control the KL9108 / KL9116 from within the captured port. To bring up the toolbar, tap the OSD Hotkey (Scroll Lock or Ctrl) twice. The toolbar appears in the upper left corner of the screen:

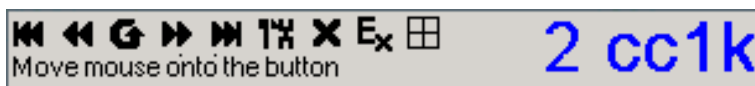

Depending on the settings that were selected under *ID Display* (see page 40), the Port Number and/or the Port Name display at the right of the toolbar.

-
- Note:**
1. Click on a free area of the toolbar and drag to move it around the screen.
 2. When the toolbar displays, mouse input is confined to the toolbar area and keyboard input has no effect. To carry out operations on the computer connected to the port, close the toolbar by clicking the **X** on it; or, recall the OSD and select the port again.
-

Recalling the OSD

To dismiss the toolbar and bring back the OSD display (the Main, Configuration, and Administration pages), do one of the following:

- ♦ Tap the OSD Hotkey once.
- ♦ From the toolbar, click the icon that opens the OSD (see *OSD Toolbar Icons*, page 86).

The toolbar closes, and the main OSD display reappears.









OSD Hotkey Summary Table

The following table presents a summary of the OSD Hotkey actions. See p. 40 to set the OSD Hotkey.

To...	When...	Do This...
Open the OSD Toolbar.	The OSD Toolbar is not open.	Click the OSD Hotkey twice.
Open the OSD.	The OSD Toolbar is open.	Click the OSD Hotkey once.
Open the OSD.	The OSD Toolbar is not open.	Click the OSD Hotkey three times.

OSD Toolbar Icons

The meanings of the toolbar icons are explained in the table below.

	Click to skip to the first accessible port on the entire installation without having to invoke the OSD.
	Click to skip to the first accessible port previous to the current one without having to invoke the OSD.
	Click to begin Auto Scan Mode. The KL9108 / KL9116 automatically switches among the ports that were selected for Auto Scanning under the Configuration <i>Scan Select</i> function (see page 40). This allows you to monitor their activity without having to switch among them manually.
	Click to skip from the current port to the next accessible one without having to invoke the OSD.
	Click to skip from the current port to the last accessible port on the entire installation without having to invoke the OSD.
	Click to bring up the OSD.
	Click to close the toolbar.
	Click to logout and exit the Windows Client application.
	Click to invoke Panel Array Mode (see page 87).

Panel Array Mode



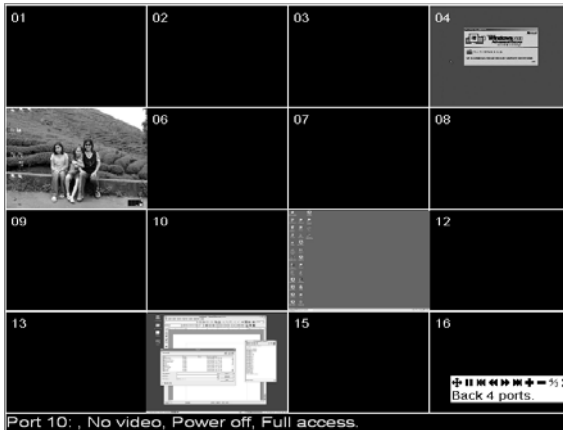







Clicking on the OSD Toolbar's *Panel* icon invokes Panel Array Mode. Under this mode, the OSD divides your screen into a 4 x 4 grid of 16 panels:



- ◆ Each panel represents one of the KL9108 / KL9116's ports. Starting with Port 1 at the upper left; going from left to right; top to bottom; Port 16 is at the lower right.
- ◆ When the Array is first invoked, it scans through each of the ports that were selected for Auto Scanning under the Configuration page's *Scan Select* function (see page 40), and displays information about the port (port name, resolution, on line status, port access status), at the bottom of the panel.
- ◆ The number of panels in the array (16, 9, 4, or 1) can be selected by clicking **Show More Ports (+)**, and **Show Fewer Ports (-)** on the panel array toolbar.
- ◆ If the computer connected to a port is on line, its screen displays in its panel, otherwise the panel is blank.
- ◆ Only ports that are accessible to the currently logged in user display (see *Port Access*, page 44). All other panels are blank.
- ◆ If you move the mouse pointer over a panel, information about the port displays at the bottom of the screen.
- ◆ You can access a computer connected to a port by moving the mouse pointer over its panel and clicking. You switch to the computer exactly as if you had selected it from the OSD Main screen.

Panel Array Toolbar

The panel array toolbar, at the lower right of the screen, provides shortcut navigation and control of the panel array as described in the table below:

	Click and drag to move the toolbar to another position on the screen.
	Pause panel scanning, leaving the focus on the panel that currently has it.
	Move back four panels.
	Move to the previous panel.
	Move to the next panel.
	Move ahead four panels.
	Increase the number of panels in the array.
	Decrease the number of panels in the array.
	Toggle 4/3 aspect ratio.
	Exit Panel Array mode.

Note: 1. We recommend that the user who starts Panel Array Mode set it to display at least four panels; otherwise, it is possible that other users may receive only part of the picture.

2. For issues affecting multiple user operation in Panel Array Mode, see *Multiuser Operation*, page 89.

Multuser Operation

The KL9108 / KL9116 supports multuser operation. Up to 32 users can log in at the same time. When multiple users simultaneously access the KL9108 / KL9116 switch from remote computers, the rules of precedence that apply are shown in the following table:

Operation	Rule
General	Once a user invokes the OSD, no other user can invoke it until the original user closes it.
Auto Scan Mode	If a user has invoked Auto Scan Mode (see page 90), but the OSD has not been invoked, another user can interrupt Auto Scan Mode by invoking the OSD.
Panel Array Mode	<ul style="list-style-type: none"> ◆ When a user has invoked Panel Array Mode (see page 87), all successive users automatically enter Panel Array Mode. Panel Array Mode continues until the original user stops it. (Administrators can override Panel Array Mode.) ◆ Only the user who starts Panel Array Mode can use the Skip Mode (see page 91) function. ◆ Only the user who starts Panel Array Mode can switch ports. Other users automatically switch to the ports that the original user selects. However, if an individual user does not have access rights to the port that the original user switches to, the user will not be able to view that port. ◆ Individual users can increase or decrease the number of panels they wish to view in Panel Array Mode; however, the picture quality may decrease as the number of panels decreases.

Note: We recommend that the user who starts Panel Array Mode set it to display at least four panels; otherwise, it is possible that other users may receive only part of the picture.

Keyboard Hotkey Operation

Keyboard hotkey combinations allow you to provide KVM focus to a port directly from the keyboard. The KL9108 / KL9116 provides the following hotkey features:

- ◆ Auto Scanning
- ◆ Skip Mode Switching

The hotkeys are: **A** and **P** for Auto Scanning; and the **Arrow Keys** for Skip Mode.

-
- Note:**
1. In order for hotkey operations to take place, the OSD Toolbar must be visible (see *Port Operation*, page 85).
 2. To use the keys designated as hotkeys (i.e. A, P, etc.) for normal, non-hotkey purposes, you must first close the toolbar.
 3. For issues affecting multiple user operation in Auto Scan Mode, see *Multiuser Operation*, page 89.
-

Auto Scanning

The Auto Scan function automatically switches among all the ports that are accessible to the currently logged on user at regular intervals, so that the user can monitor their activity automatically. (See *Scan Select*, page 40, for information regarding accessible ports.)

Setting the Scan Interval

The amount of time Auto Scan dwells on each port is set with the *Scan Duration* setting (see page 40).

Invoking Auto Scan

To start Auto Scanning, with the toolbar showing, tap the **A** key. The Auto Scan function cycles through the ports in order - starting from the first port on the installation. An **S** appears in front of the Port ID Display to indicate that the port is being accessed under Auto Scan Mode.

Pausing Auto Scan

While you are in Auto Scan Mode, you can pause the scanning in order to keep the focus on a particular computer by pressing **P**. During the time that Auto Scanning is paused, the **S** in front of the Port ID blinks On and Off.

Pausing when you want to keep the focus on a particular computer can be more convenient than exiting Auto Scan Mode because when you *Resume* scanning, you start from where you left off. If, on the other hand, you were to exit and then restart Auto Scan Mode, the scanning would start over from the very first computer on the installation.

To *Resume* Auto Scanning after a pause, press any key except [Esc] or the [Spacebar]. Scanning continues from where it left off.

Exiting Auto Scan

While Auto Scan Mode is in effect, ordinary keyboard functions are suspended. You must exit Auto Scan Mode in order to regain normal control of the keyboard. To exit Auto Scan Mode press **Esc** or the **Spacebar**. Auto Scanning stops when you exit Auto Scan Mode.

Skip Mode

Skip Mode allows you to switch ports in order to monitor the computers manually. You can dwell on a particular port for as long or as little as you like - as opposed to Auto Scanning, which automatically switches after a fixed interval. The Skip Mode hotkeys are the four Arrow keys. Their operation is explained in the table below:

Arrow	Action
←	Skips from the current port to the first accessible port previous to it. (See <i>Scan Select</i> , page 40, for information regarding accessible ports.)
→	Skips from the current port to the first accessible port that comes after it.
↑	Skips from the current port to the very first accessible port on the installation.
↓	Skips from the current port to the very last accessible port on the installation.

Keyboard and Mouse Considerations

Keystrokes

Except for [Alt + Tab] and [Ctrl + Alt + Del], all keyboard input is sent to the remote system. The above two chorded key combinations are retained on the local system to switch among applications and to recover from disaster. In order to provide the [Alt + Tab] and [Ctrl + Alt + Del] functions on the remote system, Function keys (F1 -F12) can be selected as substitute keys for both the **Alt** and **Ctrl** keys.

For example, the **F11** key could substitute for the **Ctrl** key and the **F12** key could substitute for the **Alt** key, in which case [F12 + Tab] substitutes for [Alt + Tab]; and [F11 + F12 + Del] substitutes for [Ctrl + Alt + Del]. See *Hotkey Setup*, page 76, for details on setting up a substitute key.

-
- Note:** 1. While any key may be used as a Substitute key, you *must not* use one that is being used as the first position Hotkey for another action.
2. When the KL9108 / KL9116 is being accessed with Win 98 under Full Screen Mode, if you mistakenly press Ctrl + Alt + Del, you will have to exit the Windows Client (by clicking the arrow on the Windows Client control panel), and restart the Windows Client from the KL9108 / KL9116 Main Webpage.
-

Mouse Synchronization

Until you close the KL9108 / KL9116 connection, mouse movements have no effect on your local system, but instead are captured and sent to the remote system.

From time to time, especially if you change video resolution, the local mouse movement may no longer be synchronized with the remote system's mouse pointer. There are three quick methods that can be used to bring the two pointers back into sync:

- ◆ Right-clicking on the hammer icon in the Windows Client Control Panel.
- ◆ Moving the mouse pointer into the Control Panel and back out again.
- ◆ Performing an *Auto Sync* with the Video Adjustment function (see *Video Adjustment*, page 78, for details).

If performing these actions does not resolve the problem, do the following:

1. Invoke the *Adjust Mouse* function with the *Adjust Mouse* hotkeys (see *Adjust mouse*, page 77, for details).
2. Move the local mouse pointer exactly on top of the remote mouse pointer and click.

If this procedure still does not help, you should set the mouse speed and acceleration for each problematic computer attached to the switch.

See *Additional Mouse Synchronization Procedures*, page 158, for instructions.

This Page Intentionally Left Blank

Chapter 7

Java Client Port Operation

Activating the OSD

After you have successfully logged in (see page 63), to activate the Java Client OSD do the following:

1. Click the *Java Client* button (the one without the arrow) at the left of the Webpage.

Note: You must have Sun's Java 2 JRE 1.4.2 or higher installed on your computer before running the Java Client. (At the time of writing, JRE 5.0 Update 5 was the latest release.) Java is available for free download from the Sun Java Website: <http://java.sun.com>.

2. Accept the security certificates.
3. When the browser dialog asks what to do with the program file, click **Open**.

Note: 1. If the browser cannot run the file, save it to the hard drive. Then, with your browser still open to the KL9108 / KL9116 Webpage, run the file from your disk.

2. If you use the *save to disk* method, for security purposes, you cannot simply run a previously downloaded version of the program. Each time you want to access the KL9108 / KL9116, you must log in to the Webpage with a valid username and password to download a fresh copy of the program.
-

The Java Client OSD

When you bring up the OSD, the Main Screen comes up in the center of your monitor.

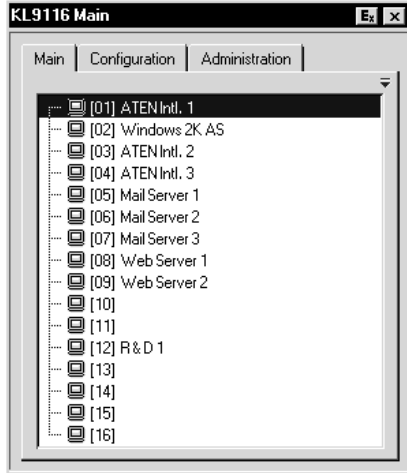

The OSD consists of three pages – Main, Configuration, and Administration.

- The Configuration and Administration pages are discussed in Chapter 4.
- The Main page is the same OSD Main page that appears when the Windows Client is invoked. For an explanation of this page refer to the discussion under *The Windows Client OSD*, page 74.

Note: The *Administration* tab is disabled for users who don't have administration privileges.

The Java Client Control Panel

Instead of a control panel like the one that the Windows Client uses, the Java Client has a hidden control panel, located at the bottom center of the screen. The panel becomes visible when the mouse pointer is moved over it.



The Java Client Control Panel icons and their functions are described in the sections that follow.



Set Video Parameters

Clicking this button brings up the *Video Adjustment* dialog box:

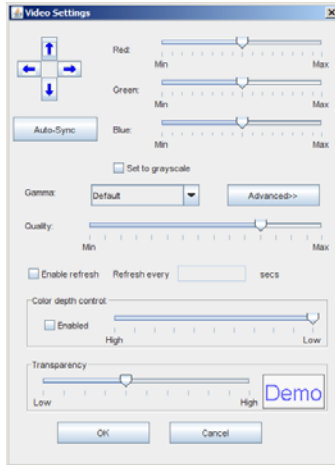

It is similar to the Windows Client Video Adjustment dialog box. See *Video Adjustment*, page 78, for details.



Keypad

Some keyboard combinations cannot be captured and sent to the KL9108 / KL9116. In order to implement their effects on the remote system, this function provides a one-click implementation of some common window control combinations.





Mouse Synchronization

At times the local mouse movement may lose sync with the remote mouse movement. The Mouse Synchronization function gets them back into sync. There are two methods available to bring the pointers into sync:

1. Click the Mouse Synchronization button; wait for the remote mouse pointer to move to the upper left corner of the screen; move your local mouse pointer directly on top of the remote pointer, and click.
2. Move your local mouse pointer over the Java Client Control Panel, and click.



Message Board

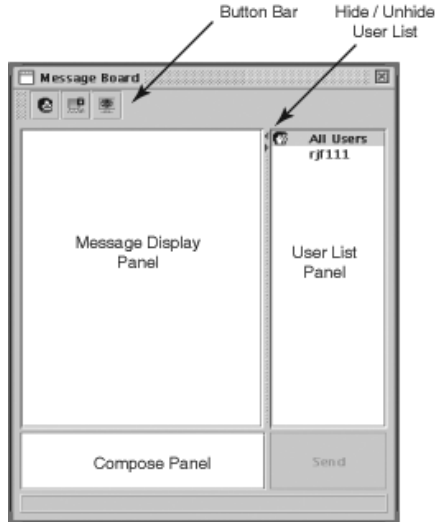

The KL9108 / KL9116 supports multiple user logins, which can possibly give rise to access conflicts. To alleviate this problem, a message board feature, similar to an Internet chat program, allows users to communicate with each other.

When you click the Message Board icon on the Java Client Control Panel (see page 96), a screen similar to the one below appears:



The Message Board Button Bar

The buttons on the Button Bar are toggles. Their actions are described in the table below:

Button	Action
	Enable/Disable Chat. When disabled, messages posted to the board are not displayed. The button is shadowed when Chat is disabled. The icon displays next to the user's name in the User List panel when the user has disabled Chat.
	Occupy/Release Keyboard/Video/Mouse. When you Occupy the KVM, other users cannot see the video, and cannot input keyboard or mouse data. The button is shadowed when the KVM is occupied. The icon displays next to the user's name in the User List panel when the user has occupied the KVM.
	Occupy/Release Keyboard/Mouse. When you Occupy the KM, other users can see the video, but cannot input keyboard or mouse data. The button is shadowed when the KM is occupied. The icon displays next to the user's name in the User List panel when the user has occupied the KM.

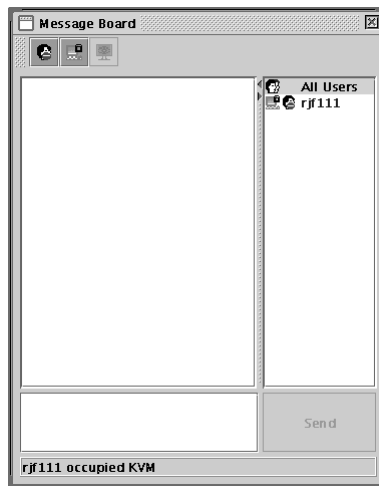

- ◆ Messages that users post to the board - as well as system messages - display in the *Message Display* panel. If you disable Chat, however, messages that get posted to the board won't appear.
- ◆ Key in the messages that you want to post to the board in the *Compose* panel. Click **Send**, to post the message to the board.
- ◆ The names of all the logged in users appear in the *User List* panel.

- ◆ By default, messages are posted to all users. To post a message to one individual user, select the user's name before sending your message.
- ◆ If a user's name is selected, and you want to post a message to all users, select *All Users* before sending your message.
- ◆ If a user has disabled Chat, its icon displays before the user's name to indicate so.
- ◆ If a user has occupied the KVM or the KM, its icon displays before the user's name to indicate so.
- ◆ To Hide/Unhide the *User List* panel, click on the arrows in the panel separator.



Lock Key LEDs and Resolution

These LEDs show the Num Lock, Caps Lock, and Scroll Lock status of the remote computer. They turn Green when the Lock status is **On**. Click on the icon to toggle the status.

Note: When you first connect, the LED display may not be accurate. To be sure, click on the LEDs to set them.

The video resolution of the device connected to the remote port displays directly below the Lock LEDs.



Switch Screen Mode

Clicking this button toggles Full Screen Mode on and off. (By default the Java Client opens in Full Screen Mode.)



About

Clicking this button opens the About dialog box, which displays the Java Client Version information. Click the OK button to close the dialog box.



Send Ctrl+Alt+Del

Clicking this button sends a Ctrl+Alt+Del signal to the remote system.



Help

Clicking this button brings up the online help screen for the Java Client.



Exit









Clicking the Exit button terminates the Java Client session.

Port Operation

Java Client port operation is the same as for the Windows Client. See *Port Operation*, page 85, for details.

Panel Array Mode

This is very similar to the Windows Client Panel Array Mode (see page 87 for details), except for some differences in the toolbar. The Java Client Panel Array Mode Toolbar is described in the table below:

	Pauses panel scanning, leaving the focus on the panel that had it when you clicked. After you click <i>Pause</i> , the button changes to an arrowhead and its caption changes to <i>Resume</i> . To resume scanning, click the Resume button.
	Move back four panels.
	Move to the previous panel.
	Move to the next panel.
	Move ahead four panels.
	Increase the number of panels in the array.
	Decrease the number of panels in the array.
	Toggle 4/3 aspect ratio.
	Exit Panel Array mode.

Keyboard Hotkey Operation

Keyboard hotkey operation is the same as for the Windows Client. See *Keyboard Hotkey Operation*, page 90, for details.

Chapter 8

The Log File

The Main Screen

The KL9108 / KL9116 logs all the events that take place on it. To view the contents of the log file, click the *Log* icon at the left of the Webpage. A screen similar to the one below appears:



A maximum of 512 events are stored in the log file. To clear the log file, click on the *Clear Log* icon at the lower right of the screen.

Note: The Log File is a temporary file that is erased when the KL9108 / KL9116 is turned off or loses power. It is recommended that you install the Log Server to backup the contents of the log file.

This Page Intentionally Left Blank

Chapter 9

The Log Server

The Windows-based Log Server is an administrative utility that records all the events that take place on selected KL9108 / KL9116 units and writes them to a searchable database. This chapter describes how to install and configure the Log Server.

Installation

1. From the computer that you want to use as the Log Server, open your browser and log into the KL9108 / KL9116 (see page 63).
2. Click the *Log Server* button at the left of the Webpage to start the Log Server installation program.
3. If any security warning dialog boxes appear, ignore them and click **Run** or **Open**.

Note: If the browser cannot run the file, save it to disk, instead, and run the file from your disk.

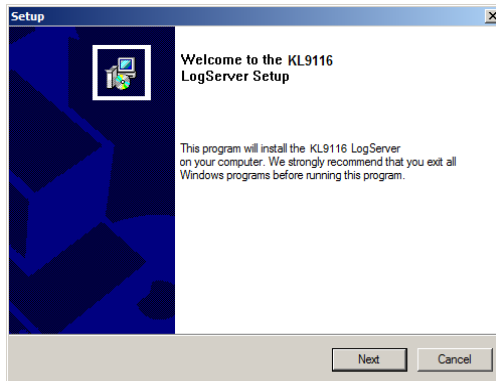

4. Click **Next**. Then follow the on-screen instructions to complete the installation and have the Log Server program icon placed on your desktop.

Starting Up

To bring up the Log Server, either double click the program icon, or key in the full path to the program on the command line. The first time you run it, a screen similar to the one below appears:

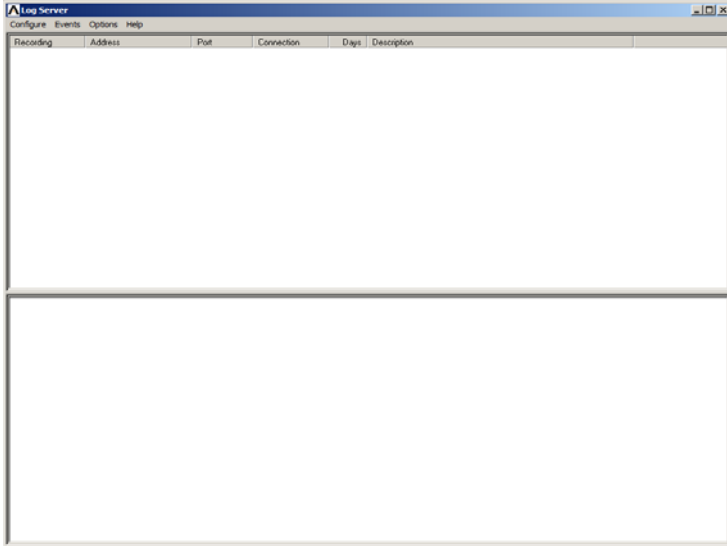

-
- Note:**
1. The MAC address of the Log Server computer must be specified on the *Service Configuration* page of the *Administrator Utility* (see page 45).
 2. The Log Server requires the Microsoft Jet OLEDB 4.0 driver in order to access the database.
-

The screen is divided into three components:

- ♦ A *Menu Bar* at the top
- ♦ A panel that will contain a list of KL9108 / KL9116 units in the middle (see *The Log Server Main Screen*, page 111, for details).
- ♦ A panel that will contain an *Events List* at the bottom

Each of the components is explained in the sections that follow.

The Menu Bar

The Menu bar consists of four items:

- ◆ Configure
- ◆ Events
- ◆ Options
- ◆ Help

These are discussed in the sections that follow.

Note: If the Menu Bar appears to be disabled, click in the KL9108 / KL9116 List window to enable it.

Configure

The Configure menu contains three items: Add, Edit, and Delete. They are used to add new KL9108 / KL9116 units to the KL9108 / KL9116 List; edit the information for units already on the list; or delete KL9108 / KL9116 units from the list.

- ◆ To add a KL9108 / KL9116 to the KL9108 / KL9116 List, click **Add**.
- ◆ To edit or delete a listed KL9108 / KL9116, first select the one you want in the KL9108 / KL9116 List window, then open this menu and click **Edit** or **Delete**.

When you choose *Add* or *Edit*, a dialog box, similar to the one below appears:

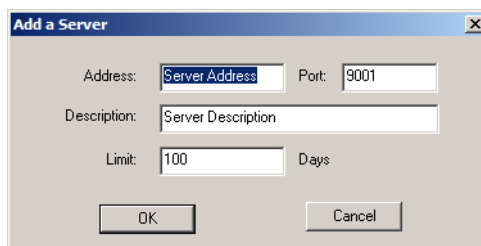

The screenshot shows a dialog box titled "Add a Server" with a close button (X) in the top right corner. The dialog contains the following fields and controls:

- Address:** A text input field containing "Server Address".
- Port:** A text input field containing "9001".
- Description:** A text input field containing "Server Description".
- Limit:** A text input field containing "100", followed by the label "Days".
- Buttons:** "OK" and "Cancel" buttons at the bottom.

A description of the fields is given in the table, below:

Field	Explanation
Address	This can either be the IP address of the KL9108 / KL9116 or its DNS name (if the network administrator has assigned it a DNS name).
Port	The port number that was assigned to the Log Server in the KL9108 / KL9116 OSD (see <i>Log Server</i> , page 46).
Description	This field is provided so that you can put in a descriptive reference for the unit to help identify it.
Limit	This specifies the number of days that an event should be kept in the Log Server's database before it expires and it is cleared out.

Fill in or modify the fields, then click **OK** to finish.

Events

The Events Menu has two items: *Search* and *Maintenance*.

Search

Search allows you to search for events containing specific words or strings. When you access this function, a screen similar to the one below appears:

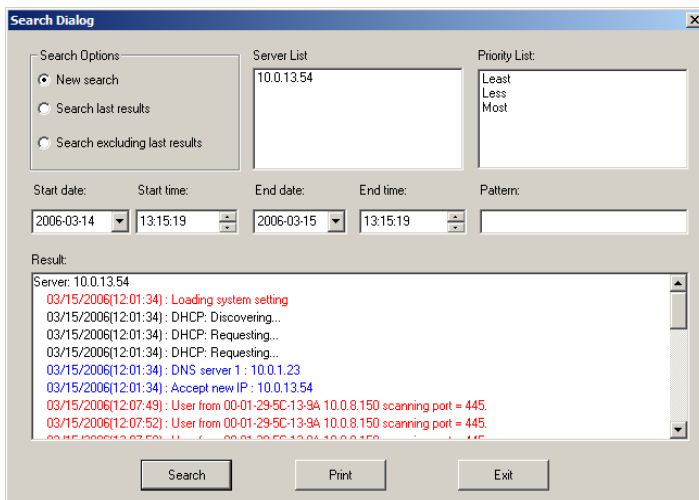

A description of the items is given in the table below:

Item	Explanation
New search	This is one of three radio buttons that define the scope of the search. If it is selected, the search is performed on all the events in the database for the selected KL9108 / KL9116.
Search last results	This is a secondary search performed on the events that resulted from the last search.
Search excluding last results	This is a secondary search performed on all the events in the database for the selected KL9108 / KL9116 <i>excluding</i> the events that resulted from the last search.
Server List	KL9108 / KL9116 units are listed according to their IP address. Select the unit that you want to perform the search on from this list. You can select more than one unit for the search. If no units are selected, the search is performed on all of them.
Priority List	Sets the level for how detailed the search results display should be. 1 is the most general; 3 is the most specific.
Start Date	Select the date that you want the search to start from. The format follows the MM/DD/YYYY convention, as follows: 11/04/2005
Start Time	Select the time that you want the search to start from.
End Date	Select the date that you want the search to end at.
End Time	Select the time that you want the search to end at.
Pattern	Key in the pattern that you are searching for here. The multiple character wildcard (%) is supported. E.g., h%ds would match <i>hands</i> and <i>hoods</i> .
Results	Lists the events that contained matches for the search.
Search	Click this button to start the search.
Print	Click this button to print the search results.
Exit	Click this button to exit the Search dialog box.

Maintenance

This function allows the administrator to perform manual maintenance of the database, such as erasing specified records before the expiration time that was set with the *Limit* setting of the Edit function (see page 108).

Options

Network Retry allows you to set the number of seconds that the Log Server should wait before attempting to connect if the previous attempt to connect failed. When you click this item, a dialog box, similar to the one below appears:

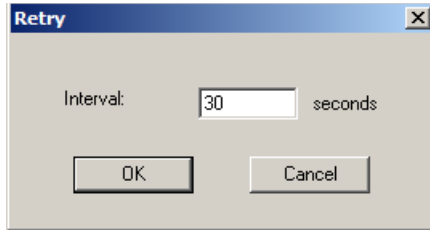

Key in the number of seconds, then click **OK** to finish.

Help

From the Help Menu, click **Contents** to access the online Windows Help file. The help file contains instructions about how to setup, operate and troubleshoot the Log Server.

The Log Server Main Screen

Overview

The Log Server Main Screen is divided into two main panels.

- ◆ The upper (List) panel lists the KL9108 / KL9116 units that have been selected for the Log Server to track (see *Configure*, page 107).
- ◆ The lower (Event) panel displays the log events for the currently selected KL9108 / KL9116 (the highlighted one - if there are more than one). To select a KL9108 / KL9116 unit in the list, simply click on it.

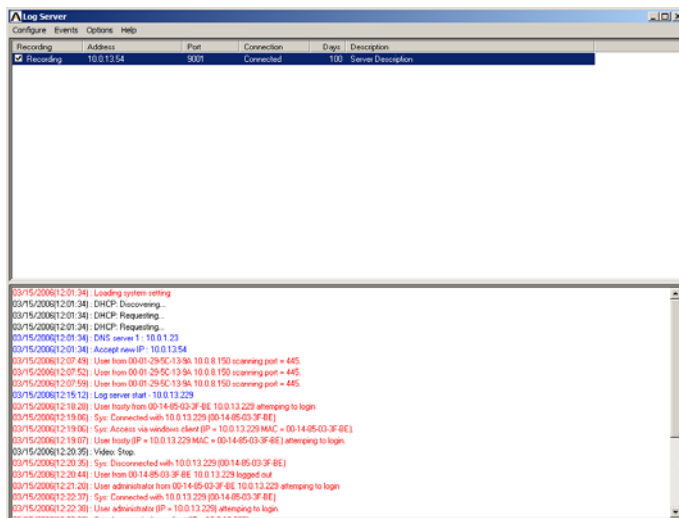

The List Panel

The List panel contains six fields:

Field	Explanation
Recording	Determines whether the Log Server records log events for this KL9108 / KL9116 or not. If the Recording check box is checked, the field displays <i>Recording</i> , and log events are recorded. If the Recording check box is not checked, the field displays <i>Paused</i> , and log events are not recorded. Note: Even though a KL9108 / KL9116 is not the currently selected one, if its Recording check box is checked, the Log Server will still record its log events.
Address	This is the IP Address or DNS name that was given to the KL9108 / KL9116 when it was added to the Log Server (see <i>Configure</i> , page 107).
Port	This is the port number that was assigned to the Log Server in the KL9108 / KL9116 OSD (see <i>Log Server</i> , page 46).
Connection	If the Log Server is connected to the KL9108 / KL9116, this field displays <i>Connected</i> . If it is not connected, this field displays <i>Waiting</i> . This means that the Log Server's MAC address has not been set properly. It needs to be set on the <i>Service Configuration</i> page of the <i>Administrator Utility</i> (see page 45).
Days	This field displays the number of days that the KL9108 / KL9116's log events are to be kept in the Log Server's database before expiration (see <i>Configure</i> , page 107).
Description	This field displays the descriptive information given for the KL9108 / KL9116 when it was added to the Log Server (see <i>Configure</i> , page 107).

The Event Panel

The lower panel displays tick information for the currently selected KL9108 / KL9116. Note that if the installation contains more than one switch, even though a switch isn't currently selected, if its *Recording* checkbox is checked, the Log Server records its tick information and keeps it in its database.

Chapter 10

AP Operation

Overview

In some cases, the Administrator may not want the KL9108 / KL9116 to be available via browser access. AP versions of the Windows Client and the Java Client are provided to enable direct access of the KL9108 / KL9116 without having to go through a browser.

The programs are initially downloaded from the browser page. After they have been downloaded by the Users, the Administrator can disable browser access (see *Working Mode*, page 55).

The Windows Client

Installation

To install the Windows Client on your computer, do the following:

1. Log into the KL9108 / KL9116 with your browser, and click the second *Windows Client* button (the one with the arrow). A screen similar to the one below appears:

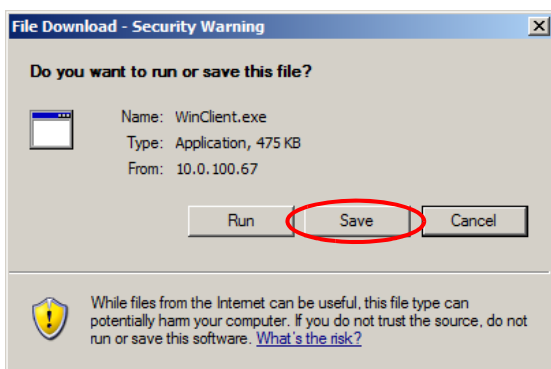

2. Click **Save**.
3. In the dialog box that comes up specify a location on your hard disk to save it to.

Starting Up

To connect to the KL9108 / KL9116, go to the location on your hard disk that you saved the Windows Client program to, and double-click its icon (WinClient.exe) to bring up the Windows Client Connection Screen:

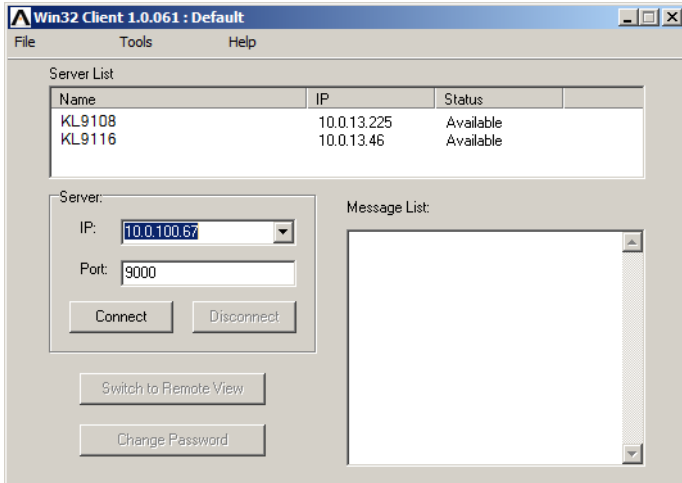

Note: You must have DirectX 7.0 or higher installed on your computer. If not, the Client program will not load.

(Continues on next page.)

(Continued from previous page.)

A description of the Connection Screen is given in the following table:

Item	Description
Menu Bar	<p>The Menu Bar contains three items: File, Tools, and Help.</p> <ul style="list-style-type: none"> ◆ The <i>File Menu</i> allows the operator to Create, Save, and Open user created Work files (see page 116 for details). ◆ The <i>Tools Menu</i> contains two entries: <i>Keyboard</i> and <i>Config</i>, (see page 116 for details).
Server List	<p>Each time the WinClient.exe file is run, it searches the User's local LAN segment for KL9108 / KL9116 units, and lists whichever ones it finds in this box. If you want to connect to one of these units, double-click it.</p>
Server	<p>This area is used when you want to connect to a KL9108 / KL9116 at a remote location. You can drop down the <i>IP</i> list box and select an address from the list. If the address you want isn't listed, you can key in the IP address you want. Then, key in the Port number in the <i>Port</i> field. If you don't know the Port number, then contact the Administrator.</p> <p>When the IP address and Port number for the unit you wish to connect to have been specified, Click Connect to start the connection. When you have finished with your session, Click Disconnect to end the connection.</p>
Message List	<p>Lists status messages regarding the connection to the KL9108 / KL9116.</p>
Switch to Remote View	<p>Once contact with a KL9108 / KL9116 has been established, this button becomes active. Click it to switch and take over console control of the unit that is attached to the KL9108 / KL9116.</p> <p>The screen output of the unit appears on your monitor. Your keystrokes and mouse movements are captured and sent to the KL9108 / KL9116 to be executed on the attached unit.</p> <p>If the KL9108 / KL9116 is connected to a KVM switch, you can control the switch and the computers connected to it just as if you were connected locally.</p>
Change Password	<p>This button becomes active after a connection to a KL9108 / KL9116 unit has been established. It allows the User to change the password used to log in to the KL9108 / KL9116.</p>

The File Menu

The *File Menu* allows the operator to Create, Save, and Open user created Work files. A Work File consists of all the information specified in a Client session. This includes the Server List and Server IP list items, as well as the Hotkey settings.

Whenever a user runs the Client program, it opens with the values contained in the *current work file*. The current work file consists of the values that were in effect the last time the program was closed.

The File menu consists of three items, as follows:

New	Allows the user to create a named work file so its values will not be lost, and it will be available for future recall.
Open	Allows the user to open a previously saved work file and use the values contained in it.
Save	Allows the user to save the values presently in effect as the <i>current work file</i> .

The Tools Menu

Tools menu operations are performed after you connect, but before you switch to remote view. There are two entries on the Tools Menu: Keyboard and Config. They are explained in the sections that follow.

Keyboard

Various configuration actions related to the keyboard, video, and mouse can be performed via hotkey combinations. The Hotkey Setup utility is accessed by opening the *Tools* menu and selecting *Keyboard*. The Hotkey Setup Screen that appears is essentially the same dialog box discussed in the browser-based *Windows Client* chapter. See *Hotkey Setup*, page 76 for details.

Config

When you select *Config*, a screen similar to the one below appears:

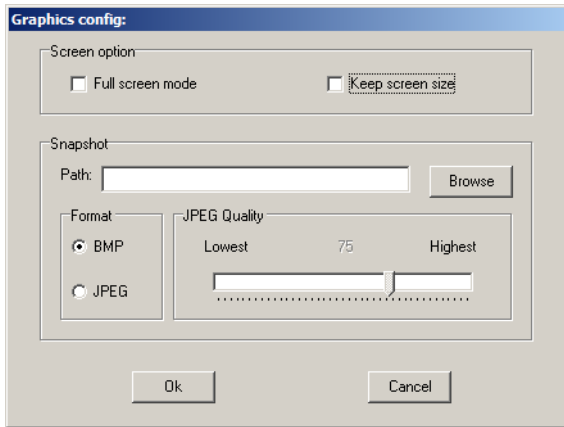

The dialog box is organized into two main parts: Screen Options, and Snapshot. *Screen Options* lets you set up the way the remote display appears on the local monitor; *Snapshot* lets the user configure the KL9108 / KL9116's screen capture parameters.

This is the same dialog box that is discussed in the browser-based *Windows Client Port Operation* chapter. See *Graphics Configuration Dialog Box*, page 72, for details.

Connecting

To connect to a KL9108 / KL9116 unit:

1. If the device that you wish to connect to is in the *Server List*, **double click** it. If you are using the *Server IP* input box, specify the IP address and Port number, then click **Connect**. The *Login* dialog box appears:

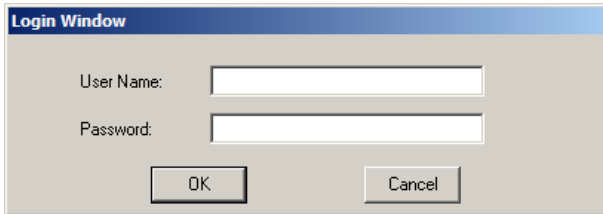

2. Key in a valid Username and Password, and then click **OK**.
The program attempts to connect to the selected KL9108 / KL9116 unit. While it does so, you can check the *Message List* window for status messages regarding the operation's progress.
3. Once contact with the KL9108 / KL9116 has been established, the *Switch to Remote View* button becomes active. Click it to connect to the KL9108 / KL9116 and take over console control of the unit that is connected to it.

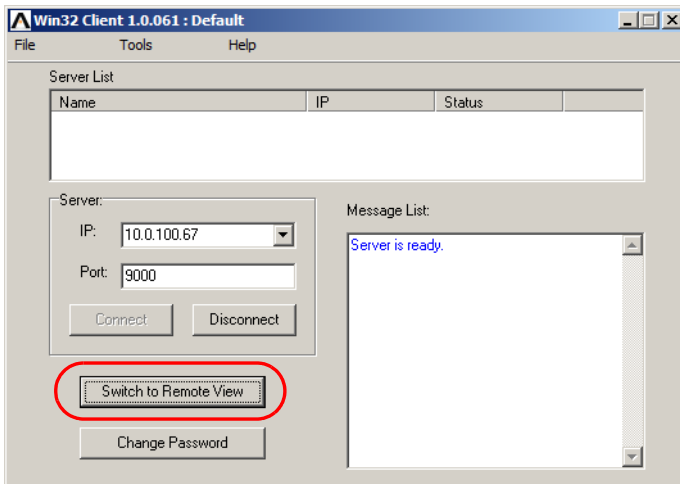

Operation

Once a connection to the KL9108 / KL9116 has been established, the remote system's video output is captured and displayed on your monitor. At the same time, your local keystroke and mouse input is captured and sent to the remote system.

The look and feel of the AP Windows client operation is the same as for the browser version of the Windows client. Refer back to Chapter 6, *Windows Client Port Operation* for details.

Ending the Session

After you log out of the KL9108 / KL9116, you return to the Connection dialog box. Click **Disconnect** to end the session.

The Java Client

Installation

To install the Java Client on your computer, do the following:

1. Log into the KL9108 / KL9116 with your browser, and click the second *Java Client* button (the one with the arrow). A screen similar to the one below appears:

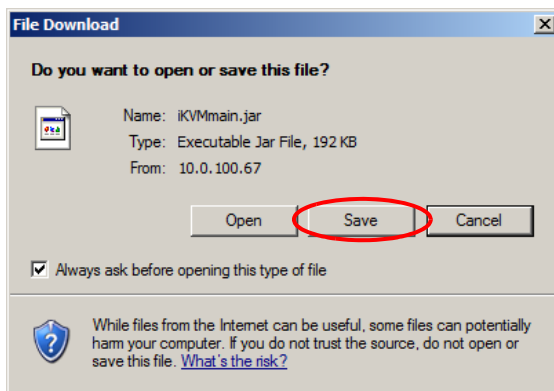

2. Click **Save**.
3. In the dialog box that comes up specify a location on your hard disk to save it to.

Starting Up

To connect to the KL9108 / KL9116, go to the location on your hard disk that you saved the Java Client program to, and double click its icon to bring up the *Address Input* dialog box.

Note: The Java Client requires Java version 1.4.2 or higher.



1. Key in the IP address for the unit you want to connect to – including a forward slash followed by the login string (set by the administrator), then click **OK**.

Note: For security purposes, the login string must be specified correctly as part of the IP address. The system administrator may change the string from time to time to thwart unauthorized access attempts. Be sure you have the correct string when you attempt to connect.

2. After you establish a connection, a Login dialog box appears. Provide a valid Username and Password, and then click **OK**.



Once the authentication procedure completes successfully, the KL9108 / KL9116 main page displays on your monitor.

Operation

The look and feel of the AP Java client operation is the same as for the browser version of the Java client. See *Java Client Port Operation*, page 95, for details.

This Page Intentionally Left Blank

Chapter 11

LDAP Server Configuration

Introduction

The KVM Over the NET™ switch allows log in authentication and authorization through external programs. This chapter describes how to configure Active Directory for KVM Over the NET™ switch authentication and authorization.

To allow authentication and authorization via LDAP or LDAPS, the Active Directory's LDAP *Schema* must be extended so that an extended attribute name for the KVM Over the NET™ switch – *ikvm2116-userProfile* – is added as an optional attribute to the *person* class.

Note: *Authentication* refers to determining the authenticity of the person logging in; *authorization* refers to assigning permission to use the device's various functions.

In order to configure the LDAP server, you will have to complete the following procedures: 1) Install the Windows Server Support Tools; 2) Install the Active Directory Schema Snap-in; and 3) Extend and Update the Active Directory Schema.

The following section provides an example of configuring LDAP under Windows 2003 Server.

Install the Windows 2003 Support Tools

To install the Windows 2003 Support Tools, do the following:

1. On your Windows Server CD, open the Support → Tools folder.
2. In the right panel of the dialog box that comes up, double click **SupTools.msi**.
3. Follow along with the Installation Wizard to complete the procedure.

Install the Active Directory Schema Snap-in

To install the Active Directory Schema Snap-in, do the following:

1. Open a Command Prompt.
2. Key in: `regsvr32 schmmgmt.dll` to register schmmgmt.dll on your Active Directory computer.
3. Open the *Start* menu; click **Run**; key in: `mmc /a`; click **OK**.
4. On the *File* menu of the screen that appears, click **Add/Remove Snap-in**; then click **Add**.
5. Under *Available Standalone Snap-ins*, double click **Active Directory Schema**; click **Close**; click **OK**.
6. On the screen you are in, open the *File* menu and click **Save**.
7. For *Save in*, specify the `C:\Windows\system32` directory.
8. For *File name*, key in **schmmgmt.msc**.
9. Click **Save** to complete the procedure.

Create a Start Menu Shortcut Entry

To create a shortcut entry on the Start Menu for the Active Directory Schema, do the following:

1. Right click Start; select: **Open all Users** → **Programs** → **Administrative Tools**.
2. On the *File* menu, select **New** → **Shortcut**
3. In the dialog box that comes up, browse to, or key in the path to schmmgmt.msc (`C:\Windows\system32\schmmgmt.msc`), then click **Next**.
4. In the dialog box that comes up, key in *Active Directory Schema* as the name for the shortcut, then click **Finish**.

Extend and Update the Active Directory Schema

To extend and update the Active Directory Schema, you must do the following 3 procedures: 1) create a new attribute; 2) extend the object class with the new attribute; and 3) edit the active directory users with the extended schema.

Creating a New Attribute

To create a new attribute do the following:

1. From the Start menu, open Administrative Tools → Active Directory Schema.
2. In the left panel of the screen that comes up, right-click **Attributes**:

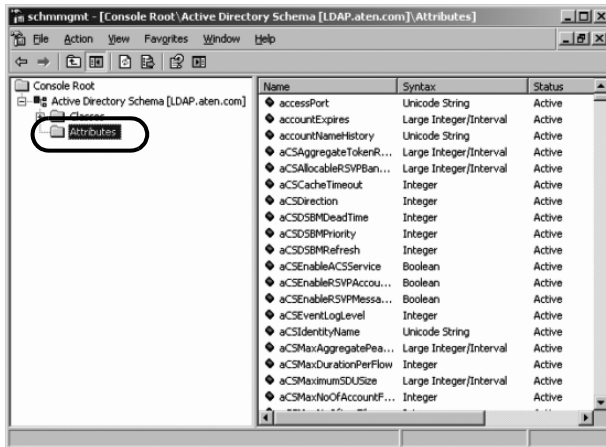

3. Select New → Attribute.
4. In the warning message that appears, click **Continue** to bring up the *Create New Attribute* dialog box.

(Continues on next page.)

(Continued from previous page.)

5. Fill in the dialog box to match the entries for *Description* and *Common Name* shown below, then click **OK** to complete the procedure.

Note: The Unique X500 Object ID uses periods, not commas.

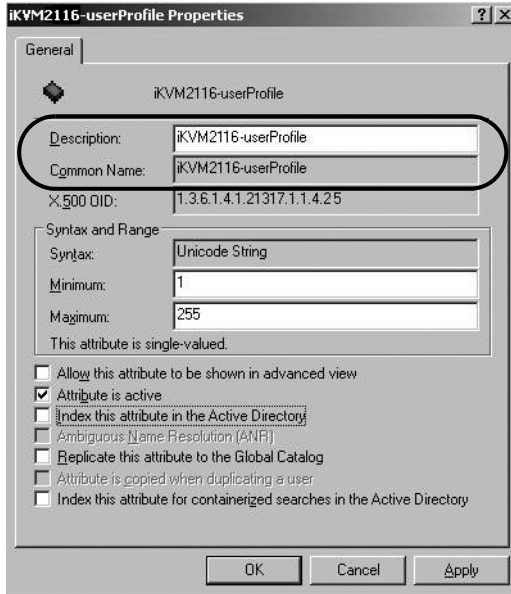

Extending the Object Class With the New Attribute

To extend the object class with the new attribute, do the following:

1. Open the Control Panel → Administrative Tools → Active Directory Schema.
2. In the left panel of the screen that comes up, select **Classes**.
3. In the right panel, right-click **person**:

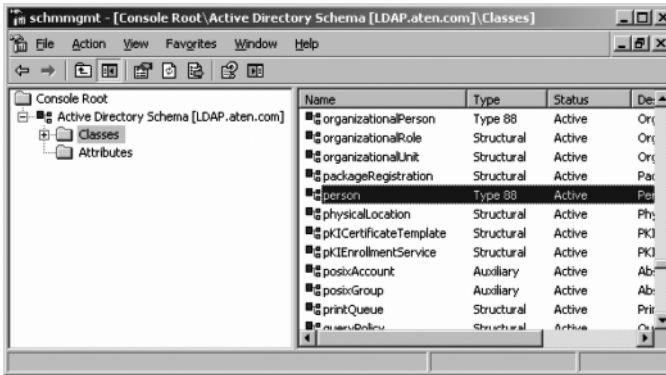

4. Select **Properties**; the *person Properties* dialog box comes up with the *General* page displayed. Click the *Attributes* tab.



5. On the *Attributes* page, click **Add**:

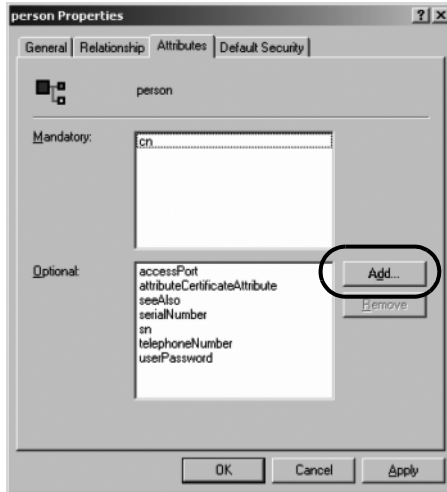

6. In the list that comes up, select **iKVM2116-userProfile**, then click **OK** to complete the procedure.

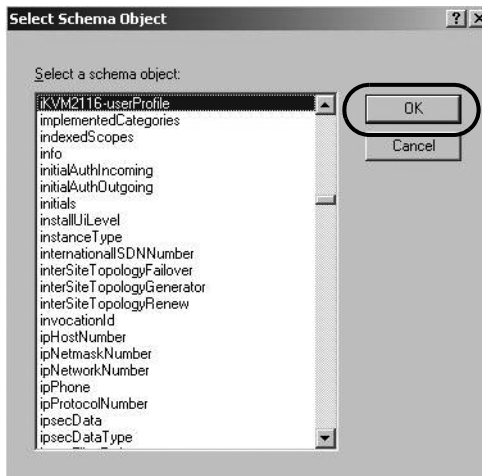

Editing Active Directory Users

To edit Active Directory Users With the Extended Schema, do the following:

1. Run **ADSI Edit**. (Installed as part of the *Support Tools*.)
2. In the left panel, open **Domain**, and navigate to the **DC=aten,DC=com** **CN=Users** node.
3. In the right panel, locate the user you wish to edit. (Our example uses *jason*.)

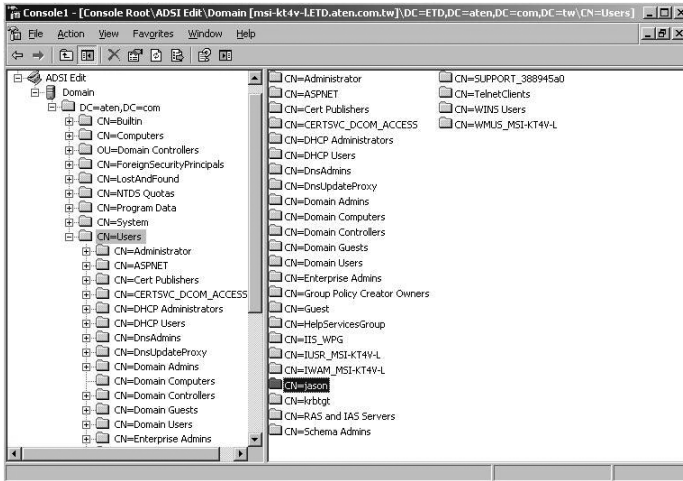

4. Right-click on the user's name and select **properties**.

(Continues on next page.)

(Continued from previous page.)

5. On the *Attribute Editor* page of the dialog box that appears, select **iKVM2116-userProfile** from the list.

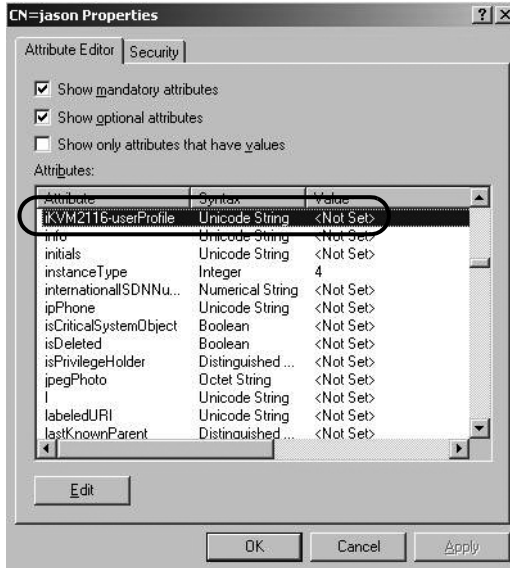

6. Click **Edit** to bring up the *String Attribute Editor*:



(Continues on next page.)

(Continued from previous page.)

7. Key in the KVM Over the NET™ switch permission attribute values. For example:



Note: The possible string attributes are the same as for Radius. See the table on page 48 for full details.

8. Click **OK**. When you return to the *Attribute Editor* page, the *iKVM2116-userProfile* entry now reflects the new permissions:

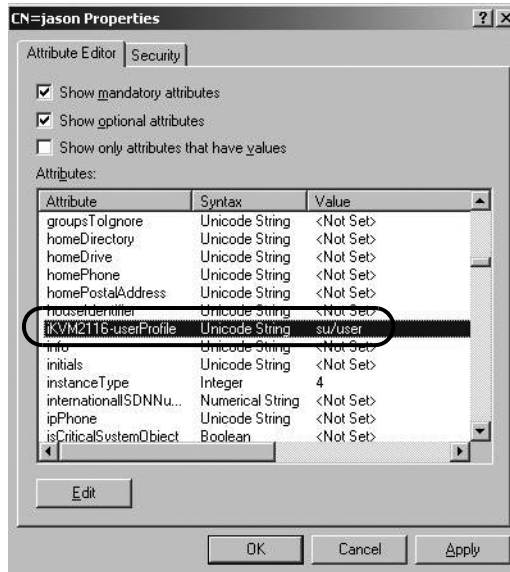

- a) Click **Apply** to save the change and complete the procedure. Jason now has the same permissions as *user*.
- b) Repeat the *Editing Active Directory Users* procedure for any other users you wish to add.

OpenLDAP

OpenLDAP is an Open source LDAP server designed for Unix platforms. A Windows version can be downloaded from:

```
http://download.bergmans.us/openldap/openldap-2.2.29/  
openldap-2.2.29-db-4.3.29-openssl-0.9.8a-  
win32_Setup.exe.
```

OpenLDAP Server Installation

After downloading the program, launch the installer, select your language, accept the license and choose the target installation directory. The default directory is: *c:\Program Files\OpenLDAP*.

When the *Select Components* dialog box appears, select *install BDB-tools* and *install OpenLDAP-slapd as NT service*, as shown in the diagram, below:

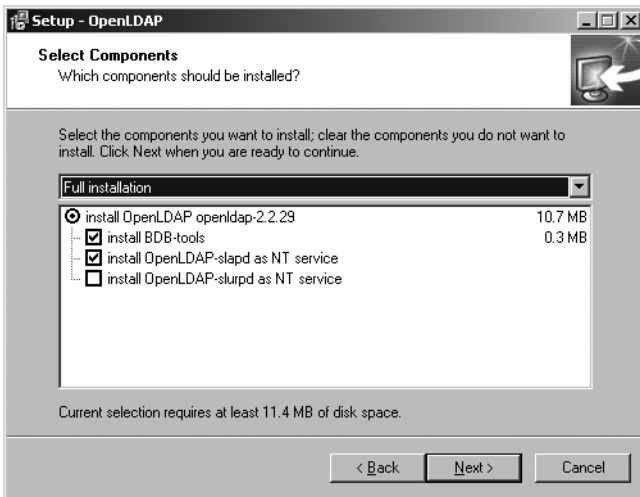

OpenLDAP Server Configuration

The main OpenLDAP configuration file, `slapd.conf`, has to be customized before launching the server. The modifications to the configuration file will do the following:

- ◆ Specify the Unicode data directory. The default is `./ucdata`.
- ◆ Choose the required LDAP schemas. The core schema is mandatory.
- ◆ Configure the path for the OpenLDAP `pid` and `args` start up files. The first contains the server pid, the second includes command line arguments.
- ◆ Choose the database type. The default is `bdb` (Berkeley DB).
- ◆ Specify the server suffix. All entries in the directory will have this suffix, which represents the root of the directory tree. For example, with suffix `dc=aten,dc=com`, the fully qualified name of all entries in the database will end with `dc=aten,dc=com`.
- ◆ Define the name of the administrator entry for the server (`rootdn`), along with its password (`rootpw`). This is the server's super user. The rootdn name must match the suffix defined above. (Since all entry names must end with the defined suffix, and the rootdn is an entry.)

An example configuration file is provided in the figure, below:

```
ucdata-path ./ucdata
include ./schema/core.schema

pidfile ./run/slapd.pid
argsfile ./run/slapd.args

database bdb
suffix "dc=aten,dc=com"
rootdn "cn=Manager,dc=aten,dc=com"
rootpw secret
directory ./data
```

Starting the OpenLDAP Server

To start the OpenLDAP Server, run **slapd** (the OpenLDAP Server executable file) from the command line. slapd supports a number of command line options, the most important option is the **d** switch that triggers debug information. For example, a command of:

```
slapd -d 256
```

would start OpenLDAP with a debug level of 256, as shown in the following screenshot:

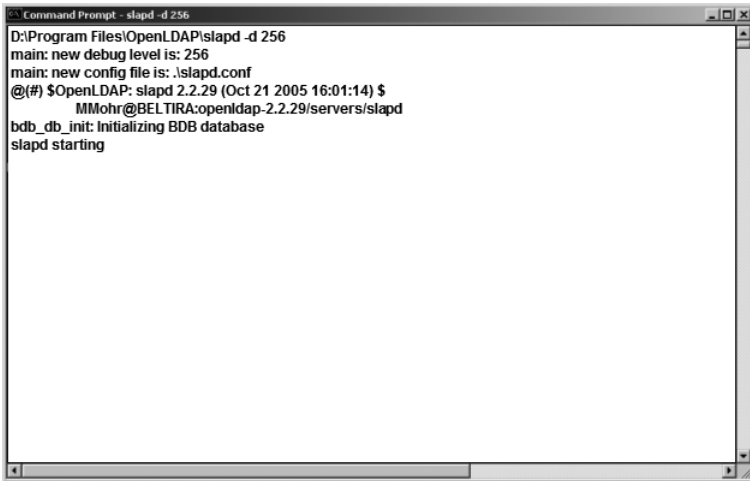

```
Command Prompt - slapd -d 256
D:\Program Files\OpenLDAP\slapd -d 256
main: new debug level is: 256
main: new config file is: .\slapd.conf
@(#) $OpenLDAP: slapd 2.2.29 (Oct 21 2005 16:01:14) $
MMohr@BELTIRA:openldap-2.2.29/servers/slapd
bdb_db_init: Initializing BDB database
slapd starting
```

Note: For details about slapd options and their meanings, refer to the OpenLDAP documentation.

Customizing the OpenLDAP Schema

The schema that slapd uses may be extended to support additional syntaxes, matching rules, attribute types, and object classes.

In the case of the KL9108 / KL9116, the *User Class* and the *User Profile* attribute are extended to define a new schema (e.g. kn2116.schema). The extended schema file used to authenticate and authorize users logging in to the KL9108 / KL9116 is shown in the figure, below:

```
#####
##   Copyright (C) 2008-2009 ATEN CANADA TECHNOLOGIES INC.
##   Summary: Define the LDAP schema used in KN9116
#####
#
#   ATEN OID:=(1.3.6.1.4.1.2131*7)
#
attributetype ( 1.3.6.1.4.1.21317.1.1.4.2.5
                NAME 'KVM2116-userProfile'
                EQUALITY caseIgnoreMatch
                SUBSTR caseIgnoreSubstringsMatch
                SYNTAX 1.3.6.1.4.1.1466.115.121.1.15
                SINGLE-VALUE )

objectclass ( 1.3.6.1.4.1.21317.1.1.4.1.5
              NAME 'kn2116user'
              SUP organizationalPerson
              STRUCTURAL
              MAY (KVM2116-userProfile $ userCertificate ))
```

LDAP DIT Design and LDIF File

LDAP Data Structure

An LDAP Directory stores information in a tree structure known as the Directory Information Tree (DIT). The nodes in the tree are directory entries, and each entry contains information in attribute-value form. An example of the LDAP directory tree for the KL9108 / KL9116 is shown in the figure, below:

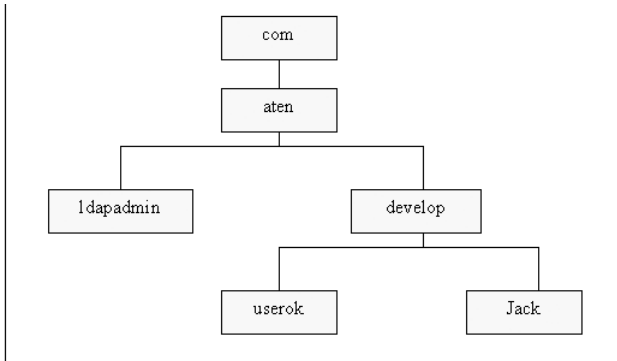

(Continues on next page.)

(Continued from previous page.)

DIT Creation

The LDAP Data Interchange Format (LDIF) is used to represent LDAP entries in a simple text format (please refer to RFC 2849). The figure below illustrates an LDIF file that creates the DIT for the KL9108 / KL9116 directory tree (shown in the figure, above).

```
dn: dc=aten,dc=com
objectclass: top
objectclass: dcObject
objectclass: organization

dn: cn=ldapadmin,dc=aten,dc=com
objectclass: top
objectclass: person
objectclass: organizationalPerson
cn: ldapadmin
sn: ldapadmin
userPassword: password

dn: ou=develop,dc=aten,dc=com
objectclass: top
objectclass: organizationalUnit
ou: develop

dn: cn=user-ldap,ou=develop,dc=aten,dc=com
objectclass: top
objectclass: person
objectclass: organizationalPerson
objectclass: kl2116user
cn: user-ldap
sn: user-ldap
iKV M2116-userProfile: w,j,c
userPassword: password
```

Note: The example above shows the permissions for a Type 1 Schema. For a Type 2 Schema, change the permissions line to su/user. (Where *user* represents the Username of a KL9108 / KL9116 user whose permissions reflect the permissions you want **steve** to have.)

(Continues on next page.)

(Continued from previous page.)

Using the New Schema

To use the new schema, do the following:

1. Save the new schema file (e.g., kn2116.schema) in the /OpenLDAP/schema/ directory.
2. Add the new schema to the slapd.conf file, as shown in the figure, below:

```

ucldata-path  ./ucldata
include       ./schema/core.schema
include       ./schema/cosine.schema
include       ./schema/inetorgperson.schema
include       ./schema/openldap.schema
include       ./schema/kn2116.schema

#Define global ACLs to disable default read access.
    access to dn:children="cu=develop,dc=aten,dc=com"
        by dn="cn=ldapadmin,dc=aten,dc=com" write
        by self read
        by anonymous auth
        by * none

pidfile       ./run/slapd.pid
argsfile      ./run/slapd.args
#####
#BDB database definitions
#####
database      bdb
suffix        "dc=aten,dc=com"
rootdn        "cn=ldapadmin,dc=aten,dc=com"
rootpw        password
directory     ./data
#Indices to maintain
index objectClass eq

```

3. Restart the LDAP server.
4. Write the LDIF file and create the database entries in init.ldif with the *ldapadd* command, as shown in the following example:

```

ldapadd -f init.ldif -x -D "cn=Manager,dc=aten,dc=com"
-w secret

```

Safety Instructions

General

- ◆ This product is for indoor use only.
- ◆ Read all of these instructions. Save them for future reference.
- ◆ Follow all warnings and instructions marked on the device.
- ◆ To prevent damage to your installation it is important that all devices are properly grounded.
- ◆ Do not place the device on any unstable surface (cart, stand, table, etc.). If the device falls, serious damage will result.
- ◆ Do not use the device near water.
- ◆ Do not place the device near, or over, radiators or heat registers.
- ◆ The device cabinet is provided with slots and openings to allow for adequate ventilation. To ensure reliable operation, and to protect against overheating, these openings must never be blocked or covered.
- ◆ The device should never be placed on a soft surface (bed, sofa, rug, etc.) as this will block its ventilation openings. Likewise, the device should not be placed in a built in enclosure unless adequate ventilation has been provided.
- ◆ Never spill liquid of any kind on the device.
- ◆ Unplug the device from the wall outlet before cleaning. Do not use liquid or aerosol cleaners. Use a damp cloth for cleaning.
- ◆ The device should be operated from the type of power source indicated on the marking label. If you are not sure of the type of power available, consult your dealer or local power company.
- ◆ The device is designed for IT power distribution systems with 230V phase-to-phase voltage.
- ◆ The device is equipped with a 3-wire grounding type plug. This is a safety feature. If you are unable to insert the plug into the outlet, contact your electrician to replace your obsolete outlet. Do not attempt to defeat the purpose of the grounding-type plug. Always follow your local/national wiring codes.
- ◆ Do not allow anything to rest on the power cord or cables. Route the power cord and cables so that they cannot be stepped on or tripped over.

- ◆ If an extension cord is used with this device make sure that the total of the ampere ratings of all products used on this cord does not exceed the extension cord ampere rating. Make sure that the total of all products plugged into the wall outlet does not exceed 15 amperes.
- ◆ To help protect your system from sudden, transient increases and decreases in electrical power, use a surge suppressor, line conditioner, or uninterruptible power supply (UPS).
- ◆ Position system cables and power cables carefully; Be sure that nothing rests on any cables.
- ◆ Never push objects of any kind into or through cabinet slots. They may touch dangerous voltage points or short out parts resulting in a risk of fire or electrical shock.
- ◆ Do not attempt to service the device yourself. Refer all servicing to qualified service personnel.
- ◆ If the following conditions occur, unplug the device from the wall outlet and bring it to qualified service personnel for repair.
 - ◆ The power cord or plug has become damaged or frayed.
 - ◆ Liquid has been spilled into the device.
 - ◆ The device has been exposed to rain or water.
 - ◆ The device has been dropped, or the cabinet has been damaged.
 - ◆ The device exhibits a distinct change in performance, indicating a need for service.
 - ◆ The device does not operate normally when the operating instructions are followed.
- ◆ Only adjust those controls that are covered in the operating instructions. Improper adjustment of other controls may result in damage that will require extensive work by a qualified technician to repair.

Rack Mounting

- ◆ Before working on the rack, make sure that the stabilizers are secured to the rack, extended to the floor, and that the full weight of the rack rests on the floor. Install front and side stabilizers on a single rack or front stabilizers for joined multiple racks before working on the rack.
- ◆ Always load the rack from the bottom up, and load the heaviest item in the rack first.
- ◆ Make sure that the rack is level and stable before extending a device from the rack.
- ◆ Use caution when pressing the device rail release latches and sliding a device into or out of a rack; the slide rails can pinch your fingers.
- ◆ After a device is inserted into the rack, carefully extend the rail into a locking position, and then slide the device into the rack.
- ◆ Do not overload the AC supply branch circuit that provides power to the rack. The total rack load should not exceed 80 percent of the branch circuit rating.
- ◆ Ensure that proper airflow is provided to devices in the rack.
- ◆ Do not step on or stand on any device when servicing other devices in a rack.

Consignes de sécurité

Général

- ♦ Ce produit est destiné exclusivement à une utilisation à l'intérieur.
- ♦ Veuillez lire la totalité de ces instructions. Conservez-les afin de pouvoir vous y référer ultérieurement.
- ♦ Respectez l'ensemble des avertissements et instructions inscrits sur l'appareil.
- ♦ Ne placez jamais l'unité sur une surface instable (chariot, pied, table, etc.). Si l'unité venait à tomber, elle serait gravement endommagée.
- ♦ N'utilisez pas l'unité à proximité de l'eau.
- ♦ Ne placez pas l'unité à proximité de ou sur des radiateurs ou bouches de chaleur.
- ♦ Le boîtier de l'unité est doté de fentes et d'ouvertures destinées à assurer une ventilation adéquate. Pour garantir un fonctionnement fiable et protéger l'unité contre les surchauffes, ces ouvertures ne doivent jamais être bloquées ou couvertes.
- ♦ L'unité ne doit jamais être placée sur une surface molle (lit, canapé, tapis, etc.) car ses ouvertures de ventilation se trouveraient bloquées. De même, l'unité ne doit pas être placée dans un meuble fermé à moins qu'une ventilation adaptée ne soit assurée.
- ♦ Ne renversez jamais de liquides de quelque sorte que ce soit sur l'unité.
- ♦ Débranchez l'unité de la prise murale avant de la nettoyer. N'utilisez pas de produits de nettoyage liquide ou sous forme d'aérosol. Utilisez un chiffon humide pour le nettoyage de l'unité.
- ♦ L'appareil doit être alimenté par le type de source indiqué sur l'étiquette. Si vous n'êtes pas sûr du type d'alimentation disponible, consultez votre revendeur ou le fournisseur local d'électricité.
- ♦ Afin de ne pas endommager votre installation, vérifiez que tous les périphériques sont correctement mis à la terre.
- ♦ L'unité est équipée d'une fiche de terre à trois fils. Il s'agit d'une fonction de sécurité. Si vous ne parvenez pas à insérer la fiche dans la prise murale, contactez votre électricien afin qu'il remplace cette dernière qui doit être obsolète. N'essayez pas d'aller à l'encontre de l'objectif de la fiche de terre. Respectez toujours les codes de câblage en vigueur dans votre région/pays.

-
- ◆ L'équipement doit être installé à proximité de la prise murale et le dispositif de déconnexion (prise de courant femelle) doit être facile d'accès.
 - ◆ La prise murale doit être installée à proximité de l'équipement et doit être facile d'accès.
 - ◆ Veillez à ce que rien ne repose sur le cordon d'alimentation ou les câbles. Acheminez le cordon d'alimentation et les câbles de sorte que personne ne puisse marcher ou trébucher dessus.
 - ◆ En cas d'utilisation d'une rallonge avec cette unité, assurez-vous que le total des ampérages de tous les produits utilisés sur cette rallonge ne dépasse pas l'ampérage nominal de cette dernière. Assurez-vous que le total des ampérages de tous les produits branchés sur la prise murale ne dépasse pas 15 ampères.
 - ◆ Pour contribuer à protéger votre système contre les augmentations et diminutions soudaines et transitoires de puissance électrique, utilisez un parasurtenseur, un filtre de ligne ou un système d'alimentation sans coupure (UPS).
 - ◆ Placez les câbles du système et les câbles d'alimentation avec précaution ; veillez à ce que rien ne repose sur aucun des câbles.
 - ◆ Lors du branchement ou du débranchement à des blocs d'alimentation permettant la connexion à chaud, veuillez respecter les lignes directrices suivantes:
 - ◆ Installez le bloc d'alimentation avant de brancher le câble d'alimentation à celui-ci.
 - ◆ Débranchez le câble d'alimentation avant de retirer le bloc d'alimentation.
 - ◆ Si le système présente plusieurs sources d'alimentation, déconnectez le système de l'alimentation en débranchant tous les câbles d'alimentation des blocs d'alimentation.
 - ◆ N'insérez jamais d'objets de quelque sorte que ce soit dans ou à travers les fentes du boîtier. Ils pourraient entrer en contact avec des points de tension dangereuse ou court-circuiter des pièces, entraînant ainsi un risque d'incendie ou de choc électrique.
 - ◆ N'essayez pas de réparer l'unité vous-même. Confiez toute opération de réparation à du personnel qualifié.
 - ◆ Si les conditions suivantes se produisent, débranchez l'unité de la prise murale et amenez-la à un technicien qualifié pour la faire réparer:
 - ◆ Le cordon d'alimentation ou la fiche ont été endommagés ou éraillés.
 - ◆ Du liquide a été renversé dans l'unité.
-

- ◆ L'unité a été exposée à la pluie ou à l'eau.
- ◆ L'unité est tombée ou le boîtier a été endommagé.
- ◆ Les performances de l'unité sont visiblement altérées, ce qui indique la nécessité d'une réparation.
- ◆ L'unité ne fonctionne pas normalement bien que les instructions d'utilisation soient respectées.
- ◆ N'utilisez que les commandes qui sont abordées dans le mode d'emploi. Le réglage incorrect d'autres commandes peut être à l'origine de dommages qui nécessiteront beaucoup de travail pour qu'un technicien qualifié puisse réparer l'unité.

Montage sur bâti

- ◆ Avant de travailler sur le bâti, assurez-vous que les stabilisateurs sont bien fixés sur le bâti, qu'ils sont étendus au sol et que tout le poids du bâti repose sur le sol. Installez les stabilisateurs avant et latéraux sur un même bâti ou bien les stabilisateurs avant si plusieurs bâtis sont réunis, avant de travailler sur le bâti.
- ◆ Chargez toujours le bâti de bas en haut et chargez l'élément le plus lourd en premier.
- ◆ Assurez-vous que le bâti est à niveau et qu'il est stable avant de sortir une unité du bâti.
- ◆ Agissez avec précaution lorsque vous appuyez sur les loquets de libération du rail d'unité et lorsque vous faites coulisser une unité dans et hors d'un bâti ; vous pourriez vous pincer les doigts dans les rails.
- ◆ Une fois qu'une unité a été insérée dans le bâti, étendez avec précaution le rail dans une position de verrouillage puis faites glisser l'unité dans le bâti.
- ◆ Ne surchargez pas le circuit de l'alimentation CA qui alimente le bâti. La charge totale du bâti ne doit pas dépasser 80 % de la capacité du circuit.
- ◆ Assurez-vous que tous les équipements utilisés sur le bâti, y-compris les multiprises et autres connecteurs électriques, sont correctement mis à la terre.
- ◆ Assurez-vous que les unités présentes dans le bâti bénéficie d'une circulation d'air suffisante.
- ◆ Assurez-vous que la température ambiante de fonctionnement de l'environnement du bâti ne dépasse pas la température ambiante maximale spécifiée pour l'équipement par le fabricant.
- ◆ Ne marchez sur aucun appareil lors de la maintenance d'autres appareils d'un bâti.
- ◆ **Attention:** Glisser / rail (LCD KVM) monté l'équipement ne doit pas être utilisé comme une étagère ou un espace de travail.

Technical Support

Technical support is available both by email and online (with a browser over the web):

International

- ◆ For online technical support – including troubleshooting, documentation, and software updates: **<http://eservice.aten.com>**
- ◆ For telephone support, see *Telephone Support*, page iii

North America

Email Support		support@aten-usa.com
Online Technical Support	Troubleshooting Documentation Software Updates	http://www.aten-usa.com/support
Telephone Support		1-888-999-ATEN ext 4988

When you contact us, please have the following information ready beforehand:

- ◆ Product model number, serial number, and date of purchase.
- ◆ Your computer configuration, including operating system, revision level, expansion cards, and software.
- ◆ Any error messages displayed at the time the error occurred.
- ◆ The sequence of operations that led up to the error.
- ◆ Any other information you feel may be of help.

Specifications

Function		KL9108	KL9116	
Computer Connections	Direct	8	16	
	Max.	64 (via Cascade)	128 (via Cascade)	
Console Connections	Local	1		
	Remote	1		
Port Selection		OSD, Hotkey, Pushbutton		
Connectors	Console Port	Keyboard	1 x 6-pin Mini-DIN Female (Purple)	
		Video	1 x HDB-15 Female (Blue)	
		Mouse	1 x 6-pin Mini-DIN Female (Green)	
	KVM Port		8 x SPHD-15 Female (Yellow)	16 x SPHD-15 Female (Yellow)
	Power		1 x 3 Prong AC Socket	
	External Mouse		1 x 6-pin Mini-DIN Female (Green)	
	LAN		1 x RJ-45 Female (Black)	
	PON		1 x DB-9 Male (Black)	
	Switches	Reset	1 x Semi-recessed Pushbutton	
Power		1 x Rocker		
Port Selection		2 x Pushbutton		
LCD Power		1 x Pushbutton		
LCM Adjustment		4 x Pushbutton		
LEDs	On Line	8 (Green)	16 (Green)	
	Selected	8 (Orange)	16 (Orange)	
	Power	1 (Blue)		
	Num Lock	1 (Green)		
	Caps Lock	1 (Green)		
	Scroll Lock	1 (Green)		
	Link	1 (Green)		
	10/100 Mbps	1 (Orange/Green)		

(Continues on next page.)

(Continued from previous page.)

Function		KL9108	KL9116
Emulation	Keyboard/Mouse	PS/2	
Video	17" LCD	1280 x 1024 @ 75 Hz; DDC2B	
	Remote	1600 x 1200 @ 60 Hz; DDC2B	
Scan Interval		1–255 Seconds	
I/P Rating		100–240V AC, 50/60 Hz, 1A	
Power Consumption		120V/31W; 230V/39W	
Environment	Operating Temp.	0–40° C	
	Storage Temp.	-20–60° C	
	Humidity	0–80% RH, Non-condensing	
Physical Properties	Housing	Metal	
	Weight	17.10 kg	17.30 kg
	Dimensions (L x W x H)	70.50 x 48.20 x 4.40 cm (19"/1U)	70.50 x 48.20 x 4.40 cm (19"/1U)

OSD Factory Default Settings

The factory default settings are as follows:

Setting	Default
OSD Hotkey	[Scroll Lock] [Scroll Lock]
Port ID Display	Port Number + Name
Port ID Display Duration	5 Seconds
Scan / Skip Mode	All
Scan Duration	10 Seconds
Screen Blanker	0 Minutes (disabled)
Beeper	On
Accessible Ports	F (Full) For all Users on all Ports

Trusted Certificates

Overview

When you try to login to the KL9108 / KL9116 from your Web browser, a Security Alert message appears to inform you that the device's certificate is not trusted, and asks if you want to proceed.

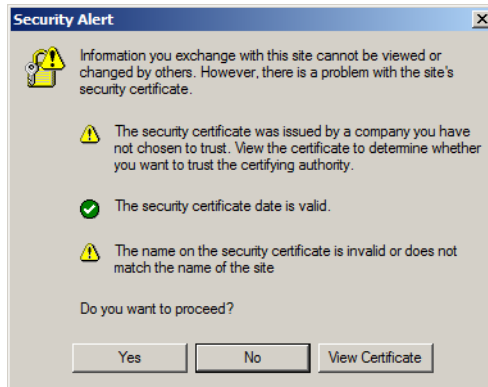

The certificate can be trusted, but the alert is triggered because the certificate's name is not found on Microsoft's list of Trusted Authorities. You have two options: 1) you can ignore the warning and click **Yes** to go on; or 2) you can install the certificate and have it be recognized as trusted.

- ◆ If you are working on a computer at another location, accept the certificate for just this session by clicking **Yes**.
- ◆ If you are working at your own computer, install the certificate on your computer (see below for details). After the certificate is installed, it will be recognized as trusted.

Installing the Certificate

To install the certificate:

1. In the **Security Alert** dialog box, click **View Certificate**. The **Certificate** dialog box appears.

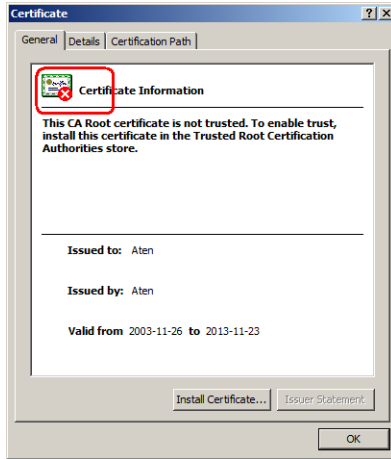

Note: There is a red and white **X** logo over the certificate to indicate that it is not trusted.

2. Click **Install Certificate**.
3. Follow the Installation Wizard to complete the installation. Unless you have a specific reason to choose otherwise, accept the default options. The Wizard presents a caution screen:

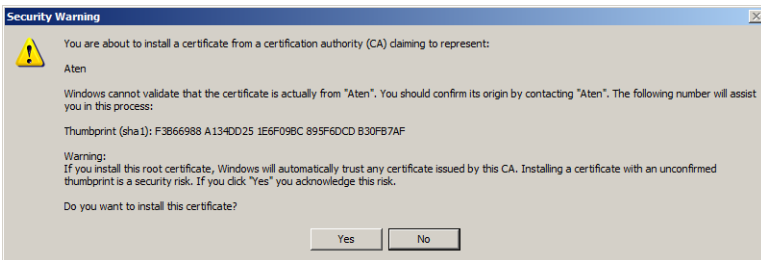

4. Click **Yes**.

5. Click **Finish** to complete the installation.
6. Click **OK** to close the dialog box.

Certificate Trusted

The certificate is now trusted:

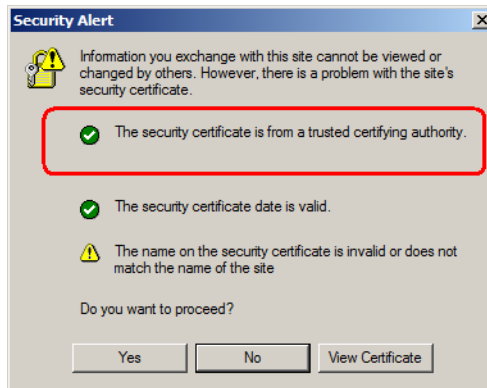

When you click **View Certificate**, you can see that the red and white **X** logo is no longer present – further indication that the certificate is trusted.

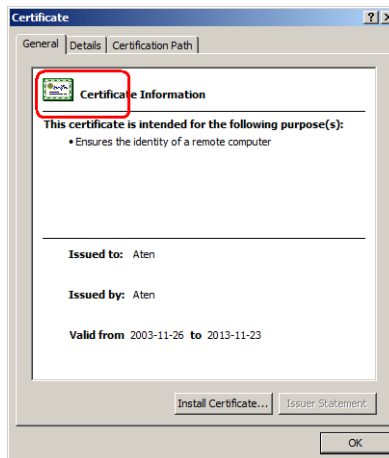

Troubleshooting

Overview

Operation problems can be due to a variety of causes. The first step in solving them is to make sure that all cables are securely attached and seated completely in their sockets.

In addition, updating the product's firmware may solve problems that have been discovered and resolved since the prior version was released. If your product is not running the latest firmware version, we strongly recommend that you upgrade. See *Upgrading the Firmware*, page 61, for upgrade details.

Administration

Problem	Resolution
After upgrading firmware, the KL9108 / KL9116 still appears to be using the old firmware version.	Delete all temporary Internet files and cookies, close the Web browser, and then open a new instance of the Web browser.
After making changes and checking <i>Reset on exit</i> and then logging out, the KL9108 / KL9116 doesn't reset after I exit.	Upgrade your browser to IE 6.0.2800.1106 or higher.
After making changes and checking <i>Reset on exit</i> , when I log back in the calendar changes to an incorrect (much earlier) date.	Log in from a remote console to automatically recover the correct date. If you log in from the local console, go to the Administration page and reset the calendar to the correct date (see page 41 and page 59).

General Operation

Problem	Resolution
Erratic operation	Press and hold the <i>Reset</i> button (see page 9) for at least three seconds.
Mouse and/or keyboard not responding	Unplug the cable(s) from the console port(s), and then plug it back in again.
Sudden loss of network connection	Close your KL9108 / KL9116 connection. Wait approximately 30 seconds, and then log in again.
When logging in from a browser, the following message appears: <i>404 Object Not Found</i> .	Make sure to include the forward slash and correct login string when you specify the KL9108 / KL9116's IP address. (See <i>Default Webpage Name</i> , page 54.)
Two pointers appear when I login from a remote computer.	You can shrink the non-functioning pointer so that it is almost invisible. See <i>Toggle mouse display</i> , page 77, for details.
The OSD display is intermittent when accessing a computer for which the display refresh rate is set to 56Hz.	Press [F6] to blank the background when using the OSD.
I can't set the computers' screen resolutions higher than 1280 x 1024, even though the KL9108 / KL9116 supports 1600 x 1200 for remote computers.	If you wish to set the screen resolutions of the connected computers to something higher than 1280 x 1024, see <i>Screen Resolutions Higher than 1280 x 1024</i> , page 156.
When I switch to one of the computers on my installation, the LCD monitor screen goes blank. All I see is a black screen.	To resolve the problem, connect an external KVM console (with a monitor capable of displaying the problem computer's screen resolution) to the KL9108 / KL9116's external console ports. Use the external console to access the problem computer and reduce its resolution to 1280 x 1024. Note: Although the LCD monitor only supports video resolutions of up to 1280 x 1024, the KL9108 / KL9116, itself can support video resolutions up to 1600 x 1200 @ 60 Hz. If you wish to set the screen resolutions of the connected computers to something higher than 1280 x 1024, see <i>Screen Resolutions Higher than 1280 x 1024</i> , page 156 for details.
When viewing a computer with a high screen resolution from a remote computer, I can't see the entire desktop.	Try to move the pointer up and down, and side to side to expose the parts of the desktop that you can't see. If this doesn't work, toggling the mouse display will allow you to use the computer's own pointer to view the rest of the desktop. See <i>Toggle mouse display</i> , page 77.

The Java Client

For mouse synchronization problems, see *The Message Board Button Bar*, page 99, and *Additional Mouse Synchronization Procedures*, page 158. For connection and operation problems, see the table below:

Problem	Resolution
Java Client won't connect to the KL9108 / KL9116.	<ol style="list-style-type: none"> 1. Java 2 JRE 1.4.2 or higher must be installed on your computer. 2. Make sure to include the forward slash and <i>login string</i> (see <i>Default Webpage Name</i>, page 54) when you specify the KL9108 / KL9116's IP address. 3. Close the Java Client, reopen it, and try again.
Pressing the Windows Menu key has no effect.	Java doesn't support the Windows Menu key.
Java Client performance deteriorates.	Exit the program and start again.
National language characters do not appear.	If the local keyboard is set to a non-English layout, you must set the remote computer's keyboard layout to English.
IP and MAC address filters do not work with the Java Client.	IP and MAC address filters only work with the Windows Client. We recommend using the <i>Default Web page name</i> (see page 53) as a means to enhance the overall security of the KVM switch.

The Log Server

Problem	Resolution
The Log Server program does not run.	<p>The Log Server requires a file provided by Microsoft in order to access the database.</p> <p>This file is automatically installed with Windows ME, 2000, and XP.</p> <p>For Windows 98 and NT you will have to go to the Microsoft download site:</p> <p>http://www.microsoft.com/data/download.htm to retrieve the file:</p> <p>MDAC 2.7 RTM - Refresh (2.70.9001.0)</p> <p>Since this driver is used in Windows Office Suite, an alternate method of obtaining it is to install Windows Office Suite. Once the driver file or Suite has been installed, the Log Server will run.</p>

Panel Array Mode

Problem	Resolution
Low resolution video in Panel Array Mode.	Increase the number of panels that are displayed.
When multiple remote users are logged in concurrently, some of them only receive a partial image.	The first user to invoke Panel Array Mode should set it to display at least 4 panels.

The Windows Client

Problem	Resolution
The Windows Client won't connect to the KL9108 / KL9116.	DirectX 7.0 or higher must be installed on the remote computer.
The remote computer's pointer is out of sync.	<ol style="list-style-type: none"> 1. Use the AutoSync feature (see <i>Video Adjustment</i>, page 78), to sync the local and remote monitors. 2. If that doesn't resolve the problem, use the <i>Adjust Mouse</i> feature (see <i>Adjust mouse</i>, page 77) to bring them back in sync. 3. If the two methods described above fail to resolve the problem, use the <i>Toggle Mouse Display</i> function (see page 77). 4. See <i>Additional Mouse Synchronization Procedures</i>, page 158.
Part of the remote window is off my monitor.	<ol style="list-style-type: none"> 1. If <i>Keep Screen Size</i> (see page 72) is not enabled, use the <i>AutoSync</i> feature (see <i>Video Adjustment</i>, page 78) to synchronize the local and remote monitors. 2. If <i>Keep Screen Size</i> is enabled, you can scroll to the areas that are off the screen. See the note on page 72 for details.
The remote computer's display is rotated 90 degrees.	Enable <i>Keep Screen Size</i> (see page 72).
I cannot run <i>Net Meeting</i> when the Windows Client is running.	Enable <i>Keep Screen Size</i> (see page 72).
When I log in, the browser generates a <i>CA Root certificate is not trusted</i> , or a <i>Certificate Error</i> response.	The certificate's name is not found on Microsoft's list of Trusted Authorities. However, the certificate can be trusted. See <i>Trusted Certificates</i> , page 149, for details.

Sun Systems

Problem	Resolution
Video display problems with HDB-15 interface systems (e.g. Sun Blade 1000 servers).	<p>The display resolution should be set to 1024 x 768 @ 60Hz.</p> <p>Under Text Mode:</p> <ol style="list-style-type: none"> 1. Enter the <code>ok</code> prompt and issue the following firmware commands: <pre>setenv output-device screen:r1024x768x60 reset-all</pre> <p>Under XWindow:</p> <ol style="list-style-type: none"> 1. Open a console and issue the following command: <pre>m64config -res 1024x768x60</pre> 2. Log out. 3. Log in.
Video display problems with 13W3 interface systems (e.g. Sun Ultra servers).*	<p>The display resolution should be set to 1024 x 768 @ 60Hz.</p> <p>Under Text Mode:</p> <ol style="list-style-type: none"> 1. Enter the <code>ok</code> prompt and issue the following firmware commands: <pre>setenv output-device screen:r1024x768x60 reset-all</pre> <p>Under XWindow:</p> <ol style="list-style-type: none"> 1. Open a console and issue the following command: <pre>ffbconfig -res 1024x768x60</pre> 2. Log out. 3. Log in.

* These solutions work for most common Sun VGA cards. If using them fails to resolve the problem, consult the Sun VGA card's manual.

Screen Resolutions Higher than 1280 x 1024

The maximum screen resolution of the KL9108 / KL9116's integrated LCD monitor is 1280 x 1024. In order to protect it from being damaged by resolutions that are beyond its display capability, we recommend that the screen resolutions of the connected computers be set to 1280 x 1024 or lower.

If you wish to display screen resolutions higher than 1280 x 1024, follow the procedure described below to change the computers' screen resolutions and safeguard the KL9108 / KL9116's LCD monitor:

Note: We strongly recommend that you close the KL9108 / KL9116 LCD console before continuing (see *Closing the Console*, page 25.) Using the LCD monitor to view computers that are set to resolutions that exceed its maximum capability can damage it and shorten its life span.

To access computers from the local console when the integrated console is closed, simply connect an external KVM console with a monitor that supports 1600 x 1200 @ 60 Hz to the KL9108 / KL9116's external console ports.

1. From a remote computer, log into the KL9108 / KL9116 and access the computer whose screen resolution you wish to change.
2. Open the computer's *Control Panel* and double-click **Display**. The *Display Properties* dialog box appears.
3. Click the **Settings** tab, and then click **Advanced**.
4. In the dialog box that appears, click the **Monitor** tab.
5. Under *Monitor settings*, click to clear the *Hide modes that this monitor cannot display* check box.
6. Click **Apply**.
7. Click the **Adapter** tab, and then click **List All Modes**. The *List All Modes* dialog box appears.
8. Under *List of valid modes*, select the display mode that you want the computer to use.

Note: The maximum screen resolution and refresh rate that the KL9108 / KL9116 supports for remote computers is 1600 x 1200@60 Hz.

9. Click **OK**, and then click **Apply**. The display mode changes to the one you selected.
10. If the *Monitor Settings* dialog box appears requesting you to confirm the settings change, click **Yes**.
11. After the Monitor Settings dialog box closes, click **OK**.
12. In the Display Properties dialog box, click **OK**.

This completes the procedure. Repeat these steps for any other computer whose screen resolution you wish to change.

Additional Mouse Synchronization Procedures

If the mouse synchronization procedures mentioned in the manual fail to resolve mouse pointer problems for particular computers, try the following:

-
- Note:** 1. These procedures are to be performed on the computers attached to the KL9108 / KL9116's ports - not on the computer you are using to access the KL9108 / KL9116.
2. In order for the local and remote mice to synchronize, you must use the generic mouse driver supplied with the Windows operating system. If you have a third party driver installed - such as one supplied by the mouse manufacturer - you must remove it.
-

Windows:

1. Windows 2000:
 - a) Open the Mouse Properties dialog box (Control Panel → Mouse → Mouse Properties)
 - b) Click the *Motion* tab
 - c) Set the mouse speed to the middle position (6 units in from the left)
 - d) Set the mouse acceleration to *None*

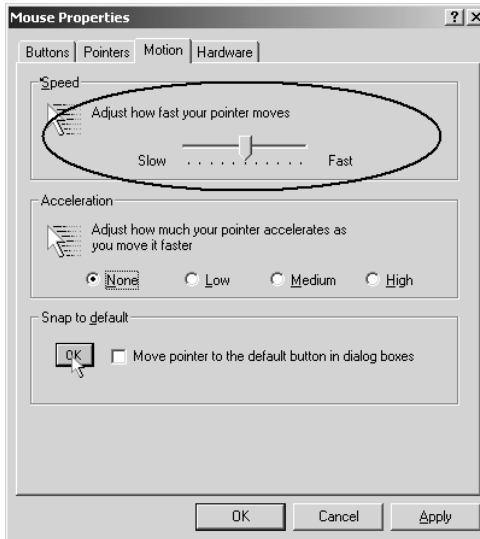

2. Windows XP / Windows Server 2003:

- a) Open the Mouse Properties dialog box (Control Panel → Mouse)
- b) Click the *Pointer Options* tab
- c) Set the mouse speed to the middle position (6 units in from the left)
- d) Disable *Enhance Pointer Precision*

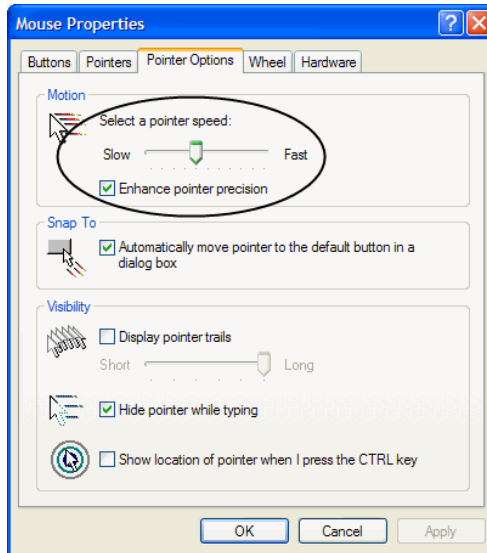

3. Windows ME:

Set the mouse speed to the middle position; disable mouse acceleration (click **Advanced** to get the dialog box for this).

4. Windows NT / Windows 98 / Windows 95:

Set the mouse speed to the slowest position.

Sun / Linux:

Open a terminal session and issue the following command:

Sun: `xset m 1`

Linux: `xset m 0`

Administrator Login Failure

If you are unable to perform an Administrator login (because the Username and Password information has become corrupted, or you have forgotten it, for example), there is a procedure you can use to clear the login information.

Note: Performing this procedure also returns all settings to their defaults.

To clear the login information (and return all settings to their defaults), do the following:

1. Power off the KL9108 / KL9116 and remove the power cord from the power socket.
2. Remove the cover from the KL9108 / KL9116.
3. Using a jumper cap, short the jumper labeled J18 on the mainboard.

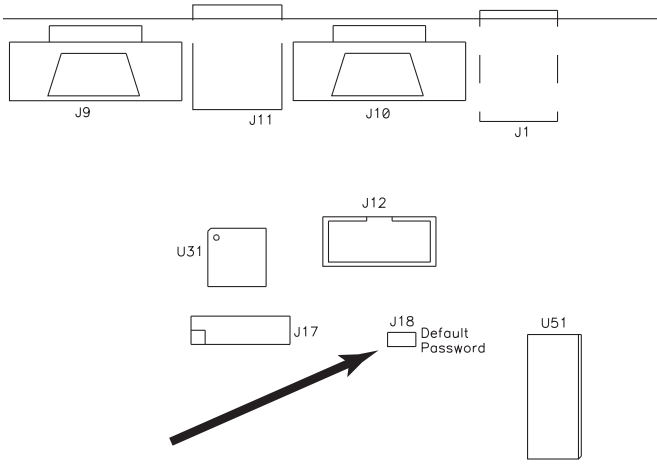

4. Replace the power cord and power on the KL9108 / KL9116.
5. When the front panel LEDs flash, power off the KL9108 / KL9116 and remove the power cord from the power socket again.
6. Remove the jumper cap from the jumper.
7. Replace the cover on the switch. Replace the power cord and power on the KVM switch.
8. After powering on the unit, you can use the default Username and Password (see page 31) to log in.

Optional Rack Mounting

For convenience and flexibility, three optional rack mounting kits are available as shown in the following table:

KVM Model	Bracket Type	Size (cm)
KL9108 / KL9116	Standard Installation – Long	68.0–105.0
	Easy Installation – Short	57.0–70.0
	Easy Installation – Long	68.0–105.0

To install the long bracket standard rack mount kit, simply replace the short L brackets on the standard rack mount kit with the long ones, and mount the switch according to the instructions given for *Standard Rack Mounting*, page 14.

While it takes two people to perform a standard installation, with an *Easy-Installation* kit, one person can mount the switch. To install the *Easy-Installation* kit, do the following:

1. Remove the standard L brackets and the side mounting brackets from both sides of the switch.

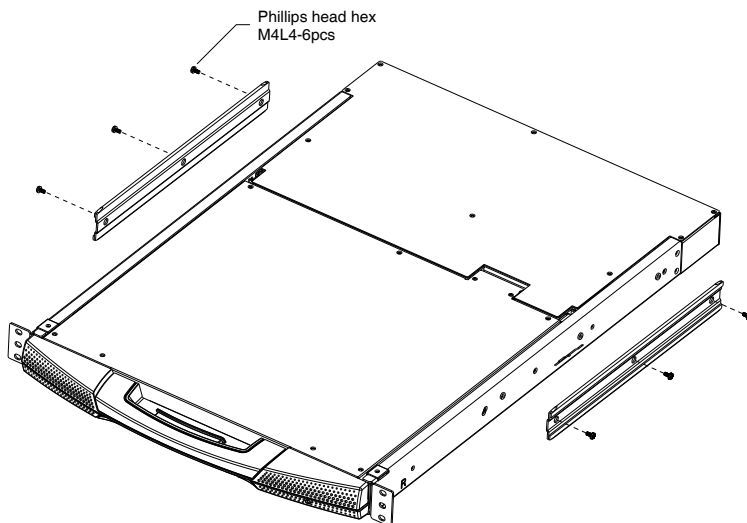

2. Attach the left and right *easy-installation* mounting rails to the inside of the rack. The flange that supports the switch will be to the inside.

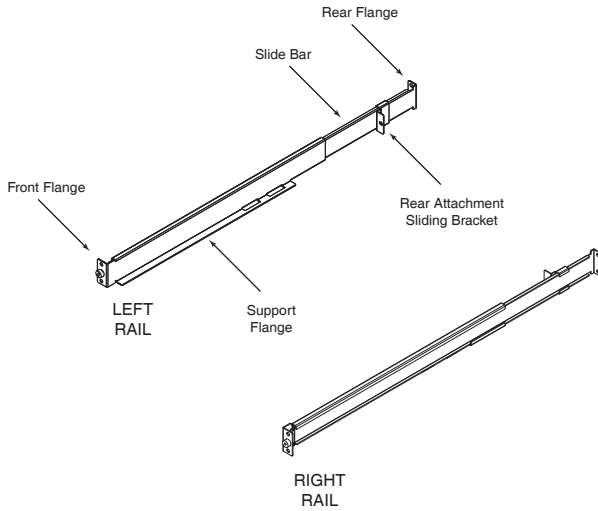

- a) Screw the front flanges to the rack first.
- b) Slide the bars with the rear flanges toward the rack until the flanges make contact with the rack, then screw the rear flanges to the rack.

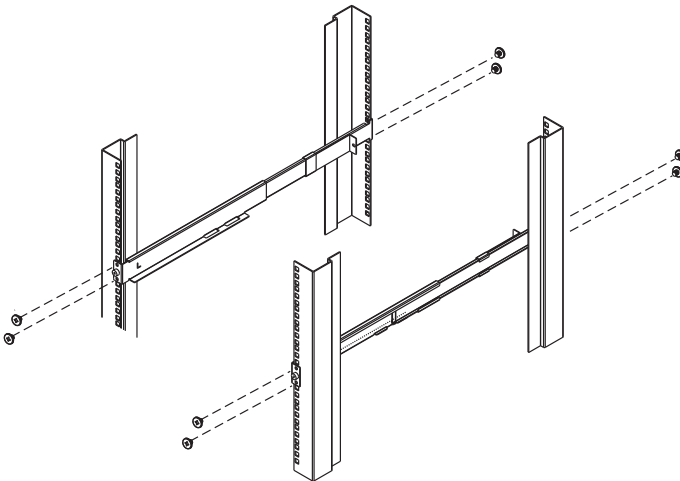

- Slide the switch onto the support flanges. Use the screws supplied with this package to loosely attach the front of the switch to the front of the rack (only tighten the screws part way).

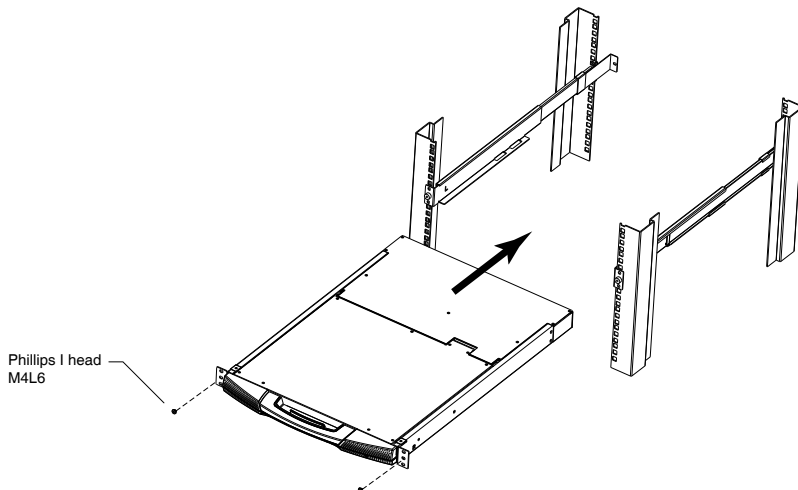

- Slide the rear attachment sliding brackets along the slide bars until they contact the rear of the switch, then use the screws supplied with this package to attach the bars to the rear of the switch (tighten the screws all the way).

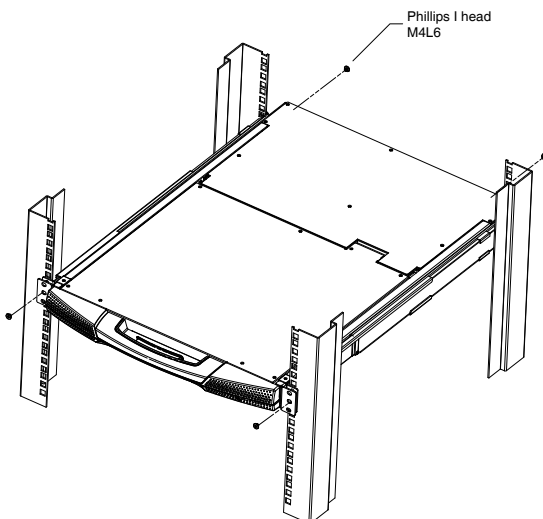

5. Slide the switch open and closed a couple of times to be sure that it is properly aligned and operating smoothly. (See *Opening the Console*, page 21 for opening and closing procedures.)
6. After determining that the switch is properly lined up and operating correctly, finish up by fully tightening down the partially tightened front attachment screws inserted in Step 3.

Dedicated Invocation Keys

Two dedicated keys (below) are provided on the keyboard module to make it easy to invoke the OSD and the OSD Toolbar:



Note: These keys are toggles. Press once to invoke the feature, press again to exit.

- ♦ The KVM OSD Key invokes the OSD See *The Local Console*, page 31, for details.
- ♦ The KVM Hotkey Key opens the OSD Toolbar, which allows you to control the KL9108 / KL9116 from within the captured port. See *The OSD Toolbar*, page 85, for details.

About SPHD Connectors



This product uses SPHD connectors for its KVM and/or Console ports. We have specifically modified the shape of these connectors so that only KVM cables that we have designed to work with this product can be connected.

Supported KVM Switches

The following is a list of supported KVM switches that can be cascaded from the KL9108 / KL9116.

- ◆ KH88
- ◆ KH98
- ◆ CS88A
- ◆ CS138A
- ◆ CS9134
- ◆ CS9138

Note: The KL9108 / KL9116 OSD port list does not display ports on cascaded KVM switches. After accessing a cascaded switch, invoke its OSD to manage its ports.

Limited Warranty

ATEN warrants this product against defects in material or workmanship for a period of one (1) year from the date of purchase. If this product proves to be defective, contact ATEN's support department for repair or replacement of your unit. ATEN will not issue a refund. Return requests can not be processed without the original proof of purchase.

When returning the product, you must ship the product in its original packaging or packaging that gives an equal degree of protection. Include your proof of purchase in the packaging and the RMA number clearly marked on the outside of the package.

This warranty becomes invalid if the factory-supplied serial number has been removed or altered on the product.

This warranty does not cover cosmetic damage or damage due to acts of God, accident, misuse, abuse, negligence or modification of any part of the product. This warranty does not cover damage due to improper operation or maintenance, connection to improper equipment, or attempted repair by anyone other than ATEN. This warranty does not cover products sold AS IS or WITH FAULTS.

IN NO EVENT SHALL ATEN'S LIABILITY EXCEED THE PRICE PAID FOR THE PRODUCT. FURTHER, ATEN SHALL NOT BE RESPONSIBLE FOR DIRECT, INDIRECT, SPECIAL, INCIDENTAL OR CONSEQUENTIAL DAMAGES RESULTING FROM THE USE OF THE PRODUCT, ITS ACCOMPANYING SOFTWARE, OR ITS DOCUMENTATION. ATEN SHALL NOT IN ANY WAY BE RESPONSIBLE FOR, WITHOUT LIMITATION, LOSS OF DATA, LOSS OF PROFITS, DOWNTIME, GOODWILL, DAMAGE OR REPLACEMENT OF EQUIPMENT OR PROPERTY, AND ANY EXPENSES FROM RECOVERY, PROGRAMMING, AND REPRODUCTION OF ANY PROGRAM OR DATA.

ATEN makes no warranty or representation, expressed, implied, or statutory with respect to its products, contents or use of this documentation and all accompanying software, and specifically disclaims its quality, performance, merchantability, or fitness for any particular purpose.

ATEN reserves the right to revise or update its product, software or documentation without obligation to notify any individual or entity of such revisions, or update.

For details about extended warranties, please contact one of our dedicated value added resellers.