

# DISC PAD BUYERS GUIDE

## FA11 48 x 9mm

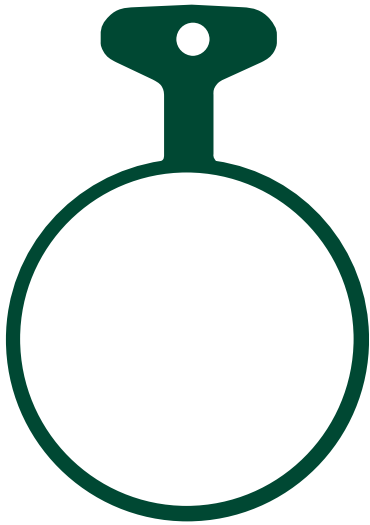

### YAMAHA

RD 250 A/B/C	75-77	F
RD 250 D	77	F & R
RD 350 A/B	74-76	F
XS 360 B	75	F
RD 400 C/D	76-77	F & R
TX/XS 500 B	75-77	F
XS 650	75	F

### ISR CALIPERS

22-023-0A (2 Piston)	F
22-026-0A (Sprocker Caliper)	F

### Competitor X Ref

Dunlop	Ferodo	SBS	Vesrah
DP400	FDB157	504	VD-201

### Equivalents OE #

1A1 W0045 00	306 25811 06
306 25811 04	409 W0045 00
306 25811 05	409 25811 01

### MATERIAL AVAILABILITY AND PART NO.

STD	OPTIONS			
FA	HH	R	MXS	GFA
FA11	-	-	-	-

## FA12 50 x 13/20mm

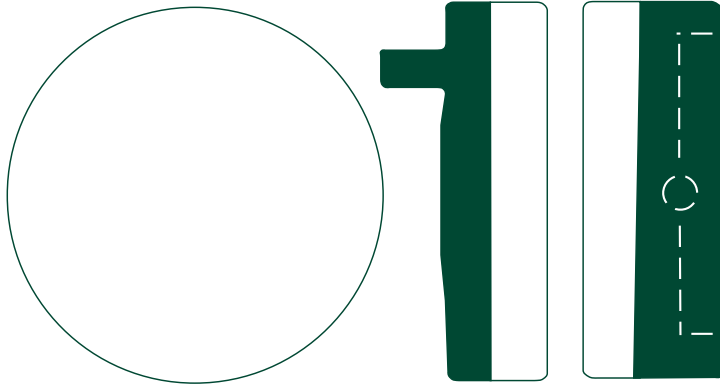

### HONDA

CB 750 K0-K6	69-77	F
--------------	-------	---

### Equivalents OE #

45105 300 040 A	45106 341 000 B
45105 341 000 A	45106 341 003 B
45105 341 003 A	45106 300 004 B

### Competitor X Ref

Dunlop	Ferodo	SBS	Vesrah
-	-	502	VD-101

### MATERIAL AVAILABILITY AND PART NO.

STD	OPTIONS			
FA	HH	R	MXS	GFA
FA12	-	-	-	-

## FA13 52 x 13/20mm

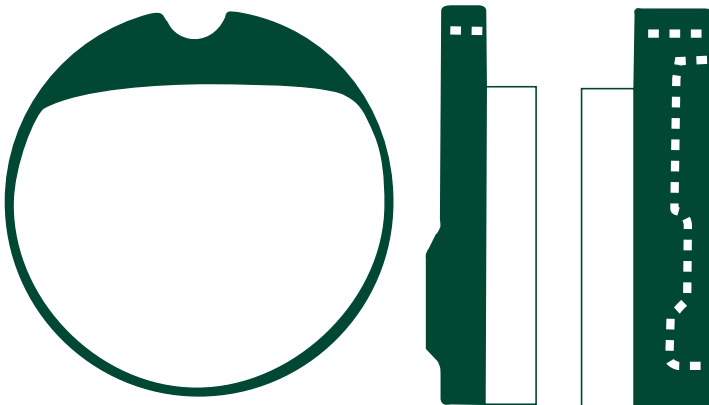

### HONDA

CB 250 G5	75	F
CJ 250 T	77	F
CB 360 G5	75	F
CJ 360 T	78	F
CB 400 F/F1/F2	75-79	F
CB 500 T	75-77	F
CB 500 K1/K2/F	75-77	F
CB 550 F/F1/F2/F3	78-80	F
CB 750 F/F1	76-77	F
CB 750 K7	78	F

### Competitor X Ref

Dunlop	Ferodo	SBS	Vesrah
-	FDB119	501	VD102-106

### Equivalents OE #

45102 393 700	45105 323 043 A	45106 323 036 B
45105 323 006 A	45105 390 003 A	45106 323 043 B
45105 323 013 A	45105 390 006 A	45106 390 003 B
45105 323 023 A	45106 323 013 B	
45105 323 036 A	45106 323 023 B	

### MATERIAL AVAILABILITY AND PART NO.

STD	OPTIONS			
FA	HH	R	MXS	GFA
FA13	-	-	-	-

# FA16 59.7 x 51.6 x 10mm

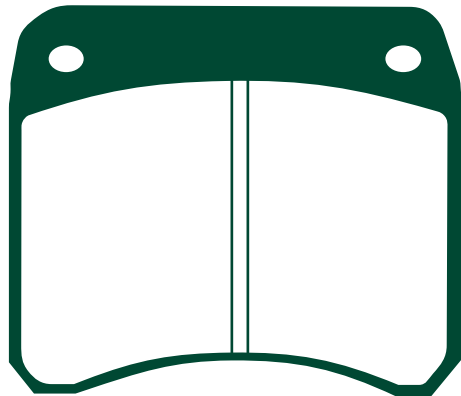

## DUCATI

750 Sport 74 F

## ISR CALIPERS

22-030 (2 piston rear) F

22-033 (2 piston HD) F

## LOCKHEED

2 Piston Caliper

## TRIUMPH

Bonneville 750 Twin (Lockheed caliper) -84 F&R

Equivalents OE # N/A

### Competitor X Ref

Dunlop	Ferodo	SBS	Vesrah
DP500	FDB342R	698	VD-906

MATERIAL AVAILABILITY AND PART NO.				
STD	OPTIONS			
FA	HH	R	MXS	GFA
FA16	FA16HH	-	-	GFA16HH
FA16'S' (Green)				

# FA18 55.7 x 55 x 9mm

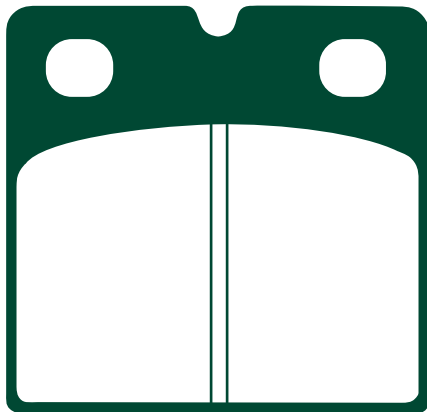

### Equivalents OE #

34 11 1 451 995	14654601
34 11 1 454 724	14654650
34 11 1 458 388	0795 39 856
34 1 2 301 360	0979 39 856
34 21 7 657 025	0960 39 656
34 21 1 236 221	61654630
34 21 2 332 988	

### Competitor X Ref

Dunlop	Ferodo	SBS	Vesrah
DP600	FDB108/148	506	VD-907

MATERIAL AVAILABILITY AND PART NO.				
STD	OPTIONS			
FA	HH	R	MXS	GFA
FA18	FA18HH	-	-	-

### BENELLI

354 -82 R  
 K 75/75-S 75- F  
 900 SEi (6 cyl) 83 F

### BIMOTA

All early models -83 F & R

### BMW

K 75/75-S 84-90 F  
 K 75/75-S 08/90-96 R  
 K 75 C 85-08/88 F  
 K 75 RT 89-96 R  
 K 75 S 85-09/88 F&R  
 K 75 S 09/88-95 R  
 K 75 S 85-09/88 F&R  
 K 75 S 09/88-85 R  
 K 1000 82-09/88 F&R  
 K 100/2 87-08/88 F&R  
 K 100/2 09/88-90 R  
 K 100/2 87-08/88 F&R  
 K 100/2 09/88-90 R  
 K 100 LT 86-08/88 F&R  
 K 100 LT 09/88-91 R  
 K 100 LT 86/08-88 F&R  
 K 100 LT 09/88-91 R  
 K 100 RS 83-09/88 F&R  
 K 100 RS 10/88-89 R  
 K 100 RS 83-09/88 F&R  
 K 100 RS 10/88-89 R  
 K 100 RS 83-09/88 F&R  
 K 100 RT 83-09/88 F&R  
 K 100 RT 10/88-89 R  
 K 100 RT 83-09/88 F&R  
 K 100 RT 10/88-89 R  
 K 100 RT 83-09/88 F&R  
 K 100 RT 10/88-89 R  
 K 100 RS 89-92 R  
 K 100 RS 89-92 R  
 K 100 RS 88-93 R  
 K1 89-07/93 R  
 KL 1100 LT 89-07/93 R  
 KL 1100 LT 08/93-99 R

### BMW Contd.

KL 1100 LT 08/93-99 R  
 K 1100 RS 92-96 R  
 K 1100 RS 92-96 R  
 K 1200 RS 96-00 R  
 K 1200 RS 01-04 R  
 K 1200 GT 03-06 R  
 R 45/45N 78-85 F  
 R 65 07/88-92 F  
 R 65 T (Brembo Caliper) 80-85 F  
 R 65 LS (Brembo Caliper) 81-85 F  
 R 65 GS 87-92 F  
 R 65 RT 85-88 F  
 R 80 RT 82-84 F  
 R 80/R 80 RT 84-08/88 F  
 R 80 GS 80-87 F  
 R 80 ST 82-84 F  
 R 80 TIC 09/80-85 F  
 R 100/7T 09/80-84 F  
 R 100 S 09/80-84 F&R  
 R 100 RS 10/80-84 F&R  
 R 100 RS 86-08/88 F  
 R 100 RT 10/80-84 F&R  
 R 100 RT 87-08/88 F  
 R 100 RS 92-01 R

### DUCATI

250/350/450 Desmo -76 F  
 600 Pantah 81 F&R  
 650 Pantah -84 F&R  
 750 SS 75-76 F&R  
 751 F1 98 F&R  
 750 Paso 87-90 F  
 750 Sport 88-90 F&R  
 860 GT/GTS 75-76 F&R  
 900 GTS 75-76 F&R  
 900 SS Darmah 76-78 F&R  
 900 Hailwood Replica 79 F&R  
 906 Paso 88-89 F&R

### DUCATI Contd.

1000 R1 Hailwood Replica 84 F&R  
**HOREX**  
 HRD 600 85 F & R  
 500/600 Columbus 88- F & R  
**LAVERDA**  
 750 SF2 74 F  
 750 SFC 74 F&R  
 750 SF3 76-77 F&R  
 1000 3C 74-75 F&R  
 1000 3CL 76-78 F&R  
 1000 3CL Jarama/Jota 79-81 F&R  
 1000 RGS 82 F&R  
 1000 RGA/RGS Exec 83 F&R  
 1000 RGS Corsa 84 R  
 1000 SFC 85-86 F&R  
**MOTO GUZZI**  
 850 All models 75- F & R  
 1000 Spada 78-94 F  
 Le Mans 1000 92-94 F & R  
 1000 S/SE 92-93 F & R  
 California/LAPD/Classic 92-95 F & R  
 California 1100 Carb/Injection 94-97 F & R

### MZ

ETZ 125/150/250/300 85-92 F  
 Saxon 125/251/301/500 93-97 F  
 Saxon 150 95 F  
 Saxon Tour 251/301 93-98 F  
 251 Fun 95-96 F  
 Saxon 500 All models 93-98 F

### TRIUMPH

Bonneville 750 Twin (Brembo caliper) 85-86 F&R

# FA21 47 x 16.2mm

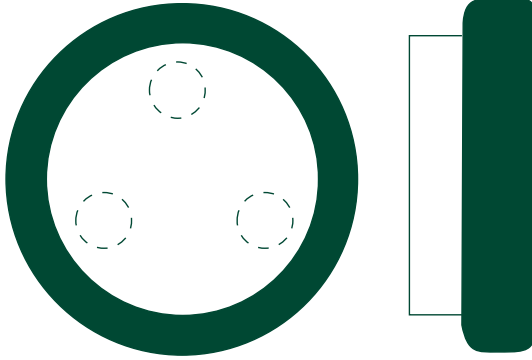

## YAMAHA

YFM 200 N/DXW/DX/DXA	85-90	R
YTM 200 EL/DX	89	R
YTM 225 DRN	85	R
YFM 225 S/T/U	86-89	R
YFM 250 W/A/B	90-92	R
YFM 350 FWT/FWU/FWW/FWA		
FWB/FWD/FWE/FWF/		
FWG "Big Bear"	87-95	R
YFM 350 ERD/ERE/ERF/ERG	92-95	R

MATERIAL AVAILABILITY AND PART NO.				
STD	OPTIONS			
FA	HH	R	MXS	GFA
FA21	-	FA21R	-	-

### Equivalents OE #

<u>Competitor X Ref</u>	<u>Dunlop</u>	<u>Ferodo</u>	<u>SBS</u>	<u>Vesrah</u>	2HR W0045 00	5V6 W0045 01
	-	-	576	VD234	5V6 W0045 00	

# FA22 71.8 x 35mm

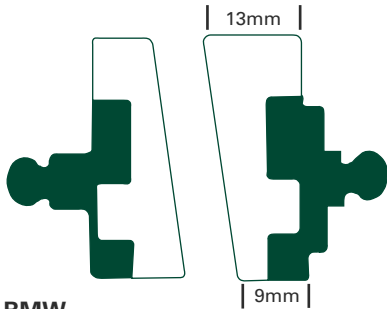

**Note: 1 pad left  
1 pad right  
Tapered finish**

## BMW

R 60/7	76-80	F
R 60 TIC	78-82	F
R 75/6/75/7	73-79	F
R 80	77-84	F
R 80 TIC	78-08/80	F
R 90 S	73-76	F
R 90/6	73-76	F
R 100	76-77	F
R 100/TT	77-09/80	F
R 100 S	76/08/80	F
R 100 RS	76-09/80	F
R 100 RT	78-09/80	F

## Competitor X Ref

<u>Dunlop</u>	<u>Ferodo</u>	<u>SBS</u>	<u>Vesrah</u>
-	FDB155	520	VD910

### Equivalents OE #

34 11 2 301 358	34 11 1 233 319
-----------------	-----------------

MATERIAL AVAILABILITY AND PART NO.				
STD	OPTIONS			
FA	HH	R	MXS	GFA
FA22	-	-	-	-

# FA24/2 113.8 x 66.8 x 7mm

## HARLEY DAVIDSON

FX/FXE/FXEF/FXWG/FXS	73-83	R
FL/FLH	72-84	F
FL/FLH	72-80	R

**(BANANA CALIPER)**

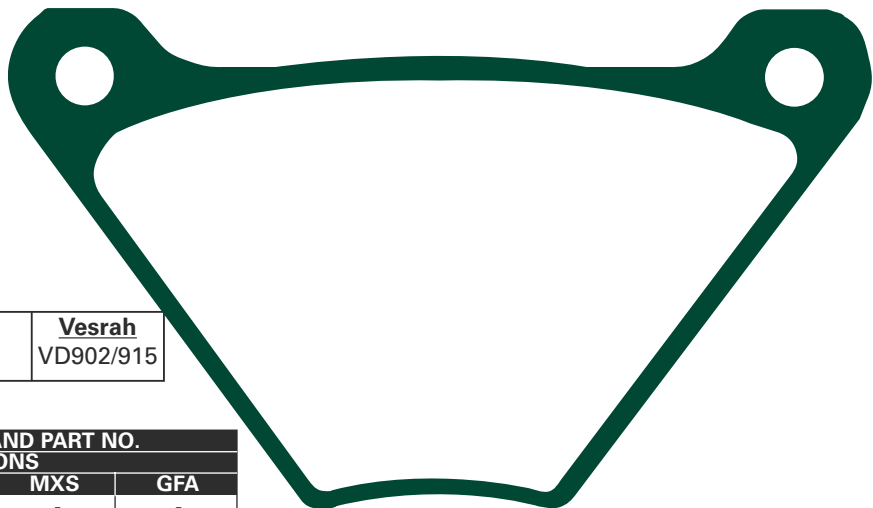

### Equivalents OE #

44005 74
44135 74

### Competitor X Ref

<u>Dunlop</u>	<u>Ferodo</u>	<u>SBS</u>	<u>Vesrah</u>
DP906	FDB185/R	513	VD902/915

MATERIAL AVAILABILITY AND PART NO.				
STD	OPTIONS			
FA	HH	R	MXS	GFA
FA24/2	-	-	-	-

# FA26 78 x 52.5 x 6.3mm

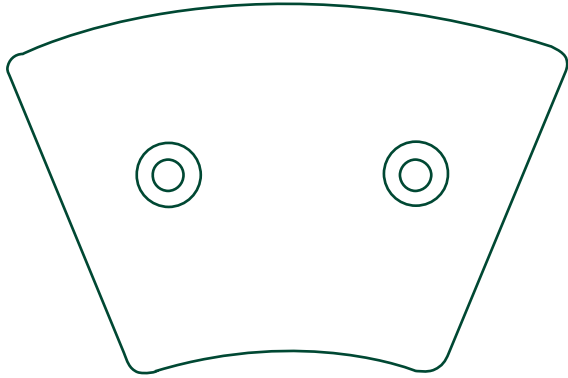

**COMPLETE WITH  
TWO RIVETS**

## HARLEY DAVIDSON

FX, FXE, FXEF, FXWG, FXS 73-77 F  
XL, XLH, XLCH, XLS, XLX 73-77 F

### Equivalents OE #

--

### Competitor X Ref

Dunlop	Ferodo	SBS	Vesrah
-	-	679	VD901

MATERIAL AVAILABILITY AND PART NO.				
STD	OPTIONS			
FA	HH	R	MXS	GFA
FA26	-	-	-	-

# FA27 44.4 x 55.4 x 9.5mm



## NORTON

Commando Mk3 71-75 F & R

### Equivalents OE #

06 6005	06 6186
06 1894	

### Competitor X Ref

Dunlop	Ferodo	SBS	Vesrah
-	FDB88	505	VD904

MATERIAL AVAILABILITY AND PART NO.				
STD	OPTIONS			
FA	HH	R	MXS	GFA
FA27	-	-	-	-

# FA28 45.3 x 12/15.5mm

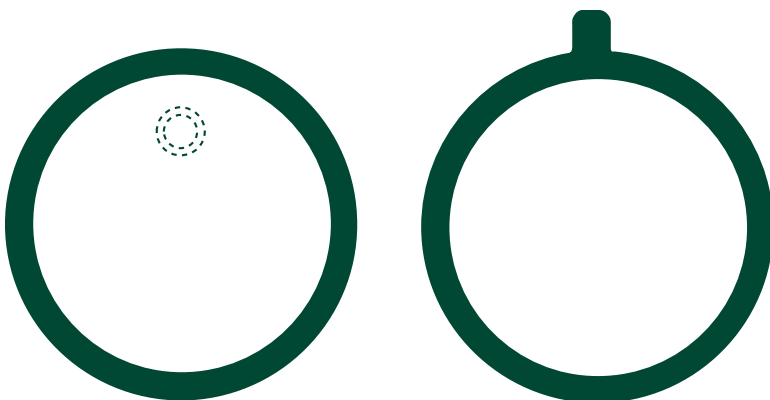

## YAMAHA

FSIE DX 77-79 F  
RD 50 M 78 F  
RS 100 DX 77-80 F  
RD 125 DX 75-77 F  
RS 125 DX 76-80 F  
RD 200 DX 75-78 F

### Competitor X Ref

Dunlop	Ferodo	SBS	Vesrah
-	-	500	VD202/203

### Equivalents OE #

1V1 W0045 00	404 W0045 12
404 2000 11	464 20000 11
404 2000 12	464 20000 12

MATERIAL AVAILABILITY AND PART NO.				
STD	OPTIONS			
FA	HH	R	MXS	GFA
FA28	-	-	-	-

# FA29 67 x 49.2 x 11mm

# FA30 67 x 49.2 x 10mm

# FA31 67 x 49.2 x 9mm

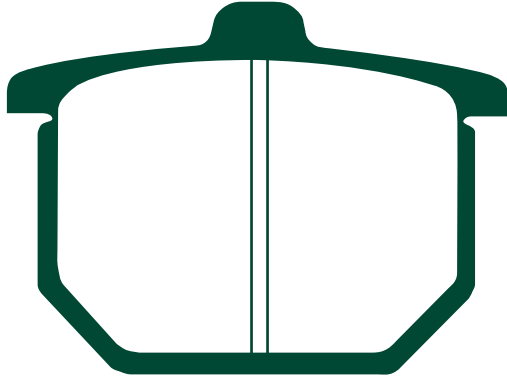

**Competitor X Ref**

	<u>Dunlop</u>	<u>Ferodo</u>	<u>SBS</u>	<u>Vesrah</u>
FA29	DP102	-	508	VD107/112
FA30	DP101	FDB182	-	VD112/3
FA31	-	-	517	VD112

**Equivalents OE #  
FA30**

43105 461 771	45105 415 772	45105 438 008
43105 461 772	45105 438 000	06455 410 405
45105 415 006	45105 438 004	06435 410 305
45105 415 770	45105 438 007	06435 415 405

MATERIAL AVAILABILITY AND PART NO.				
STD	OPTIONS			
FA	HH	R	MXS	GFA
FA30	-	-	-	-

**FA29 - HONDA**

CX 500 CA/CB/Z/A/B	79-81	F
CBX 1000 Z	79-80	F
GL 1000 K3/KZ "Goldwing"	78-79	F

**FA30 - HONDA**

CB 400 N/NA/NB	78-81	F
CB 750 F2	79	R
CBX 1000 Z	79-80	R
GL 1000 K/K1/K2/KZ 'Goldwing'	75-77	F
GL 1100 A/DA/B/DB (SC02)	80-81	F & R

**FA31 - HONDA**

CB 750 F2	79	F
CB 750 FZ/FA/FB	78-82	F & R
CB 900 FZ/FA	80-81	F & R

**Equivalents OE #  
FA29**

43105 461 771	45105 410 004
43105 461 772	45105 410 006
45105 415 006	45105 410 007
45105 415 770	45105 410 016
45105 415 772	45105 410 026

**Equivalents OE #  
FA31**

43105 461 770	06435 761 405
45105 371 00	06455 371 405

MATERIAL AVAILABILITY AND PART NO.				
STD	OPTIONS			
FA	HH	R	MXS	GFA
FA29	-	-	-	-

MATERIAL AVAILABILITY AND PART NO.				
STD	OPTIONS			
FA	HH	R	MXS	GFA
FA31	-	-	-	-

# FA32 57.8 x 65.3 x 11mm

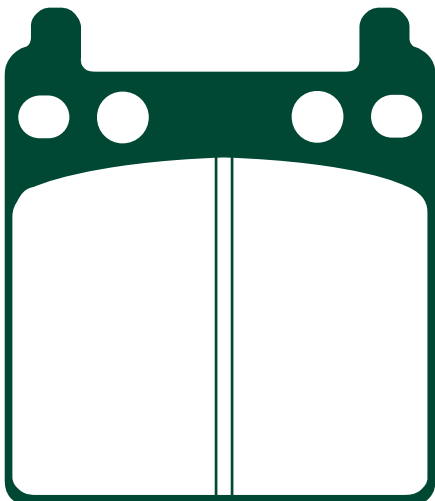

**HONDA**

CB 750 F/F1	76-77	R
GL 1000 K/K1/K2/K3/KZ 'Goldwing'	75-79	R

**PERFORMANCE MACHINE**

162X2

**Competitor X Ref**

<u>Dunlop</u>	<u>Ferodo</u>	<u>SBS</u>	<u>Vesrah</u>
-	FDB134R	509	VD108/116

**Equivalents OE #**

431A0 431 673	43211 431 671
43211 371 006	43211 431 672
43211 392 006	43211 431 673
43211 392 016	

MATERIAL AVAILABILITY AND PART NO.				
STD	OPTIONS			
FA	HH	R	MXS	GFA
FA32	-	-	-	-

# FA33 A = 51.3 x 12.3mm B = 50 x 12.5mm

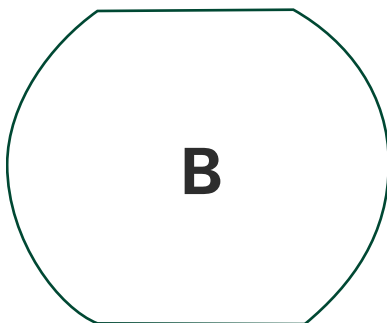
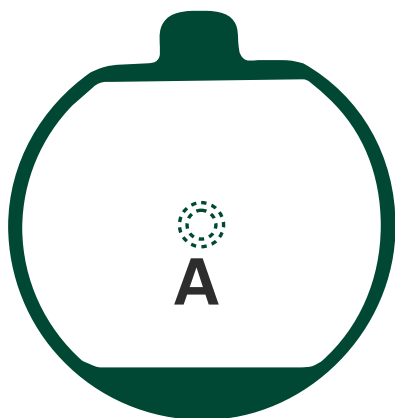

## KAWASAKI

KH 250 B1-B5	77-82	F
KH 400 'All models'	76-81	F
Z 400 G1	79	F
KH 500 A8	76	F
Z 650 B1-B3	79-81	F
Z 650 C1/C2	76-77	F
Z 750 B1/B2/D1	76-78	F
Z 900 A4	77-78	F
Z 1000 A1-A2	74-82	F
Z 1000 D1 (Z1-R)	78-	F
Z 1000 H1	74	F

## Equivalents OE #

43050 005 A	43050 1006	43051 007 B
43050 006 A	43050 1021	43051 008 B
43050 007 A	43050 5001	43051 011 B
43050 008 A	43050 5002	43082 1001
43050 009 A	43050 5003	43082 1005
43050 011 A	43051 006 B	

## Competitor X Ref

MATERIAL AVAILABILITY AND PART NO.				
STD	OPTIONS			
FA	HH	R	MXS	GFA
FA33	-	-	-	-

Dunlop	Ferodo	SBS	Vesrah
DP300	FDB132	510	VD404/408/ 409/411

# FA34 57.8 x 65.3 x 11mm

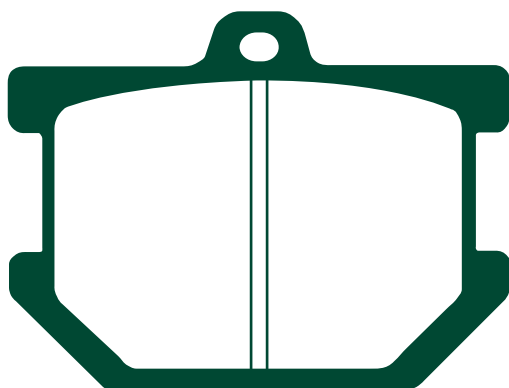

## YAMAHA

XS 250 C	78	F & R
XS 250 D/E	79-81	F
XS 360 C	76	F & R
XS 400 C	78	F & R
XS 400	79	F
SR 500	78-82	F
XS 500 C/D	78-79	F & R
XJ 650	80-84	F
XJ 650 LH Midnight	81	F
XJ 650 RJ 'Seca'	82	F
XS 650	77-81	F
XS 650 SE	79-80	F & R
XS 650 SE	81	F
XS 750	77-79	F & R
XS 750 SE	79-80	R
XS 850	80	F & R
XV 1000 TRI	81	F
XS 1100	78-80	F & R
XS 1100 S	81	R

## Equivalents OE #

1J3 20000 10	1J3 W0045 00	1U4 W0046 01	2M0 W0046 01
1J3 20000 13	1J3 W0046 00	1U4 W0046 02	3G1 W0046 00
1J3 20000 63	1J9 20000 02	2J2 W0046 00	3H5 W0045 01
1J3 20000 64	1L9 W0045 00	2J2 W0046 01	4K0 W0045 00
1J3 20000 70	1L9 W0046 00	2M0 W0046 00	4K0 W0045 01

## Competitor X Ref

Dunlop	Ferodo	SBS	Vesrah
DP401	FDB177R	507	VD205-212

MATERIAL AVAILABILITY AND PART NO.				
STD	OPTIONS			
FA	HH	R	MXS	GFA
FA34	-	-	-	-

# FA35 51 x 11/12mm

## SUZUKI

GS 400 B/C	77-78	F
GS 425 EN	78-80	F
GS 750 B/DB/DC/EC/EN	77-80	F

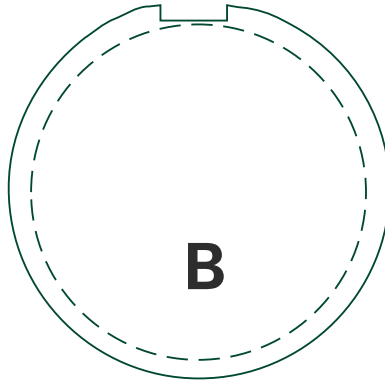
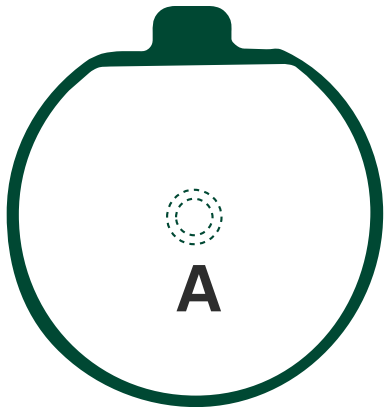

### Equivalents OE #

59100 45820	59300 44822
59300 44810	59300 45890
59300 44820	59300 45891
59300 44821	

### Competitor X Ref

Dunlop	Ferodo	SBS	Vesrah
-	FDB150	511	VD305

### MATERIAL AVAILABILITY AND PART NO.

STD	OPTIONS			
FA	HH	R	MXS	GFA
FA35	-	-	-	-

# FA36 57.6 x 52.8 x 9mm

## SUZUKI

GSX 400 FX/FZ/FD	81-83	R
GS 550 EC/EN	78-79	R
GS 550 ET/EX/EZ/LT/LX/MX/MZ	80-84	R
XN 85 Turbo	83	R
GS 650 GTX/GTZ/GTD/GX/GZ	81-83	R
GS 700 EF/ESF	85	R
GS 750 B/DB/DC/EC/EN	77-80	R
GSX 750 ET/EX/ESD/EFE/ESG		
/ESE/ESH/ESF	82-86	R
GSX 750 SE Katana	85	R
GSX 750 S/SS (G57SX-106815-) Katana	84	R
GSX 750 S-2/S-2C		
(GS75X-114747-) Katana	84	R
GS 850 GN/GT/GX/GZ/GE/GG	79-85	R
GS 1000 HC/EC/EN/SN	78-80	R
GS 1000 ET/GT/GX	81-82	R
GSX 1000 SZ "Katana"	82	R
GSX 1100 ET/EX/EZ/ESD	80-83	R
GS 1100 GZ	82	R
GSX 1100 SZ/SD Katana	82-83	R
GV 1200 GLF/GLF2/GLG Madura	85-86	R

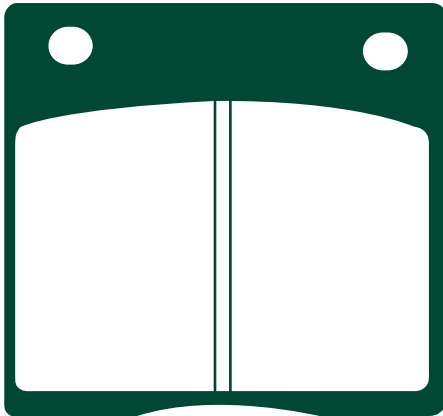

### Equivalents OE #

43050 010	69130 45001	69130 45990
43050 1013	69130 45010	69100 34870
43082 1059	69130 45020	69101 45820
69130 34220	69130 45021	69101 45840
69130 34240	69130 45100	
69130 45000	69130 45101	

### Competitor X Ref

Dunlop	Ferodo	SBS	Vesrah
DP203	FDB151R	512	VD306

## KAWASAKI

Z 500 B1/B2	79-80	R
Z 650 C3/D2/D3-SR	78-80	R
Z 650 D2/D3 (SR)	79-80	R
Z 1000 D1/D3 (Z1R)	78-79	R
Z 1000 A1-A4	77-80	R
Z 1000 ST (E1-E2 shaft)	79-82	R
Z 1000 H1	74	R
Z 1300 A1-A5	79-83	R
ZG 1300 A1-A3	84-86	R

### MATERIAL AVAILABILITY AND PART NO.

STD	OPTIONS			
FA	HH	R	MXS	GFA
FA36	-	-	-	-

# FA37 51.5 x 13/12mm

## KAWASAKI

Z 650 C1/C2	76-77	R
Z 750 B1/B2	77-78	R
Z 750 D1	76	R

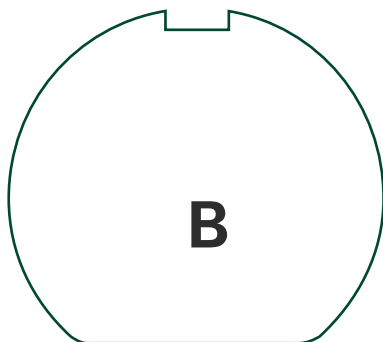
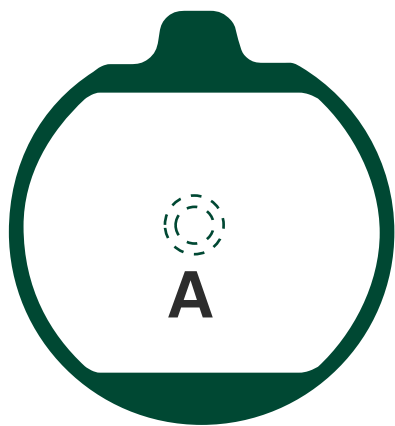

### Equivalents OE #

43051 009 B	43050 1006
43050 1008 A	43050 5002

### Competitor X Ref

Dunlop	Ferodo	SBS	Vesrah
-	FDB181R	514	VD405/412

### MATERIAL AVAILABILITY AND PART NO.

STD	OPTIONS			
FA	HH	R	MXS	GFA
FA37	-	-	-	-

# FA38 A. 50 x 12mm B. 50 x 11.9mm

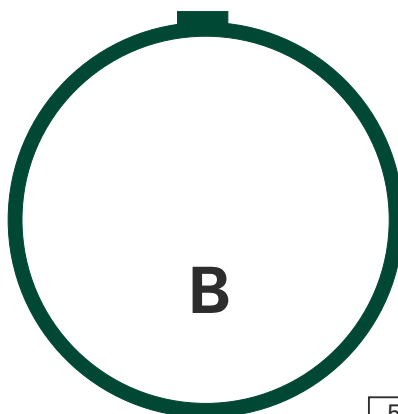
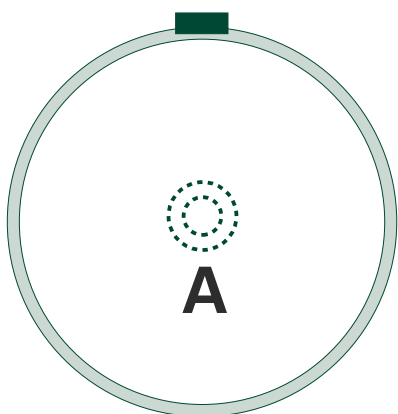

## SUZUKI

GT 125 C/EC/EN	80-82	F
GT 200 EN/EX "X5"	79-82	F
GT 250 EN/ET/EX "X7"	78-81	F
GS 550 DB/DC/EC/EN	77-79	F
GS 850 GN/GT/GX	79-81	F
GS 1000 HC/EC/EN/SN	78-80	F

### Equivalents OE #

59100 11850	59300 47820
59100 34820	59300 47830
59300 45820	59300 47840
59300 47810	59300 47850

### Competitor X Ref

Dunlop	Ferodo	SBS	Vesrah
-	FDB181R	515	VD307/308 310/315/ 316/320

### MATERIAL AVAILABILITY AND PART NO.

STD	OPTIONS			
FA	HH	R	MXS	GFA
FA38	-	-	-	-

# FA39 43.50Ø x 12/10mm

## KAWASAKI

KH 125 A1-A4	77-81	F
Z 200 A1-A5	77-82	F

## SUZUKI

GT 50 KB/KEN	77-80	F
ZR 50 KEN/KEX "X1"	79-83	F

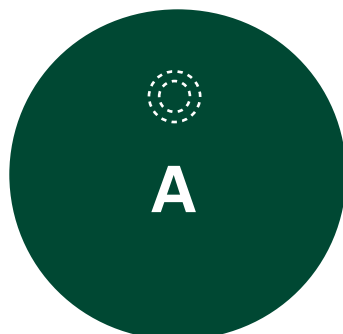
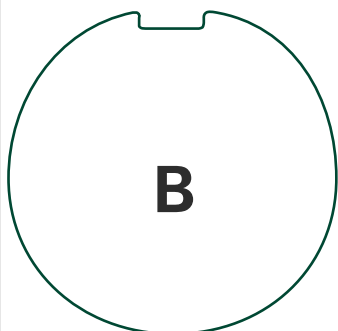

### Equivalents OE #

43050 1009 A	59300 46811
43050 1010 B	59300 46820
59300 46810	

### Competitor X Ref

Dunlop	Ferodo	SBS	Vesrah
-	-	516	VD309/410

MATERIAL AVAILABILITY AND PART NO.				
STD	OPTIONS			
FA	HH	R	MXS	GFA
FA39	-	-	-	-



# FA40 41 x 21/11mm

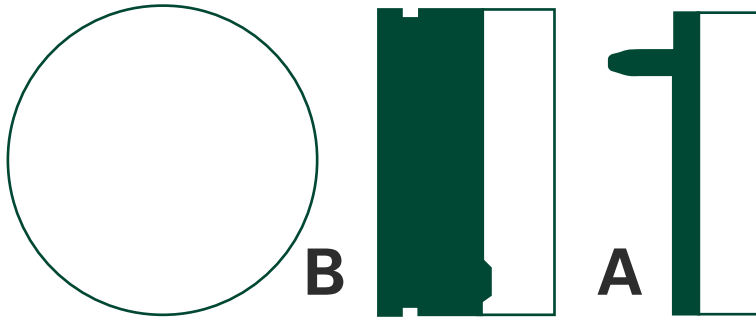

### HONDA

CB 50 J	81	F
SS 50 ZB2	77-80	F
CB 125 J/T	78-79	F
FL 250 Odyssey	77-84	R

### POLARIS

Trail Boss 2 x 4	85-87	R
Scrambler 3 wheeler	85-86	R
Cyclone '250 X'	87	R

#### Competitor X Ref

Dunlop	Ferodo	SBS	Vesrah
-	-	525	VD109/111

#### MATERIAL AVAILABILITY AND PART NO.

STD	OPTIONS			
FA	HH	R	MXS	GFA
FA40	-	-	-	-

#### Equivalents OE #

45340 107 720 A	45340 149 003 A	45345 107 720 B	45345 149 003 B	45350 950 000
45340 107 721 A	45340 149 720 A	45345 107 721 B	45345 149 720 B	
45340 107 722 A	45340 950 000 A	45345 107 722 B	45350 107 720	
45340 149 000 A	45345 950 000 B	45345 149 000 B	45350 107 720 B	

# FA41 94.5 x 56mm



### YAMAHA

RD 250 E/F	78-79	F&R
XS 250 SE/SF	79-81	F
RD 400 E/F	78-79	F&R
XS 400 SE	80-81	F
XS 750 SE	79-80	F (Right)

#### Competitor X Ref

Dunlop	Ferodo	SBS	Vesrah
-	FDB184	528	VD215

#### Equivalents OE #

2G2 W0045 00	3J6 W0045 01
2R8 W0045 003	4W1 W0046 00
3H6 W0045 00	

#### MATERIAL AVAILABILITY AND PART NO.

STD	OPTIONS			
FA	HH	R	MXS	GFA
FA41	-	-	-	-

# FA42 45 x 45 x 10/16mm

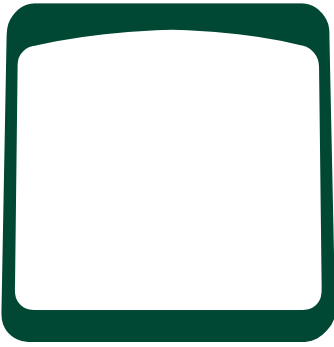

## YAMAHA

FS 1 DX	79-80	F
RD 50 M	79-80	F
RD 125 DX	78-81	F
RS 125 DX	81	F
RD 200 DX	78-80	F

### Equivalents OE #

2R6 W0045 00	2R6 W0045 11
2R6 W0045 10	

### Competitor X Ref

Dunlop	Ferodo	SBS	Vesrah
-	FDB248	531	VD-213

### MATERIAL AVAILABILITY AND PART NO.

STD	OPTIONS			
FA	HH	R	MXS	GFA
FA42	-	-	-	-

# FA43 46 x 21/11mm

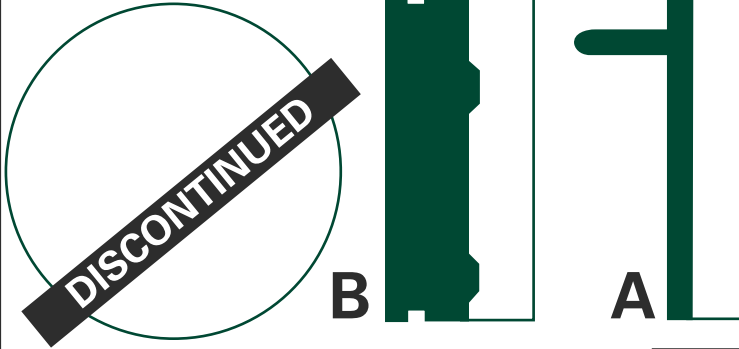

## HONDA

CB 125 K6/S2	76	F
CB 200 B	76-79	F

### Equivalents OE #

45340 351 700 A
45345 351 700 B

### Competitor X Ref

Dunlop	Ferodo	SBS	Vesrah
-	-	521	VD-110

### MATERIAL AVAILABILITY AND PART NO.

STD	OPTIONS			
FA	HH	R	MXS	GFA
-	-	-	-	-

# FA45 54 x 53 x 11mm

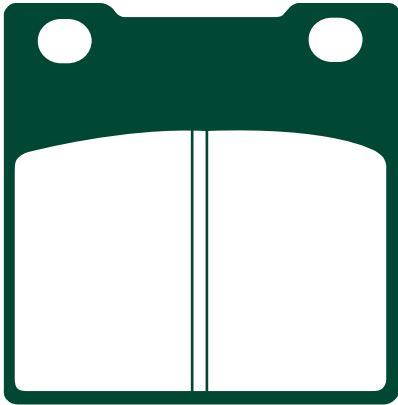

## HONDA

CB 250 T/N/NA/NB/NDB/NDC	78-82	F
CB 250 RSA/RSD	81-84	F
CM 250 TB	81	F
CB 400 A 'Honda-matic'	79	F
CB 400 T	78	F
CB 650 Z/B	79-81	F
CB 750 KZ	80	F

### Equivalents OE #

45105 413 003	45105 425 003	45105 MA5 671
45105 413 305	45105 425 006	06455 425 405
45105 413 871	45105 471 006	

### Competitor X Ref

Dunlop	Ferodo	SBS	Vesrah
DP103	FDB183	526	VD113/117

### MATERIAL AVAILABILITY AND PART NO.

STD	OPTIONS			
FA	HH	R	MXS	GFA
FA45	-	-	-	-

# FA46 44 x 11.5/13mm

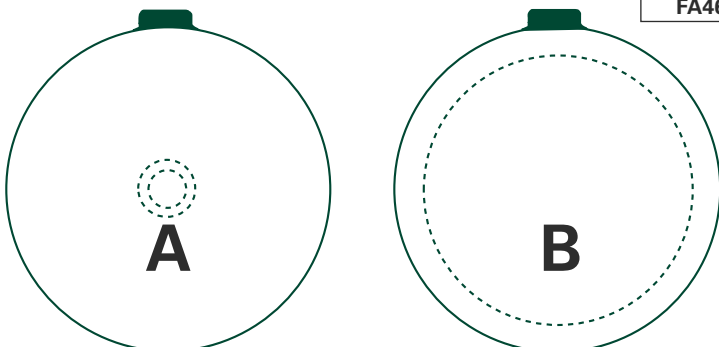

### MATERIAL AVAILABILITY AND PART NO.

STD	OPTIONS			
FA	HH	R	MXS	GFA
FA46	-	-	-	-

## SUZUKI

GP 100 C/N/X/DED	78-87	F
------------------	-------	---

### Equivalents OE #

59300 39840
-------------

### Competitor X Ref

Dunlop	Ferodo	SBS	Vesrah
-	-	538	VD-314

# FA47 40 x 58 x 7mm

## FA47/2 40 x 58 x 5.5mm

## FA47/3 40 x 58 x 9.3mm

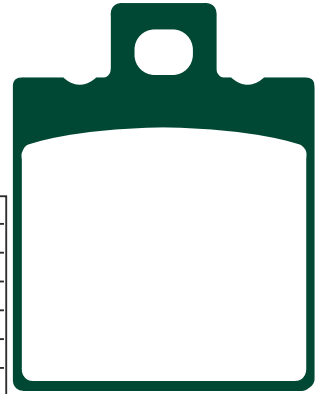

### Equivalents OE # - FA47

8103662	8113651	323 627	613 4007 71A	61340 311A	2547/F/S
8113016	8113662	326 446	43105 NN2 600	61340 281A	211082010
8113064	8213145	341 170	8000 46147	04700 2000037	000316546650
8113118	8213197	19654600	8000 90156	119 52200	00276546100
8113196	8213200	19654601	2525 242000	9021035000	107 28 86 30
8113222	19654600	491 13 409 044	8A00 46147	252524000	107 5365 13
8113323	8000 29070	3SH F5811 20	8000 46147	000276546100	KA3496535
8113638	8000 39730	613 4008 1A	03613 9666	613 4 0541A	

### Equivalents OE # - FA47/3

43105 KBS 405	43105 KY4 902
43105 KBS W00	43105 NW2 610
43105 KY4 901	

### Competitor X Ref - FA47

Dunlop	Ferodo	SBS	Vesrah
DP601	FDB207/R /FDB705	519	VD911

### Competitor X Ref - FA47/2

Dunlop	Ferodo	SBS	Vesrah
-	-	583	-

### Competitor X Ref - FA47/3

Dunlop	Ferodo	SBS	Vesrah
-	-	646	VD911/2

MATERIAL AVAILABILITY AND PART NO.					
STD	OPTIONS				
FA	TT	HH	R	MXS	GFA
FA47	FA47TT	FA47HH	FA47R	-	-

MATERIAL AVAILABILITY AND PART NO.				
STD	OPTIONS			
FA	HH	R	MXS	GFA
FA47/2	-	FA47/2R	-	-

MATERIAL AVAILABILITY AND PART NO.				
STD	OPTIONS			
FA	HH	R	MXS	GFA
FA47/3	-	-	-	-

### FA47

#### ACCOSSATO

CE 50/80/KR 80 87- F  
Enduro Codice 50 89- F

#### AGRALE

Elefantre 30.0 F

#### ALFER

80 MC 87- F  
125 MC 87 F  
125 MC 88- R  
250 MC 85-86 F  
250 MC 87 F&R  
250 MC 88- R  
250 GR/Enduro 85-87 F  
250 GR/Enduro 88- R  
300 GR Enduro 88- R

#### APRILIA

Classic 50 92-01 F  
AF1 Futura 50 90-92 F  
RS 50 93-98 F  
Europa 50 90-92 F  
AF1 125 87-89 R  
RS 125 (All models) 92-05 R  
AF 125 90-91 R  
Red Rose 125 87 R  
Tuono 125 03-04 R  
250 86 F  
RS 250 (All models) 95-02 R

#### BENELLI

124/125 2C/125 2T/2CSE 76- F  
125 T 83 F  
250 C/TS, 250/4 76- F  
304 83 F  
354 -82 F  
354 Sport 2 83 F&R  
500/4 76- F  
654 Sport 83 F&R  
666 Scooter "Born in Hell" 98-99 R

#### BERINGER

6 piston old design  
2 piston

#### BETA

Eikon 125/150 00-06 F

#### BIMOTA

All models 89-03 R  
Tesi 2D 04-06 R  
SB8K Gobert (996cc Suzuki engine) 06 R  
SB8K Santamonica (992cc Suzuki engine) R

### BREBMO

20 5185 11 (P32B) Single pad fixing 2 Piston  
20 5161 42 (P32F) Single pad fixing 2 Piston

### CAGIVA

Cucciolo 50 97 F  
W4 50 91-95 F  
Blues 125 92-95 R  
Cucciolo 125 00 F  
Frecia 125 SY 89 R  
NI 125 97 R  
Planet 125 99-03 R  
Supercity 125 92 R  
Mito 125 (all models) 91-07 R  
Raptor 125 03-07 R  
SST 250/350 80-82 F  
SX 250 82 F  
WMX 125 86 F  
WMX 250 -85 F  
Mito 500 91-92 r  
WMX 500 84-86 F  
Excaltiber 501 RX 92- R  
River 600 95-99 R  
650 Elephant 85- R  
650 Elefant 88-89 R

### DERBI

### DUCATI

GPI 250 05 R  
Supersport 400 93-97 R  
400 Monster/Dark 95-04 R  
500 GTL 75 F  
500 GTV Pantah 77 F&R  
500 Sport Desmo 77 F&R  
500 Pantah 79 F&R  
600 Monster 93-99 R  
600 Monster Dark 98-99 R  
600 Monster City/City Dark 99 R  
600 Monster 00-01 R  
600 Supersport 91-97 R  
620/IE/SIE Monster 02-04 R  
620 Sport 03 R  
Monster 620 05-06 R  
S2R Dark (803cc) 06 R  
S2R (992cc) 06 R  
S4RS (998cc) 06 R  
Monster 620 Dark 03-06 R  
Multistrada 620 05-06 R  
695 Monster 06-07 R  
748 SP/Biposto 95-98 R  
748 Racing/SPS 98 R  
748 Biposto 99 R  
748 Racing 99 R

### DUCATI Contd.

748 SPS 99 R  
748 Biposto 00-02 R  
748 R/RS/S 00 R  
748 R 01-02 R  
748 RS 01 R  
748 S 01-02 R  
748 Testa Bassa 01 R  
748 E R  
750 Paso 87-90 R  
750 Supersport 91-98 R  
750 Monster 96-98 R  
750 Monster City/City Dark 99 R  
750 Monster/Monster Dark 99 R  
750 Monster 00-01 R  
Monster 800/IE/SIE 03-04 R  
800 Supersport 03 R  
Monster S2R (803cc) 05-07 R  
851 Superbike Biposto 89-92 R  
888 SP4/SP5 92-93 R  
888 Superbike Strada 94-95 R  
900 Supersport 89-90 R  
900 Supersport/Superlight 91-97 R  
900 Supersport CR USA 98 R  
900 Supersport FE 98 R  
900 Monster 93-99 R  
900 Monster Cromo/Special 98 R  
900 Monster City/City Dark 99 R  
900 IE Monster 00-01 R  
907 IE 90-93 R  
916 SP 94-96 R  
916 Biposto-Senna 94-98 R  
916 SPS (996cc) 98 R  
Monster S4 01-03 R  
996 98 R  
996 SPS/SPS II 99-00 R  
996 00 R  
996 S 01 R  
998 S 02 R  
998 R 02 R  
998 02-03 R  
Monster 1000 IE/SIE 03-05 R  
Monster 1000/1000 S4R 04-05 R  
S4R (998cc) Testastretta 07 R

**FANTIC**  
50 Caballero/Caballero RC 91- F  
80 Caballero/Caballero RC 91- F

**GILERA**  
RV 50 NGR 88- R  
125 HX LC 83- F  
125 RX 84- F

# FA47 Contd. 40 x 58 x 7mm

# FA47/2 Contd. 40 x 58 x 5.5mm

# FA47/3 Contd. 40 x 58 x 9.3mm

DISC PADS  
BUYERS GUIDE

### GILERA Contd.

RX 125 Arizona	88-	F
GFR 125	94	R
Nordwest	94	R
125 CX	91-	R
125 MX1/MXR	89-	R
125 SP 01/SP 02	89-	R
125 XR1/XR2	89-	R
RX 200/Arizona/Enduro	85-	F
200 Fast Bike	87-	R
RV 200	85-86	R
RV 200 ES	87-	R
HX 250 LC	83-	F
NGR 250	85-	R
250 RX Arizona Rally	86-	F
RC 250 Rally	87-	R
Saturno 350 Bialbero	90-	R
XRT 350	90-	R
Nord-West 350	94-	R
Saturno 500 S/Bialbero/Piuma	90-	R
XRT 600	88-	R
<b>HRD</b>		
WH 125 Road/Red Horse	85-	F
<b>HARRISON BILLET</b>		
Early design 4/6 piston		
<b>HONDA HM (Italy)</b>		
CRE 50 Six/Baja/Derapage	95-02	R
<b>HYOSUNG</b>		
Grand Prix 125	99-04	F
Exceed 125 (MS1 125/150)	02-04	F
Boomer/Exceed 125	02-03	F
MS1 125/150	05	F
<b>HUSQVARNA</b>		
XC 125	85-86	F
CR 240	85-86	F
CR 250	85-86	F
XC 250	85-86	F
CR 500	85-86	F
XC 500	85-86	F
TC 510	87-88	F
TE 510	87-88	F
TX 510	87-88	F
<b>ISR CALIPERS</b>		
22-025-XX (4 piston)		F
22-027 (2 piston rear)		F
22-028 (2 piston)		F
22-029 (Rear 2 piston)		F

### KEEWAY

ARN 125	07	F
<b>KTM</b>		
MX/MXC 125	85	F
GSXC/GS 125	85	F
MX/MXC/GS 125	86	F&R
MX/MXC 250	85	F
GSXC/GS 250	85	F
MX/MXC/GS 250	86	F&R
MX/MXC 300	85	F
GSXC/GS 300	85	F
MX/MXC/GS 300	86	F&R
MX/MXC/GS 350	86	F&R
350 Four Stroke	83	F
MX/MXC/XC-GS 500	85	F
<b>LAVERDA</b>		
OR 50 Atlas	87-	F&R
GS 125 Lesmo	86-89	F&R
LZ 125 Sport Brembo caliper	80-82	F
Montjuic	76	F&R
Alpino 500	76	F&R
650 All models	94-95	R
668 All Models	96-98	R
750 All Models	98-01	R
<b>MAICO</b>		
All Models	85	F
<b>MALAGUTI</b>		
50 Enduro MEX	85-86	F
Enduro MDX 80	84-	F
Ciak 125/150/200	01-07	F
F18 125/150 Warrior	00-03	F
<b>MALANCA</b>		
E2 C80/CS		F&R
125 GTI		F&R
125 Mark Enduro	-84	F
Ciak 200	06	F
<b>MONTESA</b>		
311 (Honda) 260cc	92-93	R
314R (Honda)	94-96	R
315R (Honda)	97-00	R
<b>MOTO GUZZI</b>		
350 up to 500 (All Models)	75	F&R
350 Nevada	92-	F&R
V35/V50/V65	78-80	F&R
650 Florida	92	F&R
750 SP	92	F&R
750 T	92-94	F&R

### MOTO GUZZI Contd.

750 Nevada	91-92	F&R
750 Nevada Club	98-01	F
Daytona 1000	93-97	R
Quota 1000	93-95	R
V10 Centauro	98-00	R
V11 (All models)	99-06	R
1100 Sport/Sport Inj/VII	96-01	R
Griso	04	R
<b>MOTO MORINI</b>		
Dart 350	87	R
350 Kanguro	87	R
Excaliber 350/501 RLX	93-	R
<b>MZ/MUZ</b>		
Tour/Traveller	95-02	R
SkorpionSport/Replica/Cup	95-01	R
<b>PRO-ONE</b>		
2 Piston		
<b>TM</b>		
SMM 125 Black Dream (Rim brake)	04-07	R
SMM 400 (4T) Rim brake	04-	R
SMM 530 F Black Dream Rim brake	04-07	R
<b>VOXAN</b>		
Charade Racing	06	R
<b>YAMAHA</b>		
TZR 125 RR	96-	R
SZR 660	96-97	R
<b>FA47/2</b>		
<b>GARELLI</b>		
Urka 50	91-	F
125 XR/XRD Tiger	83-	F
<b>GILERA</b>		
50 Rally	87-	F
R1/50	90-	F
<b>KTM</b>		
80 MX	86-92	F
<b>FA47/3</b>		
<b>HONDA</b>		
NSR 125 FM/RK/RL/RM/RN/FP		
/RP/RR/RV/RW/RX/RY/R1	91-04	R
CRM 125 RL/RM/RN/RP/RR/RV/RX	90-99	R

# FA48 46 x 44 x 16/11mm

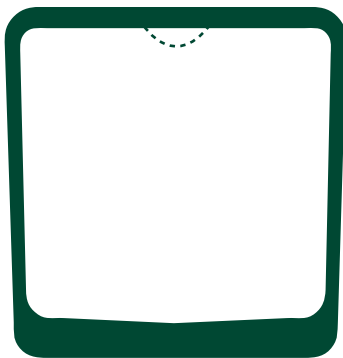

### KAWASAKI

KH 100 G2/G3	81-83	F
Z 400 B1/B2	78-80	F

### Equivalents OE #

43050 1007 A	43050 5004
43050 1007 B	

### Competitor X Ref

Dunlop	Ferodo	SBS	Vesrah
-	FDB248	522	VD-413

MATERIAL AVAILABILITY AND PART NO.				
STD	OPTIONS			
FA	HH	R	MXS	GFA
FA48	-	-	-	-

# FA50 41.5 x 49 x 5.5mm



Equivalents OE # N/A

Competitor X Ref	Dunlop	Ferodo	SBS	Vesrah
-	-	FDB213	532	VD-912

MATERIAL AVAILABILITY AND PART NO.				
STD	OPTIONS			
FA	HH	R	MXS	GFA
FA50	-	-	-	-

<b>CASAL</b>		
All disc models		F
<b>CIMATTI</b>		
Gringo	-85	F
<b>FANTIC</b>		
50 Strada Super Six	73-	F
<b>HERCULES (SACHS)</b>		
Diff. older models with disc brake		F
50 KX 5		F
50 Ultra, RS Ultra		F
80 Ultra, F Ultra, RS Ultra		F
80 Ultra Chopper		F
80 Ultra AC		F
80 Ultra AC Chopper		F
80 XE 9		F
<b>HOREX</b>		
Rebell 80 N		F
Rebell 80 T		F
Sport 80 L		F
<b>MALAGUTI</b>		
Chopper 25/40	-82	F
50 LX Sport	-82	F
50 Ronco RCW	-82	F
50 Fity HF	-82	F
VA Olympique	-82	F
50 watercooled	-82	F
50 Grizzly RCX 10	87-	F
Chopper 80	-82	F
<b>MALANCA</b>		
125/ST 54/GT 5		F
<b>PGO</b>		
M 50 SP Spoke wheel	75-77	F
M 50 SDP Cast Wheel	75-77	F

# FA51 78 x 50 x 11.5mm

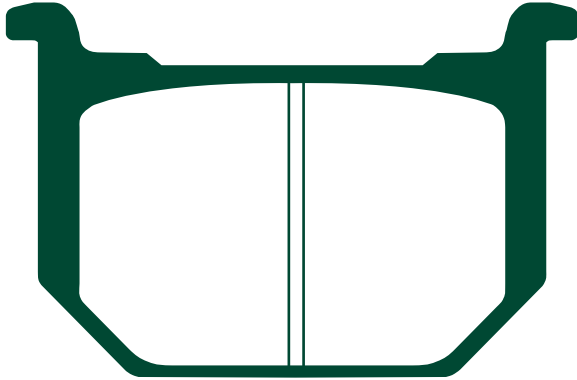

Competitor X Ref

Dunlop	Ferodo	SBS	Vesrah
DP205	FDB218	532	VD-912

Equivalents OE #

59130 45230	59301 45850	59330 38310
59301 45810	59300 05810	
59301 45811	59330 38300	

## SUZUKI

GN 250 F/J/M/R/T	85-97	F
GS 250 TT/TX	80-81	F
GSX 250 ET/EX/EZ	80-82	F
GN 400 TT	80	F
GSX 400 ET/EX/EZ	81-83	F
GSX 400 LX/TX	81	F
GS 450 ET/EG/EJ	80-88	F
GS 700 EF/ESF	85	F
GSX 750 ESD/EFE/ESG/ESE/ESH/EFF	82-86	F
GSX 750 ET/EX	80-81	F
GS 850 GZ/GE/GG	82-85	F
GS 1000 GT/GX	81-82	F
GV 1200 GLF/GLF2/GLG Madura	85-86	F

## MATERIAL AVAILABILITY AND PART NO.

STD	OPTIONS			
FA	HH	R	MXS	GFA
FA51	-	-	-	-

# FA52 41 x 21/11mm



## HONDA

CB 100 N	78-80	F
CB 125 T2	79	F

Equivalents OE #

45340 399 700	45345 399 700
45340 399 701	45345 399 701
45340 399 702	45345 399 702

MATERIAL AVAILABILITY AND PART NO.				
STD	OPTIONS			
FA	HH	R	MXS	GFA
FA52	-	-	-	-

Competitor X Ref

Dunlop	Ferodo	SBS	Vesrah
-	-	529	VD119

# FA54 39.5 x 45 x 7.5mm

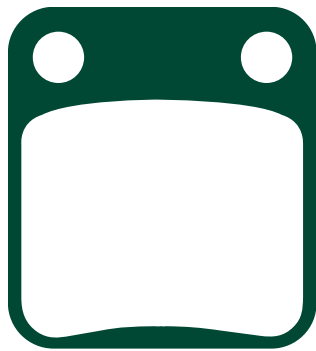

## HONDA

MB 5 S	80-82	F
MG 50 S/X/1/3 Magna 50	95-03	F
MRX 50	88-	F
MBX 80 FWDD/FWDF	83-86	F
CB 125 RS	83	F
CBX 125 TS Custom	82	F
CG 125 ES4	04-07	F
CG 150 ESD Titan	04-05	F
CG 150 KS/ES Titan	04-05	F
CBX 200 Strada	97-01	F
ATC 250 RB	81	F

## HYOSUNG

TE 450 Quad	06-07	F&R
-------------	-------	-----

## KAWASAKI

KX 65 A1/A2/A3/A4/A5/A6/A6F/A7F	00-07	R
KH 125 K1	83	F
BN 125 A1/A2 'Eliminator'	98-99	F
KVF 300 A1/A2/A3/A4/B1/B2/B3/B4 (Prairie 4x4/2x4)	99-02	F
KVF 360 A1-A3/A6F/B1-B3/C1-C3/C6F Prairie	03-06	F
KVF 400 A1/A2/B1 'Prairie'	97-98	F
KVF 400 C1/C2/C3/C4/D1/D2/D3/D4 (Prairie 4x4/2x4)	99-02	F

## KEEWAY

Dragon 250 Quad	07	R
-----------------	----	---

## SUZUKI

RM 65 K3/K4/K5	03-05	R
DF 125		F
DR 125 SF/SH/SJ	85-94	F
DR 125 SEX/SEY	99-01	F
TS 125 XUF/XUG/XUH/XUJ	86-90	F
DF 200 EV/EW/EY (SH42A)	98-00	F
DR 200 G/H/J	86-89	F
DR 200 SEP/SER/SES/SEV/SEW/SEX/SEY (SH42A)	93-99	F
DR 200 SE Trojan		F
DR 200 SEK1-SEK6	01-05	F
SX 200 R/R2/RJ/RM	90-91	F
LT-F 250 K2/K3/K4/K5/K6 Ozark	02-06	F
TS 250 XE/XG/XH/XJ/XK	85-89	F
LT-A 400 FK2/FK3/FK4/FK5/FK6/FK7 Eiger 4WD	02-07	F
LT-A 400 K2/K3/K4 Eiger	02-04	F
LT-F 400 FK2/FK3/FK4/FK5/FK6/FK7 (Eiger 4WD)	02-07	F
LT-F 400 K2/K3/K4/FK5/FK6/FK7 Eiger	02-04	F
LT-A 500 FK2/FK3/FK4 Vinson 4WD Auto	02-07	F
LT-F 500 FK3/FK4/FK5/FK6/FK7 Vinson	03-07	F

## YAMAHA

YFS 200 R/S/T/V Blaster	03-06	F
YFM 250 XN/XP/XR/XS	01-04	F
YFM 250 BT/BV/BW Big Bear	05-07	F
YFM 350 XD/XE/XF/XG/XH/XJ/XK/XL/XM /XN/XP/XR	92-03	F
YFZ 350 U/B/D/E/F/G/H/J/K/L/M/N/P/R /S/T/V Banshee	88-06	F
YFM 350 FXG/FXH/FXJ/FXK/FXL/FXM/FXN /FXP/FXR/FXS Wolverine	95-04	F

### Competitor X Ref

<b>Dunlop</b>	<b>Ferodo</b>	<b>SBS</b>	<b>Vesrah</b>
DP107	FDB250	536	VD120/333

## YAMAHA Contd.

YFM 350 L Big Bear	99	F
YFM 350 FAS/FAT/FAV Bruin 4x4	04-06	F
YFM 350 ANS/ANT/ANV Bruin 2x4	04-06	F
YFM 350 FGW Grizzly	07	F
YFM 400 FAM/FAN	00-01	F
YFM 400 FPR/FPS	03-04	F
YFM 400 FWT (Big Bear)	05	F
YFM 400 FGW Grizzly	07	F
YFM 450 FAR/FAS	03-04	F
YFM 450 FAT/FAHT/FAV (Kodiak)	05-06	F
YFM 450 FGW Grizzly	07	F

## CCM

C-XR 230 E	07	R
C-XR 230 S	07	R

## DAELIM

Cordi 50/SE 50 R	04-07	F
Altino 125	01-04	F
Otello 125 (NS 125 DLX)	00-02	F
NS 125 DLX/III	03-07	F&R
History 125	01-06	F&R
Tapo Message 50	04	F

## GARELLI

Fashion F150	07	F
--------------	----	---

## HUSQVARNA

TC/TE 610	92-94	R
-----------	-------	---

## JIALING

JH 125 B Roadstar	98	F
-------------------	----	---

## TAISHAN

XT 50	03-04	F
Sport 50	03-04	F
CT 125	04	F

## PGO

BR 150 A Bugxter	04-06	R
Bugrider 50 (Buggie)	06	R

## SACHS

X Road	07	R
Mad Ass 50	06-07	R
Mad Ass 125	06-07	R

## SYM

Quadraider 600	06	F
----------------	----	---

### Equivalent OE #

43082 1241	59340 22A00
43082 0043	59340 42A10
45105 166 007	59340 44A00
45105 GE3 601	3GD W0045 00
45105 GE3 602	06455 GBF J01
45105 GC4 601	5LP W0045 00
45105 GC4 602/603	59100 38870
45105 GW6 004	59100 38880
45105 GBF 405	59101 38810
45112 GC4 601	59101 38820
45112 GC4 831	59101 38850
800070854	59101 38860
43082 1028	K4308 21241
43082 1201	06455 KEH 900
59300 44870	06455 GBZ 701
59300 42810	06455 KRM 861
59300 42850	55100 23044 08
59340 13A00	

MATERIAL AVAILABILITY AND PART NO.				
STD	OPTIONS			
FA	HH	R	MXS	GFA
FA54TT	FA54HH	FA54R	MXS54	-

# FA55 50 x 12/9mm

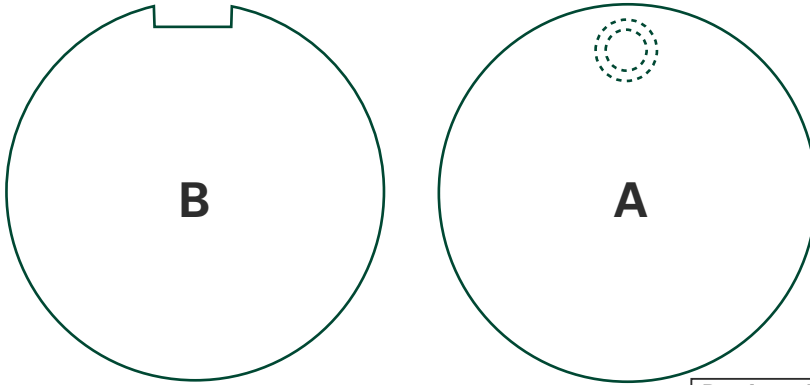

### KAWASAKI

HID/E/F	73-75	F
Z 900 ZIA/ZIB	74-76	F

### SUZUKI

GT 125 L/M/A/B	76-79	F
GT 185 (All Models)	73-79	F
GT 250 (All Models)	73-78	F
GT 380 (All Models)	73-77	F
RE5 M/A	75-77	F
GT 500 A/B	75-78	F
GT 550 K/L/M/A/B	73-77	F
GT 750 K/L/M/A/B	73-77	F

### Competitor X Ref

Dunlop	Ferodo	SBS	Vesrah
DP200/201	-	503	VD301/302 /303/304/ 401/402

### Equivalents OE #

59100 18840	59100 31831	43082 001
59100 18841	43050 001	59300 18810
59100 36830/1	43050 002	59300 36840
59100 39810	43051 001	
59100 31830	43071 001	

MATERIAL AVAILABILITY AND PART NO.				
STD	OPTIONS			
FA	HH	R	MXS	GFA
FA55	-	-	-	-

# FA56 43.5 x 8mm



### SUZUKI

GP 125 C/N/X/D	78-84	F
----------------	-------	---

### HYOSUNG

GF/A 125 'Speed'	99-06	F
Cruise II GA 125 F	99-04	F

### KREIDLER

50 RS-G/RSH-G and GS		F
80 E/L Florett		F
125 RS		F

### LIFAN

LT 125-3A		F
-----------	--	---

### MOTO ROMA

MXR 125	03	F
---------	----	---

### SUPERBYKE

R-SR125 4V		F
------------	--	---

### Equivalents OE #

59300 39820	59340 39100
59300 39821	59330 39100
59302 39870	

### Competitor X Ref

Dunlop	Ferodo	SBS	Vesrah
-	-	524	VD-312

MATERIAL AVAILABILITY AND PART NO.				
STD	OPTIONS			
FA	HH	R	MXS	GFA
FA56	-	-	-	-

# FA57 55.7 x 53 x 9mm

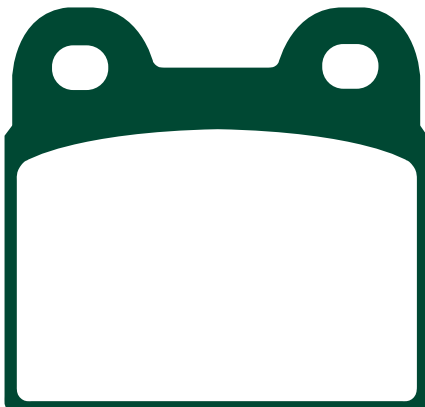

### BMW

R 45/45 N	78-85	F
R 45 T	80-85	F
R 65 LS	81-85	F
R 65 T	80-85	F

### Equivalents OE #

34 71 2 301 359
34 11 1 238 083

### Competitor X Ref

Dunlop	Ferodo	SBS	Vesrah
-	-	527	VD-935

MATERIAL AVAILABILITY AND PART NO.				
STD	OPTIONS			
FA	HH	R	MXS	GFA
FA57	-	-	-	-

# FA58 USE FA161

## FA59 32 x 18.8mm



### BENELLI

254 83 F

### CAGIVA

XSST 125 -80 F  
SST 250 -80 F

#### Competitor X Ref

Dunlop	Ferodo	SBS	Vesrah
-	-	-	-

#### Equivalents OE #

N/A

#### MATERIAL AVAILABILITY AND PART NO.

STD	OPTIONS			
FA	HH	R	MXS	GFA
-	-	-	-	-

## FA60 35.2 x 51.5 x 6mm

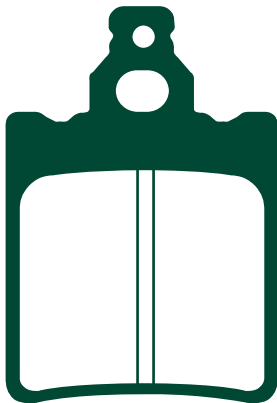

#### Competitor X Ref

Dunlop	Ferodo	SBS	Vesrah
DP611	FDB694	574	VD-920/937

#### Equivalents OE #

8113104	8213051	326 478
8000 33545	8213104	8000 40413
8000 37009	238 076570	
8000 40413	245 07 6340	

#### MATERIAL AVAILABILITY AND PART NO.

STD	OPTIONS			
FA	HH	R	MXS	GFA
FA60	-	-	-	-

### APRILIA

Europa 50 90-92 R  
AF1 Futura 50 90-92 R  
MX 50 03-05 R  
RS 50 93-06 R  
RX 50 C/CD 93-04 R  
Tuorno 50 03-04 R  
RX 50 Raing 03-06 R  
RX3-5 Marce (M/N/P/R) 91-94 R

### KEEWAY

X Ray 50 Supermoto 06 R

### MOTO GUZZI

250 (All Models) 75- F

### CAGIVA

W4 50 91-95 R  
WSXT 125 "Aletta Rossa" 83-84 F  
XSST 125 81-82 F  
SXT 125 82- F  
W8 125 93-98 R

### FANTIC

50 Caballero/Caballero RC 91- R  
50.1 Oasis 86- R  
50.1 Oasis E.S. 87- R  
50 Kaloa F&R  
80 Caballero/Caballero RC 91- R  
80 Kaloa F&R

### GARELLI

125 Tiger XLE 86- R  
GTA 125 85 F  
GTA 125 86- F&R

### GENERIC

Trigger X50 06-07 R  
Trigger SM 50 06-07 R

### GILERA

RV 50 NGR 88- F  
NGR 250 85- F

### LAVERDA

LB 125 Custom/Sarbia/Strada Sport 85-87 F

### MALAGUTI

50 MXR 89- F

### MALANCA

125 ob one M6 85- F&R  
125 ob one M6 Racing 85- F&R  
125 Mark Enduro 85- F



# FA61 94.5 x 56mm Tapered 1 Left/1Right



## YAMAHA

XJ 650 G/H/J/K Maxim  
 XJ 650 LH Midnight  
 XS 750 SE  
 XV 750 SE

80-83 F  
 81 F  
 79-80 F(left)  
 81 F

### Competitor X Ref

Dunlop	Ferodo	SBS	Vesrah
-	FDB247	545	VD-216

### Equivalents OE #

2G2 W0045 01	3J6 W0045 11	4H7 W0045 12
2G2 W0045 10	4H7 W0045 00	4W5 W0045 00
3J6 W0045 10	4H7 W0045 10	

MATERIAL AVAILABILITY AND PART NO. OPTIONS				
STD	HH	R	MXS	GFA
FA61	-	-	-	-

# FA62 51.3 x 11mm

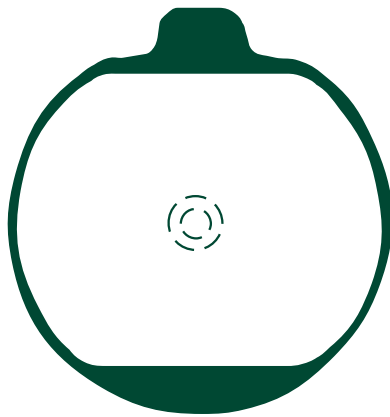

## KAWASAKI

Z 1000 ST (E1/E2 shaft) 79-82 F  
 Z 1300 A1-A5 79-83 F  
 ZG 1300 A1-A3 84-86 F

### Competitor X Ref

Dunlop	Ferodo	SBS	Vesrah
DP303	FDB220	530	VD-423

### Equivalents OE #

43082 1004
43082 1058

MATERIAL AVAILABILITY AND PART NO. OPTIONS				
STD	HH	R	MXS	GFA
FA62	-	-	-	-

# FA63 52.6 x 53 x 9mm

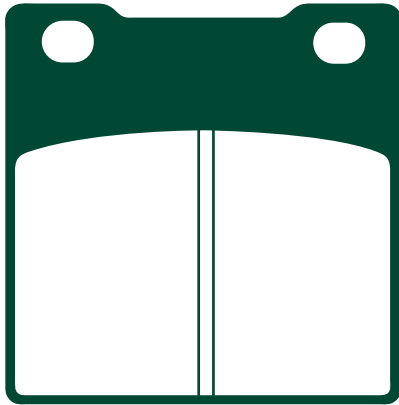

## HYOSUNG

Comet 250/600 02 R

## MAGNI

Sport 1200 'S' 01 R

## SUZUKI

GSF 250 N/ZM/P/NP/ZP/N/NR	92-96	R
GSF 250 VS/S Bandit	97	R
GSX 250 R CH/H (GJ72A)		R
GSX 250 SSM Katana (GJ76A)	91	R
GSXR 250 J (GJ72A)		R
GSXR 250 CK		R
GSXR 250 RK (GJ73A)	89	R
RG 250 WD 'Gamma'	83	F&R
RG 250 WE/FG/CH/FCH/FH 'Gamma'	84-88	R
RGV 250 J/K/L	88-90	R
TV 250 J/K/AK/L (VJ21A) Wolf	88-90	R
SG 350 N 'Goose'	92	R
GSXR 400 H	87	R
GSXR 400 J/RR/RAK (GK73A)	88-90	R
GSXR 400 RL/RM/RN/RS (GK76A)	90-95	R
GSF 400 All models (Bandit)	89-97	R
GSX 400 R2/RG (GK71B/F)		R
GSX 400 X/XA/XS Impulse		R
GSX 400 FJ/FK/FAK/FL (GK74A)	88-90	R
GSX 400 R/S/T/ZR/ZS/ZT/X Impulse Type S	94-99	R
GSX 400 FW/FWS/FWS-2		F&R
GSX 400 SSN (GK77A) Katana	92	R
GSX 400 FSV/FSK1 (GK7B) Inazuma	00	R
RF 400 RP/RR/VR/RT/RVT/RV-V (GK78A)	93-97	R
RG 400 EWF/EW-2G/EWH Walter Wolf (Type 1&2)	85-87	R
GS 500 EK/EL/EM/EN/EP/ER/ES/ET/EV/EW/EX /EY/K1/K2/K3/FK4/K4/FK5/K5/FK6/K6/K7/FK7	89-07	R
RG 500 G/CH	85-87	R
GSX 550 ESD/ESE/EFE/EFF/ESH/EFG	84-87	F&R
GSX 600 FJ/FK/FL/FM/FN/FP/FR/FS/FT/FV	88-97	R
GSX 600 FW/FX/FY/FK1/FK2/FK3/FK4/FK5/FK6	98-06	R
GSF 600 S/T/ST/V/SV/W/SW/X/SX/SY/Y/K1/SK1 /K2/SK2/K3/SK3/K4/SK4 "Bandit"	95-04	R
RF 600 RP/RR/RS/RT/RV	93-97	R
GSXR 600 V/W/X/Y/K1/K2/K3/ZK3	97-03	R
SV 650 X/Y/K1/K2	99-02	R
SV 650 SX/SY/SK1/SK2	99-01	R
GSX 750 SE "Katana"	85	F
GSX 750 FK/FL/FM/FN/FP/FR/FS/FT/FV	89-97	R
GSX 750 RG	89	R
GSX 750 FW/FX/FY/FK1/FK2/FK3/FK4/FK5/FK6	98-06	R
GSX 750 W/X/Y/K1	98-03	R
GSXR 750 F/G/H/J/K/L/M/WN/WP/WR/WS /TN/W/X/Y/K1/K2/K3	85-00	R
GSXR 750 RG	86	R
RF 900 RT/RV/RW	96-98	R
TL 1000 SV/SW/SX/RW/RX/SY/RZ/SK1/RK1	97-02	R
GSXR 1100 G/H/J/K/L/M/N	86-92	R
GSXR 1100 WP/WR/WS/WT	93-96	R
GSF 1200 T/ST/V/SV/S/SW/X/SX/SY/SK1/K1 /K2/SK2/K3/SK3/K4/SK4/K5/SK5 'Bandit'	96-05	R
GSF 1200 SAV ABS-Bandit	97	R
GSX 1200 FSW/FSX 'Inazuma'	98-99	R
GSX 1300 RX/RZ/RK1/RK2/RZK3/RK3 /RK4/RK5/K6/K7 'Hayabusa'	99-07	R

### Equivalent OE #

59130 16700	69100 05870	69100 21820
59130 16720	69130 16700	69130 27A10
59130 16730	69130 16740	69130 30B21
59130 16740	69130 20A10	69130 33C00
59130 16750	69130 21E00	69130 21820
59130 16810	69100 05830	69130 34C00
59130 30B00	69100 05860	69100 34860
59130 30B10	69100 05890	69101 05820
59130 30B20	69100 06810	69100 05890
59130 30B21	69100 20810	69100 0BE00

### Competitor X Ref

Dunlop	Ferodo	SBS	Vesrah
DP207	FDB338/R	556	VD-327

### MATERIAL AVAILABILITY AND PART NO.

STD	OPTIONS			
FA	HH	R	MXS	GFA
FA63	FA63HH	-	-	-

# FA64 65.3 x 59 x 10mm

**YAMAHA**  
RD 250/350 LC

80 F

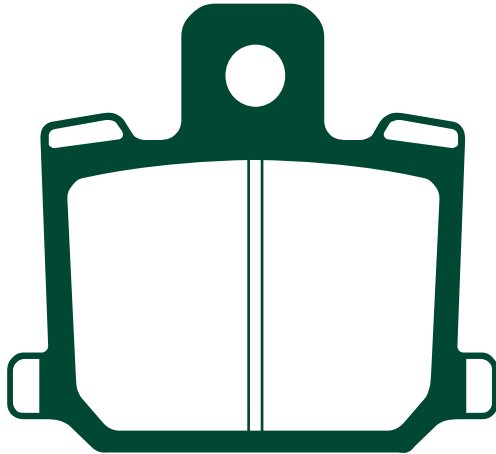

### Equivalents OE #

4LO W0045 00	4KO W0045 00
4LO W0045 10	4KO W0045 10

### Competitor X Ref

Dunlop	Ferodo	SBS	Vesrah
-	-	535	VD-221

### MATERIAL AVAILABILITY AND PART NO.

STD	OPTIONS			
FA	HH	R	MXS	GFA
FA64	-	-	-	-

# FA65 71.6 x 45.2 x 11.5mm

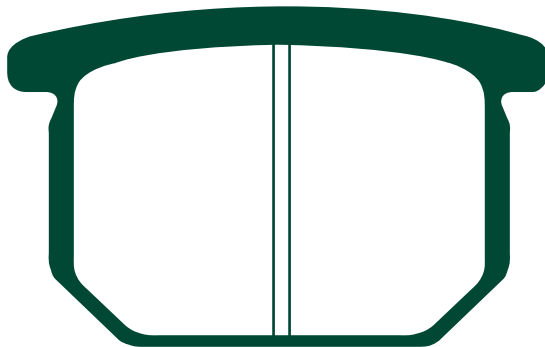

### SUZUKI

GS 550 ET/EX/EZ/LT/LX/MX/MZ	80-84	F
GR 650 D/XD Tempter	83	F
GS 650 GTX/GTZ/GTD/GX/GZ	81-83	F
GSX 750 S/SS (G57SX-106815-) Katana	84	F
GSX 750 S-2/S-2C (GS75X-114747-) Katana	84	F
XN 85 Turbo	83	F
GS 1000 ET	81	F
GSX 1000 SZ 'Katana'	82	F
GSX 1100 ET/EX/EZ/ESD	80-83	F
GS 1100 GZ	82	F
GSX 1100 SZ/SD 'Katana'	82-83	F

### Competitor X Ref

Dunlop	Ferodo	SBS	Vesrah
DP206	FDB217	534	VD-324

### MATERIAL AVAILABILITY AND PART NO.

STD	OPTIONS			
FA	HH	R	MXS	GFA
FA65	-	-	-	-

### Equivalents OE #

59300 49820	59300 49850
59300 49821	

# FA66 USE FA68

**FA67 B. 85 x 43 x 8mm**

**A. 55.5 x 37 x 10mm**

**FA67/2 B. 85 x 43 x 6.2mm**

**A. 55.5 x 37 x 8.5mm**

**FA67/3 B. 85 x 43 x 7mm**

**A. 55.5 x 37 x 9mm**

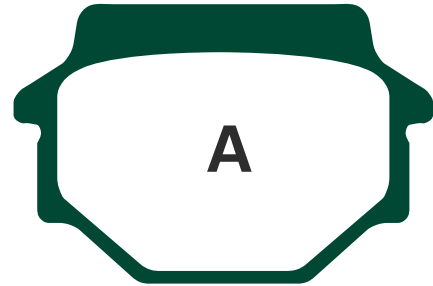
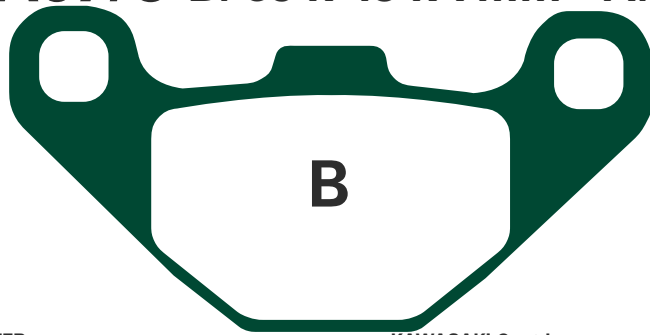

<b>ALFER</b> AR 250	93-	R	<b>KAWASAKI Contd.</b> GPZ 305 B1-B10/A1	83-96	F	<b>SUZUKI</b> RB 50 H 'GSXR 50'	87	F
<b>BAROSSA</b> 170 Cheetah	03-06	R	ZR 400 A1/B1 (Z 400F)	83-84	F	RG 50 EW		F
250 Cheetah	03-06	R	Z 400 C2/C3 (Z400 F2)	85-87	F	OR 50 ET	80	F
<b>CAGIVA</b> WMX 125/250	89	R	ZL 400 B 'Eliminator' 400 SE	88	F	ZR 50 SLKX	81	F
<b>DERBI</b> DXR 200	04-07	R	FX 400 R (ZX 400 E1-E3)	86-88	F	ZR 50 SKX/SKE/SKH	83-87	F
DXR 250	04-07	R	GPZ 400 R (ZX 400 D/D3/D3A)	85-87	F	GN 125 Z/M/R/V/W/X/Y/K1	94-01	F
<b>GAS-GAS</b> 80/125 Enduro	94-95	R	GPZ 500 S (EX 500 B1-B5)	88-93	F	GS 125 ESZ	82	F
MX 80	96	R	GPZ 500 S (EX 500 E1-E10)	94-03	R	GS 125 ESR/ESX	95-00	F
<b>GOES</b> Goes 220	05-06	R	KX 500 A1/A2/B1	83-85	F	X4 125		F
<b>KTM</b> 125/250/350/500 MX	89-91	F&R	KX 500 B2	86	F&R	GSX 250 FXK2	02	R
125/250/300/500 MX	92-93	R	KX 500 C1/D1	87-88	R	GSX 400 FX/FZ/FD	81-83	F
125/250/300/600 Enduro	92-93	R	ZR 550 A1/A2 (Z 550F)	83-84	F	<b>TGB</b> 250 Blade/Congo ATV	06-07	F
250/300 E/XC/GS	90-91	R	GT 550 G1-G9	83-01	F	<b>FA67/2 - FANTIC</b> 50 Strada	82-	F
EXC/020/EGS/620 SX	94-95	R	KLR 600 A1/A2/B1-B4/86-89	84-94	F	50/50.1 Raider	81-	F
<b>KAWASAKI</b> KSR 1 (KMX50 B1/B2)	90-91	R	KL 650 B1/B2/B3 "Tengai"	89-92	R	<b>HERCULES (SACHS)</b> 50 Supra 4 GP		F
KSR 11 (KMX80 B1/B2)	90-91	R	KL 650 C1-C10	95-04	R	<b>MALAGUTI</b> 50 MDX Gold Enduro	87-	F
KH 100 G4-G8 (EX)	83-87	F	<b>KTM</b> MX 125	89-91	F&R	50 Enduro MEX	87-	F
AR 125 A1-A7/B1-B8	82-94	F	MX 125	92-93	R	50 Enduro MSX	85-	F
KH 125 K2-K10	82-98	F	EXC 125	89	F&R	<b>QUADZILLA</b> Stinger R 250 E	06	R
KH 125 L1 (EX)	84	F	D-XC/E-XC/E-GS 125	90-91	F&R	250 E	06	R
KMX 125 A1-A5/B1-B12	86-03	R	D-XC/E-XC/E-GS 125	92-93	R	300 SE 4 Valve	06-07	R
KX 125 B2/C1/D1	83-85	F	MX 250	89-91	F&R	4 Cross 200 E SUV	06-07	R
KX 125 E1	86	F&R	MX 250	90-91	F&R	ST 200 E (5 Speed Manual)	06-07	R
KX 125 E2/F1	87-88	R	EXC/EGS 250	89	F&R	<b>FA67/3 - KAWASAKI</b> KLE 250 A2 (Anhelio)	95	R
KMX 200 A2/A3	88-92	R	D-XC/E-XC/E-GS 250	91	F&R	KLE 250 A3/A5/A6	97/00-01	R
KDX 200 C1-C3/E1-E4	86-92	F	D-XC/E-XC/T-XC/E-GS 250	92-93	R	ZZR 250 (EX 250 H1-H13)	90-03	R
Z 200 A6	83	F	MX 350	89-91	F&R	ZXR 250 C1-C3	91-93	R
BJ 250 B1-B7A 'Estrella'	92-99	F&R	DXC/EXC/EGS 350	90-91	F&R	ZXR 250 R/SP/D1	91	R
BJ 250 C1-C7 Estrella RS	95-01	F&R	EXC 350	89	F&R	ZR 250 A1-A5	91-95	R
KL 250 J1-J3 Stockman	00-02	F	MX 500	92-94	R	ZR 400 D1/D3/D4 'Xanthus'	92-95	R
KLX 250 G1/G1A Super Sherpa	97	R	LC-4 MX 500	90-91	F&R	GPZ 500 S (EX 500 D1-D7)	94-01	R
KR 250 A1/A2	84-86	F	LC-4 EXC 500	90-91	F&R	KLE 500 A1-A12	91-04	R
KX 250 C1/C2/D1	83-85	F	LC-4 MX/EXC 600	90-91	F&R	KLE 500 B1/B1P/B6F	05-06	R
KX 250 D2	86	F&R	LC-4 EXC 600	92-93	R	KLR 650 A1-A10	87-89	R
KX 250 E1/F1	87-88	R	LC-4 EXC 600	92-93	R	<b>KRAM-IT (KRAMER)</b> ER 125/250/300 RV3	88-	R
KLR 250 D2-D22	84-05	F	LC-4 EXC 600	94-	R	ER 500/600	96-	R
KLX 250 H1 'Super Sherpa'	98	R	LC-4 EXC 600					
EL 252 (EX 250 F2/F3)	97-03	F	LC-4 EXC 600					
ZR 250 B6 Balius-II	02	R	LC-4 EXC 600					
KLF 300 B1-B17 "Bayou"	88-04	F	LC-4 EXC 600					

**Equivalents OE # - FA67**

43050 1063	43082 1063	43082 1163	59130 26820	59300 36821	K4308 21204
43050 1064	43082 1064	43082 1191	59300 04830	59300 36822	513506
43050 1073	43082 1070	43082 1204	59300 04831	59300 36871	00Q25001198
43050 1082	43082 1073	43082 120	59300 26820	59301 39810	
43082 1027	43082 1084	45815 RAM 000	59300 33810	59301 39811	
430821031	43082 1086	59100 33810	59300 36810	59301 39812	
43082 1051	43082 1092	59100 33812	59300 36811	59301 33810	
43082 1056	43082 1096	59100 33820	59300 36820	545 13209 044	

**Equivalents OE # - FA67/2**

238 07 6340    240 07 6340

**Competitor X Ref**

<b>Dunlop</b>	<b>Ferodo</b>	<b>SBS</b>	<b>Vesrah</b>
DP310	FDB314	586/546	VD-325

**MATERIAL AVAILABILITY AND PART NO.**

STD	OPTIONS			
FA	HH	R	MXS	GFA
FA67/2	-	-	-	-

**Equivalents OE # - FA67/3**

43082 1116

**MATERIAL AVAILABILITY AND PART NO.**

STD	OPTIONS				
FA	TT	HH	R	MXS	GFA
FA67	FA67TT	FA67HH	FA67R	-	-

**MATERIAL AVAILABILITY AND PART NO.**

STD	OPTIONS			
FA	HH	R	MXS	GFA
FA67/3	-	-	-	-

# FA68 67.8 x 40.7 x 9.5mm

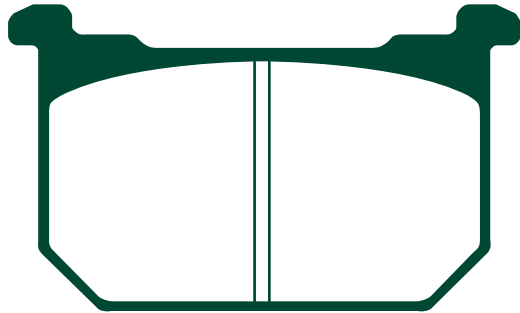

MATERIAL AVAILABILITY AND PART NO.				
STD	OPTIONS			
FA	HH	R	MXS	GFA
FA68	FA68HH	-	-	-

### Competitor X Ref

Dunlop	Ferodo	SBS	Vesrah
DP308/309	FDB298/R	539/540	VD-420/421

### KAWASAKI

Z 250 A3	81	F
Z 400 J2/J3	81-83	F
Z 440 C2	81	F
Z 440 D5/D6 (LTD)	83-84	F
Z 440 H1/H2	82-83	F
GPZ 550 H1/H2	82-83	F&R
GPZ 550 D1	82	F&R
Z 550 A2/A3/C1/C2/LTD	81-84	F
Z 650 F2/F3/F4	80-83	F
Z 700 A1 'Ltd'	84	F&R
Z 750 E1	80	F&R
Z 750 H1/H2/LTD	80-81	F&R
Z 750 L1/L2/L3/L4	81-84	F&R
Z 750 N1/N2 'Spectre'	82-83	F&R
GT 750 P1-P9	82-96	F&R
GPz 750 R1	82	F&R
Z 750 Y1 (LTD)	82	F
Z 1000 J1/J2/J3/K1/LTD/R2	81-83	F&R
Z 1100 A1-A3	81-83	F&R
GPz 1100 B1/B2	82-83	F&R
Z 1100 D1/D2 'Spectre'	82-83	F&R
Z 1100 R1 'Lawson Replica'	84	R

### Equivalents OE #

43082 1007	43082 1021	43082 1025
43082 1008	43082 1022	43082 1026

# FA69 90 x 49 x 10mm

# FA69/2 90 x 49 x 9mm

# FA69/3 90 x 49 x 11.3mm

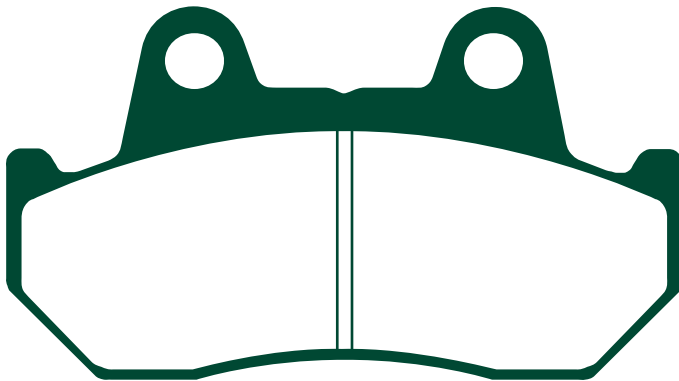

### Equivalents OE # - FA69

06435 MT8 405	43105 MC7 014	45105 MF2 670
06455 MA3 405	43105 MJ6 004	45105 MJ1 672
451A0 MM9 670	43105 MJ6 007	45105 MK4 004
431A0 MC7 024	43105 MJ6 014	45105 MK6 671
431A0 MC7 305	45105 MA6 671	45105 MK7 671
451A0 MM9 670	45105 MB0 007	45105 MK7 672
43105 KE7 702	45105 MB0 008	45105 MM9 670
43105 MA3 004	45105 MB1 701	45105 MM9 781
43105 MA3 007	45105 MB1 702	
43105 MC7 004 007/024	45105 MC4 004	

### Equivalents OE # - FA69/2

06455 443 405	43105 MJ6 724	45105 KN8 007
06455 KN8 405	45105 443 761	45105 006/016/026
431A0 MC7 024	45105 443 762	45105 KN8 712
45105 KL8 405	45105 KL8 004	45105 MC7 004
45105 KL8 405	45105 KL8 007	45105 MC7 007
43105 KN8 007	45105 KL8 014	45105 MC7 014
43105 MJ6 721/722/723	45105 KL8 712	45105 MC7 024

### Equivalents OE # - FA69/3

06435 MT8 405	43105 MB6 018/008	43105 MN5 008
06435 ML7 405	43105 MG9 007/017	43105 MT8 008
06435 ML7 415	43105 ML7 006	431A0 MN5 670
43105 MB4 007/017	43105 ML7 007	451A0 MM8 670
43105 MB4 008	43105 ML7 017	
43105 MB4 305	43105 ML7 027	

### Competitor X Ref

Dunlop	Ferodo	SBS	Vesrah
DP104/105	FDB244/R	542/572	VD-123/132

### FA69 - HONDA

CB 125 TDC/TDE/TDJ	83-89	F
CBX 125 F	84-	F
CBX 250 RSE	84	F
NS 400 RF/RG	85-87	F&R
CMX 450 CH/CJ Rebel	87-88	F
CX 500 CC	82	F
CX 500 EC	82	F&R
CX 500 TCC 'Turbo'	83	F&R
FT 500 C	82	F&R
GL 500 DC	82	F
VF 500 FE/F2E/FF/F2F	84-85	F&R
XBR 500 F/G/H/SJ	85-89	F
XL 600 VH/VJ/VK "Transalp"	87-90	F
CX 650 ED	83	R
CB 750 FC/F2C/FD/F2D	83-84	R
CBX 750 FE	84	F
VF 750 C Shadow	83	F
VF 750 S Sabre	82-83	F
VF 750 FD/FE	83-84	F
VF 750 SC	82	F
XLV 750 R	83-88	R
CB 900 FB/F2B	82-85	R
CB 900 FC/F2C/FD/F2D	84-85	F&R
CBX 1000 B/C	81-82	R
VF 1000 FE/FF/FG/F2F/F2G	84-86	F
VF 1000 RE/RF/RG	84-86	F
CB 1100 RBII/RCII/RDII	80-83	F&R
GL 1100 C/DC/AD 'Goldwing'	82-83	R

### FA69/2 - HONDA

CN 250 H/J/L/M/P/R/S/T/V/X SPAZIO/Helix	87-98	F
GB 250 E/H 'Clubman'	84-87	F
NS 250 FE (MC11)	84	F
NS 250 RE/RG (MC11)	84-86	F
CB 400 NC	82	F
CX 650 TD 'Turbo'	83	F
CX 650 ED	83	F
GL 650 D2-E	84	F
CB 750 FC/F2C/FD/F2D	83-84	F
CB 900 FB/F2B	82-88	F
CBX 1000 B/C	81-82	F
GL 1100 C/DC/1C Interstate 'Goldwing'	82	F
GL 1100 AC Aspencade 'Goldwing'	82	F
GL 1100 C/DC/AD	82	F

### FA69/3 - HONDA

NS 250 FE (MC11)	84	F
NS 250 RE/RG (MC11)	84-86	F
NSR 250 RG (MC16)	86	R
CBR 400 RG/RHYA (NC23)	86-87	R
VFR 400 ZG/ZH/RG-YA (NC21)	85-87	R
CBR 500 FH/FJ/FK/FL	87-90	R
CBR 600 FH/FJ/FK/FL	87-90	R
CBR 750 FH Superaero	87	R
CBX 750 FE	84	R
VF 750 FD/FE	83-84	R
VF 750 CH	87	F
VFR 750 FG/FH	86-87	R
VF 1000 FE/FF/FG/F2F/F2G	84-86	R
CBR 1000 FH/FJ	87-88	R
CB 1100 RB2/RC2/RD2	80-83	R
VT 1100 CH/CJ/CN/CP Shadow	87-93	F
GL 1200 DE/DF/DG/AE/AF/AG	84-86	F&R
GL 1500 J/K/L/SEM/SEN/SEP/SER		
/SES/SEV/SEW/SEX/SEY "Goldwing"	88-00	R

### MATERIAL AVAILABILITY AND PART NO.

STD	OPTIONS			
FA	HH	R	MXS	GFA
FA69	FA69HH	-	-	-

### MATERIAL AVAILABILITY AND PART NO.

STD	OPTIONS			
FA	HH	R	MXS	GFA
FA69/2	-	-	-	-

### MATERIAL AVAILABILITY AND PART NO.

STD	OPTIONS			
FA	HH	R	MXS	GFA
FA69/3	FA69/3HH	-	-	-

# FA70 66.5 x 59 x 10mm

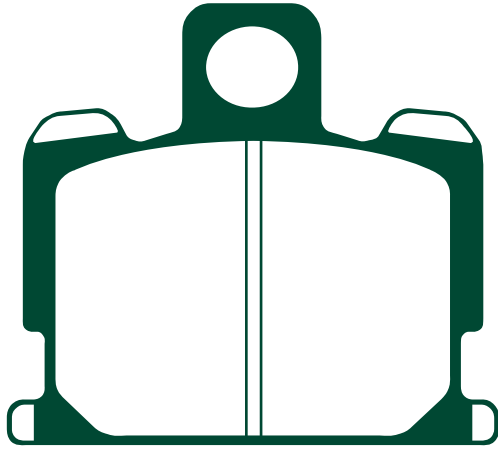

## YAMAHA

RD 50 MX/RD 50	81-87	F
RD 80 (Air Cooled)	82	F
RD 250	80-83	F
RZ 250 (4L3)		F
RD 350 LX	81-82	F
XJ 550	81-84	F
XJ 550 H/J/K Maxim	81-83	F
XJ 550 RH/RJ/RK Seca	81-83	F
XJ 750	82-84	F
XJ 750 RF/RJ/RK Seca	81-83	F
XS 1100 S	81	F

### Equivalents OE #

23W W0045 01	4W1 W0045 00
23W W0045 10	4W1 W0045 00
4L3 W0045 00	4W1 W0045 20
4L3 W0045 10	4W1 W0045 30

MATERIAL AVAILABILITY AND PART NO.				
STD	OPTIONS			
FA	HH	R	MXS	GFA
FA70	-	-	-	-
FA70S (Green)				

### Competitor X Ref

Dunlop	Ferodo	SBS	Vesrah
DP402	FDB277	547	VD-228

# FA71 69.5 x 53.8 x 6.5mm



## HARLEY DAVIDSON

FX/FXE/FXEF/FXWG/FXS	Late 78-83	F
XL/XLH/XLCH/XLS/XLX	79-83	F
FXD, FXDL, FXDWG, FXR, FXRS, FXRT, FXRD, FXCR, FXDX	82-83	F

### Equivalents OE #

44032 77
44032 79

### Competitor X Ref

Dunlop	Ferodo	SBS	Vesrah
DP907	FDB333	537	VD-903/908

MATERIAL AVAILABILITY AND PART NO.				
STD	OPTIONS			
FA	HH	R	MXS	GFA
FA71	-	-	-	-

# FA72 89 x 71.2 x 6.5mm



## HARLEY DAVIDSON

XL/XLH/XLCH/XLS/XLX	79-81	R
FLT/FLHT/FHTCI/FLHTWI	80-83	F

### Equivalents OE #

43395 80
----------

### Competitor X Ref

Dunlop	Ferodo	SBS	Vesrah
DP908	FDB334/R	543	VD-909

MATERIAL AVAILABILITY AND PART NO.				
STD	OPTIONS			
FA	HH	R	MXS	GFA
FA72	-	-	-	-

# FA73 A. 51.3 x 9.4mm B. 50 x 8mm

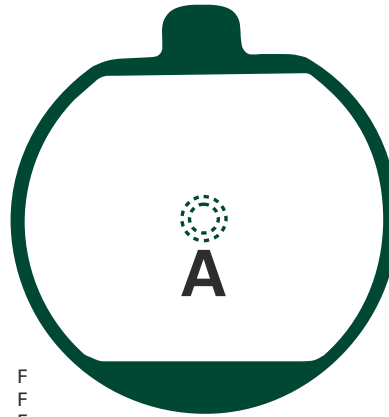
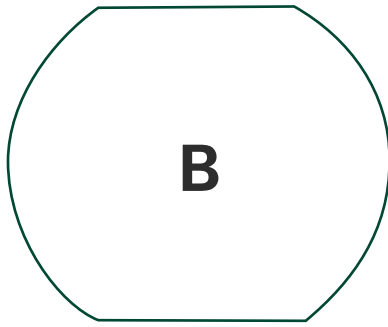

### Equivalents OE #

43082 1001
43082 1005

### KAWASAKI

Z 250 A1/A2	78-80	F
Z 400 J1	80	F
Z 440 A2/C1	79-80	F
Z 440 D4 (LTD)	82	F
Z 500 B1/B2	79-80	F
Z 550 A1	80	F
Z 650 C3 (D2/D-SR)	78-80	F
Z 650 F1	79	F
Z 650 D2/D3 (SR)	79-80	F
Z 1000 A3/A4	79-80	F
Z 1000 H1/H2	74-75	F
Z 1000 D3 (ZIR)	79	F

### Competitor X Ref

Dunlop	Ferodo	SBS	Vesrah
DP302/305	FDB132	510	VD-403/417

### MATERIAL AVAILABILITY AND PART NO.

STD	OPTIONS			
FA	HH	R	MXS	GFA
FA73	-	-	-	-

# FA74 38 x 51.5 x 7mm

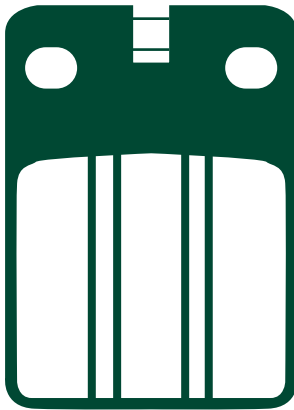

### LAVERDA

LZ 125 Sport Grimeca caliper	80-82	F
<b>MOTO MORINI</b>		
125 KJ/T/KT Kanguro	84-	F
350 Sport	82-	F&R
350 Kanguro	84-86	F

### Equivalents OE #

430963

### Competitor X Ref

Dunlop	Ferodo	SBS	Vesrah
N/A	N/A	N/A	N/A

### MATERIAL AVAILABILITY AND PART NO.

STD	OPTIONS			
FA	HH	R	MXS	GFA
FA74	-	-	-	-

# FA76 49 x 59 x 6mm

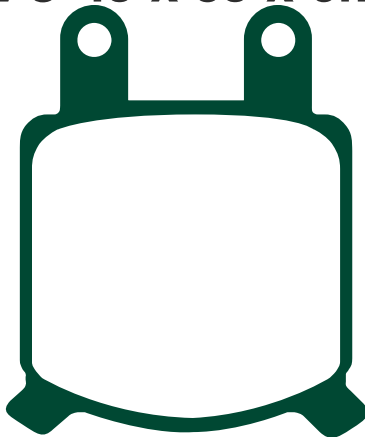

### ASPES

125 Duma		F
----------	--	---

### JAYBRAKE

2 Piston Caliper (Large)

### GARELLI

TSR 125	-83	F
---------	-----	---

### GILERA

80 TG 1/2/3		F
125 GR 1		F
125 TG 1/2/3		F
200 T4/T4 C/T4 S		F

### GMA

2 Piston Caliper model B

### KREIDLER

Mustang 125		F
-------------	--	---

### LAVERDA

125 (Grimeca Caliper)	82-	F
-----------------------	-----	---

### MOTO MORINI

125 Monocilindro	79-	F
250 All models	71-	F
350 Sport	-79	F&R
350 Sport	80-81	F
350 FT/Turismo	80-	F

### NVT

125/175 Rambler		F
-----------------	--	---

### MATERIAL AVAILABILITY AND PART NO.

STD	OPTIONS			
FA	HH	R	MXS	GFA
FA76	-	-	-	-

### Equivalents OE #

310 292  
430 09 11

### Competitor X Ref

Dunlop	Ferodo	SBS	Vesrah
-	FDB205	560	VD-928

# FA77 60 x 58 x 9mm

## BENELLI

900 SE1 (6 cyl) 83 R

## BMW

R 65 07/88-08/89 F  
 R 80/R 80 RT 84-07/95 F  
 R 80 GS 87-95 F  
 R 80 PD/CH 90-95 F  
 R 850 GS 96 F  
 R 100 GS 86-94 F  
 R 100 PD 89-96 F

## LAVERDA

1000 RGS Corsa 84 F

## MOTO GUZZI

1000 Spada 78-94 R

### Equivalents OE #

34 11 1 354 720	34 11 2 310 601
34 11 2 331 177	18654660
34 11 2 314 545	

### Competitor X Ref

Dunlop	Ferodo	SBS	Vesrah
DP620	FDB204/R	554	VD-933

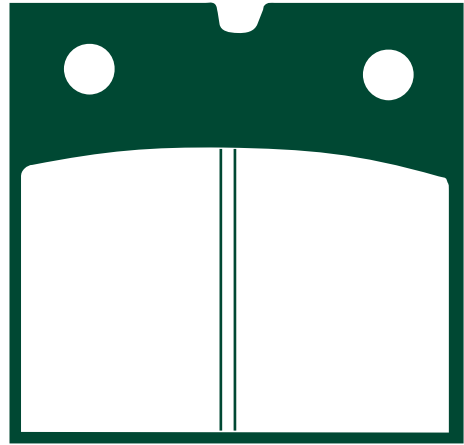

### MATERIAL AVAILABILITY AND PART NO.

STD	OPTIONS			
	HH	R	MXS	GFA
FA77	-	-	-	-

# FA78 74.2 x 49 x 12mm



**NOW INCLUDES  
SHIMS x 2**

## HARLEY DAVIDSON

FX/FXE/FXEF/FXWG/FXS 84-86 R  
 FXWG/FXSB 83 R  
 XL/XLH/XLCH/XLS/XLX 82-Early 87 R  
 FXD, FXDL, FXDWG, FXR, FXRS, FXRT, FXRD, FXLR, FXDX 82-early 87 R  
 FXST, FXSTB, FXSTC, FXSTS, FLST, FLSTC, FLSTF, FLSTS, FLSTN 84-early 87 R

### Equivalents OE #

44209 82
44209 82A

### Competitor X Ref

Dunlop	Ferodo	SBS	Vesrah
DP901	FDB335/R	549	VD918

### MATERIAL AVAILABILITY AND PART NO.

STD	OPTIONS			
	HH	R	MXS	GFA
FA78	-	-	-	-

# FA79 174 x 73.2 x 9.3mm

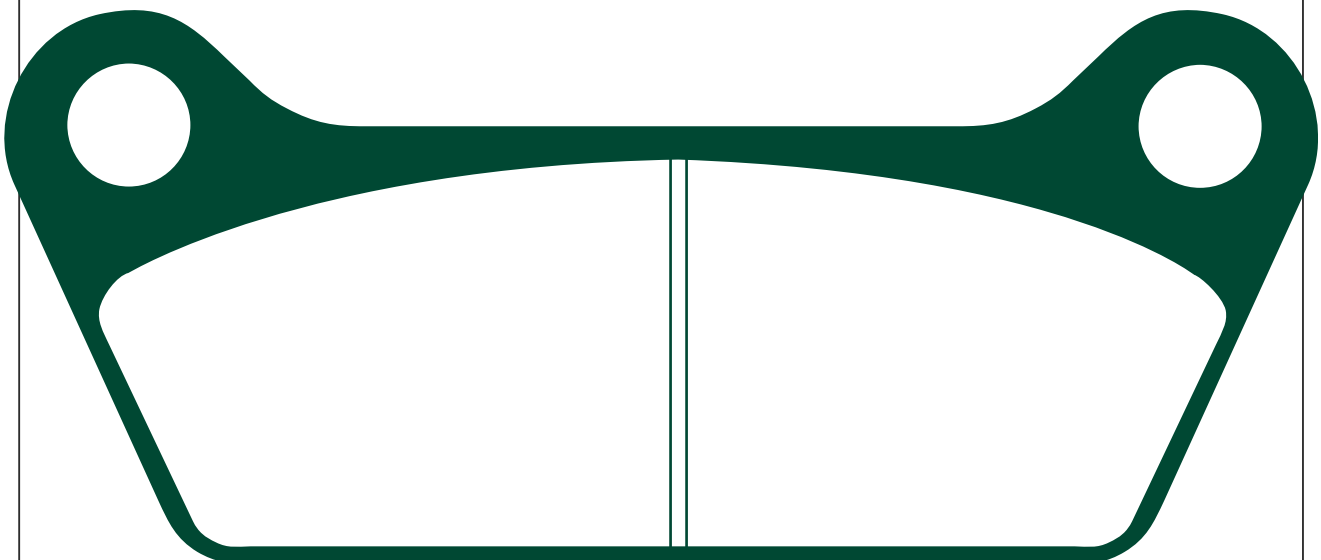

## HARLEY DAVIDSON

FL/FLH 81-84 R  
 FLT/FLHT/FLHTCI/FLHTCUI 80-85 R

### Equivalents OE #

43957 80
----------

### Competitor X Ref

Dunlop	Ferodo	SBS	Vesrah
-	-	553	VD-917

### MATERIAL AVAILABILITY AND PART NO.

STD	OPTIONS			
	HH	R	MXS	GFA
FA79	-	-	-	-



# FA80 92 x 53 x 8mm

## FA80/2 92 x 53 x 9.5mm

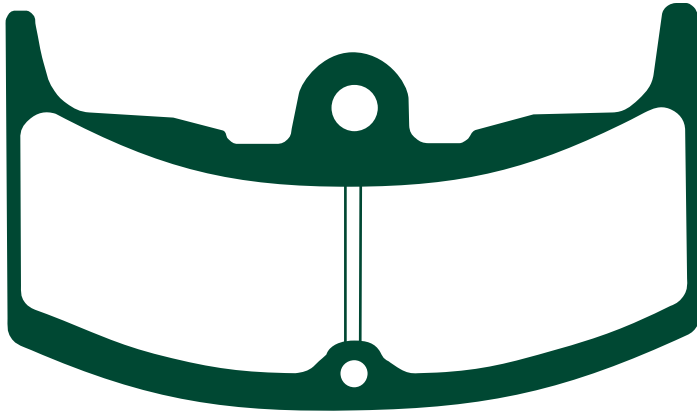

### FA80 - HONDA

CBX 550 FC/F2C/FD/F2D 82-84 F

### FA80/2 - HONDA

MXV 250 F (MC92) 83-88 F  
 VT 250 FD 83 F  
 VF 400 FD 83-85 F&R  
 VT 500 ED/EF 83-85 F  
 CBX 550 FC/F2C/F2D/FD 82-84 R

#### Equivalents OE # FA80

45105 MA7 007	45105 MA7 305
45105 MA7 004	

#### Equivalents OE # FA80/2

45105 MA6 004	45105 MA6 305
45105 MA6 007	

#### Competitor X Ref

Dunlop	Ferodo	SBS	Vesrah
DP106	FDB310/R	552/571	VD-129/129/2

MATERIAL AVAILABILITY AND PART NO.				
STD	OPTIONS			
FA	HH	R	MXS	GFA
FA80	-	-	-	-

MATERIAL AVAILABILITY AND PART NO.				
STD	OPTIONS			
FA	HH	R	MXS	GFA
FA80/2	-	-	-	-

# FA81 68 x 60 x 10.5mm

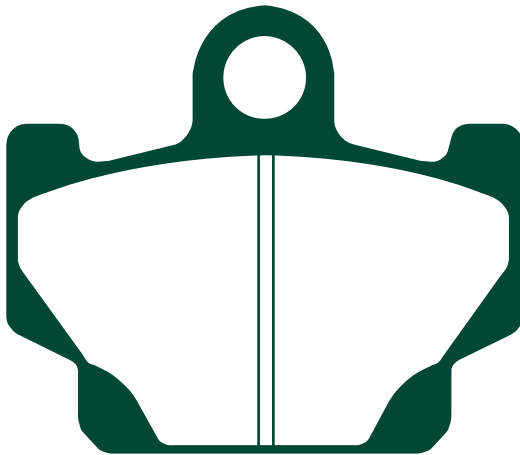

### YAMAHA

DT 80 LC (37A) 81-84 F  
 RD 80 LC 82 F  
 RX 115 (5FS3) 99 F  
 RD 125 LC 82-84 F  
 SR 125 SE 92-96 F  
 RX 135 (13X) 81 F  
 RZ 250 R (29L) F  
 XV 250 Virago 89-94 F  
 RD 350 YPVS 83-84 F  
 XS 400 82 F  
 XZ 550 82-84 F  
 XT 600 84-86 F  
 XT 600 (Z Tenere) 84 F  
 XJ 650 Turbo 82 F  
 XJ 650 LK 'Seca' 83 F

#### Competitor X Ref

Dunlop	Ferodo	SBS	Vesrah
DP403	FDB311	550	VD-235

#### Equivalents OE #

11H W0045 00	11U W0045 10	2UJ W0045 00	4X8 W0045 00
11H W0045 01	22U W0045 10	2UJ W0045 01	52R W0045 00
11H W0045 11	29L W0045 00	34L W0045 10	5R2 W0045 00
11L W0045 00	29L W0045 10	43F W0045 00	3XL W0045 00
11U W0045 00	2KJ W0045 00	43F W0045 01	

MATERIAL AVAILABILITY AND PART NO.				
STD	OPTIONS			
FA	HH	R	MXS	GFA
FA81	-	FA81R	-	-

# FA83 A. 47.5 x 37 x 9mm B. 85 x 42.5 x 7mm

## FA83/2 A. 47.5 x 37 x 10mm B. 85 x 42.5 x 7.8mm

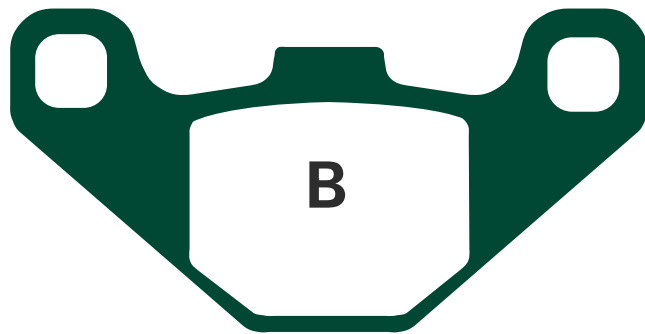

<b>KAWASAKI</b>					
AR 50 A1/C2-C10	81-97	F			
AH 80 Address	92-94	F			
AR 80 A1/C1-C8	81-91	F			
KX 80 E2/E3/G1/G2/J1/J2/L1-L3/N2/N3/ R1-R6/T1-T6	84-96	F			
AH 100 Address	92-94				
KX 100 A1/A2/B1-B6	89-96	F			
<b>KAWASAKI Contd.</b>					
KMX 125 A1-A5/B1-B9	86-98	F			
KX 125 B1	82	F			
KDX 125 A1/A2/B1/B2	90-94	F			
KMX 200 A2/A3	88-92	F			
KX 250 B1	82	F			
KXT 250 A1 Tecate	84	R			
KXF 250 A1/A2 'Tecate 4'	87-88	R			
<b>ADLY</b>					
50 RS Supersonic	06	F&R			
Silver Fox 50/100	06	F			
Activator/Thunderbike 125		F&R			
Jet 50/100		F			
Predator 50/100		F			
Panther 50/100	02-06	F			
Cosy 50/80	02-06	F			
RT 50/100		F			
SS 50 1/11 Supersonic	04-05	F			
SS 100 1/11 Supersonic	04-05	F			
SS 125 B/D Supersonic	04-05	F&R			
150 Crusader Quad	06	F&R			
150 Interceptor	06	F&R			
Interceptor 300	06	R			
300 Crusader Quad	06	F&R			
<b>AEON</b>					
Aero 50/100 (Scooter)	06	F			
Nox 50/100/125/150 Scooter	06	F			
Regal 50/90 (Scooter)	06	F			
Revo R50 Cobra 2 (AT34 Type) (Quad)	04-06	R			
Revo R100 Cobra 2 (AT34 Type) (Quad)	04-06	R			
Pulsar 100/125/150 (Scooter)	06	F			
Sporty 125 (AT05 type) (Quad)	01-05	R			
Sporty 180 (AT05 type) (Quad)	04-05	R			
200 Two Hundred Quad	05	F&R			
Cobra 220 (Quad)	06-07	F			
Overland 300 (Quad) (AT20)	06-07	F&R			
<b>BLANEY (Quads)</b>					
XC 125 Trojan	03-04	R			
<b>BOMBARDIER</b>					
Rally 200	03-06	F			
<b>BSM</b>					
TB 100		F			
TB 125		F&R			
<b>CAN-AM</b>					
Rally 200 (4A7A/B/C/D/E/F)	07	F			
<b>COR QUADS</b>					
DN 50/50 E	05	R			
DN 100/100 E	05	R			
DN 150/150 E	05	R			
DN 250	05	R			
<b>CPI</b>					
50 Hussar	01-03	F			
50 Mars	01	F			
Baby J 50	02	F			
Quad	03	R			
Popcorn 50	02-03	F			
ST 250 Sector Quad	05-06	F			
XS 250 Power Quad	07	F			
<b>COR</b>					
DN 250/Hammel	06	F&R			
DN 100	06	R			
DN 250 Dolphin	06	R			
RX 260	06	F&R			
Utility 250	06	F&R			
DN 150		R			
DN 150 Extreme		R			
<b>DAELIM</b>					
ET 250 Quad	06	F			
<b>DERBI</b>					
DXR 200	04-07	F			
DXR 250	04-07	F			
<b>E-TON QUADS</b>					
BXL-50 Draco	05-06	R			
EXL 50 Viper 50	07	R			
Viper 50 Mini RXL 50 M	03-07	R			
Viper 50 RXL 50	03-06	R			
Viper 70 RLX 70	05-07	R			
BXL 100 Draco	05-06	R			
RXL 90 Viper 90	03-07	R			
RXL 90 R Viper 90 R Reverse	03-07	R			
Viper EXL 150 ST Quad	05-07	F			
EXL 150 Yukon ST	05-06	F			
VXL 250 Vector	06	F&R			
Vector VXL 250 ST Quad	06-07	F&R			
VXL 300 Vector	07	F			
VXL 300 ST Vector ST	07	F			
VTX 300 Vortex	07	F			
VTX 300 ST Vortex ST	07	F			
<b>GARELLI</b>					
Queenie	95-	F			
Grinta	95-	F			
<b>GILERA</b>					
Stalker 50	03-07	F			
<b>GOES (Quads)</b>					
220	06-07	F&R			
320 Max	07	F&R			
<b>HYOSUNG</b>					
Super Cab/Cab Plus/Sense 50/Prima 50/Avanti	99-06	F			
SF 50 R Rally Prima	00-06	F			
SD 50	00-06	F			
EZ 100	99-02	F			
SF 100 R	05-06	F			
FX 110 DLX Midas	99-04	F			
Krillo Master	04	F			
<b>KEEWAY</b>					
Focus 25/50	07	F			
Matrix 25/50	06	F			
Hurricane 50	07	F			
Hurricane 50-Base	07	F			
Focus 125	07	F			
Matrix 125	06	F			
Dragon 250 Quad	07	F			
<b>MASAI</b>					
A 300 Quad	05-07	F			
A 450 Quad	05-07	F			
<b>MOTO-ROMA</b>					
Grand Prix 50/100	99-03	F			
Grand Prix 125	02	F&R			
Geko 300 Quad	04-06	F			
<b>MZ/MUZ</b>					
Moskito 50/50 SX	02	F			
Moskito 125	02	F			
VRS 150 Quad	05	R			
<b>PEUGEOT (Heng Tong calipers)</b>					
Various Scooter models (Check pad shape)		F			
Trekker Off Road	98-01	F			
Speed Fight	97-98	F			
<b>PGO</b>					
Galaxy 25/50/90	94-	F			
Mega 50	94-	F			
Rider 150 50/90/110	04-05	R			
<b>POLARIS</b>					
Phoenix 200	05	R			
<b>QUADZILLA</b>					
X 50	06-07	R			
Black Max M100 (SE)	06	R			
R 100	06-07	R			
Pro Shark	06	R			
Pro Shark Type R	06	R			
Pro Shark 100 R MX	07	R			
Stinger R 250 E	06	F			
250 E	06	F			
300 E XLC	06-07	F			
300 SE 4 Valve	06-07	F			
4 Cross 200 E SUV	06-07	F			
X 100 E (XLC)	06-07	R			
Pro Shark-E	06	R			

# FA83 Contd. FA83/2 Contd.

## QUADZILLA Contd.

ST 200 E (5 Speed Manual)  
450 R

## ROXON

RX 150 (Quad)  
Sport Spirit NFS 150 (Quad)

## SUZUKI

AD 50 T/Tune/V-Tune  
AE 50 R  
AJ 50 ZZ/RS Sepia  
CP 50 C  
CR 50 DC  
RM 80 XL/XM/XN/XP/XR/XS  
RM 80 T/V/W/X/Y/K1  
RM 85 K2/LK2/K3/LK3/K4/LK4  
AH 100 P Address  
UE 125/150 CTK1

## TGB

Delivery 50 (From FE no 609100)  
Hornet 50/90 Quad  
Key West 50  
RS 50cc  
Sunset 50  
Trigger 50  
High Wheel 50  
F409 Cruise 50/125

06-07 F  
06-07 F  
04-06 R  
04-06 R  
88 F  
F  
92- F  
F  
F  
90-95 F&R  
96-01 R  
02-04 R  
95-96 F  
01-03 F  
06-07 F  
04-05 R  
06-07 F  
06-07 F  
07 F  
F  
F  
F  
05 F

## TGB Contd.

250 Blade/Congo ATV  
309 RS 50  
204 Classic  
R 50 X/507  
101 S  
Sunset 150

## TM

80/85 Minicross/Junior

## VIALLI

RX Sport 50

## FA83/2

### SUZUKI

RM 80 XG/XH/XJ/XK

### KAWASAKI

KSR1 (KMX50 B1/B2)  
KSR11 (KMX80 B1/B2)

### HONDA

MB 80 (MB8)

### MCX 80

### PIAGGIO

NRG 50 DD  
NRG 50 Pure Jet  
NRG 50 Power DT  
Typhoon 50

06-07 R  
F  
F  
03-04 F  
06 R  
06 F  
07 F  
96-00 F  
06 F  
86-89 F  
90-91 F  
90-91 F  
80- F  
82- F  
06-07 F  
06-07 F  
05-06 F  
06-07 F

### Equivalents OE # - FA83/2

497417

### Equivalents OE # - FA83

43050 1040	43082 1083	59300 03870	514069
43050 1043	43082 1115	59330 46F00	67131 5EE0 0000
43050 1044	43082 1164	59340 46F00	GFS359902
43050 1048	45120 119 00	736502	59300 03860
43050 1051	69100 02821	752426	45110 B20T 000
43050 1126	59100 02820	752818	610143
43050 1169	59100 02821	GF5359902	45110 JHFT 000
43082 1065	59100 02830	705 600 285	
43082 1079	59300 09810	45815RAM00/01	
43082 1081	59300 09811	610113 497417	

### Competitor X Ref

Dunlop	Ferodo	SBS	Vesrah
DP312	FDB313	544	VD-339/342/442

### MATERIAL AVAILABILITY AND PART NO.

STD	OPTIONS			
FA	HH	R	MXS	GFA
FA83TT	FA83HH	FA83R	-	-

### MATERIAL AVAILABILITY AND PART NO.

STD	OPTIONS			
FA	HH	R	MXS	GFA
FA83/2TT	-	FA83/2R	-	-

# FA84 46 x 45 x 7.8mm

# FA84/2 46 x 45 x 6.5/7.8mm (1 piece each size per set)

# FA84/3 46 x 45 x 6.5mm



### FA84

#### ARCTIC CAT

DVX 400 04-07 F

#### HONDA

CR 80 RG/RH/RJ/RK/RL/RM/RN//RP/RR/RS/RT/RBT/RV

/RBV/RW/RBW/RX/RB/RBY/R1/RB1/RB2/R2

CR 85 R3/RB3/R4/RB4/R5/RB5/R6/RB6/R7/RS7

CRF 150 RB7/R7

ATC 250 RD 86-02 F

ATC 250 RC 03-07 F

TRX 250 EX1/2/3/4/5/6/7 07 F

TRX 300 EX P/R/S/T/V/W/X/Y/1/2/3/4/5/6/7 83-84 F&R

TRX 400 EXX/EXY/EX1/EX6 82 F

TRX 420 FE7/TE7/FM7/TM7 Fourtrax Rancher 01-07 F

#### HONDA HM (Italy)

CR 85 R/R2 03-07 F

CR 150 R/R2 07 F

#### HUSQVARNA

CR 125 92-94 R

WR 125 93-94 R

CR 250 92-94 R

WR 250 92-94 R

TE 350 92-94 R

CR 360 92-94 R

WR 360 92-94 R

TC 610 92-94 R

TE 610 92-94 R

### KAWASAKI

KX 80 L1-L3/N2/N3/R1-R7/T1-T6/W1/W2/W3 88-00 R

KX 85 A1-A5/A6F/A7F/B1-B5/B6F/B7F 01-07 R

KX 100 A1/A2/B1-B7/C1/C2/C3 89-00 R

KSF 250 A8-A18 94-04 R

KEF 300 B1/B2/B3 Lakota Sport 01-03 R

KVF 400 A1/A2/A3 (KFX 400) 03-05 F

KFX 450 R Quad 07 R

### SUZUKI

RM 100 K3 03 R

LT-Z 400 K3/K4/K5/K6/K7 03-07 F

LT-Z 250 F4/F5/F6/F7 QuadSport 04-07 F

### YAMAHA

YFS 200 R/S/T/V Blaster 03-06 R

YFZ 350 U/B/D/E/F/G/H/J/K/L/M/N/P/R/S/T/V Banshee 88-06 R

YFM 350 XD/XE/XF/XG/XH/XJ/XK/XL/XM/XN

/XP/XR/XS 92-04 R

YFM 350 FXG/FXH/FXJ/FXK/FXL/FXM

/FXN/FXP/FXR/FXS Wolverine 95-04 R

YFM 350 S/T/V/R-WV/RW Raptor 04-07 F&R

YFM 400 FWP Big Bear 4x4 02 F

YFZ 450 S/T 04-05 R

YFM 600 FWAK/FWAL/FWAM/FWAN 'Grizzly' 98-01 F

YFM 600 HM "Grizzly Hunting" 00 F

YFM 660 RN/RP/RR/RS Raptor 01-04 F&R

YFM 660 FWAP/FWAR/FWAS/FWAT/FWAW/FGW Grizzly 02-07 F

YFM 660 FR/FS/FT Grizzly 03-05 F

### FA84/2

#### HONDA

ATC 200 XD 83 F&R

### FA84/3

#### SUZUKI

RM 125 J 88 R

RM 250 H/J 87-88 R

#### TM

80/85 Minicross/Junior 96-00 R

### YAMAHA

YZ 80 E/F/LWF/LWG/G/LWH/H

/LWJ/J/LWK/K/L/LWL/LWM/M/LWN/N 93-01 R

YZ 85 P/LWP/R/LWR/S/LWS/T/LWT/V/LWW/W/LWW 02-07 R

YZ 125 W 89 R

YZ 250 W/WRW 89 R

### Equivalents OE # - FA84/2

431A0 965 000	45105 961 006
431A0 965 670	43120 965 000
43120 HC0 007	

### Equivalents OE # - FA84/3

69140 26C00	3JD W0046 00
3JD W0046 01	4ES W0046 00
3JD W0046 10	5PA W0046 00

### Competitor X Ref - FA84

Dunlop	Ferodo	SBS	Vesrah
DP811	FDB381	592	VD-128

### Competitor X Ref - FA84/2

Dunlop	Ferodo	SBS	Vesrah
-	-	562	VD-127/2

### Competitor X Ref - FA84/3

Dunlop	Ferodo	SBS	Vesrah
DP816	FDB661	584	VD-127

### Equivalents OE # - FA84

06435 HA5 405	43120 HA5 305	06455 GBF J01
06435 HA5 670	43120 HA5 670	5LP W0046 00
1UY W0046 00	69140 19A00	5LP W0046 50
43082 5006	69140 19A01	K4308 21205
43082 1205	69140 19A11	59300 42850
43106 961 006	69140 19A10	3406 031
45105 961 000	4WV W0045 00	3406 032
45110 HB7 007	45105 GC4 601	59300 42860
451A0 HB5 670	45105 GC4 602/603	59300 42870
43082 1066	45105 GBF 405	800070854
43082 1082	45112 GC4 601	800071451
431A0 HA5 670	45112 GC4 831	06435 HP5602

### MATERIAL AVAILABILITY AND PART NO.

STD	OPTIONS			
FA	HH	R	MXS	GFA
FA84TT	-	FA84R	MXS84	-

### MATERIAL AVAILABILITY AND PART NO.

STD	OPTIONS			
FA	HH	R	MXS	GFA
FA84/2TT	-	FA84/2R	-	-

### MATERIAL AVAILABILITY AND PART NO.

STD	OPTIONS			
FA	HH	R	MXS	GFA
FA84/3TT	-	FA84/3R	MXS84/3	-

# FA85 A. 111 x 50 x 9.5mm B. 69x 43.5x 9.8mm



### KAWASAKI

EL 250 'Eliminator'	87-89	F
EL 250 D1-D5	90-94	F
ER 250 B1-B3 (Z250T Scorpion)	83-88	F
GPZ 250 R (EX 250 E)	86	F&R
KR 250 A1/A2	84-86	R
Z 400 C2/C3 (Z 400 F2)	85-87	R
ZL 400 A 'Eliminator'	86-87	F
FX 400 R (ZX400 E1-E3)	86-88	R
GPX 400 R (ZX 400 D1/D3/D3A)	85-87	R
LTD 450 (EN 450 A1-A5)	86-89	F
EN 500 A1-A3/B1-B2/C1-C9	90-04	F
GPz 550 A1-A4 (ZX 550 A1-A4)	84-87	F&R
GPz 600 R A1-A5A	85-89	F&R
VN 700 A1 'Vulcan'	85	F
ZN 700 A1/A2 'Ltd'	84-85	F&R
GPz 750 A1-A5	83-87	F&R

GPz 750 E1-E2 (Turbo)	84-87	F&R
GPz 750 R G2/G3	85-86	F&R
VN 750 A2-A5/A10	86-94	F
VN 800 A1-A3	95-99	F
GPz 900 R (A1-A6)	84-89	F&R
ZL 900 A1/A2 'Eliminator'	85-86	F&R
GPz 1000 RX (A1-A3)	86-88	F&R
ZL 1000 A1	87	F&R
1000 GTR (ZG 1000 A1-A7)	86-93	F&R
1000 GTR (ZR 1000 A9-A14)	94-99	R
GPz 1100 A1-A3	83-85	F&R
Z 1100 R1 'Lawson Replica'	84	F
VN 1500 B2-B6 (VN15SE)	88-92	F&R
VN 1500 A6 (VN15)	92	F&R
VN 1500 C1/C2 (VN15)	94-95	F&R
VN 1500 D1/D2/E1/E2 "Classic"	96-99	R
VN 1500 G1/G2 'Classic Tourer'	98-99	R

### Equivalents OE #

43082 1029	43082 1061	43082 1167
43082 1031	43082 1062	43082 1194
43082 1057	43082 1080	

### Competitor X Ref

Dunlop	Ferodo	SBS	Vesrah
DP311	FDB339/R	557	VD-424/ 426

### MATERIAL AVAILABILITY AND PART NO.

STD	OPTIONS			
FA	HH	R	MXS	GFA
FA85	FA85HH	-	-	-

# FA86 77.3 x 42.2 x 7.2mm

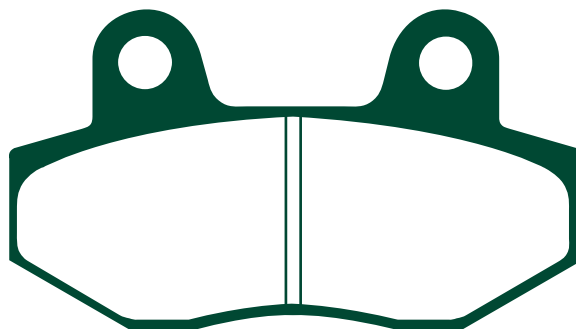

## CCM

C-XR 230 E	07	F
C-XR 230 S	07	F

## DAELIM

Citi Ace 110	03-07	F
--------------	-------	---

## GARELLI

Comfort 125	07	F
Mosquito 150	07	F

## HERO

Slickster 125	06	F
---------------	----	---

## HONDA

MBX 50 SD/SF	83-85	F
NSR 50 FP/FR/FS	93-95	F
NSR 50 SK/SP/SR/SS	89-95	F
NSR 80 J-2/K/L/N (HC06)	88-92	F
CBX 125 Custom	88-	F
FS 125 Sonic	03-04	F
LS 125 RY	00-	F
MBX 125 FE	84-86	F
CBX 250	84-98	F

## HONGDOU

CTM 125 Chituma	04	F
-----------------	----	---

## HYOSUNG

RX 125	01-02	F
RX 125 SM	06-07	F&R
Comet 125	02	F
RT Karion 125	02-06	F
Exceed 125 (MS 125/150)	02-04	R
GV 125	04-07	F
GV 250	01-07	F
XRX 125	04-07	F
RX 400	05	F
GV 650	04-05	F
GV 1000	04	F
Comet 650	04	F&R
GT 250	04-07	F&R
GT 125	04-07	F&R
GT 125 R	06-07	F
Comet 125/250	04	F&R
Comet 650	04	F&R
GT 650 R	04-07	F&R
GT 650 S	05-07	F&R
GT 650	06-07	F&R
GT 650 X	07	F&R
GV 650	06-07	F&R
GT 250 R	06-07	F&R

## ITALJET

Grifon # 59 (650cc)	06	F&R
Bazooka (650cc)	06	F&R

## JIALING

JE 125 E Dragon	98	F
-----------------	----	---

## KYMCO

Pulsar 125 (Luxe)/CK 125	99-06	F
Spike 100/125	00-06	F

## LIFAN

LF 100 A		F
----------	--	---

## QUADZILLA

WK 110	05-06	R
WK 125 (All models)	06	R

## SACHS

Madass 50 (4 stroke)	04-05	F
Madass 50 (2 stroke)	04-05	F
Mad Ass 50	06-07	F
Madass 125	05	F&R
Mad Ass 125	06-07	F

## SUPERBYKE

CQ 50 Road Classic		R
CU 125 Road Classic		R
M-Ped 125 Road Classic		F
R-SR 250		F&R

## SYM

Wolf Legend	04-05	F
-------------	-------	---

## VIALLI

Truro 50	06	F
----------	----	---

### Equivalents OE #

451A0 KR3 603	45105 KK4 014	45105 KR3 603
45105 GE2 004	45105 KR3 004	45105 KW7 405
45105 GE2 006	45105 KR3 007	45105 KBH E000 GM
45105 GE2 305	45105 KR3 014	P4064905001002640
45105 KK4 004	45105 KR3 601	
45105 KK4 007	45105 KR3 602	

### Competitor X Ref

<b>Dunlop</b> DP111	<b>Ferodo</b> FDB312	<b>SBS</b> 551	<b>Vesrah</b> VD-131
------------------------	-------------------------	-------------------	-------------------------

### MATERIAL AVAILABILITY AND PART NO.

STD	OPTIONS			
FA	HH	R	MXS	GFA
FA86	FA86HH	-	-	-

# FA88 64 x 55 x 9mm

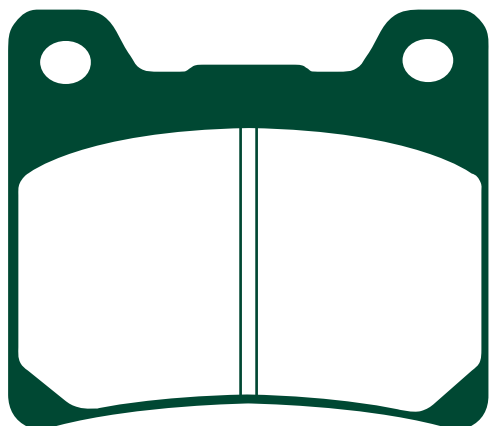

### Equivalents OE #

1FK W0045 00	26H W0045 10	38A W0045 01
1FK W0045 00	26H W0046 00	3HE W0045 00
1FK W0046 00	26H W0046 01	3HE W0045 11
1FK W0046 01	29L W0046 01	3XF W0045 00
1FX W0046 01	31A W0046 00	47X W0045 00
1KF W0045 00	31A W0046 10	47X W0045 01
1UF W0045 00	33M W0045 01	4FM W0046 00
1UF W0045 01	33M W0045 10	4SV W0045 50
26H W0045 00	36H W0046 01	
26H W0045 01	37A W0045 00	

### Competitor X Ref

Dunlop	Ferodo	SBS	Vesrah
DP404	FDB337/R	555	VD-236

MATERIAL AVAILABILITY AND PART NO.				
STD	OPTIONS			
FA	HH	R	MXS	GFA
FA88	FA88HH	-	-	-

## NORTON

Commander	90	F&R
<b>YAMAHA</b>		
TZR 125	90-92	F
RD 350 YPVS	83-84	R
FZ 400	96	R
FZ 400 N (IFK/46X/33M)	85	F
FZR 400 Genesis (1WG)	86	F
SRX 400 (1JL)	85	F
XJR 400	95-	R
RD 500 LC	84-86	F
FZ 600	87-88	F
FZR 600	89	F&R
FZR 600	90-93	R
FZR 600 R	94-95	R
YZF 600 R "Thundercat"	96-03	R
XJ 600	84-91	F&R
YX 600 S/SC/T/TC/UC/U/W/WC		
/A/AC 'Radian'	86-90	F
FZX 700 S/SC/T/TC Fazer	86-87	F&R
FZ 750	85-88	F&R
FZ 750	89-91	R
FZX 750	87	F&R
FZR 750 'Genesis'	87	R
FZR 750 R "OWOI"	89-90	R
XV 750 Virago	92-93	F
YZF 750 R/SP	93-97	R
TDM 850	91-01	R
TRX 850	96-99	R
XJ 900/900 F	83-92	F&R
XJ 900 S "Diversion"	95-03	R
GTS 1000	93-99	R
FZR 1000 Genesis	87-88	R
FZR 1000 'EX UP'	89-95	R
YZF 1000 R "Thunderace"	96-02	R
XV 1000/1000 SE "Virago"	86-88	F
BT 1100 P/R/S/T/V Bulldog	02-06	R
FJ 1100	84-85	F&R
XV 1100 Virago	89-93	F
XV 1100 Virago	99	R
XVS 1100 Dragstar	99-04	R
XVS 1100 A "Dragstar Classic"	00-07	R
FJ 1200 (ITX Type)	86-87	F&R
FJ1200 (3CV/3XW Type)	88-95	R
FJ 1200 A (ABS model)	91-95	R
XVZ 12 TD	85	F&R
V-MAX 12	91-92	F&R
V-MAX 12	93-03	R
XJR 1200	95-98	R
XJR 1300 (5EA1/5EA7) Brembo calipers		
(320mm front discs)	98-99	R
XJR 1300 L 5EA2/5EA3/5EA4	99	R
XJR 1300 M 5EAA/5EAB/5EAC	00	R
XJR 1300/1300 SP	99-01	R
XJR 1300 SP (L) 5EA5/5EA6/5EA8	99	R
XJR 1300 SP (M) 5EAD/5EAE/5EAF	00	R
XJR 1300 SP (N) 5EAL/5EAM/5EAN	01	R

# FA90 91 x 51 x 10mm

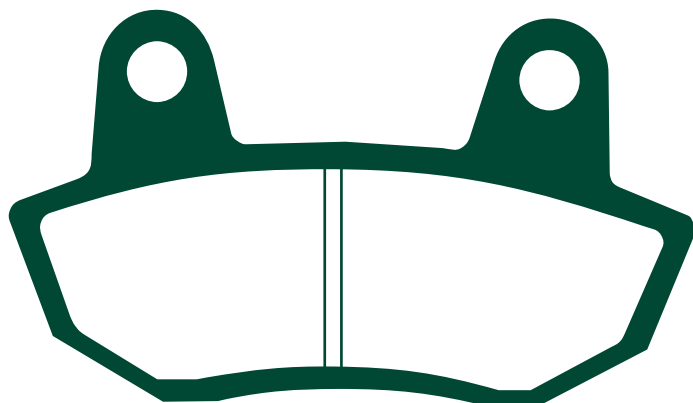

### Equivalents OE #

45105 MA5 771
45105 MA5 772
45105 MC9 305

### Competitor X Ref

Dunlop	Ferodo	SBS	Vesrah
-	FDB2020	561	VD-130

MATERIAL AVAILABILITY AND PART NO.				
STD	OPTIONS			
FA	HH	R	MXS	GFA
FA90	-	-	-	-

## HONDA

CB 650 SCC "Nighthawk"	82	F
------------------------	----	---

# FA92 81 x 42 x 7.5mm

## FA92/2 Use FA323/2

## FA92/3 Use FA323/3

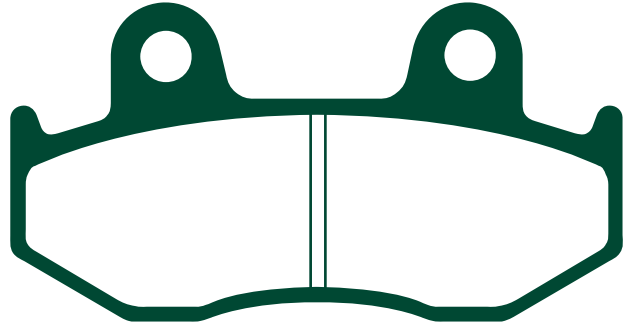

### HONDA

CR 125 RE/RF/RG	84-86	F
MTX 125 RWE/RWF/RWH/RWL	85-95	F
XL 125 RF/RH	85-86	F
XL 200 R	85	F
MTX 200 RWF	85	F
FTR 223 (MC34) Y/2/A2	00-02	F
ATC 250 RF/RG	85-86	F&R
CR 250 RE/RF/RG	84-86	F
XR 250 RE/RF/RG/RH	84-87	F
XLR 250 R (MD22)	88-90	F
TRX 250 RG/RH/RJ/RK	86-89	R
XR 350 RE	84	F
CR 500 RE/RF/RG	84-86	F
XR 500 RD/RE	84-85	F
XL 600 RD/LD/RE/LE/RF/RG/RH	83-87	F
XL 600 LMF	85	F
XR 600 RF-RH	85-87	F

### Equivalents OE # - FA92

43105 HB9 008	45105 HA2 671	45105 KE1 744
431A0 HB9 008	45105 HB9 008	45105 KS5 004
451A0 MG3 670	45105 KA3 731	45105 KS5 006
451A0 KA3 731	45105 KE1 742	45105 MG3 006
45105 G04 601	45105 KE1 743	06455 KPM 006

### Competitor X Ref

Dunlop	Ferodo	SBS	Vesrah
DP812/114	FDB382	558	VD-134/ 136

### MATERIAL AVAILABILITY AND PART NO.

STD	OPTIONS			
FA	HH	R	MXS	GFA
FA92TT	-	FA92R	-	-

# FA93 A. 88 x 48 x 7.8mm B. 56 x 36.6 x 10.2mm

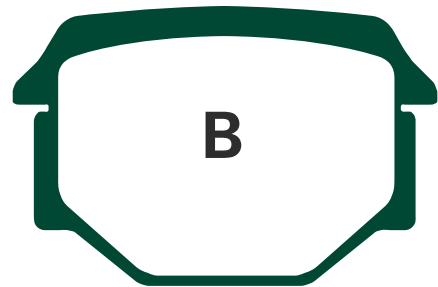

### DERBI

GPI 250 i	07	R
-----------	----	---

### SUZUKI

GS 125 ESD/ESF/ESK/ESM	83-94	F
GX 125 (SJ 125)	03	F

### EASY RIDER

JC 125/8 Dragon	98	F
-----------------	----	---

### HARTFORD

HD 125 L/150 L	00-04	F
----------------	-------	---

### KEEWAY

Speed 125	07	F
-----------	----	---

### MOTO-ROMA

Virage 125	01	F
------------	----	---

### SUPERBYKE

RFX 50 Road Trail		F
RFX 125 Road Trail		F

### TGB

R9 125cc	06-07	F
Delivery 151cc	04-07	F
302 Sport	03-04	F
303R Hawk/Laser 125/150	04-07	F
304 Sport	03-04	F
404 Executive	03-04	F
F409 (50/125/150)	06	F
R 50 X/507	06-07	F

### WUYANG

WY 125-12	06-07	F
WY 125 16C	06-07	F

### Competitor X Ref

Dunlop	Ferodo	SBS	Vesrah
-	FDB384	585	VD-346

### Equivalents OE #

59301 39841	45120 128 000
59300 29820	

### MATERIAL AVAILABILITY AND PART NO.

STD	OPTIONS			
FA	HH	R	MXS	GFA
FA93	-	-	-	-



# FA94 60 x 63 x 13mm



## HARLEY DAVIDSON

FXD/FXD/L/FXDWG/FXR/FXRS/FXRT/FXRD/FXLR	91-99	F
FXST/FXSTB/FXSTC/FXSTS/FLST/FLSTC/FLSTF/FLSTS/FLSTN	84-99	F
FLSTSC/FLSTSCI	05	F
FX/FXE/FXEF/FXWG/FXS	84-86	F
XL/XLH/XLCH/XLS/XLXH	84-99	F
FXR/FXRS/FXRT/FXRD/FXLR	94-97	F
FLT/FLHT/FLHTCI/FLHTCUI	84-99	F
FLHR/FLHRC/FLTRI	94-99	F
FXSTS/FXSTSi	00-04/06	F
FLSTS Heritage Springer	00-03	F
FLSTSC/FLSTSCI Springer Softail	06-07	F

### Competitor X Ref

Dunlop	Ferodo	SBS	Vesrah
DP900	FDB352/R	579	VD-919

### Equivalents OE #

43063 83	44063 83A	44063 839	44063 83C
----------	-----------	-----------	-----------

### MATERIAL AVAILABILITY AND PART NO.

STD	OPTIONS			
FA	HH	R	MXS	GFA
FA94	FA94HH	-	-	-

# FA95 69.2 x 51 x 8.2mm

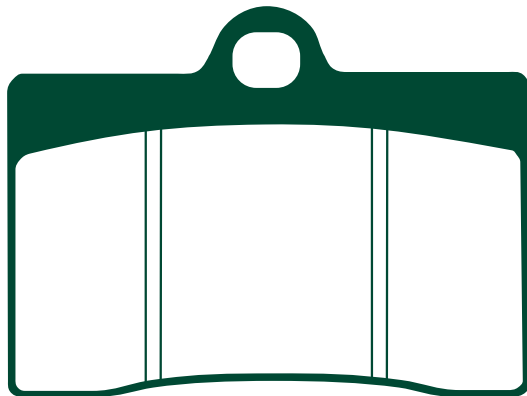

<b>HONDA</b> CBR 900 'Evolution Blade'	99	F
<b>HUSQVARNA</b> SM 400 R	02	F
SM 450 R	03-06	F
SM 510 R	06-	F
SM 570 R	01-04	F
SMR 630	06	F
<b>KTM</b> Sting 125	97-99	F
Duke 400 LC4	94-98	F
Duke 620 LC4	94-98	F
SMC 660 Supermoto	03-04	F
<b>LAVERDA</b> 650 All models	94-95	F
668 All models	96-98	F
750 All models	98-01	F
<b>MONDIAL</b> Piega 1000	02	F
<b>MOTO GUZZI</b> Daytona 1000 (RS)	93-97	F
V10 Centauro/GT	98-00	F
California EV 1100	98	F
Sport V11	98-99	F
California/EV/Special	99-00	F
<b>MZ/MUZ</b> Skorpion/Tour/Sport/Traveller/Cup	95-02	F
<b>NORTON</b> Formula One	90	F
F1 (Rotary) P55 Model	90-91	F
<b>PGO</b> G Max 125	06-07	F
G Max 250	06	F
<b>REVTECH/WILWOOD</b> CCI Polished Caliper (CC159-110)		F&R
<b>TM</b> SMR 125	05	F
SM 250	02	F
SME 250 (4T)	04-	F
SME 400 (4T)	04	F
SM 400	02-03	F
SMR 450/530 FAE	05	F
SMR 450 FES	05-07	F
EN 530 F-ES	03-04	F
SM 530	02-03	F
SME 530 (4T)	04-	F
SMR 530 FES	05-07	F
530 (4T) Cross	02-03	F
SMR 125/250/250 (4T)/300	06	R
SMX 660 F	04-	F
<b>YAMAHA</b> TZR 125 RR	96-	F
SZR 660	96-97	F
<b>SACHS</b> XTC 125 Supersport	00-07	F
X Road 125	06-07	F
Roadster 650	05	F
Roadster 800	01-05	F
B-805	03-04	F
<b>VOR</b> SM-E 450/530	03-04	F
<b>VOXAN</b> Cyclope 1000	02	F
Cafe Racer 1000	02-05	F
Roadster 1000	02-05	F
Street Scrambler	03-05	F

### Equivalents OE #

4SU F5811 00	8000 78331	800094411
613 4 004 24	047 00 2000036	211041010
613 4 009 1A	573 V3 030 000	27 69173
613 4 0041 A	90210 55000	
8113585	BE250122065SM	

### Competitor X Ref

Dunlop	Ferodo	SBS	Vesrah
DP614	FR 408	566	VD-945

### MATERIAL AVAILABILITY AND PART NO.

STD	OPTIONS			
FA	HH	R	MXS	GFA
FA95	FA95HH	-	-	GFA95HH

<b>APRILIA</b> RS 250 All models	95-97	F
B 500 CR	02	F
B 500 MT	02	F
<b>BENELLI</b> 666 Scooter "Born in Hell"	98-99	F
<b>BETA</b> Euro/Jonathan 350	03-06	F
Jonathan 125	00-05	F
<b>BIMOTA</b> Various models	89-03	F
Tesi 2D	05-06	F
<b>BREMBO</b> 20 5165 55/65 Goldline 4 piston (single pin pad fixing)		
20 4756 05/06 Billet 4 piston (single pin pad fixing)		
<b>BORILE</b> B 500 CR	02-04	F
B 500 MT	02	F
<b>CAGIVA</b> Mito 125	93-07	F
N1 125	97	F
Planet 125	99-03	F
Raptor 125	03-07	F
Mito 500	07	F
River 600	95-99	F
<b>CCM</b> CR 40 S Cafe Racer	07	F
CR 40 Street	07	F
<b>DUCATI</b> Supersport 400	93-97	F
400 Monster	95-97	F
600 Monster	93-99	F
600 Monster Dark	98-99	F
600 Monster City/City Dark	99	F
600 Supersport	91-97	F
748 SP/Biposto	95-98	F
750 Supersport	91-98	F
750 Monster	96-98	F
750 Monster City/City Dark	99	F
750 Monster/Monster Dark	99	F
851 Superbike Biposto	89-92	F
884 SP4/SP5	92-93	F
888 Superbike Strada	94-95	F
900 Supersport	89-90	F
900 Supersport/Superlight	91-97	F
900 Supersport CR USA	98	F
900 Supersport FE	98	F
900 Monster	93-99	F
900 Monster Cromo/Special	98	F
900 Monster City/City Dark	99	F
907 IE	90-93	F
916 SP	94-96	F
916 Biposto-Senna	94-98	F
916 Racing (996cc)	98	F
996 Racing	99	F
<b>GAS GAS</b> SM 125/250/400 FSE	02	F
SM 125/250 (2T)	01-06	F
SM 400 FSE (2T)	01-04	F
FSR 450 (4T)	07	F
SM 450	03-04	F
<b>GILERA</b> Saturno 350 Bialbero	90-	F
Saturno 500 S/Bialbero/Piuma	90-	F

# FA98 43.5 x 64.5 x 6.5mm

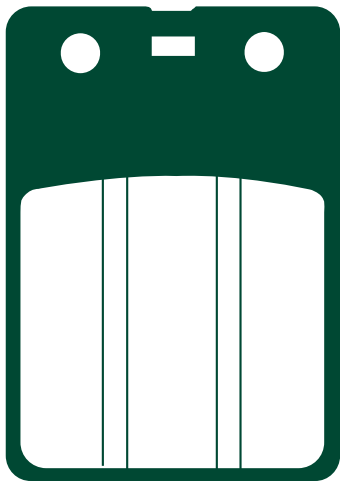

## GARELLI

Strada/Sport 125 F  
TSR 125 83- F

## GILERA

RV 125 88 F  
RV 200 85-86 F

### Competitor X Ref

Dunlop	Ferodo	SBS	Vesrah
-	FDB696	606	VD930

### Equivalents OE #

323 628
400 07 6340

### MATERIAL AVAILABILITY AND PART NO.

STD	OPTIONS			
FA	HH	R	MXS	GFA
FA98	-	-	-	-

# FA99 31.5 x 52 x 5.5mm



### Equivalents OE #

266 07 6340
510 362 4 282
464143
11933400

### Competitor X Ref

Dunlop	Ferodo	SBS	Vesrah
DP602	FDB436	595	VD-932

### MATERIAL AVAILABILITY AND PART NO.

STD	OPTIONS			
FA	HH	R	MXS	GFA
FA99	-	FA99R	-	-

## APRILIA

TRX 240 M 89 F&R

## BENELLI

Devil 50 92- R  
Spring 50 93- R  
Devil 80 92- R

## BETA

TR 32/33 125 86-87 F  
TR 33 240 86 F  
TR 34 260 89-91 F  
TR 34 86-88 F

## CIMATTI

Gringo 85- F

## FANTIC

50.1 Oasis Kick 87- F  
50.1 Trial 86- F  
50.1 Trial H 20 87- F  
Trial 125/2 F&R  
201/301 Monoshock 86 F  
243 Trial 87- F&R  
303 Monoshock 87 F&R

## GARELLI

50 Tiger XLE 86- R

## GILERA

Eaglet 50 96 F  
Built 50 90- F  
503 50cc 91- F&R

## MALAGUTI

Phantom F12 94-98 F  
Crosser CR1 97 F  
50 Enduro RCX-W/Sahib 83- F  
50 Fifty Full/CX 83- F  
50 RGT Strada 83- F  
50 Enduro Dune 87- F&R  
50 Fifty Top 85- F  
50 RGT Sport 85- F  
50 RST Sport 87- F&R  
50 Evolution 91- F  
50 Raid 91- F

# FA100 39 x 9mm



## LAMBRETTA

All disc models F

### Equivalents OE #

14744200

### Competitor X Ref

Dunlop	Ferodo	SBS	Vesrah
-	-	-	-

### MATERIAL AVAILABILITY AND PART NO.

STD	OPTIONS			
FA	HH	R	MXS	GFA
FA100	-	-	-	-

# FA101 71 x 36 x 9.2mm

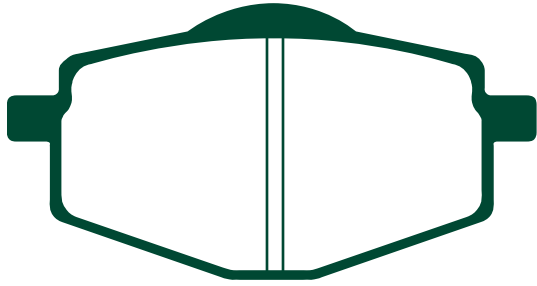

**BETA**

Euro/Jonathan 350 03-06 R

**HERO**

Quickster 125 06 F

**HONDA HM (Italy)**

CRE 50 Six/Baja/Derapage 95-02 R

**MBK**

TZR 50 X-Power 00 R

XC 125 Flame 125 96-03 F

XC 150 Vertex 97 F

**MZ**

660 SSR 95 R

**YAMAHA**

TZR 50 'Thunderkid' (5DU1/3) 97-00 R

YSR 50 T 87 F

DT 80 LC-2 (53V) 85-92 F

DT 125 LC 86-87 F

DT 125 R 88-03 F&R

DT 125 RE 04 F&R

DT 125 RE 05-07 F

TDR 125 R 93-03 R

YBR 125 ED (3D91) 05-07 F

YZ 125 U 88 R

XC 125 TR "Cygnus" 96-03 F

**YAMAHA Contd.**

DT 200 (2LR) 87 F

XT 225 W (4JG1-6 Serrow) 93-98 F

XT 225 (2LN) Serrow (1KH 020101-) 86-87 F

XT 225 (3RW1-5 Serrow)

(1KH 034101-132000) 89-93 F

YZ 250 U 88 R

YZ 250 N/S "TRI-Z" 85-86 F&R

XT 350 85-95 F

XT 600 87 R

XT 600 Z "Tenere" 88-90 R

XT 600 E 92-03 R

XTZ 660 E "Tenere" 91-98 R

**GILERA**

125 Apache 91- R

Oregon 250 Quad 07 F

RC 600 89-90 R

**ITALJET**

Millennium 100/125/150 00-01 F

**SACHS**

Roadster 650 05 R

**SIAMOTO**

KD 125 00-04 F

**Equivalents OE #**

1UY W0045 00	34X W0046 02	3JH W0045 00
1UY W0045 01	38W W0045 00	3UH W0045 00
1UY W0045 02	38W W0045 01	344 840
1UY W0045 03	3BN W0045 00	48 7100 7
2VN W0046 00	3BN W0045 01	4KL F5811 00
2VN W0046 01	3FY W0045 00	KA3495506
34X W0046 00	3XP W0045 00	
34X W0046 01	3XP W0046 00	

**Competitor X Ref**

<b>Dunlop</b>	<b>Ferodo</b>	<b>SBS</b>	<b>Vesrah</b>
DP406	FDB383	575/619	VD-239

**MATERIAL AVAILABILITY AND PART NO.**

STD	OPTIONS				
FA	TT	HH	R	MXS	GFA
FA101	FA101TT	-	FA101R	MXS101	-

# FA102 58 x 48 x 8.7mm

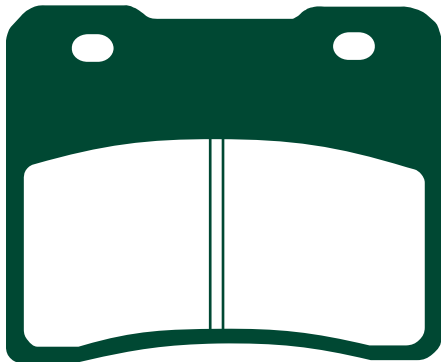

**SUZUKI**

RG 250 WE/FG/CH/FCH/FH 'Gamma' 84-88 F

GSX 400 R2 (GK71B) F

**Equivalents OE #**

59130 04A00	59100 04830
59130 04A10	

**Competitor X Ref**

<b>Dunlop</b>	<b>Ferodo</b>	<b>SBS</b>	<b>Vesrah</b>
-	FDB390	578	VD-328

**MATERIAL AVAILABILITY AND PART NO.**

STD	OPTIONS			
FA	HH	R	MXS	GFA
FA102	-	-	-	-

# FA103 58 x 53.5 x 8.7mm

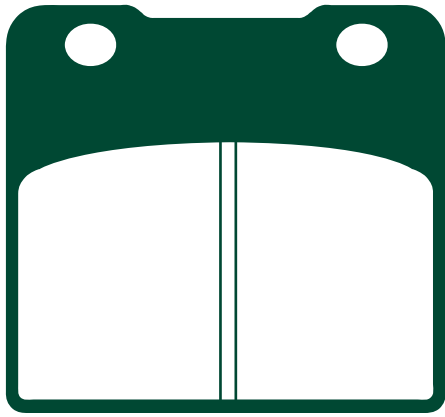

### Equivalents OE #

59100 10810	59130 06B20	69100 38840
59100 20810	59130 00810	69100 38860
59100 20820	59130 24A00	69100 38870
59100 30810	59130 27A00	69100 48810
59100 06820	59130 27A10	69130 38B10
59100 30820	59130 30B00	69130 38B00
59100 38820	59130 30B01	69130 48B00
59130 00A00	59130 30B21	69130 38820
59130 00A10	69100 38810	69130 48810
59130 06B10	69100 38820	

### SUZUKI

GSX 250 R CH/H (GJ72A)		F
GSXR 250 J (GJ72A)		F
GSXR 250 CK		F
GSXR 400 H	87	F
GSX 400 X/XA/XS "Impulse"		F
GSX 400 R3 (GK71F)		F
RG 400		F
RG 400 EWF/EW-2G/EWH Walter Wolf (Type 1&2)	85-87	F
VS 400 VR/FR/VTR/FTR/V-T/F-T	94-	F
RG 500 G/CH	85-87	F
VS 600 GLS/GLT	95-96	F
VS 700 GLEFG/GLEPG/GLEFH/GLEPH	86-87	F
VS 700 GLFH/GLPH/GLFG/GLPG	86-87	F
GSXR 750 F/G/H	85-87	F
VS 750 All models	85-91	F
VS 800 GLN/GLP/GLR/GLT/GLS/GLV/GLW/GLX	92-99	F
GSX 1100 EFE/EF/ESF	84-86	F&R
GSX 1100 FJ/FK/FL/FM/FN/FP	88-93	F
GSXR 1100 G/H/J	86-88	F
GV 1400 GDG/GTG Cavalcade	86	F&R
VS 1400 GLPH/GLFH/GLPJ/GLFJ/GLPR/GLPT/GLPV		
/GLPW/GLPX/GLPY/GLPK1/GLPK2 Intruder	87-03	F&R
VL 1500 W/X/Y/K1	98-01	F&R

### Competitor X Ref

Dunlop	Ferodo	SBS	Vesrah
DP210	FDB389/R	577	VD-330/ 331/338

### MATERIAL AVAILABILITY AND PART NO.

STD	OPTIONS			
FA	HH	R	MXS	GFA
FA103	FA103HH	-	-	-

# FA104 68 x 56.2 x 8.8mm

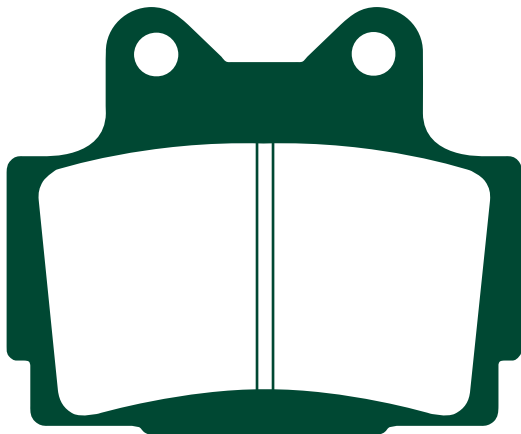

### Equivalents OE #

1KT W0046 50	1KT W0046 52	51L W0046 00	51L W0046 02
1KT W0046 51	3TJ W0046 00	51L W0046 01	4AP W0046 00

### Competitor X Ref

Dunlop	Ferodo	SBS	Vesrah
DP407	FDB386/R	570	VD-240

### MATERIAL AVAILABILITY AND PART NO.

STD	OPTIONS			
FA	HH	R	MXS	GFA
FA104	FA104HH	-	-	-

### YAMAHA

RD 125 LC (MK 2-3)	85-87	F
RZ 125 (1GV 030101-)	85	F
TZR 125	87-89	F
TZR 125	90-92	R
TZR 125 R	93-	R
TZR 150 R (4AP2)	00	R
SDR 200 (2TV)	87-89	F&R
FZR 250 R		R
FZR 250	87	R
FZX 250 Zeal (3YX1/2/4)	91-92	R
RZ 250 R (1AR/1XG)		F&R
RZ 250 R (29L)		R
RZ 250 RR (51L)		F&R
SRX 250		F
TDR 250	88-92	R
TZR 250 (2MA/2XW)	87-92	R
TZR 250 (3MA1)	89	R
TZR 250 (3MA3/A5)	90	R
TZR 250 SP (3MA4)	90	R
TZR 250 R (3XV1/4/6)	91	R
TZR 250 R (3XV8/9)	92-94	R
TZR 250 (1KT/2AW)	87	R
RD 350 N	85	F&R
RD 350 F/F2	85-92	F&R
RD 350 R	92-95	F&R
RIZ 350	92	R
FZ 400 N (IFK 146X 133M)	85	R
FZR 400 RR (4DX)	92	R
FZR 400 (3TJ1/2/6/7)		R
FZR 400 Genesis (1WG)	86	R
FZR 400 RSP (2TK EX-UP)	87	R
FZR 400 (3EN1/2)	88-89	R
SRX 400 (1JL)	85	R
SRX 400 (3VN1/3VN2/3VN5)	90-96	R
XJR 400 (4HM1/4HM2/4HM4/4HM7)	93-96	R
XJR 400 (4HM3/4HM5/4HM6/4HM9		
/4HMA/4HMB) Brembo caliper	95-99	R
RD 500 LC	84-86	R
FZ 600	87-88	R
FZS 600 Fazer	98-03	R
SRX 600	86-87	F&R
SRX 600 (1JK)	85	F&R
SRX 600 (3SX)	90-91	R
XJ 600 N	95-03	R
XJ 600 S "Diversion"	92-03	R

# FA105 91 x 30.4 x 8mm

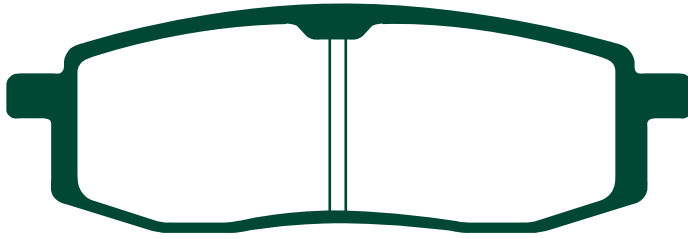

### YAMAHA

YZ 125 N/S/T/U	85-88	F
TT 250	90	F
YZ 250 N/S/T/U	85-88	F
TT 350 A (3GJ)	90-95	F
YZ 490 N/S/T/U	85-88	F
TT 600 W (59X/2JT/3SW1)	89-92	F

### Equivalents OE #

56A W0046 00	2HH W0045 00
1LN W0045 01	2HH W0045 01
1LX W0045 00	

### Competitor X Ref

Dunlop	Ferodo	SBS	Vesrah
DP405	FDB411	580	VD-241

MATERIAL AVAILABILITY AND PART NO.				
STD	OPTIONS			
FA	HH	R	MXS	GFA
FA105TT	-	FA105R	-	-

# FA106 77 x 54 x 7mm

# FA106/2 77 x 54 x 9.5mm

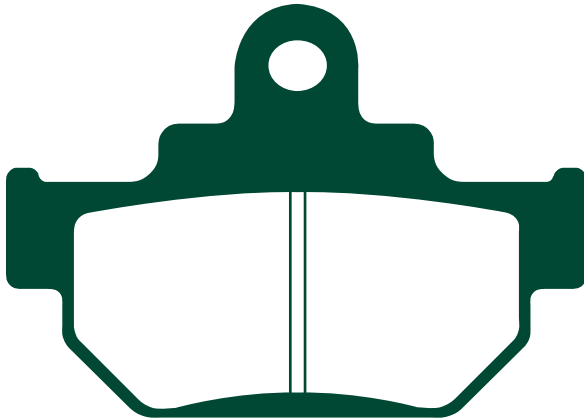

### SUZUKI

GZ 125 W/X/Y/K1-K7 'Marauder'	98-07	F
RM 125/250 F/G	85-86	F
TU 125 X Super Classic	99	F
VL 125 Y/K1/K2/K3/K4/K5/K6/K7 Intruder	00-07	F
TU 250 XV/XW	97-00	F
TU 250 S/T/XS/XT/X-ST/XSV		
/XT-W (NJ47A 10001-115972)	92-97	F
VL 250 Y/K1/K5 Intruder	00-01/05	F
LS 650 "Savage" FG/PK/PM/		
PR/PG/PT/PV/PW/PX	87-99	F

### SIAMOTO

Geco 250	04	F
----------	----	---

### MAICO

All Models	86-88	F&R
------------	-------	-----

### FA106/2 - SUZUKI

DR 600 SF/RG/RH/SG/SH	85-87	F
-----------------------	-------	---

### Competitor X Ref

Dunlop	Ferodo	SBS	Vesrah
DP405	FDB404/673	581/582	VD-329/ 329/2

MATERIAL AVAILABILITY AND PART NO.				
STD	OPTIONS			
FA	HH	R	MXS	GFA
FA106TT	-	FA106R	-	-

MATERIAL AVAILABILITY AND PART NO.				
STD	OPTIONS			
FA	HH	R	MXS	GFA
FA106/2TT	-	FA106/2R	-	-

### Equivalents OE # - FA106

59300 24830
59340 14600
59340 24B00
59340 24B10

### Equivalents OE # - FA106/2

59300 14830
59340 14500
59340 14501
59340 14510

# FA107A 82 x 54 x 8mm

# FA107/2A 82 x 54 x 7mm

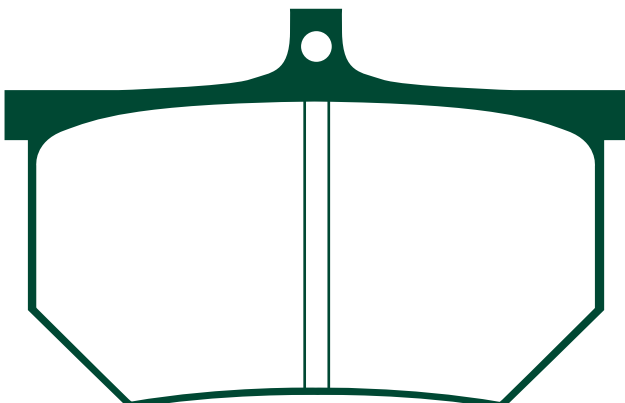

### FA107A - LOCKHEED/SPONDON

4 Piston Caliper CP4484/3369

### FA107/2A - LOCKHEED/SPONDON

4 Piston Caliper CP4484

### Competitor X Ref

Dunlop	Ferodo	SBS	Vesrah
DP624	FRP410	661	-

MATERIAL AVAILABILITY AND PART NO.				
STD	OPTIONS			
FA	HH	R	MXS	GFA
FA107A	-	-	-	-

MATERIAL AVAILABILITY AND PART NO.				
STD	OPTIONS			
FA	HH	R	MXS	GFA
FA107/2A	-	-	-	-

# FA109 50 x 55 x 11.3mm

**HONDA**  
VF 1000 RE/RF/RG

84-86 R

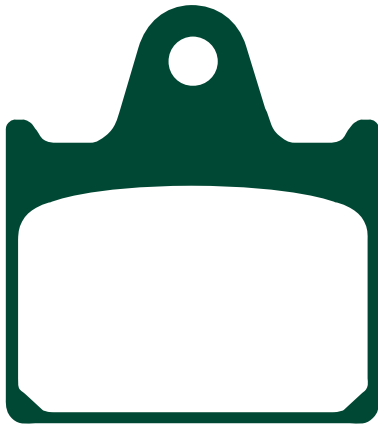

**Equivalents OE #**

43105 MJ4 007
43105 MJ4 008

**Competitor X Ref**

Dunlop	Ferodo	SBS	Vesrah
-	-	573	VD-258

MATERIAL AVAILABILITY AND PART NO.				
STD	OPTIONS			
FA	HH	R	MXS	GFA
FA109	-	-	-	-

# FA110 52.5 x 44.5 x 7.2mm

**SUZUKI**  
RG 125 (All Models)

85-91 F

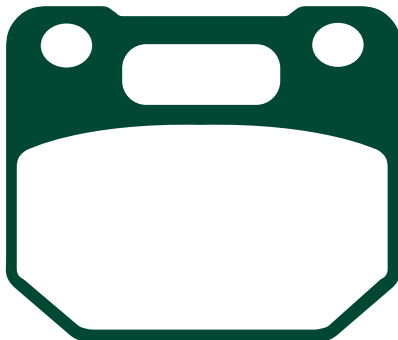

**Equivalents OE #**

59100 36850
59130 36A00
59130 36A01

**Competitor X Ref**

Dunlop	Ferodo	SBS	Vesrah
-	FDB437	587	VD-335

MATERIAL AVAILABILITY AND PART NO.				
STD	OPTIONS			
FA	HH	R	MXS	GFA
FA110	-	-	-	-

# FA111 64 x 57 x 9mm

**HONDA**  
FL 350 R Odyssey  
FL 400 R/RK/RL "Pilot"

85-87 R  
89-93 R

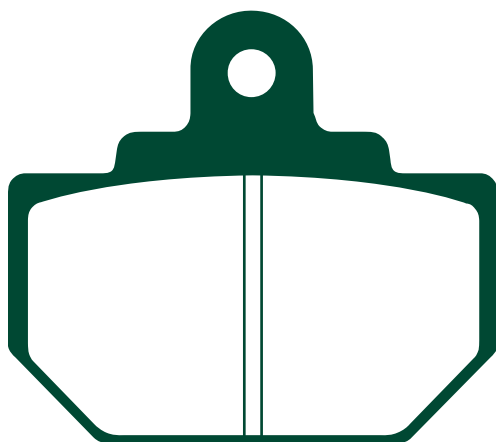

**Equivalents OE #**

43105 HE0 305	431A0 HE0 670
43105 VM0 008	431A0 VMO 008
43105 VM0 771	

**Competitor X Ref**

Dunlop	Ferodo	SBS	Vesrah
DP813	-	610	VD-931

MATERIAL AVAILABILITY AND PART NO.				
STD	OPTIONS			
FA	HH	R	MXS	GFA
FA111	-	FA111R	-	-

# FA113 78.7 x 47 x 7.4mm

**USE FA256**

# FA115 36 x 45 x 6mm

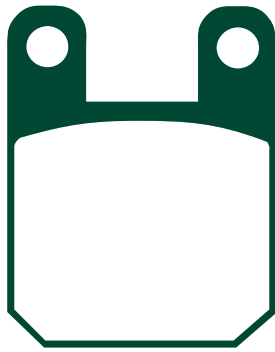

**NOTE: AJP Caliper**

## Competitor X Ref

Dunlop	Ferodo	SBS	Vesrah
DP607	FRP405	559	VD-254/ 925

## Equivalents OE #

3380925	753092	00G04700141	KA3497506	11955600
3380928	753200	00H01301931	K00996315	2133071000019
3499074	59330 06E00	00D01210221	5WX W0045 10	K00996315
8113181	45105 NN2 900	213307100003	R051	00H01303551
510 015 4 282	ODN00G04700141	P150442	460 13 016 000	
4AJ W0045 00	812732	2525350000	00009300060	
737786	2525241000	2525241000	0009307001	
752816	2525350000	59300 06E00	EJ29099074	

## MATERIAL AVAILABILITY AND PART NO.

STD		OPTIONS			
FA	TT	HH	R	MXS	GFA
FA115	FA115TT	FA115HH	FA115R	MXS115	-

DISC PADS BUYERS GUIDE

Brand	Model	Year	Caliper	Part No.	Material	Part No.	Material	Part No.	Material	Part No.	Material
<b>ALFER</b>	80 MC	87-	R								
<b>APRILIA</b>	RS 50 (Radial Caliper)	07	R								
	RX 50	07	R								
	SX 50	07	R								
	TX 125/240/311	86-88	F								
	TX 311	88	F&R								
	280 Climber	94-96	F								
	280 R Climber	92-93	F								
<b>BETA</b>	RR 50 Supermoto/Enduro	98-05	F&R								
	RR Enduro Alu 50/Motard Aly 50 /RR Enduro 50	04-07	R								
	Eickon 50	99-06	F&R								
	50 RR Enduro	97-04	F&R								
	Pro race 50	05	F								
	Rev 50/80	00-07	F&R								
	Synt/Gara	93-95	F								
	Zero	92	F								
	Super Trial ST	94	F								
	Techno	95	F								
	Eurotek/Techno 125/250	96-98	F&R								
	125 TR 34		F&R								
	Synt	92	F								
	RK6 50cc Enduro	97-02	R								
	Alp 4T 125/200	00-04	F&R								
<b>BLATA</b>	Enduro 125	07	R								
	Motard 125	07	R								
<b>CAGIVA</b>	Mito 50	99-00	R								
	Progress 50	97-99	F								
<b>CH RACING</b>	WXE 50 Enduro	05	R								
	WSM 50 Motard	05	R								
	WXE 125 Enduro	05	R								
	WSM 125 Motard	05	R								
<b>CONTI</b>	RX 356 V3 (12" wheels)	05-06	R								
	RX 356 V3 (17" wheels)	05-06	R								
<b>CP</b>	Supermoto 50 SMX	03-07	F&R								
	Supercross 50	03-06	F&R								
	SX 50	06-07	R								
<b>CZ/JAWA</b>	50 Minarelli	03-04	F								
	125 Sport	03-04	F&R								
	125 Dandy	03-04	F&R								
	50/100 Robby	03-04	F								
<b>DAELIM</b>	S 125	03	R								
<b>DERBI</b>	Atlantis 50 LC/City/Bullet	02-06	F								
	Atlantis 50 City/Bullet/Two Chic (4T) 13" wheels	04-07	F								
	X Race 50	06	F&R								
	GPX1	06	R								
	Red Bullet 50	04-05	F								
	Senda R DRD	04-05	R								
	GP-I 50	01-Feb 05									
	F&R										
	GP-I 50 Open	06-07	R								
	GP-I 150	05	R								
	GPI Scooter (Radial caliper) (Euro 2)	Mar 05-Dec05	R								
	Senda SM DRD Super Motard	04	F&R								
	Senda-R	96-02	F&R								
	Senda 50 DRD Pro SM Supermoto	05-07	R								
	Senda R Euro2	04-07	R								
	Senda R Baja Enduro	06-07	R								
	Senda R Baja Supermoto	06-07	R								
	Senda X Race SM Supermoto (260mm front disc)	03-07	F&R								
	Senda X-treme SM Supermoto (260mm front disc)	03-07	F&R								
	Senda 50 DRD Racing R Enduro	04-07	R								
	Senda 50 DRD Racing SM Supermoto	04-07	R								
	Senda 50 X-Race R Enduro (240mm front disc)	03-07	F&R								
	Senda 50 X-treme R Enduro (240mm front disc)	03-07	F&R								
	Vamos/Vamos FL	96-99	F								
	Hunter	96-99	F								
<b>DERBI Contd.</b>	GPR 50-R/Replica	98-04	R								
	GPR 50/Nude ST (Radial caliper)	04-07	R								
	Predator/Replica	98-02	F&R								
	Atlantis 50/100	99-05	F								
	DRD 50 Supermoto	03-04	F&R								
	Super Motard	01	F&R								
	SM 50 DRD Edition	05	R								
	GPR 125/Nude (Radial caliper)	05-06	R								
	Terra 125	07	R								
	Mulhacen 125	07	R								
<b>ECO</b>	Bushman 150 (LX 150 GY)		R								
<b>EXPLORER</b>	KBR 200	05	R								
<b>FACTORY</b>	RP 50	05	R								
	YM 50	05	R								
	YR 50 Desert	02-03	F&R								
	YR 50 Desert	04-05	R								
	Chrono SM 50	04	R								
	YR 125 4T	05	R								
<b>FANTIC</b>	50.5 Trial	89	F&R								
	50.7 Trial	90	F&R								
	50.9 Trial	91-	F&R								
	50 Clubman	95-	F&R								
	80 Clubman	95-	F&R								
	125/5/245/305	89	F&R								
	Series 7 Models	90	F&R								
	K-Roo (All Models)	92-95	F&R								
	309	92	F&R								
	Section 125/249 R	95-	F&R								
<b>FB MINARELLI (SPAIN)</b>	MR 80		F								
<b>FYM/X-Sport</b>	CR 110	06-07	R								
	CR 110 ESR	06-07	R								
	CR3 125	06-07	R								
	CR 125 R	06-07	R								
	X Sport Typhoon 125 Quad	06-07	R								
<b>GARELLI</b>	Sahel 50	91-	R								
	Sahel 80	91-	R								
	Trial 323	86-	F								
<b>GAS-GAS</b>	EC 50 Boy (Air cooled)	05	F								
	K 50 Quad	06	R								
	Boy 50	06-07	F								
	TXT 50 (Boy)	04-07	F&R								
	MC 65	05	R								
	Contact Models	93-95	F&R								
	JTX 125/200/270/320	95-98	F&R								
	Pampera 125/250/370	96-97	F&R								
	TX 200/270/320	98	F&R								
	Pampera 250/320	98-99	F&R								
	Contact JT25 (238cc)	93-94	F&R								
	250 Pampera	96-97	F&R								
	JTR/125/160/250/370	96-97	F&R								
	TX 200/270/320	98	F&R								
<b>GILERA</b>	GSM 50	00-03	F&R								
	H@K 50	01-02	F&R								
	RCR 50 Enduro	03-06	F&R								
	RK 50 Cannibal	96-98	F&R								
	SMT 50 Supermotard	03-06	F&R								
	SMT 50	07	F&R								
	Zulu 50	01-01	F&R								
	SC 125	06-07	R								
<b>GMA</b>	4 Piston model		F								
<b>HONDA DALL-ARA</b>	XR 125 SM	04	R								
<b>HONDA HM (Italy)</b>	CRE 50 Baja/Derapage	01-02	R								
<b>HRD</b>	Cabriolet 125	01	R								
	Sonic 2 Trail 50		R								
	Sonic 2 Supermotard 50		R								



# FA115 Contd.

## PEUGEOT (AJP CALIPER) Contd.

Metal X 50  
XR6 '50cc'  
XP6 Enduro 50  
Elyseo 100  
LOOXOR 125/150  
Elystar 50 TSDI  
Jet Force 50  
Ludix Urban Track  
Ludix Red Zone  
Ludix Acid  
Looxor 50 TSDI (Rear disc)  
XPS 125 CT  
Ludix Blaster  
XP 125 Street Evo 2  
**PGO**  
RS2 NKD  
**PIAGGIO**  
Diesis 50  
Diesis 100  
**RIEJU**  
MRX 50  
NKD 50  
RS1 50cc  
RR 50 cc Thunderfire

02-03 F  
02-07 R  
02-07 F&R  
03 F&R  
03-06 R  
02-05 F  
03-06 F&R  
06-07 F  
06 F  
06 F  
06 F&R  
05-07 F&R  
05-07 F  
05 R  
05 R  
01-05 F  
01-03 F  
03-06 F&R  
07 R  
97-00 F&R  
97-02 F&R

**RIEJU Contd.**  
RR 50 Castrol  
RR 50 Sport  
MRX 50 PRO  
Spike 50  
Spike 50 Pro  
SMX 50 Pro Supermotard/Top  
RS1 50cc  
SMX 50  
MRX 50 Castrol/SMX 50  
RS2 125  
125 NKD  
SMX 125  
MRX 125  
RS2 Matrix  
Spike X50  
RRX 50  
**ROXON**  
Duel 50 SM  
Duel 50 TT  
**SACHS**  
Madass 50 (2 stroke) (Hydraulic rear brake)  
**SCORPA**  
250 Easy

00-02 R  
03-06 F&R  
04-06 R  
04-06 F&R  
04 R  
04-07 R  
01-04 R  
02-06 F&R  
01-02 R  
06-07 R  
06-07 R  
02-07 R  
02-07 R  
02-07 R  
06-07 F&R  
06-07 F&R  
06 F&R  
06 F&R  
04-05 R  
96 F&R

**SCORPA Contd.**  
TY-S 125 F Enduro  
TYS 125 F  
TY-S 175 F  
**SHERCO**  
All models 0.5-2.0  
All models 1.2-2.0  
SM 50 Supermotard  
Enduro 50 (EN 50)  
SM 125/125 City Corp  
0.8  
**SIAMOTO**  
SX1 125  
**TOMOS**  
Streetmate  
SM 125  
SE 50/125  
Youngst'r  
**VECTRIX**  
Vectrix Electric 3W (MP3 style scooter)  
**YAMAHA**  
TZR 50 (5WX1)  
TY 250 R  
TY 250 R  
TYZ 250 R

03-05 F&R  
06-07 F  
06 F  
01-05 F  
01-05 R  
03-07 R  
03-07 R  
03-07 R  
03-06 R  
01-05 F  
04 R  
05 F  
05 R  
05 R  
05 F  
07 F  
03-07 R  
91-92 F  
93-94 F&R  
93-96 F&R

# FA116 31.5 x 57.2 x 5.5mm

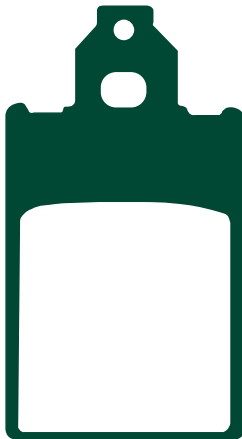

## ACCOSSATO

CE 50/80/KR 80 87- R  
Enduro Codice 50 89- R  
**BETA**  
TR34 86-88 R  
TR34 125 86- R  
Tempo 16" 94-97 F  
Tempo 98 F  
RK6 93-96 R  
**CAGIVA**  
W4 50 91-95 F  
**FANTIC**  
50.1 Oasis 86- F  
50.1 Oasis KS/Rally 86- F  
50.1 Oasis E.S. 87- F  
50 Fast 88- F  
**GARELLI**  
Sahel 50 91- F  
Sahel 80 91- F

## MALAGUTI

50 Enduro MLX 87- F  
Yesterday 98-03 F  
F15 Firefox 96-00 F  
Centro SL/SL Cat 94-00 F  
CRI Crosser 95-98 F  
Centro Base F  
F12 Phantom 50 94-03 F  
**PEUGEOT**  
SV 100 L F  
**PIAGGIO**  
Free 50 (Disc Model) 95-00 F  
Free Delivery 50 00-01 F  
**TOMOS**  
Streetmate 03-04 F  
Revival/Revival TS 03-04 F  
**YAMAHA**  
DT 50 R 97-01 F  
DR 50 R-L (SM-5VB1/VG55BK) 02-03 F

### Equivalents OE #

119 363 00
5BK F5811 00
821 3145
498840
119 468 000
119 419 000
752817
2525250000

### Competitor X Ref

Dunlop	Ferodo	SBS	Vesrah
DP610	FDB697	607	VD-937

### MATERIAL AVAILABILITY AND PART NO.

STD	OPTIONS			
FA	HH	R	MXS	GFA
FA116	-	-	-	-

# FA118 71 x 38.8 x 10mm

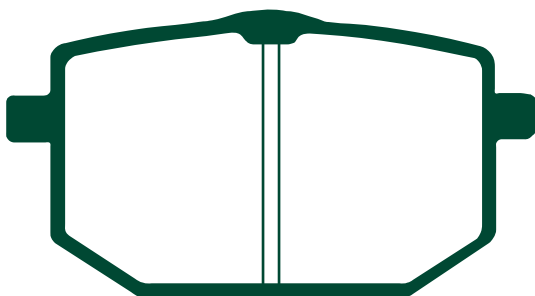

## ALFER

VRE 125 4T 98- F  
Divertida 250 Super Motard 01- F  
Diferente Enduro 01- F  
VR 250 98- F  
**YAMAHA**  
XT 600 87 F  
XT 600 (Z Tenere) 85-90 F

### Equivalents OE #

55W W0045 00
55W W0045 01

### Competitor X Ref

Dunlop	Ferodo	SBS	Vesrah
-	FDB583	596	VD-245

### MATERIAL AVAILABILITY AND PART NO.

STD	OPTIONS			
FA	HH	R	MXS	GFA
FA118	-	-	-	-



# FA119 82.6 x 21.8 x 7.1mm

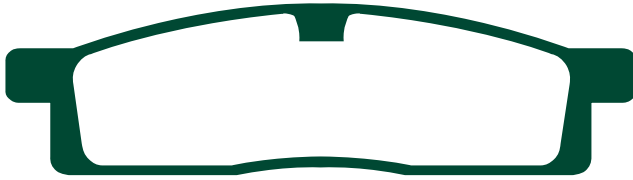

**Equivalents OE #**

1LR W0046 00	3UN W0045 00
2HF W0046 00	4ES W0045 00
2HF W0046 02	4P1 W0045 00

**Competitor X Ref**

<b>Dunlop</b>	<b>Ferodo</b>	<b>SBS</b>	<b>Vesrah</b>
DP408	FDB453	589	VD-244

**YAMAHA**

DT 50 LC	98-	F
YZ 80 S/T/U/W/E/F/LWF/LWG/G/LWH/H/LWJ /J/LWK/K/L/LWL/LWM/M/N/LWN	86-01	F
YZ 85 P/LWP/R/LWR/S/LWS/T/LWT/V/LWV /LWW/W	02-07	F
TT-R 125 LWM/LWN/LWP/LWR/LWES/LWS /LWET/LWT/LV/LEV/LEW	00-07	F

**MATERIAL AVAILABILITY AND PART NO.**

STD	OPTIONS			
FA	HH	R	MXS	GFA
FA119TT	-	FA119R	-	-

# FA120 119.8 x 52 x 8mm

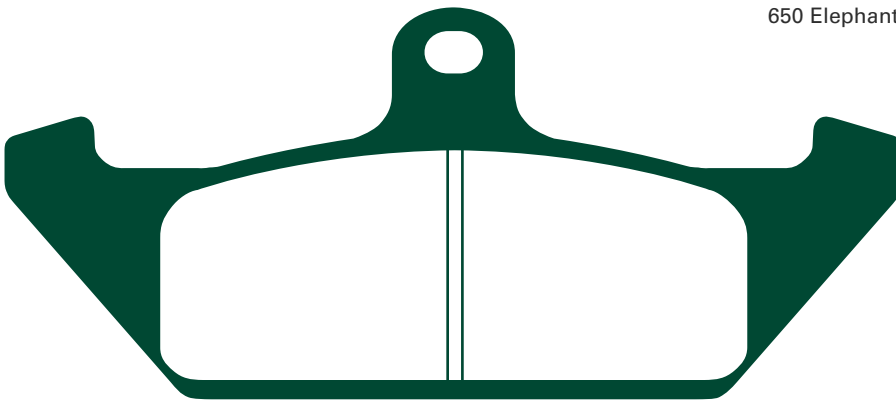

**CAGIVA**

Elefant 650	85	F
650 Elephant	88-89	F

**Equivalents OE #**

8000 45453

**Competitor X Ref**

<b>Dunlop</b>	<b>Ferodo</b>	<b>SBS</b>	<b>Vesrah</b>
-	FDB592	594	VD-924

**MATERIAL AVAILABILITY AND PART NO.**

STD	OPTIONS			
FA	HH	R	MXS	GFA
FA120	-	-	-	-

# FA121 119.8 x 52 x 8mm

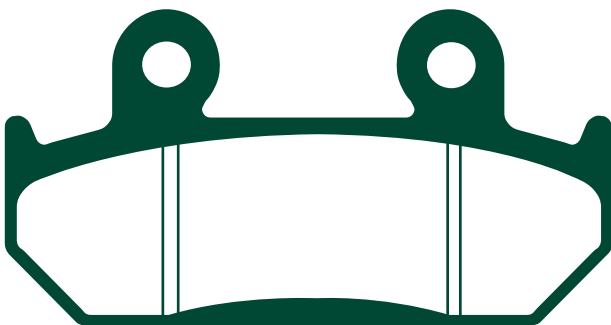

**HONDA**

CBR 250 FG/FGYA (MC14)	86	F
CBR 250 RH (MC17)	87	F
NSR 250 RG (MC16)	86	F
CB 350 SG/SJ	86-90	F
CBR 400 RG (NC23)	86	F
CBR 400 RHYA (NC23)	87	F
CB 450 SG/SJ	86-88	F
CBR 500 FH/FJ/FK/FL	87-90	F
CBR 600 FH/FJ/FK/FL	87-90	F
VFR 400 ZG/ZH/RG/RG-YA (NC21)	85-87	F
VFR 400 RH2/RJ (NC24)	87-88	F
XRV 750 L/M/N 'Africa Twin'	90-93	F

**SAME AS FA203 EXCEPT  
REDUCED THICKNESS**

**MATERIAL AVAILABILITY AND PART NO.**

STD	OPTIONS			
FA	HH	R	MXS	GFA
FA121	FA121HH	-	-	-

**Equivalents OE #**

06455 ML4 P00	45105 ML4 000	45105 ML7 017
06455 ML7 P10	45105 ML4 004	45105 ML0 007
451A0 MN4 670	45105 ML4 006	45105 MN4 007
45105 KT7 751	45105 ML4 008	45105 MN4 008
45105 KT7 761	45105 ML4 014	
45105 KT8 004	45105 ML4 024	

**Competitor X Ref**

<b>Dunlop</b>	<b>Ferodo</b>	<b>SBS</b>	<b>Vesrah</b>
DP110	FDB462	593	VD-141/142

# FA122 55 x 52.6 x 9.4mm

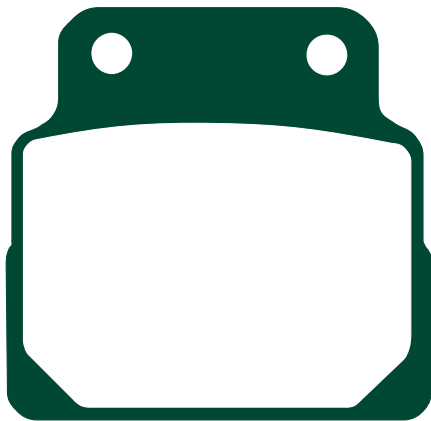

**HONDA**  
CB 450 DX-K

89-92 F&R

**Equivalents OE #**

43105 KK9 691

**Competitor X Ref**

Dunlop	Ferodo	SBS	Vesrah
-	-	598	VD-146

MATERIAL AVAILABILITY AND PART NO.				
STD	OPTIONS			
FA	HH	R	MXS	GFA
FA122	-	-	-	-

# FA123 74.8 x 54 x10mm

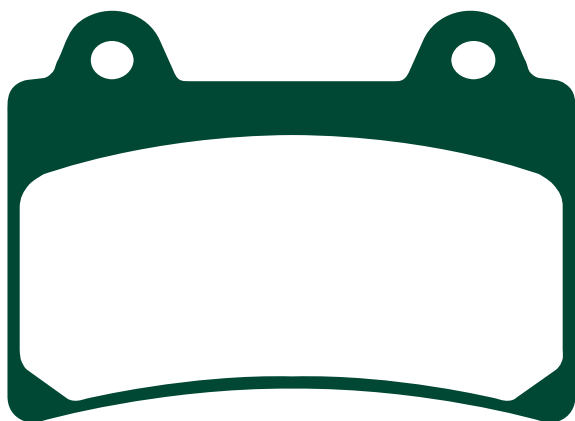

**YAMAHA**

FZR 250	87	F
TZR 250 (2MA/2XW)	87-92	F
TDR 250	88-92	F
TZR 250 (1KT/2AW)	87	F
FZR 400 (3EN1/3EN2)	88-89	F
FZR 400 RSP (2TK-EX-UP)	87	F
SRX 400 (3VN1/3VN2/3VN5)	90-96	F
SRX 600 (3SX)	90-91	F
FZ 750	89-91	F
FZR 750 'Genesis'	87	F
TDM 850	91-95	F
TRX 850	96-99	F
FZR 1000 Genesis	87-88	F
FJ 1200 (3CV/3XW type)	88-95	F
FJ 1200 A (ABS model)	91-95	F
XJR 1200	95-98	F
XVZ 13 AH/ATH "Royal Star"		
Royal Star Classic	96-00	F&R
XVZ 1300 TF Venture Star	99-01	R
XV 1600 Wildstar	99-04	R

**Equivalents OE #**

1NL W0045 00	2GH W0045 01
1NL W0045 01	3EN W0045 00
1RK W0045 00	4KG W0045 00
1RK W0045 50	4NK W0046 00
1RK W0046 00	4NK W0045 00
2GH W0045 00	4WM W0046 00

**Competitor X Ref**

Dunlop	Ferodo	SBS	Vesrah
DP409	FDB662	590	VD-242/ 242/2

MATERIAL AVAILABILITY AND PART NO.				
STD	OPTIONS			
FA	HH	R	MXS	GFA
FA123	FA123HH	-	-	-

# FA124 87.9 x 41.1 x 8.8mm

# FA124/2 87.9 x 41.1 x 9.8mm

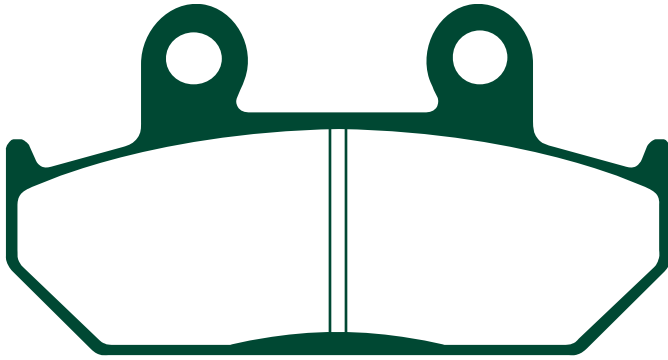

**Competitor X Ref**

Dunlop	Ferodo	SBS	Vesrah
DP109/116	FDB452 R/663	600	VD-143/ 143/2

**Equivalents OE # - FA124**

45105 ML7 006	45105 NF4 000
45105 ML7 007	451A0 ML7 670
45105 MM5 007	45105 MM5 017
45105 MM5 008	06455 MM5 P00

**Equivalents OE # - FA124/2**

06455 MT8 405	45105 MN5 018	45105 MT8 008
06455 MS8 405	45105 MN9 008	45106 MW3 671
06455 MV4	45105 MR1 671	451A0 MT8 670
06455 MS8 405	45105 MS6 901	451A0 MT2 670
06455 MS6 P00	45105 MS8 008	8000 66796
45105 KV0 701	45105 MT2 007	
45105 MN5 008	45105 MT2 008	

**HONDA**

RS 125/250	88-89	F
CBR 750 FH Superaero	87-88	F
VFR 750 FG/FH	86-87	F
CBR 1000 FH/FJ	87-88	F

**FA124/2 - CAGIVA**

Canyon 500	96-00	F
Canyon 600	96-99	F
E 750 Elefant	93-95	F
E 900 Elefant	90-92	F

**HONDA**

CD 250 UJ	88-92	F
GB 250 J/L/P/S/V 'Clubman'	89-97	F
VTZ 250 H/J/K	86-88	F
NV 400 C/J/CK 'Steed'	92-93	F
NX 500 J/K/L/M/N/P/R/S/T Dominator	92-96	F
XL 600 VM/VN/VP Trans Alp	91-93	F
VT 600 C/N "Shadow Custom"	93	F
NX 650 J/K/L/LII/M/N/P/R/S/T "Dominator"	88-96	F
XRV 650 J Africa Twin	88-89	F
GL1500 J/K/SEM/SEN/SEP/SER/SES/SEV/SEW/SEX/SEY "Goldwing"	88-00	F

**MATERIAL AVAILABILITY AND PART NO.**

STD	OPTIONS			
FA	HH	R	MXS	GFA
FA124	FA124HH	-	-	-

**MATERIAL AVAILABILITY AND PART NO.**

STD	OPTIONS			
FA	HH	R	MXS	GFA
FA124/2	FA124/2HH	-	-	-

# FA125 94.2 x 32 x 7.3mm



**1 Left/1Right**

**Competitor X Ref**

Dunlop	Ferodo	SBS	Vesrah
DP814	FDB495	603	VD-139

**Equivalents OE #**

45105 HA5 671A	45106 HA5 671B
45105 HA5 672A	45106 HA5 672B
45105 HA5 672B	45106 KS6 701A
45105 KS6 831A	45106 KS6 701B
45105 KT0 405	45106 KS6 831B
45105 KZ1 405	45106 KY7 008
45105 KW3 405	45106 KW3 681
45105 KW3 681	451A0 HB9 670
45105 KY7 008	

**HONDA**

CRM 50 RN/RP/RR/RT	93-96	F
CRM 75 RK/RL/RM/RP/RR	89-94	F
CR 125 RH/RJ/RK/RL/RM/RN/RP/RR	87-94	F
AX-1 (NX 250 J/K/R/R3)	89-94	F
CR 250 RH/RJ/RK/RL/RM/RN/RP/RR	87-94	F
CRM 250 R (RK) MK1/MD24 (100001-1008385)	89-90	F
CRM 250 R (RM) MK2/MD24 (1200001-1211634)	91-92	F
CRM 250 R (RP-RP-11) MK2/2 MD24 (1300001-)	93	F
NX 250 J/K/L/ZL/M/P/2P	87-93	F
TRX 250 RG/RH/RJ/RK	86-89	F
XL 250 RL	90	F
XR 250 RJ/RK/RL/RM/RN/RP/RR/RS	88-95	F
CR 500 RH/RJ/RK/RL/RM/RN/RP/RR	87-94	F
XR 600 RJ/RK/RL/RM	88-91	F

**ALSO SEE FA185 FOR OVERSIZE PAD**

**MATERIAL AVAILABILITY AND PART NO.**

STD	OPTIONS			
FA	HH	R	MXS	GFA
FA125TT	-	FA125R	MXS125	-

# FA126 67.5 x 51 x 7mm

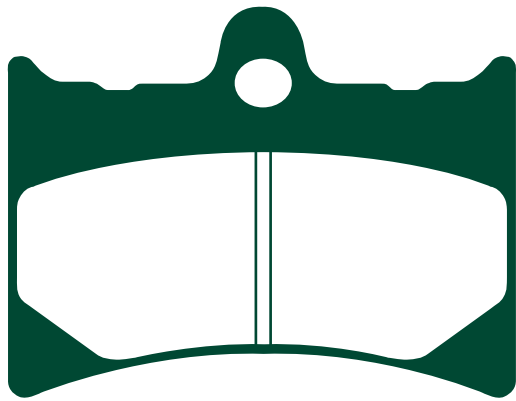

## ALFER

125 MC	88-	F
250 MC	88-	F
250 GR/Enduro	88-	F
300 GR/Enduro	88-	F

## APRILIA

AF-1 125	88-91	F
RS 125 All models	92-05	F
Tuono 125	03-04	F

## BENELLI

Devil 50	92-	F
Spring 50	93-	F
Devil 80	92-	F
Tarno 125	89-	F

## GILERA

GFR 125	94	F
Nordwest	94-96	F
125 CX	91-	F
125 MX1/MXR	89-	F
125 SP 01/SP 02	89-	F
Nord-West 350	94-	F

## KTM

Most Models	87	F&R
-------------	----	-----

## MALAGUTI

Madison 125	99	R
-------------	----	---

## MOTO GUZZI

Quota 100 D	93-95	F
-------------	-------	---

## MZ

Skorpion replica	95-96	F
------------------	-------	---

### Equivalents OE #

8113489	90214 01000
000306546310	

### Competitor X Ref

MATERIAL AVAILABILITY AND PART NO.					
STD	OPTIONS				
FA	TT	HH	R	MXS	GFA
FA126	FA126TT	FA126HH	FA126R	-	-

Dunlop	Ferodo	SBS	Vesrah
DP604	FDB498	591	VD-943

# FA128 A. 35 x 85 x 8mm B. 37 x 55.5 x 9.8mm

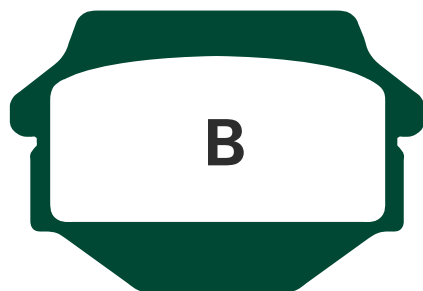
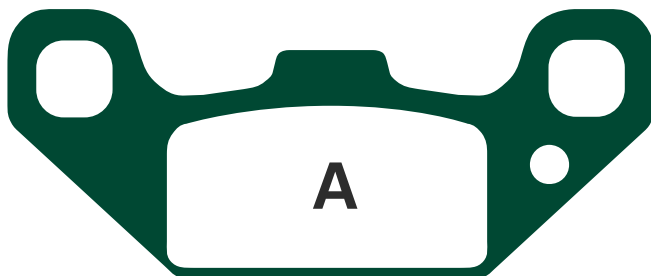

## KAWASAKI

KXF 250 A1/A2 Tecate 4	87-88	F
KSF 250 A8-A18	94-04	F
KEF 300 B1/B2 Lakota Sport	01-02	F

## SUZUKI

LT 250 RH/RJ/RK/RL	87-90	F
LT 500 RL	90	F

### Equivalents OE #

43082 1067	59300 03840
59100 43810	

### Competitor X Ref

Dunlop	Ferodo	SBS	Vesrah
DP821	FDB2013	591	VD332

MATERIAL AVAILABILITY AND PART NO.				
STD	OPTIONS			
FA	HH	R	MXS	GFA
FA128TT	-	FA128R	-	-

# FA129 A. 141 x 41.5 x 9.7mm B. 95 x 34.5 x 9.7mm

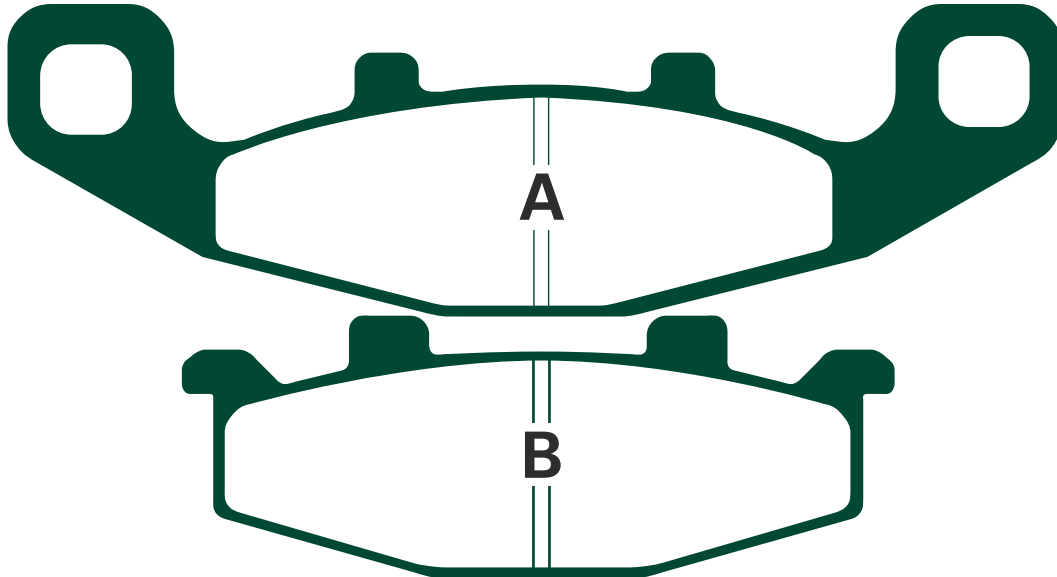

### HYOSUNG

Comet 250/600 02 F

### KAWASAKI

GPX 250 R (ZX 250 F2-F9)	88-95	F
GPX 250 R (EX 250 F)	87	F
KLE 250 A2 (Anhelo)	95	F
KLE 250 A3/A5/A6	97/00-01	F
ZZR 250 (EX 250 H1-H13)	90-03	F
ZR 250 A1-A5	91-95	F
GPX 400 R (ZX 400 F1)	87	R
GPZ 400 R 'D4'	88	R
ZRX 400 (ZR 400 E1/E2)	94-95	F
ZZR 400 (ZX 400 K1/K2/K3)	90-92	R
ER-5 (ER500 A1/A2/A3/A4)	97-00	F
GPz 500 S (EX 500 A1-A6/D1-D7)	87-01	F
KLE 500 A1-A12	91-04	F
KLE 500 B1/B1P/B6F	05-06	F
ZR 550 B2-B6 "Zephyr"	91-99	F
GPx 600 R (ZX 600 C1-C7)	88-96	F&R
ZL 600 B1 "Eliminator"	95-97	F
ZZ-R 600 (ZX 600 D1-D3)	90-93	R
KL 650 B1-B3 "Tengai"	89-92	F
GPX 750 R (ZX 750 F1-F3)	87-89	F&R

### KAWASAKI CONTD.

ZR 750 C1-C5 'Zephyr'	92-95	F&R
ZR 750 D1 'Zephyr'	96-	R
GPz 900R A7-A8	90-96	R
GPZ 900 R (ZX 900 A11)	98	R
GPZ 900 R (ZX 900 A12-15)	99-02	R
ZX 100 B1-B3 (ZX-10)	88-90	F&R
ZG 1000 A9-A18 (1000 GTR)	94-03	F
ZZR 1100 (ZX 1100 C1-C3)	90-92	R
ZR 1100 A1-A4 'Zephyr'	92-95	R
ZR 1100 B1 'Zephyr'	96-97	R
ZR 1100 B5 (Zephyr 1100 RS)	02	R

### SUZUKI

RG 125 UN 'Wolf'	92-94	F
GSF 250 N/ZM/P/NP/ZP/N/NR	92-96	F
GSX 250 SSM Katana (GJ76A)	91	F
SW-1 250 (NJ45A)	92	F
GSF 400 M/N/P Bandit	91-95	F
GS 500 EK/EL/EM/EN/EP/ER/ES	89-95	F
DR 800 SM	91	F
VX 800 L/M/N/P/R	90-96	F
GSX 1100 GM/GN	91-94	F

### Competitor X Ref

Dunlop	Ferodo	SBS	Vesrah
DP314	FDB481/R	597	VD-427

### Equivalents OE #

43082 1068	43082 1095	43082 1134	59100 26810
43082 1069	43082 1104	43082 1139	59100 45860
43082 1074	43082 1114	43082 1161	59301 45860
43082 1077	43082 1123	43082 1189	59302 45810
43082 1088	43082 1124	59100 01820	

### MATERIAL AVAILABILITY AND PART NO.

STD	OPTIONS			
FA	HH	R	MXS	GFA
FA129	FA129HH	FA129R	-	-

# FA130 A. 73.3 x 49.3 x 7mm B. 60.8 x 62.8 x 9mm

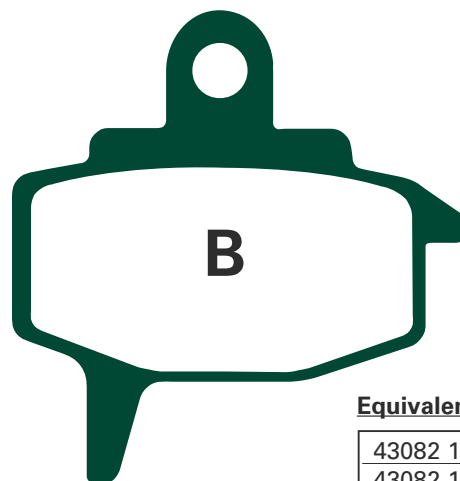
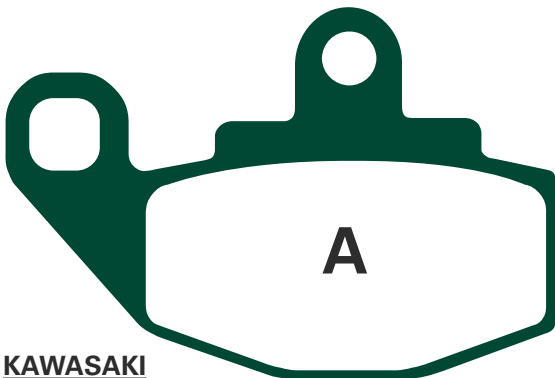

### KAWASAKI

KX 125 E2/F1	87-88	F
KX 250 E1/F1	87-88	F
KX 500 C1/D1	87-88	F
KLR 650 A1-A3	87-89	F

### Competitor X Ref

Dunlop	Ferodo	SBS	Vesrah
DP313	FDB494	602	VD-126

### Equivalents OE #

43082 1072
43082 1078

### MATERIAL AVAILABILITY AND PART NO.

STD	OPTIONS			
FA	HH	R	MXS	GFA
FA130	-	FA130R	-	-

**FA131 75 x 36 x 10.5mm**

**\*FA131R/MXS 75 x 36 x 9.5mm**

**FA131/2 75 x 36 x 7.5mm**

**FA131/3 75 x 36 x 9.5mm**

\* This pad is made to a thinner dimension to allow fitting of radiator shims to the back of pads if required.



**1 Left/1Right**

**Equivalents OE # - FA131**

06435 KCZ 000	43106 KS6 702B	43082 1267
06455 6CK 006	43082 1173	5MV W0046 00
43082 1228	5DH WD0046 00	43082 5010
43105 GT4 004A	5ET W0046 00	43082 5012
43105 GW2 004A	5GR W0046 00	43082 1292
43105 KS6 701A	69100 36820	69100 37810
43105 KS6 702A	69100 36830	BE2500 22068
43105 KZ1 405	69100 36840	69400 37820
43106 GT4 004B	69100 36850	69100 37830
43106 GW2 004B	69100 36860	69095
43106 KS6 701B	69100 36870	69096

**Equivalents OE # - FA131/2**

752394	752391
752071	

**Equivalents OE # - FA131/3**

06435 GT4 405	06431 GW2 405
---------------	---------------

**Competitor X Ref**

Dunlop	Ferodo	SBS	Vesrah
DP815/621	FDB539	604	VD-144

MATERIAL AVAILABILITY AND PART NO.				
STD	OPTIONS			
FA	HH	R	MXS	GFA
FA131	-	FA131R	MXS131	GFA131HH

MATERIAL AVAILABILITY AND PART NO.				
STD	OPTIONS			
FA	HH	R	MXS	GFA
FA131/2	-	-	-	-

MATERIAL AVAILABILITY AND PART NO.				
STD	OPTIONS			
FA	HH	R	MXS	GFA
FA131/3	-	-	-	-

<b>BETA</b>				
Alp 125.200		05-07	R	
Alp 4.0		05-07	R	
<b>CPI</b>				
Sauel 125			R	
<b>GAS-GAS</b>				
EC 125/200/250/300		00-07	R	
Enduro EC 200/250/300		99-00	R	
MC 125		05	R	
MX 125/250		01-04	R	
Pampera 125/450		05-07	R	
MX 200/250/300		99-00	R	
SM 125/250/400 FSE		02	R	
SM 125/250 (2T)		01-06	R	
Pampera 400		06	R	
SM 400 FSE (2T)		01-02	R	
FSE 450/500		05-06	R	
FSR 450 (4T)		07	R	
SM 450		03-06	R	
<b>HONDA</b>				
CB 50 V/W Dream 50		97-98	R	
NSR 50 RV/RW/RX/RV		97-00	R	
XR 50 M5 (AD14) Motard		05	R	
CR 80 RN/RP/RR/RS/RT/RBT/RV/RBV/RW/				
RBW/RX/RB/RV/RBY/R1/RB1/R2/RB2		92-02	R	
NSR 80 J-2/K/L/N/P/R/S (HC06)		88-	R	
CR 85 R3/RB3/R4/RB4/R5/RB5/R6/RB6/R7/RB7		03-07	R	

<b>HONDA Contd.</b>				
NH 90 M/P/R Yuppy		95-97	F	
XR 100 MS (HD13) Motard		05	R	
CR 125/250/500 RH/RJ/RK/RL/				
RM/RN/RP/RR/RS/RT/RV/RW/RX/RV/R1		87-01	R	
SL 230 'Free Landports' (MD33) V/W/X/1		97-01	R	
CRM 250 R (RM) MK2/MD24 (120001-1211634)		91-92	R	
CRM 250 R (RP-RP-11) MK2/2 (MD 24 1300001-)		93	R	
CRM 250 'Active Radial' (MD32) ARV/ARW		97-98	R	
XL 250 RL		90	R	
XLR 250 RM/R3N/RP/RR/R3R (MD22)		91-	R	
XR 250 RL/RM/RN/RP/RR/RS		90-95	R	
XR 250 RT/RV/RW/RX/RV/R1/R2/R3/R4		96-04	R	
XR 250 Y/3 (MD30)		00-03	R	
XR 250 3/5 (MD30) Motard		03-05	R	
XR 250 Ill Y/3 Baja		00-03	R	
NX4 Falcon		02-05	R	
XR 400 RT/RV/RW/RX/RV/R1-R5		96-05	R	
XR 400 R5/R6 (NC38E) Motard		05-06	R	
XR 600 RM/RP/RR/RS/RT/RV/RW/RX/RV		91-00	R	
XR 650 RY/R1-R6		00-06	R	
<b>HONDA DALL'ARA</b>				
XR 250 R		04	R	
XR 650 R		04	R	
<b>HONDA HM (Italy)</b>				
CR 85 R/R2		03-07	R	
<b>HYOSUNG</b>				
RX 400		05	R	
<b>HUSQVARNA</b>				
WXE 125		07	R	
<b>KAWASAKI</b>				
KX 125 K2-K5/L1/L2/L3/L4/M1/M2/M3/M6F		95-06	R	
KLX 250 J1-J6 D-Tracker		98-03	R	
KX 250 K2-K5/L1/L2/L3/L4/M1/M2/R1/R6F/R7F		95-07	R	
KLX 300 A2/A3/A4/A5/A6/A7/A8/A9/A10/A6F/A7F		97-07	R	
KLX 400 R (KLX 400 B1/B2)		03-04	R	
KX 500 E8-A16		96-04	R	
<b>SUZUKI</b>				
RM 125 T/V/W/X/Y/K1/K2/K3/K4/K5/K6/K7		96-07	R	
RM 250 T/V/W/X/Y/K1/K2/K3/K4/K5/K6/K7		96-07	R	
RMX 250 ST/SV/SW/SX (SJ14A)		96-99	R	
250 SBK2 (LX 250 L)		02	R	
DR-Z 400 SEY/EY/Y/SEK1/EK1/K2/SEK2/EK2/K3/SEK3/EK3		00-07	R	
/K4/SEK4/EK4/EK5/SK5/SK6/SK7/K7/EK7/K6				
DR-Z 400 SMK5/SMK6/SMK7		05-07	R	
<b>TM</b>				
Junior 80/85/100		05-07	R	
Cross MX 125 (2T)		01-07	R	
Enduro EN 125 (2T)		01-07	R	
SMR 125		05	R	
Cross MX 250 (2T)		01-07	R	
Enduro EN 250 (2T)		01-07	R	
EN 250 F (4T) Enduro		04-07	R	
SM 250		02	R	
SME 250 (4T)		04-	R	
250 (4T) Cross		02-07	R	
Cross MX 300 (2T)		01-07	R	
Enduro EN 300 (2T)		01-07	R	
400 (4T) MX Cross		02-03	R	
SM 400		02-03	R	
SME 400 (4T)		04	R	
EN 450 F (4T)		04-07	R	
MX 450 F (4T)		04-07	R	
SMR 450 FES		05-07	R	
SMX 450 F		05-07	R	
530 (4T) Cross		02-03	R	
EN 530 F (4T)		04-07	R	
SM 530		02-03	R	
SME 530 (4T)		04	R	
SMR 530 FES		05-07	R	
SMX 530 F		05-07	R	
SMX 660 F		04-07	R	
<b>YAMAHA</b>				
YZ 125 K/L/M/N/P		98-02	R	
YZ 250 K/L/M/N/FN/P/FP		98-02	R	
WR 250 ZK		98	R	
WR 250 FN/FP		01-02	R	
YZ 400 FL/WR 400 FL/FM/FN		99-01	R	
YZ 426 FM/FN/FP		00-02	R	
WR 426 FN/FP		01-02	R	
<b>FA131/2</b>				
<b>PEUGEOT</b>				
SV 50 Geo 80/125		91-92	F	
<b>SYM (SANYANG)</b>				
SR 100 Sunrise		97-	F	
<b>HONDA</b>				
NS-1 75		92-	R	
<b>FA131/3</b>				
<b>HONDA</b>				
SRX 50 T/W/X 'Joker/Shadow'		97-99	F	
NSR 75 N/P/R/X/Y (NS-1/NSR 80)		92-00	R	
Lead 90		88-	F	
NH 90 M/P/R		91-94	F	
SRX 90 T/W/X 'Shadow'		97-99	F	
<b>KYMCO</b>				
Super 9 50		99-01	F	
<b>PEUGEOT</b>				
SV 50 Geo 80/125		93-	F	

# FA132 79.6 x 46.5 x 9mm

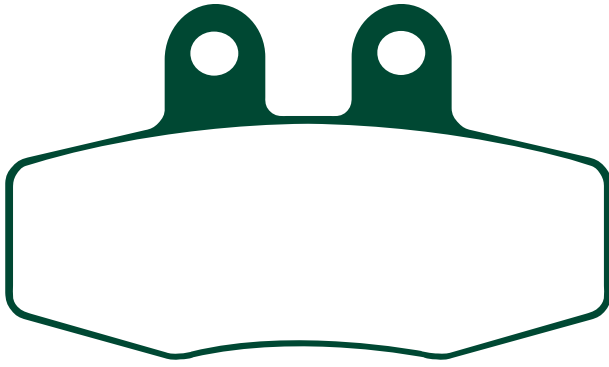

**Competitor X Ref**

<b>Dunlop</b> DP606	<b>Ferodo</b> FDB561	<b>SBS</b> 621	<b>Vesrah</b> VD-936
------------------------	-------------------------	-------------------	-------------------------

MATERIAL AVAILABILITY AND PART NO.				
STD	OPTIONS			
FA	HH	R	MXS	GFA
FA132	-	FA132R	-	-

**Equivalents OE #**

565 13209544
565 13209323

**KTM**

Most 1988 Models	88	F&R
Enduro Models	89-91	F&R
250/300 E/XC/GS	90-91	F
125/350 E/XL/GS	90-91	F&R
125/250/300/600 Enduro	92-93	F
125/250/400/600 LC Models	89-91	F&R
MX 125	89-91	F&R
MX 125	92-93	F
EXC 125	89	F&R
D-XC/E-XC/E-GS 125	90-91	F&R
D-XC/E-XC/E-GS 125	92-93	F
MX 250	88-91	F&R
EXC/EGS 250	88-89	F&R
DXC/EXC 5-0	90	F&R
D-XC/EXC/E-GS 250	91	F&R
D-XC/E-XC/T-XC/E-GS 250	92-93	F
MX/EXC/EGS 350	88	F&R
MX 350	89-91	F&R
DXC/EXC/EGS 350	90-91	F&R
EXC 350	89	F&R
LC-4 MX/EXC 500	89-91	F&R
LC-4 MX/EXC 600	89-91	F&R
LC-4 EXC 600	92-93	F

**MAICO**

All Models	89-93	F&R
250 MX	94-98	F&R
500 MX	94-98	F

**OSSA**

500	92	F
-----	----	---

**PHB**

500	92	F
-----	----	---

# FA134 99.8 x 46.7 x 8.5mm

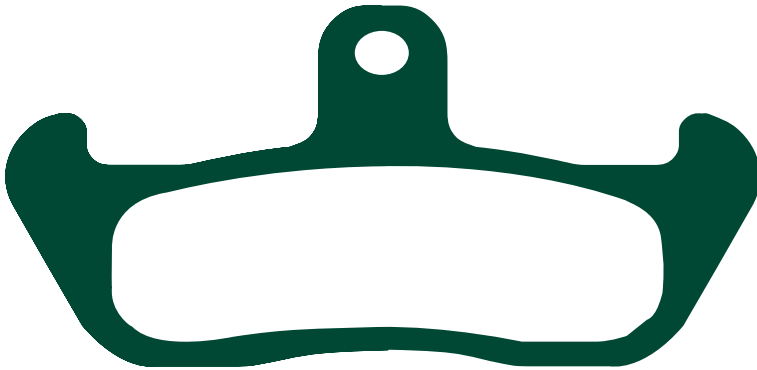

**NOTE**

EBC pads are supplied with close tolerance slider pin holes and do not therefore require use of original anti-rattle clip slider pin hole.

**Competitor X Ref**

<b>Dunlop</b> DP605	<b>Ferodo</b> FDB499	<b>SBS</b> 608	<b>Vesrah</b> VD-929/ 942
------------------------	-------------------------	-------------------	---------------------------------

**Equivalents OE #**

341878
2VW F0047 00
K00946315

MATERIAL AVAILABILITY AND PART NO.				
STD	OPTIONS			
FA	HH	R	MXS	GFA
FA134	-	FA134R	-	-

**APRILIA**

AF1 125	87	F
---------	----	---

**CAGIVA**

WMX 125	89	F
Excaliber 501 RLX	92	F
WMX 250	86-89	F
WM 125	87-88	F
750 Elefant	90-92	F

**GILERA**

125 Apache	91-	F
RC 600	89-90	F

**HONDA HM (Italy)**

CRE 50 Six/Baja/Derapage Brembo caliper/Kayaba forks	95-02	F
--	-------	---

**HUSQVARNA**

CR 125	91	F
WR 125	87-88/91	F
CR 240	87-88	F
WR 240	87-88/90-91	F
CR 250	87-88/91	F
WR 250	87-88/90-91	F
XC 250	87-88	F
WR 260	90-91	F
TE 350	90-91	F
WR 400	87-88	F
CR 430	87-88	F
WR 430	87-88	F
XC 430	87-88	F
430 Automatic	87-88	F
CR 500	87-88	F
XC 500	87-88	F
TC 510	89-90	F
TE 510	89-90	F
WMX 510	89	F
WXE 510	89	F
TC 610	91	F
TE 610	91	F

**KRAM-IT (KRAMER)**

ER 125/250/300 RV3	88-	F
ER 500/600	96-	F

**MOTO MORINI**

Excaliber 350/501 RLX	93-	F
Dart 350	87	F

**YAMAHA**

TDR 125 (3SH/3XD1)	89-93	F
--------------------	-------	---



# FA135 A. 96.7 x 42.7 x 7.4mm B. 77 x 42.2 x 7.4mm

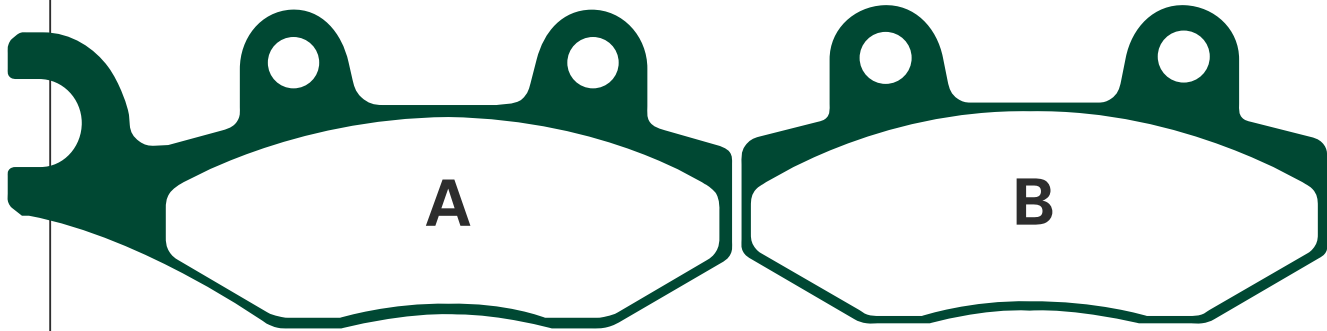

DISC PADS  
BUYERS GUIDE

## BAROSSA QUADS

170 Sport	03-04	R
170 Cheetah/Magna	03-05	R
Quarterback 250	05	R

## ECO

Bushman 150 (LX 150 GY)		F
-------------------------	--	---

## GAS GAS

KZ 250 RV Quad	06	F(left)
----------------	----	---------

## HUSQVARNA

CR 125	92-94	F
WR 125	93-94	F
CR 250	92-94	F
WR 250	92-94	F
TE 350	92-94	F
CR 360	92-94	F
WR 360	92-94	F
TE 610	92-94	F
TC 610	92-94	F

## KAWASAKI

KX125 G1/H1/H2/J1/J2	89-93	F
KDX 200 E5/E6	93-94	F
KDX 200 SR (DX200G)		F
KX 250 G1/H1/H2/J1/J2	89-93	F
KDX 250 SR (KDX 250 F1)	91	F
KDX 250 D1	91-93	F
KLF 300 C1-C17 "Bayou"	89-05	F(left)
KLF 400 B1-B7 Bayou	93-99	F(left)
KX 500 E1-E5	89-93	F
KVF 750 A1/B1/A2/B2 Brute Force 4x4	05-06	F(left)

## MOTO ROMA

Road Runner 125	04-05	F
-----------------	-------	---

## QUADZILLA

Stingr R170E	06	R
ST 200 E (Automatic)	06	R
WK 300	06-07	F

## SUZUKI

EN 125-2/125-2A	05	F
TS 125 RK/RL/RM/RN/RP/RR	90-96	F
RM 125/250 H/J/K/L/M/N/P/R/S	87-95	F
TS 200 RK/RL/RM/RN/RP/RR	89-94	F
DR 250 SL/SM/SN/SEP/SER/SES	90-95	F
RMX 250 K/M/N/P/R/S	89-95	F
RMX 250 SN/SR/SS (SJ13A)	95-97	F
DR 350 SL/SM/SN/SP/SER/SES/SET/SEV	91-97	F
LT-F 300 FK2	02	F(left)
LT-R 450 K6/K7	06-07	F(left)
LT-A 500 FY/FK1	00-01	F(left)
LT-F 500 FW/FX/FY/FK1/FK2	98-02	F(left)

## YAMAHA

YZ 125 W/A/B/D/E/F/G/H/J	89-97	F
DT 200 WR (3XP)	92-93	F
WR 200 D/E/F	92-94	F
DT 230 (4TP1/2) Lanza	91-98	F
TT 250 R (4GY) Raid/4MR2	96	F
TT 250 R RL/RM/RN/RP/RR/RS	99-04	F
WR 250 ZB/ZD/ZE/ZF/ZG/ZH/ZJ	91-97	F
YZ 250 D/E/F/G/H/J	92-97	F
YZ 250 W/WRW	89	F
YZ 250 A/WRA/B	90-91	F
YZ 250 A/WRA/B	90-91	F
YFZ 450 S/T/V/W	04-07	F(left)
YFM 450 FXV Wolverine	06	F(left)
WR 500 ZD	92	F
YXR 66 FAS/FAT Rhino 4x4 Side x Side	04-05	F(left)
YFM 700 RV/RW Raptor	06-07	F(left)
XTZ 750 "Super Tenere"	89-95	F(left)

### Competitor X Ref

<u>Dunlop</u>	<u>Ferodo</u>	<u>SBS</u>	<u>Vesrah</u>
DP411	FDB497	611	VD-340

### Equivalent OE #

43082 1089	59300 27810	4TP W0045 00
43082 1093	59300 27850	5GF W0045 00
43082 1117	59300 27860	800070888
43082 1129	3JD W0045 00	800071450
59100 39850	3SP W0045 00	59100 09870
59300 08810	3XP W0045 00	IS3 W0045 00
59300 09840	4EW W0045 00	5RM W0045 10
59300 09850	4EW W0045 01	800070858
59300 26830	4GY W0045 01	
59300 27830	4MX W0045 00	

### MATERIAL AVAILABILITY AND PART NO.

<u>STD</u>	<u>OPTIONS</u>			
<u>FA</u>	<u>HH</u>	<u>R</u>	<u>MXS</u>	<u>GFA</u>
FA135TT	-	FA135R	MXS135	-

**OVERSIZE VERSION AVAILABLE - REF: FA202**



# FA136 80 x 40 x 9.8mm

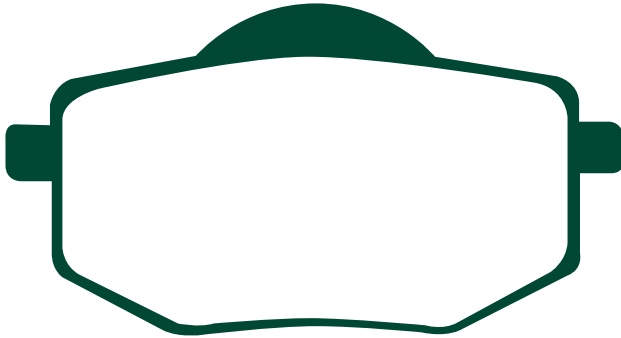

**YAMAHA**  
XV 535 Virago

88-94 F

**Equivalents OE #**

3JB W0045 00
--------------

**Competitor X Ref**

MATERIAL AVAILABILITY AND PART NO.				
STD	OPTIONS			
FA	HH	R	MXS	GFA
FA136	-	-	-	-

Dunlop	Ferodo	SBS	Vesrah
DP417	FDB591	616	VD246

# FA137 47 x 45.1 x 7.5mm

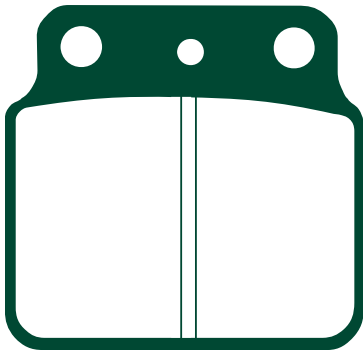

**ARCTIC CAT**

DVX 400 04-07 R

**KAWASAKI**

KSF 400 A1/A2/A3 (KFX 400) 03-05 R

**SUZUKI**

LT 250 RH/RJ/RK/RL 87-90 R

LT-Z 400 K3/K4/K5/K6/K7 03-07 R

LT-R 450 K6/K7 06-07 R

LT 500 RL 90 R

**Equivalents OE #**

43082 S007
69100 07810
69140 35B00
69140 43B00
69140 43B10
3406-075
69100 01810

**Competitor X Ref**

MATERIAL AVAILABILITY AND PART NO.				
STD	OPTIONS			
FA	HH	R	MXS	GFA
FA137TT	-	FA137R	-	-

Dunlop	Ferodo	SBS	Vesrah
DP817	FDB2016	649	VD-341

# FA138 104.3 x 62.3 x 12 mm

**REFERRED TO FA201**

# FA139 104.3 x 62 x 11mm

**REFERRED TO FA200**

# FA140 86 x 40 x 10.2mm

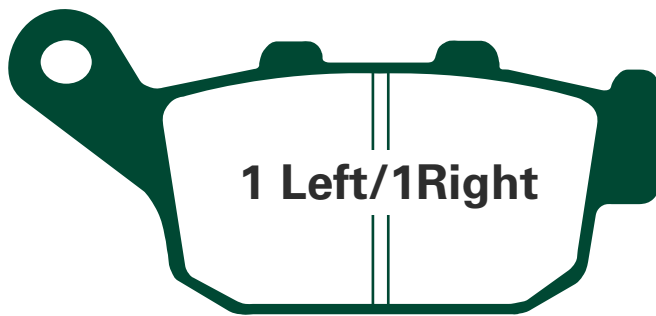

### Equivalents OE #

06435 KFG J21	43105 MN8 006	06435 KFG J21
06435 KT7 405	43106 KV3 831	754804
06435 KV3 405	43106 MN8 006	H0301 T
43105 KT7 761A	43105 MY1 405	06435 MY9 405
43105 KT7 762A	43106 KT7 762B	06435 KFK 006
43106 KT7 761B	69100 04830	
43105 KV3 831	T2020602	

### Competitor X Ref

Dunlop	Ferodo	SBS	Vesrah
DP115	FDB531	614	VD-147

MATERIAL AVAILABILITY AND PART NO.				
STD	OPTIONS			
FA	HH	R	MXS	GFA
FA140	FA140HH	-	-	-

### HONDA

FES 125/150 3/4/5/6/7 Pantheon	03-07	R
CB 250 FT/FV/FX/FY/F1 'Hornet'	96-01	R
CBR 250 RH (MC17)	87	R
CBR 250 RJ/RK/RK2 (MC19)	88-89	R
CBR 250 RRL/RRN/RRR (MC22)	90-94	R
FES 250 Y/1/2/5 Foreight	00-05	R
NSR 250 R2J (MC18)	88	R
NSR 250 RSP/RSK/RSP (MC18)		R
NSR 250 RL/RN/RSP (MC21)	95-	R
VT 250 FL Spada/Castec	88-90	R
VTR 250 W/Y/1-7 (MC33)	98-07	R
CB-1 (CB 400 F)	89-90	R
NT 400 'Bros' NC25		R
CB 400 SF (F2N/F2R) "Superfour"	92-	R
CB 400 SF (F2V/F3T) Superfour	96-97	R
CB 400 SF (F3V) Superfour	97	R
CB 400 Four V/V-II/W/W-II (NC36)	97-98	R
CBR 400 RRJ/K (NC23 Tri-arm)	92-93	R
CBR 400 RRL/RRN/RRR (NC29 Gull-arm)	90-94	R
VFR 400 RH2/RJ (NC24)	87-88	R
NX 500 J/K/L/M/N/P/R/S/T Dominator	92-96	R
NTV 600 J/K/M Reverse	88-92	R
XL 600 VM/VN/VP/VR/VT/VV/VW/VX "Trans Alp"	91-00	R
FMX 650 5/6	05-07	R
NT 650 J/K/L 'Bros'	88-92	R
NT 650 V/W	98	R
NTV 650 J/K/L/M/P/S/T/V	88-97	R
NX 650 J/K/L/LII/M/N/P/R/S/T "Dominator"	88-	R
NT 650 VV/VX/VY/V1 "Deauville"	98-01	R
XL 650 VY/V1/V2/V3/V4/V5/V6/V7 Transalp	00-07	R
XRV 650 J Africa Twin	88-89	R
XRV 750 L/M/N/P/R/S/T/V/W/X/Y "Africa Twin"	90-03	R

### BUELL

X1 Lightning	99-02	R
M2 Cyclone	98-02	R
S1 Lightning	98-02	R
S1 White Lightning	98-02	R
S3 Thunderbolt	98-02	R
S3T Thunderbolt	98-02	R
XB9R	02-07	R
XB9S	03-07	R
XB9SX	05-07	R
XB12R	04-07	R
XB12S	04-07	R
XBRX Ulysses	06-07	R
XB12 SCG	06-07	R
XB12SS	06-07	R

### PEUGEOT

SV 250	01-02	R
--------	-------	---

### SUZUKI

XF 650 V/W/X/Y Freewind	97-02	R
-------------------------	-------	---

### TRIUMPH

Daytona 600	03-04	R
Daytona 955i	01-04	R
Speedfour 600	02-05	R
TT 600	00-03	R
Daytona 675	06	R

DISC PADS BUYERS GUIDE

# FA141 A. 106 x 38.2 x 9mm B. 76.4 x 27 x 10.7mm

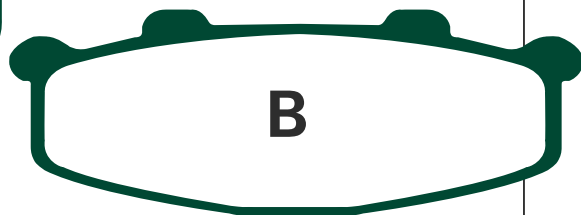

### KAWASAKI

KR-1 (KR 250 B2)	89	F&R
KR1S (KR 250C2/C3)	90-92	R
GPX 250 R (ZX 250 F2-F9)	88-95	R
GPX 250 R (EX 250 F)	87	R
GPX 250 R II (EX 250 G)	88	F&R
ZXR 250 C1-C5 (ZX 250 C1-C5)	91-95	F
ZXR 250 R (ZX 250 D1)	91	F
ZXR 250 (ZX 250 A1/A2)	89/90	F&R
ZXR 250 R (ZX 250 B1/B2)	89-90	F&R
GPX 400 R (ZX 400 F1)	87	F
GPZ 400 R 'D4'	88	F
ZR 400 D1/D3/D4 'Zanthus'	92-95	F
ZX-4 (ZX 400 G1/G1A/G1B)	88	F&R
GPZ 500 S (EX 500 E1-E10)	94-04	F
ZR 550 B2/B3 'Zephyr'	91-93	R

### SUZUKI

RGV 250 M/N/P/R/S/T	91-96	R
RGV 250 T (RGVR 250 SP VJ23A)	96	R

### Equivalents OE #

43082 1075	43082 1144
43082 1076	43082 1147
43082 1085	43082 1162
43082 1087	69100 22820
43082 1101	69100 22830
43082 1125	69100 22850
43082 1127	

### Competitor X Ref

Dunlop	Ferodo	SBS	Vesrah
DP204	FDB508	615	VD-430

MATERIAL AVAILABILITY AND PART NO.				
STD	OPTIONS			
FA	HH	R	MXS	GFA
FA141	-	-	-	-
FA141S (Green)				

# FA142 102 x 38 x 9mm

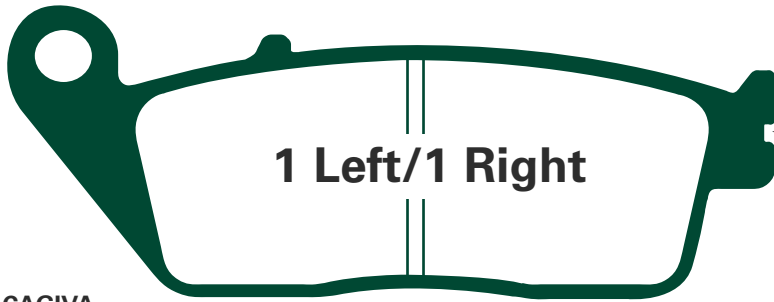

## NOTE

Later supplies have clip notch. Both designs ok for front brake use

### CAGIVA

900 IE Canyon/'Gran Canyon' 98-00 F  
Navigator 1000 00-05 F

### DAELIM

SQ 125 Freewing S2 06 F  
SQ 250 Freeway S2 06 F

### HONDA

CBR 250 RJ/RK/RK2 (MC19) 88-89 F  
CBR 250 RRL/RRN/RRR (MC22) 90-94 F  
VT 250 FL Spada/Castec 88-90 F  
CB-1 (CB 400 F) 89-90 F  
CB 400 SF "Superfour" (F2N/F2R) 92- F  
CB 400 Four V/V-II/W/W-II (NC36) 97-98 F  
CBR 400 RRJ/K (NC23 Tri-Arm) 92-93 F  
CBR 400 RRL/RRN/RRR (NC29 Gull Arm) 90-94 F  
NV 400 CS/CV 'Steed' 95-97 F  
NTV 600 J/K/M Revere 88-92 F  
VT 600 CR/CS/CT/CV/CW/CX 'Shadow Custom' 94-99 F  
NTV 650 J/K/L/M/P/S/T/V 88-97 F  
NX 650 J/K/L/LII/M/N/P/R/S/T/V 88-97 R  
CBR 750 FJ "Superaero" 88 F  
VFR 750 FJ/FK/FL/FM/FN/FP/FR/FS/FT/FV 88-97 F  
CB 750 F2N/F2R/F2S/F2T/F2V/F2W/F2X/F2Y/F2Z  
'CB Seven fifty' 92-02 F  
PC 800 'Pacific Coast' 89-97 F  
CBR 1000 FK/FL/FM/FN 89-92 F  
ST 1100 L/M/N/P/R/S/T/V/W/X/Y1  
"Pan European" 90-01 F  
ST 1100 AN/AP/AR/AS 92-95 F  
GL 1500 'CV/CW/CX/CY/C1/C2' (F6C) 97-03 F

### KAWASAKI

Z 750 (ZR 750 L7F) 07 F  
Z 750 ABS (ZR 750 M7F) 07 F

### KYMCO

Xciting 250/250 i 05-07 F  
Xciting 500/500i 04-07 F

### PEUGEOT

Satelis 125 (ABS Model) 06 F

### SUZUKI

GSX 400 R/S/T/ZR/ZS/ZT "Impulse Type" 94-96 F  
RF 400 RP/RR/VR/RT/RVT/RV-V (GK78A) 93-97 F  
RF 600 RP/RR/RS/RT/RV 93-97 F  
GSF 600 S/T/ST/V/SV/W/SW/X/SX "Bandit" 95-99 F  
AN 650 K3/K4/AK4/AK5/K5/AK6/AK7 Burgman 03-07 F

### TRIUMPH

Thruxton 900 04-07 F

### VOXAN

Scrambler 1000 02-06 F

### Equivalents OE #

06455 MR1 405	45106 ML7 922B
06455 MR4 405	45106 MR4 901
06455 MW3 405	45106 MS9 612
06455 MV4 405	45106 MT4 651/405
06455 MZ0 760	59300 21820
451A0 MT4 670	59300 21840
45105 ML7 921/922	59300 21850
45105 MS9 612	8000 88482
45105 MT4 651/405	06455 MBE 006
45105 KAZ 004	59100 21860
45105 MV4 008	59100 21870
45105 ML7 405	06455 KFR 701
45105 ML7 P10	T2020537
45106 ML7 922	

### Competitor X Ref

Dunlop	Ferodo	SBS	Vesrah
DP117	FDB570	627	VD-156

### MATERIAL AVAILABILITY AND PART NO.

STD	OPTIONS			
FA	HH	R	MXS	GFA
FA142	FA142HH	-	-	-

# FA143 94.2 x 32 x 10mm



### HONDA

NSR 250 RR/R2R (MC28) 94- R  
RVF 400 RR/RR-II/RT/RT-II (NC35) 94-96 R  
VFR 400 RK/R3L/R3M/R3N (NC30) 89-92 R  
VFR 750 RJ/RK/RL (RC30) 88-90 R  
RVF 750 RR/RS 'RC45' 94-98 R

### Competitor X Ref

Dunlop	Ferodo	SBS	Vesrah
DP113	FDB496	623	VD-139/2

### Equivalents OE #

06435 MR7 P00	43105 MT7 405
43105 MR7 007A	43106 MR7 007B
43105 MR7 017A	43106 MR7 017B

### MATERIAL AVAILABILITY AND PART NO.

STD	OPTIONS			
FA	HH	R	MXS	GFA
FA143	-	-	-	-

# FA144 use FA187

## FA145 70 x 55.5 x 8 mm

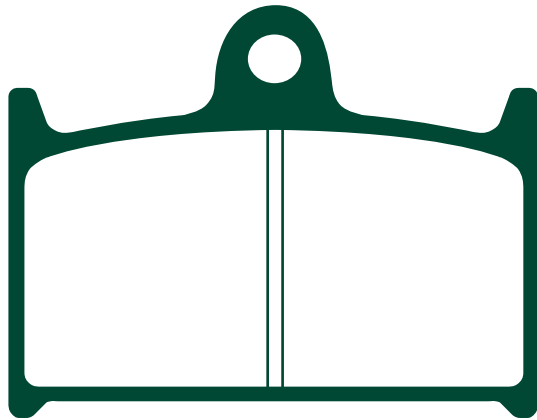

### SUZUKI

GSXR 400 RL/RM/RN/RS (GK76A)	90-95	F
GSXR 750 J/K/L/M/WN/WP	88-93	F
GSXR 750 RG	86	F
RF 900 RR/RS/RS2/RT/RV/RW	94-98	F
GSXR 1100 K/L/M/N	89-92	F
GSF 1200 T/STV/SV/W/SW/X/SX/S/SY 'Bandit'	96-00	F
GSF 1200 SAV ABS Bandit	97	F

### YAMAHA

TZ 125	94-	F
TZ 250	89-02	F
FZR 750 R "OWOI"	89-90	F

### MZ/MUZ

1000 S	03-07	F
1000 SF	05-07	F
1000 SFX	07	F
1000 ST	07	F

### Equivalents OE #

59100 33830	59300 17810
59100 40810	59300 17811
59130 17C00	3FV W0045 00
59130 33C00	3LC 25811 00
59130 33C10	3MW W0045 00
59130 40C00	3TC W0045 00

### Competitor X Ref

Dunlop	Ferodo	SBS	Vesrah
DP213	FDB557	624	VD343

### MATERIAL AVAILABILITY AND PART NO.

STD	OPTIONS			
FA	HH	R	MXS	GFA
FA145	FA145HH	-	-	GFA145HH

## FA146 58.8 x 57.1 x 9mm

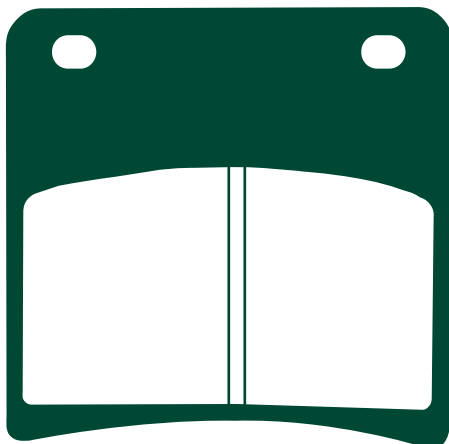

### SUZUKI

GSX 400 FJ/FK/FAK/FL (GK74A)	88-90	F
GSX 600 FJ/FK/FL/FM/FN/FP/FR/FS/FT/FV	88-97	F
GSX 750 FK/FL/FM/FN/FP/FR/FS/FT/FV	89-97	F
VX 800 L/M/N/P/R	90-96	R
GSX 1100 FJ/FK/FL/FM/FN/FP	88-93	F
GSX 1100 GM/GN	91-94	R
GV 1400 GDG/GCG/GDH/GDJ "Cavalcade"	86-88	F

### Equivalents OE #

59100 19820	69100 34860
59100 24810	69100 45890
59130 19C00	69130 34C00
59130 20C00	69130 45C00
59130 24A10	69130 45C10
59130 26D00	69130 26D00
59130 45C10	69100 26810
59130 48B00	

### MATERIAL AVAILABILITY AND PART NO.

STD	OPTIONS			
FA	HH	R	MXS	GFA
FA146	FA146HH	-	-	-

### Competitor X Ref

Dunlop	Ferodo	SBS	Vesrah
DP212	FDB569	620	VD-345/2

# FA147 A. 118 x 48 x 8.6mm B. 97.5 x 57 x 10.8mm

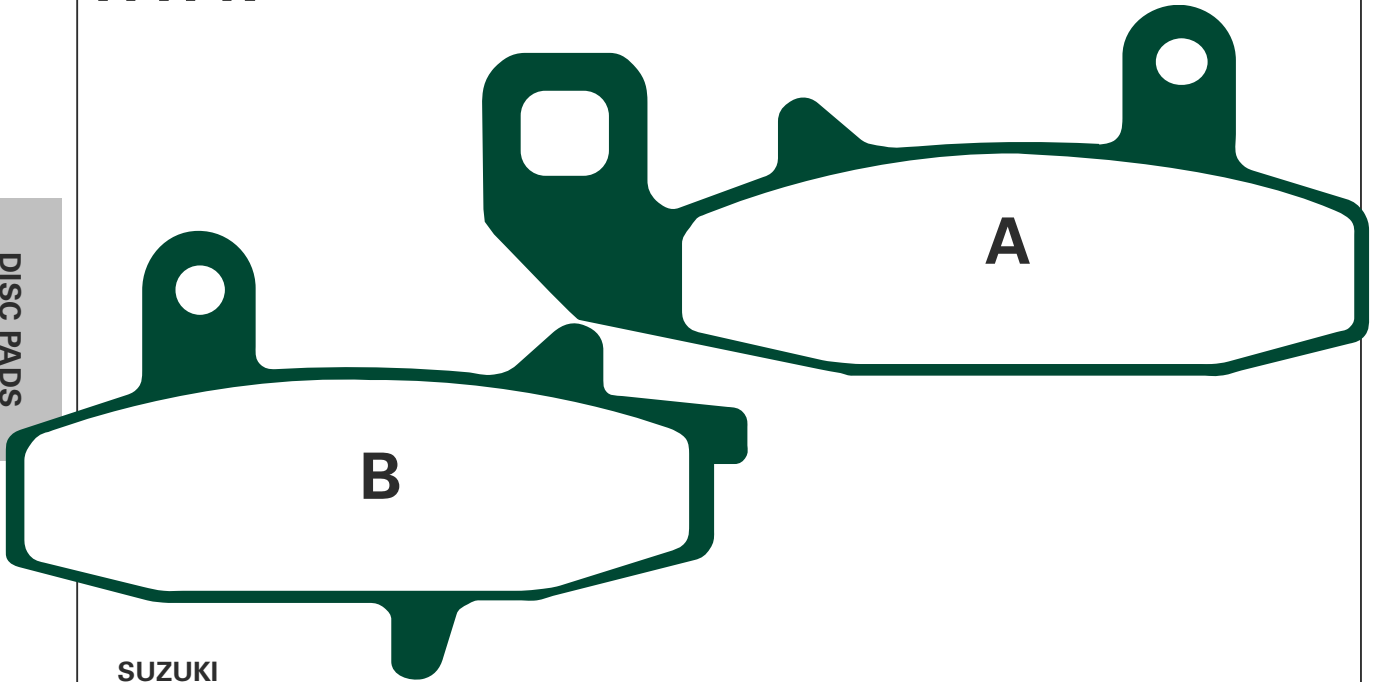

## SUZUKI

DR 650 RSEM/RSEN/RSEP/RES	91-95	F
DR 650 RL/RM (SP41A)	90-91	F
DR 650 RSL/RSM (SP42A)	90-91	F
DR 650 RUN/RN/RUP/RP (SP44A/B)	92-93	F
DR 750 SJ/SK	88-89	F
DR 800 SL	90	F

### Equivalents OE #

59300 44850

### Competitor X Ref

MATERIAL AVAILABILITY AND PART NO.				
STD	OPTIONS			
FA	HH	R	MXS	GFA
FA147	-	FA147R	-	-

Dunlop	Ferodo	SBS	Vesrah
DP214	FDB606	626	VD-347

# FA150 57.3 x 59 x 9mm

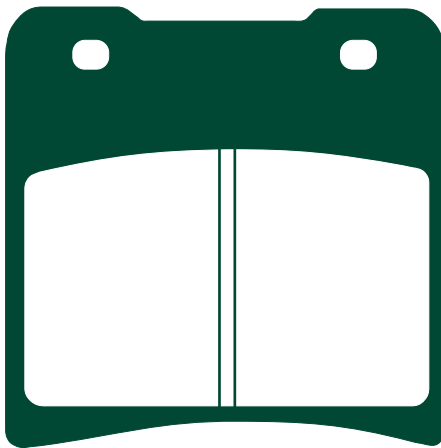

## SUZUKI

GV 1400 GDG/GCG/GDH/GDJ/GCH	86-88	R
'Cavalcade' (from f.no -103765)		

### Equivalents OE #

69100 24860	69130 24A03
69130 24A02	69130 24A04

### Competitor X Ref

Dunlop	Ferodo	SBS	Vesrah
-	FDB831	-	VD331/2

MATERIAL AVAILABILITY AND PART NO.				
STD	OPTIONS			
FA	HH	R	MXS	GFA
FA150	FA150HH	-	-	-

# FA151 51 x 36.5 x 8.3mm

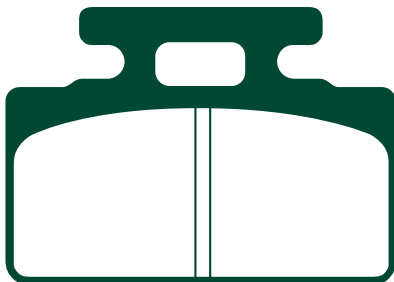

## HONDA

RS 125/250	88-06	R
------------	-------	---

## SYM

Cinderella 50/100	99-00	F
DD 50 City Trek	02-06	F
MIO 50/100	05-07	F

### Competitor X Ref

Dunlop	Ferodo	SBS	Vesrah
DP119	FDB2192	618	VD-150

### Equivalents OE #

43105 NF5 611	45105 GM9 742
45105 GH9 710	45105 GM9 743
45105 GM9 741	45105 GM9 743A

MATERIAL AVAILABILITY AND PART NO.				
STD	OPTIONS			
FA	HH	R	MXS	GFA
FA151	-	-	-	-

**FA152 62 x 40.8 x 9mm**

**FA152/2 62 x 40.8 x 11mm**

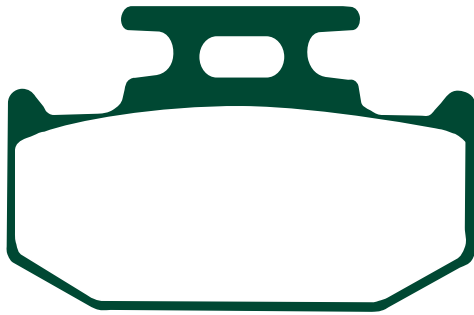

**NOTE:**  
**ANTI RATTLE SHIMS MUST BE DISCARDED TO USE THICKER PAD**

**FA152  
 CANNONDALE**

MX 400	00	R
<b>KAWASAKI</b>		
KX 125 G1/H1/H2/J1/J2/K1	89-94	R
KDX 125 A1/A2/B1/B2	90-94	R
KDX 200 E1-E6	89-94	R
KDX 200 H1-H5	95-99	R
KDX 200 SR (DX 200 G)		R
KDX 220 R A4-A12/A6F	97-06	R
KDX 220 SR (DX 220 B)		R
KDX 250 SR (KDX 250 F1)	91	R
KX 250 G1/H1/H2/J1/J2/K1	89-94	R
KDX 250 D1	91-93	R
KLX 250 R D1/D2/G1	93-97	R
KLX 250 F1-F4	94-97	R
KX 500 E1-E7	89-95	R
KLX 650 C1-C3	93-97	R

**SUZUKI**

TS 125 RK/RL/RM/RN/RR	90-96	R
RM 125/250 K/L/M	89-91	R
TS 200 RK/RL/RM/RN/RR	89-94	R
DR 250 RS/RLS/RT/RV/RLV/RLW/RW/RYS (SJ45A/DOHC)	95-00	R
DR 250 RXT/RXLT/RXV/RXLV/RXW/RXLW/RXGW/RXGLW/RXY/RXGY (Dejbel 250 XC/GPS Ver (SJ45A)		R
DR 250 SL/SM/SN/SEP/SER/SES	90-95	R
RMX 250 K/M/N/P	89-93	R
RMX 250 T/V/W	96-98	R
Serrow 250 (3C51/52)	05	R
XT 250 X	06	R
DR 350 SL/SM/SN/SP/SER/SES	91-95	R
DR 350 SET/SEV	96-99	R
DR 650 SET	96	R

**YAMAHA**

DT 125 RE	05-07	R
DT 125 X	05-06	R
YZ 125 A/B	90-91	R
TT 250 RL/RM/RN/RR/RS	99-04	R
XG 250 Tricker (5XT1)	04-06	R
YZ 250 A/WRA/B	90-91	R
WR 200 D/E/F	92-94	R
WR 250 ZB/ZD/ZE/ZF/ZG/ZH/ZJ	91-97	R
YZ 400 FK	98	R
WR 500 ZD	92	R
TT 600 RES	04	R

**FA152/2**

**SUZUKI**

RM 125 N/P/R/S	92-95	R
DR-Z 250 K1-K7	01-07	R
RM 250 N/P/R/S	92-95	R
RMX 250 R/S	94-95	R
RMX 250 SN/SR/SS (SJ13A)	95-97	R
DR 350 SEW/SEX	98-99	R

**YAMAHA**

YZ 125 D/E/F/G/H/J	92-97	R
DT 200 WR (3XP)	92-93	R
XT 225 W (4JG1-6 Serrow)	93-98	R
DT 230 (4TP1/2) Lanza	97-96	R
TT 250 R (4GY) Raid/4MR2	96	R
YZ 250 D/E/F/G/H/J	92-97	R
YZ 400 FK/WR 400 FK	98	R
WR 400 FK	98	R
TT 600 E (4GV2)	94-95	R
TT 600 K (4LW1/4GV1/4LW2)		R
Up to 4GV 003403 (Nissin rear caliper)	93-95	R

**Competitor X Ref**

Dunlop	Ferodo	SBS	Vesrah
DP315	FDB659	632/648	VD-432/2

**MATERIAL AVAILABILITY AND PART NO.**

STD	OPTIONS			
FA	HH	R	MXS	GFA
FA152TT	-	FA152R	MXS152	-

**Equivalents OE # -FA152**

43082 1090	69100 15810
43082 1118	69140 03D00
43082 1131	69140 15D00
43082 1137	69140 28C00
43082 1151	5XT W0046 50

**MATERIAL AVAILABILITY AND PART NO.**

STD	OPTIONS			
FA	HH	R	MXS	GFA
FA152/2TT	-	FA152/2R	MXS152/2	-

**Equivalents OE # -FA152/2**

69100 43820	69140 26C00	69140 43840	4GV FS811 00
69100 43840	69140 27C10	3SP W0046 00	4GY W0046 00
69100 43850	69140 27C20	3XP W0046 00	5GF W0046 00
69140 05D00	69140 43D00	4DA W0046 00	

# FA153 75 x 40 x 8mm

## HONDA

AX-1 (NX 250 J/K/R/R3)	89-94	R
CRM 250 R (RK) MK1 MD24 (100001-1008385)	89-90	R
XLR 250 R (MD22)	88-90	R
XLR 250 Baja MK2 (MD22)		R

### Equivalents OE #

43106 KW3 006B
43106 KZ9 006B

### Competitor X Ref

Dunlop	Ferodo	SBS	Vesrah
DP120	FDB568	629	VD-153



MATERIAL AVAILABILITY AND PART NO.				
STD	OPTIONS			
FA	HH	R	MXS	GFA
FA153	-	-	-	-

# FA155 40 x 23/7.8mm

## YAMAHA

YFS 200 B/F/G/H/J/K/L/M/N/P "Blaster"	91-02	R
---------------------------------------	-------	---

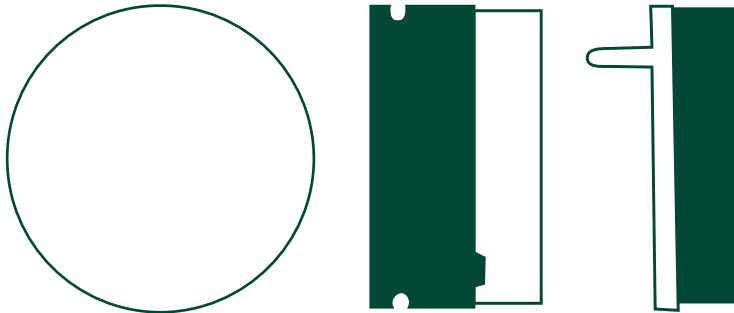

### Equivalents OE #

2XJ 25811 00
--------------

### Competitor X Ref

Dunlop	Ferodo	SBS	Vesrah
DP843	FDB2017	637	VD261

MATERIAL AVAILABILITY AND PART NO.				
STD	OPTIONS			
FA	HH	R	MXS	GFA
FA155	-	FA155R	-	-

# FA156 55.8 x 45.5 x 6mm

## APRILIA

280 Climber	94-96	R
-------------	-------	---

## BETA

Synt/Gara	93-95	R
Techno	95	R

## CAGIVA

Blues 50	93-95	F
Super City 50/80	93-95	F
Prima 50	92-94	F



### Competitor X Ref

Dunlop	Ferodo	SBS	Vesrah
-	FDB886	672	VD-943

### Equivalents OE #

800066937
-----------

MATERIAL AVAILABILITY AND PART NO.				
STD	OPTIONS			
FA	HH	R	MXS	GFA
FA156	-	-	-	-

# FA157 A. 99.3 x 44 x 7.4mm B. 47.7 x 83.3 x 9.7mm

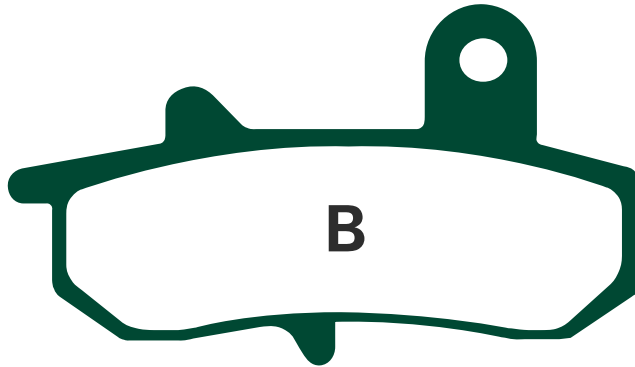
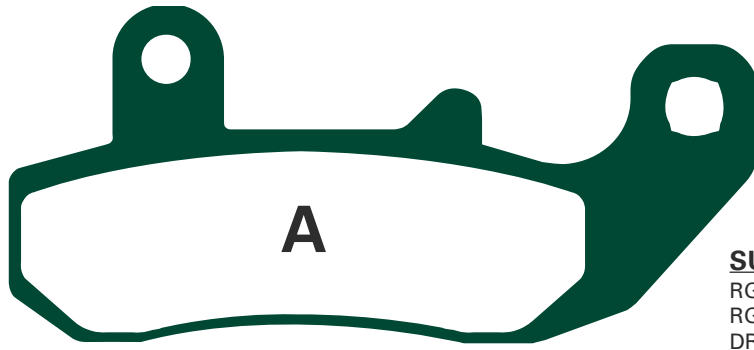

**Equivalents OE #**

69100 44860
69100 12810

**SUZUKI**

RG 125 FUN/FUP/FUR 'Gamma'	92-96	R
RG 125 UN 'Wolf'	92-94	R
DR 650 RSEM/RSEN/RSEP/RES	91-95	R
DR 650 RL/RM (SP41A)	90-91	R
DR 650 RSL/RSM (SP42A)	90-91	R
D 650 RUN/RN/RUP/RP (SP44A/B)	92-93	R
DR 750 SK	89	R
DR 800 SL	90	R

**YAMAHA**

DTZ 125 Tenere/Tenere	89-90	R
DT 125 Chesterfield Scout	89-90	R

**Competitor X Ref**

Dunlop	Ferodo	SBS	Vesrah
DP215	FDB607	635	VD-348/940

**MATERIAL AVAILABILITY AND PART NO.**

STD	OPTIONS			
	FA	HH	R	GFA
FA157	-	-	FA157R	-

# FA158 46.7 x 69.8 x 8mm

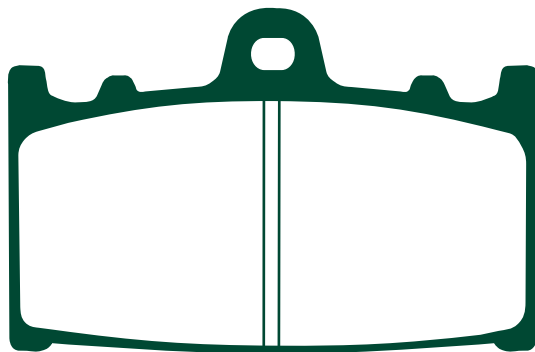

**Equivalents OE #**

43082 1097	59100 22810	59130 32C20
43082 1102	59100 32820	59130 38C00
43082 1110	59100 34830	59300 34830
43082 1111	59130 06C00	59100 35830
43082 1113	59130 22D00	59130 35850
43082 1120	59130 32000	43082 0015
43082 1142	59130 32020	43082 1169
43082 1208	59130 32C00	2654F/S/R2
43082 1288	59130 32C10	

**Competitor X Ref**

Dunlop	Ferodo	SBS	Vesrah
DP317	FDB574	631	VD-343/344

**BERINGER**

4 Piston Caliper

**KAWASAKI**

KRIS (KR 250 C2/C3)	90-92	F
ZR 400 Zephyr (G2/G3/G3A/G4/G5)	97-01	F
ZXR 400 H1/H2	89-90	F
ZXR 400 J1/J2	89-90	F
ZXR 400 R (ZX 400 M1-M4)	91-94	F
ZZR 400 (ZX 400 K1/K2/K3)	90-92	F
ZZR 400 (ZX 400 N1/N2/N3/N4/N5/N6/N7)	93-99	F
ZZR 600 (ZX 600 D1-D3)(E1-E13)	90-05	F
ZZR 600 (ZX 600 E6F)	06-07	F
ZX6 R (ZX 600 F1/F2/F3)	95-97	F
ZXR 750 H1/H2/J1/J2/K1/K2/L1/L2		
L3/M1/M2	89-95	F
GPz 900 R A7/A8	90-96	F
GPZ 900 R (ZX 900 A11)	98	F
ZX9 R (ZX 900 B1/B2)	94-95	F
ZZR 1100 (ZX 1100 C1-C3) (D1-D9)	90-01	F
ZR 1100 A1-A4 'Zephyr'	92-95	F
ZZR 1200 C1H/C2H	02-04	F
VN 2000 A1/A2/A6F/F7F	04-07	F

**SUZUKI**

RG 125 FUN/FUP/FUR 'Gamma'	92-96	F
GSXR 250 RK (GJ73A)		F
RGV 250 J/K/L/M/N/P/R/S	88-95	F
TV 250 J/K/AK/L (VJ21A) Wolf	88-90	F
SG 350 N 'Goose'	92	F
GSF 400 K/NK/Z/VM/VZM/P/NP/VP		
/VZP/VR (GK75A) "Bandit"	89-94	F
GSF 400 S/VS/V-VZ-V Bandit (GK7AA)	95-97	F
GSXR 400 J/RR/RAK (GK73A)	88-90	F
GSXR 400 K6	06	F
GSX 400 SSN (GK77A) Katana	92	F
GSR 600 K6/AK7	06-07	F
GSXR 600 V/W/X/Y/K1/K2/K3/ZK3	97-03	F
GSF 650 AK7/ASK7/AK6/ASK6	06-07	F
GSXR 750 Y/K1/K2/K3	00-02	F
SV 1000 SK3/K3/SK4/K4/SK5/K5/SK6	03-06	F
TL 1000 SV/SW/SX/SY/SK1	97-01	F
GSF 1200 AK6/SAK6/GTSAK6	06	F
GSF 1250 AK7/ASK7 Bandit	07	F

**PRE TECH**

4 piston (P402) Lockheed replacement caliper F

**PRO ONE**

4 Piston

**VERTEMATI**

4 Piston Caliper 99-04 F

**MATERIAL AVAILABILITY AND PART NO.**

STD	OPTIONS			
	FA	HH	R	GFA
FA158	FA158HH	-	-	GFA158HH



# FA159 97 x 40 x 7mm



**DANGER MUST BE FITTED IN COMPLETE FRONT AXLE SETS TO AVOID PULLING LEFT OR RIGHT**

### POLARIS

All Models 89- F

### QUADZILLA

Quadzilla 300 Utility 04-06 F  
 300 E SUV (Manual) 06-07 F  
 300 E SUV (Automatic) 06 F  
 300 E (4x4) (Auto) 06 F  
 500 4X4 06-07 F

#### Equivalents OE #

1930731	2200418	22245
2200465	2201398	2201149
2200901	2202412	1911171

#### Competitor X Ref

<b>Dunlop</b> DP902	<b>Ferodo</b> FDB2055	<b>SBS</b> 642	<b>Vesrah</b> VD-940
------------------------	--------------------------	-------------------	-------------------------

#### MATERIAL AVAILABILITY AND PART NO.

STD	OPTIONS			
FA	HH	R	MXS	GFA
FA159TT	-	FA159R	-	-

# FA160 74.8 x 53.9 x 10mm

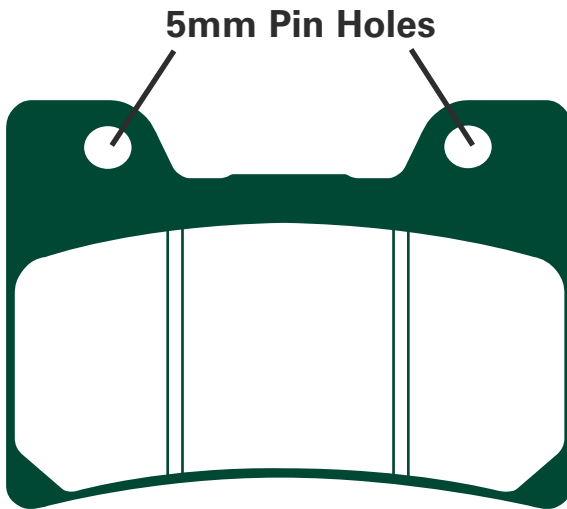

For later pad FZR 1000 92-93 with 6mm pin holes use FA182

### MZ

850 KBT 95 F

### YAMAHA

FZR 600 90-93 F  
 FZR 600 R 94-95 F  
 TDM 850 96-01 F  
 FZR 1000 EX UP 89-90 F  
 V-MAX 12 93-03 F  
 FJ 1200 A (ABS Model) 91-95 F

#### Equivalents OE #

3GM W0045 00	3GM W0045 11
3GM W0045 01	

#### Competitor X Ref

<b>Dunlop</b> DP410	<b>Ferodo</b> FDB666	<b>SBS</b> 645	<b>Vesrah</b> VD-251
------------------------	-------------------------	-------------------	-------------------------

#### MATERIAL AVAILABILITY AND PART NO.

STD	OPTIONS			
FA	HH	R	MXS	GFA
FA160	FA160HH	-	-	-

# FA161 52.6 x 52.7 x 8mm

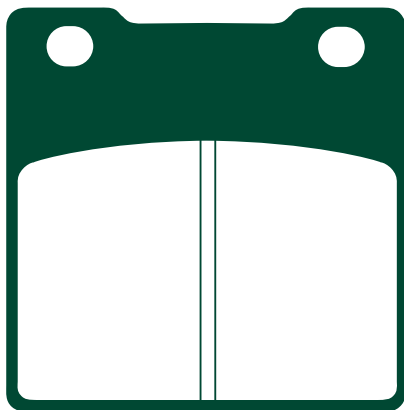

### KAWASAKI

Z 250 A1/A2/A3 78-81 R  
 ZXR 400 (L1-L9) 91-03 R  
 ZXR 400 H1/H2 89-90 R  
 ZXR 400 J1/J2 89-90 R  
 ZXR 400 R (ZX 400 M1-M4) 91-94 R  
 ZXR 750 H1/H2/J1/J2/K1/K2/L1/L2 L3/M1/M2 89-95 R  
 ZX-7R (ZX 750 P1/P2/P3/P4/P5/P6/P7) 96-03 R  
 ZZR 1100 D1-D9 93-01 R  
 ZRX 1100 (ZR 1100 C1/C2/C3/C4) 97-00 R  
 ZX12R (ZX 1200 A1/A2/B1/B2) 00-03 R  
 ZRX 1200 R(A1/A2/A3/A4/A5/A6F) 01-07 R  
 ZRX 1200 5 (B1-B3) 01-04 R  
 ZZR 1200 C1H/C2H 02-04 R  
 ZX 12R (ZX 1200 B3/B4/B6F) 04-06 R

#### Competitor X Ref

<b>Dunlop</b> DP318	<b>Ferodo</b> FDB338	<b>SBS</b> 556	<b>Vesrah</b> VD-416
------------------------	-------------------------	-------------------	-------------------------

#### Equivalents OE #

43082 1003	43082 1141	43082 1257
43082 1098	43082 1180	43082 1291
43082 1103	43082 1200	

#### MATERIAL AVAILABILITY AND PART NO.

STD	OPTIONS			
FA	HH	R	MXS	GFA
FA161	FA161HH	-	-	-

# FA162 47.8 x 48.6 x 7.2mm

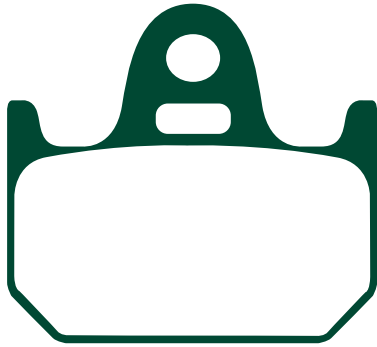

### YAMAHA

TZ 125	94-	R
TZ 250	89-	R
TZ 250 (Radial caliper)	03-05	R

### Equivalents OE #

3CL W0046 00	3LC W0046 00
3LC 25811 50	4TW W0046 00

### Competitor X Ref

Dunlop	Ferodo	SBS	Vesrah
-	FDB2194	659	-

### MATERIAL AVAILABILITY AND PART NO.

STD	OPTIONS			
FA	HH	R	MXS	GFA
FA162	-	-	-	-

# FA163 99.5 x 52 x 7.8mm

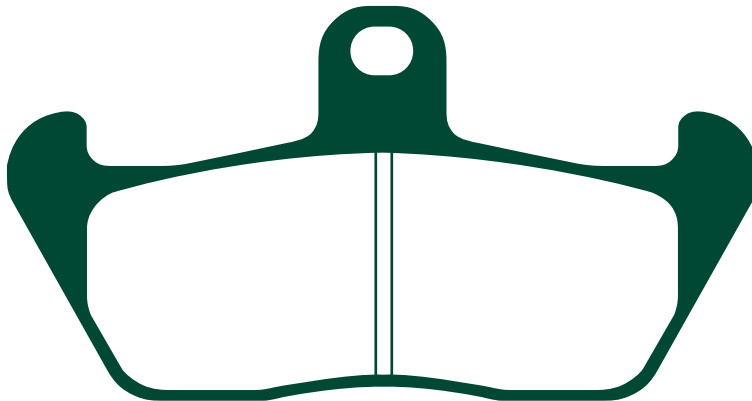

### CAGIVA

Mito 125	91-92	F
W8 125	93-98	F
Freccia 125 SY	89	F
Supercity 125	92-	F
W12 "350"	93-95	F
W16 "600"	94-98	F
750 Elefant	90-92	R

### APRILIA

Tuareg Rally 215	89	F
Tuareg Wind 600	89	F

### GILERA

Nord-West 350	94-	F
---------------	-----	---

### Equivalents OE #

8000 59214
000306546300
8113283

### Competitor X Ref

Dunlop	Ferodo	SBS	Vesrah
DP618	FDB529	641	VD-927

### MATERIAL AVAILABILITY AND PART NO.

STD	OPTIONS			
FA	HH	R	MXS	GFA
FA163	-	-	-	-

# FA164 74.2 x 40.5 x 6.7mm

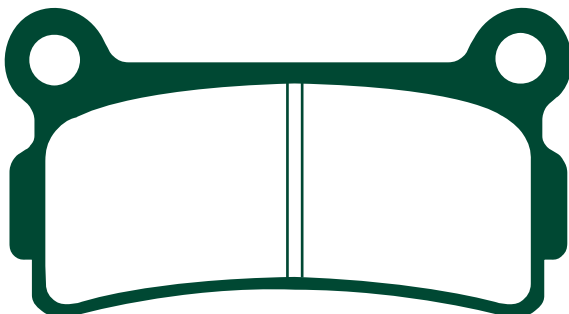

### BETA

TR34 260	89-91	R
Synt	92	R
Zero	92	R
Supertrial ST	94	R

### Equivalents OE #

N/A
-----

### Competitor X Ref

Dunlop	Ferodo	SBS	Vesrah
DP609	-	636	VD-938

### MATERIAL AVAILABILITY AND PART NO.

STD	OPTIONS			
FA	HH	R	MXS	GFA
FA164	-	FA164R	-	-

**FA165**      A. 96.7 x 42 x 7.4mm      B. 77.3 x 42 x 7.4mm

**FA165/2**      A. 96.7 x 42 x 9.7mm      B. 77.3 x 42 x 8mm

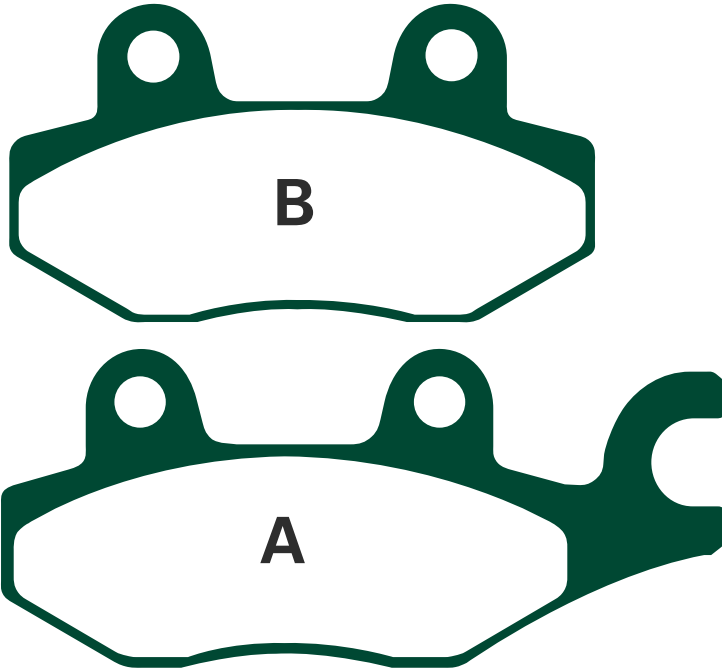

**FA165**

**AEON**

Cobra RS 180 (Quad)	06	R
Overland 125 (AT08) (Quad)	02-06	R
Overland 180 (AT08) (Quad)	02-06	R

**BLANEY (Quads)**

XL 200 Trooper	03-04	R
----------------	-------	---

**CPI**

XT 50 Quad	06	R
XS 250 Quad	06-07	R

**E-TON QUADS**

RXL 150 Viper R	05	R
CXL 150 Yukon II/Challenger	02-	R
EXL 150 Eukon St	05-07	R
RXL 150 Viper	05-06	R

**KAWASAKI**

Kazer 115		F
KLF 300 C1-C17 "Bayou"	89-05	F(right)
KLF 400 B1-B7 Bayou	93-99	F(right)
KVF 750 A1/A6F/B1/B6F Brute Force 4x4	05-06	F(right)

**MBK**

TZR 50 'X-Blazer'	00	F
-------------------	----	---

**MODENAS**

Kriss 115		F
-----------	--	---

**MOTO-ROMA**

Go-Go 110	02	F
Geko 300 Quad	04-06	R

**SUZUKI**

LT-F 300 FK2	02	R(right)
LT-R 450 K6/K7	06-07	F(right)
LTA 500 FY/FK1	00-01	F(right)
LT-F 500 FW/FX/FY/FK1/FK2	98-02	F(right)

**TAISHAN**

Panther 90 Quad	04	R
Hurricane 125 Quad	04	R
Explorer 150 Quad	04	R
Tornado 200 Quad	04	R

**YAMAHA**

YFM 450 FXV Wolverine	06	F(right)
YFZ 450 S/T/V/W	04-07	F(right)
YXR 66 FAS/FAT Rhino 4x4 Side x Side	04-05	F(right)
YFM 700 RV/RW Raptor	06-07	F(right)
XTZ 750 "Super Tenere"	89-95	F(right)

**FA165/2**

**BOMBARDIER**

Rally 200	05-06	R
-----------	-------	---

**CAGIVA**

Canyon 600 E	96-99	R
E 900 Elefant	90-92	R
900 IE Canyon/Gran Canyon	97-00	R
Canyon 500	96-00	R
Navigator 1000	00-05	R

**MZ/MUZ**

VRT 125 Quad	05	R
VRT 175 Quad	05	R

**QUADZILLA**

WK 300	06	R
--------	----	---

**SUZUKI**

DR 800 SM	91	R
-----------	----	---

**YAMAHA**

XTZ 750 "Super Tenere"	89-95	R
------------------------	-------	---

**VOXAN**

Scrambler 1000	02-05	R
----------------	-------	---

**Competitor X Ref**

Dunlop	Ferodo	SBS	Vesrah
DP412	FDB631	638	VD-250

**Equivalents OE # - FA165**

43082 1094	7 020 016
3JD W0045 10	IS3 W0046 10
59100 09840	59100 09860
59100 09850	810183
59100 39840	67131 BCAO 0000

**Equivalents OE # - FA165/2**

69100 31820	8000 66785
3LD W0046 01	A45120 168 000

MATERIAL AVAILABILITY AND PART NO.				
STD	OPTIONS			
FA	HH	R	MXS	GFA
FA165TT	-	FA165R	MXS165	-

MATERIAL AVAILABILITY AND PART NO.				
STD	OPTIONS			
FA	HH	R	MXS	GFA
FA165/2TT	-	FA165/2R	-	-

# FA166 100 x 46.7 x 7.5mm

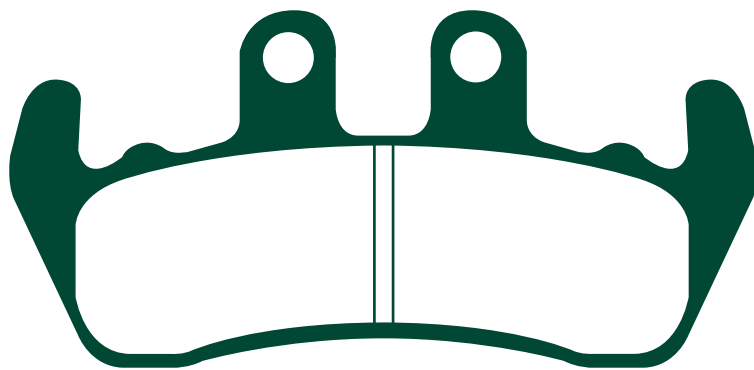

### HONDA HM (Italy)

CRE 50 Six/Baja/Derapage Grimeca  
caliper twin pin Kayaba forks 95-02 F

### YAMAHA

DT-Z 125 'Tenere/Tenere Scout' 89-90 F  
DT 125 Chesterfield Scout 89-90 F

Equivalents OE # K009463415

MATERIAL AVAILABILITY AND PART NO.				
STD	OPTIONS			
FA	HH	R	MXS	GFA
FA166	-	-	-	-

### Competitor X Ref

Dunlop	Ferodo	SBS	Vesrah
-	-	-	-

# FA167 77 x 42 x 7.5mm

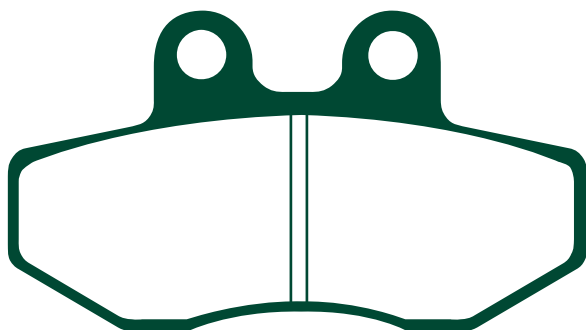

### AJP

PR4-Enduro 125/200 04-07 F  
PR4-Supermotard 125/200 04-07 F

### APRILIA

RX 50 06-07 F  
SX 50 06-07 F  
RX3-5 Marce (M/N/P/R) 91-94 F  
Tuareg Rally 125 (N) 93 F  
Pegaso 125 91 F  
Pegaso 600 91 F  
Classic 125 99 F

### BETA

RK6 93-96 F  
RK6 50cc Enduro 97-02 F  
RR Enduro Alu 50/Motard Alu 50/Enduro 50 04-07 F

### CH RACING

WXE 50 Enduro 05 F  
WSM 50 Motard 05 F  
WXE 125 Enduro 05 F  
WSM 125 Motard 05 F

### DERBI

GPR 50-R/Replica 98-03 F  
Senda R DRD 04-05 F  
Senda 50 DRD Racing R Enduro 04-07 F  
Senda 50 DRD Racing SM Supermoto 04-07 F  
SM 50 DRD Edition 05 F

### Competitor X Ref

Dunlop	Ferodo	SBS	Vesrah
DP613	FDB706	652	-

MATERIAL AVAILABILITY AND PART NO.				
STD	OPTIONS			
FA	HH	R	MXS	GFA
FA167	FA167HH	-	-	-

### EXPLORER

KBR 200 05 F

### GAS-GAS

EC 50 Rookie 01-04 F  
SM 50 Rookie 01-04 F

### HRD

Cabriolet 125 01 F  
Sonic 2 Trail 50 F  
Sonic 2 Supermotard 50 F  
Cabriolett Trail 125 F  
Cabriolett Supermotard 125 F

### HUSQVARNA

SM 50 02 F  
WR 50 02 F  
WXE 125 07 F

### MH (MOTORHISPANIA)

RX 50 Super Racing 00-07 F  
Furia Max Supermotard 05-07 F  
RYZ 50 Pro Racing Enduro 06-07 F  
RYZ 50 Racing Super Motard 06-07 F  
RYZ 50 Pro Racing Urban Bike 06-07 F  
Arena 125 Pro Racing Supermotard 06-07 F  
Arena 125 Pro Racing Urban Bike 06-07 F  
RYZ 50 Urban Bike 06-07 F  
RYZ 50 Supermotard 06-07 F

### MOTO ROMA

SMX 125 04-06 F

### PEUGEOT

XR 6 50cc 02-07 F  
xps sTREET 50 05-07 f  
XP 125 Street Evo 2 05 F

### RIEJU

RR 50 Castrol 50 00-02 F  
RS1 50cc 01-04 F  
MRX 50 Castrol/SMX 50 01-02 F  
Spike 50 Pro 04 F  
SMX 125 02-07 F  
MRX 125 02-07 F

### SACHS

Roadster 125 00-03 F

### SHERCO

SM 50 Supermotard 03-07 F  
Enduro 50 (50 EN) 03-07 F  
SM 125/125 City Corp 03-06 F

### TOMOS

SE 50/125 05 F

### Equivalents OE #

8113373	214 007 100002
8113478	00009300065
8113604	DORTS01A0015
00H 0470 2141	2525230000
P00 927 020 64 07 000	

# FA168 Use FA252

# FA169 61.1 x 27.1 x 7.3mm

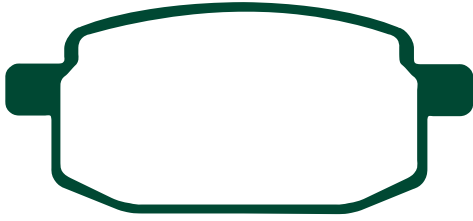

**ADLY**

City Bird		F
Fox 50		F
Road Tracer 50/90/100	04-06	F

**DAELIM**

M 50 D/MD Millenium	03	F
DX 50 D Camper	03	F
ST 90 Pro Monkey	03	F

**FYM/X-Sport**

CR 90 E	06-07	F
110 ES	06-07	F
CR 110	06-07	F
CR 110 ESR	06-07	F
X-Sport Typhoon 125 Quad	06-07	F
CR 3 125	06-07	F
CR 125 R	06-07	F

**GARELLI**

FX 50		F
Cpri 50/LX 50	07	F
Ciclone 50	07	F

**HERO**

Nipster 50	06	F
------------	----	---

**JORDAN**

Easy 50/100	03-04	F
-------------	-------	---

**KAWARA**

Fever 50/90	99	F
Stinger 90	99	F

**LIFAN**

LF 50 QGY		F
-----------	--	---

**MOTO-ROMA**

Bee 50	04-05	F
Go-Go 50/110	97-05	F
Stinger 50	01-05	F
Scrambler 50	01	F
Road Runner 50/100	01-02	F
Grand Prix 125	01	F

**MBK**

CY 50 Forte/Forte Mufa	96-97	F
CR 50 Z Target	91-95	F

**MZ/MUZ**

Moskito FB50	97-03	F
Moskito SX/JP50	00-03	F

**P.G.O**

Big Max 50/90	94-06	F
EPS	97	F
Tornado 50/125	97	F

**QUADZILLA**

WK 110	05-06	F
WK 125 (All models)	06	F

**SIAMOTO**

Birdie 50	02-04	F
Favorite	02-04	F

**SUPERBYKE**

M-Ped 50 Road Classic		F
-----------------------	--	---

**TERRA MOTO**

TDX 125 F	07	F&R
TDX 125 F Krusha	07	F&R
TDX 125 F Street Ripa	07	F&R

**THUMPSTAR**

Thumpstar Junior 90cc	04-06	F
Thumpstar Supa 110cc	04-06	F
Thumpstar Expert 125	06	F
Thumpstar Pro 125	05-06	F
Thumpstar 125 Road Ripper	06	F&R

**VIALLI**

Cargo 50	06	F
FXR Sport 50	06	F
Jupiter 50	06	F

**WUYANG**

WY 50 QT	06-07	F
----------	-------	---

**YAMAHA**

CR-Z 50 (3WN)	91-95	F
CY 50 RS Jog R	96-	F
YA 50 ZA Jog Z (4SC1)	95	F
YW 100 T Booster BWs	96	F

**Equivalents OE #**

2NA W0045 01	5JU W0045 00
5CP W0045 00	802 567 1000
45120 107 000	T01H000101
3XG W0045 00	

**Competitor X Ref**

<b>Dunlop</b>	<b>Ferodo</b>	<b>SBS</b>	<b>Vesrah</b>
N/A	FDB636	619	VD253

MATERIAL AVAILABILITY AND PART NO.				
STD	OPTIONS			
FA	HH	R	MXS	GFA
FA169	FA169HH	-	-	-

# FA170 99.8 x 55.8 x 9.3mm

**USE  
FA246**

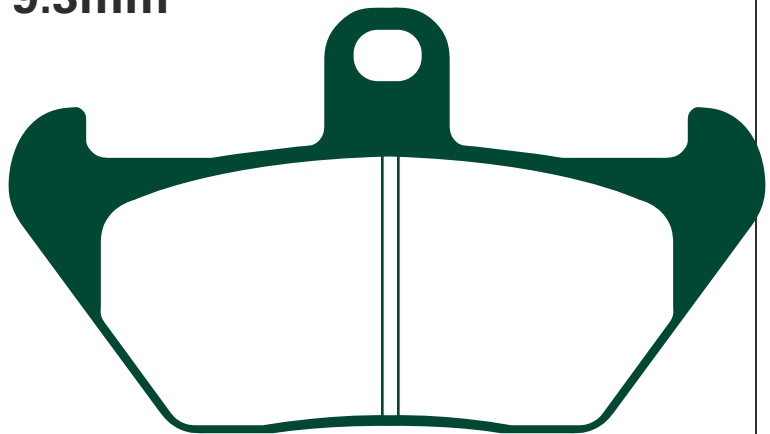

# FA171 57.7 x 53.7 x 8.9mm

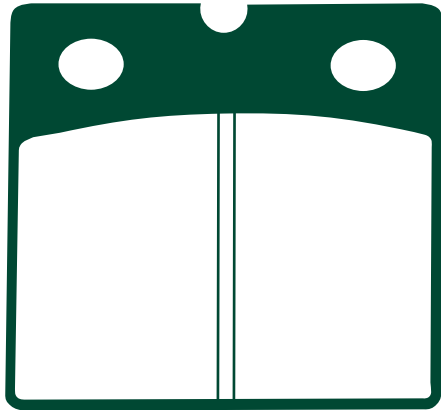

### BMW

K 75/75-2	09/88-96	F
K 75/75-S	08/90-96	F
K 75 C	09/88-02/88	F
K 75 RT	89-96	F
K 75 RT	89-96	F
K 75 S	09/88-95	F
K 75 S	09/88-95	F
K 100/2	09/88-90	F
K 100 LT	09/88-91	F
K 100 RS	10/88-89	F
K 100 RT	10/88-89	F
R 80/R 80 RT	09/88-95	F
R 100 RS	9/9-92	F
R 100 RT	09/88-95	F

### Competitor X Ref

Dunlop	Ferodo	SBS	Vesrah
DP608	FDB736	640	VD-933

### Equivalents OE #

34 11 2 310 494	34 11 2 331 175
34 11 2 311 175	34 11 2 314 546

### MATERIAL AVAILABILITY AND PART NO.

STD	OPTIONS			
FA	HH	R	MXS	GFA
FA171	FA171HH	-	-	-

# FA172 A. 104 x 45.6 x 9.8mm B. 88 x 42 x 9.8mm

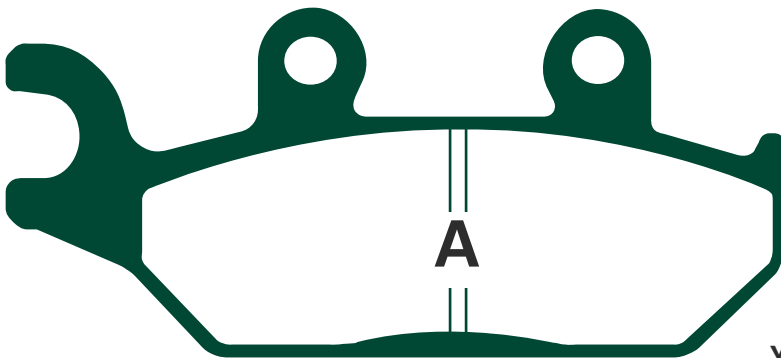

A

### YAMAHA

XT 600 E	92-03	F
XTZ 660 "Tenere"	91-98	F

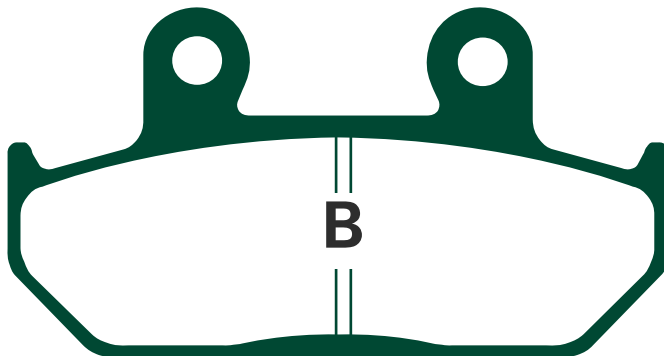

B

### Equivalents OE #

3YF W0045 00	4PT W0045 00
3TB W0045 00	

### Competitor X Ref

Dunlop	Ferodo	SBS	Vesrah
DP413	FDB737	650	VD-252

### MATERIAL AVAILABILITY AND PART NO.

STD	OPTIONS			
FA	HH	R	MXS	GFA
FA172TT	-	FA172R	-	-

# FA173 A. 85 x 42.5 x 7.3mm

# B. 56 x 35 x 9.7mm

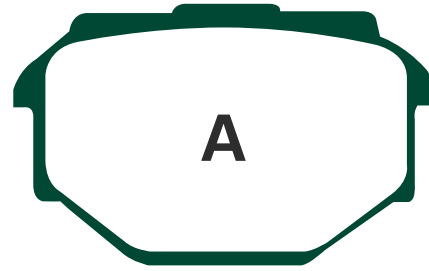
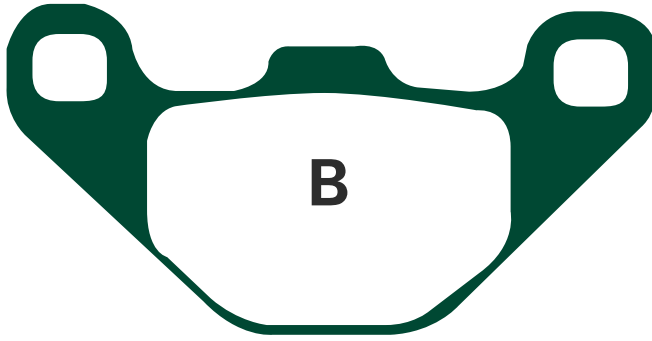

### APRILIA

ETX 125	99-01	R
Moto 6.5	95-01	R
Pegaso 650	91-00	R

### BETA

Jonathan 125	02-05	R
--------------	-------	---

### CAGIVA

W12 "350"	93-95	R
W16 "600"	94-98	R

### GILERA

Eaglet 50	96	R
50 RC Top Rally	90-	F&R

### MALAGUTI

F10 Jetline	91-93	F
50 America	91-	F

### MBK

X-Limit 50	02	R
------------	----	---

### MZ/MUZ

Baghira/Mastiff (All models)	00-05	R
------------------------------	-------	---

### YAMAHA

TDR 125 (3HS/3XD1)	89-93	R
--------------------	-------	---

### Equivalents OE #

34 11 2 310 494	902203100
8113595	3SH F5811 00
8000 68794	5VB W0045 00
11940100	

### Competitor X Ref

Dunlop	Ferodo	SBS	Vesrah
DP310	FDB828	684	VD-425

### MATERIAL AVAILABILITY AND PART NO.

STD	OPTIONS			
	HH	R	MXS	GFA
FA173	-	-	-	-

# FA174 86.3 x 41.4 x 10.2mm



### Competitor X Ref

Dunlop	Ferodo	SBS	Vesrah
DP121	FDB754	670	VD-162

### Equivalents OE #

43105 MW0 405	69100 06830	5VX W0045 00
T2020602	06435 MEE 006	43020 S020
5SL W0046 00	69100 06820	
06435 KV3 405	06435 MEJ 006	

### HONDA

CB 400 SF4/5/S5	04-05	R
CB 400 SBS	05	R
VRX 400 T (NC33)	96	R
CB 500 A4/A5/A6/A7	04-07	R
CBF 500 4 (Non ABS Model)	04-	R
CB 600 FW/FX/ "Hornet"	98-00	R
CB 600 FY/F2Y/F1/F21/F22/F22/F3/F4/F5/F6/AF7 Hornet	00-07	R
CBF 600 N4/NA4/S4/SA4/N5/NA5/S5/SA5	04-05	R
CBF 600 NA4/NA5/NA6 (ABS Model)	04-06	R
CBF 600 N7 (Radial caliper)	07	R
CBF 600 S4/S5 (Non ABS)	04-05	R
CBF 600 SA4/SA5/SA6 (ABS Model)	04-06	R
CBR 600 FM/FN/FP/FR/FS/FT/FV/FW/FX/FY	91-00	R
CBR 600 F1/F2/600 FS1/FS2 'Sport'	01-02	R
CBR 600 F3/F4/F5/F6/F7	03-07	R
CBR 600 RR3/RR4/RR5/RR6	03-06	R
CB 750 F2N/F2R/F2S/F2T/F2V/F2W/F2X/F2Y/F21		
CB Seven Fifty	92-02	R
CBR 900 RRN/RRP/RRR/RRS/RRT/RRV		
/RRW/RRX/RRY/RR1/RR2/RR3 Fireblade	92-03	R
CB 900 F2/F3/F4/F5/F6/F7 Hornet	02-07	R
CB 1000 FP/FR/FS/FT/FV	93-97	R
CBF 1000 F6/F7	06-07	F
CBR 1000 RR4/RR5 Fireblade	04-05	R
VTR 1000 FV/FW/FX/FY/F1/F2/F3/F4/F5/F6 'Firestorm'	97-06	R
VT-R 1000 SPY/SP1 (SC45)	00-01	R
VTR 1000 SP2/SP3/SP4/SP5/SP6	02-07	R
VT 1100 C4 Shadow Sabre	04-05	R
CB 1300 F3/F13	03-04	R
CB 1300 5/6 (Superfour)	05-06	R
CB 1300 A5/A6 (Superfour ABS)	05-06	R
CB 1300 SA5/SA6 Super Bol-Dor	05-06	R
VTX 1300 S3/S4/S5/S6/S7	03-07	R

### KAWASAKI

Z 750 (ZR 750 L7F)	07	R
Z 750 ABS (ZR 750 M7F)	07	R
KLX 1000 (LV 1000 A1H/A2H)	04-05	R
Z 1000 (ZR 1000 B7F)	07	R
Z 1000 ABS (ZR 1000 C7F)	07	R

### SUZUKI

DL 650 K4/K5/K6 V-Strom	04-06	R
DL 650 K7	07	R
DL 650 AK7 V-Strom ABS	07	R
GSF 650 K6/SAK6/K7/SAK7 (Bandit ABS)	06-07	R
SV 650 K3/SK3/K4/SK4/K5/SK5/K6/SK6/SK7/K7	03-07	R
SV 650 AK7/SAK7 ABS Model	07	R
DL 1000 K2/K3/K4/K5/K6/K7 V-Strom	02-07	R
SV 1000 K3/SK3/K4/SK4/K5/SK5/SK6	03-06	R
GSF 1200 AK6/SAK6/GTSAK6	06	R
GSF 1250 AK7/ASK7 Bandit	07	R

### YAMAHA

YZF-R6	03-07	R
YZF-R6S	07	R
FZ6 Fazer/Fazer A	04-07	R
FZ6 (Naked version)	04-07	R
FZ6 S2 ABS (Naked)	07	R
FZ6 Fazer S2 (ABS) (4 piston caliper)	07	R
YZF 100 R1	04-06	R
FZ1-N/NV (Naked) (1000cc) (2D11/2/3)	06-07	R
FZ1-S/FZ1-SV	06-07	R
YZF-R1SP	06	R
YZF R1 (6 piston radial caliper)	07	R

### MATERIAL AVAILABILITY AND PART NO.

STD	OPTIONS			
	HH	R	MXS	GFA
FA174	FA174HH	-	-	-

# FA175 33.7 x 50.5 x 7mm

## CFK175

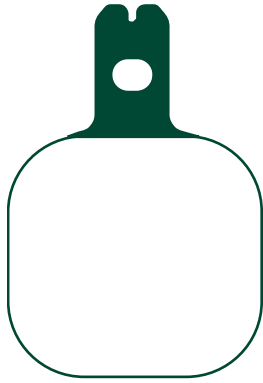

### Equivalents OE #

29-001
1296033

### HARRISON BILLET

4/6 Piston Caliper Lightweight Mini Design

### ISR CALIPERS

22-032 (6 piston large)	F
22-042 (6 piston racing)	F

### Competitor X Ref

Dunlop	Ferodo	SBS	Vesrah
-	FRP415	656	-

### MATERIAL AVAILABILITY AND PART NO.

STD	OPTIONS			
FA	HH	R	MXS	GFA
FA175	FA175HH	-	-	GFA175HH
CFK175 (Blue)				
FA175S (Green)				

# FA176 87 x 53 x 7.5mm



### HONDA

NH 50 Lead 50 SS	84	F
NH 50 Lead AF01/d716	84-85	F
NH 80 Lead 80/SS	85	F
NH 125 Lead 125	86-87	F

### Equivalents OE #

--

### Competitor X Ref

Dunlop	Ferodo	SBS	Vesrah
-	-	-	VD137

### MATERIAL AVAILABILITY AND PART NO.

STD	OPTIONS			
FA	HH	R	MXS	GFA
FA176	-	-	-	-

# FA177 87 x 53 x 7.5mm

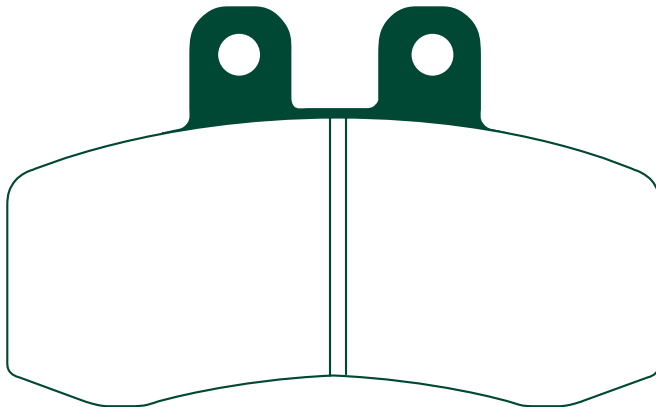

### APRILIA

Pegaso 650	91-96	F
------------	-------	---

### MZ/MUZ

Baghira/Mastiff (All models)	00-05	F
660 Supermoto	06-07	F

### Equivalents OE #

9022001000
------------

### Competitor X Ref

Dunlop	Ferodo	SBS	Vesrah
DP615	FDB782	681	-

### MATERIAL AVAILABILITY AND PART NO.

STD	OPTIONS			
FA	HH	R	MXS	GFA
FA177	-	-	-	-



# FA178 41.1 x 43 x 7.7mm



MATERIAL AVAILABILITY AND PART NO.				
STD	OPTIONS			
FA	HH	R	MXS	GFA
FA178	-	-	-	-

**Competitor X Ref**

Dunlop	Ferodo	SBS	Vesrah
DP903	-	670	VD-162

# FA179 102 x 41 x 10mm

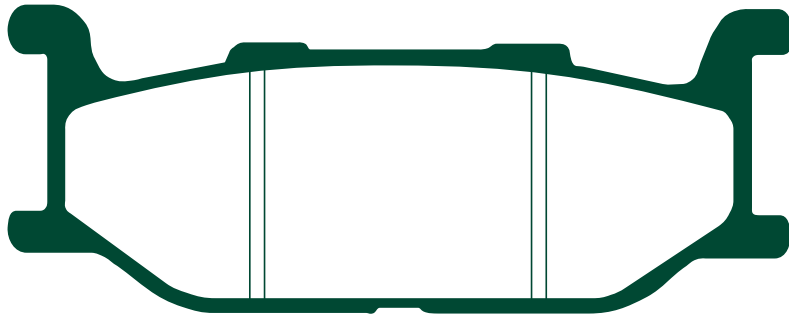

**Equivalents OE #**

3YX W0045 00	4TR W0045 00
4BP W0045 00	4WM W0045 00
4FU W0045 00	5BN W0045 00
4KM W0045 00	5RU W0045 00

**Competitor X Ref**

Dunlop	Ferodo	SBS	Vesrah
DP414	FDB781	663	VD-255

**YAMAHA**

CP 250 (EB71) Maxam	05	F
FZX 250 Zeal (3YX1/2/4)	91-92	F
SRV 250 'Soulful twin/Renaissa' (4DN1-6)	92-97	F
SR 400 (BC-RU01J)		F
XVS 400	96	F
YP 400 S Majesty (5RU1/3)	04	F
XP 500 N/P/R T-Max	01-03	F
XV 535/535 S 'Virago'	95-03	F
XJ 600 N	95-97	F
XJ 600 S "Diversion"	92-97	F
XVS 650 Drag Star	97-04	F
XVS 650 A Dragstar classic	98-07	F
XV 750 Virago	94-97	F
XJ 900 S "Diversion"	95-03	F
XV 1100 Virago	94-98	F
XVZ 1300 TF 'Venture Star'	99-01	F
XV 1600 A 'Wildstar'	99-04	F

**MATERIAL AVAILABILITY AND PART NO.**

STD	OPTIONS			
FA	HH	R	MXS	GFA
FA179	FA179HH	-	-	-

# FA180 58.9 x 40 x 8mm

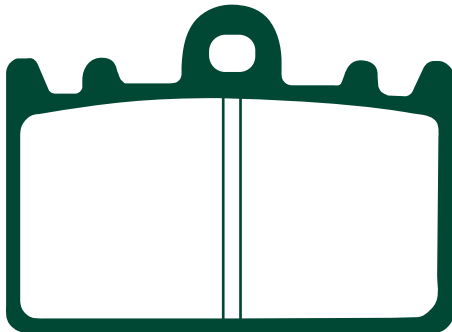

**KAWASAKI**

ZXR 400 L1-L9 91-03 F

**SUZUKI**

RGV 250 T (RGVR 250 SP VJ23A) 96 F

**AFTERMARKET CALIPERS**

PRE-TECH - 4 piston (UNI P401) F

**Equivalents OE #**

43082 1130
59300 42840

**Competitor X Ref**

Dunlop	Ferodo	SBS	Vesrah
DP319	FDB741	666	VD-433

**MATERIAL AVAILABILITY AND PART NO.**

STD	OPTIONS			
FA	HH	R	MXS	GFA
FA180	FA180HH	-	-	GFA180HH

# FA181 94 x 37.3 x 7.5mm



1 Left/1 Right

<b>APRILIA</b>				<b>KTM</b>			
RX 125	00-01	F		LC2 125	96-98	F	
MX 125	04-06	F		MX 125	92-93	F	F
SXV 4.5 Supermoto	04	F		D-XC/E-XC/E-GS 125	92-93	F	F
<b>BENELLI</b>				EXC/EGS 125	94	F	F
BX 450	07	F		EXC 125	95-07	F	F
<b>CAGIVA</b>				EXC 200/EGS	94-07	F	F
E 900 Elefant	93-97	F&R		SM 125 Supermoto	00	F	F
E 750 Elefant	93-95	R		EXE 125	00	F	F
<b>CCM</b>				EXC 200	04-07	F	F
R30 (Spoke & Mag Wheel)	02-04	F		EXC 250 Racing	06	F	F
R35/R 35 S	06	F		EXC-F 250	06-07	F	F
404E	03-04	F		EXC 300 (Upside Down Forks)	00-07	F	F
404 DS	03-04	F		MX 250	92-93	F	F
404 DS Supermoto	03-04	F		SX 250	94-07	F	F
604E Supermotard/RS/Dual Sport	98-03	F		SX-F 250	06-07	F	F
644 DS Supermoto	04	F		EXC/EGS 250	94	F	F
644 DS	04	F		EXC 250	95-05	F	F
<b>DUCATI</b>				EXC 350 LC4	94-95	F	F
Monster S2R (803cc)	05	F		SX 360	96-97	F	F
Multistrada 620	05-06	F		EXC 360	96-97	F	F
Monster Dark 620	05-06	F		SX 380	98-03	F	F
Monster 620	05-06	F		EXC 380	98-03	F	F
695 Monster	06-07	F		EXC 400 Racing	06-07	F	F
S2R Dark (803cc)	06	F		EXC 450 Racing	06-07	F	F
Paul Smart 1000 Limited	06	F		XC 525 Racing	06-07	F	F
GT 1000 Sport (992cc)	06	F		SC 400	96-99	F	F
Classic Sport Biposto (992cc)	07	F		EGS/EGS-E/LSE 400 (LC4 Enduro)	96-99	F	F
Sport 1000 S (992cc)	07	F		SX 400	00-02	F	F
<b>FACTORY</b>				EXC/EGS 400 (USD)	00-02	F	F
YR 250	03	R		EXC 400 Racing (USD)	00	F	F
<b>GAS GAS</b>				LC4-E 400 Enduro	00-01	F	F
Quad Wild HP 50	04-07	F&R		SX 440	94-95	F	F
80/125 Enduro	94-95	F		EXC 440	94-95	F	F
MX 80	96	F		SX-F 450 (USD)	03-07	F	F
80/125/250/200/300 Enduro	95-99	F		EXC 450	03-05	F	F
Enduro EC 125/200/250/300	97-99	F		MX 500	92-95	F	F
MX 200/250/300	99-00	F		SX-F 505	07	F	F
Wild HP 240/300	03-06	F&R		SX 520	01-03	F	F
Pampera 400	06	F		EXC 520	01-03	F	F
Wild HP 450 Quad	04-07	F&R		EXC 525	03	F	F
<b>GILERA</b>				SX 525	03-06	F	F
Nexus 500	03-07	F		EXC 525	04-05	F	F
GP 800	07	F		MXC 525	03-04	F	F
<b>HIGHLAND</b>				XC 525 Racing	06-07	F	F
950 V2 Outback	00-04	F		MXC 550	96	F	F
950 V2 Motard	00-04	F		SX/EXC/EGS 620	94-95	F	F
<b>HONDA HM (Italy)</b>				SX 620	96-98	F	F
CRE 50 Six	01-02	F		SC 620 Supercompetition	96-00	R	F
CRE 50 Baja/Derapage	01-02	F		EGS/EGS-E/LSE 620 Enduro	96-99	F	F
<b>HUSABERG</b>				EGS-E 620 Adventure/Rallye	99	F	F
Enforcer Four	00-03	F&R		LC4 620 SC Supermoto	00	F	F
FE 450 E	06-07	F		SXC 625	05-06	F	F
FE 550 E	06-07	F		LC4-E 640 Enduro	00-04	F	F
FE 650 E	06-07	F		LC4-E 640 Supermoto	00-06	F	F
<b>HUSQVARNA</b>				LC4 640 Adventure R	00	F	F
CR 125	95-07	F		640 LC4 Adventure	03-07	F	F
SM 125	98-00	F		LC4 625 SC Supermoto	02	F	F
SM 125 S	02-07	F		LC4 625 SC Supercompetition	02	F	F
WR 125	05-07	F		SXC 625	03-04	F	F
WRE 125	93-00	F		LC4 640 Adventure	01-06	F	F
CR 250	95-05	F		SM 950	05-06	R	F
TC 250	02-03/05-07	F		950 R Superenduro	06	R	F
TE 250	02-07	F		990 Adventure/S	06-07	R	F
WR 250	95-07	F		<b>MAICO</b>			
TE 350	95-97	F		500 MX/Enduro	99	F	
WR 360	95-02	F		<b>MBK</b>			
TE 400	02	F		XQ 125/150 Thunder	01-03	F	F
TE 410	95-00/06	F		YP 125 D Skyliner	98-06	F	F
TE 410 E	00	F		VP 300 R Kilibre	03-04	F&R	F
TC 450	03/05-07	F		XP 125 Skycruiser	06	F	F
TE 450	03-07	F		<b>MOTO GUZZI</b>			
TC 510	04-07	F		Quota 1100 ES	99-01	R	
TE 510	04-07	F		<b>PIAGGIO</b>			
TC 570	02-03	F		X9 250 Linked brake f&r wheel 14" dia	04	F	F
TE 570	01-04	F		Beverley 400ie	07	F	F
TC 610	00	F		X9 500cc Evolution	03-06	F	F
TC 610 E	95-99	F		X9 500ie	07	F	F
TE 610	00	F		<b>SHERCO</b>			
TE 610 E	95-00/02-03	F		2.5i Enduro (4T)	06	F	F
TE 610/IE	06-07	F		4.5i (450 Enduro/SM)	04-06	F	F
<b>KEEWAY</b>				5.1i Enduro (4T)	06-07	F	F
Silverblade 125/150/250	07	F		5.1i Supermotard	06-07	F	F
<b>KRAM-IT (KRAMER)</b>				<b>SUZUKI</b>			
GS 250	00-	F		UH 125 K2/K3/K4/K5/K6 Burgman	02-06	F	
SM 250	00-	F					

# FA181 Contd.

## TM

80 Enduro	96-00	F
80/85 Cross	96-01	F
80/85/100 (Big wheel)	02-04	F
Junior 80/85/100 Cross (Small wheel)	02-04	F
Junior 80/85/100	05-07	F
125 Cross	95-00	F
Cross MX 125 (2T)	01-07	F
125 Enduro	95-00	F
Enduro EN 125 (2T)	01-07	F
250 Cross	95-00	F
250 (4T) Cross	02-07	F
Cross MX 250 (2T)	01-07	F
250 Enduro	95-00	F
Enduro EN 250 (2T)	01-07	F
EN 250 F (4T) Enduro	04-07	F
300 Cross	95-00	F
Cross MX 300 (2T)	01-07	F
Enduro EN 300 (2T)	01-07	F
300 Enduro (2T)	95-00	F
400 (4T) MX Cross	02-03	F
400 Cross (4T)	95-00	F
EN 450 F (4T)	04-07	F
MX 450 F (4T)	04-07	F

## TM Contd.

530 Cross (4T)	98-00	F
EN 530 F (4T)	04-07	F
<b>VECTRIX</b>		
Vectrix Electric Std Scooter	07	F&R
Vectrix Electric 3W (MP3 style scooter)	07	R
<b>VERTEMATI</b>		
All models (2 piston Brembo)	99-04	F
<b>VOR</b>		
All models (2 piston Brembo)	03-04	F
<b>YAMAHA</b>		
YP 125 Majesty	98-07	F
XQ 125/150 N Maxster	01-03	F
VP 300 R/S Versity	03-04	F&R
XC 300 V Versity	06	F&R
TT 600 R (5CH1/5CH2/5CH3)	97-02	F
TT 600 RE (5CH5)	04	F
TT 600 E (4LW3/4LW4/4GV4/4GV5)	94-01	F
TT 600 E (4GV2)	94-95	F
TT 600 K (4LW1/4GV1/4LW2) Up to 4GV 003403	93-95	F
TT 600 K From 4GV 003404	95-96	F

### Equivalents OE #

546 13 209 044	5SE F5811 00	AB024 S	503 13 030 100	BQ300222068
5CH F5911 00	8A0074181	59330 49F00	8113593	K00976315
5DS F5811 00	8B0074181	5SE F5811 10	0624	80009634
4GV F5911 00	8C0074181	K00976315	59330 49F00	BQ300222065
8000 88482	800074181	497396	00306546250	
5NR F5811 00	AB024	800074181	613 4 072 1A	

MATERIAL AVAILABILITY AND PART NO.				
STD	OPTIONS			
FA	HH	R	MXS	GFA
FA181TT	FA181HH	FA181R	MXS181	GFA181HH

### Competitor X Ref

<b>Dunlop</b>	<b>Ferodo</b>	<b>SBS</b>	<b>Vesrah</b>
DP617	FDB2018	671	VD-947

# FA182 74.8 x 53.9 x 10mm

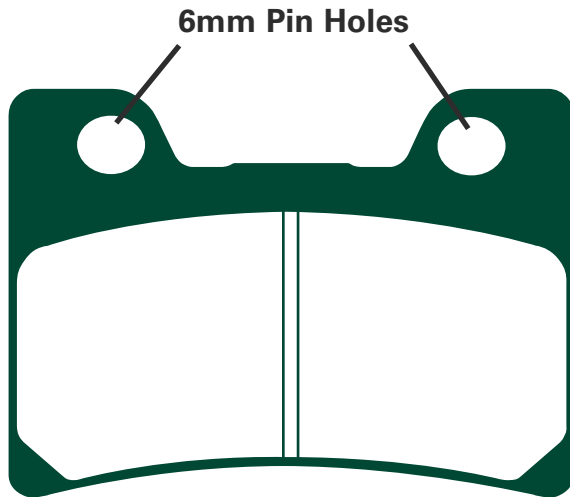

## YAMAHA

FZR 1000 EX UP 91-93 F

### Equivalents OE #

3GM W0045 50

### Competitor X Ref

<b>Dunlop</b>	<b>Ferodo</b>	<b>SBS</b>	<b>Vesrah</b>
DP415	FDB637	665	VD-257

MATERIAL AVAILABILITY AND PART NO.				
STD	OPTIONS			
FA	HH	R	MXS	GFA
FA182	FA182HH	-	-	-

# GFA183HH 102.40 x 55.25 x 8mm

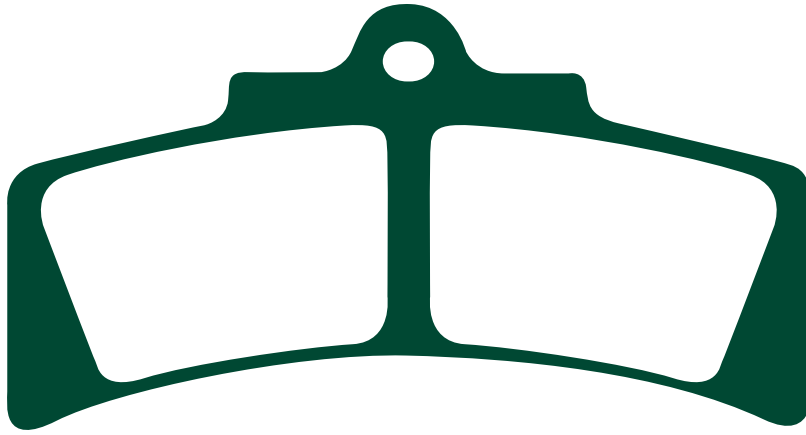

**PVM 6 PISTON LARGE CALIPER**

**Equivalents OE #**

N/A

**Competitor X Ref**

Dunlop	Ferodo	SBS	Vesrah
-	-	677	9027

MATERIAL AVAILABILITY AND PART NO.				
STD	OPTIONS			
FA	HH	R	MXS	GFA
-	-	-	-	GFA183HH

# FA184 28.5 x 45.8 x 7mm CFK184

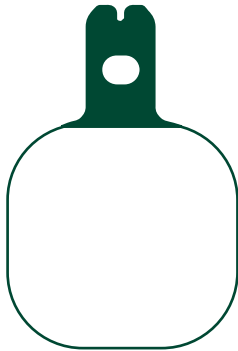

**ISR CALPER**

22-034 (6 piston small) F  
 22-036 (2 piston) F  
 22-043 (4 piston) F  
 Radial 6 piston monoblock F

**Competitor X Ref**

Dunlop	Ferodo	SBS	Vesrah
-	-	655	-

**Equivalents OE #**

ISR29-002

MATERIAL AVAILABILITY AND PART NO.				
STD	OPTIONS			
FA	HH	R	MXS	GFA
FA184	-	-	-	-
CFK184 (Blue)				

# FA185 94 x 34.2 x 7.5mm



<b>ALFER</b>						
AR 250	93-	F				
<b>APRILIA</b>						
RXV 450/550 Enduro	06-07	F				
<b>BETA</b>						
RR 250/400/450/525 Enduro	05-07	F				
<b>CANNONDALE</b>						
MX 400	00	F				
<b>CPI</b>						
Sauel 125		F				
<b>GAS-GAS</b>						
EC 125/200/250/300	00-07	F				
MC 125	05	F				
MX 125/250	01-04	F				
FSE 450/500	05-06	F				
<b>HONDA</b>						
CR 125/250 RS/RT/RV/RW/RX/R						
/R1/R2/R3/R4/R5/R6	95-06	F				
XLR 125 RW	98-01	F				
XR 125 L3/L4/L5/L6/L7	03-07	F				
<b>HONDA Contd.</b>						
CRF 150 F3/F4/F5/F6/F7	03-07	F				
CTX 200/CTX 200 A Bushlander	04-05	F				
CRF 230 F4/F5/F6/F7	04-07	F				
SL 230 'Free Landsports' (MD33)						
V/W/X/1	97-01	F				
CRM 250 RR/RR11 (MD24 140) MK3	94-96	F				
CRM 250 'Active Radial' (MD32)						
ARV/ARW	97-98	F				
CRF 250 R4/R5/R6	04-06	F				
CRF 250 X4/X5/X6	04-06	F				
XR 250 RT/RV/RW/RX/R	96-04	F				
Y/R1/R2/R3/R4	94-96	F				
XL 250 Degree (MD26)	94-96	F				
XLR 250 RM/R3N/RP/RR/R3R (MD22)	91-	F				
XLR 250 Baja MK2 (MD22)		F				
XR 250 Y/3 (MD30)	00-03	F				
XR 250 3/S (MD30) Motard	03-05	F				
XR 250 Ill Y/3 Baja	00-03	F				
NX4 Falcon	02-05	F				
XR 400 RT/RV/RW/RX/R	96-05	F				
Y/R1-R5						

# FA185 Contd.

## HONDA Contd.

XF 400 R5/R6 (NC38E) Motard	05-06	F
CRF 450 R2/R3/R4/R5/R6	02-06	F
CRF 450 X5/X6	05-06	F
TRX 450 R4/R5/R6/ER6/R7/ER7	04-07	F
CR 500 RS/RT/RV/RW/RX/R1	95-01	F
XR 600 RP/RR/RS/RT/RV/RW/RX/R1	93-00	F
XL 600 VV/VW/VX Transalp	97-00	F
XL 650 VY/V1/V2/V3/V4/V5/V6/V7 Transalp	00-07	F
XR 650 RY/R1-R7	00-07	F
XR V 750 P/R/S/T/V/W/X/Y 'Africa Twin'	94-03	F

## HONDA DALL'ARA

XR 125 SM	04	F
XR 250 R	04	F
XR 250 SM	04	F
XR 400/440 R	04	F
XR 400/440 SM	04	F
XR 650 R	04	F

## HONDA-HM (ITALY)

CRE 125 R Supermotard	02-03	F
CRE 125 R Enduro	02-06	F
CRF 230 Easy Trail	04	F
CRF 230 Easy Enduro	04	F
CRF 230 Easy Motard	04	F
CRF 230 F Easy Trial (All models)	04-07	F
CRE 250 R Supermotard	02-03	F
CRE 250 R Enduro	02-06	F
CRE 250 R Moto	04	F
CRE 250 F Enduro	04-06	F
CRE 250 X		F
CRF 250 Motard	04	F
CRE F 290 X	07	F
CRE 450 F Enduro	02-04	F
CRF 450 Motard	04	F
CRE 450 Supermoto	02-03	F
CRE 450 X		F
CRE F 490 X	07	F
CR 125 Motard	04	F

## KAWASAKI

KX 125 K1/K2/K3/K4/K5/L1		
/L2/L3/L4/M1/M2/M3/M6F/M7F	94-07	F
KDX 200 H1/H2/H3/H4/H5	95-99	F
KDX 220 R A4/A5/A6/A7/A8/A9		
/A10/A11/A12/A6F	97-06	F
KDX 220 SR (DX 220 B)		F
KLX 250 F1-F4	94-97	F

## KAWASAKI Contd.

KLX 250 R D1/D2	93-94	F
KLX 250 G1	94	F
KLX 250 J1-J6 D-Tracker	98-03	F
KLX 250 H6	04	F
KX 250 F (KX 250 N1/N2)	04-05	F
KX 250 K1-K5/L1-L4/M1-M2/R1/R6F/R7F	94-07	F
KX 250 F (T6F/T7F)	06-07	F
KLX 300 A2-A10/A6F/A7F	97-07	F
KLX 400 R (KLX 400 B1/B2)	03-04	F
KLX 450 R (A8F)	07	F
KX 450 F (D6F/D7F)	06-07	F
KX 500 E6-E16	94-04	F
KLX 650 C1/C2/C3	93-97	F

## SUZUKI

RM 125 T/V/W/X/K1/K2/K3/K4/K5/K6/K7	96-07	F
250 SBK2 (LX 250 L)	02	F
DR 250 RLV/RL/RLY/RS/RLS/RT/RV/RL/RL		
/RLW/RW/R1 (SJ45A/DOHC)	95-00	F
DR 250 RXT/RXLT/RTV/RXLV/RXLW		
/RXGW/RXGLW/RXY/RXGY		
(Dejbel 250 XC/GPS Ver (SJ45A)		F
DR-Z 250 K1-K7	01-07	F
RM 250 T/V/W/X/K1/K2/K3/K4/K5/K6/K7	96-07	F
RMX 250 T/V/W	96-98	F
RMX 250 ST/SV/SW/SX (SJ14A)	96-99	F
RM-Z 250 K4/K5/K6/K7	04-07	F
DR 350 SEW/SEX	98-99	F
DR-Z 400 SEY/EY/Y/SEK1/EK1/K1/K2/SEK2/EK2/K3/SEK3		
/EK3/K4/SEK4/EK4/SK5/EK5/K5/SK6/K6/EK7/SK7/K7	00-07	F
DR-Z 400 SMK5/SMK6/SMK7	05-07	F
RM-Z 450 K5/K6/K7	05-07	F
DR 650 SET	96	F

## YAMAHA

YZ 125 K/L/M/N/P/R/S/T/V/W	98-07	F
WR 250 ZK	98	F
WR 250 FN/FP/FR/FS/FT/FV/FW	01-07	F
YZ 250 K/L/M/N/FN/P/FP/R/FR/S/FS/T/FT		
FV/V/W	98-07	F
YZ 400 FK/FL	98-99	F
WR 400 FL/FM	99-01	F
WR 426 FN/FP	01-02	F
YZ 426 FM/FN/FP	00-02	F
YZ 450 FR/FS/FT/FV/FW	03-07	F
WR 450 FR/FS/FT/FV/FW	03-07	F

### Equivalents OE #

06455 GZ8 405	45105 KT0 405	43082 S009	59300 3K880
06455 KCZ 000	45105 KZ1 405	43082 1286	59301 36810
06455 MY1 405	45105 MY6 405	45105 KTO 405	K4308 21225
06455 MAY 000	45105 KV6 701	45105 KZI 405	K4308 21286
06455 KBR 731	45106 KV6 701	5DH W0045 00	BE 2500 22065
06455 KHA 941	43082 1149	5DH W0045 10	BC 2500 22065
06455 MAW 761	43082 1152	5MV W0045 00	59300 29860
06456 MAW 761	43082 1172	59300 13830	43082 0026
06455 MCB 611	43082 1193	59300 13860	9100788
06455 HP1 006	43082 1218	59300 36850	43082 0049
06456 MCB 611	43082 1266	59300 36860	BE250022065
43082 124	43082 S011	59300 36870	

### Competitor X Ref

Dunlop	Ferodo	SBS	Vesrah
DP321	FDB892	694	VD-161

### MATERIAL AVAILABILITY AND PART NO.

STD	OPTIONS			
FA	HH	R	MXS	GFA
FA185TT	-	FA185R	MXS185	GFA185HH

# FA186 31.5 x 51 x 5.5mm

## CAGIVA

Blues 50	93-95	R
Supercity 50/80	93-95	R
Prima 50	92-94	R

## PIAGGIO

Quartz 50	92-96	F
Sfera 50 RST	95-97	F
Skipper 125/150	94-97	F
Vespa PX 125/150/200	98-07	F
Vespa LX 60 (Special Anniversary Model)	06	F

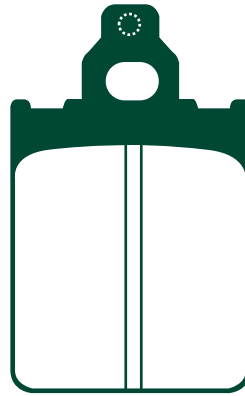

### Equivalents OE #

494762
498414
800067127

### Competitor X Ref

Dunlop	Ferodo	SBS	Vesrah
-	FDB784	680	VD949

### MATERIAL AVAILABILITY AND PART NO.

STD	OPTIONS			
FA	HH	R	MXS	GFA
FA186	-	-	-	-

# FA187 68 x 54 x 8mm

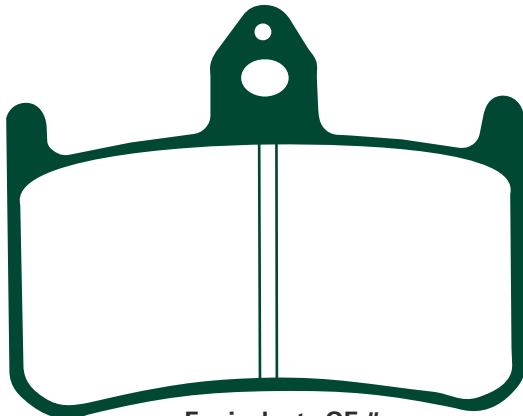

### Equivalents OE #

06455 MAS 305	45105 MR7 612
06455 MBB 006	45105 MR7 681
06455 MCZ 006	45105 MW0 405
06455 MZ1 405	45105 MW0 415
45105 MN8 006	45106 KV3 701
45105 MR7 006	

## HONDA

CB 250 FT/FV/FX/FY/F1 'Hornet'	96-01	F
NSR 250 R2J (MC18)	88	F
NSR 250 RSP/RSK/RSP (MC18)		F
NSR 250 RL/RN/RSP (MC21)	95-	F
NSR 250 RR/R2R (MC28)	94-	F
CB 400 SF (F2V/F3T) Superfour	96-97	F
NT 400 'Bros' NC25		F
VFR 400 R3K/R3L/R3M/R3N (NC30)	89-92	F
RVF 400 RR/RRII/RT/RT-II (NC35)	94-96	F
Bros Product One 650		F
NT 650 J/K/L 'Bros'	88-92	F
VFR 750 RJ/RK/RL (RC30)	88-90	F
RVF 750 RR/RS 'RC45'	94-98	F
CBR 900 RRN/RRP/RRR/RRS/RRT/RRV Fireblade	92-97	F
CB 900 F2/F3/F4/F5/F6/F7 Hornet	02-07	F
CB 1000 FP/FR/FS/FT/FV	93-97	F
VTR 1000 FV/FW/FX/FY/F1/F2/F3/F4/F5/F6 Firestorm	97-06	F
'X4' CB 1300 DCV/DCW/DCX/DCY (SC38)	97-00	F

### Competitor X Ref

Dunlop	Ferodo	SBS	Vesrah
DP112	FDB858	622	VD-154

### MATERIAL AVAILABILITY AND PART NO.

STD	OPTIONS			
FA	HH	R	MXS	GFA
FA187	FA187HH	-	-	GFA187HH

# FA188 89 x 53 x 7.3mm

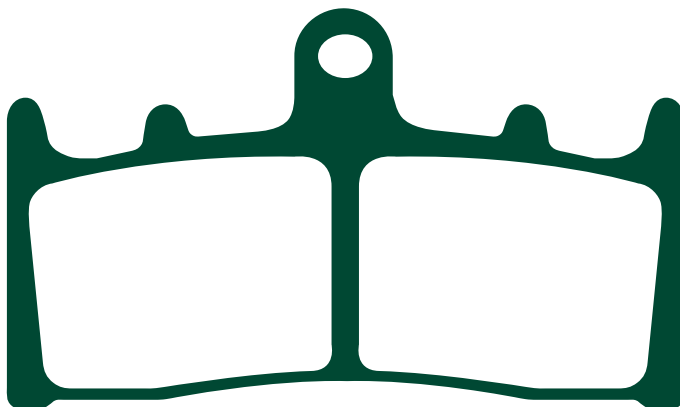

### Competitor X Ref

Dunlop	Ferodo	SBS	Vesrah
DP216	FDB873 FDB2144	686	VD-349

## KAWASAKI

ZX-6R (ZX 600 G1/G2/J1/J2)	98-01	F
ZX6R (ZX 636 A1P) '636cc'	02	F
ZX-7R (ZX 750 P1-P7)	96-03	F
GPZ 900 R (ZX 900 A12-15)	99-02	F
ZX-9R (ZX 900 B3/B4/C1/C2/E1/E2)	96-01	F
ZRX 1100 C1/C2/C3/C4	97-00	F
ZX12R (ZX 1200 A1/A2/B1/B2)	00-03	F
ZRX 1200 R(A1/A2/A3/A4/A5/A6F)	01-07	F
ZRX 1200 S (B1/B2/B3)	01-04	F
VN 1500 Mean Streak P1/P2	02-04	F
VN 1600 B1 Mean Streak	04	F

## SUZUKI

GSXR 750 WR/WS	94-95	F
GSXR 750 T/V/W/X	96-99	F
GSXR 1000 K1/K2	01-02	F
GSXR 1100 WP/WR/WS/WT	93-96	F
TL 1000 RW/RX/RV/RK1	98-02	F
GS 1200 SSK1/ZK1 (GV78A)	02	F
GSF 1200 SK1/K1/K2/SK2/K3/SK3/K4 /SK4/K5/SK5	01-05	F
GSX 1300 RX/RV/RK1/RK2/RZK3/RK3/RK4/ RK5/K6/K7 'Hayabusa'	99-07	F
GSX 1400 K1/K2/K3/K4/K5/K6/K7	01-07	F
VZ 1600 K4 Marauder	04	F

### Equivalents OE #

43082 1199	43082 1179	43082 1274
43082 1224	43082 1227	59301 33870
59130 46E00	43082 1230	59100 46820
59300 33870	43082 1250	43082 1251
59300 33890	43082 1253	59100 40830
59300 46840/830	43082 1259	K4308-21274
59300 46820	43082 1272	

### MATERIAL AVAILABILITY AND PART NO.

STD	OPTIONS			
FA	HH	R	MXS	GFA
FA188	FA188HH	-	-	GFA188HH

# FA189 125.5 x 45.1 x 9mm

**HONDA**

CBR 1000 FP/FR/FS/FT/FV/FW/FX

93-99 F&R

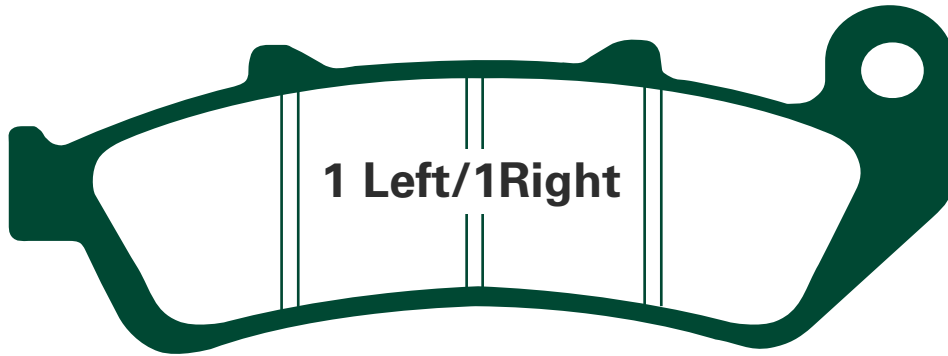

**Equivalents OE #**

06455 MZ2 405
06455 MAJ G41
06435 MAJ G41
06435 MAT 006
06455 MZ2 405

**Competitor X Ref**

Dunlop	Ferodo	SBS	Vesrah
DP122	FDB2002	685	VD-164

MATERIAL AVAILABILITY AND PART NO.				
STD	OPTIONS			
FA	HH	R	MXS	GFA
FA189	FA189HH	-	-	-
FA189S (Green)				

**LINKED BRAKE  
FIT ALL THREE SETS  
AT PAD CHANGE**

# FA190 98.9 x 49.5 x 9.5mm

# FA190HH 98.9 x 49.5 x 8.5mm

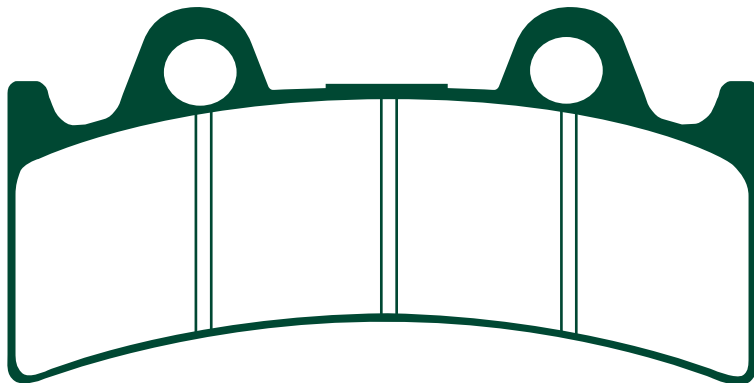

**Equivalents OE #**

4FM W0045 00	T2020221
4FM W0045 10	T2020218
T2020211	

**Competitor X Ref**

Dunlop	Ferodo	SBS	Vesrah
DP416	FDB864	683	VD-258

MATERIAL AVAILABILITY AND PART NO.				
STD	OPTIONS			
FA	HH	R	MXS	GFA
FA190	FA190HH	-	-	GFA190HH

**TRIUMPH**

Daytona Super III (3 cyl)

94-97 F

**YAMAHA**

YZF 750 R/SP

93-97 F

FZR 1000 EX UP

94-95 F

**ALCON**

6 Piston Caliper (Large Pin)

**PERFORMANCE MACHINE**

112X6RSB

112X6SSB

125X6QC

**PRE TECH**

6 Piston Caliper

# FA191 131.9 x 80 x 9.5mm

**YAMAHA**  
GTS 1000

93-99

F

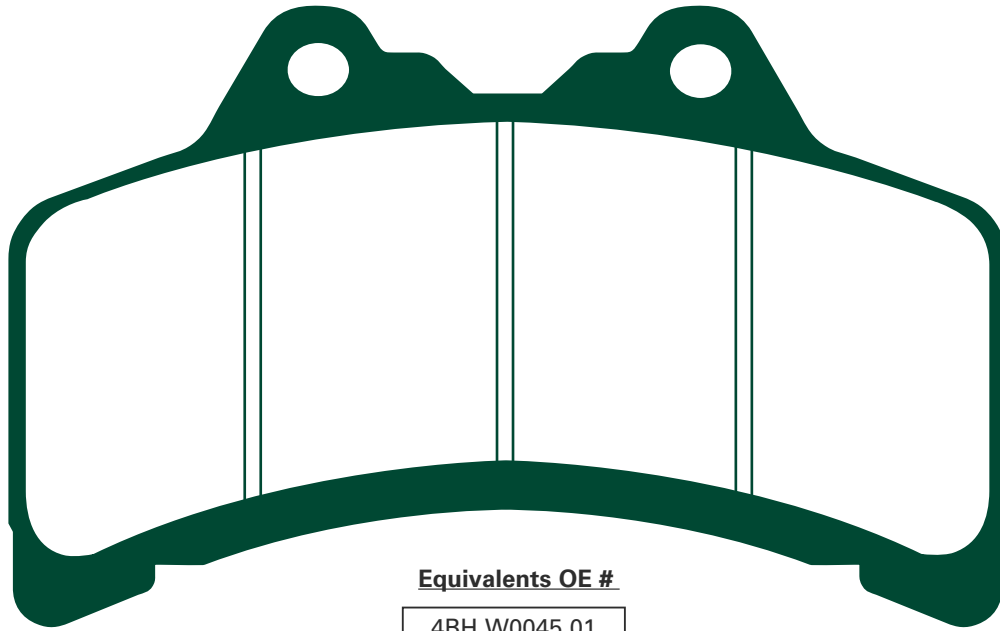

**Equivalents OE #**

4BH W0045 01

MATERIAL AVAILABILITY AND PART NO.				
STD	OPTIONS			
FA	HH	R	MXS	GFA
FA191	-	-	-	-

Competitor X Ref			
Dunlop	Ferodo	SBS	Vesrah
-	FDB865	682	VD-259

# FA192 A. 90 x 51 x 8.5mm B. 68 x 52 x 9.5mm

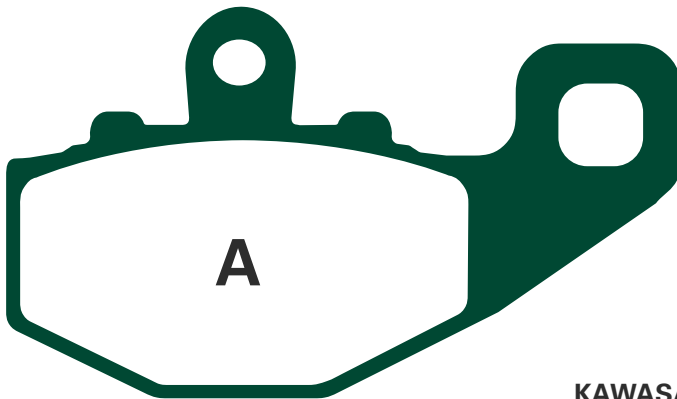

**A**

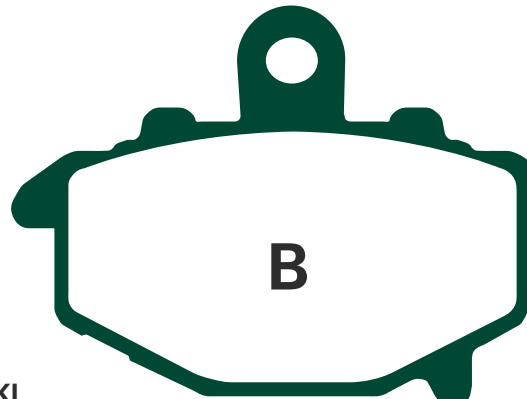

**B**

**Equivalents OE #**

43082 1148	43082 1171
43082 1157	43082 1213
43082 1160	43082 0004

**KAWASAKI**

ZR 400 Zephyr (G2/G3/G3A/G4/G5)	97-01	R
ZRX 400 (ZR 400 E1-E7)	95-01	R
ZZR 400 (ZX 400 N1/N2/N3/N4/N5/N6/N7)	93-99	R
ZR 550 B4/B5/B6 "Zephyr"	94-99	R
ZZR 600 (ZX 600 E1-E13)	93-05	R
ZZR 600 (ZX 600 E6F)	06-07	R
ZX-6R (ZX 600) F1/F2/F3/G1/G2/J1/J2)	95-01	R
ZX6R (ZX 636 A1P/B1/B2/C1) 636cc	02-05	R
ZX6R (ZX 600 P7F)	07	R
ZX6RR (ZX 600 K1/M1/N1)	03-05	R
ER-6F (EX 650 A6F/B6F/A7F/B7F)	06-07	R
ER-6N (ER 650 A6F/B6F/A7F/B7F)	06-07	R
KLE 650 A7F Versys	07	R
KLE 650 B7F Versys ABS	07	R
Z 750 (ZR 750 J1/J2)	04-05	R
Z 750 S (ZR 750 K1/K6F)	05-07	R
ZX-9R (ZX 900 B1/B2/B3/B4/C1/C2/E1/E2)	94-01	R
ZX9R (ZX 900 F1/F2)	02-04	R
Z 1000 (ZR 1000 A1/A2/A3)	03-05	R
ZX 10 R (ZX 1000 C1/C2/D6F/D7F)	04-07	R
GPZ 1100 E1/E2/F1	95-98	R

**Competitor X Ref**

Dunlop	Ferodo	SBS	Vesrah
DP320	FDB2012R	687	VD-434

MATERIAL AVAILABILITY AND PART NO.				
STD	OPTIONS			
FA	HH	R	MXS	GFA
FA192	FA192HH	-	-	-





# FA194 A. 95.5 x 42 x 8mm B. 77 x 42 x 8mm

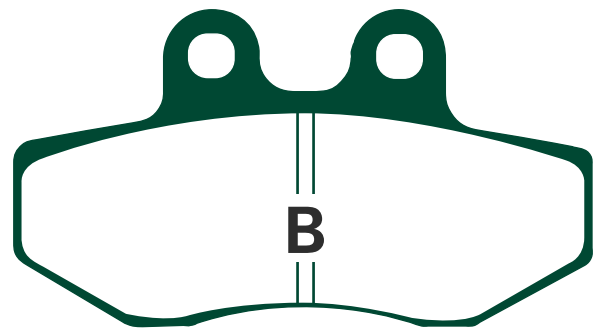
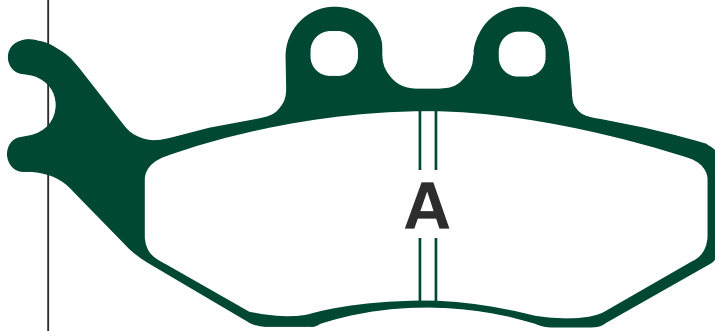

### Equivalents OE #

8113478	R43440 311A0	00009300080
8113523	754605	1D5 F5811 00
119 493 00	756020	00H04703141
119 495 00	5WX W0045 00	K00976315
494628	R290063110000	11955700

### Competitor X Ref

Dunlop	Ferodo	SBS	Vesrah
-	FDB677	689	VD9015

MATERIAL AVAILABILITY AND PART NO.				
STD	OPTIONS			
FA	HH	R	MXS	GFA
FA194	FA194HH	-	-	-

### APRILIA

MX 50	03-05	F
RS 50	99-06	F
RX 50 C/CD	93-04	F
RX 50 Racing	03-06	F
Tuorno 50	03-04	F
ETX 125	99-01	F
RX 125	92-99	F
Pegaso 125 "Kat"	94-95	F

### BENELLI

Velvet 250	99-07	F
Velvet 400 Dusk	03-04	F

### BETA

Alp 4.0	04-06	F
RR 125 (All models)	06-07	F
Alp 125/200	05-07	F
Alp 4.0	05-07	F

### CCM

SR 40 Street Scrambler	07	F
------------------------	----	---

### CPI

GTS 50/125/200	02-03	F
GTR 50/125/200	02	F
SX 50	06-07	F

### DAELIM

ST 125	03	F
--------	----	---

### DERBI

Senda R Euro2	04-07	F
Senda R Baja Enduro	06-07	F
Senda R Baja Supermoto	06-07	F
GPI 50 Open	06-07	F
Mulhacen 125	07	F

### FACTORY

RP 50	05	F
YM 50	05	F
YR 50 Desert	04-05	F
Chrono SM 50	04	F
YR 125 4T	05	F

### GAS GAS

EC 50	05	F
SM 50	05	F
Pampera 125/450	05-07	F
Pampera 250	02	F
Pampera 125/250/280	04	F
Pampera 250	02-03	F

### GENERIC

Toxic 50	07	F
Trigger X50	06-07	F
Trigger SM 50	06-07	F

### GILERA (Grimeca Calipers)

DNA 50	01-06	F
DNA 125/180	01-05	F
125 VX 4T/180 VXR 4T	01-04	F
Coguar	00-01	F
Runner 125/180 All models	98-02	F
VXR 200 Runner (4T)	02-04	F

### HONDA HM (Italy)

CRE 50 Six/Baja/Derapage Brembo caliper twin pin/41mm Paioli forks	95-02	F
CRE 50 Baja/Derapage	01-02	F

### HRD

GS 50		F
-------	--	---

### KEEWAY

X Ray 50 Supermoto	07	F
--------------------	----	---

### MALAGUTI

XSM 50	03-07	F
Madison 125/150/180	99-03	F
Madison R125	03-07	F
Phantom Max 125/200	04-07	F
Phantom Max 250	04-07	F
Madison S200	04	F
R 125 Madison	03-06	F
250 Madison	04-07	F
Password 250	05-07	F

### MBK

TZR 50 X Power	03-06	F
X-Limit Supermoto	03-06	F

### PEUGEOT

Elystar 125/150 (All models)	03-07	F
Elyseo 125/150 Rear Disc Model	03	F
Jet Force 125 (All models)	03-07	F
Satelis 125 4V Executive/Premium/City (4 stroke/4 valve)	06-07	F
Satelis 125 Compressor (4 stroke) All models	06-07	F
XPS-6 Supermotard	03-07	F
Geopolis 250 (AJP Caliper)	06-07	F
Satelis 250 (AJP Calipers)	07	F

### PGO

RS2 NKD	05	F
---------	----	---

### PIAGGIO/VESPA (Grimeca Calipers)

Beverley B 125	03-06	F&R
Beverley 200	03-05	F&R
Hexagon GT 250	98-99	F
Hexagon LX 180	98-99	F
Hexagon LXT 180	98-99	F
Hexagon LX4 125	98-99	F
Skipper LX 125/150	98-99	F
Super Hexagon GTX 125/180 (11" wheels)	00	F
Skipper ST 125/150 4T Grimeca Caliper	00-04	F
Super Hexagon GTX 250	00-02	F
GT 125 L Granturismo	03-06	F
GT 200 L Granturismo	03-06	F

### RIEJU

MRX 50 Pro/Top	04-07	F
SMX 50 Pro Supermotard/Top	04-07	F

### SACHS

ZX 125 Enduro	01	F
ZZ 125 Funbike	02	F

### SIAMOTO

SX1 125	04	F
---------	----	---

### YAMAHA

DT 50 X (Supermotard)	04-06	F
TZR 50 (5WX1)	03-07	F
XT 125 X	05-07	F

# FA196 102 x 38 x 9.8mm

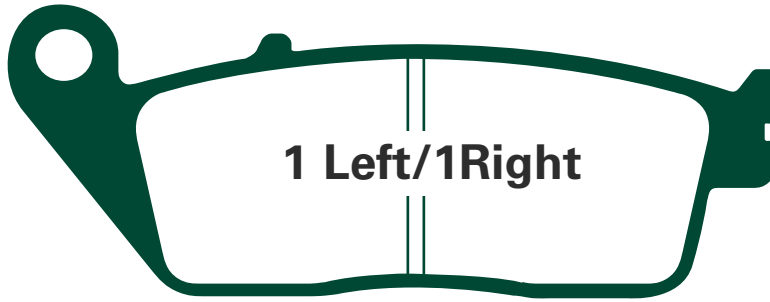

## DAELIM

VL 125 Daystar/125 L	03-06	F
VT 125 Evolution	03	F
VS 125 Evolution	01-04	F
Roadwin (VJ 125)	04-07	F

## HONDA

CB 250 N/T/W/X/Y/1/4 "Two Fifty"	92-05	F
CN 250 3 (MF02) Fusion/Fusion X/ Fusion X Special	03	F
VT 250 Spada	89-	F
VT 250 CR/CT/CV 'Magna'	95-97	F
VTR 250 W/Y/1-7 (MC33)	98-07	F
CB 400 SS (CB 400 SS2-J/SS2-3J-NC41)	01	F
FJS 400 S (NF01) Silverwing 400	01-02	R
FJS 400 D6 Silverwing	06	R
NV 400 DCY/DC1/DC2 (NC40) Shadow Slasher	00-02	F
VRX 400 T (NC33)	96	F
CBF 500 4 (Non ABS Model)	04	F
CB 500 R/T	94-96	F
600 Silverwing Scooter FJS 600 1/2/A3/D3 /A4/D4/A5/D5/A6/D6/A7	01-07	R
XL 600 VR/VT "Transalp"	94-96	F
FMX 650 5/6	05-07	F
CBR 750 FJ 'Superaero'	-88	R
VF 750 CP/CR/CS/CT/CV/CW/CX	93-99	F
VFR 750 FJ/FK/FL/FM/FN/FP/FR/ FS/FT/FV	88-97	R
VT 750 CV/C2V/CW/C2W/CX/C2X/CY/C2Y C1/C21/C31/C4/C5/C6 'Shadow'	97-06	F
VT 750 DC1/DC2 Black Widow	01-04	F
VT 750 DCA7 Shadow Spirit	07	F
CBR 1000 FK/FL/FM/FN	89-92	R
ST 1100 L/M/N/P/R/S/T/V/W/X/Y1/AN/AP/ AR/AS/A1 "Pan European"	90-01	R
VT 1100 CR/CS/CT/CV/CW Shadow	94-98	F
VT 1100 C3 Shadow		F
VT 1100 C4 Shadow Sabre	04-05	F
VTX 1300 S3/S4/S5/S6/S7	03-07	F
GL 1500 'CV/CW/CX/CY/C1/C2 (F6C)'	97-03	R

## KYMCO

Venox 250 (Custom)	00-06	F
Xciting 250/250i	05-07	R
Xciting 500/500i	04-07	R
Yup 250	04-06	R
People 250 S	06	R

## SYM

Voyager 125	05	F&R
-------------	----	-----

## TRIUMPH

Adventurer	96-01	F&R
America (cast wheel)	07	F
Bonneville America	02-06	F
Bonneville 800	01-06	F
Bonneville/Bonneville Black (865cc)	07	F
Bonneville T100	02-06	F
Legend TT	98-01	F&R
Speedmaster 800	03-04	F
Speedmaster (865cc)	05-07	F
Thunderbird	95-03	F&R
Thunderbird Sport	98-03	F&R
Tiger 885cc	92-99	F&R
Tiger 955cc Up to VIN 198874	00-04	F&R
Tiger 955 (Cast wheel model) from VIN 198875	05-06	F
Scrambler (865cc)	06-07	F
Tiger 855i (From VIN 71699)	98-99	F&R

## YAMAHA

YP 125 Majesty DX (Taiwan Production)	02	F
VP 250 W (X-City)	07	F
MT-01 (1670cc)	05-06	R
MT-01 (6 piston radial caliper)	07	R

### Equivalents OE #

06435 MCT 405	06455 MAA 405	45106 MN8 671B
06435 ML7 P01	06455 MBK 751	45106 MS9 612B
06435 ML7 415	06455 MEA 671	45106 MW3 671
06435 MS2 P00	431A0 MT4 670	T2020077
06435 MT3 405	43105 ML7 921A	T2020194
06435 MS9 405	43105 ML7 922A	T2020537
06435 MZO 006	43105 MS2 007A	06455 KFR 701
06455 MZO 760	43105 MS9 612A	45105 KED9 305
06455 MAW 621	43105 MT3/6 007	5YU W0046 00
06455 MAB 405	43105 MT4 007A	06455 MCK A01
06455 MAH 405	43105 MY7 405	45105 BA5 RB10M1
06455 KCR 405	43106 ML7 921B	45106 BA5 RB10M1

### Competitor X Ref

<b>Dunlop</b> DP118	<b>Ferodo</b> FDB664	<b>SBS</b> 700	<b>Vesrah</b> VD-156/2/3
------------------------	-------------------------	-------------------	-----------------------------

MATERIAL AVAILABILITY AND PART NO.				
STD	OPTIONS			
FA	HH	R	MXS	GFA
FA196	FA196HH	-	-	-

# FA197 A. 96.7 x 42 x 9mm B. 77.3 x 42 x 9mm

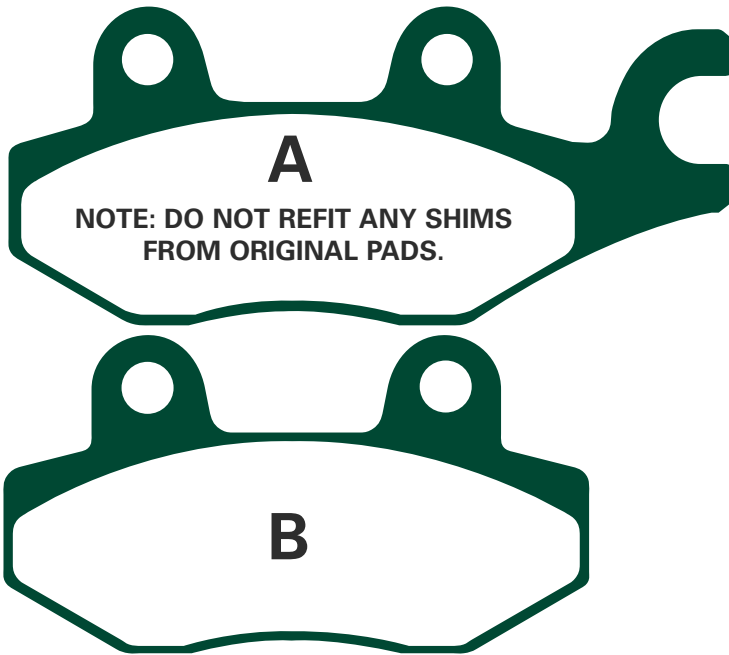

**A**  
NOTE: DO NOT REFIT ANY SHIMS FROM ORIGINAL PADS.

**B**

### AJS

Regal Raptor DD 125 E	04-06	F
Regal Raptor DD 250 E	04-06	F
<b>HONDA</b>		
CB 50 V/W Dream 50	97-98	F
NSR 50 RV/RW/RX/RY	97-00	F
XR 50 M5 (AD14) Motard	05	F
NSR 75 N/P/R/X/Y (N5-1/NSR 80)	92-00	F
NSR 80 P/R/S (HC06)	93-	F
Astra Supra NF 100	99	F
XR 100 M5 (HD13) Motard	05	F
LS 125 RY	00-	R
VT 125 CX/CY/C1/C21/C2Y /C3/C4/C7 'Shadow'	99-07	F
XL 125 V1/V2/V3/V4/V5/V6/V7 'Varadero'	01-07	F
NSR 150 RR (Malaysian market)		F&R
TA 200 (TA Shadow)	02-05	F&R
CBF 250 4/7	04-07	F

### Equivalents OE #

06455 KPC 641	43108 H3C 000A	902 300 1000
06455 GCR 006	45105 KR3 871	45105 KW6 405
3LD W0045 10	45106 KR3 871	45150 LLB5 3050
3LD W0045 30	4510A KW6 9000	4510A KFW6 900
06455 KR3 000	45105 KBE 3050 M2	06455 KTK 006
06455 KR3 405	43150 KBE 3060	4310A BA4 000M1
43082 1238	43150 LLS 3050	59100 05820

### Competitor X Ref

<b>Dunlop</b> DP129	<b>Ferodo</b> FDB2087	<b>SBS</b> 638	<b>Vesrah</b>
------------------------	--------------------------	-------------------	---------------

### ARCTIC CAT

DVX 50 (Y6)	06	R
DVX 90 (Y12 4 Stroke)	06	R
<b>CPI</b>		
125 Prince	01	F
<b>DAELIM</b>		
Roadwin (VJ125)	04-07	R
SQ 125 Freewing A2	06	R
SQ 250 Freeway S2	06	R
ET 250 Quad	06	R
<b>GARELLI</b>		
Tiger 125	07	F&R
<b>HARTFORD</b>		
VR 125/150 H/X/Z	04	R
<b>HERO</b>		
Magellan 125	06	F
Pluto 125	06	F
<b>YAMAHA</b>		
TZR 50 Thunderkid (5DU1/3)	97-00	F
Crypton-R New 110cc	04	F
<b>KAWASAKI</b>		
BN 125 A3/A4/A5/A6F/A7F Eliminator	00-07	F
Kaze-R New 112cc	04	F
<b>KYMCO</b>		
Activ 50/110/125	04-06	F
Bet & Win 50/Dink Sports 50	02-06	F
Dink 50/Spacer 50/Yager 50	98-07	F
Dink Classic 50 Euro 2	03	F
Super 9 50 (LC)	00-07	F
Super 9 (A/C) 50	00-07	F
Yager 50	07	F
Bet & Win 125/150	00-06	F&R
Cruiser 125	99	F
Dink 125/150/Spacer	97-04	F&R
Dink Classic 125/150	02	F&R
Dink LX 125/150	98-00	F&R
Grand Dink/Miler 125/150	01-07	F&R
Hipster 125/150	99-06	F
Movie XL 125/150	01-06	F
Quannon 125	07	F&R
Sector 125	99-01	F
Sector 125	98-01	F
Spike 125 R	04-06	F&R
Straight 125	05-06	F
Yager 125	00	F&R
Yager GT 125	07	F&R
Zing 125/150 Custom Style	97-06	F
Bet & Win 250	00-06	F&R
People 250	03-06	F&R
People 250 S	06	F(right)
Yup 250	03-06	F
<b>MZ/MUZ</b>		
RT 125	02-07	F&R
SM 125	02-07	R
SX 125	02-07	R
<b>PGO</b>		
G Max 125	06-07	R
G Max 250	06	R
<b>SYM</b>		
Shark 4VR-125	01-02	R
<b>SUZUKI</b>		
FX 125		F
Shogun-R FD-112	04	F
AN 400 K7 Burgman	07	F(right)
<b>WUYANG</b>		
WY 125 24B	06-07	F
<b>YAMAHA</b>		
XTZ 125 K/E	05-06	F
YBR 250	07	F

### MATERIAL AVAILABILITY AND PART NO.

STD	OPTIONS			
FA	HH	R	MXS	GFA
FA197	FA197HH	-	-	-

# FA198 106 x 31.7 x 6mm

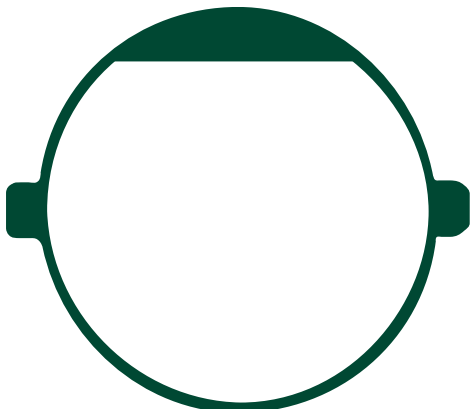

### CAGIVA

Roadster 125	96-97	F
--------------	-------	---

### CZ / JAWA

All Disc Models		F
125 Travel	03-04	F
125 Chopper	03-04	F
350 Chopper	03-04	F
350 Tramp	03-04	F
350 Californian	03-04	F

### Equivalents OE #

639 41 054

### Competitor X Ref

<b>Dunlop</b>	<b>Ferodo</b>	<b>SBS</b>	<b>Vesrah</b>
-	-	699	-

### MATERIAL AVAILABILITY AND PART NO.

STD	OPTIONS			
FA	HH	R	MXS	GFA
FA198	-	-	-	-

# FA199 93.8 x 40.3 x 9.8mm

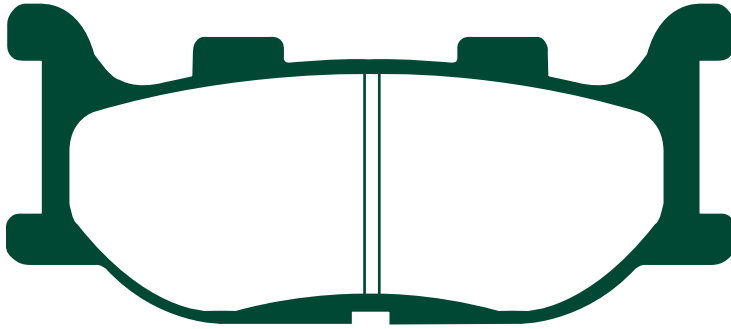

**Equivalents OE #**

4GA W0045 00	5VX W0045 00
4HM W0045 00	5VH W0045 00
4EB W0045 00	5VU W0045 00
4716630	

**Competitor X Ref**

Dunlop	Ferodo	SBS	Vesrah
DP421	FDB2003	691	VD-260

**YAMAHA**

TDR 125 R	93-03	F
XV 125 'Virago'	97-00	F
XVS 125 Dragstar	00-03	F
SR 125	97-03	F
TZR 150 R (4AP2)	00	F
XV 250 S 'Virago'	95-00	F
XVS 250 Dragstar	01-04	F
YP 250 DX/A/Majesty	98-03	F
YP 400 T/V/W Majesty	05-07	F
XJR 400 (4HM3/4HM5/4HM6 /4HM9/4HMA/4HMB)		
Brembo calipers	95-99	F
XP 500 T-Max (5VU1/2)	04-07	F
FZ6 Fazer/Fazer A	04-07	F
FZ6 (Naked version)	04-07	F
XJ 600 S/N	98-03	F
MT03V (660cc)	06-07	F
XV 1100 Virago	99	F
XVS 1100 Dragstar	99-04	F
XVS 1100 A Dragstar Classic	00-07	F
XVS 1300 A Midnight Star	07	F

**ITALJET**

Jupiter 125/150	02	F
Jupiter 250	02-03	F

**MBK**

YP 250 Skyliner	96-99	F
YP 250 Skyliner 250 (+ABS)	00-02	F
YP 400 Skyliner	04	F

**MATERIAL AVAILABILITY AND PART NO.**

STD	OPTIONS			
FA	HH	R	MXS	GFA
FA199	FA199HH	-	-	-

# FA200 104 x 62.4 x 11.2mm

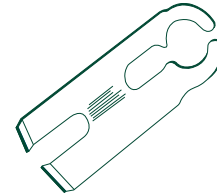
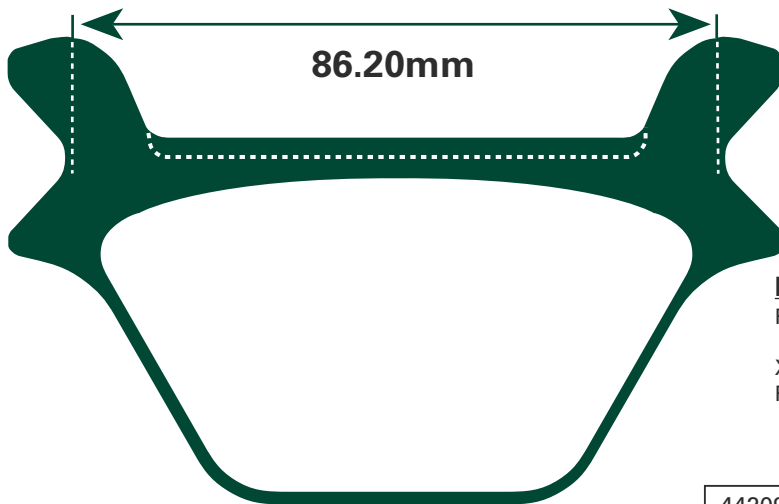

**Abutment Shims  
(2 per set)**

**HARLEY DAVIDSON**

FXST/FXSTB/FXSTC/FXSTS/FLST/ FLSTC/FLSTF/FLSTS/FLSTN	Late 87-89	R
XL/XLH/XLCH/XLS/XLX	Late 87-99	R
FXD/FXDL/FXDWG/FXR/FXRS/FXRT /FXRD/FXLR/FXDX	Late 87-99	R

**Equivalents OE #**

44209 87B	44209 87C	44213 87
-----------	-----------	----------

**Competitor X Ref**

Dunlop	Ferodo	SBS	Vesrah
DP905	FDB521/2001	669	VD-923

**MATERIAL AVAILABILITY AND PART NO.**

STD	OPTIONS			
FA	HH	R	MXS	GFA
FA200	FA200HH	-	-	-

# FA201 104 x 62.4 x 11.4mm

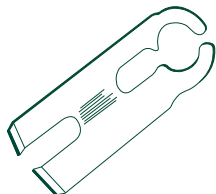
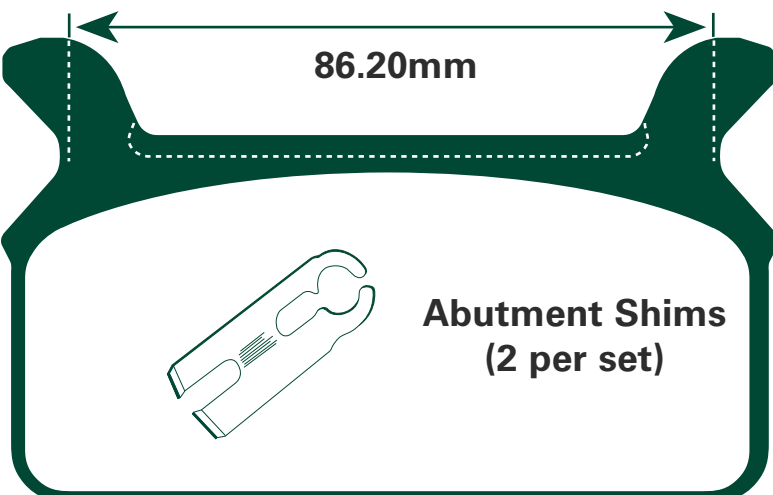

**Abutment Shims  
(2 per set)**

**HARLEY DAVIDSON**

FLT/FLHT/FLHTCI/FLTCUI	86-99	R
FLHR/FLHRCI/FLTRI	94-99	R

**Equivalents OE #**

43957 86	43957 86B
43957 86A	43957 86D

**Competitor X Ref**

Dunlop	Ferodo	SBS	Vesrah
DP904	FDB485	668	VD-922

**MATERIAL AVAILABILITY AND PART NO.**

STD	OPTIONS			
FA	HH	R	MXS	GFA
FA201	FA201HH	-	-	-

**FA202 A. 96.7 x 43.4 x 7.6mm B. 77 x 43.4 x 8mm**

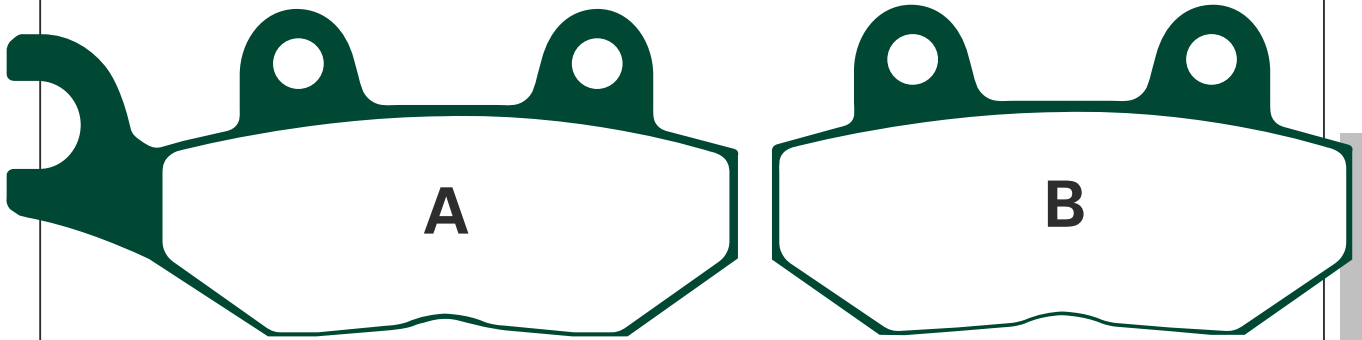

**FA202 Oversize Version of FA135  
See FA135 For Fitments**

Equivalents OE #

N/A

Competitor X Ref

Dunlop	Ferodo	SBS	Vesrah
-	-	-	-

**MATERIAL AVAILABILITY AND PART NO.**

STD	OPTIONS			
FA	HH	R	MXS	GFA
FA202	-	FA202R	-	-

**FA203 81.2 x 42 x 9.5mm**

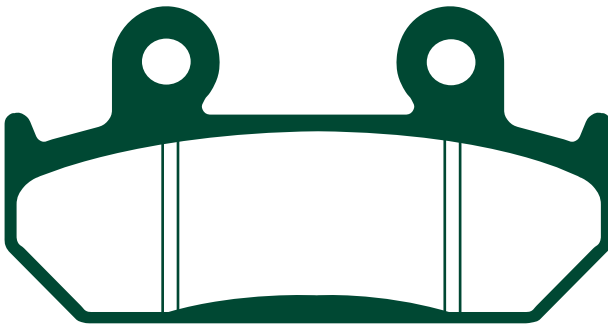

**HONDA**

CBR 600 FM/FN/FP/FR

91-94 F

Equivalents OE #

45105 MV1 008  
45105 MV1 405

Competitor X Ref

Dunlop	Ferodo	SBS	Vesrah
DP110	FDB462	593	VD142

**MATERIAL AVAILABILITY AND PART NO.**

STD	OPTIONS			
FA	HH	R	MXS	GFA
FA203	FA203HH	-	-	GFA203HH

**FA206 39.8 x 53.7 x 6.4mm**

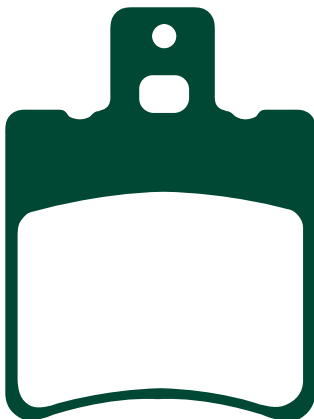

**USE FA193**



# FA208 78.13 x 41.2 x 9mm



1 Left/1Right

DISC PADS  
BUYERS GUIDE

<b>ALFER</b>		
VRE 125 4T	98-	R
Divertida 250 Super Motard	01-	R
Diferente Enduro	01-	R
VR 250	98-	R
<b>APRILIA</b>		
650 ie	01-04	R
<b>BENELLI</b>		
BX 450	07	R
<b>BORILE</b>		
B 500 CR	02-04	R
B 500 MT	02	R
<b>CCM</b>		
404 E	03-04	R
404 DS	03-04	R
404 DS Supermoto	03-04	R
644 DS Supermoto	04	R
644 DS	04	R
R 30 (Spoke & Mag)	02-04	R
R 35/R35S	06	R
<b>FACTORY</b>		
YR 250	03	R
<b>CCM</b>		
604E Dual Sport/Supermoto/RS	98-03	R
604E R30	02-04	R
<b>GAS GAS</b>		
EC 125/250/300/200 Enduro	97-99	R
Enforcer four 400/501/600 2 Quad	99	F
Enduros 125/250	00	R
<b>HIGHLAND</b>		
950 V2 Outback	00-04	R
950 V2 Motard	00-04	R
<b>HONDA HM (Italy)</b>		
FS 550 E Supermoto	05-07	R
FS 650 E Supermoto	05-07	R
<b>HRD</b>		
GS 50		R
<b>HUSABERG</b>		
FE 450 E	06-07	R
FS 450 E	06	R
FS 450 R	06	R
FE 550 E	06-07	R
FE 650 E	06-07	R
FS 650 C	06-07	R
<b>HUSQVARNA</b>		
CR 125	95-04	R
SM 125 S Supermotard	98-07	R
SM 125 S	02-07	R
SM 125	98-00	R
WRE 125	93-07	R
WR 125	95-05	R
WR/WRE 125 Dual	00-07	R
SM 610	05	R
CR 250	95-04	R
TE 250	02-05	R
TC 250	02-04	R
WR 250	92-05	R
TE 350	95-97	R
WR 360	95-03	R
SM 400 R	02	R
TE 400	01-02	R
TE 410 E	00	R
TE 410	95-00	R
SM 450 R	03-06	R
TC 450	02-04	R
TE 450	02-05	R
TC/TE 510	04-05	R
SM 510 R	05-06	R
SM 570 R	01-04	R
TC/TE 570	01-04	R
TE 570	01-04	R
TC/TE 610 E	95-04	R
LT 610	00-01	R
SMR 630	05	R
SM 610	98-00	R
SM 610 R	00	R

## HUSQVARNA Contd.

SM 610 R/IE	05-07	R
SM 610 S (Radial caliper)	06	R
SM 610 S (4 bolt front disc)	02-06	R
SM 610 ie	07	R
TC 610	00	R
TC 610 E	95-99	R
TE 610	00	R
TE 610 E	95-03	R
TE 610 IE	06-07	R
SMR 630	06	R
STR 650 CRC	07	R
<b>KRAM-IT (KRAMER)</b>		
GS 250	00-	R
SM 250	00-	R
SMR 250	00-	R
<b>KTM</b>		
LC2 125	96-98	R
Sting 125	97-99	R
SX 125	94-03	R
EXC/EGS 125	94	R
EXC 125	95-03	R
EXC/EGS 200	98-03	R
SM 125 Supermoto	00	R
EXE 125	00	R
EXC 200	98-03	R
SX 250	94-02	R
EXC/EGS 250	94	R
EXC 250	95-03	R
EXC 300	00-03	R
EXC 350	94-95	R
SX 360	96-97	R
EXC 360	96-97	R
SX 380	98-03	R
EXC 380	98-03	R
Duke 400 LC4	94-98	R
SC 400	96-99	R
EGS/EGS-3/LSE 400	96-99	R
SX 400	00-02	R
EXC/EGS 400 (USD)	00-02	R
EXC 400 Racing (USD)	00	R
LC4-E 400 Enduro	00-01	R
SX 440	94-95	R
EXC 440	94-95	R
EXC 450	03	R
MX 500	95	R
EXC 525	03	R
SX 520	01-03	R
EXC 520	01-03	R
MXC 525 (Desert Racing)	03-04	R
MXC 550	96	R
Duke 620 LC4	94-98	R
SX EXC/EGS 620	95	R
SX 620	96-99	R
SC 620 Supercompetition	96-00	R
EGS/EGS-E/LSE 620 Enduro	96-99	R
EGS-E 620 Adventure/Rallye	99	R
LC4 620 SC Supermoto/Supercompetition	00	R
LC4 625 SC Supermoto	02	R
SMC 625	05	R
SXC 625	03-04	R
Duke II 640 (All models)	01-06	R
LC4-E 640 Enduro/Supermoto/Adventure R	00-06	R
LC4 640 Adventure	01-06	R
SM 640 LC4	05	R
640 LC4 Adventure	03-07	R
SMC 660 Supermoto	03-04	R
SMC 660	05-06	R
690 Supermoto	07	R
690 SM Prestige	07	R
990 Superduke	05-07	R
990 Superduke R	07	R
<b>MAICO</b>		
500 MX/Enduro	99	R
<b>TM</b>		
80 Enduro	96-00	R
80/85 Cross	96-01	R
80/85/100 (Big wheel)	02-04	R
Junior 80/85/100 Cross (Small wheel)	02-04	R
125 Cross	95-00	R
125 Enduro	95-00	R
250 Cross	95-00	R
250 Enduro	95-00	R
300 Cross	95-00	R
300 Enduro (2T)	95-00	R
400 Cross (4T)	95-00	R
530 Cross (4T)	98-00	R
<b>VERTEMATI</b>		
All models	99-04	R
<b>VOR</b>		
All models	99-04	R
<b>YAMAHA</b>		
TT 600 R (5CH1/5CH2/5CH3)	97-02	R
TT 600 RE (5CH5)	04	R
TT 600 E (4LW3/4LW4/4GV4/4GV5)	94-01	R
TT 600 K From 4GV 003404 (Brembo rear caliper)	95-96	R

### Competitor X Ref

<b>Dunlop</b>	<b>Ferodo</b>	<b>SBS</b>	<b>Vesrah</b>
DP622	FDB2019	675	VD-953

### Equivalent OE #

800079072	AB040 S	211021038
8A0079072	546 13 309 200	4GV FS811 00
8113538	546 13 309 300	
AB040	546 13 309 400	

### MATERIAL AVAILABILITY AND PART NO.

STANDARD				
FA	HH	R	MXS	GFA
FA208TT	-	FA208R	MXS208	GFA208HH

# FA209 Use FA209/2

## FA209/2 108.9 x 41.3 x 7.6mm

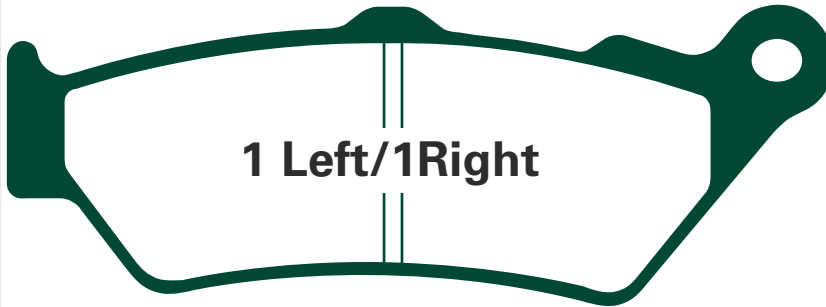

### Equivalents OE # - FA209/2

06455 MAK 000	34 11 2 345 445	5VK W0045 00
06455 MAN 911	8113533	600 13 0300 000
06455 MY5 731	34 11 7 660 340	2C8 W0045 00
06455 MAK 003	34 117 651 958	8133906
0000 365 46000	2202491	000306546260

### Competitor X Ref

<b>Dunlop</b>	<b>Ferodo</b>	<b>SBS</b>	<b>Vesrah</b>
DP623	FDB2006	674	VD958

### MATERIAL AVAILABILITY AND PART NO.

STD	OPTIONS			
FA	HH	R	MXS	GFA
FA209/2	FA209/2HH	-	-	GFA209/2HH

### APRILIA

Moto 6.5	95-01	F
Pegaso 650/650 IE	97-04	F
Pegaso 650 Trial	06-07	F
ETV 1000 Caponard/Raid/ABS	01-07	F

### BMW

C1 125	99-03	F
C1 200	01-03	F
F 650/650 ST	93-00	F
F 650 GS/Dakar GS	93-07	F
F 650 CS/Scarver	00-06	F
G 650 Xchallenge	07	F
G 650 Xcountry	07	F
HP2 1200 Enduro	05-07	F

### HONDA

CB 500 V/W/SW/X/SX/Y/SY/2/S2	97-03	F
NX 500 V/W/X Dominator	97-99	F
SRL 650 V/W	97-98	F
NT 650 VW/XV/XY/V1 'Deauville'	98-01	F
NX 650 V/W/X Dominator	97-02	F
FX 650 X/Y 'Vigor'	99-03	F

### ITALJET

Griffon # 59	07	R
--------------	----	---

### KTM

950 Adventure/S	04-06	F
990 Adventure/S	06-07	F
950 R Superenduro	06	F

### MOTO GUZZI

Breva 850	07	R
Norge 850	07	R
Griso 860	07	R
940 Custom	07	R
Quota 1100 ES	99-00	F
California/EV/Special	99	R
California EV 1100	99-00	R
California Classic 1100	07	R
Breva V1100	05	R
Breva 1100 (ABS)	07	R
Griso 1100	05-07	R
Griso 1100 (8 valve) (Radial caliper)	07	R
Breva 1100	05-06	R
Norge 1200	06-07	R
1200 Sport	07	R

### TRIUMPH

Rocket 111 2300cc	04-07	R
Rocket 111 Classic	07	R

### VICTORY

Victory All models	98-07	R
--------------------	-------	---

### YAMAHA

DT 125 X	05-06	F
XT 660 R	04-07	F

# FA210 112.1 x 56.3 x 10.0mm

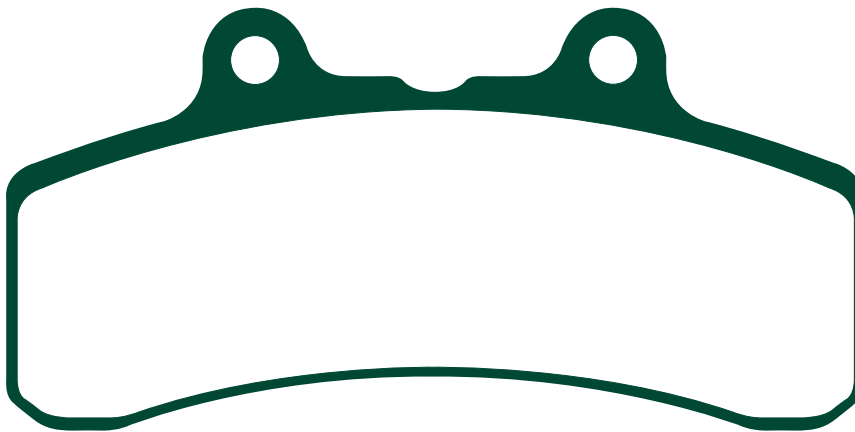

### BUELL

M2 Cyclone	94-97	F
S2 "Thunderbolt"	94-97	F
S1 Lightning	94-97	F
S3 Thunderbolt	94-97	F

### PERFORMANCE MACHINE

125X6  
137X6

### Equivalents OE #

42386 84Y
0053 1604

### Competitor X Ref

<b>Dunlop</b>	<b>Ferodo</b>	<b>SBS</b>	<b>Vesrah</b>
DP912	FDB847	658	-

### MATERIAL AVAILABILITY AND PART NO.

STD	OPTIONS			
FA	HH	R	MXS	GFA
FA210	-	-	-	-



**FA211 77.8 x 45.4 x 8.5mm**  
**FA211/2 77.8 x 45.4 x 10.4mm**

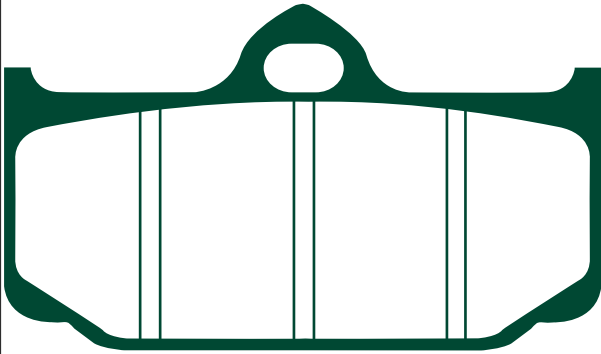

**Competitor X Ref**

Dunlop	Ferodo	SBS	Vesrah
-	FDB 2008	-	-

**FA211/2 - PVM**  
4 Piston Race Caliper

**Equivalents OE #**

N/A

MATERIAL AVAILABILITY AND PART NO.				
STD	OPTIONS			
FA	HH	R	MXS	GFA
FA211	-	-	-	-

MATERIAL AVAILABILITY AND PART NO.				
STD	OPTIONS			
FA	HH	R	MXS	GFA
FA211/2	-	-	-	-

**FA213 78.13 x 41.2 x 9mm**



**1 Left/1Right**

**Equivalents OE #**

06435 MAK 003	34 21 7 664 983	8133825
34 21 7 660 343	34 21 2 345 449	61340761A
34 21 7 660 253	5VK W0046 00	8133911

**Competitor X Ref**

Dunlop	Ferodo	SBS	Vesrah
-	-	-	-

**APRILIA**

Pegaso Strada 650	05-06	R
Pegaso 650 Trial	06	R
Pegaso 650 Factory	07	R
Pegaso 650	07	R
SL 750 Shiver	07	R
NA 850 Mana	07	R

**BETA**

Jonathan 125	00-01	R
Euro 350	00-01	R

**BMW**

C1 125	99-03	R
C1 200	01-03	R
F 650/650 ST	93-00	R
F 650 GS/Dakar GS	93-06	R
F 650 CS/Scarver	00-06	R
G 650 Xchallenge	07	R
G 650 Xmoto	07	R
G 650 Xcountry	07	R
F800 S/ST	06-07	R

**CCM**

CR 40 S Cafe Racer	07	R
CF 40 Street	07	R
SR 40 Street Scrambler	07	R

**DUCATI**

Paul Smart 1000 Limited	06-07	R
GT 1000 (992cc)	06-07	R
1000 Sport (992cc)	06-07	R
Classic Sport Biposto (992cc)	07	R
Sport 1000 S (992cc)	07	R

**HONDA**

CB 500 V/W/SW/X/SX/Y/SY/2/S2	97-03	R
NX 500 V/W/X Dominator	97-99	R
FX 650 X/Y "Vigor"	99-03	R
SLR 650 V/W	97-98	R
NX 650 V/W/X Dominator	97-99	R

**YAMAHA**

XT 660 X Supermoto	04-07	R
XT 660 R	04-07	R
MT03V (660cc)	06-07	R

MATERIAL AVAILABILITY AND PART NO.				
STD	OPTIONS			
FA	HH	R	MXS	GFA
FA213	FA213HH	-	-	-

**FA214 A. 96.7 x 42 x 7.6mm B. 77.3 x 42 x 8mm**

**FA214/2 A. 96.7 x 42 x 9.7mm B. 77.3 x 42 x 8mm**

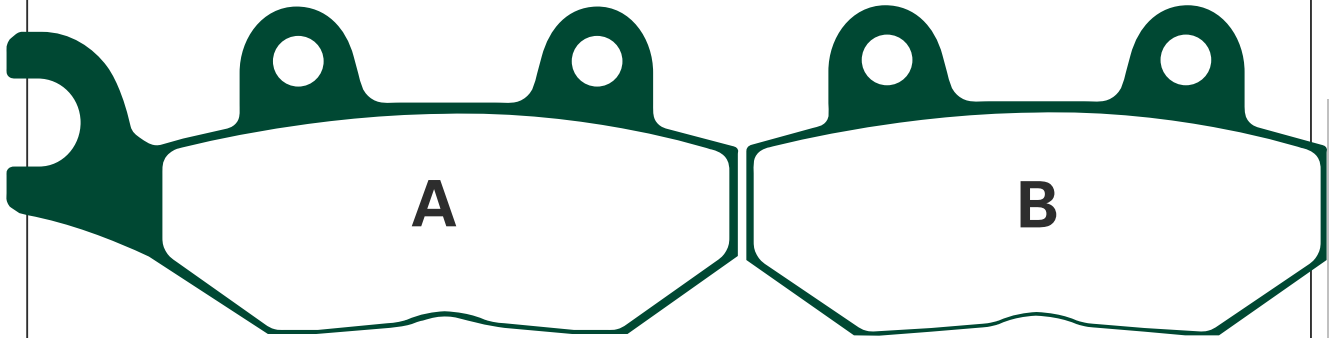

DISC PADS BUYERS GUIDE

**TRIUMPH**

Sprint (All carb models)	93	F(Left)
Tiger 885cc	92-97	F(Left)
Trident 750	92-98	F(Left)
Trident 900	92-98	F(Left)
Trophy 900	92-93	F(Left)
Trophy 1200	92-93	F(Left)

**FA214/2 - TRIUMPH**

America (Cast wheel)	07	R
Bonneville America	02-06	R
Bonneville 800	01-06	R
Bonneville T100	02-06	R
Bonneville/Bonneville Black (865cc)	07	R
T595 Daytona	97	R
Daytona 650	05	R
Daytona 955i	98-00	R
Daytona 955i	05-06	R
Speed Triple	97-01	R
Speed Triple 955cc	02-04	R
Sprint RS	99-04	R
Thruxton 900	04-07	R
Scrambler (865cc)	06-07	R
Speedmaster 800	03-04	R
Speedmaster (865cc)	05-07	R
Sprint ST (1050cc)	05-06	R
Speed Triple (1050cc)	05-07	R
Tiger 1050 (Radial caliper)	07	R

**Competitor X Ref**

Dunlop	Ferodo	SBS	Vesrah
DP411	FDB497	638	VD340

**Equivalents OE #** FA214 = T 2020071 T301

**Equivalents OE #**

FA214/2 = T 2020 555	FA214/2 = T 2020 556
FA214/2 = T 2020 072 T31	FA214/2 = T 2020 191

**MATERIAL AVAILABILITY AND PART NO.**

STD	OPTIONS			
FA	HH	R	MXS	GFA
FA214	FA214HH	-	-	-

**MATERIAL AVAILABILITY AND PART NO.**

STD	OPTIONS			
FA	HH	R	MXS	GFA
FA214/2	FA214/2HH	-	-	-

**FA215 A. 96.7 x 42 x 7.6mm B. 77.3 x 42 x 8mm**

**FA215/2 A. 96.7 x 42 x 9.7mm B. 77.3 x 42 x 8mm**

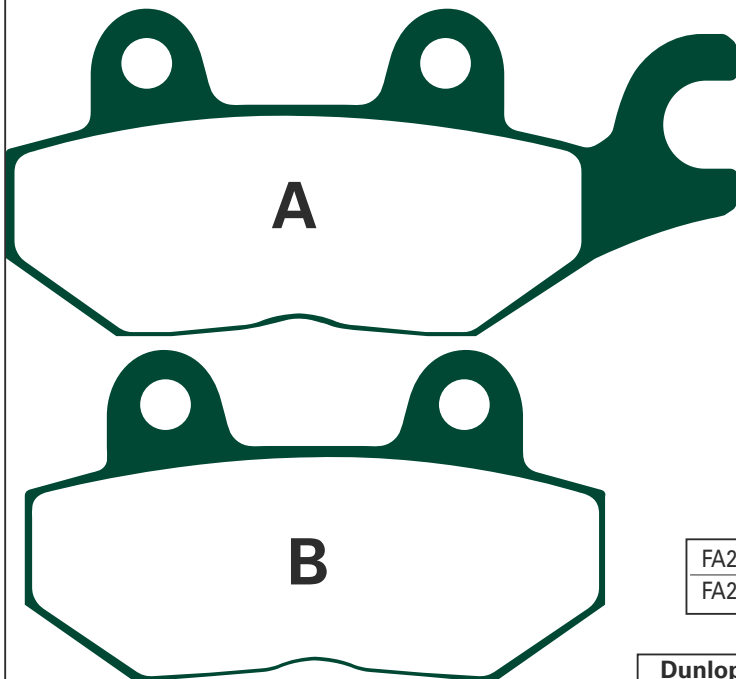

**TRIUMPH - FA215**

Sprint	93	F(Right)
Trident 750	92-98	F(Right)
Tiger 885cc	92-97	F(Right)
Trident 900	92-98	F(Right)
Trophy 900	92-93	F(Right)
Trophy 1200	92-93	F(Right)

**FA215/2 - TRIUMPH**

Daytona 750	92	R
Daytona 1000	92	R
Daytona 900	93-96	R
Daytona Super III	94-97	R
Daytona 1200	93-98	R
Speed Triple	94-97	R
Sprint	93-98	R
Sprint RS	99-02	R
Trident 750	92-98	R
Tiger 885cc	92-97	R
Trident 900	92-98	R
Trophy 900	92-01	R
Tiger 955 (from VIN198875)	04-06	R
Trophy 1200	92-01	R

**Equivalents OE #**

FA215 = T 2020072-T301	FA215/2 = T 2020561
FA215/2 = T 2020560	

**Competitor X Ref**

Dunlop	Ferodo	SBS	Vesrah
DP412	FDB631	611	VD250/250/2

**MATERIAL AVAILABILITY AND PART NO.**

STD	OPTIONS			
FA	HH	R	MXS	GFA
FA215	FA215HH	-	-	-

**MATERIAL AVAILABILITY AND PART NO.**

STD	OPTIONS			
FA	HH	R	MXS	GFA
FA215/2	FA215/2HH	-	-	-

**FA216** 69.2 x 48.8 x 8.3mm  
**FA216/2** 69.2 x 48.8 x 10.5mm  
**FA216/3** 69.2 x 48.8 x 7.8mm

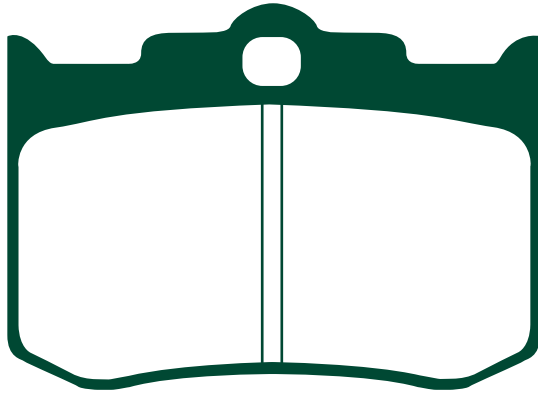

**Competitor X Ref**

<b>Dunlop</b> DP911	<b>Ferodo</b> FDB2040/H	<b>SBS</b> 678/662	<b>Vesrah</b> -
------------------------	----------------------------	-----------------------	--------------------

**FA216**

INDIAN - See page for application details  
**PERFORMANCE MACHINE** - 125X4R  
 125X4RSPH  
 137X4B

**FA216/2**

EBC 4 Piston Race Caliper  
**PERFORMANCE MACHINE**  
 124X4HR  
 137X4

**FA216/3**

Nova  
 Legends  
 Thunderheart

MATERIAL AVAILABILITY AND PART NO.				
STD	OPTIONS			
FA	HH	R	MXS	GFA
FA216	FA216HH	-	-	GFA216HH

MATERIAL AVAILABILITY AND PART NO.				
STD	OPTIONS			
FA	HH	R	MXS	GFA
FA216/2	-	-	-	-

MATERIAL AVAILABILITY AND PART NO.				
STD	OPTIONS			
FA	HH	R	MXS	GFA
FA216/3	FA216/3HH	-	-	-

**FA217** 106 x 31.7 x 8.5mm

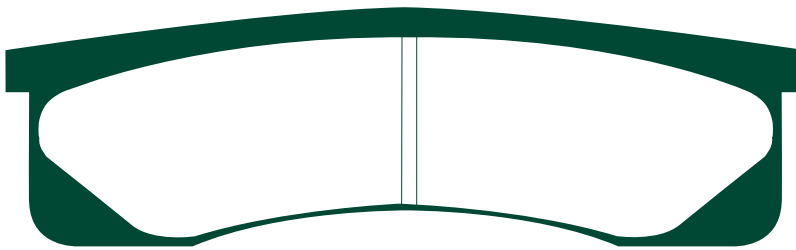

**Competitor X Ref**

<b>Dunlop</b> -	<b>Ferodo</b> FRP418	<b>SBS</b> 660	<b>Vesrah</b> -
--------------------	-------------------------	-------------------	--------------------

**Wilwood 6 Piston Caliper**  
**Lockheed 6 Piston Caliper**  
 (3366/67 Type)

**RACE USE ONLY**

**Equivalent OE #**

N/A

MATERIAL AVAILABILITY AND PART NO.				
STD	OPTIONS			
FA	HH	R	MXS	GFA
FA217	-	-	-	-

# FA218 77.65 x 40.50 x 8.5mm

**Race use only**

# FA218/2 77.65 x 40.50 x 10.40mm

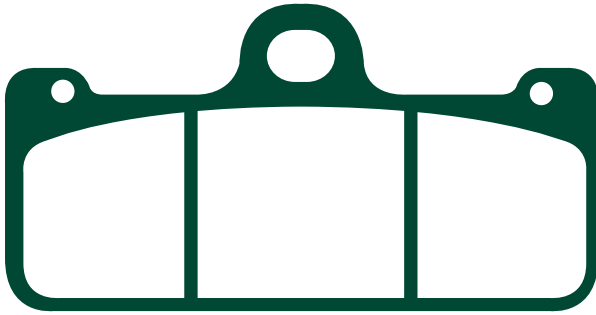

**FA218 - BREMBO**

A3 B8 60/61/30/31 Racing radial caliper 2 piece, 4 piston single pin fixing  
X 10 48 13 & 14 GP 2 piece 4 piston caliper (single pin pad fixing)

**APRILIA**

SXV 450 07 F  
SXV 549 07 F

**TM**

MX 660 06 F

**GFA218/2 - BREMBO**

97 37 60/61 Radial monoblock racing 4 piston single pin pad fixing  
X 10 17 40/41 Monobloc 4 piston caliper (single pad pin fixing)

**Equivalents OE # - FA218 Equivalents OE # - FA218/2**

07 9032 10

07 684831

**Competitor X Ref - FA218**

Dunlop	Ferodo	SBS	Vesrah
DP626	FDB2007	695	VD969/2

MATERIAL AVAILABILITY AND PART NO.				
STD	OPTIONS			
FA	HH	R	MXS	GFA
FA218	FA218HH	-	-	GFA218HH

**Competitor X Ref - FA218/2**

Dunlop	Ferodo	SBS	Vesrah
-	-	711	VD969

MATERIAL AVAILABILITY AND PART NO.				
STD	OPTIONS			
FA	HH	R	MXS	GFA
-	-	-	-	GFA218/2HH

# FA220 69 x 50.4 x 8.7 mm

**YAMAHA**

FZR 250 R 92 F  
R1-Z 350 92 F

**PIN HOLE**

Right to left 5.8mm  
Top to bottom 5.0mm

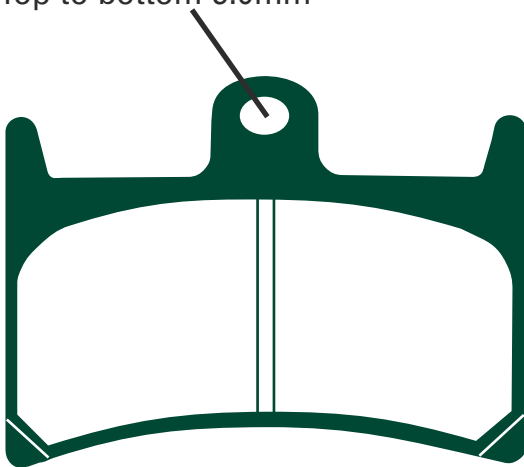

**Equivalents OE #**

3LN W0045 00

**Competitor X Ref**

Dunlop	Ferodo	SBS	Vesrah
-	-	639	VD-249

MATERIAL AVAILABILITY AND PART NO.				
STD	OPTIONS			
FA	HH	R	MXS	GFA
FA220	-	-	-	-

# FA222 52.60 x 56.30 x 9mm

**SUZUKI**

RF 900 RR/RS/RS2

94-95 R

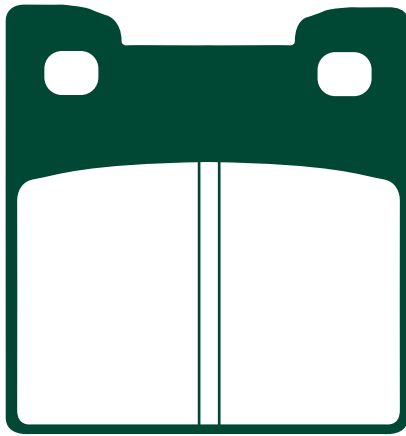

**Equivalents OE #**

69100 31830
69130 31E00

**Competitor X Ref**

Dunlop	Ferodo	SBS	Vesrah
DP217	FDB2058	701	VD-350

**MATERIAL AVAILABILITY AND PART NO.**

STD	OPTIONS			
FA	HH	R	MXS	GFA
FA222	-	-	-	-

DISC PADS  
BUYERS GUIDE

# FA226 102 x 38 x 9.0mm

# GFA226HH 102 x 38 x 9.0mm Race Use Only

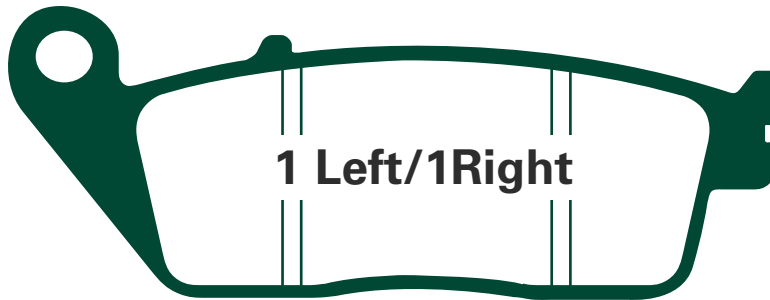

**HONDA**

RS 125	90-94	F
RS 250	90-94	F
CBR 600 FS/FT/FV/FW	95-98	F
CB 600 FW/FX/FY/F2-Y/F1/F21/F2/F22/F3/F4/F5/F6/F7 Hornet	98-07	F
CBF 600 N4/NA4/S4/SA4/N5/NA5/S5/SA5	04-05	F
CBF 600 NA4/NA5/NA6 (ABS Model)	04-06	F
CBF 600 S4/S5 (Non ABS)	04-05	F
CBF 600 SA4/SA5/SA6 (ABS Model)	04-06	F
CBF 1000 F6/F7	06-07	F

**Equivalents OE #**

06455 MV4 405
06455 MR4 405
06455 MAL G01

**Competitor X Ref**

Dunlop	Ferodo	SBS	Vesrah
DP117	FDB570	627	VD156/2

**MATERIAL AVAILABILITY AND PART NO.**

STD	OPTIONS			
FA	HH	R	MXS	GFA
FA226	FA226HH	-	-	GFA226HH

# FA228 A. 96.7 x 42 x 9mm B. 77.3 x 42 x 9mm

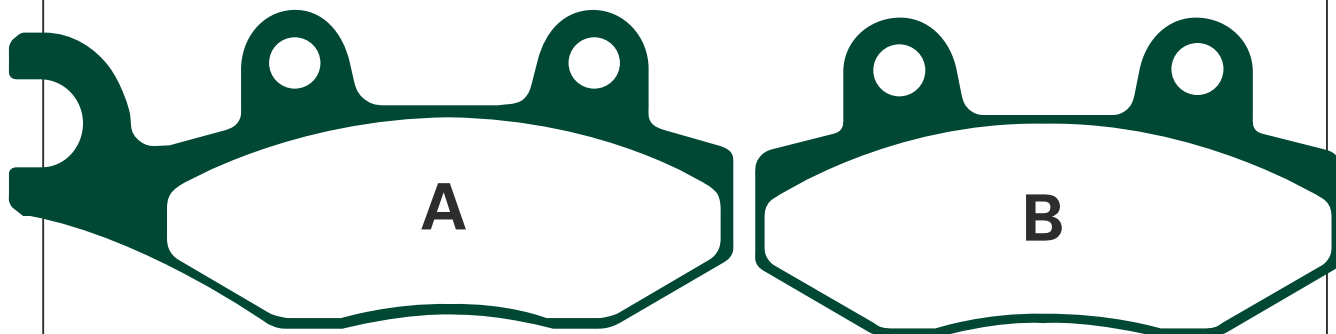

**HARTFORD**

VR-125 Z Velo Sport 00-03 F  
 VR-125 X/H Velo-Cross 00-03 F  
 CR 125/150 H/X/Z 04 F

**HONDA**

CA125 S/T 'Rebel' 95-97 F  
 CMX 250 CT 'Rebel' 96-97 F

**KEEWAY**

Outlook 125/150 07 F&R  
 Superlight 125 07 F

**KYMCO**

Agility 50 05-07 F  
 Filly 50 LX (S210) 00-06 F  
 Vitality 50 (2T & 4T) 04-07 F  
 Yup 50 01-07 F  
 Cobra 100 Racer 99-03 F  
 Agility 125 06-07 F  
 Stryker 125 01-06 F  
 Movie 125 99-00 F  
 Vivio 125/150 00-03 F  
 Stryker 150 (Off road) 00-06 F  
 People 250 S 06 F(left)  
 Vitality Cross (10" wheels) 07 F  
 Vitality Sports (12" wheels) 07 F

**MZ/MUZ**

SX 125 02-07 F  
 SM 125 02-07 F

**PEUGEOT**

Geopolis 250 (Nissin caliper) 06-07 F&R  
 Satelis 250 (Nissin calipers) 06-07 F&R  
 Geopolis 400 07 F&R

**ROYAL ENFIELD**

Bullet Electra X 05-06 F  
 Electra T 05-06 F  
 Electra Sportsman 05-06 F

**SUZUKI**

UH 125 K7 Burgman 07 R  
 UH 200 K7 Burgman 07 R  
 AN 400 K7 Burgman 07 F(left)

**SYM**

RS 150 06 R

**VIALLI**

DXB 50 06 F  
 Fireforce 50 06 F

**NOTE: Do not refit any shims from original pads**

**Equivalents OE #**

06455 KEB 900	902 3002000
45105 KCE 3050 M2	59100 05830
45105 KKD 6305	45110 K2GP 000
45150 KEC8 3050	

**Competitor X Ref**

Dunlop	Ferodo	SBS	Vesrah
DP211	FDB497	713	VD340/2

**MATERIAL AVAILABILITY AND PART NO. OPTIONS**

STD	OPTIONS			
FA	HH	R	MXS	GFA
FA228	FA228HH	-	-	-

# FA229 A. 133.50 x 36.80 x 8.40mm B. 109.60 x 51.75 x 8.50mm

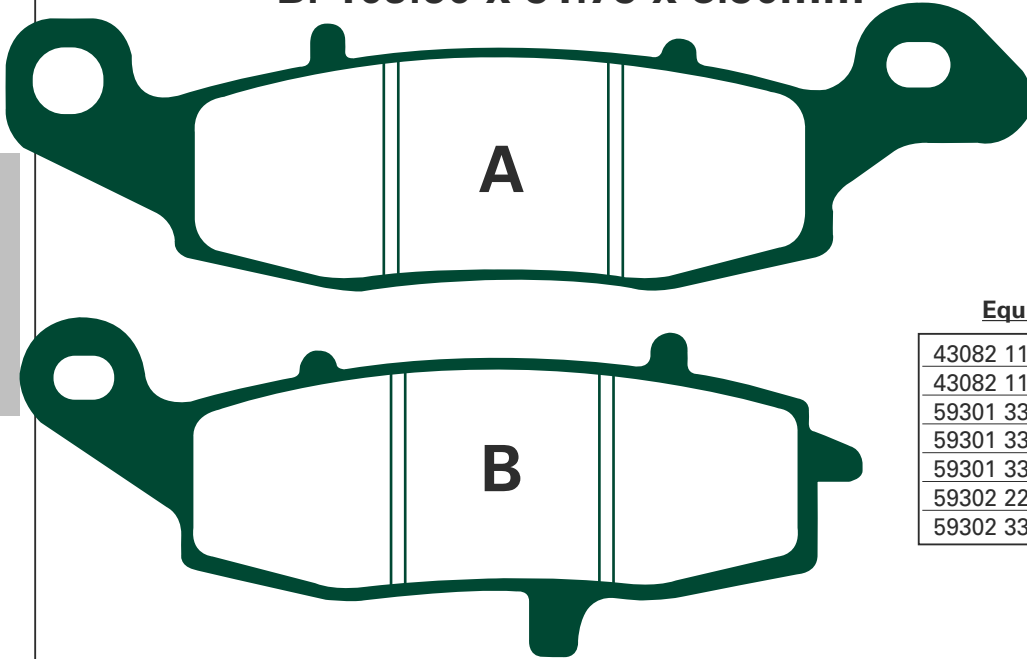

DISC PADS  
BUYERS GUIDE

### Equivalents OE #

43082 1177	43082 1223
43082 1187	43082 1234
59301 33820	43082 1244
59301 33830	43082 1282
59301 33840	43082 S019
59302 22850	59300 33830
59302 33810	

#### KAWASAKI

ZR-X 400 E3 (ZR 400 E3)	96	F(left)
ER-5 ER 500 C1-C5P	01-07	F
ER-6F (EX 650 A6F/B6F/A7F/B7F)	06-07	F(left)
ER-6N (ER 650 A6F/B6F/B7F/A7F)	06-07	F(left)
KLE 650 A7F Versys	07	F(left)
KLE 650 B7F Versys ABS	07	F(left)
KLR 650 C1-C10	95-04	F
ZR 750 D1 "Zephyr"	96-	F(left)
ZR-7 (ZR 750 F1/F3/F5)	99-04	F(left)
ZR-7S (ZR 750 H1/H2)	01-04	F(left)
Z 750 (ZR 750 J1/J2)	04-05	F(left)
Z 750 S (ZR 750 K1/K6F)	05-07	F(left)
VN 800 C1/C2/E1/E2/E3 'Drifter'	99-04	F
VN 800 B1-B10/B6F "Classic"	96-06	F
VN 900 A6F Classic	06	F
VN 900 B7F Classic (Spoke wheel)	07	F
VN 900 C7F Custom (Cast wheel)	07	F
KLV 1000 (LV 1000 A1H/A2H)	04-05	F(left)
GPZ 1100 E1/E2/F1	95-98	F(left)
ZR 1100 B1 "Zephyr"	96-97	F(left)
ZR 1100 B5 (Zephyr 1100 RS)	02	F(left)
VN 1500 D1/D2/E1/E2 "Classic"	96-99	F
VN 1500 G1/G2 Classic Tourer	98-00	F(left)
VN 1500 J1/J2/R1/R2/R3 Drifter	99-04	F
VN 1500 L1/L2/L3/L4 "Nomad Fi"	00-03	F(left)
VN 1500 N1/N2/N3 Classic Fi	00-04	F
VN 1600 A1/A2/A3/A6F	03-07	F(left)
VN 1600 D1H/D6F Classic Tourer	05-07	F(left)

#### SUZUKI

GSF 250 VS/S Bandit	97	F
TU 250 GY/GBK1 Grass Tracker/ Big Boy NJ47A-117/123)	00-01	F
GSX 600 FW/FX/FY/FK1/FK2/FK3 /FK4/FK5/FK6	98-06	F(left)
GSF 600 Y/SY/K1/SK1/K2/SK2/K3/SK3 K4/SK4 Bandit	00-04	F(left)
DL 650 K4/K5/K6 V-Strom	04-06	F(left)
DL 650 AK7 VStrom ABS	07	F(left)
DL 650 K7	07	F(left)
GSF 650 K5/SK5 Bandit	05	F(left)
GSF 650 K6/SAK6 (Bandit ABS)	06	F(left)
SV 650 X/Y/K1/K2/K3/K4/K5/K6/K7	99-07	F(left)
SV 650 SX/SY/SK1/SK2/SK3/SK4/SK5/SK6/SK7	99-07	F(left)
SV 650 AK7/SAK7 ABS model	07	F(left)
GSX 750 W/FX/FY/FK1/FK2/FK3/FK4/FK5/FK6	98-06	F(left)
GSX 750 W/X/Y	98-03	F(left)
DL 1000 K2/K3/K4/K5/K6/K7 V-Strom	02-07	F(left)
VL 1500 K2/K3	02-03	F(left)
VL 1500 K5/K6/K7 (C1500 Intruder)	05-07	F(left)

#### Competitor X Ref

Dunlop	Ferodo	SBS	Vesrah
DP322	FDB2048	705	VD-435

#### MATERIAL AVAILABILITY AND PART NO.

STD	OPTIONS			
FA	HH	R	MXS	GFA
FA229	FA229HH	-	-	GFA229HH

# FA230 A. 99.00 x 44.10 x 7.56mm B. 75.50 x 37.90 x 8.26

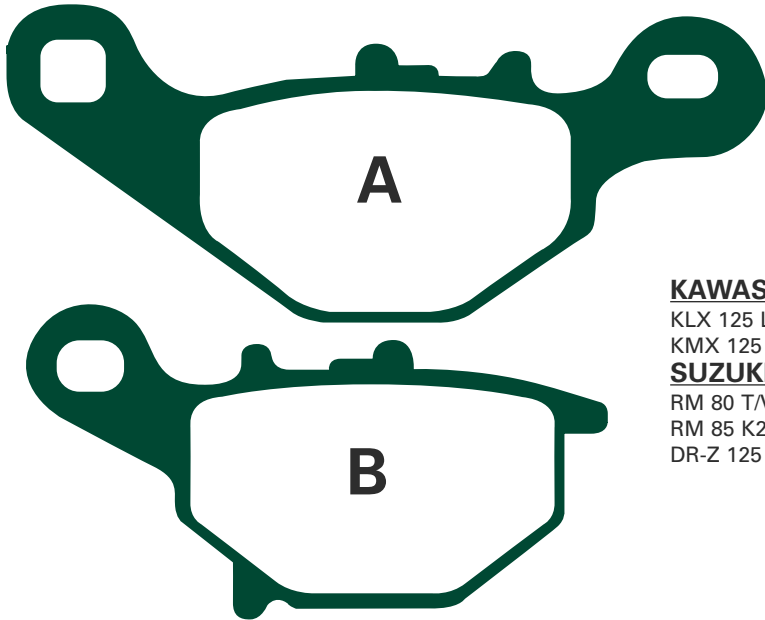

### KAWASAKI

KLX 125 L (B1/B2/B3/B6F) 03-06 F  
 KMX 125 B10/B11/B12 99-03 F

### SUZUKI

RM 80 T/V/W/X/Y/K1 96-01 F  
 RM 85 K2/LK2/K3/LK3/LK4/K4 02-04 F  
 DR-Z 125 LK3/LK4/LK5/LK6/LK7 03-07 F

### Equivalents OE #

59300 03880	43082 S005
59300 03891	43082 S015

### Competitor X Ref

Dunlop	Ferodo	SBS	Vesrah
DP218	-	702	VD-351

MATERIAL AVAILABILITY AND PART NO.				
STD	OPTIONS			
FA	HH	R	MXS	GFA
FA230TT	-	FA230R	-	-

# FA231 A. 133.50 x 36.80 x 8.40mm B. 109.60 x 51.75 x 8.50mm

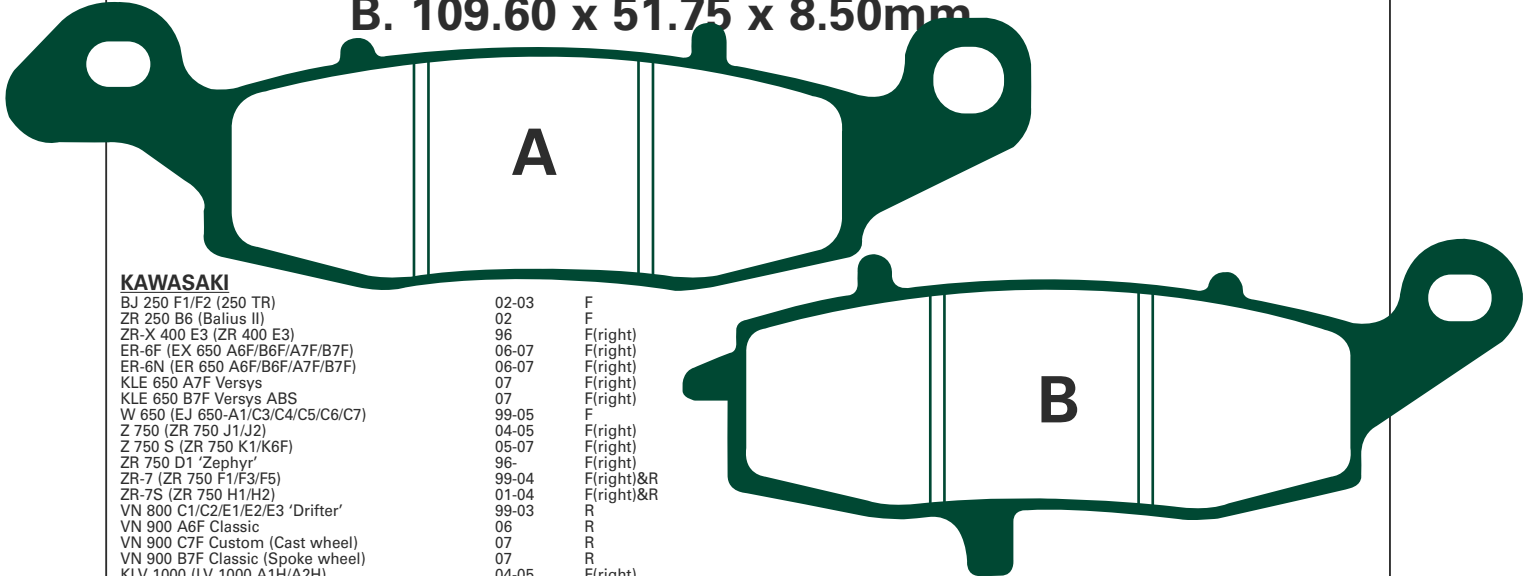

### KAWASAKI

BJ 250 F1/F2 (250 TR) 02-03 F  
 ZR 250 B6 (Balius II) 02 F  
 ZR-X 400 E3 (ZR 400 E3) 96 F(right)  
 ER-6F (EX 650 A6F/B6F/A7F/B7F) 06-07 F(right)  
 ER-6N (ER 650 A6F/B6F/A7F/B7F) 06-07 F(right)  
 KLE 650 A7F Versys 07 F(right)  
 KLE 650 B7F Versys ABS 07 F(right)  
 W 650 (EJ 650-A1/C3/C4/C5/C6/C7) 99-05 F  
 Z 750 (ZR 750 J1/J2) 04-05 F(right)  
 Z 750 S (ZR 750 K1/K6F) 05-07 F(right)  
 ZR 750 D1 'Zephyr' 96- F(right)  
 ZR-7 (ZR 750 F1/F3/F5) 99-04 F(right)&R  
 ZR-7S (ZR 750 H1/H2) 01-04 F(right)&R  
 VN 800 C1/C2/E1/E2/E3 'Drifter' 99-03 R  
 VN 900 A6F Classic 06 R  
 VN 900 C7F Custom (Cast wheel) 07 R  
 VN 900 B7F Classic (Spoke wheel) 07 R  
 KLV 1000 (LV 1000 A1H/A2H) 04-05 F(right)  
 GPz 1100 E1/E2/F1 95-98 F(right)  
 ZR 1100 B1 'Zephyr' 96-97 F(right)  
 ZR 1100 B5 (Zephyr 1100 RS) 02 F(right)  
 VN 1500 G1/G2 Classic Tourer 98-99 F(right)  
 VN 1500 J1/J2/R1/R2/R3 Drifter 99-04 R  
 VN 1500 L1/L2/L3/L4 'Nomad Fi' 00-03 F(right)&R  
 VN 1500 N1/N2/N3 'Classic Fi' 00-04 R  
 VN 1500 P1/P2 Mean Streak 02-04 R  
 VN 1600 A1/A2/A3/A6F 03-07 F(right)&R  
 VN 1600 B1 Mean Streak 04 R  
 VN 1600 B2H/B6F (Mean Streak) 05-07 R  
 VN 1600 D1H/D6H Classic Tourer 05-07 F(right)&R  
 VN 2000 A1/A2/A6F/F7F 04-07 R

### SUZUKI

RV 125 K2/K3/K4/K5/K6/K7 Van-van 02-07 F  
 RV 200 K2/K3 02-03 F  
 GSX 250 FXX2 02 F  
 TU 250 TX/X/XTY (NJ47A-115) Volty 99-00 F  
 GS 500 ET/EV/EW/EX/EY/K1/K2/K3/FK4/FK5/K5/FK6/K6/K7/FK7 96-07 F  
 GSF 600 Y/SY/K1/SY1/K2/SK2/SK3/K3 /K4/SK4 Bandit 00-04 F(right)  
 GSX 600 FW/FX/FY/FK1/FK2/FK3/FK4/FK5/FK6 98-06 F(right)  
 DL 650 K4/K5/K6 V-Strom 04-06 F(right)  
 DL 650 AK7 VStrom ABS 07 F(right)  
 DL 650 K7 07 F(right)  
 GSF 650 K5/SK5 Bandit 05 F(right)  
 GSF 650 K6/SAK6 (Bandit ABS) 06 F(right)  
 SV 650 X/Y/K1/K2/K3/K4/K5/SK6/K6/K7 99-07 F(right)  
 SV 650 SX/SY/SK1/SK2/SK3/SK4/SK5/SK6/K6/AK7 99-07 F(right)  
 SV 650 AK7/SAK7 ABS model 07 F(right)  
 XF 650 V/W/X/Y Freewind 97-02 F  
 GSX 750 FW/FX/FY/FK1/FK2/FK3/FK4/FK5/FK6 98-06 F(right)  
 GSX 750 W/X/Y 98-03 F(right)  
 VL 800 K1/K2/K3/K4 'Intruder Volusia' 01-04 F  
 VL 800 K5/K6/K7 (C 800 Intruder) 05-07 F

VZ 800 V/W/X/Y/K1/K2 Marauder 97-03 F  
 VZ 800 K5-K7 Intruder M800 05-07 F  
 DL 1000 K2/K3/K4/K5/K6/K7 V-strom 02-07 F(right)  
 VL 1500 K2/K3 02-03 F(right)  
 VL 1500 K5/K6/K7 (C1500 Intruder) 05-07 F(right)  
 VZ 1600 K4 Marauder 04 R  
 VZ 1600 K5 (M1600 Intruder) 05 R  
 VZ 1800 K6/K7 (M 1800 R Intruder) 06-07 R

### Competitor X Ref

Dunlop	Ferodo	SBS	Vesrah
DP323	FDB2049	704	VD-352

### Equivalents OE #

43082 0015	43082 1243	43082 1283	59101 33830
43082 1178	43082 1246	43082 S018	59101 33850
43082 1188	43082 1248	59100 33830	59102 33810
43082 1203	43082 1260	59100 33850	59102 33840
43082 1226	43082 1264	59100 33870	K4308-21203
43082 1232	43082 1265	59101 33810	K4308-21264
43082 1235	43082 1280	59101 33820	

### MATERIAL AVAILABILITY AND PART NO.

STD	OPTIONS			
FA	HH	R	MXS	GFA
FA231	FA231HH	-	-	GFA231HH



# FA232 72.5 x 43.7 x 7mm

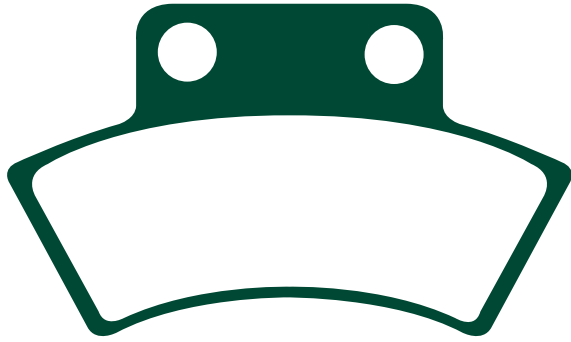

**POLARIS**

Rear pad most models 89-00  
See main application list for full details.

This pad has increased friction area.  
Can be fitted in place of FA178 to improve wear life on Polaris ATV's

**JORDAN**

HIPO/MARS/BOB 50/90/100 03-04 R

**Equivalents OE #**

2200899
2200456

**Competitor X Ref**

Dunlop	Ferodo	SBS	Vesrah
DP909	FDB2054	717	VD950

**MATERIAL AVAILABILITY AND PART NO.**

STD	OPTIONS			
FA	HH	R	MXS	GFA
FA232TT	-	FA232R	-	-

# FA233 75.1 x 37.2 x 9.5mm



**KYMCO**

Cobra 50 Cross	00-06	F
Cobra Racer (SF10AG)	00-06	F
CX 50 Super (PR50AC)	94-97	F
K12 Sport 50 (SE10CA)	95-00	F
KB 50 (SE10CA)	95-00	F
Looping 50	98	F
Top Boy 50 (SF10GG)	97-06	F
ZX 50 Super Fever/Scout	99-06	F
KB 50 Scout	97	F
Filly 50 LX	00-02	F
Sniper 50 (PR 50 B)	93	F
Sniper 50 DD (PR50BB)	94-96	F
KB 100 Manboy	97-00	F
Top Boy 100	97	F
49 ef 10"	07	F

**Equivalents OE #**

45105 KCX E050
45105 KCX 3050 MZ
45105 KCU 3050

**Competitor X Ref**

Dunlop	Ferodo	SBS	Vesrah
N/A	N/A	N/A	N/A

**MATERIAL AVAILABILITY AND PART NO.**

STD	OPTIONS			
FA	HH	R	MXS	GFA
FA233	-	-	-	-

# FA234 58.9 x 44.6 x 9.4mm

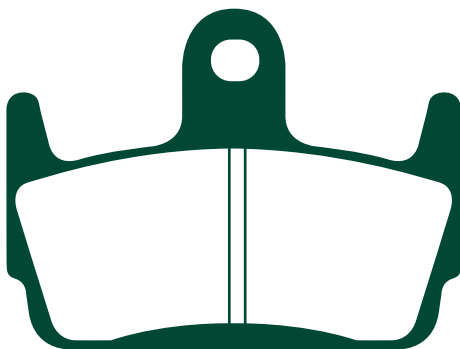

**HONDA**

SZX 50 X8R-SW/SX/SY/S1 "Supersport Scooter"	98-04	R
SZX 50 X8R-XW/XX/XY/X1 "Cross Sport"	98-04	R

**KYMCO**

Sniper 50 DD (PR50BB)	94-96	R
Heroism 150	95-97	R

**SYM**

Jet Sport X 50 (R/S/SR)	06-07	R
-------------------------	-------	---

**Equivalents OE #**

06435 GCM 900
06435 GCM 902
43105 KBF 3050 MZ
43105 KBF 9000
45105 TFA 000 A

**Competitor X Ref**

Dunlop	Ferodo	SBS	Vesrah
DP014	N/A	710	N/A

**MATERIAL AVAILABILITY AND PART NO.**

STD	OPTIONS			
FA	HH	R	MXS	GFA
FA234	-	-	-	-

# FA235 59.5 x 44.5 x 9mm

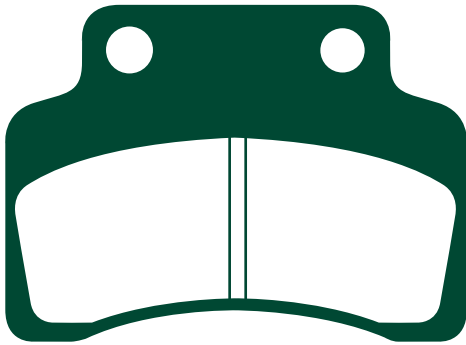

**Equivalents OE #**

45150 KBK 9000 MZ
45110 J4FT 000

**Competitor X Ref**

Dunlop	Ferodo	SBS	Vesrah
-	FDB2191	723	-

**BENELLI**

49X-Scooter 07 F

**CPI**

Argon 50 07 F  
 Argon Gp50 07 F  
 Freaky 50 07 F  
 Oliver 50 (All models) 03-06 F  
 Hussar 50 03-05 F  
 Popcorn 50 03-05 F  
 Argon Gp125 07 F  
 Oliver City 125 06 F

**CSR**

ONA 125 (4T) 04-06 F&R  
 Scoo 125 (4T) 04-06 F&R

**GARELLI**

VIP 50 07 F

**GENERIC**

XOR 50 05-07 F  
 Ideo 50 05-07 F  
 Soho 125 06-07 F  
 XOR 125 05-07 F

**KEEWAY**

Flash 50 07 F  
 F-Act 50 07 F  
 Matrix 50 07 F  
 Matrix 125 07 F

**KM (KEENMOTORBIKES)**

Badboy 50 CX 05 F  
 Badboy 100 CX 05 F

**KYMCO**

DJW 50 World (PR50AD) 95-97 R  
 Heroism 125 (SE25BA) 95-97 F  
 Heroism 50 (SE10BA) 95-97 F  
 Heroism 150 (SE30AD) 95-97 F

**MATERIAL AVAILABILITY AND PART NO.**

STD	OPTIONS			
FA	HH	R	MXS	GFA
FA235	-	-	-	-

# FA236 70 x 55.5 x 8.3mm

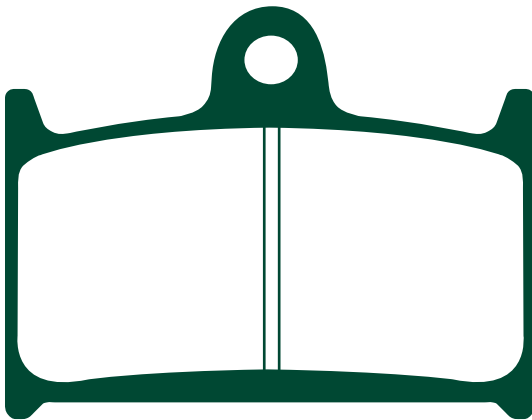

**TRIUMPH**

T595 Daytona 97 F  
 Daytona 600 03-04 F  
 Daytona 650 05 F  
 Speedfour 600 02-05 F  
 TT 600 00-03 F  
 Daytona 750 92 F  
 Daytona 900 93-96 F  
 Trophy 900 94-01 F  
 Daytona 955i 98-06 F  
 Speed Triple 94-01 F  
 Speed Triple 955cc 02-04 F  
 Daytona 1000 92 F  
 Daytona 1200 93-98 F  
 Trophy 1200 94-01 F  
 Rocket 111 (2300cc) 04-07 F  
 Rocket 111 Classic 07 F  
 Sprint 94-98 F  
 Sprint RS/ST 99-04 F  
 Sprint ST (1050cc) 05-06 F

**Equivalents OE #**

2020073 T0301	T2020245
T2020193	T2020246

**Competitor X Ref**

Dunlop	Ferodo	SBS	Vesrah
DP213	FDB557	624	VD343

**MATERIAL AVAILABILITY AND PART NO.**

STD	OPTIONS			
FA	HH	R	MXS	GFA
FA236	FA236HH	-	-	-

# FA237 USE FA229

**FA239 69.65 x 51.85 x 8.5mm**

**GFA239HH 69.65 x 51.85 x 8.5mm Race use only**

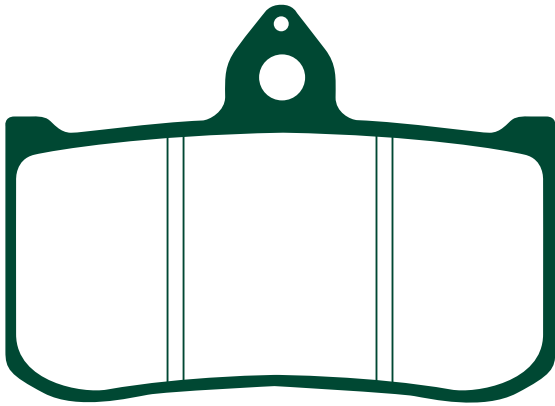

**HONDA (RACE BIKES)**

RS 125	95-06	F
RS 250	93-06	F

**Equivalents OE #**

45105 NX4 770

**Competitor X Ref**

Dunlop	Ferodo	SBS	Vesrah
RDP123	FDB858	-	-

**MATERIAL AVAILABILITY AND PART NO.**

STD	OPTIONS			
FA	HH	R	MXS	GFA
FA239	-	-	-	GA239HH

# FA243 98.9 x 49.5 x 8.5mm

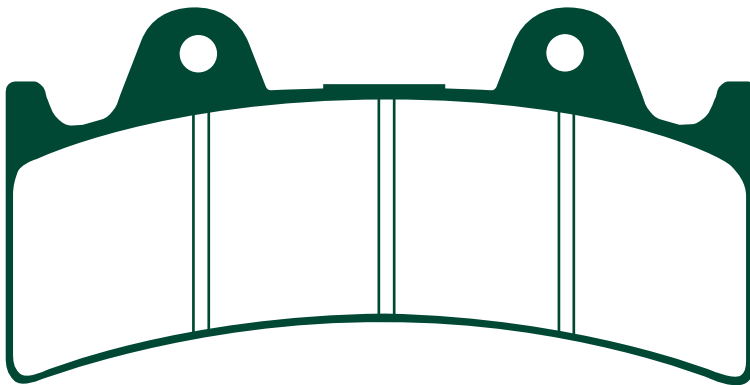

**ALCON**

6 Piston Race Caliper with 4.0mm pin set

Similar to FA190 with difference in pad pin diameter and thickness

**JAYBRAKE**

6 piston caliper

**Equivalents OE #**

N/A

**Competitor X Ref**

Dunlop	Ferodo	SBS	Vesrah
DP627	FDB2031	-	-

**MATERIAL AVAILABILITY AND PART NO.**

STD	OPTIONS			
FA	HH	R	MXS	GFA
FA243	FA243HH	-	-	GFA243HH

# FA244 75 x 55 x 8.70mm

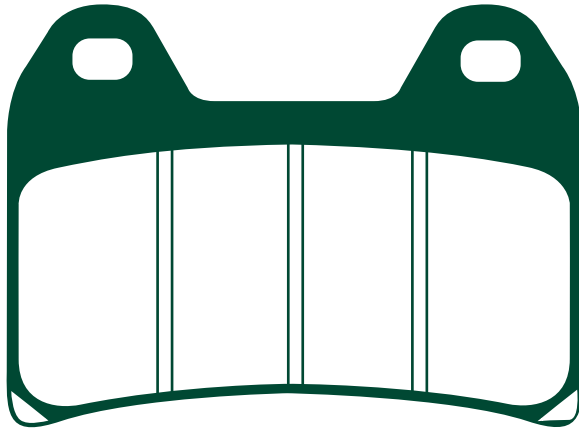

## APRILIA

RS 250	98-02	F
Pegaso Strada 650	05-06	F
Pegaso 650 Factory	06	F
Pegaso 650	07	F
ETV 1000 Caponord	01-02	F
RSV 1000 "All models"	98-99	F
SL 1000 Falco	00-04	F
RSV 1000 Mille/Miller	00	F
RST Futura 1000	01-04	F
1000 Tuono (All models)	02-06	F

## BIMOTA

Later models	98/99-	F
SB8K Gobert (996cc Suzuki engine)	06	F

## BENELLI

TNT 899 Tornado Naked Tre	07	F
Trek 899	07	F
Tornado 900	02	F
TNT 1130 Cafe Racer	05	F
TNT 1130 Titanium	05	F
TNT 1130 Tornado Naked Tre	06-07	F
TRE-K 1130	06-07	F
Trek 1130 Amazonas	07	F

## BMW

F 800 S/ST	06-07	F
G 650 Xmoto	07	F

## BREMBO

20 6800 10/20 4 piston (two pin pad fixing)

## CAGIVA

Raptor 650	00-07	F
1000 Raptor/V-Raptor	00-05	F

## DUCATI

400 Monster/Dark	00-04	F
600 Monster	00-01	F
620/IE/SIE Monster	02-04	F
620 Sport	03	F
Monster 620 Dark	03-04	F
Monster 620 Catwoman	05	F
Multistrada 620 Dark	05-06	F
748 Racing/SPS	98	F
748 Biposto	99	F
748 Racing	99	F
748 SPS	99	F
748 Biposto	00-02	F
748 R/RS/S	00	F
748 S	01-02	F
748 Testa Bassa	01	F
748 E		F
750 Supersport	99	F
750 Supersport IE	00-02	F

### Equivalent OE #

06455 MY9 871	8113754	R30000126000
4HM W0045 00	8113720	2202492
4HM W0045 50	8133614	1D2 W0045 00
59100 03860	8000 88772	211082018
613 4 0201 A	8000 95542	4KG W045 10
613 4 0211 B	000016546300	107 6708 21
613 4 0411 A	587 13 030 000	

### MATERIAL AVAILABILITY AND PART NO.

STD	OPTIONS			
FA	HH	R	MXS	GFA
FA244	FA244HH	-	-	GFA244HH

750 Sport	01-02	F
750 Monster	0-01	F
Monster 800/IE/SIE	03-04	F
800 Sport	03	F
800 Supersport	03-04	F
900 Supersport	98-99	F
900 Supersport IE	00-01	F
900 Sport	02	F
900 IE Monster	00-01	F
900 MH Evoluzione	00-01	F
916 SPS (996cc)	98	F
Sport Touring ST4-916cc	99-03	F
Monster S4	01-03	F
Sport Touring ST2-944cc	97-02	F
996	98	F
996 SPS/SPS II	99-00	F
996	00	F
996 S	01	F
Monster S4R (996cc)	03-06	F
Sport Touring ST4S 996cc	01-05	F
Sport Touring 996cc ST4S-ABS	03-05	F
S2R (992cc)	06	F
STS 3 (992)	04-05	F
ST3S (ABS Model)	06-07	F
998	02-03	F
Multi Strada 1000 DS/1000 SDS	03-06	F
1000 Supersport DS	03-06	F
Monster 1000 IE/SIE	03-05	F
Multistrada 1100/1100 S (1078cc)	07	F

## HONDA

CB 400 SF (F3V) Superfour	97	F
---------------------------	----	---

## HUSQVARNA

SM 610 (6 bolt front disc)	98-00	F
SM 610/S (4 bolt front disc)	02-06	F
SM 610 R	00	F
LT 610 (6 bolt front disc)	00	F

## KTM

SMC 625	05	F
Duke II 640 (All models)	01-00	F
SMC 640 LC4	05	F
SMC 660	05-06	F
690 Supermoto	07	F

## MAGNI

Sport 1200 'S'	01	F
----------------	----	---

## MOTO GUZZI

Breva V 750 IE	03-07	F
Nevada Classic 750 ie	05-07	F
Nevada 750 Touring	07	F
Breva 850	07	F
Griso 850	07	F
Norge 850	07	F
940 Custom	07	F
Breva V1100	05	F
Breva 1100 (ABS)	07	F
Griso 1100	05	F
VII (All models)	99-06	F
California EV/Special/Jackal	01	F
California Classic 1100	07	F
V 1100 Breva	04	F
Breva 1100	05-06	F
Griso 1100	05-07	F
Griso 1100 (8 valve) (Radial caliper)	07	F
Norge 1200	06-07	F
1200 Sport	07	F

## MOTO MORINI

Corsaro 1200	05-06	F
Corsaro 1200 Veloce	07	F
MM3 (1187cc)	07	F
9 1/2 (998cc)	06	F

## SCORPA

Raidster 660	07	F
--------------	----	---

## SUZUKI

GSX 400 X Impulse	99	F
GSX 400 FSV/FSK1 (GK7B) Inazuma	00	F
GSX 1200 FSW/FSX 'Inazuma'	98-99	F

## VICTORY

Victory All models	98-07	F
--------------------	-------	---

## VOXAN

Black Magic	04-05	F
VB1-Evo	03-04	F
Cafe Racer	06	F
Roadster	06	F

## YAMAHA

FZ 400	96	F
XJR 400 (4HM3/4HM5/4HM6/4HM9/4HMA/4HMB) Brembo calipers)	95-99	F
XT 660 X Supermoto	04-07	F
XJR 1300 (5EA1/5EA7 Brembo calipers (320mm front discs)	98-99	F

### Competitor X Ref

Dunlop	Ferodo	SBS	Vesrah
DP630	FDB2042	706/727	-

# FA245 94 x 37.3 x 8mm

**APRILIA**  
RST 1000 Futura

01-04 R



1 Left/1Right

Equivalents OE #

8133516

Competitor X Ref

<b>Dunlop</b> DP628	<b>Ferodo</b> FDB2039R	<b>SBS</b> 742	<b>Vesrah</b> VD947
------------------------	---------------------------	-------------------	------------------------

MATERIAL AVAILABILITY AND PART NO.				
STD	OPTIONS			
FA	HH	R	MXS	GFA
FA245	FA245HH	-	-	-

DISC PADS  
BUYERS GUIDE

# FA246 USE FA407

# FA249 91.6 x 51.5 x 8.5mm

# FA249/2 91.6 x 51.5 x 12mm

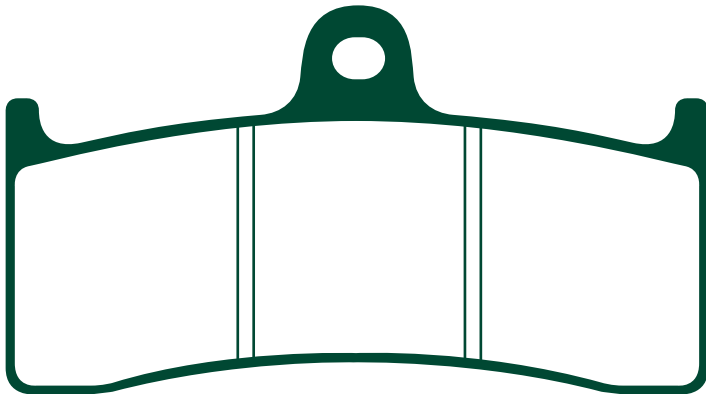

**PERFORMANCE MACHINE**

112X6B  
112X6QC

**PRE TECH**

6 Piston (Radial Mount)

**FA249/2**

Behringer Endurance Caliper

Competitor X Ref - FA249

<b>Dunlop</b> DP324	<b>Ferodo</b> FDB2036	<b>SBS</b> 779	<b>Vesrah</b> VD437
------------------------	--------------------------	-------------------	------------------------

MATERIAL AVAILABILITY AND PART NO.				
STD	OPTIONS			
FA	HH	R	MXS	GFA
FA249	FA249HH	-	-	GFA249HH

MATERIAL AVAILABILITY AND PART NO.				
STD	OPTIONS			
FA	HH	R	MXS	GFA
FA249/2	-	-	-	GFA249/2HH

# FA251 A. 55.5 x 37 x 10mm B. 85 x 43 x 8mm

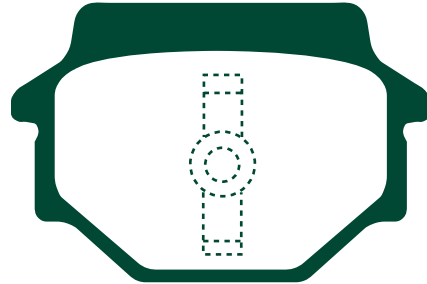
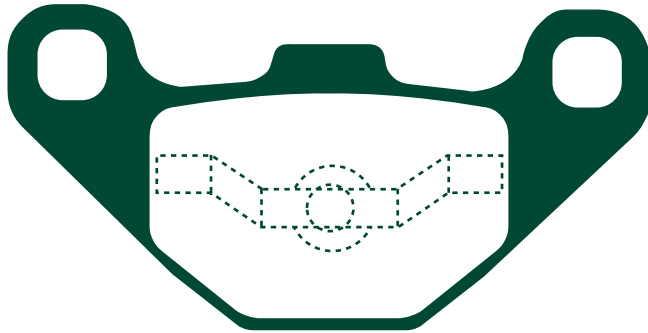

## BUELL

S2 "Thunderbolt"	94-97	R
S3 "Thunderbolt"	94-97	R
M2 Cyclone	94-97	R
S1 Lightning	94-97	R

## HUSABERG

Enforcer four 400/501/600 & Quad	99	R
----------------------------------	----	---

## HUSQVARNA

CR 125	91	R
WR 125	91	R
WR 240	90-91	R
CR 250	91	R
WR 250	90-91	R
WR 260	90-91	R
TE 350	90-91	R
TE 510	90	R
TC 510	90	R
TC 610	91	R
TE 610	91	R

## Equivalents OE #

42385 94Y
8000 60195

## Competitor X Ref

Dunlop	Ferodo	SBS	Vesrah
DP310	FDB314	692	-

## MATERIAL AVAILABILITY AND PART NO.

STD	OPTIONS			
FA	HH	R	MXS	GFA
FA251	-	-	-	-

# FA252 50.4 x 69 x 8.7mm GFA252HH (Race use only)

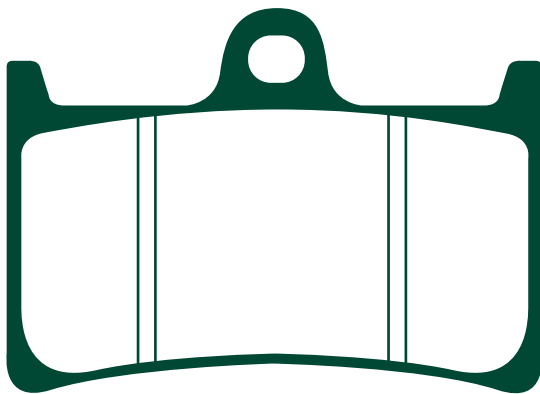

## YAMAHA

TZR 125 R	93-	F
TZR 250 R (3XV8/9)	92-94	F
TZR 250 (3MA1)	89	F
TZR 250 (3MA3/A5)	90	F
TZR 250 SP (3MA4)	90	F
TZR 250 R (3XV1/4/6)	91	F
FZR 400 RR (4DX)	92	F
FZR 400 RR (3TJ1/2/6/7)		F
FZS 600 Fazer	98-03	F
FZ6 S2 ABS (Naked)	07	F
YZF 600 R "Thundercat"	96-03	F
YZF 'R6'	99-04	F
YZF-R7 750 '0W02' (Road version)	99-01	F
TDM 900 P/R/S/T/V	02-07	F
TDM 900 AT/AW/AW (ABS)	05-07	F
FZS 1000 Fazer	01-05	F
YZF 1000 R "Thunderace"	96-02	F
YZF R1	98-03	F
BT 1100 P/R/S/T/V Bulldog	02-06	F
FJR 1300 N/P	01-02	F
FJR 1300 R/AR/S/AS/AT/T (ABS)	03-05	F
XJR 1300 L 5EA2/5EA3/5EA4	99	F
XJR 1300 M 5EAA/5EAB/5EAC	00	F
XJR 1300 5EA9/5EAG (298mm front disc)	00	F
XJR 1300 N/P 5EAP/5EAR/5EAS/5EAT		F
/5EAW/5EAV/5EAY (298mm front disc)	01-02	F
XJR 1300 R/S 5WMA/5WM3/5WM5/5WM6		F
/5WM7/5WM9	03-04	F
XJR 1300 T/W 5WMA/5WMC/5WMD/5WME	05-07	F
XJR 1300 SP (L) 5EA5/5EA6/5EA8	99	F
XJR 1300 SP (M) 5EAD/5EAE/5EAF	00	F
XJR 1300 SP (N) 5EAL/5EAM/5EAN	01	F
XV 1700 PCR	03-05	F
XV 1900 A Midnight Star	06-07	F

## Equivalents OE #

3JD W0046 00	4SV W0045 00	5SL W0045 00
3MA W0045 00	4XV W0045 00	
3TJ W0045 00	5JJ W0045 00	

## Competitor X Ref

Dunlop	Ferodo	SBS	Vesrah
DP418	FDB605	634	VD-249

## MATERIAL AVAILABILITY AND PART NO.

STD	OPTIONS			
FA	HH	R	MXS	GFA
FA252	FA252HH	-	-	GFA252HH

# FA254 59.75 x 57 x 8.0mm

**NOTE: Refit O/E  
shim & insulator)**

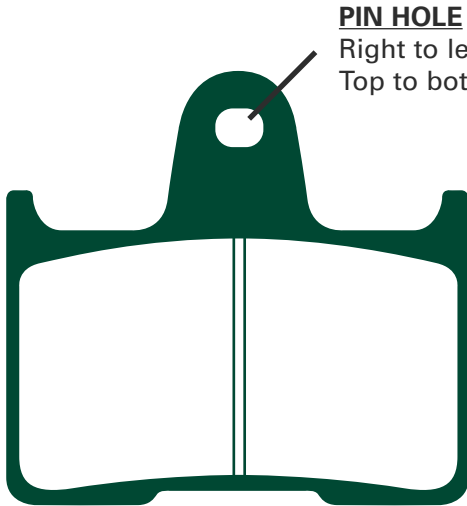

**PIN HOLE**  
Right to left 7.3mm  
Top to bottom 6.2mm

<b>HONDA</b>	
CB 400 SFX/SFY/SF1/SF2/SF3 Super Four	99-03 F
'X4' CB 1300 DCV (5C38)	97- R
CB 1300 FW/FX/FY/F1 (SC40)	98-01 R
<b>KAWASAKI</b>	
ZX-7RR (ZX750 N1/N2)	96-99 R
GTR 1400 (ZG 1400 A8F)	07 R
ZZR 1400 (ZX 1400 A6F/A7F)	06-07 R
ZZR 1400 ABS (ZX 1400 B7F)	07 R
<b>MZ/MUZ</b>	
1000 S	03-07 R
1000 SF	05-07 R
1000 SFX	07 R
1000 ST	07 R
<b>SUZUKI</b>	
GSXR 600 K4/K5	04-05 R
GSF 650 K5/SK5 Bandit	05 R
GSXR 750 K4/K5	04-05 R
GSXR 1000 K1/K2/K3/K4/K5/K6	01-06 R
GSF 1200 SSK1/ZK1 (GV78A)	02 R
GSX 1400 K1/K2/K3/K4/K5/K6/K7	01-07 R

**Equivalents OE #**

43082 1182	69100 40820	06435 MCE 006
43082 0055	69100 40840	
06435 MAZ 006	69100 18810	

**Competitor X Ref**

<b>Dunlop</b> DP220	<b>Ferodo</b> FDB211	<b>SBS</b> 715/765	<b>Vesrah</b> VD436
------------------------	-------------------------	-----------------------	------------------------

**MATERIAL AVAILABILITY AND PART NO.**

STD	OPTIONS			
FA	HH	R	MXS	GFA
FA254	FA254HH	-	-	-

# FA255 30.5 x 49 x 7.0mm

<b>PIAGGIO</b>	
Sfera RST 50	95-97 F
Sfera 125	95-97 F

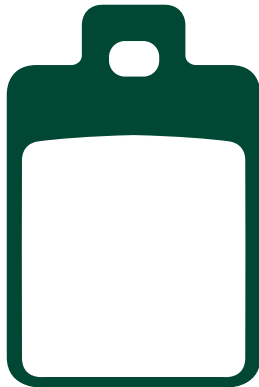

**Equivalents OE #**

498846
--------

**Competitor X Ref**

<b>Dunlop</b> -	<b>Ferodo</b> FDB2037	<b>SBS</b> 712	<b>Vesrah</b> VD955
--------------------	--------------------------	-------------------	------------------------

**MATERIAL AVAILABILITY AND PART NO.**

STD	OPTIONS			
FA	HH	R	MXS	GFA
FA255	-	-	-	-

# FA256 78.7 x 47 x 7.4mm

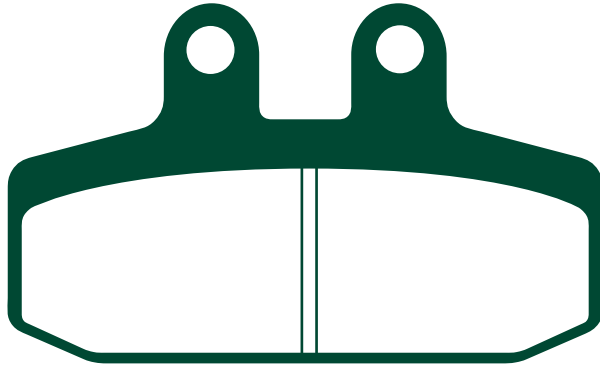

### Equivalents OE #

159 07 6340	45105 KR1 862	45105 KBS 405	06435 KBS W00
238 070 5 6340	45105 KR1 863	8000 88725	8113431
326 814	45105 KS3 901	8113865	06455 GAV 405
344839	45105 KS3 902	8133540	
45105 KB9 960	45105 KY4 901	8133724	
45105 KR1 861	45105 KY4 902	8133725	

### Competitor X Ref

Dunlop	Ferodo	SBS	Vesrah
DP108	FDB438/2146	588/793	VD152

MATERIAL AVAILABILITY AND PART NO.					
STD	OPTIONS				
FA	TT	HH	R	MXS	GFA
FA256	FA256TT	FA256HH	-	-	-

<b>APRILIA</b>			
Scarabeo 125/150/200	99-02	F	
Classic 125	96-01	F	
Sport City 125/200	04-07	F	
Red Rose 125	87-94	F	
Tuareg Rally 125 (L/M)	90-91	F	
Leonardo 250 ST/SP	00-04	F	
Sport City 250 ie	07	F	
Leonardo 300	05-06	F	
Scarabeo 400 ie	07	F	
Atlantic 500	02-04	F	
Scarabeo 500/500 AB3	03-06	F	
Scarabeo 500 Light	06	F	
Scarabeo 500 ie	07	F	
Scarabeo 125/200	03	F	
<b>CAGIVA</b>			
Blues 125	92-95	F	
Roadster 125	98-99	F	
<b>DERBI</b>			
Boulevard S125	07	F	
<b>GARELLI</b>			
50 Tiger XLE	86-	F	
125 Tiger XLE	86-	F	
<b>GILERA</b>			
Cougar 125	99-02	F	
125 XR1/XR2	89-	F	
200 Arizona Hawk	85-	F	
200 RTX	85-	F	
200 ER	87-	F	
200 Fast Bike	87-	F	
RV 200 ES	87-	F	
RC 250 Rally	87-	F	
350 Dakota	85-	F	
ER 350	87-	F	
XRT 350	90-	F	
500 Dakota	87-	F	
ER 500	87-	F	
XRT 600	88-	F	
<b>HONDA</b>			
SJ 50 P/R/S/T/V/W/X 'Bali'	93-99	F	
SJ 100 T/V/W/X 'Bali-Ex	96-99	F	
CA 125 V/W/X 'Rebel'	98-00	F	
CLR 125 W 'City Fly'	98-03	F	
CRM 125 RL/RM/RN/RP/RR/RV/RX	90-99	F	
NS 125 FG/FH/RH	86-90	F	
NSR 125 FM/RK/RL/RM/RN/FP/RP			
/RR/RV/RW/RX/RY/R1	91-04	F	
NX 125 K/S/F Transcity	89-97	F	
XL 125 L Paris-Dakar	85	F	
XL 200 L	85	F	
CMX 250 CV/CW/CX 'Rebel'	97-00	F	
<b>MALAGUTI</b>			
Spider Max GT500	04-07	F	
<b>MOTO MORINI</b>			
350 'Kanguro'	87	F	

DISC PADS BUYERS GUIDE

# FA257 41.1 x 43 x 7.7mm

# FA257/2 41.1 x 43 x 5.3mm

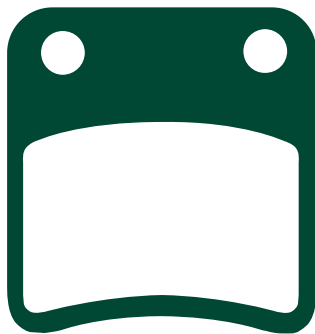

<b>CAGIVA</b>			
City 50	91-94	F	
<b>DAELIM</b>			
'S' Five (SJ50)	01-07	F	
E-Five (SJ50A)	03-06	F	
GZ 50 Message	97-02	F	
Delfino 100 (SH100)	01-04	F	
<b>GARELLI</b>			
Panther 125/150/250	02	F	
<b>HONDA</b>			
Tact 50		F	
SK 50 MM-II/MM-YD/MM-II/MP-II (AF28) Dio SR			
SK 50 MN-III/MP-III/MP-IV (AF28) Dio-ZX			
SK 50 MMR-II/MMP-II (AF28) Dio-XR			
<b>SYM</b>			
Super Fancy 50	96-02	F	
City Hopper 50	99-02	F	
<b>FA257/2</b>			
FJS 600 1/2/A3/D3/A4/D4/A5/D5/A6/D6/A7			
(Parking brake)	01-07		
<b>GILERA</b>			
Fuoco 500 IE	07		
(Parking brake)			
<b>PIAGGIO</b>			
MP3 125/250/400	07		
(Parking brake)			

### Equivalents OE #

45105 GZ0 ACA	45105 G02 000
45112 GZ0 315	45105 SE5 5001E
Y00 FA0112	45105 GAZ 5000 EU
45105 G22 000 AC	450105 GAZ 9800

### Equivalents OE #

<b>FA257/2</b>
06436 MCT 006
648476

### Competitor X Ref

Dunlop	Ferodo	SBS	Vesrah
-	-	670	VD162

MATERIAL AVAILABILITY AND PART NO.					
STD	OPTIONS				
FA	HH	R	MXS	GFA	
FA257	-	-	-	-	-
FA257/2	-	-	-	-	-



# FA258 A. 26.10 x 119.55 x 7.1mm B. 35.60 x 94.54 x 7.80mm

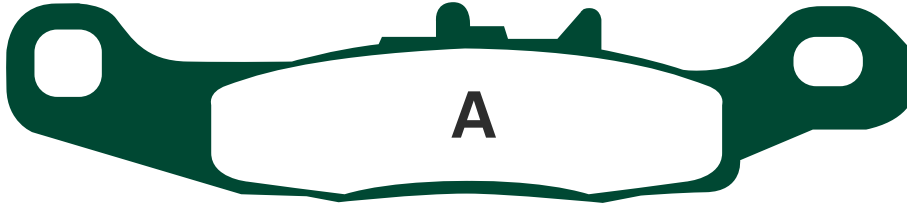
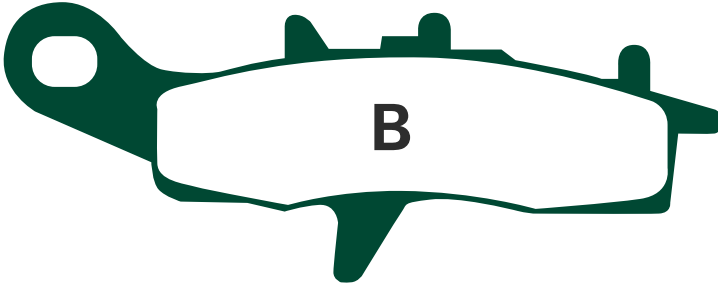

### KAWASAKI

KX 80 R7/W1/W2/W3	97-00	F
KX 85/85 II A1-A5/A6F/A7F/B1-B5/B6F/B7F	01-07	F
KX 100 B7/C1/C2/C3	97-00	F
KL 250 G1/G1A Super Sherpa	97	F
KL 250 J1-J3 Stockman	00-02	F
KLX 250 H1 'Super Sherpa'	98	F

### SUZUKI

RM 85 K5/LK5/K6/LK6/K7/LK7	05-07	F
RM 100 K3	03	F

### Equivalents OE #

43082 1196
43082 1206
K4308-21196
59301 03820

### Competitor X Ref

Dunlop	Ferodo	SBS	Vesrah
DP326	-	726	VD438

### MATERIAL AVAILABILITY AND PART NO.

STD	OPTIONS			
FA	HH	R	MXS	GFA
FA258TT	-	FA258R	-	-

# FA259 USE FA231

# FA260 35.86 x 49 x 7.0mm

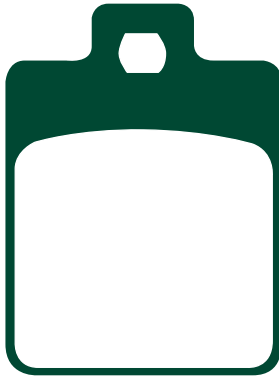

### CPI

GTR 50	03-07	R
GTS 50/125/200	02-03	R
GTR 50/125/200	02	R

### GENERIC

Toxic 50	07	R
----------	----	---

### GILERA

DNA 50	01-06	R
50 DD/SP Runner/Purejet	99-05	R
SKP 50	99-01	R
Stalker 50	97-03	R
Stalker 50	03-06	R
Runner 50 PJ/SP	06-07	R
125/180 Runner All models	99-04	R
FUOCO 500 IE	07	F

### LML

Star 125 DLX		F
--------------	--	---

### PIAGGIO

NRG 50 RST "MC2"	98	R
Zip 50 RST	96-99	F
Zip 50 SP	96-00	F
Liberty 50 2T (Grimeca Caliper)	97-07	F
Liberty 50 (Heng Tong Caliper) (2T)	97-07	F
NRG 50 Extreme	99-01	R
NRG 50 MC3 DD	01-05	R
NRG 50 DD	06-07	R
NRG 50 Pure Jet	06-07	R
Zip 50 Grimeca caliper	00-07	F
Zip 50 SP (Liquid Cooled)	01-04	F
Liberty 50 4T (Grimeca caliper)	00-07	F
Liberty 50 4T (Heng Tong caliper)	00-07	F
Liberty S 50 (2T/4T)	07	F
Zip 100	07	F
Liberty 125/200	98-07	F
Liberty S125	07	F
Zip 125	00-04	F
MP3 125 (All models)	06-07	F
Liberty S 200	07	F
MP3 250 ie (All models)	06-07	F
MP3 400 ie (All models)	07	F

### VESPA

Vespa ET2 50	97-05	F
Vespa ET4 50 (Grimeca caliper)	00-04	F
Vespa ET4 125	96-99	F
Vespa ET4 125/150	99-05	F
Vespa ET4 (Heng Tong Caliper)	00-04	F
LX 50 (2T&4T)	05-07	F
LXV 50	07	F
LX 125/150 (4T)	05-07	F
LXV 125	07	F

### Equivalents OE #

494097	498846	647157
494938	494938	647073

### Competitor X Ref

Dunlop	Ferodo	SBS	Vesrah
DP635	FDB2057	724	N/A

### MATERIAL AVAILABILITY AND PART NO.

STD	OPTIONS			
FA	HH	R	MXS	GFA
FA260	FA260HH	-	-	-

# FA261HH 115.60 x 41 x 8.30mm (& shim)

Linked Brake - fit all three sets at pad change

# FA261/2HH 115.60 x 41 x 11.50mm (& shim)



**A**



**B**

### Equivalents OE # FA261HH

06435 MAJ G41	06455 MCA 006
06435 MAT 006	06455 MCC 006
06435 MCC 006	06455 MCH 006
06435 MCH 006	06455 MBG 005
06435 MBL D01	06455 MBT 611
06435 MCS G01	06455 MCS G01
06435 MBL D01	06455 MCT 691
06455 MAJ G41	06456 MCA 006
06455 MAT 006	06456 MCC 006
06455 MAT E21	

### Equivalents OE # FA261/2HH

06435 MCA 006

### Competitor X Ref

Dunlop	Ferodo	SBS	Vesrah
DP124/5/6 DP128	FDB2073	721/722	VD165

MATERIAL AVAILABILITY AND PART NO. OPTIONS					
STD	FA	HH	R	MXS	GFA
-	-	FA261HH	-	-	-

MATERIAL AVAILABILITY AND PART NO. OPTIONS					
STD	FA	HH	R	MXS	GFA
-	-	FA261/2HH	-	-	-

### HONDA - FA261HH

FJS 400 D6 Silverwing	06	F
NT 650 V2/V3/V4/V5	02-05	F&R
NT 700 V6/VA7 Deauville	06-07	R
VFR 800 FiW/FiX/FiY/Fi1/2/3/4/5/A2/A3/A4/A5	98-05	F&R
VFR 800 6/7/A6/A7	06-07	R
XL 1000 VX/VY/V1/V2/V3/V4/V5/V6 'Varadero'	99-06	F&R
XL 1000 A4/VA4/VA5/VA6/VA7 Varadero	04-07	R
CB 1100 SFY/SF1 "XII"	00-04	F&R
CBR 1100 XXV/XXW/XXX/XXY/XX1/XX2/XX3		
/XX4/XX5/XX6 'Blackbird'	97-07	F&R
ST 1100 AT/AV/AW/AX/AY/A1		
'Pan European'	96-01	F&R
ST 1300 2/A2/3/A3/4/A4/5/A5/6/A6 'Pan European'	02-06	F&R
GL 1800 A1/A2/A3/A4/A5/A6/A7 "Goldwing"	01-07	F
VTX 1800 C2/C3/C4/C15	02-05	F&R

### HONDA - FA261/2HH

GL 1800 A1-A7	02-07	R
---------------	-------	---

# GFA263HH 100.5 x 34 x 9mm

LOCKHEED SIX PISTON CALIPER (4466/67 Type)

PFM 6 Piston Superbike caliper

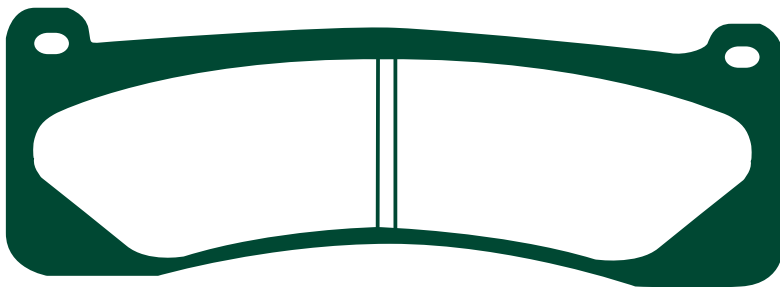

**RACE USE ONLY**

### Equivalents OE #

4466 / 4477

### Competitor X Ref

Dunlop	Ferodo	SBS	Vesrah
RDP629	FDB2043 FDB2167	707	-

MATERIAL AVAILABILITY AND PART NO. OPTIONS					
STD	FA	HH	R	MXS	GFA
-	-	-	-	-	GFA263HH

# FA264

A. 85.1 x 42.9 x 8.2mm  
B. 69.8 x 41 x 8.2mm

**Equivalents OE #**

45105 H13 000 AC	Y00FA1409	45106 SB3 0001M1
45105 G22 000 AC	413612	
45105 G02 000 AS	45105 SB3 0001M1	

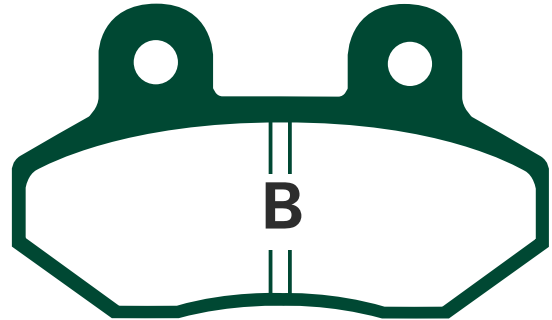
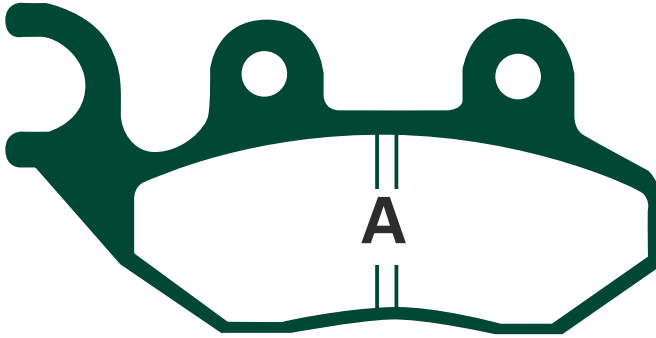

**CAGIVA**

Stella 50	97	F&R
Passing 125	93-97	F

**DAELIM**

SJ 50 R A-Four (50cc)	06-07	F
-----------------------	-------	---

**GARELLI**

KRS 50		F
Joker 125/150	02	F
Freeland 125/150		F

**PGO**

Big Max 50 S	03-04	F
G-Max 50	05-07	F
TR-3 50 (Trike)	03-04	F
My Bubu 100/125	03-05	F
T/Rex All models	99-06	F
Charge 125 A/B	00-02	F
i-Charge 125	03-05	F
PMX 50/110	00-07	F
Young Bubu 100/125	03-05	F
Ligero 125	06	F

**SYM**

Mask 50	00-05	F
Jet Basix 50	06-07	F
Jet 50/Euro XS	99-05	F
Jet Euro X 50/100	06-07	F
Jet Sport X 50 (R/S/SR)	06-07	F
Red Devil 50	99-05	F
Jungle 50	99-02	F
Jet 100 (G100P-6)	99-00	F
Attila 125	99-00	F
HD 125 S Evo	07	F
Super Duke 125/150	99-00	F
Megalo 125	00-06	F
H 200 SE	06	F
HD 200 S Evo	07	F

**TGB**

Akros Tec (50)	03-04	F
Delivery 50 Scooter (Up to E/F No 609099)	04-05	F
202 Classic	03-04	F
101 R (50/125/150)	05-06	F
203	05-06	F
Platform (50/125/150)	06	F

**Competitor X Ref**

Dunlop	Ferodo	SBS	Vesrah
-	FDB2190	708	VD9012

**MATERIAL AVAILABILITY AND PART NO.**

STD	OPTIONS			
FA	HH	R	MXS	GFA
FA264	-	-	-	-

# FA265HH

74.75 x 55.4 x 8.1mm (with fitted shim)

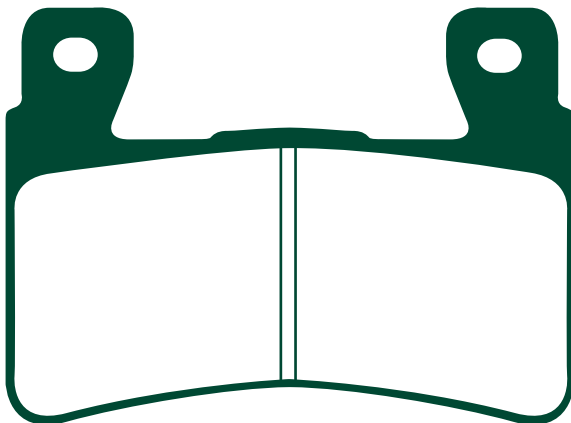

**Equivalents OE #**

06455 MAS E01	06455 MBW E11
06455 MCF 006	06455 MFA D11

**HONDA**

CBR 900 RRW/RRX/RRY/RR1/RR2/RR3 'Fireblade'	98-03	F
VTR 1000 SPY/SP1 (SC45)	00-01	F
VTR 1000 SP-2/SP-3/SP-4/SP-5/SP-6	02-06	F
CB 1300 F1 (SC40)	01	F

**Competitor X Ref**

Dunlop	Ferodo	SBS	Vesrah
DP127	FDB2079	734	VD166/2

**MATERIAL AVAILABILITY AND PART NO.**

STD	OPTIONS			
FA	HH	R	MXS	GFA
-	FA265HH	-	-	GFA265HH

# FA266 54.05 x 50.90 x 7.50mm

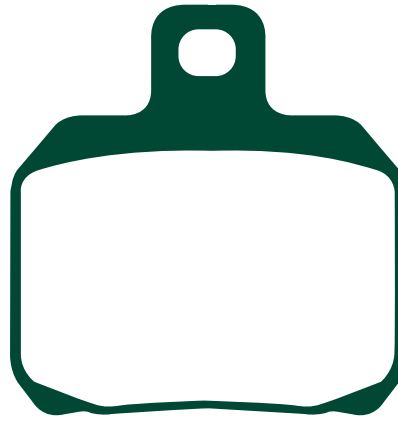

<b>APRILIA</b>		
RS 50	07	F
RSV 1000 (All models)	98-07	R
SL 1000 Falco	00-04	R
ETV 1000 Caponard/Raid/ABS	01-07	R
1000 (Tuono/Factory)	02-07	R
<b>BENELLI</b>		
2-UE (750cc)	07	R
TNT 899 Tornado Naked Tre	07	R
Trek 899	07	R
Tornado 900	02	R
Tornado LE/Tre Novecento/RS	03-05	R
TNT 1130 Sport/Sport Evo	04-07	R
TNT 1130 Cafe Racer	05-07	R
TNT 1130 Titanium	05-06	R
TRE-K 1130	06-07	R
Trek 1130 Amazonas	07	R
Tornado TRE1130 (Radial caliper)	06-07	R
Tornado Naked TRE TNT 1130	06-07	R
<b>BIMOTA</b>		
Elirio	06	R
DB5 (All models)	06-07	R
DB5R	06-07	R
DB6 Delirio 992cc Ducati engine)	07	R
<b>BOMBARDIER</b>		
Traxter (4x4)	99-01	F&R
<b>BREMBO</b>		
20 6950 51 (P32G) Single pad fixing 2 piston		
20 6951 50/45 (P34G) Single pad fixing 2 piston		
<b>CAGIVA</b>		
Raptor/V-Raptor 650	00-07	R
1000 Raptor/V-Raptor	00-05	R
<b>CPI</b>		
X-Large 125/150/200	02-03	F&R
GTR 50	03-07	F
<b>DERBI</b>		
GPR 50/Nude/ST (Radial Caliper)	04-07	F
Senda 50 DRD Pro SM Supermoto	05-07	F
Senda 50 DRD Pro R Enduro	05-07	F
GRP 80 Cup (Radial Caliper)	04-05	F
GP 125	06-07	F&R
GPI 150	05	F
GPI 250	06-07	F
GPI 250i	07	F
GPI Scooter (Radial caliper) "Euro 2"	Mar 05-Dec 05	F
Mulhacen 659	06-07	R
Mulhacen 659 Hot Bob	07	R
Mulhacen 659 Cafe	07	R
Mulhacen 659 X Vision	07	R
GPX1	06	F
GPI 250	06-07	R
<b>DUCATI</b>		
Monster 620 Catwoman	05	R
Multistrada 620 Dark	05-06	R
749/749 S/749 R	03-06	R
749 Dark	04-06	R
750 Supersport	99	R
750 Supersport IE	00-02	R
750 Sport	01-02	R
800 Supersport	03-04	R
900 Supersport	98-99	R
900 Supersport IE	00-01	R
900 Sport	02	R
900 MH Evoluzione	00-01	R
Desmosedici RR (D16RR) (989cc)	07	R
Sport Touring ST4-916cc	99-03	R
Sport Touring ST2-944cc	97-02	R
Sport Touring ST4S 996cc	01-05	R
Sport Touring 996cc ST4S-ABS	03-05	R
Monster S4R (996cc)	03-06	R
STS 3 (992cc)	04-05	R
ST3S (ABS Model)	06-07	R
999/999 S/999 R	03-06	R
Multi Strada 1000 DS/1000 SDS	03-06	R
1000 Supersport DS	03-06	R
999 R (Xerox)	06	R
1098/1098 S/1098 Tricolore	07	R
Hypermotard	07	R
Multistrada 1100/1100 S (1078cc)	07	R
<b>GILERA</b>		
Nexus 500	03-07	R
<b>KEEWAY</b>		
Silverblade 125/150/250	07	R
<b>LAVERDA</b>		
SFC 1000	03-04	R
<b>MALAGUTI</b>		
NKD 50 Drakon	05-07	F
Drakon S	06	F
<b>MBK</b>		
XQ 125/150 Thunder	01-03	R
YP 125 D Skyliner	00-06	R
XP 125 Skycruiser	06	R
<b>MONDIAL</b>		
Piega 1000	03-04	R
EVO	04	R
<b>MOTO GUZZI</b>		
1100 California EV	98-00	R
Nevada 750 (Club)	98-04	R
Nevada Classic 750 ie	05-07	R

Nevada 750 Touring	07	R
V 750 ie Brevia	03-07	R
MGS-01	03-04	R
MGS-01 Corsa	07	R
V 1100 Brevia	04	R
Fionda 1100	05	R
<b>MOTO MORINI</b>		
Corsaro 1200	05-06	R
Corsaro 1200 Veloce	07	R
9 1/2 (998cc)	06	R
MM3 (1187cc)	07	R
<b>PETRONAS</b>		
FP1	05	R
<b>PIAGGIO</b>		
X8 125	04-05	R
X9 125	00-02	F&R
X9 125 Evolution	03-05	F&R
X9 180 Amalfi	00-03	F&R
X8 200	04-05	R
X9 200	02-03	F&R
X9 200 Evolution	03-04	F&R
X9 250/250 SL	00-04	F&R
X9 250 Linked brake f&r wheel 14" dia	04	R
Beverley B500	02-04	F&R
Beverley 500	06	F
Beverley Cruiser 500 ie	07	F&R
X9 500/500 SL	00-02	F&R
X9 500cc Evolution (inc ABS)	03-06	R
X9 500 ie	07	R
<b>RIEJU</b>		
Tango 125	06-07	F
<b>SUZUKI</b>		
UH 125 K2/K3/K4/K5/K6 Burgman	02-06	R
<b>TOMOS</b>		
SM 125	05	F
<b>VOXON</b>		
Cafe Racer	06	R
Roadster	06	R
<b>YAMAHA</b>		
XQ 125/150 Maxster	01-03	R
YP 125 Majesty	01-07	R
YP 125 X-Max	06-07	R
YP 180 Majesty	06	R
<b>VOXAN</b>		
Cyclope 1000	02	R
Cafe Racer 1000	02-05	R
Roadster 1000	02-05	R
Black Magic	04-05	R
Street Scrambler	03-05	R
VB1-Evo	03-04	R

**Equivalents OE #**

613 4 021 1A	497083	107 694 936
8113751	69130 49F00	862489
8113898	R180100127000	862698
494966	497394	861760
613 403 81A	09130 07E00	647077
5NR F5811 00	R44422001A	5NR F5811 10
8000 95280	8133542	

**Competitor X Ref**

<b>Dunlop</b>	<b>Ferodo</b>	<b>SBS</b>	<b>Vesrah</b>
DP631	FDB2074	730	-

MATERIAL AVAILABILITY AND PART NO.				
STD	OPTIONS			
FA	HH	R	MXS	GFA
FA266	FA266HH	FA266R	-	-

# FA267 51.85 x 59.75 x 8.90mm

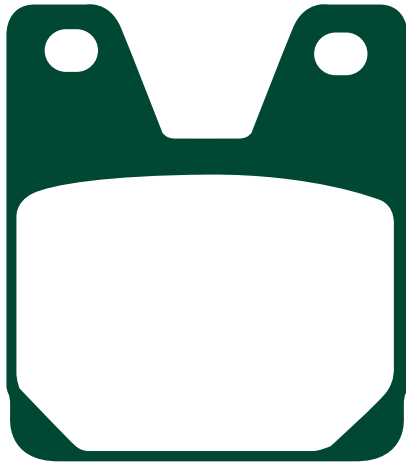

## YAMAHA

YZF 1000 R1	98-00	R
YZF R7 750 'OWO2' Road version	99-00	R
XJR 1300 (5EA9/5EAG) (298mm front disc)	00	R

### Equivalents OE #

4XV W0046 00
4XV W0046 10
5EA W0046 50
5FL W0046 50

### Competitor X Ref

Dunlop	Ferodo	SBS	Vesrah
DP419	FDB2084	733	VD264

### MATERIAL AVAILABILITY AND PART NO.

STD	OPTIONS			
FA	HH	R	MXS	GFA
FA267	FA267HH	-	-	-

# FA268 45.80 x 52.80 x 6.50mm

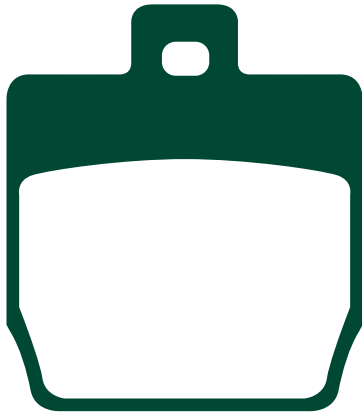

## YAMAHA

YQ 50 Aerox R	97-07	R
EW 50 Slider	00-05	F

## MBK

EW 50 Stunt	00-06	F
YQ 50 Nitro	97-06	R
EW 50 Stunt Naked	05-06	F

### Equivalents OE #

5BR F5811 00

### Competitor X Ref

Dunlop	Ferodo	SBS	Vesrah
DP013 DP422	FDB2062	731	-

### MATERIAL AVAILABILITY AND PART NO.

STD	OPTIONS			
FA	HH	R	MXS	GFA
FA268	-	-	-	-

# FA269 use FA234

# FA270 73.85 x 52.8 x 6.82mm

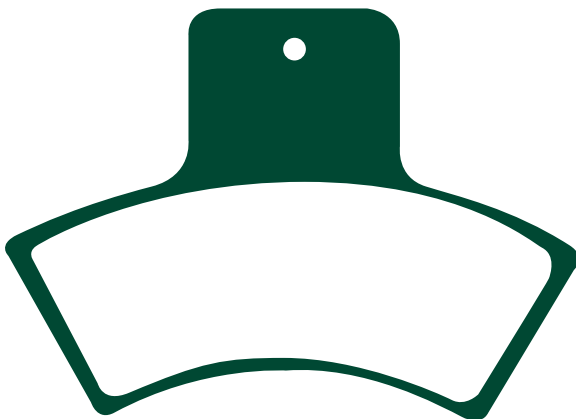

## POLARIS

Most models 98 onwards. Check application pages for fitment details.

## QUADZILLA

Quadzilla 300 "Utility"	04-06	R
300 E SUV	06	R
300 E (4x4) (Auto)	06-07	R
400 4x4	06-07	R

### Equivalents OE #

1910339	2201189
1930860	2201399
1910333	2201732
2201093	22111

### Competitor X Ref

Dunlop	Ferodo	SBS	Vesrah
DP915	FDB2121	755	-

### MATERIAL AVAILABILITY AND PART NO.

STD	OPTIONS			
FA	HH	R	MXS	GFA
FA270TT	-	FA270R	-	-

# FA271 67.6 x 43.95 x 7.7mm

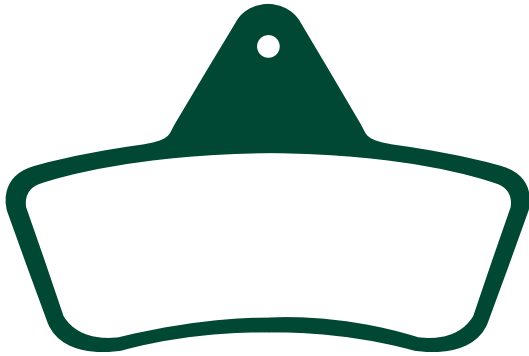

### ARCTIC CAT

Most models 96-04 F&R  
Check application fitment details

### LAVERDA

Quasar 4x4 500c 04 F&R  
Quasar 4x4 500 04 F&R  
Quasar 4x4 400 04 F&R

### MASSEY FERGUSON (ATV)

MF 250 (2WD/4WD) 04 F&R  
MF 300 (2WD/4WD) 04 F&R  
MF 400 4WD 04 F&R  
MF 400 Auto 4WD 04 F&R  
MF 500 (Auto 4WD) TBX Auto 04 F&R

### Equivalents OE #

0502 019	0402 096	0402 494	0402 882
----------	----------	----------	----------

### Competitor X Ref

Dunlop	Ferodo	SBS	Vesrah
DP914	FDB2175	758	-

MATERIAL AVAILABILITY AND PART NO.				
STD	OPTIONS			
FA	HH	R	MXS	GFA
FA271TT	-	FA271R	-	-

# FA272 39.6 x 44.4 x 7mm



### AP LOCKHEED

Caliper no. CP4226.4 R

### Equivalents OE #

CP4226-4
----------

### Competitor X Ref

Dunlop	Ferodo	SBS	Vesrah
-	-	719	-

MATERIAL AVAILABILITY AND PART NO.				
STD	OPTIONS			
FA	HH	R	MXS	GFA
FA272	-	-	-	-

# FA273R 60.7 x 50.3 x 12.3mm

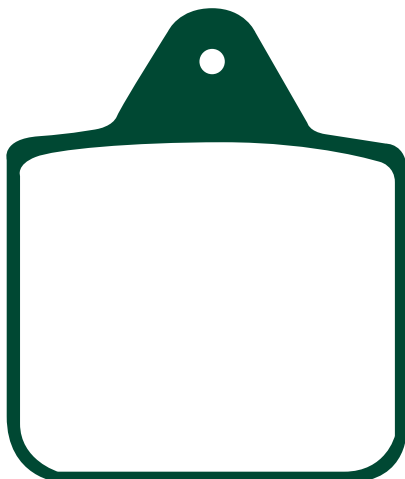

### POLARIS

Big Boss 400 L 6x6 96  
Big Boss 425 6x6 96 Middle Axle Brake  
ranger 99 R

### Equivalents OE #

2200807
---------

### Competitor X Ref

Dunlop	Ferodo	SBS	Vesrah
-	FDB2135	756	-

MATERIAL AVAILABILITY AND PART NO.				
STD	OPTIONS			
FA	HH	R	MXS	GFA
-	-	FA273R	-	-

# FA275 99.77 x 30.2 x 9mm

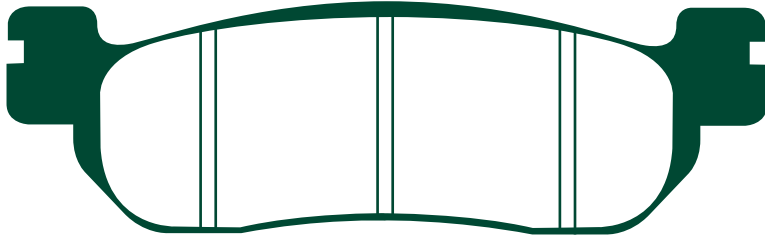

<b>YAMAHA</b>		
RZ 50 (5FC1/2)	02	F
T 105 E (5ER1/2) Crypton-R	99	F
T 105 SE Crypton (5EA3)	02	F
V 110 ZE/ZK/ZHE/ZHK		
FIZR/FIZR Sport	96	F
TW 125	99-04	F
TW 200 (2JL/4CS1/2/3/4/5/6/5LB1/2)	01-02	F
ST 225 (5BT) Bronco	97	F
TW 225 E (5VC1/2)	03	F
Serrow 250 (3C51/52)	05	F VP
250 W (X-City)	07	R
XG 250 Tricker (5XT1)	04-06	F
YP 250 (X-Max)	05-07	R
XT 250 X	06	F
YP 250 DX/A Majesty	98-03	R
YZF 600 R 'R6'	99-02	R
YZF 1000 R1	02-03	R
<b>MBK</b>		
YP 250 Skyliner 250 (+ABS)	98-02	R
<b>ITALJET</b>		
Jupiter 125/150	02	R

**Equivalents OE #**

4730480	5EK W0045 10
4JG W0045 00	5EB W0046 00
4US W0045 00	5GM W0046 00
3 YR W0045 00	5PW W0046 50
5CG W0046 00	5LB W0045 00
5CG W0046 20	5XT W0045 00

**Competitor X Ref**

<b>Dunlop</b>	<b>Ferodo</b>	<b>SBS</b>	<b>Vesrah</b>
DP420	FDB2083	728	VD265

**MATERIAL AVAILABILITY AND PART NO.**

STD	OPTIONS			
FA	HH	R	MXS	GFA
FA275	FA275HH	-	-	-

# GFA276HH 95.8 x 47.5 x 8.4mm

**Race use only**



**PVM**  
6 piston

**Equivalents OE #**

-
---

**Competitor X Ref**

<b>Dunlop</b>	<b>Ferodo</b>	<b>SBS</b>	<b>Vesrah</b>
-	-	-	VD9027

**MATERIAL AVAILABILITY AND PART NO.**

STD	OPTIONS			
FA	HH	R	MXS	GFA
-	-	-	-	GFA276HH

# FA281 115.6 x 41 x 9.3mm

**Equivalents OE #**

06455 KFG 016
06455 KFG 641
06455 KPB 406
119 481 00
754808

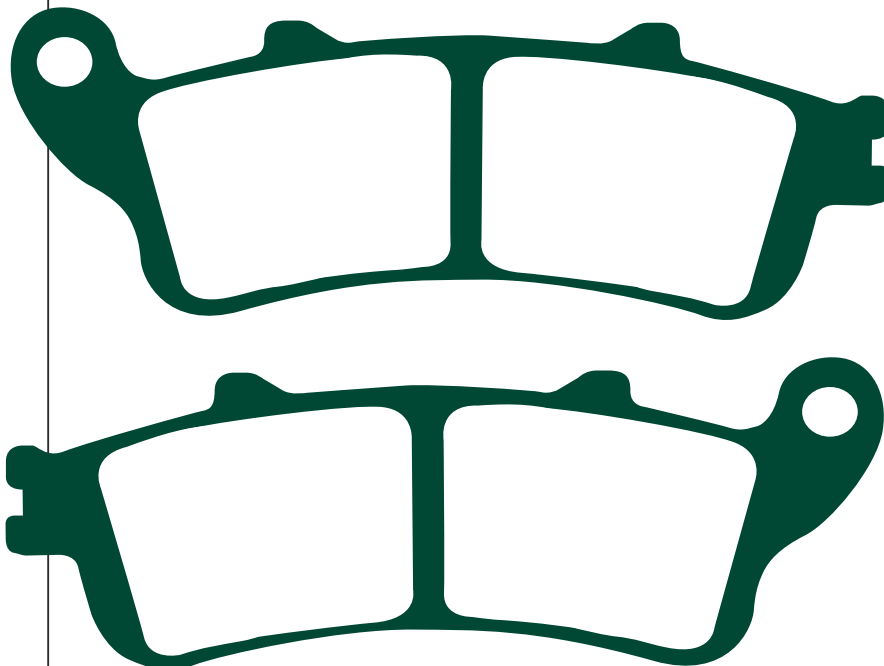

**GARELLI**

Skyнет 250/400	02	F
----------------	----	---

**HONDA**

FES 125 W/Y/1/2/3/4/5/6/7 Pantheon	98-07	F
FES 150 W/Y/1/2/3/4/5 Pantheon	98-06	F
FES 250 W/X/Y/1/2/5 Foresight	98-05	F
NSS 250 Y/AY/1/A1/A3/3 Forza/Forza-S		
/Forza-T/Forza-ST/Jazz/Reflex		
(MF04/MF06)	00-04	F
FJS 400 2 (NF01) Silverwing 400	01-02	F
FJS 400 D6 Silverwing	06	F
600 Silverwing Scooter FJS 600 1/2/A3/D3		
/A4/D4/A5/D5/A6/D6/A7	01-07	F

**PEUGEOT**

SV 250	01-02	F
--------	-------	---

**Competitor X Ref**

STD	OPTIONS			
FA	HH	R	MXS	GFA
FA281	FA261HH	-	-	-

<b>Dunlop</b>	<b>Ferodo</b>	<b>SBS</b>	<b>Vesrah</b>
DP124	FDB2075	722	-

# FA282R 31.25 x 35.85 x 5.12mm



## HUSQVARNA

Husky Boy 50

98-99 F&R

## HYOSUNG

TE 50

05-07 R

TE 90

05-07 R

TE 100

05-07 R

### Equivalents OE #

59300 21000

### Competitor X Ref

MATERIAL AVAILABILITY AND PART NO.				
STD	OPTIONS			
FA	HH	R	MXS	GFA
-	-	FA282R	-	-

Dunlop	Ferodo	SBS	Vesrah
-	-	-	-

# FA283 53.5 x 44.7 x 8.6mm

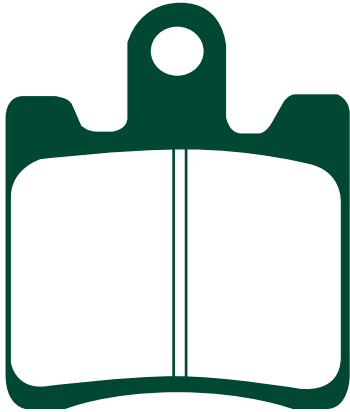

**NOTE:**  
2 sets  
required to  
replace one  
caliper set

## KAWASAKI

SC 250 A1 Epsilon

02-03 F

## SUZUKI

AN 250 W/X/Y Burgman

98-00 F

AN 250 K1/K2 Burgman

01-02 F

AN 400 X/Y/K1/K2 Burgman

99-02 F

AN 400 K3-K6

03-06 F

## SYM

GTS 250 Joymax

07 F

GT 500

04 F

### Equivalents OE #

59300 14870	59301 14810
59300 14880	59301 14820
43082 S002	

### Competitor X Ref

Dunlop	Ferodo	SBS	Vesrah
DP219	FDB2085	740	VD353

MATERIAL AVAILABILITY AND PART NO.				
STD	OPTIONS			
FA	HH	R	MXS	GFA
FA283	FA283HH	-	-	-

# FA291 43.8 x 56.8 x 6.45mm

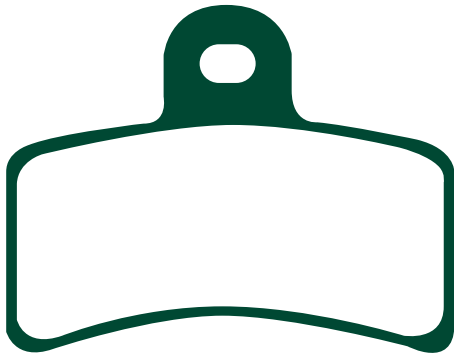

## FANTIC

Trial 50

06 F&R

## GAS GAS

Cross MC 50

06 F

125/200/249/270/280/321 TXT

99-03 F&R

50/80 TXT

01-02 F&R

50 EC Rookie

01-02 R

50 EC Boy

01 F&R

TXT Boy 50/280

01 F&R

EC Boy 50

01 F&R

EC 50 (Boy)

01-04 F&R

EC 50 (Rookie)

01-04 R

EC 50

05 R

TXT 50 (Boy)

01 F&R

TXT 50/80 (Rookie)

02-03 F&R

SM 50 (Rookie)

01-04 R

SM 50

05 R

Pampera 125/250/280

04 R

Pampera 250

02 R

SM 50 Rookie

01-02 R

TXT Rookie 50/80 Trail

06-07 F

TXT 200/270/321

99 F&R

TXT 125/200/249/280/321

00-03 F&R

Pampera 250

02-03 R

## BETA

RR Enduro Alu/Motard Alu

03- R

### Competitor X Ref

Dunlop	Ferodo	SBS	Vesrah
DP640	FDB2103	815	-

### Equivalents OE #

BT-27922065  
BT-280022065

MATERIAL AVAILABILITY AND PART NO.				
STD	OPTIONS			
FA	HH	R	MXS	GFA
FA291	-	-	-	-



**FA293S = Green**  
**FA293 = Blue**

**A. 22Ø x 5.95mm (Plain pin)**  
**B. 22Ø x 5.95mm (Thread pin)**

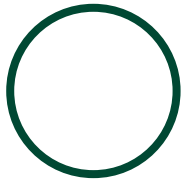

**MINI MOTO**  
Pasini/Polini/GRC  
**HRD**  
SX 50 Mini Cross

F&R

**Equivalents OE #**

143 750 009

MATERIAL AVAILABILITY AND PART NO.				
STD	OPTIONS			
FA	HH	R	MXS	GFA
FA293	-	-	-	-
FA293S (Green)				

**Competitor X Ref**

Dunlop	Ferodo	SBS	Vesrah
-	-	-	-

**FA294HH 81 x 45.9 x 7.7mm**

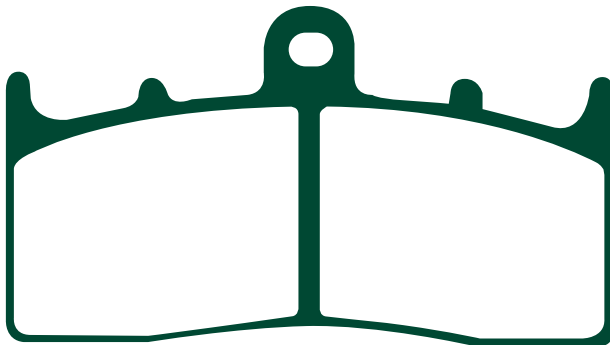

**BMW**

R 850 R	04-06	F
R 1100 S (with integral ABS)	12/00-06	F
R 1150 R/RS	01-06	F
R 1150 R Rockster	03-06	F
R 1150 Rockster Edition 80	04	F
R 1150 GS Adventure	03-06	F
K 1200 LT	11/00-07	F
K 1200 R	05-07	F
R 1200 CL	03-04	F
R 1200 C Independent (Cast wheel)	03-04	F
R 1200 C Montauk	04	F
R 1200 C Classic	03-04	F
R 1200 R Sport	06-07	F
K 1200 R Sport	07	F

**KAWASAKI**

ZRX 400 (ZR 400 E4-E7)	98-01	F
------------------------	-------	---

**Equivalents OE #**

34 11 7 658 386  
34 11 7 655 898  
43082 1217

**Competitor X Ref**

Dunlop	Ferodo	SBS	Vesrah
DP639	FDB2124	743/778	VD439

MATERIAL AVAILABILITY AND PART NO.				
STD	OPTIONS			
FA	HH	R	MXS	GFA
-	FA294HH	-	-	-

**GFA295HH 77.6 x 44 x 10.4mm**

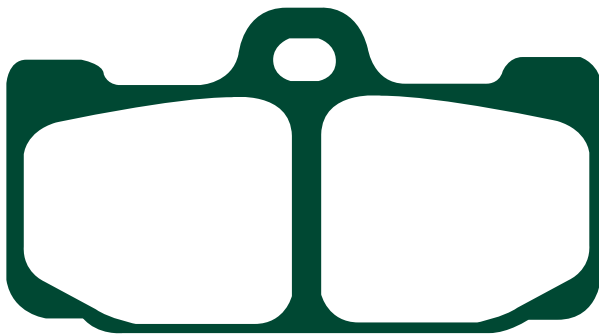

**Race use only**

**BREMBO**

P4 32/36 X 97.37.80/81

**Equivalents OE #**

**Competitor X Ref**

Dunlop	Ferodo	SBS	Vesrah
-	-	741	VD9021

MATERIAL AVAILABILITY AND PART NO.				
STD	OPTIONS			
FA	HH	R	MXS	GFA
-	-	-	-	GFA295HH

# FA296HH 74.75 x 55.4 x 7.6mm (No shim fitted)

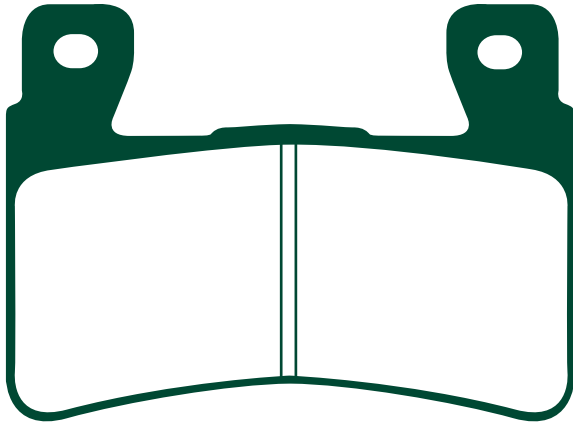

## HONDA

CB 400 SFX/SFY/SF1/SF2/SF3 Super Four	99-03	F
CB 400 SBS	05	F
CB 400 SF4/5/S5	04-05	F
CBR 600 FX/FY	99-00	F
CBR 600 F1/F2/ CBR 600 FS1/FS2 'Sport'	01-02	F
CBR 600 F3/F4/F5/F6/F7	03-07	F
CBR 600 RR3/RR4	03-04	F
CB 1300 F3/F13	03-04	F
CB 1300 5/6 (Superfour)	05-06	F
CB 1300 A5/A6 (Superfour ABS)	05-06	F
CB 1300 S5	05	F
CB 1300 SA5/SA6 Super Bol-Dor	05-06	F

### Equivalents OE #

06455 MBW 006
06455 MBW E11

### Competitor X Ref

Dunlop	Ferodo	SBS	Vesrah
DP127	FDB2079	734	VD166

### MATERIAL AVAILABILITY AND PART NO.

STD	OPTIONS			
FA	HH	R	MXS	GFA
-	FA296HH	-	-	GFA296HH

# FA297 A. 105 x 43.6 x 7.84mm B. 66 x 36.5 x 12.7mm

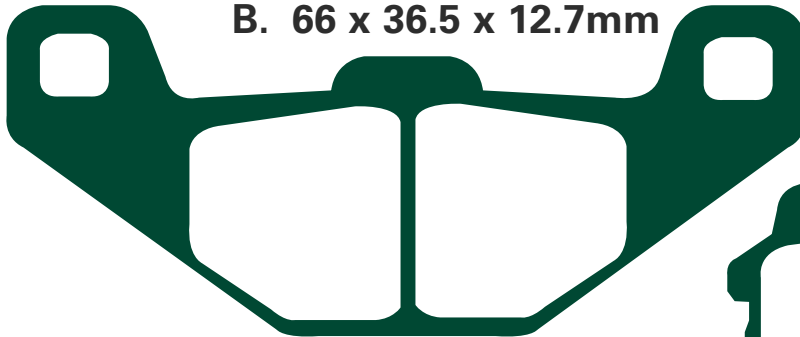

## SYM

Huskey 125/150	99-05	F
CT 125	03-04	F



### Equivalents OE #

45105 N02 001 A
-----------------

### Competitor X Ref

Dunlop	Ferodo	SBS	Vesrah
-	FDB2129	745	VD9019

### MATERIAL AVAILABILITY AND PART NO.

STD	OPTIONS			
FA	HH	R	MXS	GFA
FA297	-	-	-	-

# FA298 50.96 x 53.40 x 9.5mm



## APRILIA

SR 50 (All models with rear disc)	00-07	R
Scarabeo 50 (Di-Tech)	01-04	R
Atlantic 125/200/250	03-06	R
RS 125 (Radial Caliper model)	06-07	R
Leonardo 250 ST/SP	00-04	R
Scarabeo 125/150/200	99-02	R
Scarabeo 125/200	03	R
Scarabeo 125/150/250 GT	04-06	R
Scarabeo 125/200	07	R
Scarabeo 250	06	R
Scarabeo 250 ie	07	R
Leonardo 300	05-06	R
Sport City 125/200	04-07	R
Sport City 250 ie	07	R
Atlantic 400 Sprint	07	R
Scarabeo 400 ie	07	R
Atlantic 500	02-04	R
Atlantic 500 Sprint	05-07	R
Scarabeo 500	03-06	R

Scarabeo 500 ie	07	R
Scarabeo 500 Light	07	R
<b>BENELLI</b>		
Velvet 250	99-07	R
Velvet 400	03-04	R
<b>BETA</b>		
Eikon 125/150	00-06	R
<b>DERBI</b>		
Boulevard S125	07	R
<b>MALAGUTI</b>		
Madison T125/150/R180/S250	99-03	R
F18 Warrior 125/150	00-03	R
Phantom Max 125/200	04-07	R
Phantom Max 250	04-07	R
Spider Max GT 500	04-07	R
R 125 Madison	03-07	R
Madison S 200	04	R
250 Madison	04-07	R
Madison K 400	02-06	R
Password 250	05-07	R

### Equivalents OE #

811 3869	11948600	8213577
119 491 00	8213506	8133726
2525371000	8133539	8133946
R44440161A0	8133946	

### Competitor X Ref

Dunlop	Ferodo	SBS	Vesrah
-	FDB2090	747	-

### MATERIAL AVAILABILITY AND PART NO.

STD	OPTIONS			
FA	HH	R	MXS	GFA
FA298	-	-	-	-

# FA299

A. 92.9 x 65.15 x 7.5mm  
B. 92.9 x 65.15 x 7.5mm



**Replaced by  
FA400**

**Competitor X Ref**

Dunlop	Ferodo	SBS	Vesrah
DP918	FDB2097	750	VD971

**Will be replaced by FA400  
when stocks exhausted**

MATERIAL AVAILABILITY AND PART NO.				
STD	OPTIONS			
FA	HH	R	MXS	GFA
FA299	FA299HH	-	-	-

**Equivalents OE #**

44082-00

**HARLEY DAVIDSON**

New 4 piston caliper 2000-2004 models F&R  
Check page 39/40 for application details.

**IMPORTANT NOTE:**

This pad fits 04 and prior models only.  
See also FA400 which has similar  
shape but larger friction area.  
**DO NOT ATTEMPT TO FIT THIS PAD IN  
MODELS AFTER 05.**  
Always compare old pad shape.



**If you still have stock  
of FA299/299HH refer to  
note opposite**

# FA301

53.90 x 50.75 x 8.00mm

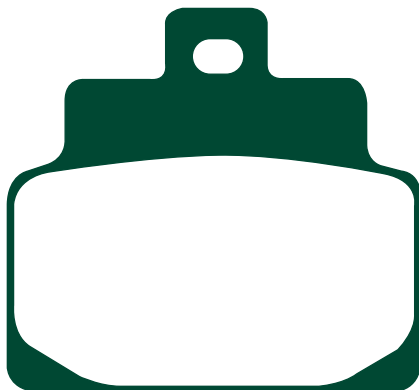

**APRILIA**

Scarabeo 100	00-02	F
Habana 125	00-02	F
Leonardo 125/150 ST/SP	99-04	F
Leonardo 125	05-06	F
SR 125/150	99-02	F
Mojito/Mojito Custom 125	03-07	F

**Equivalents OE #**

8213460
8213462

**Competitor X Ref**

Dunlop	Ferodo	SBS	Vesrah
-	FDB2095	748	-

MATERIAL AVAILABILITY AND PART NO.				
STD	OPTIONS			
FA	HH	R	MXS	GFA
FA301	-	-	-	-

**FA302** A. 67.65 x 36.52 x 7.58mm  
B. 51.90 x 40.10 x 7.62mm

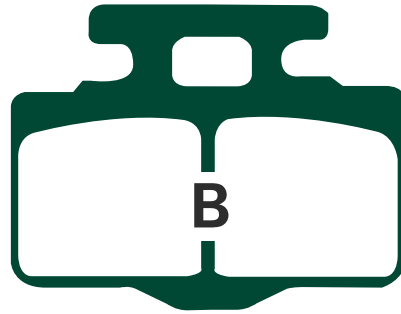
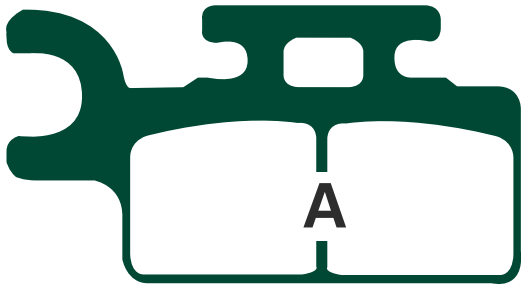

**KAWASAKI**

KX 65 A1/A2/A3/A4/A5/A6/A6F/A7F 00-07 F

**SUZUKI**

RM 65 K3/K4/K5 03-05 F

**Competitor X Ref**

<b>Dunlop</b> DP328	<b>Ferodo</b> FDB2110	<b>SBS</b> 752	<b>Vesrah</b> VD440
------------------------	--------------------------	-------------------	------------------------

**Equivalents OE #**

43082-1242	K4308-21242
43082-0042	

**MATERIAL AVAILABILITY AND PART NO.**

STD	OPTIONS			
FA	HH	R	MXS	GFA
FA302TT	-	FA302R	-	-

**FA303** 49.95 x 43.85 x 5.9mm



**AJP**

PR4-Enduro 125/200 04-07 R  
PR4-Supermotard 125/200 04-07 R

**BETA**

Rev 3 125/200 00-06 F&R  
Rev3 125/200 06 F  
Rev 3 250/270 00-04 F&R  
Rev 3 250/270 05-07 F  
RR Enduro Alu 03- F

**GAS-GAS**

TXT 125/200/250/280/300 (TXT PRO) 04-07 F  
EC 50 Boy (LC) 05 F  
TXT 80 Rookie 04-05 F

**SHERCO**

1.25 06-07 F  
2.5/2.9 01-07 F  
3.2 (320 4T) 05-07 F  
Trials 0.8 06-07 F

**HONDA/MONTESA**

315R 01-04 F  
250 4RT Cota 05-07 F

**SCORPA**

SY 125 F Trials 03-05 F  
SY 175 F 06 F  
SY 250 F 06-07 F  
SY 250 Long Ride 04-07 F  
SY 250 00-07 F

**Equivalents OE #**

45105 NN3 830	2525352000	00TRS01A0027
6211	C389	

**Competitor X Ref**

<b>Dunlop</b> -	<b>Ferodo</b> FDB2109	<b>SBS</b> 802	<b>Vesrah</b> -
--------------------	--------------------------	-------------------	--------------------

**MATERIAL AVAILABILITY AND PART NO.**

STD	OPTIONS			
FA	HH	R	MXS	GFA
FA303	-	-	-	-

**FA304** 75.05 x 54.90 x 8.97mm



**BMW**

R 1200 CL 03-04 R  
K 1200 LT (All models) 97-07 R

**Equivalents OE #**

34 2 17 671 246
34 2 17 657 492
34 2 12 333 337

**Competitor X Ref**

<b>Dunlop</b> DP637	<b>Ferodo</b> FDB2102	<b>SBS</b> 746	<b>Vesrah</b> -
------------------------	--------------------------	-------------------	--------------------

**MATERIAL AVAILABILITY AND PART NO.**

STD	OPTIONS			
FA	HH	R	MXS	GFA
FA304	FA304HH	-	-	-

# FA305

A 84.95 x 43.5 x 8.60mm  
B 63.95 x 36 x 10.96mm

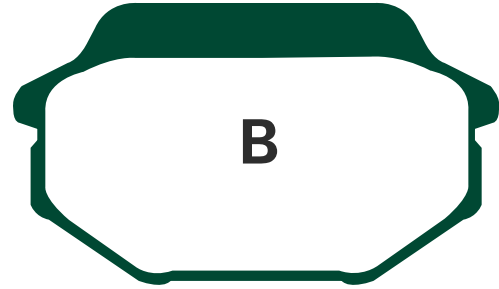

**Equivalents OE #**

8900539	43082 Y001
45105 KFA6 3050	

**LAVERDA**

Phoenix 125/150/200	01-04	R
<b>KYMCO</b>		
People 50/125/150	99-06	F
People S 50/125/200	05-07	F
Super 9 50 (LC)	01-07	R
Mxer 50 (Quad)	00-07	R
Mxer 150 Quad	02-07	R
MXU 50/150	05-06	R
Maxxer 90	05-06	R
People S125/200 (BA40BA)	05-06	F

**SYM**

HD 125/200	04-07	F
Joyride 125/150/200	01-07	R
SK 125	03-04	R
GT 500	04	R

**Competitor X Ref**

Dunlop	Ferodo	SBS	Vesrah
-	FDB2096	749	-

**MATERIAL AVAILABILITY AND PART NO.**

STD	OPTIONS			
FA	HH	R	MXS	GFA
FA305	-	FA305R	-	-

# FA306

70.13 x 41.85 x 8.07mm

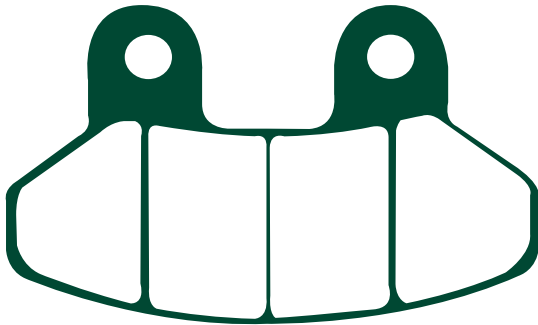

**LAVERDA**

Phoenix 125/150/200	01-04	F
---------------------	-------	---

**SYM**

RS 50	04-07	F
Shark 50	99-03	F
RS 125	04-06	F
Euro MX 125/150	02-06	F
SK 125	03-04	F
Shark 125/150	99-02	F
Shark 4VR 125	01-02	F
Joyride 125/150/200	01-07	F
VS 125/150	06-07	F
RS 150	06	F
Euro MX125	06	F

**Equivalents OE #**

45105 HA3A 000
8900239

**Competitor X Ref**

Dunlop	Ferodo	SBS	Vesrah
-	FDB2108	749	-

**MATERIAL AVAILABILITY AND PART NO.**

STD	OPTIONS			
FA	HH	R	MXS	GFA
FA306	-	-	-	-

# FA307 A 82.08 x 40.85 x 9.46mm

# B 62.03 x 40.80 x 9.46mm

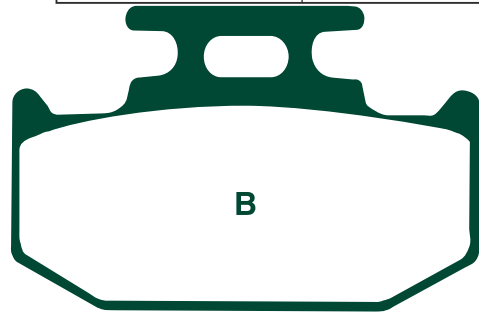
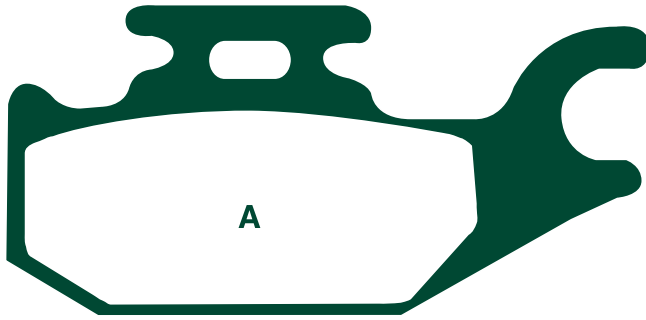

### Equivalents OE #

5GH W0046 00	705 600 398
705 600 014	705 600 349
ID9 W0046 00	

### YAMAHA

YFM 400 FAM/FAN	00-01	R
YFM 400 FWT (Big Bear)	05	R
YFM 400 FGW Grizzly	07	R
YFM 450 FAR/FAS	03-04	R
YFM 450 FAT/FAHT/FAV (Kodiak)	05-06	R
YFM 450 FXV Wolverine	06	R
YFM 450 FGW Grizzly	07	R

### BOMBARDIER

Most models (see application pages)	01-06	F(left)&R
-------------------------------------	-------	-----------

### CAN-AM

Rally 200 (4A7A/B/C/D/E/F)	07	R
Outlander 400 (4x4 STD) (2D7A/B/C/D/E/F/G/H)	07	F(left)&R
Outlander 400 (XT 4x4) (2E7A/B/C/D/E/F)	07	F(left)&R
Outlander Max 400 (STD 4x4) (2F7B/C/D/E/F/G/H/J)	07	F(left)&R
Outlander Max 400 (XT 4x4) (2G7A/B/C/D/E)	07	F(left)&R

Outlander 500 (STD 4x4) (2T7A/B/C/D) (2W7A/B/C)	07	F(left)&R
Outlander 500 (XT 4x4) (207A/B/C/D)	07	F(left)&R
Outlander Max 500 (XT 4x4) (2X7A/B/C)	07	F(left)&R
DS 650 X (3B7A/B)	07	F(left)&R
Outlander 650 (4x4 STD) (2N7A/B/C/D/E/F/G/H)	07	F(left)&R
Outlander 650 (XT 4x4) (2P7A/B/C/D/E/F)	07	F(left)&R
Outlander Max 650 (STD 4x4) (2R7A/B/C/D/E/F/G/H/J/K)	07	F(left)&R
Outlander Max 650 (XT 4x4) (2S7A/B/C/D/E/F)	07	F(left)&R
Outlander 800 (STD 4x4) (2H7A/B/C/D/E/F/G/H)	07	F(left)&R
Outlander Max 800 (Ltd 4x4) (2M7A/B/C) (STD 4x4) (2K7A/B/C/D/E/F/G/H/J)	07	F(left)&R
Outlander (XT 4x4) (2J7A/B/C/D/E/F)	07	F(left)&R

### CANNONDALE

All quads (check main application pages for fitments)	01-04	F(left)&R
---	-------	-----------

### JOHN DEERE ATV

Most models (see application pages)	04-05	F(left)&R
-------------------------------------	-------	-----------

### Competitor X Ref

Dunlop	Ferodo	SBS	Vesrah
DP327	FDB2148	754	VD266

### MATERIAL AVAILABILITY AND PART NO.

STD FA	OPTIONS			
	HH	R	MXS	GFA
FA307TT	-	FA307R	-	-

# FA313R 123.5 x 55 x 9.25mm

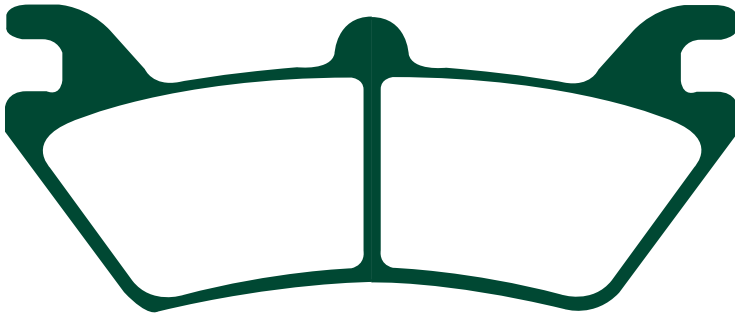

### POLARIS

Sportsman 6x6	00-03	R
PTV (6x6)	03	R
PPS/PTV 6x6/Series 10		R
PPS LUH 6x6	02	R

### Equivalents OE #

2201685
2201749

### Competitor X Ref

Dunlop	Ferodo	SBS	Vesrah
-	FDB2177	757	-

### MATERIAL AVAILABILITY AND PART NO.

STD FA	OPTIONS			
	HH	R	MXS	GFA
-	-	FA313R	-	-

# FA314R 90.3 x 41.05 x 8.2mm



### Equivalents OE #

2201871
2202414
1911129

### POLARIS

Magnum 325/500	02-03	R
Xpedition 325	02	R
Magnum 330 (2x4/HDS)	03-04	R
Magnum 330 (4x4/HDS)	03-04	R
Sportsman 400	03	R
Sportsman 400	03-04	R
ATV Pro 500 4x4 TPS	02	R
Magnum 500 HDS	02-03	R
Magnum 500 (2x4/4x4 HDS)	02	R
Sportsman 500 HP	03-04	R
Sportsman 600 4x4	03-04	R
Sportsman 700 (4x4)	02-04	R
Sportsman MV 700	05	R
Sportsman 800	05	R
PPS/PTV 4x4/Series 10		R
Sportsman 500 X2	06	R

### Competitor X Ref

Dunlop	Ferodo	SBS	Vesrah
DP932	FDB2176	787	-

### MATERIAL AVAILABILITY AND PART NO.

STD FA	OPTIONS			
	HH	R	MXS	GFA
-	-	FA314R	-	-

# FA317 A 82.08 x 40.85 x 9.46mm

# B 62.03 x 40.80 x 9.46mm

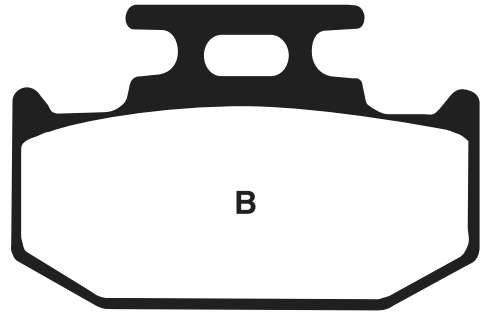
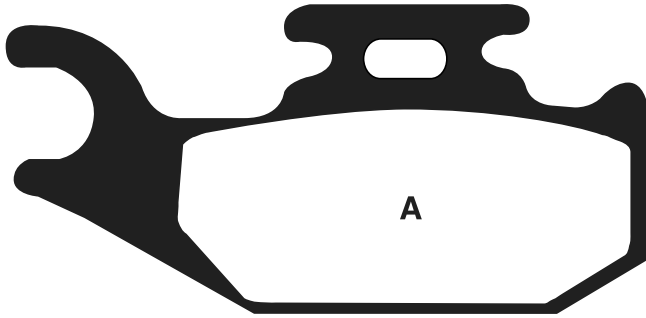

**SUZUKI**

LT-A 500 FK2 Vision 4WD 02 R

**BOMBARDIER**

Most models (see application pages) 01-06 F(right)&R

**CAN-AM**

- Outlander 400 (4x4 STD) (2D7A/B/C/D/E/F/G/H) 07 F(right)
- Outlander 400 (XT 4x4) (2E7A/B/C/D/E/F) 07 F(right)
- Outlander Max 400 (STD 4x4) (2F7B/C/D/E/F/G/H/J) 07 F(right)
- Outlander Max 400 (XT 4x4) (2G7A/B/C/D/E) 07 F(right)
- Outlander 500 (STD 4x4) (2T7A/B/C/D) 07 F(right)
- Outlander 500 (XT 4x4) (2U7A/B/C/D) 07 F(right)
- Outlander Max 500 (STD 4x4) (2W7A/B/C) 07 F(right)
- Outlander Max 500 (XT 4x4) (2X7A/B/C) 07 F(right)
- DS 650 X (3B7A/B) 07 F(right)
- Outlander 650 (4x4 STD) (2N7A/B/C/D/E/F/G/H) 07 F(right)
- Outlander 650 (XT 4x4) (2P7A/B/C/D/E/F) 07 F(right)
- Outlander Max 650 (STD 4x4) (2R7A/B/C/D/E/F/G/H/J/K) 07 F(right)
- Outlander Max 650 (XT 4x4) (2S7A/B/C/D/E/F) 07 F(right)
- Outlander 800 (STD 4x4) (2H7A/B/C/D/E/F/G/H) 07 F(right)
- Outlander 800 (XT 4x4) (2J7A/B/C/D/E/F) 07 F(right)
- Outlander Max 800 (Ltd 4x4) (2M7A/B/C) 07 F(right)
- Outlander Max 800 (STD 4x4) (2K7A/B/C/D/E/F/G/H/J) 07 F(right)
- Outlander Max 800 (XT 4x4) (2L7A/B/C/D/E/F) 07 F(right)

**CANNONDALE**

All quads (check main application pages for fitments) 01-04 F(Right)

**JOHN DEERE ATV**

Most models (see application pages) 01-05 F(right)&R

**Equivalents OE #**

705 600 004	5UG W0045 00
69100 03840	705 600 350
705 600 150	1S3 W0046 00

**Competitor X Ref**

Dunlop	Ferodo	SBS	Vesrah
DP920	FDB2149	767	-

**MATERIAL AVAILABILITY AND PART NO.**

STD	OPTIONS			
FA	HH	R	MXS	GFA
FA317TT	-	FA317R	-	-

# FA319 99.95 x 36.25 x 11.95mm

# FA319/2 99.95 x 36.25 x 9.5mm



**Equivalents OE # FA319**

5GJ W0045 00

**Equivalents OE # FA319/2**

5JW W0046 00	3P6 W0046 50
5PS W0046 00	1D7 W0046 00

**FA319 - YAMAHA**

XP 500 N/P/R T-Max 01-03 R

**FA319/2 - YAMAHA**

TDM 900 P/R/S/T/V 02-06 R

TDM 900 AT/AV/AW (ABS) 05-07 R

FJR 1300 N/P/R/AR/S/AS/AT (ABS) 01-05 R

FJR 1300 AV/ASV (3P61/2/3) (ABS) 06-07 R

FJR 1300 AS (2D21) 06-07 R

XVS 1300 A Midnight Star 07 R

XV 1700 PCR 03-05 R

XV 1900 A Mldnight Star 06-07 R

**HYOSUNG**

GV 650 04-05 R

**SYM**

Voyager 250 05 R

**Competitor X Ref FA319**

Dunlop	Ferodo	SBS	Vesrah
DP423	FB2126	768	VD269

**MATERIAL AVAILABILITY AND PART NO.**

STD	OPTIONS			
FA	HH	R	MXS	GFA
FA319	FA319HH	-	-	-

**Competitor X Ref FA319/2**

Dunlop	Ferodo	SBS	Vesrah
DP423	FB2156	769	VD269/2

**MATERIAL AVAILABILITY AND PART NO.**

STD	OPTIONS			
FA	HH	R	MXS	GFA
FA319/2	FA319/2HH	-	-	-

# FA320HH 69.75 x 42.6 x 7.45mm

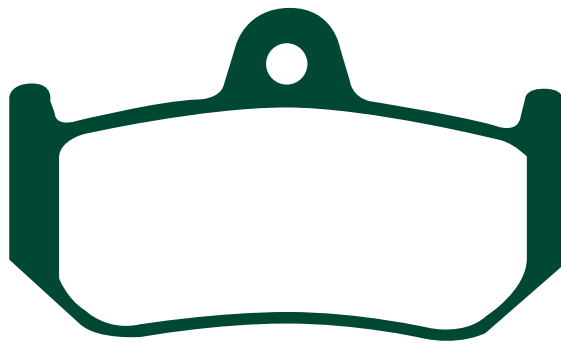

## M.V. AGUSTA

F4 750	99-03	R
Brutale 750 S	03-06	R
F4 1000	04-06	R
F4 1000 R	07	R
F4 1000 R1&1	07	R
F4 1000 CC	07	R
F4 1000 (Brembo 4 piston caliper)	06	R
Brutale 910 S	05-06	R
Brutale 910 R	05-07	R
Brutale 910 Standard	05-07	R
Brutale 910 R Italia	07	R
F4 1000 Senna	06	R

### Equivalents OE #

8000 82748

### Competitor X Ref

<u>Dunlop</u>	<u>Ferodo</u>	<u>SBS</u>	<u>Vesrah</u>
DP958	FDB2198	763	-

### MATERIAL AVAILABILITY AND PART NO.

<u>STD</u>	<u>OPTIONS</u>			
<u>FA</u>	<u>HH</u>	<u>R</u>	<u>MXS</u>	<u>GFA</u>
-	FA320HH	-	-	-

# FA321 55.5 x 49 x 7.5mm

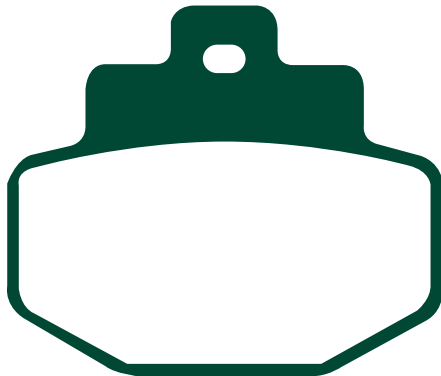

## BENELLI

Adiva 125/150 01-04 R

## GILERA

125 VX 4T/180/VXR 200 4T 01-05 R

DNA 125/180 01-03 R

VX 125 Runner (4T) 05-07 R

VXR 200 Runner (4T) 02-07 R

## PIAGGIO/VESPA

Super Hexagon GTX 125/180 12" wheels 01-03 R

Super Hexagon GTX 250 00-02 R

GT 125 L Granturismo 03-06 R

GTV 125 07 R

GT 200 L Granturismo 03-06 R

GTS 250 iE/ABS 05-07 R

GT 60 (Special Anniversary Model) (GTV 250) 06 R

GTV 250 ie 07 R

### Equivalents OE #

497002	R44440181A0
497348	647161

### Competitor X Ref

<u>Dunlop</u>	<u>Ferodo</u>	<u>SBS</u>	<u>Vesrah</u>
DP327	-	772	-

### MATERIAL AVAILABILITY AND PART NO.

<u>STD</u>	<u>OPTIONS</u>			
<u>FA</u>	<u>HH</u>	<u>R</u>	<u>MXS</u>	<u>GFA</u>
FA321	-	-	-	-



# FA322/4HH 35 x 40.53mm x 7.4mm

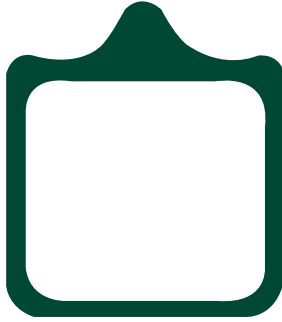

**NOTE:- Pads are sold as 4pcs - i.e. one caliper set**

**APRILIA**

RSV Mille/Mille R (inc radial mount calipers) 01-07 F  
 1000 Tuono (Factory) 02-07 F  
 Tornado LE/Tornado TRE Novecento/RS 03-05 F  
 TNT 1130 Cafe Racer 06-07 F

**BENELLI**

TNT 1130 Sport/Sport Evo 04-07 F  
 TNT 1130 Titanium 06 F  
 Tornado Tre 1130 06 F  
 2-UE (750cc) 07 F

**BIMOTA**

Elirio 06 F  
 DB5 (All models) 06-07 F  
 DB5R 06-07 F  
 DB6 Delirio (992cc Ducati engine) 07 F  
 SB8K Santamonica (996cc Suzuki engine) 07 F

**BREMBO**

20 7850 11/21 (P434A) 4 piston wire clip pad retention  
 20 8343 35/45 11/21 (P4 34B) Radial goldline  
 mount wire clip pad retention

**CAGIVA**

Raptor X3 1000 03-04 F

**DERBI**

Mulhacen 659 06-07 F  
 Mulhacen 650 Hot Bob 07 F  
 Mulhacen 659 Cafe 07 F  
 Mulhacen 659 X Vision 07 F

**DUCATI**

748 R 01-02 F  
 748 RS 01 F  
 749/749 S/749 R 03-06 F  
 749 Dark 04-06 F  
 998 S 02 F  
 998 R 02 F  
 999/999 S/999 R 03-06 F  
 S4RS (998cc) 06 F  
 S4R (998cc) Testasretta 07 F  
 999 R (Xerox) 06 F

**HUSQVARNA**

SMR 450 RR Radial caliper 06-07 F  
 SM 450 R Radial caliper 07 F  
 SM 510 R (Radial caliper) 06-07 F  
 SM 610 S (Radial caliper) 06 F  
 SM 610 ie 07 F  
 STR 650 CRC 07 F

**KTM**

690 SM Prestige 07 F  
 SM 950 Supermoto 05-06 F  
 990 Superduke 05-07 F  
 990 Superduke R 07 F

**LAVERDA**

SFC 1000 03-04 F

**MONDIAL**

Piegia 1000 03-04 F  
 EVO 04 F

**MOTO GUZZI**

MGS 01 03 F  
 MGS-01 Corsa 07 F  
 Griso 04 F  
 Fionda 1100 05 F

**M.V. AGUSTA**

F4 100 Senna 06 F  
 Brutale 910 R 05-07 F  
 Brutale 910 R Italia 07 F  
 F4 1000 (Brembo 4 piston calipers) 06 F  
 F4 1000 R 07 F  
 F4 1000 R1&1 07 F

**PETRONAS**

FP1 05 F

**TM**

SMX 450 F 05-07 F  
 SMX 530 F 05-07 F  
 SMX 660 F 05-07 F

**VOXAN**

Charade Racing 06 F

**Equivalents OE #**

613 403 01A	610 13 030 000	862697
613 40391 A	8000A2040	8000A7417
8223972	69177	
R 180 100 12600	862486	

**Competitor X Ref**

Dunlop	Ferodo	SBS	Vesrah
DP638	FDB2120	762	VD986

**MATERIAL AVAILABILITY AND PART NO.**

STD	OPTIONS			
FA	HH	R	MXS	GFA
-	FA322/4HH	-	-	GFA322/4HH

# FA323 81 x 42 x 9.3mm

# FA323/2 81 x 42 x 6.9mm

# FA323/3 81 x 42 x 8.2mm

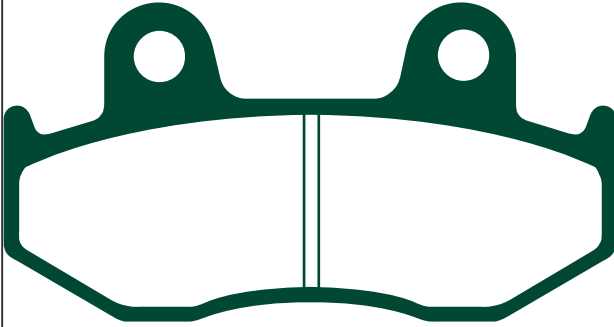

## FA323

### HONDA

NES 125 Y/1/2/3/4/5 (@ 125 Scooter)	00-05	F
PS 125 i 6/7	06-07	F
SH 125 1/3/4/5/6i	01-07	F
NES 150 Y/1/2/3/4/5 " @150 Scooter"	01-05	F
SH 150 1/3/4/5/6i/7i	01-07	F
SES 125/150 2/3/4 Dylan	02-07	F

### ITALJET

Torpedo 125	07	F
Jack 125/150	07	F&R

### MZ

Mantizz 125 S	05-07	F
---------------	-------	---

### YAMAHA

YFZ 450 V/W	06-07	R
-------------	-------	---

## FA323/2

### HONDA

CH 250 F/G "Spacy"	85-86	F
--------------------	-------	---

## FA323/3

### SUZUKI

AN 250 W/X/Y 'Burgman'	98-00	R
AN 400 X/Y 'Burgman'	99-00	R

### KAWASAKI

SC 250 A1 (Epsilon 250)	02-03	R
-------------------------	-------	---

#### Competitor X Ref FA323

Dunlop	Ferodo	SBS	Vesrah
-	FDB2119	-	-

MATERIAL AVAILABILITY AND PART NO.				
STD	OPTIONS			
FA	HH	R	MXS	GFA
FA323	-	FA323R	-	-

#### Competitor X Ref FA323/2

Dunlop	Ferodo	SBS	Vesrah
-	FDB2119	-	-

MATERIAL AVAILABILITY AND PART NO.				
STD	OPTIONS			
FA	HH	R	MXS	GFA
FA323/2	-	-	-	-

#### Competitor X Ref FA323/3

Dunlop	Ferodo	SBS	Vesrah
-	FDB2119	781	-

MATERIAL AVAILABILITY AND PART NO.				
STD	OPTIONS			
FA	HH	R	MXS	GFA
FA323/3	-	-	-	-

Equivalents OE # - FA323    06455 GCS 006    5TG W0046 10

Equivalents OE # - FA323/3

69100 14840
69100 14860
43082 S003

Equivalents OE # - FA323/2

45105 KM1 004	45105 KM1 712
45105 KM1 007	45105 KM1 710
45105 KM1 711	

# FA324 117.5 x 41.3 x 8.6mm



#### Equivalents OE #

119 481 00	8133761
81133603	

#### Competitor X Ref

Dunlop	Ferodo	SBS	Vesrah
-	FDB2105	761	VD9017

## APRILIA

Atlantic 125/200/250	03-07	F
Atlantic 400 Sprint	07	F
Atlantic 500 Sprint	05-07	F
Scarabeo 125/150/250 GT	04-06	F
Scarabeo 125/200	07	F
Scarabeo 250 ie	07	F

## MALAGUTI

Madison S 250	99-03	F
Madison K 400	02-06	F

## PEUGEOT

LOOXOR 125/150	03-06	F
----------------	-------	---

MATERIAL AVAILABILITY AND PART NO.				
STD	OPTIONS			
FA	HH	R	MXS	GFA
FA324				

# FA325R 43.45 x 25.2 x 5mm



**Equivalents OE #**

451 13 030 000

## HUSQVARNA

CR 50 Senior Pro	05	R
<b>LEM</b>		
R2/R3 (Hydraulic System)	03-05	F&R
<b>KTM</b>		
CR 50 Senior Pro	05	R
50 SX Pro Senior LC	02-03	F
50 SX Senior Adventure	02-07	F
50 SX Pro Senior LC	04-07	F&R
50 Supermoto	06	F&R
65 SX	04-07	R
<b>TOMOS</b>		
MC 50 Senior	05	F&R

**Competitor X Ref**

MATERIAL AVAILABILITY AND PART NO.				
STD	OPTIONS			
FA	HH	R	MXS	GFA
FA325TT	-	FA325R	-	-

Dunlop	Ferodo	SBS	Vesrah
DP923	FDB2183	794	-

# FA335HH 77.2 x 51.45 x 8.55mm

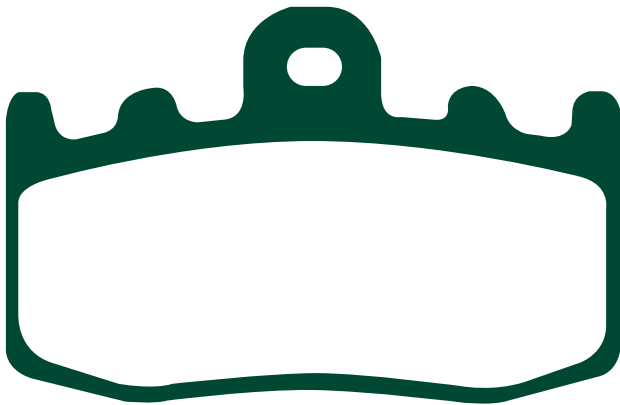

## BMW

R 850 RT	06	F
R 1100 S (Non ABS)	12/00-03	F
R 1150 GS	12/01-04	F
R 1150 RT (Integral ABS)	00-04	F
R 1200 GS	04-07	F
K 1200 RS/R/S	01-05	F
K 1200 GT (K41)	03-06	F
K 1200 GT (K44)	06-07	F(left)
K 1200 S (K40)	05-07	F
R 1200 RT (K26)	03-07	F
R 1200 ST (K28)	03-07	F
R 1200 S	06-07	F
HP2 Megamoto	07	F
R 1200 GS Adventure (Spoke wheel)	07	F

**Equivalents OE #**

34 11 7 660 448  
34 11 7 671 780

**Competitor X Ref**

MATERIAL AVAILABILITY AND PART NO.				
STD	OPTIONS			
FA	HH	R	MXS	GFA
-	FA335HH	-	-	-

Dunlop	Ferodo	SBS	Vesrah
DP641	FDB2125	796	-

# FA336 77.85 x 46.5 x 7.05mm

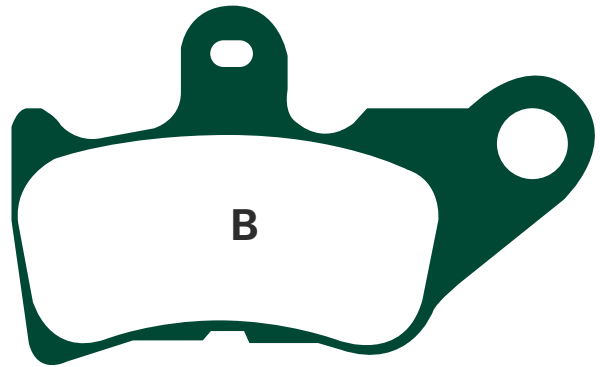
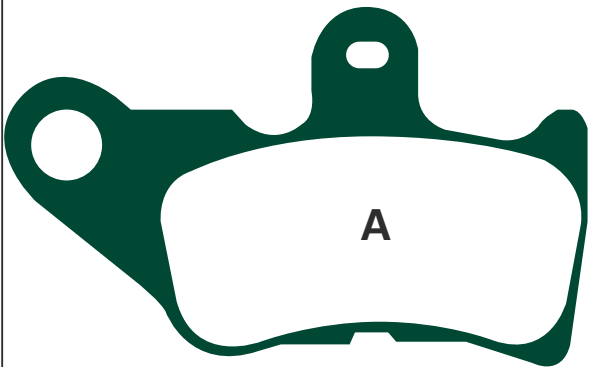

## YAMAHA

CV 50 ZR (5PT1) Evolution	01-02	F
CV 50 (5KN1/2) Jog-Cool Style	00-02	F
MI0 (113cc)	05-07	F
MI0 Sporty (113cc)	05-07	F
Nuovo-Z (113cc)	06-07	F

**Equivalents OE #**

5KN W0045 00

**Competitor X Ref**

MATERIAL AVAILABILITY AND PART NO.				
STD	OPTIONS			
FA	HH	R	MXS	GFA
FA336	-	-	-	-

Dunlop	Ferodo	SBS	Vesrah
-	764	764	VD267

# FA337 35.2 x 51.5 x 6mm

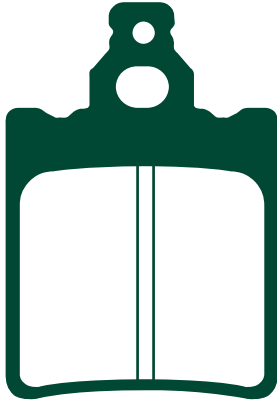

## APRILIA

280 R Climber

92-93 R

## BETA

M4 350 Supermotard

04-06 R

## JCM

240 Europa

89- R

## KTM

60 SX

00 R

65 SX

00-03 R

### Equivalents OE #

460 13 090 000

### Competitor X Ref

MATERIAL AVAILABILITY AND PART NO.				
STD	OPTIONS			
FA	HH	R	MXS	GFA
FA337TT	-	FA337R	-	-

Dunlop	Ferodo	SBS	Vesrah
-	-	-	-

# FA342R A. 26.1 x 119.55 x 7.1mm

B. 35.6 x 94.54 x 7.8mm

### Equivalents OE #

43082 1255

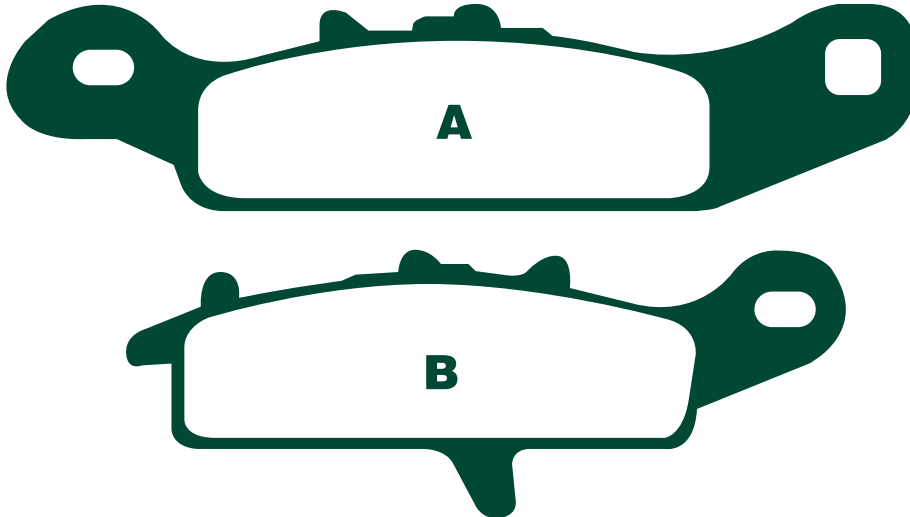

## KAWASAKI

KFX 450 R Quad

07

F(Left)

KVF 650 A1/A2 Prairie

02-03

F(Left)

KVF 650 D1/D6F Brute Force 4x4

05-06

F(Left)

KVF 650 E1/E6F Brute Force 4x4

Hardwoods Green HD

05-06

F(Left)

KSV 700 A1/B1/A2/A6F/B2/B6F (KFX 700)

04-06

F(Left)

KVF 700 A1/B1/A2/A6F/B2/B6F 4x4 (Prairie)

04-06

F(Left)

KVF 700 D1 Team Green

05

F(Left)

## SUZUKI

LT-V 700 FK4/FK5 Twin Peaks

04-05

F(Left)

### Competitor X Ref

MATERIAL AVAILABILITY AND PART NO.				
STD	OPTIONS			
FA	HH	R	MXS	GFA
-	-	FA342R	-	-

Dunlop	Ferodo	SBS	Vesrah
DP929	FDB2188	801	VD441

# FA343 A. 107 x 41 x 10mm B. 91.6 x 40.6 x 10mm

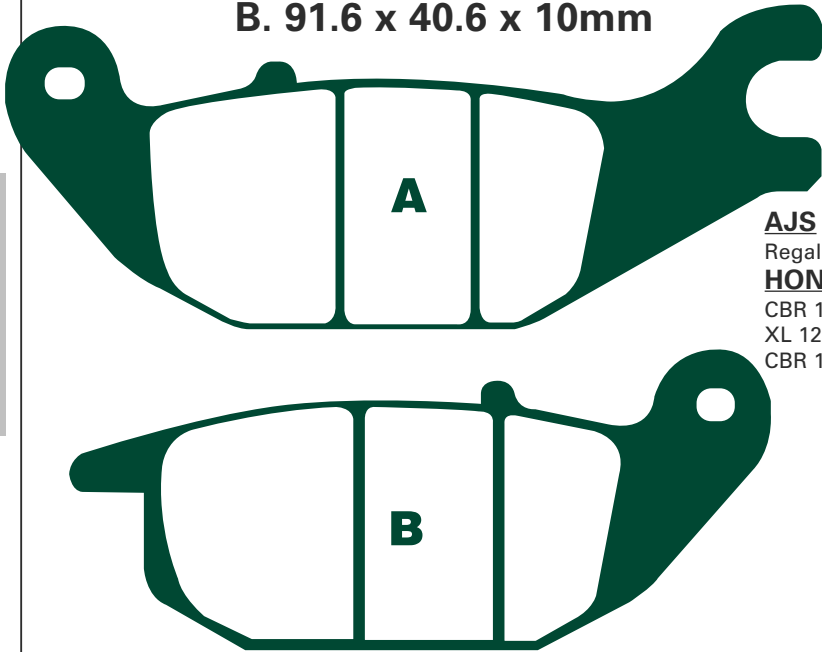

<b>AJS</b>	Regal Raptor CR3-125	06	R
<b>HONDA</b>	CBR 125 RR4/RR5/RS5/RW5/RR6/R7	04-07	R
	XL 125 V1/V2/V3/V4/V5/V6/V7 Varadero	01-07	R
	CBR 150 R	00-03	R

**Equivalents OE #**

06435 KPC 641
06435 KPP 901

**Competitor X Ref**

MATERIAL AVAILABILITY AND PART NO.				
STD	OPTIONS			
FA	HH	R	MXS	GFA
FA343	-	-	-	-

Dunlop	Ferodo	SBS	Vesrah
DP129	FDB2143	784	-

# FA344 65.5 x 44.75 x 11.65mm

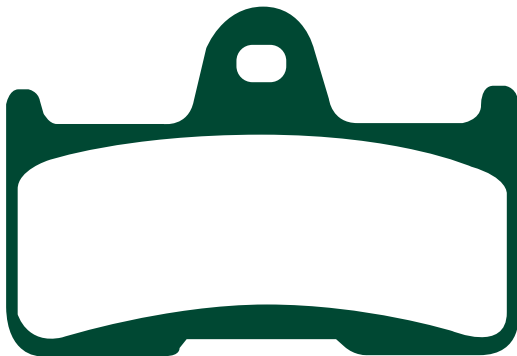

<b>YAMAHA</b>	YFM 660 FWAP/FWAR/FWAS/FWAT/FWAW/FGW Grizzly	02-07	R
	YFM 660 FR/FS/FT Grizzly	03-05	R

**Equivalents OE #**

5KM W0046 00
--------------

**Competitor X Ref**

Dunlop	Ferodo	SBS	Vesrah
DP930	FDB2193	799	VD270

MATERIAL AVAILABILITY AND PART NO.				
STD	OPTIONS			
FA	HH	R	MXS	GFA
FA344TT	-	FA344R	-	-

# FA345HH 91.7 x 49.3 x 8.1mm



**NOTE:  
REFIT ORIGINAL HEAT SHIM  
TO NEW EBC PADS**

<b>BUELL</b>	XB9R	02-07	F
	XB9S	03-07	F
	XB9SX	05-07	F
	XB 12 S	04-07	F
	XB 12 R	04-07	F
	XB 12 SS	06-07	F
	XB 12 SCG	06-07	F
	XB 12 X Ulysses	06-07	F

**Equivalents OE #**

H0300-02A8
------------

**Competitor X Ref**

MATERIAL AVAILABILITY AND PART NO.				
STD	OPTIONS			
FA	HH	R	MXS	GFA
-	FA345HH	-	-	GFA345HH

Dunlop	Ferodo	SBS	Vesrah
DP926	FDB2145	795	-

# FA346 60 x 44.8 x 11mm

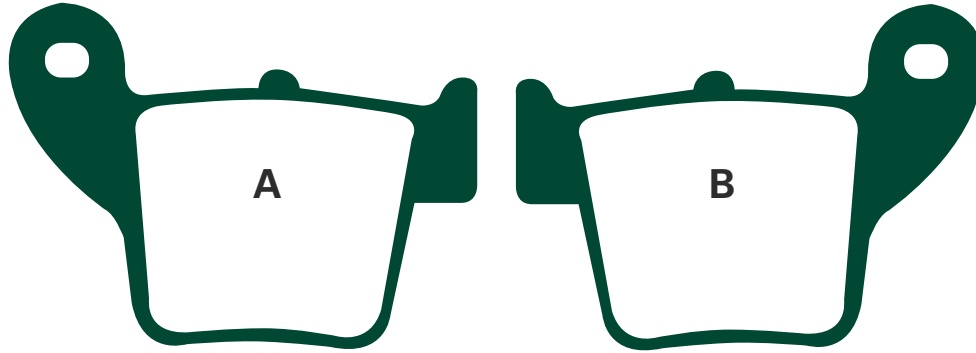

## HONDA

CR 125 R2/R3/R4/R5/R6	02-06	R
CRF 150 RB7/R7	07	R
CR 250 R2/R3/R4/R5/R6	02-06	R
CRF 250 R4/R5/R6	04-06	R
CRF 250 X4/X5/X6	04-06	R
CRF 450 R2/R3/R4/R5/R6	02-06	R
CRF 450 X5/X6	05-06	R

## HONDA-DALL'ARA

XR 250 SM	04	R
XR 400/440 R	04	R
XR 400/440 SM	04	R

## HONDA-HM (ITALY)

CRE 125 R Supermotard	02-03	R
CRE 125 R Enduro	04-06	R
CR 125 Motard	04	R
CRE 125 R Enduro	02-03	R
CRM 125 R Supermoto	07	R
CR 150 R/R2	07	R
CR 230 Easy Trail	04	R
CRF 230 Easy Enduro	04	R
CRF 230 Easy Motard	04	R
CRE 250	02	R
CRE 250 R Supermotard	02-03	R
CRE 250 R Enduro	02-06	R
CRE 250 X		R
CRM 250 X Supermoto	07	R
CR 250 R Moto	04	R
CRE 250 F Enduro	04	R
CRF 250 Motard	04	R
CRE F 290 X	07	R
CRE 450 F Enduro	02-06	R
CRE 450 F	02	R
CRF 450 Motard	04	R
CRE 450 F Supermoto	02-03	R
CRE 450 X		R
CRM F 450 R/X Supermoto	07	R
CRE F 490 X	07	R
CRM F 490 X Supermoto	07	R

## Equivalents OE #

06435 KZ4 J41	06434 KRN 711
---------------	---------------

## Competitor X Ref

MATERIAL AVAILABILITY AND PART NO.				
STD	OPTIONS			
FA	HH	R	MXS	GFA
FA346TT	-	FA346R	MXS346	GFA346HH

Dunlop	Ferodo	SBS	Vesrah
DP921	FDB2139	777	VD168

# FA347HH 69.5 x 49.55 x 7mm

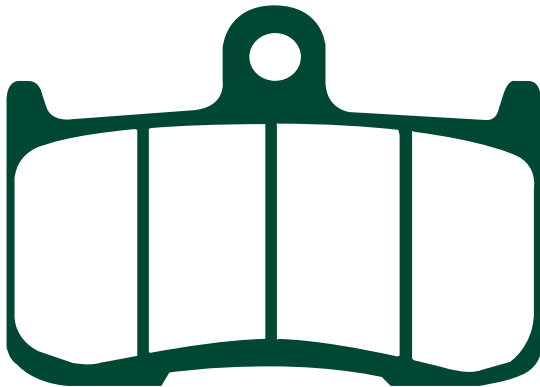

## KAWASAKI

ZX9R (ZX 900 F1/F2)	02-04	F
Z 1000 (ZR 1000 A1/A2/A3)	03-05	F

## TRIUMPH

Speed Triple (Radial caliper)	06-07	F
Daytona 675	06	F
Tiger 1050 (radial caliper)	07	F

## YAMAHA

TZ 250 (Radial Caliper)	03-05	F
-------------------------	-------	---

## Equivalents OE #

43082 1290	T 2020 329
43082 0002	T 2020 475
5XE W0045 00	

## Competitor X Ref

MATERIAL AVAILABILITY AND PART NO.				
STD	OPTIONS			
FA	HH	R	MXS	GFA
-	FA347HH	-	-	GFA347HH

Dunlop	Ferodo	SBS	Vesrah
DP922	FDB2158	782	VD443

# FA348 63.35 x 60.32 x 8.9mm



## YAMAHA

FZS 1000 Fazer	01-05	R
XJR 1300 N/P /5EAP/5EAR/5EAS/5EAT/5EAW /5EAV/5EAY) (298mm front disc)	01-02	R
XJR 1300 R/S 5WM1/5WM3/5WM5 /5WM6/5WM7/5WM9	03-04	R
XJR 1300 T/V/W 5WMA/5WMC /5WMD/5WMF	05-07	R

### Equivalents OE #

5LV W0046 50

### Competitor X Ref

Dunlop	Ferodo	SBS	Vesrah
-	FDB2150	770	VD268

MATERIAL AVAILABILITY AND PART NO.				
STD	OPTIONS			
FA	HH	R	MXS	GFA
FA348	FA348HH	-	-	-

# FA349R A. 26.1 x 119.55 x 7.1mm

B. 35.6 x 94.54 x 7.8mm

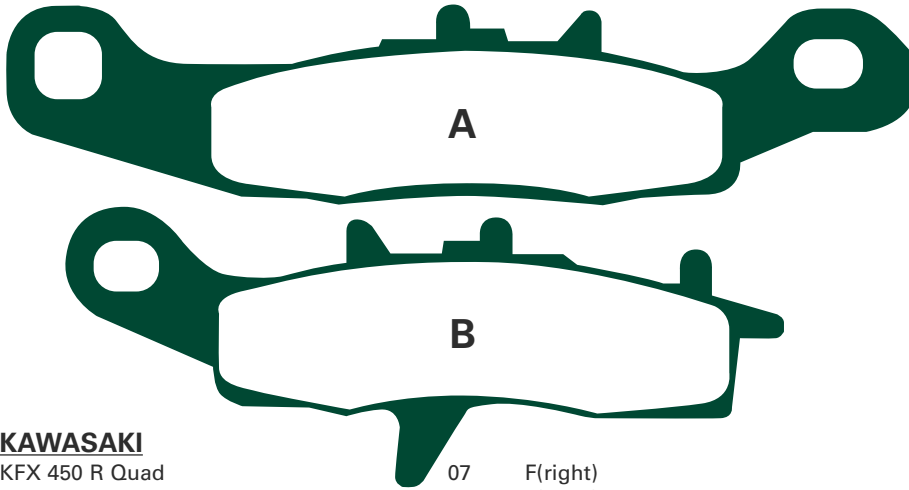

### Equivalents OE #

43082 1273

## KAWASAKI

KFX 450 R Quad	07	F(right)
KVF 650 A1/A2 Prairie	02-03	F(right)
KVF 650 D1/D6F Brute Force 4x4	05-06	F(right)
KVF 650 E1/E6F Brute Force 4x4 Hardwoods Green HD	05-06	F(right)
KSV 700 A1/A2/A6F/B2/B6F (KFX 700)	04-06	F(right)
KVF 700 A1/B1/A2/A6F/B2/B6F 4x4 (Prairie)	04-06	F(right)
KVF 700 D1 Team Green	05	F(right)

## SUZUKI

LT-V 700 FK4/FK5 Twin Peaks	04-05	F(right)
-----------------------------	-------	----------

### Competitor X Ref

Dunlop	Ferodo	SBS	Vesrah
-	-	798	VD442

MATERIAL AVAILABILITY AND PART NO.				
STD	OPTIONS			
FA	HH	R	MXS	GFA
-	-	FA349R	-	-

# FA350 50.1 x 47.4 x 6.8mm

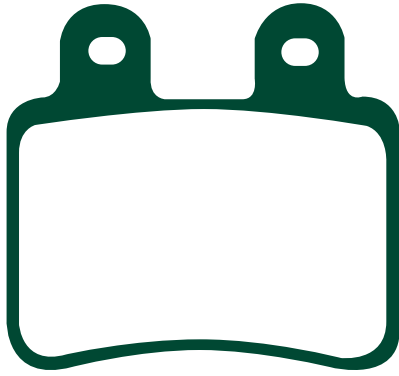

## DERBI

Rambla 50	06	F&R
Rambla 125	06	F&R
Boulevard 125/150/200	03-07	F
Terra 125	07	F
Freexter 125	07	R

## HONDA HM (Italy)

CRE 50 Baja/Six/Derapage	03-06	R
--------------------------	-------	---

## PEUGEOT

Elyseo 125/150	01-03	R
Elystar 125/150 (All models)	02-07	R
Elystar 50 TSDi Advantage	02-07	R
Jet Force 125 (All models)	03-07	R
Satelis 125 4V Executive/Premium/City (4 stroke/4 valve)	06-07	R
Satelis 125 Compressor 4 stroke all models	06-07	R
Geopolis 250 (AJP Caliper)	06-07	R
Satelis 250 (AJP Calipers)	07	R

## ITALJET

Jet Set 50/125/150	02-03	F
Millenium 100/125/150	02-04	F

## MBK

X-Limit Enduro	03-06	F&R
X-Limit Supermoto	03-06	R

## YAMAHA

DT 50 R	02-07	F&R
DT 50 X	04-07	R
XT 125 R	05-07	F&R
XT 125 X	05-07	R

### Equivalents OE #

745658	00G01202221	00H01304931
4722090	3D6 F5811 00	K01303070
755981	1D4 F5742 00	7588626

### Competitor X Ref

Dunlop	Ferodo	SBS	Vesrah
-	FDB2128	773	-

MATERIAL AVAILABILITY AND PART NO.				
STD	OPTIONS			
FA	HH	R	MXS	GFA
FA350	-	-	-	-

# FA351 36 x 39 x 6mm

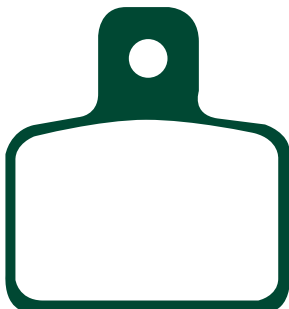

## APRILIA

Mini RX 50 Experience	04	F
-----------------------	----	---

## BETA

Minicross Pro Race 12/10	04-06	F&R
Pro Race 50	05	R

## FACTORY

Phantom R14 Agua	04	F
------------------	----	---

## GAS-GAS

Cross MC 50	06	R
Cross MC 65	06	F&R
TXT Cadet 80	06	F&R
TXT Rookie 50/80 Trail	06-07	R
TXT 125/200/250/280/300 (TXT PRO)	04-07	R
EC 50 Boy (Air cooled)	05	R
EC 50 Boy (LC)	05-07	R
MC 65	05	F
TXT 80 Rookie	04-05	R

## HONDA HM (Italy)

Baja 10/10 JR & SR	99-07	F&R
Baja 12/14 MX	99-07	F&R

## HUSQVARNA

CR 50 Senior Pro	05	F
CR 50 Junior	05	F
TE 100	05	F

## SHERCO

All models 0.8	01-05	R
1.25	06-07	R
All models 2.5/2.90	01-06	R
3.2 (320 4T)	05	R
Trials 0.8	06	R
2.5i Enduro (4T)	06	R

## MONTESA/HONDA

Honda 315 R	01-04	R
250 4RT Cota	05-07	R

## SCORPA

SY 125 F Trials	03-06	R
SY 250	00-07	R
SY 250 Long Ride	04-07	R
TYS 125 F	06-07	R
SY 175 F	06	R
TY-S 175 F	06	R
SY 250 F	06-07	R
Roadster 660	07	R

## TOMOS

MC 50 Senior Pro	05-07	F&R
------------------	-------	-----

### Equivalents OE #

43105 NN3 820	BT280222068
7040	KM0961320
C390	

### Competitor X Ref

Dunlop	Ferodo	SBS	Vesrah
-	FDB2127	803	-

MATERIAL AVAILABILITY AND PART NO.				
STD	OPTIONS			
FA	HH	R	MXS	GFA
FA351	-	-	-	-



# FA352 37.55 x 31.3 x 5.55mm

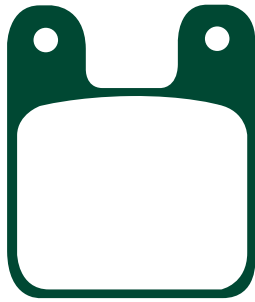

## MINI MOTO

Polini/Pasini/GRC Calipers (Square 2 pin type) F & R

### Equivalents OE #

144 750 008

MATERIAL AVAILABILITY AND PART NO.				
STD	OPTIONS			
FA	HH	R	MXS	GFA
FA352	-	-	-	-

### Competitor X Ref

Dunlop	Ferodo	SBS	Vesrah
DP951	-	-	-

# FA353 A. 96.8 x 39.35 x 9.3mm B. 77 x 42 x 9.3mm

**NOTE: HENG TONG CALIPER**

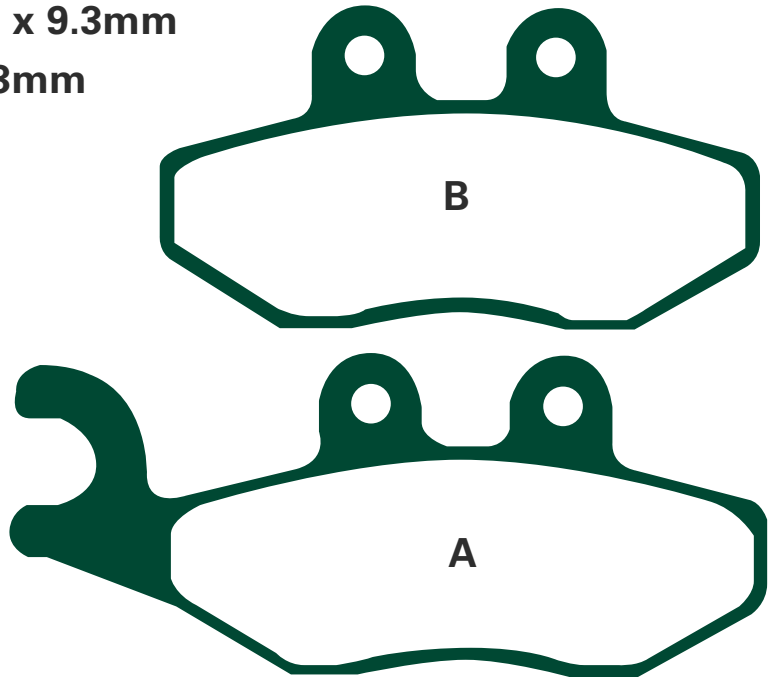

### Equivalents OE #

497072
497116
647078

### Competitor X Ref

Dunlop	Ferodo	SBS	Vesrah
-	-	-	-

MATERIAL AVAILABILITY AND PART NO.				
STD	OPTIONS			
FA	HH	R	MXS	GFA
FA353	-	-	-	-

## GILERA

DNA 50 (Heng Tong Caliper)	01-05	F
125 VX/180 VXR (4T)	01-04	F
Runner 125/180 FX/FXR/SP (2T)	99-02	F
Runner 50 PJ/SP	06-07	F
VXR 200 Runner (4T)	02-04	F
Nexus 125	07	F&R
Nexus 250 ie	07	F&R
VX 125 Runner (4T)	05-07	F
VX 200 Runner (4T)	05-07	F

## KEEWAY

K2 125/150/250	07	F&R
----------------	----	-----

## PIAGGIO/VESPA

Fly 50 (2T/4T)	05-07	F
Fly 100	07	F
Beverley 125	07	F
Beverly B125	02-06	F&R
Beverley S 125	07	f&r
Fly 125/150	05-07	F
GT 125 L Granturismo Heng Tong Caliper	03-06	F
GTV 125	07	F
Skipper ST 125/150 4T	00-04	F
Super Hexagon GTX 125/180 (11" wheels)	00	F
Super Hexagon 125/180 (12" wheels)	01-03	F

X8 125	04-06	F
X8 125 ie	07	F
X8 125/Street	07	F
X9 125	06-07	F(left)
X8 150 Street	07	F
Beverly B 200	02-05	F&R
GT 200 L Granturismo Heng Tong Caliper	03-06	F
X8 200	04-05	F
Beverly 250	06	F&R
Beverley 250 ie		F&R
Beverley S 250 ie	07	F&R
GTS 250 ie/ABS	05-07	F
GTV 250 ie	07	F
GT 60 (Special Anniversary Model) (GTV 250)	06	F
X8 250 ie	05-06	F
X8 2560 ie	07	F
X9 250	05-06	F(left)
Beverley 400 ie	07	R
X8 400 ie	07	F

# FA354R 97 x 51.7 x 6.95mm

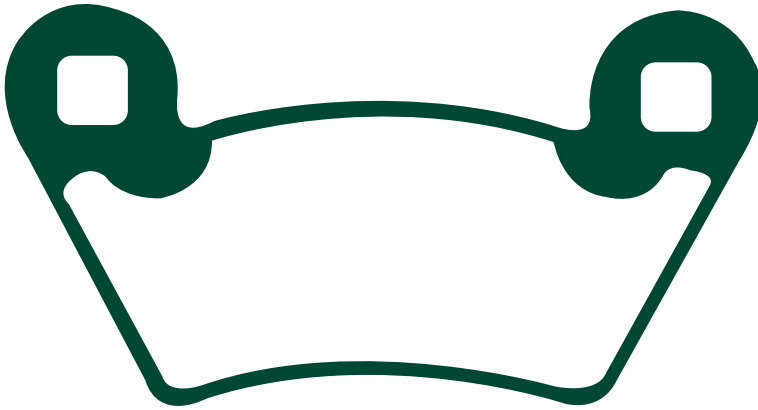

## POLARIS

Ranger (2x4/4x4)	02-04	F&R
UTV 2x4 (Utility task vehicle series 10)	03	F&R
PPS/UTV/Series 10 2x4		F&R
PPS/UTV/Series 10 4x6		F&R
PPS/Series II UTV 1500 2x4		F&R
Ranger Series 10		F&R
Ranger Series 10 "500 6x6"		F&R
Ranger Series 11		F&R
PPS/Series 11 2x4/4x4		F&R
PPS/Series 11 6x6		F&R
Ranger 6x6	04-05	F&R
Ranger TM	04-05	F&R
Ranger XP	05	F&R
Ranger 2x4/4x4	04-06	R
Ranger 500 (2x4/4x4)	06	F&R
Ranger 500 (4x4 EFi)	06	F&R
Ranger 6x6 EFi 700	06	F&R
Ranger XP 700 4x4	06	F&R
Ranger TM	06	F&R

### Equivalents OE #

191 0514
2202413

### Competitor X Ref

MATERIAL AVAILABILITY AND PART NO.				
STD	OPTIONS			
FA	HH	R	MXS	GFA
-	-	FA354R	-	-

Dunlop	Ferodo	SBS	Vesrah
-	-	800	VD9024

# FA355 44.9 x 50.75 x 7mm



## ARCTIC CAT

DVX 250 06 R

## KYMCO

Grand Dink 250	01-06	F
KXR 250 Mongoose Quad	04-07	R
MXU 250	04-07	R
Urban Quad 250	06	R
Maxxer 300	06-07	R

## GILERA

Oregon 250 Quad 07 R

## MASAI

A 300 Quad	05-07	R
A 450 Quad	05-07	R

## SYM

Voyager 250	05	F
Voymax 250	06	F

### Equivalents OE #

45105 HMA 000A	00156924
45106 KKC4 9000	

### Competitor X Ref

MATERIAL AVAILABILITY AND PART NO.				
STD	OPTIONS			
FA	HH	R	MXS	GFA
FA355	-	FA355R	-	-

Dunlop	Ferodo	SBS	Vesrah
-	-	775	-

# FA356 55.5 x 46 x 7.1mm

**KYMCO**

Grand Dink 250

01-06 R

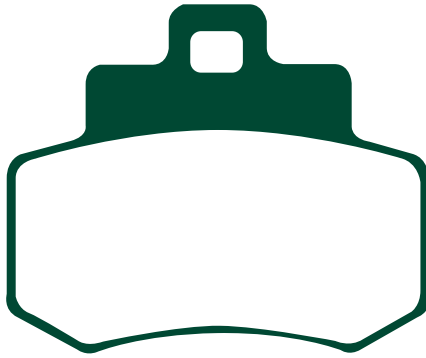

**Equivalents OE #**

43105 KKC4 9000

**Competitor X Ref**

MATERIAL AVAILABILITY AND PART NO.				
STD	OPTIONS			
FA	HH	R	MXS	GFA
FA356	-	-	-	-

Dunlop	Ferodo	SBS	Vesrah
-	-	776	-

# FA357 62.1 x 31.4 x 6.55mm

**KTM**

65 SX  
SX 85

02-07 F  
03-07 F&R

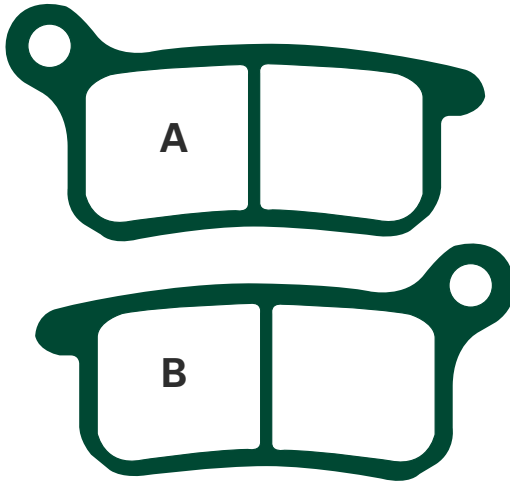

**Equivalents OE #**

461 13 030 000  
470 13 090 000

**Competitor X Ref**

MATERIAL AVAILABILITY AND PART NO.				
STD	OPTIONS			
FA	HH	R	MXS	GFA
FA357TT	-	FA357R	-	-

Dunlop	Ferodo	SBS	Vesrah
DP924	FDB2157	783	-

# FA358 A. 86.1 x 40 x 8.9mm

B. 86.1 x 40 x 8.9mm

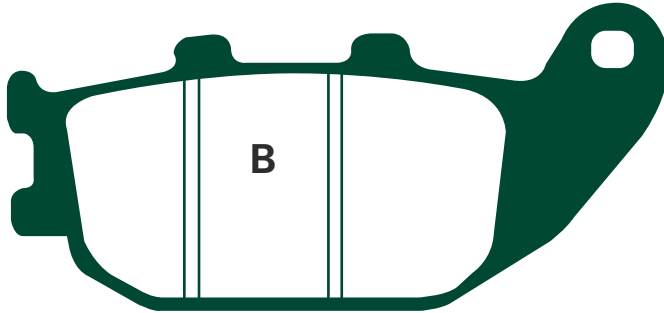
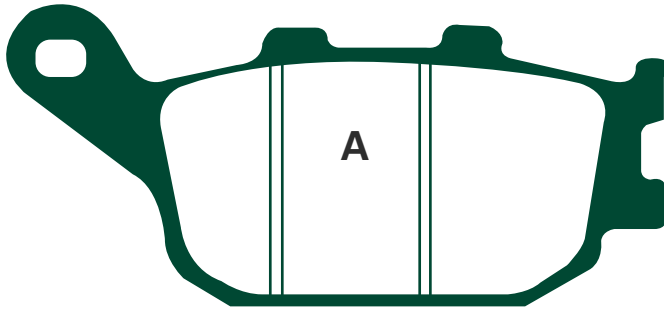

## HONDA

NSS 250 Y/AY/1/A1/A3/3 Forza/Forza-S  
/Forza-T/Forza-ST/Jazz/Reflex  
(MF04/MF06)

00-04 R

### Equivalents OE #

06435 KPB 016

MATERIAL AVAILABILITY AND PART NO.				
STD	OPTIONS			
FA	HH	R	MXS	GFA
FA358	-	-	-	-

### Competitor X Ref

Dunlop	Ferodo	SBS	Vesrah
DP928	-	753	VD169

# FA363 A. 94 x 37.3 x 8.6mm

B. 94 x 37.3 x 10.1mm



1 left / 1 right

## BMW

R 850 C	97-00	R
R 850 GS	96-00	R
R 850 R	94-06	R
R 850 RT	96-01	R
R 850 RT	06	R
R 1100 GS	93-99	R
R 1100 R	93-01	R
R 1100 S	96-06	R
R 1100 RT	94-01	R
R 1150 GS	98-04	R
R 1150 R	01-06	R
R 1150 RS	01-04	R
R 1150 RT	00-04	R
R 1150 R Rockster	03-06	R
HP2 1200 Enduro	05-07	R
R 1200	00-02	R
R 1200 C	96-04	R
R 1200 GS	04-06	R
K 1200 S (K40)	05-06	R
K 1200 R	05-06	R
R 1200 ST (K28)	03-07	R
R 1200 RT (K26)	03-07	R
R 1200 S	06-07	R
R 1200 R Sport	06-07	R
K 1200 R Sport	07	R
HP2 Megamoto	07	R
R 1200 GS Adventure (Spoke wheel)	07	R

### Equivalents OE #

34 21 2 314 947  
34 21 2 335 465  
34 21 2 330 633  
34 21 7 660 281

MATERIAL AVAILABILITY AND PART NO.				
STD	OPTIONS			
FA	HH	R	MXS	GFA
FA363	FA363HH	-	-	-

### Competitor X Ref

Dunlop	Ferodo	SBS	Vesrah
-	FDB2039	742	-

# FA366 69.8 x 46.7 x 13.05mm

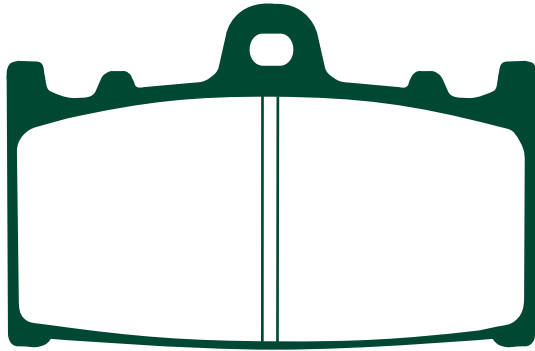

## SUZUKI

VL 1500 K2/K3/K5 Intruder 02-03/05 R  
 VL 1600 K5/K6/K7 (C 1500 Intruder) 05-07 R

### Equivalents OE #

69100 10820

MATERIAL AVAILABILITY AND PART NO.				
STD	OPTIONS			
FA	HH	R	MXS	GFA
FA366TT	-	-	-	-

### Competitor X Ref

Dunlop	Ferodo	SBS	Vesrah
-	FDB2163	789	-

# FA367 66.9 x 36.1 x 10.75mm



1 pad left  
/ 1 pad right

## APRILIA

RXV 450/550 Enduro 06-07 R  
 SVX 450/550 Supermotard 06-07 R  
 SXV 450 07 R  
 SXV 459 07 R

## BETA

RR 125 (All models) 06-07 R  
 RR 250/400/450/525 Enduro 05-07 R  
 M4 350 Motard 07 R

## KAWASAKI

KX 250 F (KX 250 N1/N2) 04-05 R  
 KX 250 F (T6F/T7F) 06-07 R  
 KX 450 F (D6F/D7F) 06-07 R  
 KLX 450 R (A8F) 07 R

## SHERCO

4.5i (450 SM/LT) 04-07 R  
 4.5i Enduro (4T) 06-07 R  
 5.1i Enduro 06-07 R  
 5.1i Supermotard 06-07 R

## SUZUKI

RM-Z 250 K4/K5/K6/K7 04-07 R  
 RM-Z 450 K5/K6/K7 05-07 R

## TM

SMX 660 06 R

## YAMAHA

YZ 125 R/S/T/V/W 03-07 R  
 YZ 250 R/S/T/V/W 03-07 R  
 YZ 250 FR/FS/FT/FV/FW 03-07 R  
 WR 250 FR/FS/FT/FV/FW 03-07 R  
 WR 450 FR/FS/FT/FV/FW 03-07 R  
 YZ 450 FR/FS/FT/FV 03-06 R

### Equivalents OE #

5UN W0046 00	K4308 0006	69100 35810
5UN W0046 50	IC3 W0046 10	43082 0048
5UN W0046 51	25.25362.0.00	9100797
43082 0006	0631	2525345000

### Competitor X Ref

MATERIAL AVAILABILITY AND PART NO.					Dunlop	Ferodo	SBS	Vesrah
STD	OPTIONS							
FA	HH	R	MXS	GFA				
FA367TT	-	FA367R	MXS367	GFA367HH	DP940	FDB2162	790	VD271

# FA368 A. 64 x 41.6 x 9.25mm

## B. 64 x 41.6 x 9.25mm



1 pad left  
/ 1 pad right

### Equivalents OE #

548 13 090 000
548 13 090 100
8000A2790
548 13 090 300

### Competitor X Ref

Dunlop	Ferodo	SBS	Vesrah
DP935	FDB2165	791	-

MATERIAL AVAILABILITY AND PART NO.				
STD	OPTIONS			
FA	HH	R	MXS	GFA
FA368TT	-	FA368R	MXS368	GFA368HH

### HUSQVARNA

CR 125	05-07	R
WR 125	06-07	R
CR 250	05	R
TC 250	05-07	R
TE 250	06-07	R
WR 250	06-07	R
TE 410	06	R
SMR 450 RR (Radial caliper)	06-07	R
SM 450 R Radial Caliper	07	R
TC 450	05-07	R
TE 450	06-07	R
SM 510 R (Radial caliper)	06-07	R
TC 510	05-07	R
TE 510	06-07	R

### KTM

SX 125	04-07	R
EXC 125	04-07	R
EXC 200	04-07	R
SX 250	03-07	R
SX-F 250	06-07	R
EXC 250	04-07	R
EXC 250 Racing	06	R
EXC-F 250	06-07	R
EXC 300	04-07	R
EXC 400 Racing	06-07	R
EXC 450 Racing	06-07	R
SMR 450	04-06	R
SX-F 450	03-07	R
EXC 450	04-05	R
SMR 450	07	R
SX-F 505	07	R
SMR 525	04	R
SX 525	03-06	R
EXC 525	04-05	R
XC 525 Racing	06-07	R
SMR 560	07	R
SXC 625	05-06	R
SMR 650 Supermoto	06	R
SMR 525	05	R

### YAMAHA

YZ 450 FW	07	R
-----------	----	---

# FA369/4HH 49.2 x 38.6 x 7.75mm

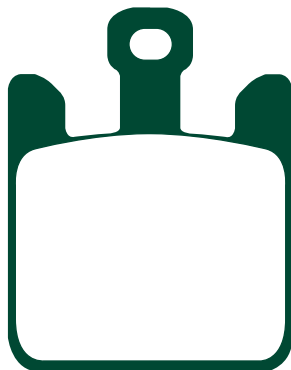

### KAWASAKI

ZX-6RR (ZX 600 K1/M1/N1/N6F)	03-06	F
ZX6R (ZX 636 B1/B2/C1/C6F)	03-06	F
ZX 10 R (ZX 1000 C1/C2/D6F/D7F)	04-07	F
ZX 12 R (ZX 1200 B3/B4/B6F)	04-06	F
VN 1600 B2H/B6F (Mean Streak)	05-06	F

### SUZUKI

GSXR 1000 K3	03	F
VZ 1600 K5 (M 1600 Intruder)	05	F

### Equivalents OE #

59100 18851	43082 0019	43082 0037
43082 1293	43082 0021	
43082 0018	43082 0031	

### Competitor X Ref

MATERIAL AVAILABILITY AND PART NO.					Dunlop	Ferodo	SBS	Vesrah
STD	OPTIONS				DP942	FDB2164	788	VD354
FA	HH	R	MXS	GFA		FDB2203		
-	FA369/4HH	-	-	GFA369/4HH				

# FA372R

A. 37 x 55.5 x 10.94mm  
B. 85 x 35 x 8.7mm

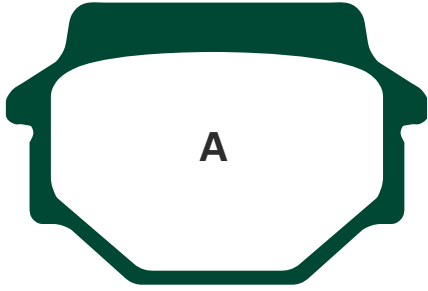

**SUZUKI**

LT-A 500 FK3/FK4/FK5/FK6/FK7 Vinson 4WD Auto 03-07 R  
LT-F 500 FK3/FK4/FK5/FK6/FK7 03-07 R

**Equivalents OE #**

69100 03850
69100 03860

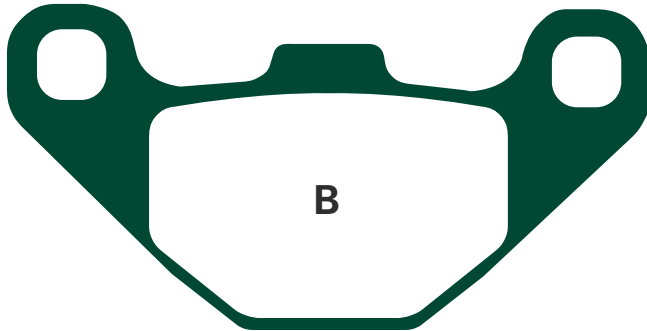

**Competitor X Ref**

MATERIAL AVAILABILITY AND PART NO.				
STD	OPTIONS			
FA	HH	R	MXS	GFA
-	-	FA372R	-	-

Dunlop	Ferodo	SBS	Vesrah
-	-	-	-

# FA373R

75.35 x 39.35 x 11.75mm

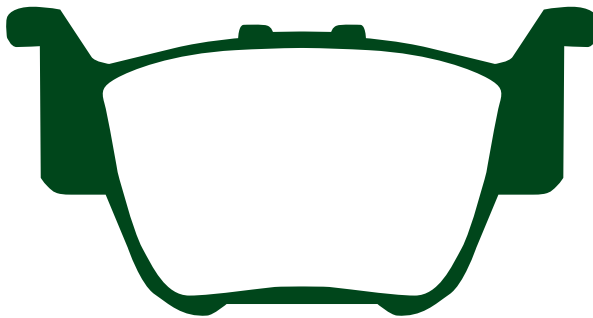

**Equivalents OE #**

06435 HN8 006
06435 HP1 006

**HONDA**

TRX 450 R4/R5/R6/ER6/R7/ER7 04-07 R  
TRX 650 FA3/FA4/FA5 Rincon 03-05 R  
TRX 680 FGA6/FA6/7 Fourtrax Rincon 06-07 R

**Competitor X Ref**

MATERIAL AVAILABILITY AND PART NO.				
STD	OPTIONS			
FA	HH	R	MXS	GFA
-	-	FA373R	-	-

Dunlop	Ferodo	SBS	Vesrah
DP944	FDB2182	813	VD171

# FA374 A. 95.5 x 42 x 8mm

B. 77 x 42 x 8mm

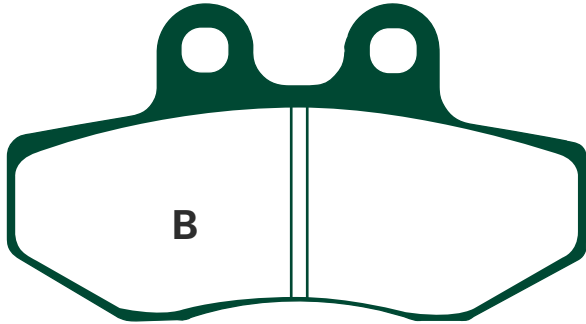
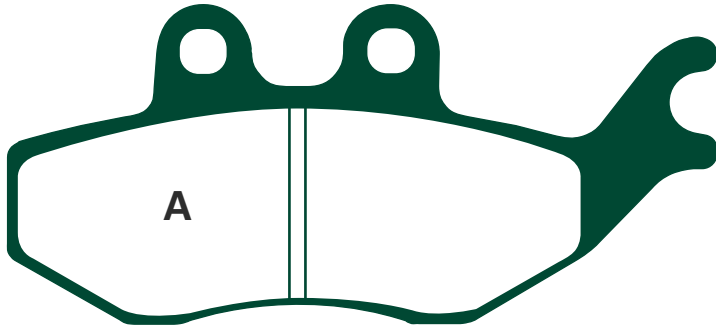

**ITALJET**

Jupiter 250

02-03 R

**RIEJU**

NKD 50

07 F

RS2 Matrix (50cc)

02-07 F

RS2 125

06-07 F

125 NKD

06-07 F

**Equivalents OE #**

4716610
00009307000

**Competitor X Ref**

Dunlop	Ferodo	SBS	Vesrah
-	FDB2147	780	VD9013

**MATERIAL AVAILABILITY AND PART NO.**

STD	OPTIONS			
FA	HH	R	MXS	GFA
FA374	-	-	-	-

# FA375 A. 110.6 x 34.6 x 7.6mm

B. 98.7 x 33.5 x 7.5mm

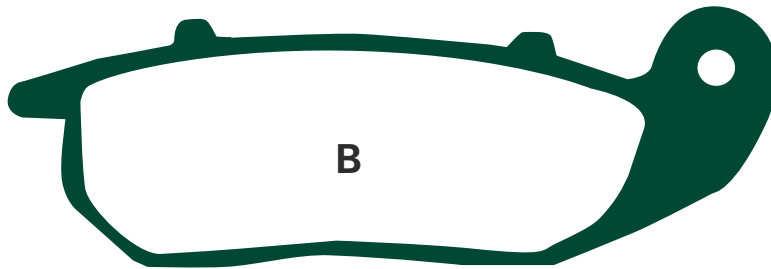
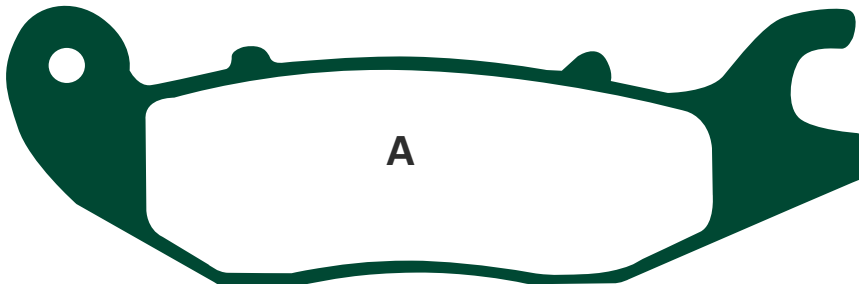

**AJS**

Regal Raptor CR3-125

06 F

**HONDA**

ANF 125 3/S/T5/6/7

03-07 F

CBR 125 RR4/RR5/RS5/RWS

/RR6/RS6/R7

04-07 F

FS 125 Sonic

03-04 R

CBR 150 R

00-03 F

**LIFAN**

Smart 50/125

F

**SUPERBYKE**

CQ 50 Road Classic

F

CU 125 Road Classic

F

**Equivalents OE #**

06455 KPH 951
06455 KPP 901

**Competitor X Ref**

Dunlop	Ferodo	SBS	Vesrah
-	FDB2169	797	-

**MATERIAL AVAILABILITY AND PART NO.**

STD	OPTIONS			
FA	HH	R	MXS	GFA
FA375	-	-	-	-



# FA377 A. 94 x 46 x 8.5mm B. 73 x 46 x 11mm

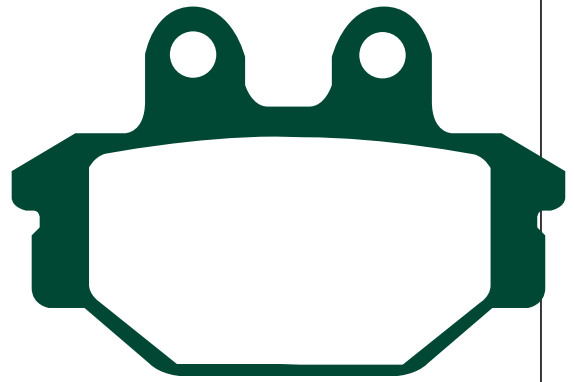
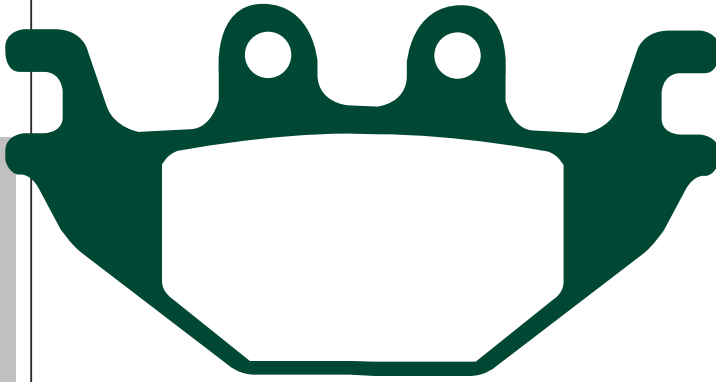

<b>ADLY</b>		
Interceptor 300	06	F
<b>ARCTIC CAT</b>		
DVX 250	06	F
<b>BOMBARDIER</b>		
DS 250	06	F&R
<b>CAN-AM</b>		
DS 250 (3J7A/B)	07	F&R
<b>CPI</b>		
XS 250 Quad	06-07	F
<b>KYMCO</b>		
KXR 250 Mongoose Quad	04-07	F
MXU 250	04-07	F
Urban Quad 250	06	F
MXU 300	06-07	F&R
Maxxer 300	06-07	F
MXU 500 (4x4)	06-07	F&R
<b>PGO</b>		
BR-500i Racer	07	R
<b>SYM</b>		
Trackrunner 200 Quad	05-07	F
Quadlander 250	05-07	F
Outlander 300 S	07	F&R
Citymax 300 Quad	06	F
Quadraider 600	06	R
<b>TGB</b>		
Outback 425 Quad	07	F&R

**Equivalents OE #**

45105 LB17 3050	S4311ARCA000
00157056	515049
S4511ARCA000	515050

**Competitor X Ref**

Dunlop	Ferodo	SBS	Vesrah
DP967	FDB2184	810	VD9026

**MATERIAL AVAILABILITY AND PART NO.**

STD	OPTIONS			
FA	HH	R	MXS	GFA
FA377		FA377R		

# FA379HH 71.45 x 49.9 x 7.76mm

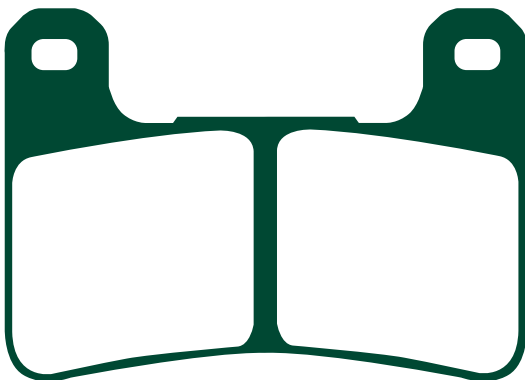

**SUZUKI**

GSXR 600 K4/K5/K6/K7	04-07	F
GSXR 750 K4/K5/K6/K7	04-07	F
GSXR 1000 K4/K5/K6/K7	04-07	F
VZR 1800 K6/K7 (M 1800 R Intruder)	06-07	F

**Equivalents OE #**

59100-29820
59100-29840
59100 29850

**Competitor X Ref**

Dunlop	Ferodo	SBS	Vesrah
DP947	FDB2178 FDB2204	306	VD355

**MATERIAL AVAILABILITY AND PART NO.**

STD	OPTIONS			
FA	HH	R	MXS	GFA
-	FA379HH			GFA379HH

# FA380HH 50.4 x 69 x 8.7mm

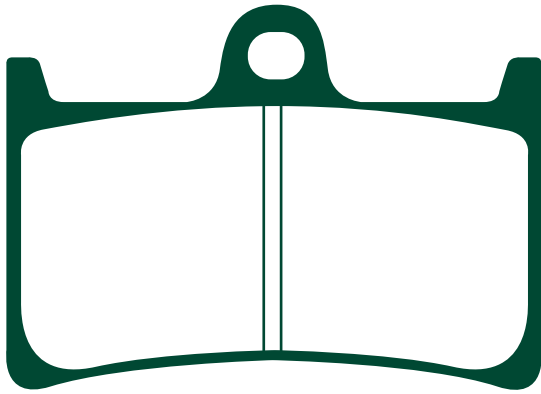

### YAMAHA

FZ6 Fazer S2 (ABS) (4 piston caliper)	07	F
YZF R6	04-07	F
YZF R6S	07	F
YZF R1	04-06	F
FZ1-N/NV (Naked) (1000cc) (2D11/2/3)	06-07	F
FZ1-S/FZ1-SV	06-07	F
MT-01 (1670cc)	05-06	F
YZF-R1SP	06	F

Equivalents OE # 5VY W0045 00

### Competitor X Ref

Dunlop	Ferodo	SBS	Vesrah
DP418	FDB605	634	VD248/274

### MATERIAL AVAILABILITY AND PART NO.

STD	OPTIONS			
FA	HH	R	MXS	GFA
-	FA380HH			GFA380HH

# FA381 103 x 48 x 10.9mm

Total thickness with refitted O/E shim & insulator  
(size of pad on its own 8.9mm)

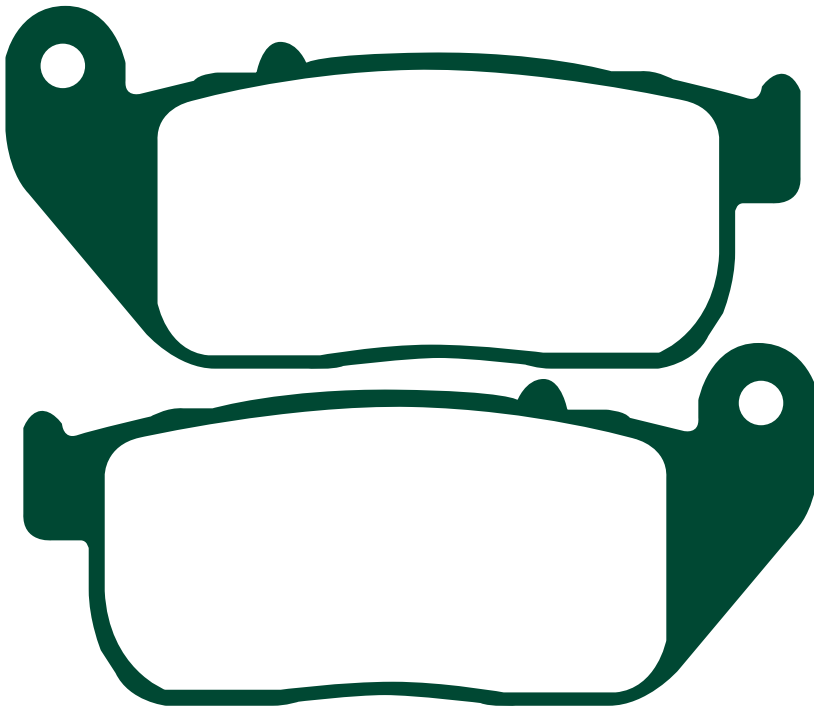

**NOTE: Only refit shim & insulator to HH pads**

### HARLEY DAVIDSON

XL 50 50th Anniversary Sportster	07	F
XL 883 Sportster STD	04-07	F
XL 883C Sportster Custom	04-07	F
XL 883 R Sportster	05-07	F
XL 1200 C Sportster Custom	04-07	F
XL 1200 R Sportster Roadster	04-07	F
XL 1200 L Sportster Low	07	F

### Equivalents OE #

42831-04

### MATERIAL AVAILABILITY AND PART NO.

STD	OPTIONS			
FA	HH	R	MXS	GFA
FA381	FA381HH			

### Competitor X Ref

Dunlop	Ferodo	SBS	Vesrah
DP948	FDB2179	807	VD9009JL

**FA382** A. 85.12 x 42.70 x 7.4mm  
B. 56 x 34.75 x 9.6mm

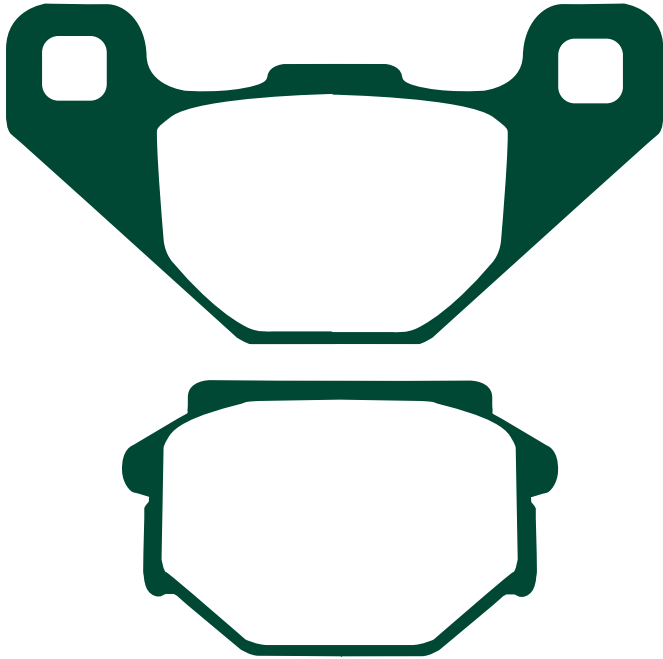

<b>APRILIA</b>			
MX 125		04-06	R
Tuareg Rally 125		89-93	R
Tuareg Rally 125 (L/M)		90-91	R
RX 125		92-01	R
Pegaso 125		91	R
Pegaso 125 KAT		94-95	R
Pegaso 600		91	R
Tuareg Wind 600		89	R
<b>BETA (Street)</b>			
ALP 4.0		04	R
<b>HONDA HM (Italy)</b>			
CRE 50 Six		01-02	R
CRE 50 Six/Baja/Derapae		95-02	R
CRE 50 Six/Baja/Derapage Grimeca caliper		95-02	F&R
<b>MZ</b>			
660 Supermoto		06-07	R
<b>SACHS</b>			
XTC 125 Supersport		00-07	R
X Road 125		06	R
Roadster 650		01-04	R
<b>YAMAHA</b>			
DT 50 R-L (SM-5VB1/VG55BK)		02-03	F

**Equivalents OE #**

5VB W0045 00
8113375
KA3497506

**Competitor X Ref**

Dunlop	Ferodo	SBS	Vesrah
-	-	682	-

**MATERIAL AVAILABILITY AND PART NO.**

STD	OPTIONS			
FA	HH	R	MXS	GFA
FA382				

**FA384** A. 99 x 42.5 x 8mm  
B. 77.1 x 40.8 x 8.95mm



<b>YAMAHA</b>			
CV 50 A/R Jog (5SU1/2)		03	F

**Equivalents OE #**

5SU W0045 00
--------------

**Competitor X Ref**

Dunlop	Ferodo	SBS	Vesrah
-	-	-	-

**MATERIAL AVAILABILITY AND PART NO.**

STD	OPTIONS			
FA	HH	R	MXS	GFA
FA384				

# FA387 87 x 50 x 10.4mm (Note refit o/e shim to HH pads only)



**Equivalents OE #**

42836-04

**HARLEY DAVIDSON**

XL 50 50th Anniversary Sportster	07	R
XL 883 Sportster Standard	04-07	R
XL 883 (XL53X) Sportster Custom	04-07	R
XL 883 R Sportster	05-07	R
XL 1200 C Sportster Custom	04-07	R
XL 1200 R Sportster Roadster	04-07	R
XL 1200 L Sportster Low	07	R

**Competitor X Ref**

<b>Dunlop</b> DP949	<b>Ferodo</b> FDB2180	<b>SBS</b> 808	<b>Vesrah</b> VD9010JL
------------------------	--------------------------	-------------------	---------------------------

**MATERIAL AVAILABILITY AND PART NO.**

STD	OPTIONS			
FA	HH	R	MXS	GFA
FA387	FA387HH			

# FA388HH 118 x 47 x 8.3mm (Refit O/E shim)

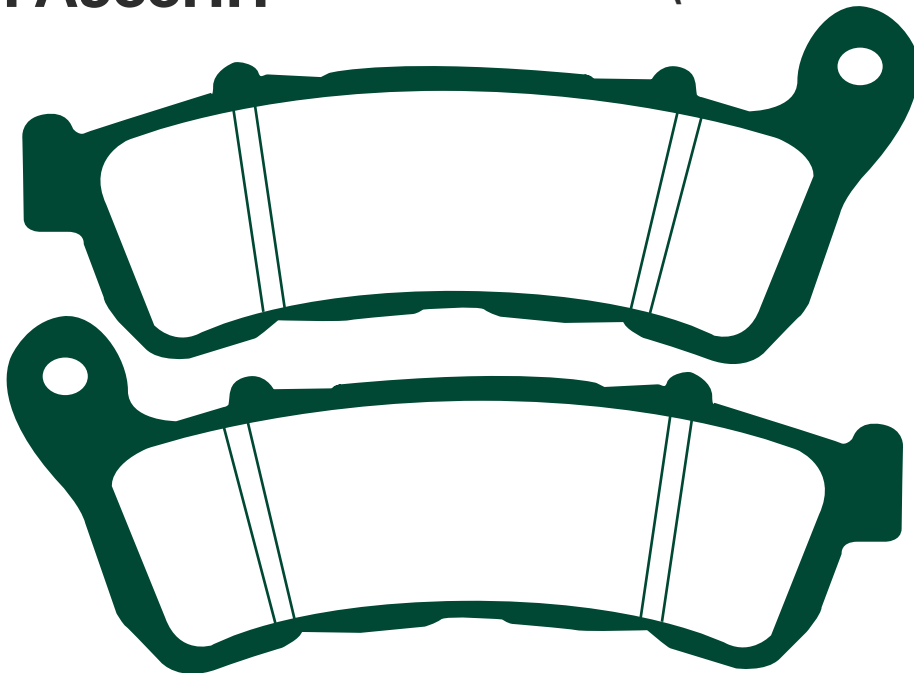

**Equivalents OE #**

06455 MBT D51
06455 MET 651
06455 KSV J03
06455 KSV J41
06455 KSV J01
06455 MCW H01
06456 MCW H01
06455 MFA D11
06455 KTW 901

**HONDA**

NSS 250 EX5/EX6 (ABS) Forza EX	05-06	F
NSS 250 AX5/AX6/A7 (ABS) Forza Z	05-07	F
PS 250 5/6 Big Ruckus	05-06	F
SH 300i A7	07	F
CBF 500 A4/A5/A6 (ABS)	04-07	F
CB 600 AF7 Hornet (ABS)	07	F

NT 700 V6/VA7 Deauville	06-07	F
VFR 800 6/7/A6/A7	06-07	F
CBF 1000 FA6/FA7 (ABS Model)	06-07	F&R
XL 1000 VA4/VA5/VA6/VA7 Varadero (ABS)	04-07	F

**SUZUKI**

UH 125 K7 Burgman	07	F
UH 200 K7 Burgman	07	F

**Competitor X Ref**

<b>Dunlop</b> DP954	<b>Ferodo</b> FDB2196	<b>SBS</b> 828	<b>Vesrah</b> VD172
------------------------	--------------------------	-------------------	------------------------

**MATERIAL AVAILABILITY AND PART NO.**

STD	OPTIONS			
FA	HH	R	MXS	GFA
FA388	FA388HH	-	-	-

# FA389 USE FA185TT

## FA390 75 x 48 x 8mm

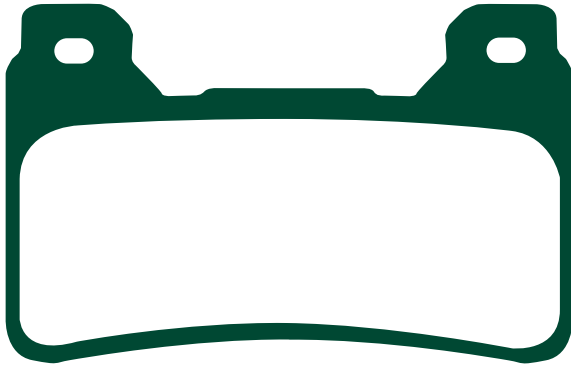

### HONDA

CBF 600 N7 (Radial Caliper)	07	F
CBR 600 RR5/RR6/RR7 (Radial Caliper)	05-07	F
CBR 1000 RR4/RR5/RR6/RR7 Fireblade	04-07	F

### Equivalents OE #

06455 MEL 003
06455 MFJ D01

### Competitor X Ref

Dunlop	Ferodo	SBS	Vesrah
DP950	FDB2181 FDB2205	809	VD170

MATERIAL AVAILABILITY AND PART NO.				
STD	OPTIONS			
FA	HH	R	MXS	GFA
	FA390HH			GFA390HH

## FA393 77 x 42 x 9.3mm

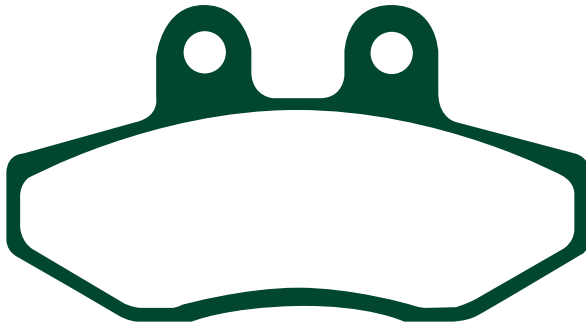

### YAMAHA

XC 125 Cygnus X 04-07 F

### MBK

YP 125 Flamex 04-06 F

### Equivalents OE #

5NW W0045 00
--------------

### Competitor X Ref

Dunlop	Ferodo	SBS	Vesrah
-	-	823	VD273

MATERIAL AVAILABILITY AND PART NO.				
STD	OPTIONS			
FA	HH	R	MXS	GFA
FA393	-	-	-	-

## FA395 95 x 48 x 7mm



### ARCTIC CAT

250 (2x4/4x4)	05	F&R
300 (4x4)	05	F&R
400 FIS/4x4 FIS	05	F&R
500 FIS	05	F&R
500 TRV	05	F&R
650 H1 (4x4 Auto)	05	F&R
650 H1 Auto	06	F&R
650 V-Twin Auto FI5	06	F&R
650 V-Twin 4x4 FI5	04-05	F&R
700 4x4 Auto FI5/EFI	06-07	F&R

### PIAGGIO

Trackmaster 400 Quad 06 F&R

### Equivalents OE #

0502-604
0502-875
2203045

### Competitor X Ref

Dunlop	Ferodo	SBS	Vesrah
DP956	-	822	VD9023

MATERIAL AVAILABILITY AND PART NO.				
STD	OPTIONS			
FA	HH	R	MXS	GFA
FA395TT		FA395R		

# FA396 A. 99.00 x 44.10 x 7.56mm B. 75.50 x 37.90 x 8.26

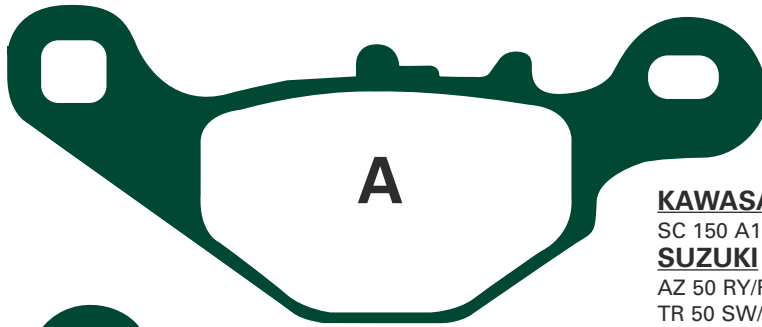

**A**

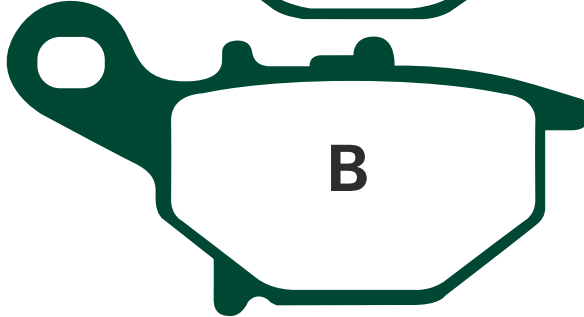

**B**

**KAWASAKI**

SC 150 A1 (Epsilon 150) 02-03 F

**SUZUKI**

AZ 50 RY/RK2 (ZZ Inch Up Sport) 00-02 F

TR 50 SW/SX 98-00 F

UG 110 W/SW/Y/SY/SK1 Hokuto/Address 98-02 F

AN 125 S/T/V/W/XX 95-00 F

UC 125 X/Y 'Epicuro' 99-02 F

UZ 125 K5/GK5 (CF46A) (V126G) 05 F

**Equivalents OE #**

43082 S001	59300 20830
59300 20841	59300 20880
59300 20890	59300 20890

**Competitor X Ref**

Dunlop	Ferodo	SBS	Vesrah
DP218	-	702	-

**MATERIAL AVAILABILITY AND PART NO.**

STD	OPTIONS			
FA	HH	R	MXS	GFA
FA396				

# FA398R 95.4 x 39.55 x 6.85mm

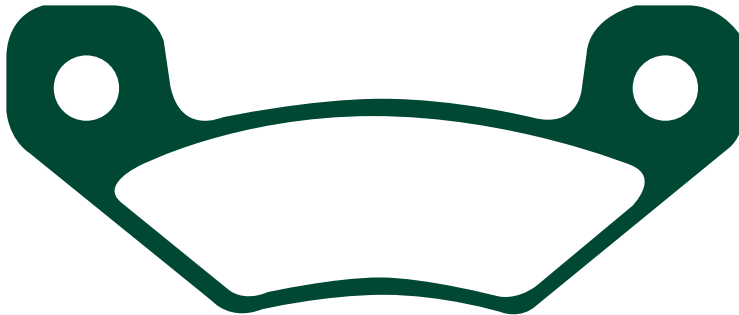

**JOHN DEERE**

Gator HPX All models 04-05 F&R

**Equivalents OE #**

VGA 12182
-----------

**Competitor X Ref**

Dunlop	Ferodo	SBS	Vesrah
-	-	-	-

**MATERIAL AVAILABILITY AND PART NO.**

STD	OPTIONS			
FA	HH	R	MXS	GFA
-	-	FA398R	-	-

# FA399 69.65 x 51.55 x 7.25mm



**BLATA**

Enduro 125 07 F

Motard 125 07 F

**CONTI**

RX 356 V3 (12" wheels) 05-06 F

RX 356 V3 (17" wheels) 05-06 F

**DERBI**

GPR 125/Nude (Radial caliper) 04-06 F

Freexter 125 07 F

**GILERA**

SC 125 06-07 F

**Competitor X Ref**

Dunlop	Ferodo	SBS	Vesrah
-	FDB2201	821	-

**Equivalents OE #**

00H01201221
-------------

**MATERIAL AVAILABILITY AND PART NO.**

STD	OPTIONS			
FA	HH	R	MXS	GFA
FA399	-	-	-	-

# FA400 A. 97.54 x 64.2 x 7.5mm B. 97.54 x 64.2 x 7.5mm

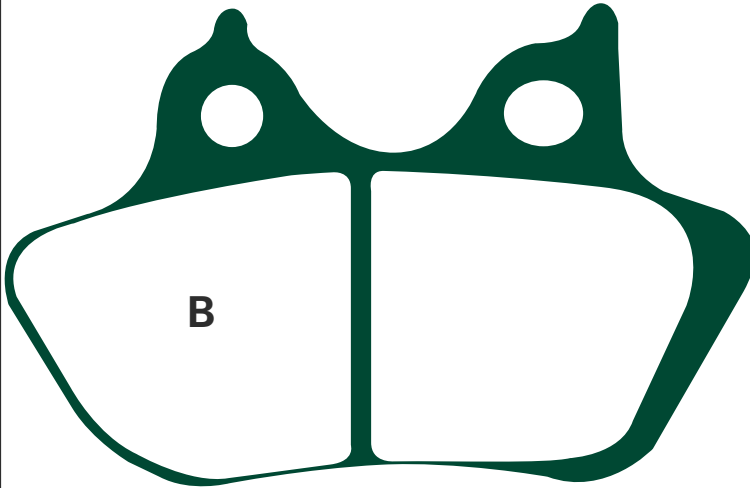

**NOTE: THIS PAD REPLACES  
FA299/299HH**

**HARLEY DAVIDSON**

Most models  
Check application listings for details

06-07 F&R

**Equivalents OE #**

44082 00C

**Competitor X Ref**

Dunlop	Ferodo	SBS	Vesrah
DP957	-	826	VD9022

**MATERIAL AVAILABILITY AND PART NO.**

STD	OPTIONS			
FA	HH	R	MXS	GFA
FA400	FA400HH	-	-	-

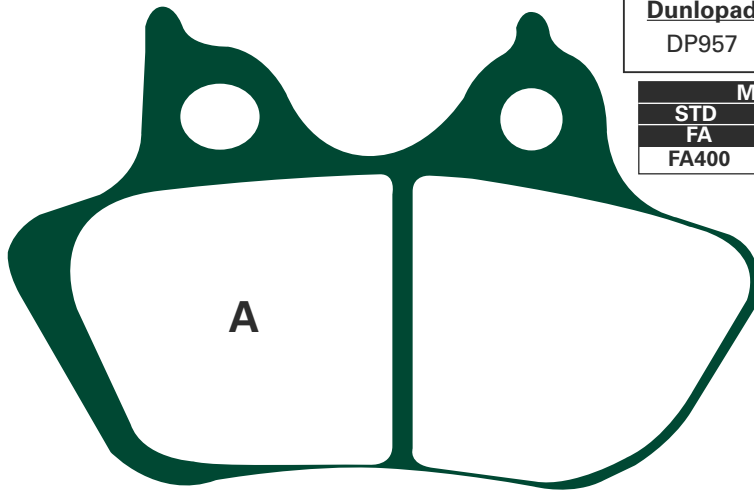

**CHECK PAD SHAPE TO  
CONFIRM CORRECT PAD  
HAS BEEN SELECTED**

# FA401 A. 99 x 40.1 x 7.56mm B. 75.5 x 37.9 x 8.26mm

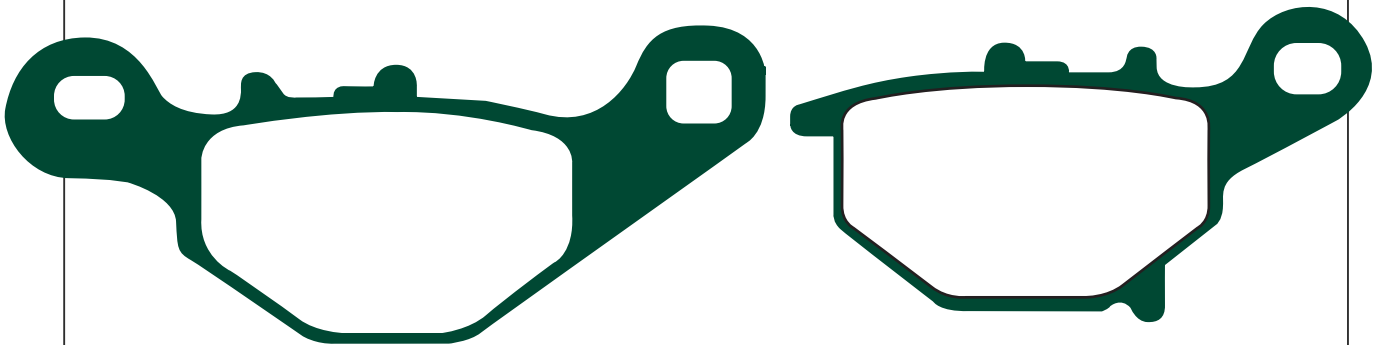

**Equivalents OE #**

69100 03880

**Competitor X Ref**

Dunlop	Ferodo	SBS	Vesrah
DP953	FDB2197	820	VD358

**SUZUKI**

RM 85 LK5/K5/LK6/K6/LK7/K7

05-07 R

**MATERIAL AVAILABILITY AND PART NO.**

STD	OPTIONS			
FA	HH	R	MXS	GFA
FA401TT	-	FA401R	-	-

# FA403 41.1 x 44.7 x 6.45mm



**BETA**

REV 3 125/200  
REV 3 250/270

06 R  
05-07 R

**Equivalents OE #**

25 25-363 0 00

**Competitor X Ref**

MATERIAL AVAILABILITY AND PART NO.				
STD	OPTIONS			
FA	HH	R	MXS	GFA
FA403	-	-	-	-

<u>Dunlop</u>	<u>Ferodo</u>	<u>SBS</u>	<u>Vesrah</u>
-	-	-	-

# MXS405 76.35 x 49.4 x 7.9mm



**APRILIA**

SVX 450/550 Supermotard 06-07 F

**BEHRINGER**

4 Piston radial 05 F

**FTE**

4 Piston Radial Supermoto

**HUSABERG**

FS 450 C 06 F

FS 450 E 06 F

FS 550 E Supermoto 05-07 F

FS 650 C 06-07 F

FS 650 E Supermoto 05-07 F

**KTM**

SMR 450 05-06 F

SMR 525 05

SMR 650 Supermoto 06 F

**Equivalents OE #**

586 13 030 100  
9100906  
1200 S/R2

**Competitor X Ref**

MATERIAL AVAILABILITY AND PART NO.				
STD	OPTIONS			
FA	HH	R	MXS	GFA
-	-	-	MXS405	GFA405HH

<u>Dunlop</u>	<u>Ferodo</u>	<u>SBS</u>	<u>Vesrah</u>
-	-	-	VD9030

# MXS406 102.2 x 47.8 x 7.9mm

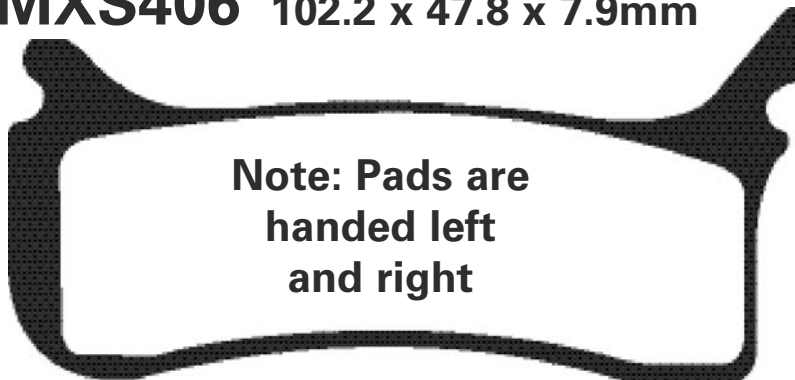

**Equivalents OE #**

800 13 030 000  
1100 S/R2

**BEHRINGER**

6 Piston (Supermoto)

**HUSABERG**

FS Supermotard Models 04- F

**KTM**

SMR 450/525 04 F

**Competitor X Ref**

MATERIAL AVAILABILITY AND PART NO.				
STD	OPTIONS			
FA	HH	R	MXS	GFA
-	-	-	MXS406	GFA406HH

<u>Dunlop</u>	<u>Ferodo</u>	<u>SBS</u>	<u>Vesrah</u>
-	-	-	-



# FA407 100.10 x 57.20 x 8.40mm



INCLUDES CLIP AND RIVET

**BMW**

K 100 RS	89-92	F
K1	88-93	F
K 1100 LT	89-07/93	F
KL 1100 LT	89-99	F
K 1100 RS	92-96	F
K 1200 RS	96-00	F
K 1200 LT	97-10/00	F
R 80 Mystic	94-95	F
R 80 R	91-94	F
R 850 C	97-00	F
R 850 GS	96-00	F
R 850 R	94-02	F
R 850 RT	96-01	F
R 100 Mystic	93-96	F
R 100 R	91-95	F
R 1100 GS	93-99	F
R 1100 R	93-01	F
R 1100 RS	92-01	F
R 1100 S	96-11/00	F
R 1100 RT	94-01	F
R 1150 GS	97-11/01	F
R 1200	00-02	F
R 1200 C	96-02	F

**Equivalents OE #**

34 11 2 314 996	34 11 7 655 687	34 11 7 658 156
34 11 2 310 983	34 11 2 331 173	34 11 2 333 045
34 11 7 663 764	34 11 2 314 512	

**NOTE: THIS PAD REPLACES  
FA246**

**Competitor X Ref**

Dunlop	Ferodo	SBS	Vesrah
DP625	FDB2050	703	VD959

**MATERIAL AVAILABILITY AND PART NO.**

OPTIONS				
STD	HH	R	MXS	GFA
FA407	FA407HH	-	-	-

# FA408 99.84 x 38.52 x 11.8mm

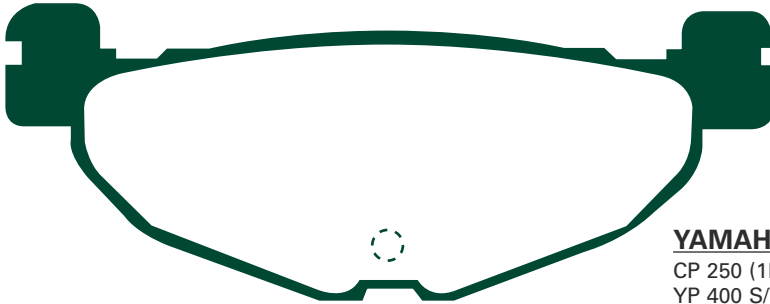

**YAMAHA**

CP 250 (1B71) Maxam	05	R
YP 400 S/T Majesty (5RU1/3)	04	R
YP 400 T/V/W Majesty	05-07	R
XP 500 T-Max (5VU1/2)	04-07R	

**MBK**

YP 400 Skyliner	04	R
-----------------	----	---

**Equivalents OE #**

5VU W0046 01	1B7 W0046 00
--------------	--------------

**Competitor X Ref**

MATERIAL AVAILABILITY AND PART NO.				
OPTIONS				
STD	HH	R	MXS	GFA
FA408	-	-	-	-

Dunlop	Ferodo	SBS	Vesrah
-	FDB2200	812	VD275

# FA409HH 91.95 x 56 x 7.05mm

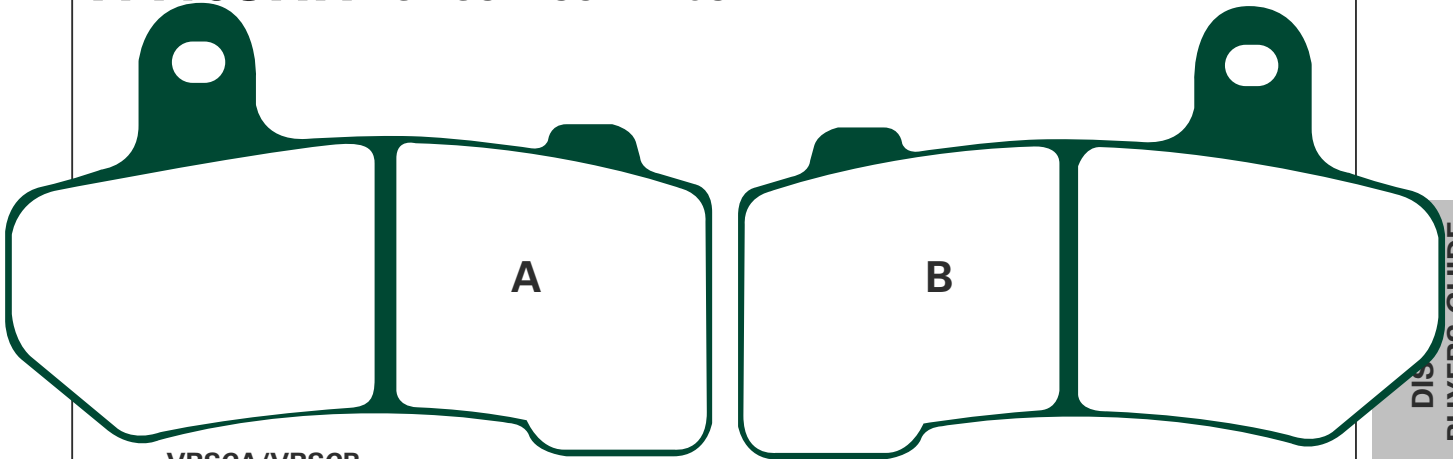

### VRSCA/VRSCB

VRSCR Street Rod	05-07	F&R
VRSCD Night Road	05-07	F&R
VRSCAW VRod	07	F&R
VRSCDX Night Rod Special	07	F&R
VRSCX VRod	07	F&R

### Equivalents OE #

42850-06

### Competitor X Ref

MATERIAL AVAILABILITY AND PART NO.				
STD	OPTIONS			
FA	HH	R	MXS	GFA
FA409	FA409HH	-	-	-

Dunlop	Ferodo	SBS	Vesrah
DP962	-	830	VD9025

# FA410 81.8 x 38.45 x 10.15mm

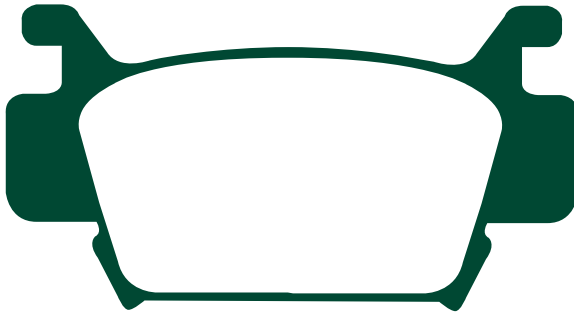

### HONDA

TRX 500 FA5/FA6/FA7/FGA5/6/7	05-07	F
TRX 680 FGA6/FA6/7 Fourtrack Rincon	06-07	F

### Equivalents OE #

06451 HPO A01  
06452 HPO A01

### Competitor X Ref

MATERIAL AVAILABILITY AND PART NO.				
STD	OPTIONS			
FA	HH	R	MXS	GFA
FA410TT	-	FA410R	-	-

Dunlop	Ferodo	SBS	Vesrah
959	-	829	VD175

# FA411 81 x 42 x 8.3mm

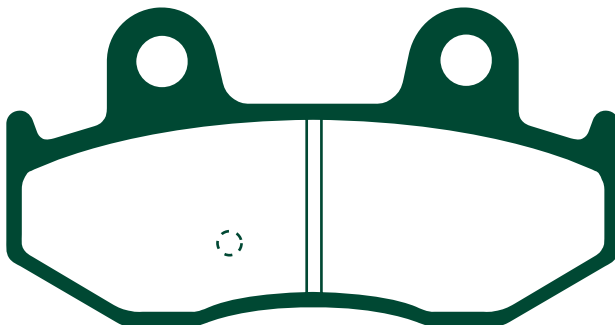

### SUZUKI

AN 400 K1-K6	01-06	R
AN 250 K1/K2 Burgman	01-02	R

### Equivalents OE #

69100 14860  
69100 14890

### Competitor X Ref

MATERIAL AVAILABILITY AND PART NO.				
STD	OPTIONS			
FA	HH	R	MXS	GFA
FA411	FA411HH	-	-	-

Dunlop	Ferodo	SBS	Vesrah
-	-	781	VD356

# FA412 87.9 x 41.1 x 8.4mm

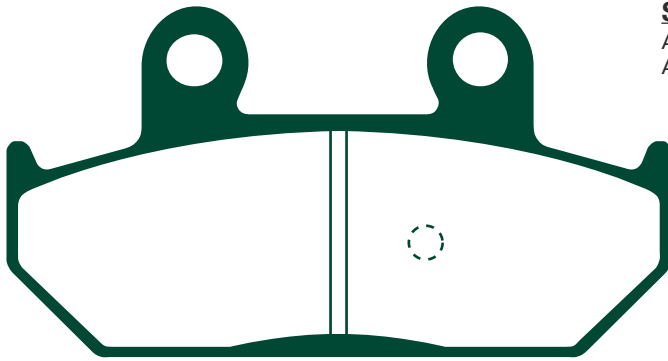

**SUZUKI**

AN 400 K7 Burgman 07 R  
AN 650 K3/K4/AK4/AK5/K5/AK6A/AK7 Burgman 03-07 R

**Equivalents OE #**

69100 10840
69100 10860

**Competitor X Ref**

MATERIAL AVAILABILITY AND PART NO.				
STD	OPTIONS			
FA	HH	R	MXS	GFA
FA412	FA412HH	-	-	-

Dunlop	Ferodo	SBS	Vesrah
DP968	-	804	VD357

# FA413 A. 82 x 40.85 x 8.22mm B. 62 x 40.8 x 8.6mm

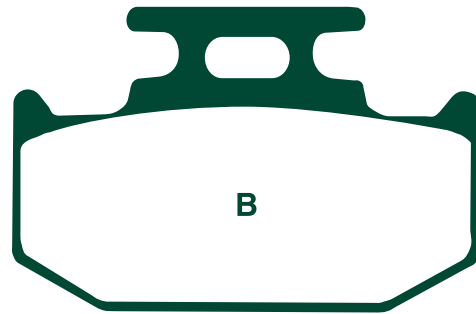
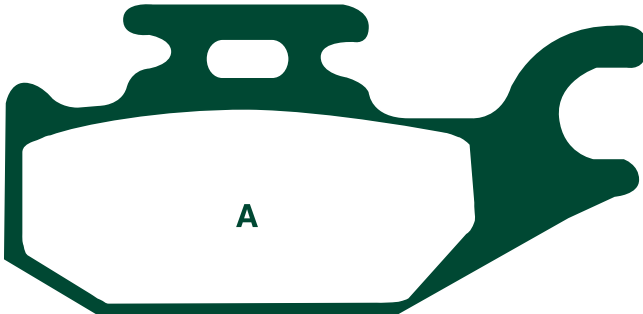

**SUZUKI**

LT-A 450 XK7 07 F(left)  
LT-A 700 XK5/XCK6/XK6/XK7 Kingquad 05-07 F(left)

**Equivalents OE #**

59100 31860
-------------

**Competitor X Ref**

MATERIAL AVAILABILITY AND PART NO.				
STD	OPTIONS			
FA	HH	R	MXS	GFA
FA413TT	-	FA413R	-	-

Dunlop	Ferodo	SBS	Vesrah
DP920	-	835	VD266/2

# FA414 A. 82 x 40.85 x 8.22mm B. 62 x 40.8 x 8.6mm

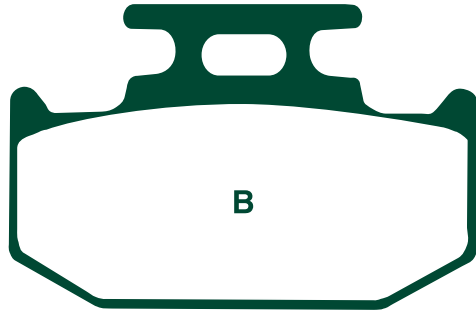
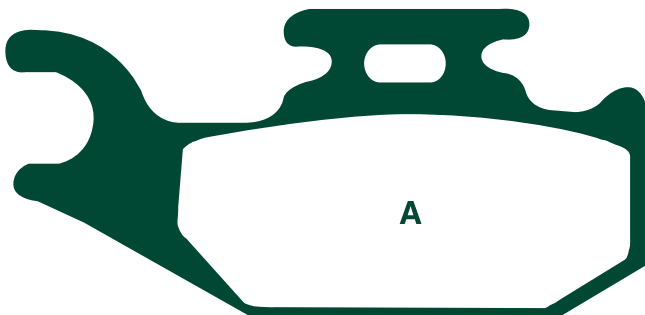

**SUZUKI**

LT-A 450 XK7 07 F(right)  
LT-A 700 XK5/XCK6/XK6/XK7 Kingquad 05-07 F(right)

**Equivalents OE #**

59100 31850
-------------

**Competitor X Ref**

MATERIAL AVAILABILITY AND PART NO.				
STD	OPTIONS			
FA	HH	R	MXS	GFA
FA414TT	-	FA414R	-	-

Dunlop	Ferodo	SBS	Vesrah
DP919	-	836	VD979/2

# FA415 37.35 x 81.7 x 8.95mm - Refit O/E shim

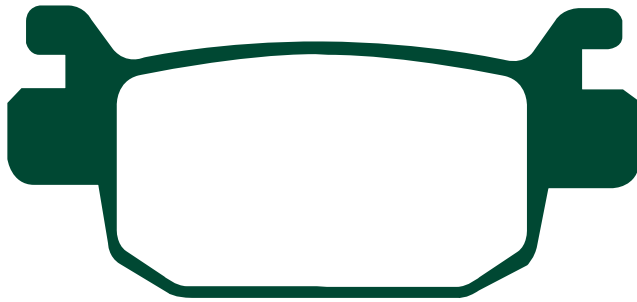

### HONDA

NSS 250 EX5/EX6 Forza EX	05-06	R
NSS 250 AX5/AX6 (ABS) Forza Z	05-06	R
SH 300 i A7	07	R

### Equivalents OE #

06435 KSV J01
06435 KSV J02
43251 KTW 901

### Competitor X Ref

MATERIAL AVAILABILITY AND PART NO.				
STD	OPTIONS			
FA	HH	R	MXS	GFA
FA415	FA415HH	-	-	-

Dunlop	Ferodo	SBS	Vesrah
-	-	832	VD173

# FA416 A. 85 x 37 x 7.9mm B. 31.8 x 48.1 x 10.2mm



### PGO

BR 150 E Bugrider	04-07	F
BR-200 Bugrider	07	F
BR 250 Bugrider E	05-07	F
Bugrider 50 (Buggie)	06	F

### QUADZILLA

XRV 250 (Off road)	06-07	F
XRV 250 E	06-07	F

### Equivalents OE #

--

### Competitor X Ref

MATERIAL AVAILABILITY AND PART NO.				
STD	OPTIONS			
FA	HH	R	MXS	GFA
FA416TT	-	FA416R	-	-

Dunlop	Ferodo	SBS	Vesrah
-	-	-	-

# FA417/4HH 49.85 x 37.75 x 7.78mm

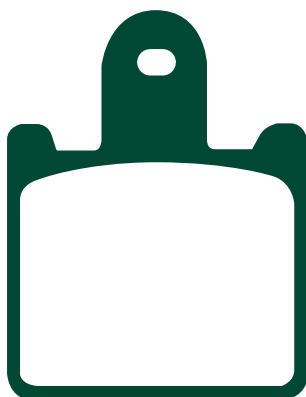

### KAWASAKI

ZX6R (ZX 600 P7F)	07	F
Z 1000 (ZR 1000 B7F)	07	F
Z 1000 ABS (ZR 1000 C7F)	07	F
GTR 1400 (ZG 1400 A8F)	07	F
ZZR 1400 (ZX 1400 A6F/A7F)	06-07	F
ZZR 1400 ABS (ZX 1400 B7F)	07	F

### Equivalents OE #

43082 0053
------------

### Competitor X Ref

MATERIAL AVAILABILITY AND PART NO.				
STD	OPTIONS			
FA	HH	R	MXS	GFA
-	FA417/4HH	-	-	GFA417/4HH

Dunlop	Ferodo	SBS	Vesrah
DP964	-	838	VD354

# FA418 A. 96.8 x 39.35 x 9.3mm B. 77 x 42 x 9.3mm

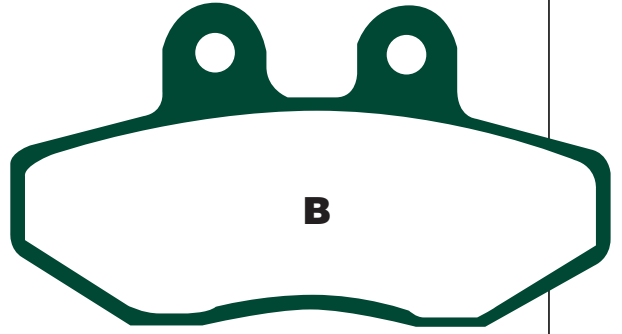
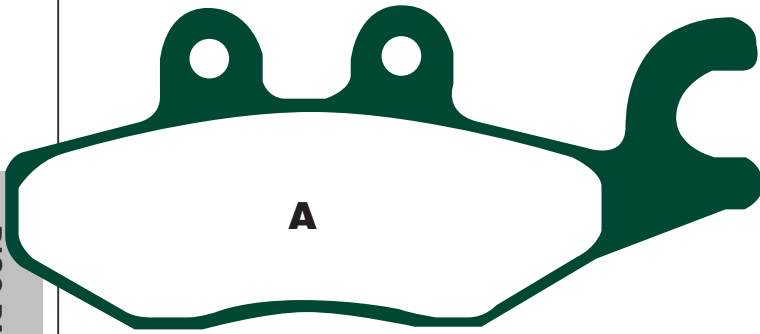

**PIAGGIO**

X9 125 06-07 F(right)  
X9 250 05-06 F(right)

**Equivalents OE #**

497395

**Competitor X Ref**

MATERIAL AVAILABILITY AND PART NO. OPTIONS				
STD	HH	R	MXS	GFA
FA				
FA418	-	-	-	-

Dunlop	Ferodo	SBS	Vesrah
-	-	818	-

# FA419 A. 89.25 x 40.65 x 9.75mm B. 89.25 x 40.65 x 9.75mm

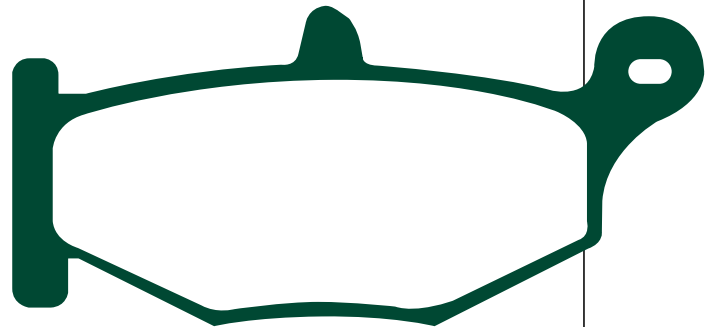
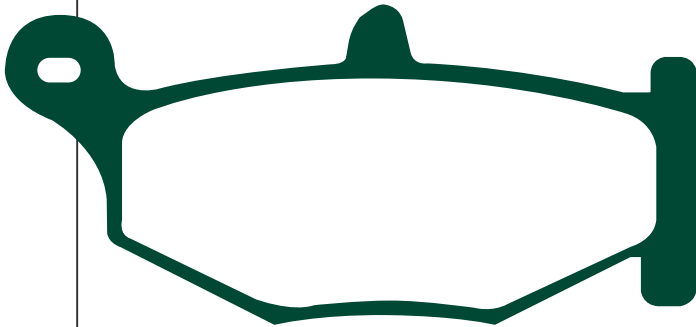

**SUZUKI**

GSR 400 K6 06 R  
GSR 600 K6/AK7 06-07 R  
GSXR 600 K6/K7 06-07 R  
GSXR 750 K6/K7 06-07 R  
GSXR 1000 K7 07 R

**Equivalents OE #**

69101 44810

**Competitor X Ref**

MATERIAL AVAILABILITY AND PART NO. OPTIONS				
STD	HH	R	MXS	GFA
FA				
FA419	FA419HH	-	-	-

Dunlop	Ferodo	SBS	Vesrah
DP963	-	833	SD359

# FA420 69.28 x 50.5 x 7.9mm

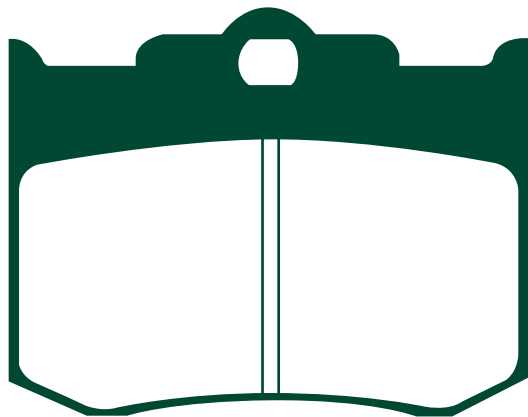

**PERFORMANCE MACHINE**

137X4

06

**Equivalents OE #**

137 X 4
---------

**Competitor X Ref**

MATERIAL AVAILABILITY AND PART NO. OPTIONS				
STD	HH	R	MXS	GFA
FA				
-	FA420HH	-	-	-

Dunlop	Ferodo	SBS	Vesrah
-	-	-	-

# FA423/4HH 44.7 x 53.5 x 8.45mm

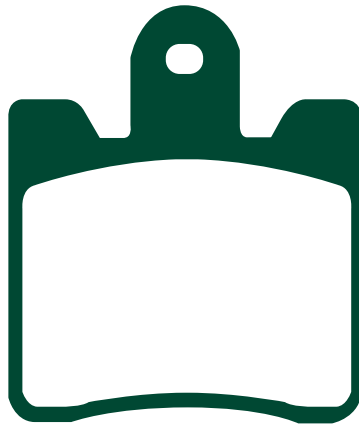

## YAMAHA

FJR 1300 AV/ASV (ABS) (3P61/2/3)  
FJR 1300 AS (2D21)

06-07 F  
06-07 F

### Equivalents OE #

3P6 W0045 00

### Competitor X Ref

MATERIAL AVAILABILITY AND PART NO.				
STD	OPTIONS			
FA	HH	R	MXS	GFA
-	FA423/4HH	-	-	-

Dunlop	Ferodo	SBS	Vesrah
DP965	-	740	VD353

# FA424 91.6 x 39.1 x 8.2mm

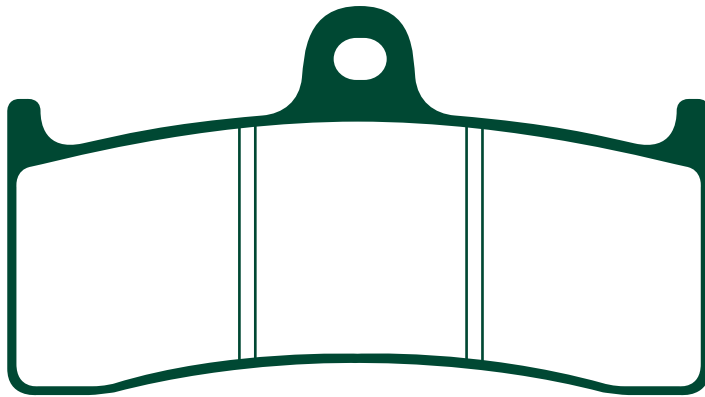

## HONDA

CB 1300 FW/FX/FY (SC40)

98-00 F

## KAWASAKI

ZX-7RR (ZX750 N1/N2)

96-99 F

## YAMAHA

YZF-R7 750 '0W02' (Race version)

99-01 F

## M.V. AGUSTA (Nissin Calipers)

F4 750

99-03 F

Brutale 750 S

03-06 F

F4 1000

04-06 F

Brutale 910 S

05-07 F

Brutale 910 Standard

05-07 F

## MONDIAL

Piega 1000

02 F

## BUELL

X1 Lightning

99-02 F

M2 Cyclone

98-02 F

S1 Lightning

98-00 F

S1 Whitelighting

98-00 F

S3 Thunderbolt

98-00 F

S3T Thunderbolt

98-00 F

### Equivalents OE #

43082 1181

800094024

### Competitor X Ref

MATERIAL AVAILABILITY AND PART NO.				
STD	OPTIONS			
FA	HH	R	MXS	GFA
FA424	FA424HH	-	-	GFA424HHLC

Dunlop	Ferodo	SBS	Vesrah
-	-	-	-

# FA425 55.5 x 54.5 x 8mm

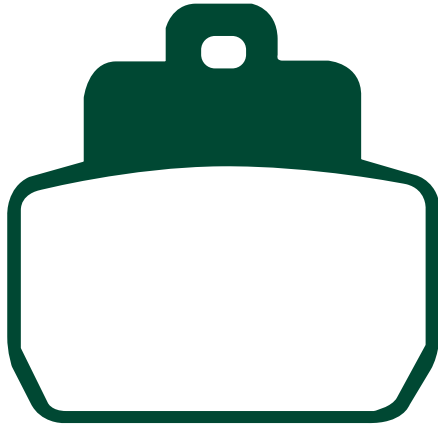

**GILERA**

Fuoco 500 ie	07	R
<b>PIAGGIO</b>		
MP3 125 (All models)	06-07	R
X8 125	05-06	R
X8 125 ie	07	R
X8 125/Street	07	R
X9 125	06	R
X8 150 Street	07	R
MP3 250 ie (All models)	06-07	R
X8 250 ie	05-07	R
X9 250	05-07	R
MP3 400 ie (All models)	07	R
X8 400 ie	07	R
Beverly 500	06	R

**Equivalents OE #**

497429
647080
647400

**Competitor X Ref**

MATERIAL AVAILABILITY AND PART NO.				
STD	OPTIONS			
FA	HH	R	MXS	GFA
FA425	-	-	-	-

Dunlop	Ferodo	SBS	Vesrah
-	-	831	-

# FA426 64 x 48 x 7.8mm

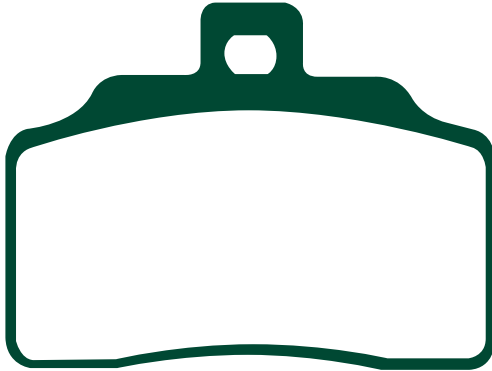

**BETA**

M4 350 Supermotard	04-07	F
--------------------	-------	---

**Equivalents OE #**

252524600
-----------

**Competitor X Ref**

MATERIAL AVAILABILITY AND PART NO.				
STD	OPTIONS			
FA	HH	R	MXS	GFA
FA426	-	-	-	-

Dunlop	Ferodo	SBS	Vesrah
-	-	-	-

# FA427 94 x 36.1 x 10.3mm

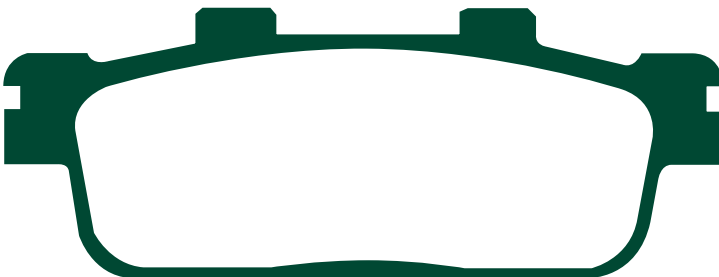

**CPI**

ST 250 Sector Quad	05-06	R
--------------------	-------	---

**E-TON**

RXL 150 Vector	07	R
VXL 250 ST Vector	06-07	R
VXL 250 Vector	06-07	R
VXL 300 Vector	07	R
VXL 300 ST Vector ST	07	R
VTX 300 Vortex	07	R
VTX 300 ST Vortex ST	07	R

**SYM**

HD 200 S Evo	07	R
GTS 250 Joymax	07	R
Trackrunner 200 Quad	05-07	R
Quadlander 250	05-07	R
GTS 125/200 Voyager	06-07	F&R
H200SE	06	R
Joymax 250 GTS	06-07	R
Citymax 300 Quad	06	R

**Equivalents OE #**

G7131 LRAO 000
812111

**Competitor X Ref**

MATERIAL AVAILABILITY AND PART NO.				
STD	OPTIONS			
FA	HH	R	MXS	GFA
FA427	-	FA427R	-	-

Dunlop	Ferodo	SBS	Vesrah
-	-	-	-

# FA428 A. 82.08 x 40.85 x 9.5mm B. 62.03 x 40.8 x 9.5mm

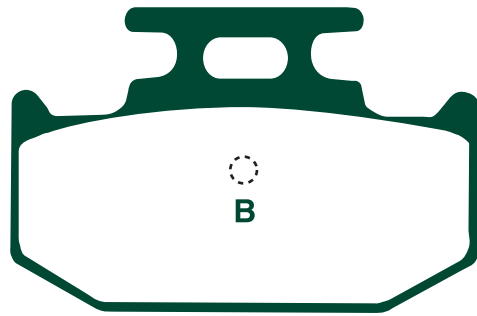
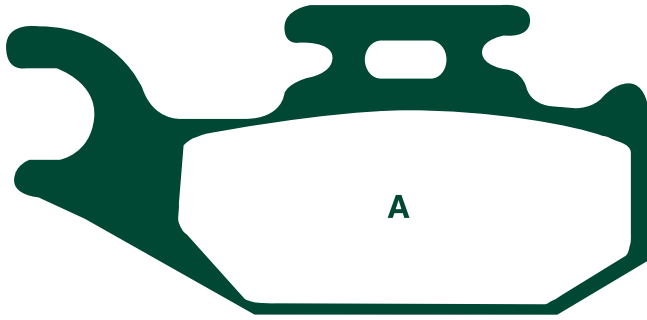

**YAMAHA**

YXR 66 FAS/FAT/FAV Rhino 4x4 Side x Side  
YFM 700 RV/RW Raptor

04-06 R  
06-07 R

**Equivalents OE #**

1S3 W0046 00  
5UG W0046 00

MATERIAL AVAILABILITY AND PART NO.				
STD	OPTIONS			
FA	HH	R	MXS	GFA
FA428TT	-	FA428R	-	-

**Competitor X Ref**

Dunlop	Ferodo	SBS	Vesrah
-	-	816	VD276

# FA430 A. 94.5 x 40 x 7.5mm B. 94.5 x 40 x 7.5mm

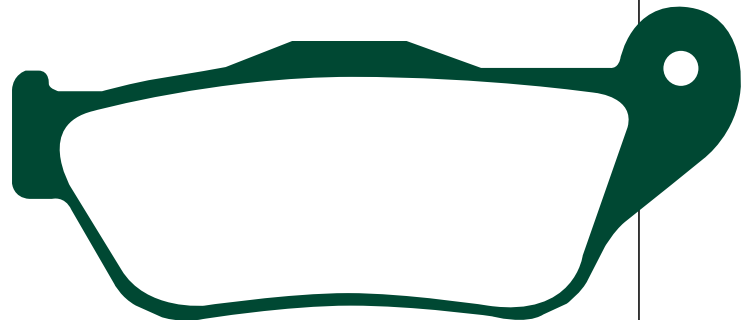
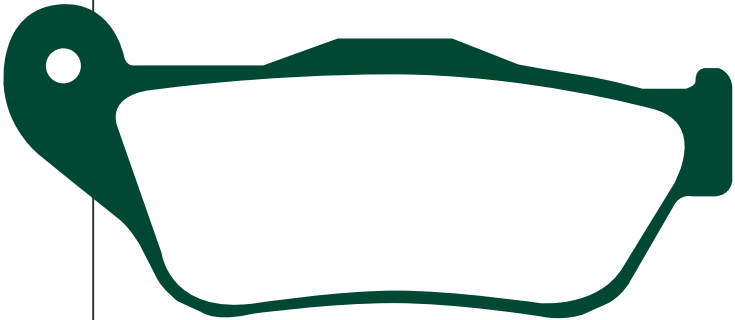

**YAMAHA**

YP 125 X-Max  
YP 250 (X-Max)

06-07 F  
05-07 F

**Equivalents OE #**

1B9 W0045 00

MATERIAL AVAILABILITY AND PART NO.				
STD	OPTIONS			
FA	HH	R	MXS	GFA
FA430	-	-	-	-

**Competitor X Ref**

Dunlop	Ferodo	SBS	Vesrah
-	-	837	-

# FA431TT A. 103.5 x 42.6 x 9mm B. 62.95 x 34.5 x 5.4mm

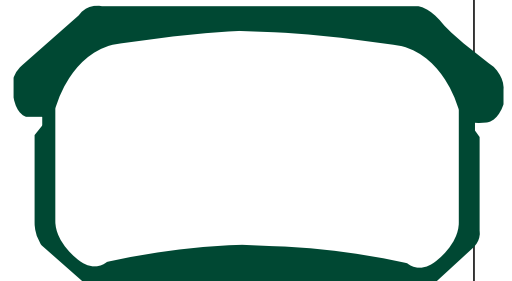

**CPI**

XS 250 Power Quad

07 R

**QUADZILLA**

XRV 250 (Off road)

06-07 R

XRV 250 E

06-07 R

**PGO**

BR-200 Bugdrider

07 R

250 E Bugdrider

05-07 R

**Equivalents OE #**



**Competitor X Ref**

MATERIAL AVAILABILITY AND PART NO.				
STD	OPTIONS			
FA	HH	R	MXS	GFA
FA431TT	-	FA431R	-	-

Dunlop	Ferodo	SBS	Vesrah
-	-	-	-

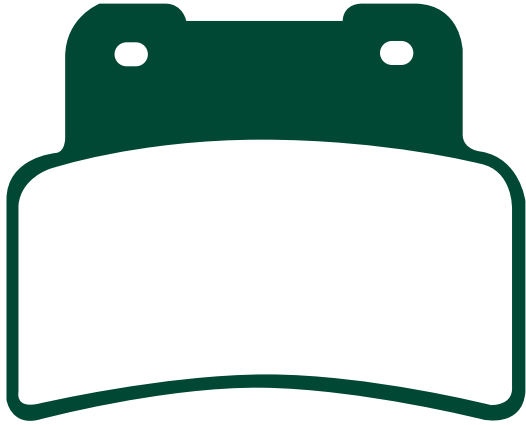

# FA432 68 x 55 x 9mm



**APRILIA**

RS 125 (Radial Caliper)  
 SL 750 Shiver  
 NS 850 Mana

06 F  
 07 F  
 07 F

**Equivalents OE #**

8133943

**Competitor X Ref**

MATERIAL AVAILABILITY AND PART NO.				
STD	OPTIONS			
FA	HH	R	MXS	GFA
FA432	FA432HH	-	-	-

Dunlop	Ferodo	SBS	Vesrah
-	-	844	-

# FA433/4HH

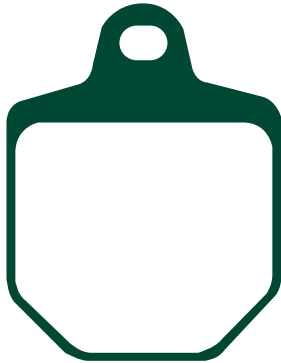

**APRILIA**

MXV 450 Magura Calipers

07 F

**HONDA HM (Italy)**

CRM 125 R Supermoto  
 CRM 250 X Supermoto  
 CRM 450 R/X Supermoto  
 CRM F 490 X Supermoto

07 F  
 07 F  
 07 F  
 07 F

**KTM**

SMR 450  
 SMR 560

07 F  
 07 F

**MAGURA**

4 piston radial supermoto caliper

**Equivalents OE #**

0722189  
 072223

SINTERED  
 CARBON

**Competitor X Ref**

MATERIAL AVAILABILITY AND PART NO.				
STD	OPTIONS			
FA	HH	R	MXS	GFA
FA433/4	FA433/4HH	-	-	-

Dunlop	Ferodo	SBS	Vesrah
-	-	843	-

# FA434HH A. 97.54 x 64.2 x 8mm B. 97.54 x 64.2 x 8mm



**NOTE:  
DOUBLE CHECK PAD  
SHAPE. DO NOT  
CONFUSE WITH FA400.**

DISC PADS  
BUYERS GUIDE

**HARLEY DAVIDSON**

FXST/FXSTi/FXSTS/FXSTS <i>i</i> Softail Standard	06-07	R
FXSTB/FXSTBi Night Train	06-07	R
FLSTSC/FLSTSC <i>i</i> Springer Softail	06-07	R
FXSTS/FXSTS <i>i</i> Springer Softail	06	R

**Equivalents OE #**

46721-06
----------

**Competitor X Ref**

MATERIAL AVAILABILITY AND PART NO.				
STD	OPTIONS			
FA	HH	R	MXS	GFA
FA434	FA434HH	-	-	-

Dunlop	Ferodo	SBS	Vesrah
DP971	-	-	-

# GFA435/4HHLC 43.5 x 49 x 9.5mm

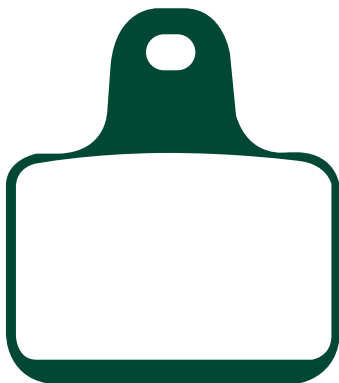

**BREMBO**

X 99.04 Raidal mount caliper 4 piston/4 pad  
**PVM**  
 4 Piston Radial Mount Caliper F

**Equivalents OE #**

07 7874 24
------------

**Competitor X Ref**

MATERIAL AVAILABILITY AND PART NO.				
STD	OPTIONS			
FA	HH	R	MXS	GFA
-	-	-	-	GFA435HHLC

Dunlop	Ferodo	SBS	Vesrah
-	-	805	-

# FA436 77.5 x 42.5 x 8.8mm

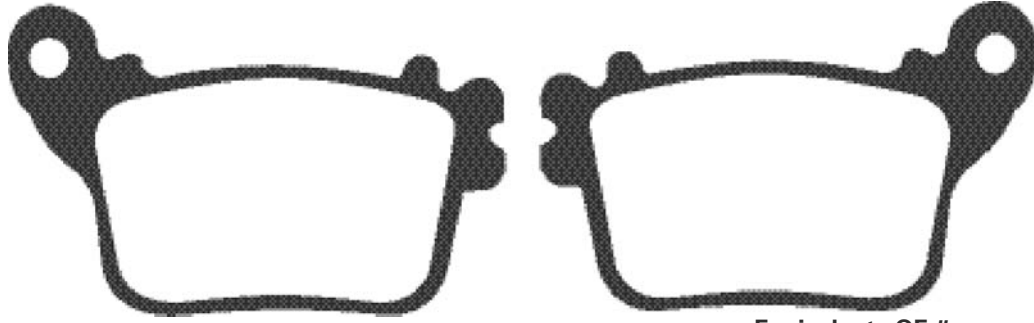

**HONDA**

CB 600 F7 Hornet  
CBR 600 RR7  
CBR 1000 RR6/RR7

07 R  
07 R  
06-07 R

**Equivalents OE #**

06435 MEL D21
06435 MFG D02

**Competitor X Ref**

MATERIAL AVAILABILITY AND PART NO.				
STD	OPTIONS			
FA	HH	R	MXS	GFA
FA436	FA436HH	-	-	-

Dunlop	Ferodo	SBS	Vesrah
DP973	-	834	-

# FA438HH A. 102.9 x 37.3 x 8.52mm B. 102.9 x 37.3 x 8.45mm

**NOTE: Need to order new wear lead Part no. MWL002**

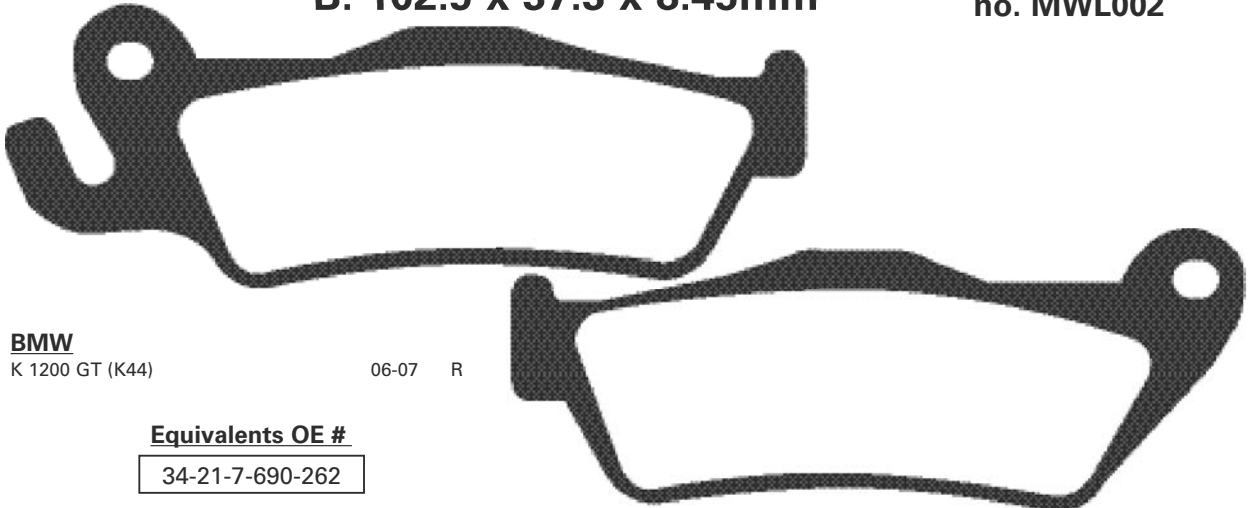

**BMW**

K 1200 GT (K44)

06-07 R

**Equivalents OE #**

34-21-7-690-262
-----------------

**Competitor X Ref**

MATERIAL AVAILABILITY AND PART NO.				
STD	OPTIONS			
FA	HH	R	MXS	GFA
-	FA438HH	-	-	-

Dunlop	Ferodo	SBS	Vesrah
-	-	-	-

# FA441HH A. 77.3 x 51.45 x 8.55mm B. 77.3 x 51.45 x 8.55mm

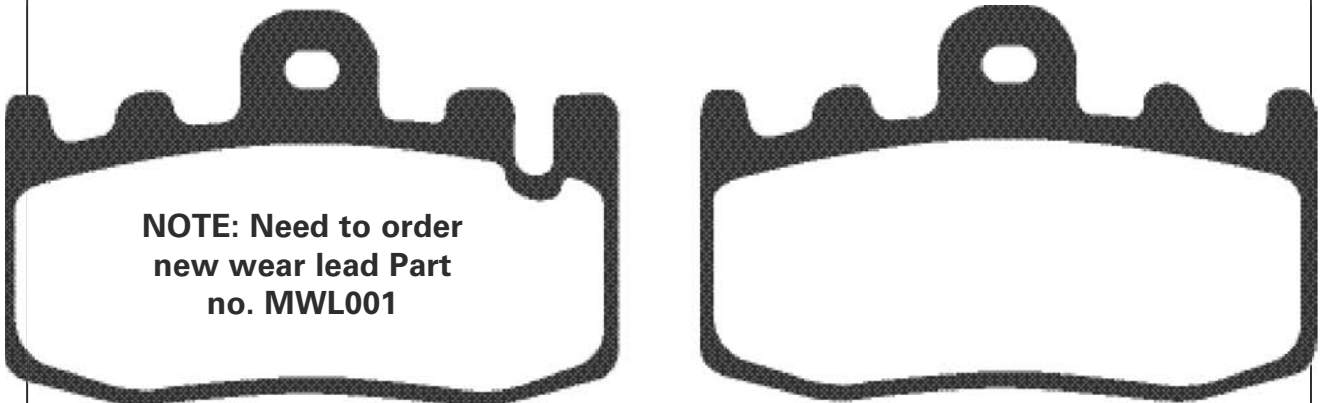

**NOTE: Need to order new wear lead Part no. MWL001**

**Equivalents OE #**

34-22-7-690-259
-----------------

**BMW**

K 1200 GT (K44)

06-07 F(right)

**Competitor X Ref**

MATERIAL AVAILABILITY AND PART NO.				
STD	OPTIONS			
FA	HH	R	MXS	GFA
-	FA441HH	-	-	-

Dunlop	Ferodo	SBS	Vesrah
-	-	-	-

# FA442/4HH A. 61.85 x 44.25 x 8.1mm B. 48 x 30.8 x 8.1mm

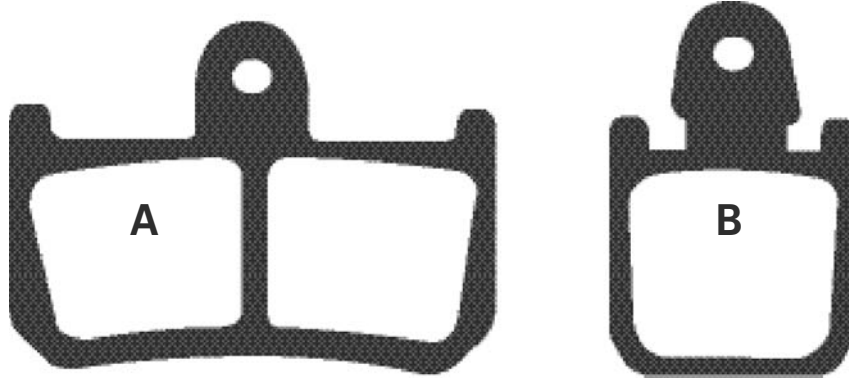

**Equivalents OE #**  
 4C8 W0045 00

**YAMAHA**  
 YZF R1 (6 piston radial caliper)  
 MT-01 (6 piston radial caliper)

07 F  
 07 F

**Competitor X Ref**

MATERIAL AVAILABILITY AND PART NO.				
STD	OPTIONS			
FA	HH	R	MXS	GFA
FA442/4	FA442/4HH	-	-	GFA442/4HH

Dunlop	Ferodo	SBS	Vesrah
DP977	-	839	-

# FA443TT A. 107 x 33.75 x 8mm B. 91.66 x 38.2 x 8mm

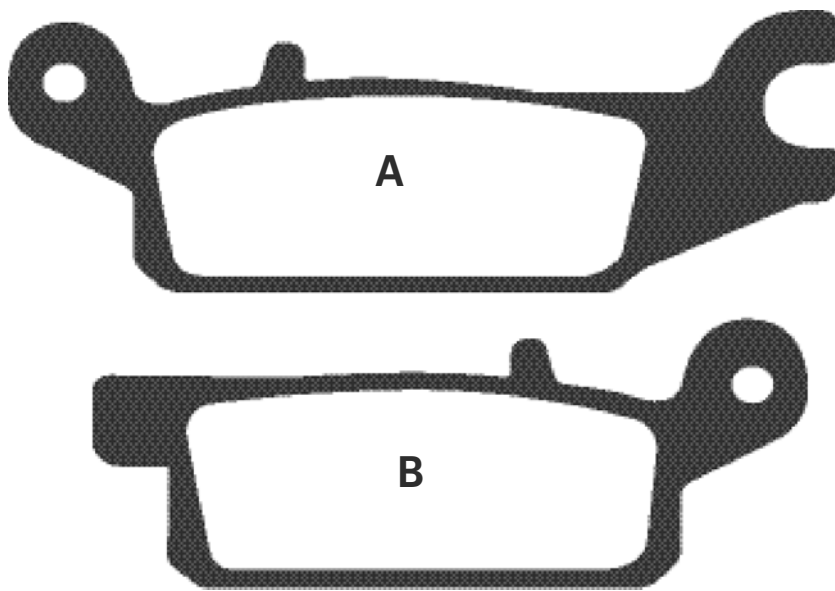

**YAMAHA**  
 YFM 700 FGPW Grizzly

07 F(left)

**Equivalents OE #**  
 3B4 W0045 00

**Competitor X Ref**

MATERIAL AVAILABILITY AND PART NO.				
STD	OPTIONS			
FA	HH	R	MXS	GFA
FA443TT	-	FA443R	-	-

Dunlop	Ferodo	SBS	Vesrah
DP979	-	-	-

# FA444TT A. 107 x 33.75 x 8mm B. 91.66 x 38.2 x 8mm

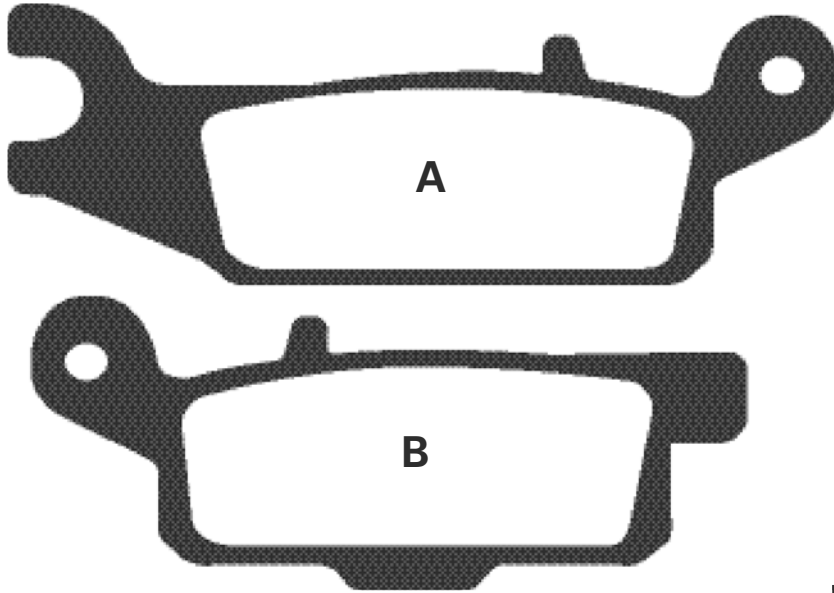

**Equivalents OE #**

3B4 W0045 10

**YAMAHA**

YFM 700 FGPW Grizzly

07 F(right)

**Competitor X Ref**

MATERIAL AVAILABILITY AND PART NO.				
STD	OPTIONS			
FA	HH	R	MXS	GFA
FA444TT	-	FA444R	-	-

Dunlop	Ferodo	SBS	Vesrah
DP980	-	-	-

# FA445TT A. 107 x 33.75 x 8mm B. 91.66 x 38.2 x 8mm

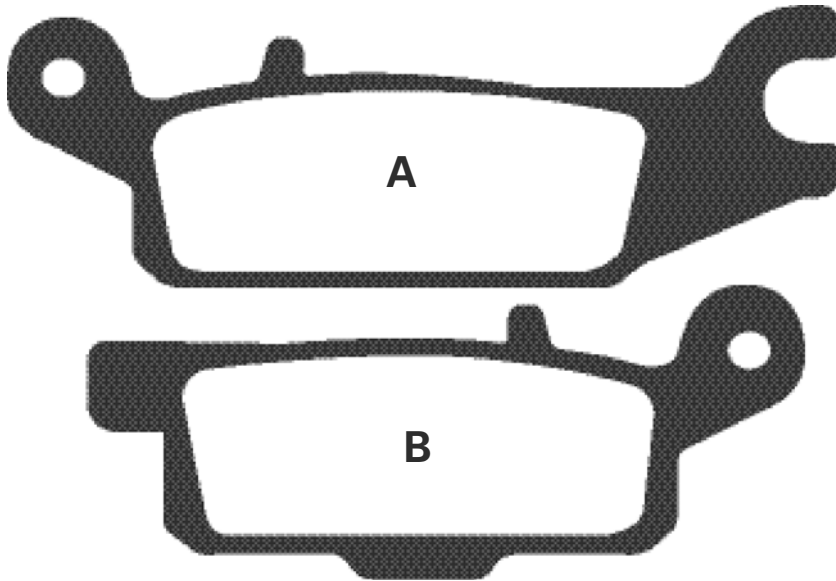

**Equivalents OE #**

3B4 W0046 00

**YAMAHA**

YFM 700 FGPW Grizzly

07 R(left)

**Competitor X Ref**

MATERIAL AVAILABILITY AND PART NO.				
STD	OPTIONS			
FA	HH	R	MXS	GFA
FA445TT	-	FA445R	-	-

Dunlop	Ferodo	SBS	Vesrah
DP981	-	-	-

# FA446TT A. 107 x 33.75 x 8mm B. 91.66 x 38.2 x 8mm

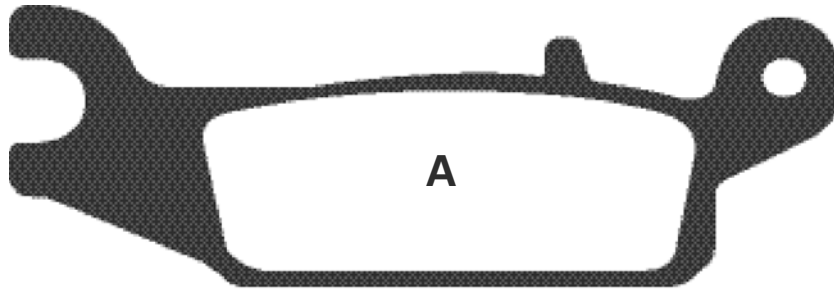

A

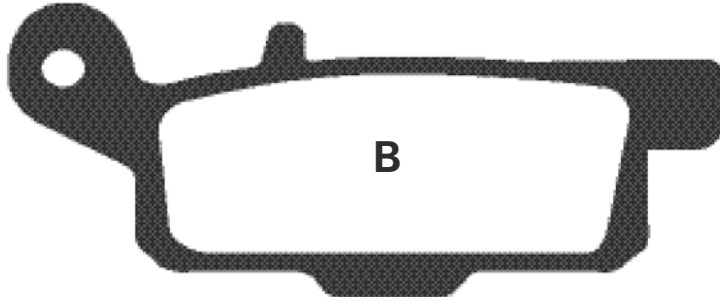

B

**Equivalents OE #**

3B4 W0046 10

**YAMAHA**

YFM 700 FGPW Grizzly

07 R(right)

**Competitor X Ref**

MATERIAL AVAILABILITY AND PART NO.				
STD	OPTIONS			
FA	HH	R	MXS	GFA
FA446TT	-	FA446R	-	-

Dunlop	Ferodo	SBS	Vesrah
DP982	-	-	-

# FA447HH 102.25 x 42.25 x 7.5mm

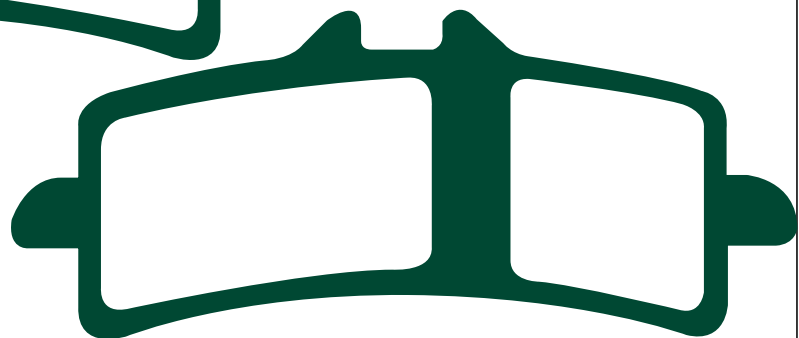

**BREMBO**

Monobloc M4 Radial Mount (1 pc pad)

**DUCATI**

Desmosedici RR (D16RR) (989cc)

1098

1098 S

1098 Tricolore

Hypermotard

**MV AGUSTA**

F4 1000 CC

07 F  
07 F  
07 F  
07 F  
07 F  
07 F

**Equivalents OE #**

61340791A

07 9882 10

**Competitor X Ref**

MATERIAL AVAILABILITY AND PART NO.				
STD	OPTIONS			
FA	HH	R	MXS	GFA
-	FA447HH	-	-	GFA447HH

Dunlop	Ferodo	SBS	Vesrah
DP978	-	841	-

# FA448 58.1 x 33.35 x 6mm

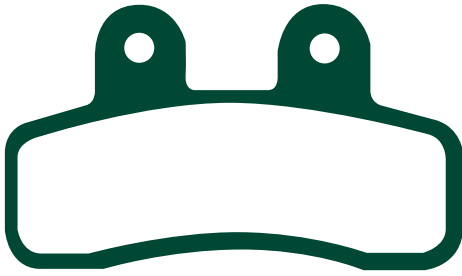

**ELSTARS (PIT BIKES)**

Various models (Check parts before fitting)

**ITALJET**

Pit Jet 125 4T

F&R

07

F&R

**Equivalents OE #**

**Competitor X Ref**

MATERIAL AVAILABILITY AND PART NO.				
STD	OPTIONS			
FA	HH	R	MXS	GFA
FA448	-	-	-	-

Dunlop	Ferodo	SBS	Vesrah
-	-	-	-

# FA450TT 94.2 x 31.8 x 7.2mm



**YAMAHA**

YZ 250 FW

07

F

**Equivalents OE #**

5XC W0045 00

**Competitor X Ref**

MATERIAL AVAILABILITY AND PART NO.				
STD	OPTIONS			
FA	HH	R	MXS	GFA
FA450TT	-	FA450R	MXS450	-

Dunlop	Ferodo	SBS	Vesrah
DP983	-	840	-

# DISC BRAKE PAD COMPETITOR INTERCHANGE LIST

BREMBO	EBC	BREMBO	EBC	BREMBO	EBC	BREMBO	EBC
07BB0106	FA47	07BB24SA	FA407HH	07HD16SA	FA400HH	07HO31SP	FA196HH
07BB0109	FA47/3	07BB2507	FA304	07HD16SP	FA400HH	07HO3405	FA196
07BB0110	FA47	07BB2607	FA335HH	07HO0130	FA13	07HO34SP	FA196HH
07BB0111	FA47	07BB26SA	FA335HH	07HO0229	FA12	07HO3509	FA124
07BB01SP	FA47HH	07BB2750	FA368	07HO0307	FA30	07HO35SA	FA124HH
07BB0210	FA208/213	07BB27SD	FA368R	07HO0411	FA32	07HO3607	FA174
07BB0250	FA208R/213HH	07BB27SX	FA368R	07HO0531	FA43	07HO36SP	FA174HH
07BB-2SD	FA208/213	07GR0101	FA50	07HO0631	FA40	07HO3907	FA189
07BB02SX	FA208R/213HH	07GR0204	FA76	07HO0712	FA45	07HO39SA	FA189HH
07BB02TT	FA208/213	07GR1001	FA98	07HO0831	FA52	07HO39SP	FA189HH
07BB0306	FA209/2	07GR1406	FA167	07HO0906	FA54	07HO4008	FA197
07BB0310	FA209/2	07GR1506	FA166	07HO09SD	FA54HH	07HO4108	FA196
07BB0311	FA209/2	07GR1705	FA156	07HO09SX	FA54R	07HO41SA	FA196HH
07BB0350	FA209/2HH	07GR2106	FA177	07HO09TT	FA54TT	07HO4206	FA281
07BB03SA	FA209/2HH	07GR35SP	FA320HH	07HO1010	FA69/3	07HO42SA	FA261HH
07BB0410	FA181	07GR4804	FA351	07HO10SA	FA69/3HH	07HO4308	FA281
07BB0450	FA181HH/R	07GR49SD	FA307TT	07HO10SP	FA69/3HH	07HO43SA	FA261HH
07BB04SA	FA245HH	07GR49SX	FA307R	07HO1118	FA83	07HO43SP	FA261HH
07BB04SD	FA245HH	07GR50SD	FA317TT	07HO1212	FA29	07HO4507	FA296HH
07BB04SP	FA363HH	07GR50SX	FA317R	07HO1406	FA80	07HO45RC	FA296HH
07BB04SX	FA245HH	07GR5105	FA291	07HO1505	FA92TT	07HO45SA	FA296HH
07BB04TT	FA245	07GR5209	FA377	07HO15SD	FA92R	07HO45SC	FA296HH
07BB0510	FA322/4HH	07GR52SD	FA377R	07HO15SX	FA92R	07HO4607	FA153
07BB05RC	FA322/4HH	07GR52SX	FA377R	07HO15TT	FA92TT	07HO48SD	FA346R
07BB05SA	FA322/4HH	07GR53SD	FA395R	07HO1609	FA90	07HO48SX	FA346R
07BB05SC	FA322/4HH	07GR54SD	FA271R	07HO1708	FA80/2	07HO48TT	FA346TT
07BB0606	FA120	07GR54SX	FA271R	07HO1807	FA69/2	07HO4905	FA343
07BB0708	FA251	07GR55SD	N/A	07HO018SP	N/A	07HO50RC	FA390HH
07BB0810	FA268	07GR5605	FA126	07HO1912	FA109	07HO50SA	FA390HH
07BB0907	FA134	07GR56SC	FA126HH	07HO20SD	FA84/3R	07HO50SC	FA390HH
07BB1205	FA115	07GR5705	FA164	07HO20TT	FA84TT	07HO55SD	FA373R
07BB12TT	FA115	07GR5804	FA303	07HO2107	FA121	07HO5606	FA375
07BB1305	FA60	07GR5915	FA22	07HO21SA	FA121HH	07HO57SA	FA388HH
07BB1310	FA60	07GR6007	FA57	07HO21SC	FA121HH	07HO58SD	FA410R
07BB13SD	FA337R	07GR6207	FA188	07HO2205	FA84/3TT	07KA0122	FA73
07BB1408	FA18	07GR62SA	FA188HH	07HO22SD	FA84/3R	07KA0223	FA55
07BB1410	FA18	07GR6319	FA56	07HO22SX	FA84/3R	07KA0328	N/A
07BB14SP	FA18HH	07GR6407	FA132	07HO22TT	FA84/3TT	07KA0414	FA62
07BB1507	FA95	07GR64TT	FA132	07HO2307	FA124	07KA0506	FA68
07BB1510	FA95	07GR6527	FA48	07HO23SA	FA124HH	07KA0608	FA68
07BB1511	FA95	07GR6610	FA16	07HO23SP	FA124HH	07KA0717	FA83TT
07BB15RC	FA95	07GR6706	FA107A	07HO2408	FA122	07KA07SD	FA83HH
07BB15SA	FA95HH	07GR68SA	FA345HH	07HO2506	FA125TT	07KA07SX	FA83R
07BB15SC	FA95HH	07GR69SD	FA357R	07HO25SD	FA125R	07KA0808	FA85
07BB1606	FA163	07GR69SX	FA357R	07HO25SX	FA125R	07KA08SA	FA85HH
07BB1710	FA193	07GR70SD	FA325R	07HO25TT	FA125TT	07KA08SP	FA85HH
07BB1750	FA193HH	07GR70SX	FA325R	07HO2608	FA131TT	07KA0933	FA129
07BB1810	FA193	07GR71SD	FA355R	07HO26SD	FA131R	07KA09SA	FA129HH
07BB1811	FA193	07GR71SX	FA355R	07HO26SX	FA131R	07KA09SP	FA129HH
07BB1907	FA244	07HD0105	FA24/2	07HO26TT	FA131TT	07KA10TT	FA130
07BB1910	FA244	07HD0202	FA71	07HO2711	FA140	07KA1117	FA141
07BB1950	FA244HH	07HD0303	FA72	07HO27SP	FA140HH	07KA11SA	N/A
07BB19RC	FA244	07HD0413	FA78	07HO2807	FA187	07KA11SP	N/A
07BB19SA	FA244	07HD0507	FA79	07HO28RC	FA187	07KA12SD	FA152R
07BB19SC	FA244HH	07HD0614	FA94	07HO28SA	FA187HH	07KA12SX	FA152R
07BB2010	FA266	07HD0910	FA201	07HO28SC	FA187HH	07KA12TT	FA152TT
07BB2050	FA266HH	07HD1011	FA200	07HO2911	FA143	07KA1306	FA158
07BB2107	FA171	07HD1109	FA210	07HO29SP	N/A	07KA13RC	FA158
07BB21SA	FA171HH	07HD1210	FA400	07HO3005	FA142	07KA13SA	FA158HH
07BB2207	FA407	07HD12SA	FA400HH	07HO30RC	FA142	07KA13SC	FA158HH
07BB22SA	FA407HH	07HD12SP	FA400HH	07HO30SA	FA142HH	07KA1406	FA180
07BB2307	FA77	07HD13SA	FA381HH	07HO30SC	FA142HH	07KA14SA	FA180HH
07BB2407	FA407	07HD14SP	FA387HH	07HO3109	FA196	07KA14SC	FA180HH



# DISC BRAKE PAD COMPETITOR INTERCHANGE LIST

DISC PADS  
BUYERS GUIDE

BREMBO	EBC	BREMBO	EBC	BREMBO	EBC	BREMBO	EBC
07KA1617	FA192	07SU1121	FA128TT	07YA16SX	FA119R	07008	FA99
07KA16SP	FA192HH	07SU11SD	FA128R	07YA1711	FA123	07009	FA116
07KA1705	FA185TT	07SU11SX	FA128R	07YA17SA	FA123HH	07010	FA131/2
07KA17SD	FA185R	07SU1215	FA228	07YA17SP	FA123HH	07011	FA131/3
07KA17SX	FA185R	07SU12SD	FA228HH	07YA1809	FA118	07012	FA194
07KA17TT	FA185TT	07SU12SX	FA135R	07YA18SA	N/A	07012ST	FA194HH
07KA1807	FA231	07SU12TT	FA135TT	07YA1909	FA136	07013	FA186
07KA18RC	FA231	07SU1407	FA236	07YA2008	FA215/2	07013ST	N/A
07KA18SA	FA231HH	07SU14RC	FA236	07YA20SP	FA215/2HH	07014	FA382
07KA18SC	FA231HH	07SU14SA	FA236HH	07YA2106	FA197	07015	FA382
07KA1907	FA229	07SU14SC	FA236HH	07YA21SA	FA197HH	07016	FA234
07KA19RC	FA229	07SU1509	FA147	07YA21SD	FA197HH	07017	FA255
07KA19SA	FA229HH	07SU15SA	FA147R	07YA21SX	FA135R	07018	FA235
07KA19SC	FA229HH	07SU15TT	FA147	07YA21TT	FA135TT	07018ST	N/A
07KA2009	FA424	07SU1718	FA157	07YA2206	FA228	07019	FA260
07KA20RC	FA424	07SU17SP	FA157R	07YA22SA	FA228HH	07019ST	FA260HH
07KA20SA	FA424HH	07SU17TT	FA157	07YA22SD	FA228HH	07020	FA298
07KA20SC	FA424HH	07SU18SD	FA152/2R	07YA22TT	FA165TT	07020ST	N/A
07KA2107	FA254	07SU18TT	FA152/2TT	07YA2307	FA252	07021	FA321
07KA22SD	FA258TT	07SU1907	FA188	07YA23RC	FA252	07021ST	N/A
07KA2305	N/A	07SU19RC	FA188	07YA23SA	FA252HH	07022	FA305
07KA23RC	N/A	07SU19SA	FA188HH	07YA23SC	FA252HH	07022ST	FA305R
07KA23A	FA347HH	07SU19SC	FA188HH	07YA2409	FA160	07023	FA297
07KA23SC	FA347HH	07SU2007	FA222	07YA24SA	FA160HH	07024	FA257
07KA24SD	FA342R	07SU20SP	N/A	07YA24SC	FA160HH	07024ST	N/A
07KA25SX	FA349R	07SU22SA	FA236HH	07YA2508	FA172TT	07025	FA69/3
07KA26SA	FA294HH	07SU25SP	FA254HH	07YA25SA	FA172R	07025ST	FA69/3HH
07KA27SD	FA302TT	07SU26RC	N/A	07YA25SC	FA172R	07026	FA83TT
07KA27SX	FA302R	07SU26SA	FA369/4HH	07YA2609	FA182	07027	FA167
07KS0124	FA55	07SU26SC	FA369/4HH	07YA26SA	FA182HH	07028	FA131/3
07KS0207	FA36	07SU27RC	N/A	07YA26SC	FA182HH	07028ST	N/A
07KS0321	FA39	07SU27SA	FA379HH	07YA2709	FA179	07029	FA140
07KS0432	FA67	07SU27SC	FA379HH	07YA27SA	FA179HH	07029ST	FA140HH
07KS04SD	FA67HH	07SU2906	FA137TT	07YA3108	FA191	07030	FA174
07KS04SX	FA67R	07SU29SD	FA137R	07YA3208	FA190	07031	FA151
07KS04TT	FA67TT	07SU29SX	FA137R	07YA32SA	FA190HH	07032	FA257
07KS0507	FA63	07SU31SD	FA401R	07YA32SC	FA190HH	07033	FA197
07KS05RC	FA63	07SU32SP	FA419HH	07YA3408	FA199	07033ST	FA197HH
07KS05SP	FA63HH	07YA0113	FA28	07YA34SA	FA199HH	07034	FA281
07PO0106	FA159TT	07YA0207	FA11	07YA3509	FA123	07034ST	FA261HH
07PO01SD	FA159R	07YA0309	FA34	07YA35SA	FA123HH	07035	FA228
07PO01SX	FA159R	07YA0413	FA41	07YA3707	FA275	07035ST	FA228HH
07PO02SD	FA159R	07YA0527	FA42	07YA37SP	FA275HH	07036	FA396
07PO03SD	FA232R	07YA0609	FA64	07YA3807	FA267	07036ST	N/A
07PO03SX	FA232R	07YA0713	FA61	07YA38SP	FA267HH	07037	FA283
07PO04SD	FA270R	07YA0809	FA70	07YA3908	FA319/2	07037ST	FA283HH
07PO04SX	FA270R	07YA1011	FA81	07YA39SP	FA319/2HH	07038	FA323
07PO05SX	FA313R	07YA1107	FA88	07YA4007	FA348	07038ST	FA323HH
07PO06SD	FA314R	07YA11SA	FA88HH	07YA40SP	FA348HH	07039	FA101
07PO06SX	FA314R	07YA11SP	FA88HH	07YA41SD	FA367R	07039ST	N/A
07PO07SD	FA354R	07YA1207	FA104	07YA41SX	FA367R	07041	FA169
07PO08SD	FA237R	07YA12SA	FA104HH	07YA44SD	FA155R	07041ST	FA169HH
07SU0125	FA35	07YA12SP	FA104HH	07YA45SD	FA344R	07042	FA199
07SU0220	FA38	07YA13SD	FA105R	07001ST	FA181TT	07042ST	FA199HH
07SU0312	FA51	07YA13SX	FA105R	0700S	FA193	07043	FA275
07SU0412	FA65	07YA13TT	FA105TT	07002ST	FA193HH	07043ST	FA275HH
07SU0526	FA46	07YA1407	FA101	07003ST	FA193HH	07045	FA324
07SU0607	FA103	07YA14SD	FA101R	07004	FA266	07045ST	FA336
07SU0707	FA102	07YA14SX	FA101R	07004ST	FA266HH	07047	FA321
07SU0808	FA106/2TT	07YA14TT	FA101TT	07005	FA264	07048	FA350
07SU08TT	FA106/2TT	07YA1519	FA21	07006	FA256	07049	FA194
07SU0904	FA106TT	07YA1605	FA119TT	07006ST	FA256HH	07050	FA355
07SU1005	FA110	07YA16SD	FA119R	07007	FA256	07051	FA356

# DISC BRAKE PAD COMPETITOR INTERCHANGE LIST

BREMBO	EBC	DUNLOPAD	EBC	DUNLOPAD	EBC	DUNLOPAD	EBC
07052	FA319	DP101	FA30	DP315	FA152	DP626	FA218
07052ST	FA319HH	DP102	FA29	DP316	FA141	DP627	FA243
07053	FA358	DP103	FA45	DP317	FA158	DP628	FA245
07054	FA374	DP104	FA69/2	DP318	FA161	DP629	FA263
07055	FA411	DP105	FA69	DP319	FA180	DP630	FA244
07056	FA353	DP106	FA80	DP320	FA192	DP631	FA266
07057	FA256	DP107	FA54	DP321	FA185	DP633	FA193
07058	FA412	DP108	FA113	DP322	FA229	DP634	FA206
07059	FA408	DP109	FA124	DP323	FA231	DP635	FA260
07059ST	N/A	DP110	FA121	DP324	FA249	DP637	FA304
07060	FA418	DP111	FA86	DP326	FA258	DP638	FA322
07061	FA425	DP112	FA187	DP327	FA307	DP639	FA294
07061ST	N/A	DP113	FA143	DP328	FA302	DP640	FA291
07062	FA306	DP114	FA92/2	DP400	FA11	DP641	FA335
07063	FA388	DP115	FA140	DP401	FA34	DP701	FA18
07064	FA415	DP116	FA124/2	DP402	FA70	DP811	FA84
		DP117	FA142	DP403	FA81	DP812	FA92
		DP118	FA196	DP404	FA88	DP813	FA111
		DP119	FA151	DP405	FA105	DP814	FA125
		DP120	FA153	DP406	FA101	DP815	FA131
		DP121	FA174	DP407	FA104	DP816	FA84/3
		DP122	FA189	DP408	FA119	DP817	FA137
		DP123	GFA239	DP409	FA123	DP821	FA67/2
		DP124	FA281	DP410	FA160	DP841	FA21
		DP125	FA261	DP411	FA135	DP842	FA20
		DP126	FA261	DP412	FA165/2	DP843	FA155
		DP127	FA265	DP413	FA172	DP900	FA94
		DP128	FA261	DP414	FA179	DP901	FA78
		DP129	FA343	DP415	FA182	DP902	FA159
		DP200	FA55	DP416	FA190	DP903	FA54/2
		DP201	FA55	DP417	FA136	DP904	FA201
		DP203	FA36	DP418	FA252	DP905	FA200
		DP204	FA141	DP419	FA267	DP906	FA24/2
		DP205	FA51	DP420	FA275	DP907	FA71
		DP206	FA65	DP421	FA199	DP908	FA72
		DP207	FA63	DP422	FA268	DP909	FA232
		DP208	FA106	DP423	FA319	DP911	FA216
		DP209	FA106/2	DP424	FA275	DP912	FA210
		DP210	FA103	DP500	FA16	DP913	FA216
		DP211	FA135	DP501	FA196	DP914	FA271R
		DP212	FA146	DP600	FA18	DP915	FA270R
		DP213	FA145	DP601	FA47	DP916	FA32
		DP214	FA147	DP602	FA99	DP917	FA76
		DP215	FA157	DP604	FA126	DP918	FA299
		DP216	FA188	DP605	FA134	DP919	FA307
		DP217	FA222	DP606	FA132	DP920	FA317
		DP218	FA230	DP607	FA115	DP921	FA346
		DP219	FA283	DP608	FA171	DP922	FA347
		DP220	FA254	DP609	FA164	DP923	FA357
		DP300	FA33	DP610	FA116	DP924	FA325R
		DP302	FA73	DP611	FA60	DP926	FA345
		DP303	FA62	DP612	FA166	DP927	FA323/3
		DP304	FA36	DP613	FA167	DP928	FA358
		DP305	FA73	DP614	FA95	DP929	FA342R
		DP307	FA58	DP615	FA170	DP930	FA344
		DP308	FA68	DP617	FA181	DP931	FA348
		DP309	FA68	DP618	FA163	DP932	FA314R
		DP310	FA67	DP620	FA77	DP935	FA368
		DP310-C	FA67	DP621	FA131/2	DP936	FA351
		DP311	FA85	DP622	FA208	DP937	FA303
		DP312	FA83	DP623	FA209	DP940	FA367
		DP313	FA130	DP624	FA107A	DP942	FA369/4HH
		DP314	FA129	DP625	FA246	DP944	FA373R

DISC PADS  
BUYERS GUIDE

# DISC BRAKE PAD COMPETITOR INTERCHANGE LIST

DISC PADS  
BUYERS GUIDE

DUNLOPAD	EBC	FERODO	EBC	FERODO	EBC	FERODO	EBC
DP946	FA366	FDB 88	FA27	FDB 384	FA93	FDB 665	FA69/3
DP947	FA379HH	FDB 108	FA18	FDB 386	FA104	FDB 666	FA160
DP948	FA381	FDB 108R	FA18	FDB 386R	FA104	FDB 672	FA131/3
DP949	FA381	FDB 119	FA13	FDB 389	FA103	FDB 673	FA106/2
DP950	FA379HH	FDB 132	FA33	FDB 389R	FA103	FDB 677	FA194
DP951	FA352	FDB 134R	FA32	FDB 390	FA102	FDB 680	FA193
DP952	FA194	FDB 148	FA18	FRP 403	FA11	FDB 694	FA60
DP953	FA401	FDB 148R	FA18	FDB 404	FA106	FDB 695	FA74
DP954	FA388	FDB 150	FA35	FRP 405	FA115	FDB 696	FA98
DP956	FA395	FDB 151R	FA36	FRP 408	FA95	FDB 697	FA116
DP957	FA400	FDB 155	FA22	FRP 410	GFA107A	FDB 698	N/A
DP958	FA320	FDB 157	FA11	FDB 411	FA105	FDB 699	FA166
DP959	FA410	FDB 177	FA34	FRP 415	FA175	FDB 705	FA47
DP961	FA373	FDB 177R	FA34	FRP 418	GFA217	FDB 706	FA167
DP962	FA409	FDB 178	FA38	FRP 419	FA95/2	FDB 731	FA67/2
DP963	FA419	FDB 181R	FA37	FDB 436	FA99	FDB 736	FA171
DP964	FA417	FDB 182	FA30	FDB 437	FA110	FDB 737	FA172
DP965	FA423/4	FDB 183	FA45	FDB 438	FA113	FDB 741	FA180
DP966	FA411	FDB 184	FA41	FDB 449	FA123	FDB 754	FA174
DP967	FA377	FDB 185	FA24/2	FDB 449R	FA123	FDB 781	FA179
DP968	FA412	FDB 185R	FA24/2	FDB 452	FA124	FDB 782	FA177
DP971	FA434	FDB 204	FA77	FDB 452R	FA124	FDB 783	FA131/2
DP973	FA436	FDB 204R	FA77	FDB 453	FA119	FDB 784	FA186
DP976	FA442	FDB 207	FA47	FDB 462	FA121	FDB 828	FA173
DP977	FA435	FDB 207R	FA47	FDB 475	FA101	FDB 831	FA150
DP978	FA447	FDB 213	FA76	FDB 481	FA129	FDB 847	FA210
DP979	FA443	FRP 213	FA16	FDB 481R	FA129	FDB 851	FA142
DP980	FA444	FDB 217	FA65	FDB 485	FA201	FDB 858	FA187
DP981	FA445	FDB 218	FA51	FDB 494	FA130	FDB 864	FA190
DP982	FA446	FDB 220	FA62	FDB 495	FA125	FDB 865	FA191
DP983	FA450	FDB 244	FA69	FDB 496	FA143	FDB 866	FA156
		FDB 244R	FA69	FDB 497	FA135	FDB 873	FA188
		FDB 247	FA61	FDB 498	FA126	FDB 889	FA206
		FDB 248	FA42	FDB 499	FA134	FDB 892	FA185
		FDB 250	FA54	FDB 508	FA141	FDB 2001	FA200
		FDB 277	FA70	FDB 521	FA200	FDB 2002	FA189
		FDB 298	FA68	FDB 529	FA163	FDB 2003	FA199
		FDB 298R	FA68	FDB 531	FA140	FDB 2005	FA208
		FDB 299	FA68	FDB 533	FA187	FDB 2006	FA209
		FDB 310	FA80	FDB 538	FA69/2	FDB 2007	FA218
		FDB 310R	FA80	FDB 539	FA131	FDB 2008	FA211
		FDB 311	FA81	FDB 557	FA145	FDB 2012	FA192
		FDB 312	FA86	FDB 561	FA132	FDB 2013	FA128
		FDB 313	FA83	FDB 568	FA153	FDB 2014	FA21
		FDB 314	FA67	FDB 569	FA146	FDB 2015	FA119
		FDB 333	FA71	FDB 570	FA142	FDB 2016	FA137
		FDB 334	FA72	FDB 574	FA158	FDB 2017	FA155
		FDB 334R	FA72	FDB 583	FA118	FDB 2018	FA181
		FDB 335	FA78	FDB 591	FA136	FDB 2019	FA208
		FDB 335R	FA78	FDB 592	FA120	FDB 2022	FA196
		FDB 337	FA88	FDB 605	FA252	FDB 2031	FA243
		FDB 337R	FA88	FDB 606	FA147	FDB 2033	FA361HH
		FDB 338	FA63	FDB 607	FA157	FDB 2034	FA362HH
		FDB 338R	FA63	FDB 625	FA178	FDB 2036	FA249
		FDB 339	FA85	FDB 631	FA165	FDB 2037	FA255
		FDB 339R	FA85	FDB 636	FA169	FDB 2039	FA245
		FDB 342	FA16	FDB 637	FA182	FDB 2040	FA216
		FDB 342R	FA16	FDB 657	FA170	FDB 2041	FA216/2
		FDB 352	FA94	FDB 659	FA152	FDB 2042	FA244
		FDB 352R	FA94	FDB 661	FA84/3	FDB 2043	FA263
		FDB 381	FA84	FDB 662	FA123	FDB 2044	FA107A
		FDB 382	FA92	FDB 663	FA124/2	FDB 2048	FA231
		FDB 383	FA101	FDB 664	FA196	FDB 2049	FA229

# DISC BRAKE PAD COMPETITOR INTERCHANGE LIST

FERODO	EBC	FERODO	EBC	LOCKHEED	EBC	LOCKHEED	EBC
FDB 2050	FA246	FDB 2142	FA353	LMP100	FA28	LMP161	FA90
FDB 2053	FA201	FDB 2143	FA343	LMP101	FA13	LMP162	FA84
FDB 2054	FA232	FDB 2144	FA188	LMP102	FA12	LMP166	FA95
FDB 2055	FA159	FDB 2145	FA345	LMP103	FA55	LMP170	FA104
FDB 2056	FA255	FDB 2146	FA256	LMP104	FA11	LMP171	FA80/2
FDB 2057	FA260	FDB 2147	FA374	LMP105	FA27	LMP172	FA69/2
FDB 2058	FA222	FDB 2148	FA307	LMP106	FA18	LMP173	FA109
FDB 2059	FA196	FDB 2149	FA317	LMP107	FA34	LMP174	FA60
FDB 2060	FA256	FDB 2150	FA348	LMP108	FA29	LMP175	FA101
FDB 2062	FA268	FDB 2153	N/A	LMP109	FA32	LMP176	FA21
FDB 2073	FA261	FDB 2155	N/A	LMP110	*FA33/	LMP177	FA103
FDB 2074	FA266	FDB 2156	FA319/2		FA73	LMP178	FA102
FDB 2075	FA261	FDB 2157	FA357	LMP111	FA35	LMP179	FA94
FDB 2079	FA265	FDB 2158	FA347	LMP112	FA36	LMP180	FA105
FDB 2080	FA258	FDB 2162	FA367	LMP113	FA24	LMP181	FA106
FDB 2081	FA47	FDB 2163	FA366	LMP114	FA37	LMP182	FA106/2
FDB 2083	FA275	FDB 2164	FA369/4	LMP115	FA38	LMP183	FA47/2
FDB 2084	FA267	FDB 2165	FA368	LMP116	FA39	LMP184	FA84/2
FDB 2085	FA283	FDB 2166	GFA435/4	LMP117	*FA30/	LMP185	FA93
FDB 2086	FA323/3	FDB 2167	GF263		FA31	LMP187	FA110
FDB 2087	FA197	FDB 2168	N/A	LMP118	NONE	LMP188	FA113
FDB 2090	FA298	FDB 2169	FA375	LMP119	FA47	LMP189	FA119
FDB 2091	FA515	FDB 2170	N/A	LMP120	FA22	LMP190	FA123
FDB 2095	FA301	FDB 2171	N/A	LMP121	FA43	LMP191	FA67/2
FDB 2096	FA305	FDB 2178	FA412	LMP122	FA48	LMP192	FA84
FDB 2097	FA299	FDB 2175	FA271	LMP123	FA16	LMP193	FA121
FDB 2098	FA261	FDB 2176	FA314	LMP124	FA56	LMP194	FA120
FDB 2099	FA244	FDB 2177	FA313	LMP125	FA40	LMP195	FA99
FDB 2100	FA186	FDB 2178	FA379	LMP126	FA45	LMP196	FA118
FDB 2101	FA234	FDB 2179	FA381	LMP127	FA57	LMP197	FA129
FDB 2102	FA304	FDB 2180	FA387	LMP128	FA41	LMP198	FA122
FDB 2103	FA291	FDB 2181	FA390	LMP129	FA52	LMP199	RFA107
FDB 2105	FA324	FDB 2182	FA373	LMP130	FA62	LMP200	FA124
FDB 2106	FA194	FDB 2183	FA325	LMP131	FA42	LMP201	FA126
FDB 2107	FA115	FDB 2184	FA377	LMP132	FA50	LMP202	FA130
FDB 2108	FA306	FDB 2185	FA426	LMP133	FA51	LMP203	FA125
FDB 2109	FA303	FDB 2186	FA418	LMP134	FA65	LMP204	FA131
FDB 2110	FA302	FDB 2187	FA142	LMP135	FA64	LMP205	FA98
FDB 2111	FA254	FDB 2188	FA342	LMP136	FA54	LMP206	FA111
FDB 2113	FA203	FDB 2189	N/A	LMP137	FA71	LMP207	FA116
FDB 2114	FA296	FDB 2190	FA264	LMP138	FA46	LMP208	FA134
FDB 2115	FA321	FDB 2191	FA235	LMP139	FA68	LMP209	FA201
FDB 2116	FA323	FDB 2192	FA151	LMP140	FA68	LMP210	FA111
FDB 2120	FA322HH	FDB 2193	FA344	LMP141	FA67/2	LMP211	FA135
FDB 2121	FA270R	FDB 2194	FA162	LMP142	FA69	LMP212	FA200
FDB 2122	N/A	FDB 2196	FA388	LMP143	FA72	LMP213	FA123
FDB 2123	FA295	FDB 2197	FA401	LMP144	FA83	LMP214	FA140
FDB 2124	FA294HH	FDB 2198	FA320	LMP145	FA61	LMP215	FA141
FDB 2125	FA335HH	FDB 2200	FA408	LMP146	FA67	LMP216	FA136
FDB 2126	FA319	FDB 2201	FA399	LMP147	FA70	LMP217	FA20
FDB 2127	FA351	FDB 2203	FA369/4	LMP148	FA83/2	LMP218	FA151
FDB 2128	FA350	FDB 2204	FA379	LMP149	FA78	LMP219	FA169
FDB 2129	FA297	FDB 2205	FA390	LMP150	FA81	LMP220	FA146
FDB 2130	FA358			LMP151	FA86	LMP221	FA132
FDB 2131	FA196	FRP 213	FA16	LMP152	FA80	LMP222	FA144
FDB 2132	FA323/3	FRP 219	FA95/2	LMP153	FA79	LMP223	FA143
FDB 2133	FA230	FRP 405	FA115	LMP154	FA77	LMP224	FA145
FDB 2134	FA227	FRP 408	FA95	LMP155	FA88	LMP225	FA204
FDB 2135	N/A	FRP 410	FA107A	LMP156	FA63	LMP226	FA147
FDB 2136	N/A	FRP 415	FA175	LMP157	FA85	LMP227	FA142
FDB 2139	FA346	FRP 416	FA47/3	LMP158	FA92	LMP228	FA151
FDB 2140	FA356	FRP 417	FA183	LMP159	FA115	LMP229	FA153
FDB 2141	FA357	FRP 419	FA95	LMP160	FA76	LMP230	FA196

# DISC BRAKE PAD COMPETITOR INTERCHANGE LIST

DISC PADS  
BUYERS GUIDE

LOCKHEED	EBC	SBS	EBC	SBS	EBC	SBS	EBC
LMP231	FA158	500	FA28	563	FA75/2	628	FA151
LMP232	FA152	501	FA13	565	FA89	629	FA153
LMP233	FA165	502	FA12	566	FA95	630	FA196
LMP234	FA252	503	FA55	568	FA96	631	FA158
LMP235	FA157	504	FA11	569	FA149/2	632	FA152
LMP236	FA164	505	FA27	570	FA104	633	FA165
LMP238	FA165	506	FA18	571	FA80/2	634	FA252
LMP239	FA220	507	FA34	572	FA69/2	635	FA157
LMP240	FA171	508	FA29	573	FA109	636	FA164
LMP242	FA159	509	FA32	574	FA60	637	FA155
LMP243	FA178	510	FA33	575	FA101	638	FA165
LMP244	FA170	511	FA35	576	FA21	639	FA220
LMP245	FA160	512	FA36	577	FA103	640	FA171
LMP246	FA47/3	513	FA24/2	578	FA102	641	FA163
LMP247	FA124/2	514	FA37	579	FA94	642	FA159
LMP248	FA152	515	FA38	580	FA105	643	FA54
LMP296	FA113	516	FA39	581	FA106	644	FA170
LMP297	FA193	517	FA31	582	FA106/2	645	FA123
LMP298	FA16	519	FA47	583	FA47/2	646	FA47/3
LMP299	FA198	520	FA22	584	FA84/2	647	FA124/2
LMP300	FA196	521	FA43	585	FA93	648	FA152
LMP301	FA222	522	FA48	586	FA67	649	FA137
LMP302	FA230	523	FA16	587	FA110	650	FA172
LMP303	FA246	524	FA56	588	FA113	651	FA173
LMP304	FA231	525	FA40	589	FA119	652	FA167
LMP305	FA229	526	FA45	590	FA123	653	FA166
LMP306	FA244	527	FA57	591	FA128	654	FA196
LMP307	FA263	528	FA41	592	FA84	655	FA184
LMP308	FA264	529	FA52	593	FA121	656	FA175
LMP309	FA92/3	530	FA62	594	FA120	657	FA174
LMP310	FA234	531	FA48	595	FA99	658	FA210
LMP311	FA218/2	532	FA50	596	FA118	659	FA162
LMP312	FA255	533	FA51	597	FA129	660	GFA217
LMP313	FA228	534	FA65	598	FA122	661	FA107A
LMP314	FA145	535	FA64	599	FA107	662	FA95
LMP315	FA254	536	FA54	600	FA124	663	FA179
LMP316	FA159	537	FA71	601	FA126	664	N/A
LMP317	FA232	538	FA46	602	FA130	665	FA182
LMP318	FA47	539	FA66	603	FA125	666	FA180
LMP319	N/A	540	FA68	604	FA131	667	FA193
LMP320	N/A	541	FA67/2	605	FA98	668	FA201
LMP321	FA261	542	FA69	606	FA111	669	FA200
LMP322	FA261	543	FA72	607	FA116	670	FA257
		544	FA83	608	FA134	671	FA181
		545	FA61	609	FA201	672	FA156
		546	FA67	610	FA117	673	FA131/2
		547	FA70	611	FA135	676	FA249
		548	FA83/2	612	FA200	677	FA183
		549	FA78	613	FA123	678	FA95
		550	FA81	614	FA140	679	FA26
		551	FA86	615	FA141	680	FA116
		552	FA80	616	FA136	681	FA177
		553	FA79	617	FA20	682	FA191
		554	FA77	618	FA151	683	FA190
		555	FA88	619	FA169	684	FA173
		556	FA63	620	FA146	685	FA189
		557	FA85	621	FA132	686	FA188
		558	FA92	622	FA187	687	FA192
		559	FA115	623	FA143	688	FA197
		560	FA76	624	FA145	689	FA194
		561	FA90	625	N/A	690	FA131/3
		562	FA84	626	FA147	691	FA199
		563	FA75	627	FA142	692	FA67

# DISC BRAKE PAD COMPETITOR INTERCHANGE LIST

DISC PADS  
BUYERS GUIDE

SBS	EBC	SBS	EBC	SBS	EBC	VESRAH	EBC
694	FA185	758	FA271R	834	FA436	VD-101	FA12
695	FA218	760	N/A	835	FA413	VD-102	FA13
696	FA113	761	FA324	836	FA414	VD-103	FA13
697	FA193	762	FA322HH	837	FA430	VD-104	FA13
698	FA16	763	FA320	838	FA417/4	VD-105	FA13
699	FA198	764	FA336	839	FA442/4	VD-106	FA13
700	FA196	765	FA254	840	FA450	VD-107	FA29
701	FA222	766	N/A	841	FA447	VD-108	FA32
702	FA230	767	FA317	842	FA405	VD-109	FA40
703	FA246	768	FA319	843	FA433/4	VD-110	FA43
704	FA231	769	FA319/2	844	FA432	VD-111	FA40
705	FA229	770	FA348			VD-112	FA31
706	FA244	771	FA193			VD-112/2	FA29
707	FA263	777	FA346			VD-112/3	FA30
708	FA264	778	FA294			VD-113	FA45
709	FA92/3	779	FA249/2			VD-114	FA29
710	FA234	781	FA411			VD-115	FA30
711	FA255	782	FA347			VD-116	FA32
712	FA255	783	FA357			VD-117	FA45
713	FA228	785	N/A			VD-118	FA30
714	FA145	787	FA314			VD-119	FA52
715	FA254	788	FA369			VD-120	FA54
716	FA159	789	FA366			VD-122	FA83/2
717	FA232	790	FA367			VD-123	FA69
718	FA47	791	FA368			VD-123/2	FA69/2
719	FA272	793	FA256			VD-123/3	FA69/3
720	N/A	794	FA325R			VD-123/4	FA69/3
721	FA261	795	FA345			VD-124	FA69/2
722	FA261	796	FA335			VD-125	FA29
723	FA235	797	FA375			VD-126	FA130
724	FA260	798	FA349			VD-127	FA84/3
725	FA193	799	FA344			VD-127/2	FA84
726	FA258	800	FA354			VD-127/3	FA84/2
727	FA244	801	FA342			VD-128	FA84
728	FA275	802	FA303			VD-129	FA80/2
729	FA249	803	FA351			VD-129	FA197
730	FA266	804	FA412			VD-129/2	FA80
731	FA258	805	GFA435/4			VD-130	FA90
732	N/A	806	FA379			VD-131	FA86
733	FA267	807	FA381			VD-132	FA69
734	FA265	808	FA387			VD-133	FA69/3
735	FA261	809	FA390			VD-134	FA92
736	FA261	810	FA377			VD-135	FA80
737	FA47	812	FA408			VD-136	FA92/2
738	FA196	813	FA373			VD-137	FA176
740	FA283	814	FA86			VD-138	FA111
741	FA295	815	FA291			VD-138/2	FA111/2
742	FA363	816	FA428			VD-139	FA125
743	FA294	817	FA167			VD-139/2	FA143
744	FA206	818	FA418			VD-140	FA109
745	FA297	819	FA115			VD-141	FA121
746	FA304	820	FA401			VD-142	FA121
747	FA298	821	FA399			VD-143	FA124
748	FA301	822	FA395			VD-143/2	FA124/2
749	FA305	823	FA393			VD-144	FA131
750	FA299	824	FA47			VD-144/2	FA131
751	N/A	825	N/A			VD-146	FA122
752	FA302	826	FA400			VD-147	FA140
753	FA174	829	FA410			VD-150	FA151
754	FA307	830	FA409			VD-152	FA113
755	FA270R	831	FA425			VD-153	FA153
756	FA273R	832	FA415			VD-154	FA187
757	FA313R	833	FA419			VD-156	FA142

# DISC BRAKE PAD COMPETITOR INTERCHANGE LIST

DISC PADS  
BUYERS GUIDE

VESRAH	EBC	VESRAH	EBC	VESRAH	EBC	VESRAH	EBC
VD-156/2	FA196	VD-259	FA199	VD-342/2	FA83/2	VD-903	FA71
VD-160	N/A	VD-260	FA199	VD-343	FA158	VD-904	FA27
VD-161	FA185	VD-261	FA155	VD-344	FA158	VD-906	FA16
VD-162	FA257	VD-262	FA244	VD-344/2	FA158	VD-907	FA18
VD-163	FA174	VD-263	N/A	VD-345	FA146	VD-907/2	FA18
VD-164	FA189	VD-264	FA267	VD-345/2	FA146	VD-908	FA71
VD-165	FA261	VD-265	FA275	VD-346	FA93	VD-909	FA72
VD-166	FA265	VD-266	FA307	VD-347	FA147	VD-910	FA22
VD-166/2	FA265	VD-266/2	FA413	VD-348	FA157	VD-911	FA47
VD-168	FA346	VD-267	FA336	VD-349	FA188	VD-911/2	FA47/3
VD-169	FA358	VD-268	FA348	VD-350	FA222	VD-912	FA50
VD-170	FA390	VD-269	FA319	VD-351	FA230	VD-913	FA18
VD-171	FA373	VD-269/2	FA319/2	VD-352	FA231	VD-915	FA24/2
VD-172	FA388	VD-270	FA344	VD-353	FA283	VD-916	N/A
VD-173	FA415	VD-271	FA367	VD-354	FA369/4	VD-917	FA79
VD-174	FA436	VD-272	FA384	VD-354	FA423/4	VD-918	FA78
VD-175	FA410	VD-273	FA393	VD-355	FA379	VD-919	FA94
VD-201	FA11	VD-274	FA380	VD-356	FA411	VD-920	FA60
VD-202	FA28	VD-275	FA408	VD-357	FA412	VD-921	N/A
VD-203	FA28	VD-276	FA428	VD-358	FA401	VD-922	FA201
VD-204	FA11	VD-277	FA442/4	VD-359	FA419	VD-923	FA200
VD-205	FA34	VD-301	FA55	VD-401	FA55	VD-924	FA120
VD-206	FA34	VD-302	FA55	VD-402	FA55	VD-925	FA115
VD-207	FA34	VD-303	FA55	VD-403	N/A	VD-926	FA204
VD-208	FA34	VD-304	FA55	VD-404	FA33	VD-927	FA163
VD-209	FA34	VD-305	FA35	VD-405	FA37	VD-928	FA76
VD-210	FA34	VD-306	FA36	VD-406	FA36	VD-929	FA134
VD-211	FA34	VD-306/2	RFA36/2	VD-408	FA33	VD-930	FA98
VD-212	FA34	VD-307	FA38	VD-409	FA33	VD-931	FA111
VD-213	FA42	VD-308	FA38	VD-410	FA39	VD-932	FA99
VD-214	FA34	VD-309	FA39	VD-411	FA33	VD-933	FA77
VD-215	FA41	VD-310	FA38	VD-412	FA37	VD-934	FA171
VD-216	FA61	VD-311	FA36	VD-413	FA48	VD-935	FA57
VD-221	FA64	VD-312	FA56	VD-414	FA33	VD-936	FA132
VD-222	FA20	VD-313	FA35	VD-415	FA36/2	VD-937	FA116
VD-228	FA70	VD-314	FA46	VD-416	FA161	VD-938	FA164
VD-231	FA81	VD-315	FA38	VD-417	FA73	VD-939	FA54/2
VD-234	FA21	VD-316	FA38	VD-419	N/A	VD-940	FA159
VD-235	FA81	VD-318	FA35	VD-420	FA68	VD-941	FA170
VD-236	FA88	VD-320	FA38	VD-420/2	FA68	VD-942	FA134
VD-237	FA38A	VD-322	FA51	VD-421	FA68	VD-943	FA126
VD-238	FA89	VD-323	FA51	VD-422	FA83	VD-945	FA95
VD-239	FA101	VD-324	FA65	VD-423	FA62	VD-947	FA245
VD-240	FA104	VD-325	FA67	VD-424	FA85	VD-948	FA193
VD-241	FA105	VD-327	FA63	VD-425	FA173	VD-950	FA232
VD-242	FA123	VD-327/2	FA161	VD-426	FA85	VD-953	FA208
VD-242/2	FA123	VD-328	FA102	VD-427	FA129	VD-955	FA255
VD-244	FA119	VD-329	FA106	VD-428	FA130	VD-956	FA201
VD-245	FA118	VD-329/2	FA106/2	VD-430	FA141	VD-957	FA200
VD-246	FA136	VD-330	FA103	VD-432	FA152	VD-958	FA209
VD-247	FA169	VD-331	FA103	VD-432/2	FA152/2	VD-959	FA246
VD-248	FA252	VD-331/2	FA150	VD-433	FA180	VD-960	FA268
VD-249	FA220	VD-332	FA67/2R	VD-434	FA192	VD-961	GFA263
VD-250	FA214	VD-333	FA54	VD-435	FA259	VD-962	FA234
VD-250/2	FA215/2	VD-334	FA84/2	VD-437	FA249	VD-963	FA270
VD-251	FA160	VD-335	FA110	VD-438	FA258	VD-964	FA266
VD-252	FA172	VD-336	FA84	VD-439	FA294	VD-965	FA271
VD-253	FA169	VD-337	FA106/2	VD-440	FA302	VD-967	FA194
VD-254	FA115	VD-338	FA103	VD-441	FA342	VD-968	FA260
VD-255	FA179	VD-339	FA83	VD-442	FA349	VD-967	FA194
VD-256	FA206	VD-340	FA214	VD-443	FA347	VD-968	FA260
VD-257	FA182	VD-341	FA137	VD-901	FA26	VD-969/2	FA295
VD-258	FA190	VD-342	FA83	VD-902	FA24/2	VD-971	FA299

# DISC BRAKE PAD COMPETITOR INTERCHANGE LIST

VESRAH	EBC	VESRAH	EBC	VESRAH	EBC	VESRAH	EBC
VD-972	FA304						
VD-973	FA313						
VD-974	FA298						
VD-975	FA210						
VD-976	FA301						
VD-977	-						
VD-978	-						
VD-979/2	FA414						
VD-981	FA321						
VD-982	FA177						
VD-983	FA353						
VD-984	-						
VD-986	FA322/4						
VD-987	FA355						
VD-988	FA356						
VD-991	FA325						
VD-992	FA314						
VD-993	FA345						
VD-994	FA306						
VD-995	FA305						
VD-996	FA235						
VD-997	FA368						
VD-998	FA320						
VD-999	FA350						
VD-9000	FA335						
VD-9001	FA303						
VD-9002	FA352						
VD-9003	FA351						
VD-9006	FA357						
VD-9007	FA167						
VD-9009	FA381						
VD-9010	FA387						
VD-9011	TBA						
VD-9012	FA264						
VD-9013	FA374						
VD-9015	FA194						
VD-9017	FA324						
VD-9019	FA297						
VD-9020	FA294						
VD-9022	FA400						
VD-9023	FA395						
VD-9024	FA354						
VD-9025	FA409						
VD-9026	FA377						
VD-9027	GFA183HH						
VD-9030	MXS405						

DISC PADS  
BUYERS GUIDE



# BRAKE SHOE BUYERS GUIDE

Part No.	Make/Model	Year		Part No.	Make/Model	Year	
<b>H301</b>	<b>HONDA</b>			<b>H303 Cont.</b>	<b>HONDA Cont.</b>		
06430 GAB 003	CRF 50 F4/F5/F6/F7	04-07	F&R		SH 100 T/W/X/Y/1 Scoopy	96-01	R
06430 GA8 003	NB 50 ME Aero	84	F		SJ 100 T 'Bali Ex'	96-99	R
06430 GZ9 003	NB 50 MF/MG/TH 'Vision'	86-88	F		CT 110 K/M/P	89-93	F
06450 147 671	NE 50 MF/MG 'Vision'	86-87	F		SL 125 'K1A'	76	F&R
43120 GK8 305	NC 50 K1/KZ 'Express'	79-82	F&R		CB 125 S	75-79	F&R
43120 GZ9 003	NC 50 C 'Express 2'	82	F		CG 125 K/B/C/E	77-84	F&R
45120 044 003	NC 50 A/B 'Express 3 Delux'	82	F		CG 125 BR-K/BR-T	85-97	R
45120 063 003	NP 50 D 'Melody Mini'	83	F		CH 125 D/E/G 'Spacy'	84-86	F&R
45120 147 010	NS 50 'Melody'/MSB 'Melody Delux'	82	F		CH 125 J/L/M/N/P/R/T Spacy	88-96	F&R
45120 147 671	NT 50 F/G/H 'Melody Mini'	85-87	F&R		NH 125 MD-D 'Lead'	83	F&R
45120 147 672	NX 50 A/B/MB 'Caren'	80-82	F		NH 125 "Lead 125"	86-87	R
45120 GE8 003	PC 50 K1	79	F&R		NS 125 FG/FH/RH	86-90	R
45120 GE8 505	QR 50 D/E/F	83-87	F		NX 125 K/S/F Transcity	89-97	R
	QR 50 M/R/V/W/Y	93-03	F		Passing 125	93-97	R
	XR 50 R1/R2/R3	01-03	F&R		TRX 125 J	88	F
	Z 50 R 'All models'	79-86	F&R		XL 125 K3/K4	79	F
					XL 125 L Paris-Dakar	85	R
<b>H302</b>	<b>HONDA</b>				ATC 125 ME/MG	84-85	F
06430 GE8 405	NB 50 ME 'Aero'	82	R		ATC 185 A/SB	80-81	F
06430 187 003	NB 50 MF/MG/TH 'Vision'	86-88	R		ATC 200 B/ESE/ESF/SE	81-84	F
06430 GA7 405	NE 50 MF/MG 'Vision'	86-87	R		XL 200 L/R	85	R
06430 GE8 003	NC 50 C 'Express 2'	82	R		<b>CPI</b>		
06430 GE8 405	NC 50 A/B 'Express 3 Delux'	82	R		50 Hussar	01	R
43120 187 003	ND 50 C/ML 'Melody 2 Delux'	82	R		50 Mars	01	R
43120 187 005	NH 50 "Lead 50 SS"	84	R		<b>E-TON QUADS</b>		
43120 187 009	NH 50 "Lead AF01/D716"	84-85	R		CXL 150 Challenger	02-07	F
43120 GA6 003	NP 50 D 'Melody Mini'	83	R		RXL 150 Viper R	05	F
43120 GA6 005	NS 50 'Melody'	82	R		RXL 150 Viper	07	F
43120 GA7 003	NU 50 MC 'Runaway'	82	R		RXL 150 Yukon	00-02	F
43120 GA7 005	NV 50 MSD 'Stream'	84	F&R		<b>KM</b>		
43120 GA7 305	NX 50 A/B/MB 'Caren'	80-82	R		Badboy 50/100 CX	05	R
43120 GE8 003	NH 80 MD-D/MD-G	83-86	R		<b>MOTO ROMA</b>		
43120 GE8 405	NH 80 Lead 80	85	R	45120 101 000	Wasp 50	99-03	F
43120 GA8 003	PX 50	82-83	R		<b>PEUGEOT</b>		
43120 GC8 003	QR 50 D/E/F	83-87	R	725436	Streetboard/Trekker (All models)	00-06	R
43120 GC8 004	<b>KYMCO DJ 50 Refind</b>		R	727730	Ludix 50cc One	04-07	F&R
43120 GC8 005	<b>QUADZILLA Buzz 50</b>	03-06	R	739653	Ludix Snake 50cc	04-07	R
43120 GF8 003	<b>SYM Fiddle 50</b>	99-05	R	757782	Ludix Bullet 50cc	04	R
43120 GC2 003					Ludix Trend 50cc	04-07	R
43120 GK1 000					Ludix Elegance 50c	04-07	R
					Ludix Ambition 125cc	04	R
<b>H303</b>	<b>HONDA</b>				Ludix Classic (14" wheels)	04-05	F&R
06430 GN2 730	C 50 (All Models)	75-93	F&R		Ludix Urban Track	06-07	R
06430 HF7J20	C 50 N (Single seat model)	95	F		Ludix Red Zone	06	R
06430 KEE 630	C 50 P/S/V/X/Y/1/2	96-02	F		Ludix Acid	06	R
06450 001 405	CF 50 'Chaly'	79	F&R		Ludix Blaster	05-07	R
06450 096 651	PK 50 Wallaro All models	90-01	R		Vivacity 50/100	04-06	R
06450 096 652	SFX 50 S/T/V/X/Y/1	95-04	R		Metal X 50	02-03	R
06450 178 932	SGX 50 V/W/X/Y/1	97-03	R		SV 50 J (Fromt drum model)	91-95	F&R
06430 GAG 003	SH 50 E/H/K/M/P/DP 'City Express'	85-96	F		Elyseo 50/100	98-02	R
06430 KS3 921	SH 50 T 'Fifty/Scoopy W/X/Y/1'	97-03	R		SV 50/80/125	91-95	R
06450 096 405	SJ 50 P/R/S/T/V/W/X 'Bali'	93-99	R		Buxy/M/RM	94-97	R
06450 968 681	SRX 50 T/W/X Joker/Shadow	97-99	R		Speed Fight (50/100) A/C	97-07	R
06450 GAG 003	SS 50 ZK2	75-77	F&R		Speedake	95-97	R
06450 GBY 911	SS 50 ZB2	77-80	R		Squab	95-97	R
43120 383 900	ST 50 'Dax' J/K	78-93	F&R		Zenith LS	96-99	R
43120 GB0 900	SXR 50 W/S/X/SX	98-99	R		Zenith M/N	96-00	F&R
43120 KB1 910	TC 50 M/P/V "Gyro Canopy"	96-00	F		Vivacity 50/100 (All models)	99-07	R
43120 KG1 920	C 70 (All models)	75-85	F&R		LOOXOR 50	01-05	R
43120 KG8 003	CF 70/C	77-78	F&R		SV 100 L		R
43120 KG8 005	NF 75	79	F&R		Fox/Fox L 50	94-98	F&R
43120 KG8 006	SA 75 Vision	89-	F		TKR (All)	06-07	R
43120 KS8 901	SH 75 Scoopy H/K/M/P/DP/S/DS	87-95	F		<b>KYMCO</b>		
43120 KS8 921	XR 75 K4	75-78	R		Agility 50	05-07	R
43120 KS3 901	XR 75 K5	79	F&R	45120 E60 000	Bet & Win 50/Dink Sports 50	02-06	R
43120 KS3 921	NH 80 MD-D/MD-G	83-86	F	45120 096 6520 M2	Calypso 50/125	99	R
43120 KV7 671	NH 80 MDR	94-	F	43121 A F01 000	Super 9 (A/C)	00-07	R
43120 178 932	C 90 (All models)	75-92	F&R	45120 GC8 000	Cobra Racer	00-06	R
45110 GJ3 604	EZ 90 'Cub'	91-95	F&R	43120 KXC 9000	Cobra 50 Cross	00-06	R
45120 096 651	NH 90 M/P/R Yuppy	91-94	R	4312A LAB4 90B	Cobra 100 Racer	99-03	R
45120 096 652	SRX 90 Shadow T/W/X	97-99	R	5312A KXCX900	Fever ZX 50/Scout	99-03	R
45120 096 653	TRX 90 Fourtrax/Sportrax (all models)	93-06	F		Dink 50/Spacer 50/Yager 50	98-07	R
45120 096 654	TRX 90 EX	07	F		Dink Classic Euro 2 50	03	R
45120 001 010/20	Astrea Supra NF100	99	R		DJW 50 World	95-97	F
45120 107 000	Astrea Grand/Supra	97-98	F&R		DJX 50	91-92	F
45120 383 900	H 100 A/SD/SG/SJ	82-92	F&R				



Part No.	Make/Model	Year		Part No.	Make/Model	Year	
<b>H307</b>	<b>POLARIS Contd.</b> Predator 50 (2 stroke) Scrambler 50 Predator 90 Scrambler 90/90 X Sportsman 90 <b>ROXON</b> Fox 50 (Quad) <b>SYM</b> 125 Attila Super Duke 125/150 KXR 50/90 Mongoose	04 01-03 03-04 01-03 01-04	R R R R R	<b>H315</b> 06430 HC4 901 06430 HC4 671 43120 286 000 43120 369 670 43120 HC4 671 43120 HC4 405 43120 KC4 000 43120 KG4 003 43120 KG4 006 431A2 KG4 006	<b>HONDA</b> ATC 250 ESF/ESG/ESH/ESJ CB 250 K3-K5 CB 250 G5 CJ 250 T MXV 250 F (MC92) TRX 250 F/G/H TRX 300 FWJ/K/L/T/V/W/X/Y TRX 300 J/K/L/T/V/W/X CB 350 K4 CB 360 G5 CJ 360 T CB 400 F/F1/F2	85-88 73-75 75 77 83-88 85-87 88-00 88-99 74 75 78 75-79	R R R R R R R R R R R
<b>H308</b> 45120 235 000 45120 354 670	<b>HONDA</b> CB 125 K1 to K5 CB 175 (All models)	72-76 74-76	F F	<b>H316</b> 43120 216 000 43120 216 670 43120 283 000 43120 458 670 43120 283 670 43120 404 003 43120 458 305 43120 485 670	<b>HONDA</b> CB 500 T CB 500 K1/K2/F CB 550 F/F1/F2/K3	75-77 75-77 78-80	R R R
<b>H309</b> 06430 354 405 43120 354 405 43120 354 670 43120 473 003 431A2 354 670 45120 240 000 45120 240 010 06430 354 670 43120 354 405 43120 354 670 43120 473 003 431A2 354 670 45120 240 000 45120 240 010	<b>HONDA</b> CB 175 (All models) CB 200 B CB 250 RSA/RSD CL 250 SC CBR 250 FG/FGYA (MC14) VT 250 FD VTZ 250 H/J/K XL 500 SB	74-76 76-79 81-84 81 86 83 86-88 81	R R R R R R R R	<b>H318</b> 06430 429 000 06430 429 405 06430 GBJ 740 06430 GBJ 742 06430 GBJ K20 06430 MMG 780 43120 429 000 43120 429 010 43120 429 405 43120 MM9 600 43120 MM9 780 43120 MM9 781 431A2 429 010	<b>HONDA</b> CA 125 S/T/V/W/X/1 CBX 125 F NES 125 Y (@ 125 Scooter) VT 125 CX/CY/C1/C21/C3 /C4/C7 'Shadow' XL 250 SB CBX 250 RSE CMX 250 CT/CV/CW/CX 'Rebel' GB 250 E/H Clubman GB 250 J/L/P/S/V "Clubman" XL 500 SZ XL 500 RC XR 500 SZ/SA XR 500 RB XL 600 RD/LD/RE/LE/RF/RG/RH XL 600 LM-F XL 600 VH/VJ/VK 'Transalp'	95-01 84- 00-01 99-07 82 84 96-00 84-87 88-97 80 82 79-80 81 83-87 85 87-90	R R R R R R R R R R R R R
<b>H310</b> 06430 KC1 690 06430 KC1 750 06430 362 000 06430 362 405 06430 KBG 702 06430 KEW 900 43120 240 000 43120 240 670 43120 362 000 43120 362 405 43120 362 670 43120 957 000 43120 957 305 431A2 362 000	<b>HONDA</b> ATC 70 (All models) CB 125 K1 to K5 CB 125 K6/S2 CB 125 T/T2 CB 125 RS CB 125 TDC/TDE/TDJ CBX 125 TS Custom CD 125 TC CM 125 CC/CF CD 185 T CD 200 TA/TB CM 200 TA/TB CD 250 UJ CB 250 N/T/W/X/Y/1/4 'Two fifty'	78-85 72-76 76 78-79 83 83-89 82- 78 82-85 78 79-80 79-80 89-92 92-05	R R R R R R R R R R R R R	<b>H319</b> 43120 KA4 003 43120 KA4 005	<b>HONDA</b> CR 125 RC CR 450 RB	82 81	F R
<b>H311</b> 45120 329 000 45120 329 670	<b>HONDA</b> XL 250 K3/K4	78-79	F	<b>H320</b> 43120 300 010 43120 393 003 43120 393 006 43120 393 305 431A2 393 006	<b>HONDA</b> CB 650 Z/B CB 650 SCC 'Night Hawk' CB 750 K0-K6 CB 750 K7 CB 750 KZ	79-81 82 69-77 78 80	R R R R R
<b>H312</b> 06430 329 305 06430 329 670 06450 KBG 000 06450 KC2 681 43120 329 000 43120 329 306 43120 329 670 45120 473 003 45120 473 006	<b>HONDA</b> CD 125 TC CM 125 CC/CF CD 185 T CD 200 TA/TB CM 200 TA/TB CL 250 SC XL 250 S/SZ/SA/SB XR 250 SZ/SA XL 250 K3/K4 XL 500 SZ	78 82-85 78 79-80 79-80 81 78-82 79-80 78-79 80	F F F F F F F R R F	<b>H321</b> 06430 415 000 06430 MR1 611 06430 MW3 671 43120 415 000 43120 MW3 671 431A2 415 006 43120 KED9 900	<b>HONDA</b> VT 250 CR/CT/CV "Magna" NV 400 CJ/CK "Steed" NV 400 CS/CV Steed CB 450 SG/SJ CB 500 R/T CX 500 CA/CB/Z/A/B CX 500 CC GL 500 DC VT 600 CN/CR/CS/CT/CV/CW Shadow Custom GL 650 D2-E VF 750 SC VF 750 S "Sabre" <b>KYMCO</b> Venox 250 (RA 50 AA)	95-97 92-93 95-97 86-88 94-96 79-81 82 82 93-99 84 82 82-83 00-06	R R R R R R R R R R R R
<b>H313</b> 06430 413 405 43120 413 000 43120 413 003 43120 413 006 43120 413 405 431A2 413 006	<b>HONDA</b> CB 250 T/N/NA/NB/ND/NDB/NDC CM 250 TB CB 350 SG/SJ CB 400 A 'Honda-matic' CB 400 T CB 400 N/NA/NB/NC CMX 450 CH/CJ Rebel VT 500 ED/EF	78-82 81 86-90 79 78 78-82 87-88 83-85	R R R R R R R R	<b>H322</b> 450-09-030-000 45120 GE8 003 45120 GE8 505 43120 GZ9 003 45120 093 003 43120 148 305 43120 148 670 43120 KED9 900 45130 148 670 752789 NY1-W2534-00 45009 035 000	<b>HONDA</b> PA 50 'Camino' PF 50 M 'Novio' PX 50 <b>KREIDLER</b> 50 MF2 50 MF4 later models 50 Flory MF 20/22 50 MP1 later models	80 75 82-84	F&R F&R F F&R F&R F&R F&R
<b>H314</b> 45120 286 000 45120 369 670 45120 369 305	<b>HONDA</b> CB 250 K3-K5 CB 350 K4	73-75 74	F F				

Part No.	Make/Model	Year		Part No.	Make/Model	Year		
<b>H322</b> <b>Contd.</b>	<b>KTM</b>			<b>H330</b> <b>Contd.</b>	<b>E-TON Contd.</b>			
	50 SX/SXR Pro Junior/Senior /Adventure	96-03	F&R		Viper EXL 150 ST Quad	05-07	R	
	50 SX Mini Adventure	04-07	F&R		EXL 150 Yukon ST	05-07	R	
	50 SX Pro Senior LC	02-03	R		<b>BOMBARDIER</b>			
	50 SX Pro Senior LC	02-07	R		DS 50 (2 stroke)	02-04	R	
	50 SX Mini Senior Adventure	02-07	R		Quest 50	03-04	R	
	<b>MOTOBECANE</b>				DS 90 (2 stroke/4 stroke)	02-04	R	
	50 all mod. Atom hub	88-	F		Quest 90 (2 stroke/4 stroke)	03-04	R	
	50 all mod. Leleu hub	88-	F					
	51 VLM		R		<b>H331</b>	<b>HONDA</b>		
	<b>PEUGEOT</b>				43120 KA3 305	CR 125 RD	83	F&R
	Most Mofas/Mopeds		F&R		43120 KA3 711	CR 125 RE/RF	84-85	R
103 Pro, SP 3		F&R	43120 KA3 731	CR 250 RD/RE/RF	83-85	R		
<b>PUCH</b>			43120 KA3 732	XR 350 RD	83	F		
Maxi (Spoke wheels)	All	F&R	43120 KA3 831	CR 480 RD	83	R		
Monza 4 SL/GP		F&R	43120 KA3 832	CR 500 RE/RF	84-85	R		
Imola X/GX		R	45120 KA4 711					
Cobra 80/80-6/80-6 GT/GTL		R	45120 KA4 712					
<b>H323</b>	<b>HONDA</b>			<b>H332</b>	<b>HONDA</b>			
	06430 KBR 003	NX 250 J/K/L/M/P/2P	87-93	45120 MC4 005	XL 500 RC	82	F	
	06430 428 003	XL 250 Degree (MD26)	R	45120 MC4 405				
	43120 428 003	XL 250 S/SZ/SA	78-81	06450 MC4 415				
	43120 428 005	XL 250 RC	82					
	43120 428 013	XL 250 RE/RF	84-85	<b>H333</b>	<b>HONDA</b>			
	43120 428 015	XLR 250 Baja MK1 (MD22)	R	06430 GCW 000	CHF 50-1/Scoopy 50	01-05	F&R	
	43120 428 405	XR 250 SZ/SA	79-80	06430 GE1 405	SA 50 J/M/P/R/S 'Vision Met-in'	88-95	F&R	
	43120 KW3 611	XR 250 RB/RC/RD	81-83	06430 GE1 670	CR 50 RE/RF	84-85	F&R	
	43120 KW3 612			06430 GE1 671	NJ 50 MDY/M2/MD2 Gyro-X	00-02	F&R	
	431A2 428 013			06430 GET 000	NU 50 MC 'Runaway'	82	F	
				06430 GCW 000	NPC 50 2/3 (AF59) Bite	02-03	F&R	
			06430 GN1 730	NPS 50 1/2/3/5/6/7 (AF58) Zoomer	01-07	F&R		
			06430 GC4 405	NVS 50 1SH2 Today 50	01-05	F		
			06450 KJ2 405	PK 50 Wallaro All models	90-01	F		
			06450 KJ2 305	SK 50 MM/MM-YA/MM-YC				
			06450 GT8 B41	/MN/MN-YA/MN-YB/MP				
			06450 GT8 B40	/MP-YA/MMR/MMR (AF27) Dio		F&R		
			43120 GC4 003	SK 50 MM-II/MM-YD/MN-II				
			43120 GC4 005	/MPLI (AF28) Dio SR		R		
			43120 GC4 006	SK 50 MN-III/MP-III/MP-IV (AF28) Dio-ZX		R		
			43120 GE1 671	SK 50 MMR-II/MMT (AF28) Dio XR		R		
			43120 GM9 003	SN 50 N/R/S "Giorno"	94	F&R		
			43120 GM9 711	Tact 50		R		
			43120 GY1 921	TC 50 M/P/V "Gyro Canopy"	96-00	R		
			43120 KJ2 003	TC 50 Y/2 Gyro Canopy	00-02	R		
			43120 KJ2 004	TLM 50 F	85	F&R		
			431A2 GC4 005	QR 50 M/R/V/W/Y	93-03	R		
			45120 GC1 003	CR 60 RF/RF	85-86	F&R		
			45120 GC1 006	CRF 70 F4/F5/F6/F7	04-07	F&R		
			45120 GC2 003	XR 70 RV/RW/RX/RV/R1/R2/R3	97-03	F&R		
			45120 GC2 004	SA 75 Vision	89-	R		
			45120 GC2 405	CR 80 RC	82	R		
			45120 GY1 921	CR 80 RD/RE	83-84	F&R		
			45120 GY1 922	CR 80 RF	85	F		
			45120 KJ2 000	CRF 80 F4/F5/F6/F7	04-07	F&R		
			45120 KJ2 003	XR 80 R	87-88	F&R		
			45120 KJ2 004	NH 80 MDR	94-	R		
			451A2 KJ2 003	NH 80 Lead 80 SS	85			
			43120 KJ2 405	Lead 90	88-	R		
			43120 GY1 922	CRF 100 R4/R5/R6/R7	04-07	F&R		
			43120 GE1 6720 M1	XR 100 RP/RR/RS/RT/RV/RW/RX/RV/R1-R3	93-03	F&R		
			43128 KC 9000	TLR 200 D/E	83-85	F&R		
			43120 E22 000	TLR 200 G/H	86-87	R		
			4312A E22 000	<b>KYMCO</b>				
				CX 50	93	R		
				CX 50 Super	94-97	R		
				DJW 50 World	94-00	R		
				DJX 50	91-92	R		
				DJY 50 Refined	93-06	R		
				<b>SYM</b>				
				DD 50 City Trek	02-07	R		
				<b>H334</b>	<b>HONDA</b>			
				43120 GE9 003	PXR 50	84	F	
				43130 GE9 003				
				<b>H335</b>	<b>HONDA</b>			
				45120 GB7 305	PXR 50	84	R	
				45120 GB7 851				
				45130 GB7 851				
				45120 GB7 852				
				45130 GB7 852				















Part No.	Make/Model	Year		Part No.	Make/Model	Year	
<b>Y503 Contd.</b>	<b>YAMAHA Contd.</b>			<b>Y503 Contd.</b>	<b>MBK Contd.</b>		
	YFM 80 WP/WR/WVS/RT/RV /RW Raptor	02-07	F		CW 50 Fizz 50	93-97	R
	YFM 80 GT/GV/GW Grizzly	05-07	F		CY 50 Forte/Forte Mufa	96-97	R
	TT-R 90 M/N/P/R/ES/S/T/ET/EV/EW	00-07	R		EW 50 'Stunt'	00-06	R
	AG 100 J (3HAA)	82	F		YH 50 'Flipper'	98-06	R
	AG 100 E 'Farm Bike'	93	F		YN 50 R Ovetto	98-06	R
	RT 100 E/F/K	93-03	F&R		CV 80 Evolis	97	R
	YB 100	82-86	R		XC 125 Flame 125	96-03	R
	YB 100	87-92	F&R		CS 50 Z/CS 50 Mach G	02-06	R
	YZ 100 J/K	82-83	F		CW 50 RS Booster NG	95-06	R
	RX 115 (5FS3)	99	R		CW 50 RSX Booster Track	96-98	R
	YFM 125 S/GT/GV/GW Grizzly	04-07	F		CW 50 Booster	90-91	F&R
	SR 125 (3MW2)	89-91	R		CT 50 S 50RR 150	91-92	F&R
	SR 125 SE	82	R		CR 50 Z Target	91-95	R
	SR 125	97-02	R		YE 50 Evolis	92-95	R
	TT-R 125 M/N/P/R/ES/S/T/ET/EV/EW	00-07	F&R		CW 50 Booster	92-94	F&R
	TT-R 125 LWM/LWN/LWP/LWR/LWES /LWS/LWET/LWT/LV/LEV/LEW	00-07	R		CW 50 Booster (12" wheels)	06	R
	TW 125	99-02	R		CW 50 Power Rocket	06	R
	XC 125 TR 'Cygnus'	96-03	R		CT 50 SS Sorriso	93-95	F&R
	XT 125	82	R		EW 50 Stunt Naked	05-06	R
	AG 200 E (3GX6)	93	F		YA 50 R Forte	94-95	R
	TW 200 (2JL/4CS1/2/3/4/5/6/5LB1/2)	01-02	R		YM 50 Fizz	94-95	R
	YTM 200 EL/DX	89	F		XC 125 T Flame	95-96	R
	YFS 200 B/F/G/H/J/K/L/M/N/P 'Blaster'	91-02	F		YA 50 TA Sorriso	95-96	F&R
	YFM 200 N	85	F		CW 50 Booster Spirit	96-98	R
	YFM 200 DXW/DX/DXA	89-90	F		<b>QUADZILLA</b>		
	ST 225 (5BT) Bronco	97	R		X 100 E (XLC)	06	F
	XT 225 (2LN) Serrow (1KH 20101-)	86-87	R		Pro Sharke	06	F
	XT 225 (3RW1-5 Serrow) (1KH 034101-132000)	89-93	R		Pro Shark 100 R MX	07	F
	YTM 225 DRN	85	F	8025686000	Stinger R 170 E	06	F
	YFM 225 S/T/U	86-89	F	802569600	ST 200 E (Automatic)	06	F
	YFAI W/A/B//F/G/H/J/K/L /M/N/P/R Breeze	89-03	F	T01-46421-00	<b>TGB</b>		
	YFB 250 D/E/F Timberwolf	92-94	F		Trigger 50		R
	<b>BSM</b>				Akros Tec 50		R
	TB 100		R		High Wheel 50		R
	<b>ADLY</b>				101 R (50/125/150)	05-06	R
	Jet 50/100		R		309 RS 50		R
	City Bird		R		F409 Cruise 50/125	05	R
	Predator 50/100		R		F409 (50/125/150)	06	R
	Fox 50		R		<b>PGO</b>		
	Panther 50/100	02-06	R		My Bubu 50	03	R
	Cosy 50/80	02-06	R	<b>Y504</b>			
	Road Tracer 50/90/100	04-06	R	122 25330 00	<b>CPI</b>		
	SS 50 1/11 Supersonic	04-05	R	296 25330 00	Popcorn 50	03-06	R
	SS 100 1/11 Supersonic	04-05	R	326 25330 00	<b>YAMAHA</b>		
	<b>CPI</b>			326 25330 10	DT 50 M/MX	78-86	F&R
54200 BMBT 000	Baby J 50	02	R	326 W2536 00	FS1E	74-76	F&R
54200 BOOT 000	Oliver 50 (All models)	03-06	R	393 25130 00	FS1E 'DX'	77-79	R
	Popcorn 50	02	R	10X W25236 00	FS1 'DX'	79-80	R
	50 Hussar	01-05	R	2JL W2536 00	FS1 'SE'	81-82	F&R
	<b>DERBI</b>			2JL W2536 01	RD 50 M	78-80	R
	DXR 200 Quad	04	F	2JN W2536 00	RD 50 MX/RD 50 M	81-87	R
	DXR 250 Quad	04-05	F	437 25130 00	TY 50/50 M	77-80	F&R
	<b>GARELLI</b>			2JL W2534 00	V 50 M/P	74-82	F&R
	Queenie	95-	R	2JL W2534 20	V 70 A	76	F&R
	Grinta	95-	R	54200 BMAT 000	V 75 A	77	F&R
	FX 50		R		DT 80 MX	81-83	F&R
	<b>GENERIC</b>				LB 2/80 'Bop 2'	80	F&R
	XOR 50	05-07	R		RD 80 (Air Cooled) (LC)	82	R
	Ideo 50	05-07	R		TY 80	77	R
	<b>JORDAN</b>				V 80	79-82	F&R
	Easy 50/100	03-04	R		YZ 80 D/E/F	77-79	R
	<b>KEEWAY</b>				V 90	78	F&R
	Hurricane 50	07	R		DT 100	76-80	F
	Hurricane 50-Base	07	R		RS 100	75-80	F&R
	RY8	07	R		RS 100 DX	77-80	R
	Focus 25/50	07	R		YB 100	78-81	F&R
	<b>POLARIS</b>				YB 100	82-86	F
	Cyclone '250X'	87	F		YZ 100 E/F/G/H	78-81	F
	Scrambler (3 wheeler)	85-86	F		IT 125 G/H/J	80-82	F
	Trail Boss 2x4	85-87	F		TY 125	82	F
	<b>MBK</b>				TY 175	77-80	F
	CV 50 Evolis	97	R		TY 250 D/E	77-78	F
	CW 50 RS 'Booster' 'Spirit'	99-06	R		TY 250 S/R	84-92	R
	CW 50 RSP "Rocket"	97-98	R				













Part No.	Make/Model	Year		Part No.	Make/Model	Year	
<b>860 Contd.</b>	<b>BMW Contd.</b> R 100 RS R 100 RT	76-09/80 78-09/80	R R	<b>885</b> 2691825	<b>PIAGGIO</b> Sefera Base 50 Sefera 50 Maquillage 2 SXR 80 City	91-93 94 99	F F F
<b>861</b> 34-21-2-310-523	<b>BMW</b> K 75/7-2 K 75 C R 45/45 N R 45 T R 65 R 65 GS R 65 RT R 65 T R 80 R 80/R 80 RT R 80 RT R 80/R 80 RT R 80 GS R 80 ST R 80 TIC R 100/7T R 100 RS R 100 RT	84-96 85-02/88 10/80-85 80-85 07/88-08/89 87-92 85-88 80-85 10/80-84 84-07/90 82-84 84-95 80-87 82-84 09/80-85 09/80-84 86-08/89 87-08/89	R R R R R R R R R R R R R R R R R R R	<b>886</b> 272714	<b>PIAGGIO</b> Quartz 50	92-96	R
<b>862</b> 34 21 1 242 603 34 21 1 242 604	<b>BMW</b> R 65 LS	81-85	R	<b>889</b>	<b>MONTESA</b> Old models		R
<b>863</b>	<b>BMW</b> K 75/75-S	84-08/88	R	<b>890</b> 499124	<b>PIAGGIO</b> Scatto 50	92-93	F&R
<b>864</b> 34 11 2 311 079	<b>BMW</b> R 50/5 / 60/5 / 60/6 / 75/5	69-76	F	<b>893</b> 8213133	<b>APRILIA</b> Amico 'All models' SR Scooters 'All air cooled models' Rally Scooter 'All air cooled models' Gulliver 'All models' Sonic (All models) Scarabeo 50 Scarabeo 50 2T (Rear drum models)	96-98 93-02 95-02 95-98 98-07 93-99 98-07	R R R R R R R
<b>869</b>	<b>KREIDLER</b> RS Typ K 54/53 RSH Typ K 54/53H	F&R F&R		1242150000	<b>BETA</b> Tempo Quadra 50 Ark (Air Cooled)	94-02 97-00 96-07	R R R
<b>873</b>	<b>MOTO BECANE</b> 50 all mod. Atom hub 50 all mod. Leleu hub	88- 88-	R R	44790031A0	<b>BENELLI</b> K2 Scooter 50 Naked 50 Naked 100 Pepe 50/50 LX 491 (All drum rear models) Pepe 100 LX	98-01 02-03 02 99-07 98-04 99-02	R R R R R R
<b>875</b>	<b>CASAL</b> Mofas Boss		F&R F&R	Y00FA0152	<b>CAGIVA</b> City 50 <b>MALAGUTI</b> Ciak 50/100 Centro SL/SL Cat Centro Base 50 F10 Jet Line/Jet Line WAP Firefox F15 (Air cooled models) F15 RR Phantom F12 (A/C) Phantom F69 (70cc) Yesterday 50 America 50 Raid	91-94 00-04 94-00 93-94 96-07 99-06 99-00 94-07 98 98-03 91- 91-	R R R R R R R R R R R
<b>877</b>	<b>GARELLI</b> 50 Team Matic <b>MOTO BECANE</b> 51 SUE Rock/Rock A Magnum/A/racing	88-	F F&R F&R F&R	11940300 11946300	<b>PIAGGIO</b> Typhoon 50	06-07	R
<b>878</b>	<b>MOTOBECANE</b> 40 AE/41 AE 50 A/E/AE 51 SA/SAE/SV/SVE 51 VLM		F&R F&R F&R F&R	<b>894</b>	<b>CASAL</b> Mofas drum dia. 110mm		F&R
<b>881</b> 414437	<b>PIAGGIO</b> Cosa CL/CLX 125 Cosa 2 125 Cosa CL/CLX 150 Cosa 2 50 Cosa CL/CLX 200 Cosa 2 200	88-91 91-97 88-91 91-97 88-91 91-97	R R R R R R	<b>895</b>	<b>CASAL</b> 50 Ciclomotori		F&R
<b>882</b> 414429	<b>PIAGGIO</b> Cosa CL/CLX 125 Cosa 2 50/125 Cosa CL/CLX 150 Cosa CL/CLX 200 Cosa 2 200	88-91 91-97 88-91 88-91 91-97	F F F F F	<b>896</b> 498117	<b>CASAL - Mofas drum dia. 140mm</b> <b>PIAGGIO</b> Superbrand 50 Zip 7 Zip 50 Bimodale	85-90 94-97	F F
<b>883</b>	<b>GILERA</b> Bullit 50	90-	R	<b>897</b> 64400 41820 64400 41840 64400 41850	<b>ADLY</b> RT 50/100 <b>HYOSUNG</b> Grand Prix 125 <b>PGO</b> G-Max 50 Rodo Show PMX 50/110 Mega 50 Big Max 50/90 EPS Tornado 50/125 Galaxy 25/50/90 <b>SUZUKI</b> TR 50 SW/SX UG 110 W/SW/Y/SY/SK1 Address/Yokuto	99-04 05-07 00-06 00-07 94- 94-06 97 97 94-	R R R R R R R R



Part No.	Make/Model	Year		Part No.	Make/Model	Year	
<b>909</b> 414497	<b>FANTIC</b> 50 Sprinter/3V.R <b>GARELLI</b> Junior Turismo <b>GILERA</b> 50 GSA/Vale 50 Trend 50 Trial/Enduro <b>PIAGGIO (VESPA)</b> Ciao All Models Ciao 50 Catalitico Bravo 50 Alloy Wheels Free 50 Zip 50 Base (Drum Model) Grillo 50 S1 50 Alloy Wheels S1 50 FL2 Bravo 3 Boss 50	83-  89-  71-99 99-05 73-81 92-00 89-93 79-88 91-97 87-90 88-89	F&R  F&R  F F&R F&R  F F F F F F F F	<b>926</b> <b>926G</b> 8213179 11907700	<b>ACCOSSATO</b> 50 Cross Mini <b>ASPES</b> 50 Navaho <b>FANTIC</b> 50 Trial <b>GARELLI</b> 50 Ciclone/KL 50 SV Gran Turismo <b>MALAGUTI</b> Centro Base 50 50 Fifty HF 50 Watercooled 50 Fifty Full/CX 50 Fifty Top <b>SWM (SWM)</b> 50/80 TR/TL Trial	82-  -83  93-94 -82 -82 83- 85-  -83	F&R  F&R  F  F&R F&R  F R R R R  F&R
<b>921</b> 8135159	<b>APRILIA</b> Classic 125 Red Rose 125 (Spoke wheel) <b>DUCATI</b> 250/350/450 Desmo <b>GILERA</b> RV 125 125 Cougar Strada/Sport 125 125 TG 1/2/3 TSR 125 TSR 125 200 T4/T4 C/T4 S <b>HERCULES (SACHS)</b> 50 Ultra, RS Ultra 80 Ultra, F Ultra, RS Ultra 80 Ultra Chopper <b>LAVERDA</b> LB 125 Custom/Sarbia LZ 125 Sport LZ 125 Sport <b>MOTO MORINI</b> 250 all models 350 Sport 350 FT/Turismo	95-01 87  74-77  88 99-02  -83 83-  85-87 80-82 80-82  71- 80 80-	R R  R  R R R R R R R R R R R R	<b>927G</b>	<b>MOTO MORINI</b> 350 Kanguro 350 Kanguro	-83 84-86	F&R R
967211	<b>DUCATI</b> 250/350/450 Desmo <b>GILERA</b> RV 125 125 Cougar Strada/Sport 125 125 TG 1/2/3 TSR 125 TSR 125 200 T4/T4 C/T4 S <b>HERCULES (SACHS)</b> 50 Ultra, RS Ultra 80 Ultra, F Ultra, RS Ultra 80 Ultra Chopper <b>LAVERDA</b> LB 125 Custom/Sarbia LZ 125 Sport LZ 125 Sport <b>MOTO MORINI</b> 250 all models 350 Sport 350 FT/Turismo	74-77  88 99-02  -83 83-  85-87 80-82 80-82  71- 80 80-	R  R R R R R R R R R R R R R	<b>928</b>	<b>DUCATI</b> 250/350/450 Desmo	-76	F
	<b>APRILIA</b> Classic 125 Red Rose 125 (Spoke wheel) <b>DUCATI</b> 250/350/450 Desmo <b>GILERA</b> RV 125 125 Cougar Strada/Sport 125 125 TG 1/2/3 TSR 125 TSR 125 200 T4/T4 C/T4 S <b>HERCULES (SACHS)</b> 50 Ultra, RS Ultra 80 Ultra, F Ultra, RS Ultra 80 Ultra Chopper <b>LAVERDA</b> LB 125 Custom/Sarbia LZ 125 Sport LZ 125 Sport <b>MOTO MORINI</b> 250 all models 350 Sport 350 FT/Turismo	95-01 87  74-77  88 99-02  -83 83-  85-87 80-82 80-82  71- 80 80-	R R  R  R R R R R R R R R R	<b>929</b>	<b>BENELLI</b> 124/125 2C/125 2T/2CSE 125 2C twin brake 125 T 250 C/TS, 250/4 254/304 500-4 <b>DUCATI</b> 250/350/450 Desmo	76- -76 83 76- 83 76-  -76	R R R R R R R
	<b>APRILIA</b> Classic 125 Red Rose 125 (Spoke wheel) <b>DUCATI</b> 250/350/450 Desmo <b>GILERA</b> RV 125 125 Cougar Strada/Sport 125 125 TG 1/2/3 TSR 125 TSR 125 200 T4/T4 C/T4 S <b>HERCULES (SACHS)</b> 50 Ultra, RS Ultra 80 Ultra, F Ultra, RS Ultra 80 Ultra Chopper <b>LAVERDA</b> LB 125 Custom/Sarbia LZ 125 Sport LZ 125 Sport <b>MOTO MORINI</b> 250 all models 350 Sport 350 FT/Turismo	95-01 87  74-77  88 99-02  -83 83-  85-87 80-82 80-82  71- 80 80-	R R  R  R R R R R R R R R	<b>930G</b>	<b>FANTIC</b> 50/50.1 Raider 50.1 Oasis KS/Rally 50.1 Trial Trial 50 Junior 80 Trial <b>GARELLI</b> Trial 323 <b>MALAGUTI</b> 50 Enduro RCW-X/Sahib	81- 86- 86- 87- 83-  86-  83-	R R R F&R F&R  R
<b>922</b> <b>922G</b>	<b>FANTIC</b> 50 Trial 50 Enduro 50 Caballero 80 Trial <b>GILERA</b> 50 GR 2 98 Giubileo 124 Giubileo 125 Arcore <b>HERCULES (SACHS)</b> 50 Supra Enduro 80 Ultra AC 80 Ultra AC Chopper <b>MALAGUTI</b> 50 MDX Gold Enduro 50 Enduro MEX 50 Enduro MEX 50 Enduro MGX 50 Enduro MLX 50 Enduro MXS 50 RGT Sport 50 Fifty HF/NL 4 gears	-83 83- -83 -83  87- 85-86 87- 87- 87- 87- 85- 85- 87-	R F&R F&R F&R  F R R R R F&R R R F&R R R F&R	<b>931</b> <b>931G</b>	<b>TOMOS</b> Moped with cast wheels <b>BENELLI</b> 50 G2 Elle <b>GARELLI</b> 50 Vip/Noi/Basic Alu wheel Formuno 50 50 Team Matic <b>MALAGUTI</b> 50 RGT Strada 50 Custom Fox 50 Dribbling 50 Fifty RV 50 Grizzly RCX 4/RCX 12 50 Grizzly RCX 10 50 Ranocchio 3 wheels	79-  87- 88-  83- 87- 87- 87- 87- 87- 87- 87-	F&R  F&R F&R R R R F&R F&R F&R F&R R F&R
<b>923</b>	<b>GILERA</b> 50 GR 2		F	<b>932</b>	<b>KREIDLER</b> 50 Flory MF 12/13 50 Flory MF 23/24/25 50 LH/LF/LFF 50 RMC/RMC-BG Mustang 125 125 125 RS		F&R F&R F&R F&R R R R
<b>924</b>	<b>GILERA</b> 50 GSA/Vale		R	<b>933</b> <b>933G</b> MC2855 0650	<b>MONTESA/HONDA</b> Cota 123/290/349 Cota 123/200/242/349 348 Trial Enduro <b>PUCH</b> Monza 50	-83 84	F&R R F&R
<b>925</b>	<b>GILERA</b> 150 Arcore		F			83-	F&R

Part No.	Make/Model	Year		Part No.	Make/Model	Year	
934G	<b>OSSA</b> Pre 1980 Models 125 Cross 250 Cross/Fuego/Super Pioneer	74- 74-	F&R F F		RX 125 Arizona	88	R
935G	<b>OSSA</b> 81 Onwards		F	957	<b>LAMBRETTA</b> 125/150 D-LD		R
936G	<b>OSSA</b> 81 Onwards <b>FB MINARELLI (SPAIN)</b> MR 80 <b>PUCH</b> Monza 50 50 Alu Wheels	84-	R R F&R	958	<b>LAMBRETTA</b> All disc models 125/150/175 L1		R F&R
937G	<b>MONTESA/HONDA</b> Cota 123/200/242/349	84	F	959	<b>LAMBRETTA</b> 125/150/200 DL		F&R
938 64400 HK3100	<b>HYOSUNG</b> TE 50 TE 90 TE 100	05-07 05-07 05-07	F F F	965 965G	<b>ITALJET</b> (All Models 125cc) <b>BENELLI</b> S 50 Scooter	81-	R F&R
939G	<b>FANTIC</b> 300 Trial <b>BETA</b> 240 TR 32	84-85	F F	966	<b>KREIDLER</b> 50 RM 80 E/L Florett		F&R R
940G	<b>ACCOSSATO</b> CE 80/120 Cross/Enduro H 20	84-	F	967	<b>KREIDLER</b> 125		F
941	<b>ASPES</b> RCL 80		F&R	970	<b>PUCH</b> MS 50/50 L		F&R
V942 266509	<b>PIAGGIO (VESPA)</b> Vespa PK 50 S Automatica Vespa FL2 Automatica Vespa PK 125 S Automatica	84-89 90-91 84-89	R R R	972	<b>PUCH</b> 50 KA/K2/K25/K3T/MSP		F&R
944 944G	<b>CAGIVA</b> WMX 125 (Rimoldi Hub) <b>HRD</b> RP 50 Cross RP 80 Cross	-85 83-	F&R F&R	977G	<b>CAGIVA</b> WMX 125 WM 125 WMX 250	86 87-88 86-88	R R R
945	<b>BENELLI</b> S 50 Scooter <b>FANTIC</b> 50 Iesimo spoke wheel 50 Joy	81- 92-	F F&R F&R	978	<b>MZ</b> Saxon 125 Saxon 150 ETZ 250/300 TS 125/150 TS 250 251 Fun Saxon 'Tour' 251/301 Saxon 500 'All models'	93-97 95 85-92 95-96 93-98 93-98	R R F F&R R R R
946	<b>BENELLI</b> 125 2C twin brake	-76	F	979	<b>MZ</b> TS 125/150 ETZ 125/150	85-92	R R
949	<b>CAGIVA</b> Roadster 125 <b>CZ / JAWA</b> 125/175/250/350 125/175/250/350	96-99 -74 75-	R F&R R	980	<b>MZ</b> Simpson	80-94	F&R
950	<b>CZ / JAWA</b> Scrambler Cross 125 x 300 Jawa 250/400 Cross 250/380 (Models 513/514)	65-76 65-76 77-79	F&R F&R R	982G	<b>CAGIVA</b> WMX 500	84-86	R
951	<b>CZ / JAWA</b> 125/175/250/350	75-	F	983	<b>GARELLI</b> GTA 125	85	R
952	<b>GARELLI</b> 125 XR/XRD Tiger <b>GILERA</b> 125 HX LC	83- 83-	R R	984 XH295500	<b>HUSQVARNA</b> Husky Boy Husky Boy J Husky Boy R Husky Boy Racing S Husky Boy Racing J Husky Boy S	00-02 01-02 01 00 00 01-02	F&R R R F&R F&R R
954	<b>GILERA</b> 125 RX RX 200/Arizona/Enduro 200 Arizona Hawk 200 RTX 200 ER	84- 85- 85- 85- 87-	R R R R R	985	<b>FB MINARELLI (SPAIN)</b> Rieju Marathon	74-	F&R
				987	<b>GILERA</b> 350 Dakota ER 350 500 Dakota ER 500	85- 87- 87- 87-	R R R R
				990G	<b>OSSA</b> 125 Cross 250 Cross/Fuego/Super Pioneer	74- 74-	R R

Part No.	Make/Model	Year		Part No.	Make/Model	Year	
991	use S624						
995 8213179	APRILIA Classic 50 FANTIC 50.1 Oasis Kick 50.1 Trial H 20	92-01	R				
		87-	R				
		87-	R				



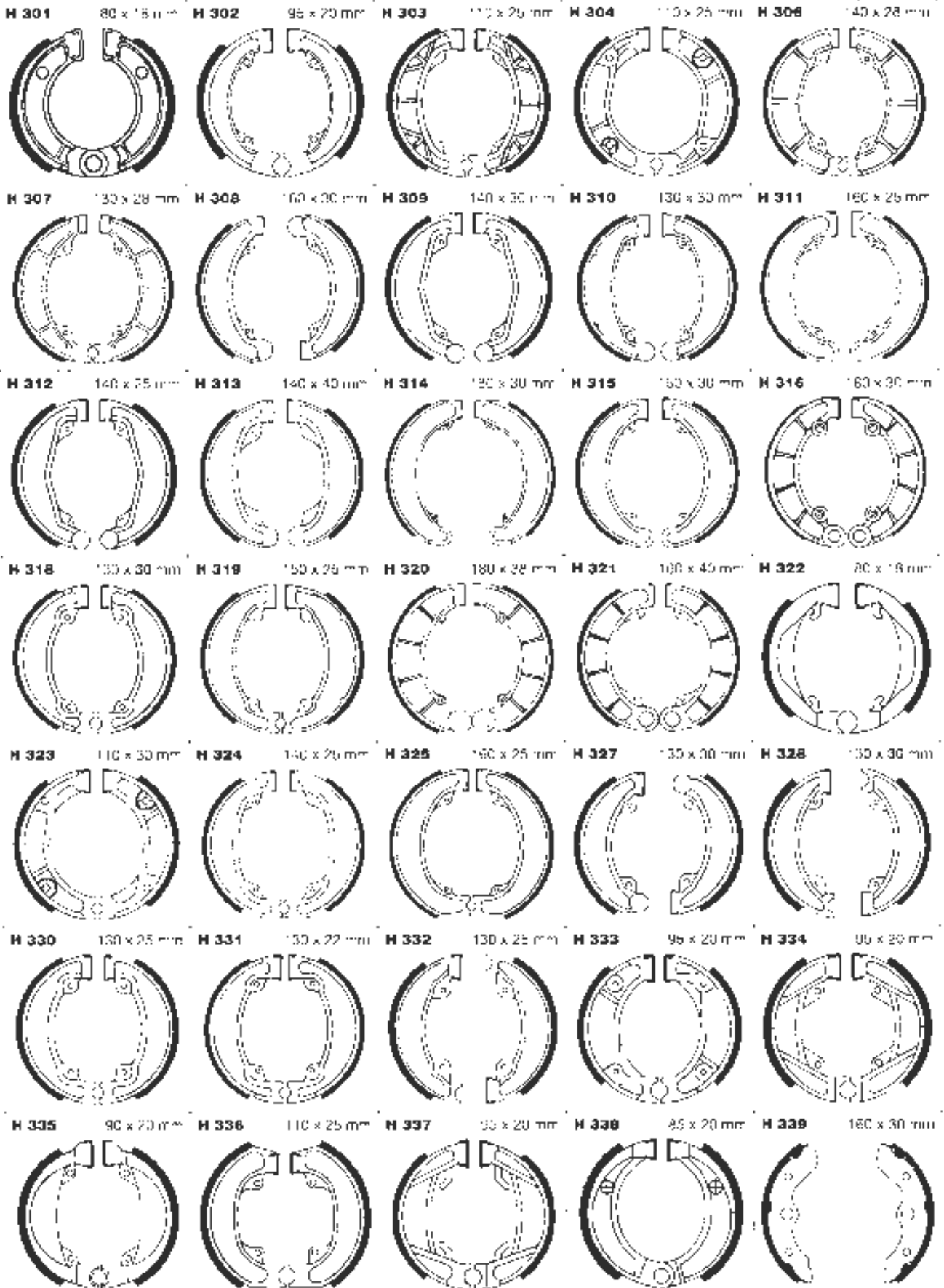



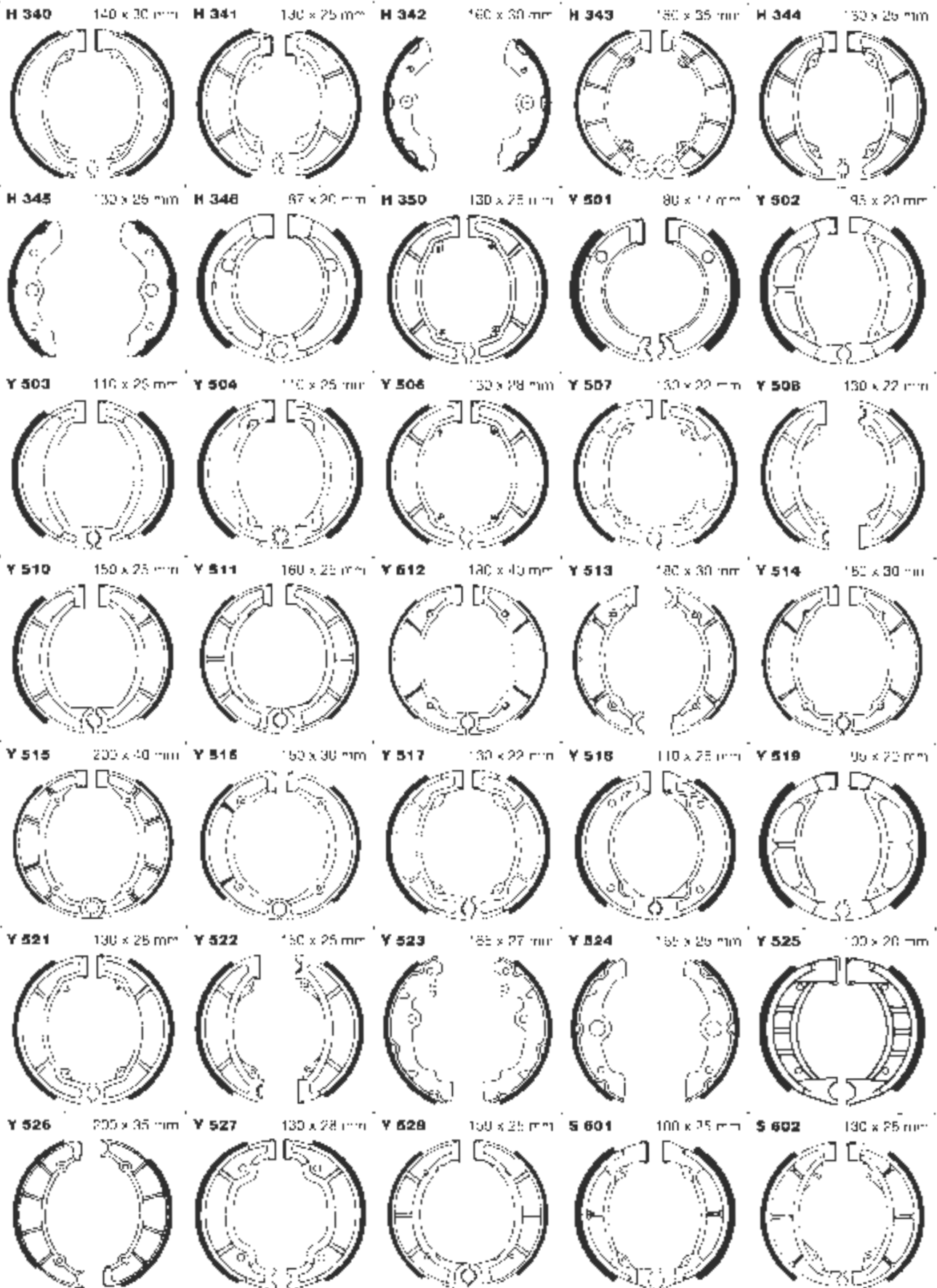



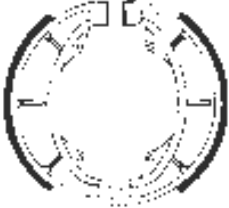

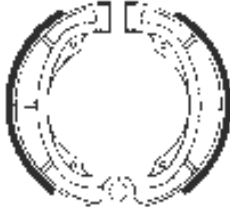

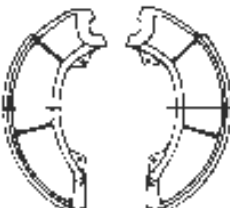
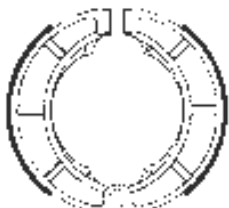



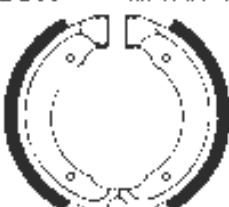



# BRAKE SHOE ILLUSTRATIONS

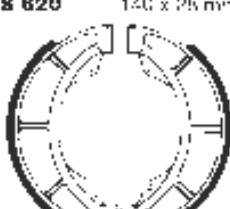
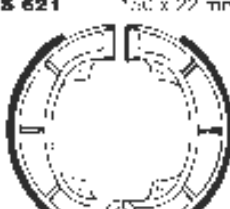
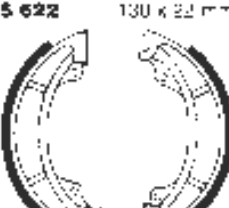
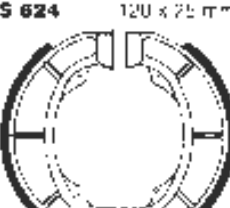

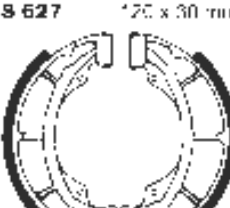
# BRAKE SHOE ILLUSTRATIONS

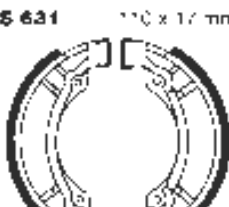
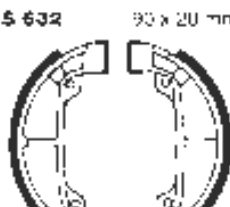

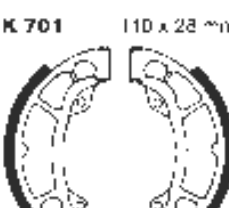
# BRAKE SHOE ILLUSTRATIONS

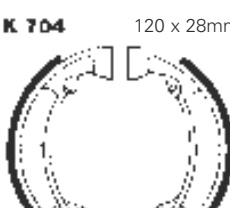
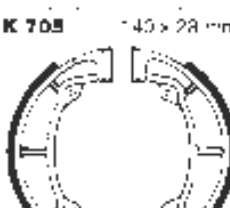
<b>S 602 A</b> 130 x 25 mm 	<b>S 603</b> 110 x 30 mm 	<b>S 604</b> 110 x 25 mm 	<b>S 605</b> 150 x 28 mm 	<b>S 606</b> 160 x 30 mm 
<b>S 607</b> 108 x 28 mm 	<b>S 608</b> 175 x 28 mm 	<b>S 609</b> 160 x 28 mm 	<b>S 610</b> 180 x 40 mm 	<b>S 611</b> 180 x 22 mm 
<b>S 612</b> 200 x 40 mm 	<b>S 613</b> 90 x 20 mm 	<b>S 614</b> 80 x 20 mm 	<b>S 615</b> 100 x 20 mm 	<b>S 616</b> 120 x 22 mm 
<b>S 617</b> 120 x 28 mm 	<b>S 618</b> 130 x 22 mm 	<b>S 619</b> 130 x 23 mm 	<b>S 620</b> 140 x 25 mm 	<b>S 621</b> 150 x 22 mm 
<b>S 622</b> 130 x 22 mm 	<b>S 624</b> 120 x 25 mm 	<b>S 625</b> 140 x 20 mm 	<b>S 626</b> 130 x 36 mm 	<b>S 627</b> 120 x 30 mm 
<b>S 628</b> 170 x 32 mm 	<b>S 630</b> 160 x 30 mm 	<b>S 631</b> 170 x 17 mm 	<b>S 632</b> 90 x 20 mm 	<b>S 633</b> 150 x 30 mm 
<b>K 701</b> 110 x 28 mm 	<b>K 702</b> 110 x 30 mm 	<b>K 703</b> 125 x 35 mm 	<b>K 704</b> 120 x 28 mm 	<b>K 705</b> 145 x 28 mm 

DISCONTINUED

USE S634

USE S606



# BRAKE SHOE ILLUSTRATIONS

SHOE  
BUYERS GUIDE

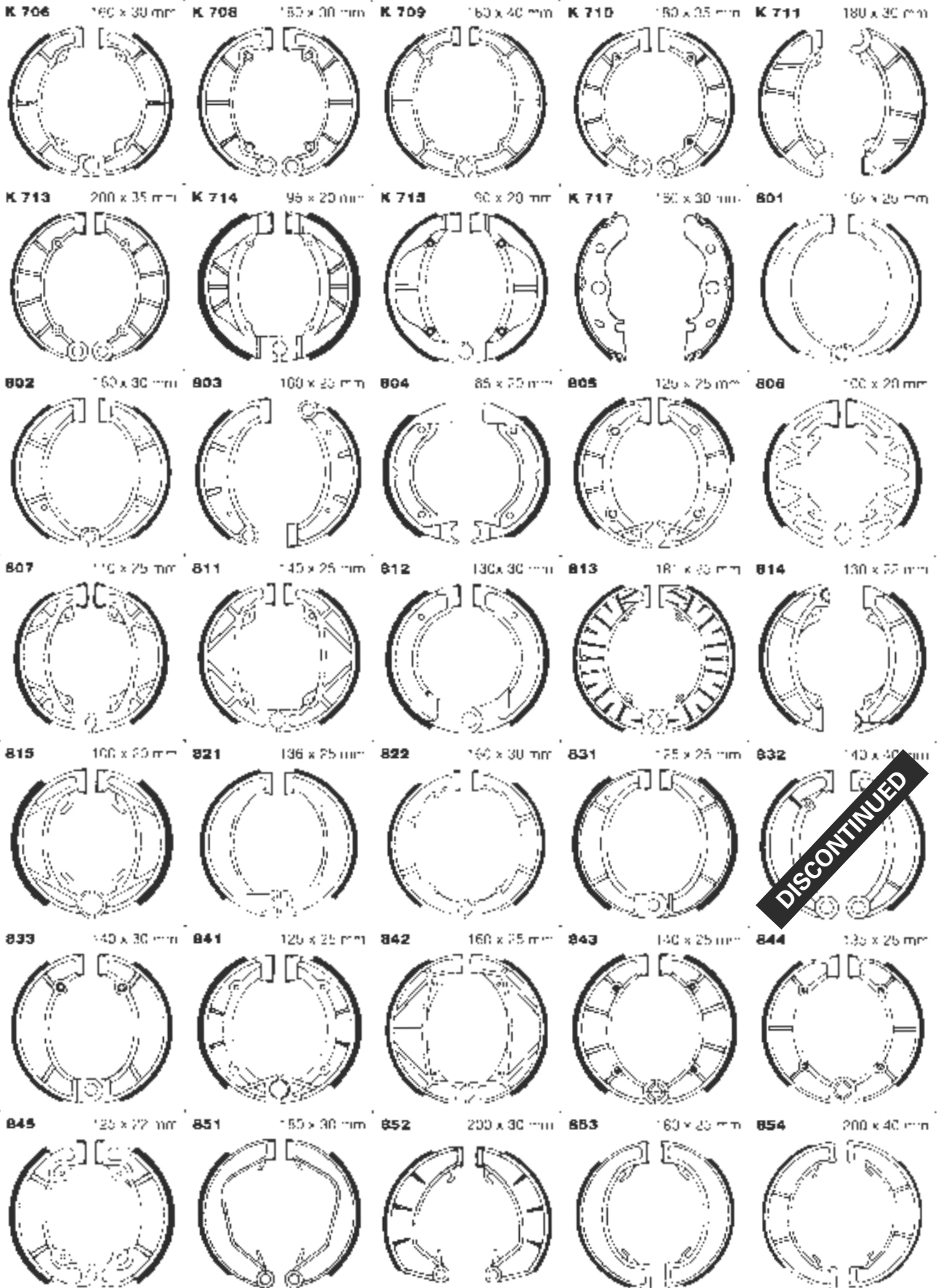

# BRAKE SHOE ILLUSTRATIONS

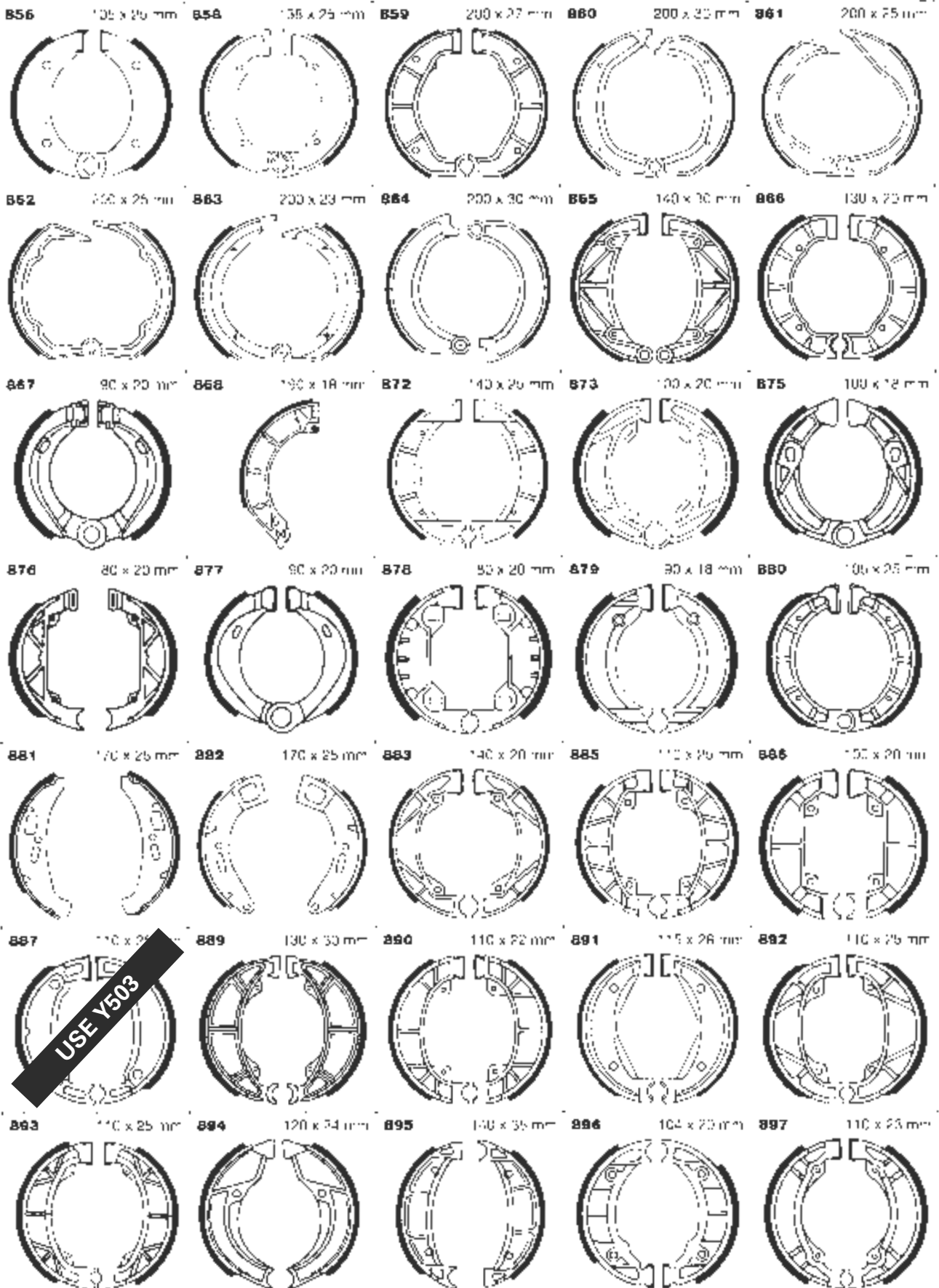

USE Y503

# BRAKE SHOE ILLUSTRATIONS

SHOE  
BUYERS GUIDE

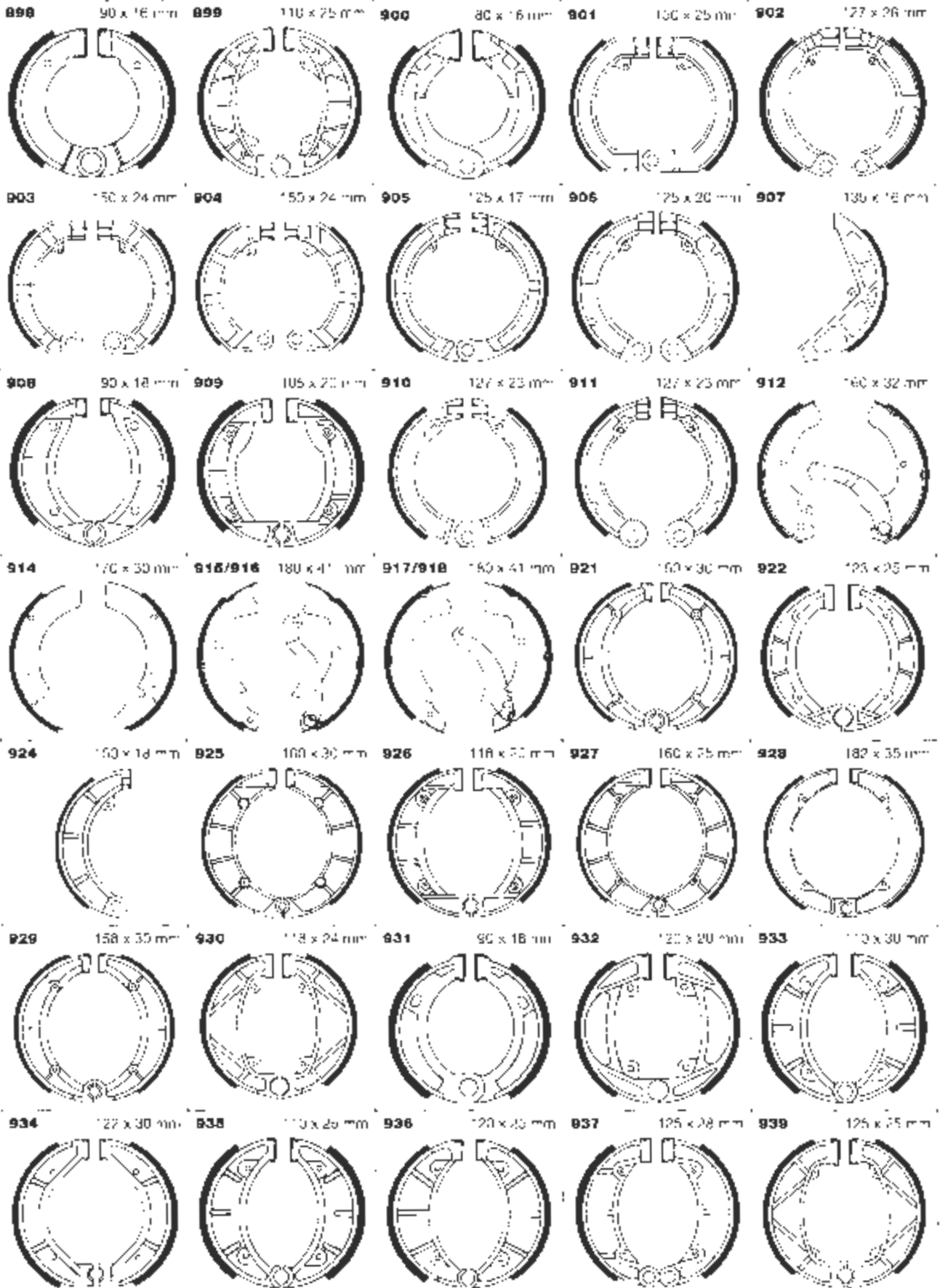

# BRAKE SHOE ILLUSTRATIONS

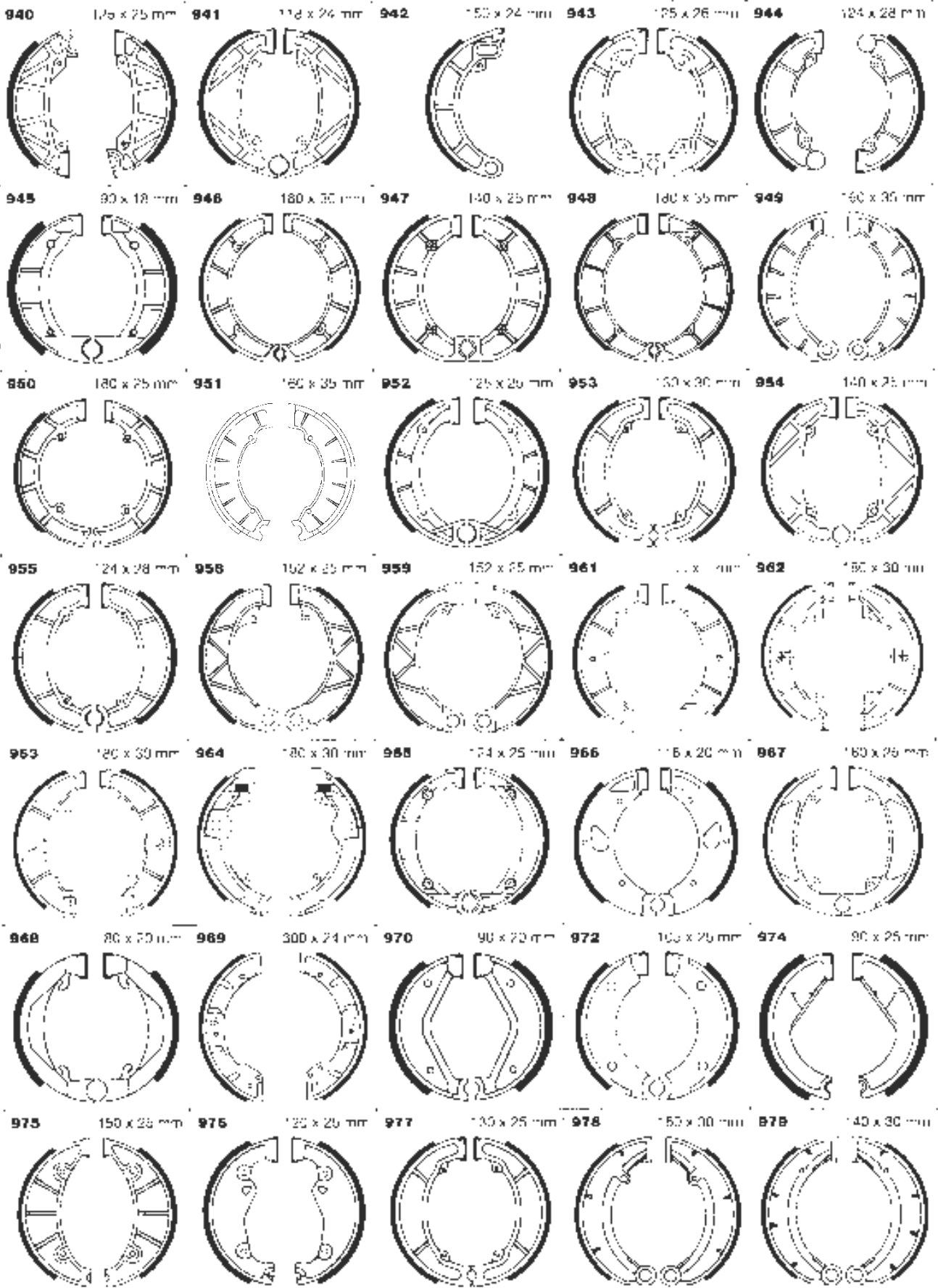

# BRAKE SHOE ILLUSTRATIONS

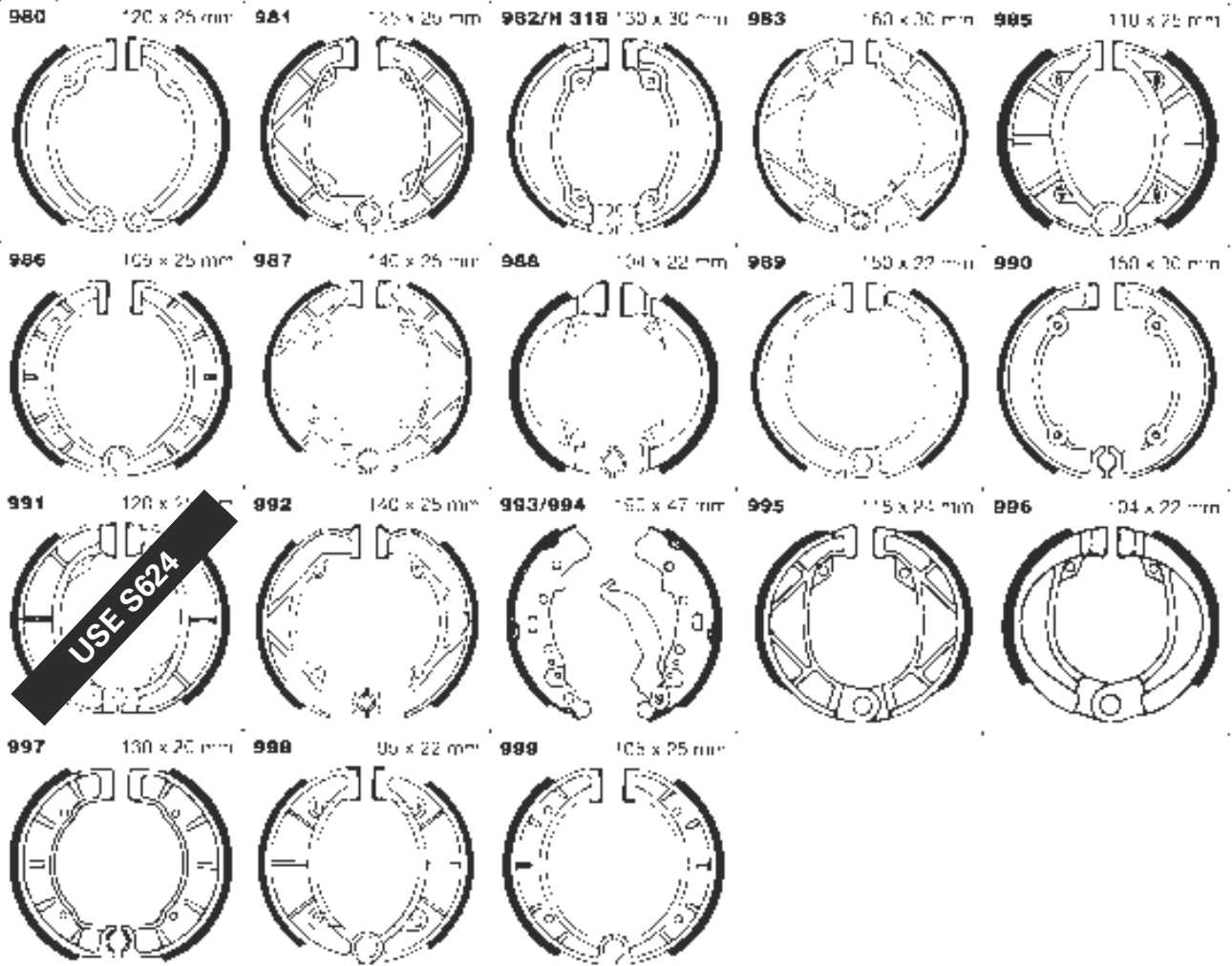

USE S624

# BRAKE SHOE ILLUSTRATIONS

H 347	160 x 20mm	H 347S	160 x 20mm	H 351	160 x 30mm	Y 520	165 x 30mm	S 629	165 x 28mm
S 634	180 x 40mm	K 718	165 x 26mm	K 719	180 x 26mm	K 720	180 x 25mm	810	140 x 25mm
816	140 x 25mm	817	120 x 25mm	818	130 x 25mm	819	150 x 30mm	820	130 x 28mm
			<b>NO PIC AVAILABLE</b>	<b>NO PIC AVAILABLE</b>	<b>NO PIC AVAILABLE</b>	<b>NO PIC AVAILABLE</b>	<b>NO PIC AVAILABLE</b>	<b>NO PIC AVAILABLE</b>	<b>NO PIC AVAILABLE</b>
857	130 x 25mm	957	142 x 20mm	H352	130 x 25mm	H353	110 x 25mm	Y530	110 x 25mm
<b>NO PIC AVAILABLE</b>	<b>NO PIC AVAILABLE</b>	<b>NO PIC AVAILABLE</b>	<b>NO PIC AVAILABLE</b>	<b>NO PIC AVAILABLE</b>	<b>NO PIC AVAILABLE</b>	<b>NO PIC AVAILABLE</b>	<b>NO PIC AVAILABLE</b>	<b>NO PIC AVAILABLE</b>	<b>NO PIC AVAILABLE</b>
Y531	130 x 28mm	Y532	160 x 30mm	Y533	150 x 28mm	Y534	160 x 32mm	S635	130 x 28mm
<b>NO PIC AVAILABLE</b>	<b>NO PIC AVAILABLE</b>	<b>NO PIC AVAILABLE</b>	<b>NO PIC AVAILABLE</b>	<b>NO PIC AVAILABLE</b>	<b>NO PIC AVAILABLE</b>	<b>NO PIC AVAILABLE</b>	<b>NO PIC AVAILABLE</b>	<b>NO PIC AVAILABLE</b>	<b>NO PIC AVAILABLE</b>
S636	140 x 30mm	938	110 x 22mm	984	90 x 20mm				
<b>NO PIC AVAILABLE</b>	<b>NO PIC AVAILABLE</b>	<b>NO PIC AVAILABLE</b>	<b>NO PIC AVAILABLE</b>	<b>NO PIC AVAILABLE</b>	<b>NO PIC AVAILABLE</b>				

# BRAKE SHOE COMPETITOR INTERCHANGE

SHOE  
BUYERS GUIDE

VESRAH	EBC	VESRAH	EBC	DP	EBC	SBS	EBC	SBS	EBC
VB101	H303	VB315	S621	9138	S614	SBS2012	H303	SBS2102	S616
VB110	H303	VB316	S616	9139	H318	SBS2013	H304	SBS2103	S617
VB117	H317	VB318	S620	9140	Y518	SBS2014	S602	SBS2104	S618
VB119	H314	VB319	S/Y502	9141	Y519	SBS2015	S603	SBS2107	S621
VB123	H307	VB320	S625	9142	K702	SBS2016	K706	SBS2108	S622
VB124	H311	VB321	S626	9143	K703	SBS2017	S604	SBS2110	S629
VB125	H312	VB322	S601	9144	K602A	SBS2018	S606	SBS2111	S606
VB126	H304	VB323	S614	9145	K710	SBS2019	H306	SBS2112	Y501
VB127	H315	VB324	S631	9146	H339	SBS2020	S613	SBS2113	Y513
VB128	H316	VB325	S632	9147	H342	SBS2021	Y519	SBS2114	Y520
VB129	H320	VB326	S633	9148	H343	SBS2022	S615	SBS2115	Y521
VB130	H310	VB327	S628	9149	H345	SBS2023	H312	SBS2116	801
VB132	H313	VB328	S624	9150	H347	SBS2024	H315	SBS2117	802
VB133	H321	VB329	S629	9151	Y527	SBS2025	K703	SBS2118	803
VB134	H301	VB330	897	9152	Y528	SBS2026	H318	SBS2120	812
VB135	H306	VB404	K708	9153	S610	SBS2027	H320	SBS2121	813
VB136	H318	VB405	K713	9154	-	SBS2028	Y503	SBS2122	814
VB137	H324	VB406	K/S603	9155	S624	SBS2029	H323	SBS2139	860
VB138	H325	VB407	K/S605	9156	S625	SBS2030	H332	SBS2140	861
VB139	H309	VB408	K704	9157	S626	SBS2031	H324	SBS2141	862
VB140	H323	VB409	K602A	9158	S628	SBS2032	Y504	SBS2143	859
VB141	H302	VB410	K/S602	9159	S629	SBS2033	Y507	SBS2146	V903
VB142	H330	VB411	K705	9160	S633	SBS2034	Y506	SB2171	978
VB143	H331	VB412	K709	9161	K705	SBS2035	Y511	SBS2172	979
VB144	H328	VB413	K706	9162	K717	SBS2036	Y508	SBS2177	Y523
VB146	H343	VB414	K701	9163	Y520	SBS2037	Y510	SBS2178	Y524
VB147	H339	VB415	K714	9165	Y524	SBS2038	K706	SBS2181	S624
VB148	H332	VB416	K703	9166	Y523	SBS2039	K704	SBS2182	Y502
VB149	H327	VB417	K715	9167	H351	SBS2040	K705	SBS2183	K602A
VB150	H333	VB418	K717	9168	807	SBS2041	H330	SBS2184	882
VB151	H341	VB419	K710	9169	893	SBS2042	H331	SBS2185	881
VB152	H345			9170	K715	SBS2043	H338	SBS2186	885
VB153	H342	<b>DP</b>	<b>EBC</b>	9171	-	SBS2044	H339	SBS2187	886
VB154	H331	9100	H303	9172	H350	SBS2045	H342	SBS2188	897
VB156	H347	9101	H304	9173	806	SBS2046	H343	SBS2189	H350
VB157	H351	9102	H310	9174	810	SBS2047	H344	SBS2190	Y526
VB158	H340	9103	H313	9175	816	SBS2048	H346	SBS2191	Y525
VB159	H330	9104	H322	9176	886	SBS2049	Y517	SBS2182	Y522
VB206	Y513	9105	H301	9177	-	SBS2050	Y518	SBS2193	H335
VB208	Y510	9106	H302	9178	899	SBS2051	S625	SBS2194	H334
VB210	Y510	9107	Y504	9179	V903	SBS2052	S626	SBS2195	899
VB212	Y504	9108	Y506	9180	-	SBS2053	S628	SBS2196	909
VB219	Y507	9109	Y501	9181	-	SBS2054	K717	SBS2197	K710
VB220	Y511	9110	Y502	9182	-	SBS2056	K703	SBS2198	H351
VB223	Y506	9111	Y503	9184	908	SBS2057	H333	SBS2199	Y527
VB224	Y501	9112	S602	9185	885	SBS2058	H313	SBS2200	806
VB225	Y514	9113	S603	9186	H340	SBS2059	H321	SBS2201	817
VB226	Y502	9114	S613	9187	S634	SBS2060	K709	SBS2202	S635
VB227	Y512	9115	S601	9188	860	SBS2063	Y512	SBS2203	818
VB228	Y510	9116	S606	9189	861	SBS2064	Y514	SBS2204	810
VB229	Y503	9117	K706	9190	H321	SBS2065	Y515	SBS2205	816
VB230	Y515	9118	K709	9191	815	SBS2069	H310	SBS2207	H351
VB231	Y516	9119	H315	9192	H338	SBS2070	H325		
VB233	Y517	9120	H316	9193	816	SBS2071	H314		
VB234	Y508	9121	H320	9194	897	SBS2072	H316		
VB235	Y506	9122	H306	9195	Y528	SBS2074	H322		
VB238	Y520	9123	H309	9196	S635	SBS2075	H325		
VB239	Y527	9124	H324	9197	817	SBS2077	H332		
VB240	Y524	9125	H330	9198	857	SBS2080	H336		
VB302	K/S602	9126	H333	9199	H352	SBS2082	H341		
VB304	S608	9127	Y511	9200	H346	SBS2085	H347		
VB305	S609	9128	Y514	9201	H307	SBS2087	K701		
VB306	S610	9129	Y512	9202	K718	SBS2088	K708		
VB307	S611	9130	Y510	9203	K719	SBS2091	K713		
VB308	S606	9131	Y515	9204	K720	SBS2092	K714		
VB309	K/S605	9132	Y516	9205	864	SBS2093	K715		
VB310	S604	9133	S605	9206	S636	SBS2094	S601		
VB311	S617	9134	S604			SBS2097	S609		
VB312	K/S603	9135	S617	<b>SBS</b>	<b>EBC</b>	SBS2098	S634		
VB313	S613	9136	K704	SBS2010	H301	SBS2099	S611		
VB314	S618	9137	S627	SBS2011	H302	SBS2101	S614		

# BRAKE SHOE COMPETITOR INTERCHANGE

LUCAS	EBC	LUCAS	EBC			
MCS800	H303	MCS963	Y519			
MCS802	H315	MCS964	Y517			
MCS803	H312	MCS967	Y526			
MCS804	H304	MCS968	Y527			
MCS805	H318	MCS969	Y521			
MCS806	H321	MCS980	V903			
MCS807	H313	MCS981	V905			
MCS808	H320	MCS982	882			
MCS809	H316	MCS983	881			
MCS810	N/A	MCS984	889			
MCS811	H309	MCS985	896			
MCS812	H323	MCS986	V904			
MCS813	H302	MCS987	885			
MCS815	H332	MCS988	908			
MCS816	H327	MCS989	806			
MCS817	H310	MCS990	897			
MCS819	H330	MCS991	S632			
MCS820	H336	MCS993	S615			
MCS821	H340	MCS994	816			
MCS822	H343	MCS995	H351			
MCS824	H344	MCS996	N/A			
MCS825	H333					
MCS827	H301					
MCS828	H322					
MCS831	H350					
MCS832	H338					
MCS833	Y511					
MCS834	Y512					
MCS850	H316					
MCS851	K713					
MCS852	K709					
MCS853	K706					
MCS854	S603					
MCS855	S602					
MCS856	S617					
MCS857	K715					
MCS858	K711					
MCS861	K703					
MCS890	978					
MCS891	979					
MCS892	H320					
MCS901	S604					
MCS902	S605					
MCS904	S609					
MCS905	S634					
MCS906	S611					
MCS907	S606					
MCS915	S616					
MCS918	S627					
MCS919	S606					
MCS920	804					
MCS921	S624					
MCS940	860					
MCS941	861					
MCS942	862					
MCS943	863					
MCS944	864					
MCS945	859					
MCS950	Y512					
MCS951	Y504					
MCS952	Y511					
MCS953	Y506					
MCS954	Y513					
MCS955	Y510					
MCS956	Y518					
MCS957	Y515					
MCS958	Y516					
MCS959	N/A					
MCS960	Y501					
MCS961	Y502					
MCS962	Y503					