

Quick Start

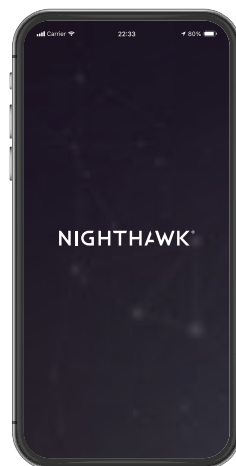

1

Download the Nighthawk app

On your mobile phone, download the Nighthawk app, available on Google Play and the Apple App Store.

2

Install your router with the app

Open the Nighthawk app and follow the step-by-step instructions to set up your router.

3

Get ready to game

Go to your router web interface at **<http://www.routerlogin.net>** and sign in with the same credentials used for your Nighthawk app. By logging in, you can unlock all of your router's gaming features, including bandwidth allocation and latency reduction.

Contents

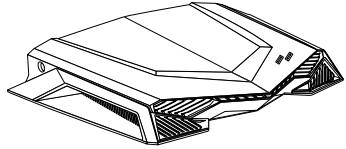

Router

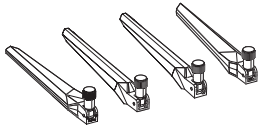

Antenna x 4

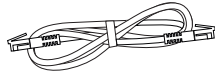

Ethernet Cable

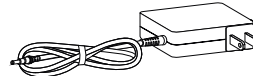

Power Adapter
(varies by region)

Overview

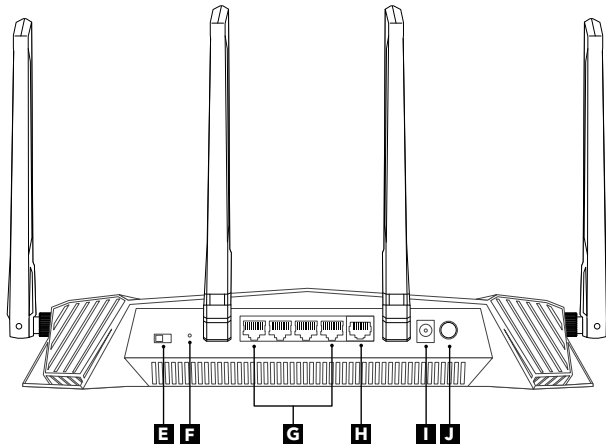
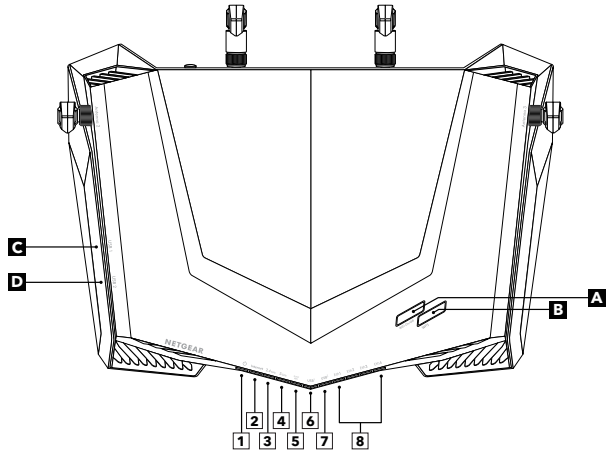

- 1** Power LED
- 2** Internet LED
- 3** 2.4 GHz WiFi LED
- 4** 5 GHz WiFi LED
- 5** Guest WiFi LED
- 6** USB 1 LED
- 7** USB 2 LED
- 8** Ethernet ports 1-4 LEDs
- A** WiFi On/Off button with LED
- B** WPS Button with LED
- C** USB port 1
- D** USB port 2
- E** LED On/Off switch
- F** Reset button
- G** Ethernet ports 1-4
- H** Internet port
- I** Power connector
- J** Power On/Off button

Troubleshooting

If you're having problems with the installation, try one of the following:

- Turn off your modem and router and disconnect them. Reboot your modem. Reconnect your router to your modem, and try installing with the Nighthawk app again.
- If you're still unable to install your router using the Nighthawk app, manually install it using the router web interface. Visit <http://www.routerlogin.net> to access the router web interface.

For more information, visit netgear.com/routerhelp.

Support and Community

Visit netgear.com/support to get your questions answered and access the latest downloads.

You can also check out our NETGEAR Community for helpful advice at community.netgear.com.

Regulatory and Legal

Si ce produit est vendu au Canada, vous pouvez accéder à ce document en français canadien à <https://www.netgear.com/support/download/>.

(If this product is sold in Canada, you can access this document in Canadian French at <https://www.netgear.com/support/download/>.)

For regulatory compliance information including the EU Declaration of Conformity, visit <https://www.netgear.com/about/regulatory/>.

See the regulatory compliance document before connecting the power supply.

For NETGEAR's Privacy Policy, visit <https://www.netgear.com/about/privacy-policy>.

By using this device, you are agreeing to NETGEAR's Terms and Conditions at <https://www.netgear.com/about/terms-and-conditions>. If you do not agree, return the device to your place of purchase within your return period.

