

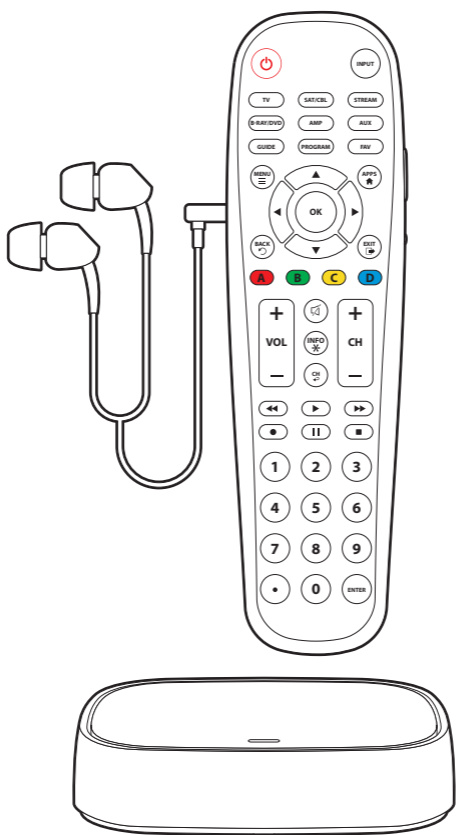

6-DEVICE UNIVERSAL REMOTE

WITH WIRELESS AUDIO TRANSMITTER
AND STEREO HEADPHONES



User Guide

BWA18AV007

v1.0 (2018)

TABLE OF CONTENTS

UNIVERSAL REMOTE CONTROL

- GETTING STARTED (BATTERIES) 02
- IN THE BOX 03
- GETTING STARTED (BUTTONS) 04
- PROGRAMMING YOUR REMOTE (DIRECT CODE ENTRY) 06
- PROGRAMMING YOUR REMOTE (AUTO CODE SEARCH) 09
- FAVORITE CHANNELS 10
- VOLUME LOCK 11
- CHANNEL LOCK 12
- CODE IDENTIFICATION & FACTORY RESET 13

WIRELESS AUDIO TRANSMITTER

- ABOUT PRIVATE LISTENING 14
- GET TO KNOW YOUR AUDIO TRANSMITTER 15
- HOW TO SETUP YOUR AUDIO TRANSMITTER 16
- OTHER CONNECTION OPTIONS 18
- PRIVATE LISTENING THROUGH YOUR REMOTE 20
- TROUBLESHOOTING 23
- FCC INFORMATION 25
- LIMITED 90-DAY WARRANTY 26

GETTING STARTED (BATTERIES)

Thank you for choosing the Blackweb Universal Remote Control and Wireless Audio Transmitter. This remote control can operate a wide range of electronic devices, works across most brands and models, and comes pre-programmed to operate many Samsung TVs (see the *Programming Your Remote* sections if your device is not compatible). Your remote can control up to 6 devices and is remarkably easy to set up. To get started, please install two AA alkaline batteries (not included) as shown below.

Installing the Batteries

1. Remove the battery cover.
2. Insert the batteries as shown.
3. Snap the battery cover back into place.

Battery Precautions

- Do not mix old and new batteries.
- Do not mix alkaline, standard (carbon-zinc) or rechargeable (nickel-cadmium) batteries.
- Always remove old, weak or worn-out batteries promptly and recycle or dispose of them in accordance with local and national regulations.

Low Battery Indicator

If while using the remote, the  button's red indicator light flashes 3 times, this indicates the batteries need to be replaced. Please replace the batteries as soon as possible when this indication occurs.

Code Saver

When changing the batteries of your remote, please do so quickly. You have up to 20 minutes to change the batteries in your remote without losing the programmed codes.

Battery Saver

To conserve battery power, the remote will automatically turn off if any button is pressed for more than 60 seconds (except during programming). This feature is helpful in the event that the remote is stuck in a location where the buttons remain depressed, such as between sofa cushions.

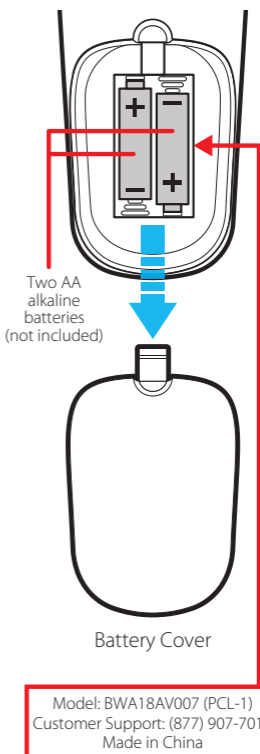

Your remote control's model number can be found in the battery compartment

IN THE BOX



REMOTE CONTROL

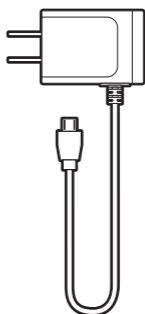

USB CHARGER

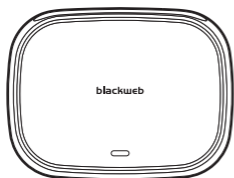

AUDIO TRANSMITTER

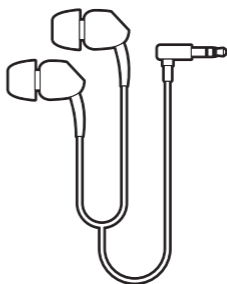

STEREO HEADPHONES



USER GUIDE

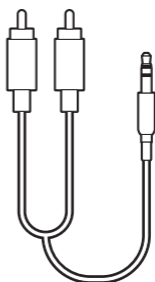

RCA/3.5MM
AUDIO CABLE

GETTING STARTED (BUTTONS)

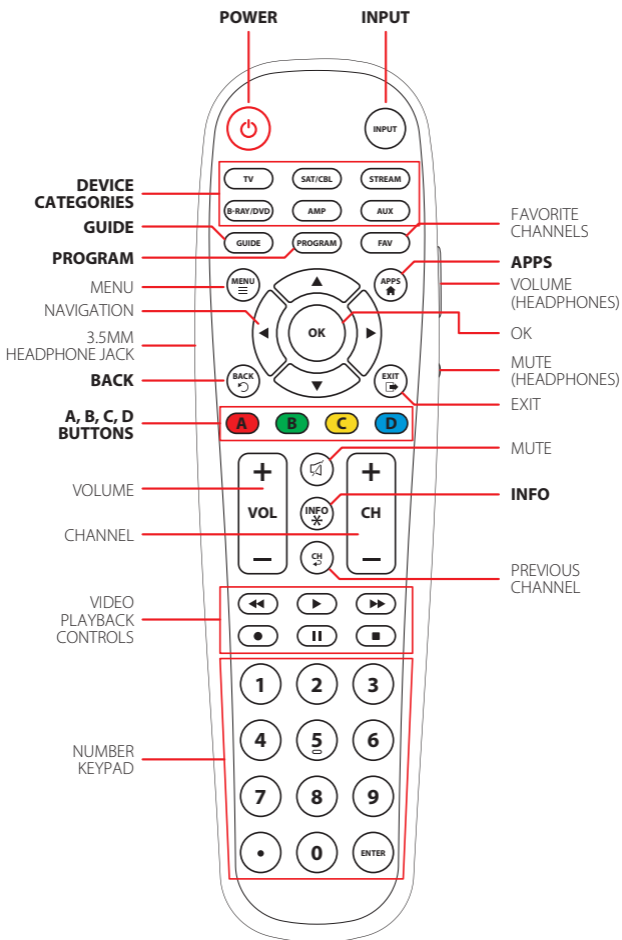

NOTE: Some of the buttons on the remote may not be supported by your device.



POWER

Turns your device On/Off and also serves as an indicator when the remote is being programmed



INPUT

Switches between the sources connected to your TV



DEVICE CATEGORIES

Use these buttons to select the device you want to control



PROGRAM

Use to put your remote in programming mode



GUIDE

Use to access the guide of satellite and cable set-top boxes



APPS

Use to access your smart TV's apps (if supported)



BACK

Return to the previous menu or screen



A, B, C, D BUTTONS

Use to access device shortcuts for additional features or custom apps on your device (if supported)



INFO

Use to access on-screen content description and information

PROGRAMMING YOUR REMOTE (DIRECT CODE ENTRY)

Programming your remote is as easy as 1, 2, 3

Before beginning, please make sure that the device you want to control is powered on and follow these three simple steps.

NOTE: Press **PROGRAM** to exit at any time.

1.

Press and hold the **PROGRAM** button until the  button lights up red.

The  button's red indicator light remains on.



Red indicator light



NOTE: The Blackweb universal remote comes pre-programmed to operate many Samsung TVs.

2.

Select the device you want to program from the **Device Categories**:



The  button's red indicator light blinks once and remains on.



Red indicator light

Device Categories



3.

Enter the 4-digit code from the included list for the category and brand of your device.

The  button's red indicator light shuts off if a valid code was entered.

If the  button's red indicator light flashes and remains on after entering four digits, that means an invalid code was entered. In that case, check the list again and re-enter the code.

NOTE: Test the remote with the device to make sure the buttons work as expected. If some of the buttons/features don't work, try a different code on the list. Repeat this process for each device you wish to control.



Code list and other helpful information available at:
www.myblackwebremote.com



Enter the code

PROGRAMMING YOUR REMOTE (AUTO CODE SEARCH)

It's recommended to program your remote by using the **Direct Code Entry** method, however if with that method you were not able to find a code that is compatible with your device, you may try the **Auto Code Search** method below:

1. Power on the device that you want to control.
2. Press and hold the **PROGRAM** button until the  button lights up red. The  button's red indicator light remains on.
3. Select a device from **Device Categories** you would like to control. The  button's red indicator light blinks once and remains on.





Device Categories





NOTE: Please refer to the list below if you are unsure about the device category.

- **TV:** TV, TV/DVD and other TV combinations
- **SAT/CBL:** Satellite, Cable, DVR, and other set-top boxes
- **STREAM:** Roku, Apple TV, Xbox, and other streaming media players*
- **B-RAY/DVD:** Blu-ray Players and DVD Players
- **AMP:** Sound Bars, Audio Receivers, and other audio devices
- **AUX:** VCRs, Digital Frames, and devices not found on the code list

*Compatible with Apple TV® and most Roku® devices; not compatible with Roku® Streaming Stick®, Amazon® Fire TV and any voice-search features







4. Point the remote at the device you wish to control and then press and hold the  button until the device turns off. The  button's red indicator light will blink as the codes are being tested.
5. When the device turns off, immediately release the  button to lock in the code. The  button's red indicator light will turn off. Test the remote with the device to make sure all the buttons work as expected. If some of the buttons/features don't work, repeat the process or try the **Direct Code Entry** method.

NOTE: It may take over 10 minutes to scan through all the possible codes for your device. If during the Auto Code Search you have either accidentally or deliberately released the  button, you may repeat steps 1 through 5 above to resume the code search where it left off.

After the Auto Code Search has exhausted all available codes for the selected category, the remote's  button's red indicator light blinks three times and turns off. If none of the codes worked with your device, try the Direct Code Entry method.



FAVORITE CHANNELS

For easy access to up to 10 of your favorite channels, follow the steps below.

1. Select a device from **Device Categories** that controls the channels. The  button's red indicator light will blink once.
2. Press and hold the **PROGRAM** button until the  button lights up red. The  button's red indicator light remains on.
3. Press the **FAV** button. The  button's red indicator light blinks once and remains on.
4. Select the button (0 – 9) that you will use for storing your favorite channel. The  button's red indicator light blinks once and remains on.
5. Enter the channel number you wish to program as a favorite channel.
6. Press the **FAV** button, the  button's red indicator light will turn off and the channel is saved.

NOTE: To change a stored favorite channel, repeat steps 1-6 above.







To Access Your Favorite Channels:

1. Press the **FAV** button. The  button's red indicator lights up and remains lit.
2. To access the favorite channel, press the programmed button for that channel (0-9). The  button's red indicator light blinks, then turns off as the command is sent.





VOLUME LOCK

Use this feature to lock a device to the remote's volume control. For example, the remote can be in TV mode while the volume buttons control your sound bar.

Enabling Volume Lock:

1. Press and hold the **PROGRAM** button until the  button lights up red. The  button's red indicator light remains on.
2. Select a device from **Device Categories** that you want to lock to the remote's volume control. The  button's red indicator light blinks once and remains on.
3. Press the **VOL+** button. The  button's red indicator light blinks once and remains on.
4. Press the  button. The  button's red indicator light will blink twice and turn off.

Disabling Volume Lock:





1. Press and hold the **PROGRAM** button until the  button lights up red. The  button's red indicator light remains on.
2. Press the **VOL-** button. The  button's red indicator light blinks once and remains on.
3. Press the  button. The  button's red indicator light will blink twice and turn off.

NOTE: On most newer HDMI-connected devices, the Volume Lock feature may be unnecessary as this feature is already built-in.





CHANNEL LOCK

Use this feature to lock a device to the remote's channel control. For example, the remote can be in TV mode while the channel buttons control your satellite or cable box.

Enabling Channel Lock:

1. Press and hold the **PROGRAM** button until the  button lights up red. The  button's red indicator light remains on.
2. Select a device from **Device Categories** that you want to lock to the remote's channel control. The  button's red indicator light blinks once and remains on.
3. Press the **CH+** button. The  button's red indicator light blinks once and remains on.
4. Press the **OK** button. The  button's red indicator light will blink twice and turn off.

Disabling Channel Lock:







1. Press and hold the **PROGRAM** button until the  button lights up red. The  button's red indicator light remains on.
2. Press the **CH-** button. The  button's red indicator light blinks once and remains on.
3. Press the **OK** button. The  button's red indicator light will blink twice and turn off.

NOTE: On most newer HDMI-connected devices, the Channel Lock feature may be unnecessary as this feature is already built-in.

CODE IDENTIFICATION & FACTORY RESET







Code Identification:

To identify any of your programmed codes, follow the steps below.

1. Press and hold the **PROGRAM** button until the  button lights up red. The  button's red indicator light remains on.
2. Select a device from **Device Categories** that you would like the code for. The  button's red indicator light blinks once and remains on.
3. Press the **A** button. The  button's red indicator light blinks once and remains on.
4. Press the **1** button. Count the number of times the  button's red indicator light flashes. This is the number corresponding to the first digit of the code. If the  button does not flash, the corresponding code number is 0. Repeat the process by pressing the **2**, **3** and **4** buttons for the remaining digits.
5. Press the **A** button to exit.

NOTE: Press **A** to exit at any time.

Reset to Factory Settings:

1. Press and hold the **PROGRAM** button until the  button lights up red. The  button's red indicator light remains on.
2. Press the  button. The  button's red indicator light blinks once and remains on.
3. Press the  button. The  button's red indicator light will flash twice and the remote will revert to factory settings.

ABOUT PRIVATE LISTENING

When you want to watch without disturbing others, you can use the universal remote's **Private Listening** feature by inserting headphones into the universal remote and transmitting the sound from the audio transmitter attached to your television.

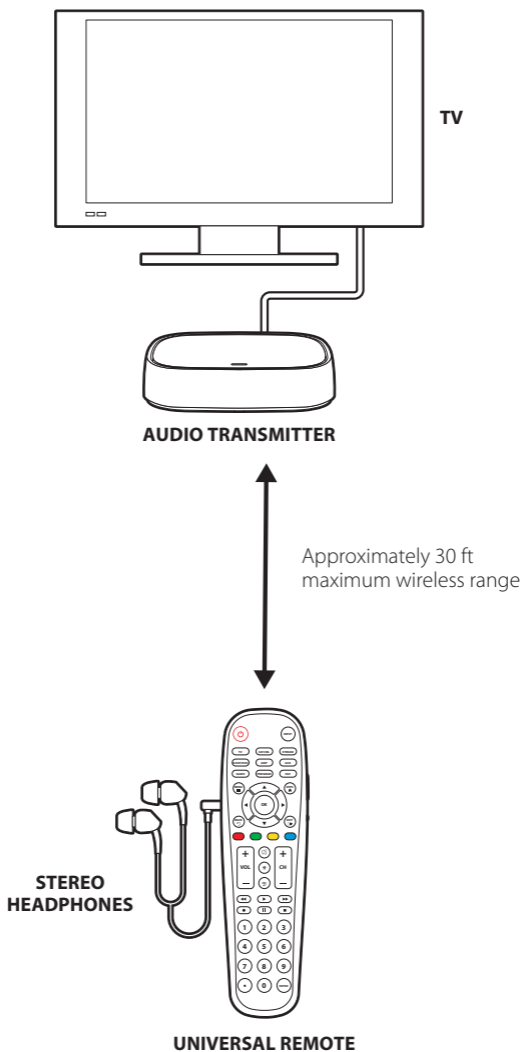

GET TO KNOW YOUR AUDIO TRANSMITTER

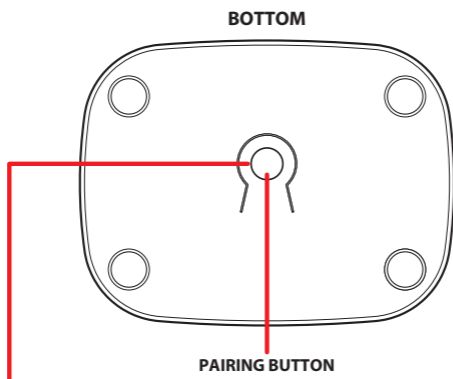
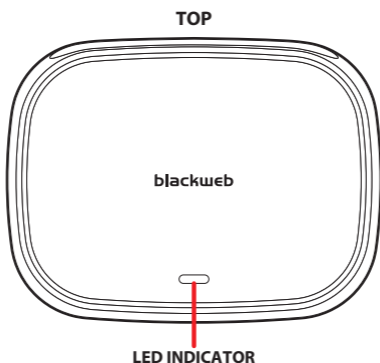
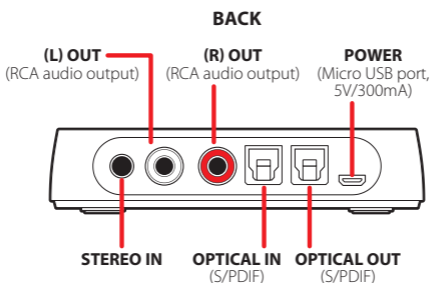

CAUTION: Don't press this button unless you want to unpair the remote from the audio transmitter (your universal remote and audio transmitter are already paired to work together out of the box).

For more information, please refer to "**PAIRING MODE**" in Troubleshooting.

HOW TO SET UP YOUR AUDIO TRANSMITTER

1. Connect the supplied USB charger to the audio transmitter's USB port labeled "**POWER**".

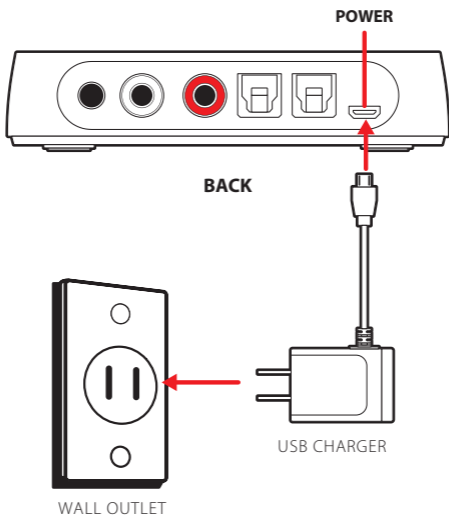

When connected to a power source, the audio transmitter's LED indicator turns solid blue.

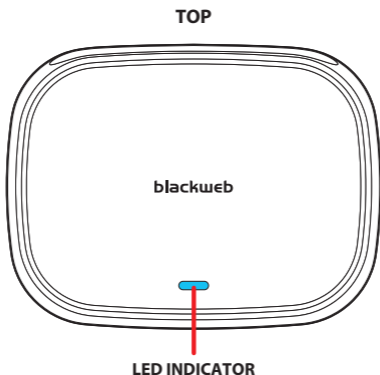

NOTE: A steady blue light indicates that the audio transmitter is paired to the remote (by default). If the LED indicator is continuously flashing, it indicates that the audio transmitter and remote are not properly paired (please refer to "Pairing Mode" in Troubleshooting).

2. Connect the white and red plugs of the supplied RCA/3.5mm audio cable to the **(L) and (R) AUDIO OUT** on your television's connection panel.

NOTE: Ensure the cables are **NOT** plugged into the TV's audio input.

3. Connect the 3.5mm stereo plug to the audio transmitter's **"STEREO IN"** port as shown below.

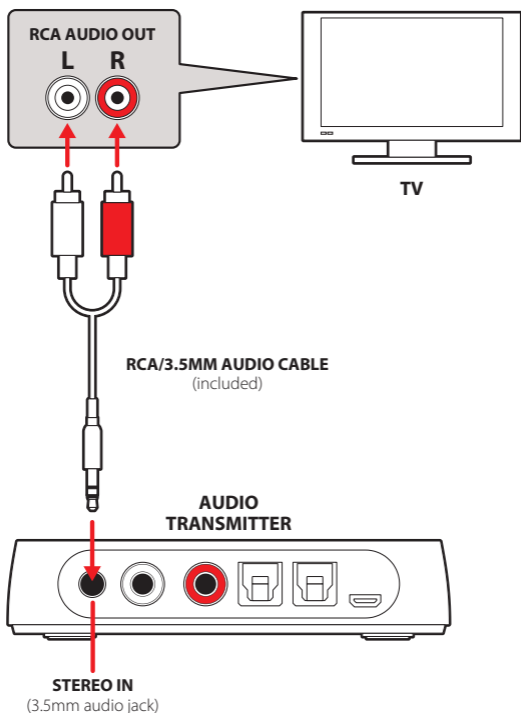

NOTE: The **Private Listening** feature **DOES NOT SILENCE** the audio that may be playing through your television's built-in speakers, sound bar or other connected A/V equipment.

- You can use the equipment manufacturer's remote or the universal remote's volume, mute or power controls to silence the audio.
- On some televisions, you may need to manually switch the audio output from the built-in speakers to the connected audio transmitter equipment. Please consult your equipment manufacturer's manual for instructions.

OTHER CONNECTION OPTIONS

If you have a sound bar or other audio equipment already connected to your television's audio jacks, you can use the audio transmitter's audio passthrough connection labeled "(L) OUT" and "(R) OUT" to connect to your other audio equipment.

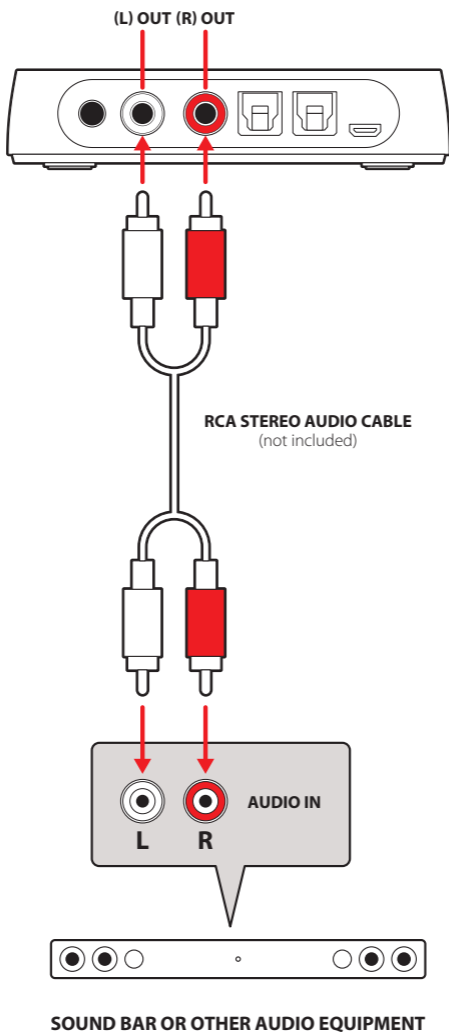

Using an S/PDIF optical cable for digital audio

For televisions equipped with an S/PDIF optical output, you may connect an optical cable (not included) to the TV's connection panel. Connect the other end of the optical cable into the audio transmitter's **"OPTICAL IN"** port (supports 96kHz/24bit).

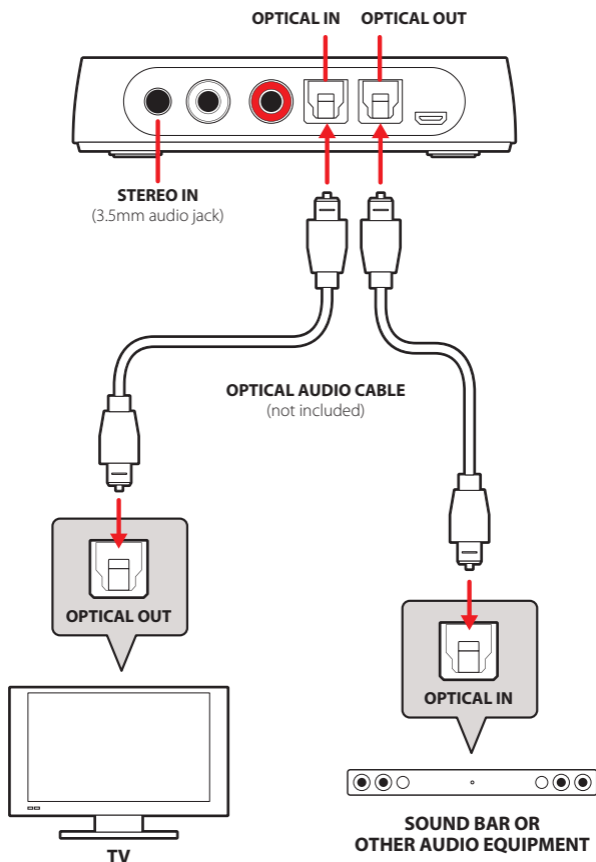

If you have a sound bar or other audio equipment already connected to your television, you can use the audio transmitter's audio passthrough connection labeled **"OPTICAL OUT"** to connect to your other audio equipment.

NOTE: When an audio source is connected to the audio transmitter's **"STEREO IN"**, the optical ports will not function.

PRIVATE LISTENING THROUGH YOUR REMOTE

You may control the headphone's audio volume with the **HEADPHONE VOLUME** buttons located on the right side of the remote.

To mute and unmute the headphone audio, press the **HEADPHONE MUTE** button located on the right side of the remote.

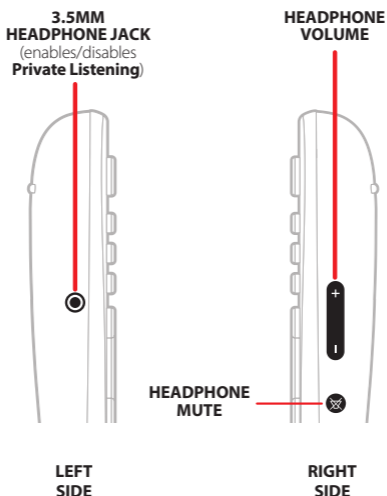

The buttons below **ARE NOT** used for controlling the headphone's audio volume.



Activating Private Listening

To activate the universal remote's **Private Listening** feature, simply plug in a pair of headphones into the **3.5MM HEADPHONE JACK** located on the left side of the remote.

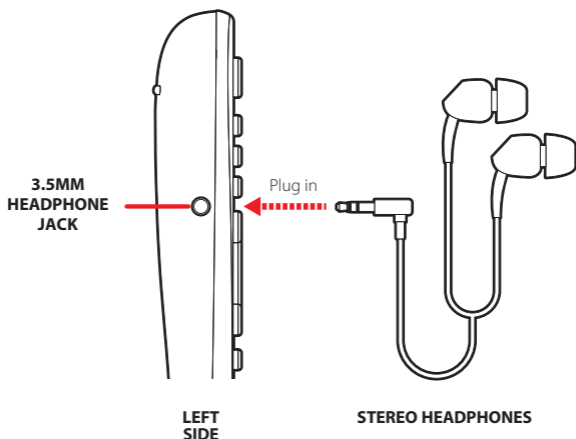

After inserting the headphones, the audio transmitter's LED indicator will flash three times and play a beep in the headphones indicating when the **Private Listening** feature has been activated.

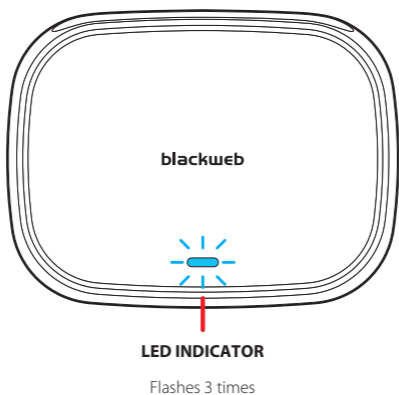

Deactivating Private Listening

To deactivate the universal remote's **Private Listening** feature, **simply unplug the headphones.**



CAUTION: DON'T FORGET TO UNPLUG THE HEADPHONES OR IT WILL DRAIN THE REMOTE'S BATTERIES.

When the headphones are unplugged, the audio transmitter's LED indicator will flash once to indicate that the **Private Listening** feature has been deactivated.

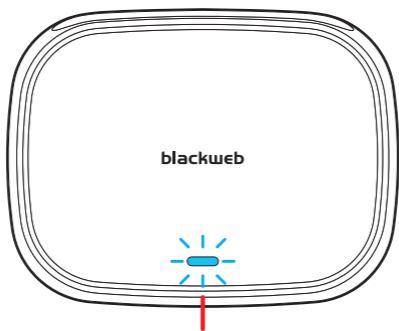

LED INDICATOR

Flashes once

TROUBLESHOOTING

If you are having issues with the universal remote:

The tips below can help you solve problems and answer questions you may have with your remote control. In general, always make sure:

- 1) The remote is in the correct device category mode (TV, SAT/CBL, STREAM, B-RAY/DVD, AMP, AUX); this tells the remote which device to operate.
- 2) The batteries are fresh and properly installed.
- 3) To remove any obstacles between the remote and the device, and that you're aiming the remote at the device's IR sensor.

The remote can't be programmed to operate my device.

- If you're using the Direct Code Entry method to enter the codes for your brand and the device is still not functioning properly after trying all the code options, try the Auto Code Search method.
- To control combo devices like TV/VCRs or TV/DVDs, you must program the individual corresponding device buttons to control each part of the combo unit.

Some of the buttons of the remote are not supported or working properly on my device.

- It's possible the code that you programmed is not fully compatible with your device. Try selecting the next code from the options available for the category and brand of your device.
- There may be some buttons from your device's original remote that are not supported.
- You may have pressed an invalid button for the device category mode the remote is in.

The remote will not change the channels on my device.

- Make sure the remote is in the correct device category mode (TV, SAT/CBL, STREAM, B-RAY/DVD, AMP, AUX) that controls the channels.
- Try pressing the ENTER button after you enter a channel number (a requirement with certain models and brands of TV and/or Cable/Satellite boxes).

The remote will not adjust the volume on my device.

- Make sure the remote is in the correct device category mode (TV, SAT/CBL, STREAM, B-RAY/DVD, AMP, AUX) that controls the volume.

My device's menu or app hub does not appear.

- Menu and app hub access isn't supported for all brands. You may need to use your original remote control to access the menu functions and/or app hub for some devices.

My remote's light is blinking

- If while using the remote the indicator light flashes 3 times, this indicates the batteries need to be replaced.

If you are having issues with the Private Listening feature:

- Ensure the batteries in your remote are working and the audio transmitter is connected to a power source.
- Ensure the television's selected audio output is configured to send the audio to the audio transmitter.
- Ensure the television's audio output volume is not too low or muted
- Ensure the headphones are plugged in properly.
- Raise the headphone volume using the volume control on the right side of the universal remote.

If the LED indicator is continuously flashing:

Your universal remote and audio transmitter are already paired to work together out of the box. The LED indicator on your audio transmitter will be steady blue when paired properly and will flash 1-3 times when the **Private Listening** feature is activated or deactivated. If you notice the LED indicator is continuously flashing, it means that the audio transmitter and universal remote are not paired. In that case, please follow the instructions below.

Follow these instructions only if the LED indicator is continuously flashing on the audio transmitter

PAIRING MODE

To enter pairing mode:

1. Connect the audio transmitter to a power source.
2. Plug the headphones into the universal remote.
3. Locate the **PAIRING** button on the bottom of the audio transmitter.
4. Locate the **HEADPHONE MUTE** button on the universal remote.
5. With the devices no further than 18" apart, hold down both buttons for 5 seconds.

When your devices are paired there will be a short beep in the headphones and the audio transmitter's LED indicator will become steady blue.

AUDIO TRANSMITTER
BOTTOM

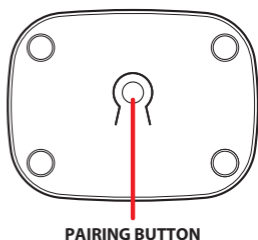

PAIRING BUTTON

REMOTE
RIGHT SIDE

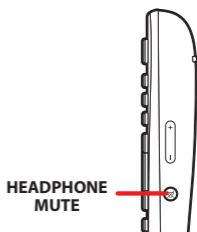

HEADPHONE
MUTE

For more information, please visit www.myblackwebremote.com or call the Customer Support Help Line: (877) 907-7010

FCC INFORMATION

This device complies with part 15 of the FCC rules. Operation is subject to the following two conditions:

- (1) this device may not cause harmful interference, and
- (2) this device must accept any interference received, including interference that may cause undesired operation.

NOTE: This equipment has been tested and found to comply with the limits for a Class B digital device, pursuant to Part 15 of the FCC Rules. These limits are designed to provide reasonable protection against harmful interference in a residential installation. This equipment generates, uses and can radiate radio frequency energy and, if not installed and used in accordance with the instructions may cause harmful interference to radio communications. However, there is no guarantee that interference will not occur in a particular installation. If this equipment does cause harmful interference to radio or television reception, which can be determined by turning the equipment off and on, the user is encouraged to try to correct the interference by one or more of the following measures:

- Reorient or relocate the receiving antenna.
- Increase the separation between the equipment and receiver.
- Connect the equipment into an outlet on a circuit different from that to which the receiver is connected.
- Consult the dealer or an experienced radio/TV technician for help.

CAUTION: Any changes or modifications not expressly approved by the party responsible for compliance could void the user's authority to operate this equipment.

LIMITED 90-DAY WARRANTY

Product Type: Universal Remote Control & Wireless Audio Transmitter

Territory: United States / Canada

Warranty Period: 90 (Ninety) days

To obtain warranty service:

- Call the Customer Support number or go to our website portal (shown below) to receive an SRO number.
- Include the dated receipt or proof of purchase within the package.
- Prepay all shipping costs to the Authorized Service Center below (remember to insure your return).
- Include a return shipping address (no P.O. Boxes), telephone contact number, and the defective product within the package.
- Be sure to write your SRO number on the outside of the package.
- Describe the defect or reason you are returning the product.

Customer Support:

- (877) 907-7010 (Monday-Friday, 8AM - 10PM EST)
- www.myblackwebremote.com (click on "Product Support")

Your product will be repaired or replaced, at our option, for the same or similar model of equal value if examination by the service center determines the product is defective. Products received damaged as a result of shipping will require you to file a claim with the carrier.

Authorized Service Center
Customer Service - Dept. 36
400 Kennedy Drive
Sayreville, NJ 08872

Warranty service not provided

This warranty does not cover damage resulting from accident, misuse, abuse, improper installation or operation, lack of reasonable care and unauthorized modification. This warranty is voided in the event any unauthorized person opens, alters or repairs this product. All products being returned to the authorized service center for repair must be suitably packaged.

NO WARRANTIES, WHETHER EXPRESS OR IMPLIED, INCLUDING, BUT NOT LIMITED TO, ANY IMPLIED WARRANTIES OF MERCHANTABILITY OR FITNESS FOR A PARTICULAR PURPOSE, OTHER THAN THOSE EXPRESSLY DESCRIBED ABOVE SHALL APPLY. DISTRIBUTOR FURTHER DISCLAIMS ALL WARRANTIES AFTER THE EXPRESS WARRANTY PERIOD STATED ABOVE. NO OTHER EXPRESS WARRANTY OR GUARANTY GIVEN BY ANY PERSON, FIRM OR ENTITY WITH RESPECT TO THE PRODUCT SHALL BE BINDING ON DISTRIBUTOR. REPAIR, REPLACEMENT, OR REFUND OF THE ORIGINAL PURCHASE PRICE - AT DISTRIBUTOR'S SOLE DISCRETION - ARE THE EXCLUSIVE REMEDIES OF THE CONSUMER. IN NO EVENT WILL DISTRIBUTOR OR ITS MANUFACTURERS BE LIABLE FOR ANY INCIDENTAL, DIRECT, INDIRECT, SPECIAL, PUNITIVE OR CONSEQUENTIAL DAMAGES (SUCH AS, BUT NOT LIMITED TO, DAMAGES FOR LOSS OF PROFITS, BUSINESS, SAVINGS, DATA OR RECORDS) CAUSED BY THE USE, MISUSE OR INABILITY TO USE THE PRODUCT. EXCEPT AS STATED

HEREIN, NO OTHER WARRANTIES SHALL APPLY. NOTWITHSTANDING THE FOREGOING, CONSUMER'S RECOVERY AGAINST DISTRIBUTOR SHALL NOT EXCEED THE PURCHASE PRICE OF THE PRODUCT SOLD BY DISTRIBUTOR. THIS WARRANTY SHALL NOT EXTEND TO ANYONE OTHER THAN THE ORIGINAL CONSUMER WHO PURCHASED THE PRODUCT AND IS NOT TRANSFERABLE.

Some countries, states or provinces do not allow the exclusion or limitation of incidental or consequential damages or allow limitations on warranties, so limitation or exclusions may not apply to you. This warranty gives you specific legal rights, and you may have other rights that vary from state to state or province to province. Contact your authorized retailer to determine if another warranty applies.

©2018 Wal-Mart Stores, Inc.

Blackweb is a trademark of Wal-Mart Stores, Inc. All Rights Reserved.

Distributed by Wal-Mart Stores, Inc., Bentonville, AR 72716

MADE IN CHINA

Walmart.com