

***Nikon***

**En**

The Nikon Guide to Digital Photography  
with the

**D50**

**DIGITAL CAMERA**



**CE**

# About This Manual

The topics in this manual are arranged in order from easy to advanced.

These chapters cover all you need to know for simple, “point-and-shoot” photography

Read these chapters for a complete description of all aspects of camera operation

## **Introduction (pages 1–13)**

Learn the names of camera parts and ready the camera for use.

## **Tutorial: Photography and Playback (pages 14–24)**

The basic operations involved in taking photographs and playing them back.

## **Reference: More on Photography (pages 30–50)**

Play with exposure and explore the creative possibilities of some of the camera’s more advanced settings.

## **Reference: More on Playback (pages 51–67)**

Learn more about camera playback, transferring photographs to a computer, and printing photographs.

## **Setup: Basic Camera Settings (pages 68–75)**

Basic camera setup, including formatting memory cards and setting the camera clock.









## **Setup: Shooting, Playback, and Custom Settings (pages 76–100)**

Read this chapter for more information on Custom Settings and on shooting and playback options.

## **Technical Notes (pages 101–103)**

Read this chapter for information on camera specifications, accessories, and troubleshooting.

---

Introduction	
Tutorial	Photography and Playback 
Reference	More on Photography 
	More on Playback 
Setup	Basic Camera Settings: The Setup Menu 
	Shooting Options: The Shooting Menu 
	Playback Options: The Playback Menu 
	Custom Settings: The Custom Settings Menu 
Technical Notes	

## Trademark Information

Macintosh, Mac OS, and QuickTime are registered trademarks of Apple Computer, Inc. Microsoft and Windows are registered trademarks of Microsoft Corporation. The SD logo is a trademark of the SD Card Association. Adobe and Acrobat are registered trademarks of Adobe Systems Inc. PictBridge is a trademark. All other trade names mentioned in this manual or the other documentation provided with your Nikon product are trademarks or registered trademarks of their respective holders.

# For Your Safety







To prevent damage to your Nikon product or injury to yourself or to others, read the following safety precautions in their entirety before using this equipment. Keep these safety instructions where all those who use the product will read them.

The consequences that could result from failure to observe the precautions listed in this section are indicated by the following symbol:



This icon marks warnings, information that should be read before using this Nikon product to prevent possible injury.

## WARNINGS

-  **Do not look at the sun through the viewfinder**  
Viewing the sun or other strong light source through the viewfinder could cause permanent visual impairment.
-  **Turn off immediately in the event of malfunction**  
Should you notice smoke or an unusual smell coming from the equipment or from the AC adapter (available separately), unplug the AC adapter and remove the battery immediately, taking care to avoid burns. Continued operation could result in injury. After removing the battery, take the equipment to a Nikon-authorized service center for inspection.
-  **Do not use in the presence of flammable gas**  
Do not use electronic equipment in the presence of flammable gas, as this could result in explosion or fire.
-  **Do not place strap around the neck of an infant or child**  
Placing the camera strap around the neck of an infant or child could result in strangulation.
-  **Do not disassemble**  
Touching the product's internal parts could result in injury. In the event of a malfunction, the product should be repaired only by a qualified technician. Should the product break open as the result of a fall or other accident, remove the battery and/or AC adapter and then take the product to a Nikon-authorized service center for inspection.
-  **Observe proper precautions when handling batteries**  
Batteries may leak or explode if improperly handled. Observe the following precautions when handling batteries for use in this product:
  - Be sure the product is off before replacing the battery. If you are using an AC adapter, be sure it is unplugged.
  - Use only batteries approved for use in this equipment. Do not mix old and new batteries or batteries of different types.
  - Do not attempt to insert the battery upside down or backwards.
  - Do not short or disassemble the battery.
  - Do not expose the battery to flame or to excessive heat.
  - Do not immerse in or expose to water.
  - Replace the terminal cover when transporting the battery. Do not transport

---

or store with metal objects such as necklaces or hairpins.

- Batteries are prone to leakage when fully discharged. To avoid damage to the product, be sure to remove the battery when no charge remains.
- When the battery is not in use, attach the terminal cover and store in a cool place.
- Immediately after use, or when the product is used on battery power for an extended period, the battery may become hot. Before removing the battery, turn the camera off and allow the battery to cool.
- Discontinue use immediately should you notice any changes in the battery, such as discoloration or deformation.

 **Use appropriate cables**

When connecting cables to the input and output jacks, use only the cables provided or sold by Nikon for the purpose, to maintain compliance with product regulations.

 **Keep out of reach of children**

Particular care should be taken to prevent infants from putting the battery or other small parts into their mouths.

 **CD-ROMs**

The CD-ROMs on which the software and manuals are distributed should not be played back on audio CD equipment. Playing CD-ROMs on an audio CD player could cause hearing loss or damage the equipment.

 **Observe caution when using the flash**

- Do not operate the flash with the flash window touching a person or object. Failure to observe this precaution could result in burns or fire.
- Using the flash close to your subject's eyes could cause temporary visual impairment. Particular care should be observed if photographing infants, when the flash should be no less than one meter (39") from the subject.

 **When using the viewfinder**

When operating the diopter adjustment control with your eye to the viewfinder, care should be taken not to put your finger in your eye accidentally.

 **Avoid contact with liquid crystal**

Should the monitor break, care should be taken to avoid injury due to broken glass and to prevent liquid crystal from the monitor touching the skin or entering the eyes or mouth.

# Notices

- No part of the manuals included with this product may be reproduced, transmitted, transcribed, stored in a retrieval system, or translated into any language in any form, by any means, without Nikon's prior written permission.
- Nikon reserves the right to change the specifications of the hardware and software described in these manuals at any time and without prior notice.
- Nikon will not be held liable for any damages resulting from the use of this product.
- While every effort has been made to ensure that the information in these manuals is accurate and complete, we would appreciate it were you to bring any errors or omissions to the attention of the Nikon representative in your area (address provided separately).

## Notice for customers in the U.S.A.

### Federal Communications Commission (FCC) Radio Frequency Interference Statement



This equipment has been tested and found to comply with the limits for a Class B digital device, pursuant to Part 15 of the FCC rules. These limits are designed to provide reasonable protection against harmful interference in a residential installation. This equipment generates, uses, and can radiate radio frequency energy and, if not installed and used in accordance with the instructions, may cause harmful interference to radio communications. However, there is no guarantee that interference will not occur in a particular installation. If this equipment does cause harmful interference to radio or television reception, which can be determined by turning the equipment off and on, the user is encouraged to try to correct the interference by one or more of the following measures:

- Reorient or relocate the receiving antenna.
- Increase the separation between the equipment and receiver.
- Connect the equipment into an outlet on a circuit different from that to which the receiver is connected.
- Consult the dealer or an experienced radio/television technician for help.

### CAUTIONS

#### *Modifications*

The FCC requires the user to be notified that any changes or modifications made to this device that are not expressly approved by Nikon Corporation may void the user's authority to operate the equipment.

#### *Interface Cables*

Use the interface cables sold or provided by Nikon for your equipment. Using other interface cables may exceed the limits of Class B Part 15 of the FCC rules.

### Notice for customers in the State of California

**WARNING:** Handling the cord on this product will expose you to lead, a chemical known to the State of California to cause birth defects or other reproductive harm.

***Wash hands after handling.***

Nikon Inc.,  
1300 Walt Whitman Road, Melville, New York  
11747-3064, U.S.A. Tel.: 631-547-4200

### Notice for customers in Canada

#### CAUTION

This class B digital apparatus meets all requirements of the Canadian Interference Causing Equipment Regulations.

#### ATTENTION

Cet appareil numérique de la classe B respecte toutes les exigences du Règlement sur le matériel brouilleur du Canada.

---

## Notice Concerning Prohibition of Copying or Reproduction

Note that simply being in possession of material that has been digitally copied or reproduced by means of a scanner, digital camera or other device may be punishable by law.

### • Items prohibited by law from being copied or reproduced

Do not copy or reproduce paper money, coins, securities, government bonds, or local government bonds, even if such copies or reproductions are stamped "Sample."

The copying or reproduction of paper money, coins, or securities which are circulated in a foreign country is prohibited.

Unless the prior permission of the government has been obtained, the copying or reproduction of unused postage stamps or post cards issued by the government is prohibited.

The copying or reproduction of stamps issued by the government and of certified documents stipulated by law is prohibited.

### • Cautions on certain copies and reproductions

The government has issued cautions on copies or reproductions of securities issued by private companies (shares, bills, checks, gift certificates, etc.), commuter passes, or coupon tickets, except when a minimum of necessary copies are to be provided for business use by a company. Also, do not copy or reproduce passports issued by the government, licenses issued by public agencies and private groups, ID cards, and tickets, such as passes and meal coupons.

### • Comply with copyright notices

The copying or reproduction of copyrighted creative works such as books, music, paintings, woodcut prints, maps, drawings, movies, and photographs is governed by national and international copyright laws. Do not use this product for the purpose of making illegal copies or to infringe copyright laws.

## Disposing of Data Storage Devices

Please note that deleting images or formatting memory cards or other data storage devices does not completely erase the original image data. Deleted files can sometimes be recovered from discarded storage devices using commercially available software, potentially resulting in the malicious use of personal image data. Ensuring the privacy of such data is the user's responsibility.

Before discarding a data storage device or transferring ownership to another person, erase all data using commercial deletion software, or format the device and then completely refill it with images containing no private information (for example, pictures of empty sky). Be sure to also replace any pictures selected for preset white balance (page 81). Care should be taken to avoid injury or damage to property when physically destroying data storage devices.

## Symbol for separate collection applicable in European countries

This symbol indicates that this product is to be collected separately.



The following apply only to users in European countries.

- This product is designated for separate collection at an appropriate collection point. Do not dispose of as household waste.
- For more information, contact the retailer or the local authorities in charge of waste management.

# Table of Contents

For Your Safety.....	ii
Notices.....	iv
<b>Introduction.....</b>	<b>1</b>
Getting to Know the Camera.....	2
<b>First Steps .....</b>	<b>7</b>
Attaching a Lens .....	7
Charging and Inserting the Battery.....	8
Basic Setup .....	10
Inserting Memory Cards.....	11
Adjusting Viewfinder Focus.....	13
<b>Tutorial: Photography and Playback .....</b>	<b>14</b>
Taking Photographs in  Mode.....	14
Digital Vari-Programs .....	19
Choosing a Shooting Mode.....	21
Using the Self-timer or Remote Control.....	22
Basic Playback .....	24
<b>Reference.....</b>	<b>25</b>
Using Camera Menus.....	26
<b>Reference: More on Photography .....</b>	<b>30</b>
Image Quality and Size.....	30
Image Quality .....	31
Image Size .....	32
Choosing the Focus Area.....	33
Manual Focus .....	35
Flash Sync Mode.....	36
Sensitivity (ISO Equivalency).....	39
P, S, A, and M Modes .....	40
Choosing an Exposure Mode.....	40
P: Programmed Auto.....	42
S: Shutter-Priority Auto.....	43
A: Aperture-Priority Auto .....	44
M: Manual.....	45
Exposure Compensation (P, S, and A Modes Only) .....	47
Optimizing Images .....	48
White Balance.....	49
Restoring Default Settings .....	50
<b>Reference: More on Playback.....</b>	<b>51</b>
Viewing Photographs.....	51
Protecting Photographs from Deletion.....	56
Deleting Individual Photographs.....	57
Viewing Photographs on TV .....	58



Viewing Photographs on a Computer .....	59
Printing Photographs .....	62
<b>Setup.....</b>	<b>68</b>
<b>Basic Camera Settings.....</b>	<b>68</b>
Format.....	68
CSM/Setup Menu .....	69
Date .....	69
LCD Brightness .....	69
Video Mode.....	69
Language (LANG).....	70
Image Comment.....	70
USB .....	71
Folders.....	71
File No. Seq.....	73
Mirror Lock-up.....	73
Dust Ref Photo.....	74
Firmware Ver.....	75
Image Rotation .....	75
<b>Shooting Options.....</b>	<b>76</b>
Optimize Image.....	76
Long Exp. NR .....	78
Image Quality .....	78
Image Size .....	78
White Balance.....	79
ISO .....	82
<b>Playback Options .....</b>	<b>83</b>
Delete.....	84
Playback Fldr.....	84
Rotate Tall.....	84
Slide Show.....	85
Print Set.....	86
Small Picture .....	86
<b>Custom Settings .....</b>	<b>87</b>
<b>Technical Notes.....</b>	<b>101</b>
Camera Settings .....	101
Optional Accessories.....	104
Caring for the Camera.....	115
Troubleshooting.....	120
Appendix.....	126
Specifications .....	129
Index .....	136

A two-button reset (page 50) and Custom Setting R (**Menu Reset**; page 87) can be used to restore factory default settings.

---

### **Foreign Matter on the Low-Pass Filter**

Nikon takes every possible precaution to prevent foreign matter from coming into contact with the low-pass filter during production and shipping. The D50, however, is designed to be used with interchangeable lenses, and foreign matter may enter the camera when lenses are removed or exchanged. Once inside the camera, this foreign matter may adhere to the low-pass filter, where it may appear in photographs taken under certain conditions. To prevent foreign matter from entering the camera, do not exchange lenses in dusty environments. To protect the camera when no lens is in place, be sure to replace the body cap provided with the camera, being careful to first remove all dust and other foreign matter that may be adhering to the body cap.

Should foreign matter find its way onto the low-pass filter, clean the low-pass filter as instructed on pages 116–117 of this manual, or have the low-pass filter cleaned by authorized Nikon service personnel. Photographs affected by the presence of foreign matter on the low-pass filter can be retouched using Nikon Capture 4 Version 4.3 or later (available separately) or the clean image options available in some third-party imaging software.

### **Take Test Shots**

Before taking pictures on important occasions (for example, at weddings or before taking the camera with you on a trip), take a test shot to ensure that the camera is functioning normally. Nikon will not be held liable for damages or lost profits that may result from product malfunction.

### **Life-Long Learning**

As part of Nikon's "Life-Long Learning" commitment to ongoing product support and education, continually-updated information is available on-line at the following sites:

- For users in the U.S.A.: <http://www.nikonusa.com/>
- For users in Europe and Africa: <http://www.europe-nikon.com/support>
- For users in Asia, Oceania, and the Middle East: <http://www.nikon-asia.com/>

Visit these sites to keep up-to-date with the latest product information, tips, answers to frequently-asked questions (FAQs), and general advice on digital imaging and photography. Additional information may be available from the Nikon representative in your area. See the URL below for contact information:







<http://nikonimaging.com/>

# Introduction

Thank you for your purchase of a Nikon D50 single-lens reflex (SLR) digital camera with interchangeable lenses. This manual has been written to help you enjoy taking pictures with your Nikon digital camera. Read this manual thoroughly before use, and keep it handy when using the product. The documentation for this product also includes the manuals listed below. Please be sure to read all instructions thoroughly to get the most from the camera.

- **Quick Start Guide:** The Quick Start Guide takes you through the process of unpacking and setting up your Nikon digital camera, taking your first photographs, and transferring them to your computer.
- **PictureProject Reference Manual (on CD):** The *PictureProject Reference Manual* contains information on using the PictureProject software provided with your camera. For information on viewing the reference manual, see the *Quick Start Guide*.

To make it easier to find the information you need, the following symbols and conventions are used:

 This icon marks cautions, information that should be read before use to prevent damage to the camera.	 This icon marks tips, additional information that may be helpful when using the camera.
 This icon marks notes, information that should be read before using the camera.	 This icon indicates that more information is available elsewhere in this manual or in the <i>Quick Start Guide</i> .
 This icon marks settings that can be adjusted using camera menus.	 This icon marks settings that can be fine-tuned from the Custom Settings menu.

## Lens

An AF-S DX 18–55 mm f/3.5-5.6G ED lens is used in this manual for illustrative purposes. See the manual provided with the lens for more information.

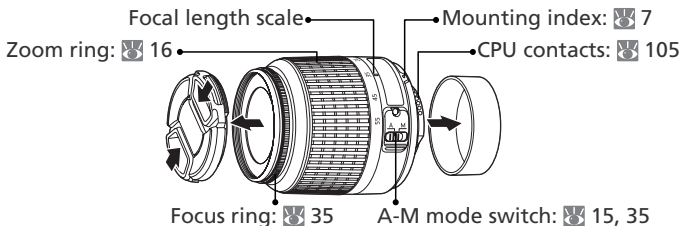

# Getting to Know the Camera

Take a few moments to familiarize yourself with camera controls and displays. You may find it helpful to bookmark this section and refer to it as you read through the rest of the manual.

## Camera Body

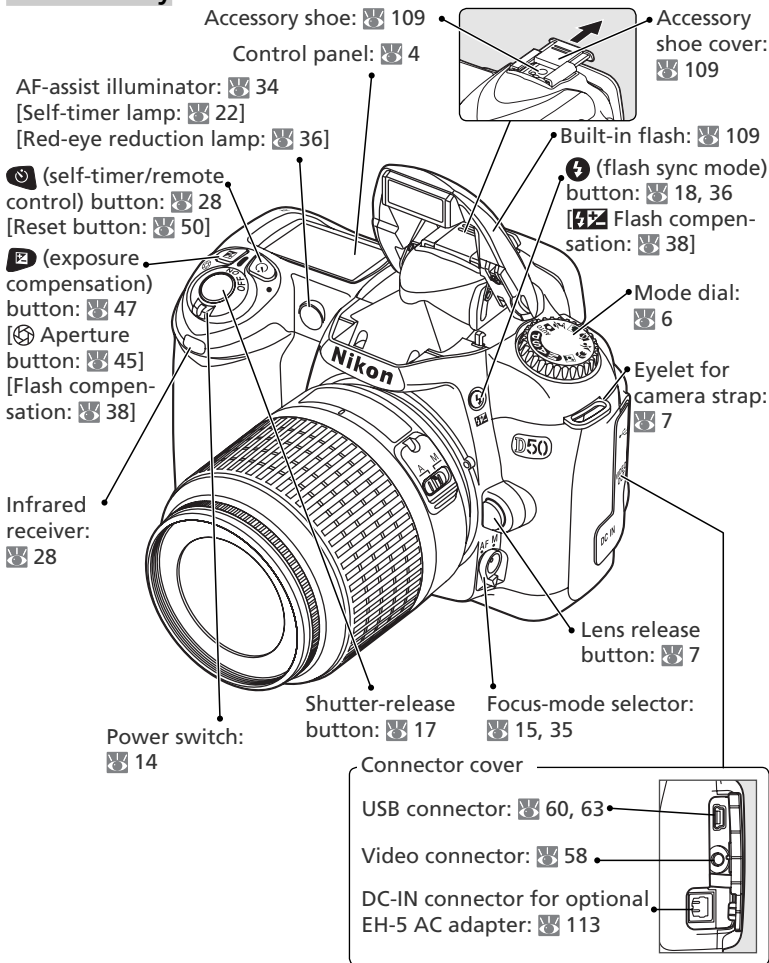

## Camera Body (continued)

Viewfinder eyepiece: 5, 13, 16 Viewfinder eyepiece cup: 13

(shooting mode) button: 21  
[Reset button: 50]

(playback) button: 24, 51

(MENU) (menu) button: 26

(thumbnail) button: 54  
[ISO (sensitivity) button: 39]

(help/protect) button: 26, 56  
[WB (white balance) button: 49]

(ENTER) (enter) button: 29  
[QUAL (image quality/size) button: 32]  
[Q (playback zoom) button: 55]

Reset switch: 120

Diopter adjustment control: 13

(AE-L/AF-L) (AE/AF lock) button: 34, 97, 98

Command dial: 43–45, 51–55

Memory card slot cover: 11, 12

Memory card access lamp: 11, 12, 17

(delete) button: 24, 57

Battery-chamber cover latch: 9

Battery-chamber cover: 9

Tripod socket

Monitor: 24, 26

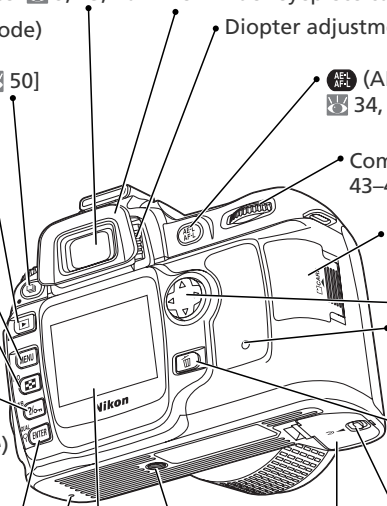

### Multi selector

The multi selector is used for menu navigation and to control the display of photo information during playback.

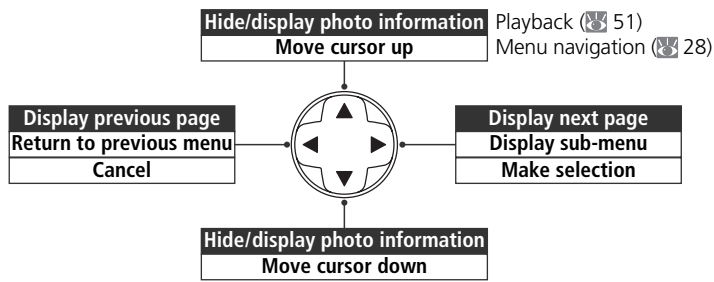

## Control Panel

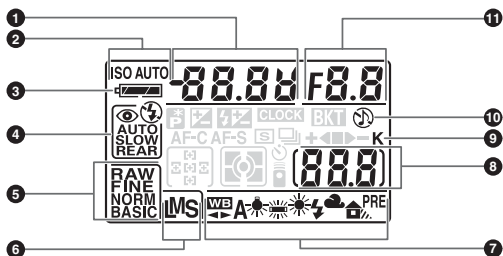

- |   |   |
|---|---|
| <p><b>1</b> Shutter speed ..... 40–45<br/>         Exposure compensation value ..... 47<br/>         Flash compensation value ..... 38<br/>         Sensitivity (ISO equivalency) ..... 39</p> <p><b>2</b> Sensitivity (ISO) indicator ..... 39<br/>         Auto sensitivity indicator ..... 91, 92</p> <p><b>3</b> Battery indicator ..... 14</p> <p><b>4</b> Flash sync mode ..... 36</p> <p><b>5</b> Image quality ..... 31</p> <p><b>6</b> Image size ..... 32</p> <p><b>7</b> White balance mode ..... 49</p> | <p><b>8</b> Number of exposures remaining ... 14<br/>         Number of shots remaining before memory buffer fills ..... 21<br/>         Preset white balance recording indicator ..... 79<br/>         PC mode indicator ..... 59</p> <p><b>9</b> "K" (appears when memory remains for over 1000 exposures) ..... 5</p> <p><b>10</b> "Beep" indicator ..... 88</p> <p><b>11</b> Aperture (f/-number) ..... 40–45<br/>         PC mode indicator ..... 60</p> |
|---|---|

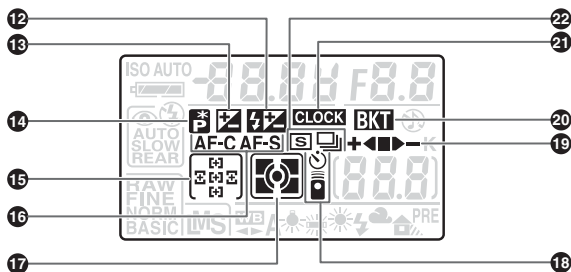

- |  |   |
|--|---|
| <p><b>12</b> Flash compensation indicator ..... 38</p> <p><b>13</b> Exposure compensation indicator .. 47</p> <p><b>14</b> Flexible program indicator ..... 42</p> <p><b>15</b> Focus area ..... 16, 33<br/>         AF-area mode ..... 89</p> <p><b>16</b> AF mode ..... 88</p> <p><b>17</b> Metering mode ..... 96</p> | <p><b>18</b> Self-timer/remote control indicator ..... 22</p> <p><b>19</b> Bracketing progress indicator ..... 93</p> <p><b>20</b> Bracketing indicator ..... 93</p> <p><b>21</b> Clock battery indicator ..... 10, 123</p> <p><b>22</b> Shooting mode ..... 21</p> |
|--|---|

## The Viewfinder Display

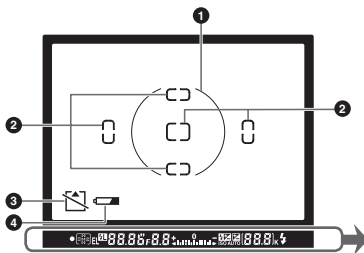

When the battery is totally exhausted, the display in the viewfinder will dim. The viewfinder display will return to normal when a fully-charged battery is inserted.

- |   |   |
|---|---|
| <p>1 Reference circle for center-weighted metering..... 96</p> <p>2 Focus brackets (focus areas).... 16, 33</p> <p>3 “No memory card” warning .. 11, 123</p> <p>4 Battery indicator ..... 14</p> <p>5 Focus indicator ..... 17, 35, 123</p> <p>6 Focus area ..... 16, 33<br/>AF-area mode..... 89</p> <p>7 Flash value (FV) lock..... 98</p> <p>8 Shutter speed .....40–45</p> <p>9 Aperture (f/-number) .....40–45</p> <p>10 Flash compensation indicator..... 38</p> <p>11 Exposure compensation indicator.. 47</p> | <p>12 Number of exposures remaining ... 14</p> <p>Number of shots remaining before memory buffer fills..... 21</p> <p>Preset white balance recording indicator ..... 79</p> <p>Exposure compensation value ..... 47</p> <p>Flash compensation value ..... 38</p> <p>PC mode indicator ..... 59, 60</p> <p>13 Flash-ready indicator ..... 18</p> <p>14 Autoexposure (AE) lock..... 97</p> <p>15 Electronic analog exposure display.. 46</p> <p>Exposure compensation ..... 47</p> <p>16 Auto sensitivity indicator..... 91, 92</p> <p>17 “K” (appears when memory remains for over 1000 exposures) ..... 5</p> |
|---|---|

### Large-Capacity Memory Cards

When enough memory remains on the memory card to record a thousand or more pictures at current settings, the number of exposures remaining will be shown in thousands, rounded down to the nearest hundred (e.g., if there is room for approximately 1,260 exposures, the exposure count display will show 1.2K).

### Camera Off Display

If the camera is turned off with a battery and memory card inserted, the number of exposures remaining will be displayed in the control panel.

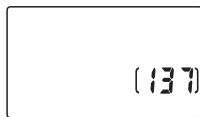
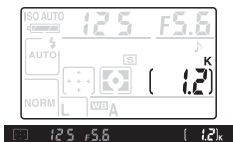

## The Mode Dial

The D50 offers a choice of the following eleven shooting modes:



### Advanced Modes (Exposure Modes)

Select these modes for full control over camera settings, including shutter speed and aperture.

**P: Programmed auto** (📷 42)      **S: Shutter-priority auto** (📷 43)  
**A: Aperture-priority auto** (📷 44)      **M: Manual** (📷 45)



### Point-and-Shoot Modes (Digital Vari-Programs)

Selecting a Digital Vari-Program automatically optimizes settings to suit the selected scene, making creative photography as simple as rotating the mode dial.

**AUTO:** Auto (📷 14)      **Portrait** (📷 19)  
**Landscape** (📷 20)      **Child** (📷 20)  
**Sports** (📷 20)      **Close up** (📷 20)  
**Night portrait** (📷 20)



# First Steps

## Attaching a Lens

Care should be taken to prevent dust from entering the camera when the lens is removed.

- 1 Turn the camera off and remove the body cap. Remove the rear lens cap from the lens.

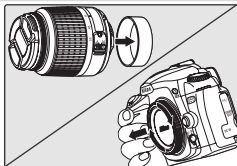

- 2 Keeping the mounting index on the lens aligned with the mounting index on the camera body, position the lens in the camera's bayonet mount. Being careful not to press the lens-release button, rotate the lens counter-clockwise until it clicks into place.

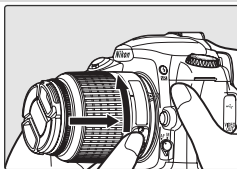

## Detaching Lenses

*Be sure the camera is off* when removing or exchanging lenses. To remove the lens, press and hold the lens-release button while turning the lens clockwise.

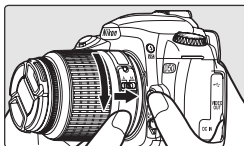

## Aperture Ring

If the lens is equipped with an aperture ring, lock aperture at the minimum setting (highest f/-number). See the lens manual for details.

## Attaching the Camera Strap

Attach the strap as shown below.

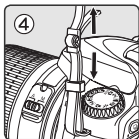
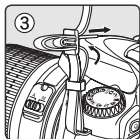
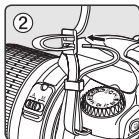
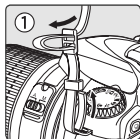

## Charging and Inserting the Battery

Use the supplied EN-EL3a battery and MH-18a quick charger.

### 1 Charge the battery

- 1.1 Connect the power cord to the charger and plug it in.

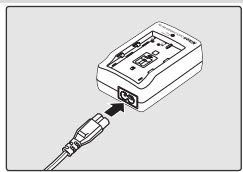

- 1.2 Place the battery in the charger. The CHARGE lamp will blink as the battery charges. About 135 minutes are required for an exhausted battery to fully charge.

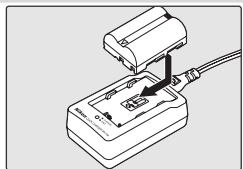

- 1.3 Charging is complete when the CHARGE lamp stops blinking. Remove the battery from the charger and unplug the charger.

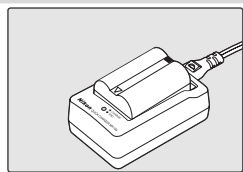

### ✓ The Battery and Charger

*Read and follow the warnings and cautions on pages ii–iii and 118–119 of this manual, together with any warnings and instructions provided by the battery manufacturer.*

Do not use the battery at ambient temperatures below 0°C (32°F) or above 40°C (104°F). During charging, the temperature should be in the vicinity of 5–35°C (41–95°F). Note that the battery may become hot during use; wait for the battery to cool before charging. Failure to observe these precautions could damage the battery, impair its performance, or prevent it from charging normally.

The supplied power cable is intended solely for use with the MH-18a and is for domestic use only. It may be necessary to purchase another cable for use abroad; consult with a local Nikon-authorized retailer or service representative.

## 2 Insert the battery

2.1 After confirming that the camera is off, open the battery chamber cover.

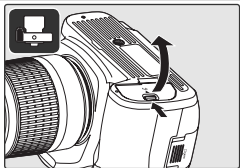

2.2 Insert a fully charged battery as shown at right. Close the battery chamber cover.

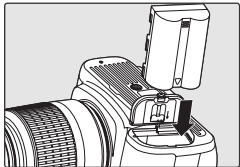





### Removing the Battery



Turn the camera off before removing the battery. Replace the terminal cover when the battery is not in use.

## Basic Setup

The first time the camera is turned on, the language selection dialog shown in Step 1 will be displayed in the monitor. Follow the steps below to choose a language and set the time and date.

- 1**  

Display language-selection dialog.
- 2**  

Select language.
- 3**  

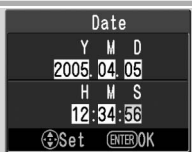
Display DATE menu.
- 4**  

Press multi selector left or right to select item, up or down to change.
- 5** 

Exit DATE menu. Monitor turns off.

### **Choosing a Language from the Setup Menu** **68**

Selecting **Language (LANG)** in the setup menu displays the menu shown in Step 1. Highlight an option with the multi selector and press the **MENU** button to return to the setup menu.

### **Changing the Time and Date** **68**

Selecting **Date** in the setup menu displays the menu shown in Step 3. Set the time and date as described in Step 4 and press the **MENU** button to return to the setup menu.

## Inserting Memory Cards

The camera stores pictures on Secure Digital (SD) memory cards (available separately).

### 1 Insert a memory card

- 1.1** Before inserting or removing memory cards, **turn the camera off** and open the card slot cover.

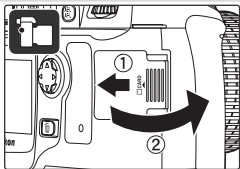

- 1.2** Slide the memory card in as shown at right until it clicks into place. The memory card access lamp will light for about a second. Close the memory card slot cover.

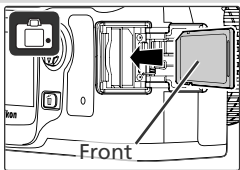

- 1.3** Turn the camera on. If the control panel shows the number of exposures remaining, the card is ready for use.



If the message shown at right is displayed in the monitor, the memory card must be formatted before it can be used in the camera. Proceed to Step 2.

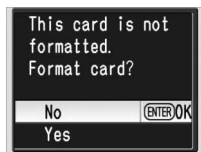

### The Write Protect Switch

SD cards are equipped with a write protect switch to prevent accidental loss of data. When this switch is in the “lock” position, the camera will display a message to warn that photos can not be recorded or deleted and the memory card can not be formatted.

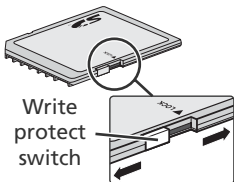

## 2 Format the memory card

Formatting memory cards permanently deletes all photographs and other data they may contain. Be sure all data you wish to keep have been copied to another storage device before formatting the card.

**2.1**



This card is not formatted.  
Format card?

No  
Yes ENTER OK

Highlight Yes.

**2.2**



Begin formatting. Do not turn camera off or remove battery or memory card until formatting is complete.

**2.3** Monitor turns off when formatting is complete.

### Formatting Memory Cards

Use the camera **Format** option to format memory cards. Performance may drop if cards are formatted in a computer.

### Removing Memory Cards

1 Confirm that the access lamp is off.

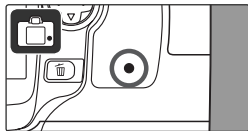

2 Turn the camera off and open the memory card slot cover.

3 Press the card in to eject (1). The card can then be removed by hand (2).

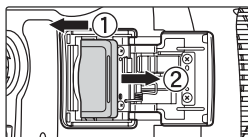

## Adjusting Viewfinder Focus

Photographs are framed in the viewfinder. Before shooting, make sure that the display in the viewfinder is in clear focus.

- 1 Remove the lens cap and turn the camera on.



- 2 Slide the diopter adjustment control up and down until the focus brackets are in sharp focus. When operating the diopter adjustment control with your eye to the viewfinder, be careful not to put your fingers or fingernails in your eye.

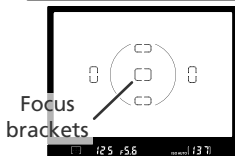
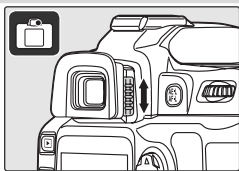

The eyepiece cup can be removed when adjusting viewfinder focus.

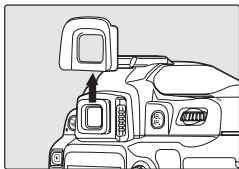

# Tutorial:

## Photography and Playback

### Taking Photographs in Mode

*"Point-and-Shoot" Photography*







This section describes how to take pictures in  (auto) mode, an automatic, "point-and-shoot" mode in which the majority of settings are controlled by the camera in response to shooting conditions.

#### 1 Turn the camera on

- 1.1** Remove the lens cap and turn the camera on. The control panel will turn on and the display in the viewfinder will light. The monitor remains off during shooting.



- 1.2** Check the battery level in the viewfinder or control panel.

Control panel	Viewfinder	Description
	—	Battery fully charged.
	—	Battery partially discharged.
		Low battery. Ready fully-charged spare battery.
		Shutter-release disabled. (blinks) (blinks) Change battery.



- 1.3** The exposure count displays in the control panel and viewfinder show the number of photographs that can be stored on the memory card. Check the number of exposures remaining.

If there is not enough memory to store additional photographs at current settings, the display will flash as shown at right. No further pictures can be taken until the memory card has been replaced or pictures have been deleted.

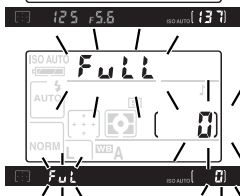



## 2 Select <sup>AUTO</sup> mode and adjust camera settings

2.1 Rotate the mode dial to <sup>AUTO</sup> .



2.2 Rotate the focus-mode selector to AF (autofocus).

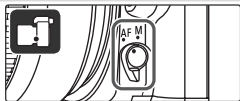

2.3 Slide the lens A-M mode switch to A (autofocus). See the lens manual for details.

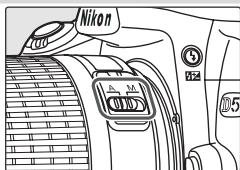

### Illustrations

In illustrations throughout this manual, indicators in the control panel and viewfinder are relevant to the explanation in accompanying text are shown in black. Indicators not mentioned in the text are shown in gray.



## 3 Frame a photograph

### 3.1 Hold the camera as shown.

#### *Holding the Camera*

Hold the handgrip in your right hand and cradle the camera body or lens with your left. Keep your elbows propped lightly against your torso for support.



### 3.2 Frame a photo in the viewfinder with the main subject positioned in any of the five focus areas.



#### *Using a Zoom Lens*

Use the zoom ring to zoom in on the subject so that it fills a larger area of the frame, or zoom out to increase the area visible in the final photograph.

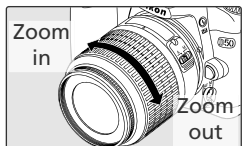

## 4 Focus and shoot

- 4.1** Press the shutter-release button halfway. The camera will automatically select the focus area containing the subject closest to the camera and focus on this subject. When the focus operation is complete, the selected focus area will be highlighted, a beep will sound, and the in-focus indicator (●) will appear in the viewfinder. Focus will lock while the shutter-release button is pressed halfway.

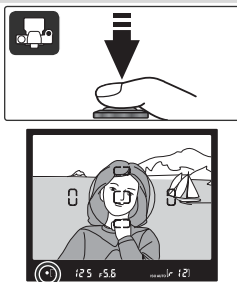

If the subject is dark, the AF-assist illuminator may light to assist the focus operation and the flash may pop up.

- 4.2** Smoothly press the shutter-release button the rest of the way down to release the shutter and record the photograph. The photograph will be displayed in the monitor and the access lamp next to the card slot cover will light. ***Do not eject the memory card, turn the camera off, or remove or disconnect the power source until the lamp has gone out and recording is complete.***

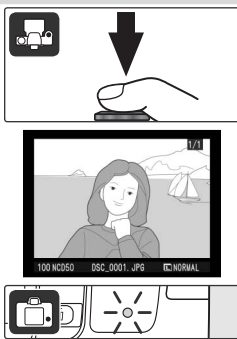

### The Shutter-Release Button

The camera has a two stage shutter-release button. The camera focuses when the button is pressed halfway; focus locks until the button is released. To take the picture, press the shutter-release button the rest of the way down.

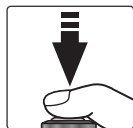
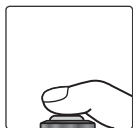

Lock focus





Take  
photograph

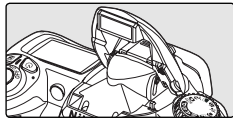

## The Built-in Flash

If additional lighting is required for correct exposure in **Auto** mode, the built-in flash will pop up automatically when the shutter-release is pressed halfway. Subjects outside the range of the flash (0.6–7.5m/2'–24'7") may not be properly lit. Remove lens hoods when using the flash.





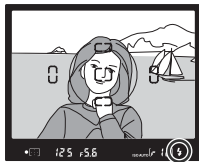

Once the flash is raised, it will only fire when required for additional lighting. If the flash is required, photographs can only be taken when the  (flash-ready) indicator is displayed. Wait until the flash-ready indicator is displayed before shooting.



To save battery power when the flash is not in use, return it to the closed position by pressing it gently downward until the latch clicks into place.





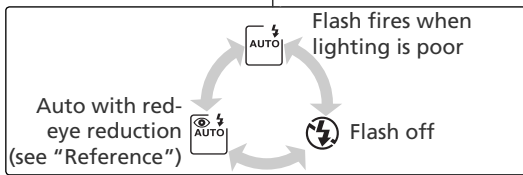
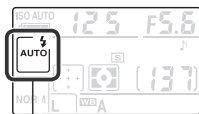
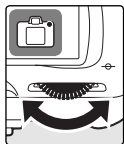



If desired, the flash can be turned off so that it will not fire even when lighting is poor. Press the  button and rotate the command dial until  is displayed in the control panel. To turn the flash back on, press the  button and rotate the command dial until  is displayed in the control panel.



# Digital Vari-Programs

*Creative Photography*

In addition to , the D50 offers a choice of six Digital Vari-Program modes. Selecting a program automatically optimizes settings to suit the selected scene, making creative photography as easy as rotating the mode dial.

Mode	Description
 <b>Portrait</b>	For portraits.
 <b>Landscape</b>	For landscapes.
 <b>Child</b>	For pictures of children.
 <b>Sports</b>	For moving subjects.
 <b>Close up</b>	For close up shots of small objects.
 <b>Night portrait</b>	For portraits taken against a backdrop of night scenery.

To take pictures in Digital Vari-Program modes:

- 1 Rotate the mode dial to select a Digital Vari-Program mode.

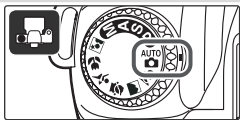

- 2 Frame a photograph, focus, and shoot as described for  mode.





## **Portrait: Bringing out a Portrait Subject**

Use for portraits. Camera selects focus area containing subject closest to camera; this subject stands out clearly while background details are softened, lending composition sense of depth. Colors are processed for soft, natural-looking skin tones.



- Degree of softening depends on amount of light available. Increase distance between subject and background or use telephoto lens for best results.

## **The Built-in Flash**

If additional lighting is required for correct exposure in , , , and , modes, the built-in flash will pop up automatically when the shutter-release is pressed halfway. See "Taking Photographs in  Mode."



### **Landscape: Capturing Nature's Majesty**

Use for vivid landscape shots that enhance outlines, colors, and contrast in such subjects as skylines and forests.

- Camera selects focus area containing subject closest to camera.
- Built-in flash and AF-assist illuminator turn off automatically.

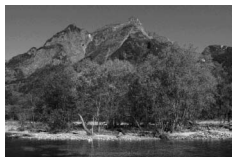

### **Child: Kid Pics in Living Color**

Use for snapshots of children. Clothing and background details are vividly rendered while skin tones remain soft and natural.

- Camera selects focus area containing subject closest to camera.



### **Sports: Bodies in Motion**

High shutter speeds freeze motion for dynamic sports shots in which main subject stands out clearly.

- Camera focuses continuously on subject in center focus area while shutter-release button is pressed halfway. Beep does not sound when camera focuses.
- Built-in flash and AF-assist illuminator turn off automatically.



### **Close up: Photographing Small Objects**

Use for close-up shots of flowers, insects, and other small objects.

- Camera focuses on subject in center focus area.
- Tripod recommended to prevent blurring at slow shutter speeds.



### **Night Portrait: Taking Portraits at Night**



Provides natural balance between main subject and background in portraits taken under low light.

- Camera selects focus area containing subject closest to camera.
- Tripod recommended to prevent blurring at slow shutter speeds.



# Choosing a Shooting Mode

Shooting mode determines how the camera takes photographs: one at a time or continuously while the shutter-release button is held down.

Mode	Description
 Single frame (default)	Camera takes one photograph each time shutter-release button is pressed.
 Continuous (burst mode)	Camera records photographs at rate of up to about 2.5 frames per second while shutter-release button is pressed.

To choose a shooting mode, press the  button and rotate the command dial until the desired mode is displayed in the control panel.

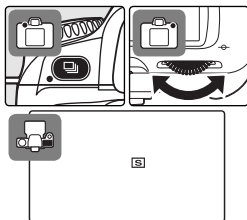

## The Memory Buffer

The camera is equipped with a memory buffer for temporary storage, allowing shooting to continue while photographs are being saved to the memory card. When the buffer is full, the shutter is disabled until enough data have been transferred to the memory card to make room for another photograph. In continuous mode, shooting will continue as long as the shutter-release button is held down, although the frame rate will drop once the buffer has filled.

The number of images that can be stored in the memory buffer at current settings is shown in the exposure-count displays in the viewfinder and control panel while the shutter-release button is pressed.

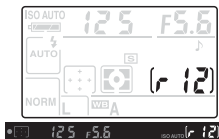

# Using the Self-timer or Remote Control





The self-timer or optional ML-L3 remote control can be used for photographs in which you wish to appear yourself. To use the self-timer:

- 1 Mount the camera on a tripod (recommended) or place the camera on a stable, level surface.



- 2 The current self-timer/remote control mode is shown in the control panel. Use the  button to select one of the following modes:



Mode	Description
 NO Timer ICON off	Photos are taken when shutter-release button is pressed.
 Self-timer	Photos are taken about 10s after shutter-release button is pressed.
 Delayed remote	Photos are taken about 2s after shutter-release button on remote control is pressed.
 Quick-response remote	Photos are taken when shutter-release button on remote control is pressed.



- 3 Frame the photograph.

- 4 To prevent light entering via the viewfinder from interfering with exposure, cover the viewfinder eyepiece with the supplied eyepiece cap as shown at right.

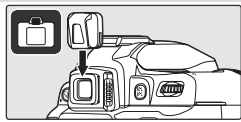

## Mode Selection

The self-timer/remote control mode can also be selected by pressing the  button and rotating the command dial.



5 Take the photograph.

**Self-timer:** Press the shutter-release button all the way down to start the self-timer. The self-timer lamp (AF-assist lamp) will blink for about eight seconds. The lamp stops blinking two seconds before the photograph is taken and remains lit until the shutter is released.



**Remote control:** From a distance of 5 m (16') or less, point the remote control at the infrared receiver on the front of the camera and press the shutter-release button on the remote control. In delayed remote mode, the shutter will be released about two seconds after the shutter-release button is pressed.

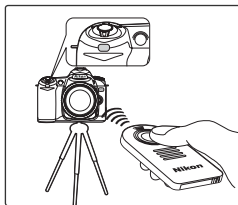

# Basic Playback



Photographs are displayed automatically after shooting. If no photograph is displayed in the monitor, the most recent picture can be viewed by pressing the  button. Additional pictures can be displayed by rotating the command dial or pressing the multi selector left or right.

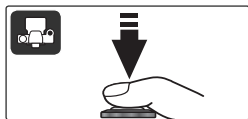

To end playback and return to shooting mode, press the shutter-release button halfway.



## *Deleting Unwanted Photographs*

To delete the photograph currently displayed in the monitor, press the  button. A confirmation dialog will be displayed. Press the  button again to delete the image and return to playback. Press any other button to exit without deleting the picture.

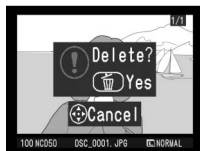

# Reference

This section builds on the Tutorial to cover more advanced shooting and playback options.

Adjust image quality and size according to how the picture will be used	Image Quality: 📷 31 Image Size: 📷 32
Choose the focus area or focus manually	Choosing the Focus Area: 📷 33 Manual Focus: 📷 35
Take photographs where lighting is poor	Flash Sync Mode: 📷 36 Flash Compensation: 📷 38 Sensitivity (ISO Equivalency): 📷 39
Let the camera choose shutter speed and aperture	Exposure Mode P (Programmed Auto): 📷 42
Freeze or blur motion	Exposure Mode S (Shutter-Priority Auto): 📷 43
Control depth of field	Exposure Mode A (Aperture-Priority Auto): 📷 44
Choose shutter speed and aperture manually	Exposure Mode M (Manual): 📷 45
Make photographs brighter or darker or enhance contrast	Exposure Compensation: 📷 47
Make colors look natural Take photos under unusual lighting	White Balance: 📷 49
Viewing Photographs	📷 51
Viewing Photographs on a Computer	📷 59
Printing Photographs	📷 62

# Using Camera Menus

Most shooting, playback, and setup options can be accessed from the camera menus. To view the menus, press the **MENU** button.



Choose from playback, shooting, Custom Settings, and setup menus (see below)

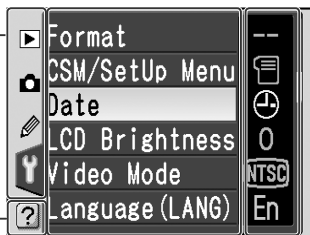

Slider is displayed if more options are available in current menu

This icon indicates that help is available for current menu item. Press **?** button to view help.

Current setting for each option is shown by icon

Current menu item is highlighted

Menu	Description
Playback	Adjust playback settings and manage photos.
Shooting	Adjust shooting settings.
Custom Settings	Personalize camera settings.
Setup	Format memory cards and perform basic camera setup.



## Navigating the Menu

To make changes to a menu item, first select the menu from the playback, shooting, Custom Settings, and setup menus (1), then select the menu item (2), and finally select an option (3).

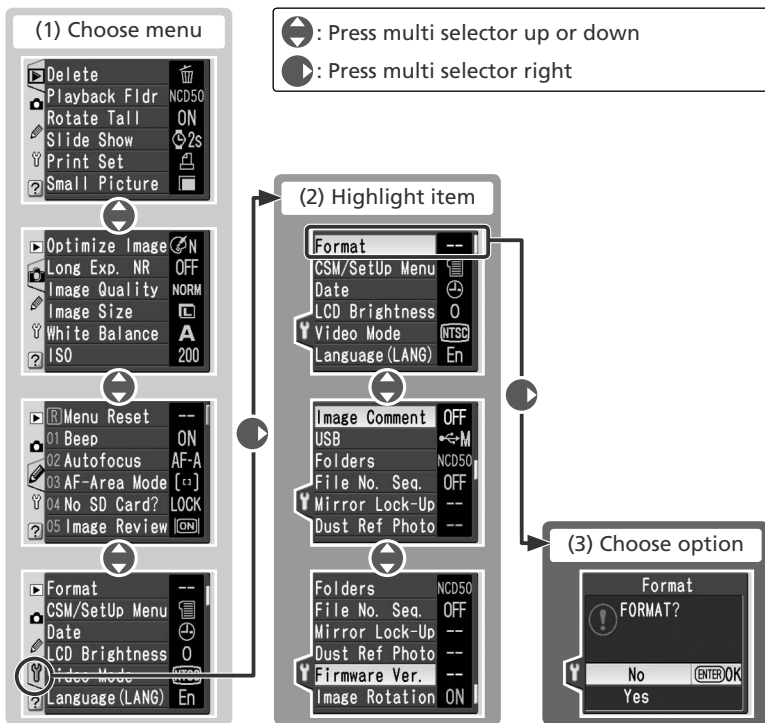

Some menus may contain multiple pages. The selection for some options is made from a sub-menu.

## Making a Selection

The multi selector is used to navigate through the camera menus.

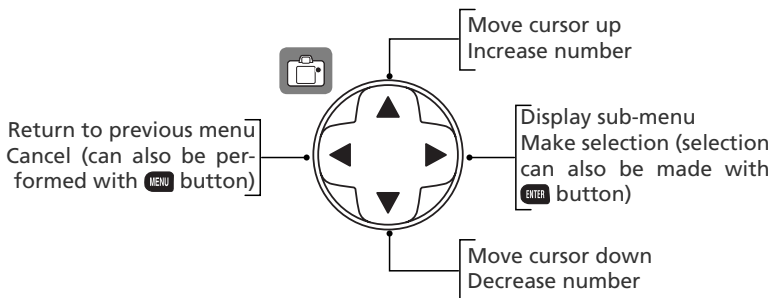

To modify menu settings:

- 1 Display menus

Format	--
CSM/SetUp Menu	
Date	
LCD Brightness	0
Video Mode	NTSC
Language (LANG)	En
- 2 Highlight icon for current menu

Format	--
CSM/SetUp Menu	
Date	
LCD Brightness	0
Video Mode	NTSC
Language (LANG)	En
- 3 Select menu

Optimize Image	ON
Long Exp. NR	OFF
Image Quality	NORM
Image Size	
White Balance	A
ISO	200
- 4 Position cursor in selected menu

Optimize Image	ON
Long Exp. NR	OFF
Image Quality	NORM
Image Size	
White Balance	A
ISO	200
- 5 Highlight menu item

Optimize Image	ON
Long Exp. NR	OFF
Image Quality	NORM
Image Size	
White Balance	A
ISO	200

6

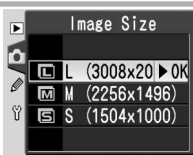

Display options

7



Highlight option

8



Make selection

- Menu items that are displayed in gray are not currently available.
- When formatting memory cards and in other cases in which user confirmation is required, a selection can only be made by pressing the **ENTER** button. A message to this effect will appear in the display.
- To exit the menus and return to shooting mode, press the shutter-release button halfway.

# Reference: More on Photography

## Image Quality and Size

Controls used: **MENU** ▶ Shooting menu ▶ Image Quality  
**MENU** ▶ Shooting menu ▶ Image Size

Together, image quality and size determine how much space each photograph occupies on the memory card. Larger, higher quality images look better when printed at a larger size but also require more memory, meaning that fewer such images can be stored on the memory card.

Image Quality and Size

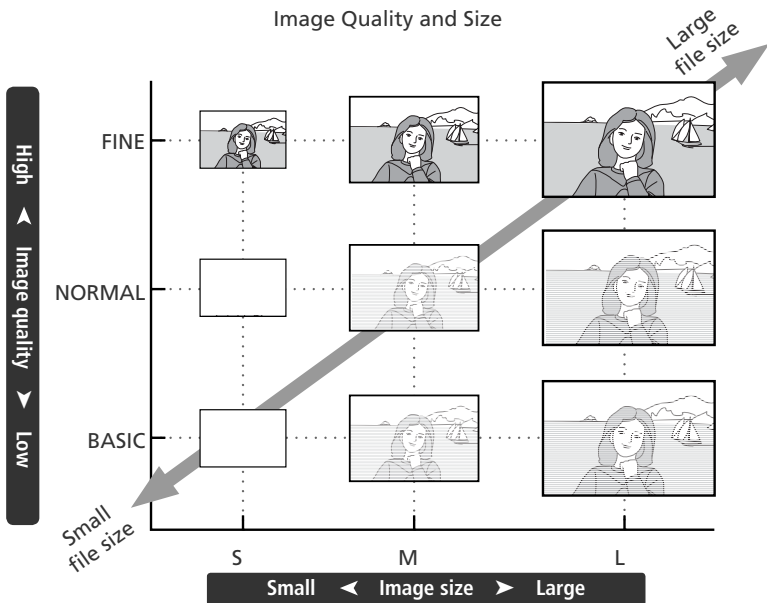

### Image Quality, Image Size, and File Size

See the Appendix (📖 126) for information on the number of pictures that can be stored on a memory card.



## Image Quality

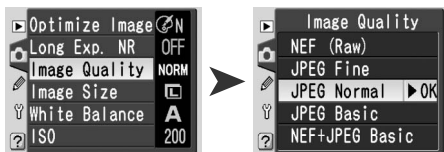

The following options are available:

Option	Format	Description		
<b>NEF (Raw)</b> (RAW)	NEF	Raw data from image sensor are saved in compressed Nikon Electronic Format (NEF). Suitable for images that will be processed on a computer.		
<b>JPEG Fine</b> (FINE)	JPEG	Fine image quality, suitable for enlargements or high-quality prints.	Low (1:4)	Compression ratio
<b>JPEG Normal</b> (NORM)		Normal image quality, suited to most applications.	Medium (1:8)	
<b>JPEG Basic</b> (BASIC)		Smallest file size, suitable to distribution by e-mail or use in web pages.	High (1:16)	
<b>NEF+JPEG Basic</b> (RAW BASIC)	NEF+JPEG	Two images are recorded, one NEF (RAW) image and one basic-quality JPEG image. Image size automatically set to L; JPEG image is 3,008 × 2,000 pixels in size.		

The current image quality setting is displayed in the control panel.

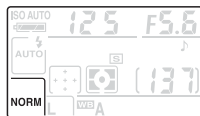

### NEF (Raw)/NEF+JPEG

NEF images can only be viewed using Nikon Capture 4 Version 4.3 or later (available separately) or PictureProject. When opened on a computer, NEF images are 3,008 × 2,000 pixels in size. When photographs taken at **NEF+JPEG Basic** are viewed on the camera, only the JPEG image will be displayed. When photographs taken at **NEF+JPEG Basic** are deleted, both NEF and JPEG images will be deleted.

## Image Size

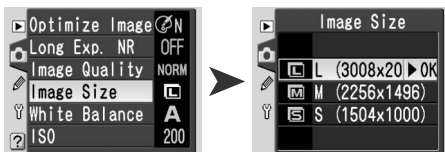

The following options are available:

Image size	Size	Size (pixels)	Approximate size when printed at 200 dpi
<b>L (3008×2000)</b>	Large	3,008 × 2,000	38 × 25 cm (15" × 10")
<b>M (2256×1496)</b>	◆	2,256 × 1,496	29 × 19 cm (11.5" × 7.5")
<b>S (1504×1000)</b>	Small	1,504 × 1,000	19 × 13 cm (7.5" × 5")

The current image size setting is displayed in the control panel.



### The QUAL Button

If the monitor is off, image quality and size can be set by pressing the **ENTER** (QUAL) button and rotating the command dial until the desired combination of image quality and size is displayed in the control panel.



### File Names

Photographs are stored as image files with names of the form "DSC\_nnnn.xxx," where nnnn is a four-digit number between 0001 and 9999 assigned automatically in ascending order by the camera, and xxx is one of the following three letter extensions: "NEF" for NEF images, "JPG" for JPEG images, and "NDF" for Dust Off ref photos. The NEF and JPEG files recorded at a setting of **NEF + JPEG Basic** have the same file names but different extensions. Small copies created with the small picture option have file names beginning with "SSC\_" and ending with the extension ".JPG" (e.g., "SSC\_0001.JPG"), while images recorded at an **Optimize Image > Color Mode** setting of **II (Adobe RGB)** have names that begin with an underscore, (e.g., "\_DSC0001.JPG", or "\_SSC0001.JPG" for small copies of Color Mode II pictures).

# Choosing the Focus Area

Controls used: Multi selector

The D50 offers a choice of five focus areas that together cover a wide area of the frame. By default, the camera selects the focus area automatically or focuses on the subject in the center focus area. The focus area can also be selected manually to allow photographs to be composed with the main subject almost anywhere in the frame.

## Manual Focus Area Selection

- 1 Select **Single Area** or **Dynamic Area** for Custom Setting 3 (**AF-Area Mode**). Manual focus area selection is not available with **Closest Subject**, which is the default setting in **AUTO**, **S**, **L**, **A**, and **M** modes.



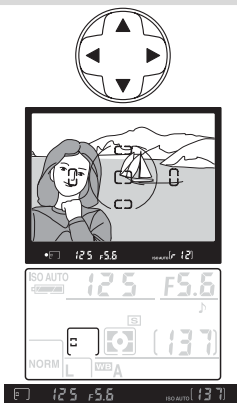

- 2 Press the multi selector left, right, up, or down to select the focus area. The selected focus area will be displayed in the viewfinder, highlighted in red if necessary to establish contrast with the background. The selected focus area is also shown in the control panel and viewfinder status display.



## Advanced Settings

**3: AF-Area Mode** controls focus-area selection (89). **8: AF Area III** determines when the active focus area is highlighted (91).

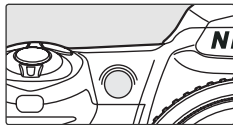

### The AF-Assist Illuminator

If the subject is poorly lit, the AF-assist illuminator will light to assist the focus operation when the shutter-release button is pressed halfway. The AF-assist illuminator is not available in  or  mode or when **Off** is selected for Custom Setting 7 (**AF Assist**).



For the AF-assist illuminator to function correctly, the lens must have a focal length of 24–200 mm and the subject must be in range of the illuminator (0.5–3 m/1'8"–9'10"). Lens hoods should be removed.

### Focus Lock

Focus lock can be used to focus on a subject that will not be in one of the five focus areas in the final composition. It can also be used when the autofocus system is unable to focus ( 121). Single or dynamic area AF is recommended when using focus lock ( 89).

- 1 Position the subject in the center focus area and press the shutter-release button halfway.

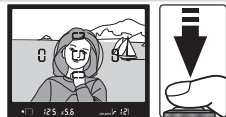

- 2 Check that the in-focus indicator (●) appears in the viewfinder. Focus will lock when the in-focus indicator appears, and remain locked while the shutter-release button is pressed halfway. Focus can also be locked by pressing the **AE-L/AF-L** button while the shutter-release button is pressed halfway. Focus will remain locked while the **AE-L/AF-L** button is pressed, even if you later remove your finger from the shutter-release button.

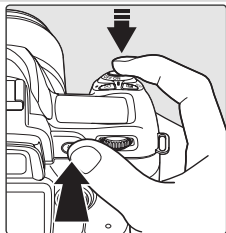

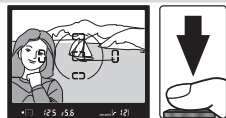

- 3 Recompose the photograph and shoot. Do not change the distance between the camera and subject while focus lock is in effect.



### *Taking Multiple Photographs Without Refocusing*

Focus will remain locked between shots if the shutter-release button is kept pressed halfway. In continuous mode ( 21), focus will remain locked if the **AE-L/AF-L** button is kept pressed between shots.

### Advanced Settings

 **14: AE-L/AF-L** controls the function performed by the **AE-L/AF-L** button ( 98).

# Manual Focus

Controls used: Focus-mode selector ► Lens focus ring

Manual focus is available for manual focus lenses or when autofocus does not produce the desired results. To focus manually, set the focus-mode selector to **M** and rotate the lens focus ring until the image displayed on the clear matte field in the viewfinder is in focus. Photographs can be taken at any time, even when the image is not in focus.

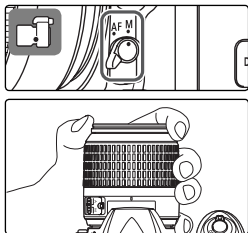

## A-M Selection/Autofocus with Manual Priority

When using a lens that offers A-M selection, select M when focusing manually. With lenses that support M/A (autofocus with manual priority), focus can be adjusted manually with the lens set to M or M/A. See the documentation provided with your lens for details.

## The Electronic Range Finder

If the lens has a maximum aperture of f/5.6 or faster, the viewfinder focus indicator can be used to confirm whether the subject in the selected focus area is in focus. After positioning the subject in the active focus area, press the shutter-release button halfway and rotate the lens focus ring until the in-focus indicator (●) is displayed.



## Focal Plane Position

To determine the distance between your subject and the camera, measure from the focal plane mark on the camera body.



# Flash Sync Mode

Controls used: button + command dial

Choose a flash sync mode according to shooting conditions. The current flash mode is displayed in the control panel as shown below. is displayed when the flash is off.

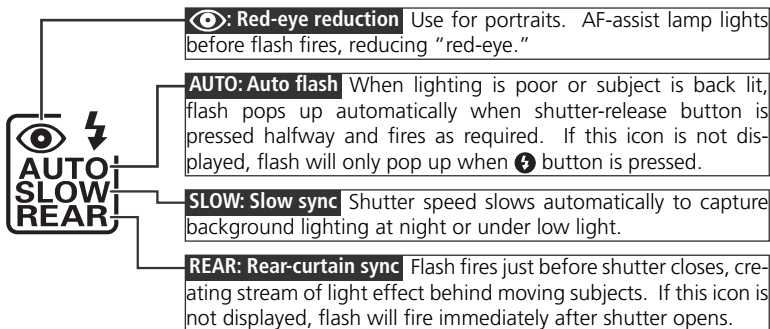
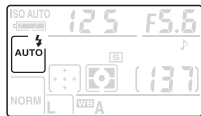

The flash sync modes available depend on the mode currently selected with the mode dial.

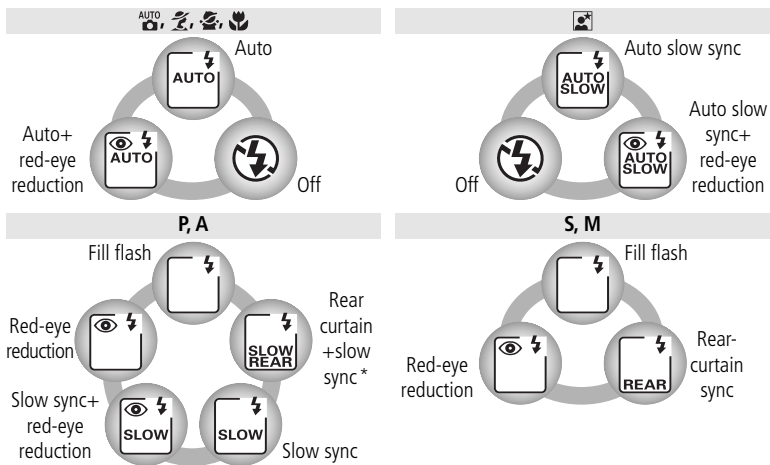



\* SLOW is displayed after command dial is released.

## Choosing a Flash Sync Mode

Press the  button and rotate the command dial. The current flash sync mode is displayed in the control panel.



## Using the Built-in Flash

**AUTO, , , and  modes:** Choose the flash sync mode as described on the preceding page. The flash will pop-up as required when the shutter-pressed halfway, and fire when a photograph is taken.





**P, S, A, and M modes:** Press the  button to raise the built in flash and then choose a flash sync mode as described on the preceding page. Select a metering method and set exposure before taking photographs.

## Lowering the Built-in Flash

To save battery power when the flash is not in use, press it gently downward until the latch clicks into place.

## Using the Built-in Flash

Use with lenses with a focal length of 18–300mm (CPU lenses; the maximum focal length when the built-in flash is used with non-CPU lenses is 200mm) and remove lens hoods to prevent them from casting shadows on the subject. The flash has a minimum range of 60cm (2'), and can not be used in the macro range of macro zoom lenses. See “Optional Accessories” ( 108) for details.

If the flash is used in continuous shooting mode ( 21), only one picture will be taken each time the shutter-release button is pressed.

After the built-in flash has been used for several consecutive shots, the shutter release may be briefly disabled to protect the flash. The flash can be used again after a short pause.



See the Appendix for information on the type of flash control used by the built-in Speedlight ( 127).

## Optional Flash Units (Speedlights)

See “Optional Accessories” for information on using optional flash units ( 109).

## Advanced Settings

See “FV Lock” for information on locking flash output for a selected subject ( 98).



** 10: ISO Auto** can be used to adjust sensitivity for optimal flash output ( 92). 

**16: Flash Mode** can be used for manual control of flash output ( 99).

## Flash Compensation (P, S, A, and M Modes Only)

Controls used:  and  buttons + command dial

Flash compensation can be used to increase or reduce flash output from the level chosen by the camera's flash control system. Flash output can be increased to make the main subject appear brighter, or reduced to prevent unwanted highlights or reflections.

Pressing the  and  buttons, rotate the command dial and confirm flash compensation in the control panel or viewfinder. Flash compensation can be set to values between  $-3$  EV (darker) and  $+1$  EV (brighter) in increments of  $\frac{1}{3}$  or  $\frac{1}{2}$  EV. At values other than  $\pm 0$ , a  icon will be displayed in the control panel and viewfinder after the buttons are released.

Normal flash output can be restored by setting flash compensation to  $\pm 0.0$ . Flash compensation is not reset when the camera is turned off.

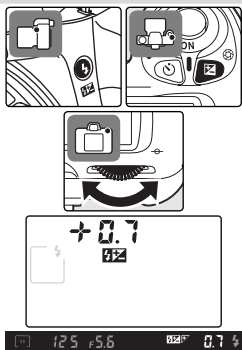

### 6: Flash Level ( 90)

This option can be used to select a value for flash compensation from a menu.

### Advanced Settings

 11: EV Step controls the size of the increments for flash compensation ( 92).







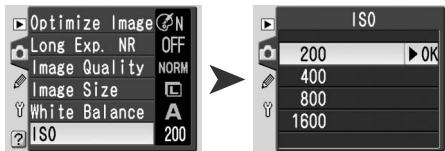

# Sensitivity (ISO Equivalency)

Controls used:  Shooting menu ► ISO



Photographs taken at slow shutter speeds are prone to blurring. If sensitivity is raised above the default value of ISO 200 equivalent, the same exposure can be achieved at faster shutter speeds, preventing blur. Sensitivity can be set to values between ISO 200 and ISO 1600 in steps of 1EV.

## Digital Vari-Program Modes

At default settings, manual sensitivity adjustment is *not* available in , , , and  modes. Instead, the camera adjusts sensitivity automatically. To adjust sensitivity manually, select **Off** for Custom Setting 9 (**ISO Control**;  91).

## The ISO Button

If the monitor is off, sensitivity can be set by pressing the  (ISO) button and rotating the command dial until the desired value is displayed in the control panel.

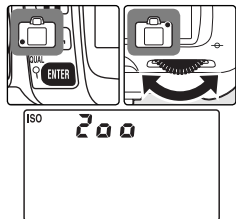

## Sensitivity

“Sensitivity” is the digital equivalent of film speed. The higher the sensitivity, the less light needed to make an exposure, allowing higher shutter speeds or smaller apertures. Just as higher speed films tend to be “grainy,” pictures taken at high sensitivities are prone to mottling.

# P, S, A, and M Modes

**P, S, A,** and **M** modes offer control over a variety of advanced settings, including shutter speed, aperture, and white balance.

## Choosing an Exposure Mode

Controls used: Mode dial



**P, S, A,** and **M** modes offer varying degrees of control over shutter speed and aperture.

Mode	Description
<b>P</b> Programmed auto	Camera sets shutter speed and aperture for optimal exposure. Recommended for snapshots and in other situations in which little time is available for adjusting camera settings.
<b>S</b> Shutter-priority auto	User chooses shutter speed; camera selects aperture for best results. Use to freeze or blur motion.
<b>A</b> Aperture-priority auto	User chooses aperture; camera selects shutter speed for best results. Use to blur background or bring both foreground and background into focus.
<b>M</b> Manual	User controls both shutter speed and aperture. Set shutter speed to “bulb” for long time-exposures.



### P, S, A, and M Modes

When using a CPU lens equipped with an aperture ring, lock the aperture ring at the minimum aperture (highest f/-number). Non-CPU lenses can only be used in mode **M**, when aperture can be adjusted manually using the lens aperture ring. The camera exposure meter can not be used. See “Optional Accessories” (📖 105).

If the limits of the exposure metering system are exceeded, one of the following indicators will be displayed in the control panel and viewfinder:

Indicator	Description
	Subject too bright. Lower sensitivity or use optional Neutral Density (ND) filter.
	Subject too dark. Raise sensitivity or use flash.

### Advanced Settings

 **11: EV Step** controls the size of the increments for shutter speed and aperture (📖 92).  **12: BKT SET** can be used to vary exposure automatically over a series of photographs (📖 93). Exposure can be locked using AE lock (📖 97).



## Exposure

Exposure controls the brightness of photographs. The same exposure can be achieved with different combinations of shutter speed and aperture, allowing you to blur or freeze motion or control depth of field. The following figure shows how shutter speed and aperture affect exposure.

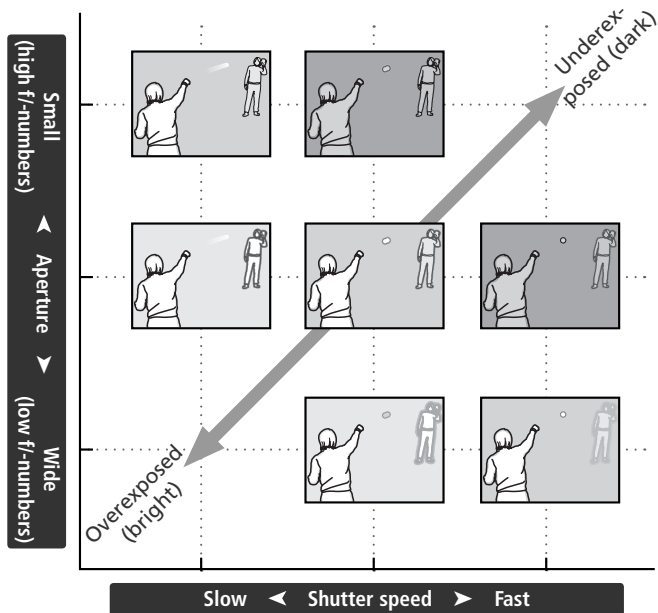

## P: Programmed Auto



In this mode, the camera sets shutter speed and aperture for optimal exposure. This mode is recommended for snapshots and other situations in which little time is available for adjusting camera settings.

- 1 Rotate the mode dial to P.



- 2 Frame a photograph, focus, and shoot.

### Flexible Program

In mode P, different combinations of shutter speed and aperture can be selected by rotating the command dial (“flexible program”). All combinations produce the same exposure. While flexible program is in effect, a  icon appears in the control panel. To restore the default shutter speed and aperture, rotate the command dial until the  icon is no longer displayed.



## S: Shutter-Priority Auto

In mode **S**, you choose the shutter speed while the camera automatically selects the aperture that will produce optimal exposure. Use slow shutter speeds to suggest motion by blurring moving objects, high shutter speeds to “freeze” motion.

- 1 Rotate the mode dial to **S**.

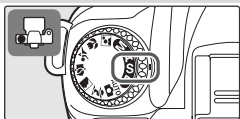

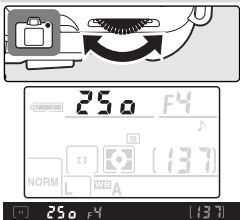

- 2 Rotate the command dial to choose a shutter speed between 30s and 1/4,000s.



- 3 Frame a photograph, focus, and shoot.

### Shutter Speed and Camera Shake

To prevent blurring caused by camera shake, the shutter speed should be faster than the inverse of the focal length of the lens, in seconds (for example, if a lens has a focal length of 300 mm, shutter speed should be faster than 1/300 s). Use of a tripod is recommended when shooting at slower shutter speeds. To prevent blur, try increasing sensitivity ( 39), using the built-in flash ( 18), mounting the camera on a tripod, or attaching a VR lens.

## A: Aperture-Priority Auto

In mode **A**, you choose the aperture while the camera controls shutter speed for optimal exposure. Small apertures (high  $f$ -numbers) increase depth of field, bringing both the main subject and background into focus. Large apertures (low  $f$ -numbers) soften background details and let more light into the camera, increasing the range of the flash and making photographs less susceptible to blurring.

- 1 Rotate the mode dial to **A**.

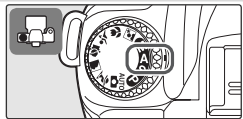

- 2 Rotate the command dial to choose the desired aperture.

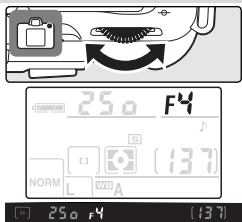

- 3 Frame a photograph, focus, and shoot.



## M: Manual

In mode **M**, the user controls both shutter speed and aperture. Shutter speed can be set to values between 30s and  $\frac{1}{4,000}$ s, or the shutter can be held open indefinitely for a long time-exposure (**bulb**). Aperture can be set to values between the minimum and maximum values for the lens.

- 1 Rotate the mode dial to **M**.



- 2 Rotate the command dial to choose a shutter speed. To set aperture, rotate the command dial while pressing the **AE-L/AF-ON** button. Check exposure in the electronic analog exposure display (see following page), and continue to adjust shutter speed and aperture until the desired exposure is achieved.

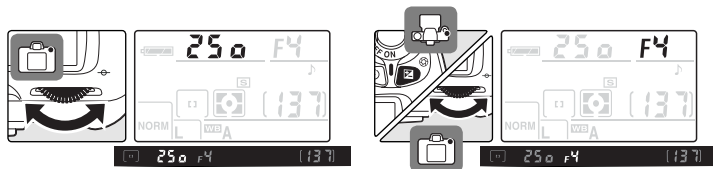

- 3 Frame a photograph, focus, and shoot.

## Long Time-Exposures

At a shutter speed of **b u l b**, the shutter will remain open while the camera shutter-release button is held down. In delayed remote and quick-response remote modes, **- -** is displayed instead of **b u l b**; the shutter opens when the shutter-release button on the optional ML-L3 remote control is pressed (2 s after the button is pressed in delayed remote mode) and remains open until the remote-control shutter-release button is pressed a second time (maximum 30 minutes). Nikon recommends using a fully-charged battery or an optional EH-5 AC adapter to prevent loss of power while the shutter is open. Note that if the shutter is open for more than approximately 1 s at any setting, “noise” in the form of randomly-spaced, brightly-colored pixels may appear in the final photograph. Noise can be reduced by turning long exposure noise reduction on before taking photographs ( 78).

## Electronic Analog Exposure Display

The electronic analog exposure display in the viewfinder shows whether the photograph would be under- or over-exposed at current settings. Depending on the option chosen for Custom Setting 11 (**EV Step**), the amount of under- or over-exposure is shown in increments of  $\frac{1}{3}$  EV or  $\frac{1}{2}$  EV. If the limits of the exposure metering system are exceeded, the display will flash.

<b>“EV Step” set to “1/3 Step”</b>	<b>“EV Step” set to “1/2 Step”</b>
Optimal exposure + . . 0 . . -	Optimal exposure + . . . 0 . . . -
Underexposed by $\frac{1}{3}$ EV + . . 0 . . -	Underexposed by $\frac{1}{2}$ EV + . . . 0 . . . -
Overexposed by more than 2 EV + . . . . 0 . . -	Overexposed by more than 3 EV + . . . . . 0 . . . -

The electronic analog exposure display is not shown when **b u l b** is selected for shutter speed or a non-CPU lens is attached.







## Exposure Compensation (P, S, and A Modes Only)

Controls used:  button + command dial

To obtain the desired results with certain subject compositions, it may be necessary to use exposure compensation to alter exposure from the value suggested by the camera. As a rule of thumb, positive compensation may be needed when the main subject is darker than the background, negative values when the main subject is brighter than the background. Center-weighted or spot metering is recommended when using exposure compensation.

Pressing the  button, rotate the main command dial and confirm exposure compensation in the control panel or the electronic analog exposure display. Exposure compensation can be set to values between  $-5$  EV (underexposure) and  $+5$  EV (overexposure) in increments of  $\frac{1}{3}$  or  $\frac{1}{2}$  EV.

The current value for exposure compensation is displayed in the control panel and viewfinder when the  button is pressed.

Normal exposure can be restored by setting exposure compensation to  $\pm 0$ . Exposure compensation is not reset when the camera is turned off.

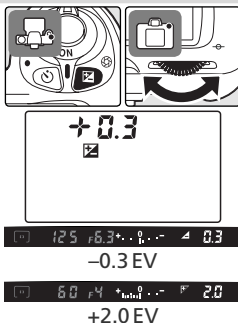

### Advanced Settings







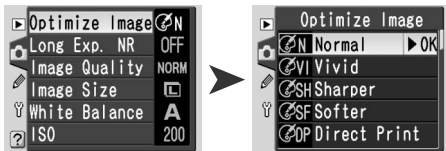



 **11: EV Step** controls the size of the increments for exposure compensation (see page 92).

## Optimizing Images

Controls used:  Shooting menu ► Optimize Image



The options in the Optimize Image menu control sharpening, contrast, saturation, and hue.

Option	Description
 <b>Normal</b> (default)	Recommended for most situations.
 <b>Vivid</b>	Enhances saturation, contrast, and sharpness to produce vivid images with vibrant reds, greens, and blues.
 <b>Sharper</b>	Sharpens outlines.
 <b>Softer</b>	Softens outlines. Use to ensure soft, natural-looking flesh tones in portrait subjects or when taking pictures that will be sharpened in image application.
 <b>Direct Print</b>	Optimizes images for printing “as is” via direct USB connection (  62). Images will be sharp and clear even when enlarged.
 <b>Portrait</b>	Lowers contrast while lending natural texture and rounded feel to skin of portrait subjects.
 <b>Landscape</b>	Enhances saturation and sharpness to produce landscapes with vibrant greens and blues.
 <b>Custom</b>	Customize sharpness, contrast, color reproduction, saturation, and hue (  76).

### At Settings Other than Custom

At settings other than **Custom**:

- Photographs are optimized for current shooting conditions. Results will vary with exposure and the position of the subject in the frame, even in scenes of the same type.
- Photographs are recorded in the sRGB color space.
- Use a type G or D lens for best results ( 105).







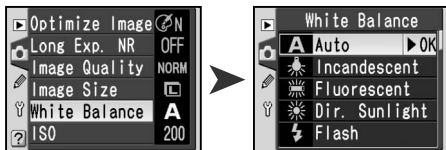

## White Balance

Controls used:  Shooting menu ► White Balance



White balance ensures that colors appear natural regardless of the color of the light source. Auto white balance is recommended in most situations, but it may necessary to choose another option if colors seem too cold or warm.

Option	Description
<b>A Auto</b> (default)	White balance automatically adjusted to suit lighting conditions. Recommended for most situations.
 <b>Incandescent</b>	Use under incandescent lighting.
 <b>Fluorescent</b>	Use under fluorescent lighting.
 <b>Dir. sunlight</b>	Use with subjects lit by direct sunlight.
 <b>Flash</b>	Use with the built-in flash or optional Nikon flash units.
 <b>Cloudy</b>	Use in daylight under overcast skies.
 <b>Shade</b>	Use in daylight with subjects in the shade.
<b>PRE Preset</b>	Use gray or white object or existing photograph as reference for white balance (  79).

The current white balance setting is shown in the control panel.



### The WB Button

If the monitor is off, white balance can be set by pressing the  (WB) button and rotating the command dial until the desired setting is displayed in the control panel.





### Advanced Settings

 **12: BKT SET** can be used to vary white balance automatically over a series of photographs ( 93).









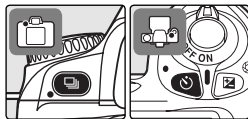



# Restoring Default Settings









Two-Button Reset

Controls used:  button +  button

The camera settings listed below can be restored to default values by holding the  and  buttons down together for more than two seconds (these buttons are marked by a green dot). The monitor will turn off briefly while these settings are reset. Other settings are unaffected.



Option	Description
Shooting mode  21)	Single
Self-timer/ remote control  22)	Off
Image quality  31)	JPEG Normal
Image size  32)	L
Focus area  33)	Center
Flash sync mode  36)	
Mode	    Auto
	 Auto slow sync
	P, S, A, M Fill flash
ISO  39)	200

Option	Description	
Flexible program  42)	Off	
Exposure compensation  47)	Off (0.0)	
Optimize image  48)	Normal	
White balance  49)	Auto	
AE lock  97)	Off	
FV lock  98)	Off	
Custom Settings	6: Flash Level  90)	0
	12: BKT Set  93)	Off
	13: Metering  96)	Matrix

## Defaults

# Reference: More on Playback

## Viewing Photographs

















Photographs can be viewed in the monitor one at a time (“single-image playback”) or in “contact sheets” of up to nine images (“thumbnail playback”).

### Single-Image Playback

Press the  button to view the most recent photograph in the monitor. Photographs taken in “tall” (portrait) orientation are displayed in tall orientation.



The following operations can be performed in single-image playback:

To	Use	Description
View additional photos	 or 	Press multi selector right or rotate command dial right to view photographs in order recorded. Press multi selector left or rotate command dial left to view photographs in reverse order.
View photo information		Press multi selector up or down to view information about current photograph (  52).
Zoom in on photo	 (Q)	Press  button for enlarged view of current photograph (  55).
Delete photo		Delete photograph (  57).
Protect photo		Protect photograph (  56).
View thumbnails		View thumbnail display (  54).
Return to shooting mode	Shutter release/ 	To turn monitor off and return to shooting mode, press  button or press shutter-release button halfway.
Display menus		Display menus (  26).

## Photo Information

Photo information is superimposed on images displayed in single-image playback. Press the multi-selector up or down to cycle through photo information as follows: File Information ↔ Shooting Data Page 1 ↔ Shooting Data Page 2 ↔ High-Lights ↔ Histogram ↔ File Information.



### File Information

- |  |    |                      |    |
|--|----|----------------------|----|
| 1 Protect status.....                    | 56 | 4 File name.....     | 32 |
| 2 Frame number/total<br>number of images |    | 5 Image size .....   | 32 |
| 3 Folder name .....                      | 71 | 6 Image quality..... | 31 |

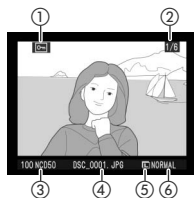

### Shooting Data, Page 1

- |  |    |                               |    |
|--|----|-------------------------------|----|
| 1 Protect status.....                    | 56 | 7 Shutter speed .....         | 40 |
| 2 Frame number/total<br>number of images |    | 8 Aperture.....               | 40 |
| 3 Camera name                            |    | 9 Mode .....                  | 6  |
| 4 Date of recording.....                 | 10 | Exposure<br>compensation..... | 47 |
| 5 Time of recording .....                | 10 | 10 Focal length.....          | 1  |
| 6 Metering .....                         | 96 | 11 Flash control .....        | 36 |

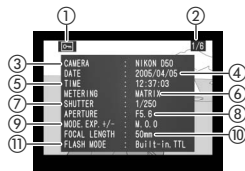

### Shooting Data, Page 2

- |   |    |                                     |    |
|---|----|-------------------------------------|----|
| 1 Protect status.....                                 | 56 | 7 Sharpening .....                  | 76 |
| 2 Frame number/total<br>number of images              |    | 8 Tone compensation..               | 77 |
| 3 Image optimization..                                | 48 | 9 Color mode .....                  | 77 |
| 4 Sensitivity<br>(ISO equivalency) <sup>1</sup> ..... | 39 | Hue .....                           | 78 |
| 5 White balance .....                                 | 49 | 10 Saturation.....                  | 77 |
| 6 Image size .....                                    | 32 | 11 Image comment <sup>2</sup> ..... | 70 |
| Image quality.....                                    | 31 |                                     |    |

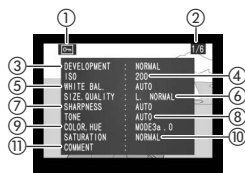

- 1 Displayed in red if Custom Setting 10 (**ISO Auto**) was on when photograph was taken and sensitivity was altered from value selected by user.
- 2 Only first twelve letters appear in photo information display.

## Highlights

- 1 Protect status..... 56
- 2 Image highlights (brightest areas of image) are marked by a flashing border.
- 3 Frame number/total number of images

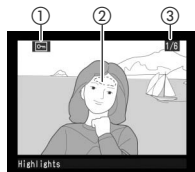

## Histogram

- 1 Protect status..... 56
- 2 Frame number/total number of images
- 3 Histogram showing the distribution of tones in the image. The horizontal axis corresponds to pixel brightness, with dark tones to the left and bright tones to the right. The vertical axis shows the number of pixels of each brightness in the image. Note that camera histogram is intended as guide only and may differ from histograms displayed in imaging applications.

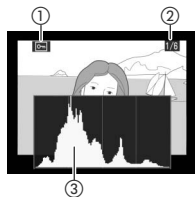













## Advanced Settings

**Rotate Tall** controls whether “tall” (portrait-orientation) photographs are displayed in tall orientation during playback (84). **5: Image Review** controls whether photographs are automatically displayed in the monitor after shooting (90). **17: Monitor Off** controls how long the monitor will remain on when no operations are performed (100).

## Viewing Multiple Images: Thumbnail Playback

To display images in “contact sheets” of four or nine images, press the  button in single-image playback. The following operations can be performed while thumbnails are displayed:



















To	Use	Description
View additional pages of photos		Rotate command dial right to view photographs in order recorded, left to view photographs in reverse order.
Change number of images displayed		Press  button to switch between four-thumbnail display, nine-thumbnail display, and single-image playback.
Highlight photographs		Press multi selector up, right, left, or down to highlight thumbnails.
Zoom in on photograph	 (Q)	Press  button for enlarged view of highlighted photograph (  55).
Delete photo		Delete highlighted photograph (  57).
Protect photo		Protect highlighted photograph (  56).
Return to shooting mode	Shutter release/ 	To turn monitor off and return to shooting mode, press  button or press shutter-release button halfway.
Display menus		Display menus (  26).





## Taking a Closer Look: Playback Zoom

Press the  button to zoom in on the image displayed in single-image playback or on the image currently highlighted in thumbnail playback. The following operations can be performed while zoom is in effect:



To	Use	Description
Change zoom ratio/ navigate to other areas of image	 + 	Press  button to display frame showing area currently zoomed in. While  button is pressed, multi selector can be used to move frame and command dial can be used to control size of frame—rotate dial counterclockwise to zoom out, clockwise to zoom in to maximum of approximately 4.7× (large images), 3.5× (medium images), or 2.4× (small images). Release  button to magnify selected area to fill monitor.
View other images		Rotate command dial to view same area of other images at current zoom ratio.
View other areas of image		Use multi selector to view area not visible in monitor. Hold multi selector down to scroll rapidly to other areas of frame.
Cancel zoom	 (Q)	Cancel zoom and return to single-image or thumbnail playback.
Delete photo		Delete photograph (  57).
Protect photo		Protect photograph (  56).
Return to shooting mode	Shutter release/ 	To turn monitor off and return to shooting mode, press  button or press shutter-release button halfway.
Display menus		Display menus (  26).

# Protecting Photographs from Deletion

In full-frame, zoom, and thumbnail playback, the  button can be used to protect photographs from accidental deletion. Protected files can not be deleted using the  button or the **Delete** option in the playback menu, and have DOS “read-only” status when viewed on a Windows computer. Note that protected images *will* be deleted when the memory card is formatted ( 68).

To protect a photograph:

1 Display the image in full-frame playback or highlight it in the thumbnail list.

2 Press the  button. The photograph will be marked with a  icon.

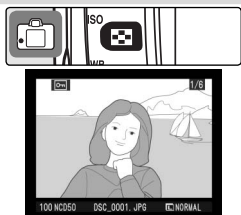

To remove protection from the photograph so that it can be deleted, display the photograph or highlight it in the thumbnail list and then press the  button.

# Deleting Individual Photographs

To delete a photograph displayed in single-image playback, or the photograph highlighted in thumbnail playback, press the  button. Once deleted, photographs can not be recovered.

**1** Display the image in full-frame playback or highlight it in the thumbnail list. Note that protected images ( 56) can not be deleted.

**2** Press the  button. A confirmation dialog will be displayed.

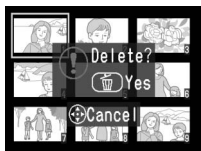
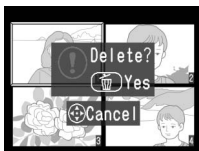
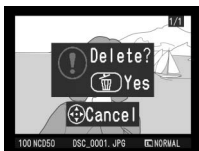

**3** To delete the photograph, press the  button again. Press any other button to exit without deleting the photograph.

## Advanced Settings

 **Delete** can be used to delete multiple photographs ( 84).

# Viewing Photographs on TV

The supplied video cable can be used to connect the camera to a television or VCR for playback or recording.

- 1 Select the appropriate video mode from the **Video Mode** menu (▶ 69).



- 2 **Turn the camera off.** Always turn the camera off before connecting or disconnecting the video cable.



- 3 Connect the video cable as shown below.



Connect to video device

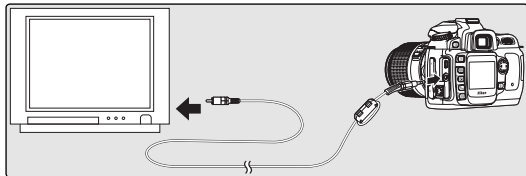

Connect to camera

- 4 Tune the television to the video channel.

- 5 Turn the camera on. During playback, images will be displayed on the television screen or recorded to video tape; the camera monitor will remain off. Note that the television may not be able to display the entire image when pictures are played back.

## Use an AC Adapter

Use of an EH-5 AC adapter (available separately) is recommended for extended playback. When the EH-5 is connected, the camera monitor-off delay will be fixed at ten minutes and the exposure meters will no longer turn off automatically.

# Viewing Photographs on a Computer

The supplied USB cable can be used to connect the camera to a computer. Once the camera is connected, the supplied PictureProject software can be used to copy photographs to the computer, where they can be viewed and retouched.

## Before Connecting the Camera

Install PictureProject after reading the manuals and reviewing the system requirements. To ensure that data transfer is not interrupted, be sure the camera battery is fully charged. If in doubt, charge the battery before use or use an EH-5 AC adapter (available separately).

Before connecting the camera, choose a camera USB option (71) according to the computer operating system:



Operating system	USB option
Windows XP Home Edition Windows XP Professional	Choose <b>PTP</b> or <b>Mass Storage</b>
Mac OS X	
Windows 2000 Professional Windows Millennium Edition (Me) Windows 98 Second Edition (SE)	Choose <b>Mass Storage</b> *

\* Do NOT select **PTP**. If **PTP** is selected when the camera is connected, the Windows hardware wizard will be displayed. Click **Cancel** to exit the wizard, and then disconnect the camera. Be sure to select **Mass Storage** before reconnecting the camera.

## Nikon Capture 4

Nikon Capture 4 Version 4.3 or later (available separately) can be used to control the camera from a computer and supports batch processing and more advanced image editing options. Before connecting the camera to a computer running Nikon Capture 4 Camera Control, set **USB to PTP** (71). The display shown at right will appear in the control panel and viewfinder while Camera Control is running.

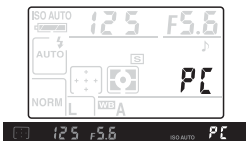

## Connecting the USB Cable

1 Turn the computer on and wait for it to start up.

2 Turn the camera off and connect the supplied USB cable as shown. Do not use force or attempt to insert the connectors at an angle. Connect the camera directly to the computer; do not connect the cable via a USB hub or keyboard.

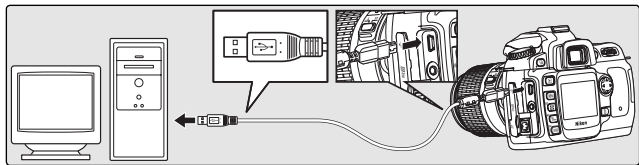

3 Turn the camera on. If **Mass Storage** is selected for **USB**, the control panel and viewfinder will display the icons shown at right (this display is not shown when **PTP** is selected). Photographs can be transferred to the computer as described in the *PictureProject Reference Manual* (on the silver CD).

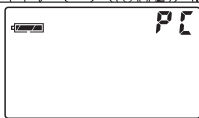

PC

## Disconnecting the Camera

If **PTP** is selected for **USB** (🔌 71), the camera can be turned off and the USB cable disconnected once transfer is complete. If the **USB** option in the camera setup menu is still at its default setting of **Mass Storage**, the camera must first be removed from the system as described below.

### *Windows XP Home Edition/Windows XP Professional*

Click the “Safely Remove Hardware” icon (🔌) in the taskbar and select **Safely remove USB Mass Storage Device** from the menu that appears.



### *Windows 2000 Professional*

Click the “Unplug or Eject Hardware” icon (🔌) in the taskbar and select **Stop USB Mass Storage Device** from the menu that appears.



### *Windows Millennium Edition (Me)*

Click the “Unplug or Eject Hardware” icon (🔌) in the taskbar and select **Stop USB Disk** from the menu that appears.



### *Windows 98 Second Edition (SE)*

In My Computer, click with the right mouse button on the removable disk corresponding to the camera and select **Eject** from the menu that appears.

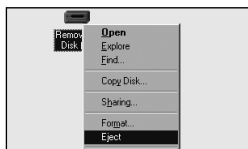

### *Macintosh*

Drag the camera volume (“NIKON D50”) into the Trash.

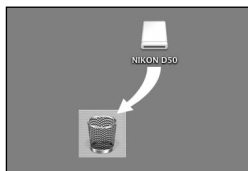

# Printing Photographs

Photographs can be printed by any of the following methods:

- Connect the camera to a printer and print photographs directly from the camera (📷 63).
- Insert the memory card in a printer equipped with a card slot (see the printer manual for details). If the printer supports DPOF (📷 128), photographs can be selected for printing using **Print Set** (📷 67).
- Take the memory card to a developer or digital print center. If the center supports DPOF (📷 128), photographs can be selected for printing using **Print Set** (📷 67).
- Transfer the pictures using PictureProject and print them from a computer (see the *PictureProject Reference Manual*, on CD).

Note that RAW photographs can only be printed by transferring them to a computer and printing them using Nikon Capture 4 Version 4.3 or later (available separately) or PictureProject.

## Printing Via Direct USB Connection

When the camera is connected to a printer that supports PictBridge (📷 128), photographs can be printed directly from the camera.

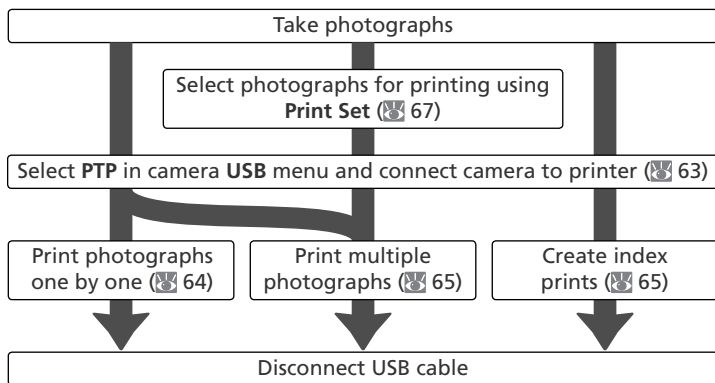

### 🔧 Printing Via Direct USB Connection

If possible, use the EH-5 AC adapter when printing to reduce the drain on the camera battery. When taking photographs to be printed without modification in **P**, **S**, **A**, and **M** modes, choose **Direct Print** for **Optimize image** (📷 48) or select **Custom** and set **Color mode** to **Ia (sRGB)** or **IIIa (sRGB)** (the default option).



## Connecting the Printer

- 1 Set the **USB** option in the setup menu to **PTP** (71).

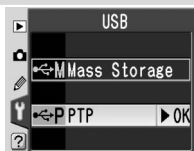

- 2 Turn the printer on.

- 3 Turn the camera off and connect the supplied USB cable as shown. Do not use force or attempt to insert the connectors at an angle. Connect the camera directly to the printer; do not connect the cable via a USB hub.

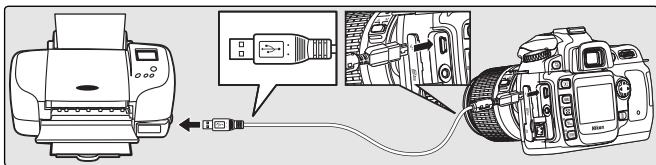

- 4 Turn the camera on. A welcome screen will be displayed, followed by the PictBridge playback display. Proceed to "Printing Photographs One at a Time" (64) or "Printing Multiple Photographs" (65).



Press the multi selector left or right to view additional photographs, or press and hold the **ENTER** button to zoom in on the current photo (66). To view six photographs at a time, press the **6x** button. Use the multi selector to highlight photographs, or press the **6x** button again to display the highlighted photograph full frame.

## Printing Pictures One at a Time

To print the photograph selected in the PictBridge playback display, press and release the **ENTER** button. The menu shown at right will be displayed. Press the multi selector up or down to highlight an option and press to the right to select.

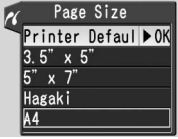
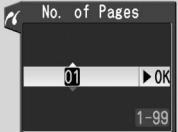
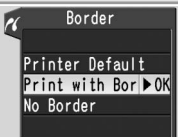
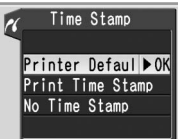

Option	Description
<b>Start Printing</b>	Print selected picture. To cancel and return to PictBridge playback display before all images have been printed, press <b>ENTER</b> button. PictBridge playback display will be shown when printing is complete. Print additional pictures as described above or turn camera off and disconnect USB cable.
<b>Page Size</b>	Page sizes for current printer will be displayed. Press multi selector up or down to highlight desired page size, then press multi selector to right to select and return to print menu. 
<b>No. of Pages</b>	Menu shown at right will be displayed. Press multi selector up or down to choose number of copies (maximum 99), then press multi selector to right to select and return to print menu. 
<b>Border</b>	Menu shown at right will be displayed. Press multi selector up or down to highlight <b>Printer Default</b> (default setting for current printer), <b>Print with Border</b> (print photo with white border), or <b>No Border</b> , then press multi selector to right to select and return to print menu. 
<b>Time Stamp</b>	Menu shown at right will be displayed. Press multi selector up or down to highlight <b>Printer Default</b> (default setting for current printer), <b>Print Time Stamp</b> (print time and date of recording on photo), or <b>No Time Stamp</b> , then press multi selector to right to select and return to print menu. 

### Paper Size

The camera supports the following page sizes: **Printer Default** (the default page size for the current printer), **3.5"x5"**, **5"x7"**, **Hagaki**, **100mmx150mm**, **4"x6"**, **8"x10"**, **Letter**, **A3**, and **A4**. Only sizes supported by the current printer will be displayed.

### Border and Time Stamp

Choose **Printer Default** to print at current printer settings.

Option	Description
<b>Cropping</b>	Menu shown at right will be displayed. Press multi selector up or down to highlight <b>Crop</b> (crop photo for printing) or <b>No Cropping</b> , then press multi selector to right.
	If <b>Crop</b> is selected, dialog shown at right will be displayed; rotate command dial to choose size of crop and use multi selector to choose position of crop. Press <b>ENTER</b> to return to print menu.

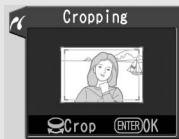
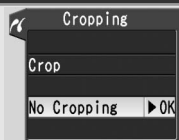

## Printing Multiple Pictures

To print multiple selected pictures or to create an index print listing all JPEG photographs as small thumbnail images, press the **MENU** button. The menu shown at right will be displayed. Press the multi selector up or down to highlight an option and press to the right to select.

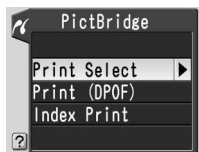

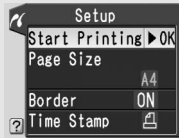

Option	Description
<b>Print Select</b>	Print selected pictures (66).
<b>Print (DPOF)</b>	Print current DPOF print order (67).
<b>Index Print</b>	Create index print of all JPEG photos (if memory card contains more than 256 photos, only 256 photos will be printed). Press <b>ENTER</b> button to display menu shown below at right; choose page size, border, and time stamp options as described on page 64 (warning will be displayed if selected page size is too small). To start printing, highlight <b>Start Printing</b> and press multi selector right. PictBridge menu will be displayed when printing is complete.



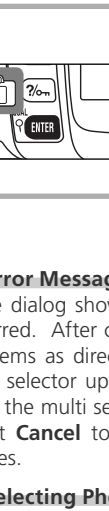

## Printing Selected Photographs

Choosing **Print Select** in the PictBridge menu (see above) displays the menu shown in Step 1.

**1**  

Scroll through pictures. To display current picture full screen, press  button.\*

**2**  

Select current picture and set number of prints to 1. Selected pictures marked by  icon.

\* To print photos in print order created with **Print Set** ( 67), select **Print (DPOF)** in PictBridge menu. Print order can be modified as described on this page.

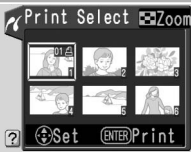
**3**  

Specify number of prints (up to 99). To deselect picture, press multi selector down when number of prints is 1. Repeat steps 1–3 to select additional pictures.

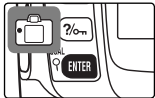
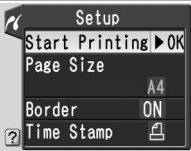
**4**  

Display print options. Choose page size, border, and time stamp options as described on page 64. To print selected pictures, highlight **Start Printing** and press multi selector right. PictBridge menu will be displayed when printing is complete.

### Error Messages

If the dialog shown at right is displayed, an error has occurred. After checking the printer and resolving any problems as directed in the printer manual, press the multi selector up or down to highlight **Continue** and press the multi selector to the right to resume printing. Select **Cancel** to exit without printing the remaining images.

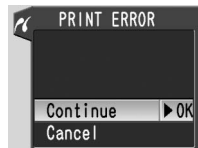

### Selecting Photographs for Printing

NEF (RAW) photos and pictures created using the small picture option ( 86) are displayed in the Print Selected menu but can not be selected for printing.

## Print Set

The **Print Set** option in the playback menu is used to create digital “print orders” for PictBridge-compatible printers and devices that support DPOF. Selecting **Print Set** from the playback menu (📖 83) displays the menu shown in Step 1.

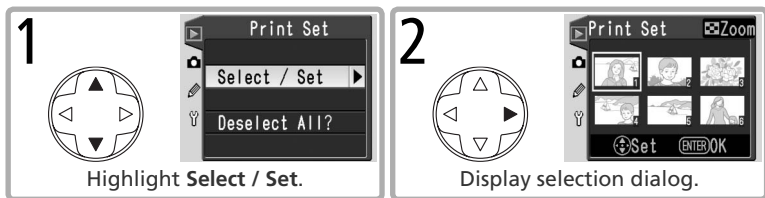

**3** Select pictures and specify number of prints as described in Steps 1–3 on previous page.

**4** Return to **Print Set** menu. To select or deselect options, highlight and press multi selector to right. Selected items are marked with a ✓.

- **Data Imprint:** Print shutter speed and aperture on all pictures in print order.
- **Imprint Date:** Print date of recording on all pictures in print order.

To complete print order and return to playback, highlight **Done** and press multi selector right. To exit without altering print order, press **MENU** button.

### 📄 Print Set

NEF (RAW) photos and pictures created using the small picture option (📖 86) are displayed in the **Print Set** menu but can not be selected for printing. Note that the **Print Set** option may not be available if there is not enough space on the memory card to store the print order. After creating a print order, do not change the hidden status of images in the print order or use a computer or other device to delete images. Either action could cause problems during printing.

# Setup

## Basic Camera Settings

The Setup Menu

The setup menu contains the following options.

Option	Page
Format	68
CSM/Setup Menu	69
Date	69
LCD Brightness	69
Video Mode	69
Language (LANG)	70
Image Comment	70
USB	71



Select Detailed (69) to display the following additional options:

Option	Page
Folders	71
File No. Seq.	73
Mirror Lock-Up	116
Dust Ref Photo	74
Firmware Ver.	75
Image Rotation	75

### Format

Formats the memory card. Note that this permanently deletes all photographs and any other data the card may contain. Copy all required files to a computer before formatting.

#### Formatting Memory Cards

Do not turn the camera off or remove the memory card while formatting is in progress.



## CSM/Setup Menu

Choose **Simple** to display only basic options in the Custom Settings (87) and setup menus (68), **Detailed** to list all options.

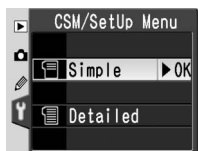

## Date

Set the camera clock (10). Nikon recommends resetting the clock monthly.

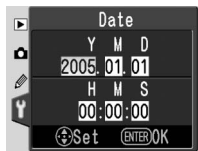

## LCD Brightness

Adjust monitor brightness.

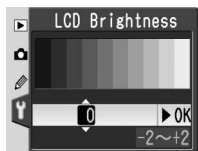

## Video Mode

Before connecting your camera to a video device such as a television or VCR, choose a video mode setting that matches the video standard used in the device.

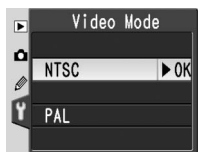

## The Clock Battery

The clock-calendar is powered by an independent, rechargeable power source, which is charged as necessary when the main battery is installed or the camera is powered by an optional EH-5 AC adapter. Three days of charging will power the clock for about one month. If the **CLOCK** icon flashes in the control panel, the clock battery is exhausted and the clock has been reset. Set the clock to the correct date and time.

## Language (LANG)

Choose from the following languages:

De <b>Deutsch</b>	German	Po <b>Português</b>	Portuguese
En <b>English</b>	English	Pу <b>Русский</b>	Russian
Es <b>Español</b>	Spanish	Sv <b>Svenska</b>	Swedish
Fr <b>Français</b>	French	繁 中文(繁體)	Traditional Chinese
It <b>Italiano</b>	Italian	簡 中文(简体)	Simplified Chinese
Ne <b>Nederlands</b>	Dutch	日 日本語	Japanese
		한 한글	Korean



## Image Comment

Add brief text comments to photographs as they are taken. Comments can be viewed when the photographs are displayed using PictureProject or Nikon Capture 4 Version 4.3 or later. The first twelve letters of the comment are also visible on the third page of the photo information display (52).

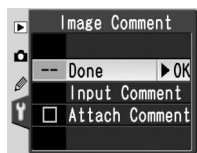

**Done:** Save changes and return to the setup menu.

**Input comment:** The following dialog will be displayed. Enter a comment as described below.

**Keyboard area:** Use multi selector to highlight letters, press **OK** button to select.

**Comment area:** Comment appears here. To move cursor, press **Left** button and use multi selector.



To delete the character at the current cursor position, press the **Right** button. To return to the setup menu without changing the comment, press the **MENU** button.

Comments can be up to thirty-six characters long. Any additional characters will be deleted.

After editing the comment, press **ENTER** to return to the image comment menu.

**Attach comment:** A comment is added to all photographs taken when this option is checked (✓). Highlight this option and press the multi selector to the right to toggle the check mark on or off.



## USB

Choose a USB option for connection to a computer or PictBridge printer. Choose **PTP** when connecting to a PictBridge printer or using the Camera Control function in Nikon Capture 4 Version 4.3 (available separately). See “Viewing Photographs on a Computer” for information on selecting a USB option for use with PictureProject (📖 59).



## Folders

Create, rename, or delete folders and to choose the folder in which new photographs will be stored.

### Select Folder

Choose the folder in which subsequent images will be stored.



### Folder Names

On the memory card, folder names are preceded by a three-digit folder number assigned automatically by the camera (e.g., 100NCD50). Each folder can contain up to 999 photographs. If a photograph is taken when the current folder contains 999 files or a picture numbered 9999, the camera will create a new folder by adding one to the current folder number (e.g., 101NCD50). For the purposes of selection and naming, all folders with the same name are treated as the same folder. For example, if the folder NIKON is selected, pictures in all folders named NIKON (100NIKON, 101NIKON, 102NIKON, etc.) will be visible when **Current** is selected in the **Playback Fldr** menu (📖 84). Renaming similarly applies to all folders with the same name. During shooting, pictures are stored in the highest-numbered folder with the selected name.

## New

Create a folder with a new name as described in “Naming Folders,” below.

## Rename

Rename an existing folder. Select the folder from a list of existing folders and rename it as described in “Naming Folders,” below.

## Delete



Delete all empty folders on the memory card.

### Naming Folders

**Keyboard area:** Use multi selector to highlight letters, press  button to select.

**Name area:** Folder name appears here. To move cursor, press  button and use multi selector.



To delete the character at the current cursor position, press the  button. To exit without changing the folder name, press the  button.

Folder names can be up to five characters long. Any additional characters will be deleted.

After editing the folder name, press  to return to the setup menu.

## File No. Seq.

Choose how the camera names files.

- **Off** (default): File numbering is reset to 0001 when a new folder is created, the memory card is formatted, or a new memory card is inserted in the camera.
- **On**: When a new folder is created, the memory card is formatted, or a new memory card is inserted in the camera, file numbering continues from the last number used. If a photograph is taken when the current folder contains a photograph numbered 9999, a new folder will be created and file numbering will begin again from 0001.
- **Reset**: As for **On**, except that file numbering is reset to 0001 with the next photograph taken (a new folder will be created if the current folder already contains photographs).



## Mirror Lock-up

Lock the mirror in the up position for inspection or cleaning of the low-pass filter that protects the image sensor (🔒 116).

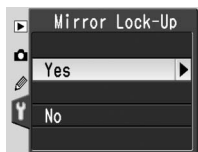

### File Numbering

If the current folder is numbered 999 and contains 999 photographs or a photograph numbered 9999, the shutter release will be disabled. If **File No. Seq.** is on, turn it off, then format the memory card or insert another memory card in the camera.

## Dust Ref Photo

Acquire reference data for the Image Dust Off function in Nikon Capture 4 Version 4.3 or later (available separately; for more information, see the *Nikon Capture 4 User's Manual*).



- 1 Highlight **Yes** and press the multi selector to the right. The message shown at right will be displayed, and **rEF** will be displayed in the control panel and viewfinder.

To cancel the operation and return to the setup menu, press the **MENU** button.

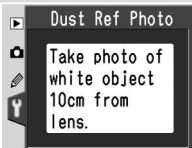

- 2 With the lens ten centimeters (four inches) from a bright, featureless white object, frame the object so that nothing else is visible in the viewfinder and press the shutter-release button halfway. In autofocus mode, focus will automatically be set to infinity; in manual focus mode, set focus to infinity manually before pressing the shutter-release button.

- 3 Press the shutter-release button the rest of the way down to acquire Image Dust Off reference data. The monitor turns off when the shutter-release button is pressed.

If the reference object is too bright or too dark, the camera may be unable to acquire Image Dust Off reference data and the message shown at right will be displayed. Choose another reference object and repeat the process from Step 1.



## Firmware Ver.

View the current camera firmware version.

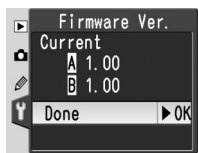

## Image Rotation

Photographs taken while **Automatic** (the default option) is selected contain information on camera orientation, allowing them to be rotated automatically during playback (84) or when viewed in PictureProject or Nikon Capture 4 Version 4.3 or later (available separately).\* The following orientations are recorded:

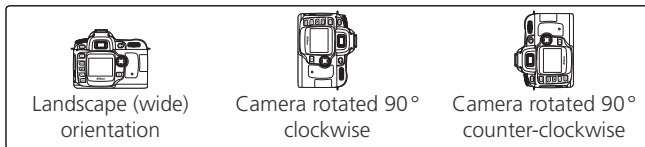
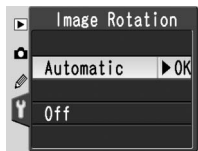

\* In continuous mode (21), orientation recorded for first shot applies to all images in same burst, even if camera orientation is changed during shooting.

Camera orientation is not recorded when **Off** is selected. Choose this option when taking photographs with the lens pointing up or down.

## Image Dust Off

Dust Ref Photo is only available with CPU lenses. A lens with a focal length of at least 50mm is recommended (105). If using a zoom lens, zoom all the way in.

The same reference image can be used for other photographs taken with different lenses or at different apertures. Reference images can not be viewed using computer imaging software. A grid pattern is displayed when reference images are viewed on the camera.



# Shooting Options

The Shooting Menu

Adjustments to shooting options are made from the shooting menu (📷 26).



Option	Description	Page
<b>Optimize Image</b>	Optimize images for type of scene.	48, 76
<b>Long Exp. NR</b>	Reduce noise at slow shutter speeds.	78
<b>Image Quality</b>	Choose file type and compression ratio.	31
<b>Image Size</b>	Choose image size.	32
<b>White Balance</b> <sup>1</sup>	Adjust colors according to color of light source.	49, 79
<b>ISO</b> <sup>2</sup>	Raise sensitivity when lighting is poor.	39

1 Available in **P**, **S**, **A**, and **M** modes only.

2 Available in **P**, **S**, **A**, and **M** modes and when **Off** is selected for Custom Setting 9 (**ISO Control**) in 📷, 📷, 📷, 📷, 📷, 📷, and 📷 modes.

## Optimize Image

See “Optimizing Images” (📷 48) for more information.



## Optimize Image > Custom

To make separate adjustments to sharpening, contrast, color reproduction, saturation, and hue, select **Custom** for **Optimize Image**.



### Sharpening

Choose the degree to which outlines are sharpened. The default setting is **Auto**.

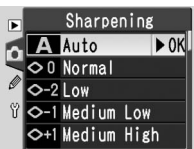

### Tone Comp.

Choose the amount of contrast. The default setting is **Auto**; a setting of Custom is available to select a user-defined tone curve downloaded to the camera using Nikon Capture 4 Version 4.3 or later (available separately). See the Nikon Capture 4 manual for details.



### Color Mode

Choose from the following options for color reproduction:

Option	Description
<b>III a (sRGB)</b> (default)	Produces nature and landscape shots with vivid colors. Photographs are adapted to sRGB color space.
<b>Ia (sRGB)</b>	Produces portraits with soft, natural colors. Photographs are adapted to sRGB color space.
<b>II (Adobe RGB)</b>	Photographs taken at this setting are adapted to Adobe RGB color space. This color space is capable of expressing wider gamut of colors than sRGB, making it preferred choice for images that will be extensively processed or retouched.

### Saturation

Control the vividness of colors. The default setting is **Normal**.



#### "Auto"

If **Auto** is selected for **Sharpening** or **Tone Comp.**, results will vary with exposure and the position of the subject in the frame. A type G or D lens is recommended.

#### Color Mode

Choose the "Adobe RGB" color profile when using imaging software to open photographs taken in Mode II. See the software documentation for details. Modes IIIa and Ia are recommended for photographs that will be printed without modification or viewed in applications that do not support color management.

## Hue Adjustment

Hue can be adjusted from the default setting of 0° in increments of 3°. Taking red as an example, raising hue introduces a yellow cast, making reds more orange. Lowering hue introduces a blue cast, making reds more purple.

## Long Exp. NR

Photographs taken at slow shutter speeds are subject to “noise” (randomly-spaced, brightly-colored pixels that tend to appear predominantly in shadows). If **On** is selected, photos taken at shutter speeds slower than about 1 s will be processed to reduce noise before being recorded to the memory card (the default setting is **Off**). Note that the time required to process images more than doubles when noise reduction is on; during processing, the display shown at right appears in the control panel and viewfinder. The next photo can be taken when the display stops blinking.



## Image Quality

See “Image Quality and Size” (📷 31) for more information.



## Image Size

See “Image Quality and Size” (📷 32) for more information.





## White Balance

See “White Balance” (📖 49) for more information.

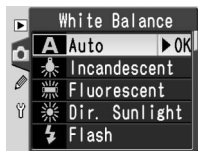

## White Balance > Preset



Preset white balance is used to record and recall custom white balance settings for shooting under mixed lighting, to compensate for light sources with a strong color cast, or to replicate the white balance used in an existing photo. Two methods are available for setting preset white balance:

Option	Description
<b>Measure</b>	Neutral gray or white object is placed under lighting that will be used in final photograph and white balance is measured by camera.
<b>Use Photo</b>	White balance value is copied from photo on memory card (note that Nikon Capture 4 Version 4.3 or later can be used to adjust white balance of existing pictures if desired).

### Measuring a Value for White Balance

The existing measured value is lost when a new value is measured. The value for **Use Photo** is unaffected.

**1** Place a neutral gray or white object under the lighting that will be used in the final photograph. For more accurate results, use an 18% diffusion panel to make the reference object appear gray.

**2** Select **Measure**.

- 3 Press the shutter-release button halfway to return to shooting mode.



- 4 Press the **WB** button until a blinking **PrE** appears in the control panel and viewfinder.

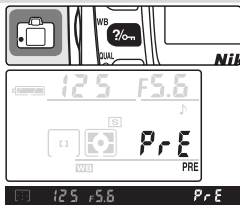

- 5 Frame the reference object so that it fills the viewfinder and press the shutter-release button all the way down. No photograph will be recorded; white balance can be measured accurately even when the camera is not in focus.

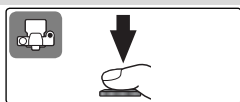

To exit without measuring a new value for white balance, press the **WB** button.

- 6 If the camera was able to measure a value for white balance, **Good** will flash in the control panel, while the viewfinder will show a flashing **Gd**. White balance is set to the new value, and the new value will be used whenever **Preset > Measure** is selected for white balance.



If lighting is too dark or too bright, the camera may be unable to measure white balance. A flashing **no Gd** will appear in the control panel and viewfinder. Return to Step 4 and measure white balance again.



## Copying White Balance from a Photograph

Selecting a new source photograph overwrites any white balance values previously selected with **Use Photo**. The value for **Measure** is unaffected.

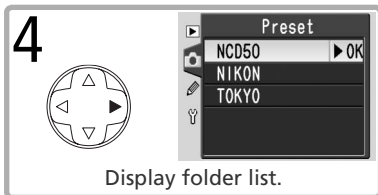
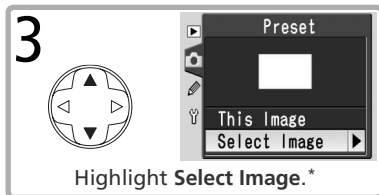
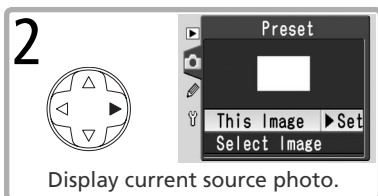
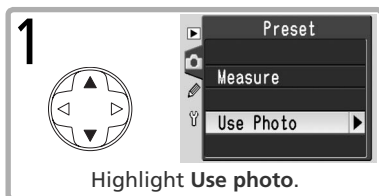

\* Select **This Image** to use white balance value for current photo.

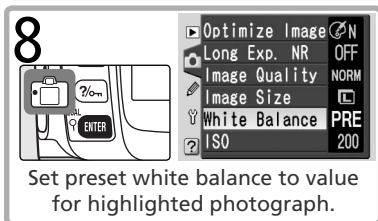
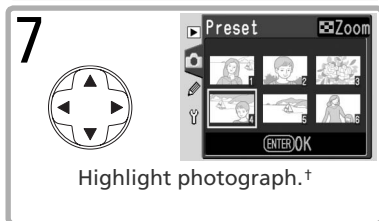

† Images displayed may include those created by other cameras, but only photographs created with D50 can be used as source for preset white balance.

## ISO

See “Sensitivity (ISO Equivalency)” (📷 39) for more information.



# Playback Options

## The Playback Menu

Adjustments to playback options are made from the playback menu (26). Note that the playback menu is only displayed when a memory card is inserted.

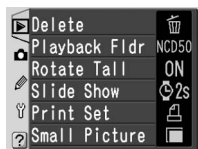

Option	Description	Page
<b>Delete</b>	Delete all or selected photos.	84
<b>Playback Fldr</b>	Choose folder for playback.	84
<b>Rotate Tall</b>	Rotate portrait ("tall") orientation photos for playback.	84
<b>Slide Show</b>	Play photos back in automatic slide show.	85
<b>Print Set</b>	Select photos for printing.	67, 86
<b>Small Picture</b>	Create small copies of photos.	86

### Selecting Multiple Pictures

To select multiple pictures in the **Delete > Selected** (84), **Print Set > Select/Set** (67, 86), **Small Picture** (86), or **Print Select** (66) menus:

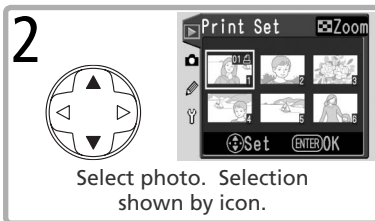
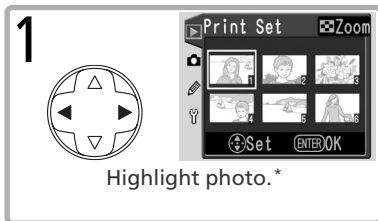

\* Press and hold  button to view selected photo full frame. Thumbnail display restored when button is released.

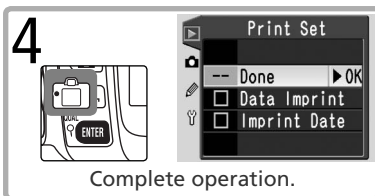
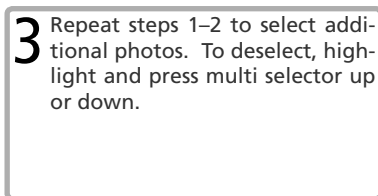



## Delete

Choose from:

Option	Description
<b>Selected</b>	Delete selected photos.
<b>All</b>	Delete all photos.



Note that photographs marked with an  icon are protected and can not be deleted ( 56). More time may be required if the number of photographs to be deleted is very large.

## Playback Fldr

Choose the folder from which photographs will be played back.

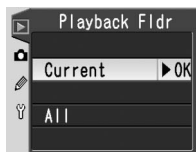

Option	Description
<b>Current</b>	Only images in folder currently selected for storage in setup <b>Folders</b> menu are displayed during playback (  51). This option is selected automatically when photo is taken. If memory card is inserted and this option selected before photos have been taken, message stating that folder contains no images will be displayed during playback. Select <b>All</b> to begin playback.
<b>All</b>	View photos in all folders.

## Rotate Tall

Select **Yes** to rotate portrait-orientation (“tall”) photographs for display in the monitor. Photographs taken with **Off** selected for **Image Rotation** ( 75) will be displayed in landscape (“wide”) orientation.

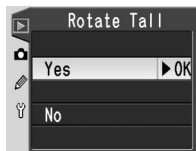





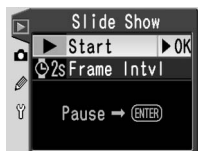

## Slide Show

View photographs in an automated slide show (see “Playback Fldr” for information on choosing the folder from which photographs will be played back;  84).



### Start

Start the slide show. The following operations can be performed during a slide show:

To	Use	Description
Go forward or back one frame		Press multi selector left to return to previous frame, right to skip to next frame.
View photo info		Change photo info displayed during slide show.
Pause		Pause slide show (see below).
Exit to playback menu		End slide show and display playback menu.
Exit to playback mode		End slide show and return to single-image or thumbnail playback.
Exit to shooting mode		Press shutter-release button halfway to turn monitor off and return to shooting mode.

The dialog shown at right is displayed when the show ends or when the  button is pressed to pause playback. Select **Restart** to restart the show or **Exit** to return to the playback menu.

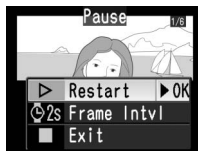

### Frame Intvl

Choose how long each slide is displayed. The default setting is 2 s.



---

## Print Set

Choose **Select/Set** to select photographs for printing on a PictBridge printer or DPOF-compatible device (📷 128). Choose **Deselect All** to remove all photos from the current print order.

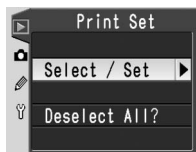

---

## Small Picture

Create small JPEG copies of selected pictures for e-mail or the web. Choose **Select Pictures** to select the pictures (📷 83) and select **Choose Size** to choose a size from **640 × 480**, **320 × 240**, **160 × 120**. A 640 × 480 pixel copy is about one-twentieth the size of a Large (3,008 × 2,000) photo.



### **Small Picture**

During playback, small copies are indicated by a gray border. Copies can only be created if sufficient memory is available. Small copies may not display or transfer correctly when viewed on other models of Nikon camera.



# Custom Settings

## The Custom Settings Menu

Custom Settings are used to customize camera settings to suit individual preferences.



Option	Value
R Menu Reset	87
1 Beep	88
2 Autofocus	88
3 AF-Area Mode	89

Option	Value
4 No SD Card?	90
5 Image Review	90
6 Flash Level	38, 90

To display the following options, select **Detailed** for the **CSM/Setup Menu** option in the setup menu (69):

Option	Value
7 AF Assist	90
8 AF Area Illm	91
9 ISO Control	91
10 ISO Auto	92
11 EV Step	92
12 BKT Set	93
13 Metering	96

Option	Value
14 AE-L/AF-L	98
15 AE Lock	99
16 Flash Mode	99
17 Monitor Off	100
18 Meter Off	100
19 Self-Timer	100
20 Remote	100

## R: Menu Reset

Select **Reset** to restore all Custom Settings (including those that are not affected by a two-button reset; 50) to their default values. See pages 101–103 for a complete list of default settings.

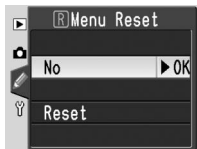

## 1: Beep

At the default setting of **On**, a beep will sound while the release timer is running in self-timer and delayed remote modes (👁️ 22), when a photograph is taken in quick-response remote mode (👁️ 22), or when the camera has focused in single-servo AF (👁️ 88). The beep will not sound when **Off** is selected. The current setting is shown in the control panel: 🎵 for **On** and 🚫 for **Off**.



## 2: Autofocus

Choose from:

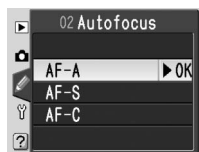

Option	Description
<b>AF-A</b> (default)	Camera selects AF-S or AF-C mode automatically according to shooting conditions and whether the subject is moving.
<b>AF-S</b>	Single-servo AF. Focus locks when shutter-release button is pressed halfway. Use with stationary subjects.
<b>AF-C</b>	Continuous-servo AF. Camera focuses continuously while shutter-release button is pressed halfway; AF-assist illuminator turns off. Use with moving subjects.

This option takes effect only in P, S, A, and M modes. The current autofocus mode is shown in the control panel when **AF-S** or **AF-C** is selected. No icon is displayed in AF-A mode.

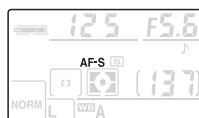

### 👁️ Focus Lock (Continuous-Servo AF)

The  button can be used to lock focus when **AF-C** is selected.

### 3: AF-Area Mode

Choose how the camera focuses in autofocus mode.



Option	Description
[□] <b>Single Area</b> <sup>1</sup>	User selects focus area manually (Ⓜ 33); camera focuses on subject in selected focus area only. Use for stationary subjects.
[•••] <b>Dynamic Area</b> <sup>2</sup>	User selects focus area manually (Ⓜ 33), but camera uses information from multiple focus areas to determine focus. If subject leaves selected focus area even briefly, camera will focus based on information from other focus areas. Use with erratically moving subjects.
[📷] <b>Closest Subject</b> <sup>3</sup>	Camera automatically selects focus area containing subject closest to camera. If subject leaves active focus area, camera will focus based on information from other focus areas. Works best when there is contrast between subject and background.

1 Default for P, S, A, M, and 📷 modes.

2 Default for 📷 mode.

3 Default for 📷, 📷, 📷, 📷, and 📷 modes.

The current AF-area mode is displayed in the control panel and viewfinder (icon shows active focus area).

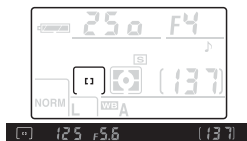

#### AF-Area Mode

Choose **Single Area** or **Dynamic Area** when using focus lock.

## 4: No SD Card?

At the default setting of **Release Locked**, the shutter-release button is only enabled when a memory card is inserted. Choose **Enable Release** to enable the shutter-release button when no memory card is inserted. Photographs will be displayed in the monitor but will not saved.



## 5: Image Review

This option determines whether photographs are automatically displayed in the monitor after shooting (**On**, the default option) or only when the  button is pressed (**Off**).



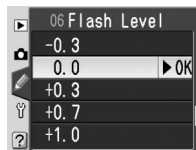

## 6: Flash Level

Adjust flash level (**P**, **S**, **A**, and **M** modes only;  38). The default setting is 0.



## 7: AF Assist

At the default setting of **On**, the AF-assist lamp lights automatically when required to assist the focus operation. The AF-assist lamp will not light when **Off** is selected or when the camera is focusing using continuous-servo autofocus ( 88). This option is not available in  and  modes.



## 8: AF Area III m

At the default setting of **Auto**, the active focus area will be highlighted in red in the viewfinder as needed to establish contrast with the background. The active focus area will not light if **Off** is selected; if **On** is selected, the focus area will light regardless of the brightness of the background (this may make it difficult to see the focus active focus area against a bright background).



## 9: ISO Control

At the default setting of **On**, the camera will automatically adjust sensitivity (ISO equivalency) to help achieve optimal exposure in **AUTO**, **S**, **A**, **M**, **L**, **P**, **S**, **A**, and **M** modes. **ISO AUTO** will be displayed in the control panel and viewfinder. Select **Off** to choose a value for sensitivity using the **ISO** option in the shooting menu (39). This option is not available in **P**, **S**, **A**, and **M** modes.

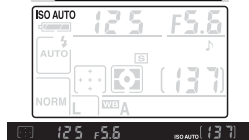

### “ISO Control” “ISO Auto”

These settings determine how sensitivity is set:

	Mode	
	AUTO, S, A, M, L, P, S, A, M	P, S, A, M
Camera sets sensitivity	<b>9: ISO Control &gt; On</b>	—
User sets sensitivity	<b>9: ISO Control &gt; Off</b>	<b>10: ISO Auto &gt; Off</b>
	<b>10: ISO Auto &gt; Off</b>	
User sets sensitivity; camera adjusts for optimal exposure	<b>9: ISO Control &gt; Off</b>	<b>10: ISO Auto &gt; On</b>
	<b>10: ISO Auto &gt; On</b>	

The sensitivity value displayed when the **ISO** button is pressed is the value selected by the user. Values selected automatically by the camera are not displayed (39).

## 10: ISO Auto

At the default setting of **Off**, sensitivity (ISO equivalency) will remain fixed at the value selected by the user (39). If **On** is selected, the camera will automatically choose a sensitivity between ISO 200 and 1600 if optimal exposure can not be achieved at current settings. An **ISO AUTO** icon is displayed in the control panel and viewfinder; this icon will blink when sensitivity is altered from the value selected by the user.

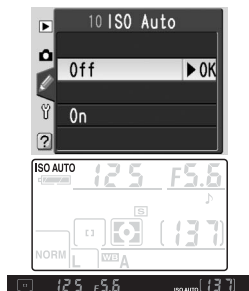

Selecting **On** displays the menu shown at right. In **P**, **A**, **AUTO**, **SPORTS**, **SCN**, **SPORTS**, **SPORTS**, and **SPORTS** modes, the user can choose a maximum shutter speed. If the shutter speed would exceed this value at the sensitivity selected by the user, the camera will automatically raise sensitivity to compensate. Select **P**, **A**, **DVP mode** to choose a maximum shutter speed (the default is  $\frac{1}{30}$ s). Select **Done** to exit to the CSM menu.

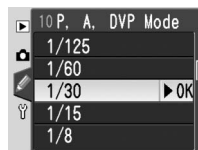

## 11: EV Step

Choose whether the camera makes adjustments to shutter speed, aperture, exposure compensation, bracketing, and flash compensation in increments equivalent to  $\frac{1}{3}$ EV (**1/3 Step**, the default option) or  $\frac{1}{2}$ EV.



## 12: BKT Set

In **P**, **S**, **A**, and **M** modes, the camera offers the following bracketing options:



Option	Description
<b>Off</b> (default)	No bracketing performed.
<b>AE &amp; Flash</b>	Camera varies exposure and flash level over three shots, "bracketing" optimal exposure value.
<b>WB Bracketing</b>	Camera creates three images each time shutter is released, "bracketing" current white balance setting. Not available at image qualities of <b>NEF (Raw)</b> or <b>NEF+JPEG Basic</b> .

### Exposure and Flash Bracketing

- 1 Highlight **AE & Flash** and press the multi selector to the right.



- 2 Highlight a bracketing increment and press the multi selector to the right. The settings available depend on the option selected for Custom Setting 11 (**EV Step**).



- 3 Press the shutter-release button halfway to exit to shooting mode. The display shown at right will appear in the control panel and viewfinder.

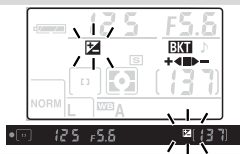

**4** Take a series of three photographs. The first photograph will be taken at optimal exposure, the second will be underexposed by the selected exposure increment, and the third overexposed by the same amount. A segment will disappear from the bracketing progress indicator after each shot. Repeat Steps 3–4 to record additional bracketing sequences.

To end bracketing when shooting is complete, select **Off** for Custom Setting 12.

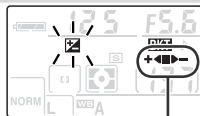

- +◀▶— Start
- +◀▶— After 1st shot
- +◀▶— After 2nd shot
- +◀▶— After 3rd shot
- +◀▶— Series complete

### Exposure and Flash Bracketing

In continuous mode, shooting will stop after each series of three photographs. Bracketing is not cancelled when the camera is turned off or the memory card is exchanged. Bracketing will however be cancelled if the user selects a mode other than **P**, **S**, **A**, or **M**.



## White Balance Bracketing

- 1 Highlight **WB Bracketing** and press the multi selector to the right.



- 2 Highlight a bracketing increment and press the multi selector to the right.

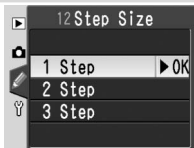

- 3 Press the shutter-release button halfway to exit to shooting mode. The display shown at right will appear in the control panel and viewfinder.

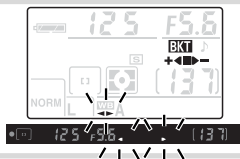

- 4 Compose a photograph, focus, and shoot. Each photograph will be processed to create three images, the first with unmodified white balance, the second with slightly warmer colors, and the third with slightly colder colors. Repeat Steps 3–4 to record additional bracketing sequences.

To end bracketing when shooting is complete, select **Off** for Custom Setting 12.



### White Balance Bracketing

The shutter is released only once each time the shutter-release button is pressed, even in continuous mode. Each shot is processed to create three separate images.

## 13: Metering

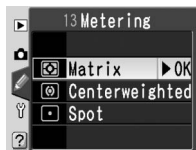
In **P**, **S**, **A**, and **M** modes, metering determines how the camera sets exposure.



Option	Description
 <b>Matrix</b> (default)	Camera meters wide area of frame and instantly sets exposure based on composition, distance, shading, and color. Produces natural-looking results in almost any situation.
 <b>Center-weighted</b>	Camera meters entire frame but assigns greatest weight to center. Classic meter for portraits.
 <b>Spot</b>	Camera meters active focus area only (if <b>Closest Subject</b> is selected for <b>AF-Area Mode</b> , camera meters center focus area). Ensures that main subject will be correctly exposed, even when background is much brighter or darker.

### Metering

Metering is available with CPU lenses only. If a type G and D lens is used when matrix metering is selected, the camera will set exposure using the full range of information available from its 420-segment RGB sensor (*3D color matrix metering II*). *Color matrix metering II* is used with other CPU lenses.

## Autoexposure Lock

If the subject is not in the metered area when center-weighted or spot metering is used, exposure will be based on lighting conditions in the background, and the main subject may not be correctly exposed. This can be prevented using autoexposure lock:

**1** Rotate the mode dial to **P**, **S**, or **A** and select center-weighted or spot metering (exposure lock has no effect in mode **M**).

**2** Position the subject in the selected focus area and press the shutter-release button halfway (when using center-weighted metering, position the subject in the center focus area). With the shutter-release button pressed halfway and the subject still positioned in the focus area, press the **AE-L/AF-L** button to lock exposure. Confirm that the in-focus indicator (●) appears in the viewfinder.

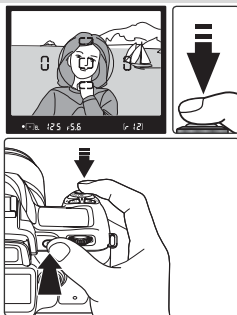

While exposure lock is in effect, an **EL** indicator will appear in the viewfinder.

**3** Without releasing the **AE-L/AF-L** button, re-compose the photograph and shoot.

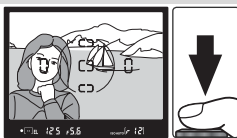

## Adjusting Shutter Speed and Aperture

While exposure lock is in effect, the following settings can be changed without altering the metered value for exposure:

Mode	Description
<b>P</b>	Shutter speed and aperture (flexible program;  42)
<b>S</b>	Shutter speed
<b>A</b>	Aperture

## Advanced Settings

**14: AE-L/AF-L** controls the function performed by the **AE-L/AF-L** button ( 98).

**15: AE Lock** controls whether exposure locks when the shutter-release button is pressed halfway ( 99).

## 14: AE-L/AF-L

Choose the function performed by the **AE-L/AF-L** button.



Option	Description
<b>AE/AF Lock</b> (default)	Pressing button locks both focus ( 34) and exposure ( 97).
<b>AE Lock Only</b>	Pressing button locks exposure only ( 97).
<b>AF Lock Only</b>	Pressing button locks focus only ( 34).
<b>AE Lock Hold</b>	Exposure locks when button is pressed and remains locked until button is pressed again ( 97).
<b>AF AF-ON</b>	Camera focuses when button is pressed. Camera does not focus when shutter-release button is pressed halfway.
<b>FV Lock</b>	Flash level locks when button is pressed and remains locked until button is pressed again (see below).

### FV Lock

This feature is used to recompose photographs without changing the metered flash value, ensuring that flash level is appropriate to the subject even when the subject is not in the center of the frame.

- 1 Highlight **FV Lock** and press the multi selector to the right.



- 2 Press the shutter-release button halfway to exit to shooting mode. In **P**, **S**, **A**, and **M** modes, press the button to raise the flash.

- 3 Position the subject in the center of the frame and press the shutter-release button halfway.

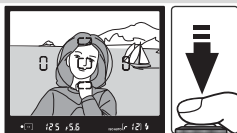

- 4 Confirm that the flash-ready indicator is displayed in the viewfinder and press the **AE-L/AF-L** button. The built-in flash will emit a low-intensity pulse to determine the appropriate flash level. Flash output will be locked at this level and an **EL** icon will be displayed in the viewfinder.

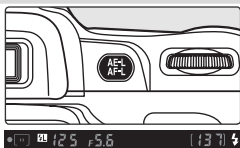

- 5 Recompose the photograph and shoot. If desired, additional pictures can be taken without releasing FV lock. When shooting is complete, press the **AE-L/AF-L** button to release FV lock.

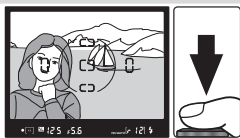



## 15: AE Lock

At the default setting of **AE-L Button**, exposure can only be locked by pressing the **AE-L/AF-L** button (97). If **+Release Bttn** is selected, exposure will also lock when the shutter-release button is pressed halfway.



## 16: Flash Mode

At the default setting of **TLL**, the camera adjusts flash level automatically in response to shooting conditions. Selecting **Manual** allows the user to select the flash level for **P**, **S**, **A**, and **M** modes from the menu shown below at right (at full power, built-in flash has a Guide Number [m/ft] of 17/56 [ISO 200] or 12/39 [ISO 100]).   icons will blink in the control panel and viewfinder when **Manual** is selected.

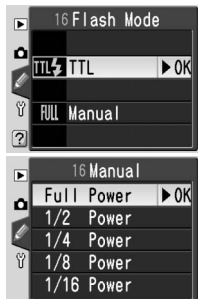

## 17: Monitor Off

Choose how long the monitor will remain on when no operations are performed. The default setting is 20s.



## 18: Meter Off

Choose how long the camera continues to meter exposure when no operations are performed. The default setting is 8s. When the exposure meter turns off, the viewfinder and the shutter speed and aperture displays in the control panel will also turn off to save power. Press the shutter-release button halfway to reactivate the display.



## 19: Self-Timer

Choose the length of the shutter-release delay in self-timer mode (📷 22). The default setting is 10s.



## 20: Remote

Choose how long the camera will wait for a signal from the remote control when no operations are performed in delayed or quick-response remote modes (📷 22). The default setting is one minute. Remote mode will end if no signal is received in the specified period.



### The EH-5 AC Adapter

When the camera is powered by an optional EH-5 AC adapter, exposure meters will not turn off and the monitor will only power off after ten minutes, regardless of the options chosen for Custom Settings 17 (**Monitor Off**) and 18 (**Meter Off**).

# Technical Notes

## Camera Settings

Available Settings and Defaults

The following table lists the settings that can be adjusted in each mode.

	AUTO									
Shooting menu	Optimize Image  48) <sup>1</sup>						✓	✓	✓	✓
	Long Exp. NR  78)	✓	✓	✓	✓	✓	✓	✓	✓	✓
	Image Quality  31) <sup>1</sup>	✓	✓	✓	✓	✓	✓	✓	✓	✓
	Image Size  32) <sup>1</sup>	✓	✓	✓	✓	✓	✓	✓	✓	✓
Other settings	White Balance  49) <sup>1</sup>						✓	✓	✓	✓
	ISO  39) <sup>1</sup>	✓ <sup>2</sup>	✓ <sup>2</sup>	✓ <sup>2</sup>	✓ <sup>2</sup>	✓ <sup>2</sup>	✓ <sup>2</sup>	✓	✓	✓
	Shooting mode  21) <sup>1</sup>	✓	✓	✓	✓	✓	✓	✓	✓	✓
	Flexible program  42) <sup>1</sup>						✓			
	Autoexposure lock  97) <sup>1</sup>	✓	✓	✓	✓	✓	✓	✓	✓	✓
	Exposure compensation  47) <sup>1</sup>						✓	✓	✓	
	Flash sync mode  36) <sup>1</sup>	✓ <sup>3</sup>	✓ <sup>3</sup>		✓ <sup>3</sup>		✓ <sup>3</sup>	✓ <sup>3</sup>	✓	✓
	1: Beep  88) <sup>4</sup>	✓	✓	✓	✓	✓	✓	✓	✓	✓
	2: Autofocus  88) <sup>4</sup>						✓	✓	✓	✓
	3: AF-Area Mode  89) <sup>4</sup>	✓ <sup>3</sup>	✓ <sup>3</sup>	✓ <sup>3</sup>	✓ <sup>3</sup>	✓ <sup>3</sup>	✓ <sup>3</sup>	✓	✓	✓
	4: No SD Card?  90) <sup>4</sup>	✓	✓	✓	✓	✓	✓	✓	✓	✓
	5: Image Review  90) <sup>4</sup>	✓	✓	✓	✓	✓	✓			✓
	6: Flash Level  38, 90) <sup>1, 4</sup>						✓	✓	✓	✓
	7: AF Assist  90) <sup>4</sup>	✓	✓		✓		✓	✓	✓	✓
	8: AF Area Illm  91) <sup>4</sup>	✓	✓	✓	✓	✓	✓	✓	✓	✓
	9: ISO Control  91) <sup>4</sup>	✓	✓	✓	✓	✓	✓			
	10: ISO Auto  92) <sup>4</sup>	✓ <sup>2</sup>	✓ <sup>2</sup>	✓ <sup>2</sup>	✓ <sup>2</sup>	✓ <sup>2</sup>	✓ <sup>2</sup>	✓	✓	✓
	11: EV Step  92) <sup>4</sup>	✓	✓	✓	✓	✓	✓	✓	✓	✓
	12: BKT Set  93) <sup>1, 4</sup>						✓	✓	✓	✓
	13: Metering  96) <sup>1, 4</sup>						✓	✓	✓	✓
14: AE-L/AF-L  98) <sup>4</sup>	✓	✓	✓	✓	✓	✓	✓	✓	✓	
15: AE Lock  99) <sup>4</sup>	✓	✓	✓	✓	✓	✓	✓	✓	✓	
16: Flash Mode  99) <sup>4</sup>						✓	✓	✓	✓	
17: Monitor Off  100) <sup>4</sup>	✓	✓	✓	✓	✓	✓	✓	✓	✓	
18: Meter Off  100) <sup>4</sup>	✓	✓	✓	✓	✓	✓	✓	✓	✓	
19: Self-Timer  100) <sup>4</sup>	✓	✓	✓	✓	✓	✓	✓	✓	✓	
20: Remote  100) <sup>4</sup>	✓	✓	✓	✓	✓	✓	✓	✓	✓	

1 Reset with two-button reset 50).

2 Available when **Off** is selected for Custom Setting 9.

3 Reset when mode dial rotated to new setting.

4 Reset with **R: Menu Reset** 87).



The following defaults are restored when a two-button reset is performed:

	AUTO							P	S	A	M	
Shooting menu	Optimize Image ( 48)	—						Normal				
	Image Quality ( 31)	JPEG Normal										
	Image Size ( 32)	L (3008 × 2000)										
	White Balance ( 49)	—						Auto				
	ISO ( 39)	200 (Custom Setting 9 off)						200				
Other settings	Shooting mode ( 21)	Single frame										
	Focus area ( 33)	—		Center		—		Center				
	Focus lock ( 34)	Off										
	Flexible program ( 42)	—						Off		—		
	Autoexposure lock ( 97)	Off										
	Exposure compensation ( 47)	—						Off (0.0)				
	Flash sync mode ( 36)		—			—						
	CSM	6: Flash Level ( 38, 90)	—						Off (0.0)			
12: BKT Set ( 93)		—						Off				
13: Metering ( 96)		—						Matrix				

The following defaults are restored with Custom Setting R (**Menu Reset**):

	AUTO							P	S	A	M	
Custom Settings	1: Beep ( 88)	On										
	2: Autofocus ( 88)	—						AF-A				
	3: AF-Area Mode ( 89)	Closest Subject		DA* SA* CS*		Single Area						
	4: No SD Card? ( 90)	Release Locked										
	5: Image Review ( 90)	On										
	6: Flash Level ( 38, 90)	—						0.0				
	7: AF Assist ( 90)	On	Off	On	Off	On						
	8: AF Area Illm ( 91)	Auto										
	9: ISO Control ( 91)	On						—				
	10: ISO Auto ( 92)	Off										
	11: EV Step ( 92)	1/3 Step										
	12: BKT Set ( 93)	—						Off				
	13: Metering ( 96)	—						Matrix				
	14: AE-L/AF-L ( 98)	AE/AF Lock										
	15: AE Lock ( 99)	AE-L Button										
	16: Flash Mode ( 99)	—						TTL				
	17: Monitor Off ( 100)	20s										
	18: Meter Off ( 100)	8s										
	19: Self-Timer ( 100)	10s										
	20: Remote ( 100)	1 min										

\* DA=Dynamic Area, SA=Single Area; CS=Closest Subject.



Factory defaults for other menu options are listed below. These settings are not affected by two-button resets or Custom Setting R (**Menu Reset**).

<b>Shooting menu</b>	<b>Long Exp. NR</b> (8 78)	Off
<b>Playback menu</b>	<b>Playback Fldr</b> (8 84)	Current
	<b>Rotate Tall</b> (8 84)	Yes
<b>Setup menu</b>	<b>CSM/Setup Menu</b> (8 69)	Simple
	<b>LCD Brightness</b> (8 69)	0
	<b>Video Mode</b> (8 69)	Varies with region of sale
	<b>Language (LANG)</b> (8 70)	Varies with region of sale
	<b>Image Comment</b> (8 70)	None
	<b>USB</b> (8 71)	Mass Storage
	<b>File No. Seq.</b> (8 73)	Off
	<b>Image Rotation</b> (8 75)	Automatic



# Optional Accessories

One advantage of digital SLR cameras is the wide variety of accessories available for broadening the scope of digital photography. The following types of accessory are available for the D50:

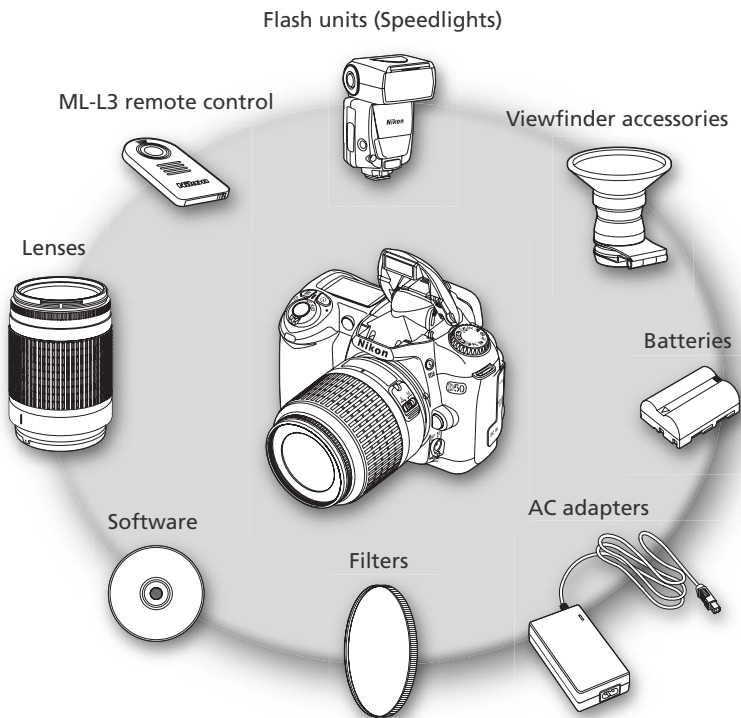

## Use Only Nikon Brand Accessories

Only Nikon brand accessories certified by Nikon specifically for use with your Nikon digital camera are engineered and proven to operate within its operational and safety requirements. THE USE OF NON-NIKON ACCESSORIES COULD DAMAGE YOUR CAMERA AND MAY VOID YOUR NIKON WARRANTY.



## Lenses

CPU lenses (particularly type G and D lenses) are recommended for use with the D50 (note that IX Nikkor CPU lenses can not be used). CPU lenses can be identified by the presence of CPU contacts. Type G lenses have no aperture ring and are marked with a "G" on the lens barrel. Type D lenses are indicated by a "D."

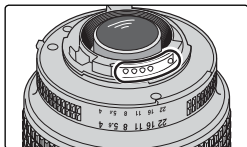

CPU lens

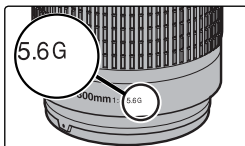

Type G lens

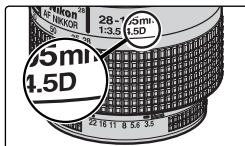

Type D lens

### Calculating Picture Angle

The size of the area exposed by a 35-mm camera is 36 × 24 mm. The size of the area exposed by the D50, in contrast, is 23.7 × 15.6 mm, meaning that the diagonal picture angle of a 35-mm camera is approximately 1.5 times that of the D50.

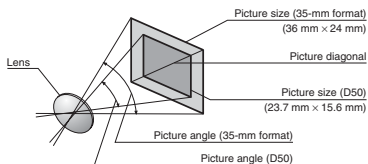

The following lenses can be used with the D50:

Camera setting Lens/accessory		Focus			Mode		Metering
		AF	M (with electronic range finder)	M	DVP, P, S, A	M	
CPU lenses <sup>1</sup>	Type G or D AF Nikkor <sup>2</sup> ; AF-S, AF-I Nikkor	✓	✓	✓	✓	✓	✓ <sup>3</sup>
	PC-Micro Nikkor 85 mm f/2.8D <sup>4</sup>	—	✓ <sup>5</sup>	✓	—	✓	✓ <sup>3</sup>
	AF-S/AF-I Teleconverter <sup>6</sup>	✓ <sup>7</sup>	✓ <sup>7</sup>	✓	✓	✓	✓ <sup>3</sup>
	Other AF Nikkor (except lenses for F3AF)	✓ <sup>8</sup>	✓ <sup>8</sup>	✓	✓	✓	✓ <sup>3</sup>
	AI-P Nikkor	—	✓ <sup>9</sup>	✓	✓	✓	✓ <sup>3</sup>
Non-CPU lenses <sup>10</sup>	AI-modified, AI-, AI-S, or Series E Nikkor	—	✓ <sup>9</sup>	✓	—	✓ <sup>11</sup>	—
	Medical Nikkor 120 mm f/4	—	✓ <sup>9</sup>	✓	—	✓ <sup>12</sup>	—
	Reflex Nikkor	—	—	✓	—	✓ <sup>11</sup>	—
	PC-Nikkor	—	✓ <sup>5</sup>	✓	—	✓ <sup>11</sup>	—
	AI-type Teleconverter	—	✓ <sup>7</sup>	✓	—	✓ <sup>11</sup>	—
	PB-6 Bellows Focusing Attachment <sup>13</sup>	—	✓ <sup>9</sup>	✓	—	✓ <sup>11</sup>	—
	Auto extension rings (PK-series 11-A, 12, or 13; PN-11)	—	✓ <sup>9</sup>	✓	—	✓ <sup>11</sup>	—

1 IX Nikkor lenses can not be used.

2 Vibration Reduction (VR) supported with VR lenses.

3 Spot metering meters selected focus area.

4 The camera's exposure metering and flash control systems do not work properly when shifting and/or tilting the lens, or when an aperture other than the maximum aperture is used.

5 Electronic range finder can not be used with shifting or tilting.

6 Compatible with AF-I Nikkor lenses and with all AF-S lenses except DX 12–24 mm f/4G, ED 17–35 mm f/2.8D, DX ED 17–55 mm f/2.8G, DX ED 18–70 mm f/3.5–4.5G, ED 24–85 mm f/3.5–4.5G, VR ED 24–120 mm f/3.5–5.6G, and ED 28–70 mm f/2.8D.

7 With maximum effective aperture of f/5.6 or faster.

8 If AF 80–200 mm f/2.8S, AF 35–70 mm f/2.8S, new-model AF 28–85 mm f/3.5–4.5S, or AF 28–85 mm f/3.5–4.5S is zoomed in while focusing at minimum range, image on matte screen in viewfinder may not be in focus when in-focus indicator is displayed. Focus manually using image in viewfinder as guide.

9 With maximum aperture of f/5.6 or faster.

10 Some lenses can not be used (see following page).

11 Can be used in mode **M**, but camera exposure meter can not be used.

12 Can be used in mode **M** at shutter speeds slower than 1/125 s, but camera exposure meter can not be used.

13 Attach in vertical orientation (can be used in horizontal orientation once attached).



**❏ Incompatible Accessories and Non-CPU Lenses**

The following accessories and non-CPU lenses can NOT be used with the D50:

- TC-16A AF Teleconverter
- Non-AI lenses
- Lenses that require the AU-1 focusing unit (400mm f/4.5, 600mm f/5.6, 800mm f/8, 1200mm f/11)
- Fisheye (6mm f/5.6, 8mm f/8, OP 10mm f/5.6)
- 21mm f/4 (old type)
- K2 rings
- ED 180–600mm f/8 (serial numbers 174041–174180)
- ED 360–1200mm f/11 (serial numbers 174031–174127)
- 200–600mm f/9.5 (serial numbers 280001–300490)
- Lenses for the F3AF (80mm f/2.8, 200mm f/3.5, TC-16 Teleconverter)
- PC 28mm f/4 (serial number 180900 or earlier)
- PC 35mm f/2.8 (serial numbers 851991–906200)
- PC 35mm f/3.5 (old type)
- 1000mm f/6.3 Reflex (old type)
- 1000mm f/11 Reflex (serial numbers 142361–143000)
- 2000mm f/11 Reflex (serial numbers 200111–200310)

**✎ Compatible Non-CPU Lenses**

Non-CPU lenses not included in the list above can be used, but only in mode **M**. Aperture must be adjusted manually using the lens aperture ring and the camera exposure meter and TTL flash control can not be used. If another mode is selected when a non-CPU lens is attached, the shutter-release will be disabled.

**✎ AF-Assist Illumination**

The following lenses may block the AF-assist illuminator at ranges under 1 m (3'3"). Note that the camera may not be able to focus using autofocus if the AF-assist illuminator is blocked.

- AF Micro ED 200mm f/4D
- AF-S ED 17–35mm f/2.8D
- AF ED 18–35mm f/3.5–4.5D
- AF 20–35mm f/2.8D
- AF-S ED 28–70mm f/2.8D
- AF ED 24–85mm f/2.8–4D
- AF-S VR ED 24–120mm f/3.5–5.6G
- AF 24–120mm f/3.5–5.6D
- AF Micro ED 70–180mm f/4.5–5.6D
- AF-S DX IF ED 17–55mm f/2.8G

AF assist is not available with the following lenses:

- AF-S VR ED 70–200mm f/2.8G
- AF ED 80–200mm f/2.8D
- AF-S VR ED 200–400mm f/4G
- AF-S VR 300mm f/2.8G
- AF-S ED 80–200mm f/2.8D
- AF VR ED 80–400mm f/4.5–5.6D
- AF-S VR 200mm f/2G



### Using the Built-in Flash

The built-in flash can be used with any CPU lens with a focal length of 18–300 mm. Note that the flash may be unable to light the entire subject if the following lenses are not used at or above the minimum ranges given below:

Lens	Zoom position	Minimum Range
AF-S DX ED 12–24 mm f/4G	20 mm	2.5 m/8'2"
	24 mm	1.0 m/3'3"
AF-S ED 17–35 mm f/2.8D	20 mm, 24 mm	2.5 m/8'2"
	28 mm	1.0 m/3'3"
	35 mm	0.6 m/2'
AF-S DX IF ED 17–55 mm f/2.8G	20 mm, 24 mm	2.5 m/8'2"
	28 mm	1.5 m/4'11"
	35 mm	0.7 m/2'4"
	45–55 mm	0.6 m/2'
AF ED 18–35 mm f/3.5–4.5D	18 mm, 21 mm	2.0 m/6'7"
	24 mm	0.7 m/2'4"
	28–35 mm	0.6 m/2'
AF 20–35 mm f/2.8D	20 mm	1.5 m/4'11"
	24 mm	1.0 m/3'3"
	28–35 mm	0.6 m/2'
AF-S VR ED 24–120 mm f/3.5–5.6G	24 mm	0.8 m/2'7"
	28–120 mm	0.6 m/2'
AF-S ED 28–70 mm f/2.8D	28 mm	3.0 m/9'10"
	35 mm	1.0 m/3'3"
	50–70 mm	0.6 m/2'
AF-S VR 200–400 mm f/4G	200 mm	4.0 m/13'1"
	250 mm	2.5 m/8'2"
	300–400 mm	0.6 m/2'
AF-S 18–70 mm f/3.5–4.5G	18 mm	1.0 m/3'3"
	24–70 mm	0.6 m/2'

### Red-Eye Reduction

Some lenses may interfere with red-eye reduction by preventing the subject from seeing the AF-assist illuminator.



## Optional Flash Units (Speedlights)

When used with a compatible Speedlight such as the SB-800 or SB-600 (available separately), the D50 supports the Nikon Creative Lighting System (CLS), including i-TTL flash control (📷 127), Flash Color Information Communication, and FV lock (📷 98). The built-in flash does not fire when an optional flash unit is used.

### *SB-800 and SB-600 Speedlights*

These high performance Speedlights have Guide Numbers of 53/174 and 42/138 respectively (m/ft, 35-mm zoom head position, ISO 200, 20°C/68°F; GNs at ISO 100 are 38/125 and 30/98 respectively). The flash head can be rotated through 90° above the horizontal, 180° left, and 90° right for bounce-flash or close-up photography. The SB-800 can be rotated 7° below the horizontal. Auto power zoom (24–105 mm and 24–85 mm, respectively) ensures that the illuminating angle is adjusted in accord with lens focal length. The built-in wide panel can be used for an angle of 14 mm (the SB-800 also supports 17 mm). An illuminator is included to assist in adjusting settings in the dark.

### ✔ Use Only Nikon Flash Accessories

Use only Nikon Speedlights. Negative voltages or voltages over 250V applied to the accessory shoe could not only prevent normal operation, but damage the sync circuitry of the camera or flash. Before using a Nikon Speedlight not listed in this section, contact a Nikon-authorized service representative for more information.

#### 🔍 The Accessory Shoe

The D50 is equipped with an accessory shoe that allows SB-series Speedlights, including the SB-800, 600, 80DX, 28DX, 28, 27, 23, 22S, and 29S to be mounted directly on the camera without a sync cable. The accessory shoe is equipped with a safety lock for Speedlights with a locking pin, such as the SB-800 and SB-600. Before attaching an optional flash unit, remove the accessory shoe cover.

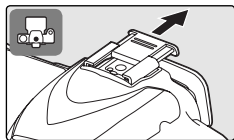

#### 🔍 The AS-15 Accessory Shoe Adapter

An AS-15 accessory shoe adapter (available separately) can be mounted on the accessory shoe to allow flash accessories to be attached via a sync cable.

The following features are available with SB-800 and SB-600 Speedlights:

Flash mode/feature		Speedlight			
		SB-800	SB-800 (Advanced Wireless Lighting)	SB-600	SB-600 (Advanced Wireless Lighting)
i-TTL <sup>1</sup>		✓ <sup>2</sup>	✓	✓ <sup>2</sup>	✓
AA	Auto aperture <sup>1</sup>	✓ <sup>3</sup>	✓	—	—
A	Non-TTL auto	✓ <sup>3</sup>	✓ <sup>4</sup>	—	—
GN	Range-priority manual	✓ <sup>5</sup>	—	—	—
M	Manual	✓	✓	✓	✓
RPT	Repeating flash	✓	—	—	—
REAR	Rear-curtain sync	✓	✓	✓	✓
	Red-eye reduction	✓	—	✓	—
Flash Color Information Communication		✓	—	✓ <sup>3</sup>	—
FV lock <sup>1</sup>		✓	✓	✓	✓
AF-assist for multi-area AF <sup>6</sup>		✓	—	✓	—
Auto zoom <sup>1</sup>		✓	—	✓	—
ISO Auto (Custom Setting 10) <sup>1</sup>		✓	—	✓	—

1 Available only with CPU lenses (IX Nikkor lenses excluded).

2 Standard i-TTL Flash for Digital SLR is used when spot metering is selected. Otherwise, i-TTL Balanced Fill-Flash for Digital SLR is used.

3 Use Speedlight controls to select flash mode.

4 Available only with non-CPU lenses.

5 Adjusted automatically according to camera aperture setting when CPU lens is used. When non-CPU lens is used, must be adjusted manually to match aperture selected with lens aperture ring.

6 Available with CPU AF lenses only (IX Nikkor lenses excluded).





The following Speedlights can be used in non-TTL auto and manual modes. If they are set to TTL, the camera shutter-release button will lock and no photographs can be taken.

Flash mode		Speedlight		
		SB-80DX, SB-28DX, SB-28, SB-26, SB-25, SB-24	SB-50DX, SB-23, SB-29 <sup>2</sup> , SB-21B <sup>2</sup> , SB-29S <sup>2</sup>	SB-30, SB-27 <sup>1</sup> , SB- 22S, SB-22, SB-20, SB-16B, SB-15
A	Non-TTL auto	✓	—	✓
M	Manual	✓	✓	✓
	Repeating flash	✓	—	—
REAR	Rear-curtain sync	✓	✓	✓

<sup>1</sup> When an SB-27 is mounted on the D50, the flash mode is automatically set to TTL, and the shutter-release will be disabled. Set the SB-27 to A (non-TTL auto flash).

<sup>2</sup> Autofocus is only available with AF-Micro lenses (60 mm, 105 mm, 200 mm, or 70–180 mm).

### AUTO, and Modes

When an optional Speedlight is attached in and modes, the flash fires whenever a photograph is taken. The following flash modes are available:

- and modes: Front-curtain sync and red-eye reduction. If off or auto front-curtain sync is selected when an optional Speedlight is attached, the flash sync mode selection will change to front-curtain sync. Auto with red-eye reduction becomes red-eye reduction.
- and modes: Front-curtain sync is selected automatically. Red-eye reduction can also be selected.
- mode: Slow sync, slow sync with red-eye reduction, and front-curtain sync. Auto slow sync becomes slow sync, auto slow sync with red-eye reduction becomes red-eye reduction, and off becomes front-curtain sync.



## Notes on Optional Speedlights

Refer to the Speedlight manual for detailed instructions. If the Speedlight supports the Creative Lighting System, refer to the section on CLS-compatible digital SLR cameras. The D50 is not included in the “digital SLR” category in the SB-80DX, SB-28DX, and SB-50DX manuals.







The shutter will synchronize with an external flash at speeds of  $\frac{1}{500}$ s or slower.







i-TTL and Auto Aperture (AA) flash control are available only with CPU lenses. Selecting spot metering while an SB-800 or SB-600 Speedlight is attached activates standard i-TTL Flash for Digital SLR.

i-TTL flash control is available at all sensitivity (ISO equivalency) settings. If the flash-ready indicator blinks for about three seconds after a photograph is taken with i-TTL flash control, the photograph may be underexposed.

When an SB-800 or SB-600 is mounted on the camera, AF-assist illumination and red-eye reduction are performed by the optional Speedlight. With other Speedlights, AF-assist illumination is performed using the AF-assist illuminator on the camera (34).

Auto power zoom is available only with SB-800 and SB-600 Speedlights.

In P, , , , , , and  modes, the maximum aperture (minimum f-number) is limited according to sensitivity (ISO equivalency) as shown below:

Mode	Maximum aperture at ISO equivalent of			
	200	400	800	1600
P,  ,  ,  ,  ,  , 	4	4.8	5.6	6.7
	8	9.5	11	13

For each one-step increase in sensitivity (e.g., from 200 to 400), aperture is stopped down by half an f-stop. If the maximum aperture of the lens is smaller than that listed above, the maximum value for aperture is the maximum aperture of the lens.

When an SC-series 17, 28, or 29 sync cable is used for off-camera flash photography, correct exposure may not be achieved using i-TTL Balanced Fill-Flash for Digital SLR. We recommend that you choose spot metering to select Standard i-TTL Flash for Digital SLR. Take a test shot and view the results in the monitor.

In i-TTL mode, use the flash panel provided with your Speedlight. Do not use other panels such as diffusion panels, as this may produce incorrect exposure.



## Other Accessories

At the time of writing, the following accessories were available for the D50. Contact your retailer or local Nikon representative for details.

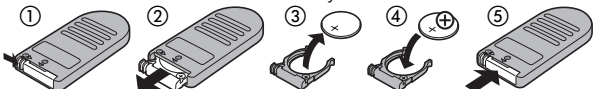
<b>Batteries/ Chargers/ AC adapters</b>	<ul style="list-style-type: none"><li>◆<b>EN-EL3a Rechargeable Li-ion Battery:</b> Additional EN-EL3a batteries are available from local retailers and Nikon service representatives.</li><li>◆<b>EH-5 AC Adapter:</b> Use the EH-5 to power the camera for extended periods.</li><li>◆<b>MH-19 Multi Charger:</b> The MH-19 can be used to recharge the following batteries: EN-EL3a rechargeable Li-ion batteries, MN-30 batteries for the F5 camera (with MC-E1), MN-15 batteries for the F100 camera (with MC-E2), EN-4 batteries (for D1 series cameras), or EN-3 batteries for the E3 camera. The charger can charge two pairs of batteries of different types, for a total of four batteries, and comes with a twelve-volt cable for connection to a cigarette-lighter socket.</li></ul>
<b>Viewfinder eyepiece accessories</b>	<ul style="list-style-type: none"><li>◆<b>Dioptr-Adjustment Viewfinder Lenses:</b> Lenses are available with diopters of <math>-5</math>, <math>-4</math>, <math>-3</math>, <math>-2</math>, <math>0</math>, <math>+0.5</math>, <math>+1</math>, <math>+2</math>, and <math>+3\text{ m}^{-1}</math>. Use diopter adjustment lenses only if the desired focus can not be achieved with the built-in diopter adjustment control (<math>-1.6</math> to <math>+0.5\text{ m}^{-1}</math>). Test diopter adjustment lenses before purchase to ensure that the desired focus can be achieved.</li><li>◆<b>DG-2 Magnifier:</b> Magnify the scene displayed in the center of the viewfinder for close-up photography, copying, telephoto lenses, and other tasks that call for added precision. Eyepiece adapter required (available separately).</li><li>◆<b>Eyepiece Adapter:</b> Use to attach the DG-2 Magnifier to the D50.</li><li>◆<b>DR-6 Right-Angle Viewing Attachment:</b> The DR-6 attaches at a right angle to the viewfinder eyepiece, allowing the image in the viewfinder to be viewed from above when the camera is in the horizontal shooting position.</li></ul>
<b>Body caps</b>	<ul style="list-style-type: none"><li>◆<b>BF-1A Body Cap:</b> The BF-1A keeps the mirror, viewfinder screen, and low-pass filter free of dust when a lens is not in place.</li></ul>
<b>Remote controls</b>	<ul style="list-style-type: none"><li>◆<b>ML-L3 Wireless Remote Control:</b> Use the ML-L3 as a remote shutter release for self-portraits or to prevent blur caused by camera shake. The ML-L3 uses a 3V CR2025 battery.</li></ul> 



**Filters**

- Nikon filters can be divided into three types: screw-in, drop-in, and rear-interchange. Use Nikon filters; other filters may interfere with autofocus or electronic range finding.
- The D50 can not be used with linear polarizing filters. Use the C-PL circular polarizing filter instead.
- The NC and L37C filters are recommended for protecting the lens.
- When using an R60 filter, set exposure compensation to +1.
- To prevent moiré, use of a filter is not recommended when the subject is framed against a bright light, or when a bright light source is in the frame.
- Center-weighted metering is recommended with filters with exposure factors (filter factors) over 1 × (Y48, O56, R60, X0, X1, C-PL, ND4S, ND8S, A2, A12, B2, B8, B12).

**Software**

- ◆ **Nikon Capture 4 (Version 4.3 or Later):** Nikon Capture 4 Version 4.3 or later can be used to capture photos to a computer and to edit and save RAW images in other formats.

## Approved Memory Cards

The following cards have been tested and approved for use in the D50:

SanDisk	64 MB, 128 MB, 256 MB, 512 MB, 1 GB
Toshiba	64 MB, 128 MB, 256 MB, 512 MB
Panasonic	64 MB, 128 MB, 256 MB, 512 MB, 1 GB

Operation is not guaranteed with other makes of card. For more details on the above cards, please contact the manufacturer.

### Memory Cards

- Format memory cards in the camera before first use.
- Turn the power off before inserting or removing memory cards. Do not remove memory cards from the camera, turn the camera off, or remove or disconnect the power source during formatting or while data are being recorded, deleted, or copied to a computer. Failure to observe these precautions could result in loss of data or in damage to the camera or card.
- Do not touch the card terminals with your fingers or metal objects.
- Do not apply force to the card casing. Failure to observe this precaution could damage the card.
- Do not bend, drop, or subject to strong physical shocks.
- Do not expose to heat, water, high levels of humidity, or direct sunlight.

# Caring for the Camera

## Storage

When the camera will not be used for an extended period, remove the battery, and store the battery in a cool, dry area with the terminal cover in place. To prevent mold or mildew, store the camera in a dry, well-ventilated area. Do not store your camera with naphtha or camphor moth balls or in locations that:

- are poorly ventilated or subject to humidities of over 60%
- are next to equipment that produces strong electromagnetic fields, such as televisions or radios
- are exposed to temperatures above 50°C/122°F (for example, near a space heater or in a closed vehicle on a hot day) or below -10°C (14°F)

## Cleaning

<b>Camera body</b>	Use a blower to remove dust and lint, then wipe gently with a soft, dry cloth. After using the camera at the beach or seaside, wipe off sand or salt with a cloth lightly dampened in distilled water and dry thoroughly. <b>IMPORTANT:</b> Dust or other foreign matter inside the camera may cause damage not covered under warranty.
<b>Lens, mirror, and viewfinder</b>	These elements are made of glass and are easily damaged. Remove dust and lint with a blower. If using an aerosol blower, keep the can vertical to prevent the discharge of liquid. To remove fingerprints and other stains, apply a small amount of lens cleaner to a soft cloth and clean with care.
<b>Monitor</b>	Remove dust and lint with a blower. When removing fingerprints and other stains, wipe the surface lightly with a soft cloth or cham- ois leather. Do not apply pressure, as this could result in damage or malfunction.

### **The Monitor**

Should the monitor break, care should be taken to avoid injury caused by broken glass and to prevent liquid crystal from entering your eyes and mouth.

### **The Control Panel**

Rarely, static electricity may cause the control panel to brighten or darken. This does not indicate a malfunction; the display will shortly return to normal.



## The Low-Pass Filter

The image sensor that acts as the camera's picture element is fitted with a low-pass filter to prevent moiré. Although this filter prevents foreign objects from adhering directly to the image sensor, under certain conditions dirt or dust on the filter may appear in photographs. If you suspect that dirt or dust inside the camera is affecting your photographs, you can check for the presence of foreign objects on the low-pass filter as described below.

**1** Remove the lens and turn the camera on.

**2** Choose **Yes** for the **Mirror Lock-Up** option in the setup menu (▶ 68). The message, "Press shutter-release button" will be displayed.

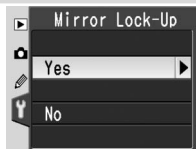

**3** Press the shutter-release button all the way down. The mirror will be raised and the shutter curtain will open, revealing the low-pass filter, and a row of dashes will blink in the control panel.

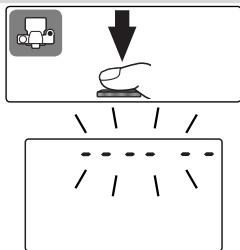

**4** Holding the camera so that light falls on the low-pass filter, examine the filter for dust or lint. If there are foreign objects on the filter, the filter requires cleaning. See the following section.

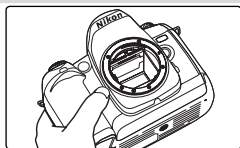

**5** Turn the camera off. The mirror will return to the down position and the shutter curtain will close. Replace the lens or body cap and disconnect the AC adapter.

### Use a Reliable Power Source

To prevent the camera from powering off while the mirror is raised, use a fully-charged battery or an EH-5 AC adapter (available separately) for prolonged inspection or cleaning of the low-pass filter.



## *Cleaning the Low-Pass Filter*

The low-pass filter is extremely delicate and easily damaged. Nikon recommends that filter be cleaned only by Nikon-authorized service personnel. Should you choose to clean the filter yourself, follow the steps below.

**1** Raise the mirror as described in steps 1–3 on the preceding page.

**2** Remove dust and lint from the filter with a blower. Do not use a blower-brush, as the bristles could damage the filter. Dirt that can not be removed with a blower can only be removed by Nikon-authorized service personnel. Under no circumstances should you touch or wipe the filter.

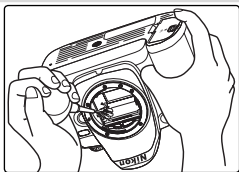

**3** Turn the camera off. The mirror will return to the down position and the shutter curtain will close. Replace the lens or body cap.



## **✓ Servicing the Camera and Accessories**

The D50 is a precision device and requires regular servicing. Nikon recommends that the camera be inspected by the original retailer or Nikon service representative once every one to two years, and that it be serviced once every three to five years (note that fees apply to these services). Frequent inspection and servicing are particularly recommended if the camera is used professionally. Any accessories regularly used with the camera, such as lenses or optional Speedlights, should be included when the camera is inspected or serviced.



## Caring for the Camera and Battery: Cautions

### Do not drop

The product may malfunction if subjected to strong shocks or vibration.

### Keep dry

This product is not waterproof, and may malfunction if immersed in water or exposed to high levels of humidity. Rusting of the internal mechanism can cause irreparable damage.

### Avoid sudden changes in temperature

Sudden changes in temperature, such as occur when entering or leaving a heated building on a cold day, can cause condensation inside the device. To prevent condensation, place the device in a carrying case or a plastic bag before exposing it to sudden changes in temperature.

### Keep away from strong magnetic fields

Do not use or store this device in the vicinity of equipment that generates strong electromagnetic radiation or magnetic fields. Strong static charges or the magnetic fields produced by equipment such as radio transmitters could interfere with the monitor, damage data stored on the memory card, or affect the product's internal circuitry.

### Do not leave the lens pointed at the sun

Do not leave the lens pointed at the sun or another sight source for an extended period. Intense light may cause the image sensor to deteriorate or produce a white blur effect in photographs.

### Blooming

Vertical white streaks may appear in photographs of the sun or other strong light sources. This phenomenon, known as "blooming," can be prevented by reducing the amount of light that falls on the image sensor, either by choosing a slow shutter speed and small aperture or by using an ND filter.

### Do not touch the shutter curtain

The shutter curtain is extremely thin and easily damaged. Under no circumstances should you exert pressure on the curtain, poke it with cleaning tools, or subject it to powerful air currents from a blower. These actions could scratch, deform, or tear the curtain.

### Handle all moving parts with care

Do not apply force to the battery-chamber, card-slot, or connector covers. These parts are especially susceptible to damage.

### Cleaning

- When cleaning the camera body, use a blower to remove dust and lint, then wipe gently with a soft, dry cloth. After using your camera at the beach or seaside, wipe off any sand or salt using a cloth lightly dampened with pure water and then dry your camera thoroughly. In rare instances, static electricity produced by a brush or cloth may cause the LCD displays to light up or darken. This does not indicate a malfunction, and the display will shortly return to normal.
- When cleaning the lens and mirror, remember that these elements are easily damaged. Dust and lint should be gently removed with a blower. When using an aerosol blower, keep the can vertical (tilting the can could result in liquid being sprayed on the mirror). If you do get a fingerprint or other stain on the lens, apply a small amount of lens cleaner to a soft cloth and wipe the lens carefully.
- See "Cleaning the Low-Pass Filter" for information on cleaning the low-pass filter (📖 117).

### Storage

- To prevent mold or mildew, store the camera in a dry, well-ventilated area. If you will not be using the product for long periods, remove the battery to prevent leakage and store the camera in a plastic bag containing





---

a desiccant. Do not, however, store the camera case in a plastic bag, as this may cause the material to deteriorate. Note that desiccant gradually loses its capacity to absorb moisture and should be replaced at regular intervals.

- Do not store the camera with naphtha or camphor moth balls, close to equipment that produces strong magnetic fields, or in areas subject to extremes of temperature, for example near a space heater or in a closed vehicle on a hot day.
- To prevent mold or mildew, take the camera out of storage at least once a month. Turn the camera on and release the shutter a few times before putting the camera away again.
- Store the battery in a cool, dry place. Replace the terminal cover before putting the battery away.

#### **Notes on the monitor**

- The monitor may contain a few pixels that are always lit or that do not light. This is a characteristic common to all TFT LCD monitors and does not indicate a malfunction. Images recorded with the product will not be affected.
- Images in the monitor may be difficult to see in a bright light.
- Do not apply pressure to the monitor; this could cause damage or malfunction. Dust or lint on the monitor can be removed with a blower. Stains can be removed by rubbing the surface lightly with a soft cloth or chamois leather.
- Should the monitor break, care should be taken to avoid injury due to broken glass and to prevent the liquid crystal from the monitor touching the skin or entering the eyes or mouth.

#### **Turn the product off before removing or disconnecting the power source**

Do not unplug the product or remove the battery while the product is on, or while images are being recorded or deleted. Forcibly cutting power to the product in these circumstances could result in loss of data or in damage to product memory or internal circuitry. To prevent an accidental interruption of power, avoid carrying the product from one location to another while the AC adapter is connected.

#### **Batteries**

- Dirt on the battery terminals can prevent the camera from functioning.
- When you turn the device on, check the battery-level displayed in the control panel to determine whether the battery needs to be recharged or replaced. The battery needs to be recharged or replaced when the battery-level indicator is flashing.
- When taking photographs on important occasions, ready a spare EN-EL3a battery and keep it fully charged. Depending on your location, you may find it difficult to purchase replacement batteries on short notice.
- On cold days, the capacity of batteries tends to decrease. Be sure the battery is fully charged before taking photographs outside in cold weather. Keep a spare battery in a warm place and exchange the two as necessary. Once warmed, a cold battery may recover some of its charge.
- Should the battery terminals become dirty, wipe them off with a clean, dry cloth before use.
- After removing the battery from the camera, be sure to replace the terminal cover.
- Used batteries are a valuable resource. Please recycle used batteries in accord with local regulations.



# Troubleshooting



If the camera fails to function as expected, check the list of common problems below before consulting your retailer or Nikon representative. Refer to the page numbers in the right-most column for more information.

Problem	Solution	
Camera takes time to turn on.	Delete files or folders.	84
Viewfinder is out of focus.	<ul style="list-style-type: none"><li>• Adjust viewfinder focus.</li><li>• Use optional diopter adjustment lens.</li></ul>	13 113
Viewfinder is dark.	Charge battery or insert charged battery.	14
Displays turn off without warning.	Choose longer monitor off or meter of delays.	100
Unusual characters displayed in control panel	See "A Note on Electronically Controlled Cameras," below.	—
Displays in control panel or viewfinder are slow and dim	Displays are affected by high or low temperatures.	—
<ul style="list-style-type: none"><li>• Fine lines around active focus area in viewfinder</li><li>• Viewfinder display turns red</li></ul>	These phenomena are normal and do not indicate a malfunction.	—
Menu item is not displayed.	Select <b>Detailed</b> for <b>CSM/Setup Menu</b> .	69
Menu item is unavailable.	Choose another mode or insert memory card.	11 101
Image size can not be changed.	<b>NEF (Raw)</b> or <b>NEF+JPEG Basic</b> selected for image quality.	31
Shutter release is disabled.	<ul style="list-style-type: none"><li>• Aperture not locked at highest f/-number.</li><li>• Memory card is locked.</li><li>• Memory card is full.</li><li>• Flash is charging.</li></ul>	7 11 14 18

## A Note on Electronically-Controlled Cameras

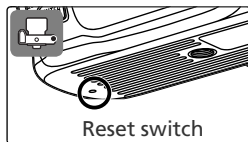
In extremely rare instances, unusual characters may appear in the control panel and the camera may stop functioning. In most cases, this phenomenon is caused by a strong external static charge. Turn the camera off, remove and replace the battery, and turn the camera on again, or, if you are using an AC adapter (available separately), disconnect and reconnect the adapter and turn the camera on again. If the problem persists, press the reset switch (see right) and then reset the camera clock to the correct date and time (🕒 68). In the event of continued malfunction, contact your retailer or Nikon representative. Note that disconnecting the power source as described above may result in loss of any data not recorded to the memory card at the time the problem occurred. Data already recorded to the card will not be affected.











Problem	Solution	
Shutter release is disabled (continued).	• Camera is not in focus.	17
	• Non-CPU lens: camera not in <b>M</b> mode.	45
	• Mode dial rotated to <b>S</b> after shutter speed of bulb selected in <b>M</b> mode: choose new shutter speed.	43
No photo taken when remote control shutter release is pressed.	• Replace battery in remote control.	113
	• Choose remote control mode.	22
	• Time selected for <b>Remote</b> has passed: reselect remote control mode.	100
Can not select focus area.	• Bright light is interfering with remote.	23
	• <b>AF-Area Mode</b> set to <b>Closest Subject</b>	89
AF-assist illuminator does not light.	• Monitor is on: camera in playback mode.	24
	• Mode dial is rotated to  or  .	34
	• Continuous-servo AF is in effect.	88
	• <b>Off</b> selected for <b>AF Assist</b> .	90
Slow shutter speeds not available.	• Illuminator has turned off automatically. Illuminator may become hot with continued use; wait for lamp to cool down.	—
Flash raised ( <b>P</b> , <b>S</b> , <b>A</b> , and <b>M</b> modes)		128
Focus does not lock when shutter-release button is pressed halfway.	Flash raised ( <b>P</b> , <b>S</b> , <b>A</b> , and <b>M</b> modes)	34
Area shown in viewfinder is smaller than final photo.	<b>AF-C</b> selected for <b>Autofocus</b> ( <b>P</b> , <b>S</b> , <b>A</b> , and <b>M</b> modes): use  button to lock focus.	88
	Viewfinder has vertical and horizontal frame coverage of about 95%.	—
Photos are out of focus.	• Rotate focus-mode selector to <b>AF</b> .	15
	• Camera unable to focus using autofocus: use manual focus or focus lock. Camera may not focus if focus area contains objects at different distances from camera or subject is low contrast, contains highly detailed or repeating patterns, is much brighter or darker than background, or is much smaller than objects in background.	34 35
Recording time increases.	Turn noise reduction off.	78
Randomly-spaced bright pixels ("noise" appears in photos).	• Choose lower sensitivity.	39
	• Shutter speed is slower than 1": use noise reduction.	78
Blotches appear on photos.	• Clean lens.	115
	• Clean low-pass filter.	116
Colors are unnatural.	• Select <b>P</b> , <b>S</b> , <b>A</b> , or <b>M</b> mode and adjust white balance to match light source.	49
	• Select <b>P</b> , <b>S</b> , <b>A</b> , or <b>M</b> mode and adjust <b>Optimize Image</b> setting.	48











Problem	Solution	
Can not measure white balance.	Subject is too dark or too bright.	80
Image can not be selected as source for preset white balance.	Image was not created with D50.	81
White balance bracketing unavailable.	<b>NEF (Raw)</b> or <b>NEF+JPEG Basic</b> selected for image quality.	31 93
Results for <b>Optimize Image</b> vary from shot to shot.	Select <b>Custom</b> and choose setting other than <b>Auto</b> for <b>Sharpening</b> and <b>Tone Comp.</b>	76
Metering can not be changed.	Autoexposure lock is in effect.	96
Exposure compensation can not be used.	Rotate mode dial to <b>P</b> , <b>S</b> , or <b>A</b> .	47
Continuous shooting ends unexpectedly.	<ul style="list-style-type: none"> <li>• <b>P</b>, <b>S</b>, <b>A</b>, and <b>M</b> modes: lower flash.</li> <li>• Turn bracketing off.</li> </ul>	37 93
RAW image is not displayed during playback.	Photo taken at image quality of <b>NEF+JPEG Basic</b> .	31
"Tall" (portrait-orientation) photos are displayed in "wide" (landscape) orientation.	<ul style="list-style-type: none"> <li>• Select <b>Yes</b> for <b>Rotate Tall</b>.</li> <li>• Photo was taken with <b>Off</b> selected for <b>Image Rotation</b>.</li> </ul>	84 75
	<ul style="list-style-type: none"> <li>• Camera orientation was changed while shutter-release button was pressed in continuous mode.</li> </ul>	75
	<ul style="list-style-type: none"> <li>• Camera was pointed up or down when shot was taken.</li> </ul>	75
Can not delete photo.	<ul style="list-style-type: none"> <li>• Photo is protected: remove protection.</li> <li>• Memory card is locked.</li> </ul>	56 11
Some photos are not displayed during playback.	Select <b>All</b> for <b>Playback Fldr.</b> Note that <b>Current</b> will automatically be selected when next photo is taken.	84
Photos are not displayed in monitor after shooting.	Select <b>On</b> for <b>Image Review</b> .	90
Can not change print order.	<ul style="list-style-type: none"> <li>• Memory card is full: delete photos.</li> <li>• Memory card is locked.</li> </ul>	84 11
Can not print pictures via direct USB connection.	Set <b>USB</b> to <b>PTP</b> .	71
Can not select photo for printing.	Photo is a RAW (NEF) image. Use PictureProject or Nikon Capture 4 Version 4.3 or later (available separately) to print photo.	59
Photo is not displayed on TV.	Choose correct video mode.	69
Can not copy photos to computer.	Choose correct USB option.	59
Can not use Nikon Capture 4 Camera Control.	Set <b>USB</b> to <b>PTP</b> .	59 71
Date of recording is not correct.	Set camera clock.	69

## Camera Error Messages and Displays

This section lists the indicators and error messages that appear in the viewfinder, control panel, and monitor when there is a problem with the camera.

Indicator		Problem	Solution	
Control panel	Viewfinder			
		Low battery.	Ready a fully-charged spare battery.	8 14
 (blinks)	 (blinks)	Battery exhausted.	Replace battery.	8 14
 (blinks)		Camera can not detect battery.	Insert battery.	8
<b>CLOCK</b> (blinks)		Camera clock is not set.	Set camera clock.	10 68
-E- (blinks)	 (blinks) -E-	No memory card.	Insert memory card.	11
<b>Full</b>  (blinks)	<b>Full</b>  (blinks)	Memory insufficient to record further photos at current settings, or camera has run out of file or folder numbers.	<ul style="list-style-type: none"> <li>• Reduce quality or size.</li> <li>• Delete photographs.</li> <li>• Insert new memory card.</li> </ul>	30 84 11
<b>FE</b> (blinks)	<b>FE</b> (blinks)	Lens aperture ring is not locked at minimum aperture.	Lock ring at minimum aperture (largest f/-number).	7
<b>F-</b> (blinks)	<b>F-</b> (blinks)	No lens attached, or non-CPU lens attached.	Attach CPU lens (IX Nikkor excluded), or rotate mode dial to <b>M</b> and use lens aperture ring to set aperture.	7 45 105
	● (blinks)	Camera unable to focus using autofocus.	Focus manually.	35
<b>H!</b>		Subject too bright; photo will be overexposed.	<ul style="list-style-type: none"> <li>• Choose lower sensitivity.</li> <li>• Use optional Neutral Density (ND) filter</li> <li>• In mode:               <ul style="list-style-type: none"> <li><b>S</b> Increase shutter speed</li> <li><b>A</b> Choose smaller aperture (larger f/-number)</li> </ul> </li> </ul>	39 114 43 44



Indicator		Problem	Solution	
Control panel	Viewfinder			
		Subject too dark; photo will be underexposed.	<ul style="list-style-type: none"> <li>• Choose higher sensitivity.</li> <li>• Use built-in flash.</li> <li>• In mode:                             <ul style="list-style-type: none"> <li><b>S</b> Lower shutter speed</li> <li><b>A</b> Choose larger aperture (smaller f/-number)</li> </ul> </li> </ul>	39 36 43 44
		<ul style="list-style-type: none"> <li>• Flash required for correct exposure (<b>P, S, A, M</b> modes).</li> <li>• Flash has fired at full power ( blinks for three seconds after flash fires) .</li> </ul>	<ul style="list-style-type: none"> <li>• Raise built-in flash.</li> <li>• Check photo in monitor; if underexposed, adjust settings and try again.</li> </ul>	36 24
		Speedlight that does not support i-TTL flash control attached and set to TTL.	Change flash mode setting on optional Speedlight.	110 127
		 selected in mode <b>M</b> and mode dial rotated to <b>S</b> .	Change shutter speed or select mode <b>M</b> .	43 45
- - (blinks)		- - selected in mode <b>M</b> and mode dial rotated to <b>S</b> .	Change shutter speed or select mode <b>M</b> .	43 45
		Camera malfunction.	Release shutter. If error persists or appears frequently, consult with Nikon-authorized service representative.	—

Indicator		Problem	Solution	
Monitor	Control panel			
NO CARD PRESENT	{- E -}	Camera cannot detect memory card.	Turn camera off and confirm that card is correctly inserted.	11
THIS CARD CAN NOT BE USED	{ERR} (blinks)	<ul style="list-style-type: none"> <li>• Error accessing memory card.</li> <li>• Unable to create new folder</li> <li>• Card has not been formatted for use in D50.</li> </ul>	<ul style="list-style-type: none"> <li>• Use Nikon-approved card.</li> <li>• Check that contacts are clean. If card is damaged, contact retailer or Nikon representative.</li> <li>• Delete files or insert new memory card.</li> <li>• Format memory card.</li> </ul>	114 — 11 84 11
CARD IS NOT FORMATTED	{For} (blinks)	Memory card has not been formatted for use in D50.	Format memory card.	11
FOLDER CONTAINS NO IMAGES		<ul style="list-style-type: none"> <li>• Memory card contains no images.</li> <li>• Current folder is empty.</li> </ul>	<ul style="list-style-type: none"> <li>• Insert another card.</li> <li>• Set <b>Playback fldr</b> to <b>All</b>.</li> </ul>	11 84
FILE DOES NOT CONTAIN IMAGE DATA		File has been created or modified using a computer or different make of camera, or file is corrupt.	Delete file or reformat memory card.	11 84
CARD IS LOCKED	{ERR, L} (blinks)	Memory card is locked (write protected).	Slide write-protect switch to “write” position.	11



# Appendix

## Memory Card Capacity and Image Quality/Size

The following table shows the approximate number of pictures that can be stored on a 256 MB card at different image quality and size settings.

Image quality	Image size	File size (MB) <sup>1</sup>	No. of images <sup>1</sup>	Buffer capacity <sup>2</sup>	
				Long Exp. NR Off	Long Exp. NR On
NEF (Raw)	—	5.0	33	4	3
JPEG Fine	L	2.9	70	9	7
	M	1.6	123	10	8
	S	0.8	258	19	17
JPEG Normal	L	1.5	137	12	10
	M	0.8	233	16	14
	S	0.4	464	27	25
JPEG Basic	L	0.8	258	19	17
	M	0.4	423	27	25
	S	0.2	770	49	47
NEF+JPEG Basic	—/L	5.8 <sup>3</sup>	29	4	3

1 All figures are approximate. File size varies with scene recorded and make of memory card.

2 Maximum number of frames that can be stored in memory buffer. Actual number of photos that can be taken before buffer fills may vary with make of memory card. Additional photographs can be taken as soon as enough memory is available in buffer.

3 Total file size of NEF (RAW) and JPEG images.





## Exposure Program (Mode P)

The exposure program for mode **P** is shown in the following graph:

- F (lens focal length)  $\leq 55$  mm
- $55 < F \leq 135$  mm
- - - F  $> 135$  mm

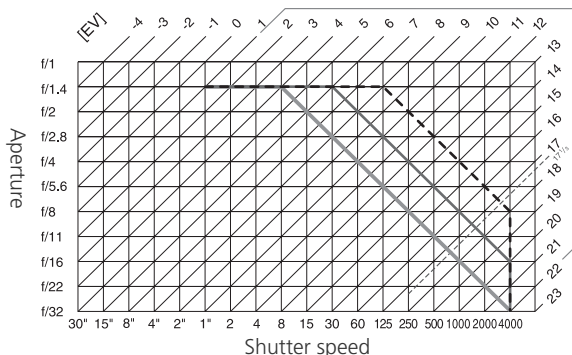

The maximum and minimum values for EV vary with sensitivity (ISO equivalency); the above graph assumes a sensitivity of ISO 200 equivalent. When matrix metering is used, values over  $17\frac{1}{2}$  EV are reduced to  $17\frac{1}{2}$  EV.

## Flash Control (36, 109)

The following types of flash control are supported when a CPU lens is used in combination with the built-in flash or an optional SB-800 or SB-600 Speedlight:

**i-TTL Balanced Fill-Flash for Digital SLR:** Flash output is adjusted for a natural balance between the main subject and the background.





**Standard i-TTL Flash for Digital SLR:** Flash output is adjusted for the main subject; the brightness of the background is not taken into account. Recommended for shots in which the main subject is emphasized at the expense of background details, or when exposure compensation is used.

Standard i-TTL flash control is used when **Spot** is selected for Custom Setting 13 (**Metering**; 96) or exposure mode **M** is selected when the built-in flash is used. i-TTL balanced fill-flash for digital SLR is used in all other cases.



## Shutter Speeds Available with Built-in Flash

The following shutter speeds are available when the built-in flash is used.

Mode	Shutter speed	Mode	Shutter speed
AUTO,  ,  , P, A	1/500–1/60 S		1/500–1 S
	1/500–1/125 S	S, M	1/500–1/30 S

## Flash Range, Aperture, and Sensitivity

Flash range varies with sensitivity (ISO equivalency) and aperture.

Aperture at ISO equivalent of				Range	
200	400	800	1600	m	ft
2	2.8	4	5.6	1.0–7.5	3'3"–24'7"
2.8	4	5.6	8	0.7–5.4	2'4"–17'8"
4	5.6	8	11	0.6–3.8	2'–12'6"
5.6	8	11	16	0.6–2.7	2'–8'9"
8	11	16	22	0.6–1.9	2'–6'3"
11	16	22	32	0.6–1.4	2'–4'7"
16	22	32	—	0.6–0.9	2'–2'11"
22	32	—	—	0.6–0.7	2'–2'4"

## Supported Standards

**DCF Version 2.0:** Design Rule for Camera File System (DCF) is standard widely used in the digital camera industry to ensure compatibility among different makes of camera.

**DPOF:** Digital Print Order Format (DPOF) is an industry-wide standard that allows pictures to be printed from print orders stored on the memory card.

**Exif version 2.21:** The D50 supports Exif (**Exchangeable Image File Format** for Digital Still Cameras) version 2.21, a standard that allows information stored with photographs to be used for optimal color reproduction when images are output on Exif-compliant printers.

**PictBridge:** A standard developed by in cooperation with the digital camera and printer industries, allowing photographs to be output directly to a printer without connecting the camera to a computer.









# Specifications

Type	Single-lens reflex digital camera with interchangeable lenses
Effective pixels	6.1 million
CCD	23.7 × 15.6 mm; total pixels: 6.24 million
Image size (pixels)	<ul style="list-style-type: none"> <li>• 3008 × 2000 (Large)</li> <li>• 2256 × 1496 (Medium)</li> <li>• 1504 × 1000 (Small)</li> </ul>
Lens mount	Nikon F mount (with AF coupling and AF contacts)
<b>Compatible lenses*</b>	
Type G or D AF Nikkor	All functions supported
Micro Nikkor 85 mm f/2.8D	All functions supported except autofocus and some exposure modes
Other AF Nikkor†	All functions supported except 3D color matrix metering II
AI-P Nikkor	All functions supported except 3D color matrix metering II and autofocus
Non-CPU	Can be used in mode <b>M</b> , but exposure meter does not function; electronic range finder can be used if maximum aperture is f/5.6 or faster
* IX Nikkor lenses can not be used † Excluding lenses for F3AF	
Picture angle	Equivalent in 35-mm format is approximately 1.5 times lens focal length
Viewfinder	Fixed-eyelevel penta-Dach-mirror type
Diopter adjustment	-1.6–+0.5 m <sup>-1</sup>
Eyepoint	18 mm (-1.0 m <sup>-1</sup> )
Focusing screen	Type B BriteView clear matte screen Mark V with superimposed focus brackets
Frame coverage	Approximately 95% of lens (vertical and horizontal)
Magnification	Approximately 0.75× (50-mm lens at infinity; -1.0 m <sup>-1</sup> )
Reflex mirror	Quick return
Lens aperture	Electronically controlled with instant return
Focus-area selection	Can be selected from 5 focus areas
Lens servo	<ul style="list-style-type: none"> <li>• Autofocus (AF): Instant single-servo AF (AF-S); continuous-servo AF (AF-C); auto AF-S/AF-C selection (AF-A); predictive focus tracking automatically activated according to subject status</li> <li>• Manual focus (M)</li> </ul>















<b>Autofocus</b>	TTL phase detection by Nikon Multi-CAM900 autofocus module with AF-assist illuminator (range approximately 0.5–3.0 m/1'8"–9'10")
<b>Detection range</b>	–1 – +19 EV (ISO 100 at 20 °C/68 °F)
<b>AF-area mode</b>	Single-area AF, dynamic-area AF, dynamic-area AF with closest subject priority
<b>Focus lock</b>	Focus can be locked by pressing shutter-release button halfway (single-servo AF) or by pressing <b>AE-L/AF-L</b> button

<b>Exposure</b>	
<b>Metering</b>	Three-mode through-the-lens (TTL) exposure metering
<b>Matrix</b>	3D color matrix metering II (type G and D lenses); color matrix metering II (other CPU lenses); metering performed by 420-segment RGB sensor
<b>Center-weighted</b>	Weight of 75% given to 8-mm circle in center of frame
<b>Spot</b>	Meters 3.5-mm circle (about 2.5% of frame) centered on active focus area
<b>Range</b> (ISO 100 equivalent, f/1.4 lens, 20 °C/68 °F)	0–20 EV (3D color matrix or center-weighted metering) 2–20 EV (spot metering)
<b>Exposure meter coupling</b>	CPU coupling
<b>Exposure control</b>	
<b>Operating mode</b>	Digital Vari-Program (  auto,  portrait,  landscape,  child,  sports,  close up,  night portrait), programmed auto ( <b>P</b> ) with flexible program; shutter-priority auto ( <b>S</b> ); aperture priority auto ( <b>A</b> ); manual ( <b>M</b> )
<b>Exposure compensation</b>	–5 – +5 EV in increments of 1/3 or 1/2 EV
<b>Bracketing</b>	Exposure and/or flash bracketing (up to ±2 EV over 3 exposures)
<b>Exposure lock</b>	Luminosity locked at detected value with <b>AE-L/AF-L</b> button

<b>Shutter</b>	Combined mechanical and CCD electronic shutter
<b>Speed</b>	30 – 1/4000 s in steps of 1/3 or 1/2 EV, bulb, remote

<b>Sensitivity</b>	200 – 1600 (ISO equivalent) in steps of 1 EV
<b>White balance</b>	Auto (TTL white-balance with 420 pixels RGB sensor), six manual modes with preset white balance
<b>Bracketing</b>	3 exposures in increments of 1, 2, or 3

Built-in Speedlight	<ul style="list-style-type: none"> <li>•     : auto flash with auto pop-up</li> <li>• <b>P, S, A, M</b>: manual pop-up with button release</li> </ul>
Guide number (m/ft at 20 °C/68 °F)	<ul style="list-style-type: none"> <li>• ISO 200: approximately 15/49 (manual 17/56)</li> <li>• ISO 100: approximately 11/36 (manual 12/39)</li> </ul>
<b>Flash</b>	
Sync contact	X-contact only; flash synchronization at up to 1/500 s
<b>Flash control</b>	
TTL	TTL flash control by 420-segment RGB sensor (CPU lenses only) <ul style="list-style-type: none"> <li>• <b>Built-in Speedlight</b>: i-TTL balanced fill-flash for digital SLR, or standard i-TTL flash for digital SLR (spot metering)</li> <li>• <b>SB-800 or 600</b>: i-TTL balanced fill-flash for digital SLR, or standard i-TTL flash for digital SLR (spot metering)</li> </ul>
Auto aperture	Available with SB-800 with CPU lens
Non-TTL auto	Available with such Speedlights as SB-800, 80DX, 28DX, 28, 27, and 22s
Range-priority manual	Available with SB-800
Sync modes	<ul style="list-style-type: none"> <li>•    : front curtain sync, red-eye reduction</li> <li>• : slow sync, slow sync with red-eye reduction</li> <li>•  : front curtain sync and red-eye reduction available with optional Speedlights</li> <li>• <b>P, S, A, M</b>: front curtain sync, slow sync, rear-curtain sync, red-eye reduction, slow sync with red-eye reduction</li> </ul>
Flash compensation	-3 – +1 EV in increments of 1/3 or 1/2 EV
Accessory shoe	Standard ISO hot-shoe contact with safety lock
Nikon Creative Lighting System	Supports Flash Color Information Communication and FV lock with built-in Speedlight, SB-800, and SB-600. SB-800 and 600 also support Advanced Wireless Lighting.
<b>Storage</b>	
Media	SD (Secure Digital) memory cards
File system	Compliant with Design Rule for Camera File System (DCF) 2.0 and Digital Print Order Format (DPOF)
Compression	<ul style="list-style-type: none"> <li>• <b>NEF (RAW)</b>: compressed 12-bit</li> <li>• <b>JPEG</b>: JPEG baseline-compliant</li> </ul>
Self-timer	Electronically controlled timer with 2 – 20 s duration
Monitor	2.0", 130,000-dot, low-temperature polysilicon TFT LCD with brightness adjustment



<b>Video output</b>	Can be selected from NTSC and PAL
<b>External interface</b>	USB 2.0 Hi-speed
<b>Tripod socket</b>	¼" (ISO)
<b>Firmware upgrades</b>	Firmware can be upgraded by user
<b>Supported languages</b>	Chinese (Simplified and Traditional), Dutch, English, French, German, Italian, Japanese, Korean, Portuguese, Russian, Spanish, Swedish
<b>Power source</b>	<ul style="list-style-type: none"> <li>• One rechargeable Nikon EN-EL3a Li-ion battery; charging voltage (MH-18a quick charger or optional MH-19 multi charger): 7.4V DC</li> <li>• EH-5 AC adapter (available separately)</li> </ul>
<b>Dimensions (W × H × D)</b>	Approximately 133 × 102 × 76 mm (5.2" × 4.0" × 3.0")
<b>Weight</b>	Approximately 540g (1 lb 3 oz) without battery, memory card, or body cap
<b>Operating environment</b>	
<b>Temperature</b>	0–+40 °C (+32–104 °F)
<b>Humidity</b>	Less than 85% (no condensation)

- Unless otherwise stated, all figures are for a camera with a fully-charged battery operating at an ambient temperature of 20 °C (68 °F).
- Nikon reserves the right to change the specifications of the hardware and software described in this manual at any time and without prior notice. Nikon will not be held liable for damages that may result from any mistakes that this manual may contain.



### ***MH-18a Quick Charger***

<b>Rated input</b>	AC 100–240 V, 50/60 Hz
<b>Rated output</b>	DC 8.4 V/900 mA
<b>Supported batteries</b>	EN-EL3a rechargeable Li-ion batteries
<b>Charging time</b>	Approximately 135 min
<b>Operating temperature</b>	0–+40 °C (+32–104 °F)
<b>Length of cord</b>	Approximately 1800 mm (5'11")
<b>Dimensions (W × H × D)</b>	Approximately 58 × 90 × 35 mm (2.3" × 3.5" × 1.4")
<b>Weight</b>	Approximately 80 g (2.8 oz), excluding power cable

### ***EN-EL3a Rechargeable Li-ion Battery***

<b>Type</b>	Rechargeable lithium-ion battery
<b>Rated capacity</b>	7.4 V/1500 mAh
<b>Dimensions (W × H × D)</b>	Approximately 39.5 × 56 × 21 mm (1.6" × 2.2" × 0.8")
<b>Weight</b>	Approximately 80 g (2.8 oz), excluding terminal cover



## AF-S 18–55 mm, f/3.5–5.6G Lens

Type	Type G CPU AF-S DX Nikkor zoom lens with Nikon mount
Supported cameras	Nikon DX-format digital SLR cameras
Focal length	18–55 mm
Max. reproduction ratio	1:3.5–5.6
Construction	7 elements in 5 groups, including 1 ED glass element and 1 aspherical element
Zoom positions	18, 24, 35, 45, and 55 mm
Distance information	Supplied to camera body
Zoom	Zoom adjusted by rotating lens zoom ring
Focus	Autofocus with Silent Wave motor; manual focus
Min. focus distance	0.28 m at all zoom positions
Aperture	Auto aperture
Aperture range	f/3.5–22 (18 mm zoom); f/5.6–38 (55 mm zoom)
Metering	Maximum aperture
Attachment diameter	52 mm (P=0.75 mm)
Dimensions (W × H × D)	Approximately 69 mm diameter × 74 mm (2.7" × 2.9')
Weight	Approximately 210 g (7.4 oz)

**Lens hoods** HB-33 (available separately; attaches as shown below)

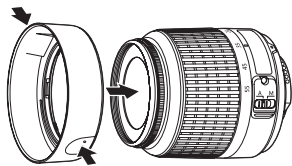



## Battery Life

The number of shots that can be taken with a fully-charged EN-EL3a battery (1500mAh) varies with the condition of the batteries, temperature, and how the camera is used. The following measurements were performed at a temperature of 20°C (68°F).

### *Example 1: 2500 shots*

AF-S DX ED 18–55mm f/3.5–5.6G lens; continuous shooting mode; continuous-servo autofocus; image quality set to JPEG Basic; image size set to **M**; shutter speed  $\frac{1}{250}$ s; shutter-release pressed halfway for three seconds and focus cycled from infinity to minimum range three times; after six shots, monitor turned on for five seconds and then turned off; cycle repeated once exposure meters have turned off.

### *Example 2: 500 shots*

AF-S DX ED 18–55mm f/3.5–5.6G lens; single-frame shooting mode; single-servo autofocus; image quality set to JPEG Normal; image size set to **L**; shutter speed  $\frac{1}{250}$ s; shutter-release pressed halfway for five seconds and focus cycled from infinity to minimum range once with each shot; built-in Speedlight fired at full power with every other shot; AF-assist illuminator lights when Speedlight is used; cycle repeated once exposure meters have turned off; camera turned off for one minute with every ten shots.

The following can reduce battery life:

- Using the monitor
- Keeping the shutter-release button pressed halfway
- Repeated autofocus operations
- Taking NEF (RAW) photographs
- Slow shutter speeds

To ensure maximum battery performance:

- Keep the battery contacts clean. Soiled contacts can reduce battery performance.
- Use EN-EL3a batteries immediately after charging. Batteries will lose their charge if left unused.



# Index

## Symbols

 See Exposure compensation

 See Flash compensation

 See Flash ready indicator

 See FV lock

     See Mode, Digital Vari-Program

 See Remote control

 See Self-timer

 See Shooting mode

## A

A. See Mode

Advanced Wireless Lighting, 110

**AE-L/AF-L**, 98

**AE Lock**, 99

AF. See Focus mode; Autofocus

**AF Area Illum**, 91

**AF-Area Mode**, 89

**AF Assist**, 90

AF-assist illuminator, 34

Aperture, 40–45

 (auto) mode, 14

Autoexposure lock, 97

**Autofocus**, 88

Autofocus, 33, 88, 89

**AF-A**, 88

**AF-C**, 88

**AF-S**, 88

## B

BASIC. See **Image Quality**

Battery, 8–9

EN-EL3a, 8

inserting, 8–9

life, 135

storage, 118–119

**Beep**, 88

BKT. See bracketing

**BKT Set**, 93

Blur, reducing, 43

Bracketing, 93–95. See also

Exposure bracketing; white balance, bracketing

Brightness. See **LCD Brightness**

Bulb. See long time exposures

## C

CCD, 129

cleaning, 116–117

Clock, 69

**CLOCK**. See Clock

Closest subject priority. See

AF-area mode

**Color Mode**, 77

Color profile. See **Color**

**Mode**

Computer, 59–61

Continuous shooting. See

shooting mode

Contrast. See **Tone Comp.**

CPU lenses, 105–106

Custom Settings, 87–100, 101

defaults, 87, 102

CSM. See Custom Settings

**CSM/Setup Menu**, 69

## D

Date. See **Date**

**Date**, 69

**Delete**, 84

Deleting, 57, 84. See also

Memory card, formatting

all images, 84

selected images, 84

single-frame playback, 24

Digital Print Order Format,

67, 128

Digital Vari-Program. See  mode

mode

Diopter, 13

DPOF. See Digital Print Order

Format

**Dust Ref Photo**, 74

DVP. See mode, Digital Vari-

Program

Dynamic-area AF. See AF-area

mode.

## E

EL. See Autoexposure lock

Electronic analog exposure

display, 45–46

Electronic range finder, 35

**EV Step**, 92

Exif version 2.21, 128

Exposure bracketing, 93–94

Exposure compensation, 47

Exposure meters, 96. See also

**Meter Off**

Eyepiece cap, 13

## F

**File No. Seq.**, 73

Files. See image files

FINE. See **Image quality**

Firmware, 75

**Firmware Ver.**, 75

Flash, 18, 36–38, 109–112.

See also Speedlight

bracketing, 93–94

Flash Color Information Com-

munication, 109–110

Flash exposure compensa-

tion, 38

**Flash Level**, 90

**Flash Mode**, 99

Flash-ready indicator, 18

Flash sync mode, 36–37

Flexible program, 42. See also

Mode, **P, S, A, M**

Focal plane mark, 35

Focus. See Autofocus; Focus

mode; Manual focus

Focus area (focus brackets), 33

Focus lock, 34

Focus mode, 15, 35

Folders, 71–72, 84

**Folders**, 71

**Format**, 68

FV lock, 98–99

## H

Highlight display, 53

Histogram, 53

**Hue Adjustment**, 78

## I

**Image Comment**, 70

Image dust off, 74

Image files, 31–32

**Image Quality**, 31

Image review, 90

**Image Review**, 90

**Image Rotation**, 75

**Image Size**, 32

**ISO**, 39. See also Sensitivity

**ISO Auto**, 92



## ISO Control, 91

i-TTL flash control, 109–110, 127

## J

JPEG, 31

## L

L. See **Image size**

Language. See **Language (LANG)**

**Language (LANG)**, 70

**LCD Brightness**, 69

Lens, 105–108

attaching, 7

compatible, 105–108

CPU, 105–106

non-CPU, 106–107

type G or D, 105–108

Long time-exposures, 45–46

**Long Exp. NR**, 78

Low-pass filter, 116–117

## M

M. See **Image Size**; Manual focus; Mode

Manual focus, 35

**Mass Storage**, 59, 71

Memory buffer, 21

Memory card, 11–12

approved, 114

capacity of, 126

formatting, 68

**Menu Reset**, 87

**Metering**, 96

**Meter Off**, 100

**Mirror Lock-Up**, 116

Mode, 6

Digital Vari-Program, 14–20

P, S, A, M, 40–46

Monitor, 115

auto off, 100

**Monitor Off**, 100

## N

NEF, 31–32. See also **Image Quality**; RAW

Nikon Capture 4, 31, 59, 114

Noise, 46

reduction, 78

NORMAL. See **Image Quality**

**NO SD Card?**, 90

## O

**Optimize Image**, 48, 76

## P

P. See mode

P\*. See Flexible program

PictBridge, 62–67, 128

PictureProject, 31, 59–60

Picture Transfer Protocol. See **PTP**.

**PTP**.

Photo information, 52–53

Playback, 51–67

**Playback Fldr**, 84

Playback menu, 83–86

PRE. See White balance, preset

Predictive focus tracking, 129

Printing photographs, 62–67

**Print Set**, 67

Protecting images, 56

**PTP**, 59, 63 71

## R

RAW, 32. See also **Image Quality**; NEF

Red-eye reduction, 36

**Remote**, 100

Remote control, 22–23

**Rotate Tall**, 84

## S

S. See **Image Size**; Mode

S. See Shooting mode

**Saturation**, 77

SD. See Memory card

Secure Digital. See Memory card

Self-portraits. See Remote control; Self-timer

Self-timer, 22–23

**Self-Timer**, 100

Sensitivity, 39. See also **ISO**

Setup menu, 68–75

**Sharpening**, 76

Shutter speed, 40–45

and flash synchronization, 128

Shooting menu, 76–82,

101–103

Shooting mode, 21

Single-area AF. See AF-area mode.

Single-frame playback, 51–53

Single-frame shooting. See

Shooting mode

Size. See **Image Size**

**Slide Show**, 85

Slide shows. See **Slide Show**

**Small Picture**, 86

Speedlight, 109–112. See

also flash

built-in, 18, 36–38

optional, 109–112

sRGB. See **Color Mode**

## T

Television, 58, 69

Time. See **Date**

Time exposures. See Long

time-exposures

Thumbnail playback, 54

**Tone Comp.**, 77

Two-button reset, 50

## U

**USB**, 59, 63, 71

## V

Video device, 58, 69

**Video Mode**, 69

VIDEO OUT, 58

Viewfinder, 13, 16–17

focus. See diopter

## W

WB. See White balance

**White Balance**, 47, 79

White balance, 49

bracketing, 93, 95

preset, 79–82



# ***Nikon***

No reproduction in any form of this manual, in whole or in part (except for brief quotation in critical articles or reviews), may be made without written authorization from NIKON CORPORATION.

**NIKON CORPORATION**

Fuji Bldg., 2-3 Marunouchi 3-chome,  
Chiyoda-ku, Tokyo 100-8331, Japan

SB5H02(11)  
6MBA4411-02