

**H97-PRO**

**ASUS**<sup>®</sup>

**Motherboard**

**Copyright© 2014 ASUSTeK COMPUTER INC. All Rights Reserved.**

No part of this manual, including the products and software described in it, may be reproduced, transmitted, transcribed, stored in a retrieval system, or translated into any language in any form or by any means, except documentation kept by the purchaser for backup purposes, without the express written permission of ASUSTeK COMPUTER INC. ("ASUS").

Product warranty or service will not be extended if: (1) the product is repaired, modified or altered, unless such repair, modification of alteration is authorized in writing by ASUS; or (2) the serial number of the product is defaced or missing.

ASUS PROVIDES THIS MANUAL "AS IS" WITHOUT WARRANTY OF ANY KIND, EITHER EXPRESS OR IMPLIED, INCLUDING BUT NOT LIMITED TO THE IMPLIED WARRANTIES OR CONDITIONS OF MERCHANTABILITY OR FITNESS FOR A PARTICULAR PURPOSE. IN NO EVENT SHALL ASUS, ITS DIRECTORS, OFFICERS, EMPLOYEES OR AGENTS BE LIABLE FOR ANY INDIRECT, SPECIAL, INCIDENTAL, OR CONSEQUENTIAL DAMAGES (INCLUDING DAMAGES FOR LOSS OF PROFITS, LOSS OF BUSINESS, LOSS OF USE OR DATA, INTERRUPTION OF BUSINESS AND THE LIKE), EVEN IF ASUS HAS BEEN ADVISED OF THE POSSIBILITY OF SUCH DAMAGES ARISING FROM ANY DEFECT OR ERROR IN THIS MANUAL OR PRODUCT.

SPECIFICATIONS AND INFORMATION CONTAINED IN THIS MANUAL ARE FURNISHED FOR INFORMATIONAL USE ONLY, AND ARE SUBJECT TO CHANGE AT ANY TIME WITHOUT NOTICE, AND SHOULD NOT BE CONSTRUED AS A COMMITMENT BY ASUS. ASUS ASSUMES NO RESPONSIBILITY OR LIABILITY FOR ANY ERRORS OR INACCURACIES THAT MAY APPEAR IN THIS MANUAL, INCLUDING THE PRODUCTS AND SOFTWARE DESCRIBED IN IT.

Products and corporate names appearing in this manual may or may not be registered trademarks or copyrights of their respective companies, and are used only for identification or explanation and to the owners' benefit, without intent to infringe.

**Offer to Provide Source Code of Certain Software**

This product contains copyrighted software that is licensed under the General Public License ("GPL"), under the Lesser General Public License Version ("LGPL") and/or other Free Open Source Software Licenses. Such software in this product is distributed without any warranty to the extent permitted by the applicable law. Copies of these licenses are included in this product.

Where the applicable license entitles you to the source code of such software and/or other additional data, you may obtain it for a period of three years after our last shipment of the product, either

(1) for free by downloading it from <http://support.asus.com/download>

or

(2) for the cost of reproduction and shipment, which is dependent on the preferred carrier and the location where you want to have it shipped to, by sending a request to:

ASUSTeK Computer Inc.  
Legal Compliance Dept.  
15 Li Te Rd.,  
Beitou, Taipei 112  
Taiwan

In your request please provide the name, model number and version, as stated in the About Box of the product for which you wish to obtain the corresponding source code and your contact details so that we can coordinate the terms and cost of shipment with you.

The source code will be distributed WITHOUT ANY WARRANTY and licensed under the same license as the corresponding binary/object code.

This offer is valid to anyone in receipt of this information.

ASUSTeK is eager to duly provide complete source code as required under various Free Open Source Software licenses. If however you encounter any problems in obtaining the full corresponding source code we would be much obliged if you give us a notification to the email address [gpl@asus.com](mailto:gpl@asus.com), stating the product and describing the problem (please DO NOT send large attachments such as source code archives, etc. to this email address).

# Contents

Safety information.....	vi
About this guide.....	vii
H97-PRO specifications summary.....	ix
Package contents.....	xiii
Installation tools and components.....	xiv

## Chapter 1: Product Introduction

<b>1.1</b>	<b>Special features.....</b>	<b>1-1</b>
1.1.1	Product highlights.....	1-1
1.1.2	5X Protection.....	1-2
1.1.3	ASUS Exclusive Features.....	1-2
1.1.4	Other special features.....	1-2
<b>1.2</b>	<b>Motherboard overview.....</b>	<b>1-3</b>
1.2.1	Before you proceed.....	1-3
1.2.2	Motherboard layout.....	1-4
1.2.3	Central Processing Unit (CPU).....	1-6
1.2.4	System memory.....	1-7
1.2.5	Expansion slots.....	1-9
1.2.6	Onboard buttons and switches.....	1-11
1.2.7	Jumpers.....	1-13
1.2.8	Onboard LEDs.....	1-14
1.2.9	Internal connectors.....	1-15

## Chapter 2: Basic installation

<b>2.1</b>	<b>Building your PC system.....</b>	<b>2-1</b>
2.1.1	Motherboard installation.....	2-1
2.1.2	CPU installation.....	2-3
2.1.3	CPU heatsink and fan assembly installation.....	2-4
2.1.4	DIMM installation.....	2-6
2.1.5	ATX Power connection.....	2-7
2.1.6	SATA device connection.....	2-8
2.1.7	Front I/O Connector.....	2-9
2.1.8	Expansion Card installation.....	2-10
<b>2.2</b>	<b>Motherboard rear and audio connections.....</b>	<b>2-11</b>
2.2.1	Rear I/O connection.....	2-11
2.2.2	Audio I/O connections.....	2-13
<b>2.3</b>	<b>Starting up for the first time.....</b>	<b>2-15</b>
<b>2.4</b>	<b>Turning off the computer.....</b>	<b>2-15</b>

## **Chapter 3: BIOS setup**

<b>3.1</b>	<b>Knowing BIOS</b> .....	<b>3-1</b>
<b>3.2</b>	<b>BIOS setup program</b> .....	<b>3-2</b>
	3.2.1 EZ Mode.....	3-3
	3.2.2 Advanced Mode .....	3-4
	3.2.3 QFan Control.....	3-7
	3.2.4 EZ Tuning Wizard .....	3-9
<b>3.3</b>	<b>My Favorites</b> .....	<b>3-11</b>
<b>3.4</b>	<b>Main menu</b> .....	<b>3-13</b>
<b>3.5</b>	<b>Ai Tweaker menu</b> .....	<b>3-15</b>
<b>3.6</b>	<b>Advanced menu</b> .....	<b>3-25</b>
	3.6.1 CPU Configuration .....	3-26
	3.6.2 PCH Configuration .....	3-28
	3.6.3 PCH Storage Configuration.....	3-30
	3.6.4 System Agent Configuration .....	3-32
	3.6.5 USB Configuration .....	3-33
	3.6.6 Platform Misc Configuration.....	3-34
	3.6.7 Onboard Devices Configuration.....	3-36
	3.6.8 APM Configuration.....	3-38
	3.6.9 Network Stack Configuration.....	3-39
<b>3.7</b>	<b>Monitor menu</b> .....	<b>3-39</b>
<b>3.8</b>	<b>Boot menu</b> .....	<b>3-43</b>
<b>3.9</b>	<b>Tool menu</b> .....	<b>3-49</b>
	3.9.1 ASUS EZ Flash 2 Utility .....	3-49
	3.9.2 ASUS Overclocking Profile .....	3-50
	3.9.3 ASUS SPD Information .....	3-51
<b>3.10</b>	<b>Exit menu</b> .....	<b>3-52</b>
<b>3.11</b>	<b>Updating BIOS</b> .....	<b>3-53</b>
	3.11.1 EZ Update.....	3-53
	3.11.2 ASUS EZ Flash 2.....	3-54
	3.11.3 ASUS CrashFree BIOS 3.....	3-55

## **Chapter 4: Software support**

<b>4.1</b>	<b>Installing an operating system</b> .....	<b>4-1</b>
<b>4.2</b>	<b>Support DVD information</b> .....	<b>4-1</b>
	4.2.1 Running the support DVD .....	4-1
	4.2.2 Obtaining the software manuals.....	4-3
<b>4.3</b>	<b>Software information</b> .....	<b>4-4</b>

<b>4.4</b>	<b>AI Suite 3</b> .....	<b>4-4</b>
4.4.1	DIGI+ VRM.....	4-7
4.4.2	EPU.....	4-8
4.4.3	TurboV EVO.....	4-9
4.4.4	USB 3.0 Boost.....	4-11
4.4.5	EZ Update.....	4-12
4.4.6	Fan Xpert 3.....	4-13
4.4.7	Push Notice.....	4-15
4.4.8	System Information.....	4-18
4.4.9	Version.....	4-19
<b>4.5</b>	<b>Audio configurations</b> .....	<b>4-20</b>
<b>4.6</b>	<b>Intel® SBA support</b> .....	<b>4-21</b>

**Chapter 5: RAID support**

<b>5.1</b>	<b>RAID configurations</b> .....	<b>5-1</b>
5.1.1	RAID definitions.....	5-1
5.1.2	Installing Serial ATA hard disks.....	5-2
5.1.3	Setting the RAID item in BIOS.....	5-2
5.1.4	Intel® Rapid Storage Technology Option ROM utility.....	5-3
<b>5.2</b>	<b>Creating a RAID driver disk</b> .....	<b>5-7</b>
5.2.1	Creating a RAID driver disk without entering the OS.....	5-7
5.2.2	Creating a RAID driver disk in Windows®.....	5-8
5.2.3	Installing the RAID driver during Windows® OS installation.....	5-8

**Appendices**

<b>Notices</b> .....	<b>A-1</b>
<b>ASUS contact information</b> .....	<b>A-4</b>

# Safety information

## Electrical safety

- To prevent electrical shock hazard, disconnect the power cable from the electrical outlet before relocating the system.
- When adding or removing devices to or from the system, ensure that the power cables for the devices are unplugged before the signal cables are connected. If possible, disconnect all power cables from the existing system before you add a device.
- Before connecting or removing signal cables from the motherboard, ensure that all power cables are unplugged.
- Seek professional assistance before using an adapter or extension cord. These devices could interrupt the grounding circuit.
- Ensure that your power supply is set to the correct voltage in your area. If you are not sure about the voltage of the electrical outlet you are using, contact your local power company.
- If the power supply is broken, do not try to fix it by yourself. Contact a qualified service technician or your retailer.

## Operation safety

- Before installing the motherboard and adding devices on it, carefully read all the manuals that came with the package.
- Before using the product, ensure all cables are correctly connected and the power cables are not damaged. If you detect any damage, contact your dealer immediately.
- To avoid short circuits, keep paper clips, screws, and staples away from connectors, slots, sockets and circuitry.
- Avoid dust, humidity, and temperature extremes. Do not place the product in any area where it may become wet.
- Place the product on a stable surface.
- If you encounter technical problems with the product, contact a qualified service technician or your retailer.

## About this guide

This user guide contains the information you need when installing and configuring the motherboard.

## How this guide is organized

This guide contains the following parts:

### 1. Chapter 1: Product introduction

This chapter describes the features of the motherboard and the new technology it supports. It includes description of the switches, jumpers, and connectors on the motherboard.

### 2. Chapter 2: Basic installation

This chapter lists the hardware setup procedures that you have to perform when installing system components.

### 3. Chapter 3: BIOS setup

This chapter tells how to change system settings through the BIOS Setup menus. Detailed descriptions of the BIOS parameters are also provided.

### 4. Chapter 4: Software support

This chapter describes the contents of the support DVD that comes with the motherboard package and the software.

### 5. Chapter 5: RAID support

This chapter describes the RAID configurations.

## Where to find more information

Refer to the following sources for additional information and for product and software updates.

### 1. ASUS website

The ASUS website ([www.asus.com](http://www.asus.com)) provides updated information on ASUS hardware and software products.

### 2. Optional documentation

Your product package may include optional documentation, such as warranty flyers, that may have been added by your dealer. These documents are not part of the standard package.

## Conventions used in this guide

To ensure that you perform certain tasks properly, take note of the following symbols used throughout this manual.



**DANGER/WARNING:** Information to prevent injury to yourself when trying to complete a task.



**CAUTION:** Information to prevent damage to the components when trying to complete a task



**IMPORTANT:** Instructions that you **MUST** follow to complete a task.



**NOTE:** Tips and additional information to help you complete a task.

## Typography

**Bold text**

Indicates a menu or an item to select.

*Italics*

Used to emphasize a word or a phrase.

<Key>

Keys enclosed in the less-than and greater-than sign means that you must press the enclosed key.

Example: <Enter> means that you must press the Enter or Return key.

<Key1> + <Key2> + <Key3>

If you must press two or more keys simultaneously, the key names are linked with a plus sign (+).



## H97-PRO specifications summary

<b>CPU</b>	<p>LGA1150 socket for the 4th, New 4th &amp; 5th Generation Intel® Core™ i7 / Core™ i5 / Core™ i3, Pentium®, and Celeron® processors</p> <p>Supports 22nm CPU</p> <p>Supports Intel® Turbo Boost Technology 2.0*</p> <p>* <b>The Intel® Turbo Boost Technology 2.0 support depends on the CPU types.</b></p> <p>** <b>Refer to <a href="http://www.asus.com">www.asus.com</a> for Intel® CPU support list.</b></p>
<b>Chipset</b>	<p>Intel® H97 Express Chipset</p>
<b>Memory</b>	<p>4 x DIMM, max. 32 GB, DDR3 1600/1333 MHz, non-ECC, un-buffered memory*</p> <p>Dual channel memory architecture</p> <p>Supports Intel® Extreme Memory Profile (XMP)</p> <p>* <b>Refer to <a href="http://www.asus.com">www.asus.com</a> for the Memory QVL (Qualified Vendors List).</b></p> <p>** <b>Due to Intel® chipset limitation, DDR3 1600 MHz and higher memory modules on XMP mode will run at the maximum transfer rate of DDR3 1600 Mhz.</b></p>
<b>Expansion slots</b>	<p>1 x PCI Express 3.0/2.0 x16 slot (at x16 mode)</p> <p>1 x PCI Express 2.0 x16 slot* (max. at x4 mode, compatible with PCIe x1 and x4 devices)</p> <p>2 x PCI Express 2.0 x1 slots*</p> <p>3 x PCI slots</p> <p>* <b>The PCIe x1_1, PCIe x1_2 slots share bandwidth with PCIe x16_2 slot. The PCIe x16_2 slot runs at x2 mode as default. Please check BIOS for more configuration.</b></p>
<b>VGA</b>	<p>Integrated Graphics Processor - Intel® HD Graphics support</p> <p>Multi-VGA output support: HDMI, DVI-D, RGB port</p> <ul style="list-style-type: none"> <li>- Supports HDMI with max. resolution 4096x2160@24Hz / 2560x1600@60Hz</li> <li>- Supports DVI-D with max. resolution 1920 x 1200@60Hz</li> <li>- Supports RGB with max. resolution 1920 x 1200@60Hz</li> </ul> <p>Supports Intel® InTru™ 3D/Quick Sync Video/Clear Video HD Technology/ Insider™</p> <p>Supports up to three displays simultaneously</p> <p>Maximum shared memory 512 MB</p>
<b>Multi-GPU support</b>	<p>Supports AMD® Quad-GPU CrossFireX™ Technology</p>
<b>Storage</b>	<p><b>Intel® H97 Express Chipset with RAID 0, 1, 5, 10 and Intel® Rapid Storage Technology 13 support</b></p> <ul style="list-style-type: none"> <li>- 1 x SATA Express port (black, compatible with 2 x SATA 6.0 Gb/s ports)</li> <li>- 1 x M.2 Socket 3*</li> <li>- 4 x SATA 6.0 Gb/s ports (gray)</li> <li>- Supports Intel® Smart Response Technology, Intel® Rapid Start Technology, Intel® Smart Connect Technology**</li> </ul> <p>* <b>M.2 Socket 3 shares bandwidth with SATA Express. This socket supports M Key and both SATA and PCIe mode type 2242/2260/2280 storage devices (Type 2242 storage device is supported on Rev.2.01 or later versions of this motherboard).</b></p> <p>** <b>These functions will work depending on the CPU installed.</b></p>
<b>LAN</b>	<p>Gigabit Intel® LAN controller</p> <ul style="list-style-type: none"> <li>- 802.3az Energy Efficient Ethernet (EEE) appliance</li> </ul> <p>Intel® I218-V Gigabit LAN</p> <ul style="list-style-type: none"> <li>- Dual interconnect between the integrated media Access Controller (MAC) and physical layer (PHY)</li> </ul>

(continued on the next page)

## H97-PRO specifications summary

<b>USB</b>	<b>Intel® H97 Express Chipset - supports ASUS USB 3.0 Boost</b> <ul style="list-style-type: none"> <li>- 6 x USB 3.0/2.0 ports (2 ports at mid-board, 4 ports at back panel [blue])</li> <li>- 8 x USB 2.0/1.1 ports (6 ports at mid-board, 2 ports at back panel)</li> </ul>
<b>Audio</b>	<b>Realtek® ALC892 7.1-channel high definition audio CODEC featuring Crystal Sound 2</b> <ul style="list-style-type: none"> <li>- Audio Shielding: Ensures precision analog/digital separation and greatly reduced multi-lateral interference</li> <li>- Dedicated audio PCB layers: Separate layers for left and right channels to guard the quality of the sensitive audio signals</li> <li>- Audio amplifier: Provides the highest-quality sound for headphone and speakers</li> <li>- Premium Japanese-made audio capacitors: Provide warm, natural and immersive sound with exceptional clarity and fidelity</li> <li>- Unique de-pop circuit: Reduces start-up popping noise to audio outputs</li> <li>- Supports jack-detection, multi-streaming, and front panel jack-retasking</li> </ul>
<b>ASUS Exclusive Features</b>	<b>High Performance</b> <b>ASUS 5X PROTECTION</b> <ul style="list-style-type: none"> <li>- ASUS DIGI+ VRM - 6 Phase digital power design</li> <li>- ASUS Enhanced DRAM Overcurrent Protection - Short circuit damage prevention</li> <li>- ASUS ESD Guards - Enhanced ESD protection</li> <li>- ASUS High-Quality 5K-Hour Solid Capacitors - 2.5x long lifespan with excellent durability</li> <li>- ASUS Stainless Steel Back I/O - 3x more durable corrosion-resistant coating</li> </ul> <b>UEFI BIOS</b> <ul style="list-style-type: none"> <li>- Most advanced options with fast response time</li> </ul> <b>M.2 &amp; SATA Express onboard</b> <ul style="list-style-type: none"> <li>- The latest transfer technologies with up to 10Gb/s data-transfer speeds</li> </ul> <b>ASUS Fan Xpert3</b> <ul style="list-style-type: none"> <li>- Featuring Fan Auto Tuning function and multiple thermistors selection for optimized system cooling control</li> </ul> <b>ASUS EPU</b> <ul style="list-style-type: none"> <li>- EPU</li> </ul> <b>Interactive HomeCloud</b> <b>Media Streamer</b> <ul style="list-style-type: none"> <li>- Pipe music or movies from your PC to a smart TV</li> <li>- Media Streamer app for portable smartphone/tablet, supporting iOS 7 and Android 4.0 system</li> </ul> <b>Gaming Scenario</b> <b>Crystal Sound 2</b> <ul style="list-style-type: none"> <li>- Flawless audio that makes you part of the game</li> </ul> <b>Turbo LAN</b> <ul style="list-style-type: none"> <li>- Experience smooth online gaming with lower pings and less lags</li> </ul> <b>Steam Support</b> <ul style="list-style-type: none"> <li>- Compatible with the most fun gaming platform under Windows® system</li> </ul>

(continued on the next page)

# H97-PRO specifications summary

<b>ASUS Exclusive Features</b>	<b>ASUS Exclusive Features</b> <ul style="list-style-type: none"><li>- ASUS USB 3.0 Boost featuring speedy USB 3.0 transmission</li><li>- ASUS Disk Unlocker featuring 3TB+ HDD support</li><li>- ASUS AI Charger</li><li>- ASUS GPU Boost with GPU Boost switch</li><li>- ASUS AI Suite 3</li><li>- MemOK!</li><li>- Anti Surge</li></ul> <b>EZ DIY</b> <b>Push Notice</b> <ul style="list-style-type: none"><li>- Monitor your PC status with smart devices in real time</li></ul> <b>UEFI BIOS EZ Mode</b> <ul style="list-style-type: none"><li>- Friendly graphics user interface</li><li>- ASUS CrashFree BIOS 3</li><li>- ASUS EZ Flash 2</li></ul> <b>Q-Design</b> <ul style="list-style-type: none"><li>- ASUS Q-Connector</li><li>- ASUS Q-Shield</li><li>- ASUS Q-Slot</li></ul> <b>Other features</b> <ul style="list-style-type: none"><li>- Support SBA</li></ul>
<b>ASUS Quiet Thermal Solution</b>	<b>Quiet Thermal Design</b> <ul style="list-style-type: none"><li>- ASUS Fan Xpert 3</li><li>- ASUS Stylish Fanless Design: PCH Heat-sink &amp; MOS Heat-sink solution</li></ul>
<b>Back Panel I/O Ports</b>	1 x PS/2 keyboard/mouse combo port 1 x HDMI port 1 x DVI-D port 1 x VGA port 1 x LAN (RJ45) port 4 x USB 3.0/2.0 ports (blue) 2 x USB 2.0/1.1 ports 7.1-channel Audio I/O ports(6-jacks)

*(continued on the next page)*

# H97-PRO specifications summary

<p><b>Internal I/O Connectors</b></p>	<p>1 x USB 3.0/2.0 connector support additional 2 USB ports (19-pin)            3 x USB 2.0/1/1 connectors support additional 6 USB ports            1 x SATA Express port (black, compatible with 2 x SATA 6.0 Gb/s ports)            1 x M.2 Socket 3*            4 x SATA 6.0Gb/s connectors (gray)            1 x CPU Fan connector (4-pin) for both 3-pin(DC mode) and 4-pin(PWM mode) CPU coolers control**            3 x Chassis Fan connectors (4-pin) for both 3-pin(DC mode) and 4-pin(PWM mode) coolers control            1 x Front panel audio connector (AAFP)            1 x S/PDIF out header            1 x TPM connector            1 x COM connector            24-pin EATX Power connector            8-pin EATX 12V Power connector            System panel connector (Q-Connector)            1 x MemOK! button            1 x Clear CMOS jumper(s)            1 x GPU Boost switch</p> <p>* M.2 Socket 3 shares bandwidth with SATA Express. This socket supports M Key and both SATA and PCIE mode type 2242/2260/2280 storage devices (Type 2242 storage device is supported on Rev.2.01 or later versions of this motherboard).            ** The CPU Q-Fan control setting is set as default in Auto mode for detecting the type of CPU fan installed and switches to the control mode automatically.</p>
<p><b>BIOS</b></p>	<p>128 Mb Flash ROM, UEFI AMI BIOS, PnP, DMI2.7, WfM2.0, SM BIOS 2.8, ACPI 5.0, Multi-language BIOS, ASUS EZ Flash 2, CrashFree BIOS 3, F6 Qfan Control, F11 EZ Tuning Wizard, F3 My Favorites &amp; Shortcut, Quick Note, Last Modified log, F12 PrintScreen, and ASUS DRAM SPD (Serial Presence Detect) memory information</p>
<p><b>Manageability</b></p>	<p>WfM 2.0, DMI 2.7, WOL by PME, PXE</p>
<p><b>Support DVD</b></p>	<p>Drivers            ASUS Utilities            EZ Update            Anti-virus software (OEM version)</p>
<p><b>Operating system support</b></p>	<p>Windows® 8.1 / Windows® 8            Windows® 7</p>
<p><b>Form factor</b></p>	<p>ATX form factor: 12 in. x 8.6 in. (30.5 cm x 21.8cm)</p>



Specifications are subject to change without notice.

# Package contents

Check your motherboard package for the following items

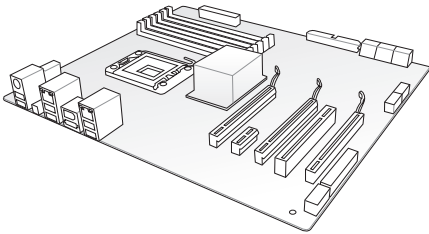

**ASUS H97-PRO Series motherboard**

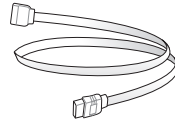

**4 x Serial ATA 6 Gb/s cables**

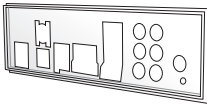

**1 x ASUS Q-Shield**



**User manual**

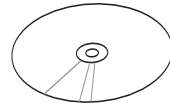

**Support DVD**

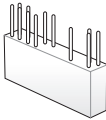

**1 x 2-in-1 ASUS Q-Connector kit**



- 
- If any of the above items is damaged or missing, contact your retailer.
  - The illustrated items above are for reference only. Actual product specifications may vary with different models.
-

# Installation tools and components

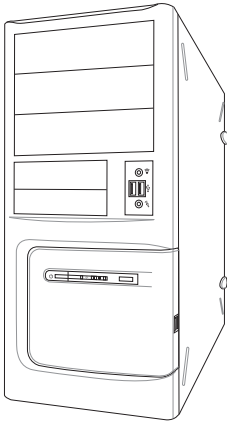

PC chassis

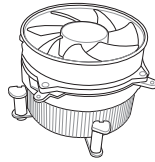

Intel® LGA1150 compatible CPU Fan

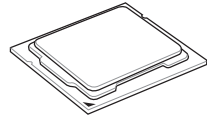

Intel® LGA1150 CPU

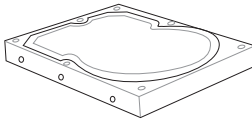

SATA hard disk drive



Philips (cross) screwdriver

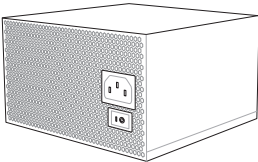

Power supply unit

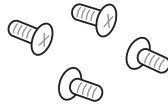

1 bag of screws

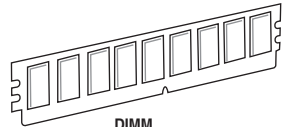

DIMM

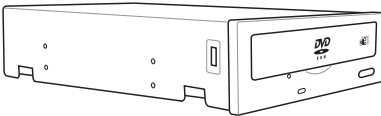

SATA optical disc drive (optional)

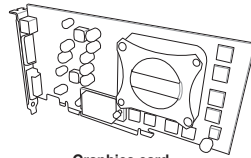

Graphics card



---

The tools and components in the table above are not included in the motherboard package.

---

# Product introduction

# 1

## 1.1 Special features

### 1.1.1 Product highlights

#### **LGA1150 socket for the 4th, New 4th & 5th Generation Intel® Core™ i7/Intel® Core™ i5/Intel® Core™ i3, Pentium® and Celeron® processors**

This motherboard supports the 4th, New 4th & 5th Generation Intel® Core™ i7/Intel® Core™ i5/Intel® Core™ i3, Pentium®, and Celeron® processors in the LGA1150 package. It provides great graphics and system performance with its GPU, dual-channel DDR3 memory slots and PCI Express 2.0/3.0 expansion slots.

#### **Intel® H97 Express Chipset**

Intel® H97 Express Chipset is a single chipset that supports the LGA1150 socket for the 4th, New 4th & 5th Generation Intel® Core™ i7/Intel® Core™ i5/Intel® Core™ i3, Pentium®, and Celeron® processors. It utilizes the serial point-to-point links, which increases bandwidth and enhances the system's performance. It natively supports up to six USB 3.0 ports, six SATA 6 Gb/s ports, and M.2 support for faster data retrieval. It also enables the iGPU function for Intel® integrated graphics performance.

#### **PCI Express® 3.0**

PCI Express® 3.0 (PCIe 3.0) is the PCI Express bus standard that provides twice the performance and speed of PCIe 2.0. It provides an optimal graphics performance, unprecedented data speed and seamless transition with its complete backward compatibility to PCIe 1.0/2.0 devices.

#### **Intel® Desktop Responsiveness Technologies**

Intel Desktop Responsiveness Technologies comprise of three technologies: Intel Rapid Start Technology, Intel Smart Connect Technology, and Intel Smart Response Technology. These technologies provide faster and better performance for your computer, allow your system to receive the freshest updates from the Internet, and quickly resume your system from a deep sleep or hibernate mode.

#### **Quad-GPU CrossFireX™ Support**

This motherboard features the most powerful Intel® H97 platform that optimizes PCIe allocation in multi-GPU CrossFireX™ solution, giving you a brand-new gaming enjoyment.

#### **SATA Express support**

SATA Express provides faster data transfer speeds of up to 10 Gb/s, allowing your system to catch up with the speed of the SSDs. It also features backward compatibility with up to two SATA drives of the same speed.

## M.2 Support

This motherboard features the M.2 socket 3, which shares bandwidth with the SATA Express port to speed up data transfer up to 10 Gb/s. This helps enhance the performance of your SSD (Solid State Drive) that is dedicated only to the operating system. The M.2 socket 3 also includes Intel Rapid Storage Technology support for faster access to data and applications, and quicker wake up time for your system.

## Complete USB 3.0 integration

This motherboard offers you the strategic USB 3.0 accessibility for both the front and rear panels, allowing you to experience the convenience of the latest plug and play connectivity solution at speed up to ten times faster than USB 2.0.

### 1.1.2 5X Protection

#### 5X PROTECTION

ASUS motherboards guard your PC with 5X PROTECTION. We use quality components like ESD units tested to strict standards that eliminate electrostatic interference, polyswitches (resettable fuses) around DRAM slots to prevent overcurrent and short-circuit damage, and a corrosion-resistant back I/O shield. All examples of ASUS providing the best possible reliability and durability.

### 1.1.3 ASUS Exclusive Features

#### Crystal Sound 2

Crystal Sound 2 makes short work of optimizing audio settings for the way you want to listen, be it gaming, chatting, watching movies or relaxing to your favorite music. Onboard physical shielding, professional engineered design and premium components, including Japanese-made audio capacitors and operational amplifiers (op-amps), result in sound output that has exceptional clarity and fidelity. Discover a whole new dimension of superior audio and get ready to rule!

#### ASUS HomeCloud

ASUS HomeCloud creates a world without boundaries. It lets you access your PC remotely, stream multimedia content to wherever you want, and manage all your stuff from anywhere—no matter where it's stored. Use the built-in Wake on WAN feature to remotely wake and control your PC with a single smart device, anywhere and anytime. It even turns your hard drive into a private cloud, removing worries about storage limits. With HomeCloud, your PC becomes the gateway to your world.

### 1.1.4 Other special features

#### ErP Ready

The motherboard is European Union's Energy-related Products (ErP) ready, and ErP requires products to meet certain energy efficiency requirement in regards to energy consumptions. This is in line with ASUS vision of creating environment-friendly and energy-efficient products through product design and innovation to reduce carbon footprint of the product and thus mitigate environmental impacts.



## 1.2 Motherboard overview

### 1.2.1 Before you proceed

Take note of the following precautions before you install motherboard components or change any motherboard settings.



- 
- Unplug the power cord from the wall socket before touching any component.
  - Before handling components, use a grounded wrist strap or touch a safely grounded object or a metal object, such as the power supply case, to avoid damaging them due to static electricity.
  - Hold components by the edges to avoid touching the ICs on them.
  - Whenever you uninstall any component, place it on a grounded antistatic pad or in the bag that came with the component.
  - Before you install or remove any component, ensure that the ATX power supply is switched off or the power cord is detached from the power supply. Failure to do so may cause severe damage to the motherboard, peripherals, or components.
-

## 1.2.2 Motherboard layout

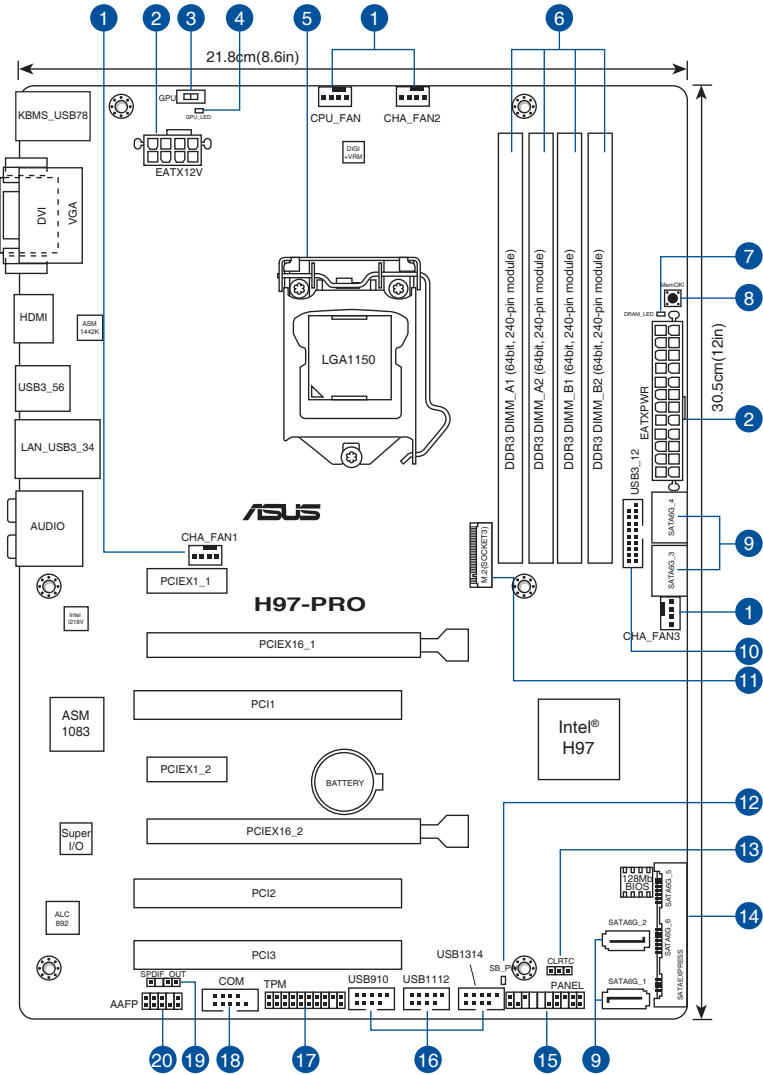

Refer to **1.2.9 Internal connectors** and **2.3.1 Rear I/O connection** for more information about rear panel connectors and internal connectors.



## Layout contents

Connectors/Jumpers/Buttons and switches/Slots	Page
1. CPU and chassis fan connectors (4-pin CPU_FAN, 4-pin CHA_FAN1/2/3)	1-21
2. ATX power connectors (24-pin EATXPWR, 8-pin EATX12V)	1-15
3. GPU Boost switch	1-12
4. GPU Boost LED	1-15
5. LGA1150 CPU socket	1-6
6. DDR3 DIMM slots	1-7
7. DRAM LED	1-14
8. MemOK! button	1-11
9. Intel® Serial ATA 6 Gb/s connectors (7-pin SATA6G_1~4)	1-16
10. USB 3.0 connectors (20-1 pin USB3_12)	1-19
11. M.2 socket 3	1-23
12. Standby power LED (SB_PWR)	1-14
13. Clear CMOS jumper (CLR_CMOS)	1-13
14. Intel® H97 Serial ATA 6.0 Gb/s connectors (SATA6G_56, SATAEXPRESS)	1-20
15. System panel connector (20-8 pin PANEL)	1-22
16. USB 2.0 connectors (10-1 pin USB910; USB1112; USB1314)	1-20
17. TPM connector (20-1 pin TPM)	1-17
18. Serial port connector (10-1 pin COM)	1-18
19. Digital audio connector (4-1 pin SPDIF_OUT)	1-17
20. Front panel audio connector (10-1 pin AAFP)	1-18

### 1.2.3 Central Processing Unit (CPU)

The motherboard comes with a surface mount LGA1150 socket designed for the 4th, New 4th & 5th Generation Intel® Core™ i7 / Intel® Core™ i5 / Intel® Core™ i3, Pentium®, and Celeron® processors.

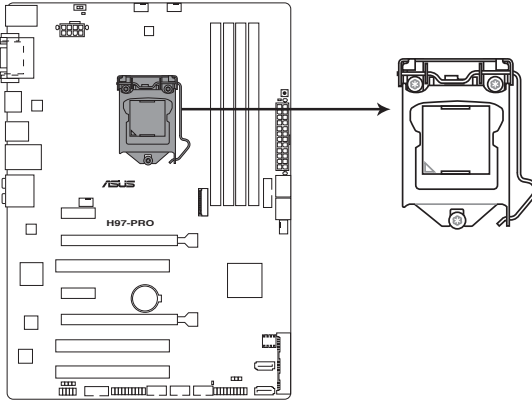

#### H97-PRO CPU socket LGA1150



---

Ensure that you install the correct CPU designed for LGA1150 socket only. DO NOT install a CPU designed for LGA1155 and LGA1156 sockets on the LGA1150 socket.

---



- Ensure that all power cables are unplugged before installing the CPU.
  - Upon purchase of the motherboard, ensure that the PnP cap is on the socket and the socket contacts are not bent. Contact your retailer immediately if the PnP cap is missing, or if you see any damage to the PnP cap/socket contacts/motherboard components. ASUS will shoulder the cost of repair only if the damage is shipment/transit-related.
  - Keep the cap after installing the motherboard. ASUS will process Return Merchandise Authorization (RMA) requests only if the motherboard comes with the cap on the LGA1150 socket.
  - The product warranty does not cover damage to the socket contacts resulting from incorrect CPU installation/removal, or misplacement/loss/incorrect removal of the PnP cap.
-

## 1.2.4 System memory

The motherboard comes with four DDR 3 (Double Data Rate 3) Dual Inline Memory Modules (DIMM) slots.



A DDR3 module is notched differently from a DDR or DDR2 module. DO NOT install a DDR or DDR2 memory module to the DDR3 slot.

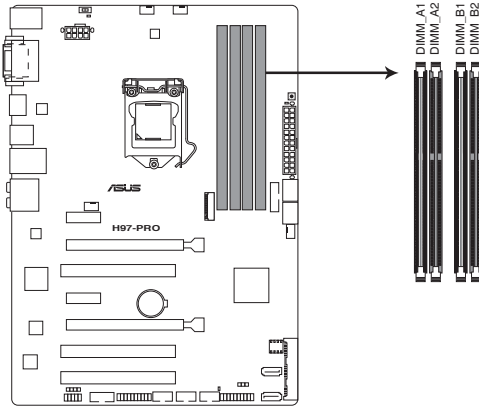

**H97-PRO 240-pin DDR3 DIMM sockets**

### Recommended memory configurations

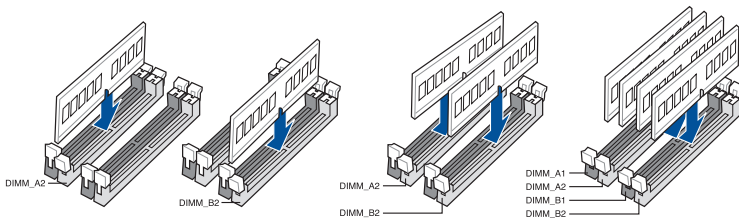

## Memory configurations

You may install 2 GB, 4 GB and 8 GB unbuffered and non-ECC DDR3 DIMMs into the DIMM sockets.



- 
- You may install varying memory sizes in Channel A and Channel B. The system maps the total size of the lower-sized channel for the dual-channel configuration. Any excess memory from the higher-sized channel is then mapped for single-channel operation.
  - According to Intel® CPU spec, DIMM voltage below 1.65 V is recommended to protect the CPU.
  - Due to the memory address limitation on 32-bit Windows® OS, when you install 4GB or more memory on the motherboard, the actual usable memory for the OS can be about 3GB or less. For effective use of memory, we recommend that you do any of the following:
    - a) Use a maximum of 3GB system memory if you are using a 32-bit Windows® OS.
    - b) Install a 64-bit Windows® OS when you want to install 4 GB or more on the motherboard.
    - c) For more details, refer to the Microsoft® support site at <http://support.microsoft.com/kb/929605/en-us>.
  - This motherboard does not support DIMMs made up of 512 Mb (64 MB) chips or less (Memory chip capacity counts in Megabit, 8 Megabit/Mb = 1 Megabyte/MB).
- 



- 
- The default memory operation frequency is dependent on its Serial Presence Detect (SPD), which is the standard way of accessing information from a memory module. Refer to section **3.5 Ai Tweaker menu** for manual memory frequency adjustment.
  - For system stability, use a more efficient memory cooling system to support a full memory load (4 DIMMs).
  - Always install the DIMMS with the same CAS Latency. For an optimum compatibility, we recommend that you install memory modules of the same version or data code (D/C) from the same vendor. Check with the vendor to get the correct memory modules.
- 



- 
- Due to Intel® chipset limitation, DDR3 1600 MHz and higher memory modules on XMP mode will run at the maximum transfer rate of DDR3 1600 MHz.
  - Visit the ASUS website for the latest QVL.
-

## 1.2.5 Expansion slots



Unplug the power cord before adding or removing expansion cards. Failure to do so may cause you physical injury and damage motherboard components.

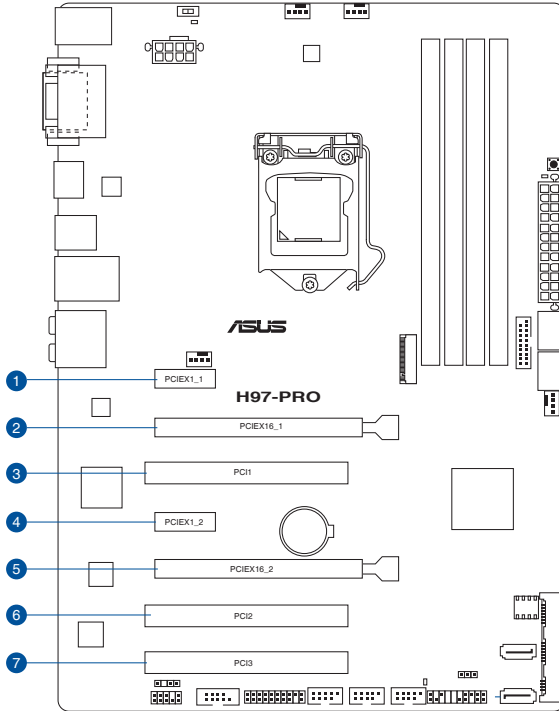

Slot No.	Slot Description
1	PCIe 2.0 x1_1 slot
2	PCIe 3.0/2.0 x16_1 slot
3	PCI_1 slot
4	PCIe 2.0 x1_2 slot
5	PCIe 2.0 x16_2 slot
6	PCI_2 slot
7	PCI_3 slot

VGA configuration	PCI Express 3.0 operating mode	
	PCIe 3.0/2.0 x16_1	PCIe 2.0 x16_2
Single VGA/PCIe card	x16 (single VGA recommended)	N/A
Dual VGA/PCIe card	x16	x4



- In single VGA card mode, use the PCIe 3.0/2.0 x16\_1 slot (gray) for a PCI Express x16 graphics card to get better performance.
- We recommend that you provide sufficient power when running CrossFireX™ mode.
- Connect a chassis fan to the motherboard connector labeled CHA\_FAN1/2/3 when using multiple graphics cards for better thermal environment.
- The PCIe x1\_1 and PCIe x1\_2 slots share bandwidth with the PCIe x16\_2 slot. The PCIe x16\_2 slot runs at x2 mode as default. Please check BIOS for more configuration.

## IRQ assignments for this motherboard

	A	B	C	D	E	F	G	H
PCIe x16_1	shared	-	-	-	-	-	-	-
PCIe x16_2	shared	-	-	-	-	-	-	-
PCIe x1_1	-	-	shared	-	-	-	-	-
PCIe x1_2	-	-	-	shared	-	-	-	-
PCI1	-	-	-	shared	-	-	-	-
PCI2	shared	-	-	-	-	-	-	-
PCI3	-	shared	-	-	-	-	-	-
Intel® SATA Controller	-	-	-	shared	-	-	-	-
Intel® LAN	-	-	-	-	shared	-	-	-
Intel® xHCI	-	-	-	-	-	shared	-	-
Intel® EHCI 1	-	-	-	-	-	-	-	shared
Intel® EHCI 2	shared	-	-	-	-	-	-	-
HD Audio	-	-	-	-	-	-	shared	-



## 1.2.6 Onboard buttons and switches

Onboard buttons and switches allow you to fine-tune performance when working on a bare or open-case system. This is ideal for overclockers and gamers who continually change settings to enhance system performance.

### 1. MemOK! button

Installing DIMMs that are not compatible with the motherboard may cause system boot failure, and the DRAM\_LED near the MemOK! button lights continuously. Press and hold the MemOK! button until the DRAM\_LED starts blinking to begin automatic memory compatibility tuning for successful boot.

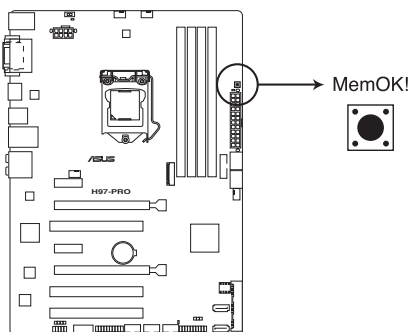

**H97-PRO MemOK! button**



- Refer to section **1.2.8 Onboard LEDs** for the exact location of the DRAM\_LED.
- The DRAM\_LED also lights up when the DIMM is not properly installed. Turn off the system and reinstall the DIMM before using the MemOK! function.
- The MemOK! button does not function under Windows® OS environment.
- During the tuning process, the system loads and tests failsafe memory settings. It takes about 30 seconds for the system to test one set of failsafe settings. If the test fails, the system reboots and test the next set of failsafe settings. The blinking speed of the DRAM\_LED increases, indicating different test processes.
- Due to memory tuning requirement, the system automatically reboots when each timing set is tested. If the installed DIMMs still fail to boot after the whole tuning process, the DRAM\_LED lights continuously. Replace the DIMMs with ones recommended in the Memory QVL (Qualified Vendors Lists) in this user manual or at [www.asus.com](http://www.asus.com).
- If you turn off the computer and replace DIMMs during the tuning process, the system continues memory tuning after turning on the computer. To stop memory tuning, turn off the computer and unplug the power cord for about 5–10 seconds.
- If your system fails to boot up due to BIOS overclocking, press the MemOK! button to boot and load the BIOS default settings. A message will appear during POST reminding you that the BIOS has been restored to its default settings.
- We recommend that you download and update to the latest BIOS version from [www.asus.com](http://www.asus.com) after using the MemOK! function.

## 2. GPU Boost switch

This switch allows you to enable or disable the GPU Boost function.

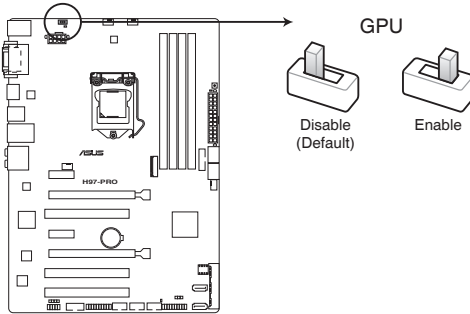

**H97-PRO GPU Boost switch**



- The GPU Boost LED (GPU\_LED) near the GPU Boost switch lights up when the GPU Boost switch is enabled. Refer to section **1.2.8 Onboard LEDs** for the exact location of the GPU Boost LED.
- If you enable this switch under Windows® OS environment, the GPU Boost function will be activated after the next system bootup.
- You may use the TurboV feature in the AI Suite 3 application, adjust the BIOS setup program or enable the GPU Boost switch at the same time. However, the system will use the last setting you have made.

## 1.2.7 Jumpers

### 1. Clear RTC RAM (3-pin CLRRTC)

This jumper allows you to clear the Real Time Clock (RTC) RAM in CMOS. You can clear the CMOS memory of date, time, and system setup parameters by erasing the CMOS RTC RAM data. The onboard button cell battery powers the RAM data in CMOS, which include system setup information such as system passwords.

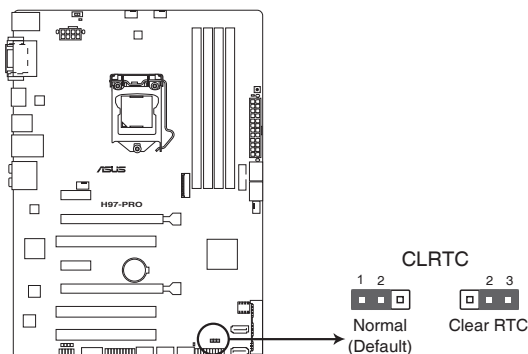

#### H97-PRO Clear RTC RAM

##### To erase the RTC RAM:

1. Turn OFF the computer and unplug the power cord.
2. Move the jumper cap from pins 1-2 (default) to pins 2-3. Keep the cap on pins 2-3 for about 5-10 seconds, then move the cap back to pins 1-2.
3. Plug the power cord and turn ON the computer.
4. Hold down the <Del> key during the boot process and enter BIOS setup to re-enter data.



Except when clearing the RTC RAM, never remove the cap on CLRRTC jumper default position. Removing the cap will cause system boot failure!



- If the steps above do not help, remove the onboard battery and move the jumper again to clear the CMOS RTC RAM data. After clearing the CMOS, reinstall the battery.
- You do not need to clear the RTC when the system hangs due to overclocking. For system failure due to overclocking, use the CPU Parameter Recall (C.P.R.) feature. Shut down and reboot the system, then the BIOS automatically resets parameter settings to default values.

## 1.2.8 Onboard LEDs

### 1. Standby Power LED

The motherboard comes with a standby power LED that lights up to indicate that the system is ON, in sleep mode, or in soft-off mode. This is a reminder that you should shut down the system and unplug the power cable before removing or plugging in any motherboard component. The illustration below shows the location of the onboard LED.

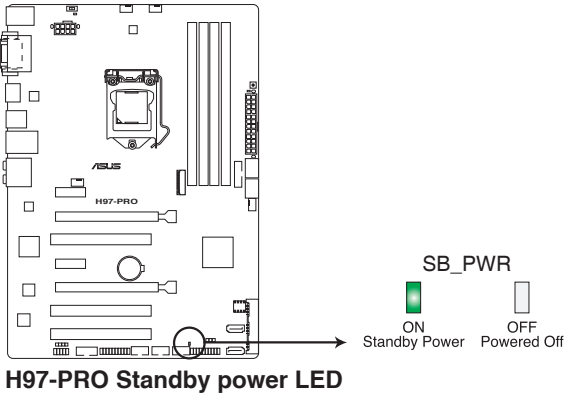

### 2. DRAM LED

DRAM LED checks the DRAM in sequence during motherboard booting process. If an error is found, the LED next to the error device will continue lighting until the problem is solved. This user-friendly design provides an intuitive way to locate the root problem within a second.

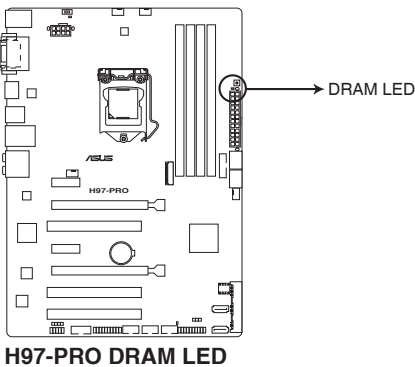

### 3. GPU Boost LED

The GPU Boost LED lights up when the GPU Boost switch is enabled.

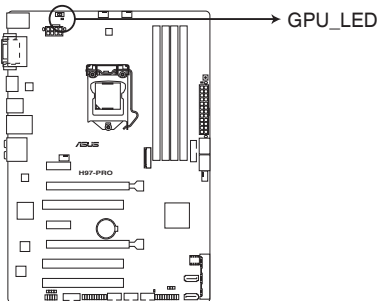

H97-PRO GPU Boost LED

## 1.2.9 Internal connectors

### 1. ATX power connectors (24-pin EATXPWR; 8-pin EATX12V)

These connectors are for ATX power supply plugs. The power supply plugs are designed to fit these connectors in only one orientation. Find the proper orientation and push down firmly until the connectors completely fit.

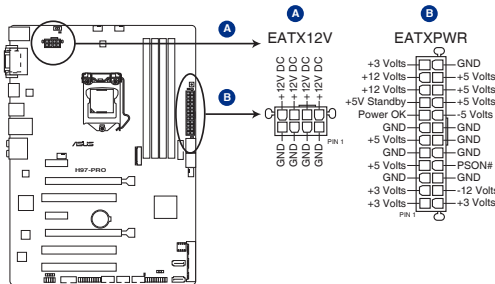

H97-PRO ATX power connectors



- For a fully configured system, we recommend that you use a power supply unit (PSU) that complies with ATX 12 V Specification 2.0 (or later version) and provides a minimum power of 350 W.
- DO NOT forget to connect the 4-pin/8-pin EATX12 V power plug. Otherwise, the system will not boot.
- We recommend that you use a PSU with a higher power output when configuring a system with more power-consuming devices. The system may become unstable or may not boot up if the power is inadequate.
- If you want to use two or more high-end PCI Express x16 cards, use a PSU with 1000W power or above to ensure the system stability.
- If you are uncertain about the minimum power supply requirement for your system, refer to the Recommended Power Supply Wattage Calculator at <http://support.asus.com/PowerSupplyCalculator/PSCalculator.aspx?SLanguage=en-us> for details.

## 2. Intel® H97 Serial ATA 6 Gb/s connectors (7-pin SATA6G\_1~4)

These connectors connect to Serial ATA 6 Gb/s hard disk drives via Serial ATA 6 Gb/s signal cables.

If you installed Serial ATA hard disk drives, you can create a RAID 0, 1, 5, and 10 configuration with the Intel® Rapid Storage Technology through the onboard Intel® H97 chipset.

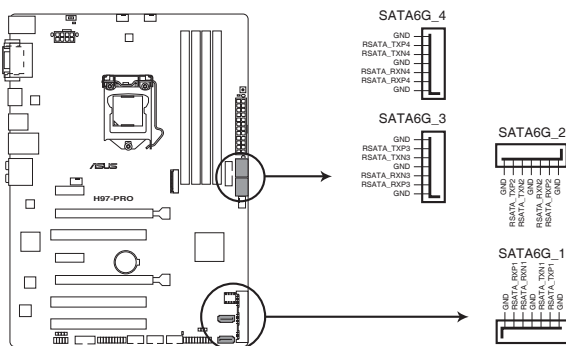

### H97-PRO Intel® SATA 6.0Gb/s connectors



- These connectors are set to **[AHCI]** by default. If you intend to create a Serial ATA RAID set using these connectors, set the SATA Mode item in the BIOS to **[RAID]**. Refer to section **3.6.3 PCH Storage Configuration** for details.
- Before creating a RAID set, refer to section **5.1 RAID configurations** or the manual bundled in the motherboard support DVD.



The M.2 Socket 3 and SATA Express slot share the same PCIe bandwidth. When you use both connectors, the system automatically detects the devices connected to these connectors and set a higher priority to M.2 Socket 3 than SATA Express slot. Refer to section **3.6.3 PCH Storage Configuration** of this user guide for more details.

### 3. TPM connector (20-1 pin TPM)

This connector supports a Trusted Platform Module (TPM) system, which securely store keys, digital certificates, passwords and data. A TPM system also helps enhance network security, protect digital identities, and ensures platform integrity.

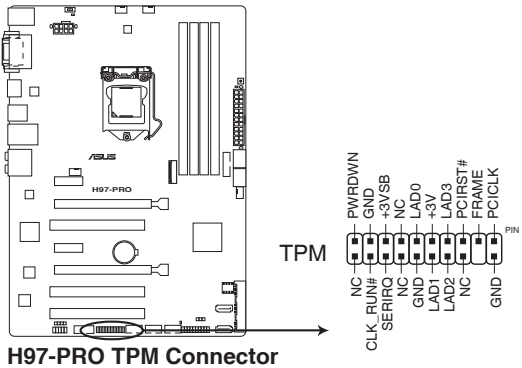

**H97-PRO TPM Connector**



The TPM module is purchased separately.

### 4. Digital audio connector (4-1 pin SPDIF\_OUT)

This connector is for an additional Sony/Philips Digital Interface (S/PDIF) port. Connect the S/PDIF Out module cable to this connector, then install the module to a slot opening at the back of the system chassis.

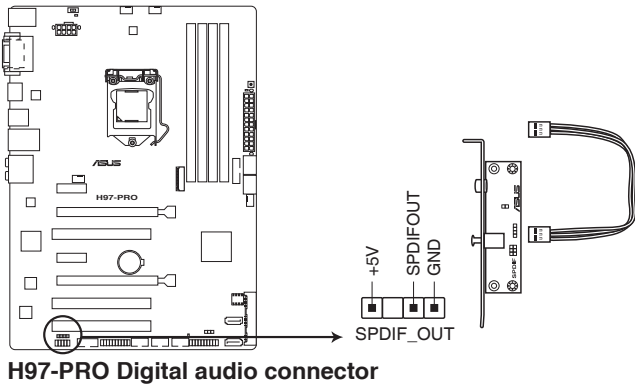

**H97-PRO Digital audio connector**



The S/PDIF module is purchased separately.

### 5. Front panel audio connector (10-1 pin AAFP)

This connector is for a chassis-mounted front panel audio I/O module that supports either HD Audio or legacy AC '97 audio standard. Connect one end of the front panel audio I/O module cable to this connector.

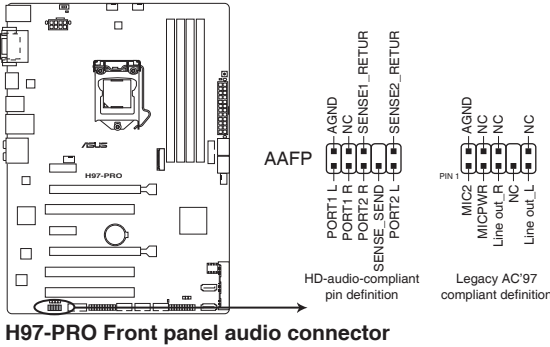

H97-PRO Front panel audio connector



- We recommend that you connect a high-definition front panel audio module to this connector to avail of the motherboard's high-definition audio capability.
- If you want to connect a high-definition or an AC'97 front panel audio module to this connector, set the Front Panel Type item in the BIOS setup to **[HD Audio]** or **[AC97]**.

### 6. Serial port connector (10-1 pin COM)

This connector is for a serial (COM) port. Connect the serial port module cable to this connector, then install the module to a slot opening at the back of the system chassis.

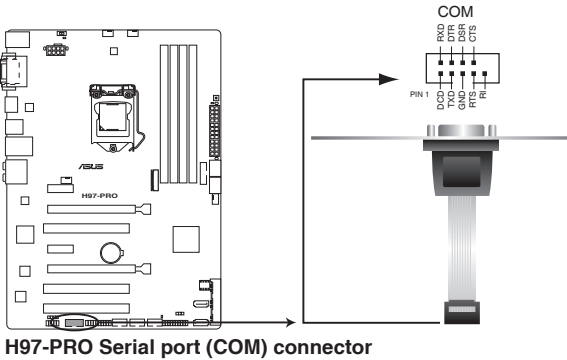

H97-PRO Serial port (COM) connector



The COM module is purchased separately.



## 7. USB 3.0 connectors (20-1 pin USB3\_12)

These connectors allow you to connect a USB 3.0 module for additional USB 3.0 front or rear panel ports. With an installed USB 3.0 module, you can enjoy all the benefits of USB 3.0 including faster data transfer speeds of up to 5 Gb/s, faster charging time for USB-chargeable devices, optimized power efficiency, and backward compatibility with USB 2.0.

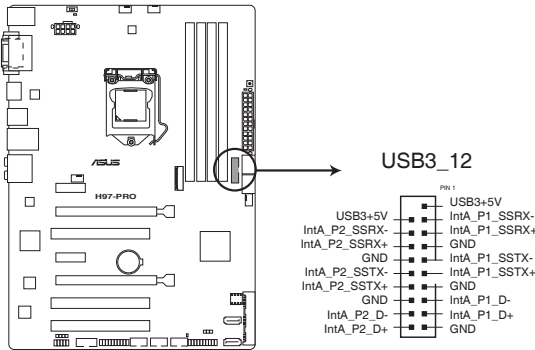

**H97-PRO USB3.0 connector**



The USB 3.0 module is purchased separately.



- These connectors are based on xHCI specification. We recommend you to install the related driver to fully use the USB 3.0 ports under Windows® 7.
- The plugged USB 3.0 device may run on xHCI or EHCI mode depending on the operating system's setting.

## 8. USB 2.0 connectors (10-pin USB910, USB1112, USB1314)

These connectors are for USB 2.0 ports. Connect the USB module cable to any of these connectors, then install the module to a slot opening at the back of the system chassis. These USB connectors comply with USB 2.0 specification that supports up to 48 Mb/s connection speed.

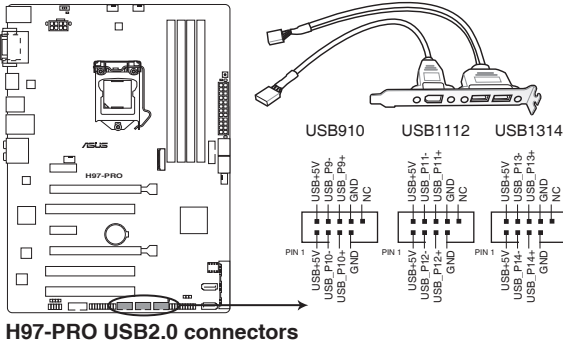

**H97-PRO USB2.0 connectors**



DO NOT connect a 1394 cable to the USB connectors. Doing so will damage the motherboard!



The USB 2.0 module is purchased separately.

## 9. Intel® Serial ATA 6 Gb/s connectors (7-pin SATA6G\_56, SATAEXPRESS)

These connectors connect to Serial ATA 6 Gb/s hard disk drives via Serial ATA 6 Gb/s signal cables.

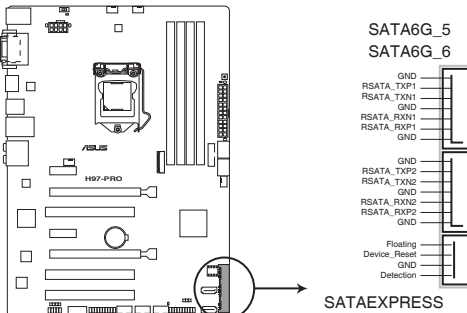

**H97-PRO Intel® SATA 6 Gb/s connectors**



- The M.2 Socket 3 and SATAEXPRESS connector shares the same bandwidth. When you use both connectors, the system automatically detects the devices connected to these connectors and set a higher priority to M.2 Socket 3 than SATAEXPRESS interface. Refer to section **3.6.3 PCH Storage Configuration** of this user guide for more details.
- The SATAEXPRESS connector can support one SATA Express device or two SATA devices.

## 10. CPU and chassis fan connectors (4-pin CPU\_FAN; 4-pin CHA\_FAN1/2/3)

Connect the fan cables to the fan connectors on the motherboard, ensuring that the black wire of each cable matches the ground pin of the connector.



- DO NOT forget to connect the fan cables to the fan connectors. Insufficient air flow inside the system may damage the motherboard components. These are not jumpers! Do not place jumper caps on the fan connectors!
- Ensure that the CPU fan cable is securely installed to the CPU fan connector.

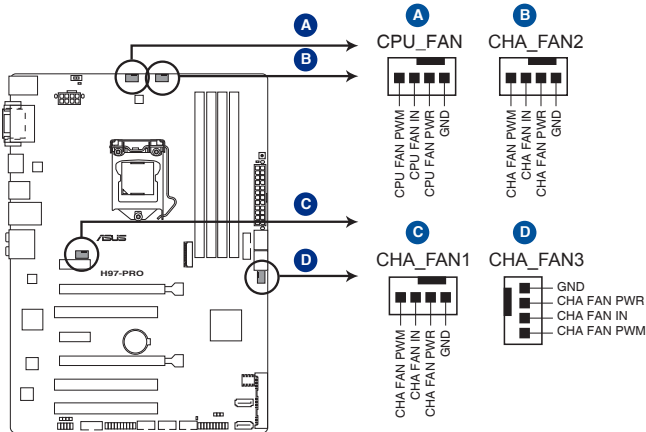

**H97-PRO Fan connectors**



- The CPU\_FAN connector supports the CPU fan of maximum 1A (12W) fan power.
- The CPU\_FAN connector and CHA\_FAN connectors support the ASUS FAN Xpert 3 feature.
- The CPU fan connector detects the type of CPU fan installed and automatically switches the control modes. To configure the CPU fan's control mode, go to **Advanced Mode > Monitor > CPU Q-Fan Control** item in BIOS.
- The chassis fan connectors support DC and PWM modes. To set these fans to DC or PWM, go to **Advanced Mode > Monitor > Chassis Fan 1/2/3 Q-Fan Control** items in BIOS.

## 11. System panel connector (20-8 pin PANEL)

This connector supports several chassis-mounted functions.

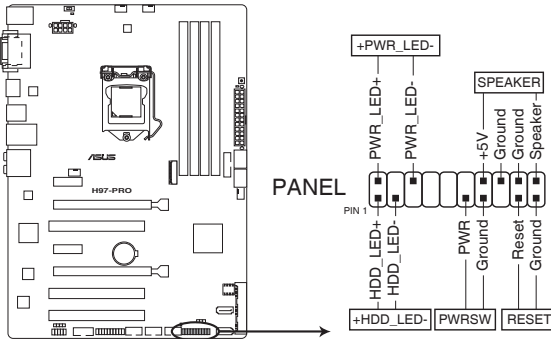

**H97-PRO System panel connector**

- **System power LED (2-pin +PWR\_LED-)**

This 2-pin connector is for the system power LED. Connect the chassis power LED cable to this connector. The system power LED lights up when you turn on the system power, and blinks when the system is in sleep mode.

- **Hard disk drive activity LED (2-pin +HDD\_LED-)**

This 2-pin connector is for the HDD Activity LED. Connect the HDD Activity LED cable to this connector. The HDD LED lights up or flashes when data is read from or written to the HDD.

- **System warning speaker (4-pin SPEAKER)**

This 4-pin connector is for the chassis-mounted system warning speaker. The speaker allows you to hear system beeps and warnings.

- **ATX power button/soft-off button (2-pin PWR\_SW)**

This connector is for the system power button. Pressing the power button turns the system on or puts the system in sleep or soft-off mode depending on the operating system settings. Pressing the power switch for more than four seconds while the system is ON turns the system OFF.

- **Reset button (2-pin RESET)**

This 2-pin connector is for the chassis-mounted reset button for system reboot without turning off the system power.

## 12. M.2 Socket 3

This socket allows you to install an M.2 (NGFF) SSD module.

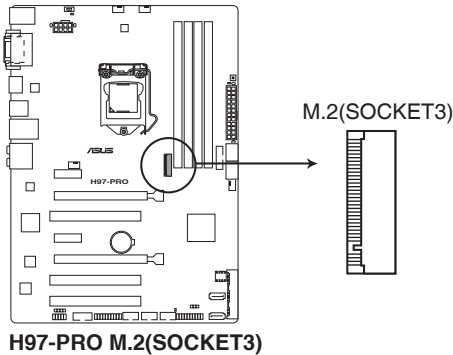

**H97-PRO M.2(SOCKET3)**



- M.2 Socket 3 shares bandwidth with SATA Express. This socket supports M Key and both SATA and PCIe mode type 2242/2260/2280 storage devices (Type 2242 storage device is supported on Rev.2.01 or later versions of this motherboard).
- The M.2 Socket 3 shares bandwidth with SATA Express slot. Refer to section **3.6.3 PCH Storage Configuration** of this user guide for more details.
- When using Intel® Desktop Responsiveness technologies with PCIe M.2 device, ensure to set up the Windows® UEFI operating system under RAID mode.



The M.2 (NGFF) SSD module is purchased separately.

24 horizontal lines for writing.

# Basic installation

# 2

## 2.1 Building your PC system

### 2.1.1 Motherboard installation



The diagrams in this section are for reference only. The motherboard layout may vary with models, but the installation steps are the same for all models.

1. Install the ASUS Q-Shield to the chassis rear I/O panel.

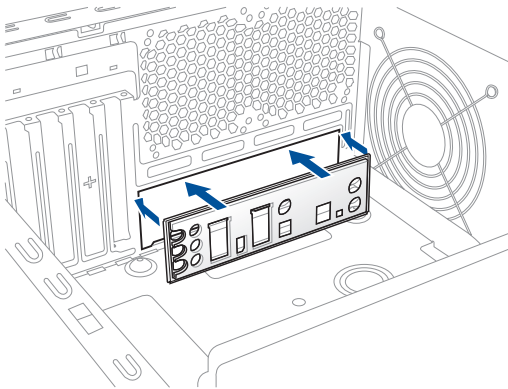

2. Place the motherboard into the chassis, ensuring that its rear I/O ports are aligned to the chassis' rear I/O panel.

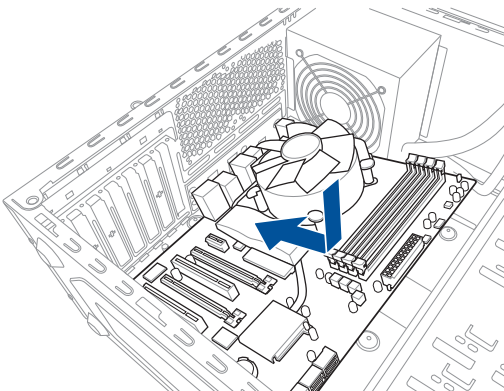

- Place nine screws into the holes indicated by circles to secure the motherboard to the chassis.

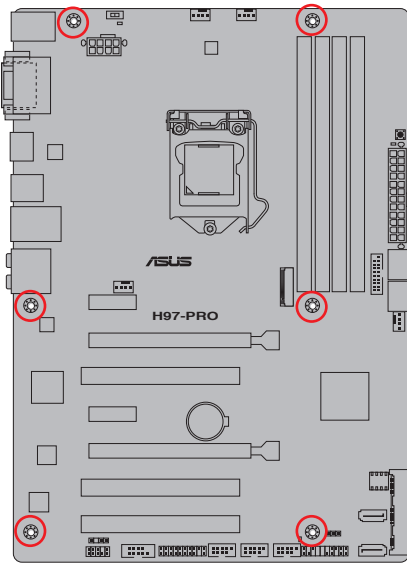
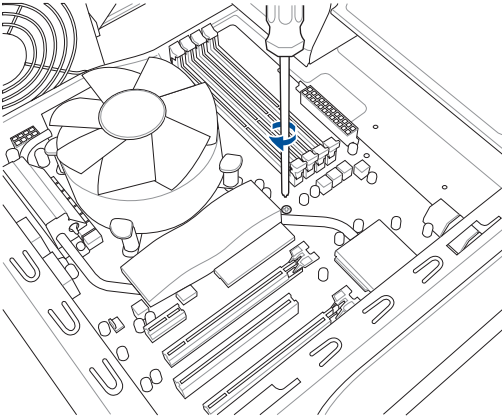

DO NOT overtighten the screws! Doing so can damage the motherboard.



## 2.1.2 CPU installation



Ensure that you install the correct CPU designed for LGA1150 socket only. DO NOT install a CPU designed for LGA1155 and LGA1156 sockets on the LGA1150 socket.

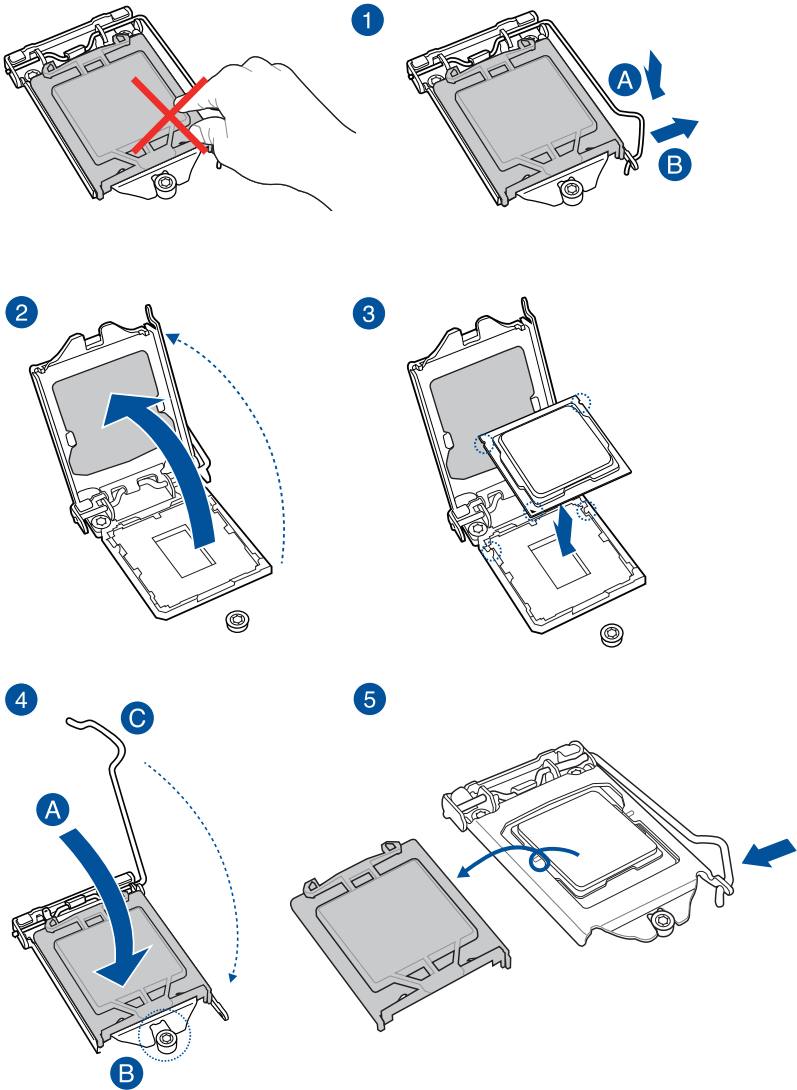

## 2.1.3 CPU heatsink and fan assembly installation

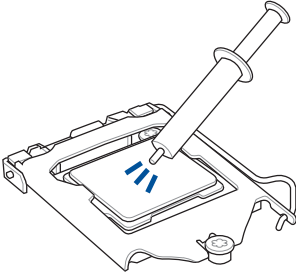

Apply the Thermal Interface Material to the CPU heatsink and CPU before you install the heatsink and fan, if necessary.

To install the CPU heatsink and fan assembly

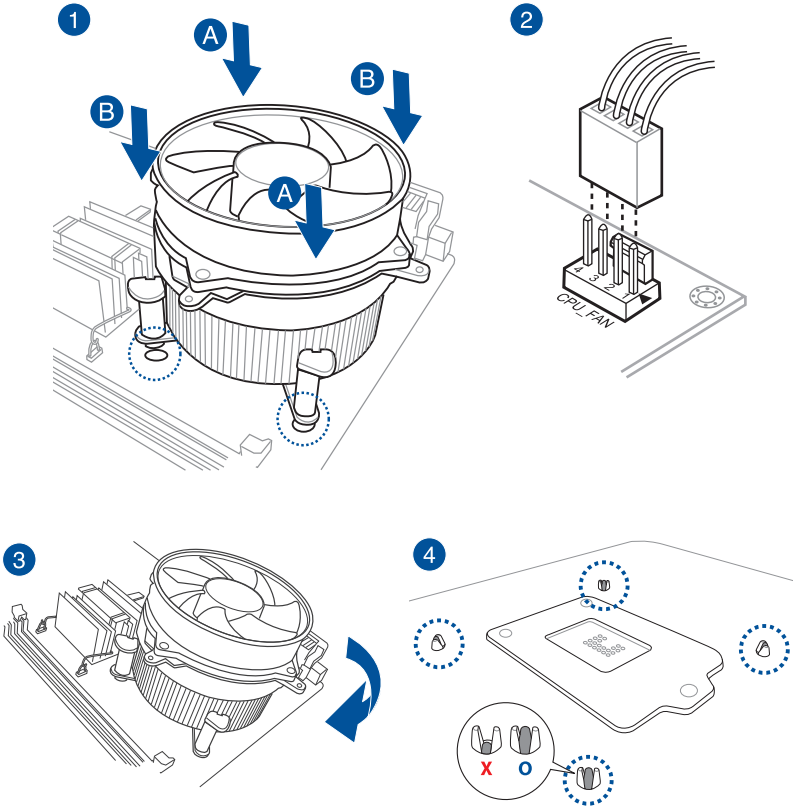

To uninstall the CPU heatsink and fan assembly

1

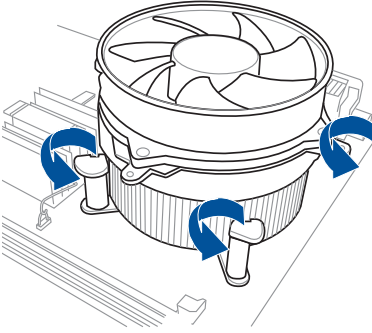

2

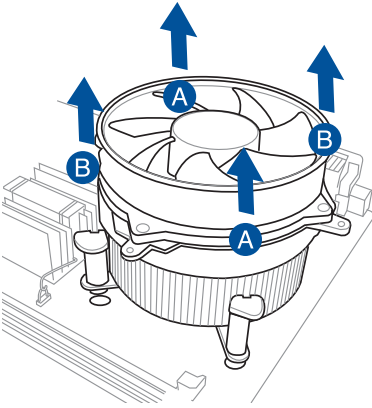

### 2.1.4 DIMM installation

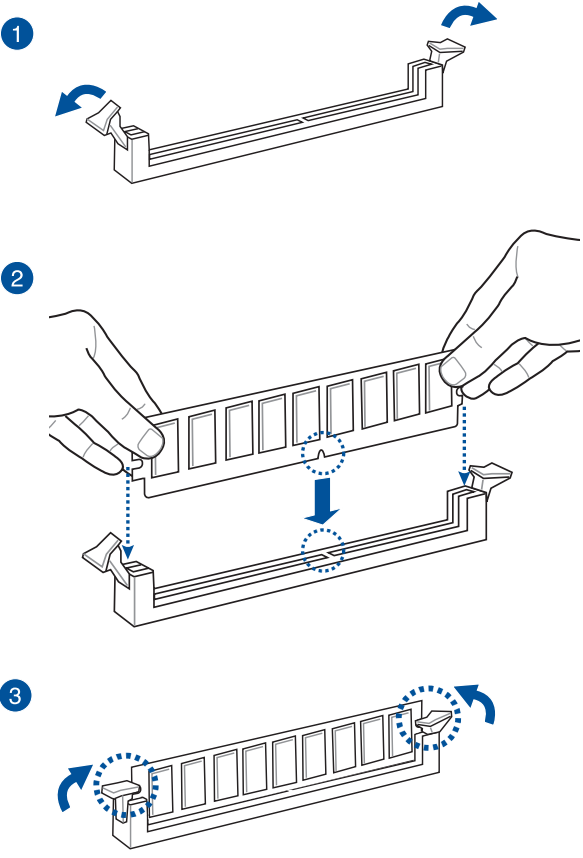

### To remove a DIMM

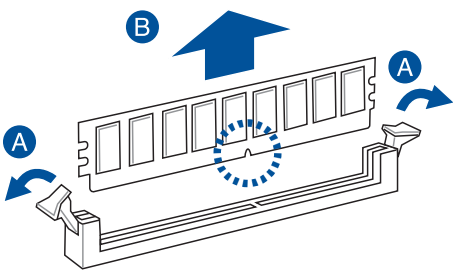

## 2.1.5 ATX Power connection

1

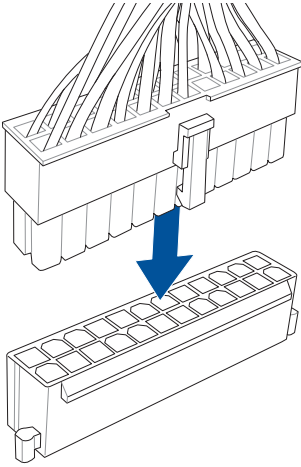

2

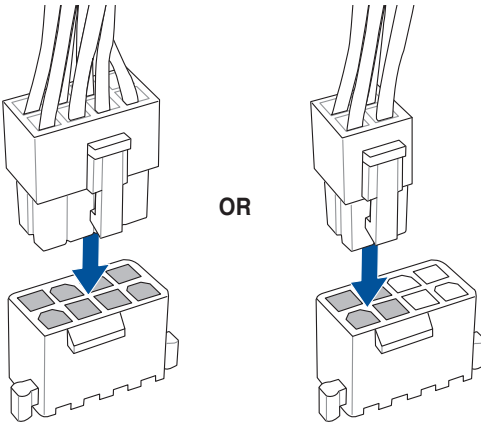

## 2.1.6 SATA device connection

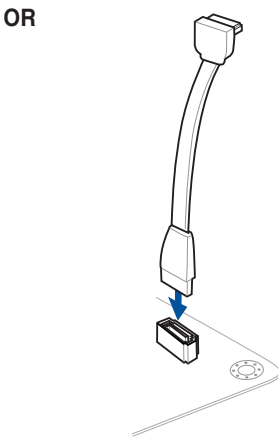
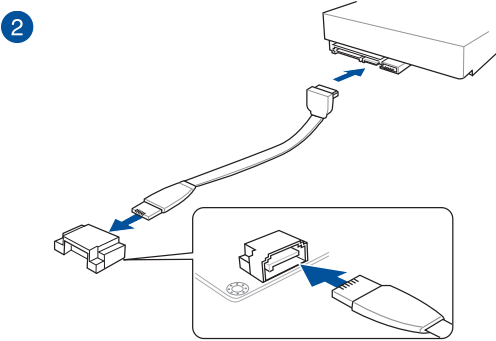
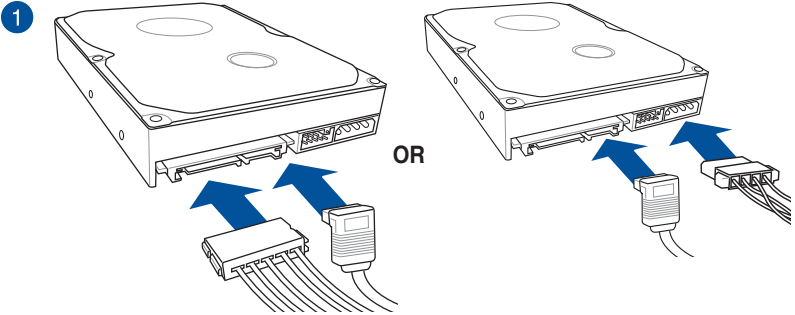

## 2.1.7 Front I/O Connector

To install USB 2.0 connector

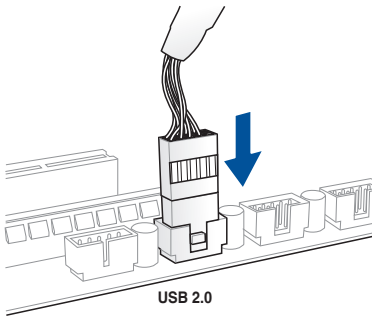

To install front panel audio connector

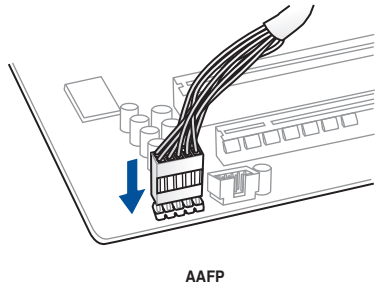

To install USB 3.0 connector

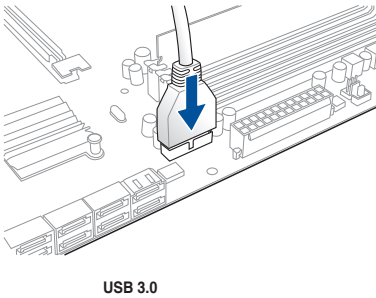

## 2.1.8 Expansion Card installation

To install PCIe x16 cards

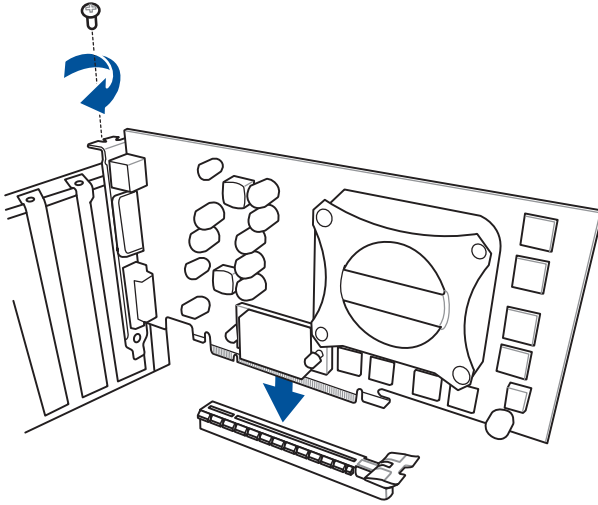

To install PCIe x1 cards

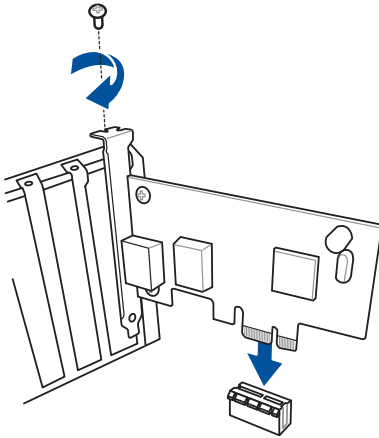

To install PCI cards

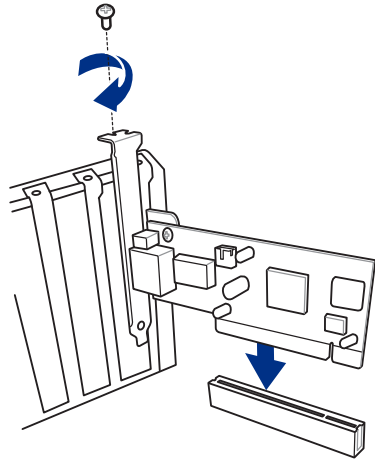



## 2.2 Motherboard rear and audio connections

### 2.2.1 Rear I/O connection

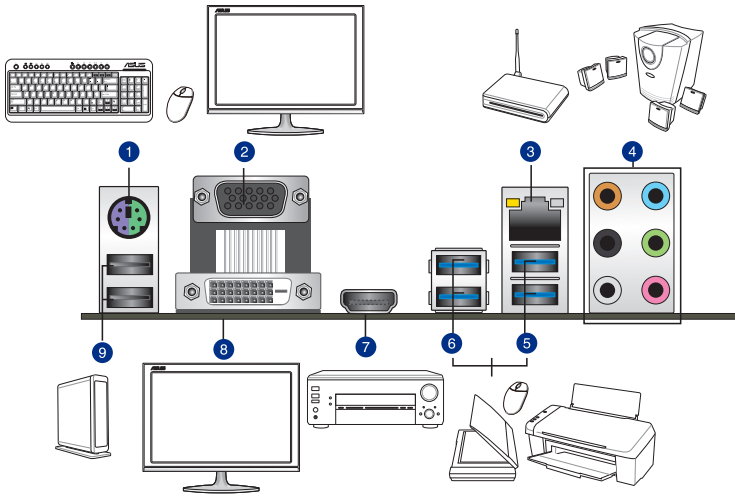

#### Rear panel connectors

1. PS/2 Keyboard / Mouse Combo port	6. USB 3.0 ports 56
2. Video Graphics Adapter (VGA) port	7. HDMI port
3. Intel® LAN port (LAN)*	8. DVI-D port
4. Audio I/O ports**	9. USB 2.0 ports 78
5. USB 3.0 ports 34	

\* and \*\*: Refer to the tables on the next page for LAN port LEDs, and audio port definitions.



- The plugged USB 3.0 device may run on xHCI mode or EHCI mode, depending on the operating system's setting.
- We strongly recommend that you connect USB 3.0 devices to USB 3.0 ports for faster and better performance for your USB 3.0 devices.
- Due to the design of the Intel® 9 series chipset, all USB devices connected to the USB 2.0 and USB 3.0 ports are controlled by the xHCI controller. Some legacy USB devices must update their firmware for better compatibility.
- Multi-VGA output supports up to three displays under Windows® OS environment, two displays under BIOS, and one display under DOS.
- Intel display architecture design supports the following maximum supported pixel clocks (Pixel Clock = H total x V Total x Frame Rate (Fresh screen rate)):
  - DVI port supports: 165 MHz
  - VGA port supports: 180 MHz
  - HDMI port: 300 MHz

### \* LAN port LED indications

Activity Link LED		Speed LED	
Status	Description	Status	Description
Off	No link	Off	10 Mbps connection
Orange	Linked	Orange	100 Mbps connection
Orange (Blinking)	Data activity	Green	1 Gbps connection
Orange (Blinking then steady)	Ready to wake up from S5 mode		

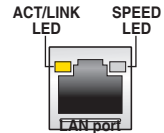

### \*\* Audio 2.1, 4.1, 5.1, or 7.1-channel configuration

Port	Headset 2.1-channel	4.1-channel	5.1-channel	7.1-channel
Light Blue	Line In	Line In	Line In	Line In
Lime	Line Out	Front Speaker Out	Front Speaker Out	Front Speaker Out
Pink	Mic In	Mic In	Mic In	Mic In
Orange	–	–	Center/Subwoofer	Center/Subwoofer
Black	–	Rear Speaker Out	Rear Speaker Out	Rear Speaker Out
Gray	–	–	-	Side Speaker Out

## 2.2.2 Audio I/O connections

### Audio I/O ports

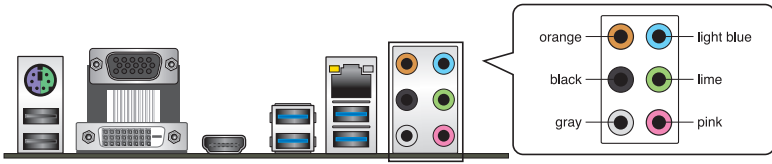

### Connect to Headphone and Mic



### Connect to Stereo Speakers

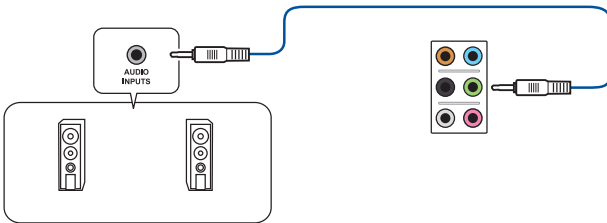

### Connect to 2.1 channel Speakers

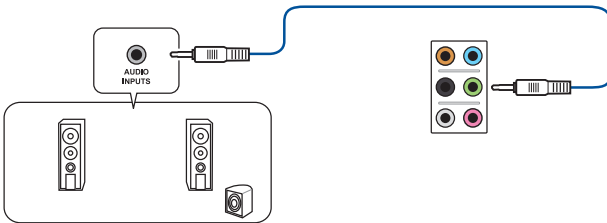

## Connect to 4.1 channel Speakers

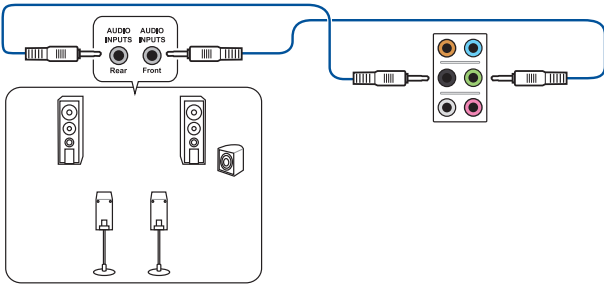

## Connect to 5.1 channel Speakers

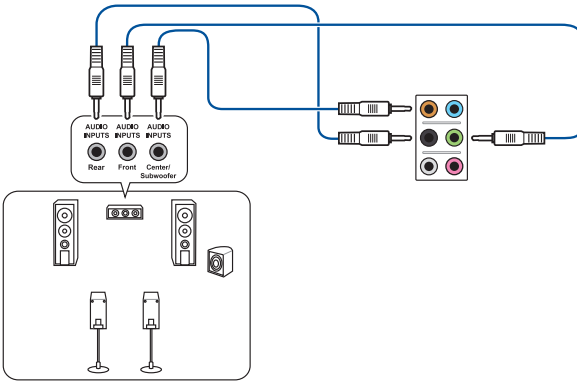

## Connect to 7.1 channel Speakers

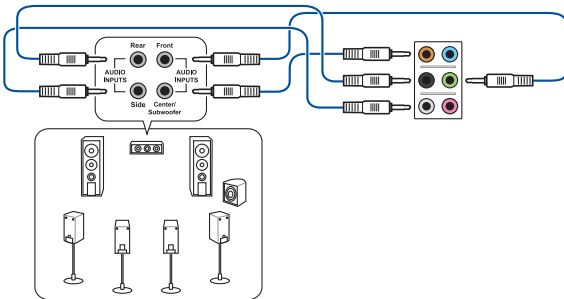

## 2.3 Starting up for the first time

1. After making all the connections, replace the system case cover.
2. Ensure that all switches are off.
3. Connect the power cord to the power connector at the back of the system chassis.
4. Connect the power cord to a power outlet that is equipped with a surge protector.
5. Turn on the devices in the following order:
  - a. Monitor
  - b. External SCSI devices (starting with the last device on the chain)
  - c. System power
6. After applying power, the system power LED on the system front panel case lights up. For systems with ATX power supplies, the system LED lights up when you press the ATX power button. If your monitor complies with the “green” standards or if it has a “power standby” feature, the monitor LED may light up or change from orange to green after the system LED turns on.

The system then runs the power-on self tests (POST). While the tests are running, the BIOS beeps (refer to the BIOS beep codes table) or additional messages appear on the screen. If you do not see anything within 30 seconds from the time you turned on the power, the system may have failed a power-on test. Check the jumper settings and connections or call your retailer for assistance.

BIOS Beep	Description
One short beep	VGA detected Quick boot set to disabled No keyboard detected
One continuous beep followed by two short beeps then a pause (repeated)	No memory detected
One continuous beep followed by three short beeps	No VGA detected
One continuous beep followed by four short beeps	Hardware component failure

7. At power on, hold down the <Delete> or <F2> key to enter the BIOS Setup. Follow the instructions in Chapter 3.

## 2.4 Turning off the computer

While the system is ON, press the power button for less than four seconds to put the system on sleep mode or soft-off mode, depending on the BIOS setting. Press the power switch for more than four seconds to let the system enter the soft-off mode regardless of the BIOS setting.



# BIOS setup

# 3

## 3.1 Knowing BIOS



---

The new ASUS UEFI BIOS is a Unified Extensible Interface that complies with UEFI architecture, offering a user-friendly interface that goes beyond the traditional keyboard-only BIOS controls to enable a more flexible and convenient mouse input. You can easily navigate the new UEFI BIOS with the same smoothness as your operating system. The term "BIOS" in this user manual refers to "UEFI BIOS" unless otherwise specified.

---

BIOS (Basic Input and Output System) stores system hardware settings such as storage device configuration, overclocking settings, advanced power management, and boot device configuration that are needed for system startup in the motherboard CMOS. In normal circumstances, the default BIOS settings apply to most conditions to ensure optimal performance. **DO NOT change the default BIOS settings** except in the following circumstances:

- An error message appears on the screen during the system bootup and requests you to run the BIOS Setup.
- You have installed a new system component that requires further BIOS settings or update.



---

Inappropriate BIOS settings may result to instability or boot failure. **We strongly recommend that you change the BIOS settings only with the help of a trained service personnel.**

---



---

When downloading or updating the BIOS file, rename it as **H97PRO.CAP** for this motherboard.

---

## 3.2 BIOS setup program

Use the BIOS Setup to update the BIOS or configure its parameters. The BIOS screen include navigation keys and brief onscreen help to guide you in using the BIOS Setup program.

### Entering BIOS at startup

To enter BIOS Setup at startup, press <Delete> or <F2> during the Power-On Self Test (POST). If you do not press <Delete> or <F2>, POST continues with its routines.

### Entering BIOS Setup after POST

To enter BIOS Setup after POST:

- Press <Ctrl>+<Alt>+<Delete> simultaneously.
- Press the reset button on the system chassis.
- Press the power button to turn the system off then back on. Do this option only if you failed to enter BIOS Setup using the first two options.

After doing either of the three options, press <Delete> or <F2> key to enter BIOS.



- 
- The BIOS setup screens shown in this section are for reference purposes only, and may not exactly match what you see on your screen.
  - Ensure that a USB mouse is connected to your motherboard if you want to use the mouse to control the BIOS setup program.
  - If the system becomes unstable after changing any BIOS setting, load the default settings to ensure system compatibility and stability. Select the **Load Optimized Defaults** item under the **Exit** menu or press hotkey <F5>. See section 3.10 **Exit Menu** for details.
  - If the system fails to boot after changing any BIOS setting, try to clear the CMOS and reset the motherboard to the default value. See section 1.2.7 **Jumpers** for information on how to erase the RTC RAM via the Clear CMOS jumper.
  - The BIOS setup program does not support the Bluetooth devices.
- 

### BIOS menu screen

The BIOS Setup program can be used under two modes: **EZ Mode** and **Advanced Mode**. Press <F7> to change between the two modes.



### 3.2.1 EZ Mode

By default, the EZ Mode screen appears when you enter the BIOS setup program. The EZ Mode provides you an overview of the basic system information, and allows you to select the display language, system performance mode and boot device priority. To access the Advanced Mode, click **Advanced Mode** or press <F7> hot key for the advanced BIOS settings.



The default screen for entering the BIOS setup program can be changed between EZ Mode or Advanced Mode. Refer to the Setup Mode item in section **3.8 Boot menu** for details.

The screenshot shows the ASUS UEFI BIOS Utility - EZ Mode interface. The top bar displays the date (04/23/2014), time (11:27), language (English), and EZ Tuning Wizard (F11). The main area is divided into several sections:

- Information:** Shows system details like BIOS version (0326), CPU (Intel(R) Core(TM) i5-4570S), speed (2900 MHz), and memory (4096 MB).
- CPU Temperature:** Displays 36°C.
- CPU Voltage:** Displays 0.925 V.
- Motherboard Temperature:** Displays 27°C.
- DRAM Status:** Lists DIMM slots and their configurations.
- SATA Information:** Lists SATA ports and their configurations.
- Intel Rapid Storage Technology:** Includes a checkbox for RAID mode (currently Disabled).
- FAN Profile:** Shows CPU Fan at 1217 RPM and other fans (CHA1, CHA2, CHA3) as N/A.
- CPU FAN:** A graph showing fan speed over time, with a 'Manual Fan Tuning' button.
- EZ System Tuning:** Offers 'Performance' and 'Energy Saving' modes, currently set to 'Normal'.
- Boot Priority:** Lists boot devices like 'UEFI: (FAT) TOSHIBA TransMemory (3745MB)' and 'P3: WDC WD1600AAJS-00B4A0 (152627MB)'. A 'Switch all' button is present.
- Boot Menu (F8):** A button to access the boot menu.
- Navigation:** Bottom buttons for 'Default (F5)', 'Save & Exit (F10)', and 'Advanced Mode (F7)'.

Callouts and their descriptions:

- Displays the system properties of the selected mode. Click < > to switch EZ System Tuning modes** (points to EZ System Tuning)
- Displays the CPU/motherboard temperature, CPU voltage output, CPU/chassis/power fan speed, and SATA information** (points to Information, CPU Temperature, CPU Voltage, Motherboard Temperature, DRAM Status, SATA Information)
- Selects the display language of the BIOS setup program** (points to English)
- Creates storage RAID and configures system overlocking** (points to Intel Rapid Storage Technology)
- Enables or disables the SATA RAID mode for Intel Rapid Storage Technology** (points to X.M.P Disabled)
- Displays the CPU Fan's speed. Click the button to manually tune the fans** (points to CPU FAN 1217 RPM and Manual Fan Tuning)
- Shows the bootable devices** (points to Boot Priority)
- Loads optimized default settings** (points to Default (F5))
- Saves the changes and resets the system** (points to Save & Exit (F10))
- Displays the Advanced mode menus** (points to Advanced Mode (F7))
- Selects the boot device priority** (points to Boot Priority)



The boot device options vary depending on the devices you installed to the system.

### 3.2.2 Advanced Mode

The Advanced Mode provides advanced options for experienced end-users to configure the BIOS settings. The figure below shows an example of the Advanced Mode. Refer to the following sections for the detailed configurations.



To switch from EZ Mode to Advanced Mode, click **Advanced Mode F7** or press F7 hotkey.

The screenshot shows the ASUS UEFI BIOS Utility in Advanced Mode. The interface includes a menu bar at the top with options like My Favorites, Main, Ai Tweaker, Advanced, Monitor, Boot, Tool, and Exit. The main area is divided into configuration fields (e.g., HD Audio Controller, Front Panel Type, SPDIF Out Type, Depop, PCI Express X16\_2 slot(Black) bandwidth, Intel LAN Controller, Intel LAN PXE Option ROM, Charging USB devices in Power State S5, Serial Port Configuration) and a Hardware Monitor section on the right. The Hardware Monitor displays CPU (Frequency: 2800 MHz, Temperature: 36°C, BCLK: 100.0 MHz, Vcore: 0.848 V, Ratio: 28x) and Memory (Frequency: 1333 MHz, Voltage: 1.500 V, Capacity: 1024 MB) information. A Voltage section shows +12V (+5V: 5.160 V), 12.192 V, +3.3V, and 3.344 V. Labels point to various elements: Menu bar, Language, MyFavorite, Q-Fan control, EZ Tuning Wizard, Quick Note, Hot Keys, Sub-menu item, Item description, Configuration fields, Drop-down list, Last modified settings, Last Modified, EzMode(F7) [-], and a note: Displays the CPU/motherboard temperature, CPU and memory voltage output.

## Menu bar

The menu bar on top of the screen has the following main items:

<b>My Favorites</b>	For saving the frequently-used system settings and configuration.
<b>Main</b>	For changing the basic system configuration
<b>Ai Tweaker</b>	For changing the overclocking settings
<b>Advanced</b>	For changing the advanced system settings
<b>Monitor</b>	For displaying the system temperature, power status, and changing the fan settings.
<b>Boot</b>	For changing the system boot configuration
<b>Tool</b>	For configuring options for special functions
<b>Exit</b>	For selecting the exit options and loading default settings

## Menu items

The highlighted item on the menu bar displays the specific items for that menu. For example, selecting **Main** shows the Main menu items.

The other items (My Favorites, Ai Tweaker, Advanced, Monitor, Boot, Tool, and Exit) on the menu bar have their respective menu items.

## Submenu items

A greater than sign (>) before each item on any menu screen means that the item has a submenu. To display the submenu, select the item and press <Enter>.

## Language

This button above the menu bar contains the languages that you can select for your BIOS. Click this button to select the the language that you want to display in your BIOS screen.

## MyFavorites (F3)

This button above the menu bar shows all BIOS items in a Tree Map setup. Select frequently-used BIOS settings and save it to MyFavorites menu.



---

Refer to section **3.3 My Favorites** for more information.

---

## Q-Fan Control (F6)

This button above the menu bar displays the current settings of your fans. Use this button to manually tweak the fans to your desired settings.



---

Refer to section **3.2.3 QFan Control** for more information.

---

## EZ Tuning Wizard (F11)

This button above the menu bar allows you to view and tweak the overclocking settings of your system. It also allows you to change the motherboard's SATA mode from AHCI to RAID mode.



---

Refer to section **3.2.4 EZ Tuning Wizard** for more information.

---

### Quick Note (F9)

This button above the menu bar allows you to key in notes of the activities that you have done in BIOS.



- The Quick Note function does not support the following keyboard functions: delete, cut, copy and paste.
- You can only use the alphanumeric characters to enter your notes.

### Hot keys

This button above the menu bar contains the navigation keys for the BIOS setup program. Use the navigation keys to select items in the menu and change the settings.

### Drop-down list

Select a menu item and press <Enter> to display a drop-down list with the configuration options for that item.

### Scroll bar

A scroll bar appears on the right side of a menu screen when there are items that do not fit on the screen. Press the Up/Down arrow keys or <Page Up> / <Page Down> keys to display the other items on the screen.

### General help

At the top right corner of the menu screen is a brief description of the selected item. Use <F12> key to capture the BIOS screen and save it to the removable storage device.

### Configuration fields

These fields show the values for the menu items. If an item is user-configurable, you can change the value of the field opposite the item. You cannot select an item that is not user-configurable.

A configurable field is highlighted when selected. To change the value of a field, select it and press <Enter> to display a list of options.

### Last Modified button

This button shows the items that you last modified and saved in BIOS Setup.

### 3.2.3 QFan Control

The QFan Control allows you to set a fan profile or manually configure the operating speed of your CPU and chassis fans.

The screenshot shows the ASUS Q-Fan Tuning interface in the UEFI BIOS. It features a fan selection menu, a graph showing fan speed (%) vs. temperature (°C), and several control buttons. Callouts provide instructions for each element:

- Click to select a fan to be configured:** Points to the fan selection menu (CPU FAN, CHA1 FAN, CHA2 FAN, CHA3 FAN).
- Click to activate PWM Mode:** Points to the 'PWM' button in the mode selector.
- Click to activate DC Mode:** Points to the 'DC' button in the mode selector.
- Select a profile to apply to your fans:** Points to the 'Standard', 'Silent', 'Turbo', and 'Full Speed' radio buttons.
- Click to apply the fan setting:** Points to the 'Apply' button.
- Click to go back to main menu:** Points to the 'Exit (ESC)' button.
- Select to manually configure your fans:** Points to the 'Manual' button.
- Click to undo the changes:** Points to the 'Undo' button.

The graph shows a fan speed profile for a selected fan. The y-axis represents fan speed in percentage (0% to 100%), and the x-axis represents temperature in degrees Celsius (0 to 100). The profile shows a step increase in fan speed as temperature rises, with a red line indicating the current profile and a white line showing a different profile.

## Configuring fans manually

Select **Manual** from the list of profiles to manually configure your fans' operating speed.



To configure your fans:

1. Select the fan that you want to configure and to view its current status.
2. Click and drag the speed points to adjust the fans' operating speed.
3. Click **Apply** to save the changes then click **Exit (ESC)**.

## 3.2.4 EZ Tuning Wizard

EZ Tuning Wizard allows you to overclock your CPU and DRAM, computer usage, and CPU fan to their best settings. You can also easily set RAID in your system using this feature.

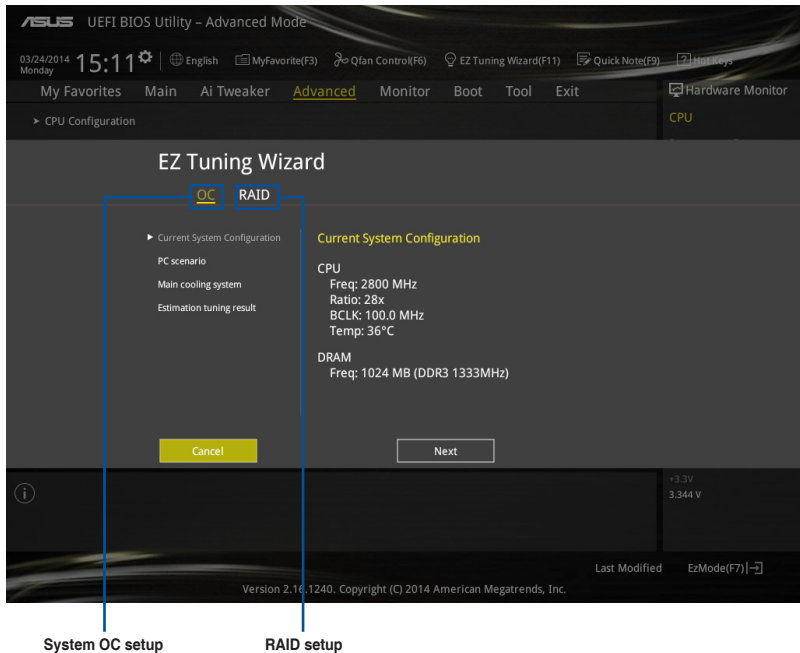

### Tuning your system settings

To tune your settings:

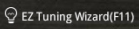
1. Press <F11> on your keyboard or click  from the BIOS screen to open EZ Tuning Wizard screen, then click **Next**.
2. Select a PC scenario **Daily Computing** or **Gaming/Media Editing**, then click **Next**.
3. Select the CPU fan type (**Box cooler**, **Tower cooler**, or **Water cooler**) that you installed then click **Next**.



If you are not sure of the CPU fan type, click **I'm not sure**. The system automatically detects the CPU fan type.

4. Click **Next** then click **Yes** to confirm auto-tuning.

## Creating RAID

To create RAID:

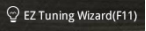
1. Press <F11> on your keyboard or click  from the BIOS screen to open EZ Tuning Wizard screen.
2. Click **RAID** then click **Next**.



- Ensure that your HDDs have no existing RAID volumes.
- Ensure to connect your HDDs to Intel® SATA connectors.

3. Select the type of storage for your RAID **Easy Backup** or **Super Speed**, then click **Next**.

- a. For Easy Backup, click **Next** then select from **Easy Backup (RAID1)** or **Easy Backup (RAID10)**.



You can only select Easy Backup (RAID 10) if you connect four (4) HDDs.

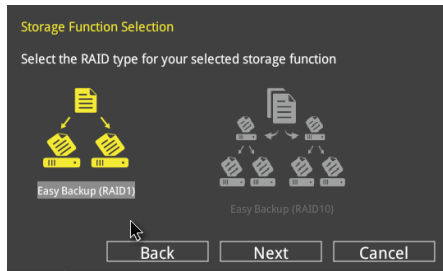

- b. For Easy Backup, click **Next** then select from **Super Speed (RAID0)** or **Super Speed (RAID5)**.

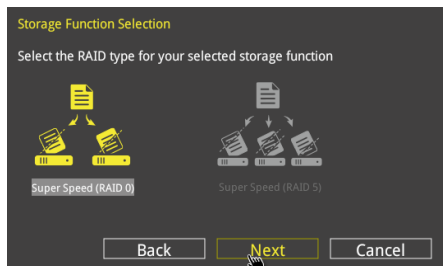

4. After selecting the type of RAID, click **Next** then click **Yes** to continue the RAID setup.
5. After the RAID setup is done, click **Yes** to exit the setup then click **OK** to reset your system.



### 3.3 My Favorites

MyFavorites is your personal space where you can easily save and access your favorite BIOS items.



## Adding items to My Favorites

To add BIOS items:

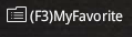
1. Press <F3> on your keyboard or click  from the BIOS screen to open Setup Tree Map screen.
2. On the Setup Tree Map screen, select the BIOS items that you want to save in MyFavorites screen.

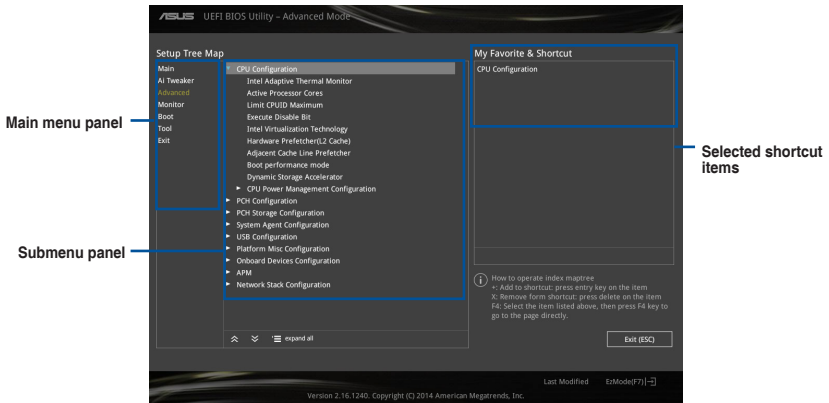

3. Select an item from main menu panel, then click the submenu that you want to save as favorite from the submenu panel and tap or click  or press <Enter> on your keyboard.



You cannot add the following items to My Favorite items:

- Items with submenu options
- User-managed items such as language and boot order
- Configuration items such as Memory SPD Information, system time and date.

4. Click **Exit (ESC)** or press <esc> key to close Setup Tree Map screen.
5. Go to My Favorites menu to view the saved BIOS items.

## 3.4 Main menu

The Main menu screen appears when you enter the Advanced Mode of the BIOS Setup program. The Main menu provides you an overview of the basic system information, and allows you to set the system date, time, language, and security settings.



## Security

The Security menu items allow you to change the system security settings.

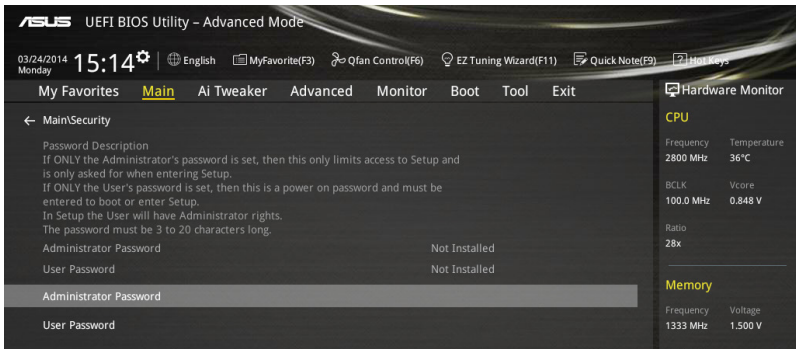

- If you have forgotten your BIOS password, erase the CMOS Real Time Clock (RTC) RAM to clear the BIOS password. See section 1.2.7 Jumpers for information on how to erase the RTC RAM via the Clear CMOS jumper.
- The Administrator or User Password items on top of the screen show the default **[Not Installed]**. After you set a password, these items show **[Installed]**.

## Administrator Password

If you have set an administrator password, we recommend that you enter the administrator password for accessing the system. Otherwise, you might be able to see or change only selected fields in the BIOS setup program.

### To set an administrator password:

1. Select the **Administrator Password** item and press <Enter>.
2. From the **Create New Password** box, key in a password, then press <Enter>.
3. Confirm the password when prompted.

### To change an administrator password:

1. Select the **Administrator Password** item and press <Enter>.
2. From the **Enter Current Password** box, key in the current password, then press <Enter>.
3. From the **Create New Password** box, key in a new password, then press <Enter>.
4. Confirm the password when prompted.

To clear the administrator password, follow the same steps as in changing an administrator password, but press <Enter> when prompted to create/confirm the password. After you clear the password, the **Administrator Password** item on top of the screen shows **Not Installed**.

## User Password

If you have set a user password, you must enter the user password for accessing the system. The User Password item on top of the screen shows the default Not Installed. After you set a password, this item shows Installed.

### To set a user password:

1. Select the **User Password** item and press <Enter>.
2. From the **Create New Password** box, key in a password, then press <Enter>.
3. Confirm the password when prompted.

### To change a user password:

1. Select the **User Password** item and press <Enter>.
2. From the **Enter Current Password** box, key in the current password, then press <Enter>.
3. From the **Create New Password** box, key in a new password, then press <Enter>.
4. Confirm the password when prompted.

To clear the user password, follow the same steps as in changing a user password, but press <Enter> when prompted to create/confirm the password. After you clear the password, the **User Password** item on top of the screen shows **Not Installed**.

## 3.5 Ai Tweaker menu

The Ai Tweaker menu items allow you to configure overclocking-related items.



Be cautious when changing the settings of the Ai Tweaker menu items. Incorrect field values can cause the system to malfunction.



The configuration options for this section vary depending on the CPU and DIMM model you installed on the motherboard.

Scroll down to display other BIOS items.

The screenshot shows the ASUS UEFI BIOS Utility in Advanced Mode. The top navigation bar includes 'My Favorites', 'Main', 'Ai Tweaker' (selected), 'Advanced', 'Monitor', 'Boot', 'Tool', and 'Exit'. The 'Ai Tweaker' menu is expanded, showing the following settings:

- Target CPU Turbo-Mode Frequency: 3600MHz
- Target DRAM Frequency: 1600MHz
- Target Cache Frequency: 3600MHz
- Target DMI/PEG Frequency: 100MHz
- Target CPU Graphics Frequency: 1150MHz
- Ai Overclock Tuner: Auto
- CPU Core Ratio: Auto
- Min. CPU Cache Ratio: Auto
- Max. CPU Cache Ratio: Auto
- CPU Ratio Tuner: Auto
- BCLK Frequency : DRAM Frequency Ratio: Auto
- DRAM Frequency: Auto
- Max. CPU Graphics Ratio: Auto

On the right, the 'Hardware Monitor' panel displays:

- CPU**: Frequency 2900 MHz, Temperature 37°C, BCLK 100.0 MHz, Vcore 0.925 V, Ratio 29x
- Memory**: Frequency 1600 MHz, Voltage 1.650 V, Capacity 4096 MB
- Voltage**: +12V 12.096 V, +5V 5.080 V, +3.3V 3.376 V

At the bottom, there is a note: 'i XMP: When the XMP(extreme memory profile) mode is selected, the CPU ratio and memory parameters will be optimized automatically.' The footer shows 'Version 2.16.1240. Copyright (C) 2014 American Megatrends, Inc.' and 'Last Modified | EzMode(F7) | ->'.

## Ai Overclock Tuner [Auto]

This item allows you to select the CPU overclocking options to achieve the desired CPU internal frequency. Select any of these preset overclocking configuration options:

- [Auto] Loads the optimal settings for the system.
- [XMP] When the XMP (Extreme Memory Profile) mode is selected, the memory parameters will be optimized automatically



---

The following item appears only when you set the Ai Overclock Tuner to [XMP].

---

### XMP DDR3-xxxxxxx [Profile #1]

Selects the XMP mode supported by the memory module.

## CPU Core Ratio [Auto]

This item allows you to set the CPU core ratio limit per core or synchronize automatically to all cores.

Configuration options: [Auto] [Sync All Cores] [Per Core]

When the CPU Core Ratio is set to [Per Core], the following items appear:

### 1-Core Ratio Limit [Auto]

Select [Auto] to apply the CPU default Turbo Ratio setting or manually assign a 1-Core Limit value that must be higher than or equal to the 2-Core Ratio Limit.

### 2-Core Ratio Limit [Auto]

Select [Auto] to apply the CPU default Turbo Ratio setting or manually assign a 2-Core Limit value that must be higher than or equal to the 3-Core Ratio Limit.



---

If you assign a value for 2-Core Ratio Limit, do not set the 1-Core Ratio Limit to [Auto].

---

### 3-Core Ratio Limit [Auto]

Select [Auto] to apply the CPU default Turbo Ratio setting or manually assign a 3-Core Limit value that must be higher than or equal to the 4-Core Ratio Limit.



---

If you assign a value for 3-Core Ratio Limit, do not set the 1-Core Ratio Limit and 2-Core Ratio Limit to [Auto].

---

### 4-Core Ratio Limit [Auto]

Select [Auto] to apply the CPU default Turbo Ratio setting or manually assign a 4-Core Limit value that must be higher than or equal to the 3-Core Ratio Limit.



---

If you assign a value for 4-Core Ratio Limit, do not set the 1-Core Ratio Limit, 2-Core Ratio Limit, and 3-Core Ratio to [Auto].

---

## Min. CPU Cache Ratio [Auto]

This item allows you to set the minimum possible ratio on the Uncore part of the processor. Use the <+> or <-> keys to adjust the value. The values depend on the CPU installed.

### Max. CPU Cache Ratio [Auto]

This item allows you to set the maximum possible ratio on the Uncore part of the processor. Use the <+> or <-> keys to adjust the value. The values depend on the CPU installed.

### CPU Ratio Tuner [Auto]

This item allows you to enable or disable the CPU ratio tuner. Enabling this item may enhance the overlocking capability of non-K series CPUs. Configuration options: [Auto] [Enabled] [Disable]

### BCLK Frequency : DRAM Frequency ratio [Auto]

Allows you to set the BCLK Frequency to DRAM Frequency ratio.

- [Auto] The ratio is set to the optimized settings.
- [100:133] The BCLK Frequency to DRAM Frequency ratio is set to 100:133.
- [100:100] The BCLK Frequency to DRAM Frequency is set to 100:100.

### DRAM Frequency [Auto]

This item allows you to set the memory operating frequency. The configurable options vary with the BCLK (base clock) frequency setting.



---

Selecting a very high memory frequency may cause the system to become unstable! If this happens, revert to the default setting.

---

### Max. CPU Graphics Ratio [Auto]

Allows you to set the CPU Graphics maximum ratio. The maximum ratio is 60x. Use <+>/<-> to adjust the value.

### GPU Boost [Keep Current Settings]

GPU Boost accelerates the integrated GPU for extreme graphics performance. Configuration options: [Keep Current Settings] [Enabled].

### EPU Power Saving Mode [Disabled]

The ASUS EPU (Energy Processing Unit) sets the CPU in its minimum power consumption settings. Enable this item to set lower CPU VCCIN and Vcore voltages and achieve the best energy saving condition.

Configuration options: [Disabled] [Enabled]

### DRAM Timing Control

The subitems in this menu allow you to set the DRAM timing control features. Use the <+> or <-> keys to adjust the value. To restore the default setting, type [auto] using the keyboard and press the <Enter> key.



---

Changing the values in this menu may cause the system to become unstable! If this happens, revert to the default settings.

---

## DIGI+ VRM

### CPU Load-line Calibration [Auto]

Load-line is defined by Intel VRM spec and affects CPU voltage. The CPU working voltage will decrease proportionally to CPU loading. Higher value gets a higher voltage and better overclocking performance, but increases the CPU and VRM thermal. Configuration options: [Auto] [Regular] [Medium] [High] [Ultra High] [Extreme]



---

The actual performance boost may vary depending on your CPU specification.

---



---

DO NOT remove the thermal module. The thermal conditions should be monitored.

---

### CPU VRM Switching Frequency [Auto]

This item affects the VRM transient response speed and the component thermal production. Select [Manual] to configure a higher frequency for a quicker transient response speed.

Configuration options: [Auto] [Manual]



---

DO NOT remove the thermal module. The thermal conditions should be monitored.

---



---

The following item appears only when you set the CPU VRM Switching Frequency to [Manual].

---

#### ***Fixed CPU VRM Switching Frequency (KHz) [250]***

This item allows you to set a higher frequency for a quicker transient response speed. Use the <+> or <-> to adjust the value. The values range from 200 KHz to 350 KHz with an interval of 50 KHz.

### CPU Power Phase Control [Auto]

This item allows you to set the power phase control of the CPU.

Configuration options: [Auto] [Standard] [Optimized] [Extreme] [Power Phase Response]



---

DO NOT remove the thermal module when setting this item to [Power Phase Response]. The thermal conditions should be monitored.

---



---

The following item appears only when you set the CPU Power Phase Control to [Power Phase Response].

---

#### ***Power Phase Response [Fast]***

This item allows you to set a faster phase response for the CPU to increase system performance or to slower phase response to decrease DRAM power efficiency.

Configuration options: [Ultra Fast] [Fast] [Medium] [Regular]



### CPU Power Duty Control [T.Probe]

DIGI + VRM Duty Control adjusts the current of every VRM phase and the thermal conditions of every phase component.

[T. Probe] Select to maintain the VRM thermal balance.

[Extreme] Select to maintain the current VRM balance.



---

DO NOT remove the thermal module. The thermal conditions should be monitored.

---

### CPU Current Capability [Auto]

This item provides a total power range for CPU overclocking. A higher value setting provides higher power consumption delivery and extends the overclocking frequency range simultaneously.

Configuration options: [Auto] [100%] [110%] [120%] [130%] [140%]

## Internal CPU Power Management

The subitems in this menu allow you to set the CPU ratio and their features.

### Enhanced Intel SpeedStep Technology [Enabled]

This item allows the operating system to dynamically adjust the processor voltage and cores frequency, resulting to a decreased average power consumption and decreased average heat production. Configuration options: [Disabled] [Enabled]

### Turbo Mode [Enabled]

This item allows you to enable your core processor's speed to run faster than the base operating frequency when it is below operating power, current and temperature specification limit. Configuration options: [Disabled] [Enabled]



---

The following items appear only when you set the Turbo Mode to **[Enabled]**.

---

### *Turbo Mode Parameters*

#### **Long Duration Package Power Limit [Auto]**

Allows you to limit the Turbo Ratio's time duration that exceeds the TDP (Thermal Design Power) for maximum performance. Use the <+> or <-> keys to adjust the value. The values range from 1 W to 4096 W.

#### **Package Power Time Window [Auto]**

Also known as Power Limit 1, this item allows you to maintain the time window for Turbo Ratio over TDP (Thermal Design Power). Use the <+> or <-> keys to adjust the value. The values range from 1 to 127 in seconds.

#### **Short Duration Package Power Limit [Auto]**

Also known as Power Limit 2, this item allows you to provide rapid protection when the package power exceeds the Power Limit 1. Use the <+> or <-> keys to adjust the value. The values range from 1 W to 4096 W.

#### **CPU Integrated VR Current Limit [Auto]**

Allows you to set a higher current limit to prevent frequency and power throttling when overclocking. Use the <+> or <-> keys to adjust the value. The values range from 0.125 to 1023.875 with a 0.125 interval.

## CPU Internal Power Switching Frequency

### Frequency Tuning Mode [Auto]

This item allows you to increase or decrease the switching frequency of the internal regulator. Decrease the switching frequency to reduce the power consumption or increase the switching frequency to enhance voltage stability. When this item is set to [+ ] or [- ], the Frequency Tuning Offset appears that allows you to set its value from 0% to 6%.

## CPU Internal Power Fault Control

### Thermal Feedback [Auto]

Allows your system to take precautionary actions to protect the CPU when the thermal condition of the external regulator exceeds the threshold.

Configuration options: [Auto] [Disabled] [Enabled]

### CPU Integrated VR Fault Management [Auto]

Disable this item to prevent tripping the Fully Integrated Voltage Regulator when doing over-voltage. We recommend you to disable this item when overclocking.

Configuration options: [Auto] [Disabled] [Enabled]

## CPU Internal Power Configuration

### CPU Integrated VR Efficiency Management [Auto]

This item allows you to improve the power rating when the CPU is in low power state, or make the FIVR (fully integrated voltage regulator work in high performance at all times.

Configuration options: [Auto] [High Performance] [Balanced]

### Power Decay Mode [Auto]

This item allows your system to improve the power saving mode on the Fully Integrated Voltage Regulator as the processor goes into low current state.

Configuration options: [Auto] [Disabled] [Enabled]

### Idle Power-in Response [Auto]

This item allows you to set the slew rate for the Fully Integrated Voltage Regulator when it enters manual override mode.

Configuration options: [Auto] [Regular] [Fast]

### Idle Power-out Response [Auto]

This item allows you to set the slew rate for the Fully Integrated Voltage Regulator when it exits manual override mode. Configuration options: [Auto] [Regular] [Fast]

### Power Current Slope [Auto]

This item allows you to enhance the power saving condition or the system overclocking capability. Select a higher power current slope levels for power saving enhancement or lower power current slope levels for system overclocking enhancement.

Configuration options: [Auto] [LEVEL -4] - [LEVEL 4]

### Power Current Offset [Auto]

This item allows you to increase or decrease the output current sensed by the CPU. It finds the balance between optimal regulating while staying below the current threshold.

Configuration options: [Auto] [100%] [87.5%] [75.0%] [62.5%] [50.0%] [37.5%] [25.0%] [12.5%] [0%] [-12.5%] [-25.0%] [-37.5%] [-50.0%] [-62.5%] [-75.0%] [-87.5%] [-100%]

### **Power Fast Ramp Response [Auto]**

This item allows you to enhance the response of the CPU voltage regulator during the load transients. Use the <+> or <-> to adjust the value. The values range from 0.00 to 1.50. Configuration options: [Auto] [0.00] - [1.50]

### **CPU Internal Power Saving Control**

#### **Power Saving Level 1 Threshold [Auto]**

Lower value provides sufficient overclocking tolerance to enlarge the overclocking potential. Higher value provides better power-saving condition. Use <+> or <-> key to adjust the value. The values range from 0 A to 80 A at 1 A increment.

#### **Power Saving Level 2 Threshold [Auto]**

Lower value provides sufficient overclocking tolerance to enlarge the overclocking potential. Higher value provides better power-saving condition. Use <+> or <-> key to adjust the value. The values range from 0 A to 50 A at 1 A increment.

#### **Power Saving Level 3 Threshold [Auto]**

Lower value provides sufficient overclocking tolerance to enlarge the overclocking potential. Higher value provides better power-saving condition. Use <+> or <-> key to adjust the value. The values range from 0 A to 30 A at 1A increment.

### **Extreme Over-voltage [Disabled]**

This item allows you to set higher voltages for overclocking. When you enable this item, you can choose a high level voltage to overclock, but does not guarantee the CPU life. Configuration options: [Enabled] [Disabled]

### **CPU Core Voltage [Auto]**

This item allows you to configure the amount of voltage fed to the CPU cores. Increase the voltage when setting a high Core Frequency value.

Configuration options: [Auto] [Manual Mode] [Offset Mode]



---

The following item appears only when you set the CPU Core Voltage to **[Manual]**.

---

#### **CPU Core Voltage Override [Auto]**

This item allows you to set the CPU Core Voltage override. Use the <+> or <-> keys to adjust the value, The values range from 0.001V to 1.920 V with a 0.001 V interval.



---

The following items appear only when you set the CPU Core Voltage to **[Offset Mode]**

---

#### **Offset Mode Sign [+]**

- [+] To offset the voltage by a positive value.
- [-] To offset the voltage by a negative value.

#### **CPU Core Voltage Offset**

Use the <+> or <-> keys to adjust the value. The values range from 0.001 V to 0.999 V with a 0.001 V interval.

## CPU Cache Voltage [Auto]

This item allows you to set the amount of voltage fed to the CPU uncores including its cache. Increase the voltage when setting a high CPU cache frequency.

Configuration options: [Auto] [Manual Mode] [Offset Mode]



---

The following item appears only when you set the CPU Cache Voltage to **[Manual Mode]**.

---

### CPU Cache Voltage Override [Auto]

This item allows you to set the CPU Cache Voltage override. By default, this item takes the standard value of the installed CPU. You can use the <+> or <-> keys to adjust the value. The values range from 0.001V to 1.920 V with a 0.001 V interval.



---

The following items appear only when you set the CPU Cache Voltage to **[Offset Mode]**.

---

### Offset Mode Sign [+]

[+] To offset the voltage by a positive value.

[-] To offset the voltage by a negative value.

### CPU Cache Voltage Offset

Allows you to set the CPU cache voltage offset. By default, this item takes the standard value of the installed CPU. You can use the <+> or <-> keys to adjust the value. The values range from 0.001V to 0.999 V with a 0.001 V interval.

## CPU Graphics Voltage [Auto]

This item allows you to set the amount of voltage fed to the CPU graphics. Increase the voltage when setting a high CPU graphics frequency.

Configuration options: [Auto] [Manual Mode] [Offset Mode] [Adaptive Mode]



- 
- The following item appears only when you set the CPU Graphics Voltage to **[Manual Mode]**.
  - [Adaptive Mode] is available for some specific CPU types.
- 

### CPU Graphics Voltage Override [Auto]

This item allows you to set the CPU Graphics Voltage override. By default, this item takes the standard value of the installed CPU. You can use the <+> or <-> keys to adjust the value. The values range from 0.001V to 1.920 V with a 0.001 V interval.



---

The following items appear only when you set the CPU Graphics Voltage to **[Offset Mode]**.

---

### **Offset Mode Sign [+]**

- [+] To offset the voltage by a positive value.
- [-] To offset the voltage by a negative value.

### **CPU Graphics Voltage Offset [Auto]**

Allows you to set the CPU graphics voltage offset. By default, this item takes the standard value of the installed CPU. You can use the <+> or <-> keys to adjust the value. The values range from 0.001V to 0.999 V with a 0.001 V interval.



---

The following item appears only when you set the CPU Graphics Voltage to **[Adaptive Mode]**.

---

### **Additional Turbo Mode CPU Graphics Voltage [Auto]**

This item allows you to set the amount of voltage fed to the CPU graphics when running in turbo mode. Increase the voltage when configuring a high CPU graphics frequency. The voltage you set is affected by the offset value. Use the <+> or <-> keys to adjust the value. The values range from 0.001V to 1.920 V with a 0.001 V interval.

### **Total Adaptive Mode CPU Graphics Voltage [Auto]**

This item sums up the voltages of the CPU Graphics Voltage offset and Additional Turbo Mode CPU Graphics Voltage options.

### **CPU System Agent Voltage Offset Mode Sign [+]**

- [+] To offset the voltage by a positive value.
- [-] To offset the voltage by a negative value.

### **CPU System Agent Voltage Offset [Auto]**

This item allows you to set the amount of voltage fed to the system agent of the CPU including its PCIe controller and the PCU (power control unit). Increase the voltage to enhance the overclocking capability.

You can use the <+> or <-> keys to adjust the value. The values range from 0.001 V to 0.999 V with a 0.001 V interval.

### **CPU Analog I/O Voltage Offset Mode Sign [+]**

- [+] To offset the voltage by a positive value.
- [-] To offset the voltage by a negative value.

### **CPU Analog I/O Voltage Offset [Auto]**

This item allows you to set the amount of voltage fed to the analog portion of the I/O on the CPU. By default, this item takes the standard value of the installed CPU. Increase the amount of voltage to enhance the overclocking capability.

You can use the <+> or <-> keys to adjust the value. The values range from 0.001 V to 0.999 V with a 0.001 V interval.

## CPU Digital I/O Voltage Offset Mode Sign [+]

- [+] To offset the voltage by a positive value.
- [-] To offset the voltage by a negative value.

### CPU Digital I/O Voltage Offset [Auto]

This item allows you to set the amount of voltage fed to the digital portion of the I/O on the processor. By default, this item takes the standard value of the installed CPU. Increase the amount of voltage to enhance the overclocking capability.

You can use the <+> or <-> keys to adjust the value. The values range from 0.001 V to 0.999 V with a 0.001 V interval.

### SVID Support [Auto]

Set this item to **[Enabled]** when overclocking your system. Disabling this item stops the CPU from communicating with the external voltage regulator.

Configuration options: [Auto] [Disabled] [Enabled]



---

The following item appears only when you set SVID Support to **[Enabled]**.

---

### SVID Voltage Override [Auto]

This item allows you to set the SVID Voltage override. By default, this item takes the standard value of the installed CPU. You can use the <+> or <-> keys to adjust the value. The values range from 0.001V to 2.440 V with a 0.001 V interval.

### CPU Input Voltage (VCCIN) [Auto]

This item allows you to set an input voltage for the CPU by the external voltage regulator. By default, this item takes the standard value of the installed CPU. You can use the <+> or <-> keys to adjust the value. The values range from 0.800 V to 2.700 V with a 0.010 V interval.

### DRAM Voltage [Auto]

This item allows you to set the DRAM voltage. You can use the <+> or <-> keys to adjust the value. The values range from 1.1850 V to 1.8000 V with a 0.00500 V interval.



---

According to Intel® CPU specifications, DIMMs with voltage requirement over 1.65 V may damage the CPU permanently. We recommend that you install the DIMMs with the voltage requirement below 1.65 V.

---

### PCH VLX Voltage [Auto]

This item allows you to set the I/O voltage on the PCH (Platform Controller Hub). You can use the <+> or <-> keys to adjust the value. The values range from 1.1850 V to 2.1350 V with a 0.0050 V interval.

### PCH Core Voltage [Auto]

This item allows you to set the Core voltage for the PCH (Platform Controller Hub). You can use the <+> or <-> keys to adjust the value. The values range from 0.73500 V to 1.50000 V with a 0.00500 V interval.



---

The system may need better cooling system for a more stable performance under high voltage settings.

---

### DRAM CTRL REF Voltage [Auto]

This item allows you to set the DRAM reference voltage on the control lines from the memory bus. You can use the <+> or <-> keys to adjust the value. The values range from 0.39500x to 0.63000x with a 0.00500x interval.



To set a value for the DRAM reference voltage, we recommend you to set a value close to the standard value which is 0.500000x.

### DRAM DATA REF Voltage on CHA/CHB [Auto]

This item allows you to set the DRAM reference voltage on the data lines on Channels A and B. You can use the <+> or <-> keys to adjust the value. The values range from 0.39500x to 0.63000x with a 0.00500x interval.



To set a value for the DRAM reference voltage, we recommend you to set a value close to the standard value which is 0.500000x.

### CPU Spread Spectrum [Auto]

This item allows you to enhance the BCLK overclocking capability or reduce the EMI (electromagnetic disturbance) generated by the BCLK. Set this item to [Enabled] for EMI reduction, or set this item to [Disabled] to enhance BCLK overclocking.

Configuration options: [Auto] [Disabled] [Enabled]

## 3.6 Advanced menu

The Advanced menu items allow you to change the settings for the CPU and other system devices.



Be cautious when changing the settings of the Advanced menu items. Incorrect field values can cause the system to malfunction.

The screenshot displays the ASUS UEFI BIOS Utility in Advanced Mode. The top bar shows the date (03/24/2014), time (15:15), and language (English). The main menu includes My Favorites, Main, AI Tweaker, **Advanced**, Monitor, Boot, Tool, and Exit. The left sidebar lists configuration categories: CPU Configuration, PCH Configuration, PCH Storage Configuration, System Agent Configuration, USB Configuration, Platform Misc Configuration, Onboard Devices Configuration, APM, and Network Stack Configuration. The right sidebar shows hardware monitoring data:

CPU	
Frequency	Temperature
2800 MHz	36°C
BCLK	Vcore
100.0 MHz	0.848 V
Ratio	
28x	

Memory	
Frequency	Voltage
1333 MHz	1.500 V
Capacity	
1024 MB	

Voltage	
+12V	+5V
12.192 V	5.160 V

## 3.6.1 CPU Configuration

The items in this menu show the CPU-related information that the BIOS automatically detects.



The items in this menu may vary based on the CPU installed.



### Intel Adaptive Thermal Monitor [Enabled]

This item allows you to protect the CPU by decreasing its frequency as it reaches the thermal throttle point. The thermal monitor includes TM1 (Thermal monitor 1), TM2 (Thermal monitor 2), and EMTTM (Enhanced Multi-threaded Thermal Monitoring).

Configuration options: [Disabled] [Enabled]

### Hyper-threading [Enabled]

Allows a hyper-threading processor to appear as two logical processors, allowing the operating system to schedule two threads or processes simultaneously. Configuration options: [Disabled] [Enabled]

### Active Processor Cores [All]

This item allows you to select the number of CPU cores to activate in each processor package. Configuration options: [All] [1] [2] [3]

### Limit CPUID Maximum [Disabled]

When set to [Enabled], this item allows the legacy OS to boot even without support for CPUs with extended CPUID functions. Configuration options: [Disabled] [Enabled]



### **Execute Disable Bit [Enabled]**

Execute Disable prevents certain classes of malicious buffer overflow attacks when combined with a supporting OS (SuSE Linux 9.2, RedHat Enterprise 3 Update 3).

Configuration options: [Disabled] [Enabled]

### **Intel Virtualization Technology [Disabled]**

When set to **[Enabled]**, a VMM can utilize the additional hardware capabilities provided by Vanderpool Technology. Configuration options: [Disabled] [Enabled]

### **Hardware Prefetcher(L2 Cache) [Enabled]**

This item allows the CPU to prefetch commands and data in the L2 cache, reduces the DRAM loading time and improves the system performance.

Configuration options: [Disabled] [Enabled]

### **Adjacent Cache Line Prefetcher [Enabled]**

This item allows the mid level cache (L2) to prefetch adjacent cache lines, reducing the DRAM loading time and improves the system performance.

Configuration options: [Disabled] [Enabled]

### **Boot Performance Mode [Max on-Turbo Performance]**

This item allows you to select the CPU performance state during system boot before the operating system takes control. The CPU runs at a selected performance ratio based on CPU configuration.

Configuration options: [Max Non-Turbo Performance] [Max Battery] [Turbo Performance]

### **CPU Power Management Configuration**

This item allows you to manage and configure the CPU's power.

#### **Enhanced Intel SpeedStep Technology [Enabled]**

This item allows your system to adjust the CPU's voltage and cores frequency, resulting in decreased power consumption and heat production.

[Disabled]      The CPU runs at its default speed.

[Enabled]      The system controls the CPU speed.

#### **Turbo Mode [Enabled]**

This item allows you to automatically set the CPU cores to run faster than the base operating frequency when it is below the operating power, current and temperature specification limit. Configuration options: [Enabled] [Disabled]

#### **CPU C-states [Auto]**

This item allows you to set the power saving of the CPU states.

Configuration options: [Auto] [Disabled] [Enabled]



---

The following items appear only when you set the CPU states to **[Enabled]**.

---

#### **Enhanced C1 state [Enabled]**

This item allows your CPU to reduce power consumption when the system is in idle mode. Configuration options: [Enabled] [Disabled]

### **CPU C3 Report [Enabled]**

This item allows you to disable or enable the CPU C3 report to the operating system.

Configuration options: [Enabled] [Disabled]

### **CPU C6 Report [Enabled]**

This item allows you to disable or enable the CPU C6 report to the operating system.

Configuration options: [Enabled] [Disabled]

### **C6 Latency [Short]**

This item allows you to set the duration of C6 latency for C6 state.

Configuration options: [Short] [Long]

### **CPU C7 Report [CPU C7s]**

This item allows you to disable or enable the CPU C7 report to the operating system.

Configuration options: [Disabled] [CPU C7] [CPU C7s]

### **C7 Latency [Long]**

This item allows you to set the duration of C7 latency for C7 state.

Configuration options: [Short] [Long]

### **Package C State Support [Auto]**

This item allows you to set the a C-state support for the CPU package.

Configuration options: [Auto] [Enabled] [C0/C1] [C2] [C3] [C6] [CPU C7] [CPU C7s]

## 3.6.2 PCH Configuration

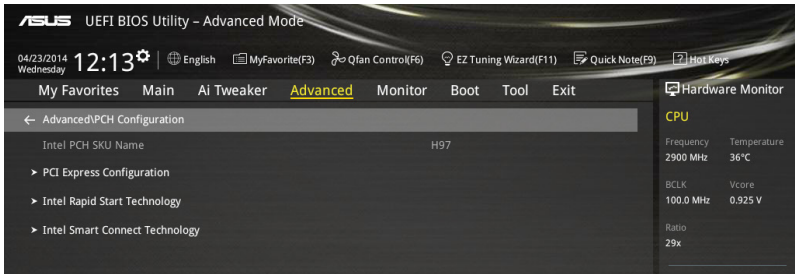

### PCI Express Configuration

This item allows you to configure the PCI Express slots.

#### **PCI-E Speed [Auto]**

This item allows your system to automatically select the PCI Express port speed. When set to [Gen1], the PCI-E port runs at PCI-E 1.0 speed. When set to [Gen2], the PCI-E port runs at PCI-E 2.0 speed.

Configuration options: [Auto] [Gen1] [Gen2]

## Intel Rapid Start Technology [Disabled]

This item allows you to enable or disable Intel® Rapid Start Technology.

Configuration options: [Enabled] [Disabled]



---

The following items appear only when you set the Intel® Rapid Start Technology to **[Enabled]**.

---

### Entry on S3 RTC Wake [Enabled]

The system automatically wakes up and set to Rapid Start Technology S3 mode.

Configuration options: [Enabled] [Disabled]

#### ***Entry After [0]***

This item allows you to set the RTC wake-up timer at S3 entry. The time ranges from 0 minute (immediately) to 120 minutes.

### Active Page Threshold Support [Enabled]

The system automatically goes into sleep mode when the partition size is not enough for the Intel® Rapid Start Technology to work.

Configuration options: [Enabled] [Disabled]

#### ***Active Memory Threshold [0]***

This item supports Intel Rapid Storage Technology when the partition size is greater than the Active Page Threshold size. When set to zero (0), it will go to Auto mode and checks if the partition size is enough at S3 entry.



---

Ensure that the caching partition size is larger than the total memory size.

---

### Hybrid Hard Disk Support [Disabled]

This item allows you to enable or disable the hybrid hard disk support for a faster resume time.

Configuration options: [Enabled] [Disabled]

## Intel Smart Connect Technology [Disabled]

This item allows the system to support Intel Smart Connect Technology, that periodically refreshes selected applications when the system is in sleep mode.

Configuration options: [Enabled] [Disabled]

### 3.6.3 PCH Storage Configuration

While entering Setup, the BIOS automatically detects the presence of SATA devices. The SATA Port items show **Empty** if no SATA device is installed to the corresponding SATA port. Scroll down to display the other BIOS items.

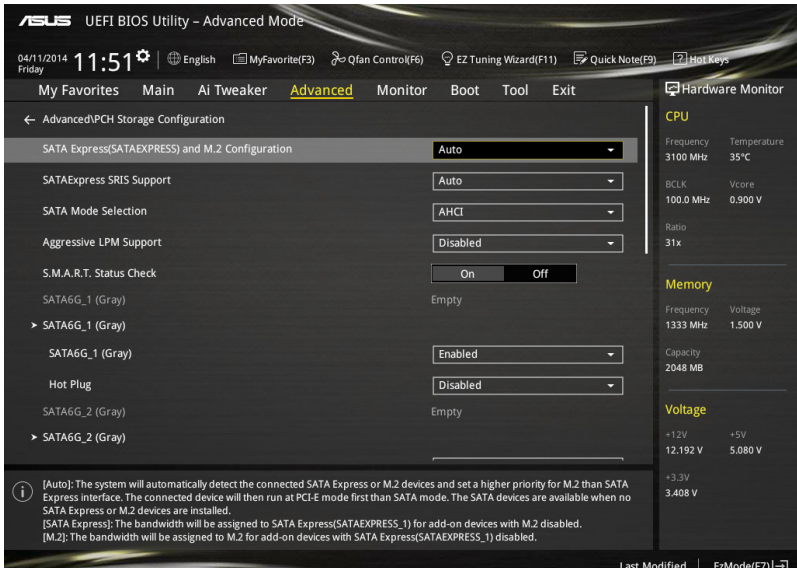

#### SATA Express (SATAEXPRESS) and M.2 Configuration [Auto]

This item allows you to set an automatic detection between the SATA Express devices and M.2 devices.

- [Auto] The system automatically detects the connected SATA Express or M.2 devices and set a higher priority to M.2 over SATA Express interface.
- [SATA Express] The system assigns the priority bandwidth to SATA Express interface.
- [M.2] The system assigns the priority bandwidth to M.2 Socket 3.



By default, the system detects the first priority device. The device detection priority is as follows: PCIe M.2 > SATA Mode M.2 > PCIe SATA Express > SATA Mode SATA Express.

#### SATAExpress SRIS Support [Auto]

This item allows you to set the SATAExpress SRIS support.

- [Auto] The system automatically adjust the SRIS (Separate Reference Clock Independent Spread Spectrum Clocking Architecture) support for connected SATA Express devices.
- [Disabled] Select this option for ASUS RUNWAY SATA Express bridge card.

## SATA Mode Selection [AHCI]

This item allows you to set the SATA configuration.

- [Disabled] Disables the SATA function.
- [IDE Mode] Set to [IDE Mode] when you want to use the Serial ATA hard disk drives as Parallel ATA physical storage devices.
- [AHCI Mode] Set to [AHCI Mode] when you want the SATA hard disk drives to use the AHCI (Advanced Host Controller Interface). The AHCI allows the onboard storage driver to enable advanced Serial ATA features that increases storage performance on random workloads by allowing the drive to internally optimize the order of commands.
- [RAID Mode] Set to [RAID Mode] when you want to create a RAID configuration from the SATA hard disk drives.



---

The following item appears only when you set the SATA Mode Selection to **[RAID]**.

---

## Pcie Nand Configuration [Auto]

This item allows you to enable or disable PCIe NAND.

Configuration options: [Disabled] [Enabled]

## Aggressive LPM Support [Disabled]

This item is designed for LPM (link power management) support with a better energy saving conditions. When disabled, the hot plug function of SATA ports are disabled.

Configuration options: [Disabled] [Enabled]

## S.M.A.R.T. Status Check [On]

S.M.A.R.T. (Self-Monitoring, Analysis and Reporting Technology) is a monitoring system that shows a warning message during POST (Power-on Self Test) when an error occurs in the hard disks. Configuration options: [On] [Off]

## Hot Plug [Disabled] (SATA6G\_1 - SATA6G\_6)

These items allow you to enable/disable SATA Hot Plug Support.

Configuration options: [Disabled] [Enabled]

## 3.6.4 System Agent Configuration

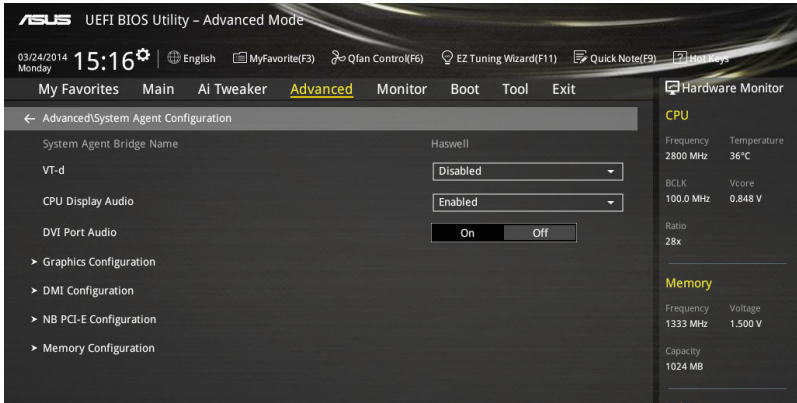

### VT-d [Disabled]

Allows you to enable or disable VT-d function on MCH. Configuration options: [Enabled] [Disabled]

### CPU Display Audio [Enabled]

Allows you to enable or disable CPU display audio support. Configuration options: [Enabled] [Disabled]

### DVI Port Audio [Off]

Allows you to enable or disable DVI port audio support. Configuration options: [On] [Off]

### Graphics Configuration

This item allows you to select a primary display from CPU and PCIe graphical devices.

#### Primary Display [Auto]

This item allows you to select the primary display from CPU and PCIe devices. Configuration options: [Auto] [CPU Graphics] [PCIe] [PCI]

#### CPU Graphics Memory [Auto]

Allows you to set the system memory size allocated to DVMT 5.0 used by the CPU graphics. Configuration options: [Auto] [32M] [64M] [96M] [128M] ~ [448M] [480M] [512M]

#### Render Standby [Auto]

Allows you to enable or disable Intel® Graphics Render Standby support to reduce iGPU power use when the system is idle. Configuration options: [Auto] [Disabled] [Enabled]

#### CPU Graphics Multi-Monitor [Disabled]

This item allows you to empower both integrated and discrete graphics devices for the multi-monitor output. The CPU graphics shared system memory size is fixed at 64 MB. Configuration options: [Disabled] [Enabled]

## DMI Configuration

This item allows you to control various DMI (direct media interface) to run at PCI-E 2.0 speed.

### DMI Gen 2 [Enabled]

Set this item to **[Enabled]** to run DMI at PCI-E 2.0 speed.

Configuration options: [Enabled] [Disabled]

## NB PCI-E Configuration

This item allows you to configure the NB PCI Express settings.

### PCI-EX16\_1Link Speed [Auto]

This item allows you to configure the PCIEx16\_1 speed.

Configuration options: [Auto] [Gen1] [Gen2] [Gen3]

## Memory Configuration

This item allows you to configure the memory configuration parameters.

### Memory Scrambler [Enabled]

Set this item to **[Enabled]** to support high frequency DRAMs for a better stability.

Configuration options: [Enabled] [Disabled]

### Memory Remap [Enabled]

Set this item to **[Enabled]** to support DRAM address remapping for 64-bit operating systems.

Configuration options: [Enabled] [Disabled]

## 3.6.5 USB Configuration

The items in this menu allow you to change the USB-related features.

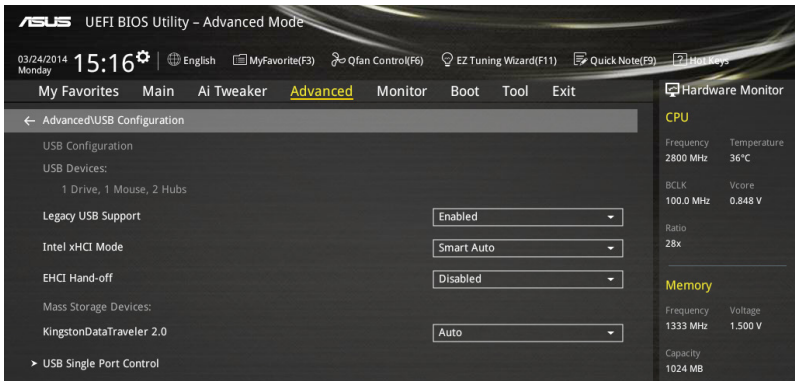

The screenshot displays the ASUS UEFI BIOS Utility in Advanced Mode. The main menu is set to 'Advanced' and shows the 'Advanced/USB Configuration' section. Under 'USB Configuration', there are three main categories: 'USB Devices' (showing 1 Drive, 1 Mouse, 2 Hubs), 'Legacy USB Support' (set to Enabled), 'Intel xHCI Mode' (set to Smart Auto), and 'EHCI Hand-off' (set to Disabled). The 'Mass Storage Devices' section lists a 'KingstonDataTraveler 2.0' drive with a setting of 'Auto'. Below this is a 'USB Single Port Control' option. On the right side, the 'Hardware Monitor' panel shows CPU and Memory status: CPU Frequency (2800 MHz), Temperature (36°C), BCLK (100.0 MHz), and Voltage (0.848 V); Memory Frequency (1333 MHz), Voltage (1.500 V), and Capacity (1024 MB).



The **Mass Storage Devices** item shows the auto-detected values. If no USB device is detected, the item shows **None**.

### Legacy USB Support [Enabled]

- [Disabled] Your USB devices can be used for BIOS setup only and cannot be recognized in the boot devices list.
- [Enabled] Your system supports the USB devices in legacy operating systems.
- [Auto] Your system automatically detects the presence of USB devices at startup. If any USB devices are detected, the legacy USB support is enabled.

### Intel xHCI Mode [Smart Auto]

- [Auto] The xHCI is automatically enabled and runs at USB 3.0 mode when the xHCI driver is installed in the operating system.
- [Smart Auto] Upon detection, the xHCI driver supports the USB 3.0 mode during both POST and operating system.
- [Enabled] Enables the xHCI controller.
- [Disabled] Disables the xHCI controller.

### EHCI Hand-off [Disabled]

- [Enabled] Enables the support for operating systems without an EHCI hand-off feature.
- [Disabled] Disables the EHCI Hand-off support.

### Mass Storage Devices [Auto]

This item allows your system to detect the devices according to their media formats.  
Configuration options: [Auto] [Floppy] [Forced FDD] [Hard Disk] [CD-ROM]

### USB Single Port Control

This item allows you to enable or disable the individual USB ports.



Refer to section 1.2.2 **Motherboard layout** for the location of the USB ports.

## 3.6.6 Platform Misc Configuration

The items in this menu allow you to configure the platform-related features.

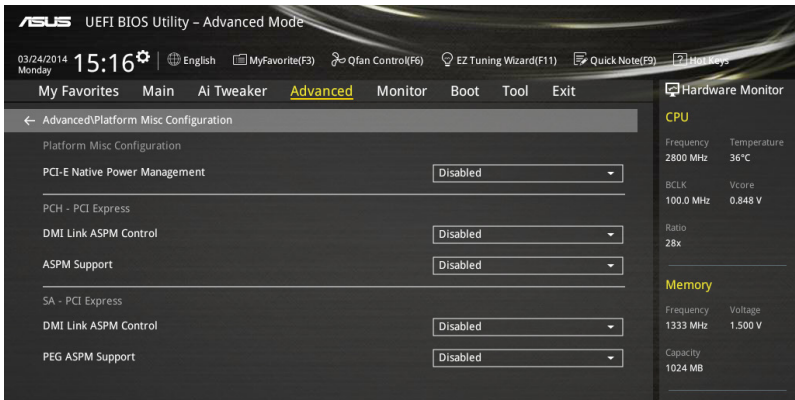



## PCI-E Native Power Management [Disabled]

This item allows you to enhance the power saving feature of PCI Express and perform ASPM operations in the operating system.

Configuration options: [Disabled] [Enabled]



---

The following item appears only when you set the PCI Express Native Power Management to [Enabled].

---

### Native ASPM [Disabled]

[Enabled] Windows® Vista OS controls the ASPM (active state power management) support for devices.

[Disabled] BIOS controls the ASPM support for the device.

## PCH - PCI Express options

### DMI Link ASPM Control [Disabled]

This item allows you to control the Active State Power Management on both NB (NorthBridge) side and SB (SouthBridge) side of the DMI Link.

Configuration options: [Disabled] [Enabled]

### ASPM Support [Disabled]

This item allows you to select the ASPM state for energy-saving conditions.

Configuration options: [Disabled] [L0s] [L1] [L0sL1] [Auto]

## SA - PCI Express options

### DMI Link ASPM Control [Disabled]

This item allows you to control the Active State Power Management on both CPU and PCH (platform controller hub) Both DMI link ASPM control items of the CPU and PCH sides must be enabled for the ASPM to take effect.

Configuration options: [Disabled] [L0s] [L1] [L0sL1]

### PEG ASPM Support [Disabled]

This item allows you to select the ASPM state for energy-saving conditions, or use the ASUS optimized energy saving profile.

Configuration options: [Disabled] [ASPM] [L0s] [L1] [L0sL1] [Auto]

### 3.6.7 Onboard Devices Configuration

Scroll down to view the other BIOS items.



#### HD Audio Controller [Enabled]

This item allows you to use the Azalia High Definition Audio Controller

Configuration options: [Disabled] [Enabled]



The following items appear only when you set the HD Audio Controller to **[Enabled]**.

#### Front Panel Type [HD Audio]

This item allows you to set the front panel audio connector (AAFP) mode to legacy AC'97 or high-definition audio depending on the audio standard that the front panel audio module supports.

[HD Audio] Sets the front panel audio connector (AAFP) mode to high definition audio.

[AC97] Sets the front panel audio connector (AAFP) mode to legacy AC'97

#### SPDIF Out Type [SPDIF]

[SPDIF] Sets to an SPDIF audio output.

[HDMI] Sets to an HDMI audio output.

### Depop [Enabled]

[Enabled] Allows you to enable the Depop.

[Disabled] Disables the Depop.

### PCI-EX16\_2 Slot (black) Bandwidth [X2 mode]

[X2 mode] This item allows your system to run at X2 mode for system resource optimization with the PCIe x1\_1 and PCIe x1\_2 slots enabled.

[X4 mode] This item allows your system to run at X4 mode for high performance support with the PCIe x1\_1 and PCIe x1\_2 slots disabled.

### Intel LAN Controller [Enabled]

This item allows you to enable or disable the Intel LAN controllers.

Configuration options: [Disabled] [Enabled]



---

The following item appears only when you set the Intel LAN Controller to **[Enabled]**.

---

#### Intel LAN PXE Option ROM [Disabled]

This item allows you to enable or disable the PXE OptionRom of the Intel® LAN controller. Configuration options: [Enabled] [Disabled]

### Charging USB devices in Power State S5 [Disabled]

[Enabled] Charges USB devices even when the system is in Power State S5. State S5 is the soft-off mode or shutdown state where your computer has no memory state and is not doing any computing tasks.

[Disabled] Disables this function.

### Serial Port Configuration

The sub-items in this menu allow you to set the serial port configuration.



---

This item functions only if there is a serial port (COM) connector on the motherboard.

---

#### Serial Port [Enabled]

Allows you to enable or disable the serial port (COM). Configuration options: [Enabled] [Disabled]

#### Change Settings [IO=3F8h; IRQ=4]

This item appears only when you set the **Serial Port** to [Enabled] and allows you to select the Serial Port base address. Configuration options: [IO=3F8h; IRQ=4] [IO=2F8h; IRQ=3] [IO=3E8h; IRQ=4] [IO=2E8h; IRQ=3]

## 3.6.8 APM Configuration



### Deep S4 [Disabled]

When enabled, the system in S4 state will further reduce power usage and will power off the USB and PS/2 devices. The system in deep S4 state can be woken up via power button, devices in LAN, or other ways except the USB and PS/2 devices. Configuration options: [Enabled] [Disabled]

### Restore AC Power Loss [Power Off]

This item allows your system to go to ON state, OFF state, or both states after an AC power loss. When setting your system to [Last State], it goes to the previous state before the AC power loss. Configuration options: [Power Off] [Power On] [Last State]

### Power On By PS/2 Keyboard [Disabled]

- [Disabled] Disables the Power On by a PS/2 keyboard.
- [Space Bar] Sets the Space Bar on the PS/2 keyboard to turn on the system.
- [Ctrl-Esc] Sets the Ctrl+Esc key on the PS/2 keyboard to turn on the system.
- [Power Key] Sets Power key on the PS/2 keyboard to turn on the system. This feature requires an ATX power supply that provides at least 1A on the +5VSB lead.

### Power On By PCI-E/PCI [Disabled]

This item allows you to enable or disable the Wake-on-LAN function of the onboard LAN controller or other installed PCI-E/PCI LAN cards. Configuration options: [Disabled] [Enabled]

### Power On By Ring [Disabled]

- [Disabled] Disables Ring to generate a wake event.
- [Enabled] Enables Ring to generate a wake event.

### Power On By RTC [Disabled]

This item allows you to enable or disable the RTC (Real-Time Clock) to generate a wake event and configure the RTC alarm date. When enabled, you can set the days, hours, minutes, or seconds to schedule an RTC alarm date.

Configuration options: [Disabled] [Enabled]

### 3.6.9 Network Stack Configuration

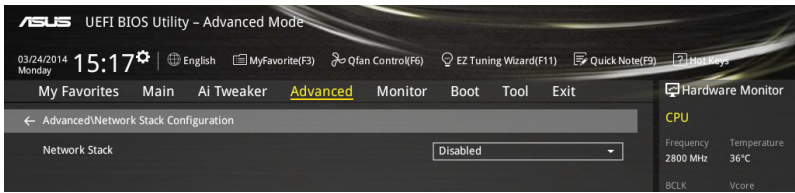

#### Network stack [Disabled]

This item allows you to disable or enable the UEFI network stack.

Configuration options: [Disabled] [Enabled]



The following item appears only when you set the Network Stack to [Enabled].

#### Ipv4/Ipv6 PXE Support [Enabled]

This item allows you to enable or disable the Ipv4/Ipv6 PXE wake event.

Configuration options: [Disabled] [Enabled]

## 3.7 Monitor menu

The Monitor menu displays the system temperature/power status, and allows you to change the fan settings.

Scroll down to display the other BIOS items.

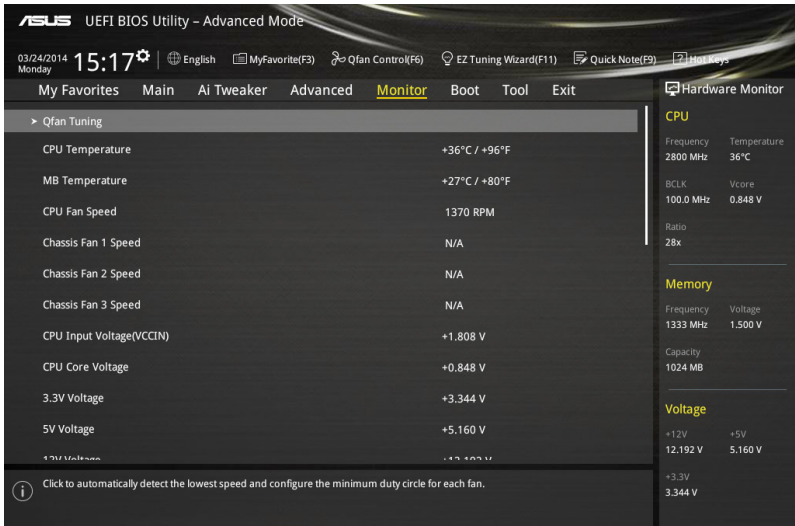

## Qfan Tuning

Click this item to automatically detect the lowest speed and configure the minimum duty cycle for each fan.

### CPU Temperature / MB Temperature [xxx°C/xxx°F] or [Ignore]

The onboard hardware monitor automatically detects and displays the CPU and motherboard temperatures. Select **[Ignore]** if you do not wish to display the detected temperatures.

### CPU Fan Speed [xxxx RPM] or [Ignore] / [N/A], Chassis Fan 1/2/3 Speed [xxxx RPM] or [Ignore] / [N/A]

The onboard hardware monitor automatically detects and displays the CPU and chassis fan speed in rotations per minute (RPM). If the fan is not connected to the motherboard, the field shows N/A. Select **[Ignore]** if you do not wish to display the detected speed.

### CPU Input Voltage(VCCIN), CPU Core Voltage, 3.3V Voltage, 5V Voltage, 12V Voltage

The onboard hardware monitor automatically detects the voltage output through the onboard voltage regulators. Select **[Ignore]** if you do not want to detect this item.

### CPU Q-Fan Control [Auto]

This item allows you to set the CPU Q-Fan operating mode.

[Auto]	Detects the type of CPU fan installed and automatically switches the mode control.
[PWM Mode]	Enable the CPU Q-Fan control in PWM mode for 4-pin CPU fan.
[DC Mode]	Enable the CPU Q-Fan control in DC mode for 3-pin CPU fan.
[Disabled]	Disables the Q-Fan control.



- The following items appear only when you set the CPU Q-Fan Control to **[Auto]**, **[PWM Mode]** or **[DC Mode]**.
- The default CPU Q-Fan settings may differ when you set the CPU Q-Fan Control item to **[Auto]**.

### CPU Fan Speed Low Limit [200 RPM]

This item allows you to set the low limit warning for CPU Fan speed.

Configuration options: [Ignore] [100 RPM] [200 RPM] [300 RPM] [400 RPM] [500 RPM]

### CPU Fan Profile [Standard]

This item allows you to set the appropriate performance level of the CPU fan.

[Standard]	Set to make the CPU fan adjust automatically depending on the CPU temperature.
[Silent]	Set to minimize the fan speed for quiet CPU fan operation.
[Turbo]	Set to achieve maximum CPU fan speed.
[Manual]	Set to assign the detailed fan speed control parameters.



The following items appear only when you set the CPU Fan Profile to **[Manual]**.

#### **CPU Upper Temperature [70]**

Use the <+> or <-> keys to adjust the upper limit of the CPU temperature. The values range from 25°C to 75°C.

#### **CPU Fan Max. Duty Cycle(%) [100]**

Use the <+> or <-> keys to adjust the maximum CPU fan duty cycle. The values range from 20% to 100%. When the CPU temperature reaches the upper limit, the CPU fan operates at the maximum duty cycle.

#### **CPU Middle Temperature [25]**

Use the <+> or <-> keys to set the value for CPU Middle Temperature. The range of the values depends on the CPU installed.

#### **CPU Fan Middle Duty Cycle(%) [20]**

Use the <+> or <-> keys to adjust the CPU fan middle duty cycle. The values range from 20% to 100%. When the CPU temperature reaches the middle value, the CPU fan operates at the middle duty cycle.

#### **CPU Lower Temperature [20]**

Use the <+> or <-> keys to adjust the CPU fan's lower temperature. The values range from 20% to 75%.

#### **CPU Fan Min. Duty Cycle(%) [20]**

Use the <+> or <-> keys to adjust the minimum CPU fan duty cycle. The values range from 20% to 100%. When the CPU temperature is under 20°C, the CPU fan operates at the minimum duty cycle.

### **Chassis Fan 1/2/3 Q-Fan Control [DC Mode]**

These items allow you to set the chassis fans' Q-Fan control feature into DC Mode, PWM Mode, or disable these Q-Fan controls from your motherboard.

Configuration options: [Disabled] [PWM Mode] [DC Mode]



---

The following items appear only when you set the Chassis Fan 1/2/3 Q-Fan Control to [PWM Mode] or [DC Mode].

---

#### **Chassis Fan 1/2/3 Q-Fan Source [CPU]**

This item controls the assigned fan according to the selected temperature source.

Configuration options: [CPU] [MB]

#### **Chassis Fan 1/2/3 Speed Low Limit [600 RPM]**

This item allows you to disable or set the chassis fan warning speed.

Configuration options: [Ignore] [200 RPM] [300 RPM] [400 RPM] [500 RPM] [600 RPM]

#### **Chassis Fan 1/2/3 Profile [Standard]**

This item allows you to set the appropriate performance level of the chassis fan.

[Standard] Set to make the chassis fan adjust automatically depending on the chassis temperature.

[Silent] Set to minimize the fan speed for quiet chassis fan operation.

[Turbo] Set to achieve maximum chassis fan speed.

[Manual] Set to assign detailed fan speed control parameters.



---

The following items appear only when you set the Chassis Fan 1/2/3 Profile to [Manual].

---

**Chassis Fan 1/2/3 Upper Temperature [70]**

Use the <+> or <-> keys to adjust the upper limit of the chassis temperature. The values range from 40°C to 90°C.

**Chassis Fan 1/2/3 Max. Duty Cycle(%) [100]**

Use the <+> or <-> keys to adjust the maximum chassis fan duty cycle. The values range from 20% to 100%. When the chassis temperature reaches the upper limit, the chassis fan will operate at the maximum duty cycle.

**Chassis Fan 1/2/3 Middle Temperature [45]**

Use the <+> or <-> keys to set the value for Chassis Fan Middle Temperature.

**Chassis Fan 1/2/3 Middle Duty Cycle(%) [60]**

Use the <+> or <-> keys to adjust the chassis fan middle duty cycle. The values range from 20% to 100%.

**Chassis Fan 1/2/3 Lower Temperature [40]**

Use the <+> or <-> keys to adjust the chassis fans' lower temperature. The values range from 20% to 75%.

**Chassis Fan 1/2/3 Min. Duty Cycle(%) [60]**

Use the <+> or <-> keys to adjust the minimum chassis fan duty cycle. The values range from 20% to 100%. When the chassis temperature is under 40°C, the chassis fan operates at the minimum duty cycle.

**Allow Fan Stop [Disabled]**

This item appears only when you set **Chassis Fan 1/2/3 Profile** to [Manual] and allows your fans to run at 0% duty cycle when the temperature of the source drops below the lower temperature. Configuration options: [Disabled] [Enabled]

**Anti-Surge Support [Enabled]**

This item allows you to enable or disable the OVP (Over Voltage Protection) and UVP (Under Voltage Protection) functions. This causes the system to automatically shut down when the voltage exceeds the safe range that protects the motherboard's components.

Configuration options: [Disabled] [Enabled]



## 3.8 Boot menu

The Boot menu items allow you to change the system boot options.

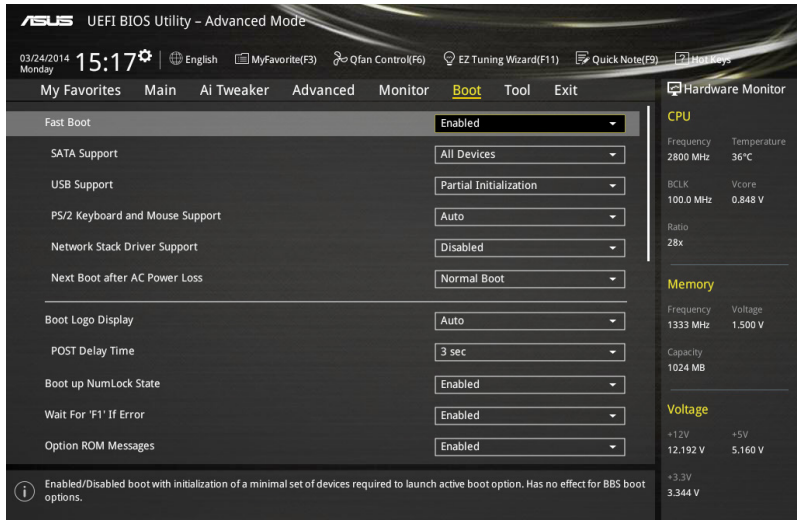

### Fast Boot [Enabled]

[Disabled] This item allows your system to go back to its normal boot speed.

[Enabled] This item allows your system to accelerate the boot speed.



The following items appear only when you set the Fast Boot to **[Enabled]**.

### SATA Support [All Devices]

[All Devices] All devices connected to SATA ports are available during POST. This process extends the POST time.

[Hard Drive Only] Only hard drives connected to SATA ports are detected during POST.

[Boot Drive Only] Only boot drives connected to a SATA ports are detected during POST.

### USB Support [Partial Initialization]

[Disabled] All USB devices will not be available until OS boot up for a fastest POST time.

[Full Initialization] All USB devices will be available during POST. This process will extend the POST time.

[Partial Initialization] For a faster POST time, only the USB ports with keyboard and mouse connections will be detected.

### PS/2 Keyboard and Mouse Support [Auto]

Select any of these settings when PS/2 keyboard and mouse are installed. These settings only apply when Fast Boot is enabled.

- [Auto] For a faster POST time, PS/2 devices will only be available when the system boots up or rebooted when the PS/2 devices have not been reconnected or changed. If you disconnect or change PS/2 devices before restarting the system, PS/2 devices will not be available and BIOS setup program will not be accessible via PS/2 devices.
- [Full Initialization] For full system control, PS/2 devices will be available during POST at any circumstances. This process will extend POST time.
- [Disabled] For the fastest POST time, all PS/2 devices will not be available until your computer enters the operating system.

### Network Stack Driver Support [Disabled]

- [Disabled] Select to skip the network stack driver from loading during POST.
- [Enabled] Select to load the network stack driver during POST.

### Next Boot after AC Power Loss [Normal Boot]

- [Normal Boot] Returns to normal boot on the next boot after an AC power loss.
- [Fast Boot] Accelerates the boot speed on the next boot after an AC power loss.

### Boot Logo Display [Auto]

- [Auto] Sets the boot logo to display during POST.
- [Full Screen] Sets the boot logo display in full screen during POST.
- [Disabled] Disables the boot logo display during POST.



---

The following item appears only when you set the Boot Logo Display to **[Auto]** and **[Full Screen]**.

---

### Post Delay Time [3 sec]

This item allows you to select a desired additional POST waiting time to easily enter the BIOS Setup. You can only execute the POST delay time during normal boot. The values range from 0 to 10 seconds.



---

This feature only works when set under normal boot.

---



---

The following items appear only when you set the Boot Logo Display to **[Disabled]**.

---

### Post Report [5 sec]

This item allows you to select a desired POST report waiting time.  
Configuration options: [1 sec] - [10 sec] [Until Press ESC]

### Bootup NumLock State [Enabled]

This item allows you to enable or disable power-on state of the NumLock.  
Configuration options: [Disabled] [Enabled]

### Wait For 'F1' If Error [Enabled]

This item allows your system to wait for the <F1> key to be pressed when error occurs.

Configuration options: [Disabled] [Enabled]

### Option ROM Messages [Enabled]

[Enabled] The third-party ROM messages will be displayed during POST.

[Disabled] Disables the ROM messages and displays only the ASUS logo during POST.

### Interrupt 19 Capture [Disabled]

This item allows you to trap Interrupt 19 by the option ROMs.

Configuration options: [Disabled] [Enabled]

### Above 4G Decoding [Disabled]

This item allows you to decode the 64-bit capable devices above 4G address space. Ensure that your system supports 64-bit PCI decoding.

Configuration options: [Disabled] [Enabled]

### Setup Mode [EZ Mode]

[Advanced Mode] This item allows you to go to Advanced Mode of the BIOS after POST.

[EZ Mode] This item allows you to go to EZ Mode of the BIOS after POST.

### CSM (Compatibility Support Module)

This item allows you to configure the CSM (Compatibility Support Module) items to fully support the various VGA, bootable devices and add-on devices for better compatibility.

#### Launch CSM [Enabled]

[Auto] The system automatically detects the bootable devices and the add-on devices.

[Enabled] For better compatibility, enable the CSM to fully support the non-UEFI driver add-on devices or the Windows® UEFI mode.

[Disabled] Disables the CSM to fully support the non-UEFI driver add-on devices or the Windows® UEFI mode.



---

The following items appear only when you set the Launch CSM to [Enabled].

---

#### ***Boot Device Control [UEFI and Legacy OPROM]***

This item allows you to select the type of devices that you want to boot.

Configuration options: [UEFI and Legacy OPROM] [Legacy OPROM only] [UEFI only]

#### ***Boot from Network Devices [Legacy OPROM first]***

This item allows you to select the type of network devices that you want to launch.

Configuration options: [Legacy OPROM first] [UEFI driver first] [Ignore]

### **Boot from Storage Devices [Legacy OPROM first]**

This item allows you to select the type of storage devices that you want to launch. Configuration options: [Both, Legacy OPROM first] [Both, UEFI first] [Legacy OPROM first] [UEFI driver first] [Ignore]

### **Boot from PCI-E/PCI Expansion Devices [Legacy OPROM first]**

This item allows you to select the type of PCIe/PCI expansion devices that you want to launch.

Configuration options: [Legacy OPROM first] [UEFI driver first]

## **Secure Boot**

This item allows you to configure the Windows® Secure Boot settings and manage its keys to protect the system from unauthorized access and malwares during POST.

### **OS Type [Windows UEFI Mode]**

- |                     |  |
|---------------------|--|
| [Windows UEFI Mode] | This item allows you to select your installed operating system. Execute the Microsoft® Secure Boot check. Only select this option when booting on Windows® UEFI mode or other Microsoft® Secure Boot compliant OS. |
| [Other OS]          | Get the optimized function when booting on Windows® non-UEFI mode. Microsoft® Secure Boot only supports Windows® UEFI mode.  |



---

The following item appears only when you set the OS Type to **[Windows UEFI mode]**.

---

### **Key Management**

This allows you to manage the Secure Boot keys.

#### **Install Default Secure Boot keys**

This item allows you to immediately load the default Security Boot keys, Platform key (PK), Key-exchange Key (KEK), Signature database (db), and Revoked Signatures (dbx). When the default Secure boot keys are loaded, the PK state will change from Unloaded mode to loaded mode.

#### **Clear Secure Boot keys**

This item appears only when you load the default Secure Boot keys. This item allows you to clear all default Secure Boot keys.

#### **Save Secure Boot Keys**

This item allows you to save the PK (Platform Keys) to a USB storage device.

### **PK Management**

The Platform Key (PK) locks and secures the firmware from any permissible changes. The system verifies the PK before your system enters the OS.

#### **Delete PK**

This item allows you to delete the PK from your system. Once the PK is deleted, all the system's Secure Boot keys will not be active.

Configuration options: [Yes] [No]

### **Load Default PK**

Select Yes to load the system default PK or select No to load a downloaded PK from a USB storage device.



---

The PK file must be formatted as a UEFI variable structure with time-based authenticated variable.

---

### **KEK Management**

The KEK (Key-exchange Key or Key Enrollment Key) manages the Signature database (db) and Revoked Signature database (dbx).



---

Key-exchange Key (KEK) refers to Microsoft® Secure Boot Key-Enrollment Key (KEK).

---

#### **Delete KEK**

This item allows you to delete the KEK from your system.

Configuration options: [Yes] [No]

#### **Load Default KEK**

Select Yes to load the system default KEK or select No to load a downloaded KEK from a USB storage device.

#### **Append Default KEK**

Select Yes to append the system default KEK or select No to append a downloaded KEK from a USB storage device.



---

The KEK file must be formatted as a UEFI variable structure with time-based authenticated variable.

---

### **DB Management**

The db (Authorized Signature database) lists the signers or images of UEFI applications, operating system loaders, and UEFI drivers that you can load on the single computer.

#### **Delete the db**

This item allows you to delete the db file from your system.

Configuration options: [Yes] [No]

#### **Load Default db**

Select Yes to load the system default db or select No to load a downloaded db from a USB storage device..

#### **Append Default db**

Select Yes to append the system default db or select No to append a downloaded db from a USB storage device.



---

The db file must be formatted as a UEFI variable structure with time-based authenticated variable.

---

## DBX Management

The dbx (Revoked Signature database) lists the forbidden images of db items that are no longer trusted and cannot be loaded.

### **Delete the dbx**

This item allows you to delete the dbx file from your system.

### **Load Default dbx**

Select Yes to load the system default dbx or select No to load a downloaded dbx from a USB storage device.

Configuration options: [Yes] [No]

### **Append Default dbx**

Select Yes to append the system default dbx or select No to append a downloaded dbx from a USB storage device.



---

The dbx file must be formatted as a UEFI variable structure with time-based authenticated variable.

---

## Boot Option Priorities

These items specify the boot device priority sequence from the available devices. The number of device items that appears on the screen depends on the number of devices installed in the system.



- To access Windows® OS in Safe Mode, press <F8 > after POST (Windows® 8 not supported).
  - To select the boot device during system startup, press <F8> when ASUS Logo appears.
- 

## Boot Override

This item displays the available devices. The number of device items that appear on the screen depends on the number of devices installed in the system. Click an item to start booting from the selected device.

## 3.9 Tool menu

The Tool menu items allow you to configure options for special functions. Select an item then press <Enter> to display the submenu.

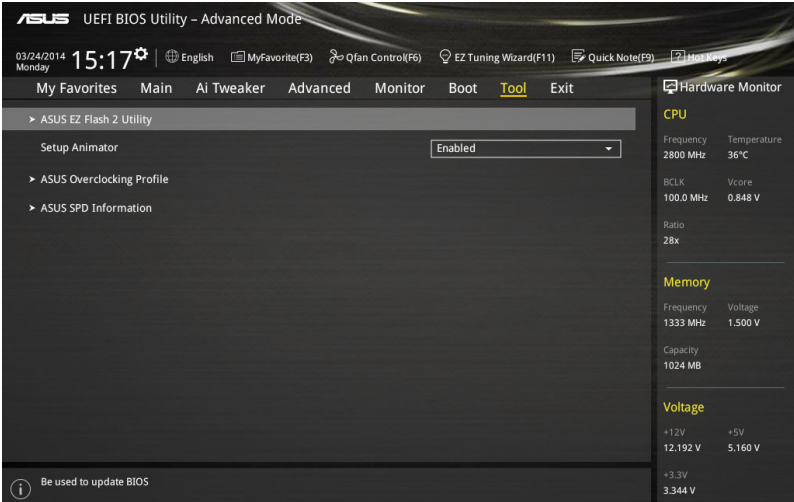

### 3.9.1 ASUS EZ Flash 2 Utility

This item allows you to run ASUS EZ Flash 2. When you press <Enter>, a confirmation message appears. Use the left/right arrow key to select between [Yes] or [No], then press <Enter> to confirm your choice.



For more details, refer to section [3.11.2 ASUS EZ Flash 2](#).

#### Setup Animator [Enabled]

This item allows you to enable or disable the Setup animator.

Configuration options: [Disabled] [Enabled]

### 3.9.2 ASUS Overclocking Profile

This item allows you to store or load multiple BIOS settings.

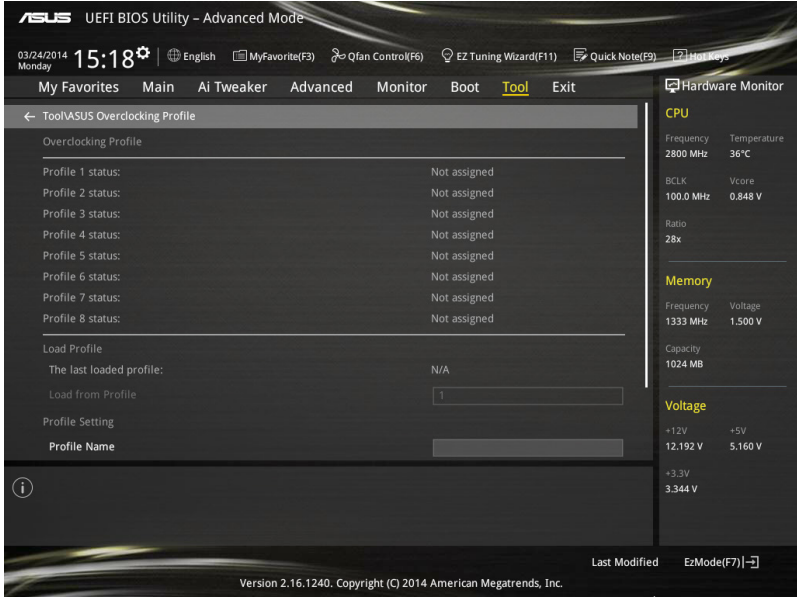

#### Load from Profile

This item allows you to load the previous BIOS settings saved in the BIOS Flash. Key in the profile number that saved your BIOS settings, press <Enter>, and then select **Yes**.



- DO NOT shut down or reset the system while updating the BIOS to prevent the system boot failure!
- We recommend that you update the BIOS file only coming from the same memory/ CPU configuration and BIOS version.

#### Profile Name

This item allows you to key in a profile name.

#### Save to Profile

This item allows you to save the current BIOS settings to the BIOS Flash, and create a profile. Key in a profile number from one to eight, press <Enter>, and then select **Yes**.

#### Load/Save Profile from/to USB Drive

This item allows you to load or save profile from your USB drive, load and save profile to your USB drive.



### 3.9.3 ASUS SPD Information

This item allows you to view the DRAM SPD information.

ASUS UEFI BIOS Utility - Advanced Mode

03/24/2014 Monday 15:18 English MyFavorite(F3) Qfan Control(F6) EZ Tuning Wizard(F11) Quick Note(F9) Help(F12)

My Favorites Main AI Tweaker Advanced Monitor Boot **Tool** Exit Hardware Monitor

← Tool | ASUS SPD Information

DIMM Slot Number: DIMM\_A1

Manufacturer: Undefined  
Module Size: 1024MB  
Maximum Bandwidth: 1333MHz  
Part Number:  
Serial Number:  
Product Week/Year:  
SPD Ext.:

JEDEC ID	JEDEC	JEDEC ID	JEDEC
Frequency (MHz)	1333	tWR	10
Voltage (V)	1.500	tRRD	4
tCL	9	tRFC	60
tRCD	9	tWTR	5
tRP	9	tRTP	5
tRAS	24	tFAW	20
tRC	33		

Information icon (i)

Version 2.16.1240. Copyright (C) 2014 American Megatrends, Inc. Last Modified ExMode(F7) | →

**CPU**  
Frequency: 2800 MHz, Temperature: 36°C  
BCLK: 100.0 MHz, Vcore: 0.848 V  
Ratio: 28x

**Memory**  
Frequency: 1333 MHz, Voltage: 1.500 V  
Capacity: 1024 MB

**Voltage**  
+12V: +5V, 12.192 V, 5.160 V  
+3.3V: 3.344 V

## 3.10 Exit menu

The Exit menu items allow you to load the optimal default values for the BIOS items, and save or discard your changes to the BIOS items.



### Load Optimized Defaults

This option allows you to load the default values for each of the parameters on the Setup menus. When you select this option or if you press <F5>, a confirmation window appears. Select **OK** to load the default values.

### Save Changes & Reset

Once you are finished making your selections, choose this option from the Exit menu to ensure the values you selected are saved. When you select this option or if you press <F10>, a confirmation window appears. Select **OK** to save changes and exit.

### Discard Changes & Exit

This option allows you to exit the Setup program without saving your changes. When you select this option or if you press <Esc>, a confirmation window appears. Select **Yes** to discard changes and exit.

### Launch EFI Shell from USB device

This option allows you to attempt to launch the EFI Shell application (shellx64.efi) from one of the available USB devices.

## 3.11 Updating BIOS

The ASUS website publishes the latest BIOS versions to provide enhancements on system stability, compatibility, and performance. However, BIOS updating is potentially risky. If there is no problem using the current version of BIOS, DO NOT manually update the BIOS. Inappropriate BIOS updating may result to system's failure to boot. Carefully follow the instructions in this chapter to update your BIOS when necessary.



---

Visit <http://www.asus.com> to download the latest BIOS file for this motherboard.

---

The following utilities allow you to manage and update the motherboard BIOS setup program.

1. EZ Update: Updates the BIOS in Windows® environment.
2. ASUS EZ Flash 2: Updates the BIOS using a USB flash drive.
3. ASUS CrashFree BIOS 3: Restores the BIOS using the motherboard support DVD or a USB flash drive when the BIOS file fails or gets corrupted.
4. ASUS BIOS Updater: Updates the BIOS in DOS environment using the motherboard support DVD and a USB flash disk drive.

### 3.11.1 EZ Update

The EZ Update is a utility that allows you to update the motherboard BIOS in Windows® environment.



- EZ Update requires an Internet connection either through a network or an ISP (Internet Service Provider).
  - This utility is available in the support DVD that comes with the motherboard package.
  - Refer to section **4.4.5 EZ Update** of this user guide for more information.
-

### 3.11.2 ASUS EZ Flash 2

ASUS EZ Flash 2 allows you to update the BIOS without having to use a bootable floppy disk or an OS-based utility.



Before you start using this utility, download the latest BIOS from the ASUS website at [www.asus.com](http://www.asus.com).

#### To update the BIOS using EZ Flash 2:

1. Insert the USB flash disk that contains the latest BIOS file to the USB port.
2. Enter the Advanced Mode of the BIOS setup program. Go to the Tool menu to select ASUS EZ Flash Utility and press <Enter> to enable it.

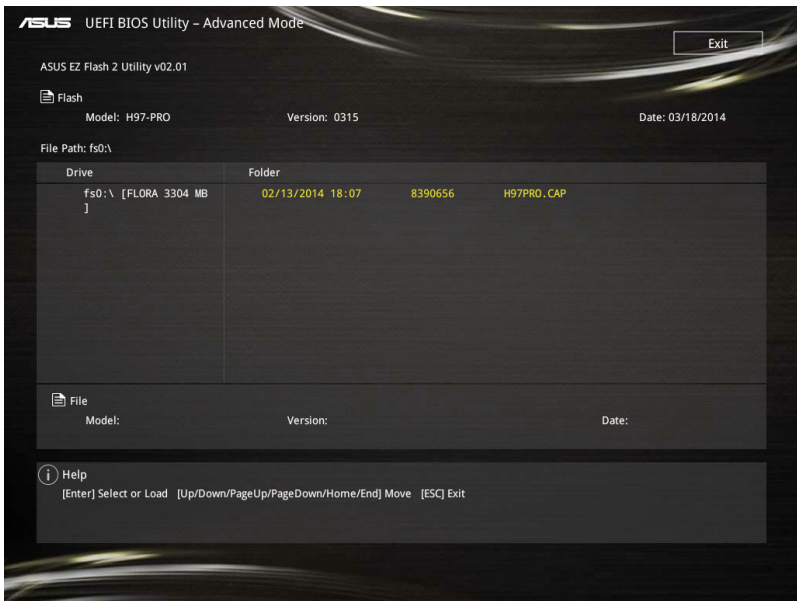

3. Press the Left/Right arrow keys to switch to the Drive field.
4. Press the Up/Down arrow keys to find the USB flash disk that contains the latest BIOS, and then press <Enter>.
5. Press <Tab> to switch to the Folder Info field.
6. Press the Up/Down arrow keys to find the BIOS file, and then press <Enter> to perform the BIOS update process. Reboot the system when the update process is done.



- 
- This function can support devices such as a USB flash disk with FAT 32/16 format and single partition only.
  - DO NOT shut down or reset the system while updating the BIOS to prevent system boot failure!
- 



Ensure to load the BIOS default settings to ensure system compatibility and stability. Select the Load Optimized Defaults item under the Exit menu. See section **3.10 Exit Menu** for details.

---

### 3.11.3 ASUS CrashFree BIOS 3

The ASUS CrashFree BIOS 3 utility is an auto recovery tool that allows you to restore the BIOS file when it fails or gets corrupted during the updating process. You can restore a corrupted BIOS file using the motherboard support DVD or a USB flash drive that contains the BIOS file.



The BIOS file in the motherboard support DVD may be older than the BIOS file published on the ASUS official website. If you want to use the newer BIOS file, download the file at <http://support.asus.com> and save it to a USB flash drive.

---

## Recovering the BIOS

### To recover the BIOS:

1. Turn on the system.
2. Insert the motherboard support DVD to the optical drive, or the USB flash drive containing the BIOS file to the USB port.
3. The utility automatically checks the devices for the BIOS file. When found, the utility reads the BIOS file and enters ASUS EZ Flash 2 automatically.
4. The system requires you to enter BIOS Setup to recover the BIOS setting. To ensure system compatibility and stability, we recommend that you press <F5> to load default BIOS values.



DO NOT shut down or reset the system while updating the BIOS! Doing so can cause system boot failure!

---

### 3.11.4 ASUS BIOS Updater

ASUS BIOS Updater allows you to update the BIOS in DOS environment.



The screen captures used in this section are for reference only and may not be exactly the same as actually shown on your computer screen.

#### Before updating BIOS

- Prepare the motherboard support DVD and a USB flash drive.
- Download the latest BIOS file and BIOS Updater from <http://support.asus.com> and save them in your USB flash drive.



NTFS is not supported under DOS environment. Ensure that your USB flash drive is in single partition and in FAT32/16 format.

- Turn off the computer.
- Ensure that your computer has a DVD optical drive.

#### Booting the system in DOS environment

To boot the system in DOS:

1. Insert the USB flash drive with the latest BIOS file and BIOS Updater to the USB port.
2. Boot your computer then press <F8> to launch the select boot device screen.
3. When the select boot device screen appears, insert the Support DVD into the optical drive then select the optical drive as the boot device.

#### Please select boot device:

↑ and ↓ to move selection  
ENTER to select boot device  
ESC to boot using defaults

P2: ST3808110AS (76319MB)  
aigo miniking (250MB)  
UEFI: (FAT) ASUS DRW-2014L1T(4458MB)  
P1: ASUS DRW-2014L1T(4458MB)  
UEFI: (FAT) aigo miniking (250MB)  
Enter Setup

- When the booting message appears, press <Enter> within five (5) seconds to enter FreeDOS prompt.

```
ISOLINUX 3.20 2006-08-26 Copyright (C) 1994-2005 H. Peter Anvin
A Bootable DVD/CD is detected. Press ENTER to boot from the DVD/CD.
If no key is pressed within 5 seconds, the system will boot next priority
device automatically. boot:
```

- On the FreeDOS prompt, type **d:** then press <Enter> to switch the disk from Drive C (optical drive) to Drive D (USB flash drive).

```
Welcome to FreeDOS (http://www.freedos.org) !
C: /> d:
D: />
```

## Updating the BIOS file

To update the BIOS file:

- On the FreeDOS prompt, type **bupdater /pc /g** and press <Enter>.

```
D: /> bupdater /pc /g
```

- On the BIOS Updater screen, press <Tab> to switch from Files panel to Drives panel then select **D:**.

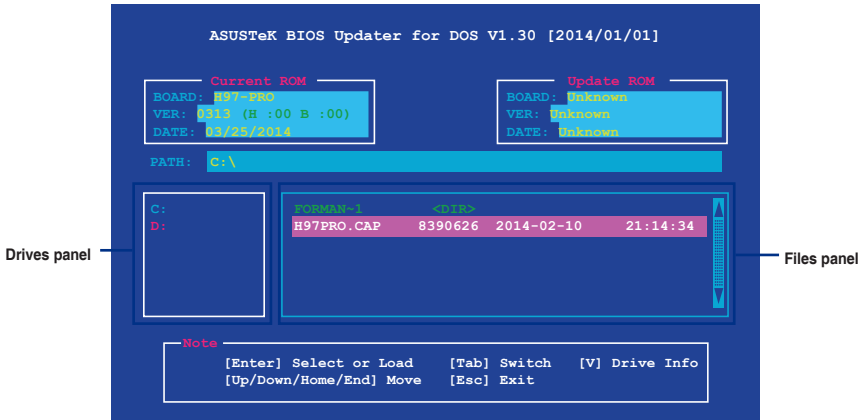

- Press <Tab> to switch from Drives panel to Files panel then press <Up/Down or Home/End> keys to select the BIOS file and press <Enter>.

4. After the BIOS Updater checks the selected BIOS file, select **Yes** to confirm the BIOS update.



---

The BIOS Backup feature is not supported due to security regulations.

---

5. Select **Yes** then press <Enter>. When BIOS update is done, press <ESC> to exit BIOS Updater.
6. Restart your computer.



---

DO NOT shut down or reset the system while updating the BIOS to prevent system boot failure.

---



---

Ensure to load the BIOS default settings to ensure system compatibility and stability. Select **Load Optimized Defaults** item under the **Exit BIOS** menu. See section **3.10 Exit menu** for details.

---



# Software support

# 4

## 4.1 Installing an operating system



- This motherboard supports 32-bit/64-bit Windows® 7, 32-bit/64-bit Windows® 8, and 32-bit/64-bit Windows® 8.1 operating systems (OS).
- Motherboard settings and hardware options vary. The setup procedures presented in this chapter are for reference only. Refer to Windows® operating system documentation for detailed information.

## 4.2 Support DVD information



The contents of the support DVD are subject to change at any time without notice. Visit the ASUS website at [www.asus.com](http://www.asus.com) for updates.

### 4.2.1 Running the support DVD



Ensure that you have an Administrator account before running the support DVD in Windows® 7, Windows® 8, or Windows® 8.1 operating systems.

To run the support DVD:

1. Place the Support DVD into the optical drive.
2. In the **AutoPlay** dialog box, click or tap **Run ASSETUP.EXE**.

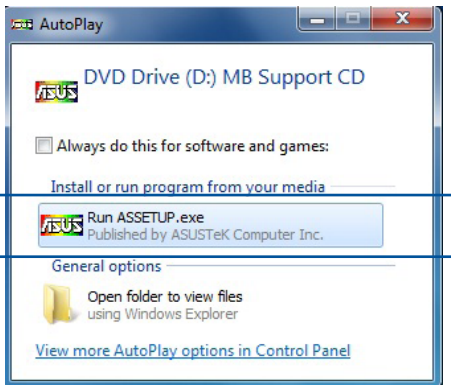

If the **AutoPlay** dialog box does not appear, browse the contents of the support DVD and double-click or tap `\\bin\ASSETUP.EXE` to launch the **ASUS motherboard support DVD** main menu.

# Support DVD main menu

The Drivers menu shows the available device drivers if the system detects installed devices. Install the necessary drivers to use the devices.

The AHCI/RAID Driver menu contains the RAID/AHCI driver disk.

The Manual menu contains the list of supplementary user guides. Click or tap an item to open the folder of the user guide.

The Utilities menu shows the applications and other software that the motherboard supports.

Click or tap an item to install

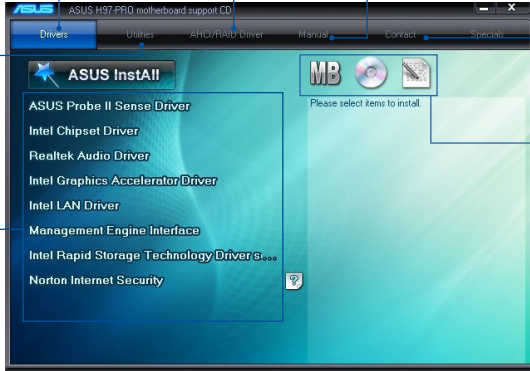

Click or tap to display the ASUS contact information.

Click or tap an icon to display DVD/motherboard information

## 4.2.2 Obtaining the software manuals

The software manuals are included in the support DVD. Follow the instructions below to get the necessary software manuals.



The software manual files are in Portable Document Format (PDF). Install the Adobe® Acrobat® Reader from the **Utilities** tab before opening the files.

To read about your motherboard's utility guide:

1. Click or tap **Manual** tab > **ASUS Motherboard Utility Guide**.

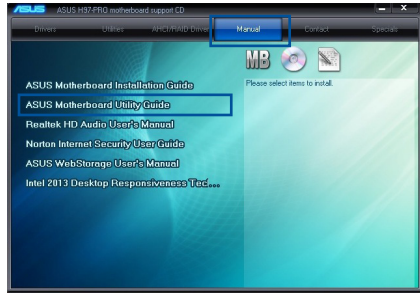

2. From the **Manual** folder, open the folder of the software manual that you wish to read.

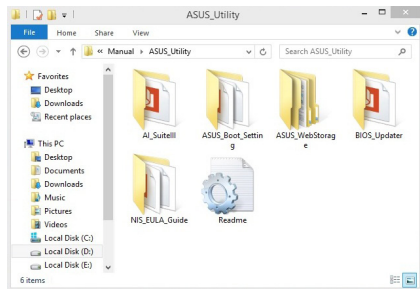

3. Some software manuals are provided in different languages. Open the language's folder to view the software manual.

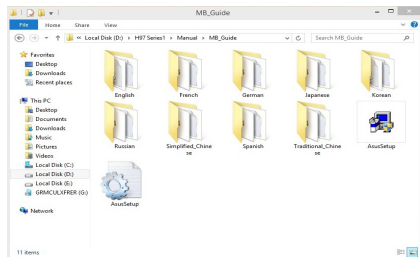

The screenshots in this section are for reference only. The actual software manuals containing in the support DVD vary by models.

## 4.3 Software information

Most of the applications in the support DVD have wizards that will conveniently guide you through the installation. View the online help or readme file that came with the software application for more information.

## 4.4 AI Suite 3

AI Suite 3 is an all-in-one interface that integrates several ASUS utilities and allows you to launch and operate these utilities simultaneously.

### Installing AI Suite 3



---

Ensure that you have an Administrator account before installing AI Suite 3 in Windows® 7, Windows® 8, or Windows® 8.1 operating systems.

---

To install AI Suite 3 on your computer:

#### Windows® 7 OS

1. Place the Support DVD into the optical drive.
2. In the **AutoPlay** dialog box, click or tap **Run ASSETUP.exe** then select the **Utilities** tab.



---

The main screen of the AI Suite 3 is for reference only and vary with models.

---

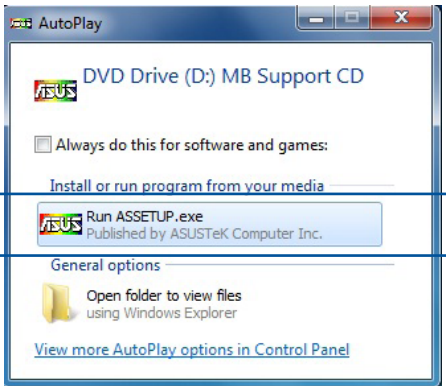

3. From the **Utilities** tab, click or tap **AI Suite 3** then follow the succeeding onscreen instructions.

## Windows® 8 and Windows® 8.1 OS

1. Place the Support DVD into the optical drive then follow onscreen instructions.
2. From the **ASUS motherboard support DVD** main menu, select the Utilities tab and click or tap **AI Suite 3**.
3. Follow the succeeding onscreen instructions.

If the **ASUS motherboard support DVD** main menu did not appear, try the following:

- a. Go to the **Start Screen** then click or tap the **Desktop** app.
- b. On the lower left corner of the Desktop, click or tap **File Explorer**  then select your DVD drive and tap or double-click or tap the **Setup** application.

## Launching AI Suite 3

### Windows® 7 OS

From the Desktop, click or tap **Start > All Programs > ASUS > AI Suite 3 > AI Suite 3**.

You can also launch AI Suite in Windows® 7 by clicking or tapping  on the Notification area.

### Windows® 8 and Windows® 8.1 OS

To launch AI Suite 3 in Windows® 8 or Windows® 8.1, tap the AI Suite 3 app on the Start Screen (or if you're using a mouse, click or tap the AI Suite 3 app on the Start Screen).

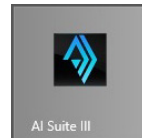

## AI Suite 3 Main menu

The AI Suite 3 main menu gives you easy-access controls and insight to what's going on with your computer - allowing you to optimize performance settings while at the same time ensuring system stability.

The AI Suite main menu includes a quick-access menu bar that allows you to swiftly launch any of the integrated ASUS utilities. Click or tap  on the top-right corner of the menu to launch the menu bar.

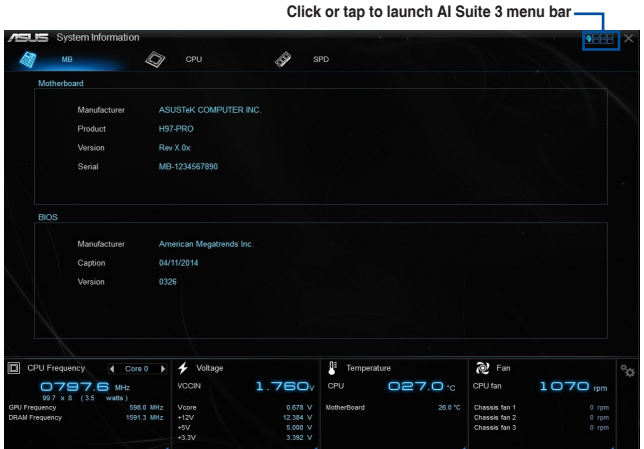

Click or tap to launch AI Suite 3 menu bar



The AI Suite 3 screenshots in this section are for reference only and can vary depending on motherboard model.

## AI Suite 3 main menu bar

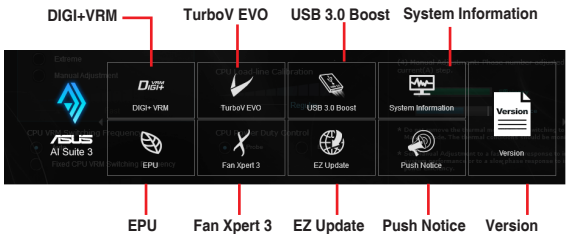

- The screenshots of AI Suite 3 in this user manual are for reference only. The actual screenshots vary with models.
- Refer to the software manual in the support DVD or visit the ASUS website at [www.asus.com](http://www.asus.com) for detailed software configuration.

## 4.4.1 DIGI+ VRM

ASUS DIGI+ VRM allows you to adjust VRM voltage and frequency modulation to enhance reliability and stability. It also provides the highest power efficiency, generating less heat to longer component lifespan and minimize power loss.

### Launching DIGI+ VRM

To launch DIGI+ VRM, click or tap  on the top-right corner of the AI Suite 3 main menu, then select **DIGI+ VRM**.

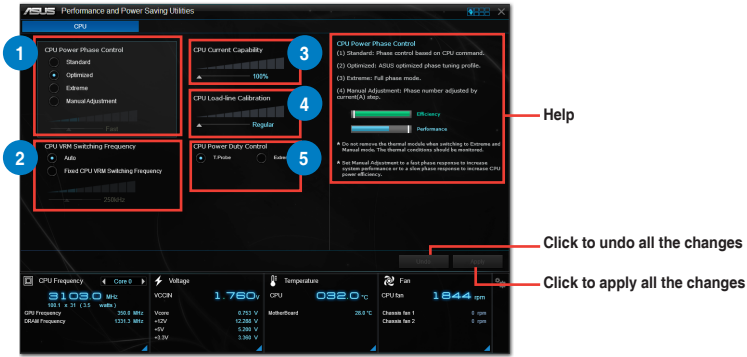

- 1 CPU Power Phase Control**  
Increase phase number under heavy system loading to get more transient and better thermal performance. Reduce phase number under light system loading to increase VRM efficiency.
- 2 CPU VRM Switching Frequency**  
Changing frequency affects the transient response and component thermal conditions. Higher frequency gets quicker transient response.
- 3 CPU Current Capability**  
CPU Current Capability provides wider total power range for overclocking. A higher value brings a wider total power range and extends the overclocking frequency range simultaneously.
- 4 CPU Load-line Calibration**  
It allows you to adjust the voltage range to control the CPU Load-line. Adjust to a high value for system performance or to a low value for power efficiency.
- 5 CPU Power Duty Control**  
CPU Power Duty Control adjusts the current of every VRM phase and the thermal of every phase component.



- The actual performance boost may vary depending on your CPU specification.
- Do not remove the thermal module. The thermal conditions should be monitored.



Visit the ASUS website at [www.asus.com](http://www.asus.com) for detailed software configuration.

## 4.4.2 EPU

EPU is an energy-saving utility that allows you to adjust the CPU, GPU, and Fan Control settings to their power-saving conditions.

### Launching EPU

To launch EPU, click or tap  on the top-right corner of the AI Suite 3 main menu, then select **EPU**.

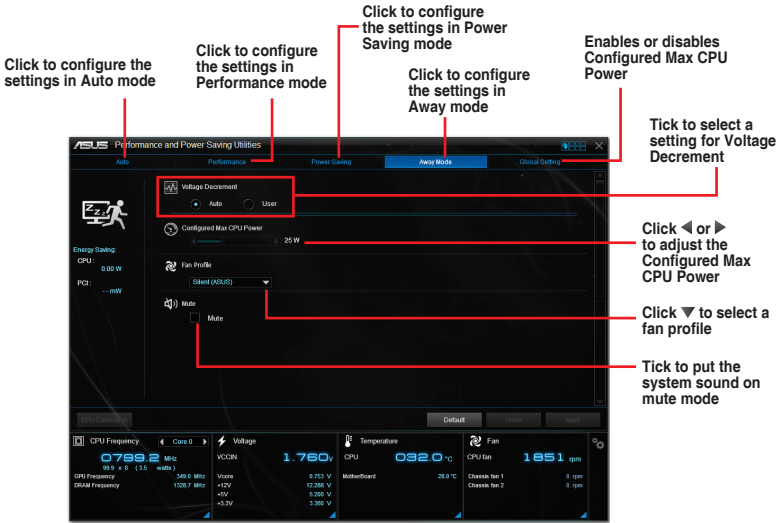

- When you enable Configured Max CPU Power for advanced energy saving condition, the CPU frequency may display 800 MHz in the Windows® OS information of your computer. However, the true CPU frequency varies depending on the wattage that you manually set. You can adjust the CPU wattage from the lowest base to your preferred default value.
- Configured Max CPU Power may decrease the total power delivery to the CPU and affects the CPU performance under system heavy load. To restore your system to its default settings, reboot your computer.



### 4.4.3 TurboV EVO

ASUS TurboV EVO allows you to manually adjust the CPU frequency, CPU Cache and Core frequencies, and related voltages for an enhanced system stability and boost performance. It also provides the Auto Tuning function that offers automatic and easy overclocking and system level up.

#### Launching TurboV EVO

To launch TurboV EVO, click or tap  on the top-right corner of the AI Suite 3 main menu, then select **TurboV EVO**.



Visit the ASUS website at [www.asus.com](http://www.asus.com) for detailed software configuration.



Refer to the CPU documentation before adjusting CPU voltage settings. Setting a high voltage may damage the CPU permanently, and setting a low voltage may make the system unstable.



For system stability, all changes made in TurboV EVO will not be saved to BIOS settings and will not be kept on the next system boot. Use the Save Profile function to save your customized overclocking settings and manually load the profile after Windows starts.

### Using TurboV EVO

#### CPU Frequency



The screenshot shows the TurboV EVO interface with the following settings and annotations:

- BCLK Frequency:** 80.0 MHz (100/10) - Annotation: Click ◀ or ▶ to adjust the BCLK Frequency
- CPU Cache Ratio:** 32 - Annotation: Click ◀ or ▶ to adjust the CPU Cache Ratio
- CPU Core Voltage:** 1.050 V (1.050/1.050) - Annotation: Drag ▲ to adjust CPU Core Voltage offset
- CPU Cache Voltage:** 1.050 V (1.050/1.050) - Annotation: Drag ▲ to adjust CPU Cache Voltage offset
- DRAM, CPU Analog I/O, PCH Core, and PCHVLX Voltages:** 1.450 V (1.450/1.450) - Annotation: Click ◀ or ▶ to adjust DRAM, CPU Analog I/O, PCH Core, and PCHVLX voltages
- CPU System Agent, CPU Digital I/O, and CPU Input (VCCIN) Voltages:** 1.050 V (1.050/1.050) - Annotation: Click ◀ or ▶ to adjust CPU System Agent, CPU Digital I/O, and CPU Input (VCCIN) voltages
- Save Profile:** Click to save the changes into a profile
- Load Profile:** Click to load the saved profile
- Default:** Click to reset to default settings
- Undo:** Click to undo all the changes
- Apply:** Click to apply all the changes

## GPU Boost

Click ◀ or ▶ to adjust the iGPU Max Ratio

Tick Adaptive or Manual to select the CPU Graphics Voltage mode

Drag ▲ to adjust CPU Graphics Voltage settings

Click to apply all the changes

Click to undo all the changes

Click to reset to default settings

Click to save the changes into a profile

Click to load the saved profile

## Auto Tuning

Select the function to auto-tune

Click to automatically overclock and achieve a total system level up.

Click to reset to default settings

## 4.4.4 USB 3.0 Boost

USB 3.0 Boost technology supports UASP (USB Attached SCSI Protocol) that automatically speeds up the transfer rates of your USB storage devices.

### Launching USB 3.0 Boost

To launch USB 3.0 Boost, click or tap  on the top-right corner of the AI Suite 3 main menu, then select **USB 3.0 Boost**.

### Using the USB 3.0 Boost

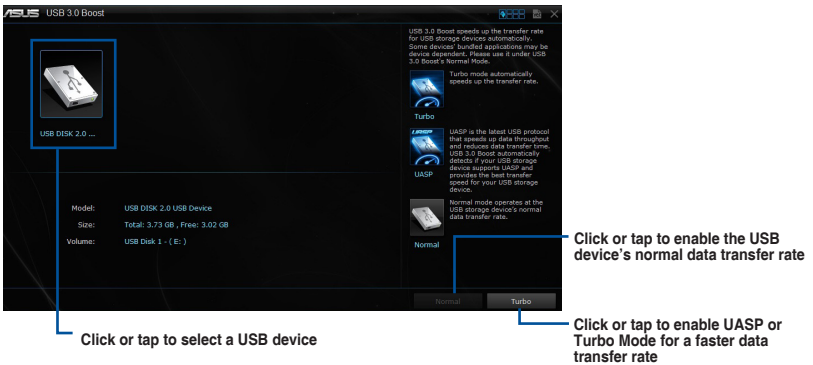

Ensure to connect your USB 3.0 device to the USB 3.0 ports that support USB 3.0 Boost. Refer to section **2.2.1 Rear I/O connection** of your user guide for more details.



- USB 3.0 Boost automatically detects the USB 3.0 devices that support UASP. For a list of UASP-supported USB 3.0 devices, visit the ASUS website at [www.asus.com](http://www.asus.com).
- The data transfer speed varies with USB devices. For a higher data transfer performance, use a USB 3.0 device.

## 4.4.5 EZ Update

EZ Update is a utility that allows you to automatically update your motherboard's software, drivers and BIOS easily.

With this utility, you can also manually update the BIOS and select the boot logo that displays during POST.

### Launching EZ Update

To launch EZ Update, click or tap  on the top-right corner of the AI Suite 3 main menu, then select **EZ Update**.

### Using EZ Update



Click or tap to automatically update your motherboard driver, software and firmware

Click or tap to search and select the BIOS file

Click or tap to select a boot logo

Click or tap to update the BIOS

### Manually update the BIOS and selecting a boot logo

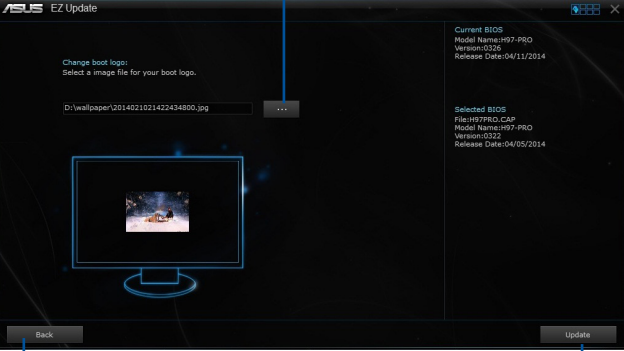

Click or tap to search an image file for your boot logo

Click or tap to go back to EZ Update main screen

Click or tap to proceed the updating BIOS and boot logo

After you click or tap **BIOS Update** button, click or tap **Flash** to update the BIOS and upload the boot logo in your system.

## 4.4.6 Fan Xpert 3

Fan Xpert 3 automatically detects and tweaks the fan speeds, and provides you with optimized fan settings based on the fans' specifications and positions.

### Launching Fan Xpert 3

To launch Fan Xpert 3, click or tap  on the top-right corner of the AI Suite 3 main menu, then select **Fan Xpert 3**.

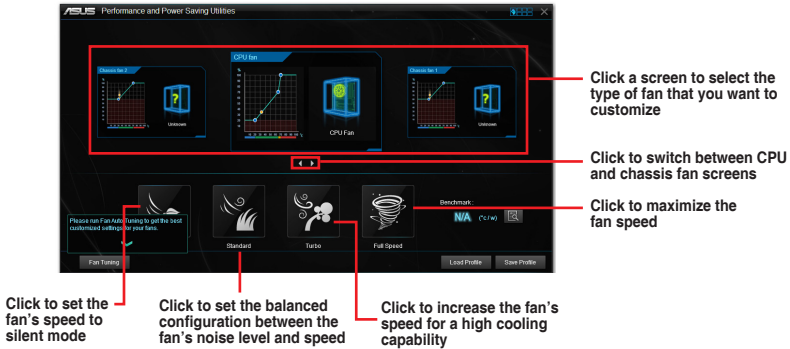

### Customizing the fan settings

#### Smart Mode

Smart Mode allows you to customize the fans' rotation speeds and responsiveness based on your system's temperature.

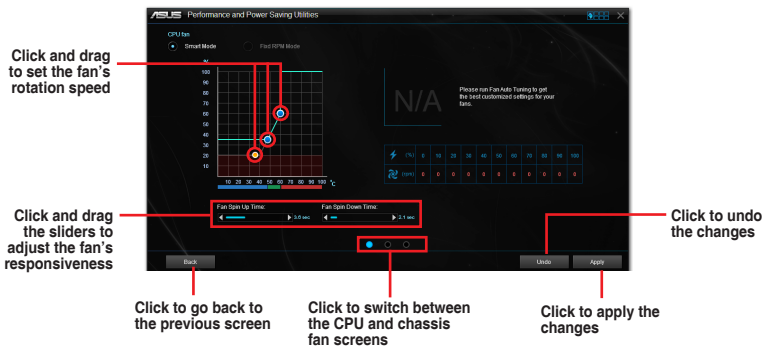

## Fixed RPM Mode

RPM Mode allows you to set the fan speed when the CPU temperature is below 75°C.

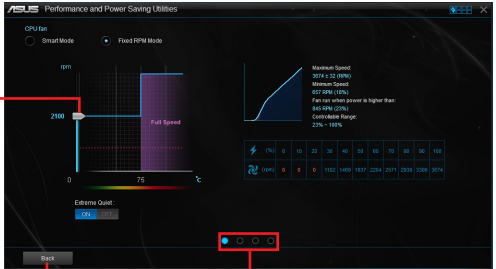

Click and drag to adjust the fan's speed

Click to go back to the previous screen

Click to switch between the CPU and chassis fan screens



- When the CPU temperature reaches 75° C, the fan will automatically run at full speed to protect the CPU.
- The Fan Xpert 3 may not be able to detect the fan speed if your fan is installed with an external control kit for rotation speed.
- Fan Xpert 3 does not support 2-pin fans. If you install a 2-pin fan, it can only run at its full speed.
- If the CPU or chassis fans have been changed, the Fan Auto Tuning process should be repeated.



**DO NOT** remove your fan during the Fan Auto Tuning process.

## 4.4.7 Push Notice

This utility allows you get the detailed status of your system to your smart device. You can also send messages to your smart device using this utility.



Before using this utility, ensure that you pair your computer with your smart device. For pairing information, refer to section **Pairing your computer and smart device**.

### Launching Push Notice on your computer

To launch Push Notice, click or tap  on the top-right corner of the AI Suite 3 main menu, then select **Push Notice**.

### Push Notice screen

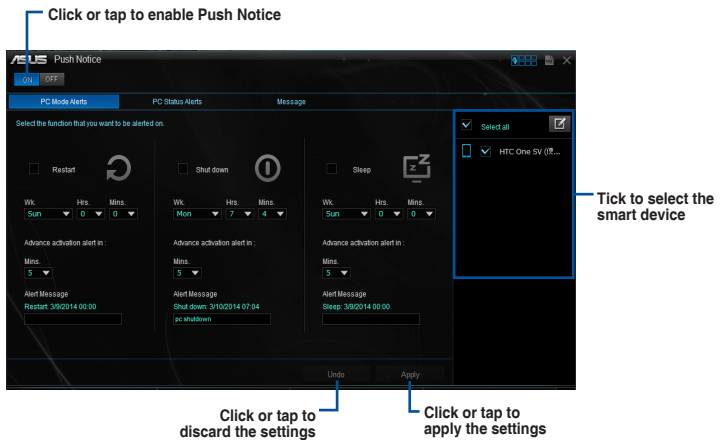

The screenshot shows the ASUS Push Notice utility interface. At the top, there is a toggle switch for 'OFF'. Below it, there are three sections: 'PC Mode Alerts', 'PC Status Alerts', and 'Message'. Each section has a checkbox to enable alerts and a 'Select all' button. The 'PC Mode Alerts' section includes 'Restart' with a 'Wk' dropdown set to 'Sun' and 'Hrs' and 'Mins' set to '0'. The 'PC Status Alerts' section includes 'Shut down' with a 'Wk' dropdown set to 'Mon' and 'Hrs' and 'Mins' set to '7' and '4'. The 'Message' section includes 'Sleep' with a 'Wk' dropdown set to 'Sun' and 'Hrs' and 'Mins' set to '0' and '0'. Each section also has an 'Advance activation alert in:' field with a 'Mins' dropdown set to '5' and an 'Alert Message' field. At the bottom, there are 'Undo' and 'Apply' buttons. Annotations with arrows point to the 'OFF' toggle, the 'Select all' button, the 'Apply' button, and the 'Undo' button.



Click or tap to enable Push Notice

Tick to select the smart device

Click or tap to discard the settings

Click or tap to apply the settings



You can also enable the Push Notice via the Push Notice shortcut on the lower-right corner of your screen. To do this, click or tap << then click or tap  then select .

### Pairing your computer and smart device

To pair your computer and smart device:

1. On your smart device, tap  to launch Push Notice.
2. Tap **Push Scan** then tap the name of your computer that you want to pair with.



To pair your computer and smart device, ensure that both are connected to the same wireless network.

## Setting up PC Mode alerts of your computer

This feature allows you to restart, shut down, or put your computer to sleep mode and sends an alert to your smart device.



The screenshot shows the 'ASUS Push Notice' application window with the 'PC Mode Alerts' tab selected. The interface is divided into three columns for 'Restart', 'Shut down', and 'Sleep'. Each column has a function icon, a 'Select the function that you want to be alerted on' checkbox, and a 'Message' field. Below these are 'Advance activation alert in' settings, including 'Wk' (Weekday), 'Hrs' (Hours), 'Mins' (Minutes), and 'Alert Message' text boxes. A 'Message' panel on the right shows a list of devices with 'HTC One SV' selected. Annotations with blue boxes and lines point to the function icons, the 'Select the function...' checkboxes, the 'Advance activation alert in' settings, the 'Alert Message' text boxes, and the device selection panel.

Tick these to enable mode alerts

Set the day and time to enable the PC modes

Set the minutes to send the alert before the PC mode/s activation

Key in your messages for more information

Tick to select the smart device

## Setting up PC Status alerts

This feature allows you to send alerts of the unusual activities of the voltage, temperature, and fan settings of your computer to your smart device.



The screenshot shows the 'ASUS Push Notice' application window with the 'PC Status Alerts' tab selected. The interface has a 'Select the system status you want to be alerted on' section with three options: 'Voltage', 'Temperature', and 'Fan', each with a checkbox. Below this is a checkbox for 'Send an alert notice when PC is back to normal'. A 'Message' panel on the right shows 'HTC One SV' selected. Annotations with blue boxes and lines point to the 'Voltage', 'Temperature', and 'Fan' checkboxes, the 'Send an alert notice when PC is back to normal' checkbox, and the device selection panel.

Tick to select and send alerts to your smart device



Tick to send alert when the components selected are back to its normal status

Tick to select the smart device



## Sending messages to your smart device

This feature allows you to send messages to your smart device.

You can also send messages via the Push Notice messaging shortcut on the lower-right corner of your screen. To do this, click or tap << then click or tap  then select .

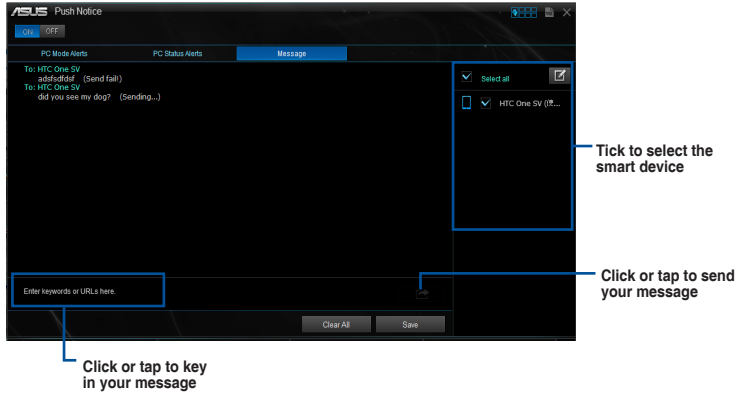

## Viewing your computer status on your smart device

Tap  on your smart device to launch Push Notice.

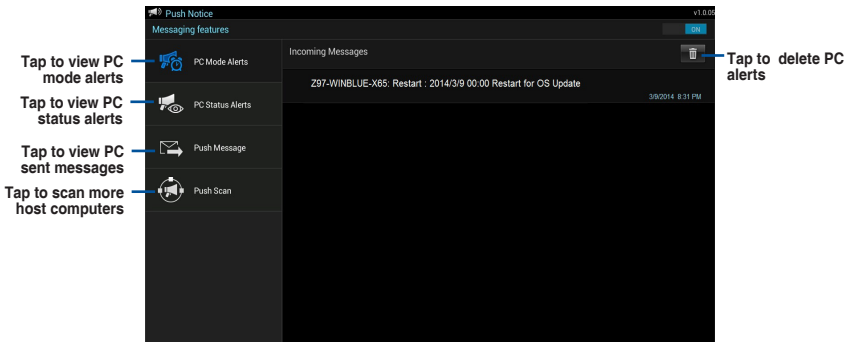

## 4.4.8 System Information

This utility allows you get the detailed information of the motherboard, CPU, and memory settings.

### Launching the System Information

To launch System Information, click or tap  on the top-right corner of the AI Suite 3 main menu, then select **System Information**.

### Viewing the motherboard information

Click or tap the **MB** tab to view the motherboard's information.

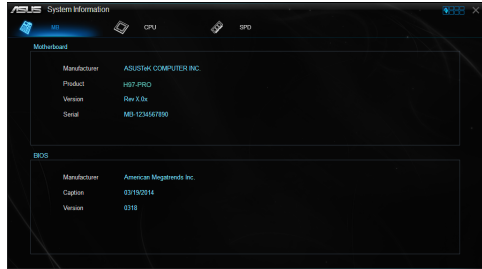

### Viewing the CPU information

Click or tap the **CPU** tab to view the processor's information.



### Viewing the SPD information

Click or tap the **SPD** tab to view the memory's information.



## 4.4.9 Version

This utility displays the version information of the utilities integrated in AI Suite 3.

### Launching Version

To launch Version, click or tap  on the top-right corner of the AI Suite 3 main menu, then select **Version**.

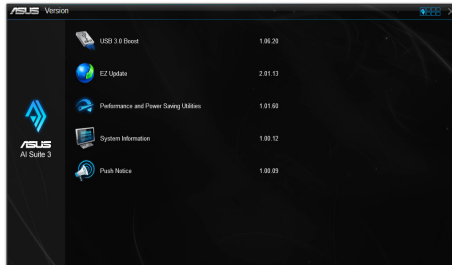

## 4.5 Audio configurations

The Realtek® audio CODEC provides 7.1-channel audio capability to deliver the ultimate audio experience on your computer. The software provides Jack-Sensing function, S/PDIF Out support, and interrupt capability. The CODEC also includes the Realtek® proprietary UAJ® (Universal Audio Jack) technology for all audio ports, eliminating cable connection errors, and giving users plug and play convenience.

Follow the installation wizard to install the Realtek® Audio Driver from the support DVD that came with the motherboard package.

If the Realtek® audio software is correctly installed, you will find the Realtek® HD Audio Manager icon on the taskbar. Double-click or tap on the icon to display the Realtek® HD Audio Manager.



Realtek® HD Audio Manager

### A. Realtek® HD Audio Manager for Windows® 8.1 / Windows® 8 / Windows® 7



## 4.6 Intel® SBA support

Intel® SBA (Small Business Advantage) is a combination of hardware and software that provides unique security and productivity capabilities designed for small businesses.



---

Intel® SBA requires MEI driver (AMT host software kit) installed.

---

### Platform requirements:

- Windows® 7 (32/64bit) / Windows® 8 (32/64bit) / Windows® 8.1 (32/64bit)

#### CPU requirements:

- \* Intel® Core™ i3 / i5 / i7
- \* Intel® Core™ i5 / i7 vPro
- The Intel® Management Engine software kit must be installed (The Local Manageability Service and the Intel® Management Engine Interface must be installed and running.)
- Local Administrator rights on the target machine



- 
- The Intel® SBA does not support the 800 x 600 screen resolution.
  - Visit the ASUS website at [www.asus.com](http://www.asus.com) for the latest CPU QVL (Qualified Vendors List).
-



# RAID support

# 5

## 5.1 RAID configurations

The motherboard supports Intel® Rapid Storage Technology with RAID 0, RAID 1, RAID 10, and RAID 5 solution.



---

If you want to install a Windows® operating system to a hard disk drive included in a RAID set, you have to create a RAID driver disk and load the RAID driver during OS installation. Refer to section **5.2 Creating a RAID driver disk** for details.

---

### 5.1.1 RAID definitions

**RAID 0 (Data striping)** optimizes two identical hard disk drives to read and write data in parallel, interleaved stacks. Two hard disks perform the same work as a single drive but at a sustained data transfer rate, double that of a single disk alone, thus improving data access and storage. Use of two new identical hard disk drives is required for this setup.

**RAID 1 (Data mirroring)** copies and maintains an identical image of data from one drive to a second drive. If one drive fails, the disk array management software directs all applications to the surviving drive as it contains a complete copy of the data in the other drive. This RAID configuration provides data protection and increases fault tolerance to the entire system. Use two new drives or use an existing drive and a new drive for this setup. The new drive must be of the same size or larger than the existing drive.

**RAID 5** stripes both data and parity information across three or more hard disk drives. Among the advantages of RAID 5 configuration include better HDD performance, fault tolerance, and higher storage capacity. The RAID 5 configuration is best suited for transaction processing, relational database applications, enterprise resource planning, and other business systems. Use a minimum of three identical hard disk drives for this setup.

**RAID 10** is data striping and data mirroring combined without parity (redundancy data) having to be calculated and written. With the RAID 10 configuration you get all the benefits of both RAID 0 and RAID 1 configurations. Use four new hard disk drives or use an existing drive and three new drives for this setup.

## 5.1.2 Installing Serial ATA hard disks

The motherboard supports Serial ATA hard disk drives. For optimal performance, install identical drives of the same model and capacity when creating a disk array.

To install the SATA hard disks for a RAID configuration:

1. Install the SATA hard disks into the drive bays.
2. Connect the SATA signal cables.
3. Connect a SATA power cable to the power connector on each drive.

## 5.1.3 Setting the RAID item in BIOS

You must enable the RAID function in the BIOS Setup before creating RAID sets using SATA HDDs.

To set the RAID item in BIOS:

1. Enter the BIOS Setup during POST.
2. Go to the **Advanced** menu > **PCH Storage Configuration**, then press <Enter>.
3. Set the SATA Mode item to **[RAID]**.
4. Save your changes, and then exit the BIOS Setup.



---

Refer to Chapter 3 for details on entering and navigating through the BIOS Setup

---



---

Due to chipset limitation, when SATA ports are set to RAID mode, all SATA ports run at RAID mode together.

---



## 5.1.4 Intel® Rapid Storage Technology Option ROM utility

To enter the Intel® Rapid Storage Technology Option ROM utility:

1. Turn on the system.
2. During POST, press <Ctrl> + <I> to display the utility main menu.

```
Intel(R) Rapid Storage Technology - Option - v10.5.1.1070
Copyright(C) 2003-14 Intel Corporation. All Rights Reserved.

[ MAIN MENU ]

1. Create RAID Volume          4. Recovery Volume Options
2. Delete RAID Volume         5. Acceleration Options
3. Reset Disks to Non-RAID    6. Exit

[ DISK/VOLUME INFORMATION ]

RAID Volumes:
None defined.

Physical Devices:
Port  Device Model  Serial #      Size   Type/Status (Vol ID)
0      ST3160812AS      9LS0HJA4     149.0GB Non-RAID Disk
1      ST3160812AS      9LS0F4HL     149.0GB Non-RAID Disk
2      ST3160812AS      3LS0JYL8     149.0GB Non-RAID Disk
3      ST3160812AS      9LS0BJ5H     149.0GB Non-RAID Disk

[↑↓]-Select      [ESC]-Exit      [ENTER]-Select Menu
```

The navigation keys at the bottom of the screen allow you to move through the menus and select the menu options.



The RAID BIOS setup screens shown in this section are for reference only and may not exactly match the items on your screen.



The utility supports maximum four hard disk drives for RAID configuration.

## Creating a RAID set

To create a RAID set:

1. From the utility main menu, select **1. Create RAID Volume** and press <Enter>. The following screen appears:

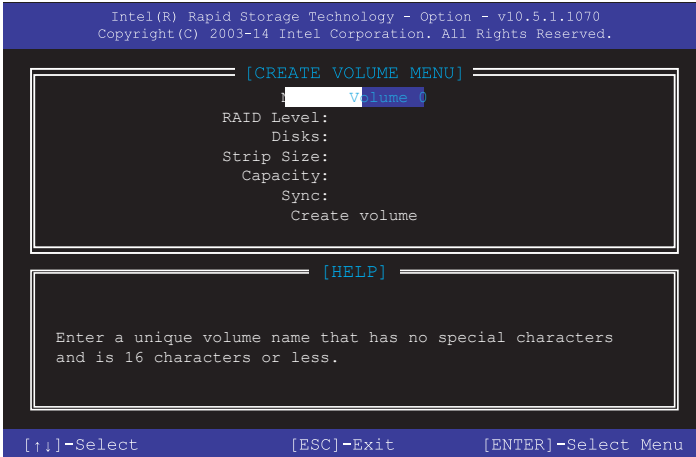

2. Enter a name for the RAID set and press <Enter>.
3. When the RAID Level item is selected, press the up/down arrow key to select a RAID level to create, and then press <Enter>.
4. When the Disks item is selected, press <Enter> to select the hard disk drives you want to include in the RAID set. The SELECT DISKS screen appears:

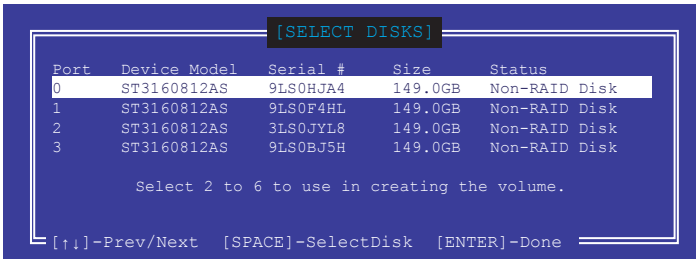

5. Use the up/down arrow key to select a drive, and then press <Space> to select. A small triangle marks the selected drive. Press <Enter> after completing your selection.
6. Use the up/down arrow key to select the stripe size for the RAID array (for RAID 0, 10 and 5 only), then press <Enter>. The available stripe size values range from 4 KB to 128 KB. The following are typical values:
  - RAID 0: 128 KB
  - RAID 10: 64 KB
  - RAID 5: 64 KB



---

We recommend a lower stripe size for server systems, and a higher stripe size for multimedia computer systems used mainly for audio and video editing.

---

7. When the **Capacity** item is selected, enter the RAID volume capacity that you want and press <Enter>. The default value indicates the maximum allowed capacity.
8. When the **Create Volume** item is selected, press <Enter>. The following warning message appears:

```
WARNING: ALL DATA ON SELECTED DISKS WILL BE LOST.  
Are you sure you want to create this volume? (Y/N)
```

9. Press <Y> to create the RAID volume and return to the main menu, or <N> to go back to the **CREATE VOLUME** menu.

## Deleting a RAID set



Be cautious when deleting a RAID set. You will lose all data on the hard disk drives when you delete a RAID set.

To delete a RAID set:

1. From the utility main menu, select **2. Delete RAID Volume** and press <Enter>. The following screen appears:

```
[DELETE VOLUME MENU]
Name      Level      Drives      Capacity      Status      Bootable
Volume0   RAID0 (Stripe)  2           298.0GB      Normal      Yes

[HELP]

Deleting a volume will reset the disks to non-RAID.

WARNING: ALL DISK DATA WILL BE DELETED.
(This does not apply to Recovery volumes)

[↑]-Select [ESC]-Previous Menu [DEL]-Delete Volume
```

2. Use the up/down arrow key to select the RAID set you want to delete, and then press <Delete>. The following warning message appears:

```
[DELETE VOLUME VERIFICATION]

ALL DATA IN THE VOLUME WILL BE LOST!
(This does not apply to Recovery volumes)

Are you sure you want to delete "Volume0"? (Y/N):
```

3. Press <Y> to delete the RAID set and return to the utility main menu, or press <N> to return to the DELETE VOLUME menu.

## Exiting the Intel® Rapid Storage Technology Option ROM utility

To exit the utility:

1. From the utility main menu, select **5. Exit**, then press <Enter>. The following warning message appears:

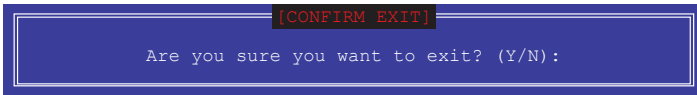

2. Press <Y> to exit or press <N> to return to the utility main menu.

## 5.2 Creating a RAID driver disk

A floppy disk with the RAID driver is required when installing a Windows® operating system on a hard disk drive that is included in a RAID set.



---

The motherboard does not provide a floppy drive connector. You have to use a USB floppy disk drive when creating a SATA RAID driver disk.

---

### 5.2.1 Creating a RAID driver disk without entering the OS

To create a RAID driver disk without entering the OS:

1. Boot your computer.
2. Press <Delete> during POST to enter the BIOS setup utility.
3. Set the optical drive as the primary boot device.
4. Insert the support DVD into the optical drive.
5. Save changes and exit BIOS.
6. When the Make Disk menu appears, press <1> to create a RAID driver disk.
7. Insert a formatted floppy disk into the USB floppy disk drive, then press <Enter>.
8. Follow the succeeding screen instructions to complete the process.

## 5.2.2 Creating a RAID driver disk in Windows®

To create a RAID driver disk in Windows®:

1. Start Windows®.
2. Plug the USB floppy disk drive and insert a floppy disk.
3. Place the motherboard support DVD into the optical drive.
4. Go to the **Intel AHCI/RAID Driver** menu then click **Intel AHCI/RAID Driver path** to open the RAID driver folder.
5. Select **32bit** or **64bit** folder depending on your operating system. Copy the files of the selected folder to the root path of your USB floppy disk drive.



---

Write-protect the floppy disk to avoid a computer virus infection.

---

## 5.2.3 Installing the RAID driver during Windows® OS installation

To install the RAID driver for Windows® 7:

1. During the OS installation, click **Load Driver** to allow you to select the installation media containing the RAID driver.
2. Insert the USB flash drive with RAID driver into the USB port or the support DVD into the optical drive, and then click **Browse**.
3. Click the name of the device you've inserted, go to **Drivers > RAID**, and then select the RAID driver for the corresponding OS version. Click **OK**.
4. Follow the succeeding screen instructions to complete the installation.



---

Before loading the RAID driver from a USB flash drive, you have to use another computer to copy the RAID driver from the support DVD to the USB flash drive.

---



---

To set up a Windows® UEFI operating system under RAID mode, ensure to load the UEFI driver for your optical drive.

---

# Appendices

## Notices

### Federal Communications Commission Statement

This device complies with Part 15 of the FCC Rules. Operation is subject to the following two conditions:

- This device may not cause harmful interference.
- This device must accept any interference received including interference that may cause undesired operation.

This equipment has been tested and found to comply with the limits for a Class B digital device, pursuant to Part 15 of the FCC Rules. These limits are designed to provide reasonable protection against harmful interference in a residential installation. This equipment generates, uses and can radiate radio frequency energy and, if not installed and used in accordance with manufacturer's instructions, may cause harmful interference to radio communications. However, there is no guarantee that interference will not occur in a particular installation. If this equipment does cause harmful interference to radio or television reception, which can be determined by turning the equipment off and on, the user is encouraged to try to correct the interference by one or more of the following measures:

- Reorient or relocate the receiving antenna.
- Increase the separation between the equipment and receiver.
- Connect the equipment to an outlet on a circuit different from that to which the receiver is connected.
- Consult the dealer or an experienced radio/TV technician for help.



The use of shielded cables for connection of the monitor to the graphics card is required to assure compliance with FCC regulations. Changes or modifications to this unit not expressly approved by the party responsible for compliance could void the user's authority to operate this equipment.

---

## IC: Canadian Compliance Statement

Complies with the Canadian ICES-003 Class B specifications. This device complies with RSS 210 of Industry Canada. This Class B device meets all the requirements of the Canadian interference-causing equipment regulations.

This device complies with Industry Canada license exempt RSS standard(s). Operation is subject to the following two conditions: (1) this device may not cause interference, and (2) this device must accept any interference, including interference that may cause undesired operation of the device.

Cet appareil numérique de la Classe B est conforme à la norme NMB-003 du Canada. Cet appareil numérique de la Classe B respecte toutes les exigences du Règlement sur le matériel brouilleur du Canada.

Cet appareil est conforme aux normes CNR exemptes de licence d'Industrie Canada. Le fonctionnement est soumis aux deux conditions suivantes :

- (1) cet appareil ne doit pas provoquer d'interférences et
- (2) cet appareil doit accepter toute interférence, y compris celles susceptibles de provoquer un fonctionnement non souhaité de l'appareil.

## Canadian Department of Communications Statement

This digital apparatus does not exceed the Class B limits for radio noise emissions from digital apparatus set out in the Radio Interference Regulations of the Canadian Department of Communications.

This class B digital apparatus complies with Canadian ICES-003.

## VCCI: Japan Compliance Statement

### VCCI Class B Statement

この装置は、クラスB情報技術装置です。この装置は、家庭環境で使用することを目的としていますが、この装置がラジオやテレビジョン受信機に近接して使用されると、受信障害を引き起こすことがあります。

取扱説明書に従って正しい取り扱いをして下さい。

VCCI-B

This is a Class B product based on the standard of the VCCI Council. If this is used near a radio or television receiver in a domestic environment, it may cause radio interference. Install and use the equipment according to the instruction manual.

## KC: Korea Warning Statement

B급 기기 (가정용 방송통신기자재)

이 기기는 가정용(B급) 전자파적합기기로서 주로 가정에서 사용하는 것을 목적으로 하며, 모든 지역에서 사용할 수 있습니다.

\*당해 무선설비는 전파혼신 가능성이 있으므로 인명안전과 관련된 서비스는 할 수 없습니다.



## REACH

Complying with the REACH (Registration, Evaluation, Authorisation, and Restriction of Chemicals) regulatory framework, we published the chemical substances in our products at ASUS REACH website at <http://csr.asus.com/english/REACH.htm>.



---

DO NOT throw the motherboard in municipal waste. This product has been designed to enable proper reuse of parts and recycling. This symbol of the crossed out wheeled bin indicates that the product (electrical and electronic equipment) should not be placed in municipal waste. Check local regulations for disposal of electronic products.

---



---

DO NOT throw the mercury-containing button cell battery in municipal waste. This symbol of the crossed out wheeled bin indicates that the battery should not be placed in municipal waste.

---

## ASUS Recycling/Takeback Services

ASUS recycling and takeback programs come from our commitment to the highest standards for protecting our environment. We believe in providing solutions for you to be able to responsibly recycle our products, batteries, other components as well as the packaging materials. Please go to <http://csr.asus.com/english/Takeback.htm> for detailed recycling information in different regions.

## ASUS contact information

### ASUSTeK COMPUTER INC.

Address 15 Li-Te Road, Peitou, Taipei, Taiwan 11259  
Telephone +886-2-2894-3447  
Fax +886-2-2890-7798  
E-mail [info@asus.com.tw](mailto:info@asus.com.tw)  
Web site [www.asus.com.com/](http://www.asus.com.com/)

#### *Technical Support*

Telephone +86-21-38429911  
Fax +86-21-5866-8722, ext. 9101#  
Online support <http://www.asus.com/tw/support/>

### ASUS COMPUTER INTERNATIONAL (America)

Address 800 Corporate Way, Fremont, CA 94539, USA  
Telephone +1-510-739-3777  
Fax +1-510-608-4555  
Web site <http://www.asus.com/us/>

#### *Technical Support*

Support fax +1-812-284-0883  
Telephone +1-812-282-2787  
Online support <http://www.service.asus.com/>

### ASUS COMPUTER GmbH (Germany and Austria)

Address Harkort Str. 21-23, D-40880 Ratingen, Germany  
Fax +49-2102-959911  
Web site <http://www.asus.com/de>  
Online contact <http://eu-rma.asus.com/sales>

#### *Technical Support*

Telephone +49-1805-010923\*  
Support Fax +49-2102-9599-11  
Online support <http://www.asus.com/de/support/>

# DECLARATION OF CONFORMITY

Per FCC Part 2 Section 2.1077(a)



Responsible Party Name: **Asus Computer International**

Address: **800 Corporate Way, Fremont, CA 94539.**

Phone/Fax No: **(510)739-3777/(510)608-4555**

hereby declares that the product

**Product Name : Motherboard**

**Model Number : H97-PRO**

Conforms to the following specifications:

- FCC Part 15, Subpart B, Unintentional Radiators

**Supplementary Information:**

This device complies with part 15 of the FCC Rules. Operation is subject to the following two conditions: (1) This device may not cause harmful interference, and (2) this device must accept any interference received, including interference that may cause undesired operation.

Representative Person's Name : Steve Chang / President

*Steve Chang*

Signature :

Date : Apr. 13, 2014

Ver: 140831

# EC Declaration of Conformity



We, the undersigned,

Manufacture: **ASUSTeK COMPUTER INC.**

Address: **4F, No. 150, LITE Rd., PEITOU, TAIPEI 112, TAIWAN**

Authorized representative in Europe: **ASUS COMPUTER GmbH**

Address, CH: **HARKORT STR. 21-23, 40880 RATINGEN**

Country: **GERMANY**

**declare the following apparatus:**

Product name : **Motherboard**  
 Model name : **H97-PRO**

conform with the essential requirements of the following directives:

**2004/108/EC-EMC Directive**

- EN 55022:2010-AC:2011
- EN 55024:2010-AC:2011
- EN 61000-3-2:2006
- EN 61000-3-3:2006
- EN 55024:2010-AC:2011
- EN 55025:2010-AC:2011

**1989/531/EEC-BAITE Directive**

- EN 300 328 V1.7.1 (2005-10)
- EN 300 440 V1.6.1 (2010-08)
- EN 300 440 V1.4.1 (2010-08)
- EN 300 440 V1.4.1 (2010-08)
- EN 300 440 V1.4.1 (2010-08)
- EN 301 108-1 V5.2 (2011-05)
- EN 301 108-2 V5.2 (2011-07)
- EN 301 108-3 V5.2 (2011-07)
- EN 302 544-2 V1.1 (2009-01)
- EN 302 523 V1.1 (2009-01)
- EN 302 326-3 V1.3 (2007-06)
- EN 302 326-2 V1.2 (2007-06)
- EN 302 291-1 V1.1 (2005-07)
- EN 302 291-2 V1.1 (2005-07)
- EN 302 291-2 V1.1 (2005-07)
- EN 301 488-1 V1.9 (2011-09)
- EN 301 488-3 V1.4 (2002-08)
- EN 301 488-4 V1.4 (2005-05)
- EN 301 488-5 V1.4 (2005-05)
- EN 301 488-6 V1.4 (2007-11)
- EN 301 488-9 V1.4 (2007-11)
- EN 301 488-17 V2.2 (2012-09)
- EN 301 488-18 V2.2 (2012-09)
- EN 302 326-2 V1.2 (2007-06)
- EN 302 326-3 V1.3 (2007-06)
- EN 302 326-3 V1.3 (2007-06)
- EN 302 291-1 V1.1 (2005-07)
- EN 302 291-1 V1.1 (2005-07)

**2006/95/EC-LVD Directive**

- EN 60950-1 A:12-2011
- EN 60950-1 A:12-2011

**2006/125/EC-EP- Directive**

- Regulation (EC) No. 1275/2008
- Regulation (EC) No. 642/2009
- Regulation (EC) No. 617/2013

**2011/65/EU-ROHS Directive**

- Regulation (EC) No. 642/2009
- Regulation (EC) No. 617/2013

**RoCE marking**



(EC conformity marking)

Position : **CEO**  
 Name : **Jerry Shen**

*Jerry Shen*

Signature : \_\_\_\_\_

Declaration Date: **13/04/2014**

Year to begin affixing CE marking: **2014**

Ver: 140831

