

SONY®

SONY  
Digital HD Video Camera Recorder  
GB

# Digital HD Video Camera Recorder

## Operating Guide

Before operating the unit, please read this manual thoroughly,  
and retain it for future reference

**HDV**  
HDV 1080i

**DVCAM**™

**DV** Digital  
Video  
Cassette

Mini **DV** Digital  
Video  
Cassette

**PROGRESSIVE**

  
MEMORY STICK™

## HVR-S270E/S270P

© 2008 Sony Corporation

<http://www.sony.net/>

Printed on 70% or more recycled paper  
using VOC (Volatile Organic Compound)  
-free vegetable oil based ink.

Printed in Japan



# Read this first

Before operating this unit, please read this manual thoroughly, and retain it for future reference.

## Notes on use

### Types of cassette you can use in your camcorder

Your camcorder is capable of recording in HDV, DVCAM and DV formats.

When recording in HDV/DV format, Sony recommends that you use standard size DV cassettes or mini DV cassettes.

When recording in DVCAM format, Sony recommends that you use standard size DVCAM cassettes or mini DVCAM cassettes. Your camcorder does not support the Cassette Memory function (p. 107).

### The HDV format

- Digital high-definition (HD) video signals are recorded and played back on a DV format cassette.
- HDV signals are compressed in MPEG2 format, which is adopted in BS (broadcast satellite) digital and terrestrial digital HDTV broadcastings and in Blu-ray disc recorders.

### Types of “Memory Stick” you can use in your camcorder

You can use any “Memory Stick” that has the following markings.

MEMORY STICK DUO MEMORY STICK PRO DUO  
MEMORY STICK PRO-HG DUO

“Memory Stick Duo”  
(This size can be used with your camcorder.)



“Memory Stick”  
(You cannot use it in your camcorder.)



### Notes

- You cannot use any type of memory card except “Memory Stick Duo.”
- “Memory Stick PRO Duo” can be used only with “Memory Stick PRO” compatible equipment.
- Do not attach a label or the like on a “Memory Stick Duo” or a “Memory Stick Duo” Adaptor.
- When using a “Memory Stick Duo” with “Memory Stick” compatible equipment, insert the “Memory Stick Duo” into the “Memory Stick Duo” Adaptor.

## Using the camcorder

- Do not hold the camcorder by the following part.

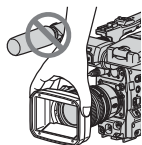

Lens hood



LCD panel

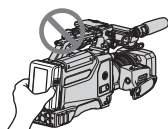

Battery pack

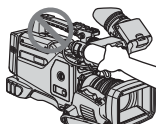

Microphone or  
Microphone holder



Viewfinder

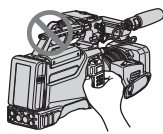

Memory  
Recording Unit

### Notes

- The camcorder is not dustproof, dripproof or waterproof. See “About handling of your camcorder” (p. 113).
- Do not connect cables to your camcorder with their terminals placed the wrong way. Squeezing the terminals into your camcorder’s jacks may damage them or result in a malfunction of your camcorder.

## About menu items, LCD panel, viewfinder, and lens

- A menu item that is grayed out is not available under the current recording or playback conditions.
- The LCD screen and the viewfinder are manufactured using extremely high-precision technology, so over 99.99% of the pixels are operational for effective use. However, there may be some tiny black points and/or bright points (white, red, blue, or green in color) that appear constantly on the LCD screen and the viewfinder. These points are normal results of the manufacturing process and do not affect the recording in any way.

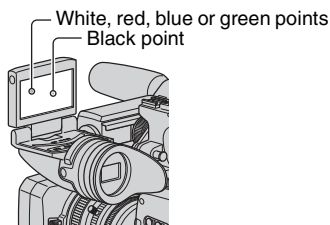

## Do not expose your camcorder's viewfinder, lens, or LCD screen to the sun or strong light source for extended periods.

- Intense light sources, especially the sun will converge on the viewfinder or lens and damage the internal parts of your camcorder. Avoid sunlight or other strong light sources when storing your camcorder. Protect this device by always closing the lens cover or by placing it in its bag when not in use.

## On recording

- Before starting to record, test the recording function to make sure the picture and sound are recorded without any problems.

## Read this first (Continued)

- Compensation for the contents of recordings cannot be provided, even if recording or playback is not possible due to a malfunction of the camcorder, storage media, etc.
- TV color systems differ depending on the countries/regions. To view your recordings on a TV, you need a PAL system-based TV.
- Television programs, films, video tapes, and other materials may be copyrighted. Unauthorized recording of such materials may be contrary to the copyright laws.
- Because of the way that the image device (CMOS sensor) reads out image signals, the subjects passing by the frame rapidly might appear crooked depending on the recording conditions. This phenomenon may be notable in displays having high motion resolution.
- Because of the way that the image device (CMOS sensor) reads out image signals, the following phenomena may occur. The phenomena can be reduced by adjusting the shutter speed.
  - Horizontal lines appear on the screen during recording under fluorescent lights.
  - Images on the screen look horizontally divided when a subject is lighted with flashlight.

### On playing back HDV tapes on other devices

A tape recorded in the HDV format cannot be played back on a device that is not compatible with the HDV format. Check the contents of tapes by playing them back on this camcorder prior to playing them back on other devices.

### Notes on the icons used in this manual

 Features available for the HDV format only.

 Features available for the DVCAM format only.

 Features available for the DV SP format only.

 The function that can be used when i.LINK cable is connected.

 The function that can be assigned to an ASSIGN button.

### About this manual

- The images of the LCD screen and the viewfinder used in this manual for illustration purposes are captured using a digital still camera, and therefore may appear different.
- The on-screen displays in each local language are used for illustrating the operating procedures. Change the screen language before using your camcorder if necessary (p. 22).
- Design and specifications of recording media and other accessories are subject to change without notice.

### About the Carl Zeiss lens

Your camcorder is equipped with a Carl Zeiss lens, which was developed jointly by Carl Zeiss, in Germany, and Sony Corporation, and produces superior images. It adopts the MTF measurement system for video cameras and offers a quality typical of a Carl Zeiss lens. Also, the lens for your camcorder is T\*-coated to suppress unwanted reflections and faithfully reproduce colors.

MTF= Modulation Transfer Function. The number value indicates the amount of light from a subject coming into the lens.

# Table of Contents

Read this first .....	2
-----------------------	---

## Getting Started







Step 1: Checking supplied items .....	8
Step 2: Attaching the supplied items .....	9
Step 3: Preparing a power supply .....	16
Step 4: Turning the power on and holding your camcorder properly .....	18
Step 5: Adjusting the viewfinder and LCD panel .....	19
Step 6: Setting the date and time .....	21
Changing the language setting .....	22
Step 7: Inserting a tape or a "Memory Stick Duo" .....	23



## Recording/Playback

Recording .....	26
Changing the settings of your camcorder recordings .....	30
Adjusting the zoom .....	30
Adjusting the focus manually .....	31
Adjusting the exposure .....	33
Adjusting to natural color (White balance) .....	35
Adjusting the black balance .....	37
Customizing the picture quality (Picture profile) .....	37
Adjusting the volume .....	46
Assigning the functions to the ASSIGN buttons .....	49
Recording an index signal .....	50
Reviewing the most recently recorded scenes (Rec review) .....	51
Searching for the last scene of the most recent recording (End search) .....	51
Playing back the most recently recorded movies (Last scene review) .....	51
Using the Shot transition .....	52
Marking focal point on the screen (Focus marking) .....	55
Playback .....	56
Changing/checking the settings in your camcorder .....	59
Changing the screen .....	59
Displaying recording data (Data code) .....	59
Displaying the settings in your camcorder (Status check) .....	60
Connecting a monitor or a TV .....	61

### Using the Menu

<i>Using the menu items</i> .....	63
Menu items .....	65
 (CAMERA SET) menu .....	68
Settings to adjust your camcorder to the recording conditions (GAIN SETUP/ BACK LIGHT/STEADYSHOT, etc.)	
 (AUDIO SET) menu .....	75
Settings for the audio recording (HDV 2CH/4CH/XLR SET, etc.)	
 (DISPLAY SET) menu .....	77
Display settings of the display and the viewfinder (MARKER/VF B.LIGHT/DISP OUTPUT, etc.)	
 (IN/OUT REC) menu .....	81
Recording settings, input and output settings (REC FORMAT/HDV PROGRE./ VIDEO OUT/EXT REC CTRL, etc.)	
 (TC/UB SET) menu .....	85
(TC PRESET/UB PRESET/TC LINK, etc.)	
 (MEMORY SET) menu .....	87
Settings for the "Memory Stick Duo" (ALL ERASE/FORMAT, etc.)	
 (OTHERS) menu .....	89
Settings while recording on a tape or other basic settings (QUICK REC/BEEP, etc.)	

### Dubbing/Editing

Recording pictures from a VCR .....	92
Copying movies on a tape to a computer .....	94

### Troubleshooting

Troubleshooting .....	97
Warning indicators and messages .....	106

## Additional Information

Maintenance and precautions .....	107
HDV format and recording/playback .....	107
Compatibility of the DVCAM/DV formats .....	108
About the "Memory Stick" .....	110
About i.LINK .....	111
About x.v.Color .....	112
About handling of your camcorder .....	113
Specifications .....	117

## Quick Reference

Identifying parts and controls .....	121
Indicators for the LCD screen and viewfinder .....	128
Index .....	132

## Step 1: Checking supplied items

Make sure that you have following items supplied with your camcorder.

The number in the parentheses indicates the number of that item supplied.

- A cassette tape and a “Memory Stick Duo” are not included. See pages 2, 107 and 110 for types of cassette tape and “Memory Stick Duo” that you can use on your camcorder.

Carl Zeiss lens (VCL-412BWS) (1) (p. 9)

This lens is pre-mounted.

Memory Recording Unit (HVR-MRC1) (1) (p. 14),



i.LINK Cradle (HVRA-CR1) (1) (p. 15)

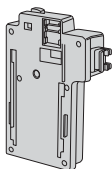

Lens hood with lens cover (1) (p. 13)

This lens hood is pre-mounted.

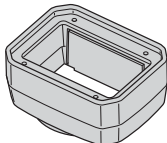

Large eyecup (1) (p. 19)

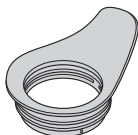

Wind Screen (1), Microphone (ECM-XM1) (1) (p. 12)

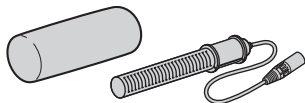

Accessory shoe kit (Accessory shoe (1), Accessory shoe plate (1), screws (4)) (p. 121)

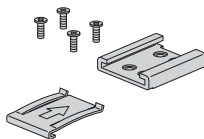

Shoulder belt (1) (p. 13)

Lens mount cap (1) (p. 127),

Rear lens cap (1) (p. 127)

Test chart for flange focal length adjustment (1) (p. 10)

CD-ROM “Manuals for Digital HD Video Camera Recorder” (1)

Operating Guide (This manual) (1)



## Step 2: Attaching the supplied items

### Mounting the lens

Make sure to turn off the POWER switch of your camcorder before mounting the lens. Refer to the manuals provided with the lens for details on the proper handling of the lens.

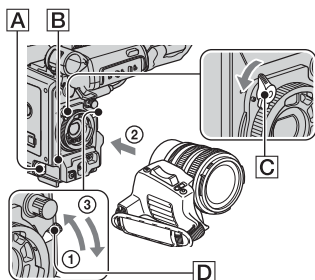

### Mounting the Carl Zeiss lens

- 1 Push the lens locking lever **D** up and remove the lens or the lens mount cap from the lens mount.
- 2 Align the center slot in the lens mount with the center pin on the lens, and insert the lens into the mount.
- 3 While holding the lens in place, push the lens locking lever **D** down to mount the lens.

#### Notes

- If the lens is not properly locked, it may come off when in use, which may cause a serious problem. Make sure that the lens is securely locked. Sony recommends that you set the lens securing tab **C** as illustrated.

### Mounting non-Carl Zeiss lens

- 1 Push the lens locking lever **D** up and remove the lens or the lens mount cap from the lens mount.
- 2 Align the center slot in the lens mount with the center pin on the lens, and insert the lens into the mount.

- 3 While holding the lens in place, push the lens locking lever **D** down to mount the lens.
- 4 Connect the lens cable to the LENS jack **A**.
- 5 Push the lens cable in the cable holder **B**.

#### Notes

- Use a lens mount adaptor suitable for your lens.
  - 1/3" bayonet mount lens  
You can mount the lens without an adaptor.
  - 2/3" bayonet mount lens  
Use a Fujinon ACM-17.  
A focal length is twice as that without the adaptor.
  - 1/2" bayonet mount lens  
Use a Fujinon ACM-12.  
A focal length is 1.3 times as that without the adaptor.
  - SONY 1/2" bayonet mount lens  
Use a Fujinon ACM-19.  
A focal length is 1.3 times as that without the adaptor.Your lens performance is not guaranteed.
- When you mount a lens other than a Carl Zeiss lens, you cannot use the following menu items. Even you set those menu items, the settings do not take effect.

#### For the lens with the lens cable (12 Pin)

AF ASSIST

ASSIGN BTN

CAMERA

ASSIGN#

FOCUS

FOCUS INFNTY

FOCUS MACRO

ONE PUSH AF

ASSIGN BTN

LENS

L1

L2

FLANGE BACK

FOCUS DISP

FOCUS MACRO

## Step 2: Attaching the supplied items (Continued)

### For the lens with the lens cable (12 Pin)

HANDLE ZOOM

SHOT TRANSITION

STEADYSHOT

S.TRANS/F.MARK

ZOOM DISPLAY\*

Extender indicator\*\*

# shows the ASSIGN BTN number.

\* If your lens does not have a zoom display function, the zoom position is not displayed on the screen.

\*\*Your camcorder does not display the extender indicator when you use the extender function of the lens.

### For the lens without the lens cable (12 Pin)

AF ASSIST

ASSIGN BTN

CAMERA

ASSIGN#

FOCUS

FOCUS INFNTY

FOCUS MACRO

ONE PUSH AF

ASSIGN BTN

LENS

L1

L2

RET

AT IRIS LMT

CAM DATA DSP (Iris value)

FLANGE BACK

FOCUS DISP

FOCUS MACRO

HANDLE ZOOM

SHOT TRANSITION

STEADYSHOT

S.TRANS/F.MARK

ZOOM DISPLAY

# shows the ASSIGN BTN number.

- If the lens is not properly locked, it may come off when in use, which may cause a serious problem. Make sure that the lens is securely locked. Sony recommends that you set the lens securing tab  as illustrated.
- Press the REC START/STOP button on the handle to record when using a lens that does not have a lens cable.

### Tips

- When you attach a non-Carl Zeiss lens, Sony recommends that you adjust the black balance with the iris closed before recording. (p. 37)

### Adjusting the flange focal length (for Carl Zeiss lens)

You need to adjust the flange focal length (the distance from the lens flange to the plane of the image along the optical axis) when you have changed lenses.

### Tips

- Your camcorder can store flange focal length data for ten different Carl Zeiss lenses (VCL-412BWS/VCL-308BWS). If you remount the lens after you have mounted ten different lenses and adjusted their flange focal length, you need to adjust the flange focal length for the lens even for the Carl Zeiss lens whose flange focal length has been adjusted.

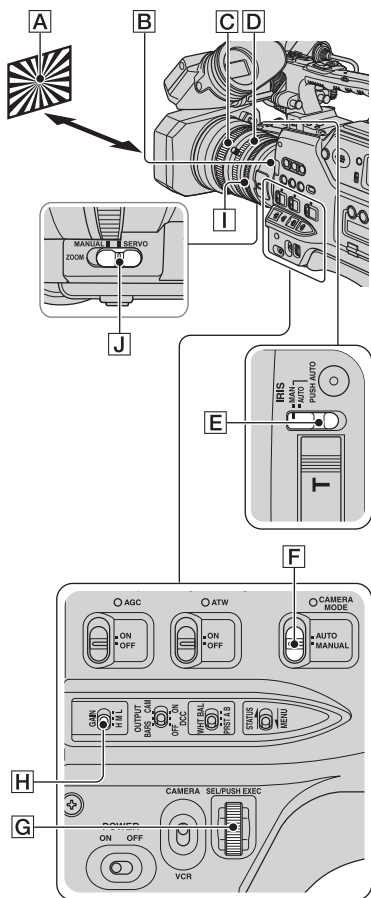

## Adjusting the flange focal length automatically

- 1 Set the CAMERA MODE switch **F** to MANUAL.
- 2 Set the IRIS switch **E** to MAN.
- 3 Set the gain to 0dB with the gain switch **H**. If you have not changed the gain switch setting from the default, set the gain switch **H** to L.

Make sure that the AGC switch is set to OFF.

- 4 Set the shutter speed to automatic adjustment mode (p. 35).
- 5 Fully open the aperture with the iris ring **I**.
- 6 Place the flange focal length adjustment test chart **A** about 2-3 meters (7-10 feet) away. Adjust the lighting or the ND filter **B** so that a subject is properly lit.
- 7 Set the ZOOM switch **J** to SERVO.
- 8 Select [AUTO ADJUST] in [FLANGE BACK] of **☰** (CAMERA SET) menu (p. 74).
- 9 Select [YES] with the SEL/PUSH EXEC dial **G**.

The flange focal length adjustment starts and [EXECUTING] appears on the screen. When the adjustment is completed, [Completed.] appears on the screen. If the adjustment fails, [Could not adjust.] appears on the screen. Try the adjustment again.

## Adjusting the flange focal length manually

- 1 Perform steps ① through ⑥ of "Adjusting the flange focal length automatically."
- 2 Set the ZOOM switch **J** to MANUAL.
- 3 Select [MANU ADJUST] in [FLANGE BACK] of **☰** (CAMERA SET) menu.
- 4 Select [YES] with the SEL/PUSH EXEC dial **G**.
- 5 Turn the zoom ring **D** fully to the telephoto side.
- 6 Turn the focus ring **C** until the subject comes in focus, then press the SEL/PUSH EXEC dial **G**.
- 7 Turn the zoom ring **D** fully to the wide angle side.
- 8 Turn the focus ring **C** until the subject comes in focus, then press the SEL/PUSH EXEC dial **G**.

## Step 2: Attaching the supplied items (Continued)

When the adjustment is completed, [Completed.] appears on the screen. If the adjustment fails, [Could not adjust.] appears on the screen. Try the adjustment again.

### 💡 Tips

- You can check the focusing easily if you do the following before adjusting the focal length.
  - Set the PEAKING switch to ON (p. 32).
  - Press the ASSIGN button to which [EXP.FOCUS] is assigned (p. 49).
- If the adjustment fails, confirm the following.
  - A bright subject is not within the view.
  - The ND filter switch does not stop at halfway between two positions.

### Attaching the supplied microphone

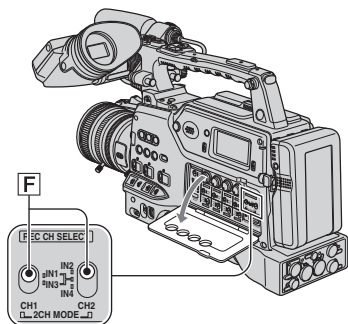
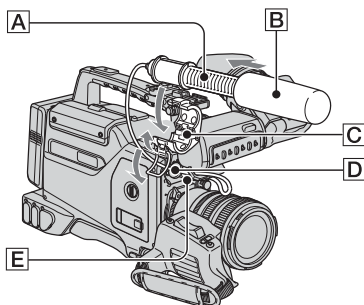

- 1 Attach the wind screen **B** to the supplied microphone **A**.

- 2 Place the microphone **A** in the microphone holder **C** with the model name facing upward, close the cover, and shut the clamp.

- 3 Connect the plug of the microphone to the AUDIO INPUT1 (L) jack **D**.

Push the plug in the jack until it is securely locked.

- 4 Put the microphone cable into the cable holder **E**.

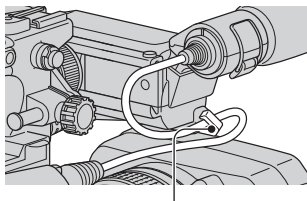

Put the cable in the outer cable holder.

- 5 Select the channel with the REC CH SELECT switch **F**.

See p. 46 for details.

### 💡 Tips

- See page 46 for adjusting the volume.
- Set the INPUT1/2/3/4 switch for the jack connected to the microphone to MIC+48V.
- When you connect a device that supports the +48V power source to any of the INPUT jacks, set the respective INPUT switch to MIC prior to connecting the device. When you disconnect the device, set the respective INPUT switch to MIC first, then disconnect it.

## Attaching the lens hood with lens cover

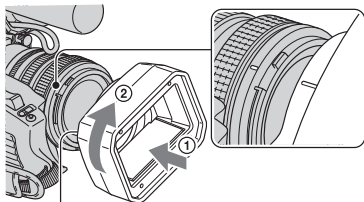

PUSH (lens hood release) button

Align the marks on the lens hood to those on the camcorder, and turn the lens hood in the direction of the arrow ②.

## To remove the Lens hood with lens cover

Turn the lens hood in the opposite direction to the arrow ② in the illustration while pressing the PUSH (lens hood release) button.

### 💡 Tips

- If you attach or remove a 72mm (2 7/8 in.) PL filter or MC protector, remove the lens hood with lens cover.

## To open or close the shutter of the Lens hood with lens cover

Move the lens cover lever up or down to open or close the lens cover.

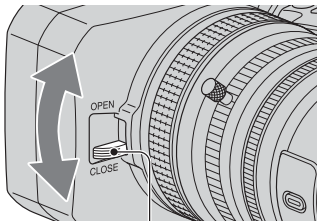

Move the lens cover lever to OPEN to open the lens cover, and move the lever to CLOSE to close the lens cover.

## Attaching the shoulder strap

### 1 Fit one of the clips to a shoulder strap fitting.

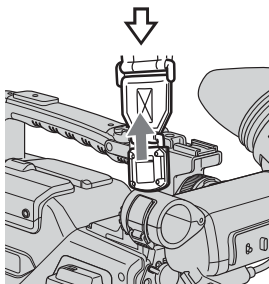
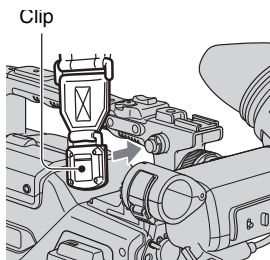

Pull up the strap to lock the fitting.

## Step 2: Attaching the supplied items (Continued)

- 2** Fit the other clip to the shoulder strap fitting on the other side of the grip in the same way.

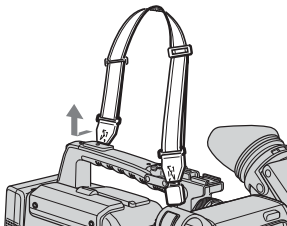

### To remove the shoulder strap

Pull in the direction of the arrow while pressing here.

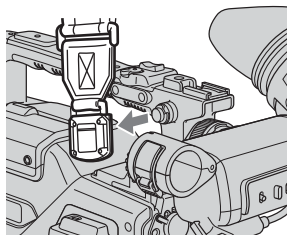
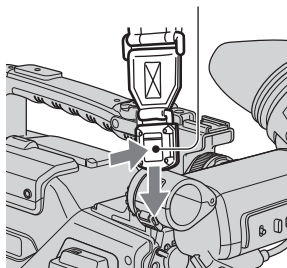

### Attaching Memory Recording Unit

Attach the Memory Recording Unit to your camcorder as illustrated after inserting your CompactFlash Card into it.

For details, refer to the Operating Instructions of the Memory Recording Unit on the CD-ROM.

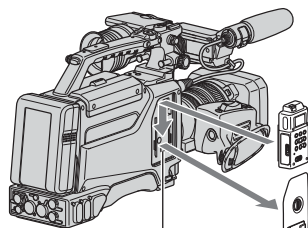

ⓘ HDV/DV jack (6-pin)

#### ⓘ Notes

- You cannot use the ⓘ HDV/DV jack when the Memory Recording Unit is attached to your camcorder.
- We recommend using Sony CompactFlash Cards with your Memory Recording Unit.

### Using non-Sony CompactFlash Cards

When you use non-Sony CompactFlash Cards, data may be recorded incorrectly. When you use non-Sony CompactFlash Cards, we recommend that you test them beforehand as follows.

- ① Format the CompactFlash Card with the Memory Recording Unit.
- ② Record at least 20 clips of about 10 seconds each in HDV recording mode.
- ③ If you have nonlinear editing software, load the files into it and check whether you can edit the data correctly.

## To remove the Memory Recording Unit

Slide the unit upward while pushing the RELEASE lever of the Memory Recording Unit downward.

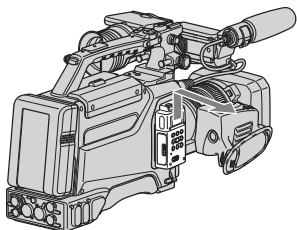

## To attach the Memory Recording Unit to the i.LINK Cradle

Attach the Memory Recording Unit to the i.LINK Cradle as illustrated.

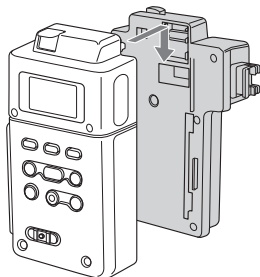

## To remove the Memory Recording Unit from the i.LINK Cradle

Slide the unit upward while pushing the RELEASE lever of the Memory Recording Unit downward.

### 💡 Tips

- Refer to the operating instructions of HVR-MRC1 on the supplied CD-ROM for details on the i.LINK Cradle.

## Step 3: Preparing a power supply

The following power supplies are recommended for your camcorder.

- BP-GL65/GL95/L60S/L80S Lithium-ion Battery Pack
- AC power using the AC-550, AC-DN2, AC-DN10 AC Adaptor

### Using a battery pack

Approximate operating time (min.) when you use a fully charged battery pack.

Model name	HDV	DVCAM (DV)
BP-GL65	240	255
BP-GL95	370	385
BP-L60S	215	230
BP-L80S	295	310

Before use, charge the battery pack with a charger suitable for each battery.

- All times are measured under following conditions.
  - when recording on both tape and Memory Recording Unit (HVR-MRC1)
  - when using the microphone (ECM-XM1)
  - when recording continuously
  - when using the viewfinder with the LCD panel closed
- For details on charging procedure, refer to the battery charger operation manual.

### Notes

- A warm battery pack may not be able to be fully recharged.
- When you set [BATTERY TYPE] appropriately for your battery, approximate remaining battery capacity is displayed on the screen. The displayed approximate remaining battery capacity may slightly differ from that indicated by the indicator on your battery (p. 91).

### To attach the battery pack

- ① Press the battery pack against the back of the camcorder, aligning the line on the side of the battery pack with the matching line on the camcorder.

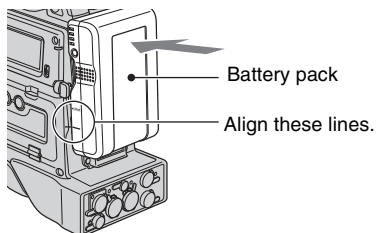

Back of the camcorder

- ② Slide the battery pack down until its "LOCK" arrow points at the matching line on the camcorder.

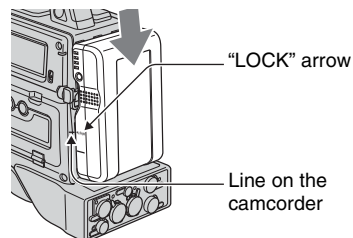

### To detach the battery pack

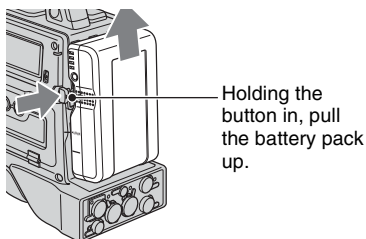

### Notes

- During recording, playback, and loading/unloading a tape, be careful never to remove the battery pack.
- Make sure to turn the camcorder off before changing the battery (except when using an AC-550 and an AC-DN2/DN10 AC Adaptor together).



## Using an AC Adaptor

### To use the AC-550 AC Adaptor

Connect the camcorder to the AC power supply through an AC-550 AC Adaptor as shown in the following figure, and turn the POWER switch of the AC-550 on.

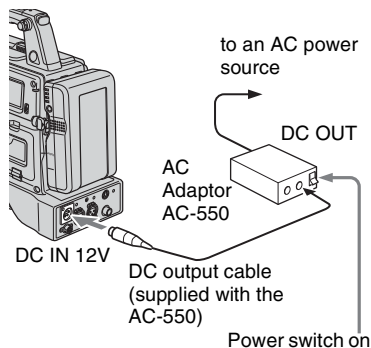

### To use the AC-DN10 AC Adaptor

Mount an AC-DN10 on the camcorder in the same way as a battery pack, then connect to the AC power supply. The AC-DN10 can supply up to 100 W of power.

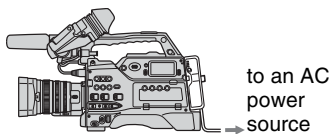

## Avoiding breaks in operation due to an exhausted battery

When the battery pack is becoming exhausted, you can perform battery replacement without causing a break to the camcorder operation by using an AC Adaptor.

- ① Turn the AC-550 AC Adaptor on.

- ② Connect an AC-550 AC Adaptor to an AC power source, then connect it to the DC IN 12V connector of the camcorder (p. 17).

The power source switches automatically from the battery pack to the AC Adaptor connected to the DC IN 12V connector.

### Notes

- There may be some noise on the video signal at the time of power source switching.
- ③ Replace the battery pack with a fully charged one.

## Step 4: Turning the power on and holding your camcorder properly

To record or play, set the CAMERA/VCR switch to respective positions.  
When you use your camcorder for the first time, [CLOCK SET] screen appears (p. 21).

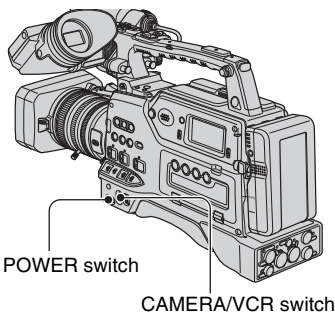

### 1 Set the POWER switch to ON, and set the CAMERA/VCR switch.

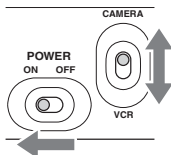

**CAMERA:** To record pictures.  
**VCR:** To play or edit pictures.

### ⚙ Notes

- The current date and time appears on the LCD screen for a few seconds when you turn on your camcorder once you set the date and time ([CLOCK SET], p. 21).

### 2 Hold the camcorder properly.

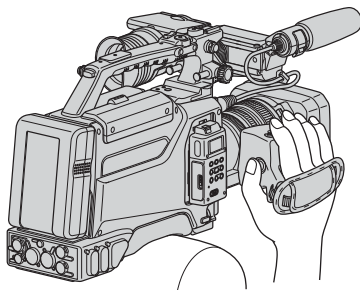

### 3 Ensure a good grip, then fasten the grip belt.

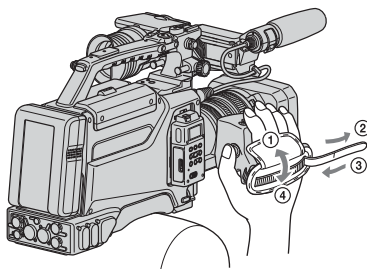

### To turn off the power

Set the POWER switch to OFF.

### ⚙ Notes

- If warning messages appear on the screen, follow the instructions.

# Step 5: Adjusting the viewfinder and LCD panel

## The viewfinder

### To attach the large eyecup

To attach the supplied large eyecup, stretch it slightly and align it with the eyecup groove in the viewfinder. You can attach the large eyecup facing either the right or left side.

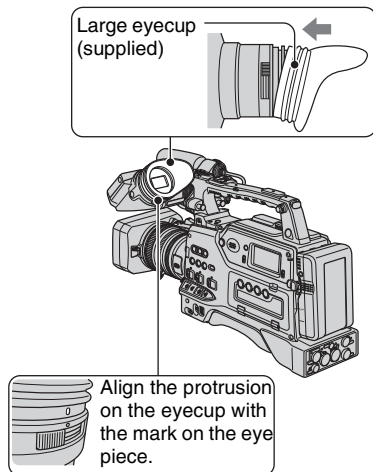

### To adjust the viewfinder position

To adjust the viewfinder left-to-right position, loosen the left-to-right fixing ring. To adjust the front-to-back position, loosen the front-to-back position locking knob.

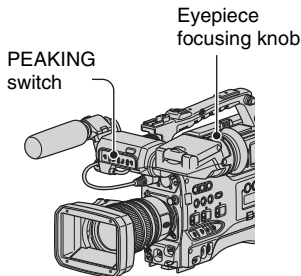
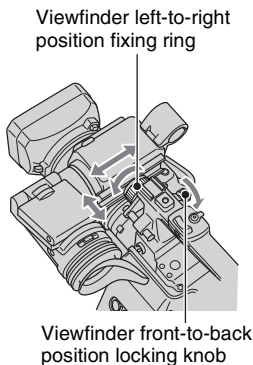

### To adjust the eyepiece focus

First focus the image with the lens, then adjust the viewfinder lens adjustment lever to get the clearest viewfinder image for your eyesight.

### To adjust the image detail

Set the PEAKING switch to ON. The detail of the viewfinder image is enhanced, which helps you to focus the image.

## Step 5: Adjusting the viewfinder and LCD panel (Continued)

### To adjust the brightness

Set the brightness in [VF B.LIGHT] of  (DISPLAY SET) menu (p. 80).

#### Notes

- You may see primary colors shimmering in the viewfinder when you move your eye line. This is not a malfunction. The shimmering colors will not be recorded on the recording media.

### The LCD panel

Set the VIDEO OUT switch to LCD.

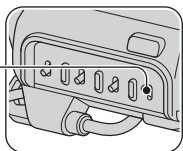

① 180 degrees (max.)

② 180 degrees (max.)

③ 90 degrees (max.)

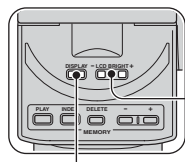
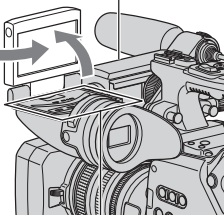

DISPLAY button

- LCD BRIGHT + buttons

#### Notes

- When you set the VIDEO OUT switch to LCD, video signals cannot be output from the VIDEO OUT jack or S VIDEO jack. To output the video signals from the VIDEO OUT jack or S VIDEO jack, set the VIDEO OUT switch to COMPOSITE. With this setting, images are not displayed on the screen.

#### Tips

- You can use the LCD panel for recording mirror image. You will see a mirror image on the LCD screen but the image will be recorded in a normal image.
- Because the LCD panel on your camcorder is a full-screen display, bottom of the screen may look distorted, such as horizontal lines on the screen. This does not affect on your images recorded on your CompactFlash Card or tape.

### To adjust the brightness

Adjust the LCD brightness with the - LCD BRIGHT + buttons. You can turn on and off the LCD backlight by pressing the DISPLAY button.

# Step 6: Setting the date and time

Set the date and time when using this camcorder for the first time. If you do not set the date and time, [CLOCK SET] screen appears every time you turn on your camcorder or change the CAMERA/VCR switch position.

## Tips

- If you do not use your camcorder for **about 3 months**, the built-in rechargeable battery gets discharged and the date and time settings may be cleared from the memory. In that case, charge the rechargeable battery and then set the date and time again (p. 115).

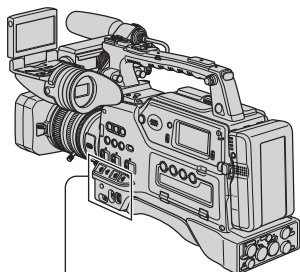

MENU/STATUS switch

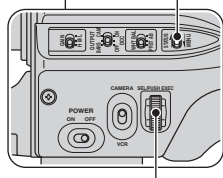

SEL/PUSH EXEC dial

Skip to step **4** when you set the clock for the first time.

- 1** Push the MENU/STATUS switch to MENU.

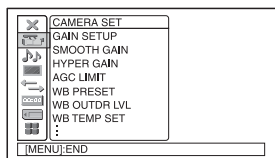

- 2** Select  (OTHERS) by turning the SEL/PUSH EXEC dial, then press the dial.

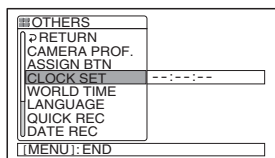

- 3** Select [CLOCK SET] by turning the SEL/PUSH EXEC dial, then press the dial.

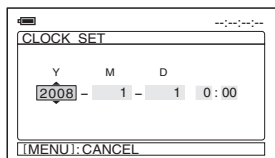

## Step 6: Setting the date and time (Continued)

---

### 4 Set [Y] (year) by turning the SEL/PUSH EXEC dial, then press the dial.

You can set any year up to the year 2079.

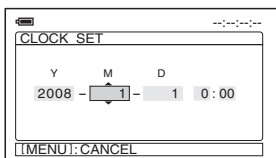

---

### 5 Set [M] (month), [D] (day), hour and minute, then press the dial.

The clock starts.

---

#### Tips

- The date and time are automatically recorded on the tape, and can be displayed during playback (DATA CODE button, p. 59).

## Changing the language setting

You can change the on-screen displays to show messages in a specified language.

Press the MENU button to select the  (OTHERS) with the SEL/PUSH EXEC dial.

Select the screen language in [LANGUAGE] (p. 90).

# Step 7: Inserting a tape or a “Memory Stick Duo”

## Cassette tape

The camcorder can use standard-size and mini-size DVCAM/DV cassettes. For details about usable cassette, see “Types of cassette you can use in your camcorder” on page 2.

**1** Set the **POWER** switch to **ON**.

**2** While sliding the open lever in the direction of the arrow, open the cassette lid.

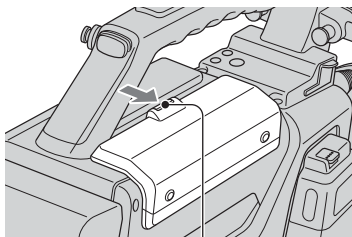

Open lever

**3** Insert the cassette with the **cassette window (on the front)** facing outward and the **REC/SAVE** switch facing upward.

Check for tape slack before inserting the cassette.

Press the center of the cassette.

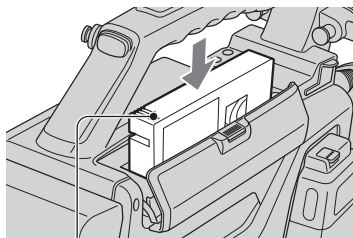

REC/SAVE switch

### To insert a mini-size cassette

Insert the cassette with the cassette window (on the front) facing outward. Push the cassette between the both guides.

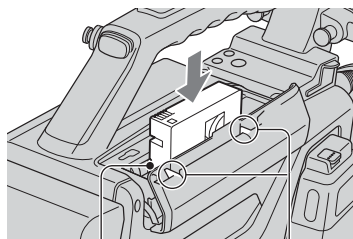

Guides

Mini-size cassette match marks

## Step 7: Inserting a tape or a “Memory Stick Duo” (Continued)

### 4 Close the cassette lid until it clicks.

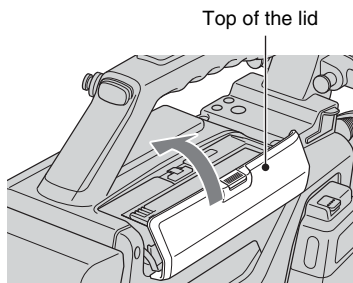

Press the lid firmly until it clicks. If the cassette lid is hard to close, press the top of the lid.

### To eject a cassette

Follow the procedure above, and take out the cassette by pressing the  (eject) button in step 3.

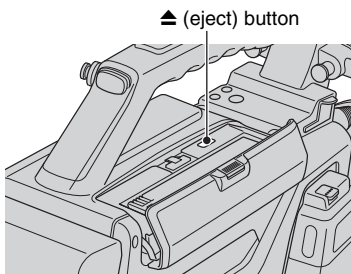

### Notes

- Before inserting a cassette, make sure that there is no cassette in the cassette compartment. Inserting two cassettes by mistake may cause a malfunction.
- Internal parts of the camcorder may become bent or otherwise damaged if you attempt to insert a mini-size cassette in the wrong direction (such as with the cassette turned backside front so the reel holes face the cassette holder window or with the cassette turned sideways so that a short side enters first).

- If a cassette is not inserted completely or gets stuck when being inserting, take out the cassette and reinsert it. If you insert a cassette forcibly, the cassette may not be inserted in the correct position or may cause a malfunction.
- When inserting a cassette, hold the center of the cassette and insert it straight toward the compartment. **Holding the side of the cassette may cause it to be inserted incorrectly.**
- When inserting a cassette, put the camcorder on a horizontal and stable surface.
- When inserting a mini DV cassette tape, strong light entering the slot may cause a malfunction such as improper cassette type detection.

### “Memory Stick Duo”

You can use only a “Memory Stick Duo” marked with **MEMORY STICK DUO**, **MEMORY STICK PRO DUO** or **MEMORY STICK PRO-HG DUO** (p. 110).

### 1 Open the audio control panel cover.

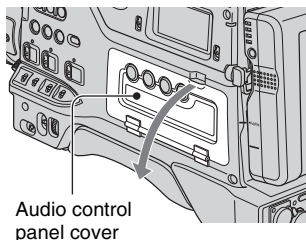



- 
- 2** Insert the “Memory Stick Duo” into the “Memory Stick Duo” slot in the right direction until it clicks.

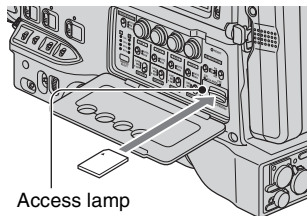

**⚡ Notes**

- If you insert the “Memory Stick Duo” into the slot in the wrong direction, the “Memory Stick Duo,” the “Memory Stick Duo” slot, or image data may be damaged.

---

**To eject a “Memory Stick Duo”**

Lightly push the “Memory Stick Duo” once.

**⚡ Notes**

- When the access lamp is lit or flashing, your camcorder is reading/writing data. Do not shake or knock your camcorder, turn the power off, eject the “Memory Stick Duo,” or remove the battery pack. Otherwise, image data may be damaged.
- When inserting or ejecting the “Memory Stick Duo,” be careful with the “Memory Stick Duo” from popping out and dropping.

# Recording

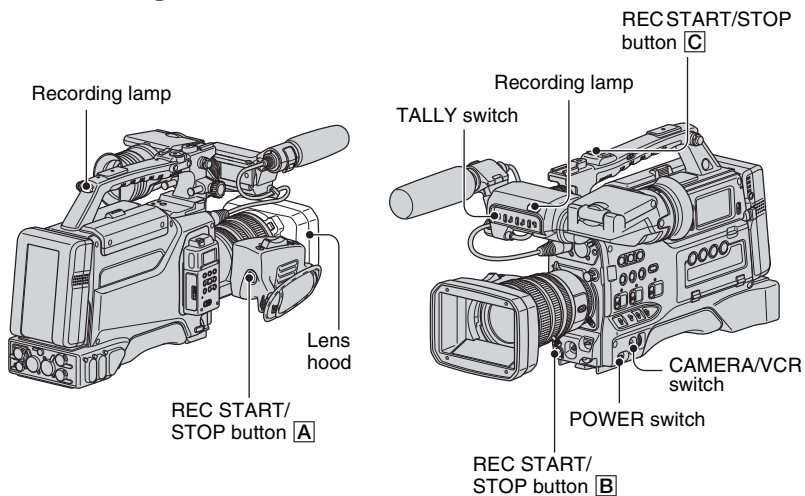

Your camcorder records movies on tape and still images on “Memory Stick Duo.” Do the following steps to record movies.

- This camcorder can record movies in HDV or DVCAM (DV) format. The factory setting is HDV format ([REC FORMAT] p. 81).

## 1 Open the shutter of the lens hood.

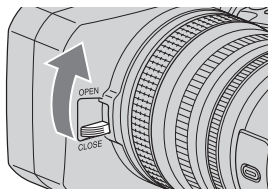

## 2 Set the POWER switch to ON and the CAMERA/VCR switch to CAMERA.

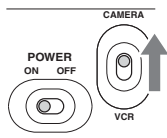

### 3 Press the REC START/STOP button **A** (or **B**, **C**).

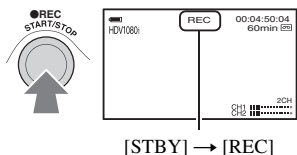

The recording lamp lights up during recording.

To stop the movie recording, press the REC START/STOP button again.

#### Tips

- When recording in HDV format, the aspect ratio is fixed to 16:9. When recording in DVCAM (DV) format, you can switch the aspect ratio to 4:3 ([DV WIDE REC] p. 83).
- You can change the screen display during recording (p. 59).
- Indicators displayed on the screen during recording are shown on page 128.
- To turn off the front recording lamp, set the TALLY switch to OFF. To turn off the rear recording lamp, set [REC LAMP[R]] (p. 91).
- You cannot record movies on a “Memory Stick Duo.”
- For low angle recording, the REC START/STOP button on the handle is convenient. Release the HOLD lever to enable the REC START/STOP button.

## Recording (Continued)

### To use the video light

Mount an Anton Bauer Ultralight 2 or equivalent (12-V supply voltage, 35-W maximum power consumption) as follows:

- ① Mount the video light on the accessory shoe on the handle of your camcorder.
- ② Connect the connector of the video light to the LIGHT connector of your camcorder.

#### ⚡ Notes

- Do not connect a video light, the power consumption of which is higher than 35W.

#### 💡 Tips

- You can turn on and off the video light linked with the start and stop recording when you connect the connector to the LIGHT connector and set the LIGHT MAN/AUTO switch to AUTO.

### To capture still images

- ① Assign [PHOTO] to an ASSIGN button.
- ② Press the ASSIGN button to which [PHOTO] is assigned.  
A still image will be recorded on the “Memory Stick Duo.”  appears when the recording is completed.

You can capture still images during movie recording.





#### ⚡ Notes

- You cannot store a still image under the following conditions:
  - When the shutter speed is slower than 1/50
  - While using the fader
  - While using smooth slow rec
  - While using shot transition
  - When [SCAN TYPE] is set to [25] (p. 82)

#### 💡 Tips

- See page 130 for indicators that appear on the screen during recording.

### Capacity of the “Memory Stick Duo” (MB) and the number of recordable pictures

	1.2M 1440 × 810 	0.9M 1080 × 810 	VGA 640 × 480 	0.2M 640 × 360 
256MB	370	500	1400	1750
512MB	760	1000	2850	3600
1GB	1550	2100	5900	7300
2GB	3150	4300	12000	15000
4GB	6300	8500	23500	29500
8GB	12500	17000	48000	60000

#### ⚡ Notes

- Specifications are for Sony “Memory Stick Duo.” The actual number of recordable pictures can vary depending on the recording environment and the type of “Memory Stick Duo.”

#### 💡 Tips

- Image sizes of still images are as follows:
  - Recording in HDV format/DVCAM (DV) format (16:9): 1.2M
  - Recording in DVCAM (DV) format (4:3): 0.9M
  - Playing back in HDV format: 1.2M
  - Playing back in DVCAM (DV) format (16:9): 0.2M
  - Playing back in DVCAM (DV) format (4:3): VGA

### To store still images captured from movies on a tape on “Memory Stick Duo”

You can capture an image in a movie and record it on a “Memory Stick Duo” as a still image. Be sure to insert a recorded tape and a “Memory Stick Duo” in your camcorder, Assign [PHOTO] to any one of ASSIGN buttons (p. 49).

- ① Set the POWER switch to ON and the CAMERA/VCR switch to VCR.

- ② Press the ► (play) button to search for the scene you want to save as a still image. Press the ASSIGN button to which [PHOTO] is assigned at the scene.

#### 🔍 Notes

- The recorded date and time on the tape and the stored date and time on the “Memory Stick Duo” are both saved on the “Memory Stick Duo.” When you view the still images, only the recorded date and time on the tape will be displayed on the screen (Data code, p. 59).
- Camera data stored on the tape will not be copied to the “Memory Stick Duo.”
- You cannot store a still image during using your camcorder with [PB ZOOM] set to [ON] (p. 90).

# Changing the settings of your camcorder recordings

## Adjusting the zoom

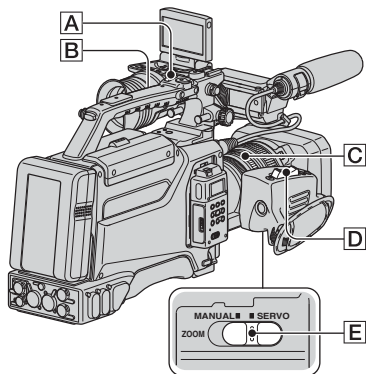

### Using the zoom lever

Set the ZOOM switch **E** to SERVO. Move the power zoom lever **D** slightly for a slower zoom. Move it further for a faster zoom.

**Wide view:** (Wide angle)

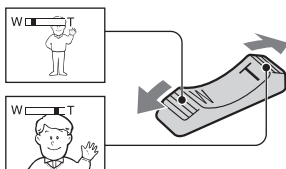

**Close view:** (Telephoto)

#### 💡 Tips

- The minimum distance required between your camcorder and the subject for focus is about 1 cm (about 13/32 in.) for wide angle and about 80 cm (about 2 5/8 feet) for telephoto.
- The focus may not be adjusted at certain zoom positions if the subject is within 80 cm (about 2 5/8 feet) from your camcorder.

- When you set [FOCUS MACRO] to [OFF] or the focus ring to the mode A position (p. 31), you cannot focus on a subject within 80 cm (about 2 5/8 feet) regardless of the zoom position (p. 71).
- Be sure to keep your finger on the power zoom lever **D**. If you move your finger off the power zoom lever **D**, the operation sound of the power zoom lever **D** may also be recorded.

### Using the handle zoom

- ① Set the ZOOM switch **E** to SERVO.
- ② Set the handle zoom switch **B** to VAR or FIX.

#### 💡 Tips

- When you set the handle zoom switch **B** to VAR, you can zoom in or out at variable speed.
  - When you set the handle zoom switch **B** to FIX, you can zoom in or out at fixed speed set in [HANDLE ZOOM] (p. 71).
- ③ Press the handle zoom lever **A** to zoom in or out.

#### ⚠ Notes

- You cannot use the handle zoom lever **A** when the handle zoom switch **B** is set to OFF.
- You cannot change the zoom speed of the zoom lever **D** with the handle zoom switch **B**.

### Using the zoom ring

You can zoom at the desired speed by turning the zoom ring **C**. Fine adjustment is also possible.

- ① Set the ZOOM switch **E** to MANUAL.
- ② Turn the zoom ring **C** to zoom in or out.

#### 💡 Tips

- You can remove the zoom pin.

## Adjusting the focus manually

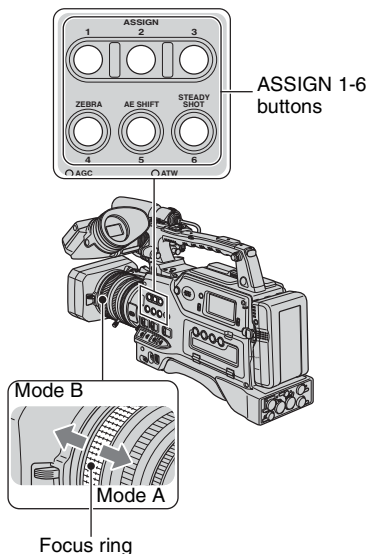

You can adjust the focus manually for different recording conditions. Use this function in the following cases.

- To record a subject behind a window covered with raindrops.
- To record horizontal stripes.
- To record a subject with little contrast between the subject and its background.
- When you want to focus on a subject in the background.

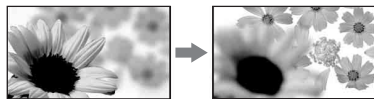

- To record a stationary subject using a tripod.

## Adjusting focus manually in mode A

In mode A, you can manually adjust focus without automatic adjustment functions. Set the focus ring to the mode A position and focus manually using the focus scale on the lens.

### Notes

- Turn the focus ring slowly. If it is forced against either end, the focus ring may move toward the mode B position and move past the end, and make noises.

## Adjusting focus manually in mode B

In mode B, you can use the automatic adjustment functions during manual focus adjustment. Set the focus ring to the mode B position and do the following steps.

- ① Assign [FOCUS] to an ASSIGN button (p. 49).
- ② Press the ASSIGN button to which [FOCUS] is assigned.  
☑ appears on the screen.
- ③ Turn the focus ring to adjust the focus.  
☑ changes to ▲ when you cannot bring any further subject in focus. ☑ changes to ■ when you cannot bring any closer subject in focus.

### Tips

For manual focus

- Zoom in and bring your camcorder in focus, then gradually zoom out.
- Fully zoom out and gradually zoom in when you shoot a close subject.

## To restore automatic adjustment

Press the ASSIGN button to which [FOCUS] is assigned once again. ☑ disappears and the automatic focus adjustment is restored.

## Changing the settings of your camcorder recordings (Continued)

### Tips



- If you want to adjust focus automatically or use automatic adjustment functions such as one push auto focus during manual focus adjustment, set the focus ring to mode B. You cannot use the automatic adjustment functions in mode A.

### Using automatic focus temporarily (One push auto focus)

You can use this function only in mode B. Do steps ① and ② of “Adjusting focus manually in mode B” in advance.

- ① Assign [ONE PUSH AF] to an ASSIGN button (p. 49).
- ② Record a movie while holding the ASSIGN button to which [ONE PUSH AF] is assigned. Automatic focus functions as long as you hold the ASSIGN button ( disappears).

### Tips

- The focal distance is always displayed while you turn the focus ring in mode A. In mode B, the focal distance is displayed for about 3 seconds in the following cases:
  - When you press the ASSIGN button to which [FOCUS] is assigned ( appears on the screen).
  - When you turn the focus ring while  is displayed on the screen.

The focal distance is not displayed when you use non-Carl Zeiss lenses.

### Using the expanded focus (Expanded focus)

During standby, press the ASSIGN button to which [EXP.FOCUS] is assigned. [EXPANDED FOCUS] appears and the center of the screen is magnified by about 2.0 times. It will be easier to confirm the focus setting during manual focusing. The screen returns to the original size when you press the button again.

### Notes

- You cannot use the expanded focus when [REC CTL MODE] in [EXT REC CTRL] is set to other than [OFF] (p. 84).
- The center of the screen is magnified by about 1.5 times when [SCAN TYPE] in [HDV PROGRE.] or [DV PROGRE.] of the  (IN/OUT REC) menu is set to [25].
- The screen returns to the original size when you start recording during the expanded focus display.

### Tips

- You can select a type of an expanded image displayed during the expanded focus ([EXP.FOCUS TYPE] p. 79).

### Focusing on a distant subject (Focus infinity)

#### Notes

- Focus infinity is available when the focus ring is set to the mode B position. It is not available during the auto focus.

- ① Assign [FOCUS INFNTY] to an ASSIGN button (p. 49).
- ② Press the ASSIGN button to which [FOCUS INFNTY] is assigned.
  - ▲ appears on the screen.

If you release the button, your camcorder returns to the manual focus mode. This function enables you to set focus on a distant subject even when the focus is automatically set on a close subject.

### Enhancing image detail for focusing (Peaking)

When you set the PEAKING switch to ON, the detail of an image on the screen is enhanced. This helps you to focus the image.

You can set the peaking sensitivity in [PEAKING] of  (DISPLAY SET) menu (p. 78).



## Notes

- Images, details of which are enhanced, will not be recorded on a tape or a "Memory Stick Duo."

## Tips

- You can focus an image more easily when you use this function with the expanded focus.

## Adjusting the exposure

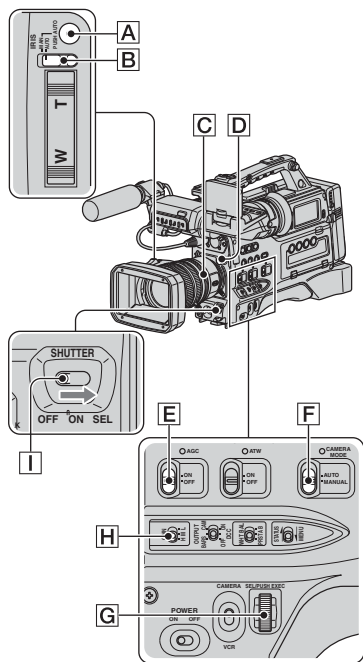

## Adjusting the iris

You can manually adjust the iris to control the volume of the light entering the lens. By adjusting the iris, you can change or close the aperture of the lens, which is expressed as an F value between F1.6 and F11. The volume of the light increases the more that you open the aperture (decreasing F value). The volume of the light decreases the more

that you close the aperture (increasing F value). The current F value appears on the screen.

- ① During recording or standby, set the CAMERA MODE switch **[F]** to MANUAL.
- ② Set the IRIS switch **[B]** to MAN.
- ③ Adjust the iris with the iris ring **[C]**. During the manual iris adjustment, you can temporarily return to the auto iris adjustment while holding down the PUSH AUTO button **[A]**.

## Tips

- The F value becomes close to F2.0 as the zoom position changes from W to T even when you open the aperture by setting the F value lower than F2.0, such as F1.6.
- The range of focus, an important effect of the aperture, is called the depth of field. The depth of field gets shallower as the aperture is opened, and deeper as the aperture is closed. Use the aperture creatively to obtain the desired effect in your photography.
- This is handy for making the background blurred or sharp.

## To adjust the iris automatically

Set the IRIS switch **[B]** or CAMERA MODE switch **[F]** to AUTO.

## Notes

- When you set the CAMERA MODE switch **[F]** to AUTO, other manually adjusted items (gain, shutter speed, white balance) also become automatic.

## Adjusting the volume of light (ND filter)

You can record the subject clearly by using the ND filter **[D]** when the recording environment is too bright. If you do not want to reduce the volume of light, use the ND filter 1. The ND filters 2, 3 and 4 reduce the volume of light to about 1/4, 1/16 and 1/64, respectively.

## Changing the settings of your camcorder recordings (Continued)

If the ND icon flashes during the iris automatic adjustment, set the ND filter **[D]** to the position that the icon indicates. The ND icon does not flash during the manual iris adjustment.

### 📌 Notes

- If you change the ND filters **[D]** during recording, the movie and sound may be distorted.
- **ND** will flash when your camcorder cannot detect the ND filter positions (1/2/3/4). Check the ND filter position.

### 💡 Tips

- While recording a bright subject, diffraction may occur if you close the aperture further down, resulting in a fuzzy focus (this is a common phenomenon with video cameras). The ND filter **[D]** suppresses this phenomenon and gives better recording results.

### Adjusting the gain

You can adjust the gain manually when you do not want to use the AGC (automatic gain control).

- ① Set the CAMERA MODE switch **[F]** to MANUAL during recording or standby.
- ② Set the AGC switch **[E]** to OFF.
- ③ Set the GAIN switch **[H]** to H, M or L. The gain value set for the selected GAIN switch position appears on the screen.

The gain value can set for each GAIN switch position from [GAIN SETUP] of the  (CAMERA SET) menu (p. 68).

### To adjust the gain automatically

Set the AGC switch **[E]** to ON, or set the CAMERA MODE switch **[F]** to AUTO. The lamps above the respective switches will turn on.

### 📌 Notes

- When you set CAMERA MODE switch **[F]** to AUTO, other manually adjusted items (iris, shutter speed, white balance) also become automatic.

### Adjusting the shutter speed

You can manually adjust and fix the shutter speed. You can make a moving subject look still or emphasize the movement of a moving subject by adjusting the shutter speed.

- ① During recording or standby, set the CAMERA MODE switch **[F]** to MANUAL.
- ② Set the SHUTTER switch **[I]** to ON. The denominator of the set shutter speed appears on the screen. For example, [100] appears on the screen when you set the shutter speed to 1/100 second. The larger the value on the screen, the faster the shutter speed.

Each time you push the SHUTTER switch **[I]** to SEL, the shutter speed mode changes in the following sequence:

Manual mode → Extended clear scan (ECS) mode → Slow shutter (SLS) mode → Auto mode → Manual mode ...

- ③ Adjust the shutter speed with the SEL/PUSH EXEC dial **[G]**. The adjustable shutter speed range varies depending on the shutter speed mode and the setting of [SCAN TYPE] ( (IN/OUT REC) menu → [HDV PROGRE.] or [DV PROGRE.]).

SCAN TYPE	[25]	[50]
Manual mode	1/50 - 1/10000 (sec.)	1/50 - 1/10000 (sec.)
ECS mode	25.00 - 200.0 (Hz)	50.00 - 200.0 (Hz)
SLS mode	1/3 - 1/25 (sec.)	1/3 - 1/25 (sec.)

## To adjust the shutter speed automatically

Push the SHUTTER switch **[I]** to SEL a few times to set to auto mode, or set the CAMERA MODE switch **[F]** to AUTO.

### Notes

- If you set the CAMERA MODE switch **[F]** to AUTO, other manually adjusted items (iris, gain, white balance) also become automatic.
- The shutter speed information will not be recorded during recording in the ECS mode.

### Tips

- Select the ECS mode if you want to obtain images with no horizontal bands of noise when you record subjects such as monitor screens.
- Select the slow shutter (SLS) mode if the subject is not well lit.
- The shutter speed is fixed to 1/50 when you set the SHUTTER switch **[I]** to OFF.
- It is difficult to focus automatically at a lower shutter speed. Sony recommends that you set up your camcorder on something stable such as a tripod, and manually adjust the focus.
- The picture may flicker or change colors under fluorescent lamps, sodium lamps or mercury lamps. You can reduce flickering by setting the shutter speed to an appropriate frequency in ECS mode.

## Adjusting to natural color (White balance)

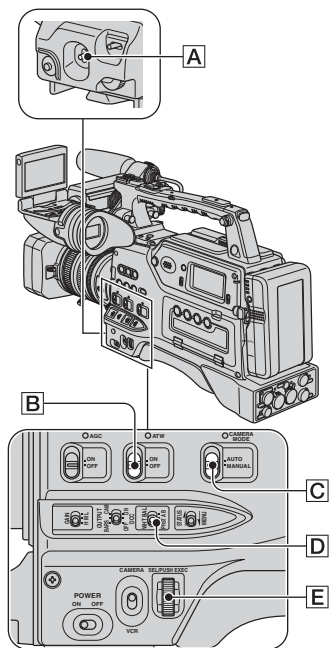





You can adjust and fix the white balance according to the lighting conditions of recording environment. You can store white balance values in memory A (A) and memory B (B), respectively. Unless a white balance is readjusted, values will remain even after the power has been turned off.

**1** During recording or standby, set the CAMERA MODE switch **[C]** to MANUAL.



**2** Set the ATW switch **[B]** to OFF.

### 3 Set the WHT BAL switch to any one of PRST/A/B.



Select A or B for recording with the white balance setting stored in memory A or B. Select PRST for recording with the white balance setting set in [OUTDOOR], [INDOOR] or [MANU WB TEMP], which you have selected in [WB PRESET] of the  (CAMERA SET) menu.

Indicator	Shooting conditions
 A (Memory A)	• White balance values adjusted for light sources can be stored in memory A and memory B. Follow the steps in “To save the adjusted white balance value in memory A or B” (p. 36).
 B (Memory B)	
 Outdoor ([OUTDOOR])	<ul style="list-style-type: none"> <li>• Recording sunset/sunrise, just after sunset or just before sunrise</li> <li>• Recording neon signs or fireworks</li> <li>• Under daylight color fluorescent lamps</li> </ul>
 Indoor ([INDOOR])	<ul style="list-style-type: none"> <li>• Under the lighting conditions that change in many ways, such as a party hall</li> <li>• Under strong light such as in a photography studio</li> <li>• Under sodium lamps or mercury lamps</li> </ul>
Color temperature ([MANU WB TEMP])	• Color temperature can be set between 2300K and 15000K (the default setting is 6500K).









#### Tips

- You can change the outdoor white balance setting by setting offset. Push the WHT/BLK switch  to WHT and turn the SEL/PUSH EXEC dial  to select an offset value from





-7 (bluish) to 0 (normal, the default setting) to +7 (reddish). Press the SEL/PUSH EXEC dial  to set the value. You can also set the white balance offset value from the menu ([WB OUTDR LVL] p. 68).

- You can change the color temperature when you set [WB PRESET] to [MANU WB TEMP] and the WHT BAL switch  to PRST. Push the WHT/BLK switch  to WHT. Turn the SEL/PUSH EXEC dial  until the desired temperature appears on the screen, then press the dial to set the temperature. You can also set the color temperature from the menu ([WB TEMP SET] p. 69).

### To save the adjusted white balance value in memory A or B

- ① Set the WHT BAL switch  to A () or B () in step 3 of “Adjusting to natural color (White balance).”
- ② Capture a white subject, such as white paper, full-screen in the same lighting condition as the one in which the subject is.
- ③ Push the WHT/BLK switch  to WHT.  
 A or  B starts flashing rapidly. It will stay on when the white balance adjustment is completed and the adjusted value is stored in  A or  B.

### To adjust the white balance automatically

Set the ATW switch  to ON or the CAMERA MODE switch  to AUTO. The lamp above the ATW switch  turns on when you set the ATW switch  to ON. The lamps above the respective switches will turn on when you set the CAMERA MODE switch  to AUTO.

#### Notes

- When you set the CAMERA MODE switch  to AUTO, other manual adjustments (iris, gain, and shutter speed) also become automatic.

## Adjusting the black balance

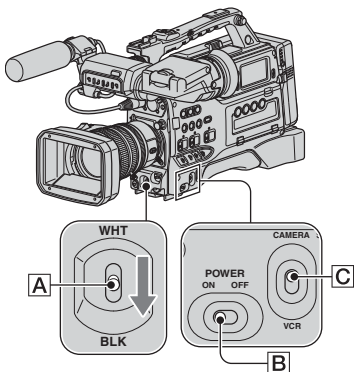

Normally, you do not need to adjust the black balance. The black balance may become off in some recording conditions. If that happens, adjust the black balance. The adjusted settings are stored only temporarily. The settings return to the default settings when you turn the power off and back on.

**1** Set the **POWER** switch **[B]** to **ON** and the **CAMERA/VCR** switch **[C]** to **CAMERA**.

**2** Push the **WHT/BLK** switch **[A]** to **BLK**.

The black balance adjustment starts. When the adjustment is completed, [Completed.] appears on the screen.

### If the black balance adjustment fails

Check that the iris is closed, then try the adjustment again.

### Notes

- You cannot adjust the black balance while the color bars are displayed.
- When using a non-Carl Zeiss lens, close the iris prior to the adjustment.

## Customizing the picture quality (Picture profile)

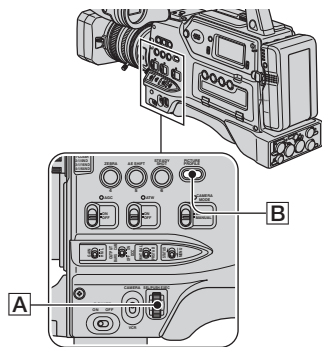

You can customize the picture quality by adjusting picture profile items such as [GAMMA] and [DETAIL]. Connect your camcorder to a TV or monitor, and adjust the picture quality while observing the picture on the TV or monitor screen. Picture quality settings for different recording conditions are stored in [PP1] through [PP6] as default settings.

### Notes

- When you set [x.v.Color] to [ON], the picture profile will be disabled.

Picture profile number (setting name)	Recording condition name
---------------------------------------	--------------------------

PP1 :USER	Default settings the same as when Picture Profile is [OFF]
--------------	--

## Changing the settings of your camcorder recordings (Continued)

Picture profile number (setting name)	Recording condition
PP2 :USER	Default settings the same as when Picture Profile is [OFF]
PP3 :PRO COLOR	Example settings of pictures recorded by a professional shoulder camcorder with ITU-709 gamma
PP4 :PD COLOR	Example settings of pictures recorded by a professional handy camcorder with PD gamma
PP5 :FILM LOOK1	Example settings of pictures recorded on cinema color negative film
PP6 :FILM LOOK2	Example settings of pictures screened with cinema color print film

**1** During standby, press the **PICTURE PROFILE** button **[B]**.

**2** Select a picture profile number with the **SEL/PUSH EXEC** dial **[A]**.

You can record with the settings of the selected picture profile.

**3** Select **[OK]** with the **SEL/PUSH EXEC** dial **[A]**.

### To cancel the picture profile recording

Select **[OFF]** in step **2** with the **SEL/PUSH EXEC** dial **[A]**.

### To change the picture profile

You can change the settings stored in [PP1] through [PP6].

- ① Press the **PICTURE PROFILE** button **[B]**.
- ② Select the **PICTURE PROFILE** number with the **SEL/PUSH EXEC** dial **[A]**.
- ③ Select **[SETTING]** with the **SEL/PUSH EXEC** dial **[A]**.
- ④ Select an item to be adjusted with the **SEL/PUSH EXEC** dial **[A]**.
- ⑤ Adjust the picture quality with the **SEL/PUSH EXEC** dial **[A]**.
- ⑥ Repeat steps ④ and ⑤ to adjust other items.
- ⑦ Select **[↵ RETURN]** with the **SEL/PUSH EXEC** dial **[A]**.
- ⑧ Select **[OK]** with the **SEL/PUSH EXEC** dial **[A]**.  
A picture profile indicator appears.

#### **Tips**

- You can assign picture profiles to the **ASSIGN** buttons and use them to turn the picture profiles on and off (p. 49).

## BLACK LEVEL

To set the black level.

Item	Description and settings
[MASTER BLACK]	Sets the master black level. -15 to +15
[BLACK R]	Sets the black level of Rch. [MASTER BLACK] + [BLACK R] is the black level of Rch. -15 to +15
[BLACK G]	Sets the black level of Gch. [MASTER BLACK] + [BLACK G] is the black level of Gch. -15 to +15
[BLACK B]	Sets the black level of Bch. [MASTER BLACK] + [BLACK B] is the black level of Bch. -15 to +15

## GAMMA

To select a gamma curve.

Item	Description and settings
[STANDARD]	Standard gamma curve
[CINEMATONE1]	Gamma curve 1 for producing tone of film camera images
[CINEMATONE2]	Gamma curve 2 for producing tone of film camera images
[ITU709]	Gamma curve that corresponds to ITU-709 . Gain in low intensity area: 4.5
[G5.0]	Gamma curve with 5.0 of a low intensity area gain
[PD]	Gamma curve for producing tone similar to DCR-PD series
[x.v.]	Gamma curve similar to x.v.Color

## BLACK GAMMA

To correct gamma in low intensity area.

Item	Description and settings
[RANGE]	Selects a correcting range. HIGH / MIDDLE / LOW
[LEVEL]	Sets the correcting level. -7 (maximum black compression) to +7 (maximum black stretch)

## Changing the settings of your camcorder recordings (Continued)

### KNEE

To set knee point and slope for video signal compression to reduce over-highlighting by limiting signals in high contrast area of the subject to the dynamic range of your camcorder. When you set the OUTPUT/DCC switch to ON, [KNEE] is automatically adjusted.

Item	Description and settings
[AUTO SET]	Available when you set the OUTPUT/DCC switch to ON Sets the maximum point and sensitivity in the automatic mode. [MAX POINT] : Sets the maximum point. 90% ~ 100% [SENSITIVITY] : Sets the sensitivity. HIGH/MIDDLE/LOW
[MANUAL SET]	Available when you set the OUTPUT/DCC switch to OFF Sets the knee point and slope manually. [POINT] : Sets the knee point. 75% ~ 105% [SLOPE] : Sets the knee slope. -5(gentle) ~ +5(steep)

### COLOR MODE

To set type and level of colors.

Item	Description and settings
[TYPE]	Selects a type of colors. [STANDARD] : Standard colors [CINEMATONE1]: Film camera image-like colors good with [GAMMA] set to [CINEMATONE1] [CINEMATONE2]: Film camera image-like colors good with [GAMMA] set to [CINEMATONE2] [ITU709 MTX] : Colors corresponding to ITU709
[LEVEL]	Sets a color level when you set [TYPE] to the settings other than STANDARD]. 1 (close to color settings of [STANDARD]) - 8 (color settings of the selected type)

### COLOR LEVEL

To set the color level.

Item	Description and settings
	-7 (light) to +7 (dark), -8: black and white

### COLOR PHASE

To set the color phase.

Item	Description and settings
	-7 (greenish) to +7 (reddish)



## COLOR DEPTH

To set the color depth for each color phase.

This function is more effective for deep colors and less effective for light colors. The color looks deeper as you increase the setting value to more positive side, and lighter as you decrease the value to more negative side. This function is effective even if you set [COLOR LEVEL] to [-8] (monotone).

Item	Description and settings
[R]	-7 to +7 (depth of red)
[G]	-7 to +7 (depth of green)
[B]	-7 to +7 (depth of blue)
[C]	-7 to +7 (depth of cyan)
[M]	-7 to +7 (depth of magenta)
[Y]	-7 to +7 (depth of yellow)

## COLOR CORRECT

To set items for the color correction.

Item	Description and settings
[TYPE]	<p>Selects color correction type.</p> <p>[OFF] : Not correct colors.</p> <p>[COLOR REVISN] : Corrects colors stored in memory. Colors not stored in memory (displayed in black and white when [COLOR EXTRCT] is set) will not be corrected.</p> <p>[COLOR EXTRCT] : Displays areas in colors that are stored in the memory. The other areas are displayed in black and white. You can use this function to add effects on your movies or to confirm the colors to be stored in the memory.</p>
[MEMORY SEL]	<p>Selects a memory to be effective.</p> <p>[1]: Sets Memory 1 to be effective.</p> <p>[2]: Sets Memory 2 to be effective.</p> <p>[1&amp;2]: Sets both Memory 1 and 2 to be effective.</p>

## Changing the settings of your camcorder recordings (Continued)

### COLOR CORRCT (Continued)

Item	Description and settings
[MEM1 COLOR]	Sets colors stored in Memory 1. [PHASE] : Sets color phase. 0 (purple) → 8 (red) → 16 (yellow) → 24 (green) → 31 (blue) [RANGE] : Sets color phase range. 0 (no color selection), 1 (narrow: to select only a single color) to 31 (wide: to select multiple colors in similar color phase) [SATURATION] : Sets saturation. 0 (to select from light colors to dark colors) to 31 (to select dark color) [ONE PUSH SET]: Automatically sets [PHASE] for a subject at the center of the marker. [SATURATION] is set to 0.
[MEM1 REVISN]	Corrects colors in Memory 1. [R GAIN] : Corrects the redness of the color in Memory 1. Tone of cyan becomes higher as the redness decreases. -15 (less reddish) to +15 (more reddish) 0 for no correction [B GAIN] : Corrects the blueness of the color in Memory 1. Tone of yellow becomes higher as the blueness decreases. -15 (less bluish) to +15 (more bluish) 0 for no correction
[MEM2 COLOR]	Sets colors stored in Memory 2. See [MEM1 COLOR] for description and settings.
[MEM2 REVISN]	Corrects colors in Memory 2. See [MEM1 REVISN] for description and settings.

#### Tips

- Setting both memories to the same setting doubles the color correction effect.
- The settings of [COLOR CORRCT] will be retained even if the power is turned off. However, if you want to correct colors that may change according to time of the day, weather, location, etc., it is recommended that you set [COLOR CORRCT] again prior to recording.
- If you change the white balance value or the settings of [WB SHIFT], [COLOR LEVEL] or [COLOR PHASE] of the picture profile, the settings of [RANGE] and [PHASE] of the selected memory will change. When you change the white balance value or the settings of the above picture profile items after you have set [RANGE] and [PHASE], check the settings of [COLOR CORRCT] prior to recording.
- During the automatic white balance adjustment, the white balance value automatically varies according to the lighting conditions of your recording environment. The manual white balance adjustment is recommended when you use [COLOR CORRCT].

## WB SHIFT

To set items for the white balance shift.

Item	Description and settings
[FILTER TYPE]	Selects a color filter type for the white balance shift. [LB-CC] : Film type (color conversion and correction) [R-B] : Video type (correction of R and B levels)
[LB[COL TEMP]]	Sets a color temperature offset value. -9 (bluish) to +9 (reddish)
[CC[MG/GR]]	Sets a color correct offset value. -9 (greenish) to +9 (magentish)
[R GAIN]	Sets an R level. -9 (low R level) to +9 (high R level)
[B GAIN]	Sets a B level. -9 (low B level) to +9 (high B level)

## DETAIL

To set items for the detail.

Item	Description and settings
[LEVEL]	Sets the detail level. -7 to +7
[MANUAL SET]	[ON/OFF] : Turns on and off the manual detail adjustment. [ON] : Enables the manual detail adjustment (automatic optimization will not be performed). [OFF] : Disables the manual detail adjustment.
[V/H BALANCE]	Sets the horizontal (H) and vertical (V) balance of detail.
[B/W BALANCE]	Selects the balance of the upper DETAIL (P) and the lower DETAIL (N). TYPE 1 (off to the lower DETAIL (N) side) TYPE 5 (off to the upper DETAIL (P) side)
[BLACK LIMIT]	Sets the limit level of the lower DETAIL (N). 0 (Low limit level: likely to be limited) to 7 (High limit level: not likely to be limited)
[WHITE LIMIT]	Sets the limit level of the upper DETAIL (P). 0 (Low limit level: likely to be limited) to 7 (High limit level: not likely to be limited)
[CRISPENING]	Sets the crispening level. 0 (shallow crispening level) to 7 (deep crispening level)
[HI-LIGHT DTL]	Sets the DETAIL level in the high intensity areas. -2 to +2

## Changing the settings of your camcorder recordings (Continued)

### SKINTONE DTL

To adjust the detail of skintone areas to reduce wrinkles.

Item	Description and settings
[ON/OFF]	Suppresses details in skin-tone areas to reduce wrinkles. Select [ON] when you want to use this function. You can also select other areas.
[LEVEL]	Sets the adjustment level. 1 (less adjust the detail) to 8 (more adjust the detail)
[COLOR SEL]	Sets color items for the detail adjustment. [PHASE] : Sets the color phase. 0 (purple) → 32 (red) → 64 (yellow) → 96 (green) → 127 (blue) [RANGE] : Sets the color range. 0 (selects no color), 1 (narrow: selects a single color) to 31 (wide: selects multiple colors in similar color phases and saturation) The detail will not be adjusted when you set [RANGE] to 0. [SATURATION] : Sets the color saturation. 0 (selects a light color) to 31 (selects a deep color) [REVERSE] : Reverses the selected color range. If you execute this function when a color has been selected, colors that were not selected will be selected instead. [Y LEVEL] : Sets the color brightness. 0 (selects a dark color) to 31 (selects a bright color) [Y RANGE] : Sets the color brightness range. 1 (narrows the brightness range) to 32 (expands the brightness range) [ONE PUSH SET]: Automatically adjusts [PHASE], [SATURATION] and [Y LEVEL] for a subject at the center of the marker. [RANGE] and [Y RANGE] will not be changed.

### PROFILE NAME

To name the picture profiles set in [PP1] through [PP6] (p. 45).

### COPY

To copy the settings of the picture profile to another picture profile number.

### RESET

To reset the picture profile to the default setting.

## To name the picture profile settings

You can name picture profile1 through 6.

- ① Press the PICTURE PROFILE button **[B]**.
- ② Select the picture profile that you want to name with the SEL/PUSH EXEC dial **[A]**.
- ③ Select [SETTING] → [PROFILE NAME] with the SEL/PUSH EXEC dial **[A]**.
- ④ Select a letter with the SEL/PUSH EXEC dial **[A]**. Repeat this operation until a complete name is entered.

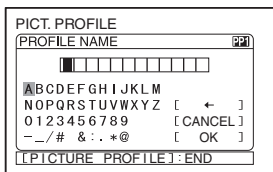

### Tips

- Each name can be up to 12 characters long. Characters that can be used in profile names:
  - A to Z
  - 0 to 9
  - - \_ / # & : . \* @

- ⑤ Select [OK] with the SEL/PUSH EXEC dial **[A]**.  
The profile name is changed.
- ⑥ Select [↵ RETURN] → [OK] with the SEL/PUSH EXEC dial **[A]**.

## To copy the picture profile setting to other picture profiles

- ① Press the PICTURE PROFILE button **[B]**.
- ② Select the picture profile that you want to copy from with the SEL/PUSH EXEC dial **[A]**.
- ③ Select [SETTING] → [COPY] with SEL/PUSH EXEC dial **[A]**.

- ④ Select the number of the picture profile that you want to copy to with the SEL/PUSH EXEC dial **[A]**.
- ⑤ Select [YES] with the SEL/PUSH EXEC dial **[A]**.
- ⑥ Select [↵ RETURN] → [OK] with the SEL/PUSH EXEC dial **[A]**.

## To reset the picture profile settings

You can reset the picture profile settings by each picture profile number. You cannot reset all picture profile settings at once.

- ① Press the PICTURE PROFILE button **[B]**.
- ② Select the number of the picture profile that you want to reset with the SEL/PUSH EXEC dial **[A]**.
- ③ Select [SETTING] → [RESET] → [YES] → [↵ RETURN] → [OK] with the SEL/PUSH EXEC dial **[A]**.

## Changing the settings of your camcorder recordings (Continued)

### Adjusting the volume

You can adjust the volume of a microphone connected to the AUDIO INPUT1 (L) jack through the AUDIO INPUT4 jack.

Set the number of channels to be recorded from [HDV 2CH/4CH] (for HDV, p. 75) or [DV AU.MODE] (for DVCAM (DV), p. 75) of the  (AUDIO SET) menu.

### ■ 2CH/FS48K recording

You can select audio input to be recorded on the audio track of a tape.

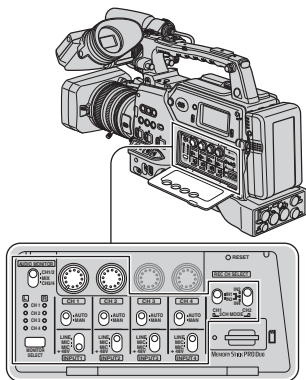

① Set the REC CH SELECT switch.

REC CH SELECT

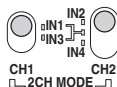

Select the recording audio input to CH1 with CH1 of the REC CH SELECT switch.

IN1: Records the audio input from the AUDIO INPUT1 (L) jack.

IN3: Records the audio input from the AUDIO INPUT3 jack.

Select the recording audio input to CH2 with CH2 of the REC CH SELECT switch.

IN2: Records the audio input from the AUDIO INPUT2 (R) jack.

Center: Records the audio input from the AUDIO INPUT jack selected with CH1 switch.

IN4: Records the audio input from the AUDIO INPUT4 jack.

### ⚡ Notes

- For stereo recording, set your camcorder to record the left-side sound in CH1 and the right-side sound in CH2.

### 💡 Tips

- Sony recommends that you set CH2 of the REC CH SELECT switch to the center position in the following cases:
  - To avoid no audio input to CH2 by recording the same audio input with that inputted to CH1.
  - To record different audio inputs from the same audio source simultaneously with different audio settings to make the audio recording reliable. For example, you can set the audio level manually for the audio input to CH1 and automatically for that to CH2, and record the inputs in the respective channels.

② Set the INPUT1/2/3/4 switch.

If your microphone needs a power supply, set the INPUT1/2/3/4 switch to MIC+48V. If it does not need a power supply, set to MIC.

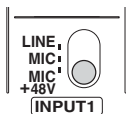

### ⚡ Notes

- Setting the INPUT1/2/3/4 switch to MIC+48V when a microphone that does not need a power supply is attached may damage the microphone or impair the sound recording quality.

### 💡 Tips

- Set the INPUT1/2/3/4 switch to MIC+48V when using the supplied microphone.
- ③ Set the level of input to be recorded on each audio track.

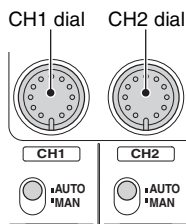

If you want to adjust the recording volume automatically, set the CH1 and CH2 switches to AUTO. If you want to adjust it manually, set the switches to MAN. When you set the switches to MAN,  $\text{JM}$  appears on the screen. The CH switch numbers you set to MAN appear on the right of the icon ( $\text{JM}$ ). You can adjust the volume when the switches are set to MAN by turning the CH1 and CH2 dials.

### 🔊 Notes

- Set the INPUT switches for the respective AUDIO INPUT jacks, and the CH switches for the corresponding recording tracks on a tape.

### Example of 2CH recording (recording audio input from INPUT1 and INPUT4)

- ① Set CH1 of the REC CH SELECT switch to IN1 and CH2 to IN4.

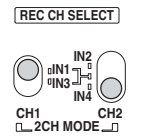

- ② Set the INPUT1 and INPUT4 switches.
- For example, set the INPUT1 switch to MIC+48V and the INPUT4 switch to MIC when the supplied microphone is

connected to the AUDIO INPUT1 (L) jack, or a microphone that does not need a power supply is connected to the AUDIO INPUT4 jack, as illustrated.

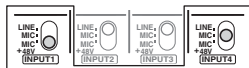

- ③ Set the CH1 and CH2 switches.
- For example, set the CH1 switch to AUTO and the CH2 switch to MAN to adjust the recording level of CH1 automatically and that of CH2 manually.

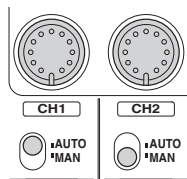

### 💡 Tips

- You cannot adjust the recording levels of CH3 and CH4 during 2-channel recording.

## Changing the settings of your camcorder recordings (Continued)

### ■ 4CH/FS32K recording

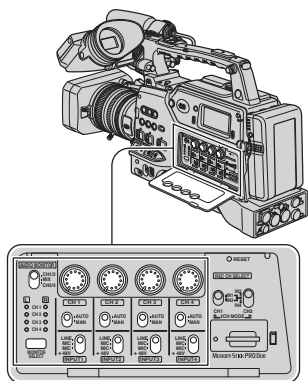

In 4-channel recording, the recording channels are designated to their respective input channels, as shown in the following table. You cannot select the channels.

The settings of REC CH SELECT switch become ineffective.

Input	Recording channel
INPUT1	→ CH1
INPUT2	→ CH2
INPUT3	→ CH3
INPUT4	→ CH4

### Monitor the recording sound

You can select audio output via headphones or line-out.

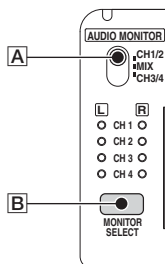

Select the channels with the AUDIO MONITOR switch **A** and the MONITOR SELECT button **B**.

The lamps of the selected output channels light up.



# Assigning the functions to the ASSIGN buttons

Some functions need to be assigned to the ASSIGN buttons for use. You can assign a single function to any one of the ASSIGN 1 to 6 buttons on the body or the L1, L2 and RET buttons on the lens.

## Notes

- The following functions cannot be assigned to the RET button.
  - FOCUS (for changing between automatic focus and manual focus)
  - ONE PUSH AF
  - FOCUS INFNTY
  - FOCUS MACRO
  - STEADYSHOT

## Tips

- The RET button is an assignable button on non-Carl Zeiss lenses.

## Functions you can assign to the ASSIGN buttons

The buttons in parentheses indicate that the functions are assigned to the buttons by default.

- FOCUS (p. 31)
- EXP.FOCUS (p. 32)
- ONE PUSH AF (p. 32)
- FOCUS INFNTY (p. 32)
- FOCUS MACRO (p. 71)
- D.EXTENDER (p. 71) (L1 button)
- HYPER GAIN (p. 68)
- AE SHIFT (p. 69) (ASSIGN 5 button)
- INDEX MARK (p. 50)
- STEADYSHOT (p. 71) (ASSIGN 6 button)
- BACK LIGHT (p. 70)
- SPOTLIGHT (p. 70)
- FADER (p. 71)
- LAST SCN RVW (p. 51)
- REC REVIEW (p. 51) (L2 or RET button)
- END SEARCH (p. 51)
- ZEBRA (p. 77) (ASSIGN 4 button)
- MARKER (p. 78)
- DISPLAY (p. 59)
- TC RESET (p. 85)
- TC COUNTUP (p. 85)
- PHOTO (p. 28)

- REC LAMP[R] (p. 91)
- PICTURE PROFILE (p. 37)

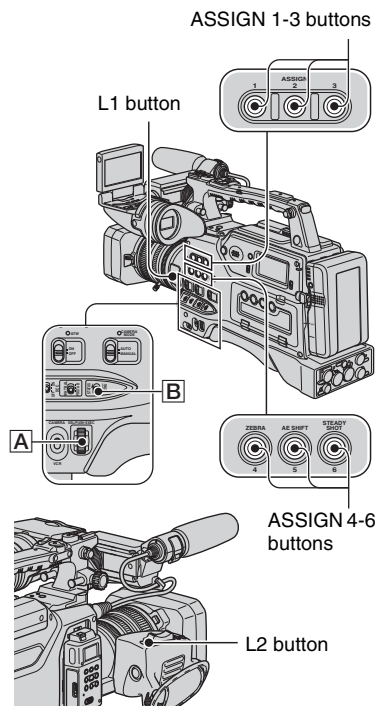

- 1** Push the MENU/STATUS switch **[B]** to MENU.
- 2** Select the **[OTHERS]** → **[ASSIGN BTN]** with the SEL/PUSH EXEC dial **[A]**.
- 3** Select **[CAMERA]** or **[LENS]**, whichever the ASSIGN button to which you want to assign a

## Assigning the functions to the ASSIGN buttons (Continued)

function is located, with the SEL/PUSH EXEC dial .

---

**4** Select the ASSIGN button to which you want to assign a function with the SEL/PUSH EXEC dial .

- You can select the ASSIGN 1 through 6 buttons on the body and the L1, L2 and RET button on the lens.
- [-----] appears if no function is assigned to the ASSIGN button.

---

**5** Select the function that you want to assign with the SEL/PUSH EXEC dial .

---

**6** Select [OK] with the SEL/PUSH EXEC dial .

---

**7** Select [RETURN] with the SEL/PUSH EXEC dial .

---

**8** Push the MENU/STATUS switch  to MENU to hide the menu screen.

---

### Recording an index signal

When you record a scene with an index signal, you can easily find the scene during playback on a device that supports this function.

The index function will make it easier to check the transition of recording or edit your pictures using index signals.

---

**1** Assign [INDEX MARK] to one of the ASSIGN buttons (p. 49).

---

**2** Press the ASSIGN button to which [INDEX MARK] is assigned.  
During recording

 appears for about 7 seconds and an index signal is recorded.

During standby

 flashes.

After you press the REC START/STOP button to start recording,  appears for about 7 seconds and an index signal is recorded.

---

### To cancel the operation

Press the ASSIGN button to which [INDEX MARK] is assigned again before you start recording.

#### Notes

- You cannot record an index signal on a recorded tape afterward.

## Reviewing the most recently recorded scenes (Rec review)

You can view about 2 seconds of the scene recorded just before you stopped the tape. This is convenient during playback of the latest scene check.

---

**Press the REC REVIEW button or the ASSIGN button to which [REC REVIEW] is assigned during standby.**

The last 2 seconds (approx.) of the most recently recorded scenes will be played back, then your camcorder returns to standby.

---

## Searching for the last scene of the most recent recording (End search)

---

**1 Assign [END SEARCH] to one of the ASSIGN buttons (p. 49).**

---

**2 Press the ASSIGN button to which [END SEARCH] is assigned.**

The last scene of the most recent recording will be played back for about 5 seconds, and the camcorder goes standby at the point where the last recording has finished.

---

### Notes

- End search will not work once you eject the tape.

- End search will not work correctly if a blank section exists between recorded sections on the tape.

## Playing back the most recently recorded movies (Last scene review)

You can set your camcorder to automatically rewind the tape to the beginning of the most recently recorded scene, play back to the end of the scene, then stop the tape.

---

**1 Assign [LAST SCN RVW] to an ASSIGN button (p. 49).**

---

**2 During standby, press the ASSIGN button to which [LAST SCN RVW] is assigned.**

The last scene review starts.

---

### Notes

- If the recording time of the movie is short, [LAST SCN RVW] may not work correctly.

### Tips

- If you press the ASSIGN button again during the last scene review, your camcorder plays back the last 5 seconds of the most recently recorded movie, then goes standby at the end of the recording.

# Using the Shot transition

You can store settings of focus, zoom, iris, gain, shutter speed and white balance, and smoothly shift from the current settings to the stored settings (shot transition).

For example, you can shift the focus from closer objects to farther objects, or change the depth of field by adjusting the iris. You can also develop scenes under different conditions smoothly. If you store manually adjusted settings of white balance, you can smoothly shift from one scene to another under different conditions, such as from indoor to outdoor.

Sony recommends that you use a tripod to avoid image blurring.

You can set the following items in [SHOT TRANSITION] of the  (CAMERA SET) menu (p. 73).

Item	Description and settings
TRANS TIME	Setting of transition time (the default setting is [4.0sec]) You can set the transition time by 0.5 sec between [3.5sec] and [15.0sec], or select from [20sec], [30sec], [45sec] and [60sec].
START TIMER	Setting of timer to start shot transition (the default setting is [OFF]) You can select from [5sec], [10sec] and [20sec].

Item	Description and settings
REC LINK	Setting of transition linked with start of recording (the default setting is [OFF]) [OFF]: Not to start transition when the recording is started. [SHOT-A]: To start transition to the SHOT-A when the recording is started. [SHOT-B]: To start transition to the SHOT-B when the recording is started.
FOCUS TRANS	Setting ([ON]/[OFF]) of focus transition (the default setting is [ON])
ZOOM TRANS	Setting ([ON]/[OFF]) of zoom transition (the default setting is [ON])
IRIS TRANS	Setting ([ON]/[OFF]) of iris transition (the default setting is [ON])

## 🔊 Notes

- You cannot manually adjust the focus, zoom, iris, gain, shutter speed and white balance while the CHECK or EXEC lamp is on. You can manually adjust the focus, zoom and iris, even the CHECK or EXEC lamp is on when you set [FOCUS TRANS], [ZOOM TRANS] and [IRIS TRANS] to [OFF], respectively.
- When [EXT REC CTRL] is set to [EXT ONLY], setting [REC LINK] (linked recording) to [SHOT-A] or [SHOT-B] links the start of transition to the start of recording on an external device (HVR-MRC1 or HVR-DR60).

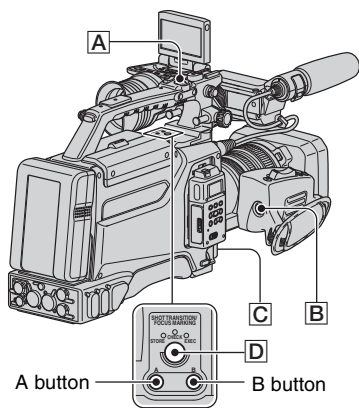

**1** Set [S.TRANS/F.MARK] of the (CAMERA SET) menu to [SHOT TRANSITION].

**2** Press the SHOT TRANSITION/ FOCUS MARKING button **D** to bring up the shot transition store screen.

The STORE lamp turns on.

**3** Press the **A** button to store the settings in SHOT-A, or the **B** button to store the settings in SHOT-B.

**Notes**

- The settings stored in SHOT-A or SHOT-B will be erased when you set the POWER switch to OFF.

**4** Press the SHOT TRANSITION/ FOCUS MARKING button **D** again to bring up the shot transition check screen.

The CHECK lamp turns on.

Press the **A** button to check SHOT-A, or the **B** button to check SHOT-B. The image will be displayed with the settings stored in the selected SHOT. The focus, zoom, iris, gain, shutter speed and white balance are automatically adjusted to the stored settings.

**Notes**

- The settings do not shift to the stored settings with the transition time set in [TRANS TIME] (p. 52).

**5** Press SHOT TRANSITION/FOCUS MARKING button **D** again to bring up the shot transition execution screen.

The EXEC lamp turns on.

**6** Press the REC START/STOP button **A** (**B** or **C**).

Press the **A** button for recording with SHOT-A, or the **B** button for recording with SHOT-B.

The settings shift from the current ones to the stored ones.

**Notes**

- When you change [SHOT TRANSITION] (p. 52), press the SHOT TRANSITION/FOCUS MARKING button repeatedly to exit the shot transition screen.
- You cannot return from the stored SHOT-A or SHOT-B settings to previous settings after you execute the shot transition during recording.

## Using the Shot transition (Continued)

- If you use the following buttons and switch during the shot transition operation, the shot transition will be canceled:
  - PICTURE PROFILE button
  - MENU/STATUS switch
  - ASSIGN button to which [EXP.FOCUS] is assigned
- You can also make a transition from the SHOT-A to the SHOT-B or from the SHOT-B to the SHOT-A. For example, to make a transition from the SHOT-A to the SHOT-B, display the shot transition check screen, press the A button to bring up the SHOT-A and press the REC START/STOP button. Then, display the shot transition execution screen and press the B button.
- You can rehearse the shot transition by pressing the respective buttons (A or B) to which your customized settings are assigned before pressing the REC START/STOP button in step 6.
- You cannot use the shot transition when you use a non-Carl Zeiss lens.
- The settings stored in the memory (SHOT-A/SHOT-B) are cleared when you remove the Carl Zeiss lens, or you adjust the flange focal length.

### To cancel the operation

Press the SHOT TRANSITION/FOCUS MARKING button  repeatedly to exit the shot transition screen.

# Marking focal point on the screen (Focus marking)

You can mark a focal point, at which you set a subject in focus, on the LCD screen prior to the recording. You can use this function during the manual focus.

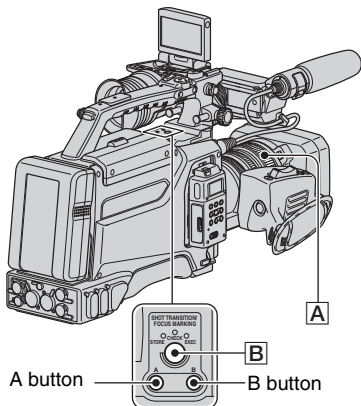

**1** Set [S.TRANS/F.MARK] of the  (CAMERA SET) menu to [FOCUS MARKING].

**2** Press the SHOT TRANSITION/ FOCUS MARKING button .

The focus marking bar appears at the bottom of the screen.

**3** Adjust the focus by turning the focus ring  and set a focal point.

A cursor on the focus marking bar moves as you turn the focus ring.

**4** Press the A button for marking a focal point at position A or the B button for marking a focal point at position B.

When you press the A button, ▼ and A appear on the focus marking bar. When you press the B button, ▲ and B appear on the focus marking bar.

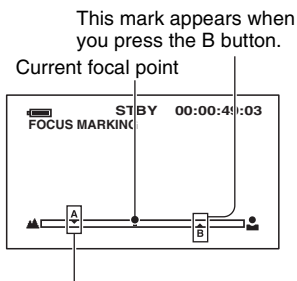

This mark appears when you press the A button.

The color of the marks changes when position A or B matches the current focal point.

## Notes

- The focus marking function does not work when [FOCUS MACRO] is set to [ON].
- You cannot use the focus marking when you use a non-Carl Zeiss lens. Marking positions A and B will be cleared when you dismount the lens or turn off the power.

## Tips

- You can use the focus marking function during the expanded focus.

# Playback

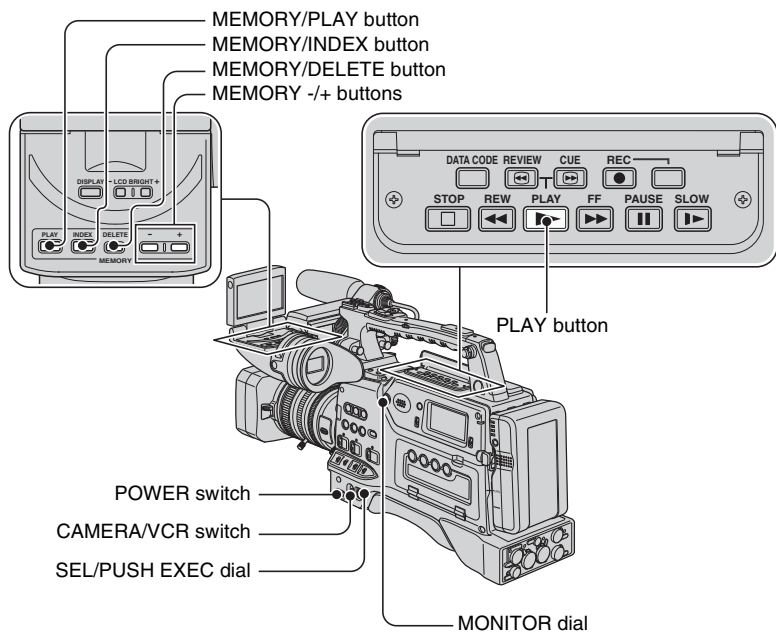

You can play back movies as follows:

## 1 Set the POWER switch to ON and the CAMERA/VCR switch to VCR

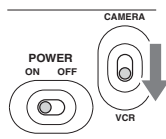

## 2 Start playing back.

Press ◀◀ (rewind) to go to the point you want to view, then press ▶▶ (play) to start playback.

- ■ : STOP
- || : PAUSE (Press ▶▶ or || again to restart the playback)
- ◀◀/▶▶ : REW (Rewind)/FF (Forward)
- ◀◀/▶▶ : REVIEW/CUE
- ▶▶ : SLOW



## Notes

- Your camcorder automatically goes into a stopped state when it is in pause for more than 3 minutes.
- The screen may temporarily go blank losing images and sound when signals switch between HDV and DVCAM (DV) during playback of a tape in which HDV format and DVCAM (DV) format are mixed.
- You cannot play back movies recorded in HDV format on DVCAM (DV) format video cameras or mini DV players.
- You can play back a DV format tape on your camcorder only when its contents are recorded in the SP mode. You cannot play back movies recorded on the DV format tape in the LP mode.
- Time code and user bits will not be displayed correctly when you play back a tape with no time code or user bit data, or a tape with time code that your camcorder does not support.

## Tips

- See page 130 for indicators displayed on the screen during playback.
- See page 59 for how to switch displays during playback.

## To search for a scene while viewing a movie

Press **◀/▶** during playback (Picture Search). To view during fast forward, press and hold **▶▶**. To view during rewind, press and hold **◀◀** (Skip Scan).

## To adjust the volume

Adjust the volume with the MONITOR dial.

## To view still images

- ① Set the POWER switch to ON and the CAMERA/VCR switch to VCR.
- ② Press the MEMORY/PLAY button.
- ③ Select a still image that you want to view using the MEMORY +/- button.  
To stop viewing still images, press the MEMORY/PLAY button again.

## To display the list of still images (index screen)

- ① Set the POWER switch to ON and the CAMERA/VCR switch to VCR.
- ② Press the MEMORY/INDEX button.

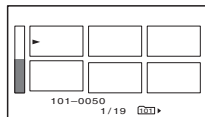

- ③ Select a still image using the MEMORY +/- button.  
To display a single image, move **▶** to that image and press the MEMORY/PLAY button.  
To stop displaying the list of still images, press the MEMORY/INDEX button again.



### To delete still images from the “Memory Stick Duo”

- ① Do the steps of “To view still images” to display still images that you want to delete.
- ② Press the MEMORY/DELETE button.
- ③ Select [YES] with the SEL/PUSH EXEC dial.  
The still image will be deleted.

#### Notes

- Still images cannot be restored once you delete them.
- You cannot delete still images when the “Memory Stick Duo” is write-protected (p. 110) or the still image is protected (p. 98).

#### Tips

- To delete a still image in the index, move ► to the still image using the VOLUME/MEMORY button, then do steps ② and ③.
- To delete all still images, do [  ALL ERASE ] of the  (MEMORY SET) menu (p. 87).

# Changing/checking the settings in your camcorder

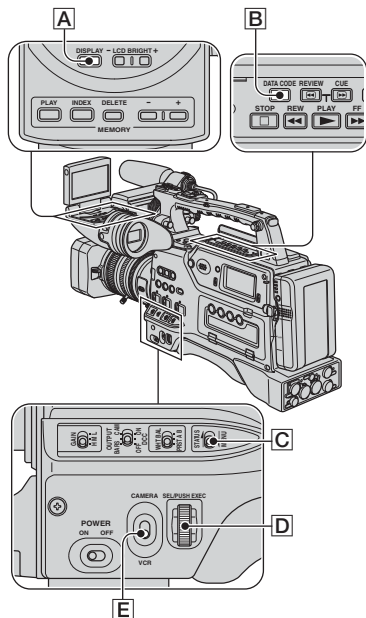

## Changing the screen

You can turn on and off the display of the time code, tape counter, and other information on the screen.

### Press the DISPLAY button **A**.

The screen indicators turn on (displayed) and off (not displayed) as you press the button.

When the CAMERA/VCR switch is set to CAMERA, the screen changes (detailed display → simple display → no display) as you press the button.

### 💡 Tips

- You can display the screen indicators during playback on a TV. Select [V-OUT/PANEL] of [DISP OUTPUT] (p. 81).

- When you assign [DISPLAY] of [ASSIGN BTN] to an ASSIGN button, you can use the ASSIGN button to change the screen.
- To output a signal containing information on indicators such as icons via the COMPONENT OUT jack or the HD/SD SDI OUT jack, set [DISP OUTPUT] to [ALL OUTPUT].

## Displaying recording data (Data code)

You can display information, including date, time and camera data, automatically stored during recording on the screen during playback.

**1** Set the CAMERA/VCR switch **E** to VCR.

**2** Press the DATA CODE button **B** during playback or pause.

The screen changes (date and time display → camera data display → no display) as you press the button.

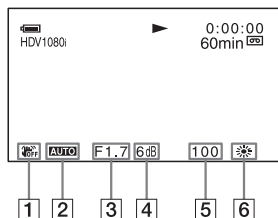

**1** SteadyShot off

**2** Exposure

**AUTO** appears during playback of the movie recorded with the iris, gain and shutter speed automatically adjusted.

## Changing/checking the settings in your camcorder (Continued)

**MANUAL** appears during playback of the movie recorded with the iris, gain and shutter speed manually adjusted.

### 3 Iris

**CLOSE** appears in the iris value display area during playback of the movie recorded with the iris manually adjusted to its maximum value.

### 4 Gain

### 5 Shutter speed

### 6 White balance

**PWB** appears during playback of the movie recorded with the shot transition or [MANU WB TEMP].

## Notes

- The exposure correction value (0EV), shutter speed and iris will be displayed during viewing of still images on “Memory Stick Duo.”
- Date and time will be displayed in the same area when you select the date and time display. If you record without setting date and time, [-- --] and [--:--:--] will be displayed.
- An accurate shutter speed may not be displayed when you playback a tape recorded with your camcorder on another device. Check the data code that is displayed on the screen when you play back the tape on your camcorder for the accurate shutter speed.
- A shutter speed is indicated with [---] during playback of the movie record in the extended clear scan (ECS) mode.

## Displaying the settings in your camcorder (Status check)

You can check the settings of the following items.

- Audio setup such as microphone volume level (p. 75)
- Output signal setup ([VCR HDV/DV], etc.) (p. 81)
- Functions assigned to the ASSIGN buttons (p. 49)
- Camera setup (p. 68)
- External devices

## 1 Push the MENU/STATUS switch **[C]** to STATUS.

## 2 Turn the SEL/PUSH EXEC dial **[D]** until a desired display shows up on the screen.

When the CAMERA/VCR switch **[E]** is set to CAMERA, the display changes in the following sequence:

AUDIO → OUTPUT → ASSIGN → CAMERA → EXT DEVICE (when an external device is connected)

When the CAMERA/VCR switch **[E]** is set to VCR, the display changes in the following sequence:

AUDIO → OUTPUT → ASSIGN → EXT DEVICE (when an external device is connected)

## To hide the display

- Push the MENU/STATUS switch **[C]** to STATUS.

# Connecting a monitor or a TV

To connect to a monitor or recorder without an  HDV/DV jack, use audio and video cables as below. You do not need an audio cable to connect a monitor that supports SDI audio input via an SDI cable. If the monitor does not support SDI audio input, you need an audio cable even if you connect the monitor via an SDI cable. When using the VIDEO OUT jack or S VIDEO jack, set the VIDEO OUT switch to COMPOSITE (no image on the LCD screen).



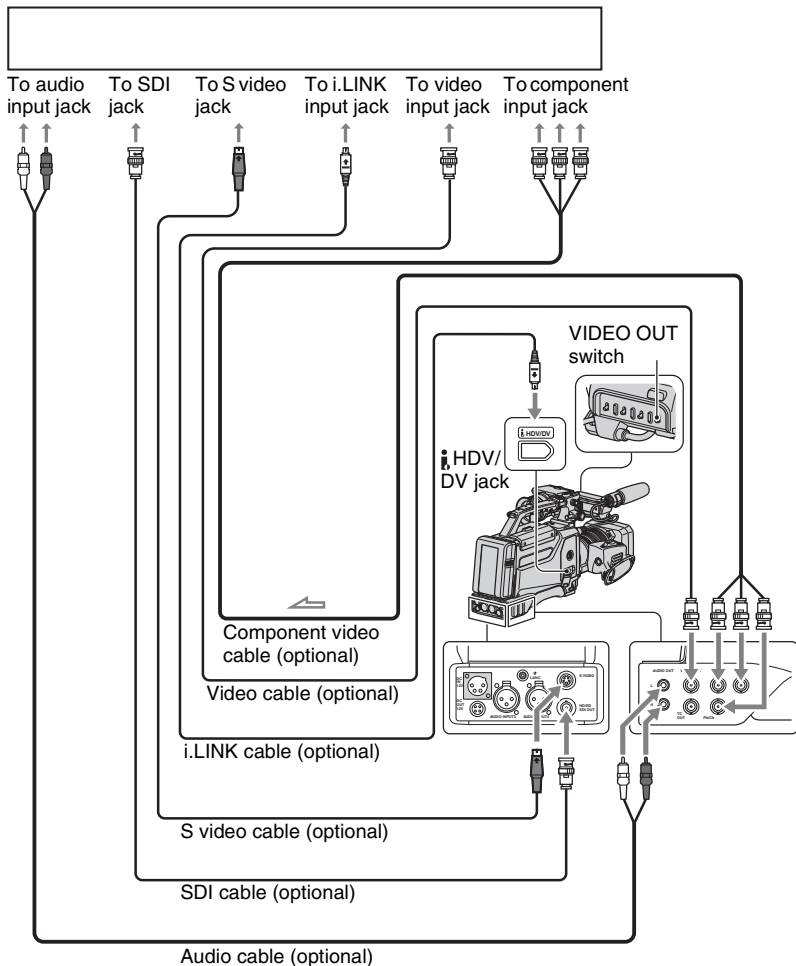









Monitor/Recorder



 :Signal flow

## Connecting a monitor or a TV (Continued)

### 🔊 Notes

- Set  (IN/OUT REC) menu → [VIDEO OUT] → [SDI/CMPNT] (p. 83) for an external device to which HDV format signals are inputted from your camcorder via an SDI cable or a component video cable. When connecting via an SDI cable, also set [SDI OUTPUT] in the  (IN/OUT REC) menu to [ON] (default setting).
- See “Specifications” (p. 117) for details on the HD/SD SDI OUT jack and the COMPONENT OUT jack.
- Video signals outputted from the HD/SD SDI OUT jack or the COMPONENT OUT jack of your camcorder have the following limitations:
  - Video signals inputted from the  HDV/DV jack of your camcorder need to be recorded to output to an external device. When recording video signals and outputting them from the  HDV/DV jack to the external device, you can view the movie reproduced by the video signal.
  - When recording a video signal inputted from the  HDV/DV jack in HDV format and outputting the signal in SDI format, the SDI signal does not meet SDI specifications.
  - Image and audio distortion may occur depending on the quality of the i.LINK signal in the device connected to your camcorder via the  HDV/DV jack, or the quality or type of SDI input jack of the connected device. Make sure the connected device is appropriate for receiving an SDI video signal.
  - Video signals are simultaneously outputted from the COMPONENT OUT jack and the HD/SD SDI OUT jack. The [SDI/CMPNT] settings in [VIDEO OUT] of the  (IN/OUT REC) menu affect both the COMPONENT OUT jack and the HD/SD SDI OUT jack.
- When down converting an HDV format signal to a DVCAM (DV) signal and outputting it, you can output a 4-channel audio signal via any jack except the  HDV/DV jack.
- You cannot up convert a DVCAM (DV) format video signal to an HDV format video signal.
- 1080/25p video signals are outputted via the COMPONENT OUT jack and the HD/SD SDI OUT jack as 1080/50i video signals.
- Make sure that [VCR HDV/DV] in the  (IN/OUT REC) menu is set to [AUTO] (default setting) before connecting an i.LINK cable. If you connect the i.LINK cable before setting [VCR HDV/DV] to [AUTO], your monitor may not recognize video signals.
- You may need to set your monitor to recognize your camcorder when connecting them via an i.LINK cable. Refer to the operating instructions of your monitor.
- A video signal and an audio signal are outputted together when your camcorder is connected to an external device via an i.LINK cable. You cannot output those signals separately.
- When you down convert an HDV format signal with 4-channel recording to a DVCAM (DV) format signal and output it via the  HDV/DV jack, the audio is output through two channels. Set  (IN/OUT REC) menu → [i.LINK SET] → [DOWN CONV AU] to select [CH1,CH2] or [CH3,CH4] output channels.
- If you change the [SDI/CMPNT] settings in [VIDEO OUT] of the  (IN/OUT REC) menu during playback, the image signals outputted from the S VIDEO OUT jack, VIDEO OUT jack and  HDV/DV jack may be temporarily distorted.
- When you down convert an HDV format progressive video signal to a DVCAM (DV) format video signal and output it via the i.LINK jack, the output signal is converted into an interlaced video signal.

# Using the menu items

You can change various settings or make detailed adjustments using the menu items displayed on the screen.

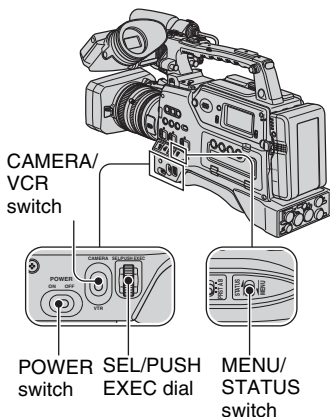

**1** Set the **POWER** switch to **ON**, then set the **CAMERA/VCR** switch to **CAMERA** or **VCR**.

**2** Push the **MENU/STATUS** switch to **MENU**.

The menu index screen appears.

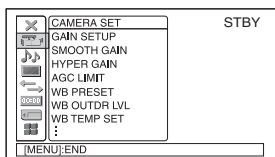

**3** Turn the **SEL/PUSH EXEC** dial until the icon of the desired menu is highlighted, then press the dial to select the menu.

- CAMERA SET (p. 68)
- AUDIO SET (p. 75)
- DISPLAY SET (p. 77)
- IN/OUT REC (p. 81)
- TC/UB SET (p. 85)
- MEMORY SET (p. 87)
- OTHERS (p. 89)

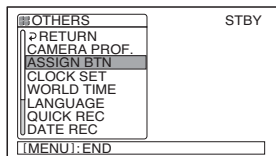

**4** Turn the **SEL/PUSH EXEC** dial until the desired menu item is highlighted, then press the dial to select the item.

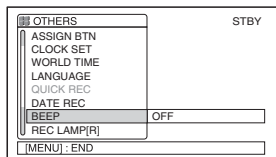

The available menu items vary depending on the position of the **CAMERA/VCR** switch of your camcorder. Unavailable items will be grayed out.

- 5** Turn the SEL/PUSH EXEC dial until the desired setting is highlighted or to bring up the desired setting, then press the dial to confirm the setting.

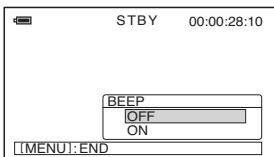

- 6** Push the MENU/STATUS switch to MENU to hide the menu screen.

To return to the previous screen, select [↩ RETURN].

---



# Menu items

Available menu items (●) vary depending on the CAMERA/VCR switch position.

Position of CAMERA/VCR switch:

CAMERA

VCR



## (CAMERA SET) menu (p. 68)











	CAMERA	VCR
GAIN SETUP	●	-
SMOOTH GAIN	●	-
HYPER GAIN (AS)	●	-
AGC LIMIT	●	-
WB PRESET	●	-
WB OUTDR LVL	●	-
WB TEMP SET	●	-
ATW SENS	●	-
SMOOTH WB	●	-
AE SHIFT (AS)	●	-
AE WINDOW	●	-
AE RESPONSE	●	-
AT IRIS LMT	●	-
FLCKR REDUCE	●	-
CNTRST ENHCR	●	-
BACK LIGHT (AS)	●	-
SPOTLIGHT (AS)	●	-
STEADYSHOT (AS)	●	-
AF ASSIST	●	-
FOCUS MACRO (AS)	●	-
HANDLE ZOOM	●	-
D.EXTENDER (AS)	●	-
FADER (AS)	●	-
SMTH SLW REC	●	-
INTERVAL REC	●	-
DV FRAME REC (DVCAM) (AV 2)	●	-
SHOT TRANSITION	●	-
S.TRANS/F.MARK	●	-
x.v.Color (HDV1080)	●	-
COLOR BAR	●	-
FLANGE BACK	●	-



## (AUDIO SET) menu (p. 75)

HDV 2CH/4CH (HDV1080)	●	-
DV AU.MODE (DVCAM) (AV 2)	●	-
AU.LMT CH1,2	●	-
AU.LMT CH3,4	●	-
XLR SET	●	-

## Menu items (Continued)



	Position of CAMERA/VCR switch:	
	CAMERA	VCR
 <b>(DISPLAY SET) menu (p. 77)</b>		
ZEBRA (AS)	●	-
HISTOGRAM	●	-
PEAKING	●	-
MARKER (AS)	●	-
CAM LEVELING	●	-
EXP.FOCUS TYPE	●	-
CAM DATA DSP	●	-
AU.LVL DISP	●	-
ZOOM DISPLAY	●	-
FOCUS DISP	●	-
SHUTTER DISP	●	-
LCD COLOR	●	●
LCD BL LEVEL	●	●
VF B.LIGHT	●	●
VF COLOR	●	●
LETTER SIZE	●	●
 REMAINING	●	●
DISP OUTPUT	●	●
 <b>(IN/OUT REC) menu (p. 81)</b>		
REC FORMAT	●	-
VCR HDV/DV	-	●
HDV PROGRE. 	●	-
DV PROGRE.  	●	-
DV REC MODE  	●	●
DV WIDE REC  	●	-
SDI OUTPUT	●	●
VIDEO OUT	●	●
i.LINK SET	●	●
EXT REC CTRL	●	-
 <b>(TC/UB SET) menu (p. 85)</b>		
TC PRESET	●	●
TC COUNTUP (AS)	●	●
UB PRESET	●	●
TC RUN	●	●
TC MAKE	●	●
TC LINK	●	-
UB TIME REC	●	●
UB-DATE/TC-TIME	●	●

Position of CAMERA/VCR switch:



CAMERA

VCR

 **(MEMORY SET) menu (p. 87)**

	CAMERA	VCR
 ALL ERASE	—	●
 FORMAT	●	●
FILE NO.	●	●
NEW FOLDER	●	●
REC FOLDER	●	●
PB FOLDER	—	●

 **(OTHERS) (p. 89)**

CAMERA PROF.	●	●
ASSIGN BTN	●	●
CLOCK SET	●	●
WORLD TIME	●	●
LANGUAGE	●	●
PB ZOOM	—	●
QUICK REC 	●	—
DATE REC	●	—
BEEP	●	●
REC LAMP[R] 	●	—
BATTERY TYPE	●	●
HOURS METER	●	●

# (CAMERA SET) menu

Settings to adjust your camcorder to the recording conditions (GAIN SETUP/BACK LIGHT/STEADYSHOT, etc.)

The default settings are marked with ►.  
The indicators in parentheses appear when the items are selected.

**See page 63 for details on selecting menu items.**

Push the MENU/STATUS switch to MENU → select the  (CAMERA SET) with the SEL/PUSH EXEC dial.

## GAIN SETUP

You can set gain values for H, M and L positions of the GAIN switch. The default settings of [H], [M] and [L] are 18dB, 9dB and 0dB, respectively.

- ① Select [H], [M] or [L] with the SEL/PUSH EXEC dial.
- ② Set the gain value with the SEL/PUSH EXEC dial, and press the dial.  
You can select the value between -6dB and 21dB by 3dB. The larger the value, the higher the gain.
- ③ Select [OK] with the SEL/PUSH EXEC dial.
- ④ Push the MENU/STATUS switch to MENU to hide the menu screen.

## SMOOTH GAIN

You can set the transition speed at which the gain setting shifts from one value to another, set for the gain switch positions, when you switch the gain switch from a position to another. You can select the transition speed from [FAST], [MIDDLE] and [SLOW] or set to [OFF]. The default setting is [OFF].

## HYPER GAIN (AS)

When you set this function to [ON] (HYPER), you can increase the gain to its limit. The default setting is [OFF].

### Notes

- During the hyper gain, you cannot use the following function.
  - [BACK LIGHT]
  - [SPOTLIGHT]
- During the hyper gain, the picture quality will be reduced due to noise.
- [HYPER GAIN] is automatically set to [OFF] if you turn the power off and back on.

### Tips

- You are recommended to use this function with manual focus.

## AGC LIMIT

You can select the upper limit for the Auto Gain Control (AGC) from [OFF] (21dB, the default setting), [18dB], [15dB], [12dB], [9dB], [6db], [3dB] and [0dB].

### Notes

- If you adjust the gain manually, you cannot obtain the effect of [AGC LIMIT].

## WB PRESET

You can use the preset white balance. For more details, see page 35.

## WB OUTDR LVL

You can set an offset value to adjust the outdoor white balance when you set [WB PRESET] to [OUTDOOR]. You can select the offset value from [-7] (bluish) - [0] (normal) - [+7] (reddish). The default setting is [0].

## WB TEMP SET

You can set the color temperature between 2,300K and 15,000K in 100K steps when you set [WB PRESET] to [MANU WB TEMP].

## ATW SENS

You can set the auto white balance operation under a reddish light source such as an incandescent lamp or candle, or under a blueish light source such as in outdoor shade.

### ► INTELLIGENT

Automatically adjusts the white balance so that scenes look natural for the light source.

### HIGH

Automatically adjusts the white balance while reducing redness or blueness.

### MIDDLE

### LOW

Automatically adjusts the white balance while increasing redness or blueness.

### 🔌 Notes

- This is only effective when white balance is adjusted automatically.
- [ATW SENS] is not effective under a clear sky or the sun.

## SMOOTH WB

You can set the transition speed at which the color temperature values shifts from the one set for one of the WHT BAL switch positions to the other set for the other WHT BAL switch position when you switch the positions. You can select the transition speed from [FAST], [MIDDLE] and [SLOW] or set to [OFF]. The default setting is [OFF].

## AE SHIFT **AS**

You can set an offset value to adjust the automatic exposure adjustment value between [-7] (dark) and [+7] (bright) with the SEL/PUSH EXEC dial. The default setting is [0]. **AS** and selected value appears on the screen when you change the value from the default setting.

### 🔌 Notes

- This function is not effective while you adjust the iris, shutter speed and gain all manually.
- This function is not effective when [HYPER GAIN] is set to [ON].

## AE WINDOW

You can select a photometric area in which the automatic exposure adjustment function detects changes in the brightness of the subject to automatically adjust the exposure. This function is not effective during the manual exposure adjustment.



STANDARD



TYPE 1



TYPE 2



TYPE 3



TYPE 4



TYPE 5

### 💡 Tips

- The photometric area stays the same even when you change the aspect ratio.

Push the MENU/STATUS switch to MENU → select the  (CAMERA SET) with the SEL/PUSH EXEC dial.

Example: TYPE 4

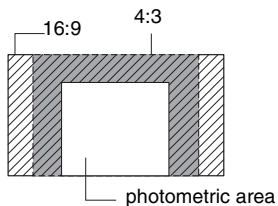

## AE RESPONSE

You can select the speed at which the automatic exposure adjustment function follows changes in the brightness of the subject. You can select the speed from [FAST], [MIDDLE] and [SLOW]. The default setting is [FAST].

## AT IRIS LMT

You can select the highest iris value for the automatic adjustment from [F11], [F9.6], [F8], [F6.8], [F5.6], [F4.8] and [F4]. The default setting is [F11].

### Notes

- This function is not effective during the manual iris adjustment.

## FLCKR REDUCE

### ▶ ON

Reduces flickering. Flickering of the screen under a light source such as fluorescent lamps will be reduced.

### OFF

Not reduce flickering. Select this when you do not want to reduce flickering.

### Notes

- Flickering may not be reduced for certain light sources.

## CNTRST ENHCR

When you set this function to [ON], your camcorder detects high contrast images, such as backlit scenes, and automatically improves the unexposed images. The default setting is [OFF].

### Notes

- When you set [BACK LIGHT] to [ON], [CNTRST ENHCR] is temporarily disabled.

## BACK LIGHT

When you set this function to [ON] () , you can correct backlighting. The default setting is [OFF].

### Notes

- [BACK LIGHT] is set to [OFF] when you set [SPOTLIGHT] to [ON].
- [BACK LIGHT] is set to [OFF] if at least two of iris, gain, and shutter speed are adjusted manually.
- [BACK LIGHT] is set to [OFF] when [HYPER GAIN] is set to [ON].

## SPOTLIGHT

When you set this function to [ON] () , you can prevent overexposure of light during recording of a subject under strong light, such as a stage. For example, you can prevent people's faces from over-highlighting. The default setting is [OFF].

### Notes

- [SPOTLIGHT] is set to [OFF] when you set [BACK LIGHT] to [ON].
- You cannot use the spotlight function if at least two of iris, gain, and shutter speed are adjusted manually.
- [SPOTLIGHT] is set to [OFF] when [HYPER GAIN] is set to [ON].

## STEADYSHOT

### ■ ON/OFF

When you select [ON], you can reduce camera shakes. Select [OFF] () when you use a tripod (optional) to make images look natural. The default setting is [ON].

### ■ TYPE

You can select a type of camera-shake reduction for different recording situations.

#### HARD

Reduces camera shakes at a high level. This setting is not suitable for panorama tilt recordings.

#### ► STANDARD

Reduces camera shakes at a standard level.

#### SOFT

Reduces camera shakes at a low level. Slight unsteadiness remains in movies, which make the movies look as they are.

## AF ASSIST

When you set this function to [ON], you can temporarily focus manually using the focus ring during the auto focus adjustment. The default setting is [OFF].

### Notes

- This function is effective only when the focus ring is set to the mode B position (p. 31).

## FOCUS MACRO

When you set this function to [ON], you can focus on a subject within 80 cm (about 2 5/8 feet). The default setting is [ON].

When you set this function to [OFF] (), you can set fine focus on a subject further than 80 cm regardless of the zoom position although you will lose focus on a subject within 80 cm.

### Notes

- This function is effective only when the focus ring is set to the mode B position (p. 31).

## HANDLE ZOOM

You can select the zoom speed for the FIX position of the handle zoom switch from [1] (slow) through [8] (fast). The default setting is [3].

## D. EXTENDER

When you set this function to [ON] (), the displayed image becomes 1.5 times larger. The image quality decreases because the image is digitally processed. This function helps you to focus on far-away subjects such as a wild bird away at a distance. The default setting is [OFF].

### Notes

- This function is automatically set to [OFF] when you turn the power off and back on.

## FADER

You can add visual effects to transition between scenes.

- ① Select [WHITE FADER] or [BLACK FADER] during standby to fade in with the selected effect or recording to fade out with the selected effect.
- ② Press the REC START/STOP button. The fader indicator stops flashing and disappears when the fading is complete.

To cancel before starting the operation, select [OFF] in step ①.

The setting will be cleared every time you press the REC START/STOP button.

Push the MENU/STATUS switch to MENU → select the  (CAMERA SET) with the SEL/PUSH EXEC dial.



## WHITE FADER



## BLACK FADER



### ⚡ Notes

- This function is automatically set to [OFF] when you turn the power off and back on.

## SMTH SLW REC

Fast moving subjects and actions, which cannot be captured under the general recording conditions, can be recorded in smooth moving slow-motion. This is useful for recording fast actions such as a golf or tennis swing.

### ① Set [REC TIME].

Select the recording time from [3sec] (the default setting), [6sec] and [12sec].

The picture quality deteriorates as the recording time increases.

### ② Set [REC TIMING].

Select the recording timing from [START TRIGGR] and [END TRIGGER] to record the action after or before the REC START/STOP button is pressed.

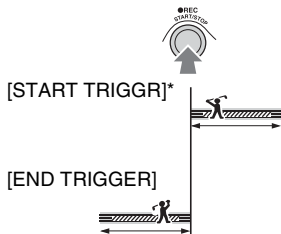

\* The default setting is [START TRIGGR].

### ③ Start recording.

Select [EXECUTE], then press the REC START/STOP button on the [SMTH SLW REC] screen.

A slow-motion movie about 4 times longer than your [REC TIME] setting is recorded. Recording ends when [Recording...] disappears from the screen.

To cancel [SMTH SLW REC], push the MENU/STATUS switch to MENU.

### ⚡ Notes

- Sounds cannot be recorded.
- The settings are automatically cleared when you turn the power off and back on.
- The shutter speed is automatically set to 1/215 second when you start [SMTH SLW REC].
- The shutter speed is fixed to 1/215 second when you set the SHUTTER switch to OFF.
- You cannot select extended clear scan (ECS) mode or SLS mode during [SMTH SLW REC]. Pushing the SHUTTER switch to SEL only enables you to select manual mode or auto mode.
- The recording time may be shorter than the set time, depending on recording conditions.
- The image quality is lower than with the regular recording.

## INTERVAL REC

You can record a series of movies on a tape at regular intervals. This function is useful to observe things like cloud movements or daylight changes. The scenes run smoothly into each other when you play back the tape. Use the AC Adapter to obtain AC power for long recording.

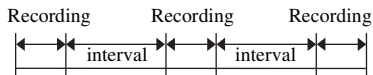

① Select [ON/OFF] → [ON] with the SEL/PUSH EXEC dial.

② Perform the following step if you are changing the recording time from the default setting of [0.5sec]. If you are keeping the default recording time, go straight to step ③.



Select [REC TIME] → [0.5sec], [1sec], [1.5sec] or [2sec] with the SEL/PUSH EXEC dial.

- ③ Perform the following step if you are changing the interval time from the default setting of [30sec]. If you are keeping the default interval time, go straight to step ④. Select [INTERVAL] → [30sec], [1min], [5min] or [10min].
- ④ Select [OK] with the SEL/PUSH EXEC dial.
- ⑤ Push the MENU/STATUS switch to MENU to hide the menu screen.
- ⑥ Press the REC START/STOP button. The [INTERVAL REC] recording starts.

To cancel [INTERVAL REC], press the REC START/STOP button.

The operation of your camcorder differs depending on when you press the REC START/STOP button.

If you press the button during [INTERVAL REC] recording, the recording temporarily stops. If you press it again, the [INTERVAL REC] recording restarts.

If you press the button during [INTERVAL REC] interval, the [INTERVAL REC] recording stops and regular recording starts.

If you press it again, regular recording stops. If you press the button once again, the [INTERVAL REC] recording restarts. To cancel the [INTERVAL REC] recording, select [ON/OFF] → [OFF] with the SEL/PUSH EXEC dial.

#### ⓘ Notes

- The recording time and interval time may differ slightly from the settings.
- If you focus manually, you can get sharp images even if the lighting changes.

### DV FRAME REC

You can record stop motion (or frame-by-frame) animation movies. That type of animation uses a technique of changing the subject, such as a doll or a toy's positions and recording it at each different position while your camcorder sits still.

#### ▶ OFF

Not use this function.

#### ON

Records a movie by stop motion (or frame-by-frame) technique.

- ① Select [ON] with the SEL/PUSH EXEC dial.
- ② Push the MENU/STATUS switch to MENU to hide the menu screen.
- ③ Press the REC START/STOP button. Your camcorder records a movie for about 5 to 8 frames and returns to standby.
- ④ Move the subject and repeat step ③.

#### ⓘ Notes

- When you use frame recording continuously, the remaining tape time will not be indicated correctly.
- The last scene will be longer than other scenes.
- You cannot record index signals during frame recording.
- This function is automatically set to [OFF] when you turn the power off and back on.

## SHOT TRANSITION

See page 52.

## S. TRANS/F. MARK

You can select a function to be assigned to the SHOT TRANSITION/FOCUS MARKING button.

#### ▶ SHOT TRANSITION

Select to assign the shot transition function to the button.

#### FOCUS MARKING

Select to assign the focus marking function to the button.

Push the MENU/STATUS switch to MENU → select the  (CAMERA SET) with the SEL/PUSH EXEC dial.

## x.v.Color HDV1080i

When you set this function to [ON], you can record with the wider color range. Your camcorder can reproduce brilliant and vivid colors for flowers and the beautiful blue-green of tropical oceans that cannot be matched by conventional technologies.

### ⚙ Notes

- The colors may not be well reproduced when you play back a movie recorded with this function set to [ON] on a TV that does not support x.v.Color.
- You cannot set [x.v.Color] in the following cases:
  - When recording in SD (standard) format
  - When recording movies
- When you set [x.v.Color] to [ON], the picture profile will be disabled.

## COLOR BAR AS

### ■ TYPE

Selects a type of the color bars.



TYPE 1



TYPE 2



TYPE 3



TYPE 4 (75% brightness of TYPE 3)

### ■ TONE

Outputs audio tone signals (1 kHz: full bit -20 dB) when you set the OUTPUT/DCC switch to BARS and [TONE] to [ON]. The default setting is [OFF].

## FLANGE BACK

You can select a mode for the flange focal length adjustment. The flange focal length is a distance from the lens flange to the plane of the image along the optical axis. See page 10 for details.

### ▶ AUTO ADJUST

Automatically adjusts the flange focal length.

### MANU ADJUST

Manually adjusts the flange focal length.

## (AUDIO SET) menu

Settings for the audio recording (HDV 2CH/4CH/XLR SET, etc.)

The default settings are marked with ►. The indicators in parentheses appear when the items are selected.

See page 63 for details on selecting menu items.

Push the MENU/STATUS switch to MENU → select the  (AUDIO SET) with the SEL/PUSH EXEC dial.

### HDV 2CH/4CH HDV1080i

You can select the number of recording channels for HDV format recording.

#### ► 2CH

Records in two channels, CH1 and CH2. Signals from AUDIO INPUT1 (L)-4 are recorded in CH1 and CH2 (p. 46).

#### 4CH

Records in four channels. Signals from AUDIO INPUT1 (L), AUDIO INPUT2 (R), AUDIO INPUT3 and AUDIO INPUT4 are recorded in CH1, CH2, CH3 and CH4, respectively.

#### Notes

- The REC CH SELECT switch settings become ineffective when you select [4CH].

### DV AU. MODE DVCAM DV SP

(DV Audio mode)

#### FS32K (32k)

Records in the 12-bit mode (2 stereo sounds). Select this setting for the DVCAM/DV SP recording.

#### ► FS48K (48k)

Records in the 16-bit mode (1 stereo sound with high quality). Select this setting for the DVCAM/DV SP recording.

#### Notes

- When recording in the HDV format, sound is automatically recorded in the [FS48K] mode.
- **NS** appears when the DVCAM standard is not met (p. 108).

### AU. LMT CH1,2

You can set the clipping-noise reduction function for CH1 and CH2.

#### ► OFF

Disables the function.

#### ON

Enables the function.

#### Notes

- This function is available only when you set the CH1/CH2 switch to MAN.

### AU. LMT CH3,4

You can set the clipping-noise reduction function for CH3 and CH4.

#### ► OFF

Disables the function.

#### ON

Enables the function.

#### Notes

- This function is available only when you set the CH3/CH4 switch to MAN.

### XLR SET

#### ■ AGC CH1,2

You can select either linked or separate AGC (Auto Gain Control) of CH1 and CH2 when using an external microphone.

#### ► SEPARATE

Separately applies the AGC for CH1/CH2. Sound inputs from CH1 and CH2 will be recorded as separate sound.

#### LINKED

Applies the AGC of CH1 linked with that of CH2. Sound inputs from CH1 and CH2 will be recorded as a set of sound such as stereo sound. A  appears on the status check screen.

Push the MENU/STATUS switch to MENU → select the  (AUDIO SET) with the SEL/PUSH EXEC dial.

### Notes

- This setting becomes effective when the CH1 and CH2 switches are both set to AUTO and the INPUT switches to CH1 and CH2 are set to MIC or MIC+48V, or both are set to LINE (p. 46).

### ■ AGC CH3,4

You can select either linked or separate AGC (Auto Gain Control) of CH3 and CH4 when using an external microphone.

#### ▶ SEPARATE

Separately applies the AGC for CH3/CH4. Sound inputs from CH3 and CH4 will be recorded as separate sound.

#### LINKED

Applies the AGC of CH3 linked with that of CH4. Sound inputs from CH3 and CH4 will be recorded as a set of sound such as stereo sound. A  appears on the status check screen.

### Notes

- This setting becomes effective when the CH3 and CH4 switches are both set to AUTO and the INPUT3 and INPUT4 switches are set to MIC or MIC+48V, or both are set to LINE (p. 46).

### ■ INPUT1 MIC NR

Reduces noise from the microphone.

#### ▶ ON

Reduces noise from the microphone.

 appears on the status check screen.

#### OFF

Does not reduce noise from the microphone.

### Notes

- The setting is not effective when you set the INPUT1 switch to LINE.

### ■ INPUT1 TRIM

Adjusts the input signal level from INPUT1.

You can select from [-18dB], [-12dB], [-6dB], [0dB], [+6dB] and [+12dB]. The default setting is [0dB].

### Notes

- The setting is not effective when you set the INPUT1 switch to LINE.

### ■ INPUT1 WIND

#### ▶ OFF

Disables wind noise reduction.

#### ON

Enables wind noise reduction.

 appears on the status check screen.

### Notes

- The setting is not effective when you set the INPUT1 switch to LINE.

### ■ INPUT2 MIC NR

### ■ INPUT2 TRIM

### ■ INPUT2 WIND

### ■ INPUT3 MIC NR

### ■ INPUT3 TRIM

### ■ INPUT3 WIND

### ■ INPUT4 MIC NR

### ■ INPUT4 TRIM

### ■ INPUT4 WIND

You can set INPUT2, INPUT3 and INPUT4 in the same way as INPUT1.

### Tips

- -48dBu is set as 0dB in your camcorder.
- Set [INPUT TRIM] to [0dB] for the supplied microphone (ECM-XM1).
- Set [INPUT TRIM] to [+12dB] for the optional microphone (Sony ECM-NV1).
- The INPUT TRIM function adjusts the input level from an external microphone. When using a highly sensitive microphone or recording loud sound, set this to the minus side. When using a less sensitive microphone or recording quiet sound, set it to the plus side.
- When recording loud sound, the sound may be distorted at either the input point or the recording point. If it is distorted at the input point, adjust the sound using the INPUT TRIM

function. If it is distorted at the recording point, lower the total volume level manually.

- If you set INPUT TRIM too far to the minus side, the microphone volume becomes too low, resulting in a poor signal to noise ratio.
- Test the effect of the INPUT TRIM function according to the microphone used or the sound field of the recording site before actual recording.

## (DISPLAY SET) menu

### Display settings of the display and the viewfinder (MARKER/WF B.LIGHT/DISP OUTPUT, etc.)

The default settings are marked with ►. The indicators in parentheses appear when the items are selected.

**See page 63 for details on selecting menu items.**

Push the MENU/STATUS switch to MENU → select the  (DISPLAY SET) with the SEL/PUSH EXEC dial.

### ZEBRA

You can display a zebra pattern as a guide for adjusting brightness.

#### ■ ON/OFF

When you select [ON],  and the brightness level appear on the screen. The zebra pattern will not be recorded on a tape or a “Memory Stick Duo.”

#### ■ LEVEL

You can select the brightness level between 70 and 100 or 100+.

#### Tips

- The zebra pattern is a strip pattern displayed over a part of an image on the screen when the part is higher than a preset brightness level.

### HISTOGRAM

You can adjust the iris while referring to a histogram. A histogram is a graph that shows the distribution of the image brightness. You can use the histogram as a guide for adjusting the iris. The histogram will not be recorded on a tape or a “Memory Stick Duo.”

Push the MENU/STATUS switch to MENU → select the  (DISPLAY SET) with the SEL/PUSH EXEC dial.

## ▶ OFF

Does not display a histogram.

## NORMAL

Displays a histogram.

## ADVANCE

Displays a histogram, and a bar that indicates an average of the brightness levels around the center of an image (within the marker) on the histogram.

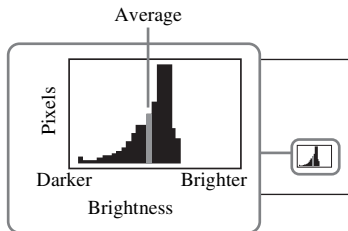

## 💡 Tips

- The left area on the graph shows the darker areas of the image while the right area shows the brighter areas.
- A vertical line that indicates the brightness level of [ZEBRA] will be displayed on the histogram when you set [ZEBRA] to [ON].

## PEAKING

You can select a peaking sensitivity from [HIGH], [MIDDLE] and [LOW]. The default setting is [MIDDLE].

## 🔊 Notes

- You cannot record an image with enhanced details on a tape or a “Memory Stick Duo.”

## 💡 Tips

- You can focus more easily using this function in combination with the expanded focus function (p. 32).

## MARKER AS

### ■ ON/OFF

When you select [ON], you can display markers. The default setting is [OFF]. Markers will not be recorded on a tape or “Memory Stick Duo.”

### ■ CENTER

When you select [ON], you can display a marker at the center of the screen. The default setting is [ON].



### ■ ASPECT

When you select [ON], you can display markers at boundaries of display area defined by the aspect ratio, which you can select from [4:3], [13:9] and [14:9]. The default setting is [OFF].



### ■ SAFETY ZONE

When you select [ON], then [80%] or [90%], you can display markers at boundaries of display area that regular home TVs can display. The default setting is [OFF].



### ■ GUIDEFRAME

When you select [ON], you can display frame markers that help you to check horizontal and vertical positions of a subject. The default setting is [OFF].



## 🔊 Notes

- You cannot output display information, such as the time code, to an external device via external output jacks when [MARKER] is set to [ON].
- You cannot display markers when you set [DATE REC] to [ON].

### Tips

- You can display all types of markers at the same time.
- You can obtain a balanced composition by positioning the subject at the cross points of the guideframe marker.
- You can display markers only on the LCD panel and viewfinder. You cannot display them on an external device.

## CAM LEVELING

When you set this function to [ON], you can display a level meter to check the level of your camcorder. The default setting is [OFF].

## EXP.FOCUS TYPE

You can set a type of the expanded focus display.

### ► TYPE 1

Simply enlarges images.

### TYPE 2

Enlarges and shows images in white and black.

## CAM DATA DSP (Camera data display)

When you set this function to [ON], you can constantly display the iris, shutter speed and gain settings on the screen. The default setting is [OFF].

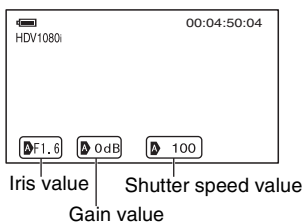

### Tips

- The settings appear on the screen during the manual adjustment regardless of the settings of this function.
-  indicates that the settings are automatically adjusted values.
- The displayed settings are different from the settings that will be displayed when you press the DATA CODE button (p. 59).

## AU.LVL DISP (Audio level display)

When you set this function to [ON], you can display the audio level meter on the screen. The default setting is [ON].

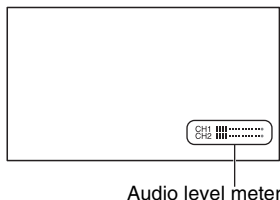

### Tips

- You can switch what channels to be displayed, CH1/CH2 or CH3/CH4, with the AUDIO LEVEL DISPLAY switch.

## ZOOM DISPLAY

### ► BAR

Displays a bar that indicates the zoom position.

### NUMBER

Displays a number (0 through 99) that indicates the zoom position.

Push the MENU/STATUS switch to MENU → select the  (DISPLAY SET) with the SEL/PUSH EXEC dial.

## FOCUS DISP

You can select how to display the focal distance during manual focus.

### ► METER

Displays the focal distance in meters.

### FEET

Displays the focal distance in feet.

## SHUTTER DISP

You can select how to display the shutter speed.

### ► SECOND

Displays the shutter speed in seconds.

### DEGREE

Displays the shutter speed in degrees.

The shutter speed equal to the period that your camcorder reads image data from the image sensor is defined as 360 degrees.

The degree is calculated based on this definition and displayed.

– When [SCAN TYPE] is set to [50], 1/50 second is defined as 360 degrees.

– When [SCAN TYPE] is set to [25], 1/25 second is defined as 360 degrees.

For details on [SCAN TYPE], see [HDV PROGRE.] (p. 82) or [DV PROGRE.] (p. 82).

### Notes

- When you press the DATA CODE button, the shutter speed will be displayed in seconds regardless of the setting of this function.

### Tips

- Shutter speed slower than 360° are displayed in multiples of 360°, such as 360° × 2.

## LCD COLOR

You can adjust the color level of the LCD panel. Changes in the LCD color level will not affect the color level of recording images.

## LCD BL LEVEL

You can adjust the backlight level of the LCD screen.

### ► NORMAL

Standard brightness.

### BRIGHT

Brightens the LCD screen.

## VF B.LIGHT

You can adjust the brightness of the viewfinder.

### ► NORMAL

Standard brightness.

### BRIGHT

Brightens the viewfinder screen.

## VF COLOR

### ► ON

Displays images in the viewfinder in color.

### OFF

Displays images in the viewfinder in black and white.

## LETTER SIZE

### ► NORMAL

Displays the menu in regular letter size.

### 2×

Displays the selected menu items in letter size, the height of which is doubled.

## REMAINING

### ► AUTO

Displays the remaining time of a tape for about 8 seconds in the following situation:

- When you set the CAMERA/VCR switch to VCR or CAMERA with a cassette inserted.
- When you press  (Play) or the DISPLAY/BATT INFO button.



**ON**

Always displays the remaining time of a tape. The remaining time is not displayed when you insert a new tape or a tape that is rewound to the beginning. It is displayed when you start playback or recording. It is always displayed on the sub LCD monitor.

**DISP OUTPUT**

You can select outputs to which display information, such as time code, is outputted.

**► LCD PANEL**

Outputs the information to the LCD screen and viewfinder.

**V-OUT/PANEL**

Outputs the information to the LCD screen, viewfinder and composite output.

**ALL OUTPUT**

Outputs the information to the LCD screen, viewfinder, SDI output, component output and composite output.

**🔍 Notes**

- You cannot output display information, such as the time code, to an external device when [MARKER] is set to [ON].

## (IN/OUT REC) menu

Recording settings, input and output settings (REC FORMAT/HDV PROGRE./VIDEO OUT/EXT REC CTRL, etc.)

The default settings are marked with ►. The indicators in parentheses appear when the items are selected.

**See page 63 for details on selecting menu items.**

Push the MENU/STATUS switch to MENU → select the  (IN/OUT REC) with the SEL/PUSH EXEC dial.

**REC FORMAT**

You can select a recording format.

**► HDV1080i (HDV1080i)**

Records in the HDV1080i format.

**DV (DVCAM DV )**

Records in the DVCAM (DV) format. Set also [DV REC MODE] when you record in this format.

**🔍 Notes**

- Set also [i.LINK SET] as necessary when you output a movie to an external device through an i.LINK cable (p. 84).

**VCR HDV/DV**

You can select a type of output signal to an external device for playing back a movie on the device. Select [AUTO] in most cases. When you connect your camcorder to an external device with an i.LINK cable, select a type of input and output signals to and from the external device via the  HDV/DV jack. You can record or play back a movie reproduced by the selected type of signals.

**► AUTO**

Automatically switches between HDV signals and DV signals during playback. During the i.LINK connection, recognizes HDV signals and DVCAM (DV) signals, and automatically inputs or outputs the

Push the MENU/STATUS switch to MENU → select the  (IN/OUT REC) with the SEL/PUSH EXEC dial.

signals to or from the external device via the  HDV/DV (i.LINK) jack for recording or playback.

### HDV (HDV1080i)

Plays back only HDV format sections of a tape.

During the i.LINK connection, inputs or outputs only HDV signals to or from an external device via the  HDV/DV (i.LINK) jack for recording or playback. Select this setting when you connect your camcorder to your computer.

### DV (DV)

Plays back only DVCAM (DV) format sections of a tape.

During the i.LINK connection, inputs or outputs only DVCAM (DV) signals to or from an external device via the  HDV/DV (i.LINK) jack for recording or playback. Select this setting when you connect your camcorder to your computer.

#### ⚙ Notes

- Make sure to disconnect the i.LINK cable prior to changing the setting. Otherwise, a video device may not recognize video signals.
- When you select [AUTO], images and sounds may be cut off on switching between HDV signals and DVCAM (DV) signals.
- When you set [i.LINK SET] → [HDV → DV CONV] to [ON], the following signals will be outputted:
  - [AUTO]: HDV signals are converted to DVCAM (DV) signals and outputted. DVCAM (DV) signals are outputted without any conversion.
  - [HDV]: HDV signals are converted to DVCAM (DV) signals and outputted. DVCAM (DV) signals will not be outputted.
  - [DV]: DVCAM (DV) signals are outputted without any conversion. HDV signals will not be outputted.

### HDV PROGRE.

#### ■ REC TYPE

You can select an HDV recording format from [INTERLACE] and [PROGRESSIVE].

#### ■ SCAN TYPE

You can select a scan type for recording in HDV format.

##### ▶ 50

Records by the interlace scan.

##### 25

Records 25 frames per second.

#### ⚙ Notes

- Selectable [SCAN TYPE] settings differ depending on the setting of [REC TYPE].
  - [INTERLACE]: [50], [25]
  - [PROGRESSIVE]: [25]
- You can only play back a tape recorded with the [REC TYPE] set to [PROGRESSIVE] on a device that supports playback of a tape recorded by progressive scanning.

### DV PROGRE.

#### ■ SCAN TYPE

You can select a scan type for recording in DVCAM/DV format.

##### ▶ 50

Records by the interlace scan.

##### 25

Records 25 frames per second.

### DV REC MODE (DV Recording mode)

This function is available only when you set [REC FORMAT] to [DV].

#### ▶ DVCAM (DVCAM)

Records in the DVCAM format.

#### DV SP

Records in the SP (Standard Play) mode of the DV format to record for a longer time than in the DVCAM format.

#### ⚙ Notes

- Mosaic-like disturbance or audio interruption may occur when you play back a movie recorded in the DV SP mode by another device.

- Image may be distorted or time code may not be properly connected between the scenes recorded in the DVCAM mode and DV SP mode.

## DV WIDE REC

DVCAM DV SP

You can record a movie in an aspect ratio that matches that of a TV that you want to connect. Refer also to the instruction manuals that come with the TV.

### ▶ ON

Records a movie in an aspect ratio that matches the full screen of a 16:9 (wide) TV.

### OFF (4:3)

Records a movie in an aspect ratio that matches the full screen of a 4:3 TV.

### 🔊 Notes

- Set [DV WIDE CONV] correctly to suite a TV that you want to connect for playback (p. 82).
- The aspect ratio will be fixed to 16:9 and you cannot set it to 4:3 when you record in HDV format.

## SDI OUTPUT

Outputs signals from the HD/SD SDI OUT jack. The default setting is [ON].

## VIDEO OUT

### ■ SDI/CMPNT

You can select the type of connection when connecting your camcorder to a TV with the SDI or component input jack.

#### 576i

Supports connection between your camcorder and a TV with a component input jack that supports the 576i format.

### ▶ 1080i/576i

Supports connection between your camcorder and a TV with a component input jack that supports the 1080i format.

### ■ DOWN CONVERT

You can select a down convert type when you down-convert HDV signal to DV signal. Use this function for signals outputting from the following output jacks:

- Component (576i)
- S Video
- Audio/Video

### ▶ SQUEEZE

Outputs a horizontally compressed image while maintaining its original height.

### LETTER BOX

Outputs an image with black bars added to the top and bottom of the original image, while maintaining the original aspect ratio.

### EDGE CROP

Outputs the central portion of the original image by cropping its right and left edges.

### 🔊 Notes

- When you view a movie recorded in the DVCAM (DV) format with [DV WIDE REC] set to [ON] on a standard 4:3 TV, images of the movie may appear vertically compressed. In such a case, set [DV WIDE CONV] to [LETTER BOX] or [EDGE CROP].

### ■ DV WIDE CONV

You can select a down convert type when you down-convert DV widescreen signal to DV signal.

Use this function for signals outputting from the following output jacks:

- Component (576i)
- S Video
- Audio/Video

### ▶ SQUEEZE

Outputs a horizontally compressed image while maintaining its original height.

### LETTER BOX

Outputs an image with black bars added to the top and bottom of the original image, while maintaining the original aspect ratio.

### EDGE CROP

Outputs the central portion of the original image by cropping its right and left edges.

Push the MENU/STATUS switch to MENU → select the  (IN/OUT REC) with the SEL/PUSH EXEC dial.

## ■ SD-SDI SET

### VIDEO INDEX

Adds a video index signal that includes information on aspect ratio and signal format to SDI output signals. The default setting is [ON].

### RP188 ATC

Adds an Ancillary Time Code (ATC) to the SDI output signal. The default setting is [ON].

### VITC LINESEL

Selects the vertical blanking interval line of the SD video signal, in which the vertical interval time code (VITC) is recorded, between 9 and 22. The default setting is 19.

## i.LINK SET

### ■ HDV → DV CONV

When you set this function to [ON], you can convert HDV format signals to DV format signals and output the DV format signals to an external device via the  HDV/DV (i.LINK) jack. You can output DV format signals without any format conversion. The default setting is [OFF].

### ■ DOWN CONVERT

You can set a down convert type when you set [HDV → DV CONV] to [ON] to convert HDV format signals to DV format signals.

#### ▶ SQUEEZE

Outputs a horizontally compressed image while maintaining its original height.

#### EDGE CROP

Outputs the central portion of the original image by cropping its right and left edges.

### ■ DOWN CONV AU



#### ▶ CH1,CH2

Outputs audio signals from CH1 and CH2.

#### CH3,CH4

Outputs audio signals from CH3 and CH4.

## 🔊 Notes

- When you set [HDV → DV CONV] to [ON] during 4-channel audio recording on an HDV device, only audio in the channel selected in [DOWN CONV AU] is outputted from the  HDV/DV (i.LINK) jack.
- For i.LINK connection, see [VCR HDV/DV] (p. 81).
- Disconnect the i.LINK cable before setting [i.LINK SET]. Otherwise, the connected video device may not be able to recognize the video signal from your camcorder.
- Even when you select [CH3,CH4] during HDV2CH recording, only audio in CH1 and CH2 will be outputted from the  HDV/DV (i.LINK) jack.

## EXT REC CTRL

You can connect your camcorder to an HDV/DVCAM/DV compatible device (digital HD video camera recorder, digital video camera recorder, hard disc recorder, etc.) with an i.LINK cable, and record movies on your camcorder and the connected device simultaneously, or continue recording from your camcorder to the connected device.

Refer also to the instruction manuals supplied with the connecting devices.

### ■ REC CTL MODE

#### ▶ OFF

Does not record on a connected device.

#### SYNCHRONOUS (EXT )

Records movies, sound and time code on a connected device in synchronization with your camcorder.

#### RELAY (EXT )

Records movies, sound and time code on a connected device when a tape on your camcorder reaches close to the end during recording.

#### EXT ONLY (EXT )

You can operate an external recording unit\* with the REC START/STOP button of your camcorder.

\*HVR-MRC1 (supplied) or HVR-DR60 (optional)

### Notes

- When this function is set to [EXT ONLY],  does not flash even when there is no tape inserted.
- You can use the REC START/STOP button of your camcorder as a recording start/stop button for the external recording unit when you set this function to [EXT ONLY]. Use the REC button of the video control buttons (p. 125) to start recording on a tape or the STOP button to stop recording.
- EXT** (EXT ONLY) flashes when you connect an external recording unit that is not supported by [EXT ONLY].

### STBY COMMAND

#### ▶ REC PAUSE

Stops recording operation of a connected device by putting it in pause when you stop recording operation of your camcorder.

#### STOP

Stops recording operation of a connected device when you stop recording operation of your camcorder.

## (TC/UB SET) menu

### (TC PRESET/UB PRESET/TC LINK, etc.)

The default settings are marked with ▶. The indicators in parentheses appear when the items are selected.

**See page 63 for details on selecting menu items.**

Push the MENU/STATUS switch to MENU → select the  (TC/UB SET) with the SEL/PUSH EXEC dial.

### TC PRESET

#### ■ PRESET

You can preset the time code.

- Select [TC PRESET] with the SEL/PUSH EXEC dial.
- Select [PRESET] with the SEL/PUSH EXEC dial.
- Select the first 2 digits with the SEL/PUSH EXEC dial.  
You can set the time code between 00:00:00:00 and 23:59:59:24.
- Set other digits by repeating step ③.
- Select [OK] with the SEL/PUSH EXEC dial.

#### ■ RESET

You can reset the time code (00:00:00:00). Select [RESET] in step ① of the [PRESET].

### TC COUNTUP

You can increment the hour of time code by 1 and reset the minute, second and frame of time code when you execute this function.

### Notes

- This function is available only when you set [TC MAKE] to [PRESET].

### UB PRESET

#### ■ PRESET

You can preset the user bit.

- Select [UB PRESET] with the SEL/PUSH EXEC dial.

Push the MENU/STATUS switch to MENU → select the **00:00** (TC/UB SET) with the SEL/PUSH EXEC dial.

- ② Select [PRESET] with the SEL/PUSH EXEC dial.
- ③ Select the first 2 digits with the SEL/PUSH EXEC dial.
- ④ Set other digits by repeating step ③.
- ⑤ Select [OK] with the SEL/PUSH EXEC dial.

#### ■ RESET

You can reset the user bit (00 00 00 00). Select [RESET] in step ① of the [PRESET].

### TC RUN

You can select how the time code advances.

#### ▶ REC RUN

Advances the time code only during recording.

Select this setting to record the time code continuous from the last time code of the previous recording.

#### FREE RUN

Advances the time code regardless of operation of your camcorder.

Select this setting to save the actual time in the time code.

### TC MAKE

#### ▶ REGENERATE

Reads the last time code of the previous recording from the tape and records the new time code consecutively from the last time code during the backspace editing. The time code runs in [REC RUN] mode regardless of the setting of [TC RUN].

#### PRESET

Records the newly set time code on the tape.

### TC LINK

You can synchronize the time codes of multiple camcorders. This function is useful for editing movies recorded by multiple camcorders.

- ① Insert a tape to the main camcorder from which you want to generate the time code.
- ② Set the CAMERA/VCR switches of the main and sub camcorders to CAMERA.
- ③ Connect the sub camcorder to the main camcorder with an i.LINK cable.
- ④ Set the main and sub camcorder as follows:
  - Set [TC RUN] to [FREE RUN] (p. 86).
  - Set [TC MAKE] to [PRESET] (p. 86).

Set the sub camcorders as follows:

- ⑤ Select [TC/UB SET] → [TC LINK] with the SEL/PUSH EXEC dial.
- ⑥ The message [Synchronize TC with connected device?] appears. Select [YES] to synchronize the time code of the sub camcorder with that of the main camcorder. Disconnect the i.LINK cable from your camcorders when synchronization is completed. You can record with the synchronized time codes using those camcorders.

#### 🔍 Notes

- If you want to execute [TC LINK] for more than two camcorders, repeat the steps for multiple sub camcorders with one main camcorder.
- Some frame shifting may occur over time after time code synchronization.
- Some frame shifting may occur if you turn the power off and back on. In such a case, set [TC LINK] again.

### UB TIME REC

#### ▶ OFF

Does not save the actual time in the user bit code.

#### ON

Saves the actual time in the user bit code.

### UB-DATE/TC-TIME

You can save the date and time set in your camcorder in the user bit and time code, respectively, when you do this function.

## (MEMORY SET) menu

### Settings for the “Memory Stick Duo” (ALL ERASE/FORMAT, etc.)

The default settings are marked with ►. The indicators in parentheses appear when the items are selected.

**See page 63 for details on selecting menu items.**

Push the MENU/STATUS switch to MENU → select the  (MEMORY SET) with the SEL/PUSH EXEC dial.

### ALL ERASE

You can delete all the still images without image protection on a “Memory Stick Duo” or in the selected folder.

- ① Select [ALL FILES] or [CURRENT FLDR].

**[ALL FILES]:** Deletes all the images on the “Memory Stick Duo.”

**[CURRENT FLDR]:** Deletes all the images in the currently selected folder.

- ② Select [YES] → [YES] with the SEL/PUSH EXEC dial.

[ Erasing all data...] appears.

[Completed.] appears when all unprotected images are deleted.

### Notes

- Release the write protect tab on the “Memory Stick Duo” beforehand for the “Memory Stick Duo” with the write-protect tab (p. 110).
- The folder will not be deleted even when you delete all the images in the folder.
- Do not do any of the following while [ Erasing all data...] is displayed:
  - Operate the POWER switch/buttons.
  - Eject the “Memory Stick Duo.”

### Notes

- This function is available in the following cases:
  - [TC MAKE] : [PRESET]
  - [TC RUN] : [FREE RUN]
  - [UB TIME REC] : [OFF]
- The time lag may occur between the set time code and the actual time as time goes on. Do [UB-DATE/TC-TIME] again prior to recording.
- The date saved in the user bit will not be automatically updated even when the actual date has been changed.

Push the MENU/STATUS switch to MENU → select the  (MEMORY SET) with the SEL/PUSH EXEC dial.

## FORMAT

You do not need to format the “Memory Stick Duo” since it is already formatted at the factory. If you want to format the “Memory Stick Duo,” select [YES]→[YES].

### Notes

- Do not do any of the following while [ Formatting...] is displayed:
  - Operate the POWER switch/buttons.
  - Eject the “Memory Stick Duo.”
- Formatting erases everything on the “Memory Stick Duo” including protected image data and newly created folders.

## FILE NO.

### SERIES

Assigns file numbers in sequence even if the “Memory Stick Duo” is replaced with another one. The file number is reset when a new folder is created or the recording folder is replaced with another.

### RESET

Resets the file number to 0001 each time the “Memory Stick Duo” is changed.

## NEW FOLDER

When you select [YES], you can create a new folder (102MSDCF to 999MSDCF) on a “Memory Stick Duo.” When a folder is full (a maximum of 9,999 images are stored), a new folder is automatically created.

### Notes

- You cannot delete the new folder once you have created it on your camcorder. Format the “Memory Stick Duo” (p. 88) or delete it on your computer.
- The number of recordable pictures on a “Memory Stick Duo” may decrease as the number of folders increases.

## REC FOLDER (Recording folder)

You can select a folder in which you want to store still images.

Select the folder with the SEL/PUSH EXEC dial.

### Tips

- The still images will be stored in the 101MSDCF folder by default.
- Once you store the still images in the current folder, the folder is selected as a playback folder.

## PB FOLDER (Playback folder)

You can select a folder in which still images you want to view are stored.

Select the folder with the SEL/PUSH EXEC dial.



## (OTHERS) menu

### Settings while recording on a tape or other basic settings (QUICK REC/BEEP, etc.)

The default settings are marked with ►. The indicators in parentheses appear when the items are selected.

**See page 63 for details on selecting menu items.**

Push the MENU/STATUS switch to MENU → select the  (OTHERS) with the SEL/PUSH EXEC dial.

### CAMERA PROF. (Camera profile)

You can save up to 99 camera setting profiles on a “Memory Stick Duo” and two profiles in your camcorder. Using these saved profiles let you quickly obtain suitable camera settings later. When using multiple camcorders of this model, you can save the setting on a “Memory Stick Duo” and load them into the other camcorders.

#### Tips

- You can save menu settings, picture profiles and button settings as a camera profile.

#### ■ To load a camera profile

You can load a camera profile and use it on your camcorder.

- ① Select [LOAD] with SEL/PUSH EXEC dial.
- ② Select the camera profile that you want to load with the SEL/PUSH EXEC dial.
- ③ Select [YES] in the check screen. Your camcorder is restarted and the selected camera profile becomes effective.

#### Notes

- You cannot load camera profile that has been saved by a different model of camcorder or edited on a computer.

#### ■ To save a camera profile

- ① Select [SAVE] with the SEL/PUSH EXEC dial.
- ② Select [MEMORY STICK] with the SEL/PUSH EXEC dial to save the camera profile on the “Memory Stick

Duo” or [CAMERA] to save it in your camcorder.

- ③ Select [NEW FILE] or an existing profile name with the SEL/PUSH EXEC dial.
- ④ Select [YES] in the check screen with the SEL/PUSH EXEC dial. The camera profile is saved.

#### Tips

- When you select [NEW FILE] in [MEMORY STICK], a camera profile is saved as [MS01] the first time you save a camera profile.
- When you select [NEW FILE] in [CAMERA], a camera profile is saved as [CAM1] or [CAM2].
- When you select an existing camera profile, the new camera profile is overwritten.
- You cannot view nor edit a camera profile saved on a “Memory Stick Duo” on your computer.
- You can save a camera profile on a “Memory Stick Duo” that has still image data.

#### ■ To change the camera profile name

You can change the camera profile name.

- ① Select [PROFILE NAME] with the SEL/PUSH EXEC dial.
- ② Select the camera profile of which you want to change the name with the SEL/PUSH EXEC dial. [PROFILE NAME] screen appears.
- ③ Change the profile name with the SEL/PUSH EXEC dial.

#### Tips

- You can enter the name in the same way as the picture profile (p. 45).
- ④ Select [OK] with the SEL/PUSH EXEC dial. Profile name is changed.

#### ■ To delete camera profile settings

- ① Select [DELETE] with the SEL/PUSH EXEC dial.
- ② Select the camera profile you want to delete with the SEL/PUSH EXEC dial.
- ③ Select [YES] on the check screen.

Push the MENU/STATUS switch to MENU → select the  (OTHERS) with the SEL/PUSH EXEC dial.

## ■ To copy a camera profile

You can copy camera profile saved on your camcorder to a “Memory Stick Duo.”

- ① Select [COPY] with the SEL/PUSH EXEC dial.
- ② Select the camera profile that you want to copy with the SEL/PUSH EXEC dial.
- ③ Select [MEMORY STICK] or [CAMERA] for a “Memory Stick Duo” or your camcorder as a copy destination of the camera profile.
- ④ Select [NEW FILE] or an existing profile name with the SEL/PUSH EXEC dial.
- ⑤ Select [YES] on the check screen.

### Tips

- You can copy a camera profile saved on a “Memory Stick Duo” to your camcorder.

## ASSIGN BTN

See page 49.

## CLOCK SET

See page 21.

## WORLD TIME

When you use your camcorder abroad, you can adjust the clock to the local time by setting the time difference with the SEL/PUSH EXEC dial.

When you set the time difference to 0, the clock returns to the original setting.

## LANGUAGE

You can select the language to be used on the LCD screen.

### Tips

- Your camcorder offers [ENG[SIMP]] (simplified English) in case that you cannot find your native tongue among the options.

## PB ZOOM (Playback zoom)

When you set this function to [ON], you can enlarge movie images about 1.1 to 5 times (still images about 1.5 to 5 times) with the handle zoom lever. The default setting is [OFF]. To end the zoom, press and hold the W side of the handle zoom lever until it stops.

### Tips

- To move the zoom horizontally, press the SEL/PUSH EXEC dial, then turn the dial. To move the zoom vertically, press the SEL/PUSH EXEC dial one more time, then turn the dial.

## QUICK REC

You can slightly reduce the recording start point time when resuming recording by changing the POWER switch from OFF to ON.

### ► OFF

It takes some time to restart recording from the state that the drum has stopped rotating, but the transition from the last recorded scene is smooth.

### ON ()

The time shortens slightly until recording restarts from the state that the drum has stopped rotating, but the transition from the last recorded scene may not be smooth. Select this when you do not want to miss a recording chance.

### Tips

- When this function is set to [ON], the interval between scenes freezes for a moment (editing on your computer is recommended).
- When the camcorder is left in standby for more than about 3 minutes, your camcorder exits from standby (the drum stops rotating) to prevent tape wear and battery loss. Since the power does not turn off, you can restart recording by pressing the REC START/STOP button again.

## DATE REC

### ► OFF

Does not superimpose the date and time on images.

### ON

Superimposes the date and time on images.

### 💡 Tips

- When [DV WIDE REC] is set to [OFF], the date and time are displayed outside the 4:3 area but properly recorded on images.
- When you record in the HDV format, the date and time are displayed at different positions during recording and playback.

## BEEP

### ► OFF

Cancels the melody.

### ON

Activates a melody when you start/stop recording.

## REC LAMP[R] (Recording lamp [rear])

When you set this function to [OFF], you can turn off the rear camera recording lamp during recording. The default setting is [ON].

## BATTERY TYPE

You can select the battery type to accurately display the remaining power of the battery installed.

### ► L SERIES

Select when using an L-series battery pack.

### GL SERIES

Select when using a GL-series battery pack.

### ANTON/BAUER

Select when using an ANTON/BAUER battery pack.

## HOURS METER

You can display the cumulative operation time of your camcorder with the total hours of operation, drum rotation, tape running, or the total number of tape unthreading operations.

### OPERATION

Displays the total hours of operation in 10-hour increments.

### DRUM RUN

Displays the total hours of drum rotation in 10-hour increments.

### TAPE RUN

Displays the total hours of tape running in 10-hour increments.

### THREADING

Displays the total number of tape unthreading operation in 10-operation increments.

# Recording pictures from a VCR i.LINK

You can record pictures from a VCR on a tape. You can record a scene as a still image on a "Memory Stick Duo." You can record pictures in the HDV format by connecting an HDV1080i specification compatible device. Be sure to insert a cassette or a "Memory Stick Duo" for recording in your camcorder beforehand.

You can connect your camcorder to a VCR device using an i.LINK cable. Connect your camcorder to the wall socket using the optional AC Adaptor for this operation (p. 17). Refer also to the instruction manuals supplied with the devices to be connected.

## Notes

- You need an i.LINK cable for this operation.
- You cannot perform this operation with the video and audio cable.
- Your camcorder has a 6-pin i.LINK terminal. Select a cable that fits the terminal on the device to be attached.
- Your camcorder can only record from a PAL source. For example, French video or TV programs (SECAM) cannot be recorded correctly. See page 103 for details on TV color systems.
- If you use a 21-pin adaptor to input PAL source, you need a dual direction 21-pin adaptor (optional).

HDV1080i  
compatible device



→ HD quality

AV device with  
i.LINK jack

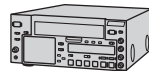

→ SD quality

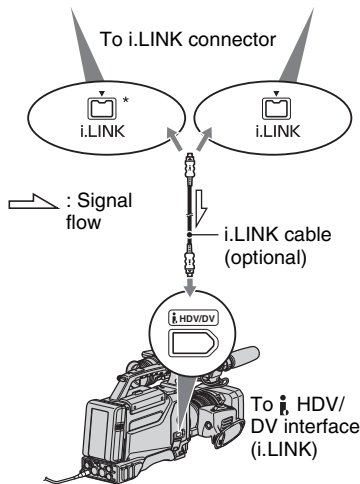

\* An i.LINK jack which is compatible with HDV1080i specification is required.

## Recording movies

**1** Set the CAMERA/VCR switch to VCR.

**2** Set the input signal of your camcorder.

Set [VCR HDV/DV] to [AUTO] when recording from an HDV format compatible device.

Set [VCR HDV/DV] to [DV] or [AUTO] when recording from a

DVCAM (DV) format compatible device (p. 81).

### 3 Connect your VCR as a player to your camcorder.

When an i.LINK cable is connected, the format of the input signal (**HDVIN** **i.LINK** or **DVIN** **i.LINK**) will be indicated on the LCD screen of your camcorder (This indicator may appear on the screen of the playback device but it will not be recorded).

### 4 Insert a cassette into the VCR.

### 5 Set your camcorder to recording pause.

While pressing **II** (PAUSE), press both **● REC** (record) buttons simultaneously.

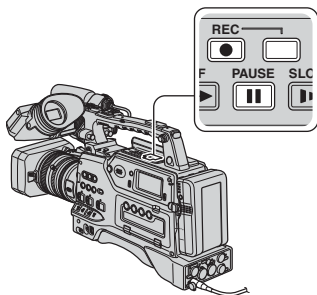

### 6 Start playing the cassette on your VCR.

The picture played on the VCR appears on the LCD screen of your camcorder.

### 7 Press **II** (PAUSE) again at the point you want to start recording.

## 8 Press **■** (STOP) to stop recording.

#### ⚡ Notes

- You cannot record TV programs from the **■** HDV/DV interface (i.LINK).
- User bits are not recorded when dubbing from a DVCAM (DV) device via an i.LINK cable.
- You can record pictures from DV devices only in the DVCAM (DV) format.
- Note the following when connecting with an i.LINK cable:
  - The recorded picture becomes rough when a picture is paused on your camcorder while recording to a VCR.
  - You cannot record the picture and sound separately.
  - If you pause or stop the recording and restart it, the picture may not be recorded smoothly.
- If video signals inputted to your camcorder via the **■** HDV/DV jack experience the phenomenon of jittering (variation in frequency), that jittering is transmitted to the video signals outputted from the COMPONENT OUT jack and A/V OUT jack. When you monitor a movie on a TV connected to your camcorder via the COMPONENT OUT jack or A/V OUT jack, images may be distorted or not be displayed. Jittering will not affect recording of the movie on a tape with your camcorder but may affect recording of the movie with another VCR connected to your camcorder via the COMPONENT OUT jack or A/V OUT jack.

#### 💡 Tips

- When a 4:3 video signal is input, it appears with black bands on the right and left sides on the screen of your camcorder.

### Recording still images

Be sure to insert a “Memory Stick Duo” for recording in your camcorder beforehand, and assign [PHOTO] to any of ASSIGN buttons (p. 49).

### 1 Perform steps 1 to 4 in “Recording movies.”

### 2 Start playing the cassette.

The pictures on the VCR appear on the screen of your camcorder.

### 3 Press the ASSIGN button to which [PHOTO] is assigned at the scene you want to record.

#### ⚙ Notes

- The image size is 1.2M when capturing a still image from a movie recorded and played back in the HDV format. The image size is 0.2M when capturing a still image from a movie recorded and played back in the DVCAM (DV) and widescreen (16:9) formats, or VGA (0.3M) when the movie is recorded and played back in the DVCAM (DV) and 4:3 formats.

## Copying movies on a tape to a computer

Connect your camcorder to the computer with an i.LINK cable.

The computer needs to have an i.LINK connector and be installed with editing software that can copy video signals. The software required depends on the format of the recorded pictures and the format for copying to the computer (HDV or DVCAM (DV)) as shown in the table below.

Recorded format	Format for copying to the computer	Required software
HDV	HDV	Editing software capable of copying HDV signal
HDV	DVCAM (DV)	Editing software capable of copying DVCAM (DV) signal
DVCAM (DV)	DVCAM (DV)	Editing software capable of copying DVCAM (DV) signal

#### ⚙ Notes

- The  HDV/DV jack of your camcorder does not have a power-supply function.
- You cannot copy movies using a USB cable.
- Refer to the operating instructions of the software for the details on image copying.
- Refer to the operating instructions of the editing software for the recommended connection.
- Some editing software on the computer may not work correctly.
- You cannot change format DVCAM (DV) to HDV.

The required menu settings vary depending on the recorded images and the format (HDV or DVCAM (DV)) to be copied to the computer.

Recorded format	Format for copying to the computer	Menu setting*
HDV	HDV	[VCR HDV/DV] → [HDV] [i.LINK SET] → [HDV → DV CONV] → [OFF]
HDV	DVCAM (DV)	[VCR HDV/DV] → [HDV] [i.LINK SET] → [HDV → DV CONV] → [ON]
DVCAM (DV)	DVCAM (DV)	[VCR HDV/DV] → [DV] [i.LINK SET] → [HDV → DV CONV] → [OFF]

\* See page 63 for menu settings.

### 💡 Tips

- To copy HDV format images as they are without changing their format, an HDV compatible environment is required. For details, refer to your software instruction manual or contact the software manufacturer.
- To play movies by a regular DVD player, you need to create DVD video in the SD format. The DVD video is not in the HDV format.

## Step 1 Connect an i.LINK cable

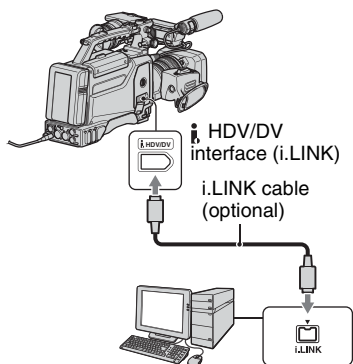

### Notes on connecting to the computer

- Connect the i.LINK cable to the computer first, then to your camcorder. Connecting in the opposite order may cause static electricity to build up, resulting in a malfunction of your camcorder.
- The computer may freeze or may not recognize the signal from your camcorder in the following situations.
  - Connecting your camcorder to a computer that does not support the video signal formats appearing on the LCD screen of your camcorder display (HDV or DVCAM (DV)).
  - Changing the settings in [VCR HDV/DV] (p. 81) and [HDV → DV CONV] of [i.LINK SET] (p. 84).
  - Changing [REC FORMAT] setting while connected with an i.LINK cable with the CAMERA/VCR switch set to CAMERA (p. 81).
  - Changing the CAMERA/VCR switch position while connected with an i.LINK cable.
- The format (HDV or DVCAM (DV)) of input/output signal appears on the LCD screen of your camcorder while connected with an i.LINK cable.

### Step:2 Copying the movies

Use the optional AC Adaptor to obtain AC power (p. 17).

- ① Prepare editing software (not provided).
- ② Turn on your computer.
- ③ Insert a tape into your camcorder and set the CAMERA/VCR switch to VCR.
- ④ Set the menu of your camcorder.  
The menu settings vary depending on the copying image.
- ⑤ Copy images to the computer with your software.

#### Notes

- If images are copied in HDV format but are not recognized, your editing software may not support HDV format. Convert the images to DVCAM (DV) format according to step ④ and copy again.
- A tape recorded in DVCAM (DV) format cannot be copied to a computer in HDV format.

#### Tips

- When images recorded in HDV format are copied to a computer, the file size is about 2GB (almost the same as a DV file) for a 10-minute movie if the video compression format is MPEG2.

### When copying the movie in the HDV format from the computer to your camcorder

Set [VCR HDV/DV] to [HDV] and [HDV → DV CONV] of [i.LINK SET] to [OFF] (p. 81, 84).

#### Notes

- To copy an HDV format movie edited on a computer back onto a tape in HDV format is possible so long as your editing software supports copying HDV movies onto tape. For details, contact the software manufacturer.

### When copying the movie in the DVCAM (DV) format from the computer to your camcorder

Set [VCR HDV/DV] to [DV] (p. 81).



# Troubleshooting

If you run into any problems using your camcorder, use the following table to troubleshoot the problem. If the problem persists, disconnect the power source and contact your Sony dealer.

- Power sources/LCD screen...p. 97
- Cassette tapes/"Memory Stick Duo"...p. 98
- Recording...p. 98
- Playback...p. 102
- Connecting to TV...p. 103
- Dubbing/Editing/Connecting to other devices...p. 104
- Connecting to a computer...p. 105

## Power sources/LCD screen

### The power does not turn on or abruptly turns off.

- Attach a charged battery pack to the camcorder (p. 16).
- Use the AC Adaptor to connect to a wall socket (p. 17).

### The camcorder does not operate even when the power is set to on.

- Disconnect the AC Adaptor from the wall socket or remove the battery pack, then reconnect it after about 1 minute.
- Press the RESET button (p. 125) using a sharp-pointed object.

### The camcorder gets warm.

- The camcorder may get warmer while you use it. This is not a malfunction.

### The remaining battery time indicator does not indicate the correct time.

- Ambient temperature is too high or too low, or the battery pack has not been charged enough. This is not a malfunction.
- Fully charge the battery again. If the problem persists, the battery may be worn-out. Replace it with a new one (p. 16, 115).
- The indicated time may not be correct in certain circumstances. For example, when you open or close the LCD panel, it takes about 1 minute to display the correct remaining battery time.
- Set proper battery type in [BATTERY TYPE] (p. 91).

### The battery pack discharges too quickly.

- Ambient temperature is too high or low, or the battery pack has not been charged enough. This is not a malfunction.
- Fully charge the battery again. If the problem persists, the battery may be worn-out. Replace it with a new one (p. 16, 115).

### The picture remains on the LCD screen.

- This occurs if you disconnect the DC plug or remove the battery pack without turning off the power first. This is not a malfunction.

### The picture in the viewfinder is not clear.

- Move the viewfinder lens adjustment lever until the picture appears clearly (p. 19).

## Cassette tapes/"Memory Stick Duo"

### The cassette cannot be ejected from the compartment.

- Make sure the power source (battery pack or AC Adaptor) is connected correctly (p. 16).
- Moisture condensation has occurred inside the camcorder (p. 113).

### The Cassette Memory indicator or title display does not appear while using a cassette with Cassette Memory function.

- This camcorder does not support Cassette Memory function, so the indicator does not appear.

### The remaining tape indicator is not displayed.

- Set [ REMAINING] to [ON] to always display the remaining tape indicator (p. 80).

### You cannot delete pictures or format the "Memory Stick Duo."

- The pictures are protected. Release the protect function on your computer, etc.

## Recording

### The recording does not start when you press the REC START/STOP button.

- Set the POWER switch to ON and the CAMERA/VCR switch to CAMERA (p. 26).
- The tape has reached the end. Rewind it, or insert a new cassette.
- Set the write-protect tab of the cassette to REC or insert a new cassette (p. 107).
- The tape is stuck to the drum due to moisture condensation. Remove the cassette and leave your camcorder for at least 1 hour, then re-insert the cassette (p. 113).
- Set [REC CTL MODE] of [EXT REC CTRL] to other than [EXT ONLY] (p. 84).

### The handle zoom does not work.



- Set the handle zoom speed switch to FIX or VAR (p. 30).

### You cannot record on the "Memory Stick Duo."

- Assign [PHOTO] to an ASSIGN button (p. 49).
- The "Memory Stick Duo" is full. Delete unnecessary pictures recorded on the "Memory Stick Duo" (p. 110).
- Format the "Memory Stick Duo" on your camcorder (p. 88) or insert another "Memory Stick Duo" (p. 24).
- You cannot record still images on the "Memory Stick Duo" in the following cases.
  - While executing [FADER]
  - While executing [SMTH SLW REC]
  - When the shutter speed is set to slower than 1/50
  - While using shot transition
  - When [SCAN TYPE] is set to [25]

---

### You cannot record a smooth transition on a tape from the last recorded scene to the next.

- Do not record progressive pictures in different [REC TYPE] settings on the same tape.
- Perform End search (p. 51).
- Do not remove the cassette (the picture will be recorded continuously without a break even when you turn the power off).
- Do not record pictures in the HDV and DVCAM (DV) formats on the same tape.
- Do not record pictures in DVCAM mode and DV SP mode on the same tape. 
- When [QUICK REC] is set to [ON], you cannot record a smooth transition (p. 90). 

---

### The shutter sound is not heard when you record a still image.

- Set [BEEP] to [ON] (p. 91).
- No shutter sound will be outputted during movie recording or while an external device is connected.

---

### End search or last scene review does not work.

- Do not eject the cassette after recording (p. 51).
- There is nothing recorded on the cassette.
- There is a blank section between recorded sections of the tape. This is not a malfunction.

---

### Auto focus does not function.

- Set the focus ring to mode B and press the ASSIGN button to which [FOCUS] is assigned until the automatic focus function is enabled (p. 31, 49).
- Adjust the focus manually if the automatic focus does not work properly (p. 31).

---

### Menu items are grayed out or do not work.

- You cannot select grayed out display items in the current recording/playback situation.
- There are some functions you cannot activate simultaneously. The following list shows examples of unworkable combinations of functions and menu items.

Cannot use	Situation
[BACK LIGHT], [SPOTLIGHT]	Two or more of iris, gain, and shutter speed are set manually.
[AE SHIFT]	Iris, gain, and shutter speed are all set manually.
[CNTRST ENHCR]	During [BACK LIGHT]
[FADER]	No tape is inserted.
[D.EXTENDER]	[REC TYPE] of [HDV PROGRE.] is set to [PROGRESSIVE]. [REC TYPE] of [HDV PROGRE.] is set to [INTERLACE] and [SCAN TYPE] is set to [25]. [SCAN TYPE] of [DV PROGRE.] is set to [25].
[ZEBRA], [PEAKING], [CAM DATA DSP], [HISTOGRAM]	The OUTPUT/DCC switch is set to BARS.

## Troubleshooting (Continued)

Cannot use	Situation
[SMTH SLW REC]	[REC TYPE] of [HDV PROGRE.] is set to [PROGRESSIVE]. [REC TYPE] of [HDV PROGRE.] is set to [INTERLACE] and [SCAN TYPE] is set to [25]. [SCAN TYPE] of [DV PROGRE.] is set to [25]. [REC CTL MODE] of [EXT REC CTRL] is set to [EXT ONLY]. The OUTPUT/DCC switch is set to BARS.
[MARKER]	During [DATE REC]
[FOCUS MACRO]	A Carl Zeiss lens is mounted, and the focus ring is set to mode B. A Carl Zeiss lens is not mounted.
[STEADYSHOT], [FLANGE BACK]	A Carl Zeiss lens is not mounted.
[TC LINK]	Your camcorder is not connected to an external device via an i.LINK cable.
[TC COUNTUP]	[TC MAKE] is set to [REGENERATE].
[UB-DATE/TC-TIME]	[TC MAKE] is set to [REGENERATE]. [TC RUN] is set to [REC RUN]. [UB TIME REC] is set to [ON]. Date and time are not set.
[WORLD TIME], [DATE REC]	Date and time are not set.
[x.v.Color]	[REC FORMAT] is set to [DV].
[INTERVAL REC]	[REC CTL MODE] of [EXT REC CTRL] is set to [EXT ONLY]. [REC TYPE] of [HDV PROGRE.] is set to [PROGRESSIVE]. [REC TYPE] of [HDV PROGRE.] is set to [INTERLACE] and [SCAN TYPE] is set to [25]. [SCAN TYPE] of [DV PROGRE.] is set to [25].
[DV FRAME REC]	[REC CTL MODE] of [EXT REC CTRL] is set to [EXT ONLY].
[EXT REC CTRL]	During [SMTH SLW REC] During [INTERVAL REC] During [DV FRAME REC]

### Shutter speed, gain, white balance or iris cannot be adjusted manually.

- Set the CAMERA MODE switch to MANUAL.

### Tiny spots in white, red, blue, or green appear on the screen.

- This phenomenon appears when using a slow shutter speed (p. 34). This is not a malfunction.

---

**The subjects passing by the frame very fast appear crooked.**

- This is called the focal plane phenomenon. This is not a malfunction. Because of the way that the image device (CMOS sensor) reads out image signals, the subjects passing by the frame rapidly might appear crooked depending on the recording conditions.

---

**The screen picture is bright, and the subject does not appear on the screen.**

- Set [BACK LIGHT] to [OFF].
- Set [HYPER GAIN] to [OFF].

---

**The screen picture is dark, and the subject does not appear on the screen.**

- Press and hold the DISPLAY button for a few seconds to turn on the backlight (p. 20).

---

**Horizontal stripes appear on the image.**

- This occurs when recording pictures under a fluorescent lamp, sodium lamp, or mercury lamp. This is not a malfunction. This can be improved by changing the shutter speed (p. 34).

---

**Black bands appear when you record a TV screen or computer screen.**

- This can be improved by adjusting the shutter speed in the ECS mode (p. 34).

---

**The beginning of the recording looks dark when the video light comes on linked to the start of movie recording (when the LIGHT MAN/AUTO switch is set to AUTO).**

- The light volume may not be stable immediately after the light comes on.
- The light does not come on during data writing in the cache memory of an external recording unit.
- Set the LIGHT MAN/AUTO switch to MAN and turn on the light before recording starts.

---

**The video light does not come on.**

- Set the video light switch to ON.
- The video light does not come on during the following kinds of recording when the LIGHT MAN/AUTO switch is set to AUTO:
  - DV frame recording
  - Smooth slow recording
  - Interval recording
  - Recording by a VCR

---

**Fine patterns flicker, diagonal lines look jagged.**

- Adjust [DETAIL] to [0] side (p. 43).

---

**Sound cannot be input to CH1.**

- When you set the CH1 switch to MAN, adjust the audio input level of CH1 with the AUDIO LEVEL dial on the front of your camcorder or the CH1 dial on the left side of it.

## Troubleshooting (Continued)

- Set the CH1 switch to AUTO.
- Set the INPUT1 switch to an appropriate position for the device connected to the AUDIO INPUT1(L) jack.
- Make sure that the connector of the cable connected to the AUDIO INPUT1(L) is locked.
- For 2CH/FS48K recording, set CH1 of the REC CH SELECT switch to IN1.

### Playback

If you are playing back pictures stored on a “Memory Stick Duo,” refer also to the Cassette tapes/“Memory Stick Duo” section (p. 98).

---

#### You cannot play back tape.

- Set the POWER switch to ON and the CAMERA/VCR switch to VCR.
- Rewind the tape (p. 56).

---

#### Image data stored on a “Memory Stick Duo” cannot be played back correctly.

- Image data cannot be played back if you have modified file names or folders, or have edited the data on a computer (In this case, the file name flashes). This is not a malfunction (p. 111).
- Pictures recorded on other devices may not be played back correctly. This is not a malfunction.

---

#### The data file name is displayed incorrectly, or flashing.

- The file is damaged.
- The file format is not supported on your camcorder (p. 107).
- Only the file name is displayed if the folder structure does not conform to the universal standard.

---

#### Horizontal lines appear on the picture. The displayed pictures are not clear or do not appear.

- Video head is dirty. Clean the head using the cleaning cassette (optional) (p. 114).

---

#### You cannot hear the sound recorded with 4CH microphone recording on your camcorder.

- Confirm the setting of AUDIO MONITOR switch (p. 48).

---

#### No sound or only a low sound is heard.

- Turn up the volume (p. 57).
- Pictures recorded using [SMTH SLW REC] do not have sounds.

---

#### The picture or sound breaks off.

- The tape was recorded in both of the HDV and DVCAM (DV) formats. This is not a malfunction.

---

**The movies freeze for a while, or the sound breaks off.**

- This occurs if the tape or video head is dirty (p. 114).
- Use the Sony standard size DV or mini DV cassette tape.

---

**“---” is displayed on the screen.**

- The tape you are playing back was recorded without setting the date and time.
- A blank section on the tape is being played back.
- The data code on a tape with a scratch or noise cannot be read.
- A movie recorded in the extended clear scan (ECS) mode is being played back.
- When a non-Carl Zeiss lens is attached, the iris value cannot be displayed.
- The tape you are playing back was recorded with the gain value set to -6dB.
- The tape you are playing back was recorded with [HYPER GAIN] set to [ON].

---

**Noises appear and **NTSC** or **60i** is displayed on the screen.**

- The tape was recorded in a TV color system other than that of your camcorder (PAL). This is not a malfunction.

---

**Date Search does not work correctly.**

- Be sure to record more than 2 minutes after the date changed. If one day's recording is too short, your camcorder may not accurately find the point where the recording date changes.
- There is a blank section between recorded sections of the tape. This is not a malfunction.

---

**No picture appears during End search, Rec review or Last scene review.**

- The tape was recorded in both HDV and DVCAM (DV) formats. This is not a malfunction.

---

**2/2-ST appears on the LCD screen.**

- This appears when you play back a tape recorded on other recording devices using a 4ch microphone.

## Connecting to TV

**You cannot view the picture on the TV connected with the i.LINK cable.**

- You cannot view the picture in the HD (high definition) quality on the TV if an i.LINK jack of the TV is not compatible with the HDV1080i specification (p. 61). Refer to the instruction manuals supplied with your TV.
- Down convert the pictures recorded in HDV format and play back in DVCAM (DV) format (SD image quality) (p. 84).
- Connect the TV with another connecting cable, and play back pictures (p. 61).

### **You cannot hear the sound on the TV connected with the S VIDEO plug (S VIDEO channel) or component video plug.**

- If you are using an S VIDEO plug or component video plug, make sure the audio cable is also connected (p. 61).
- 

### **You cannot view the picture or hear the sound on the TV connected with the component video cable.**

- Set [SDI/CMPNT] according to the requirements of the connected device (p. 83).
- 

### **You cannot output S video output or video output signals.**

- Set the VIDEO OUT switch to COMPOSITE (p. 61).
- 

## Dubbing/Editing/Connecting to other devices

### **Pictures from connected devices cannot be zoomed.**

- You cannot zoom pictures from connected devices on your camcorder.
- 

### **Time code and other information appear on the display of the connected device.**

- Set [DISP OUTPUT] to [LCD PANEL] while connected with video and audio cables (p. 81).
- 

### **You cannot dub correctly using the video and audio cables.**

- The video and audio cables are not connected properly.  
Make sure that the video and audio cable is connected to the input jack of the other device for dubbing a picture from your camcorder.
- 

### **When connected using an i.LINK cable, no picture appears on the monitor screen during dubbing.**

- Set [VCR HDV/DV] according to the requirements of the connected device (p. 81).
- 

### **You cannot add sound to the recorded tape.**

- You cannot add sound to the recorded tape on this unit.
- 

### **When you copy a movie shot in wide (16:9) format using an i.LINK cable, the screen stretches vertically.**

- You cannot output the aspect ratio setting using an i.LINK cable. Set the aspect ratio of the TV instead.
- Connect using video and audio cables instead.



## Connecting to a computer

### **The computer does not recognize your camcorder.** [i.LINK](#)

- Disconnect the cable from the computer, then connect it again securely.
  - Disconnect the cable from the computer, restart the computer, then connect the computer to your camcorder correctly.
- 

### **You cannot view or copy a movie recorded on a tape to a computer.** [i.LINK](#)

- Disconnect the cable from the computer, then connect it again.
  - You need the editing software (optional) to copy a movie recorded on a tape to your computer (p. 94).
- 

### **Your computer freezes.**

- Set [VCR HDV/DV] correctly according to the connected device (p. 81).
- Disconnect the cable from your computer and camcorder. Reboot your computer, and connect your computer and camcorder following the steps in the correct order (p. 95).

# Warning indicators and messages

## Self-diagnosis display/Warning indicators

When an error occurs, a warning indicator appears on the LCD screen or in the viewfinder, or the WARNING lamp turns on or flashes.

You can fix some problems associated with the symptoms yourself. If the problem persists even after you have tried a couple of times, contact your Sony dealer or local authorized Sony service facility.

### C:(or E:) □□:□□ (Self-diagnosis display)

#### C:21:□□

- Moisture condensation has occurred. Remove the cassette and leave your camcorder for at least 1 hour, then reinsert the cassette (p. 113).

#### C:22:□□

- Clean the head using a cleaning cassette (optional) (p. 114).

#### C:31:□□ / C:32:□□

- Symptoms that are not described above have occurred. Remove and insert the cassette, then operate your camcorder again. Do not perform this procedure if moisture condensation has occurred (p. 113).
- Remove the power source. Reconnect it and operate your camcorder again.
- Change the cassette. Press the RESET button (p. 125), and operate your camcorder again.

#### E:61:□□ / E:62:□□

- Contact your Sony dealer or local authorized Sony service facility. Inform them of the 5-digit code, which starts from "E."

### 101-1001(Warning indicator pertaining to files)

- The file is damaged.
- The file is unreadable (p. 111).

### (Battery level warning)

- The battery pack is nearly used up.
- Depending on the operating environment, or battery conditions,  may flash, even if there are approximately 5 to 10 minutes remaining.

### (Moisture condensation warning)\*

- Eject the cassette, remove the power source, and then leave it for about 1 hour with the cassette lid open (p. 113).

### (Warning indicators pertaining to the tape)

#### Slow flashing:

- There is less than 5 minutes remaining on the tape.
- No cassette is inserted.\*
- The write-protect tab on the cassette is set to lock (p. 107).\*

#### Fast flashing:

- The tape has run out.\*

### (Eject cassette warning)\*

#### Slow flashing:

- The write-protect tab on the cassette is set to lock (p. 107).

#### Fast flashing:

- Moisture condensation has occurred (p. 113).
- The self-diagnosis display code is displayed (p. 106).

\* When [BEEP] is set to [ON] (p. 91), you hear a melody when the warning indicators appear on the screen.

## Warning messages

If messages appear on the screen, follow the instructions.

# Maintenance and precautions

## HDV format and recording/ playback

Your camcorder is capable of recording in HDV/DVCAM/DV formats.

It is recommended to use a cassette with the **HDV** or **Mini DV** mark to record in the HDV/DVCAM/DV format.

It is recommended to use a cassette with the **DVCAM** mark to record in the DVCAM format.

Your camcorder is not compatible with the Cassette Memory function.

### What is the HDV format?

The HDV format is a video format developed to record and play back digital high definition (HD) video signals on a DV cassette.

Your camcorder adopts the Interlace mode with 1,080 effective scan lines of screen ruling (1080i, number of pixels 1,440 × 1,080 dots).

The video bit rate for recording is about 25 Mbps.

i.LINK is adopted for the digital interface, enabling a digital connection with an HDV compatible TV or computer.

- HDV signals are compressed in MPEG2 format, which is adopted in BS (broadcast satellite) digital, terrestrial digital HDTV broadcastings, in Blu-ray Disc recorders, etc.

### Playback

- Your camcorder can play back pictures in both the DVCAM (DV) format and HDV1080i specification.
- Your camcorder can play back pictures recorded in the HDV 720/30p format, but cannot output it from the  HDV/DV interface (i.LINK).

### To prevent a blank section from being created on the tape

Go to the end of the recorded section using [END SEARCH] (p. 51) before you begin

the next recording when you have played back the tape.

### Copyright signal

#### ■ When you play back

If the cassette you play back on your camcorder contains copyright signals, you cannot copy it to a tape in another video camera connected to your camcorder.

#### ■ When you record

You cannot record software on your camcorder that contains copyright control signals for copyright protection of software. [Cannot record due to copyright protection.] appears on the LCD screen, or on the viewfinder if you try to record such software. Your camcorder does not record copyright control signals on the tape when it records.

### Audio mode

The DVCAM format has 2 audio modes.

- You cannot dub sound onto a recorded tape with your camcorder.

#### ■ FS32K (12-bit) mode

Sound can be recorded in four 4 channels, CH1, CH2, CH3 and CH4.

You can monitor sounds by switching outputs using the AUDIO MONITOR switch. When the AUDIO MONITOR switch is set to MIX, CH1 and CH3 sounds are mixed and CH2 and CH4 sounds are mixed.

#### ■ FS48K (16-bit) mode

The original sound can be recorded in high quality using 2 channels. The audio mode can be indicated on the LCD screen or in the viewfinder.

### Notes on use

#### ■ When not using your camcorder for a long time

Remove the cassette and store it.

## Maintenance and precautions (Continued)

### ■ To prevent accidental erasure

Slide the write-protect tab on the cassette to set it to SAVE.



REC: The cassette can be recorded.

SAVE: The cassette cannot be recorded (write-protected).



### ■ When labeling the cassette

Be sure to place the label only on the locations shown in the following illustration so as not to cause a malfunction of your camcorder.

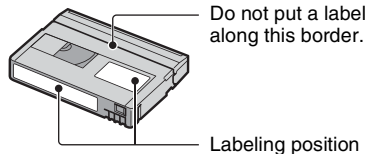

### ■ After using the cassette

Rewind the tape to the beginning to avoid distortion of the picture or the sound. The cassette should then be put in its case, and stored in an upright position.

### ■ When cleaning the gold-plated connector

Generally, clean the gold-plated connector on a cassette with a cotton-wool swab after every 10 times it has been ejected. If the gold-plated connector on the cassette is dirty or dusty, the remaining tape indicator may not show correctly.

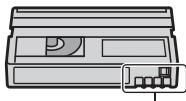

Gold-plated connector

## On Sony HDV1080i compliant TVs

HDV1080i

An HDV format compatible TV with the component input jack is required to view playback pictures recorded in the HDV format.

## Compatibility of the DVCAM/DV formats

The DVCAM format was developed as a more reliable and higher-end format than the consumer DV format. Explained here are the differences, compatibility, and limitations on editing for the DVCAM and DV formats. **NS** appears when the DVCAM standard is not met.

## Differences between the DVCAM and DV formats

Specification	DVCAM	DV
TRACK Pitch	15 $\mu$ m	10 $\mu$ m
Audio sampling frequency	12 bit:32 kHz	12 bit:32 kHz 16 bit:48 kHz
Audio recording mode*	16 bit:48 kHz	44.1 kHz 48 kHz
Audio recording mode*	Lock mode	Lock/Unlock mode

\* There are 2 modes for audio recording, lock mode and unlock mode. In lock mode, the sampling frequencies of audio and video are synchronized. Therefore, lock mode is more effective than unlock mode in digital processing and smooth transition during audio editing.

## Mini DVCAM and mini DV cassettes

The recording format of the picture is defined according to the recorder's format as described below.

Recorder's format	Cassette's format	Recording format
DVCAM	DVCAM DV	DVCAM
DV	DVCAM DV	DV

### Notes

- This camcorder complies with the DVCAM format. Though mini DV cassettes can be used for recording, we recommend you use mini DVCAM cassettes to get the most out of the high reliability of the DVCAM format.
- The recording time of mini DV cassettes is 1/3 shorter than that indicated on mini DV cassettes when recorded in the DVCAM format.

## Compatibility on playback

Tape	On DV video equipment	On DVCAM video equipment
DV formatted	Can be played back	Can be played back only when recorded in SP mode
DVCAM formatted	Can be played back on some equipment	Can be played back

## Compatibility on editing using DV jacks

When this camcorder is connected to other digital video equipment using an i.LINK cable, the recording format of edited tapes is defined according to the source tape and the recorder's format as described below. Playback or editing using the edited tape may be limited depending on dubbing operation. Start dubbing after reading "Limitations on editing" (p. 110).

Source tape	Player's format	Recorder's format	Recording format
DV formatted (SP mode only)	DVCAM	DVCAM DV	DVCAM <sup>1)</sup> DV
DV formatted	DV	DVCAM DV	DVCAM DV
DVCAM formatted <sup>2)</sup>	DVCAM	DVCAM DV	DVCAM DV
DVCAM formatted <sup>2)</sup>	DV <sup>3)</sup>	DVCAM	DVCAM (Compatibility depends on models.) DV DV

<sup>1)</sup> When using mini DVCAM video equipment to perform DV dubbing of a tape recorded in DV format, the tape produced will be in the DVCAM format which the time code format will be partly misadjusted. (there will be no effect on the recorded picture except in certain cases.)

<sup>2)</sup> If the tape that is to be dubbed is in the DVCAM format as in 1), the tape produced will be in the DVCAM format and the time code format will be partly misadjusted.

<sup>3)</sup> Some mini DV video equipment may be able to play back a DVCAM-formatted tape. Even if the tape is played back, quality of the playback cannot be guaranteed. The time code format will be partly misadjusted.

## Maintenance and precautions (Continued)

### 🔊 Notes

- If you use tapes as in 1) to 3) above for editing, the functions may be limited regardless of the format of players and recorders.

### Limitations on editing

You may find the following limitations when editing a tape produced by dubbing or editing using the HDV/DV Interface

🔌 (i.LINK) jack:

- Due to the difference in track pitch, you cannot record or edit on DV-formatted tapes using mini DVCAM video equipment.
- Depending on the DVCAM video equipment used, you may not be able to edit DVCAM formatted tapes if the audio recording mode is unlock mode. In this case, dub using audio/video jacks.

### About the “Memory Stick”

A “Memory Stick” is a compact, portable IC recording medium with a large data capacity.

You can use the following types of “Memory Stick” listed below on the camcorder. However, we do not guarantee the operation of all types of “Memory Stick” on your camcorder. (See the list below for more details.)

Types of “Memory Stick”	Recording /Playback
“Memory Stick Duo” (with MagicGate)	○
“Memory Stick PRO Duo”	○
“Memory Stick PRO-HG Duo”	○

- This product does not support high speed data transfer via a parallel interface.
- This product cannot record or play data that uses “MagicGate” technology. “MagicGate” is a copyright protection technology that records and transfers the contents in an encrypted format.
- This product is compatible with “Memory Stick Micro” (“M2”). “M2” is the abbreviation for the “Memory Stick Micro.”

- Still image format: Your camcorder compresses and records image data in the JPEG (Joint Photographic Experts Group) format. The file extension is “.JPG.”
- A “Memory Stick Duo” formatted by a computer (Windows OS/Mac OS) does not have guaranteed compatibility with your camcorder.
- Data read/write speed may vary depending on the combination of the “Memory Stick Duo” and “Memory Stick Duo” compliant product you use.
- You can prevent accidental erasure of images when you slide the write-protect tab on the “Memory Stick Duo” with a small tapered object, to the write-protect position.
- Damaged or lost image data will not be compensated for, and may occur in the following cases:
  - If you eject the “Memory Stick Duo,” turn the power off on your camcorder, or remove the battery pack for replacement while your camcorder is reading or writing image files on the “Memory Stick Duo” (while the access lamp is lit or flashing).
  - If you use the “Memory Stick Duo” near magnets or magnetic fields.
- It is recommended to make a back-up of important data on the hard disk of a computer.
- Be careful not to apply excessive force when writing on a memo area on a “Memory Stick Duo.”
- Do not attach a label or the like on a “Memory Stick Duo” or a “Memory Stick Duo” adaptor.
- When you carry or store a “Memory Stick Duo,” put it in its case.
- Do not touch, or allow metallic objects to come into contact with the terminals.
- Do not bend, drop or apply strong force to the “Memory Stick Duo.”
- Do not disassemble or modify the “Memory Stick Duo.”
- Do not let the “Memory Stick Duo” get wet.
- Be careful to keep “Memory Stick Duo” media out of the reach of small children. There is danger that a child might swallow it.
- Do not insert anything other than a “Memory Stick Duo” into the “Memory Stick Duo” slot. Doing so may cause a malfunction.

- Do not use or keep the “Memory Stick Duo” in the following locations:
  - Places subject to extremely high temperature, such as a car parked outside in the summer.
  - Places under direct sunlight.
  - Places with extremely high humidity or subject to corrosive gases.

#### ■ On the “Memory Stick Duo” adaptor

- When using a “Memory Stick Duo” with a “Memory Stick” compliant device, make sure to insert the “Memory Stick Duo” into a “Memory Stick Duo” adaptor.
- When inserting a “Memory Stick Duo” into a “Memory Stick Duo” adaptor, make sure the “Memory Stick Duo” is inserted facing in the correct direction, then insert it all the way in. Note that improper use may cause a malfunction. Also, if you force the “Memory Stick Duo” into the “Memory Stick Duo” adaptor in the wrong direction, it may be damaged.
- Do not insert a “Memory Stick Duo” adaptor without a “Memory Stick Duo” attached. Doing so may result in malfunctions of the unit.

#### ■ On a “Memory Stick PRO Duo”

- The maximum memory capacity of a “Memory Stick PRO Duo” that can be used on your camcorder is 8 GB.

### Notes on using “Memory Stick Micro”

- To use a “Memory Stick Micro” with the camcorder, you need a Duo-sized M2 Adaptor. Insert the “Memory Stick Micro” into the Duo-sized M2 Adaptor, then insert the adaptor into the “Memory Stick Duo” slot. If you insert a “Memory Stick Micro” into the camcorder without using a Duo-sized M2 Adaptor, you might not be able to remove it from the camcorder.
- Do not leave the “Memory Stick Micro” within the reach of small children. They might accidentally swallow it.

### On image data compatibility

- Image data files recorded on a “Memory Stick Duo” by your camcorder conform to the “Design rule for Camera File system” universal standard established by the JEITA (Japan Electronics and Information Technology Industries Association).
- On your camcorder, you cannot play back still images recorded on other devices (DCR-TRV900E or DSC-D700/D770) that do not conform to the universal standard. (These models are not sold in some regions.)
- If you cannot use a “Memory Stick Duo” that has been used with another device, format it with your camcorder (p. 88). Note that formatting erases all information on the “Memory Stick Duo.”
- You may not be able to play back images with your camcorder:
  - When playing back image data modified on your computer.
  - When playing back image data recorded with other devices.

### About storage of the battery pack

- If the battery pack is not used for a long time, fully charge the battery pack and use it up on your camcorder once a year to maintain proper function. To store the battery pack, remove it from your camcorder and put it in a dry, cool place.
- To discharge the battery pack on your camcorder completely, leave your camcorder in tape recording standby until the power goes off (p. 16).

### About battery life

- Battery capacity decreases over time and through repeated use. If decreased usage time between charges becomes significant, it is probably time to replace it with a new one.
- Each battery’s life is governed by storage, operating and environmental conditions.

### About i.LINK

The  HDV/DV (i.LINK) jack on your camcorder is an i.LINK-compliant 6-pin jack. This section describes the i.LINK standard and its features.

## Maintenance and precautions (Continued)

### What is i.LINK?

i.LINK is a digital serial interface for transferring digital video, digital audio, and other data to other i.LINK-compatible devices. You can also control other devices using the i.LINK.

i.LINK-compatible devices can be connected using an i.LINK cable. Possible applications are operations and data transactions with various digital AV devices.

When two or more i.LINK-compatible devices are daisy-chained with the unit, operation becomes possible from any device in the chain. Note that operation method may vary, or data transactions may not be possible, depending on specifications and characteristics of the connected devices.

#### Notes

- Normally, only one device can be connected to this unit with an i.LINK cable. When connecting this unit to an HDV/DV compatible device having two or more  HDV/DV interfaces, refer to the operating instructions of the device to be connected.
- i.LINK is a more familiar term for the IEEE 1394 data transport bus proposed by Sony, and is a trademark approved by many corporations.
- IEEE 1394 is an international standard standardized by the Institute of Electrical and Electronics Engineers.

### About the i.LINK Baud rate

i.LINK's maximum baud rate varies according to the device. There are 3 types.

S100 (approx. 100Mbps\*)

S200 (approx. 200Mbps)

S400 (approx. 400Mbps)

The baud rate is listed under "Specifications" in the operating instructions of each piece of equipment. It is also indicated near the i.LINK interface on some devices.

The baud rate may differ from the indicated value when the unit is connected to a device with a different maximum baud rate.

#### \* What is Mbps?

Mbps stands for "megabits per second," or the amount of data that can be sent or received in one second. For example, a baud rate of 100 Mbps means that 100 megabits of data can be sent in one second.

### To use i.LINK functions on this unit

For details on how to dub when this unit is connected to other video devices having an i.LINK interface, see page 95.

This unit can also be connected to other i.LINK-compatible devices made by Sony (for example, a VAIO series personal computer) as well as to video devices. Some i.LINK compatible video devices, such as Digital Televisions, DVD, MICROMV or HDV recorders/players are not compatible with this unit. Before connecting to other devices, be sure to confirm whether the device is compatible with an HDV/DV device or not. For details on precautions and compatible application software, refer also to the operating instructions for the device to be connected.

#### Notes

- When connecting a device with an i.LINK terminal to your camcorder via an i.LINK cable, switch off the device and unplug it from the power socket before plugging in or unplugging the i.LINK cable.

### About x.v.Color

- x.v.Color is a more familiar term for the x.v.YCC standard proposed by Sony, and is a trademark of Sony.
- x.v.YCC is an international standard for color space in video. This standard can express a wider color range than the currently used broadcast standard.



## About handling of your camcorder

### On use and care

- Do not use or store the camcorder and accessories in the following locations.
  - Anywhere extremely hot or cold. Never leave them exposed to temperatures above 60 °C (140 °F), such as under direct sunlight, near heaters or in a car parked in the sun. They may malfunction or become deformed.
  - Near strong magnetic fields or mechanical vibration. The camcorder may malfunction.
  - Near strong radio waves or radiation. The camcorder may not be able to record properly.
  - Near AM receivers and video equipment. Noise may occur.
  - On a sandy beach or anywhere dusty. If sand or dust gets in your camcorder, it may malfunction. Sometimes this malfunction cannot be repaired.
  - Near windows or outdoors, where the LCD screen, the viewfinder, or the lens may be exposed to direct sunlight. This damages the inside of the viewfinder or the LCD screen.
  - Anywhere very humid.
- Operate your camcorder on DC 7.2 V (battery pack) or DC 8.4 V (AC Adaptor).
- For DC or AC operation, use the accessories recommended in these operating instructions.
- Do not let your camcorder get wet, for example, from rain or sea water. If your camcorder gets wet, it may malfunction. Sometimes this malfunction cannot be repaired.
- If any solid object or liquid gets inside the casing, unplug your camcorder and have it checked by a Sony dealer before operating it any further.
- Avoid rough handling, disassembling, modifying, physical shock, or impact such as hammering, dropping or stepping on the product. Be particularly careful of the lens.
- Do not use a deformed or damaged battery pack.
- Keep the POWER switch setting to OFF when you are not using your camcorder.
- Do not wrap your camcorder with a towel, for example, and operate it. Doing so might cause heat to build up inside.
- When disconnecting the mains lead, pull it by the plug and not the lead.

- Do not damage the mains lead such as by placing anything heavy on it.
- Keep metal contacts clean.
- If the battery electrolytic liquid has leaked,
  - consult your local authorized Sony service facility.
  - wash off any liquid that may have contacted your skin.
  - if any liquid gets in your eyes, wash with plenty of water and consult a doctor.

### ■ When not using your camcorder for a long time



- Periodically turn on the camcorder and play a cassette for about 3 minutes.
- Use up the battery pack completely before storing it.

### Moisture condensation

If your camcorder is brought directly from a cold place to a warm place, moisture may condense inside your camcorder, on the surface of the tape, or on the lens. In this state, the tape may stick to the head drum and be damaged or your camcorder may not operate correctly. If there is moisture inside your camcorder, [Moisture condensation. Eject the cassette] or [Moisture condensation. Turn off for 1H.] appears. The indicator will not appear when the moisture condenses on the lens.

### ■ If moisture condensation has occurred

None of the functions except cassette ejection will work. Eject the cassette, turn off your camcorder, and leave it for about one hour with the cassette lid open. Your camcorder can be used again when both of the following conditions are met:

- The warning message does not appear when the power is turned on.
- Neither  nor  flashes when a cassette is inserted and the video operation buttons are pressed.

If moisture starts to condense, your camcorder sometimes cannot detect condensation. If this happens, the cassette is sometimes not ejected for 10 seconds after the cassette lid is opened. This is not a

## Maintenance and precautions (Continued)

malfunction. Do not close the cassette lid until the cassette is ejected.

### ■ Note on moisture condensation

Moisture may condense when you bring your camcorder from a cold place into a warm place (or vice versa) or when you use your camcorder in a humid place as shown below.

- When you bring your camcorder from a ski slope into a place warmed up by a heating device.
- When you bring your camcorder from an air conditioned car or room into a hot place outside.
- When you use your camcorder after a squall or a shower.
- When you use your camcorder in a hot and humid place.

### ■ How to avoid moisture condensation

When you bring your camcorder from a cold place into a warm place, put your camcorder in a plastic bag and seal it tightly. Remove the bag when the air temperature inside the plastic bag has reached the surrounding temperature (after about one hour).

## Video head

If you play back a tape recorded in HDV format, the image and sound may freeze for a while (about 0.5 seconds).

This occurs if the HDV signals cannot be recorded or played back correctly because of dirt on the tape or video head. Depending on the cassette, this fairly infrequently occurs even if the cassette is brand new or is not used a lot.

If this freezing point is created while playing back, you can solve this problem and see the pictures by rewinding after slightly forwarding. Such a freezing point cannot be recovered if it was created while recording.

To prevent such a problem, use the Sony mini DV cassette.

- If the following problem occurs, clean the video heads for 10 seconds with the Sony cleaning cassette (optional).

- Playback pictures do not move.
- Playback pictures do not appear.
- The sound breaks off.
- [X] [D] Dirty video head. Use a cleaning cassette. [ ] appears on the screen during recording.
- The following phenomenon occurs in HDV format.



The playback screen pauses.



The playback screen goes blank. (Solid blue screen)

- The following phenomenon occurs in DVCAM (DV) format.



Block-noise appears.



The playback screen goes blank. (Solid blue screen)

- The video heads will be worn after long use. If you cannot obtain a clear image even after using a cleaning cassette (optional), the video heads may be worn out. Please contact your Sony dealer or local authorized Sony service facility to have the video heads replaced.

## LCD screen

- Do not exert excessive pressure on the LCD screen, as it may cause damage.
- If your camcorder is used in a cold place, a residual image may appear on the LCD screen. This is not a malfunction.
- While using your camcorder, the back of the LCD screen may heat up. This is not a malfunction.

### ■ To clean the LCD screen

If fingerprints or dust make the LCD screen dirty, it is recommended you use a soft cloth to clean it. When you use the LCD

Cleaning Kit (optional), do not apply the cleaning liquid directly to the LCD screen. Use cleaning paper moistened with the liquid.

### On handling the casing

- If the casing is soiled, clean the camcorder body with a soft cloth lightly moistened with water, and then wipe the casing with a dry soft cloth.
- Avoid the following to avoid damage to the finish.
  - Using chemicals such as thinner, benzene, alcohol, chemical cloths, repellent, insecticide and sunscreen.
  - Handling with above substances on your hands.
  - Leaving the casing in contact with rubber or vinyl objects for a long period of time.

### About care and storage of the lens

- Wipe the surface of the lens clean with a soft cloth in the following instances:
  - When there are fingerprints on the lens surface.
  - In hot or humid locations
  - When the lens is exposed to salty air such as at the seaside.
- Store in a well-ventilated location subject to little dirt or dust.
- To prevent mold, periodically clean the lens as described above. It is recommended that you operate your camcorder about once a month to keep it in optimum state for a long time.

### On charging the pre-installed rechargeable battery

Your camcorder has a pre-installed rechargeable battery to retain the date, time, and other settings even when the POWER switch is set to OFF. The pre-installed rechargeable battery is always charged while your camcorder is connected to the wall socket via the AC Adaptor or while the battery pack is inserted. The rechargeable battery will be fully discharged in about **3 months** if you do not use your camcorder at all without the AC Adaptor connected or the battery pack attached. Use your

camcorder after charging the pre-installed rechargeable battery. However, even if the pre-installed rechargeable battery is not charged, the camcorder operation will not be affected as long as you are not recording the date.

### ■ Procedures

Connect your camcorder to a wall socket using the optional AC Adaptor, and leave it with the POWER switch set to OFF for more than 24 hours.

### Removing dust from inside the viewfinder

#### 1 Remove the eye piece of the viewfinder.

Push and hold the RELEASE buttons in the eye piece of the viewfinder (①), and remove the eye piece (②).

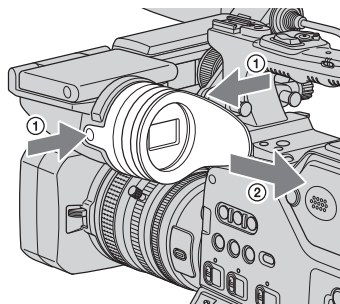

- 2** Remove dust inside the eye piece and viewfinder with a blower.

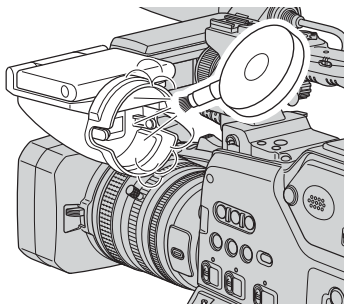

# Specifications

## System

### Video recording system (HDV)

2 rotary heads, Helical scanning system

### Video recording system (DVCAM (DV))

2 rotary heads, Helical scanning system

### Still image recording system

Exif Ver. 2.2\*

### Audio recording system (HDV)

Rotary heads,

MPEG-1 Audio Layer-2 (2-channel)

MPEG-2 Audio Layer-2 (4-channel)

Quantization: 16 bits

Fs48kHz (stereo)

transfer rate: 384 kbps

### Audio recording system (DVCAM (DV))

Rotary heads, PCM system

Quantization: 12 bits

Fs32kHz (channel 1/2, channel 3/4 stereo)

Quantization: 16 bits

Fs48kHz (channel 1/2 stereo)

### Video signal

PAL color, CCIR standards

1080/50i specification

### Usable cassette

Standard size DV cassette with the



mark printed

Standard size DVCAM cassette with

the **DVCAM** mark printed

Mini DV cassette with the <sup>Mini</sup> **DV** mark printed

Mini DVCAM cassette with the **DVCAM** mark printed

### Tape speed (HDV)

Approx. 18.831 mm/s

### Tape speed (DVCAM)

Approx. 28.221 mm/s

### Tape speed (DV SP)

Approx. 18.831 mm/s

### Recording/playback time (HDV)

276 min (using a PHDV-276DM cassette)

63 min (using a PHDVM-63DM cassette)

### Recording/playback time (DVCAM)

184 min (using a PHDV-276DM cassette)

41 min (using a PHDVM-63DM cassette)

### Recording/playback time (DV SP)

276 min (using a PHDV-276DM cassette)

63 min (using a PHDVM-63DM cassette)

### Fast forward/rewind time

Approx. 2 min (using a PHDV-276DM cassette and rechargeable battery pack)

Approx. 2 min (using a PHDV-276DM cassette and AC Adaptor)

### Viewfinder

Electric viewfinder (color, black and white)

Picture

1.1 cm (0.45 type, aspect ratio 16:9)

Total dot number

1 226 880 (approx.  $852 \times 3[\text{RGB}] \times 480$ )

### Image device

6.0 mm (1/3 type) 3CMOS sensor

Recording Pixels (HDV/DV16:9 still recording):

Max. 1.20 Mega (1 440 × 810) pixels\*\*

Gross: Approx. 1 120 000 pixels

Effective (movie, 16:9):

Approx. 1 037 000 pixels

Effective (movie, 4:3):

Approx. 778 000 pixels

Effective (still, 16:9):

Approx. 1 037 000 pixels

Effective (still, 4:3):

Approx. 778 000 pixels

### Lens

Carl Zeiss Vario-Sonnar T\*

12 × (Optical), Approx. 18 × (Digital, when [D.EXTENDER] is set to [ON])

## Specifications (Continued)

### Focal length

- $f=4.4 - 52.8$  mm (3/16 - 2 1/8 in.)  
When converted to a 35 mm still camera
- 32.0 - 384 mm (1 5/16 - 15 1/8 in.) (16:9),
- 39.5 - 474 mm (1 9/16 - 18 3/4 in.) (4:3)
- F1.6 - 2.0
- Filter diameter: 72 mm (2 7/8 in.)

### Color temperature

- [AUTO]
- [ONE PUSH AF]
- [INDOOR] (3 200K)
- [OUTDOOR] (5 800K $\pm$ 7 offset levels)
- [MANU WB TEMP] (2 300K - 15 000K in 100K steps)

### Minimum illumination

- 1.5 lx (lux) (Fixed Shutter Speed 1/25, auto gain, auto iris) (F 1.6)

\* "Exif" is a file format for still images, established by the JEITA (Japan Electronics and Information Technology Industries Association). Files in this format can have additional information such as your camcorder's setting information at the time of recording.

\*\*Still image resolution is obtained by the unique pixel array of Sony's ClearVid CMOS Sensor and image processing system (new Enhanced Imaging Processor).

### Output connectors

#### VIDEO OUT jack

- BNC connector  $\times$  1
- Video signal: 1 Vp-p, 75 (ohms)

#### S VIDEO jack

- S connector  $\times$  1
- Luminance signal: 1 Vp-p, 75 (ohms)
- Chrominance signal: 0.3 Vp-p (burst signal), 75 (ohms)

#### AUDIO OUT jack

- RCA connector  $\times$  2
- Audio signal: -10 dBu (at load impedance 47 k (kilohms)), Output impedance with less than 2.2 k (kilohms)
- (0 dBu=0.775 Vrms)

#### TC OUT jack

- BNC connector  $\times$  1
- 2.2 Vp-p, 600 (ohms) / 1.2 Vp-p, 75 (ohms)

#### COMPONENT OUT jack

- BNC connector  $\times$  3
- Y: 1 Vp-p, 75 (ohms), PB/PR, CB/CR:  $\pm$  350 mV, 75 (ohms)

#### HD/SD SDI OUT jack

- BNC type  $\times$  1
- SD-SDI: SD-SDI format, SMPTE259M-C (270Mbps)
- HD-SDI: HD-SDI format, SMPTE292M

### Input/Output connectors

#### LANC jack

- Stereo mini-minijack ( $\varnothing$  2.5 mm)

#### AUDIO INPUT1 (L)/AUDIO INPUT2 (R)/AUDIO INPUT3/AUDIO INPUT4 jack

- XLR 3-pin, female,
- 48 dBu: 3k (kilohms)
- +4 dBu: 10k (kilohms)
- (0 dBu=0.775 Vrms)

#### PHONES jack

- Stereo-minijack ( $\varnothing$  3.5 mm)

#### DC OUT 12V connector

- 4-pin, male, 12 V

#### LIGHT connector

- 2-pin, max. 35 W

#### LENS jack

- 12-pin connector

#### HDV/DV jack

- i.LINK interface (IEEE 1394, 6-pin connector S100)

**DC IN 12V connector**

XLR 4-pin, female, 11 V - 17 V

**LCD screen****Picture**

8.0 cm (3.2 type, aspect ratio 16:9)

**Total dot number**

921 600 (1 920 × 480)

**General****Power requirements**

DC 14.4 V (battery pack)

DC 12 V (11 V - 17 V) (AC Adaptor)

**Average power consumption\***

During camera recording using the viewfinder with normal brightness:

HDV recording 12.2 W

DVCAM (DV) recording 11.7 W

During camera recording using the viewfinder and Memory Recording Unit (HVR-MRC1) with normal brightness:

HDV recording 14.9 W

DVCAM (DV) recording 14.4 W

**Operating temperature**

0 °C to 40 °C (32 °F to 104 °F)

**Storage temperature**

-20 °C to +60 °C (-4 °F to +140 °F)

**Dimensions (approx.)**

305 × 277 × 505 mm

(11 1/8 × 11 × 20 in.) (w/h/d)

including the projecting parts with Carl Zeiss lens (VCL-412BWS) and lens hood with lens cover

305 × 277 × 510 mm

(11 1/8 × 11 × 20 1/8 in.) (w/h/d)

including the projecting parts with Carl Zeiss lens (VCL-412BWS), lens hood with lens cover and battery pack (BP-GL65)

**Mass (approx.)**

4.0 kg (8 lb 12 oz) camera body only

5.2 kg (11 lb 7 oz) including Carl Zeiss lens (VCL-412BWS)

6.3 kg (13 lb 15 oz) including battery pack (BP-GL95), cassette (PHDV-276DM), Carl Zeiss lens (VCL-412BWS), lens hood with lens cover and microphone (ECM-XM1)

\* When the microphone (ECM-XM1) is used

Design and specifications are subject to change without notice.

## On trademarks

- “Memory Stick,” “,” “Memory Stick Duo,” “**MEMORY STICK DUO**,” “Memory Stick PRO Duo,” “**MEMORY STICK PRO DUO**,” “Memory Stick PRO-HG Duo,” “**MEMORY STICK PRO-HG DUO**,” “Memory Stick Micro,” “MagicGate,” “**MAGIC GATE**,” “MagicGate Memory Stick” and “MagicGate Memory Stick Duo” are trademarks of Sony Corporation.
- “x.v.Colour” is a trademark of Sony Corporation.
- i.LINK and  are trademarks of Sony Corporation.
-  Mini  are trademarks.
-  is a trademark.
- Microsoft, Windows, Windows Vista, and Windows Media are trademarks or registered trademarks of U.S. Microsoft Corporation in the U.S. and other countries.
- Macintosh and Mac OS are registered trademarks of Apple Inc. in the U.S. and other countries.
- HDV and the HDV logo are trademarks of Sony Corporation and Victor Company of Japan, Ltd.
- Pentium is a trademark or registered trademark of Intel Corporation.
- Adobe, and Adobe Reader are trademarks of Adobe Systems Incorporated.

All other product names mentioned herein may be the trademarks or registered trademarks of their respective companies. Furthermore, <sup>TM</sup> and “®” are not mentioned in each case in this manual.

## Notes on the License



ANY USE OF THIS PRODUCT OTHER THAN CONSUMER PERSONAL USE IN ANY MANNER THAT COMPLIES WITH THE MPEG-2 STANDARD FOR ENCODING VIDEO INFORMATION FOR PACKAGED MEDIA IS EXPRESSLY PROHIBITED WITHOUT A LICENSE UNDER APPLICABLE PATENTS IN THE MPEG-2 PATENT PORTFOLIO, WHICH LICENSE IS AVAILABLE FROM MPEG LA, L.L.C., 250 STEELE STREET, SUITE 300, DENVER, COLORADO 80206.

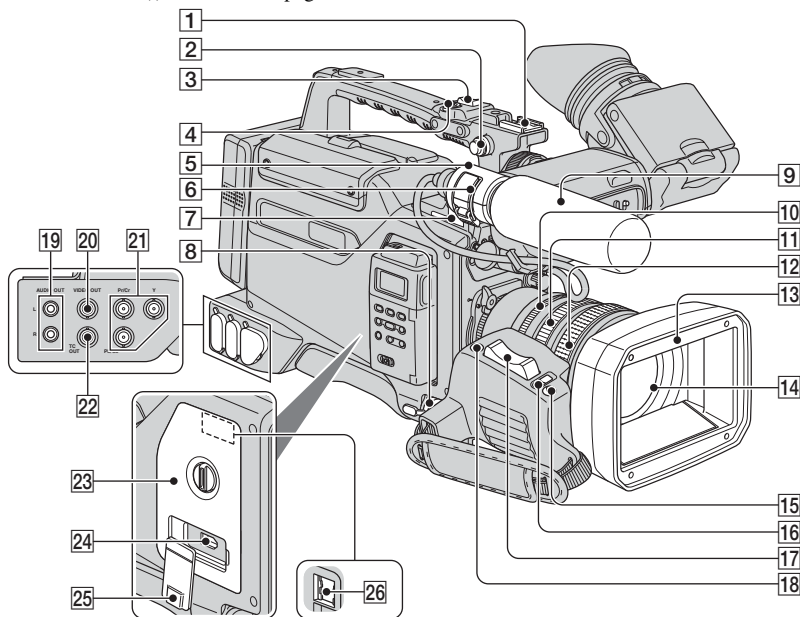

# Identifying parts and controls

The numbers in ( ) are reference pages.



- |  |   |
|--|---|
| <b>1</b> Accessory shoe (127)  | <b>14</b> Lens (9)  |
| <b>2</b> Shoulder strap fitting (13)   | <b>15</b> PUSH AUTO button (33)   |
| <b>3</b> Handle zoom lever (30)  | <b>16</b> IRIS switch (33)  |
| <b>4</b> REC START/STOP button (26)  | <b>17</b> Zoom lever (32)   |
| <b>5</b> Microphone holder (12)  | <b>18</b> REC REVIEW/L2 button (51)   |
| <b>6</b> Microphone fixing clamper (12)  | <b>19</b> AUDIO OUT jacks (61)  |
| <b>7</b> LIGHT connector (2-pin, female) (28)<br>A video light with a maximum power consumption of 35W, such as the Anton Bauer Ultralight 2 or equivalent can be connected. | <b>20</b> VIDEO OUT jack (61)   |
| <b>8</b> LENS jack (9)   | <b>21</b> COMPONENT OUT jacks (61)  |
| <b>9</b> Microphone (12)   | <b>22</b> TC OUT jack (61)  |
| <b>10</b> Iris ring (33)   | <b>23</b> Cover (14)<br>Remove this cover when you attach the Memory Recording Unit HVR-MRC1.                   |
| <b>11</b> Zoom ring (30)   | <b>24</b>  HDV/DV jack (61)  |
| <b>12</b> Focus ring (31)  | <b>25</b>  HDV/DV jack cover |
| <b>13</b> Lens hood with lens cover (13)   | <b>26</b> Memory Recording Unit jack (14)   |

## Identifying parts and controls (Continued)

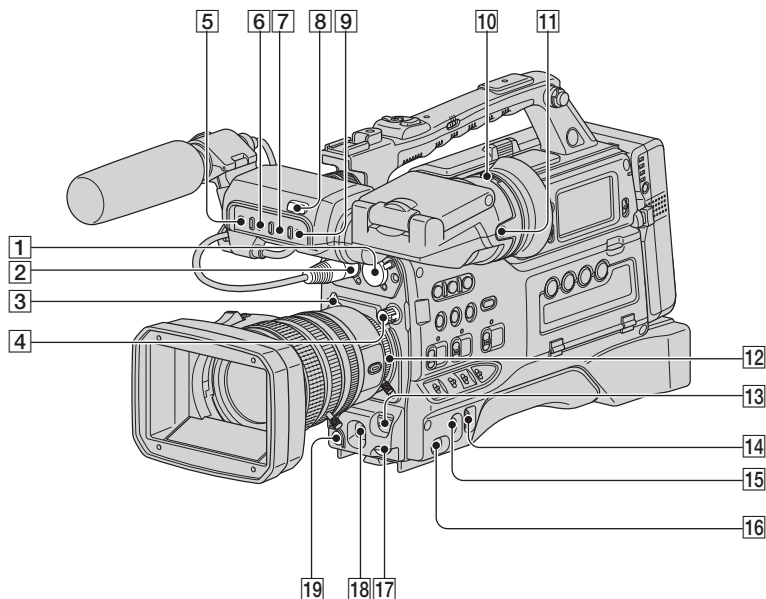

- 1** AUDIO INPUT2 (R) jack (46)
- 2** AUDIO INPUT1 (L) jack (46)
- 3** Lens mount securing tab (9)
- 4** ND filter (33)
- 5** TALLY switch  
Set to ON to turn on the front recording lamp.
- 6** PEAKING switch (19)
- 7** LIGHT ON/OFF switch  
Lights the lens to help you to see the focus scale in the dark.
- 8** Recording lamp (26)
- 9** VIDEO OUT switch (61)
- 10** Viewfinder lens adjustment lever (19)
- 11** RELEASE button (115)
- 12** Lens mount (9)
- 13** SHUTTER switch (34)
- 14** SEL/PUSH EXEC dial (21)
- 15** CAMERA/VCR switch (18)
- 16** POWER switch (18)
- 17** AUDIO LEVEL dial  
Adjusts the audio input level of CH1.
- 18** WHT/BLK switch (35)
- 19** REC START/STOP button (26)

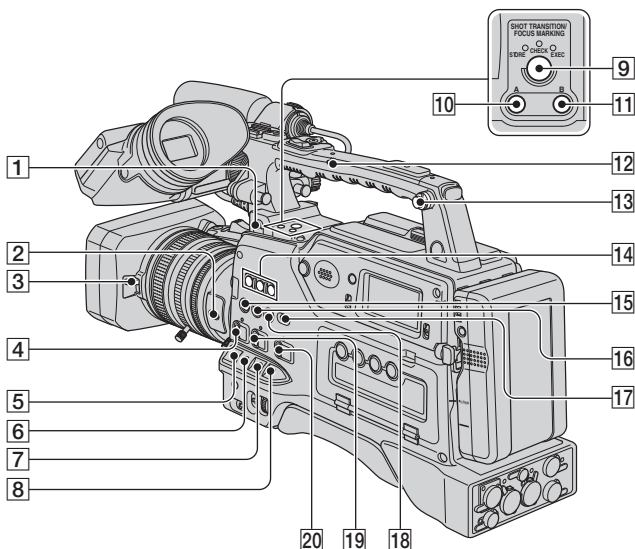

- 1** LIGHT MAN/AUTO switch  
 Select AUTO or MAN to automatically or manually turn on and off a video light connected to the LIGHT connector.  
 AUTO: The video light automatically turns on upon a start of recording when its power switch is in the on position.  
 MAN: You can manually turn on and off the video light with its power switch.

**2** DIGITAL EXTENDER/L1 button (49)

**3** Lens cover lever (13)

**4** AGC switch (34)

**5** GAIN switch (34)

**6** OUTPUT/DCC switch

Switches the video signal, which is output to the VTR part, viewfinder, and video monitor from the camera part, between the following two.

**BARS:** Outputs the color bar signal.

**CAM:** Outputs the video signal from the camera. When this is selected, you can switch DCC\* on and off.

\* **DCC (Dynamic Contrast Control):** Against a very bright background with the iris opening

adjusted to the subject, objects in the background will be lost in the glare. The DCC function will suppress the high intensity and restore much of the lost detail and is particularly effective in the following cases.

- Recording people in the shade on a sunny day
- Recording a subject indoors, against a background through a window
- Any high contrast scene

**OUTPUT: CAM, DCC: ON**

The video signal from the camera is output, and the DCC circuit operates.

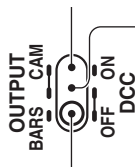

**OUTPUT: CAM, DCC: OFF**

The video signal from the camera is output, and the DCC circuit does not operate.

**OUTPUT: BARS, DCC: OFF**

A color bar signal is output and the DCC circuit does not operate. Use this setting to adjust the video monitor, to record the color bar signal, etc.

## Identifying parts and controls (Continued)

- 7** WHT BAL switch (34)
- 8** MENU/STATUS switch (63)
- 9** SHOT TRANSITION/FOCUS MARKING button (52)
- 10** A button (52)
- 11** B button (52)
- 12** Handle zoom switch (30)
- 13** Shoulder strap fitting (13)
- 14** ASSIGN 1-3 buttons (49)
- 15** ASSIGN 4 button/ZEBRA button (49)
- 16** ASSIGN 5 button/AE SHIFT button (49)
- 17** PICTURE PROFILE button (37)
- 18** ASSIGN 6 button/STEADYSHOT button (49)
- 19** ATW switch (35)
- 20** CAMERA MODE switch (33)

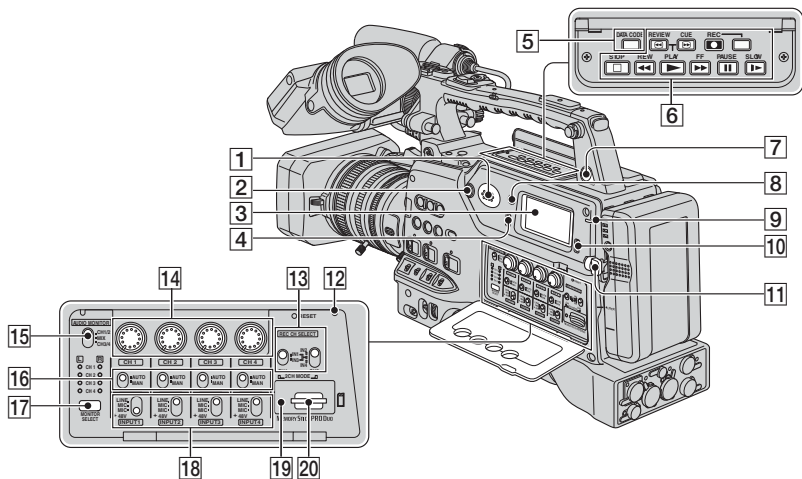

**1** Built-in speaker

The speaker can be used to monitor E-E\* sound during recording, and playback sound during playback. The speaker also sounds alarms to reinforce visual warnings. If you connect earphones to the PHONES jack, the speaker is automatically muted.

\* E-E: Abbreviation of “Electric-to-Electric.” In E-E mode, video and audio signals input to the camcorder are output after passing through internal electric circuits only. This can be used to check input signals.

**2** MONITOR dial (57)

**3** Sub LCD panel (131)

**4** LCD BACK LIGHT switch

When you set the switch to ON, the backlight of the sub LCD screen turns on.

**5** DATA CODE button (59)

**6** Video control buttons (STOP/REW/PLAY/FF/PAUSE/REC/SLOW/CUE/REVIEW) (56)

**7** PHONES jack

Plugging earphones into the jack automatically cuts off the sound from built-in speaker.

**8** TC/U-BIT button

Switches between time code and user bit to display on the sub LCD screen (display on the LCD screen also changes).

**9** WARNING lamp (106)

**10** AUDIO LEVEL DISPLAY switch

Switches between CH1/CH2 and CH3/CH4 audio level meters to display on the sub LCD screen (display on the LCD screen also changes).

**11** Battery release button (16)

**12** RESET button

If you press the RESET button, all settings including the clock setting (except the Picture profile and Camera profile settings) return to the default.

**13** REC CH SELECT switch (46)

**14** CH1/CH2/CH3/CH4 dials (46)

**15** AUDIO MONITOR switch (48)

**16** CH1/CH2/CH3/CH4 switches (46)

**17** MONITOR SELECT button (48)

**18** INPUT1/INPUT2/INPUT3/INPUT4 switches (46)

**19** Access lamp (24)

**20** “Memory Stick Duo” slot (24)

## Identifying parts and controls (Continued)

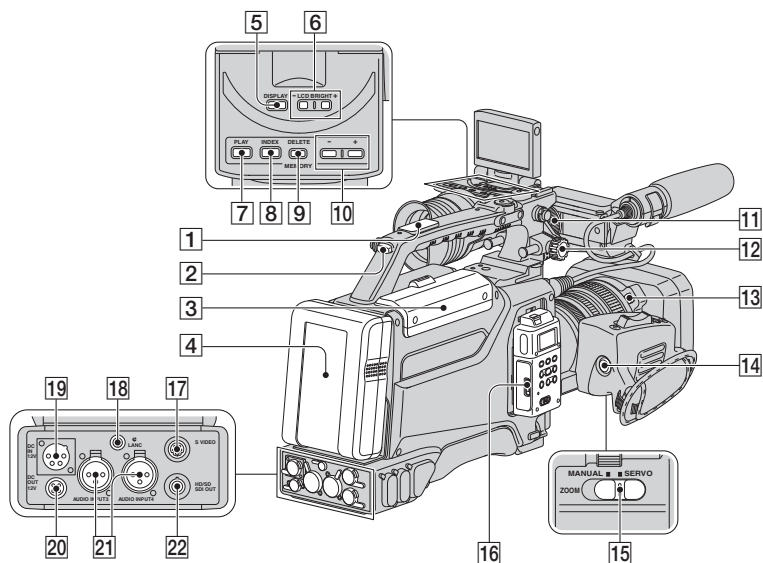

- 1** Accessory shoe mount (127)
- 2** Recording lamp (26)
- 3** Cassette lid (23)
- 4** Rechargeable battery pack (16)
- 5** DISPLAY button (20)
- 6** -LCD BRIGHT+ buttons (20)
- 7** MEMORY/PLAY button (56)
- 8** MEMORY/INDEX button (56)
- 9** MEMORY/DELETE button (56)
- 10** MEMORY +/- button (56)
- 11** Viewfinder left-to-right position fixing ring (19)
- 12** Viewfinder front-to-back position fixing ring (19)
- 13** PUSH (lens hood release) button (13)
- 14** REC START/STOP button (26)
- 15** ZOOM switch (30)
- 16** Memory Recording Unit (14)
- 17** S VIDEO jack (61)
- 18** LANC jack  
The LANC control jack is used for controlling the tape transport of video device and peripherals connected to it.
- 19** DC IN 12V connector (17)
- 20** DC OUT 12V connector  
Supplies power for a WRR-81/862 UHF Synthesizer Tuner (optional) (maximum 0.2 A).  
Do not connect any equipment other than the UHF synthesizer tuner.
- 21** AUDIO INPUT3/AUDIO INPUT4 jacks (46)
- 22** HD/SD SDI OUT jack (61)

## To mount the accessory shoe

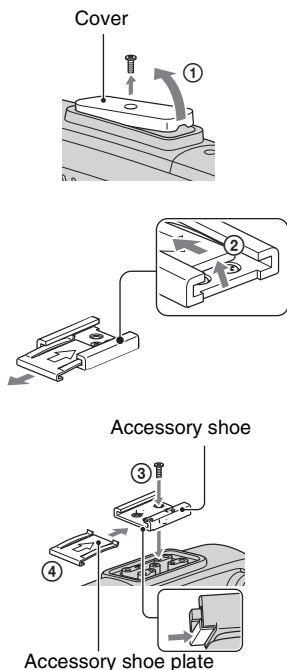

- ① Loosen the screw and remove the cover on the accessory shoe mount as illustrated.
- ② Lift the edge of the accessory shoe plate and pull it in the direction opposite to that of the arrow on the shoe plate and remove it from the accessory shoe.
- ③ Place the accessory shoe on the mount, then fix it to the mount with four screws.
- ④ Insert the accessory shoe plate in the direction of the arrow on the plate surface until the end of the plate engages the end of the shoe.

## To dismount the accessory shoe

- ① Lift the edge of the accessory shoe plate and pull it in the direction opposite to that of the arrow on the shoe plate and remove it from the accessory shoe.
- ② Loosen the four screws and remove the accessory shoe from the mount.
- ③ Place the cover on the mount and fix it to the mount with the screw.

## To attach the lens mount cap

Hold the lens mount cap with the ▲ mark facing up. Attach the lens mount cap to the lens mount with the center pin on the back of the cap inserted in the recess at the top center of the lens mount.

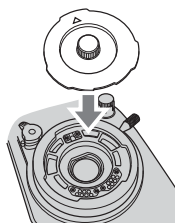

## To remove the lens mount cap

Hold the protrusion at the center of the lens mount cap and remove the cap from the lens mount.

## To attach the rear lens cap

Attach the rear lens cap to the rear of the lens.

## To remove the rear lens cap

Hold the two protrusions on the edge of the rear lens cap as illustrated and remove the cap from the lens.

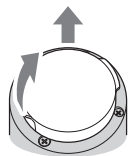

# Indicators for the LCD screen and viewfinder

The numbers in ( ) are reference pages.

The indicators will not be recorded on the tape during recording.

## Recording movies

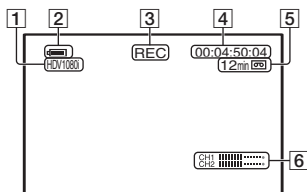

- 1** Recording format (HDV1080i or DVCAM, DV SP) (81)
- 2** Remaining battery (approx.)
- 3** Recording status ([STBY] (standby) or [REC] (recording))
- 4** During recording:  
Tape counter (hour: minute: second: frame)  
During playback:  
Time code (hour: minute: second: frame)
- 5** Recording capacity of the tape (approx.)
- 6** Audio level display (79)

## Recording still images

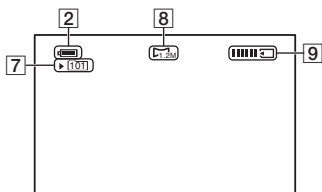

- 7** Recording folder (88)
- 8** Image size (28)
- 9** Recording indicator (28)



## Data code during recording

The date/time during recording and the camera setting data will be recorded automatically. They do not appear on the screen during recording, but you can check them on the screen by pressing the DATA CODE button during playback (p. 59).



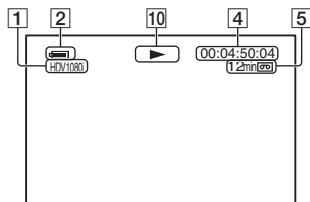



## Viewing movies

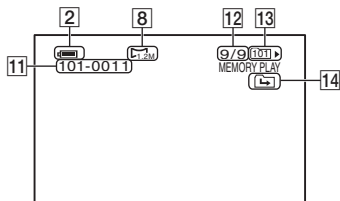

- 10** Tape transport indicator  
Recording mode (DVCAM or DV SP) appears when a tape recorded in the DVCAM or DV SP format is played back.  

## Viewing still images



- 11** Data file name
- 12** Picture number/Total number of recorded pictures in the current playback folder
- 13** Playback folder (88)
- 14** Previous/Next folder icon  
The ,  or  appears when the first or last picture of the current folder is displayed and when there are multiple folders on the same "Memory Stick Duo." You can move to Previous/Next folder with the VOLUME/MEMORY button.

## Indicators for the LCD screen and viewfinder (Continued)

### Indicators when you made changes

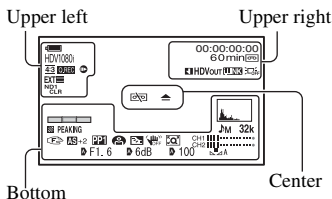

#### Upper left

Indicator	Meaning
HDV1080i	Recording format (81)
DVCAM DV SE	
4:3	DV WIDE REC (83)*
Q.REC	QUICK REC (90)**
FD	DV FRAME REC (73)*
ND1 CLR ND2 1/4	ND filter (33)
ND3 1/16 ND4 1/64	
ND	
Interval icon	INTERVAL REC (72)
EXT EXT	EXT REC CTRL (84)
EXT CF	
25pSCAN 25P	REC TYPE SCAN TYPE (82)

#### Upper right

Indicator	Meaning
IM	INDEX MARK (50)
HDVIn DVIn	HDV input/ DV input (92)
HDVout DVout	HDV output/ DV output (92)
i.LINK	i.LINK connection (61, 92)
OFF	LCD backlight off (20)

#### Center

Indicator	Meaning
Warning icon	Warning (106)

#### Bottom

Indicator	Meaning
Histogram icon	HISTOGRAM (77)
Level bar icon	CAM LEVELING (79)
2CH 4CH	HDV 2CH/4CH (75)**
NS32k NS48k 32k 48k	DV AU.MODE (DV Audio mode) (75)*
M	Manual volume control(46)
Focus icon	Manual focus (31)
PP1 ~ PP6	Picture profile (37)
Spotlight icon	SPOTLIGHT (70)
Backlight icon	BACK LIGHT(70)
SteadyShot icon	SteadyShot off (71)
PEAKING	PEAKING (32, 78)
D.Extender icon	D.EXTENDER (71)
AS	AE SHIFT (69)
Auto icon	Auto setting (79)
White balance icon	White balance (35)
Focus Macro icon	FOCUS MACRO (71)
HYPER	HYPER GAIN (68)
(COLOR)	x.v.Color (74)**
Zebra icon	ZEBRA (77)

\* The settings can be made only for the pictures in the DVCAM (DV) format.

\*\* The setting can be made only for the pictures in the HDV format.

#### 💡 Tips

- Indicators may look different or appear at different positions.

## Indicators on the sub LCD screen

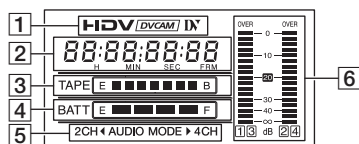

- 1** Recording format
- 2** Time code/user bit
- 3** Tape remaining indicator
- 4** Battery capacity indicator
- 5** 2CH/4CH audio mode
- 6** Audio level indicator

# Index

## A

A button ..... 52  
Access lamp ..... 25  
Accessory shoe ..... 127  
Accessory shoe kit ..... 8  
Accessory shoe mount ..... 127  
ADVANCE ..... 78  
AE RESPONSE ..... 70  
AE SHIFT ..... 69, 99  
AE SHIFT button ..... 49  
AE WINDOW ..... 69  
AF ASSIST ..... 71  
AGC CH1,2 ..... 75  
AGC CH3,4 ..... 76  
AGC LIMIT ..... 68  
AGC switch ..... 34  
ALL ERASE ..... 87  
ALL FILES ..... 87  
ALL OUTPUT ..... 81  
ANTON/BAUER ..... 91  
ASPECT ..... 78  
ASSIGN 4 button ..... 49  
ASSIGN 5 button ..... 49  
ASSIGN 6 button ..... 49  
ASSIGN BTN ..... 49  
ASSIGN buttons ..... 49  
AT IRIS LMT ..... 70  
ATW SENS ..... 69  
ATW switch ..... 35  
AUDIO INPUT1 (L) jack ..... 46  
AUDIO INPUT2 (R) jack ..... 46  
AUDIO INPUT3 jack ..... 46  
AUDIO INPUT4 jack ..... 46  
AUDIO LEVEL DISPLAY  
switch ..... 125  
AUDIO MONITOR switch  
..... 48  
AUDIO OUT jacks ..... 61  
AUDIO SET menu ..... 75  
AUTO ADJUST ..... 11  
AU.LMT CH1,2 ..... 75

AU.LMT CH3,4 ..... 75  
AU.LVL DISP  
(Audio level display) ..... 79

## B

B button ..... 52  
BACK LIGHT ..... 70, 99  
BAR ..... 79  
Battery ..... 16  
Battery release button ..... 16  
BATTERY TYPE ..... 91  
BEEP ..... 91  
Black balance ..... 37  
BLACK FADER ..... 71  
BLACK GAMMA ..... 39  
BLACK LEVEL ..... 39  
Built-in speaker ..... 125

## C

Cable holder ..... 9, 12  
CAM DATA DSP (Camera  
data display) ..... 79, 99  
CAM LEVELING ..... 79  
CAMERA MODE switch ..... 33  
CAMERA PROF.  
(Camera profile) ..... 89  
CAMERA SET menu ..... 68  
CAMERA/VCR switch ..... 18  
Cassette  
Ejecting ..... 24  
Inserting a mini-size  
cassette ..... 23  
Tape ..... 107  
Cassette lid ..... 23  
CH1 dial ..... 46  
CH1 switch ..... 46  
CH2 dial ..... 46  
CH2 switch ..... 46  
CH3 dial ..... 46  
CH3 switch ..... 46  
CH4 dial ..... 46  
CH4 switch ..... 46

CLOCK SET ..... 21  
CNTRST ENHCR ..... 70, 99  
COLOR BAR ..... 74  
COLOR CORRCT (Color  
Correct) ..... 41  
COLOR DEPTH ..... 41  
COLOR LEVEL ..... 40  
COLOR MODE ..... 40  
COLOR PHASE ..... 40  
COMPONENT OUT jacks... 61  
Connect  
TV ..... 61  
Cover ..... 121  
CURRENT FLDR ..... 87

## D

DATA CODE button ..... 59  
Date and time ..... 22, 128  
DATE REC ..... 91, 99  
DC IN 12V jack ..... 61  
DC OUT 12V jack ..... 61  
DEGREE ..... 80  
Deleting camera profile settings  
..... 89  
Deleting recorded pictures  
..... 58  
DETAIL ..... 43  
DIGITAL EXTENDER  
button ..... 49  
DISP OUTPUT ..... 81  
DISPLAY button ..... 20, 59  
DISPLAY SET menu ..... 77  
DOWN CONV AU ..... 84  
DOWN CONVERT ..... 83, 84  
DRUM RUN ..... 91  
DV ..... 81  
DV AU. MODE  
(DV Audio mode) ..... 75  
DV format ..... 82  
DV FRAME REC ..... 73, 100  
DV PROGRE ..... 82

DV REC MODE (Recording mode) .....	82
DV SP .....	82
DV WIDE CONV .....	83
DV WIDE REC .....	82, 83
DVCAM .....	82
D.EXTENDER (Digital Extender) .....	71, 99

**E**

End search .....	51
END TRIGGER .....	72
Expanded focus .....	32
EXP.FOCUS TYPE .....	79
EXT ONLY .....	84
EXT REC CTRL .....	84, 100

**F**

FADER .....	71, 99
FILE NO. (File number) .....	88
FLANGE BACK .....	74, 100
Flange focal length .....	10
FLCKR REDUCE .....	70
Focus .....	31
FOCUS DISP .....	80
FOCUS MACRO .....	71, 100
FOCUS MARKING .....	73
Focus marking .....	55
Focus ring .....	31
FOCUS TRANS .....	52
Folder	
NEW FOLDER .....	88
PB FOLDER (Playback folder) .....	88
REC FOLDER (Recording folder) .....	88
FORMAT .....	88
FREE RUN .....	86
FS32K .....	75
FS48K .....	75

**G**

Gain .....	34
GAIN SETUP .....	68
GAIN switch .....	34
GAMMA .....	39
GL SERIES .....	91
Grip belt .....	18
GUIDEFAME .....	78

**H**

HANDLE ZOOM .....	71
Handle zoom .....	30
Handle zoom lever .....	30
Handle zoom switch .....	30
HDV .....	82
HDV 2CH/4CH .....	75
HDV PROGRE. ....	82
HDV1080i .....	81
HDV/DV jack .....	61
HDV/DV jack cover .....	121
HD/SD SDI OUT jack .....	61
HISTOGRAM .....	77, 99
HOURS METER .....	91
HYPER GAIN .....	68

**I**

INDEX MARK .....	50
Index screen .....	57
Index signal .....	50
Indicators .....	130
INDOOR .....	36
Indoor .....	36
INPUT1 MIC NR .....	76
INPUT1 switch .....	46
INPUT1 TRIM .....	76
INPUT1 WIND .....	76
INPUT2 MIC NR .....	76
INPUT2 switch .....	46
INPUT2 TRIM .....	76
INPUT2 WIND .....	76

INPUT3 MIC NR .....	76
INPUT3 switch .....	46
INPUT3 TRIM .....	76
INPUT3 WIND .....	76
INPUT4 MIC NR .....	76
INPUT4 switch .....	46
INPUT4 TRIM .....	76
INPUT4 WIND .....	76
INTELLIGENT .....	69
INTERLACE .....	82
INTERVAL .....	72
INTERVAL REC .....	72, 99
IN/OUT REC menu .....	81
Iris ring .....	33
IRIS switch .....	33
IRIS TRANS .....	52
i.LINK .....	111
i.LINK cable .....	92, 94
i.LINK Cradle .....	15
i.LINK SET .....	84

**J**

JPEG .....	110
------------	-----

**K**

KNEE .....	40
------------	----

**L**

L SERIES .....	91
L1 button .....	49
L2 button .....	49
LANC jack .....	126
LANGUAGE .....	90
Last scene review .....	51
LAST SCN RVW .....	51
LCD BACK LIGHT switch .....	125
LCD BL LEVEL .....	80
-LCD BRIGHT+ buttons .....	20
LCD COLOR .....	80
Lens .....	9

## Index (Continued)

Lens cover lever ..... 13  
Lens hood with lens cover.... 13  
LENS jack ..... 9  
Lens mount ..... 9  
Lens mount cap ..... 127  
Lens mount securing tab..... 9  
LETTER SIZE..... 80  
LIGHT connector ..... 121  
LIGHT MAN/AUTO switch  
..... 123  
LIGHT ON/OFF switch ..... 122

## M

MANU ADJUST..... 11  
MANU WB TEMP..... 69  
MARKER ..... 78, 100  
Memory A ..... 36  
Memory B..... 36  
Memory Recording Unit ..... 14  
MEMORY SET menu ..... 87  
“Memory Stick” ..... 2, 110  
“Memory Stick Duo”  
    Insert/Eject ..... 24  
    Number of recordable  
    pictures ..... 28  
    Write-protect tab ..... 110  
“Memory Stick Duo” slot..... 24  
MEMORY -/+ button ..... 57  
MEMORY/DELETE button  
..... 58  
MEMORY/INDEX button ... 56  
MEMORY/PLAY button ..... 56  
Menu  
    AUDIO SET menu ..... 75  
    CAMERA SET menu ... 68  
    DISPLAY SET menu ... 77  
    IN/OUT REC menu..... 81  
    MEMORY SET menu  
    ..... 87  
    Menu items..... 65  
    OTHERS menu ..... 89  
    TC/UB SET menu ..... 85

    Using the menu..... 63  
Menu items ..... 65  
MENU/STATUS switch..... 63  
Microphone..... 12  
Microphone fixing clasper  
..... 12  
Microphone holder..... 12  
Mode A ..... 31  
Mode B ..... 31  
Moisture condensation ..... 113  
MONITOR dial..... 57  
MONITOR SELECT button  
..... 48  
MPEG2 ..... 96

## N

ND filter..... 33  
NEW FOLDER..... 88  
NTSC ..... 103  
NUMBER ..... 79

## O

ONE PUSH AF..... 32  
One push auto focus..... 32  
One push button ..... 36  
OPERATION..... 91  
OTHERS menu ..... 89  
Outdoor ..... 36  
OUTPUT/DCC switch..... 123

## P

PB FOLDER  
(Playback folder)..... 88  
PB ZOOM (Playback zoom)  
..... 90  
PEAKING ..... 78, 99  
PEAKING switch ..... 19  
PHONES jack ..... 125  
Picture profile ..... 37  
PICTURE PROFILE button  
..... 37  
Picture Search ..... 57

PLAY button ..... 56  
POWER switch ..... 18  
Pre-installed rechargeable  
battery ..... 115  
PRESET ..... 85  
PROFILE NAME..... 44  
PROGRESSIVE ..... 82  
PUSH AUTO button ..... 33  
PUSH (lens hood release)  
button..... 13

## Q

QUICK REC ..... 90

## R

Rear lens cap ..... 127  
REC CH SELECT switch  
..... 12  
REC CTL MODE..... 84  
REC FOLDER (Recording  
folder) ..... 88  
REC FORMAT ..... 81  
REC LAMP[R]..... 91  
REC LINK..... 52  
REC PAUSE ..... 85  
Rec review ..... 51  
REC REVIEW button ..... 51  
REC RUN..... 86  
REC START/STOP button  
..... 26  
REC TIME ..... 72  
REC TIMING..... 72  
REC TYPE ..... 82  
Rechargeable battery pack ... 16  
Recording ..... 26  
Recording lamp ..... 26  
REGENERATE..... 86  
RELAY ..... 84  
RELEASE button ..... 115  
REMAINING ..... 80  
RESET ..... 85  
RESET button ..... 125

RET button .....49

## S

S VIDEO jack .....61

SAFETY ZONE .....78

SCAN TYPE.....82

SDI OUTPUT .....83

SDI/CMPNT.....83

SD-SDI SET .....84

Self-diagnosis display .....106

SEL/PUSH EXEC dial .....21

SHOT TRANSITION.....73

Shot transition .....52

SHOT TRANSITION/FOCUS

MARKING button .....52

SHUTTER DISP.....80

Shutter speed.....34

SHUTTER switch.....34

SKINTONE DTL (Skintone

detail) .....44

Skip Scan .....57

SMOOTH GAIN .....68

SMOOTH WB.....69

SMTH SLW REC

(Smooth slow recording)

.....72, 100

Specifications.....117

SPOTLIGHT .....70, 99

START TIMER .....52

START TRIGGR.....72

Status check .....60

STBY COMMAND.....85

STEADYSHOT .....71, 100

STEADYSHOT button.....49

STOP .....85

Sub LCD panel .....131

Supplied items .....8

SYNCHRONOUS .....84

S.TRANS/F.MARK.....73

## T

TALLY switch.....122

Tape counter.....128

TAPE RUN .....91

TC COUNTUP.....85, 100

TC LINK .....86, 100

TC MAKE.....86

TC OUT jack.....121

TC PRESET .....85

TC RUN .....86

TC/UB SET menu .....85

TC/U-BIT button.....125

Telephoto .....30

Test chart.....10

THREADING .....91

Time code.....128

TONE .....74

Trademark .....120

TRANS TIME.....52

Troubleshooting .....97

TV .....61

## U

UB PRESET.....85

UB TIME REC.....86

UB-DATE/TC-TIME...86, 100

Using the menu items.....63

## V

VCR HDV/DV .....81

VF B.LIGHT .....80

VF COLOR .....80

Video control buttons.....56

Video head .....114

VIDEO OUT .....83

VIDEO OUT jack .....61

VIDEO OUT switch.....61

Viewfinder front-to-back

position fixing ring .....19

Viewfinder left-to-right

position fixing ring .....19

Viewfinder lens adjustment

lever.....19

Volume .....57

V-OUT/PANEL.....81

## W

Warning indicators .....106

Warning messages .....106

WB OUTDR LVL .....68

WB PRESET .....68

WB SHIFT.....43

WB TEMP SET .....69

White balance .....35

White balance memory switch

.....36

WHITE FADER .....71

WHT BAL switch.....35

WHT/BLK switch .....35

Wide angle.....30

Wind screen .....12

WORLD TIME.....90, 100

Write-protect tab.....108, 110

## X

XLR SET .....75

x.v.Color .....74, 100

## Z

ZEBRA .....77, 99

ZEBRA button.....49

Zoom.....30

ZOOM DISPLAY .....79

Zoom lever.....30

Zoom ring .....30

ZOOM switch.....30

ZOOM TRANS .....52