

# Rosemount™ 3051S MultiVariable™ Transmitter and 3051SF Series Flow Meter

with FOUNDATION™ Fieldbus Protocol



Safety messages

**NOTICE**

This guide provides basic guidelines for Rosemount™ 3051S MultiVariable™ (3051SMV) FOUNDATION™ Fieldbus Transmitters. It does not provide instructions for diagnostics, maintenance, service, or troubleshooting. Refer to the Rosemount 3051SMV FOUNDATION Fieldbus Reference Manual for more instruction. This document is also available electronically on [Emerson.com/Rosemount](http://Emerson.com/Rosemount).

**⚠ WARNING**

Explosions could result in death or serious injury.

Installation of device in an explosive environment must be in accordance with appropriate local, national, and international standards, codes, and practices.

Review Rosemount 3051SMV FOUNDATION Fieldbus Reference Manual for any restrictions associated with a safe installation.

- Before connecting a handheld communicator in an explosive atmosphere, make sure the instruments in the loop are installed in accordance with intrinsically safe or non-incendive field wiring practices.
- In an explosion-proof/flameproof installation, do not remove the transmitter covers when power is applied to the unit.

Process leaks could result in death or serious injury.

- Install and tighten process connectors before applying pressure.

Electrical shock could cause death or serious injury.

- Avoid contact with the leads and terminals. High voltage that may be present on leads can cause electrical shock.

Conduit/cable entries

- Unless marked, the conduit/cable entries in the transmitter housing use a 1/2–14 NPT thread form. Entries marked “M20” are M20 × 1.5 thread form. On devices with multiple conduit entries, all entries will have the same thread form. Only use plugs, adapters, glands, or conduit with a compatible thread form when closing these entries.
- When installing in a hazardous location, use only appropriately listed or Ex certified plugs, glands, or adapters in cable/conduit entries.

**Contents**

Mount the transmitter.....	3	Wiring, grounding, and power.....	14
Tagging.....	9	System readiness.....	19
Consider housing rotation.....	10	Zero trim the transmitter.....	20
Set the switches.....	12	Product certifications.....	21

# 1 Mount the transmitter

## 1.1 Liquid flow applications

### Procedure

1. Place taps to the side of the line.
2. Mount beside or below the taps.
3. Mount the transmitter so that the drain/vent valves are oriented upward.

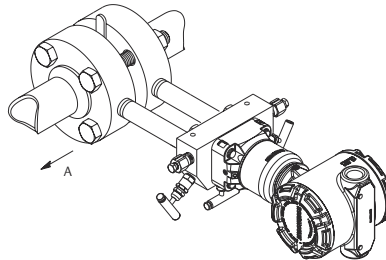

A. Direction of flow

## 1.2 Gas flow applications

### Procedure

1. Place taps in the top or side of the line.
2. Mount beside or above the taps.

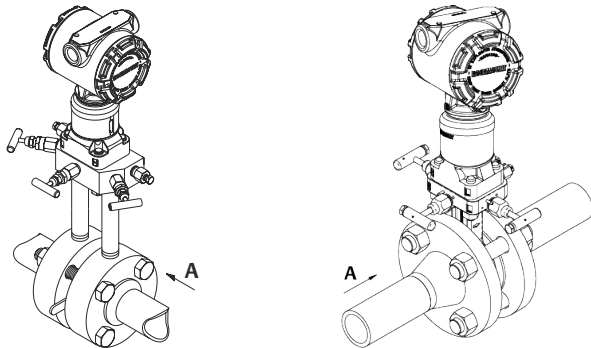

A. Direction of flow

### 1.3 Steam flow applications

#### Procedure

1. Place taps to the side of the line.
2. Mount beside or below the taps.
3. Fill impulse lines with water.

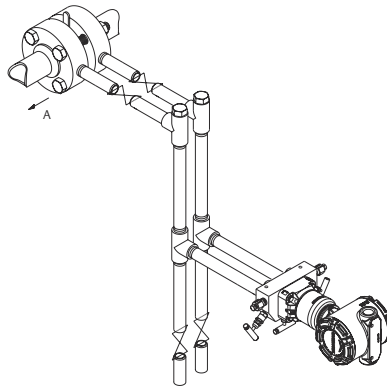

A. Direction of flow

### 1.4 Mounting brackets

**Figure 1-1: Mounting Bracket – Coplanar Flange**

Panel mount

Pipe mount

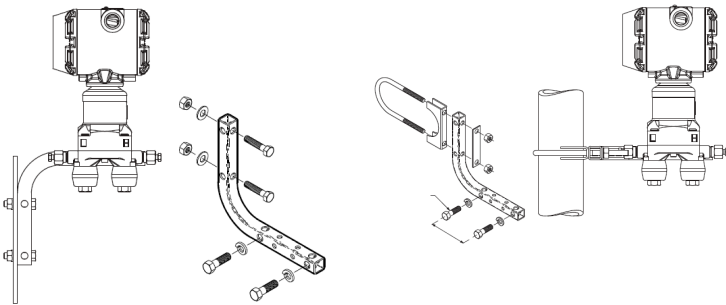

---

**Figure 1-2: Mounting Brackets – Traditional Flange**

Panel mount

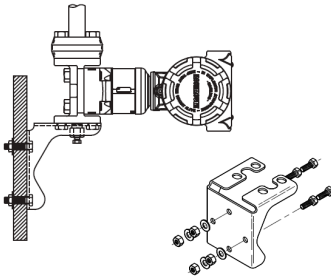

Pipe mount

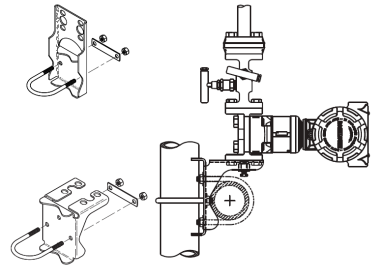
**Figure 1-3: Mounting Brackets – In-line**

Panel mount

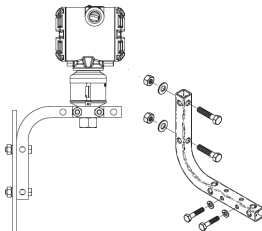

Pipe mount

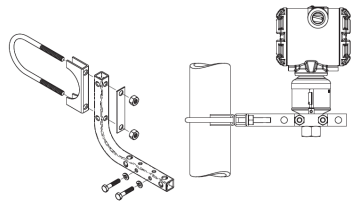

## 1.5 Bolting considerations

If the transmitter installation requires assembly of a process flange, manifold, or flange adapters, follow these assembly guidelines to ensure a tight seal for optimal performance characteristics of the transmitter. Only use bolts supplied with the transmitter or sold by Emerson™ as spare parts. [Figure 1-4](#) illustrates common transmitter assemblies with the bolt length required for proper transmitter assembly.

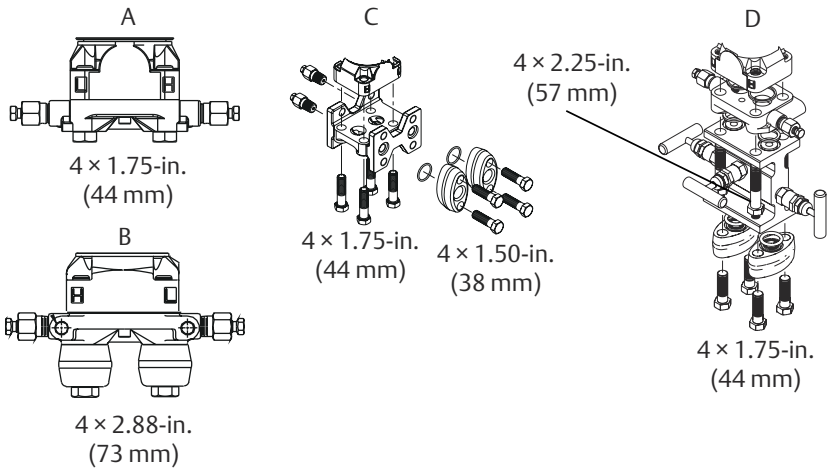
**Figure 1-4: Common Transmitter Assemblies**

- A. Transmitter with coplanar flange
- B. Transmitter with coplanar flange and optional flange adapters
- C. Transmitter with traditional flange and optional flange adapters
- D. Transmitter with coplanar flange and optional Rosemount Conventional Manifold and flange adapters

**Note**

For all other manifolds, contact Customer Central technical support.

Bolts are typically carbon steel or stainless steel. Confirm the material by viewing the markings on the head of the bolt and referencing [Table 1-1](#). If bolt material is not shown in [Table 1-1](#), contact the local Emerson representative for more information.

Use the following bolt installation procedure:

**Procedure**

1. Carbon steel bolts do not require lubrication and the stainless steel bolts are coated with a lubricant to ease installation. However, no additional lubricant should be applied when installing either type of bolt.
2. Finger-tighten the bolts.
3. Torque the bolts to the initial torque value using a crossing pattern. See [Table 1-1](#) for initial torque value.
4. Torque the bolts to the final torque value using the same crossing pattern. See [Table 1-1](#) for final torque value.

- Verify the flange bolts are protruding through the sensor module before applying pressure (see [Figure 1-5](#)).

**Example**

**Table 1-1: Torque Values for the Flange and Flange Adapter Bolts**

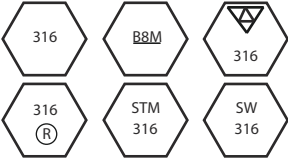
Bolt material	Head markings	Initial torque	Final torque
Carbon Steel (CS)		300 in-lb	650 in-lb
Stainless Steel (SST)		150 in-lb	300 in-lb

**Figure 1-5: Proper Bolt Installation**

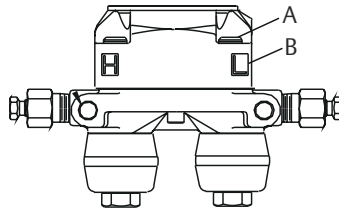

- A. Bolt
- B. Sensor module

## 1.6 O-rings with flange adapters

### **⚠ WARNING**

Failure to install proper flange adapter O-rings may cause process leaks, which can result in death or serious injury. Only use the O-ring that is designed for its specific flange adapter.

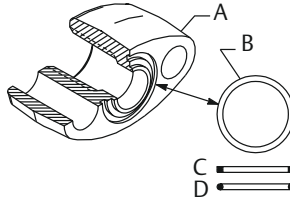

- A. Flange adapter
- B. O-ring
- C. PTFE-based profile (square)
- D. Elastomer profile (round)

Whenever the flange or adapters are removed, visually inspect the O-rings. Replace them if there are any signs of damage, such as nicks or cuts. If the O-rings are replaced, re-torque the flange bolts and alignment screws after installation to compensate for seating of the O-rings.

## 2 Tagging

### 2.1 Commissioning tag

The transmitter is supplied with a removable commissioning tag that contains both the Device ID (the unique code that identifies a particular device in the absence of a device tag) and a space to record the device tag (PD\_TAG) (the operational identification for the device as defined by the *Piping and Instrumentation Diagram* [P&ID]).

When commissioning more than one device on a Fieldbus segment, it can be difficult to identify which device is at a particular location. The removable tag, provided with the transmitter, can aid in this process by linking the Device ID to its physical location. The installer should note the physical location of the transmitter on both the upper and lower location of the commissioning tag. Tear off the bottom portion for each device on the segment and use it for commissioning the segment in the control system.

**Figure 2-1: Commissioning Tag**

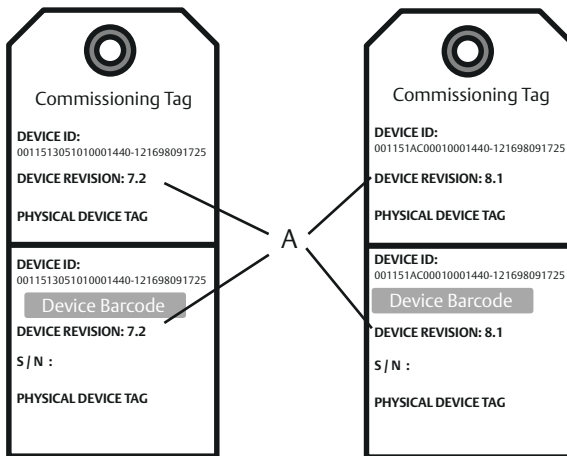

A. Device revision

## 3 Consider housing rotation

To improve field access to wiring or to better view the optional LCD display:

### Procedure

1. Loosen the housing rotation set screw.
2. Turn the housing up to 180° left or right of its original (as shipped) position.
3. Re-tighten the housing rotation set screw.

**Figure 3-1: Transmitter Housing Set Screw**

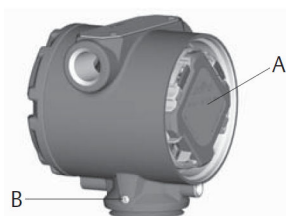

- A. LCD display  
B. Housing rotation set screw (3/32-in.)

### **CAUTION**

Do not rotate the housing more than 180° without first performing a disassembly procedure (refer to [Troubleshooting](#) for more information). Over-rotation may sever the electrical connection between the sensor module and the electronics.

### 3.1 Rotate the LCD display

Transmitters ordered with the LCD display will be shipped with the display installed.

In addition to housing rotation, the optional LCD display can be rotated in 90° increments by squeezing the two tabs, pulling out, rotating and snapping back into place.

If LCD display pins are inadvertently removed from the electronics board, carefully re-insert the pins before snapping the LCD display back into place.

Use the following procedure and [Figure 3-2](#) to install the LCD display:

## Procedure

1. If the transmitter is installed in a loop, then secure the loop and disconnect power.
  2. Required: Remove the transmitter cover on the electronics board side (opposite the field terminals side). Do not remove instrument covers in explosive environments when circuit is live.
  3. Engage the four-pin connector into the electronics board and snap LCD display into place.
  4. Required: In order to meet explosion-proof requirements, reinstall the housing cover and tighten so the cover is fully seated with metal to metal contact between the housing and cover. After the cover is seated properly, replace the flathead screw located on the bottom of the housing cover.
- 

**Figure 3-2: Optional LCD Display**

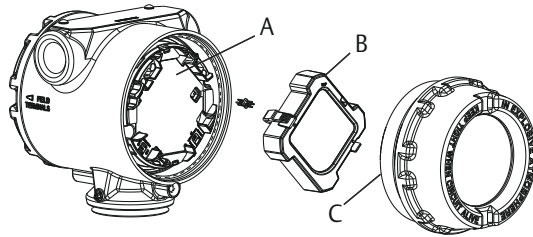

- A. Electronics board
  - B. LCD display
  - C. Display cover
-

## 4 Set the switches

### Prerequisites

Set Simulate and Security switch position before installation (location of switches shown in [Figure 4-1](#)), as desired.

- The Simulate switch enables or disables the ability to set simulated alerts or simulated measured value and status.
- The Security switch allows (🔓) or prevents (🔒) any configuration of the transmitter.

**Figure 4-1: Simulate and Security Switches**

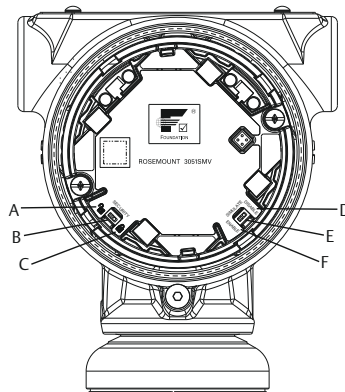

- A. Security unlocked position
- B. Security switch
- C. Security locked position
- D. Simulate disabled position
- E. Simulate switch
- F. Simulate enabled position

Further security settings are available in the software, including settings which use a software lock. Additionally, these settings can be used to disable both hardware and software locks.

Use the following procedure to change the switch configuration:

### Procedure

1. If the transmitter is installed, secure the segment, and remove power.

2. **⚠ WARNING**

**Explosions could result in death or serious injury.**

Do not remove the housing covers in explosive atmospheres when the circuit is live.

---

Remove the housing cover opposite the field terminal side.

3. Slide the security and simulate switches into the preferred position.
4. Reinstall the housing cover and tighten so the cover is fully seated with metal to metal contact between the housing and cover in order to meet explosion proof requirements.
5. If the transmitter was installed, reapply power.

## 5 Wiring, grounding, and power

Use a copper wire of sufficient size to ensure the voltage across the transmitter power terminals does not drop below 9 Vdc. Power supply voltage can be variable, especially under abnormal conditions such as when operating on battery backup. A minimum of 12 Vdc under normal operating conditions is recommended. Shielded twisted pair Type A cable is recommended.

**Figure 5-1: Wiring Terminals with RTD**

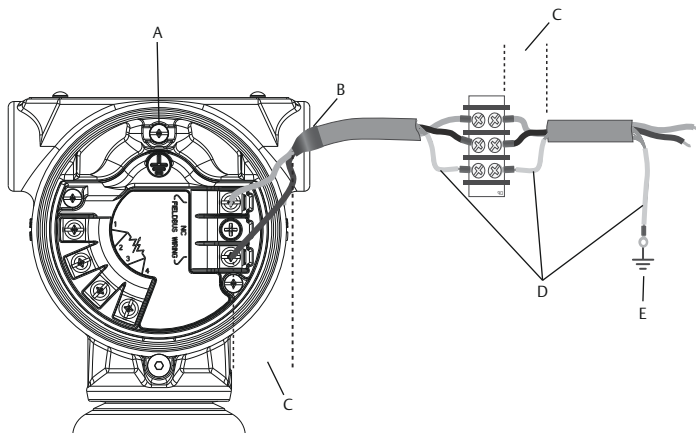

- A. Protective grounding terminal (do not ground cable shield at the transmitter)
- B. Trim shield and insulate
- C. Minimize distance
- D. Insulate shield
- E. Connect shield back to the power supply ground

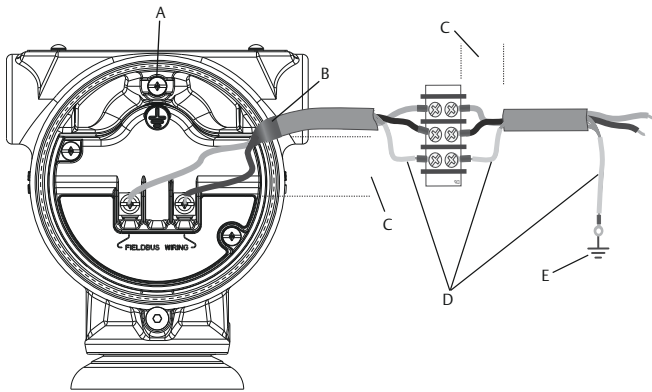
**Figure 5-2: Wiring Terminals without RTD**

- A. Protective grounding terminal (do not ground cable shield at the transmitter)
- B. Trim shield and insulate
- C. Minimize distance
- D. Insulate shield
- E. Connect shield back to the power supply ground

**Note**

The power terminals are polarity insensitive, which means the electrical polarity of the power leads does not matter when connecting to the power terminals. If polarity sensitive devices are connected to the segment, terminal polarity should be followed.

## 5.1 Signal wiring and shield grounding

Do not run signal wiring in conduit or open trays with power wiring, or near heavy electrical equipment. Grounding terminations are provided on the outside of the electronics housing and inside the terminal compartment. These grounds are used when transient protection terminal blocks are installed or to fulfill local regulations.

**Procedure**

1. Remove the field terminals housing cover.
2. To power the transmitter, connect the power leads to the terminals indicated on the terminal block label.
3. Tighten the terminal screws to ensure adequate contact.
4. Trim the cable shield as short as practical and insulate from touching the transmitter housing as indicated in [Figure 5-1](#) and [Figure 5-2](#).

---

**Note**

Do NOT ground the cable shield at the transmitter; if the cable shield touches the transmitter housing, it can create ground loops and interfere with communications. To protect the fieldbus segment from noise, grounding techniques for shield wire require a single grounding point for shield wire to avoid creating a ground loop.

---

- a) Ensure the cable shield maintains a continuous connection to the power supply ground.
  - b) Connect the cable shields for the entire segment to a single good earth ground at the power supply.
- 

**Note**

Improper grounding is the most frequent cause of poor segment communications.

---

5. Reinstall the housing cover and tighten so the cover is fully seated with metal to metal contact between the housing and cover in order to meet explosion proof requirements.
6. Plug and seal unused conduit connections.

**NOTICE**

When the enclosed threaded plug is utilized in the conduit opening, it must be installed with a minimum thread engagement in order to comply with explosion-proof requirements. For straight threads, a minimum of seven threads must be engaged. For tapered threads, a minimum of five threads must be engaged.

---

## 5.2 Power supply

The transmitter requires between 9 and 32 Vdc (9 and 30 Vdc for intrinsic safety, and 9 and 17.5 Vdc for FISCO intrinsic safety) to operate and provide complete functionality.

## 5.3 Power conditioner

A fieldbus segment requires a power conditioner to isolate the power supply, filter, and decouple the segment from other segments attached to the same power supply.

## 5.4 Grounding

Signal wiring of the fieldbus segment can not be grounded. Grounding one of the signal wires will shut down the entire fieldbus segment.

## 5.5 Signal termination

A terminator should be installed at the beginning and end of every fieldbus segment.

## 5.6 Install optional process temperature input (Pt 100 RTD Sensor)

---

### Note

To meet ATEX/IECEX Flameproof certification, only ATEX/IECEX Flameproof cables (temperature input code C30, C32, C33, or C34) may be used.

---

### Procedure

1. Mount the Pt 100 RTD Sensor in the appropriate location.  
Use shielded four-wire cable for the process temperature connection.
2. Connect the RTD cable to the Rosemount 3051S MultiVariable Transmitter by inserting the cable wires through the unused housing conduit and connect to the four screws on the transmitter terminal block. An appropriate cable gland should be used to seal the conduit opening around the cable.
3. Connect the RTD cable shield wire to the ground lug in the housing.

**Figure 5-3: Transmitter RTD Wiring Connection**

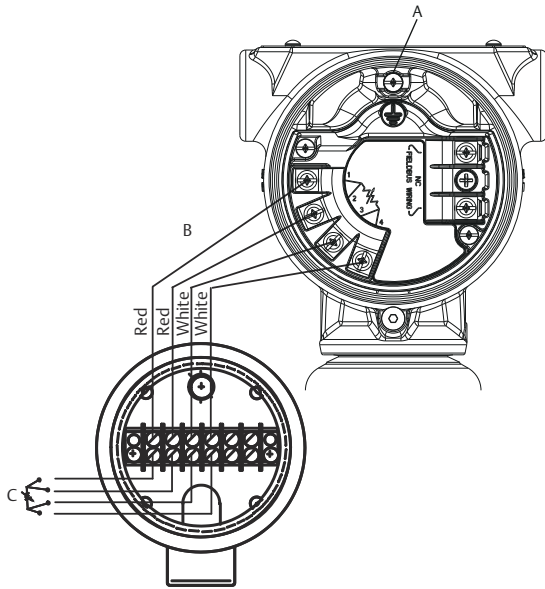

- A. Ground lug
- B. RTD cable assembly wires
- C. Pt 100 RTD sensor

## 6 System readiness

### 6.1 System readiness

#### **Confirm correct device driver**

- Verify the correct device driver (DD) is loaded on your systems to ensure proper communications.
- Download the correct device driver at your host vendor download site, [Emerson.com/Rosemount](https://emerson.com/Rosemount) by selecting **Support > Software Downloads & Drivers** or [FieldCommGroup.org](https://fieldcommgroup.org).

## 7 Zero trim the transmitter

Transmitters are shipped fully calibrated per request or by the factory default of full scale.

A zero trim is a single-point adjustment used for compensating mounting position and line pressure effects. Use the steps below if zero offset is less than five percent of URL.

### Procedure

1. When performing a zero trim, ensure the equalizing valve is open and all wet legs are filled to the correct level. Make sure the transmitter is connected to the host system.
2. Zero the differential pressure sensor by using the “Zero Differential Pressure” method in the host system.
3. Follow the zero DP trim procedure.
4. Zero the static pressure sensor by using the “Zero Static Pressure” or the “Lower Static Pressure Trim” method in the host system.
  - a) Use the “Zero Static Pressure” for a transmitter equipped with a gage static pressure sensor and the “Lower Static Pressure Trim” for a transmitter equipped with an absolute static pressure sensor.

---

### Note

When performing a lower sensor trim on a pressure sensor, it is possible to degrade the performance of the sensor if inaccurate calibration equipment is used. Use calibration equipment that is at least three times as accurate as the pressure sensor of the Rosemount 3051SMV FOUNDATION Fieldbus Transmitter.

---

5. Follow the static pressure trim procedure.

## 8 Product certifications

### 8.1 Rosemount 3051SMV/3051SFx Product Certifications

Rev 2.0

#### European Directive Information

A copy of the EU Declaration of Conformity can be found at the end of the Quick Start Guide. The most recent revision of the EU Declaration of Conformity can be found at [Emerson.com/Rosemount](http://Emerson.com/Rosemount).

#### Ordinary Location Certification

As standard, the transmitter has been examined and tested to determine that the design meets the basic electrical, mechanical, and fire protection requirements by a nationally recognized test laboratory (NRTL) as accredited by the Federal Occupational Safety and Health Administration (OSHA).

#### Installing Equipment in North America

The US National Electrical Code® (NEC) and the Canadian Electrical Code (CEC) permit the use of Division marked equipment in Zones and Zone marked equipment in Divisions. The markings must be suitable for the area classification, gas, and temperature class. This information is clearly defined in the respective codes.

#### 8.1.1 USA

##### E5 US Explosionproof (XP) and Dust-Ignitionproof (DIP)

**Certificate** FM16US0089X

**Standards** FM Class 3600 – 2011, FM Class 3615 – 2006, FM Class 3616 – 2011, 3810 – 2005, ANSI/NEMA 250 – 2003

**Markings** XP CL I, DIV 1, GP B, C, D; T5; DIP CL II, DIV 1, GP E, F, G; CL III; T5(-50 °C ≤ T<sub>a</sub> ≤ +85 °C); Factory Sealed; Type 4X

##### I5 US Intrinsically Safe (IS) and Nonincendive (NI)

**Certificate** FM16US0233

**Standards** FM Class 3600 – 2011, FM Class 3610 – 2007, FM Class 3611 – 2004, FM Class 3810 – 2005, NEMA 250 – 1991

**Markings** IS CL I, DIV 1, GP A, B, C, D; CL II, DIV 1, GP E, F, G; Class III; Class 1, Zone 0 AEx ia IIC T4; NI CL 1, DIV 2, GP A, B, C, D; T4(-50 °C ≤ T<sub>a</sub> ≤ +70 °C) when connected per Rosemount drawing 03151-1206; Type 4X

**Note**

Transmitters marked with NI CL 1, DIV 2 can be installed in Division 2 locations using general Division 2 wiring methods or Nonincendive Field Wiring (NIFW). See Drawing 03151-1206.

**IE US FISCO Intrinsically Safe**

**Certificate** FM16US0233

**Standards** FM Class 3600 – 2011, FM Class 3610 – 2010, FM Class 3611 – 2004, FM Class 3616 – 2006, FM Class 3810 – 2005, NEMA 250 – 1991

**Markings** IS CL I, DIV 1, GP A, B, C, D;

**Standards** T4( $-50\text{ }^{\circ}\text{C} \leq T_a \leq +70\text{ }^{\circ}\text{C}$ ); when connected per Rosemount drawing 03151-1006; Type 4X

**8.1.2 Canada****E6 Canada Explosionproof, Dust Ignition-proof, Division 2**

**Certificate** 1143113

**Standards** CAN/CSA C22.2 No. 0-10, CSA Std C22.2 No. 25-1966, CSA Std C22.2 No. 30-M1986, CSA C22.2 No. 94.2-07, CSA Std C22.2 No. 213-M1987, CAN/CSA C22.2 60079-11:14, CAN/CSA-C22.2 No. 61010-1-12, ANSI/ISA 12.27.01-2003, CSA Std C22.2 No. 60529:05 (R2010)

**Markings** Explosionproof Class I, Division 1, Groups B, C, D; Dust-Ignitionproof Class II, Division 1, Groups E, F, G; Class III; suitable for Class I, Division 2, Groups A, B, C, D; Type 4X

**I6 Canada Intrinsically Safe**

**Certificate** 1143113

**Standards** CAN/CSA C22.2 No. 0-10, CSA Std C22.2 No. 25-1966, CSA Std C22.2 No. 30-M1986, CSA C22.2 No. 94.2-07, CSA Std C22.2 No. 213-M1987, CAN/CSA C22.2 60079-11:14, CAN/CSA-C22.2 No. 61010-1-12, ANSI/ISA 12.27.01-2003, CSA Std C22.2 No. 60529:05 (R2010)

**Markings** Intrinsically Safe Class I, Division 1; suitable for Class 1, Zone 0, IIC, T3C,  $T_a = 70\text{ }^{\circ}\text{C}$ ; when connected per Rosemount drawing 03151-1207; Type 4X

**IF Canada FISCO Intrinsically Safe**

**Certificate** 1143113

**Standards** CAN/CSA C22.2 No. 0-10, CSA Std C22.2 No. 25-1966, CSA Std C22.2 No. 30-M1986, CSA C22.2 No. 94.2-07, CSA Std C22.2 No. 213-M1987, CAN/CSA C22.2 60079-11:14, CAN/CSA-C22.2 No. 61010-1-12, ANSI/ISA 12.27.01-2003, CSA Std C22.2 No. 60529:05 (R2010)

**Markings** FISCO Intrinsically Safe Class I, Division 1; Groups A, B, C, D; suitable for Class I, Zone 0; T3C, Ta = 70 °C; when installed per Rosemount drawing 03151-1207; Type 4X

### 8.1.3 Europe E1 ATEX Flameproof

**Certificate** KEMA 00ATEX2143X

**Standards** EN 60079-0:2012+A11:2013, EN 60079-1: 2014, EN 60079-26:2015

**Markings**  II 1/2 G Ex db IIC T6...T4 Ga/Gb, T6(-60 °C ≤ Ta ≤ +70 °C), T5/T4(-60 °C ≤ Ta ≤ +80 °C)

Temperature class	Process temperature
T6	-60 °C to +70 °C
T5	-60 °C to +80 °C
T4	-60 °C to +120 °C

#### Special Conditions for Safe Use (X):

1. This device contains a thin wall diaphragm less than 1 mm thickness that forms a boundary between Category 1 (process connection) and Category 2 (all other parts of the equipment). The model code and datasheet are to be consulted for details of the diaphragm material. Installation, maintenance, and use shall take into account the environmental conditions to which the diaphragm will be subjected. The manufacturer's instructions for installation and maintenance shall be followed in detail to assure safety during its expected lifetime.
2. Flameproof joints are not intended for repair.
3. Non-standard paint options may cause risk from electrostatic discharge. Avoid installations that could cause electrostatic build-up on painted surfaces, and only clean the painted surfaces with a damp cloth. If paint is ordered through a special option code, contact the manufacturer for more information.
4. Appropriate cable, glands, and plugs need to be suitable for a temperature of 5 °C greater than maximum specified temperature for location where installed.

## I1 ATEX Intrinsic Safety

<b>Certificate</b>	Baseefa08ATEX0064X
<b>Standards</b>	EN 60079-0:2012, EN 60079-11:2012
<b>Markings</b>	 II 1 G Ex ia IIC T4 Ga, T4(-60 °C ≤ T <sub>a</sub> ≤ +70 °C)

Parameter	HART®	FOUNDATION Fieldbus	SuperModule™ only	RTD (for 3051SFx)	
				HART	Fieldbus
Voltage U <sub>i</sub>	30 V	30 V	7.14 V	30 V	30 V
Current I <sub>i</sub>	300 mA	300 mA	300 mA	2.31 mA	18.24 mA
Power P <sub>i</sub>	1 W	1.3 W	887 mW	17.32 mW	137 mW
Capacitance C <sub>i</sub>	14.8 nF	0	0.11 μF	0	0.8 nF
Inductance L <sub>i</sub>	0	0	0	0	1.33 mH

### Special Conditions for Safe Use (X):

1. If the equipment is fitted with the optional 90 V transient suppressor, it is incapable of withstanding the 500 V isolation from earth test and this must be taken into account during installation.
2. The enclosure may be made of aluminum alloy and given a protective polyurethane paint finish; however, care should be taken to protect it from impact or abrasion if located in a Zone 0 environment.

## IA ATEX FISCO

<b>Certificate</b>	Baseefa08ATEX0064X
<b>Standards</b>	EN 60079-0:2012, EN 60079-11:2012
<b>Markings</b>	 II 1 G Ex ia IIC T4 Ga, T4(-60 °C ≤ T <sub>a</sub> ≤ +70 °C)

Parameter	FISCO
Voltage U <sub>i</sub>	17.5 V
Current I <sub>i</sub>	380 mA
Power P <sub>i</sub>	5.32 W
Capacitance C <sub>i</sub>	0
Inductance L <sub>i</sub>	0

## ND ATEX Dust

**Certificate** BAS01ATEX1374X

**Standards** EN 60079-0:2012, EN 60079-31:2009

**Markings**  II 1 D Ex ta IIIC T105 °C T<sub>500</sub> 95 °C Da, (-20 °C ≤ T<sub>a</sub> ≤ +85 °C),  
V<sub>max</sub> = 42.4 V

### Special Conditions for Safe Use (X):

1. Cable entries must be used which maintain the ingress protection of the enclosure to at least IP66.
2. Unused cable entries must be filled with suitable blanking plugs which maintain the ingress protection of the enclosure to at least IP66.
3. Cable entries and blanking plugs must be suitable for the ambient temperature range of the apparatus and capable of withstanding a 7J impact test.
4. The SuperModule(s) must be securely screwed in place to maintain the ingress protection of the enclosure(s).

## N1 ATEX Type n

**Certificate** Baseefa08ATEX0065X

**Standards** EN 60079-0:2012, EN 60079-15:2010

**Markings**  II 3 G Ex nA IIC T4 Gc, (-40 °C ≤ T<sub>a</sub> ≤ 70 °C), V<sub>max</sub> = 45 V

### Special Condition for Safe Use (X):

1. If fitted with a 90 V transient suppressor, the equipment is not capable of withstanding the 500 V electrical strength test as defined in Clause 6.5.1 of EN 60079-15:2010. This must be taken into account during installation.

### 8.1.4 International E7 IECEx Flameproof and Dust

**Certificate** IECEx KEM 08.0010X (Flameproof)

**Standards** IEC 60079-0:2011, IEC 60079-1:2014, IEC 60079-26:2014

**Markings** Ex db IIC T6...T4 Ga/Gb, T6(-60 °C ≤ T<sub>a</sub> ≤ +70 °C), T5/T4(-60 °C ≤ T<sub>a</sub> ≤ +80 °C)

Temperature class	Process temperature
T6	-60 °C to +70 °C
T5	-60 °C to +80 °C

Temperature class	Process temperature
T4	-60 °C to +120 °C

### Special Conditions for Safe Use (X):

1. This device contains a thin wall diaphragm less than 1 mm thickness that forms a boundary between EPL Ga (process connection) and EPL Gb (all other parts of the equipment). The model code and datasheet are to be consulted for details of the diaphragm material. Installation, maintenance and use shall take into account the environmental conditions to which the diaphragm will be subjected. The manufacturer's instructions for installation and maintenance shall be followed in detail to assure safety during its expected lifetime.
2. Flameproof joints are not intended for repair.
3. Non-standard paint options may cause risk from electrostatic discharge. Avoid installations that could cause electrostatic build-up on painted surfaces, and only clean the painted surfaces with a damp cloth. If paint is ordered through a special option code, contact the manufacturer for more information.
4. Appropriate cable, glands and plugs need to be suitable for a temperature of 5 °C greater than maximum specified temperature for location where installed.

Certificate: IECEx BAS 09.0014X (Dust)

Standards: IEC 60079-0:2011, IEC 60079-31:2008

Markings: Ex ta IIIC T105 °C T<sub>500</sub> 95 °C Da, (-20 °C ≤ T<sub>a</sub> ≤ +85 °C), V<sub>max</sub> = 42.4 V

### Special Conditions for Safe Use (X):

1. Cable entries must be used which maintain the ingress protection of the enclosure to at least IP66.
2. Unused cable entries must be filled with suitable blanking plugs which maintain the ingress protection of the enclosure to at least IP66.
3. Cable entries and blanking plugs must be suitable for the ambient temperature range of the apparatus and capable of withstanding a 7J impact test.
4. The Rosemount 3051S - SuperModule must be securely screwed in place to maintain the ingress protection of the enclosure.

## I7 IECEx Intrinsic Safety

**Certificate** IECEx BAS 08.0025X

**Standards** IEC 60079-0:2011, IEC 60079-11:2011

**Markings**Ex ia IIC T4 Ga, T4(-60 °C ≤ T<sub>a</sub> ≤ +70 °C)

Parameter	HART	FOUNDATION Fieldbus	SuperModule only	RTD (for 3051SFx)	
				HART	Fieldbus
Voltage U <sub>i</sub>	30 V	30 V	7.14 V	30 V	30 V
Current I <sub>i</sub>	300 mA	300 mA	300 mA	2.31 mA	18.24 mA
Power P <sub>i</sub>	1 W	1.3 W	887 mW	17.32 mW	137 mW
Capacitance C <sub>i</sub>	14.8 nF	0	0.11 μF	0	0.8 nF
Inductance L <sub>i</sub>	0	0	0	0	1.33 mH

**Special Conditions for Safe Use (X):**

1. If the equipment is fitted with the optional 90 V transient suppressor, it is incapable of withstanding the 500 V isolation from earth test and this must be taken into account during installation.
2. The enclosure may be made of aluminum alloy and given a protective polyurethane paint finish; however, care should be taken to protect it from impact or abrasion if located in a Zone 0 environment.

**IG IECEx FISCO****Certificate**

IECEx BAS 08.0025X

**Standards**

IEC 60079-0:2011, IEC 60079-11:2011

**Markings**Ex ia IIC T4 Ga, T4(-60 °C ≤ T<sub>a</sub> ≤ +70 °C)

Parameter	FISCO
Voltage U <sub>i</sub>	17.5 V
Current I <sub>i</sub>	380 mA
Power P <sub>i</sub>	5.32 W
Capacitance C <sub>i</sub>	0
Inductance L <sub>i</sub>	0

**N7 IECEx Type n****Certificate**

I ECEX BAS 08.0026X

**Standards**

IEC 60079-0:2011, IEC 60079-15:2010

**Markings**Ex nA IIC T5 Gc, (-40 °C ≤ T<sub>a</sub> ≤ 70 °C)

**Special Condition for Safe Use (X):**

1. If fitted with a 90 V transient suppressor, the equipment is not capable of withstanding the 500 V electrical strength test as defined in Clause 6.5.1 of IEC 60079-15:2010. This must be taken into account during installation.

## 8.1.5 Brazil

**E2 INMETRO Flameproof****Certificate** UL-BR 15.0393X**Standards** ABNT NBR IEC 60079-0:2008 + Corrigendum 1:2011, ABNT NBR IEC 60079-1:2009 + Corrigendum 1:2011, ABNT NBR IEC 60079-26:2008 + Corrigendum 1: 2008**Markings** Ex db IIC T\* Ga/Gb, T6( $-60\text{ }^{\circ}\text{C} \leq T_a \leq +70\text{ }^{\circ}\text{C}$ ), T5/T4( $-60\text{ }^{\circ}\text{C} \leq T_a \leq +80\text{ }^{\circ}\text{C}$ ), IP66**Special Conditions for Safe Use (X):**

1. The device contains a thin wall diaphragm less than 1mm thick that forms a boundary between zone 0 (process connection) and zone 1 (all other parts of the equipment). The model code and datasheet are to be consulted for details of the diaphragm material. Installation, maintenance, and use shall take into account the environmental conditions to which the diaphragm will be subjected. The manufacturer's instructions for maintenance shall be followed in detail to assure safety during its expected lifetime.
2. Flameproof joints are not intended for repair.
3. Non-standard paint options may cause risk from electrostatic discharge. Avoid installations that could cause electrostatic build-up on painted surfaces, and only clean the painted surfaces with a damp cloth. If paint is ordered through a special option code, contact the manufacturer for more information.

**I2 INMETRO Intrinsic Safety****Certificate** UL-BR 15.0357X**Standards** ABNT NBR IEC 60079-0:2008 + Addendum 1:2011, ABNT NBR IEC 60079-11:2009**Markings** Ex ia IIC T4 Ga ( $-60\text{ }^{\circ}\text{C} \leq T_a \leq +70\text{ }^{\circ}\text{C}$ )**Special Conditions for Safe Use (X):**

1. If the equipment is fitted with the optional 90V transient suppressor, it is incapable of withstanding the 500V isolation from earth test and this must be taken into account during installation.

- The enclosure may be made of aluminium alloy and given a protective polyurethane paint finish; however, care should be taken to protect it from impact or abrasion if located in a Zone 0 environment, areas requiring EPL Ga.

Parameter	HART		Fieldbus	
	Input	RTD	Input	RTD
Voltage $U_i$	30 V	30 V	30 V	30 V
Current $I_i$	300 mA	2.31 mA	300 mA	18.24 mA
Power $P_i$	1 W	17.32 mW	1.3 W	137 mW
Capacitance $C_i$	14.8 nF	0	0	0.8 nF
Inductance $L_i$	0	0	0	1.33 mH

## I2/IB INMETRO Intrinsic Safety/FISCO

**Certificate** UL-BR 15.0392X

**Standards** ABNT NBR IEC 60079-0:2013, ABNT NBR IEC 60079-11:2013

**Markings** Ex ia IIC T4 Ga ( $-60\text{ °C} \leq T_a \leq +70\text{ °C}$ ), IP66

### Special Conditions for Safe Use (X):

- The surface resistivity of the antenna is greater than 1 GΩ. To avoid electrostatic charge buildup, it must not be rubbed or cleaned with solvents or a dry cloth.
- The Model 701PBKGF Power Module may be replaced in a hazardous area. The Power Module has a surface resistivity greater than 1 GΩ and must be properly installed in the wireless device enclosure. Care must be taken during transportation to and from the point of installation to prevent electrostatic charge buildup.
- The 3051S enclosure may be made of aluminium alloy and given a protective polyurethane paint finish; however, care should be taken to protect it from impact or abrasion if located in areas that requires EPL Ga.

**Table 8-1: Input Parameters**

	$U_i$	$I_i$	$P_i$	$C_i$	$L_i$
SuperModule	30 V	300 mA	1.0 W	30 nF	0
3051S...A; 3051SF...A; 3051SAL...C	30 V	300 mA	1.0 W	12 nF	0
3051S...F; 3051SF...F	30 V	300 mA	1.3 W	0	0

**Table 8-1: Input Parameters (continued)**

	$U_i$	$I_i$	$P_i$	$C_i$	$L_i$
3051S...F...IB; 3051SF...F...IB	17.5 V	380mA	5.32W	0	0
3051S ...A...M7, M8, or M9; 3051SF ...A...M7, M8, or M9; 3051SAL...C... M7, M8, or M9	30 V	300 mA	1.0 W	12 nF	60 $\mu$ H
3051SAL or 3051SAM	30 V	300 mA	1.0 W	12 nF	33 $\mu$ H
3051SAL... M7, M8, or M9 3051SAM... M7, M8, or M9	30 V	300 mA	1.0 W	12 nF	93 $\mu$ H
RTD Option for 3051SF	5 V	500 mA	0.63 W	N/A	N/A

## 8.1.6 China

### E3 China Flameproof and Dust Ignition-proof

**Certificate** 3051SMV: GYJ14.1039X [Mfg USA, China, Singapore]

3051SFx: GYJ11.1466X [Mfg USA, China, Singapore]

**Standards** 3051SMV: GB3836.1-2010, GB3836.2-2010, GB3836.20-2010  
3051SFx: GB3836.1-2010, GB3836.2-2010, GB3836.20-2010,  
GB12476.1-2013, GB12476.5-2013

**Markings** 3051SMV: Ex d IIC T6/T5 Ga/Gb

3051SFx: Ex d IIC T4...T6 Ga/Gb; Ex tD A20 T<sub>A</sub> 105 °C; IP66

### Special Conditions for Safe Use (X):

1. Symbol "X" is used to denote specific conditions of use: For information on the dimensions of the flameproof joints the manufacturer shall be contacted.
2. The relationship between T code and ambient temperature range for the 3051SMV are as follows:

T code	Ambient temperature range
T6	-50 °C ~ +65 °C (-58 °F ~ +149 °F)
T5	-50 °C ~ +80 °C (-58 °F ~ +176 °F)

The relationship between T code and ambient temperature range for the 3051SFx are as follows:

T code	Ambient temperature range
T6	-60 °C ~ +70 °C (-76 °F ~ +158 °F)
T4/T5	-60 °C ~ +80 °C (-76 °F ~ +176 °F)

3. The earth connection facility in the enclosure should be connected reliably.
4. During installation, use and maintenance of the product in explosive atmosphere, observe the warning “Do not open cover when circuit is alive”. During installation, use, and maintenance in explosive dust atmosphere, observe the warning “Do not open when an explosive dust atmosphere is present”.
5. During installation there should be no mixture harmful to the housing.
6. During installation, use and maintenance in explosive dust atmosphere, product enclosure should be cleaned to avoid dust accumulation, but compressed air should not be used.
7. During installation in a hazardous location, cable glands and blanking plugs certified by state appointed inspection bodies with Ex d IIC Gb or Ex d IIC Gb DIP A20 [flow meters] IP66 type of protection should be used. Redundant cable entries should be blocked with blanking plugs.
8. End users are not permitted to change any components, but to contact the manufacturer to avoid damage to the product.
9. Maintenance should be done when no explosive gas and dust atmosphere is present.
10. During installation, use and maintenance of this product, observe following standards:
  - GB3836.13-1997 “Electrical apparatus for explosive gas atmospheres Part 13: Repair and overhaul for apparatus used in explosive gas atmospheres”
  - GB3836.15-2000 “Electrical apparatus for explosive gas atmospheres Part 15: Electrical installations in hazardous area (other than mines)”
  - GB3836.16-2006 “Electrical apparatus for explosive gas atmospheres Part 16: Inspection and maintenance of electrical installation (other than mines)”
  - GB50257-1996 “Code for construction and acceptance of electric device for explosion atmospheres and fire hazard electrical equipment installation engineering”
  - GB15577-2007 “Safety regulations for dust explosion prevention and protection”
  - GB12476.2-2010 “Electrical apparatus for use in the presence of combustible dust”

### I3 China Intrinsic Safety

- Certificate** 3051SMV: GYJ14.1040X [Mfg USA, China, Singapore]  
3051SFx: GYJ16.14 [Mfg USA, China, Singapore]
- Standards** 3051SMV: GB3836.1-2010, GB3836.4-2010, GB3836.20-2010  
3051SFx: GB3836.1/4-2010, GB3836.20-2010,  
GB12476.1-2000
- Markings** 3051SMV: Ex ia IIC T4 Ga  
3051SFx: Ex ia IIC T4 Ga, Ex tD A20 T<sub>A</sub>105 °C T<sub>500</sub>95 °C; IP66

#### Special Conditions for Safe Use (X):

1. The enclosure may contain light metal, attention should be taken to avoid ignition hazard due to impact or friction.
2. The apparatus is not capable of withstanding the 500V electrical strength test defined in Clause 6.3.12 of GB3836.4-2010.
3. Ambient temperature range: -60 °C ~ +70 °C
4. Intrinsically safe electric parameters:

Maximum input voltage: $U_i$ (V)	Maximum input current: $I_i$ (mA)	Maximum input power: $P_i$ (W)	Maximum internal parameters:	
			$C_i$ (nF)	$L_i$ ( $\mu$ H)
30	300	1.0	14.8	0

	Maximum output voltage: $U_i$ (V)	Maximum output current: $I_i$ (mA)	Maximum output power: $P_i$ (W)	Maximum external parameters:	
				$C_i$ (nF)	$L_i$ ( $\mu$ H)
RTD	30	2.31	17.32	0	0
SuperModule	7.14	300	887	110	0

5. The cables between this product and associated apparatus should be shielded cables. The shield should be grounded reliably in non-hazardous area.
6. The product should be used with Ex certified associated apparatus to establish explosion protection system that can be used in explosive gas atmospheres. Wiring and terminals should comply with the instruction manual of the product and associated apparatus.

7. End users are not permitted to change any components, contact the manufacturer to avoid damage to the product.
8. During installation in hazardous location, cable glands, conduit, and blanking plugs certified by state-appointed inspection bodies with DIP A20 IP66 type of protection should be used. Redundant cable entries should be blocked with blanking plugs.
9. During installation, use, and maintenance in explosive dust atmosphere, observe the warning “Do not open when an explosive dust atmosphere is present”.
10. Maintenance should be done when no explosive dust atmosphere is present.
11. During installation, use and maintenance of this product, observe following standards:
  - GB3836.13-2013 “Electrical apparatus for explosive gas atmospheres Part 13: Repair and overhaul for apparatus used in explosive gas atmospheres“
  - GB3836.15-2000 “Electrical apparatus for explosive gas atmospheres Part 15: Electrical installations in hazardous area (other than mines)”
  - GB3836.16-2006 “Electrical apparatus for explosive gas atmospheres Part 16: Inspection and maintenance of electrical installation (other than mines)”
  - GB3836.18-2010 “Intrinsically Safe System”
  - GB50257-1996- “Code for construction and acceptance of electric device for explosion atmospheres and fire hazard electrical equipment installation engineering”
  - GB15577-2007 Safety regulations for dust explosion prevention and protection
  - GB12476.2-2010 “Electrical apparatus for use in the presence of combustible dust”

### 8.1.7 EAC - Belarus, Kazakhstan, Russia EM Technical Regulation Customs Union (EAC) Flameproof and Dust Ignition-proof

<b>Certificate</b>	RU C-US.AA87.B.00378
<b>Markings</b>	Ga/Gb Ex d IIC T6...T4 X Ex tb IIIC T105 °C T <sub>500</sub> 95 °C Db X Ex ta IIIC T105 °C T <sub>500</sub> 95 °C Da X

### IM Technical Regulation Customs Union (EAC) Intrinsic Safety

<b>Certificate</b>	RU C-US.AA87.B.00378
--------------------	----------------------

**Markings** 0Ex ia IIC T4 Ga X

### 8.1.8 Japan E4 Japan Flameproof

**Certificate** CML 17JPN1147X

**Markings** Ex d IIC T6...T4 Ga/Gb

**Table 8-2:**

Temperature class	Ambient temperature	Process temperature
T6	-40 °C to +70 °C (-40 °F to +158 °F)	-60 °C to +70 °C (-76 °F to +158 °F)
T5	-40 °C to +75 °C (-40 °F to +167 °F)	-60 °C to +80 °C (-76 °F to +176 °F)
T4	-40 °C to +75 °C (-40 °F to +167 °F)	-60 °C to +120 °C (-76 °F to +248 °F)

#### Special Conditions for Safe Use (X):

1. This device contains a thin wall diaphragm less than 1mm thickness that forms a boundary between EPL Ga (process connection) and EPL Gb (all other parts of the equipment). The model code and datasheet are to be consulted for details of the diaphragm material. Installation, maintenance, and use shall consider the environmental conditions to which the diaphragm will be subjected. The manufacturer's instructions for installation and maintenance shall be followed in detail to assure safety during its expected lifetime.
2. Flameproof joints are not intended for repair.
3. Non-standard paint options may cause risk from electrostatic discharge. Avoid installations that could cause electrostatic build-up on painted surfaces, and only clean the painted surfaces with a damp cloth. If paint is ordered through a special option code, contact the manufacturer for more information.

### 8.1.9 Republic of Korea EP Republic of Korea Flameproof

**Certificate** 12-KB4BO-0180X [Mfg USA], 11-KB4BO-0068X [Mfg Singapore]

**Markings** Ex d IIC T6...T4

## IP Republic of Korea Intrinsic Safety [HART Only]

<b>Certificate</b>	10-KB4BO-0021X [Mfg USA, SMMC]
<b>Markings</b>	Ex ia IIC T4

### 8.1.10 Combinations

<b>K1</b>	Combination of E1, I1, N1, and ND
<b>K2</b>	Combination of E2 and I2
<b>K5</b>	Combination of E5 and I5
<b>K6</b>	Combination of E6 and I6
<b>K7</b>	Combination of E7, I7, and N7
<b>KA</b>	Combination of E1, I1, E6, and I6
<b>KB</b>	Combination of E5, I5, E6, and I6
<b>KC</b>	Combination of E1, I1, E5, and I5
<b>KD</b>	Combination of E1, I1, E5, I5, E6, and I6
<b>KM</b>	Combination of EM and IM
<b>KP</b>	Combination of EP and IP

### 8.1.11 Additional Certifications

#### SBS American Bureau of Shipping (ABS) Type Approval

<b>Certificate</b>	17-RJ1679518-PDA
<b>Intended Use</b>	Measure gauge or absolute pressure of liquid, gas or vapor applications on ABS classed vessels, marine, and offshore installations. [HART only]

#### SBV Bureau Veritas (BV) Type Approval

<b>Certificate</b>	31910
<b>BV Requirements</b>	Bureau Veritas Rules for the Classification of Steel Ships
<b>Application</b>	Class Notations: AUT-UMS, AUT-CCS, AUT-PORT and AUT-IMS. [HART only]

#### SDN Det Norske Veritas (DNV) Type Approval

<b>Certificate</b>	TAA00000K9
<b>Intended Use</b>	Det Norske Veritas' Rules for Classification of Ships, High Speed and Light Craft, and Det Norske Veritas' Offshore Standards.[HART only]



<b>Application</b>	<b>Location classes</b>	
Type	3051S	
Temperature	D	
Humidity	B	
Vibration	A	
EMC	A	
Enclosure	D/IP66/IP68	



### SLL Lloyds Register (LR) Type Approval



**Certificate** 11/60002

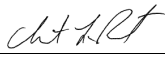

**Application** Environmental categories ENV1, ENV2, ENV3, and ENV5.  
[HART only]

## 8.2 Declaration of Conformity

	<b>EU Declaration of Conformity</b> No: RMD 1072 Rev. L	
<p>We,</p> <p style="margin-left: 40px;"><b>Rosemount Inc.</b> 8200 Market Boulevard Chanhassen, MN 55317-9685 USA</p> <p>declare under our sole responsibility that the product,</p> <p style="text-align: center;"><b>Rosemount™ Models 3051SMV &amp; 300SMV Pressure Transmitters</b></p> <p>manufactured by,</p> <p style="margin-left: 40px;"><b>Rosemount Inc.</b> 8200 Market Boulevard Chanhassen, MN 55317-9685 USA</p> <p>to which this declaration relates, is in conformity with the provisions of the European Union Directives, including the latest amendments, as shown in the attached schedule.</p> <p>Assumption of conformity is based on the application of the harmonized standards and, when applicable or required, a European Union notified body certification, as shown in the attached schedule.</p>		
 <hr style="width: 100%;"/> (signature)	Vice President of Global Quality <hr style="width: 100%;"/> (function name - printed)	
Chris LaPoint <hr style="width: 100%;"/> (name - printed)	1-Feb-19.; Shakopee, MN USA <hr style="width: 100%;"/> (date of issue & place)	
<small>Page 1 of 4</small>		<small>Document Rev: 2013_A</small>

	<h2>EU Declaration of Conformity</h2> <p>No: RMD 1072 Rev. L</p>	
<p><b>EMC Directive (2014/30/EU)</b></p>		
<p style="text-align: center;"><b>All Models 3051SMV and 300SMV Pressure Transmitters</b>          Harmonized Standards Used:          EN 61326-1:2013, EN61326-2-3: 2013</p>		
<p><b>PED Directive (2014/68/EU)</b></p>		
<p style="text-align: center;"><b>Models 3051SMV and 300SMV Pressure Transmitters</b></p>		
<p><b>Model 3051SMV with Static Pressure Range 4 only (also with P0 &amp; P9 options) Pressure Transmitter</b>          QS Certificate of Assessment – Certificate No. 12695-2018-CE-ACCREDIA          Module H Conformity Assessment          Other Standards Used:          ANSI/ISA 61010-1:2004  <i>Note – previous PED Certificate No. 59552-2009-CE-HOU-DNV</i></p>		
<p><b>All other models</b>          Sound Engineering Practice</p>		
<p><b>Transmitter Attachments: Diaphragm Seal – Process Flange - Manifold</b>          Sound Engineering Practice</p>		
<p><b>Model 3051SFx Flowmeter Transmitters</b>          See DSI 1000 Declaration of Conformity for 3051SF Series Flowmeter Information</p>		
<p><b>ATEX Directive (2014/34/EU)</b></p>		
<p><b>BAS08ATEX0064X – Intrinsically Safe</b>          Group II Category 1 G          Ex ia IIC T4 Ga          Harmonized Standards Used:          EN 60079-0:2012+A11:2013, EN60079-11:2012</p>		
<p><b>BAS08ATEX0065X – Type n</b>          Group II Category 3 G          Ex nA IIC T4 Gc          Harmonized Standards Used:          EN 60079-0:2012+A11:2013, EN60079-15:2010</p>		
<p>Page 2 of 4</p>		<p>Document Rev: 2013_A</p>

	<h2>EU Declaration of Conformity</h2> <p>No: RMD 1072 Rev. L</p>	
<p><b>BAS01ATEX1374X – Dust</b>          Group II Category 1 D          Ex ta IIIC T105°C T<sub>300</sub>95°C Da          Harmonized Standards Used:          EN 60079-0:2012+A11:2013          Other Standards Used:          EN 60079-31:2009 (a review against EN60079-31:2014, which is harmonized, shows no significant changes relevant to this equipment so EN60079:2009 continues to represent “State of the Art”)</p>		
<p><b>KEMA00ATEX2143X – Flameproof Certificate</b>          Equipment Group II, Category 1/2 G          Ex db IIC T6...T4 Ga/Gb          Harmonized Standards Used:          EN 60079-0: 2012+A11:2013, EN 60079-1:2014, EN 60079-26:2015</p>		
<p><b>PED Notified Body</b></p>		
<p><b>DNV GL Business Assurance Italia S.r.l.</b> [Notified Body Number: 0496]          Via Energy Park, 14, N-20871          Vimercate (MB), Italy  <i>Note – equipment manufactured prior to 20 October 2018 may be marked with the previous PED Notified Body number; previous PED Notified Body information was as follows:</i>  <i>Det Norske Veritas (DNV) [Notified Body Number: 0575]</i>  <i>Veritasveien 1, N-1322</i>  <i>Hovik, Norway</i></p>		
<p><b>ATEX Notified Body for EU Type Examination Certificate</b></p>		
<p><b>DEKRA Certification B.V.</b> [Notified Body Number: 0344]          Utrechtseweg 310, 6812 AR Arnhem          P.O. Box 5185, 6802 ED Arnhem          The Netherlands          Postbank 6794687</p>		
<p><b>SGS FIMCO OY</b> [Notified Body Number: 0598]          P.O. Box 30 (Särkiniementie 3)          00211 HELSINKI          Finland</p>		
Page 3 of 4		Document Rev: 2013_A

	<b>EU Declaration of Conformity</b> No: RMD 1072 Rev. L	
<b>ATEX Notified Body for Quality Assurance</b>		
SGS FIMCO OY [Notified Body Number: 0598] P.O. Box 30 (Särkiniementie 3) 00211 HELSINKI Finland		
		
Page 4 of 4		Document Rev: 2013_A

## 8.3 ChinaRoHS

含有China RoHS管控物质超过最大浓度限值的部件型号列表 Rosemount 3051SMV  
List of Rosemount 3051SMV Parts with China RoHS Concentration above MCVs

部件名称 Part Name	有害物质 / Hazardous Substances					
	铅 Lead (Pb)	汞 Mercury (Hg)	镉 Cadmium (Cd)	六价铬 Hexavalent Chromium (Cr +6)	多溴联苯 Polybrominated biphenyls (PBB)	多溴联苯醚 Polybrominated diphenyl ethers (PBDE)
电子组件 Electronics Assembly	X	O	O	O	O	O
壳体组件 Housing Assembly	X	O	O	X	O	O
传感器组件 Sensor Assembly	X	O	O	X	O	O

本表格系依据SJ/T11364的规定而制作。

This table is proposed in accordance with the provision of SJ/T11364.

O: 意为该部件的所有均质材料中该有害物质的含量均低于GB/T 26572所规定的限量要求。

O: Indicate that said hazardous substance in all of the homogeneous materials for this part is below the limit requirement of GB/T 26572.

X: 意为在该部件所使用的均质材料里，至少有一类均质材料中该有害物质的含量高于GB/T 26572所规定的限量要求。



X: Indicate that said hazardous substance contained in at least one of the homogeneous materials used for this part is above the limit requirement of GB/T 26572.









### **Global Headquarters**

Emerson Automation Solutions  
6021 Innovation Blvd.  
Shakopee, MN 55379, USA  
 +1 800 999 9307 or +1 952 906 8888  
 +1 952 949 7001  
 RFQ.RMD-RCC@Emerson.com

### **Latin America Regional Office**

Emerson Automation Solutions  
1300 Concord Terrace, Suite 400  
Sunrise, FL 33323, USA  
 +1 954 846 5030  
 +1 954 846 5121  
 RFQ.RMD-RCC@Emerson.com

### **Asia Pacific Regional Office**

Emerson Automation Solutions  
1 Pandan Crescent  
Singapore 128461  
 +65 6777 8211  
 +65 6777 0947  
 Enquiries@AP.Emerson.com

 [Linkedin.com/company/Emerson-Automation-Solutions](https://www.linkedin.com/company/Emerson-Automation-Solutions)

 [Twitter.com/Rosemount\\_News](https://twitter.com/Rosemount_News)

 [Facebook.com/Rosemount](https://www.facebook.com/Rosemount)

 [Youtube.com/user/RosemountMeasurement](https://www.youtube.com/user/RosemountMeasurement)

 [Google.com/+RosemountMeasurement](https://www.google.com/+RosemountMeasurement)

### **North America Regional Office**

Emerson Automation Solutions  
8200 Market Blvd.  
Chanhassen, MN 55317, USA  
 +1 800 999 9307 or +1 952 906 8888  
 +1 952 949 7001  
 RMT-NA.RCCRF@Emerson.com

### **Europe Regional Office**

Emerson Automation Solutions Europe GmbH  
Neuhofstrasse 19a P.O. Box 1046  
CH 6340 Baar  
Switzerland  
 +41 (0) 41 768 6111  
 +41 (0) 41 768 6300  
 RFQ.RMD-RCC@Emerson.com

### **Middle East and Africa Regional Office**

Emerson Automation Solutions  
Emerson FZE P.O. Box 17033  
Jebel Ali Free Zone - South 2  
Dubai, United Arab Emirates  
 +971 4 8118100  
 +971 4 8865465  
 RFQ.RMTMEA@Emerson.com

©2019 Emerson. All rights reserved.

Emerson Terms and Conditions of Sale are available upon request. The Emerson logo is a trademark and service mark of Emerson Electric Co. Rosemount is mark of one of the Emerson family of companies. All other marks are the property of their respective owners.