



Cordex Controller Software

Version 2.06

Part # 0350046-J0
Effective: 08/2012

CONTENTS

1	INTRODUCTION	4
1.1	Scope of the Manual	4
1.2	User Interface (see Chapter 4)	4
1.3	Software Overview	5
2	QUICK START	10
2.1	Applying Startup Power.....	10
2.2	Remote Communications (see Chapter 9).....	10
2.3	Trouble-shooting Tips	10
3	STANDARD FEATURES	11
3.1	Password Security	11
3.2	Software Configuration Loading and Updates	11
3.3	Mixed Rectifier System	11
3.4	Safe Voltage.....	11
3.5	Power Save	11
3.6	Battery Temperature Compensation.....	12
3.7	Battery Auto Equalization.....	13
3.8	Battery Monitor and Charge Current Control	13
3.9	Low Voltage Disconnect Operation.....	13
3.10	Signals Management	14
3.11	Statistics and Historical Data	14
4	OPERATION	16
4.1	Startup and Reset Procedure	16
4.2	Normal Operation	16
4.3	Mode Status (active area) and Temp Comp Indication	18
4.4	Rectifiers (and Converters) Information (active area).....	21
4.5	Analog Signals Display (active area)	23
4.6	Alarm Indication (active area)	24
4.7	Home Icon (active area).....	25
4.8	Date and Time (active area)	27
4.9	Saving Settings	27
4.10	Overview of Web Interface.....	28
5	MENU NAVIGATION AND SAMPLE PROGRAMMING	31
5.1	Menu Navigation	31
5.2	Basic Programming Example.....	32
5.3	Advanced Programming.....	32
6	MENU STRUCTURE, PROGRAMMING AND ADJUSTMENTS	34
6.1	System Info	34
6.2	Converters.....	37
6.3	Rectifiers	38
6.4	Batteries	41
6.5	Alarms	48
6.6	Signals.....	60
6.7	Controls	81
6.8	Communications	83
6.9	Hardware.....	86

6.10	Logs & Files (Web Interface only)	87
6.11	Supervisor	89
7	ADVANCED PROGRAMMING	91
7.1	Example: Customize	91
7.2	Equation Builder Keypads.....	91
7.3	Tips on Programming.....	92
8	CXC COMMUNICATIONS MENU PARAMETERS.....	93
8.1	Ethernet Port Configuration	93
8.2	PPP Connection Devices	94
8.3	Rear Port Configuration	95
9	REMOTE COMMUNICATIONS	97
9.1	Establishing a Network Connection via a Crossover Cable.....	97
9.2	PPP Serial Data Connection.....	98
9.3	Modem Connection	104
10	SIMPLE NETWORK MANAGEMENT PROTOCOL (SNMP).....	106
10.1	Overview	106
10.2	Network Manager MIB Files.....	108
10.3	Communication Configuration.....	109
11	FACTORY RANGES AND DEFAULTS	113
12	MODBUS® COMMUNICATIONS PROTOCOL	118
13	TROUBLE-SHOOTING	125
13.1	Technical Support	125
14	ACRONYMS AND DEFINITIONS	126
	INDEX.....	127

TABLES

Table A–Output channel assignments.....	50
Table B–Digital input channel assignments	52
Table C–Analog input channel assignments	61
Table D–Controller signal default definitions	64
Table E–Rectifiers menu defaults.....	113
Table F–Signals menu defaults	113
Table G–Batteries menu defaults	114
Table H–Converters menu defaults	114
Table I–Alarms menu defaults	115
Table J–Controls menu defaults.....	116
Table K–Communications menu defaults.....	117
Table L–Hardware menu defaults	117
Table M–Supervisor menu defaults.....	117
Table N–CXC Modbus PDU address definition for function code 0x01 (read coils)	118
Table O–CXC Modbus PDU address definition for function code 0x02 (read discrete inputs).....	122
Table P–CXC Modbus PDU address definition for function code 0x03 (read holding registers).....	123
Table Q–CXC Modbus PDU address definition for function code 0x04 (read input registers)	124
Table R–Trouble-shooting guide	125

1 Introduction

1.1 Scope of the Manual

This document describes the software features, on-site setup and operation of the Cordex™ System Controller (CXC) from Alpha Technologies.

Refer to the Installation manual for hardware details.

1.2 User Interface (see Chapter 4)

Located on the front panel of each CXCM (or CXCP or CXCR) model is a 160-x-160-pixel touch screen liquid crystal display (LCD) similar to that used in a personal digital assistant (PDA), see Figure 1. This graphical user interface (GUI) enables a person to interact with screen selectable items.



For CXC models with a touch screen display, the use of a PDA type stylus is recommended and may be required when accessing the on-screen keyboard for some adjustments.

Figure 1–CXC models showing features of main menu touch screen

The CXC will provide feedback during operation with different audible tones for alarms, invalid password, and menu navigation.

NOTE: Other models, such as the CXCI, only have a 4-digit display for monitoring system voltage and current. Without a touch screen display, system setup and management is performed exclusively with the web interface, see Section 4.10.

CAUTION

Do not connect anything other than the Alpha modem and Alpha-supplied DB-9 cable to the D-sub port on the front of the CXCI.

A step by step connection wizard – provided to establish remote communications with the CXC – is available via the Alpha website (www.alpha.ca).

1.3 Software Overview

The CXC software controls the entire DC power system. Features include temperature compensation, auto equalization, remote access, battery diagnostics, and web server and SNMP support.

1.3.1 New Features since version 1.2

The following changes/updates have been incorporated into version 1.3 of the CXC software:

Communications Protocol Selection – enables the Supervisor to set the communications protocol for either the Cordex series (CAN) or Pathfinder series (RS-485).

E-mail – enables communication of alarms via Ethernet or modem.

Enhancements to Battery Features – enables live Battery Discharge parameters to be viewable via Battery Log.

Enhancements to Event Logging & Statistics – provides tracking of several parameters on a daily basis, such as battery current information.

Equation Builder for Custom Alarms & Signals – enables the Supervisor to program separate triggering equations into the CXC software. The equations may reference any combination (up to 16) of the analog inputs, digital inputs, virtual inputs, and alarms (such as Fan Fail) utilizing logical and arithmetic arguments that simulate the functionality of a programmable logic controller (PLC).

Modem Support – expanded for web connections via PPP using modem (internal or external) with CXCP or CXCR models.

Third Language Support – provides for multiple language files; which can be uploaded via web interface.

1.3.2 New Features since version 1.3

The following changes/updates have been incorporated into version 1.4 of the CXC software:

220Vdc System Support – enables the Supervisor to select the system voltage as 24V, 48V or 220Vdc.

CAN Communications Protocol – expanded to include Alpha' new Cordex Shunt Multiplexer.

Web Interface Additions – provides submit (changes) button on top of every page, data logging, LVD countdown timer, and relay text labels can be edited.

1.3.3 New Features (since version 1.4)

The following changes/updates have been incorporated into version 1.5 of the CXC software:

Urgent AC Mains Fail Alarm – provides indication of alarm condition. This major alarm has a time delay; the default activation value is ten (10) minutes.

AC Phase Voltage Measurement – enables assignment (mapping) of rectifiers to a phase for individual phase voltage readings.

SNMP Trap Dial-out – enables dialup connection from CXC to SNMP manager PC over intranet via corporate intranet RAS (remote access server) port. This setup is similar to an e-mail RAS client.

1.3.4 New Features (since version 1.5)

The following changes/updates have been incorporated into version 1.6 of the CXC software:

CXCI Support – enables connectivity with Alpha' new CXCI (controller used in small power Cordex integrated rectifier systems) where system setup is performed with the CXC web interface alone.

IP Address Reset – provides a means to reset the IP address of a CXC without a touch screen display.

SNTP Support – enables synchronization of device time with an external source (see www.NTP.org).

LCD Touch Screen Calibration – enables user to fine-tune the accuracy of the touch screen on site.

Default Values for Dynamic (Editable) Text Files – may be restored to factory settings.

Calibrate Analog Inputs – feature has been improved for web interface.

1.3.5 New Features since version 1.6

The following changes/updates have been incorporated into version 1.7 of the CXC software:

12Vdc System Support – enables the Supervisor to select the system voltage as 12, 24, 48, 125 or 220Vdc.

Mixed Rectifier System – enables the use of one type of Alpha Pathfinder model rectifier working in parallel with one type of Alpha Cordex model rectifier; e.g. PFM 48V-10kW with CXRF 48-3.6kW. The menu item Rectifier Protocol is no longer required and has been removed.

Safe Voltage – enables the Supervisor to set the default system voltage (Safe Mode) in the event that communications to Cordex rectifiers should fail.

Site Number – provides an additional line of text under Contact Information for convenient display of the Site Number.

Rectifier Report Enhancements – provides new columns for device name and percentage of maximum output current (per rectifier).

Battery Information – provides an additional window to enter/view the manufacturer's data for the batteries in the system; e.g., for inventory purposes.

Alarm Configuration Screen Enhancements – provides a list of all alarms in one place (via web browser). The configuration of most alarms may be done on this one screen.

Alarm Tone – enables the Supervisor to enable/disable the audible alarm buzzer (tone).

Battery Test Alarm – provides a warning to indicate that a Battery Test is in progress.

Invalid Battery Voltage Alarm – provides for indication of invalid battery charging voltage; e.g., in the event that the sense leads have become disconnected.

SNMP Enhancements – provides SNMP/Severity level (numeric) and enables CXC supervisor to set the scheme.

AC Mains Voltage Correction – provides the means to apply a correction factor to the reading coming from the rectifier.

ADIO Enhancements – enables the Supervisor to configure individual signals for an ADIO (Analog Digital Input Output) Device; i.e., Cordex Smart Peripherals.

Custom Signal Units – enables the Supervisor to set the units value for Custom Signals; e.g., $\pm V$, AH, mm, etc.

LVD DOD Control – enables the Supervisor to configure each LVD control for activation once the percentage of Depth of Discharge (DOD) has increased above a threshold.

SNMP Community Settings – enables the Supervisor to configure CXC SNMP community settings.

SNMP Trap Recovery – enables the CXC SNMP agent to hold traps in a buffer during a network block out.

Event Notifications – Multiple SNMP and SMTP Destinations – enables the Supervisor to add up to eight (8) separate destinations for SNMP and SMTP dial-out or e-mail notifications.

Test Relays – provides a message of warning to the CXC operator before allowing the toggling of an LVD relay and allows the user to cancel the operation.

Alpha MIB File Enhancements – provides separate object identifier (OID) for active and cleared alarm traps. Alarm status and signals are reconstructed into tables and sub tables to allow for future expansion while remaining backward compatible with already defined alarms and signals.

Log File Cleanup – provides improved event log file management by filtering and condensing repetitive rectifier events on a daily basis. File retrieval has been updated for sorting by name and by chronological order. The display of log information has also been improved for ease of user navigation.

Passwords for Supervisor and User – provides two levels of password protection – the same password cannot be used for both Supervisor and User.

1.3.6 New Features (since version 1.7)

The following changes/updates have been incorporated into version 1.8 of the CXC software:

Configuration File Enhancements – enables the Supervisor to exclude settings and groups of settings when applying changes. A partial configuration file may be generated and sent to CXC (v1.81 and above).

CXCI Modem Support – enables connectivity to the CXCI's new front D-sub port with the Alpha modem and Alpha-supplied DB-9 cable.

1.3.7 New Features (since version 1.8)

The following changes/updates have been incorporated into version 1.9 of the CXC software:

Web Interface Facelift – provides more efficient access to software features. Speed/responsiveness has been improved over previous version (testing has shown up to four times faster). Each page can be accessed individually; for example, users with slow interfaces, such as modem, do not have to navigate to specific pages as before.

Modbus® Support – enables CXC communication of alarms and live signals in RTU encoded data format using Modbus protocol (messaging structure developed by Modicon®) upon query via TCP to any Modbus supervisor or master.

Remote Battery Test Mode – enables the Supervisor to define a condition (custom alarm) that will force a transition to battery test mode once the condition is met. BT mode stays active as long as the condition remains true. *This feature is exclusive for the Cordex series of rectifiers.*

ADIO Support for 4R/8D I/O Module – allows configuration of this new module in the digital alarms or custom alarm sections of the menus; where the alarm condition can be associated with a digital input and mapped to a relay. *The 4R/8D I/O module is a Cordex Smart Peripheral designed to expand the CXC I/O by four output relays and eight digital inputs.*

Temp Comp in EQ Mode (enable/disable) – allows the supervisor to enable or disable automatic battery temperature compensation in equalize mode independently from float mode.

Boost Mode – provides the supervisor with the means to equalize charge the battery at a higher voltage relative to the connected load. Activation is manual and certain conditions must be met to prevent damage to the load.

Custom/User Alarms – have increased in number from 5 to 20.

Battery Log – provides support for very slow discharges. This is accomplished by saving intermediate battery log information in the event of controller power loss before battery recharge completes.

1.3.8 New Feature for version 1.93

ADIO Support for Cordex Battery Monitor System (BMS) – enables connectivity with Alpha' new BCMC module – a Cordex Smart Peripheral – designed to monitor a number of voltages, currents and temperatures in battery strings via a number of remote devices that are managed through a ring data network. Configuration is performed in the signals section of the CXC's menus.

1.3.9 New Feature for version 1.95

Simplified BCT EQ Threshold – from rate of change to an absolute current value.

The BC Rate of Change setting used to be the rate of change of battery current in units of A/H. This setting has changed and is now BC Threshold in units of A.

NOTE: *When upgrading to v1.95 or later, users of the BCT EQ feature must re-evaluate the BC Threshold setting and enter a new value since the units of the setting has changed.*

1.3.10 New Feature for version 1.97

Cordex DC-DC Converter (CXD) Support – enables the Supervisor to configure converter settings, display and read analog values; similar to the system controller features applied to the Cordex rectifier series.

The converter defaults will be based on the system voltage if it is either 24 or 48Vdc.

NOTE: *At present, the converter software does not support:*

- Two types of converters simultaneously
- 12, 125, and 220Vdc systems.

Other features include:

- Active voltage control
- Converter locate
- Firmware upgrade
- Inventory update
- Loadsharing
- Major and minor alarms

1.3.11 New Features (since version 1.97)

The following changes/updates have been incorporated into **version 2.0** of the CXC software:

Counters and Timers – counters enable the Supervisor to monitor the number of times a particular event occurs. Timers are used to measure the amount of time since an event occurred or the amount of time between two events. These features are suitable for general-purpose signals that can be used in Custom Signal or Custom Alarm equations.

Dynamic Current Limit – enables the Supervisor to change the battery current limit based on the status of a digital input; such as, when powering a system with a generator, to limit battery recharge current to prevent the generator from overloading. See Dynamic Charge Current Control (CCC) feature.

ALCO Enhancements – enables the user to silence the alarms for a set duration (in minutes). The user may also enable or disable cutoff of each of the following when ALCO is pressed:

- Audible alarm
- Alarm relays
- E-mail
- SNMP.

Printable Configuration (Config) – enables the user to print the total CXC configuration (for a particular controller) via a Print button on the Logs&Files > Manage Configuration File page.

Equipment Inventory – a new User Inventory page allows the user to enter up to twenty inventory items. Additionally, a System Inventory page enables the user to view a single list of all CAN connected devices, user inventory items and battery information items. Previously, devices would only be shown on the individual category pages; e.g., rectifiers connected shown on the Rectifier section.

SNMP Related Features – is comprised of these new items:

- **Add Trap Acknowledge (Inform)**
CXC will wait for SNMP Manager (software) to acknowledge that it has received a trap. If the manager does not acknowledge within a certain amount of time, the trap will be resent.
- **Timestamp Varbind**
Data added to the SNMP trap to indicate the time of the event that triggered the trap to be sent.
- **Alarm Trigger Varbind**
Data added to the SNMP trap that shows the analog value that triggered an alarm activation or deactivation.
- **Multiple Community Strings**
The user may enter more than one set of SNMP community strings. This is to permit multiple SNMP NMS programs, with different community strings, to connect to the CXC. A company with multiple NMS's, each in a different region, with a different community string, will find it easier to connect to the CXC from various places.

Static Calibration – enables the Supervisor to calibrate Controller analog inputs and ADIO (except BCMC) analog inputs without the need for a live signal at the input; especially useful for calibrating current inputs for systems in the field.

Scheduler – enables the Supervisor to use the system time and date as operands in custom alarm and signal equations.

Modbus® and SNMP – additions were made for converter alarms and signals.

1.3.12 New Features since version 2.03

The following changes/updates have been incorporated into **version 2.04** of the CXC software:

- The battery log will be closed off when 96 hours has elapsed since the start of the recharge cycle. This is in addition to the existing functionality that closes off the log when the returned AH reaches 115% of the rated capacity during the recharge cycle.
- Improved response of charge current control when lithium-ion batteries are installed. Lithium-ion batteries are detected by scanning the battery information and looking for the keyword "lithium" or "li-ion" in the model comment fields.
- The rectifier start delay algorithm now allows a setting of 0 s instead of the former minimum of 1 s.

1.3.13 Alarm Tone New Features since version 2.04

The following changes/updates have been incorporated into **version 2.05** of the CXC software:

Diagnostic Capture – in the event of certain types of CXC crashes or “Improper Shutdowns”, the software will now capture a diagnostic log of the system as it is shutting down. This log can be downloaded from the CXC webpages (Under Logs and Files -> Retrieve Diagnostic File) and sent to the Alpha technical support team. See section 6.10.5 for more information on the diagnostic file.

SNMP Trap – a new feature has been added to allow users to set the value of a Custom Signal over SNMP. This custom signal can then be used in alarms and equations, and therefore trigger relays to toggle. It should be noted that the CXC will not maintain the value of a signal that has been set by SNMP during a reset. In order to accommodate customers who are already using the previously defined 10 Custom Signals, 10 additional Custom Signals were added, raising the total number of Custom Signals to 20. See section 6.6.2.5 for more information on Custom Signals.

Updates to SNMP communities names and destination fields – community and destination names can now be 31 characters long. In addition, 10 destination and community strings are allowed instead of 8. See section 10 for more information on SNMP.

Email address maximum length fixed – previously there was a bug which caused email addresses longer than 31 characters not to work for event notification. The CXC now allows email addresses up to 64 characters (63 + 1 for string termination character) as was intended. See section 10.3.3 for more information about sending notification emails from the CXC.

Improper Shutdown caused by RS485 buffer – a bug fix. In previous versions of the CXC, a problem with the RS485 interface caused occasional “Improper Shutdowns” of the unit. This problem has been solved in this release.

Update from Argus logo to Alpha logo.

A new bootloader, version 2.01, was released with CXC 2.05. Upgrade to this bootloader is recommended as it contains various bug fixes. The bootloader can be upgraded via the CXC webpages by navigating to the “Controller -> Upgrade Bootloader” menu and following the instructions there.

1.3.14 New Features since version 2.05

The following changes/updates have been incorporated into **version 2.06** of the CXC software:

SNMP Trap mapping errors (section 10.1.4) – a bug fix. VarBind (Variable Binding) values have been modified to match the MIB structure.

Silence Buzzer Function under Global Alarm Configuration menu (section 6.5.7) – The operation of this function has been modified to meet the following requirements:

If Revert Relays is disabled and Silence Buzzer is enabled, then pressing ALCO will cause the buzzer to silence and not reset the relays. In addition if Enable ALCO Duration is set, the relays are not reset after the ALCO Duration times out.

Rectifier Power Save Feature (section 6.3.3) – The rectifier power save feature now has the option to reduce shutdown and restart log entries to one every 24 hours.

Alarm Tone Volume (section 6.5.6) – Enabling the **Loud Buzzer**, under the Global Alarm Configuration menu, increases the pitch and volume of the buzzer which sounds for major and minor alarms.

2 Quick Start

2.1 Applying Startup Power

1. Initiate startup routine by applying power to the CXC; e.g. close battery breaker or close converter and rectifier input and output breakers.

NOTE: *The CXC will perform a short self-test as it boots up. Alarm alerts are normal. The LEDs perform a scrolling pattern to indicate there is activity. Please wait.*

2. Check and adjust alarms and control levels in the CXC's submenus.
3. Check and adjust group settings in the CONVERTERS and RECTIFIERS submenus; e.g. float, equalize voltage, etc.
4. Verify COMMUNICATIONS settings as needed.
5. Program the CXC's TEMP COMP and AUTO EQUALIZE settings as needed.
6. Test relay OUTPUT ALARM/CONTROLS as needed; e.g. Major Alarm, CEMF, etc.

2.2 Remote Communications (see Chapter 9)

The CXC can be set up, monitored and tested with a RS-232 serial data connection, ETHERNET 10/100 Base-T or over a phone line using a modem. Some standard scenarios are described below:

- Network (TCP/IP secured by user) to CXC rear Ethernet port.
- Computer to CXC via RS-232 serial data connection (PPP) using a null modem cable connected to the Craft port (front panel RS-232).
- Laptop to CXC via direct Ethernet connection using a standard crossover cable.
- External modem to CXC via RS-232 serial data connection using a straight through cable connected to the rear RS-232 port.
- Internal modem (see ordering options).

CAN bus (located next to the Ethernet port) is provided for connection to the Cordex series of converters and rectifiers.

RS-485 bus provides a secondary connection for products (e.g., Pathfinder rectifiers) that do not support the CAN bus interface.

2.3 Trouble-shooting Tips

See Trouble-shooting chapter for more information.

2.3.1 Converter and Rectifier Tips

The **Cordex** Converter (CXD) Rectifier (CXR) series modules are plug and play. When a CXD or CXR module is added to the system, the CXC will detect and update the inventory automatically.

If CXD or CXR module communication has failed, or a module has been removed from the system, an INVENTORY UPDATE¹ must be initiated manually.

For the **Pathfinder** series of rectifiers, ensure that the:

- Rectifiers are in NORMAL OPERATING MODE
- REMOTE ACCESS is ENABLED
- REMOTE ADJUST is ENABLED
- BAUD RATE is set to 9600 baud.

2.3.2 Cordex Controller Tips

Use the CXC GUI (Section 4.2) or web interface (4.10) to ensure that the operating levels (e.g. input/output voltage, converter voltage, etc.) are within operating parameters of alarm and control thresholds.

¹ Should Inventory Update fail: a) check cable & connections; b) check settings under System Info/System Configuration for correct voltage.

3 Standard Features

The CXC provides centralized setup, control and monitoring of a communications power system.

3.1 Password Security

Two levels of password security are available: User and Supervisor. The same password cannot be used for both.

User access (Section 4.7.1) enables navigation through menus, but no changes are permitted.

Supervisor access enables navigation and changes to parameters including Supervisor password, see 0.

The Supervisor may change the User password only via the web interface.

3.2 Software Configuration Loading and Updates

Factory software updates and adjustments to the configuration file are possible through the RS-232 serial port or Ethernet connection. The Supervisor may exclude settings and groups of settings when applying changes. A partial configuration file may also be generated and sent to CXC (v1.81 and above).

3.3 Mixed Rectifier System

The CXC enables the use of one type of Alpha Pathfinder model rectifier working in parallel with one type of Alpha Cordex model rectifier; for example, PFM 48V-10kW or PFM 48V-3kW with CXRF 48-3.6kW. Another example is PFM 24V-3kW with CXRF 24-3.1kW. The menu item Rectifier Protocol is no longer required and has been removed. The load share of each rectifier is based on the percentage of maximum output current of the rectifier; see Rectifier Report (4.4.2). In some cases, e.g. battery test algorithm, the system functionality will be limited to that of the Pathfinder rectifiers while the communications will equal that of the Cordex controller.

NOTE: *The Pathfinder rectifiers will not be shown under Upgrade Firmware as that submenu applies to Cordex rectifiers and smart peripherals only.*

3.4 Safe Voltage

Safe Voltage is the voltage that the rectifiers will default to if the controller fails. In general terms, the open circuit voltage for VRLA batteries is determined to be a point where discharge or over charge will not occur.

The Supervisor can set the default system voltage (Safe Mode) in the event that communications to Cordex rectifiers should fail. This feature has a time delay (a function of the rectifier); the activation value is five (5) minutes. The rectifier manual lists the default parameters.

3.5 Power Save

This feature improves operational efficiency when conditions warrant by running only the necessary number of rectifiers. For example, when the load is significantly less than the available system power, the controller will shut down one or more of the rectifiers so that the remaining rectifiers can operate with greater efficiency at a higher current level. A short (one-minute) time delay or hysteresis is included to avoid nuisance alarming and to eliminate changes if the load is fluctuating. Rectifiers are rotated into use on a weekly basis to share the service time.

When Power Save is enabled, it takes effect when a minimum discharge or load current (~2.5% of maximum current of one rectifier) is achieved.

Charge or battery current limit calculations are made based on rectifiers that are running.

The Power Save feature is suspended during Battery Test mode, see 4.3.4.6.

NOTE: *The remote shutdown setting (Cordex series only) enables the function in the rectifier. The Power Save feature uses this functionality when a Cordex rectifier is commanded to shut down.*

The Power Save feature does not work with the Alpha RSM 48/100 series of rectifiers.

3.6 Battery Temperature Compensation

The automatic battery temperature compensation (Temp Comp or TC) will function with Cordex series rectifiers that support CAN bus communications and Pathfinder series rectifiers that support RS-485 remote communications.

Temp Comp may be active in either float (4.3.1) or equalize (4.3.2) mode.

Temperature inputs are available on the CXC for monitoring a lead acid battery string. Temperature sensor readings can be displayed on the GUI in either Celsius (°C) or Fahrenheit (°F) scales.

The CXC will have the flexibility to display the breakpoints in voltage as well as temperature, also enabling them to be entered as voltage or temperature. However, it should be noted that the “Upper Breakpoint” must be used for the higher-temperature setting (lower voltage), and “Lower Breakpoint” must be the lower temperature (higher voltage). Confusing these will cause the temperature compensation feature to function incorrectly.

The detection of thermal runaway will be limited to a programmable Battery Over Temperature Alarm. This will enable the Supervisor to select a temperature that will trigger an alarm.

3.6.1 Theory of Battery Temperature Compensation

Battery life expectancy and performance is directly related to **battery ambient temperature**. The optimum temperature for battery operation is 25°C (77°F). Without compensation, battery life is seriously compromised at temperatures above 25°C, while battery performance is reduced below it.

Adjusting the battery’s float or equalize voltage to correspond with temperature fluctuations will ensure maximum battery performance and life expectancy. With the CXC, this may be accomplished by using the software’s built-in automatic temperature compensation function.

This function works by adjusting the system, every ten minutes, as the temperature changes and provides for a maximum voltage change of 0.1V over this interval.

While this may seem like a small voltage change, even if the battery had a temperature compensation slope as high as 5.5mV per °C, the CXC would still be able to track a temperature change in the battery of up to 4.5°C or 8°F per hour. Due to the large thermal mass of the battery string, even an extreme rise or drop in environmental temperature would be very unlikely to cause this kind of temperature change in the battery over a one hour period.

Temp Comp occurs at standard rates commonly referred to as **slope-compensation** settings. For maximum performance, it’s important to match the battery slope compensation with the setting recommended by the battery manufacturer. This is not to be confused with **slope regulation**; which refers to the process of regulating current among a group of parallel-operating rectifiers.

The Temp Comp feature has programmable **breakpoints**. These are the points at which Temp Comp will cease. Further temperature decreases or increases will NOT increase or decrease the output voltage. This protects the connected load from excessive voltage conditions. As Temp Comp is active in either float or equalize mode, breakpoints should be set with this in mind.

The Temp Comp feature also incorporates fail-safe circuitry to prevent it from driving the rectifier system to a voltage higher than is suitable for the load or battery.

3.6.2 Operation of Battery Temperature Compensation

The CXC can accommodate up to four sensors for lead acid battery temperature monitoring. If more than one probe is used and the temperature readings are within 5°C (9°F) of one another, the temperature readings will be calculated for the average. If the readings difference exceeds 5°C, it is assumed that thermal runaway is occurring in one battery string and the calculation changes from average to the highest reading. If any reading is suddenly outside the norm (i.e. cut leads or open leads), that reading is discarded and the associated Temp Sensor Fail alarm is issued. The temperature calculation will then return to the average of the remaining sensors, or next highest reading.

Temp Comp has been programmed as a low priority item; all commands and operations will take precedence over Temp Comp. If a command is issued during a Temp Comp cycle, the cycle will be put on hold until the command is completed. If any operation is happening when the Temp Comp cycle occurs, the cycle will be put on hold until the operation is completed. Temp Comp will resume when the command or operation is completed.

The Temp Comp feature can be enabled or disabled in the CXC’s Batteries menu.

3.7 Battery Auto Equalization

Auto Equalize (Auto-EQ) is a protective feature designed to ensure optimal lead acid battery life and performance. With the CXC, auto equalize is used for two basic purposes: first, for providing a quick battery recharge after an AC power failure, and second, as a long-term battery maintenance solution.

Refer to the battery manufacturer's recommendations for equalization charging.

3.7.1 Battery Charge Auto Equalize

Battery Charge Auto Equalize can be used after a prolonged AC power failure, when the battery voltage has decreased to a low level.

Once the batteries have decreased beyond the auto equalize low voltage threshold, the CXC will enter an armed mode. When AC power returns, the system voltage begins to increase, which charges the batteries.

Once the system voltage increases to the high voltage threshold, the CXC enters the equalize mode and begins to equalize charge the batteries for a period specified by the Supervisor in the AUTO-EQ DURATION submenu. This is done to ensure the EQ duration is not effectively reduced by the time it takes to recharge the battery back to the nominal system voltage.

3.7.2 Periodic Auto Equalize

Periodic Auto Equalize can be used for maintaining the long-term integrity of a battery string. Over time, individual battery cell voltages may vary greatly. As a result, to ensure that batteries remain in optimum condition, they should be equalize charged at regular intervals. The CXC enables the Supervisor to program the time between automatic equalize charging of the battery string in the AUTO-EQ INTERVAL submenu.

3.7.3 Battery Current Termination (BCT) Equalize

The BCT Equalize feature provides an alternative method of ending EQ mode early to prevent over-charging of the battery. Once enabled, it will only be active when EQ mode is caused by a Charge Auto Equalize.

BCT EQ will terminate Charge Auto EQ when the battery current falls below the BC Threshold setting. Upon initial activation of EQ mode – that is triggered by the Charge Auto EQ feature – the CXC will wait for one minute of system stabilization time before monitoring the battery current for BCT EQ. After one minute, the battery current is checked about once per second to see if the current has fallen below the BC Threshold.

When the battery current falls below the BC Threshold, and remains below the threshold for three seconds, the EQ duration is replaced with the BCT duration. After this time, the system returns to FL mode.

3.8 Battery Monitor and Charge Current Control

The Battery Monitor feature enhances the CXC's capability to provide information about the battery to the User. Charge Current Control will help increase battery longevity by keeping the battery current to within specified limits.

Charge current to the battery during recharge will be limited to a value as programmed by the Supervisor. This value will be derived from the battery manufacturer's specification sheet and entered by the Supervisor.

A battery run time prediction will be performed while the battery is supplying power to the load. The CXC will collect data to estimate the time it will take the battery to be drained. If the Battery Monitor feature is enabled and the battery is sourcing current to the load, a time estimate appears in the Mode Status screen. *Runtime estimate is also available in the Analog Signals display, which can be enabled for display status in (SIGNALS) CONFIGURE SIGNALS\CONTROLLER SIGNALS.*

During an AC outage or Battery Test, data will be collected to calculate a capacity prediction. A capacity of 80% means the battery is due to be replaced. The accuracy of this will improve as the battery undergoes more discharge cycles.

3.9 Low Voltage Disconnect Operation

Whenever the system parameters require that the LVD be activated, a 60-second countdown and audible warning will commence. When the countdown reaches zero, the LVD will be activated. During this countdown, an icon on the GUI may be pressed to evoke a prompt to inhibit LVD controls – activated by entering the Supervisor password. There is a 10-minute time-out for this. See also LVD Inhibit 6.7.2.

3.10 Signals Management

The CXC enables the Supervisor to view and edit a signal equation of the selected signal. The Supervisor may also configure custom signals; properties may be modified or disabled as required. All signals in the system can be selected for a signal equation builder making it possible to combine logic conditions and analog values to generate an alarm.

The Supervisor can select which Temperature Sensor (including any smart peripheral temperature sensors) is enabled for Battery Temp Sensor Signal.

3.11 Statistics and Historical Data

The CXC is capable of tracking several statistical parameters on a daily basis; e.g., analog statistics or triggered items (listed below), such as, battery log and event log, see Data Logging (web interface only), Section 6.6.3.

Data is stored in local memory and may be accessed via a web interface. The logged data is comma-delimited such that it can be automatically viewable in rows and columns in MS Excel. The data is stored on a first-in-first-out basis.

3.11.1 Analog Statistics

All statistics, to a maximum of 90 records (one per day) contain a time stamp and date. Daily analog statistics include the minimum, maximum and average of:

Load Voltage	Load Current
Battery Voltage	Battery Current
AC Mains	Battery Temperature
Total Rectifier Current	Average DC Voltage
Average AC Voltage	Number of Acquired Rectifiers
Number of Sourcing Rectifiers	Ten Custom Signals

3.11.2 Battery Log

A maximum of 40 records can be logged for battery statistics and events. The Battery Log contains the following:

Event Type	Capacity Rating
Battery Test Start Time	Depth of Discharge
Discharge Duration Time	Capacity
Amp Hours Delivered	Recharge Duration
Amp Hours Recharge Return	Peukert Number
1-5 Max. Midpoint Deviation Discharge	Data1
1-5 Max. Midpoint Deviation Recharge	Data2
Battery Current/Average Battery Current	Battery Temperature/Average Battery Temperature
Battery Voltage/Battery Test End Voltage	Open Circuit Voltage
Battery Test Result	

During a battery discharge, active battery log information is displayed in a row above the Battery Log. This information is then no longer available after the battery has finished recharging.

The Battery Log also provides support for very slow discharges. This is accomplished by saving intermediate battery log information in the event of controller power loss before battery recharge completes.

When a battery test (BT) is started by the remote BT feature, the battery log will show "Remote BT" in the Event Type column.

3.11.3 Event Log

In addition, the CXC can record up to 500 events. All events are stamped with the date and time. Some of the events available include the following:

- All alarm events (activation and deactivation),
- Rectifier alarm details,
- Any change of state of the digital inputs,
- Other miscellaneous events; such as, rectifiers being turned off or on due to the Power Save feature.

3.11.4 Data Logging

This feature of the CXC web interface allows the user to perform complex/custom configurations of the data gathered by the Alpha controller. Various ways of setting the log frequency/limit and start/stop triggers enables greater management of the events for collection.

The data is stored in files showing the records associated with each for easy archiving and retrieval. File Save Option enables a FIFO (first in first out) or “Stop when full” means of data collection.

Recommended size is up to seven signals and a maximum one thousand entries, as very large log files may not be viewable. If the datalog screen comes up blank, the log is too large to be displayed.

4 Operation

4.1 Startup and Reset Procedure

When the CXC is powered-up or reset, it will first perform a 15-second self-test before displaying the Cordex logo and various identification messages. The three front-panel LED's will illuminate temporarily, but will extinguish after the system has finished its self-test. Next, the GUI will display the power system's parameters during Normal operating mode, see Figure 2.

4.2 Normal Operation

This is the default-operating mode or "home page." The GUI displays system status information and monitors all input channels.

Active areas to tap and activate are noted below:

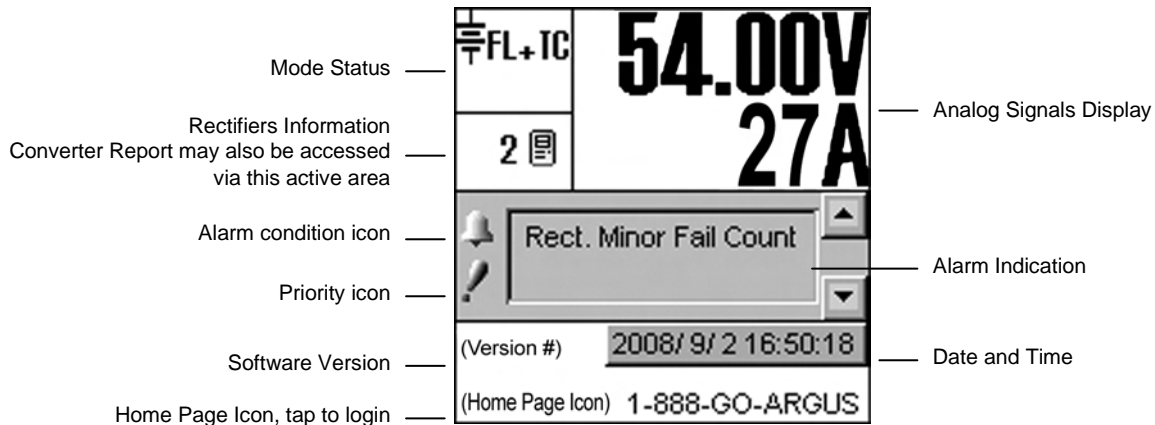

Figure 2—Sample of CXC default operating screen

4.2.1 Activation/Tapping

Each active area is touch sensitive and responds better to a stylus suited for this purpose; i.e. PDA type.

The Analog Signals Display on the home page will show two lines of text for system voltage and current by default (Figure 2). Tap this active area to decrease the font size for four lines of text showing the system values and the corresponding labels (Figure 3). The large font reappears after 20 minutes of inactivity (no user input); otherwise tap again to enter a new window of operation (Figure 10) or select a different active area as required. Refer also to 5.1.3.

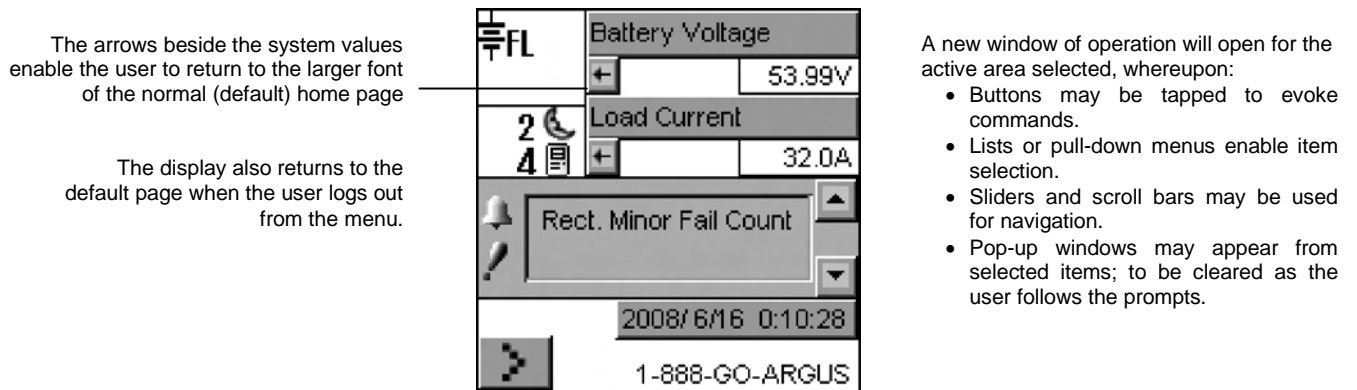

Figure 3—Sample of CXC home page with user-activated Analog Signals Display

4.2.2 LCD Touch Screen Calibration

A touch screen calibration page may be evoked from the user interface default operating screen:

Perform a diagonal action or "swipe" from the top right area of the LCD to the bottom left area:

CAUTION: Do not use a pen, pencil or other sharp object to tap on the CXC screen. This will scratch the screen and may void the warranty.

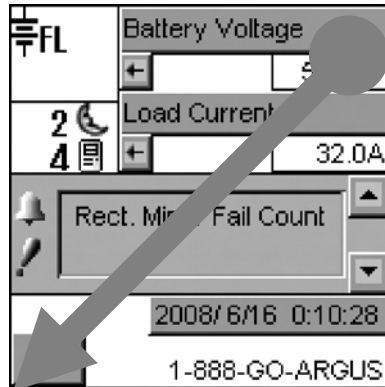

Figure 4—Begin LCD touch screen calibration (default operating screen)

When the calibration screen appears, tap on the center of the first target within 20 seconds to complete this step:

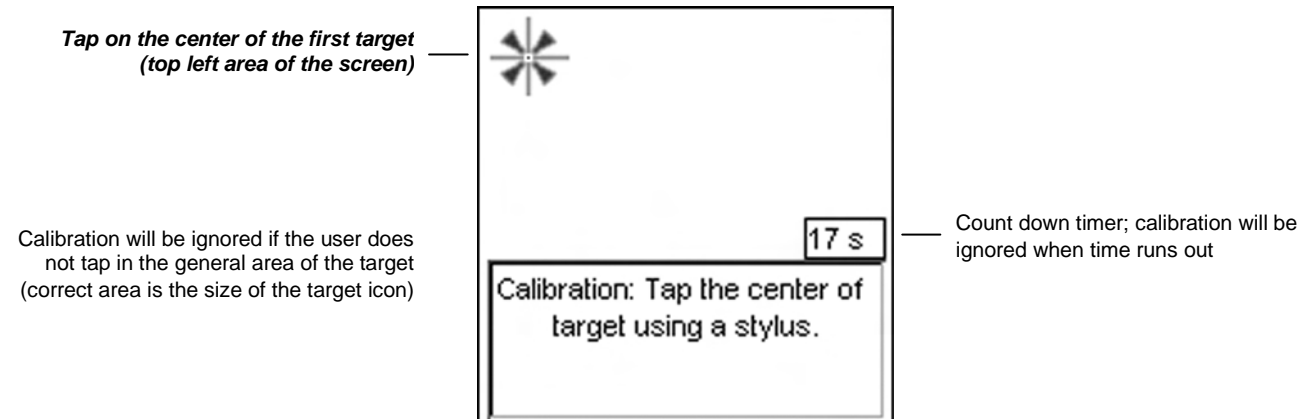

Figure 5— LCD touch screen calibration screen target one

Tap on the center of the second target (bottom right area of the screen) to complete the calibration:

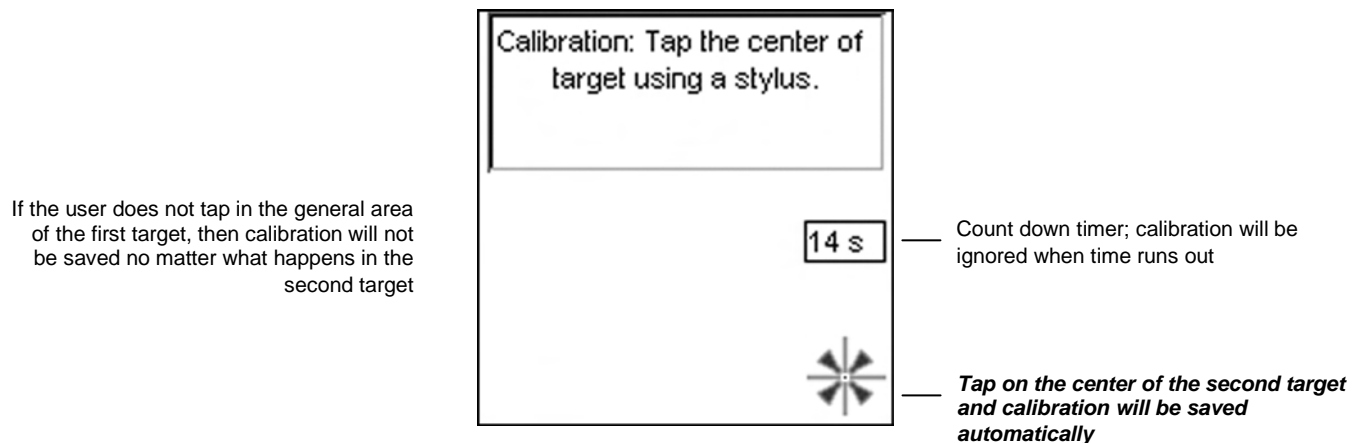

Figure 6— LCD touch screen calibration screen target two

NOTE: Both the targets must be tapped correctly for the calibration to take effect. This is done to prevent the calibration from changing dramatically from the default.

4.3 Mode Status (active area) and Temp Comp Indication

The CXC has four modes of operation: float (FL), equalize (EQ), boost (BST) and battery test (BT). The mode, along with temperature compensation (TC or Temp Comp) activation, is indicated in the top left “active area” of the GUI, see Figure 2. The time duration, until the mode changes, will also be shown in that active area.

Tap this active area to enter a new screen, or window of operation, for mode selection, see Figure 7 below:

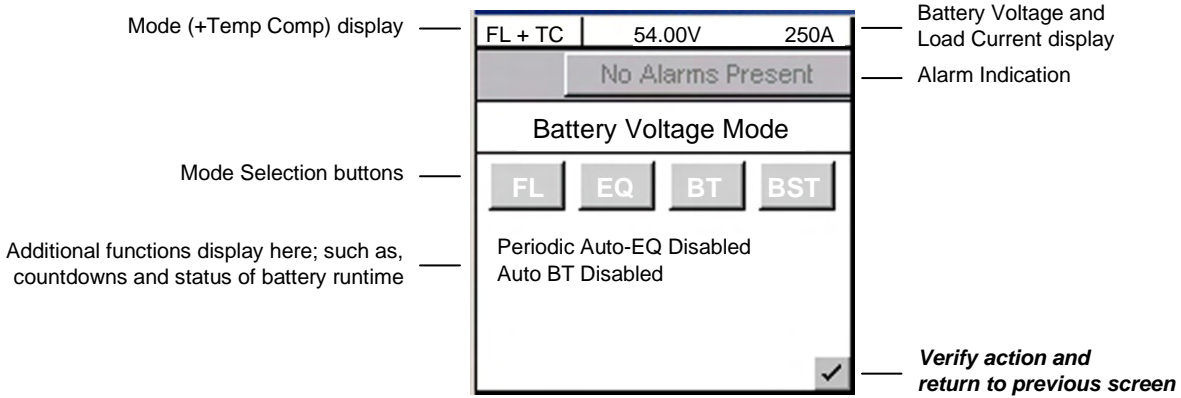

Figure 7–Mode selection screen

4.3.1 Float (FL) Mode

This is the CXC’s default mode at start up and during normal system operation. When in this mode, the rectifier’s charge (or output) voltage is driven by the float voltage setting found in the CXC’s Rectifiers menu, see 6.3.2. The icon (message) FL will display on the GUI’s upper left corner (Figure 2) when the CXC is operating in float mode. **Do not adjust the float voltage of the rectifiers when they are in Current Limit.**

When operating in a mode other than float mode, tap the **FL mode selection button** to return to the default-operating mode. Tap the “check mark” button in the lower right corner of the GUI to verify the action and return to the previous screen.

4.3.2 Equalize (EQ) Mode

The equalize mode is used to equalize charge a battery string. This mode can be selected via the **Mode Status active area** and by tapping the **EQ mode selection button** or by sending an external command; e.g., via web interface. When in this mode, the rectifier’s charge (or output) voltage is driven by the equalize voltage setting found in the CXC’s Rectifiers menu, see 6.3.2. The EQ icon will display when the CXC is operating in equalize mode.

A maximum time limit for equalize charging can be programmed to prevent accidental over-charge of a battery string. This limit is determined by the setting found in the EQ Timeout menu, see 6.3.2.10. **Do not adjust the equalize level of the rectifiers while they are in current limit.**

When operating in EQ mode, the text below the Mode Selection buttons (shown above) will display the time until FL mode in hours. Tap the “check mark” button in the lower right corner of the GUI to verify the action and return to the previous screen.

4.3.3 Boost (BST) Mode

This feature (see 0) provides the supervisor with the means to equalize charge the battery at a higher voltage relative to the connected load. Activation is manual and certain conditions must be met to prevent damage to the load.

A custom alarm must be created to include all the desired factors that must be taken into account before activating BST mode. This mode will then only be permitted if the alarm is false.

Once activated, BST mode concludes with a timeout or whenever the status of the custom alarm is true and reverts to FL mode. BST mode can also be cancelled if the conditions that are required in order to activate BST mode have changed.

4.3.4 Battery Discharge Test or Battery Test (BT) Mode

The battery discharge test is used to update the status of the lead acid battery capacity. BT can be set to run automatically or can be initiated manually (via Mode Selection button).

4.3.4.1 Definitions

End/Terminal Voltage — The voltage at which the test will end or terminate.

Timeout — The maximum time the test will be permitted to run before it is aborted.

Period in Days — The time between each Auto-BT.

Battery On Discharge (BOD) Alarm — This alarm will indicate that the battery is discharging.

4.3.4.2 Manual Activation

The user can manually activate the test by tapping the **BT mode selection button** (Figure 7).

4.3.4.3 Auto-BT Feature

This feature will enable the CXC to start a test automatically on a periodic basis. The Supervisor may enable or disable the feature *in (BATTERIES) BATTERY TEST/AUTO-BT menu*, see 6.4.5.2.

4.3.4.4 Tips on Using the BT Mode

Use Charge Current Control (6.4.3) to limit the battery recharge current to the battery manufacturer's specified maximum value.

The resultant battery capacity estimate will be more accurate if the test is started when the battery is fully charged. If a recent discharge has occurred within the last 96 hours, when a mode change to BT is selected, a dialog box will prompt the user to confirm the mode change.

During a test, the runtime hours will be accessible through the Analog Signals display or Mode Status screen. The runtime hours will reflect the time remaining in the test.

The runtime will be displayed after the start of an outage and when a BOD condition is detected; i.e., battery is sourcing current and voltage is below open circuit.

When a test is started by the remote BT feature, the battery log will show "Remote BT" in the Event Type column.

The BT depth of discharge (DOD) can be accessed via the Analog Signals Display; provides an additional indication of test progress.

BT information is available via the CXC's battery log web page when a test is in progress. In addition, the new battery capacity estimate can be accessed via the Analog Signals display at any time before, during or after the test.

4.3.4.5 BT Initiation

When the test begins, an entry will be made in the event log. If enabled, an alarm will provide a warning to indicate that a Battery Test is in progress.

The test will continue, depending on the type of rectifier in use, in accordance with the following algorithms (as applied to lead acid batteries):

Algorithm 1 — For rectifiers that support Battery Test (BT) mode:

1. A command is sent to put the rectifiers into BT mode.
2. BT mode runs for the period set as Timeout or until BT End Voltage is reached.

Algorithm 2 — For (Pathfinder) rectifiers that do not support BT mode:

1. Rectifiers are commanded to go to nominal voltage.
2. The rectifiers are periodically scanned to be sure that they do not begin sourcing current. When 3% DOD is reached and the rectifiers are still not sourcing current, the rectifiers are turned off.
3. The rectifier float setting is reset to the setting stored in the system controller.
4. When the system voltage reaches the end (termination) voltage or a timeout occurs, the system controller will command the rectifiers to turn ON and enter FL mode.

4.3.4.6 Activity During BT Mode

Temp Comp and Power Save features are suspended during a battery test.

When the battery is discharging, a BOD alarm will be active.

During a test, the mode symbol in the upper left corner of the GUI will be similar to the FL mode symbol except that the letters “FL” will be replaced with “BT.”

Runtime estimate begins at 3% DOD.

Capacity estimate also begins at 3% DOD, but will not be stored unless DOD > 20%; the point at which reasonable accuracy can be assured.

4.3.4.7 AC Failure During BT Mode

If the AC fails during a battery test, the test will be aborted. This will place the rectifiers into a state that will enable them to resume providing power to the load when AC returns. If the Runtime is being displayed, it will continue to update.

4.3.4.8 Addition of Rectifiers During BT Mode

If rectifiers are added to the system when a battery test is active, they will be placed into the same state as the other rectifiers. They will be:

- Placed into BT mode (for rectifiers that support BT mode), or
- Placed into remote shutdown, or
- Set to the same voltage as the other rectifiers.

4.3.4.9 Conditions to Watch for During BT Mode

If the voltage drops below 47V before or when 3% DOD is reached, the test is aborted and the battery capacity is set to 0% (resulting in a Battery Capacity Low alarm). This provides an indication that the battery is very weak². The battery capacity must be manually reset to 100%, or to the percentage of expected battery capacity before the next battery test is started, in order for the battery monitor to again attempt to compute the battery capacity.

If rectifiers are seen to be sourcing current during the test and the battery ceases to be discharging, the test is aborted.

4.3.4.10 Canceling BT Mode

BT mode can be cancelled by changing mode to FL or EQ.

² In some cases, incorrect battery parameters can cause this condition to occur with a good battery.
0350046-J0 Rev C

4.3.4.11 Battery Discharge Test Completion

The test is considered complete once the battery begins to charge. This could be due to the test ending from timeout, the system reaching the end (termination) voltage or an abort condition.

Once the battery begins to charge, the recharge cycle begins. Live battery recharge information is available from the battery log web page.

4.3.4.12 Remote BT Mode

This feature will force a transition to BT mode when a user-defined condition (custom alarm) is true.

When this condition is true, BT mode is entered regardless of the regular safety checks that are performed during manual or automatic changes to BT mode. BT mode stays active as long as the condition remains true.

A check box is used to enable/disable this feature. The default is disabled. If the condition is true and the check box is disabled, then the system will be put into FL mode.

If the condition becomes false, disabled, invalid, or the (assigned custom alarm) equation is empty, the system will be put into FL mode.

NOTE: *This feature is exclusive for the Cordex series of rectifiers. If Remote BT is active and a rectifier other than the Cordex series is added to the system then Remote BT will be aborted.*

4.4 Rectifiers (and Converters) Information (active area)

Tap this active area, located below Mode Status on the “home” page (Figure 2), to enter a new window of operation for converter/rectifier updates and reports, see Figure 8 below:

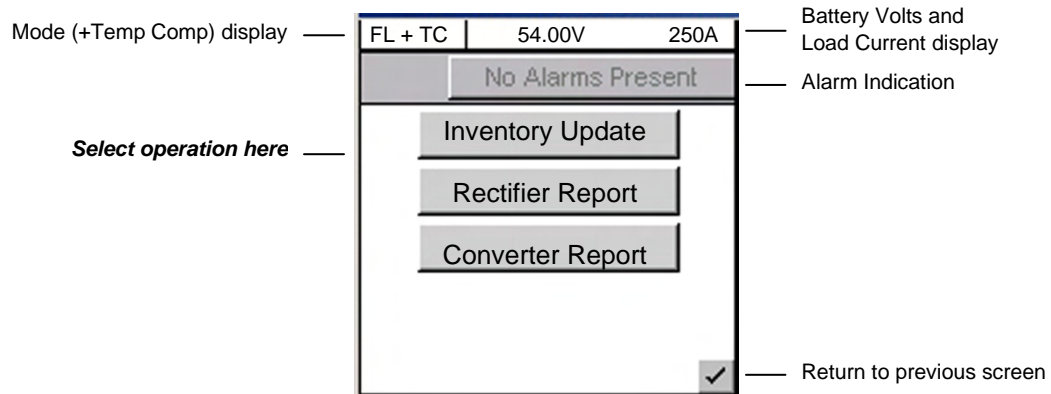

Figure 8—Update (inventory) and report selection screen

4.4.1 Inventory Update

This button will enable the user to re-acquire all the attached modules to the CXC; to verify the existence of all connected modules. *Tap to evoke this command (and return to the home page).*

A pop-up window (not shown here) will appear over the home page to show a progress bar of the number of modules acquired during the update that has just been evoked. *Tap the “X” button to clear the pop-up from the active area.*

Inventory update must be done whenever a module is removed from the system. The system is polled with respect to the following scenarios:

- Module has failed and is no longer able to communicate, or
- User has removed a module from the system.

4.4.2 Rectifier Report (Converter Report similar)

This button (or menu item in 6.3.1) will enable the user to view, in a list (report), all of the acquired modules in the system. *Tap to evoke this command.*

A new active area will be displayed, see Figure 9 below. The first column lists the serial numbers of the modules. The report then displays the current output (A) of each module (or toggle for % of maximum output) and the number of active alarms (if that module is issuing an alarm). The rightmost column displays the number of settings out of tolerance (OOT per web interface).

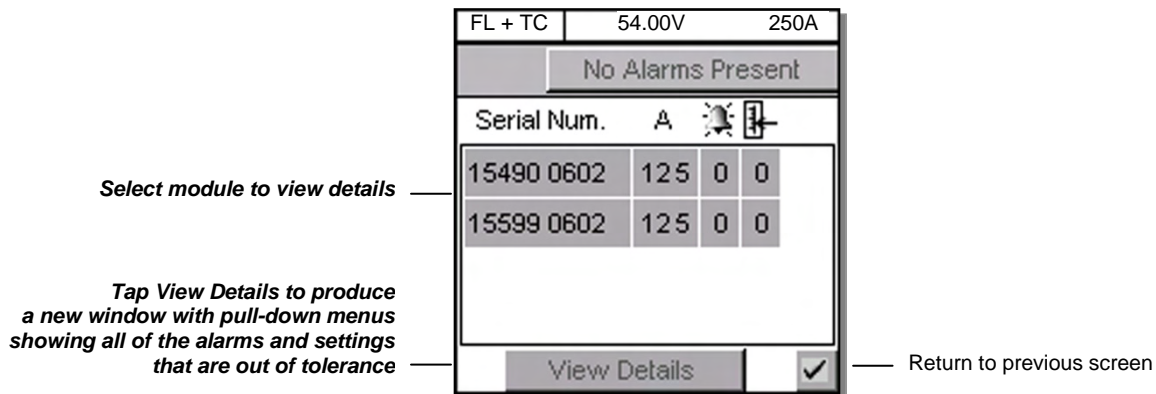

Figure 9—Rectifier (or Converter) report screen

Rectifier (or Converter) Locate Feature — Once a module is selected, the (module) LED’s will start flashing.

4.5 Analog Signals Display (active area)

Tap this active area³, top right of the “home” page (Figure 2), to enter a new window of operation for analog signals display and configuration, see Figure 10 below:

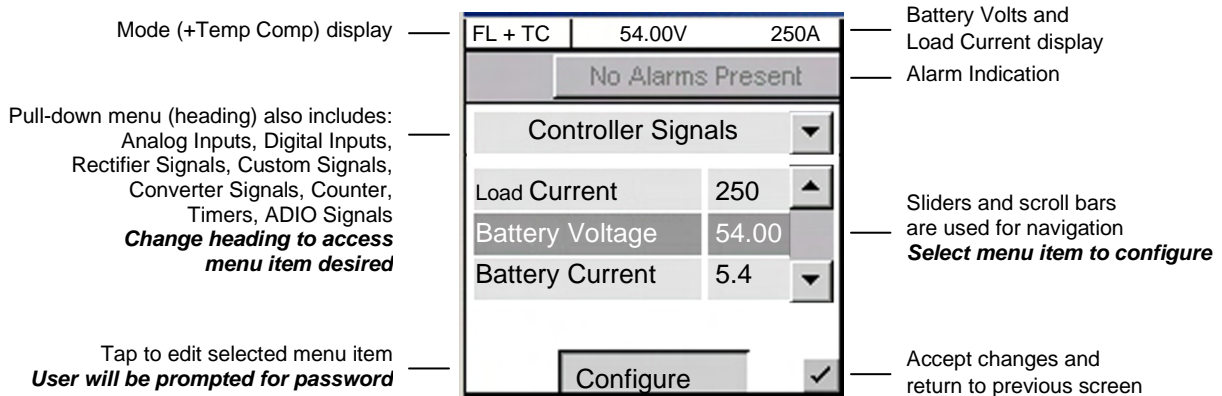

Figure 10—Analog signals display screen

The item selected from the analog signals active area will now be the highlighted item listed in the new window. The pull-down menu enables the user to select the signal group; signal items are listed below the group heading. Navigate the menu list to select the desired item.

4.5.1 Controller Signals

Once a menu item is selected, tap the “Configure” button to produce another window and list of items to navigate, see 6.6.2. To edit items, the User will be prompted for a password (via a pop-up window).

4.5.2 Analog Inputs

Once a menu item is selected, tap the “Calibrate” button to produce another window and list of items to navigate, see 6.6.1. To edit items, the User will be prompted for a password (via a pop-up window).

4.5.3 Digital Inputs

Under this menu heading, the user can view the list of digital inputs, see Table B.

4.5.4 Rectifier Signals

Under this menu heading, the user can view the list of rectifier signals, see Table E.

4.5.5 Custom Signals

Once a menu item is selected, tap the “Configure” button to produce another window and list of items to navigate. To edit items, the User will be prompted for a password (via a pop-up window).

4.5.6 Converter Signals

Under this menu heading, the user can view the list of converter signals, see Table H.

4.5.7 Counter

Once a menu item is selected, tap the “Configure” button to produce another window and list of items to navigate. To edit items, the user will be prompted for a password (via a pop-up window).

4.5.8 Timers

Once a menu item is selected, tap the “Configure” button to produce another window and list of items to navigate. To edit items, the user will be prompted for a password (via a pop-up window).

4.5.9 ADIO Signals

Under this menu heading, the user can view the live data from an ADIO device (i.e., Cordex Smart Peripherals) connected to the CXC. Refer also to Section 6.6.2.6, Example Four.

³ When labels are not shown, digits are displayed two rows high. See Figure 2 for Normal Operation. **Tap to minimize (see Figure 1) and tap again to enter new window of operation.**

4.6 Alarm Indication (active area)

Within the default operating screen, the Alarm Indication window may show icons on the left margin to indicate various alerts (such as an active alarm and priority of the condition). In the middle of the window, text will scroll indicating alarm notification or status. Navigation keys (on the right) aid the user to view the text.

Tap this active area, located below Analog Signals Display on the “home” page (Figure 2), to enter a new window of operation for alarm display and configuration, see Figure 11 below:

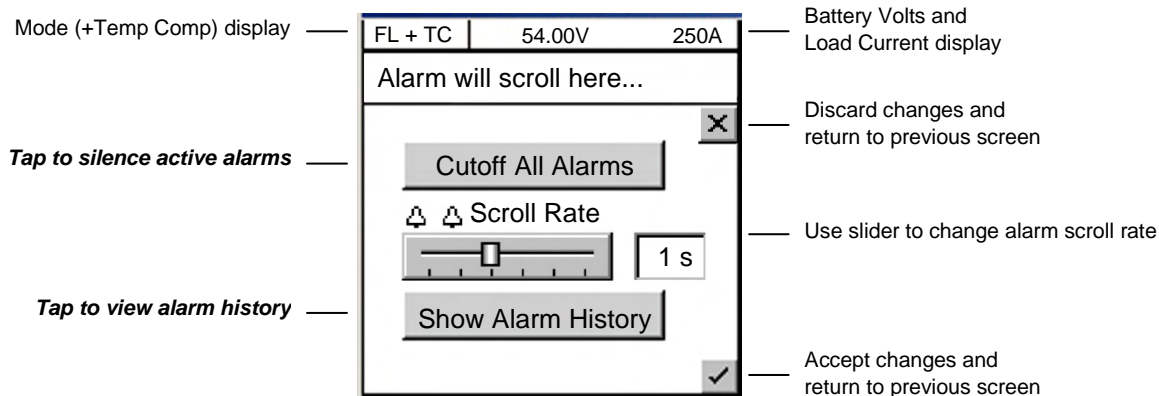

Figure 11–Alarm indication display screen

4.6.1 Cutoff All Alarms

Tap “Cutoff All Alarms” (button shown above) to silence active alarms. In addition, on any screen where the alarm indication is shown (as in previous figures), the User may tap the alarm indication “button” to display a pull-down menu (Figure 12 below) for alarm cutoff (also known as ALCO, see 6.5.1):

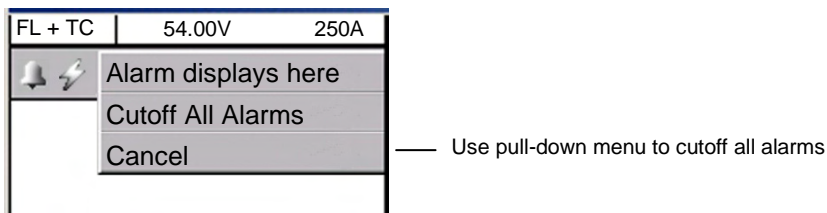

Figure 12–Alarm cutoff pull-down menu

4.6.2 Alarm History

Tap “Show Alarm History” to enter another screen that will list past alarms. Two pull-down menus enable the user to select which alarms will be displayed according to status and priority, see Figure 13 below:

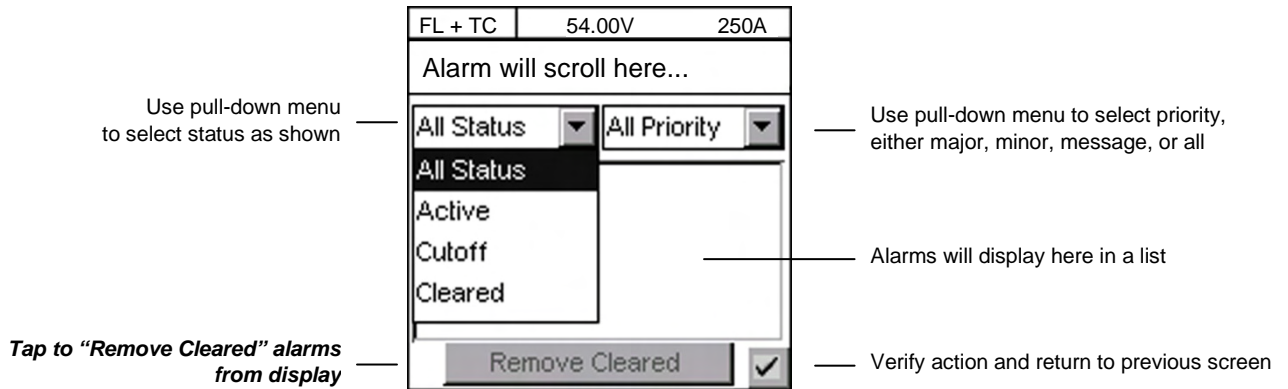

Figure 13–Alarm History screen

4.7 Home Icon (active area)

Tap the Home icon at the lower left of the “home” page to login (password entry), adjust contrast of display, reset, and select language, see Figure 14 below:

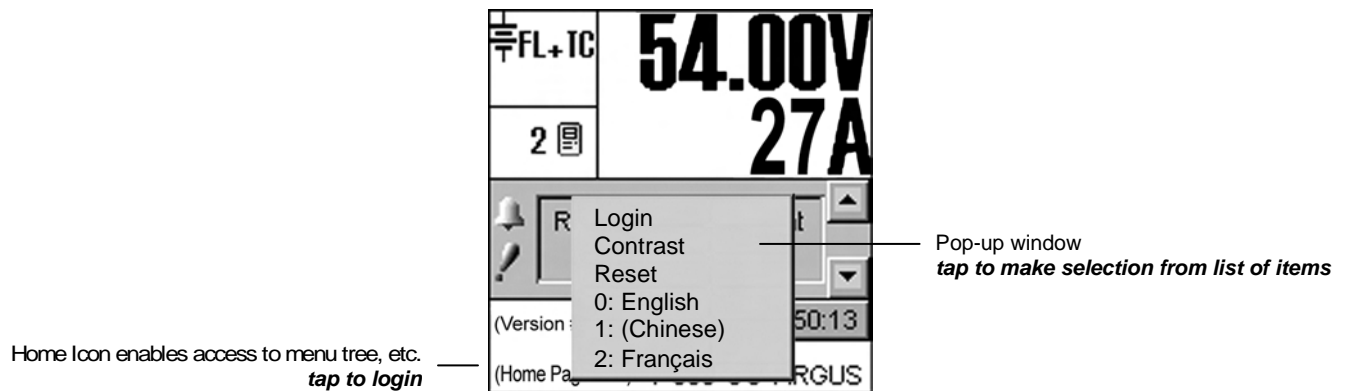

Figure 14–Alpha icon pop-up window on home page

4.7.1 Login (password entry)

When the user attempts to login (e.g. tapping the icon and selecting Login from the menu prompt), a pop-up window for password entry will be presented, see Figure 15 below:

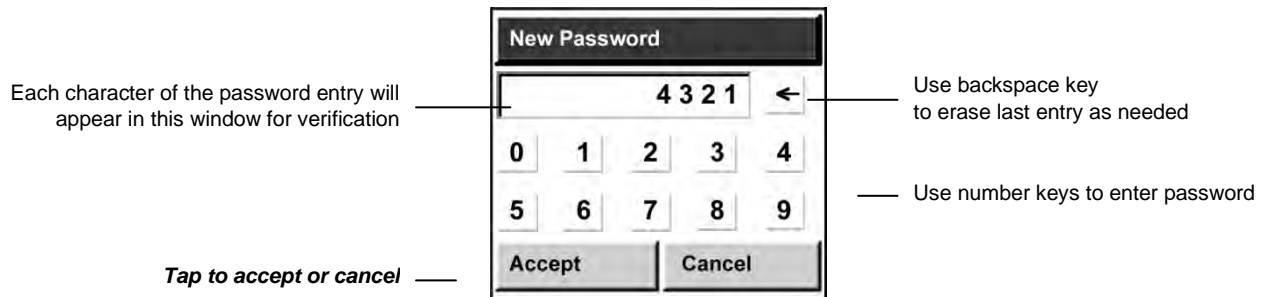

Figure 15–Password entry pop-up window

NOTE: If the CXC is already being accessed remotely, a pop-up window will appear to notify the local user that she or he will not be able to login and that “Another operator is currently logged in.”

Once the password is verified, appropriate access level will be granted and a pop-up window will provide acknowledgement; e.g., “Supervisor Access Granted.” If no password is entered, the user will be granted User access. *In User access mode, the user cannot make changes to parameters but may navigate through menus, see Figure 23.*

4.7.2 Contrast Adjustment of the GUI

Via the Alpha icon, a pop-up window enables the user to access the contrast adjustment of the GUI. Tap “Contrast” on the pop-up window. Figure 16 below shows the contrast adjustment window. Use the slider on the GUI to adjust contrast as desired.

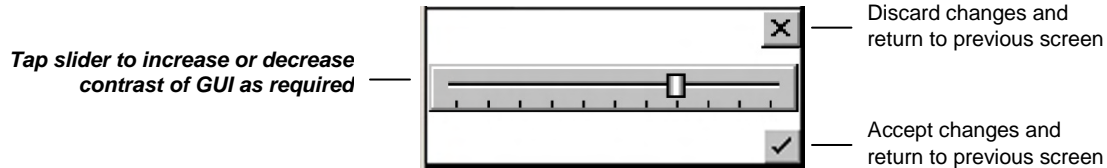

Figure 16–Contrast adjustment pop-up window

4.7.3 Reset

Via the Alpha icon, the user can reset the CXC. This enables the CXC to finish saving files to flash memory.

NOTE: *The CXCP and CXCR models provide battery backup of time and date; the other CXC models do not.*

Tap “Reset” on the pop-up window. A new pop-up window will alert the user “You are about to perform a system reset.”

To abort the operation, tap “Cancel” or the “X” button to clear the pop-up from the active area.

To proceed, tap “Accept” and a pop-up window will notify the user “Performing Reset, please wait...” This window will then be replaced with a window showing a timer counting down from 60 seconds and a button enabling the user to “Reset Now.” A message will also appear in this window to notify the user “It is now safe to reset the system.” The user may then tap the button or wait for the timer to count down and the operation will proceed automatically to completion. The screen will go blank and the LED’s will flash as the CXC performs a short self-test before returning to Normal operating mode.

4.7.4 Language Selection

Via the Home icon, a pop-up window enables the user to select English, French, Portuguese, Spanish or Chinese characters for the display of text labels and messages.

Language files can be uploaded via web interface. The CXC can be set up for a maximum of three language files (default plus two others) at one time pending availability.

4.8 Date and Time (active area)

On the “home” page (Figure 2), below the Alarm Indication, the date and time are displayed. To change the date (year, month, day) and time (hour, minute, second) settings, tap the active area of the screen to enter a new window of operation, see Figure 17 below:

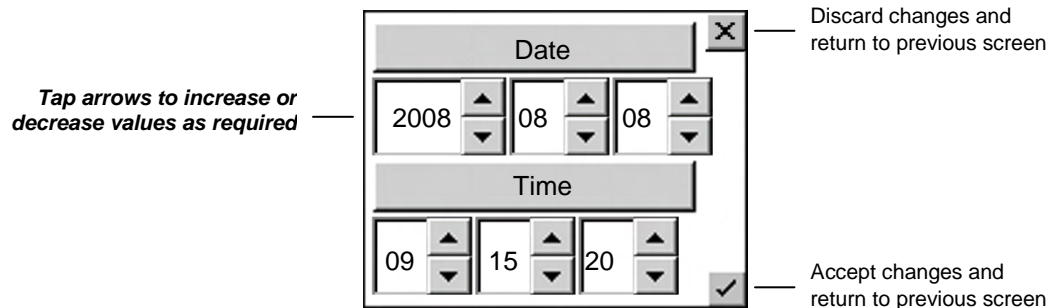

Figure 17–Date and time setting window

NOTE: *The CXCP and CXCR models provide battery backup of time and date; the other CXC models do not. With the web interface, SNTP (Simple Network Time Protocol) may be used, see 4.10.1. This feature enables synchronization of the CXC device time with an external source; i.e., the user’s network.*

4.9 Saving Settings

Return to MAIN MENU navigation screen.

1. Press the OPTION button to evoke the SAVE/LOGOUT pop-up window, see 5.1.2.
2. Select SAVE to save the new settings (or select LOGOUT to clear).

A pop-up window will appear for confirmation of the selection.

Alternatively, for the web interface:

1. Click Submit Changes (upper left on web interface window).
2. Click Accept button on the Compare Settings window.

4.10 Overview of Web Interface

Refer to Chapter 9 to establish remote communications, then launch Internet Explorer® 6 or greater. Under Tools\Internet Options\Security, add the logon address of the CXC to the “Trusted Sites.”

Logon to address 10.10.10.201



Figure 18—Enter Network Password window

Enter no USER NAME and default PASSWORD. Select OK to proceed to Language Selection window:

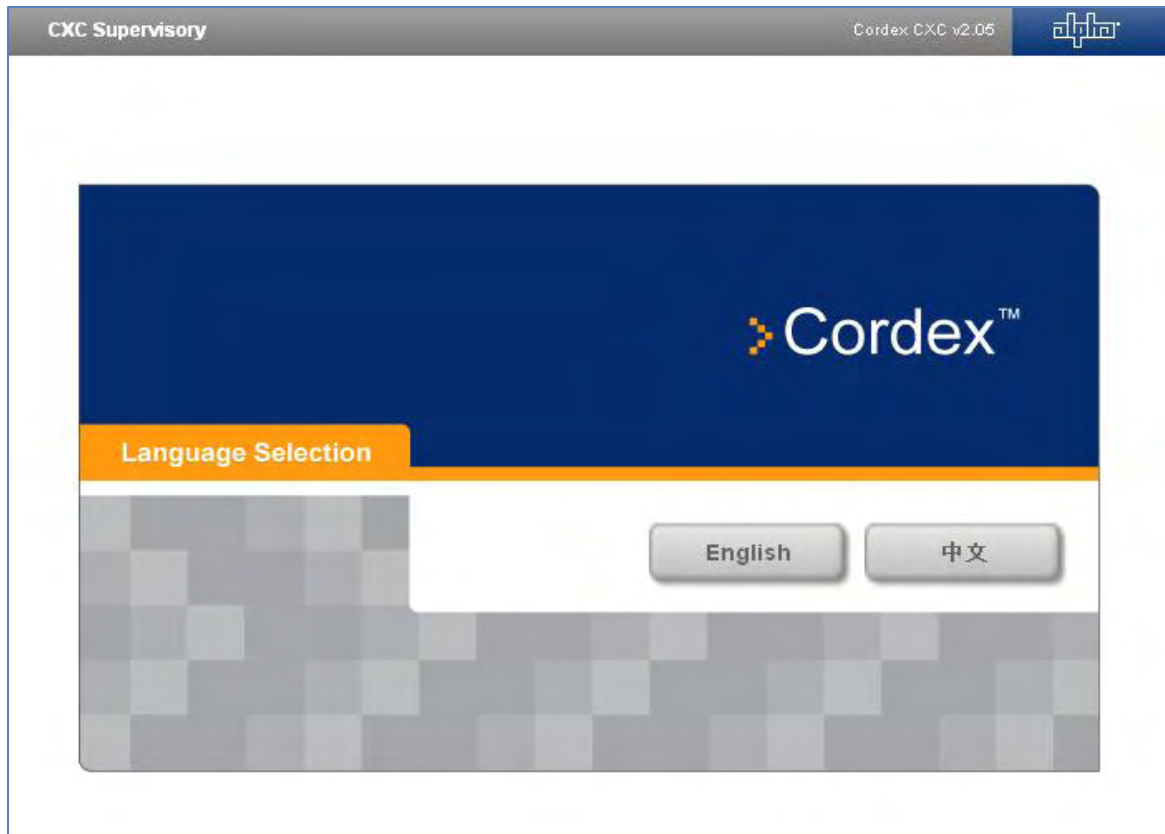

Figure 19—Language Selection window

The following images show examples of windows presented when using a desktop browser to set-up or monitor the CXC – contact Alpha for assistance as required.

The screenshot displays the CXC Supervisory web interface for a system in Burnaby, B.C. The interface includes a top navigation bar with 'Language' and 'Logout' options, and a status bar showing 'Normal' and 'Alarm Cut Off' buttons. Key system metrics are displayed: Battery Voltage at 25.14V and Load Current at -0.2A. A main menu lists various system components like Mains, Rectifiers, Load, Converters, LVD, and Batteries. The 'View Live Status' page is active, showing detailed data for each component.

System > View Live Status

Mains	
Avg AC Voltage:	---
Avg. AC Phase R:	---
Avg. AC Phase S:	---
Avg. AC Phase T:	---

Rectifiers	
Output Current:	---
Mode:	FL
# Acquired Rectifiers:	---
# Power Saving Rectifiers:	---

Load	
Load Voltage:	22.63V
Load Current:	-0.2A

Converters	
Device Name:	---
Output Current:	---
Output Voltage:	---
# Acquired Conv.:	---

LVD	
Activated LVDs:	0
Enabled LVDs :	3

Batteries	
Battery Voltage:	25.14V
Battery Current:	---
Battery Temperature:	---
Battery Runtime:	---
Battery Capacity:	100.0%
Battery DOD:	---

Figure 20–Web Interface window (sample home page)

4.10.1 SNTP (Simple Network Time Protocol)

This feature enables synchronization of the CXC device time with an external source; i.e., the user's network. SNTP is an adaptation or basic subset of NTP which is used for more comprehensive device time synchronization (see www.NTP.org).

CAUTION

The CXC SNTP client will only accept responses from the external server with the 'stratum' parameter set in the range of 1 through 14.

With the web interface, select the Controller page and then the Date & Time window:

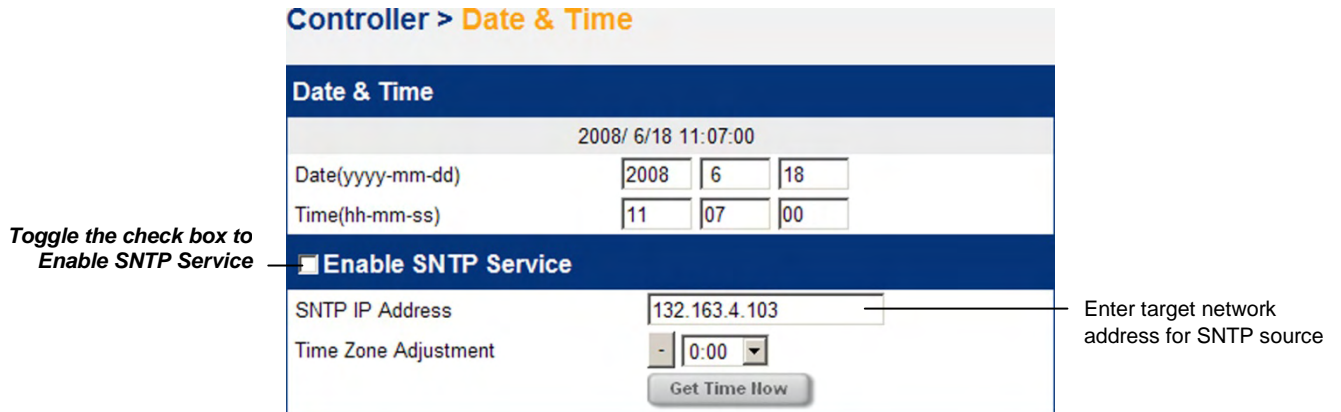
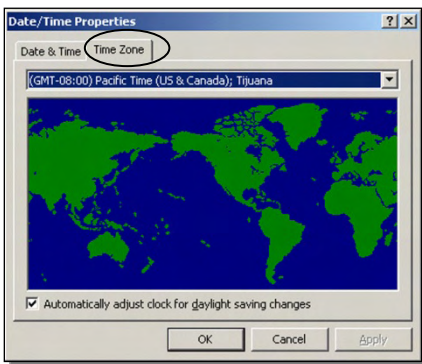

Figure 21–Date & Time window (Controller page)

To verify the Date/Time properties of the PC, select Start, Settings then Control Panel (Windows® 2000 operating system). Select Date/Time and verify properties with the target network:



Select the tab for Time Zone

Use the pull-down menu to select the correct time zone; e.g. Pacific Time

In this example, the Time Zone Adjustment for the CXC is -8:00

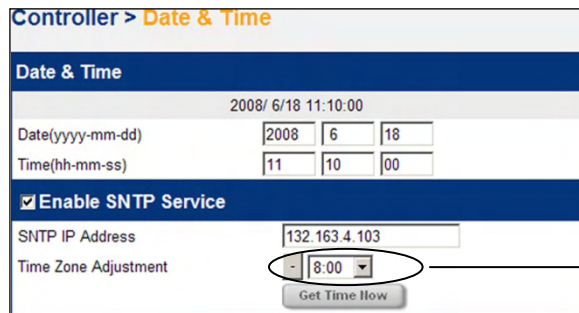
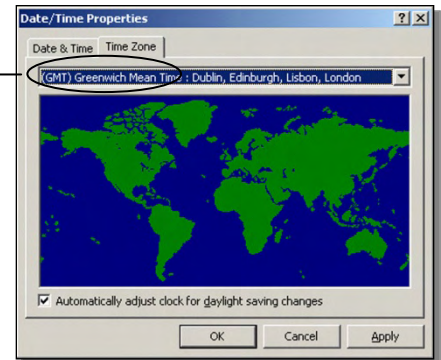

Figure 22–Example of time zone adjustment

Use the “-” button in addition to the pull-down menu to change the Time Zone Adjustment, then select Get Time Now to synchronize

Select Get Time Now to synchronize.

NOTE: SNTP service will automatically re-synchronize twenty-four hours from the time of the last synchronization.

5 Menu Navigation and Sample Programming

5.1 Menu Navigation

The sample screen shown below (Figure 23) is presented upon login, see 4.7.1. From here, the user may navigate (e.g. browse – as on a personal computer) each of the CXC's menu items, including alarms, controls and configuration items.

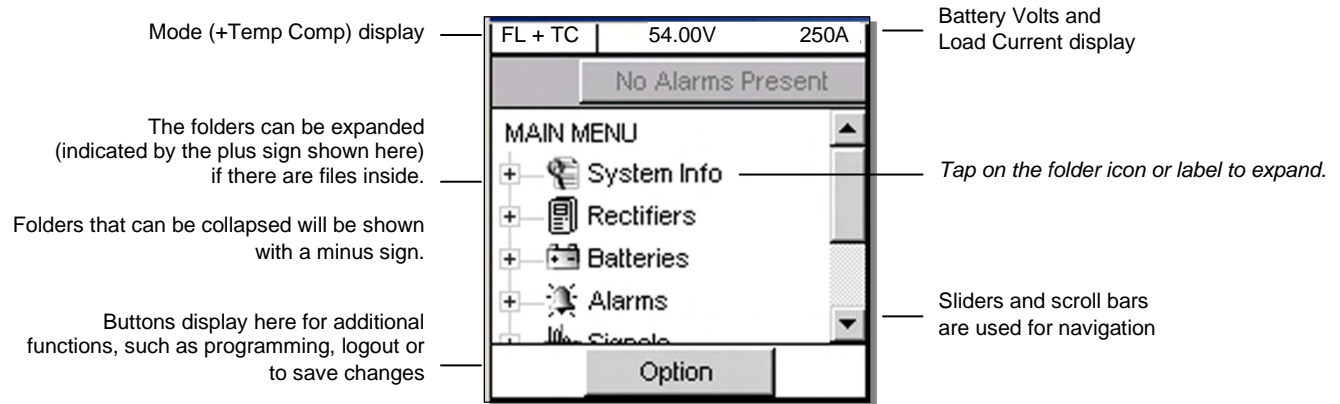

Figure 23–Menu navigation sample screen

The “Option” button is used to logout or save changes.

The menu structure is shown in Figure 25. The next chapter describes the items that may be changed.

5.1.1 Option to Logout

Via the Option button, a pop-up window enables the user to logout of the menu navigation screen and return to the home page.

If changes have been made, another pop-up window will prompt the user with buttons to “Save” or “Discard.” In each case, the active area will return to the home page and a pop-up window will confirm the selection. *Tapping the “X” button will clear the pop-up from the active area.*

If changes have been made, and logout is selected, another pop-up window will prompt the user with buttons to “Save” or “Discard.”

5.1.2 Option to Save

Saving in menu navigation (Supervisor only) will result in a prompt (pop-up window) to appear; e.g., “Save Complete” when the settings are downloaded.

If there are no changes made, then saving in menu navigation will result in a prompt (pop-up window) to appear; e.g., “There are no changes to save.”

In each case, tapping the “X” button will clear the pop-up from the active area and remain in menu navigation. The Supervisor will retain the security access level to continue making changes and does not return to the home page.

5.1.3 Auto-Logout Timeout

After 20 minutes of inactivity (no user input), the CXC will automatically logoff the user. The CXC will discard any unsaved changes made by the user while logged in the system and return to Normal Operation mode. The access level will be reset to the default user access and the screen will continue to display live data.

5.1.4 Backlight Timeout

After one minute of inactivity (no user input), the CXC will automatically turn off the LCD backlight.

5.1.5 Virtual Numeric Keypad

Whenever a numeric field is selected, a virtual numeric keypad will appear (in a pop-up window) to enable editing of the value, see Figure 24 below:

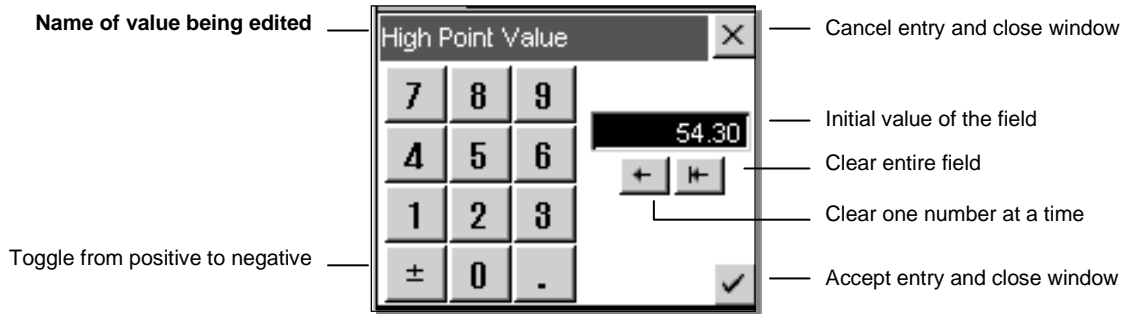

Figure 24–Virtual numeric keypad pop-up window

Tap the keypad to edit or enter a value. Use the virtual function buttons described above to navigate, cancel or accept.

5.2 Basic Programming Example

To adjust settings in the RECTIFIERS\ CONFIGURE SETTINGS menu, see 6.3.2:

1. Using the navigation arrows, scroll to the item that is to be changed; e.g. FLOAT VOLTAGE.
2. Enter a new value using the CXC’s virtual numeric keypad (shown above); e.g. 54.00.

Download new settings to all connected rectifiers:

3. Return to MAIN MENU navigation screen and press the OPTION button to evoke the SAVE/LOGOUT pop-up window.
4. Select SAVE to save the new settings or select LOGOUT to clear. A pop-up window will appear to confirm the selection.

5.3 Advanced Programming

See Section 7.

When configuring Alarms (6.5.3), Signals (6.6.2), or Controls (0), an option to CUSTOMIZE will be presented at the bottom of the screen. This enables the Supervisor to program separate triggering equations into the CXC software. The equations may reference any combination (up to 16) of the analog inputs, digital inputs, virtual inputs, and alarms utilizing logical and arithmetic arguments that simulate the functionality of a programmable logic controller (PLC).

MAIN MENU

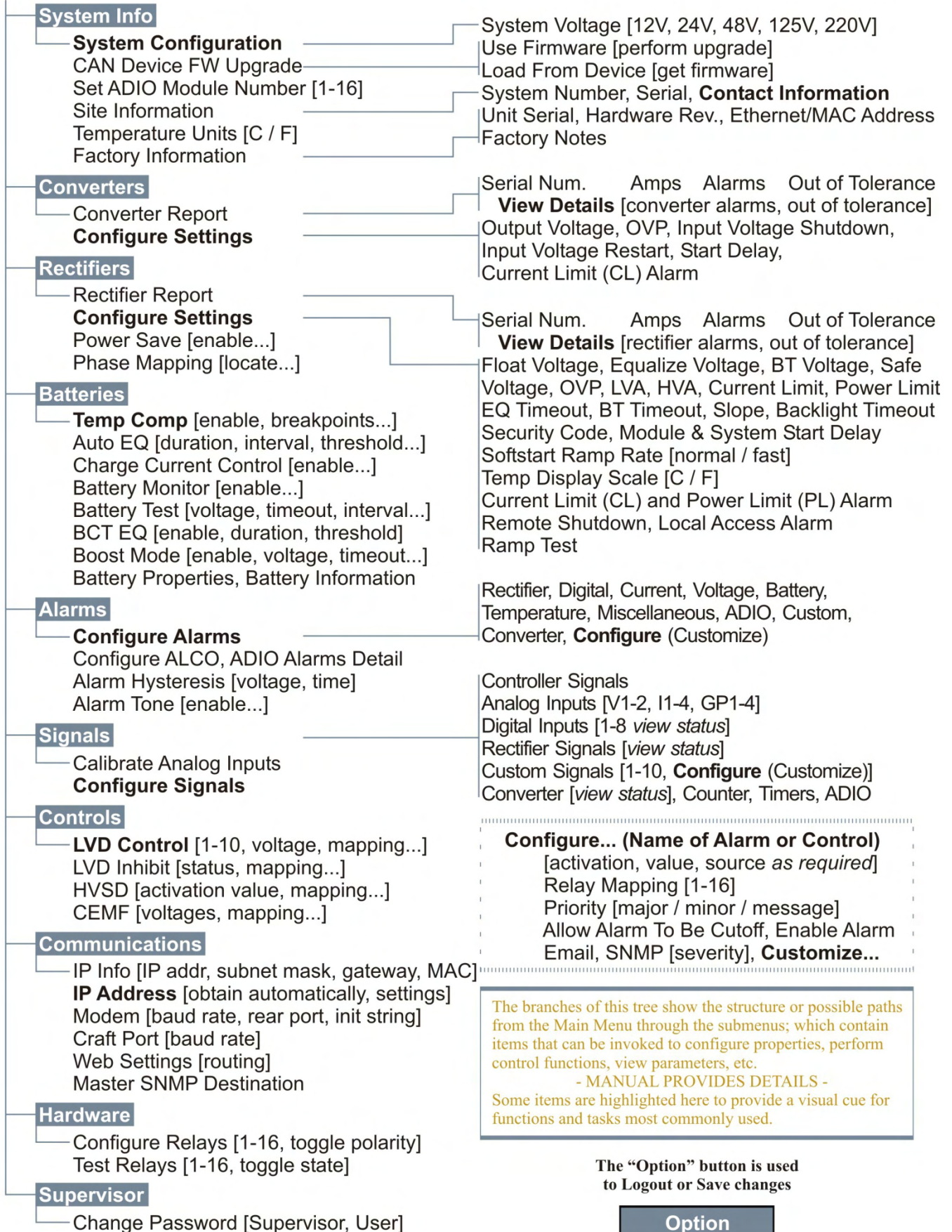

Configure... (Name of Alarm or Control)
 [activation, value, source as required]
 Relay Mapping [1-16]
 Priority [major / minor / message]
 Allow Alarm To Be Cutoff, Enable Alarm
 Email, SNMP [severity], **Customize...**

The branches of this tree show the structure or possible paths from the Main Menu through the submenus; which contain items that can be invoked to configure properties, perform control functions, view parameters, etc.
 - MANUAL PROVIDES DETAILS -
 Some items are highlighted here to provide a visual cue for functions and tasks most commonly used.

The "Option" button is used to Logout or Save changes



Figure 25–Menu structure

6 Menu Structure, Programming and Adjustments

The CXC menu structure (Figure 25) consists of two basic components: Menu Categories and Sub-Menu Items. This chapter describes each of the CXC's menu items, including alarms, controls and configuration items. They are arranged, as they would appear in the **touch screen** menus subject to product enhancements.

NOTE: *Items specific to the CXC **web interface** will be indicated separately.*

6.1 System Info

This menu category consists of Factory, Site and System data. Information pertaining to the CXC, the related site and system may be accessed here. The Supervisor can set parameters; such as, system number (Figure 28), system serial number, and temperature display units (Figure 29).

For the **web interface**, this section has been divided and expanded for the associated menus/pages into "System" and "Controller." See Figure 20 (sample home page).

The System page still allows the Contact and System Information to be configured, the Voltage Mode to be selected, the Firmware to be upgraded, and the ADIO Module Number to be set. See the following sections 6.1.1 through 6.1.4.

The Controller page allows the Date & Time (4.8), and Temperature Units (6.1.6) to be set, and the Factory Information is displayed (6.1.7). In addition, the menu links are located here to upgrade the Bootloader and Software. A remote reset of the CXC may also be commanded via a link on this page.

NOTE: *Bootloader is the program that the CXC starts up with first and then it loads the Cordex operating system (similar to DOS); therefore, when upgrading the Cordex software, the bootloader should be installed after the new operating system.*

6.1.1 System Configuration

This menu item enables the Supervisor to select the system voltage. *Use pull-down menu to make selection.*

CAUTION

This item effects all system settings that pertain to the system voltage including LVD levels.

6.1.2 CAN Device Firmware (FW) Upgrade [CX Series only]

This menu item enables the Supervisor to select, transfer and upgrade firmware for the CAN-enabled system devices; such as, Shunt Multiplexer (MUX) or CXRC rectifier shown in the following example:

1. Select Load From Device to see a list of Acquired Devices (or select the X icon to cancel entry and close window).
2. Select device from list. Get Firmware will produce a message window prompting to accept (or cancel).
3. Select Accept to proceed with firmware transfer. Select the X icon (in the message window) when transfer is complete.
4. Select Use Firmware to see a list of Upgrade Devices (or select the X icon to cancel entry and close window).
5. Use the check box to select/deselect device from list. Perform Upgrade will produce a message window prompting to accept (or cancel).
6. Select Accept to proceed with firmware upgrade. Rectifier LEDs will flash in sequence to indicate data transfer. Select the X icon when upgrade is complete.

7.

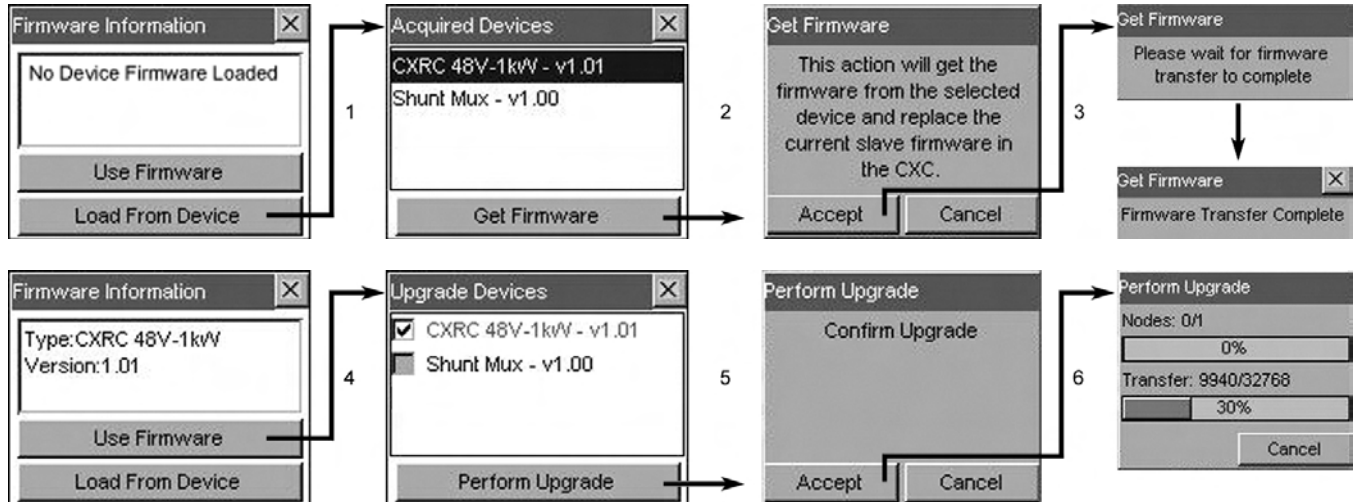

Figure 26–Firmware upgrade procedure

NOTE: Repeat the steps above choosing Shunt MUX as required.

6.1.3 Set ADIO Module Number

This menu item enables the Supervisor to select and map the order number in which CAN-enabled system devices, such as Battery Cell Monitor (BCM), are to appear in the CXC menus; shown in the examples below:

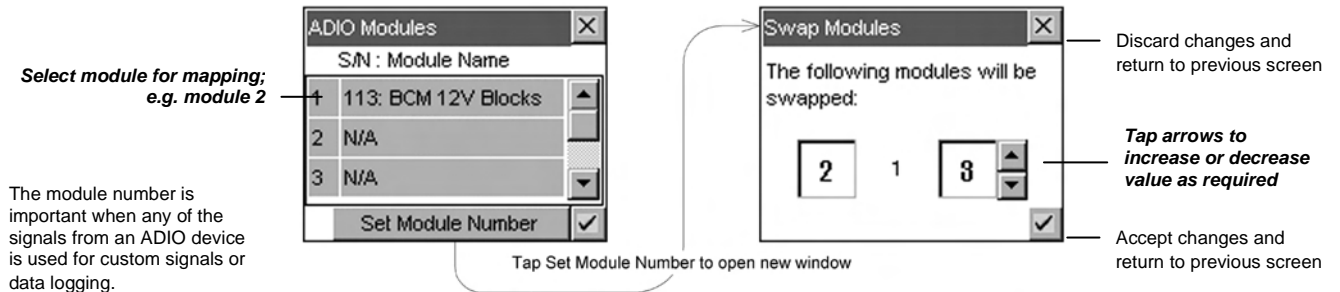

Figure 27–ADIO Modules and Swap Modules windows

NOTE: When replacing ADIO modules, assign the new identical device with the same ADIO module number of the old device. This is to preserve the functionality of any equations that use signals originating on the old device.

6.1.4 Site Information

6.1.4.1 System Number

This is where the power system number is displayed/edited.

6.1.4.2 System Serial

This is where the power system serial number is displayed/edited.

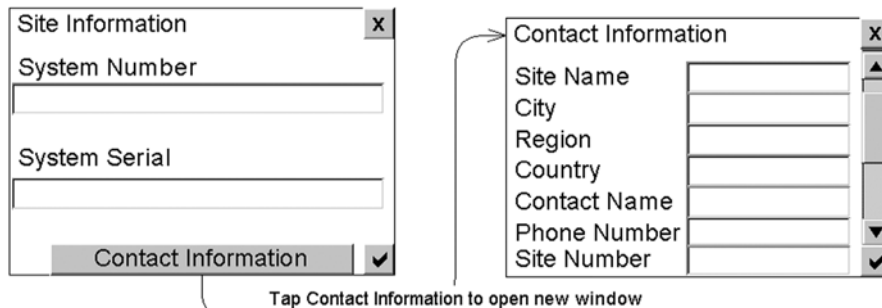

Figure 28–Site Information and Contact Information windows

6.1.5 Contact Information

This menu item provides for a convenient display of the site and contact information. A scroll bar enables the user to navigate the list of text items for viewing; i.e., Site Name, City, Region, Country, Contact Name, Phone Number and Site Number.

6.1.6 Temperature Units

This menu item enables the Supervisor to select the temperature display units (Celsius or Fahrenheit).

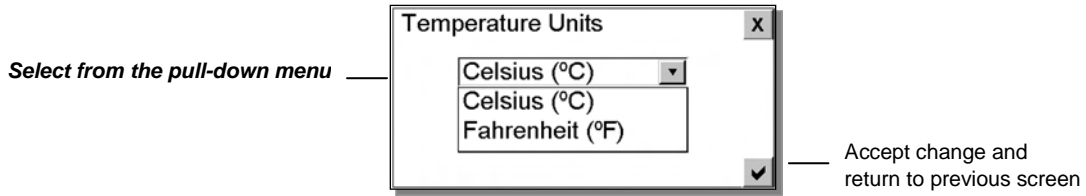

Figure 29–Temperature Units selection window

6.1.7 Factory Information

This is where the CXC’s factory unit default values are displayed. A scroll bar enables the user to navigate the list of text items for viewing; i.e., Unit Serial, Hardware Rev. (revision), Ethernet/MAC Address and Factory Notes.

6.1.8 User Inventory (Web Interface Only)

This page enables the user to enter data for up to 20 inventory items. When entering data, the tab key may be used to move the cursor from one data entry box to the next. See Figure 30 below:

System > User Inventory					
User Inventory					
#	Serial Number	Name	Description	Date Installed	Comments
1	As245	External Load	none	1999-02-05	24/48V load
2	Aj345	Automatic Load		2008-06-12	24V load only
3	Cvg56	Fan	40W	20010406	
4					

Figure 30–User Inventory window (web interface only)

6.1.9 System Inventory (Web Interface Only)

This page enables the user to view a single list of all CAN connected devices, user inventory items, and battery information items. See Figure 31 below:

Select pull-down menu for device details:

BCMC	
Ring Device	Total
BCM	4
HVM	1
SM	1

System > Inventory

Acquired CAN Devices

Device Name	Serial Number	Version
BCMC	SN000122/L02	1.02
CXRF 48-3.6kW	S/N 133456	1.16

No Acquired Converters

User Inventory

Serial Number	Name	Description	Date Installed	Comments
Aj345	Automatic Load		2008-06-12	24V load only
As245	External Load	none	1999-02-05	24/48V load
Cvg56	Fan	40W	20010406	

Battery Information

Battery ID	Manufacturer	Model	Date Code	Comments
24V Battery String	Alpha	12V-200Ah	2000-03-24	80% capacity
24V battery string	Alpha	12V-200Ah	2004-03-12	90% capacity
48V Battery String	Yuasa	12V-150Ah	20020912	Overstock

Figure 31–System Inventory window (web interface only)

6.2 Converters

This menu category consists of converter alarms and controls. Parameters can be set/accessed such as output voltage, OVP, high/low voltage alarms, and start delay.

The converter defaults will be based on the system voltage if it is either 24 or 48Vdc.

NOTE: *At present, the converter software does not support:*

- Two types of converters simultaneously
- 12, 125, and 220Vdc systems.

Other features include:

- | | |
|------------------------|------------------------|
| Active voltage control | Inventory update |
| Converter locate | Loadsharing |
| Firmware upgrade | Major and minor alarms |

6.2.1 Converter Report

This feature will enable the user to view, in a list report (see 4.4.2, Figure 9), all of the acquired converters in the system. The first column lists the serial numbers of the converters. The report then displays the output current of each converter under the Amps column (or toggle for % of maximum output) and the number of active alarms under the Alarms column (if that converter is issuing an alarm). The rightmost column displays the number of settings out of tolerance (OOT per web interface).

Select a converter and tap **“View Details”** to produce another list showing details of the entire converter alarms and settings that are out of tolerance.

6.2.2 Configure Settings

This feature will enable the user to configure settings (via menu items) for all of the acquired converters in the system; such as:

- | | |
|------------------------|-----------------------|
| Output Voltage | Start Delay |
| OVP | Enable CL Alarm |
| Input Voltage Shutdown | Input Voltage Restart |

6.3 Rectifiers

This menu category consists of rectifier alarms and controls. Parameters can be set/accessed such as float/equalize voltages, high/low voltage alarms, and start delay.

6.3.1 Rectifier Report

This feature will enable the user to view, in a list report (see 4.4.2, Figure 9), all of the acquired rectifiers in the system. The first column lists the serial numbers of the rectifiers. The report then displays the output current of each rectifier under the Amps column (or toggle for % of maximum output) and the number of active alarms under the Alarms column (if that rectifier is issuing an alarm). The rightmost column displays the number of settings out of tolerance (OOT per web interface).

Select a rectifier and tap “**View Details**” to produce another list showing details of the entire rectifier alarms and settings that are out of tolerance.

6.3.2 Configure Settings

This feature will enable the user to configure settings (via menu items) for all of the acquired rectifiers in the system.

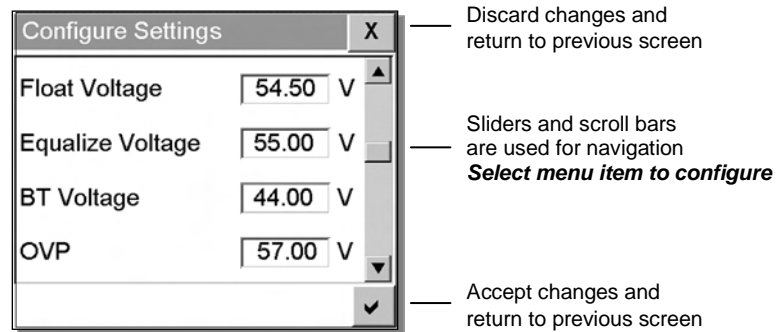

Figure 32–Configure Settings (rectifiers) window

The menu items described below may be configured via a virtual numeric keypad (5.1.5) or by toggling the listed item. **For a basic programming example, see 5.2.**

6.3.2.1 Float (FL) Voltage

This menu item enables the Supervisor to set the system BATTERY VOLTAGE (measured at an analog input channel) to the desired float voltage value. Float voltage charges the battery string and supplies the load. Normally, the power system will operate in the float mode. This setting should have a minimum of LVD + 1V and a maximum of OVP – 1V.

6.3.2.2 Equalize (EQ) Voltage

This menu item enables the Supervisor to set the system BATTERY VOLTAGE (measured at an analog input channel) to the desired equalize voltage value. Equalize voltage charges the battery string at a higher than normal voltage to either recharge batteries after a power failure or to balance individual cell voltages. Periodic equalizing of the battery string may be required to optimize battery performance and life. This setting should have a minimum of LVD + 1V and a maximum of OVP – 1V.

6.3.2.3 Battery Test (BT) Voltage

This menu item enables the Supervisor to set the Battery (Discharge) Test Voltage to the desired value during the test (mode). This setting should have a minimum of LVD + 1V.

6.3.2.4 Safe Voltage

This menu item enables the Supervisor to set the default system voltage (Safe Mode) in the event that communications to Cordex rectifiers should fail. See 3.4 for more details about this feature.

6.3.2.5 OVP Voltage

This menu item enables the Supervisor to program one OVP setting for all connected rectifiers. OVP will disable a rectifier that outputs an abnormally high voltage.

6.3.2.6 Low Voltage Alarm (LVA)

This menu item enables the Supervisor to program one LVA setting for all connected rectifiers. LVA serves as a warning to the user indicating that output voltage is dropping.

6.3.2.7 High Voltage Alarm (HVA)

This menu item enables the Supervisor to program one HVA setting for all connected rectifiers. HVA serves as a warning to the user indicating that output voltage is rising. This value should be less than the OVP setting in order for the HVA to work effectively.

6.3.2.8 Current Limit (CL)

This menu item sets the level as a percentage at which current limiting activates in all connected rectifiers.

Current limiting is a primary response to output over current situations. If the output current on the rectifiers exceeds the current limit setting, their output voltage will automatically decrease but will maintain the current output at the current limit level. This prevents potential damage to the rectifiers.

If the CXC finds rectifiers in the system that cannot meet the default current limit value, the CXC will correct its default limit setting to match the rectifiers.

6.3.2.9 Power Limit (PL)

This menu item sets the level as a percentage at which power limiting activates in all connected Cordex rectifiers.

6.3.2.10 EQ Timeout

This menu item controls the maximum equalize time setting for all connected rectifiers. This control is designed to prevent accidental over-charge of the batteries. CXC will send the command to change the equalize time-out setting in all the rectifiers.

6.3.2.11 BT Timeout

This menu item controls the duration of the Battery Test.

6.3.2.12 Slope (Pathfinder rectifiers only)

This menu item sets all connected rectifiers to the same slope adjustment value. Slope determines the regulation percentage of the current between rectifiers in a group. When load sharing is initialized, CXC will send commands to the rectifiers to try to adjust their output voltage within this slope range. The rectifiers should have their output voltage as close to being equal, in order to balance (or share) the load current between them.

6.3.2.13 Backlight Timeout (Pathfinder rectifiers w/LCD only)

This menu item controls the amount of time of GUI inactivity permitted before the rectifier automatically turns off the LCD backlight.

6.3.2.14 Security Code (Pathfinder rectifiers w/LCD only)

This menu item enables the Supervisor to program one security access code for all connected rectifiers. CXC logs in each of the rectifiers as Factory Access and sends the direct command to change the access code.

6.3.2.15 Module Start Delay

This menu item controls the stagger-start timer for all connected rectifiers.

With start delay, rectifiers start up in a time-delayed sequence. This prevents excessive loading of the AC source. For example, setting a start delay time of 5 seconds will cause rectifier#1 to start at 1 second, rectifier#2 at 5 seconds, rectifier#3 at 10 seconds, etc. In the case where the start delay exceeds the maximum range, the next rectifier in sequence will start its delay at zero and increment again by the value specified in this menu item.

When the rectifier Module Start Delay is set to 0 s, all the rectifiers start with a 0 s delay.

6.3.2.16 System Start Delay

This menu item controls the amount of time, in seconds, before the stagger-start timer commences, see 6.3.2.15 above.

6.3.2.17 Soft Start Ramp Rate (Cordex rectifiers only)

This menu item enables the Supervisor to select the soft start ramp rate (normal or fast). Current limit ramps up at about 12%/s during normal soft start and 33%/s during fast.

For systems without batteries, select the Fast setting for the Soft Start Ramp Rate.

6.3.2.18 Temp Display Scale (Pathfinder rectifiers w/LCD only)

This menu item enables the Supervisor to select the temperature display scale (Celsius or Fahrenheit).

6.3.2.19 Check to Enable

This menu item enables the Supervisor to toggle (enable or disable) the following list of items:

- CL and PL Alarm
- Remote Shutdown (Cordex rectifiers only; affects operation of Power Save, see below)
- Local Access Alarm (Pathfinder rectifiers w/LCD only)
- Ramp Test (Cordex rectifiers only)

6.3.3 Power Save

This feature will enable the Supervisor to improve operational efficiency when conditions warrant by running only the necessary number of rectifiers. The remote shutdown setting (enable or disable) affects correct operation of the Power Save feature. See also 3.5 for more details.

6.3.3.1 Enable

This menu item enables the Supervisor to control the CXC's Power Save feature.

6.3.3.2 Redundant Rectifiers

This menu item enables the Supervisor to specify the number of extra rectifiers to turn on.

6.3.3.3 Max (Maximum) Power Usage

This menu item enables the Supervisor to specify the percentage (of maximum power usage) per rectifier module used in the computation of the Power Save feature. This works to avoid rectifiers operating continuously at greater than the set limit (i.e. 95%) and going into current limit frequently due to load surges or power limit conditions; such as, low line voltage or high temperature.

6.3.3.4 Limit Power Save Log

The logs “Power Save Restart” and “Power Save Shutdown” are limited to one every 24 hours.

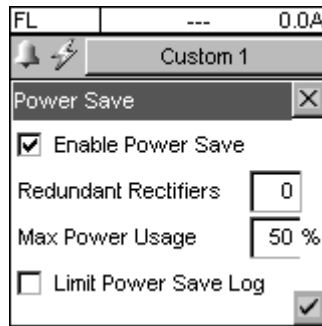

Figure 33–Power Save options

6.3.4 Phase Mapping

This feature will enable the user to assign or map a rectifier per input signal for individual phase voltage readings:

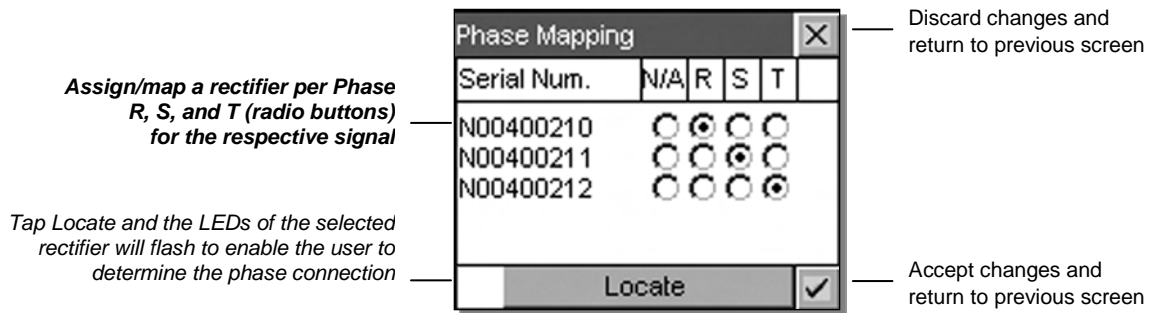

Figure 34–Phase Mapping (rectifiers) window

6.4 Batteries

This menu category consists of battery controls. Parameters can be set/accessed, such as automatic temperature compensation, auto equalize and battery current (I) limit.

See Standard Features chapter for an explanation of temperature compensation and lead acid battery auto equalization.

6.4.1 Temperature Compensation (Temp Comp)

6.4.1.1 Enable

This menu item enables the Supervisor to control the CXC’s temperature compensation feature. Automatic battery temperature compensation may be enabled in equalize mode independently from float mode. **Battery Properties section must be completed to enable this feature.**

6.4.1.2 Upper/Lower Breakpoints

This menu item enables the Supervisor to program the temperature at which automatic voltage changes in the system will cease. There are voltage and temperature values for both breakpoints (upper and lower). However, note that the Upper Breakpoint refers to the higher temperature at which automatic voltage changes will cease. Lower Breakpoint refers to the lower temperature. Reversing these (placing the lower temperature as the “Upper Breakpoint” and the lower temperature as the “Lower Breakpoint” will not work.

6.4.1.3 Battery Properties (See 6.4.8)

The “Battery Properties” button at the bottom of the Temp Comp window is a link to the Battery Properties window.

The return path (the menu structure) will remain intact; i.e., the user will return through the window where the Battery Properties button was tapped.

6.4.2 Auto Equalize

6.4.2.1 EQ Duration

This menu item enables the Supervisor to program the duration of the auto equalize cycle, in hours.

The duration setting is also used in manual equalize mode. Consult the battery manufacturer for suggested duration of equalize charge cycles.

6.4.2.2 Periodic Auto-EQ

Enable

This menu item enables the Supervisor to control the CXC’s periodic auto equalize feature.

Interval

This menu item enables the Supervisor to program the time between auto equalize charging of the battery string in days. Consult the battery manufacturer for suggested equalize charge-time interval.

6.4.2.3 Charge Auto-EQ

Enable

This menu item enables the Supervisor to control the CXC’s Charge Auto Equalize feature.

Activation (High Voltage) Threshold

This menu item enables the Supervisor to program the voltage at which the auto equalize charging will activate.

Arming (Low Voltage) Threshold

This menu item enables the Supervisor to program the voltage at which the auto equalize charging will arm.

6.4.2.4 Battery Properties (See 6.4.8)

The “Battery Properties” button at the bottom of the Auto Equalize window is a link to the Battery Properties window.

The return path (the menu structure) will remain intact; i.e., the user will return through the window where the Battery Properties button was tapped.

6.4.3 Charge Current Control (CCC)

6.4.3.1 Enable

This menu item enables the Supervisor to control the CXC's Charge Current Control feature. **Battery Properties section must be completed to enable this feature.**

6.4.3.2 Charge Rate Limit

This menu item enables the Supervisor to program the amount of current that goes into the battery and is dependent upon the Supervisor-entered parameter Capacity Rating (C), see 6.4.8.1. The Charge Rate amount is represented in amps (X) or as a C/X value (Capacity Rating/Charge Rate Amps).

The Charge Rate Amps is recalculated if the Charge Rate C/X value or the Capacity Rating is modified.

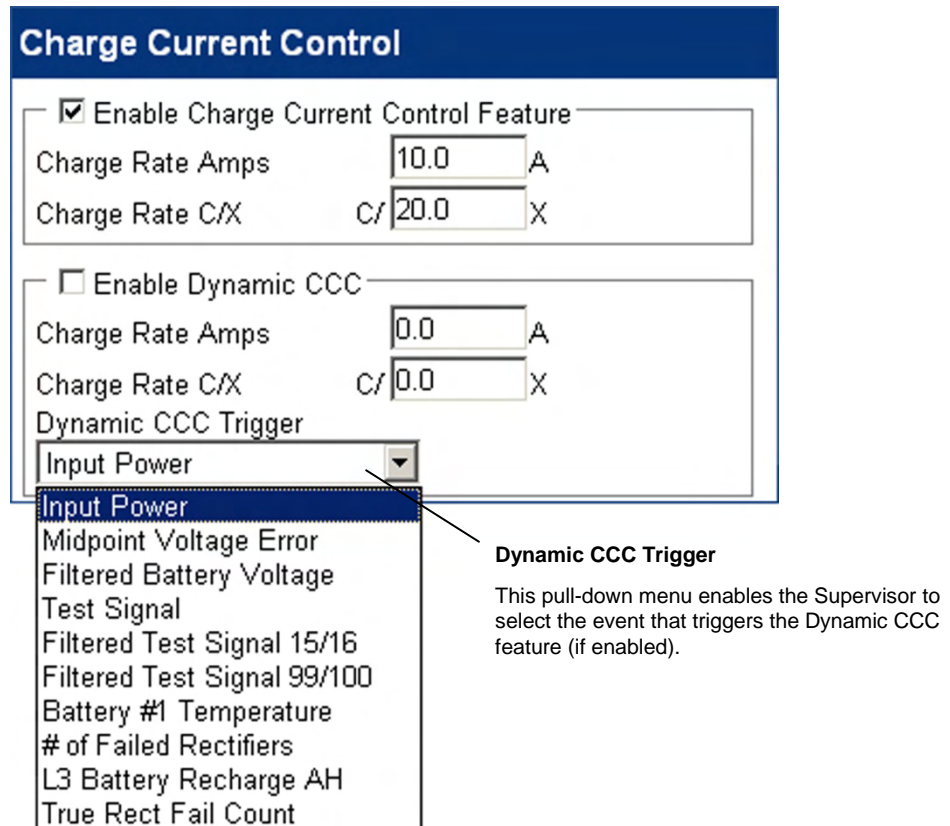

Figure 35—Charge Current Control web interface window

6.4.3.3 Enable Dynamic CCC

This menu item enables the Supervisor to control the CXC's Dynamic Charge Current Control feature. **Battery Properties section must be completed to enable this feature.**

NOTE: *There is a separate set of Charge Rate Limit values that can be input for the Dynamic CCC feature.*

6.4.3.4 Battery Properties (See 6.4.8)

The “Battery Properties” button at the bottom of the Charge Current Control window is a link to the Battery Properties window.

The return path (the menu structure) will remain intact; i.e., the user will return through the window where the Battery Properties button was tapped.

6.4.4 Battery Monitor

6.4.4.1 Enable

This menu item enables the Supervisor to control the CXC's battery monitor feature.
Battery Properties section must be completed to enable this feature.

6.4.4.2 Load Type

This menu item enables the Supervisor to select the type of load on the system: constant power, current, or resistive. This is used for battery capacity calculations.

6.4.4.3 Disconnect Voltage

The disconnect voltage should be set to the value of the LVD that will disconnect the battery from the load. The Battery Runtime algorithm uses this value to calculate the hours remaining during an AC outage.

6.4.4.4 Reset Battery Monitor

The Battery Monitor should be reset when installing new or different batteries.

6.4.4.5 Battery Properties (See 6.4.8)

The "Battery Properties" button at the bottom of the Battery Monitor window is a link to the Battery Properties window.

The return path (the menu structure) will remain intact; i.e., the user will return through the window where the Battery Properties button was tapped.

6.4.5 Battery (Discharge) Test

The Battery Test (BT) is used to update the status of the battery capacity. It can be set to run automatically or can be initiated manually (via Mode Selection button). See 4.3.4 for more details.

6.4.5.1 BT End Voltage

This menu item controls the end (or termination) voltage of the BT; +0.5V above Rectifier BT Voltage is recommended.

Rectifier BT Voltage (identical to 6.3.2.3 – a change in one alters the other)

This menu item enables the Supervisor to set the Rectifier BT Voltage to the desired value during the test (mode). This setting should have a minimum of LVD + 1V.

Rectifier BT Timeout (identical to 6.3.2.11 – a change in one alters the other)

This menu item controls the duration of the Battery Test.

6.4.5.2 Auto-BT

Enable

This menu item enables the Supervisor to control the CXC's Auto-BT feature.

Interval

This menu item enables the Supervisor to program the time, in days, between Auto Battery Tests.

6.4.5.3 Remote BT Mode

This feature will force a transition to BT mode when a user-defined condition (custom alarm) is true.

Enable

This menu item enables the Supervisor to control the CXC's Remote BT feature.

Remote BT (Custom 1-20)

This menu item enables the Supervisor to assign the Custom Alarm (see 6.5.3 Configure Alarms) number between 1 and 20.

NOTE: *This feature is exclusive for the Cordex series of rectifiers. If Remote BT is active and a rectifier other than the Cordex series is added to the system then Remote BT will be aborted.*

6.4.5.4 Battery Properties (See 6.4.8)

The "Battery Properties" button at the bottom of the Battery Test window is a link to the Battery Properties window.

The return path (the menu structure) will remain intact; i.e., the user will return through the window where the Battery Properties button was tapped.

6.4.6 Battery Current Termination (BCT) Equalize

Refer to Section 3.7.3 for feature overview.

Since the BC Threshold is in amps, it has to be set with caution since the battery current input has limited accuracy. If it is too low, the threshold may never be reached. The threshold should be at least twice as large as the jitter on the battery current input. If this limitation forces the threshold to be set higher than desired, the BCT Duration can be increased slightly to compensate.

6.4.6.1 Enable

This menu item enables the Supervisor to control the CXC's BCT Equalize feature.

6.4.6.2 Duration

This menu item enables the Supervisor to program the duration of the BCT Equalize in hours.

6.4.6.3 BC Threshold

This menu item enables the Supervisor to program the threshold (in amps) for the battery charging current that will trigger the BCT Equalize.

6.4.6.4 Battery Properties (See 6.4.8)

The "Battery Properties" button at the bottom of the BCT Equalize window is a link to the Battery Properties window.

The return path (the menu structure) will remain intact; i.e., the user will return through the window where the Battery Properties button was tapped.

6.4.7 Boost (BST) Mode

This feature will allow a transition to BST mode when a user-defined condition (custom alarm) is false.

NOTE: *Activation is manual and certain conditions must be met to prevent damage to the load.*

A custom alarm must be created to include all the desired factors that must be taken into account before activating BST mode. This mode will then only be permitted if the alarm is false.

Once activated, BST mode concludes with a timeout or whenever the status of the custom alarm is true and reverts to FL mode. BST mode can also be cancelled if the conditions that are required in order to activate BST mode have changed.

6.4.7.1 Enable

This menu item enables the Supervisor to control the CXC's Boost Mode feature.

6.4.7.2 Voltage

This menu item controls the deviation of the Boost Mode voltage.

6.4.7.3 Timeout

This menu item controls the duration of the Boost Mode.

6.4.7.4 Inhibit

This menu item enables the Supervisor to assign the Custom Alarm (see 6.5.3 Configure Alarms) number between 1 and 20.

6.4.7.5 Battery Properties (See 6.4.8)

The "Battery Properties" button at the bottom of the Boost Mode window is a link to the Battery Properties window.

The return path (the menu structure) will remain intact; i.e., the user will return through the window where the Battery Properties button was tapped.

6.4.8 Battery Properties

Battery Properties contain information that is provided by the battery manufacturer. This data is used by Charge Current Control, Battery Monitor, and Temperature Compensation.

6.4.8.1 Capacity Rating (20-Hour Rate)

This menu item will enable the Supervisor to set the specified total capacity of the battery string (derived from battery manufacturer's specifications and should correspond to the C/20 Capacity if possible). This value will be used in the calculations for charge current control function and capacity estimation.

NOTE: *If multiple strings are used, this value will represent the total combined capacity of all battery strings summed together.*

6.4.8.2 Capacity Calibration

Selecting this Item will enable the Supervisor to enter a value to effectively "calibrate" the Battery Capacity. This is necessary when the batteries are first commissioned and whenever an independent test is done to measure the battery's capacity.

6.4.8.3 Open Circuit Voltage

This menu item will enable the Supervisor to set the open circuit voltage (derived from battery manufacturer's specifications).

6.4.8.4 Peukert Number

This number can be entered in two ways. If the Supervisor has a Peukert number from the battery manufacturer, then it can be entered as a simple, one step numeric entry.

NOTE: *The Peukert number relates to the internal resistance of a battery and provides an indication (inversely) of the expected capacity; that is, a lower number is better.*

If the Supervisor does not have a Peukert number, it must be calculated. This multi-step process involves entering four numbers derived from battery manufacturer's specifications. Resulting Peukert number should be above 1.000 and below 2.000.

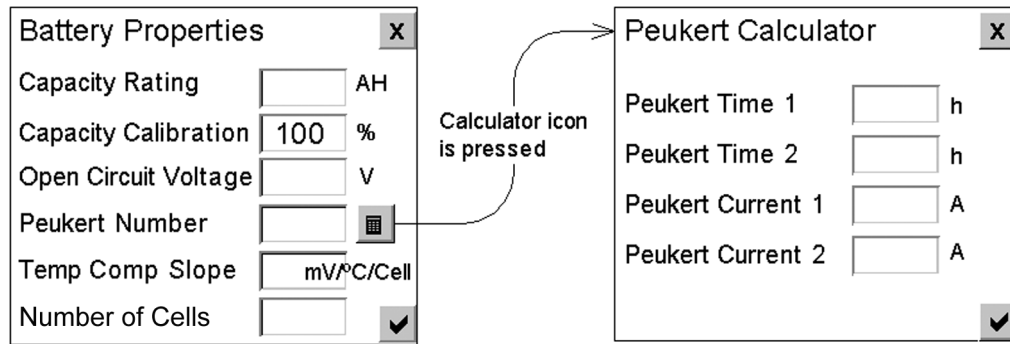

Figure 36–Battery Properties and Peukert Calculator windows

Peukert Calculator

To calculate the Peukert number the Supervisor must enter unique values for Peukert Time 1 and Peukert Time 2 and the corresponding discharge current for each. This information is taken from the battery specification sheet. Typically, time values of two hours and twenty hours provide the necessary data for the Peukert number calculation.

6.4.8.5 Temp Comp Slope

This menu item enables the Supervisor to enter the desired temperature compensation slope.

6.4.8.6 Number of Cells

This menu item enables the Supervisor to enter the number of battery cells per string.

6.4.9 Battery Information

The web interface provides an additional window to enter/view the manufacturer's data for the batteries in the system; e.g., for inventory purposes. When entering data, the tab key may be used to move the cursor from one data entry box to the next data entry box. See Figure 37 below.

NOTE: *This information is separate from the battery properties (see previous section) used for the existing battery management features of the CXC. The data must be obtained from the battery supplier and entered by the CXC Supervisor.*

Batteries > Battery Information					
Battery Information					
#	Battery ID	Manufacturer	Model	Date Code	Comments
1	<input type="text"/>	<input type="text"/>	<input type="text"/>	<input type="text"/>	<input type="text"/>
2	<input type="text"/>	<input type="text"/>	<input type="text"/>	<input type="text"/>	<input type="text"/>
3	<input type="text"/>	<input type="text"/>	<input type="text"/>	<input type="text"/>	<input type="text"/>
4	<input type="text"/>	<input type="text"/>	<input type="text"/>	<input type="text"/>	<input type="text"/>

Figure 37–Battery Information web interface window

6.5 Alarms

This menu category consists of power system alarms. Parameters can be set/accessed such as power system high/low voltage alarms, AC Mains high/low voltage alarms, Supervisor programmable alarms and alarm tone enable (audible alarm buzzer).

All voltage-related alarms (HVA 1 and 2, LVA 1 and 2) are based on voltage readings taken from analog input channel for the power system's BATTERY VOLTAGE.

See Table I for factory default settings.

6.5.1 Definitions

Major — This alarm consists of a group of alarm conditions that are considered serious or an immediate threat to service. The red front panel LED illuminates and the Major Alarm icon displays on the GUI.

Minor — This alarm consists of alarm conditions that are considered to be of a less serious nature or not an immediate threat to service. The yellow front panel LED illuminates and the Minor Alarm icon displays on the GUI.

Message — This is a non-audible non-priority alert. There is no change of LED activity and the Message icon displays on the GUI. The Supervisor may define the condition(s) and set relays to change.

Rectifier Major Fail Count — This alarm is the count of the number of rectifiers that are in a fail condition resulting in a major alarm or an immediate threat to service. The setting can be adjusted in the RECTIFIER MAJOR FAIL COUNT submenu.

Rectifier Minor Fail Count — This alarm is the count of the number of rectifiers that are in a fail condition resulting in a minor alarm or non-immediate threat to service. The setting can be adjusted in the RECTIFIER MINOR FAIL COUNT submenu.

Rectifier Minor Alarm — This is an alarm condition detected in a rectifier but is not considered an immediate threat to the operation of that rectifier.

Rectifier Fail Alarm — This is an alarm condition detecting a true or actual rectifier failure.

ALCO — Alarm cutoff (see Cutoff All Alarms button on page 24) will silence all ALCO enabled alarms as well as change relay state. For controls, the relay does not change state – only the audible alert is silenced.

6.5.2 Alarm Icons

The following icons display on the GUI to indicate condition and priority:

 — An active alarm condition.

 — An alarm condition that has been silenced.

 — A power system Major Alarm.

 — A power system Minor Alarm.

 — A power system Message alert.

 — Rectifier Information accompanied by the number of rectifiers in the system.

 — Power Save feature enabled and active accompanied by the number of rectifiers shut down.

6.5.3 Configure Alarms

Under this window of operation, there is a pull-down menu of the following headings:

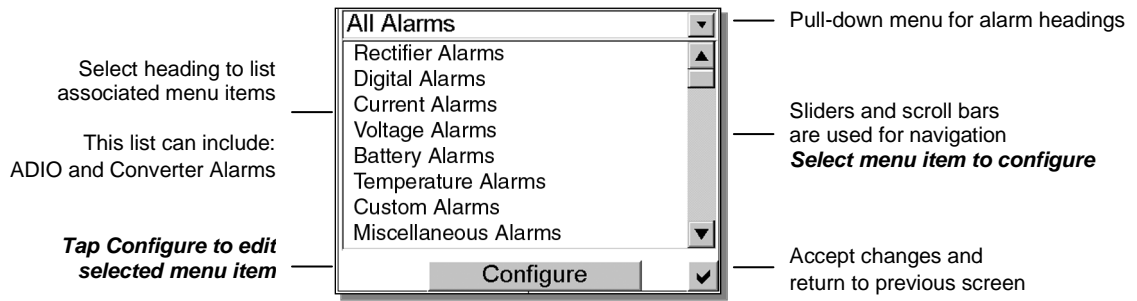

Figure 38—Configure Alarms window showing headings

For each of these headings there is a list of menu items with a scroll bar for navigation. *Tap to select.*

Tap “Configure” to enter a new window of operation for the item selected. In this new window, the Supervisor can set the following parameters:

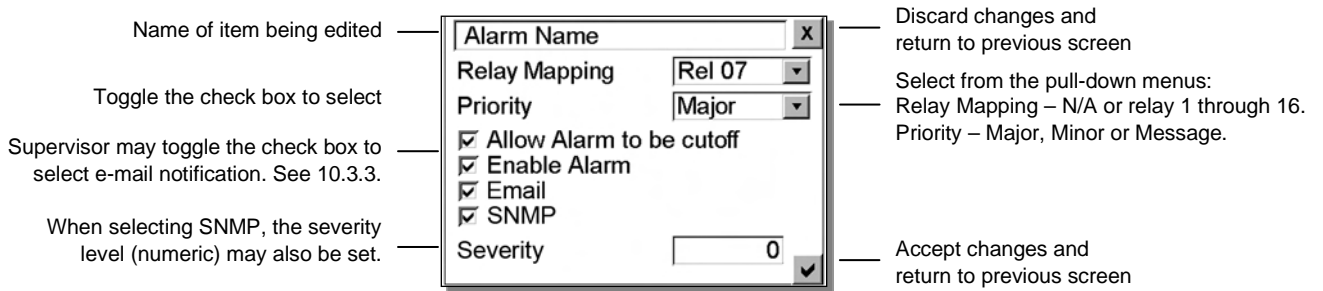

Figure 39—Configure (item selected) sample window

Alarms cannot be mapped to a relay unless it is enabled. Disabling an alarm that is mapped to a relay will free up that relay.

Occupied relays are indicated by the tilde “~” character beside the relay number.

Some parameters are factory set and will not be displayed under the Configure window for all alarms. Here are some of the additional parameters the Supervisor can expect to encounter:

Activation — Select from the pull-down menu; e.g., High or Low.

Activation Value — Tap on the number to edit via a virtual numeric keypad.

Equation — Tap Customize to edit (via Custom Alarms window).

Source — Select from the pull-down menu; e.g., Dig1 through Dig8.

The web interface provides a list of all alarms in one place. The configuration of most alarms may be done on this one screen:

The screenshot shows the 'Alarms > Configure Alarms' web interface. At the top, there is a dropdown menu for 'Alarm Configuration' set to 'Voltage Alarms'. Below this is a table with columns: Alarm Name, Activation Value, Enable, Priority, Relay Mapping, Alarm Cut Off, Email, SNMP, and Severity. The table lists various alarms such as 'AC Mains High', 'AC Mains Low', 'High Voltage 1', 'High Voltage 2', 'Low Voltage 1', 'Low Voltage 2', and five 'Midpoint Monitor' entries. The 'Midpoint Monitor' entries have a link icon next to their names. An arrow points from the text 'Click on the link to open a new window for editing the advanced setting.' to the link icon for 'Midpoint Monitor 1'. This opens a pop-up window titled 'Advanced Setting' for 'Midpoint Monitor 1', which contains an 'Input' field with a dropdown menu showing options V1, V2, I1, I2, I3, I4, and CPU. To the right of the pop-up, text explains that the supervisor can toggle the 'Email' checkbox and that selecting 'SNMP' requires setting a severity level.

Alarm Name	Activation Value	Enable	Priority	Relay Mapping	Alarm Cut Off	Email	SNMP	Severity
AC Mains High	270.0	<input checked="" type="checkbox"/>	Minor	Relay 6 (K6)	<input checked="" type="checkbox"/>	<input type="checkbox"/>	<input type="checkbox"/>	0
AC Mains Low	180.0	<input checked="" type="checkbox"/>	Minor	Relay 6 (K6)	<input checked="" type="checkbox"/>	<input type="checkbox"/>	<input type="checkbox"/>	0
High Voltage 1	55.50	<input checked="" type="checkbox"/>	Minor	N/A	<input checked="" type="checkbox"/>	<input type="checkbox"/>	<input type="checkbox"/>	0
High Voltage 2	56.50	<input checked="" type="checkbox"/>	Major	N/A	<input checked="" type="checkbox"/>	<input type="checkbox"/>	<input type="checkbox"/>	0
Low Voltage 1	48.00	<input checked="" type="checkbox"/>	Minor	N/A	<input checked="" type="checkbox"/>	<input type="checkbox"/>	<input type="checkbox"/>	0
Low Voltage 2	46.50	<input checked="" type="checkbox"/>	Major	N/A	<input checked="" type="checkbox"/>	<input type="checkbox"/>	<input type="checkbox"/>	0
Midpoint Monitor 1	0.50	<input checked="" type="checkbox"/>	Minor	N/A	<input checked="" type="checkbox"/>	<input type="checkbox"/>	<input type="checkbox"/>	0
Midpoint Monitor 2	0.50	<input type="checkbox"/>	Minor	N/A	<input checked="" type="checkbox"/>	<input type="checkbox"/>	<input type="checkbox"/>	0
Midpoint Monitor 3	0.50	<input type="checkbox"/>	Minor	N/A	<input checked="" type="checkbox"/>	<input type="checkbox"/>	<input type="checkbox"/>	0
Midpoint Monitor 4	0.50	<input type="checkbox"/>	Minor	N/A	<input checked="" type="checkbox"/>	<input type="checkbox"/>	<input type="checkbox"/>	0
Midpoint Monitor 5	0.50	<input type="checkbox"/>	Minor	N/A	<input checked="" type="checkbox"/>	<input type="checkbox"/>	<input type="checkbox"/>	0

Figure 40—Configure Alarms sample web interface window

6.5.3.1 Overview of Output Relay Channels and Configuration

One active control can be mapped for each of the relays; for example, Relay 1 can be unassigned from LVD 1 then remapped as an **alarm** relay.

Any **alarm** (even multiple alarms) can be mapped to any unoccupied relay.

The table below summarizes the output channel assignments:

Channel Description	Factory Default Designation
Relay 1	LVD 1
Relay 2	LVD 2
Relay 3	LVD 3
Relay 4	POWER SYSTEM MINOR ALARM
Relay 5	POWER SYSTEM MAJOR ALARM
Relay 6	AC MAINS HIGH/LOW ALARM
Relay 7	RELAY 7 (Unassigned)
Relay 8	RELAY 8 (Unassigned)
Relay 9 – 16	...(Unassigned)

Table A—Output channel assignments

The following sections describe the menu headings and the associated lists of items.

6.5.3.2 Rectifier Alarms

Rectifier Fail

This menu item enables the Supervisor to set an alarm condition for a true or actual rectifier failure. The activation value is factory set.

Rectifier Minor

This menu item enables the Supervisor to set an alarm condition for a minor rectifier failure; i.e., an alarm condition detected in a rectifier, but one that is not considered an immediate threat to the operation of that rectifier. The activation value is factory set.

Rect. Major Fail Count

This menu item enables the Supervisor to set the total number of rectifier fail alarms that will trigger the CXC's rectifier major alarm. The activation value must be greater than or equal to the total number entered for the minor rectifier fail count alarm.

Rect. Minor Fail Count

This menu item enables the Supervisor to set the total number of rectifier fail alarms that will trigger the CXC's rectifier minor alarm. The activation value must be less than or equal to the number entered for the major rectifier fail count alarm.

Rectifier Lockout (Pathfinder series only)

This menu item enables the Supervisor to set an alarm condition when a Pathfinder series rectifier lockout is detected. The activation value is factory set.

Out of Tolerance

This menu item enables the Supervisor to set an alarm condition when a rectifier out of tolerance is detected. The activation value is factory set.

Rect. Comms Lost

This menu item enables the Supervisor to set an alarm condition when rectifier communications is lost. The activation value is factory set.

Rect. Equalize Activated

This menu item enables the Supervisor to set an alarm condition when a rectifier in EQ mode is detected. The activation value is factory set.

Rect. AC Mains Fail

This menu item enables the Supervisor to set an alarm condition when a rectifier AC mains fail is detected. The activation value is factory set.

The activation value for AC Mains Fail detection is determined to be when the number of rectifiers in AC Fail divided by the number of rectifiers acquired is greater than or equal to 90%.

Max Rectifiers Exceeded

This menu item enables the Supervisor to set an alarm condition when the maximum number of rectifiers is exceeded. The activation value is factory set.

Fan Fail Alarm (for Fan Cooled Systems)

The purpose of this feature is to enable the CXC to trigger the alarm when a fan fail (speed error or failed fan) condition has occurred in any of the rectifiers in the system.

- The Fan Fail Alarm is true when the CXC receives a Fan Fail or Fan Speed Error alarm from any rectifier.
- The Fan Fail Alarm is cleared when all Fan Fail and Fan Speed Error alarms are cleared from all the rectifiers.
- Each time that the Fan Fail Alarm goes on/off, the "event" is logged in the Event History. Since it is a rectifier alarm, up to nine rectifiers (up to 27 fan fail alarms) that are in alarm will be logged. If more than nine rectifiers are in alarm an additional entry will be made indicating the total number of rectifiers in alarm.

The activation value is factory set.

Power Save

This menu item enables the Supervisor to set an alarm condition when a rectifier is in Power Save mode. The activation value is factory set.

Urgent AC Mains Fail

This menu item enables the Supervisor to set a major alarm condition when the Rectifier AC Mains Fail alarm has been active for a period of time; the default activation value is ten (10) minutes:

The screenshot shows a configuration window titled "Urgent Rect. AC Mains Fail". The window contains the following fields and controls:

- Activation Value:** A numeric keypad input showing "10" and a unit selector dropdown showing "m".
- Relay Mapping:** A pull-down menu showing "N/A".
- Priority:** A pull-down menu showing "Major".
- Checkboxes:**
 - Allow Alarm to be cutoff
 - Enable Alarm
 - Email
 - SNMP
- Severity:** A numeric keypad input showing "3" and a confirmation checkmark.

Callouts from the left side:

- "Tap on the Activation Value to edit via a virtual numeric keypad" points to the "10" input.
- "Toggle the check box to select" points to the "Allow Alarm to be cutoff" checkbox.
- "Supervisor may toggle the check box to select e-mail notification. See 10.3.3." points to the "Email" checkbox.
- "When selecting SNMP, the severity level (numeric) may also be set." points to the "3" input.

Callouts from the right side:

- "Discard changes and return to previous screen" points to the "X" button in the top right corner.
- "Select from the pull-down menus: Relay Mapping – N/A or relay 1 through 16. Priority – Major, Minor or Message." points to the "Relay Mapping" and "Priority" dropdowns.
- "Accept changes and return to previous screen" points to the checkmark button in the bottom right corner.

Figure 41–Configure Urgent AC Mains Fail sample window

6.5.3.3 Digital Alarms

This menu item enables the Supervisor to configure the alarms associated with each digital input.

Each digital input channel is designed to detect zero-system voltage (i.e. off/on) signal. Six of the digital channels have assigned functions, while two are unassigned. The Table below summarizes the digital channel assignments:

Channel Description	Factory Default Designation
DIG1 (D1 on PCB)	Distribution Fuse/Circuit Breaker
DIG2 (D2 on PCB)	Battery Fuse/Circuit Breaker
DIG3 (D3 on PCB)	LVD Manual In
DIG4 (D4 on PCB)	LVD Manual Out
DIG5 (D5 on PCB)	Converter Fail
DIG6 (D6 on PCB)	Converter I/P Breaker Trip
DIG7 (D7 on PCB)	Digital 7 (unassigned)
DIG8 (D8 on PCB)	Digital 8 (unassigned)

Table B–Digital input channel assignments

Digital events occurring on one of the digital inputs can be programmed to the output alarm relays using the programming feature for the relay contact similar to analog alarms.

User (or Supervisor) may view status of each digital input under the Signals menu, see 6.6.2.3.

The following menu items enable the Supervisor to configure the alarms associated with each analog input.

6.5.3.4 Current Alarms

Battery Current High

This menu item enables the Supervisor to program the setting for the battery amps alarm. When the total current to the battery exceeds this setting, the alarm is activated and the message BATTERY CURRENT HIGH is displayed on the GUI.

Load Current High

This menu item enables the Supervisor to program the setting for the load amps alarm. When the current to the load has exceeded this setting, an alarm is activated and the message LOAD CURRENT HIGH is displayed on the GUI.

6.5.3.5 Voltage Alarms

AC Mains High

This menu item enables the Supervisor to program the setting for the mains high alarm. When the AC exceeds this setting, the alarm is activated and the message AC MAINS HIGH is displayed on the GUI.

AC Mains Low

This menu item enables the Supervisor to program the setting for the mains low alarm. When the AC input to the power system falls below this setting, the alarm is activated and the message AC MAINS LOW is displayed on the GUI.

High Voltage [1-2]

When the power system's DC voltage exceeds the Supervisor-specified value, the alarm is activated and the message HIGH VOLTAGE 1 (or 2) is displayed.

Low Voltage [1-2]

When the power system's DC voltage falls below the Supervisor-specified value, the alarm is activated and the message LOW VOLTAGE 1 (or 2) is displayed.

Midpoint Monitor [1-5]

This menu item enables the Supervisor to program the setting for the midpoint monitor voltage alarm. When the voltage reading (1 through 5) exceeds this setting (from the midpoint), the alarm is activated and the message MIDPOINT MONITOR 1 (or 2-5) is displayed.

6.5.3.6 Battery Alarms

Battery Runtime Low

The Supervisor can specify, in hours, when the battery runtime alarm activates with respect to the hours remaining in the battery runtime prediction.

Battery Capacity (Remaining) Low

This menu item enables the Supervisor to set the battery capacity alarm trigger point as a percentage. When the capacity of the battery is depleted to this specified value, the capacity alarm is activated.

Battery Overtemp

This menu item enables the Supervisor to set the temperature at which the battery over temperature alarm will activate.

Battery On Discharge

This menu item enables the Supervisor to set an alarm when the battery is on discharge; e.g., during AC Fail or BT mode.

Battery Test

This menu item enables the Supervisor to set an alarm when the Battery Test is in progress.

Boost Mode

This menu item enables the Supervisor to set an alarm when the BST mode is activated.

6.5.3.7 Temperature Alarms

Temp Sensor Fail [1-4]

This menu item enables the Supervisor to set an alarm when any temperature sensor fails.

TC Sensor Fail

This menu item enables the Supervisor to set an alarm when a sensor enabled for Temp Comp fails.

6.5.3.8 Miscellaneous Alarms

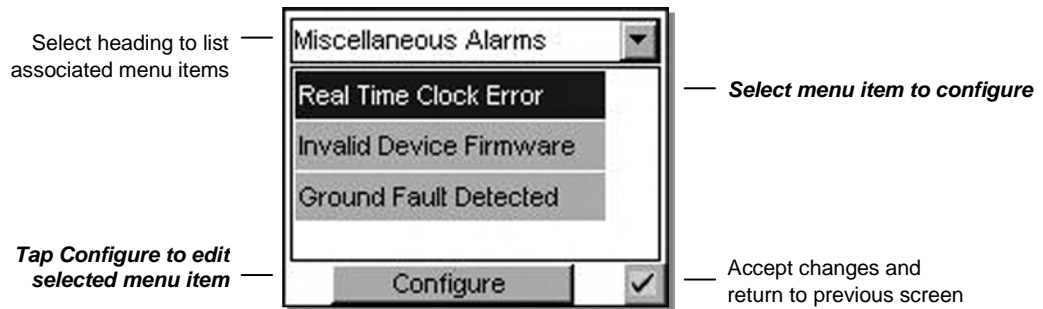

Figure 42–Miscellaneous Alarms window showing menu items

Real Time Clock Error

This menu item enables the Supervisor to set an alarm when any change to the CXC’s clock occurs; due to a battery failure or the real time clock itself failing. The alarm will become active whenever the date is before Jan. 1, 2000 or after Dec. 31, 2030.

Invalid Device Firmware

This menu item enables the Supervisor to set an alarm in the event that the firmware of a device (e.g. Cordex rectifier) has become corrupt and is no longer functioning.

Ground Fault Detected (High Voltage CXC only)

This menu item enables the Supervisor to set the value at which the ground fault detected alarm will activate. The default value is +/-5mA.

Improper Controller Shutdown

This menu item enables the Supervisor to set an alarm in the event that the firmware of the controller has become corrupt and is no longer functioning.

Invalid Battery Voltage

This menu item enables the Supervisor to set an alarm when the charging voltage is invalid; e.g., in the event that the sense leads have become disconnected. The alarm activates when the charge volts signal drops below 5V and halts all control of the system that relies on this signal. If activated (enabled) an entry will be made in the event log.

System Major

This menu item enables the Supervisor to map a relay to the power system major alarm, which is activated if there are one or more active MAJOR alarms. A pull-down menu with scroll bars may be used for navigation.

System Minor

This menu item enables the Supervisor to map a relay to the power system minor alarm, which is activated if there are one or more active MINOR alarms. A pull-down menu with scroll bars may be used for navigation.

6.5.3.9 ADIO Alarms

This menu item enables the Supervisor to configure the alarms associated with each ADIO device. Events occurring on one of the inputs can be programmed to the output alarm relays using the programming feature for the relay contacts similar to other alarms.

User (or Supervisor) may view the device status under the ADIO Alarms Detail menu, see 6.5.4.

6.5.3.10 Custom Alarms (1-20)

This menu item enables the Supervisor to program 20 separate alarm-triggering equations into the CXC software. The equations may reference any combination (up to 16) of the analog inputs, digital inputs, virtual inputs, and alarms (such as Fan Fail) utilizing logical and arithmetic arguments that simulate the functionality of a programmable logic controller (PLC). See also 7.2 Equation Builder Keypads.

Signal and a Numeric Value Selected

In this example, one signal (V1) and a numeric value (53.50) are selected for the Custom1 alarm to be triggered when $[V1] > 53.50$. The first operand chosen (top pull-down menu) is Analog Inputs. The next pull-down menu shows that the Supervisor must select from a list of inputs of that type. An operator is selected from the virtual keypad. The keypad is then changed to numeric in order to enter a numeric value to complete the equation.

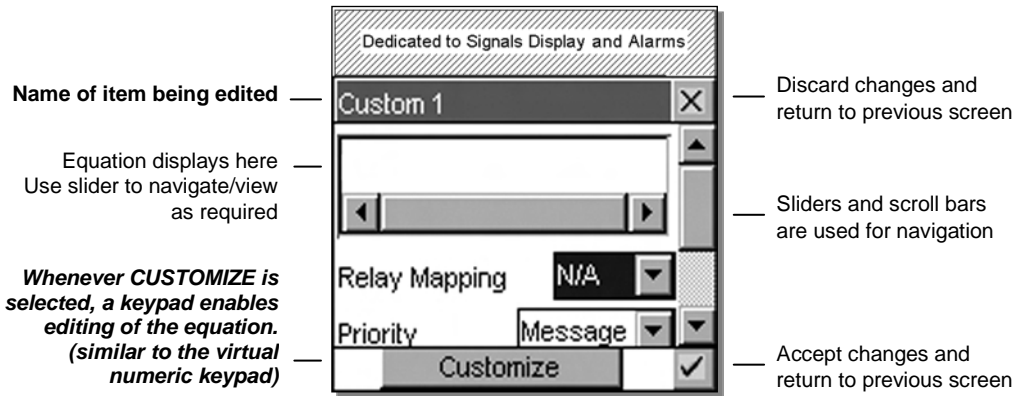

Figure 43—Custom Alarm screen

Select Customize to program an alarm-triggering equation as described below.

At any time, as required, select the X icon to cancel entry and close window.

1. Inside the first window shown, after Customize is selected, is the equation building area, numeric keypad and other function keys. Select [Op] for operand (pull-down menu of alarms, signals, etc.).
2. Use pull-down menus to locate Analog Inputs: V1.
3. Select signal (e.g. V1) to add to equation builder.
4. Select Sym for arithmetic symbols (e.g. >) and logic operators and continue to build equation.
5. Select 123 to return to numeric keypad. Enter value (e.g. 53.50) to complete equation.
6. When equation is complete, select the check mark icon (in the lower right corner) to accept changes and return to previous window.

These notes correspond to the numbers in the sequence of figures below:

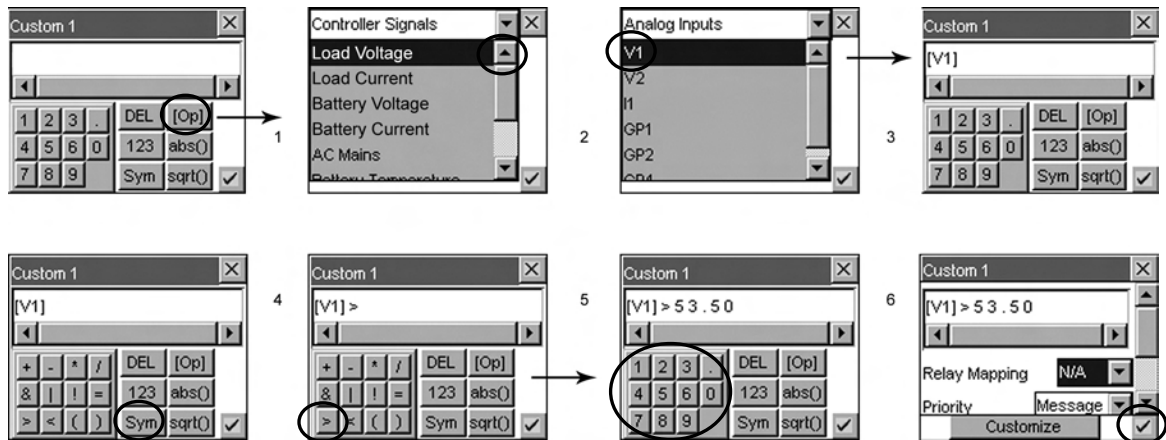

Figure 44—Customize Alarm example

Example 1: Add More Rectifiers Alarm

The function of the following equation is to activate a custom alarm when load increases to a point where redundancy is compromised, but before any rectifiers go into power limit.

Enter the equation taking into consideration logic operators and the number and type of brackets used:

$$[\text{Load Current}] > ((([\# \text{ Acquired Rectifiers}]-1)*55)-5.5)$$

Where 1 is the number of redundant rectifiers, 55 is the max output current of a single rectifier before going into power limit (3kW PFM in this case), and 5.5 is the number of excess amps in the system required for battery float charging, LVD coils or anything that draws current from the rectifiers that is not the load.

Example 2: Generator ON/OFF Control

The function of the following equations will establish a pair of custom alarms that will activate one relay to start a secondary generator and another relay that stops the generator.

2a) Custom Alarm A to start a secondary generator:

$$((V2 \leq 46) \& (D8 = 0) \& (D7 = 0)) | (V2 < 44.5)$$

When battery is discharged (system voltage (V2) is less than 46V) and primary (D7) and secondary (D8) generators are not on, OR system voltage is very low, activate. This alarm is exclusively mapped to a relay that is used to start the secondary generator.

2b) Custom Alarm B to stop a secondary generator:

$$((I2 \leq 6) \& (V2 > 53) \& (D8=1)) | (D7= 1)$$

When battery is charged (battery current (I2) is low and system voltage (V2) is near normal) OR primary (D7) generator is on, activate. This alarm is exclusively mapped to a relay that is used to stop the secondary generator.

Example 3: AC Voltage Reading in Mixed Rectifier Systems

The following scenario involves a CXC controlling Pathfinder 10kW rectifiers and Cordex 3.6kW rectifiers in a system with 277Vac. The CXC will compute the average AC reading of all rectifiers (for the AC MAINS HIGH/LOW alarms). In a PFM-CXR system, it may be desirable to have a separate AC alarm for each rectifier type.

To create separate alarms, first use the rectifier Phase Mapping feature (6.3.4) to assign each group of rectifiers to a different phase.

NOTE: *the three individual phase voltages will no longer apply; instead, the average of the AC input voltage on each system would be given.*

Next, disable the regular AC alarms (6.5.3.5).

Finally, create custom alarms using the average phase voltages. Here is one possible equation:

$$([\text{Average AC Phase R}] < 240) | ([\text{Average AC Phase R}] > 300)$$

Scheduler Usage

The controller has basic scheduling capability that is implemented by using a System Time or System Date signal in any customizable equation; used to trigger external events on a timely basis, whether daily or at a specific date.

This is accomplished by using the System Time or System Date signal as an operator in a Custom Alarm equation, which has been configured to change the state of a relay output. The equation can include any other signals such as battery current or voltage for more advanced control. The System Time or System Date signal can only be used with the following operators: >, <, and =.

NOTE: *the formats used for the Time and Date Operands are very specific and must match exactly in order for an equation to be valid. For the System Time the format is <hh.mm.ss>> and for System Date the format is <<20YY.MM.DD>>. The '20' prefix for the year is what distinguishes the date from the time so it must not be omitted when entering a Date Operand.*

Example 1: The following equation in a Custom Alarm will cause the alarm to be true for ten seconds (10s) at 2:35AM:

[System Time (HH.MM.SS)] > <<02.35.00>> & [System Time (HH.MM.SS)] < <<02.35.10>>

If the alarm is mapped to a relay, the relay will activate for 10s.

Example 2: Another example activates the alarm daily at 23:59:45 and clears when the battery voltage is less than 46V. This is the equation for the alarm named Custom 2:

(([System Time (HH.MM.SS)] > <<23.59.45>>) | ([Custom 2] > 0)) & ([Battery Voltage] > 46)

Note the term: ([Custom 2] > 0). This is to latch the alarm ON since the term: ([System Time (HH.MM.SS)] > <<23.59.45>>) will evaluate to false once the midnight rollover* (<<00.00.00>>) happens.

**Midnight Rollover is described with an example under Custom Signals.*

Example 3: We can use the previous example along with a Counter to set the alarm to activate every three days. These are the equations for Counter 1:

Count Event "[System Time (HH.MM.SS)] > <<01.00.00>>"
Reset Event "[Counter 1]>2"

This will cause Counter 1 to count once daily at 01.00.00. When the count gets to three, it is immediately reset back to zero. So, every third day, the count returns to zero.

Our Custom 2 alarm equation can now be:

(([System Time (HH.MM.SS)] > <<23.59.45>>) | ([Custom 2] > 0)) & ([Battery Voltage] > 46) & ([Counter 1] = 0)

The resulting behavior will be similar to that in Example 2, except the alarm will only activate once every 3 days.

The following sub-section describes the converter alarms menu headings and the associated items.

6.5.3.11 Converter Alarms

Converter Fail

This menu item enables the Supervisor to set an alarm condition for a true or actual converter failure. The activation value is factory set.

Converter Minor

This menu item enables the Supervisor to set an alarm condition for a minor converter failure; i.e., an alarm condition detected in a converter, but one that is not considered an immediate threat to the operation of that converter. The activation value is factory set.

Conv. Major Fail Count

This menu item enables the Supervisor to set the total number of converter fail alarms that will trigger the CXC's converter major alarm. The activation value must be greater than or equal to the total number entered for the minor converter fail count alarm.

Conv. Minor Fail Count

This menu item enables the Supervisor to set the total number of converter fail alarms that will trigger the CXC's converter minor alarm. The activation value must be less than or equal to the number entered for the major converter fail count alarm.

Conv. Out of Tolerance

This menu item enables the Supervisor to set an alarm condition when a converter out of tolerance is detected. The activation value is factory set.

Conv. Comms Lost

This menu item enables the Supervisor to set an alarm condition when converter communications is lost. The activation value is factory set.

Conv. Input Voltage Fail

This menu item enables the Supervisor to set an alarm condition when a converter input voltage fail is detected. The activation value is factory set.

The activation value for Input Voltage Fail detection is determined to be when the number of converters in Input Voltage Fail divided by the number of converters acquired is greater than or equal to 90%.

Conv. Fan Fail

The purpose of this feature is to enable the CXC to trigger the alarm when a fan fail (speed error or failed fan) condition has occurred in any of the converters in the system.

- The Fan Fail Alarm is true when the CXC receives a Fan Fail or Fan Speed Error alarm from any converter.
- The Fan Fail Alarm is cleared when all Fan Fail and Fan Speed Error alarms are cleared from all the converters.
- Each time that the Fan Fail Alarm goes on/off, the "event" is logged in the Event History. Since it is a converter alarm, up to nine converters (up to 27 fan fail alarms) that are in alarm will be logged. If more than nine converters are in alarm an additional entry will be made indicating the total number of converters in alarm.

The activation value is factory set.

Conv. Load Current High

This menu item enables the Supervisor to program the setting for the converter load amps alarm. When the current to the load has exceeded this setting, an alarm is activated and the message CONV. LOAD CURRENT HIGH is displayed on the GUI.

Conv. Low Output Voltage

When the converter's output voltage falls below the Supervisor-specified value, the alarm is activated and the message CONV. LOW OUTPUT VOLTAGE is displayed on the GUI.

Conv. High Output Voltage

When the converter's output voltage exceeds the Supervisor-specified value, the alarm is activated and the message CONV. HIGH OUTPUT VOLTAGE is displayed on the GUI.

6.5.4 ADIO Alarms Detail

6.5.4.1 View Details

This menu item enables the user to select an ADIO device (i.e., Cordex Smart Peripheral) that is connected to the CXC and view the alarms with respect to: Cell Deviation, Current, Voltage, Temperature, and Comms.

6.5.5 Alarm Hysteresis

6.5.5.1 Voltage

Voltage Hysteresis applies only to Voltage Alarms (6.5.3.5). This value is the voltage range where the alarm can clear or activate. For example, if the low voltage alarm activates at 43.00V, having a voltage hysteresis of 0.50V means it will clear when the voltage reaches 43.50V.

6.5.5.2 Time

Time Hysteresis is the amount of time in seconds that the condition has to be true before the alarm is enunciated. In the example above, if the value of time hysteresis is 5 seconds, the voltage must be below 43.00V for at least 5 seconds before the alarm is activated. Similarly, to clear the alarm, the voltage must be above 43.50V for 5 seconds.

This feature is used only for the following:

- Current, Voltage, Battery, and Temperature alarms
- HVSD and CEMF controls.

6.5.6 Alarm Tone

This feature is found under the **Global Alarm Configuration** menu (submenu of Alarms) and the tone is enabled by default. The Supervisor may enable/disable the **Audible Alarm Buzzer** (tone). Enabling the **Loud Buzzer** option increases the pitch and volume of the buzzer.

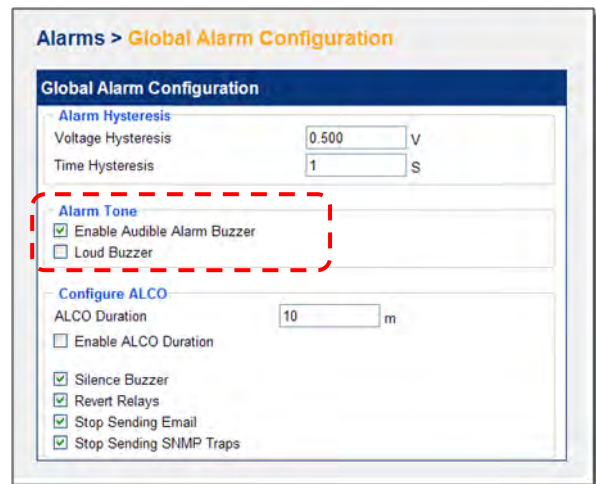
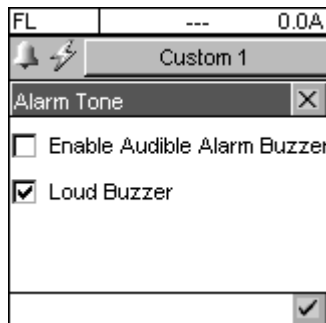

Figure 45—Global Alarm Configuration LCD and web interface

6.5.7 Configure ALCO

This feature is found under the Global Alarm Configuration menu (submenu of Alarms), see Figure below:

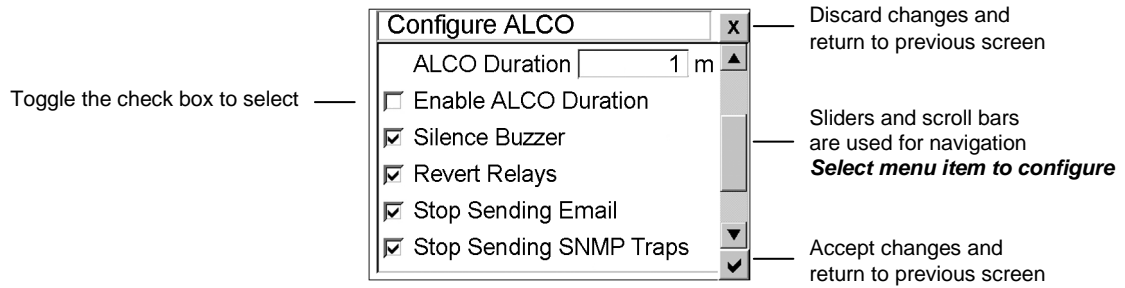

Figure 46—Configure ALCO window

6.5.7.1 ALCO Duration

This menu item enables the user to program the duration in minutes that all ALCO enabled alarms will be affected by the parameters set by this feature. Tap on the number to edit via a virtual numeric keypad.

6.5.7.2 Enable ALCO Duration

This menu item enables the user to control the ALCO Duration feature.

6.5.7.3 Silence Buzzer

This menu item enables the user to control the audible alerts for ALCO enabled alarms.

6.5.7.4 Revert Relays

This menu item enables the user to control the state of ALCO enabled relays.

6.5.7.5 Stop Sending Email

This menu item enables the user to control the transmission of Email communications.

6.5.7.6 Stop Sending SNMP Traps

This menu item enables the user to control the transmission of SNMP communications.

6.6 Signals

This menu category consists of system identifiers and calibration controls. Parameters can be set/accessed such as controller signals, rectifier signals, analog and digital inputs. With the web interface, data logging may be performed.

6.6.1 Calibrate Analog Inputs

This menu item provides a direct link to the Analog Inputs menu heading; which may also be accessed via the menu item Configure Signals, see 6.6.2.

6.6.1.1 Analog Inputs

This menu item will display a list of all the existing analog input channels.

Definitions

The majority of the CXC's analog input channels are each designed to accept a specific input signal, where:

√	=	Installed
BiV	=	-60V to +60V
I	=	-50mV to +50mV
T	=	-55°C to +100°C (powered)
V	=	0 to 60V
X	=	Not Installed

The following table summarizes the analog input channel assignments; which may vary depending on the hardware configuration (list options):

Channel Assignment	List Option						
	120	121	122	123	124	125	129
V1	√	√	√	√	√	√	√
V2	√	√	X	√	√	√	√
GP1	T1	T1	T1	T1	V3	T1	T1
GP2	T2	T2	T2	T2	V4	T2	T2
GP3	X	T3	X	T3	V5	BiV	T3
GP4	BiV	T4	BiV	T4	T1	BiV	T4
I1	√	√	√	√	√	√	√
I2	X	√	X	X	X	√	√
I3	X	X	X	X	X	√	√
I4	X	X	X	X	X	√	√

Table C—Analog input channel assignments

Calibration

From this pop-up window, the Supervisor can calibrate the selected channel by setting the high point or low point or both as shown in the following example:

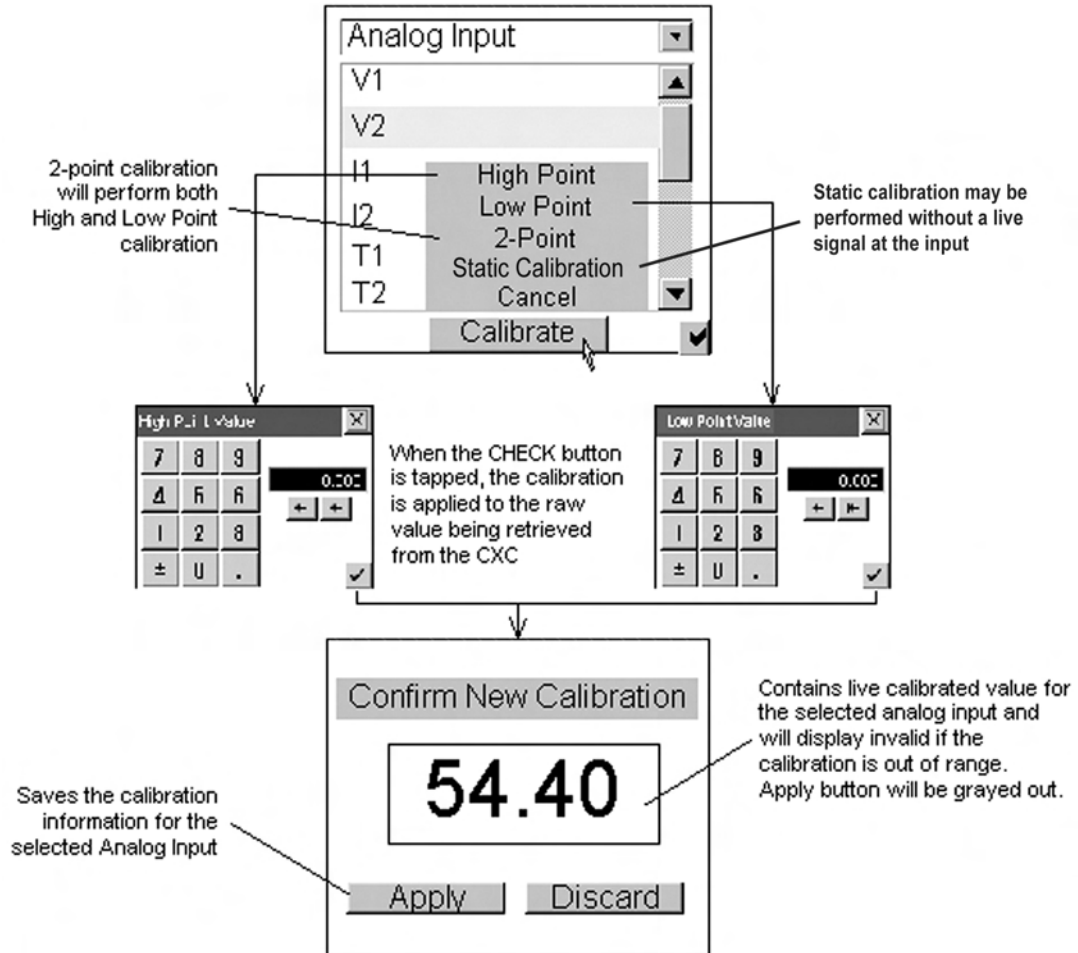

Figure 47—Analog Inputs calibration example

Tap to Cancel or proceed through the screens in the example above. *Apply* or *Discard* the calibration information as desired.

NOTE: a more detailed method of procedure can be found by visiting the Alpha website at www.alpha.ca. Look under the **Support** menu item!

Static Calibration

Static calibration enables the Supervisor to calibrate controller analog inputs without the need for a live signal at the input. This is especially useful for calibrating current inputs for systems in the field. See Figures below:

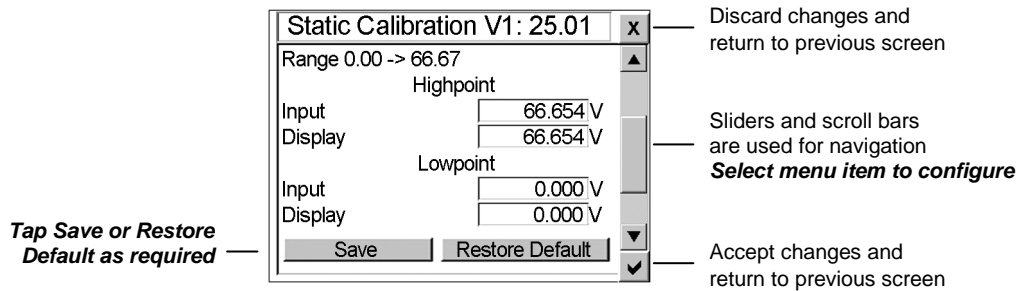

Figure 48–Static calibration window

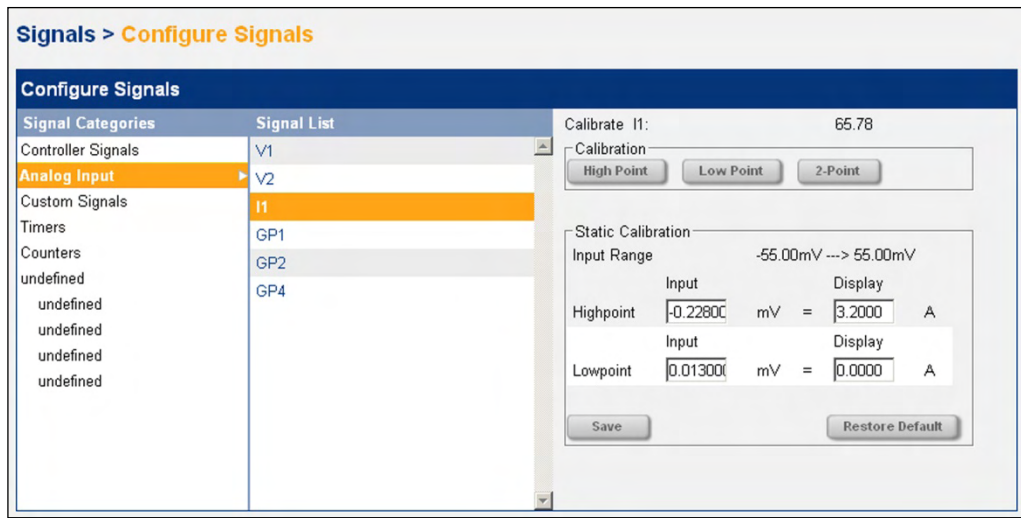

Figure 49–Static calibration (via web interface)

6.6.2 Configure Signals

This menu item provides a link for the Supervisor to configure controller Signals (and Analog Inputs described above). The status of Digital Inputs and Rectifier Signals may also be viewed under this menu.

6.6.2.1 Controller Signals

Select this heading from the pull-down menu to access/edit the list of Controller Signals (4.5) menu items such as load current and battery temperature (to enable sensors, see Figure 52).

Once a menu item is selected, tap the “Configure” button to produce another window and list of items⁴ to navigate and edit. See examples on the next page.

Definitions

Load Voltage — The discharge voltage.

Load Current — The discharge current.

Battery Voltage — The charge or system voltage.

Battery Current — The charge current.

AC Mains — The average rectifier input voltage. AC Correction appears when AC Mains is selected.

Total Rectifier Current — The sum of rectifier output currents.

Battery Temperature — The average of enabled sensors (if temperature sensors agree within 5%) or the peak value of enabled sensors (if temperature sensors do not agree within 5%).

Battery Run Time — The estimated time remaining before LVD.

Battery Capacity — A battery’s estimated ability to store charge.

Battery Depth of Discharge — An estimate of the energy removed from a battery during a discharge.

Converter Load Voltage — The converter output voltage.

Converter Load Current — The converter output current.

The table below summarizes the default controller signal equations:

Controller Signals	Signal Equations
Load Voltage	[V1]
Load Current	[I1]
Battery Voltage	[V2]
Battery Current	[Total Rectifier Current] – [Load Current]

Table D—Controller signal default definitions

6.6.2.2 Analog Inputs

Select this heading from the pull-down menu to access/edit list of Analog Inputs menu items. See 6.6.1 for details.

6.6.2.3 Digital Inputs

Select this heading from the pull-down menu to access a list of all the existing digital channels, see 6.5.3.3 for Alarms. The status of the channel, high or low, is displayed in the column next to the channel name.

6.6.2.4 Rectifier Signals

Select this heading from the pull-down menu to access a list of all the existing rectifier signals. The status of the signal is displayed in the column next to the signal name.

⁴ “Signal Equation” or “Customize” does not appear for AC Mains or Battery related menu items.
0350046-J0 Rev C

AC Mains Voltage Correction – provides the means to apply a correction factor to the reading coming from the rectifier. There are correction factors for each ac input phase and for the combined average ac voltage.

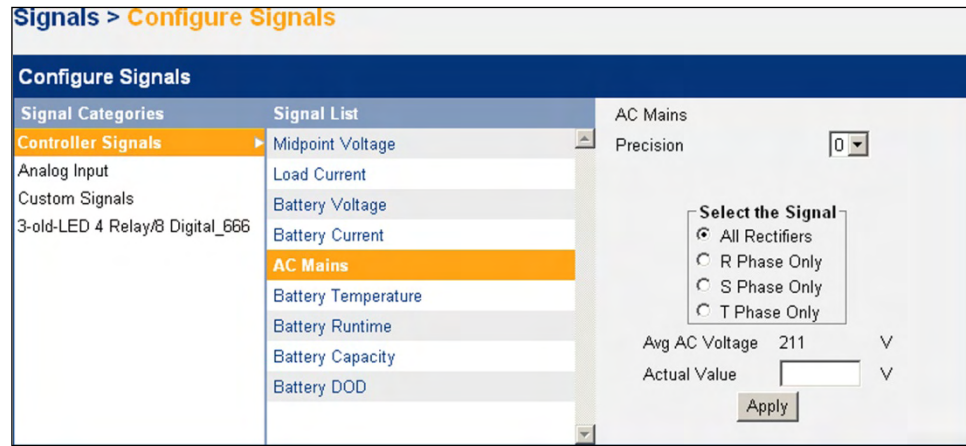

Figure 50–AC mains voltage correction (via web interface)

6.6.2.5 Custom Signals

Select this heading from the pull-down menu to access/edit a list of Custom Signals. Once a menu item is selected, tap the “Configure” button to produce another window and list of items to navigate. With the web interface, the Supervisor may define the unit text string that represents the units value; e.g., $\pm V$, AH, mm, etc. The user may choose to use an equation to define the value of a Custom Signal, or they may allow the signal to be “settable” over SNMP.

6.6.2.6 Examples of Signal Configuration and Customization

Example One – Configure Signal and Customize Signal Equation

From this window, the Supervisor can configure the selected signal. Use the pull-down menu to set the decimal precision or tap Customize to build a signal equation similar to the equation shown in 6.5.3.10 Custom Alarms. See also 7.2 Equation Builder Keypads.

NOTE: *Once a signal equation has been built – it may be edited or disabled – it cannot be removed.*

Example Two – Configure AC Mains

From this window, the Supervisor can configure the AC Mains signal. Use the pull-down menu to set the decimal precision as shown in the following example:

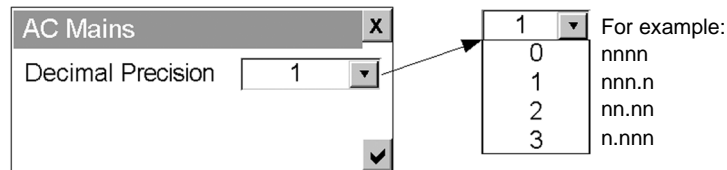

Figure 51–Controller Signals configuration example two (set decimal precision)

Example Three – Configure (Battery Temperature sensors)

From this window, the Supervisor can configure the Battery Temperature signal and sensors. Use the pull-down menu to set the decimal precision and tap/toggle the check boxes to enable sensor(s) for battery temperature as shown in the following example:

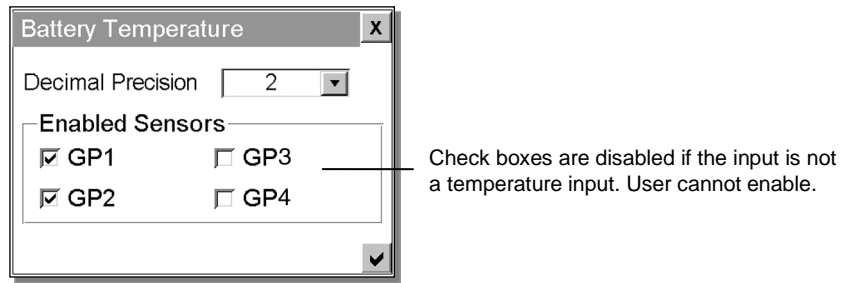

Figure 52–Controller Signals configuration example three (enable temperature sensors)

Example Four – Configure ADIO01 (Shunt MUX)

Under the menu item Configure Signals, the Supervisor can configure the input range of each of 16 channels for the Cordex Shunt MUX.

1. Select channel (CH15 in the example below) and then Configure.
2. The window changes to show a list (for review) of the input range of each channel. Multiple channels can be selected for the new value. Select channels and then Set Range to configure (or select the ✓ icon to accept the list and return to the previous window).
3. The virtual numeric keypad enables editing of the input range. Select the X icon to return to the previous window or select the ✓ icon to accept the new setting.

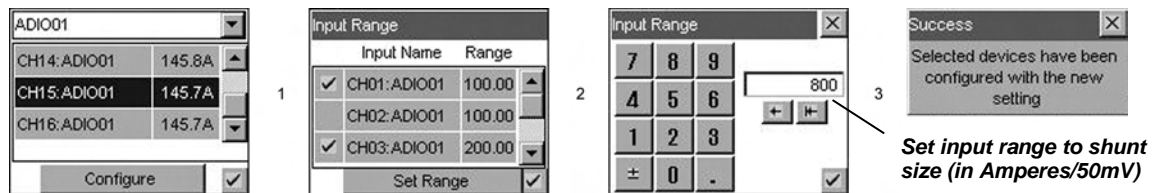
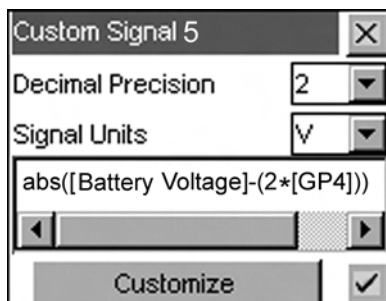

Figure 53–Controller Signals configuration example four (configure input range for Shunt MUX channels)

A message will indicate that the selected devices have been configured with the new setting. Select the X icon to return to the first window.

Example Five – Midpoint Voltage Error

The following is an example of a Custom Signal configured for an analog input (GP4) reading the midpoint voltage of the battery (or system). A Custom Alarm is then configured to track the signal deviations.



For the Custom Signal equation, the midpoint voltage of the battery (from GP4) is doubled and then subtracted from the total voltage reading provided by the Battery Voltage signal. An absolute value yields a positive integer.

Figure 54–Controller Signals configuration example five (part one) (configure custom signal for input reading midpoint voltage)

NOTE: To Customize, review 7.1 Advanced Programming Example and 6.5.3.10 Custom Alarms. The text labels may be edited using the web interface of the CXC and are provided here as default labels for demonstration purposes only.

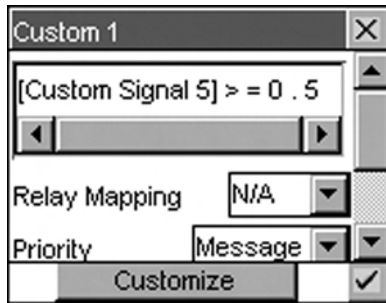

For the Custom Alarm equation, the Custom Signal is compared to the maximum* allowable voltage deviation in battery string halves. In this example a message is recorded when the midpoint voltage is in error.

* Some fine-tuning may be required to obtain the ideal setting that is sensitive enough to detect a 'bad' cell and will not produce false alarms.

**Figure 55–Controller Signals configuration example five (part two)
(configure custom alarm for input reading error)**

6.6.2.7 Midnight Rollover

The Scheduler (see Scheduler Usage and Custom Alarm examples above) functionality is simple. It tests to see if the System Time is greater than the time entered by the user. This means that at midnight, 00.00.00, the user time will always be greater than the System Time.

Example

So how can the scheduler be set up to ensure that this midnight rollover will not cause a problem with any Custom Signal that uses the System Time? In real life, you might want to trigger a generator and keep it on for some amount of time regardless of the midnight rollover.

These sample equations will configure Custom Signal 1 to remain on for about 30s even if midnight rollover occurs.

Custom Signal 1 Equation:

$$([\text{System Time (HH.MM.SS)}] > \ll 23.59.55 \gg) | [\text{Custom Signal 1}] \& ([\text{Timer 1}] < 29)$$

Timer 1 Equations:

Run Event: $[\text{System Time (HH.MM.SS)}] > \ll 23.59.55 \gg$

Stop Event: $[\text{Timer 1}] > 30$

By this example, we see Custom Signal 1 go to 1.00 at 5 seconds to midnight, then go to 0.00 at about 25 seconds after midnight. This behavior will repeat daily.

6.6.2.8 Converter Signals

This feature will enable the user to view the status for all of the acquired converters in the system; including but not limited to:

Total Conv. Current	# Failed Conv.	# Conv. Input Voltage Failed	# Conv. Fan Failed
Avg Conv. Output Voltage	# Conv. Minor Alarm	# Out Of Tolerance Conv.	Converter Load Voltage
Total Conv. Input Current	# Conv. In Comms Lost	# Conv. In Current Limit	Converter Load Current
# Acquired Conv.			

The existing Controller Signals category now includes signals for Converter Load Voltage and Converter Load Current; by default, Average Conv. Output Voltage and Total Conv. Output Current are used respectively.

Re-configurable System Load Current and System Battery Voltage

For converter shelves that do not have any Cordex rectifiers in the system, the system Load Current may be re-configured to display the total converter output current and the system Battery Voltage may be re-configured to display converter output voltage; that is, the signals can be renamed.

Recommendation For Converter Redundancy

A redundant converter in a system will allow one converter to be shut down while the other converters supply power to the load; e.g., during firmware upgrade.

6.6.2.9 Counter

Select this heading from the pull-down menu to access individual counters. See figure below:

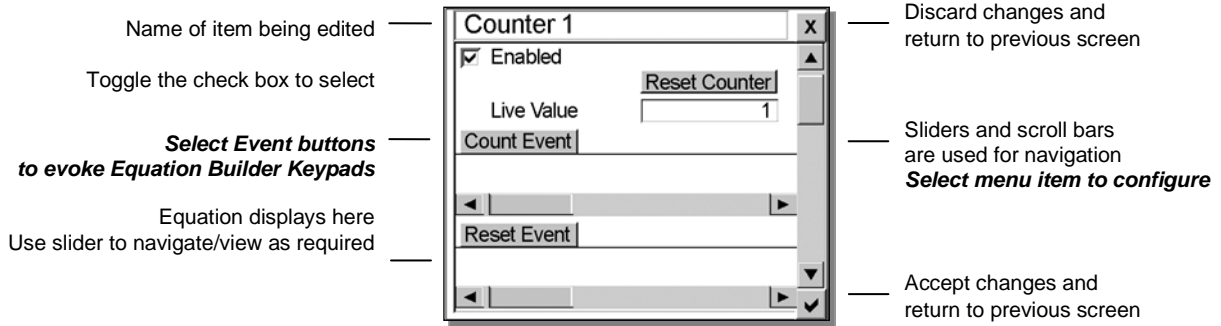

Figure 56–Counter access window

Summary: The Counter feature allows the tracking of event occurrences for any signal that the controller software is able to monitor as an equation. Any signal that is viewable through the equation builder is available.

Enable: Check the Enable checkbox to activate the counter.

Line Value: Current count value. The reset button will set the value to 0.

Count Event: The Count Event is an equation entry indicating the condition to count. This equation is used to detect transitions. For example, if the equation is set to [AC Main] > 24, the counter will trigger when the voltage moves from 24 volts or less to above 24 volts.

Reset Event: The Reset Event is the trigger condition that sets the Count value back to 0.

General Note: The Timer and Counter values themselves can be used in equations. They can monitor each other.

6.6.2.10 Timers

Select this heading from the pull-down menu to access individual timers. See figures below:

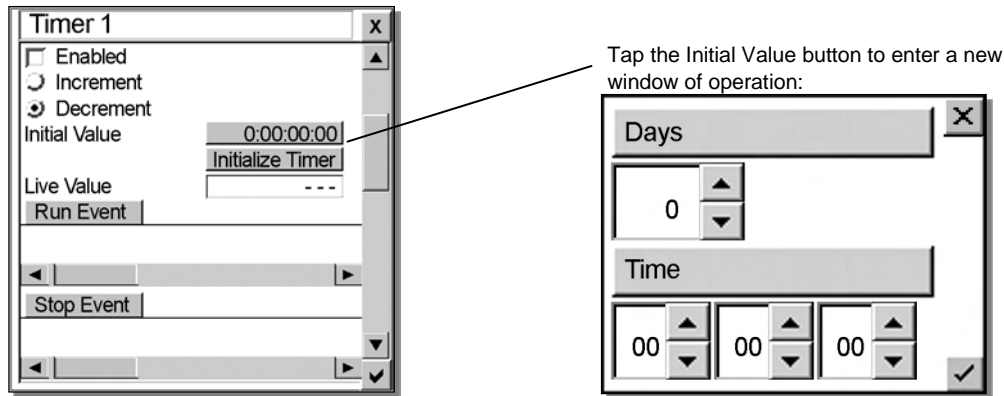

Figure 57–Timers access windows

Enable: Check the Enable checkbox to activate the timer.

Increment/Decrement: This indicates whether the timer counts up or down from the initial value.

Initial Value: Set the starting value for the time. The time format is shown above the fields as DDDD:HH:MM:SS, which means 4 digits for days, 2 digits for hours, minutes, and seconds.

Line Value: Current time value for the timer.

Run Event: Trigger equation indicating a timer start.

Stop Event: Trigger equation indicating a timer stop.

Note (Run/Stop): The Run Event acts as a level detector if the Stop Event is left empty. With a set Stop Event, the Run Event acts as an edge detector where a transition will cause the timer to start, but the same event in the reverse direction will not cause the timer to stop. This allows the Run and stop events to be completely separate and unrelated events.

General Note: The Timer and Counter values themselves can be used in equations. They can monitor each other.

6.6.2.11 ADIO Signals

Select this heading from the pull-down menu to access individual signals for an ADIO (Analog Digital Input Output) Device; i.e., Cordex Smart Peripherals (ref. 4.5.7).

ADIO Live Status – is displayed via another link/window for the device, if so equipped:

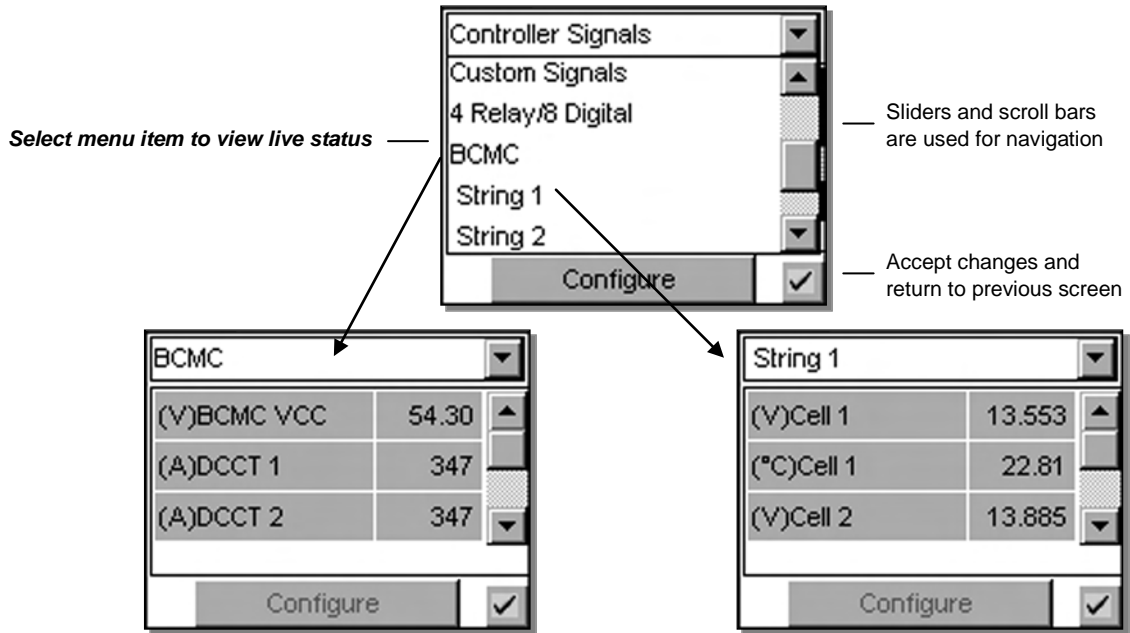

Figure 58–ADIO live information windows

View Live Status (Web Interface) – ADIO live information is displayed via another link/window for the device, if so equipped:

Signals > View Live Status

Signal List		
Signal Categories	Signals Name	Value
Onboard Inputs		
Controller Signals	BCMC VCC	54.30 V
Analog Input	DCCT 1	348 A
Digital Input	DCCT 2	0.00 A
Rectifier Signals	DCCT 3	0.00 A
Custom Signals	DCCT 4	0.00 A
4 Relay/8 Digital		
BCMC	Average Voltages	
	Avg String 1	13.512 V
	Avg String 2	0.000 V
	Avg String 3	0.000 V
	Avg String 4	0.000 V

Click for details

When the BCMC (if so equipped) is selected from the Signal List, a new button/link provides access to a more comprehensive view of the BCMC parameter/status.

Figure 59–View Live Status (Signals) web interface window

Activity icon

Onboard Inputs

BCMC VCC	54.30 V
DCCT 1	347 A
DCCT 2	347 A
DCCT 3	347 A
DCCT 4	348 A

Strings Overview

String name	Devices	Average Voltages
String 1	6	13.511 V
String 2	0	0.000 V
String 3	0	0.000 V
String 4	0	0.000 V

String 1 String 2 String 3 String 4

Device Total: Devices: 6

Voltage Summary: Min: 13.27, Max: 14.01, Avr: 13.51

Temperature Summary: Min: 22.00, Max: 22.51, Avr: 22.18

Shunt Monitor Data: -128 A, 14.8 °C

High Voltage Monitor Data: 40.88 V, 23.29 °C

Graph filter: Show All Cells in alarm only

Bar sorting: Default Ascending Descending

Bar size: Min Normal Max

Voltage Graph

String 1	String 2	String 3	String 4
13.267	13.38	13.399	14.009

Temperature Graph

String 1	String 2	String 3	String 4
22.01	22.09	22.52	22.09

String 1 String 2 String 3 String 4

Device Total: Devices: 6

Voltage Summary: Min: 13.27, Max: 14.00, Avr: 13.52

Temperature Summary: Min: 22.00, Max: 22.50, Avr: 22.16

Graph filter: Show All Cells in alarm only

Bar sorting: Default Ascending Descending

Voltage Graph

String 1	String 2	String 3	String 4
13.27	13.392	13.413	13.997

Cell 4: 13.997 V, 22.07 °C

Select bar to activate the window to display cell data as highlighted here

Figure 60–Detailed status view and bar graph (BCMC only) web interface window

ADIO Configure Signals – enables the Supervisor to input a value for a range to be applied to all selected channels. In this case, the BCMC if so equipped:

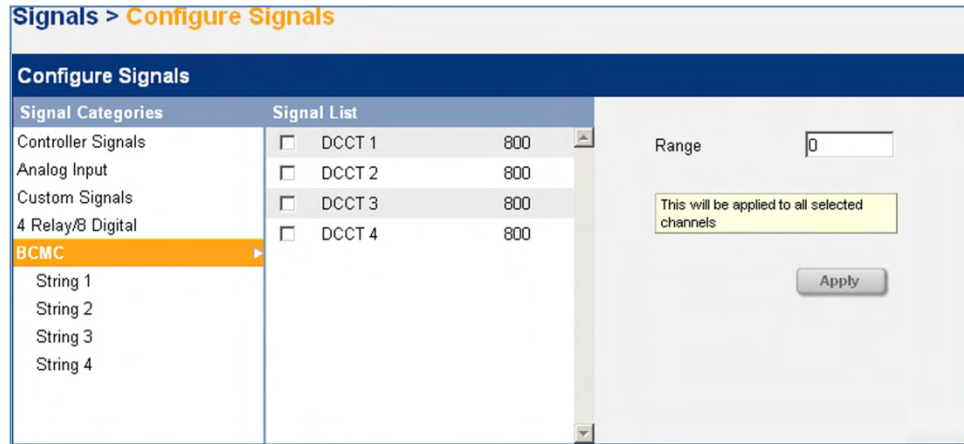

Figure 61–BCMCM configuration example one (set DCCT range in Amps)

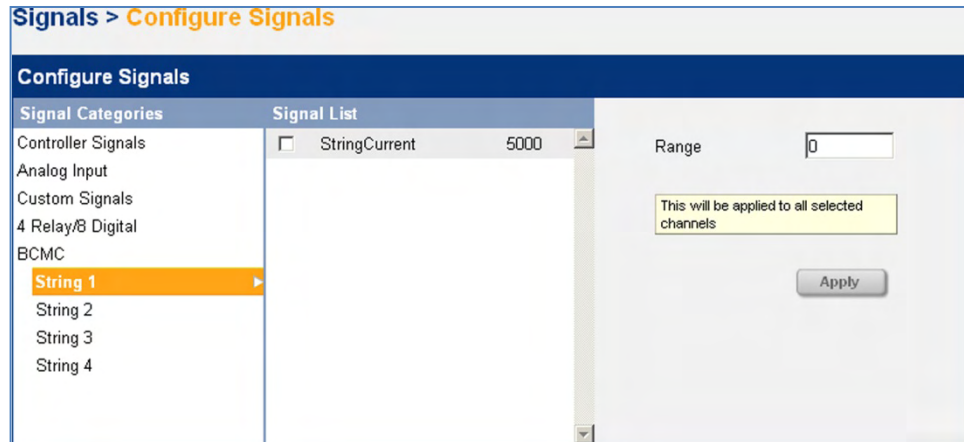

Figure 62–BCMCM configuration example two (set String Current range in Amps)

ADIO Static Calibration (Web Interface Only) – enables the Supervisor to calibrate ADIO (except BCMCM) analog inputs without the need for a live signal at the input. This is similar to Static Calibration for controller analog inputs described previously.

6.6.3 Data Logging (Web Interface Only)

6.6.3.1 Configure Data Logging

To edit the data log configuration, browse to SIGNALS page and select Configure Data Logging:

Start/Stop trigger buttons are found at the top of this window. Delete will remove the file altogether.

Description of log file is shown here. **Click to edit.**

Select Log Signals to edit.

Select number of log records and file save option.

Start Trigger and Stop Trigger enable preset configuration and customization of the beginning and end of each event to be logged.

Figure 63–Configure Data Logging web interface window

Data Log Files – this list shows the filename (up to 16) and the number of records associated with each. Select the filename to display/edit the information in the adjacent window.

File Information – description and status of the log file is shown here.

Log Records is the number of records to be saved in the log file. Click on the value to edit. Log Limit is displayed below and changes depending on the number of signals selected and the number of records in the other log files.

Recommended size is up to seven signals and a maximum one thousand entries, as very large log files may not be viewable. If the datalog screen comes up blank, the log is too large to be displayed.

File Save Option enables a FIFO (first in first out) or “Stop when full” means of data collection.

Select Log Signals to edit from a list (max. 32) for the log:

Signal List			
Controller Signals	Signals Name	Value	Enable Logging
Analog Input	Midpoint Voltage	27.38V	<input checked="" type="checkbox"/>
Digital Input	Load Current	5.3A	<input checked="" type="checkbox"/>
Rectifier Signals	Battery Voltage	54.19V	<input checked="" type="checkbox"/>
Custom Signals	Battery Current	0.1A	<input checked="" type="checkbox"/>
3-old-LED 4 Relay/8 Digital_666	AC Mains	209V	<input checked="" type="checkbox"/>
	Battery Temperature	73°F	<input checked="" type="checkbox"/>
	Battery Runtime	---	<input checked="" type="checkbox"/>
	Battery Capacity	28.2%	<input checked="" type="checkbox"/>
	Battery DOD	27.2%	<input checked="" type="checkbox"/>

Total Signals Selected: 10

Unselect All Apply

Figure 64–Enable Signals for Data Logging web interface window

Log Frequency – determines how often the data is collected. The default time interval is 60 seconds and the range is from ten to 86,400 seconds (24 hours). An interval may also be set based upon when a selected signal changes by the Delta Level; click on the value to edit.

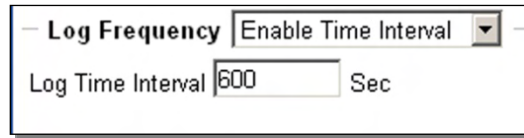

Figure 65–Log Frequency (web interface) window to enable time interval

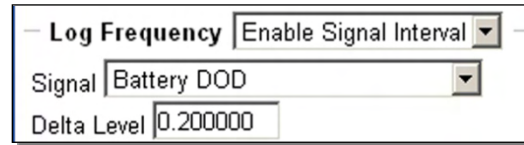
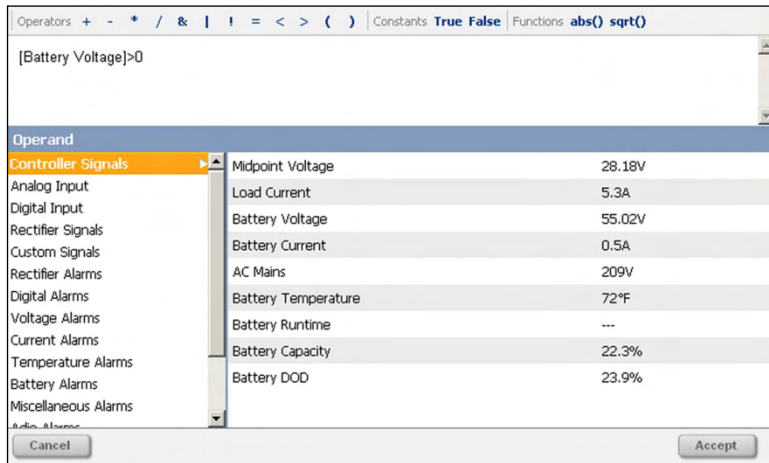

Figure 66–Log Frequency (web interface) window to enable signal interval

Start Trigger – enables data collection to be started manually, by event or by time. For example, select Customize to edit/build an equation from the list of operands (alarms and signals) and operators (arithmetic and logic):



Mathematical operators:

- + = Add
- = Subtract
- * = Multiply
- / = Divide

Logical operators:

- & = AND
- | = OR
- ! = NOT TRUE
- = is EQUAL TO (compare for equality)
- < is LESS THAN
- > is GREATER THAN
- (is OPEN PARENTHESIS (used with a close parenthesis to set apart arguments to a mathematical function)
-) is CLOSE PARENTHESIS (see open parenthesis; used to clarify the order of operations)

Figure 67–Alarm Equation web interface window

Stop Trigger – enables data collection to be stopped manually, by event or by time. For example, to specify a period of time when data collection is allowed, select Duration and click on the values (Hrs, Min, Sec) to configure.

NOTE: After configuring a Data Log, select *Submit Changes* to accept (save) the changes.

6.6.3.2 Starting/Stopping Data Logging

To activate the log file, press the “Start” button at the top of the Configure Data Logging page (next to File Information). A message window will prompt to start logging data for the selected file. Under Data Log Files, displayed next to the log filename, the number of records will increase. Under File Information, the status will indicate the log file is running.

To discontinue logging, press the “Stop” button; status will change to stopped.

“Delete” the log file to clear the configuration and data.

6.6.3.3 Retrieve Logs

From the LOGS & FILES page of the web interface, select Retrieve Logs:

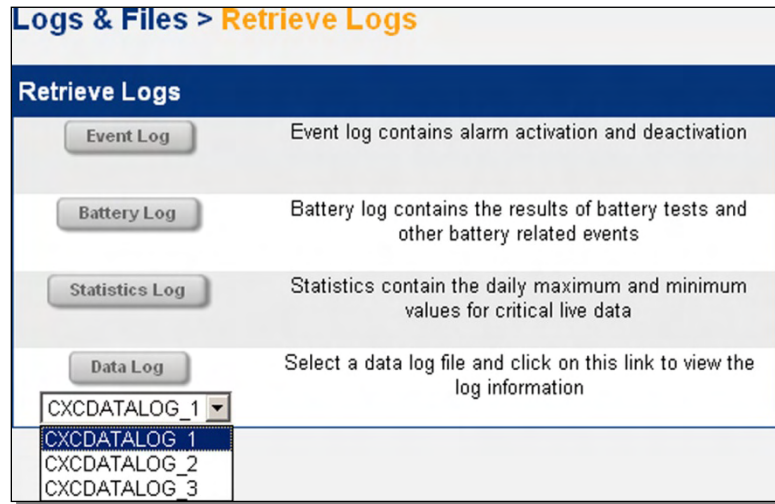

Figure 68–Retrieve Logs web interface window

On the new page, locate the Data Log drop-down menu and “Select a data log file” to view the log information:

Page 1 / 3 ->>

CXCDATALOG_1

Date & Time	Midpoint Voltage	Load Current	Battery Voltage	Battery Current	AC Mains	Battery Temperature	Battery Runtime	Battery Capacity	Battery DOD	Digital_input_1
2007/07/01 10:15:24	28.25	5.30	55.04	0.41	208.85	22.30		22.28	23.87	0.00
2007/07/01 10:05:24	28.18	5.30	55.04	0.43	210.43	22.30		22.28	23.87	0.00
2007/07/01 9:55:24	28.13	5.30	55.04	0.46	209.69	22.30		22.28	23.87	0.00
2007/07/01 9:45:24	28.18	5.30	55.02	0.53	208.53	22.30		22.28	23.87	0.00
2007/07/01 9:35:24	28.10	5.30	55.04	0.55	210.11	22.14		22.28	23.87	0.00
2007/07/01 9:25:24	28.04	5.30	55.04	0.58	209.48	22.14		22.28	23.87	0.00
2007/07/01 9:15:24	27.97	5.30	55.04	0.67	208.11	22.14		22.28	23.87	0.00
2007/07/01 9:05:24	27.89	5.30	55.04	0.82	209.58	22.14		22.28	23.87	0.00

Figure 69–Sample (data) log information web interface window

NOTE: The date and time is recorded for every data sample. Up to 32 signals can be selected per log file.

The text (rows and columns) can be copied and pasted into a spreadsheet program for analysis; e.g., graphing.

Recommended size is up to seven signals and a maximum one thousand entries, as very large log files may not be viewable. If the datalog screen comes up blank, the log is too large to be displayed.

6.6.3.4 Example One – Logging Three Phase Voltage Input (Rectifier System)

The following is an example of a Data Log configured to monitor the voltage input for a three phase rectifier system.

With the web interface, select the Signals page and then the Configure Data Logging window:

Under Data Log Files, select a new file to edit

Under Log Frequency, select Enable Time Interval and enter 600 seconds (10 minutes)

Enter description of new file

Enter number of Log Records you wish to keep and select FIFO

Under Start Trigger and Stop Trigger, select Manual for each

Figure 70–Configure (Signals) Data Logging web interface window, example one

Under File Information, select Log Signals to enable the signals for logging:

Select Rectifier Signals

Toggle each phase for logging

Figure 71–Enable (Rectifier) Signals for Data Logging web interface window

Select Apply (to accept changes and return to Configure Data Logging window).

Once the Data Log is configured, select Submit Changes to accept (save) the changes:

Submit changes then start the log to collect data

Figure 72–Main Menu (web interface Submit Changes item)

Start the log (trigger button located next to the heading of the File Information window). Once the data has collected for the desired interval, return to this window to select the Stop trigger button.

From the Logs & Files page, select Retrieve Logs. Locate the pull-down menu to select the file created then select Data Log to view the log information. Copy and paste the data from the new web browser window into a spreadsheet application for analysis.

6.6.3.5 Example Two – Battery System

The following is an example of a Data Log configured to monitor the battery voltage, current, temperature and other parameters for a battery system.

With the web interface, select the Signals page and then the Configure Data Logging window:

Figure 73–Configure (Signals) Data Logging web interface window, example two

Under File Information, select Log Signals to enable the signals for logging:

Controller Signals	Signals Name	Value	Enable Logging
Analog Input	Load Voltage	54.00V	<input type="checkbox"/>
Digital Input	Load Current	0.1A	<input type="checkbox"/>
Rectifier Signals	Battery Voltage	54.00V	<input checked="" type="checkbox"/>
Custom Signals	Battery Current	1.2A	<input checked="" type="checkbox"/>
BCM 12V Battery Blocks	AC Mains	223.2V	<input type="checkbox"/>
	Battery Temperature	25.21°C	<input checked="" type="checkbox"/>
	Battery Runtime	---	<input checked="" type="checkbox"/>
	Battery Capacity	100.0%	<input checked="" type="checkbox"/>
	Battery DOD	---	<input checked="" type="checkbox"/>

Figure 74–Enable (Controller) Signals for Data Logging web interface window

Select Apply (to accept changes and return to Configure Data Logging window).

Under Log Frequency, use the pull-down menu to select the Battery Voltage signal. The default Delta level should suffice.

Once the Data Log is configured, select Submit Changes to accept the changes as before.

Start the log (trigger button located next to the heading of the File Information window). Once the data has collected for the desired interval, return to this window to select the Stop trigger button.

From the Logs & Files page, select Retrieve Logs. Locate the pull-down menu to select the file created then select Data Log to view the log information. Copy and paste the data from the new web browser window into a spreadsheet application for analysis.

6.6.3.6 Example Three – Generator Voltage

The following is an example of a Data Log configured to monitor the input voltage of a system when a generator is activated (for emergency backup power).

With the web interface, select the Signals page and then the Configure Data Logging window:

Figure 75–Configure (Signals) Data Logging web interface window, example three

Under File Information, select Log Signals to enable the signal for logging:

Signals Name	Value	Enable Logging
Total Rectifier Current	1.27A	<input type="checkbox"/>
Avg DC Voltage	52.47V	<input type="checkbox"/>
Avg AC Voltage	223.4V	<input checked="" type="checkbox"/>
# Acquired Rectifiers	2	<input type="checkbox"/>
# Sourcing Rectifiers	1	<input type="checkbox"/>
# Failed Rectifiers	0	<input type="checkbox"/>
# Minor Alarm Rectifiers	0	<input type="checkbox"/>
# Comms Lost Rectifiers	0	<input type="checkbox"/>
# AC Failed Rectifiers	0	<input type="checkbox"/>
# Out Of Tolerance	0	<input type="checkbox"/>
# Locked Out Rectifiers	0	<input type="checkbox"/>
# Equalize Rectifiers	0	<input type="checkbox"/>
# Current Limit Rectifiers	0	<input type="checkbox"/>
# Power Limit Rectifiers	0	<input type="checkbox"/>
# Fan Failed Rectifiers	0	<input type="checkbox"/>

Figure 76–Enable (Controller) Signals for Data Logging web interface window

Select Apply (to accept changes and return to Configure Data Logging window).

Once the Data Log is configured, select Submit Changes to accept the changes as before.

In this example, the data will start logging when the digital input signal from the generator switches on. The log will stop once the data has collected for the desired interval.

From the Logs & Files page, select Retrieve Logs. Locate the pull-down menu to select the file created then select Data Log to view the log information. Copy and paste the data from the new web browser window into a spreadsheet application for analysis.

6.6.4 ADIO Device Configuration (Web Interface Only)

The Supervisor can modify the name of the signal or configure an alarm for a selected item. Some examples are shown below.

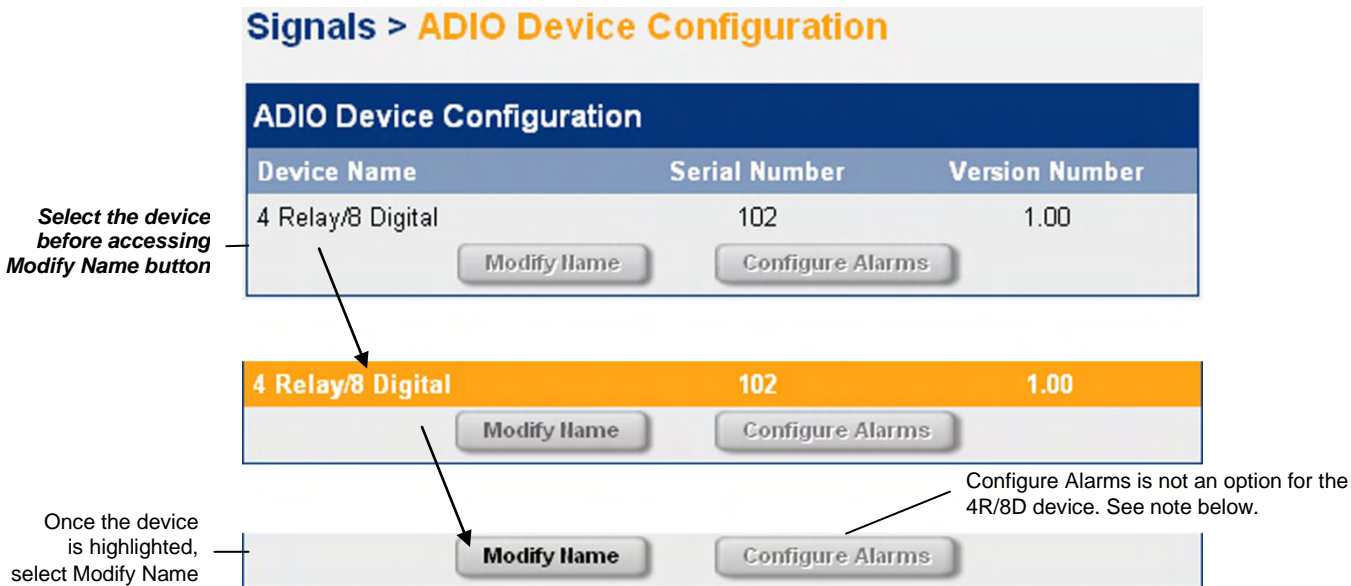

Figure 77–ADIO Device Configuration web interface window (showing 4R/8D device)

NOTE: Complete alarm configuration/programming for the 4R/8D in the custom alarm sections of the menu where the alarm condition can be associated with a digital input and mapped to a relay.

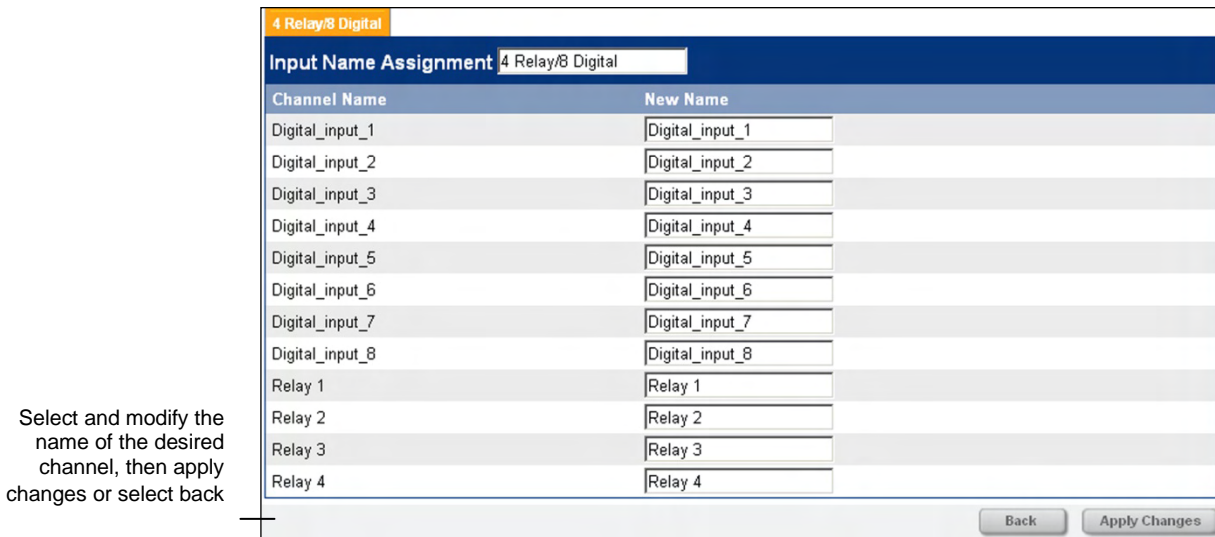

Figure 78–Input Name Assignment web interface window (showing 4R/8D device)

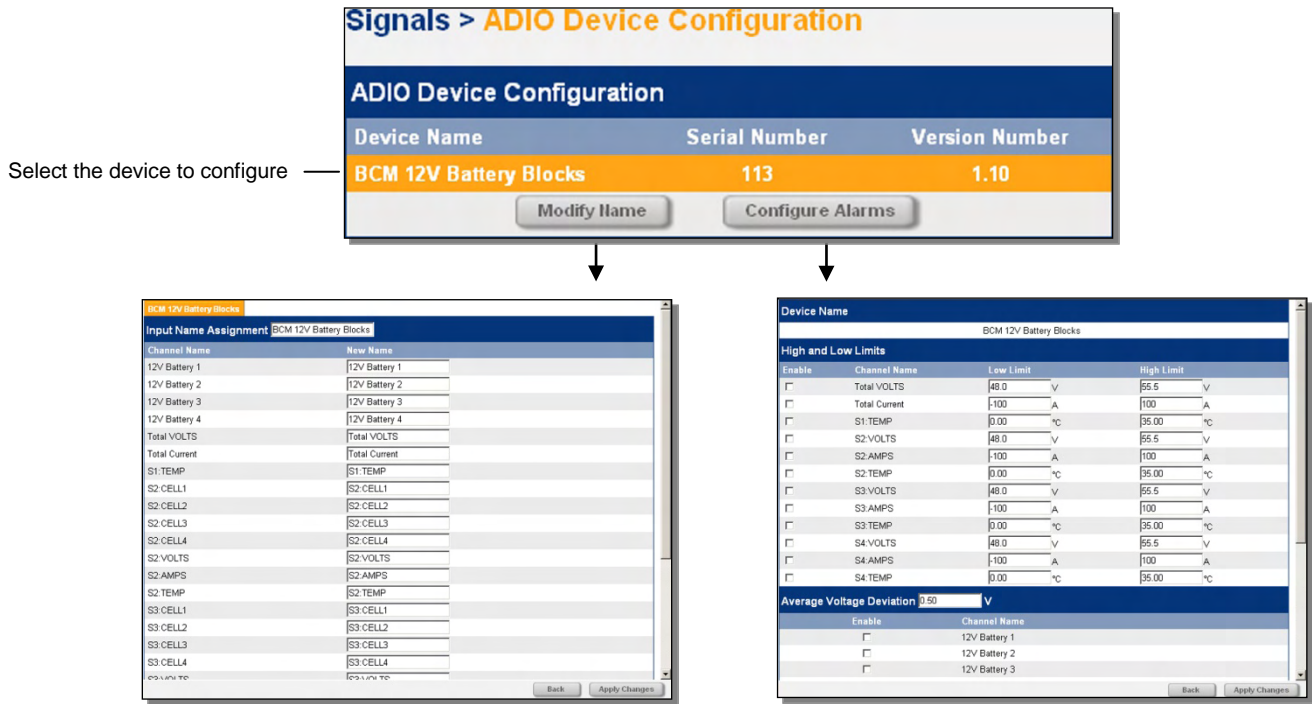

Figure 79–ADIO device configuration examples (showing BCM device)

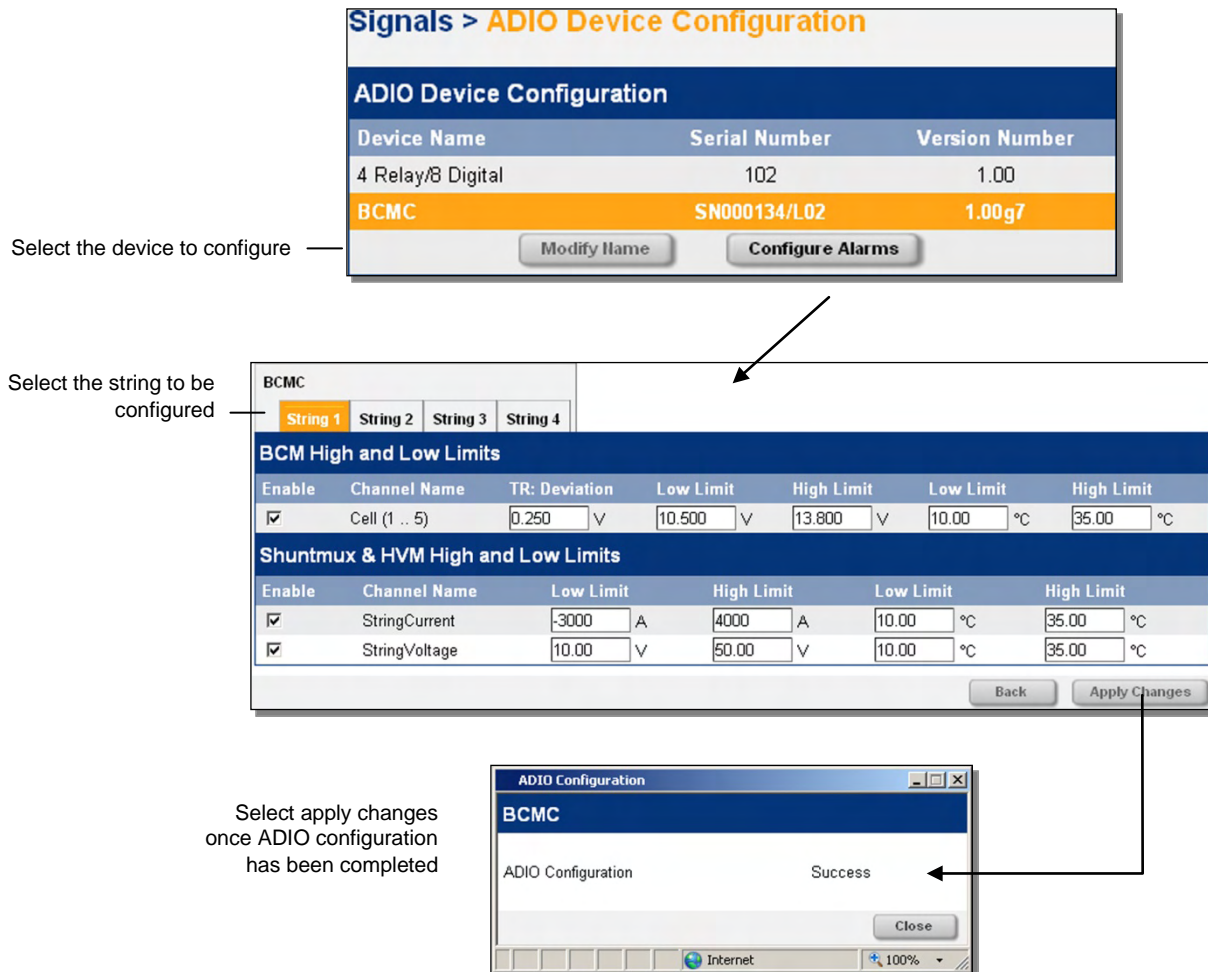

Figure 80–ADIO device configuration examples (showing BCMC device)

Refer to the back of this manual for Factory Service and Technical Support contact information

6.7 Controls

This menu category consists of power system controls. Parameters can be set/accessed such as low voltage disconnect (LVD), high voltage shutdown (HVSD), and counter electro-motive force (CEMF) in/out.

Many of the parameters are similar to the items found in 6.5.3 Configure Alarms; such as, relay mapping and alarm priority. Some parameters will not be displayed under the Configure window for all controls. Here are some of the additional parameters the Supervisor can expect to encounter:

Activation Timer — For LVD countdown timer (activation), tap on the number to edit via a virtual numeric keypad. Use with caution. Refer to the following section LVD Control.

NOTE: *There are three possible triggers for opening the LVD, one of which is that loss of AC mains immediately starts the activation timer, if it is enabled, and the LVD will open at the timeout point.*

DOD Activation — For LVD control, tap on the number (percentage of DOD) to edit via a virtual numeric keypad.

Disconnect Voltage, Connect Voltage — for each LVD (1-10), tap on the number(s) to edit via a virtual numeric keypad.

Inhibit Status — For LVD Inhibit, select from the pull-down menu; e.g., Inactive or Active. Selection will be in effect real-time and not saved.

Activation Value — For HVSD, tap on the number to edit via a virtual numeric keypad.

Bypass Voltage, In-Circuit Voltage — For CEMF, tap on the number(s) to edit via a virtual numeric keypad.

6.7.1 LVD Control (USE WITH CAUTION)

The LVD feature controls a high capacity relay that disconnects the load during extremely low voltage conditions — such as a deep discharge of the batteries during an AC fail — and automatically reconnects the load once AC power returns. Discharging the battery down to an extremely low voltage can cause damage to the load and the battery. Having multiple LVDs will provide the capability of load shedding; where the least critical loads are disconnected first.

With the CXC, the Supervisor can program connect/disconnect settings to govern the operation of ten separate LVD controls. The LVD is activated when the Activation Voltage or the Activation Time is reached; whichever comes first. The LVD also extends an alarm signal and a message will display on the GUI.

Under this window of operation, there is a list of menu items (*tap to select*) with scroll bars for navigation, see Figure 81 below:

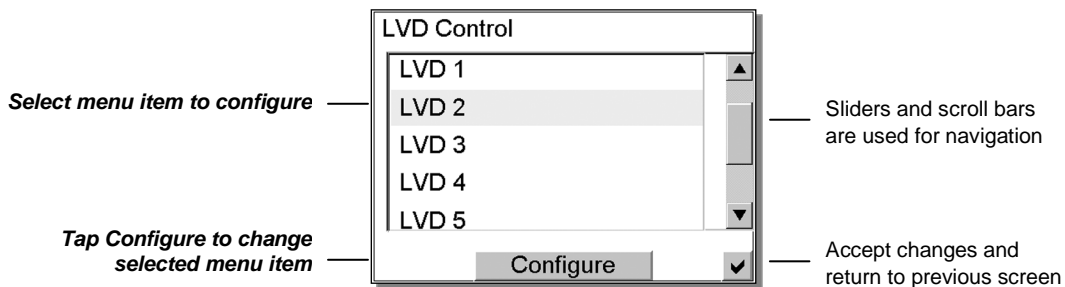

Figure 81–LVD Control window

Tap "Configure" to enter a new window of operation for the item selected. In this new window (Figure 82 below), the Supervisor can set the following parameters:

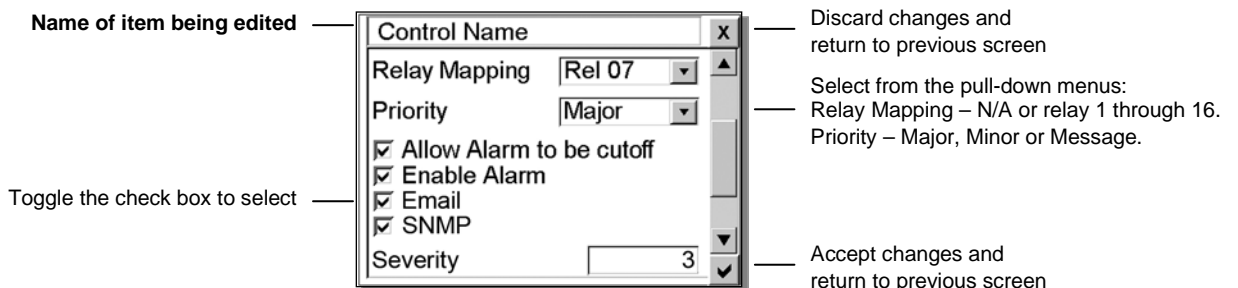

Figure 82–Configure (item selected) sample window

6.7.1.1 DOD Activation

This menu item (LVD DOD Control) allows the Supervisor to configure each LVD control for activation once the percentage of Depth of Discharge (DOD) has increased above a threshold. This control works in conjunction with the existing LVD countdown timer and the disconnect voltage. Whichever programmable parameter is met first, the LVD will be activated. Typically, LVD DOD control is needed when ac mains fails, battery monitor is enabled, battery has discharged for more than one (1) minute and DOD has risen above the threshold. If DOD activates LVD, then the low voltage connect (LVC) causes reconnect.

6.7.2 LVD Inhibit

The LVD Inhibit feature provides the means to temporarily prevent all LVD controls from activating without disabling the LVDs altogether, see example below. The Supervisor will then have 10 minutes to assess and correct the condition(s) causing the LVD activation.

This menu item differs from other controls in that it cannot be disabled; "Enable Alarm" is grayed out. With that exception, the remainder of the configuration is similar to all other controls (relay mapping, etc.), see Figure 82 above. It is logged in an identical manner, except that the only possibilities are ACTIVE and INACTIVE. Selection will be in effect real-time and not saved – resets on power off.

Operation Example:

1. LVD condition occurs.
2. Audible alert sounds and a pop-up window will appear on the GUI prompting the user to "Inhibit LVDs."
3. For up to 60 seconds, LVD Inhibit may be evoked by the Supervisor. A password prompt (with counter) will appear as required.
4. Selecting "Cancel" will reset the 60-second countdown; otherwise, if this time should expire, the LVD Control will proceed to disconnect the load as configured.
5. Once evoked, LVD Inhibit control, now ACTIVE, will prevent LVD controls from activating for 10 minutes.
6. LVD condition is corrected by Supervisor or LVD Inhibit may be evoked again.
7. Once LVD condition is corrected, LVD Inhibit must be reset manually as required.

6.7.3 HVSD

This menu item enables the Supervisor to program the setting for a HVSD control, which energizes a relay that can shut down one or more rectifiers when the output voltage exceeds the Activation Value. The output from HVSD relay is connected to the Remote Shutdown input on the rectifier cabinet. An alarm is also activated and the message HIGH VOLTAGE SHUTDOWN will display on the CXC's GUI.

6.7.4 CEMF

The CEMF Cell is a stand-alone panel; which is used to reduce the load voltage (by up to 3.0Vdc) to protect sensitive loads from high voltages during battery equalize and float cycles.

6.7.4.1 Bypass Voltage

This menu item enables the Supervisor to set the voltage breakpoint to close the CEMF relay and bypass the CEMF cell (or diode); to directly connect the load to the rectifiers without voltage drops.

6.7.4.2 In-Circuit Voltage

This menu item enables the Supervisor to set the voltage breakpoint to open the CEMF relay and connect the CEMF cell (or diode); to give the appropriate voltage drop to protect the load connected to the rectifiers.

6.8 Communications

This menu category consists of rectifier and power system communications controls. Parameters can be set/accessed such as the web interface (e.g. IP address), and baud rates.

For a more detailed explanation, refer to the next chapters of the CXC Communications Menu Parameters and Remote Communications.

6.8.1 Port Status (Web Interface Only)

This page displays the status of the Cordex controller ports; active or inactive for each of the following, shown below:

Port Status	
CAN	Active
RS485	Inactive
Craft Port	Inactive
Ethernet Port	Active

IP Information	
IP Address	216.13.201.229
Subnet Mask	255.255.255.240
Gateway	216.13.201.225
Ethernet/Mac Address	0090EAC004AD

Figure 83–Port Status and IP Information window

6.8.2 IP Information

This is where the CXC factory unit default values are displayed. Scroll bars enable the user to navigate the list of text items for viewing; i.e., IP address, Subnet Mask, Gateway and Ethernet/MAC Address.

6.8.3 IP Address (“Ethernet” per web interface)

This menu item enables the Supervisor to program the web interface parameters, see Figure 84 below:

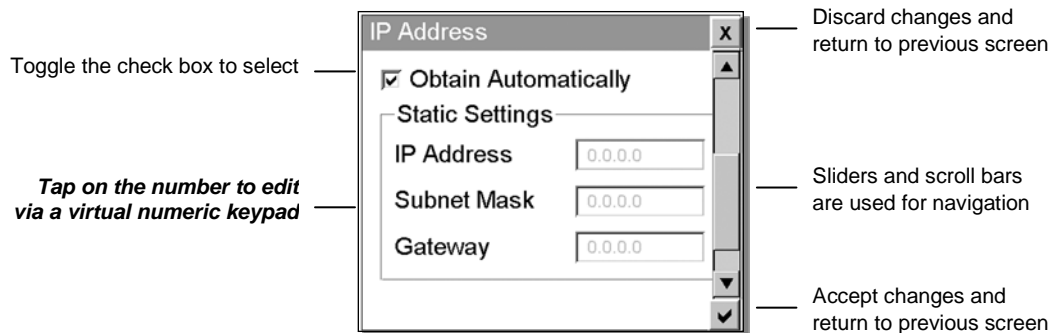

Figure 84–IP Address window

6.8.3.1 CXCI IP Address Reset and Startup

This feature enables the user to reset the IP address of the CXCI. It is a function of the front panel reset button on Cordex controllers that have only a 4-digit display.

The reset button located on the front panel of the CXCI is for restarting the microprocessor. When pressed momentarily, the unit beeps twice then resets. The front-panel LED's will illuminate temporarily, but will extinguish after the system has finished its 15-second self-test.

To reset the IP address, press and hold the front panel reset button for three seconds. The unit will beep three times, IP will be reset (to 10.10.10.201) and DHCP (see 8.1.1.5) will be disabled. The settings will be saved and the unit will then reset.

There is also a "hard" reset button located on the side of the CXCI. Pressing this button will reset the CXC but will not affect any settings; has the same functionality as the reset button on a CXC with a touch screen LCD.

The CXCI, upon startup⁵, will set the time based on the following priorities:

1. Attempt to synchronize with the NTP server (see www.NTP.org), otherwise:
2. Retrieve the last time stamp from the Event Log, otherwise:
3. Retrieve the last time stamp from the Statistics Log, otherwise:
4. Set the time to 2005-01-01 midnight (if the above methods fail).

6.8.4 Modem ("PPP Connection Device/Rear Modem Port" per web interface)

This menu item enables the Supervisor to set the baud rate and the CXC's rear port device (Internal / External / NULL modem). The Modem Init String⁶ is displayed here, see Figure 85 below:

See 8.3 for modem compatibility. See tables for factory defaults (baud rate and initialize string). *Modem baud rate is initialized to the value stored in the settings file on start up.*

Factory setting is displayed here and may be edited via the web interface

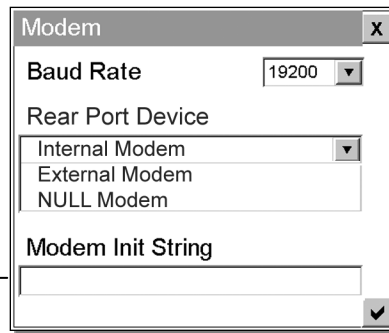

Discard changes and return to previous screen

Select from the pull-down menus

Modem menu/window may appear different for systems equipped with a CXCI

Accept changes and return to previous screen

Figure 85–Modem window

6.8.4.1 Modem Init String

This menu item may only be edited via the web interface. Select Configure Communication Parameters from CXC web interface Communications menu.

NOTE: *Although the Cordex modem is universal, in some cases it may be necessary to include a Country Code with the Modem Init String. Consult the support section of the manufacturer's website (multitech.com) for the latest country code approvals and for more information regarding AT commands.*

After Modem Init String has been edited, save settings as follows:

1. Select Logs & Files - Manager Configure File.
2. Click Submit.
3. Click Accept to download the setting to CXC on the compare window.

NOTE: *a more detailed method of procedure can be found by visiting the Alpha website at www.alpha.ca. Look under the Support menu item!*

⁵ Whenever the unit is reset or power is completely removed from the CXCI.

⁶ Modem Init String can be edited via the web interface (4.10).

6.8.5 Craft Port (“PPP Connection Device/Front Craft Port” per web interface)

This menu item enables the Supervisor to set the baud rate at which the Craft Port communicates with the CXC. *Select from the pull-down menu.*

6.8.6 Web Settings

This menu item enables the Supervisor to set the port routing for the CXC web interface (accessed via PPP for modem), see Figure 86 below:

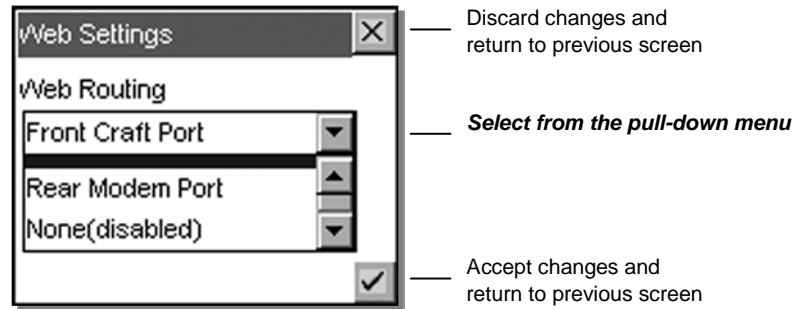

Figure 86–Web Settings window

6.8.7 Master SNMP Destination (Web Interface Only)

See 0.

6.8.8 SNMP Multiple Community Names (Web Interface Only)

See 10.3.1.

6.8.9 Event Notification Destination (Web Interface Only)

See 10.3.3.

6.9 Hardware

This menu category consists of output relay configuration and testing. See also 6.5.3.1 for Overview.

6.9.1 Configure Relays

This menu item will display a list of the normal state of all the existing output relays. A relay must be selected in order to configure the settings. See Figure 87 below.

From the pop-up menu, the Supervisor can **configure** the relay for email notification and/or SNMP dial out trap notification. The Supervisor can also **toggle polarity**; that is, specify if the relay is normally energized or normally de-energized.



Figure 87—Configure Relays window

6.9.2 Test Relays

This menu item will display a list of the present state of all existing output relays. See Figure 88 below.

From this menu the Supervisor can toggle the state; that is, specify if the relay is presently energized or de-energized to verify its condition. Change of state will be temporary as all relays return to their default states after leaving this menu.

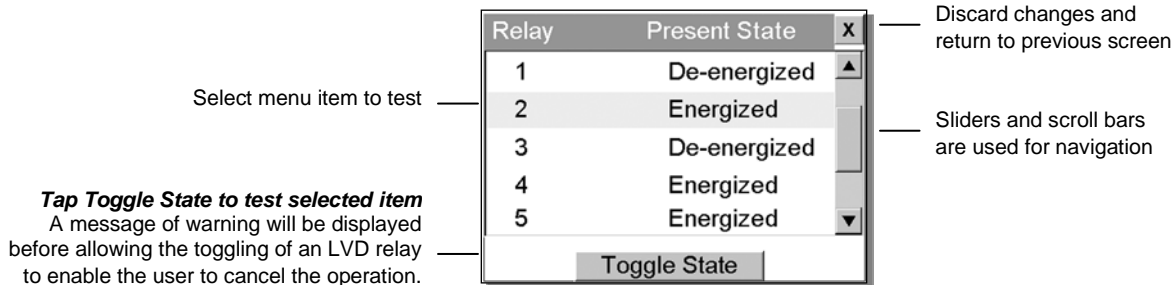

Figure 88—Test Relays window

6.9.3 Test Modem (Web Interface only)

See 9.3.3.

6.10 Logs & Files (Web Interface only)

This menu category consists of retrieving logs for event, battery, statistics and data; and managing files for configuration, dynamic (editable) text, and language.

6.10.1 Retrieve Logs

See also 6.6.3.3 (under Data Logging).

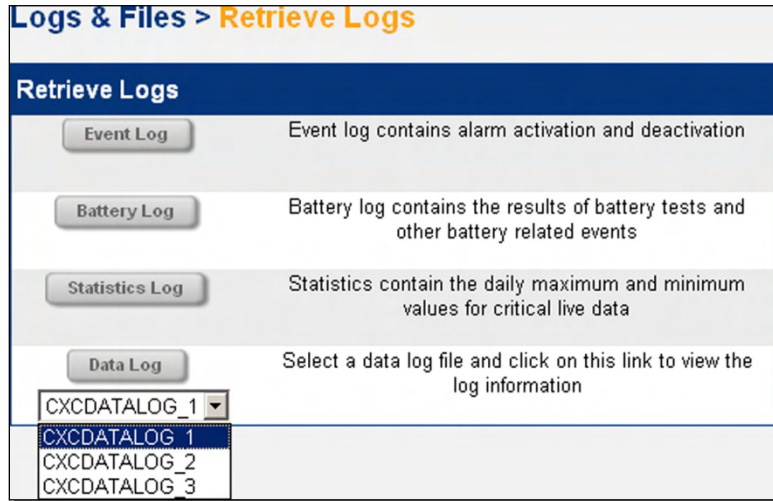

Figure 89—Retrieve Logs web interface window

6.10.2 Manage Configuration File

The Supervisor may exclude settings and groups of settings when applying changes. A partial configuration file may also be generated and sent to CXC (v1.81 and above).

NEW!
for version 2 software

Tap the Print Configuration button to evoke a standard print dialog window.

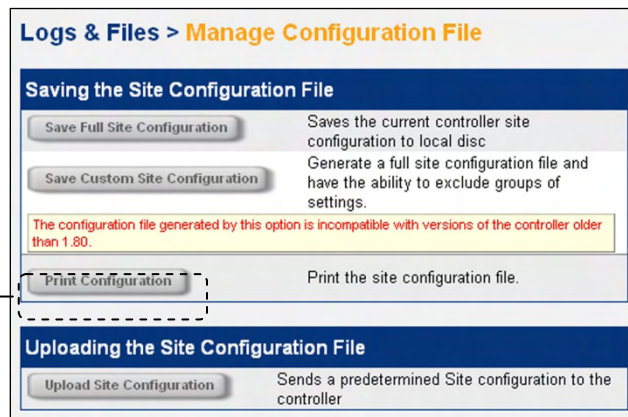

Figure 90—Manage Configuration File web interface window

6.10.2.1 Printing Custom Site Configuration

Right-click in the window showing the settings and be careful to then select Print Preview. See Figure 91 below:

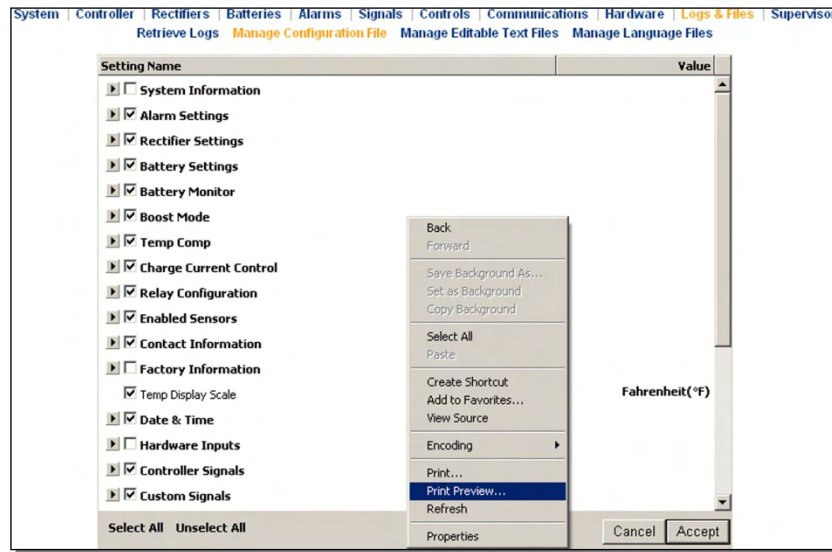

Figure 91–Logs & Files “Print Preview” (web interface)

CAUTION

By default the browser will print out all settings requiring approximately 50 letter-size pages.

Continue with the page setup and print dialog as required. You may reduce the page range or print to PDF if your workstation is configured to do so.

6.10.3 Manage Dynamic (Editable) Text Files

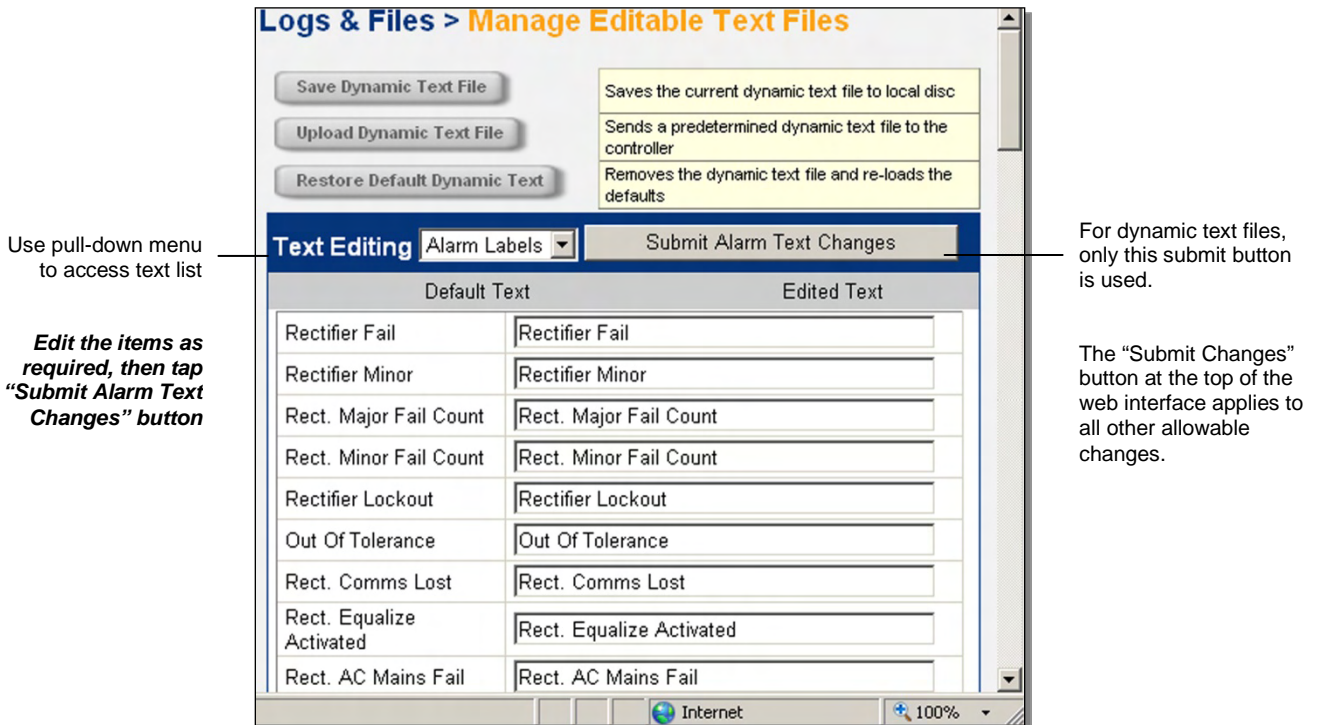

Figure 92–Manage Editable Text Files web interface window

6.10.4 Manage Language Files

Language files can be uploaded via web interface. The CXC can be set up for a maximum of three language files (default plus two others) at one time pending availability.

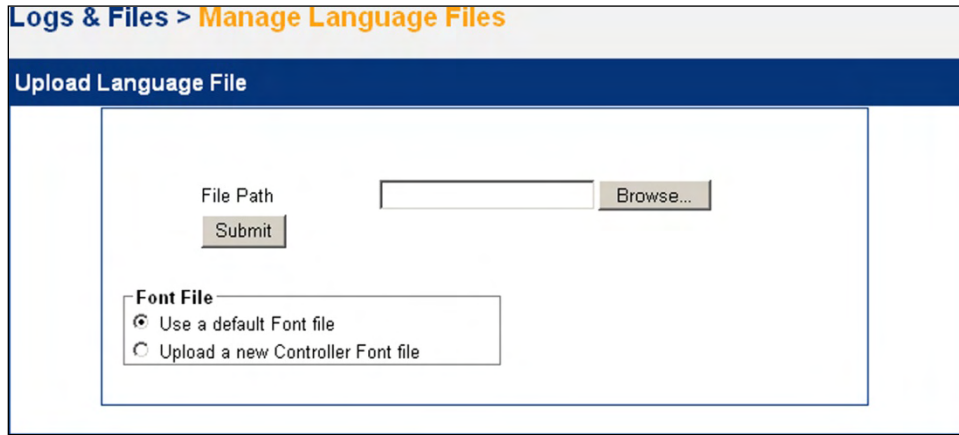

Figure 93–Manage Language Files web interface window

6.10.5 Retrieve Diagnostic File

A new feature in version 2.05 will collect diagnostic information about the system in the event of an Improper Shutdown. This is saved in a diagnostic file on the system and may be downloaded at a later time and sent to Alpha Technical Support to help analyze the problem that occurred. No configuration is required for this feature to function. In order to send a diagnostic file to Alpha, it must be downloaded from the Logs and Files -> Retrieve Diagnostic File menu on the webpage.

Note that only one diagnostic file is saved on the CXC system. Therefore, when downloading the diagnostic file only the information about the latest error is retrieved. Therefore, it is important to save the file as soon as possible after an error has occurred. Otherwise, the file may be overwritten by a subsequent Improper Shutdown.



6.11 Supervisor

This menu category displays only when logged in with Supervisor level access. The web interface enables two levels of password protection: User and Supervisor. The same password cannot be used for both.

6.11.1 Change Password

This menu item enables the Supervisor to change the password. *Tap to proceed.* A pop-up window for new password entry is presented, see Figure 94 below:

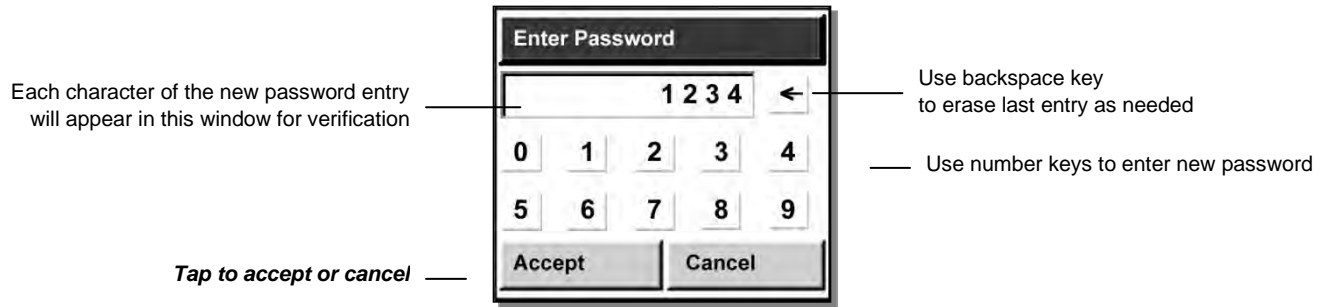

Figure 94—Change password pop-up window



Figure 95—Change password web interface window

7 Advanced Programming

7.1 Example: Customize

When configuring Alarms (Section 6.5.3), Signals (6.6.2), or Controls (0), an option to CUSTOMIZE will be presented at the bottom of the screen, see Figure 96 below. This enables the Supervisor to program separate triggering equations into the CXC software. The equations may reference any combination (up to 16) of the analog inputs, digital inputs, virtual inputs, and alarms (such as Load Voltage shown below) utilizing logical and arithmetic arguments that simulate the functionality of a programmable logic controller (PLC).

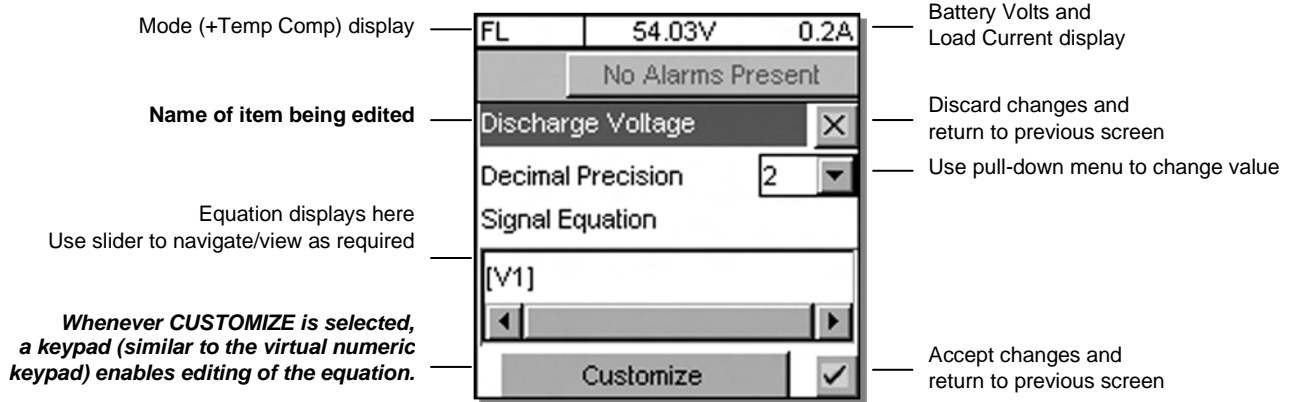

Figure 96—Screen showing example of item to be edited/customized

7.2 Equation Builder Keypads

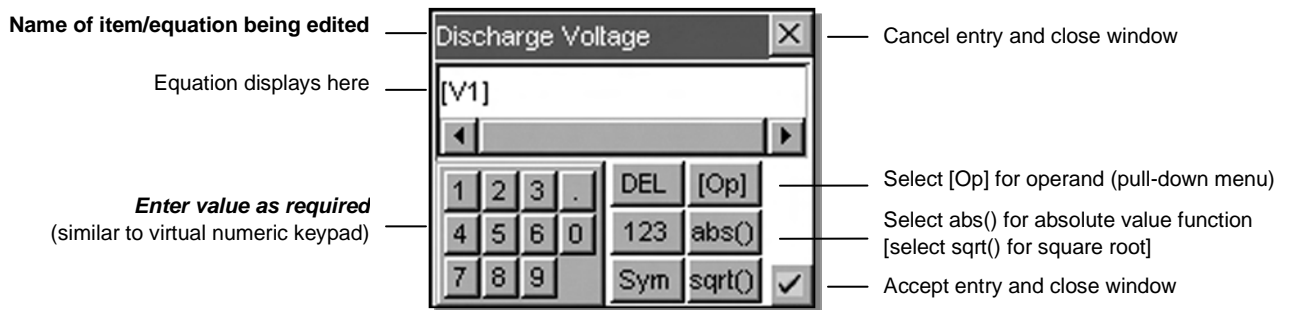

Figure 97—Equation builder keypad pop-up window

Tap to edit or enter a value. Use the virtual function buttons described above to navigate, cancel or accept.

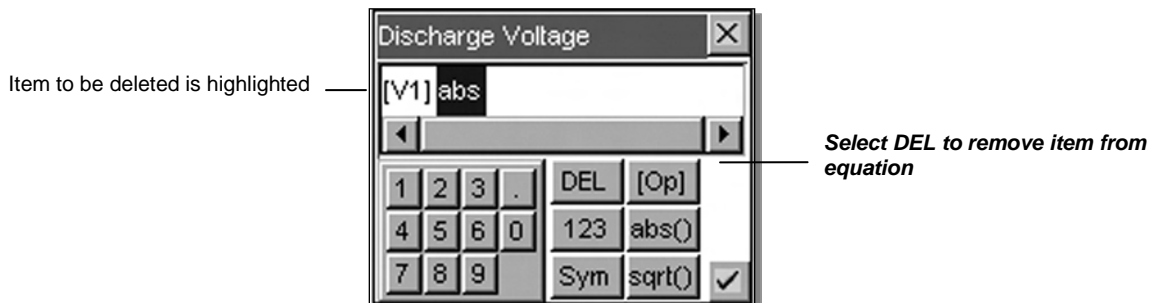
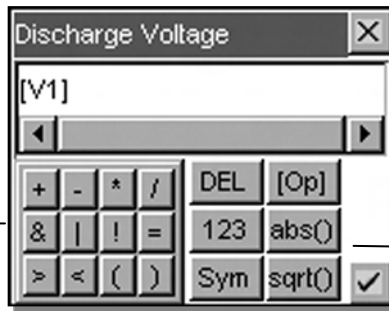

Figure 98—Equation builder keypad delete key

Mathematical operators:

- + = Add
- = Subtract
- * = Multiply
- / = Divide

Keypad changed from numeric to symbol



Select Sym

for mathematical and logic operators
[select 123 to return to numeric keypad]

Figure 99–Equation builder keypad symbol key

Logical operators:

- & = AND
- | = OR
- ! = NOT TRUE
- = is EQUAL THAN (compare for equality)
- > is GREATER THAN
- < is LESS THAN
- (is OPEN PARENTHESIS (used with a close parenthesis to set apart arguments to a mathematical function)
-) is CLOSE PARENTHESIS (see open parenthesis; used to clarify the order of operations)

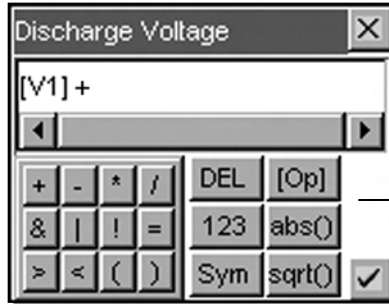

Select + key for addition function

Figure 100–Equation builder keypad function keys

7.3 Tips on Programming

Square parenthesis [] are reserved for CXC signal names.

Use only round parenthesis () for manipulating the order of operations in an equation.

The counters will increment approximately every half-second by default. A cascading counter can be written to create a longer time between increments.

Here is a delay counter for AC fail alarm. The “AC Fail Delay” works by counting up from 0 to 30 when Rect. AC Mains Fail alarm is true. When Rect. AC Mains Fail is false it will count down to 0.

$$[\text{AC Fail Delay}] + (([\text{AC Fail Delay}] < 30) * [\text{Rect. AC Mains Fail}]) - (([\text{AC Fail Delay}] > 0) * ![\text{Rect. AC Mains Fail}])$$

Here is a custom signal set up to filter the battery voltage. "Filtered Battery Voltage" is the custom signal name:

$$(([\text{Filtered Battery Voltage}] * 15) + [\text{Battery Voltage}]) / 16$$

8 CXC Communications Menu Parameters

This chapter provides definitions regarding Ethernet, IP Addresses, and CXC communications (port) configurations.

8.1 Ethernet Port Configuration

8.1.1 About IP Addresses

IP stands for Internet Protocol. Every device on an IP-based LAN or WAN network (including the CXC controller, as well as PCs, and routers) requires an IP address to uniquely identify the source node or destination node for packets sent across the network. This applies to WAN and LAN connections. There are two ways of assigning an IP address to a network device: Static IP Address and Dynamic IP Address.

8.1.1.1 Static IP Address

A static IP address is a fixed IP address that the user assigns manually to the CXC or to a PC or any other device on the network. This address remains valid until the user disables it, thus ensuring that the device will always have that same IP address until the user changes it. Check with the LAN administrator to see if they have allocated a Static or Dynamic IP address for the CXC on the network.

8.1.1.2 Dynamic IP Address

A dynamic IP address is one that is automatically assigned to any device on the LAN network. This address is called “dynamic” because it is only temporarily assigned to the CXC, PC or other network device. After a certain time, it expires and may change. If a PC logs onto the network (or the Internet) and its dynamic IP address has expired, the DHCP server (see below) will assign it a new dynamic IP address.

NOTE: *DHCP Server (8.1.1.5) may choose to assign the same IP address every time based on the MAC address.*

8.1.1.3 Subnet Mask

The Subnet Mask (also known as the Network Mask) determines which portion of an IP address is the network portion, which portion is the host portion, and directs the CXC regarding communications via the Default Gateway (8.1.1.4).

If not connected to CXC via crossover, hub, or switch, then misconfigured subnet and gateway will result in the inability to communicate with the CXC.

8.1.1.4 Default Gateway

This IP address should be the IP address of the gateway device that enables contact between the CXC and the remote network or host. If the destination node is not in the local sub network, the protocol is sent to the default gateway (and may not be required for a small network).

8.1.1.5 DHCP (Dynamic Host Configuration Protocol) Servers

A DHCP server can automatically assign a new IP address to the CXC (or any other network device that uses dynamic IP addressing). In this case, the CXC is called the DHCP client. DHCP frees the administrator from having to assign an IP address manually every time a new user is added to the network. A DHCP server is usually a dedicated network device such as a router or firewall.

By default, the CXC is configured to enable the DHCP client (the “Obtain Address Automatically” checkbox is selected). If the DHCP Client is enabled, then the DHCP server automatically provides the Subnet Mask and Default Gateway parameters. If the DHCP client is disabled (clear checkbox for “Obtain Address Automatically”) then it is possible to explicitly specify the Subnet Mask and Default Gateway.

8.1.2 IP Information

This is where the CXC's current IP Address Settings are displayed for the LCD menu. Scroll bars enable the user to navigate the list of text items for viewing; i.e., IP Address, Subnet Mask, Gateway, and Ethernet/MAC Address.

For the web interface, the current IP Address Settings are found by clicking on the "View Live Status" link of the Communications submenu.

8.1.3 Configuring IP Address Settings

This section discusses how to change CXC communications parameters in the IP Address section of the menu (or web interface). See 6.8.3 and Figure 84. **To save changes, refer to Section 4.9.**

8.1.3.1 Obtain Address Automatically

If selected, this checkbox will enable the CXC to automatically obtain an IP address from a DHCP server at system boot-up (if checked it will enable the DHCP client protocol).

8.1.3.2 Static Settings

All three fields in this area are only enabled if the "Obtain Address Automatically" checkbox is not selected.

IP Address

This field is the Static IP Address to use for the CXC device. The format of the IP address must be a so-called "dotted quad" – that is a series of 4 values in the range 0-255 each separated by a period. For example, an example of a dotted quad would be: "192.168.1.23".

An incorrect example would be: "213.12.24.264" (264 is outside the range 0-255).

NOTE: *The rules and restrictions for valid IP addresses are beyond the scope of this manual. Check with the LAN administrator for details.*

Subnet Mask

This field contains the dotted quad for the static Subnet Mask for the CXC.

Gateway

This field contains the dotted quad to specify the gateway to use for routing packets if the destination IP address is not local.

8.2 PPP Connection Devices

One of two PPP Connection devices can be selected from a pull-down menu for HTTP web server connection: Front Craft Port or Rear Modem Port (Figure 101). PPP connections over serial ports are mutually exclusive to each other.

NOTE: *The PPP connection for HTTP web server connection has no effect on enabling the HTTP web server for the Ethernet port. The HTTP web server for the Ethernet port cannot be disabled.*

8.2.1 Front Craft Port

Front Craft Port does not support modem connection. For most CXC models, it is used with NULL modem connection for HTTP web server connection.

CAUTION

For the CXCI, do not connect anything other than the Alpha modem and Alpha-supplied DB-9 cable to the D-sub port on the front.

8.2.2 Rear Modem Port

Rear Modem Port provides three choices for installed modem; selected from a pull-down menu: Internal Modem, External Modem, and NULL Modem. When connection is established, the HTTP web server, SMTP outbound e-mail notification and/or SNMP dial out trap notification can be delivered through PPP.

Modem Init String needs to be specified in order to initiate external (remote) modem connection.

To save changes, refer to Section 4.9.

Modem menu/window may appear different for systems equipped with a CXCI

Figure 101–PPP Connection Device web interface window

8.3 Rear Port Configuration

This section provides information on setting up and configuring the rear port modem device (or a direct null modem serial cable connection) with the CXC to provide inbound web server support and/or outbound e-mail alarm support and/or SNMP trap dial-out support. **To save changes, refer to Section 4.9.**

The Alpha Cordex Controller (CXC, Alpha P/N 018-557-20 or 018-587-20) supports connection to one of the following:

- Alpha-supplied internal modem daughterboard module (via rear RJ-11 jack), or
- External AT-class V.34 or V.90 modem (via rear RS-232 serial port with DB-9 connector), or
- Null modem direct cable connection (either front or rear RS-232 serial port) to a computer running Windows® 2000.

8.3.1 Internal Modem Support

The V.90 internal modem (Alpha P/N #707-329-20) module requires the CXC to be supplied with List Option 101 (modem module supporting global usage); which includes the List Option 95 Communications Board assembly.

8.3.2 External Modem Support

The CXC also supports the use of a standard external AT-class V.34 or V.90 modem (e.g. US Robotics Sportster 33.6 or similar). The external modem must be connected by a standard DB-9 straight through serial cable to the rear RS-232 serial port (requires the CXC to be supplied with the List Option 95 Communications Board assembly).

8.3.3 Null Modem Direct Cable Connection Support

The CXC supports the use of a direct DB-9 null modem cable connection to a computer running Windows® 2000. The null modem cable is connected to either the front panel RS-232 serial craft port interface or rear RS-232 serial port interface (requires the CXC to be supplied with the List Option 95 Communications Board assembly).

A null modem cable connection to the front port typically requires just a simple three-wire null modem cable (TxD, RxD and GND) for terminal emulation access (Alpha diagnostics usage). However, for a fully functional Windows® PPP web connection for the TCP/IP, the Windows® serial driver on the computer connecting to the CXC requires a standard null modem cable. See Figure 102 that follows:

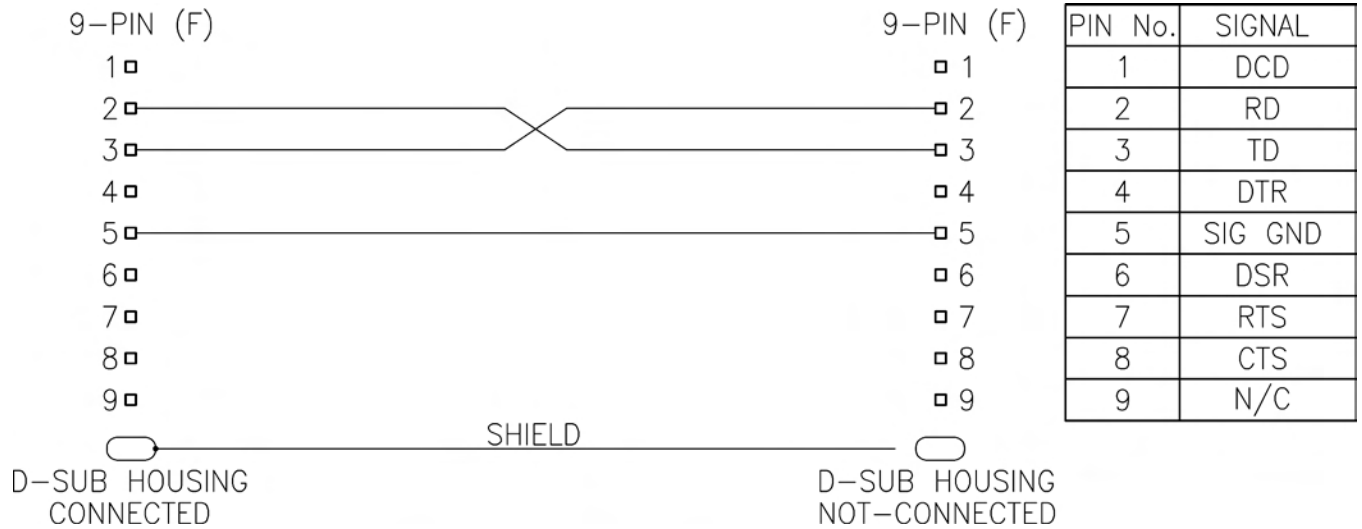

Figure 102–RS-232 null modem cable pinouts

8.3.4 Configuring Rear Modem Port Settings (CXCP or CXCR only)

The “Rear Port Device” section of the Modem menu (or the corresponding section of the “Configure Communications Parameters” page of the web interface) enables the user to configure which type of serial device is enabled for the rear port, see 6.8.4.

8.3.4.1 Internal Modem

Use this list box selection if the system includes List Option 101.

8.3.4.2 External Modem

Use this list box selection if there is an external modem connected with a straight through DB-9 cable to the DB-9 port on the communications daughterboard (requires List Option 95).

8.3.4.3 NULL Modem

Use this list box selection if there is a standard crossover null modem cable connecting a computer running Windows® 2000 to the DB-9 port on the communications daughterboard (requires List Option 95).

9 Remote Communications

The instructions provided in this chapter should enable the user to establish remote communications with the CXC. The communications protocol supports a web interface. All CXC models may be set up, monitored and tested with an Ethernet 10/100 Base-T either locally or remotely. Local connection is also possible with a PPP serial data connection. The installation manual describes some standard scenarios. See also 2.2.

NOTE: *A step by step connection wizard – provided to establish remote communications with the CXC – is available via the Alpha website (www.alpha.ca).*

9.1 Establishing a Network Connection via a Crossover Cable

1. Connect the network crossover cable between the host computer (e.g. laptop) and the Cordex controller.
2. In Windows® 2000, select START MENU, SETTINGS, and then select NETWORK AND DIAL-UP CONNECTIONS.
3. Right-click on the icon for the LOCAL AREA CONNECTION (to be used by the laptop computer) and then select PROPERTIES.
4. Make sure INTERNET PROTOCOL (TCP/IP) is checked; highlight it and then select PROPERTIES.
5. Check the radio button beside USE THE FOLLOWING IP ADDRESS and enter or verify the following information:
 IP address: 10.10.10.202
 Subnet mask: 255.255.255.0
6. Click OK to close each window opened thus far.
7. **Login to the CXC:** First, tap on the Home icon button at the bottom left corner of the LCD touch screen and select LOGIN. Next, enter the password 1234 and tap on ACCEPT. Last, close the message window (access granted to the controller).
8. On the main menu, scroll down and tap on COMMUNICATIONS and then tap on IP ADDRESS (Figure 84).
9. Ensure the checkbox beside OBTAIN AUTOMATICALLY is clear, and enter or verify the following information:
 IP address: 10.10.10.201 (factory default)
 Subnet mask: 255.255.255.0

NOTE: *To change a number, tap on the numeric field to edit via the CXC's virtual numeric keypad, see Figure 24.*

10. Select the ✓ icon to accept the new setting and return to the previous menu.
11. Return to MAIN MENU navigation screen and press the OPTION button to evoke the SAVE/LOGOUT pop-up window.
12. Select SAVE to save the new settings. A pop-up window appears to confirm the selection (select the X icon).
13. Select the OPTION button again and choose LOGOUT.
14. Tap on the home icon at the bottom left corner of the LCD touch screen and select RESET, see Section 4.7.3. To confirm the reset, tap ACCEPT and then REBOOT NOW.
15. **In Windows® 2000**, once the CXC has rebooted, launch Internet Explorer® 6 or greater and enter the IP address of the CXC (10.10.10.201) in the address bar. Under Tools\Internet Options\Security, add the logon address of the CXC to the "Trusted Sites."
16. If the connection was successful, the password prompt will appear. Enter the USER NAME and the default PASSWORD (1234). Select OK to proceed to the language selection window.
17. See Section 4.10 for a sample window when using a desktop browser to set-up or monitor the CXC controller.

9.1.1 Support for CXCI

The CXCI has only a 4-digit display for monitoring system voltage and current (IP address display may be included in future revisions). Without a touch screen display, system setup and management is performed exclusively with the web interface. To establish remote communications, begin setup as follows:

Perform steps 1 through 6 above.

Reboot the CXCI (see 6.8.3.1): press and hold the front panel reset button for three seconds. The unit will beep three times, IP will be reset (to 10.10.10.201) and DHCP will be disabled. The settings will be saved and the unit will then reboot/reset.

Perform steps 15 through 17 above.

9.2 PPP Serial Data Connection

The user must set up a “direct cable connection” for the workstation to be connected (with a null modem cable) to the CXC Craft port (**address 10.10.10.203**). Follow the example (e.g., in Windows® 2000) below:

9.2.1 Starting Networking Wizard

Select START MENU, SETTINGS, and then select NETWORK AND DIAL-UP CONNECTIONS as shown below:

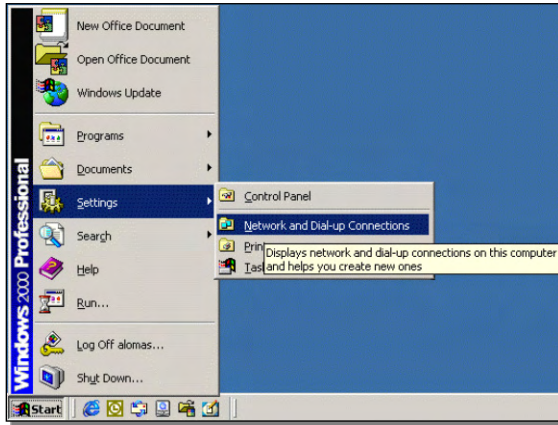

Figure 103–Starting networking wizard

A new window will open, similar to below:

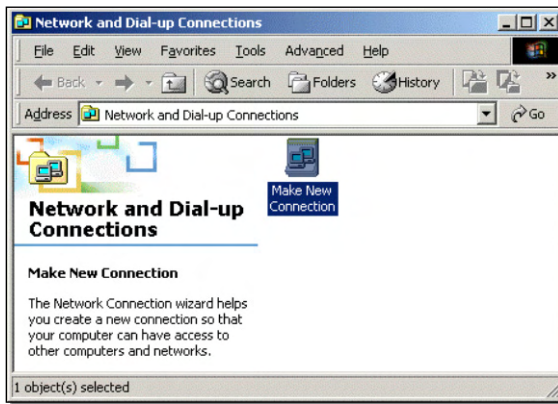

Figure 104–Make New Connection icon

Double-click the MAKE NEW CONNECTION icon to start the Network Connection Wizard.

9.2.2 Network Connection Wizard

This wizard is used to create several different types of connection, so it is important to follow the steps carefully. The first page is merely a welcome screen. Select NEXT to continue.

On the page shown below, select **CONNECT DIRECTLY TO ANOTHER COMPUTER** and then select NEXT to continue.

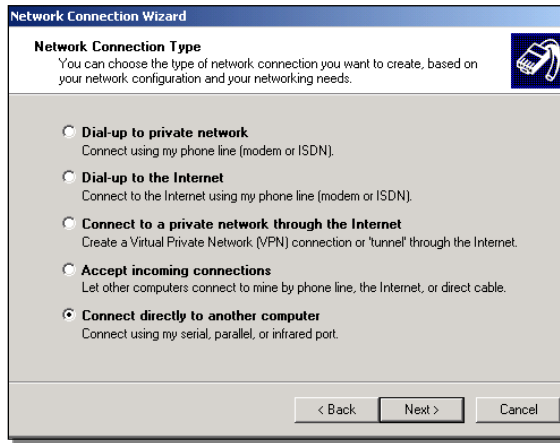

Figure 105–Network Connection Type

Host or Guest? Page

Select GUEST, and then select NEXT to continue.

Select a Device Page

Select COMMUNICATIONS PORT COM1 or COM2, and then select NEXT to continue.

Connection Availability Page

Select FOR ALL USERS, and then select NEXT to continue.

Connection Name Page

Type a name for the connection in the COMPUTER NAME box.

Complete this section of the installation by selecting FINISH.

See next image (DIRECT CONNECTION icon is highlighted):

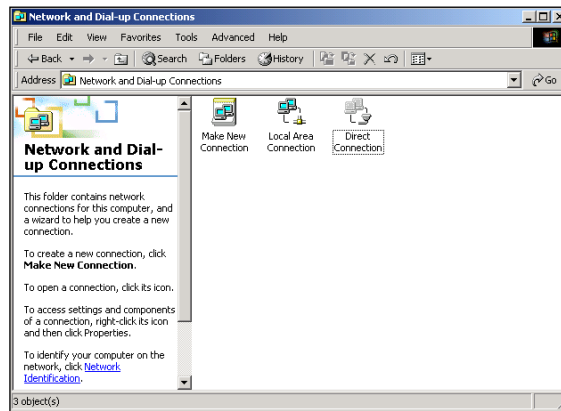

Figure 106–Direct Connection icon

9.2.3 Direct Connection Properties

Right-click on the DIRECT CONNECTION icon to verify the properties of the new connection as follows:

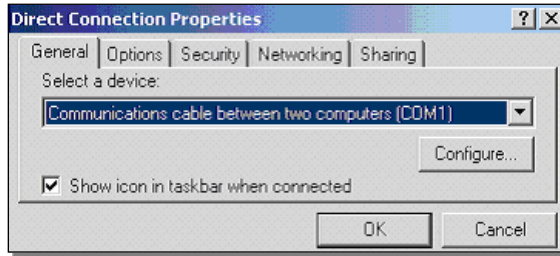

Figure 107–Direct Connection Properties

General Tab

Select a device COMMUNICATIONS CABLE BETWEEN TWO COMPUTERS... as shown above.

Options Tab

Uncheck PROMPT FOR NAME...

Security Tab

Check TYPICAL (RECOMMENDED SETTINGS) and select ALLOW UNSECURED PASSWORD.

Networking Tab

Select PPP type. Ensure component TCP/IP is checked and uncheck all others.

Sharing Tab

No changes are required.

9.2.3.1 Modem Configuration

Under the General tab of the Direct Connection properties click on the CONFIGURE button to open the Modem Configuration window and set the COM port speed to match with the server's baud rate; typically 57600 bps as below:

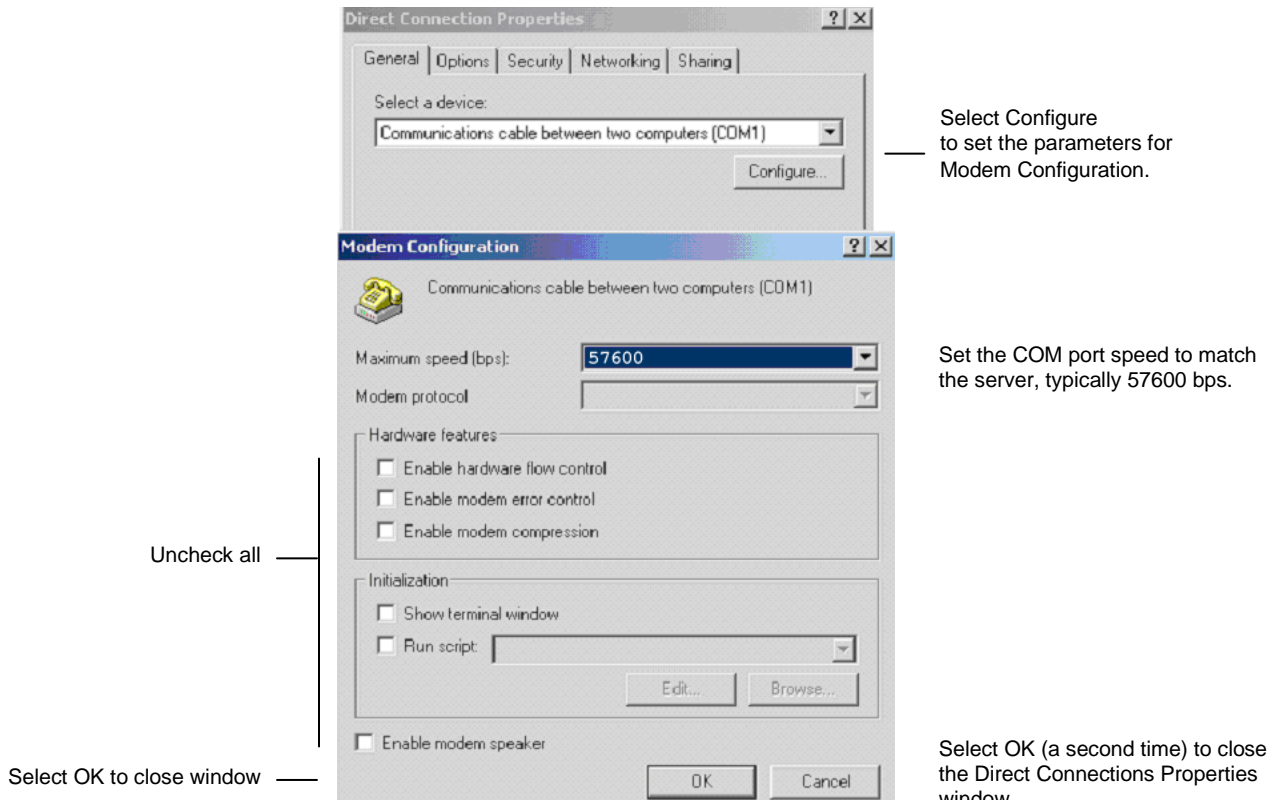

Figure 108–Modem Configuration

9.2.4 Phone and Modem Options

Select START MENU, SETTINGS, and then select CONTROL PANEL. Open PHONE AND MODEM OPTIONS to check the speed of the COM port as shown below:

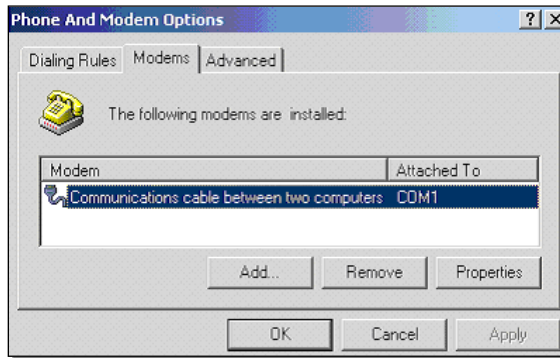

Figure 109–Phone and Modem Options

Select PROPERTIES and verify Maximum Port Speed (determined previously) as shown below:

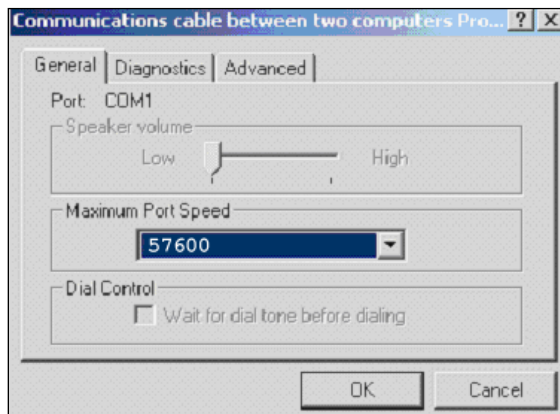

Figure 110–Modem Properties

Select OK to close each of these windows.

9.2.5 Connect Direct Connection

Select START MENU, SETTINGS, and then select NETWORK AND DIAL-UP CONNECTIONS as before. Select DIRECT CONNECTION to open password entry window shown below:

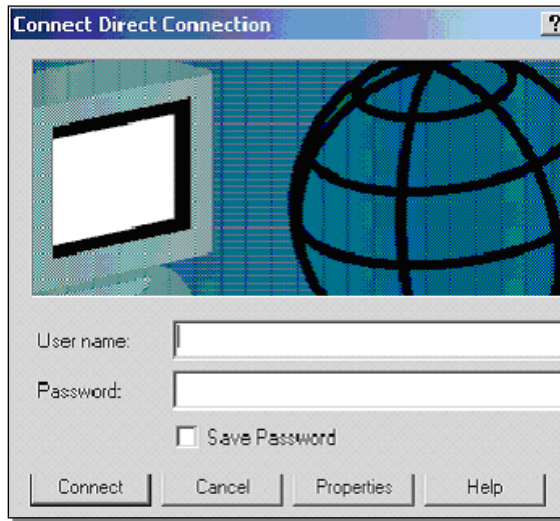

Figure 111–Connect Direct Connection (password entry)

Select CONNECT to continue.

A Connection Complete dialog box should be presented as below:

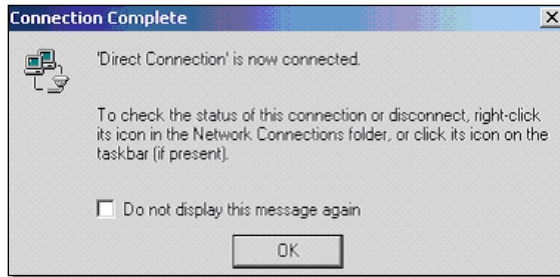

Figure 112–Connection Complete (message)

Select OK to continue.

9.2.6 Dial the Modem and Connect to the CXC

1. Once the connection is established (icon in bottom right tray), right click on the icon
2. Select Status
3. Click on the Details tab
4. Use the Server IP address for the web address
5. The Server IP address default is '10.10.10.203' (as shown below)
6. Access the CXC via Internet Explorer® 6 or up.

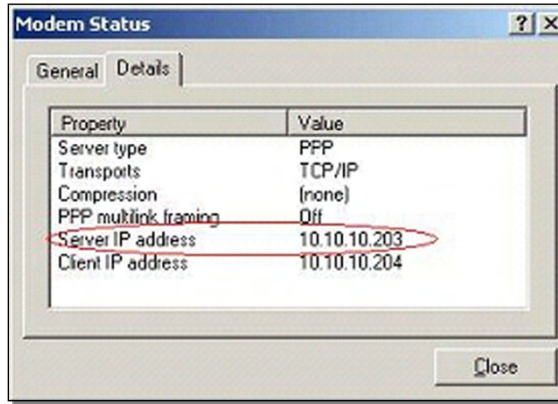

Figure 113–Modem Status

9.3 Modem Connection

9.3.1 Controller Setup

NOTE: If using a CXCI: configure modem settings via Ethernet (web server) only.

CAUTION

Do not connect anything other than the Alpha modem and Alpha-supplied DB-9 cable to the D-sub port on the front of the CXCI.

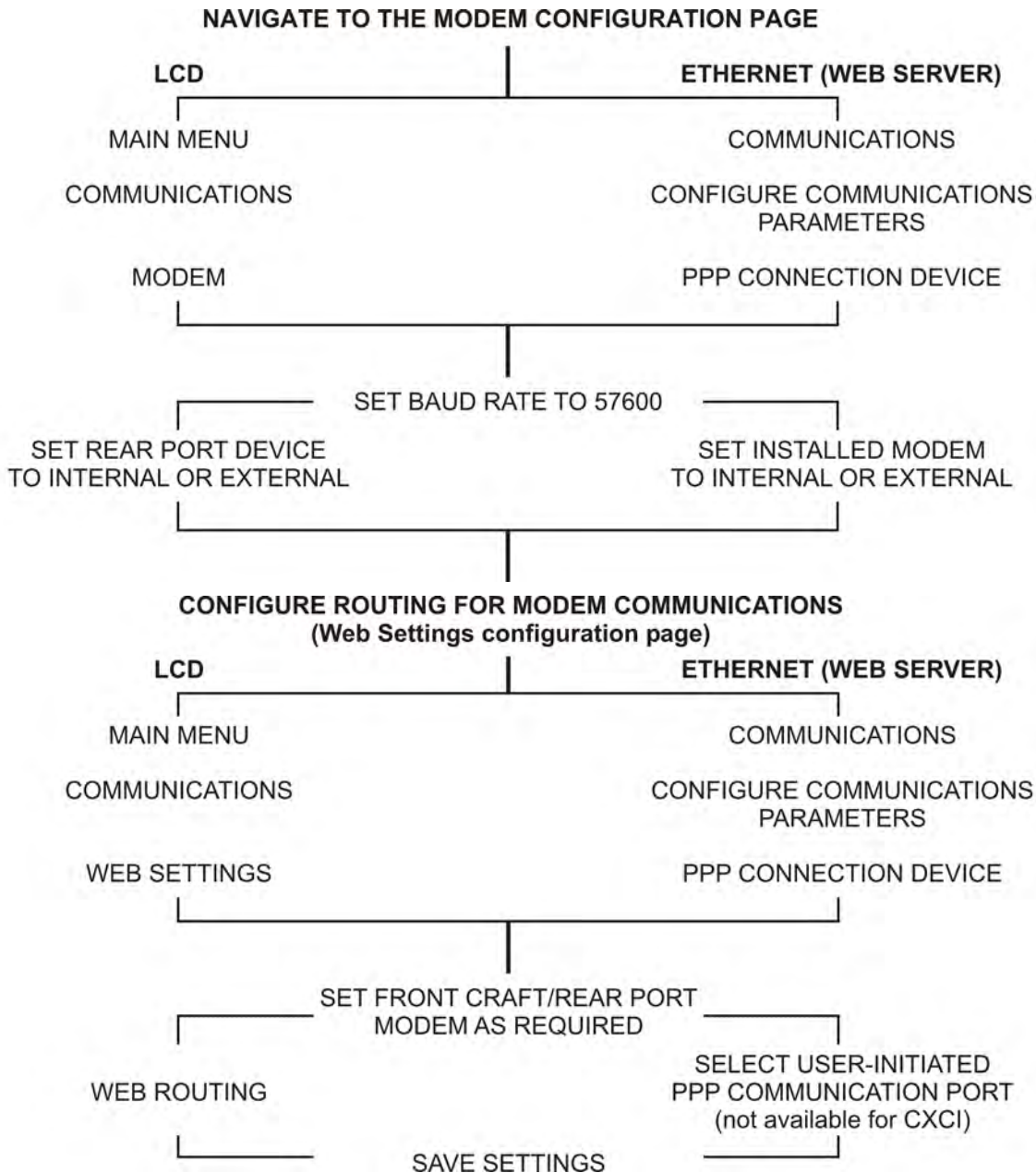

NOTE: To set the modem number of rings, edit the MODEM INIT STRING; for example:
E1MIQ0X4S0=N, where N is the number of rings. Recommended value is 1 to 5.

9.3.2 Computer Setup

1. In Windows® 2000, select START menu, SETTINGS, and then select NETWORK AND DIAL-UP CONNECTIONS.
2. Double-click the MAKE NEW CONNECTION icon to start the Network Connection Wizard.
3. Select DIAL-UP TO PRIVATE NETWORK. Note: Some systems may come up with another pop-up selection for modem or infrared port. Modem should be selected.
4. Enter the phone number for the Cordex (this field can be blank and the phone number may be entered in the pop-up connection window, see note below).
5. Select FOR ALL USERS or ONLY FOR MYSELF as required. Then select NEXT to continue.
6. Select a Unique name for the Cordex connection; for example, "SiteName CXC.modem." Then select FINISH to continue. Note: A dialup connection interface may appear. (If not, enter the phone number as in step 4. If in Step 5, FOR ALL USERS was selected, then there is no need to enter user name and password. Leave these two fields blank.)
7. Select PROPERTIES. Ensure the correct modem appears under "CONNECT USING." Then select CONFIGURE to continue.
8. Change MODEM SPEED (BPS) to 57600. Deselect all HARDWARE FEATURES and select OK to continue.
9. Select the NETWORKING tab (Dial-up Connection Properties window).
10. Select Internet Protocol (TCP/IP). Then select PROPERTIES to continue.
11. Select OBTAIN IP ADDRESS AUTOMATICALLY and select OK to continue.

Launch Internet Explorer® version 6.0 or greater to access the Cordex web interface. Type the address <http://10.10.10.203> into the URL section.

9.3.3 CXC Modem Test Feature (via Web interface only)

This feature is a modem dial out test and can only be done using the web interface with Ethernet (Local or Remote) connection. Refer to controller setup and computer setup above.

1. Connect the computer modem to a phone jack.
2. Establish connection between controller and computer and launch CXC user web interface.
3. Once the connection is established, navigate to HARDWARE and then TEST MODEM (Figure 114).
4. Enter the TELEPHONE NUMBER.
5. Click on TEST MODEM to initiate test.

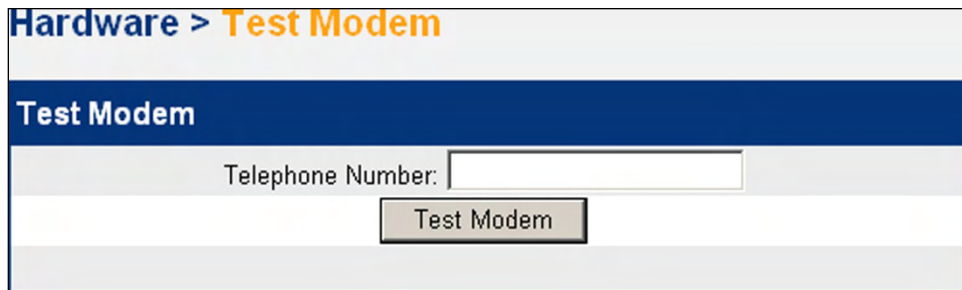

The screenshot shows a web browser window with the title "Hardware > Test Modem". The main content area has a dark blue header with the text "Test Modem" in white. Below the header, there is a text input field labeled "Telephone Number:" followed by a button labeled "Test Modem".

Figure 114–Test Modem web interface window

10 Simple Network Management Protocol (SNMP)

10.1 Overview

SNMP was developed in 1988 as an operating system for the management of the data flow from a series of remote information generators, or Agents, connected to a central computer, or Manager, by way of a network.

The software installed in the Agent (whether it is supplied by Alpha or customer supplied) uses SNMP to translate the data stream into a format that can be readily downloaded by way of the client's network to the Manager computer located at the customer's Central Office used as a hub for the network.

Each Agent collects data from a source, translates that data into the SNMP format and then transmits the translated data, when requested, to the Manager computer.

In the case of a network of Alpha Power Systems, the data stream from an individual power plant is developed through the CXC System Controller, which directly interfaces with that power system. This data stream is referred to as the Management Information Base or MIB, see 0.

An SNMP may have a number of simple messages that can be sent directed towards the retrieval of single or multiple object variables or to establish the value of a single variable.

The Alpha SNMP Agent software employs an event notification called a "Trap" to the management system to identify the occurrence of conditions that exceed a predetermined value such as an alarm event. Trap Protocol Data Units or PDU's have the following format:

Enterprise – identifies the type of object causing the trap.

Agent Address – IP address of agent that sent the trap.

Generic Trap ID – the common standard traps.

Specific Trap ID – proprietary or enterprise trap.

Time Stamp – when trap occurred in time ticks.

10.1.1 Outline of the SNMP Protocol

- Each SNMP managed object belongs to a community.
- Network Management Station (NMS) may belong to multiple communities.
- A community is defined by a community name, which is an Octet String with 0 to 255 octets in length.
- Each SNMP message consists of three components:
 1. Version number
 2. Community name
 3. Data - a sequence of PDU's associated with the request.

10.1.2 Underlying Communication Protocols

SNMP assumes that the communication path is a connectionless communication sub-network. In other words, no prearranged communication path is established prior to the transmission of data. As a result, SNMP makes no guarantees about the reliable delivery of the data. Although in practice most messages get through, and those that don't can be retransmitted. The primary protocols that SNMP implements are the User Datagram Protocol (UDP) and the Internet Protocol (IP). SNMP also requires Data Link Layer protocols such as Ethernet or Token Ring to implement the communication channel from the management to the managed agent.

SNMP's simplicity and connectionless communication also produce a degree of robustness. Neither the manager nor the agent relies on the other for its operation. Thus, a manager may continue to function even if a remote agent fails. When the agent resumes functioning, it can send a trap to the manager, notifying it of its change in operational status. The connectionless nature of SNMP leaves the recovery and error detection up to the Manager computer and even up to the Agent.

10.1.3 Typical UDP Transport

- Agent listens on UDP port 161.
- Responses are sent back to the originating NMS port from a dynamic port, although many agents use port 161 also for this target.
- Maximum SNMP message size is limited by maximum UDP message size; i.e. 65507 octets.
- All SNMP implementations have to receive packets at least 484 octets in length.
- Some SNMP implementation will (incorrectly or not) handle packets exceeding 484 octets.
- Asynchronous Traps are received on port 162 of the NMS.
- UDP is more suitable than TCP when dynamic route changes occur often; e.g., when there are problems in the network.
- UDP packets minimize the demands placed on the network (no resource tied up as with connection mode).
- Agent and NMS are responsible for determining error recovery.

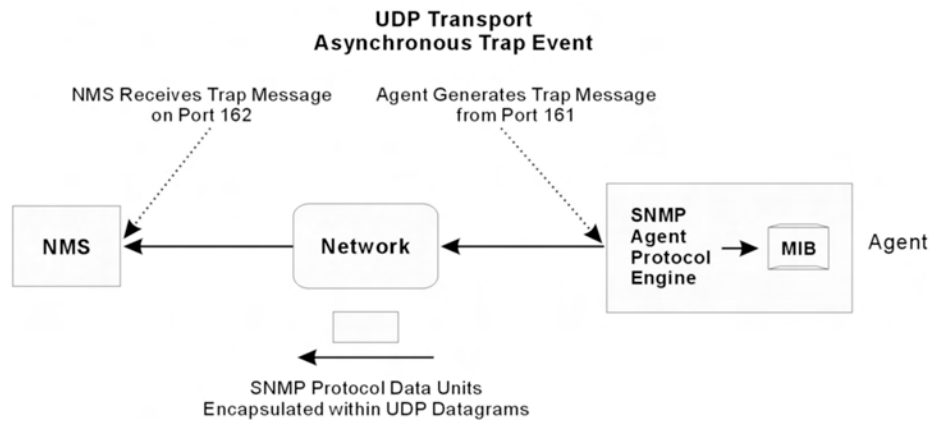

Figure 115–UDP transport (trap event)

SNMP is transport independent (although original design was connectionless transport function, which corresponds to the UDP protocol) and can be implemented on other transports as well:

- TCP (Connected approach)
- Direct mapping onto Ethernet MAC level
- Encapsulation onto X25 protocol
- Encapsulation onto an ATM Cell.

10.1.4 Variable Binding (VarBind)

A VarBind is a sequence of two specific fields, an Object Identifier (ID) and the value for/from that Object ID. A VarBindList is a simple list of these pairings.

Among the Event Properties employed, the following example highlights two new VarBinds for version 2 software: Timestamp & Alarm Trigger.

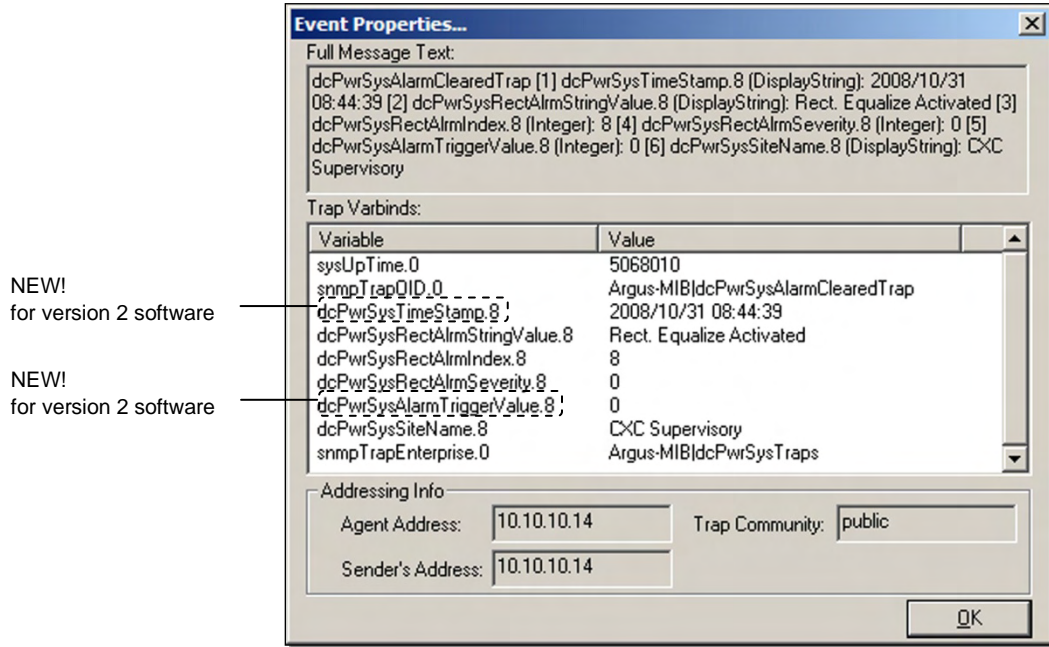

Figure 116–VarBinds, showing Timestamp and Alarm Trigger

10.2 Network Manager MIB Files

The SNMP network manager will require the following files: 1) Alpha_System_Controller.MIB, 2) MIB_ii.MIB, and 3) SMI.MIB.

To obtain MIB files, logon to www.alpha.ca/downloads and select software. From the home page, this is located under the right-most column entitled "Support."

A password will be required to access these secure pages and may be obtained via Login (on the home page). Select "Create New Account" and fill out the User Registration Form. Select "Save" upon completion and an Alpha Sales Representative will contact you by e-mail to complete the process.

The MIB variables (in the file Alpha_System_Controller.MIB) are as follows:

- Site Information
- System Information
- Battery Voltage
- Battery Amperage
- Load Voltage
- Load Amperage
- System Major Alarm
- System Minor Alarm
- Table of Numeric Values
- Table of String Values.

The Alpha_System_Controller.MIB file provides separate object identifier (OID) for active and cleared alarm traps.

Alarm status and signals are reconstructed into tables and sub tables to allow for future expansion while remaining backward compatible with already defined alarms and signals.

See 10.3.

10.3 Communication Configuration

SNMP Communication Configuration is only accessible via the web interface.

Select Configure SNMP from CXC web interface Communications menu as shown below.

10.3.1 SNMP Multiple Community Names

This menu item enables the User to configure multiple CXC SNMP community settings for get (read) and set (write). This is to permit multiple SNMP NMS programs, with different community strings, to connect to the CXC.

NOTE: Before this feature, the CXC had one set of community strings, which meant that any NMS that tried to connect to the CXC must be a match.

Now, a company with multiple NMS's, each in a different region, with a different community string, will find it easier to connect to the CXC from various places. See Figure below:

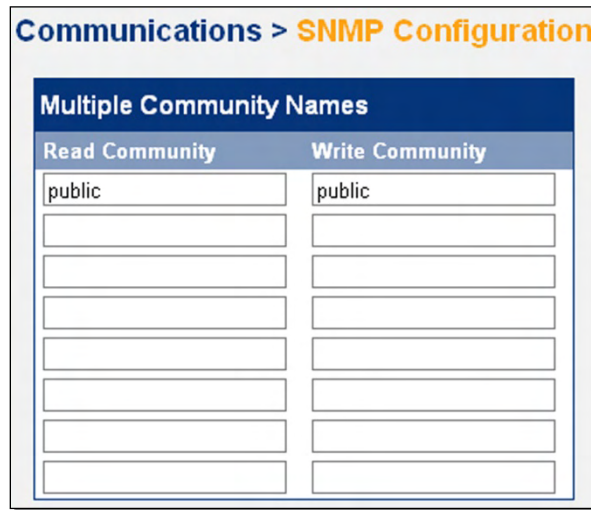

Figure 117–SNMP Community Name web interface window

10.3.2 SNMP Trap Recovery

This feature enables the CXC SNMP agent to hold traps in a buffer during a network block out period. The master network management station (NMS) must be monitoring (polling) the SNMP agent in order for the agent to resend the traps after the network connection has again been established.

NOTE: The following items along with any item from the Argus MIB will reset the poll timer:

- sysDescr.0
- sysContact.0
- sysName.0
- sysLocation.0

An ICMP⁷ echo request packet or “ping” is used to determine whether a trap may be received (recovered) by the SNMP client. Once successful, the trap is sent.

The time-out before failure of ping has been increased from two seconds to eight.

NOTE: Master NMS destination can be selected from Master SNMP Destination pull-down menu (see next section Event Notification).

⁷ Internet control message protocol
0350046-J0 Rev C

10.3.3 Event Notification Destination – Multiple SNMP and SMTP Destinations

This menu item enables the Supervisor to add up to eight (8) separate destinations for SNMP and SMTP dial-out of e-mail notifications. A wizard is provided to assist the Supervisor with the addition of new destinations. See the following example.

NOTE: Login credential information must be provided by your network administrator.

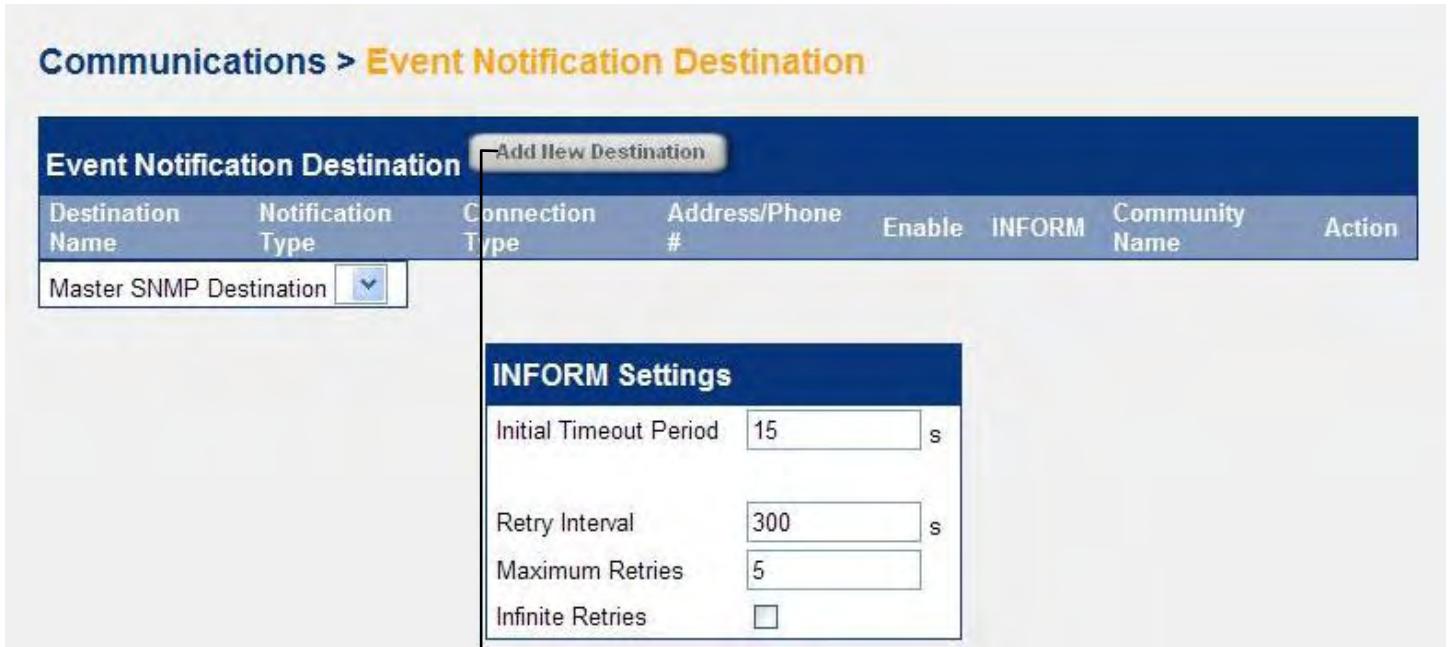

For SNMP Configuration:

- Select Broadcast if CXC is located in the same segment as NMS. IP Address is not required. Broadcast cannot be used as master.
- Select IP Address if value is known for NMS. This is the recommended setup selection for SNMP destination configuration.
- Select Host Name if CXC has a fully qualified domain name that can be resolved by a DNS server. IP address must be obtained automatically from DHCP server.

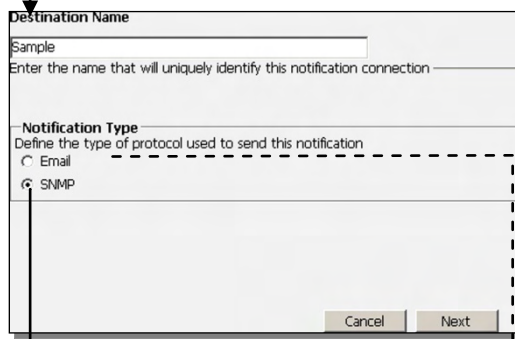

For Email Configuration,

- Enter SMTP IP Address unless Host Name is preferred (Dedicated Connection only). Send Domain is optional for SMTP "hello" packet and may be left blank.
- Enter From Address and To Address. Copy Address is optional.

Alternate Configuration

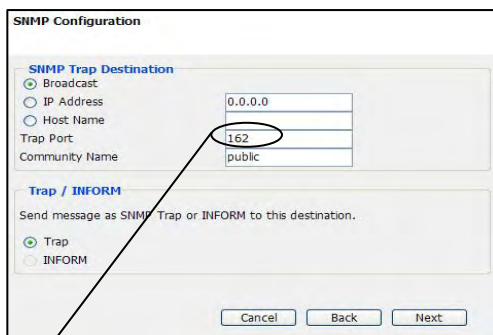

(Default value)

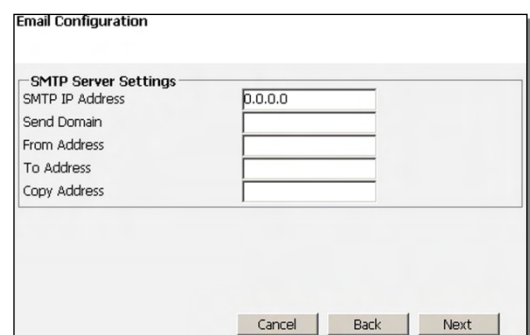

Select Next to proceed with wizard for new destination.

For SNMP Configuration, Dedicated Connection is the default selection of Connection Type:
 -Information for Destination was established in the configuration window.
 For Email Configuration:
 -Enter SMTP IP Address unless already established in the configuration window.
 -Select Host Name if CXC has a fully qualified domain name that can be resolved by a DNS server. IP address must be obtained automatically from DHCP server.
 Enter login credential information as provided by your network administrator.

Connection Type
 Define the type of method used when connecting to this destination

Dedicated Connection
 Sends the notification to a permanent LAN or Internet (WAN) connection. This includes a pre-established serial PPP connection through the craft or modem port.

Dial-Out Connection
 A connection must be established using a modem by dialing out to a remote host

Cancel Back Next

For Dial-Out Connection:
 -Enter phone number of the remote connecting modem.
 -Enter login credential information as provided by your network administrator.
 Domain name is only required if the CXC dials out to a RAS server.

Alternate Configuration

Select Next

Dial-Out Connection

Phone Number

Authentication

Login Account

Password

Domain Name

Cancel Back Next

Destination Wizard Completed

The following summary of settings will be added to the event notification destination list

Destination Name	Sample
Notification Type	SNMP
Connection Type	Dedicated Connection

Cancel Back Finish

Destination Wizard Completed

The following summary of settings will be added to the event notification destination list

Destination Name	Alternate Sample
Notification Type	Email
Connection Type	Dial-Out Connection

Cancel Back Finish

Select Finish to complete the destination wizard setup and return to the Event Notification Destination window.

Communications > Event Notification Destination

Event Notification Destination Add New Destination

Destination Name	Notification Type	Connection Type	Address/Phone #	Enable	INFORM	Community Name	Action
Sample	SNMP	Dedicated Connection	Broadcast	<input checked="" type="checkbox"/>	<input type="checkbox"/>	public	Edit / Remove

Master SNMP Destination

10.3.3.1 Master SNMP Destination

This menu item enables the Supervisor to set a NMS destination as master.
 Select from the pull-down menu.

Select None if SNMP connection is by dial-out or no trap recovery (after network block out) is required. This is the default to be backward compatible with legacy CXC trap notification method.

Note that “Master SNMP Destination” should NOT be set if using “Inform” (see the next section for details on Inform).

10.3.3.2 Inform Settings (Trap Acknowledge)

INFORM is similar to a Trap message; except that it requires a response from the Network Management Software (NMS) to the SNMP Agent. The SNMP Agent will continue to send the Inform message if no acknowledgement is received. The “INFORM Settings” on the Event Notification Destination page allow the user to set the behavior of Inform retries. See Figure below:

Communications > Event Notification Destination

Event Notification Destination Add New Destination

Destination Name	Notification Type	Connection Type	Address/Phone #	Enable	INFORM	Community Name	Action
Email Alert	Email	Dedicated Connection	172.17.1.57	<input type="checkbox"/>	<input type="checkbox"/>	public	Edit / Remove
SNMP sendout bad destination	SNMP	Dedicated Connection	10.10.10.1	<input type="checkbox"/>	<input checked="" type="checkbox"/>	public	Edit / Remove

Master SNMP Destination: SNMP sendout bad destination

INFORM Settings

Initial Timeout Period: s

Retry Interval: s

Maximum Retries:

Infinite Retries:

Any destination set with INFORM should never be used as Master SNMP Destination.

11 Factory Ranges and Defaults

Submenu Item	Programmable Range	Default Setting				
		12Vdc	24Vdc	48Vdc	125Vdc	220Vdc
Float (FL) Voltage	0-9999999999	13.50V	27.00V	54.00V	130.50V	229.5V
Equalize (EQ) Voltage	0-9999999999	13.75V	27.50V	55.00V	132.92V	233.75V
Battery Test (BT) Voltage	0-9999999999	11.50V	22.00V	44.00V	106.33V	187.00V
OVP	0-9999999999	14.25V	29.00V	57.00V	137.75V	242.25V
LVA	0-9999999999	11.00V	22.00V	44.00V	106.33V	187.00V
HVA	0-9999999999	14.00V	28.00V	55.50V	134.13V	235.88V
Current Limit (CL)	0-9999999999	100%				
Power Limit (PL)	0-9999999999	100%				
Equalize Timeout	0-9999999999	30 hours				
Battery Test Duration	0-9999999999	8.0 hours				
Slope (Adjust)	0-9999999999	1.00%				
Backlight Timeout	0-32767	1 minute				
Security Code	0-32767	123				
Module Start Delay	0-32767	1 second				
System Start Delay	0-32767	0 seconds				
Soft Start Ramp Rate	Normal/Fast	Normal				
Temp Display Scale	Celsius/Fahrenheit	Celsius				
Current/Power Limit Alarm	Enable/Disable	Disable				
Remote Shutdown	Enable/Disable	Enable				
Local Access Alarm	Enable/Disable	Enable				
Ramp Test	Enable/Disable	Enable				
Power Save	Enable/Disable	Disable				
Redundant Rectifiers	0-32767	1				
Maximum Power Usage	0-32767	80%				

Table E—Rectifiers menu defaults

Submenu Item	Programmable Range	Default Setting
Load Voltage (V1)	Decimal precision: 0-3	2
Load Current (I1)	Decimal precision: 0-3	1
Battery Voltage (V2)	Decimal precision: 0-3	2
Battery Current (I2)	Decimal precision: 0-3	1
AC Mains	Decimal precision: 0-3	1
Battery Temperature	Decimal precision: 0-3	2
Temp Comp Sensor 1	Enable/Disable	Disable
Temp Comp Sensor 2	Enable/Disable	Disable
Temp Comp Sensor 3 (GP1)	Enable/Disable	Disable
Temp Comp Sensor 4 (GP2)	Enable/Disable	Disable
Battery Runtime	Decimal precision: 0-3	2
Battery Capacity	Decimal precision: 0-3	1
Battery Depth of Discharge (DOD)	Decimal precision: 0-3	1
Analog Inputs	See 6.6.1.1	N/A
Digital Inputs (1-8)	High/Low	Low
Rectifier Signals	See Menu Tree	N/A
Custom Signals (1-20)	Decimal precision: 0-3	2
Signal Units (1-20)	A, V, W, °C (°F)	V

Table F—Signals menu defaults

Submenu Item	Programmable Range	Default Setting					
		12Vdc	24Vdc	48Vdc	125Vdc	220Vdc	
Capacity Rating	0-9999999999	0.0 AH					
Capacity Calibration	0-9999999999	100%					
Open Circuit Voltage	0-9999999999	12.84V	25.68V	51.36V	124.12V	218.28V	
Peukert Number	0-9999999999	1.000					
Peukert Time 1	0-9999999999	0 hours					
Peukert Time 2	0-9999999999	0 hours					
Peukert Current 1	0-9999999999	0A					
Peukert Current 2	0-9999999999	0A					
Temp Comp Slope	0-9999999999	2.50mV/°C					
Charge Current Control	Enable/Disable	Disable					
Charge Rate Amps	0-9999999999	0.0A					
Charge Rate C/X	0-9999999999	0.0					
Battery Monitor	Enable/Disable	Disable					
Load Type	Power/Current/Resist	Power					
Disconnect Voltage	0-9999999999	10.50V	21.00V	42.00V	101.50V	178.50V	
Battery Test (BT) End Voltage	0-9999999999	11.63V	22.50V	44.50V	107.54V	189.13V	
Periodic Auto BT	Enable/Disable	Disable					
Auto BT Interval	1-32767	180 days					
Auto Equalize Duration	1-32767	8 hours					
Periodic Auto Equalize (EQ)	Enable/Disable	Disable					
Auto EQ Interval	1-32767	30 days					
(Battery) Charge Auto EQ	Enable/Disable	Enable					
Activation Threshold (Auto EQ HV)	0-9999999999	13.25V	26.50V	53.00V	128.08V	225.25V	
Arming Threshold (Auto EQ LV)	0-9999999999	12.00V	24.00V	48.00V	116.00V	204.00V	
Temp Comp (Interval fixed at 10 min.)	Enable/Disable	Disable					
Upper Breakpoint	Voltage	0-9999999999	13.13V	26.25V	52.50V	126.88V	223.13V
	Temperature	-99999999 to 9999999999	50°C				
Lower Breakpoint	Voltage	0-9999999999	13.88V	27.75V	55.50V	134.13V	235.88V
	Temperature	-99999999 to 9999999999	0°C				
Battery Current Termination (BCT) EQ	Enable/Disable	Disable					
BCT EQ Duration	0-65536	1 hour					
BC Threshold	0.1-9999999999	5.0A					
Boost (BST) Mode	Enable/Disable	Disable					
BST Mode Voltage (V/cell)	0-9999999999	2.30	2.30	2.30	2.30	2.30	
BST Mode Timeout	1-32767	4 hours					
BST Mode Inhibit	Custom 1 – 20	Custom 1					

Table G—Batteries menu defaults

Submenu Item	Programmable Range	24V–48V Defaults	48V–24V Defaults
Output Voltage	0-9999999999	54.00V	27.00V
OVP	0-9999999999	57.00V	28.50V
Input Voltage Shutdown	0-9999999999	21.0V	42.0V
Input Voltage Restart	0-9999999999	25.0V	50.0V
Start Delay	0-32767	1 second	
Current Limit (CL) Alarm	Enable/Disable	Enable	

Table H—Converters menu defaults

Submenu Item	Programmable Range	Default Setting: Priority, Activation Value				
		12Vdc	24Vdc	48Vdc	125Vdc	220Vdc
Rectifier Fail	Major/Minor/Message	Minor				
Rectifier Minor	Major/Minor/Message	Minor				
Rect. Major Fail Count	Major/Minor/Message	Major, 2				
Rect. Minor Fail Count	Major/Minor/Message	Minor, 1				
Rectifier Lockout	Major/Minor/Message	Minor				
Out of Tolerance	Major/Minor/Message	Minor				
Rect. Communications Lost	Major/Minor/Message	Minor				
Rect. Equalize Activated	Major/Minor/Message	Minor				
Rect. AC Mains Fail	Major/Minor/Message	Minor				
Max. Rectifiers Exceeded	Major/Minor/Message	Minor				
Fan Fail Alarm	Major/Minor/Message	Minor				
Power Save	Major/Minor/Message	Message				
Distribution Fuse (Digital 1)	Major/Minor/Message	Minor, High				
Battery Fuse (Digital 2)	Major/Minor/Message	Major, High				
LVD Manual In (Digital 3)	Major/Minor/Message	Minor, High				
LVD Manual Out (Digital 4)	Major/Minor/Message	Major, High				
Converter Fail (Digital 5)	Major/Minor/Message	Minor, High				
Conv. I/P Breaker Trip (Digital 6)	Major/Minor/Message	Major, High				
Digital 7-8	Major/Minor/Message	Message, High				
Battery Current High	Major/Minor/Message	Major, 100A				
Load Current High	Major/Minor/Message	Major, 1000A				
AC Mains High	Major/Minor/Message	Minor, 270V	Minor, 270V	Minor, 270V	Minor, 270V	Minor, 270V
AC Mains Low	Major/Minor/Message	Minor, 180V	Minor, 180V	Minor, 180V	Minor, 180V	Minor, 180V
High Voltage 1	Major/Minor/Message	Minor, 14.00V	Minor, 28.00V	Minor, 55.50V	Minor, 134.13V	Minor, 235.88V
High Voltage 2	Major/Minor/Message	Major, 14.25V	Major, 29.00V	Major, 56.50V	Major, 136.54V	Major, 240.13V
Low Voltage 1	Major/Minor/Message	Minor, 12.00V	Minor, 24.00V	Minor, 48.00V	Minor, 116.00V	Minor, 204.00V
Low Voltage 2	Major/Minor/Message	Major, 11.62V	Major, 23.25V	Major, 46.50V	Major, 112.38V	Major, 197.63V
Midpoint Monitor 1-5	Major/Minor/Message	Minor, 0.50V				
Battery Runtime Low	Major/Minor/Message	Minor, 3 hours				
Battery Capacity Low	Major/Minor/Message	Minor, 80%				
Battery Overtemp	Major/Minor/Message	Minor, 40°C				
Battery On Discharge	Major/Minor/Message	Major				
Temp Sensor 1-5 Fail	Major/Minor/Message	Message				
TC Sensor Fail	Major/Minor/Message	Message				
Miscellaneous/Real Time Clock Error	Major/Minor/Message	Minor				
Custom 1-20	See 6.5.3.10	Message				
Relay Mapping System Major	See 6.5.3.8	Major, Relay 5				
System Minor	See 6.5.3.8	Minor, Relay 4				
Alarm Hysteresis Voltage	0-999999999	0.25V	0.50V	0.50V	0.50V	0.50V
Time Hysteresis	0-32767	0 seconds				
Battery Test	Major/Minor/Message	Minor				

Table I—Alarms menu defaults

Submenu Item	Programmable Range	Default Setting				
		12Vdc	24Vdc	48Vdc	125Vdc	220Vdc
LVD 1	0-9999999999	10.5V	21.00V	42.00V	101.50V	178.50V
LVC 1	0-9999999999	12.5V	25.00V	50.00V	120.83V	212.50V
Alarm Priority	Major/Minor/Message	Major				
Relay Mapping	1-16 or N/A (mapping disabled)	1				
Control	Check = enable LVD control	Checked				
Alarm cutoff	Check = allow alarm to be cutoff	Not checked				
LVD 2	0-9999999999	10.5V	21.00V	42.00V	101.50V	178.50V
LVC 2	0-9999999999	12.5V	25.00V	50.00V	120.83V	212.50V
Alarm Priority	Major/Minor/Message	Major				
Relay Mapping	1-16 or N/A (mapping disabled)	2				
Control	Check = enable LVD control	Checked				
Alarm cutoff	Check = allow alarm to be cutoff	Not checked				
LVD 3	0-9999999999	10.5V	21.00V	42.00V	101.50V	178.50V
LVC 3	0-9999999999	12.5V	25.00V	50.00V	120.83V	212.50V
Alarm Priority	Major/Minor/Message	Major				
Relay Mapping	1-16 or N/A (mapping disabled)	3				
Control	Check = enable LVD control	Checked				
Alarm cutoff	Check = allow alarm to be cutoff	Not checked				
LVD 4-10	0-9999999999	10.5V	21.00V	42.00V	101.50V	178.50V
LVC 4-10	0-9999999999	12.5V	25.00V	50.00V	120.83V	212.50V
Alarm Priority	Major/Minor/Message	Major				
Relay Mapping	1-16 or N/A (mapping disabled)	N/A				
Control	Check = enable LVD control	Not checked				
Alarm cutoff	Check = allow alarm to be cutoff	Not checked				
LVD Inhibit (Status)	Active/Inactive	Inactive				
Alarm Priority	Major/Minor/Message	Major				
Relay Mapping	1-16 or N/A (mapping disabled)	N/A				
Alarm cutoff	Check = allow alarm to be cutoff	Not checked				
High Volt. Shutdown	0-9999999999	14.25V	29.50V	58.00V	140.17V	246.50V
Alarm Priority	Major/Minor/Message	Major				
Relay Mapping	1-16 or N/A (mapping disabled)	N/A				
Control	Check = enable LVD control	Not checked				
Alarm cutoff	Check = allow alarm to be cutoff	Not checked				
CEMF In-circuit Voltage	0-9999999999	13.70V	27.40V	54.80V	132.43V	232.90V
Bypass Voltage	0-9999999999	13.55V	27.10V	54.20V	130.98V	230.35V
Alarm Priority	Major/Minor/Message	Major				
Relay Mapping	1-16 or N/A (mapping disabled)	N/A				
Control	Check = enable LVD control	Not checked				
Alarm cutoff	Check = allow alarm to be cutoff	Not checked				

Table J—Controls menu defaults

Submenu Item	Programmable Range	Default Setting
IP Address	Check = obtain automatically	Not checked, 10.10.10.201
Subnet Mask	0.0.0.0 – 255.255.255.255	255.255.255.0
Gateway	0.0.0.0 – 255.255.255.255	10.10.10.1
Modem Rear Port Device	Internal/External/NULL	NULL
Baud Rate	9600 – 57600 baud	19200 baud
Enable Callback	Check = enable	Not checked
Modem Init String	Consult factory	A0 S1 B3 &F2
Craft Port Baud Rate	9600 – 57600 baud	57600 baud
RAS Client Settings Phone Number	64 characters maximum	N/A
Login Account	64 characters maximum	N/A
Domain Name	64 characters maximum	N/A
Password	64 characters maximum	N/A
Web Settings Routing	Front Craft Port, Rear Modem, None	Front Craft Port
SMTP Server Settings IP Address	64 characters maximum	N/A
Send Domain	64 characters maximum	N/A
From Address	64 characters maximum	N/A
To Address	64 characters maximum	N/A
Copy Address	64 characters maximum	N/A

Table K–Communications menu defaults

Submenu Item	Programmable Range	Default Setting
Configure Relays (1–16)	Energized/De-Energized	De-Energized

Table L–Hardware menu defaults

Submenu Item	Programmable Range	Default Setting
Supervisor Access Code	0-9999999999	1234

Table M–Supervisor menu defaults

12 Modbus® Communications Protocol

This feature enables CXC communication of alarms and live signals using Modbus protocol (messaging structure developed by Modicon®).

A message is encoded in Remote Terminal Unit (RTU) data format and is communicated upon query via Transmission Control Protocol (TCP) to any Modbus supervisor or master. *Reference: Modbus application protocol specification v1.1a (www.Modbus-IDA.org).*

The CXC acts as a server on Ethernet networks known as Modbus TCP RTU: TCP/IP over Ethernet, default TCP port = 502. The server is always up and running when CXC starts up; ready to respond to a client query.

CXC communications cannot be configured as Modbus gateway, to behave as both server and client at the same time, and does not support Modbus Plus high speed token passing network.

Modbus protocol offers service specified by function codes (see tables provided). A function code is an element of a Modbus request/reply Protocol Data Unit (PDU). The CXC supports the following:

- **0x01** (Read Coils): Read CXC relay status bits,
- **0x02** (Read Discrete inputs): Read alarm tables status bits,
- **0x03** (Read Holding registers): Read CXC live signals from signals tables,
- **0x04** (Read Input registers): Read CXC relay or alarm table status registers.

PDU Address	Variable Name	Variable Description	Response Data Format
0x0001	Relay1_Status_Bit	Relay 1 (K1)	BINARY
0x0002	Relay2_Status_Bit	Relay 2 (K2)	BINARY
0x0003	Relay3_Status_Bit	Relay 3 (K3)	BINARY
0x0004	Relay4_Status_Bit	Relay 4 (K4)	BINARY
0x0005	Relay5_Status_Bit	Relay 5 (K5)	BINARY
0x0006	Relay6_Status_Bit	Relay 6 (K6)	BINARY
0x0007	Relay7_Status_Bit	Relay 7 (K7)	BINARY
0x0008	Relay8_Status_Bit	Relay 8 (K8)	BINARY
0x0009	Relay9_Status_Bit	Relay 9 (K9)	BINARY
0x000A	Relay10_Status_Bit	Relay 10 (K10)	BINARY
0x000B	Relay11_Status_Bit	Relay 11 (K11)	BINARY
0x000C	Relay12_Status_Bit	Relay 12 (K12)	BINARY
0x000D	Relay13_Status_Bit	Relay 13 (K13)	BINARY
0x000E	Relay14_Status_Bit	Relay 14 (K14)	BINARY
0x000F	Relay15_Status_Bit	Relay 15 (K15)	BINARY
0x0010	Relay16_Status_Bit	Relay 16 (K16)	BINARY

Table N–CXC Modbus PDU address definition for function code 0x01 (read coils)

PDU Address	Variable Name	Variable Description	Response Data Format
0x0001	Alarm1_In_Alarm_Table_1_Status_Bit	Rectifier Fail	BINARY
0x0002	Alarm2_In_Alarm_Table_1_Status_Bit	Rectifier Minor	BINARY
0x0003	Alarm3_In_Alarm_Table_1_Status_Bit	Rect. Major Fail Count	BINARY
0x0004	Alarm4_In_Alarm_Table_1_Status_Bit	Rect. Minor Fail Count	BINARY
0x0005	Alarm5_In_Alarm_Table_1_Status_Bit	Rectifier Lockout	BINARY
0x0006	Alarm6_In_Alarm_Table_1_Status_Bit	Out Of Tolerance	BINARY
0x0007	Alarm7_In_Alarm_Table_1_Status_Bit	Rect. Comms Lost	BINARY
0x0008	Alarm8_In_Alarm_Table_1_Status_Bit	Rect. Equalize Activated	BINARY
0x0009	Alarm9_In_Alarm_Table_1_Status_Bit	Rect. AC Mains Fail	BINARY
0x000A	Alarm10_In_Alarm_Table_1_Status_Bit	Max Rectifiers Exceeded	BINARY
0x000B	Alarm11_In_Alarm_Table_1_Status_Bit	Fan Fail Alarm	BINARY
0x000C	Alarm12_In_Alarm_Table_1_Status_Bit	Power Save	BINARY
0x000D	Alarm13_In_Alarm_Table_1_Status_Bit	Urgent Rect. AC Mains Fail	BINARY
--	--	--	

0x0041	Alarm1_In_Alarm_Table_2_Status_Bit	Distribution Fuse	BINARY
0x0042	Alarm2_In_Alarm_Table_2_Status_Bit	Battery Fuse	BINARY
0x0043	Alarm3_In_Alarm_Table_2_Status_Bit	LVD Manual In	BINARY
0x0044	Alarm4_In_Alarm_Table_2_Status_Bit	LVD Manual Out	BINARY
0x0045	Alarm5_In_Alarm_Table_2_Status_Bit	Converter Fail	BINARY
0x0046	Alarm6_In_Alarm_Table_2_Status_Bit	Conv. I/P Breaker Trip	BINARY
0x0047	Alarm7_In_Alarm_Table_2_Status_Bit	Digital 7	BINARY
0x0048	Alarm8_In_Alarm_Table_2_Status_Bit	Digital 8	BINARY
--	--	--	
0x0081	Alarm1_In_Alarm_Table_3_Status_Bit	Battery Current High	BINARY
0x0082	Alarm2_In_Alarm_Table_3_Status_Bit	Load Current High	BINARY
--	--	--	
0x00C1	Alarm1_In_Alarm_Table_4_Status_Bit	AC Mains High	BINARY
0x00C2	Alarm2_In_Alarm_Table_4_Status_Bit	AC Mains Low	BINARY
0x00C3	Alarm3_In_Alarm_Table_4_Status_Bit	High Voltage 1	BINARY
0x00C4	Alarm4_In_Alarm_Table_4_Status_Bit	High Voltage 2	BINARY
0x00C5	Alarm5_In_Alarm_Table_4_Status_Bit	Low Voltage 1	BINARY
0x00C6	Alarm6_In_Alarm_Table_4_Status_Bit	Low Voltage 2	BINARY
0x00C7	Alarm7_In_Alarm_Table_4_Status_Bit	Midpoint Monitor 1	BINARY
0x00C8	Alarm8_In_Alarm_Table_4_Status_Bit	Midpoint Monitor 2	BINARY
0x00C9	Alarm9_In_Alarm_Table_4_Status_Bit	Midpoint Monitor 3	BINARY
0x00CA	Alarm10_In_Alarm_Table_4_Status_Bit	Midpoint Monitor 4	BINARY
0x00CB	Alarm11_In_Alarm_Table_4_Status_Bit	Midpoint Monitor 5	BINARY
--	--		
0x0101	Alarm1_In_Alarm_Table_5_Status_Bit	Battery Runtime Low	BINARY
0x0102	Alarm2_In_Alarm_Table_5_Status_Bit	Battery Capacity Low	BINARY
0x0103	Alarm3_In_Alarm_Table_5_Status_Bit	Battery Overtemp	BINARY
0x0104	Alarm4_In_Alarm_Table_5_Status_Bit	Battery On Discharge	BINARY
0x0105	Alarm5_In_Alarm_Table_5_Status_Bit	Battery Test Alarm	BINARY
--	--		
0x0141	Alarm1_In_Alarm_Table_6_Status_Bit	Temp Sensor 1 Fail	BINARY
0x0142	Alarm2_In_Alarm_Table_6_Status_Bit	Temp Sensor 2 Fail	BINARY
0x0143	Alarm3_In_Alarm_Table_6_Status_Bit	Temp Sensor 3 Fail	BINARY
0x0144	Alarm4_In_Alarm_Table_6_Status_Bit	Temp Sensor 4 Fail	BINARY
0x0145	Alarm5_In_Alarm_Table_6_Status_Bit	TC Sensor Fail	BINARY
--	--		
0x0181	Alarm1_In_Alarm_Table_7_Status_Bit	Custom 1	BINARY
0x0182	Alarm2_In_Alarm_Table_7_Status_Bit	Custom 2	BINARY
0x0183	Alarm3_In_Alarm_Table_7_Status_Bit	Custom 3	BINARY
0x0184	Alarm4_In_Alarm_Table_7_Status_Bit	Custom 4	BINARY
0x0185	Alarm5_In_Alarm_Table_7_Status_Bit	Custom 5	BINARY
0x0186	Alarm6_In_Alarm_Table_7_Status_Bit	Custom 6	BINARY
0x0187	Alarm7_In_Alarm_Table_7_Status_Bit	Custom 7	BINARY
0x0188	Alarm8_In_Alarm_Table_7_Status_Bit	Custom 8	BINARY
0x0189	Alarm9_In_Alarm_Table_7_Status_Bit	Custom 9	BINARY
0x018A	Alarm10_In_Alarm_Table_7_Status_Bit	Custom 10	BINARY
0x018B	Alarm11_In_Alarm_Table_7_Status_Bit	Custom 11	BINARY
0x018C	Alarm12_In_Alarm_Table_7_Status_Bit	Custom 12	BINARY
0x018D	Alarm13_In_Alarm_Table_7_Status_Bit	Custom 13	BINARY
0x018E	Alarm14_In_Alarm_Table_7_Status_Bit	Custom 14	BINARY
0x018F	Alarm15_In_Alarm_Table_7_Status_Bit	Custom 15	BINARY
0x0190	Alarm16_In_Alarm_Table_7_Status_Bit	Custom 16	BINARY
0x0191	Alarm17_In_Alarm_Table_7_Status_Bit	Custom 17	BINARY

0x0192	Alarm18_In_Alarm_Table_7_Status_Bit	Custom 18	BINARY
0x0193	Alarm19_In_Alarm_Table_7_Status_Bit	Custom 19	BINARY
0x0194	Alarm20_In_Alarm_Table_7_Status_Bit	Custom 20	BINARY
--	--		
0x01C1	Alarm1_In_Alarm_Table_8_Status_Bit	Real Time Clock Error	BINARY
0x01C2	Alarm2_In_Alarm_Table_8_Status_Bit	Invalid Device Firmware	BINARY
0x01C3	Alarm3_In_Alarm_Table_8_Status_Bit	Ground Fault Detected	BINARY
0x01C4	Alarm4_In_Alarm_Table_8_Status_Bit	Improper CXC Shutdown	BINARY
0x01C5	Alarm5_In_Alarm_Table_8_Status_Bit	Invalid Charge Voltage	BINARY
0x01C6	Alarm6_In_Alarm_Table_8_Status_Bit	System Major	BINARY
0x01C7	Alarm7_In_Alarm_Table_8_Status_Bit	System Minor	BINARY
--	--		
0x0201	Alarm1_In_Alarm_Table_9_Status_Bit	LVD 1	BINARY
0x0202	Alarm2_In_Alarm_Table_9_Status_Bit	LVD 2	BINARY
0x0203	Alarm3_In_Alarm_Table_9_Status_Bit	LVD 3	BINARY
0x0204	Alarm4_In_Alarm_Table_9_Status_Bit	LVD 4	BINARY
0x0205	Alarm5_In_Alarm_Table_9_Status_Bit	LVD 5	BINARY
0x0206	Alarm6_In_Alarm_Table_9_Status_Bit	LVD 6	BINARY
0x0207	Alarm7_In_Alarm_Table_9_Status_Bit	LVD 7	BINARY
0x0208	Alarm8_In_Alarm_Table_9_Status_Bit	LVD 8	BINARY
0x0209	Alarm9_In_Alarm_Table_9_Status_Bit	LVD 9	BINARY
0x020A	Alarm10_In_Alarm_Table_9_Status_Bit	LVD 10	BINARY
0x020B	Alarm11_In_Alarm_Table_9_Status_Bit	CEMF Control	BINARY
0x020C	Alarm12_In_Alarm_Table_9_Status_Bit	HVSD Control	BINARY
0x020D	Alarm13_In_Alarm_Table_9_Status_Bit	LVD Inhibit	BINARY
--	--		
0x0241	Alarm1_In_Alarm_Table_10_Status_Bit	ADIO_1_Cell Deviation	BINARY
0x0242	Alarm2_In_Alarm_Table_10_Status_Bit	ADIO_1_Current Alarm	BINARY
0x0243	Alarm3_In_Alarm_Table_10_Status_Bit	ADIO_1_Voltage Alarm	BINARY
0x0244	Alarm4_In_Alarm_Table_10_Status_Bit	ADIO_1_Temperature Alarm	BINARY
0x0245	Alarm5_In_Alarm_Table_10_Status_Bit	ADIO_1_Comms Alarm	BINARY
0x0246	Alarm6_In_Alarm_Table_10_Status_Bit	ADIO_2_Cell Deviation	BINARY
0x0247	Alarm7_In_Alarm_Table_10_Status_Bit	ADIO_2_Current Alarm	BINARY
0x0248	Alarm8_In_Alarm_Table_10_Status_Bit	ADIO_2_Voltage Alarm	BINARY
0x0249	Alarm9_In_Alarm_Table_10_Status_Bit	ADIO_2_Temperature Alarm	BINARY
0x024A	Alarm10_In_Alarm_Table_10_Status_Bit	ADIO_2_Comms Alarm	BINARY
0x024B	Alarm11_In_Alarm_Table_10_Status_Bit	ADIO_3_Cell Deviation	BINARY
0x024C	Alarm12_In_Alarm_Table_10_Status_Bit	ADIO_3_Current Alarm	BINARY
0x024D	Alarm13_In_Alarm_Table_10_Status_Bit	ADIO_3_Voltage Alarm	BINARY
0x024E	Alarm14_In_Alarm_Table_10_Status_Bit	ADIO_3_Temperature Alarm	BINARY
0x024F	Alarm15_In_Alarm_Table_10_Status_Bit	ADIO_3_Comms Alarm	BINARY
0x0250	Alarm16_In_Alarm_Table_10_Status_Bit	ADIO_4_Cell Deviation	BINARY
0x0251	Alarm17_In_Alarm_Table_10_Status_Bit	ADIO_4_Current Alarm	BINARY
0x0252	Alarm18_In_Alarm_Table_10_Status_Bit	ADIO_4_Voltage Alarm	BINARY
0x0253	Alarm19_In_Alarm_Table_10_Status_Bit	ADIO_4_Temperature Alarm	BINARY
0x0254	Alarm20_In_Alarm_Table_10_Status_Bit	ADIO_4_Comms Alarm	BINARY
0x0255	Alarm21_In_Alarm_Table_10_Status_Bit	ADIO_5_Cell Deviation	BINARY
0x0256	Alarm22_In_Alarm_Table_10_Status_Bit	ADIO_5_Current Alarm	BINARY
0x0257	Alarm23_In_Alarm_Table_10_Status_Bit	ADIO_5_Voltage Alarm	BINARY
0x0258	Alarm24_In_Alarm_Table_10_Status_Bit	ADIO_5_Temperature Alarm	BINARY
0x0259	Alarm25_In_Alarm_Table_10_Status_Bit	ADIO_5_Comms Alarm	BINARY
0x025A	Alarm26_In_Alarm_Table_10_Status_Bit	ADIO_6_Cell Deviation	BINARY
0x025B	Alarm27_In_Alarm_Table_10_Status_Bit	ADIO_6_Current Alarm	BINARY

0x025C	Alarm28_In_Alarm_Table_10_Status_Bit	ADIO_6_Voltage Alarm	BINARY
0x025D	Alarm29_In_Alarm_Table_10_Status_Bit	ADIO_6_Temperature Alarm	BINARY
0x025E	Alarm30_In_Alarm_Table_10_Status_Bit	ADIO_6_Comms Alarm	BINARY
0x025F	Alarm31_In_Alarm_Table_10_Status_Bit	ADIO_7_Cell Deviation	BINARY
0x0260	Alarm32_In_Alarm_Table_10_Status_Bit	ADIO_7_Current Alarm	BINARY
0x0261	Alarm33_In_Alarm_Table_10_Status_Bit	ADIO_7_Voltage Alarm	BINARY
0x0262	Alarm34_In_Alarm_Table_10_Status_Bit	ADIO_7_Temperature Alarm	BINARY
0x0263	Alarm35_In_Alarm_Table_10_Status_Bit	ADIO_7_Comms Alarm	BINARY
0x0264	Alarm36_In_Alarm_Table_10_Status_Bit	ADIO_8_Cell Deviation	BINARY
0x0265	Alarm37_In_Alarm_Table_10_Status_Bit	ADIO_8_Current Alarm	BINARY
0x0266	Alarm38_In_Alarm_Table_10_Status_Bit	ADIO_8_Voltage Alarm	BINARY
0x0267	Alarm39_In_Alarm_Table_10_Status_Bit	ADIO_8_Temperature Alarm	BINARY
0x0268	Alarm40_In_Alarm_Table_10_Status_Bit	ADIO_8_Comms Alarm	BINARY
0x0269	Alarm41_In_Alarm_Table_10_Status_Bit	ADIO_9_Cell Deviation	BINARY
0x026A	Alarm42_In_Alarm_Table_10_Status_Bit	ADIO_9_Current Alarm	BINARY
0x026B	Alarm43_In_Alarm_Table_10_Status_Bit	ADIO_9_Voltage Alarm	BINARY
0x026C	Alarm44_In_Alarm_Table_10_Status_Bit	ADIO_9_Temperature Alarm	BINARY
0x026D	Alarm45_In_Alarm_Table_10_Status_Bit	ADIO_9_Comms Alarm	BINARY
0x026E	Alarm46_In_Alarm_Table_10_Status_Bit	ADIO_10_Cell Deviation	BINARY
0x026F	Alarm47_In_Alarm_Table_10_Status_Bit	ADIO_10_Current Alarm	BINARY
0x0270	Alarm48_In_Alarm_Table_10_Status_Bit	ADIO_10_Voltage Alarm	BINARY
0x0271	Alarm49_In_Alarm_Table_10_Status_Bit	ADIO_10_Temperature Alarm	BINARY
0x0272	Alarm50_In_Alarm_Table_10_Status_Bit	ADIO_10_Comms Alarm	BINARY
0x0273	Alarm51_In_Alarm_Table_10_Status_Bit	ADIO_11_Cell Deviation	BINARY
0x0274	Alarm52_In_Alarm_Table_10_Status_Bit	ADIO_11_Current Alarm	BINARY
0x0275	Alarm53_In_Alarm_Table_10_Status_Bit	ADIO_11_Voltage Alarm	BINARY
0x0276	Alarm54_In_Alarm_Table_10_Status_Bit	ADIO_11_Temperature Alarm	BINARY
0x0277	Alarm55_In_Alarm_Table_10_Status_Bit	ADIO_11_Comms Alarm	BINARY
0x0278	Alarm56_In_Alarm_Table_10_Status_Bit	ADIO_12_Cell Deviation	BINARY
0x0279	Alarm57_In_Alarm_Table_10_Status_Bit	ADIO_12_Current Alarm	BINARY
0x027A	Alarm58_In_Alarm_Table_10_Status_Bit	ADIO_12_Voltage Alarm	BINARY
0x027B	Alarm59_In_Alarm_Table_10_Status_Bit	ADIO_12_Temperature Alarm	BINARY
0x027C	Alarm60_In_Alarm_Table_10_Status_Bit	ADIO_12_Comms Alarm	BINARY
0x027D	Alarm61_In_Alarm_Table_10_Status_Bit	ADIO_13_Cell Deviation	BINARY
0x027E	Alarm62_In_Alarm_Table_10_Status_Bit	ADIO_13_Current Alarm	BINARY
0x027F	Alarm63_In_Alarm_Table_10_Status_Bit	ADIO_13_Voltage Alarm	BINARY
0x0280	Alarm64_In_Alarm_Table_10_Status_Bit	ADIO_13_Temperature Alarm	BINARY
0x0281	Alarm65_In_Alarm_Table_10_Status_Bit	ADIO_13_Comms Alarm	BINARY
0x0282	Alarm66_In_Alarm_Table_10_Status_Bit	ADIO_14_Cell Deviation	BINARY
0x0283	Alarm67_In_Alarm_Table_10_Status_Bit	ADIO_14_Current Alarm	BINARY
0x0284	Alarm68_In_Alarm_Table_10_Status_Bit	ADIO_14_Voltage Alarm	BINARY
0x0285	Alarm69_In_Alarm_Table_10_Status_Bit	ADIO_14_Temperature Alarm	BINARY
0x0286	Alarm70_In_Alarm_Table_10_Status_Bit	ADIO_14_Comms Alarm	BINARY
0x0287	Alarm71_In_Alarm_Table_10_Status_Bit	ADIO_15_Cell Deviation	BINARY
0x0288	Alarm72_In_Alarm_Table_10_Status_Bit	ADIO_15_Current Alarm	BINARY
0x0289	Alarm73_In_Alarm_Table_10_Status_Bit	ADIO_15_Voltage Alarm	BINARY
0x028A	Alarm74_In_Alarm_Table_10_Status_Bit	ADIO_15_Temperature Alarm	BINARY
0x028B	Alarm75_In_Alarm_Table_10_Status_Bit	ADIO_15_Comms Alarm	BINARY
0x028C	Alarm76_In_Alarm_Table_10_Status_Bit	ADIO_16_Cell Deviation	BINARY
0x028D	Alarm77_In_Alarm_Table_10_Status_Bit	ADIO_16_Current Alarm	BINARY
0x028E	Alarm78_In_Alarm_Table_10_Status_Bit	ADIO_16_Voltage Alarm	BINARY
0x028F	Alarm79_In_Alarm_Table_10_Status_Bit	ADIO_16_Temperature Alarm	BINARY
0x0290	Alarm80_In_Alarm_Table_10_Status_Bit	ADIO_16_Comms Alarm	BINARY

--	--	--	
0x0040 *(X-1)	Alarm1_In_Alarm_Table_X_Status_Bit	Read alarm1 status bit in alarm table X	BINARY
--	--	--	
AX	AlarmAX_In_Alarm_Table_X_Status_Bit	Read alarmAX status bit in alarm table X	BINARY

Table O–CXC Modbus PDU address definition for function code 0x02 (read discrete inputs)

PDU Address	Variable Name	Variable Description	Number of Bytes
0x0001	Signal_Tables_Total	Read number of signal tables (S) (S<=0x3F)	2
0x0002	Signals_Total_In_Signal_Table_1	Read number of signals in signal table 1 (S1) (S1<=0x20)	2
0x0003	Signals_Total_In_Signal_Table_2	Read number of signals in signal table 2 (S2) (S2 <=0x20)	2
0x0001 + S	Signals_Total_In_Signal_Table_S	Read number of signals in signal table 2 (SS) (SS <=0x20)	2
0X0042	Signal_1_In_Signal_Table_1	Digital Input 1	4 (signed int_32)
0X0044	Signal_2_In_Signal_Table_1	Digital Input 2	4 (signed int_32)
0X0046	Signal_3_n_Signal_Table_1	Digital Input 3	4 (signed int_32)
0X0048	Signal_4_In_Signal_Table_1	Digital Input 4	4 (signed int_32)
0X004A	Signal_5_In_Signal_Table_1	Digital Input 5	4 (signed int_32)
0X004C	Signal_6_In_Signal_Table_1	Digital Input 6	4 (signed int_32)
0X004E	Signal_7_In_Signal_Table_1	Digital Input 7	4 (signed int_32)
0X0050	Signal_8_In_Signal_Table_1	Digital Input 8	4 (signed int_32)
0x0082	Signal_1_In_Signal_Table_2	Load Voltage (x100)	4 (signed int_32)
0x0084	Signal_2_In_Signal_Table_2	Load Current (x100)	4 (signed int_32)
0x0086	Signal_3_In_Signal_Table_2	Battery Voltage (x100)	4 (signed int_32)
0x0088	Signal_4_In_Signal_Table_2	Battery Current (x100)	4 (signed int_32)
0x008A	Signal_5_In_Signal_Table_2	AC Mains (x100)	4 (signed int_32)
0x008C	Signal_6_In_Signal_Table_2	Battery Temperature (x100)	4 (signed int_32)
0x008E	Signal_7_In_Signal_Table_2	Battery Runtime (x100)	4 (signed int_32)
0x0090	Signal_8_In_Signal_Table_2	Battery Capacity (x100)	4 (signed int_32)
0x0092	Signal_9_In_Signal_Table_2	Battery DOD (x100)	4 (signed int_32)
0x0094	Signal_10_In_Signal_Table_2	Converter Load Current (x100)	4 (signed int_32)
0x0096	Signal_11_In_Signal_Table_2	Converter Load Voltage (x100)	4 (signed int_32)
0x0098	Signal_12_In_Signal_Table_2	System Voltage Mode (0-float, 1-equalize)	4 (signed int_32)
0x00C2	Signal_1_In_Signal_Table_3	Total Rectifier Current (x100)	4 (signed int_32)
0x00C4	Signal_2_In_Signal_Table_3	Average DC Voltage (x100)	4 (signed int_32)
0x00C6	Signal_3_In_Signal_Table_3	Average AC Voltage (x100)	4 (signed int_32)
0x00C8	Signal_4_In_Signal_Table_3	Number of Acquired Rectifiers	4 (signed int_32)
0x00CA	Signal_5_In_Signal_Table_3	Number of Sourcing Rectifiers	4 (signed int_32)
0x00CC	Signal_6_In_Signal_Table_3	Number of Failed Rectifiers	4 (signed int_32)
0x00CE	Signal_7_In_Signal_Table_3	Number of Minor Alarm Rectifiers	4 (signed int_32)
0x00D0	Signal_8_In_Signal_Table_3	Number of Comm. Lost Rectifiers	4 (signed int_32)
0x00D2	Signal_9_In_Signal_Table_3	Number of AC Failed Rectifiers	4 (signed int_32)
0x00D4	Signal_10_In_Signal_Table_3	Number of Out of Tolerance	4 (signed int_32)
0x00D6	Signal_11_In_Signal_Table_3	Number of Locked Out Rectifiers	4 (signed int_32)
0x00D8	Signal_12_In_Signal_Table_3	Number of Equalize Rectifiers	4 (signed int_32)
0x00DA	Signal_13_In_Signal_Table_3	Number of Current Limit Rectifiers	4 (signed int_32)
0x00DC	Signal_14_In_Signal_Table_3	Number of Power Limit Rectifiers	4 (signed int_32)
0x00DE	Signal_15_In_Signal_Table_3	Number of Fan Failed Rectifiers	4 (signed int_32)
0x00E0	Signal_16_In_Signal_Table_3	Number of Power Saving Rectifiers	4 (signed int_32)
0x00E2	Signal_17_In_Signal_Table_3	Average AC Phase R (x100)	4 (signed int_32)
0x00E4	Signal_18_In_Signal_Table_3	Average AC Phase S (x100)	4 (signed int_32)
0x00E6	Signal_19_In_Signal_Table_3	Average AC Phase T (x100)	4 (signed int_32)
0x0102	Signal_1_In_Signal_Table_4	Custom Signal 1 (x100)	4 (signed int_32)
0x0104	Signal_2_In_Signal_Table_4	Custom Signal 2 (x100)	4 (signed int_32)
0x0106	Signal_3_In_Signal_Table_4	Custom Signal 3 (x100)	4 (signed int_32)
0x0108	Signal_4_In_Signal_Table_4	Custom Signal 4 (x100)	4 (signed int_32)
0x010A	Signal_5_In_Signal_Table_4	Custom Signal 5 (x100)	4 (signed int_32)
0x010C	Signal_6_In_Signal_Table_4	Custom Signal 6 (x100)	4 (signed int_32)

0x010E	Signal_7_In_Signal_Table_4	Custom Signal 7 (x100)	4 (signed int_32)
0x0110	Signal_8_In_Signal_Table_4	Custom Signal 8 (x100)	4 (signed int_32)
0x0112	Signal_9_In_Signal_Table_4	Custom Signal 9 (x100)	4 (signed int_32)
0x0114	Signal_10_In_Signal_Table_4	Custom Signal 10 (x100)	4 (signed int_32)
0x0115	Signal_11_In_Signal_Table_4	Custom Signal 11 (x100)	4 (signed int_32)
0x0116	Signal_12_In_Signal_Table_4	Custom Signal 12 (x100)	4 (signed int_32)
0x0117	Signal_13_In_Signal_Table_4	Custom Signal 13 (x100)	4 (signed int_32)
0x0118	Signal_14_In_Signal_Table_4	Custom Signal 14 (x100)	4 (signed int_32)
0x0119	Signal_15_In_Signal_Table_4	Custom Signal 15 (x100)	4 (signed int_32)
0x0120	Signal_16_In_Signal_Table_4	Custom Signal 16 (x100)	4 (signed int_32)
0x0121	Signal_17_In_Signal_Table_4	Custom Signal 17 (x100)	4 (signed int_32)
0x0122	Signal_18_In_Signal_Table_4	Custom Signal 18 (x100)	4 (signed int_32)
0x0123	Signal_19_In_Signal_Table_4	Custom Signal 19 (x100)	4 (signed int_32)
0x0124	Signal_20_In_Signal_Table_4	Custom Signal 20 (x100)	4 (signed int_32)
0x0040 * S	Signal_1_In_Signal_Table_S	Read Signal 1 in Signal table S (x100)	4 (signed int_32)
0x0040 * S + ((SS-1) * 2)	Signal_SS_In_Signal_Table_S	Read Signal SS in Signal table S (x100)	4 (signed int_32)
0x0182	Signal_1_In_Signal_Table_5	Timer 1	4 (signed int_32)
0x0184	Signal_2_In_Signal_Table_5	Timer 2	4 (signed int_32)
0x0186	Signal_3_In_Signal_Table_5	Timer 3	4 (signed int_32)
0x0188	Signal_4_In_Signal_Table_5	Timer 4	4 (signed int_32)
0x018A	Signal_5_In_Signal_Table_5	Timer 5	4 (signed int_32)
0x018C	Signal_6_In_Signal_Table_5	Timer 6	4 (signed int_32)
0x018E	Signal_7_In_Signal_Table_5	Timer 7	4 (signed int_32)
0x0190	Signal_8_In_Signal_Table_5	Timer 8	4 (signed int_32)
0x0192	Signal_9_In_Signal_Table_5	Timer 9	4 (signed int_32)
0x0194	Signal_10_In_Signal_Table_5	Timer 10	4 (signed int_32)
0x01C2	Signal_1_In_Signal_Table_6	Counter 1	4 (signed int_32)
0x01C4	Signal_2_In_Signal_Table_6	Counter 2	4 (signed int_32)
0x01C6	Signal_3_In_Signal_Table_6	Counter 3	4 (signed int_32)
0x01C8	Signal_4_In_Signal_Table_6	Counter 4	4 (signed int_32)
0x01CA	Signal_5_In_Signal_Table_6	Counter 5	4 (signed int_32)
0x01CC	Signal_6_In_Signal_Table_6	Counter 6	4 (signed int_32)
0x01CE	Signal_7_In_Signal_Table_6	Counter 7	4 (signed int_32)
0x01D0	Signal_8_In_Signal_Table_6	Counter 8	4 (signed int_32)
0x01D2	Signal_9_In_Signal_Table_6	Counter 9	4 (signed int_32)
0x01D4	Signal_10_In_Signal_Table_6	Counter 10	4 (signed int_32)

Table P–CXC Modbus PDU address definition for function code 0x03 (read holding registers)

PDU Address	Variable Name	Variable Description	Response Data Format
0x0001	Relays_Total (Y)	Read number of relays	BINARY
0x0002	Total_Active_Alarms (Z)	Read total active alarms	BINARY
0x0003	System_Major_Alarm	Read system major alarm status	BINARY
0x0004	System_Minor_Alarm	Read system minor alarm status	BINARY
--	--	--	
0x0011	Alarm_Tables_Total (X)	Read number of alarm tables (X<=0x1E)	BINARY
0x0012	Alarms_Total_In_Alarm_Table_1 (A1)	Read number of alarm in alarm table 1 (A1 <= 0x3F)	BINARY
0x0013	Alarms_Total_In_Alarm_Table_2 (A2)	Read number of alarm in alarm table 2 (A2 <= 0x3F)	BINARY
--	--	--	
0x0011 + X	Alarms_Total_In_Alarm_Table_X (AX)	Read number of alarm in alarm table X (AX <= 0x3F)	BINARY
--	--	--	
0x0031	Number_of_Active_Alarms_In_Alarm_table_1	Read number of active alarms in alarm table 1	BINARY
0x0032	Number_of_Active_Alarms_In_Alarm_table_2	Read number of active alarms in alarm table 2	BINARY
--	--		
0x0031 + (X-1)	Number_of_Active_Alarms_In_Alarm_table_X	Read number of active alarms in alarm table X	BINARY

Table Q–CXC Modbus PDU address definition for function code 0x04 (read input registers)

13 Trouble-shooting

To use the following trouble-shooting guide, look for the specific symptom that you are experiencing:

Symptom	Solution
Rectifier Communications Lost (RECT COMMS LOST)	Check RS-485 or CAN cable connections for breaks and loose contacts. Ensure all rectifiers are secured and tightly screwed in to the shelf. Perform "Inventory Update" (from RECTIFIERS menu).
Rectifier Lockout (RECT LOCKOUT)	Pathfinder rectifier modules with LCD option: Check if any rectifiers menu has been accessed. Rectifier must be in normal operation mode. Perform "Inventory Update." Set all rectifiers for Remote Access enabled and Remote Adjust Access enabled.
Rectifier Out Of Tolerance (OUT OF TOLERANCE)	Check all settings in RECTIFIERS menu; e.g., float voltage, equalize voltage, etc. If it is in current limit, percentage may be too low. Ensure all parameters are properly set. Return to menu navigation, press OPTION and then select SAVE.
No Communications at RS-232 Port	Set web routing to Front Craft Port in the web settings option of the COMMUNICATIONS menu. Ensure the Baud rate is set to match. Ensure you are using a null modem cable.
Relays Not Triggering During Alarm Condition	Ensure alarm condition is mapped to a relay (from ALARMS menu). Ensure polarity of relay is set correctly (from HARDWARE menu). Ensure Cutoff All Alarms has not been selected.
Rectifier Minor/Major Alarm	Ensure system load is at least 5% of the current rating of the power modules used in the system or a battery is connected. Check the rectifier sending the alarm for specific alarm condition. Perform "Rectifier Report" (from RECTIFIERS menu).
New Rectifier Has Not Been Acquired	Ensure all rectifiers are secured and tightly screwed in to the shelf. Perform "Inventory Update" (from RECTIFIERS menu). Perform "Rectifier Report" (from RECTIFIERS menu) to confirm acquisition.
Unable to communicate with CXC via the Ethernet port	Ensure IP settings are correct (from COMMUNICATIONS menu). Reboot CXC after changing IP settings: select Reset from the Option button and save settings if prompted. Use a straight-through cable for network connection. Use a cross-over cable only when connecting directly to a PC. Try pinging the CXC IP address to verify connectivity. Contact your IT department to ensure both the CXC and PC can actually communicate across the network.
Web interface loads but shows no live data	Ensure you are using the latest version of Internet Explorer®.
Data logging will not start/stop	Start/stop logging equations should not be true at the same time.
Screen is too bright/dim	Tap the Home icon and select Contrast from the pop-up window. Use the slider on the GUI to adjust contrast as desired. Tap the check mark to complete adjustment.

Table R–Trouble-shooting guide

13.1 Technical Support

Technical Support Staff are available for answering general questions related to installation, operation and maintenance of Alpha products. In the USA and Canada, call Alpha toll free 7:30 am to 5:00pmPST at:

1-888-462-7487

For emergencies, call this number 24 hours a day, seven days a week.

Customers outside Canada and the U.S.A., Call 1-604-436-5547 for technical support.

14 Acronyms and Definitions

AC	Alternating current
ADIO	Analog-digital input-output
ALCO	Alarm cutoff
ATM	Asynchronous Transfer Mode; e.g. ATM cell
BCT	Battery current termination
BOD	Battery on discharge
BT	Battery test (or test mode)
CAN	Controller Area Network
CEMF	Counter electro-motive force
CX	Cordex series; e.g. CXC for Cordex™ System Controller
DC	Direct current
DOD	Depth of discharge
EQ	Equalize (mode or voltage)
FL	Float (mode or voltage)
GUI	Graphical user interface
HVA	High voltage alarm
HVSD	High voltage shutdown
ICMP	Internet control message protocol
IP	Internet Protocol
LCD	Liquid crystal display
LED	Light emitting diode
LVA	Low voltage alarm
LVC	Low voltage connect
LVD	Low voltage disconnect
MAC	Media Access Control; e.g. MAC address
MIB	Management Information Base
MUX	Multiplexer
OVP	Over-voltage protection
PDA	Personal digital assistant
PPP	Point to Point Protocol
RAS	Remote access server
SCI	Serial Communication Interface
SNMP	Simple Network Management Protocol
TCP/IP	Transmission Control Protocol / Internet Protocol
Trap	Event notification

Index

A

alarms, 22, 37, 38, 47, 48, 49, 51, 52, 53, 54, 55, 58, 64, 65, 115, 125
alerts, 24, 26, See alarms
analog signals, 14, 19, 23, 24
auto equalize, 10, 13, 41, 42
Auto-EQ. See auto equalize

B

battery
 monitor, 13, 44
 test, 19, 20, 21
baud, 10, 83, 84, 85, 100, 117
BCT equalize, 45, 46
breakpoints, 12, 41
BT. See battery test, See mode (of operation)

C

CAN bus. See communications
Celsius. See temperature units
charge current, 8, 13, 41, 43, 46
communications, 10, 12, 51, 58, 83, 97, 99
configuration file. See technical support
configure, 14, 23, 32, 38, 49, 52, 53, 54, 64, 65, 66, 86
crossover cable, 10

D

default, 16, 18, 31, 36, 39, 48, 83

E

EQ. See equalize voltage or mode (of operation)
equalize
 charging, 13, 18
 voltage, 10, 38
Ethernet, 10, 11, 36, 83, 97

F

Fahrenheit. See temperature units
FL. See float voltage or mode (of operation)
float voltage, 10, 12, 18, 20, 32, 38, 82

G

gateway, 117
GUI, 4, 10, 16, 17, 18, 26, 39

I

interface. See communications
inventory, 10, 21
inventory update. See inventory
IP address, 117

M

major alarm, 10, 48, 125
menu, 31, 33, 34, 89
mode, 10
mode (of operation), 16, 18

BT, 19, 20, 21, 53
EQ, 13, 18, 42, 51
FL, 18, 20, 38, 45
 normal, 26, 31
modem, 10, 84
monitoring, 11, 12

N

navigation, 11, 16, 27, 31, 32, 49, 54, 81, 125
network, 10, 98, 99

P

password, 11, 14, 23, 25, 26, 90
Pathfinder, 10, 12, 20, 39, 40, 125
power save, 40, 52, 113, 115

R

remote access, 125
reset, 16, 20, 31
RS-232. See serial
RS-485, 10, 12, 125

S

self-test, 10, 16, 26
serial, 10, 11, 22, 34, 35, 37, 38, 97
slope, 39, See temperature compensation
software updates. See technical support
startup, 10, 16
straight through cable, 10, 98
submenus, 10, 34
subnet mask, 117
supervisor access, 5, 11, 12, 13, 19, 26, 31, 32, 34, 36, 38, 39, 40, 41, 42, 43, 44, 45, 46, 47, 48, 49, 51, 52, 53, 54, 55, 58, 59, 62, 64, 65, 66, 81, 82, 83, 84, 85, 86, 89, 90, 91, 109, 110, 112, 117

T

technical support, 125
Temp Comp. See temperature compensation
temperature
 compensation, 5, 12, 13, 18, 41, 42, 47, 54
 monitoring, 12
 sensor, 12, 54, 66
 units, 34, 36, 40
touch screen, 4, 17

U

user access, 11, 23, 26
user interface. See GUI

W

web
 browser, 28, 97
 interface, 14, 18, 83, 84, 97

**Alpha Technologies Ltd.**

7700 Riverfront Gate
Burnaby, BC V5J 5M4
Canada
Tel: +1 604 436 5900
Fax: +1 604 436 1233
Toll Free: +1 800 667 8743

Outback Power

5917 195th St NE,
Arlington, WA 98223
United States
Tel: +1 360 435 6030
Fax: +1 360 435 6019

Alpha Technologies Europe Ltd.

Twyford House Thorley
Bishop's Stortford
Hertfordshire, CM22 7PA
United Kingdom
Tel: +44 1279 501110
Fax: +44 1279 659870

Alpha Technologies

Suite 1903, 191F., Tower 1,
33 Canton Rd. Tsim Sha Tsui
China, Hong Kong City,
Kowloon, Hong Kong
Tel: +852 2736 8663
Fax: +852 2199 7988

**Alpha Energy,
Alpha Technologies Inc.**

3767 Alpha Way
Bellingham, WA 98226
United States
Tel: +1 360 647 2360
Fax: +1 360 671 4936

Alpha Technologies GmbH

Hansastrasse 8
D-91126
Schwabach, Germany
Tel: +49 9122 79889 0
Fax: +49 9122 79889 21

Alphatec Ltd.

339 St. Andrews St.
Suite 101 Andrea Chambers
P.O. Box 56468
3307 Limassol, Cyprus
Tel: +357 25 375 675
Fax: +357 25 359 595

Alpha Innovations Brasil

Rua Manuel Augusto
de Alvarenga, 155
São Paulo, SP - Brasil
Tel: +55 11 2476 0150
Fax: +55 11 2476 0150

Alpha Industrial Power Inc.

1075 Satellite Blvd NW,
Suite 400
Suwanee, GA 30024
United States
Tel: +1 678 475 3995
Fax: +1 678 584 9259

Alpha Technologies S.A.

131 Boulevard de l'Europe
1301 Wavre
Belgium
Tel: +32 10 438 510
Fax: +32 10 438 213

Alpha TEK ooo

Khokhlovskiy Pereulok 16
Stroenie 1, Office 403
Moscow, 109028
Russia
Tel: +7 495 916 1854
Fax: +7 495 916 1349

Alphatec Baltic

S. Konarskio Street 49-201
Vilnius, LT-03123
Lithuania
Tel: +370 5 210 5291
Fax: +370 5 210 5292

For technical support, contact Alpha Technologies:
Canada and USA: 1-888-462-7487
International: +1-604-436-5547

Visit us at www.alpha.ca

Power