

# Find-It-In-Front: Dr. Pinball Section

The inside cover & the front pages  
DR. ① thru DR. ⑩ covers the basics...

Find the answers to your questions here...  
If you still need help, give us a call!



THIS PINBALL GAME IS  
**TOPS**  
TOURNAMENT PINBALL  
SYSTEM READY!

Order the optional  
Kit SP-PIN-  
502-5011-00

The Portals™ Service Menu,  
Section 3, is your Technical Friend...

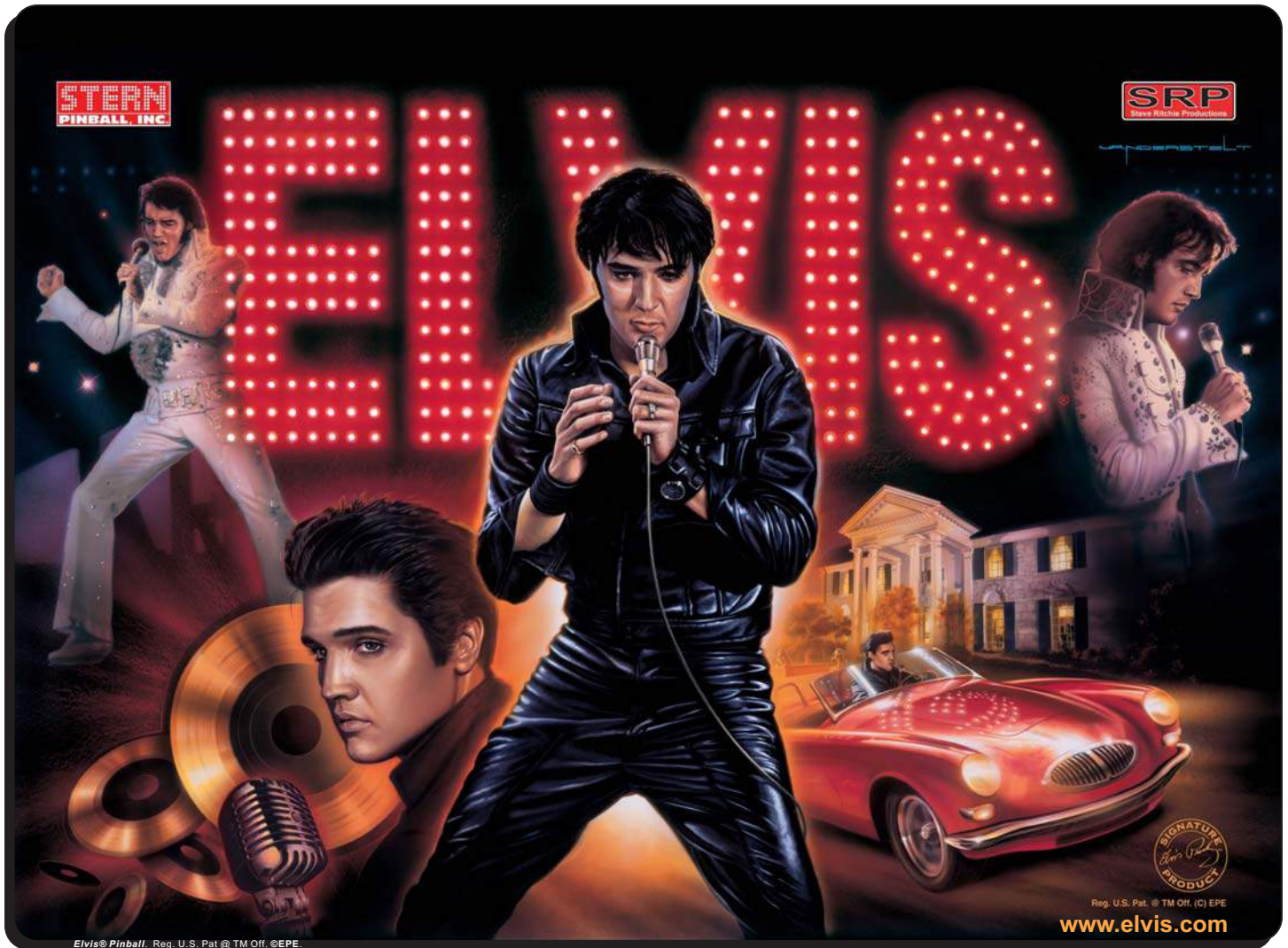

**Joe Blackwell**  
DIRECTOR,  
Parts Sales &  
Technical Support

**Patty Schraps**  
Parts Sales  
MANAGER

**Dorothy Brown**  
Parts Sales  
REPRESENTATIVE

Your Parts Sales & Technical Support Team

**Chas Siddiqi**  
Technical Support  
ENGINEER

**Patrick Powers**  
Technical Support  
ENGINEER

**J. Alfer**  
Technical Support  
Documentation  
ADMINISTRATOR

Please call us at 1-800-542-5377 or  
**1-800-KICKERS** for Technical Support.

Visit us at our Web Site [www.SternPinball.com](http://www.SternPinball.com).

Stern® Pinball, Inc.  
All Rights Reserved.  
Printed in the U.S.A.  
October 2004

SPI Part Number  
**780-5084-00**

For Proper Operation of this Pinball Game, four (4) Pinballs must be installed!



### Easy Access Drop Target Replacment

This new Drop Target Design allows for EASY ACCESS to the DROP TARGETS while the entire assembly stays secured to the underside of the playfield.

To remove the Drop Target Access Plate, simply remove seven (7) screws. Five (5) from the plate and two (2) that secure this plate to the underside of the playfield (Ref. A).

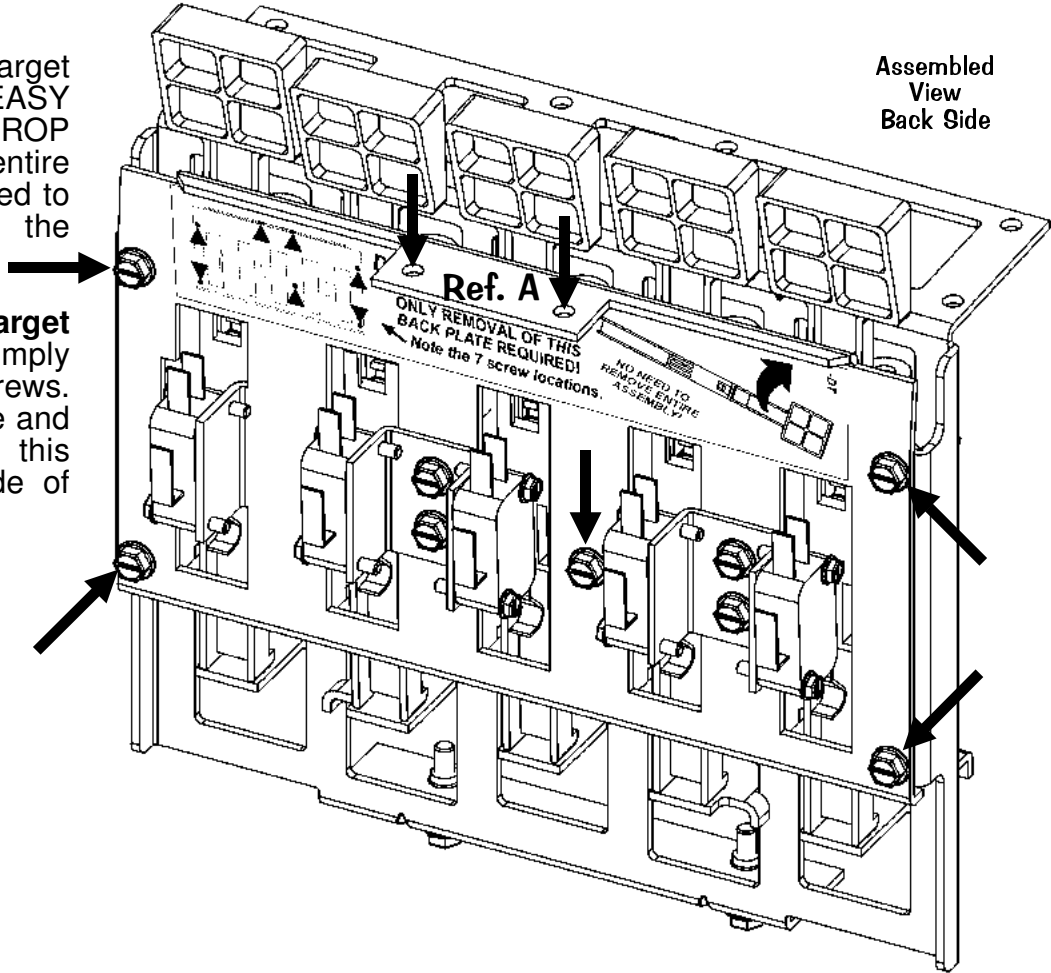

Assembled View Back Side



Exiting Portals™ or turning game on/off will start the Power-Up Routine. Upon Power-Up, HOLD IN THE RIGHT FLIPPER BUTTON to view the CPU Game & Display Code Versions (+ Check-Sums), followed by the Location & Game ID Numbers and Alerts, if any (see Sec. 3, Chp. 2, GO TO DIAGNOSTICS MENU, Technician Alerts).



Look over the TOURNAMENT MENU in Portals™!

Read over Section 3, Chapter 7, Pages 53-57.



An Optional Tournament Kit is required for this ToPS™ Ready Pinball Game.

You can now easily set-up, start and end Tournaments for cash, tokens, tickets or points!



Set-up Tournaments...

2 personal messages can be added ...

### New to our Pinball Games?

Don't forget to go over Section 3, Chapter 1, Portals™ Service Menu Introduction. If using Diagnostics...very useful! Got confused? Comments? Questions? Call Technical Support at 800-542-5377 or 708-345-7700 (Option 1).

# Backbox PCB Fuses, ROMs, Bridges, Relays, P/F & Cabinet Fuses, Cab. Switches

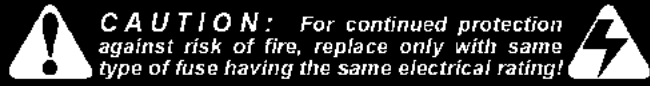

## QUICK REFERENCE FUSE CHART

### Backbox Fuses

LOC: DISPLAY POWER SUPPLY (P.S.) BOARD			
F1	¼A 250v S.B.	90v DC	High Voltage Display
LOC: I/O POWER DRIVER BOARD			
F6	7A 250v S.B.	50v DC	Primary High Power Coils/Flippers
F7	5A 250v S.B.	20v DC	Low Power Coils
F8	5A 250v S.B.	12v DC	Logic Power
F9	5A 250v S.B.	12v DC	Logic Power
F20	4A 250v S.B.	50v DC	Magnets
F21	3A 250v S.B.	50v DC	Coils
F22	8A 250v S.B.	18v DC	Controlled Lamps
F23	4A 250v S.B.	5v DC	Logic
F24	5A 250v S.B.	6.3v AC	G.I. Lamps (BRN-WHT↔WHT-BRN)
F25	5A 250v S.B.	6.3v AC	G.I. Lamps (YEL↔WHT-YEL)
F26	5A 250v S.B.	6.3v AC	G.I. Lamps (GRN↔WHT-GRN)
F27	5A 250v S.B.	6.3v AC	G.I. Lamps (VIO↔WHT-VIO)
F28	3A 250v S.B.	24v AC	Not Used / Spare

### Cabinet Fuses

LOC: SERVICE (AC) OUTLET BOX (Cabinet Bottom)			
n/a	8A 250v S.B.	115v AC	Main Fuse Line (Domestic or USA)
n/a	5A 250v S.B.	220v AC	Main Fuse Line (International)

### Playfield (P/F) Fuses

LOC: UNDER PLAYFIELD (near Flippers)			
n/a	3A 250v S.B.	50v DC	Right Flipper (BLU-YEL↔RED-YEL)
n/a	3A 250v S.B.	50v DC	Left Flipper (GRY-YEL↔RED-YEL)
n/a	3A 250v S.B.	50v DC	Upr. Rt. Flipper (BLU-YEL↔RED-YEL)
n/a	3A 250v S.B.	50v DC	Upr. Lt. Flipper (GRY-YEL↔RED-YEL)

For locations & more information on fuses, see Sec. 5, Chapter 2.

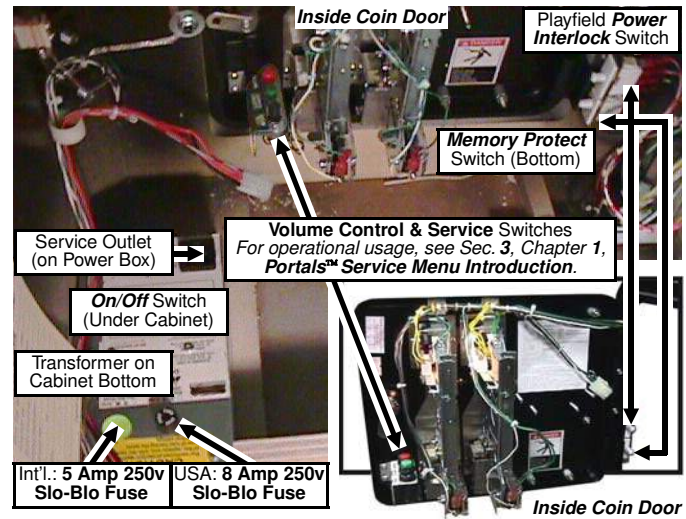

ROM TYPE on BD	LOCATION	SIZE	PART NUMBER
CPU Sound	U7	512K	965-0415-84
CPU Game	U210	1 MB	965-0416-84
CPU Voice ROM 1	U17	8 MB	965-0417-84
CPU Voice ROM 2	U21	8 MB	965-0418-84
CPU Voice ROM 3	U36	8 MB	965-0419-84
CPU Voice ROM 4	U37	8 MB	965-0420-84
DISPLAY Controller	U5	4 MB	965-0421-84

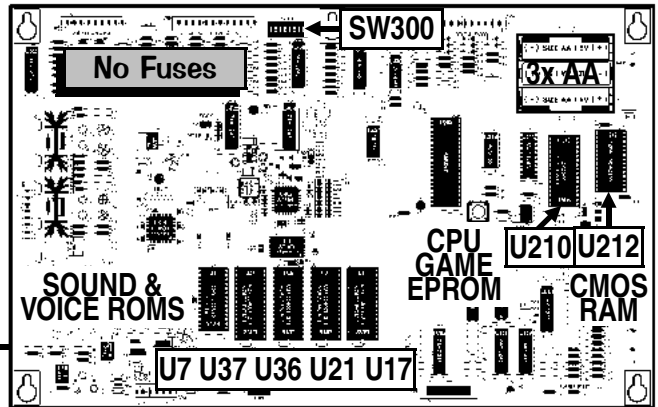

For Schematics and/or Component Parts on PC Boards shown on this page, review Section 5, Chapter 4, Printed Circuit Boards (The Yellow Pages).

### CPU/Sound Bd. II w/ATMEL ▲

### I/O Power Driver Board ▼

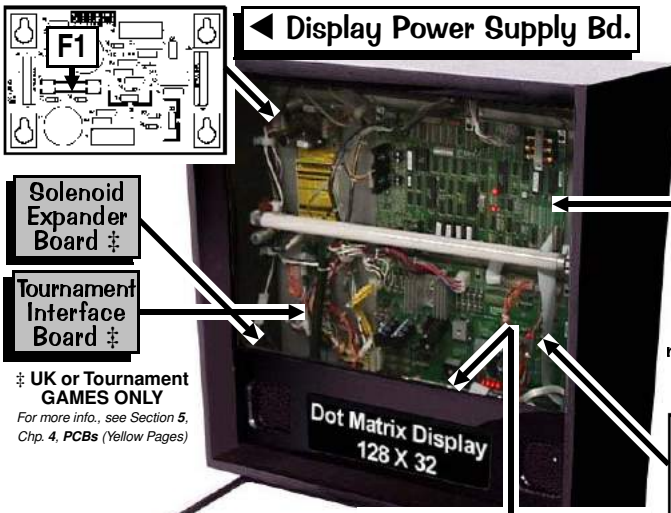

‡ UK or Tournament GAMES ONLY  
For more info., see Section 5, Chp. 4, PCBs (Yellow Pages)

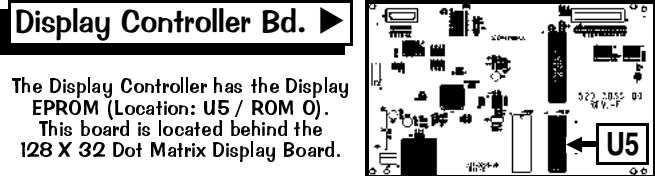

The Display Controller has the Display EPROM (Location: U5 / ROM 0). This board is located behind the 128 X 32 Dot Matrix Display Board.

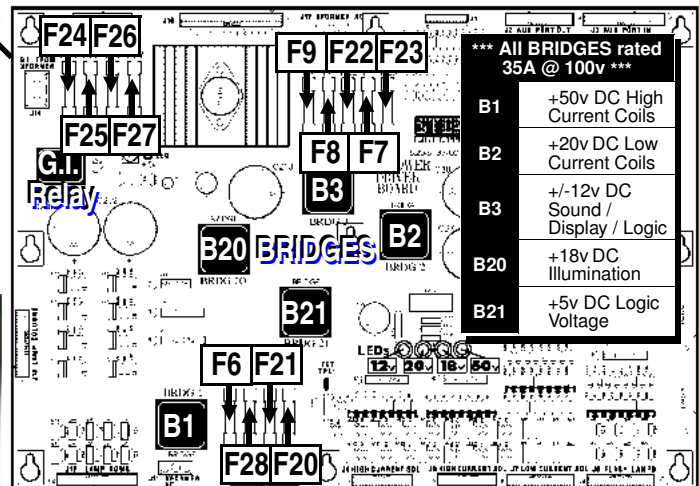
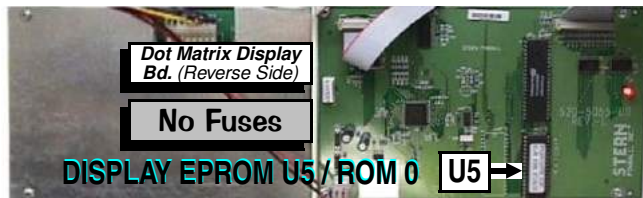

\*\*\* All BRIDGES rated 35A @ 100v \*\*\*

B1	+50v DC High Current Coils
B2	+20v DC Low Current Coils
B3	+/- 12v DC Sound / Display / Logic
B20	+18v DC Illumination
B21	+5v DC Logic Voltage



# ////// FIND-IT-IN-FRONT: Dr. Pinball Section Explained ////

The key technical data from various parts of the manual were extracted and combined into the "Find- It-In-Front: Dr. Pinball Section." This section (pages DR. ① - ⑩) will assist the technician in locating important technical information needed to troubleshoot the Pinball Machine. **Dr. Pinball** is also available in a Flow Chart Help Format in the Game Display. To access, enter the **Portals™ Service Menu**.

## ////// How It Works ////

First, the operator / technician must enter the **Service Menu Mode** (for a complete description of the **Portals™ Service Menu and ICONS Read! Section 3, Chapter 1**). To get into the **Service Menu Mode**, power-up the game (if not already) and open the **Coin Door**. On the **Coin Door** is the **Portals™ Service Switch Set** (Red, Green & Black Buttons).

**Step 1:** Push down the **Black "BEGIN TEST" Button**. Looking at the Video Display you will momentarily see the introductory screen followed by the **MAIN MENU**.

**Step 2:** Move through the Menus by pushing the **Red "LEFT" or Green "RIGHT" Buttons**.



**Step 3:** Select or activate the *Icons* by pushing the **Black "ENTER" Button**.

While in the **Portals™ Service Menu**, the **Start Button** can be used in lieu of the **Black Button**; the **Left & Right Flipper Buttons** can be used in lieu of the **Red & Green Buttons**. However, in *Switch or Active Switch Tests* **only** the **Red & Green Buttons** can be used.



In our **Portals™ Service Menu**, selecting the "DR." *Icon* will bring the operator/technician into **DR. PINBALL** (Flow Chart Menus), the "on-screen" diagnostic aide. This is a feature that will allow you to utilize the power of the micro-processor assisting in troubleshooting a problem with the machine in a **Flow Chart** format (follow the questions & answer by using the *Mini-Icons* in the display).



After entering **Portals™**, the **MAIN MENU** now appears with the "DIAG" *Icon* (GO TO DIAGNOSTICS MENU) flashing; press the **Black "ENTER" Button** to activate this **ICON**. The **DIAGNOSTICS MENU** now appears with the "SW" *Icon* (GO TO SWITCH MENU) flashing; use the **Red "LEFT" or Green "RIGHT" Buttons**, until the "DR." *Icon* (DR. PINBALL) is flashing:



Press the **Black "ENTER" Button** to activate this **ICON**. The **DR. PINBALL MENU** (Flow Chart Menus) now appears with the **COIL "DR." Icon** flashing. Three (3) *Icons*, **Coil "DR."**, **Switch "DR."** and **Lamp "DR."** are available for selection. Selecting a particular *Icon* will give you a choice of which specific **Coil** (any and all coil assemblies such as *Flippers, VUKs, Magnets, etc.*), **Switch** or **Lamp Circuit** needs to be diagnosed. After selection, **Dr. Pinball** will now display a question or a procedure to follow such as "Does the lamp turn on?" or "Check bridge rectifier BR-20, if short replace." When **Dr. Pinball** displays a question or requests a procedure, **Dr. Pinball** will expect a response such as "NO" or "YES". You the operator/technician must respond by using the **Red or Green Buttons** to "SELECT" a *Mini-Icon* and the **Black Button** to "ACTIVATE or ENTER" your selection.



For *Mini-Icons* explanations & details, see the end of **Section 3, Chapter 2, GO TO DIAGNOSTICS MENU, Dr. Pinball**.

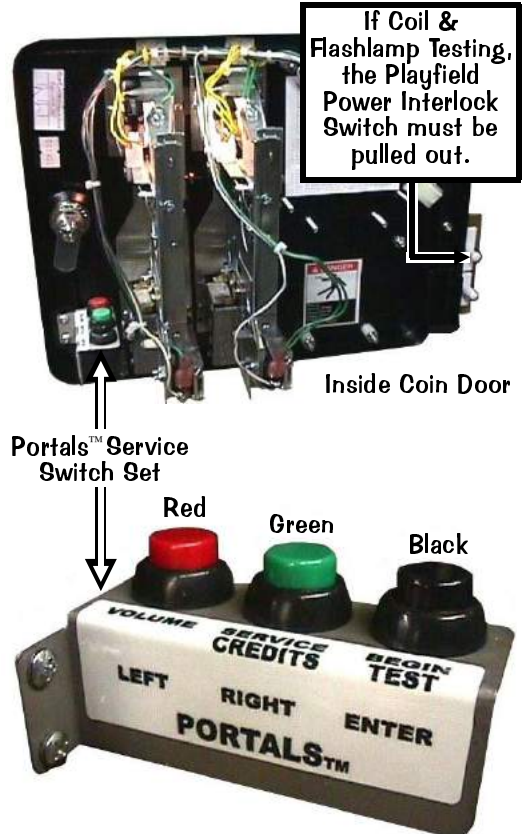

# DIAGNOSTIC AIDS

## OPEN THE DOOR

If this **display flashes**, the game is indicating that **CMOS RAM** memory (*CPU Loc. U212*) has been corrupted. This is caused by either failure in memory (*e.g. batteries are dead and/or faulty RAM*) or upon installation of updated version of game code. Opening the **Coin Door** will initiate a **Factory Restore (Reset)**, by opening the **Memory Protect Switch**. Check battery voltage at **VBATT Test Point** on the **CPU/Sound Bd.** (*more details in Section 5, Chapter 4, PCBs*).

## OPERATOR ALERT! #2 AUTO LAUNCH COIL MALFUNCTION

This **display** is shown momentarily during **Game Mode** or **Power-Up** to alert the operator of a coil malfunction (*coil doesn't energize or coil fires a multiple number of times*). **OPERATOR ALERT!** works by monitoring any **switch activated coil** that has the potential to trap a ball when disabled (*e.g. in the Auto Launch, Scoop, Eject, etc.*). This alert can also appear if a switch associated with a coil (*e.g. #16 Shooter Lane & #2 Auto Launch*) is stuck closed (*caused by a switch jam or stuck ball*); the **CPU/Sound Board** will activate the coil approximately ten times and if the switch remains closed, the game will report this switch in **Technician Alerts** & will indicate the *following display warning*:

## PLEASE CHECK TECH REPORT PORTALS->DIAG->TECH

If this **Tech Report Alert flashes** (*along with an audible sound*), the game has detected faulty switches and/or missing pinballs. Select the "TECH" *Icon* for information (*review Technician Alerts, Pages 24-25*). For this **Alert display** to appear, *Standard Adj. 49, must be changed to POWERUP, COIN DOOR or POWERUP AND COIN DOOR, the default is NEVER* (*review Section 3, Chp. 4, GO TO ADJUSTMENTS MENU, Standard Adjustments, Page 44*).

# CPU DIP SWITCH SETTINGS

*Location of Dip Switch [SW300] is on the CPU/Sound Board (Right of CN6, Top Middle)*

CPU COUNTRY SETTING:								
Pos.	1	2	3	4	5	6	7	8
USA	ON	▼	▼	▼	▼	▼	▼	▼
	OFF	▼	▼	▼	▼	▼	▼	▼

CPU COUNTRY SETTING:								
Pos.	1	2	3	4	5	6	7	8
Austria	ON ▲	▼	▼	▼	▼	▼	▼	▼
	OFF ▼	▼	▼	▼	▼	▼	▼	▼

CPU COUNTRY SETTING:								
Pos.	1	2	3	4	5	6	7	8
France	ON ▲▲	▼	▼	▼	▼	▼	▼	▼
	OFF ▼	▼	▼	▼	▼	▼	▼	▼

CPU COUNTRY SETTING:								
Pos.	1	2	3	4	5	6	7	8
Norway	ON ▲	▲	▲	▼	▼	▼	▼	▼
	OFF ▼	▼	▼	▼	▼	▼	▼	▼

CPU COUNTRY SETTING:								
Pos.	1	2	3	4	5	6	7	8
Australia	ON ▲	▲	▲	▼	▼	▼	▼	▼
	OFF ▼	▼	▼	▼	▼	▼	▼	▼

CPU COUNTRY SETTING:								
Pos.	1	2	3	4	5	6	7	8
Germany	ON ▲▲▲	▲	▼	▼	▼	▼	▼	▼
	OFF ▼	▼	▼	▼	▼	▼	▼	▼

CPU COUNTRY SETTING:								
Pos.	1	2	3	4	5	6	7	8
Portugal	ON ▲	▲	▲	▼	▼	▼	▼	▼
	OFF ▼	▼	▼	▼	▼	▼	▼	▼

CPU COUNTRY SETTING:								
Pos.	1	2	3	4	5	6	7	8
Belgium	ON ▲	▲	▼	▼	▼	▼	▼	▼
	OFF ▼	▼	▼	▼	▼	▼	▼	▼

CPU COUNTRY SETTING:								
Pos.	1	2	3	4	5	6	7	8
Greece	ON ▲▲▲	▲	▲	▼	▼	▼	▼	▼
	OFF ▼	▼	▼	▼	▼	▼	▼	▼

CPU COUNTRY SETTING:								
Pos.	1	2	3	4	5	6	7	8
So. Africa	ON ▲	▲	▲	▲	▼	▼	▼	▼
	OFF ▼	▼	▼	▼	▼	▼	▼	▼

CPU COUNTRY SETTING:								
Pos.	1	2	3	4	5	6	7	8
Canada	ON ▲▲	▼	▼	▼	▼	▼	▼	▼
	OFF ▼	▼	▼	▼	▼	▼	▼	▼

CPU COUNTRY SETTING:								
Pos.	1	2	3	4	5	6	7	8
Italy	ON ▲	▲	▲	▼	▼	▼	▼	▼
	OFF ▼	▼	▼	▼	▼	▼	▼	▼

CPU COUNTRY SETTING:								
Pos.	1	2	3	4	5	6	7	8
Spain	ON ▲	▲	▲	▼	▼	▼	▼	▼
	OFF ▼	▼	▼	▼	▼	▼	▼	▼

CPU COUNTRY SETTING:								
Pos.	1	2	3	4	5	6	7	8
Croatia	ON ▲	▲	▲	▼	▼	▼	▼	▼
	OFF ▼	▼	▼	▼	▼	▼	▼	▼

CPU COUNTRY SETTING:								
Pos.	1	2	3	4	5	6	7	8
Japan	ON ▲	▲	▲	▲	▼	▼	▼	▼
	OFF ▼	▼	▼	▼	▼	▼	▼	▼

CPU COUNTRY SETTING:								
Pos.	1	2	3	4	5	6	7	8
Sweden	ON ▲▲	▲	▲	▼	▼	▼	▼	▼
	OFF ▼	▼	▼	▼	▼	▼	▼	▼

CPU COUNTRY SETTING:								
Pos.	1	2	3	4	5	6	7	8
Denmark	ON ▲	▲	▲	▼	▼	▼	▼	▼
	OFF ▼	▼	▼	▼	▼	▼	▼	▼

CPU COUNTRY SETTING:								
Pos.	1	2	3	4	5	6	7	8
Netherlands	ON ▲	▲	▼	▼	▼	▼	▼	▼
	OFF ▼	▼	▼	▼	▼	▼	▼	▼

CPU COUNTRY SETTING:								
Pos.	1	2	3	4	5	6	7	8
Switzerland	ON ▲	▲	▲	▼	▼	▼	▼	▼
	OFF ▼	▼	▼	▼	▼	▼	▼	▼

CPU COUNTRY SETTING:								
Pos.	1	2	3	4	5	6	7	8
Finland	ON ▲	▲	▼	▼	▼	▼	▼	▼
	OFF ▼	▼	▼	▼	▼	▼	▼	▼

CPU COUNTRY SETTING:								
Pos.	1	2	3	4	5	6	7	8
New Zealand	ON ▲	▼	▼	▼	▼	▲	▼	▼
	OFF ▼	▼	▼	▼	▼	▼	▼	▼

CPU COUNTRY SETTING:								
Pos.	1	2	3	4	5	6	7	8
UK	ON ▲	▲	▲	▼	▼	▼	▼	▼
	OFF ▼	▼	▼	▼	▼	▼	▼	▼





In SWITCH MENU also select:

ACTIVE and DEDICATED SWITCH TESTS

## SWITCH MATRIX GRID, DEDICATED SWITCHES & LOCATIONS

Column (Drive)	1: Q1	2: Q2	3: Q3	4: Q4	5: Q5	6: Q6	7: Q7	8: Q8	GROUND	GROUND
Row (Return)	GRN-BRN CN5-P1	GRN-RED CN5-P3	GRN-ORG CN5-P4	GRN-YEL CN5-P5	GRN-BLK CN5-P6	GRN-BLU CN5-P7	GRN-VIO CN5-P8	GRN-GRY CN5-P9	IC U206 INPUTS	BLK CN6-P1, -P11
1: U400	1 Cabinet Side LT BUTTON (UK ONLY) Sw. Part Number: 180-5160-00	9 Below P/F SPOT NOTE STANDUP 515-5162-08	17 Below P/F (E) LVIS 180-5158-00	25 Above P/F SPINNER 180-5010-04	33 Below P/F ELVIS HOME 180-5189-00	41 Below P/F LEFT TOP LANE 500-6227-02	49 Below P/F LEFT BUMPER 180-5015-05	57 Below P/F LEFT OUTLANE 500-6227-02	1: U206 GRY-BRN CN6-P2 Sw. Part Number: 180-5160-00	DS-1 on Cabinet Side #1 LEFT FLIPPER BUTTON 180-5160-00
2: U400	2 Coin Door 4TH COIN SLOT 180-5204-00	10 Above P/F SHOOTER LANE EXIT 180-5190-28	18 Below P/F E(L) VIS 180-5158-00	26 Above P/F LEFT ORBIT HI 180-5087-00	34 Below P/F CENTER SAUCER EJECT 180-5186-00	42 Below P/F MIDDLE TOP LANE 500-6227-02	50 Below P/F RIGHT BUMPER 180-5015-05	58 Below P/F LEFT RETURN LANE 500-6227-02	2: U206 GRY-RED CN6-P3 Sw. Part Number: 180-5149-00 on Flipper	DS-2 Below Playfield #2 LEFT FLIPPER E.O.S (End-of-Stroke) 180-5149-00 on Flipper
3: U400	3 Coin Door 6TH COIN SLOT Future Use	11 Below P/F 4-BALL TROUGH #1 (LEFT) 180-5119-02	19 Below P/F EL(V) IS 180-5158-00	27 Above P/F INNER LOOP 180-5087-00	35 NOT USED	43 Below P/F RIGHT TOP LANE 500-6227-02	51 Below P/F BOTTOM BUMPER 180-5015-05	59 Below P/F LEFT SLINGSHOT 180-5054-00 (x2)	3: U206 GRY-ORG CN6-P4 Sw. Part Number: 180-5164-00 Doubled	DS-3 on Cabinet Side #3 RIGHT FLIPPER BUTTON 180-5164-00 Doubled
4: U400	4 Coin Door RIGHT COIN SLOT 180-5204-00	12 Below P/F 4-BALL TROUGH #2 180-5119-02	20 Below P/F ELV(I) S 180-5158-00	28 Above P/F RIGHT RAMP EXIT 180-5010-01	36 Below P/F (K) ING 515-7381-00	44 NOT USED	52 Mini P/F TOP HOTEL STANDUP 515-5162-08	60 Below P/F RIGHT OUTLANE 500-6227-02	4: U206 GRY-YEL CN6-P6 Sw. Part Number: 180-5162-02	DS-4 Below Playfield #4 RIGHT FLIPPER E.O.S (End-of-Stroke) 180-5162-02 on Flipper
5: U401	5 Coin Door CENTER COIN SLOT / DBA 180-5204-00	13 Below P/F 4-BALL TROUGH #3 180-5119-02	21 Below P/F ELVI(S) DOTS 180-5158-00	29 NOT USED	37 Below P/F K(I) NG 515-7381-00	45 Above P/F RIGHT RAMP MADE 180-5190-28	53 Mini P/F BOTTOM HOTEL STANDUP 515-5162-08	61 Below P/F RIGHT RETURN LANE 500-6227-02	5: U206 GRY-GRN CN6-P7 Sw. Part Number: Same as DS-3 above.	DS-5 on Cabinet Side #5 UPPER RT. FLIPPER BUTTON 180-5192-02
6: U401	6 Coin Door LEFT COIN SLOT 180-5204-00	14 Below P/F 4-BALL TROUGH VUK OPTO See Sw. 14 Note	22 Below P/F (T) CB 515-5162-08	30 Above P/F LEFT RAMP MADE 180-5087-00	38 Below P/F KI(N) G 515-7381-00	46 Above P/F RIGHT ORBIT LOW 180-5087-00	54 In Cabinet START BUTTON 180-5174-00	62 Below P/F RIGHT SLINGSHOT 180-5054-00 (x2)	6: U206 GRY-BLU CN6-P8 Sw. Part Number: 180-5192-02	DS-6 on Coin Door #6 VOLUME (RED BUTTON) (In Test: LEFT) 180-5192-02
7: U401	7 Coin Door 5TH COIN SLOT Future Use	15 Below P/F 4-BALL STACKING OPTO See Sw. 15 Note	23 Below P/F T(C) B 515-5162-08	31 Above P/F LEFT RAMP EXIT 180-5010-01	39 Below P/F KIN(G) G 515-7381-00	47 Above P/F RIGHT ORBIT HI 180-5087-00	55 In Cabinet TOURNAMENT START 180-5174-00	63 Above P/F HOTEL DOOR 180-5119-02	7: U206 GRY-VIO CN6-P9 Sw. Part Number: 180-5192-00	DS-7 on Coin Door #7 SERV. CRED. (GREEN BUTTON) (In Test: RIGHT) 180-5192-00
8: U401	8 Cabinet Side RT BUTTON (UK ONLY) 180-5160-00	16 Below P/F SHOOTER LANE 180-5157-00	24 Below P/F TC(B) B 515-5162-08	32 Below P/F TOP SAUCER EJECT 180-5186-00	40 Below P/F SCARF STANDUP 515-5967-02	48 Above P/F HOTEL POST 180-5189-00	56 In Cabinet PLUMB BOB TILT See Sw. 56 Note	64 Above P/F HOUND DOG 180-5190-28	8: U206 GRY-BLK CN6-P10 Sw. Part Number: 180-5192-00	DS-8 on Coin Door #8 BEGIN TEST (BLACK BUTTON) (In Test: ENTER) 180-5192-00

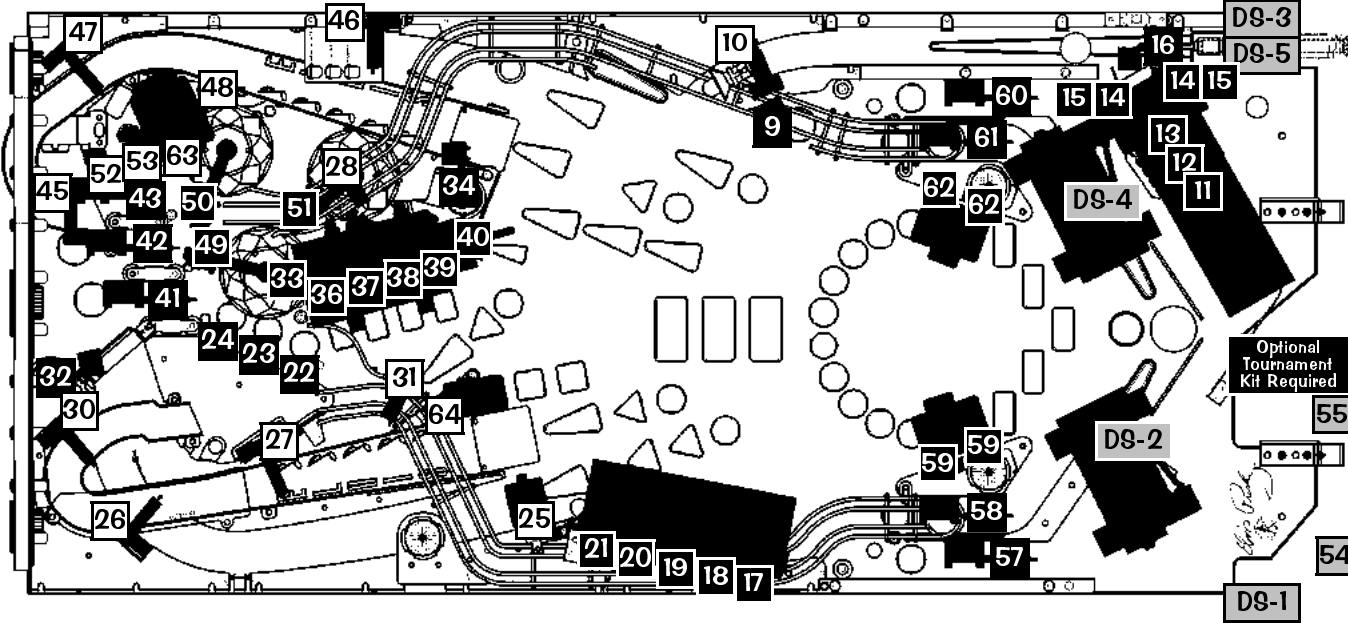

### Playfield ▲

- = Switches above Playfield.
- = Switches below Playfield.
- = Switches not on Playfield.

**Switch Part Notes:** ¥ Yen Coin Switch is 180-5091-00. Part Numbers which start with 515- or 500- include the bracket, target, and/or housing.  
**Switches 14 & 15 Part Note:** Transmitter & Receiver OPTO  
**PC Boards are used as Switches:** Transmitter: 515-0173-00 (Sw. 14 & 15); Receiver: 515-0174-00 (Sw. 14 & 15);  
**Sw. 56 Part Note:** The Switch is comprised of a Hanger Bracket (535-5319-00) and Contact Wire (535-7563-01) located in the Cabinet.  
**Some Switch Diodes may be located under the playfield, in the Cabinet or Backbox on Terminal Strips or Diode Boards and not on the assemblies.**  
**DOTS:** □ diode □ n □ terminal □ trip, see Sec. 5, Chp.2, Playfield Wiring.

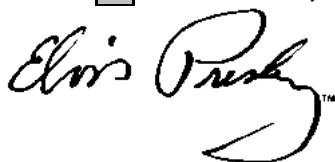

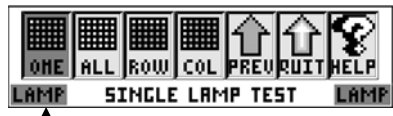

In LAMP MENU also select:  
TEST ALL LAMPS, ROW & COLUMN LAMP TESTS

### LAMP MATRIX GRID & LOCATIONS

Column (18v)	1: U17	2: U16	3: U15	4: U14	5: U13	6: U12	7: U11	8: U10
Row (Ground)	YEL-BRN J13-P9	YEL-RED J13-P8	YEL-ORG J13-P7	YEL-BLK J13-P6	YEL-GRN J13-P5	YEL-BLU J13-P4	YEL-VIO J13-P3	YEL-GRY J13-P1
1: Q33	#555 Clear Bulb ROCK AGAIN	#555 Clear Bulb LEFT OUTLANE	#555 Clear Bulb LEFT RETURN LANE	#555 Clear Bulb RIGHT RETURN LANE	#555 Clear Bulb RIGHT OUTLANE	#555 Clear Bulb SPOT NOTE	#555 Clear Bulb SCARF	#555 Clear Bulb ( T )CB
2: Q34	#555 Clear Bulb HOUND DOG	#555 Clear Bulb BLUE SUEDE SHOES	#555 Clear Bulb HEARTBREAK HOTEL	#555 Clear Bulb JAILHOUSE ROCK	#555 Clear Bulb ALL SHOOK UP	#555 Clear Bulb HITS COMPLETED	#555 Clear Bulb ELVIS COLLECTED	#555 Clear Bulb TOP 10 COMPLETED
3: Q35	#555 Clear Bulb 10	#555 Clear Bulb 9	#555 Clear Bulb 8	#555 Clear Bulb 7	#555 Clear Bulb 6	#555 Clear Bulb LEFT RAMP ARROW	#555 Clear Bulb SHOOK	#555 Clear Bulb LEFT RAMP NOTE
4: Q36	#555 Clear Bulb 5	#555 Clear Bulb 4	#555 Clear Bulb 3	#555 Clear Bulb 2	#555 Clear Bulb 1	#555 Clear Bulb RIGHT RAMP ARROW	#555 Clear Bulb UP	#555 Clear Bulb RIGHT RAMP NOTE
5: Q37	#44 Clear Bulb ( E )LVIS	#44 Clear Bulb E ( L )VIS	#44 Clear Bulb EL ( V )IS	#44 Clear Bulb ELV ( I )S	#44 Clear Bulb ELVI ( S )	#44 Clear Bulb RIGHT ORBIT ARROW	#555 Clear Bulb GIFT FROM ELVIS	#555 Clear Bulb RIGHT ORBIT NOTE
6: Q38	#555 Clear Bulb LEFT ORBIT ARROW	#555 Clear Bulb L. ORBIT BLUE SUEDE SHOES	#555 Clear Bulb ALL	#555 Clear Bulb LEFT ORBIT NOTE	#44 Clear Bulb ( K )ING	#44 Clear Bulb K ( I )NG	#44 Clear Bulb KI ( N )G	#44 Clear Bulb KIN ( G )
7: Q39	#555 Clear Bulb HOUND	#555 Clear Bulb DOG	#555 Clear Bulb CENTER LOOP ARROW	#555 Clear Bulb C. LOOP BLUE SUEDE SHOES	#555 Clear Bulb CENTER LOOP NOTE	#555 Clear Bulb LOCK	#555 Clear Bulb JACKPOT	#555 Clear Bulb SUPER JACKPOT
8: Q40	#555 Clear Bulb LEFT TOP LANE	#555 Clear Bulb MIDDLE TOP LANE	#555 Clear Bulb RIGHT TOP LANE	#44 Clear Bulb HEART	#44 Clear Bulb BREAK	#44 Clear Bulb HOTEL	#555 Clear Bulb T ( C )B	#555 Clear Bulb TC ( B )
9: Q41	#44 Yellow Bulb VIDEO MODE	#44 Yellow Bulb GOLD RECORD	#44 Yellow Bulb KING OF ROCK N ROLL	#44 Yellow Bulb LITE EXTRA BALL	#44 Yellow Bulb ENCORE LETTER	#44 Blue Bulb GRACELAND	#44 Red Bulb SPECIAL	#44 Orange Blb. EXTRA BALL
10: Q42	#44 Clear Bulb ( E )N CORE	#44 Clear Bulb E ( N ) CORE	#44 Clear Bulb EN ( C ) CORE	#44 Clear Bulb ENC ( O ) RE	#44 Clear Bulb ENCO ( R ) E	#44 Clear Bulb ENCOR ( E )	#555 Clear Bulb TOURNAMENT BUTTON	#555 Clear Bulb START BUTTON

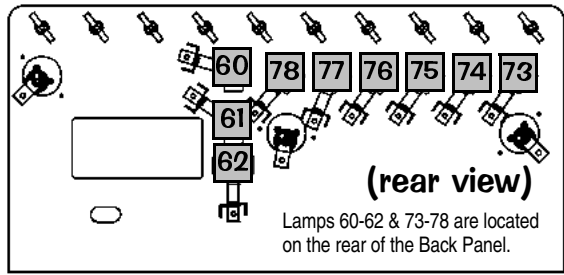
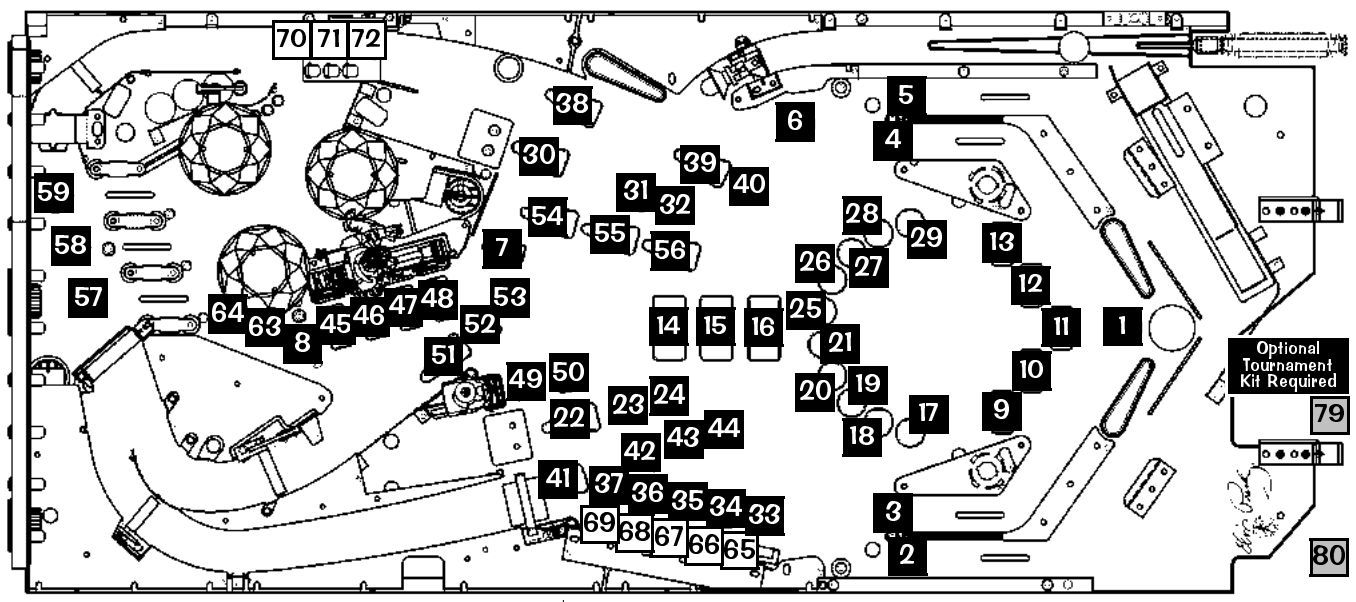

#### Playfield ▲ Backpanel ◀

- = Lamps above Playfield.
- = Lamps below Playfield.
- = Lamps not on Playfield.

**Lamp Part Notes:** #555 Bulb Clear = 165-5002-00.  
#44 Bulb (Hvy. Fil.) Clear = 165-5000-44-HF. #44 Bulb Red = 165-5053-02.  
#44 Bulb Blue = 165-5053-05. #44 Bulb Yellow = 165-5053-06.  
#44 Bulb Orange = 165-5053-07 (can sub. with Amber -03).  
See Section 4, Chapter 1, **Parts Identification & Location**, Pages 72-74 for more details on bulbs and corresponding sockets.  
**Some Lamp Diodes may be located under the playfield, in the Cabinet or Backbox on Terminal Strips and not on or with the Lamp Socket.**  
DOTS: □ diode □ n □ terminal □ trip, see Sec. 5, Chapter 2, **Playfield Wiring**.





In COIL MENU  
also select:

CYCLING  
COIL  
TEST

## COILS DETAILED CHART TABLE

High Current Coils Group 1		Drive Transistor	Driver Output Board	Power Line Color	Power Line Connection	Power Voltage	Drive Transistor Control Line Color	D.T. Control Line Connect	Coil GA-Turn or Bulb Type
#1	TROUGH UP-KICKER	Q1	▲ I/O Power Driver ▼	YEL-VIO	J10-P4/5	50v DC	BRN-BLK	J8-P1	26-1200 ∪ 090-5044-00B
#2	AUTO LAUNCH	Q2		YEL-VIO	J10-P4/5	50v DC	BRN-RED	J8-P3	23-800 ∪ 090-5001-00B
#3	ELVIS 5-BANK RESET	Q3		YEL-VIO	J10-P4/5	50v DC	BRN-ORG	J8-P4	24-940 ∪ 090-5036-00B
#4	(OPT) SHAKER MOTOR	Q4		RED-WHT	J17-P7	16v AC 12v DC	BRN-YEL	J8-P5	Motor Only 041-5029-01
#5	MAGNET	Q5		VIO-YEL	J10-P3	50v DC	BRN-GRN	J8-P6	22-650 ∪ 090-5042-00
#6	CENTER EJECT	Q6		YEL-VIO	J10-P4/5	50v DC	BRN-BLU	J8-P7	24-940 ∪ 090-5036-00B
#7	HOTEL LOCK RELEASE	Q7		YEL-VIO	J10-P4/5	50v DC	BRN-VIO	J8-P8	23-800 ∪ 090-5001-00B
#8	CONTROL GATE	Q8		YEL-VIO	J10-P4/5	50v DC	BRN-GRY	J8-P9	32-1800 ∪ 090-5031-00B

High Current Coils Group 2		Drive Transistor	Driver Output Board	Power Line Color	Power Line Connection	Power Voltage	Drive Transistor Control Line Color	D.T. Control Line Connect	Coil GA-Turn or Bulb Type
#9	LEFT BUMPER	Q9	▲ I/O Power Driver ▼	YEL-VIO	J10-P4/5	50v DC	BLU-BRN	J9-P1	26-1200 ∪ 090-5044-00T
#10	RIGHT BUMPER	Q10		YEL-VIO	J10-P4/5	50v DC	BLU-RED	J9-P2	26-1200 ∪ 090-5044-00T
#11	BOTTOM BUMPER	Q11		YEL-VIO	J10-P4/5	50v DC	BLU-ORG	J9-P4	26-1200 ∪ 090-5044-00T
#12	TOP EJECT	Q12		YEL-VIO	J10-P4/5	50v DC	BLU-YEL	J9-P5	24-940 ∪ 090-5036-00B
#13	UPPER LEFT FLIPPER	Q13		GRY-YEL-3A Fuse-RED-YEL	J10-P1/2	50v DC	BLU-GRN	J9-P6	23-900 ∪ 090-5020-30
#14	UPPER RIGHT FLIPPER	Q14		BLU-YEL-3A Fuse-RED-YEL	J10-P1/2	50v DC	BLU-BLK	J9-P7	23-900 ∪ 090-5020-30
#15	LEFT FLIPPER (50v RED/YEL)	Q15		GRY-YEL-3A Fuse-RED-YEL	J10-P1/2	50v DC	ORG-GRY	J9-P8	22-900 ∪ 090-5020-20T
#16	RIGHT FLIPPER (50v RED/YEL)	Q16		BLU-YEL-3A Fuse-RED-YEL	J10-P1/2	50v DC	ORG-VIO	J9-P9	22-900 ∪ 090-5020-20T

Low Current Coils Group 1		Drive Transistor	Driver Output Board	Power Line Color	Power Line Connection	Power Voltage	Drive Transistor Control Line Color	D.T. Control Line Connect	Coil GA-Turn or Bulb Type
#17	LEFT SLINGSHOT	Q17	▲ I/O Power Driver ▼	BROWN	J7-P1	20v DC	VIO-BRN	J7-P2	23-800 ∪ 090-5001-00T
#18	RIGHT SLINGSHOT	Q18		BROWN	J7-P1	20v DC	VIO-RED	J7-P3	23-800 ∪ 090-5001-00T
#19	HOTEL DOOR	Q19		BROWN	J7-P1	20v DC	VIO-ORG	J7-P4	27-1500 ∪ 090-5004-00B
#20	FLASH: BACK PANEL X2	Q20		ORANGE	J6-P10	20v DC	VIO-YEL	J7-P6	#89 Bulb 165-5000-89-HF
#21	FLASH: BACKPANEL TCB	Q21		ORANGE	J6-P10	20v DC	VIO-GRN	J7-P7	#89 Bulb 165-5000-89-HF
#22	FLASH: SPINNER	Q22		ORANGE	J6-P10	20v DC	VIO-BLU	J7-P8	#906 Bulb 165-5004-00
#23	FLASH: UPR RT FLIPPER X2	Q23		ORANGE	J6-P10	20v DC	VIO-BLK	J7-P9	#906 Bulb 165-5004-00
#24	OPTIONAL COIL	Q24		RED	J16-P7	5v DC	VIO-GRY	J7-P10	Opt. 5v

D iode O n T ermin al S trip (if noted)

Low Current Coils Group 2		Drive Transistor	Driver Output Board	Power Line Color	Power Line Connection	Power Voltage	Drive Transistor Control Line Color	D.T. Control Line Connect	Coil GA-Turn or Bulb Type
#25	STEPPER #1	Q25	▲ I/O Power Driver ▼	GRY-RED	J16-P3	12v DC	RED	J6-P1	Stepper Motor Only 041-5069-00
#26	STEPPER #2	Q26		GRY-RED	J16-P3	12v DC	GREEN	J6-P2	
#27	STEPPER #3	Q27		GRY-RED	J16-P3	12v DC	BLACK	J6-P3	
#28	STEPPER #4	Q28		GRY-RED	J16-P3	12v DC	BLUE	J6-P4	
#29	ELVIS LEGS	Q29		RED-WHT TO BROWN	J7-P1	20v DC	RED-WHT TO BLK-GRN	J6-P5	29-1400 ∪ 090-5072-03
#30	ELVIS ARMS	Q30		RED-WHT TO BROWN	J7-P1	20v DC	RED-WHT TO BLK-BLU	J6-P6	29-1400 ∪ 090-5072-03
#31	FLASH: ELVIS SPOT LIGHT	Q31		ORANGE	J6-P10	20v DC	BLK-VIO	J6-P7	#906 Bulb 165-5004-00
#32	FLASH: SLINGS X2	Q32		ORANGE	J6-P10	20v DC	BLK-GRY	J6-P8	#906 Bulb 165-5004-00

Note: In Test Flash Lamps Menu ("Flash" Icon), Flashers tested are all Flash Lamps located between Q1-Q32 (This Game: Q20-Q23, Q31-Q32)

Auxiliary (UK ONLY)		Drive Transistor	Driver Output Board	Power Line Color	Power Line Connection	Power Voltage	Drive Transistor Control Line Color	D.T. Control Line Connect	Coil GA-Turn
AUX 1: LEFT UP/DOWN POST		Q1	UK 3X Trans. Driver Board	BROWN	J7-P1	20v DC	WHITE	J2-P3	26-1200 ∪ 090-5044-00T
AUX 2: CENTER UP/DOWN POST		Q2		BROWN	J7-P1	20v DC	RED	J2-P4	23-1100 ∪ 090-5030-00T
AUX 3: RIGHT UP/DOWN POST		Q3		BROWN	J7-P1	20v DC	ORANGE	J2-P7	26-1200 ∪ 090-5044-00T

∪ Coil Note: ∪ Either -00B or -00T can be used for coil replacements. B/T listed is preferable for easier diode access & may differ on game.

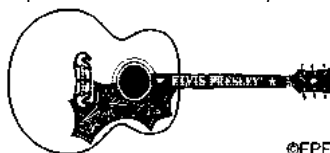



# COIL & FLASH LAMP LOCATIONS

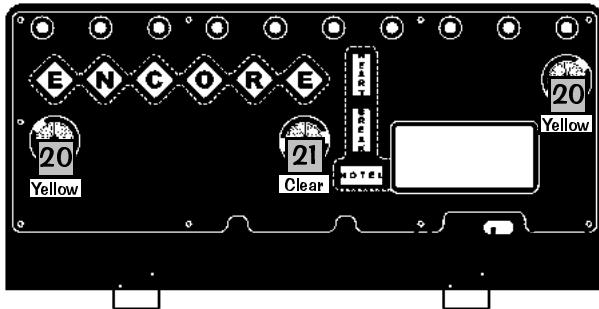

◀ Backpanel

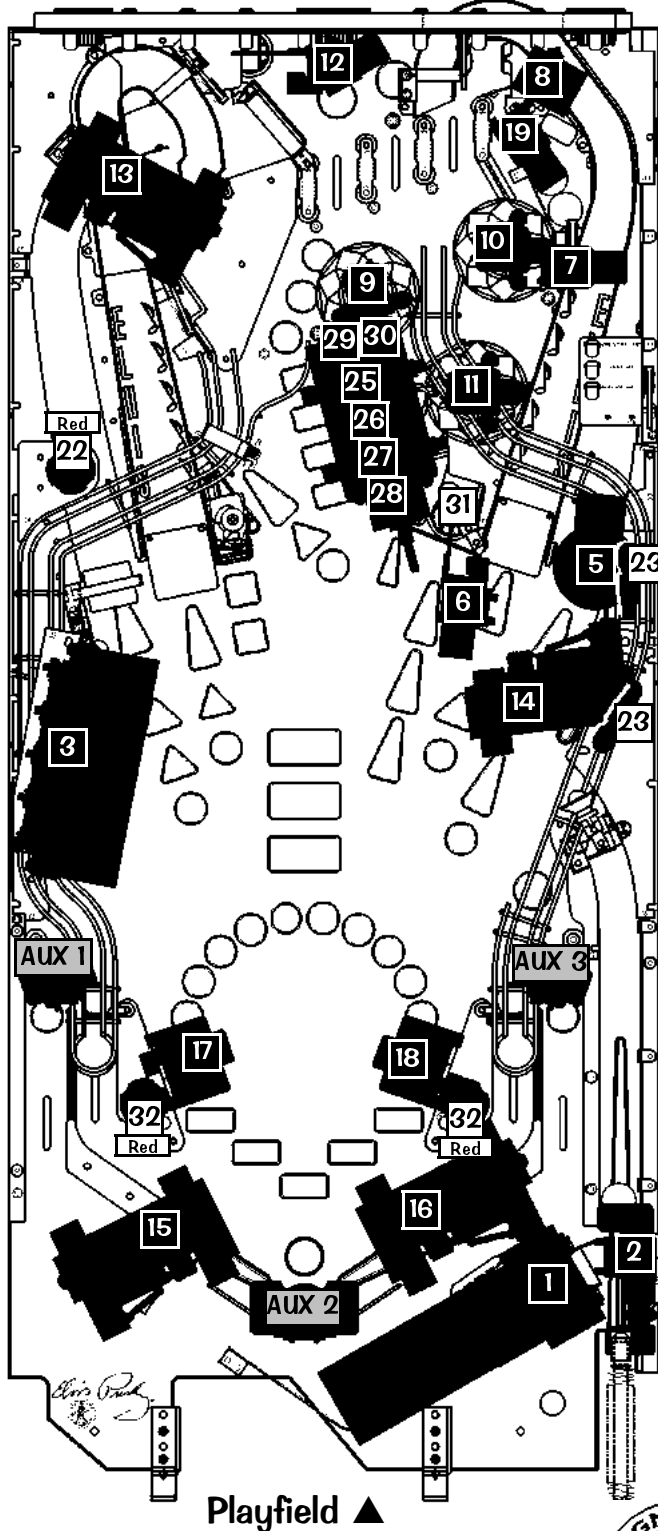

### Typical Switch Wiring & Schematic

(Column: Switch Drive Wire) GRN-XXX  
(Row: Switch Return Wire) WHT-XXX

N.O. Normally Open Switch Terminal  
COM. Common Switch Terminal  
N.C. Normally Closed Switch Terminal

### Dedicated Switch Schematic

Dedicated Sw. Inputs GRY-XXX  
Ground BLK

N.O. Normally Open Switch Terminal  
COM. Common Switch Terminal

### Typical Lamp Wiring & Schematic

COMMON  
RED  
YEL  
Diode 1N4001

YEL-XXX 18V COL  
RED-XXX GND ROW

### Typical Coil Wiring

Anode (Non-Banded Side)  
Cathode (Banded Side)  
Drive Transistor  
Power Supply Voltage

- = Coils / Flash Lamps above Playfield.
- = Coils / Flash Lamps below Playfield.
- = Coils / Flash Lamps not on Playfield.
- [Color]** = Color of Mini-Mars of Flash Lamp Bulb.

Some Coil or Flash Lamp Diodes may be located under the playfield, in the Cabinet or Backbox on Terminal Strips or Diode Boards and not on the assemblies.  
DOTS: Diode On Terminal Strip See Section 5, Chapter 2, Playfield Wiring.

Coil Q24 is optional. If either a Coin Meter, Token Dispenser or Knocker (all optional equipment) is required, call Technical Support for more information, 1-800-542-5377 or 1-708-345-7700.



## Domestic Pinball & Redemption Distributors Map

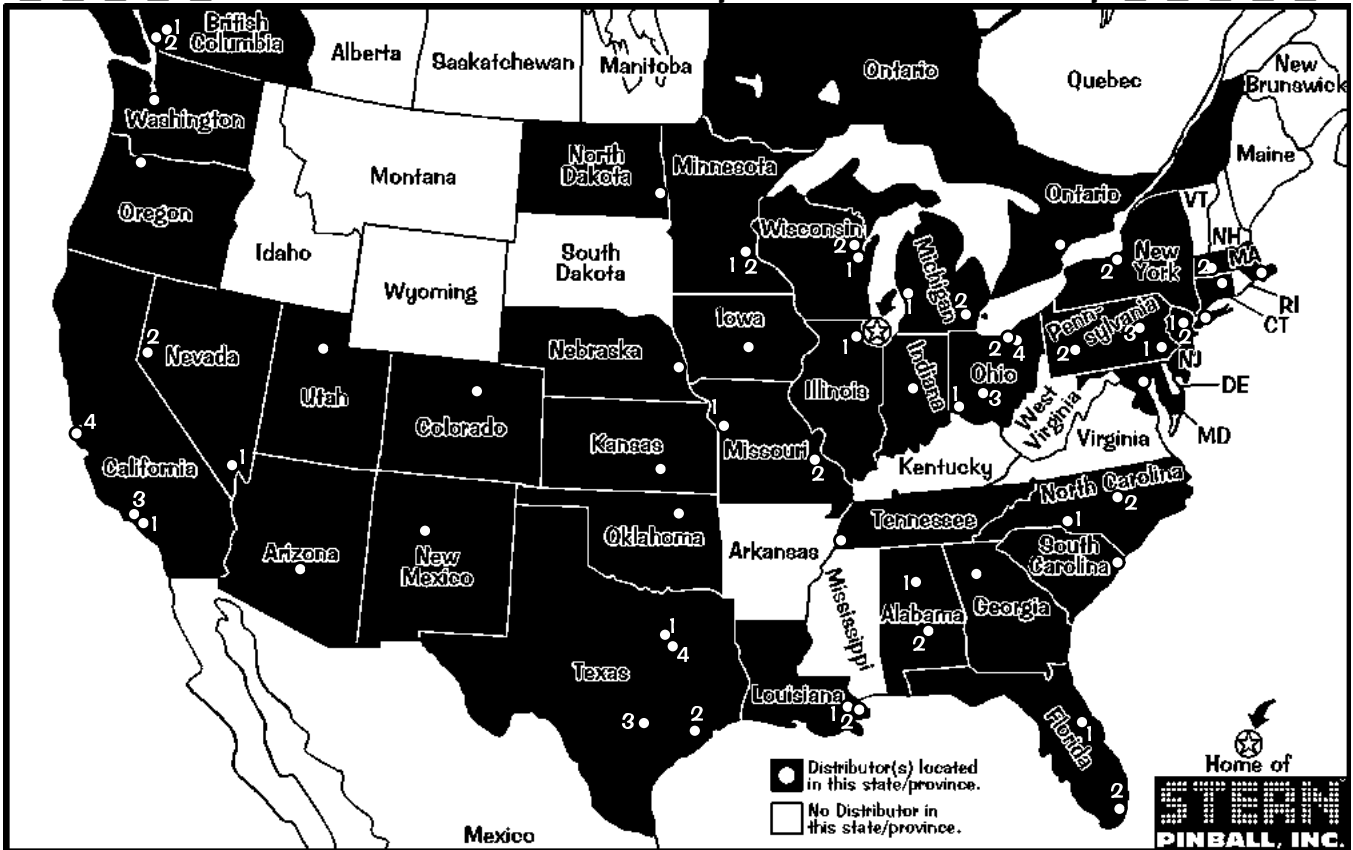

## International Distributors Map

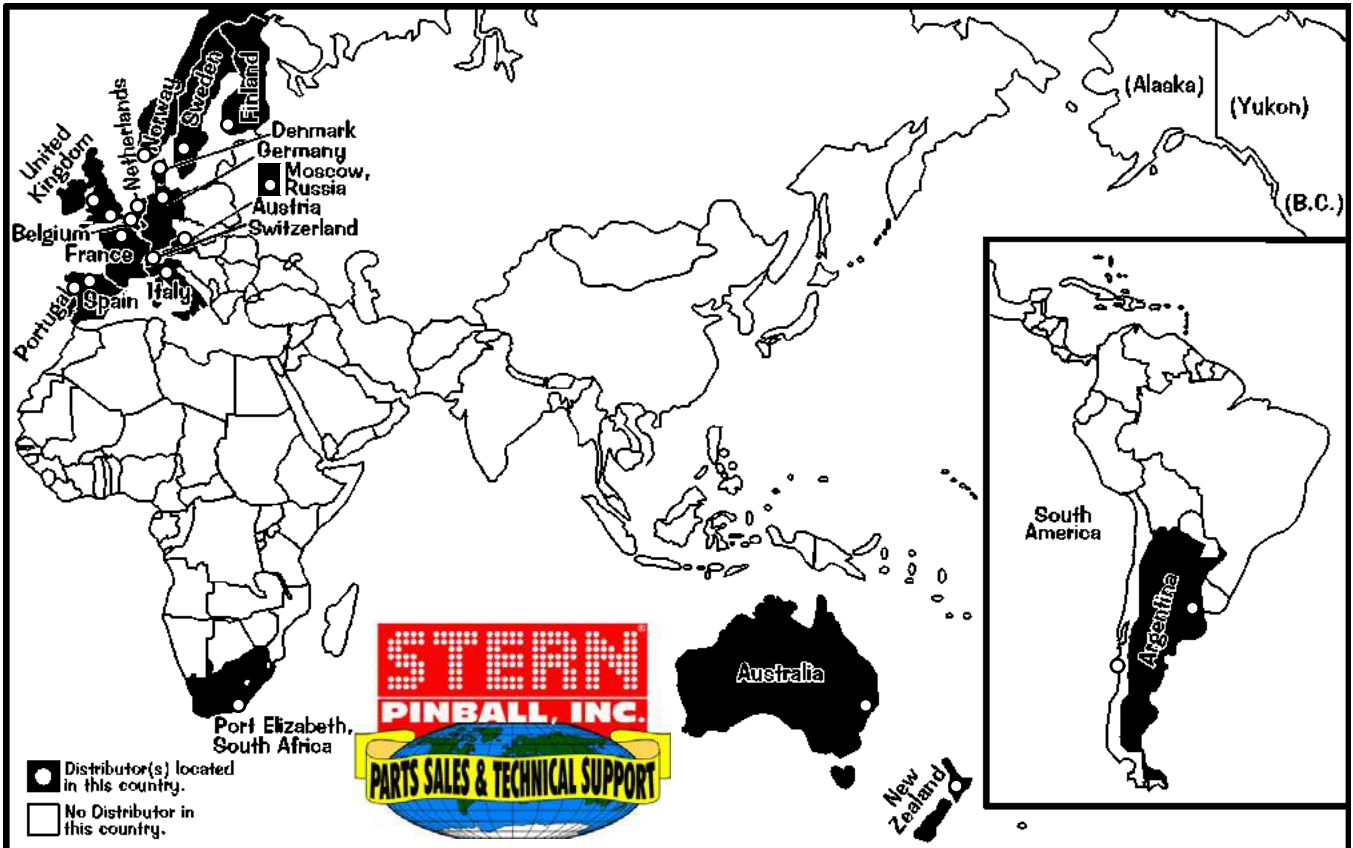

For *Parts & Service*, call your nearest Distributor. View the above maps & the directories on the next page to locate your closest Distributor in your state, province, or country. Distributors and phone numbers are subject to change. Call **Stern® Pinball, Inc. (Parts Sales & Technical Support)** with any questions or if your Distributor cannot help you: 1-800-542-5377 (in USA or Canada) or 1-708-786-5466. Visit us at [www.SternPinball.com](http://www.SternPinball.com) for current Distributor Information & other pinball needs.

# Domestic Pinball & Redemption Distributors Directory

<p><b>ALABAMA</b></p> <p>Birmingham Vending Birmingham (1) 1-205-324-7526</p> <p>Franco Distributing Montgomery (2) 1-334-834-3455</p> <p><b>ARIZONA</b></p> <p>Betsom West Phoenix 1-480-380-8857</p> <p>Mountain Coin Phoenix 1-602-269-7596</p> <p><b>CALIFORNIA</b></p> <p>Betsom West Buena Park (1) 1-714-228-7500</p> <p>So. San Francisco (2) 1-650-952-4220</p> <p>C.A. Robinson Los Angeles (3) 1-323-735-3001</p> <p>San Francisco (4) 1-650-871-4280</p> <p><b>COLORADO</b></p> <p>Mountain Coin Denver 1-303-427-2133</p> <p><b>CONNECTICUT</b></p> <p>TDM Distributing Williamantic 1-860-423-1403</p> <p><b>FLORIDA</b></p> <p>Birmingham Vending Orlando (1) 1-407-425-1505</p> <p>Brady Distributing Miami [Miramar] (2) 1-954-874-1100</p> <p>Orlando (1) 1-407-872-1666</p> <p><b>GEORGIA</b></p> <p>Greater Southern Dist. Smyrna 1-770-803-3040</p> <p><b>ILLINOIS</b></p> <p>American Vending Elk Grove Village 1-847-439-9400</p> <p>Atlas Dist. International Elk Grove Village 1-847-952-7500</p> <p>World Wide Distributing Elk Grove Village 847-434-0400</p>	<p><b>IOWA</b></p> <p>Greater America Dist. Johnston 1-515-278-4455</p> <p>Moss Distributing Des Moines 1-515-266-6422</p> <p><b>INDIANA</b></p> <p>Atlas Dist. International Indianapolis 1-317-786-6892</p> <p>Shaffer Distributing Indianapolis 1-317-899-2530</p> <p><b>KANSAS</b></p> <p>United Dist., Inc. Wichita 1-316-263-6181</p> <p><b>LOUISIANA</b></p> <p>AMA Distributors, Inc. Metairie (1) 1-504-835-3232</p> <p><b>Parts &amp; Service Only:</b></p> <p>New Orleans Novelty New Orleans (2) 1-504-888-3500</p> <p><b>MARYLAND</b></p> <p>Betsom Enterprises Baltimore 1-410-646-4100</p> <p><b>Parts &amp; Service Only:</b></p> <p>Weiner Distributing Baltimore 1-410-525-2600</p> <p><b>MASSACHUSETTS</b></p> <p>Betsom Ent. (NECO) Norwood (1) 1-781-769-9760</p> <p>Gekay Sales E. Longmeadow (2) 1-413-525-2700</p> <p><b>MICHIGAN</b></p> <p>Atlas Dist. International Wyoming (1) 1-616-241-1472</p> <p>Cleveland Coin Machine Livonia (2) 1-734-432-1040</p> <p><b>MINNESOTA</b></p> <p>Lieberman Music Minneapolis (1) 1-952-887-5299</p> <p>Moss Distributing Richfield (2) 1-612-798-8030</p>	<p><b>MISSOURI</b></p> <p>Greater America Dist. Kansas City (1) 1-816-531-4300</p> <p>Moss Distributing Kansas City (1) 1-816-231-6600</p> <p>Shaffer Distributing St. Louis (2) 1-314-645-3393</p> <p><b>NEBRASKA</b></p> <p>Central Dist. Omaha 1-402-493-5600</p> <p>Greater America Dist. Omaha 1-402-553-2812</p> <p><b>NEVADA</b></p> <p>Mountain Coin Las Vegas (1) 1-702-798-0900</p> <p>Reno Game Sales Reno (2) 1-775-829-2080</p> <p><b>NEW JERSEY</b></p> <p>Betsom Enterprises Carlstadt (1) 1-201-438-1300</p> <p>Jack Guarneri Service Co., Inc. (Pinballsales.com) Lakewood (2) 1-732-364-9900</p> <p><b>NEW MEXICO</b></p> <p>Mountain Coin Albuquerque 1-505-345-7706</p> <p><b>NEW YORK</b></p> <p>Betsom Enterprises New Hyde Park (2) 1-516-354-4647</p> <p>Syracuse (3) 1-315-437-2400</p> <p><b>Parts &amp; Service Only:</b></p> <p>Bay Coin Richmond Hill (1) 1-718-291-5757</p> <p><b>NORTH CAROLINA</b></p> <p>Brady Distributing Charlotte (1) 1-704-357-6284</p> <p>Operators Distributing Archdale (2) 1-336-884-5714</p>	<p><b>NORTH DAKOTA</b></p> <p>M.H. Associates, Inc. Fargo 1-701-282-7877</p> <p><b>OHIO</b></p> <p>Atlas Dist. International Cincinnati (1) 1-513-851-4100</p> <p>Cleveland Coin Cleveland (2) 1-216-692-0960</p> <p>Shaffer Distributing Columbus (3) 1-614-421-6800</p> <p>Macedonia (4) 1-330-467-4850</p> <p><b>OKLAHOMA</b></p> <p>Galaxy Distributing Tulsa 1-918-835-1166</p> <p><b>OREGON</b></p> <p>Betsom West Portland 1-503-772-4567</p> <p>Mountain Coin Portland 1-503-234-5491</p> <p>Specialty Coin Products Portland 1-503-786-9200</p> <p>Toll-Free 1-800-987-4946</p> <p><b>PENNSYLVANIA</b></p> <p>Betsom Enterprises King Of Prussia (1) 1-610-265-1155</p> <p>Pittsburgh (2) 1-412-331-8703</p> <p>Cleveland Coin Machine Pittsburgh (2) 1-412-920-1300</p> <p>Roth Novelty (Superior) Wilkes-Barre (3) 1-570-824-9994</p> <p><b>SOUTH CAROLINA</b></p> <p><b>Parts &amp; Service Only:</b></p> <p>Green Coin Myrtle Beach 1-843-626-1900</p>	<p><b>TENNESSEE</b></p> <p>Brady Distributing Memphis 1-901-345-7811</p> <p><b>Parts &amp; Service Only:</b></p> <p>Green G.A.M.E.S. Memphis 1-901-353-1000</p> <p><b>TEXAS</b></p> <p>Amusement Distributors San Antonio (3) 1-210-225-3844</p> <p>Betsom Texas Dallas (1) 1-214-638-4900</p> <p>Commercial Music Dallas (1) 1-214-741-6381</p> <p>Discount Arcade Games Crowley (1) 1-817-297-0440</p> <p>H.A. Franz, &amp; Co. Houston (2) 1-713-523-7366</p> <p>San Antonio (3) 1-210-226-6322</p> <p>Master Sales Corsicana (4) 1-903-874-4740</p> <p><b>UTAH</b></p> <p>Mountain Coin Salt Lake City 1-801-262-5494</p> <p>Struve Distributing Salt Lake City 1-801-328-1636</p> <p><b>WASHINGTON</b></p> <p>Mountain Coin Seattle 1-206-682-5700</p> <p><b>WISCONSIN</b></p> <p>Pioneer Sales &amp; Svc. Green Bay (1) 1-920-336-5800</p> <p>Menomonee Falls (2) 1-262-781-1420</p> <p>Lieberman/Viking Vend. Menomonee Falls (2) 1-262-703-4168</p>	<p><b>CANADA</b></p> <p><b>ONTARIO</b></p> <p>Starburst Coin Mach. Toronto 1-416-251-2122</p> <p><b>BRITISH COLUMBIA</b></p> <p><b>Parts &amp; Service Only:</b></p> <p>Can. Coin Machine Burnaby (1) 1-604-420-4008</p> <p><b>Parts &amp; Service Only:</b></p> <p>Pacific Vending Vancouver (2) 1-604-324-2164</p>
--	--	---	---	---	--

*Note: For states and Canadian Provinces which do not have Distributors, call the neighboring state or province with the city closest to you (indicated with a white dot). States or Provinces with more than 1 city containing a distributor are numbered. View the map on the previous page.*

**Note: Distributors are subject to change. Visit us at [www.SternPinball.com](http://www.SternPinball.com) for current Distributor Information.**

# International Distributors Directory

<p><b>ARGENTINA</b></p> <p>South Company Mar Del Plata [54] 2234-95-5532</p> <p><b>AUSTRALIA</b></p> <p>Amusement Mach. Dist. Matraville [61] 2931-6-6000</p> <p><b>AUSTRIA</b></p> <p><b>Parts &amp; Service Only:</b></p> <p>R. Rupp Leibnitz [43] 3452-8-6105</p> <p><b>Parts &amp; Service Only:</b></p> <p>TAB Ansfelden [43] 7229-7-8040</p> <p><b>BELGIUM</b></p> <p>NAMUSCO Brussels [32] 2414-4596</p>	<p><b>DENMARK</b></p> <p>JK Automater A/B Thisted [45] 9792-0925</p> <p><b>ENGLAND</b></p> <p>see UNITED KINGDOM</p> <p><b>FINLAND</b></p> <p>Pelika net Oy Vantaa [35] 8 (0) 9-290-450</p> <p><b>FRANCE</b></p> <p>Avranches Automatic Ducey [33] 2338-9-6162</p> <p>9FA Paris [33] 1532-6-8080</p>	<p><b>GERMANY</b></p> <p>ADP Gauselmann Espelkamp [49] 5741-27-3384</p> <p>Bergmann Int'l Gaming Rellingen [49] 4101-3-0240</p> <p>Witten [49] 2302-28-2540</p> <p>MEXIM Espelkamp [49] 5772-4-9422</p> <p><b>HOLLAND</b></p> <p>see THE NETHERLANDS</p> <p><b>ITALY (RSM)</b></p> <p>Tecnoplay S.A. San Marino [39] 5499-0-1508</p> <p><b>THE NETHERLANDS</b></p> <p>JVH Gaming Products Tilburg [31] 1359-5-3200</p>	<p><b>NEW ZEALAND</b></p> <p>Coin Cascade Ltd. Christchurch [64] 3338-1411</p> <p><b>Parts &amp; Service Only:</b></p> <p>Amco Machine Supplies Auckland [64] 9846-7606</p> <p><b>NORWAY</b></p> <p>Vendomatic Oslo [47] 2291-8383</p> <p><b>PORTUGAL</b></p> <p>Jacinto &amp; Martins, S.A. Belas [35] 1214-32-5624 or [35] 1214-32-5638</p> <p><b>RUSSIA</b></p> <p>O.D.A. Game Machines Moscow [095] 219-2949 or [095] 219-8917</p>	<p><b>SOUTH AFRICA</b></p> <p>K &amp; W Amusements Port Elizabeth [27] 4148-4-3344 or [27] 4148-4-2940</p> <p><b>SPAIN</b></p> <p>Comercial Cocomatic Coslada (Madrid) [34] 9167-1-6980</p> <p><b>Parts &amp; Service Only:</b></p> <p>Sente, S.A. Madrid [34] 9154-1-7112</p> <p><b>SWEDEN</b></p> <p>Bjuvia Fritid AB Bjuv [46] 4238-6900</p> <p><b>SWITZERLAND</b></p> <p>Novomat, A.G. Harkingon [41] 6238-8-8961</p>	<p><b>UNITED KINGDOM</b></p> <p>Electrocoin London, England [44] 2089-65-2055</p> <p><b>Parts &amp; Service Only:</b></p> <p>Electrocoin AfterSales Cardiff, S. Glamorgan [44] 2920-45-0345</p>
---	--	--	--	---	---

*Note: From inside the US, use prefix 011-.*



**Find-It-In-Front:  
Dr. Pinball**



# POWER REQUIREMENTS



This game **must be connected to a properly grounded outlet to reduce shock hazard** & insure proper game operation. See *Sec. 5, Schematics & Troubleshooting, Chp. 3, Cabinet Wiring (Transformer Power Wiring)*, for transformer connections required for **Normal, High, and Low Line** conditions.



Normal Line:		110v AC - 125v AC @ 60Hz	
<b>Domestic</b> use an 8AMP 250v Slo-Blo Fuse.	<b>AVG OPERATION</b>	CURRENT: <b>2.8AMP</b> WATTAGE: <b>329w</b>	<b>MAX OPERATION</b> CURRENT: <b>8AMP</b> WATTAGE: <b>940w</b>
	<b>High Line:</b> use 2x 5AMP 250v Slo-Blo Fuses. (*England & Hong Kong use an 8AMP 250v S/B Fuse.)		218v AC - 240v AC @ 50Hz <b>AVG OPERATION</b> CURRENT: <b>1.8AMP</b> WATTAGE: <b>412w</b>
<b>Export</b> use 2x 5AMP 250v Slo-Blo Fuses. (*England & Hong Kong use an 8AMP 250v S/B Fuse.)	<b>MAX OPERATION</b>	CURRENT: <b>5AMP</b>   <b>8AMP*</b> WATTAGE: <b>1145w</b>   <b>1832w*</b>	England & Hong Kong use an 8A Fuse.
	<b>Low Line:</b> use an 8AMP 250v Slo-Blo Fuse.		95v AC - 108v AC @ 50Hz / 60Hz <b>AVG OPERATION</b> CURRENT: <b>2.6AMP</b> WATTAGE: <b>264w</b>

# TRANSPORTATION

# GAME DIMENSIONS

## BEFORE TRANSPORTING



To reduce the possibility of damage, observe **ALL** precautions whenever transporting the game.

**Read & follow Section 1, Chapter 1, Pinball Game Set-Up Procedures, and How to Secure the Backbox for Transporting.** Remove the legs and secure the game within the transporting vehicle.

**SAVE AND RETAIN ALL PRINTED INFORMATION INSIDE THE CABINET !**

**Shipping Box Dimensions**

Height 56" Width 31"  
 Depth 31"  
 Approx. Unboxed Weight: 270lbs. (+/- 10)  
 Boxed Weight: Wt. 290lbs. (+/- 5)

**CAUTION**

At least 2 people are required to move and maneuver this game. Use proper moving equipment & extreme care while handling!

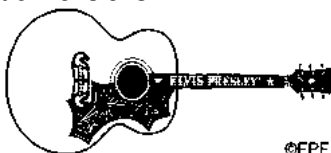
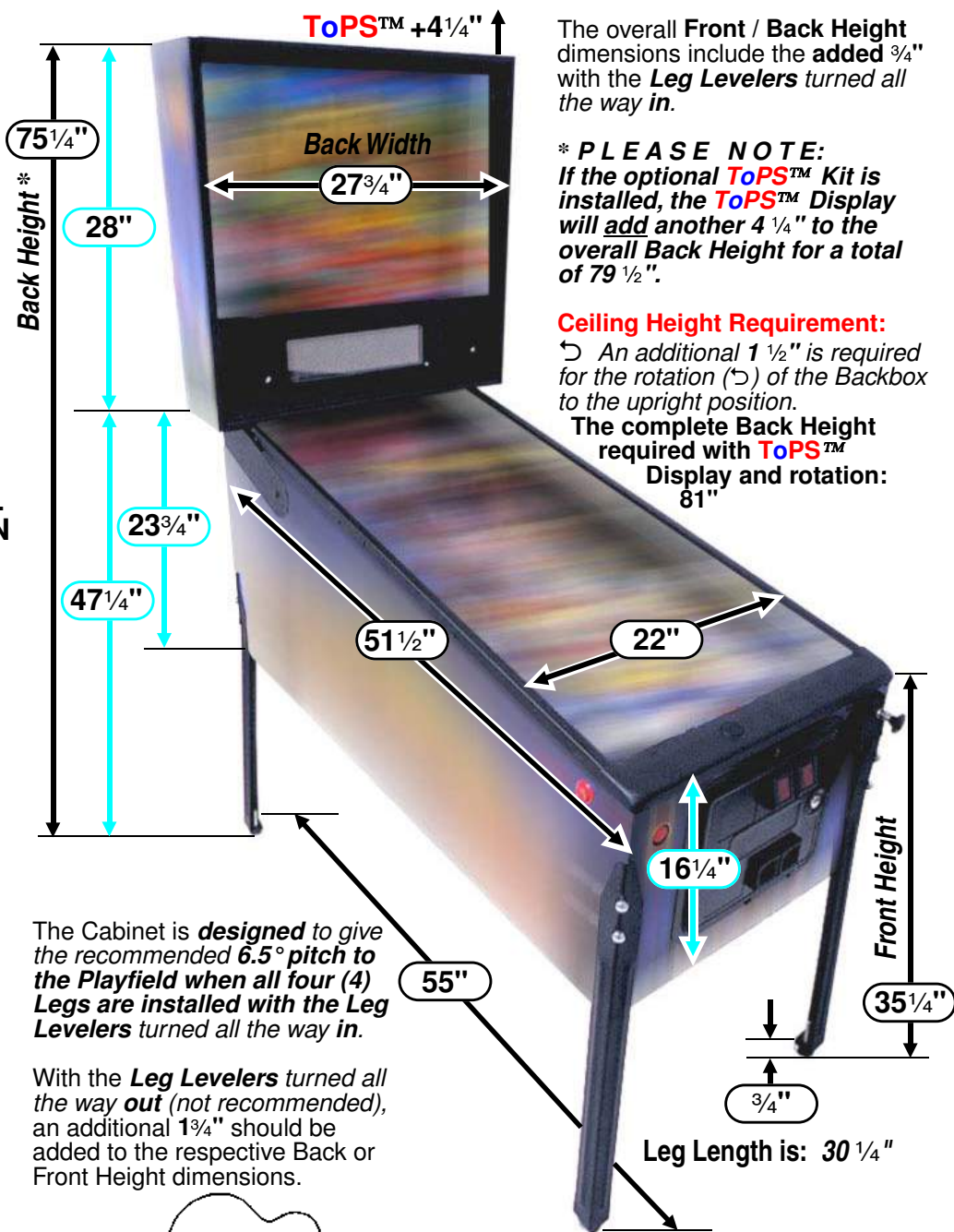

©EPE

Find-It-In-Front:  
 Dr. Pinball





The **Elvis®** Pinball Game Service Manual General Table of Contents  
 See Sections 3 & 5, Table Of Contents, for details of that Section and it's Chapters.

**For Proper Operation..., four (4) Pinballs must be installed! ..... Inside Front**

- ▶ Backbox PCB Fuses, ROMs, Bridges, Relays Playfield/Cabinet Fuses, Cab. Switches.....DR. ①
- ▶ Find-It-In-Front: Dr. Pinball Section Explained ▶ How It Works .....DR. ②
- ▶ Diagnostic Aids ▶ CPU DIP Switch Setting .....DR. ③
- ▶ Switch Matrix Grid, Dedicated Switches & Locations .....DR. ④
- ▶ Lamp Matrix Grid & Locations.....DR. ⑤
- ▶ Coils Detailed Chart Table .....DR. ⑥
- ▶ Coil & Flash Lamp Locations .....DR. ⑦
- ▶ Domestic Pinball & Redemption and International Distributors Maps .....DR. ⑧
- ▶ Domestic Pinball & Redemption and International Distributors Directories .....DR. ⑨
- ▶ Power Requirements ▶ Transportation ▶ Game Dimensions.....DR. ⑩

**Game Manual General Table of Contents ..... i - ii**

**SECTION 1..... 1 - 4**

- Chapter 1, After Set-Up ..... 1**
- ▷ Pinball Game Set-Up Procedures ..... 1
- ▷ Pinball Game Set-Up Future Reference..... 2 - 3
- ▷ How to Secure the Backbox... ▷ Leg Leveler Adjustment ▷ Easy Access... - 2 Positions ..... 4

**SECTION 2..... 5 - 6**

- Chapter 1, Game Operation & Features ..... 5**
- ▷ Start of Game Features (Starting a Normal Game, ... Team Play, ... Tournament Play with ToPS™)
- ▷ During Game Features (Feature Mode & Combination Shots, Multiball, Replay Feature)
- ▷ End of Game Features (Game Endings, Match Features, Entering Initials/Name) ..... 5
- ▷ Auto Percentaging ▷ Instruction Card ..... 6

**SECTION 3..... 7 - 57**

- ▷ Table of Contents (*Section 3: Chapters 1-7 Only*) ..... 7
- ▷ Portals™ Service Switch Set Access & Use (Function 1, ...; Function 2, ...; Function 3, ...)
- Chapter 1, Portals™ Service Menu Introduction ..... 9**
- ▷ How to Use This Section ..... 9
- ▷ Portals™ Service Menu Icon Tree..... 10 - 11
- ▷ Portals™ Service Menu Example ▶ Exiting the Portals™ Service Menu ..... 12 - 14
- Chapter 2, Go To Diagnostics Menu ..... 15 - 31**
- Chapter 3, Go To Audits Menu ..... 32 - 37**
- Chapter 4, Go To Adjustments Menu ..... 38 - 46**
- Chapter 5, Go To Installs Menu ..... 47 - 50**
- Chapter 6, Go To Reset Menu..... 51 - 52**
- Chapter 7, Go To Tournament Menu ..... 53 - 57**

**SECTION 4..... 58 - 74**

- Chapter 1, Parts Identification & Location (The Pink Pages)..... 59**
- ▷ Table of Contents (*Section 4, Chapter 1 Only*) and Overview ..... 59
- Elvis® Pinball** Backbox Assembly ..... 60
- Speaker Panel Assy. for the Backbox & Associated Parts:..... 61
- Cabinet - General Parts & Switches ..... 62 - 63
- Playfield - General Parts, Miscellaneous Switches & Switches on Assemblies ( **Above** ) ..... 64 - 65
- Playfield - General Parts, Miscellaneous Switches & Switches on Assemblies ( **Below** ) ..... 66
- Playfield - Plastics (Screened & Clear) Kit, Upper Playfield and Decals & Mylar Kits ..... 67
- Playfield - Rubber Parts Black & White ( **Rings Actual Size**) ..... 68

Section 4, Chapter 1, Parts Identification & Location (The Pink Pages) Continued on the Next Page



Playfield - Metal Posts (Screws) and Nuts ( <b>Actual Size</b> ) .....	69
Playfield - Hex Spacers ( <b>Actual Size</b> ) .....	70
Playfield - Plastic Posts & Spacers ( <b>Actual Size</b> ) .....	71
Playfield & Back Panel - Small Bayonet Type Bulbs & Sockets ( <b>Actual Size</b> ) .....	72
Playfield & Back Panel - Large Bayonet Type Bulb and Sockets ( <b>Actual Size</b> ) .....	73
Playfield - Wedge Base Bulbs and Sockets ( <b>Actual Size</b> ) .....	74
<b>Chapter 2, Drawings for Major Assemblies &amp; Ramps (The Blue Pages)</b> .....	<b>75-98</b>
▷ Table of Contents ( <i>Section 4, Chapter 2 Only</i> ) and Overview .....	75
Ball Shooter (Plunger) Assembly, <b>500-6146-00-07</b> .....	(Top) 76
Autoplunger Arm Weld Assembly, <b>500-6091-00</b> with ...Coil Assembly, <b>500-6092-03B</b> .....	(Bottom) 76
4-Ball Trough Assembly, <b>500-6318-24</b> and Associated Parts: .....	77
Flipper (Left) Assembly, <b>500-6543-11</b> and Associated Parts: .....	78
Flipper (Right) Assembly, <b>500-6543-01</b> and Associated Parts: .....	79
Flipper (Upper Left) Assembly, <b>500-6543-33-84</b> and Associated Parts: .....	80
Flipper (Upper Right) Assembly, <b>500-6543-23-84</b> and Associated Parts: .....	81
Slingshot (Left & Right) Assemblies, <b>500-5849-00</b> (Qty. 2) .....	82
Bumper Top (Left, Right & Bottom) Assemblies, <b>515-6459-01</b> (Qty. 3) .....	(Top) 83
Bumper Bottom (Left, Right & Bottom) Assy., <b>515-6459-04</b> (Qty. 3) .....	(Middle) 83
Bumper Switch Assy., <b>515-6459-09R</b> (Qty. 3) and Associated Parts: .....	(Bottom) 83
5-Bank Drop Target Assembly, <b>500-6795-00</b> .....	84 - 85
Ball Eject Bottom Assy., <b>515-7447-00</b> ; Ball Eject Top (Left ...) Assy., <b>515-7448-00</b> and Assoc. Parts: .....	86
Ball Eject Bottom Assy., <b>515-7447-00</b> Ball Eject Top (Right ...) Assy., <b>515-7448-01</b> and Assoc. Parts: .....	87
Hound Dog Pop-Up Target Individual Parts Only .....	88
Magnet Coil, Bracket ( <i>with Threaded Bushing</i> ) and Miscellaneous Parts .....	(Top) 89
Ball Lock Assembly, <b>500-5867-07</b> .....	(Bottom) 89
Elvis, Stepper Motor & 3-Bank Stand-Up Target <b>Individual Parts Only</b> .....	90 - 91
Hotel Plastics & Decal Reference ... <b>Assembly Reference Only</b> .....	(Left) 92
Hotel Door Coil Assembly, 500-6752-01 .....	(Right) 92 - (Top) 93
Hotel Frame, Stand-Up Targets & Switch <b>Individual Parts Only</b> .....	(Bottom) 93
Upper Playfield <b>Individual Parts Only</b> .....	94
Right Steel Ramp & Right Wire Ramp <b>Individual Parts Only</b> .....	95
Left Wire Ramp & Lt. Steel Ramp <b>Individual Parts Only</b> .....	96 - (Top) 97
Back Panel <b>Individual Parts Only</b> .....	(Bottom) 97
▷ <b>UK ONLY OPTIONAL: Ball Deflector Assemblies, 500-5788-02 (Qty. 2)</b> .....	(Left) 98
▷ <b>UK ONLY OPTIONAL: Up/Down Post Assembly, 500-6293-00</b> .....	(Right) 98
<b>SECTION 5</b> .....	<b>99-148</b>
<b>Chapter 1, Backbox Wiring (The Yellow Pages)</b> .....	<b>99 - 102</b>
▷ Table of Contents ( <i>Section 5: Chapters 1-4 Only</i> ) .....	99
▷ Coils Detailed Chart Table .....	100
<b>Chapter 2, Playfield Wiring (The Yellow Pages)</b> .....	<b>103 - 106</b>
<b>Chapter 3, Cabinet Wiring (The Yellow Pages)</b> .....	<b>107 - 108</b>
<b>Chapter 4, Printed Circuit Boards (PCBs) (The Yellow Pages)</b> .....	<b>109 - 148</b>
<b>APPENDIXES A-J</b> .....	<b>A1-J1</b>
▷ Table of Contents ( <i>Appendixes Only</i> ) .....	after 148
▷ <b>Appendixes A-J</b> .....	<b>A1-J1</b>
Plastic Part Color Chart .....	(Bottom) H1 + (Top) I1
Glossary of Terms .....	Last Page
Limited Warranty, Cautions, Warnings & Notices .....	Last Page
▶ <b>Switch Matrix Grid &amp; Dedicated Switches</b> ▶ <b>Lamp Matrix Grid</b> .....	<b>Inside Back</b>

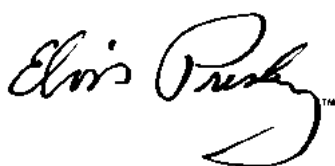









# Service Menu System

## Table of Contents



	<b>Chapter 1, Portals™ Service Menu Introduction</b> .....	<b>7</b>
	<b>Service Switch Set (Red, Green &amp; Black Buttons) Access &amp; Use</b> .....	<b>8</b>
	◇ Function 1, Volume Menu / Function 2, Service Credits Menu / Function 3, Portals™ Service Menu.....	8
	<b>How to Use This Section</b> .....	<b>9</b>
	<b>Portals™ Service Menu Icon Tree for Elvis® Pinball</b> .....	<b>10-11</b>
	◇ Example.....	12-13
	<b>QUIT THIS SESSION (Exiting the Portals™ Service Menu) &amp; Problem / Solution Table</b> .....	<b>14</b>
	<b>Chapter 2, Go To Diagnostics Menu (Overview)</b> .....	<b>15</b>
	<b>GO TO DIAGNOSTICS MENU</b> .....	<b>15</b>
	■ <b>Go To Switch Menu</b> ■■ <b>Switch Test</b> ■■ <b>Active Switch Test</b> ■■ <b>Dedicated Switch Test</b> .....	<b>16</b>
	◇ Switch Matrix Grid & Dedicated Switches.....	
	◇ Switch Matrix Grid Locations, Typical Switch Wiring & Schematic, Dedicated Switch Schematic.....	17
	■ <b>Go To Coil Menu</b> ■■ <b>Single Coil Test</b> ■■ <b>Cycling Coil Test</b> .....	<b>18</b>
	◇ Partial Coils Detailed Chart ...	
	◇ Coil & Flash Lamp Locations, Typical Coil Wiring, Bulb Types used for Flash Lamps.....	19
	◇ Coils Detailed Chart Table.....	20
	◇ Backbox I/O Power Driver Board Detailed Wiring Diagram.....	21
	■ <b>Go To Lamp Menu</b> ■■ <b>Single Lamp Test</b> ■■ <b>Test All Lamps</b> ■■ <b>Row &amp; Column Lamp Tests</b> .....	<b>22</b>
	◇ Lamp Matrix Grid.....	
	◇ Lamp Matrix Grid Locations, Typical Lamp Wiring & Schematic, Bulb Types used for Lamps.....	23
	■ <b>Test Flash Lamps</b> ■ <b>Clear Ball Trough</b> .....	<b>24</b>
	■ <b>Technician Alerts (Switch Detection and Pinball Detection)</b> .....	<b>24-25</b>
	■ <b>Service Phone #</b> ■ <b>Begin Play Test</b> .....	<b>25</b>
	■ <b>Fire Knocker</b> ■ <b>Sound / Speaker Test (Speaker Phase Testing)</b> ■ <b>Begin Burn In</b> .....	<b>26</b>
	■ <b>Dot Matrix Test (Dot Matrix Display Explained)</b> .....	<b>26-27</b>
	■ <b>Elvis® Test: Stepper Motor</b> (see <i>Go To Switch or Coil Menu for general testing</i> ).....	<b>27-28</b>
	■ <b>Go To Fuse Table (with Example)</b> .....	<b>29</b>
	<b>BACKBOX LAYOUT LOCATIONS: Fuses, Bridges, Relays &amp; ROMs</b> .....	<b>30</b>
	■ <b>Dr. Pinball</b> ■■ <b>Coil Flow Chart</b> ■■ <b>Switch Flow Chart</b> ■■ <b>Lamp Flow Chart</b> .....	<b>31</b>
	<b>Chapter 3, Go To Audits Menu (Overview)</b> .....	<b>33</b>
	◇ <b>EARNINGS &amp; STANDARD AUDIT TABLES</b> .....	32
	<b>GO TO AUDITS MENU</b> .....	<b>33</b>
	■ <b>Earnings Audits (01-14)</b> .....	<b>33</b>
	■ <b>Standard Audits (01-68)</b> .....	<b>34-35</b>
	■ <b>Feature Audits (01-116)</b> .....	<b>36</b>
	■ <b>Go To Printer Menu</b> ■■ <b>Quick Printout</b> ■■ <b>Full Printout</b> ■■ <b>Reset Printer</b> .....	<b>37</b>
	<b>Chapter 4, Go To Adjustments Menu (Overview)</b> .....	<b>39</b>
	◇ <b>STANDARD &amp; FEATURE ADJUSTMENT TABLES</b> .....	38
	<b>GO TO ADJUSTMENTS MENU</b> .....	<b>39</b>
	■ <b>Standard Adjustments (01-55)</b> .....	<b>39-43</b>
	■ <b>Feature Adjustments (01-16)</b> .....	<b>44-46</b>
	■ <b>Custom Message (Direct Access to Standard Adjustment 31)</b> .....	<b>46</b>
	<b>Chapter 5, Go To Installs Menu (Overview)</b> .....	<b>47</b>
	<b>GO TO INSTALLS MENU</b> .....	<b>47</b>
	■ <b>Install Extra Easy, Easy, Normal, Hard or Extra Hard</b> .....	<b>47</b>
	■ <b>Install Directors Cut</b> ■ <b>Install 3-Ball or 5-Ball</b> ■ <b>\$.50 Competition</b> ■ <b>Free Play Competition</b>	
	■ <b>Install Home Play</b> ■ <b>Film Star Reset</b> ■ <b>Install Novelty</b> ■ <b>Install Add-A-Ball</b> ■ <b>Install Factory</b> .....	<b>48</b>
	◇ Overview of Standard Adjustment Changes upon selectoin of an Install:.....	49
	◇ Overview of Feature Adjustment Changes upon selection of an Install:.....	49-50
	<b>Chapter 6, Go To Reset Menu (Overview)</b> .....	<b>51</b>
	<b>GO TO RESET MENU</b> .....	<b>51</b>
	■ <b>Reset Coin Audits</b> ■ <b>Reset Game Audits</b> ■ <b>Reset High Scores</b> ■ <b>Reset Credits</b> ■ <b>Factory Reset</b> .....	<b>51</b>
	◇ Example.....	52
	<b>Chapter 7, Go To Tournament Menu</b> .....	<b>53</b>
	<b>GO TO TOURNAMENT MENU (OPTIONAL USE ONLY)</b> .....	<b>53</b>
	◇ <b>TOURNAMENT ADJUSTMENT TABLES &amp; TOURNAMENT AUDIT TABLE</b> .....	54
	■ <b>Tournament Adjustments (01-13)</b> .....	<b>55</b>
	■ <b>Start Tournament</b> ■ <b>Stop Tournament</b> ■ <b>Tournament Prizes</b> ■ <b>Tournament Audits (01-14)</b> .....	<b>56</b>
	■ <b>Tournament Audits Continued</b> ■ <b>Sign Messages A-B (Tournie Adj. 14-15)</b> .....	<b>57</b>

**Sec. 3: ...Menu Intro.**



# Backbox Wiring Table of Contents

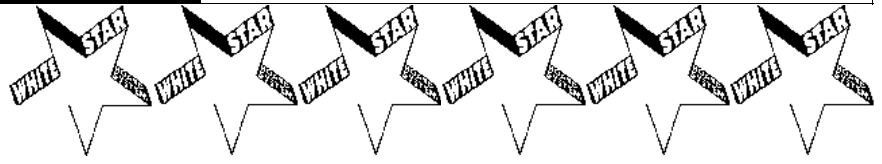

- Chapter 1, Backbox Wiring ..... 99
  - COILS DETAILED CHART TABLE ..... 100
  - Backbox I/O Power Driver Board Detailed Wiring Diagram ..... 101
  - Backbox Board Layout Wiring Diagram ..... 102
- Chapter 2, Playfield Wiring..... 103
  - General Illumination Circuit Detailed Wiring Diagram ..... 103
  - Playfield Switch Wiring Diagram & Playfield Lamp Wiring Diagram ..... 104
  - Playfield Terminal Strips, Fuses & Misc. Wiring Descriptions & Locations ..... 105
  - 4-Flipper Circuit Wiring Diagram ..... 106
- Chapter 3, Cabinet Wiring ..... 107
  - Transformer Power Wiring Diagram ..... 107
  - Cabinet / Coin Door Wiring Diagram ..... 108
- Chapter 4, Printed Circuit Boards (PCBs) ..... 109
  - Trough Up-Kicker Dual OPTO Boards Theory of Operation & Schematic ..... (Top) 109
  - Trough Up-Kicker Dual OPTO Boards Component Layout & Parts ..... (Bot) 109
  - OPTO Troubleshooting ..... (Top) 110
  - Trough Dual OPTO Boards Alignment / Tests for LED1 & LED2..... 110-111
  - Dot Matrix Display / Display Controller Bd. Combined Display Connections ..... 112
  - Display Power Supply Board Schematic, Component Layout & Parts ..... 113
  - Display Controller Board Schematic ..... 114-115
  - Display Controller Board Component Layout & Parts ..... 116
  - I/O Power Driver Board Theory of Operation ..... 117
  - I/O Power Driver Board Schematic  
(Sheet 1 of 5), (Sheet 2 of 5), (Sheet 3 of 5), (Sheet 4 of 5), (Sheet 5 of 5)..... 118-127
  - I/O Power Driver Board Component Layout ..... 128
  - I/O Power Driver Board Parts ..... 129
  - CPU/Sound Board II (with ATMEL Processor) Theory of Operation ..... 131
  - CPU/Sound Board II (with ATMEL Processor) Schematic  
(Sheet 1 of 4), (Sheet 2 of 4), (Sheet 3 of 4), (Sheet 4 of 4) ..... 132-139
  - CPU/Sound Board II (with ATMEL Processor) Component Layout ..... 140
  - CPU/Sound Board II (with ATMEL Processor) Parts ..... 141
  - UK & Special App. 3X Transistor Driver Bd. Schematic & Component Layout ..... 142
  - UK 3X Transistor Driver Bd. for Up-Posts & P/F Dot Display or LED Sign (if used) .. 143
  - UK 3X Trans. Driver Board ... with the Tournament Serial Interface (TSI) Board ..... 144
  - Aux. 3X Trans. Driver Board ... with the TSI Board and Ticket Interface ..... 145
  - Tournament Serial Interface Board Schematic ..... 146-147
  - Tournament Serial Interface Board Component Layout ..... 148

Visit [www.SternPinball.com/schematics.htm](http://www.SternPinball.com/schematics.htm) for the latest 11" X 17" Schematics (or "Split 8-1/2" X 11") for the Display Power Supply, Display Controller, I/O Power Driver & CPU/Sound Boards (White Star System Only). Along with the schematics you'll find the component layout and theory of operation. Keep visiting as these files are updated. For more information on the schematics you can utilize internal links where addresses may direct you to another sheet in this schematic set (further instructions within documents). To "download" once open, in your browser click "File" "Send" "Page by eMail". It will be sent to your eMail Address, where there you can save the file to your hardrive.

All 11 X 17 Schematics and other PDF files are also available on CD-ROM.

**Backbox  
Wiring**





Use the below **Coils Detailed Chart Table** in conjunction with *Sec. 5, Chp. 1, Backbox I/O Power Driver Board Detailed Wiring Diagram (I/O Board Connectors J6, J7, J8 & J9) and Backbox Board Layout Wiring Diagram:*

## COILS DETAILED CHART TABLE

High Current Coils Group 1		Drive Transistor	Driver Output Board	Power Line Color	Power Line Connection	Power Voltage	Drive Transistor Control Line Color	D.T. Control Line Connect	Coil GA-Turn or Bulb Type
#1	TROUGH UP-KICKER	Q1	▲ I/O Power Driver ▼	YEL-VIO	J10-P4/5	50v DC	BRN-BLK	J8-P1	26-1200 ♂ 090-5044-00B
#2	AUTO LAUNCH	Q2		YEL-VIO	J10-P4/5	50v DC	BRN-RED	J8-P3	23-800 ♂ 090-5001-00B
#3	ELVIS 5-BANK RESET	Q3		YEL-VIO	J10-P4/5	50v DC	BRN-ORG	J8-P4	24-940 ♂ 090-5036-00B
#4	(OPT) SHAKER MOTOR	Q4		RED-WHT	J17-P7	16v AC 12v DC	BRN-YEL	J8-P5	Motor Only 041-5029-01
#5	MAGNET	Q5		VIO-YEL	J10-P3	50v DC	BRN-GRN	J8-P6	22-650 ♂ 090-5042-00
#6	CENTER EJECT	Q6		YEL-VIO	J10-P4/5	50v DC	BRN-BLU	J8-P7	24-940 ♂ 090-5036-00B
#7	HOTEL LOCK RELEASE	Q7		YEL-VIO	J10-P4/5	50v DC	BRN-VIO	J8-P8	23-800 ♂ 090-5001-00B
#8	CONTROL GATE	Q8		YEL-VIO	J10-P4/5	50v DC	BRN-GRY	J8-P9	32-1800 ♂ 090-5031-00B
High Current Coils Group 2		Drive Transistor	Driver Output Board	Power Line Color	Power Line Connection	Power Voltage	Drive Transistor Control Line Color	D.T. Control Line Connect	Coil GA-Turn or Bulb Type
#9	LEFT BUMPER	Q9	▲ I/O Power Driver ▼	YEL-VIO	J10-P4/5	50v DC	BLU-BRN	J9-P1	26-1200 ♂ 090-5044-00T
#10	RIGHT BUMPER	Q10		YEL-VIO	J10-P4/5	50v DC	BLU-RED	J9-P2	26-1200 ♂ 090-5044-00T
#11	BOTTOM BUMPER	Q11		YEL-VIO	J10-P4/5	50v DC	BLU-ORG	J9-P4	26-1200 ♂ 090-5044-00T
#12	TOP EJECT	Q12		YEL-VIO	J10-P4/5	50v DC	BLU-YEL	J9-P5	24-940 ♂ 090-5036-00B
#13	UPPER LEFT FLIPPER	Q13		GRY-YEL-3A Fuse-RED-YEL	J10-P1/2	50v DC	BLU-GRN	J9-P6	23-900 ♂ 090-5020-30
#14	UPPER RIGHT FLIPPER	Q14		BLU-YEL-3A Fuse-RED-YEL	J10-P1/2	50v DC	BLU-BLK	J9-P7	23-900 ♂ 090-5020-30
#15	LEFT FLIPPER (50v RED/YEL)	Q15		GRY-YEL-3A Fuse-RED-YEL	J10-P1/2	50v DC	ORG-GRY	J9-P8	22-900 ♂ 090-5020-20T
#16	RIGHT FLIPPER (50v RED/YEL)	Q16		BLU-YEL-3A Fuse-RED-YEL	J10-P1/2	50v DC	ORG-VIO	J9-P9	22-900 ♂ 090-5020-20T
Low Current Coils Group 1		Drive Transistor	Driver Output Board	Power Line Color	Power Line Connection	Power Voltage	Drive Transistor Control Line Color	D.T. Control Line Connect	Coil GA-Turn or Bulb Type
#17	LEFT SLINGSHOT	Q17	▲ I/O Power Driver ▼	BROWN	J7-P1	20v DC	VIO-BRN	J7-P2	23-800 ♂ 090-5001-00T
#18	RIGHT SLINGSHOT	Q18		BROWN	J7-P1	20v DC	VIO-RED	J7-P3	23-800 ♂ 090-5001-00T
#19	HOTEL DOOR	Q19		BROWN	J7-P1	20v DC	VIO-ORG	J7-P4	27-1500 ♂ 090-5004-00B
#20	FLASH: BACK PANEL X2	Q20		ORANGE	J6-P10	20v DC	VIO-YEL	J7-P6	#89 Bulb 165-5000-89-HF
#21	FLASH: BACKPANEL TCB	Q21		ORANGE	J6-P10	20v DC	VIO-GRN	J7-P7	#89 Bulb 165-5000-89-HF
#22	FLASH: SPINNER	Q22		ORANGE	J6-P10	20v DC	VIO-BLU	J7-P8	#906 Bulb 165-5004-00
#23	FLASH: UPR RT FLIPPER X2	Q23		ORANGE	J6-P10	20v DC	VIO-BLK	J7-P9	#906 Bulb 165-5004-00
#24	OPTIONAL COIL	Q24		RED	J16-P7	5v DC	VIO-GRY	J7-P10	Opt. 5v
D iode O n T ermin al S trip (if noted)									
Low Current Coils Group 2		Drive Transistor	Driver Output Board	Power Line Color	Power Line Connection	Power Voltage	Drive Transistor Control Line Color	D.T. Control Line Connect	Coil GA-Turn or Bulb Type
#25	STEPPER #1	Q25	▲ I/O Power Driver ▼	GRY-RED	J16-P3	12v DC	RED	J6-P1	Stepper Motor Only 041-5069-00
#26	STEPPER #2	Q26		GRY-RED	J16-P3	12v DC	GREEN	J6-P2	
#27	STEPPER #3	Q27		GRY-RED	J16-P3	12v DC	BLACK	J6-P3	
#28	STEPPER #4	Q28		GRY-RED	J16-P3	12v DC	BLUE	J6-P4	
#29	ELVIS LEGS	Q29		RED-WHT TO BROWN	J7-P1	20v DC	RED-WHT TO BLK-GRN	J6-P5	29-1400 ♂ 090-5072-03
#30	ELVIS ARMS	Q30		RED-WHT TO BROWN	J7-P1	20v DC	RED-WHT TO BLK-BLU	J6-P6	29-1400 ♂ 090-5072-03
#31	FLASH: ELVIS SPOT LIGHT	Q31		ORANGE	J6-P10	20v DC	BLK-VIO	J6-P7	#906 Bulb 165-5004-00
#32	FLASH: SLINGS X2	Q32		ORANGE	J6-P10	20v DC	BLK-GRY	J6-P8	#906 Bulb 165-5004-00
Note: In Test Flash Lamps Menu ("Flash" Icon), Flashers tested are all Flash Lamps located between Q1-Q32 (This Game: Q20-Q23, Q31-Q32)									
Auxiliary (UK ONLY)		Drive Transistor	Driver Output Board	Power Line Color	Power Line Connection	Power Voltage	Drive Transistor Control Line Color	D.T. Control Line Connect	Coil GA-Turn
	AUX 1: LEFT UP/DOWN POST	Q1	UK 3X Trans. Driver Board	BROWN	J7-P1	20v DC	WHITE	J2-P3	26-1200 ♂ 090-5044-00T
	AUX 2: CENTER UP/DOWN POST	Q2		BROWN	J7-P1	20v DC	RED	J2-P4	23-1100 ♂ 090-5030-00T
	AUX 3: RIGHT UP/DOWN POST	Q3		BROWN	J7-P1	20v DC	ORANGE	J2-P7	26-1200 ♂ 090-5044-00T

Sec. 5: Schematics...

♂ Coil Note: ♂ Either -00B or -00T can be used for coil replacements. B/T listed is preferable for easier diode access & may differ on game.



# After Set-Up

## Pinball Game Set-Up Procedures

...after reading the Pinball Game Set-Up Instruction Sheet (SPI Part N<sup>o</sup> 755-5310-00) included with your New Pinball Game, continue with the below procedures:

### With the Back Glass Removed:

1. Check all connectors in the Backbox for loose wire terminations. Reseat any loose wire by pushing in on the terminal. Push on all connectors plugged into the CPU/Sound Board, I/O Power Driver Board, and the Display Power Bd. to check that they are properly seated. Ensure Fluorescent Light Tube is seated correctly. Check that all fuses are seated properly. Close and lock the Backbox and secure its keys back inside the Coin Door.

### With the Playfield Glass Removed:

2. Remove all shipping tie downs, shipping blocks, packing foam, etc., if present. **READ ALL PRINTED INFORMATION!** Shipping Instructions and/or Decals describe warnings, cautions, and/or important information specific to the game. **SAVE ALL IN CABINET!**

If pinballs were already installed into the Ball Trough (under the arch), remove them before performing the following step. **\*\*\*Pinballs can fall out and away from the playfield\*\*\***

3. Raise the playfield and rest it against the Backbox. See the illustration "Easy Access Service System - 2 Positions" on Page 4.

4. Visually inspect all cabinet cables and connector terminations; ensure no wires or cables are pinched and that cable harnesses are not pulled tight.

5. Make sure the proper amount of pinballs are installed (Amount of balls are always specified on decal attached to the lock down assembly and at the top of the inside cover).

6. Lower the playfield and ensure game is **level side-to-side** by adjusting Leg Levelers, if required. See the illustration "Leg Leveler Adjustment" on Page 4. Start with the Leg Levelers turned all the way in (1.25" from floor to bottom of leg), depending on the condition of the floor, adjust the Leg Levelers as required until the **game pitch is 6.5°**, determined by the Bubble Level.

**USE THE BUBBLE LEVEL ON THE WOOD RAIL (LOWER RIGHT) TO DETERMINE IF LEVEL IS ACHIEVED. BUBBLE SHOULD APPEAR BETWEEN THE 2 BLACK LINES. SEE PAGE 4 FOR AN ILLUSTRATION.**

The playfield incline affects difficulty of play. Use the recommended incline; Game difficulty is best varied using game adjustments.

### With the Coin Door Open:

7. If desired, perform any self tests at this time (see Section 3, Chapter 1, Portals™ Service Menu Introduction, and Chapter 2, GO TO DIAGNOSTICS MENU, for instructions on how to enter "Begin Play Test" and "Game Name Test" Menus to test components on the game).

8. If desired, adjust Game Pricing, Standard and/or Custom (see Section 3, Chapter 4, GO TO ADJUSTMENTS MENU and Section 3, Chapter 5, GO TO INSTALLS MENU to adjust Game Difficulty, 3- or 5-Ball Play, Home or Tournament Settings, Novelty, Add-A-Ball, etc.).

### PINBALL GAME SET-UP

CAUTION: At least 2 people are required to move and maneuver game. Use proper moving equipment & extreme care while handling. Pinball game is 200lbs (+/- 10). Refer to Game Manual for further Game Set-Up Procedures (Sec. 1, Chap. 1) and other important information!

TOOLS REQUIRED: 5/8" Socket Wrench & Utility Knife

NOTE: KEYS are tied to the Shooter Rod\* (if equipped) or tied to the Playfield Glass if equipped with Auto Plunger Button). Remove the other set is used to unlock the Back Glass to gain access to the White Star Board System.

REMOVE THE PINBALL GAME MANUAL (stapled to side of the left wall of the cabinet). Review Section 1, Chapter 1, which describes how to lift the playfield to access the Plumb Bob Assembly. The manual gives you all the important information you need to prepare for final setup and other important information (such as Parts, Diagnostics, Schematics and more...).

SPI Part N<sup>o</sup> 755-5310-00

Per CE: "The appliance has to be placed in a horizontal position." This appliance is not to be cleaned by a Water Jet."



After Set-Up



# Pinball Game Set-Up Future Reference

Open up the Printable Version in both 8-1/2 X 11 & 11 X 17.

**CAUTION:** At least 2 people are required to move and maneuver game.

Use proper moving equipment & extreme care while handling. Pinball game is 260lbs (+/- 10).

Refer to Game Manual for further Game Set-Up Procedures (Sec. 1, Chp. 1) and other important information!

**TOOLS REQUIRED:** 5/8" Socket Wrench & Utility Knife

Sec. 1: After Set-Up



1. Before unpacking box, lay the box flat on its side with "TRUCK THIS SIDE ONLY" facing the floor.



2. Slide game out using the **Black Nylon Strapping** as a handle.

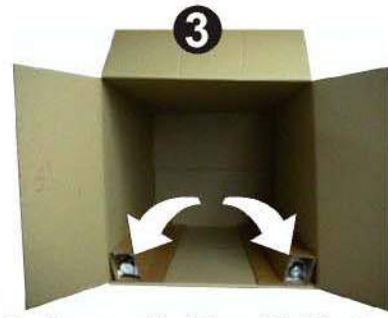

3. Remove the **Four (4) Identical Legs with Levelers** from the carton and set aside. (**SAVE!** all packing materials and information sheets related to this pinball until Set-Up is complete.)

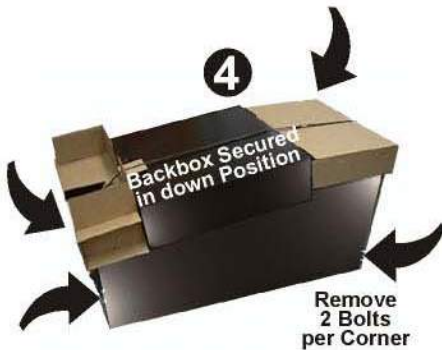

4. At this point **DO NOT CUT STRAPPING** (You want to keep the Backbox secured in the down position). Loosen and remove the 8 Leg Bolts (use 5/8" Socket Wrench) and set aside.



5. Lift game into an **UPRIGHT POSITION** (Coin Door Facing Up).



6. Install **FRONT LEGS** using the bolts removed from **Step 4**. Secure tightly. **Take care not to scratch the Black Finish on any of the Legs.**



7. Carefully set the game down on the **FRONT LEGS**. Care should be taken... Game is heavy, two (2) people are recommended for this and the following step.



8. Using supports or two (2) people, prop the rear of the cabinet up and install **REAR LEGS**. Secure tightly.



9. Cut **BLACK NYLON STRAPPING**. **CAUTION:** Strapping will **SNAP**, protect your eyes! Use extreme care when using a utility knife or scissors.

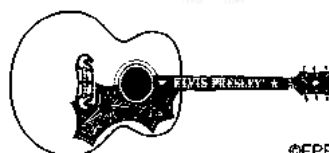

# Pinball Game Set-Up Future Reference Continued

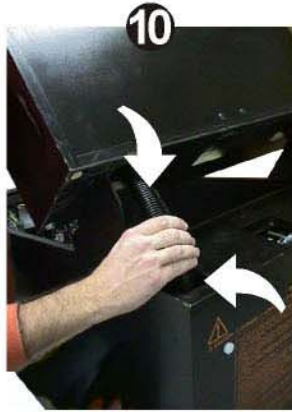

10. Lift the Backbox into the **UPRIGHT POSITION** (Ensure the cables do not get pinched).



11. After the **BACKBOX** is in the **UPRIGHT POSITION**, locate the **5/16" HEX KEY**. While inserted, rotate **KEY** with a **3/4 turn** until latched & locked.



12. The next step you will remove the **PLAYFIELD GLASS & BACK GLASS** to access the inside of the cabinet & Backbox.

**NOTE: KEYS** are tied to the **Shooter Rod\*** (if equipped) or taped to the **Playfield Glass** (if equipped with **Auto Plunger Button**). Remove keys. One (1) set of keys opens the **Coin Door**, the other set is used to unlock the **Back Glass** to gain access to the **White Star Board System**.

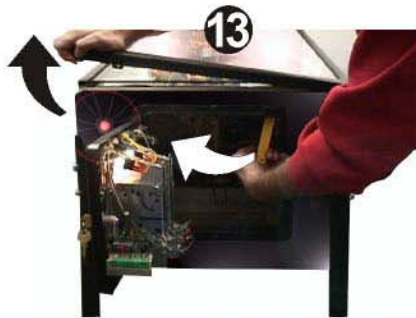

13. Open the **Coin Door** and pull the **YELLOW HANDLE** to the **LEFT** and at the same time pull up on the **FRONT TOP MOLDING** and remove. The **GLASS** can now be pulled out towards you and removed. **TAKE CARE** while moving; set glass on a safe surface.



14. Through the open **Coin Door**, remove the **RETAINING RING** at the rear of the **CASH BOX** and open. Remove the **PINBALLS & the PLUMB BOB** from the **SPARE PARTS BAG**. (Save the other spare parts in cabinet). Install the **PINBALLS** by placing them on the playfield so they can roll into the **Outhole Ball Trough**.



15. Install the **PLUMB BOB** on the **Hanger Wire** & tighten the **Thumb Screw**. Loosening the **Thumb Screw** & lowering or raising the **PLUMB BOB** makes the **Games Tilt Function** more or less sensitive.

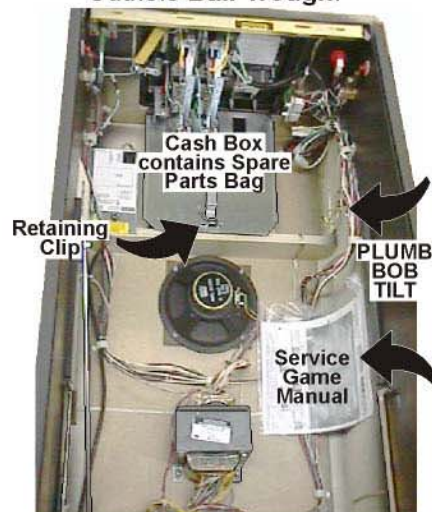

Remove the **PINBALL GAME MANUAL** (stapled to side of the left wall of the cabinet). Review **Section 1, Chapter 1**, which describes how to lift the playfield to access the **Plumb Bob Tilt Assembly**. The manual gives you all the important information you need to prepare for final set-up and other important information (such as Parts, Diagnostics, Schematics and more...).

**ALWAYS STORE THE MANUAL & INFORMATION SHEETS INSIDE THE CABINET WHEN NOT USING.**



# How to Secure the Backbox for Transporting

For more Backbox details & part numbers, see Section 4, Chapter 1, **Backbox Assembly**, Pages 60-61.

Sec. 1: After Set-Up

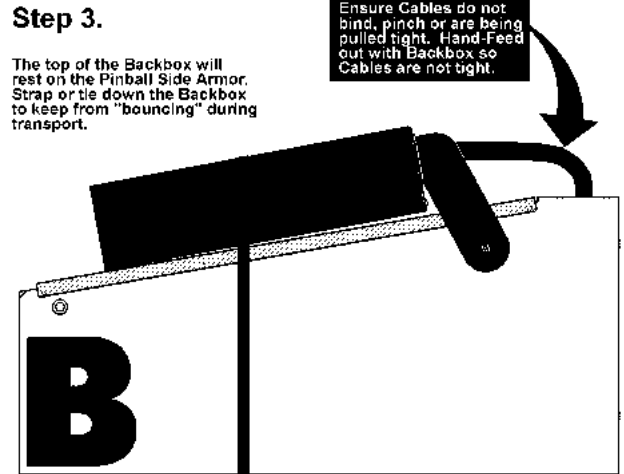
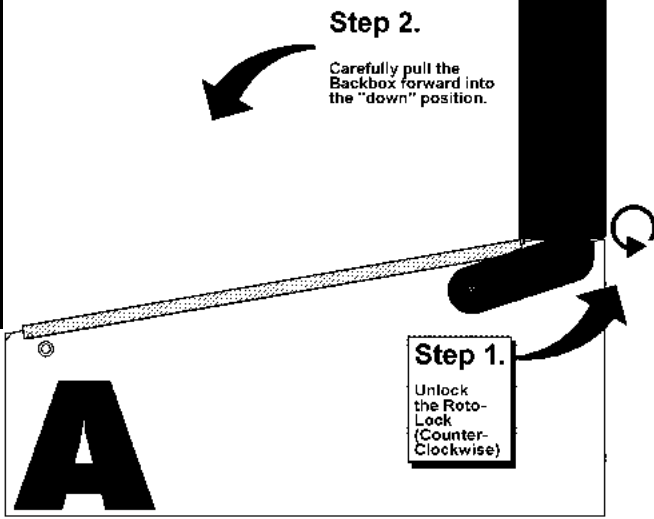

## Leg Leveler Adjustment

Attach the four (4) Leg Assemblies to cabinet corners with the eight (8) leg bolts provided .

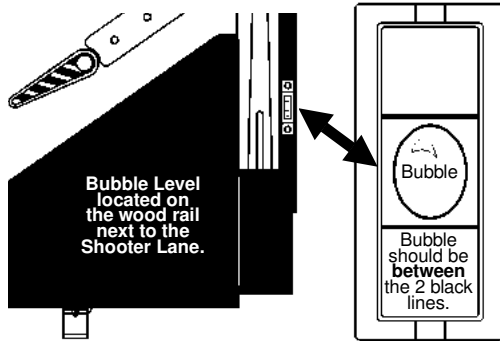

Start adjustment with the leg levelers *turned all the way in*.

View the *bubble* in the level provided on the right side wood rail.

Adjust the front or rear levelers as necessary to cause the bubble to float between the two (2) black lines.

Use a pinball to roll down the center of the playfield for side-to-side leveling.

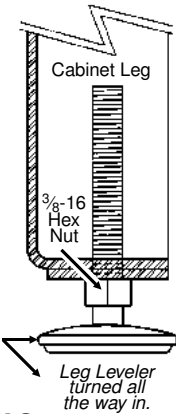

**YOUR PLAYFIELD PITCH IS NOW AT 6.5° AS REQUIRED FOR PROPER GAME PLAY!**

*Note: For custom adjustment greater than >6.5° can be achieved by turning out the rear leg leveler(s), however, it is not recommended.*

## Easy Access Service System - 2 Positions

With the front molding & glass removed, carefully lift the playfield (*take care when using the Bottom Arch to hoist*).

### Position 1

When lifted high enough, the **Playfield Support Slide Brackets** (Fig. 1A) can be seen and can clear the cabinet front (Fig. 1B). At this time, pull the playfield toward the front of the cabinet, checking that the mechanical components clear the cabinet front, then rest the playfield on the **Playfield Support Slide Brackets** at the front channel of cabinet (Fig. 1C);

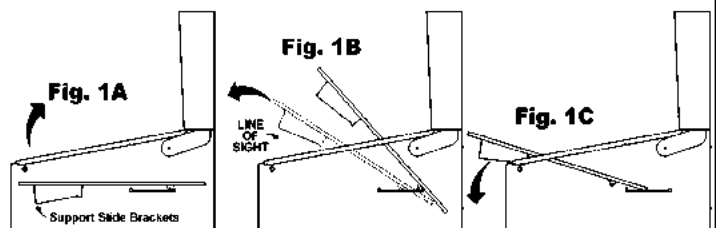

### Position 2

With the playfield at rest, hold the sides & pull toward the front of the cabinet (*approx. 6" to 8"*), until resistance is felt from **Edge Slide Brackets** stopping against the **Slide & Pivot Support Brackets** located on either side of the cabinet (Fig. 2A). At this time, swivel the playfield toward the Backbox, then rest on the top edge (Fig. 2B & 2C).

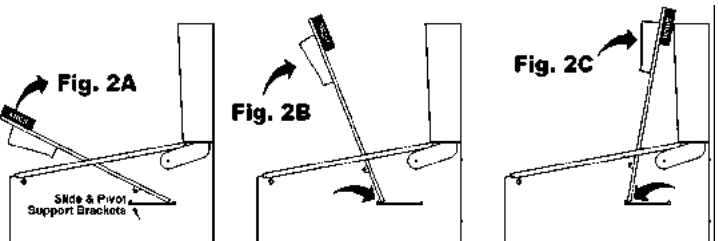

## Game Operation & Features

### Start of Game Features

#### Starting a Normal Game

Insert coin(s). The game generates a sound for the first coin & for each subsequent coin with the display indicating the number of credits posted. Press the **Start Button** and a start-up sound is produced, and the posted credits are reduced by one. Subsequent players can be added (**up to 4 can play!**) by pressing the **Start Button** before the end of ball 1 (*with sufficient credit in the game*).

The display now indicates the player or # of players selected from the total depressions of the **Start Button**. The display indicates the ball in play, and a ball is served to the *Shooter Lane*. An introduction is shown followed by Skill Shot Graphics and/or instructions. Pressing the **Start Button** after ball 1 of any player will start a new game (*if credits are available*), **but only** if the **Start Button** is depressed for 2-3 seconds. This delay is to avoid accidental "re-starts" of a game. **Note:** *Any partial credit remaining during game play after the end of ball 1, or power down, will be eliminated.*

#### Starting Team Play (Doubles!)

This option is adjustable with **Standard Adj. 50, Team Scores** (Default = **NO**). If **Standard Adj. 50, Team Scores** is changed to **YES**, then Team Play will be made available. **Team Play only works in a 4-Player Game**. The totals for Players 1/ 3 (Team 1) & Players 2 / 4 (Team 2) are then displayed individually **as well as** the combined score for **BOTH TEAMS**.

#### Starting Tournament Play with

This Pinball Game is **ToPS™ (Tournament Pinball System) Ready**. **Optional Tournament equipment & hardware (sold separately) is required**. Review **Section 3, Chp. 7, GO TO TOURNAMENT MENU**, for more info!

Unlike a "Normal Game", the Tournament Game is started by depressing the **Tournament Start Button** (*located on the Front Molding, if installed*). If adequate credit(s) are posted **and a Tournament is started** via **Portals™** (*select the "TOUR" Icon in the Main Menu*), the **Tournament Start Button** will flash. *Any adjustments or installs changed will not be in affect. Starting a Tournament Game defaults to preprogrammed Tournament Rules (e.g. No Extra Balls, Specials or Bonus Credits are awarded); however, starting a Normal Game after a Tournament Game will then revert back to any unique adjustments or installs performed previously.* **During and End of Game Features** operate in the same manner (*differences in adjustment defaults are present*).

### During Game Features

#### Feature Mode & Combination Shots

Features are lit on the playfield and started by completing *certain shots (e.g. completion of Target Banks, Orbit(s), Ramp(s) and/or any combination of the shots)*.

#### Multiball

Multiball is started after completion of certain features (*amount of balls used depends on game rules*).

#### Replay Feature

Replay awards are given as the player exceeds a High Score Level during game play. This can be adjusted with **Standard Adj. 3, Replay Award** (Default = **CREDIT**). Players exceeding the High Score Levels can receive: **CREDIT**, **EXTRA BALL**, or **SPECIAL**. Adjust to **NONE** if a replay award is not desired.

### End of Game Features

#### Game Endings

When all player(s) have played all balls (including any Extra Balls), the game ends. If power is interrupted during the course of a game, it will end that game (**see Starting a Normal Game**). Closure of the Plumb Bob Tilt Switch according to the number of tilts set, **Standard Adj. 15, Tilt Warnings** (Default = **01**) or prolonged closure, will end the current Ball-In-Play. Closure of the Slam Tilt Switch on the Coin Door ends the current game(s).

#### Match Feature

At the end of each ball, earned bonuses are collected. At the end of the last ball of a game (including any extra balls, if applicable), earned bonuses are collected, then the system produces a random 2-digit number (a multiple of 10; 00 to 90). Matching the last 2 digits of the player's score with this number awards a credit. In **Std. Adj. 13, Match Percentage** (Default = **8%**) can be changed from 0-10%. Changing the percentage to **0% displays** the "Match Animation" at the end of the game, however, will never match nor award anything. Changing this adjustment to **OFF** will **not display** the "Match Animation" nor award anything.

#### Entering Initials/Name

If player achieved a new *High Score* in a game or achieved a *Special Feature (if given)* the player may enter 3 Initials. In **Std. Adj. 29, High Score Initials** (Default = **3 Initials**) can also be changed to **10-Letter Name**. Use the **Flipper Buttons** to choose a letter or character as seen on the Dot Display. Hitting the **Start Button** locks in the letter or character and proceeds to the next letter. The game then proceeds into the **Game-Over Mode** and then to the **Attract Mode**.

**Note:** **Standard Adj. 31, Custom Message** (Default = **ON**) can be displayed during the **Attract Mode**; enter letters in the same fashion.

*For more details on Adjustments, see Sec. 3, Chp. 4.*

**Continued Next Page.**



# Auto Percentaging

This game is equipped with Auto Percentaging, **Standard Adj. 01, Replay Type** (Default = **AUTO**, adjustable). The *Replay Percent* is automatically adjusted, **Standard Adj. 02, Replay Percentage**, or you can set a *Fixed Replay Score*. Four levels may be selected. Adjustments allow awarding of a "CREDIT" (or your setting) as each level is exceeded. This can be adjusted with, **Standard Adj. 03, Replay Award** (Default = **CREDIT**). With the **Autopercentage Feature**, if the actual replay percentage is higher or lower than that desired, the game will automatically adjust for the new recommended percentage score(s). You may choose to make a different "score-to-beat" adjustment; this is done by utilizing **Standard Adj. 04, Replay Levels**. *For more details with Adjustments, see Section 3, Chapter 4, GO TO ADJUSTMENTS MENU; also, see Section 3, Chapter 5, GO TO INSTALLS MENU for further customization of your Pinball Game.*

Sec. 2: Game Op.

## Instruction Card

Below is a **COPY** of the Game Instruction Card (SPI N<sup>o</sup>: 755-5184-00 USA). For a replacement Game Instruction Card on Astrobright Solar Yellow Card Stock, add **-Y** to the end of the Part Number above. If your card is lost or damaged, simply **COPY** this page and **cut out** the card as a temporary replacement until a new card is ordered.

(Hint: **COPY & CUT** along the dotted line and fold in the center to keep the "COPY" sturdy.)

COPY & CUT



For more detailed game rules, visit our website @ [www.SternPinball.com](http://www.SternPinball.com) and click on the " **Elvis®** " or "Game Archive" Pop Bumper Link.

FOLD HERE

Click on card to open the Instruction Card for printing.

**OBJECTIVE** : Get to *Graceland* by lighting the following:

- **FEATURED HITS COMPLETED ( start all 5 song modes ) ~**
  - Hound Dog ( Shoot **HOUND DOG** Target )
  - Blue Suede Shoes ( Shoot **CENTER LOOP** with Upper Right Flipper )
  - Heartbreak Hotel ( Shoot balls into **HEARTBREAK HOTEL** on Upper Playfield )
  - Jailhouse Rock ( Shoot balls into the **JAILHOUSE EJECT HOLE** )
  - All Shook Up ( Shoot **ALL-SHOOK-UP** shots )
- **GIFTS FROM ELVIS COMPLETED ~** Shoot **E-L-V-I-S** Drop Targets to light **GIFT FROM ELVIS** on the **TOP EJECT HOLE**.
- **TOP TEN COUNTDOWN COMPLETED ~** Shoot lit s to advance **TOP 10 COUNTDOWN**.

**SKILL SHOT** : Plunge ball into the **WLVS** Top Lanes or **E-L-V-I-S** Drop Targets.  
**MYSTERY** : Ball in the **Pop Bumpers** will change channels until all 3 TVs match.  
**EXTRA BALL** : Shoot **Right Ramp** to light **Extra Ball**.  
**TCB** : Complete **T-C-B** to double all scoring.  
**ENCORE** : Spell **E-N-C-O-R-E** ( letters lit in Back Panel ) to earn an **Extra Multiball** after the game.



Elvis® Pinball. Reg. U.S. Pat @ TM Off. ©EPE

SPI PART N<sup>o</sup>: 755-5184-00 USA

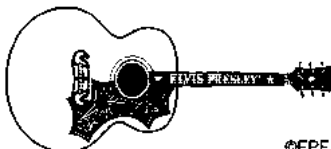

# Service Switch Set (Red, Green & Black Buttons) Access & Use

The **Service Switch Set** provides access for **three (3) functions** available for your use. They are **Volume Menu**, **Service Credits Menu** and **Portals™ Service Menu**. All are accessed separately depending on which colored button (**Red**, **Green** or **Black**) is **pushed first**.

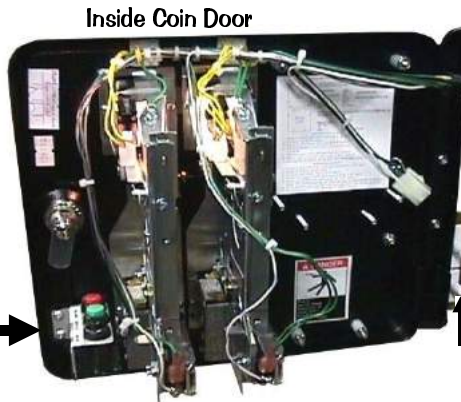

If Coil & Flashlamp Testing, the Playfield Power Interlock Switch must be pulled out.

The Memory Protect Switch is disabled when the Coin Door is open (required for any changes...)

To access any of these **three (3) functions** you must first open the **Coin Door** (see pictorial above) with the Game in the **Attract Mode** (not already in any Function or Menu stated below).

Sec. 3: ...Menu Intro.

## Function 1, Volume Menu



Pushing the **Red "VOLUME" Button** first, enters the **Volume Menu**. While in this Mode, to **DECREASE** the volume, hold down or depress the **Red "LEFT" Button** until desired the volume is achieved; to **INCREASE** the volume, hold down or depress the **Green "RIGHT" Button** until the desired volume is achieved.

*Note: Pushing the Left or Right Flipper Buttons operates the same as the Red or Green Buttons of the Service Switch Set, while in this Volume Mode.*

Set between **0-31**; Once your adjustments are made, this menu will **automatically exit** a few seconds after the last button depression.

## Function 2, Service Credits Menu



Pushing the **Green "SERVICE CREDITS" Button** first, adds **Service Credits** (will not affect your audits as "paid" credits). This is useful for the technician to test games in regular play without affecting the game audits. Each depression adds **1 credit**; up to **50 credits** can be applied. **Std. Adj. 16, Credit Limit**, determines this, however, it can be changed from 04-50; for details see **Chapter 4 of this Section 3**. Once your credits are added, this menu will **automatically exit** a few seconds after the last button depression.

*Note: This function is disabled if **Standard Adjustment 30, Free Play**, is set to **YES**. The Service Credits are limited to the Credit Limit in addition to any paid credits present in the game (e.g. If the Credit Limit is 30, and there are 8 paid credits present, only 22 Service Credits can be applied).*

open  
Adjustments

## Function 3, Portals™ Service Menu

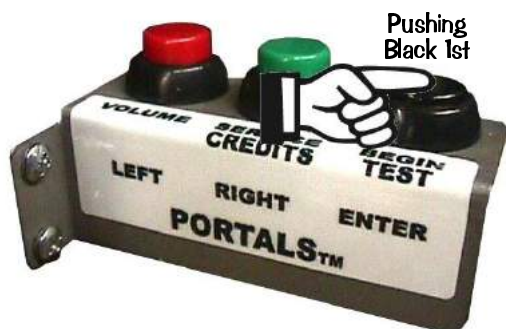

Pushing the **Black "BEGIN TEST" Button** first, enters the **Portals™ Service Menu**. Once in, navigate through all menus depressing the **Red "LEFT" or Green "RIGHT" Buttons**.

*Note: Pushing the Left or Right Flipper Buttons operates the same as the Red or Green Buttons of the Service Switch Set, while in this Service Mode.*

Select or activate the **Icon** chosen (the **Icon** will be "flashing") by pushing down or depressing the **Black "ENTER" Button**.

*Note: Pushing the **Start Button** operates the same as the **Black Button** of the Service Switch Set, while in this Service Mode.*

**Please read** the remainder of this Chapter for more information on the **Portals™ Service Menu**. The remaining six (6) Chapters of this Section explains all **Icons & Menus** in detail. **Read! Read! Read!**

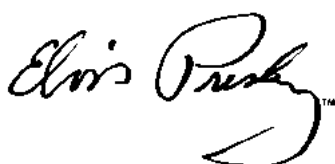



# Portals™ Service Menu Introduction

**Important:** The **Dual Switch Bracket** holds the **Playfield Power Interlock & Memory Protect Switches**. It is located just inside the Coin Door frame (see pictorial of the **Coin Door** on the previous page). The Button Switch at the top is the **Playfield Power Interlock Switch**. It must be pulled out for electro-mechanical device testing or diagnostic purposes (this is required). If this button is pushed in, the **Playfield Power** is disabled while the **Coin Door** is **OPEN**. The Button Switch at the bottom is the **Memory Protect Switch**. It is enabled while the **Coin Door** is **CLOSED**; meaning any adjustment changes that are made **will not be written to memory**. If changing adjustments is required, ensure the **Coin Door** is **OPEN** to disable this switch, thus allowing for desired changes.

## How to Use This Section

This section will cover all functions available in the **Portals™ Service Menu** in a *Step-By-Step* process. This section is divided into chapters which coincide with the **MAIN MENU**. The previous and following pages in this Chapter will instruct the operator on how to move through the Menus. It's simple, easy and fun to use!

To get into the **Service Menu Mode** review "**Function 3, Portals™ Service Menu**" on the previous page. After Power-Up, push down the **Black "BEGIN TEST" Button** to begin. Looking at the display you will momentarily see "**Service Menu**" with a satellite flying from right to left pulling a banner "**Portals©™**" followed by the **MAIN MENU**:

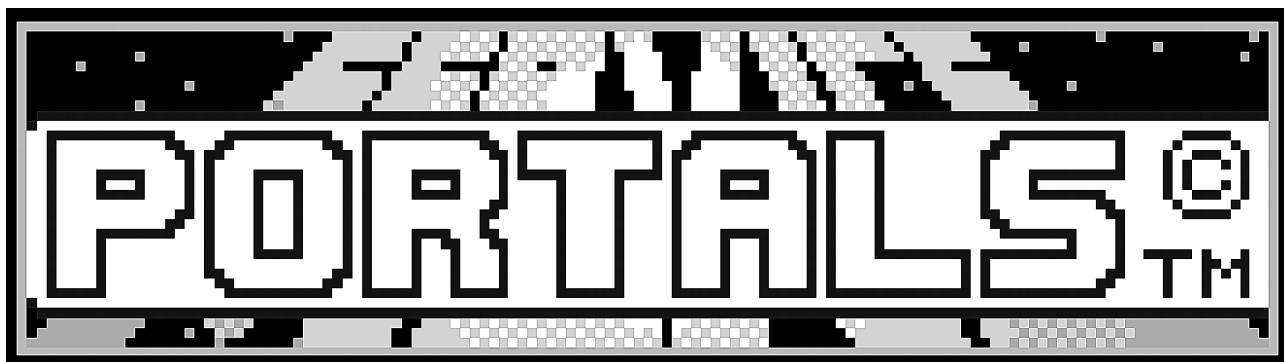

Use the **Red "LEFT" & Green "RIGHT" Buttons** (or **Left & Right Flipper Buttons**) to move the selected **Icon** left or right, and the **Black "ENTER" Button** (or **Start Button**) to activate the selected **Icon**. The use of the Service Switch Set (**Red, Green, & Black Buttons**) *is required* in **Switch Test** or **Active Switch Test**, as the **Start & Flipper Buttons** are a part of this test.

The **MAIN MENU** now appears with the "**DIAG**" **Icon** (**GO TO DIAGNOSTICS MENU**) flashing:



As the operator views the Menu Screen(s), the **MORE MORE** symbols indicates that there are more **Icons** to select in each direction. The **Icon** selected will blink. Pushing the **Black "ENTER" Button** (or **Start Button**) will select the **Icon** and the Menu Screen will change to the menu selected. Select the "**PREV**" **Icons** to move backwards through the menu levels. Select the "**QUIT**" **Icon** to completely exit the Service Mode.

View the **Portals™ Service Menu Icon Tree** on the next pages for a complete overview of all menus used in this system. The "**HELP**" **Icon** & "**?**" **Mini-Icon** provide explanation of **ICON** usage in the Menu where the "**HELP**" **Icon** or "**?**" **Mini-Icon** was selected. View **QUIT THIS SESSION (Exiting the Portals™ Service Menu)** at the end of this chapter (reference **Section 3, Chapter 1, Portals™ Service Menu Introduction**).

The **chapters** in this **section**, which coincide with the **MAIN MENU**, will also provide more detailed information. **Use both the manual and the display to help customize, troubleshoot and/or diagnose faults, if any.**



*Elvis Presley*

# Portals™ Service Menu Icon Tree

**COIN DOOR IS OPEN  
PLAYFIELD HIGH POWER  
DISABLED BY  
COIN DOOR INTERLOCK**

\* WHEN ENTERING THESE NOTED MENUS, YOU MUST PULL OUT the Power Interlock Switch for operation with the Coin Door open.

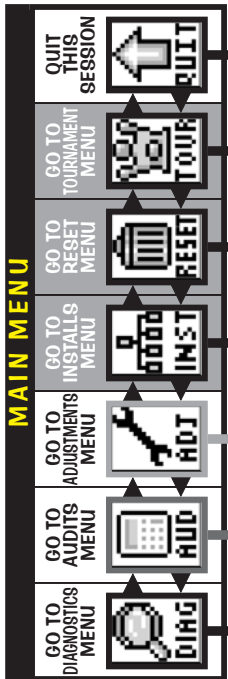

These **non-selectable** icons appear in the selected Menu only when there are **MORE** icons to the **LEFT** or to the **RIGHT** available for selection.

**CONTINUED NEXT PAGE.**

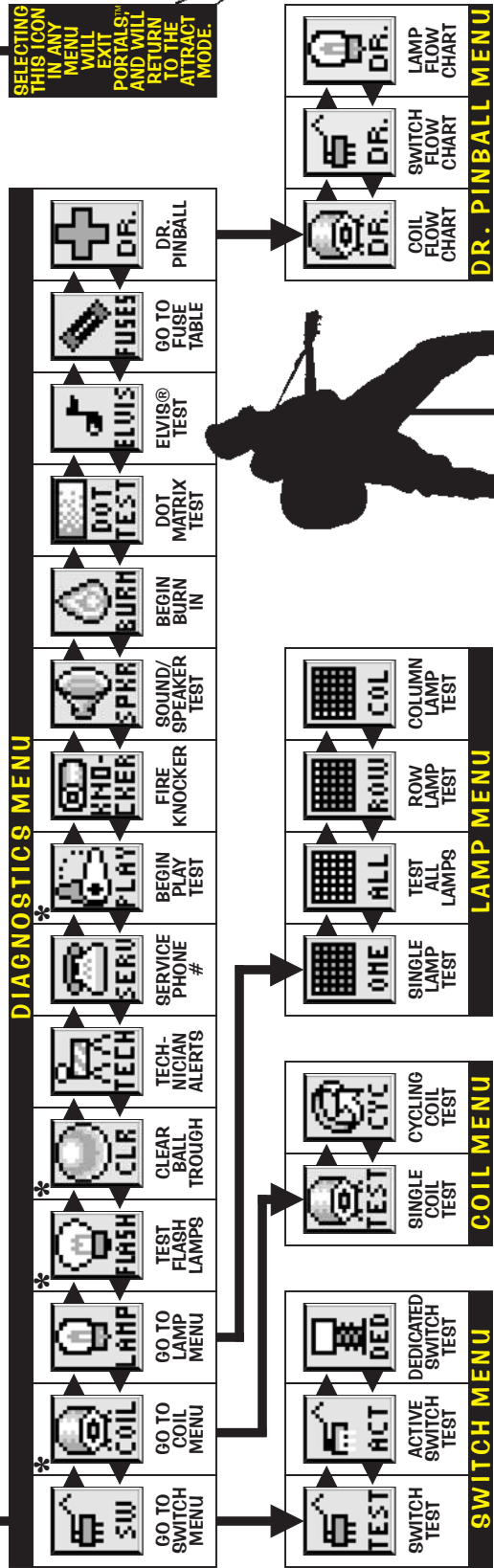

SELECTING THIS ICON IN ANY MENU WILL EXIT PORTALS™ AND WILL RETURN TO THE ATTRACT MODE.



**Note:** In Sub-Menu Tests or Displays, further action is required: select & appropriate Mini-Icon(s).

**PREV** Return to the PREVIOUS Menu.

**QUIT** QUIT, exits & returns to the Attract Mode.

**HELP** View HELP Screens of the current Menu.

**Note:** If a new MINI-ICON is used for a specific function, select the "P" icon for more information.

**PREV** Return to the PREVIOUS Menu.

**QUIT** QUIT, exits & returns to the Attract Mode.

**HELP** View HELP Screens of the current Menu.

**END** END current coil selection to select a new coil for diagnosing in Dr. Pinball Menu.

**NO** Answer NO or YES for Flow Chart Menu questions in Dr. Pinball Menu.

**YES** Answer YES for Flow Chart Menu questions in Dr. Pinball Menu.

**ORIG** View the schematic (DRAWING) of current display. Select while current switch, lamp or coil is viewed.

**RUN** RUN (or activate) selected test or coil.

**FILSE** PULSE coil.

**DECR** DECREMENT (-) or INCREMENT (+) displayed value or select previous/next.

**BACK** Move LEFT or RIGHT, select previous/next or move backwards/ forwards.

**502-5031-00**

**OPTIONAL PRINTOUT KIT (sold separately) IS REQUIRED FOR OPERATION OF THIS MENU.**



# Portals™ Service Menu Icon Tree Continued

**Note:** After selection of any of the 1st 13 Install Icons, the request is installed and returns to the Install Menu. The last icon activated before exiting this menu will supersede any previous icon selected in the group.

**Note:** After selection of any of the 1st 4 Reset Icons, the request is installed and returns to the Reset Menu. Selecting a "FACT" icon, the request is installed and exits the Portals™ Service Menu System.

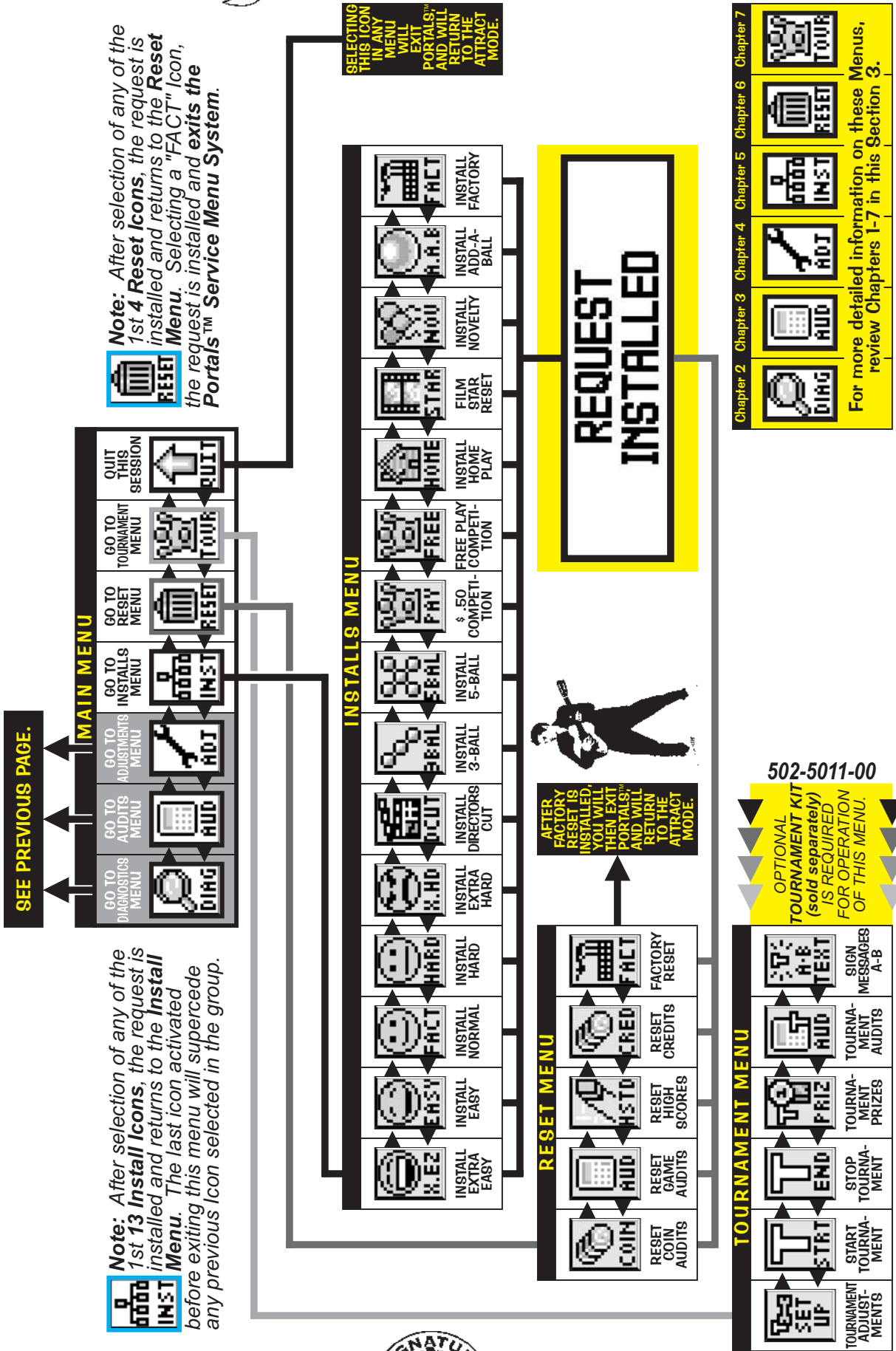

## Portals™ Service Menu Example





This example will demonstrate activation of *Icons* in the **DIAGNOSTICS MENU**. The example will show activation of the "SW" *Icon* (**GO TO SWITCH MENU**). In this menu, the switches can be tested individually and also all active switches can be tested. Use the same technique to access all the *Icons* in the **Portals™ Service Menu**. Follow **Portals™ Service Menu Icon Tree** on the previous pages as a guide to help navigate through the entire system (Also, go to the chapter in this manual explaining the icon(s) selected.).

If the display is in any other menu other than the **MAIN MENU**, use the **Red "LEFT" & Green "RIGHT" Buttons** to select the "PREV" *Icon* and press the **Black "ENTER" Button** to *activate* the **ICON** thus moving back to the previous menu. Do so until **MAIN MENU** appears.

Chapters 2 through 7 will cover all menu items within the **Portals™ Service Menu**. The *Icon* is shown preceding the text. Find the *Icon* in the **Portals™ Service Menu** by navigating with the **Red or Green Buttons**. Each chapter started is from the **MAIN MENU**. Within the chapter, and Sub-Menu will be covered sequentially with their explanation & function. If the operator "*gets lost*", select and *activate* the "PREV" *Icon* until the display indicates **MAIN MENU**. For more help on Button Usage, select & *activate* the "HELP" *Icon* or "?" *Mini-Icons*.

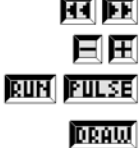

### EXPLANATION & USAGE OF COMMON LARGE & MINI-ICONS USED IN VARIOUS MENUS & SUB-MENUS:

					<p><i>Select and activate to:</i></p> <p>Move LEFT or RIGHT, select previous / next or move backwards / forwards.</p> <p>DECREMENT (-) or INCREMENT (+) displayed value or select previous / next.</p> <p>RUN (or activate) selected test or coil</p> <p>PULSE coil.</p> <p>DRAW View the schematic (DRAWing) of current display. Select while current switch, lamp or coil is viewed.</p>
<p><b>MORE MORE</b></p> <p>These <i>non-selectable Icons</i> appear in the selected <i>Menu</i> only when there are MORE Icons to the LEFT or to the RIGHT available for selection.</p>	<p>Select and activate to return to the <b>PREVIOUS</b> Menu.</p>	<p>Select and activate to <b>QUIT</b>, exits &amp; returns to the <b>Attract Mode</b>.</p>	<p>Select and activate to view <b>HELP</b> Screens of the current <i>Menu</i>*.</p>		<p>* <i>Help Note: An explanation of each Mini-Icon at that menu level will cycle continuously. To exit a display where no Mini-Icons are available for selection, pressing any button will exit the display.</i></p>

Sec. 3: ...Menu Intro.

### Example:

After entering **Portals™**, the **MAIN MENU** now appears with the "DIAG" *Icon* (**GO TO DIAGNOSTICS MENU**) flashing:



Press the **Black "ENTER" Button** to *activate* this **ICON**. The **DIAGNOSTICS MENU** now appears with the "SW" *Icon* (**GO TO SWITCH MENU**) flashing:

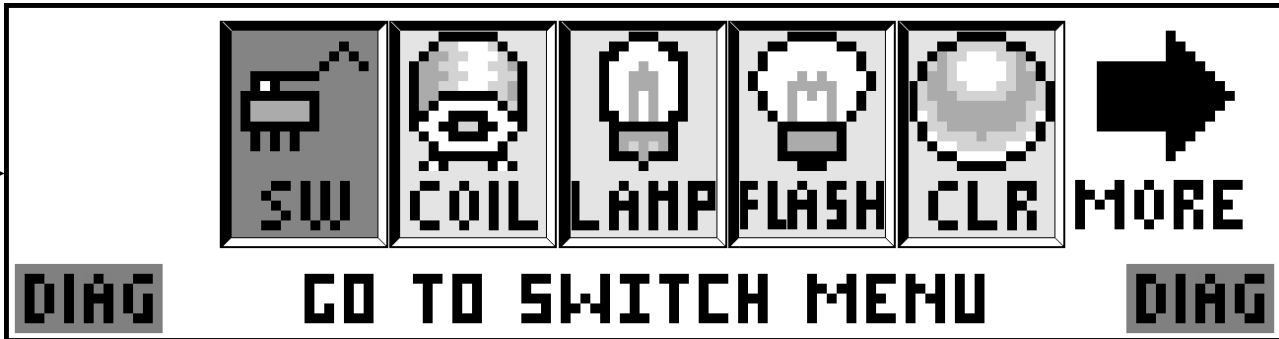

Press the **Black Button** to *activate* this **ICON**. The **SWITCH TEST MENU** now appears with the "TEST" *Icon* (**SWITCH TEST**) flashing:

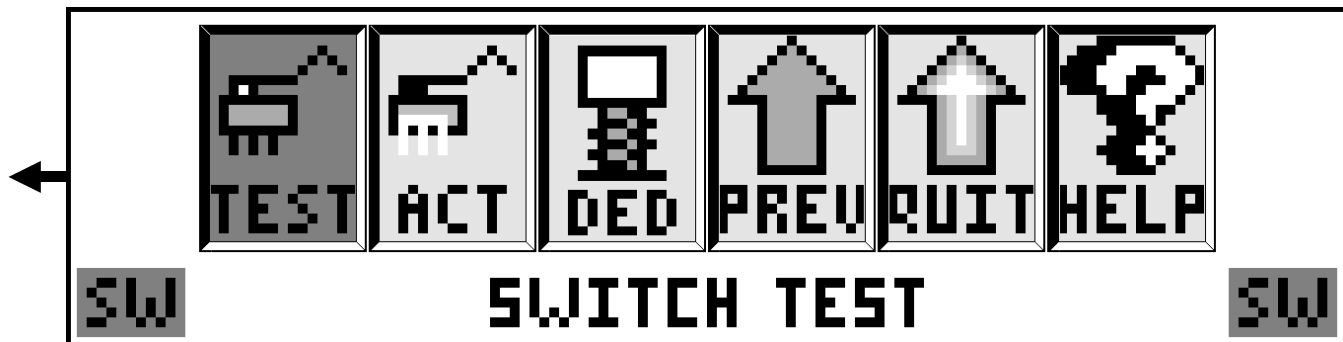

Press the **Black "ENTER" Button** to *activate* this icon. The **Switch Test Display** now appears.

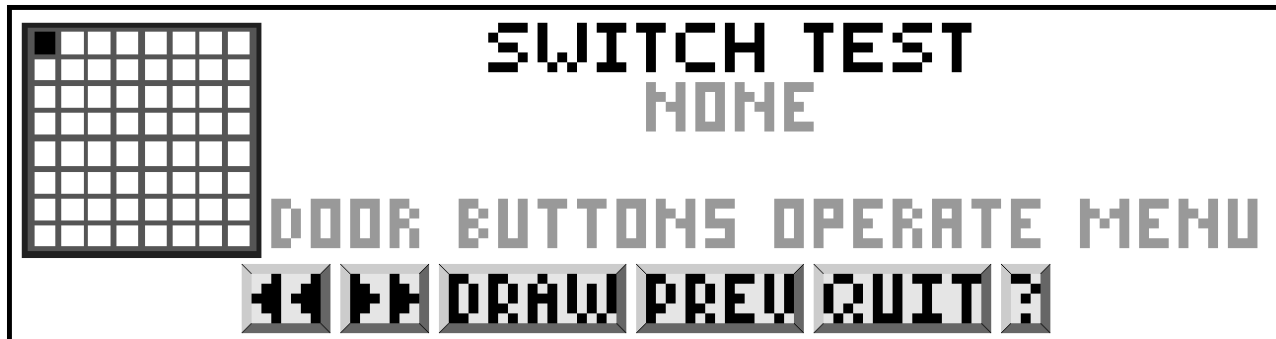

All switches can be tested one at a time. When possible, use a pinball to close any playfield switches; rolling the ball at Stand-Up Targets or over/under switches is suggested. Use finger for all non-playfield switches. As each switch is closed, the respective Switch Matrix Grid Position (1-64) will be lit.

To view the schematic for the switch selected, press either the **Red** or **Green Button** to select the "DRAW" *Mini-Icon*. Press the **Black Button** to *activate* this *Mini-Icon*; do so while the switch is momentarily closed. This will bring up the **Switch Schematic Display**. The display describes the switch in the Switch Matrix which includes the name of the switch, the Return (Row) Wire and the Drive (Column) Wire, drive transistor, and the "Pin-Outs" from the CPU/Sound Board. *Activating* the "DRAW" *Icon* when a switch is not closed, will give the generic switch schematic as shown below.

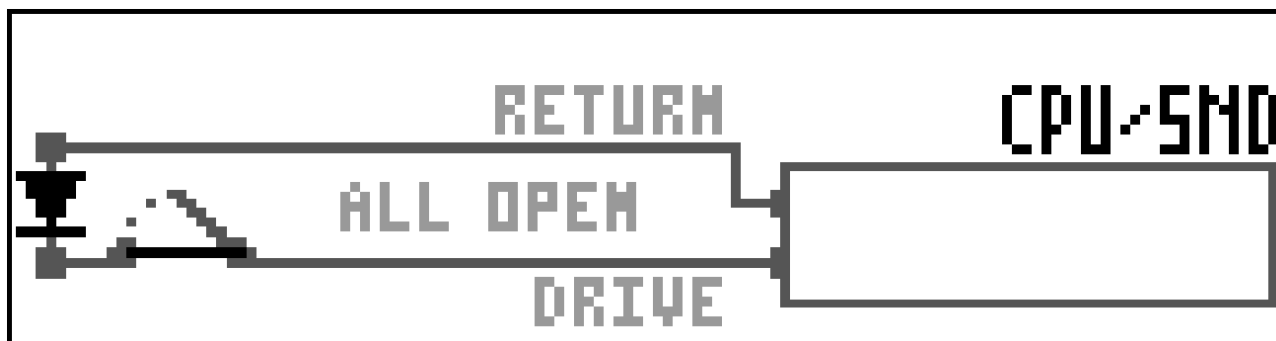

To **exit any display where there are no Mini-Icons** (Schematics or Help Displays), **press any button** to return to the previous Menu.

While in **Switch Test** or **Active Switch Test**, the **Flipper & Start Buttons** are deactivated (because they can be part of these tests). Use the **Red "LEFT," Green "RIGHT"** and/or **Black "ENTER" Buttons** to select and *activate* the "**MINI-ICONS**" at the bottom of the display. In **Switch Test**, if the "<<" or ">>" *Mini-Icon* is *activated*, the display will go to (slip between) the previous tests (*Active & Dedicated Switch Tests*). Use either the **Red** or **Green Button** to select the "**PREV**" *Mini-Icon*. Press the **Black "ENTER" Button** to return to **Switch Test Menu**. To exit out of this Sub-Menu, select and *activate* the "**PREV**" *Icon* in the Menu. The **DIAGNOSTICS MENU** now appears with the "SW" *Icon* (**GO TO SWITCH MENU**) flashing. Go through other **Diagnos**tics selections or exit.

To exit the **Portals™ Service Menu**, select & *activate* the "QUIT" *Icon* (see the next page).





# QUIT THIS SESSION (Exiting the Portals™ Service Menu)

In the **MAIN MENU** and in all **SUB-MENUS**, if the "QUIT" *Icon* or "QUIT" *Mini-Icon* is selected and *activated*, the **Portals™ Service Menu Session** will be exited and returned to the **Attract Mode**.

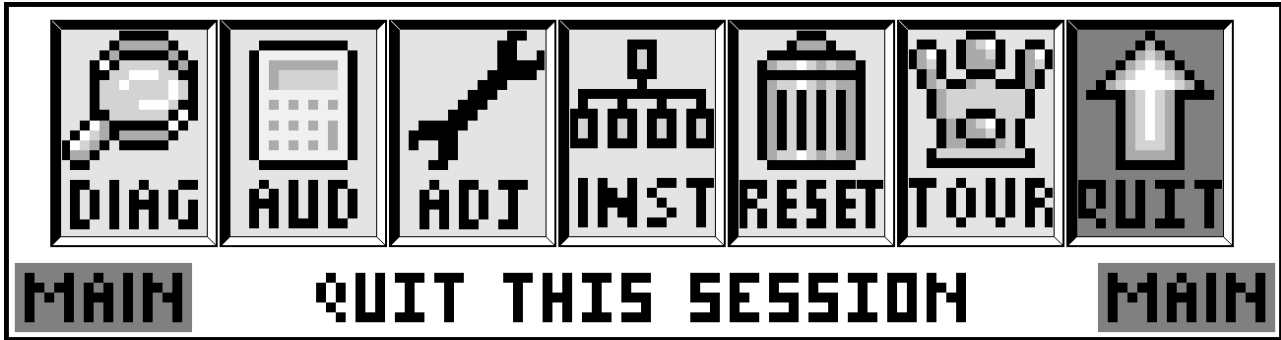

Exiting **Portals™** or turning game on/off will start the *Power-Up Routine*. Upon **Power-Up**, **HOLD IN THE RIGHT FLIPPER BUTTON** to *view* the CPU Game & Display Code Versions (+ Check-Sums), followed by the Location & Game ID Numbers and Alerts, if any (see *Sec. 3, Chp. 2, GO TO DIAGNOSTICS MENU, Technician Alerts*).



The below **Problem / Solution Table** was designed to answer some common problems frequently asked.

## Problem / Solution Table

Sec. 3: ...Menu Intro.

PROBLEM	SOLUTION
Will not enter the <b>Service Mode</b> after depressing the <b>Black "BEGIN TEST" Button</b> .	<ul style="list-style-type: none"> <li>• Check the Service Switch(es) (<b>Red, Green &amp; Black Buttons</b>) for loose connections or bad Ground.</li> <li>• Check the associated wiring harness to/from the CPU/Sound Board, Connector <b>CN6</b>.</li> <li>• Check CPU/Sound Board for possible failure.</li> </ul>
All Service Buttons ( <b>Red, Green and Black</b> ) appear nonfunctional.	<ul style="list-style-type: none"> <li>• Check the Service Switches wiring harness for poor or no connection and/or broken wires.</li> </ul>
The <b>Green Service Button</b> in the Attract Mode will not enter the <b>SERVICE CREDITS MENU</b> to add Service Credits.	<ul style="list-style-type: none"> <li>• Check to make sure the Game is not in "<b>Free Play</b>." <i>If the game is set to Free Play, adding Service Credits is not required.</i></li> <li>• Check the Service Switches wiring harness for poor or no connection and/or broken wires.</li> </ul>
The <b>Display</b> "blanks out."	<ul style="list-style-type: none"> <li>• Check the Dot Matrix Display for loose wiring harness for poor or no connection and/or broken wires.</li> <li>• Check <b>F1 (3/4A Fuse)</b> on the Display Power Supply Board. Refer to Section 5, Chapter 4, <b>SCHEMATICS &amp; TROUBLESHOOTING</b>.</li> </ul>
Icons " <i>scroll</i> " along continuously in the <b>MAIN MENU</b> .	<ul style="list-style-type: none"> <li>• Check for a stuck switch on the <b>Green Button</b>.</li> <li>• If the Service Switch Set and/or the Coin Door was replaced, ensure the Locking Mechanism on the <b>Green Button</b> was removed. If the Green Button "clicks" and locks into an up/down position, the <b>Green Button</b> has this lock switch. Remove it. (Ref. to Svc. Bulletin #74.)</li> </ul>
The <b>Start and Flipper Buttons</b> do not select or activate <i>Icons</i> in the <b>SWITCH TEST MENU</b> .	<ul style="list-style-type: none"> <li>• This is normal. These switches are deactivated, as they are a part of the Switch Test. Use the <b>Red "LEFT" or Green "RIGHT" &amp; Black "ENTER" Buttons</b> in this Sub-Menu. Refer to Section 3, Chapter 2, <b>GO TO DIAGNOSTICS MENU, Switch Test</b>.</li> </ul>
Can't move selection of <i>Icon</i> with the <b>Left and/or Right Flipper Buttons</b> .	<ul style="list-style-type: none"> <li>• Check the <b>Flipper Buttons</b> for loose connections or bad Ground and refer to Section 5, Chapter 2, Playfield Wiring, #-Flipper Circuit Wiring Diagram.</li> <li>• This is normal <i>only</i> in <b>Diagnostic's Switch &amp; Active Switch Tests</b> (see <i>previous Problem</i>).</li> </ul>
Some <i>Icons</i> appear non-functional in the <b>PRINTER MENU(S)</b> .	<ul style="list-style-type: none"> <li>• If no printing equipment is connected, the <b>"-" Icon, "+" Icon</b> and <b>"RUN" Icon</b> will appear not to function. Refer Section 3, Chapter 3, <b>GO TO PRINTER MENU</b>.</li> </ul>
Some <i>Icons</i> appear non-functional in the <b>GAME SPECIFIC MENU</b> under the <b>DIAGNOSTICS MENU</b> .	<ul style="list-style-type: none"> <li>• If there is no other test under this Menu, the <b>"&lt;&lt;" &amp; "&gt;&gt;" Mini-Icons</b> will appear not to function. The remaining <i>Icons</i> should function as normal. <b>Note:</b> <i>If there is no "Go To (Game Name) Test(s), the "GAME NAME" Icon will not invoke another display.</i></li> </ul>
The display returns to the <b>ATTRACT MODE</b> exiting the Service Session after a <b>FACTORY RESET</b> .	<ul style="list-style-type: none"> <li>• This is normal. After a <b>FACTORY RESET</b>, the Service Session is automatically exited. Refer to Section 3, Chapter 6, <b>GO TO RESET MENU, Factory Reset</b>.</li> </ul>
In <b>COIL TEST MENU</b> , the coils and flashlamps <b>do not</b> fire after activating the <b>"RUN" Icon</b> .	<ul style="list-style-type: none"> <li>• Ensure the <b>POWER INTERLOCK SWITCH is pulled out</b> (see the start of this Chapter).</li> </ul>
In <b>ADJUSTMENTS MENU</b> , with the Coin Door <b>CLOSED</b> , adjustments are not getting changed as desired (using the <b>Flipper &amp; Start Buttons</b> ).	<ul style="list-style-type: none"> <li>• This is normal. The <b>Memory Protect Switch</b> is enabled when the Coin Door is <b>CLOSED</b>. Changes can be made with the Coin Door <b>OPEN</b> only.</li> </ul>
In <b>Portals™ Service Menu</b> , the volume cannot be adjusted with the <b>Red or Green Buttons</b> .	<ul style="list-style-type: none"> <li>• The Volume adjustment can only be made when in the <b>Attract Mode</b>. The <b>Volume Mode</b> is entered by pressing the <b>Red "VOLUME" Button</b>. Then use the <b>Red "LEFT" to decrease / decrement (-) or Green "RIGHT" Button</b> to increase / increment (+) the volume.</li> </ul>
In <b>Portals™ Service Menu</b> , the display seems to lock up, or the Help Display appears to be non-functional.	<ul style="list-style-type: none"> <li>• If you cannot clear the situation by exiting back one Menu, exit completely out of the <b>Portals™ Service Menu</b>, and re-enter. If the problem persists, call Technical Support for additional help.</li> </ul>



# Go To Diagnostics Menu

## Overview

The **Portals™ Service Menu System** provides tests for sounds, display, lamps, switches and coils. Each feature may be tested manually or automatically after entering the **Portals™ Service Menu** (see *Chapter 1 of this Section*). The automatic tests (e.g. **Cycling Coils**, **Test Flash Lamps**) may be used for a quick verification of automatic test functions and the manual tests (**Begin Play Test**, **Single Lamp / All / Row / Column Tests**, and **'Game Name' Tests**) may be used for troubleshooting. All *Icons* and there usages are explained throughout this chapter in order.

**Important:** Upon **Power-Up** (Game Reset) or opening the **Coin Door** watch the **Display** for any **Alerts**.\*



If this **display flashes**, the game is indicating that **CMOS RAM** memory (CPU Loc. U212) has been corrupted. This is caused by either failure in memory (e.g. **batteries are dead and/or faulty RAM**) or upon installation of updated version of game code. Opening the **Coin Door** will initiate a **Factory Restore (Reset)**, by opening the **Memory Protect Switch**.

Check battery voltage at **VBATT Test Point** on the **CPU/Sound Bd.** (more details in *Sec. 5, Chp. 4, PCBs*).



This **flashing display** is shown immediately upon opening the **Coin Door** as a reminder that **20v/50v DC** power to the playfield is **disabled**. All electro-mechanical devices (such as **Coils**) **cannot be tested** with the switch pushed in. **PULL OUT** the **Power Interlock Switch ONLY** if you're in a **Testing Menu** requiring power. See **Access & Use** in Chapter 1 of this Section for the location of this switch. **Closing the Coin Door** will automatically reset this switch.



This **display** is shown momentarily during **Game Mode** or **Power-Up** to alert the operator of a coil malfunction (*coil doesn't energize or coil fires a multiple number of times*). **OPERATOR ALERT!** works by monitoring any **switch activated coil** that has the potential to trap a ball when disabled (more details in this Chapter, **Technician Alerts, Pages 24-25**).



\* If this **Tech Report Alert flashes** (along with an audible sound), the game has detected faulty switches and/or missing pinballs. Select the "TECH" *Icon* for information (review **Technician Alerts, Pages 24-25**). \* For this **Alert display** to appear, **Standard Adj. 49, must be changed to POWERUP, COIN DOOR or POWERUP AND COIN DOOR**, the default is **NEVER** (review *Section 3, Chp. 4, GO TO ADJUSTMENTS MENU, Standard Adjustments, Page 44*).

**CAUTION:** Remove all pinballs from the Ball Trough prior to lifting the playfield to it's full upright position for servicing. **PULL OUT** the **Power Interlock Switch** for operation. To eject pinballs, select the "DIAG" *Icon* from the **MAIN MENU** to go to the **DIAGNOSTICS MENU**, then select the "CLR" *Icon* to enter the **CLEAR BALL TROUGH MENU**. Select the "RUN" *Mini-Icon* and press the **Black "ENTER" Button** or **Start Button** to remove one pinball at a time (this feature also useful to retrieve a pinball for game testing in **Begin Play Test & Game Specific Tests**).



### EXPLANATION & USAGE OF COMMON LARGE & MINI-ICONS USED IN VARIOUS MENUS & SUB-MENUS:

Select and activate to:

					Move LEFT or RIGHT, select previous / next or move backwards / forwards.
<b>MORE MORE</b>	<b>PREU</b>	<b>RUIT</b>	<b>HELP</b>		DECREMENT (-) or INCREMENT (+) displayed value or select previous / next.
These <i>non-selectable icons</i> appear in the selected Menu only when there are MORE icons to the LEFT or to the RIGHT available for selection.	Select and activate to return to the PREVIOUS Menu.	Select and activate to QUIT, exits & returns to the Attract Mode.	Select and activate to view HELP Screens of the current Menu*.		RUN (or activate) selected test or coil PULSE coil.
					View the schematic (DRAWing) of current display. Select while current switch, lamp or coil is viewed.

\* **Help Note:** An explanation of each Mini-Icon at that menu level will cycle continuously. To exit a display where no Mini-Icons are available for selection, pressing any button will exit the display.

## GO TO DIAGNOSTICS MENU

After entering **Portals™**, the **MAIN MENU** now appears. To initiate, from the **MAIN MENU**, select the "DIAG" *Icon* with either the **Red "LEFT"** or **Green "RIGHT"** Buttons (the **Flipper Buttons** operates in the same manner) and press the **Black "ENTER" Button** (the **Start Button** operates in the same manner). The **DIAGNOSTICS MENU** appears. Continue through this chapter for the explanation & usage of the *Icons* in the **DIAGNOSTICS MENU**. **Usage Note:** Only in **Switch & Active Switch Tests**, the **Flipper & Start Buttons cannot be used** as the alternate navigation buttons as they are a part of these tests. After exiting these tests, the **Left & Right Flipper** and **Start Buttons** can once again be used. Continue through this chapter for the explanation & usage of the *Icons* in the **DIAGNOSTICS MENU**.





# Go To Switch Menu

To initiate, from the **DIAGNOSTICS MENU**, select the "SW" *Icon* with either the **Red "LEFT"** or **Green "RIGHT"** **Buttons** and press the **Black "ENTER"** **Button**. Switches are configured in an 8 x 8 Matrix of Columns (Switch Drives) and Rows (Switch Returns) with up to **64** possible switches. The **SWITCH TEST MENU** consists of three (3) parts: **Switch Test, Active Switches & Dedicated Switch Test**. **Reminder:** *The Flipper & Start Buttons (part of Switch Tests) cannot be used as navigation buttons during these test(s)*



## Switch Test

To initiate, from the **SWITCH MENU**, select the "TEST" *Icon* with either the **Red** or **Green Buttons** & press the **Black Button**. In **Switch Test**, close each switch and observe the display. The display will describe the switch in the Switch Matrix Grid (*below*), which includes the switch name, Return (Row) Wire, Drive (Column) Wire and the "Pin-Outs" from the **CPU/Sound Board**. When the switch is closed, the information is displayed momentarily. To view the schematic for the switch selected, press either the **Red** or **Green Button** to select the "DRAW" *Mini-Icon*. Press the **Black Button** to *activate* this *Mini-Icon*; do so while the switch is momentarily closed. To return to **Switch Test**, press the **Black Button** again.



## Active Switch Test

To initiate, from the **SWITCH MENU**, select the "ACT" *Icon* with either the **Red** or **Green Buttons** & press the **Black Button**. If still in a previous test, select the "PREV" *Mini-Icon* to return to **SWITCH MENU** or select either of the "<<" or ">>" *Mini-Icons* to move through the tests. In **Active Switch Test**, if any switches are stuck closed (*or made from the presence of a pinball*), the display sequences through the Switch Names, Return (Row) Wire, Drive (Column) Wire, Drive Transistor, Part Number and the "Pin-Outs" from the **CPU/Sound Board**. This cycle continues until all switches are cleared or until the test is exited.



## Dedicated Switch Test

To initiate, from the **SWITCH MENU**, select the "DED" *Icon* with either **Flipper Button** & press the **Start Button** (*the Service Switches are deactivated during this test.*). In **Dedicated Switch Test**, the display will describe the switch which includes the Switch Name, Return (Row) Wire, Drive (Column) Wire, Part Number and the "Pin-Outs" from the **CPU/Sound Board**.

### SWITCH MATRIX GRID & DEDICATED SWITCHES

Column (Drive)	1: Q1	2: Q2	3: Q3	4: Q4	5: Q5	6: Q6	7: Q7	8: Q8
Row (Return)	<b>GRN-BRN</b> CN5-P1	<b>GRN-RED</b> CN5-P3	<b>GRN-ORG</b> CN5-P4	<b>GRN-YEL</b> CN5-P5	<b>GRN-BLK</b> CN5-P6	<b>GRN-BLU</b> CN5-P7	<b>GRN-VIO</b> CN5-P8	<b>GRN-GRY</b> CN5-P9
1: U400	1 Cabinet Side LT BUTTON (UK ONLY) Sw. Part Number: 180-5160-00	9 Below P/F SPOT NOTE STANDUP 515-5162-08	17 Below P/F (E)LVIS 180-5158-00	25 Above P/F SPINNER 180-5010-04	33 Below P/F ELVIS HOME 180-5189-00	41 Below P/F LEFT TOP LANE 500-6227-02	49 Below P/F LEFT BUMPER 180-5015-05	57 Below P/F LEFT OUTLANE 500-6227-02
2: U400	2 Coin Door 4TH COIN SLOT Sw. Part Number: 180-5204-00	10 Above P/F SHOOTER LANE EXIT 180-5190-28	18 Below P/F E(L)VIS 180-5158-00	26 Above P/F LEFT ORBIT HI 180-5087-00	34 Below P/F CENTER SAUCER EJECT 180-5186-00	42 Below P/F MIDDLE TOP LANE 500-6227-02	50 Below P/F RIGHT BUMPER 180-5015-05	58 Below P/F LEFT RETURN LANE 500-6227-02
3: U400	3 Coin Door 6TH COIN SLOT Sw. Part Number: Future Use	11 Below P/F 4-BALL TROUGH #1 (LEFT) 180-5119-02	19 Below P/F EL(V)IS 180-5158-00	27 Above P/F INNER LOOP 180-5087-00	35 NOT USED	43 Below P/F RIGHT TOP LANE 500-6227-02	51 Below P/F BOTTOM BUMPER 180-5015-05	59 Below P/F LEFT SLINGSHOT 180-5054-00 (x2)
4: U400	4 Coin Door RIGHT COIN SLOT Sw. Part Number: 180-5204-00	12 Below P/F 4-BALL TROUGH #2 180-5119-02	20 Below P/F ELV(I)S 180-5158-00	28 Above P/F RIGHT RAMP EXIT 180-5010-01	36 Below P/F (K)ING 515-7381-00	44 NOT USED	52 Mini P/F TOP HOTEL STANDUP 515-5162-08	60 Below P/F RIGHT OUTLANE 500-6227-02
5: U401	5 Coin Door CENTER COIN SLOT / DBA Sw. Part Number: 180-5204-00	13 Below P/F 4-BALL TROUGH #3 180-5119-02	21 Below P/F ELVI(S) 180-5158-00	29 NOT USED	37 Below P/F K(I)NG 515-7381-00	45 Above P/F RIGHT RAMP MADE 180-5190-28	53 Mini P/F BOTTOM HOTEL STANDUP 515-5162-08	61 Below P/F RIGHT RETURN LANE 500-6227-02
6: U401	6 Coin Door LEFT COIN SLOT Sw. Part Number: 180-5204-00	14 Below P/F 4-BALL TROUGH VUK OPTO See Sw. 14 Note	22 Below P/F (T)CB 515-5162-08	30 Above P/F LEFT RAMP MADE 180-5087-00	38 Below P/F KI(N)G 515-7381-00	46 Above P/F RIGHT ORBIT LOW 180-5087-00	54 In Cabinet START BUTTON 180-5174-00	62 Below P/F RIGHT SLINGSHOT 180-5054-00 (x2)
7: U401	7 Coin Door 5TH COIN SLOT Sw. Part Number: Future Use	15 Below P/F 4-BALL STACKING OPTO See Sw. 15 Note	23 Below P/F T(C)B 515-5162-08	31 Below P/F LEFT RAMP EXIT 180-5010-01	39 Below P/F KIN(G) 515-7381-00	47 Above P/F RIGHT ORBIT HI 180-5087-00	55 In Cabinet TOURNAMENT START 180-5174-00	63 Above P/F HOTEL DOOR 180-5119-02
8: U401	8 Cabinet Side RT BUTTON (UK ONLY) Sw. Part Number: 180-5160-00	16 Below P/F SHOOTER LANE 180-5157-00	24 Below P/F TC(B) 515-5162-08	32 Below P/F TOP SAUCER EJECT 180-5186-00	40 Below P/F SCARF STANDUP 515-5967-02	48 Above P/F HOTEL POST 180-5189-00	56 In Cabinet PLUMB BOB TILT See Sw. 56 Note	64 Above P/F HOUND DOG 180-5190-28

GROUND	GROUND
IC U206 INPUTS	<b>BLK</b> CN6-P1, -P11
1: U206	DS-1 on Cabinet Side #1 LEFT FLIPPER BUTTON Sw. Part Number: 180-5160-00
2: U206	DS-2 Below Playfield #2 LEFT FLIPPER E.O.S (End-of-Stroke) Sw. Part Number: 180-5149-00 on Flipper
3: U206	DS-3 on Cabinet Side #3 RIGHT FLIPPER BUTTON Sw. Part Number: 180-5164-00 Doubled
4: U206	DS-4 Below Playfield #4 RIGHT FLIPPER E.O.S (End-of-Stroke) Sw. Part Number: 180-5149-00 on Flipper
5: U206	DS-5 on Cabinet Side #5 UPPER RT. FLIPPER BUTTON Sw. Part Number: Same as DS-3 above
6: U206	DS-6 on Coin Door #6 VOLUME (RED BUTTON) (In Test: LEFT) Sw. Part Number: 180-5192-02
7: U206	DS-7 on Coin Door #7 SERV. CRED. (GREEN BUTTON) (In Test: RIGHT) Sw. Part Number: 180-5192-04
8: U206	DS-8 on Coin Door #8 BEGIN TEST (BLACK BUTTON) (In Test: ENTER) Sw. Part Number: 180-5192-00

Sec. 3: ... Diagnostics

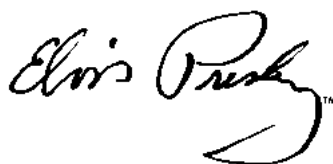



# SWITCH MATRIX GRID LOCATIONS

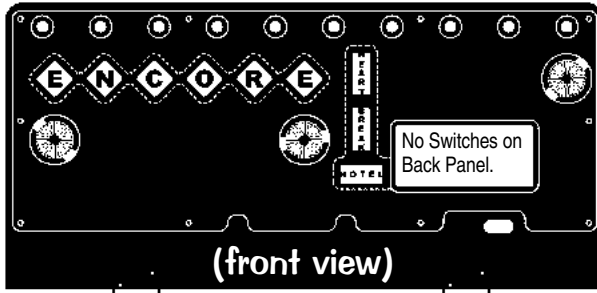

◀ Backpanel

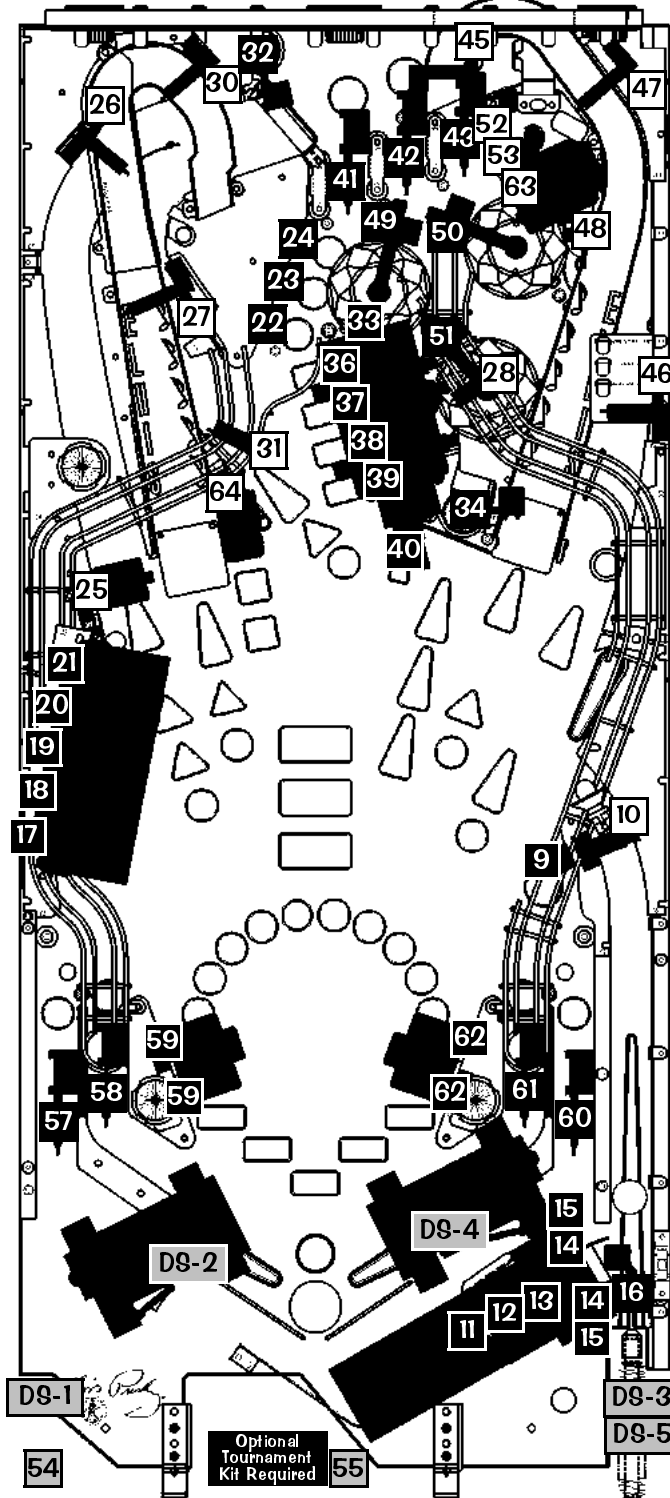

Playfield ▲

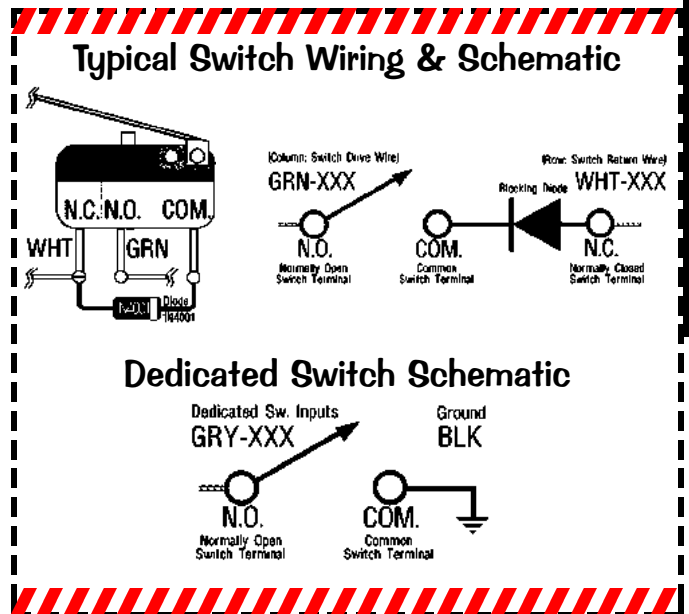

Sec. 3: ... Diagnostics

- = Switches above Playfield.
- = Switches below Playfield.
- = Switches not on Playfield.

**Switch Part Notes:** ¥ Yen Coin Switch is 180-5091-00. Part Numbers which start with 515- or 500- include the bracket, target, and/or housing.  
**Sw. 14 & 15 Part Note:** OPTO PC Boards are used as Switches:  
 Trans.: 515-0173-00 (Sw. 14 & 15); Receiver: 515-0174-00 (Sw. 14 & 15);

**Sw. 56 Part Note:** The Switch is comprised of a Hanger Bracket (535-5319-00) and Contact Wire (535-7563-01) located in the Cabinet.  
 Some Switch Diodes may be located under the playfield, in the Cabinet or Backbox on Terminal Strips or Diode Boards and not on the assemblies.  
 DOTS: Diode On Iterminal Strip, see Section 5, Chapter 2, Playfield Wiring.

Go To  
Diagnostics Menu





## Go To Coil Menu

To initiate, from the **DIAGNOSTICS MENU**, select the "COIL" *Icon* with either the **Red "LEFT"** or **Green "RIGHT" Buttons** and press the **Black "ENTER" Button**. The coils are listed in groups. Coils **01-16** are typically High Current Coils (*although Low Current Coils may be used in these positions & will be noted*). Coils **17-32** are typically Low Current Coils. Flash Lamps are typically used in positions **25-32** (*although may be used in any position & will be noted*).



**PULL OUT** the Power Interlock Switch for operation with the Coin Door open.

**Important:** The Partial Coils Detailed Chart Table is used as a reference against the Coil & Flash Lamp Locations on the next page. For the **complete** Coils Detailed Chart Table, see the reverse of the following page. The Chart is shown to compare against the Backbox I/O Power Driver Board Detailed Wiring Diagram (shown again in Sec. 5, Chapter 1, **Playfield Wiring**). For more on troubleshooting and diagnosing, see Sec. 5, Chapter 4, **Printed Circuit Boards**.



## Single Coil Test

To initiate, from the **COIL MENU**, select the "TEST" *Icon* with either the **Red or Green Buttons** and press the **Black Button**. Ensure the **Power Interlock Switch** is pulled out. Select either the "-" or "+" *Mini-Icons*. Start with the "+" *Mini-Icon* to start the manual **Single Coil Test** from #1 (*the test runs through all Coils and Flash Lamps #1-#32 & Optional UK Only Auxiliary Positions AUX 1-3*). Press the **Black Button** on the "+" *Mini-Icon*, as each coil is selected, the display will describe the Coil or Flash Lamp Name with the corresponding number, the wire with colors, the "Pin-Outs" from the I/O Power Driver Board, the Coil Voltage and Gauge-Turns (*e.g. 23-800*). Press the **Black Button** again to move forward in the test. To test and view a particular Coil or Flash Lamp, select the "RUN" *Mini-Icon* and press the **Black Button**. Each time the **Black Button** is pushed, the Coil or Flash Lamp will fire on the Playfield and/or Backbox, with the display indicating the Coil or Flash Lamp information. Continue with the same procedure to run through the entire test.



## Cycling Coil Test

To initiate, from the **COIL MENU**, select the "CYC" *Icon* with either the **Red or Green Buttons** and press the **Black Button**. If still in a previous test, select the "PREV" *Mini-Icon* to return to **COIL MENU** or select either of the "<<" or ">>" *Mini-Icons* to move to **Cycling Coil Test** (*selecting again will return to Coil Test*). The test pulses each regular Coil or Flash Lamp sequentially (*cycling*) on the Playfield and in the Backbox (*if Coils are used*). The display indicates **CYCLING COILS**.

⊖ **Coil Note:** ⊖ Either -00B or -00T can be used for coil replacements. B/T listed is preferable for easier diode access & may differ on game.

## PARTIAL COILS DETAILED CHART ...

High Current Coils Group 1		Drive Transistor	Coil GA-Turn or Bulb Type
#1	TROUGH UP-KICKER	Q1	26-1200 ⊖ 090-5044-00B
#2	AUTO LAUNCH	Q2	23-800 ⊖ 090-5001-00B
#3	ELVIS 5-BANK RESET	Q3	24-940 ⊖ 090-5036-00B
#4	(OPT) SHAKER MOTOR	Q4	Motor Only 041-5029-01
#5	MAGNET	Q5	22-650 ⊖ 090-5042-00
#6	CENTER EJECT	Q6	24-940 ⊖ 090-5036-00B
#7	HOTEL LOCK RELEASE	Q7	23-800 ⊖ 090-5001-00B
#8	CONTROL GATE	Q8	32-1800 ⊖ 090-5031-00B

High Current Coils Group 2		Drive Transistor	Coil GA-Turn or Bulb Type
#9	LEFT BUMPER	Q9	26-1200 ⊖ 090-5044-00T
#10	RIGHT BUMPER	Q10	26-1200 ⊖ 090-5044-00T
#11	BOTTOM BUMPER	Q11	26-1200 ⊖ 090-5044-00T
#12	TOP EJECT	Q12	24-940 ⊖ 090-5036-00B
#13	UPPER LEFT FLIPPER	Q13	23-900 ⊖ 090-5020-30
#14	UPPER RIGHT FLIPPER	Q14	23-900 ⊖ 090-5020-30
#15	LEFT FLIPPER (50v RED/YEL)	Q15	22-900 ⊖ 090-5020-20T
#16	RIGHT FLIPPER (50v RED/YEL)	Q16	22-900 ⊖ 090-5020-20T

Low Current Coils Group 1		Drive Transistor	Coil GA-Turn or Bulb Type
#17	LEFT SLINGSHOT	Q17	23-800 ⊖ 090-5001-00T
#18	RIGHT SLINGSHOT	Q18	23-800 ⊖ 090-5001-00T
#19	HOTEL DOOR	Q19	27-1500 ⊖ 090-5004-00B
#20	FLASH: BACK PANEL X2	Q20	#89 Bulb 165-5000-89-HF
#21	FLASH: BACKPANEL TCB	Q21	#89 Bulb 165-5000-89-HF
#22	FLASH: SPINNER	Q22	#906 Bulb 165-5004-00
#23	FLASH: UPR RT FLIPPER X2	Q23	#906 Bulb 165-5004-00
#24	OPTIONAL COIL	Q24	Opt. 5v

Low Current Coils Group 2		Drive Transistor	Coil GA-Turn or Bulb Type
#25	STEPPER #1	Q25	
#26	STEPPER #2	Q26	
#27	STEPPER #3	Q27	
#28	STEPPER #4	Q28	Stepper Motor Only 041-5069-00
#29	ELVIS LEGS	Q29	29-1400 ⊖ 090-5072-03
#30	ELVIS ARMS	Q30	29-1400 ⊖ 090-5072-03
#31	FLASH: ELVIS SPOT LIGHT	Q31	#906 Bulb 165-5004-00
#32	FLASH: SLINGS X2	Q32	#906 Bulb 165-5004-00

Auxiliary (UK ONLY)		Drive Transistor	Coil GA-Turn
AUX 1:	LEFT UP/DOWN POST	Q1	26-1200 ⊖ 090-5044-00T
AUX 2:	CENTER UP/DOWN POST	Q2	23-1100 ⊖ 090-5030-00T
AUX 3:	RIGHT UP/DOWN POST	Q3	26-1200 ⊖ 090-5044-00T



# COIL & FLASH LAMP LOCATIONS

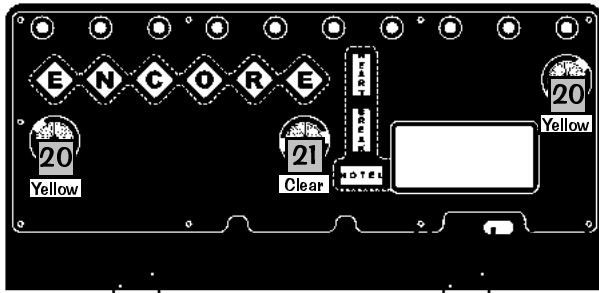

◀ Backpanel

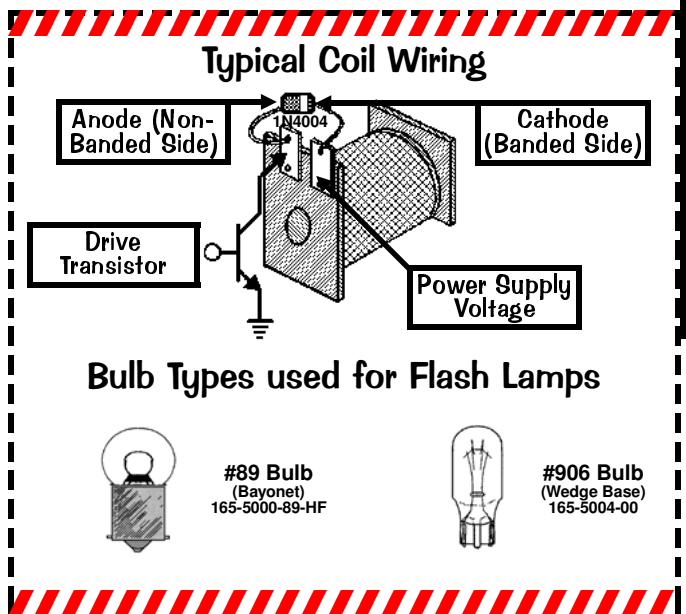
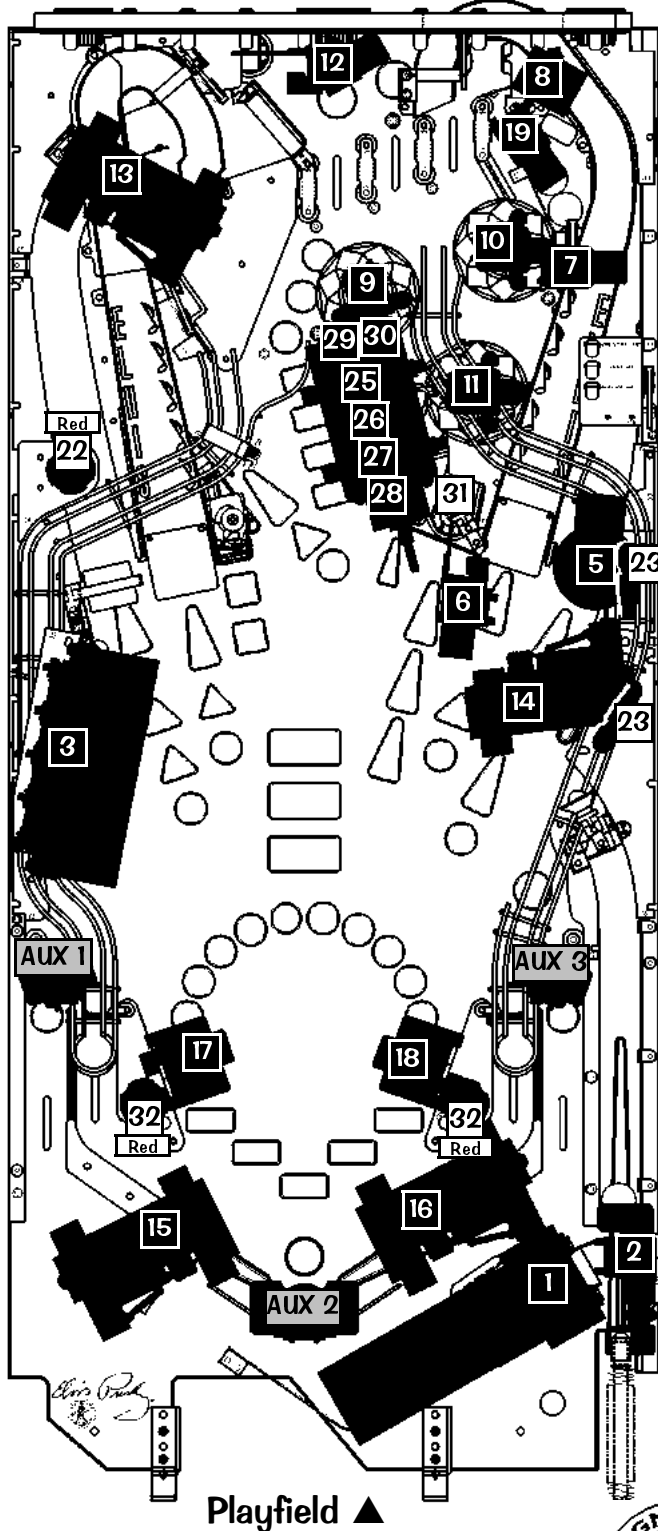

Sec. 3: ... Diagnostics

- = Coils / Flash Lamps above Playfield.
- = Coils / Flash Lamps below Playfield.
- = Coils / Flash Lamps not on Playfield.
- Color** = Color of Mini-Mars of Flash Lamp Bulb.

Some Coil or Flash Lamp Diodes may be located under the playfield, in the Cabinet or Backbox on Terminal Strips or Diode Boards and not on the assemblies.  
 DOTS: Diode Qn Terminal Strip See Section 5, Chapter 2, Playfield Wiring.

Coil Q24 is Optional. If either a Coin Meter, Token Dispenser or Knocker (all optional equipment) is required, call Technical Support for more information, 1-800-542-5377 or 1-708-345-7700.

Go To  
Diagnostics Menu





In COIL MENU  
also select:

CYCLING  
COIL  
TEST

## COILS DETAILED CHART TABLE

High Current Coils Group 1		Drive Transistor	Driver Output Board	Power Line Color	Power Line Connection	Power Voltage	Drive Transistor Control Line Color	D.T. Control Line Connect	Coil GA-Turn or Bulb Type
#1	TROUGH UP-KICKER	Q1	▲ I/O Power Driver ▼	YEL-VIO	J10-P4/5	50v DC	BRN-BLK	J8-P1	26-1200 ♂ 090-5044-00B
#2	AUTO LAUNCH	Q2		YEL-VIO	J10-P4/5	50v DC	BRN-RED	J8-P3	23-800 ♂ 090-5001-00B
#3	ELVIS 5-BANK RESET	Q3		YEL-VIO	J10-P4/5	50v DC	BRN-ORG	J8-P4	24-940 ♂ 090-5036-00B
#4	(OPT) SHAKER MOTOR	Q4		RED-WHT	J17-P7	16v AC 12v DC	BRN-YEL	J8-P5	Motor Only 041-5029-01
#5	MAGNET	Q5		VIO-YEL	J10-P3	50v DC	BRN-GRN	J8-P6	22-650 ♂ 090-5042-00
#6	CENTER EJECT	Q6		YEL-VIO	J10-P4/5	50v DC	BRN-BLU	J8-P7	24-940 ♂ 090-5036-00B
#7	HOTEL LOCK RELEASE	Q7		YEL-VIO	J10-P4/5	50v DC	BRN-VIO	J8-P8	23-800 ♂ 090-5001-00B
#8	CONTROL GATE	Q8		YEL-VIO	J10-P4/5	50v DC	BRN-GRY	J8-P9	32-1800 ♂ 090-5031-00B

High Current Coils Group 2		Drive Transistor	Driver Output Board	Power Line Color	Power Line Connection	Power Voltage	Drive Transistor Control Line Color	D.T. Control Line Connect	Coil GA-Turn or Bulb Type
#9	LEFT BUMPER	Q9	▲ I/O Power Driver ▼	YEL-VIO	J10-P4/5	50v DC	BLU-BRN	J9-P1	26-1200 ♂ 090-5044-00T
#10	RIGHT BUMPER	Q10		YEL-VIO	J10-P4/5	50v DC	BLU-RED	J9-P2	26-1200 ♂ 090-5044-00T
#11	BOTTOM BUMPER	Q11		YEL-VIO	J10-P4/5	50v DC	BLU-ORG	J9-P4	26-1200 ♂ 090-5044-00T
#12	TOP EJECT	Q12		YEL-VIO	J10-P4/5	50v DC	BLU-YEL	J9-P5	24-940 ♂ 090-5036-00B
#13	UPPER LEFT FLIPPER	Q13		GRY-YEL-3A Fuse-RED-YEL	J10-P1/2	50v DC	BLU-GRN	J9-P6	23-900 ♂ 090-5020-30
#14	UPPER RIGHT FLIPPER	Q14		BLU-YEL-3A Fuse-RED-YEL	J10-P1/2	50v DC	BLU-BLK	J9-P7	23-900 ♂ 090-5020-30
#15	LEFT FLIPPER (50v RED/YEL)	Q15		GRY-YEL-3A Fuse-RED-YEL	J10-P1/2	50v DC	ORG-GRY	J9-P8	22-900 ♂ 090-5020-20T
#16	RIGHT FLIPPER (50v RED/YEL)	Q16		BLU-YEL-3A Fuse-RED-YEL	J10-P1/2	50v DC	ORG-VIO	J9-P9	22-900 ♂ 090-5020-20T

Low Current Coils Group 1		Drive Transistor	Driver Output Board	Power Line Color	Power Line Connection	Power Voltage	Drive Transistor Control Line Color	D.T. Control Line Connect	Coil GA-Turn or Bulb Type
#17	LEFT SLINGSHOT	Q17	▲ I/O Power Driver ▼	BROWN	J7-P1	20v DC	VIO-BRN	J7-P2	23-800 ♂ 090-5001-00T
#18	RIGHT SLINGSHOT	Q18		BROWN	J7-P1	20v DC	VIO-RED	J7-P3	23-800 ♂ 090-5001-00T
#19	HOTEL DOOR	Q19		BROWN	J7-P1	20v DC	VIO-ORG	J7-P4	27-1500 ♂ 090-5004-00B
#20	FLASH: BACK PANEL X2	Q20		ORANGE	J6-P10	20v DC	VIO-YEL	J7-P6	#89 Bulb 165-5000-89-HF
#21	FLASH: BACKPANEL TCB	Q21		ORANGE	J6-P10	20v DC	VIO-GRN	J7-P7	#89 Bulb 165-5000-89-HF
#22	FLASH: SPINNER	Q22		ORANGE	J6-P10	20v DC	VIO-BLU	J7-P8	#906 Bulb 165-5004-00
#23	FLASH: UPR RT FLIPPER X2	Q23		ORANGE	J6-P10	20v DC	VIO-BLK	J7-P9	#906 Bulb 165-5004-00
#24	OPTIONAL COIL	Q24		RED	J16-P7	5v DC	VIO-GRY	J7-P10	Opt. 5v

D i o d e O n T e r m i n a l S t r i p ( i f n o t e d )

Low Current Coils Group 2		Drive Transistor	Driver Output Board	Power Line Color	Power Line Connection	Power Voltage	Drive Transistor Control Line Color	D.T. Control Line Connect	Coil GA-Turn or Bulb Type
#25	STEPPER #1	Q25	▲ I/O Power Driver ▼	GRY-RED	J16-P3	12v DC	RED	J6-P1	Stepper Motor Only 041-5069-00
#26	STEPPER #2	Q26		GRY-RED	J16-P3	12v DC	GREEN	J6-P2	
#27	STEPPER #3	Q27		GRY-RED	J16-P3	12v DC	BLACK	J6-P3	
#28	STEPPER #4	Q28		GRY-RED	J16-P3	12v DC	BLUE	J6-P4	
#29	ELVIS LEGS	Q29		RED-WHT TO BROWN	J7-P1	20v DC	RED-WHT TO BLK-GRN	J6-P5	29-1400 ♂ 090-5072-03
#30	ELVIS ARMS	Q30		RED-WHT TO BROWN	J7-P1	20v DC	RED-WHT TO BLK-BLU	J6-P6	29-1400 ♂ 090-5072-03
#31	FLASH: ELVIS SPOT LIGHT	Q31		ORANGE	J6-P10	20v DC	BLK-VIO	J6-P7	#906 Bulb 165-5004-00
#32	FLASH: SLINGS X2	Q32		ORANGE	J6-P10	20v DC	BLK-GRY	J6-P8	#906 Bulb 165-5004-00

Note: In Test Flash Lamps Menu ("Flash" Icon), Flashers tested are all Flash Lamps located between Q1-Q32 (This Game: Q20-Q23, Q31-Q32)

Auxiliary (UK ONLY)		Drive Transistor	Driver Output Board	Power Line Color	Power Line Connection	Power Voltage	Drive Transistor Control Line Color	D.T. Control Line Connect	Coil GA-Turn
AUX 1: LEFT UP/DOWN POST		Q1	UK 3X Trans. Driver Board	BROWN	J7-P1	20v DC	WHITE	J2-P3	26-1200 ♂ 090-5044-00T
AUX 2: CENTER UP/DOWN POST		Q2		BROWN	J7-P1	20v DC	RED	J2-P4	23-1100 ♂ 090-5030-00T
AUX 3: RIGHT UP/DOWN POST		Q3		BROWN	J7-P1	20v DC	ORANGE	J2-P7	26-1200 ♂ 090-5044-00T

♂ Coil Note: ♂ Either -00B or -00T can be used for coil replacements. B/T listed is preferable for easier diode access & may differ on game.

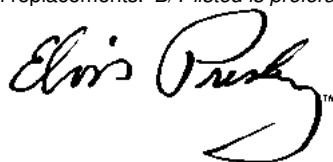

# Backbox I/O Power Driver Board Detailed Wiring Diagram

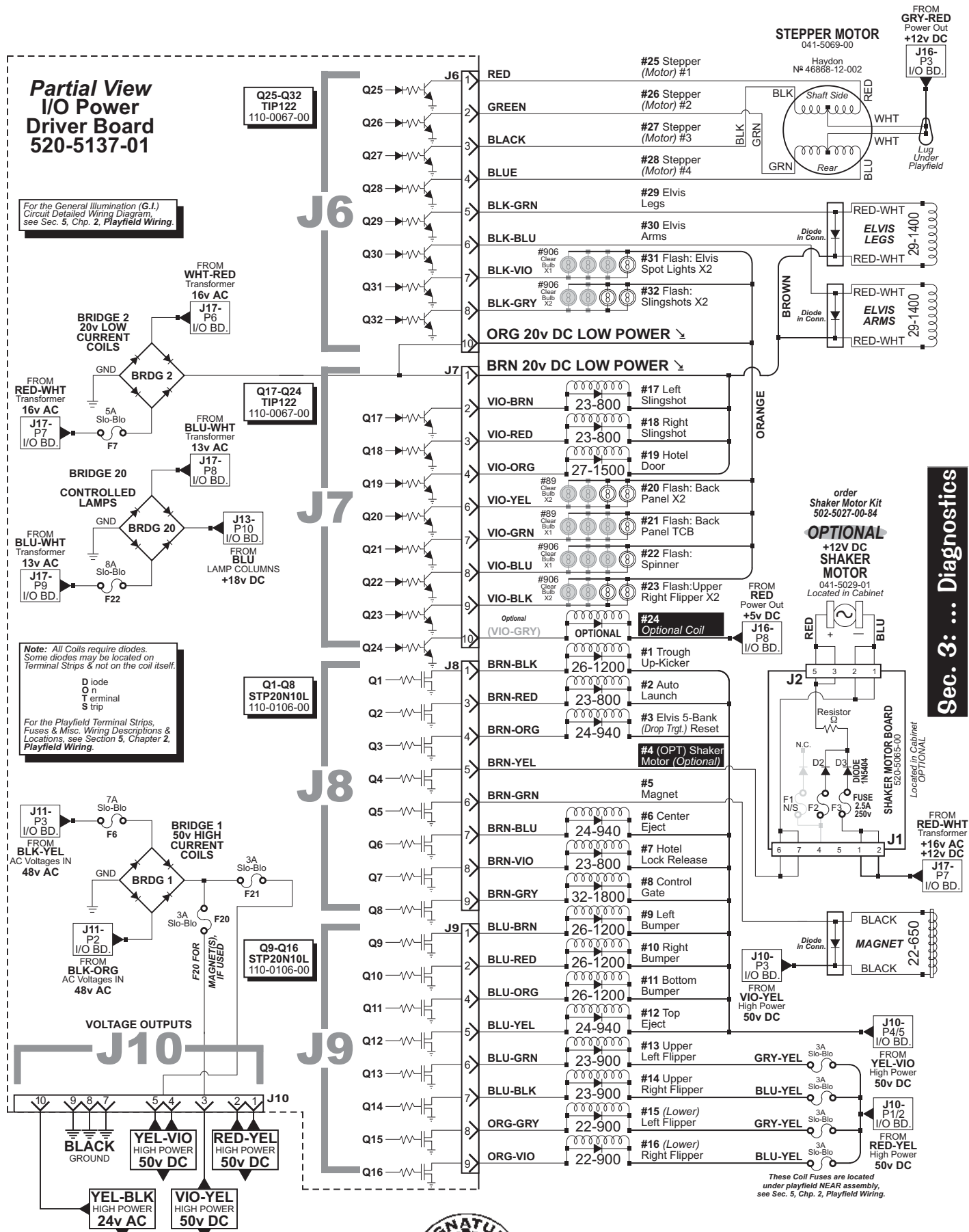

Sec. 3: ... Diagnostics

Go To  
Diagnostics Menu





# Go To Lamp Menu

To initiate, from the **DIAGNOSTICS MENU**, select the "LAMP" *Icon* with either the **Red "LEFT"** or **Green "RIGHT" Buttons** and press the **Black "ENTER" Button**. Controlled lamps are configured in an 8 x 10 Matrix of Columns (Lamp Drives) and Rows (Lamp Returns) with up to **80** lamps possible. The Lamp Test Menu consists of four (4) parts: **Single Lamp Test**, **Test All Lamps**, **Row Lamp Test** & **Column Lamp Test**.



## Single Lamp Test

To initiate, from the **LAMP MENU**, select the "ONE" *Icon* with either the **Red or Green Buttons** and press the **Black Button**. Select either the "-" or "+" *Mini-Icons*. Start with the "+" *Mini-Icon* to start the manual **Single Lamp Test** from Column 1, Row 1, Lamp 1. Press the **Black Button** on the "+" *Mini-Icon*, as each lamp is selected, the lamp will light at its location on the playfield as well as the display, indicating the Lamp Matrix Grid Position (*below*), lamp name with the corresponding number, Return (Row) Wire & Color, Drive (Column) Wire & Color, and associated drive transistors. Press the **Black Button** again to move forward in the test. To test and view a particular lamp, select the "RUN" *Mini-Icon* and press the **Black Button**. Each time the **Black Button** is pushed, the lamp will light-up on the playfield, with the display indicating the lamp information. *Continue with the same procedure to run through the entire test.*



## Test All Lamps

To initiate, from the **LAMP MENU**, select the "ALL" *Icon* with either the **Red or Green Buttons** and press the **Black Button**. If still in **Single Lamp Test** (*or any 1 of the 4 tests*), select the "PREV" *Mini-Icon* to return to **LAMP MENU** or select either of the "<<" or ">>" *Mini-Icons* to move through the tests, keep activating until **Test All Lamps** is displayed. The display will indicate **ALL LAMPS ON** and the lamps on the playfield will be lit, alternating between the rows in the Lamp Matrix Grid.



## Row & Column Lamp Tests

To initiate, from the **LAMP MENU**, select the "ROW" or "COL" *Icon* with either the **Red or Green Buttons** and press the **Black Button**. If still in a previous test, select the "PREV" *Mini-Icon* to return to **LAMP MENU** or select either of the "<<" or ">>" *Mini-Icons* to move through the tests, keep activating until **Row** or **Column Lamp Test** (*whichever desired*) is displayed. In this test, each set of lamps in each Row or Column of the Lamp Matrix Grid (*respective to each test*) will light-up on the playfield and is indicated in the display.

Sec. 3: ... Diagnostics

### LAMP MATRIX GRID

Column (18v)	1: U17	2: U16	3: U15	4: U14	5: U13	6: U12	7: U11	8: U10
Row (Ground)	YEL-BRN J13-P9	YEL-RED J13-P8	YEL-ORG J13-P7	YEL-BLK J13-P6	YEL-GRN J13-P5	YEL-BLU J13-P4	YEL-VIO J13-P3	YEL-GRY J13-P1
1: Q33	1 #555 Clear Bulb RED-BRN J12-P1 ROCK AGAIN	2 #555 Clear Bulb LEFT OUTLANE	3 #555 Clear Bulb LEFT RETURN LANE	4 #555 Clear Bulb RIGHT RETURN LANE	5 #555 Clear Bulb RIGHT OUTLANE	6 #555 Clear Bulb SPOT NOTE	7 #555 Clear Bulb SCARF	8 #555 Clear Bulb (T)CB
2: Q34	9 #555 Clear Bulb RED-BLK J12-P2 HOUND DOG	10 #555 Clear Bulb BLUE SUEDE SHOES	11 #555 Clear Bulb HEARTBREAK HOTEL	12 #555 Clear Bulb JAILHOUSE ROCK	13 #555 Clear Bulb ALL SHOOK UP	14 #555 Clear Bulb HITS COMPLETED	15 #555 Clear Bulb ELVIS COLLECTED	16 #555 Clear Bulb TOP 10 COMPLETED
3: Q35	17 #555 Clear Bulb RED-ORG J12-P3 10	18 #555 Clear Bulb 9	19 #555 Clear Bulb 8	20 #555 Clear Bulb 7	21 #555 Clear Bulb 6	22 #555 Clear Bulb LEFT RAMP ARROW	23 #555 Clear Bulb SHOOK	24 #555 Clear Bulb LEFT RAMP NOTE
4: Q36	25 #555 Clear Bulb RED-YEL J12-P4 5	26 #555 Clear Bulb 4	27 #555 Clear Bulb 3	28 #555 Clear Bulb 2	29 #555 Clear Bulb 1	30 #555 Clear Bulb RIGHT RAMP ARROW	31 #555 Clear Bulb UP	32 #555 Clear Bulb RIGHT RAMP NOTE
5: Q37	33 #44 Clear Bulb RED-GRN J12-P5 (E)LVIS	34 #44 Clear Bulb E(L)VIS	35 #44 Clear Bulb EL(V)IS	36 #44 Clear Bulb ELV(I)S	37 #44 Clear Bulb ELVI(S)	38 #44 Clear Bulb RIGHT ORBIT ARROW	39 #555 Clear Bulb GIFT FROM ELVIS	40 #555 Clear Bulb RIGHT ORBIT NOTE
6: Q38	41 #555 Clear Bulb RED-BLU J12-P6 LEFT ORBIT ARROW	42 #555 Clear Bulb L. ORBIT BLUE SUEDE SHOES	43 #555 Clear Bulb ALL	44 #555 Clear Bulb LEFT ORBIT NOTE	45 #44 Clear Bulb (K)ING	46 #44 Clear Bulb K(I)NG	47 #44 Clear Bulb KI(N)G	48 #44 Clear Bulb KIN(G)
7: Q39	49 #555 Clear Bulb RED-VIO J12-P8 HOUND	50 #555 Clear Bulb DOG	51 #555 Clear Bulb CENTER LOOP ARROW	52 #555 Clear Bulb C. LOOP BLUE SUEDE SHOES	53 #555 Clear Bulb CENTER LOOP NOTE	54 #555 Clear Bulb LOCK	55 #555 Clear Bulb JACKPOT	56 #555 Clear Bulb SUPER JACKPOT
8: Q40	57 #555 Clear Bulb RED-GRY J12-P9 LEFT TOP LANE	58 #555 Clear Bulb MIDDLE TOP LANE	59 #555 Clear Bulb RIGHT TOP LANE	60 #44 Clear Bulb HEART	61 #44 Clear Bulb BREAK	62 #44 Clear Bulb HOTEL	63 #555 Clear Bulb T(C)B	64 #555 Clear Bulb TC(B)
9: Q41	65 #44 Yellow Bulb RED-WHT J12-P10 VIDEO MODE	66 #44 Yellow Bulb GOLD RECORD	67 #44 Yellow Bulb KING OF ROCK N ROLL	68 #44 Yellow Bulb LITE EXTRA BALL	69 #44 Yellow Bulb ENCORE LETTER	70 #44 Blue Bulb GRACELAND	71 #44 Red Bulb SPECIAL	72 #44 Orange Bulb EXTRA BALL
10: Q42	73 #44 Clear Bulb RED J12-P11 (E)NCORE	74 #44 Clear Bulb E(N)CORE	75 #44 Clear Bulb EN(C)ORE	76 #44 Clear Bulb ENC(O)RE	77 #44 Clear Bulb ENCO(R)E	78 #44 Clear Bulb ENCOR(E)	79 #555 Clear Bulb TOURNAMENT BUTTON	80 #555 Clear Bulb START BUTTON



# LAMP MATRIX GRID LOCATIONS

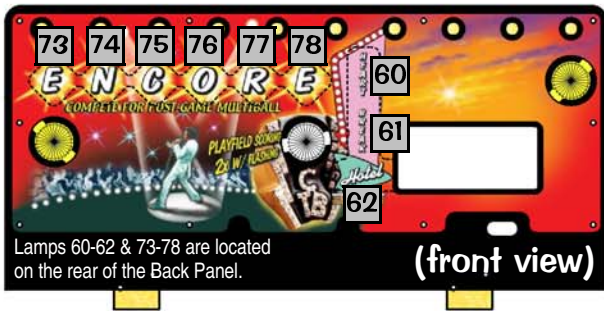

◀ Backpanel

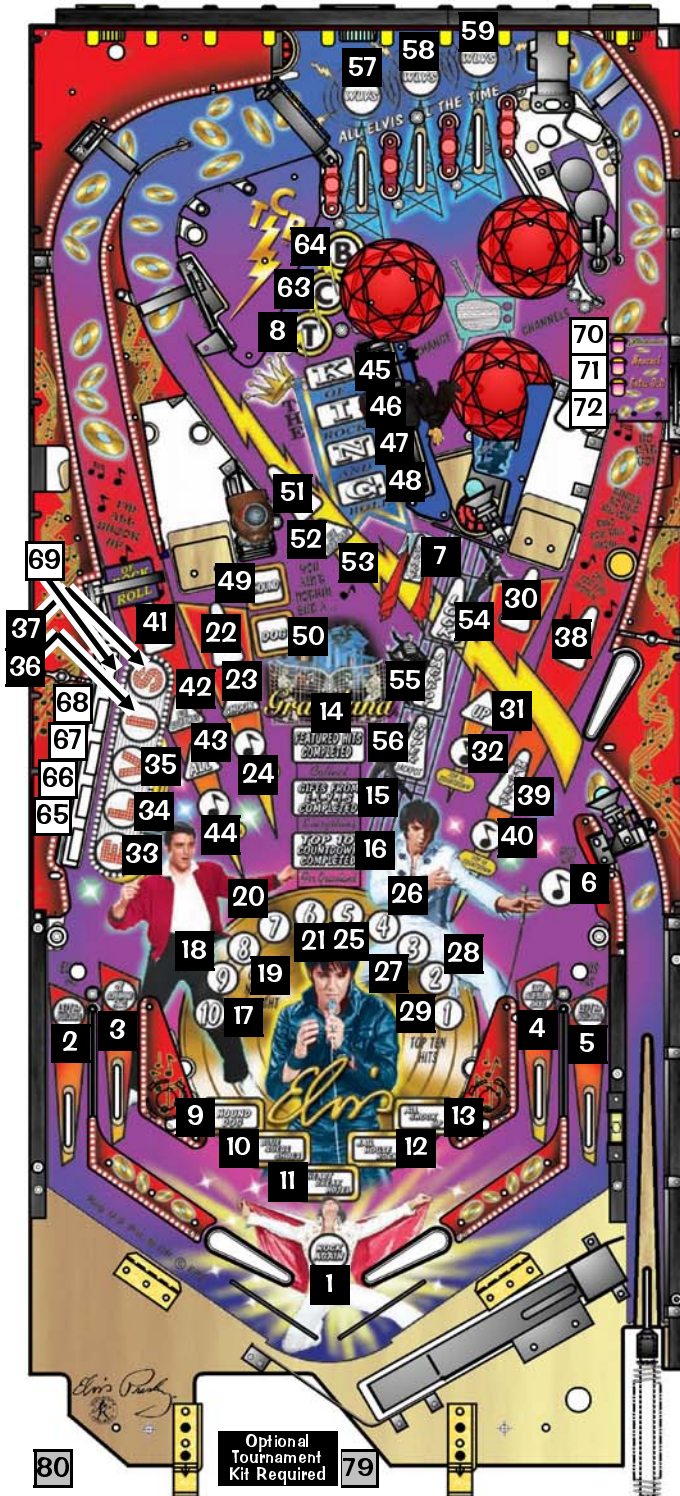

Playfield ▲

### Typical Lamp Wiring & Schematic

### Bulb Types used for Lamps

#555 Bulb (Wedge) 165-5002-00

Red Amber or Orange Clear Blue Yellow

#44 Multicolor Bulbs ▲ (Bayonet)  
165-5000-44-HF: (Clear), 165-5053-XX: (-02 Red, -07 Amber / Orange, -05 Blue, -06 Yellow)

Sec. 3: ... Diagnostics

- = Lamps above Playfield.
- = Lamps below Playfield.
- = Lamps not on Playfield.

**Lamp Part Notes:** #555 Bulb Clear = 165-5002-00.  
 #44 Bulb (Hvy. Fil.) Clear = 165-5000-44-HF. #44 Bulb Red = 165-5053-02.  
 #44 Bulb Blue = 165-5053-05. #44 Bulb Yellow = 165-5053-06.  
 #44 Bulb Orange = 165-5053-07 (can sub. with Amber -03).  
 See Section 4, Chapter 1, **Parts Identification & Location**, Pages 72-74 for more details on bulbs and corresponding sockets.  
**Some Lamp Diodes may be located under the playfield, in the Cabinet or Backbox on Terminal Strips and not on or with the Lamp Socket.**  
 DOTS: Diode On Terminal Strip, see Sec. 5, Chapter 2, **Playfield Wiring**.

Go To  
Diagnostics Menu





## Test Flash Lamps

To initiate, from the **DIAGNOSTICS MENU**, select the "FLASH" *Icon* with either the **Red "LEFT"** or **Green "RIGHT" Buttons** and press the **Black "ENTER" Button**. After selecting this *Icon* the display will indicate **CYCLING FLASHERS**. The Flash Lamps will cycle continuously until the test is exited. This test allows the technician to easily spot any burned-out bulbs and replace them. Flashers tested are Flash Lamps in Positions: **Q1-Q32** and in this game Flash Lamp(s) are : **Q20-Q23 & Q31-Q32**.



**PULL OUT** the Power Interlock Switch for operation with the Coin Door open.



## Clear Ball Trough

To initiate, from the **DIAGNOSTICS MENU**, select the "CLR" *Icon* with either the **Red "LEFT"** or **Green "RIGHT" Buttons** and press the **Black "ENTER" Button**. This Menu is provided to allow the technician a simple method of removing the balls from the trough and also, to test functionality of the trough, ensuring proper trough operation. After selecting this *Icon* the display will show a graphic of the ball trough with balls in the trough with it's corresponding switch number. Select the "RUN" *Mini-Icon* to eject the ball in the first position. Simultaneously, the display and the playfield will eject the ball to the Trough Up-Kicker, eject from the Trough Up-Kicker into the Shooter Lane and will be ejected onto the playfield where the technician can easily retrieve the pinball or allow the ball(s) to re-enter the trough to continue **Clear Ball Trough Test**.



**PULL OUT** the Power Interlock Switch for operation with the Coin Door open.

**CAUTION:** Continuous use of above test may overheat the Trough Up-Kicker Coil. **▲**



## Technician Alerts

To initiate, from the **DIAGNOSTICS MENU**, select the "TECH" *Icon* with either the **Red "LEFT"** or **Green "RIGHT" Buttons** and press the **Black "ENTER" Button**. This Menu is provided to show any switch problems and/or missing pinballs.

Sec. 3: ... Diagnostics

After selecting this *Icon*, and if any of the below criteria is met, the display will indicate *any or all* of the following categories: **POSSIBLY BROKEN SWITCH**, **CHECK SWITCHES** and/or **HYPERSENSITIVE SWITCH** (*Sw. #16, Shooter Lane, is used as an example*). If more than one switch is reported, the Switch Number and Name will cycle within the category, and then will cycle the categories. To return to the **DIAGNOSTICS MENU**, select the "PREV" *Mini-Icon* and press the **Black "ENTER" Button**.

### Switch Detection

During game play, activation of switches are monitored. In programming, every switch is given a minimum & maximum value based on the game. The switches are monitored every 5 minutes of game play with a "sliding window" of 15 minutes. If a switch is determined to be faulty, game play is compensated.

- Switches noted as **POSSIBLY BROKEN SWITCH** should be checked, then adjusted or replaced. **Important:** A switch reported as "possibly broken" may actually be an unused switch due to **lack of usage** and **not because they're broken**. This can happen, if a switch is located in a "hard" shot position, and the players are not making the shot. Game programming will still compensate for this unplayed switch.
- Switches noted as **CHECK SWITCHES** are determined to be stuck closed or open depending on switch usage. Free up the switch actuator adjust or replace if necessary.
- Switches noted as **HYPERSENSITIVE SWITCH** means just that, the switch should be readjusted or replace if necessary.



Determination of switch usage can be checked in **Audits** (review Section 3, Chapter 3, **GO TO AUDITS MENU**). Find the associated Audit with the switch in question and check usage; compare it to commonly used switches for comparison. After any switch is checked and repaired or replaced, it's suggested to test the switch in the **PLAY TEST MENU** (see the **next page**) or **Single Coil Test** (reviewed earlier in this chapter, **Page 18**) where the associated coil to the switch can be tested as well. After correcting the problem, the switch will still be reported until the game is played and the switch is again monitored as specified above. *Only you can determine if a switch getting reported is bad or if the switch is currently not getting actuated during game play.*

**Technicians Alerts continued on the next page.**

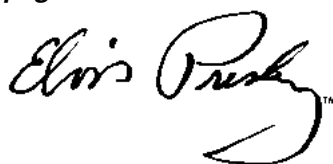





### Pinball Detection



While in **Technician Alerts** Menu, if the following is displayed, the game has detected one (1) or more pinball(s) missing and has compensated for the lost pinball(s) to provide normal game play.

**Important:** Determine where the pinball is! **Do not add pinball(s)** until it is determined the pinball(s) are indeed missing & not just stuck. If pinball(s) are added, & if the original stuck pinball has freed itself, the pinball game will not operate properly with the extra pinball(s). When the pinball is recovered, the above display **will not** appear the next time **Technician Alerts** is visited (a game must be played for the pinball to be determined as found).

During game play, a ball can get trapped or stuck. If after approximately 15 seconds of inactivity or "no scoring," **Ball Search** is started. **Note:** If the pinball is in the *Plunger Lane* or "held" on the flipper, no **Ball Search** will be performed. The game will perform one **Ball Search** in an attempt to "find" or free-up the pinball.



If the game does not see a switch closure (indicating the pinball has not been found), this display will appear with a count-down timer of 20 seconds, during which **Ball Search** will continue until the timer runs out (this feature will not happen if the game is in *Competition Mode*; **Ball Search** will continue until the pinball is found, unstuck and/or replaced manually). The display will momentarily acknowledge the missing pinball(s). The game will provide another pinball into play and will compensate for the lost pinball. Game play will appear normal.

**Note:** This detection and compensation will happen with every pinball, if each suffers the same fate of a ball trap. If **all** balls get trapped, the game cannot be played or started until the situation is rectified.

### Tech Report Alert Option

This game has the capability of **automatically alerting** the operator upon **Power-Up** and/or opening the **Coin Door** if any switch problems and/or missing pinballs has occurred. Review *Section 3, Chapter 4, GO TO ADJUSTMENTS MENU, Standard Adjustments*. The Standard Adjustment to change is **49**. The default for this feature is **NEVER**. The options are: **POWERUP**, **COIN DOOR** or **POWERUP AND COIN DOOR**.



Upon **Power-Up** (Game Reset) and/or opening the **Coin Door** (depending on the option selected), this **display** will flash three (3) times along with an audible sound. To find out the problem, enter this **Technicians Alert Menu** and wait for the displays.

**Note:** Coils **are not reported** in **Technician Alerts**, **h o w e v e r**, if a faulty switch is the culprit, the switch will then be reported. The below **display** is shown momentarily during **Game Mode** or **Power-Up** to alert the operator



of a coil malfunction (coil doesn't energize or coil fires a multiple number of times). "**OPERATOR ALERT!**" works by monitoring any switch activated coil that has the potential to trap a ball when disabled (e.g. in the *Auto Launch, Scoop, Eject, etc.*). This alert can also appear if a switch associated with a coil (example shown is #2 Auto Launch) is stuck closed (caused by a switch jam or stuck ball); the **CPU/Sound Board** will activate the coil approximately ten times and if the switch remains closed, the game will report this switch in **Technician Alerts** as **CHECK SWITCHES**. The display alert "**PLEASE CHECK TECH REPORT**" will be shown (o n l y i f **POWERUP, COIN DOOR** or **POWERUP AND COIN DOOR** is selected in Standard Adjustment **49**).

Sec. 3: ... Diagnostics



### Service Phone #

To initiate, from the **DIAGNOSTICS MENU**, select the "SERV" Icon with either the **Red "LEFT"** or **Green "RIGHT"** Buttons and press the **Black "ENTER"** Button. After selecting this Icon the display will indicate a phone number to call if technical assistance is required (In USA Code: 1-800-KICKERS).



### Begin Play Test

To initiate, from the **DIAGNOSTICS MENU**, select the "PLAY" Icon with either the **Red "LEFT"** or **Green "RIGHT"** Buttons and press the **Black "ENTER"** Button. After selecting this Icon the technician can test certain play functions to insure all switch activated coils function without entering game play. For example, by rolling the ball over the Shooter Lane switch, the Autoplunger should fire. If it kicks to early or too late, the switch actuator should be adjusted to compensate for this error. If it fails to fire, use the **Switch Test** or **Coil Test** to help determine the cause of the failure. During this Play Test, check all coil assemblies with related switches in the game. For unique Game Test(s), select the "**ELVIS**" Icon in the **DIAGNOSTICS MENU**, reviewed on Pages **27-28**.



**PULL OUT** the Power Interlock Switch for operation with the Coin Door open.





## Fire Knocker

To initiate, from the **DIAGNOSTICS MENU**, select the "KNOCKER" *Icon* with either the **Red "LEFT"** or **Green "RIGHT" Buttons** and press the **Black "ENTER" Button**. The digitally mastered "Knocker" is sounded.



## Sound / Speaker Test

To initiate, from the **DIAGNOSTICS MENU**, select the "SPKR" *Icon* with either the **Red "LEFT"** or **Green "RIGHT" Buttons** and press the **Black "ENTER" Button**. The BSMT 2000 Sound System produces true digital stereo sound from Backbox & Cabinet Speakers or "Mono" on the Cabinet Speaker (when used by itself). After selecting this *Icon*, select the "-" or "+" *Mini-Icons* and press the **Black "ENTER" Button** to *activate* the first test. Repeat to visually see & hear all tests. Select the "RUN" *Mini-Icon* to *activate* the test chosen without moving to the next test.

**Note:** During Sound Tests, the display shows the speaker identification and the corresponding sound(s). The sound functions allow verification that both channels are functioning properly & that the speaker connections are correct.

### Speaker Phase Testing

Connections to each of speakers are polarized and each must be connected appropriately for the best quality sound. If one speaker has the positive and negative connections reversed with respect to the other one, bass frequencies will not be produced properly and the overall sound quality will be poor. To test for proper speaker phasing, use the sound test to cycle through the Backbox & Cabinet, and Backbox Sine (repeated) functions. If the Cabinet Sine produces more volume and bass than the Left Sine, the speakers are connected properly. If it produces the same or less, one speaker is connected improperly. To isolate and correct reversed speaker connections, one of two methods may be used.

1. Check each speaker for polarity markings. If the speakers have polarity markings, verify that the Backbox Speaker **RED-WHT** Wire and the Cabinet Speaker **YEL-WHT** Wire is connected to the negative (-) terminal.
2. Disconnect the speaker output connector from the CPU / Sound Board and connect a 1.5-volt battery across each speaker pair one at a time while observing the speakers. Make sure the positive battery terminal is connected to the positive lead (CN4, Pin-3 (**RED-BLK**) or Pin-6 (**YEL-BLK**)) each time. As the connection is made, check speaker cone movement; proper connections are indicated by outward movement.

**Note:** For ROM Usage (Summary Table) & Locations, see Page DR.

① in the "Find-It-In-Front: Dr. Pinball Section". Voice ROMs (U17, U21, U36 and/or U37) which are 8MB must have a Jumper at W6 on the CPU/Sound Board to function properly.

Auto / Manual Tests	Sounds Produced
<b>Speaker Test</b>	<b>Tone</b>
<b>Sound/OPSYS EPROM (Loc. U7)</b>	<b>Level 1-3+ (Music Test)</b>
<b>Voice ROMs: 1 (U17) 2 (U21) 3 (U36) 4 (U37)</b>	<b>Speech Pattern 1-3+</b>



## Begin Burn In

To initiate, from the **DIAGNOSTICS MENU**, select the "BURN" *Icon* with either the **Red "LEFT"** or **Green "RIGHT" Buttons** and press the **Black "ENTER" Button**. After selecting this *Icon* the **Begin Burn-In Test** will start. At this stage the game will exercise all CPU I/O Functions (**Dot Matrix Display Test, Coil Testing, Lamp Testing, Sound...**, etc.). This is provided to constantly exercise sounds, coils, etc... Cumulative Burn-In minutes will be displayed. **Note:** To reset Burn-In minutes to 00 see Section 3, Chapter 6, GO TO RESET MENU, Factory Reset. **Caution:** Performing a Factory Reset will reset all other information as well.



## Dot Matrix Test

To initiate, from the **DIAGNOSTICS MENU**, select the "DOT TEST" *Icon* with either the **Red "LEFT"** or **Green "RIGHT" Buttons** and press the **Black "ENTER" Button**. After selecting this *Icon* the **Dot Matrix Test** immediately begins. **Note:** Pressing any button will exit the test & return to **DIAGNOSTICS MENU**. The display will immediately illuminate & cycle for 1 pass of each test continuously for each of the following:

Test 1



Illuminates 1 vertical column of dots, turning it off & illuminating the next column, until each column has been individually lit, while the other columns are off.

Test 2

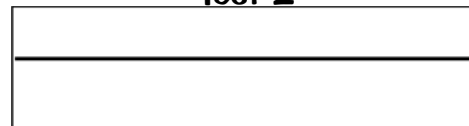

Illuminates 1 horizontal row of dots, turning it off & illuminating the next row, until each row has been individually lit, while the other rows are off.





## Dot Matrix Test Continued

### Test 3



Illuminates all the dots,  
except for one column from left to right.

### Test 4



Illuminates all the dots,  
except for one row from top to bottom.

### Test 5



Illuminates every other dot lit,  
in both the rows and columns.

**Note:** Pressing the Red, Green, Black or Flipper Buttons will exit the test & return to **DIAGNOSTICS MENU**.

## Dot Matrix Display Explained

The display utilizes a **Micro-Processor Control Board** mounted in piggyback fashion to the **Dot Matrix Display (128 X 32) Driver Board**. The purpose behind this board is to provide more information to the operator as well as displaying graphics to the player.

The board is controlled by a **6809E Microprocessor** and its personality ROM (Unique to the Game). It receives Data, Reset & Clock Information from the **CPU/Sound Board** via the ribbon cable and sends back multiple Status and Busy Signals to the **CPU**. This is to insure synchronized communication between the **CPU** and the **Display Controller Board**. The Drivers for the rows and columns are provided on 5 surface mounted integrated circuits on the **Dot Matrix Display Driver Board**.



## ELVIS Test (Stepper Motor Test)

To initiate, from the **DIAGNOSTICS MENU**, select the "ELVIS" *Icon* with either the Red "LEFT" or Green "RIGHT" Buttons and press the Black "ENTER" Button.

COIN DOOR IS OPEN  
PLAYFIELD HIGH POWER  
DISABLED BY  
COIN DOOR INTERLOCK

PULL OUT the Power Interlock Switch  
for operation with the Coin Door open.

This will bring up the **STEPPER MOTOR TEST MENU**. Upon entering the test, the display will indicate the status of the **Switch** (the "RUN" *Mini-Icon* will be flashing). *If the BOX is solid, Switch 33 is "Closed" (Elvis should be in the Home Position or closest to the Upper Playfield).*

This Sub-Menu is used to test the operation of the **Stepper Motor (Q25-Q28)**, **Elvis Legs (Q29)**, **Elvis Arms (Q30)** and the **Elvis Home Switch (Switch 33)**. After finishing the Test, select the "PREV" *Mini-Icon* to return to the previous Menu.

Select the "ARMS" *Mini-Icon* to energize the Arms Coil (Q30); select the "LEGS" *Mini-Icon* to energize the Legs Coil (Q29); select the "PULSE" *Mini-Icon* to pulse the Stepper Motor; select the "RUN" *Mini-Icon* to continuously run the Stepper Motor 1 full cycle (back-to-front or front-to-back). **Note:** Upon Power-Up (quitting or exiting the **Portals™ Service Menu** initiates the "Power-Up Mode") the mechanism will return to its **HOME** Position.

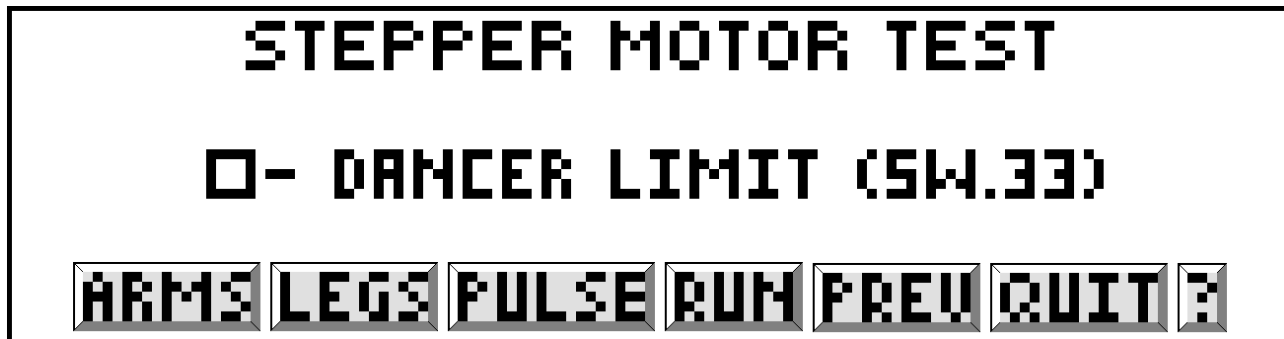

(this page is blank)

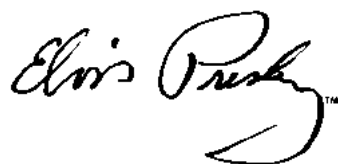



## Go To Fuse Table

To initiate, from the **DIAGNOSTICS MENU**, select the "FUSES" *Icon* with either the Red "LEFT" or Green "RIGHT" Buttons and press the Black "ENTER" Button. The **FUSE TABLE MENU** now appears. This provides the technician with the current **Fuse Table** for this game (also noted on a decal in the Backbox). The fuses are located in the Backbox (on the **Display Power Supply Board** and the **I/O Power Driver Board**), and also in the Cabinet (under the playfield by the **Flippers** and/or by any unique assembly requiring an additional fuse, such as magnets). For the complete **Fuse List** in the **Quick Reference Fuse Chart & Pictorials**, see the next page or Page DR. 1 (front of this manual).

### Example:

After entering **Portals™**, the **MAIN MENU** now appears with the "DIAG" *Icon* (GO TO DIAGNOSTICS MENU) flashing:

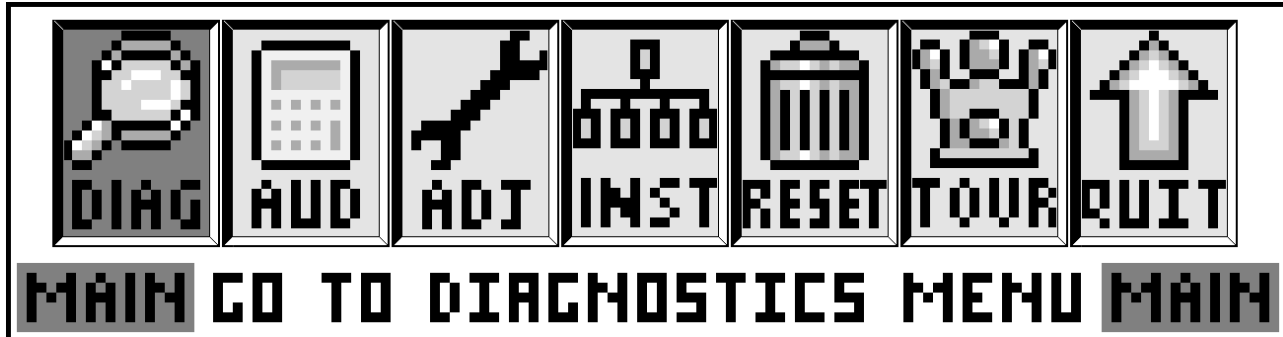

Press the Black "ENTER" Button to *activate* this **ICON**. The **DIAGNOSTICS MENU** now appears with the "SW" *Icon* (GO TO SWITCH MENU) flashing; use the Red "LEFT" or Green "RIGHT" Buttons, until the "FUSES" *Icon* (GO TO FUSE TABLE) is flashing:

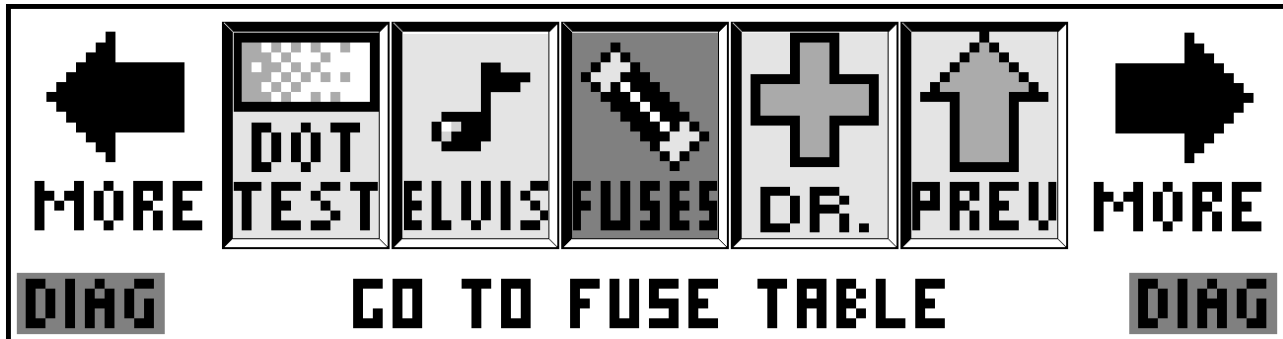

Press the Black Button to *activate* this **ICON**. The **FUSE TABLE** now appears.

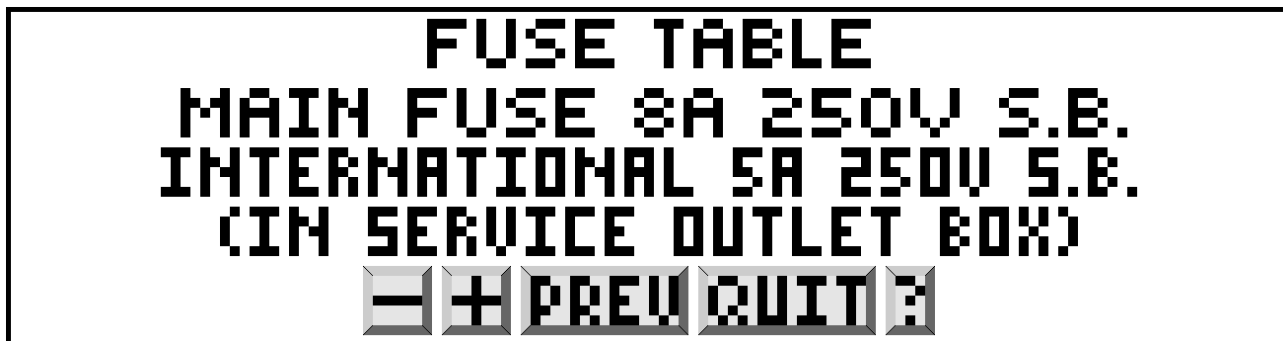

Select and *activate* the "+" *Mini-Icon* to view the next fuse in the group. Continue to select either the "+" or "-" *Mini-Icons* to view each fuse one at a time. The display will describe the fuse identification number (e.g. Main, F1, F6, F7, etc.), rating of fuse (e.g. 5A 250v S.B. - i.e. 5 Amp, 250 volt, Slo-Blo), location of fuse (i.e. Backbox: Board Name located on; or Cabinet: Under the playfield or in Service Outlet), and 'use of fuse' (e.g. 90v DC High Voltage Power, etc.). The current fuse listed will remain in the display until the next fuse is chosen or when the Sub-Menu is exited by selecting & *activating* the "PREV" or "QUIT" *Mini-Icons*.

*Go To Fuse Table continued on the next page.*



# Backbox PCB Fuses, ROMs, Bridges, Relays, P/F & Cabinet Fuses, Cab. Switches

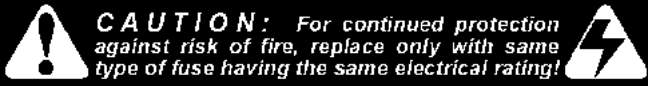

## QUICK REFERENCE FUSE CHART

### Backbox Fuses

LOC: DISPLAY POWER SUPPLY (P.S.) BOARD			
F1	¼A250v S.B.	90v DC	High Voltage Display
LOC: I / O POWER DRIVER BOARD			
F6	7A 250v S.B.	50v DC	Primary High Power Coils/Flippers
F7	5A 250v S.B.	20v DC	Low Power Coils
F8	5A 250v S.B.	12v DC	Logic Power
F9	5A 250v S.B.	12v DC	Logic Power
F20	4A 250v S.B.	50v DC	Magnets
F21	3A 250v S.B.	50v DC	Coils
F22	8A 250v S.B.	18v DC	Controlled Lamps
F23	4A 250v S.B.	5v DC	Logic
F24	5A 250v S.B.	6.3v AC	G.I. Lamps (BRN-WHT↔WHT-BRN)
F25	5A 250v S.B.	6.3v AC	G.I. Lamps (YEL↔WHT-YEL)
F26	5A 250v S.B.	6.3v AC	G.I. Lamps (GRN↔WHT-GRN)
F27	5A 250v S.B.	6.3v AC	G.I. Lamps (VIO↔WHT-VIO)
F28	3A 250v S.B.	24v AC	Not Used / Spare

### Cabinet Fuses

LOC: SERVICE (AC) OUTLET BOX (Cabinet Bottom)		
n/a	8A 250v S.B.	115v AC Main Fuse Line (Domestic or USA)
n/a	5A 250v S.B.	220v AC Main Fuse Line (International)

### Playfield (P/F) Fuses

LOC: UNDER PLAYFIELD (near Flippers)			
n/a	3A 250v S.B.	50v DC	Right Flipper (BLU-YEL↔RED-YEL)
n/a	3A 250v S.B.	50v DC	Left Flipper (GRY-YEL↔RED-YEL)
n/a	3A 250v S.B.	50v DC	Upr. Rt. Flipper (BLU-YEL↔RED-YEL)
n/a	3A 250v S.B.	50v DC	Upr. Lt. Flipper (GRY-YEL↔RED-YEL)

For locations & more information on fuses, see Sec. 5, Chapter 2.

Sec. 3: ... Diagnostics

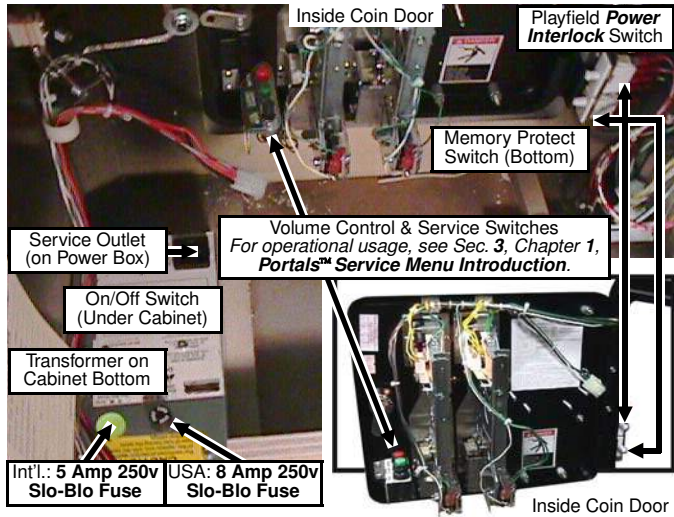
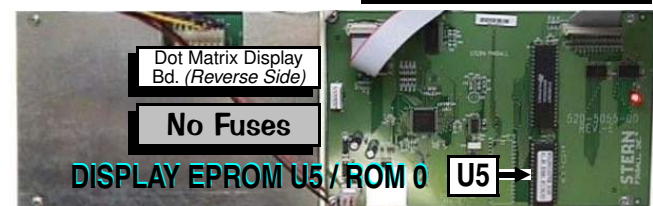
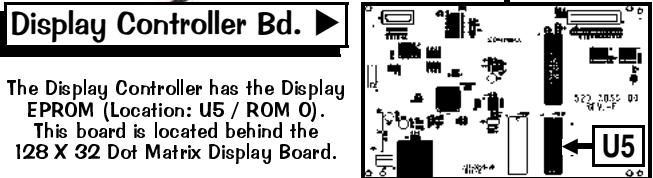
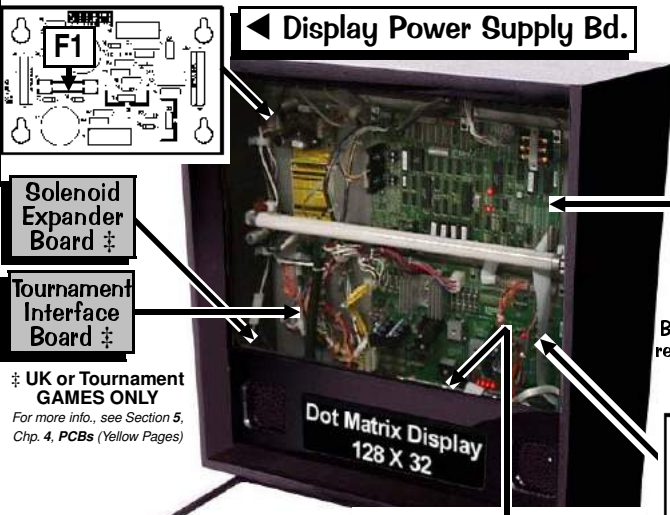

ROM TYPE on BD	LOCATION	SIZE	PART NUMBER
CPU Sound	U7	512K	965-0415-84
CPU Game	U210	1 MB	965-0416-84
CPU Voice ROM 1	U17	8 MB	965-0417-84
CPU Voice ROM 2	U21	8 MB	965-0418-84
CPU Voice ROM 3	U36	8 MB	965-0419-84
CPU Voice ROM 4	U37	8 MB	965-0420-84
DISPLAY Controller	U5	4 MB	965-0421-84

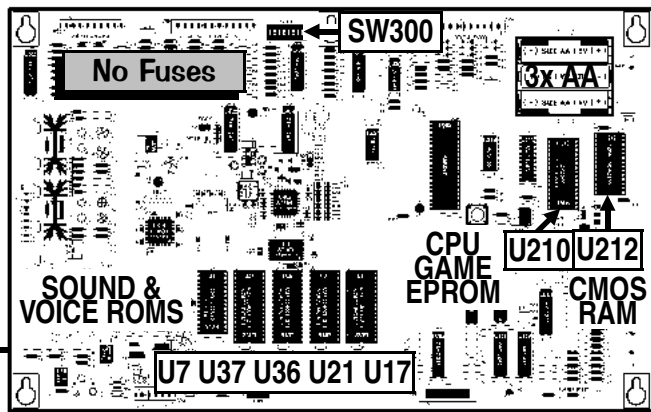

For Schematics and/or Component Parts on PC Boards shown on this page, review Section 5, Chapter 4, Printed Circuit Boards (The Yellow Pages).

### CPU/Sound Bd. II w/ATMEL ▲

### I/O Power Driver Board ▼

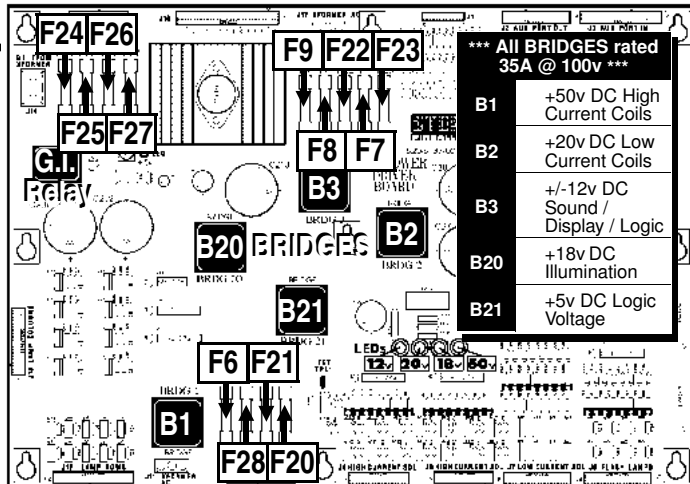

*** All BRIDGES rated 35A @ 100v ***	
B1	+50v DC High Current Coils
B2	+20v DC Low Current Coils
B3	+/- 12v DC Sound / Display / Logic
B20	+18v DC Illumination
B21	+5v DC Logic Voltage





## Dr. Pinball

To initiate, from the **DIAGNOSTICS MENU**, select the Cross "DR." *Icon* with either the **Red "LEFT"** or **Green "RIGHT" Buttons** and press the **Black "ENTER" Button**. This will bring you (the operator / technician) into **DR. PINBALL (Flow Chart Menus)** which offers you a choice of three (3) *Icons*: Coil "DR.", Switch "DR." and Lamp "DR." *Icons*. Selecting a particular *Icon* will give you a choice of which specific Coil (*any and all coil assemblies such as Flippers, VUKs, Magnets, etc.*), Switch or Lamp circuit needs to be diagnosed. *Dr. Pinball* will now display a question or give a procedure to follow such as "Does the lamp turn on?" or "Check bridge rectifier BR-20, if short replace." When *Dr. Pinball* displays a question or requests a procedure, *Dr. Pinball* will expect a response such as "NO" or "YES" (*see below examples of the Mini-Icons* which will prompt the operator). You the operator/technician must respond by using the **Red or Green Buttons** to "SELECT" a *Mini-Icon* and the **Black Button** to "ACTIVATE or ENTER" your selection.



## Coil Flow Chart

To initiate, from the **DR. PINBALL MENU**, select the Coil "DR." *Icon* with either the **Red or Green Buttons** and press the **Black Button**. This is the **Coil Flow Chart**. Follow the questions, answering by using the *Mini-Icons* in the display.



## Switch Flow Chart

To initiate, from the **DR. PINBALL MENU**, select the Switch "DR." *Icon* with either the **Red or Green Buttons** and press the **Black Button**. This is the **Switch Flow Chart**. Follow the questions, answering by using the *Mini-Icons* in the display.



## Lamp Flow Chart

To initiate, from the **DR. PINBALL MENU**, select the Lamp "DR." *Icon* with either the **Red or Green Buttons** and press the **Black Button**. This is the **Lamp Flow Chart**. Follow the questions, answering by using the *Mini-Icons* in the display.

The following are the *Mini-Icons* with explanations for the **DR. PINBALL** Sub-Menus:



Select and *activate* either the "-" or "+" *Mini-Icons* to diagnose a Coil, Lamp or Switch. Select and *activate* the "RUN" *Mini-Icon* to test selected item. The "PREV" *Mini-Icon* allows you to go back to previous question. Select the "QUIT" *Mini-Icon* to exit **Portals™** completely. Select the "?" *Mini-Icon* (Help) to see directions on button usage.



Select and *activate* either the "NO" or "YES" *Mini-Icons* to answer a question given. Select and *activate* the "END" *Mini-Icon* to change to a new item to test. The "PREV" *Mini-Icon* allows you to go back to previous question. Select the "QUIT" *Mini-Icon* to exit **Portals™** completely. Select the "?" *Mini-Icon* (Help) to see directions on button usage.



After a diagnosis is given, select and *activate* the "END" *Mini-Icon* to change to a new item to test. The "PREV" *Mini-Icon* allows you to go back to previous display. Select the "QUIT" *Mini-Icon* to exit **Portals™** completely. Select the "?" *Mini-Icon* (Help) to see directions on button usage.



In **COIL FLOW CHART MENU**, select and *activate* the "PULSE" *Mini-Icon* to pulse the coil selected. Select and *activate* the "END" *Mini-Icon* to change to a new item to test. The "PREV" *Mini-Icon* allows you to go back to previous question. Select the "QUIT" *Mini-Icon* to exit **Portals™** completely. Select the "?" *Mini-Icon* (Help) to see directions on button usage.



Copy this page for Field Audit Tracking Performance

STARTING METER Reading :

STARTING METER Date (MM/DD/YR) :

AUDITOR'S NAME :

CURRENT METER Reading :

AUDIT Date (MM/DD/YR) :

CPU Version :

DISPLAY Version :

CURRENT VOLUME SETTING:

GAME LOCATION NAME :

## EARNINGS & STANDARD AUDIT TABLES

**EARNINGS AUDITS**  
**01-14** =

Audit definitions follow in this Chapter.

01	TOTAL PAID CREDITS	06	COINS THRU RIGHT SLOT	11	TOTAL COINS
02	FREE GAME PERCENTAGE	07	COINS THRU CENTER SLOT	12	TOTAL EARNINGS
03	AVERAGE BALL TIME	08	COINS THRU 4TH SLOT	13	METER CLICKS
04	AVERAGE GAME TIME	09	COINS THRU 5TH SLOT	14	SOFTWARE METER
05	COINS THRU LEFT SLOT	10	COINS THRU 6TH SLOT		

**STANDARD AUDITS**  
**01-68** =

Audit definitions follow in this Chapter.  
 To track Feature & Tournament Audits, see Pages 36 or 54.

01	TOTAL BALLS PLAYED	25	22.5M-24.9M SCORES	49	PROPRIETARY
02	TOTAL EXTRA BALLS	26	25M-34.9M SCORES	50	BASE REPLAY
03	EXTRA BALL PERCENT	27	35M-49.9M SCORES	51	LEFT FLIPPER USED
04	REPLAY 1 AWARDS	28	50M-74.9M SCORES	52	RIGHT FLIPPER USED
05	REPLAY 2+ AWARDS	29	75M-99.9M SCORES	53	PROPRIETARY
06	TOTAL REPLAYS	30	100M-149.9M SCORES	54	PROPRIETARY
07	REPLAY PERCENT	31	150M+ SCORES	55	0-1 MINUTE GAMES
08	TOTAL SPECIALS	32	AVERAGE SCORES	56	1 - 1.5 MINUTE GAMES
09	SPECIAL PERCENT	33	SERVICE CREDITS	57	1.5 - 2 MINUTE GAMES
10	TOTAL MATCHES	34	BALL SEARCH STARTED	58	2 - 2.5 MINUTE GAMES
11	HIGH SCORE AWARDS	35	LOST BALL FEEDS	59	2.5 - 3 MINUTE GAMES
12	HIGH SCORE PERCENT	36	LOST BALL GAME STARTS	60	3 - 3.5 MINUTE GAMES
13	TOTAL FREE PLAYS	37	LEFT DRAINS	61	3.5 - 4 MINUTE GAMES
14	TOTAL PLAYS	38	CENTER DRAINS	62	4 - 5 MINUTE GAMES
15	0-1.9M SCORES	39	RIGHT DRAINS	63	5 - 6 MINUTE GAMES
16	2M-3.9M SCORES	40	TILTS	64	6 - 8 MINUTE GAMES
17	4M-5.9M SCORES	41	TOTAL BALLS SAVED	65	8 - 10 MINUTE GAMES
18	6M-7.9M SCORES	42	PROPRIETARY	66	10 - 15 MINUTE GAMES
19	8M-9.9M SCORES	43	PROPRIETARY	67	15+ MINUTE GAMES
20	10M-12.4M SCORES	44	PROPRIETARY	68	RECENT REPLAY PERCENT
21	12.5M-14.9M SCORES	45	PROPRIETARY		
22	15M-17.4M SCORES	46	PROPRIETARY		
23	17.5M-19.9M SCORES	47	PROPRIETARY		
24	20M-22.4M SCORES	48	PROPRIETARY		

Note: Audits are subject to change (with or without notice).

Sec. 3: Go To Audits





# Go To Audits Menu

## Overview

The **Portals™ Service Menu System** provides **198 Audits** for accounting purposes and for evaluation of *Game Programming*. The Audits are divided into 3 groups: • **Earnings Audits** (Audits **01-14**), • **Standard Audits** (Audits **01-68**) and • **Feature Audits (Programming Use Only)** (Audits **01-116**). For details on **Tournament Audits**, see **Section 3, Chapter 7, GO TO TOURNAMENT MENU**. Audits which are named **Proprietary** are also for **Future Expansion or Programming**. Game code may get upgraded during production; compare all Audits in the display with the manual and make any corrections to the Audit Table (*previous page*), as necessary. Audits are subject to change (*with or without notice*). To view Audits in the display, enter the **Portals™ Service Menu System**. For how to **RESET Audits**, see **Section 3, Chapter 6, GO TO RESET MENU**.

**EXPLANATION & USAGE OF COMMON LARGE & MINI-ICONS USED IN VARIOUS MENUS & SUB-MENUS:**



These *non-selectable icons* appear in the selected Menu only when there are MORE icons to the LEFT or to the RIGHT available for selection.



Select and activate to return to the PREVIOUS Menu.



Select and activate to QUIT, exits & returns to the Attract Mode.



Select and activate to view HELP Screens of the current Menu\*.



Move LEFT or RIGHT, select previous / next or move backwards / forwards.

\* Help Note: An explanation of each Mini-Icon at that menu level will cycle continuously. To exit a display where no Mini-Icons are available for selection, pressing any button will exit the display.



## GO TO AUDITS MENU

After entering **Portals™**, the **MAIN MENU** now appears. Select the "AUD" *Icon* in the **MAIN MENU** with either the **Red "LEFT"** or **Green "RIGHT"** Buttons (the **Flipper Buttons** operates in the same manner) and press the **Black "ENTER"** Button (the **Start Button** operates in the same manner). The **AUDITS MENU** appears. Continue through this chapter for the explanation & usage of the *Icons* in the **AUDITS MENU**.



## Earnings Audits (01-14)

To initiate, from the **AUDITS MENU**, select the "EARN" *Icon* with either the **Red "LEFT"** or **Green "RIGHT"** Buttons and press the **Black "ENTER"** Button. Select and *activate* either of the ">>" *Mini-Icons* to view the next or previous Audit in this group. The display will describe the **Audit Number**, **Audit Name** and the **Current Audit Total** (Value). The current Audit will remain in the display until the next Audit is viewed or when this Menu is exited.

Nr.	EARNINGS AUDIT NAME: Definition
01	<b>TOTAL PAID CREDITS:</b> Provides the total number of <i>Paid Credits</i> .
02	<b>FREE GAME PERCENTAGE:</b> Provides the percentage total by dividing Standard Audit 13, <b>TOTAL FREE PLAYS</b> , by Standard Audit 14, <b>TOTAL PLAYS</b> .
03	<b>AVERAGE BALL TIME:</b> In seconds, the average ball time is derived from the total play time divided by Standard Audit 01, <b>TOTAL BALLS PLAYED</b> .
04	<b>AVERAGE GAME TIME:</b> The average game time is expressed in minutes and seconds (0:00).
05	<b>COINS THRU LEFT SLOT:</b> Provides the total number of times Coin Mechanism Switch 06 was closed.
06	<b>COINS THRU RIGHT SLOT:</b> Provides the total number of times Coin Mechanism Switch 04 was closed.
07	<b>COINS THRU CENTER SLOT:</b> Provides the total number of times Coin Mechanism Switch 05 was closed.
08	<b>COINS THRU 4TH SLOT:</b> Provides the total number of times Coin Mechanism Switch 02 was closed.
09	<b>COINS THRU 5TH SLOT:</b> Provides the total number of times Coin Mechanism Switch 07 was closed.
10	<b>COINS THRU 6TH SLOT:</b> Provides the total number of times Coin Mechanism Switch 03 was closed.
11	<b>TOTAL COINS:</b> Provides the total amount of coins registered through all the <i>Coin Slots</i> .
12	<b>TOTAL EARNINGS:</b> The total cash value accumulated since the last Factory Reset occurred. See <b>Section 3, Chapter 6, GO TO RESET MENU, Reset Coin Audits</b> .
13	<b>METER CLICKS:</b> Provides the total number of money clicks accumulated. <i>Based on the country's lowest coin denomination used for the game credit.</i>
14	<b>SOFTWARE METER:</b> Provides the continuing total of Meter Clicks. <i>This audit cannot be reset; the display shows the constant addition of Meter Clicks.</i>





# Standard Audits (01-68)

To initiate, from the **AUDITS MENU**, select the "S.P.I." *Icon* with either the **Red "LEFT"** or **Green "RIGHT" Buttons** and press the **Black "ENTER" Button**. Select and *activate* either of the ">>" *Mini-Icons* to view the next or previous Audit in this group. The display will describe the **Audit Number**, **Audit Name** and the **Current Audit Total** (Value). The current Audit will remain in the display until the next Audit is viewed or when this Menu is exited.

Nr.	STANDARD AUDIT NAME: Definition
01	<b>TOTAL BALLS PLAYED:</b> Provides the total number of <i>Regular</i> and <i>Extra Balls</i> .
02	<b>TOTAL EXTRA BALLS:</b> Provides the total number of <i>Extra Balls</i> awarded.
03	<b>EXTRA BALLS PERCENT:</b> Provides the percentage total by dividing Standard Audit 02, <b>TOTAL EXTRA BALLS</b> , by Standard Audit 14, <b>TOTAL PLAYS</b> .
04	<b>REPLAY 1 AWARDS:</b> Provides the total <i>Awards (Credits, Extra Balls or Scores)</i> for Level 1.
05	<b>REPLAY 2+ AWARDS:</b> Provides the total <i>Awards (Credits, Extra Balls or Scores)</i> for Level 2 or higher.
06	<b>TOTAL REPLAYS:</b> Provides the total <i>Awards (Credits, Extra Balls or Scores)</i> for exceeding <i>Replay Score Levels</i> .
07	<b>REPLAY PERCENT:</b> Provides the percentage total from dividing Standard Audit 06, <b>TOTAL REPLAYS</b> , by Standard Audit 14, <b>TOTAL PLAYS</b> . The percentage reflects replay total awards for exceeding replay score levels.
08	<b>TOTAL SPECIALS:</b> Provides the total <i>Awards (Credits, Extra Balls, or Scores)</i> for making <i>Specials</i> .
09	<b>SPECIAL PERCENT:</b> Provides the percentage total by dividing Standard Audit 08, <b>TOTAL SPECIALS</b> , by Standard Audit 14, <b>TOTAL PLAYS</b> .
10	<b>TOTAL MATCHES:</b> Provides the total <i>Credits</i> awarded for matching the last two digits of the score with the <i>System-Generated Match Number</i> at the end of the game. Percentage of <i>Match Credits</i> is adjustable from 0% to 10% by Standard Adjustment 13, <b>MATCH PERCENTAGE</b> , if enabled. See Section 3, Chapter 4, <b>GO TO ADJUSTMENTS MENU, Standard Adjustments</b> .
11	<b>HIGH SCORE AWARDS:</b> Provides the total <i>Awards (Credits, Extra Balls, or Scores)</i> for exceeding the High-Score-To-Date scores.
12	<b>HIGH SCORE PERCENT:</b> Provides the percentage total by dividing Standard Audit 11, <b>HIGH SCORE AWARDS</b> , by Standard Audit 14, <b>TOTAL PLAYS</b> .
13	<b>TOTAL FREE PLAYS:</b> Provides the total <i>Free Credits</i> for <i>Replays, High-Score-To-Date, Specials and Match</i> .
14	<b>TOTAL PLAYS:</b> This total is derived by adding the sum of Earnings Audit 01, <b>TOTAL PAID CREDITS</b> , and Standard Audit 13, <b>TOTAL FREE PLAYS</b> . <i>Note: Free Credits are not recorded in the Audit until they are actually used.</i>
15	<b>0-1.9M SCORES:</b> Provides the total number of games the Player's final score was 0 and 1,999,990 points.
16	<b>2M-3.9M SCORES:</b> ... and the Player's final score was between 2,000,000 and 3,999,990 points.
17	<b>4M-5.9M SCORES:</b> ... and the Player's final score was between 4,000,000 and 5,999,990 points.
18	<b>6M-7.9M SCORES:</b> ... and the Player's final score was between 6,000,000 and 7,999,990 points.
19	<b>8M-9.9M SCORES:</b> ... and the Player's final score was between 8,000,000 and 9,999,990 points.
20	<b>10M-12.4M SCORES:</b> ... and the Player's final score was between 10,000,000 and 12,499,990 points.
21	<b>12.5M-14.9M SCORES:</b> ... and the Player's final score was between 12,500,000 and 14,499,990 points.
22	<b>15M-17.4M SCORES:</b> ... and the Player's final score was between 15,000,000 and 17,499,990 points.
23	<b>17.5M-19.9M SCORES:</b> ... and the Player's final score was between 17,500,000 and 19,999,990 points.
24	<b>20M-22.4M SCORES:</b> ... and the Player's final score was between 20,000,000 and 22,499,990 points.
25	<b>22.5M-24.9M SCORES:</b> ... and the Player's final score was between 22,500,000 and 24,999,990 points.
26	<b>25M-34.9M SCORES:</b> ... and the Player's final score was between 25,000,000 and 34,999,990 points.
27	<b>35M-49.9M SCORES:</b> ... and the Player's final score was between 35,000,000 and 49,999,990 points.
28	<b>50M-74.9M SCORES:</b> ... and the Player's final score was between 50,000,000 and 74,999,990 points.
29	<b>75M-99.9M SCORES:</b> ... and the Player's final score was between 75,000,000 and 99,999,990 points.
30	<b>100M-149.9M SCORES:</b> ... and the Player's final score was between 100,000,000 and 149,999,990 points.
31	<b>150M+ SCORES:</b> Provides the total number of games the Player's final score was 150,000,000 points and over.
32	<b>AVERAGE SCORES:</b> This total is derived from adding the <i>Final Score</i> of each game to a table and dividing this sum by Standard Audit 14, <b>TOTAL PLAYS</b> .

Sec. 3: Go To Audits

Standard Audits 33-68 continued on the next page.

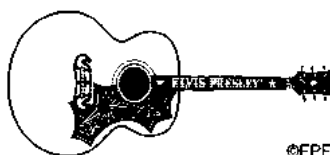



- 33 **SERVICE CREDITS:** Provides the total number of times the **Portals™ Green Button** (Dedicated Switch 7) was pushed in **Attract Mode**.  
*See Section 3, Chapter 1, Service Switch Set Access & Use, for how to receive Service Credits.*  
*See Sec. 3, Chp. 6, GO TO RESET MENU, Reset Credits, for how to delete Service (and Paid Credits).*
- 34 **BALL SEARCH STARTED:** Provides the total number of times the game performed a *Ball Search*.
- 35 **LOST BALL FEEDS:** Provides the total number of times the game added a pinball to play when it could not find a pinball after *Ball Search*.  
*See Section 3, Chapter 2, GO TO DIAGNOSTICS MENU, Technicians Alert [Pinball Detection].*
- 36 **LOST BALL GAME STARTS:** Provides the total number of times the game started with a pinball missing from the ball trough at the start of a game.  
*See Section 3, Chapter 2, GO TO DIAGNOSTICS MENU, Technicians Alert [Pinball Detection].*
- 37 **LEFT DRAINS:** Provides the total number of times Rollover Switch 57 was closed.
- 38 **CENTER DRAINS:** Provides the total number of times the pinball had drained when the last switch closed was not Switch 57 or Switch 60.
- 39 **RIGHT DRAINS:** Provides the total number of times Rollover Switch 60 was closed.
- 40 **TILTS:** Provides the total number of times Contact Switch 56 was closed.
- 41 **TOTAL BALLS SAVED:** Provides the total number of times this feature was used (*this feature can be turned ON or OFF, see Standard Adj. 38, FREEZE TIME in Section 3, Chapter 4, GO TO ADJUSTMENTS MENU, Standard Adjustments*). This feature is enabled at the start of each pinball and is disabled as soon as a predetermined number of switches are "closed" **or** the allocated time has expired.
- >> 42 - 49 **PROPRIETARY:** Proprietary Audits are used for *Future Expansion* or *Programming*.
- 50 **BASE REPLAY:** Provides the current base *Replay Level Score*.
- 51 **LEFT FLIPPER USED:** Provides the total number of times the **Left Flipper Button** (Dedicated Switch 1) was pushed in **Game Mode**.
- 52 **RIGHT FLIPPER USED:** Provides the total number of times the **Right Flipper Button** (Dedicated Switch 3) was pushed in **Game Mode**.
- >> 53 - 54 **PROPRIETARY:** Proprietary Audits are used for *Future Expansion* or *Programming*.
- 55 **0 - 1 MINUTE GAMES:** Provides the total number of games the total game time was between **0:00** and **1:00** minute.
- 56 **1 - 1.5 MINUTE GAMES:** Provides the total number of games the total game time was between **1:00** and **1:30** minutes.
- 57 **1.5 - 2 MINUTE GAMES:** Provides the total number of games the total game time was between **1:30** and **2:00** minutes.
- 58 **2 - 2.5 MINUTE GAMES:** Provides the total number of games the total game time was between **2:00** and **2:30** minutes.
- 59 **2.5 - 3 MINUTE GAMES:** Provides the total number of games the total game time was between **2:30** and **3:00** minutes.
- 60 **3 - 3.5 MINUTE GAMES:** Provides the total number of games the total game time was between **3:00** and **3:30** minutes.
- 61 **3.5 - 4 MINUTE GAMES:** Provides the total number of games the total game time was between **3:30** and **4:00** minutes.
- 62 **4 - 5 MINUTE GAMES:** Provides the total number of games the total game time was between **4:00** and **5:00** minutes.
- 63 **5 - 6 MINUTE GAMES:** Provides the total number of games the total game time was between **5:00** and **6:00** minutes.
- 64 **6 - 8 MINUTE GAMES:** Provides the total number of games the total game time was between **6:00** and **8:00** minutes.
- 65 **8 - 10 MINUTE GAMES:** Provides the total number of games the total game time was between **8:00** and **10:00** minutes.
- 66 **10 - 15 MINUTE GAMES:** Provides the total number of games the total game time was between **10:00** and **15:00** minutes.
- 67 **15+ MINUTE GAMES:** Provides the total number of games the total game time was **15:00** and over.
- 68 **RECENT REPLAY PERCENT:** *Percent figured with programming thresholds for a determined number of games (again based on programming thresholds). The percentage reflects replay total awards for exceeding replay score levels.*





# Feature Audits (01-116)

To initiate, from the **AUDITS MENU**, select the "ELVIS" Icon with either the **Red "LEFT"** or **Green "RIGHT" Buttons** and press the **Black "ENTER" Button**. Select and *activate* either of the ">>" *Mini-Icons* to view the next or previous Audit in this group. The display will describe the **Audit Number**, **Audit Name** and the **Current Audit Total** (Value). The current Audit will remain in the display until the next Audit is viewed or when this Menu is exited. **Audits Definition: Programming Use Only.** *The proprietary information provides the total number of times a feature was started, awarded, lit, played and/or completed (awarded); also, the total number of Switch Closures during certain modes or features are tracked (a predetermined single/multiple variations of switch closures are used to determine the lighting and/or completion of the feature stated).*

## FEATURE AUDIT TABLE

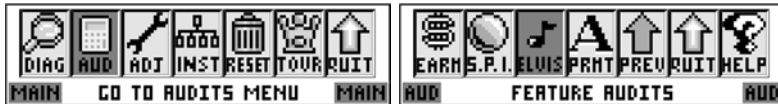

### FEATURE AUDITS

**01-116**  = 

**\*\*\* PROGRAMMING USE ONLY \*\*\***

UNLABELED BOXES ARE FOR FUTURE EXPANSION.

01	SPINNER SPINS		40	MYSTERY ENCORE LETTER		79	GIFT LIT	
02	LEFT ORBIT		41	MYSTERY XBALL LIT		80	GIFT AWARDED	
03	LEFT RAMP		42	MYSTERY 1 MIL		81	GIFT VIDEO	
04	CENTER LOOP		43	MYSTERY 10 MIL		82	GIFT RECORDS	
05	RIGHT RAMP		44	MYSTERY BONUS X		83	GIFT KORR	
06	RIGHT ORBIT		45	MYSTERY SPECIAL LIT		84	GIFT LITE XB	
07	TOP LANES		46	MYSTERY TCB		85	GIFT ENCORE LETTER	
08	TOP LANES COMPLETED		47	MYSTERY NOTE		86	FANS LEVEL 1	
09	TOP LANES MAXED		48	MYSTERY 100K		87	FANS LEVEL 2	
10	POP HITS		49	MYSTERY LTB		88	FANS LEVEL 3	
11	SPOT NOTE TARGET		50	MYSTERY HOUND DOG		89	FANS LEVEL 4	
12	HOUND DOG TARGET		51	MYSTERY HOTEL		90	FANS LEVEL 5	
13	TOP EJECT		52	MYSTERY SHOES		91	LTB COLLECTED	
14	CENTER EJECT		53	MYSTERY JAIL		92	TCB STARTED	
15	CENTER EJECT BEHIND		54	MYSTERY SCREAMING FANS		93	TCB RESTARTED	
16	HOTEL ARRIVALS		55	MYSTERY ALL SHOOK UP		94	TCB 2+ STARTS	
17	HOTEL DOOR		56	HOUND DOG STARTED		95	SCARF MORE TIME	
18	HOTEL TARGET		57	2+ HOUND DOG STARTED		96	SCARF ADD-A-BALL	
19	DROP TARGET HITS		58	HOUND DOG RECORDS		97	SCARF NOTE	
20	DROP BANKS COMPLETED		59	HOTEL STARTED		98	SCARF XB LIT	
21	TCB TARGETS		60	2+ HOTEL STARTED		99	SCARF GIFT LIT	
22	KING TARGETS		61	HOTEL RECORDS		100	SCARF LIT	
23	KING COMPLETED		62	JAIL STARTED		101	SCARF AWARD	
24	SCARF TARGET		63	2+ JAIL STARTED		102	KORR STARTED	
25	LEFT OUTLANE		64	JAIL RECORDS		103	KORR AWARD	
26	LEFT INLANE		65	LOOP CHALLENGE STARTED		104	SPOT NOTE LIT	
27	RIGHT INLANE		66	SHOES STARTED		105	NOTE SPOTTED	
28	RIGHT OUTLANE		67	2+ SHOES STARTED		106	NOTE AWARDED	
29	UPPER PLYFLD VISITS		68	SHOE RECORDS		107	HIT AWARDED	
30	UPPER PLYFLD NO FLIP		69	ASU STARTED		108	ENCORE STARTED	
31	SUPER SPINNER STARTED		70	2+ ASU STARTED		109	ENCORE LETTER	
32	SUPER SPINNER SPINS		71	ASU RECORDS		110	GRACELAND LIT	
33	SKILL SHOT		72	1 SONG		111	GRACELAND START	
34	HANDS FREE SKILL SHOT		73	2 SONGS		112	GL JUNGLE ROOM	
35	SUPER SKILL SHOT		74	3 SONGS		113	GL POOL ROOM	
36	SECRET SKILL SHOT		75	4 SONGS		114	GL MUSIC ROOM	
37	SUPER SECRET SKLL SHOT		76	HITS COMPLETED		115	GL TV ROOM	
38	SKILL SHOT RESTARTED		77	ELVIS COMPLETED		116	GL TROPHY ROOM	
39	MYSTERY TOP 10		78	TOP 10 COMPLETED				

Note: Audits are subject to change (with or without notice).

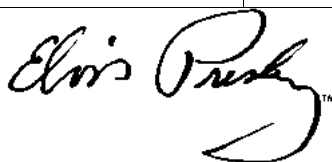



# Go To Printer Menu (OPTIONAL USE ONLY)

**Operational Usage Note:** The use of the following Sub-Menus are **OPTIONAL** and provided as a convenience only. **No special equipment was included with your Pinball Game.** To initiate, from the **AUDITS MENU**, select the "PRNT" *Icon* with either the **Red "LEFT"** or **Green "RIGHT"** **Button** and press the **Black "ENTER"** **Button**. The **PRINTER MENU** appears. A **Quick / Full Printout Kit\*** and **RS-232 Communication Device\*\*** (which can download serial information) are required for proper operation of these Sub-Menus. Entering the menus & selecting/activating the *Icons* without the equipment mentioned, will not affect the Pinball Game nor the operation of the **Portals™ Service Menu System** in any way. For more details on the equipment & hardware required, installation and set-up, read the **Quick/Full Printout Set-Up Instruction Manual** (SPI Part Number: 780-6012-00) provided in the **Quick/Full Printout Kit** (SPI Part Number: 502-5031-00).

*\*Not included with this ToPS™ Ready Pinball Game. \*\*Not included in the Quick/Full Printout Kit.*



## Quick Printout

To initiate, from the **PRINTER MENU**, select the "QUIK" *Icon* with either the **Red** or **Green Button** and press the **Black Button**. Select either the "-" or "+" *Mini-Icon* and press the **Black Button** to start the printout. Per the display instruction, the **Start Button** can also be pressed to start the printout. Only the **Earnings Audits** can be retrieved and/or printed for further processing.



## Full Printout

To initiate, from the **PRINTER MENU**, select the "ALISON" *Icon* with either the **Red** or **Green Button** and press the **Black Button**. Select either the "-" or "+" *Mini-Icon* and press the **Black Button** to start the download. Per the display instruction, the **Start Button** can also be pressed to start the download. All **Earnings, Standard, Feature & Tournament Audits** can be retrieved and/or printed for further processing.



## Reset Printer

To initiate, from the **PRINTER MENU**, select the "RESET" *Icon* with either the **Red** or **Green Button** and press the **Black Button**. Select either the "-" or "+" *Mini-Icon* and press the **Black Button** to clear the "N° of copies printed" count total appearing in the display. **Operational Usage Note:** Activating the "QUIK" *Icon* (in the previous Quick Printout) **without** the special equipment and unique software, will still provide a "count total" in this Reset Printer Menu, which does not affect the operation of the **Portals™ Service Menu System** in any way. Activating this "RESET" *Icon* will reset the "count total" in the display to **00**.

Sec. 3: Go To Audits



## FEATURE AUDIT ABBREVIATIONS USED IN THIS CHAPTER:

ASU All Shook Up		GL Graceland		KORR King of Rock N' Roll	
	LTB (Elvis has) Left the Building		MIL Million		PLYFLD Playfield
TCB Taking Care (of) Business		XBALL or XB Extra Ball		X Multiplier	



For how to RESET Audits, see Section 3, Chapter 6, GO TO RESET MENU.





Comments:

## FEATURE AUDIT TABLE



### FEATURE AUDITS

**01-116** =

\*\*\* PROGRAMMING USE ONLY \*\*\*

UNLABELED BOXES ARE FOR FUTURE EXPANSION.

01	SPINNER SPINS		40	MYSTERY ENCORE LETTER		79	GIFT LIT	
02	LEFT ORBIT		41	MYSTERY XBALL LIT		80	GIFT AWARDED	
03	LEFT RAMP		42	MYSTERY 1 MIL		81	GIFT VIDEO	
04	CENTER LOOP		43	MYSTERY 10 MIL		82	GIFT RECORDS	
05	RIGHT RAMP		44	MYSTERY BONUS X		83	GIFT KORR	
06	RIGHT ORBIT		45	MYSTERY SPECIAL LIT		84	GIFT LITE XB	
07	TOP LANES		46	MYSTERY TCB		85	GIFT ENCORE LETTER	
08	TOP LANES COMPLETED		47	MYSTERY NOTE		86	FANS LEVEL 1	
09	TOP LANES MAXED		48	MYSTERY 100K		87	FANS LEVEL 2	
10	POP HITS		49	MYSTERY LTB		88	FANS LEVEL 3	
11	SPOT NOTE TARGET		50	MYSTERY HOUND DOG		89	FANS LEVEL 4	
12	HOUND DOG TARGET		51	MYSTERY HOTEL		90	FANS LEVEL 5	
13	TOP EJECT		52	MYSTERY SHOES		91	LTB COLLECTED	
14	CENTER EJECT		53	MYSTERY JAIL		92	TCB STARTED	
15	CENTER EJECT BEHIND		54	MYSTERY SCREAMING FANS		93	TCB RESTARTED	
16	HOTEL ARRIVALS		55	MYSTERY ALL SHOOK UP		94	TCB 2+ STARTS	
17	HOTEL DOOR		56	HOUND DOG STARTED		95	SCARF MORE TIME	
18	HOTEL TARGET		57	2+ HOUND DOG STARTED		96	SCARF ADD-A-BALL	
19	DROP TARGET HITS		58	HOUND DOG RECORDS		97	SCARF NOTE	
20	DROP BANKS COMPLETED		59	HOTEL STARTED		98	SCARF XB LIT	
21	TCB TARGETS		60	2+ HOTEL STARTED		99	SCARF GIFT LIT	
22	KING TARGETS		61	HOTEL RECORDS		100	SCARF LIT	
23	KING COMPLETED		62	JAIL STARTED		101	SCARF AWARD	
24	SCARF TARGET		63	2+ JAIL STARTED		102	KORR STARTED	
25	LEFT OUTLANE		64	JAIL RECORDS		103	KORR AWARD	
26	LEFT INLANE		65	LOOP CHALLENGE STARTED		104	SPOT NOTE LIT	
27	RIGHT INLANE		66	SHOES STARTED		105	NOTE SPOTTED	
28	RIGHT OUTLANE		67	2+ SHOES STARTED		106	NOTE AWARDED	
29	UPPER PLYFLD VISITS		68	SHOE RECORDS		107	HIT AWARDED	
30	UPPER PLYFLD NO FLIP		69	ASU STARTED		108	ENCORE STARTED	
31	SUPER SPINNER STARTED		70	2+ ASU STARTED		109	ENCORE LETTER	
32	SUPER SPINNER SPINS		71	ASU RECORDS		110	GRACELAND LIT	
33	SKILL SHOT		72	1 SONG		111	GRACELAND START	
34	HANDS FREE SKILL SHOT		73	2 SONGS		112	GL JUNGLE ROOM	
35	SUPER SKILL SHOT		74	3 SONGS		113	GL POOL ROOM	
36	SECRET SKILL SHOT		75	4 SONGS		114	GL MUSIC ROOM	
37	SUPER SECRET SKLL SHOT		76	HITS COMPLETED		115	GL TV ROOM	
38	SKILL SHOT RESTARTED		77	ELVIS COMPLETED		116	GL TROPHY ROOM	
39	MYSTERY TOP 10		78	TOP 10 COMPLETED				

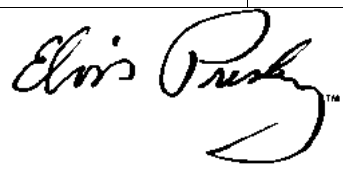

*Note: Audits are subject to change (with or without notice).*

# MULTI-WEEK TOURNAMENT AUDIT TABLES

STARTING METER Reading :

STARTING METER Date (MM/DD/YR) :

AUDITOR'S NAME : \_\_\_\_\_

CURRENT VOLUME SETTING:

CURRENT METER Reading :

AUDIT Date (MM/DD/YR) :

CPU Version :

DISPLAY Version :

GAME LOCATION NAME : \_\_\_\_\_

<b>01</b>	TOTAL PLAYS	<b>06</b>	NET EARNINGS	<b>11</b>	ACCUM. JACKPOT
<b>02</b>	TOURNAMENT PLAYS	<b>07</b>	ACCUM. TOTAL PLAYS	<b>12</b>	# TOURNAMENTS
<b>03</b>	TOTAL GAME EARNINGS	<b>08</b>	ACCUM. TOUR. PLAYS		
<b>04</b>	TOTAL TOUR. EARNINGS	<b>09</b>	ACCUM. EARNINGS		
<b>05</b>	JACKPOT	<b>10</b>	ACCUM. TOUR EARNINGS		

STARTING METER Reading :

STARTING METER Date (MM/DD/YR) :

AUDITOR'S NAME : \_\_\_\_\_

CURRENT VOLUME SETTING:

CURRENT METER Reading :

AUDIT Date (MM/DD/YR) :

CPU Version :

DISPLAY Version :

GAME LOCATION NAME : \_\_\_\_\_

<b>01</b>	TOTAL PLAYS	<b>06</b>	NET EARNINGS	<b>11</b>	ACCUM. JACKPOT
<b>02</b>	TOURNAMENT PLAYS	<b>07</b>	ACCUM. TOTAL PLAYS	<b>12</b>	# TOURNAMENTS
<b>03</b>	TOTAL GAME EARNINGS	<b>08</b>	ACCUM. TOUR. PLAYS		
<b>04</b>	TOTAL TOUR. EARNINGS	<b>09</b>	ACCUM. EARNINGS		
<b>05</b>	JACKPOT	<b>10</b>	ACCUM. TOUR EARNINGS		

STARTING METER Reading :

STARTING METER Date (MM/DD/YR) :

AUDITOR'S NAME : \_\_\_\_\_

CURRENT VOLUME SETTING:

CURRENT METER Reading :

AUDIT Date (MM/DD/YR) :

CPU Version :

DISPLAY Version :

GAME LOCATION NAME : \_\_\_\_\_

<b>01</b>	TOTAL PLAYS	<b>06</b>	NET EARNINGS	<b>11</b>	ACCUM. JACKPOT
<b>02</b>	TOURNAMENT PLAYS	<b>07</b>	ACCUM. TOTAL PLAYS	<b>12</b>	# TOURNAMENTS
<b>03</b>	TOTAL GAME EARNINGS	<b>08</b>	ACCUM. TOUR. PLAYS		
<b>04</b>	TOTAL TOUR. EARNINGS	<b>09</b>	ACCUM. EARNINGS		
<b>05</b>	JACKPOT	<b>10</b>	ACCUM. TOUR EARNINGS		

STARTING METER Reading :

STARTING METER Date (MM/DD/YR) :

AUDITOR'S NAME : \_\_\_\_\_

CURRENT VOLUME SETTING:

CURRENT METER Reading :

AUDIT Date (MM/DD/YR) :

CPU Version :

DISPLAY Version :

GAME LOCATION NAME : \_\_\_\_\_

<b>01</b>	TOTAL PLAYS	<b>06</b>	NET EARNINGS	<b>11</b>	ACCUM. JACKPOT
<b>02</b>	TOURNAMENT PLAYS	<b>07</b>	ACCUM. TOTAL PLAYS	<b>12</b>	# TOURNAMENTS
<b>03</b>	TOTAL GAME EARNINGS	<b>08</b>	ACCUM. TOUR. PLAYS		
<b>04</b>	TOTAL TOUR. EARNINGS	<b>09</b>	ACCUM. EARNINGS		
<b>05</b>	JACKPOT	<b>10</b>	ACCUM. TOUR EARNINGS		





# STANDARD & FEATURE ADJUSTMENT TABLES

(Review Overview regarding changes)

## STANDARD ADJUSTMENTS 01-55 =

Nr.	ADJUSTMENT NAME	USA DEFAULT	YOUR SETTING
01	REPLAY TYPE	AUTO	
02*	REPLAY PERCENTAGE	10%	
03	REPLAY AWARD	CREDIT	
04*	REPLAY LEVELS	1: 80,000,000	
05	REPLAY BOOST	YES	
06	SPECIAL AWARD	CREDIT	
07*	SPECIAL PERCENTAGE	2%	
08	FREE GAME LIMIT	05	
09*	EXTRA BALL LIMIT	09	
10*	EXTRA BALL PERCENTAGE	25%	
11	GAME PRICING	USA 5	
12	MATCH AWARD	CREDIT	
13*	MATCH PERCENTAGE	9%	
14	BALLS PER GAME	03	
15	TILT WARNINGS	01	
16	CREDIT LIMIT	30	
17	ALLOW HIGH SCORES	YES	
18	GRAND CHAMPION AWARDS	01	
19	HIGH SCORE #1 AWARDS	01	
20	HIGH SCORE #2 AWARDS	00	
21	HIGH SCORE #3 AWARDS	00	
22	HIGH SCORE #4 AWARDS	00	
23*	GRAND CHAMPION SCORE	250,000,000	
24*	DEFAULT HIGH SCORE #1	200,000,000	
25*	DEFAULT HIGH SCORE #2	175,000,000	
26*	DEFAULT HIGH SCORE #3	150,000,000	
27*	DEFAULT HIGH SCORE #4	125,000,000	
28	HSTD RESET COUNT	2,000	

Nr.	ADJUSTMENT NAME	USA DEFAULT	YOUR SETTING
29	HIGH SCORE INITIALS	3 INITIALS	
30	FREE PLAY	NO	
31	CUSTOM MESSAGE	ON	
32	FLASH LAMP POWER	NORMAL	
33	COIL PULSE POWER	NORMAL	
34	KNOCKER VOLUME	NORMAL	
35	GAME RESTART	YES	
36	BILL VALIDATOR	NO	
37	BKGRND MUSIC VOLUME	01	
38*	FREEZE TIME	0:10	
39	UK POST SAVE ENABLED	NO	
40	TIMED PLUNGER	OFF	
41	FLIPPER BALL LAUNCH	DISABLED	
42	COINDOOR BALL SAVER	NO	
43	COMPETITION MODE	NO	
44	CONSOLATION BALL	YES	
45	FAST BOOT	YES	
46	Q24 OPTION	COIN METER	
47	TICKET DISP. INSTALLED	NO	
48	ALLOW PLAYER COMP. MODE	YES	
49	TECH ALERT WARNING	NEVER	
50	TEAM SCORES	NO	
51	LOCATION ID	00	
52	GAME ID	00	
53	FLIPPER ADJ 1	20	
54	FLIPPER ADJ 2	50	
55	FLIPPER ADJ 3	3	

\* Defaults are subject to change during production (especially 02, 04, 07, 09, 10, 13, 23-27 & 38).

Note: If Game & Display ROMs other than USA are installed, along with the proper Dip Switch Settings, different Defaults will appear. If changes are made (or your Defaults are not USA), enter them with pencil in the YOUR SETTING spaces provided for reference.

Sec. 3: Adjustments



Shortcut to Standard Adjustment 31.

## FEATURE ADJUSTMENTS 01-16 =

Nr.	ADJUSTMENT NAME	USA DEFAULT	YOUR SETTING
01	BLUE SUEDE DIFFICULTY	MODERATE	
02	HOUND DOG DIFFICULTY	MODERATE	
03	HOTEL DIFFICULTY	EX. EASY	
04	ALL SHOOK UP DIFFICULTY	EASY	
05	JHR LOCK DIFFICULTY	EASY	
06	JHR 1ST 3-BALL JAILHOUSE	02	
07	NOTE DIFFICULTY	MODERATE	
08	SPOT NOTE DIFFICULTY	EASY	

Nr.	ADJUSTMENT NAME	USA DEFAULT	YOUR SETTING
09	SCREAMING FANS DIFFICULTY	MODERATE	
10	GIFT DIFFICULTY	MODERATE	
11	MAGNET DIFFICULTY	HARD	
12	SHOW UPPER FLIPPER	YES	
13	SPOT ASU ON BALL	02	
14	TCB MEMORY	YES	
15	KING MEMORY	YES	
16	ADULT CONTENT ENABLED	YES	

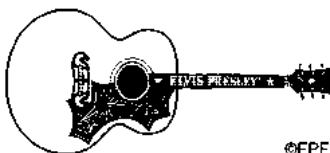

# Go To Adjustments Menu

## Overview

The **Portals™ Service Menu System** provides **71** Adjustments to vary Game Functions to customize for your particular needs. The Adjustments are divided into 2 groups: • **Standard Adjustments (01-55)** and • **Feature Adjustments (01-16)**. Game code may get upgraded during production; compare all Adjustments in the display with the manual and make any corrections to the Adjustment Table (*previous page*), as necessary. Adjustments are subject to change (*with or without notice*). To view Adjustments in the display, enter the **Portals™ Service Menu System**. When a change is made and then the next / previous Adjustment is selected (*or the Sub-Menu is exited*), the display will momentarily flash **REQUEST INSTALLED**. For **further customization of Game Play Difficulty or Game Play Type** or how to **RESET ONLY the Adjustments**, see **Section 3, Chapter 5, GO TO INSTALLS MENU**.



**Important:** The **Coin Door** must be **OPEN** allowing the **Memory Protect Switch** to be disabled, so any Adjustment changes can be made.



### EXPLANATION & USAGE OF COMMON LARGE & MINI-ICONS USED IN VARIOUS MENUS & SUB-MENUS:



These **non-selectable** icons appear in the selected Menu only when there are **MORE** icons to the **LEFT** or to the **RIGHT** available for selection.



Select and activate to return to the **PREVIOUS** Menu.



Select and activate to **QUIT**, exits & returns to the **Attract Mode**.



Select and activate to view **HELP** Screens of the current Menu\*.



Select and activate to: Move **LEFT** or **RIGHT**, select previous / next or move backwards / forwards.



**DECREMENT (-)** or **INCREMENT (+)** displayed value or select previous / next.

\* **Help Note:** An explanation of each Mini-Icon at that menu level will cycle continuously. To exit a display where no Mini-Icons are available for selection, pressing any button will exit the display.



## GO TO ADJUSTMENTS MENU

After entering **Portals™**, the **MAIN MENU** now appears. Select the "ADJ" icon in the **MAIN MENU** with either the **Red "LEFT"** or **Green "RIGHT"** Buttons (the **Flipper Buttons** operates in the same manner) and press the **Black "ENTER"** Button (the **Start Button** operates in the same manner). The **ADJUSTMENTS MENU** appears. Continue through this chapter for the explanation & usage of the *Icons* in the **ADJUSTMENTS MENU**.



## Standard Adjustments (01-55)

To initiate, from the **ADJUSTMENTS MENU**, select the "S.P.I." icon with either the **Red "LEFT"** or **Green "RIGHT"** Buttons and press the **Black "ENTER"** Button. Select and *activate* either of the ">>" *Mini-Icons* to view the next or previous Adjustment in this group. Select and *activate* either of the "-" or "+" *Mini-Icons* to change the setting, if desired (*the Default Setting is noted in the definitions below*). The display will describe the **Adjustment Number**, **Adjustment Name** and the **Current Adjustment Setting**. The current Adjustment will remain in the display until the next Adjustment is view or when this Menu is exited.

**WARNING:** Changes made in any Adjustments will be lost after a **FACTORY RESET** or removal of the **CPU/Sound Board Batteries**.

Nr.	STANDARD ADJUSTMENT NAME: Definition
-----	--------------------------------------

**REPLAY TYPE:** Set to **AUTO**, **DYNAMIC**, **FIXED** or **NONE**. Default is **AUTO**. Selecting **NONE** will make Standard Adjustments **2-5 NOT AVAILABLE**. Selecting **FIXED** will make Standard Adjustment **2 NOT AVAILABLE**. If selected **AUTO**, **DYNAMIC** or **FIXED**, you will need to then select the number of Replay Levels and Score Threshold (*in Standard Adj. 4*) desired for the player to receive a Replay Award (*select type in Standard Adj. 3*). The Default Score appears as a starting point after the Level amount is selected. **AUTO & DYNAMIC** will then get based on the Replay Percentage (*in Standard Adjustment 2*).

- 01 • Select **FIXED** to give the player a Replay Award as the Score Threshold is reached. This Score Threshold **will not** adjust up or down. • Select **AUTO** to give the player a Replay Award as the Score Threshold is reached. This Score Threshold will automatically adjust up or down based on the Replay Percentage chosen (*in Std. Adj. 2*). The game periodically adjusts based upon the Player Base Skill Level. • Select **DYNAMIC** to give the player a Replay Award as the Score Threshold is reached. This Score Threshold will go down every game based on the Replay Percentage selected. For (*Dynamic*) example, if the Score Threshold is 50,000,00 and the Replay Percentage selected is 10%, every game a player does not reach the Score Threshold, the score to reach will drop by 5,000,000 (10% of 50M). This will continue every game until the Threshold Score is reached. Thus, if the score then drops to 15,000,000 after 7 games and is then achieved, the Replay Award is given. The original Score Threshold is added to 15,000,000 and is now 65,000,000. It will then take the same player 10 games to reach 15,000,000.

*Standard Adjustments 02-11 continued on the next page.*





# Standard Adjustments Continued.

STANDARD ADJUSTMENT NAME: Definition

- 02 **REPLAY PERCENTAGE:** Set between **01%** - **50**. Default is **10%**. This Adjustment is required if Standard Adjustment 1 is set to **AUTO** or **DYNAMIC**.
- 03 **REPLAY AWARD:** Set to **EXTRA BALL**, **CREDIT**, **TICKET\*** or **TOKEN\***. Default is **CREDIT**. Select **EXTRA BALL** if awarding a **CREDIT**, **TICKET/TOKEN** is prohibited in your area.  
*\*If TICKET or TOKEN is selected, the game will require an optional Ticket or Token Dispenser if selected Token, then Standard Adjustment 46, Q24 Option, must be changed accordingly.*
- 04 **REPLAY LEVELS:** Set between **1 - 4** for the number of Replay Levels to be active. Default is **1: 80,000.00**. A "Drop-Down" Table appears showing Replay Level 1. Adjust the Replay Level between 10M - 9.99B (Default Score appears as a starting point) using the "-" or "+" Mini-Icons, then use the ">>" Mini-Icon to go to next Level (if selected more than 1) and select the next highest Threshold Score(s) desired.
- 05 **REPLAY BOOST:** Set to **YES** or **NO**. Default is **YES**. This Adjustment works only when Standard Adjustment 1, **Replay Type**, is set to **FIXED** or **AUTO**. When set to **YES**, while **FIXED** or **AUTO** maintains the Replay Levels, Replay Boost works as follows: If the Replay Level is 7,000,000 (regardless of the Replay Percentage), and the Player scores 20M, and receives the Replay Award, the next game the Current Replay Level is added to this base. Thus the next game, the Replay Level is 14,000,000. The Player again scores 20M. The next game the Player will need to achieve 21,000,00 to earn the Replay Award. If the Player does not achieve 21,000,000, the next game reverts back to the original 7,000,000 or the new adjusted level maintained by the Fixed or Autopercentaging Feature.
- 06 **SPECIAL AWARD:** Set to **EXTRA BALL**, **CREDIT**, **TICKET\***, **TOKEN\*** or **POINTS**. Default is **CREDIT**. Select **EXTRA BALL** or **POINTS** if awarding a **CREDIT** or **TICKET/TOKEN** is prohibited in your area.
- 07 **SPECIAL PERCENTAGE:** Set between **1%** - **5%**. Default is **2%**. This adjustment allows the operator to adjust how frequently the **Special Feature** is made available to the player.
- 08 **FREE GAME LIMIT:** Set between **01 - 09**, **NO FREE GAMES** or **UNLIMITED**. Default is **05**. Set the maximum number of *Free Games* that may be accumulated per game.
- 09 **EXTRA BALL LIMIT:** Set between **01 - 09**, **NO EXTRA BALLS** or **UNLIMITED**. Default is **09**. Set the number of *Extra Balls* that may be accumulated per game.
- 10 **EXTRA BALL PERCENTAGE:** Set between **01%** - **50%**. Default is **25%**. This adjustment allows the operator to adjust how frequently the **Extra Ball Feature** is made available to the player.
- 11 **GAME PRICING:** There are two (2) methods available for *Coin Switch Programming*: **Standard & Custom**. Set between **USA 1** thru **EURO 12** or **CUSTOM**. *USA Factory Default Setting is USA 5.*

Sec. 3: Adjustments

The **Dip Switch Settings (Sw. 300)** on the **CPU/Sound Board** for each Country **must match** with what is shown in the **USA & Int'l. Standard Pricing Select Tables** for your country to have correct operation (see the next page). For a **Standard Selection (USA or International)**: Select & activate either of the "-" or "+" Mini-Icons to move backward or forward in the Display; With your choice appearing in the display, select & activate the ">>" Mini-Icon to advance and "lock-in" the change (display will momentarily flash **REQUEST INSTALLED**).

If **CUSTOM** is selected (appears in display), after selecting & activating any Mini-Icon (except for "-" or "+"), the display will momentarily flash **REQUEST INSTALLED** with the display "**LEFT COIN: 0 PULSE**" appearing. Use the "<<" or ">>" Mini-Icons to **select** the next choice (see Table Examples below) and the "-" or "+" Mini-Icons to **customize** the PULSES, CREDITS & CLICKS from **0** to **99**.

The prescribed number of **PULSES** required for **1 CREDIT** must be set according to the **Pricing Scheme desired**. Some simple calculations are required to get the proper set-up. After customizing, **test the set-up** with appropriate Coins or Bills and adjust, if necessary. **Note:** Clicks can be changed if an optional Coin Meter is installed.

In **Example 1**, note the **LEFT (and RIGHT) COIN: 3 PULSES** and **ONE CREDIT: 4 PULSES**. Since every Coin inserted produces 3 Pulses & every Credit requires 4 Pulses, 2 Coins (50¢) will produce 6 Pulses (4 Pulses for the 1st Credit + 2 Pulses remains in escrow). The 3rd Coin (75¢) provides another 3 Pulses for a total of 9 Pulses (4 Pulses for the 2nd Credit + 1 Pulse remains in escrow). The 4th Coin (\$1.00) provides another 3 Pulses for a total of 12 Pulses (4 Pulses for the 3rd Credit + 0 Pulses remain). The **CENTER COIN: 12 PULSES** is set this way (with a Bill Validator attached); every \$1-Bill inserted produces 12 Pulses or 3 Credits.

LEFT	CENTER	RIGHT	4TH	Example 1				LEFT COIN:	CENTER COIN:	RIGHT COIN:	FOURTH COIN:	ONE CREDIT:	BONUS 1:	BONUS 2:	BONUS 1:	BONUS 2:	LEFT COIN:	CENTER COIN:	RIGHT COIN:	FOURTH COIN:
25c	\$1.00	25c	Not Used	1 / 50¢	2 / 75¢	3 / \$1.00	3	12	3	1	4	0	0	0	0	1	4	1	1	
Coin Mechanisms Used				Pricing Scheme Desired				PULSES	PULSES	PULSES	PULSE	PULSES	PULSES	PULSES	CREDITS	CREDITS	CLICK	CLICKS	CLICK	CLICK

In **Example 2**, similar to Example 1, however, **BONUS CREDITS** are implemented. In addition to receiving 3 plays for every \$1.00, the player is awarded an extra Credit for every 2nd dollar inserted before game start.

LEFT	CENTER	RIGHT	4TH	Example 2				LEFT COIN:	CENTER COIN:	RIGHT COIN:	FOURTH COIN:	ONE CREDIT:	BONUS 1:	BONUS 2:	BONUS 1:	BONUS 2:	LEFT COIN:	CENTER COIN:	RIGHT COIN:	FOURTH COIN:
25c	\$1.00	25c	Not Used	1 / 50¢	2 / 75¢	7 / \$2.00	3	12	3	1	4	24	0	1	0	0	1	4	1	1
Coin Mechanisms Used				Pricing Scheme Desired				PULSES	PULSES	PULSES	PULSE	PULSES	PULSES	PULSES	CREDIT	CREDITS	CLICK	CLICKS	CLICK	CLICK

Standard Adjustment 11, Custom Pricing, continued on the next page.

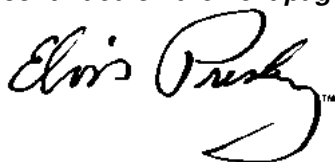



In Example 3, a Pricing Scheme for a cheaper game is shown. An extra Pulse is put in escrow for every 25c, thus at 4X 25c inserted, another Credit is given, and the BONUS 1: 20 PULSES threshold is also met, so 6/ \$1.00 is achieved. BONUS 2: 40 PULSES is set, so when this threshold is met with \$2.00, 13 Credits are produced.

Table for Example 3 showing coin mechanisms used and pricing scheme desired.

In Example 4, a Pricing Scheme using a different currency (i.e. British Sterling) is shown to provide another way coins (or tokens) can be utilized to custom tailor to your own needs.

Table for Example 4 showing coin mechanisms used and pricing scheme desired.

USA & International (non-Euro) Standard Pricing Select Tables

Main table with columns for CPU/SOUND BOARD DIP SWITCH 300 SETTING, COUNTRY SETTING OPTION(S), COIN MECHANISMS (SWITCHES), PRICING SCHEME, and Requires SPI Coin Card(s) Part Number.

Note: The Country Setting Option above noted with "«" & "»" denotes the Factory Default Setting (subject to change).

Standard Adjustment 11, Custom Pricing, and Std. Adj. 12-17 continued on the next page.





Euro 1-12 Summary & International (Euro) Standard Pricing Select Table

Table with columns: CPU/SOUND BOARD DIP SWITCH 300 SETTING, COUNTRY SETTING OPTION(S), COIN MECHANISMS (SWITCHES) COINS THRU ... SLOT: LEFT CENTER RIGHT 4TH, PRICING SCHEME, Requires SPI Coin Card(s) Part Number. Lists Euro 1-12 settings and pricing.

For a different Euro Pricing Scheme (other than below default), scroll through Standard Adjustment 11: Euro 1-12 or CUSTOM\* for new setting (reference above Euro 1-12 Summary). \* Note: Unique Coin Door & Mech. for Germany, Italy & Portugal must use CUSTOM.

Sec. 3: Adjustments

Table of international settings for countries: Austria Euro 9, Belgium Euro 1, Finland Euro 8, France Euro 10, Germany 1/2/3, Greece Euro 6, Italy 1/2, Netherlands Euro 3, Portugal, Spain Euro 3. Includes switch settings and pricing.

Note: The Country Setting Option above noted with "«" & "»" denotes the Factory Default Setting (subject to change).

12 MATCH AWARD: Set to CREDIT, TICKET\* or TOKEN\*. Default is CREDIT.

\*If TICKET or TOKEN is selected, the game will require an optional Ticket or Token Dispenser. If selected Token, then Standard Adjustment 46, Q24 Option, must be changed accordingly.

13 MATCH PERCENTAGE: Set between 0% - 10% or OFF. Default is 9%. At 0% the match display occurs at the end of the game but never awards a Credit. Set to OFF, no Match Animation Feature is shown.

14 BALLS PER GAME: Set between 02 - 10. Default is 03. Set the number of balls per game.

15 TILT WARNINGS: Set to 00, 01 or 03. Default is 01. Set the number of Plumb Bob Tilt Switch closures before the ball in play is tilted.

16 CREDIT LIMIT: Set between 04 - 50. Default is 30. Set the maximum credits allowed.

17 ALLOW HIGH SCORES: Set to YES or NO. Default is YES. When set to YES if a player exceeds any 1 of the 4 High Scores, the player may receive an award (depending on Standard Adjustment 03, Replay Award). Set to NO to disable this feature. There are 5 High Scores that will allow the player to enter their initials (or name) (see Standard Adjustment 29, High Score Initials).

Standard Adjustments 18-38 continued on the next page.

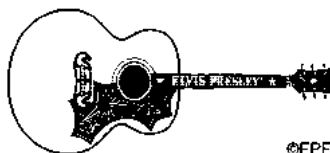



- 18 **GRAND CHAMPION AWARDS:** Set between **00 - 05**. Default is **01**. Set the number of awards, awarded for exceeding Level 1 (*the highest of the five (5) Levels*).
- 19 **HIGH SCORE #1 AWARDS:** Set between **00 - 03**. Default is **01**. Set the number of awards, awarded for exceeding Level 2.
- 20 **HIGH SCORE #2 AWARDS:** Set between **00 - 02**. Default is **00**. Set the number of awards, awarded for exceeding Level 3.
- 21 **HIGH SCORE #3 AWARDS:** Set between **00 - 01**. Default is **00**. Set the number of awards, awarded for exceeding Level 4.
- 22 **HIGH SCORE #4 AWARDS:** Set between **00 - 01**. Default is **00**. Set the number of awards, awarded for exceeding Level 5.
- 23 **GRAND CHAMPION SCORE:** Set between **1,000,000 - 9,999,000,000** or **00** (*increments of 1M*). Default is **250,000,000**. Set the desired **High Score Level** to which Level 1 may be achieved. A score higher than the default, cannot be reset by Standard Adjustment **28, HSTD Reset Count**. *The High Score will revert to the Default Score ONLY if a Factory Reset is done or the batteries are removed from the CPU/Snd. Bd.*
- 24 **DEFAULT HIGH SCORE #1:** Set between **1,000,000 - 9,999,000,000** or **00** (*increments of 1M*). Default is **200,000,000**. Set the desired **High Score Level** to which Level 2 may be achieved. *Read Std. Adj. 28.*
- 25 **DEFAULT HIGH SCORE #2:** Set between **1,000,000 - 9,999,000,000** or **00** (*increments of 1M*). Default is **175,000,000**. Set the desired **High Score Level** to which Level 3 may be achieved. *Read Std. Adj. 28.*
- 26 **DEFAULT HIGH SCORE #3:** Set between **1,000,000 - 9,999,000,000** or **00** (*increments of 1M*). Default is **150,000,000**. Set the desired **High Score Level** to which Level 4 may be achieved. *Read Std. Adj. 28.*
- 27 **DEFAULT HIGH SCORE #4:** Set between **1,000,000 - 9,999,000,000** or **00** (*increments of 1M*). Default is **125,000,000**. Set the desired **High Score Level** to which Level 5 may be achieved. *Read Std. Adj. 28.*
- 28 **HSTD RESET COUNT:** Set between **100 - 9,900** or **OFF** (*increments of 100*). Default is **2,000**. **HSTD (High Score To Date)**. Set the number of games between "automatic resets of High Score Levels" to "Default Scores" for **ONLY** Standard Adj. **24-27, Default High Score #1-#4**.
- 29 **HIGH SCORE INITIALS:** Set to **3 INITIALS** or **10 LETTER**. Default is **3 INITIALS**. When set to **3 INITIALS**, the player is allowed only 3 initials to input. When set to **10 LETTER NAME**, the player is allowed to enter 10 initials to input.
- 30 **FREE PLAY:** Set to **YES** or **NO**. Default is **NO**. When set to **YES**, no coins are required for *Game Play*.
- 31 **CUSTOM MESSAGE:** Set to **ON, CHANGE** or **OFF**. Default is **ON**. When set to **CHANGE**, a new message can be set or the old one can be edited (*select the "+" Mini-Icon to change settings until "CHANGE" appears in the display, then select the ">>" Mini-Icon to access.*). This adjustment can be accessed in two (2) ways by either selecting the "S.P.I." Icon and advancing to this Adjustment, **or** can be directly accessed by selecting the "ABCD CUST MSG" Icon in the **ADJUSTMENTS MENU**.  
*View the Custom Message Shortcut summary (end of this chapter) for how to enter text or symbols.*
- 32 **FLASH LAMP POWER:** Set to **NORMAL, DIM** or **OFF**. Default is **NORMAL**. When set to **DIM**, the Flash Lamps impulse power is reduced by **25%** and when set to **OFF** the Flash Lamps will not flash.
- 33 **COIL PULSE POWER:** Set to **NORMAL, HARD** or **SOFT**. Default is **NORMAL**. When set to **HARD**, the coil pulse power is **increased** by **12.5%** of the normal pulse rate. When set to **SOFT** the coil pulse power is **decreased** by **12.5%** of the normal pulse rate. This adj. is provided to compensate for *Low Line* or *High Line voltage* conditions where the solenoids (coils) appear to *kicking too weak or too hard*. Adjust as required.
- 34 **KNOCKER VOLUME:** Set to **NORMAL, LOW** or **OFF**. Default is **NORMAL**. When set to **LOW**, the volume is decreased 50%. When set to **OFF**, no sound is heard when the "knocker" is sounded.
- 35 **GAME RESTART:** Set to **YES** or **NO**. Default is **YES**. When set to **YES**, a new game may be started during any ball after the first ball is completed (*if credits are available*). Pressing the **Start Button** during the first ball will add additional players. When set to **NO**, the game disables the **Start Button** after the first ball until the final ball is in play. *Review Sec. 2, Chp. 1, GAME OPERATIONS & FEATURES, for details.*
- 36 **BILL VALIDATOR:** Set to **YES** or **NO**. Default is **NO**. When set to **YES**, in *Game Attract Mode* the Display will show an "*Insert Bill Animation*." When set to **NO**, the Display will show an "*Insert Coin Animation*."
- 37 **BKGRND (BACKGROUND) MUSIC VOLUME:** Set between **01 - 15**. Default is **01**. After volume is set via *Portals Service Buttons* (*see Section 3, Chapter 1, PORTALS™ SERVICE MENU INTRODUCTION*) this adjustment can be utilized to adjust the background music (*1 all the way on, 15 all the way off*) while keeping the *Special Sound FX* the same level.
- 38 **FREEZE TIME (BALL SAVE):** Set to **OFF, 0:01-0:15** or **AUTO**. Default is **0:10**. When set to **OFF** this feature is unavailable. Set between **0:01** through **0:15** (*single increments*) for the ball to be sent back into play if the time set is not met (*per ball*). Set to **AUTO** to automatically adjust the Freeze Timer based on the average ball time.

Standard Adjustments 39-52 continued on the next page.





**UK ONLY Dip Switch Must Be Set**

- 39 **UK POST SAVE ENABLED:** Set to **YES** or **NO**. Default is **NO**, (*UK Default is YES*). When set to **YES** this feature is available when lit. Set to **NO** to disable this feature. (*UK Games have Outlane/Center Post Save Devices which are accessed in differently; Non-UK Games cannot adjust this setting.*)

---

- 40 **TIMED PLUNGER:** Set to **OFF** or **0:15 - 1:00**. Default is **OFF**. When set to **0:15** to **1:00**, the plunger will "Autoplunge" the ball (*at the time set*) when the ball is at the beginning of play, awaiting the skill shot by the player.

---

- 41 **FLIPPER BALL LAUNCH:** Set to **DISABLED**, **LEFT FLIPPER**, **RIGHT FLIPPER**, **EITHER FLIPPER** or **BOTH FLIPPERS**. Default is **DISABLED**. This feature allows the player to operate the *Auto Ball Launch* with the **FLIPPER BUTTON(S)** depending on which setting is chosen.

---

- 42 **COINDOOR BALL SAVER:** Set to **YES** or **NO**. Default is **NO**. When set to **NO**, this feature is not available. When set to **YES**, this feature allows the **Coin Door** to be opened during game play; the ball will drain but the game will be placed "on hold". When the **Coin Door** is closed, the pinball will return to the Shooter Lane, and the game will resume.

---

- 43 **COMPETITION MODE:** Set to **YES** or **NO**. Default is **NO**. When set to **NO**, this feature is not available. If an **Install** of either **\$.50** or **Free Play Comp.** was made (*changing default to YES*), and was changed back to **NO**, the **COMPETITION MODE** will be turned **OFF** (*see Sec. 3, Chp. 5, GO TO INSTALLS MENU, \$. 50 or Free Play Competition*). Set to **YES**, this feature is available (*required for Competition Modes*); this feature will equalize random game features and global score values during multi-player games.

---

- 44 **CONSOLATION BALL:** Set to **YES** or **NO**. Default is **YES**. When set to **YES**, the **EXTRA BALL** (*Playfield Light Insert, location varies*) will be lit on the last ball in play, if certain programming criteria is met.

---

- 45 **FAST BOOT:** Set to **YES** or **NO**. Default is **YES**. When set to **NO** or if you hold the **RIGHT Flipper Button** during Power-Up, this feature is not available and will display all normal Power-Up screens. When set to **YES**, the game will not display the normal informative Power-Up screens, specifically the CPU Version screen and the Location/Game ID screen. Regardless of the setting, normal Power-Up safety checks are still performed.

---

- 46 **Q24 OPTION:** Set to **COIN METER**, **TOKEN DISPENSER** or **KNOCKER**. Default is **COIN METER**. This Coil (Solenoid) Location is left "open" at the Factory to allow for these optional Mechanisms to be added to the game. If selecting **TOKEN DISPENSER**, Standard Adjustments 03, 06 & 12 should be changed to **TOKEN**. *Call Technical Support at 1-800-542-5377 if more information is required on this option.*

---

- 47 **TICKET DISP. INSTALLED:** Set to **YES** or **NO**. Default is **NO**. *This adjustment is required only for games which have an optional Deltronics (DL-1275-2 PCB Style, SPI Part Nr. 515-7275-00) Ticket Dispenser installed. Unique CPU Sound Bd. Dip Switch (Sw. 300) Setting required, changes the Default to YES.*

---

- 48 **ALLOW PLAYER COMP. MODE:** Set to **YES** or **NO**. Default is **YES**. **Competition Mode** unrandomizes feature events, and standardizes game play and rule sets (*varies from game to game*) for fair competitions. With adequate credit, to enter **Competition Mode**, hold the **Flipper Button** in while pressing the **Start Button**. **Watch the Dot Display for more details** (*rules and operation are subject to change*). General rules are covered in the Instruction Card. Other **Hints and/or Rules** can be made known on this game either visually (*the Dot Display or Flashing Light Inserts*) or can be audible.

---

- 49 **TECH ALERT WARNING:** A Portals™ Function. *Review Sec. 3, Chp. 2, GO TO DIAGNOSTICS MENU, Page 25, regarding Technician Alerts and its' functions.* Set to **NEVER**, **POWERUP**, **COIN DOOR** or **POWERUP AND COIN DOOR**. Default is **NEVER**. When set to **NEVER**, the Tech Report Alert display will not appear upon Power-Up or opening the Coin Door, if the game detects any problems. When set to **POWERUP**, the display will appear only upon Power-Up (*if problems detected*). When set to **COIN DOOR**, the display will appear only when the Coin Door is opened (*if problems detected*). When set to **POWERUP AND COIN DOOR**, the display will appear upon Power-Up and if the Coin Door is opened (*if problems detected*).

---

- 50 **TEAM SCORES:** Set to **YES** or **NO**. Default is **NO**. Set to **YES**, then Team Play will be made available. **Team Play only works in a 4-Player Game**. The totals for Players 1 / 3 (Team 1) & Players 2 / 4 (Team 2) are then displayed individually **as well as** the combined score for **BOTH TEAMS** to enable **Team Play (Doubles)**. *See Section 2, Chapter 1, Game Operation & Features, for non-adjustable Features.*

---

- 51 **LOCATION ID:** Set between **00** to **9999**. Default is **00**. This adjustment allows the operator to assign a location identification number to the audit print-out sheet. (*Will not be affected by Factory Reset.*)

---

- 52 **GAME ID:** Set between **00** to **9999**. Default is **00**. This adjustment allows the operator to assign a game identification number to the audit print-out sheet. (*Will not be affected by Factory Reset.*)

Sec. 3: Adjustments

Standard Adjustments 53-55 continued on the next page.

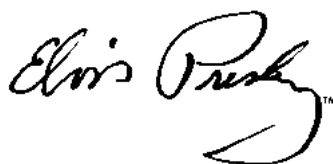



## Standard Adjustments Continued.

STANDARD ADJUSTMENT NAME: Definition

- 53 **FLIPPER ADJ 1:** Set between **05** to **40**. Default is **20**. This adjustment sets the *minimum* fire time for a flipper coil in milliseconds.
- 54 **FLIPPER ADJ 2:** Set between **40** to **60**. Default is **50**. This adjustment sets the *maximum* fire time for a flipper coil in milliseconds.
- 55 **FLIPPER ADJ 3:** Set between **0** to **10**. Default is **3**. This adjustment sets the amount of time to fire the coil *after the EOS switch is seen* in milliseconds.

Standard Adjustments 53-55 Note: • *Flippers will now fire when the button is pushed until the End-of-Stroke (EOS) Switch closure is seen. When EOS is seen, continue firing for the amount of time in Std. Adj. 55. When this time is expired, if the minimum time has not yet been met (Std. Adj. 53), then keep firing until it has. Otherwise switch to hold power.* • *If the flipper has been firing and it reaches the maximum (Std. Adj. 54), then switch to hold power.* • *If the flipper caves-in (EOS re-closes) while the button is still held, then refire the flipper at full power. Switch to hold power as soon as EOS is seen, no minimum times are enforced in this situation.* • *If the flipper caves in several times on the same single flipper button press, then stop refiring at full power and just stay at hold.* • *If the flipper fails to open the EOS switch several times, then assume it isn't working and fall back to a "safe" fire time so as not to burn up the coil.*



## Feature Adjustments (01-16)

To initiate, from the **ADJUSTMENTS MENU**, select the "ELVIS" *Icon* with either the **Red "LEFT"** or **Green "RIGHT" Buttons** and press the **Black "ENTER" Button**. Select and *activate* either of the ">>" *Mini-Icons* to view the next or previous Adjustment in this group. Select and *activate* either of the "-" or "+" *Mini-Icons* to change the setting, if desired (*the Default Setting is noted in the definitions below*). The display will describe the **Adjustment Number**, **Adjustment Name** and the **Current Adjustment Setting**. The current Adjustment will remain in the display until the next Adjustment is view or when this Menu is exited. **Game Play, Rules, Settings and Explanation Subject to Change.**

Nr.	FEATURE ADJUSTMENT NAME: Definition
01	<b>BLUE SUEDE DIFFICULTY :</b> Set to <b>EASY, MODERATE</b> or <b>HARD</b> . Default is <b>MODERATE</b> . Controls the number of loops (orbits) required to start <i>Blue Suede Shoes</i> and how many shots are needed to collect <i>Gold Records</i> .
02	<b>HOUND DOG DIFFICULTY :</b> Set to <b>EASY, MODERATE</b> or <b>HARD</b> . Default is <b>MODERATE</b> . Controls the number of <i>dog hits</i> required to start <i>Hound Dog</i> and how many switches are needed to collect <i>Gold Records</i> .
03	<b>HOTEL DIFFICULTY :</b> Set to <b>EX. EASY, EASY, MODERATE, HARD</b> or <b>EX. HARD</b> . Default is <b>EX. EASY</b> . Specifies how hard it is to open the Hotel Door. <b>EXTRA EASY</b> - door is open. <b>EASY</b> - Any target hit opens door. <b>MODERATE</b> - Only hitting the door opens the door. <b>HARD</b> - Hit all 3 targets in any order to open door. <b>EXTRA HARD</b> - Targets light 1 at a time; hit all 3 to open door.
04	<b>ALL SHOOK UP DIFFICULTY :</b> Set to <b>EX. EASY, EASY, MODERATE, HARD</b> or <b>EX. HARD</b> . Default is <b>EASY</b> . Specifies how easy it is to start <i>All Shook Up</i> . <b>EXTRA EASY</b> - any shot spots any other shot. <b>EASY</b> - All 3 shots must be shot individually in any order. <b>MODERATE</b> - Each shot must be made in ALL-SHOOK-UP order. <b>HARD</b> - Must shoot each shot twice. <b>EXTRA HARD</b> - Must shoot each shot twice in ALL-SHOOK-UP order.
05	<b>JHR (JAILHOUSE ROCK) LOCK DIFFICULTY :</b> Set to <b>EX. EASY, EASY, MODERATE, HARD</b> or <b>EX. HARD</b> . Default is <b>EASY</b> . <b>EXTRA EASY</b> - Locks are lit, a shot from the front or back will count. <b>EASY</b> - Locks are lit, only shots from the front count. <b>MODERATE</b> - Front or back shot lights lock, only front will lock. <b>HARD</b> - Only front lights lock and locks balls. <b>EXTRA HARD</b> - Only timed shots from the left inlane light lock, any shot from front will lock.
06	<b>JHR 1ST 3-BALL :</b> Set between <b>01</b> to <b>05</b> . Default is <b>02</b> . Specifies which <i>Jailhouse Rock Multiball</i> is the first one to require 3 locks.
07	<b>NOTE DIFFICULTY :</b> Set to <b>EX. EASY, EASY, MODERATE, HARD</b> or <b>EX. HARD</b> . Default is <b>MODERATE</b> . Specifies how easy it is to earn <i>Top Ten Records</i> by adjusting which and <i>shot many notes</i> are lit.
08	<b>SPOT NOTE DIFFICULTY :</b> Set to <b>EX. EASY, EASY, MODERATE, HARD</b> or <b>EX. HARD</b> . Default is <b>EASY</b> . Specifies how often the Spot Note target is lit. <b>EXTRA EASY</b> - Always on. <b>EASY</b> - Lit at ball start. <b>MODERATE</b> - Lit at game start with memory from ball-to-ball. <b>HARD</b> - Off at game start with memory from ball-to-ball. <b>EXTRA HARD</b> - Off at ball start.

Sec. 3: Adjustments

Feature Adjustments 09-16 continued on the next page.







# Feature Adjustments Continued.

FEATURE ADJUSTMENT NAME: Definition

- 09 **SCREAMING FANS DIFF. :** Set to **EX. EASY, EASY, MODERATE, HARD** or **EX. HARD**. Default is **MODERATE**. Controls which awards are given away from the *Right Ramp*.
- 10 **GIFT DIFFICULTY :** Set to **MODERATE** or **HARD**. Default is **MODERATE**. Controls whether *Gifts of Elvis* can stack or not. **MODERATE** - gifts stack. **HARD** - gifts don't stack.
- 11 **MAGNET DIFFICULTY :** Set to **EASY, MODERATE** or **HARD**. Default is **HARD**. Controls how often the magnet grabs the ball. **EASY** - magnet grabs ball coming out of the pop bumpers or the hotel. **MODERATE** - magnet grabs ball coming out of the pop bumpers. **HARD** - magnet only grabs the ball for Blue Suede Shoes shots.
- 12 **SHOW UPPER FLIPPER:** Set to **YES** or **NO**. Default is **YES**. Controls whether the game will show the flipper to the player the first time the magnet grabs the ball. When set to **YES**, the game will **flip** (actuate the coil) the Upper Right Flipper (below Magnet in the Right Orbit) in an attempt to get players to notice this potential shot (center loop) when it is fed for the first time. If the player is about to have a ball get stopped by the magnet in the Right Orbit, the game will **flip** the Upper Right Flipper 3 times. This will not occur if the first feed to a Flipper is during any Multiball Mode.
- 13 **SPOT ASU (ALL SHOOK UP) ON BALL :** Set to **OFF, 01** to **03**. Default is **02**. Specifies on which ball the game will spot the UP (right ramp) shot for All Shook Up if it hasn't been earned yet.
- 14 **TCB MEMORY:** Set to **YES** or **NO**. Default is **YES**. Specifies whether the **T-C-B Targets** stay lit from ball-to-ball.
- 15 **KING MEMORY:** Set to **YES** or **NO**. Default is **YES**. Specifies whether the **K-I-N-G Targets** stay lit from ball-to-ball.
- 16 **ADULT CONTENT ENABLED:** Set to **YES** or **NO**. Default is **YES**. Controls whether the game will make use of more mature content. Set to **NO** to disable "adult content" in both audible (sounds and/or words). Visual (dot display graphics) may be included, if present.

Sec. 3: Adjustments



## Custom Message

To go directly to **Standard Adjustment 31, Custom Message**, from the **ADJUSTMENT MENU**, select the "CUST MSG" Icon with either the **Red "LEFT"** or **Green "RIGHT"** Buttons and press the **Black "ENTER" Button**. At the top left corner of the Display, the letter **A** is indicated (blinking) in the first available position (Thirty-Six (36) characters including spaces are available). Vary the letter(s) by operating the Left and Right Flipper Buttons (or "**RED**" or "**GREEN**" Buttons). With the desired letter indicated, depress the **Start Button** to lock in the letter and advance to the next character. Repeat this procedure until the desired message is completed in the display. Select the "<" or ">" characters to back-space (erase) and/or to move forward in an already typed message. After completion, press the "**BLACK**" Button, "REQUEST INSTALLED" is indicated and then exits this sub-menu.



**For further customization of Game Play Difficulty or Game Play Type or how to RESET ONLY the Adjustments, see Section 3, Chapter 5, GO TO INSTALLS MENU.**

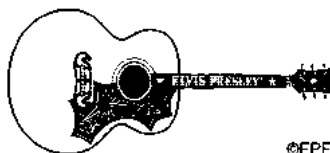

# Go To Installs Menu

## Overview

The Portals™ Service Menu System provides **15 Installs** to vary **Game Play (Feature Adjustments) Difficulty** or **Game Play Type** and **Install Factory** (restores all adjustments to Factory Defaults).



**Important:** The **Coin Door** must be **OPEN** allowing the **Memory Protect Switch** to be disabled, so any **Install** changes can be made.



For **detailed customization** or to check current **Adjustments Defaults** (either changed by YOU in the **Adjustments Menu** or by this **Installs Menu** or for **Factory Default Settings**), see **Section 3, Chapter 4, GO TO ADJUSTMENTS MENU**. **Important: Before preceding**, write down any **previously changed Adjustment Defaults**. After completing one or more of the **Installs** in this Chapter, go back to the **ADJUSTMENTS MENU** to see which **Standard and/or Feature Adjustments** have changed (*Feature Adjustments and/or settings are subject to change during production, and may differ than what is described in the tables at the end of this chapter*). If the settings are not to your liking, perform **one** of the following:

- 1.: **Manually** change the **Standard & Feature Adjustments** Settings (perform task in the **ADJUSTMENTS MENU**, see **Section 3, Chapter 4, GO TO ADJUSTMENTS MENU**).
- 2.: **Install Factory** (see opposite this page) on how to reset all of the **Standard & Feature Adjustments** back to the **Factory Default Settings**.

Multiple **Installs** can be set to vary game play; however, for **Installs** that have *one or more* Adjustments in common, the **last** "Install" selected & **activated**, will **supersede** any previously changed Adjustment(s) from any prior **Installs**. Any adjustments which you changed and are not affected by the Install will remain as set.

For example, if you want a **5-BALL Game** set to **EXTRA EASY**: Select and **activate** the "5BAL" **Icon** first (which will typically change any **Feature** Difficulty Adjustments to **HARD**), then select & **activate** the "X.EZ" **Icon** to **change back** the Difficulty Adjustments to **EXTRA EASY**. However, if the "X.EZ" **Icon** was selected & **activated** first, then the "5BAL" **Icon** was selected & **activated**, the game will be set to a **5-BALL Game** set to **HARD**.



### EXPLANATION & USAGE OF COMMON LARGE ICONS USED IN THIS MENU:



These **non-selectable icons** appear in the selected Menu only when there are **MORE** icons to the **LEFT** or to the **RIGHT** available for selection.



Select and activate to return to the **PREVIOUS** Menu.



Select and activate to **QUIT**, exits & returns to the **Attract Mode**.



Select and activate to view **HELP** Screens of the current Menu\*.

**⚠ WARNING: ⚠**

**Selection & activation of the "Install Factory" Icon, will change all Adjustments & Installs to the Factory Default!**

\* **Help Note:** An explanation of each Icon at that menu level will cycle continuously. To exit a display where no icons are available for selection, pressing any button will exit the display.

## GO TO INSTALLS MENU



After entering **Portals™**, the **MAIN MENU** now appears. Select the "INST" **Icon** in the **MAIN MENU** with either the **Red "LEFT"** or **Green "RIGHT"** Buttons (the **Flipper Buttons** operates in the same manner) and press the **Black "ENTER"** Button (the **Start Button** operates in the same manner). The **INSTALLS MENU** appears. Continue through this chapter for the explanation & usage of the **Icons** in the **INSTALLS MENU**.

View Pages **49 & 50** for an Overview of the **Standard & Feature Adjustment(s)** which have changed upon selection.



### Install Extra Easy, Easy, Normal, Hard or Extra Hard

To initiate, from the **INSTALLS MENU**, select the "X.EZ," "EASY," "FACT," "HARD," or "X.HD" **Icons** with either the **Red "LEFT"** or **Green "RIGHT"** Buttons and press the **Black "ENTER"** Button. **Game Play Difficulty** is set to **EXTRA EASY**. "**REQUEST INSTALLED**" is indicated and returns to the **INSTALLS MENU** with the previously selected **Icon** flashing.





## Install Directors Cut

To initiate, from the **INSTALLS MENU**, select the "DCUT" *Icon* with either the **Red "LEFT"** or **Green "RIGHT"** Buttons and press the **Black "ENTER"** Button. **Game Play Type** is set to programmers choice. **"REQUEST INSTALLED"** is indicated and returns to the **INSTALLS MENU** with the "DCUT" *Icon* flashing.



## Install 3-Ball or 5-Ball

To initiate, from the **INSTALLS MENU**, select the "3BAL" or "5BAL" *Icon* with either the **Red "LEFT"** or **Green "RIGHT"** Buttons and press the **Black "ENTER"** Button. **Game Play Type** is set to 3- or 5-BALL PLAY. **"REQUEST INSTALLED"** is indicated and returns to the **INSTALLS MENU** with the previously selected *Icon* flashing.



## \$ .50 Competition (a.k.a. IFPA)

To initiate, from the **INSTALLS MENU**, select the "PAY" *Icon* with either the **Red "LEFT"** or **Green "RIGHT"** Buttons and press the **Black "ENTER"** Button. **Game Play Type** is set to **TOURNAMENT PAY MODE**. **"REQUEST INSTALLED"** is indicated and returns to the **INSTALLS MENU** with the "PAY" *Icon* flashing.



## Free Play Competition (a.k.a. EXPO or PAPA)

To initiate, from the **INSTALLS MENU**, select the "FREE" *Icon* with either the **Red "LEFT"** or **Green "RIGHT"** Buttons and press the **Black "ENTER"** Button. **Game Play Type** is set to **TOURNAMENT FREE MODE**. **"REQUEST INSTALLED"** is indicated and returns to the **INSTALLS MENU** with the "FREE" *Icon* flashing.



## Install Home Play

To initiate, from the **INSTALLS MENU**, select the "HOME" *Icon* with either the **Red "LEFT"** or **Green "RIGHT"** Buttons and press the **Black "ENTER"** Button. **Game Play Type** is set to **NORMAL HOME PLAY**. **"REQUEST INSTALLED"** is indicated and returns to the **INSTALLS MENU** with the "HOME" *Icon* flashing.



## Film Star Reset

To initiate, from the **INSTALLS MENU**, select the "STAR" *Icon* with either the **Red "LEFT"** or **Green "RIGHT"** Buttons and press the **Black "ENTER"** Button. **Game Play Type** is set to **EASY HOME PLAY**. **"REQUEST INSTALLED"** is indicated and returns to the **INSTALLS MENU** with the "STAR" *Icon* flashing.



## Install Novelty

This setting is recommended where *local laws restrict certain game features*.

To initiate, from the **INSTALLS MENU**, select the "NOV" *Icon* with either the **Red "LEFT"** or **Green "RIGHT"** Buttons and press the **Black "ENTER"** Button. **Game Play Type** is set to **RESTRICTED PLAY**. **"REQUEST INSTALLED"** is indicated and returns to the **INSTALLS MENU** with the "NOV" *Icon* flashing.



## Install Add-A-Ball

This setting is recommended where *local laws restrict certain game features*.

To initiate, from the **INSTALLS MENU**, select the "A.A.B" *Icon* with either the **Red "LEFT"** or **Green "RIGHT"** Buttons and press the **Black "ENTER"** Button. **Game Play Type** is set to **RESTRICTED PLAY**. **"REQUEST INSTALLED"** is indicated and returns to the **INSTALLS MENU** with the "A.A.B" *Icon* flashing.



## Install Factory (ONLY affects all Adjustments/Installs)

To initiate, from the **INSTALLS MENU**, select the "FACT" *Icon* with either the **Red "LEFT"** or **Green "RIGHT"** Buttons and press the **Black "ENTER"** Button. **▲ All Standard & Feature Adjustments** which were changed in the **INSTALLS** or **ADJUSTMENTS MENU** are returned to the **Factory Defaults**.

## Overview of Standard Adjustment Changes upon selection of an Install:

ONLY THE STANDARD ADJUSTMENTS LISTED ARE AFFECTED AS NOTED IN THE TABLES BELOW.



Nr.	STANDARD ADJUSTMENT NAME	INSTALL EXTRA EASY	INSTALL EASY	INSTALL NORMAL	INSTALL HARD	INSTALL EXTRA HARD	INSTALL DIRECTOR'S CUT	INSTALL 3-BALL	INSTALL 5-BALL
10	EXTRA BALL PERCENTAGE	30%	25%	20%	15%	10%		20%	10%
14	BALLS PER GAME							03	05
38	FREEZE TIME	0:12	0:10	0:08	OFF	OFF		0:08	AUTO

ONLY THE STANDARD ADJUSTMENTS LISTED ARE AFFECTED AS NOTED IN THE TABLES BELOW.



Nr.	STANDARD ADJUSTMENT NAME	\$.50 COMPETITION *	FREE PLAY COMP. *	INSTALL HOME PLAY	FILM STAR RESET	INSTALL NOVELTY	INSTALL ADD-A-BALL	INSTALL FACTORY
01	REPLAY TYPE					NONE		<b>CAUTION! :</b> Upon selection of <b>Install Factory</b> ("FACT" Icon), all Standard & Feature Adjustments which were changed in the <b>INSTALLS</b> or <b>ADJUSTMENTS MENU</b> are returned to the <b>Factory Defaults</b> (see the Adjustment Tables on Page 38 for details).  * If <b>Competition Mode</b> was set, it is suggested to <b>Install Factory</b> to restore all Adjustments to the <b>Factory Defaults</b> . Then recustomize, if desired.
03	REPLAY AWARD						EX. BALL	
04	REPLAY LEVELS					NONE		
06	SPECIAL AWARD					POINTS	EX. BALL	
08	FREE GAME LIMIT					NO FREE..	NO FREE..	
09	EXTRA BALL LIMIT					NO EXTRA...	09	
10	EXTRA BALL PERCENTAGE			20%	20%			
11	GAME PRICING	USA 3						
13	MATCH PERCENTAGE			10%		OFF	OFF	
15	TILT WARNINGS	02	02					
18	GRAND CHAMPION AWARDS					00	00	
19	HIGH SCORE #1 AWARDS					00	00	
20	HIGH SCORE #2 AWARDS					00	00	
21	HIGH SCORE #3 AWARDS					00	00	
22	HIGH SCORE #4 AWARDS					00	00	
23	GRAND CHAMPION SCORE			25,000,000				
24	DEFAULT HIGH SCORE #1			20,000,000				
25	DEFAULT HIGH SCORE #2			15,000,000				
26	DEFAULT HIGH SCORE #3			10,000,000				
27	DEFAULT HIGH SCORE #4			5,000,000				
30	FREE PLAY	NO	YES	YES	YES			
35	GAME RESTART	NO	NO					
38	FREEZE TIME				0:10			
42	COINDOOR BALL SAVER **	(YES)**	(YES)**					
43	COMPETITION MODE ***	YES***	YES***					

\*\* Adjustment 42 Default will not change; Installing \$.50 or Free Play Competition will override this Adjustment regardless of the setting.  
 \*\*\* If Adjustment 43 is changed back to NO after this Install, the Competition Mode Install will be canceled (turned off).

Sec. 3: Go To Installs

## Overview of Feature Adjustment Changes upon selection of an Install:

ONLY THE FEATURE ADJUSTMENTS LISTED ARE AFFECTED AS NOTED IN THE TABLES BELOW.



Nr.	FEATURE ADJUSTMENT NAME	INSTALL EXTRA EASY	INSTALL EASY	INSTALL NORMAL (FACTORY)	INSTALL HARD	INSTALL EXTRA HARD	INSTALL DIRECTOR'S CUT	INSTALL 3-BALL	INSTALL 5-BALL
01	BLUE SUEDE DIFFICULTY	EASY	EASY	MODERATE	MODERATE	HARD	MODERATE	MODERATE	MODERATE
02	HOUND DOG DIFFICULTY	EASY	EASY	MODERATE	HARD	HARD	MODERATE	MODERATE	MODERATE
03	HOTEL DIFFICULTY	EX. EASY	EX. EASY	EX. EASY	EASY	MODERATE	EASY	EX. EASY	EASY
04	ALL SHOOK UP DIFFICULTY	EX. EASY	EASY	EASY	MODERATE	HARD	EASY	EASY	MODERATE
05	JAILHOUSE LOCK DIFF.	EX. EASY	EASY	EASY	EASY	MODERATE	EASY	EASY	EASY
06	JHR 1ST 3-BALL	02	02	02	01	01	01	02	01
07	NOTE DIFFICULTY	EX. EASY	EASY	MODERATE	HARD	EX. HARD	MODERATE	MODERATE	HARD
08	SPOT NOTE DIFFICULTY	EX. EASY	EASY	EASY	MODERATE	HARD	EASY	EASY	MODERATE
09	SCREAMING FANS DIFF.	EX. EASY	EASY	MODERATE	HARD	EX. HARD	MODERATE	MODERATE	HARD
10	GIFT DIFFICULTY	MODERATE	MODERATE	MODERATE	MODERATE	HARD	MODERATE	MODERATE	MODERATE

Overview of Feature Adjustment Changes (this table) ... continued on the next page.



# Overview of Feature Adjustment Changes upon selection of an Install Continued:

ONLY THE FEATURE ADJUSTMENTS LISTED ARE AFFECTED AS NOTED IN THE TABLES BELOW.



Nr.	FEATURE	ADJUSTMENT NAME	INSTALL EXTRA EASY	INSTALL EASY	INSTALL NORMAL (FACTORY)	INSTALL HARD	INSTALL EXTRA HARD	INSTALL DIRECTOR'S CUT	INSTALL 3-BALL	INSTALL 5-BALL
11	MAGNET DIFFICULTY		EASY	MODERATE	HARD	HARD	HARD	HARD	HARD	HARD
13	SPOT ASU ON BALL		01	01	02	03	OFF	OFF	02	OFF
14	TCB MEMORY		YES	YES	YES	NO	NO	YES	YES	YES
15	KING MEMORY		YES	YES	YES	YES	NO	YES	YES	YES

ONLY THE FEATURE ADJUSTMENTS LISTED ARE AFFECTED AS NOTED IN THE TABLES BELOW.



Nr.	FEATURE	ADJUSTMENT NAME	\$.50 COMPETITION *	FREE PLAY COMP. *	INSTALL HOME PLAY	FILM STAR RESET	INSTALL NOVELTY	INSTALL ADD-A-BALL	INSTALL FACTORY
01	BLUE SUEDE DIFFICULTY					EASY			
02	HOUND DOG DIFFICULTY					EASY			
03	HOTEL DIFFICULTY					EX. EASY			
04	ALL SHOOK UP DIFFICULTY					EX. EASY			
05	JAILHOUSE LOCK DIFF.					EX. EASY			
06	FIRST 3-BALL JAILHOUSE					02			
07	NOTE DIFFICULTY					EX. EASY			
08	SPOT NOTE DIFFICULTY					EX. EASY			
09	SCREAMING FANS DIFF.					EX. EASY			
10	GIFT DIFFICULTY					MODERATE			
11	MAGNET DIFFICULTY					EASY			
13	SPOT ASU ON BALL					01			
14	TCB MEMORY					YES			
15	KING MEMORY					YES			

**CAUTION!**  
Upon selection of **Install Factory** ("FACT" Icon), all Standard & Feature Adjustments which were changed in the **INSTALLS** or **ADJUSTMENTS MENU** are returned to the **Factory Defaults** (see the Adjustment Tables on Page 38 for details).

Sec. 3: Go To Installs



For how to **RESET Audits** (also can **RESET High Scores, Credits or Reset All Adjustments**), see **Section 3, Chapter 6, GO TO RESET MENU**.



# Go To Reset Menu

## Overview

The Portals™ Service Menu System provides five (5) functions to reset **Coin & Game Audits, High Scores, Credits** or to reset **ALL AUDITS, ADJUSTMENTS & INSTALLS** back to the *Factory Default Settings*.



**Important:** The **Coin Door** must be **OPEN** allowing the **Memory Protect Switch** to be disabled, so any **Reset** changes can be made.



### EXPLANATION & USAGE OF COMMON LARGE ICONS USED IN THIS MENU:



These **non-selectable** icons appear in the selected Menu only when there are **MORE** icons to the **LEFT** or to the **RIGHT** available for selection.



Select and activate to return to the **PREVIOUS** Menu.



Select and activate to **QUIT**, exits & returns to the **Attract Mode**.



Select and activate to view **HELP** Screens of the current Menu\*.

**⚠ WARNING: ⚠**

As soon as any **Reset Icon** is selected & activated, the information associated with the **Reset Icon**, is lost!

\* **Help Note:** An explanation of each icon at that menu level will cycle continuously. To exit a display where no icons are available for selection, pressing any button will exit the display.



## GO TO RESET MENU

After entering **Portals™**, the **MAIN MENU** now appears. Select the **"RESET"** icon in the **MAIN MENU** with either the **Red "LEFT"** or **Green "RIGHT"** Buttons (the **Flipper Buttons** operates in the same manner) and press the **Black "ENTER"** Button (the **Start Button** operates in the same manner). The **RESET MENU** appears. Continue below for the explanation & usage of the **Icons** in the **RESET MENU**.



## Reset Coin Audits

To initiate, from the **RESET MENU**, select the **"COIN"** icon with either the **Red** or **Green Buttons** and press the **Black Button**. ⚠ **ONLY** the **Coin Audits (05-13)** will be reset to zero (0), *Factory Default Settings*. **"REQUEST INSTALLED"** is indicated and returns to the **RESET MENU** with the **"COIN"** icon flashing.



## Reset Game Audits

To initiate, from the **RESET MENU**, select the **"AUD"** icon with either the **Red** or **Green Buttons** and press the **Black Button**. ⚠ **ONLY** the **Game Audits (01-04)** & **Standard Audits (01-67)** will be reset to zero (0), *Factory Default Settings*. **Note:** **Coin Audits (05-13)** & **Software Meter Audit (14)** will not be reset. **"REQUEST INSTALLED"** is indicated and returns to the **RESET MENU** with the **"AUD"** icon flashing.



## Reset High Scores

To initiate, from the **RESET MENU**, select the **"HSTD"** icon with either the **Red** or **Green Buttons** and press the **Black Button**. ⚠ **ONLY** the **High Scores** will be reset to the current values. **Note:** If these five (5) adjustments were not personally changed by you, the *Factory Default Settings* will be used (see **Section 3, Chapter 4, GO TO ADJUSTMENTS MENU, Standard Adjustments 18-22**). **"REQUEST INSTALLED"** is indicated and returns to the **RESET MENU** with the **"HSTD"** icon flashing.



## Reset Credits

To initiate, from the **RESET MENU**, select the **"CRED"** icon with either the **Red** or **Green Buttons** and press the **Black Button**. ⚠ All **Credits** will be reset to zero (0), *Factory Default Settings*. **"REQUEST INSTALLED"** is indicated and returns to the **RESET MENU** with the **"CRED"** icon flashing.



## Factory Reset

To initiate, from the **RESET MENU**, select the **"FACT"** icon with either the **Red** or **Green Buttons** and press the **Black Button**. ⚠ All **Audits (except for Audit 14, Software Meter)**, all **Adjustments** and **Installs** will be reset to the *Factory Default Settings*. **Note:** To **RESET ONLY** the **ADJUSTMENTS & INSTALLS** (leaving all the Audits alone), see **Section 3, Chapter 5, GO TO INSTALLS MENU, Install Factory**. **"REQUEST INSTALLED"** is indicated and the **Service Menu** is exited, returning to the **Attract Mode**.

Sec. 3: Go To Reset



**Example:**

After entering **Portals™**, the **MAIN MENU** now appears. Use the Red "LEFT" or Green "RIGHT" Buttons to select the "RESET" Icon (**GO TO RESET MENU**).

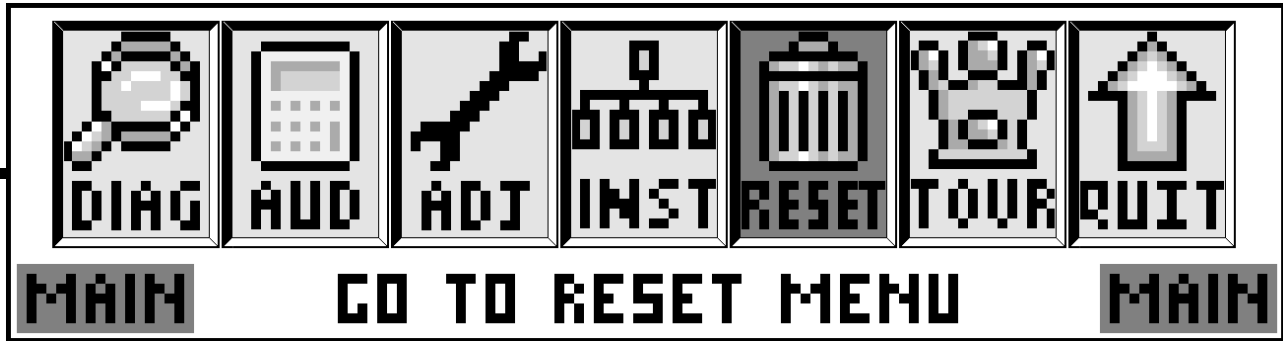

Press the **Black "ENTER" Button** to activate this **ICON**. The **RESET MENU** now appears with the "COIN" Icon (**RESET COIN AUDITS**) flashing:

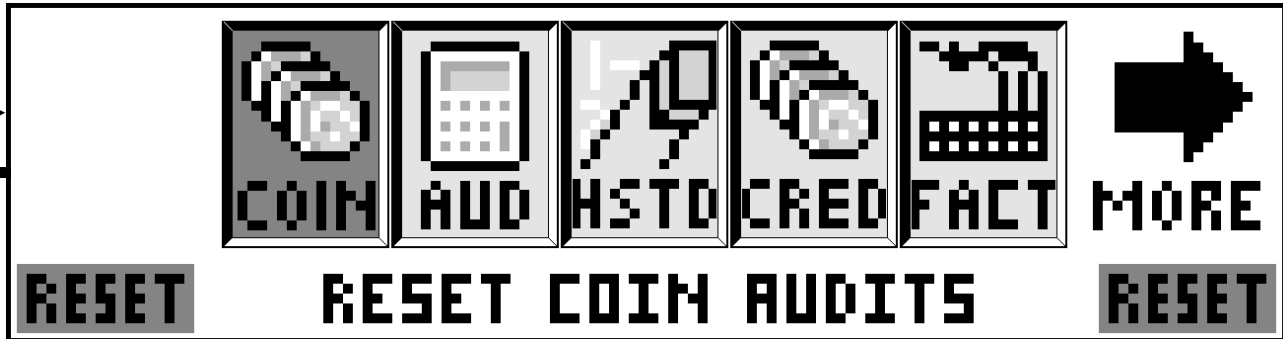

Sec. 3: Go To Reset

From the **RESET MENU**, select any of the **Icons** ("COIN", "AUD", "HSTD", "CRED") with either the **Red or Green Buttons** and press the **Black Button** to activate the **ICON** chosen. After the **ICON** is selected & activated, "**REQUEST INSTALLED**" is indicated and is returned to the **RESET MENU** with the previously selected **Icon** flashing.

**Important:**



AT THIS TIME, **DO NOT** PRESS THE **START BUTTON** OR **BLACK BUTTON** AFTER SELECTING ANY OF THE FIVE (5) ICONS UNLESS THIS IS WHAT IS DESIRED. **THE INFORMATION ASSOCIATED WITH THE RESET ICON WILL BE LOST!** PLEASE READ THE PREVIOUS PAGE FOR EXACTLY WHAT WILL HAPPEN IF ANY OF THESE FIVE (5) ICONS ARE SELECTED & ACTIVATED.



Before performing any **RESET**, write down your **last Audit Totals** (see Section 3, Chapter 3, **GO TO AUDITS MENU**) and any **personalized Adjustment changes** you may have made (see Section 3, Chapter 4, **GO TO ADJUSTMENTS MENU**).



If the "FACT" Icon is select and activated, "REQUEST INSTALLED" is indicated and the **Service Menu** is exited, returning to the **Attract Mode**. See the previous page for explanation & usage of the Icons in the **RESET MENU**.

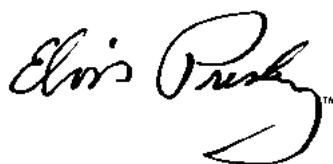



# Go To Tournament Menu Overview

The **Portals™ Service Menu System** provides **6 Steps** necessary to **SET-UP, START, MONITOR** and **END** Pinball Tournaments on your *Tournament Pinball System Ready Pinball Game*. **OPTIONAL EQUIPMENT & HARDWARE (SOLD SEPARATELY) ARE REQUIRED FOR PROPER OPERATION AND USE OF THIS MENU.**

Game code may get upgraded during production; compare all Tournament Adjustments & Audits in the display with the manual and make any corrections to the Tournament Adjustments and/or Audits Tables (*next page*), as necessary. Tournament Adjustments & Audits are subject to change (*with or without notice*). To view Tournament Adjustments & Audits in the display, enter the **Portals™ Service Menu System**. When any change is made and then the next / previous item is selected (*or the Sub-Menu is exited*), the display will momentarily flash **REQUEST INSTALLED**. For details on **Earnings, Standard & Feature Audits**, see Section 3, Chapter 3, **GO TO AUDITS MENU**. For details on **Standard & Feature Adjustments**, see Section 3, Chapter 4, **GO TO ADJUSTMENTS MENU**.



**Tournament Operation Note:**  
 The use of the *Tournament Equipment* and/or running a Tournament is **OPTIONAL** and to be used solely in the discretion of the owner.  
*It is the sole responsibility of the operator to ensure that this product is used in conformity with all applicable laws. Stern Pinball, Inc.® disclaims any such responsibility.*  
**Due to continuing product innovation, information in this chapter is subject to change without notice.**

**?** For more details on the equipment & hardware required, installation and set-up, read the **ToPS™ Tournament Pinball System Kit Installation Manual** (SPI Part Number: 780-6011-01) provided in the **Optional Tournament Kit\*** (SPI Part Number: 502-5011-00). \*Not included with this ToPS™ Ready Pinball Game.

The equipment & hardware consists of: **BETAbrite™ Electronic 7 X 80 Multi-Color Dot Display** (secured above the Backbox), **Tournament Serial Interface (TSI) Board** (secured in the Backbox), **Tournament Button + Lamp** (secured onto the Front Molding) and all necessary wiring, hardware and documentation (*which also provides suggestions and Tips for ToPS™*).

To order, contact your local Distributor (*view Pages DR. 8 & 9 in the Find-It-In-Front: Dr. Pinball*). You can also call Technical Support or visit our website (*details on the back cover of this manual*).

**! Important: The Coin Door must be OPEN allowing the Memory Protect Switch to be disabled, so any Tournament changes can be made. !**



**EXPLANATION & USAGE OF COMMON LARGE & MINI-ICONS USED IN VARIOUS MENUS & SUB-MENUS:**



These *non-selectable icons* appear in the selected Menu only when there are MORE icons to the LEFT or to the RIGHT available for selection.



Select and activate to return to the **PREVIOUS** Menu.



Select and activate to **QUIT**, exits & returns to the **Attract Mode**.



Select and activate to view **HELP Screens** of the current Menu\*.

Select and activate to:  
 Move **LEFT** or **RIGHT**, select previous / next or move backwards / forwards.  
**DECREMENT (-)** or **INCREMENT (+)** displayed value or select previous / next.

\* **Help Note:** An explanation of each Mini-Icon at that menu level will cycle continuously. To exit a display where no Mini-Icons are available for selection, pressing any button will exit the display.



## GO TO TOURNAMENT MENU (OPTIONAL USE ONLY)

After entering **Portals™**, the **MAIN MENU** now appears. Select the "TOUR" *Icon* in the **MAIN MENU** with either the **Red "LEFT"** or **Green "RIGHT"** Buttons (the **Flipper Buttons** operates in the same manner) and press the **Black "ENTER"** Button (the **Start Button** operates in the same manner). The **TOURNAMENT MENU** appears. Continue through this chapter for the explanation & usage of the *Icons* in the **TOURNAMENT MENU**.

*Tournament Adjustment & Audit Tables on the next page.*



Sec. 3: Tournament ...





# TOURNAMENT ADJUSTMENT TABLES

## TOURNAMENT ADJUSTMENTS 01-13

Nr.	ADJUSTMENT NAME	USA DEFAULT	YOUR SETTING
01	CREDITS PER PLAY	02	
02	JACKPOT BASE	\$20.00	
03	JACKPOT INCREMENT	\$00.50	
04	JACKPOT MAX.	\$2,500.00	
05	CURRENT DATE/TIME	JAN. 01, 2004 12:00:00 AM	
06	START DATE	FEB. 01, 2004 12:00:00 AM	
07	END DATE	MARCH 01, 2004 12:00:00 AM	

Nr.	ADJUSTMENT NAME	USA DEFAULT	YOUR SETTING
08	# OF PRIZES	03	
09	AWARD TYPE	CASH	
10	SHOW PLAYER'S CASH	YES	
11	TOURNAMENT TYPE	BUMP N' WIN	
12	BUMP N' WIN BASE	"varies"	
13	BALLS PER TOURNAMENT	03	

**Note:** The above adjustments must be set just before selecting and activating the "STRT" Icon (START TOURNAMENT). See the following pages for explanation and more details.



## SIGN MESSAGES A-B (ADJUSTMENTS 14-15)

Nr.	ADJUSTMENT NAME	USA DEFAULT	YOUR SETTING
14	LOCATION MESSAGE	ON	

Nr.	ADJUSTMENT NAME	USA DEFAULT	YOUR SETTING
15	PRIZE MESSAGE	ON	

Sec. 3: Tournament ...



STARTING METER Reading :

STARTING METER Date (MM/DD/YR) :

AUDITOR'S NAME :

CURRENT VOLUME SETTING :

CURRENT METER Reading :

AUDIT Date (MM/DD/YR) :

CPU Version :

DISPLAY Version :

GAME LOCATION NAME :

See Adj. 06 & 07 above >>

TOURNAMENT START DATE :

TOURNAMENT END DATE :

## TOURNAMENT AUDIT TABLE



## TOURNAMENT AUDITS 01-14

Audit definitions follow in this Chapter.

01	TOTAL PLAYS
02	TOURNAMENT PLAYS
03	TOTAL QUALIFYING PLAYS
04	TOTAL GAME EARNINGS
05	TOTAL TOUR. EARNINGS

06	JACKPOT
07	NET EARNINGS
08	ACCUM. TOTAL PLAYS
09	ACCUM. TOUR. PLAYS
10	ACCUM. QUALIFYING PLAYS

11	ACCUM. EARNINGS
12	ACCUM. TOUR EARNINGS
13	ACCUM. JACKPOT
14	# TOURNAMENTS

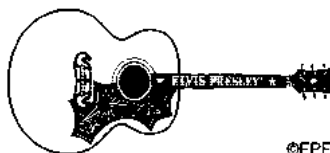



# Tournament Adjustments (01-13)

To initiate, from the **TOURNAMENT MENU**, select the "SET UP" *Icon* with either the **Red "LEFT"** or **Green "RIGHT" Buttons** and press the **Black "ENTER" Button**. Select and *activate* either of the ">>" *Mini-Icons* to view the next or previous Tournament Adjustment in this group. Select and *activate* either of the "-" or "+" *Mini-Icons* to change the setting, if desired (*the Default Setting is noted in the definitions below*). The display will describe the **Tournament Adjustment Number**, **Tournament Adjustment Name** and the **Current Tournament Adjustment Setting**. The current Tournament Adjustment will remain in the display until the next Tournament Adjustment is viewed or when this Menu is exited.

**Note on Tournament Adjustments 5, 6 & 7:** \*Requires the **TIMEKEEPER™ IC (included in the kit) installed in Location U212 on the CPU/Snd. Board**. How to change the **CURRENT DATE/TIME, START DATE & END DATE**: Upon entering the menu, the ">>" *Mini-Icon* and the Month is flashing. Use the "+" or "-" *Mini-Icon* to change the month. Select the ">>" *Mini-Icon* again, now the day can be changed. Continue this until all is set to your liking. After the **CURRENT DATE/TIME (T. Adj. 05)** and the **START & END DATE/TIME (T. Adj. 06/07)** are set, the "STRT" *Icon* must be activated, in order for the Tournament to start and end automatically. In the event you have to **End a Tournament** before your designated date/time or you do not have the **TIMEKEEPER™ IC** installed go back to the **TOURNAMENT MENU** and select the "END" *Icon* (*see the next page*) to stop the Tournament.

**IMPORTANT FOR TOURNAMENT USERS:** *Select the settings carefully.* Before allowing players to begin after you've started a Tournament, double-check the **Normal Mono-Color Dot Display** and **Top Multi-Color Dot (Beta Brite®) Display** to ensure everything you want is displayed correctly. Once a Tournament is started, no adjustments can be made until you end the Tournament (*by selecting the "END" Icon*). Allowing players to qualify, then ending a Tournament prematurely to make corrections will affect the outcome of the Tournament.

**WARNING: Changes made in any Adjustments will be lost after a FACTORY RESET or removal of the CPU/Sound Board Batteries.**

Nr.	TOURNAMENT ADJUSTMENT NAME: Definition	
01	<b>CREDITS PER PLAY</b> : Set between <b>01 - 10</b> . Default is <b>02</b> . Set the maximum number of <i>Credits</i> that may be accumulated per game.	
02	<b>JACKPOT BASE</b> : Set between <b>\$00.00 - \$999,999.00</b> ( <i>increments of \$1</i> ). Default is <b>\$20.00</b> . Set the initial <i>Prize Pool Amount</i> to be offered for the Tournament. <b>Note:</b> <i>The displays will present the words "PRIZE POOL" in lieu of the word "JACKPOT"</i> .	
03	<b>JACKPOT INCREMENT</b> : Set between <b>\$00.00 - \$999,999.99</b> ( <i>increments of 1¢</i> ). Default is <b>\$00.50</b> . Set the <i>Prize Pool Increment</i> which will increase the <i>Prize Pool Amount</i> with each Tournament Game played.	
04	<b>JACKPOT MAX.</b> : Set between <b>\$00.00 - \$999,999.00</b> ( <i>increments of \$1</i> ). Default is <b>\$2,500.00</b> . Set the maximum cap to be placed on the <i>Prize Pool</i> during a Tournament. <b>Note:</b> <i>The displays will present the words "PRIZE POOL" in lieu of "JACKPOT"</i> .	
05	<b>CURRENT DATE/TIME</b> : Set the current <b>MONTH, DAY, YEAR, HOUR (AM/PM), MINUTE</b> and <b>SECOND</b> . Default is <b>JAN. 01, 2004 12:00:00 AM</b> .	
06	<b>START DATE</b> : Set the desired <b>MONTH, DAY, YEAR, HOUR (AM/PM), MINUTE</b> and <b>SECOND</b> . Default is <b>FEB. 01, 2004 12:00:00 AM</b> .	
07	<b>END DATE</b> : Set the desired <b>MONTH, DAY, YEAR, HOUR (AM/PM), MINUTE</b> and <b>SECOND</b> . Default is <b>MARCH 01, 2004 12:00:00 AM</b> .	
08	<b># OF PRIZES</b> : Set between <b>01 - 05</b> ( <i>If Tournament Adj. 11 is set to REGULAR</i> ) or <b>02 - 05</b> ( <i>If Tournament Adj. 11 is set to BUMP N' WIN</i> ). Default (for either) is <b>04</b> . Set the max. number of <i>Prize Positions</i> to be awarded during a Tournament. <b>Selections are as follows</b> ( <i>percentage distribution cannot be changed</i> ):	
	<b>If below Tournament Adj. 11 is set to REGULAR :</b> Set to <b>01</b> 1 Winner <b>100%</b> (1) <i>Prize Pool</i> Set to <b>02</b> 2 Winners <b>65%</b> (1) <b>35%</b> (2) Set to <b>03</b> 3 Winners <b>50%</b> (1) <b>30%</b> (2) <b>20%</b> (3) Set to <b>04</b> 4 Winners <b>50%</b> (1) <b>25%</b> (2) <b>15%</b> (3) <b>10%</b> (4) Set to <b>05</b> 5 Winners <b>50%</b> (1) <b>20%</b> (2) <b>15%</b> (3) <b>10%</b> (4) <b>5%</b> (5)	<b>If Trn. Adj. 11 is set to BUMP N' WIN (Default) :</b> <i>Cannot set to 01. Minimum of 2 winners required.</i> Set to <b>02</b> 2 Winners <b>65%</b> (1) <b>35%</b> (2) Set to <b>03</b> 3 Winners <b>50%</b> (1) <b>25%</b> (2) <b>25%</b> (3) Set to <b>04</b> 4 Winners <b>40%</b> (1) <b>20%</b> (2) <b>20%</b> (3) <b>20%</b> (4) Set to <b>05</b> 5 Winners <b>40%</b> (1) <b>15%</b> (2) <b>15%</b> (3) <b>15%</b> (4) <b>15%</b> (5)
	<b>AWARD TYPE</b> : Set to <b>CASH, POINTS, TICKET, NONE</b> or <b>PRIZE</b> . Default is <b>CASH</b> . <i>This adjustment determines how the Prize Pool is to be represented in the Attract Mode on both the Normal and top Beta-Brite® Displays.</i>	
09	Select <b>CASH</b> for the displays to represent the <i>Prize Pool amount (based on Jackpot Base and Max.)</i> in <b>\$Dollars</b> . Select <b>POINTS</b> for the displays to represent the <i>Prize Pool amount</i> in <b>Points</b> . Select <b>TICKET</b> for the display to represent the <i>Prize Pool amount</i> in <b>Tickets</b> . Select <b>NONE NOT TO</b> represent the <i>Prize Pool amount (if prize(s) to be awarded are not Cash, Points or Tickets)</i> . Select <b>PRIZE</b> , if applicable.	
10	<b>SHOW PLAYER'S CASH</b> : Set to <b>YES</b> or <b>NO</b> . Default is <b>YES</b> . When set to <b>YES</b> , the >>> <b>previous</b> <<< Tournament Winners & Cash amount will show in the <b>Attract Mode</b> on both Dot Displays.	
11	<b>TOURNAMENT TYPE</b> : Set to <b>REGULAR</b> or <b>BUMP N' WIN</b> . Default is <b>BUMP N' WIN</b> .	
12	<b>BUMP N' WIN BASE</b> : Set between <b>X,000,000 - XX,000,000</b> ( <i>increments of 1M</i> ). Default is <b>*varies*</b> . Set the desired <b>Bump N' Win Tournament</b> base score. <b>Tournament Adj. 11 must be set to BUMP N' WIN</b> .	
13	<b>BALLS PER TOURNAMENT</b> : This adjustments only affects <b>TOURNAMENT GAMES</b> . Set between <b>02 - 09</b> . Default is <b>03</b> . Set the max. number of balls per game.	

Score Range and Default varies from title to title.

Sec. 3: Tournament ...





## Start Tournament (select only after Set-Up is completed)

To initiate, from the **TOURNAMENT MENU**, select the "STRT" *Icon* with either the **Red "LEFT"** or **Green "RIGHT"** Buttons and press the **Black "ENTER"** Button. The "START TOURNAMENT?" MENU appears with the "NO" *Mini-Icon* flashing.

If **Set-Up (Tournament Adjustments)** was not completed **OR** the **Tournament Audits were not recorded from the prior Tournament**, exit this Menu by activating the "NO" *Mini-Icon*. If **Set-Up** was completed and the **Tournament Audits** were recorded, select and activate the "YES" *Mini-Icon*.

The Pinball Game is set to **Tournament Ready**

**Mode** (the **Flashing Tournament Button** must be depressed for a *Tournament Game* after the proper credit is inserted). **"REQUEST INSTALLED"** is indicated and returns to the **TOURNAMENT MENU** with the "STRT" *Icon* flashing. **Note:** If the "STRT" *Icon* appears to be non-functioning, it is because a *Tournament* is in progress. The *Tournament* must first be stopped (select and activate the "END" *Icon* in the **TOURNAMENT MENU**).



## Stop Tournament (select if no TIMEKEEPER is installed\*)

\* If **Timekeeper** is **NOT installed** or you have to end the *Tournament* prematurely, use this *Icon* to end it. To initiate, from the **TOURNAMENT MENU**, select the "END" *Icon* with either the **Red "LEFT"** or **Green "RIGHT"** Buttons and press the **Black "ENTER"** Button. The "END TOURNAMENT?" MENU appears with the "NO" *Mini-Icon* flashing.

If the *Tournament* was not completed, exit this Menu by activating the "NO" *Mini-Icon*. If the *Tournament* was completed (the *End Date* set has passed), select and activate the "YES" *Mini-Icon*. The Pinball Game is taken out of **Tournament Ready Mode** (to readjust any *Tournament Adjustments*, the *Tournament* must be "stopped").

"REQUEST INSTALLED" is indicated and returns to the **TOURNAMENT MENU** with the "END" *Icon* flashing. **Record your Tournament Audits at this time as they will be reset (except for the "Accumulative Audits") if another Tournament is started!**



Sec. 3: Tournament ...



## Tournament Prizes

To initiate, from the **TOURNAMENT MENU**, select the "PRIZ" *Icon* with either the **Red "LEFT"** or **Green "RIGHT"** Buttons and press the **Black "ENTER"** Button. Select and *activate* either of the ">>" *Mini-Icons* to view the next or previous *Leader* in this group. The display will describe the **Leader Placement (1st, 2nd, 3rd, 4th & 5th)**, **Leader Name**, **4-Digit Pin-Code**, and **Prize Pool** portion for the *Current* and *Previous Tournaments*. The current *Leader* (and related information) will remain in the display until the next *Leader* is chosen or when the Sub-Menu is exited.



## Tournament Audits (01-14)

To initiate, from the **TOURNAMENT MENU**, select the "AUD" *Icon* with either the **Red "LEFT"** or **Green "RIGHT"** Buttons and press the **Black "ENTER"** Button. Select and *activate* either of the ">>" *Mini-Icons* to view the next or previous *Tournament Audit* in this group. The display will describe the **Tournament Audit Number**, **Tournament Audit Name** and the **Current Tournament Audit Total** (Value). The current *Tournament Audit* will remain in the display until the next *Tournament Audit* is viewed or when this Menu is exited.

**IMPORTANT FOR TOURNAMENT USERS:** >>>> **A L L** of the *Tournament Audits 01-14* are **RESET O N L Y** if a **Factory Reset is done** (see **Section 3, Chapter 6, GO TO RESET MENU**). >>>> **Tournament Audits 01-07** are **RESET ONLY** if a **new Tournament is started**. >>>> **Tournament Audits 07-14** are **NOT RESET\***, they're *accumulative* (totals *accumulate* since the first *Tournament* was played). \*if no **Factory Reset** is done.

Nr.	TOURNAMENT AUDIT NAME: Definition
01	<b>TOTAL PLAYS</b> : Provides the total number of <i>Regular</i> and <i>Tournament Games</i> played while a <i>Tournament</i> is active (in progress). This total is derived by adding the below <i>Tournament Audit 02</i> with <b>Regular Plays</b> .
02	<b>TOURNAMENT PLAYS</b> : Provides the total number of <i>Tournament Games</i> played while a <i>Tournament</i> is active (in progress).
03	<b>TOTAL QUALIFYING PLAYS</b> : Provides the total number of times a player qualified (invited to enter name).
04	<b>TOTAL GAME EARNINGS</b> : Provides the total <i>Gross Earnings</i> accepted, while a <i>Tournament</i> is active (in progress).
05	<b>TOTAL TOUR. EARNINGS</b> : Provides the total <i>Tournament Earnings</i> ( <i>Audit 04</i> less <i>Regular Game Earnings</i> ) while a <i>Tournament</i> is active (in progress).
06	<b>JACKPOT (PRIZE POOL TOTAL)</b> : Provides the total <i>Prize Pool</i> ( <i>Jackpot</i> ) Amount to be paid out while a <i>Tournament</i> is active (in progress).

*Tournament Audits 07-14 continued on the next page.*

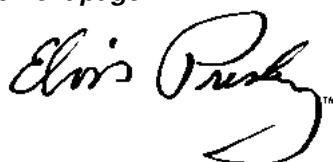



The following Tournament Audits **WILL NOT BE RESET** if a new Tournament is started. **ALL AUDITS** can be reset if a Factory Reset is done!

- 07 **NET EARNINGS** : Provides the total Net Earnings (*Gross Earnings less Prize Pool*) while a *Tournament is active (in progress)*.
- 08 **ACCUM. TOTAL PLAYS** : Provides the accumulative total amount of *Regular & Tournament Games* played since the first Tournament was played.
- 09 **ACCUM. TOUR. PLAYS** : Provides the accumulative total amount of *Tournament Games* played since the first Tournament was played.
- 10 **ACCUM. QUALIFYING PLAYS** : Provides the accumulative total number of times a player qualified (*invited to enter name*).
- 11 **ACCUM. EARNINGS** : Provides the total Gross Earnings *accepted*, since the first Tournament was played.
- 12 **ACCUM. TOUR EARNINGS** : Provides the accumulative total Tournament Game Earnings since the first Tournament was played.
- 13 **ACCUM. JACKPOT** : Provides the accumulative total of Prize Pool (*Jackpot*) Amounts paid out since the first Tournament was played.
- 14 **# TOURNAMENTS** : Provides the number of Tournaments (*not individual Tournament Games*) since the first Tournament was played.



## Sign Messages A-B (Tournie Adj. 14-15)

To initiate, from the **TOURNAMENT MENU**, select the "A-B TEXT" *Icon* with either the **Red "LEFT"** or **Green "RIGHT"** *Buttons* and press the **Black "ENTER"** *Button*. Select and *activate* either of the ">>" *Mini-Icons* to view the next or previous Tournament Adjustment in this group. Select and *activate* either of the "-" or "+" *Mini-Icons* to change the setting, if desired (*the Default Setting is noted in the definitions below*). The display will describe the **Tournament Adjustment Number**, **Tournament Adjustment Name** and the **Current Tournament Adjustment Setting**. The current Tournament Adjustment will remain in the display until the next Tournament Adjustment is viewed or when this Menu is exited.

### Nr. TOURNAMENT ADJUSTMENT NAME: Definition

- 14 **LOCATION MESSAGE** : Set to **ON**, **CHANGE** or **OFF**. Default is **ON**.  
When set to **CHANGE**, a new message can be set or the old one can be edited (*select the "+" Mini-Icon to change settings until "CHANGE" appears in the display, then select the ">>" Mini-Icon to access*). At the top left corner of the Display, the letter **A** is indicated (*blinking*) in the first available position. Vary the letter(s) by operating the Left and Right Flipper Buttons (or **"RED"** or **"GREEN"** *Buttons*). With the desired letter indicated, depress the **Start Button** to lock in the letter and advance to the next character. Repeat this procedure until the desired message is completed in the display. Select the "<" or ">" characters to back-space (*erase*) and/or to move forward in an already typed message. After completion, press the **"BLACK"** *Button*, **"REQUEST INSTALLED"** is indicated and then exits this sub-menu.
- 15 **PRIZE MESSAGE** : Set to **ON**, **CHANGE** or **OFF**. Default is **ON**.  
*Procedure identical to Tournament Adjustment 14, Location Message.*

The **DEFAULT LOCATION MESSAGE** is:

STERN PINBALL PROUDLY PRESENTS...

The **DEFAULT PRIZE MESSAGE** is:

YOU CAN BE THE NEXT BIG WINNER!



**IMPORTANT FOR TOURNAMENT USERS:**  
**2 additional messages can be added** by using the **Beta Brite® Remote**. More details in the **ToPS™ Tournament Pinball System Kit Installation Manual** (*SPI Part Number: 780-6011-01*) provided in the **Optional Tournament Kit** (*SPI Part Number: 502-5011-00*).

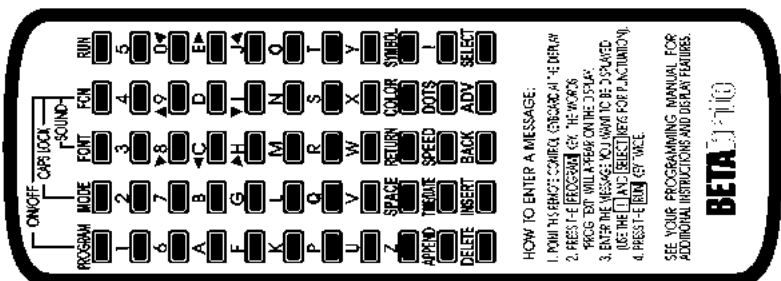



# Parts Identification & Location (The Pink Pages)

## ? Table of Contents & Overview

This section provides the Part Number and locations of most of the components in this Pinball Machine. The parts are arranged in 3 groups: **BACKBOX, CABINET & PLAYFIELD.** Generic parts which may change as production continues (*quantity and/or size*) are listed together. Quantities **greater** > than "0" indicates that the part is used in this game. *Since quantity changes may occur, an item indicating a zero quantity may be used.* Compare the item which needs to be replaced with the drawings provided (*the Posts, Sockets, Bulbs & Rubber Rings are drawn actual size*).



**Important:** Read all ("Take Note:" items.

**Backbox**

60

**Speaker Panel**

61

**Cabinet**

62

**Cabinet Continued**

63

**P/F - Gen. Parts, (Above)**

64

**Playfield (Above) Cont.**

65

**P/F - Gen. Parts, (Below)**

66

**Plastics & Decals Kits**

67

**Rubber Parts**

68

**Metal Posts & Nuts**

69

**Hex Spacers**

70

**Plastic Posts & Spacers**

71

**Sm. Sockets & Bulbs**

72

**Lg. Sockets & Bulbs**

73

**W.B. Sockets & Bulbs**

74

**Pinball Location Maintenance Kit**  
Available  
502-6002-84 (Standard)  
This kit consists of  
8 oz. Novus Wax #2 Fine (Red)  
(675-0003-01),  
cloth and all Rubber Rings & Bulbs  
used in this Pinball Machine.

Ask your distributor about the  
**Deluxe**  
Pinball Location Maintenance Kit  
which includes  
**Flipper Rebuild Kits!**  
502-6003-84 (Deluxe)  
*Drawings for Assemblies & Ramps,  
see the Blue Pages, 75-98.*

**The Blue Pages**

75

Sec. 4: Parts Id. ...



**Not sold as an assembly, order the individual part(s) actually required.**

**Elvis® Pinball Backbox Assembly, 505-6002-84-84 (Items 1-27)**

‡ Item 20, Button Hole Plug (Black) is the optional ToPS™ Access Hole; if removing for the Optional ToPS™ Kit, save with the game.

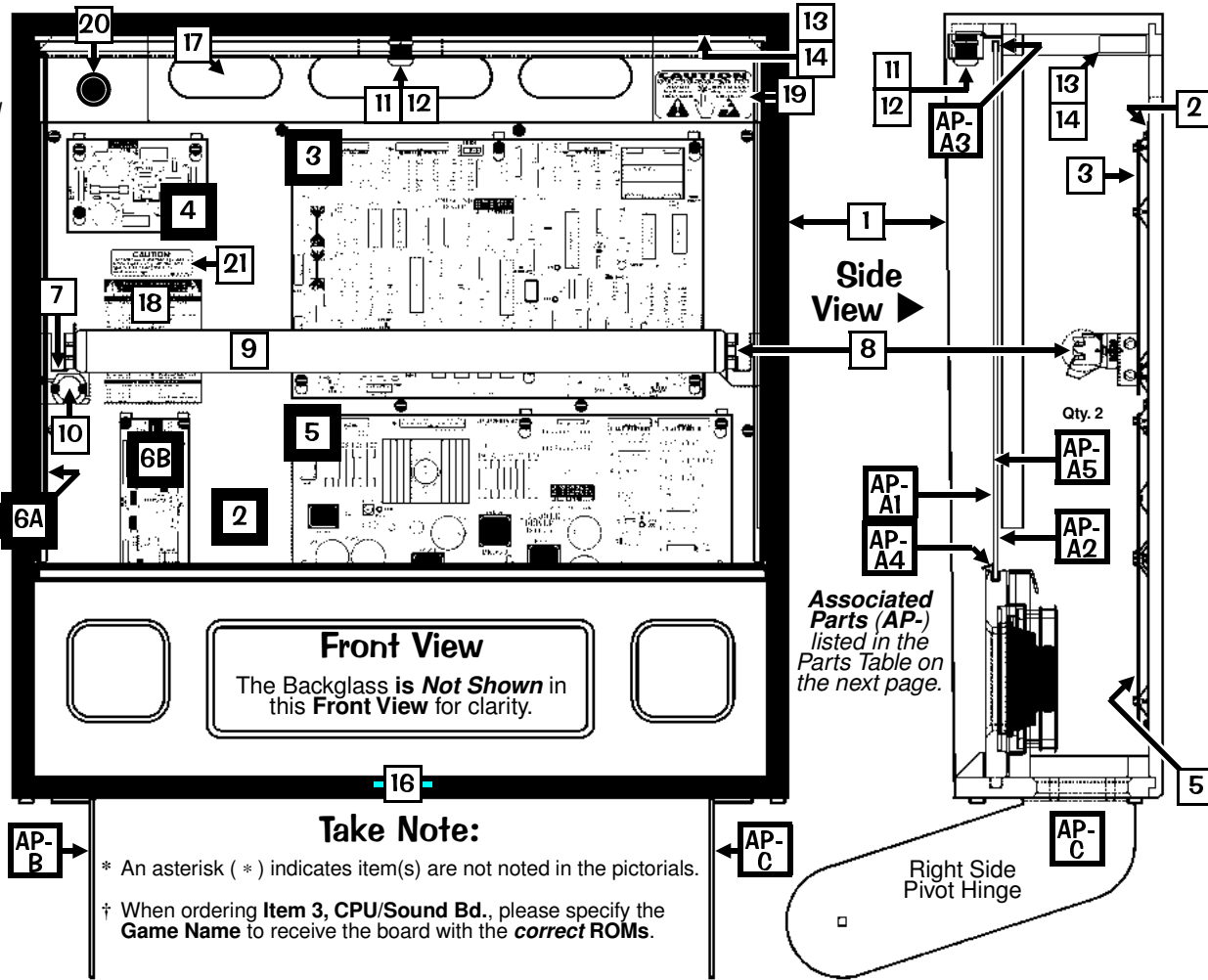

Sec. 4: Parts Id. ...

Nº	BACKBOX PART NAME	QTY.	SPI PART Nº	Nº	BACKBOX PART NAME	QTY.	SPI PART Nº
1	Backbox <b>ELVIS® Screened No Parts</b>	1	525-5631-00-84	13	Ballast Mounting Plate	1	535-8657-00
<i>Item 1 Note: Black over Gold T-Molding is installed and cannot be ordered separately.</i>							
2	PCB Metal Mounting Plate	1	535-5809-14	14	Ballast CU45Z-W 1/2" Core 120v 60 Hz 13W	1	010-5015-00
<i>Item 2 is secured to Item 1 by: #8 X 1/2" SLT HWH AB (Zinc) (Qty. 13) (234-5101-00) and #10 Washer 7/32" I.D. X .5" O.D. X 1/16" Thick (Qty. 4) (242-5003-00)</i>							
3 †	CPU/Snd. Bd. w/ATMEL Sound Processor	1	520-5300-00	<i>Ballast, EU / UK Only 5/8" Core 50/60 Hz 010-5015-01</i>			
4	Display Power Supply Board	1	520-5138-00	<i>Items 13 &amp; 14 are secured to Item 1 by: #6 X 5/8" SLT HWH AB (Zc) (Qty. 2) (234-5102-04)</i>			
5	I/O Power Driver Board Rev. G or higher	1	520-5137-01	15*	#1 Roto Lock Male (on Cabinet)	1	355-5006-01
<i>Items 3, 4 &amp; 5 are secured to Item 2 by: #8-32 X 3/8" HWH MS (Qty. 19) (237-5903-00)</i>							
6A	3X Trans. Drvr. Bd. (UK/Special Apps.Only)	1	520-5068-01	16	#1 Roto Lock Female (R2-0002-02)	1	355-5006-02
6B	ToPS™ Tournament Serial Interface (TSI) Board	1	520-5220-00	<i>Item 16 is secured by: #10-24 X 1-3/4" CBSN (Qty. 2) (231-5022-00), #10-24 Keps Nut (Qty. 2) (240-5207-00) and #10 Washer 7/32" ID X .5" OD X 1/16" (Qty. 2) (242-5003-00)</i>			
<i>** optional** Item 6A is required for UK Games to support Auxiliary assemblies listed under the Coil Matrix of Q1-Q32; also used for Special Applications such as Ticket / Coin Dispensers used in conjunction with **optional** Item 6B ToPS™ TSI Board.</i>							
7	Fluorescent Light Bracket Assy. Left	1	515-6545-00	17	Back Vent Grill 2-1/2" X 18"	1	545-5072-02
<i>For Individual Items use : Fluorescent Light Bracket Left (535-7739-00), Lamp Holder** (Self-Locking) (077-5214-00) and Starter Base (with Leads)*** (077-5213-00).</i>							
8	Fluorescent Light Bracket Assy. Right	1	515-6545-01	<i>Item 17 is secured by: Staple 5/16" (Qty. 24) (631-5000-00)</i>			
<i>For Individual Items use : Fluorescent Light Bracket Right (535-7739-01), Lamp Holder** (Self-Locking) (077-5214-00) and Starter Base (with Leads)*** (077-5213-00).</i>							
<i>** secured by: #6-32 X 5/8" PPH MS (Sems) Zinc (Qty. 1) (232-5203-00)</i>							
<i>*** secured by: #4-40 X 1/2" PPH MS (Sems) Zinc (Qty. 2) (237-5813-00)</i>							
<i>Items 7 &amp; 8 are secured to Item 1 by: #10-24 X 1-1/4" Carriage Bolt Sq. Neck (Qty. 2/per) (231-5012-00), #10-24 Keps Nut (Qty. 2/per) (240-5207-00) and 3/4" X 3" Reinforced Strapping Tape (Qty. 1, Sold in 12" Lengths only) (626-5040-00)</i>							
9	Fluorescent Tube 24" (F20T9CW)	1	165-5061-00	18	Fuse Description Decal (Generic)	1	820-6152-02
10	Starter - Fluorescent (FS2 Light)	1	165-5011-01	19	"CAUTION - VERY HOT" Decal	1	820-6266-00
11	Lock Mounting Plate	1	535-8128-01	20‡	Button Hole Plug (Blk) (Happ #52-6214-00)	1	500-6566-00
12	Lock 5/8" Barrel, 3/4"ø, 1.5" Flat Cam	1	355-5055-00	21	Fuse Label (UL)	1	820-6143-00
<i>Items 11-12 are secured by: #8 X 5/8" TP Torx T20 (Qty. 4) (237-5947-00)</i>							
				22*	Backbox Date Label	1	820-5091-00
				23*	Ribbon Cable, 20-Pin (4")	1	036-5000-04
<i>Item 23 (20-Pin) connects the CPU/Sound Board to the I/O Power Driver Board.</i>							
				24*	Ribbon Cable, 26-Pin (40")	1	036-5001-40
<i>Item 24 (26-Pin) connects the CPU/Sound Board to the Display Controller Board.</i>							
				25*	1/4" Clamp (Double)	2	040-5000-23
				26*	1/2", 3/4" & 1" Clamp (Single)	9	040-5000-XX
<i>Items 25-26 are secured to Item 1 by: #8 X 1/2" SLT HWH AB (Zc) (Qty. 13) (234-5101-00) -XX Note: for 1/2" use -06 (Qty. 1); for 3/4" use -08 (Qty. 2); for 1" use -09 (Qty. 6)</i>							
				27*	Ground Strap (5") (by Item 12)	1	600-5006-05

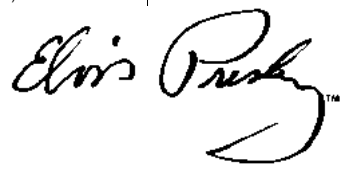

**Not sold as an assembly, order the individual part(s) actually required.**

**Elvis® Pinball Speaker Panel Assy. for the Backbox, 515-6888-03 (Items 1-15) and Assoc. Parts: Backglass Assembly & Pivot Hinges (Left & Right) (Items AP-A - AP-C)**

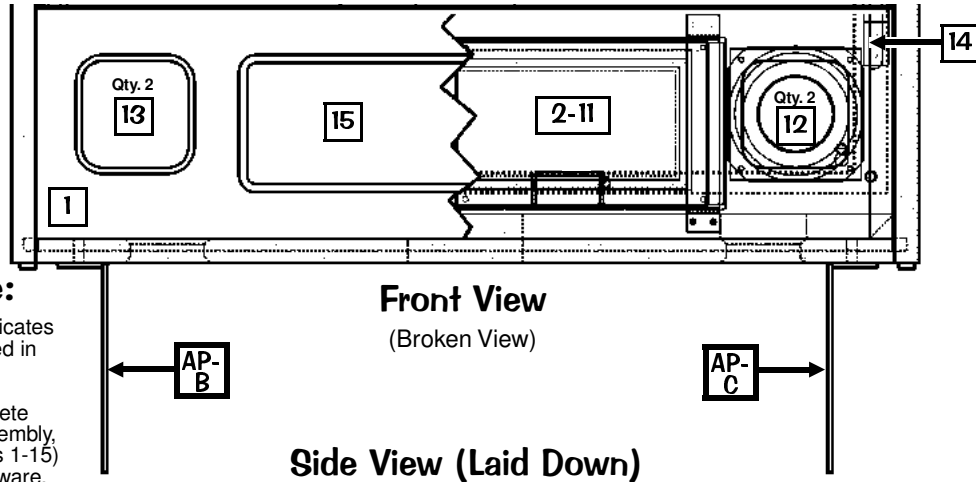

**Take Note:**

\* An asterisk ( \* ) indicates item(s) are not noted in the pictorials.

1. Ordering the complete Speaker Panel Assembly, 515-6888-03 (Items 1-15) will include all hardware.

For clarity, the below drawing *does not show* the speaker(s).

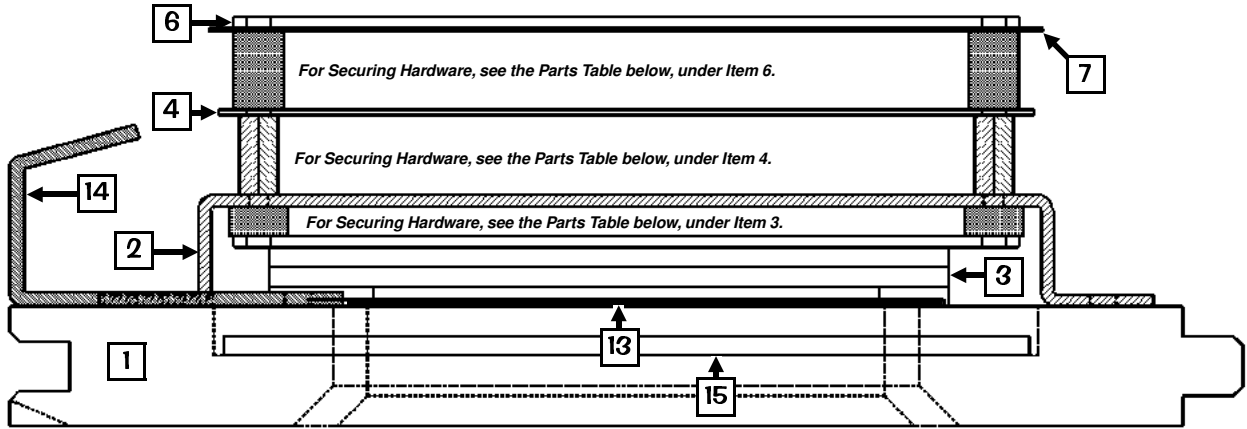

Nº	SPEAKER PANEL PART NAME	QTY.	SPI PART Nº	Nº	INDIVIDUAL PART NAME	QTY.	SPI PART Nº
1	Speaker Panel (Black Wood)	1	525-5515-00	15	Plastic Shield (Display Cover)	1	545-5884-00
2	Dot Matrix Disp. Bd. Mounting Bracket	2	535-8368-01	Item 15 is secured to Item 2 by: #6 X 3/8" SLT HWH AB (Zinc) (Qty. 8) (234-5000-00)			
3	Dot Matrix Display Board 128 X 32	1	520-5052-00	The Associated Parts AP-A thru AP-C are also noted in the Backbox Assembly drawings on the previous page.			
4	Static Shield (Steel Plate)	1	535-6437-00	ASSOC. PARTS ARE NOT INCLUDED WITH BACKBOX/SPKR. PANEL ASSY'S.			
5*	Edge Protector (on Item 4)	2	545-5592-01	Nº	ASSOC. BACKBOX PART NAME	QTY.	SPI PART Nº
6	Display Controller Board FCC-FEB98	1	520-5055-03	AP-A	Backglass Assembly (Game Nº 84)	1	See Parts Below
7	RF Shield	1	820-5092-00	<b>ORDER ONLY INDIVIDUAL PART(S) NEEDED:</b>			
8*	Ground Strap (25") (on Items 4, 6, 12)	4	600-5006-25	AP-A1	Clear Backglass 25.906" X 19.187"	1	660-5038-02
9*	1/2" Clamp (Single) (on Item 4)	1	040-5000-06	AP-A2	ELVIS® Film Art w/Hologram (#84)	1	515-7252-84
10*	Ribbon Cable, 14-Pin	1	036-5260-00	<b>Note: The Elvis Backglass Film Art must have the Official Elvis® EPE® Hologram Logo affixed. It cannot be displayed without it!</b>			
11*	Foam 3/16" Thk. X 1/4" X 36"	6	626-5026-00	AP-A3	Top Plastic Channel - 26"	1	545-5018-15
12	Speaker (Shld.) 4" 8Ω MG Elec #4060SH	2	031-5004-01	AP-A4	Bottom Plastic Lift Channel - 26-1/16"	1	545-5021-01
13	Speaker Grill (Black w/no Artwork)	2	535-8081-01	AP-A5	Plastic Edging (Left/Right) - 18-1/8"	2	545-5018-14
14	Speaker Panel Hook Bracket	2	535-7009-02	AP-A6*	Tape (double-sided) (12" Length)	1	626-5005-00
Items 12, 13 & 14 are secured by: #8 X 3/4" SLT HWH AB (Zinc) (Items 12/13: Qty. 4/per; Item 14: Qty. 2/per) (234-5103-00)				<b>Note: AP-A6 secures AP-A3--A5 to AP-A1 (only 6" required)</b>			
				AP-B	Pivot Hinge Left	1	535-7999-00
				AP-C	Pivot Hinge Right	1	535-7999-01
				Items AP-B & AP-C are secured to Backbox by: 1/4"-20 X 1-1/4" C.B. Sq. Neck (Qty. 4) (231-5003-00), 1/4"-20 Flange Nut (Qty. 4) (240-5300-00) and Fend Washer 1/4" I.D. X 1" O.D. (Qty. 1) (242-5009-00)			
				Items AP-B & AP-C are secured to Cabinet by: 1/4"-20 X 7/8" Carriage Bolt Sq. Neck (Qty. 2) (231-5014-00), Hinge Spacer (Qty. 2) (530-5099-00), Washer 1/4" I.D. X 7/8" O.D. X 1/8" Yellow (Qty. 1/per) (242-5016-01), Fend Washer 1/4" I.D. X 1" O.D. (Qty. 1/per) (242-5009-00) and 1/4"-20 Flange Nut (Qty. 1/per) (240-5300-00)			
				<b>Note: Inside cabinet holes are covered by BLACK MYLAR COVER DISCS (QTY. 2) (820-5041-00) to hide securing hardware (AP-B &amp; AP-C above) from player view.</b>			





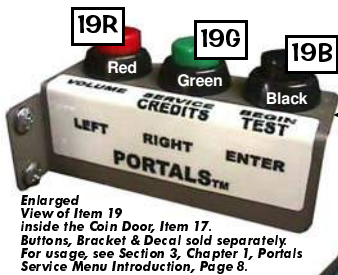

## Cabinet - General Parts ■ & Switches □

For Backbox Parts see the previous two pages.

Enlarged View of Item 19 inside the Coin Door, Item 17. Buttons, Bracket & Decal sold separately. For usage, see Section 3, Chapter 1, Portals Service Menu Introduction, Page 8.

### Take Note:

Item 11, Button Hole Plug (Blk) is the Optional Tourne Button Access Hole. If removing for the Optional Tournament Button, save with the game.

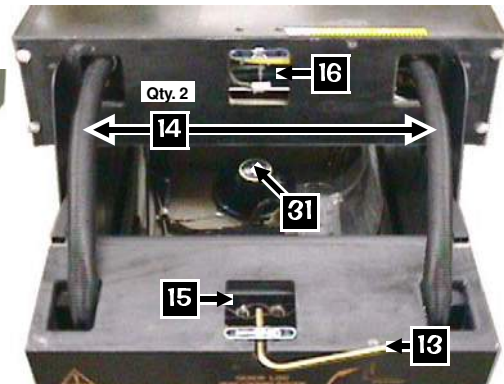

View of the back of the Cabinet with the Backbox in the down position.



Item 26 is stapled on the inside back wall and the inside bottom of the cabinet.

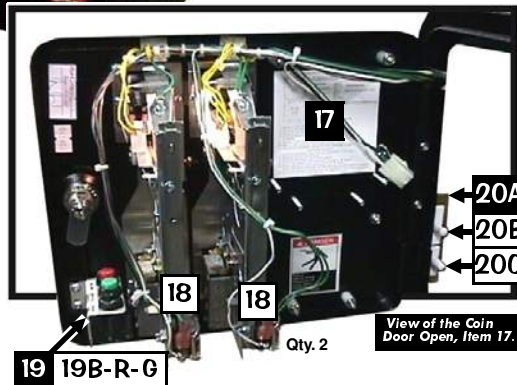

View of the Coin Door Open, Item 17.

### Take Note:

\* An asterisk ( \* ) indicates item(s) are not noted in the pictorials.

**Legend Note:** Items noted with a black square ■ are General Parts. Items noted with a white square □ are Switches.

Item 32J (On/Off Switch) is located under the Cabinet (Front Right) directly below the Power Box.

Qty. 4

**Item 2 ORDERING NOTE:** Leg comes with Leveler. Leveler can be purchased separately. Leg cannot be ordered WITH OUT Leveler. See Table below, Item 2.

Sec. 4: Parts Id. ...

Nº	CABINET PART NAME	QTY.	SPI PART Nº	Nº	CABINET PART NAME	QTY.	SPI PART Nº
1	ELVIS Screened Cabinet (No Parts)		525-5395-15P-84	10	Front Molding - Black	1	500-5757-02-00
2	Black Leg with Leveler Asm.	4	500-5921-50	Item 10 requires: Self-Adhesive Foam Rubber 3/8" X 3/16" X 20-3/8" (626-5001-00).			
Item 2 is secured by: Leg Bolt Back Plate (535-5703-00) and Leg Bolt 3/8" X 16 X 2-1/2" Hex 5/8" Hd. (2/per) (231-5001-01) Leg Leveler ONLY (3/8"-16 X 3") (500-5017-00).							
3	Start Button (Red) + Lamp Assembly	1	500-6388-02	11	Button Hole Plug (Blk) (Happ #52-6214-00)	1	500-6566-00
Item 3 includes the Switch. FOR SWITCH ONLY see Item 25 on the Next Page.							
*	Diode Terminal Strip 2-Lug (810) Isolated	1	055-5203-00	12	P/F Glass (Tmprd.) 21" X 43" X 3/16"	1	660-5001-00
Above item is secured below button in cabinet by: #6 X 1/2" SLT HWH AB Zinc (Qty. 1) (234-5101-02). Note: 1N4004 Diodes (112-5003-00) are used in all Diode applications.							
4*	#555 Wedge Base Bulb (Clear)	1	165-5002-00	13	Hex Key Allen Wrench 5/16"	1	777-0001-00
Item 4 is included with Item 3, for just a replacement Bulb use the above number.							
5	Ball Shooter (Plunger) Assembly	1	500-6146-00-07	14	Corrugated Tubing Black 1"ø X 2.6' Lg.	1	605-5008-03
FOR A BREAKDOWN OF PARTS SEE: Sec. 4, Chp. 2, Drawings for ... Assemblies...							
6	Flipper Button (Red) Assembly	2	500-5026-32	15	#1 Roto Lock Male (R2-0055-02)	1	355-5006-01
Item 6 is secured by: Pal Nut for Flipper Button (Metal) (Qty. 2/per) (240-5003-01) and is fitted with: O-Ring 11/32" X 7/32" X 1/16" (Qty. 1/per) (545-5850-00) Item 6 DOES NOT include the Switch. FOR SWITCHES ONLY see Items 23A/B on the Next Page.							
7	Rear Glass Channel 20-3/8" Length	1	545-5038-00	Item 15 is secured by: #10-24 X 1-3/4" Carr. Bolt Sq. Neck (Qty. 2) (231-5022-00), #10-24 Nylon Stop Nut (Qty. 2) (240-5206-00) and #10 Washer 7/32" X .5" X 1/16" (Qty. 2) (242-5009-00) Note: For Coin Door other than USA call Technical Support for SPI Part Nº.			
8	Plastic Channel 42-5/8" Lg. (Left/Rt.)	2	545-5017-00	16	#1 Roto Lock Female (on Backbox)	1	355-5006-02
9	Side Armor "with holes" (Left & Right)	2	535-7297-02	17	Coin Door (with Validator) USA only	1	500-5018-172
Item 9 is secured @ front by: Pem Stud 1/4 X 1" FH (Qty. 1/per) (237-6116-01) and 1/4-20 Flange Nut (Qty. 1/per) (240-5300-00); @ center by: #8 X 5/8" PPH AB Black (Qty. 2/per) (232-5101-01); @ rear (backbox) by: #10-24 X 1" Sq. Neck Carriage Bolt Black (Qty. 1/per) (231-5021-00) and #10-24 Hex Nut (Qty. 1/per) (240-5202-00)							
18	ALT. SWITCHES			18	Coin Door Sw. (USA) (Happ Control)	2	180-5024-01
				18J:	Coin Door Switch ( ¥ Japan)		(180-5091-00)
				19	SWITCHES		
				Bracket for below Portals™ Switches 1 535-6860-03			
				19B:	Push-Button Portals™ Switch (Black)		(180-5192-00)
				19R:	Push-Button Portals™ Switch (Red)		(180-5192-02)
				19G:	Push-Button Portals™ Switch (Green)		(180-5192-04)
Ordering Note: Securing hardware for switches included. For Decal Kit, see Page 67.							

Parts Table & Views continue on the next page.

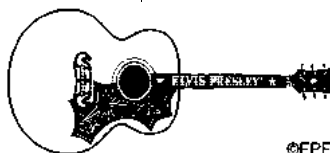

# Cabinet - General Parts & Switches Continued

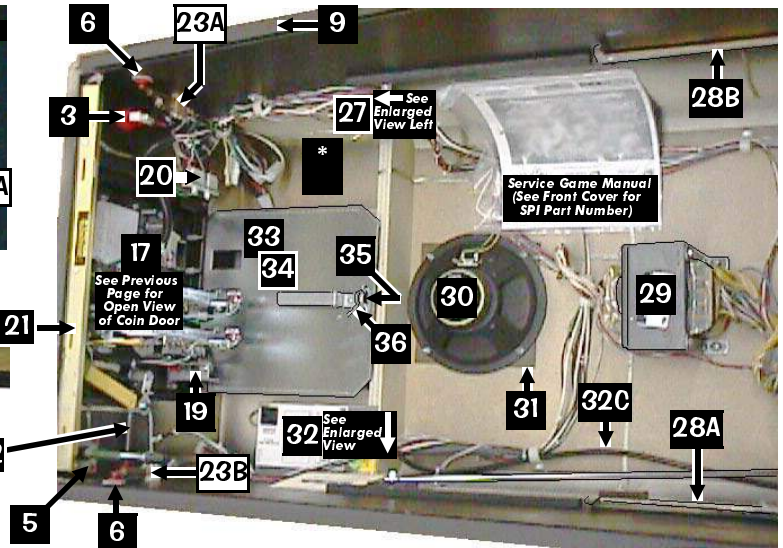
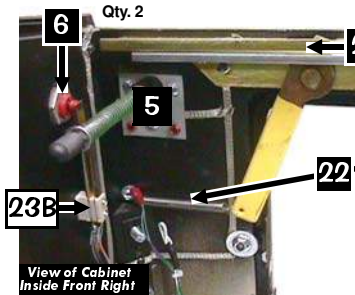
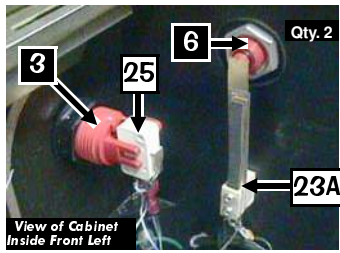
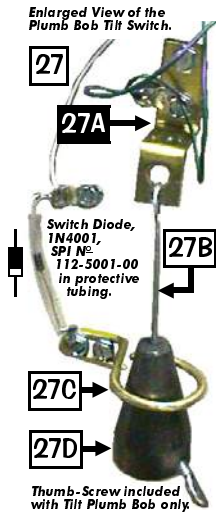

## Take Note:

\* An asterisk (\*) indicates item(s) are not noted in the pictorials.

**Legend Note:** Items noted with a black square ■ are General Parts. Items noted with a white square □ are Switches.

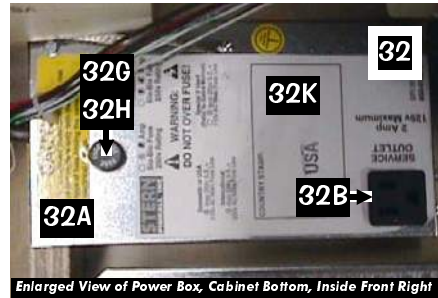

**Cabinet Back Lights are located on the Wood Back Panel:**  
 See [The Blue Pages](#), Section 4, Chapter 2, Drawings for Major Assemblies ... , Page 97.  
**For General Bulbs & Sockets:**  
 See these [Pink Pages](#), Section 4, Chapter 1, Parts Identification & Location, Pages 72-74

**Pinball Rejuvenation Kit Available: 502-6002-84 (Std.)**  
 This kit consists of 8 oz. Novus Wax #2 Fine (Red) (675-0003-01), cloth and all Rubber Rings & Bulbs used in this Pinball Machine.

Nº	INDIVIDUAL PART NAME	QTY.	SPI PART Nº
<i>Parts Table &amp; Views continue on the previous page.</i>			
20	Dual Switch Assembly	1	500-5808-00
<b>ORDERING ABOVE (ITEM 20) ASSEMBLY PART Nº WILL INCLUDE:</b>			
20A	Mounting Bracket	1	535-6958-00
20B	Playfield Power Interlock Sw. (Top)	1	180-5136-00
20C	Memory Protect Switch (Bottom)	1	180-5000-01
<i>Item 20 is secured to Cabinet by: #8 X 1/2" SLT HWH AB (Zinc) (Qty. 2) (234-5101-00)</i>			
21	Front Molding Lockdown Assembly	1	500-6509-00
<i>Item 21 is secured by: #10-24 X 1-1/4" Carr. Bolt (Qty. 2) (231-5012-00), #10-24 Keps Nut (Qty. 2) (240-5207-00), #8 X 5/8" HWH AB Zinc (Qty. 4) (234-5102-04) and #10 Washer 7/32" ID X 1/2" OD X 1/16" (Qty. 2) (242-5003-00)</i>			
22	Lockdown Spring (connected to handle)	1	265-5008-00
23A	Flipper Switch - Self-Cleaning (Lt. Flipper)	1	180-5160-00
23B	Flipper Sw. - X2 Stack (Lwr./Upr. Flipper(s))	1	180-5164-00
24*	Foam Strip (For Item 23 - Noise Suppression)	1	626-5042-00
25	Start Button Switch (ONLY)	1	180-5174-00
26	Grills 2-1/2" X 18" (on Back & Bottom)	2	545-5072-02
27	Cabinet Plumb Bob Tilt Switch	1	See Parts Below
<b>ORDER ONLY INDIVIDUAL PART(S) NEEDED:</b>			
27A	Bracket for Hanger Wire	1	535-5221-00
27B	Hanger Wire	1	535-5319-00
27C	Contact Wire Form	1	535-7563-01
27D	Plumb Bob Weight (includes Thumb-Screw)	1	535-5029-00
<i>Items 27A &amp; 27C are secured by: #8 X 1/2" SLT HWH AB (Zinc) (Qty. 4) (234-5101-00)</i>			
28A	Slide & Pivot Support Bracket - Right	1	535-5990-00
28B	Slide & Pivot Support Bracket - Left	1	535-5989-00
<i>Items 28A &amp; 28B are secured by: #10-24 X 1-1/4" Carriage Bolt Sq. Neck (3/per) (231-5012-00) and #10-24 KEPS Nut (3/per) (240-5207-00)</i>			

Nº	INDIVIDUAL PART NAME	QTY.	SPI PART Nº
29	Transformer 5.7v AC (with Ballast Winding)	1	010-5012-01
<i>Item 29 is secured by: 1/4"-20 X 5/8" PPH MS (Zinc) (Qty. 4) (237-5854-00) and 1/4" Split Lock Washer (Qty. 4) (244-5000-00)</i>			
30	Speaker 8" ø Rd. 8010 4Ω	1	031-5007-00
31	Speaker Grill 7" X 7"	1	545-5072-03
<i>Items 30 &amp; 31 are secured by: #6-32 X 1-1/4" Fin Shank Screw (Qty. 4) (237-5883-00) and #6-32 Keps Nut (Qty. 4) (240-5008-00)</i>			
32	Power Input Box Sub-Assy.	1	515-5360-07
<b>ORDERING ABOVE (ITEM 32) SUB-ASSY. PART Nº WILL INCLUDE:</b>			
32A	Power Box (Plain)	1	535-5932-00
32B	Service Outlet (for USA)	1	180-5008-01
32C	Line Cord 10' ROJ 3" Max.	1	034-5000-10
32D	Recessed Cup for Line Cord	1	545-5122-00
32E*	Line Filter	1	150-5000-00
32F*	Varistor TNR159211KM	1	150-5001-00
32G	Fuse 8 Amp 250v Slo-Blo (Domestic)	1	200-5000-05
32H	Fuse Holder	1	205-5001-00
32I*	On/Off Switch Bracket	1	535-8318-00
32J	On/Off Rocker Sw. (APEM R2101C5NBB)	1	180-5001-03
32K	Power Box Decal	1	820-6123-03
33	Cash Box Plastic Bottom	1	545-5090-00
34	Cash Box Cover (Validator)	1	535-5013-03
35	Cash Box Lock Bracket (wire)	1	535-7562-00
36	Large Hair-Pin Clip	1	535-7772-00
37*	Optional Meter (+12v DC w/Diode & Bracket)		G-0053-013-102
	Optional Meter (+12v DC w/Diode, No Bracket)		G-0053-013-102A
<b>OPTIONAL</b>			
* Shaker Motor Kit		1	502-5027-00-84

Sec. 4: Parts Id. ...



**Playfield - General Parts ■, Misc. Switches □ & Switches on Asm. ■ (Above)**

Nº	ABOVE PLAYFIELD PART NAME	QTY.	SPI PART Nº	Nº	ABOVE PLAYFIELD PART NAME	QTY.	SPI PART Nº
PF	P/F Screened w/ Inserts & NO Parts	1	830-5100-84	<b>Flat Rails, Wire Forms &amp; Ball Guides</b>			
	P/F Complete w/ Inserts & ALL Parts	1	505-6004-84-84	26	Flat Rail #1 (for Switch, see Item A below)	1	535-9423-00

**General Items**

1	Arch (Black Metal) no Forks	1	535-8392-01
<b>Item 1 is secured to the playfield by:</b> #10-32 X 5/16" PH FL U/C MS STL Zinc (Qty. 2) (237-6013-00). <b>Usage Note:</b> When replacing the Arch, order new replacement <b>Nelson Protect Strips</b> (not included) (Qty. 2) (545-5212-02).			
2	Instruction Card (USA) <Elvis®>	1	755-5184-00
<b>Note:</b> Visit <a href="http://www.sternpinball.com">www.sternpinball.com</a> for a PDF copy of the Game Instruction Card which will also have any translated Instruction Cards made for this game. Find Game Link or Archives. <b>Spanish</b> 755-5184-02; <b>German</b> 755-5184-03; <b>Italian</b> 755-5184-04; <b>French</b> 755-5184-05.			
3	Coin Card (2-Sided) Yellow Stock	1	755-5400-00-Y
<b>Usage Notes:</b> Use Item 3 (Back: 1 Play 50¢ - 5 Plays \$2) for Adj. 6, Game Pricing, USA 5 Setting, or (Front: 1 Play 50¢ - 3 Plays \$1) for Adj. 6, Game Pricing, USA 8 Setting.			
4	Coin Card (2-Sided) Yellow Stock	1	755-5400-02-Y
<b>Usage Notes:</b> Use Item 4 (Front: 1 Play 50¢) for Adj. 6, Game Pricing, USA 2-7 Setting, (Back: is Blank) for Custom Settings. <b>Availability:</b> See Appendix J (back of manual) for all current Coin Cards (USA, Canada, Euro & other International). If this is a non-US Game, Coin Card(s) provided will differ.			
5	Light Reflector (Silver Color Plastic)	3	545-5409-01
6	Mini-Mars Lite Cover (Snap-In) (see Note)	3	550-5030-02
<b>(Note: Additional on Back Panel: -01 Clear X1, -06 Yellow X2)</b>			
7	Bubble Level Assembly	1	500-6815-00
<b>For Individual Items use:</b> Level .8mm Empire #0224 (545-6001-01) or Level Mount (545-6068-00). <b>Flange secured by:</b> #6-32 X 1/4" PPH MS (no Sems) Zinc (237-5500-00) and #6-32 Keps Nut (240-5008-00). <b>Item 7 is secured to the wood rail by:</b> #6 X 1/2" HWH AB Zinc Red (Qty. 2) (234-5001-02)			
8	Pinball (Steel) 1 1/8" Ø	4	260-5000-00
9*	Plug-Cap (3/16") Black Plastic	0	545-5232-01
<b>Note:</b> Item 9 should plug hole if a Center Post (@ Drain) is used, then removed.			

**Spinners, Wire Gates & Flap Gates**

10	Spinner Bracket	1	535-5128-00
	Spinner	1	515-5553-00
<b>Item 10 is secured by:</b> #6 X 1/2" SHWH AB (Red) (Qty. 2) (234-5001-02). <b>For the entire assembly (includes Switch &amp; Wiring) use:</b> 500-5656-00-84			
11	Gate Bracket (sec'd onto Items 29, 32 & 33)	3	535-7756-02
	Wire Form	3	535-7755-01
<b>Item 11 is secured Items 29, 32 &amp; 33 by:</b> #6-32 X 3/8" PPH MS Ext. Sems (Zinc) (Qty. 2) (232-5201-00) and #6-32 Nylon Stop Nut (Qty. 2) (240-5005-00)			
12	1-Way Gate Bracket	1	535-9489-00
	Wire Form	1	535-9490-00
13	Rollunder Gate Bracket (for Plastic -18)	1	535-9480-01
	Wire Form	1	535-9481-00
	Ball Gate Bracket	1	535-9470-00
	Ball Gate Flap	1	535-9471-00
14	Rebound Hinge	1	535-5372-04
	Wire Form (Right Style)	1	535-7721-02
15	Gate Bracket (Shooter Lane) w/Hole	1	535-9171-02
	Wire Form	1	535-9172-00

**Brackets for Mounting**

16	Playfield Hanger Bracket	2	535-8385-00
<b>Item 16 is secured to the P/F by:</b> #8-32 X 7/8" HWH MS Zinc (Qty. 2/per) (237-5890-00)			
17	Arch Retaining (Hold-Down) Brackets	2	535-8394-00
<b>Item 17 is secured to the P/F by:</b> #8 X 1/2" SLT HWH AB (Zinc) (Qty. 3/per) (234-5101-00)			
18	Bracket, Mounting (for Plastic -19)	2	535-8941-00
19	Mntg. Brckt. (for Hex Spacers on Wood Rails)	1	515-6508-00

**Brackets for Ball Stops, Traps or Protect**

20	Snubber Bracket (by Eject Holes)	2	535-8250-05
<b>Item 20 is secured to the P/F by:</b> #8-32 X 3/4" SHWH Sw. (Zinc) Wax (Qty. 2) (237-5975-02) and #8-32 T-Nut (Qty. 2) (240-5101-00)			
21	Protect Plate (under Plastic -10, same shape)	1	535-9486-00

**Wood Rails**

22	Wood Rail #1, 42"	1	525-5007-59
23	Wood Rail #2, 23.5"	1	525-5007-06
24	Wood Rail #3, 15.25"	1	525-5007-63
25	Wood Rail #4, 9.25"	1	525-5007-64
<b>Items 22-25 are secured by:</b> #6 X 1-1/4" PFH A (Zinc) (Qty. 14 total) (237-5804-00)			

26	Flat Rail #1 (for Switch, see Item A below)	1	535-9423-00
27	Flat Rail #2 (by Center Eject, Right Side)	1	535-9442-00
28	Flat Rail #3 (Center Loop, Left)	1	535-9413-00
29	Flat Rail #4 (for Switch, see Item B below)	1	535-9416-00
30	Flat Rail #5 (Upr. Rt. Orbit, Left Side)	1	535-9419-00
31	Flat Rail #6 (Shooter Lane, Adjustable)	1	515-7367-00
32	Flat Rail #7 (for Switch, see Item B below)	1	535-9418-00
33	Flat Rail #8 (for Switch, see Item B below)	1	535-9412-00
34	Flat Rail #9 (by Lwr. Pop & Upr. Rt. Flipper)	2	535-9424-00
35	Flat Rail #10 (by Bottom Arch Drain)	1	535-8393-00
36	Flat Rail #11 (Left Orbit, Right Side)	1	535-9414-00
37	Flat Rail #12 (by Center Eject, Left Side)	1	535-9441-00
38	Flat Rail #13 (by Right Steel Ramp, Rt.)	1	535-9465-00
39	Flat Rail #14 (for Switch, see Item D below)	1	535-9415-00
40	Ball Guide (Plastic, Long Clear)	2	550-5037-01
41	Wire Form (on Plastic Ball Guide)	2	535-5642-00
42	Snubber Wire (3.125") (by Lwr. Flippers)	2	535-5373-01
43	Ball Guide Rail .12" Ø X 5.5"	1	535-5373-01
<b>Items 26-43 are secured at Tabs by:</b> #8 X 1/2" SLT HWH AB (Zinc) (Qty. 1/per tab) (234-5101-00) and/or by: #8 Washer (Qty. 1/per) (242-5005-00) and #8-32 Nylon Stop Nut (Qty. 1/per) (240-5102-00)			

**Miscellaneous**

44	Elvis™ Kit (Complete)	1	502-6796-84
<b>For Individual Items use:</b> See the Parts Table on Page 91, Items 21 and 26-31.			
45	Elvis™ Kit (Torso & Pivot Pin Only)	1	502-6796-84T
46	Rubber Bumper (Blue) (sec'd onto Item 36)		626-5058-00
47	Kit: Decals (for Items 1 & 10)	1	802-5000-84
<b>Note:</b> Individual Decals (820-6356-XX) are not available individually, ordering of kit is required. For all pieces, see P/F - Plastics (Screened & Clear) & Decals, Page 67.			
48	Kit: Plastics (for Items 13 & 18)	1	803-5000-84
<b>Note:</b> Individual Plastics (830-6029-XX) are not available individually, ordering of kit is required. For all pieces, see P/F - Plastics (Screened & Clear) & Decals, Page 67.			

**Miscellaneous Switches**

A	Micro Switch (sec'd onto Item 26)	1	180-5189-00
B	Micro Switch (sec'd onto Items 11 & 13 Brkts.)	4	180-5087-00
<b>Items A &amp; B require a Switch Body Protect Plate (535-6539-00) &amp; Diode 1N4004 (112-5003-00) and are secured by:</b> #2-56 X 1/2" HWH Sr (Qty. 2/per) (237-5937-02) and #2-56 Hex Nut (Qty. 2/per) (240-5301-00). <b>Item A:</b> Cable Wiring (036-5500-21-84, Sw. 48); <b>Item B:</b> CW (036-5500-04-84, Sw. 26; 036-5500-06-84, Sw. 47; 036-5500-09-84, Sw. 27; 036-5500-13-84, Sw. 46); Cable Wiring each include a 2-Pin Connector, 045-5007-02.			
C	Micro Sw. (1.25") (sec'd onto Item 10 Spinner Brkt.)	1	180-5010-04
D	Micro Switch (sec'd onto Item 15 Gate Brkt.)	1	180-5190-28
<b>Items C &amp; D require a Switch Body Protect Plate (535-6539-00) &amp; Diode 1N4004 (112-5003-00) and is secured by:</b> #2-56 X 1/2" PPH MS Zinc (Qty. 2) (237-5806-00). <b>Item C:</b> Cable Wiring (036-5500-10-84, Sw. 25); <b>Item D:</b> CW (036-5500-08-84, Sw. 10);			

**Switches on Top Assemblies**

<b>Note:</b> For more views of Switches, Targets and/or PCBs used on Assemblies, see Section 4, Chapter 2, (The Blue Pages) Drawings for Major Assemblies & Ramps.			
E	Micro Switch (Short Flat Actuator)	1	180-5190-28
<b>Item E located on the Hound Dog Assembly on Page 88.</b>			
F	Micro Switch (Roller Actuator, Lite Force)	1	180-5119-02
G	1" Sq. Stand-Up Target (White)	2	515-5162-08
<b>Items F &amp; G located on the Upper Playfield Hotel Frame on Page 93.</b>			
H	Micro Switch	1	180-5190-28
<b>Item H located on the Right Steel Ramp Exit Gate on Page 95.</b>			
I	Micro Switch (1-5/8" Actuator)	2	180-5010-01
<b>Item I located on the Right &amp; Left Wire Ramp Exit Gates on Page 95-97.</b>			
J	Micro Switch	1	180-5087-00
<b>Item J located on the Left Steel Ramp Exit Gate on Page 96-97.</b>			

**Pinball Rejuvenation Kit Available: 502-6002-84 (Std.)**  
This kit consists of 8 oz. Novus Wax #2 Fine (Red) (675-0003-01), cloth and all Rubber Rings & Bulbs used in this Pinball Machine.

Ask your distributor about the Deluxe Pinball Loc. Maint. Kit which (502-6003-84) includes Flipper Rebuild Kits!

Sec. 4: Parts Id. ...

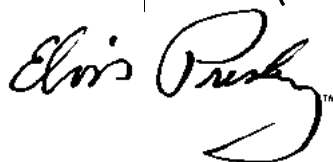

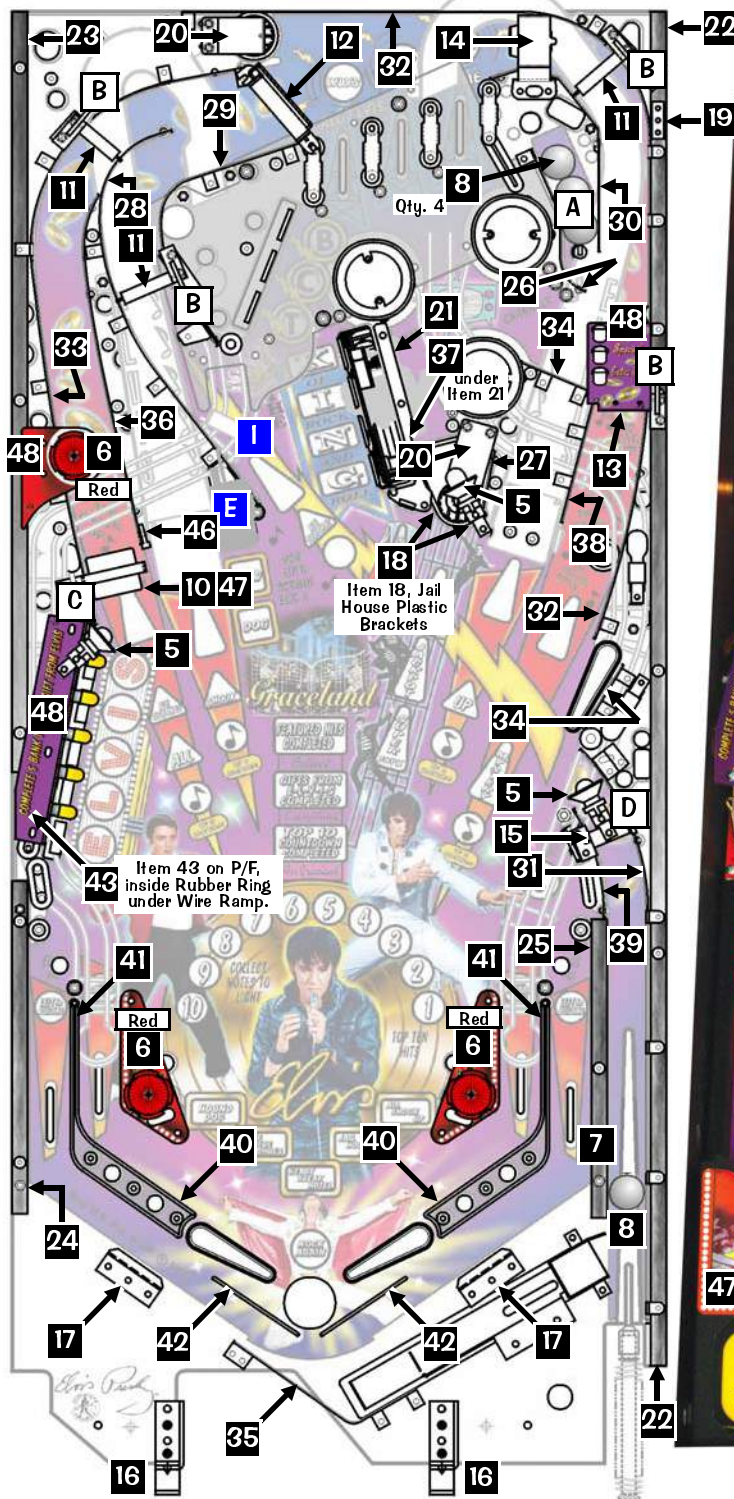

Sec. 4: Parts Id. ...

**Take Note:**

1. Items 10, 13 & 18 have associated **Individual Plastics and/or Decals**. These pieces are not available individually. For the Plastic and/or Decal Kits (or views), see the page after next, **Playfield - Plastics (Screened & Clear) & Decals, Page 67**.
2. For Sockets & Bulbs (drawings & part numbers) see Pgs. 72-74.
3. **Legend Note:** Items noted with a black square ■ are General Parts. Items noted with a white square □ are Switches and/or Misc. PC Board(s). Items noted with a blue square ■ are Switches on Major Assemblies and Ramps; see **The Blue Pages, Sec. 4, Chp. 2** for parts required not appearing on this page.
- a. If you still cannot find the part required, Call **Stern® Pinball, Inc. Technical Support, 1-800-542-5377 or 1-708-345-7700 (Opt. 1)**.

See Appendix J at the back of this manual for all current Cards (USA, Canada, Euro & International) available through your distributor or download via our website (see back of manual cover).



# Playfield - General Parts ■, Misc. Switches □ & Switches on Asm. ■ (Below)

Nº BELOW PLAYFIELD PART NAME QTY. SPI PART Nº

## General Items

1	Insulation Fiche Paper (under Lower Flippers)	2	545-5721-00
2	Diode Terminal Strip 2-Lug (810) Isolated	1	055-5203-00
3	Diode Terminal Strip 4-Lug (821) Isolated	1	055-5204-04
4	Diode Terminal Strip 7-Lug Isolated	1	055-5204-07
Items 2-4 are secured by: #6 X 3/8 HWH AB Zinc (Qty. 1-2/per) (234-5000-00).			
<i>Note: 1N4004 Diodes (112-5003-00) are used in all Diode applications. 1N4001 Diodes can be used for Switches and/or Lamps. See Sec. 5, Chp. 2, P/F Diode Terminal Strip...</i>			
5	Eject Hole Base - Red	1	545-5060-02
5m	Eject Hole Base - Red (Modifield)	1	545-5060-02-84
	3A 250v Slo-Blo Fuse	4	200-5000-08
6	Fuse Clip Holder (Socket)	4	205-5000-01
Item 6 is secured by: #6 X 1/2" PPH AB (Qty. 1/per) (237-5805-00)			
<i>Note: Item 6, Fuse Clip Holder (Socket) 205-5000-01 is part of a set of 12 (205-5000-12). You can order them as individuals (...-01) or a set of 12 (...-12).</i>			
7*	Diode Terminal Strip/Fuse Decals A-D	1	820-6221-84
<i>Note: For Decal Descriptions &amp; Locations, see Sec. 5, Chp. 2, Playfield Wiring, Page 105.</i>			
8	Mini-Coil Assembly (for Control Gate)	1	515-6543-00
<i>For Individual Items use : Coil, 32-1800 (No Sleeve) (090-5031-00), Trip Coil Frame (535-6198-00), Spring (265-5045-01), #8-32 X 3/8" PPH MS Ext. Sems (Zinc) (232-5301-00) and Cable Wiring (036-5500-11-84 includes 2-Pin Connector 045-5007-02)</i>			
<i>Ordering Note: For Items 8 &amp; 9 assembled with Cable Wiring use 515-6544-01-84.</i>			

## Brackets for Mounting

9	Bracket, Mini-Coil Asm. Mounting	1	535-7727-01
Item 9 is secured by: #8 X 1/2" SLT HWH AB (Zinc) (Qty. 2) (234-5101-00)			
10	Playfield Support Slide Bracket	2	535-6862-02
Item 10 is secured by: #8 X 1/2" SLT HWH AB (Zinc) (Qty. 2/per) (234-5101-00) and #8-32 X 5/8" HWH Swage (Serr) Zinc (Qty. 1/per) (237-5975-03)			
11	Edge Slide Bracket (Extended)	2	535-5988-01
Item 11 is secured by: #4 X 1/2" PFH (Zinc) (Qty. 5/per) (237-5840-00)			
12	Pivot Pin Bracket Welded Assembly	2	500-5329-03
13	Bracket, Eject Hole Base (for Item 5B)	1	535-9484-00
Item 13 is secured by: #6 X 1/2" SLT HWH AB (Zinc) (Qty. 2/per) (234-5001-02)			
14	Bracket, Back Panel Mounting	2	535-8964-00
Item 14 is secured by: #8 X 1/2" SLT HWH AB (Zc) (Qty. 2/per) (234-5101-00)			
15	Tie Post 3.5" (Ladder), White Plastic	10	545-5253-01
Item 15 is secured by: #6 X 5/8" SLT HWH AB (Zc) (Qty. 1/per) (234-5002-00)			

## Miscellaneous Switches

A	Shooter Sw. Assembly (at Shooter Lane)	1	500-6096-00
<i>For Individual Items use : Switch Bracket (535-6173-00), Micro Switch (180-5157-00 ◄), Switch Body Protect Plate (535-6539-00), Diode 1N4004 (112-5003-00), #2-56 X 1/2" Unslit. Serr. HWH #4 Hd.TR3 (Qty. 2) (237-5937-02) and #2-56 Hex Nut (Qty. 2) (240-5301-00)</i>			
B	Eject Sw. Assembly (at Ejects)	2	500-6520-00
<i>For Individual Items use : Switch Bracket (535-6173-00), Micro Switch (180-5157-00 ◄), Switch Body Protect Plate (535-6539-00), Diode 1N4004 (112-5003-00), #2-56 X 1/2" Unslit. Serr. HWH #4 Hd.TR3 (Qty. 2) (237-5937-02) and #2-56 Hex Nut (Qty. 2) (240-5301-00)</i>			
C	Micro Sw. Roll-Over Right Brkt. Assy.	7	500-6227-02
Item C is secured by: #6 X 1/2" SLT HWH AB (Zinc) (Qty. 2/per) (234-5001-02)			
D	Switch & Target Assy. 1" Square (White)	4	515-5162-08
E	Switch & Target Assy. Narrow (Red)	1	515-5967-02
Items D-E are secured by: #8 X 1/2" SLT HWH AB (Zinc) (Qty. 2/per) (234-5101-00)			
<i>Note Items D-E: For better view(s) or entire assembly, see Appdx. I, Pg. 11 (end of manual).</i>			

## Switches & PCBs on Bottom Assemblies

<i>Note: For more views of Switches, Targets and/or PCBs used on Assemblies, see Section 4, Chapter 2, (The Blue Pages) Drawings for Major Assemblies &amp; Ramps</i>			
F	Dual OPTO TRANS PC Board Asm.	1	515-0173-00
G	Dual OPTO REC PCB Assembly	1	515-0174-00
H	Micro Switch (Roller Actuator, Lite-Force)	3	180-5119-02
Items F, G & H located on the 4-Ball Trough Assembly on Page 77.			
I	Power (EOS / End-of-Stroke) Switch	1/per	180-5149-00
Item I located on the Flipper (Left & Right, Lower) Assemblies on Pages 78-79.			
J	Slingshot Stack (Blade) Switch	2/per	180-5054-00
Item J located on Slingshot Assemblies on Page 82.			
K	Bumper Stack (Blade) Switch	1/per	180-5015-05
Item K located on Bumper Switch Assemblies on Page 83.			
L	Switch (Drop Target)	5	180-5158-00
Item L located on 5-Bank Drop Target Assembly on Pages 84-85.			
M	1" Sq. Stand-Up (Side Lugs, No Brkt.)	4	515-7381-00
N	Micro Switch (Short Actuator, Bend)	1	180-5189-00
Items M & N located on Elvise, Stepper Motor & 3-Bank Stand-Up ... on Pages 90-91.			

Pinball Location Maint. Kit Available: 502-6002-84 (Std.)

This kit consists of 8 oz. Novus Wax #2 Fine (Red) (675-0003-01), cloth and all Rubber Rings & Bulbs used in this Pinball Machine.

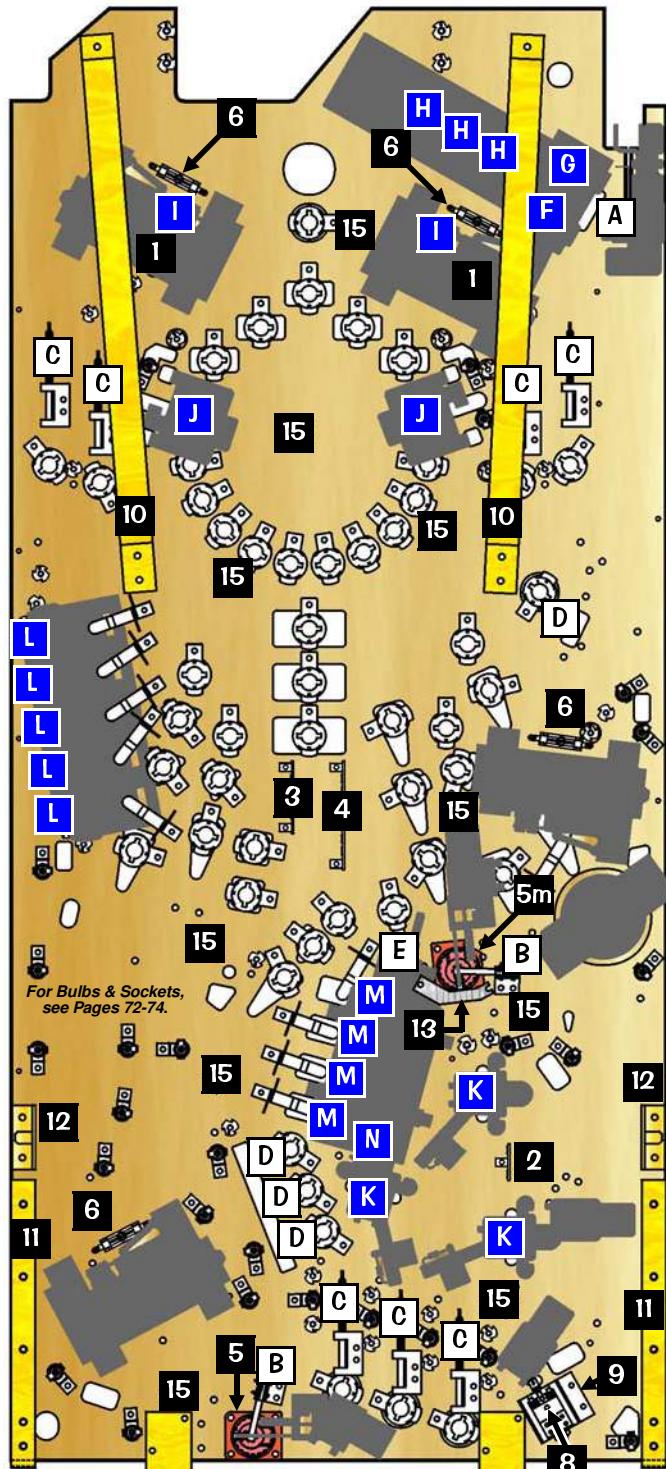

### Take Note:

- \* An asterisk (\*) indicates item(s) are not noted in the pictorials.
- 1. For Sockets & Bulbs (drawings & part numbers) see Pgs. 72-74.
- 2. **Legend Note:** Items noted with a black square ■ are General Parts. Items noted with a white square □ are Switches, Coils, and/or Miscellaneous PC Board(s). Items noted with a blue square ■ are Switches on Major Assemblies; see **The Blue Pages**, Sec. 4, Chp. 2 for parts required not appearing on this page. If you still cannot find the part required, Call Stern@ Pinball, Inc. Technical Support, 1-800-542-5377 or 1-708-345-7700 (Opt. 1).

Ask your distributor about the Deluxe Pinball Location Maintenance Kit (502-6003-84) which includes Flipper Rebuild Kits!

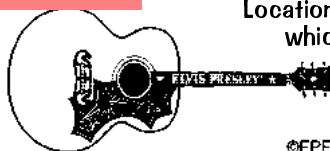



# Playfield - Plastics (Screened & Clear) Kit, Upper P/F and Decals & Mylar Kits

## PLASTICS KIT & UPPER PLAYFIELD SPI PART N°

Kit: Playfield Plastics (Screened & Clear)

**803-5000-84 Kit includes:**

Screened Set (830-6029-XX), Clear Set (830-6030-XX), Screened Piece (Back Panel) (830-6031-00) and Clear Piece (830-6032-00)

**Note:** The following Screened Plastics have various parts (brackets) riveted to them. If replacing these plastics, the rivets must be drilled out to replace. Items can be remounted with appropriate sized screw & nut combo.

-27, -28, -29, -31 & -35 (see Page 92 for Assy. Ref.); -19; -21 & -25 (see Pages 96-97 for Assembly Reference)

**Most last 2-digits are sequential. The following numbers were not used:** -12, -20, -22, -23, -26, -38 — 44.

**For Views & Usage of some plastics on Assemblies:**

-30 (Pg. 88); -09 (Pg. 93); -34 & 545-6104-00 (Pg. 94); -32 & -45 (Pg. 95); 830-6032-00 & -36 (Pgs. 96-97); 830-6031-00 (Pg. 97).

**545-6104-00 Clear Thick Plastic Upper Playfield**  
(see Page 94 for Assembly Reference)

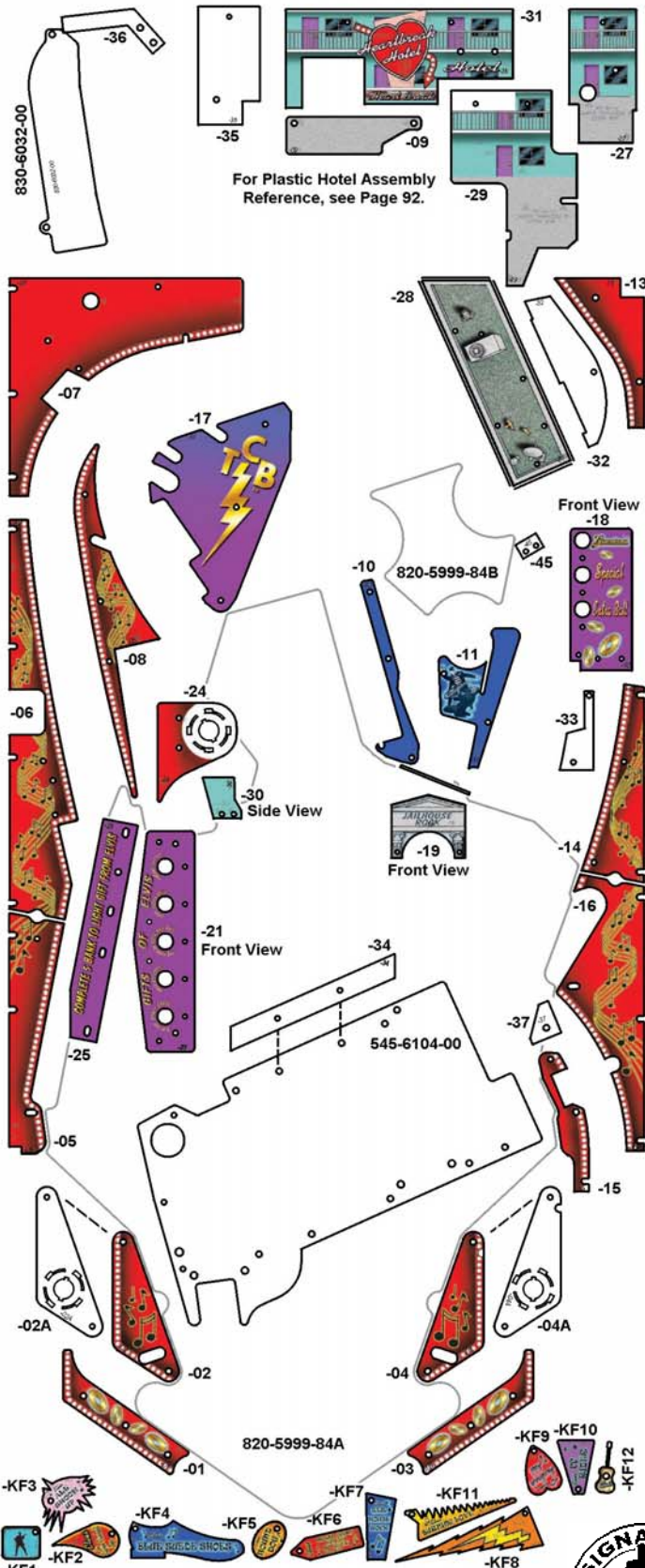

## DECALS & MYLAR KITS SPI PART N°

Kits: Playfield & Assembly Decals & Mylar

**802-5000-84 Kit (Regular) includes:**

Decal Set (820-6356-XX)

**Most last 2-digits are sequential. The following numbers were not used:** -13 — -16, -19 — -79, -84 — -97.

**802-5001-84 Kit (Lexan) includes:**

Suede Lexan Drop Targets (820-6361-00, Qty. 10) and Suede Lexan Hotel Door (820-6362-00, Qty. 1)

**802-5002-84 Kit (Mylar) includes:**

Full Playfield Mylar (820-5999-84A) and Pop Bumper Area Mylar (820-5999-84B)

**Attention: No individual Plastic or Decal can be ordered separately, unless noted otherwise.\***

Other miscellaneous plastics and/or decals can be found on the **Backbox & Speaker Panel Assemblies** (Pages 60-61), **Cabinet - General Parts** (Pages 62-63) and **Playfield - General Parts & Switches** (Below) (Page 66).



Parts Identification & Location



Sec. 4: Parts Id. ...

LEXAN KIT USE 802-5001-84 includes 10 Drop Targets & 1 Door

# Playfield - Rubber Parts Black & White (Rings Actual Size) †

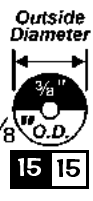
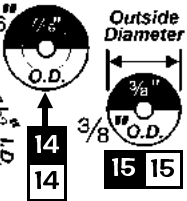
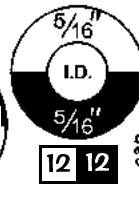
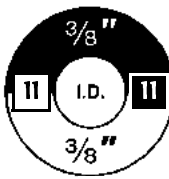
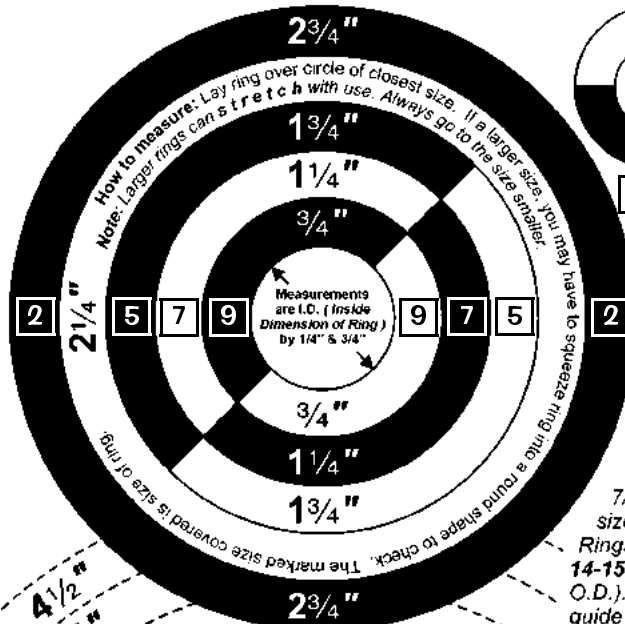

Items 1-13 are measured by the Inside Diameter (I.D.). Items 1-9 and 11 are approximately 1/4" thick. Items 10, 12-15 are approximately 3/16" thick. Item 13 can also be a 7/32" I.D. Ring. The size is imprinted on all Rings except for Items 14-15 (7/16" O.D. & 3/8" O.D.). Use this page as a guide to measure rings where the size imprint or mark does not exist. Size 2 1/4" I.D. (Black or White) was never used. Choose a Ring Size +/- 1/4" I.D. if required.

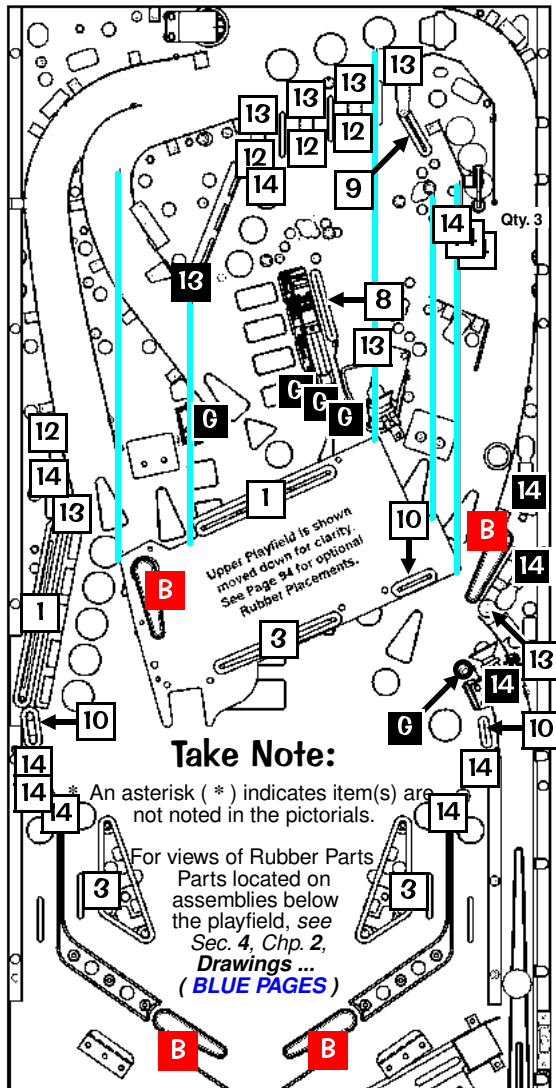

### Take Note:

\* An asterisk (\*) indicates item(s) are not noted in the pictorials.

For views of Rubber Parts located on assemblies below the playfield, see Sec. 4, Chp. 2, Drawings ... (BLUE PAGES)

Note: Item 14, 7/16" O.D. Black Rings (Qty. 33/37) are used to cushion the Bayonet Sockets under the playfield.

Note: Sizes larger than 3" I.D. currently available in Black Only (Not Used): 3 1/2" (-545-5348-11); 4" (-12); 4 1/2" (-13); 5" (-14); 5 1/2" (-15); 6" (-16). Sizes Not Shown on this page, listed in the Parts Table below or are noted with N/U (Not Used) are currently not available.

Sec. 4: Parts Id. ...

Nº	RUBBER PART NAME	QTY.	SPI PART Nº
A	Small Flipper <b>BLACK</b> Ring		545-5207-00
	Sm. Flipper <b>RED (Soft Duro)</b> Ring		545-5207-22
B	Large Flipper <b>BLK (50 Duro)</b> Ring	4	545-5277-00
	Lg. Flipper <b>RED (Soft Duro)</b> Ring		545-5277-22
C	Bumper (Deflector Pad) on Asm's 4 below / 1 above		545-5428-00
D*	Bumper (Grommet) 1138 (A60)	1	545-5105-00
E*	Bumper (Post)		545-5009-00
F*	Bumper (Post Sleeve, Short)		545-5151-00
	Bumper <b>RED</b> (Post Sleeve, Tall)		545-5308-22
G	Bumper <b>BLACK</b> (Post Sleeve, Tall)	5	545-5308-00
	Bumper <b>WHITE</b> (Post Sleeve, Tall)		545-5308-08
H*	O-Ring 11/32" X 7/32" X 1/16"		545-5850-00

(Located inside Cabinet by each Flipper Button Assembly)

Nº	SPI PART Nº	QTY.	RUBBER PART NAME	QTY.	SPI PART Nº	Nº
	545-5348-10		◀Black 3" I.D. Ring White▶	2	545-5348-60	1
	545-5348-20		◀Black 2 3/4" I.D. Ring White▶		-70 N/U	2
	545-5348-09		◀Black 2 1/2" I.D. Ring White▶	3	545-5348-59	3
	545-5348-08		◀Black 2" I.D. Ring White▶		545-5348-58	4
	545-5348-21		◀Black 1 3/4" I.D. Ring White▶		-71 N/U	5
	545-5348-07		◀Black 1 1/2" I.D. Ring White▶	1	545-5348-57	6
	545-5348-06		◀Black 1 1/4" I.D. Ring White▶		545-5348-56	7
	545-5348-05		◀Black 1" I.D. Ring White▶	1	545-5348-55	8
	545-5348-04		◀Black 3/4" I.D. Ring White▶	1	545-5348-54	9
	545-5348-18		◀Black 7/16" I.D. Ring White▶	3	545-5348-68	10
	545-5348-03		◀Black 3/8" I.D. Ring White▶		-53 N/U	11
	545-5348-02		◀Black 5/16" I.D. Ring White▶	4	545-5348-52	12
	545-5348-01	1	◀Black 3/16" I.D. Ring White▶	7	545-5348-51	13
	545-5348-17	37	◀Black 7/16" O.D. Ring White▶	11	545-5348-67	14
	545-5348-19		◀Black 3/8" O.D. Ring White▶		545-5348-69	15

† Items with no Qty. (quantity) are not used in this game. Size and/or quantities may change during production.

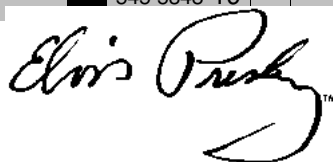

# Playfield - Metal Posts (Screws) & Nuts (Actual Size) † #8-32

Item 4 Post can use 5/16" I.D. Black Ring, 545-5348-02 or White Ring 545-5348-52.  
 Items 6-8 Posts can use 3/8" O.D. Black Ring, 545-5348-19 or White Ring, 545-5348-69.

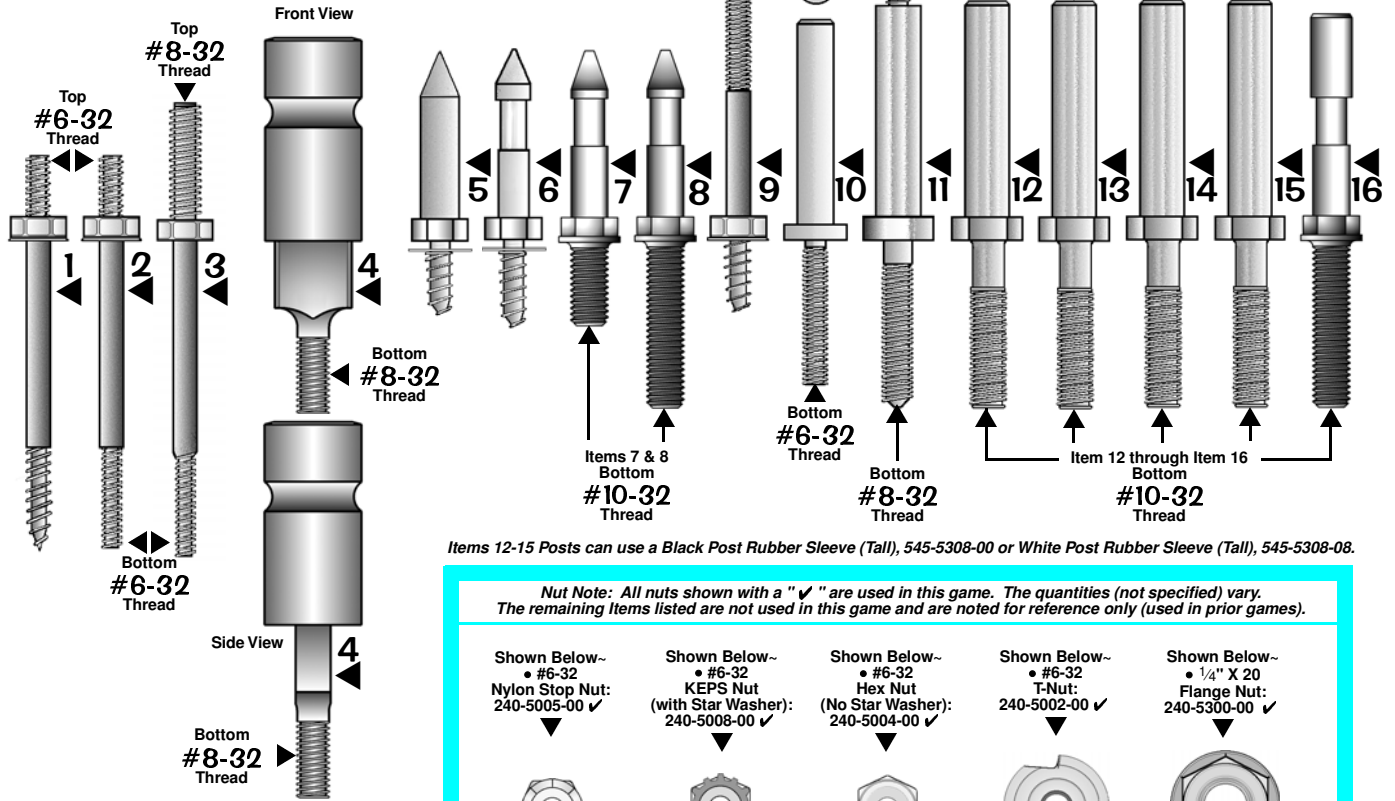

Items 12-15 Posts can use a Black Post Rubber Sleeve (Tall), 545-5308-00 or White Post Rubber Sleeve (Tall), 545-5308-08.

**Nut Note:** All nuts shown with a "✓" are used in this game. The quantities (not specified) vary. The remaining items listed are not used in this game and are noted for reference only (used in prior games).

Shown Below~ • #6-32 Nylon Stop Nut: 240-5005-00 ✓	Shown Below~ • #6-32 KEPS Nut (with Star Washer): 240-5008-00 ✓	Shown Below~ • #6-32 Hex Nut (No Star Washer): 240-5004-00 ✓	Shown Below~ • #6-32 T-Nut: 240-5002-00 ✓	Shown Below~ • 1/4" X 20 Flange Nut: 240-5300-00 ✓
Top & Side Views	Bottom & Side Views	Top View	Bottom & Side Views	Top & Side Views
<b>Nylon Stop Nuts Not Shown:</b>	<b>KEPS Nuts Not Shown:</b>	<b>Hex Nuts Not Shown:</b>	<b>T-Nuts Not Shown:</b>	<b>Miscellaneous Nuts Not Shown:</b>
<ul style="list-style-type: none"> <li>• #6-32 (w/ 1/4" Hex Body): 240-5010-00</li> <li>• #8-32: 240-5102-00 ✓</li> <li>• #10-32: 240-5203-00 ✓</li> <li>• #10-24: 240-5206-00 ✓</li> <li>• #4-40: 240-5303-01</li> <li>• #4-40 (18/8 Stainless): 240-5303-01</li> <li>• 5/16"-18: 240-5316-00</li> </ul>	<ul style="list-style-type: none"> <li>• #6-32 (w/ 1/4" Hex Body): 240-5011-00</li> <li>• #8-32: 240-5104-00 ✓</li> <li>• #10-32: 240-5208-00 ✓</li> <li>• #10-24: 240-5207-00 ✓</li> <li>• #4-40: 240-5318-00</li> </ul>	<ul style="list-style-type: none"> <li>• #8-32: 240-5103-00</li> <li>• #10-32: 240-5201-00</li> <li>• #10-24: 240-5202-00 ✓</li> <li>• #10-32 X 3/8": 240-5209-00</li> <li>• 3/4-16: 240-5315-00 ✓</li> <li>• #2-56: 240-5301-00 ✓</li> <li>• 7/8"-14: 240-5317-00</li> </ul>	<ul style="list-style-type: none"> <li>• #6-32 (w/Side Cut Off): 240-5002-01</li> <li>• #8-32: 240-5101-00 ✓</li> <li>• #10-32 (Black Oxide): 240-5007-00</li> <li>• #10-32 (w/Side Cut Off): 240-5205-00</li> <li>• #10-32 X 5/16": 240-5211-00</li> <li>• #10-24: 240-5200-00</li> </ul>	<ul style="list-style-type: none"> <li>• Plastic Pal Nut (on Flipper Buttons): 240-5003-00</li> <li>• Metal Pal Nut (on Flipper Buttons): 240-5003-01</li> <li>• #6-32 Wing Nut: 240-5001-00</li> <li>• #8-32 Wing Nut: 240-5100-00</li> <li>• #10-24 Wing Nut: 240-5211-00</li> <li>• 1/4"-20 Wing Nut: 240-5302-00</li> <li>• 1/4"-20 Toggle Wing: 240-5324-00</li> </ul>

Items A & B are typically used to secure Hex Spacers above the Playfield.  
 Item C is typically used with the bottom Cabinet Speaker (used with #6-32 Nylon Stop Nut, 240-5005-00).  
 Item D is typically used to secure "Item 15 (515-5939-00) in Bumper Bottom Assy, 515-6459-04".  
 Note: The "Fins" keep the screw from turning inside the wood hole.

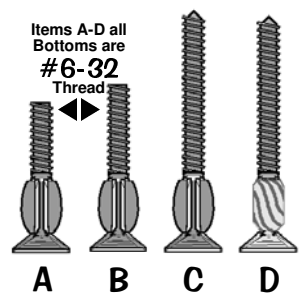

† Items with no Qty. (quantity) are not used in this game. Size and/or quantities may change during production.

Nº	METAL POST NAME	QTY.	SPI PART Nº	Nº	METAL POST NAME	QTY.	SPI PART Nº
1	Post Fstn. #6-32 Top / Wood Scr. Bot.	14	530-5010-02	11	Post Fasten #6-32 Top / #8-32 Bot.	1	530-5007-00
2	Post Fasten #6-32 Top / #6-32 Bot.	3	530-5012-02	12	Post Hex Base #6-32 Tap/#10-32 Bot.	2	530-5332-01
3	Post Fasten #8-32 Top / #6-32 Bot.		530-5008-00	13	Post Hex Base (No Tap)/#10-32 Bot.		530-5332-00
4	Adjustable Sliding Post (Brass) #8-32 Bot.		530-5621-00	14	Post Hex Base #8-32 Top/#10-32 Bot.		530-5332-02
5	Mini-Post Wood Screw (no cut-away)	4	530-5004-01	15	Post Hex Base #6-32 Top/#10-32 Bot.	3	530-5332-03
6	Mini-Post Wood Screw	1	530-5004-00	16	Post Hex Base #6-32 Tap/#10-32 Bot.	5	530-5679-00
7	Mini-Post MS / #10-32 Bot. .4" Thread	7	530-5005-01				
8	Mini-Post MS / #10-32 Bot. .875" Thread	13	530-5005-00	A	#6-32 X 3/4" Fin Shank Screw		237-5921-02
9	Post #6-32 Top / Wood Screw Bottom		530-5263-01	B	#6-32 X 7/8" Fin Shank Screw	9	237-5921-04
10	Post #6-32 Tap / #6-32 Bottom		530-5127-00	C	#6-32 X 1 1/4" Fin Shank Screw	4	237-5883-00
				D	#6-32 X 1 3/16" Spiral Fin Shank Screw	9	237-5957-00





# Playfield - Hex Spacers (Actual Size) †

Hex Spacers:

#6-32

Tap

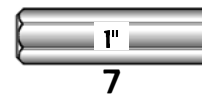
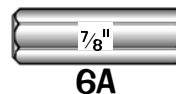
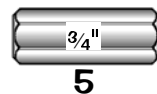
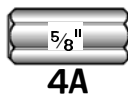
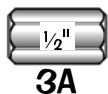

example of "Bs"  
with Male #6-32 Thread  
1-end, #6-32 Tap on other.



## Take Note:

Items 1-33 are 1/4" wide. Items 34-39 are 5/16" wide. With Items 1-3A, 4A, 5 & 6A (the tap goes thru the length of spacer). With Items 7, 8A, 9-33 & 34-49, the tap is up to 5/8" deep on each end. **Note:** Items 3B, 4B, 6B (Not Shown) & 8B (Shown as example of all "B" Styles) all have a #6-32 Threaded end, the other end Tapped (same as Items 7-33).

‡ Hex Spacers Not Used in current games may no longer be available. Choose an available size (+/-) and compensate with washers or other spacers.



Top & Bottom #8-32 Thread



A Standard USA 9 Inch Ruler is provided on the back cover.

Sec. 4: Parts Id. ...

Nº	HEX SPACER NAME	QTY.	SPI PART Nº	Nº	HEX SPACER NAME	QTY.	SPI PART Nº
1	1/4" X 1/4" : #6-32 Tap (both ends)		254-5008-00	19	2 3/8" X 1/4" : #6-32 Tap (both ends)		254-5008-28
2	3/8" X 1/4" : #6-32 Tap (both ends)		254-5008-12	20	2 1/2" X 1/4" : #6-32 Tap (both ends)	3	254-5008-16
3A	1/2" X 1/4" : #6-32 Tap (both ends)	6	254-5008-03	21	2 5/8" X 1/4" : #6-32 Tap (both ends)	3	254-5008-08
3B*	Identical to 3A with #6-32 Thread end		254-5024-03	22	2 3/4" X 1/4" : #6-32 Tap (both ends)	2	254-5008-15
4A	5/8" X 1/4" : #6-32 Tap (both ends)		254-5008-02	23	2 7/8" X 1/4" : #6-32 Tap (both ends)		254-5008-31
4B*	Identical to 4A with #6-32 Thread end		254-5024-02	24	3" X 1/4" : #6-32 Tap (both ends)	2	254-5008-14
5	3/4" X 1/4" : #6-32 Tap (both ends)	1	254-5008-04	25	3 1/8" X 1/4" : #6-32 Tap (both ends)		254-5008-19
6A	7/8" X 1/4" : #6-32 Tap (both ends)		254-5008-05	26	3 1/4" X 1/4" : #6-32 Tap (both ends)		254-5008-26
6B*	Identical to 6A with #6-32 Thread end		254-5024-05	27	3 1/2" X 1/4" : #6-32 Tap (both ends)		254-5008-27
7	1" X 1/4" : #6-32 Tap (both ends)		254-5008-06	28	3 5/8" X 1/4" : #6-32 Tap (both ends)		254-5008-25
8A	1 1/8" X 1/4" : #6-32 Tap (both ends)		254-5008-17	29	3 3/4" X 1/4" : #6-32 Tap (both ends)		254-5008-36
8B	Identical to 8A with #6-32 Thread end	2	254-5024-17	30	4" X 1/4" : #6-32 Tap (both ends)		254-5008-21
9	1 1/4" X 1/4" : #6-32 Tap (both ends)		254-5008-11	31	4 1/4" X 1/4" : #6-32 Tap (both ends)		254-5008-30
10	1 5/16" X 1/4" : #6-32 Tap (both ends)		254-5008-34	32	4 3/8" X 1/4" : #6-32 Tap (both ends)		254-5008-29
11 ‡	1 3/8" X 1/4" : #6-32 Tap (both ends)		254-5008-33	33	5 1/4" X 1/4" : #6-32 Tap (both ends)		254-5008-35
12 ‡	1 1/2" X 1/4" : #6-32 Tap (both ends)		254-5008-09	34	1 1/4" X 5/16" : #6-32 Tap (both ends)		254-5018-09
13 ‡	1 5/8" X 1/4" : #6-32 Tap (both ends)		254-5008-13	35	1 3/4" X 5/16" : #6-32 Tap (both ends)		254-5018-06
14 ‡	1 3/4" X 1/4" : #6-32 Tap (both ends)	1	254-5008-10	36	2" X 5/16" : #6-32 Tap (both ends)		254-5018-07
15 ‡	1 7/8" X 1/4" : #6-32 Tap (both ends)		254-5008-20	37	4" X 5/16" : #6-32 Tap (both ends)		254-5018-03
16	2" X 1/4" : #6-32 Tap (both ends)	2	254-5008-07	38	4 5/16" X 5/16" : #6-32 Tap (both ends)		254-5018-00
17	2 1/8" X 1/4" : #6-32 Tap (both ends)		254-5008-32	39	4.92" X 5/16" : #6-32 Tap (both ends)		254-5018-04
18	2 1/4" X 1/4" : #6-32 Tap (both ends)	1	254-5008-18	40	1 7/8" X 3/8" : #8-32 Thread (both ends)		530-5285-00

† Items with no Qty. (quantity) are not used in this game. Size and/or quantities may change during production.

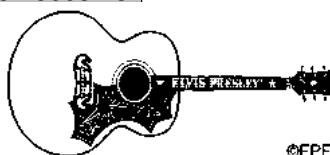

# Playfield - Plastic Posts & Spacers (Actual Size) †

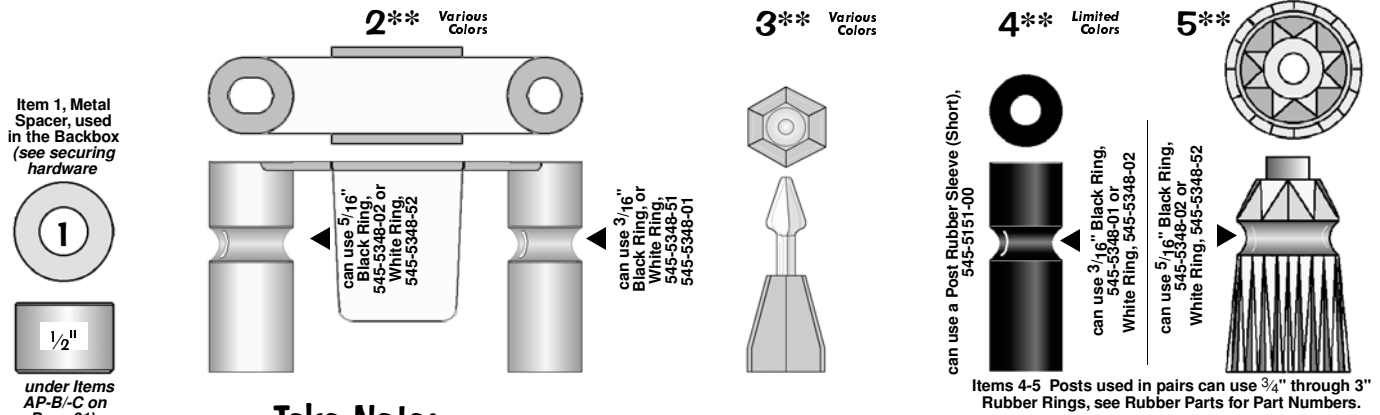

under Items AP-B/-C on Page 61).

## Take Note:

PLASTIC PART COLOR CHART					
Nº	Color	Nº	Color	Nº	Color
-00	Black	-06	Yellow	-12	Fluor. Blue
-01	Clear	-07	Orange	-13	Teal Green
-02	Red	-08	White	-14	Gray
-03	Amber	-09	Purple	-15	Luminescent
-04	Green	-10	Fluor. Orange	-16	Gold
-05	Blue	-11	Fluor. Green		

\*\* Items 2, 4 & 5 come in various colors (may not be available in every color). Item 4 is currently only available in the color(s) stated in this game manual (other colors used in prior games may no longer be available). The "-XX" or last 2-Digits in Part Nºs which come in various colors, should be replaced with the desired 2-Digit Nº from the above Color Chart. Some colors may no longer be available for desired item.

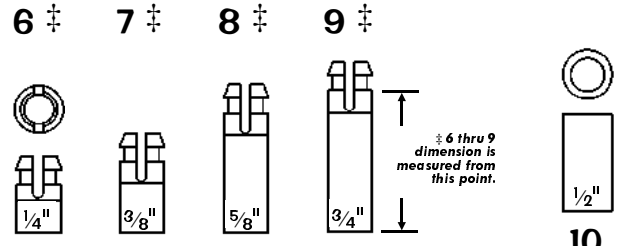

† Items 6 through 9 dimensions are measured from bottom to just under the cut-away. Item 30 dimension is measured from top-to-top of curve. See pictorials with Items 9 & 30.

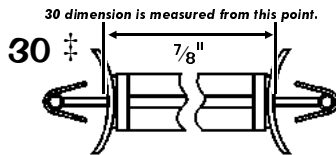

## Take Note:

If any one of Items 11-23 Plastic Spacers is not available in the size required, order the smaller sized spacers required to stack sizes together until appropriate size is achieved (e.g. If 1 1/8" is needed but unavailable, order a 1/2" + 5/8" & stack to = 1 1/8").

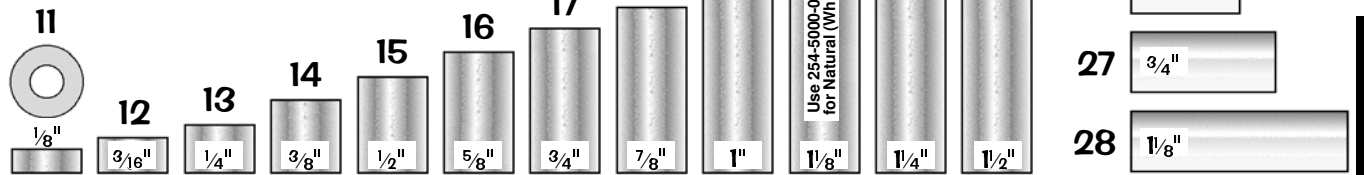

† Items with no Qty. (quantity) are not used in this game. Size and/or quantities may change during production.

Nº	POST & SPACER NAME	QTY.	SPI PART Nº	Nº	POST & SPACER NAME	QTY.	SPI PART Nº
1	3/8" X 1/2" Metal Spacer (Backbox)	2	530-5099-00	14	3/8" X 3/8" Plastic Spacer Gray	1	254-5000-12
2**	Top Lane Plastic Mini-Lite Hood (Red)	4	550-5061-02	15	1/2" X 3/8" Plastic Spacer Gray	1	254-5000-01
Item 2 typically secured by: #6-32 X 1-3/4" PPH MS (Zinc) (Qty. 2/per) (237-5511-00) and Washer 9/64" X 5/16" OD X 1/32" (Qty. 2/per) (242-5017-00), if used.							
3**	Mini-Jewel Plastic Post (Clear)	1	550-5052-01	16	5/8" X 3/8" Plastic Spacer Gray	5	254-5000-14
Item 3 typically secured by: #6 X 3/8" HWH AB (Zinc) (Qty. 1/per) (234-5000-00)							
4**	1 1/16" 1-Groove Plastic Post (Black)		550-5059-00	17	3/4" X 3/8" Plastic Spacer Gray	2	254-5000-07
	1 1/16" 1-Groove Plastic Post (Clear)	27	550-5059-01	18	7/8" X 3/8" Plastic Spacer Gray		254-5000-11
5**	1-Groove Jewel Plastic Post (Clear)	2	550-5034-01	19	1" X 3/8" Plastic Spacer Gray or Black		254-5000-04
Items 4 & 5 typically secured by: Post Fastening Screw #6-32 Top / #6-32 Bottom (Qty. 1/per) (530-5012-02, Item 6 Page 69).							
6 †	1/4" Slf. Rtn. Plastic Spacer White		254-5007-02	20	1 1/8" X 3/8" Plastic Spacer Gray		254-5000-06
7 †	3/8" Slf. Rtn. Plastic Spacer White	4	254-5007-01	21	1 1/4" X 3/8" Plastic Spacer Gray	1	254-5000-05
8 †	5/8" Slf. Rtn. Plastic Spacer White		254-5007-00	22	1 1/2" X 3/8" Plastic Spacer Gray		254-5000-08
9 †	3/4" Slf. Rtn. Plastic Spacer White		254-5007-03	23	1 15/16" X 3/8" Plastic Spacer Gray	1	254-5000-15
10	1/2" X 1/4" Plastic Spacer White (Narrow)		254-5000-03	24	1/4" X 5/16" X .144" I.D. Metal Spacer	1	254-5014-03
11	1/8" X 3/8" Plastic Spacer Gray		254-5000-19	25	1/2" X 5/16" X .144" I.D. Metal Spacer	3	254-5014-00
12	3/16" X 3/8" Plastic Spacer Gray	6	254-5000-18	26	9/16" X 5/16" X .144" I.D. Metal Spacer		254-5014-04
13	1/4" X 3/8" Plastic Spacer Gray	4	254-5000-02	27	3/4" X 5/16" X .144" I.D. Metal Spacer		254-5014-01
				28	1 1/8" X 5/16" X .144" I.D. Metal Spacer		254-5014-02
				29	1" X 5/16" X .144" I.D. Metal Spacer		254-5001-00
				30 †	7/8" Plastic Spacer Support (Dual-Locking)		254-5039-14



# Playfield & Back Panel - Small Bayonet Type Bulbs & Sockets (Actual Size) †

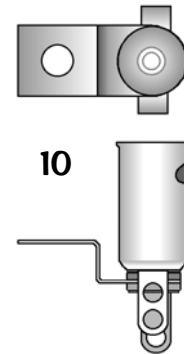
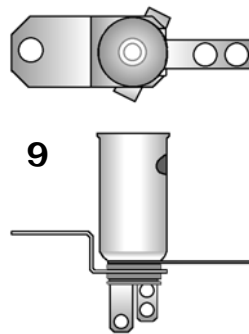
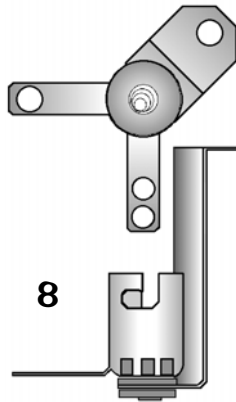
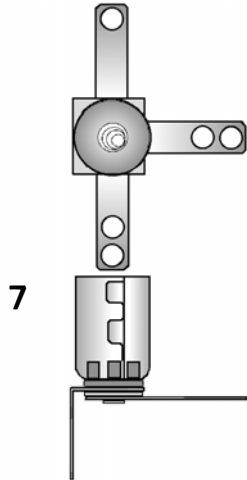
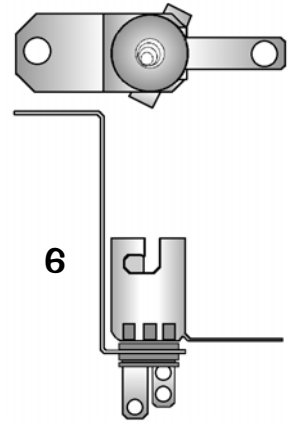
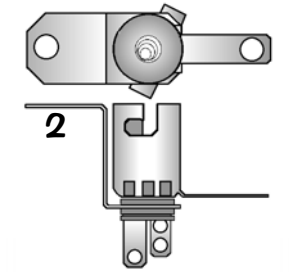
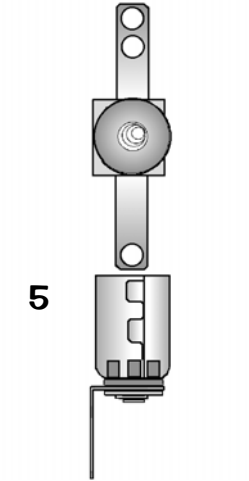
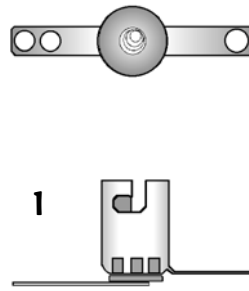
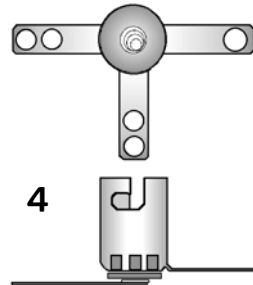
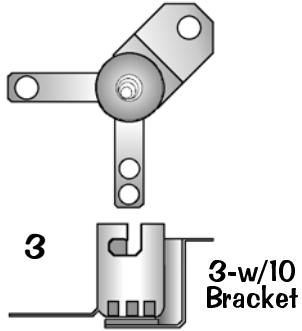
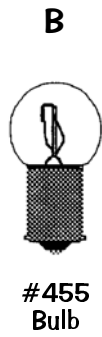
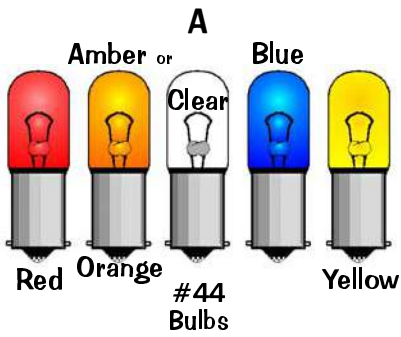

Sec. 4: Parts Id. ...

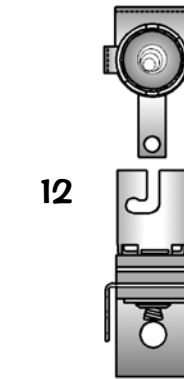
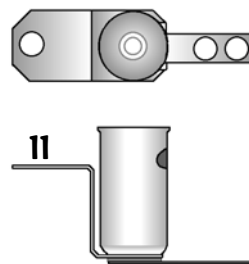

Nº	SMALL BULB or SOCKET NAME	QTY.	SPI PART Nº
A	#44 Bulb (Clear) <i>Heavy Filament</i>	64	165-5000-44-HF
A	#44 Bulb (Red)	1	165-5053-02
A	#44 Bulb (Amber)		165-5053-03
A	#44 Bulb (Orange)	1	165-5053-07
A	#44 Bulb (Blue)	1	165-5053-05
A	#44 Bulb (Yellow)	5	165-5053-06
B	#455 Twinkle Bulb		165-5003-00
1	2-Lug Staple Down Socket	14	077-5000-00
2	3-Lug Stand-Up Short Socket	8	077-5008-00
3	2-Lug Stand-Up Short Socket		077-5002-00
3-10	2-Lug S-U Short Socket w/ Item 10 Bracket	22	077-5002-31
4	3-Lug Staple Down Socket		077-5001-00
5	2-Lug Laydown Socket		077-5003-00
6	3-Lug Stand-Up Long Socket	5	077-5009-00
7	3-Lug Laydown Socket (3 Lugs Flat)		077-5006-00
8	2-Lug Stand-Up Long Socket		077-5005-00
9	3-Lug Stand-Up Long Shell Socket		077-5013-00
10	2-Lug Stand-Up Lg. Shell Socket (G1S)	5	077-5031-00

Nº	SOCKET NAME	QTY.	SPI PART Nº
11	1-Lug Stand-Up Long Shell Socket		077-5012-00
12	3-Lug Laydown Socket (2 Lugs Bent)	14	077-5032-00

† Items with no Qty. (quantity) are not used in this game. Size and/or quantities may change during production.



# Playfield & Back Panel - Large Bayonet Type Bulb & Sockets (Actual Size) †

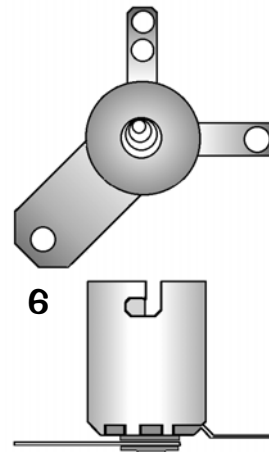
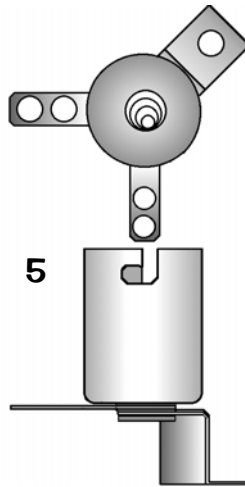
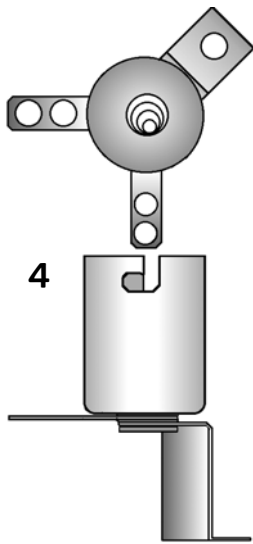
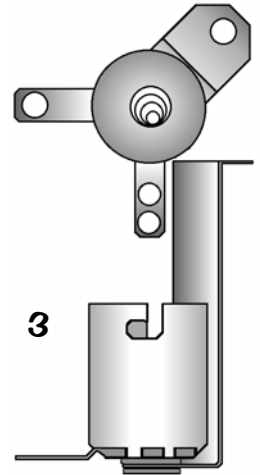
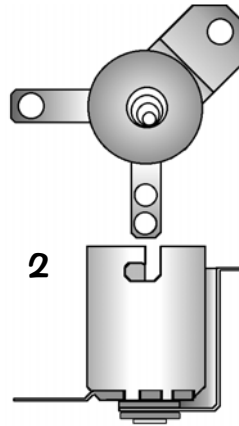
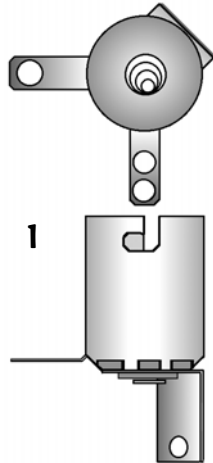
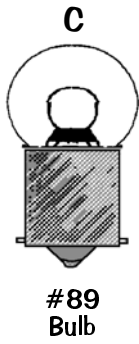

† Items with no Qty. (quantity) are not used in this game. Size and/or quantities may change during production.

Nº	LARGE BULB & SOCKET NAME	QTY.	SPI PART Nº	Nº	LARGE BULB & SOCKET NAME	QTY.	SPI PART Nº
C	#89 Bulb <i>Heavy Filament</i>	3	165-5000-89-HF	3	2-Lug Stand-Up Long Socket		077-5102-00
1	2-Lug Laydown Standard Socket		077-5100-00	4	2-Lug Stand-Up Rev. Mount Socket		077-5103-00
2	2-Lug Stand-Up Short Socket	3	077-5101-00	5	2-Lug Stand-Up Rv. Mnt. Short Socket		077-5106-00
				6	2-Lug Straight Leg Socket		077-5107-00



# Playfield - Wedge Base Bulbs & Sockets (Actual Size) †

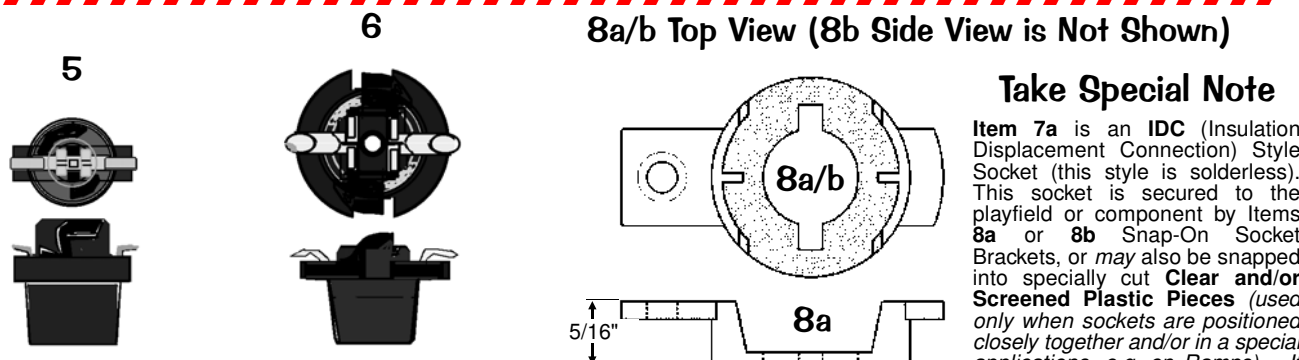
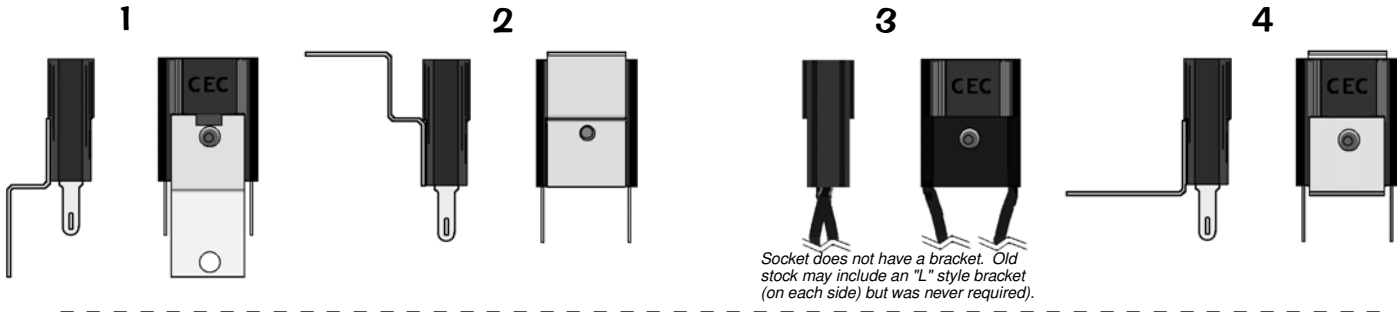
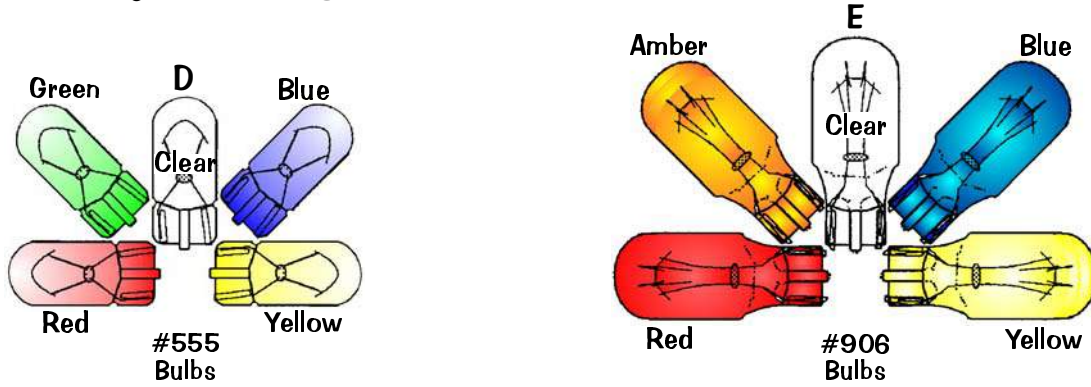

### Take Special Note

Item 7a is an IDC (Insulation Displacement Connection) Style Socket (this style is solderless). This socket is secured to the playfield or component by Items 8a or 8b Snap-On Socket Brackets, or may also be snapped into specially cut **Clear and/or Screened Plastic Pieces** (used only when sockets are positioned closely together and/or in a special applications, e.g. on Ramps). If Plastic Pieces are used to mount some 7a or 7b Sockets, it will be noted on Page 67, Playfield - Plastics & Decals.

### Take Note:

- \* An asterisk ( \* ) indicates item(s) are not noted in the pictorials.
- 1. Item 3 Socket has 2 Wires attached are approximately 12" ea.
- 2. Item 5 Socket **was** used on PC Light Boards to position bulbs vertically; Item 5 Socket is secured by "twisting" into place.
- 3. Item D Bulb (#555) can be used in all sockets, *except* Item 6.
- 4. Item E Bulb (#906) can be used in all sockets, *except* Item 5.
- 5. Item 7a Socket is equipped with a *built-in* Diode, 1N4003 (112-5003-00), however, replacement can be made with a 1N4001 Diode (112-5001-00).
- 6. Item 7b Socket is **NOT** equipped with a diode (Not Required).

**Note:** Always replace with same type bulb in original application.

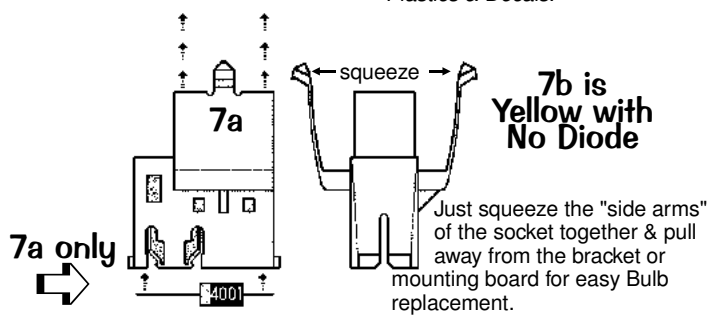

Sec. 4: Parts Id. ...

Nº	WEDGE BULB & SOCKET NAME	QTY.	SPI PART Nº	Nº	WEDGE BULB & SOCKET NAME	QTY.	SPI PART Nº
D	#555 Wedge Base Bulb (Clear)	57	165-5002-00	1	Wedge Base Socket (Laydown)	5	077-5026-01
D	#555 Wedge Base Bulb (Red)		165-5054-02	2	Wedge Base Socket (Offset)		077-5029-00
D	#555 Wedge Base Bulb (Green)		165-5054-04	3	W.B. Socket (Bumpers/Special App.)	3	077-5206-00
D	#555 Wedge Base Bulb (Blue)		165-5054-05	4	Wedge Base Socket (Laydown Gl)		077-5030-00
D	#555 Wedge Base Bulb (Yellow)		165-5054-06	5	#555 <i>only</i> Wedge Base Socket (Twist)		077-5007-00
E	#906 Wedge Base Bulb (Clear)	7	165-5004-00	6	#906 <i>only</i> Wedge Base Socket (Twist)		077-5016-00
E	#906 Wedge Base Bulb (Red)		165-5004-02	7a	IDC Snap-On Socket	52	077-5216-00
E	#906 Wedge Base Bulb (Amber)		165-5004-03	7b	IDC Snap-On Socket <b>No Diode</b>	3	077-5216-01
E	#906 Wedge Base Bulb (Blue)		165-5004-05	8a	5/16" Ht. Snap-On Socket Bracket	51	545-5760-18
E	#906 Wedge Base Bulb (Yellow)		165-5004-06	8b*	19/32" Ht. Snap-On Socket Bracket		545-5760-19

† Items with no Qty. (quantity) are not used in this game. Size and/or quantities may change during production.

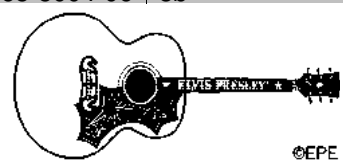

# Drawings for Major Assemblies & Ramps (The Blue Pages)

For Cabinet, Backbox and/or General Playfield Parts (not described herein), see the Pink Pages, 59-74.

## ? Table of Contents & Overview

Drawings are provided for the Major Assemblies in this game with individual parts of each assembly numbered. Items noted with a white circle ○ are mounted above the playfield; items noted with a black circle ● are mounted below. All numbered parts describe the **NAME, QUANTITY & PART NR. & ASSOCIATED PARTS (AP-)**.

**Important:** Read all "Take Note:" items.

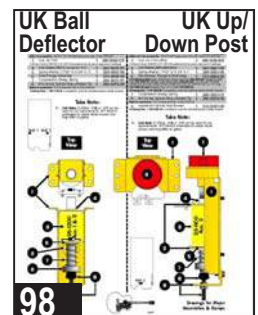
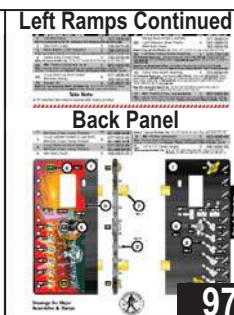
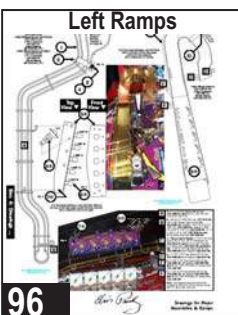
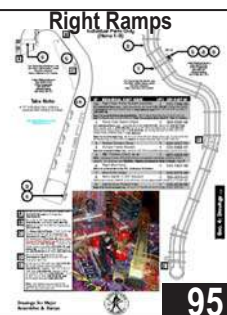
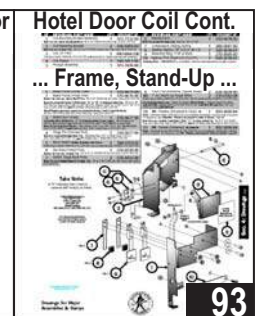
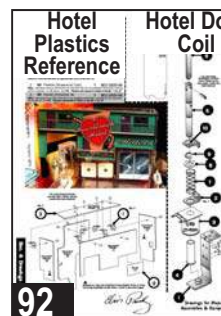
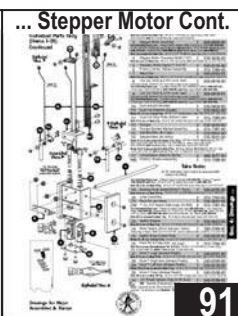
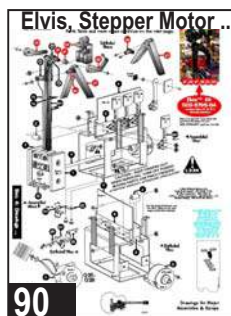
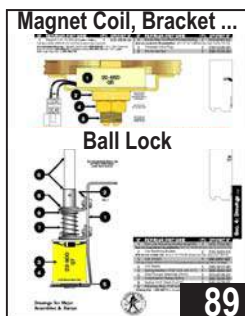
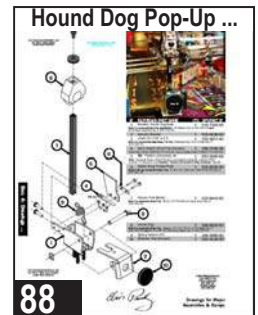
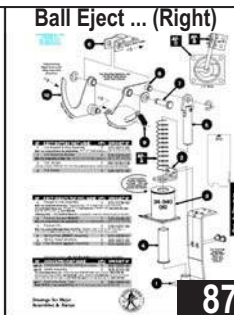
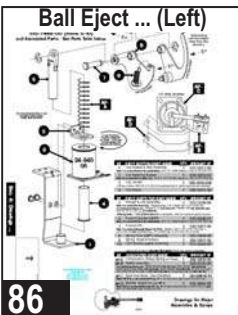
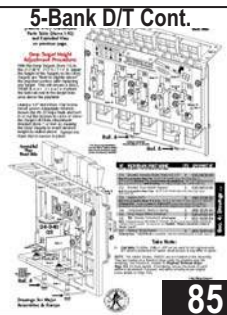
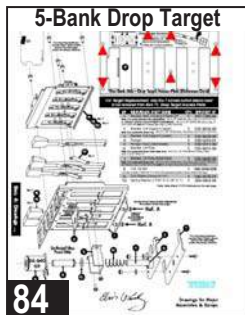
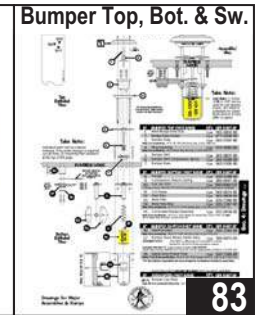
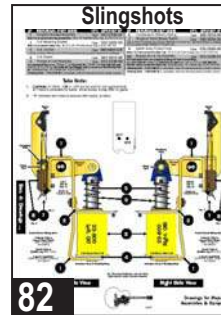
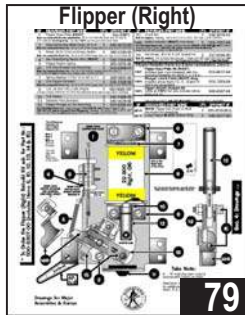
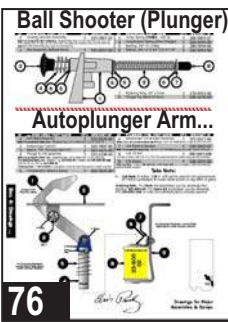

Sec. 4: Drawings ...



# Ball Shooter (Plunger) Assembly, 500-6146-00-07 (Items 1-8)

Manually launch the ball into play.

Nº	INDIVIDUAL PART NAME	QTY.	SPI PART Nº	Nº	INDIVIDUAL PART NAME	QTY.	SPI PART Nº
1	Housing (Shooter Assembly)	1	535-5067-02	3	Comp. Spring (ORANGE, .038" ø)	1	266-5001-07
<small>Item 1 is secured to the Cabinet by: Support Plate (Qty. 1) (535-5027-00), #10-32 X 1/2" PPH (Sems) Zinc TF (Qty. 3) (237-6033-00), #10 Split Lock Washer (Qty. 3) (244-5003-00) and #6 X 5/8" SHWH AB (Zinc) (Qty. 2) (234-5002-00)</small>				4	Compression Spring (Short Plunger)	1	266-5010-00
2	Rod Assembly (w/Black Knob)	1	515-6557-00	5	Bushing, 3/8" I.D. (Oilite)	2	280-5010-00
				6	Washer, 3/8" I.D. X 5/8" O.D. X 1/16"	3	242-5014-00

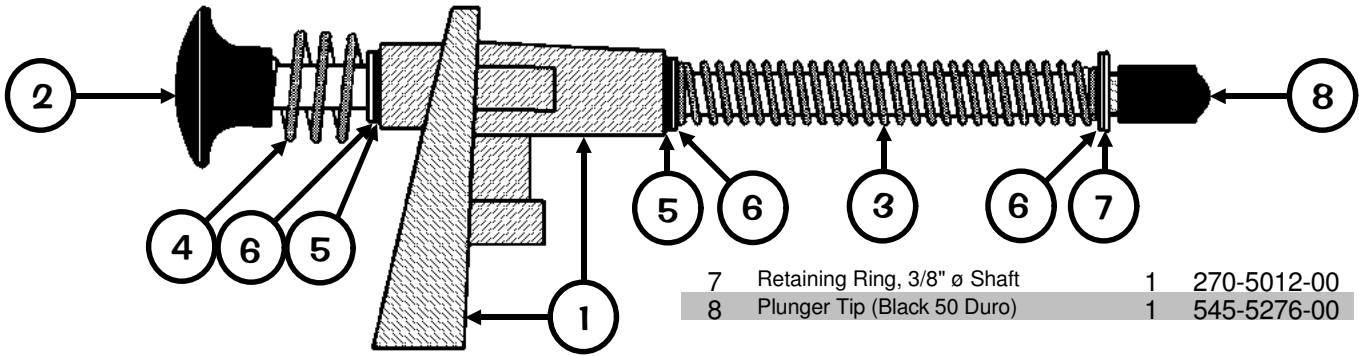

7	Retaining Ring, 3/8" ø Shaft	1	270-5012-00
8	Plunger Tip (Black 50 Duro)	1	545-5276-00

## Autoplunger Arm Weld Assembly, 500-6091-00 (Items 1-5)

Automatically launches the ball into play.



## Autoplunger Coil Assembly, 500-6092-03B (Items 6-9)

Works in conjunction with the Arm Weld Asm.

Nº	... ARM WELD PART NAME	QTY.	SPI PART Nº	Nº	'PLUNGER COIL PART NAME	QTY.	SPI PART Nº
1	Arm Weld Assembly	1	515-6526-00	6	Autoplunger Coil Bracket Assembly	1	515-6527-00
<small>Item 1 is secured to Item 2 by: Retaining Ring, 1/4" ø Shaft (Qty. 1) (270-5002-00)</small>				<small>Items 1 &amp; 6 are secured below the P/F by: #8 X 1/2" SHWH AB (Zc.) (Qty. 9) (234-5101-00)</small>			
2	Autoplunger Fulcrum	1	535-7697-00	7	Coil Retainer Bracket	1	535-5203-03
3	Nyliner, 1/4" (Thomson #411-FF)	2	545-5423-00	<small>Item 7 is secured to Item 6 by: #8-32 X 1/4" PPH MS (Sems) Zinc (Qty. 2) (232-5300-00)</small>			
4	Plunger & Link Assembly	1	515-5338-00	8	Coil, 23-800	1	090-5001-00B
<small>Item 4 is secured to Item 1 by: Retaining Ring, 1/4" ø Shaft (Qty. 1) (270-5002-00)</small>				<small>Coil has a Diode (1N4004) (112-5003-00) positioned @ bot. (below lugs opposite windings).</small>			
<small>For Individual Items use : Plunger 2" Lg. (530-5025-01), Plunger Link (545-5293-00) and Roll Pin 1/8" ø x 5/8" Lg. (251-5008-00)</small>				9	Coil Sleeve	1	545-5031-00
<small>Ordering Note: If 515-5338-00 is unavailable, order the individual part(s) actually required.</small>				<small>Ordering Note: If either 500-6091-00 or 500-6092-03B are unavailable, order the individual part(s) actually required.</small>			
5	Compression (Return) Spring	1	266-5020-00				

### Take Note:

⊖ **Coil Note:** ⊖ Either -00B or -00T can be used for coil replacements. B/T listed is preferable for easier diode access & may differ on game.

**Ordering Note:** For Items 1-5 assembled, use the Assembly Part Number, 500-6091-00. For Items 6-9 assembled, use the Assembly PN, 500-6092-03B; or order the individual part(s) actually required.

Sec. 4: Drawings ...

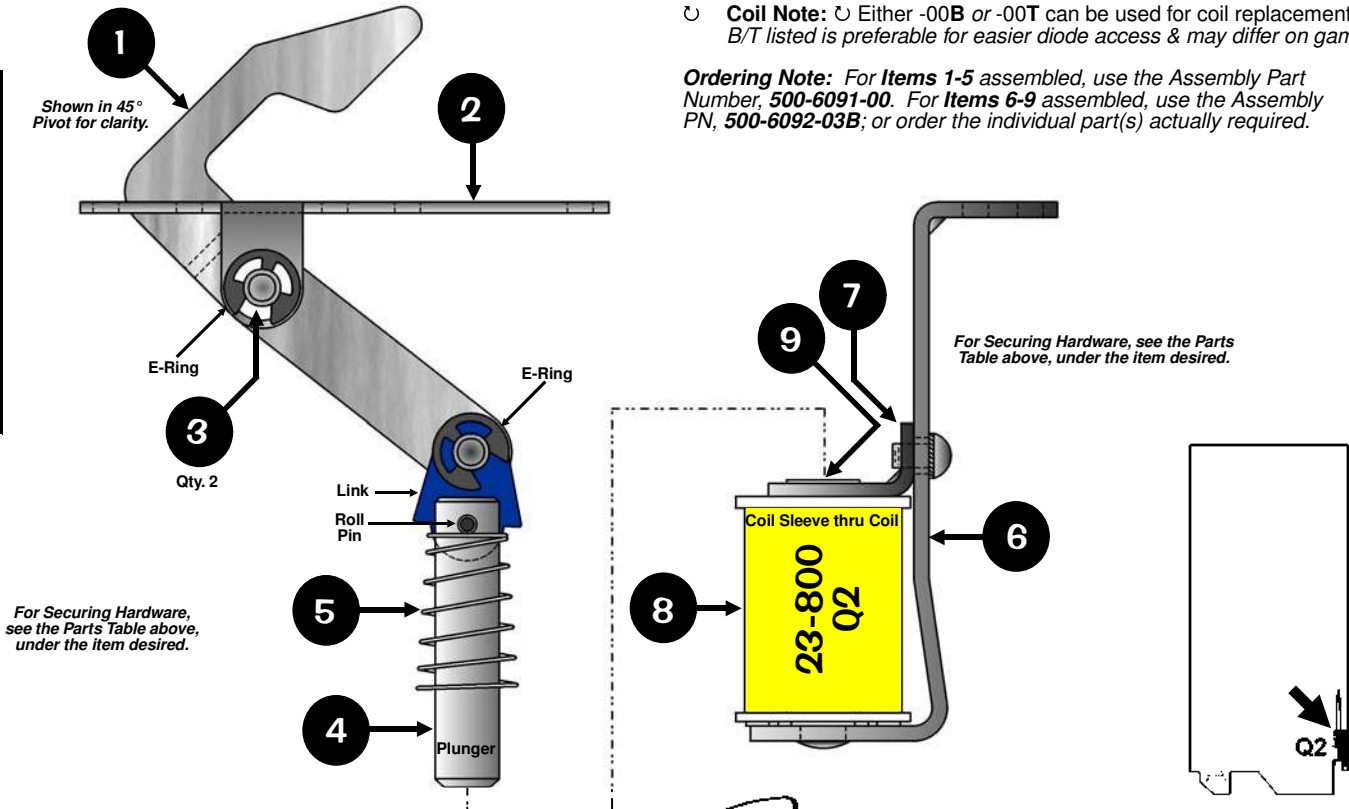

For Securing Hardware, see the Parts Table above, under the item desired.

For Securing Hardware, see the Parts Table above, under the item desired.

*Elvis Presley*

# 4-Ball Trough Assembly, 500-6318-24 (Items 1-13) and Associated Parts: See Parts Table below.

**Ordering Note: Identical to 500-6318-14 with exceptions, see note below Item 13 (Parts Table).**

№	INDIVIDUAL PART NAME	QTY.	SPI PART №	№	INDIVIDUAL PART NAME	QTY.	SPI PART №
1	Ball Trough Outhole Mounting Bracket	1	515-6580-01	11	Trough Ball Guide Plate	1	535-7801-00
Item 1 is secured below the playfield by: #8 X 1/2" SHWH AB (Zinc) (Qty. 6) (234-5101-00)							
2	Micro Switch (Roller Actuator, Lite-Force)	3	180-5119-02	12	Dual OPTO TRANS Board Assembly	1	515-0173-00
Item 2 requires: Heat Shrink Tubing 1/8" ø PUI-24 (Qty. 1"/per) (605-5006-00) Switch has a Diode (1N4004) (112-5003-00). Can be replaced with (1N4001) (112-5001-00).							
3	Sw. Body Protect Plate <i>Not Required</i>	0	535-6539-00	13	Dual OPTO REC Board Assembly	1	515-0174-00
Items 12 & 13 are by: #6-32 X 5/8" HWH Swage (Serr) Zinc (Qty. 3/per) (237-5976-04) <i>For Individual Items use:</i> Dual OPTO Transmitter Board (Qty. 1) (520-5173-00), Dual OPTO Receiver Board (Qty. 1) (520-5174-00), OPTO PCB Tube Spacer (Brass) (Qty. 3/per) (530-5308-02) and OPTO PCB Rubber Grommet (Qty. 3/per) (545-5518-00)							
4	Coil Mounting Bracket	1	535-7330-01	<b>Ordering Note:</b> If 500-6318-24 is unavailable, order the individual part(s) actually required. This assembly is identical to 500-6318-14, -15 or -25 except for the quantity of Item 2 (an additional switch & diode is required for the 5-Ball Trough) and Item 3, Switch Body Protect Plates, are not required when using Item 11 (req. for Magnet use).			
ASSOCIATED PARTS ARE NOT INCLUDED WITH THE ABOVE ASSEMBLY.							
5	Coil Retaining Bracket	1	535-5203-03	<b>№ ASSOCIATED PART NAME</b>			
Item 5 is secured to Item 4 by: #8-32 X 1/4" HWH MS (Serr) Zinc (Qty. 2) (237-5964-01)							
6	Coil, 26-1200	1	090-5044-00B	AP-A	Ball Trough Enter / Exit Scoop	1	535-7329-01
Coil has a Diode (1N4004) (112-5003-00) positioned @ bot (below lugs opposite windings).							
7	Coil Sleeve (Short) (Formost #10-7077)	1	545-5076-01	Item AP-A secured to the playfield by: #8 X 1/2" SHWH AB (Zinc) (Qty. 4) (234-5101-00).			
8	Plunger Assembly	1	515-5941-01	AP-B	* Steel Balls (1-1/16" ø)	4	260-5000-00
<i>For Individual Items use:</i> Plunger (530-5210-00) & Nylon Plunger (530-5277-01)							
9	Compression (Return) Spring	1	266-5020-00				
10	Rubber Bumper (Grommet)	1	545-5105-00				

### Take Note:

\* An asterisk (\*) indicates item(s) are not noted in the pictorials.

⊖ **Coil Note:** ⊖ Either -00B or -00T can be used for coil replacements. B/T listed is preferable for easier diode access & may differ on game.

For a break-down of parts of Items 12 & 13, OPTO Boards (515-0173-00 & 515-0174-00), see Section 5, Chapter 4, Trough Up-Kicker Dual OPTO Boards Theory of Operation & Schematic, Component Layout & Parts.

### Take Special Note:

Item AP-A, Enter / Exit Scoop, 535-7329-01 (not included with the 4-Ball Trough Assembly), is shown how it is actually positioned over the 4-Ball Trough Assembly. It is mounted above the playfield.

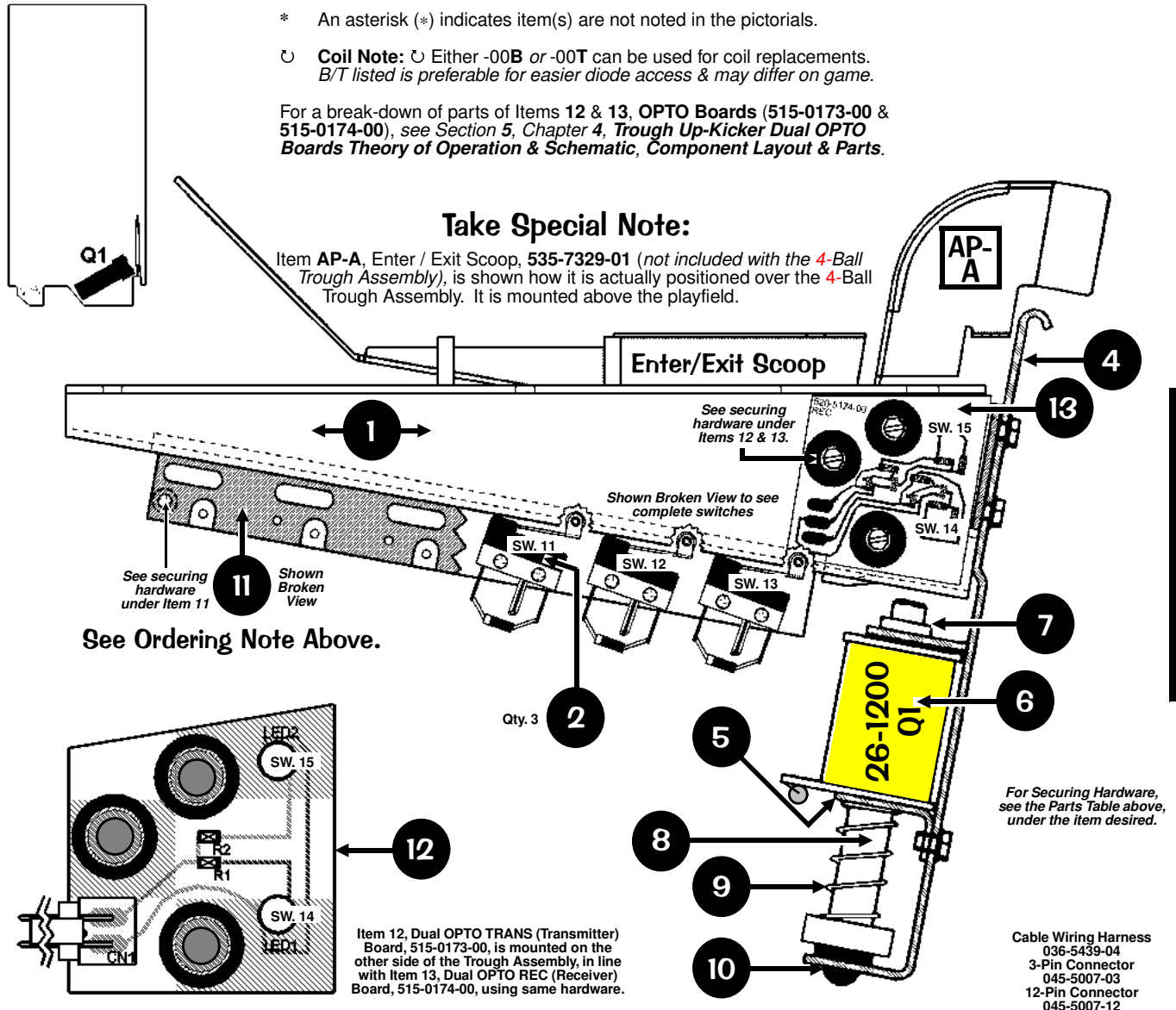



# Flipper (Left) Assembly, 500-6543-11 (Items 1-15) and Assoc. Parts: White Flipper Bat & Shaft Assy., 515-5133-08-06 (Item AP-A/-B)



Nº	INDIVIDUAL PART NAME	QTY.	SPI PART Nº	Nº	INDIVIDUAL PART NAME	QTY.	SPI PART Nº
1	Flipper Base Plate (LEFT)	1	See FRP1	13	Crank Bar	1	530-5070-02
Item 1 is secured below the playfield by: #10 X 1/2" HWH MS (Serr) Zinc ST (Qty. 8) (237-5949-00) <b>Ordering Note:</b> Use Item FRP1, see the end of this Parts Table.				Item 13 requires: Bushing, .192" ø ID X .312" ø OD X .195" (Qty. 1) (530-5139-00)			
2	Flipper Bat Bushing (White Plastic) 1/4" ø I.D.	1	545-5070-00	14®	Switch Actuator (LEFT) Sub-Assy.	1	515-7257-01
Item 2 is secured to Item 1 by: #6-32 X 3/8" HWH Swage (Ser.) Zc. (Qty. 3) (237-5976-02)				For Individual Items use : Actuator & Spring Bracket (LEFT) (535-9038-01) and @ Switch Actuator (White Plastic) (545-5612-00) and is secured to the Bracket by: Rivet, 1/8" ø X 1/4" Lg. (Qty. 1) (249-5003-00)			
3	Power (EOS / End-of-Stroke) Switch	1	180-5149-00	15	Set Screw: #10-32 X 3/4" Socket Hd.	2	237-6144-00
Item 3 is secured to Item 1 by: #6-32 X 5/8" HWH Swage (Ser.) Zc. (Qty. 2) (237-5976-04)				Item 15 requires: #10-32 Nylon Stop Nut (Qty. 1 Flipper Link Side Only) (240-5203-00) and #10 Split Lock Washer (244-5003-00) <b>Tool Required for Item 15:</b> 5/32" or 4mm Allen Wrench			
4	Sw. Plate/Spring Return Brkt. (LEFT)	1	535-7354-01	<b>Flipper Rebuild Parts for Easier Installation, Save \$:</b>			
5	Flipper Return Spring	1	265-5035-00	<b>FRP1 Flipper Base Plate Kit (LEFT)</b>			
6	Coil Stop Bracket Sub-Assembly	1	515-6308-01	Includes Item 1 pre-threaded, with the Securing Hardware for Items 2, 3, 6 & 8.			
Item 6 is secured to Item 1 by: #10-32 X 3/8" SHWH Swage (Serr) Zinc (Qty. 2) (237-5985-00) and #10 Split Lock Washer (Qty. 2) (244-5003-00)				<b>FRP2 Plunger, Link &amp; Crank (LEFT) Assy.</b>			
7	Spring Washer (17/32" ID X 3/4" X 1")	1	269-5002-00	Includes above Items 12, 13, 14 and 15 and is pre-assembled.			
8	Coil Support Bracket	1	535-7356-00	<b>FRP3 Flipper (LEFT) Rebuild Kit</b>			
Item 8 is secured to Item 1 by: #8-32 X 3/8" HWH Swage (Ser.) Zc. (Qty. 2) (237-5975-00)				Same as FRP2, but also includes above Items 6 & 10.			
9	Coil, 22-900 (YELLOW) (Left)	1	090-5020-20T	ASSOCIATED PARTS ARE NOT INCLUDED WITH THE ABOVE ASSEMBLY.			
Coil has a Diode (1N4004) (112-5003-00) positioned @ top (above lugs next to windings).				<b>Nº ASSOCIATED PART NAME QTY. SPI PART Nº</b>			
10	Coil Sleeve	1	545-5388-00	AP-A	WHITE Flipper Bat (Plain) & Shaft (Non-Knurled End) Assembly	1	515-5133-08-06
11	Deflector Pad (Bumper)	1	545-5428-00	AP-B	Large Flipper BLACK Rubber Ring	1	545-5277-00
12	Flipper Plunger & Link Sub-Assy.	1	515-6304-03				
For Individual Items use : Flipper Plunger (530-5349-01) and Plunger "Flipper" Link (545-5611-01) and is secured to the Plunger by: Bushing, .16" ø ID X .281" ø OD X .187" (Qty. 1) (530-5532-00) and Spiral Pin ø 5/32" X 3/4" Lg. (Qty. 1) (251-5015-02)							

Sec. 4: Drawings ...

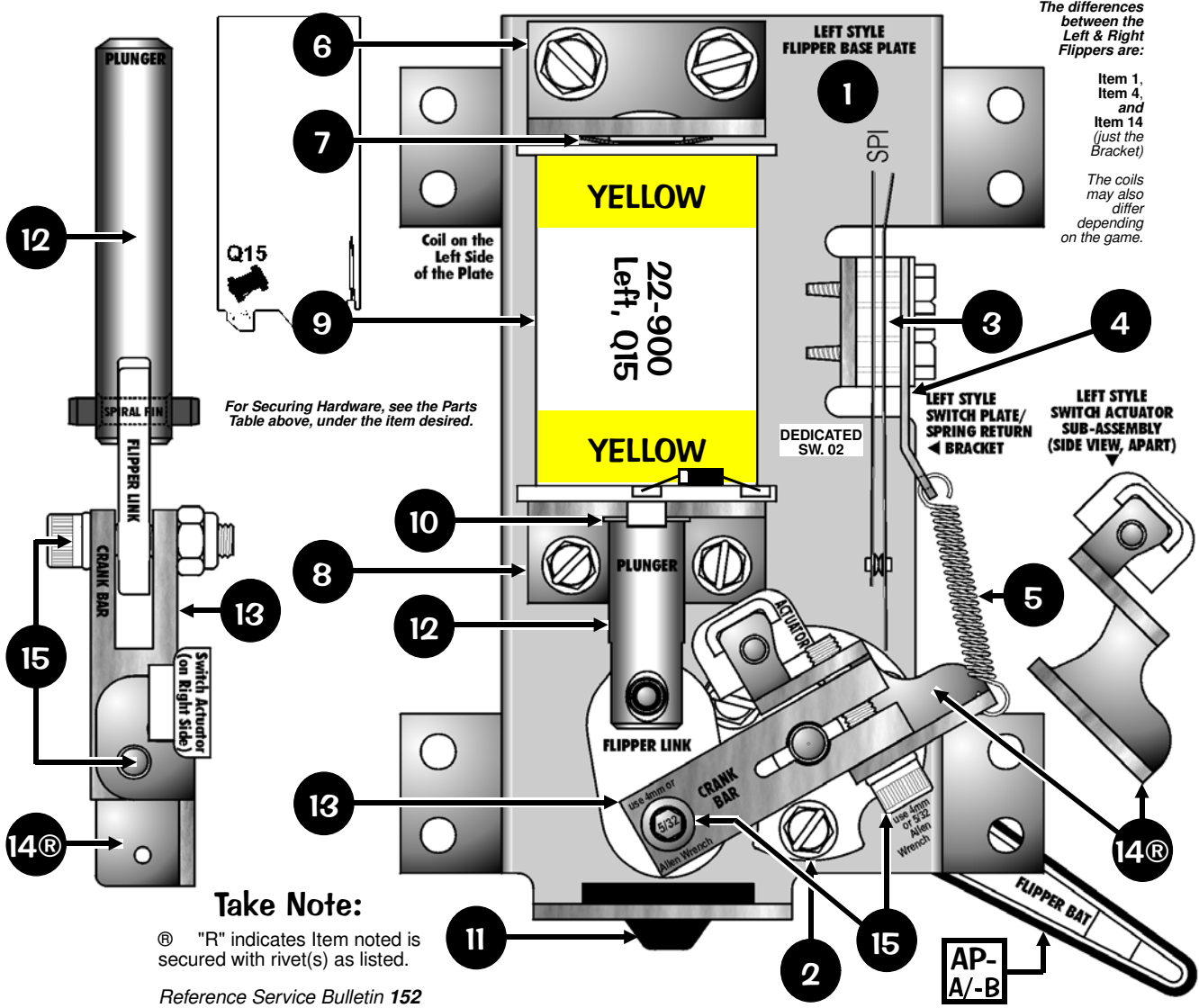

The differences between the Left & Right Flippers are:  
Item 1, Item 4, and Item 14 (just the Bracket)  
The coils may also differ depending on the game.

**Take Note:**  
® "R" indicates Item noted is secured with rivet(s) as listed.  
Reference Service Bulletin 152 for additional information on Items 12 & 14.

\* To Order the Flipper (Left) Rebuild Kit ask for Part Nr.: 500-6307-10 (includes Items 6, 10, 12, 13, 14 & 15)

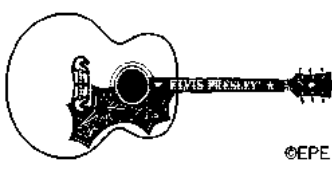

# Flipper (Right) Assembly, 500-6543-01 (Items 1-15) and Assoc. Parts: White Flipper Bat & Shaft Assy., 515-5133-08-06 (Item AP-A/-B)



Nº	INDIVIDUAL PART NAME	QTY.	SPI PART Nº	Nº	INDIVIDUAL PART NAME	QTY.	SPI PART Nº
1	Flipper Base Plate (RIGHT)	1	See FRP1	13	Crank Bar	1	530-5070-02
Item 1 is secured below the playfield by: #10 X 1/2" HWH MS (Serr) Zinc ST (Qty. 8) (237-5949-00) <b>Ordering Note:</b> Use Item FRP1, see the end of this Parts Table.				Item 13 requires: Bushing, .192" ø ID X .312" ø OD X .195" (Qty. 1) (530-5139-00)			
2	Flipper Bat Bushing (White Plastic) 1/4" ø I.D.	1	545-5070-00	14®	Switch Actuator (RIGHT) Sub-Assy.	1	515-7257-00
Item 2 is secured to Item 1 by: #6-32 X 3/8" HWH Swage (Ser.) Zc. (Qty. 3) (237-5976-02)				For Individual Items use : Actuator & Spring Bracket (RIGHT) (535-9038-00) and @ Switch Actuator (White Plastic) (545-5612-00) and is secured to the Bracket by: Rivet, 1/8" ø X 1/4" Lg. (Qty. 1) (249-5003-00)			
3	Power (EOS / End-of-Stroke) Switch	1	180-5149-00	15	Set Screw: #10-32 X 3/4" Socket Hd.	2	237-6144-00
Item 3 is secured to Item 1 by: #6-32 X 5/8" HWH Swage (Ser.) Zc. (Qty. 2) (237-5976-04)				Item 15 requires: #10-32 Nylon Stop Nut (Qty. 1 Flipper Link Side Only) (240-5203-00) and #10 Split Lock Washer (244-5003-00) <b>Tool Required for Item 15:</b> 5/32" or 4mm Allen Wrench			
4	Sw. Plate/Spring Return Brkt. (RIGHT)	1	535-7354-00	<b>Flipper Rebuild Parts for Easier Installation, Save \$:</b>			
5	Flipper Return Spring	1	265-5035-00	<b>FRP1 Flipper Base Plate Kit (RIGHT)</b>			
6*	Coil Stop Bracket Sub-Assembly	1	515-6308-01	Includes Item 1 pre-threaded, with the Securing Hardware for Items 2, 3, 6 & 8.			
Item 6 is secured to Item 1 by: #10-32 X 3/8" SHWH Swage (Serr) Zinc (Qty. 2) (237-5985-00) and #10 Split Lock Washer (Qty. 2) (244-5003-00)				<b>FRP2 Plunger, Link &amp; Crank (RIGHT) Assy.</b>			
7	Spring Washer (17/32" ID X 3/4" X 1")	1	269-5002-00	Includes above Items 12, 13, 14 and 15 and is pre-assembled.			
8	Coil Support Bracket	1	535-7356-00	<b>FRP3 Flipper (RIGHT) Rebuild Kit</b>			
Item 8 is secured to Item 1 by: #8-32 X 3/8" HWH Swage (Ser.) Zc. (Qty. 2) (237-5975-00)				Same as FRP2, but also includes above Items 6 & 10.			
9	Coil, 22-900 (YELLOW) (Right)	1	090-5020-20T	ASSOCIATED PARTS ARE NOT INCLUDED WITH THE ABOVE ASSEMBLY.			
Coil has a Diode (1N4004) (112-5003-00) positioned @ top (above lugs next to windings).				<b>Nº ASSOCIATED PART NAME QTY. SPI PART Nº</b>			
10	Coil Sleeve	1	545-5388-00	AP-A	WHITE Flipper Bat (Plain) & Shaft (Non-Knurled End) Assembly	1	515-5133-08-06
11	Deflector Pad (Bumper)	1	545-5428-00	AP-B	Large Flipper BLACK Rubber Ring	1	545-5277-00
12	Flipper Plunger & Link Sub-Assy.	1	515-6304-03				
For Individual Items use : Flipper Plunger (530-5349-01) and Plunger "Flipper" Link (545-5611-01) and is secured to the Plunger by: Bushing, .16" ø ID X .281" ø OD X .187" (Qty. 1) (530-5532-00) and Spiral Pin ø 5/32" X 3/4" Lg. (Qty. 1) (251-5015-02)							



\* To Order the Flipper (Right) Rebuild Kit ask for Part Nr.: 500-6307-00 (includes Items 6, 10, 12, 13, 14 & 15)

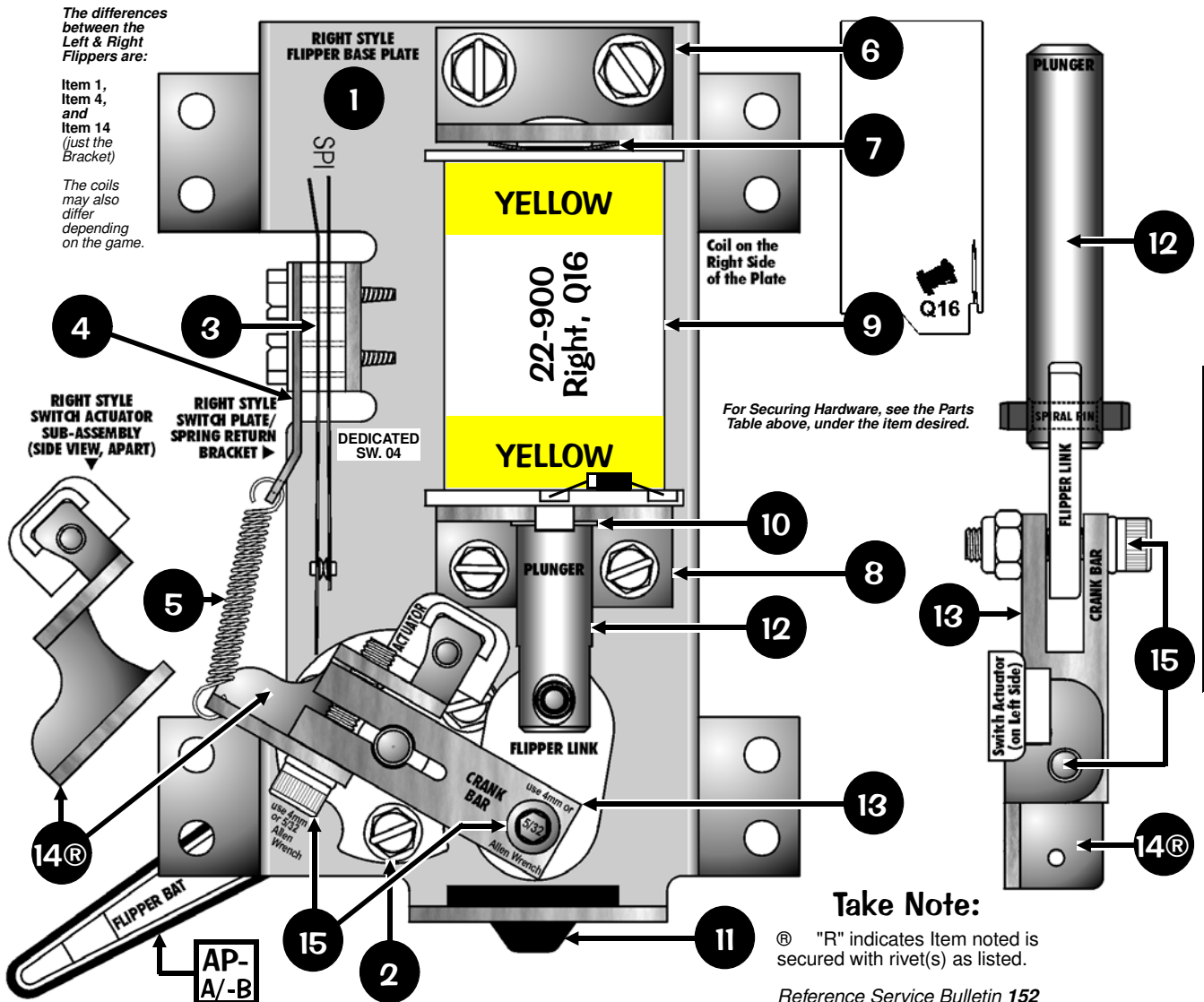

The differences between the Left & Right Flippers are:

Item 1, Item 4, and Item 14 (just the Bracket)

The coils may also differ depending on the game.

RIGHT STYLE SWITCH ACTUATOR SUB-ASSEMBLY (SIDE VIEW, APART)

RIGHT STYLE SWITCH PLATE/SPRING RETURN BRACKET

DEDICATED SW. 04

For Securing Hardware, see the Parts Table above, under the item desired.

### Take Note:

® "R" indicates Item noted is secured with rivet(s) as listed.

Reference Service Bulletin 152 for additional information on Items 12 & 14.

Sec. 4: Drawings ...



**Flipper (Upper Left) Assembly, 500-6543-33-84 (Items 1-15)**  
**and Assoc. Parts: Lg. White Flipper Bat & Shaft Assy., 515-7399-08 (Item AP-A/-B)**



Nº	INDIVIDUAL PART NAME	QTY.	SPI PART Nº	Nº	INDIVIDUAL PART NAME	QTY.	SPI PART Nº
1	Flipper Base Plate (LEFT)	1	See FRP1	14®	Switch Actuator (LEFT) Sub-Assy.	1	515-7257-01
Item 1 is secured below the playfield by: #10 X 1/2" HWH MS (Serr) Zinc ST (Qty. 8) (237-5949-00) <b>Ordering Note:</b> Use Item FRP1, see the end of this Parts Table.				For Individual Items use : Actuator & Spring Bracket (LEFT) (535-9038-01) and ® Switch Actuator (White Plastic) (545-5612-00) and is secured to the Bracket by: Rivet, 1/8" ø X 1/4" Lg. (Qty. 1) (249-5003-00)			
2	Flipper Bat Bushing (Red Plastic) .281" I.D.	1	▶ 545-5070-01	15	Set Screw: #10-32 X 3/4" Socket Hd.	2	237-6144-00
Item 2 is secured to Item 1 by: #6-32 X 3/8" HWH Swage (Ser.) Zc. (Qty. 3) (237-5976-02)				Item 15 requires: #10-32 Nylon Stop Nut (Qty. 1 Flipper Link Side Only) (240-5203-00) and #10 Split Lock Washer (244-5003-00) <b>Tool Required for Item 15:</b> 5/32" or 4mm Allen Wrench			
3	1/4" X 3/8" Spacer Gray	2	254-5000-02	<b>Flipper Rebuild Parts for Easier Installation, Save \$:</b>			
Item 3 is secured to Item 1 by: #6-32 X 5/8" HWH Swage (Ser.) Zc. (Qty. 2) (237-5976-04)				FRP1	<b>Flipper Base Plate Kit (LEFT)</b> Includes Item 1 pre-threaded, with the Securing Hardware for Items 2, 3, 6 & 8.	515-6617-01	
4	Sw. Plate/Spring Return Brkt. (LEFT)	1	535-7354-01	FRP2	<b>Plunger, Link &amp; Crank (LEFT) Assy.</b> Includes above Items 12, 13, 14 and 15 and is pre-assembled.	515-7203-01	
5	Flipper Return Spring	1	265-5035-00	FRP3	<b>Flipper (LEFT) Rebuild Kit</b> Same as FRP2, but also includes above Items 6 & 10.	500-6307-10	
6	Coil Stop Bracket Sub-Assembly	1	515-6308-01	ASSOCIATED PARTS ARE NOT INCLUDED WITH THE ABOVE ASSEMBLY.			
Item 6 is secured to Item 1 by: #10-32 X 3/8" SHWH Swage (Serr) Zinc (Qty. 2) (237-5985-00) and #10 Split Lock Washer (Qty. 2) (244-5003-00)				Nº	ASSOCIATED PART NAME	QTY.	SPI PART Nº
7	Spring Washer (17/32" ID X 3/4" X 1")	1	269-5002-00	AP-A	Large WHITE Flipper (Plain) Bat & Shaft, 4.89" (Non-Knurled End) Assembly	1	▶ 515-7399-08
8	Coil Support Bracket	1	535-7356-00	AP-B	Large Flipper BLACK Rubber Ring	1	545-5277-00
Item 8 is secured to Item 1 by: #8-32 X 3/8" HWH Swage (Ser.) Zc. (Qty. 2) (237-5975-00)				Below 2 Items (Not Shown) support the shaft under the Upper P/F:			
9	Coil, 23-900 (GREEN) (Left)	1	090-5020-30	AP-C	Spacer, WHITE .25" ID X 1" OD X .63"	1	530-5633-00
Coil has a Diode (1N4004) (112-5003-00) positioned @ top (above lugs next to windings).				AP-D	Tube-Clear, .375" ID X .5" OD X 2.072"	1	530-5634-01
10	Coil Sleeve	1	545-5388-00	READ NOTE ABOVE REGARDING BUSHING CHANGE (ITEM 2)			
11	Deflector Pad (Bumper)	1	545-5428-00	POWER (End-of-Stroke) SWITCH NOT REQUIRED FOR UPPER FLIPPERS			
12	Flipper Plunger & Link Sub-Assy.	1	515-6304-03	For Securing Hardware, see the Parts Table above, under the item desired.			
For Individual Items use : Flipper Plunger (530-5349-01) and Plunger "Flipper" Link (545-5611-01) and is secured to the Plunger by: Bushing, .16" ø ID X .281" ø OD X .187" (Qty. 1) (530-5532-00) and Spiral Pin ø 5/32" X 3/4" Lg. (Qty. 1) (251-5015-02)				Take Note:			
13	Crank Bar	1	530-5070-02	® "R" indicates Item noted is secured with rivet(s) as listed.			
Item 13 requires: Bushing, .192" ø ID X .312" ø OD X .195" (Qty. 1) (530-5139-00)				Reference Service Bulletin 152 for additional information on Items 12 & 14.			

**Sec. 4: Drawings ...**

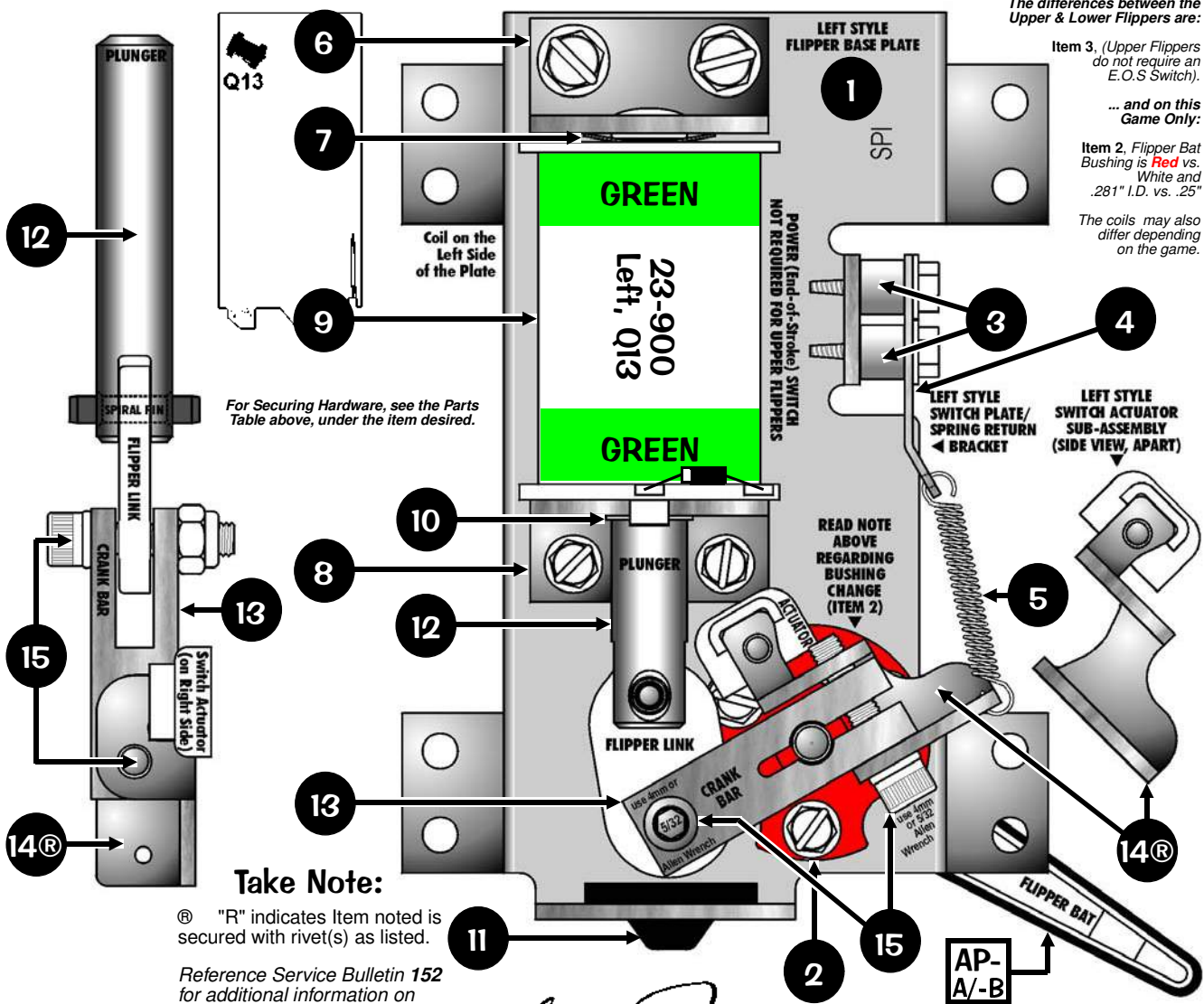

The differences between the Upper & Lower Flippers are:

Item 3, (Upper Flippers do not require an E.O.S Switch).

... and on this Game Only:

Item 2, Flipper Bat Bushing is Red vs. White and .281" I.D. vs. .25"

The coils may also differ depending on the game.



**\* To Order the Flipper (Left) Rebuild Kit ask for Part Nr.: 500-6307-10 (includes Items 6, 10, 12, 13, 14 & 15)**

*Elvis Presley*

# Flipper (Upper Right, Modified) Assy., 500-6543-23-84 (Items 1-15) and Assoc. Parts: White Flipper Bat & Shaft Assy., 515-5133-08-06 (Item AP-A/-B)



Nº	INDIVIDUAL PART NAME	QTY.	SPI PART Nº	Nº	INDIVIDUAL PART NAME	QTY.	SPI PART Nº
1	Flipper 3-Footed Base Plate (RIGHT)	1	See FRP1	13*	Crank Bar	1	530-5070-02
Item 1 is secured below the playfield by: #10 X 1/2" HWH MS (Serr) Zinc ST (Qty. 6) (237-5949-00) <b>Ordering Note:</b> Use Item FRP1, see the end of this Parts Table.				Item 13 requires: Bushing, .192" ø ID X .312" ø OD X .195" (Qty. 1) (530-5139-00)			
2	Flipper Bat Bushing (White Plastic) 1/4" ø I.D.	1	545-5070-00	14®	Switch Actuator (RIGHT) Sub-Assy.	1	515-7257-00
Item 2 is secured to Item 1 by: #6-32 X 3/8" HWH Swage (Ser.) Zc. (Qty. 3) (237-5976-02)				For Individual Items use : Actuator & Spring Bracket (RIGHT) (535-9038-00) and @ Switch Actuator (White Plastic) (545-5612-00) and is secured to the Bracket by: Rivet, 1/8" ø X 1/4" Lg. (Qty. 1) (249-5003-00)			
3	1/4" X 3/8" Spacer Gray	2	254-5000-02	15	Set Screw: #10-32 X 3/4" Socket Hd.	2	237-6144-00
Item 3 is secured to Item 1 by: #6-32 X 5/8" HWH Sw. (Ser.) Zc. (Qty. 1/per) (237-5976-04)				Item 15 requires: #10-32 Nylon Stop Nut (Qty. 1 Flipper Link Side Only) (240-5203-00) and #10 Split Lock Washer (244-5003-00) <b>Tool Required for Item 15:</b> 5/32" or 4mm Allen Wrench			
4	Sw. Plate/Spring Return Brkt. (RIGHT)	1	535-7354-00	<b>Flipper Rebuild Parts for Easier Installation, Save \$:</b>			
5	Flipper Return Spring	1	265-5035-00	FRP1	Flipper 3-Footed Base Plate Kit (Upr. Rt.) Includes Item 1 MODIFIED & pre-threaded, with the Sec. Hardware for Items 2, 3, 6 & 8.		▶515-6617-84
6*	Coil Stop Bracket Sub-Assembly	1	515-6308-01	FRP2	Includes above Items 12, 13, 14 and 15 and is pre-assembled.		515-7203-00
Item 6 is secured to Item 1 by: #10-32 X 3/8" SHWH Swage (Serr) Zinc (Qty. 2) (237-5985-00) and #10 Split Lock Washer (Qty. 2) (244-5003-00)				FRP3	Flipper (RIGHT) Rebuild Kit Same as FRP2, but also includes above Items 6 & 10.		500-6307-00
7	Spring Washer (17/32" ID X 3/4" X 1")	1	269-5002-00	ASSOCIATED PARTS ARE NOT INCLUDED WITH THE ABOVE ASSEMBLY.			
8	Coil Support Bracket	1	535-7356-00	Nº	ASSOCIATED PART NAME	QTY.	SPI PART Nº
Item 8 is secured to Item 1 by: #8-32 X 3/8" HWH Swage (Ser.) Zc. (Qty. 2) (237-5975-00)				AP-A	WHITE Flipper Bat (Plain) & Shaft (Non-Knurled End) Assembly	1	515-5133-08-06
9	Coil, 23-900 (GREEN) (Upr. Rt.)	1	090-5020-30	AP-B	Large Flipper BLACK Rubber Ring	1	545-5277-00
Coil has a Diode (1N4004) (112-5003-00) positioned @ top (above lugs next to windings).							
10	Coil Sleeve	1	545-5388-00				
11	Deflector Pad (Bumper)	1	545-5428-00				
12	Flipper Plunger & Link Sub-Assy.	1	515-6304-03				
For Individual Items use : Flipper Plunger (530-5349-01) and Plunger "Flipper" Link (545-5611-01) and is secured to the Plunger by: Bushing, .16" ø ID X .281" ø OD X .187" (Qty. 1) (530-5532-00) and Spiral Pin ø 5/32" X 3/4" Lg. (Qty. 1) (251-5015-02)							

\* To Order the Flipper (Right) Rebuild Kit ask for Part Nr.: 500-6307-00 (includes Items 6, 10, 12, 13, 14 & 15)

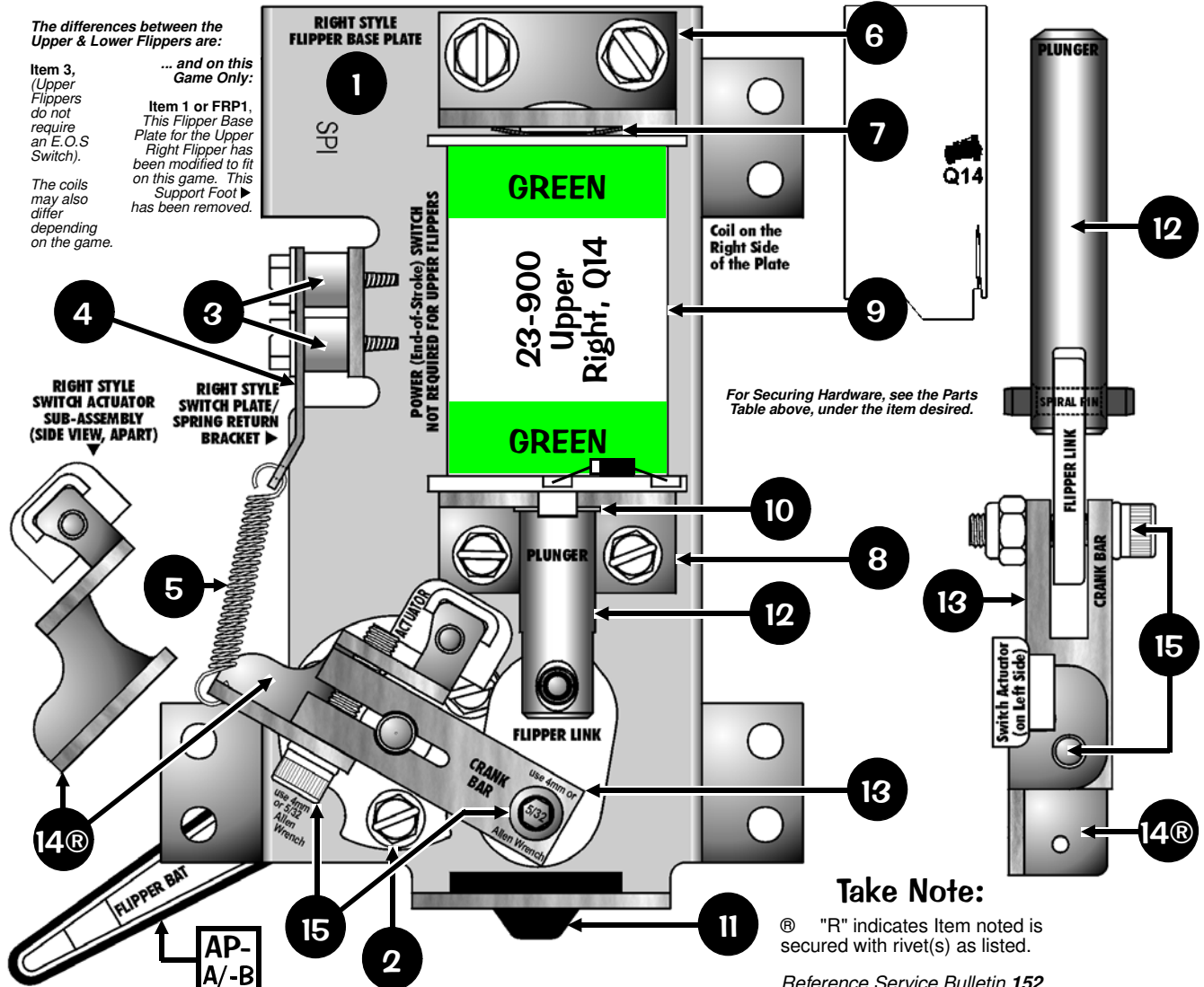

Sec. 4: Drawings ...



# Slingshot (Left & Right) Assemblies, 500-5849-00 (Qty. 2) (Items 1-9)

Nº	INDIVIDUAL PART NAME	QTY.	SPI PART Nº	Nº	INDIVIDUAL PART NAME	QTY.	SPI PART Nº
1	Slingshot Bracket Assembly	1/per	515-5339-01	6	Compression (Return) Spring	1/per	266-5020-00
Item 1 is secured below the playfield by: #8 X 1/2" SHWHAB (Zinc) (Qty. 3) (234-5101-00)							
2	Coil Retaining Bracket	1/per	535-5203-03	7	Slingshot Stack (Blade) Switch	2/per	180-5054-00
Item 2 is secured to Item 1 by: #8-32 X 3/8" PPH MS (Sems) (Qty. 2) (232-5301-00)							
3	Coil, 23-800	1/per	090-5001-00T	8	Switch Body Protect Plate	2/per	535-5045-00
Coil has a Diode (1N4004) (112-5003-00) positioned @ top (above lugs next to windings).							
4	Coil Sleeve	1/per	545-5031-00	9®	Riveted Arm & Tip Assembly	1/per	515-5340-01
5	Plunger & Link Assembly	1/per	515-5338-00	Items 7 & 8 are secured to Item 1 by: #6-32 X 5/8" HWH Swage (Qty. 4) (237-5976-04)			
For Individual Items use : Plunger 2" Lg. (530-5025-01), Plunger Link (545-5293-00) and Roll Pin 1/8" ø x 5/8" Lg. (251-5008-00) The Plunger Link is secured to the Riveted Arm by: Retaining Ring, 1/4" ø Shaft (Qty. 1) (270-5002-00)							
Ordering Note: If 515-5338-00 is unavailable, order the individual part(s) actually required.				Ordering Note: If 515-5340-01 is unavailable, order the individual part(s) actually required.			
Ordering Note: If 500-5849-00 is unavailable, order the individual part(s) actually required.							

## Take Note:

⊖ **Coil Note:** ⊖ Either -00B or -00T can be used for coil replacements. B/T listed is preferable for easier diode access & may differ on game.

® "R" indicates Item noted is secured with rivet(s) as listed.

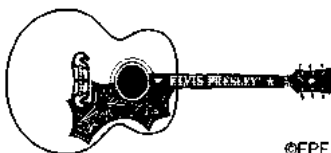
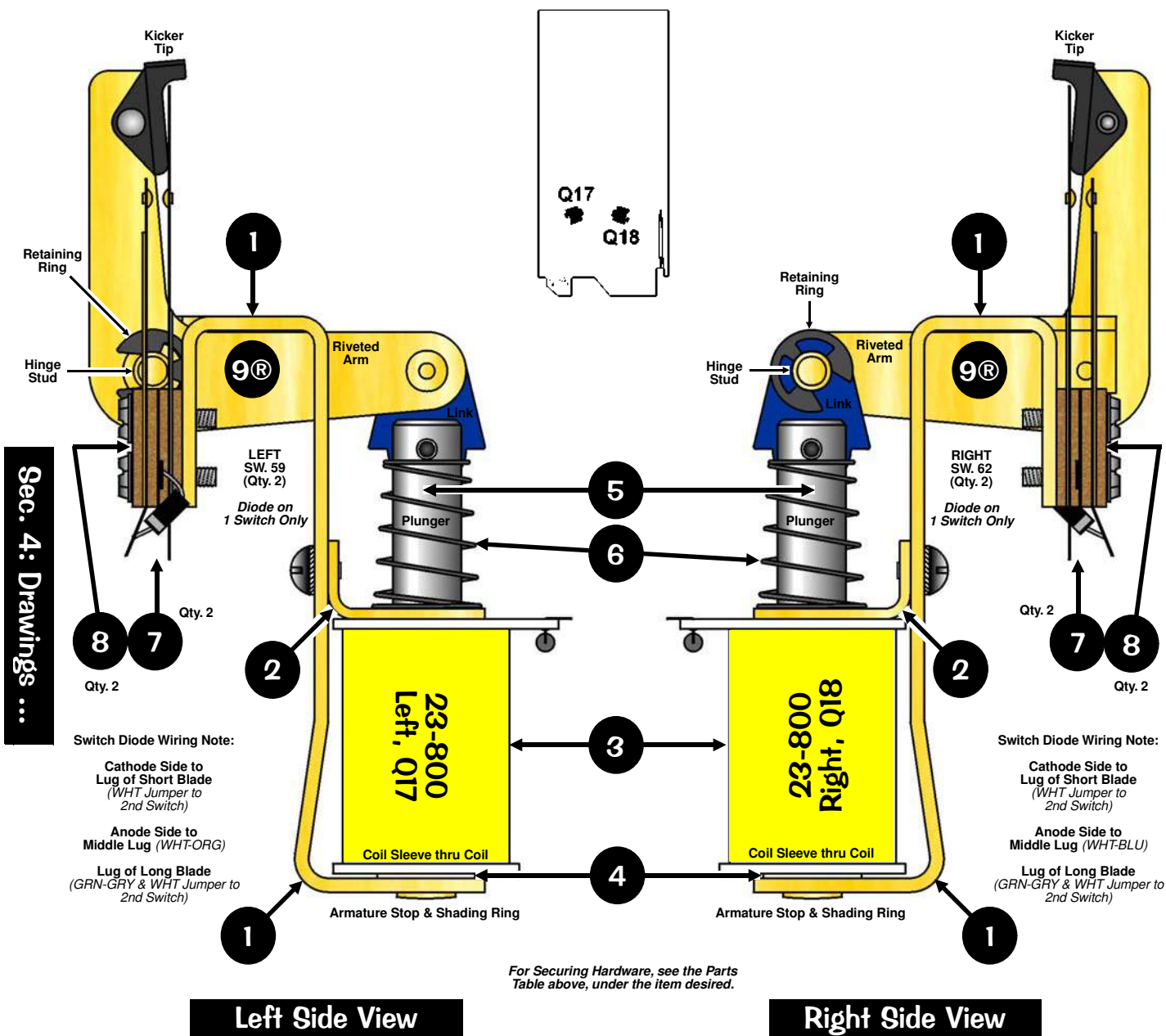

**Bumper Top (Left, Right & Bottom) Assemblies, 515-6459-01 (Qty. 3) (Items 1-7),  
Bumper Bottom (Left, Right & Bottom) Assy., 515-6459-04 (Qty. 3) (Items 8-15),  
Bumper Switch (Left, Right & Bottom) Assy., 515-6459-09R (Qty. 3) (Items 16-18)  
and Associated Parts: See Parts Table below.**

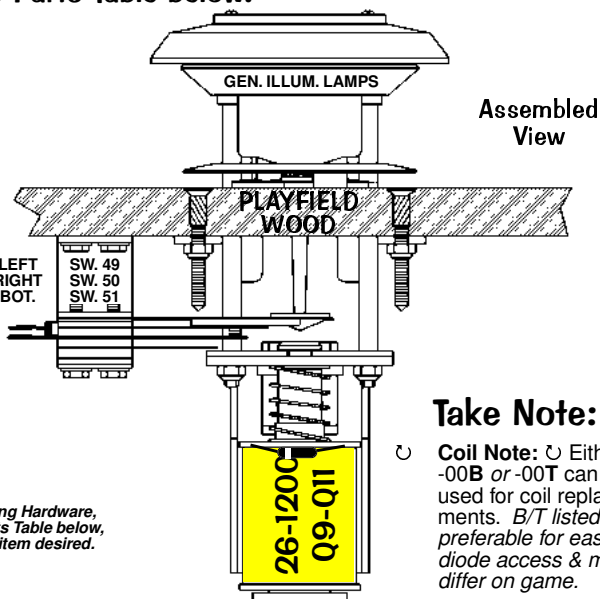
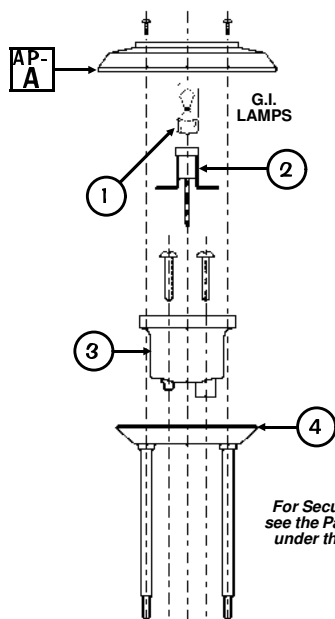
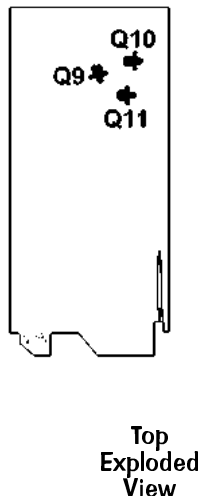

**Take Note:**

⊖ **Coil Note:** ⊖ Either -00B or -00T can be used for coil replacements. B/T listed is preferable for easier diode access & may differ on game.

**Take Note:**

Individual parts can be ordered. However, if the entire Bumper is required, use all three (3) Assembly Part Numbers at the top of this page.

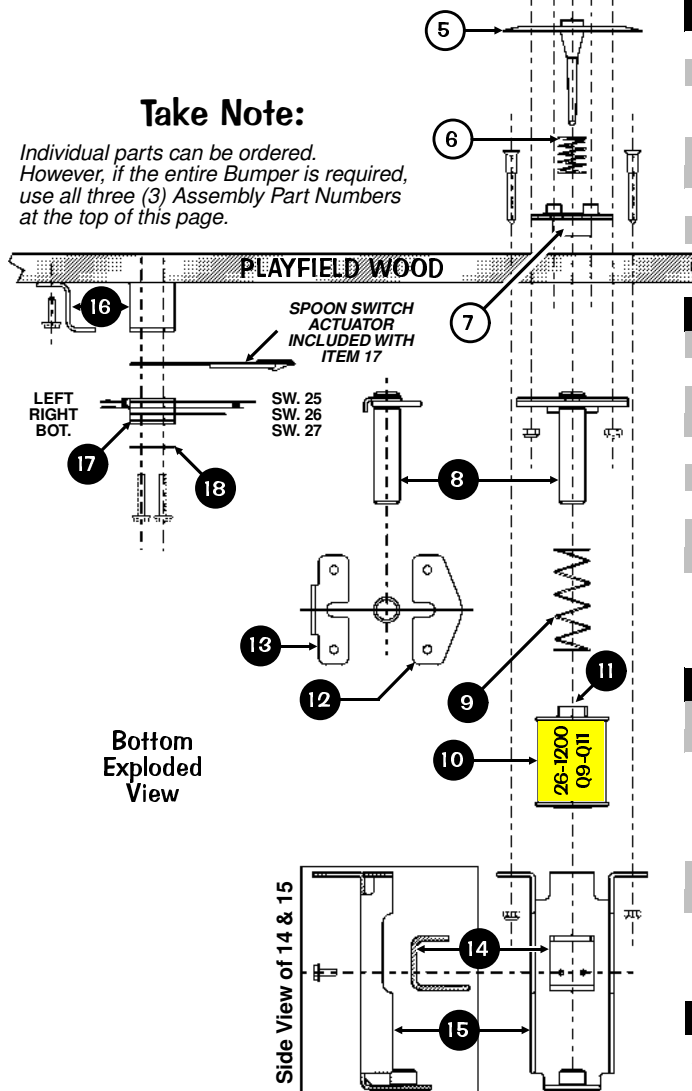

Nº	BUMPER TOP PART NAME	QTY.	SPI PART Nº
1	#555 Wedge Base Bulb	1/per	165-5002-00
2	Wedge Base Socket	1/per	077-5206-00
3	Bumper Body	1/per	545-5197-00
Item 3 is secured by: #5 X 7/8" PRH AB (Zinc) (Qty. 2) (237-5826-00)			
4	Ring Assembly	1/per	515-5085-00
Item 4 is secured by: #6-32 Nylon Stop Nut (Qty. 2) (240-5005-00)			
5	Bumper Skirt	1/per	545-5607-00
6	Bumper Skirt Compression Spring	1/per	266-5048-00
7	Bumper Base	1/per	545-5195-00

Nº	BUMPER BOTTOM PART NAME	QTY.	SPI PART Nº
8	Plunger	1/per	530-5348-00
9	Compression (Return) Spring	1/per	266-5047-00
10	Coil, 26-1200	1/per	090-5044-00T
Coil has a Diode (1N4004) (112-5003-00) positioned @ top (above lugs next to windings).			
11	Coil Sleeve	1/per	545-5031-00
12	Fiber Yoke	1/per	545-5609-00
13	Metal Yoke	1/per	535-7346-00
14	Metal Yoke Stop	1/per	535-7347-00
Item 14 is secured by: #6-32 X 1/4" HWH Swage (Serr.) Zinc (Qty. 2) (237-5976-01)			
15	Coil Bracket Welded Assembly	1/per	515-5939-00
Item 15 is secured by: #6-32 X 1-3/16" Spiral Fin Shank (Qty. 3) (237-5957-00) and #6-32 Nylon Stop Nut (Qty. 3) (240-5005-00)			

Nº	BUMPER SWITCH PART NAME	QTY.	SPI PART Nº
16	Switch Bracket	1/per	535-7342-00
Item 16 is secured by: #8 X 1/2" HWH AB (Zinc) (Qty. 2) (234-5101-00)			
17	Bumper Stack (Blade) Switch Assy.	1/per	180-5015-05
<b>ASSEMBLY NOTE:</b> This Switch is -05 because it is mounted in reverse. Identical to 180-5015-04 but mounted in reverse.			
<b>Included with Item 17:</b> Spoon Switch Actuator (545-5610-02). Switch has a Diode (1N4004) (112-5003-00). Can be replaced with (1N4001) (112-5001-00).			
18	Switch Body Protect Plate	1/per	535-7344-00
Items 17 & 18 are secured by: #6-32 X 3/4" HWH Swage (Serr.) Zc. (Qty. 2) (237-5976-05)			
The Top & Bottom Assemblies are secured together by hardware included in assemblies.			

ASSOCIATED PARTS ARE NOT INCLUDED WITH THE ABOVE ASSEMBLY.

Nº	ASSOCIATED PART NAME	QTY.	SPI PART Nº
AP-A	Bumper Cap (Red)	1/per	550-5057-02
Item AP-A is secured to Item 4 by: #4 X 3/4" PRH (Zinc) T-25 (Qty. 2/per) (237-5873-00)			

Sec. 4: Drawings ...



# 5-Bank Drop Target Assembly, 500-6795-00 (Items 1-17)

Parts Table (Items 11-17) and Assembled Views on the next page.

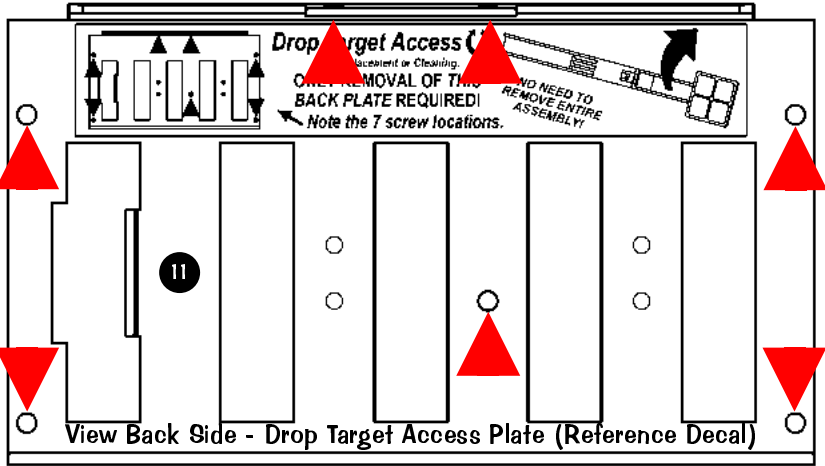
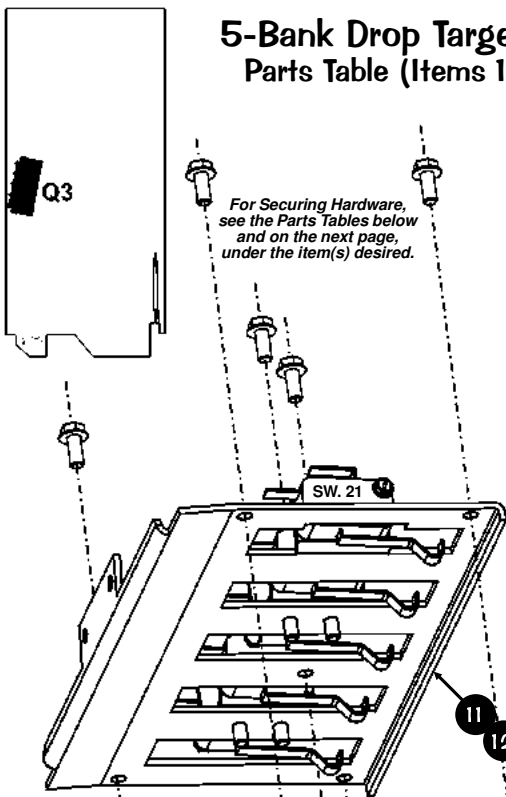

**For Target Replacement, only the 7 screws noted above need to be removed from Item 11, Drop Target Access Plate.**

Nº	INDIVIDUAL PART NAME	QTY.	SPI PART Nº
1	Bracket, Main Housing 5-Bank D/T	1	515-7380-00
Item 1 is secured below the playfield by: #8 X 1/2" SHWH AB (Zinc) (Qty. 6) (234-5101-00)			
▶ TARGET HEIGHT ADJUSTMENT HARDWARE : #8-32 X 3/4" SHWH MS (Zinc) (Qty. 2) (237-6010-00) and #8-32 Keps Nuts (Qty. 2) (240-5104-00)			
2	Bracket, Coil Support (Upper)	1	535-9434-00
Item 2 is secured to Item 1 by: #8-32 X 3/8" SHWH (Ser, Zinc) Wax (Qty. 2) (237-5975-00)			
3	Bracket, Coil Support (Lower)	1	535-9430-00
4	Plunger	1	530-5410-01
5	Plunger Head (Detachable)	1	530-5511-00
6	Bracket, Lift Plate	1	535-9431-00
Item 6 is secured to Item 5 into Item 4 by: #10-32 X 1/2" PPH MS Ext. Sems (Zinc) (Qty. 1) (232-5402-00)			
7	Bracket, Lift Plate Attachment	1	535-9440-00
Item 7 is secured to Item 6 by: #8-32 X 1/2" SHWH (Ser, Zinc) Wax (Qty. 2) (237-5975-01) #8 Washer (Qty. 2) (242-5005-00) and #8-32 Nylon Stop Nut (Qty. 2) (240-5102-00)			
8	Coil, 24-940	1	090-5036-00B
Coil has a Diode (1N4004) (112-5003-00) positioned @ the bottom (below the lugs).			
9	Coil Sleeve (Formost #10-7077)	1	545-5076-01
10	Spring Washer (17/32" ID X 3/4" X 1")	1	269-5002-00

Parts Table (Items 11-17) Continued on the next page.

Sec. 4: Drawings ...

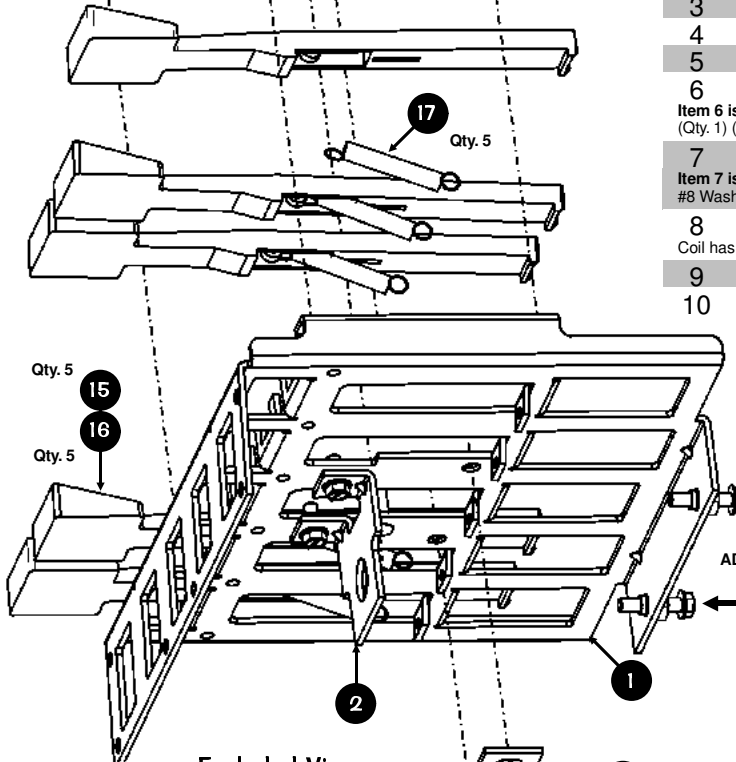

Exploded View Front Side

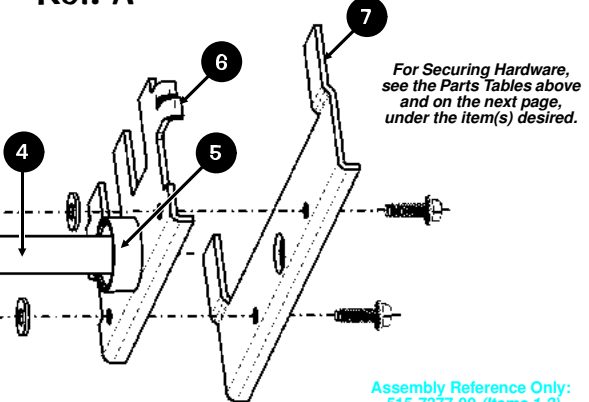
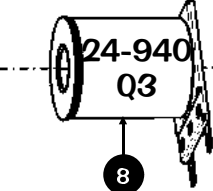

Assembly Reference Only:  
515-7377-00 (Items 1-2)  
515-7374-00 (Items 4-6)

*Elvis Presley*

**5-Bank Drop Target Assembly, 500-6795-00 (Items 1-17) Continued**  
**Parts Table (Items 1-10)**  
**and Exploded View**  
**on previous page.**

**Drop Target Height Adjustment Procedure:**

With the Drop Targets (Item 15) in the **DOWN POSITION**, adjust the height of the Targets so the Drop Targets are "flush to slightly above" the playfield surface after replacing any target. This will ensure a **BALL TRAP** is **not created** where the ball can rest in the target hole area above the playfield.

Using a 1/4" Nut Driver, Flat Screw Driver and/or Adjustable Wrench, loosen the #8-32 Keps Nuts and turn in or out the Screws to raise or lower the Target Lift Plate Attachment Bracket (Item 7 or Ref. A) causing the Drop Targets to reach desired height as stated above. Tighten the Keps Nut to secure in place.

Assembled View Back Side

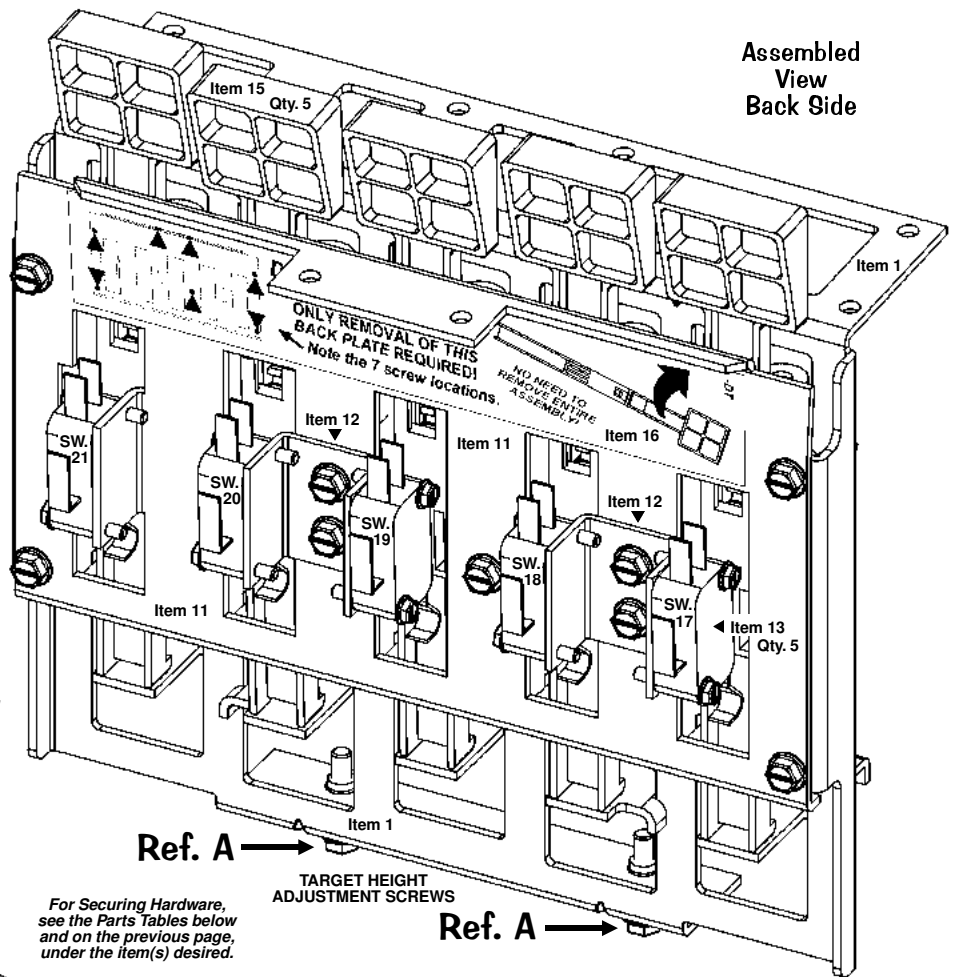

Assembled View Front Side

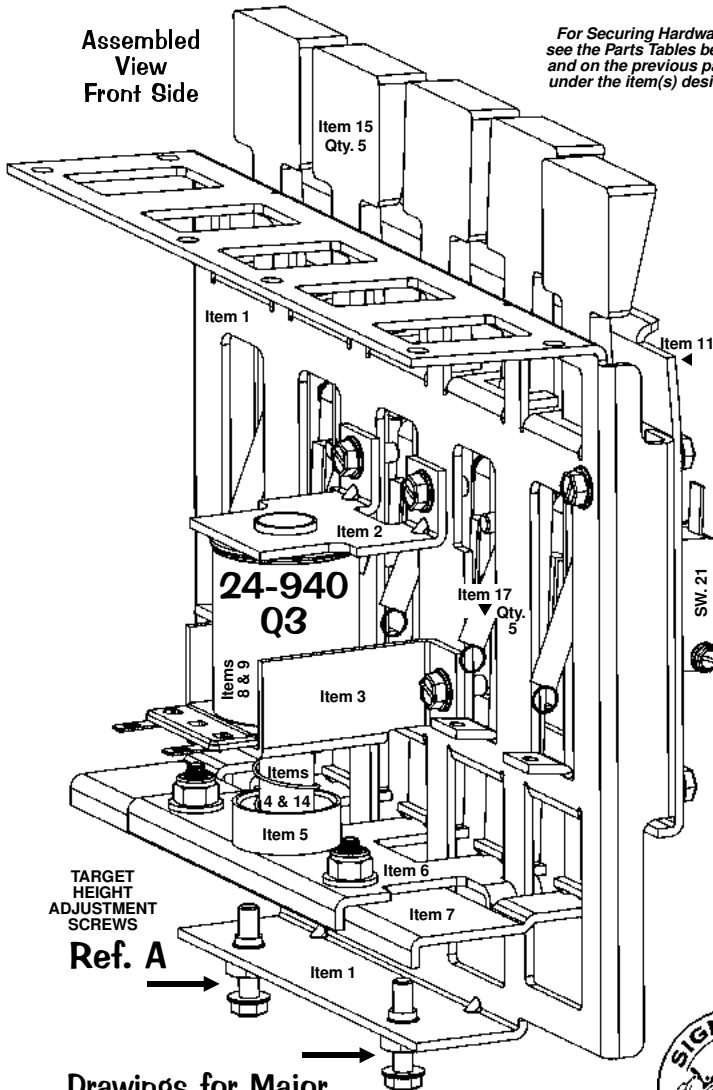

For Securing Hardware, see the Parts Tables below and on the previous page, under the Item(s) desired.

**№ INDIVIDUAL PART NAME QTY. SPI PART №**  
*Parts Table (Items 1-10) on the previous page.*

11	Bracket, Access (Back) Plate 5-B. D/T	1	535-9439-00
Item 11 is secured to Item 1 by: #8-32 X 3/8" SHWH (Ser. Zinc) Wax (Qty. 5) (237-5975-00) and Item 11 is secured below the playfield by: #8 X 1/2" SHWH AB (Zinc) (Qty. 2) (234-5101-00) Cable Dressing: 1/4" Clamp (Single) (Qty. 1) (040-5000-03)			
12	Bracket, Dual Switch Support	2	535-9433-00
Item 12 is secured to Item 11 by: #8-32 X 3/8" SHWH (Ser. Zinc) Wax (Qty. 2/per) (237-5975-00)			
13	Switch (D/T)	5	180-5158-00
Item 13 is secured to Items 11 & 12 by: #4-40 X 5/8" HWH TF (Qty. 2/per) (237-5945-00) <b>Ordering Note:</b> If replacing Item 13, Switch (D/T), ensure the diode on the switch is desoldered (if present) and wired correctly as per original (more details on Page 105).			
14	Compression (Return) Spring	1	266-5020-00
15	Drop Target White (Rollover)	5	545-6102-01
16	Kit: Decals (Screened) -DT & Targets	1	802-5000-84
<b>Note:</b> Individual Decals (820-6356-DT, 820-6361-00 (Qty. 5)) are not available individually, ordering of kit is required. For all pieces, see Playfield - Plastics (Screened & Clear) & Decals, Page 67.			
17	Spring, Target Reset	5	265-5003-00
<b>Ordering Note:</b> If 500-6795-00 is unavailable, order the individual part(s) actually required.			

**Take Note:**

**Coil Note:** ∅ Either -00B or -00T can be used for coil replacements. B/T listed is preferable for easier diode access & may differ on game.

**DOTS:** The Switch Diodes, 1N4001, are not located on this Assembly. They are located on a Terminal Strips under the playfield near this assembly. See Section 5, Chapter 2, Playfield Terminal Strips ... , Page 105, for more details. If reordering, ensure the diode on each switch is desoldered, if present, and wired correctly as per original (more details on Page 105).

Cable Wiring Harness  
 036-5500-18-84  
 9-Pin Connector  
 045-5007-09  
 Polarizing Key  
 060-5000-00

Drawings for Major Assemblies & Ramps



Sec. 4: Drawings ...



**Ball Eject Bottom Assembly,  
515-7447-00 (Items 1-4)  
Ball Eject Top (Left Style) Assembly,  
515-7448-00 (Items 5-10)  
and Associated Parts: See Parts Table below.**

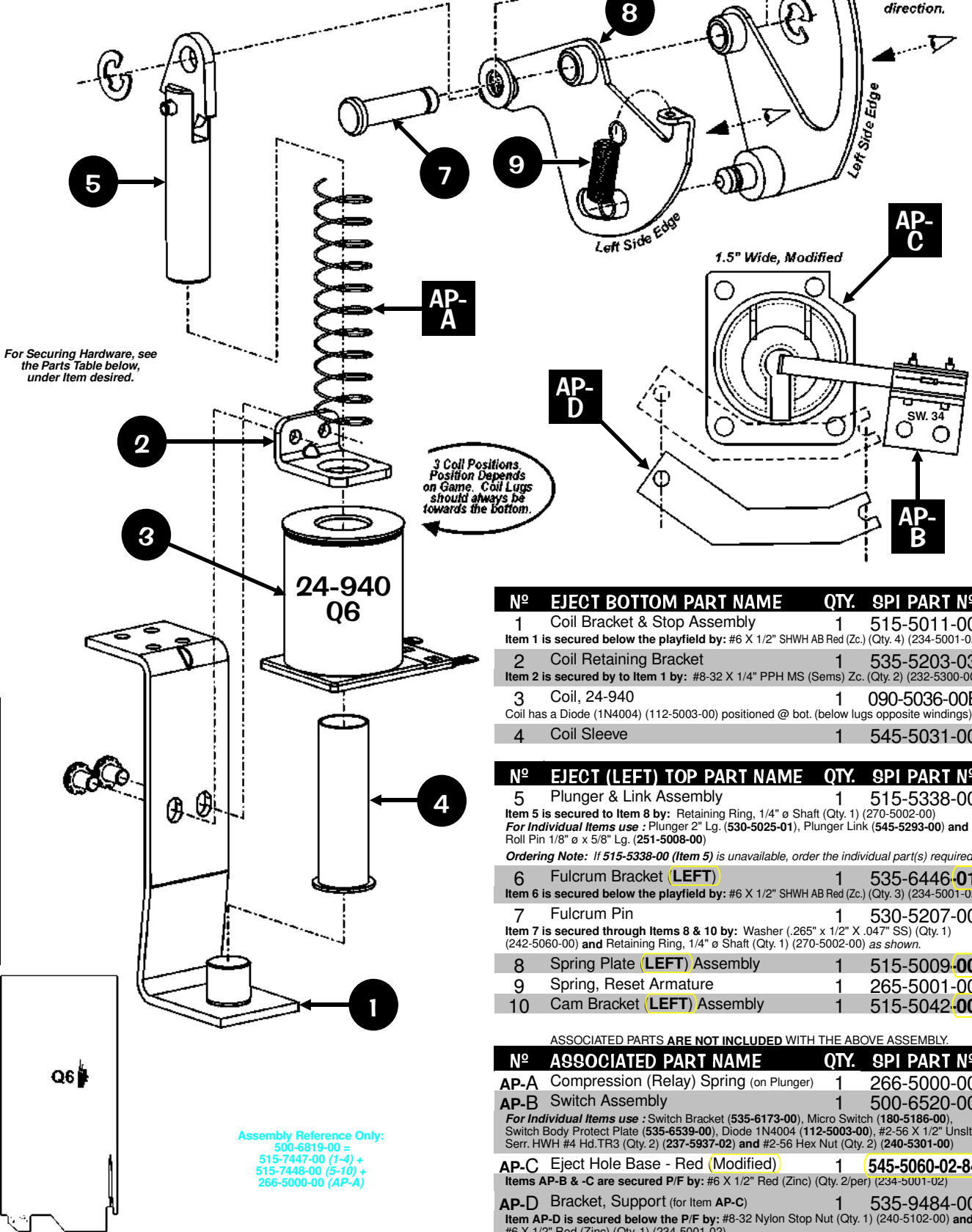

Sec. 4: Drawings ...

Nº	EJECT BOTTOM PART NAME	QTY.	SPI PART Nº
1	Coil Bracket & Stop Assembly	1	515-5011-00
Item 1 is secured below the playfield by: #6 X 1/2" SHWH AB Red (Zc.) (Qty. 4) (234-5001-02)			
2	Coil Retaining Bracket	1	535-5203-03
Item 2 is secured by to Item 1 by: #8-32 X 1/4" PPH MS (Sems) Zc. (Qty. 2) (232-5300-00)			
3	Coil, 24-940	1	090-5036-00B
Coil has a Diode (1N4004) (112-5003-00) positioned @ bot. (below lugs opposite windings).			
4	Coil Sleeve	1	545-5031-00

Nº	EJECT (LEFT) TOP PART NAME	QTY.	SPI PART Nº
5	Plunger & Link Assembly	1	515-5338-00
Item 5 is secured to Item 8 by: Retaining Ring, 1/4" ø Shaft (Qty. 1) (270-5002-00)			
For Individual Items use : Plunger 2" Lg. (530-5025-01), Plunger Link (545-5293-00) and Roll Pin 1/8" ø x 5/8" Lg. (251-5008-00)			
Ordering Note: If 515-5338-00 (Item 5) is unavailable, order the individual part(s) required.			
6	Fulcrum Bracket (LEFT)	1	535-6446-01
Item 6 is secured below the playfield by: #6 X 1/2" SHWH AB Red (Zc.) (Qty. 3) (234-5001-02)			
7	Fulcrum Pin	1	530-5207-00
Item 7 is secured through Items 8 & 10 by: Washer (.265" x 1/2" X .047" SS) (Qty. 1) (242-5060-00) and Retaining Ring, 1/4" ø Shaft (Qty. 1) (270-5002-00) as shown.			
8	Spring Plate (LEFT) Assembly	1	515-5009-00
9	Spring, Reset Armature	1	265-5001-00
10	Cam Bracket (LEFT) Assembly	1	515-5042-00

ASSOCIATED PARTS ARE NOT INCLUDED WITH THE ABOVE ASSEMBLY.

Nº	ASSOCIATED PART NAME	QTY.	SPI PART Nº
AP-A	Compression (Relay) Spring (on Plunger)	1	266-5000-00
AP-B	Switch Assembly	1	500-6520-00
For Individual Items use : Switch Bracket (535-6173-00), Micro Switch (180-5186-00), Switch Body Protect Plate (535-6539-00), Diode 1N4004 (112-5003-00), #2-56 X 1/2" Unslt. Serr. HWH #4 Hd.TR3 (Qty. 2) (237-5937-02) and #2-56 Hex Nut (Qty. 2) (240-5301-00)			
AP-C	Eject Hole Base - Red (Modified)	1	545-5060-02-84
Items AP-B & -C are secured P/F by: #6 X 1/2" Red (Zinc) (Qty. 2/per) (234-5001-02)			
AP-D	Bracket, Support (for Item AP-C)	1	535-9484-00
Item AP-D is secured below the P/F by: #8-32 Nylon Stop Nut (Qty. 1) (240-5102-00) and #6 X 1/2" Red (Zinc) (Qty. 1) (234-5001-02)			

Assembly Reference Only:  
500-6819-00 =  
515-7447-00 (1-4) +  
515-7448-00 (5-10) +  
266-5000-00 (AP-A)

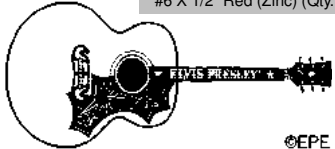

**Ball Eject Bottom Assembly, 515-7447-00 (Items 1-4)**  
**Ball Eject Top (Right Style) Assembly, 515-7448-01 (Items 5-10)**  
 and Associated Parts: See Parts Table below.

Assembly Reference Only:  
 500-6819-01 =  
 515-7447-00 (1-4) +  
 515-7448-01 (5-10) +  
 266-5000-00 (AP-A)

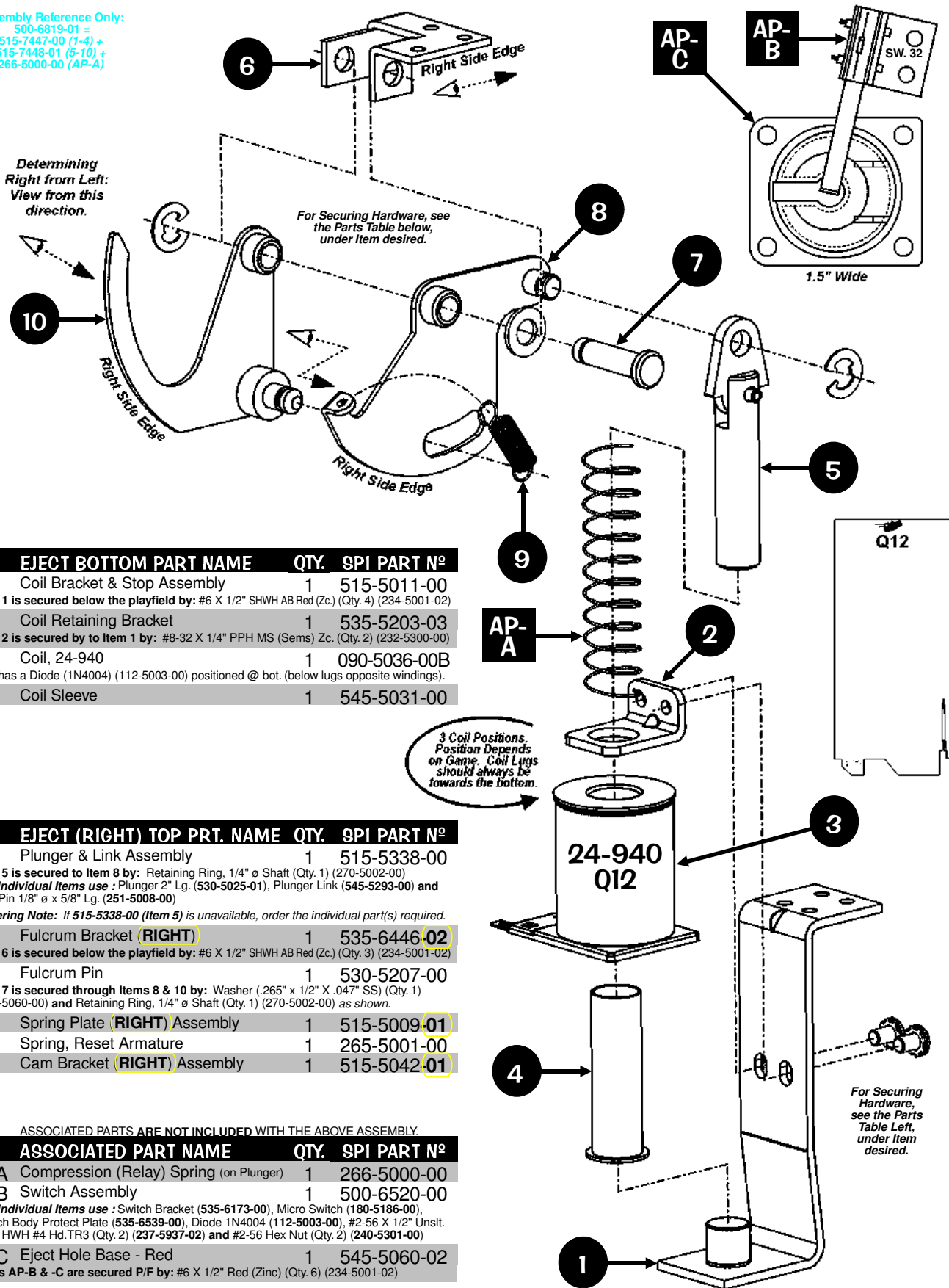

Nº	EJECT BOTTOM PART NAME	QTY.	SPI PART Nº
1	Coil Bracket & Stop Assembly	1	515-5011-00
Item 1 is secured below the playfield by: #6 X 1/2" SHWH AB Red (Zc.) (Qty. 4) (234-5001-02)			
2	Coil Retaining Bracket	1	535-5203-03
Item 2 is secured by to Item 1 by: #8-32 X 1/4" PPH MS (Sems) Zc. (Qty. 2) (232-5300-00)			
3	Coil, 24-940	1	090-5036-00B
Coil has a Diode (1N4004) (112-5003-00) positioned @ bot. (below lugs opposite windings).			
4	Coil Sleeve	1	545-5031-00

Nº	EJECT (RIGHT) TOP PRT. NAME	QTY.	SPI PART Nº
5	Plunger & Link Assembly	1	515-5338-00
Item 5 is secured to Item 8 by: Retaining Ring, 1/4" ø Shaft (Qty. 1) (270-5002-00)			
For Individual Items use : Plunger 2" Lg. (530-5025-01), Plunger Link (545-5293-00) and Roll Pin 1/8" ø x 5/8" Lg. (251-5008-00)			
Ordering Note: If 515-5338-00 (Item 5) is unavailable, order the individual part(s) required.			
6	Fulcrum Bracket (RIGHT)	1	535-6446-02
Item 6 is secured below the playfield by: #6 X 1/2" SHWH AB Red (Zc.) (Qty. 3) (234-5001-02)			
7	Fulcrum Pin	1	530-5207-00
Item 7 is secured through Items 8 & 10 by: Washer (.265" x 1/2" X .047" SS) (Qty. 1) (242-5060-00) and Retaining Ring, 1/4" ø Shaft (Qty. 1) (270-5002-00) as shown.			
8	Spring Plate (RIGHT) Assembly	1	515-5009-01
9	Spring, Reset Armature	1	265-5001-00
10	Cam Bracket (RIGHT) Assembly	1	515-5042-01

ASSOCIATED PARTS ARE NOT INCLUDED WITH THE ABOVE ASSEMBLY.

Nº	ASSOCIATED PART NAME	QTY.	SPI PART Nº
AP-A	Compression (Relay) Spring (on Plunger)	1	266-5000-00
AP-B	Switch Assembly	1	500-6520-00
For Individual Items use : Switch Bracket (535-6173-00), Micro Switch (180-5186-00), Switch Body Protect Plate (535-6539-00), Diode 1N4004 (112-5003-00), #2-56 X 1/2" Unsl. Serr. HWH #4 Hd.TR3 (Qty. 2) (237-5937-02) and #2-56 Hex Nut (Qty. 2) (240-5301-00)			
AP-C	Eject Hole Base - Red	1	545-5060-02
Items AP-B & -C are secured P/F by: #6 X 1/2" Red (Zinc) (Qty. 6) (234-5001-02)			

**Sec. 4: Drawings ...**



# Hound Dog Pop-Up Target Individual Parts Only (Items 1-10)

For Securing Hardware, see the Parts Table below, under Item desired.

Assembly Reference Only:  
500-6781-00 (1-10)



Nº	INDIVIDUAL PART NAME	QTY.	SPI PART Nº
----	----------------------	------	-------------

1	Bracket, Hound Dog Base	1	515-7365-00
---	-------------------------	---	-------------

Item 1 is secured below the playfield by: #8 Washer (Qty. 3) (242-5005-00) and #8-32 Nylon Stop Nut (Qty. 3) (240-5102-00)

2	Actuator Bracket	1	535-9428-00
---	------------------	---	-------------

3	Clevis Pin 3/16" ø S.S.	1	530-5657-00
---	-------------------------	---	-------------

Item 3 is secured through Items 1 & 2 by: Retaining Ring, 3/16" ø Shaft (Qty. 1) (270-5024-00).

4	Micro Switch (Short Flat Actuator)	1	180-5190-28
---	------------------------------------	---	-------------

Switch has a Diode (1N4004) (112-5003-00). Can be replaced with (1N4001) (112-5001-00).

5	Kit: Plastics (Screened) -30	1	803-5000-84
---	------------------------------	---	-------------

Note: Individual Plastics (830-6029-30) is not available individually, ordering of kit is required. For all pieces, see Playfield - Plastics (Screened & Clear) & Decals, Page 67.

6	Switch Body Protect Plate	1	535-6539-00
---	---------------------------	---	-------------

Items 5 & 6 are secured to Item 1 by: #2-56 X 1/2" Unslt. Serr. HWH #4 Hd. TR3 (Qty. 2) (237-5937-02)

7	Square Post (Black)	1	535-9443-00
---	---------------------	---	-------------

Item 7 is secured to Item 1 by: #6-32 x 1/2" PPH MS Ext. Sems (Zinc) (Qty. 2) (232-5202-00)

8	Hound Dog	1	500-6820-00
---	-----------	---	-------------

Item 8 is secured to Item 7 by: Washer, 1/4" I.D. X 7/8" O.D. X 1/8" Black (Qty. 1) (242-5016-00) and #8-32 X 3/8" PPH MS Sems (Black) (Qty. 1) (232-5301-01)

9	Spring Tension H/D	1	266-5080-00
---	--------------------	---	-------------

10	Deflector Pad (Bumper)	1	545-5428-00
----	------------------------	---	-------------

Sec. 4: Drawings ...

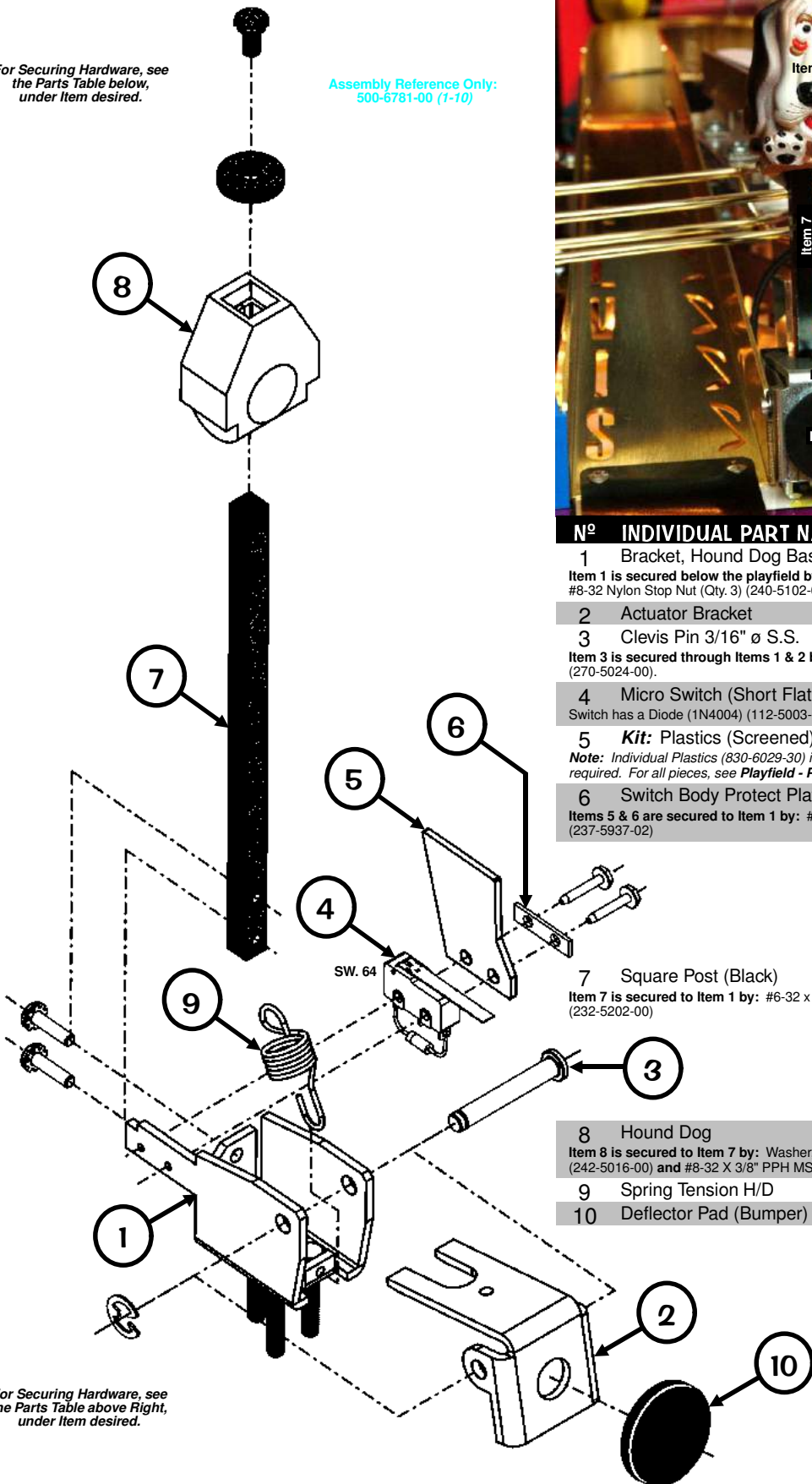

For Securing Hardware, see the Parts Table above Right, under Item desired.

Cable Wiring Harness  
036-5500-07-84  
2-Pin Connector  
045-5007-02  
Shrink Tubing  
605-5002-00

# Magnet Coil, Bracket (with Threaded Bushing) and Miscellaneous Parts (Items 1-4)

When energized, holds the ball above the Upper Right Flipper and then releases it.

Nº	INDIVIDUAL PART NAME	QTY.	SPI PART Nº	Nº	INDIVIDUAL PART NAME	QTY.	SPI PART Nº	
1	Magnet Coil, 22-650 (6" Leads + Conn.)	1	500-6808-00	2	Bracket, Mag. Core Mount (Threaded Bushing)	1	515-6141-02	
Coil has a Diode (1N4004) (112-5003-00) located in the Connector.								
<i>For Individual Items use :</i> Magnet Coil (22-650) (090-5042-00), 1 X 2, .093" Connector Plug 03-09-2022 (045-5004-02), Insulating Tubing (605-5001-00) (Qty. .08 Ft.) and Male Lugs 18ga (Qty. 2) (055-5021-09)								
				Item 2 is secured to the playfield by: #8 X 1/2" SLT SHWH AB (Zinc) (Qty. 4) (234-5101-00)				
				3	Threaded Core Plug	1	530-5320-00	
				4	3/4-16 Hex Nut	1	240-5315-00	

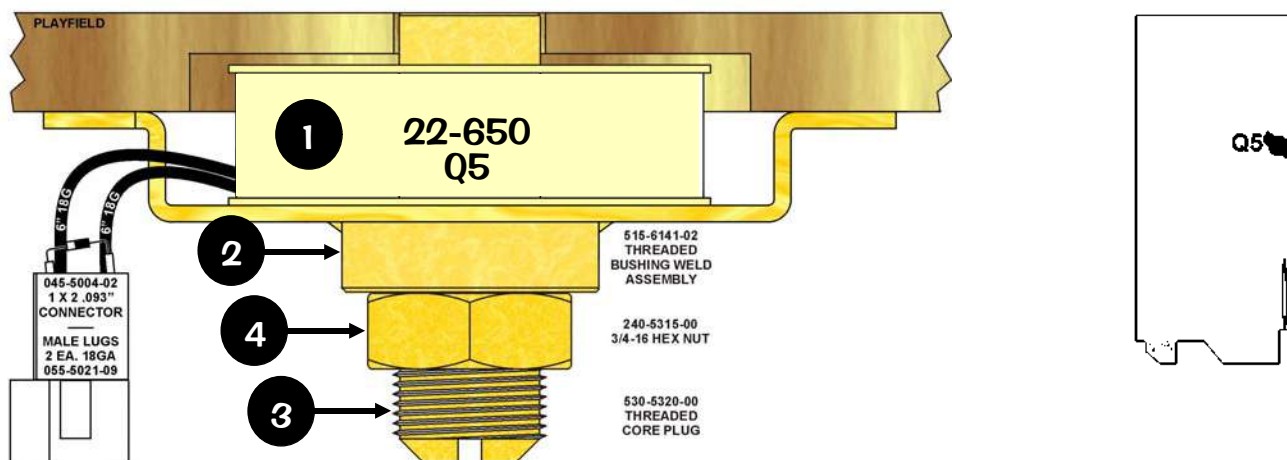

# Ball Lock Assembly, 500-5867-07 (Items 1-9)

When energized, the post goes down below the playfield allowing the locked pinball(s) to escape.

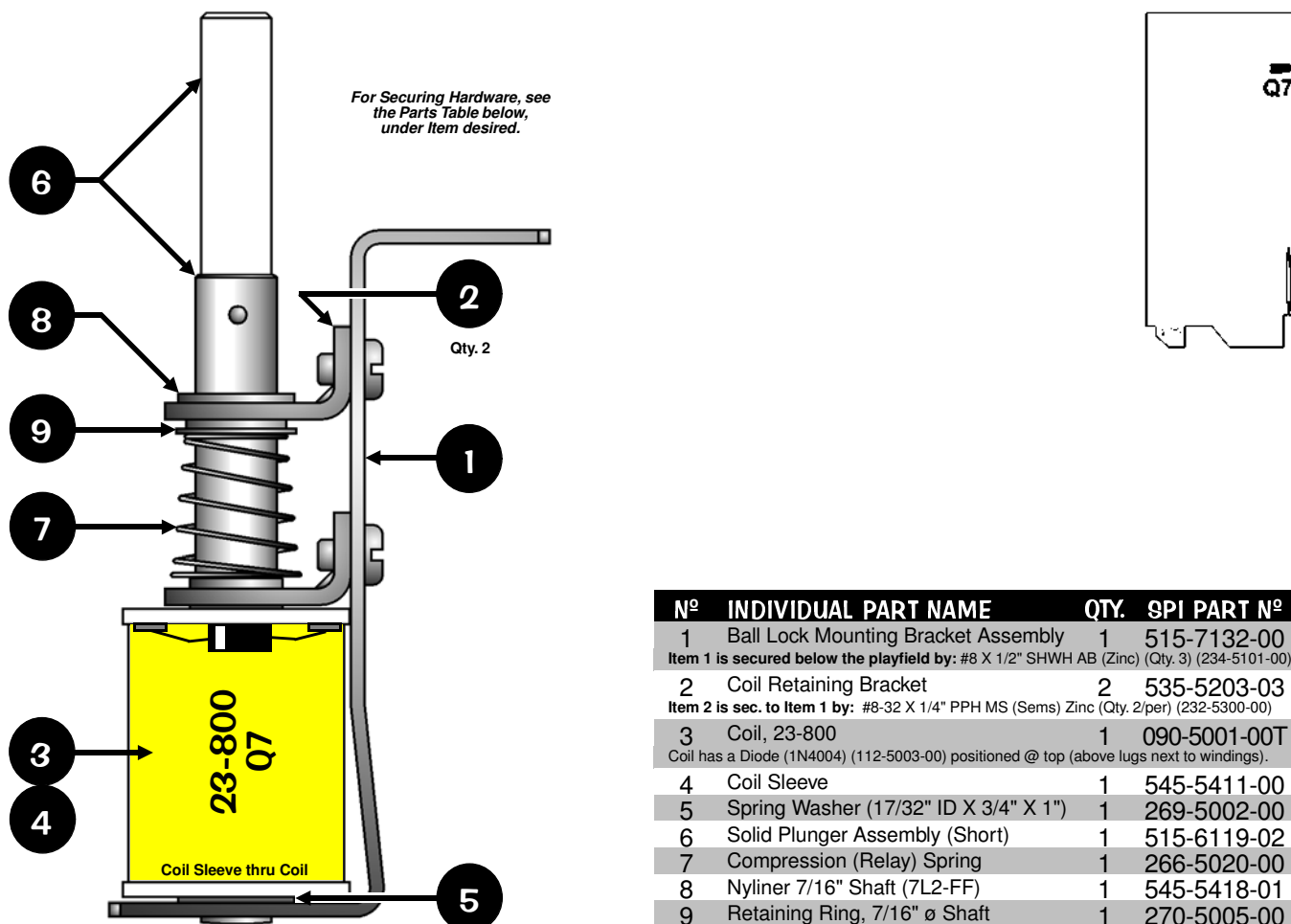

Nº	INDIVIDUAL PART NAME	QTY.	SPI PART Nº
1	Ball Lock Mounting Bracket Assembly	1	515-7132-00
Item 1 is secured below the playfield by: #8 X 1/2" SHWH AB (Zinc) (Qty. 3) (234-5101-00)			
2	Coil Retaining Bracket	2	535-5203-03
Item 2 is sec. to Item 1 by: #8-32 X 1/4" PPH MS (Sems) Zinc (Qty. 2/per) (232-5300-00)			
3	Coil, 23-800	1	090-5001-00T
Coil has a Diode (1N4004) (112-5003-00) positioned @ top (above lugs next to windings).			
4	Coil Sleeve	1	545-5411-00
5	Spring Washer (17/32" ID X 3/4" X 1")	1	269-5002-00
6	Solid Plunger Assembly (Short)	1	515-6119-02
7	Compression (Relay) Spring	1	266-5020-00
8	Nyliner 7/16" Shaft (7L2-FF)	1	545-5418-01
9	Retaining Ring, 7/16" ø Shaft	1	270-5005-00

Ordering Note: If 500-5867-07 is unavailable, order the individual part(s) actually required.



For Securing Hardware, see the Parts Table on the next page, under Item desired.

# Elvis, Stepper Motor & 3-Bank Stand-Up Target Individual Parts Only (Items 1-31)

Parts Table and more views continue on the next page.



21 26 27 28 29 30 31

**Elvis™ Kit**  
**502-6796-84**  
 Includes Items 21, 26-31 & Securing Hardware

Note: For just the Torso (Item 30) and Pivot Pin (Item 21) use 502-6796-84T (add the T to PN).

◀ Assembled View



**CAUTION! - KEEP FINGERS OUT!**  
**WHEN SERVICING, TURN OFF POWER!**  
**MOVING PARTS CAN PINCH FINGERS!**  
 ATTENTION! VORSICHT! ATTENZIONE! PRECAUCIÓN!

Cable Wiring Harness for Switch & Targets : 036-5500-17-84  
 10-Pin Connector : 045-5007-10  
 2-Pin + 3-Pin Connectors : 045-5003-02 + -03  
 Shrink Tubing : 605-5003-00 (.08 ft.)

Assembly Reference Only:  
 500-6796-00 (1-31)  
 515-7385-00 (1-5)  
 500-6799-00 (6-21)  
 515-7386-00 (13-15)  
 515-7391-00 (13-14 & 16)  
 500-6817-00 (22R, 23-25 + 036-5500-17-84 Wiring)  
 515-7402-00 (23-25)  
 515-7395-00 (26-27)  
 Kit 502-6796-84 (21, 26-31)  
 Kit 502-6796-84T (21, 30)

Sec. 4: Drawings ...

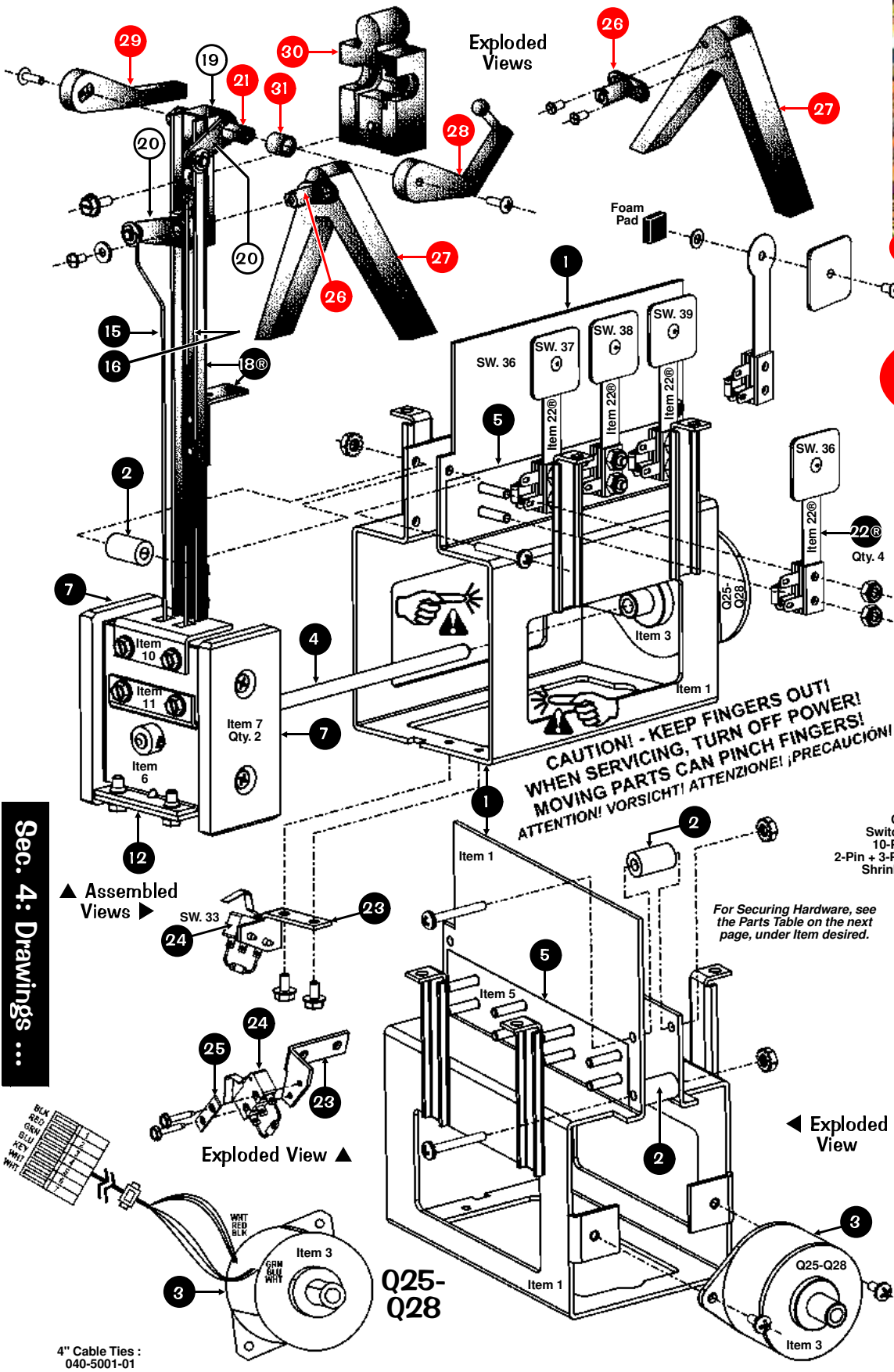

▲ Assembled Views

◀ Exploded View

Exploded View ▲

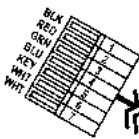

4" Cable Ties : 040-5001-01

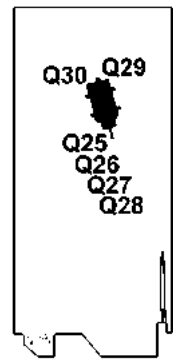

# Elvis, Stepper Motor & 3-Bank Stand-Up Target Individual Parts Only (Items 1-31) Continued

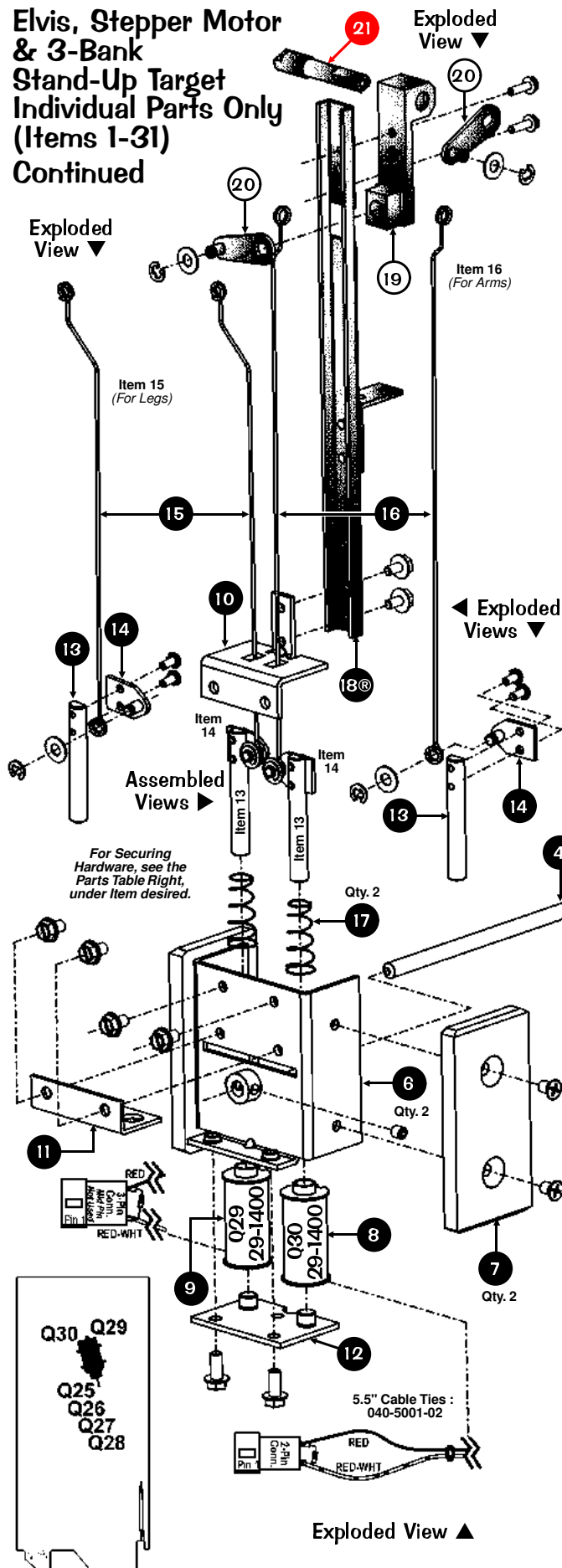

Nº	INDIVIDUAL PART NAME	QTY.	SPI PART Nº
1	Frame (Bracket Base) Welded Asm.	1	515-7390-00
Item 1 is secured below the playfield by: #8 X 1/2" SHWH AB (Zinc) (Qty. 6) (234-5101-00)			
2	5/8" X 3/8" Plastic Spacer Gray	3	254-5000-14
Item 2 is secured to Item 1 by: #6-32 X 1" PPH MS Ext. Sems (Zinc) (Qty. 1/per) (232-5206-00) and #6-32 Keps Nut (Qty. 1/per) (240-5008-00)			
3	Stepper Motor Assembly	1	500-6809-00
For Individual Items use : Stepper Motor (Haydon #46868-12-002 12v DC 10W) (041-5089-00), 7-Pin Connector (28 AWG MT End, CE100F28-7) (045-5157-07), 7-Pin Z-Header (MWW5100-2207) (045-5110-07), Polarizing Key (060-5000-01) and Shrink Tubing (.4 ft.) (605-5004-01)			
Item 3 is secured to Item 1 by: #6-32 X 5/16" PPH MS Ext. Sems (Zinc) (Qty. 2) (232-5208-00)			
4	Stepper Motor Threaded Shaft (7.25")	1	530-5658-00
Item 4 is sec. to Item 6 by: #8-32 X 3/16" Set-Screw (MMC 91375A189) (Qty. 2) (237-6153-00)			
5	Insulator (Fiche Paper) 1" X 4.75"	1	545-6116-00
6	Frame (Carrier) Welded Assembly	1	515-7384-00
7	Wear Pad	2	545-6103-01
Item 7 is sec. to Item 6 by: #8-32 X 1/4" PFH 82° U/cut MS (Zc.) (Qty. 2/per) (237-6030-02)			
8	Coil (29-1400) & 2-Pin Conn. Asm.	1	500-6818-00
Coil has a Diode (1N4004) (112-5003-00) located in the Connector. For Individual Items use : Coil (Med. Bobin) 29-1400 (TMI 4955-0 T543950) (090-5072-03), 2-Pin Conn. (.093 03-09-2022) (045-5004-02) and Male Lugs 18AWG (055-5021-09)			
9	Coil (29-1400) & 3-Pin Conn. Asm.	1	500-6818-01
Coil has a Diode (1N4004) (112-5003-00) located in the Connector. For Individual Items use : Coil (Med. Bobin) 29-1400 (TMI 4955-0 T543950) (090-5072-03), 3-Pin Conn. (.093 03-09-2032) (045-5004-03) and Male Lugs 18AWG (055-5021-09)			
10	Dual Actuator Bracket	1	535-9450-00
11	Dual Coil Retainer Bracket	1	535-9462-00
Items 10 / 11 sec. to Item 6 by: #8-32 X 1/4" SSWH SW (Zc.) Wax (Qty. 2/per) (237-5975-04)			
12	Dual Coil Stop Plate (Bottom) Asm.	1	515-7389-00
Item 12 is sec. to Item 6 by: #8-32 X 3/8" SHWH SW (Zinc) Wax (Qty. 2) (237-5975-00)			
13	Plunger	2	530-5659-00
14	Plunger Bracket Welded Assembly	2	515-7387-00
15	Actuator Wire (for Legs)	1	535-9452-00
16	Actuator Wire (for Arms)	1	535-9451-00
Items 15 & 16 are secured to Items 13 & 14 by: #8 Fiber Washer (MC96100A125) 3/8" O.D. (Qty. 1/per) (242-5082-00), #4-40 X 1/4" PPH MS Ext. Sems (Zinc) (Qty. 2/per) (237-5909-00) and Retaining Ring, 5/32" ø Shaft (Qty. 1/per) (270-5025-00)			
Items 15 & 16 are secured to Item 20 by: #8 Fiber Washer (MC96100A125) 3/8" O.D. (Qty. 1/per) (242-5082-00) and Retaining Ring, 5/32" ø Shaft (Qty. 1/per) (270-5025-00)			
17	Compression (Return) Spring	2	266-5077-00
18®	Platform Riveted Assembly	1	515-7388-00

## Take Note:

® "R" indicates Item noted is secured with rivet(s) as listed.

For Individual Items use : Platform Support Bracket (535-9454-00), Support Channel (535-9448-00) and Rivet, 1/8" ø X 3/16" Lg. (Black Zinc) (Qty. 2) (249-5001-01)

Item 18 is sec. to Item 10 by: #6-32 X 1/4" SHWH SW (Zinc) Wax (Qty. 2) (237-5976-01)

19	Bearing Block (behind Elvis™ Torso)	1	545-6105-00
Item 19 is sec. to Item 18® by: #4-40 X 1/4" PFH MS Black Oxide (Qty. 2) (237-5983-02)			
20	Lever Assembly	2	515-7393-00
21	Pivot Pin (for Arms)	1	530-5663-00
22®	1" Sq. S/U Target (Side-Lugs, No Brkt)	4	515-7381-00
For Individual Items use : Stand-Up Target, Side Lugs (180-5083-01), 1" Sq. Target Top White (545-5470-08), Washer 9/64" I.D. X 5/16" O.D. X 1/32" (242-5017-00), Rivet, 1/8" ø X 3/16" Lg. (Zinc) (249-5001-00) and Foam Pad (Adhesive, Sq., Black) (626-5029-00)			
Item 22® is secured to Item 1 by: #6-32 Nylon Stop Nut (Qty. 2/per) (240-5005-00)			
23	Switch Bracket	1	535-9463-00
Item 23 is sec. to Item 1 by: #6-32 X 1/4" SHWH SW (Zinc) Wax (Qty. 2) (237-5976-01)			
24	Micro Switch (Short Actuator, Bend)	1	180-5189-00
Switch has a Diode (1N4004) (112-5003-00). Can be replaced with (1N4001) (112-5001-00).			
25	Switch Body Protect Plate	1	535-6539-00
Items 24 / 25 sec. to Item 23 by: #2-56 X 1/2" SHWH #4 Hd.TR3 (Qty. 2) (237-5937-02)			
26	Pivot Pin & Plate Asm. (for Legs)	1	515-7394-00
Item 26 is secure through Items 18® & 20 by: #4-40 X 1/4" PPH MS Ext. Sems (Zinc) (Qty. 1) (237-5909-00) and #4 Washer (Qty. 1) (242-5002-00)			
27	Elvis™ Legs (Molded Plastic)	1	545-6107-00
Item 27 is sec. to Item 26 by: #4-40 X 1/4" PFH Blk. Oxd. U/Cut 82° (Qty. 2) (237-5983-04)			
28	Elvis™ Right Arm (Molded Plastic)	1	545-6109-00
29	Elvis™ Left Arm (Molded Plastic)	1	545-6110-00
Items 28 & 29 are secured to Item 21 by: #4-40 X 3/8" PTH Blk. (Qty. 1/per) (237-6154-01)			
30	Elvis™ Torso (Molded Plastic)	1	545-6108-00
Item 30 is sec. to Item 18® by: #6-32 X 3/8" HWH Swage (Ser.) Zinc (Qty. 1) (237-5976-02)			
31	Spacer Black 31" od x .26" id x .28" (in Rt. Arm)	1	545-6106-00
Not Shown Kit: Decals (Screened) -80-81 1 802-5000-84			

Note: Individual Decals (820-6356-XX) are not available individually, ordering of kit is required. For all pieces, see Playfield - Plastics (Screened & Clear) & Decals, Page 67.

Sec. 4: Drawings ...



**Hotel Plastics & Decal Reference  
(Items 1-3) Included in Kit:  
Plastics 803-5000-84 &  
Decals 802-5000-84  
Brackets Not Included.  
Assembly Reference Only  
(Covers the Hotel Frame on the next page)**



Nº	INDIVIDUAL PART NAME	QTY.	SPI PART Nº
1	Bracket, 90°	6	535-8941-04

Item 1 is secured to Item 2's by: Rivet, 1/8" ø X 3/16" Lg. (Qty. 2/per) (249-5001-00)

Replacing Plastics requires drilling out the rivets. If capable, use the rivets stated above or reassemble with an appropriate size screw and nut.

**2 Kit: Plastics (Screened & Clear) 1 803-5000-84**  
 Note: Individual Plastics (830-6029-XX, 830-6030-35) are not available individually, ordering of kit is required. For all pieces, see P/F - Plastics (Screened & Clear) & Decals, Page 67.

**3 Kit: Decals (Screened) -83. 1 802-5000-84**  
 Note: Individual Decal (820-6356-83) is not available individually, ordering of kit is required. For all pieces, see P/F - Plastics (Screened & Clear) & Decals, Page 67.



For Securing Hardware, see the Parts Tables above, under the item desired.

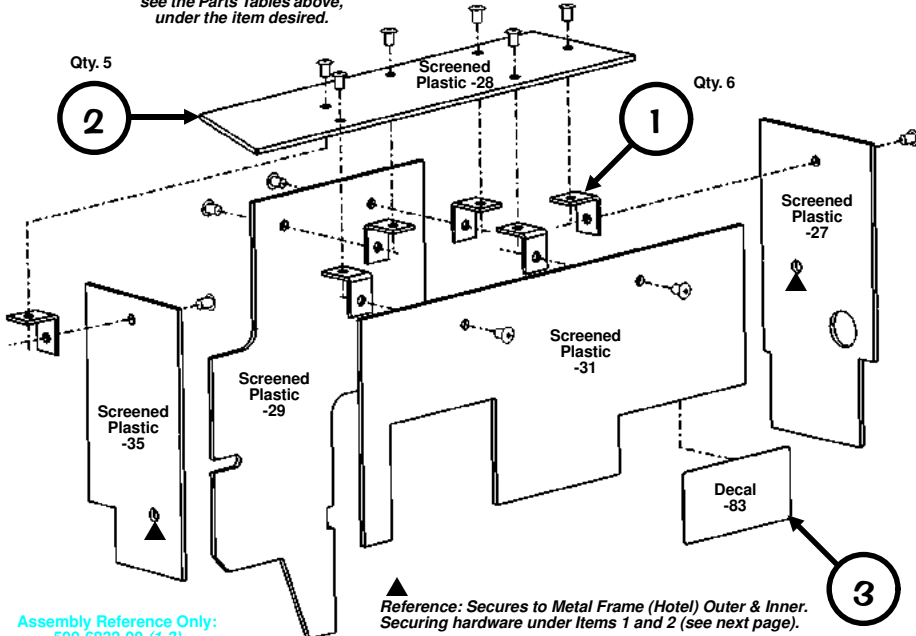

Assembly Reference Only:  
500-6832-00 (1-3)

<UPDATED AFTER MANUAL PRINTING> 112204

**Hotel Door Coil Assembly,  
500-6752-01 (Items 1-10)**

Parts Table ▶  
for this Assembly  
on the next page.

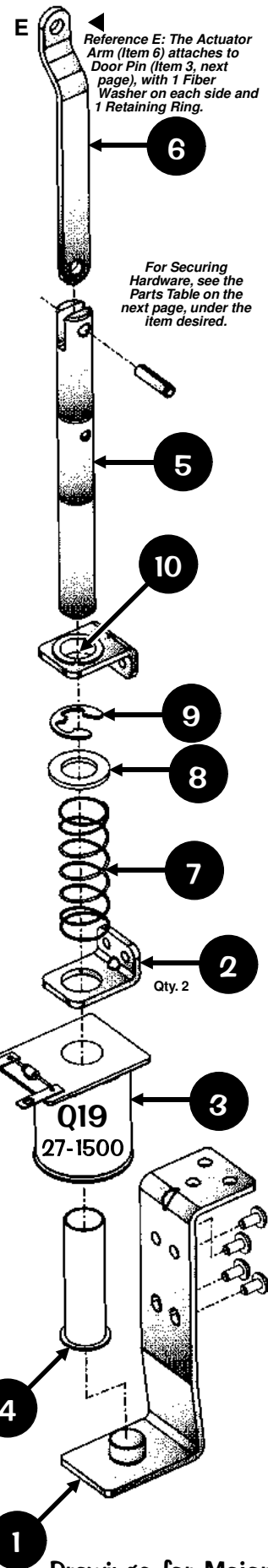
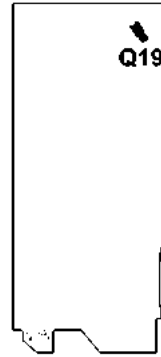

Sec. 4: Drawings ...

*Elvis Presley*

# Hotel Door Coil Assembly, 500-6752-01 (Items 1-10) Continued

◀ Assembly View on previous page. Actuator Arm (Item 6) Controls Hotel Door (Item 3) below.

Nº	INDIVIDUAL PART NAME	QTY.	SPI PART Nº	Nº	INDIVIDUAL PART NAME	QTY.	SPI PART Nº
1	Coil Mounting Bracket Assembly	1	515-7132-00	6	Actuator Arm	1	535-9478-00
Item 1 is sec. below the playfield by: #8 X 1/2" SHWH AB (Zinc) (Qty. 3) (234-5101-00)							
2	Coil Retaining Bracket	2	535-5203-03	7	Compression (Relay) Spring	1	266-5047-00
Item 2 is sec. to Item 1 by: #8-32 X 1/4" PPH MS (Sems) Zinc (Qty. 2/per) (232-5300-00)							
3	Coil, 27-1500	1	090-5004-00B	8	Washer (Nylon) .75" O.D. X .44" I.D.	1	242-5081-00
Coil has a Diode (1N4004) (112-5003-00) positioned @ bot. (below lugs opposite windings).							
4	Coil Sleeve	1	545-5411-00	9	Retaining Ring, 7/16" ø Shaft	1	270-5005-00
5	Plunger Assembly	1	515-7409-00	10	Nyliner 7/16" Shaft O.D. (7L2-FF)	1	545-5418-01
Ordering Note: If 500-6752-01 is unavailable, order the individual part(s) actually required.							

## Hotel Frame, Stand-Up Targets & Switch Individual Parts Only (Items 1-11)

Nº	INDIVIDUAL PART NAME	QTY.	SPI PART Nº	Nº	INDIVIDUAL PART NAME	QTY.	SPI PART Nº
1	Metal Frame (Hotel) Outer	1	535-9475-00	8	Foam Pad (Adhesive, Square Black)	2	626-5029-00
2	Metal Frame (Hotel) Inner	1	535-9476-00	9@	1" Sq. Stand-Up Target White	2	515-5162-08
Items 1 & 2 are sec. above the P/F by: #8 X 1/2" SHWH AB (Zc) (Qty. 1/per) (234-5101-00)							
Item 2 is secured to Item 1 (Reference "A" & "B" in drawing below) by: #8-32 X 5/8" PPH MS Ext. Sems (Zinc) (Qty. 2) (232-5303-00), Washer 13/64" I.D. X 5/8" O.D. X .105" R-A (Qty. 2) (242-5039-00) and #8-32 Nylon Stop Nut (Qty. 2) (240-5102-00)							
Hotel Plastics (previous page) are secured to Items 1 and 2 respectively by: #8-32 X 3/8" SHWH Swg. Ser. (Zinc) Wax (Qty. 1/per) (237-5975-01)							
3	Metal Door (Hotel)	1	535-9477-00	10	Kit: Plastics (Screened & Clear) -09	1	803-5000-84
Assembly Note (Reference "E" in drawing below & prev. page): The Actuator Arm (Item 6, above & prev. page) attaches to Door Pin, with 1 Fiber Washer on each side.							
Item 3 is sec'd @ Door Pin by: Fiber Washer 3/16" I.D. X 3/8" O.D. X .031" (MC95601A305) (Qty. 2) (242-5083-00) and Retaining Ring, 3/16" ø Shaft (Qty. 2) (270-5001-00)							
4	Hinge Pin (Grooved Rod)	1	530-5677-00	Note: Individual Plastic (830-6029-09) is not available individually, ordering of kit is required. For all pieces, see Playfield - Plastics (Screened & Clear) & Decals, Page 67.			
Item 4 is secured through Item 3 by: Retaining Ring, 5/32" ø Shaft Truarc 5133-15 (Qty. 1/per side) (270-5021-15) and #8 Washer (Qty. 1, Right Side) (242-5005-00)							
5	Micro Switch (Roller Actuator, Lite-Force)	1	180-5119-02	Item 10 is sec. to Item 1 and Item 2 (Ref. "C" in drwg. below) by: #8-32 X 1/2" SHWH Swg. Ser. (Zinc) Wax (Qty. 2) (237-5975-01) and #8-32 Nylon Stop Nut (Qty. 2) (240-5102-00)			
Switch has a Diode (1N4004) (112-5003-00). Can be replaced with (1N4001) (112-5001-00).							
6	Sw. Body Protect Plate	1	535-6539-00	11	Kit: Decals (Screened) -82, Hotel Dr.	1	802-5000-84
Items 5 & 6 are sec. to Item 2 by: #2-56 X 1/2" USHWH #4 Hd.Tr3 (Qty. 2) (237-5937-02)							
7	Switch Target Back Plate	2	535-6452-00	Note: Individual Decals (820-6356-82, 820-6362-00) are not available individually, ordering of kit is required. For all pieces, see P/F - Plastics (Screened & Clear) & Decals, Page 67.			
Item 7 is sec'd behind Item 9@ to Item 1 by: #6-32 X 3/4" HWH Sw. Ser. (Zinc) (Qty. 2/per) (237-5976-05)							

### Take Note:

@ "R" indicates Item noted is secured with rivet(s) as listed.

Cable Wiring Harness  
036-5500-16-84  
6-Pin Connector  
045-5007-06  
Shrink Tubing  
605-5004-01 (1') 605-5002-00 (.25')

For Securing Hardware,  
see the Parts Table above,  
under the item desired.

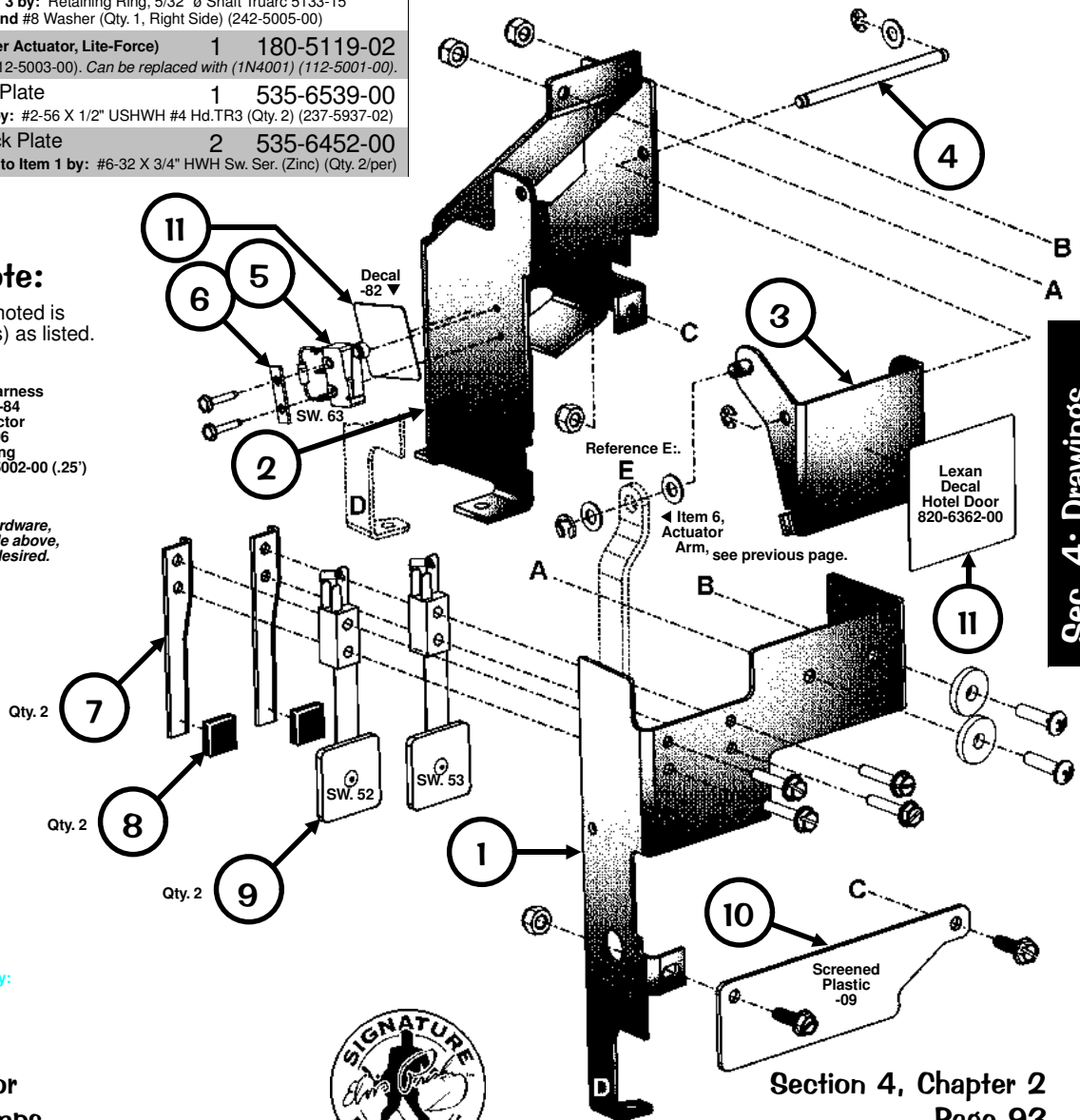

Assembly Reference Only:  
500-6813-00 (1-11)





# Upper Playfield Individual Parts Only (Items 1-10)



Nº	INDIVIDUAL PART NAME	QTY.	SPI PART Nº
1	Upper Playfield Plastic, Thick (Clear)	1	545-6104-00
2	Flatrail (Upper Playfield)	1	535-9410-00
Item 2 is secured to Item 1 by: #8-32 X 1/2 PPH MS Ext. Sems (Zinc) (Qty. 2) (232-5302-00) and #8-32 Nylon Stop Nut (Qty. 2) (240-5102-00)			
3	Support Bracket, Left Wire Ramp	1	535-9472-00
4	Support Bracket, Right Wire Ramp	1	535-9473-00
Items 3 & 4 are secured to Item 1 by: #4-40 X 3/8" PFH MS Blk. Oxide (Qty. 2/per) (237-5983-00) and #4-40 Nylon Stop Nut (Qty. 2/per) (240-5303-00)			
5	Mini-Post MS / #10-32 Bot. .4" Thread	7	530-5005-01
6	Post Hex Base #6-32 Tap/#10-32 Bot.	2	530-5679-00
Items 5 & 6 are secured to Item 1 by: #10-32 Nylon Stop Nut (Qty. 1/per) (240-5203-00)			
7	Rubber Ring, White, 7/16" I.D.	1	545-5348-68
8	Rubber Ring, White, 2.5" I.D.	1	545-5348-59
9	Rubber Ring, White, 3.0" I.D.	1	545-5348-60
10	Kit: Plastics (Clear) -34	1	803-5000-84
Note: Individual Plastic (830-6030-34) is not available individually, ordering of kit is required. For all pieces, see Playfield - Plastics (Screened & Clear) & Decals, Page 67.			
Item 10 is sec. to Item 6 by: #6-32 X 3/8" PPH MS Ext. Sems (Zinc) (Qty. 2) (232-5201-00)			

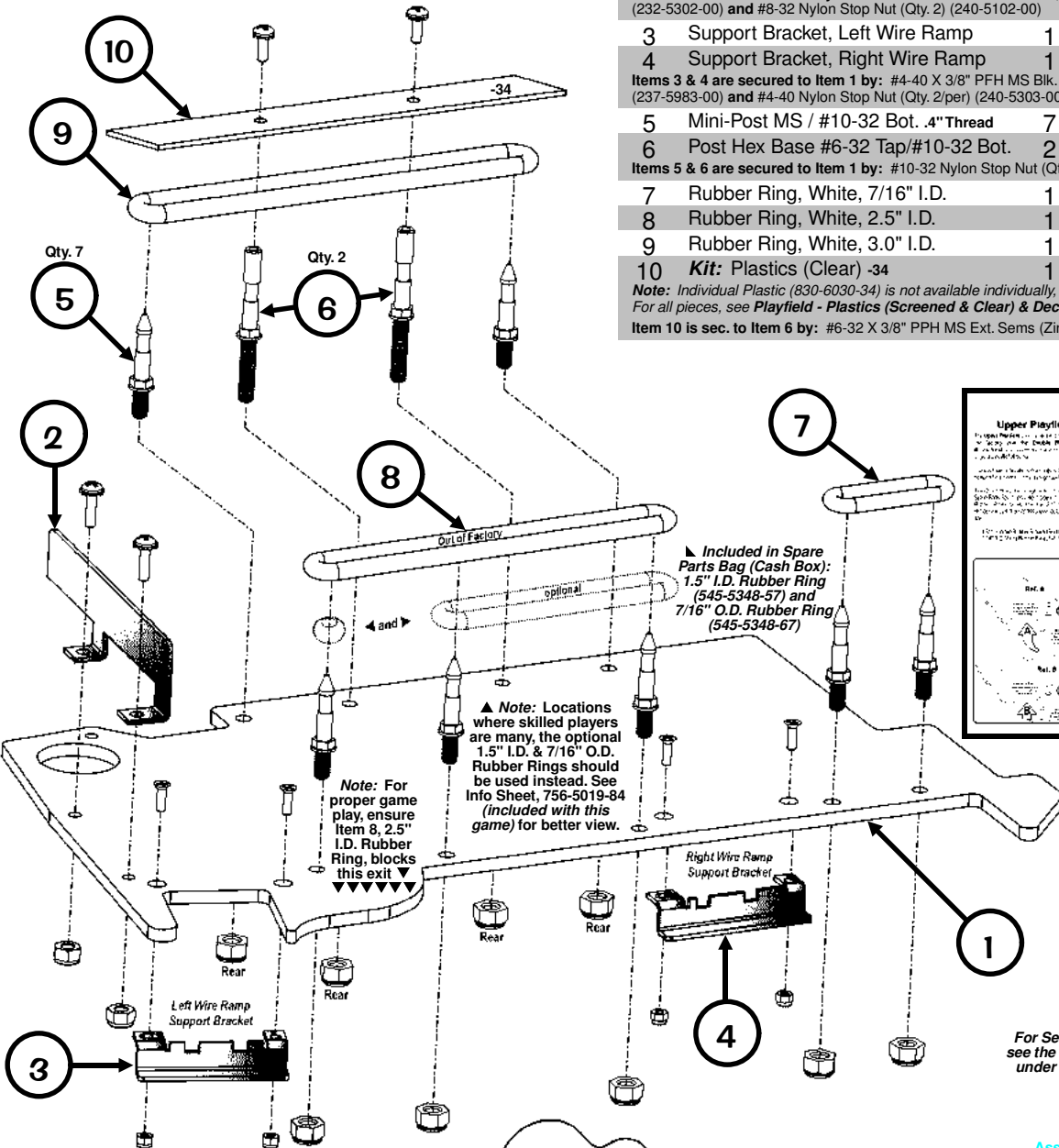

Sec. 4: Drawings ...

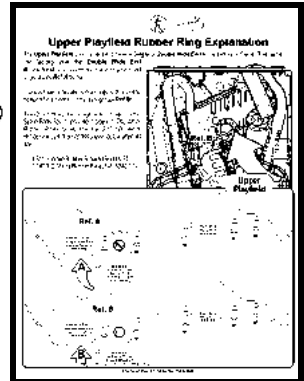

Note: For proper game play, ensure item 8, 2.5" I.D. Rubber Ring, blocks this exit

Note: Locations where skilled players are many, the optional 1.5" I.D. & 7/16" O.D. Rubber Rings should be used instead. See Info Sheet, 756-5019-84 (included with this game) for better view.

Note: See Info Sheet, 756-5019-84 (included with this game) for Detailed Rubber Ring Explanation and better view

For Securing Hardware, see the Parts Table above, under the item desired.

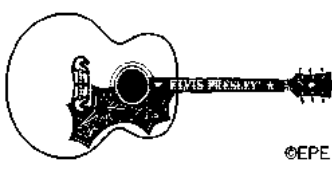

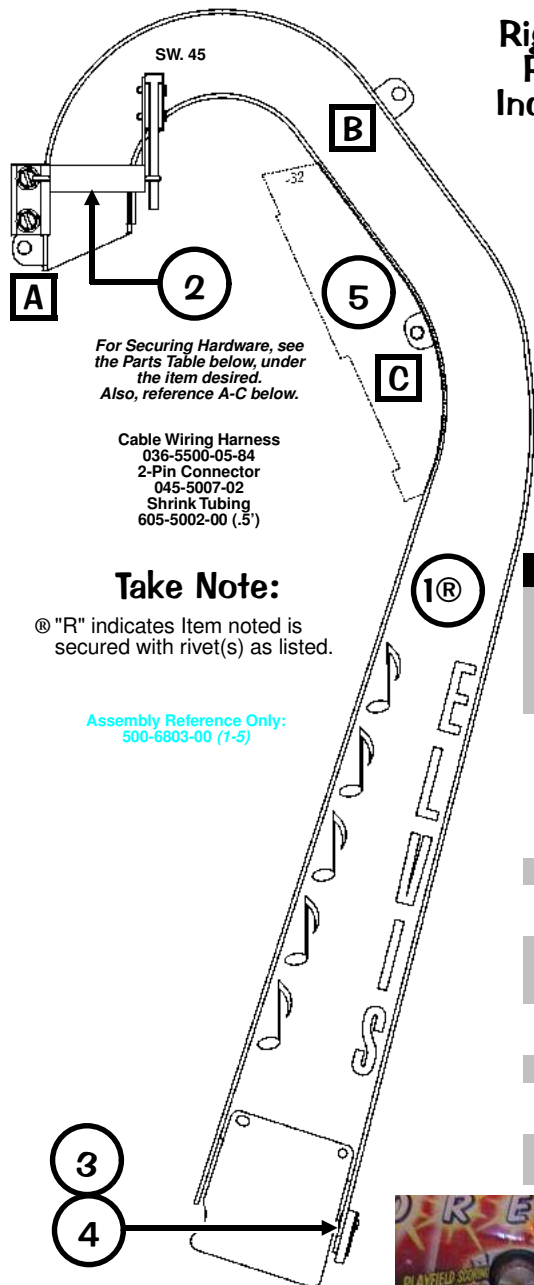

For Securing Hardware, see the Parts Table below, under the item desired.  
Also, reference A-C below.

Cable Wiring Harness  
036-5500-05-84  
2-Pin Connector  
045-5007-02  
Shrink Tubing  
605-5002-00 (.5')

### Take Note:

® "R" indicates Item noted is secured with rivet(s) as listed.

Assembly Reference Only:  
500-6803-00 (1-5)

## Right Steel Ramp & Right Wire Ramp Individual Parts Only (Items 1-9)

For the Support Bracket, see Item 4 on the Previous Page.

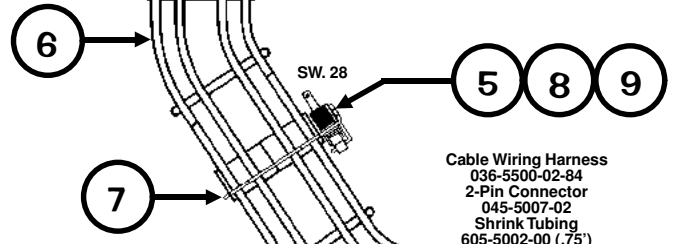

For Securing Hardware, see the Parts Table below, under the item desired.  
Also, reference D-E below.

Cable Wiring Harness  
036-5500-02-84  
2-Pin Connector  
045-5007-02  
Shrink Tubing  
605-5002-00 (.75')

Nº	INDIVIDUAL PART NAME	QTY.	SPI PART Nº
1®	Right Steel Ramp Riveted Assembly	1	515-7396-00
For Individual Items use : Right Steel Ramp (No Parts) (515-7382-00), Ramp Flap (Right) (535-9444-01), #6 Lock Washer (Qty. 2) (246-5000-00) and Rivet, 1/8" ø X 3/16" Lg. (Qty. 2) (249-5001-00).			
Item 1 is secured below the playfield by: #8-32 Nylon Stop Nut (Qty. 2) (240-5102-00) and #8 Washer (Qty. 2) (242-5005-00) Item 1 is secured above the P/F: Ref. A-C below.			
2	Ramp Gate Switch (Right)	1	500-6593-00
For Individual Items use : Gate Bracket (Left) (535-9171-00), Wire Form (535-9172-00), Micro Switch (Qty. 1) (180-5190-28), #2-56 X 1/2" HWH Ser Black (Qty. 2) (237-5937-02), Switch Body Protect Plate (Qty. 1) (535-6539-00), #2-56 Hex Nut (Qty. 2) (240-5301-00), Switch Diode (1N4004) (Qty. 1) (112-5003-00)			
Item 2 is sec'd to Item 1 by: #6-32 X 1/2" PPH MS Ext. Sems (Zinc) (Qty. 2) (232-5202-00), #6 Washer (Qty. 2) (242-5001-00) and #8-32 Nylon Stop Nut (Qty. 2) (240-5102-00)			
3	Rubber Bumper (Blue)	1	626-5057-01
4	Bumper Holder Bracket	1	535-9366-01
Item 4 is secured to Item 1 by: #4-40 X 5/16" PFH U/cut MS (Zinc) (Qty. 2) (237-6151-00)			
5	Kit: Plastics (Clear) -32, -45	1	803-5000-84
Note: Individual Plastics (830-6030-XX) are not available individually, ordering of kit is required. For all pieces, see Playfield - Plastics (Screened & Clear) & Decals, Page 67.			
6	Right Wire Ramp	1	515-7407-00
Item 6 is secured above the P/F: Reference D-E below.			
7	Wire Form (Gate)	1	535-9375-00
8	Micro Switch (1-5/8" Actuator)	1	180-5010-01
Switch has a Diode (1N4004) (112-5003-00). Can be replaced with (1N4001) (112-5001-00).			
9	Switch Body Protect Plate	1	535-6539-00
Items 8 & 9 sec'd to Item 6 by: #2-56 X 1/2" SHWH #4 Hd.TR3 (Qty. 2) (237-5937-02)			

- A** = #6-32 X 3/8" PPH MS Ext. Sems (Zinc) (232-5201-00) and #6-32 Keps Nut (240-5008-00)
  - B** = 2-5/8" X 1/4" Hex Spacer #6-32 Tap (254-5008-08), #6 Washer (242-5001-00) and #6-32 X 3/8" PPH MS Ext. Sems (Zinc) (232-5201-00)
  - C** = Above Tab to Plastic: 1-1/8" X 1/4" Hex Spacer #6-32 Tap / #6-32 Threaded End (254-5024-17) and #6-32 X 3/8" PPH MS Ext. Sems (Zinc) (232-5201-00) **Note: Other Corner of Clear Plastic has #6-32 X 2-1/4" PPH MS Zinc (237-5514-00), 1-15/16" X 3/8" Plastic Spacer (Gry/Blk) (254-5000-15) and below tab: 2-5/8" X 1/4" Hex Spacer #6-32 Tap (254-5008-08) & #6 Wshr (242-5001-00)**
  - D** = 2" X 1/4" Hex Spacer #6-32 Tap (254-5008-07) and #6-32 X 3/8" PFH 82° U/cut (237-5871-00)
  - E** = #6-32 X 3" PPH MS Zinc (237-5515-00), 5/8" X 3/8" Plastic Spacer (Gry/Blk) (254-5000-15), Washer, .187" I.D. X .875" X .048" Zinc (242-5059-00), Washer, 13/64" I.D. X 5/8" X .105" R-A (242-5039-00), .2" I.D. X .625" O.D. X .058" (242-5038-00) and #6-32 Nylon Stop Nut (240-5005-00)
- Note:** Hex Spacers are secured to the Playfield by #6-32 X 7/8" Fin Shank Screw BNT PT Zinc (237-5921-04).

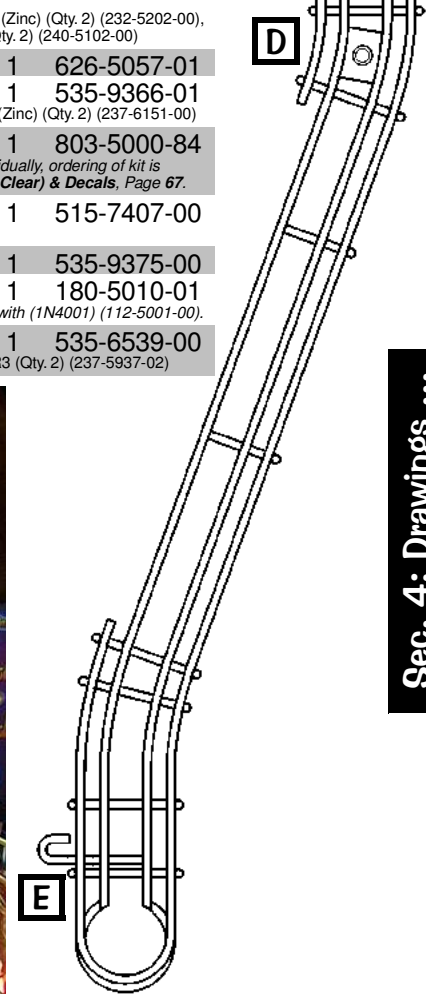

Assembly Reference Only:  
500-6811-00 (6-9)

Sec. 4: Drawings ...



# Left Wire Ramp & Lt. Steel Ramp Ind. Parts Only (Items 1-11) C

Parts Table on the next page. ▶

- Cable Wiring Harness (Switch)  
036-5500-12-84
- Cable Wiring Harness (Q31 Flash)  
036-5500-25-84
- 2-Pin Connector  
045-5007-02
- Shrink Tubing  
605-5002-00 (.75")
- Cable Wiring Harness (Lamps)  
036-5500-19-84
- 2 X 3 Connector  
045-5004-06
- Shrink Tubing  
605-5002-00 (.75")

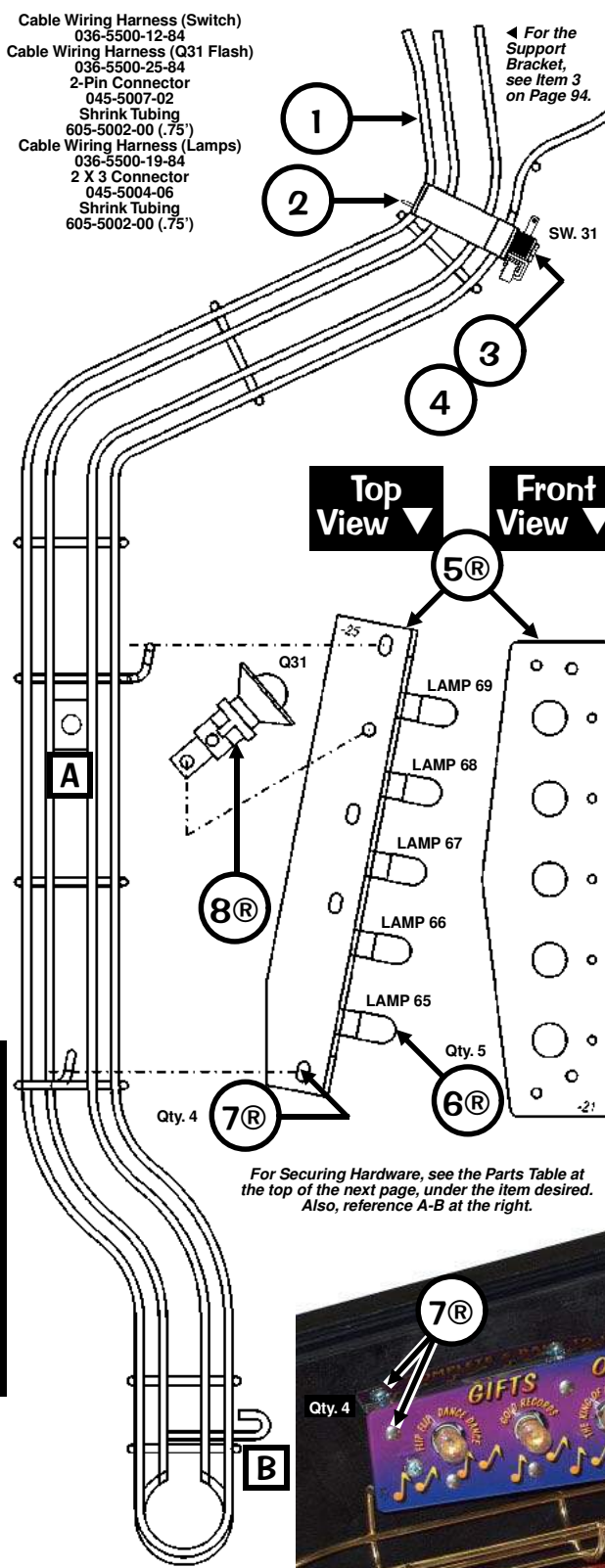

For Securing Hardware, see the Parts Table at the top of the next page, under the item desired. Also, reference C-F below.



- Cable Wiring Harness  
036-5500-05-84
- 2-Pin Connector  
045-5007-02
- Shrink Tubing  
605-5002-00 (.5")



Sec. 4: Drawings ...

For Securing Hardware, see the Parts Table at the top of the next page, under the item desired. Also, reference A-B at the right.

Assembly Reference Only:  
500-6804-00 (9-17)

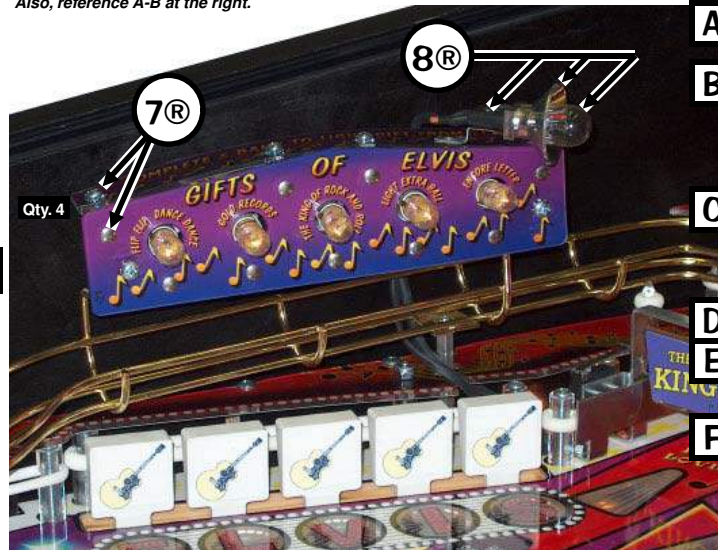

- A** = 2" X 1/4" Hex Spacer #6-32 Tap (254-5008-07) and #6-32 X 3/8" PFH 82° U/cut (237-5871-00)
- B** = #6-32 X 3" PPH MS Zinc (237-5515-00), 5/8" X 3/8" Plastic Spacer (Gry/Blk) (254-5000-15), Washer, .187" I.D. X .875" X .048" Zinc (242-5059-00), Washer, 13/64" I.D. X 5/8" X .105" R-A (242-5039-00), .2" I.D. X .625" O.D. X .058" (242-5038-00) and #6-32 Nylon Stop Nut (240-5005-00)
- C** = Above Tab to Plastic: 1-1/8" X 1/4" Hex Spacer #6-32 Tap / #6-32 Threaded End (254-5024-17) and #6-32 X 3/8" PPH MS Ext. Sems (Zinc) (232-5201-00) and below tab: 2-5/8" X 1/4" Hex Spacer #6-32 Tap (254-5008-08) & #6 Washer (242-5001-00)
- D** = 2-5/8" X 1/4" Hex Spacer #6-32 Tap (254-5008-08) & #6 Washer (242-5001-00)
- E** = 2-3/4" X 1/4" Hex Spacer #6-32 Tap (254-5008-15), #6 Washer (242-5001-00) and #6-32 X 3/8" PPH MS Ext. Sems (Zinc) (232-5201-00)
- F** = 2-1/4" X 1/4" Hex Spacer #6-32 Tap (254-5008-18), #6 Washer (242-5001-00) and #6-32 X 3/8" PPH MS Ext. Sems (Zinc) (232-5201-00)

Note: Hex Spacers are secured to the Playfield by #6-32 X 7/8" Fin Shank Screw BNT PT Zinc (237-5921-04).

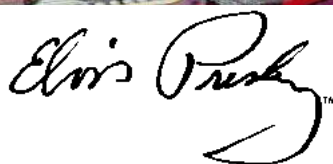

# Left Wire Ramp & Left Steel Ramp (Items 1-11) Individual Parts Only Continued

◀ Views on previous previous page.

Nº	INDIVIDUAL PART NAME	QTY.	SPI PART Nº	Nº	INDIVIDUAL PART NAME	QTY.	SPI PART Nº
1	Left Wire Ramp	1	515-7406-00	8®	Wedge Base Socket (Laydown)	1	077-5026-01
Item 1 is secured above the P/F: Reference A-B at bottom of the previous page.							
2	Wire Form (Gate)	1	535-9375-00		Light Reflector (Silver Plastic)	1	545-5409-01
3	Micro Switch (1-5/8" Actuator)	1	180-5010-01		#906 Bulb (Clear)		165-5004-00
Switch has a Diode (1N4004) (112-5003-00). Can be replaced with (1N4001) (112-5001-00).							
4	Switch Body Protect Plate	1	535-6539-00	Items 6-8 are sec'd to Plastics by: Rivet, 1/8" ø X 3/16" Lg. (Qty. 1/per) (249-5001-00)			
Items 3 & 4 sec'd to Item 1 by: #2-56 X 1/2" SHWH #4 Hd.TR3 (Qty. 2) (237-5937-02)							
5®	Kit: Plastics (Screened) -21, -25	1	803-5000-84	9®	Left Steel Ramp Riveted Assembly	1	515-7397-00
Note: Individual Plastics (830-6029-XX) are not available individually, ordering of kit is required. For all pieces, see Playfield - Plastics (Screened & Clear) & Decals, Page 67.							
6®	3-Lug Stand-Up Short Socket	5	077-5008-00	For Individual Items use : Left Steel Ramp (No Parts) (515-7383-00), Ramp Flap (Left) (535-9444-00), #6 Lock Washer (Qty. 2) (246-5000-00) and Rivet, 1/8" ø X 3/16" Lg. (Qty. 2) (249-5001-00).			
	#44 Bulb (Yellow)		165-5053-06	Item 9 is sec'd below the P/F by: #8-32 Nylon Stop Nut (Qty. 2) (240-5102-00) and #8 Washer (Qty. 2) (242-5005-00) Item 9® is sec'd above the P/F: Ref. C-F bot. prev. pg.			
7®	Bracket, 90°	4	535-8941-00	10	Ramp Gate Switch Assembly	1	515-6556-05
Items 5 & 7 are secured to Plastic -25 & Item 1 by: #6-32 X 3/8" PPH MS Ext. Sems (Zinc) (Qty. 1/per) (232-5201-00) and #6-32 Keps Nut (Qty. 1/per) (240-5008-00)							
For Individual Items use : Gate Bracket (535-7756-02), Wire Form (535-6304-03), Micro Switch (Qty. 1) (180-5087-00), #2-56 X 1/2" HWH Ser Black (Qty. 2) (237-5937-02), Switch Body Protect Plate (Qty. 1) (535-6539-00), #2-56 Hex Nut (Qty. 2) (240-5301-00), Switch Diode (1N4004) (Qty. 1) (112-5003-00)							
Item 10 is secured to Item 9® by: #6-32 X 3/8" PPH MS Ext. Sems (Zinc) (Qty. 2) (232-5201-00) and #8-32 Nylon Stop Nut (Qty. 2) (240-5102-00)							
				11	Kit: Plastics (Clear) -36 & 830-6032-00	1	803-5000-84
Note: Individual Plastic (830-6030-36 & 830-6032-00) is not available individually, ordering of kit is required. For all pieces, see P/F - Plastics (Screened & Clear) & Decals, Page 67.							

## Take Note:

® "R" indicates Item noted is secured with rivet(s) as listed.



## Back Panel Individual Parts Only (Items 1-8)

Nº	INDIVIDUAL PART NAME	QTY.	SPI PART Nº	Nº	INDIVIDUAL PART NAME	QTY.	SPI PART Nº
1	Elvis Back Panel (Wood) No Parts	1	525-5639-00	6	Mini-Mars (Yellow)	1	550-5031-06
2	2-Lug Staple-Down Socket	10	077-5000-00	7	Bracket, Back Panel & Playfield Mount	2	535-8964-00
	#44 Bulb (Clear) Heavy Filament		165-5000-44-HF	Items 5 - 7 are sec'd to Item 1 by: #8 X 1/2" SHWH AB (Zinc) (Qty. 2/per) (234-5101-00)			
3	3-Lug Laydown Socket (2 Lugs Bent)	9	077-5032-00	8	Kit: Plastics (Screened)	1	803-5000-84
	#44 Bulb (Clear) Heavy Filament		165-5000-44-HF	Note: Individual Plastics (830-6031-00) are not available individually, ordering of kit is required. For all pieces, see Playfield - Plastics (Screened & Clear) & Decals, Page 67.			
4	2-Lug Stand-Up Short Socket	3	077-5032-00	Not Shown 1/4" & 1/2" Clamp (Single) 3 040-5000-XX			
	#89 Bulb (Clear) Heavy Filament		165-5000-89-HF	Above secured to Item 1 by: #6 X 1/2" SLT HWH AB (Red) (Qty. 1/per) (234-5001-02)			
5	Mini-Mars (Clear)	1	550-5031-01	-XX Note: for 1/4" use -03 (Qty. 2); for 1/2" use -06 (Qty. 1);			

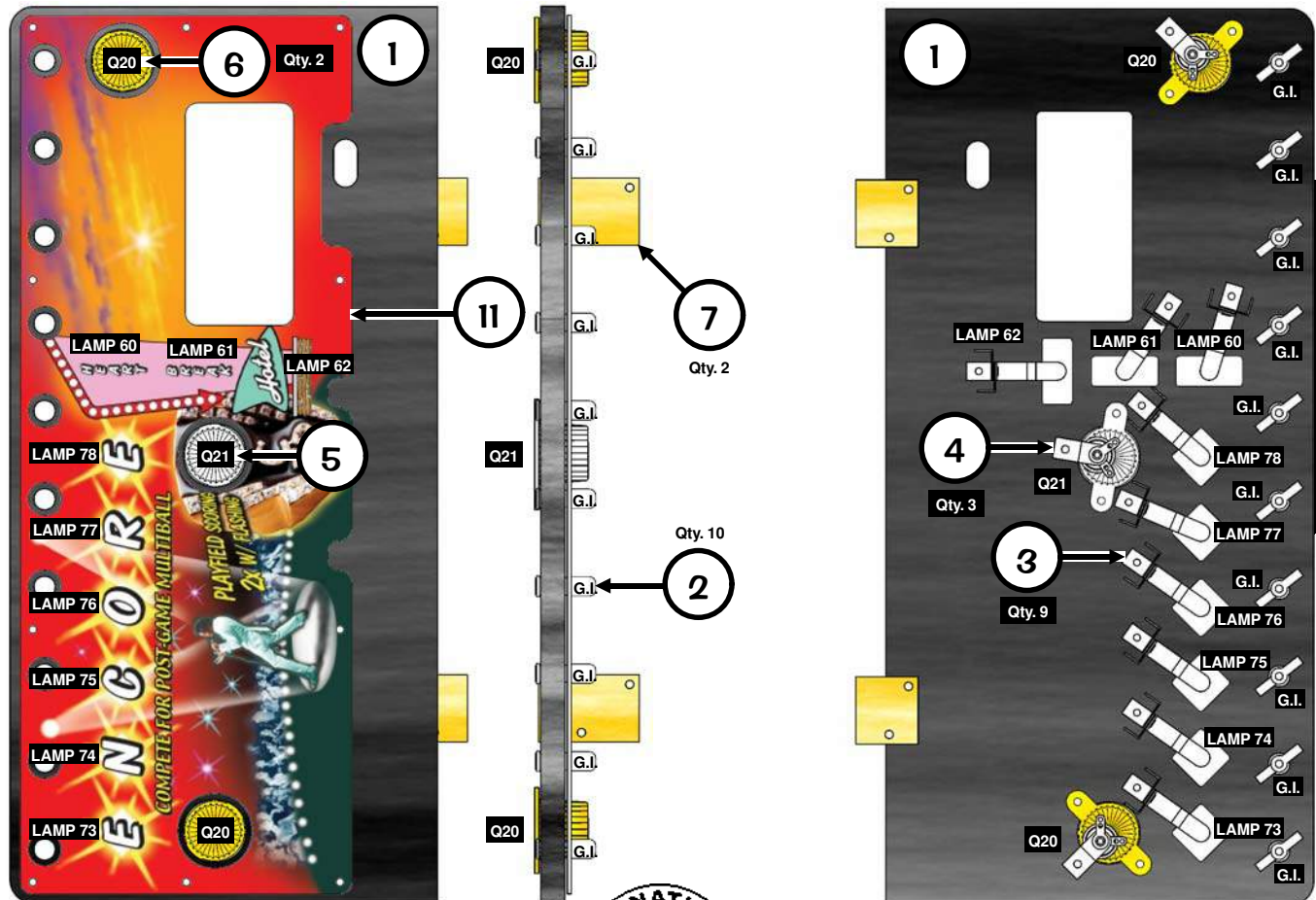

**UK ONLY OPTIONAL**  
**Ball Deflector Assemblies, 500-5788-02**  
**(Qty. 2) (Items 1-8)**

**UK ONLY OPTIONAL**  
**Up/Down Post Assy., 500-6293-00**  
**(Items 1-9)**

Nº	INDIVIDUAL PART NAME	QTY.	SPI PART Nº
1	Ball Deflector Coil Mounting Bracket	1	535-6857-02
Item 1 is secured below the playfield by: #8 X 1/2" HWH AB (Zinc) (Qty. 4) (234-5101-00)			
2	Coil Retaining Bracket	1	535-5203-03
Item 2 is secured by: #8-32 X 1/4" PPH MS (Sems) Zinc (Qty. 2) (232-5300-00)			
3	Coil, 26-1200	1	090-5044-00T
Coil has a Diode (1N4004) (112-5003-00) positioned @ top (above lugs next to windings).			
4	Coil Sleeve (Short) (Formost #10-7077)	1	545-5076-01
5	Spring Washer (17/32" ID X 3/4" X 1")	1	269-5002-00
6	Solid Plunger Assembly	1	515-6858-00
7	Compression (Relay) Spring	1	266-5022-01
8	#10-32 Adj. Spindle Stop w/Rubber Tip	1	280-5014-00
Item 8 is secured by: #10-32 Keps Nut (Qty. 1) (240-5208-00)			
<b>Ordering Note:</b> If 500-5788-02 is unavailable, order the individual part(s) actually required.			

Nº	INDIVIDUAL PART NAME	QTY.	SPI PART Nº
1	Up/Down Post Coil Mounting Bracket	1	515-6840-00
Item 1 is secured below the playfield by: #8 X 1/2" HWH AB (Zinc) (Qty. 6) (234-5101-00)			
2	Coil Retaining Bracket	2	535-7356-00
Items 2 & 3 are secured by: #8-32 X 3/8" Swage (Serr) Zinc (Qty. 2/per) (237-5975-00)			
3	Coil, 23-1100 (ORG)	1	090-5030-00T
Coil has a Diode (1N4004) (112-5003-00) positioned @ top (above lugs next to windings).			
4	Coil Sleeve (with extension)	1	545-5847-00
5	Spring Washer, 17/32" ID X 3/4" X 1"	1	269-5002-00
6	Ball Bumper, Plunger & Shaft Assy.	1	515-6844-00
<b>For Individual Items use:</b> Ball Bumper Plastic (Top) Red (550-5029-02), Plunger & Shaft Only (515-6841-00), Plunger Head (detachable) (530-5511-00), #10-32 X 3/8" PPH MS (Sems) Zinc (secures Plunger Head to Shaft) (232-5401-00), Roll Pin 3/32" ø x 1/2" Long (251-5002-00) and Retaining Ring, 1/4" ø Shaft (270-5002-00)			
<b>Ordering Note:</b> If 515-6844-00 is unavailable, order the individual part(s) actually required.			
7	Compression (Relay) Spring	1	266-5022-01
8	#10-32 Adj. Spindle Stop w/Rubber Tip	1	280-5014-00
Item 9 is secured by: #10-32 Keps Nut (Qty. 1) (240-5208-00)			
9	Adjustment Spindle Stop Bracket	1	535-8303-00
<b>Ordering Note:</b> If 500-6293-00 is unavailable, order the individual part(s) actually required.			

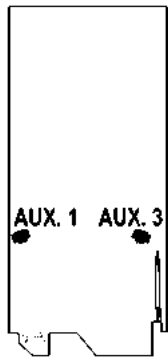

**Take Note:**

⊖ **Coil Note:** ⊖ Either -00B or -00T can be used for coil replacements. B/T listed is preferable for easier diode access and may differ on game.

**Top View**

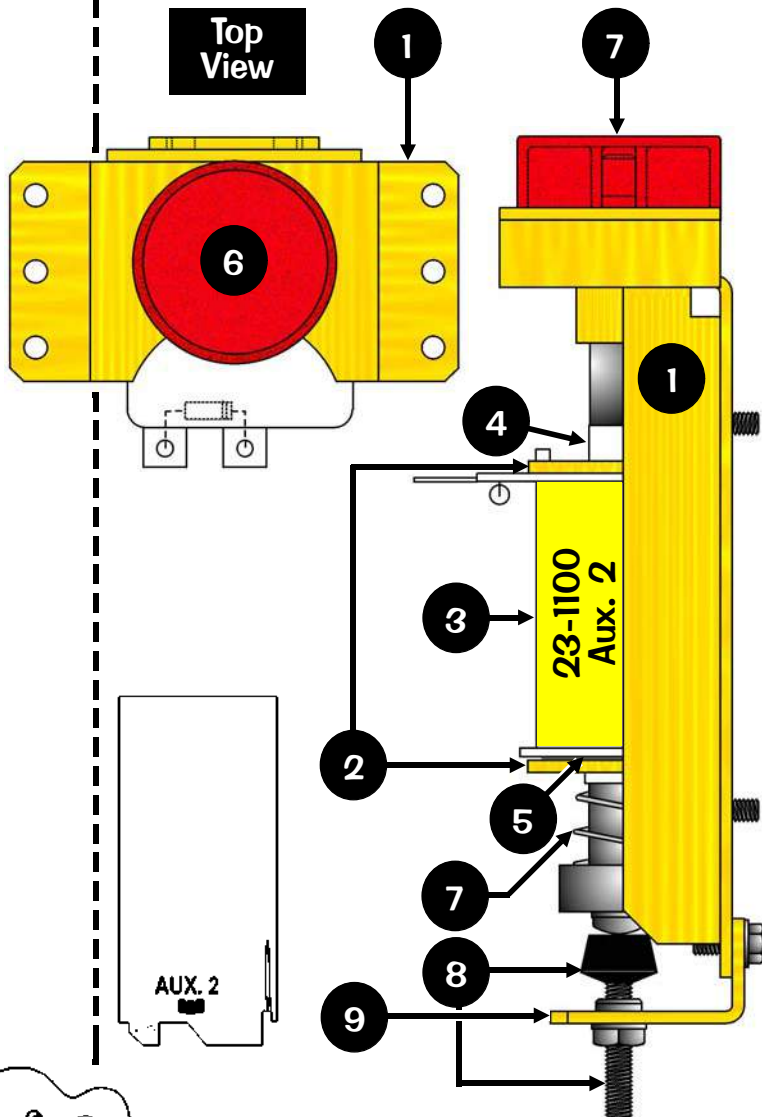
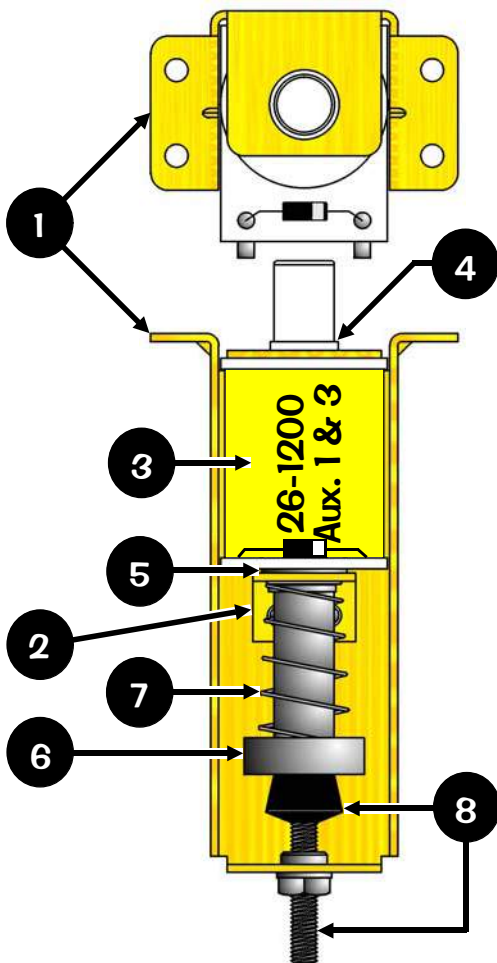

**Take Note:**

⊖ **Coil Note:** ⊖ Either -00B or -00T can be used for coil replacements. B/T listed is preferable for easier diode access and may differ on game.

**Top View**

# Backbox I/O Power Driver Board Detailed Wiring Diagram

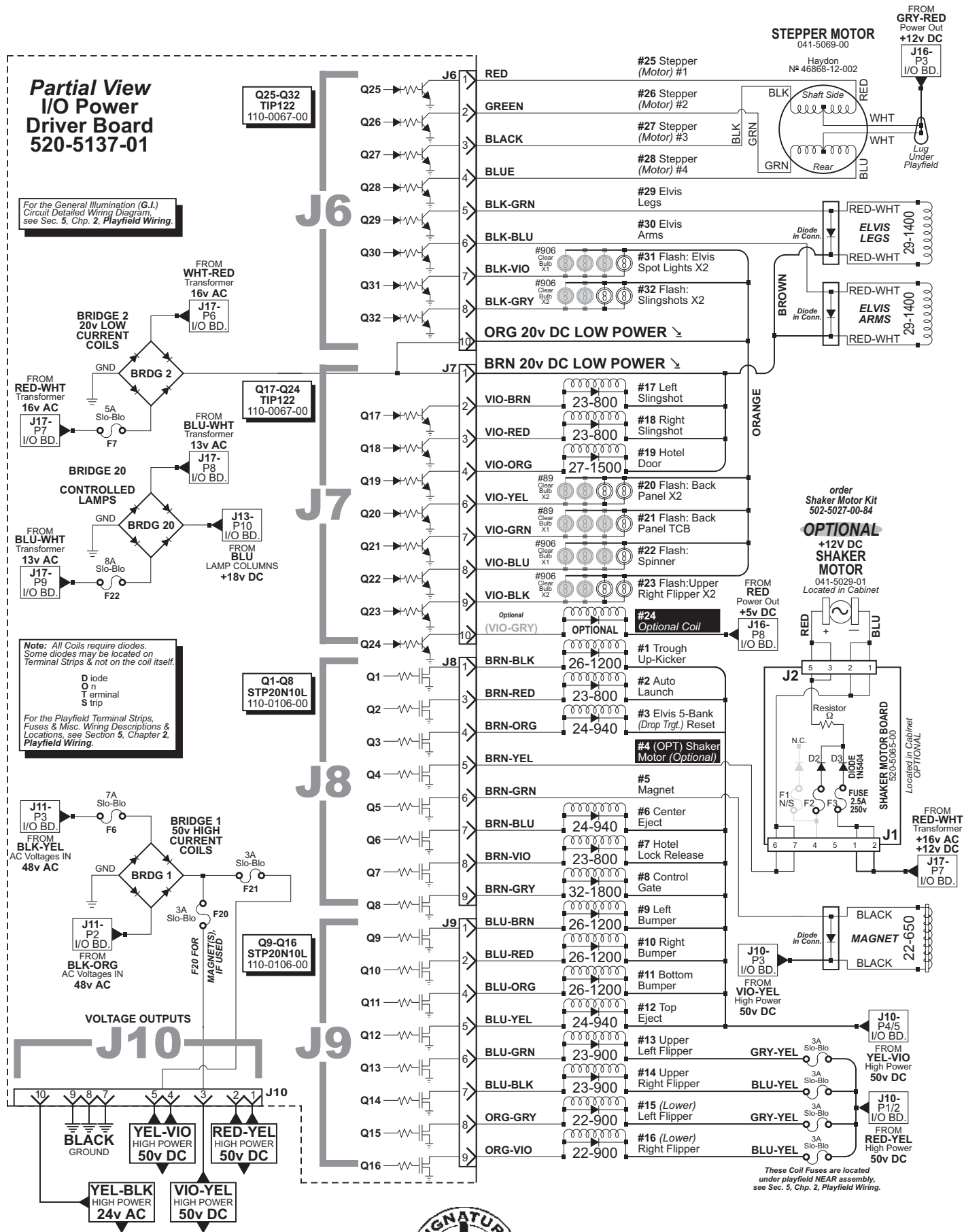

# Backbox Board Layout Wiring Diagram

See Section 5, Chapter 4, Printed Circuit Boards (PCBs), Pages 143-148, for UK & Special Application(s) 3X Transistor Driver Board and ToPS™ Overview & Wiring, regarding the use of J2 & J3.

**J3 ONLY** used if UK GAME (Aux. Driver Bd. Required) or if ToPS™ Kit is installed, Tournament Serial Interface (TSI) Board required. or if Printer Interface Board is used (see Sec. 5, Chp. 3, Cabinet/Coin Door Wiring Diagram, bottom right corner).

**J2 I/O** to under Playfield Connector for 19-LED Board (Rings)..

Move Conn. J2 to J4 on TSI Bd. if ToPS™ Kit installed, then connect the Tournament Connector from J1 on TSI Bd. to J2 I/O Board.

**Note:** If the Printer Interface Board is used, the Dot Display or Tournament Wiring must be disconnected from J2 and/or J3.

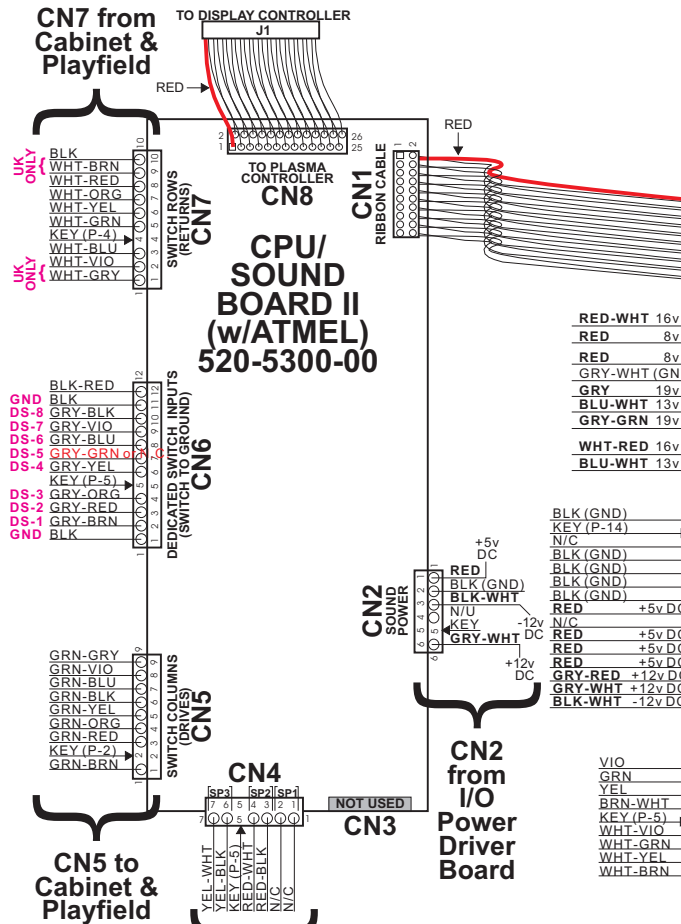

**Important:** When connecting any Ribbon Cable, always ensure the "Red Line" side of the ribbon cable goes to the Pin-1 side of any Dual 0.1" Header Connector.

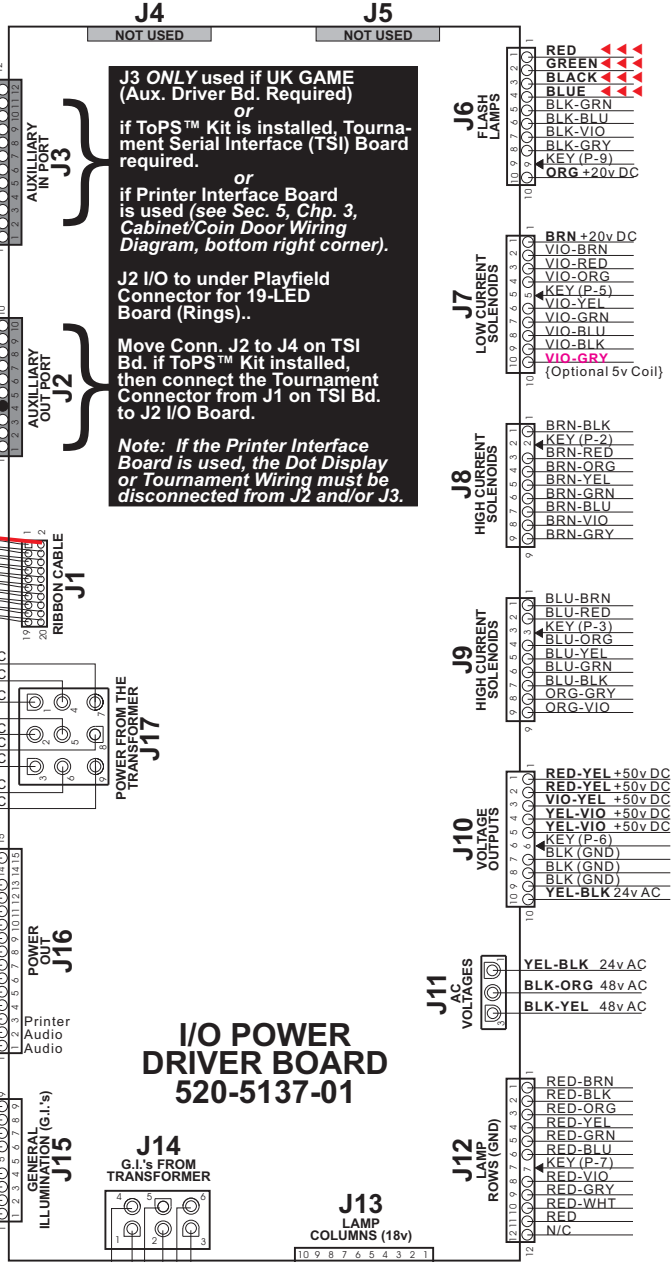

Sec. 5: Backbox ...

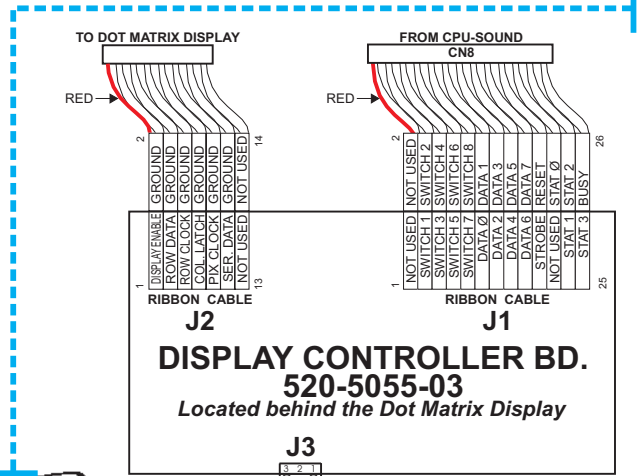
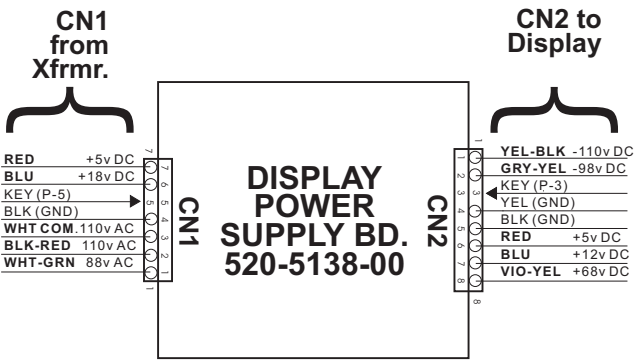

*Elvis Presley*

# Playfield Wiring

## General Illumination Circuit Detailed Wiring Diagram

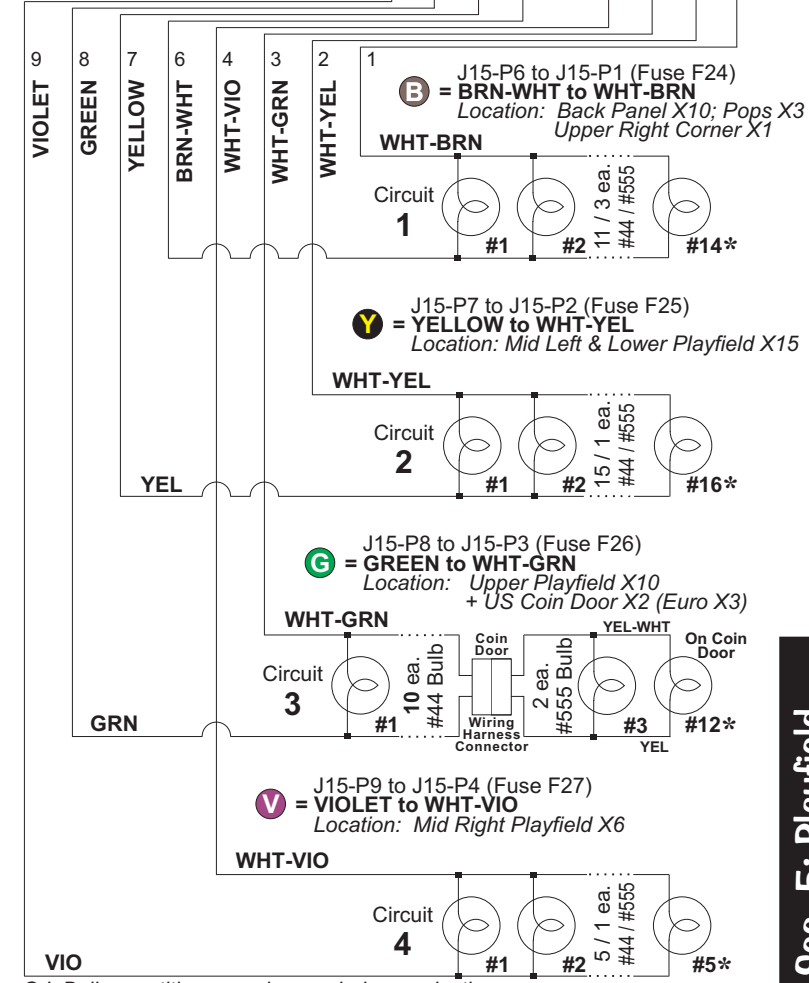
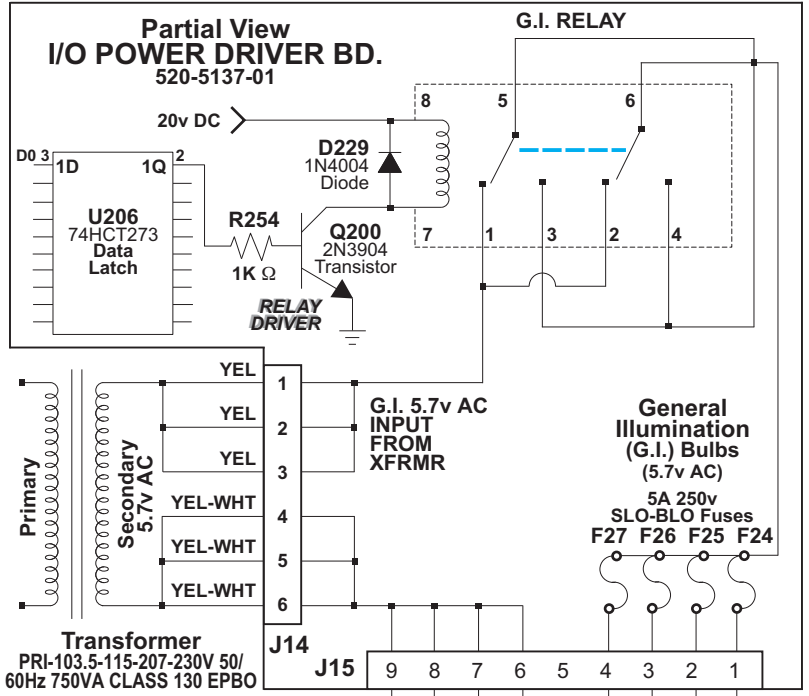
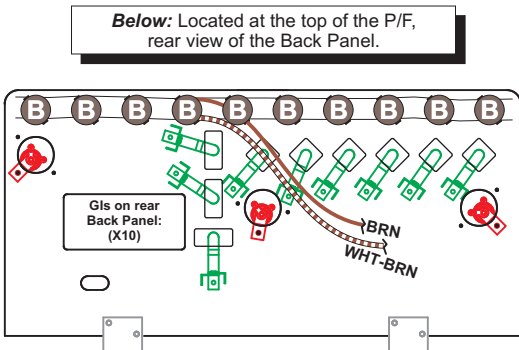
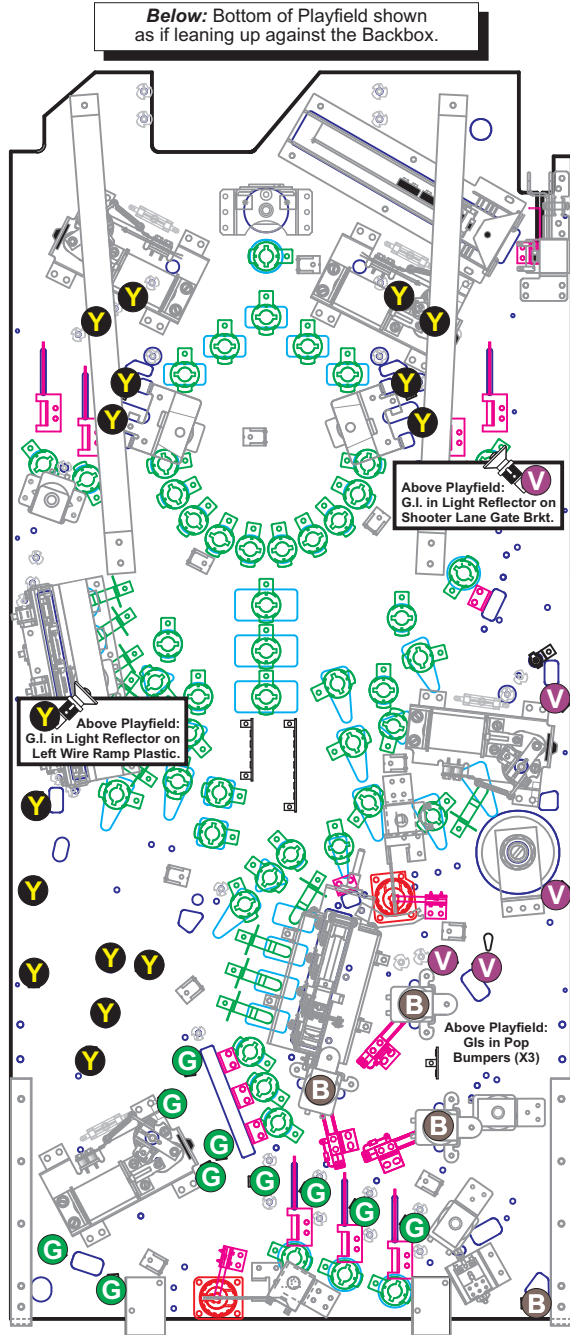

\* G.I. Bulb quantities may change during production.





# Playfield Switch Wiring Diagram

Note: All Switch, Lamp & Coil assemblies require diodes. Some diodes are located under the playfield on Terminal Strips or Diode Boards and not on the assemblies.

For Switch(es): 17-21

Diode On Terminal Strip

Diode On Diode Board

Switch Drive Transistor Source N#: 2N3904

SWITCH DRIVE Wire & Transistor

CN5 PIN

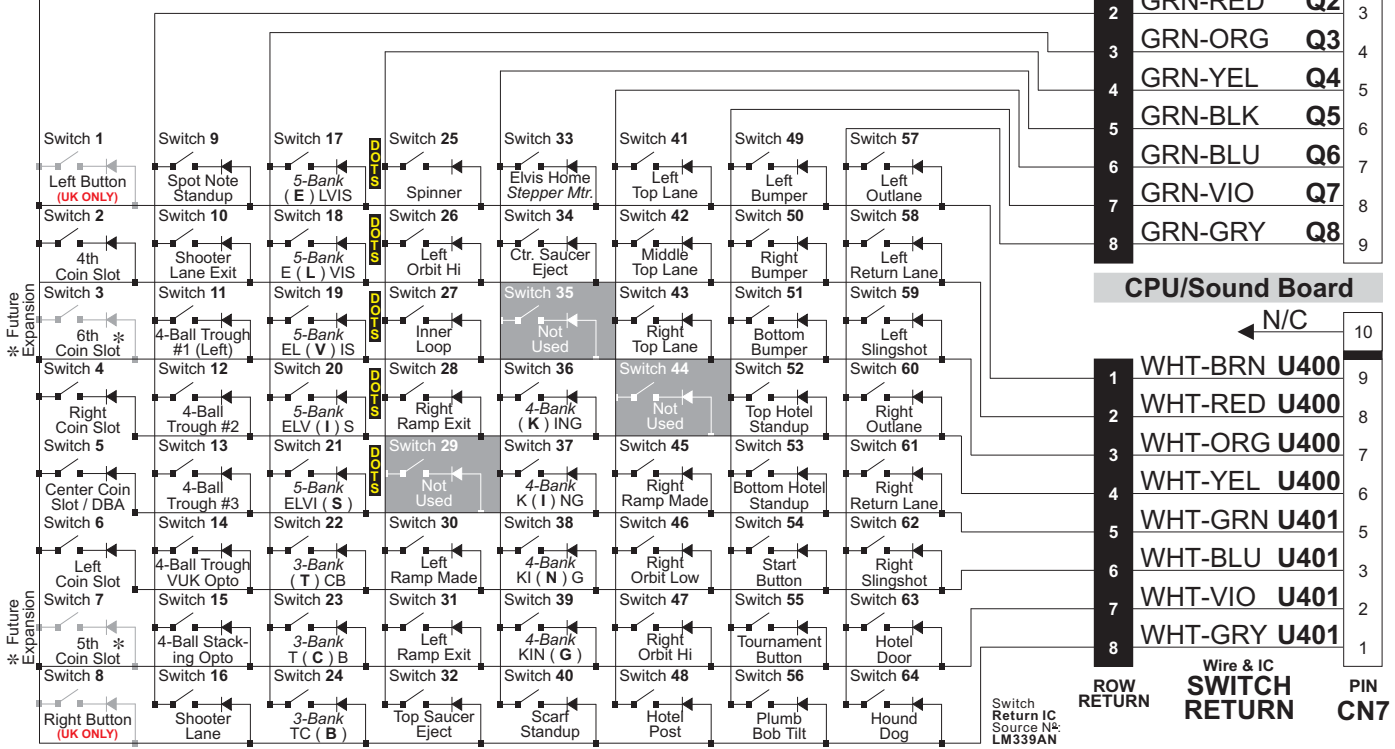

# Playfield Lamp Wiring Diagram

Note: All Switch, Lamp & Coil assemblies require diodes. Some diodes are located under the playfield on Terminal Strips or Diode Boards and not on the assemblies.

For Lamp(s): No DOTS

Diode On Terminal Strip

Diode On Diode Board

J13-Pin 10 is Power Out for +18v DC to the Display Power Supply Bd at CN1-Pin 6

BLUE

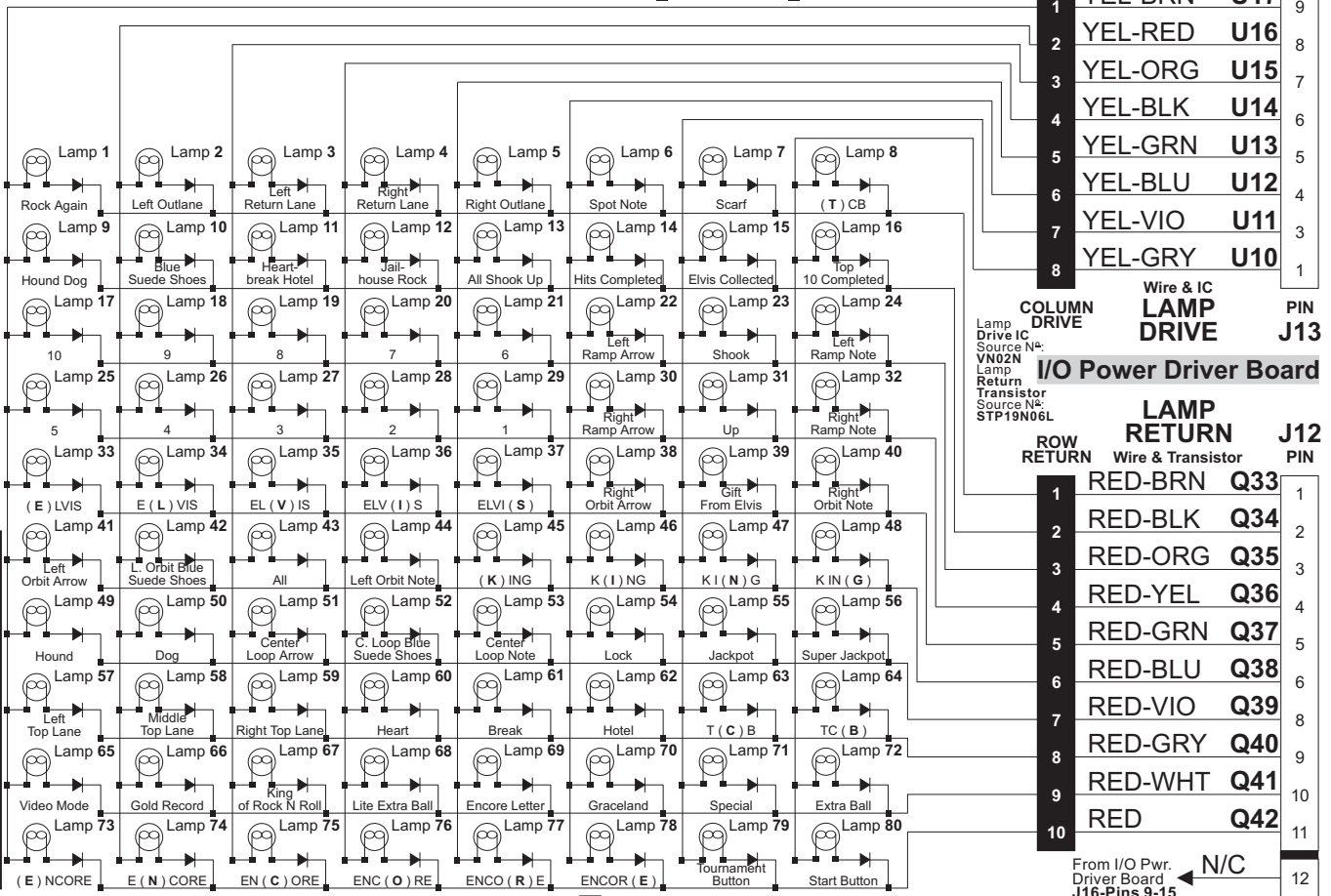

Sec. 5: Playfield ...



# Playfield Terminal Strips, Fuses & Misc. Wiring Descriptions & Locations

Please Note: Terminal Strip(s), Diode Board(s) and/or Fuse Holder(s) locations shown, represent the general location (your game may differ slightly).

All fuses are rated:  
**3A 250v Slo-Blo**  
 Do Not Over-Fuse

Bottom of Playfield  
 Shown as if leaning  
 up against the  
 Backbox.

## Explanation:

All Switch, Lamp & Coil assemblies require diodes. Some diodes are **located under the playfield** on Terminal Strips **or** Diode Boards and not on the assemblies. The Switch and Lamp Matrix Grids also note which Switch or Lamp has a diode on a Terminal Strip (noted by **"DOTS"** meaning: **"Diode On Terminal Strip"**) or on a Diode Board (noted by **"DODB"** meaning: **"Diode On Diode Board"**).

## Legend:

S = Switch Matrix Number (Below P/F Only)

L = Lamp Matrix Number (Below P/F Only)

Q = Coil / Flash (see Page 101)

DTS / TS = (Diode) Terminal Strips & Lug  
 (A-D)

**LOWER LEFT FLIPPER FUSE**

RED 3A S.B. GRY-YEL  
 -YEL

**LOWER RIGHT FLIPPER FUSE**

RED 3A S.B. BLU-YEL  
 -YEL

**UPPER RIGHT FLIPPER FUSE**

RED 3A S.B. BLU-YEL  
 -YEL

**UPPER LEFT FLIPPER FUSE**

RED 3A S.B. GRY-YEL  
 -YEL

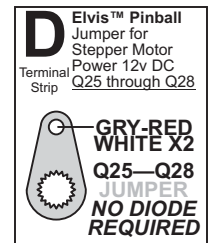
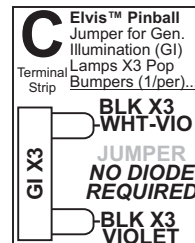
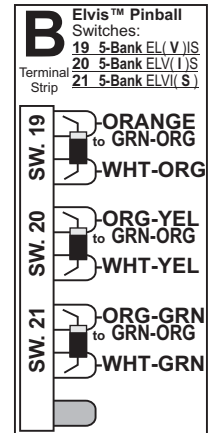
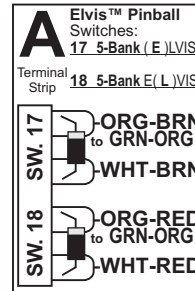
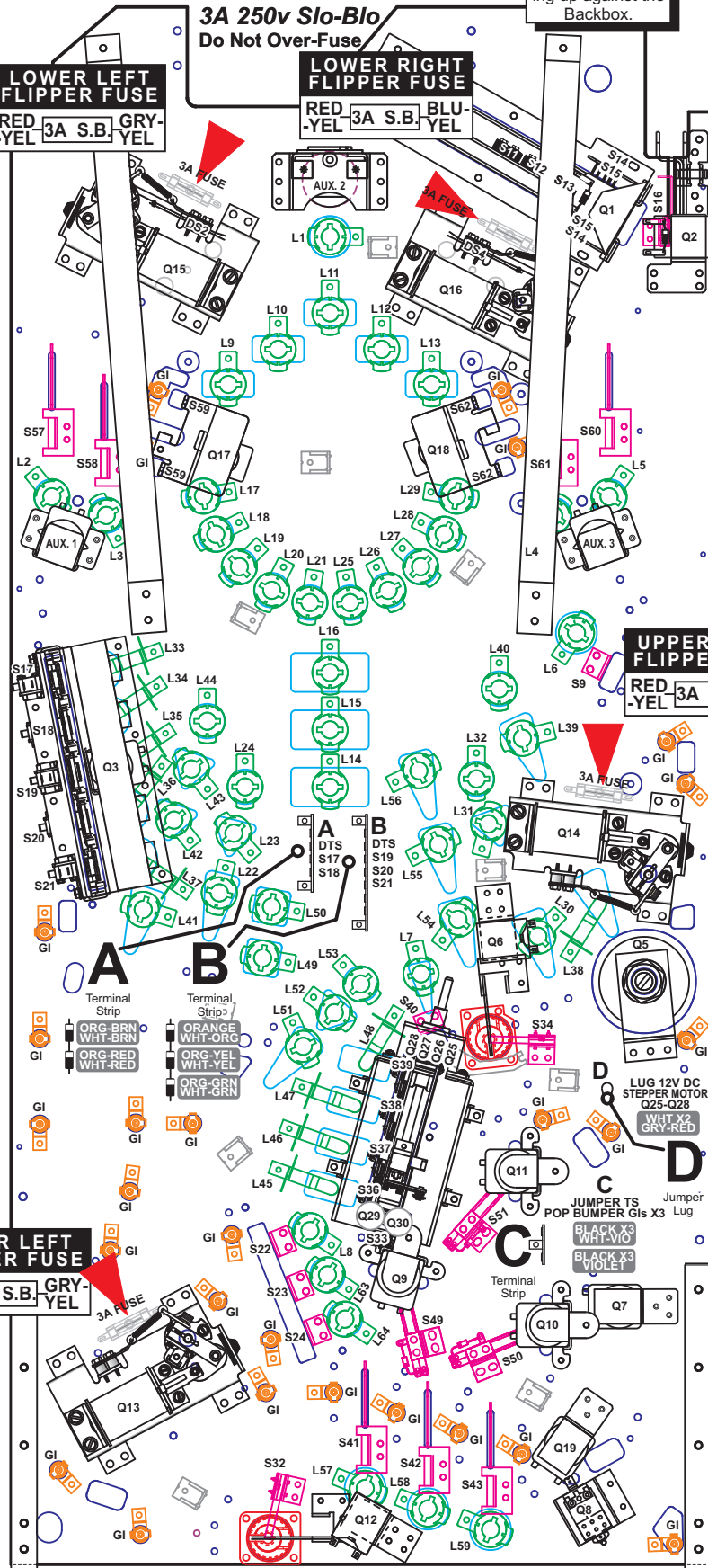

See the Pink Pages, Playfield - General Parts & Switches (Below) (Pg. 66) for Terminal Strips, Diodes, Fuses and Fuse Holders Part Numbers.



# 4-Flipper Circuit Wiring Diagram

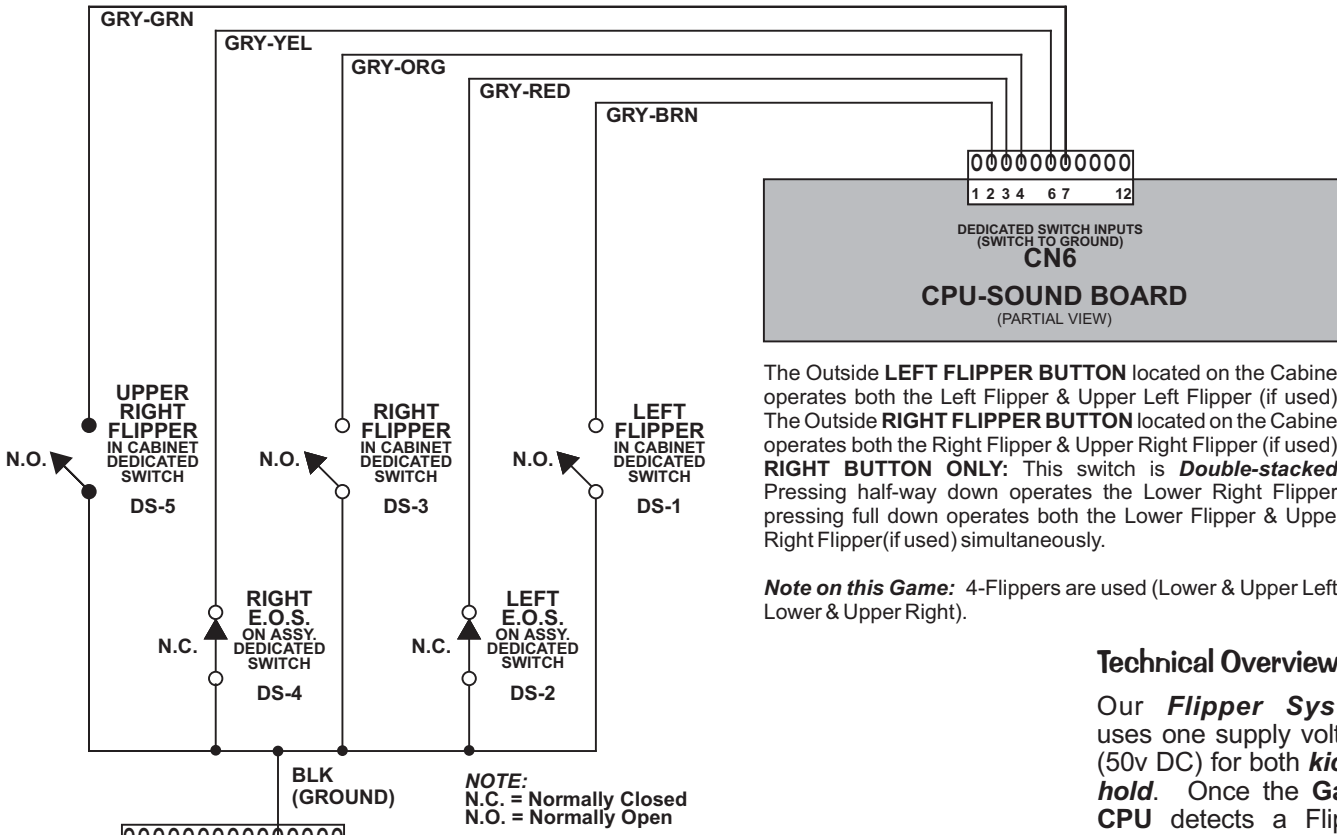

The Outside **LEFT FLIPPER BUTTON** located on the Cabinet operates both the Left Flipper & Upper Left Flipper (if used). The Outside **RIGHT FLIPPER BUTTON** located on the Cabinet operates both the Right Flipper & Upper Right Flipper (if used). **RIGHT BUTTON ONLY:** This switch is **Double-stacked**. Pressing half-way down operates the Lower Right Flipper; pressing full down operates both the Lower Flipper & Upper Right Flipper(if used) simultaneously.

**Note on this Game:** 4-Flippers are used (Lower & Upper Left, Lower & Upper Right).

## Technical Overview

Our **Flipper System** uses one supply voltage (50v DC) for both **kick & hold**. Once the **Game CPU** detects a Flipper Cabinet Switch closure (during game play) it applies a 40msec pulse to the gate of the Flipper Drive Transistor (STP-20N10L). If it continues to detect a Flipper Cabinet Switch closure (*the player holding the button in*) it will continue to pulse the flipper drive transistor 1msec every 12msecs for the duration of the hold cycle.

The **E.O.S.** (End-Of-Stroke) **Switch** serves the same function as before as it prevents foldback when the player has the flipper energized to capture balls. The **E.O.S. Switch** is a normally closed switch which opens approximately 1/16" when the flipper is energized. The **Game CPU** will detect a switch closure if the flipper bat is forced back by a high velocity shot or rebound on the playfield and will apply another 40msec pulse of 50v DC to the coil.

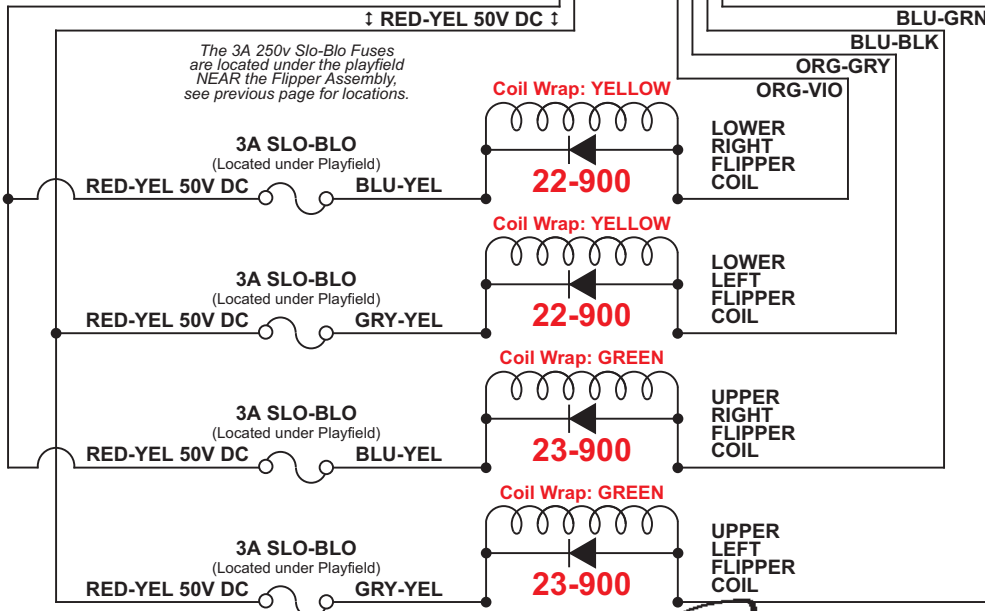
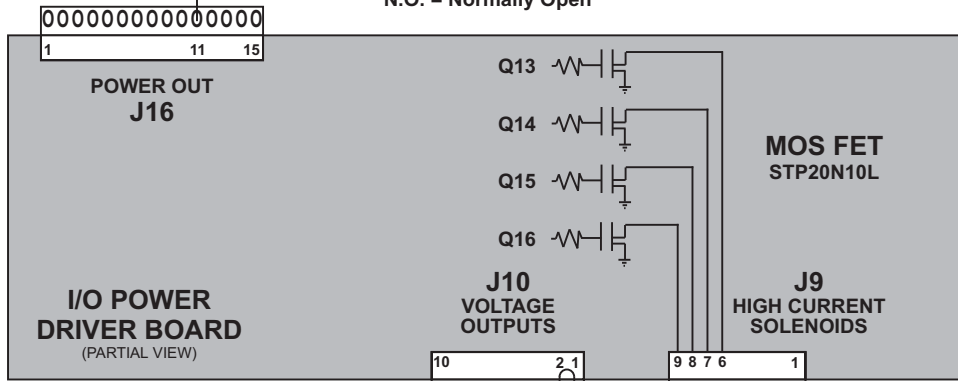

Sec. 5: Playfield ...

*Elvis Presley*

# Cabinet Wiring

## Transformer Power Wiring Diagram

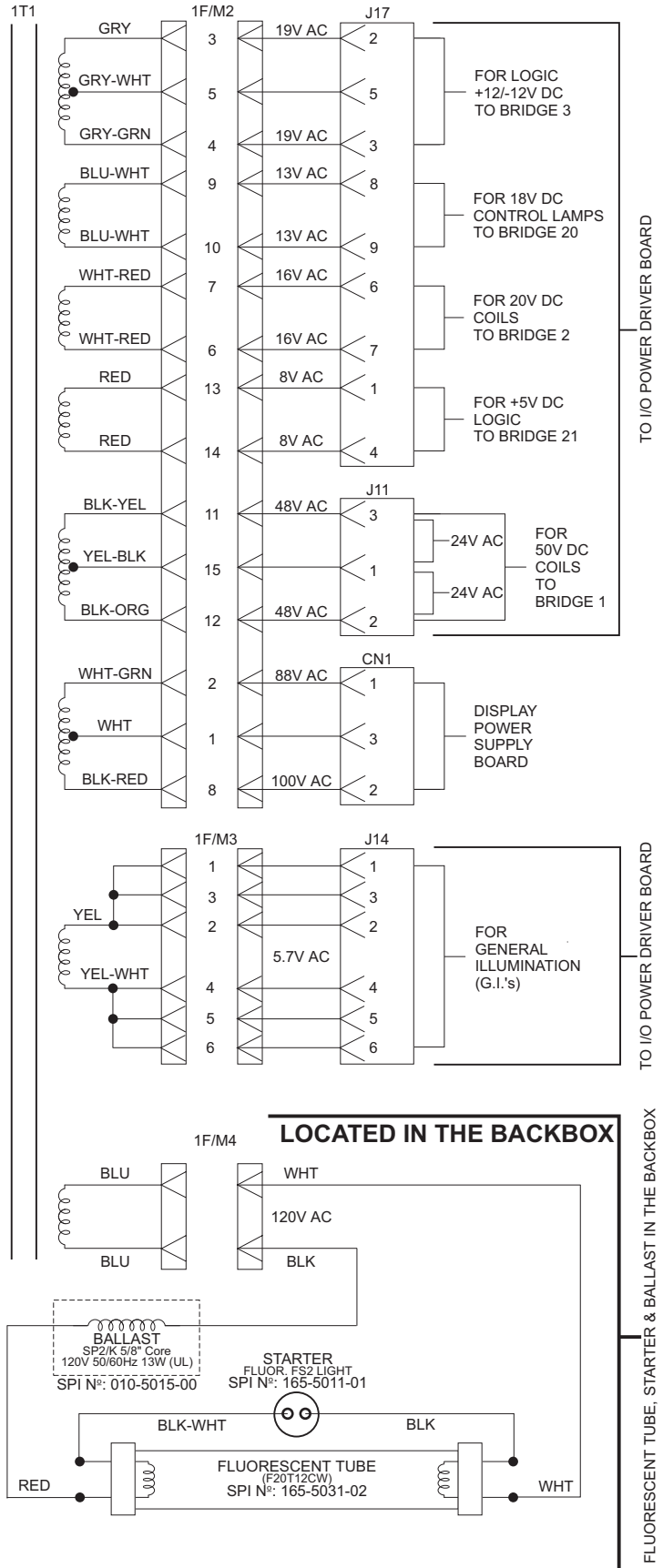
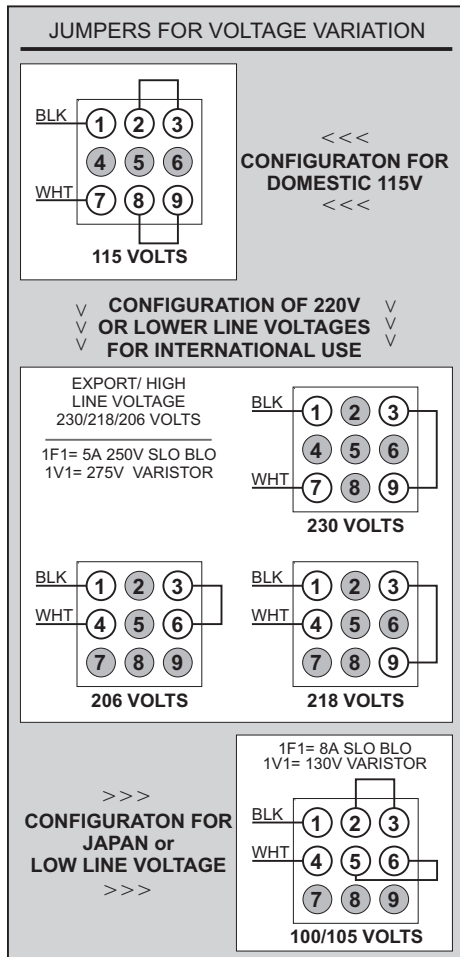
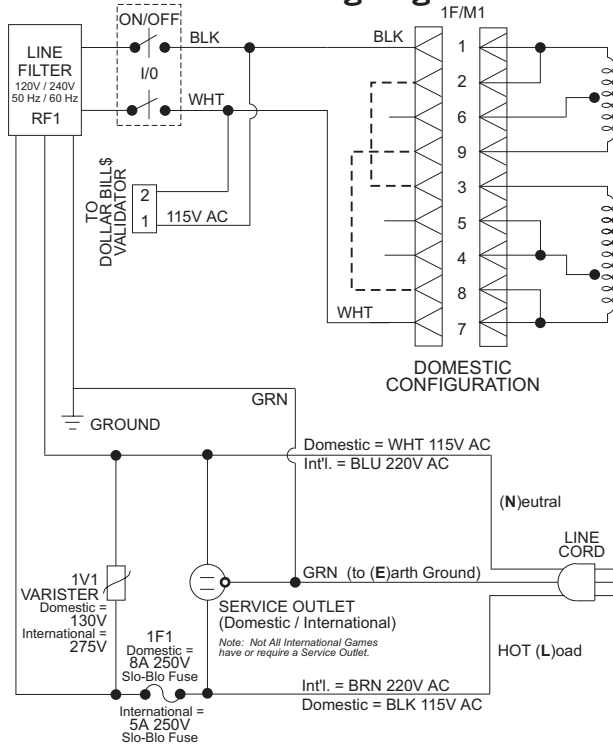

# Cabinet / Coin Door Wiring Diagram

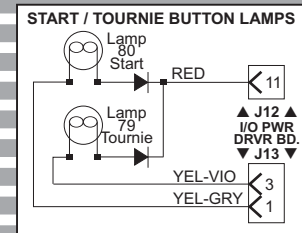
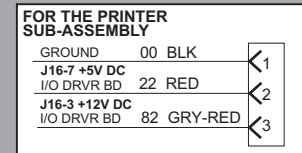
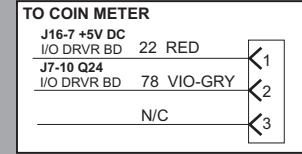
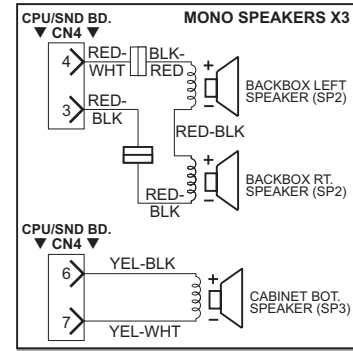
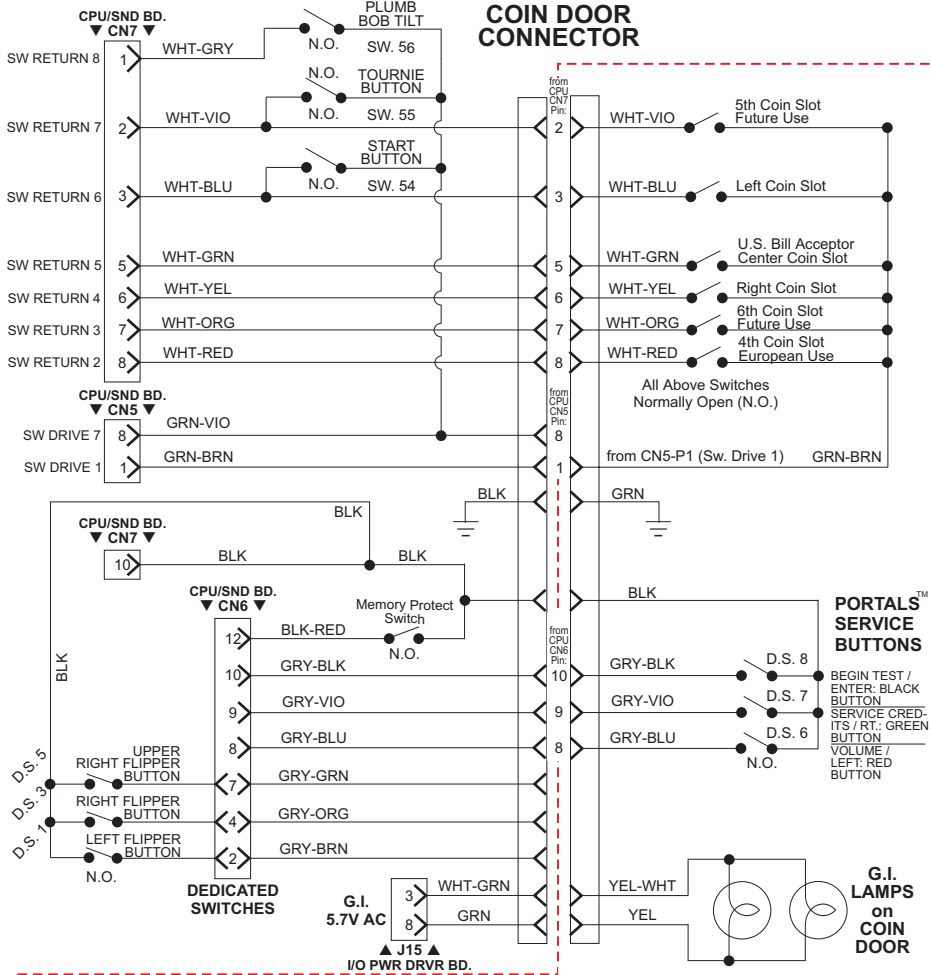

**UK ONLY:** 2 Extra Cabinet Buttons for the Post Save™ Feature are used. The Left Button operates the Left Outlane Ball Deflector. The Right Button operates the Right Outlane Ball Deflector. Both buttons pushed together operate the Center Up/Down Post. Both buttons are located under the Flipper Buttons.

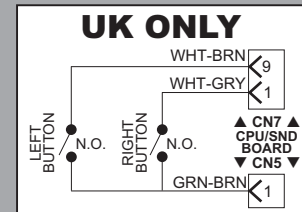

**PRINTER INTERFACE OPTIONAL**

Cable Wiring Harness SPI Part N°: 036-5408-00

RS-232 Printer Interface Board SPI Part N°: 520-5069-00

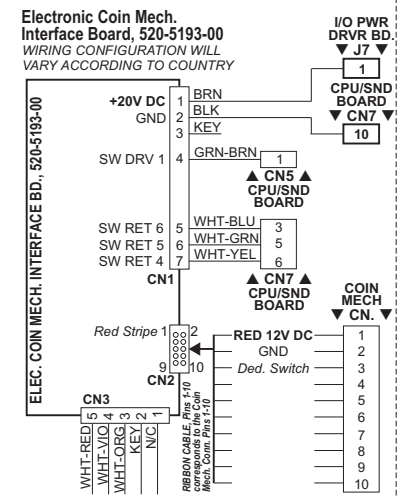
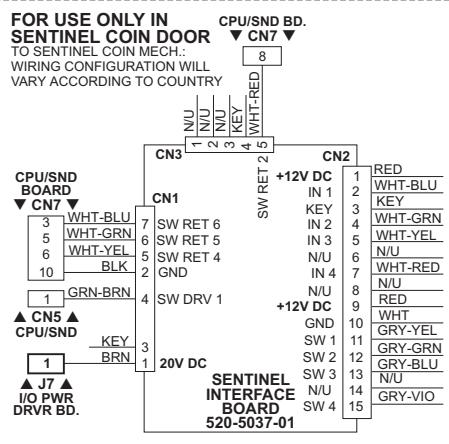
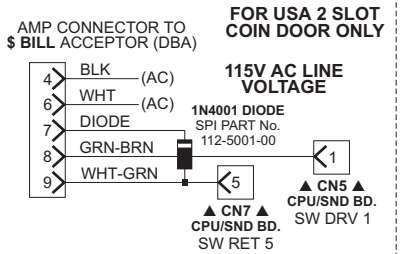
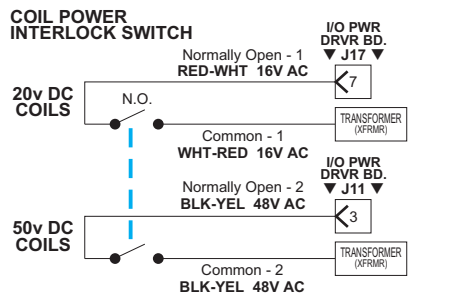
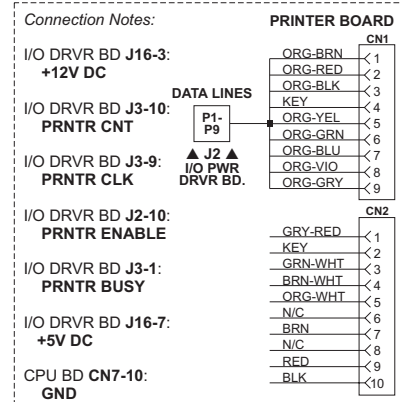

**COIN DOOR**

Sec. 5: Cabinet ...



# Printed Circuit Boards (PCBs)

## Trough Up-Kicker Dual OPTO Boards Theory of Operation & Schematic

As light from the **Transmitter LED1** falls on the **Receiver LED1**, it generates a Positive Bias Voltage (0.7v to 1.5v) which is applied to the **Gate (G)** of **Q1 (Fet 2N5460)** turning **Q1** off. When **Q1** is held off, no current flows through **Q2's (2N3906) Base (B)**. With no *base current*, **Q2** is off and acts as an **OPEN SWITCH**. When the light is interrupted (**BLOCKED**) **R1 (Rec. Bd.)** bleeds the gate voltage off of **Q1** allowing it to conduct, switching **Q2** on, which acts as a **CLOSED SWITCH**. The **LED2 (Trans/Rec) Circuit** operates identical as the **LED1 Circuit**.

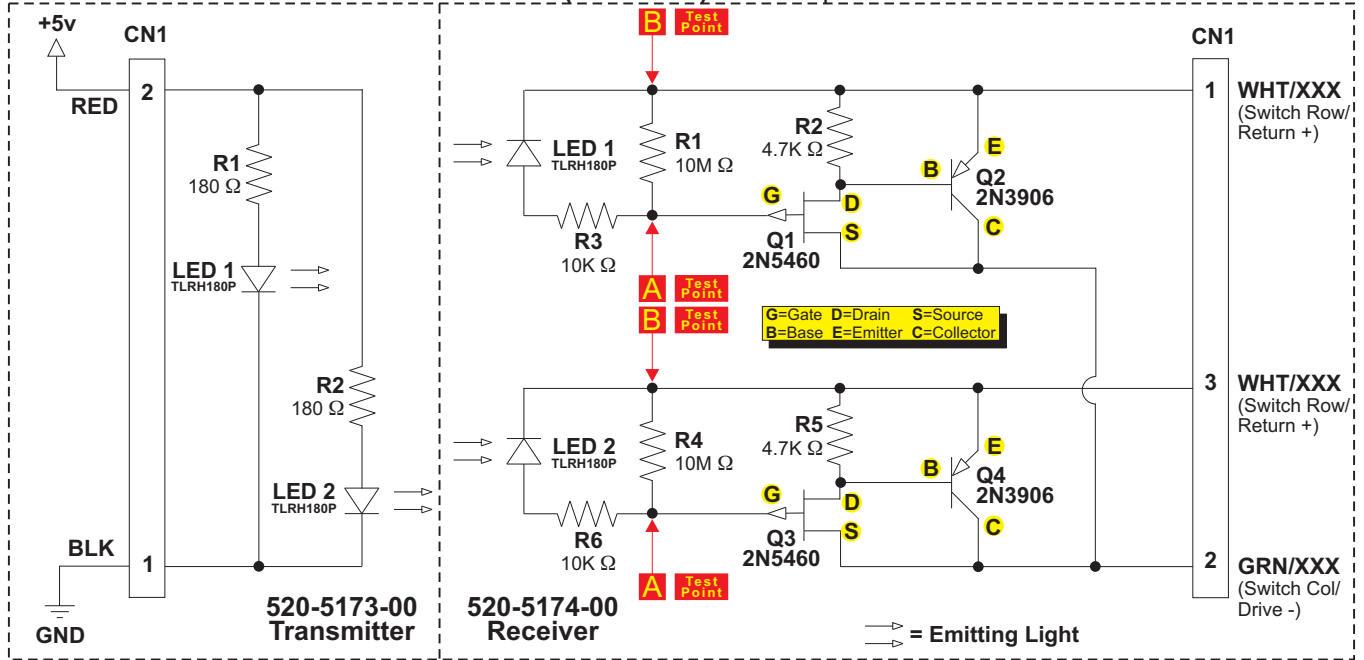

## Trough Up-Kicker Dual OPTO Boards Component Layout & Parts

520-5173-00 (TRANS)

Boards Actual Size  
(Screened Text Printed Larger for Clarity)

520-5174-00 (REC)

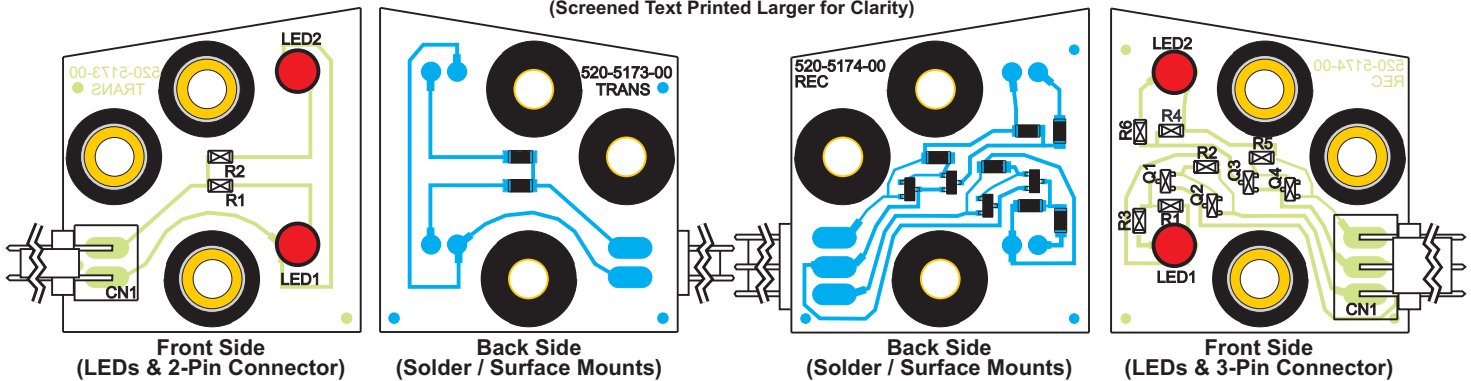

ITEM	QTY	PART NUMBER	REF-DESIGNATOR	DESCRIPTION
A	1	515-0173-00	Dual-OPTO Trans. Bd. Assy.	<b>PCB Assy.</b> (with all Items 1-5) <b>PCB Assy.</b> (with Items 1-3 only) 2X, .156" Rt. Angle (26-60-5020) Conn. <b>LED TLRH180P (Ultra Bright Red)</b> 180 Ω 1/8W Chip Res. (CRCW) OPTO PCB Brass Tube Spacer OPTO PCB Rubber Grommet
—	1	520-5173-00	Dual-OPTO Trans. Board	
01	1	045-5111-02	CN1	
02	2	165-5052-00	LED1, LED2	
03	2	121-5067-00	R1, R2	
04	3	530-5308-02	n/a	
05	3	545-5518-00	n/a	
B	1	515-0174-00	Dual-OPTO Rec. Bd. Assy.	
—	1	520-5174-00	Dual-OPTO Rec. Board	
01	1	045-5111-03	CN1	<b>PCB Assy.</b> (with all Items 1-9) <b>PCB Assy.</b> (with Items 1-7 only) 3X, .156" Rt. Angle (26-60-5030) Conn. <b>LED TLRH180P (Ultra Bright Red)</b> 2N5460, Transistor (P-FET SOT-23) 2N3906, Transistor 10M Ω 1/8W Chip Res. (CRCW) 4.7K Ω 1/8W Chip Res. (CRCW) 10K Ω 1/8W Chip Res. (CRCW) OPTO PCB Brass Tube Spacer OPTO PCB Rubber Grommet
02	2	165-5052-00	LED 1, LED 2	
03	2	110-5006-00	Q1, Q3	
04	2	110-0086-00	Q2, Q4	
05	2	121-5082-00	R1, R4	
06	2	121-5083-00	R2, R5	
07	2	121-5011-00	R3, R6	
08	3	530-5308-02	n/a	
09	3	545-5518-00	n/a	

Replacement Part:  
**LED TLRH180P**  
**(T1-3/4 GaAlAs)**  
 SPI Part N°:  
**165-5052-00**



# OPTO Troubleshooting

## 1. Volt Meter Test (indicates normal operating condition):

A. **OPEN OPTO** (Light Falling on LED) = *SWITCH OPEN*. Place meter leads across points **A** and **B** on the **LED1 Circuit** (Refer to Schematic Drawing on previous page, 520-5174-00 Receiver Side). It should read approximately 0.8 - 1.2v DC. The **LED2 Circuit** operates the same.

B. **CLOSED OPTO** (Light Blocked) = *SWITCH CLOSED*. Place meter leads across points **A** and **B** on the **LED1 Circuit** (Refer to Schematic Drawing on previous page, 520-5174-00 Receiver Side). It should read approximately 0.0 - 0.1v DC. The **LED2 Circuit** operates the same.

## 2. Oscilloscope Test (indicates normal operating condition):

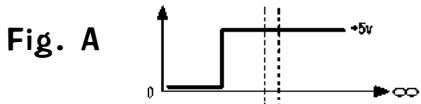

A. **OPEN OPTO** (Light Falling on LED) = *SWITCH OPEN*. Place Scope lead at **Pin-1** of OPTO Rec. Board with Scope Grounded (see Schematic). The Scope should display a **STEADY +5v** as shown in **Fig. A**, Wave Form Diagram.

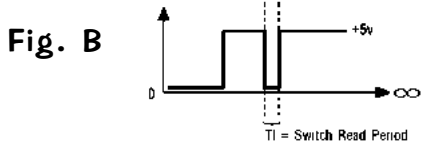

B. **CLOSED OPTO** (Light Blocked) = *SWITCH CLOSED*. Place Scope lead at **Pin-1** of OPTO Rec. Board with Scope Grounded (see Schematic). The Scope should display a **PULSE STREAM** indicating **Q2** has switched "On" as shown in **Fig. B**, Wave Form Diagram. This is your Switch Drive Pulse.

## 3. Bench Test (See Fig. C):

Please Note: To perform this test you must use a spare 560Ω Pull-Up Resistor, SPI N<sup>o</sup>: 121-5047-00

Disconnect the **OPTO Transmitter / Receiver Board** from the circuit. Connect one side of a 560Ω Pull-Up Resistor to **Pin-1** of the OPTO Receiver Bd. and the other side of the resistor to a 5v DC source. Connect **Pin-2** to GND. Connect a +5v DC source to **Pin-1** of the Transmitter & GND to **Pin-2**. Align with the Receiver OPTO approx. 3" distance. Using your Volt-Meter or an Oscilloscope, monitor **Pin-1** while **BLOCKING** and **UNBLOCKING** the **BEAM** from the Trans. The output will be approx. +5v DC when the **BEAM IS NOT BLOCKED** and approx. 0v when the **BEAM IS BLOCKED**.

Fig. C

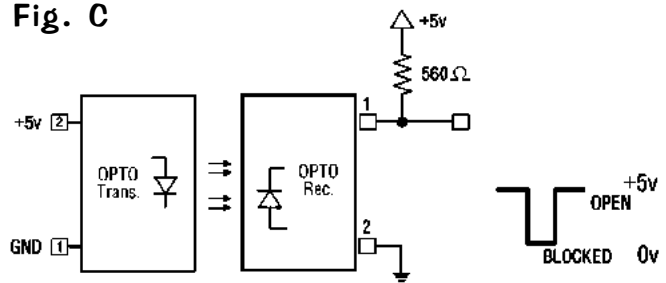

## Trough Dual OPTO Boards Alignment / Test for LED1

When a working **OPTO** is installed and connected in a game, the transmitter should light (**LED1 lower & LED2 upper**) when the power is switched on. With the playfield in **Service Position #1** (playfield lifted up and resting on Playfield Support Slide Brackets) and the game on, the LED lights should show up as a **BRIGHT RED RINGS** through the back of the Receiver Board around the **Receivers LED1 & LED2** (see **Fig. 1**). Testing only **LED1**: With the game in **Switch Test Mode**, lifting the Trough Plunger with a fingertip should block the **BEAM** and cause the Switch Position to trigger (see **Fig. 2**). View **Fig. 2a & 2b** (on the next page) for a sectional view of the Light Path (note alignment) and what happens as a ball breaks the light beam.

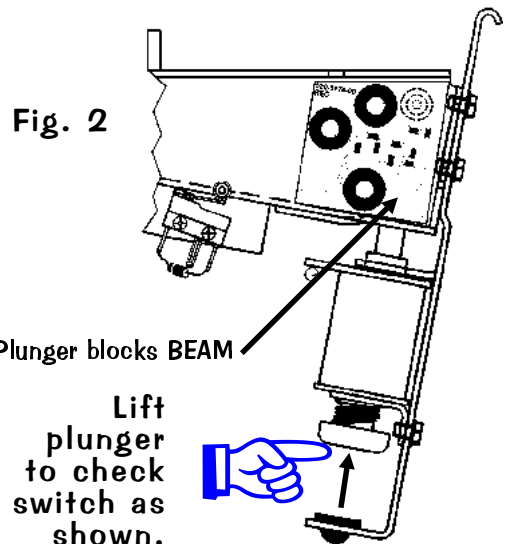
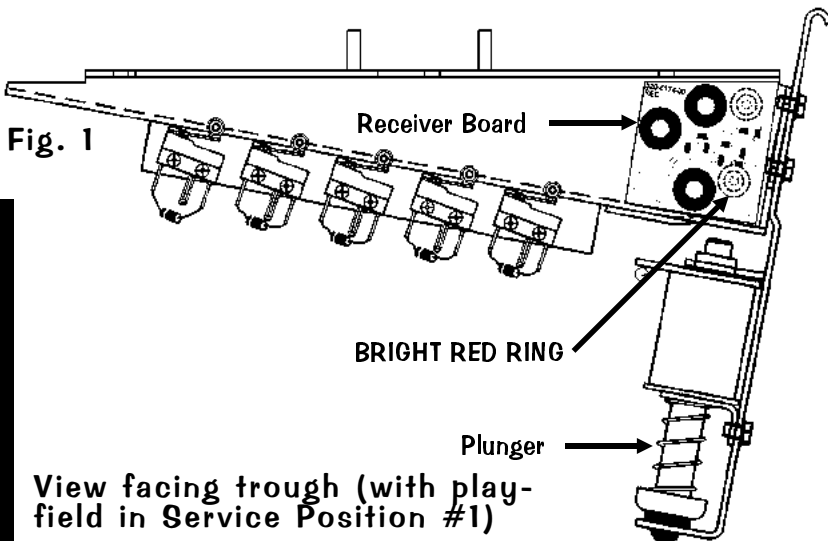

## Sectional view from right (Fig. 2a & 2b)

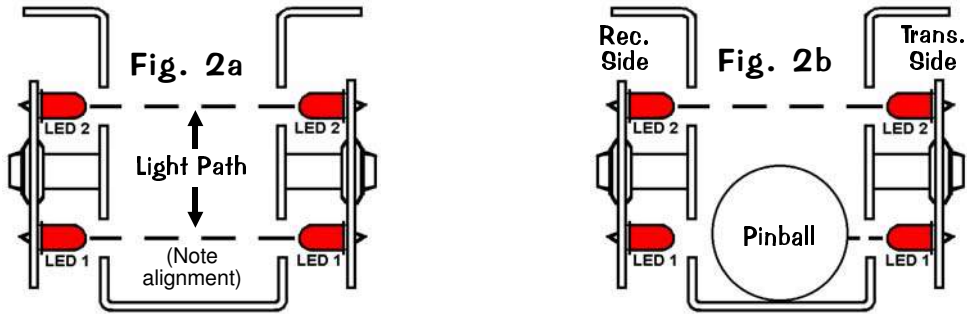

### Trough Dual OPTO Boards Alignment / Test for LED2

When a working **OPTO** is installed and connected in a game, the transmitter should light (**LED1** lower & **LED2** upper) when the power is switched on. With the playfield in **Service Position #1** (playfield lifted up and resting on the Playfield Support Slide Brackets) and the game on, the LED lights should show up as a **BRIGHT RED RINGS** through the back of the Receiver Board around the **Receivers LED1 & LED2** (see Fig. 1, previous page). Testing only **LED2**: **TO PERFORM THIS TEST, A PINBALL MUST BE IN THE BALL TROUGH.** With the game in **Switch Test Mode**, lifting the Trough Plunger with a finger tip should block the **BEAM** on LED2 and cause the Switch Position to trigger (see Fig. 3). View Fig. 3a & 3b for a sectional view of the Light Path (note alignment) and what happens as a "double-stacked" ball scenario breaks the light beam.

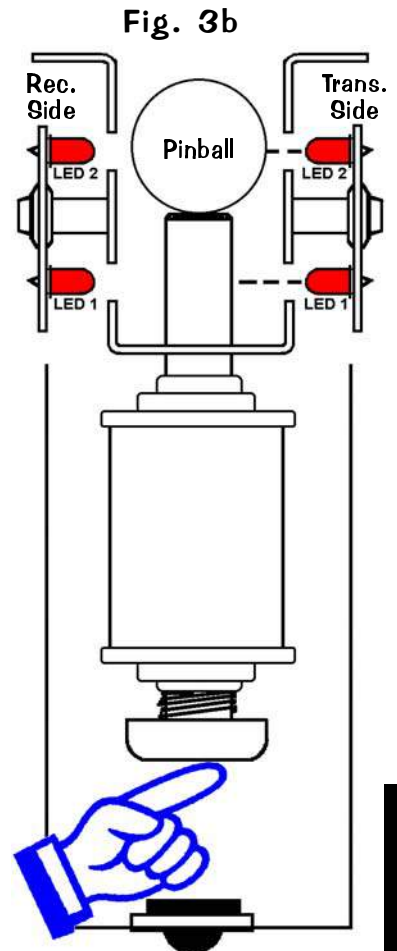
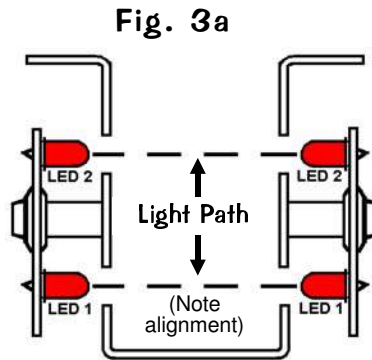
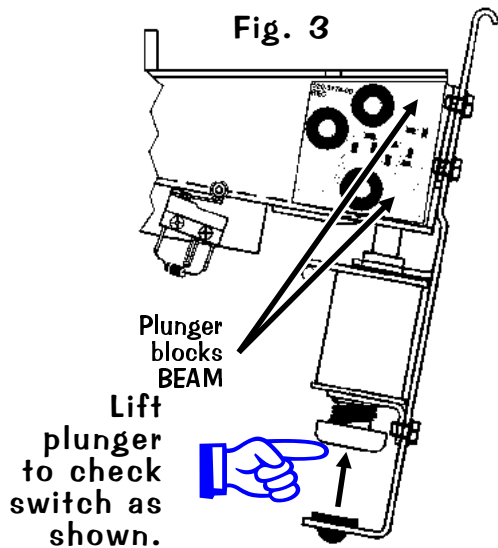

## I M P O R T A N T

If replacement of **LED** is required, insure that is **mounted correctly before and after soldering** (See Fig. 4a / 4b).

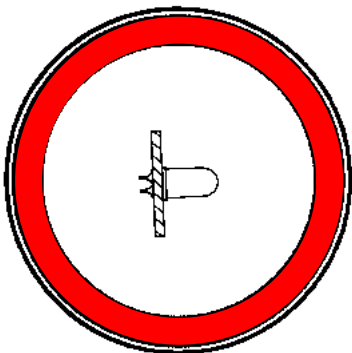

Fig. 4a  
Correct Position

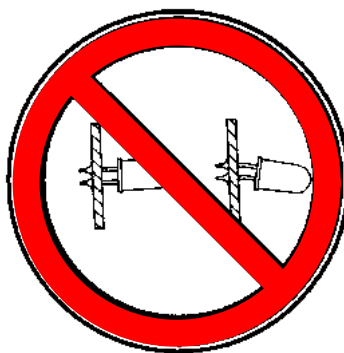
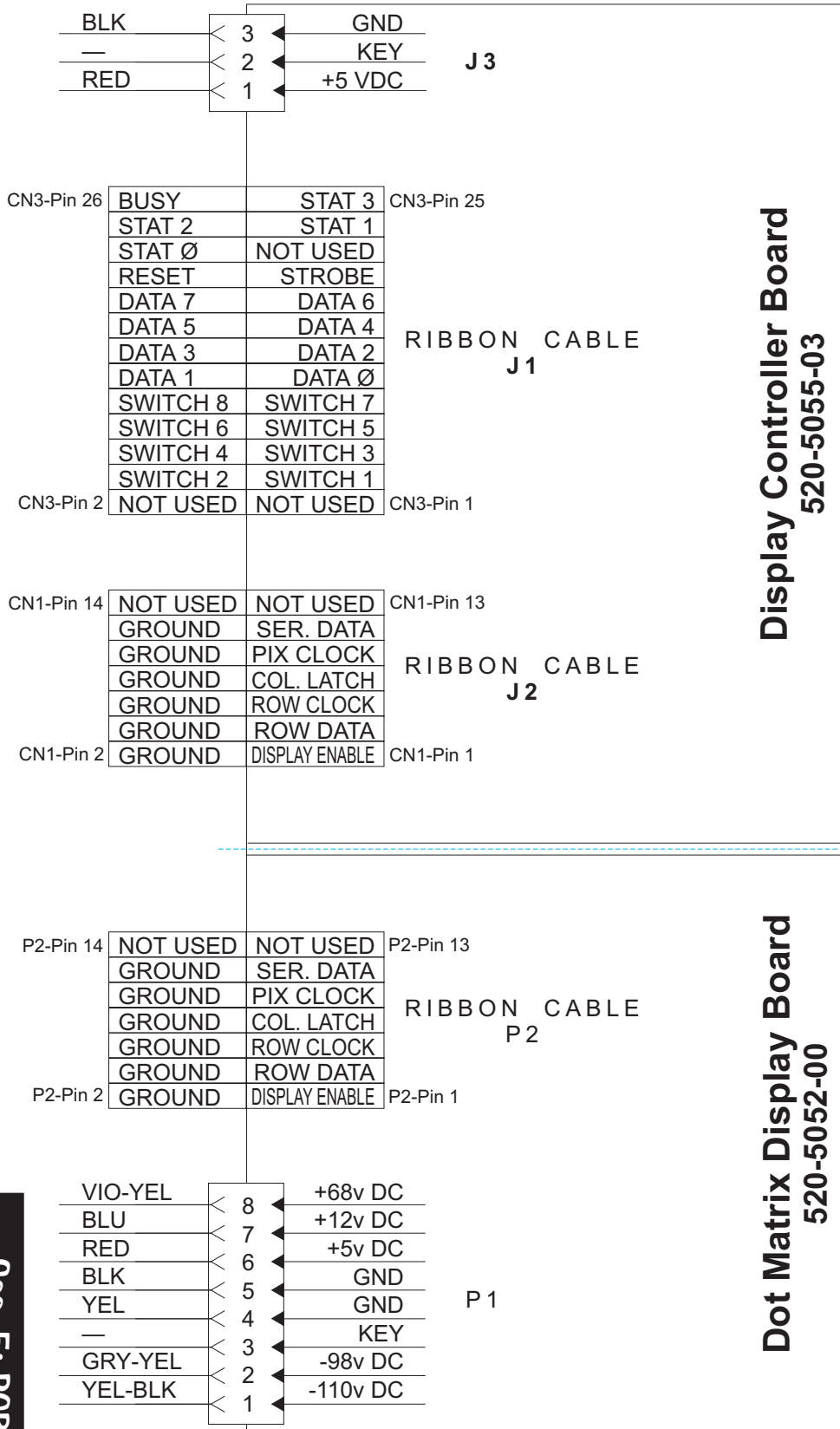

Fig. 4b  
Incorrect Position



Dot Matrix Display / Display Controller Bd. Combined Display Connections



**Dot Matrix Display Explained**

The display utilizes a Micro-Processor Control Board mounted in piggyback fashion to the Dot Matrix Display (128 X 32) Driver Board. The purpose behind this board is to provide more information to the operator as well as displaying graphics to the player.

The board is controlled by a 6809E Micro processor and its personality ROM (Unique to the Game). It receives Data, Reset & Clock Information from the CPU/Sound Board via the ribbon cable and sends back multiple Status and Busy Signals to the CPU. This is to insure synchronized communication between the CPU and the Display Controller Board. The Drivers for the rows and columns are provided on 5 surface mounted integrated circuits on the Dot Matrix Display Driver Board.



# Display Power Supply Board Schematic

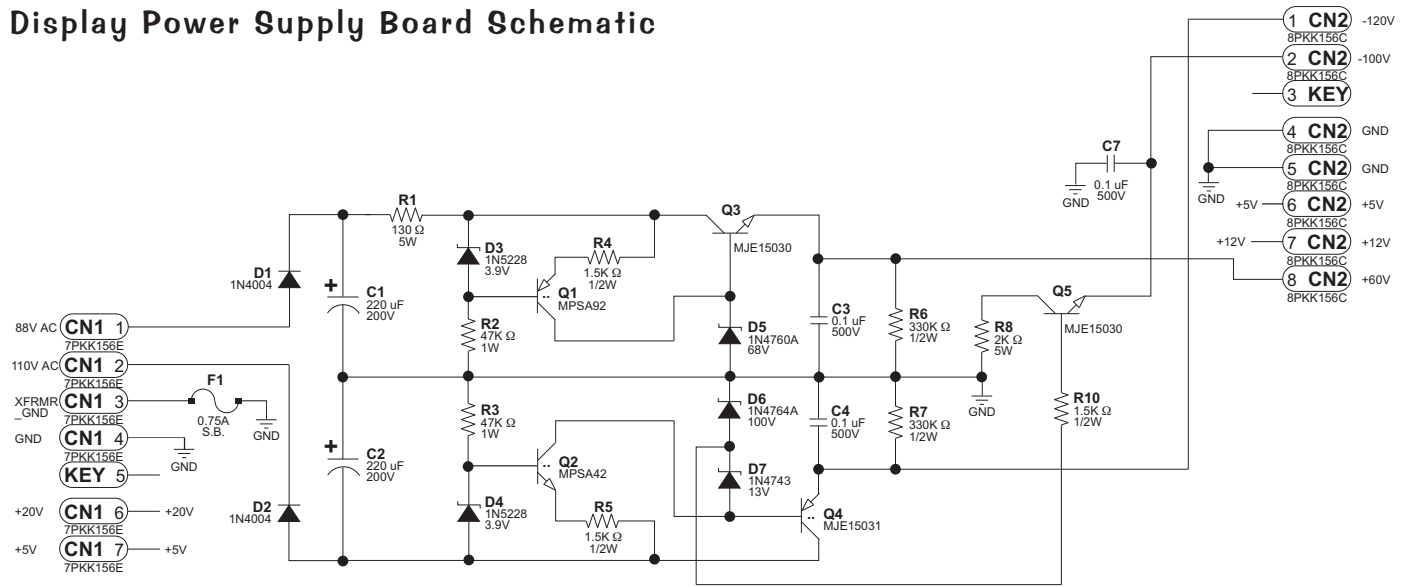

# Display Power Supply Board Component Layout & Parts

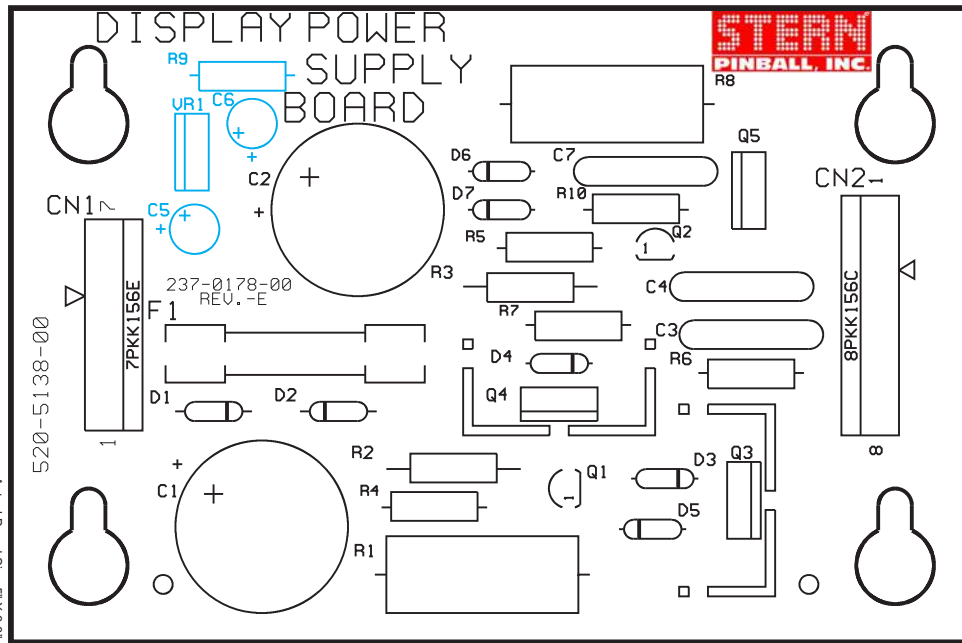

ITEM	QTY	PART NUMBER	REF-DESIGNATOR	DESCRIPTION (NS = Not Stuffed)
—	1	<b>520-5138-00</b>	<b>Display Power Supply Board</b>	<b>Complete PCB Assembly</b>
01	2	125-5044-00	C1, C2	220uF, 200v, Radial Lytic Cap.
02	3	125-5035-00	C3, C4, C7	0.1uF, 500v, Ceramic Disk Cap.
03	0	125-5003-00	(C5, C6: NS)	22uF, 35v, Rad Lytic Cap
04	1	045-5015-07	CN1	7PKK156E (PIN5=KEY)
05	1	045-5015-08	CN2	8PKK156E (PIN3=KEY)
06	2	112-5003-00	D1, D2	1N4004, Diode
07	2	112-0053-00	D3, D4	1N5228, 3.9v, Diode
08	1	112-0062-00	D5	1N4760A, 68v, Diode
09	1	112-0049-00A	D6	1N4764A, 100v, Diode
10	1	112-0061-00	D7	1N4743, 13v, Diode
11	1	200-5000-17	F1	3/4A (0.75A) S.B. Fuse
12	2	205-0004-00	F1	Fuse Clip
13	1	110-0100-00	Q1	MPSA92, Transistor
14	1	110-0082-00	Q2	MPSA42, Transistor
15	2	110-0101-00	Q3, Q5	MJE15030, Transistor
16	2	535-5000-11	Q3, Q4	Heatsinks - AAVID #563002
17	2	240-5008-00	Q3, Q4	#6-32 KEPS Nut
18	2	237-5501-00	Q3, Q4	#6-32 X 3/8" PPH Screw
19	1	110-0103-00	Q4	MJE15031, Transistor
20	1	121-5061-00	R1	130 Ω 5W Res.
21	2	121-5060-00	R2, R3	47K Ω 1W Res.
22	3	121-5038-00	R4, R5, R10	1.5K Ω 1/2W Res. (R9: NS)
23	2	121-5059-00	R6, R7	330K Ω 1/2W Res.
24	1	121-5062-00	R8	2K Ω 5W Res.
25	0	124-5003-00	(VR1: NS)	7812CT

Sec. 5: PCBs



# Display Controller Board Schematic

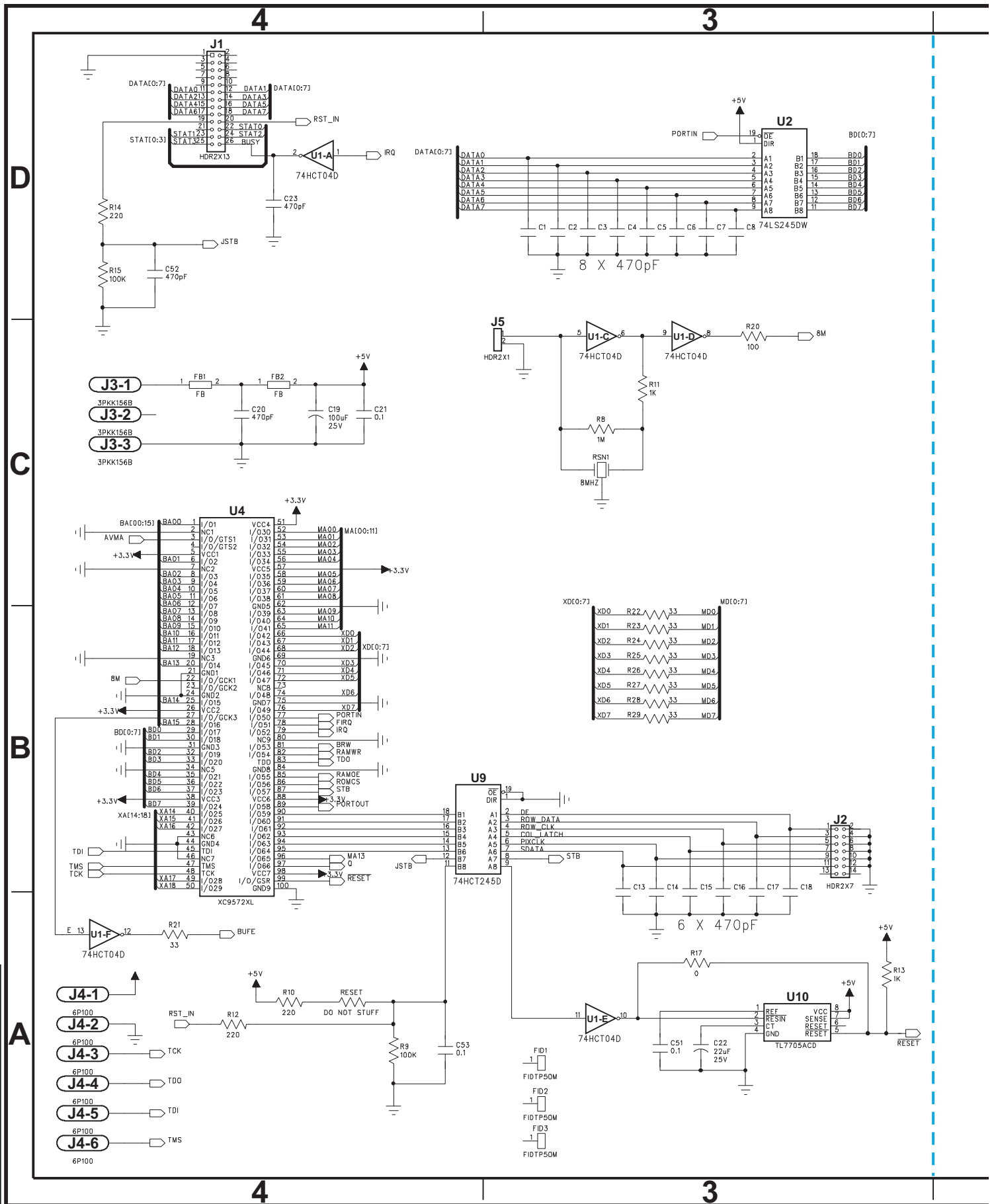

Sec. 5: PCBs

# Display Controller Board Schematic

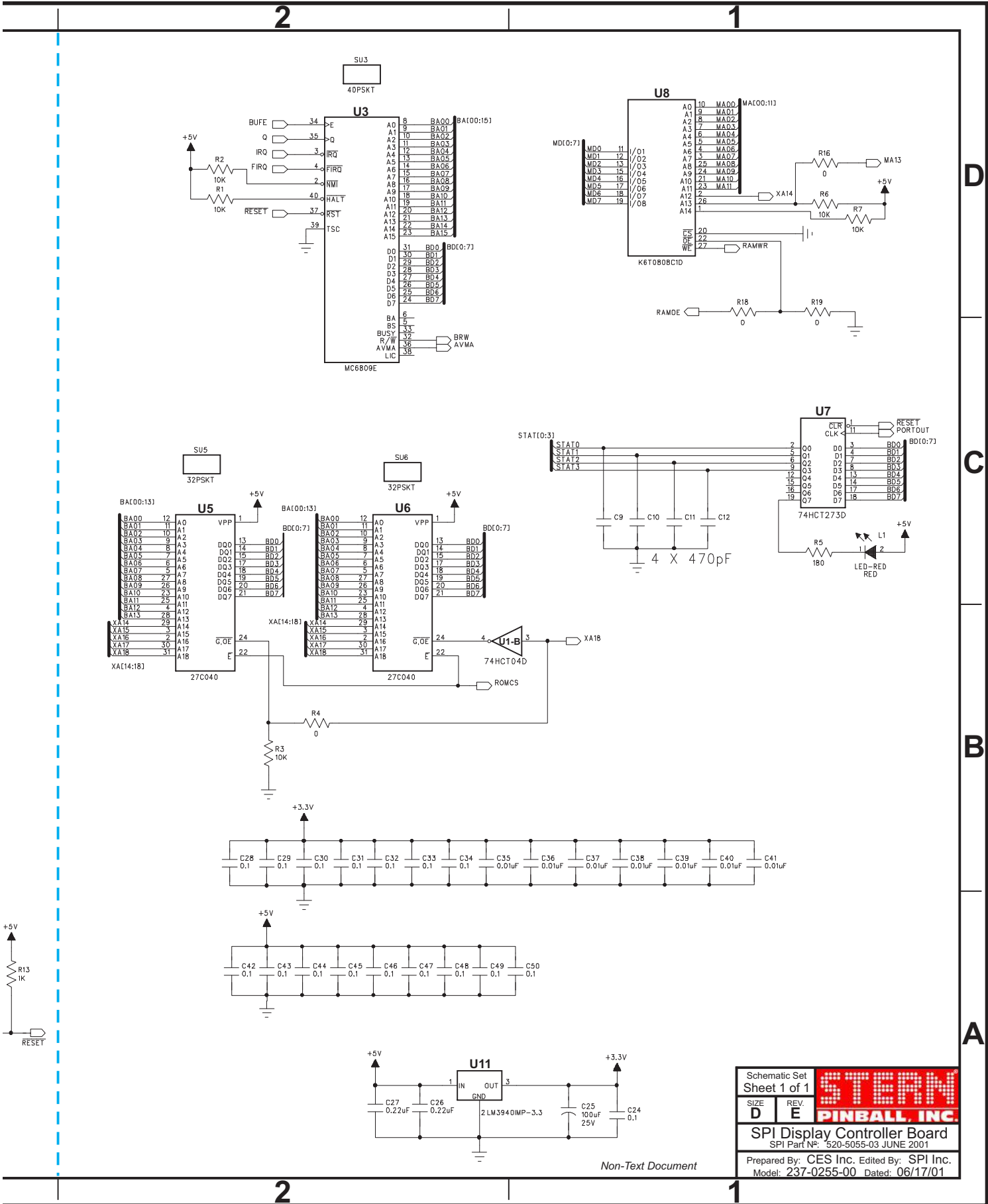

D  
C  
B  
A

Sec. 5: PCBs

Schematic Set  
Sheet 1 of 1

**STERN**  
**PINBALL, INC.**

SPI Display Controller Board  
SPI Part No: 520-5055-03 JUNE 2001

Prepared By: CES Inc. Edited By: SPI Inc.  
Model: 237-0255-00 Dated: 06/17/01

SIZE	REV.
D	E

Non-Text Document



# Display Controller Board Component Layout & Parts

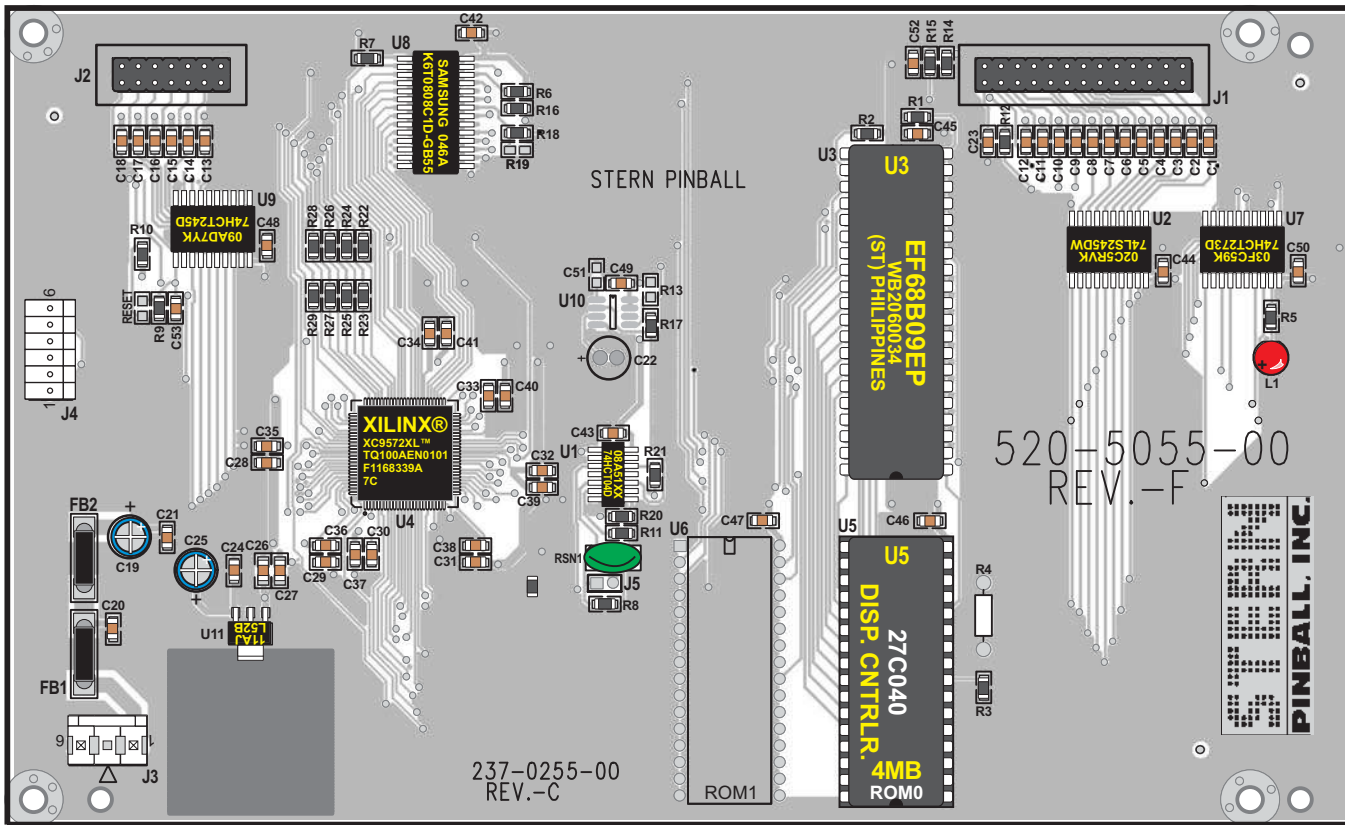

Actual Board Size 20.5cm X 12.5cm

ITEM	QTY	PART NUMBER	REF-DESIGNATOR	DESCRIPTION (NS = Not Stuffed)
—	1	<b>520-5055-03</b>	<b>Display Controller Bd. (FCC FEB98) Rev. E June 2001</b>	<b>Complete PCB Assembly</b>
01	1	045-5015-26	J1	13-Pin, Dual row .1" Hdr. Conn HDR2X13
02	1	045-5015-02	J2	7-Pin, Dual Row .1" Hdr. Conn HDR2X7
03	1	045-5015-03	J3	3-Pin, PKK156B Connector
04	1		J4	6-Pin (6P100)
05	7		C35-C39, C40, C41	SMT 0.01uF, 50v Cap. 103-0805-X7R
06	20		C21, C24, C28-C32, C33, C34, C42, C43, C44, C45, C46 C47, C48, C49, C50, C53 (C51: NS)	SMT 0.1uF, 50v Cap. 104-0805
07	2		C26, C27	SMT 0.22uF, 50v Cap. 224-1206-Z5U
08	21		C1-C12, C13-C18, C20, C23, C52	SMT 470pF, 50v Cap. 471-0805
09	2		C19, C25	100uF, 25v TCap.
10	1	<b>165-5099-00</b>	<b>L1</b>	<b>LED T1-3/4 DIFFUSER RED</b>
11	4		R16-R18 (R19: NS)	0 Ω 1/10W Resistor 0805
12	1	n/a	RESET	<b>DO NOT STUFF</b>
13	2		R11, R13	SMT 1K Ω 1/10W Resistor 0805
14	1		R8	SMT 1M Ω 1/10W Resistor 0805
15	5		R1, R2, R3, R7 (R6: NS)	SMT 10K Ω 1/10W Resistor 0805
16	9		R21, R22-R29	SMT 33 Ω 1/10W Resistor 0805
17	1		R20	SMT 100 Ω 1/10W Resistor 0805
18	2		R9, R15	SMT 100K Ω 1/10W Resistor 0805
19	1		R5	SMT 180 Ω 1/10W Resistor 0805
20	3		R10, R12, R14	SMT 220 Ω 1/10W Resistor 0805
21	1		U1	74HCT04D (74LS04)
22	1		U2	74LS245DW
23	1	100-0189-01	U3 (40-Pin Socket, 077-X)	MC6809E
24	1	100-5044-00	U4	XC9572XL, Int. Xilinx®
25	2 (See Pg. DR. Table)		U5 (ROM0) (U6: NS) (32-Pin, IC Dip Socket, 077-5217-00)	4MB ROM 27C040 (M27C401-100)
26	1		U7	74HCT273D
27	1	100-5045-00	U8	K6T0808C1D-GB55, Int. Samsung 046A
28	1		U9	74HCT245D
29	1		U11	LM3940IMP-3.3
30	1		RSN1	8MHZRSN (8Mhz) Crystal
31	2	n/a	FB1, FB2	Ferrite Bead, FB0370
32	0		FID1-3	FIDTP50M

If a part is required where a part number is not provided, call Technical Support (see back of cover).

Sec. 5: PCBs



# I/O Power Driver Board Theory of Operation

## 5v Supply:

An AC voltage of approximately 9v comes into the board at [J17-(1-4)] this AC voltage is then *full-wave rectified* by bridge **BRDG 21** and filtered by Capacitor **C203**. The resulting voltage is 11v DC which is inserted into a linear voltage regulator for the output of 5v DC. This 5v regulated voltage can be adjusted by potentiometer **R116** the voltage should be set to 5.00v. Besides powering the **I/O Board** the regulated 5 volts supplies power to the **CPU / Sound Board, Gas Plasma (Dot Matrix) Display and Plasma (Display) Controller Board**. Power for these devices comes off the **I/O Board** on [J16-(4-8)].

## +5v, +20v, +50v, +18v, & +12v LED Indicators:

These DC voltages are derived on the **I/O Board** by rectification and filtering. Each has a **LED** indicating that power is being supplied to each of these voltage sources. The **-12v** supply comes from the same transformer winding as the **+12v** thus it does not have a **LED** indicator.

LED	SUPPLY VOLTAGE
L2	+ 5
L200	+ 20v
L201	+ 50v
L202	+ 18v
L203	+ 12v

**\*\* Note that the +50v & +20v power sources are turned off by the Interlock Switches when the Coin Door is OPEN.**

## Reset Circuitry:

The **I/O** will reset in three (3) cases:

1. The CPU is in reset. The CPU's reset signal is fed into the **I/O** through connector **J1** and forces the **I/O** into reset.
2. The 5v supply has fallen below 4.75v.
3. The watchdog is not being fed by the scanning of the light matrix. More specifically **Pin-19** of **U6** must be toggling once every **50ms** to prevent the watchdog from resetting. The scanning of the light matrix is controlled by the CPU through **J1**.

**LED L204** shows the reset state of the **I/O Board**. If this **LED** is not lit either the 5v DC is below 4.75v or the **CPU/Sound Board** is holding the **I/O** in reset. If the **LED** is flashing this means that the watchdog is not being fed by the **CPU/Sound Board** and the **I/O** is oscillating into and out of reset. If the **LED** is continuously on the board is out of reset and communication from the CPU to the lamp matrix is confirmed. **Testpoint Blanking** is the actual reset signal on the **I/O Board**. A low voltage indicates that it is in reset this will turn off all Solenoid (*Coil*) Drivers, Flash Lamps, Lamp Matrix Drivers, Auxiliary Outputs and Flipper Outputs. A high voltage indicates that it is out of reset and normal operation can take place.

## Address Decoding:

All Address decoding is done by two **74LS138's (U204 & U205)** (3 of 8 decoder). Both of these must be in operation for the **I/O Board** to function properly.

## Solenoid (Coil) Drivers & Flash Lamps:

**J8 & J9** are high side drivers for driving solenoids and other heavy loads. Each connector has its own buffer driving 8 drivers. **J8 & J9** consist of **MOSFET Drivers 20N10L** which can easily & safely be tested by clipping one end of a clip-lead to test point **FET TPL1** and then the other to the corresponding gate resistor **R1-R16** (see *Note 1*). This will apply 3.4v to the gate of the **MOSFET Transistor** thus switching it on. **J7 & J6** each are a bank of 8 low side driver for driving lamps or other lower current solenoids (*coils*). They use a Bipolar Power Transistor **TIP122** which can also be tested by using **TEST POINT TIP TPL3** and the corresponding resistors **R17-R32\*** (see *Note 1*).

**Note 1 •** Clip on the resistor side with the white stripe. •• R1 controls Q1, R2 controls Q2, et cetera...

## Auxiliary In & Out:

**J2-8 CMOS** Outputs sometimes used for a printer interface.

**J3-8 CMOS** Inputs general purpose inputs.

## Lamp Matrix:

**J12** has 10 low side drivers for the lamp strobes which consist of **19N06L MOSFETS**. Only one lamp strobe should be low at any time. Again the scanning of the lamp strobes keeps the **I/O** from resetting. **J13** has 8 high side drivers with each having a status indicator. All the status indicators are logically 'OR'ed together and fed back to the **CPU/Sound Board**. The status can identify open loads (for example open lamp filaments or intermittent connections) and short circuits. These drivers are also short-circuit protected.

## General Illumination (G.I.) Lights:

**J15** has 6v AC switched on & off by a relay on the **I/O Board**. The relay is controlled by **Q200** which supplies power to the 24v coil winding to activate the relay. There are 4 taps on **J15** each fused at 5A for this 6v AC source.



# I/O Power Driver Board Schematic (Sheet 1 of 5)

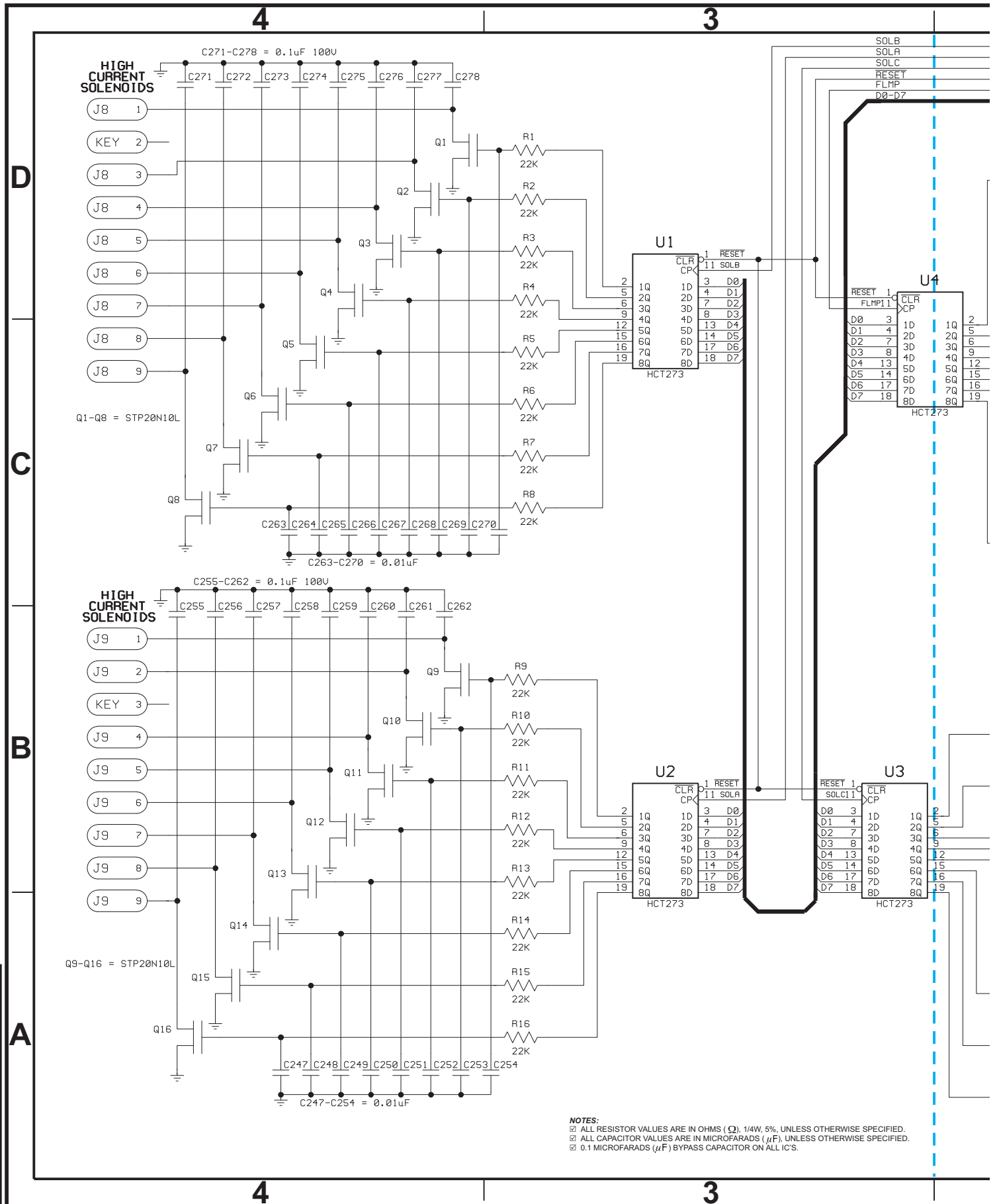

- NOTES:**
- ☑ ALL RESISTOR VALUES ARE IN OHMS (Ω), 1/4W, 5%, UNLESS OTHERWISE SPECIFIED.
  - ☑ ALL CAPACITOR VALUES ARE IN MICROFARADS (μF), UNLESS OTHERWISE SPECIFIED.
  - ☑ 0.1 MICROFARADS (μF) BYPASS CAPACITOR ON ALL IC'S.

Sec. 5: PCBs

*Elvis Presley*

# I/O Power Driver Board Schematic (Sheet 1 of 5)

2

1

SOLB	(4-4D)
SOLA	(4-4D)
SOLC	(4-4D)
RESET	(2-4A, 3-4B, 4-1D)
FLMP	(4-4D)
D0-D7	(2-4A, 3-4B, 4-4B)

The above circuit(s) continue at the address shown (#-XY).  
# = Sheet Number (1-5), X = Column Grid, Y = Row Grid

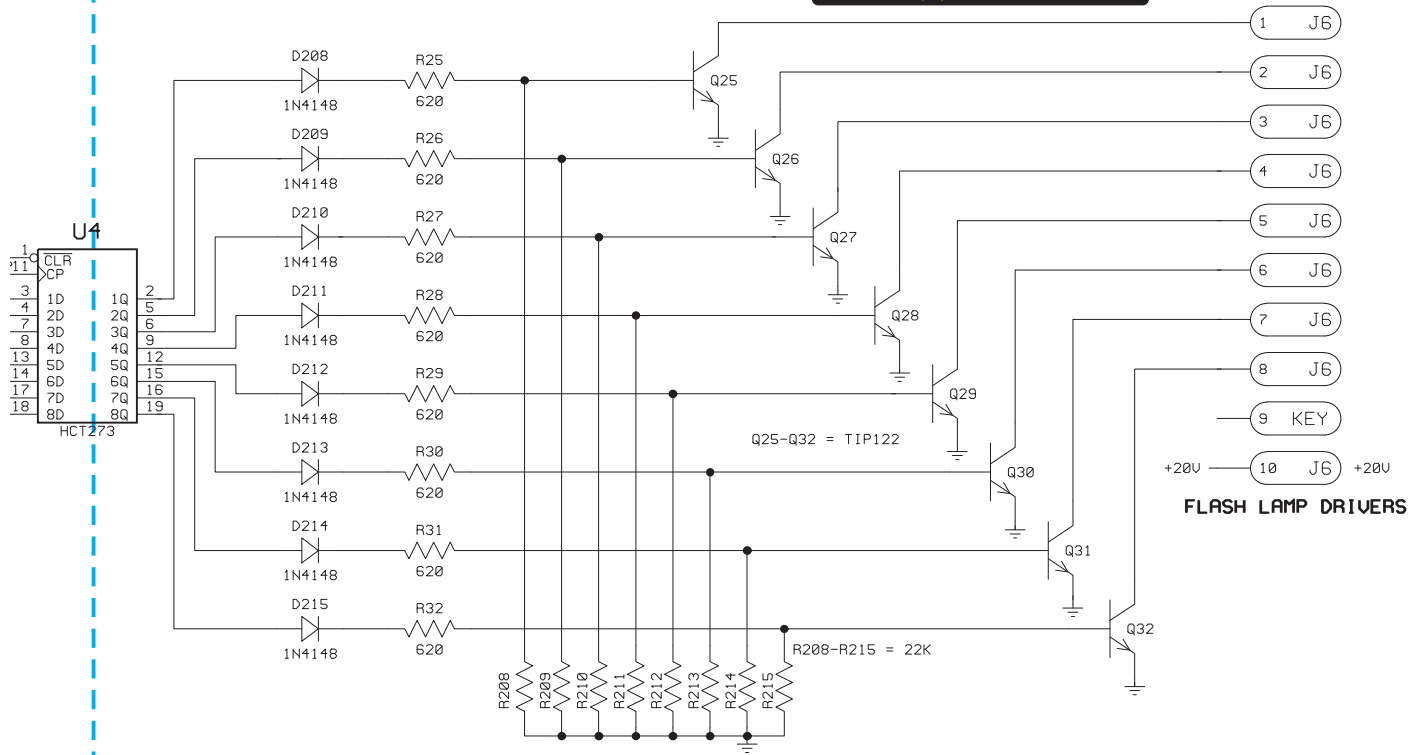

### LOW CURRENT SOLENOIDS

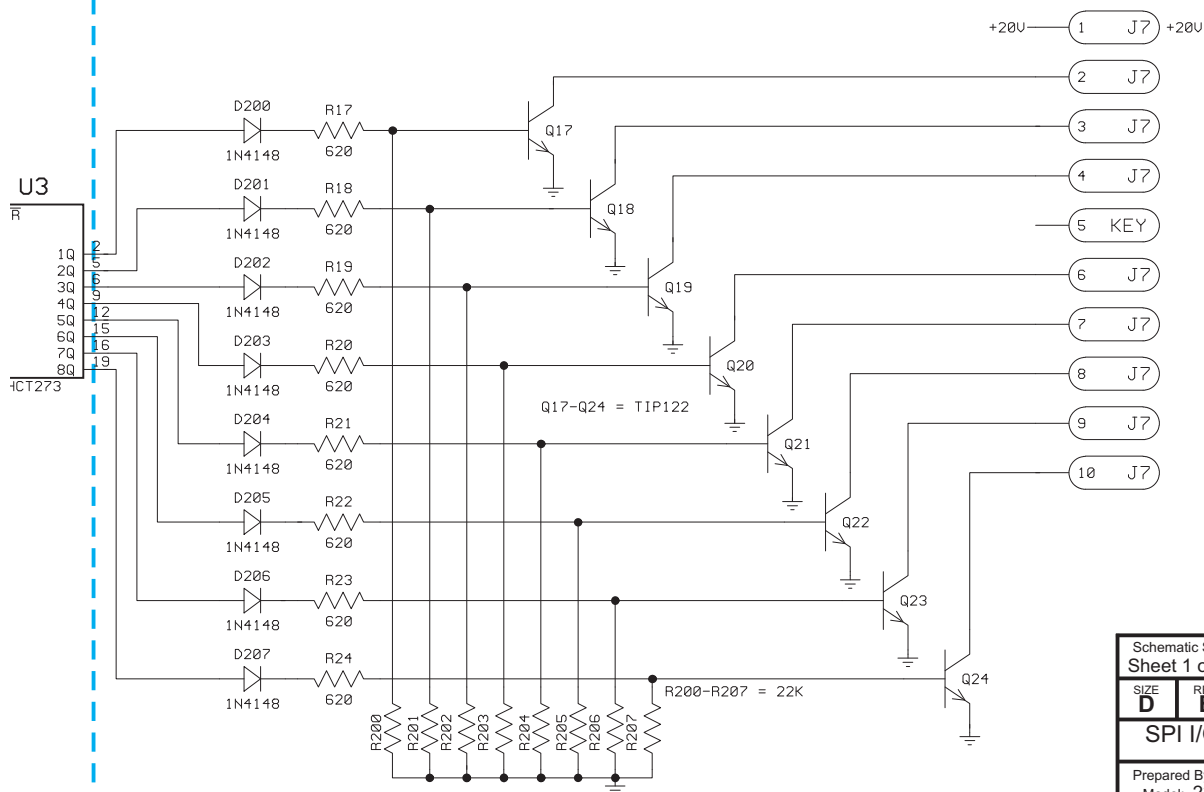

Schematic Set		<b>STERN</b>
Sheet 1 of 5		
SIZE	REV.	<b>PINBALL, INC.</b>
D	E	
SPI I/O Power Driver Board		
SPI Part No: 520-5137-01		
Prepared By: CES Inc. Edited By: SPI Inc.		
Model: 237-0161-00 Dated: 09/05/97		

D

C

B

A

Sec. 5: PCBs

2

1





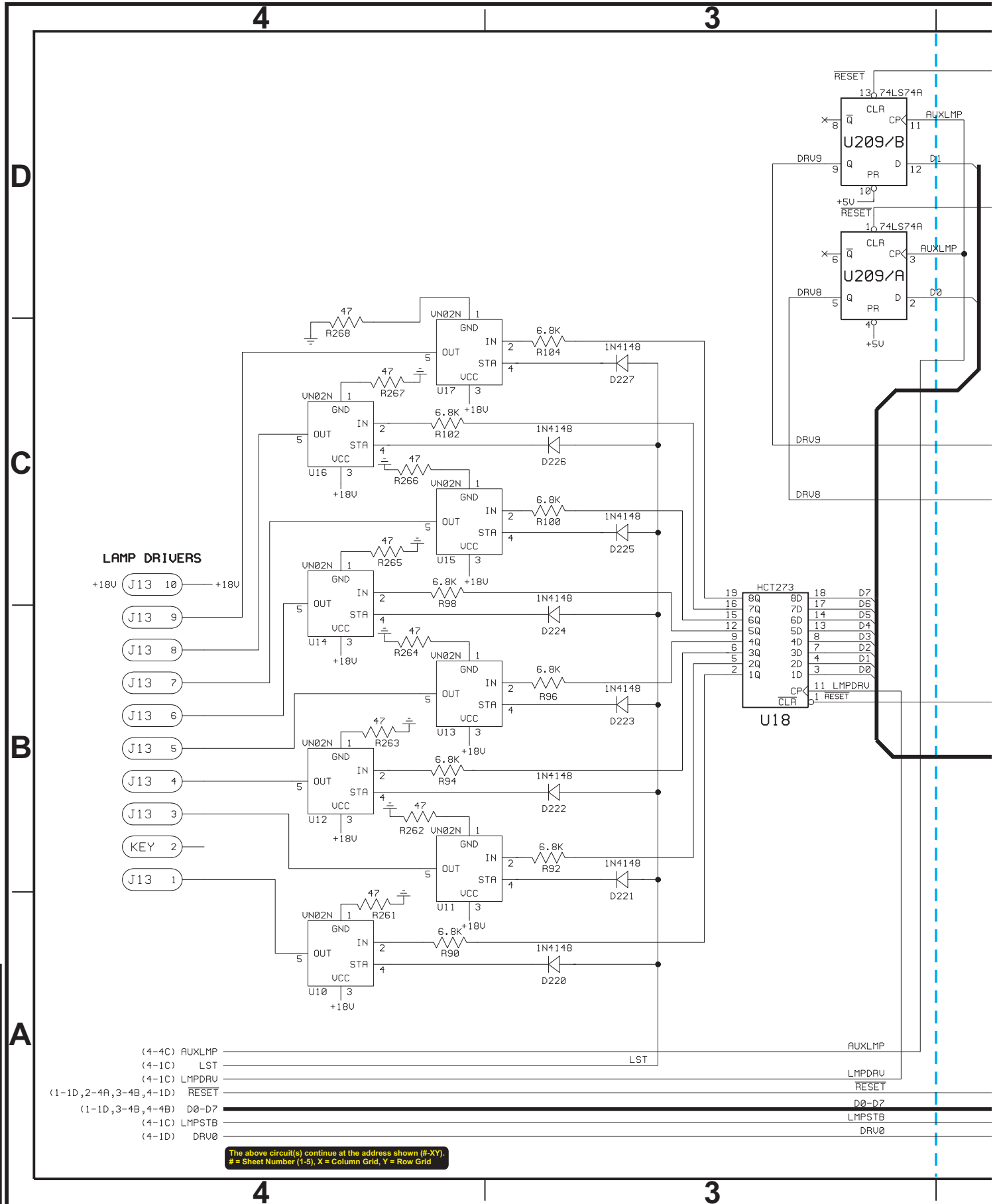

Sec. 5: PCBs



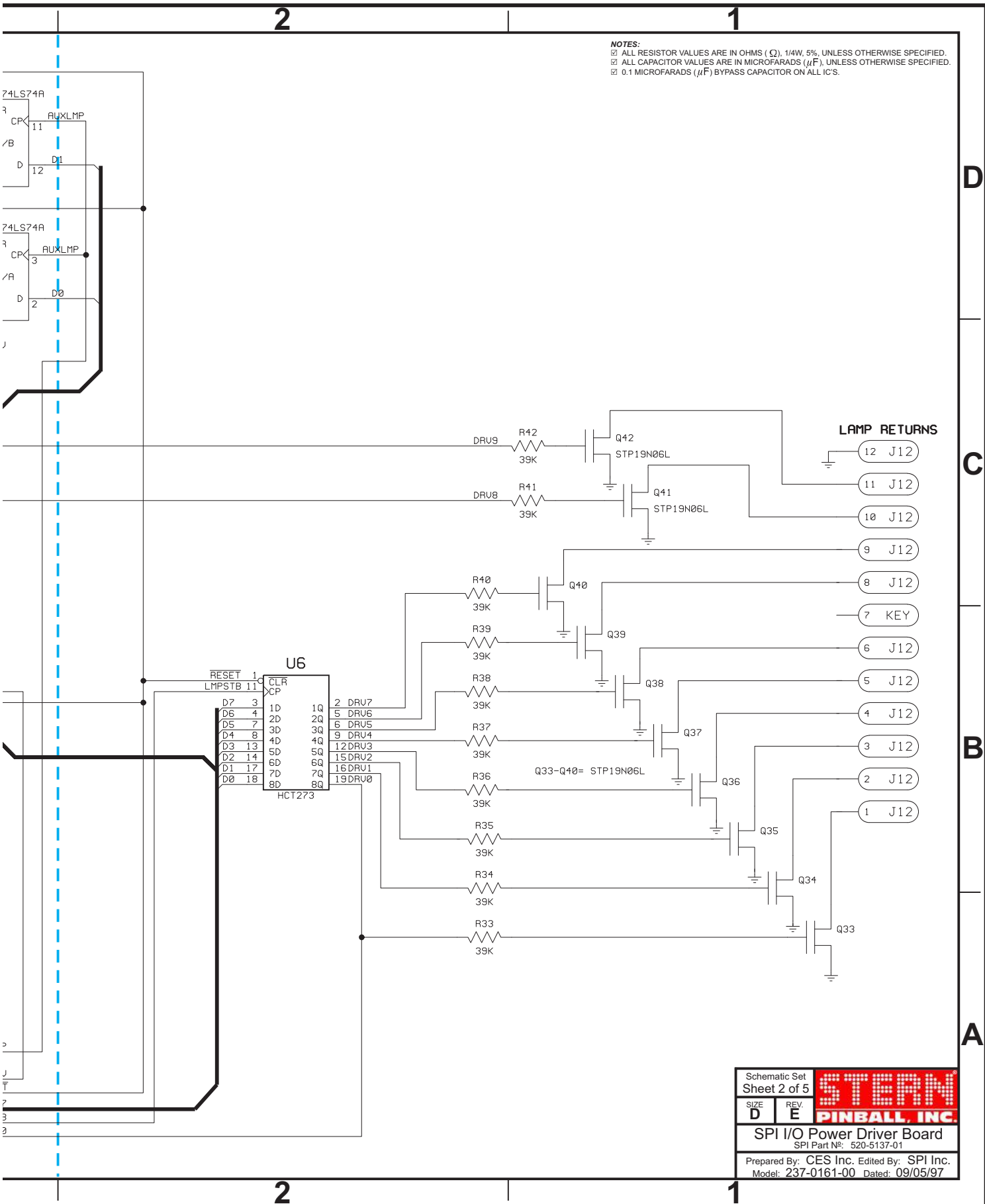

Schematic Set Sheet 2 of 5		<b>STERN</b> <b>PINBALL, INC.</b>
SIZE D	REV. E	
SPI I/O Power Driver Board SPI Part No: 520-5137-01		
Prepared By: CES Inc. Edited By: SPI Inc. Model: 237-0161-00 Dated: 09/05/97		

Sec. 5: PCBs



# I/O Power Driver Board Schematic (Sheet 3 of 5)

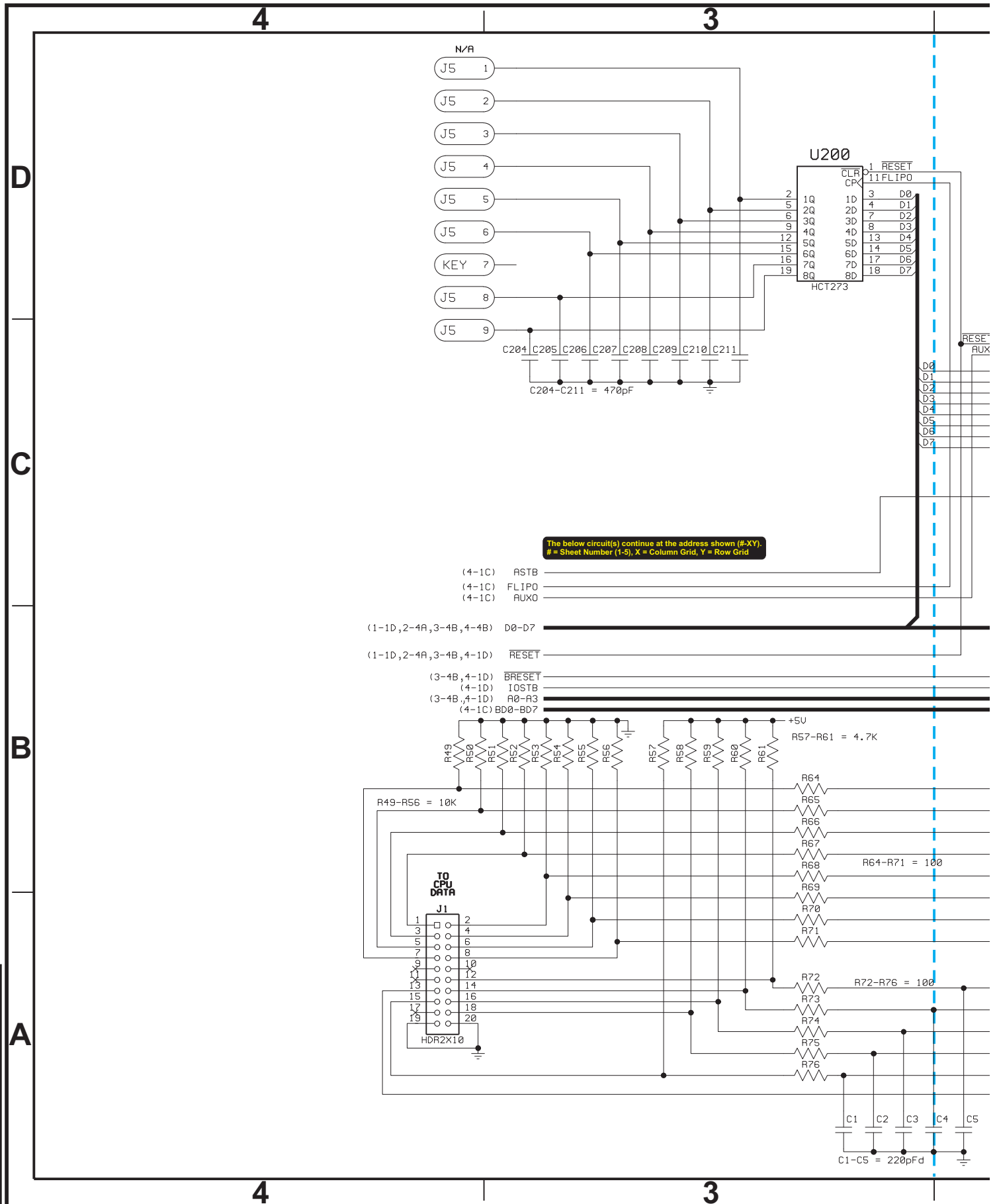

The below circuit(s) continue at the address shown (#-XY).  
 # = Sheet Number (1-5), X = Column Grid, Y = Row Grid

Sec. 5: PCBs



2

1

**NOTES:**  
 ☑ ALL RESISTOR VALUES ARE IN OHMS (Ω), 1/4W, 5%, UNLESS OTHERWISE SPECIFIED.  
 ☑ ALL CAPACITOR VALUES ARE IN MICROFARADS (μF), UNLESS OTHERWISE SPECIFIED.  
 ☑ 0.1 MICROFARADS (μF) BYPASS CAPACITOR ON ALL IC'S.

DATE	DESCRIPTION OF CHANGES / REVISIONS	REQ.	BY.
JAN 2001	Cut trace on solder side at Aux. Out Port J2-PIN1 thru J2-PIN3 & J2-PIN5 thru J2-PIN9; Soldered <b>Resistor 100Ω</b> 1/4W 5% (SPI N#: 121-5007-00). This Modification (highlighted below at J2 with a dotted-line box) was accomplished on boards produced after Jan. 1, 2001. This board is backwards compatible for the White Star™ Board System.	TS	JET

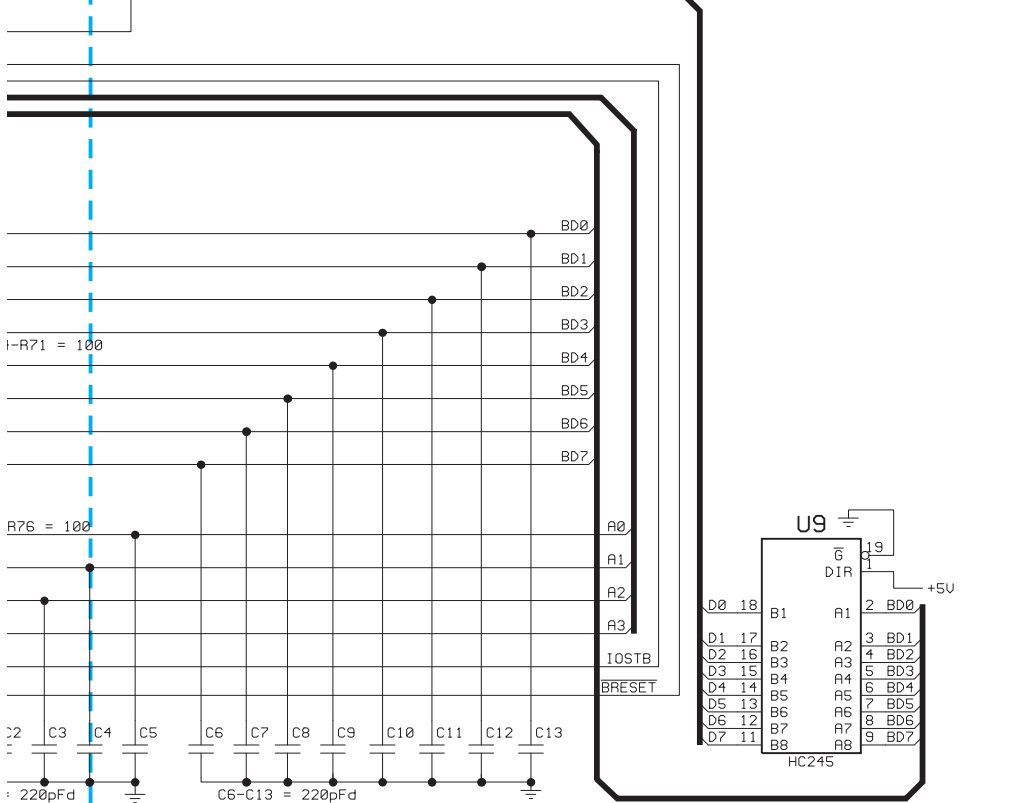
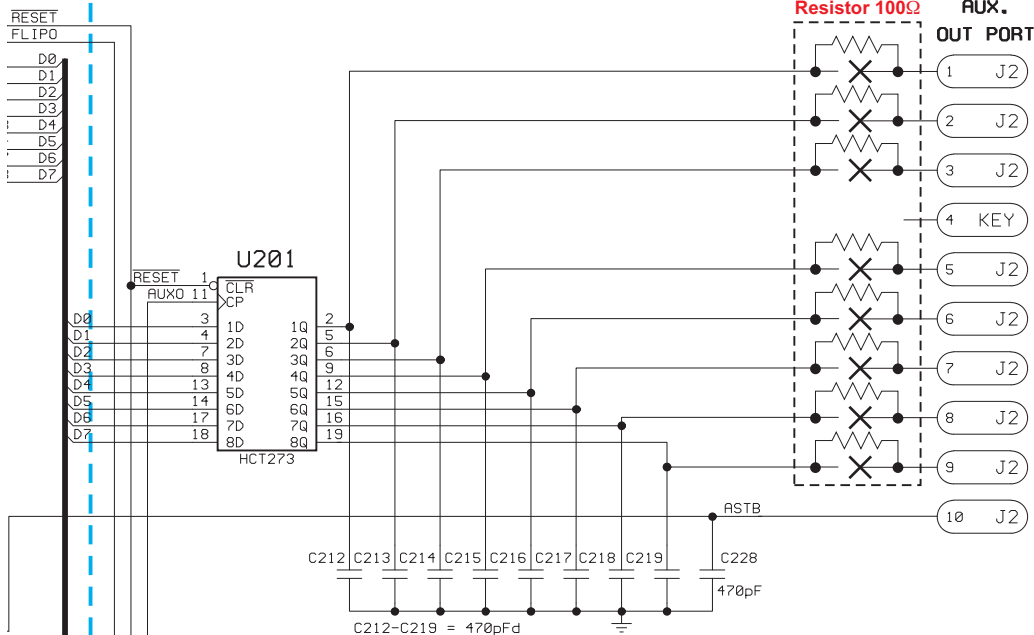

2

1

D  
C  
B  
A

Schematic Set		<b>STERN</b>
Sheet 3 of 5		
SIZE	REV.	<b>PINBALL, INC.</b>
D	E	
SPI I/O Power Driver Board		
SPI Part N#: 520-5137-01		
Prepared By: CES Inc. Edited By: SPI Inc.		
Model: 237-0161-00 Dated: 09/05/97		

Sec. 5: PCBs



# I/O Power Driver Board Schematic (Sheet 4 of 5)

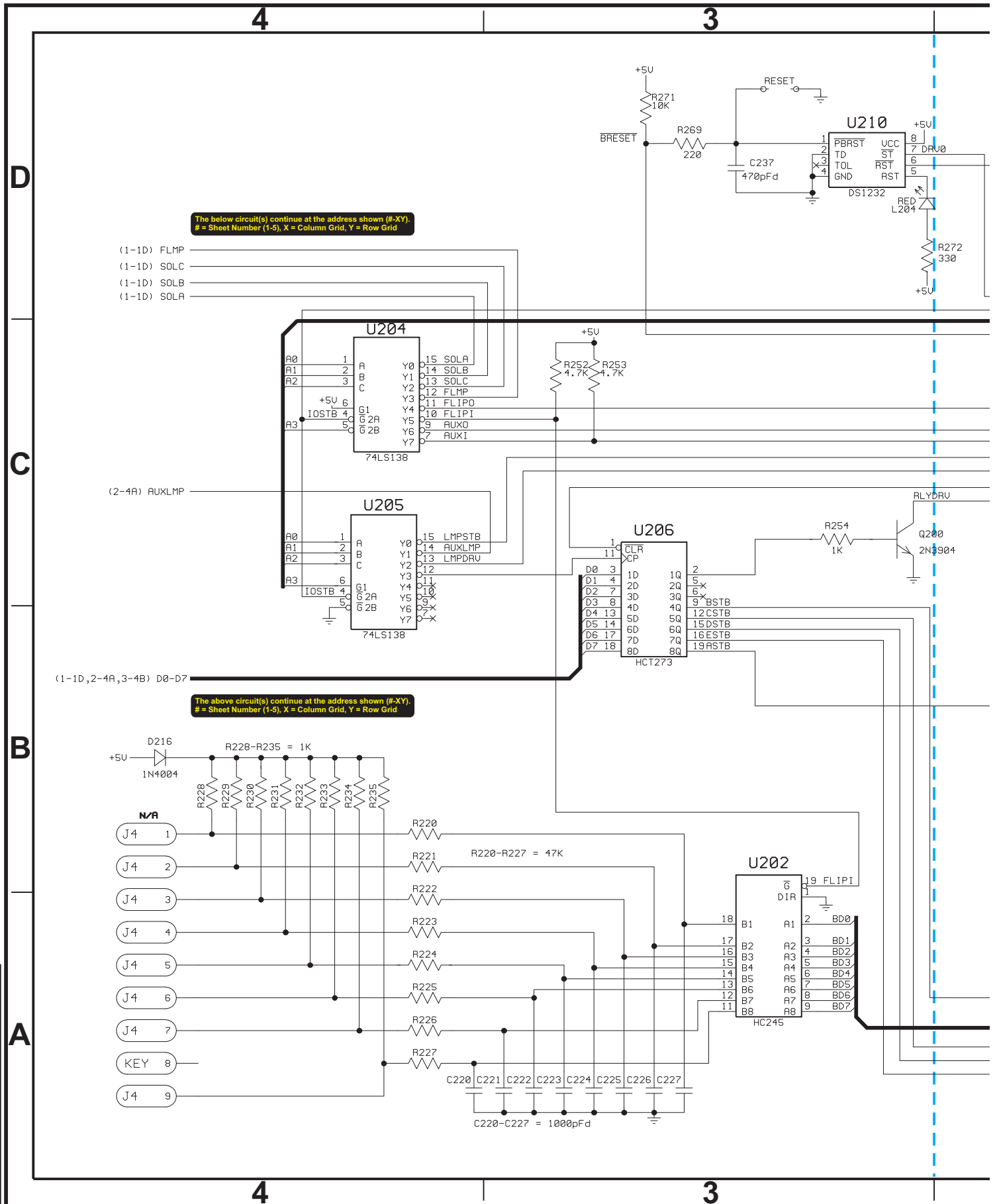

The below circuit(s) continue at the address shown (#-XY).  
# = Sheet Number (1-5), X = Column Grid, Y = Row Grid

The above circuit(s) continue at the address shown (#-XY).  
# = Sheet Number (1-5), X = Column Grid, Y = Row Grid

Sec. 5: PCBs



# I/O Power Driver Board Schematic (Sheet 4 of 5)

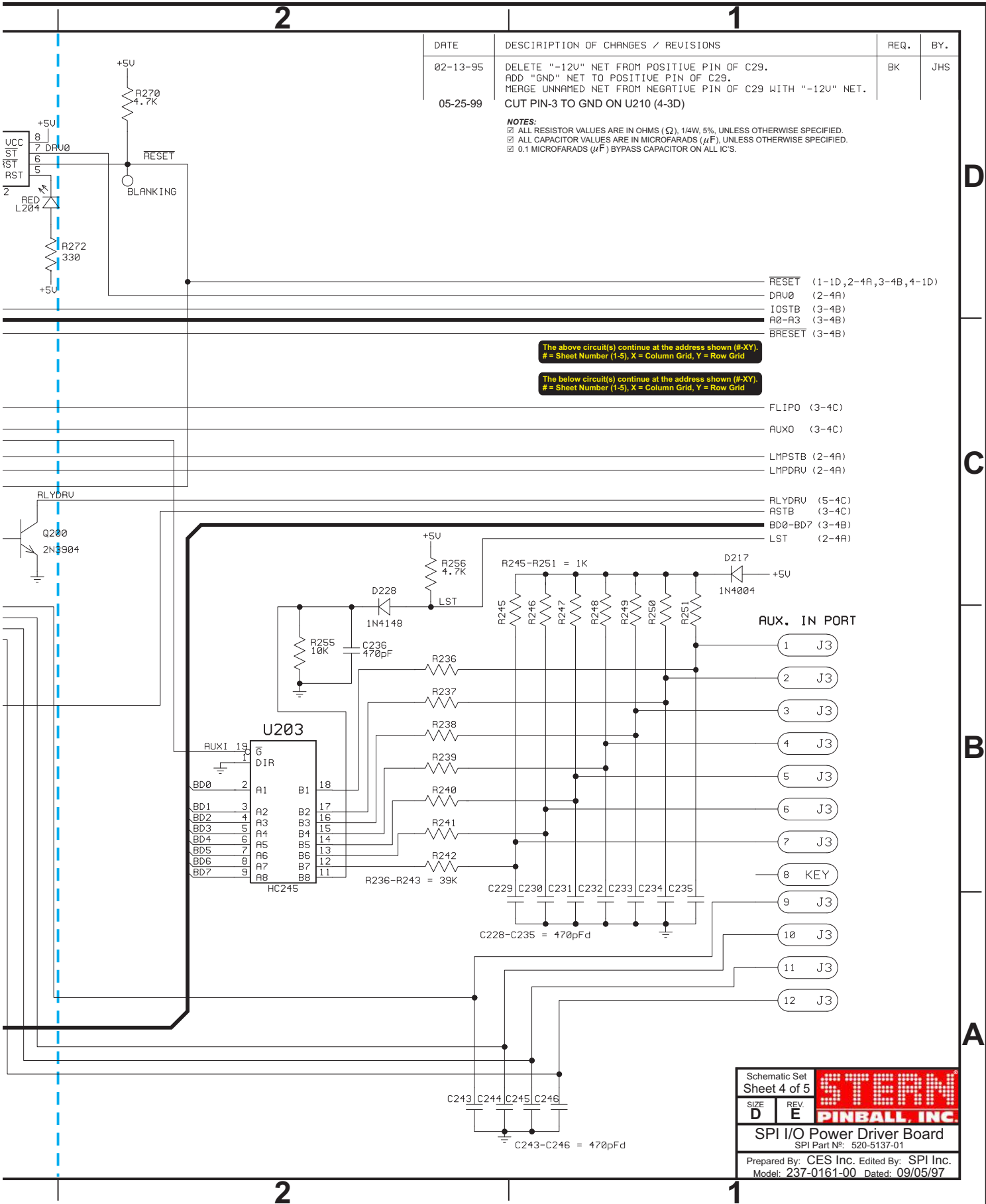

D  
C  
B  
A

Sec. 5: PCBs

Schematic Set Sheet 4 of 5		<b>STERN</b> <b>PINBALL, INC.</b>
SIZE <b>D</b>	REV. <b>E</b>	
SPI I/O Power Driver Board SPI Part No: 520-5137-01		
Prepared By: CES Inc. Edited By: SPI Inc. Model: 237-0161-00 Dated: 09/05/97		



# I/O Power Driver Board Schematic (Sheet 5 of 5)

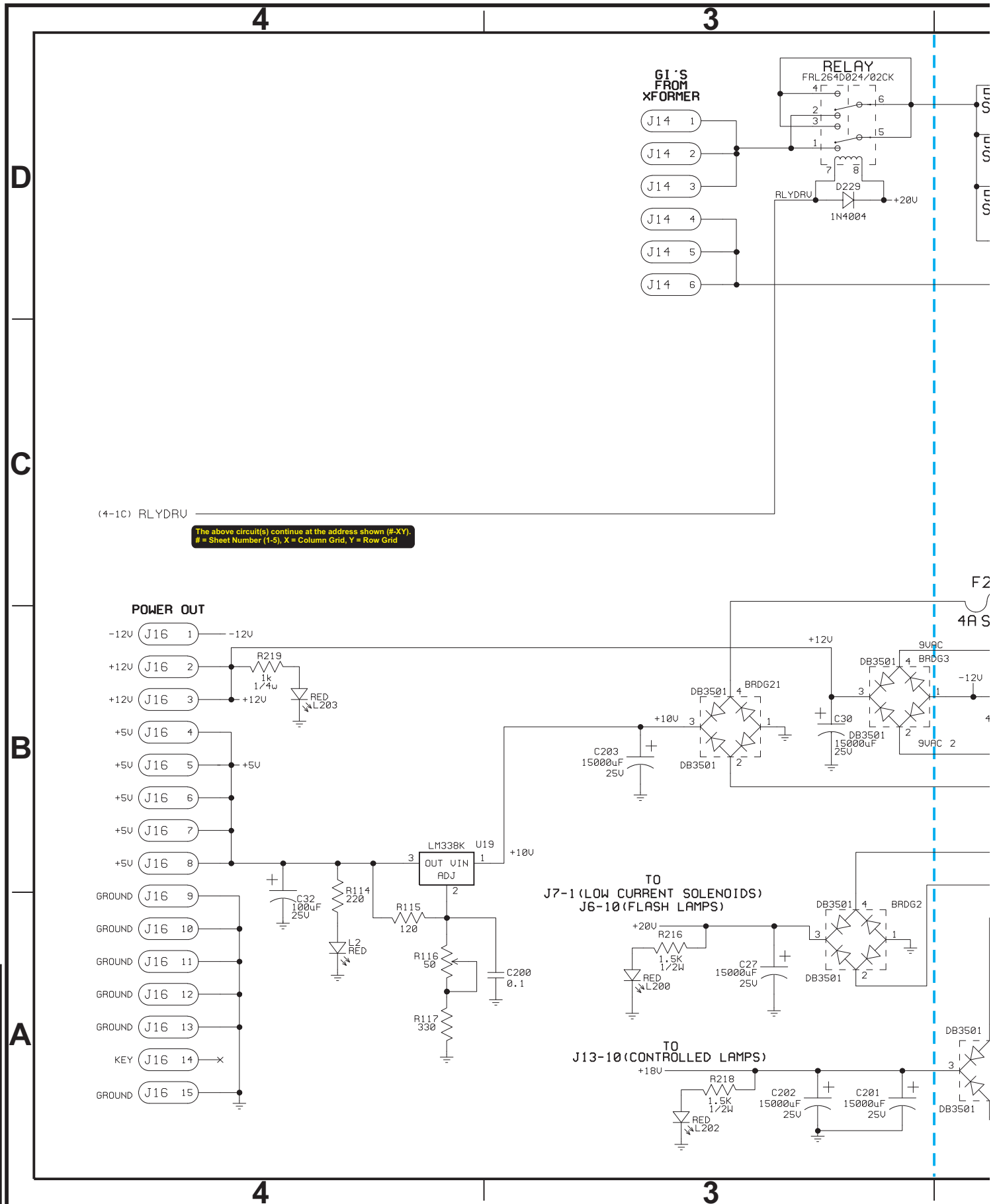

Sec. 5: PCBs

*Elvis Presley*

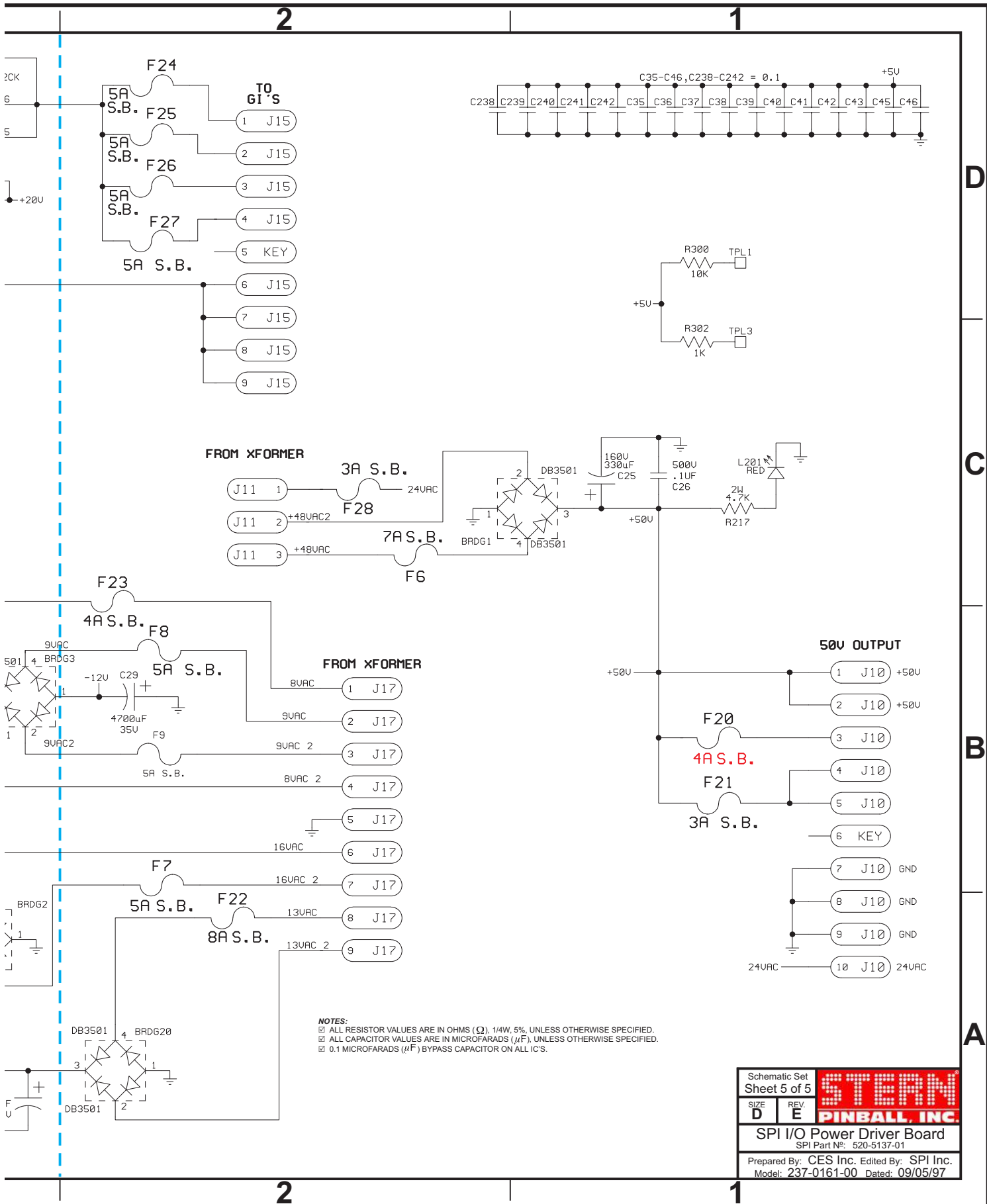

**NOTES:**  
 ☑ ALL RESISTOR VALUES ARE IN OHMS (Ω), 1/4W, 5%, UNLESS OTHERWISE SPECIFIED.  
 ☑ ALL CAPACITOR VALUES ARE IN MICROFARADS (μF), UNLESS OTHERWISE SPECIFIED.  
 ☑ 0.1 MICROFARADS (μF) BYPASS CAPACITOR ON ALL IC'S.

Schematic Set Sheet 5 of 5		<b>STERN</b> <b>PINBALL, INC.</b>
SIZE <b>D</b>	REV. <b>E</b>	
SPI I/O Power Driver Board SPI Part No: 520-5137-01		
Prepared By: CES Inc. Edited By: SPI Inc. Model: 237-0161-00 Dated: 09/05/97		

Sec. 5: PCBs





# I/O Power Driver Board Component Layout

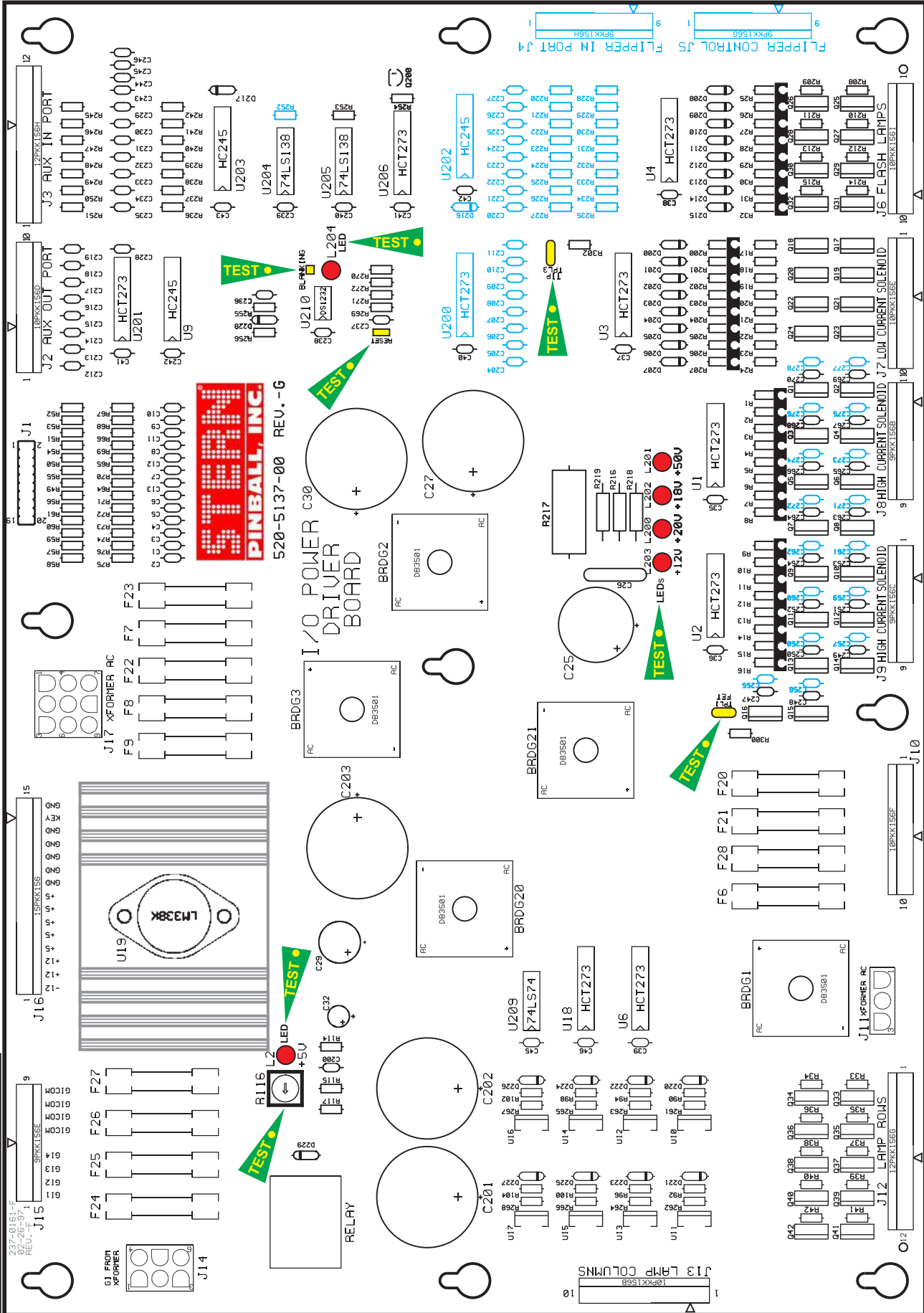

Test Points:



← TIP TPL3  
← BLANKING  
← L204 LED

← RESET

LEDs :  
← L201+50v  
← L202+18v  
← L200+20v  
← L203+12v

← FET TPL1

LED :  
← L2+5V  
← R116 POT

Actual Board Size 15.698" X 11"



# I/O Power Driver Board Parts

ITEM	QTY	PART NUMBER	REF-DESIGNATOR	DESCRIPTION (NS = Not Stuffed)
—	1	520-5137-01	I/O Power Driver Board Rev. G	<b>Complete PCB Assembly</b>
01	5	112-5000-00	BRDG1, BRDG2, BRDG3, BRDG20, BRDG21	DB3501
02	13	125-5030-00	C1, C2, C3>C6, C7, C8, C9>C10, C11, C12	220pF, (221), Cap.
03	1	125-5033-00	C25	100uF, 150v, Radial Lytic Cap.
04	1	125-5035-00	C26	.1uF, 500v, Ceramic Disk Cap.
05	5	125-5036-00	C27, C30, C201, C202, C203	15000uF, 25v, Radial Lytic Cap.
06	1	125-5034-00	C29	4700uF, 35v, Radial Lytic Cap.
07	1	125-5032-00	C32	100uF, 25v, Radial Lytic Cap.
08	17	125-5031-00	C35, C36, C37, C38, C39, C40, C41, C42, C43, C45, C46, C200, C238, C239, C240, C241, C242	0.1uF, (104), Cap.
09	22	125-5028-00	C212>C219, C228>C237, C243>C246 (C204-C211: NS)	470pF, (471), Axial Cap.
10	0	n/a	(C220>C227: NS)	
11	16	125-5029-00	C247>C254, C263>C270	0.01uF, (103), 100v Cap.
12	0	125-5027-00	(C255>C262, C271>C278: NS)	0.1uF, (104), 100v, Cap.
13	25	112-0054-00	D200>D207, D208>D215, D220, D221, D222, D223, D224, D225, D226, D227	1N4148, Diode
14	2	112-5003-00	D217, D229 (D216: NS)	1N4004, Diode
15	26	205-0004-00	F6, F7, F8, F9, F20, F21, F22, F23, F24> F27, F28	Fuse Clips
16	1	200-5000-03	F6	7A 250v S.B. Fuse
17	7	200-5000-01	F7, F8, F9, F24>F27	5A 250v S.B. Fuse
18	2	200-5000-08	F21, F28	3A 250v S.B. Fuse
19	1	200-5000-05	F22	8A 250v S.B. Fuse
20	2	200-5000-06	F20, F23	4A 250v S.B. Fuse
21	1	045-5015-01	J1	20-Pin, 0.1 Dual Row Header
22	1	045-5014-01	J2 (Key Pin-4), J6 (Key Pin-9), J7 (Key Pin-5) J10 (Key Pin-6), J13 (Key Pin-2)	10PKK156
23	1	045-5015-00	J3 (Key Pin-8)	12PKK156
	0	n/a	(J4, J5: NS)	
24	1	045-5013-00	J8 (Key Pin-2), J9 (Key Pin-3), J15 (Key Pin-5)	9PKK156
25	1	045-0014-03	J11	10-84-4030 (3-Pin MOLEX)
26	1	045-5015-00	J12 (Key Pin-7)	12PKK156
27	1	045-0014-06	J14	10-84-4060 (6-Pin MOLEX)
28	1	045-5016-00	J16 (Key Pin-14)	15PKK156
29	1	045-0014-09	J17	10-84-4090 (9-Pin MOLEX)
30	6	165-5099-00	L2, L200, L201, L202, L203, L204	<b>LED T1-3/4 DIFFUSER LED</b>
31	16	110-0106-00	Q1>Q16	22NE10L STP, Transistor
32	16	110-0067-00	Q17>Q24, Q25>Q32	TIP122
33	10	110-0088-00	Q33>Q42	19N06L STP, Transistor
34	1	110-0069-00	Q200	2N3904, Transistor.
35	32	121-5042-00	R1>R8, R9>R16, R200>R207, R208>R215	22K $\Omega$ 1/4W Res.
36	16	121-5003-00	R17>R24, R25>R32	620 $\Omega$ 1/4W Res.
37	17	121-5045-00	R33>R42, R236>R242	39K $\Omega$ 1/4W Res.
38	8	121-5021-00	R49, R57>R61, R253, R256, R270 (R252: NS)	4.7K $\Omega$ 1/4W Res.
39	11	121-5011-00	R50>R56, R255, R271, R300	10K $\Omega$ 1/4W Res.
40	13	121-5007-00	R64>R76	100 $\Omega$ 1/4W Res.
<b>Resistors on Solder Side @ J2-Pins: 1-3 &amp; 5-9</b>				
41	8	121-5029-00	R90, R92, R94, R96, R98, R100, R102, R104	6.8K $\Omega$ 1/4W Res.
42	2	121-5033-00	R114, R269	220 $\Omega$ 1/4W Res.
43	1	121-5030-00	R115	120 $\Omega$ 1/4W Res.
44	1	121-5039-00	R116	50 $\Omega$ Pot
45	2	121-5036-00	R117, R272	330 $\Omega$ 1/4W Res.
46	2	121-5038-00	R216, R218	1.5K $\Omega$ 1/2W Res.
47	1	121-5050-00	R217	4.7K $\Omega$ 2W Res. (SANDBAR)
48	1	121-5009-00	R219, R245>R251, R254, R302 (R228>R235: NS)	1K $\Omega$ 1/4W Res.
49	8	121-5016-00	R261, R262, R263, R264, R265, R266, R267, R268	47 $\Omega$ 1/4W Res.
50	1	190-5002-00	RELAY	FRL264D024/02CK Relay
51	2	n/a	TPL1, TPL3	<b>Test Point Wire (24ga.) Loops</b>
52	8	100-5012-00	U1, U2, U3, U4, U6, U18, U201, U206 (U200: NS)	74HCT273
53	1	110-0058-00	U9	74LS245
54	1	100-5023-00	U210	DS1232
55	8	110-0089-00	U10, U11, U12, U13, U14, U15, U16, U17	VN02N
56	1	100-0356-00	U19	LM338K
57	1	n/a	U19	Heatsink (5v Reg.)
58	1	100-0338-00	U203 (U202: NS)	74HC245
59	2	100-0148-00	U204, U205	74LS138
60	1	100-0037-00	U209	74LS74
61	1	n/a	BLANKING, RESET	<b>Test Points</b>



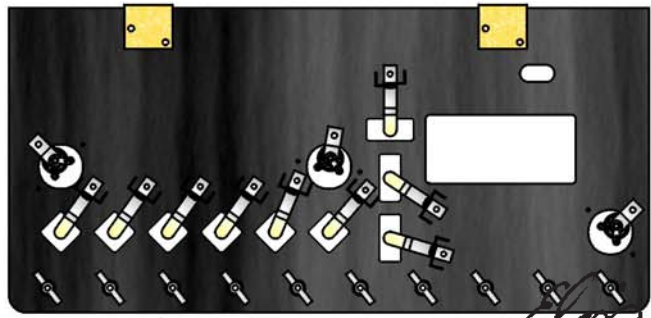
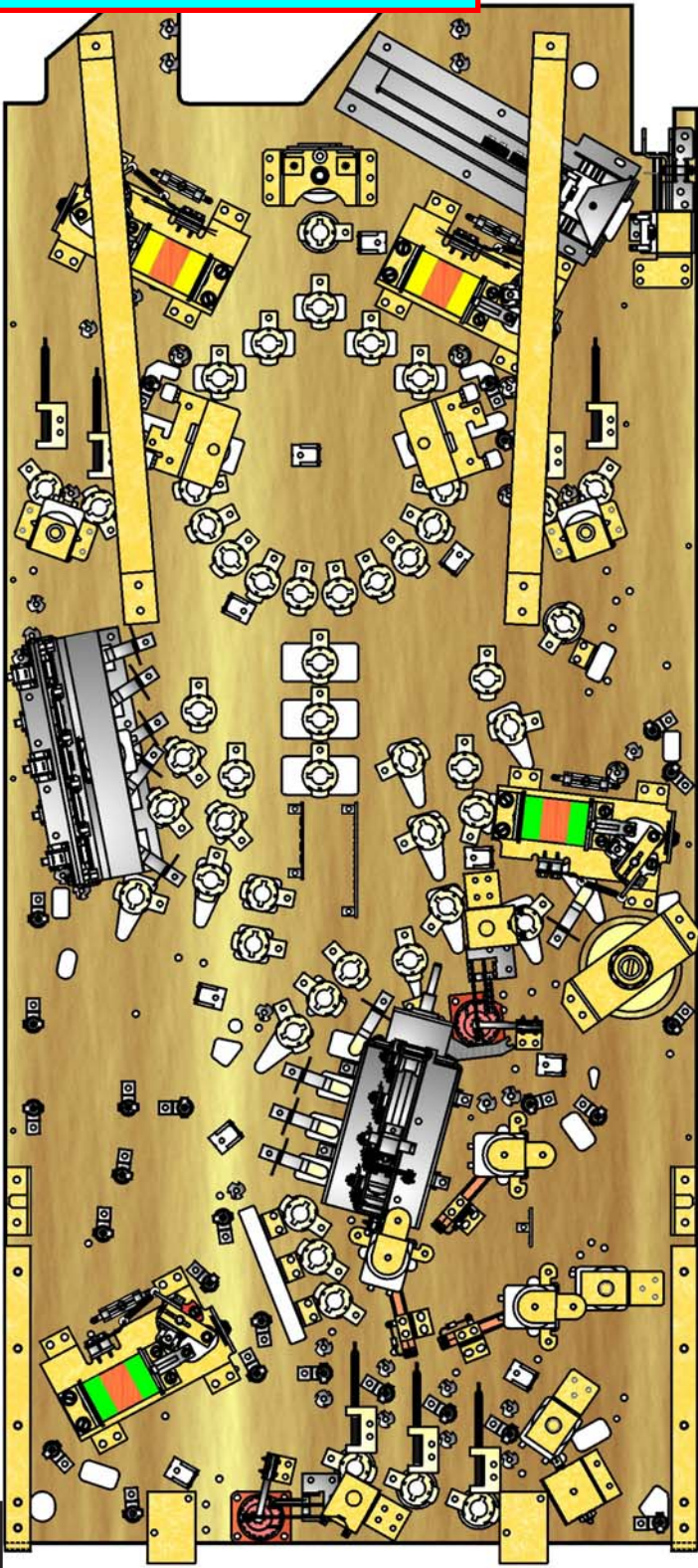
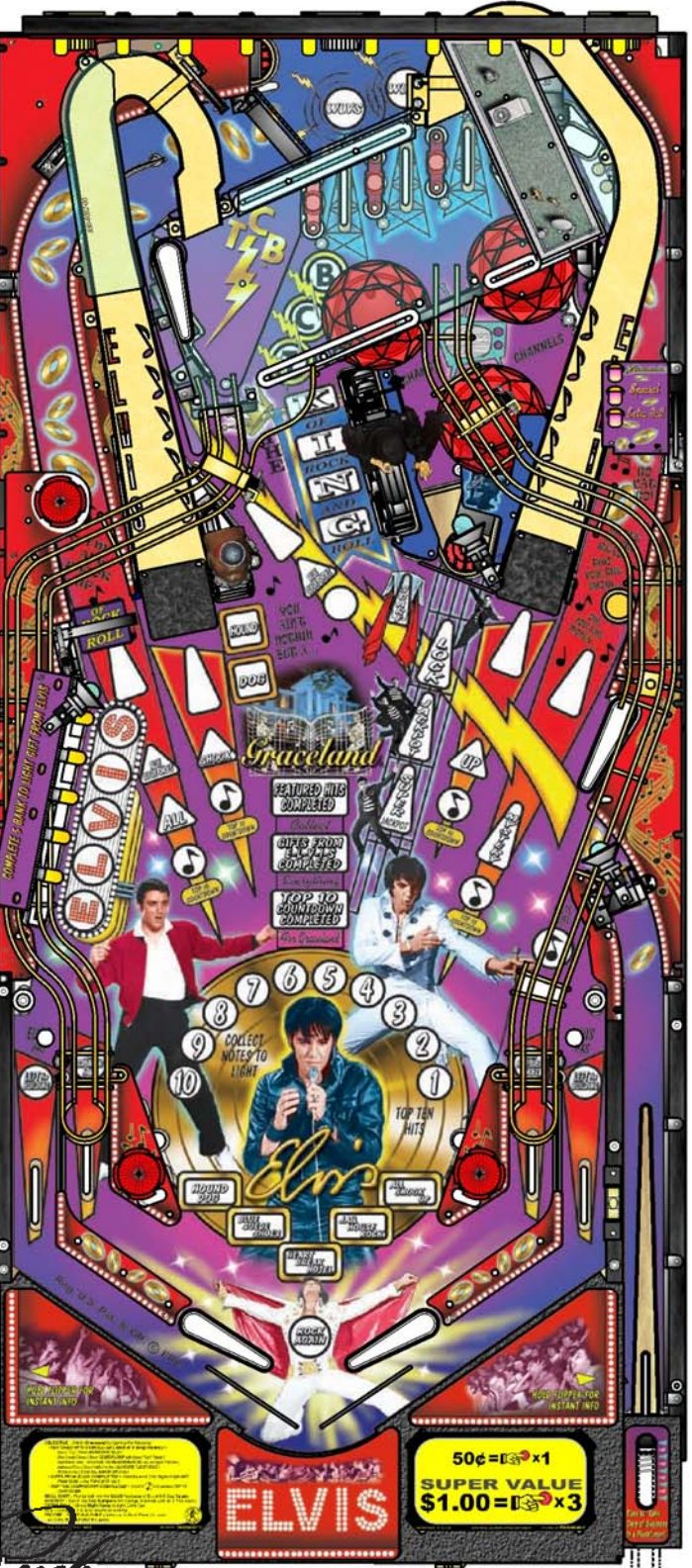

Sec. 5: PCBs

## CPU/Sound Board II (with ATMEL Processor) Theory of Operation

### CPU Section:

The **CPU** is a **68B09E (U209)** with up to 8 MBytes of **CPU Code Space (U210)**. The **CPU** code is bank selected by the use of **U211** and each bank consists of 16 KBytes. 8 KBytes of **RAM (U212)** is available to the **CPU**. The RAM is battery backed and has a write protected area. Battery back up is accomplished by **3-AA Cells (BAT1)** Battery Pack which has a **TEST POINT (TP): VBATT** to check the battery voltage status. The write protected area consists of 512 Bytes used for storing game settings. This section of **RAM** can only be written to when the coin door is open. The Coin Door switch comes into the **CPU** on **CN6-12** and is fed into the address decoding **PAL U213**. When this memory protect signal is low writes to the protected **RAM** area are prohibited. Address decoding for the system is accomplished by one **PAL U213** and one 1-of-8 decoder **U214**.

A watchdog is used to monitor the **CPU** and the 5v supply. If the 5v supply is below 4.75 the watchdog will hold the **CPU/Sound Board & I/O Board** in *reset*. The watchdog must be fed at a rate of **250ms** or faster. The signal used to feed the watchdog comes from the EPROM Bank select signal used to load **U211**.

The **I/O** Interface **CN1** is buffered by two (2) **HC245** Chips (**U207 & U208**). The **CPU's** reset line is buffered by **Q10** and fed over to the **I/O** through **CN1**. An *I/O Strobe Signal* is fed through **CN1-15** and is used to notify the **I/O** that a valid address is being sent.

### Switches:

The Switch Matrix consists of eight (8) **2N3904** Transistors (**Q1-Q8**) which pull one of 8 strobes 'low' to *activate* a Single Column of switches. The *Switch Return Signals* are fed into **CN7** [SWITCH ROWS] and are highly filtered and compared to a 2.5v *reference voltage*. The *Switch Return Voltage* must be below 2.5v to make a *Valid Switch Closure*. If *false switches* are appearing, check that none of the **2N3904** Transistors are permanently pulling the *strobe line low*. Only one strobe from **CN5** [SWITCH COLUMNS] should be *low at any time*. **CN6** [DEDICATED SWITCH IN] is a *Dedicated Bank of Input Switches*. Switches connected to **CN6** are connected to ground instead of a strobe and may be read at any time.

### Plasma Interface:

The data path for communication to and from the **Plasma Controller Board** is 8 bits wide. There are separate *Input* and *Output Busses*. Data going out to the controller comes from the **CPU's Data Bus** through **U201** and onto **CN8-Pins 11-18**. Status back from the Plasma Controller comes in on **CN8-Pins 22-26** and is fed into **U202** for input to the **CPU's Data Bus**. Two control signals that go out to the Plasma Controller are **PRES** [TP17: PLASMA RESET] and **CN8-Pin 19 [PSTB - Plasma Strobe]**. The Plasma Reset is software controllable through **U216/B** and also has a test point "Plasma Reset". The *Plasma Strobe Signal* to the controller is generated from **U216/A** and is *used to latch data* into the Plasma Controller.

### Other Test Points (TP):

**TP 7: E & TP5: Q** - The **CPU** signals for both **68B09E** processors. Should be at 2Mhz with **Q** leading **E** by **500 nsec**. **TP2: P0. TP3: P1. TP4: P2. TP20: (near U402). TP8: (near U219). TP1: +3.3V.**



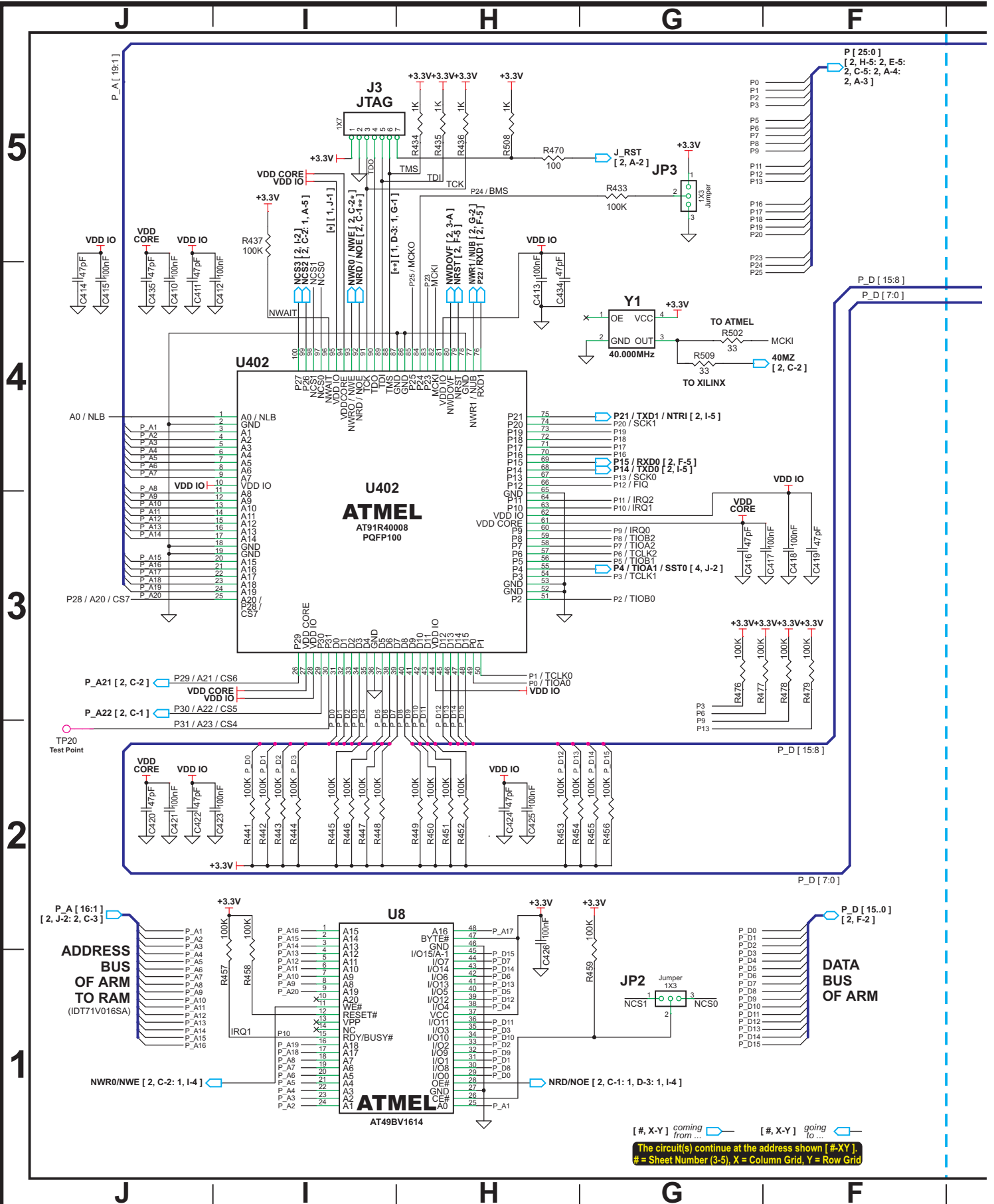

Sec. 5: PCBs

[#, X-Y] coming from ...    [#, X-Y] going to ...

The circuit(s) continue at the address shown [ #-XY ].

# = Sheet Number (3-5), X = Column Grid, Y = Row Grid



# CPU/Sound Board II (with ATMEL Processor) Schematic (Sheet 1 of 4)

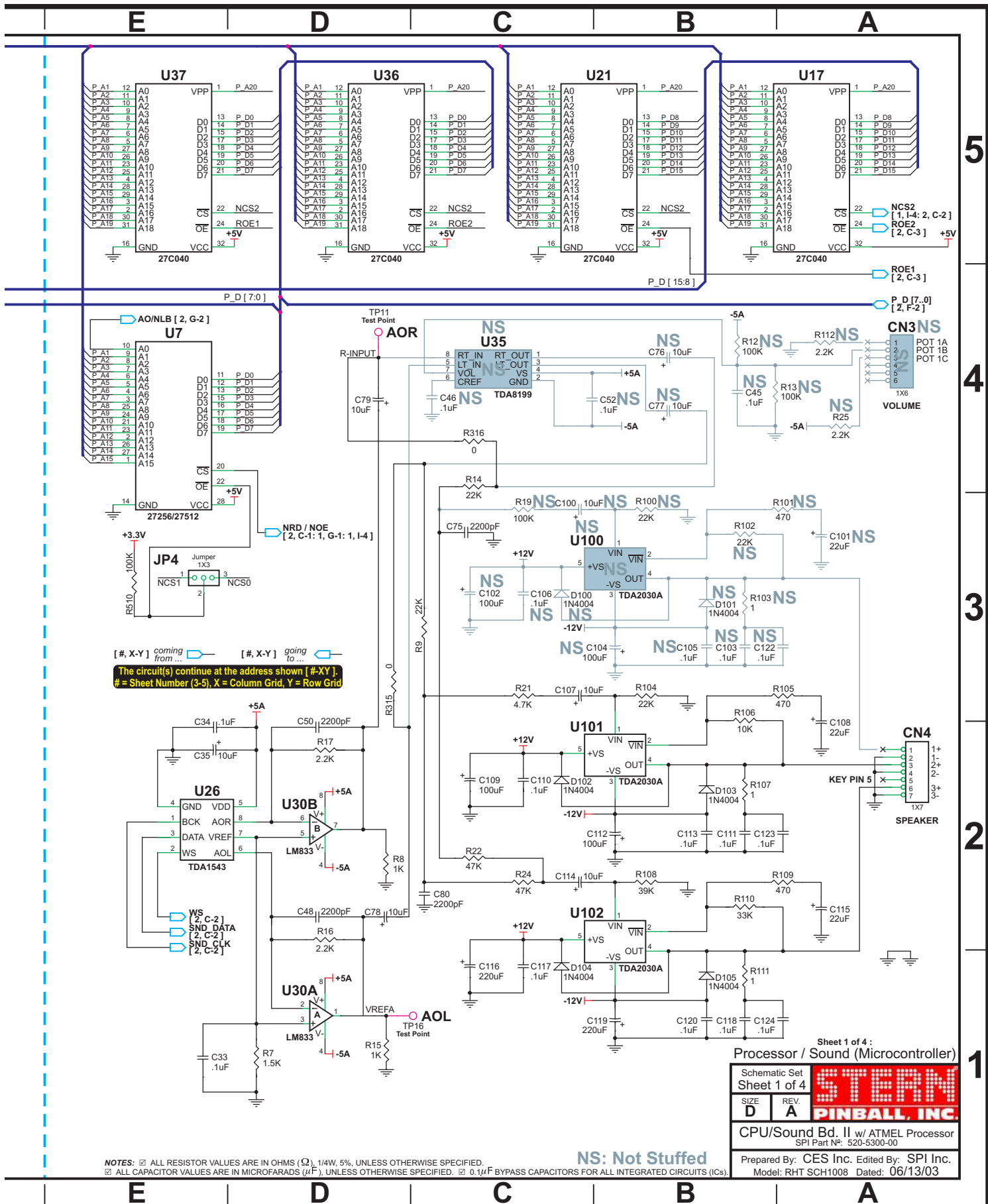

Sec. 5: PCBs



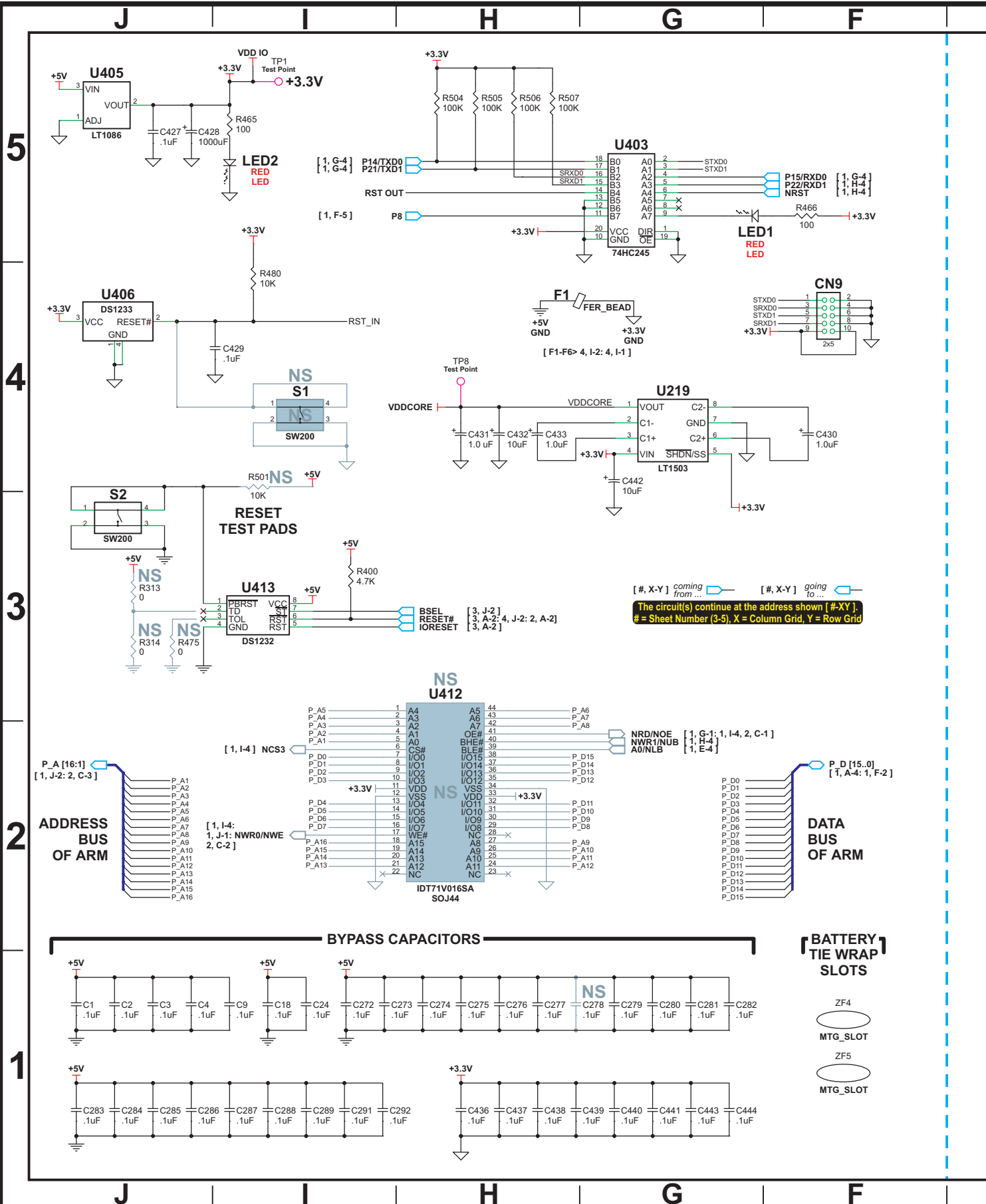

Sec. 5: PCBs

*Elvis Presley*

CPU/Sound Board II (with ATMEL Processor) Schematic (Sheet 2 of 4)

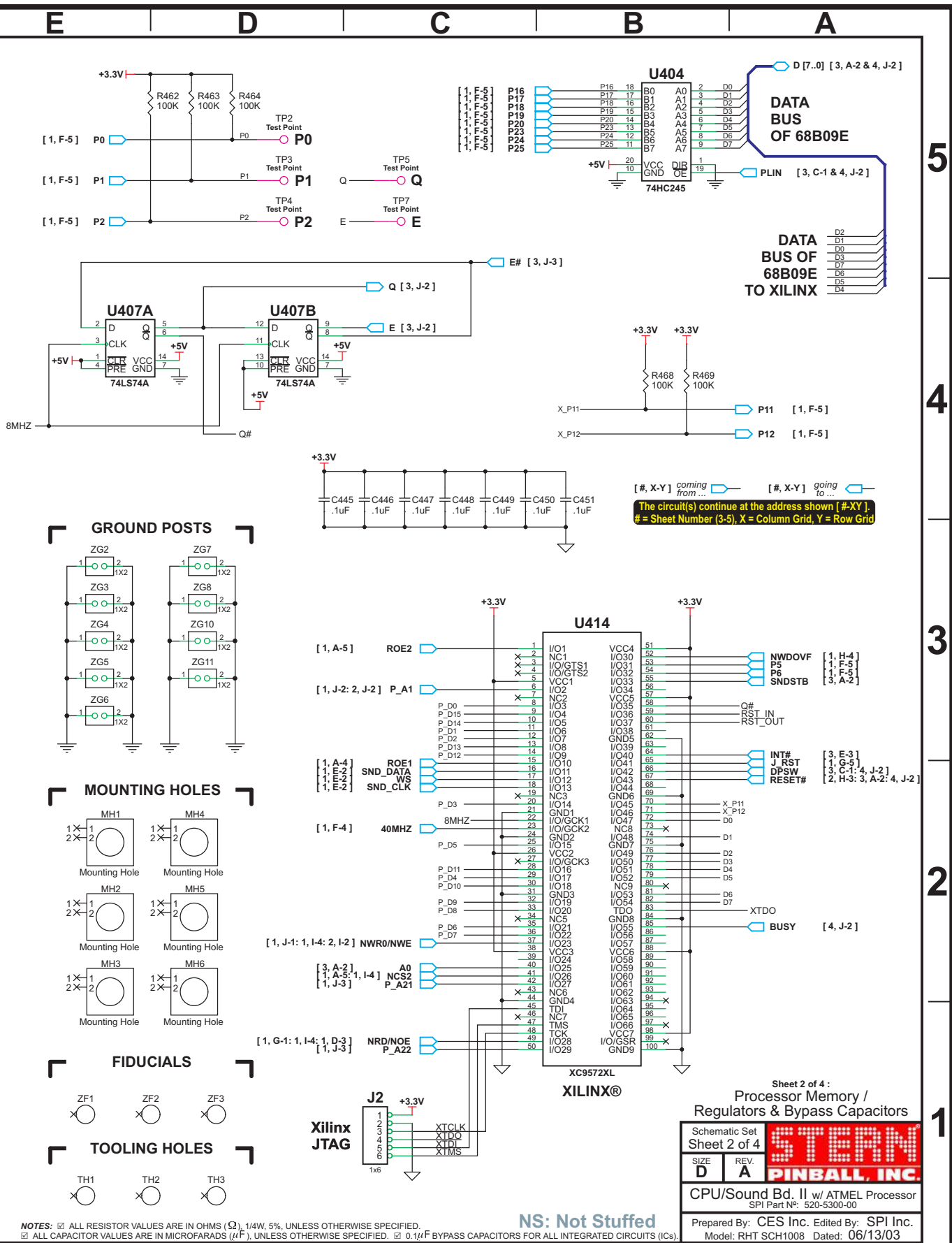

NOTES: □ ALL RESISTOR VALUES ARE IN OHMS (Ω), 1/4W, 5%, UNLESS OTHERWISE SPECIFIED.  
 □ ALL CAPACITOR VALUES ARE IN MICROFARADS (μF), UNLESS OTHERWISE SPECIFIED. □ 0.1μF BYPASS CAPACITORS FOR ALL INTEGRATED CIRCUITS (ICs).

NS: Not Stuffed

Sheet 2 of 4 : Processor Memory / Regulators & Bypass Capacitors

Schematic Set	Sheet 2 of 4	<b>STERN</b>
SIZE	REV	
<b>D</b>	<b>A</b>	<b>PINBALL, INC.</b>

CPU/Sound Bd. II w/ ATMEL Processor  
 SPI Part N°: 520-5300-00

Prepared By: CES Inc. Edited By: SPI Inc.  
 Model: RHT SCH1008 Dated: 06/13/03



Sec. 5: PCBs



[ #, X-Y ] coming from ... [ #, X-Y ] going to ...  
 The circuit(s) continue at the address shown [ #-XY ].  
 # = Sheet Number (3-5), X = Column Grid, Y = Row Grid

5

4

3

2

1

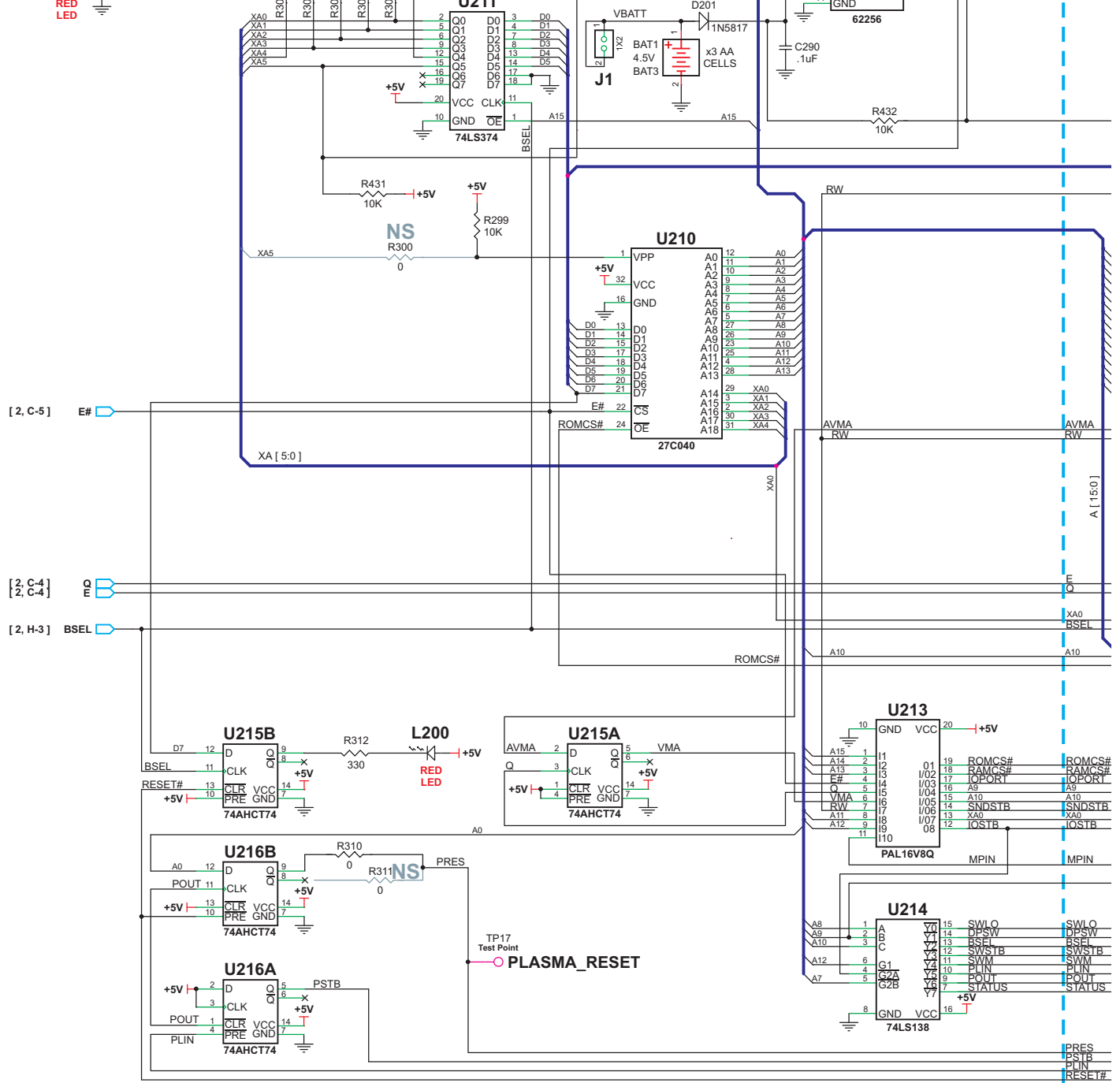
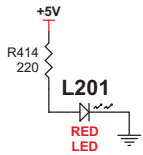

Sec. 5: PCBs



# CPU/Sound Board II (with ATMEL Processor) Schematic (Sheet 3 of 4)

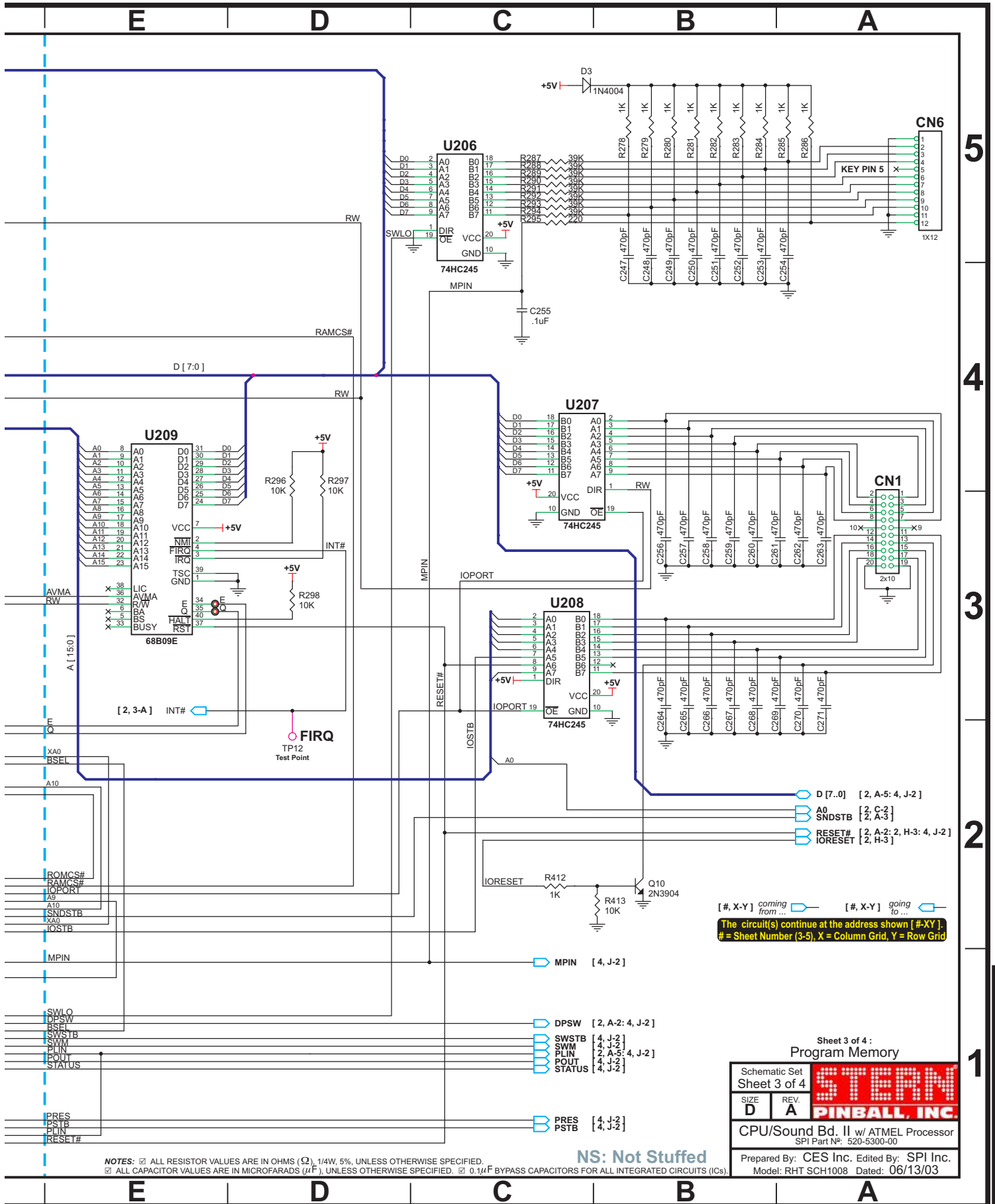

5  
4  
3  
2  
1

Sec. 5: PCBs

Sheet 3 of 4:  
Program Memory

Schematic Set	Sheet 3 of 4	<b>STERN</b>
SIZE	REV	
D	A	<b>PINBALL, INC.</b>

CPU/Sound Bd. II w/ ATMEL Processor  
SPI Part N<sup>o</sup>: 520-5300-00

Prepared By: CES Inc. Edited By: SPI Inc.  
Model: RHT SCH1008 Dated: 06/13/03



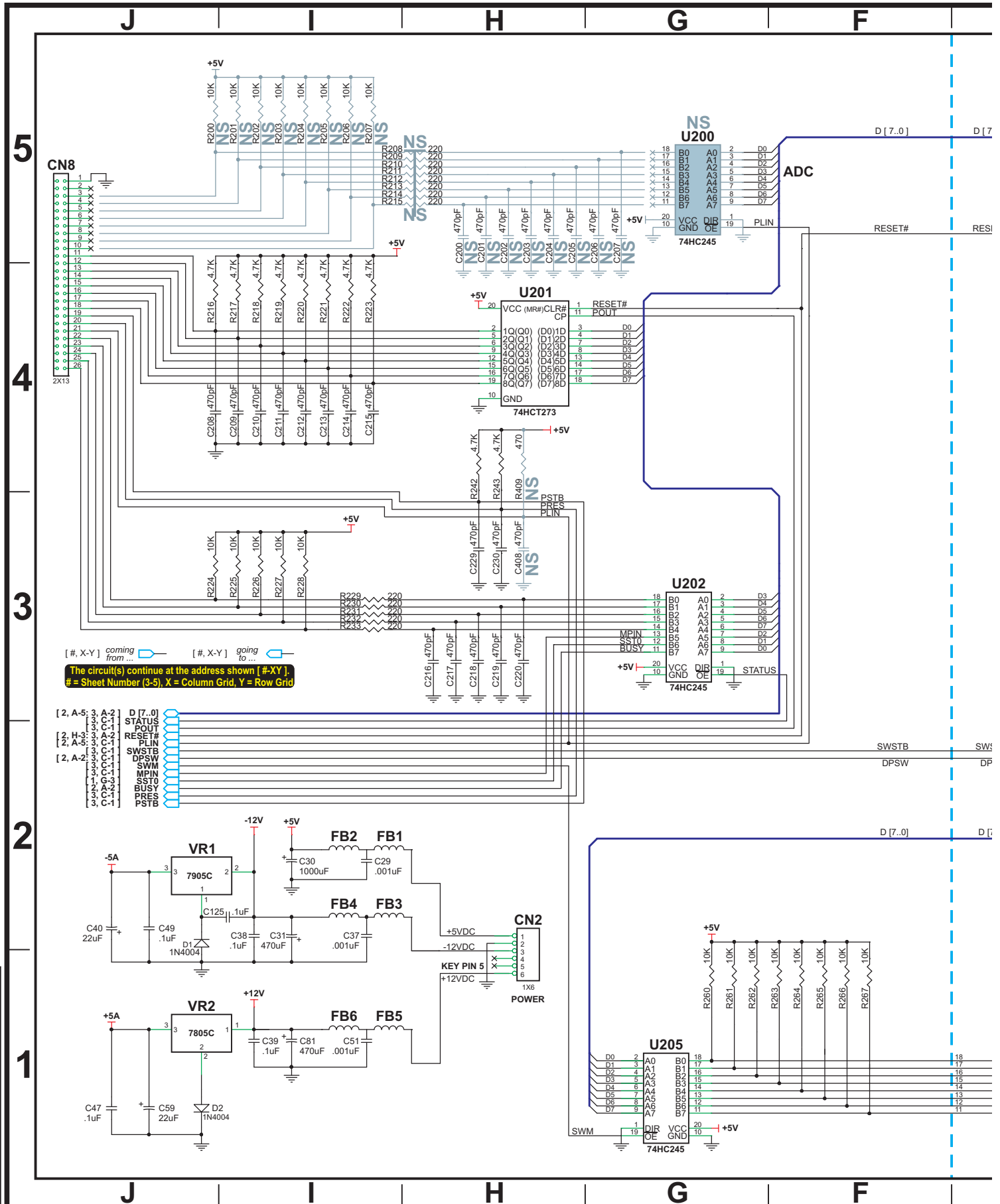

Sec. 5: PCBs

*Elvis Presley*

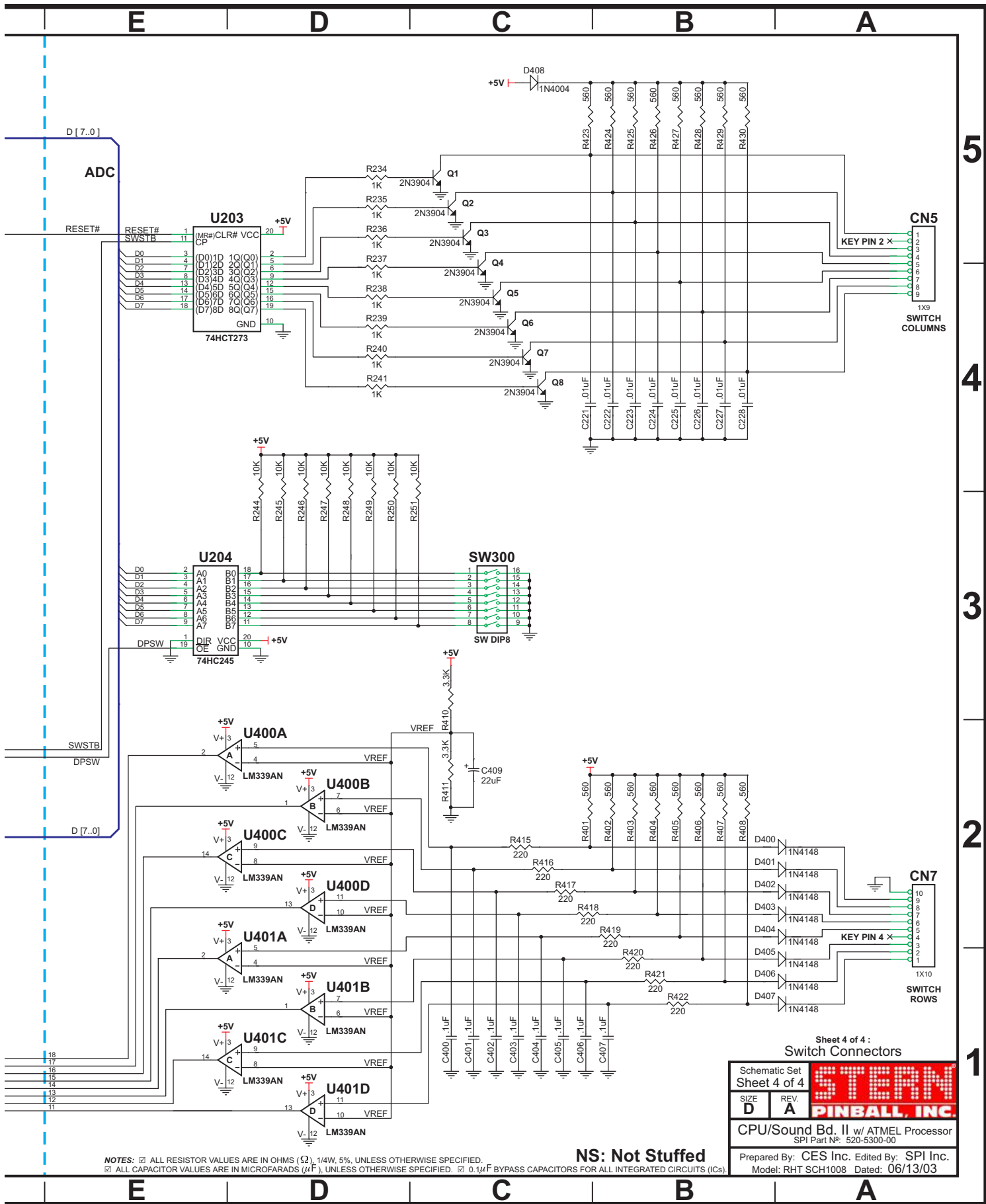

NOTES: □ ALL RESISTOR VALUES ARE IN OHMS (Ω), 1/4W, 5%, UNLESS OTHERWISE SPECIFIED.  
 □ ALL CAPACITOR VALUES ARE IN MICROFARADS (μF), UNLESS OTHERWISE SPECIFIED. □ 0.1μF BYPASS CAPACITORS FOR ALL INTEGRATED CIRCUITS (ICs).

NS: Not Stuffed

Sheet 4 of 4:  
 Switch Connectors

Schematic Set		<b>STERN</b>	
Sheet 4 of 4		PINBALL, INC.	
SIZE	REV		
D	A		
CPU/Sound Bd. II w/ ATMEL Processor			
SPI Part N°: 520-5300-00			
Prepared By: CES Inc. Edited By: SPI Inc.			
Model: RHT SCH1008 Dated: 06/13/03			



Sec. 5: PCBs



# CPU/Sound II Board (with Atmel Processor) Parts

ITEM	QTY	PART NUMBER	REF-DESIGNATOR	DESCRIPTION (NS = Not Stuffed)	
	1	520-5300-00	<b>CPU/Sound II Board (with Atmel Processor)</b>	<b>Complete PCB Assembly</b>	
<b>Connectors</b>	01		JP1, JP2, JP3, JP4	3-Pin Jumper & 2-Pin Cover	
	02		CN2 (Key Pin-5)	6-Pin, 6PKK156	
	03	045-5015-06	J2 JTAG Xilinx®	6-Pin, ## Header	
	04		CN4 (Key Pin-5)	7-Pin, 7PKK156	
	05		J3 JTAG	7-Pin, ## Header	
	06		CN5 (Key Pin-2)	9-Pin, 9PKK156	
	07		CN9	10-Pin, 0.1 Header	
	08		CN7 (Key Pin-4)	10-Pin, 10PKK156	
	09		CN6 (Key Pin-5)	12-Pin, 12PKK156	
	10		CN1	20-Pin, 0.1 Header	
	11		CN8	26-Pin, 0.1 Header	
	12	3	125-5043-00	C29, C37, C51	0.001uF (102), Cap.
	13	4	125-5039-00	C48, C50, C75, C80	0.0022uF or 2200pF, (222), Cap.
	14	8	125-5029-00	C221>C228	0.01uF (103), 100v Cap.
	15	52	125-5031-00	C1>C4, C9, C18, C24, C33, C34, C38, C39, C47, C49, C110, C111, C113, C117, C118, C120, C123, C124, C125, C255, C272>C277, C279>C292, C400>C407, C444 (C45, C46, C52, C103, C105, C106, C122, C278: NS)	0.1uF (104), Axial Cer. Cap.
<b>Capacitors*</b>	16	3	C430, C431, C433 (near U403, U404)	1.0uF, ##v, Radial Lytic Cap.	
	17	1	125-5017-00	10uF, 16v, Radial Tant. Cap.	
	18	4	125-5017-00	10uF, 25v-35v, Radial Lytic Cap.	
	19	2	125-5015-00	100uF, 25v, Radial Lytic Cap.	
	20	1	125-5014-00	22uF, 16v, Radial Lytic Cap.	
	21	4	125-5020-00	22uF, 25v, Radial Lytic Cap.	
	22	2	125-5012-00	220uF, 25v, Radial Lytic Cap.	
	23	2	125-5019-00	470uF, 25v, Radial Lytic Cap.	
	24	39	125-5028-00	470pF (471), Cer. Cap.	
	25	2	125-5037-00	1000uF, 16v, Radial Lytic Cap.	
	26	17		SMT .1uF Cap.	
	27	2		SMT 10uF Cap.	
	28	9		SMT 47pF Cap.	
	29	10		SMT 100nF Cap.	
	<b>Diodes &amp; LEDs*</b>	30	7	112-5003-00	D1>D3, D102>D105, D408 (D100, D101: NS)
31		2	112-5008-00	D200, D201	
32		8	112-0054-00	D400-D407	
33		4	165-5099-00	<b>LED1, LED2, L200, L201</b>	
34		3	124-5064-00	R310, R315, R316 (R300, R311, R313, R314, R475: NS)	
35		2	121-5041-00	R107, R111 (R103: NS)	
36		20	121-5009-00	R8, R15, R234>R241, R278>R286, R412	
37		1	121-5018-00	R7	
38		2	121-5043-00	R16, R17 (R25, R112: NS)	
39		2	121-5048-00	R410, R411	
40		12	121-5021-00	R21, R216>R223, R242, R243, R400	
41		36	121-5011-00	R106, R224>R228, R244>R251, R260>R267, R296>R299, R301>R306, R413, R431, R432 (R200>R207, R501: NS)	
42		3	121-5023-00	R9, R14, R104 (R100, R102: NS)	
43		1	121-5022-04	R110	
44		9	121-5045-00	R108, R287>R294	
<b>Resistors / Transistors*</b>	45	2	121-5032-00	R22, R24	
	46	15	121-5014-00	R229>R233, R295, R414>R422 (R208>R215: NS)	
	47	1	121-5036-00	R312	
	48	2	121-5046-01	R105, R109 (R101, R409: NS)	
	49	16	121-5047-00	R401>R408, R423>R430	
	50	1		F1	
	51	4		R434, R435, R436, R508	
	52	1		R480	
	53	2		R502, R509	
	54	3		R465, R466, R470	
	55	35		R433, R437, R441>R459, R462>R464, R468, R469, R476>R479, R504>R507, R510	
	56	9	110-0069-00	Q1-Q8, Q10	
	57	1		U402	
	58	1		U8	
	59	1		U414	
60	1		U7		
<b>ICs / RAMs / ROMs / EPROMs</b>	61		U210 (32-Pin, IC Socket, 077-5217-00)	2N3904, Transistor	
	62	4	U17, U21, U36, U37 (32-Pin, IC Socket, 077-5217-00)	<b>ATMEL</b> , AT91R40008	
	63	1	U213 (BLUE DOT)	<b>ATMEL</b> , AT49BV1614	
	64	1	U212 (28-Pin, IC Dip Socket, 077-5208-00)	<b>XILINX®</b> , XC9572XL	
	65	1	U209 (40-Pin, IC Socket, 077-5209-00)	<b>512K EPROM</b> Sound (27512)	
	66	1	U215, U216	<b>1MB EPROM</b> CPU Game (27C040)	
	67	2	100-5015-00	<b>8MB EPROM</b> Voice 1-4 (M27C04001-12FI)	
	68	8	100-0338-00	<b>PAL16V8Q (Programmed) BLUE DOT</b>	
	69	2	100-5012-00	6264/MS62256 (MS6264A) (28-Pin)	
	70	1	100-0037-00	68B09E (40-Pin)	
	71	1	100-0148-00	74AHC74 (14-Pin)	
	72	1	100-0064-00	74HC245 (20-Pin)	
	73	1		74HCT273 (20-Pin)	
	74	1		74LS74 (14-Pin)	
	75	1		74LS138 (16-Pin)	
76	1		74LS374 (20-Pin)		
77	1	124-5002-00	3.3v Watchdog, DS1233 (3-Pin)		
78	1	124-5001-00	5.0v Watchdog, DS1232 (8-Pin)		
79	2	100-0377-00	1.8v Volt. Regulator LT1503 (8-Pin)		
80	1	100-0375-00	3.3v Volt. Regulator LT1086 (3-Pin)		
81	1	100-5018-00	-5v Regulator, LM7905CT		
82	2	100-5016-20	+5v Regulator, LM7805CT		
83	1		LM339AN (14-Pin)		
84	1		LM833 (8-Pin)		
85	1		TDA1543 (8-Pin)		
86	1		TDA2030A (5-Pin)		
			40MHz Clock PLE SQ3300S		
			Dip Switch 8-Pos., (KSD08H Black)		
			Ferrite Bead		
			Heat Sink (AAVID 531102)		
			Push-Button Switch (B3F4000)		
			BAT1 HOLDER (Always replace all 3, Size AA 1.5v Cells, with new ones, when required)		

\* Surface Mounts (SMT) are not listed.

\* Surface Mounts (SMT) are not listed.

If a part is required where a part number is not provided, call Tech. Support (see back of cover).

**Test Point Wire (24ga.) Loops:**  
 VBATT, GND (near CN7),  
 GND (near CN9), GND (near L200),  
 GND\_SIGNAL (near U405)

**Test Point Pads:**  
 TP1>TP5, TP7, TP8, TP11,  
 TP12, TP16, TP17, TP20



Sec. 5: PCBs

# UK & Special App. 3X Transistor Driver Bd. Schematic

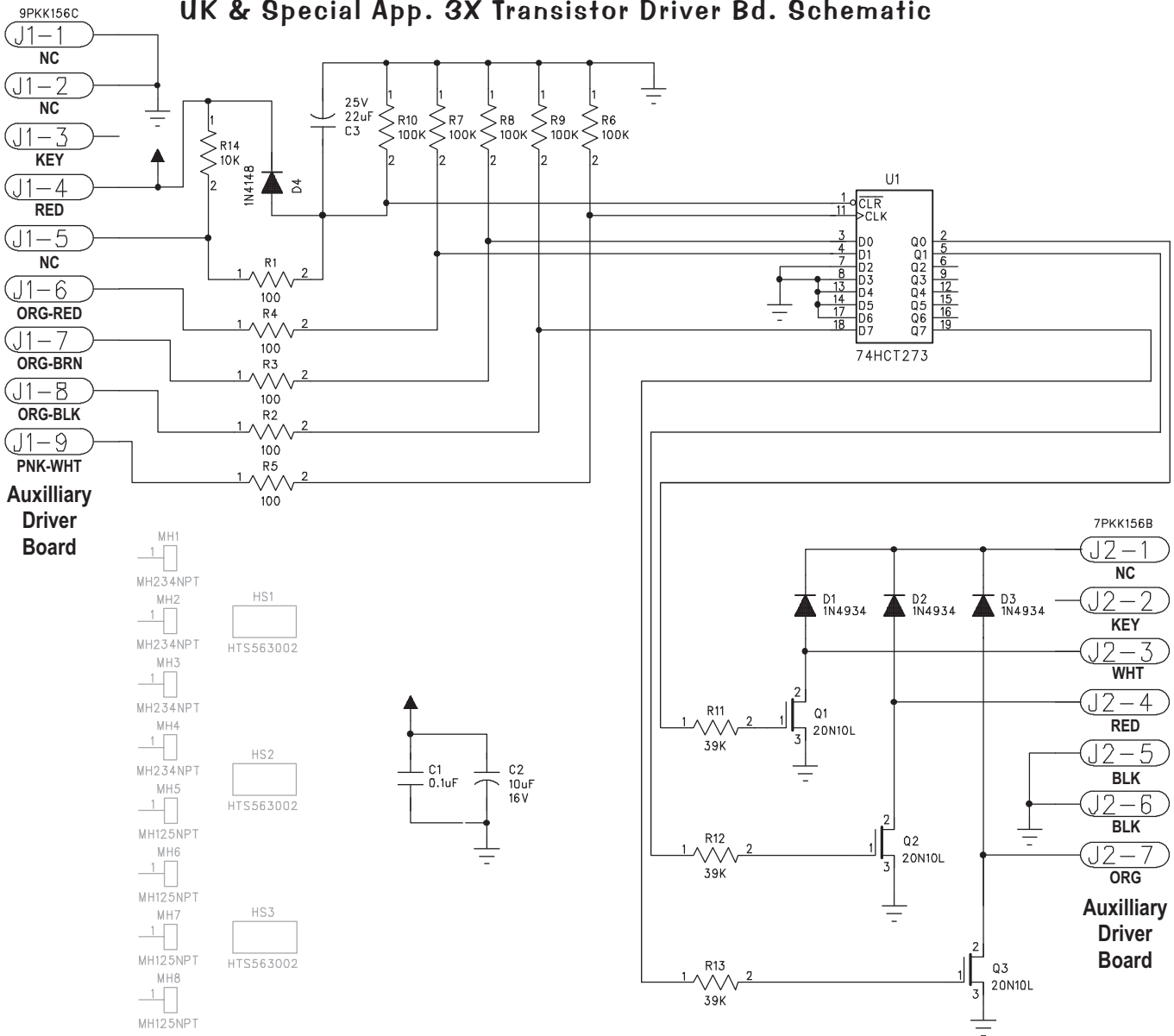

# UK & Special App. 3X Transistor Driver Bd. Component Layout (Sol. Exp. Bd.)

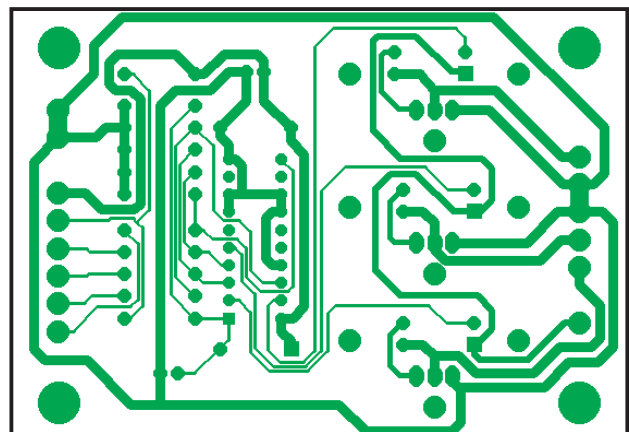
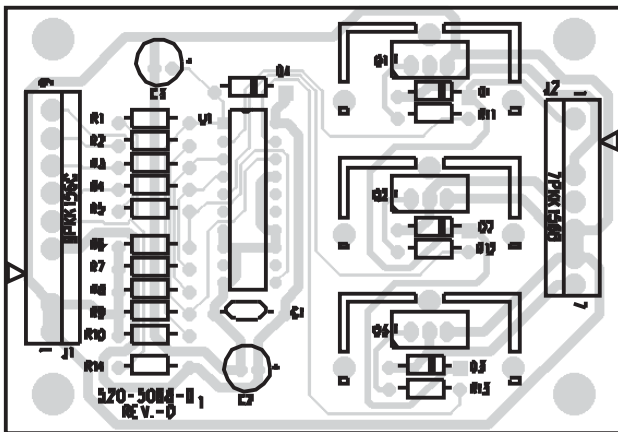

Sec. 5: PCBs

ITEM	QTY	PART NUMBER	REF-DESIGNATOR	DESCRIPTION
—	1	520-5068-01	Solenoid Expander (x3 Transistor) PC Board	Complete PCB Assembly

*Elvis Presley*

# UK 3X Transistor Driver Board for Up-Posts & P/F Dot Display or LED Sign (if used)

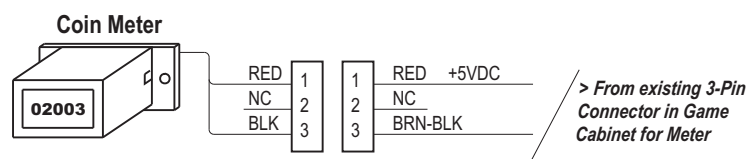
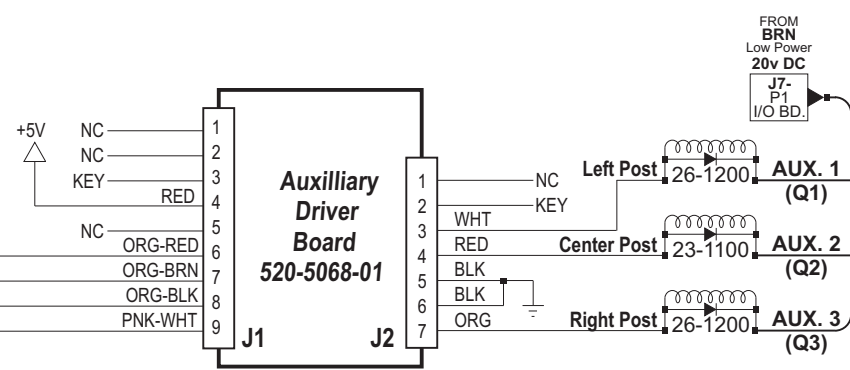
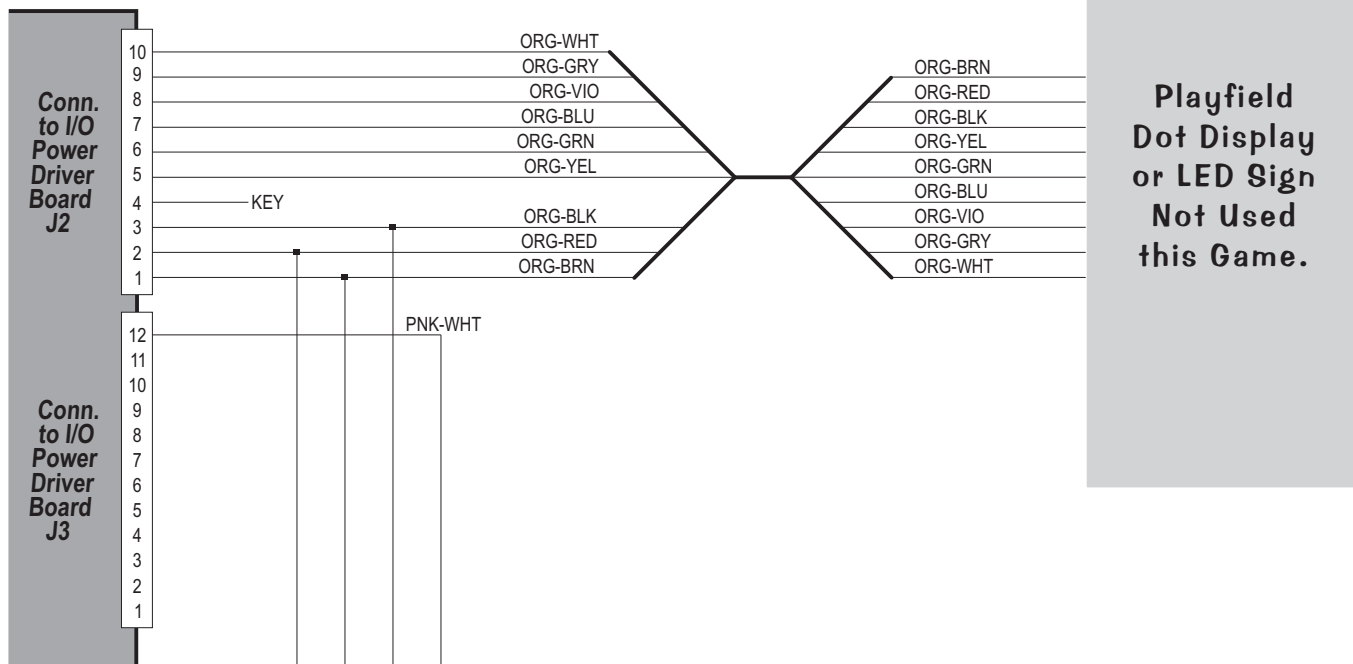

Sec. 5: PCBs





# UK 3X Transistor Driver Board for Up-Posts & P/F Dot Display or LED Sign (if used) with the Tournament Serial Interface (TSI) Board

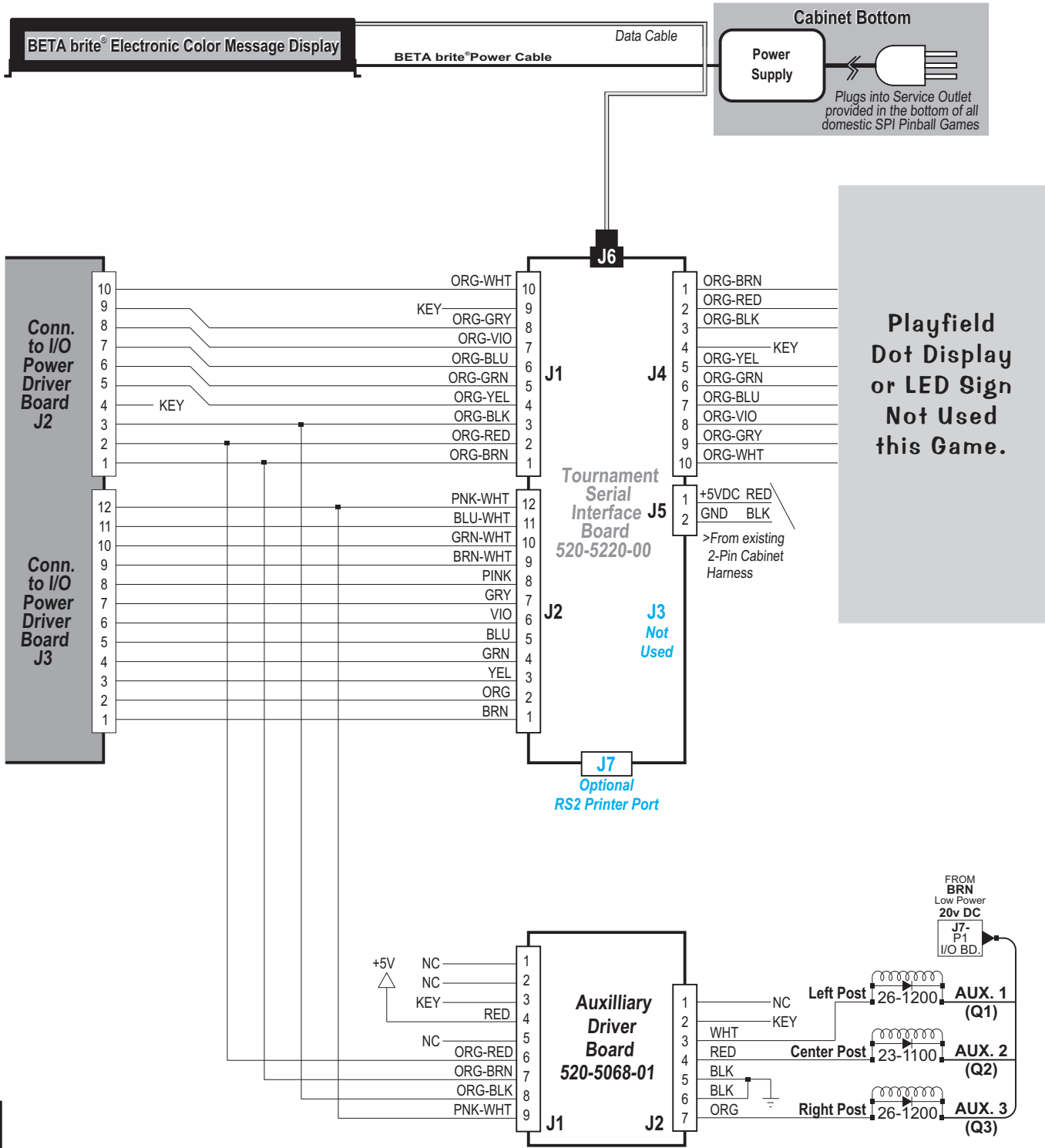

**Playfield Dot Display or LED Sign Not Used this Game.**

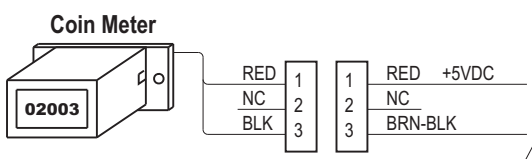

Order the Optional TOPS™ (Tournament Pinball System) Kit!  
Call Technical Support at 1-800-542-5377 for more information



Sec. 5: PCBs



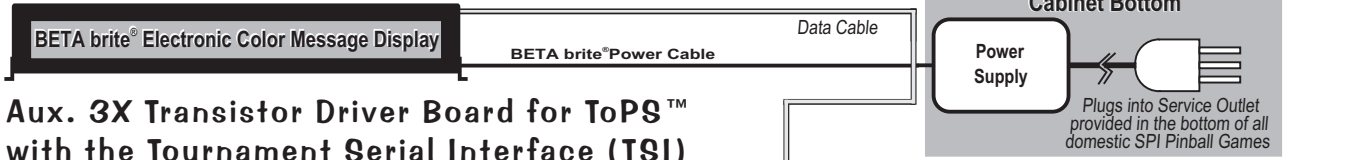

**Aux. 3X Transistor Driver Board for ToPS™ with the Tournament Serial Interface (TSI) Board and Ticket Interface**

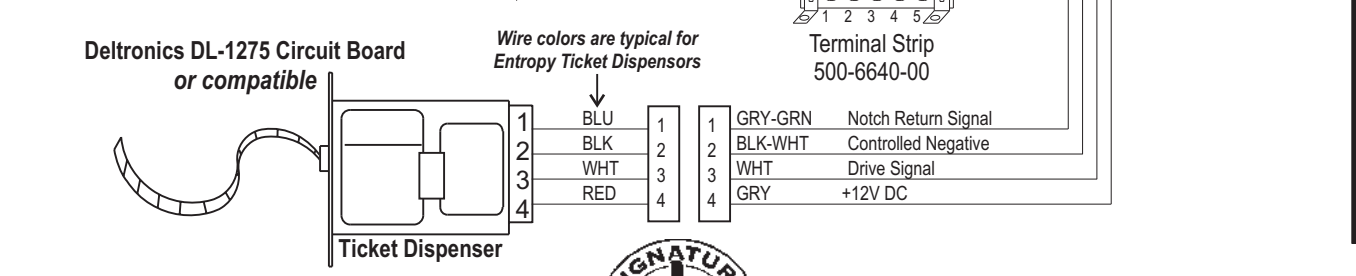
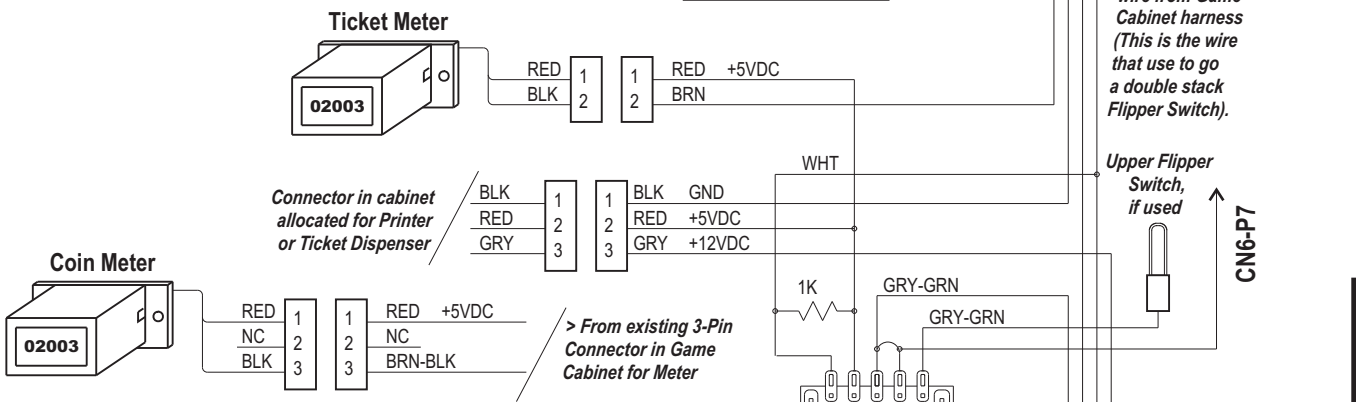
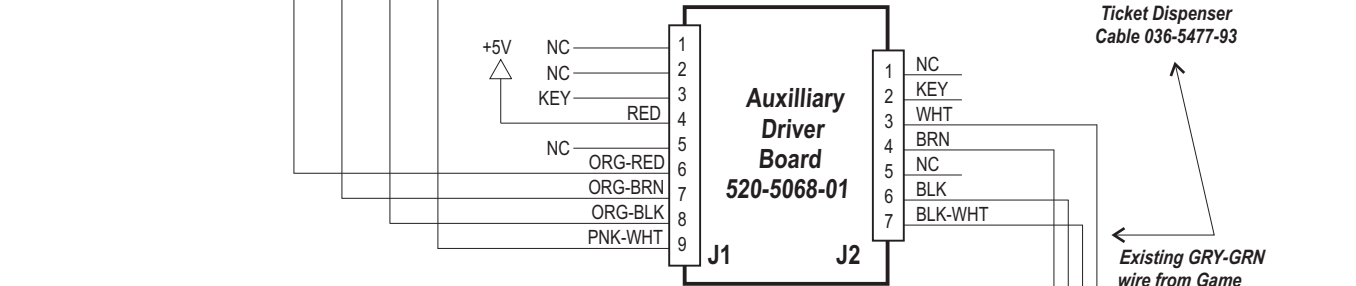
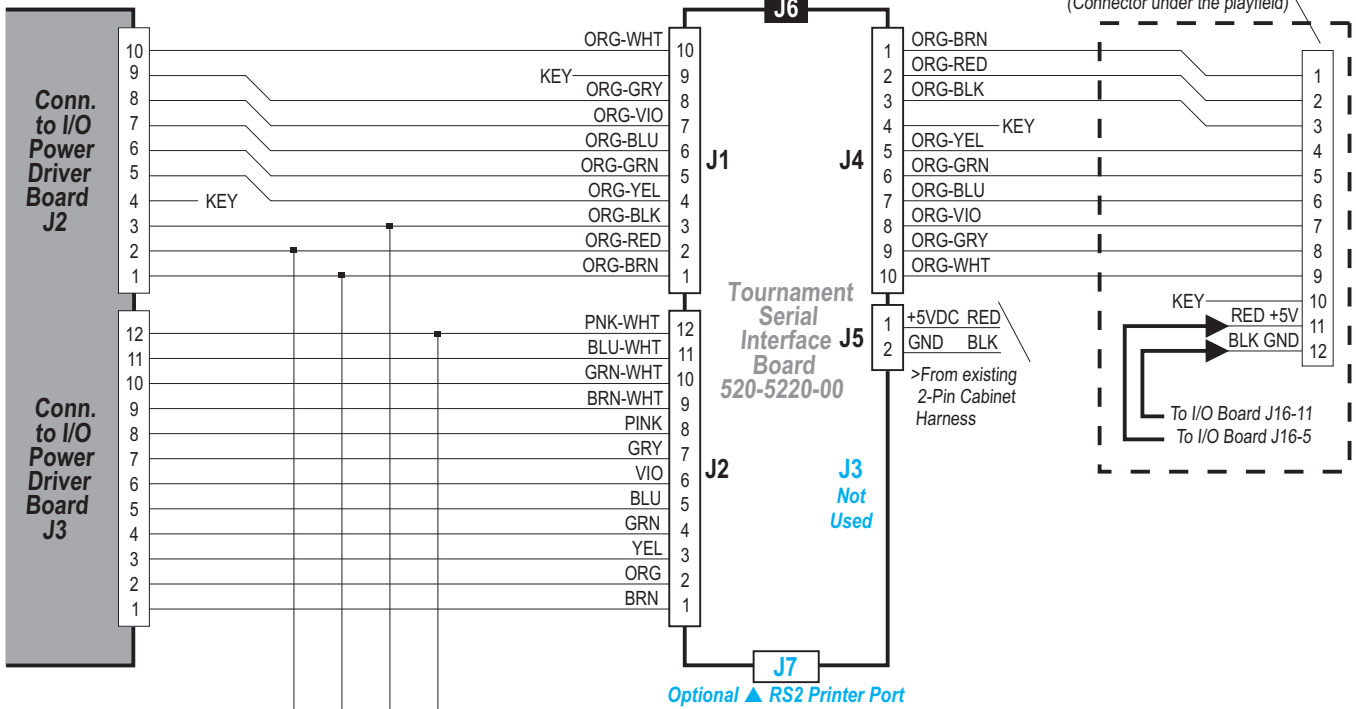

# Tournament Serial Interface Board Schematic (Sheet 1 of 1)

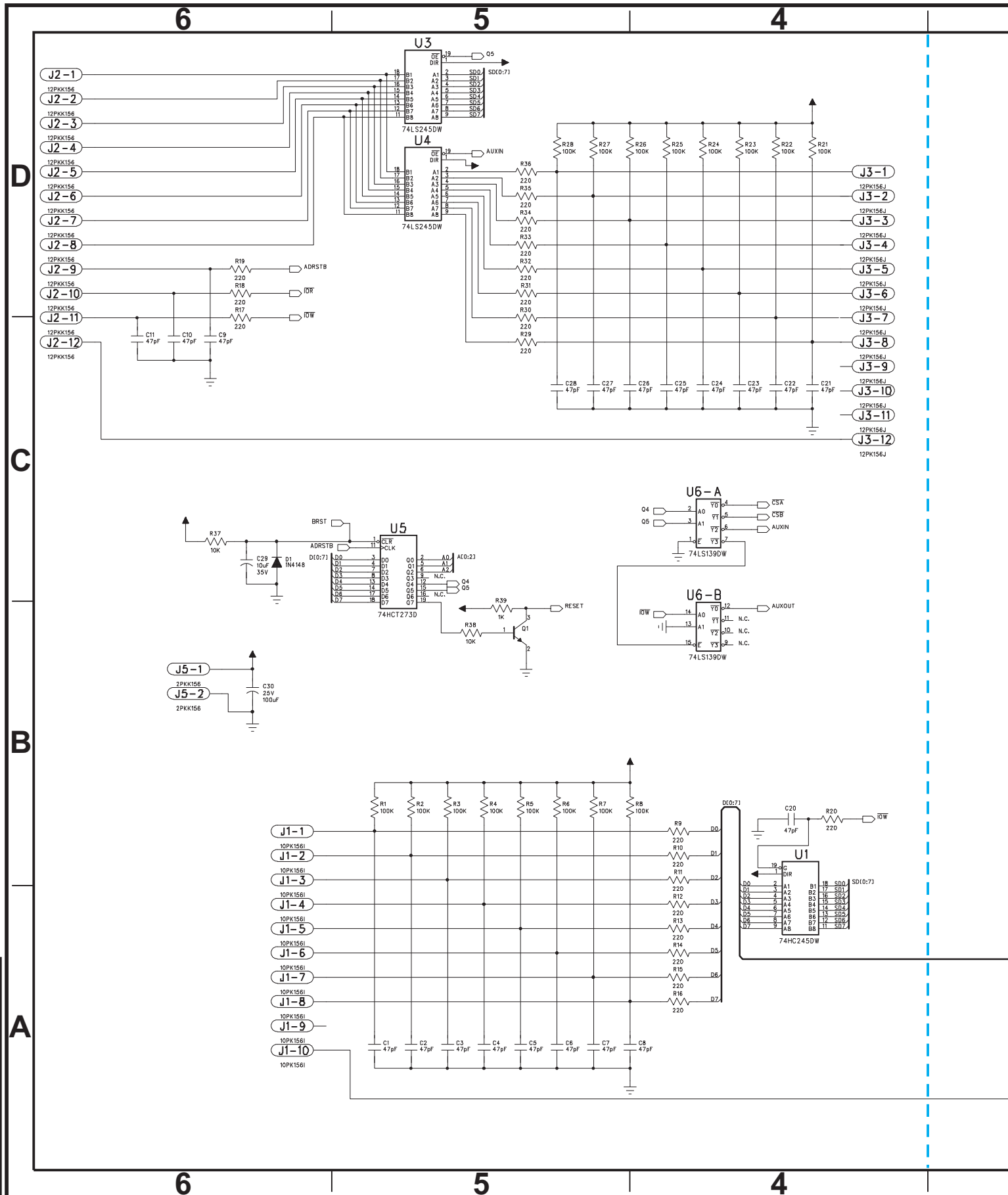

Sec. 5: PCBs

*Elvis Presley*

# Tournament Serial Interface Board Schematic (Sheet 1 of 1)

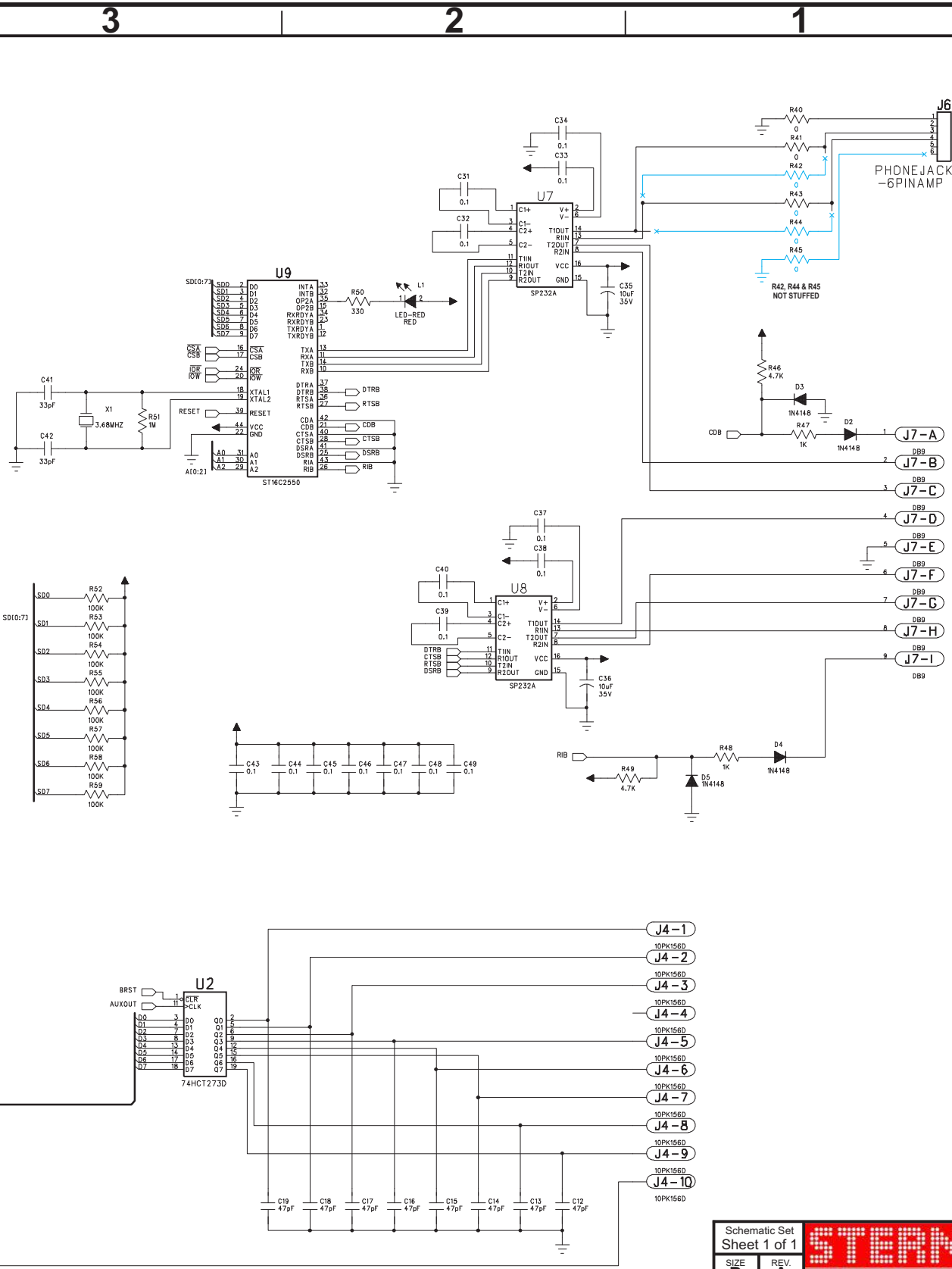

**NOTES:**  
 [ ] ALL RESISTOR VALUES ARE IN OHMS ( $\Omega$ ), 1/4W, 5%, UNLESS OTHERWISE SPECIFIED.  
 [ ] ALL CAPACITOR VALUES ARE IN MICROFARADS ( $\mu$ F), UNLESS OTHERWISE SPECIFIED.  
 [ ] 0.1 MICROFARADS ( $\mu$ F) BYPASS CAPACITOR ON ALL IC'S.

Non-Text Document

Schematic Set Sheet 1 of 1		<b>STERN</b>
SIZE <b>D</b>	REV. <b>A</b>	
PINBALL, INC.		
SPI Tournament Serial Interface Bd. SPI Part No: 520-5220-00		
Prepared By: CES Inc. Edited By: SPI Inc. Model: 237-0268-00 Dated: 08/2002		



# Tournament Serial Interface Board Component Layout

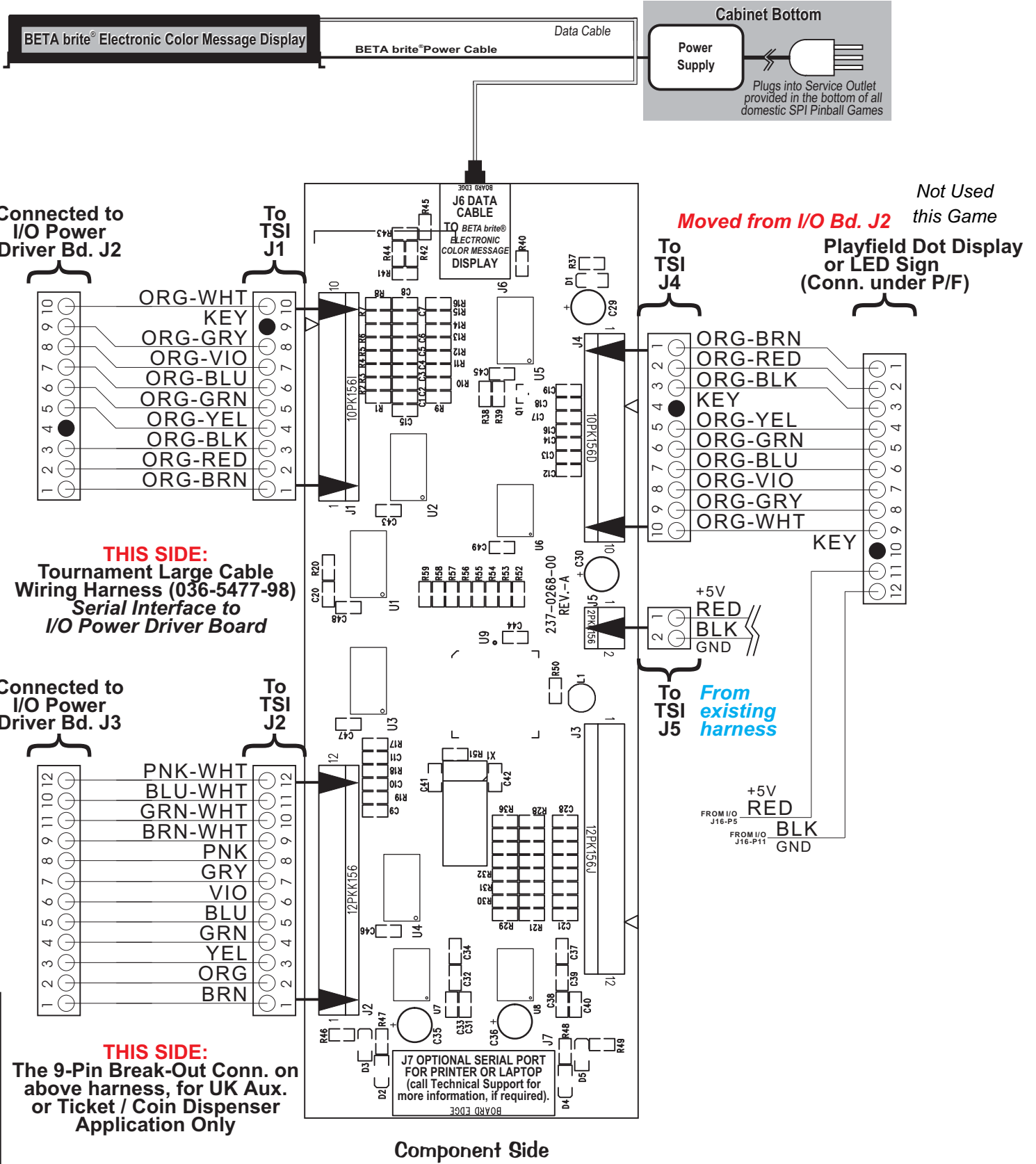

Sec. 5: PCBs

ITEM	QTY	PART NUMBER	REF-DESIGNATOR	DESCRIPTION
--	1	520-5220-00	Tournament Serial Interface (TSI) Board	PCB Assembly



# Appendixes A through J

## Table of Contents

- Appendix A
- Pinball Game Firmware Table ..... A1-A2**  
**[ White Star Board System Only\* ]** ...describes the ROM / Chip Size / Program & Raw Part Number / USA Version / Check Sum, and CPU/Snd Bd. I & II ROM locations for Games Apollo 13 — current.
- Appendix B
- Semi-Conductors / I.C.'s / Relays Cross-Reference Table ..... B1**  
 ...describes diodes and transistors with Source Number, SPI Part Number, NTE Number, ECG Number, Radio Shack Number & RCA Part Number (*If applicable*).
- Appendix C
- Production Start Date, Manual Part N<sup>o</sup>, ROM Size & Positions and Jumper W6 ..... C1**  
**[ White Star Board System Only\* ]** ...provides the Production Start Date, Manual Part Number, ROM Position(s), and Jumpers Installed for Games Apollo 13 — current.
- Appendix D
- Board Type Table ..... D1-D2**  
**[ White Star Board System Only\* ]** ...provides the Flipper\*\*, I/O Power Driver, CPU/Sound, Display Power Supply, Dot Matrix Display, Display Controller, OPTOs and Misc. Board Part Numbers for Games Apollo 13 — current. \*\**Flipper Bd. with White Star Bd. System for A13 & Golden Eye only.*
- Appendix E
- Generic Coil Cross-Reference Guide & Flipper Coil Table ..... E1-E2**  
**[ White Star Board System Only\* ]** ...provides the Coils used with Part Number and Gauge-Turns (*of the coil*) for Games Apollo 13 — current.
- Appendix F
- Motor Specification Table ..... F1-F2**  
**[ White Star Board System Only\* ]** ...provides all the Motor Function, Specifications and Part Number for Games Apollo 13 — current.
- Appendix G
- Part Number Prefix Classification Codes ..... G1**  
 ...explains how our Part Numbers are developed to help sort parts easier.
- Appendix H
- Playfield Inserts (Plastic Light Covers) ..... H1**  
 ...gives a pictorial view with the name and Part Nr. of all the inserts used (*with Color Code Chart*).
- Appendix I
- Stand-Up Targets (Happ Modular & Regular) ..... I1**  
 ...gives a pictorial view with the name and Part Number of all the Single Stand-Up Targets used (*with Color Code Chart*).
- Appendix J
- Coin Cards (USA & International) ..... J1**  
 ...gives a pictorial view with the name and Part Number of all the current Coin Cards for USA, Canada, Euro and other International Countries.
- Glossary of Terms ..... Last Page  
 ...gives definitions or explanations of some pinball terms and acronyms.
- Limited Warranty, Cautions, Warnings & Notices ..... Last Page

\* **Note:** For complete Appendix Information (**Appendixes A, C, D, E & F**) for Games **Laser War** through **Batman Forever**, see any Service Game Manual between **Apollo 13** through **Ripley's Believe It or Not!** or on-line at our website [www.sternpinball.com/parts.htm](http://www.sternpinball.com/parts.htm); also available on CD-R, 970-2003-00 (**The Simpsons™ Pinball Party**, **Terminator® 3** and **The Lord of the Rings™**).





# APPENDIX A

## Pinball Game Firmware (White Star Board System Only\*) Table



ROM	Chip Size	Program Part N°	USA Check Sum	Ver. & Loc.	Bd. Loc.	Raw Part N°
<b>* Note:</b> For complete Appendix Information for Games <i>Laser War</i> through <i>Batman Forever</i> , see any Service Game Manual between <i>Apollo 13</i> through <i>Ripley's Believe It or Not!</i> or on-line at our website <a href="http://www.sterpinball.com/parts.htm">www.sterpinball.com/parts.htm</a> ; also available on CD-R, 970-2003-00 ( <i>The Simpsons™ Pinball Party</i> , <i>T3®</i> and <i>The Lord of the Rings™</i> ).						
<b>Apollo 13 (Note 1)</b>						
Game ROM	(1M)	965-0208-00	A5.01	\$09FF	U210	960-5009-00
Sound	(512K)	965-0212-00	1.00	\$5244	U7	960-7001-02
Display	(4M)	965-0213-00	A5.00	\$B92B	ROM 0	960-5015-01
Voice 1	(4M)	965-0209-00	1.00	\$7FC7	U17	n/a (masked)
Voice 2	(4M)	965-0210-00	1.00	\$8E55	U21	n/a (masked)
Voice 3	(4M)	965-0211-00	1.00	\$08EE	U36	n/a (masked)
<b>Golden Eye (Note 1)</b>						
Game ROM	(1M)	965-0214-42	A4.04	\$3FFF	U210	960-5009-00
Sound	(512K)	965-0217-42	1.00	\$D615	U7	960-7001-02
Display	(4M)	965-0218-42	A4.00	\$E6ED	ROM 0	960-5015-01
Voice 1	(4M)	965-0215-42	1.00	\$3E32	U17	n/a (masked)
Voice 2	(4M)	965-0216-42	1.00	\$71F0	U21	n/a (masked)
<b>Twister (Note 2)</b>						
Game ROM	(1M)	965-0219-41	A4.05	\$E9FF	U210	960-5009-00
Sound	(512K)	965-0221-41	1.00	\$1FFF	U7	960-7001-02
Display	(4M)	965-0222-41	A4.00	\$FD01	ROM 0	960-5015-01
Voice 1	(4M)	965-0220-41	1.00	\$3650	U17	960-5015-01
Voice 2	(4M)	965-0223-41	1.00	\$9300	U21	960-5015-01
<b>ID4: Independence Day (Note 2)</b>						
Game ROM	(1M)	965-0224-45	A2.02	\$9CFF	U210	960-5009-00
Sound	(512K)	965-0227-45	1.00	\$22EB	U7	960-7001-02
Display	(4M)	965-0225-45	A2.00	\$ABF7	ROM 0	960-5015-01
Voice 1	(4M)	965-0225-45	1.00	\$3AE1	U17	960-5015-01
Voice 2	(4M)	965-0226-45	1.00	\$206E	U21	960-5015-01
<b>Space Jam (Note 2)</b>						
Game ROM	(1M)	965-0229-43	A3.00	\$E6FF	U210	960-5009-00
Sound	(512K)	965-0233-43	1.00	\$F1E7	U7	960-7001-02
Display	(4M)	965-0234-43	A3.00	\$0057	ROM 0	960-5015-01
Voice 1	(4M)	965-0230-43	1.00	\$DBA8	U17	960-5015-01
Voice 2	(4M)	965-0231-43	1.00	\$DDF1	U21	960-5015-01
Voice 3	(4M)	965-0232-43	1.00	\$F32A	U36	960-5015-01
<b>The Star Wars Trilogy - Special Edition (S.E.) (Note 2)</b>						
Game ROM	(1M)	965-0235-56	A4.03	\$5EFF	U210	960-5009-00
Sound	(512K)	965-0238-56	1.00	\$4A7D	U7	960-7001-02
Display	(4M)	965-0239-56	A4.00	\$8817	ROM 0	960-5015-01
Voice 1	(4M)	965-0236-56	1.00	\$E66B	U17	960-5015-01
Voice 2	(4M)	965-0237-56	1.00	\$8F54	U21	960-5015-01
<b>The Lost World: Jurassic Park (Note 2)</b>						
Game ROM	(1M)	965-0240-53	A2.02	\$C8FF	U210	960-5009-00
Sound	(512K)	965-0243-53	1.00	\$A35B	U7	960-7001-02
Display	(4M)	965-0244-53	A2.01	\$7F46	ROM 0	960-5015-01
Voice 1	(4M)	965-0241-53	1.00	\$1D27	U17	960-5015-01
Voice 2	(4M)	965-0242-53	1.00	\$8DA4	U21	960-5015-01
<b>The X-Files (Note 2)</b>						
Game ROM	(1M)	965-0245-46	A3.03	\$A2FF	U210	960-5009-00
Sound	(512K)	965-0248-46	1.00	\$6648	U7	960-7001-02
Display	(4M)	965-0249-46	A3.00	\$66D0	ROM 0	960-5015-01
Voice 1	(4M)	965-0246-46	1.00	\$349D	U17	960-5015-01
Voice 2	(4M)	965-0247-46	1.00	\$629C	U21	960-5015-01
<b>Starship Troopers (Note 3)</b>						
Game ROM	(1M)	965-0250-59	A2.00	\$85FF	U210	960-5009-00
Sound	(512K)	965-0253-59	1.00	\$64B2	U7	960-7001-02
Display	(4M)	965-0254-59	A2.00	\$E77B	ROM 0	960-5015-01
Voice 1	(4M)	965-0251-59	1.00	\$152A	U17	960-5015-01
Voice 2	(4M)	965-0252-59	1.00	\$0291	U21	960-5015-01
Voice 3	(4M)	965-0255-59	1.00	\$95A7	U36	960-5015-01
<b>Viper Night Drivin' (Note 4)</b>						
Game ROM	(1M)	965-0266-35	A2.01	\$C5FF	U210	960-5009-00
Sound	(512K)	965-0271-35	1.00	\$4DF8	U7	960-7001-02
Display	(4M)	965-0272-35	A2.01	\$C17D	ROM 0	960-5015-01
Voice 1	(4M)	965-0267-35	1.00	\$8018	U17	960-5015-01
Voice 2	(4M)	965-0268-35	1.00	\$2157	U21	960-5015-01
Voice 3	(4M)	965-0269-35	1.00	\$B5A6	U36	960-5015-01
Voice 4	(4M)	965-0270-35	1.00	\$D01E	U37	960-5015-01
<b>Lost In Space (Note 4)</b>						
Game ROM	(1M)	965-0282-60	A1.01	\$B2FF	U210	960-5009-00
Sound	(512K)	965-0287-60	1.00	\$A6AF	U7	960-7001-02
Display	(4M)	965-0288-60	A1.02	\$32AB	ROM 0	960-5015-01
Voice 1	(4M)	965-0283-60	1.00	\$4391	U17	960-5015-01
Voice 2	(4M)	965-0284-60	1.00	\$8215	U21	960-5015-01
Voice 3	(4M)	965-0285-60	1.00	\$5B32	U36	960-5015-01
Voice 4	(4M)	965-0286-60	1.00	\$8971	U37	960-5015-01
<b>Godzilla (Note 4)</b>						
Game ROM	(1M)	965-0289-40	A2.05	\$B1FF	U210	960-5009-00
Sound	(512K)	965-0294-40	1.00	\$0CC8	U7	960-7001-02
Display	(4M)	965-0295-40	A2.00	\$C929	ROM 0	960-5015-01
Voice 1	(4M)	965-0290-40	1.00	\$0D75	U17	960-5015-01
Voice 2	(4M)	965-0291-40	1.00	\$CCCF	U21	960-5015-01
Voice 3	(4M)	965-0292-40	1.00	\$227F	U36	960-5015-01
Voice 4	(4M)	965-0293-40	1.00	\$DB69	U37	960-5015-01
<b>South Park (Notes 4, 5)</b>						
Game ROM	(1M)	965-0301-71	A1.03	\$58FF	U210	960-5009-00
Sound	(512K)	965-0306-71	1.00	\$1286	U7	960-7001-02
Display	(4M)	965-0307-71	A1.01	\$166F	ROM 0	960-5015-01
Voice 1	(8M)	965-0302-71	1.00	\$7BF8	U17	960-5016-00
Voice 2	(8M)	965-0303-71	1.00	\$9CCC	U21	960-5016-00
Voice 3	(8M)	965-0304-71	1.00	\$ADD9	U36	960-5016-00
Voice 4	(8M)	965-0305-71	1.00	\$6659	U37	960-5016-00

ROM	Chip Size	Program Part N°	USA Check Sum	Ver. & Loc.	Bd. Loc.	Raw Part N°
<b>Harley-Davidson® (Notes 4, 5, 6) Original (1999-2001)</b>						
Game ROM	(1M)	965-0319-67	A1.03	\$3EFF	U210	960-5009-00
Sound	(512K)	965-0320-67	1.00	\$F4FF	U7	960-7001-02
Display	(4M)	965-0321-67	A1.04	\$FC7C	ROM 0	960-5015-01
Voice 1	(8M)	965-0322-67	1.00	\$CD26	U17	960-5016-00
Voice 2	(8M)	965-0323-67	1.00	\$3956	U21	960-5016-00
Voice 3	(8M)	965-0324-67	1.00	\$F872	U36	960-5016-00
Voice 4	(4M)	965-0325-67	1.00	\$6100	U37	960-5015-01
<b>► Harley-Davidson® (Notes 4, 5, 6, 8) 2nd Edition (2002-2003)</b>						
Game ROM	(1M)	965-0319-67A	A1.08	\$23FF	U210	960-5009-00
Display	(4M)	965-0321-67A	A1.05	\$B594	ROM 0	960-5015-01
<b>► Harley-Davidson® (Notes 4, 5, 6, 8) 3rd Edition (2004)</b>						
Game ROM	(1M)	965-0319-87	A3.00	\$22FF	U210	960-5009-00
Display	(4M)	965-0321-87	A3.00	\$5596	U5	960-5015-01
<b>Striker Xtreme (Notes 4, 5)</b>						
Game ROM	(1M)	965-0326-68	A1.02	\$E4FF	U210	960-5009-00
Sound	(512K)	965-0327-68	1.00	\$78CA	U7	960-7001-02
Display	(4M)	965-0328-68	A1.03	\$1957	ROM 0	960-5015-01
Voice 1	(8M)	965-0329-68	1.00	\$482A	U17	960-5016-00
Voice 2	(8M)	965-0330-68	1.00	\$7312	U21	960-5016-00
Voice 3	(8M)	965-0331-68	1.00	\$DE2F	U36	960-5016-00
Voice 4	(8M)	965-0332-68	1.00	\$C508	U37	960-5016-00
<b>NFL (Notes 4, 5) Not on CD-R or Website: Code through Distributor Only.</b>						
Game ROM	(1M)	965-0339-73	A1.00	\$D2FF	U210	960-5009-00
Sound	(512K)	965-0340-73	1.00	\$0000	U7	960-7001-02
Display	(4M)	965-0341-73	A1.01	\$845A	ROM 0	960-5015-01
Voice 1	(8M)	965-0342-73	1.00	\$0000	U17	960-5016-00
Voice 2	(8M)	965-0343-73	1.00	\$0000	U21	960-5016-00
Voice 3	(8M)	965-0344-73	1.00	\$0000	U36	960-5016-00
Voice 4	(8M)	965-0345-73	1.00	\$0000	U37	960-5016-00
<b>Sharkey's Shootout (Notes 4, 5)</b>						
Game ROM	(1M)	965-0333-72	A2.11	\$49FF	U210	960-5009-00
Sound	(512K)	965-0334-72	1.00	\$9796	U7	960-7001-02
Display	(4M)	965-0335-72	A2.01	\$6C33	ROM 0	960-5015-01
Voice 1	(8M)	965-0336-72	1.00	\$58EA	U17	960-5016-00
Voice 2	(8M)	965-0337-72	1.00	\$272B	U21	960-5016-00
Voice 3	(8M)	965-0338-72	1.00	\$41AE	U36	960-5016-00
<b>High Roller Casino (Notes 4, 5)</b>						
Game ROM	(1M)	965-0346-65	A3.00	\$90FF	U210	960-5009-00
Sound	(512K)	965-0347-65	1.00	\$581C	U7	960-7001-02
Display	(4M)	965-0348-65	A3.00	\$74B3	ROM 0	960-5015-01
Voice 1	(8M)	965-0349-65	1.00	\$12D	U17	960-5016-00
Voice 2	(8M)	965-0350-65	1.00	\$8F4	U21	960-5016-00
Voice 3	(8M)	965-0351-65	1.00	\$1B54	U36	960-5016-00
Voice 4	(8M)	965-0352-65	1.00	\$D720	U37	960-5016-00
<b>Austin Powers™ (Notes 4, 5)</b>						
Game ROM	(1M)	965-0353-74	A3.02	\$5DFF	U210	960-5009-00
Sound	(512K)	965-0354-74	1.00	\$DA7B	U7	960-7001-02
Display	(4M)	965-0355-74	A3.00	\$6A3A	ROM 0	960-5015-01
Voice 1	(8M)	965-0356-74	1.00	\$D2B9	U17	960-5016-00
Voice 2	(8M)	965-0357-74	1.00	\$9E75	U21	960-5016-00
Voice 3	(8M)	965-0358-74	1.00	\$51F3	U36	960-5016-00
Voice 4	(8M)	965-0359-74	1.00	\$0AE5	U37	960-5016-00
<b>Monopoly® (Notes 4, 5)</b>						
Game ROM	(1M)	965-0360-75	A3.03	\$5EFF	U210	960-5009-00
Sound	(512K)	965-0361-75	1.00	\$8C18	U7	960-7001-02
Display	(4M)	965-0362-75	A3.01	\$A381	ROM 0	960-5015-01
Voice 1	(8M)	965-0363-75	1.00	\$59E6	U17	960-5016-00
Voice 2	(8M)	965-0364-75	1.00	\$B35A	U21	960-5016-00
Voice 3	(8M)	965-0365-75	1.00	\$8A9F	U36	960-5016-00
<b>Playboy (Notes 4, 5, 7)</b>						
Game ROM	(1M)	965-0367-76	A5.00	\$7DFF	U210	960-5009-00
Sound	(512K)	965-0368-76	1.02	\$E7C2	U7	960-7001-02
Display	(4M)	965-0369-7				



# APPENDIX A

## Pinball Game Firmware (White Star Board System Only\*) Table



ROM	Chip Size	Program Part N <sup>o</sup>	USA Ver. & Check Sum	Bd. Loc.	Raw Part N <sup>o</sup>	ROM	Chip Size	Program Part N <sup>o</sup>	USA Ver. & Check Sum	Bd. Loc.	Raw Part N <sup>o</sup>
<b>Ripley's Believe It or Not!® (Notes 7, 8)</b>											
Sound	(512K)	965-0408-81	1.00   \$D93D	U7	960-7001-02						
Game ROM	(1M)	965-0409-81	<b>A3.10</b>   <b>\$F4FF</b>	<b>U210</b>	960-5009-00						
Voice 1	(8M)	965-0410-81	1.00   \$067B	U17	960-5016-00						
Voice 2	(8M)	965-0411-81	1.00   \$C8B8	U21	960-5016-00						
Voice 3	(8M)	965-0412-81	1.00   \$64C2	U36	960-5016-00						
Voice 4	(8M)	965-0413-81	1.00   \$5341	U37	960-5016-00						
Display	(4M)	965-0414-81	<b>A3.00</b>   <b>\$DE4B</b>	<b>U5</b> Disp. Cntrlr.	960-5015-01						
<b>Elvis® (Notes 7, 8)</b>											
Sound	(512K)	965-0415-84	1.00   \$8CD2	U7	960-7001-02						
Game ROM	(1M)	965-0416-84	<b>A4.00</b>   <b>\$90FF</b>	<b>U210</b>	960-5009-00						
Voice 1	(8M)	965-0417-84	1.00   \$538D	U17	960-5016-00						
Voice 2	(8M)	965-0418-84	1.00   \$8BCD	U21	960-5016-00						
Voice 3	(8M)	965-0419-84	1.00   \$60F8	U36	960-5016-00						
Voice 4	(8M)	965-0420-84	1.00   \$14D8	U37	960-5016-00						
Display	(4M)	965-0421-84	<b>A4.01</b>   <b>\$0502</b>	<b>U5</b> Disp. Cntrlr.	960-5015-01						

### footnotes:

- ROMs on CPU/Sound Bd.: 520-5136-00 (Stereo) & Display Cont. Bd.: 520-5055-01
- ROMs on CPU/Sound Bd.: 520-5136-10 (Mono) & Display Cont. Bd.: 520-5055-01
- ROMs on CPU/Sound Board: 520-5136-15\* (Mono) (\*FCC 11-97) & Display Controller Board: 520-5055-02\* (\*FCC 11-97)
- ROMs on CPU/Sound Bd.: 520-5136-16\* (Mono) (\*FCC 02-98) & Display Controller Board: 520-5055-03\* (\*FCC 02-98)
- This game uses **8MB VOICE ROMS** at U17, U21, U36 & U37 (if 3 ROMs use U37 will be unused) requiring a **Jumper at Loc. W6**. Refer to CPU/Snd. Bd. Schematic (2 of 3).
- Harley-Davidson® 2nd Edition:** For Game ROM, Sound & Display info (version, check sums, part numbers) call Tech Support or check our website (see back cover) for current versions or other info. Raw Part numbers are identical to the H-D® original.
- ToPS™ (Tournament Pinball System) READY!**
- ROMs on CPU/Sound Board II (with ATMEL Processor): 520-5300-00 & Display Cont. Bd.: 520-5055-03\* (\*FCC 02-98)

**Game Revisions can be updated after the Production Run.** This Table is accurate as of the printing of this manual. If any changes occurred, the next game manual will include the updated information. The version stated is USA. If there is a question of as to the latest Code Revision & Check Sum call our Technical Support Dept., 1-800-542-5377 or 1-708-345-7700 (Select Opt. 1).

Visit our website [www.SternPinball.com](http://www.SternPinball.com) where the latest code can be downloaded (an EPROM Burner is required).

Code also available on CD-R Disc 2

**Please Note:**  
Sound & Display Files in languages other than USA (English) can be distinguished as follows:  
File name ends with letter code:  
\*\*\*\*\*A: USA  
\*\*\*\*\*F: France  
\*\*\*\*\*G: Germany  
\*\*\*\*\*I: Italy  
\*\*\*\*\*S: Spain  
\*\*\*\*\*L: Spain





## APPENDIX B

### Semi-Conductors / Integrated Circuits (I.C.) / Relays Cross-Reference Table

Table No	Type	Source Number	STERN™ PINBALL	N T E®	E C G®	Radio Shack®	R C A®
<b>RECTIFICATION, BLOCKING, DAMPENING DIODES AND/OR LIGHT EMITTING DIODES (LEDs)</b>							
<b>1</b>	Diode	1N4001	112-5001-00	NTE552	ECG552	- - - - -	SK9000
	Diode	1N4004	112-5003-00	NTE116	ECG116	276-1103	SK3312
	Diode	1N5401	112-0056-00	NTE5801	ECG5801	276-1143	SK9004
	Diode	1N5404	112-5004-00	NTE5804	ECG5804	276-1144	SK9007
	Diode	T6A10L	112-5006-01	NTE5812	ECG5812	- - - - -	- - - - -
	Diode	FR302	112-5009-00	NTE588	ECG588	- - - - -	SK5014
	Diode, Signal	1N914	112-5014-00	- - - - -	- - - - -	- - - - -	- - - - -
LED	<b>MT5000UR</b> or <b>TLRH180P</b> (T1-3/4 GaAlAs)	165-5052-00 <i>(old SPI Part No: 165-5100-00)</i>	- - - - -	- - - - -	276-066B	- - - - -	
<b>ZENER DIODES</b>							
<b>2</b>	Diode	1N4742A 12v	112-0061-00	NTE142A	ECG142A	276-563	SK12V
	Diode	1N4760B 68v	112-0062-00B	NTE5092A	ECG5092A	- - - - -	SK68V
	Diode	1N4764A 100v	112-0049-00A	NTE5096A	ECG5096A	- - - - -	SK100V
	Diode	1N5228 3.9v	112-0053-00	NTE5007A	ECG5007A	- - - - -	SK3A9
	Diode	1N5234B 6.2v	112-0047-00B	NTE5013A	ECG5013A	276-561	SK6A2
	Diode	1N5379 110v	112-0072-00	NTE5157	ECG5157	- - - - -	SK110X
	Diode	1N6267A 6.8v	112-5011-00	NTE4902	ECG4902	- - - - -	- - - - -
	Diode	1N4752A 33v	112-5010-00A	NTE147A	ECG147A	- - - - -	SK33V
Diode	1N4736 6.8v 1w	112-5007-00	NTE5071A	ECG5071A	- - - - -	- - - - -	
<b>TRANSISTORS - TYPE FET, NPN, PNP AND/OR SCR</b>							
<b>3</b>	FET Trans.	STP20N10L	110-0106-00	NTE2987	ECG2987	- - - - -	- - - - -
	FET Trans.	STP19N06L	110-0088-00	NTE2985	ECG2985	- - - - -	- - - - -
	FET Trans.	VN02N	110-0089-00	- - - - -	- - - - -	- - - - -	- - - - -
	NPN Trans.	2N4401	110-0073-00	NTE85	ECG85	276-2009	SK3124A
	NPN Trans.	2N6427	110-0070-00	NTE48	ECG48	- - - - -	SK4906
	NPN Trans.	MJE340	110-0071-00	NTE157	ECG157	- - - - -	SK3747
	NPN Trans.	MPSA42	110-0082-00	NTE287	ECG287	- - - - -	SK3232
	NPN Trans.	2N3904	110-0069-00	NTE123AP	ECG123AP	276-2009	- - - - -
	NPN Trans.	TIP122	110-0067-00	NTE261	ECG261	276-2068	SK3896
	NPN Trans.	MJE15030	110-0101-00	NTE375	ECG375	- - - - -	SK9118
	PNP Trans.	2N5401	110-0078-00	NTE288	ECG288	- - - - -	SK3434
	PNP Trans.	MJE15031	110-0103-00	NTE292	ECG292	- - - - -	SK3441
	PNP Trans.	MJE350	110-0072-00	NTE374	ECG374	- - - - -	SK9042
	PNP Trans.	MPSA92	110-0100-00	NTE288	ECG278	- - - - -	SK3434
	PNP Trans.	TIP42	110-0068-00	NTE332	ECG332	- - - - -	SK9236
	PNP Trans.	TIP32C	110-0081-00	NTE292	ECG292	- - - - -	SK3441
	PNP Trans.	TIP36C	110-0077-00	NTE393	ECG393	- - - - -	SK3961
	SCR Trans.	2N5060	110-0074-00	NTE5400	ECG5400	276-1067	SK3950
SCR Trans.	SCR2800B	110-0083-00	NTE5461-8	ECG5461-8	- - - - -	- - - - -	
<b>BRIDGE RECTIFIERS (BR)</b>				<b>Comments:</b>			
<b>4</b>	BR (Present)	DB3501 or CM3501	112-5000-00	For White Star I/O Bds., BR = 35 Amp @ 100v P.I.V.			
<b>RELAYS</b>				<b>Comments:</b>			
<b>5</b>	Relay	FRL-264 D024/02CK	190-5002-00	For PPB, Power Supply, & White Star I/O Boards, Relay = 24v DC 10 Amp DPDT			
	Relay	FRL-264 D006/04CV	190-5001-00	For CPU Boards, Relay = 6v DC 5 Amp 4 Pole DT			

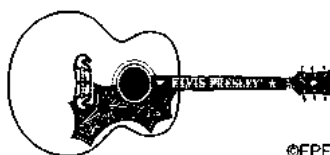



# APPENDIX C



## Production Start Date, Manual Part No., ROM Size & Positions and Jumper W6 Installed Note‡ (White Star Board System Only\*)

Game\ Name White Star Board System™	Production Start Date and Manual PN <sup>o</sup>	CPU/Sound Board Sound U7 512K CPU/Sound Board Game U210 1MB CPU/Sound Board Voice ROMS:				Jumper Installed (‡ see Note)	
		U17	U21	U36	U37		
* <b>Note:</b> For complete Appendix Information for Games <i>Laser War</i> through <i>Batman Forever</i> , see any <i>Service Game Manual</i> between <i>Apollo 13</i> through <i>Ripley's Believe It or Not!</i> or on-line at our website <a href="http://www.sternpinball.com/parts.htm">www.sternpinball.com/parts.htm</a> ; also available on CD-R, 970-2003-00 ( <i>The Simpsons™ Pinball Party</i> , <i>T3®</i> and <i>The Lord of the Rings™</i> ).							
29	Apollo 13 (A13)	NOV 95 780-5044-00	4MB	4MB	4MB	Not Used	n / a
30	Golden Eye	FEB 96 780-5042-00	4MB	4MB	Not Used	Not Used	n / a
31	Twister	APR 96 780-5041-00	4MB	4MB	Not Used	Not Used	n / a
32	ID4: Independence Day	JUL 96 780-5045-00	4MB	4MB	Not Used	Not Used	n / a
33	Space Jam	OCT 96 780-5043-00	4MB	4MB	4MB	Not Used	n / a
34	The Star Wars Trilogy - Sp. Ed.	FEB 97 780-5056-00	4MB	4MB	Not Used	Not Used	n / a
35	The Lost World: Jurassic Park	JUN 97 780-5053-00	4MB	4MB	Not Used	Not Used	n / a
36	The X-Files	AUG 97 780-5046-00	4MB	4MB	Not Used	Not Used	n / a
37	Starship Troopers	NOV 97 780-5059-00	4MB	4MB	4MB	Not Used	n / a
38	Viper Night Drivin'	FEB 98 780-5035-00	4MB	4MB	4MB	4MB	n / a
39	Lost In Space	JUN 98 780-5060-00	4MB	4MB	4MB	4MB	n / a
40	Godzilla	SEP 98 780-5040-00	4MB	4MB	4MB	4MB	n / a
41	South Park	JAN 99 780-5071-00	8MB	8MB	8MB	8MB	W6
42 a	Harley-Davidson®	AUG 99 780-5067-01	8MB	8MB	8MB	8MB	W6
42 b	Harley-Davidson® 2nd Ed.	SEP 02 780-5067-10	8MB	8MB	8MB	8MB	W6
42 c	Harley-Davidson® 3rd Ed.	OCT 04 780-5087-00	8MB	8MB	8MB	8MB	W6
43 a	Striker Xtreme	MAR 00 780-5068-01	8MB	8MB	8MB	8MB	W6
43 b	NFL	OCT 00 780-5073-00	8MB	8MB	8MB	8MB	W6
44	Sharkey's Shootout	JUL/OCT 00 780-5072-01	8MB	8MB	8MB	Not Used	W6
45	High Roller Casino	JAN 01 780-5065-00	8MB	8MB	8MB	8MB	W6
46	Austin Powers™	MAY 01 780-5074-00	8MB	8MB	8MB	8MB	W6
47	MONOPOLY®	SEP 01 780-5075-00	8MB	8MB	8MB	Not Used	W6
48	Playboy	FEB 02 780-5076-00	8MB	8MB	8MB	8MB	W6
49	RollerCoaster Tycoon™	AUG 02 780-5078-00	8MB	8MB	8MB	Not Used	W6
50	The Simpsons™ Pinball Party	JAN 03 780-5077-00	8MB	8MB	8MB	8MB	W6
51	T3®: Rise of the Machines™	MAY 03 780-5079-00	8MB	8MB	8MB	8MB	W6

Game\ Name White Star Board System™	Production Start Date and Manual PN <sup>o</sup>	CPU/Sound Board Sound U7 512K CPU/Sound Board Game U210 1MB CPU/Sound Board Voice ROMS:				
		U17	U21	U36	U37	
52	The Lord of the Rings™	NOV 03 780-5080-00	8MB	8MB	8MB	8MB
53	Ripley's Believe It or Not!®	APR 04 780-5081-00	8MB	8MB	8MB	8MB
54	Elvis®	AUG 04 780-5084-00	8MB	8MB	8MB	8MB

See **Apdx. A** for more detailed information on **Pinball Game Firmware (ROM Name, Size, Part Numbers, USA Version & Checksum and Board Locations)**.

‡ **Additional Information for Installed Jumper (above games 41-51):**

- Installed **W6** so 8MB ROMS can be utilized. See the **CPU/Sound Board Schematic** (Sheet 2 of 3, Address Location 3E) in the games' *Service Game Manual*. Game 52 - current has a new CPU/Sound Board (see Pages 131-141).

See **Apdx. A** for more detailed information on **Pinball Game Firmware (ROM Name, Size, Part Numbers, USA Version & Checksum and Board Locations)**.





# APPENDIX D

## Board Type (White Star Board System Only\*) Table



Game Name	Flipper	I/O Power Driver	CPU/Sound Stereo	Disp. Power Supply	Dot Matrix Display	Display Controller	OPTO Transmitter	OPTO Receiver	OPTO Application	
<b>* Note:</b> For complete Appendix Info, for Games <b>Laser War</b> through <b>Batman Forever</b> , see any Service Game Manual between <b>Apollo 13</b> through <b>Ripley's BION!</b> or on-line at our website <a href="http://www.sterpinball.com/parts.htm">www.sterpinball.com/parts.htm</a> ; also available on CD-R, 970-2003-00 ( <b>The Simpsons™ Pinball Party, T3®</b> and <b>The Lord of the Rings™</b> ).										
Apollo 13	520-5080-00 2-Flipper	520-5137-00	520-5136-00	520-5138-00	520-5052-00 128 X 32	520-5055-01	520-5124-00 Single OPTO	520-5125-00 Single OPTO	5-Ball Trough over Up-Kicker	
	Miscellaneous PC Boards:	Light Boards 520-5130-01, -04 & -05 Magnet Interface, 7-Segment Display & Light Bd. 520-5130-06 Magnet Driver Board 520-5130-02 Switch Membrane Board 520-5130-03				Relay Board 520-5010-00				
Golden Eye	520-5080-00 2-Flipper	520-5137-00	520-5136-00	520-5138-00	520-5052-00 128 X 32	520-5055-01	520-5124-00 Single OPTO	520-5125-00 Single OPTO	5-Ball Trough over Up-Kicker	
	Miscellaneous PC Boards:	Light Boards 520-5128-05 through -08		Mag. Processor X2 Driver Bd. 520-5143-00		Relay Board 520-5010-00				
<b>GAMES HEREON NO LONGER REQUIRE THE FLIPPER BOARD WITH THE WHITE STAR BOARD SYSTEM™</b>										
Game Name	I/O Power Driver	CPU/Sound Mono	Disp. Power Supply	Dot Matrix Display	Display Controller	OPTO Transmitter	OPTO Receiver	OPTO Application	Misc OPTO & App.	
Twister	520-5137-01	520-5136-10	520-5138-00	520-5052-00 128 X 32	520-5055-01	520-5124-00 Single OPTO	520-5125-00 Single OPTO	4-Ball Trough over Up-Kicker		
	Miscellaneous PC Boards:	Light Boards 520-5145-01 through -07		Mag. Drv. Bd. 520-5143-00	Relay Board 520-5010-00					
Independence Day (ID4)	520-5137-01	520-5136-10	520-5138-00	520-5052-00 128 X 32	520-5055-01	520-5124-00 Single OPTO	520-5125-00 Single OPTO	4-Ball Trough over Up-Kicker		
	Miscellaneous PC Boards:	Light Boards 520-5149-01 through -10		Servo Mtr. Bd. 520-5152-00		520-5082-00 Long Hop opto	520-5083-00 Long Hop opto	Alien Head Enter		
Space Jam	520-5137-01	520-5136-10	520-5138-00	520-5052-00 128 X 32	520-5055-01	520-5124-00 Single OPTO	520-5125-00 Single OPTO	5-Ball Trough over Up-Kicker		
	Miscellaneous PC Boards:	2X 7-Segment Display Board 520-5153-00								
The Star Wars Trilogy - Special Ed.	520-5137-01	520-5136-10	520-5138-00	520-5052-00 128 X 32	520-5055-01	520-5124-00 Single OPTO	520-5125-00 Single OPTO	4-Ball Trough over Up-Kicker		
	Miscellaneous PC Boards:	Relay Board 520-5010-00								
The Lost World: J.P.	520-5137-01	520-5136-10	520-5138-00	520-5052-00 128 X 32	520-5055-01	520-5124-00 Single OPTO	520-5125-00 Single OPTO	4-Ball Trough over Up-Kicker	520-5162-00 2-Pos. Motor Sensor on Snagger Motor	
	Miscellaneous PC Boards:	DC Relay Bd. 520-5066-00	Shaker Mtr. Bd. 520-5065-00							
The X-Files	520-5137-01	520-5136-10	520-5138-00	520-5052-00 128 X 32	520-5055-01	520-5124-00 Single OPTO	520-5125-00 Single OPTO	4-Ball Trough over Up-Kicker	520-5155-00 3-Pos. Motor Sensor on File Cab. Motor	
	Miscellaneous PC Boards:					520-5082-00 Long Hop opto	520-5083-00 Long Hop opto	File Cabinet Enter		
Starship Troopers	520-5137-01	520-5136-15	520-5138-00	520-5052-00 128 X 32	520-5055-02	520-5124-00 Single OPTO	520-5125-00 Single OPTO	4-Ball Trough over Up-Kicker		
	Miscellaneous PC Boards:	4X 7-Segment Display Board 520-5166-00					520-5082-00 Long Hop opto	520-5083-01 Long Hop opto	L/R Orbit Lane Enter	
Viper Night Drivin'	520-5137-01	520-5136-16	520-5138-00	520-5052-00 128 X 32	520-5055-03	520-5124-00 Single OPTO	520-5125-00 Single OPTO	4-Ball Trough over Up-Kicker		
	Miscellaneous PC Boards:	Relay Board 520-5010-00					520-5082-00 Long Hop opto	520-5083-01 Long Hop opto	Jump Ramp	
Lost In Space	520-5137-01	520-5136-16	520-5138-00	520-5052-00 128 X 32	520-5055-03	515-0173-00 Dual OPTO	515-0174-00 Dual OPTO	4-Ball Trough over Up-Kicker		
	Miscellaneous PC Boards:	Relay Board 520-5010-00								
Godzilla	520-5137-01	520-5136-16	520-5138-00	520-5052-00 128 X 32	520-5055-03	515-0173-00 Dual OPTO	515-0174-00 Dual OPTO	4-Ball Trough over Up-Kicker		
	Miscellaneous PC Boards:	Shaker Mtr. Bd. 520-5065-00								
South Park	520-5137-01	520-5136-16	520-5138-00	520-5052-00 128 X 32	520-5055-03	515-0173-00 Dual OPTO	515-0174-00 Dual OPTO	5-Ball Trough over Up-Kicker		
	Miscellaneous PC Boards:					520-5082-00 Long Hop opto	520-5083-01 Long Hop opto	Kenny Under Trough Enter		
Harley-Davidson® 1st-3rd* Editions	520-5137-01	520-5136-16 *520-5300-00*	520-5138-00	520-5052-00 128 X 32	520-5055-03	515-0173-00 Dual OPTO	515-0174-00 Dual OPTO	4-Ball Trough over Up-Kicker		
	Miscellaneous PC Boards:	Relay Board 520-5010-00	Shaker Mtr. Bd. 520-5065-00	Diode Board 520-5146-00		520-5082-00 Long Hop opto	520-5083-01 Long Hop opto	Motorcycle Enter		
Striker Xtreme (NFL)	520-5137-01	520-5136-16	520-5138-00	520-5052-00 128 X 32	520-5055-03	515-0173-00 Dual OPTO	515-0174-00 Dual OPTO	4-Ball Trough over Up-Kicker	520-5155-00 3-Pos. Motor Sensor on Goalie Motor	
	Miscellaneous PC Boards:	DC Relay Bd. 520-5066-00	Relay Board 520-5010-00	Diode Board 520-5146-00	for UK ONLY- Solenoid Expander Bd. 520-5192-00	520-5082-00 Long Hop opto	520-5083-01 Long Hop opto	Goalie Under- Trough Enter		
Sharkey's Shootout	520-5137-64	520-5136-64	520-5138-00	520-5052-00 128 X 32	520-5055-03	515-0173-00 Dual OPTO	515-0174-00 Dual OPTO	4-Ball Trough over Up-Kicker	520-5194-00 4-Pos. Motor Sensor on ? -Ball Motor	
	Miscellaneous PC Boards:	Relay Board 520-5010-00	Sol. Exp. Bd. 520-5192-00							
High Roller Casino	520-5137-01	520-5136-16	520-5138-00	520-5052-00 128 X 32	520-5055-03	515-0173-00 Dual OPTO	515-0174-00 Dual OPTO	4-Ball Trough over Up-Kicker	520-5194-00 4-Pos. Motor Sensor on Roulette Wheel Motor	
	Miscellaneous PC Boards:	Dot Display (5X7) in Slot Mach. 520-5197-00				for UK ONLY- Solenoid Expander Bd. 520-5192-00	520-5196-00 3-Pos. OPTO	520-5195-00 3-Pos. OPTO	Ball Lock under Roulette Up/Dn Ramp in Slot Mach.	
Austin Powers™	520-5137-01	520-5136-16	520-5138-00	520-5052-00 128 X 32	520-5055-03	515-0173-00 Dual OPTO	515-0174-00 Dual OPTO	4-Ball Trough over Up-Kicker	520-5212-00 Pulse-Stretcher OPTO on Spini-Me	
	Miscellaneous PC Boards:	Relay Bd. (X3) 520-5010-00			for UK ONLY- Solenoid Expander Bd. 520-5192-00	520-5082-00 Long Hop opto	520-5083-01 Long Hop opto	Time Machine Ramp		
Monopoly®	520-5137-01	520-5136-16	520-5138-00	520-5052-00 128 X 32	520-5055-03	515-0173-00 Dual OPTO	515-0174-00 Dual OPTO	4-Ball Trough over Up-Kicker		
	Miscellaneous PC Boards:	DC Relay Bd. 520-5066-00	Mini-Dot Display (3 by 5X7) 520-5197-00 (Electric C Sign)		for UK ONLY- Solenoid Expander Bd. 520-5192-00	520-5218-00 4-Pos. OPTO	520-5210-00 4-Pos. OPTO	Bank Door		

Table continued on the next page.

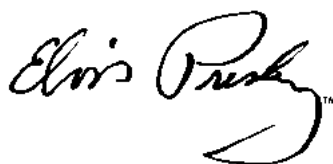



# APPENDIX D

## Board Type (White Star Board System Only\*) Table



Game Name	I/O Power Driver	CPU/Sound (old & new)	Disp. Power Supply	Dot Matrix Display	Display Controller	OPTO Transmitter	OPTO Receiver	OPTO Application	Misc OPTO & App.
Playboy	520-5137-01	520-5136-16	520-5138-00	520-5052-00 128 X 32	520-5055-03	515-0173-00 Dual OPTO	515-0174-00 Dual OPTO	4-Ball Trough over Up-Kicker	
	Miscellaneous PC Boards:	DC Relay Bd. 520-5066-00	Relay Bd. 520-5010-00		for UK ONLY > Solenoid Expander Bd. 520-5192-00				
RollerCoaster Tycoon™	520-5137-01	520-5136-16	520-5138-00	520-5052-00 128 X 32	520-5055-03	515-0173-00 Dual OPTO	515-0174-00 Dual OPTO	4-Ball Trough over Up-Kicker	520-5222-00 1-Position Switch Detect on Wheel Spin
	Miscellaneous PC Boards:	DC Relay Bd. 520-5066-00	Mini-Dot Display (3 by 5X7) 520-5221-00 (Ramp Enter Sign)		for UK ONLY > Solenoid Expander Bd. 520-5192-00	520-5082-00 Long Hop OPTO	520-5083-01 Long Hop OPTO	Behind 1-Bank Drop Target	
The Simpsons™ Pinball Party	520-5137-01	520-5136-16	520-5138-00	520-5052-00 128 X 32	520-5055-03	515-0173-00 Dual OPTO	515-0174-00 Dual OPTO	4-Ball Trough over Up-Kicker	
	Miscellaneous PC Boards:	LED Bd. 520-5219-00	Color Dot Display (4 by 5X7) 520-5225-00 (TV Set)		for UK ONLY <<<< Aux. Driver Bd. 520-5068-01				
Terminator® 3: Rise of the Machines™	520-5137-01	<b>520-5136-16</b>	520-5138-00	520-5052-00 128 X 32	520-5055-03	515-0173-00 Dual OPTO	515-0174-00 Dual OPTO	4-Ball Trough over Up-Kicker	
	Miscellaneous PC Boards:				for UK ONLY <<<< Aux. Driver Bd. 520-5068-01	515-7307-00 Single OPTO	515-7308-00 Single OPTO	TXCannon Trough	
The Lord of the Rings™	520-5137-01	<b>New</b> <b>520-5300-00</b>	520-5138-00	520-5052-00 128 X 32	520-5055-03	515-0173-00 Dual OPTO	515-0174-00 Dual OPTO	4-Ball Trough over Up-Kicker	500-6746-00 (White Trans.) 500-6747-00 (Black Rec.)
	Miscellaneous PC Boards:	19-LED PCB 520-5242-00	OPTO Transmitter / Receiver Amplifier PCB 520-5239-00		for UK ONLY <<<< Aux. Driver Bd. 520-5068-01	515-7307-00 Single OPTO	515-7308-00 Single OPTO	Orthanc Tower Trough	
Ripley's Believe It or Not!®	520-5137-01	520-5300-00	520-5138-00	520-5052-00 128 X 32	520-5055-03	515-0173-00 Dual OPTO	515-0174-00 Dual OPTO	4-Ball Trough over Up-Kicker	500-6775-00 OPTO Trnscvr
	Miscellaneous PC Boards:	520-5236-00 X3 Dot Display	OPTO Transmitter / Receiver Amplifier PCB 520-5239-01		for UK ONLY <<<< Aux. Driver Bd. 520-5068-01	520-5234-00 3-Pos. OPTO	520-5234-00 3-Pos. OPTO	Vari-Target	520-5235-03 X3 Aux. Drvr
Elvis®	520-5137-01	520-5300-00	520-5138-00	520-5052-00 128 X 32	520-5055-03	515-0173-00 Dual OPTO	515-0174-00 Dual OPTO	4-Ball Trough over Up-Kicker	
	Miscellaneous PC Boards:				for UK ONLY <<<< Aux. Driver Bd. 520-5068-01				



# APPENDIX E

## Generic Coil Cross-Reference Guide

GA-TURNS	Res. (Ω)	SPI PART N°	COMMENTS	GA-TURNS	Res. (Ω)	SPI PART N°	COMMENTS
<b>STANDARD COILS (TYPICAL APPLICATIONS)</b>				<b>LARGE COILS (FLIPPERS &amp; SPECIAL APPLICATIONS)</b>			
20-400	1.0 Ω	090-5021-00	Diode Top	21-900	Ω	090-5020-01	Diodes Top X2 1N4004 + 1N5404 (3-Lug) <BROWN>
22-500	1.7 Ω	090-5017-00	Diode (Top)			090-5020-10	Diode (Top), <RED>
22-600	2.2 Ω	090-5023- use	-0B Diode Bottom, -0T Diode Top	22-750/ 30-2600	2.6 Ω 92.0 Ω	090-5011-00	DUAL-WOUND COIL, Diode Top X2 1N4004 (3-Lug), <>
23-700	3.1 Ω	090-5022- use	-00 Diode Bottom, -0T Diode Top	22-900	3.45 Ω	090-5020-20T	Diode Top <YELLOW>
23-750	3.4 Ω	090-5019-00	Diode (Top)	22-1080	4.3 Ω	090-5032- use	-0B Diode Bot., -0T Diode Top, -NL No Lugs-X" Leads <YEL-GRN> Wrap
23-800	3.6 Ω	090-5001- use	-0B Diode Bottom, -0T Diode Top, -NL No Lugs-11" Leads	23-620/ 30-2600	2.4 Ω 75.0 Ω	090-5006-00	DUAL-WOUND COIL, Diode Top X2 1N4004 (3-Lug), <>
23-840	4.0 Ω	090-5005-00	Diode (Top)	23-700/ 30-2600	3.0 Ω 83.5 Ω	090-5013-00	DUAL-WOUND COIL, Diode (Top) <>
23½-765	3.6 Ω	090-5037-03	Diode Top	23-800/ 30-2600	2.8 Ω 90.5 Ω	090-5012-00	DUAL-WOUND COIL, Diode (Top) <>
24-900	5.0 Ω	090-5002- use	-02 Diode (Top), -10 No Lugs-14" Lds	23-900	4.05 Ω	090-5020-30	Diode Top <GREEN>
24-940	5.5 Ω	090-5036- use 090-5051-01	-0B Diode Bottom, -0T Diode Top No Lugs-11" Leads	23-1100	5.1 Ω	090-5030-0T	Diode Top <ORANGE>
25-1240	9.3 Ω	090-5034-00	Diode Bottom	23-1200	7.1 Ω	090-5008-00	Diode Top <BLACK>
26-1200	10.3 Ω	090-5044- use	-0B Diode Bottom, -0T Diode Top, -NL No Lugs-11" Leads	23-1500	4.4 Ω	090-5062-00	Diode Top <BLUE>
27-1300	14.2 Ω	090-5003-00	Diode (Top)	24-1570	9.5 Ω	090-5025-00	Diode Top <BLUE>
27-1400	14.7 Ω	090-5015-00	Diode Bottom	25-1400	Ω	090-5067-0T	Diode Top <RED>
27-1500	16.3 Ω	090-5004- use	-0B Diode Bottom, -0T Diode Top	25-1600	Ω	090-5068-0T	Diode Top <WHITE>
29-2000	33.6 Ω	090-5016-00	Diode (Top)	25-1800	13.8 Ω	090-5041-0T	Diode Top <BLUE-GREEN>
<b>MAGNET COILS (LARGE, MEDIUM &amp; MINI)</b>				<b>MINI-COILS (RESET / TRIP APPLICATIONS)</b>			
20½-480	2.9 Ω	090-5064-02	Large No Lugs-14" Leads / No Core	27-950	Ω	090-5046-01	Diode Top, <>
22-650	4.3 Ω	090-5042-00 090-5042-01	Large No Lugs-6" Leads / No Core Large No Lugs-12" Leads / No Core	28-1050	11.5 Ω	090-5046-00	Diode Top, <>
24-780	8.0 Ω	090-5061-00	Medium No Lugs-6" Leads / No Core	31-590	Ω	090-5010-00	Diode (Top), <>
29-1000	15.2 Ω	090-5059-00	Mini w/ Magnet Core, w/Lugs + Diode	32-1250	35.0 Ω	515-6916-01	with Flap & Screw, <YELLOW>
31-1500	52.0 Ω	090-5054-00 090-5055-00	Mini w/ Mag. Core, Str. Lugs + Diode Mini w/ Mag. Core, 90° Lugs + Diode	32-1800	50.2 Ω	515-6110-00 090-5031- use	w/ Mounting & Armature Brackets, <> -0B Diode Bottom, -0T Diode Top
<b>Ordering Note:</b> Coils typically should not come with Coil Sleeves. <b>IF A SLEEVE EXISTS</b> , ensure it is the correct sleeve for the application usage. For the correct Coil Sleeve, refer to the Assembly Drawing the coil exists on and order separately.				33-1590 59.0 Ω 515-6916-00 with Brackets, <WHITE>			
<b>Please Note:</b> Ohm values may vary +/- .03Ω depending on meter calibration.							



### Flipper Coil (White Star Board System Only\*) Table



	FLIPPERS				FLIPPERS no E.O.S. Switch	
	SPI N° / GAUGE-TURNS / Color		SPI N° / GAUGE-TURNS / Color		SPI N° / GAUGE-TURNS / Color	
	LOWER LEFT	LOWER RIGHT	UPPER LEFT	UPPER RIGHT		
<b>* Note:</b> For complete Appendix Information for Games <i>Laser War</i> through <i>Batman Forever</i> , see any Service Game Manual between <i>Apollo 13</i> through <i>Ripley's Believe It or Not!</i> ; or order CD-R, 970-2003-00 ( <i>The Simpsons™ Pinball Party</i> , <i>Terminator® 3</i> and <i>The Lord of the Rings™</i> ).						
Apollo 13	2	090-5032-0T 22-1080 -YEL-GRN-	SAME	Not Used	Not Used	
Golden Eye	2	090-5032-0T 22-1080 -YEL-GRN-	SAME	Not Used	Not Used	
Twister	2	090-5020-20T 22-900 -YELLOW-	090-5032-0T 22-1080 -YEL-GRN-	Not Used	Not Used	
ID4: Independence Day	3	090-5032-0T 22-1080 -YEL-GRN-	SAME	Not Used	090-5020-30 23-900 -GREEN-	
Space Jam †	2	090-5032-0T 22-1080 -YEL-GRN-	090-5020-20T 22-900 -YELLOW-	Not Used	Not Used	
The Star Wars Trilogy - Special Edition †	2	090-5032-0T 22-1080 -YEL-GRN-	SAME	Not Used	Not Used	
The Lost World: Jurassic Park †	2	090-5032-0T 22-1080 -YEL-GRN-	SAME	Not Used	Not Used	
The X-Files †	2	090-5032-0T 22-1080 -YEL-GRN-	SAME	Not Used	Not Used	
Starship Troopers †	3	090-5030-0T 23-1100 -ORANGE-	SAME	Not Used	090-5032-0T 22-1080 -YEL-GRN-	
Viper Night Drivin' †	2	090-5030-0T 23-1100 -ORANGE-	SAME	Not Used	Not Used	
Lost In Space †	2	090-5030-0T 23-1100 -ORANGE-	090-5032-0T 22-1080 -YEL-GRN-	Not Used	Not Used	
Godzilla †	2	090-5032-0T 22-1080 -YEL-GRN-	SAME	Not Used	Not Used	
South Park †	2	090-5030-0T 23-1100 -ORANGE-	SAME	Not Used	Not Used	

Table continued on the next page.

† Coil Part Numbers ending with a "T" signifies the Diode is on the top of the lug (on the coil-winding side); Coil Part Numbers ending with a "B" signifies the Diode is on the bottom of the lugs.

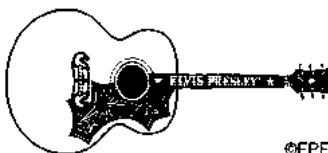



# APPENDIX E

## Flipper Coil (White Star Board System Only\*) Table



GAME NAME	Nº of Flippers	FLIPPERS w/E.O.S. Switch		FLIPPERS no E.O.S. Switch	
		SPI Nº / GAUGE-TURNS / Color		SPI Nº / GAUGE-TURNS / Color	
		LOWER LEFT	LOWER RIGHT	UPPER LEFT	UPPER RIGHT
Harley-Davidson® † and 1st through 3rd Editions	2	090-5032-0T 22-1080 -YEL-GRN-	090-5030-0T 23-1100 -ORANGE-	Not Used	Not Used
Striker Xtreme (NFL) †	3	090-5032-0T 22-1080 -YEL-GRN-	090-5030-0T 23-1100 -ORANGE-	090-5030-0T 23-1100 -ORANGE-	Not Used
Sharkey's Shootout †	3	090-5030-0T 23-1100 -ORANGE-	SAME	090-5030-0T 23-1100 -ORANGE-	Not Used
High Roller Casino †	2	090-5020-20T 22-900 -YELLOW-	090-5032-0T 22-1080 -YEL-GRN-	Not Used	Not Used
Austin Powers™ †	2	090-5020-30 23-900 -GREEN-	090-5030-0T 23-1100 -ORANGE-	Not Used	Not Used
MONOPOLY® †	3	090-5032-0T 22-1080 -YEL-GRN-	SAME	Not Used	090-5062-0T 23-1500 -BLUE-
Playboy †	2	090-5030-0T 23-1100 -ORANGE-	SAME	Not Used	Not Used
RollerCoaster Tycoon™ †	4	090-5032-0T 22-1080 -YEL-GRN-	SAME	090-5067-0T 25-1400 -RED-	090-5068-0T 25-1600 -WHITE-
The Simpsons™ Pinball Party †	6** (5 with Flipper Bats)	090-5032-0T 22-1080 -YEL-GRN-	SAME	Not Used	090-5030-0T 23-1100 -ORANGE-
		** The Homer Head Assembly is affixed to an Upr. Rt. Style Flipper (no E.O.S. Switch):		Flippers (Mini-Bats) on 2nd Level Playfield:	
			** 090-5020-20T 22-900 -YELLOW-	090-5041-00T 25-1800 -BLU-GRN-	090-5025-00 24-1570 -BLUE-
Terminator® 3: Rise of the Machines™ †	2	090-5032-0T 22-1080 -YEL-GRN-	SAME	Not Used	Not Used
The Lord of the Rings™ †	2	090-5020-20T 22-900 -YELLOW-	SAME	Not Used	Not Used
Ripley's Believe It or Not!® †	3	090-5032-0T 22-1080 -YEL-GRN-	SAME	Not Used	090-5067-00T 25-1400 -RED-
Elvis® †	4	090-5020-20T 22-900 -YELLOW-	SAME	090-5020-30 23-900 -GREEN-	SAME

† Coil Part Numbers ending with a "T" signifies the Diode is on the top of the lug (on the coil-winding side); Coil Part Numbers ending with a "B" signifies the Diode is on the bottom of the lugs.





# APPENDIX F

## Motor Specification (White Star Board System Only\*) Table



Game Name	Function	Specifications	Part No
<b>* Note:</b> For complete Appendix Info. for Games <b>Laser War</b> through <b>Batman Forever</b> , see any Service Game Manual between <b>Apollo 13</b> through <b>Ripley's</b> or on-line at our website <a href="http://www.sternpinball.com/parts.htm">www.sternpinball.com/parts.htm</a> ; also available on CD-R, 970-2003-00 ( <b>The Simpsons™ Pinball Party, T3®</b> and <b>The Lord of the Rings™</b> ).			
<b>Apollo 13</b>	Rocket Up/Down Movement	Bowman Motor 24v A.C. 60Hz 3W 6 RPM CCW	515-6383-00 <i>incl. Connector</i>
	Moon Unit Rotational Orbit	Multi Products Motor 24v A.C. 50/60Hz 3W 6 RPM CCW	515-6487-00 <i>incl. Connector</i>
	Shaker	Johnson Motor (Vibrator) 10.5v D.C. 10 AMP 2950 RPM CW	041-5029-00 <b>MOTOR ONLY</b>
<b>Golden Eye</b>	Satellite Left/Right Movement	Bowman Motor 24v A.C. 60Hz 3W 6 RPM CW	515-6528-00 <i>incl. Connector</i>
<b>Twister</b>	Spinning Disc with Magnet	Multi Products Motor 24v A.C. (041-5026-00) 50/60Hz 3W 325 RPM CCW	515-6347-00 <i>incl. Connector</i>
	Backbox Fan (Tornado Wind)	Multi Products Motor 24v A.C. (041-5052-00) 50/60Hz 3W 3600 RPM CW	515-6531-00 <i>incl. Connector</i>
<b>ID4: Independence Day</b>	Alien Head Open/Close Movement	Servo Motor (94322)	041-5045-00 <b>MOTOR ONLY</b>
<b>SPACE JAM (NO MOTOR USED)</b>			
<b>The Star Wars Trilogy - S.E.</b>	X-Wing Left/Right Movement	Bowman Motor 24v A.C. (041-5058-00) 60Hz 3W 10 RPM CCW	515-6383-01 <i>incl. Connector</i>
<b>The Lost World: J.P.</b>	Snagger & Center Link Lift Up/Down Movement	Multi Products Motor 20v D.C. (041-5059-03) 9 RPM Non-Directional	515-6715-03 <i>incl. Connector</i>
	Shaker	Johnson Motor (Vibrator) 10.5v D.C. 10 AMP 2950 RPM CW	041-5029-00 <b>MOTOR ONLY</b>
<b>The X-Files</b>	X-File Cabinet Lift Up/Down Movement	Multi Products Motor 20v D.C. 9 RPM CCW	041-5057-00 <b>MOTOR ONLY</b>
<b>Starship Troopers</b>	Warrior Bug Forward/Reverse Movement	Haydon Switch & Instrument, Inc. Stepper Motor 12v D.C. 4.6W (041-5062-00), Series 36000: 1.4"ø (Non-Captive Shaft not incl.) HSI #36864-12 (Unipolar) Travel per Step: .004 Step Angle: 15°	515-6794-00 <i>incl. Connector</i> Requires 7" Shaft: 530-5503-00
<b>VIPER NIGHT DRIVIN' (NO MOTOR USED)</b>			
<b>Lost In Space</b>	Spinning Disc with Magnet	Multi Products Motor 24v A.C. (041-5046-00) 50/60Hz 3W 325 RPM CCW	515-6347-00 <i>incl. Connector</i>
<b>Godzilla</b>	Shaker ‡	Johnson Motor (Vibrator) 10.5v D.C. 10 AMP 2950 RPM CW ‡	041-5029-01 <b>MOTOR ONLY</b>
<b>SOUTH PARK (NO MOTOR USED)</b>			
<b>Harley-Davidson® 1st through 3rd Editions</b>	Shaker ‡	Johnson Motor (Vibrator) 10.5v D.C. 10 AMP 2950 RPM CW ‡	041-5029-01 <b>MOTOR ONLY</b>
	Motorcycle Lift Up/Down Movement	Autotrol 24v A.C. (041-5072-02) 20 RPM CCW	515-7025-00 <i>incl. Connector</i>
<b>Striker Xtreme (NFL)</b>	Goalie (Linebacker) Left to Right Movement	Multi #3590 12v D.C. (041-5075-00) 60 RPM	515-7071-00 <i>incl. Connector</i>
<b>Sharkey's Shootout</b>	Mystery Ball Rotating Movement	Hankscraft Motor Model-E 24v A.C. (041-5076-00) 50/60Hz 3W 20 RPM CW	515-7095-00 <i>incl. Connector</i>
<b>High Roller Casino</b>	Roulette Wheel Rotating Movement	Multi Products Motor 20V D.C. (041-5078-00) 17 RPM CCW	515-7153-00 <i>incl. Connector</i>
	Up/Dn. Ramp in Slot Mach. Lift Up/Down Movement	Haydon Switch & Instrument, Inc. Stepper Motor 12v D.C. 4.6W (041-5062-00), Series 36000: 1.4"ø (Non-Captive Shaft not incl.) HSI #36864-12 (Unipolar) Travel per Step: .004 Step Angle: 15°	515-6794-00 <i>incl. Connector</i> Requires Shaft 4 1/4": 530-5503-01
<b>Austin Powers™</b>	Time Machine Rotating Movement	Multi Products Motor 24v A.C. (041-5079-00) 50/60Hz 20RPM CCW	515-7141-00 <i>incl. Connector</i>
	Laser Beam Left to Right Directional	Autotrol Motor 24V A.C. (041-5081-00) 50/60Hz 4W 10RPM Bi-Directional	515-7171-00 <i>incl. Connector</i>
	Dr. Evil Target Lift Up/Down Movement	Hankscraft Motor Model-E 24v A.C. (041-5030-00) 50/60Hz 6RPM CCW	515-5900-00 <i>incl. Connector</i>
<b>Monopoly®</b>	Mini-Flipper (Waterworks) Rotating Movement	Multi Prod. Motor & Gear Box #7000 EX00159A 20v D.C. 50/60Hz 85RPM CC/CCW	041-5083-00 <b>MOTOR ONLY</b>
<b>Playboy</b>	Triangular Billboard Rotating Movement	Autotrol Motor (BD511 150-1387) 24v A.C. 50/60Hz 12RPM Bi-Directional	041-5086-02 <b>MOTOR ONLY</b>
	Centerfold Mechanism Open/Close Movement	Multi Products (3680) Motor 12v DC 10/12 RPM CC/CCW	041-5075-04 <b>MOTOR ONLY</b>
	Tease Drop Screen Lift Up/Down Movement	Haydon Switch & Instrument, Inc. Stepper Motor 12v D.C. 4.6W (041-5062-00), Series 36000: 1.4"ø (Non-Captive Shaft not incl.) HSI #36864-12 (Unipolar) Travel per Step: .004 Step Angle: 15°	515-6794-00 <i>incl. Connector</i> Requires 7" Shaft: 530-5503-00

‡ **Please Note:** "-01" Shaker Motor is **Not Compatible** with old Shaker Motor 041-5029-00 (Shaker Motor Assy. 515-5893-00). THIS NEW MOTOR CAN ONLY BE USED IN NEW SHAKER MOTOR ASSY. 515-5893-01.

Table continued on the next page.



# APPENDIX F



## Motor Specification (White Star Board System Only\*) Table

Game Name	Function	Specifications	Part N <sup>o</sup>
<i>ROLLERCOASTER TYCOON™ (NO MOTOR USED)</i>			
<i>THE SIMPSONS™ PINBALL PARTY (NO MOTOR USED)</i>			
<b>Terminator® 3: Rise of the Machines™</b>	Backbox Ball Shooter Up/Down Movement	Multi Products Motor 24V A.C. (041-5079-01) 21 RPM CW	515-7317-00 <i>incl. Connector</i>
<b>The Lord of the Rings™</b>	Balrog (Motor & Gate) Open/Close Movement	Multi Prod. Motor 20V D.C. Series 600B ( <i>or equiv.</i> ) 50/60Hz 10 RPM Bi-Directional	041-5088-01 <b>MOTOR ONLY</b>
<i>RIPLEY'S BELIEVE IT OR NOT!® (NO MOTOR USED)</i>			
<b>Elvis®</b>	Elvis™ Front/Back Movement	Haydon Switch & Instrument, Inc. Stepper Motor 12v D.C. 10W (041-5089-00), HSI #46868-12-002	500-6809-00 <i>incl. Connector</i> Requires 7.25" Shaft: 530-5658-00
	▶▶▶ <b>OPTIONAL</b> ◀◀◀ Shaker	Johnson Motor (Vibrator) 10.5v D.C. (041-5029-01) 10 AMP 2950 RPM CW & Wiring Harness	515-5893-01 <i>incl. Connector</i>





# APPENDIX G

## Part Number Prefix Classification Codes





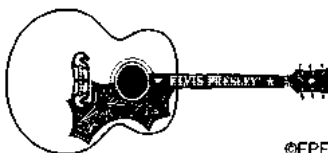











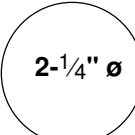
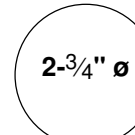



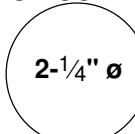
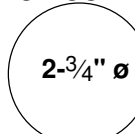

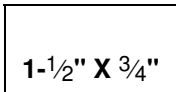
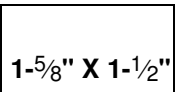
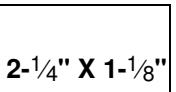
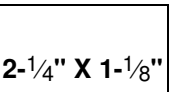
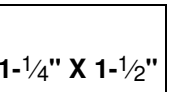
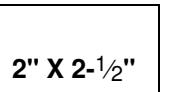

---

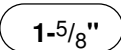
- I. Electrical Source, Energy & Signal Converters**
  - 010- Transformers
  - 031- Speakers
  - 090- Solenoids (Coils)
- II. Conductors, Connectors & Insulators**
  - 034- Line Cords
  - 036- Cable and Harness Assemblies
  - 041- Motors
  - 045- Connectors (All Types)
  - 077- Lamp Sockets
- III. Circuits & Circuit Elements**
  - 100- ICs
  - 110- Transistors
  - 112- Diodes
  - 121- Resistors
  - 123- Resistors (Variable & Adjustable)
  - 124- Regulators & Bridge Rectifiers
  - 125- CAPS
  - 140- Crystals
  - 165- Light Bulbs
  - 180- Switches
  - 190- Relays
- IV. Bolts, Screws, Nuts & Washers**
  - 231- Bolts
  - 232- Screws (Pan Head)
  - 234- Screws (HWH)
  - 237- Screws (Misc.)
  - 240- Nuts (Misc.)
  - 242- Washers (Flat, Round)
  - 244- Washers (Split Lock)
  - 246- Washers (Lockers, External Tooth)
- V. Mechanical Components**
  - 249- Rivets
  - 251- Pins (Dowel)
  - 254- Stand-Offs, Spacers and Shims
  - 260- Steel Ball
  - 265- Springs (Extension)
  - 266- Springs (Compression)
  - 269- Springs (Washers - Belleville, Wave)
  - 280- Grommets and Bushing
- VI. Handles, Locks, Catches & Latches, Keys & Hinges**
  - 355- Handles, Locks, Catches & Latches and Keys
  - 390- Hinges
- VII. Fabricated Parts (In-House Assemblies)**
  - 500- End Product (Systems and Models)
  - 515- Sub-Assemblies
  - 520- Printed Circuit Boards (PCBs)
  - 522- Display Glass
  - 525- Wood Parts
  - 530- Screw Machined Parts
  - 535- Fabricated Parts
  - 545- Molded (Extruded) Plastic/Rubber Parts
  - 550- Molded (Inserts)
- VIII. Bulk Materials**
  - 600- Braided Ground Wire
  - 601- Stranded Wire
  - 602- Ribbon Cable
  - 605- Sleeving (Shrink Tubing)
  - 626- Foam Rubber
- IX. Miscellaneous**
  - 705- Packing & Shipping Items
  - 820- Decals and Labels (Sets & Misc.)
  - 830- Butyrate (Plastic Pieces)
  - 900- Game Posters
  - 960- EPROM (Raw Part)
  - 965- EPROM (Programmed Part)

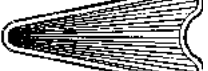
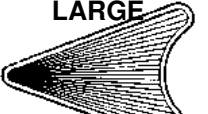

# APPENDIX H

## Playfield Inserts (Plastic Light Covers)

<b>Patterns:</b> <b>STARBURST</b>  <b>STIPPLE</b> 	<b>STARBURST CIRCULAR</b>  <b>550-5000-XX</b>	<b>STARBURST CIRCULAR</b>  <b>550-5001-XX</b>	<b>STARBURST CIRCULAR</b>  <b>550-5002-XX</b>	<b>STARBURST CIRCULAR</b>  <b>550-5003-XX</b>	<b>STARBURST CIRCULAR</b>  <b>550-5004-XX</b>
<b>STARBURST CIRCULAR</b>  <b>550-5005-XX</b>	<b>STARBURST CIRCULAR</b>  <b>550-5006-XX</b>	<b>PLAIN CIRCULAR</b>  <b>550-5007-XX</b>	<b>PLAIN CIRCULAR</b>  <b>550-5008-XX</b>	<b>PLAIN CIRCULAR</b>  <b>550-5009-XX</b>	<b>PLAIN CIRCULAR</b>  <b>550-5010-XX</b>
<b>PLAIN CIRCULAR</b>  <b>550-5011-XX</b>	<b>PLAIN CIRCULAR</b>  <b>550-5012-XX</b>	<b>STIPPLE CIRCULAR</b>  <b>550-5048-XX</b>	<b>STIPPLE 1" SQUARE</b>  <b>550-5019-XX</b>	<b>ROLLOVER BUTTON BASE</b>  <b>550-5026-XX</b>	<b>WHITE STAR (only in white)</b>  <b>545-5015-00</b>
<b>STIPPLE RECTANGULAR</b>  <b>550-5018-XX</b>	<b>STIPPLE RECTANGULAR</b>  <b>550-5051-XX</b>	<b>STARBURST RECTANGULAR</b>  <b>550-5044-XX</b>	<b>PLAIN RECTANGULAR</b>  <b>550-5049-XX</b>	<b>PLAIN RECTANGULAR</b>  <b>550-5050-XX</b>	<b>PLAIN RECTANGULAR</b>  <b>550-5063-XX</b>
<b>STARBURST MINI SHIELD</b>  <b>550-5024-XX</b>	<b>STARBURST LARGE SHIELD</b>  <b>550-5025-XX</b>	<b>MINI HOT DOG</b>  <b>550-5020-XX</b>	<b>BEVEL HOT DOG</b>  <b>550-5021-XX</b>	<b>PLAIN HOT DOG</b>  <b>550-5022-XX</b>	<b>BANANA</b>  <b>550-5023-XX</b>
<b>STARBURST ARROW-SMALL</b>  <b>550-5013-XX</b>	<b>STARBURST ARROW-LARGE</b>  <b>550-5070-XX</b>	<b>STARBURST ARROW-HEAD SMALL</b>  <b>550-5014-XX</b>	<b>STARBURST ARROW-HEAD LARGE</b>  <b>550-5015-XX</b>	<b>STARBURST BULLET</b>  <b>550-5016-XX</b>	<b>STARBURST TRIANGLE</b>  <b>550-5017-XX</b>

**Note:** The shapes and sizes shown above are not to scale. Some shapes may no longer be available in every color.

**Instructions:** Parts which may come in various colors (i.e. targets, some posts, playfield inserts, etc.) end in a 2-digit N<sup>o</sup> which correspond to the color of that part. The "-XX" in Part N<sup>o</sup>s which may come in various colors should be replaced with the desired 2-Digit N<sup>o</sup>. corresponding to the color desired. *Not all colors may be available.*

PLASTIC PART COLOR CHART											
N <sup>o</sup>	Color	N <sup>o</sup>	Color	N <sup>o</sup>	Color	N <sup>o</sup>	Color	N <sup>o</sup>	Color	N <sup>o</sup>	Color
-00	Black or Solid Clear	-03	Amber	-06	Yellow	-09	Purple	-12	Fluor. Blue	-15	Luminescent
-01	Clear	-04	Green	-07	Orange	-10	Fluor. Orange	-13	Teal Green	-16	Gold
-02	Red	-05	Blue	-08	White	-11	Fluor. Green	-14	Gray	-17	Trans. Brown



# APPENDIX I

## Stand-Up Targets

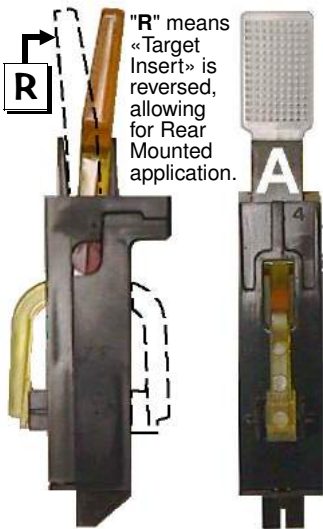

"R" means «Target Insert» is reversed, allowing for Rear Mounted application.

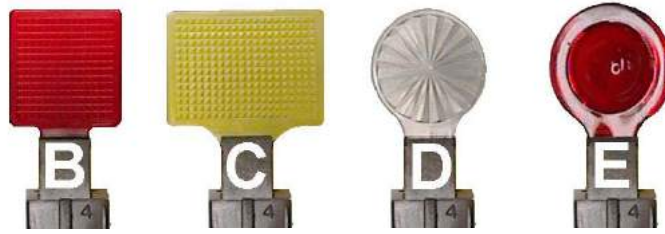

### Take Note:

- For Items A-E, for the Target Assembly use the "500-" SPI N°; For the Target Assy. with Rear Mount add "R" to "500-" SPI N°; For just the «Target Insert» use the "545-" SPI N°.
- Items A-E come in various colors. *These targets may not be available in every color.* The "-XX" in should be replaced with the desired 2-Digit N° for the color desired described in the Chart **†**.  
**As of date of print, the following colors were used for Items A-E:**  
-01 Clear (A, D); -02 Red (A, B, C, D, E); -03 Amber (D, E); -04 Green (A, B); -05 Blue (C); -06 Yellow (A, C); -09 Purple (B, D); -11 Fluorescent Green (A, B, D).
- See Section 3, Chapter 2, **Go To Diagnostics Menu**, for switches used corresponding to the Switch Matrix Grid of this game.

PLASTIC PART COLOR CHART	
N°	Color
-00	Black
-01	Clear
-02	Red
-03	Amber
-04	Green
-05	Blue
-06	Yellow
-07	Orange
-08	White
-09	Purple
-10	Fluor. Orange
-11	Fluor. Green
-12	Fluor. Blue
-13	Teal Green
-14	Gray
-15	Luminescent
-16	Gold

N°	STAND-UP TARGET NAME	SPI PART N°	N°	STAND-UP TARGET NAME	SPI PART N°
A	Modular Stand-Up Target Narrow Assy.	500-6138-XX	D	Modular Stand-Up Target Round Assy.	500-6075-XX
	Stand-Up Target Narrow (Insert)	545-6138-XX		Stand-Up Target Round (Insert)	545-6075-XX
B	Modular Stand-Up Target Square Assy.	500-6139-XX	E	Mod. Stand-Up Target 1" Spherical Assy.	500-6189-XX
	Stand-Up Target Square (Insert)	545-6139-XX		Stand-Up Target 1" Spherical (Insert)	545-6189-XX
C	Modular Stand-Up Target Rectangle Assy.	500-6228-XX			
	Stand-Up Target Rectangle (Insert)	545-6228-XX			

**Note:** To receive the Target Assembly with the «Target Insert» «Reversed» simply add a "R" at the end of the Part N°. See Side View picture above to compare (dashed line shows target reversed).

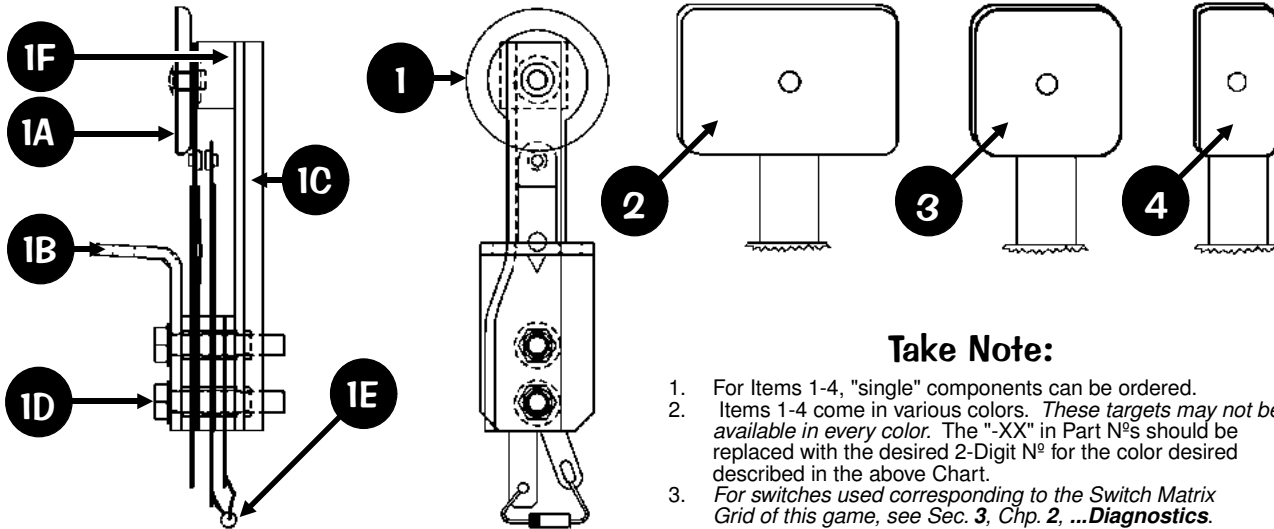

### Take Note:

- For Items 1-4, "single" components can be ordered.
- Items 1-4 come in various colors. *These targets may not be available in every color.* The "-XX" in Part N°s should be replaced with the desired 2-Digit N° for the color desired described in the above Chart.
- For switches used corresponding to the Switch Matrix Grid of this game, see Sec. 3, Chp. 2, ...**Diagnostics**.

N°	STAND-UP (FLAT) TARGET NAME	SPI PART N°	N°	STAND-UP (FLAT) TARGET NAME	SPI PART N°
1	1" Round Stand-Up Target Assy.	500-5835-XX	3	1" Sq. Stand-Up Target Assy.	500-5232-XX
<b>ORDERING ABOVE (ITEM 1) ASSY. PART N° WILL INCLUDE:</b> 1A‡ Switch & Target Assy. 1" Round 515-5966-XX 1B Mounting Bracket 535-6896-00 1C Switch Back Plate 535-6452-00 1D 6-32 X 3/4 HWH Swage (Qty. 2) 237-5976-05 1E Switch Diode, 1N4001 112-5001-00 1F Foam Pad 626-5029-00 ‡ <b>Note:</b> Item 1A, is a riveted Sub-Assy, which includes the following items for reference: A1— Stack Switch Radius End (180-5133-00), A2— Washer 5/16" (242-5017-00), A3— Rivet 1/8" ø X 3/16" (249-5001-00) and A4— 1" Round Target (545-5456-XX).			‡ <b>Note:</b> Item 2A, is a riveted Sub-Assy, which includes the following items for reference: A1— Stack Switch Radius End (180-5133-00), A2— Washer 5/16" (242-5017-00), A3— Rivet 1/8" ø X 3/16" (249-5001-00) and A4— Rectangular Target (545-5145-XX).		
2	1" X 1 1/2" Stand-Up Rect. Target Assy.	500-5321-XX	4	Narrow Stand-Up Target Assy.	500-5857-XX
<b>ORDERING ABOVE (ITEM 2) ASSY. PART N° WILL INCLUDE:</b> 2A‡ Sw. & Target Assy. 1" X 1 1/2" Rect. 515-6027-XX Items 2B-F are identical to 1B-F Same as 1B-F			<b>ORDERING ABOVE (ITEM 3) ASSY. PART N° WILL INCLUDE:</b> 3A‡ Sw. & Target Assy. 1" Square 515-5162-XX Items 3B-F are identical to 1B-F Same as 1B-F ‡ <b>Note:</b> Item 3A, is a riveted Sub-Assy, which includes the following items for reference: A1— Stack Switch Radius End (180-5133-00), A2— Washer 5/16" (242-5017-00), A3— Rivet 1/8" ø X 3/16" (249-5001-00) and A4— 1" Square Target (545-5470-XX).		
<b>Item 2 Table Note continued in the next column.</b>			<b>ORDERING ABOVE (ITEM 4) ASSY. PART N° WILL INCLUDE:</b> 4A‡ Sw. & Target Assy. Narrow 515-5967-XX Items 4B-F are identical to 1B-F Same as 1B-F ‡ <b>Note:</b> Item 4A, is a riveted Sub-Assy, which includes the following items for reference: A1— Stack Switch Square End (180-5132-00), A2— Washer 5/16" (242-5017-00), A3— Rivet 1/8" ø X 3/16" (249-5001-00) and A4— Narrow Target (545-5210-XX).		

*Elvis Presley*™

APPENDIX J



Coin Cards (USA & International Pricing Defaults) ▶ For Yellow Stock add -Y to the Part Number

If more than one Pricing Scheme is shown (available) for countries listed, the **F.** listed beside the option, denotes the Factory Default Setting.

USA 8 or CANADA		USA 5 <b>F.</b>		USA 1 (*OPTIONAL)		USA 2-7 or CANADA		FOR CUSTOM PRICING †		USA 1 (*OPTIONAL)	
								Backside is Blank (Border Only) Typeset your Custom Pricing			
755-5400-00 Front		755-5400-00 Back		755-5400-01 Front		755-5400-02 Front		755-5400-01 or -02 Back		755-5400-05 1-Side Only	
USA 3 with ToPS™		USA 5 with ToPS™		US, CAN., AUST. or N.Z. with ToPS™ ...CUSTOM PRICING †		(*OPTIONAL) Any Country Setting Option = 1 Play per Click					
								Backside is Blank (Border Only) Typeset your Custom Pricing			
755-5400-03 Front		755-5400-03 Back		755-5400-04 Back		755-5400-04 Back		755-5400-06 Front		755-5400-06 Back	
AUSTRALIA 1 <b>F.</b>		AUSTRALIA 2		CROATIA		FOR CUSTOM PRICING †		DENMARK 1 <b>F.</b>		DENMARK 2	
						Backside is Blank (Border Only) Typeset your Custom Pricing					
755-5406-00 Front		755-5406-00 Back		755-5410-00 Front		755-5410-00 Back		755-5402-00 Front		755-5402-00 Back	
JAPAN 1		JAPAN 2 <b>F.</b>		NEW ZEALAND 1 <b>F.</b>		NEW ZEALAND 2		NORWAY 1 <b>F.</b>		NORWAY 2	
755-5408-01 Front		755-5408-01 Back		755-5406-00 Back		755-5406-00 Front		755-5403-00 Front		755-5403-00 Back	
SOUTH AFRICA		FOR CUSTOM PRICING †		SWEDEN 1 <b>F.</b>		SWEDEN 2		SWITZERLAND 1 <b>F.</b>		SWITZERLAND 2	
		Backside is Blank (Border Only) Typeset your Custom Pricing									
755-5409-01 Front		755-5409-01 Back		755-5404-00 Front		755-5404-00 Back		755-5405-00 Front		755-5405-00 Back	
UK 1		UK 3		UK 5 <b>F.</b>		FOR CUSTOM PRICING †		UK with ToPS™ FOR CUSTOM PRICING †			
						Backside is Blank (Border Only) Typeset your Custom Pricing				Backside is Blank (Border Only) Typeset your Custom Pricing	
755-5407-00 Front		755-5407-00 Back		755-5407-01 Front		755-5407-01 Back		755-5407-02 Front		755-5407-02 Back	
EURO 1		EURO 2		EURO 3		EURO 4		EURO 5		EURO 6	
755-5401-01 1-Side Only		755-5401-02 1-Side Only		755-5401-03 1-Side Only		755-5401-04 1-Side Only		755-5401-05 1-Side Only		755-5401-06 1-Side Only	
EURO 7		EURO 8		EURO 9		EURO 10		EURO 11		EURO 12	
755-5401-07 1-Side Only		755-5401-08 1-Side Only		755-5401-09 1-Side Only		755-5401-10 1-Side Only		755-5401-11 1-Side Only		755-5401-12 1-Side Only	
EURO with ToPS™ FOR CUSTOM PRICING †		Backside is Blank (Border Only) Typeset your Custom Pricing									
		Backside is Blank (Border Only) Typeset your Custom Pricing									
755-5401-20 Front		755-5401-20 Back									
EURO 1		EURO 2		EURO 3		EURO 4		EURO 5		EURO 6	
BELGIUM ITALY 1 PORTUGAL		GERMANY 2		NETHERLANDS SPAIN				EURO 9		EURO 10	
								EURO 11		EURO 12	
								AUSTRIA		FRANCE	

▶ EURO FACTORY DEFAULT SUMMARY TABLE ◀

EURO 5	EURO 6	EURO 7	EURO 8	EURO 9	EURO 10	EURO 11	EURO 12
	GREECE		FINLAND	AUSTRIA	FRANCE		

Section 3, Chapter 4, GO TO ADJUSTMENTS MENU, Adj. 11, Game Pricing, USA & International (non-Euro) and Euro 1-12 Summary & International (Euro) Standard Pricing Select Tables, summarizes Custom or Standard Pricing Schemes above Coin Cards represent.





# GLOSSARY OF TERMS

- A** Followed after a number means "Amp." or Ampage in an expression relating to an electrical object. (e.g. **8A**).
- AC** (Acronym) **Alternating Current**.
- Adj.** (Abbreviation) Adjustment(s).
- Assy.** (Abbreviation) Assembly.
- Au.** (Abbreviation) Audit(s).
- Bd.** (Abbreviation) Board.
- BOT** (Abbreviation) Bottom.
- Brkt.** (Abbreviation) Bracket.
- Bridge Rectifier** A configuration of a diode that allows current to flow in one direction producing both positive and negative pulsating DC Voltages.
- Color Coding** See Appendix H or I, Plastic Part Color Chart or Section 4, Chapter 1, Playfield - Plastic Posts & Spacers.
- Combination (Combo) [Shot]** Any variable pinball shot(s) made successively.
- Conn.** (Abbreviation) Connector.
- CMOS** Short for COSMOS (Complementary Symmetry M.O.S.); Complementary Metal-Oxide Semi-Conductor.
- CN** (Abbreviation) Connector (e.g. **CN5-P3**).
- CT** (Abbreviation) Center.
- DC** (Abbreviation) Direct Current.
- DT** (Abbreviation) Drop Target(s).
- DOTS** (Acronym) **Diode On Terminal Strip**.
- EB** (Abbreviation) Extra Ball.
- Eject** Playfield surface device to kick ball back into play; Saucer.
- EPROM** (Acronym) **Erasable Programmable Read Only Memory**. Can be erased using UV Light and re-programmed.
- e.g.** (Abbreviation) Latin- Exempla gratia. For Example.
- EOS** (Acronym) **End-Of-Stroke** (i.e. Switch for flipper).
- F** (Abbreviation) Fuse (i.e. **F23**).
- GA-Turn** Gauge & Turn describing the windings on a coil (e.g. 23-800, 23 is the gauge of wire and 800 is the amount of windings).
- G.I.** (Abbreviation) General Illumination (Lamps).
- HWH** (Abbreviation) Hex Washer Head.
- IC** (Acronym) **Integrated Circuit** (As in after 24-Pin IC).
- ID or I.D.** (Acronym) **Inside Dimension**.
- i.e.** (Abbreviation) Latin- Id est. That is.
- IO or I/O** (Abbreviation) Input / Output (e.g. I/O Power Driver Bd.)
- LT, Lt. or L.** (Abbreviation) Left.
- Laser Kick** A coil/plunger used above the playfield to kick pinball back into play.
- LED** (Acronym) **Light Emitting Diode**.
- Loop [Shot]** Continuously up a ramp and back to the flipper.
- Lwr.** (Abbreviation) Lower.
- Orbit [Shot]** From the left or right flipper around the back rail of the playfield back to the flipper.
- MB** (Abbreviation) Magnet Board.
- M-BALL or MBALL** (Abbreviation) Multiball™ More than 1 ball in game play.
- MID** (Abbreviation) Middle
- Non-Reflexive** See Reflexive.
- No. or N° or #** (Abbreviation) Number
- NPF** (Acronym) **No Problem Found**.
- N.C. or NC** (Abbreviation) Normally Closed.
- N.O. or NO** (Abbreviation) Normally Open.
- NS** (Abbreviation) Not Stuffed. (Use in Part Listings, Sec. 5)
- OD or O.D.** (Abbreviation) Outside Dimension.
- P** (Abbreviation) Pin (e.g. **CN5-P3**).
- PCB** (Acronym) **Printed Circuit Board**
- P/F** (Abbreviation) Playfield.
- PIA LED** (Acronym) **Peripheral Interface Adapter Light Emitting Diode**. This is a diagnostic LED on the CPU; it should not be lit during normal operation of a pinball game.
- Plumb Bob Tilt** Weight on Tilt Assembly.
- PPH** (Abbreviation) Phillips Pan Head.
- Pop(s)** Another term for Turbo Bumper(s).
- PPB** (Acronym) Playfield Power Board ("Popcorn-Popping Bd.").
- PREV** (Abbreviation) Previous.
- PSB** (Abbreviation) Power Supply Board
- RAM** (Acronym) **Random Access Memory**. **RAM can** store input instructions and supply output information.
- Reflexive/Non-Reflexive Reflexive**—Solenoid Drive Transistor is enabled directly by a switch closure on the (Relating to CPU Boards) solenoid assembly (Ver. 1/2).
- Non-Reflexive**—Solenoid Drive Transistor is enabled by the CPU after reading a switch closure in the Switch Matrix (Ver. 3). Also note: All CPU Boards are backwards compatible (e.g. Jurassic Park/Ver. 3 to Time Machine/ Ver. 2). Swapping a Ver. 2 Board to a Ver. 3 is not possible due to the special solenoids section (i.e. Slingshots, Turbo Bumpers, etc.) changing from **REFLEXIVE** to **NON-REFLEXIVE** on Ver. 3 Boards.
- Relay** An automatic switch operated by current in a coil.
- ROM** (Acronym) **Read Only Memory**. **ROM cannot** store input instructions but can supply output information. **ROM can be programmed only once**.
- RMA** (Abbreviation) Return Merchandise Authorization Number
- RT, Rt. or R.** (Abbreviation) Right; ("**R**" at the end of Target Assy. Part N° signifies Target Insert is Reversed.)
- RO** (Abbreviation) Rollover (switches).
- Saucer** See Eject.
- Scoop** A hole into the playfield. A metal scoop is in place to guide the ball into the kick-back under the playfield.
- Slam Tilt** A switch which closes when the game is slammed into or the Coin Door is slammed shut. Depending on adjustable settings, will cancel game in play when the number of closures required is achieved.
- SMB** (Abbreviation) Shaker Motor Board.
- Solenoid** A coil used for Electro Magnetic devices such as relays, flippers, slingshots, etc.
- SSFB** (Abbreviation) Solid State Flipper Board.
- STEP** Refers to the service switches on the coin door.
- Sub-Assy.** (Abbreviation) Sub-Assembly.
- S-U or S/U** (Abbreviation) Stand-Up ( targets).
- TM** (Abbreviation) Trademark
- Transfer [Shot]** Maneuvering the ball in play from one flipper to the other. With flipper in the up position and the ball cradled by that flipper one would activate the flipper button in a quick repetitive manner to bounce the ball to the other side. Skilled players can rebound the ball off the slingshot.
- Tri-Ball** Three balls in play.
- TTL** (Abbreviation) Transistor-Transistor Logic
- Upr.** (Abbreviation) Upper.
- V or v** (Abbreviation) Volt(s).
- Ver.** (Abbreviation) Version.
- VUK** (Acronym) **Vertical Up-Kicker** (Super or Standard).
- X** (Abbreviation) "Times" A multiplier; also used in dimensions.
- X-Ball** An undetermined number of ball(s) during game play.
- Zener Diode** A semi-conductor diode used for voltage regulation. Application depends on reverse break-down voltage.
- "-00B"** "B" at the end of Coil Part Numbers signifies that the diode is attached to the bottom of the lug.
- "-00T"** "T" at the end of Coil Part Numbers signifies that the diode is attached to the top of the lug (the side nearest the coil-winding).



# STERN® PINBALL, INC. LIMITED WARRANTY

STERN® PINBALL, INC., ("SELLER") WARRANTS ONLY TO THE INITIAL PURCHASER OF ITS PRODUCTS THAT THE ITEMS LISTED BELOW ARE FREE FROM DEFECTS IN MATERIAL AND WORKMANSHIP UNDER NORMAL USE AND SERVICE FOR THE WARRANTY PERIOD SPECIFIED:

PRINTED CIRCUIT BOARDS (GAME LOGIC): 2 MONTHS  
DOT MATRIX DISPLAY BOARDS: 9 MONTHS

NO OTHER PARTS OF SELLER'S PRODUCT ARE WARRANTED.

WARRANTY PERIODS ARE EFFECTIVE FROM THE INITIAL DATE OF SHIPMENT FROM SELLER TO ITS AUTHORIZED DISTRIBUTORS.

SELLER'S SOLE LIABILITY SHALL BE, AT ITS OPTION, TO REPAIR OR REPLACE PRODUCTS WHICH ARE RETURNED TO SELLER DURING THE WARRANTY PERIODS SPECIFIED, PROVIDED:

1. SELLER IS NOTIFIED PROMPTLY UPON DISCOVERY BY PURCHASER THAT STATED PRODUCTS ARE DEFECTIVE.
2. SUCH PRODUCTS ARE PROPERLY PACKAGED AND THEN RETURNED FREIGHT PREPAID, TO SELLER'S PLANT.

THIS WARRANTY DOES NOT APPLY TO ANY PARTS DAMAGED DURING SHIPMENT AND/OR DUE TO IMPROPER HANDLING, OR DUE TO IMPROPER INSTALLATION OR USAGE, OR ALTERATION. IN NO EVENT SHALL THE SELLER BE LIABLE FOR ANY ANTICIPATED PROFITS, LOSS OF PROFITS, LOSS OF USE, ACCIDENTAL OR CONSEQUENTIAL DAMAGES OR ANY OTHER LOSSES INCURRED BY THE CUSTOMER IN CONNECTION WITH THE PURCHASE OF A STERN® PINBALL, INC. PRODUCT.

## WARRANTY DISCLAIMER

EXCEPT AS SPECIFICALLY PROVIDED IN A WRITTEN CONTRACT BETWEEN SELLER AND PURCHASER, THERE ARE NO OTHER WARRANTIES, EXPRESS OR IMPLIED, INCLUDING ANY IMPLIED WARRANTIES OF MERCHANTABILITY OR FITNESS FOR A PARTICULAR PURPOSE.

## CAUTIONS, WARNINGS & NOTICES

### Caution

 FOR SAFETY AND RELIABILITY, SUBSTITUTE PARTS AND EQUIPMENT MODIFICATIONS ARE NOT RECOMMENDED (AND MAY VOID ANY WARRANTIES). USE OF NON-STERN® PINBALL INC. PARTS OR MODIFICATIONS OF GAME CIRCUITRY, MAY ADVERSELY AFFECT GAME PLAY, OR MAY CAUSE INJURIES. TRANSPORT PINBALL GAMES WITH HINGED BACKBOX IN THE DOWN POSITION ONLY! ALWAYS TAKE GREAT CARE WHEN SERVICING ANY GAME. ALWAYS READ THE SERVICE MANUAL BEFORE REPLACING OR SERVICING COMPONENTS. SUBSTITUTIONS OF PARTS OR EQUIPMENT MODIFICATIONS MAY VOID FCC TYPE ACCEPTANCE.

 Always Disconnect The Line Voltage Before Servicing. Some Parts May Still Hold Current When Unplugged.

### Warning

 THIS EQUIPMENT GENERATES, USES, AND CAN RADIATE RADIO FREQUENCY ENERGY, AND IF NOT INSTALLED AND USED IN ACCORDANCE WITH THE INSTRUCTIONS MANUAL, MAY CAUSE INTERFERENCE TO RADIO COMMUNICATIONS. IT HAS BEEN TESTED AND FOUND TO COMPLY WITH THE LIMITS FOR A CLASS A COMPUTING DEVICE PURSUANT TO SUBPART J OF PART 15 OF FCC RULES, WHICH ARE DESIGNED TO PROVIDE REASONABLE PROTECTION AGAINST SUCH INTERFERENCE WHEN OPERATED IN A COMMERCIAL ENVIRONMENT. OPERATION OF THIS EQUIPMENT IN A RESIDENTIAL AREA IS LIKELY TO CAUSE INTERFERENCE IN WHICH CASE THE USER AT HIS OWN EXPENSE WILL BE REQUIRED TO TAKE WHATEVER MEASURES MAY BE REQUIRED TO CORRECT THE INTERFERENCE.

RF INTERFERENCE NOTICE, CABLE HARNESS PLACEMENTS AND GROUND STRAP ROUTING ON THIS GAME HAVE BEEN DESIGNED TO KEEP RF RADIATION AND CONDUCTION WITHIN LEVELS ACCEPTED BY THE FCC RULES. TO MAINTAIN THESE LEVELS, REPOSITION HARNESSES AND RECONNECT GROUND STRAPS TO THEIR ORIGINAL PLACEMENTS, IF THEY BECOME DISCONNECTED DURING MAINTENANCE.

### Notices

THIS DOCUMENT AND THE DATA DISCLOSED HEREIN OR HERewith IS NOT TO BE REPRODUCED (EXCEPT WHERE NOTED), USED OR OTHERWISE DISCLOSED IN WHOLE OR IN PART TO ANYONE WITHOUT WRITTEN CONSENT OF STERN® PINBALL, INC. WARNING: PRODUCTS IN THIS MANUAL, THE COMPANY NAME AND DEVICES AND THE DESIGN OF THE MANUAL ITSELF, ARE PROTECTED BY FEDERAL PATENTS (AND PATENTS PENDING), DESIGN REGISTRATIONS, TRADEMARKS AND COPYRIGHTS. ACTION WILL BE TAKEN IN THE EVENT OF INFRINGEMENT OR IMITATION. THE RIGHT IS RESERVED TO CHANGE SPECIFICATIONS WITHOUT PRIOR NOTICE.

© 2004 Manufactured by Stern® Pinball, Inc.. Portals, Icon Designs, TOPS™ Logo, Bump N' Win™ Logo & all related indicia are trademarks of Stern® Pinball, Inc. All Rights Reserved. Made in the USA.

"Multiball" is a registered trademark of Williams Electronics Games, Inc. Used by permission.

PCB Schematics (Section 5, Chapter 4) by CES (Creative Electronics & Software, Inc.) © 1995.

Reg. U.S. Pat. @ TM Office © EPE Elvis®



Copyright © 1998 BETA-BRITE and logo are trademarks of Adaptive Micro Systems, Inc. registered in the United States Patent and Trademark Office. All Rights Reserved.



Designed by Steve Ritchie Productions, 2004.



In SWITCH MENU also select:

ACTIVE and DEDICATED SWITCH TESTS

## SWITCH MATRIX GRID & DEDICATED SWITCHES (for notes & locations, see Page DR. 4 or 17)

Column (Drive)	1: Q1	2: Q2	3: Q3	4: Q4	5: Q5	6: Q6	7: Q7	8: Q8	GROUND	GROUND
Row (Return)	<b>GRN-BRN CN5-P1</b>	<b>GRN-RED CN5-P3</b>	<b>GRN-ORG CN5-P4</b>	<b>GRN-YEL CN5-P5</b>	<b>GRN-BLK CN5-P6</b>	<b>GRN-BLU CN5-P7</b>	<b>GRN-VIO CN5-P8</b>	<b>GRN-GRY CN5-P9</b>	IC 206 INPUTS	<b>BLK CN6-P1, -P11</b>
1: <b>U400</b>	1 Cabinet Side <b>WHT-BRN CN7-P9</b> LT BUTTON (UK ONLY) Sw. Part Number: 180-5160-00	9 Below P/F SPOT NOTE STANDUP 515-5162-08	17 Below P/F (E)LVIS 180-5158-00	25 Above P/F SPINNER 180-5010-04	33 Below P/F ELVIS HOME 180-5189-00	41 Below P/F LEFT TOP LANE 500-6227-02	49 Below P/F LEFT BUMPER 180-5015-05	57 Below P/F LEFT OUTLANE 500-6227-02	1: <b>U206</b> <b>GRY-BRN CN6-P2</b> Sw. Part Number: 180-5160-00	DS-1 on Cabinet Side #1 LEFT FLIPPER BUTTON
2: <b>U400</b>	2 Coin Door <b>WHT-RED CN7-P8</b> 4TH COIN SLOT 180-5204-00	10 Above P/F SHOOTER LANE EXIT 180-5190-28	18 Below P/F E(L)VIS 180-5158-00	26 Above P/F LEFT ORBIT HI 180-5087-00	34 Below P/F CENTER SAUCER EJECT 180-5186-00	42 Below P/F MIDDLE TOP LANE 500-6227-02	50 Below P/F RIGHT BUMPER 180-5015-05	58 Below P/F LEFT RETURN LANE 500-6227-02	2: <b>U206</b> <b>GRY-RED CN6-P3</b> Sw. Part Number: 180-5149-00 on Flipper	DS-2 Below Playfield #2 LEFT FLIPPER E.O.S (End-of-Stroke)
3: <b>U400</b>	3 Coin Door <b>WHT-ORG CN7-P7</b> 6TH COIN SLOT Future Use	11 Below P/F 4-BALL TROUGH #1 (LEFT) 180-5119-02	19 Below P/F EL(V)IS 180-5158-00	27 Above P/F INNER LOOP 180-5087-00	35 NOT USED	43 Below P/F RIGHT TOP LANE 500-6227-02	51 Below P/F BOTTOM BUMPER 180-5015-05	59 Below P/F LEFT SLINGSHOT 180-5054-00 (x2)	3: <b>U206</b> <b>GRY-ORG CN6-P4</b> Sw. Part Number: 180-5164-00 Doubled	DS-3 on Cabinet Side #3 RIGHT FLIPPER BUTTON
4: <b>U400</b>	4 Coin Door <b>WHT-YEL CN7-P6</b> RIGHT COIN SLOT 180-5204-00	12 Below P/F 4-BALL TROUGH #2 180-5119-02	20 Below P/F ELV(I)S 180-5158-00	28 Above P/F RIGHT RAMP EXIT 180-5010-01	36 Below P/F (K)ING 515-7381-00	44 NOT USED	52 Mini P/F TOP HOTEL STANDUP 515-5162-08	60 Below P/F RIGHT OUTLANE 500-6227-02	4: <b>U206</b> <b>GRY-YEL CN6-P6</b> Sw. Part Number: 180-5149-00 on Flipper	DS-4 Below Playfield #4 RIGHT FLIPPER E.O.S (End-of-Stroke)
5: <b>U401</b>	5 Coin Door <b>WHT-GRN CN7-P5</b> CENTER COIN SLOT / DBA 180-5204-00	13 Below P/F 4-BALL TROUGH #3 180-5119-02	21 Below P/F ELVI(S) 180-5158-00	29 NOT USED	37 Below P/F K(I)NG 515-7381-00	45 Above P/F RIGHT RAMP MADE 180-5190-28	53 Mini P/F BOTTOM HOTEL STANDUP 515-5162-08	61 Below P/F RIGHT RETURN LANE 500-6227-02	5: <b>U206</b> <b>GRY-GRN CN6-P7</b> Sw. Part Number: 180-5164-00 Doubled	DS-5 on Cabinet Side #5 UPPER RT. FLIPPER BUTTON
6: <b>U401</b>	6 Coin Door <b>WHT-BLU CN7-P3</b> LEFT COIN SLOT 180-5204-00	14 Below P/F 4-BALL TROUGH VUK OPTO See Sw. 14 Note	22 Below P/F (T)CB 515-5162-08	30 Above P/F LEFT RAMP MADE 180-5087-00	38 Below P/F KI(N)G 515-7381-00	46 Above P/F RIGHT ORBIT LOW 180-5087-00	54 In Cabinet START BUTTON 180-5174-00	62 Below P/F RIGHT SLINGSHOT 180-5054-00 (x2)	6: <b>U206</b> <b>GRY-BLU CN6-P8</b> Sw. Part Number: 180-5192-02	DS-6 on Coin Door #6 VOLUME (RED BUTTON) (In Test: LEFT)
7: <b>U401</b>	7 Coin Door <b>WHT-VIO CN7-P2</b> 5TH COIN SLOT Future Use	15 Below P/F 4-BALL STACKING OPTO See Sw. 15 Note	23 Below P/F T(C)B 515-5162-08	31 Below P/F LEFT RAMP EXIT 180-5010-01	39 Above P/F KIN(G) 515-7381-00	47 Above P/F RIGHT ORBIT HI 180-5087-00	55 In Cabinet TOURNAMENT START 180-5174-00	63 Above P/F HOTEL DOOR 180-5119-02	7: <b>U206</b> <b>GRY-VIO CN6-P9</b> Sw. Part Number: 180-5192-04	DS-7 on Coin Door #7 SERV. CRED. (GREEN BUTTON) (In Test: RIGHT)
8: <b>U401</b>	8 Cabinet Side <b>WHT-GRY CN7-P1</b> RT BUTTON (UK ONLY) 180-5160-00	16 Below P/F SHOOTER LANE 180-5157-00	24 Below P/F TC(B) 515-5162-08	32 Below P/F TOP SAUCER EJECT 180-5186-00	40 Below P/F SCARF STANDUP 515-5967-02	48 Above P/F HOTEL POST 180-5189-00	56 In Cabinet PLUMB BOB TILT See Sw. 56 Note	64 Above P/F HOUND DOG 180-5190-28	8: <b>U206</b> <b>GRY-BLK CN6-P10</b> Sw. Part Number: 180-5192-00	DS-8 on Coin Door #8 BEGIN TEST (BLACK BUTTON) (In Test: ENTER)



In LAMP MENU also select:

TEST ALL LAMPS, ROW & COLUMN LAMP TESTS

## LAMP MATRIX GRID (for notes & locations, see Page DR. 5 or 23)

Column (18v)	1: U17	2: U16	3: U15	4: U14	5: U13	6: U12	7: U11	8: U10
Row (Ground)	<b>YEL-BRN J13-P9</b>	<b>YEL-RED J13-P8</b>	<b>YEL-ORG J13-P7</b>	<b>YEL-BLK J13-P6</b>	<b>YEL-GRN J13-P5</b>	<b>YEL-BLU J13-P4</b>	<b>YEL-VIO J13-P3</b>	<b>YEL-GRY J13-P1</b>
1: <b>Q33</b>	1 #555 Clear Bulb <b>RED-BRN J12-P1</b> ROCK AGAIN	2 #555 Clear Bulb LEFT OUTLANE	3 #555 Clear Bulb LEFT RETURN LANE	4 #555 Clear Bulb RIGHT RETURN LANE	5 #555 Clear Bulb RIGHT OUTLANE	6 #555 Clear Bulb SPOT NOTE	7 #555 Clear Bulb <b>SCARF</b>	8 #555 Clear Bulb (T)CB
2: <b>Q34</b>	9 #555 Clear Bulb <b>RED-BLK J12-P2</b> HOUND DOG	10 #555 Clear Bulb BLUE SUEDE SHOES	11 #555 Clear Bulb HEARTBREAK HOTEL	12 #555 Clear Bulb JAILHOUSE ROCK	13 #555 Clear Bulb ALL SHOOK UP	14 #555 Clear Bulb HITS COMPLETED	15 #555 Clear Bulb ELVIS COLLECTED	16 #555 Clear Bulb TOP 10 COMPLETED
3: <b>Q35</b>	17 #555 Clear Bulb <b>RED-ORG J12-P3</b> 10	18 #555 Clear Bulb 9	19 #555 Clear Bulb 8	20 #555 Clear Bulb 7	21 #555 Clear Bulb 6	22 #555 Clear Bulb LEFT RAMP ARROW	23 #555 Clear Bulb <b>SHOOK</b>	24 #555 Clear Bulb LEFT RAMP NOTE
4: <b>Q36</b>	25 #555 Clear Bulb <b>RED-YEL J12-P4</b> 5	26 #555 Clear Bulb 4	27 #555 Clear Bulb 3	28 #555 Clear Bulb 2	29 #555 Clear Bulb 1	30 #555 Clear Bulb RIGHT RAMP ARROW	31 #555 Clear Bulb <b>UP</b>	32 #555 Clear Bulb RIGHT RAMP NOTE
5: <b>Q37</b>	33 #44 Clear Bulb <b>RED-GRN J12-P5</b> (E)LVIS	34 #44 Clear Bulb E(L)VIS	35 #44 Clear Bulb EL(V)IS	36 #44 Clear Bulb ELV(I)S	37 #44 Clear Bulb ELVI(S)	38 #44 Clear Bulb RIGHT ORBIT ARROW	39 #555 Clear Bulb GIFT FROM ELVIS	40 #555 Clear Bulb RIGHT ORBIT NOTE
6: <b>Q38</b>	41 #555 Clear Bulb <b>RED-BLU J12-P6</b> LEFT ORBIT ARROW	42 #555 Clear Bulb L. ORBIT BLUE SUEDE SHOES	43 #555 Clear Bulb ALL	44 #555 Clear Bulb LEFT ORBIT NOTE	45 #44 Clear Bulb (K)ING	46 #44 Clear Bulb K(I)NG	47 #44 Clear Bulb KI(N)G	48 #44 Clear Bulb KIN(G)
7: <b>Q39</b>	49 #555 Clear Bulb <b>RED-VIO J12-P8</b> HOUND	50 #555 Clear Bulb DOG	51 #555 Clear Bulb CENTER LOOP ARROW	52 #555 Clear Bulb C. LOOP BLUE SUEDE SHOES	53 #555 Clear Bulb CENTER LOOP NOTE	54 #555 Clear Bulb LOCK	55 #555 Clear Bulb JACKPOT	56 #555 Clear Bulb SUPER JACKPOT
8: <b>Q40</b>	57 #555 Clear Bulb <b>RED-GRY J12-P9</b> LEFT TOP LANE	58 #555 Clear Bulb MIDDLE TOP LANE	59 #555 Clear Bulb RIGHT TOP LANE	60 #44 Clear Bulb HEART	61 #44 Clear Bulb BREAK	62 #44 Clear Bulb HOTEL	63 #555 Clear Bulb T(C)B	64 #555 Clear Bulb TC(B)
9: <b>Q41</b>	65 #44 Yellow Bulb <b>RED-WHT J12-P10</b> VIDEO MODE	66 #44 Yellow Bulb GOLD RECORD	67 #44 Yellow Bulb KING OF ROCK N ROLL	68 #44 Yellow Bulb LITE EXTRA BALL	69 #44 Yellow Bulb ENCORE LETTER	70 #44 Blue Bulb GRACELAND	71 #44 Red Bulb <b>SPECIAL</b>	72 #44 Amber Bulb EXTRA BALL
10: <b>Q42</b>	73 #44 Clear Bulb <b>RED J12-P11</b> (E)NCORE	74 #44 Clear Bulb E(N)CORE	75 #44 Clear Bulb EN(C)ORE	76 #44 Clear Bulb ENC(O)RE	77 #44 Clear Bulb ENCO(R)E	78 #44 Clear Bulb ENCOR(E)	79 #555 Clear Bulb TOURNAMENT BUTTON	80 #555 Clear Bulb START BUTTON



▼ U.S. ▼  
Customary  
Inch Ruler

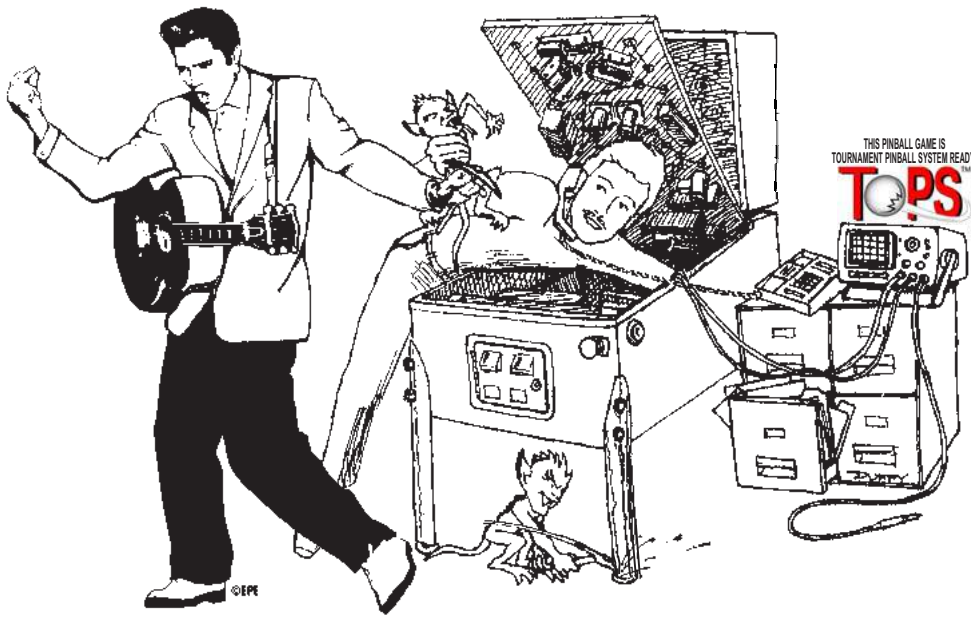

**Metric Conversion**

1" = 2.54cm /25.4mm  
1cm = .3937"  
1mm = .03937"

- For metric, multiply inch value by metric value, e.g. 5" X 2.54cm = 12.7cm or 127mm.
- For US, multiply metric value by inch value, e.g. 13cm X .3937" = 5.1181"

Elvis Has Returned to the Building with Stern's new Elvis Pinball Machine!

<http://www.SternPinball.com>

Visit our website for Pinball game information, Technical Support & Part Sales (for Service Bulletins and a whole lot more!), Stern News, Pinball Links and Distributor Listings. **HELP US, HELP YOU!** If you have any suggestions, questions, need technical advice, find errors or have comments, contact us through our website or call!

This Game Service Manual and all other documents relating to this product, playfield components, features, rules, programming and operation are subject to change without notice (Service Bulletins, if applicable, available through our website).



2020 Janice Avenue, Melrose Park, IL 60160



1-800-789-5432  
 Tel 708-345-7700 (Option 1) Fax 708-345-7889 eMail [parts.service@SternPinball.com](mailto:parts.service@SternPinball.com)

