

USER'S MANUAL

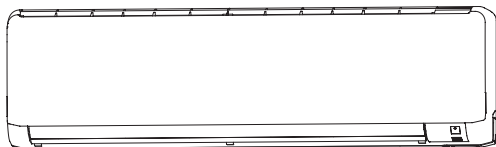

AIR-CONDITIONER

ENGLISH



SRK63ZR-S
SRK71ZR-S
SRK80ZR-S

MANUEL DE L'UTILISATEUR
CLIMATISEUR

FRANÇAIS

ANWENDERHANDBUCH
KLIMAGERÄT

DEUTSCH

ISTRUZIONI PER L'USO
CONDIZIONATORE D'ARIA

ITALIANO

MANUAL DEL PROPIETARIO
ACONDICIONADOR DE AIRE

ESPAÑOL

GEBRUIKERSHANDLEIDING
AIRCONDITIONING

NEDERLANDS

MANUAL DO UTILIZADOR
APARELHO DE AR CONDICIONADO

PORTUGUÊS

ΟΔΗΓΙΕΣ ΧΡΗΣΗΣ
ΚΛΙΜΑΤΙΣΤΙΚΟ

ΕΛΛΗΝΙΚΑ

РУКОВОДСТВО ПО ЭКСПЛУАТАЦИИ
ΚΟΝΔΙΤΙΟΝΕΡ ВОЗДУХА

РУССКИЙ

KULLANIM KILAVUZU
SPLIT KLİMA

TÜRKÇE



This air-conditioner complies with **EMC** Directive 2004/108/EC, LV Directive 2006/95/EC.

Este acondicionador de aire cumple con la directiva **EMC**: 2004/108/EC, LV Directiva 2006/95/EC.

Ce climatiseur est conforme à la Directive **EMC**: 2004/108/EC, LV Directive 2006/95/EC.

Deze airconditioner voldoet aan **EMC** Directive 2004/108/EC, LV Directive 2006/95/EC.

Dieses Klimagerät erfüllt die **EMC** Direktiven 2004/108/EC, LV Direktiven 2006/95/EC.

Este aparelho de ar condicionado está em conformidade com a Directiva **EMC** 2004/108/EC e a Directiva LV 2006/95/EC.

Questo condizionatore d'aria è conforme alla Direttiva **EMC**: 2004/108/EC, LV Direttiva 2006/95/EC.

Αυτό το κλιματιστικό είναι σύμφωνο με τις προδιαγραφές της Οδηγίας **EMC** 2004/108/EK και της Οδηγίας LV 2006/95/EK.

Thank you for purchasing a MITSUBISHI HEAVY INDUSTRIES, LTD. Air-Conditioner. To get the best long-lasting performance, please read and follow this User's Manual carefully before using your air-conditioner. After reading, please store the Manual in a safe place and refer to it for operational questions or in the event of any irregularities.

This air-conditioner is intended for domestic use.

Do not vent R410A into the atmosphere: R410A is a fluorinated greenhouse gas, covered by the Kyoto Protocol with a Global Warming Potential (GWP) = 1975.

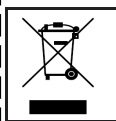

Your Air Conditioning product may be marked with this symbol. It means that waste electrical and electronic equipment (WEEE as in directive 2012/19/EU) should not be mixed with general household waste. Air conditioners should be treated at an authorized treatment facility for re-use, recycling and recovery and not be disposed of in the municipal waste stream. Please contact the installer or local authority for more information.



This symbol printed in the batteries attached to your Air Conditioning product is information for end-users according to the EU directive 2006/66/EC article 20 annex II. Batteries, at their end-of-life, should be disposed of separately from general household waste. If a chemical symbol is printed beneath the symbol shown above, this chemical symbol means that the batteries contain a heavy metal at a certain concentration. This will be indicated as follows: Hg:mercury(0.0005%), Cd:cadmium(0.002%), Pb:lead(0.004%) Please, dispose of batteries correctly at your local community waste collection or the recycling center.



The emission sound pressure level from each Indoor and Outdoor unit is under 70 dB(A).

contents

Safety precautions.....2	SLEEP TIMER operation 16
Name of each part and its function.....6	OFF-TIMER operation..... 16
Remote control handling.....8	ON-TIMER operation..... 17
Operation failure with the remote control.....8	SLEEP TIMER + ON-TIMER operation 17
Temporary run operation8	ON-TIMER + OFF-TIMER operation 18
Installing two air-conditioners in the same room9	ALLERGEN CLEAR operation 18
Child Lock.....9	WEEKLY TIMER operation 19
Airflow range setting 10	HIGH POWER/ECONOMY operation..... 23
Operation and display section for remote control..... 11	NIGHT SETBACK operation..... 24
Current time setting 12	SILENT operation 24
AUTO mode operation..... 12	SELF CLEAN operation..... 25
Temperature adjustment during AUTO 13	Auto restart function 25
FAN SPEED 13	Tips for effective operation 25
COOL/HEAT/DRY/FAN mode operation 14	Maintenance 26
Air-conditioner operable temperature setting.... 14	Proper installation..... 28
Characteristics of HEAT mode operation..... 14	Troubleshooting 28
Airflow direction adjustment..... 15	Notice 29
3D AUTO operation 15	Contact your dealer 30
	About the Multiple Air-conditioner..... 30
	Self diagnosis function..... 31



Safety precautions

- Before starting to use the system, please read these “Safety precautions” carefully to ensure proper operation of the system.
- When you have read this instruction manual, please keep it safely. If someone else takes over as operator, make sure that the manual is also passed on to the new operator.







 WARNING	Improper handling could lead to drastic results like death, serious injury, etc.
 CAUTION	Might pose a serious problem, depending on the circumstances.

Please observe these precautions with great care, since they are essential to your safety.

- Symbols which appear frequently in the text have the following meaning:

	Strictly prohibited		Observe instructions with great care		Provide proper earthing
---	----------------------------	---	---	---	--------------------------------

■ INSTALLATION PRECAUTIONS

 WARNING	
	<ul style="list-style-type: none"> • The system is for domestic and residential use. If used in severe environments, such as an engineering workplace, the equipment may function poorly.
	<ul style="list-style-type: none"> • The system must be installed by your dealer or a qualified professional. It is not advisable to install the system by yourself, as faulty handling may cause leakage of water, electric shock or fire.
 CAUTION	
	<ul style="list-style-type: none"> • Do not install it where flammable gas may leak. Gas leaks may cause fire.
	<ul style="list-style-type: none"> • Depending on the place of installation, an earth leakage breaker may be necessary. If you do not install an earth leakage breaker, you may get an electric shock. • Make sure to install the drain hose properly so that all the water is drained out. Improper installation may lead to water drop in the room resulting in wet furniture.
	<ul style="list-style-type: none"> • Make sure that the system has been properly earthed. Earth cables should never be connected to a gas pipe, water pipe, lightning conductor or telephone earth cable. Improper installation of the earth cable may produce an electric shock.

■ Safety precautions

■ OPERATION PRECAUTIONS

⚠ WARNING



- **Children shall not play with the appliance.**
- **Do not expose yourself to the cooling air for a long period.**
This could affect your physical condition and cause health problems.

- **Cleaning and user maintenance shall not be made by children without supervision.**
- **Do not insert anything into the air outlet.**
This may cause injury, as the internal fan rotates at high speed.



- **This appliance can be used by children aged from 8 years and above and people with reduced physical, sensory or mental capabilities or lack of experience and knowledge, if they have been given supervision or instruction concerning use of the appliance in a safe way and understand the hazards involved.**
- **Store the remote control out of reach of infants.**
Failure to observe this may result in the batteries being swallowed or other accidents.

⚠ CAUTION



- **Only use approved fuses.**
Use of steel or copper wire instead of an approved fuse is strictly prohibited, as it may cause a breakdown or fire.
- **Do not handle the switches with wet hands.**
This may cause an electric shock.
- **Do not swing from the indoor unit.**
If the indoor unit falls down, you may get injured.
- **Do not place a flammable insecticide or paint spray near the blower, nor spray it directly on the system.**
This may result in a fire.
- **You should not expose any combustion appliance directly to the air stream of the air-conditioner.**
The appliance may then work inadequately.
- **Do not wash the air-conditioner with water.**
This could cause an electric shock. Using a high pressure washer may cause damage to the aluminum fins, resulting in performance decrement.

- **Do not use for preservation of food, plants or animals, precision devices or works of art.**
The system is only intended for use in ordinary domestic rooms. Any other use of the system may damage the quality of food, etc.
- **Do not place anything containing water, like vases, on top of the unit.**
Water entering the unit could damage the insulation and therefore cause an electric shock.
- **Do not install the system where the airflow direction is aimed directly at plants or animals.**
This will damage their health.
- **Do not sit on the outdoor unit nor put anything on it.**
If the unit falls down or things drop off it, people could get hurt.
- **After a long period of use, check the unit's support structure from time to time.**
If you do not repair any damage right away, the unit may fall down and cause personal injury.

■ Safety precautions

⚠ CAUTION



- **Do not touch the aluminum fins on the air heat exchanger.**
It may result in injury.
- **Do not place household electrical appliances or household items under neath the indoor or outdoor units.**
Condensation falling from the unit may stain objects and cause accidents or electrical shock.
- **Do not operate the system without the air filter.**
It can cause malfunction of the system due to clogging of the heat exchanger.
- **Do not shut off the power source immediately after stopping the operation.**
Wait at least 5 minutes, otherwise there is a risk of water leakage or breakdown.
- **Do not control the system with main power switch.**
It can cause fire or water leakage. In addition, the fan can start unexpectedly, which can cause personal injury.
- **Do not pour liquid into this unit and do not put water container on this unit.**
Water entering the unit could damage the insulation and therefore cause an electric shock.



- **If you operate the system together with a combustion appliance, you must regularly ventilate the indoor air.**
Insufficient ventilation may cause accidents due to oxygen deficiency.
- **Stand firmly on a stepladder or other stable object when removing the inlet panel and filters.**
Failure to observe this may result in injury through insecure objects toppling over.
- **When you clean the system, stop the unit and turn off the power source.**
Never open the panel while the internal fan is rotating.
- **Do not place objects near the outdoor unit or allow leaves to gather around the unit.**
If there are objects or leaves around the outdoor unit, small animals may enter unit and contact electrical parts and may cause a break-down, smoke or fire.
- **Contact your dealer to clean inside the indoor unit, do not attempt to do by yourself.**
The use of a non-approved detergent or improper washing method may damage the unit's plastic components and cause leaks. Damage, smoke, or fire may also happen if the detergent comes in contact with electrical parts or the unit's motor.
- **Stop the unit and turn off the power if you hear thunder or there is a danger of lightning.**
It may damage the unit.
- **If the power cord becomes damaged, contact your dealer or a qualified engineer.**
If it is not replaced, it may cause a breakdown or fire.

■ Safety precautions

■ PRECAUTIONS FOR RELOCATION OR REPAIRS

WARNING



- **Do not perform any repairs or modifications by yourself. Consult the dealer if the unit requires repair.**

If you repair or modify the unit, it can cause water leaks, electric shocks or fire.



- **Consult your dealer for repairs.**

Wrong repairs could cause an electric shock, fire, etc.

- **In case the air-conditioner is relocated elsewhere, contact your dealer or a professional fitter.**

Faulty installation may cause water leakage, electric shock, fire, etc.

- **If you notice anything abnormal (smell of burning, etc.), stop the system, turn off the power source and consult your dealer.**

Continued use of the system in abnormal circumstances may result in malfunctioning, electric shock, fire, etc.

- **If the air-conditioner fails to cool or warm the room, it may have a refrigerant leakage. Contact your dealer.**

If refrigerant needs to be added, check with your dealer for proper instructions.

If the refrigerant comes in contact with the bare skin, it may cause cold injury.

If the refrigerant gas is inhaled excessively, it may cause deterioration of nerve function like dizziness and headache, or deterioration of heart function like irregular heartbeat and heart palpitation temporarily. If refrigerant unexpectedly leaks from the unit onto a fan heater, stove, hotplate or other heat source, harmful gases could be generated.

Name of each part and its function

INDOOR UNIT

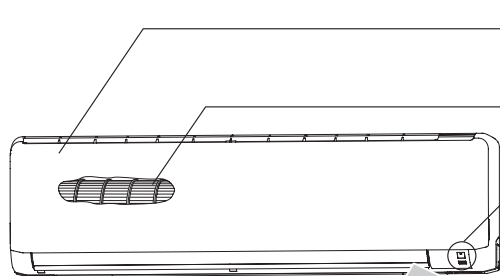

Air inlet panel

➔ Page 26

Indoor unit fan

Unit display section

➔ Page 7

Wireless remote control

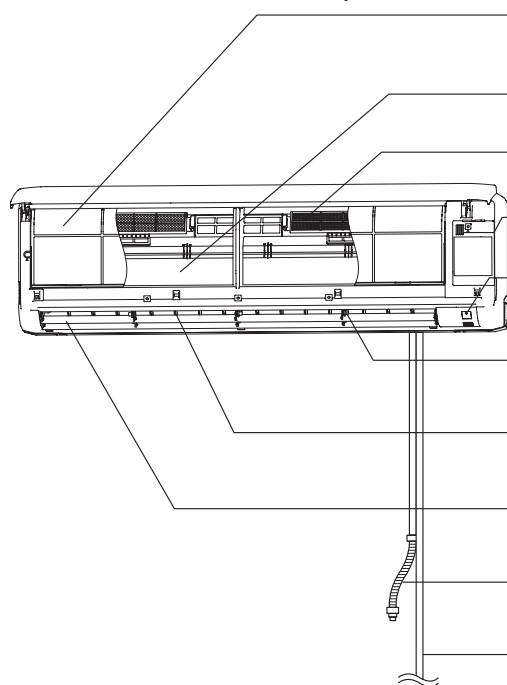

Air filter

Removes dust or dirt from the inlet air. ➔ Page 26

Heat exchanger

Air-cleaning filter

Room temperature sensor

Unit operation switch

Air outlet

Air blows out of here.

Left/right air flow direction adjustment louver

➔ Page 15

Up/down air flow direction adjustment flap

➔ Page 15

Drain hose

Drains water from the indoor unit.

Refrigerant piping connection and electric wire

OUTDOOR UNIT

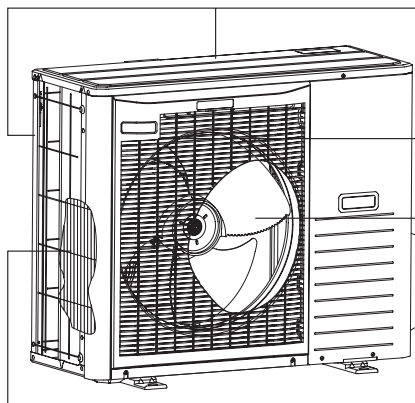

Air inlet

(On side & rear surface)

Air outlet

Outdoor unit fan

Heat exchanger

* The appearance varies by models.

Name of each part and its function

Unit display section

Unit ON/OFF button

This button can be used for turning on/off the unit when a remote control is not available.  Page 8

ON/OFF

Remote control signal receiver

RUN (HOT KEEP) light (green)



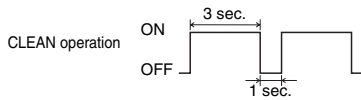
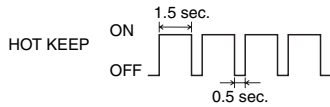

- Illuminates during operation.
- Blinks when airflow stops due to the 'HOT KEEP', 'CLEAN operation' and 'operation mode invalid'.

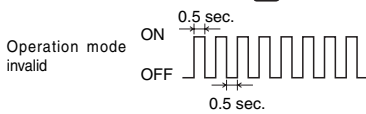

 Page 25



 Page 30

RUN 
TIMER 
HI POWER 
3D AUTO 

TIMER light (yellow)

Illuminates during TIMER operation.

HI POWER light (green)

Illuminates during HIGH POWER operation.

3D AUTO light (green)

Illuminates during 3D AUTO operation.

Accessories



Wireless remote control

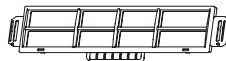

Filter holder x2



Wireless remote control holder

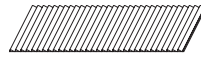

Allergen clear filter
(Light orange)



Photocatalytic washable
deodorizing filter (Orange)



Battery x2
(R03 (AAA, Micro))



Wood screw x2
(for remote control holder mounting)

NOTE

• Buzzer sound for remote control

When preset temperature 24°C, automatic operation and automatic airflow are selected, the buzzer sound (PiPi) is produced. When turning off the air-conditioner by pressing ON/OFF button (except CLEAN mode), the buzzer sound (Pi) is produced. This function is useful for operating the air-conditioner in the darkness.

Air flow setting

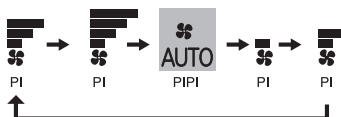

Preset temperature



Remote control handling

Replacing the batteries

The following cases show exhausted batteries. Replace old batteries with new ones.

- Receiving beep is not emitted when a signal is transmitted.
- Display fades away.

1 Pull out the cover and take out old batteries.

2 Insert new batteries. R03 (AAA, Micro) x2

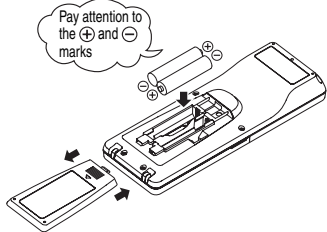

3 Close the cover.

4 Press the ACL switch with the tip of a ballpoint pen.

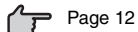

NOTE

- Do not use old and new batteries together.
- Remove the batteries when the remote control is not used for a long period.
- The recommended effective period of a battery conforming to JIS or IEC should be 6 to 12 months with normal use. If used longer, or when an unspecified battery is used, liquid may leak from the battery, causing the remote control to malfunction.
- The recommendable effective period is printed on the battery. This may be shorter due to manufacturing time to the unit. However, the battery may still be in working order after expiry of its nominal life.

- When the display shows any abnormal condition, press the ACL switch with the tip of a ballpoint pen.

Using the remote control holder

The remote control can be attached to a wall or pillar by using a remote control holder. Before installing the remote control, check that the air-conditioner receives the signals properly.

For installing or removing the remote control, move it up or down in the holder.

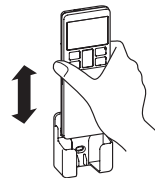

Warning note for remote control handling

⊘ Strictly prohibited

- | | | |
|--|--|--|
| <ul style="list-style-type: none"> • Do not go near high temperature places, such as an electric carpet or a stove. | <ul style="list-style-type: none"> • Do not leave the remote control exposed to direct sunlight or other strong lighting. | <ul style="list-style-type: none"> • Do not drop the remote control. Handle with care. |
| <ul style="list-style-type: none"> • Do not put any obstructing obstacles between the remote control and the unit. | <ul style="list-style-type: none"> • Do not spill any liquid on the remote control. | <ul style="list-style-type: none"> • Do not place heavy objects on the remote control, or step on it. |

Operation failure with the remote control

- Are the batteries running down?



"Replacing the batteries" above.

Replace the batteries with new ones and retry the operation.

- If the operation fails, operate the unit with temporary operation function.

Contact your dealer to have the remote control checked.



Below

Temporary run operation

- The unit ON/OFF button on the unit operates ON/OFF temporarily when the remote control is not used.

Operation program

- OPERATION MODE : AUTO
- FAN SPEED : AUTO
- AIR FLOW : AUTO

- Operation starts by pressing the unit ON/OFF button; it stops if you press the button again.

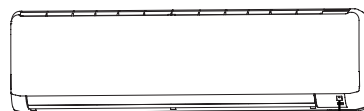

Unit ON/OFF button

NOTE

- Do not hold the Unit ON/OFF button down for more than 5 seconds. (Holding it down longer than 5 seconds sets the automatic cooling used during servicing or when relocating the air-conditioner.)

Installing two air-conditioners in the same room

- When two air-conditioners are installed in the same room, use this setting when the two air-conditioners are not operated with one remote control. Set the remote control and indoor unit.

Setting the remote control

- 1** Pull out the cover and take out batteries.
- 2** Disconnect the switching line next to the battery with wire cutters.

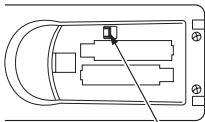

Disconnect

- 3** Insert batteries. Close the cover.

Setting an indoor unit

- 1** Turn off the power source and turn it on after 1 minute.
- 2** Point the remote control that was set according to the procedure described on the left side at the indoor unit and send a signal by pressing the ACL switch on the remote control.

Since the signal is sent in about 6 seconds after the ACL switch is pressed, point the remote control at the indoor unit for some time.

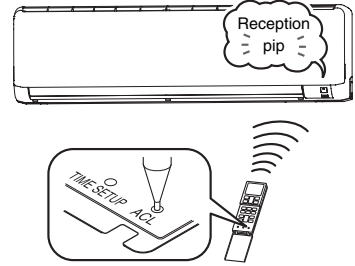

- 3** Check that the reception buzzer sound "pip" is emitted from the indoor unit.

At completion of the setting, the indoor unit emits a buzzer sound "pip". (If no reception tone is emitted, start the setting from the beginning again.)

Child Lock

- This function locks the remote control operation to prevent an operation error.

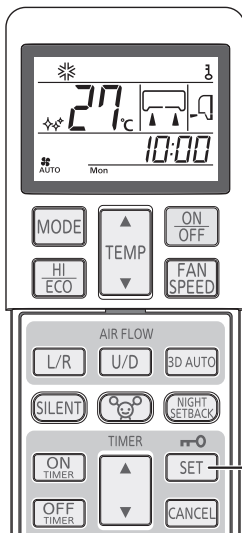

- 1** Press the SET button for 3 seconds or longer.

is displayed. While Child Lock is set, only the ON/OFF button can be operated.

Releasing procedure

Turn off the light by pressing the SET button for 3 seconds or longer.

NOTE

- While Child Lock is set, the settings of temperature, fan speed and airflow direction cannot be changed. To change the settings, reset Child Lock.
- Child lock will not function during ALLERGEN CLEAR operation.

Airflow range setting

- Take the air-conditioner location into account and adjust the left/right airflow range to maximize air-conditioning.

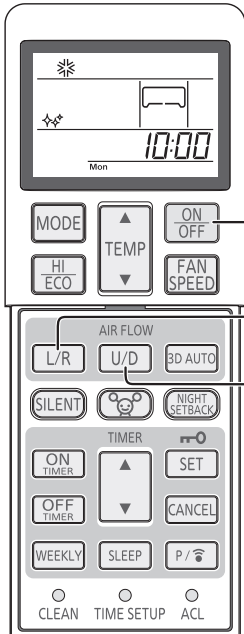

1 If the air-conditioner is running, press the ON/OFF button to stop.

The airflow range setting cannot be made while the unit is running.

2 Press the AIR FLOW U/D (UP/DOWN) button and the AIRFLOW L/R (LEFT/RIGHT) button together for 5 seconds or more.

The airflow range setting display illuminates.

3 Setting the airflow range setting.

Press the AIR FLOW L/R (LEFT/RIGHT) button and adjust to the desired location. Each time the AIR FLOW L/R (LEFT/RIGHT) button is pressed, the display is switched in the order of:



4 Press the ON/OFF button.

The air-conditioner's airflow range setting is set. Press within 60 seconds of setting the airflow range setting (while the airflow range setting display illuminates).

Press within 60 sec.!

Air-conditioner installation location and airflow range

The diagram below indicates the airflow ranges corresponding to the air-conditioner's installation location. Consider your room's layout and set the airflow range to maximize conditioning effectiveness.

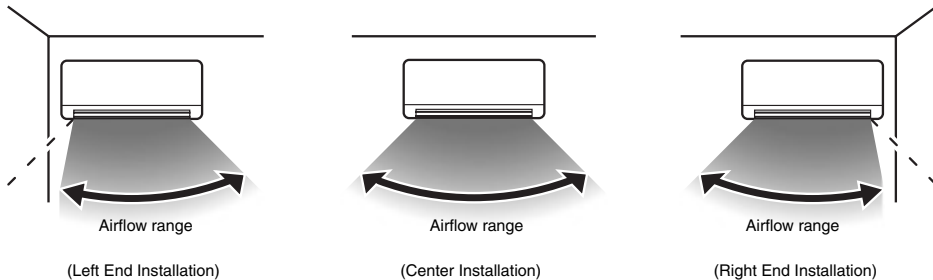

NOTE

- Once the airflow range setting is configured, it is stored in the air-conditioner even if the power source is turned off. To change the airflow range setting, set range again with the remote control.
- During the operation, an airflow range setting cannot be set.
- When the air-conditioner is installed at the location within 50 cm from the wall, it is recommended to change the airflow range setting to "Right End Installation" or "Left End Installation".

Operation and display section for remote control

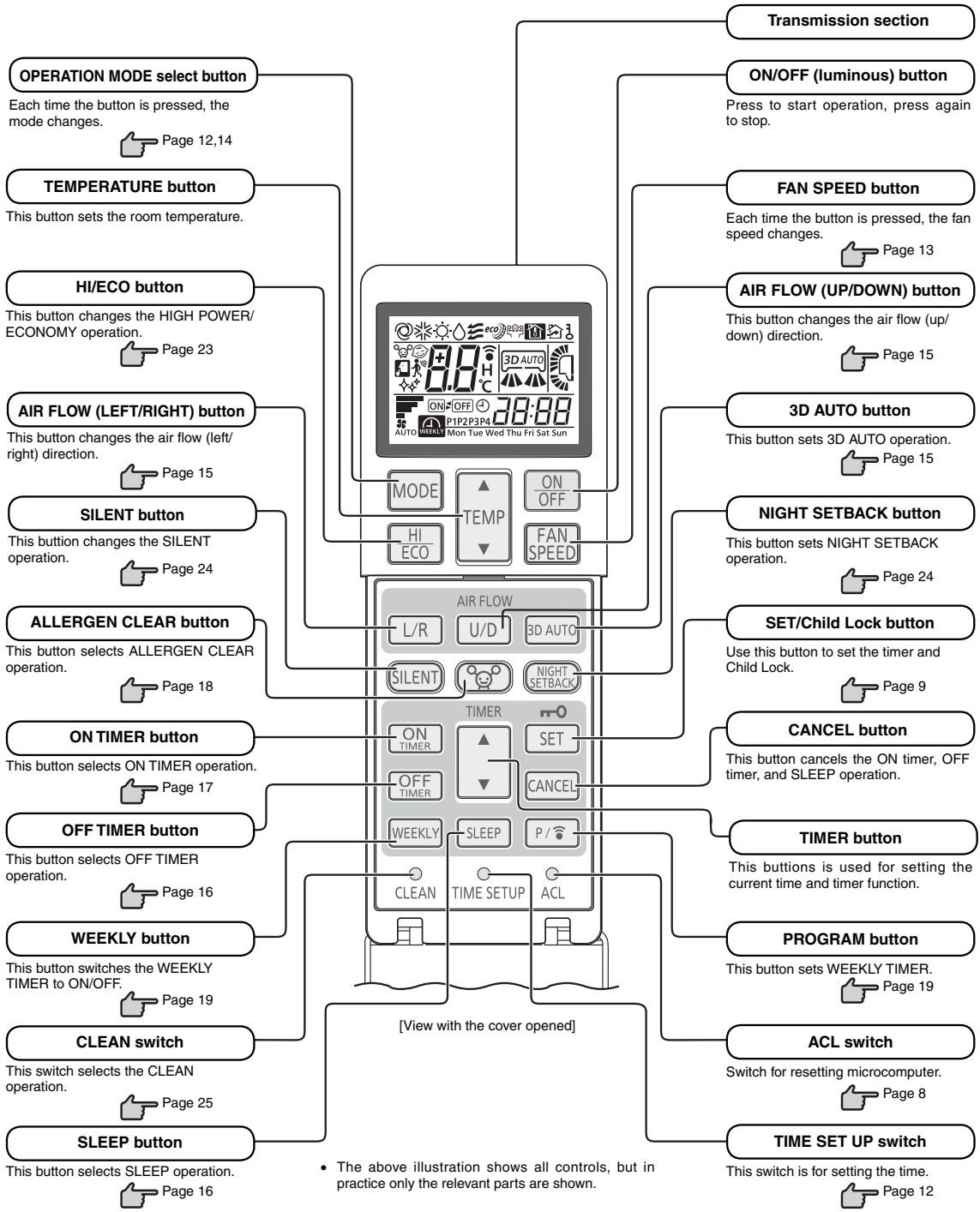

OPERATION MODE select button
 Each time the button is pressed, the mode changes.
 ➔ Page 12,14

TEMPERATURE button
 This button sets the room temperature.

HI/ECO button
 This button changes the HIGH POWER/ECONOMY operation.
 ➔ Page 23

AIR FLOW (LEFT/RIGHT) button
 This button changes the air flow (left/right) direction.
 ➔ Page 15

SILENT button
 This button changes the SILENT operation.
 ➔ Page 24

ALLERGEN CLEAR button
 This button selects ALLERGEN CLEAR operation.
 ➔ Page 18

ON TIMER button
 This button selects ON TIMER operation.
 ➔ Page 17

OFF TIMER button
 This button selects OFF TIMER operation.
 ➔ Page 16

WEEKLY button
 This button switches the WEEKLY TIMER to ON/OFF.
 ➔ Page 19

CLEAN switch
 This switch selects the CLEAN operation.
 ➔ Page 25

SLEEP button
 This button selects SLEEP operation.
 ➔ Page 16

Transmission section

ON/OFF (luminous) button
 Press to start operation, press again to stop.

FAN SPEED button
 Each time the button is pressed, the fan speed changes.
 ➔ Page 13

AIR FLOW (UP/DOWN) button
 This button changes the air flow (up/down) direction.
 ➔ Page 15

3D AUTO button
 This button sets 3D AUTO operation.
 ➔ Page 15

NIGHT SETBACK button
 This button sets NIGHT SETBACK operation.
 ➔ Page 24

SET/Child Lock button
 Use this button to set the timer and Child Lock.
 ➔ Page 9

CANCEL button
 This button cancels the ON timer, OFF timer, and SLEEP operation.

TIMER button
 This buttons is used for setting the current time and timer function.

PROGRAM button
 This button sets WEEKLY TIMER.
 ➔ Page 19

ACL switch
 Switch for resetting microcomputer.
 ➔ Page 8

TIME SET UP switch
 This switch is for setting the time.
 ➔ Page 12

• The above illustration shows all controls, but in practice only the relevant parts are shown.

[View with the cover opened]

Display in OFF status

The current time, day of the week, and present OPERATING MODE are displayed while the air-conditioner is turned off.

Transmission procedure

When each button on the remote control is pressed – with the remote control pointing towards the air-conditioner unit, a signal is transmitted. When the air-conditioner receives the signal correctly, it will beep.

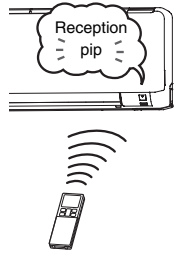

Current time setting

- When inserting the batteries, the current time is automatically set to time setting mode. Mon and 13:00 are displayed as the current time. Set a correct day of the week and a time.

Example: Set to Sat 10:30.

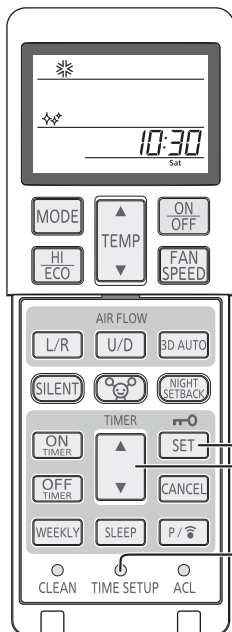

1

Press the TIME SET UP switch.

Press with the tip of a ballpoint pen, etc.
The day of the week display blinks, enabling the setting of a day of the week.

2

Press the “▲ or ▼ (TIMER)” button.

(Set to Sat)

3

Press the SET button.

The day of the week display changes from blinking to steady lighting, completing the setting of a day of the week, and the time display blinks. Make sure to press the button within 60 seconds from the last operation in step 2, otherwise the day of the week is not set.

4

Press the “▲ or ▼ (TIMER)” button.

(Set to 10:30)

5

Press the SET button.

The time display changes from blinking to steady lighting and the setting is complete. Make sure to press the button within 60 seconds from the last operation in step 4, otherwise the time is not set.

NOTE

- The timer operation works based on the time clock, so please set it correctly.
- The remote control data is reset when the present time is set.
- When the battery of the remote control is replaced or the ACL switch is pressed, the remote control is set to the initial state. Since the WEEKLY TIMER program is not set in the initial state, set the program according to the setting procedure.

AUTO mode operation

- Automatically selects the operation mode (COOL, HEAT, DRY) depending on the room temperature when switched on.

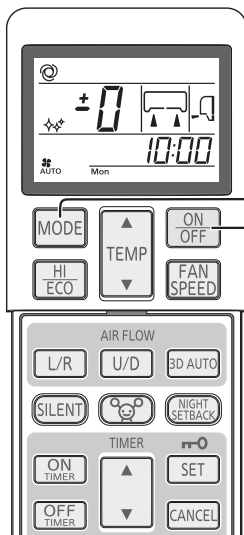

1

Press the MODE button.

The mode changes whenever the button is pressed.
Set to .

2

Press the ON/OFF button.

To stop:

Press the ON/OFF button.

NOTE

- In case air is not blowing out during the operation. Page 29
- When the included clean filter is installed the air-conditioner will clean the air during automatic operation.

AUTO mode can be operated by simply pressing the ON/OFF button.



- If you do not want the AUTO mode program, change to COOL, HEAT, DRY or FAN instead of AUTO. Page 14
- Airflow direction adjustment procedure. Page 15

Temperature adjustment during AUTO

- Air temperature adjustment is possible even during automatic operation. There are 6 levels of adjustment possible with the ▲ button or the ▼ button. During automatic operation, 24°C is preset both for heating and cooling.

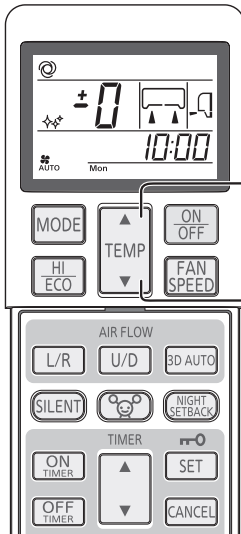

1 Press the “▲ or ▼ (TEMP)” button.

When it is a little cold

Press the ▲ button.

- Each time the ▲ button is pressed, the switch over occurs in the following order
-6 → -5 → -1 → ±0 → +1 +6.

When +6 is indicated, even if the ▲ button is pressed, the indicator does not change.

When it is a little hot

Press the ▼ button.

- Each time the ▼ button is pressed, the switch over occurs in the following order
+6 → +5 → +1 → ±0 → -1 -6.

When -6 is indicated, even if the ▼ button is pressed, the indicator does not change.

	Remote Control display												
Setting	-6	-5	-4	-3	-2	-1	±0	+1	+2	+3	+4	+5	+6
temp.(°C)	18	19	20	21	22	23	24	25	26	27	28	29	30

FAN SPEED

- You can choose the fan speed of your air-conditioner without dry mode.

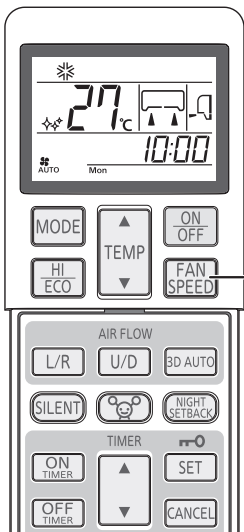

1 Press the FAN SPEED button.

Each time the button is pressed, the fan speed changes.

Operation capacity by your choice	FAN SPEED
Set automatically by microcomputer	AUTO
Silent operation	ULo
Energy-saving operation	Lo
Standard operation	Me
Powerful operation with high capacity	Hi

NOTE

- When FAN SPEED is changed from Hi to Lo or ULo, the sound of refrigerant flowing may be heard.

COOL/HEAT/DRY/FAN mode operation

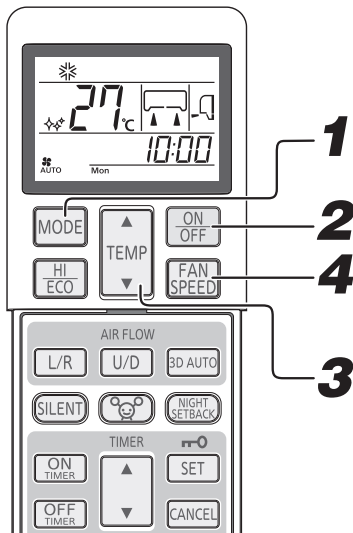

Airflow direction adjustment procedure. Page 15

1

Press the MODE button.

Set to a required mode.

* (Cool), ☀ (Heat), △ (Dry), ㊦ (Fan)

2

Press the ON/OFF button.

3

Press the TEMP button.

Press ▲ or ▼ button for the preferred temperature.

Recommendation

COOL	26°C~28°C	HEAT	22°C~24°C	DRY	24°C~26°C	FAN	--
------	-----------	------	-----------	-----	-----------	-----	----

4

Press the FAN SPEED button

Set the fan speed as preferred.

A fan speed cannot be set under Dry operation.

NOTE

- In case air is not blown out, when starting the heating operation. Page 29
- The operation mode can also be set or changed when the air-conditioner is not in operation.

To stop:

Press the ON/OFF button.

Air-conditioner operable temperature setting

- Use within the following operational range. Operating outside of this range may result in the protection devices being activated, preventing the unit from working.

	Cooling operation	Heating operation
Outside temperature	Approximately -15 to 46 °C	Approximately -15 to 24 °C
Inside temperature	Approximately 18 to 32 °C	Approximately 10 to 30 °C
Inside humidity	Below approximately 80% The long-term use of the unit with a humidity level exceeding 80% may result in condensation forming on the surface of the indoor unit, leading to water drops.	

Characteristics of HEAT mode operation

Mechanism and capacity of HEAT mode operation

■ Mechanism

- The unit draws heat from the cold outside air, transfers it to indoors and heats the room. As a characteristic of heat pump system, the heating capacity reduces when the outside air temperature gets colder.
- It may take some time to supply hot air after turning on the air-conditioner.
- If the outside temperature becomes extremely low, it would be better to use an additional source of heating.

Defrosting

If the outside temperature becomes low and humidity is high, the heat exchanger in the outdoor unit may frost over, which prevents efficient heating. **If this happens, the automatic defrost function is activated and during defrosting the heating operation stops for 5 to 15 minutes during defrosting.**

- Both indoor and outdoor fans stop and the RUN light blinks slowly (1.5 sec. ON, 0.5 sec. OFF) during defrosting.
- The outdoor unit may give off some steam during defrosting. This is to help the defrosting process and is not a defect.
- The HEAT operation resumes as soon as defrosting has been completed.

Airflow direction adjustment

- Up/down direction can be adjusted with the AIRFLOW U/D (UP/DOWN) button on the remote control. Every time you press this button the mode changes as follows:

Change on AIRFLOW (UP/DOWN) mode.

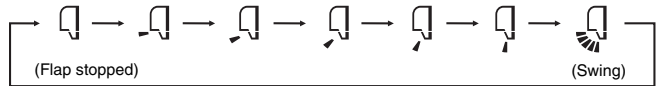

- Left/right direction can be adjusted with the AIRFLOW L/R (LEFT/RIGHT) button on the remote control. Every time you press this button the mode changes as follows:

Change on AIRFLOW (LEFT/RIGHT) mode.

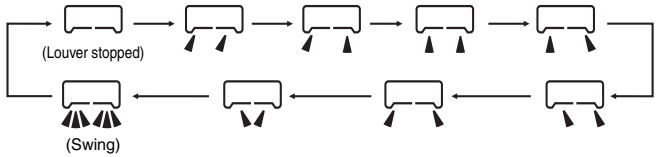

NOTE

- The actual position of the flap and louver may differ from the display shown.

NOTE FOR HEATING OPERATION

- When operation starts, the flap and louver direction is fixed at the horizontal / center position in order to avoid cold draft, and return to the set the position that was set after the warm air supply is starting.
- The flap and louver direction will be controlled to the horizontal/center position when the room temperature reaches the set temperature and compressor stops or when defrosting is in operation.
- The airflow direction cannot be set during the period mentioned above. Change the airflow direction settings after the warm air is supplied and the flap/louver goes to the set position.

MEMORY FLAP (FLAP OR LOUVER STOPPED)

When you press the AIRFLOW (U/D or L/R) button once while the flap or louver is operating, it stops swinging at the position. Since this angle is memorized in the microcomputer, the flap or louver will automatically be set at this angle when the next operation is started.

- WARNING**
Do not expose directly to airflow from the air-conditioner for a long time.

- CAUTION**
When in COOL or DRY operation, do not operate for a long period with the airflow blowing straight down. Otherwise, condensation may appear on the outlet grill and drip down.
- Do not try to adjust the flaps and louvers by hand, as the control angle may change or the flap or louver may not be closed completely.

- Recommended angle of the flap when stopping

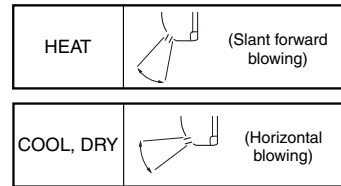

3D AUTO operation

- Fan speed and air flow direction are automatically controlled, allowing the entire room to be efficiently conditioned.

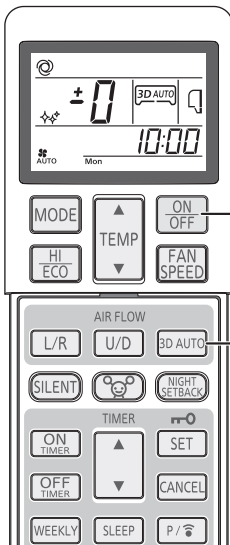

- Press the ON/OFF button.

- Press the 3D AUTO button.

Each time the 3D AUTO button is pressed, the display is switched in the order of:

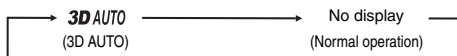

Releasing procedure

Press the 3D AUTO button to turn off the 3D AUTO display.

NOTE

- 3D AUTO operation is canceled when you switch the operation mode.
- If 3D AUTO operation is cancelled then the air flow direction changes to that used before 3D AUTO was set.
- 3D AUTO operation can be set in AUTO, COOL, or HEAT operation mode only.

SLEEP TIMER operation

- The unit will stop automatically after the set time lapses.

The set temperature is automatically adjusted according to the lapse time in order to avoid too much cooling or heating.  Page 18

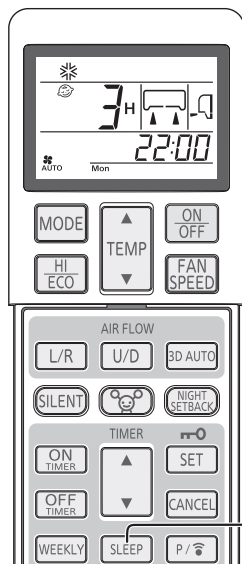

Changing of set time

Set a new time by pressing SLEEP button.

How to cancel

Press the CANCEL button to turn off the SLEEP display.

1

Press the SLEEP button.

- If it is pressed while the unit is off

SLEEP TIMER operation starts with the previous operation settings, and the air-conditioner is turned off after the set time lapses.

- If it is pressed while the unit is running

The air-conditioner is turned off after the set time lapses.

Every time the button is pressed, the display changes as follows:

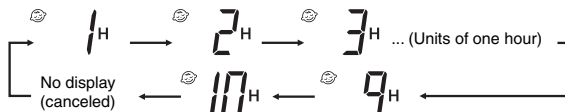

Example: You prefer it to stop after 7 hours.

Set to 7^H

The timer light (yellow) is on.

- The unit stops after the set time lapses.

NOTE

- SLEEP operation will not function during ALLERGEN CLEAR operation.
- Cannot be set at the same time with OFF-TIMER.

OFF-TIMER operation

- The unit stops automatically when the set time comes.

With the air-conditioner turned off, start the operation from Step 1. With the air-conditioner running, start from Step 2.

Example: You prefer it to stop 22:30.

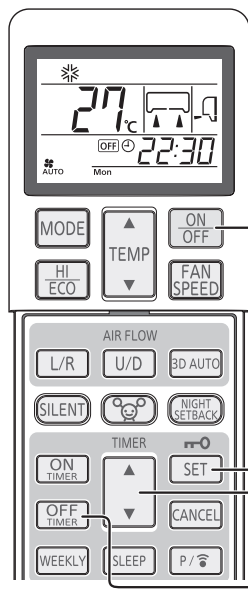

Changing of set time

Set a new time by using the OFF-TIMER button.

How to cancel

Press the CANCEL button to turn off the timer display.

1

Press the ON/OFF button.

2

Press the OFF-TIMER button.

OFF TIMER display  is blinking.

3

Press the “▲ or ▼ (TIMER)” button.

Every time the ▲ button is pressed, the display is switched in the order of:

→0:00→0:10→0:20→...→1:00→1:10→ (Units of ten minutes)

Every time the ▼ button is pressed, the display is switched in the order of:

→0:00→23:50→23:40→...→23:00→22:50→ (Units of ten minutes)

Set at 22:30.

4

Press the SET button.

The display changes from blinking to steady lighting and the setting is complete.

The timer light (yellow) is on.

NOTE

- The unit stops at the end of the set period of time.
- Make sure to press the button within 60 seconds from the last operation in step 3, otherwise the setting is not completed.
- The current time is not displayed during OFF-TIMER operation.
- OFF-TIMER operation will not function during ALLERGEN CLEAR operation.
- Different from SLEEP TIMER operation, automatic set temperature adjustment is not done during OFF-TIMER operation.

ON-TIMER operation

- Operation starts 5 to 60 minutes before the set time so that the room temperature reaches the optimum temperature at the set time.  Page 18
ON-TIMER operation can be set regardless of whether the air-conditioner is running or not.

Example: When the preferred room temperature is required at 8:00.

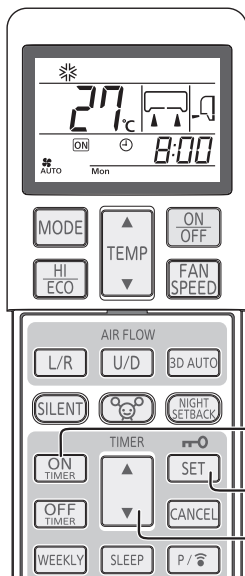

1

Press the ON-TIMER button.

ON-TIMER display  is blinking.

2

Press the “▲ or ▼ (TIMER)” button.

Every time the ▲ button is pressed, the display is switched in the order of:

→0:00→0:10→0:20→...→1:00→1:10→ (Units of ten minutes)

Every time the ▼ button is pressed, the display is switched in the order of:

→0:00→23:50→23:40→...→23:00→22:50→ (Units of ten minutes)

Set at 8:00.

3

Press the SET button.

The display changes from blinking to steady lighting and the setting is complete.
The timer light (yellow) is on.
The operation stops if it is set during operation.

NOTE

- Operation starts 5 to 60 minutes before the set time.
- The timer light (yellow) goes out at the set time.
- Make sure to press the button within 60 seconds from the last operation in step 2, otherwise the setting is not completed.
- The current time is not displayed during ON-TIMER operation.
- ON-TIMER operation will not function during ALLERGEN CLEAR operation.
- If the ON/OFF button is pressed after setting the ON-TIMER, the setting will be canceled.

Changing of set time

Set a new time by using the ON-TIMER button.

How to cancel

Press the CANCEL button to turn off the timer display.

SLEEP TIMER + ON-TIMER operation

- Combined timer operation of SLEEP TIMER and ON-TIMER.

Example: When it is required to stop after 3 hours and then start operation at 8:00, near the set temperature.

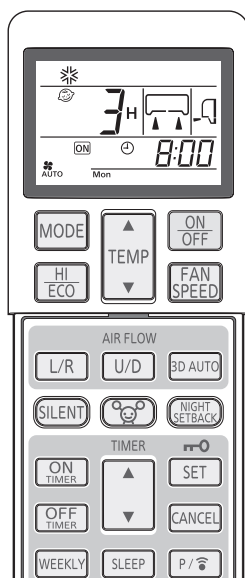

1

SLEEP TIMER setting

Set by the procedures on page 16.

Set to  3H

2

ON-TIMER operation setting

Set by the above procedure mentioned in ON-TIMER.

Set to  8:00

The setting of the lighting of the timer light (yellow) of this unit is complete.



- After the SLEEP TIMER set time has lapsed, the operation stops, and it starts from 5 to 60 minutes before the ON-TIMER's set time.
- The timer light is turned off when ON-TIMER set time comes.

Changing of set time

Set a new time by using the SLEEP or ON-TIMER button.

How to cancel

Press the CANCEL button to turn off the timer display.

ON-TIMER + OFF-TIMER operation

- The timer operations of the combination of ON and OFF-TIMER.

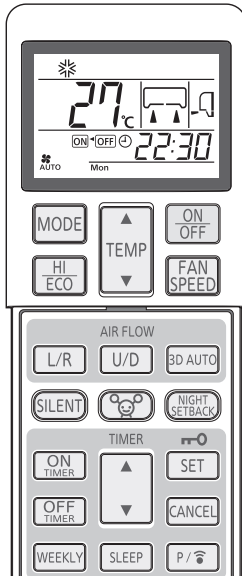

Example: Present time is 21:00. The air-conditioner running.
When it is preferred to stop at 22:30, and then start operation at 8:00, near the set temperature.

1 OFF-TIMER operation setting

Set by the procedures on page 16. Set to OFF 22:30

2 ON-TIMER operation setting

Set by the procedures on page 17. Set to ON 8:00

Timer light (yellow) on the unit will light when the setting is completed.

- The set time will be displayed on the remote control. The display will change depending on the operational status.

- The air-conditioner stopping.
 First the air-conditioner starts running with ON-TIMER. After the air-conditioner stops running with OFF-TIMER.
- The air-conditioner running.
 First the air-conditioner stops running with OFF-TIMER. After the air-conditioner starts running with ON-TIMER.

Changing of set time

Set a new time by using the OFF-TIMER or ON-TIMER button.

How to cancel

Press the CANCEL or ON/OFF button to turn off the timer display.

NOTE

- Timer operation can be set only for next 24 hours.

Comfort Start-up

In ON-TIMER operation, the unit starts the operation a little earlier, so that the room can approach optimum temperature at ON time. This is so called "Comfort start-up".

- Mechanism
The room temperature is checked 60 minutes before the ON time. Depending on the temperature at that time, the operation starts 5 to 60 minutes before the timer is at ON.
- The function is available for both COOL and HEAT operation mode (including AUTO). It does not work for DRY mode.

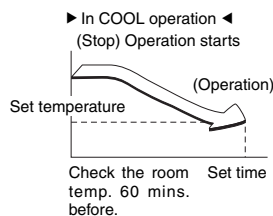

SLEEP TIMER

When SLEEP TIMER is selected, the set temperature is automatically adjusted after a while, ensuring that the room is not too cold during cooling or too warm during heating.

- During cooling: The preset temperature is lowered by 1°C at the start of SLEEP operation (when the timer is set). After that, the temperature goes up by 1°C every an hour to become 1°C higher than the present temperature.
- During heating: The preset temperature is lowered by 1°C at the start of SLEEP operation (when the timer is set). After that the temperature becomes 3°C lower in an hour and 6°C lower in two hours than the present temperature.

ALLERGEN CLEAR operation

- The power of enzymes is used to eliminate allergy-causing allergens that accumulate on the allergen clear filter.

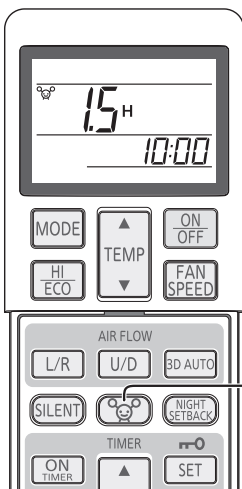

1

Press the ALLERGEN CLEAR button.

To stop: Press the ON/OFF or ALLERGEN CLEAR button.

NOTE

- Since the room temperature may change quite a bit, it is recommended that this be used when no one is in the room. (It completes automatically in approximately 90 min.)
- During ALLERGEN CLEAR operation temperature, fan speed, airflow direction and timer operations settings cannot be made.
- In case of SCM multi system, ALLERGEN CLEAR control function is invalid.
- In case of SCM multi system, if ALLERGEN button is pressed by mistake, the indoor unit which received such command stops.









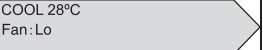
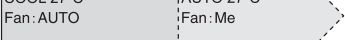

WEEKLY TIMER operation

- Up to 4 programs with timer operation (ON-TIMER / OFF-TIMER) are available for each day of the week. Max 28 programs per week are available. Once this has been set, the timer operation will be repeated at the same programs every week unless the WEEKLY TIMER is canceled.

Sample (At cooling season)

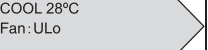
 : WEEKLY TIMER setting

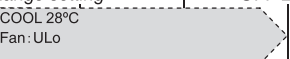
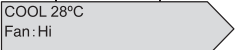
 : MANUAL setting

	6:00	8:00	10:00	12:00	14:00	16:00	18:00	20:00	22:00
Mon	Program 1 ON 6:00	Program 2 OFF 8:30				Program 3 ON 17:00			Program 4 OFF 22:00
									
Tue	Program 1 ON 5:30	Change setting	Program 2 OFF 12:00	ON		Program 3 ON 17:00			Program 4 OFF 22:00
									
Wed ~ Fri		ON	Program 1 OFF 10:00	ON	Program 2 OFF 14:00	Program 3 ON 18:00			Program 4 OFF 22:00
									
Sat	Program 1 ON 7:30	Change setting	Program 2,3 No setting			Change setting			Program 4 OFF 22:00
									
Sun		Program 2 ON 7:00	Off	Program 1 ON 12:00			Program 3 ON 19:00		Program 4 OFF 22:00
									

WEEKLY TIMER ON/OFF setting

- Switch the WEEKLY TIMER to ON/OFF by using the WEEKLY button.

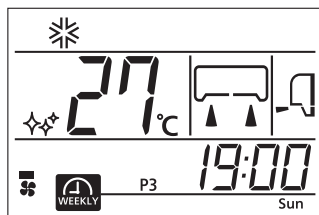

1

Press the WEEKLY button.

The WEEKLY TIMER becomes effective.

Every time the WEEKLY button is pressed, the display is switched in the order of:

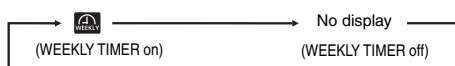

When the WEEKLY TIMER is set to ON, the timer light (yellow) of the air-conditioner is on.

When the battery of the remote control is replaced or the ACL switch is pressed, the remote control is set to the initial state. Since the WEEKLY TIMER program is not set in the initial state, set the program according to the setting procedure.

NOTE

- The WEEKLY TIMER is switched to ON/OFF regardless of whether the air-conditioner is running or not.
- The ON-TIMER operation of the WEEKLY TIMER is effective regardless of whether the air-conditioner is running or not. When the ON-TIMER setting time is reached, the remote control operates according to the contents that are set. The remote control display is also switched to the operation contents that are set. The setting can be changed from the remote control after ON-TIMER operation of the WEEKLY TIMER. The following contents can be set by the ON-TIMER. Operation mode, fan speed, temperature, airflow direction, ECONOMY, 3D AUTO, NIGHT SETBACK, SILENT. Comfort start-up is not performed for WEEKLY TIMER ON-TIMER operation.
- OFF-TIMER operation of the WEEKLY TIMER is effective only when the air-conditioner is running. When the time set by the OFF-TIMER is reached, the air-conditioner stops.
- When multiple program numbers are set for the current day (day of the week), the operation is performed from the earliest time that is set.
- When various timers (ON-TIMER, OFF-TIMER, and SLEEP TIMER) are operating, the WEEKLY TIMER does not operate even if the time set in the ON-TIMER or OFF-TIMER is reached. The WEEKLY TIMER becomes effective after various timers are terminated.
- The ON-TIMER or OFF-TIMER of the same time in the same day of the week cannot be set.
- In case of the WEEKLY TIMER being not set in the remote control, the TIMER light is not on even if the WEEKLY button is pressed and  is displayed on the remote control.

Setting mode <Individual setting>

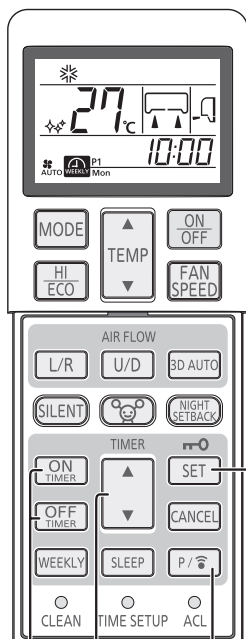

6

2,4

1

3,5

Set after setting the current day of the week and the time.

1

Press the PROGRAM button.

and current day of the week blink.

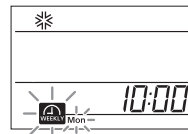

2

Press the “▲ or ▼ (TIMER)” button.

Select a day of the week to be reserved.
Every time the ▲ button is pressed, the display is switched in the order of:

→ Mon → Tue → Wed → ... → Sun → Display of all of the days of the week

Every time the ▼ button is pressed, the display is switched in the order of:

→ Mon → Display of all of the days of the week → Sun → Sat → ... → Tue



3

Press the SET button.

The day of the week is determined and the program number blinks.

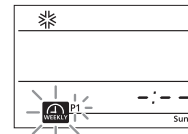

4

Press the “▲ or ▼ (TIMER)” button.

Select a program number.
Every time the ▲ button is pressed, the display is switched in the order of:

→ P1 → P2 → P3 → P4

Every time the ▼ button is pressed, the display is switched in the order of:

→ P1 → P4 → P3 → P2

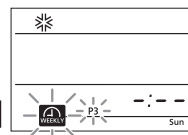

5

Press the SET button.

When no set contents (ON-TIMER or OFF-TIMER) are available, both the and timers blink.

When set contents (ON-TIMER or OFF-TIMER) are available, either one of or is lit.

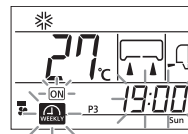
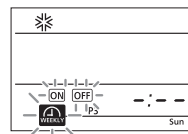

6

Press the ON-TIMER or OFF-TIMER button.

ON-TIMER or OFF-TIMER is determined and time display blinks.

ON-TIMER is selected

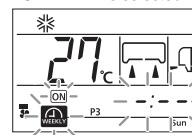

OFF-TIMER is selected

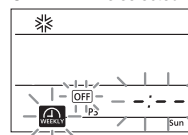

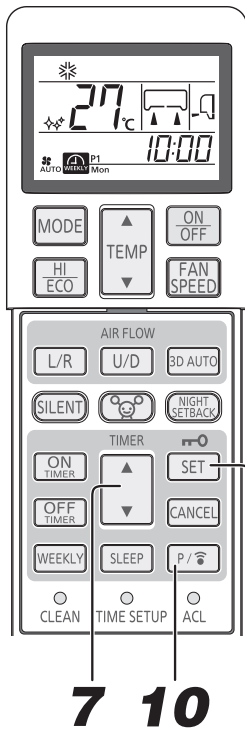

7 **10**
8,9,10

7

Press the “▲ or ▼ (TIMER)” button.

Set a time.

Every time the ▲ button is pressed, the display is switched in the order of:

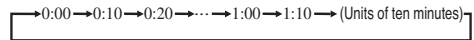

Every time the ▼ button is pressed, the display is switched in the order of:

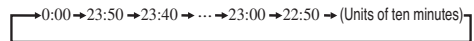

When ON-TIMER is selected, go to Step 8.
When OFF-TIMER is selected, go to Step 9.

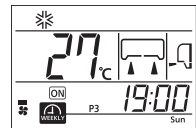

8

Set required operation contents.

When ON-TIMER is selected, operation mode, fan speed, and air flow direction can be changed and the ECONO, SILENT or NIGHT SETBACK operation can be set.

9

Press the SET button.

The time is determined and and blink.

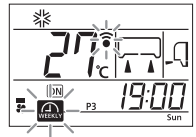

10

Press the PROGRAM button or SET button.

When the PROGRAM button is pressed, the setting is sent to the air-conditioner. Since it takes 3 seconds for transmission, point the remote control at the remote control signal receiver of the indoor unit during the period.

When the setting is received, a buzzer sound (pip, pip, pip) is emitted.
When the SET button is pressed, the setting continues from Step 2.

Setting mode <Collective setting>

- Set the same operation contents to the same program number of all the days of the week. In Step 2 above, select “all of the days of the week”. When the contents that were individually set exist in the same program number, the contents are overwritten.

NOTE

- If no operation is performed for 60 seconds in setting mode, the setting changes that have been made until then become invalid and the setting mode terminates. Subsequently, and all the program numbers (P1, P2, P3 and P4) blink for 10 seconds. (This blinking can not be observed if setting mode gets terminated while setting only one program.)
- At the end of the setting mode, point the remote control at the air-conditioner and press the PROGRAM button. In this case, check that the air-conditioner emits a reception buzzer sound three times (pip, pip, pip). If the buzzer sound is not emitted, set the mode to the setting mode again by pressing the PROGRAM button and check that the buzzer sound is emitted.

How to cancel the setting <Individual setting>

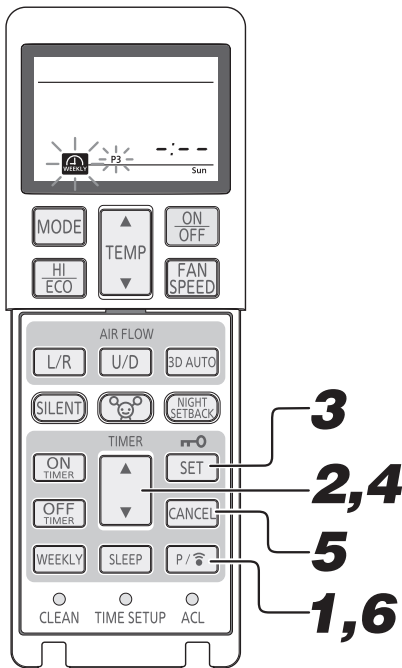

1 Press the PROGRAM button.

and current day of the week blink.

2 Press the “▲ or ▼ (TIMER)” button.

Select a day of the week to be canceled.

3 Press the SET button.

The day of the week is determined and the program number blinks.

4 Press the “▲ or ▼ (TIMER)” button.

Select a program number to be canceled.

At cancelation operation, do not press the SET button. If the SET button is pressed, the mode is shifted to the Set mode.

5 Press the CANCEL button.

The setting contents of the ON or OFF-TIMER are canceled and - : - - is displayed on the time display section.

6 Press the PROGRAM button.

When the PROGRAM button is pressed, the setting is sent to the air-conditioner.

When the setting is received, a buzzer sound (pip, pip, pip) is emitted.

The setting contents of each program are canceled. Perform the operation indicated above for each program to be canceled.

How to cancel the setting <Collective setting>

- When the same operation contents exist in the same program number of all the days of the week, collective erase is allowed. In Step 2 above, select “all of the days of the week”. The procedure from Step 3 is the same as that indicated above.

If the operation contents have been changed or erased by individual setting after the collective setting described in page 21, causing setting content discrepancies among the days of the week, collective erase is not allowed.

Confirm mode

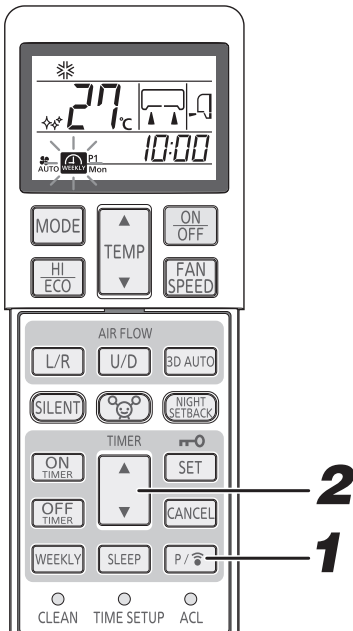

The WEEKLY TIMER setting contents can be confirmed.

1 Press the PROGRAM button for 3 seconds or more.

blinks and the setting content lights.

2 Press the “▲ or ▼ (TIMER)” button.

Select a day of the week and a program number to be confirmed.

Display starts from the current day of the week. For the program without setting, - : - - is displayed. When the PROGRAM button is pressed in Confirm mode, a setting mode is set.

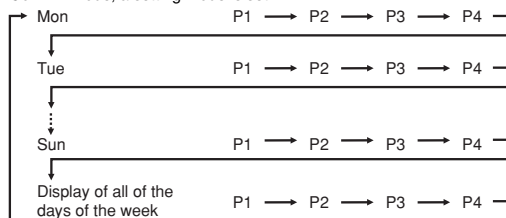

Releasing procedure

The Confirm mode can be terminated by pressing the ON/OFF, CANCEL or SET button.

NOTE

- If no operation is performed for 60 seconds in Confirm mode, the Confirm mode is terminated.

HIGH POWER/ECONOMY operation

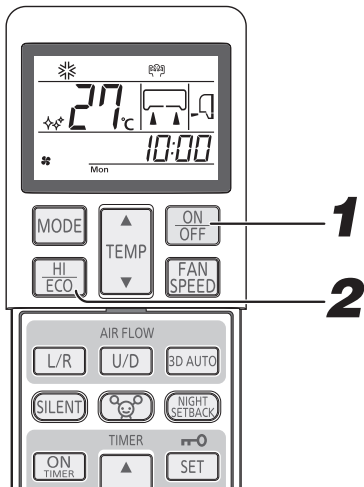

1

Press the ON/OFF button.

2

Press the HI/ECO button.

- When the operating mode is AUTO, COOL or HEAT
Every time the HI/ECO button is pressed, the display is switched in the order of:



- When the operating mode is DRY or ON-TIMER + OFF-TIMER
Every time the HI/ECO button is pressed, the display is switched in the order of:

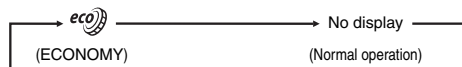

HIGH POWER operation

Pressing the HI/ECO button intensifies the operating power and initiates powerful cooling or heating operation for 15 minutes continuously. The remote control displays and the FAN SPEED display disappears.

NOTE

- During the HIGH POWER operation, the room temperature is not controlled. When it causes an excessive cooling or heating, press the HI/ECO button again to cancel the HIGH POWER operation.
- HIGH POWER operation is not available during the DRY and ON-TIMER + OFF-TIMER operations.
- When HIGH POWER operation is set after setting ON-TIMER operation, HIGH POWER operation will start from the set time.
- After HIGH POWER operation, the sound of refrigerant flowing may be heard.
- When the following operations are set, HIGH POWER operation will be canceled.
 - When the HI/ECO button is pressed again.
(The operation mode will be changed to the ECONOMY operation)
 - When the operation mode is changed.
 - When it has been 15 min. since HIGH POWER operation has started.
 - When the 3D AUTO button is pressed.
 - When the SILENT button is pressed.
 - When the NIGHT SETBACK button is pressed.
- Not operable while the air-conditioner is OFF.

ECONOMY operation

Pressing the HI/ECO button initiates a soft operation with the power suppressed in order to avoid an excessive cooling or heating. The unit operates 1.5°C higher than the setting temperature during cooling or 2.5°C lower than that during heating. The remote control displays and the FAN SPEED display disappears.

NOTE

- It will go into ECONOMY operation at the next time the air-conditioner runs in the following case.
 - When the air-conditioner is stopped by ON/OFF button during ECONOMY operation.
 - When the air-conditioner is stopped in SLEEP or OFF TIMER operation during ECONOMY operation.
 - When the operation is retrieved from CLEAN or ALLERGEN CLEAR operation.
- When the following operations are set, ECONOMY operation will be canceled.
 - When the HI/ECO button is pressed again.
 - When the operation mode is changed from DRY to FAN.
 - When the NIGHT SETBACK button is pressed.
- Not operable while the air-conditioner is OFF.

NIGHT SETBACK operation

- During the cold season, the room temperature can be maintained at a comfortable level during the absence, at night, and while the room is unattended. The air-conditioner maintains the constant temperature at about 10°C.

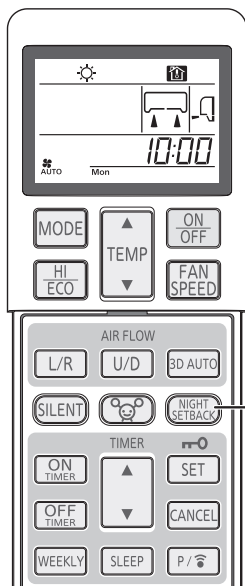

1

Press the NIGHT SETBACK button.

Every time the NIGHT SETBACK button is pressed, the display is switched in the order of:

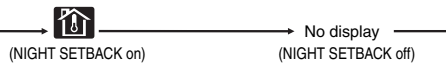

Releasing procedure

Press the NIGHT SETBACK button or MODE button to turn off the NIGHT SETBACK display.

NOTE

- During NIGHT SETBACK operation, the air-conditioner maintains the set temperature at about 10°C.
- During NIGHT SETBACK operation, temperature settings cannot be made.
- Since the room temperature may change quite a bit, it is recommended that this be used when no one is in the room.
- During NIGHT SETBACK operation, HIGH POWER and ECONOMY operations cannot be set.
- When NIGHT SETBACK operation is canceled by pressing the NIGHT SETBACK button, the operation mode is reset to the mode immediately prior to the NIGHT SETBACK operation.

SILENT operation

- When the SILENT operation is set, the unit operates more silently reducing noise from the outdoor unit. With the air-conditioner turned off, start the operation from Step 1. With the air-conditioner running, start from Step 2.

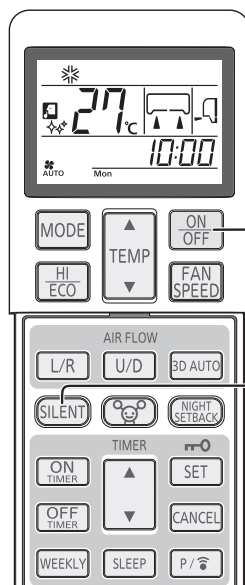

1

Press the ON/OFF button.

2

Press the SILENT button.

- When the operating mode is AUTO, COOL, HEAT or NIGHT SETBACK. Every time the SILENT button is pressed, the display is switched in the order of:



Releasing procedure

Press the SILENT button to turn off the SILENT display.

NOTE

- During SILENT operation, the maximum cooling and heating capacities deteriorate.
- SILENT operation will not function during DRY and FAN operation.
- In case of following operations, the air-conditioner will resume SILENT operation whenever it turns ON again.
 - ① When the air-conditioner is stopped by ON/OFF button during SILENT operation.
 - ② When the air-conditioner is stopped in SLEEP or OFF-TIMER operation during SILENT operation.
 - ③ When the operation is retrieved from CLEAN or ALLERGEN CLEAR operation.
- Not operable while the air-conditioner is OFF.
- The noise level of the outdoor unit may not decrease depending on the condition.

SELF CLEAN operation

- CLEAN operation should be run after AUTO, COOL and DRY operation to remove the moisture from inside the indoor unit and control the growth of mold and bacteria.

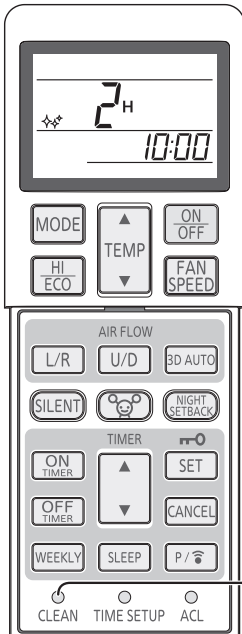

1

In order to active CLEAN operation, press the CLEAN switch with the tip of a ballpoint pen.

Every time the CLEAN switch is pressed, the display is switched in the order of:



NOTE

- Two hours later, the air-conditioner stops CLEAN operation automatically. To stop the air-conditioner immediately, press the ON/OFF button.
- CLEAN operation is not operated after HEAT, FAN, OFF-TIMER, SLEEP and ALLERGEN CLEAR operations have finished.
- The indoor unit fan runs for about two hours in CLEAN operation.
- The RUN light illuminates during CLEAN operation.

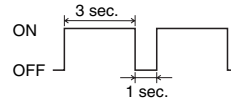

- Pressing the SLEEP button, ALLERGEN CLEAR button or NIGHT SETBACK button during CLEAN operation cancels the CLEAN operation and then the unit is set to SLEEP, ALLERGEN CLEAR or NIGHT SETBACK operation.
- This is not a function for removing mold, germs or grime that have already adhered to the unit.

Auto restart function

■ What is auto restart function?

- Auto restart function records the operational status of the air-conditioner immediately prior to be switched off by a power cut, and then automatically resumes operations after the power has been restored.
- The following settings will be canceled:
 - ① Timer settings
 - ② HIGH POWER operations

NOTE

- Auto restart function is set at on when the air-conditioner is shipped from the factory. Consult with your dealer if this function needs to be switched off.
- When power failure occurs, the timer setting is canceled. Once power is resumed, set the timer again.

Tips for effective operation

- Please observe the following for the most economic and comfortable use of your unit.

<p>Set a suitable room temperature.</p> <p>Excessively high or low temperatures are not good for your health and waste of electricity.</p>	<p>Clean the filters frequently.</p> <p>Clogged filters may block the airflow and cause less efficient operation.</p>	<p>Avoid direct sunlight and draught.</p> <p>Cut out direct sunlight by drawing the curtains or blinds when cooling. Keep windows and doors shut, except when ventilating.</p>
<p>Adjust the airflow direction properly.</p> <p>Adjust the up/down and left/right airflow to ensure a steady room temperature.</p>	<p>Operate the unit only when needed.</p> <p>Use the timer properly to operate the unit only when needed.</p>	<p>Keep heat source away when cooling.</p> <p>Keep heat sources out of the room as much as possible.</p>

Maintenance

Before maintenance

Turn off the power source.



• Do not spill any liquid.

There's a danger of electric shock.

Wipe the unit with a soft, dry cloth.



• Do not touch the aluminum fins on the heat exchanger.

• Stand firmly on a stepladder or other stable object when removing the inlet panel and filter.

Do not use the following articles:

- Hot water (40°C or more)
It may deform or discolour the unit.
- Petrol, paint thinner, benzine or cleanser, etc.
They may deform or scratch the unit.

During the operational season

Cleaning the air filter

Standard interval is once every two week

1 Remove the air filter



- Pull up the air inlet panel forward.
- Lightly hold the knobs both sides and lift a little to remove the panel forward.



2 Cleaning If the filter is very dirty, clean it with warm water (approx. 30°C), and dry it thoroughly.

CAUTION

- Do not clean the filters with boiling water.
- Do not dry them over an open flame.
- Pull them out gently.



3 Reinstall the air filter

- Hold firmly the filter at both sides as shown at right and insert securely.
- Operating without putting back the air filters will make the unit dusty, and may cause damage.

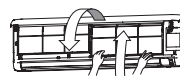

Cleaning the unit

- Wipe the unit with a soft, dry cloth, or use a vacuum cleaner.
- If the unit is very dirty, wipe it with a cloth soaked in warm water.

Cleaning the air inlet panel

- Removal, installation of air inlet panel.
- The panel can be washed with water. After washing with water, wipe any moisture off the panel and dry out of direct sunlight.

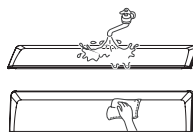

How to open, close the air inlet panel

Open

Place fingers at the recesses on both sides of the panel and pull up the panel forward so that it will be open by about 60 degrees.

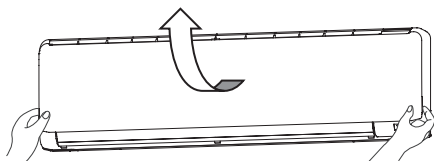

Close

Push both ends evenly and press further lightly at the center.

Removal, installation of air inlet panel

Removal

When removing the air inlet panel for internal cleaning or others, open the panel by 80 degrees and then pull it forward.

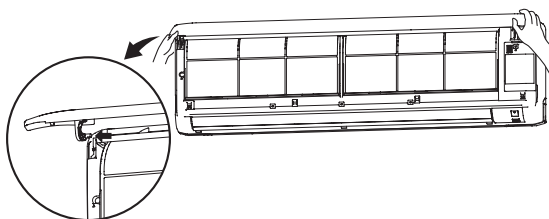

Installation

Secure the upper edge of the air inlet panel by lightly pushing it in, and then close the panel.

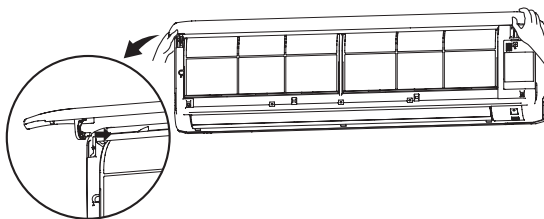

NOTE

Cooling/heating is affected by an air filter clogged up with dust etc., and the operation noise becomes louder. It may also use extra electricity. Please clean the air filter at appropriate intervals.

At the end of the season**1 Perform the fan operation for 2 to 3 hours.**

Dry the inside of the unit.

2 Stop the unit and turn off the power source.

The unit consumes approx. 4W even when the unit is not operating. Turning off the power source will help saving energy consumption and cost.

3 Clean and reinstall the air filters.**4 Clean both the indoor and outdoor units.****5 Remove batteries from the remote control.****At the beginning of the season****1 Ensure that the earth wiring is not snapped nor disconnected.****2 Check if there is no corrosion or rust on the base frame of the outdoor unit.****3 Make sure that there are no obstacles blocking the airflow around the air intake and outlet openings of the indoor and outdoor units.****4 Turn on the power source.****5 Insert batteries in the remote control.****Installing, inspecting and replacing the air-cleaning filter**

1. Open the air inlet panel and remove the air filters.  Page 26
2. Remove the filter holders, with the air-cleaning filter installed in the folders, from the air-conditioner.
3. Remove the allergen clear filter (Light orange) from filter holder and inspect the filter. Use a vacuum cleaner to remove any dust or dirt from the allergen clear filter. Replace the allergen clear filter if it cannot be cleaned or if it has been for about 1 year.

(The allergen clear filter should be replaced after about 1 year of use. However, the actual replacement period may vary depending on the conditions in which the filter is used.)

Remove the photocatalytic washable deodorizing filter (orange) from the filter holder and inspect the filter. Periodically, remove any dust or dirt from the photocatalytic washable deodorizing filter. If the photocatalytic washable deodorizing filter is particularly dirty, it may be washed with water. However, the filter is fragile so be sure to wash it installed in the filter holder to avoid damaging it. After washing the filter, place it in sunlight to dry. Placing the filter in sunlight revitalizes the deodorizing effect.

(Do not dispose of the filter holders. They are reusable.)

4. Install the air-cleaning filter in the filter holders, and then install the filter holders in the air-conditioner.

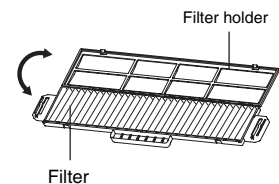
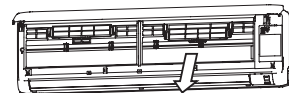
**NOTE**

- The allergen clear filter and the photocatalytic washable deodorizing filter may be installed on either the right or left side of the air-conditioner.
- Install the allergen clear filter with the light orange side front.

5. Install the air filters and close the air inlet panel.  Page 26

CAUTION

- The heat exchanger may injure your fingers.
- Stand firmly on a stepladder or other stable object when removing the inlet panel and filters.

For replacement the air-cleaning filter, contact your dealer.

Item	Feature	Color
Allergen clear filter	The power of enzyme is used to eliminate allergy-causing allergens that accumulate on the filter.	Light orange
Photocatalytic washable deodorizing filter	Sources of odors on the filter are broken up, resulting in a deodorizing effect.	Orange

Proper installation

Suitable installation position

- Do not put any obstruction in front of the indoor unit, preventing proper ventilation and functioning.
- Do not install the unit in any of the following places:
 - Where there is a danger of leaking flammable gases.
 - Where there is substantial splashing of oil.
- Malfunctioning due to corrosion may occur if the unit is installed in a spa where sulfide gases are generated, or in a seaside resort exposed to sea breezes. Contact your dealer.
- The air-conditioner and remote control must be at least 1 meter away from a TV set or radio.
- Drain the dehumidified liquid from the indoor unit into a spot that drains well.

Pay attention to operating noises!

- When you install the unit, take care to choose a place that can comfortably stand the weight of the unit and does not increase the operating noise or vibration. If vibration is transmitted through the house, fix the unit with the aid of vibration-proof pads between the unit and the fittings.
- Select a place where cold or hot air, operation noises from the indoor and outdoor units do not cause any inconvenience to your neighbours.
- Do not leave any obstacles near the outlet and inlet of the outdoor unit. This may cause malfunctioning and increased operating noise.
- If you hear an irregular noise during operation, contact your dealer.

Inspection and maintenance

Depending on operating environment, the inside of the air-conditioner may become dirty after a few year operations. This will reduce performance. In addition to normal cleaning, we would recommend inspection and maintenance. (This may lead the air-conditioner to having a longer life without any trouble.)

- Contact your dealer, or any distributor, for inspection and maintenance. (There will be a charge for this service).
- We would recommend inspection and maintenance to be carried out during the off-season.
- If the supply cord of this appliance is damaged, it must only be replaced by a repair shop appointed by the manufacturer, because special purpose tools are required.

Troubleshooting

Please carry out the following checks before making a service call.

The air-conditioner does not work at all.

Has the power switch been turned off?



Has the timer been set in the "ON" position?



Is there a power failure or a blown fuse?



If the air-conditioner does not operate properly after you have checked the left points, or if any doubt still exists after you have consulted page 29, or if things happen as shown on page 30, switch off the power and contact your dealer.

Poor cooling or heating

Have you set the thermostat at a suitable temperature?

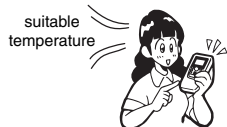

Is the air filter clean? (Not clogged?)

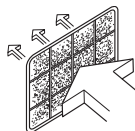

Did you leave any doors or windows open?

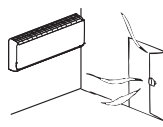

Poor cooling

Is there any direct sunlight entering the room?

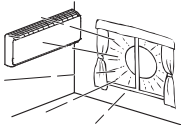

Is there a heat source in the room?

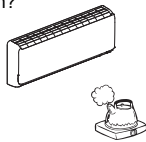

Are there too many people in the room?



An alternative refrigerant (R410A) is used in this air-conditioner. When asking your dealer for service or inspection and maintenance, explain the dealer about it.

Notice



Air flow

<p>Airflow is not blown out when starting the HEATING operation.</p> <p>RUN light blinks slowly (1.5 sec ON, 0.5 sec OFF)</p>	<p>Airflow has stopped to prevent blowing out of cold air until the indoor heat exchanger has warmed up. (2 to 5 min.) (HOT KEEP program)</p>
<p>Airflow is not blown out for 5 to 15 min. or blown out not warm wind for a moment at HEATING operation.</p> <p>RUN light blinks slowly (1.5 sec ON, 0.5 sec OFF)</p>	<p>When outdoor temperature is low and humidity is high, the unit sometimes performs defrosting automatically. Please wait. During defrosting, water or steam may escape from the outdoor unit.</p>
<p>Airflow is not blown out when starting the DRY operation.</p> <p>(RUN light is on)</p>	<p>The indoor fan may stop to prevent re-evaporation of dehumidified moisture and to save energy.</p>

Noise

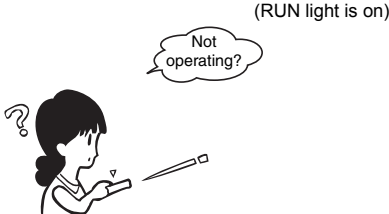

<p>You hear a slight gurgling sound.</p>	<p>This is caused by refrigerating liquid moving within the unit.</p>
<p>You hear a slight cracking sound.</p>	<p>This is caused by heat expansion or contraction.</p>
<p>You hear a hissing or clicking sound.</p>	<p>This is caused by the operation of the refrigerant control valves or electric components.</p>
<p>Whistling noise is heard from the outdoor unit.</p>	<p>The noise means that the revolution speed of the compressor is increasing or decreasing.</p>
<p>Sometimes a “Shooooo” sound might come for a short time from the unit that is turned off.</p>	<p>This is the sound when operation of another indoor unit is stopped.</p>

Others

<p>The unit does not restart immediately after you have stopped it.</p> <p>(RUN light is on)</p> 	<p>Restart is blocked for 3 minutes after you have stopped the operation to protect the unit.</p>  <p>The three-minute protection timer in the microcomputer automatically starts it up again.</p>
<p>Some steam escapes during COOL operation.</p>	<p>This may occur if the room's temperature and humidity are very high. It disappears as soon as the temperature and humidity decrease.</p>
<p>There is a slight smell.</p>	<p>Air blown out during operation may smell. This is caused by tobacco or cosmetics adhering to the unit.</p>
<p>After a power cut, the unit does not restart even if power has been restored.</p>	<p>If the auto restart function is not set, the unit will not restart automatically. Use the remote control to start the operation again.</p>
<p>Remote control signals are not received.</p>	<p>Remote control signals may not be received if the signal receiver on the air-conditioner is exposed to direct sunlight or other bright light. If so, cut out the sunlight or reduce the other light.</p>
<p>Moisture may form on the air outlet grills.</p>	<p>If the unit is operated for a long time in high humidity, moisture may form on the air outlet grills and start dripping.</p>
<p>Fan will not stop immediately after unit operation was stopped.</p>	<p>Indoor fan : Fan will not stop after 2 hours if set to CLEAN operation. Outdoor fan : Fan will not stop about a 1 minute period in order to protect the unit.</p>
<p>RUN light stays on even though operation was stopped.</p>	<p>The RUN light illuminates during CLEAN operation. Run light turns off when CLEAN operation ends.</p>

Contact your dealer

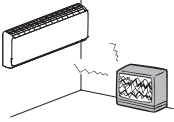
- Turn off the power switch immediately and inform your dealer in any of the following situations:

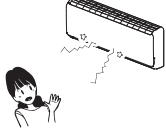
<p>The fuse or switch blows continuously.</p> 	<p>The cable becomes extremely hot. The covering of the cable is cracked.</p> <p style="text-align: center;">⚠ CAUTION</p> <p>If the power cord becomes damaged, ask your dealer or a qualified engineer to install the replacement to avoid accidents.</p>	
<p>The TV, radio or other equipment starts to malfunction.</p> 	<p>A switch does not activate properly.</p> 	<p>You hear a strange noise during operation.</p> 
<p>When abnormalities occur, turn off the power source immediately and turn it on after 3 minutes. Restart the operation with ON/OFF button of the remote control and the abnormalities still continue.</p>		<p>The RUN and TIMER lights on the unit display section blink quickly (0.5 sec. ON; 0.5 sec. OFF) and do not work.</p>

About the Multiple Air-conditioner

Simultaneous Operation

- The air-conditioners cannot be in different operating modes at the same time, such as one unit being in the "Cool" mode and one unit being in the "Heat" mode.
- When conducting different operations, the air-conditioner that was operated first will be given priority, so the air-conditioner that is operated after that will conduct air blowing operation.
- When you want to give priority to the air-conditioner that was started later, either stop the air-conditioner that has priority or cause the operation type of the unit operated first to match that of the unit operated second.
- When other indoor units are operating in different modes, the RUN light illuminates.

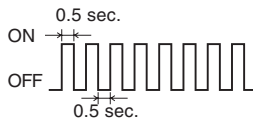

Automatic Operation

- When the remote control operation switch is in the "Auto" mode, the air-conditioner automatically selects either "Cool," "Dry," or "Heat" when operation is started depending on the room temperature.
- During simultaneous operation of air-conditioner units, operation modes may be automatically changed in response to the temperatures of the individual rooms; this will result in the operation of the outdoor unit being stopped. In such a case, COOL or HEAT mode should be used instead of AUTO. (This is only relevant when more than one air-conditioner unit is being used.)

Refrigerant (oil) recovery operation

- If all of the indoor units are not operated at the same time for an extended period, the cooling or heating performance may temporarily decrease. This is in order to control the recovery of the refrigerant (oil) in the stopped indoor unit(s). At this time, the sound of refrigerant flowing may be heard from the stopped indoor unit(s).

Self diagnosis function

■ We are constantly trying to do better service to our customers by installing such judges that show abnormality of each function as follows

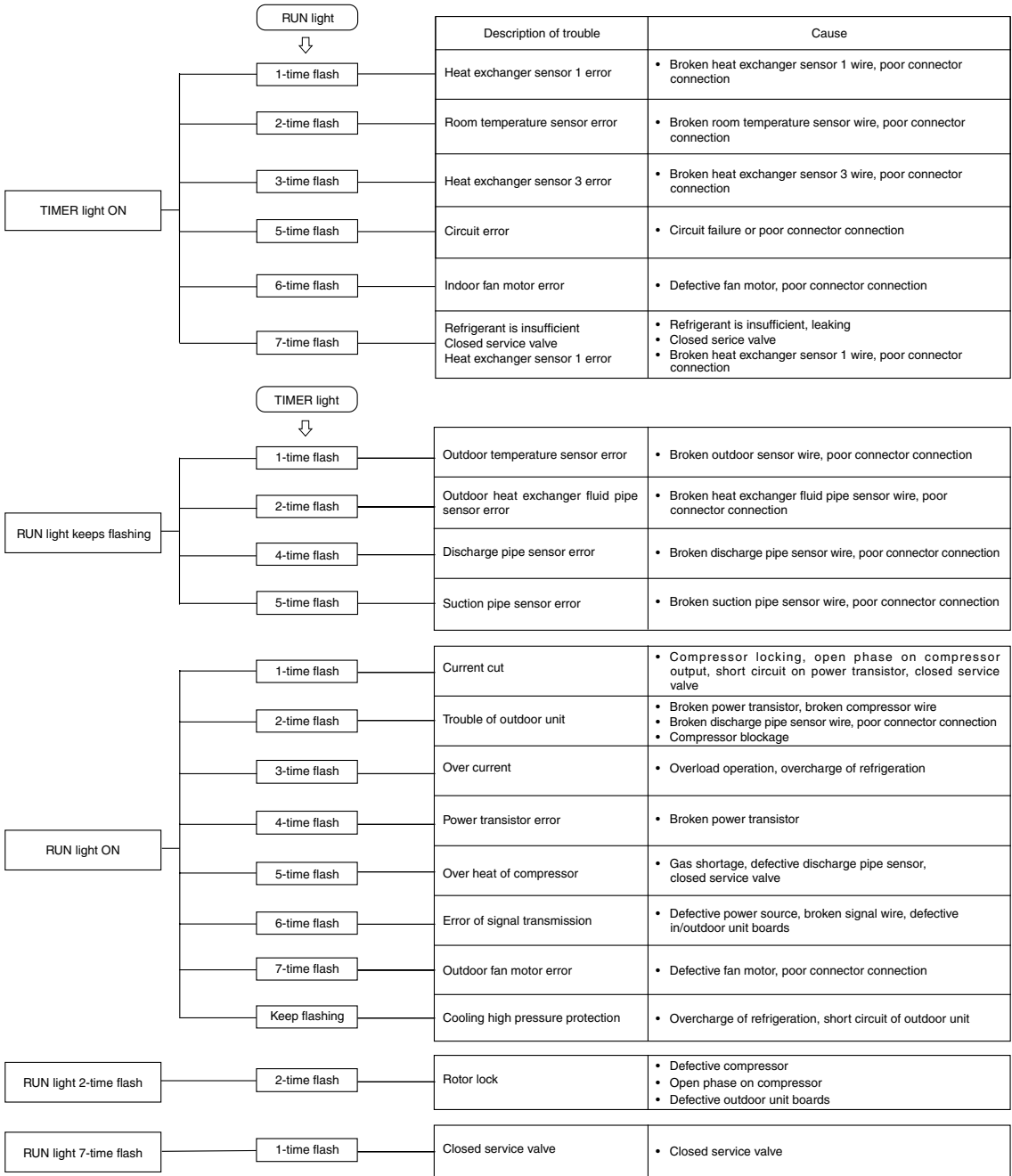



MITSUBISHI HEAVY INDUSTRIES, LTD.

AIR-CONDITIONING & REFRIGERATION DIVISION

3-1, Asahi, Nishibiwajima-cho, Kiyosu, Aichi, 452-8561, Japan
<http://www.mhi.co.jp>

MITSUBISHI HEAVY INDUSTRIES AIR-CONDITIONING EUROPE, LTD.

7 Roundwood Avenue, Stockley Park, Uxbridge, Middlesex, UB11 1AX, United Kingdom
Tel : +44-20-7025-2750
Fax: +44-20-7025-2751
<http://www.mhiae.com>

MITSUBISHI HEAVY INDUSTRIES AIR-CONDITIONERS AUSTRALIA, PTY. LTD.

9C Commercial Road Kingsgrove NSW 2208 PO BOX 318 Kingsgrove NSW 1480
Tel : +61-2-8571-7977
Fax: +61-2-8571-7992
<http://www.mhiae.com.au>