

Help Guide

Driver Download:

<https://plustek.com/us/products/film-photo-scanners/ephoto-z300/support.php>

Please contact us directly if you have any questions

Tel: (714) 670-7713, Mon-Fri 9:00AM~5:30PM, PST

eMail: infoUSA@plustekus.com

Or fill out a technical support form at

<https://plustek.com/us/support/technical-support-form.php>



Scanner User's Guide ePhoto

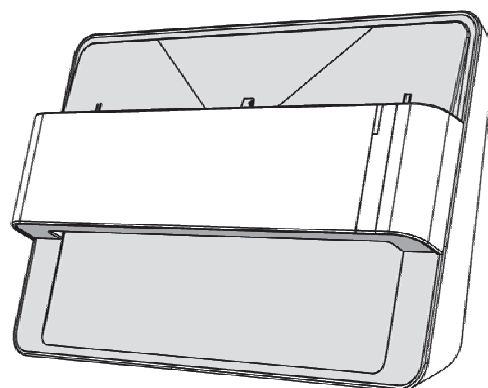

Trademarks

© 2021 Plustek Inc. All rights are reserved. No portion of this document may be reproduced without permission.

All trademarks and brand names mentioned in this publication are property of their respective owners.

Liability

While all efforts have been made to ensure the accuracy of all contents in this manual, we assume no liability for errors or omissions or by statements of any kind in this manual, whether such errors are omissions or statements resulting from negligence, accidents, or any other cause. The contents of this manual are subject to change without notice. We will not shoulder any legal liability, if users failed to follow the operation instructions in this manual.

Copyright

The scanning of certain documents, for example checks, bank notes, I.D. cards, government bonds, or public documents, may be prohibited by law and/or subject to criminal prosecution. We recommend you to be responsible and respectful of the copyrights laws when you are scanning books, magazines, journals and other materials.

Environmental Information

Recycle or disposal at end-of-life information, please ask local distributors or suppliers for recycle and disposal information. The product is designed and produced to achieve sustainable environmental improvement. We strive to produce products in compliance with global environmental standards. Please consult your local authorities for proper disposal.

The product packaging is recyclable.

Attention for recycling (For EU country only)

Protect your environment! This product should not be thrown into the household waste container. Please give it to the free collecting center in your community.

Screen Examples in This Manual

The screen shots in this guide were made with Windows 7. If you are using Windows 8 / 10, your screen will look somewhat different but functions the same.

Table of Contents

INTRODUCTION	1
HOW TO USE THIS GUIDE.....	1
A NOTE ABOUT ICONS	2
SAFETY PRECAUTIONS.....	2
SYSTEM REQUIREMENTS	3
BOX CONTENTS	4
SCANNER OVERVIEW	5
LED INDICATOR	6
POWER SAVE	6
CHAPTER I. INSTALLING THE SCANNER	7
INSTALLING AND SETTING UP THE SCANNER	8
<i>Windows Installation</i>	8
<i>Mac OS X Installation</i>	9
UPDATE THE LATEST DRIVER (ONLY FOR Z300).....	11
CHAPTER II. OPERATING THE SCANNER	12
STEP 1. TURN ON YOUR SCANNER	12
STEP 2. LAUNCH PLUSTEK ePHOTO	12
STEP 3. SCAN	13
CHAPTER III. CARE AND MAINTENANCE	14
CLEANING THE SCANNER	14
<i>Cleaning Materials</i>	14
<i>Cleaning the Scanner</i>	14
CALIBRATING THE SCANNER	16
USAGE & MAINTENANCE TIPS	17
APPENDIX A: SPECIFICATIONS	18
APPENDIX B: ePHOTO HOTKEYS	20
APPENDIX C: CUSTOMER SERVICE AND WARRANTY	22
SERVICE & SUPPORT INFORMATION (FOR EU COUNTRY ONLY).....	22
STATEMENT OF LIMITED WARRANTY	23
FCC RADIO FREQUENCY STATEMENT	24

Introduction

Welcome to the world of Plustek scanners – the ultimate in computer imaging. Your new scanner will improve the professionalism of your day-to-day computing tasks by allowing you to input images into your computer system.

Like all of our products, your new scanner is thoroughly tested and backed by our reputation for unsurpassed dependability and customer satisfaction.

Thank you for choosing us as your scanner supplier. We hope you will continue to turn to us for additional quality products as your computing needs and interests grow.

How to Use This Guide

This User's Guide provides instructions and illustrations on how to install and operate your scanner. This guide assumes the user is familiar with Microsoft Windows. If this is not the case, we suggest you learn more about Microsoft Windows by referring to your Microsoft Windows manual before using your scanner.

The Introduction section of this manual describes the box contents and minimum computer requirements to use this scanner. Before you start installing your scanner, check the box contents to make sure all parts are included. If any items are damaged or missing, please contact the vendor where you purchased your scanner or our customer service directly.

Chapter I. Installing the Scanner describes how to install scanner's software and connect the scanner to your computer.

Chapter II. Operating the Scanner describes how to operate the scanner.

Chapter III. Care and Maintenance describes how to maintain and clean your scanner.



Appendix A: Specifications contains the Specifications of the scanner you purchased.

Appendix B: ePhoto Hotkeys contains general shortcuts information in the ePhoto program.

Appendix C: Customer Service and Warranty contains our limited warranty agreement and FCC statement concerning the product.

A Note about Icons

This guide uses the following icons to point out information that deserves special attention.

 Warning	Warning: A procedure that must be followed carefully to prevent injury, or accidents.
 Attention	Attention: Instructions that are important to remember and may prevent mistakes.
 Information	Information: Optional tips for your reference.

Safety Precautions

Before using this device, please read the following important information to eliminate or reduce any possibility of causing damage and personal injury.

1. Usage, the product is for indoor use in dry locations. Moisture condensation may occur inside this device and cause malfunction at these conditions:
 - when this device is moved directly from a cold to a warm location;
 - after a cold room is heated;
 - when this device is placed in a damp room.

To avoid the moisture condensation, you are recommended to follow the procedure:

- i. Seal this device in a plastic bag for it to adapt to room conditions.
 - ii. Wait for 1-2 hours before removing this device from the bag.
2. Do use the power adapter and USB cable provided with the scanner. Use of other power adapter and cables may lead to malfunction.
 3. Keep the space around the AC adapter clear in case you need to quickly unplug the AC adapter during emergencies.
 4. Damaged wire could cause fire or electrical shock. Keep the power cord straight and without being twisted, bended, or scraped.
 5. Unplug this device if you don't need to use for a certain period of time, such as, during night or long weekend, to avoid any risks of causing fire.
 6. Do not attempt to disassemble the scanner. There is danger of an electrical shock and opening your scanner will void your warranty.
 7. Be sure not to bump or knock the scanner as it is fragile and could break.

8. Before installing the device drivers, please disconnect all other imaging devices (other scanners, printers, digital cameras, web cameras) from the PC.
9. Save the Setup/Application DVD. You may need to reinstall the driver and software in the future. Save the Calibration Sheet in case you need to calibrate the scanner in the future.

System Requirements¹

Windows

- 🔌 2 GHz CPU or above
- 🔌 2 GB RAM (4 GB RAM recommended)
- 🔌 10 GB Free Hard Disk Space
- 🔌 DVD Drive or Internet Connection
- 🔌 USB Port
- 🔌 Microsoft Windows 7 / 8 / 10 (Specifications are subject to change without notification, for more information please check our official website.)

Macintosh

- 🔌 2 GHz CPU or above (INTEL based CPU, NO PowerPC)
- 🔌 2 GB RAM (4 GB RAM recommended)
- 🔌 10 GB Free Hard Disk Space
- 🔌 DVD Drive or Internet Connection
- 🔌 USB Port
- 🔌 Mac OS X 10.8.x, 10.9.x, 10.10.x, 10.11.x, 10.12.x, 10.13.x, 10.14.x, 10.15.x
(Specifications are subject to change without notification, for more information please check our official website.)

¹ Higher requirements might be needed when you scan or edit a large quantity of image data. The system requirements here are only a guideline, as in general the better the computer (motherboard, processor, hard disk, RAM, video graphic card), the better the results.

Box Contents²

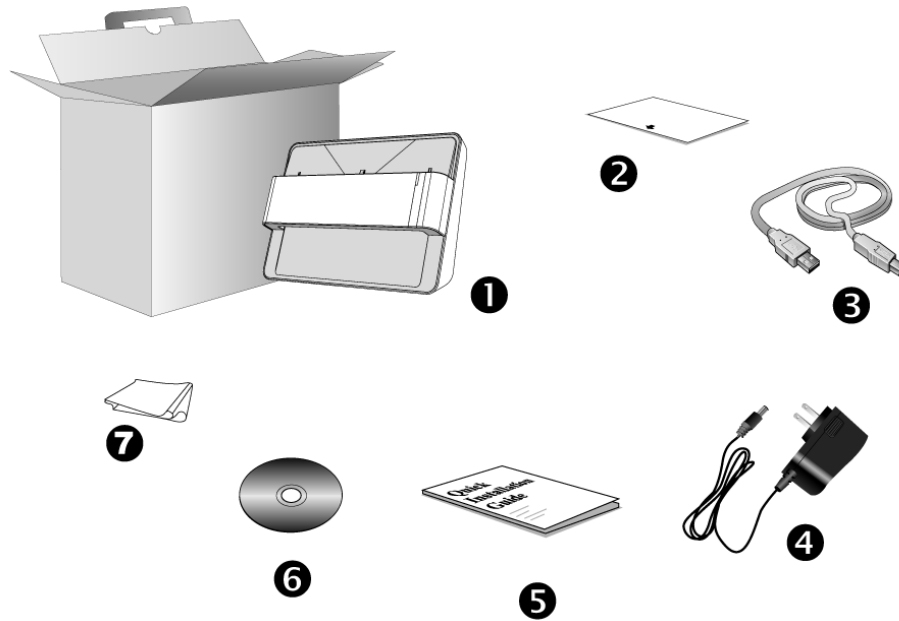

1. Scanner
2. Calibration Sheet
3. USB Cable
4. Power Adapter
5. Quick Guide
6. Plustek Setup / Application DVD-ROM
7. Cleansing Cloth

² Save the box and packing materials in case you need to transport this scanner in the future.
Box contents may change at any time without prior notice.

Scanner Overview

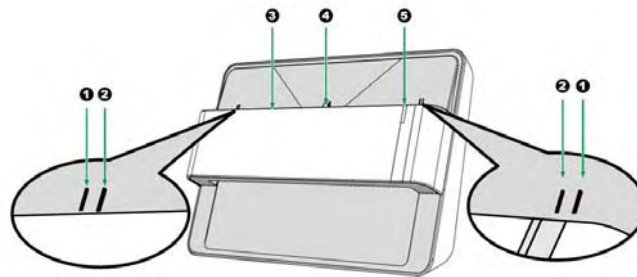

1. **Calibration Alignment Mark**

Always align the edges of the calibration sheet to both calibration alignment marks.

2. **Maximum Scan Area Mark**

Please place the edges of your photo / document between both maximum scan area marks.

3. **Page Feed Slot**

Feed the photo / document into the scanner from this slot. You can feel the photo / document being grabbed by the scanner.

4. **Scan Alignment Mark**

Always align the center of your photo / document edge to this alignment mark .

5. **LED Indicator**

It indicates the scanner's current status.

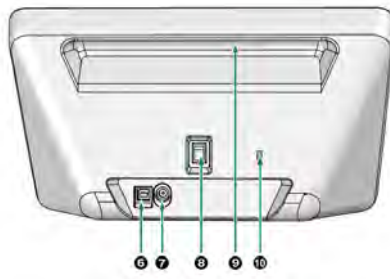

6. **USB Port**

It connects the scanner to a USB port on your computer by the included USB cable.

7. **Power Receptor**

It connects the scanner to a standard AC power outlet by the included power adapter.

8. **Power switch**

Use this to turn the scanner ON or OFF.

9. **Hand Holder**

It is ergonomically designed for you to carry the scanner with ease.

10. **Kensington Security Slot**

Used for attaching lock-and-cable apparatuses to prevent device theft.

LED Indicator

The LED indicates different scanner status.

Light	Status
Orange	The scanner is turned on.
Blue	The Plustek ePhoto is activated. The scanner is ready to scan.
Blinking Blue	The scanner is scanning.
Off	The scanner is off, either because the power is not turned on, or because the AC adapter is not properly plugged into an AC power outlet.

Power Save

To save power consumption, the scanner light source always automatically turns itself off after the scanning process is finished.

Chapter I. Installing the Scanner

Before installing your scanner, please verify that you have all of the proper components. A list of the package contents is provided in the Box Contents section of this guide.



Information

Before installing the scanner, please remember to do the followings:

1. Tear off the stickers on both sides of the scanner.

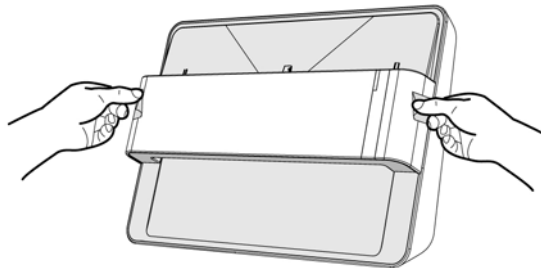

2. Open the cover of the scanner, then tear off the stickers and the protective EPE strip inside the scanner.

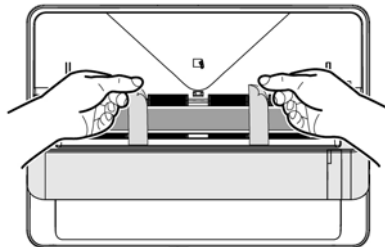

Installing and Setting up the Scanner

Please follow the step-by-step procedures described below to install the USB scanner.

Windows Installation



1. Insert the Setup/Application DVD-ROM, included with your scanner, into your DVD-ROM drive.



2. Click [Run install.exe] in the [AutoPlay] window. If the installation does not start automatically, browse your DVD-ROM drive and manually run the [install.exe] file. Click on the [Yes] button if the [User Account Control] dialog pops up.

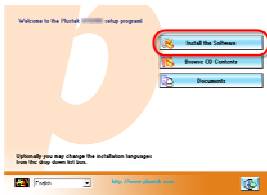

3. Follow the on-screen instructions to install all software that your new USB scanner requires.

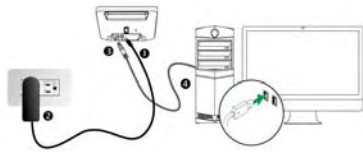

4. Plug the power adapter into the scanner's power receptor. Plug the other end of the power adapter into a standard AC power outlet. Plug the square end of the included USB cable to the USB port at the rear of the scanner. Plug the rectangular end of the USB cable to the USB port on the back of your computer. Switch the scanner power on. When the scanner is detected by the operation power on. When the scanner is detected by the operation system, the connection is completed.

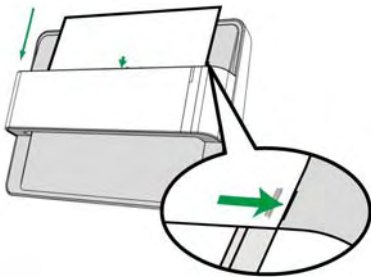

5. After the software is installed, you will be prompted to perform the scanner calibration. Insert the special calibration sheet, included with the scanner, face down into the page feed of the scanner. Align the calibration sheet to the calibration alignment mark on the scanner. Follow the on-screen instructions to complete the scanner calibration. **Save the Calibration Sheet in case you need to calibrate the scanner in the future.** If you are not prompted to perform the scanner calibration, please skip to procedure 6.

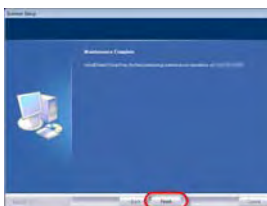

6. After the software is installed, close all open applications and click on the [Finish] button to restart your computer.

Mac OS X Installation



1. Insert the Setup/Application DVD-ROM, included with your scanner, into your DVD-ROM drive and a



[PlusTek Scanner] icon will show on the desktop of your Mac OS X. Double-click on the icon, and a window will pop up displaying the file folder.

2. Double-click on the app file, and the Scanner Installer will start to guide you through the installation. Follow the on-screen guide in the installer window.



Attention

For Windows 8 / 10, please follow the on-screen installation instructions after connecting the scanner.

For Windows OS:

If you are facing difficulty in installing the scanner driver, please try manually installing the software.

1. Please open [Start] > [Control Panel] > [System] > [Hardware] > [Device Manager]. In the [Device Manager] window, right-click on this scanner under [Other devices] and select [Update Driver Software] from the pop-up menu.

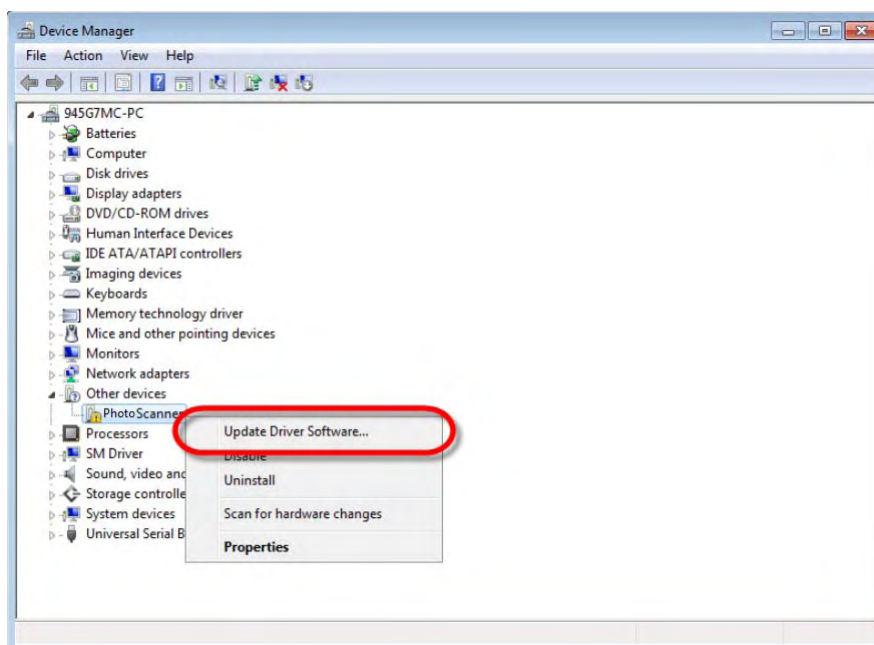

Information

2. Click [Browse my computer for driver software] in the window that appears, and click the [Browse] button. In the [Browse For Folder] window, select the folder or the DVD-ROM drive that contains this scanner's driver and click the [OK] button to return to the previous screen. Click the [Next] button and click [Install this driver software anyway] if the [Windows Security] window appears.
3. Browse your DVD-ROM drive and manually run the [install.exe] file. Click on the [Yes] button if the [User Account Control] dialog pops up. Follow the on-screen instructions to install all software that your new USB scanner requires.

Update the Latest Driver (Only for Z300)

1. Do one of the following to check and download the latest driver:
 - Please visit our official website <http://www.plustek.com>, and go to ePhoto product page to check if there is any update.
 - Click **?** button in the toolbar of the ePhoto interface, select **Preference** to open the **Preference** dialog.

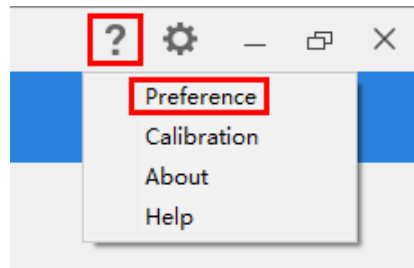

Click the **Check for Updates** button to check if there is any update.

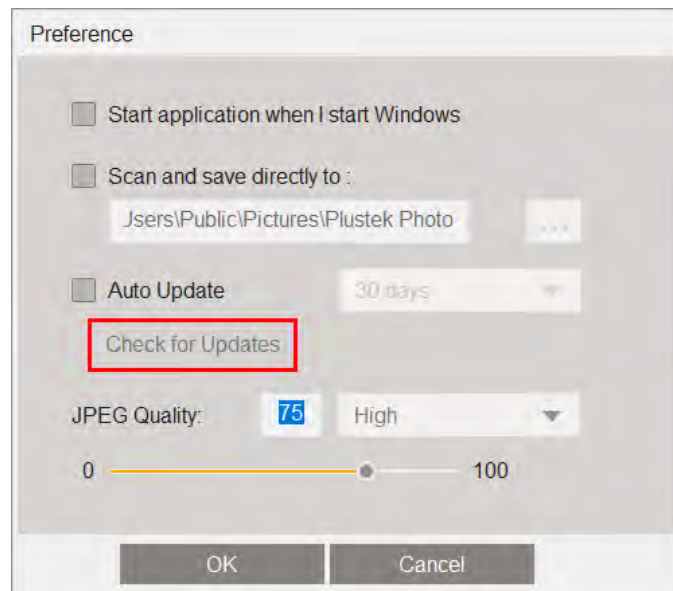

2. If you have already installed the ePhoto software, please **uninstall** the current version before updating the latest driver.

If you have not installed the ePhoto software yet, simply unzip the downloaded installer, follow the on-screen instructions to complete the installation.

Chapter II. Operating the Scanner

Your scanner accepts photos and documents. However, some software programs have limitations as to the information they can handle. The capacity of the computer's memory and free space on your hard drive can also limit the physical size of the photo / document that you scan.

Your scanner comes with the advanced and feature rich scanning application Plustek ePhoto. This stand alone program allows you to perform advanced scanning features.

Step 1. Turn on Your Scanner

Please make sure the scanner's USB and power cables are properly connected and that the scanner is turned on. The LED will turn on to indicate that the device is powered on.

Step 2. Launch Plustek ePhoto

Launch Plustek ePhoto using the Plustek ePhoto shortcut on your Desktop. Adjust the scan settings. Click the  button within the Plustek ePhoto window for more information about the settings.

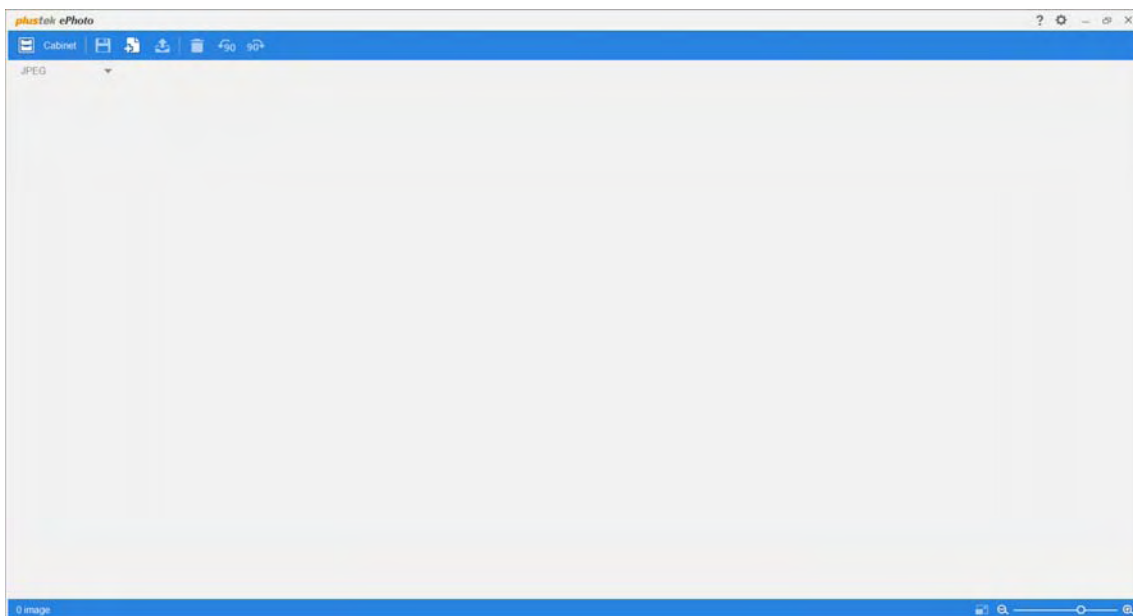

Step 3. Scan

Insert the photo / document face down into the scanner. Always align the center of your photo / document edge to this alignment mark . Please place the edges of your photo / document between both maximum scan area marks. The scanning starts immediately. The scanned images are displayed in Plustek ePhoto, and you may perform the image editing tasks. To scan more photos or documents, please wait until the blue light LED stop blinking, and then place another photo / document into the scanner to continue the scanning.

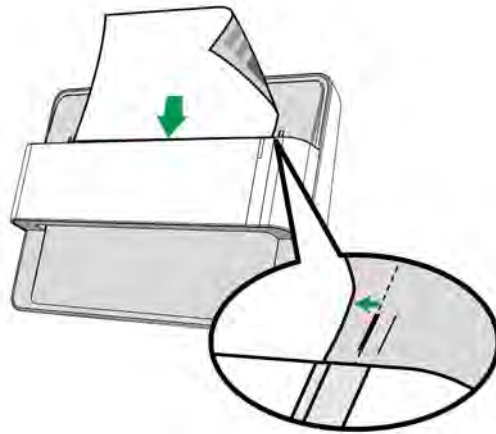

Chapter III. Care and Maintenance

Your scanner is designed to be maintenance-free. However, constant care and maintenance can keep your scanner working smoothly.

Cleaning the Scanner

Paper powder, dust, ink and toner from paper being scanned may make the inner scanner dirty, which leads to poor image quality or document-feeding errors. How often to clean your scanner depends on the type of paper and number of pages being scanned.

Perform the following procedures to clean the scanner. Gently wipe locations described herein. Do not rub too hard.



Warning

- Before cleaning the scanner, turn off the scanner and disconnect the scanner's power cable and USB cable, and then wait a few minutes for the glass and/or the inner scanner to cool to ambient temperature.
- Wash your hands with soap and water after cleaning the scanner.

Cleaning Materials

Have the following cleaning materials ready to clean the scanner:

- soft, dry, lint-free cloth (or a cotton swab)
- **non-abrasive cleaner**—Isopropyl alcohol (95%). DO NOT use water.



Attention

- Alternatively you can use glass cleaner or neutral detergent for windows cleaning to clean the scanner glass.
- However, DO NOT use either of them to clean the feed roller.
- Use of other cleaning materials could damage your scanner.

Cleaning the Scanner

1. Open the scanner cover gently.

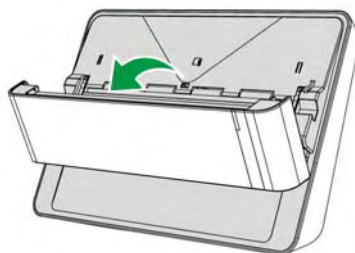

2. Gently wipe the following areas with the cloth dampened with the cleaner. Be careful NOT to scratch their surfaces.

Clean Feed Roller:

Wipe the Feed Roller from side to side and then rotate it. Repeat this until its entire surface is cleaned.

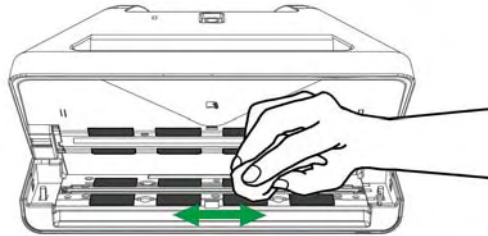

Clean Scanner Glass:

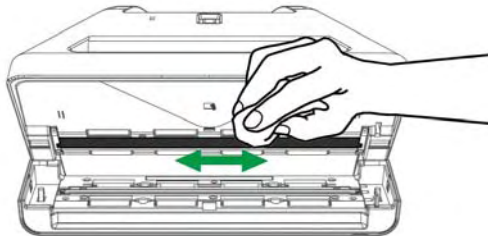

 Attention	Do not spray cleaner directly onto the scanner glass. Excess liquid residue may fog or damage the scanner.
---	--

3. Wait for cleaned areas to dry completely.
4. Close the cover by pushing it back down until it snaps back into place.

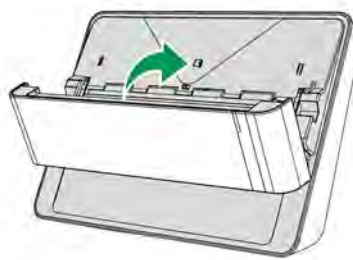

Calibrating the Scanner

Calibrate the scanner if colors appear in areas that should be white, or colors of the scanned image and the original vary a lot. This allows you to adjust and compensate for variations that can occur in the optical component over time by its nature.

The following describes how to calibrate the scanner:

1. Click **?** button in the toolbar of the ePhoto interface, select **Calibration** to open the **Calibration** dialog.

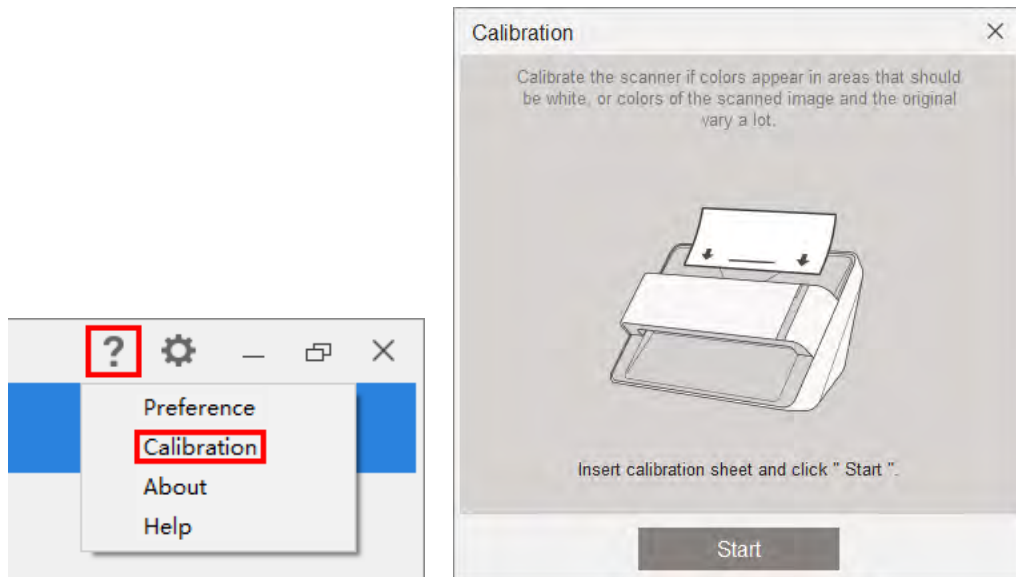

2. Insert the special calibration sheet face down into the page feed slot of the scanner. Align the calibration sheet to the calibration alignment mark on the scanner.

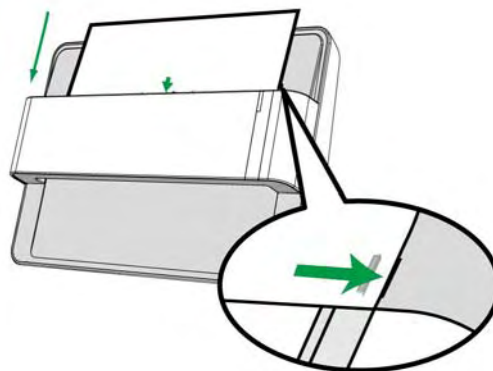

 Attention	<ul style="list-style-type: none">● Please insert the special calibration sheet included with the scanner.● Save the Calibration Sheet in case you need to calibrate the scanner in the future.
---	--

3. Click on the **Start** button to begin the calibration process.
4. The scanner pulls the calibration sheet through the scanner, which completes this scanner calibration. After the calibration is complete, click **OK**.

Usage & Maintenance Tips



Information

To keep your scanner working smoothly, take a moment to review the following maintenance tips.

- Avoid using the scanner in a dusty environment. When it is not in use, keep the scanner covered. Dust particles and other foreign objects may damage the unit.
- Do not attempt to disassemble the scanner. There is danger of an electrical shock and opening your scanner will void your warranty.
- Do not subject the scanner to excessive vibration. It may damage the internal components.
- Your scanner operates best in temperatures between 10° C to 40° C (50° F to 104° F).

Appendix A: Specifications³

ePhoto Z300	
Image Sensor	Color CCD
Light Source	LED
Optical Resolution	300 dpi / 600 dpi
Scan Modes	Color: Input 48-bit , Output 24-bit Grayscale: Input 16-bit , Output 8-bit
Scanning Speed	4" x 6" Photo: Approx. 2 sec. Document (A4): Approx. 5 sec.
Scanning Area (W x L)	Min.: 1" x 1" Max.: 8.5" x 11.7"
Acceptable Paper Weight (Thickness)	Non-embossed: 0.76 mm or less
Power Supply	24 Vdc / 0.75 A
Interface	USB 2.0
Net Weight	1.48 Kg (3.26 Lbs)
Dimensions (W x D x H)	289.9 mm x 160.6 mm x 158mm (11.4" x 6.3" x 6.2")

³ Hardware specifications may change at any time without prior notice.

ePhoto Z600	
Image Sensor	Color CCD
Light Source	LED
Optical Resolution	300 dpi / 600 dpi
Scan Modes	Color: Input 48-bit , Output 24-bit Grayscale: Input 16-bit , Output 8-bit
Scanning Speed	4" x 6" Photo: Approx. 2 sec. Document (A4): Approx. 3 sec.
Scanning Area (W x L)	Min.: 1" x 1" Max.: 8.5" x 36"
Acceptable Paper Weight (Thickness)	Non-embossed: 0.76 mm or less
Daily Duty Scan (Sheets)	500
Power Supply	24 Vdc / 0.75 A
Interface	USB 2.0
Net Weight	1.48 Kg (3.26 Lbs)
Dimensions (W x D x H)	289.9 mm x 160.6 mm x 158mm (11.4" x 6.3" x 6.2")

Appendix B: ePhoto Hotkeys

For Windows OS

Keyboard Shortcuts

The following table contains general keyboard shortcuts in the Scan screen.

Press this key	To do this
Ctrl	Select non-consecutive images
Shift	Select a consecutive group of images
Ctrl + Z	Undo an action (Including the operation of rotate, delete, etc.)
Ctrl + Y	Redo an action (Including the operation of rotate, delete, etc.)
Ctrl + A	Select all images
Ctrl + S	Save all images
Delete	Delete the selected image(s)
→ Right Arrow	Move the selection right by one image
← Left Arrow	Move the selection left by one image
↑ Up Arrow	Move the selection up by one image
↓ Down Arrow	Move the selection down by one image

The following table contains general keyboard shortcuts in the Edit screen.

Press this key	To do this
Ctrl + Z	Undo an action (Including the operation of rotate, delete, etc.)
Ctrl + Y	Redo an action (Including the operation of rotate, delete, etc.)
Delete	Delete the selected image(s)
→ Right Arrow	Move the selection right by one image
← Left Arrow	Move the selection left by one image

Mouse Control

Action	To do this
Click on the image	Select the image, you may use the keyboard hotkey to select multiple images.
Double-click on the image	Enter the Edit screen.
Click and drag the image	Move the image to Cabinet folder or reorder the sequence of the images.
Click on the blank area and drag	Select all images in the rectangular selection area.

For Mac OS

Keyboard Shortcuts

The following table contains general keyboard shortcuts in the Scan screen.

Press this key	To do this
Command	Select non-consecutive images
Shift	Select a consecutive group of images
Command-Z	Undo an action (Including the operation of rotate, delete, etc.)
Command-Y	Redo an action (Including the operation of rotate, delete, etc.)
Command-A	Select all images
Command-S	Save all images
Delete	Delete the selected image(s)
Right Arrow	Move the selection right by one image
Left Arrow	Move the selection left by one image
Up Arrow	Move the selection up by one image
Down Arrow	Move the selection down by one image

The following table contains general keyboard shortcuts in the Edit screen.

Press this key	To do this
Command-Z	Undo an action (Including the operation of rotate, delete, etc.)
Command-Y	Redo an action (Including the operation of rotate, delete, etc.)
Delete	Delete the selected image(s)
Right Arrow	Move the selection right by one image
Left Arrow	Move the selection left by one image

Mouse Control

Action	To do this
Click on the image	Select the image, you may use the keyboard hotkey to select multiple images.
Double-click on the image	Enter the Edit screen.
Click and drag the image	Move the image to Cabinet folder or reorder the sequence of the images.
Click on the blank area and drag	Select all images in the rectangular selection area.

Appendix C: Customer Service and Warranty

Please visit our website www.plustek.com for more customer service information. To avoid delays, please have the following information available:

- 🔧 **Scanner name and model number**
- 🔧 **Scanner serial number**
- 🔧 **Scanner DVD version and part number**
- 🔧 **A detailed description of the problem**
- 🔧 **Your computer manufacturer and its model number**
- 🔧 **The speed of your CPU**
- 🔧 **Your current operating system and BIOS (optional)**
- 🔧 **Name of software package(s), version or release number and manufacturer of the software**
- 🔧 **Other USB devices installed**

Service & Support Information (For EU country only)

Where appropriate, the period of availability of spare parts and the possibilities of upgrading products information. Please ask local distributors and suppliers for spare parts information and product upgrade information.

Information requested by relevant Implementing Measure. Please ask local distributors and suppliers for the related information of Implementing Measure test report.

Do not dispose anything of products before you ask local distributors and suppliers to get correct information for decreases of environmental impact with right methods and procedures.

If you want to disposals the product and/or an accessory, please ask local distributors and suppliers to get the contact information of nearest disposal manufactures.

If you have any maintenance inquiry, please ask local distributors and suppliers to get the contact information of nearest maintenance center in order to extend the product usage life time.

If you want to maintain and clearance the product, please ask local distributors and suppliers to get the right information of nearest stores.

Statement of Limited Warranty

This Statement of Limited Warranty applies only to the options you originally purchase for your use, and not for resale, from an authorized reseller.

The manufacturer warranty includes all parts and labor, and is not valid without the receipt of original purchase. To obtain warranty service, you may contact the authorized dealer or distributor, or visit our website to check out the available service information, or send a request via E-mail for further help.

If you transfer this product to another user, warranty service is available to that user for the remainder of the warranty period. You should give your proof of purchase and this statement to that user.

We warrant that this machine will be in good working order and will conform to its functional descriptions in the documentation provided. Upon provision of proof of purchase, replacement parts assume the remaining warranty of the parts they replace.

Before presenting this product for warranty service, you must remove all programmes, data and removable storage media. Products returned without guides and software will be replaced without guides and software.

This Limited Warranty service does not provide for carry-in exchange when the problem results from accident, disaster, vandalism, misuse, abuse, unsuitable environment, programme modification, another machine or non-vendor modification for this product.

If this product is an optional feature, this Limited Warranty applies only when the feature is used in a machine for which it was designed.

If you have any questions about your Limited Warranty, contact the approved retailer from whom you bought the product or the manufacturer.

THIS LIMITED WARRANTY REPLACES ALL OTHER WARRANTIES, EXPRESS OR IMPLIED, INCLUDING, BUT NOT LIMITED TO, THE IMPLIED WARRANTIES OF MERCHANTABILITY AND FITNESS FOR A PARTICULAR PURPOSE. HOWEVER, SOME LAWS DO NOT ALLOW THE EXCLUSION OF IMPLIED WARRANTIES. IF THESE LAWS APPLY, THEN ALL EXPRESS AND IMPLIED WARRANTIES ARE LIMITED IN DURATION TO THE WARRANTY PERIOD. NO OTHER WARRANTIES APPLY AFTER THAT PERIOD.

Some jurisdictions do not allow limitations on how long an implied warranty lasts, so the above limitation may not apply.

Under no circumstances are we liable for any of the following:

- ☛ Third party claims against you for losses or damages.
- ☛ Loss of, or damage to, your records or data; or
- ☛ Economic consequential damages (including lost profits or savings) or incidental damages, even if we are informed of their possibility.

Some jurisdictions do not allow the exclusion or limitations of incidental or consequential damages, so the above limitation or exclusion may not apply to you.

This Limited Warranty gives you specific legal rights, and you may also have other rights that vary from jurisdiction to jurisdiction.

To obtain the warranty service, you may:

- contact the authorized dealer or distributor.
- visit our website to check out the up-to-date service.
- send a request via E-mail for further help.

FCC Radio Frequency Statement

This equipment has been tested and found to comply with the limits for a Class B digital device, pursuant to part 15 of the FCC rules. These limits are designed to provide reasonable protection against harmful interference in a residential installation.

This equipment generates, uses and can radiate radio frequency energy and, if not installed and used in accordance with the instructions, may cause harmful interference to radio communications. However, there is no guarantee that interference will not occur in a particular television reception (which can be determined by turning the equipment off and on), the user is encouraged to try to correct the interference by one or more of the following measures:

- Reorient or relocate the receiving antenna.
- Increase the separation between the equipment and receiver.
- Connect the equipment to an outlet on a circuit different from that which the receiver is connected.
- Shielded interconnect cables and shielded power cord which are supplied with this equipment must be employed with this equipment to ensure compliance with the pertinent RF emission limits governing this device.
- Consult the dealer or an experienced radio/TV technician for help if the conditions persist.
- Changes or modifications not expressly approved by the manufacturer or authorized service center could void the user's authority to operate this equipment.

ePhoto Online Help

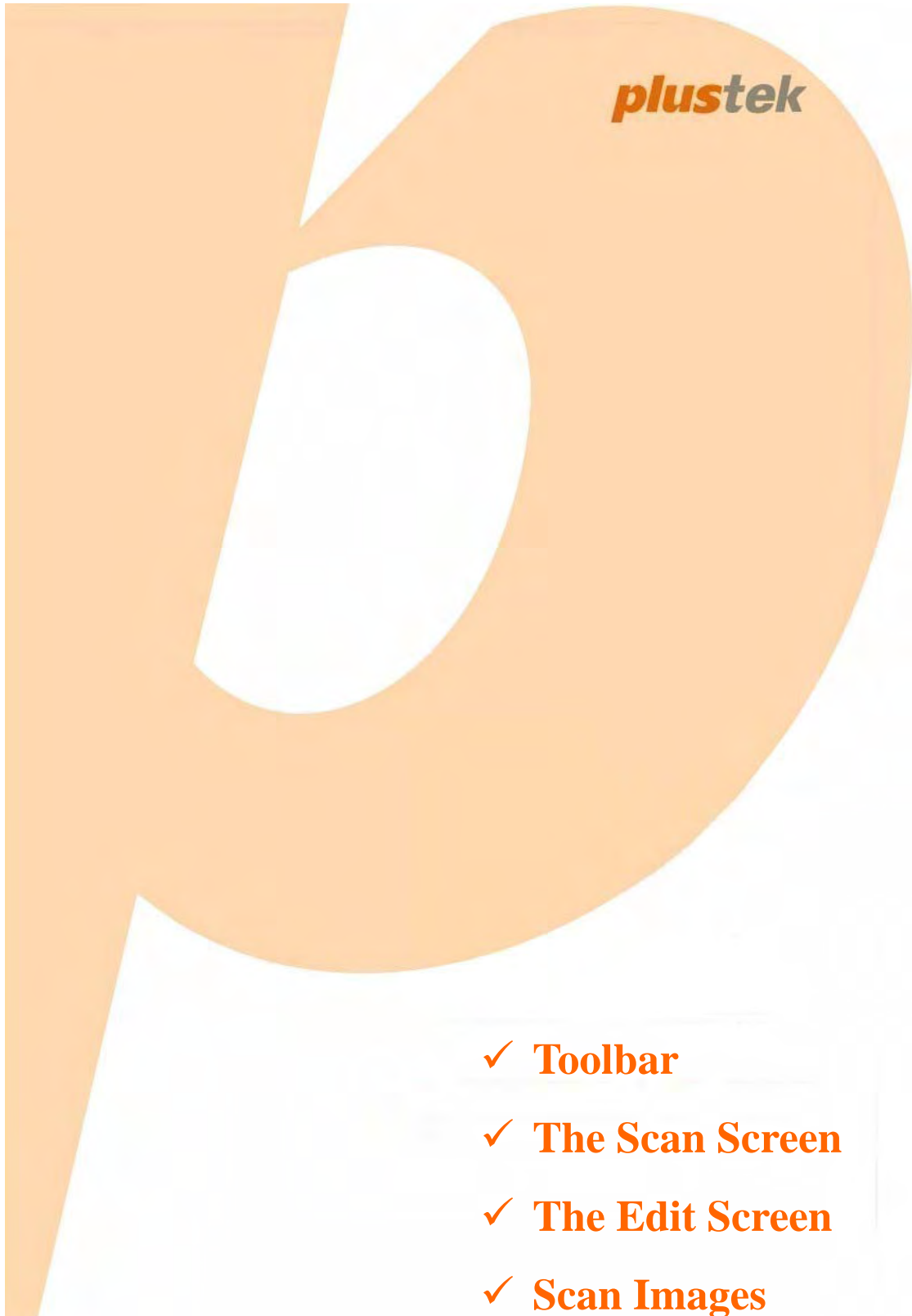

plustek

- ✓ **Toolbar**
- ✓ **The Scan Screen**
- ✓ **The Edit Screen**
- ✓ **Scan Images**

ePhoto: Table of Contents

Part I Introduction	2
Part II User Interface Overview	2
1 Toolbar	3
2 Cabinet	5
3 The Scan Screen	6
4 The Edit Screen	8
Adjust (For images and documents)	9
Adjust (For images)	10
Adjust (For documents)	11
Part III Working with this program	12
1 Scan Images	12

1 Introduction

This program is a specialized image scanning program that allows you to conveniently scan and edit photos and documents, and automatically save their electronic files in the designated folder. This program, seamlessly integrating the operation of your scanner with your computer, provides a quick and convenient way to perform various functions.

This help file will familiarize you with the program's user interface and related functions. We will also walk you through practical applications to your daily work step by step. The programs included on the Setup/Application CD must be installed on your computer in order for the scanner functions in this program to work properly.

This help assumes the user is familiar with Microsoft Windows / Mac OS. If this is not the case, we suggest you learn more about Microsoft Windows / Mac OS by referring to your Microsoft Windows / Mac OS manual before using your scanner. The screen shots in this online help were made with Windows 7. If you are using Mac OS, your screen will look somewhat different but functions the same.

2 User Interface Overview

The user interface contains the following components:

- [The Scan screen](#): The **Scan** screen is where you set your scanning parameters. You may select one or multiple images to edit, share or delete.
- [The Edit screen](#): The **Edit** screen is where you can apply various filter effects and make more detailed adjustments to your images.

To launch the program, you can do one of the following:



For Windows OS:

1. Click on the **Plustek ePhoto** shortcut from the Windows **Start** menu > **All Programs** > **Your Scanner Model Name** folder. (For Windows 8.1 users: Point your mouse cursor to the upper or lower right corner of your screen to open the **Charm** bar. Click on the **Start** charm, then click on the downwards arrow button in the lower left corner of the screen. The **Apps** screen will be shown. Move your cursor to the right edge of the screen to scroll right until you find **Your Scanner Model Name**, and then click on **Plustek ePhoto**.)





2. Double-click the icon  on the desktop.

For Mac OS:

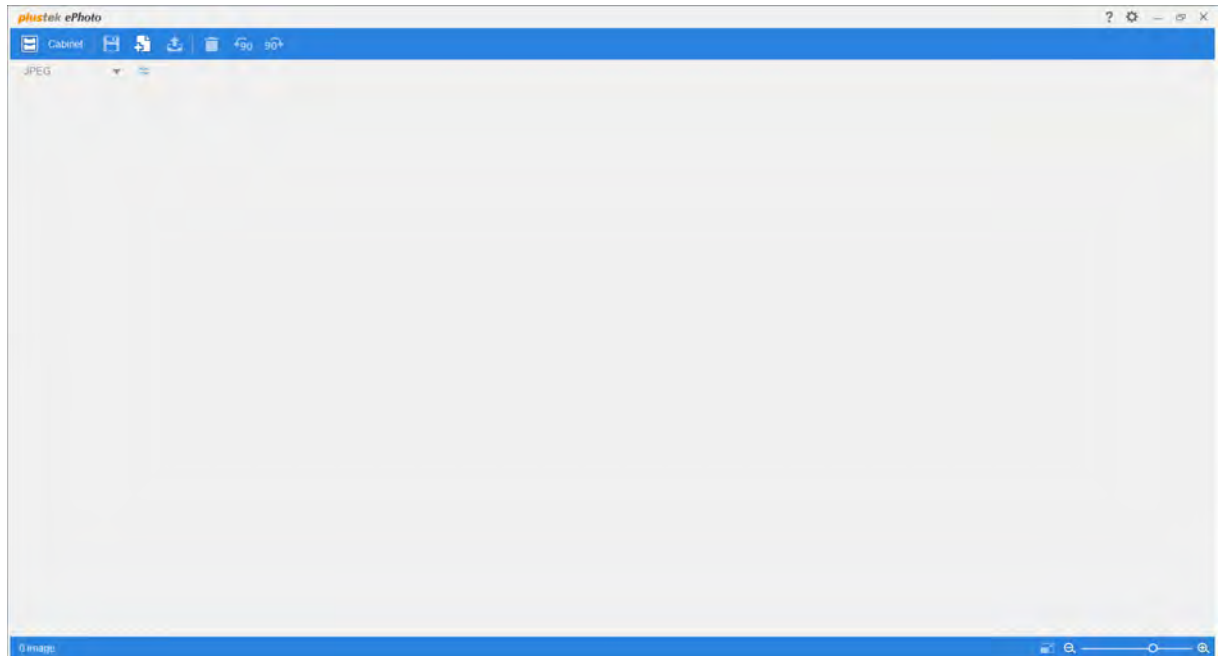
1. Double-click the icon  in **Finder > Applications > Plustek > Your scanner model name**.
2. Click the icon  in the Dock.



To close the program, please click the **Close** button  in the upper right corner of the program window. Right-click the  **ePhoto** icon in the system tray, and select **Exit** from the pop-up menu to exit the program.



2.1 Toolbar

The Toolbar features frequently-needed functions to make working with this program faster and easier.





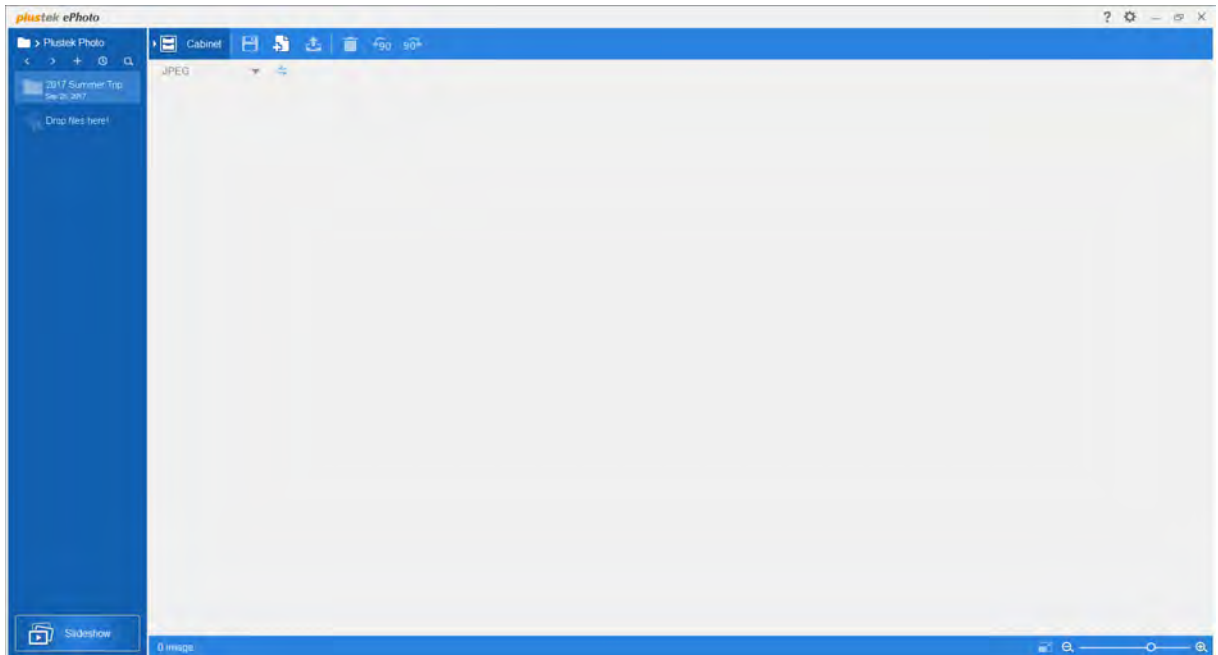

The following toolbar buttons are available.

?	<p>Click on this button to open a context menu with the following items:</p> <ul style="list-style-type: none"> ○ Preference: Select this item to open the Preference dialog. <ul style="list-style-type: none"> ● Start application when I start Windows: Activate this checkbox to start the ePhoto program automatically when you boot the Windows computer. ● Scan and save directly to: Activate this checkbox to scan and save the images directly to the specific folder without opening the program window. <p>Click on the Browse button  and use the dialog to select the folder where you wish to store your scanned images. For example, the default saving path in Windows 7 is Users > Public > Public Pictures > Plustek Photo.</p> <ul style="list-style-type: none"> ● Auto Update: Activate this checkbox and select a value from the drop-down list to set how often this program should automatically check for updates. Click the Check for Updates button to check if there is any update. (This function may or may not be available depending on the scanner model you purchase.) ● JPEG Quality: Adjust the quality settings of JPEG file format. ● ICC Profile: Activate this checkbox and select a profile from the drop-down list to set device output color standard. ○ Calibration: Select this item to open the calibration dialog. Follow the on-screen instructions to complete the scanner calibration. Save the Calibration Sheet in case you need to calibrate the scanner in the future. ○ About: Select this item to open the program information dialog. <ul style="list-style-type: none"> ● Go to website: Click this button to launch the Plustek website in your default web browser. ○ Help: Select this item to launch the on-line help file.
⚙	<p>Click on this button to open a Settings dialog. You may adjust settings in this dialog.</p> <ul style="list-style-type: none"> ● Color: Select a desired color mode from the drop-down list. ● Resolution: Select a desired resolution from the drop-down list. The higher the resolution, the more detailed the scan and the resulting file will be. ● File name: Enter the desired file name into the field. The default uses your computer's date and time. ● OCR Language: Select a desired OCR language from the drop-down list. ● Scan as: Select a desired scan type from the drop-down list. ● Auto Crop & Auto Deskew: Tick this check box to have ePhoto automatically identify the dimensions of the image you scanned and straighten the skewed image after auto crop is done. The crop shape will be a square or rectangle and it will not trace the edges of oddly-shaped images. ● Apply Quick Fix: Tick this check box to apply quick fix function, optimize the scanned images.
—	Click on this button to minimize this program to the task bar.
□	Click on this button to enlarge this program to the full screen.
✕	Click on this button to close this program.



2.2 Cabinet

Click on the  **Cabinet** button to display the setting panel, you may add folders, find the recent folders and quick search for the desired folders. You may also create your own slideshow here. Click on the  **Cabinet** button again to close the setting panel.

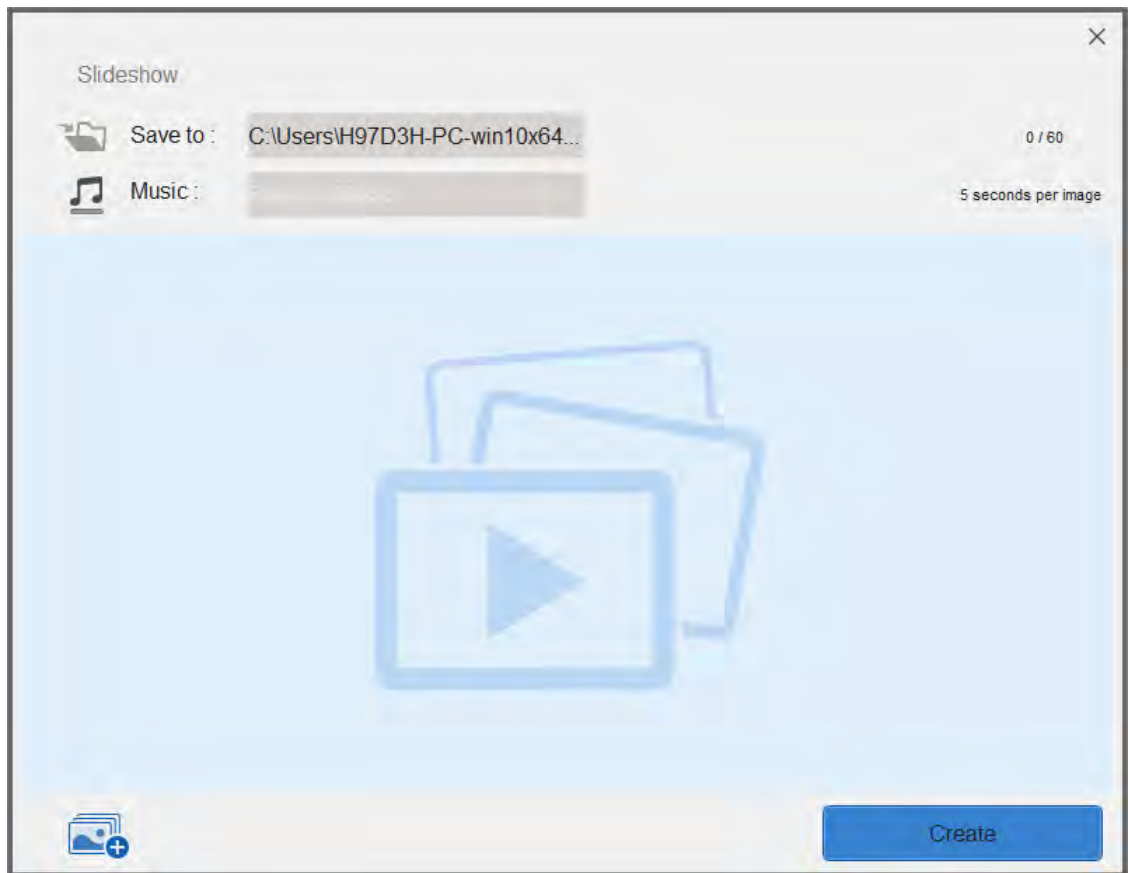

-  **Go back:** Click on this button to go back to the previous folder.
-  **Go forward:** Click on this button to go forward to the next folder.
-  **New folder:** Click on this button to add new folder. You may name the folder in the blank. You may sort your scanned images by drag and drop to the desired folders here.
-  **Recent folders:** Click on this button to display recently visited folders.
-  **Quick search:** Click on this button to quick search the desired folders.
-  **Slideshow:** Click on this button to popup the Slideshow dialog. You will be prompted to download the FFMpeg program.



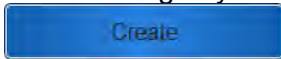





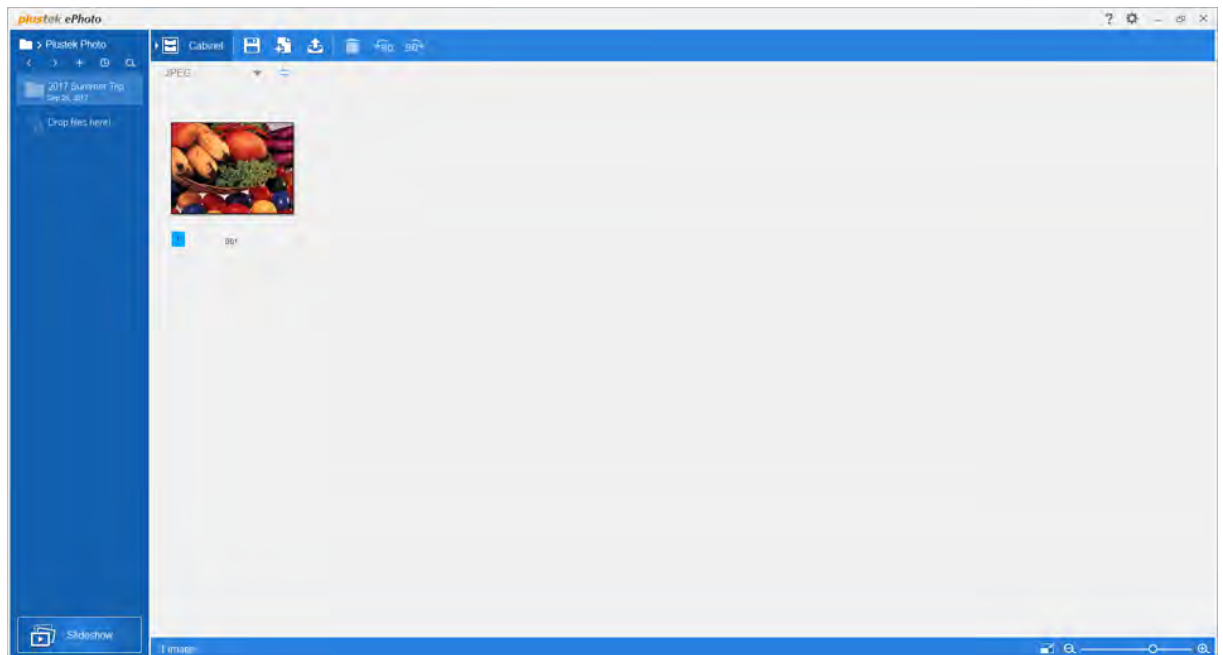



- *  **Save to:** Click on the gray column to select the desired saving folder for your slideshow.
- *  **Music:** Click on the gray column to add music to your slideshow. The music file should be shorter than 5 minutes.
- *  **Add images:** Click on this button to select the desired images for your slideshow. The maximum values is 60 images. You may transpose the desired image by drag-and-drop operation to re-arrange the image order.
- *  **Create:** Click on this button to create your own slideshow.

2.3 The Scan Screen

Insert the photo / document face down into the scanner. Always align the center of your photo / document edge to this alignment mark . Please place the edges of your photo / document between both maximum scan area marks. The scanning starts immediately. The scanned images are displayed in Plustek ePhoto, and you may perform the image editing tasks. The maximum scan images at a time for Windows OS is 50, and that for Mac OS is 60.



You may select one or multiple images to edit, share or delete. Simply click an image to select the desired image, you may use the **Shift** button in the keyboard to select multi-images. Selected images will be highlighted with a blue rectangle around the images. Click on the blank area to de-select the images.







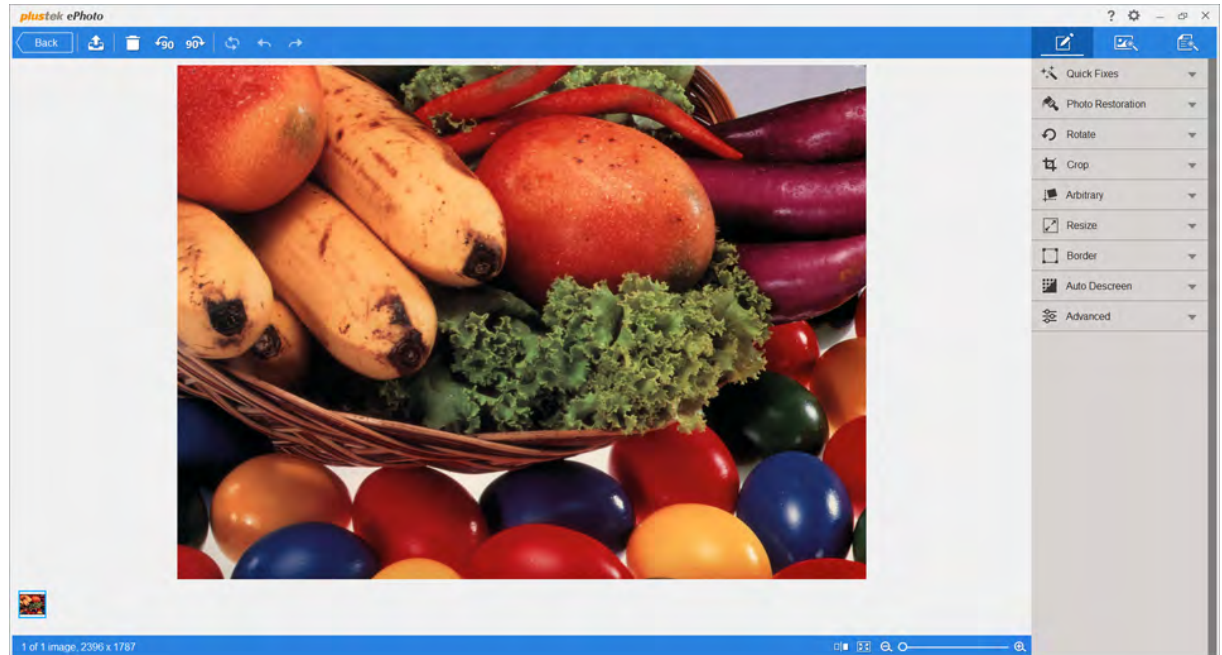

-  **Save:** Click on this button to save images.
-  **Add existing photos:** Click on this button to import existing images to the ePhoto.
-  **File output:** Click on this button to output the selected images to the desired destinations. You may share the images to the most popular social media or cloud services, print the images by connected printer, or send the images by email.
-  **Delete:** Click on this button to delete the selected images.
-  **Rotate counterclockwise:** Click on this button to rotate the selected images in a counterclockwise direction.
-  **Rotate clockwise:** Click on this button to rotate the selected images in a clockwise direction.
-  **File format:** Click on this button to save the images in other file format. Select the desired format from the dropdown list.
-  **Sequence:** Click on this button to arrange the scanned images in ascending order or in descending order.
-  **Full screen view:** Click this button to switch to the full screen display mode.
-  **Zoom out:** Click this button to shrink the thumbnail of the scanned images.
-  **Zoom in:** Click this button to enlarge the thumbnail of the scanned images.

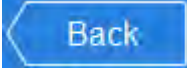

2.4 The Edit Screen

Double click on the selected images bring you to the **Edit** screen.





The **Edit** screen is where you can apply various filter effects and make more detailed adjustments to your images. To help you visualize the effects and adjustments, you can switch to "Dual-view" mode. All changes can be undone and redone step by step and you can also reset the image back to its original state.

-  **Back:** Click on this button to bring you back to the **Scan** screen.
-  **File output:** Click on this button to output the selected images to the desired destinations. You may share the images to the most popular social media or cloud services, print the images by connected printer, or send the images by email.
-  **Delete:** Click on this button to delete the selected images.
-  **Rotate counterclockwise:** Click on this button to rotate the selected images in a counterclockwise direction.
-  **Rotate clockwise:** Click on this button to rotate the selected images in a clockwise direction.
-  **Reset:** Click on this button to reset the selected images to their original state.
-  **Undo:** Click on this button to undo the last effect or adjustment.
-  **Redo:** Click on this button to redo the last effect or adjustment.
-  **Dual-view:** Click on this button to switch to the dual-view mode.

-  **Scale to fit:** Click on this button to view the scanned image in fit window size.
-  **Zoom out:** Click this button to zoom out of the currently selected image. You can also use mouse wheel down to perform the same action.
-  **Zoom in:** Click this button to zoom in on the currently selected image. You can also use mouse wheel up to perform the same action.

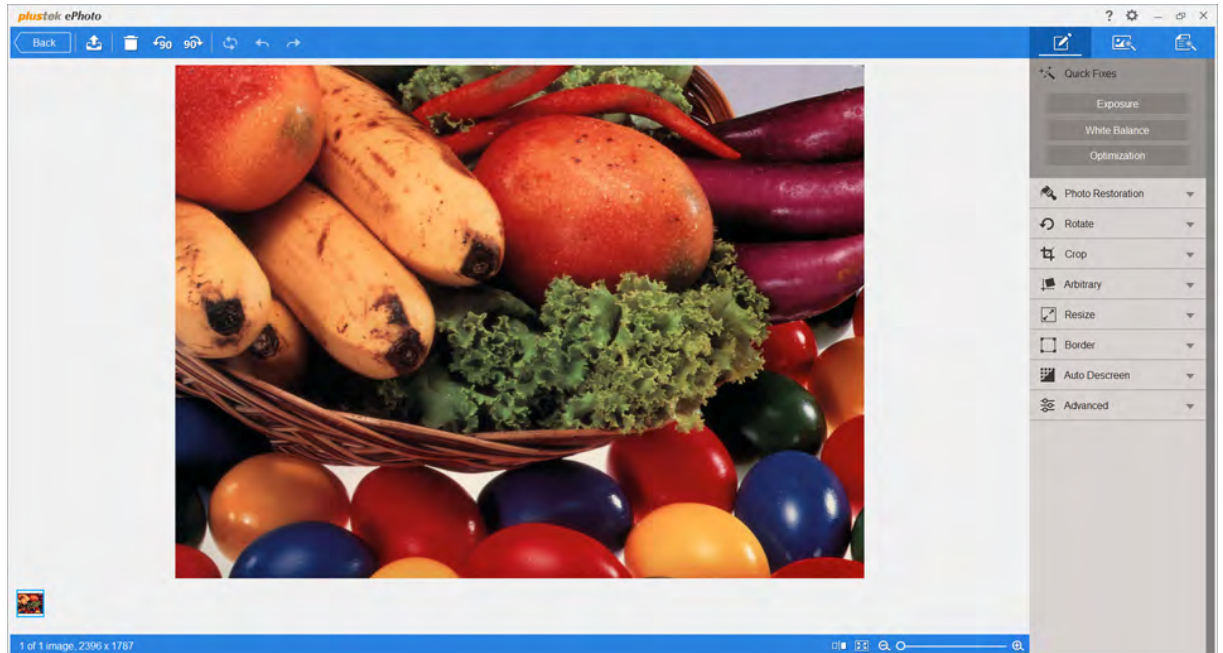
2.4.1 Adjust (For images and documents)





Click on the  tab to view all available adjustments you can apply to your images and documents. Click on any adjustment to apply it to the currently selected image. If the adjustment has sub-items you can select, it will be expanded when you click on it. Select the desired adjustments and click on the **Apply** button to apply the adjustment or click on the **Cancel** button to close the adjustment sub-items.

- **Quick Fixes:** You may click on **Exposure** button to get auto exposure image, click on **White Balance** button to perform auto white balance, or click on **Optimization** button to see the optimized result of the selected image.
- **Photo Restoration:** You may click on **Auto Correction** button to see the auto correction result, click on **Auto Contrast** button to perform auto contrast, or click on **Auto Color** button to get auto color image.
- **Rotate:** You may click on the desired rotation method here.
- **Crop:** You may click on the desired cropping ratio here.
- **Arbitrary:** You may adjust the image angle if necessary.

- **Resize:** Enter the desired **Width**, **Height** and **Resolution** to resize the scanned image.
- **Border:** Select to set the border inward or outward, configure the **Thickness** and/or **Round Corner** values, and select the border color.
- **Auto Descreen:** You may click on **General**, **Newspaper** or **Magazine** button to see the respective result.
- **Advanced:** You may adjust the **Contrast**, **Brightness**, **Saturation**, **Hue** and **Gamma** of the scanned image.

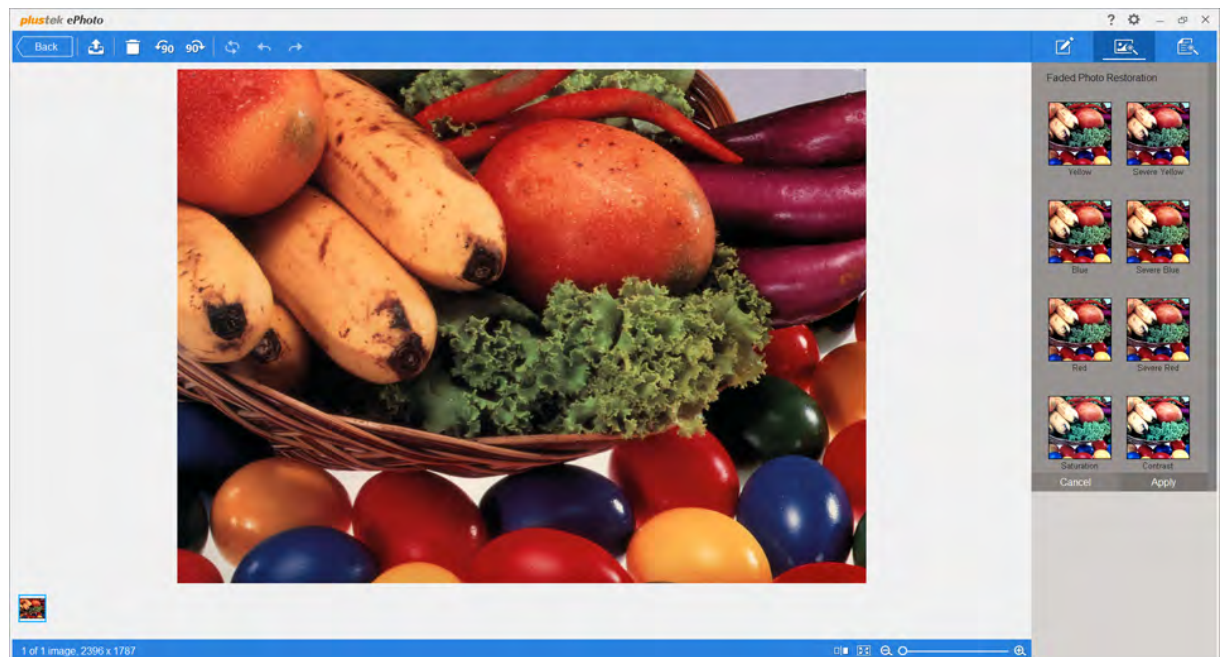
2.4.2 Adjust (For images)





Click on the  tab to view all available adjustments you can apply to your images. Click on any adjustment to apply it to the currently selected image. If the adjustment has sub-items you can select, it will be expanded when you click on it. Select the desired adjustments and click on the **Apply** button to apply the adjustment or click on the **Cancel** button to close the adjustment sub-items.

- **Faded Photo Restoration:** You may select the desired restoration method for your faded photo images.
- **Sharpen:** You may configure the sharpness strength here.
- **Blur:** You may adjust the blur level here.
- **Anti RedEye:** You may click on **Auto** or **Manual** button to see the respective result.

- **Collage:** You may create your own collage photo here. Select the desired images value and the collage layout. Then adjust the **Scale** of the images, and configure the border **Thickness**, **Round Corner** and **Color**.
- **Merge:** Select the desired layout to merge your images.
- **Effects:** Click on any category title to expand that category's list. Use your mouse wheel to scroll through the list of available effects, then select a desired effect with a mouse click. The selected effect will be laid over your images to better visualize the effect for you.

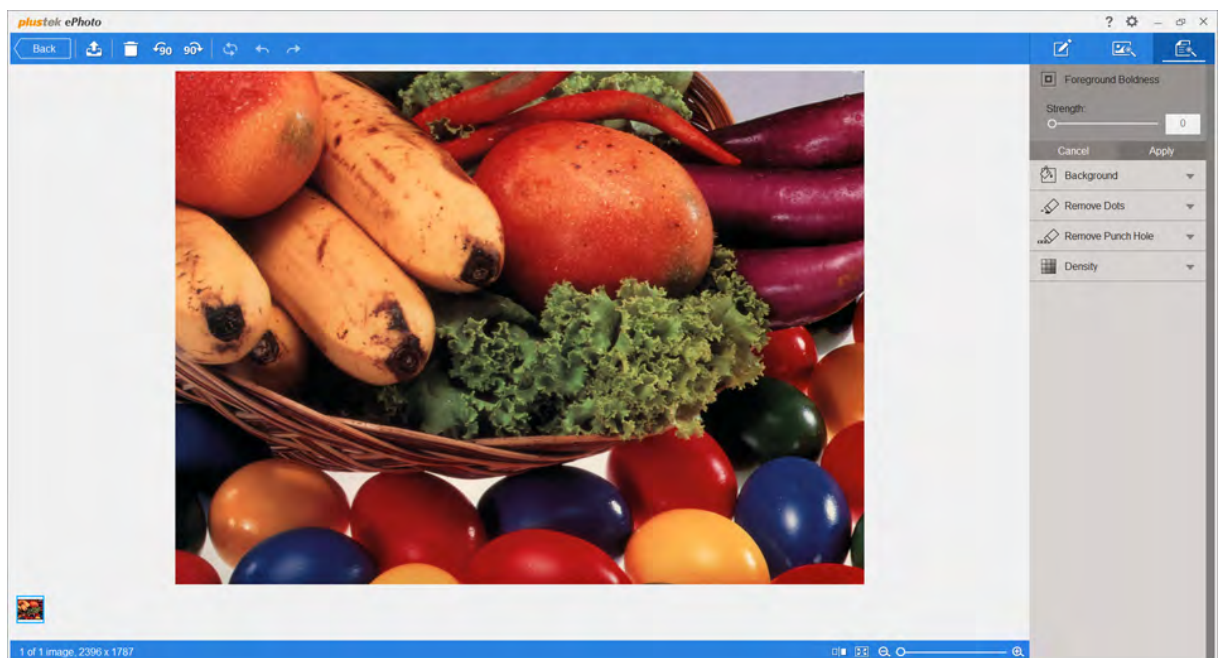
2.4.3 Adjust (For documents)



Click on the  tab to view all available adjustments you can apply to your documents. Click on any adjustment to apply it to the currently selected image. If the adjustment has sub-items you can select, it will be expanded when you click on it. Select the desired adjustments and click on the **Apply** button to apply the adjustment or click on the **Cancel** button to close the adjustment sub-items.

- **Foreground Boldness:** You may enhance characters of the scanned image by adjusting the foreground boldness.
- **Background:** You may select to perform **Background fill** or **Edge fill** with the background color or your selected color.
- **Remove Dots:** You may adjust the strength of **Remove Dots**.

- **Remove Punch Hole:** You may select to fill the punch holes with background color or your selected color.
- **Density:** You may adjust the strength of **Density** to improve the visual appearance of the scanned image.

3 Working with this program

This section covers the most frequent how-tos you may want to know with this program. We'll walk you through these practical applications step by step.

- **Scan Images:** Scan and save one or more images without processing them. The scanned images will be saved in the file format and folder of your choice.

3.1 Scan Images

Follow the steps described below:

1. To launch the program, you can do one of the following:

For Windows OS:

- Click on the **Plustek ePhoto** shortcut from the Windows **Start** menu > **All Programs** > **Your Scanner Model Name** folder. (For Windows 8.1 users: Point your mouse cursor to the upper or lower right corner of your screen to open the **Charm** bar. Click on the **Start** charm, then click on the downwards arrow button in the lower left corner of the screen. The **Apps** screen will be shown. Move your cursor to the right edge of the screen to scroll right until you find **Your Scanner Model Name**, and then click on **Plustek ePhoto**.)



Plustek ePhoto

- Double-click the icon on the desktop.

For Mac OS:

- Double-click the icon in **Finder** > **Applications** > **Plustek** > **Your scanner model name**.



- Click the icon in the Dock.

2. You will be greeted by the **Scan** screen. If it is necessary, adjust the scan settings by clicking the **Setting** button in the toolbar.
3. Insert the photo / document face down into the scanner. Always align the center of your photo / document edge to this alignment mark . Please place the edges of

your photo / document between both maximum scan area marks. The scanning starts immediately.

4. The scanned images are displayed in Plustek ePhoto, and you may perform the image editing tasks.
5. Click on the **Save** button, your images are already saved and can be found in the folder you set under **Scan and save directly to** in the **Preference** dialog.

You may select one or multiple images to delete, rotate or share at the same time. Simply click an image to select the desired image. Selected images will be highlighted with a blue rectangle around the images. Double click on the selected images bring you to the **Edit** screen, you may apply various filter effects and make more detailed adjustments to your images.