

## California Proposition 65 Warning

**WARNING:** This product contains or emits chemicals known to the state of California to cause cancer and birth defects or other reproductive harm.

### Event Data Recorders

**This vehicle is equipped with an event data recorder (EDR).**

The main purpose of an EDR is to record, in certain crash or near crash-like situations, such as an air bag deployment or hitting a road obstacle, data that will assist in understanding how a vehicle's systems performed. **The EDR is designed to record data related to vehicle dynamics and safety systems for a short period of time, typically 30 seconds or less. The EDR in this vehicle is designed to record such data as:**

- **How various systems in your vehicle were operating;**
- **Whether or not the driver and passenger safety belts were buckled/fastened;**
- **How far (if at all) the driver was depressing the accelerator and/or brake pedal; and,**
- **How fast the vehicle was traveling.**

These data can help provide a better understanding of the circumstances in which crashes and injuries occur. NOTE: EDR data are recorded by your vehicle only if a non-trivial crash situation occurs; no data are recorded by the EDR under normal driving conditions and no personal data (e.g., name, gender, age, and crash location) are recorded. However, other parties, such as law enforcement, could combine the EDR data with the type of personally identifying data routinely acquired during a crash investigation.

To read data recorded by an EDR, special equipment is required, and access to the vehicle or the EDR is needed. In addition to the vehicle manufacturer, other parties, such as law enforcement, that have the special equipment, can read the information if they have access to the vehicle or the EDR.

The data belongs to the vehicle owner and may not be accessed by anyone else except as legally required or with the permission of the vehicle owner.

### Service Diagnostic Recorders

This vehicle is equipped with service-related devices that record information about powertrain performance. The data can be used to verify emissions law requirements and/or help technicians diagnose and solve service problems. It may also be combined with data from other sources for research purposes, but it remains confidential.

### California Perchlorate Contamination Prevention Act

The airbags, seat belt tensioners, and CR type batteries in this vehicle may contain perchlorate materials - special handling may apply. See [www.dtsca.gov/hazardouswaste/perchlorate/](http://www.dtsca.gov/hazardouswaste/perchlorate/)

As you read this manual, you will find information that is preceded by a **NOTICE** symbol. This information is intended to help you avoid damage to your vehicle, other property, or the environment.

## A Few Words About Safety

---

Your safety, and the safety of others, is very important. And operating this vehicle safely is an important responsibility.

To help you make informed decisions about safety, we have provided operating procedures and other information on labels and in this manual. This information alerts you to potential hazards that could hurt you or others.

Of course, it is not practical or possible to warn you about all the hazards associated with operating or maintaining your vehicle. You must use your own good judgment.

You will find this important safety information in a variety of forms, including:

- **Safety Labels** - on the vehicle.
- **Safety Messages** - preceded by a safety alert symbol  and one of three signal words: **DANGER**, **WARNING**, or **CAUTION**. These signal words mean:

 **DANGER**

You WILL be KILLED or SERIOUSLY HURT if you don't follow instructions.

 **WARNING**

You CAN be KILLED or SERIOUSLY HURT if you don't follow instructions.

 **CAUTION**

You CAN be HURT if you don't follow instructions.

- **Safety Headings** - such as Important Safety Precautions.
- **Safety Section** - such as Safe Driving.
- **Instructions** - how to use this vehicle correctly and safely.

This entire book is filled with important safety information - please read it carefully.

This owner's manual should be considered a permanent part of the vehicle and should remain with the vehicle when it is sold.

This owner's manual covers all models of your vehicle. You may find descriptions of equipment and features that are not on your particular model.

Images throughout this owner's manual (including the front cover) represent features and equipment that are available on some, but not all, models. Your particular model may not have some of these features.

This owner's manual is for vehicles sold in the United States and Canada.

The information and specifications included in this publication were in effect at the time of approval for printing. Honda Motor Co., Ltd. reserves the right, however, to discontinue or change specifications or design at any time without notice and without incurring any obligation.

## ➤ Safe Driving P. 27

For Safe Driving P. 28      Seat Belts P. 32      Airbags P. 39

## ➤ Instrument Panel P. 67

Indicators P. 68      Gauges and Displays P. 82

## ➤ Controls P. 103

Clock P. 104      Locking and Unlocking the Doors P. 106  
Opening and Closing the Moonroof\* P. 130  
Adjusting the Seats P. 146  
Climate Control System\* P. 165

## ➤ Features P. 169

Audio System P. 170      Audio System Basic Operation P. 176, 179, 197  
Customized Features\* P. 233      *Bluetooth*® HandsFreeLink®\* P. 246, 277

## ➤ Driving P. 303

Before Driving P. 304      Towing a Trailer P. 309  
Rearview Camera\* P. 342      Refueling P. 343      Fuel Economy P. 346

## ➤ Maintenance P. 349

Before Performing Maintenance P. 350      Maintenance Minder™ P. 353  
Checking and Maintaining Wiper Blades P. 389  
Heating and Cooling System\*/Climate Control System\* Maintenance P. 403

## ➤ Handling the Unexpected P. 409

Tools P. 410      If a Tire Goes Flat P. 411  
Overheating P. 433      Indicator, Coming On/Blinking P. 435

## ➤ Information P. 445

Specifications P. 446      Identification Numbers P. 450  
Emissions Testing P. 453      Warranty Coverages P. 455

# Contents

Child Safety P. 52

Exhaust Gas Hazard P. 64

Safety Labels P. 65

Opening and Closing the Trunk P. 121

Security System P. 125

Opening and Closing the Windows P. 128

Operating the Switches Around the Steering Wheel P. 131

Adjusting the Mirrors P. 144

Interior Lights/Interior Convenience Items P. 154

Heating and Cooling\* P. 161

Audio Error Messages P. 224

General Information on the Audio System P. 230

When Driving P. 313

Braking P. 337

Parking Your Vehicle P. 341

Accessories and Modifications P. 347

Maintenance Under the Hood P. 361

Replacing Light Bulbs P. 376

Checking and Maintaining Tires P. 391

Battery P. 400

Remote Transmitter Care\* P. 401

Cleaning P. 404

Engine Does Not Start P. 426

Jump Starting P. 429

Shift Lever Does Not Move P. 432

Fuses P. 439

Emergency Towing P. 443

Devices that Emit Radio Waves P. 451

Reporting Safety Defects P. 452

Authorized Manuals P. 457

Customer Service Information P. 458

Quick Reference Guide P. 4

Safe Driving P. 27

Instrument Panel P. 67

Controls P. 103

Features P. 169

Driving P. 303

Maintenance P. 349

Handling the Unexpected P. 409

Information P. 445

Index P. 459



# Visual Index

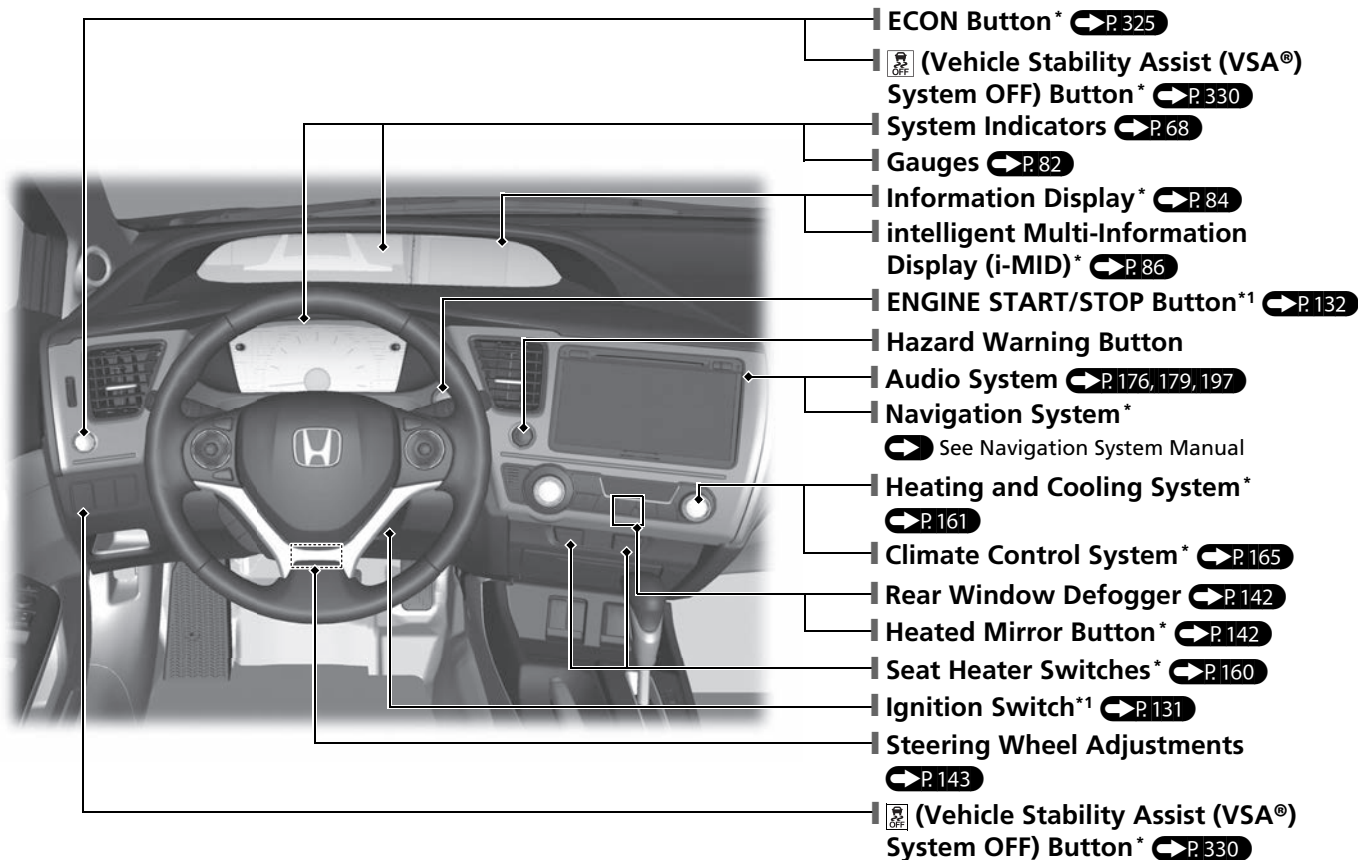

\*1: Models with the keyless access system have an **ENGINE START/STOP** button instead of an ignition switch.

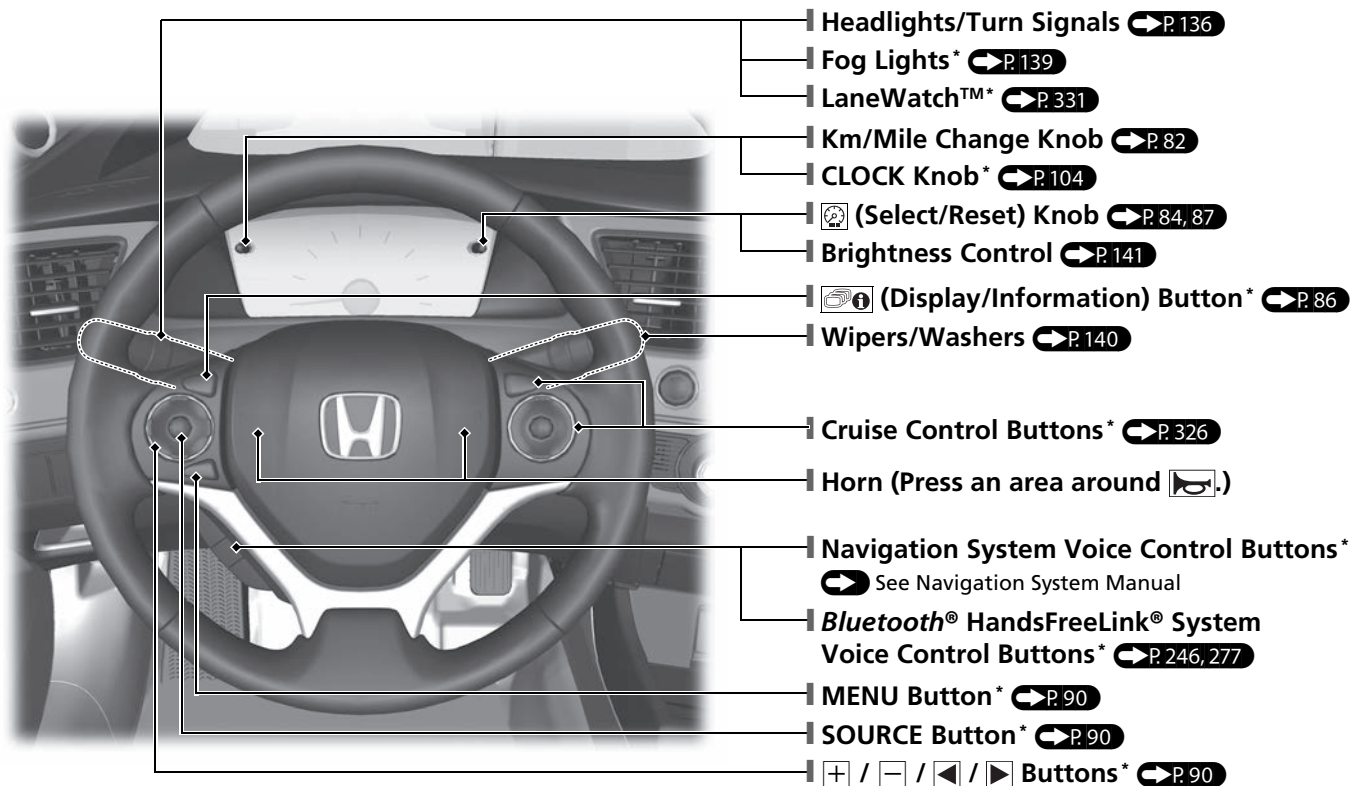

Headlights/Turn Signals ➔ P. 136

Fog Lights\* ➔ P. 139

LaneWatch™\* ➔ P. 331

Km/Mile Change Knob ➔ P. 82

CLOCK Knob\* ➔ P. 104

 (Select/Reset) Knob ➔ P. 84, 87

Brightness Control ➔ P. 141

 (Display/Information) Button\* ➔ P. 86

Wipers/Washers ➔ P. 140

Cruise Control Buttons\* ➔ P. 326

Horn (Press an area around )

Navigation System Voice Control Buttons\*

 See Navigation System Manual

Bluetooth® HandsFreeLink® System

Voice Control Buttons\* ➔ P. 246, 277

MENU Button\* ➔ P. 90

SOURCE Button\* ➔ P. 90

 /  /  /  Buttons\* ➔ P. 90

# Visual Index

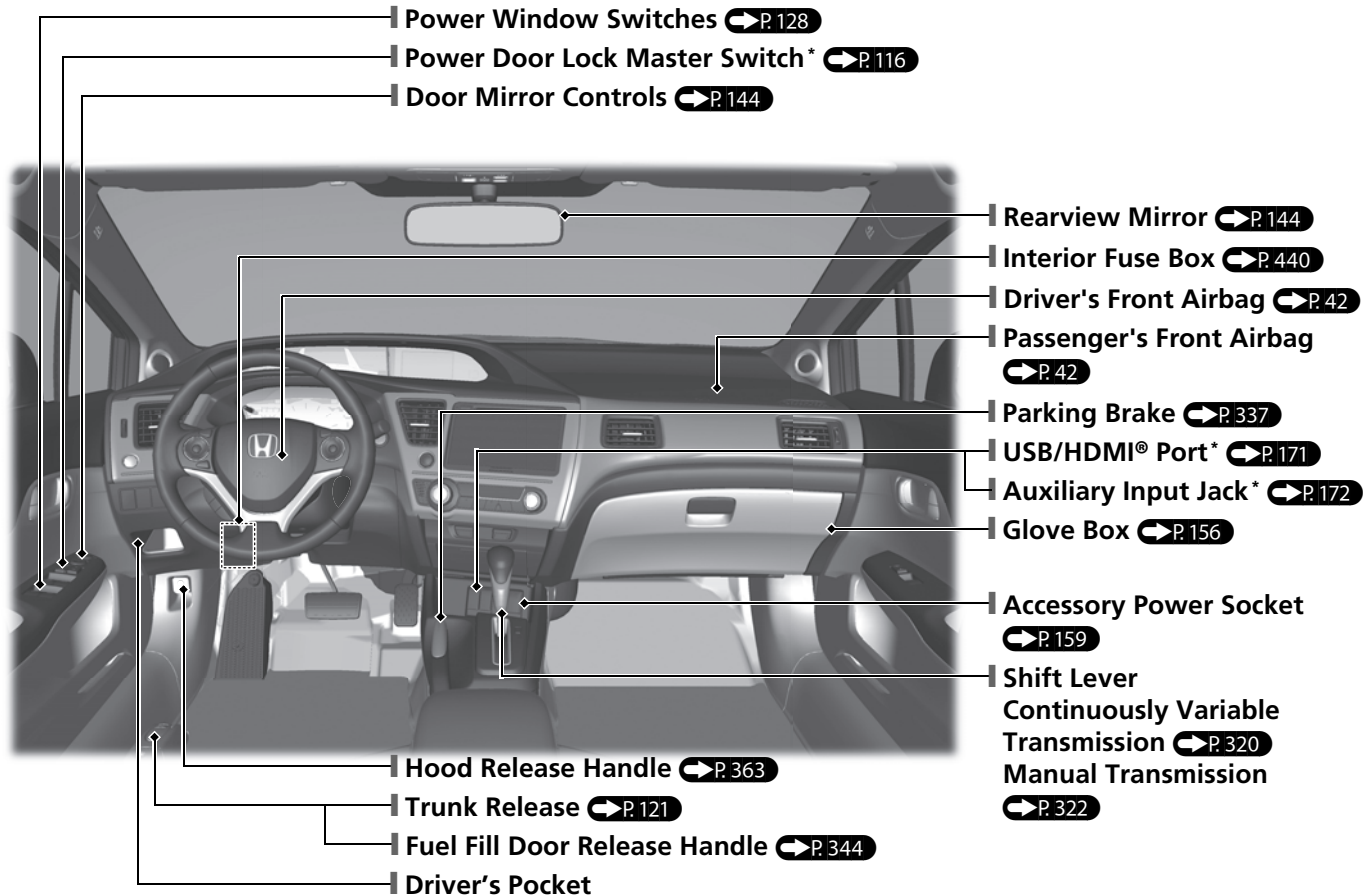

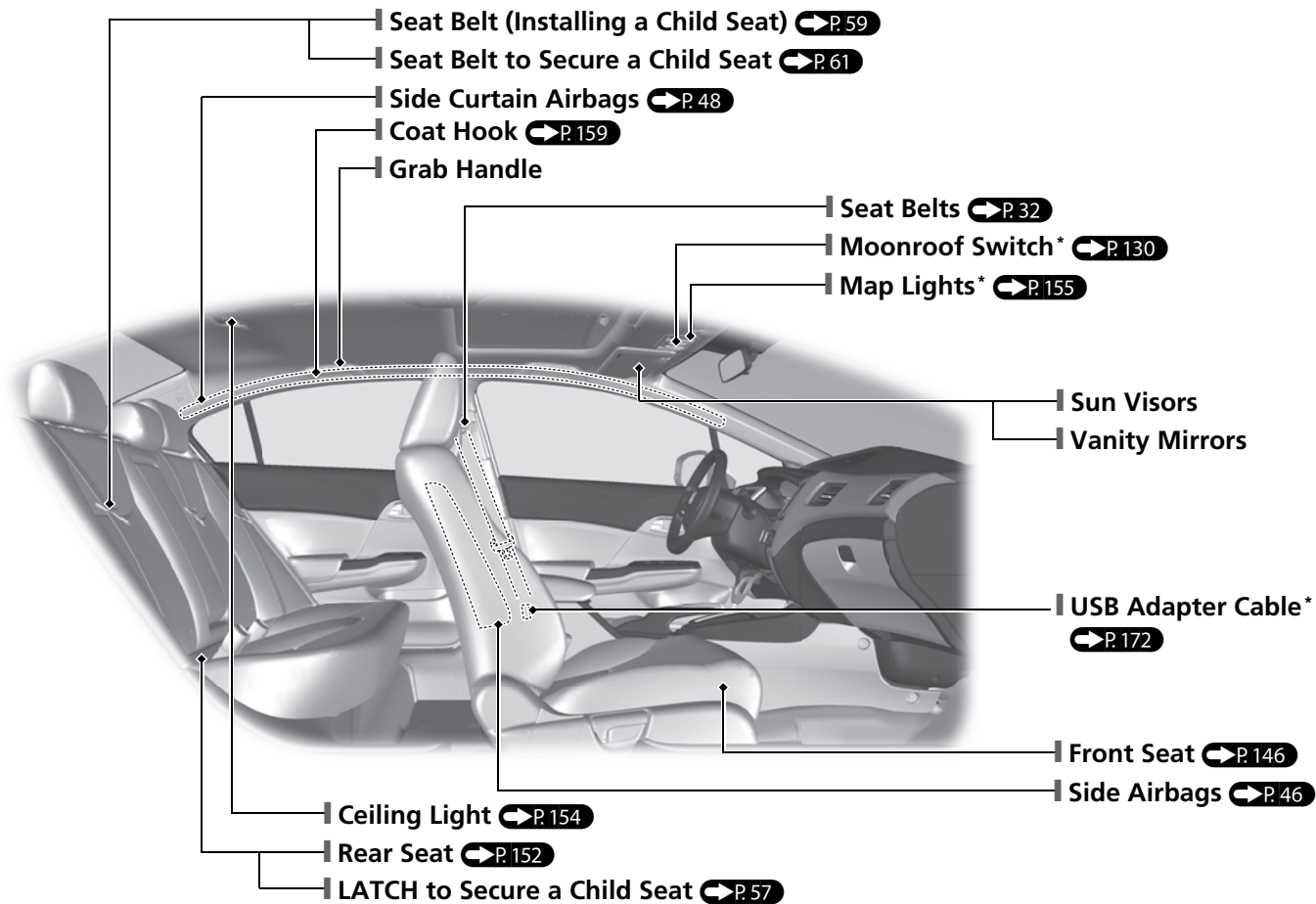

\* Not available on all models

# Visual Index

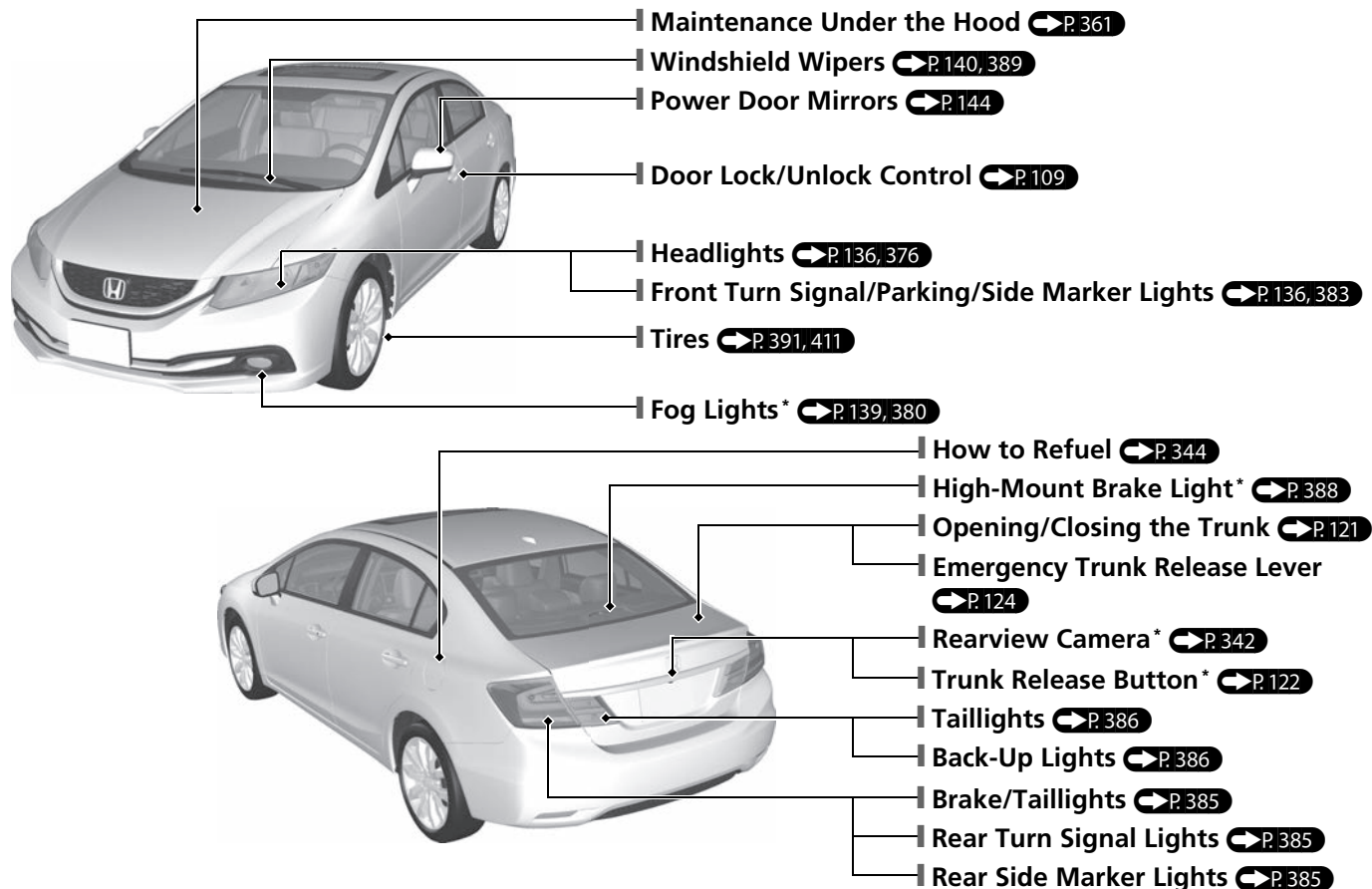

# Eco Assist System\*

➔ P. 325

## Ambient Meter

- Changes color to reflect your driving style.  
Green: Fuel efficient driving  
Blue green: Moderate acceleration/ deceleration  
Blue: Aggressive acceleration/ deceleration
- The ambient meter color changes in accordance with your brake or accelerator pedal operation.

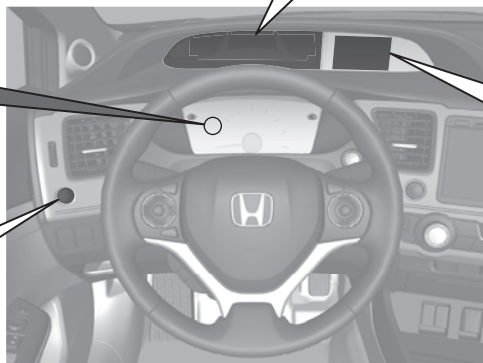

### ECON Button ➔ P. 325

Helps maximize fuel economy.

### ECON Mode Indicator ➔ P. 76

Comes on when the ECON button is pressed.



### Models with i-MID

The message is displayed for a few seconds when the ECON button is pressed.

# Safe Driving P. 27

## Airbags P. 39

- Your vehicle is fitted with airbags to help protect you and your passengers during a moderate-to-severe collision.

## Child Safety P. 52

- All children 12 and younger should be seated in the rear seat.
- Smaller children should be properly restrained in a forward-facing child seat.
- Infants must be properly restrained in a rear-facing child seat.

## Exhaust Gas Hazard P. 64

- Your vehicle emits dangerous exhaust gases that contain carbon monoxide. Do not run the engine in confined spaces where carbon monoxide gas can accumulate.

## Seat Belts P. 32

- Fasten your seat belt and sit upright well back in the seat.
- Check that your passengers are wearing their seat belts correctly.





## Before Driving Checklist P. 31

- Before driving, check that the front seats, head restraints, steering wheel, and mirrors have been properly adjusted.















Fasten your lap belt as low as possible.

# Instrument Panel



Gauges /Information Display\*   
 intelligent Multi-Information Display (i-MID)\* /System Indicators 

## System Indicators

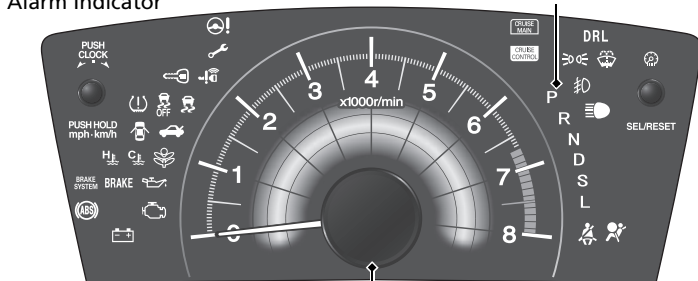
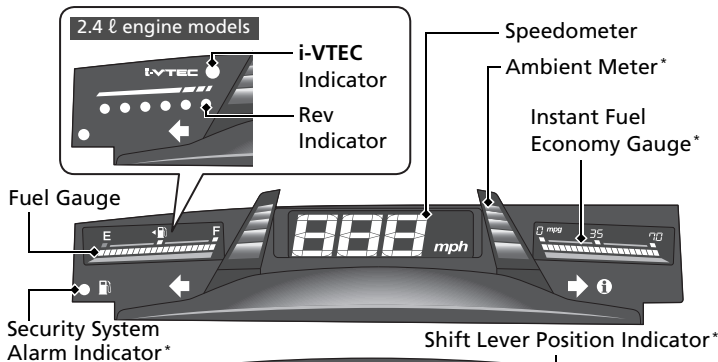

-  Malfunction Indicator Lamp
-  Low Oil Pressure Indicator
-  Charging System Indicator
-  Anti-lock Brake System (ABS) Indicator
-  Vehicle Stability Assist (VSA®) System Indicator
-  VSA® OFF Indicator
-  Door Open Indicator
-  Trunk Open Indicator
-  ECON Mode Indicator\*
-  BRAKE U.S. Parking Brake and Brake System Indicator (Red)
-  BRAKE SYSTEM U.S. Brake System Indicator (Amber)
-  BRAKE SYSTEM Canada















## System Indicators

-  Immobilizer System Indicator
-  Smart Entry System Indicator\*
-  Low Tire Pressure/TPMS Indicator\*

## Lights Indicators

-  Lights On Indicator
-  High Beam Indicator
-  Fog Light Indicator\*

## System Indicators

-  Turn Signal and Hazard Warning Indicators
-  Electric Power Steering (EPS) System Indicator
-  High Temperature Indicator
-  Low Temperature Indicator
-  Low Fuel Indicator
-  Seat Belt Reminder Indicator
-  Supplemental Restraint System Indicator
-  CRUISE MAIN Indicator\*
-  CRUISE CONTROL Indicator\*
-  System Message Indicator\*
-  Maintenance Minder Indicator\*
-  DRL Daytime Running Lights Indicator\*
-  Washer Level Indicator\*

\* Not available on all models



# Controls P. 103

## Clock P. 104

Models without navigation system

Models without display audio

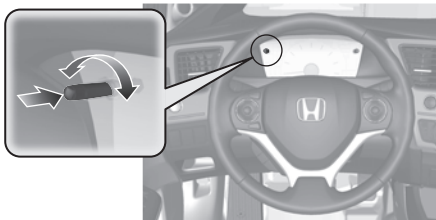

- 1 Press the **CLOCK** knob to access the clock adjustment mode screen.
- 2 Turn the **CLOCK** knob to adjust the hours.
- 3 Press the **CLOCK** knob. The display switches to minute adjustment.
- 4 Turn the **CLOCK** knob to adjust the minutes.
- 5 Press the **CLOCK** knob to complete clock adjustment.

Models with navigation system

The navigation system receives signals from GPS satellites, updating the clock automatically.

## ENGINE START/STOP Button\*

- Press the button to change the vehicle's power mode.



## Turn Signals P. 136

Turn Signal Control Lever



## Lights P. 136

Light Control Switches

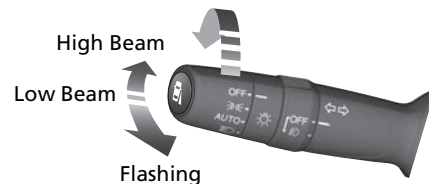

## Wipers and Washers

 P. 140

Wiper/Washer Control Lever

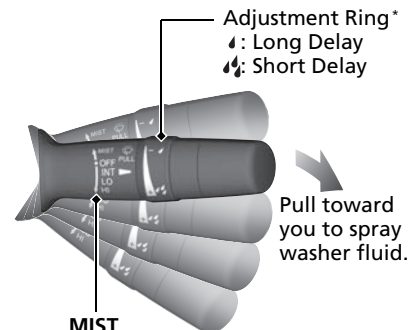

**MIST**  
**OFF**

**INT:** Low speed with intermittent  
**LO:** Low speed wipe  
**HI:** High speed wipe

## Steering Wheel P. 143

- To adjust, pull the adjustment lever towards you, adjust to the desired position, then lock the lever back in place.

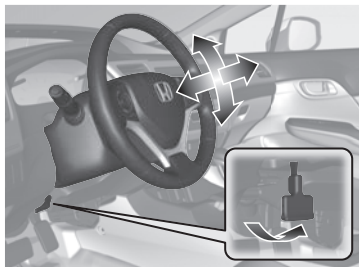

## Unlocking the Front Doors from the Inside

 P. 114

- Pull either front door inner handle to unlock and open it at the same time.



## Trunk P. 121

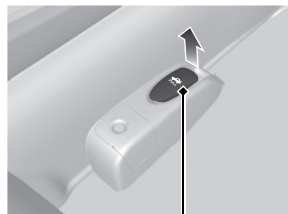

Trunk Release

- To unlock and open the trunk:
- Pull the trunk release.
- Press the trunk release button\* on the remote transmitter or the smart entry remote.
- Press the trunk release button\* on the trunk lid.
- Turn the key in the cylinder on the trunk\*.

## Power Door Mirrors

 P. 144

- With the ignition switch in ON \*, move the selector switch to L or R.
- Push the appropriate edge of the adjustment switch to adjust the mirror.

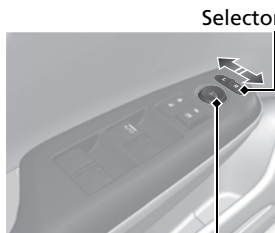

Adjustment Switch





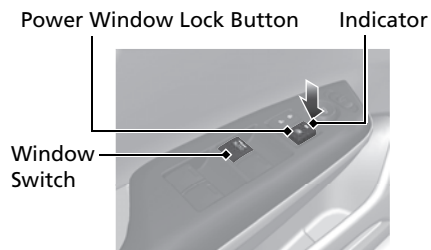

## Power Windows P. 128

- With the ignition switch in ON \*, open and close the power windows.
- If the power window lock button is in the off position, each passenger's window can be opened and closed with its own switch.
- If the power window lock button is in the on position (indicator is on), each passenger's window switch is disabled.







\*1: Models with the smart entry system have an **ENGINE START/STOP** button instead of an ignition switch.

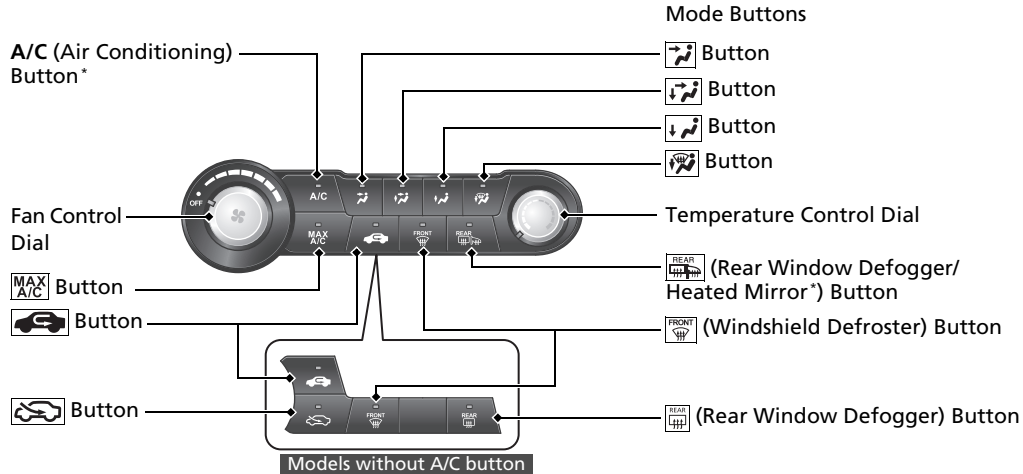

## Heating and Cooling System\* P. 161

- Rotate the fan control dial to adjust the fan speed and airflow.
- Press the Mode buttons ( /  /  / ) to select the vents air flows from.
- Rotate the temperature control dial to adjust the temperature.
- Use the  button for maximum cool setting.
- Rotate the fan control dial to **OFF** to turn the system off.
- Press the  button to defrost the windshield.



-  Air flows from dashboard vents.
-  Air flows from floor and dashboard vents.
-  Air flows from floor vents.
-  Air flows from floor and windshield defroster vents.

# Climate Control System\*

- Press the **AUTO** button to activate the climate control system.
- Press the  button to turn the system on or off.
- Press the  button to defrost the windshield.

On models with navigation system

The climate control system is voice operable. See the Navigation System Manual for complete details.

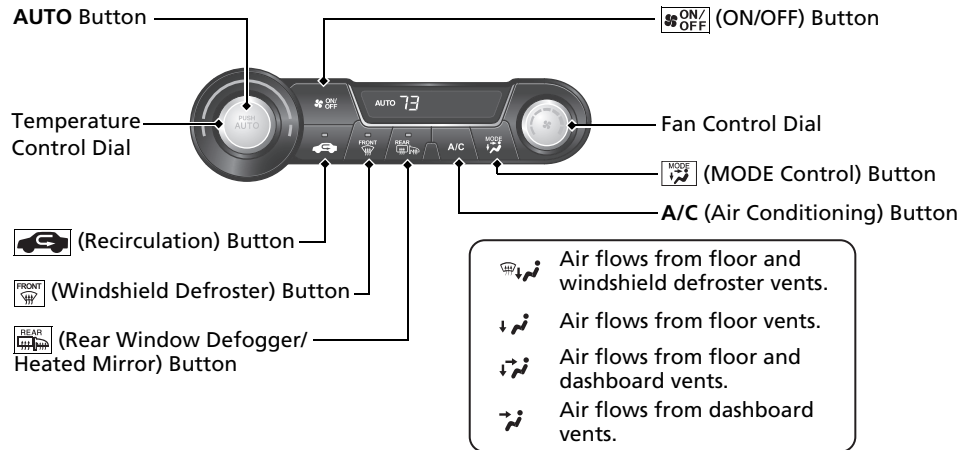



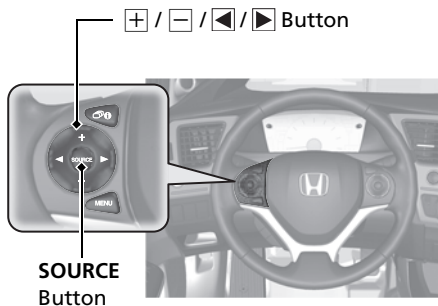

# Features P. 169

## Audio Remote Controls\*

 P. 174



-   Button  
Press to adjust the volume up/down.
- **SOURCE** Button  
Press to change the audio mode: FM1/  
FM2/AM/CD/AUX.
-   Button  
Radio: Press to change the preset station.  
Press and hold to select the next or  
previous strong station.  
CD/USB device:  
Press to skip to the beginning of  
the next song or return to the  
beginning of the current song.  
Press and hold to change a folder.

## Audio system P. 170

For navigation system operation  See the Navigation System Manual

Models with information display  P. 176

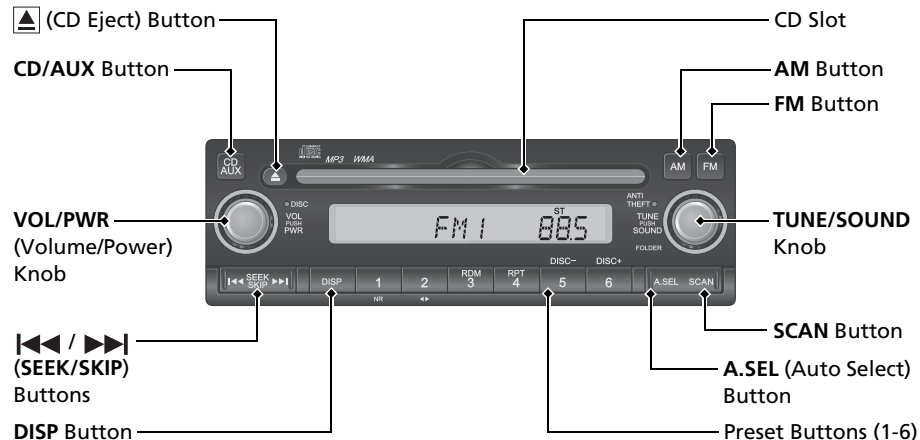

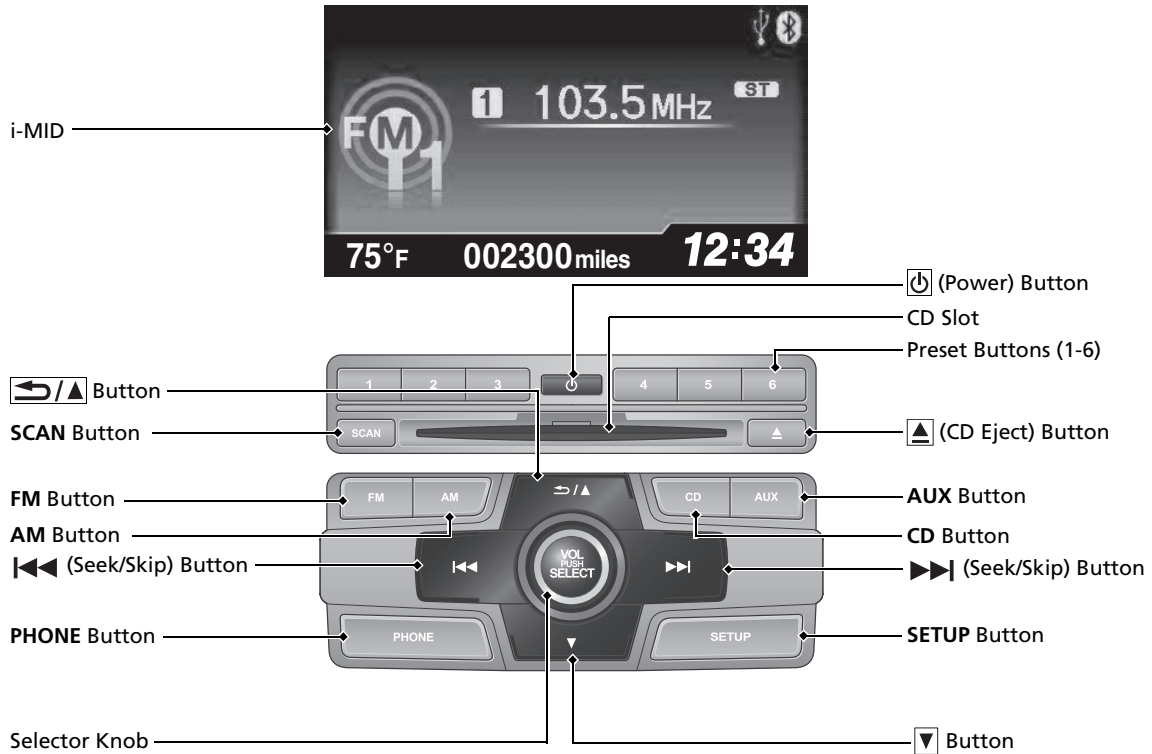

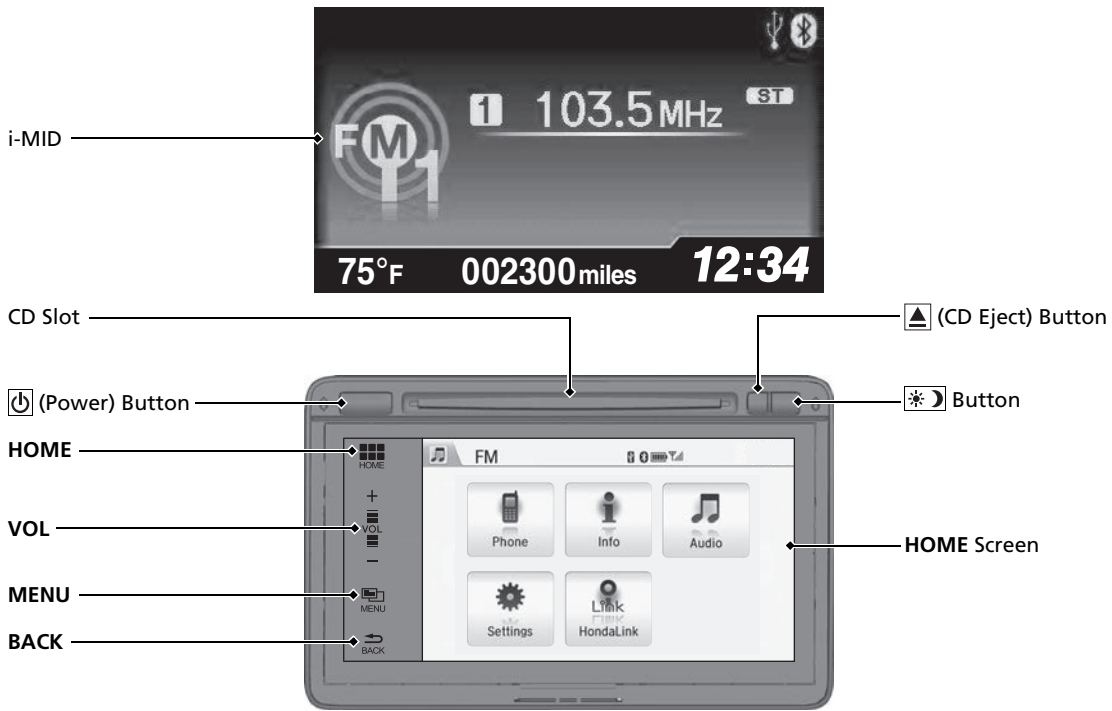

# Driving P. 303

## Manual Transmission \* P. 322

## Continuously Variable Transmission \* P. 320

- Shift to **P** and depress the brake pedal when starting the engine.

### ● Shifting

**P** **Park**  
Turn off or start the engine.  
Transmission is locked.

**R** **Reverse**  
Used when reversing.

**N** **Neutral**  
Transmission is not locked.

**D** **Drive**  
Normal driving.

**S** **Drive (S)**

- Better acceleration.
- Increased engine braking.
- Going up or down hills.

**L** **Low**

- Further increased engine braking.
- Going up or down hills.

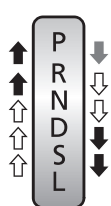

Depress the brake pedal and press the release button to move out of **P**.

Press the release button to move the shift lever.

Move the shift lever without pressing the release button.



## VSA® OFF Button P. 330

- The vehicle stability assist (VSA®) system helps stabilize the vehicle during cornering, and helps maintain traction while accelerating on loose or slippery road surfaces.
- VSA® comes on automatically every time you start the engine.
- To turn VSA® on or off, press and hold the button until you hear a beep.

## Cruise Control\* P. 326

- Cruise control allows you to maintain a set speed without keeping your foot on the accelerator pedal.
- To use cruise control, press the **CRUISE** button, then press the **-/SET** button once you have achieved the desired speed (above 25 mph or 40 km/h).

U.S. models

## Tire Pressure Monitoring System (TPMS) P. 333

- Detects a change in tire conditions and overall dimensions due to decrease in tire pressures.
- The TPMS is turned on automatically every time you start the engine.
- A calibration procedure must be performed when certain conditions arise.

## Refueling P. 343

**Fuel recommendation:** **1.8 l engine models**

**Unleaded gasoline with a pump octane number 87 or higher required**

**2.4 l engine models**

**Unleaded premium gasoline with a pump octane number 91 or higher recommended**

**Fuel tank capacity: 13.2 US gal (50 L)**

- 1** Push the fuel fill door release handle.

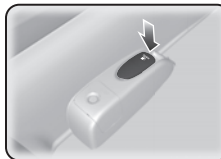

- 2** Turn the fuel fill cap slowly to remove the cap.



- 3** Place the cap in the holder on the fuel fill door.



- 4** After refueling, screw the cap back on until it clicks at least once.

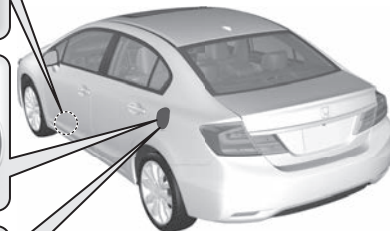

# Maintenance P. 349

## Under the Hood P. 361

- Check engine oil, engine coolant, and windshield washer fluid. Add when necessary.
- Check brake fluid and clutch\* fluid.
- Check the battery condition monthly.

- 1 Pull the hood release handle under the corner of the dashboard.

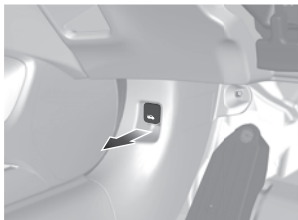

- 2 Locate the hood latch lever, pull the lever up, and lift up the hood.



- 3 When finished, close the hood and make sure it is firmly locked in place.

## Wiper Blades P. 389

- Replace blades if they leave streaks across the windshield.

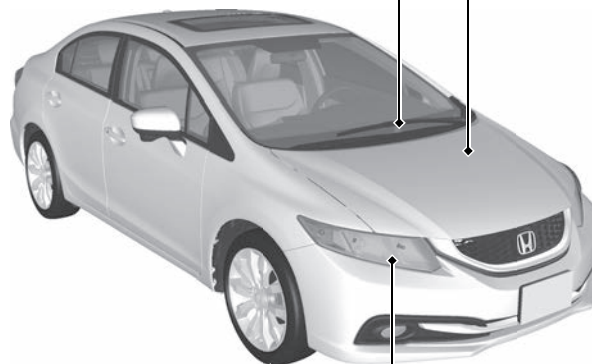

## Tires P. 391

- Inspect tires and wheels regularly.
- Check tire pressures regularly.
- Install snow tires for winter driving.

## Lights P. 376

- Inspect all lights regularly.

# Handling the Unexpected P. 409

## Flat Tire P. 411, 418

- Park in a safe location and replace the flat tire with the compact spare tire\* in the trunk, or repair the flat tire using the tire repair kit\*.



## Engine Won't Start P. 426

- If the battery is dead, jump start using a booster battery.

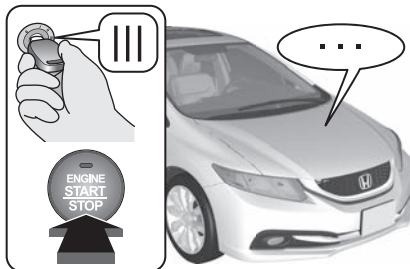

## Overheating P. 433

- Park in a safe location. If you do not see steam under the hood, open the hood, and let the engine cool down.



## Indicators Come On P. 435

- Identify the indicator and consult the owner's manual.



## Blown Fuse P. 439

- Check for a blown fuse if an electrical device does not operate.

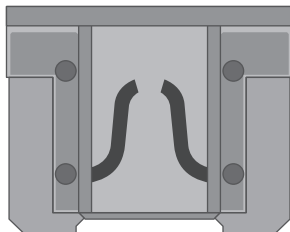

## Emergency Towing P. 443

- Call a professional towing service if you need to tow your vehicle.



# What to Do If

**Q** The ignition switch does not turn from **0** to **I**\*1. Why?

**A**

- The steering wheel may be locked.

Models without smart entry system

- Try to turn the steering wheel left and right while turning the ignition key.

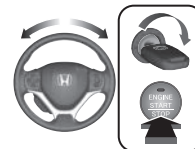

Models with smart entry system\*2

- Move the steering wheel left and right while pressing the **ENGINE START/STOP** button at the same time.

**Q** The ignition switch does not turn from **I** to **0**\*1 and I cannot remove the key. Why?

**A** The shift lever should be moved to **P**.



**Q** Why does the brake pedal pulsate slightly when applying the brakes?

**A** This can occur when the ABS activates, and does not indicate a problem. Apply firm, steady pressure on the brake pedal. Never pump the brake pedal.

\*1: Models with the smart entry system have an **ENGINE START/STOP** button instead of an ignition switch.

\*2: Except U.S. models with continuously variable transmission

**Q** The rear door cannot be opened from inside the vehicle. Why?

**A** Check if the childproof lock is in the lock position. If so, open the rear door with the outside door handle. To cancel this function, push the lever to the unlock position.

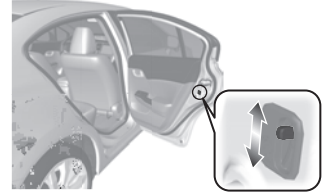

**Q** **Models with remote transmitter**  
Why do the doors lock after I unlocked the doors using a remote transmitter?

**A** If you do not open the doors within 30 seconds, the doors are relocked automatically for security.

**Q** Why does the beeper sound when I open the driver's door?

**A** The beeper sounds when:

- The key is left in the ignition switch\*.
- The power mode\* is in ACCESSORY.
- The exterior lights are left on.

**Q** Why does the beeper sound when I start driving?

**A** The beeper sounds when:

- Driver and/or front passenger are not wearing their seat belts.
- The parking brake lever is not fully released.

**Q** Why do I hear a screeching sound when I apply the brake pedal?

**A** The brake pads may need to be replaced. Have your vehicle inspected by a dealer.

---

2.4 l engine models



**Is it possible to use unleaded gasoline with a Pump Octane Number (PON) of 87 or higher on this vehicle?**



Unleaded gasoline with a pump octane number of 91 or higher is recommended.

If premium unleaded gasoline with a PON of 91 or higher is not available, you can temporarily use the gasoline with a PON of 87 or higher.

This will result in decreased engine performance, and can cause occasional metallic knocking noise in the engine.

---



# Safe Driving

You can find many safety recommendations throughout this chapter, and throughout this manual.

## **For Safe Driving**

Important Safety Precautions .....	28
Your Vehicle's Safety Features.....	30

## **Seat Belts**

About Your Seat Belts.....	32
Fastening a Seat Belt.....	35
Seat Belt Inspection.....	38

## **Airbags**

Airbag System Components.....	39
Types of Airbags .....	42
Front Airbags (SRS) .....	42
Side Airbags.....	46

Side Curtain Airbags.....	48
Airbag System Indicators.....	49
Airbag Care .....	51

## **Child Safety**

Protecting Child Passengers .....	52
Safety of Infants and Small Children .....	54
Safety of Larger Children .....	62

## **Exhaust Gas Hazard**

Carbon Monoxide Gas.....	64
--------------------------	----

## **Safety Labels**

Label Locations .....	65
-----------------------	----



The following pages explain your vehicle's safety features and how to use them properly. The safety precautions below are ones that we consider to be among the most important.

## Important Safety Precautions

### ■ Always wear your seat belt

A seat belt is your best protection in all types of collisions. Airbags are designed to supplement seat belts, not replace them. So even though your vehicle is equipped with airbags, make sure you and your passengers always wear your seat belts, and wear them properly.

### ■ Restrain all children

Children ages 12 and under should ride properly restrained in a back seat, not the front seat. Infants and small children should be restrained in a child seat. Larger children should use a booster seat and a lap/shoulder seat belt until they can use the belt properly without a booster seat.

### ■ Be aware of airbag hazards

While airbags can save lives, they can cause serious or fatal injuries to occupants who sit too close to them, or are not properly restrained. Infants, young children, and short adults are at the greatest risk. Be sure to follow all instructions and warnings in this manual.

### ■ Don't drink and drive

Alcohol and driving don't mix. Even one drink can reduce your ability to respond to changing conditions, and your reaction time gets worse with every additional drink. So don't drink and drive, and don't let your friends drink and drive, either.

### ▣ Important Safety Precautions

Some states, provinces and territories prohibit the use of cell phones other than hands-free devices by the driver while driving.

■ **Pay appropriate attention to the task of driving safely**

Engaging in cell phone conversation or other activities that keep you from paying close attention to the road, other vehicles, and pedestrians could lead to a crash. Remember, situations can change quickly, and only you can decide when it is safe to divert some attention away from driving.

■ **Control your speed**

Excessive speed is a major factor in crash injuries and deaths. Generally, the higher the speed, the greater the risk, but serious injuries can also occur at lower speeds. Never drive faster than is safe for current conditions, regardless of the maximum speed posted.

■ **Keep your vehicle in safe condition**

Having a tire blowout or a mechanical failure can be extremely hazardous. To reduce the possibility of such problems, check your tire pressures and condition frequently, and perform all regularly scheduled maintenance.

## Your Vehicle's Safety Features

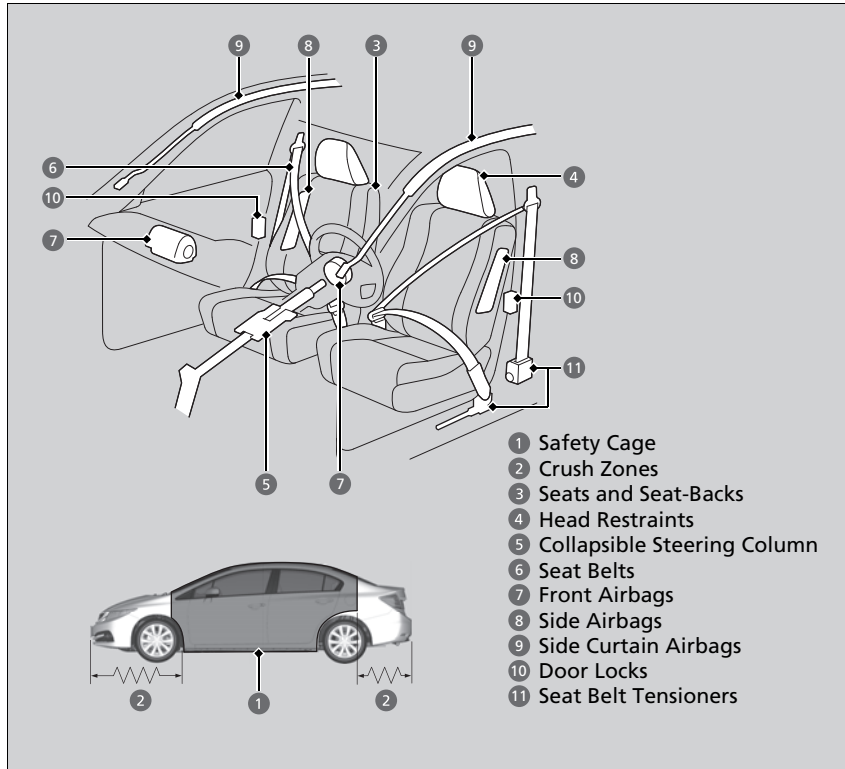

The following checklist will help you take an active role in protecting yourself and your passengers.

### ►► Your Vehicle's Safety Features

Your vehicle is equipped with many features that work together to help protect you and your passengers during a crash.

Some features do not require any action on your part. These include a strong steel framework that forms a safety cage around the passenger compartment, front and rear crush zones, a collapsible steering column, and tensioners that tighten the front seat belts in a sufficient crash.

However, you and your passengers cannot take full advantage of these features unless you remain seated in the correct position and always wear your seat belts. In fact, some safety features can contribute to injuries if they are not used properly.

## Safety Checklist

For the safety of you and your passengers, make a habit of checking these items each time before you drive.

- After everyone has entered the vehicle, be sure all doors are closed and locked. Locking the doors helps prevent an occupant from being ejected and an outsider from unexpectedly opening a door.

➤ **Locking/Unlocking the Doors from the Inside** P. 114

- Adjust your seat to a position suitable for driving. Be sure the front seats are adjusted as far to the rear as possible while allowing the driver to control the vehicle. Sitting too close to a front airbag can result in serious or fatal injury in a crash.

➤ **Adjusting the Seats** P. 146

- Adjust head restraints to the proper position. Head restraints are most effective when the center of the head restraint aligns with the center of your head. Taller persons should adjust their head restraint to the highest position.

➤ **Adjusting the Head Restraints** P. 149

- Always wear your seat belt, and make sure you wear it properly. Confirm that any passengers are properly belted as well.

➤ **Fastening a Seat Belt** P. 35

- Protect children by using seat belts or child seats according to a child's age, height and weight.

➤ **Child Safety** P. 52

### Safety Checklist

If the door open indicator is on, a door is not completely closed. Close all doors tightly until the indicator goes off.

➤ **Door Open Indicator** P. 72

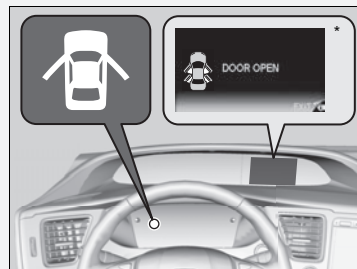

## About Your Seat Belts

Seat belts are the single most effective safety device because they keep you connected to the vehicle so that you can take advantage of many built-in safety features. They also help keep you from being thrown against the inside of the vehicle, against other passengers, or out of the vehicle. When worn properly, seat belts also keep your body properly positioned in a crash so that you can take full advantage of the additional protection provided by the airbags.

In addition, seat belts help protect you in almost every type of crash, including:

- frontal impacts
- side impacts
- rear impacts
- rollovers

### ■ Lap/shoulder seat belts

All five seating positions are equipped with lap/shoulder seat belts with emergency locking retractors. In normal driving the retractor lets you move freely while keeping some tension on the belt. During a collision or sudden stop the retractor locks to restrain your body. The rear seat belts also have a lockable retractor for use with child seats.

➤ **Installing a Child Seat with a Lap/Shoulder Seat Belt** P. 59

### ➤ About Your Seat Belts

## **WARNING**

**Not wearing a seat belt properly increases the chance of serious injury or death in a crash, even though your vehicle has airbags.**

**Be sure you and your passengers always wear seat belts and wear them properly.**

Seat belts cannot completely protect you in every crash. But in most cases, seat belts can reduce your risk of serious injury.

Most states and all Canadian provinces and territories require you to wear seat belts.

The emergency locking retractor may lock if you lean forward too quickly. Slower movements will allow the belt to extend fully without locking.

## ■ Proper use of seat belts

Follow these guidelines for proper use:

- All occupants should sit upright, well back in the seat, and remain in that position for the duration of the trip. Slouching and leaning reduce the effectiveness of the belt and can increase the chance of serious injury in a crash.
- Never place the shoulder part of a lap/shoulder seat belt under your arm or behind your back. This could cause very serious injuries in a crash.
- Two people should never use the same seat belt. If they do, they could be very seriously injured in a crash.
- Do not put any accessories on the seat belts. Devices intended to improve comfort or reposition the shoulder part of a seat belt can reduce the protective capability and increase the chance of serious injury in a crash.

## ■ Seat Belt Reminder



Your vehicle monitors front seat belt use. If the ignition switch is turned to ON **II**\*1 before the driver's seat belt is fastened, the beeper will sound and the indicator will blink. If the driver does not fasten the belt before the beeper stops, the indicator will remain on.

The beeper will also periodically sound and the indicator will blink while driving until the driver's and front passenger's seat belts are fastened.

\*1: Models with the smart entry system have an **ENGINE START/STOP** button instead of an ignition switch.

\* Not available on all models

## ▶ About Your Seat Belts

If a rear seat passenger moves around and extends the seat belt, the lockable retractor may activate. If this happens, release the retractor by unfastening the seat belt and allow the belt to retract completely. Then refasten the belt.

## ▶ Seat Belt Reminder

The indicator will also come on if a front passenger does not fasten their seat belt within six seconds after the ignition switch is turned to ON **II**\*1. When no one is sitting in the front passenger's seat, the indicator will not come on and the beeper will not sound. The indicator also may not come on and the beeper may not sound when the occupant is not heavy enough to trigger the weight sensor. Such occupants (e.g., infants and smaller children) should be moved to the rear seat as a deploying front airbag likely will injure or kill them.

▶ **Protecting Child Passengers** P. 52

## ■ Automatic Seat Belt Tensioners

The front seats are equipped with automatic seat belt tensioners to enhance safety.

The tensioners automatically tighten the front seat belts during a moderate-to-severe frontal collision, sometimes even if the collision is not severe enough to inflate the front airbags.

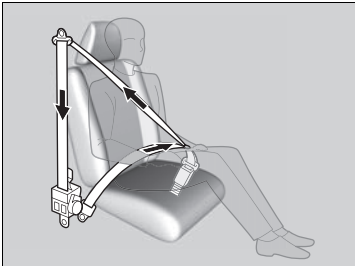

## ▶▶ Automatic Seat Belt Tensioners

The seat belt tensioners can only operate once. If a tensioner is activated, the SRS indicator will come on. Have a dealer replace the tensioner and thoroughly inspect the seat belt system as it may not offer protection in a subsequent crash.

During a moderate-to-severe side impact, the tensioner on that side of the vehicle also activates.

## Fastening a Seat Belt

After adjusting a front seat to the proper position, and while sitting upright and well back in the seat:

▶ **Adjusting the Seats** P. 146

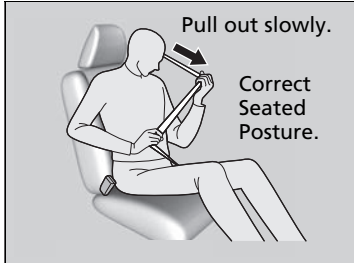

1. Pull the seat belt out slowly.

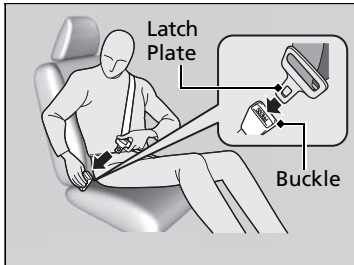

2. Insert the latch plate into the buckle, then tug on the belt to make sure the buckle is secure.

▶ Make sure that the belt is not twisted or caught on anything.

### ▶▶ Fastening a Seat Belt

No one should sit in a seat with an inoperative seat belt or one that does not appear to be working correctly. Using a seat belt that is not working properly may not protect the occupant in a crash. Have a dealer check the belt as soon as possible.

Never insert any foreign objects into the buckle or retractor mechanism.





3. Position the lap part of the belt as low as possible across your hips, then pull up on the shoulder part of the belt so the lap part fits snugly. This lets your strong pelvic bones take the force of a crash and reduces the chance of internal injuries.
4. If necessary, pull up on the belt again to remove any slack, then check that the belt rests across the center of your chest and over your shoulder. This spreads the forces of a crash over the strongest bones in your upper body.

### Adjusting the Shoulder Anchor

The front seats have adjustable shoulder anchors to accommodate taller and shorter occupants.

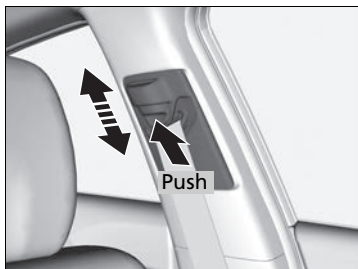

1. Move the anchor up and down while holding the release button.
2. Position the anchor so that the belt rests across the center of your chest and over your shoulder.

### Fastening a Seat Belt

#### **WARNING**

Improperly positioning the seat belts can cause serious injury or death in a crash.

**Make sure all seat belts are properly positioned before driving.**

To release the belt, push the red **PRESS** button then guide the belt by hand until it has retracted completely.

When exiting the vehicle, be sure the belt is out of the way and will not get caught by closing the door.

### Adjusting the Shoulder Anchor

The shoulder anchor height can be adjusted to four levels. If the belt contacts your neck, lower the height one level at a time.

After an adjustment, make sure that the shoulder anchor position is secure.

## Advice for Pregnant Women

If you are pregnant, the best way to protect yourself and your unborn child when driving or riding in a vehicle is to always wear a seat belt and keep the lap part of the belt as low as possible across the hips.

Wear the shoulder belt across the chest avoiding the abdomen.



Wear the lap part of the belt as low as possible across the hips.

## Advice for Pregnant Women

Each time you have a checkup, ask your doctor if it is okay for you to drive.

To reduce the risk of injuries to both you and your unborn child that can be caused by an inflating front airbag:

- When driving, sit upright and adjust the seat as far back as possible while allowing full control of the vehicle.
- When sitting in the front passenger's seat, adjust the seat as far back as possible.

## Seat Belt Inspection

Regularly check the condition of your seat belts as follows:

- Pull each belt out fully, and look for frays, cuts, burns, and wear.
- Check that the latches work smoothly and the belts retract easily.
  - ▶ If a belt does not retract easily, cleaning the belt may correct the problem. Only use a mild soap and warm water. Do not use bleach or cleaning solvents. Make sure the belt is completely dry before allowing it to retract.

Any belt that is not in good condition or working properly will not provide proper protection and should be replaced as soon as possible.

A belt that has been worn during a crash may not provide the same level of protection in a subsequent crash. Have your seat belts inspected by a dealer after any collision.

### Seat Belt Inspection

#### **WARNING**

**Not checking or maintaining seat belts can result in serious injury or death if the seat belts do not work properly when needed.**

**Check your seat belts regularly and have any problem corrected as soon as possible.**

## Airbag System Components

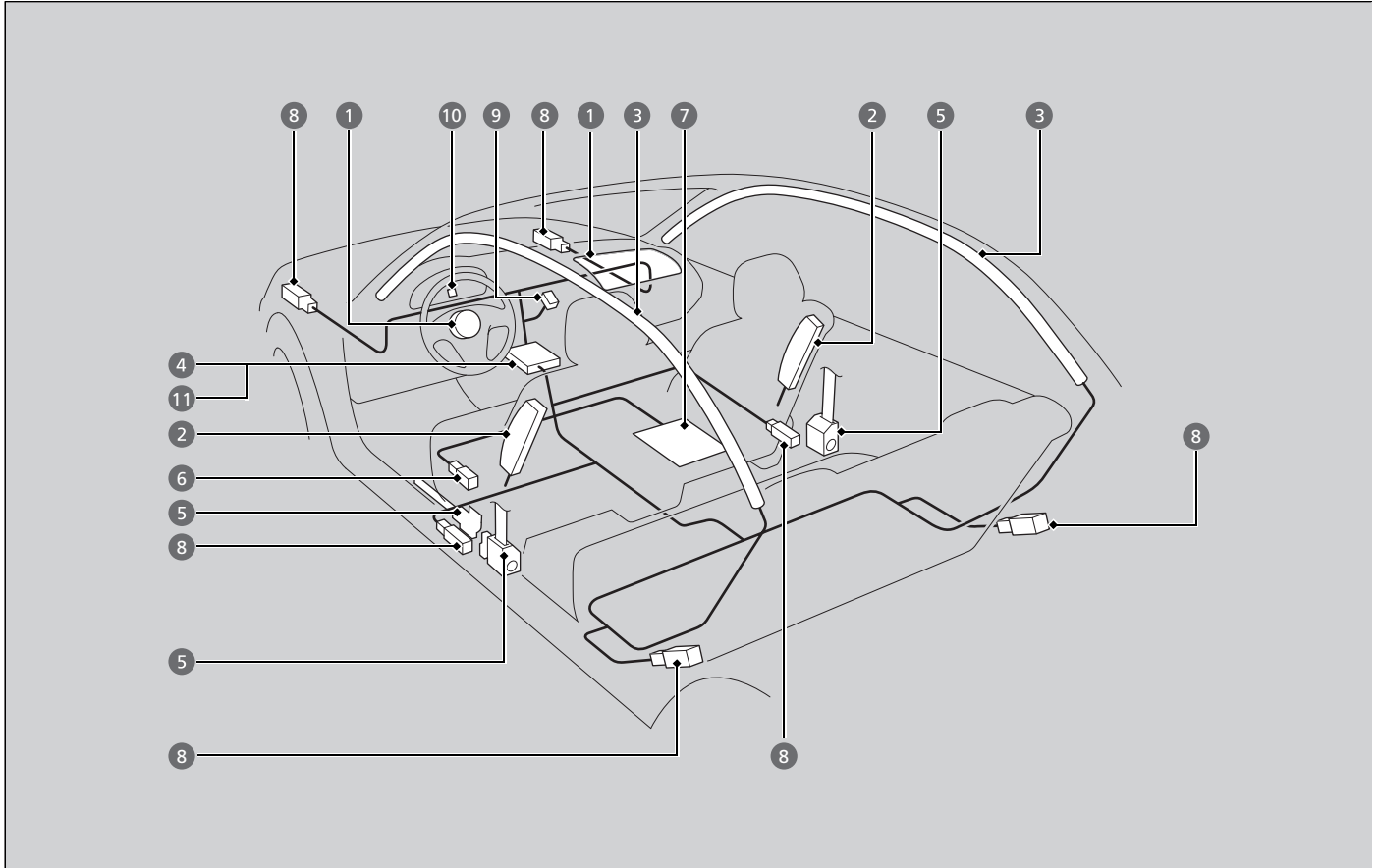

Continued

The front, front side, and side curtain airbags are deployed according to the direction and severity of impact. Both side curtain airbags are deployed in a rollover. The airbag system includes:

- 1 Two SRS (Supplemental Restraint System) front airbags. The driver's airbag is stored in the center of the steering wheel; the front passenger's airbag is stored in the dashboard. Both are marked **SRS AIRBAG**.
- 2 Two side airbags, one for the driver and one for a front passenger. The airbags are stored in the outer edges of the seat-backs. Both are marked **SIDE AIRBAG**.
- 3 Two side curtain airbags, one for each side of the vehicle. The airbags are stored in the ceiling, above the side windows. The front and rear pillars are marked **SIDE CURTAIN AIRBAG**.
- 4 An electronic control unit that continually monitors and can record information about the sensors, the airbag activators, the seat belt tensioners, and driver and front passenger seat belt use when the ignition switch is in ON \*1.
- 5 Automatic front seat belt tensioners. The driver's and front passenger's seat belts incorporate sensors that detect whether or not they are fastened.
- 6 A driver's seat position sensor. If the seat is too far forward, the airbag will inflate with less force.
- 7 Weight sensors in the front passenger's seat. The front passenger's airbag will be turned off if the weight on the seat is 65 lbs (29 kg) or less (the weight of an infant or small child).
- 8 Impact sensors that can detect a moderate-to-severe front or side impact.
- 9 An indicator on the dashboard that alerts you that the front passenger's front airbag has been turned off.
- 10 An indicator on the instrument panel that alerts you to a possible problem with your airbag system or seat belt tensioners.
- 11 A rollover sensor that detects whether the vehicle is about to roll over.

\*1: Models with the smart entry system have an **ENGINE START/STOP** button instead of an ignition switch.

## Important Facts About Your Airbags

Airbags can pose serious hazards. To do their job, airbags must inflate with tremendous force. So, while airbags help save lives, they can cause burns, bruises, and other minor injuries, sometimes even fatal ones if occupants are not wearing their seat belts properly and sitting correctly.

**What you should do:** Always wear your seat belt properly, and sit upright and as far back from the steering wheel as possible while allowing full control of the vehicle. A front passenger should move their seat as far back from the dashboard as possible.

Remember, however, that no safety system can prevent all injuries or deaths that can occur in a severe crash, even when seat belts are properly worn and the airbags deploy.

**Do not place hard or sharp objects between yourself and a front airbag.**

Carrying hard or sharp objects on your lap, or driving with a pipe or other sharp object in your mouth, can result in injuries if your front airbag inflates.

**Do not attach or place objects on the front airbag covers.** Objects on the covers marked **SRS AIRBAG** could interfere with the proper operation of the airbags or be propelled inside the vehicle and hurt someone if the airbags inflate.

## Important Facts About Your Airbags

Do not attempt to deactivate your airbags. Together, airbags and seat belts provide the best protection.

When driving, keep hands and arms out of the deployment path of the front airbag by holding each side of the steering wheel. Do not cross an arm over the airbag cover.

## Types of Airbags

Your vehicle is equipped with three types of airbags:

- **Front airbags:** Airbags in front of the driver's and front passenger's seats.
- **Side airbags:** Airbags in the driver's and front passenger's seat-backs.
- **Side curtain airbags:** Airbags above the side windows.

Each is discussed in the following pages.

## Front Airbags (SRS)

The front SRS airbags inflate in a moderate-to-severe frontal collision to help protect the head and chest of the driver and/or front passenger.

**SRS** (Supplemental Restraint System) indicates that the airbags are designed to supplement seat belts, not replace them. Seat belts are the occupant's primary restraint system.

### Housing Locations

The front airbags are housed in the center of the steering wheel for the driver, and in the dashboard for the front passenger. Both airbags are marked **SRS AIRBAG**.

\*1: Models with the smart entry system have an **ENGINE START/STOP** button instead of an ignition switch.

### Types of Airbags

The airbags can inflate whenever the ignition switch is in ON \*1.

After an airbag inflates in a crash, you may see a small amount of smoke. This is from the combustion process of the inflator material and is not harmful. People with respiratory problems may experience some temporary discomfort. If this occurs, get out of the vehicle as soon as it is safe to do so.

### Front Airbags (SRS)

#### Dual-Stage, Multiple-Threshold Front Airbags (SRS)

Your vehicle is equipped with dual-stage, multiple-threshold front airbags (SRS).

During a frontal crash severe enough to cause one or both front airbags to deploy, the airbags can inflate at different rates, depending on the severity of the crash, whether or not the seat belts are latched, and/or other factors. Frontal airbags are designed to supplement the seat belts to help reduce the likelihood of head and chest injuries in frontal crashes.

## ■ Operation

Front airbags are designed to inflate during moderate-to-severe frontal collisions. When the vehicle decelerates suddenly, the sensors send information to the control unit which signals one or both front airbags to inflate.

A frontal collision can be either head-on or angled between two vehicles, or when a vehicle crashes into a stationary object, such as a concrete wall.

## ■ How the Front Airbags Work

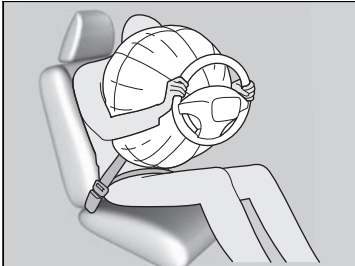

While your seat belt restrains your torso, the front airbag provides supplemental protection for your head and chest.

The front airbags deflate immediately so that they won't interfere with the driver's visibility or the ability to steer or operate other controls.

The total time for inflation and deflation is so fast that most occupants are not aware that the airbags deployed until they see them lying in front of them.

### ✎ How the Front Airbags Work

Although the driver's and front passenger's airbags normally inflate within a split second of each other, it is possible for only one airbag to deploy. This can happen if the severity of a collision is at the margin, or threshold, that determines whether or not the airbags will deploy. In such cases, the seat belt will provide sufficient protection, and the supplemental protection offered by the airbag would be minimal.



### ■ When front airbags should not deploy

**Minor frontal crashes:** Front airbags were designed to supplement seat belts and help save lives, not to prevent minor scrapes, or even broken bones that might occur during a less than moderate-to-severe frontal crash.

**Side impacts:** Front airbags can provide protection when a sudden deceleration causes a driver or front passenger to move towards the front of the vehicle. Side airbags and side curtain airbags have been specifically designed to help reduce the severity of injuries that can occur during a moderate-to-severe side impact which can cause the driver or passenger to move towards the side of the vehicle.

**Rear impacts:** Head restraints and seat belts are your best protection during a rear impact. Front airbags cannot provide any significant protection and are not designed to deploy in such collisions.

**Rollovers:** Seat belts and, in vehicles equipped with a rollover sensor, side airbags and side curtain airbags offer the best protection in a rollover. Because front airbags could provide little if any protection, they are not designed to deploy during a rollover.

### ■ When front airbags deploy with little or no visible damage

Because the airbag system senses sudden deceleration, a strong impact to the vehicle framework or suspension might cause one or more of the airbags to deploy. Examples include running into a curb, the edge of a hole, or other low fixed object that causes a sudden deceleration in the vehicle chassis. Since the impact is underneath the vehicle, damage may not be readily apparent.

### ■ When front airbags may not deploy, even though exterior damage appears severe

Since crushable body parts absorb crash energy during an impact, the amount of visible damage does not always indicate proper airbag operation. In fact, some collisions can result in severe damage but no airbag deployment because the airbags would not have been needed or would not have provided protection even if they had deployed.

## Advanced Airbags

Your front airbags have advanced features to help reduce the likelihood of airbag related injuries to smaller occupants.

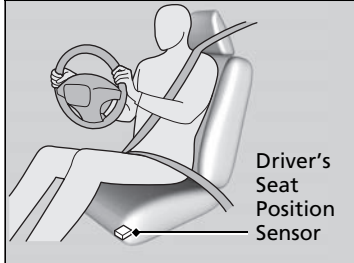

The driver's advanced front airbag system includes a seat position sensor.

If the seat is too far forward, the airbag inflates with less force, regardless of the severity of the impact.

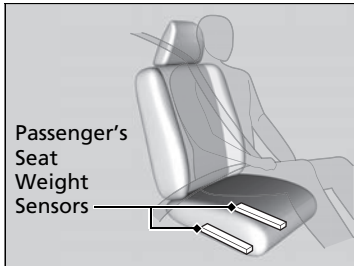

The passenger's advanced front airbag system has weight sensors.

Although Honda recommends against carrying an infant or small child in front, if the sensors detect the weight of a child (up to about 65 lbs or 29 kg), the system will automatically turn off the passenger's front airbag.

### Advanced Airbags

If there is a problem with the driver's seat position sensor, the SRS indicator will come on and the airbag will inflate with full (normal) force, regardless of the driver's seating position.

For both advanced front airbags to work properly:

- Do not spill any liquid on or under the seats.
- Do not put any object under the passenger's seat.
- Make sure any objects are positioned properly on the floor. Improperly positioned objects can interfere with the advanced airbag sensors.
- All occupants should sit upright and wear their seat belts properly.
- Do not place any cover over the passenger side dashboard.

## Side Airbags

The side airbags help protect the torso and pelvis of the driver or a front passenger during a moderate-to-severe side impact.

### Housing Locations

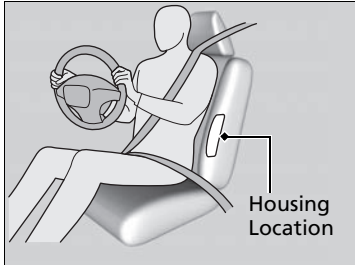

The side airbags are housed in the outside edge of the driver's and passenger's seat-backs.

Both are marked **SIDE AIRBAG**.

### Operation

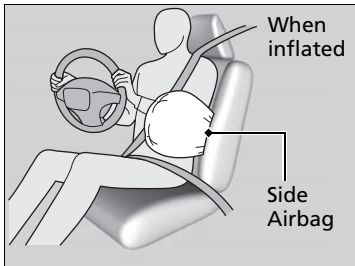

When the sensors detect a moderate-to-severe side impact, the control unit signals the side airbag on the impact side to immediately inflate.

### Side Airbags

Make sure you and your front passenger always sit upright. Leaning into the path of a side airbag can prevent the airbag from deploying properly and increases your risk of serious injury.

Do not attach accessories on or near the side airbags. They can interfere with the proper operation of the airbags, or hurt someone if an airbag inflates.

If the impact is on the passenger side, the airbag deploys even if there is no passenger in the front passenger seat.

Do not cover or replace the front seat-back covers without consulting a dealer.

Improperly replacing or covering front seat-back covers can prevent your side airbags from properly deploying during a side impact.

**■ When a side airbag deploys with little or no visible damage**

Because the airbag systems senses sudden acceleration, a strong impact to the side of the vehicle's framework can cause a side airbag to deploy. In such cases, there may be little or no damage, but the side impact sensors detected a severe enough impact to deploy the airbag.

**■ When a side airbag may not deploy, even though visible damage appears severe**

It is possible for a side airbag to not deploy during an impact that results in apparently severe damage. This can occur when the point of impact was towards the far front or rear of the vehicle, or when the vehicle's crushable body parts absorbed most of the crash energy. In either case, the side airbag would not have been needed nor provided protection even if it had deployed.

## Side Curtain Airbags

The side curtain airbags help protect the heads of the driver and passengers in outer seating positions during a moderate-to-severe side impact. The side curtain airbags equipped in this vehicle are also designed to help reduce the likelihood of partial and complete ejection of vehicle occupants through side windows in crashes, particularly rollover crashes.

### Housing Locations

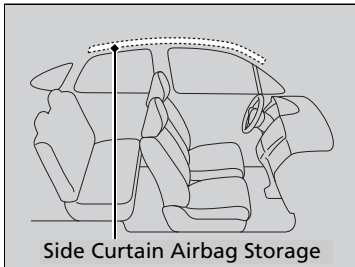

The side curtain airbags are located in the ceiling above the side windows on both sides of the vehicle.

### Operation

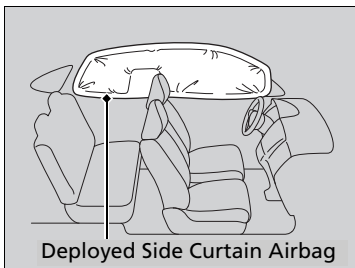

The side curtain airbag is designed to deploy in a rollover or a moderate-to-severe side impact.

### Side Curtain Airbags

If the SRS control unit senses that your vehicle is about to rollover, it immediately deploys both side curtain airbags and activates both front seat belt tensioners.

If the impact is on the passenger's side, the passenger's side curtain airbag will inflate even if there are no occupants on that side of the vehicle.

To get the best protection from the side curtain airbags, occupants should wear their seat belts properly and sit upright and well back in their seats.

Do not attach any objects to the side windows or roof pillars as they can interfere with the proper operation of the side curtain airbags.



**■ When side curtain airbags deploy in a frontal collision**

One or both side curtain airbags may inflate in a moderate-to-severe angled frontal collision.

In this case, the side curtain airbags will deploy slightly after the front airbags.

**Airbag System Indicators**

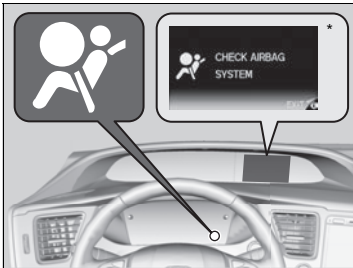
If a problem occurs in the airbag system, the SRS indicator will come on and a message appears on the i-MID\*.

**■ Supplemental Restraint System (SRS) Indicator****■ When the ignition switch is turned to ON \*1**

The indicator comes on for a few seconds, then goes off. This tells you the system is working properly.

If the indicator comes on at any other time, or does not come on at all, have the system checked by a dealer as soon as possible. If you don't, your airbags and seat belt tensioners may not work properly when they are needed.

\*1: Models with the smart entry system have an **ENGINE START/STOP** button instead of an ignition switch.

\* Not available on all models

 Supplemental Restraint System (SRS) Indicator

**⚠ WARNING**

Ignoring the SRS indicator can result in serious injury or death if the airbag systems or tensioners do not work properly.

Have your vehicle checked by a dealer as soon as possible if the SRS indicator alerts you to a possible problem.

*Continued*

## ■ Passenger Airbag Off Indicator

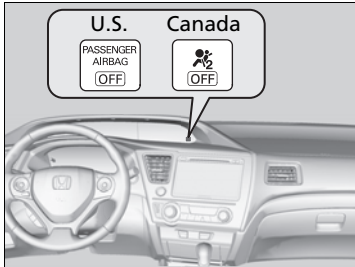

### ■ When the passenger airbag off indicator comes on

The indicator comes on to alert you that the passenger's front airbag has been turned off. This occurs when the weight sensors detect 65 lbs (29 kg) or less, the weight of an infant or small child, on the seat.

Infants and small children should always ride properly restrained in a back seat.

▶ **Child Safety** P. 52

Objects placed on the seat can also cause the indicator to come on.

If the front passenger seat is empty, the passenger's front airbag will not deploy and the indicator will not come on.

## ▶▶ Passenger Airbag Off Indicator

If the indicator comes on with no front passenger and no objects on the passenger's seat, or with an adult riding there, something may be interfering with the weight sensors, such as:

- An object hanging on the seat or in the seat-back pocket.
- A child seat or other object pressing against the rear of the seat-back.
- A rear passenger pushing or pulling on the back of the front passenger's seat.
- The front seat or seat-back is forced back against an object on the seat or floor behind it.
- An object placed under the front passenger's seat.

If none of these conditions exist, have your vehicle checked by a dealer as soon as possible.

The passenger airbag off indicator may come on and goes off repeatedly if the total weight on the seat is near the airbag cutoff threshold.

## Airbag Care

You do not need to, and should not, perform any maintenance on or replace any airbag system components yourself. However, you should have your vehicle inspected by a dealer in the following situations:

### ■ When the airbags have deployed

If an airbag has inflated, the control unit and other related parts must be replaced. Similarly, once an automatic seat belt tensioner has been activated, it must be replaced.

### ■ When the vehicle has been in a moderate-to-severe collision

Even if the airbags did not inflate, have your dealer inspect the following: the driver's seat position sensor, weight sensors in the passenger's seat, front seat belt tensioners, and each seat belt that was worn during the crash.

### ■ Do not remove or modify a front seat without consulting a dealer

This would likely disable the driver's seat position sensor or the weight sensors in the passenger's seat. If it is necessary to remove or modify a front seat to accommodate a person with disabilities, contact a Honda dealer, or for U.S. vehicles, American Honda Automobile Customer Service at 800-999-1009 and for Canadian vehicles, Honda Canada Customer Relations at 888-9-HONDA-9.

#### ✘ Airbag Care

We recommend against the use of salvaged airbag system components, including the airbag, tensioners, sensors, and control unit.



## Protecting Child Passengers

Each year, many children are injured or killed in vehicle crashes because they are either unrestrained or not properly restrained. In fact, vehicle accidents are the number one cause of death of children ages 12 and under.

To reduce the number of child deaths and injuries, every state, Canadian province and territory requires that infants and children be properly restrained when they ride in a vehicle.

**Children should sit properly restrained in a rear seat.** This is because:

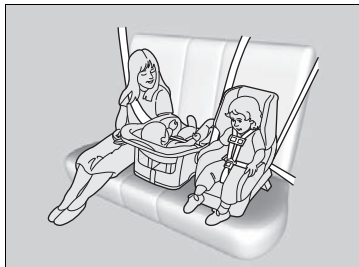

- An inflating front or side airbag can injure or kill a child sitting in the front seat.
- A child in the front seat is more likely to interfere with the driver's ability to safely control the vehicle.
- Statistics show that children of all sizes and ages are safer when they are properly restrained in a rear seat.

### Protecting Child Passengers

#### **⚠ WARNING**

**Children who are unrestrained or improperly restrained can be seriously injured or killed in a crash.**

**Any child too small for a seat belt should be properly restrained in a child seat. A larger child should be properly restrained with a seat belt, using a booster seat if necessary.**

The National Highway Traffic Safety Administration and Transport Canada recommend that all children ages 12 and under be properly restrained in a rear seat. Some states or provinces/territories have laws restricting where children may ride.

- Any child who is too small to wear a seat belt correctly must be restrained in an approved child seat that is properly secured to the vehicle using either the lap belt portion of the lap/shoulder belt or the lower anchors of the LATCH system.
- Never hold a child on your lap because it is impossible to protect them in the event of a collision.
- Never put a seat belt over yourself and a child. During a crash, the belt would likely press deep into the child and cause serious or fatal injuries.
- Never let two children use the same seat belt. Both children could be very seriously injured in a crash.
- Do not allow children to operate the doors, windows or seat adjustments.
- Do not leave children in the vehicle unattended, especially in hot weather when the inside of the vehicle can get hot enough to kill them. They could also activate vehicle controls causing it to move unexpectedly.

## ▶▶ Protecting Child Passengers

**⚠ WARNING**

Allowing a child to play with a seat belt or wrap one around their neck can result in serious injury or death.

Instruct children not to play with any seat belt and make sure any unused seat belt a child can reach is buckled, fully retracted, and locked.

To deactivate a lockable retractor, release the buckle and allow the seat belt to wind up all the way.

To remind you of the passenger's front airbag hazards and child safety, your vehicle has warning labels on the dashboard (U.S. models) and on the front visors. Please read and follow the instructions on these labels.

▶▶ **Safety Labels** P. 65

## Safety of Infants and Small Children

### Protecting Infants

An infant must be properly restrained in a rear-facing, reclining child seat until the infant reaches the seat maker's weight or height limit for the seat, and the infant is at least one year old.

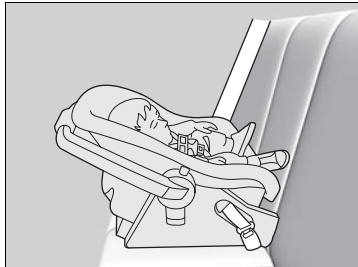

#### Positioning a rear-facing child seat

Child seats must be placed and secured in a rear seating position.

When properly installed, a rear-facing child seat may prevent the driver or a front passenger from moving their seat all the way back, or from locking their seat-back in the desired position.

It can also interfere with proper operation of the passenger's advanced front airbag system.

➤ **Airbags** P. 39

If this occurs, we recommend that you install the child seat directly behind the front passenger's seat, move the seat as far forward as needed, and leave it unoccupied. Or, you may wish to get a smaller rear-facing child seat.

### Protecting Infants

#### **WARNING**

Placing a rear-facing child seat in the front seat can result in serious injury or death during a crash.

Always place a rear-facing child seat in the rear seat, not the front.

Rear-facing child seats should never be installed in a forward facing position.

Always refer to the child seat manufacturer's instructions before installation.

## ■ Protecting Smaller Children

If a child is at least one year old and within the weight range indicated by the child seat manufacturer, the child should be properly restrained in a firmly secured forward-facing child seat.

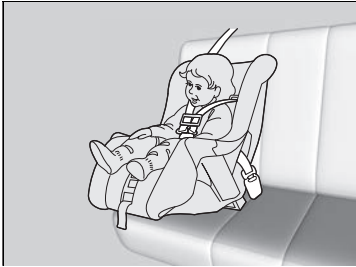

### ■ Forward-facing child seat placement

We strongly recommend placing a forward-facing child seat in a rear seating position.

Placing a forward-facing child seat in the front seat can be hazardous, even with advanced front airbags that automatically turn the passenger's front airbag off. A rear seat is the safest place for a child.

## ⊠ Protecting Smaller Children

### ⚠ WARNING

Placing a forward-facing child seat in the front seat can result in serious injury or death if the front airbag inflates.

If you must place a forward-facing child seat in front, move the vehicle seat as far back as possible, and properly restrain the child.

Educate yourself about the laws and regulations regarding child seat use where you are driving, and follow the child seat manufacturer's instructions.

Many experts recommend use of a rear-facing seat for a child up to two years old if the child's height and weight are appropriate for a rear-facing seat.

## ■ Selecting a Child Seat

Most child seats are LATCH-compatible (Lower Anchors and Tethers for Children). Some have a rigid-type connector, while others have a flexible-type connector. Both are equally easy to use. Some existing and previously owned child seats can only be installed using the seat belt. Whichever type you choose, follow the child seat manufacturer's use and care instructions as well as the instructions in this manual. Proper installation is key to maximizing your child's safety.

In seating positions and vehicles not equipped with LATCH, a LATCH compatible child seat can be installed using the seat belt and a top tether for added security. This is because all child seats are required to be designed so that they can be secured with a lap belt or the lap part of a lap/shoulder belt. In addition, the child seat manufacturer may advise that a seat belt be used to attach a LATCH-compatible seat once a child reaches a specified weight. Please read the child seat owner's manual for proper installation instructions.

### ■ Important consideration when selecting a child seat

Make sure the child seat meets the following three requirements:

- The child seat is the correct type and size for the child.
- The child seat is the correct type for the seating position.
- The child seat is compliant with Federal Motor Vehicle Safety Standard 213 or Canadian Motor Vehicle Safety Standard 213.

## ▶▶ Selecting a Child Seat

Installation of a LATCH-compatible child seat is simple.

LATCH-compatible child seats have been developed to simplify the installation process and reduce the likelihood of injuries caused by incorrect installation.

## ■ Installing a LATCH-Compatible Child Seat

A LATCH-compatible child seat can be installed in either of the two outer rear seats. A child seat is attached to the lower anchors with either the rigid or flexible type of connectors.

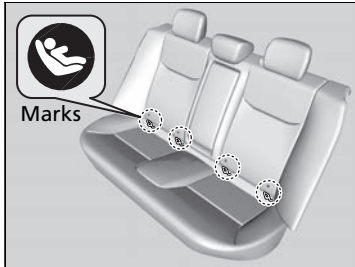

1. Locate the lower anchors under the marks.

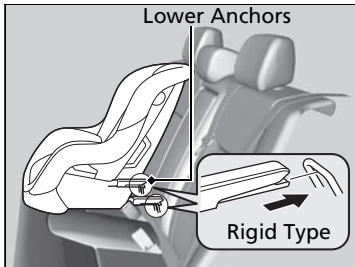

2. Place the child seat on the vehicle seat then attach the child seat to the lower anchors according to the instructions that came with the child seat.

- ▶ When installing the child seat, make sure that the lower anchors are not obstructed by the seat belt or any other object.

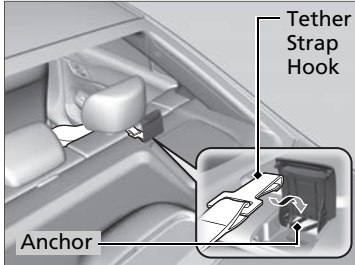
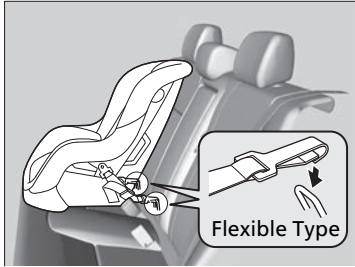

3. Open the tether anchor cover behind the head restraint.
4. Raise the head restraint to its highest position, then route the tether strap between the head restraint legs, and secure the tether strap hook onto the anchor.
5. Tighten the tether strap as instructed by the child seat manufacturer.
6. Make sure the child seat is firmly secured by rocking it forward and back and side to side; little movement should be felt.
7. Make sure any unused seat belt that a child can reach is buckled, the lockable retractor is activated, and the belt is fully retracted and locked.

#### ▶▶ Installing a LATCH-Compatible Child Seat

For your child's safety, when using a child seat installed using the LATCH system, make sure that the seat is properly secured to the vehicle. A child seat that is not properly secured will not adequately protect a child in a crash and may cause injury to the child or other vehicle occupants.

## ■ Installing a Child Seat with a Lap/Shoulder Seat Belt

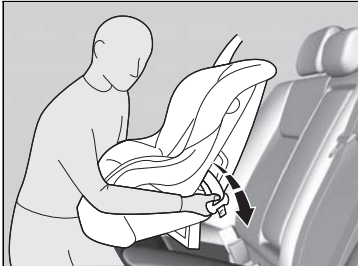

1. Place the child seat on the vehicle seat.
2. Route the seat belt through the child seat according to the seat manufacturer's instructions, and insert the latch plate into the buckle.
  - ▶ Insert the latch plate fully until it clicks.

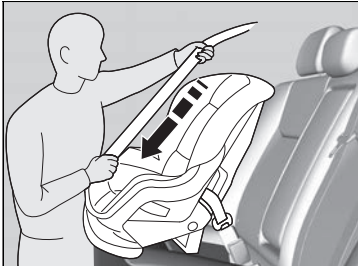

3. Slowly pull the shoulder part of the belt all the way out until it stops. This activates the lockable retractor.
4. Let the seat belt completely wind up into the retractor, then try to pull it out to make sure the retractor is locked.
  - ▶ If you are able to pull the shoulder belt out, the lockable retractor is not activated. Pull the seat belt all the way out, and repeat steps 2 – 4.



5. Grab the shoulder part of the seat belt near the buckle, and pull up to remove any slack from the lap part of the belt.
  - ▶ When doing this, place your weight on the child seat and push it into the vehicle seat.

### ⊠ Installing a Child Seat with a Lap/Shoulder Seat Belt

A child seat that is not properly secured will not adequately protect a child in a crash and may cause injury to the child or other vehicle occupants.



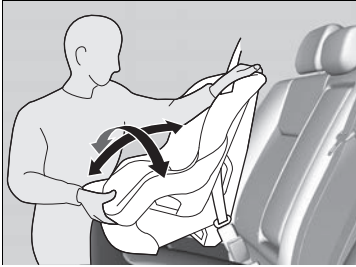

6. Make sure the child seat is firmly secured by rocking it forward and back and side to side; little movement should be felt.
7. Make sure any unused seat belt that a child can reach is buckled, the lockable retractor is activated, and the belt is fully retracted and locked.

#### ▶▶ Installing a Child Seat with a Seat Belt

To deactivate a lockable retractor, release the buckle and allow the seat belt to wind up all the way.

## Adding Security with a Tether

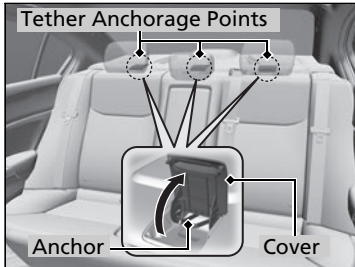

A tether anchorage point is provided behind each rear seating position. A child seat that is installed with a seat belt and comes with a tether can use the tether for additional security.

**1.** Locate the appropriate tether anchorage point and lift the cover.

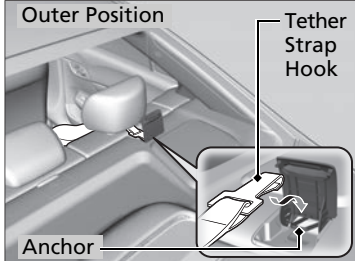

**2.** Raise the head restraint to its highest position, then route the tether strap through the head restraint legs. Make sure the strap is not twisted.

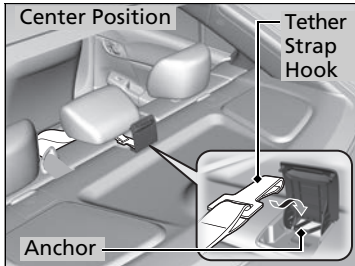

**3.** Secure the tether strap hook onto the anchor.

**4.** Tighten the tether strap as instructed by the child seat manufacturer.

### Adding Security with a Tether

Since a tether can provide additional security to the lap/shoulder seat belt installation, we recommend using a tether whenever one is available.

## Safety of Larger Children

### Protecting Larger Children

The following pages give instructions on how to check proper seat belt fit, what kind of booster seat to use if one is needed, and important precautions for a child who must sit in front.

### Checking Seat Belt Fit

When a child is too big for a child seat, secure the child in a rear seat using the lap/shoulder seat belt. Have the child sit upright and all the way back, then answer the following questions.

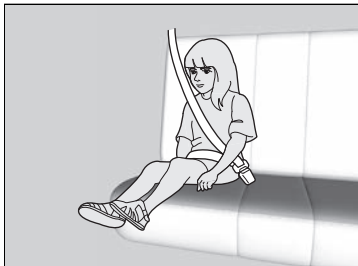

#### Checklist

- Do the child's knees bend comfortably over the edge of the seat?
- Does the shoulder belt cross between the child's neck and arm?
- Is the lap part of the seat belt as low as possible, touching the child's thighs?
- Will the child be able to stay seated like this for the whole trip?

If you answer yes to all these questions, the child is ready to wear the lap/shoulder seat belt correctly. If you answer no to any question, the child needs to ride on a booster seat until the seat belt fits properly without a booster seat.

### Safety of Larger Children

#### **⚠ WARNING**

Allowing a child age 12 or under to sit in front can result in injury or death if the passenger's front airbag inflates.

If a larger child must ride in front, move the vehicle seat as far to the rear as possible, have the child sit up properly and wear the seat belt properly, using a booster seat if needed.

## Booster Seats



If a lap/shoulder seat belt cannot be used properly, position the child in a booster seat in a rear seating position. For the child's safety, check that the child meets the booster seat manufacturer's recommendations.

## Protecting Larger Children-Final Checks

Your vehicle has a rear seat where children can be properly restrained. If you ever have to carry a group of children, and a child must ride in front:

- Make sure you read and fully understand the instructions and safety information in this manual.
- Move the front passenger seat as far back as possible.
- Have the child sit upright and well back in the seat.
- Check that the seat belt is properly positioned so that the child is secure in the seat.

## Monitoring child passengers

We strongly recommend that you keep an eye on child passengers. Even older, more mature children sometimes need to be reminded to fasten their seat belts and sit up properly.

### Booster Seats

When installing a booster seat, make sure to read the instructions that came with it, and install the seat accordingly.

There are high- and low-type booster seats. Choose a booster seat that allows the child to wear the seat belt correctly.

Some U.S. states and Canadian provinces and territories require children to use a booster seat until they reach a given age or weight (e.g. 6 years or 60 lbs). Be sure to check current laws in the state or province, or territory where you intend to drive.

## Carbon Monoxide Gas

The engine exhaust from this vehicle contains carbon monoxide, a colorless, odorless, and highly toxic gas. As long as you properly maintain your vehicle, carbon monoxide gas will not get into the interior.

### ■ Have the exhaust system inspected for leaks whenever

- The exhaust system is making an unusual noise.
- The exhaust system may have been damaged.
- The vehicle is raised for an oil change.

When you operate a vehicle with the trunk open, airflow can pull exhaust gas into the interior and create a hazardous condition. If you must drive with the trunk open, open all the windows and set the heating and cooling system\*/climate control system\* as shown below.

1. Select the fresh air mode.
2. Select the  mode.
3. Set the fan speed to high.
4. Set the temperature control to a comfortable setting.

Adjust the heating and cooling system\*/climate control system\* in the same manner if you sit in your parked vehicle with the engine running.

### Carbon Monoxide Gas

## **WARNING**

Carbon monoxide gas is toxic. Breathing it can cause unconsciousness and even kill you.

Avoid any enclosed areas or activities that expose you to carbon monoxide.

An enclosed area such as a garage can quickly fill up with carbon monoxide gas.

Do not run the engine with the garage door closed. Even when the garage door is open, drive out of the garage immediately after starting the engine.

## Label Locations

These labels are in the locations shown. They warn you of potential hazards that can cause serious injury or death. Read these labels carefully.

If a label comes off or becomes hard to read (except for the U.S. dashboard label which may be removed by the owner), contact a dealer for a replacement.

### Sun Visor

#### U.S. models

**⚠ WARNING**

**EVEN WITH ADVANCED AIR BAGS**



- Children can be tied or unbelted in the air bag.
- The back seat is the safest place for children.
- Never put a rear-facing child seat in the front.
- Always use seat belts and child restraints.
- See owner's manual for more information about air bags.

#### Canadian models

**CAUTION**  
TO AVOID SERIOUS INJURY:  
• FOR MAXIMUM SAFETY PROTECTION IN ALL TYPES OF CRASHES, YOU MUST ALWAYS WEAR YOUR SAFETY BELT.  
• DO NOT INSTALL REARWARD-FACING CHILD SEATS IN ANY FRONT PASSENGER SEAT POSITION.  
• DO NOT SIT OR LEAN UNNECESSARILY CLOSE TO THE AIR BAG.  
• DO NOT PLACE ANY OBJECTS OVER THE AIR BAG OR BETWEEN THE AIR BAG AND YOURSELF.  
• SEE THE OWNER'S MANUAL FOR FURTHER INFORMATION AND EXPLANATIONS.

**PRECAUTIONS:**  
POUR EVITER DES BLESSURES GRAVES:  
• POUR PROFITER D'UNE PROTECTION MAXIMALE LORS D'UNE COLLISION BOULECIEZ TOUJOURS VOTRE CEINTURE DE SECURITE.  
• N'INSTALLEZ JAMAIS UN SIEGE POUR ENFANTS FASANT FACE A L'ARRIERE SUR LE SIEGE DU PASSAGER AVANT.  
• NE VOUS APPUYEZ PAS ET NE VOUS ASSOYEZ PAS PRES DU COUSSIN GONFLABLE.  
• NE DEPOSEZ AUCUN OBJET SUR LE COUSSIN GONFLABLE OU ENTRE LE COUSSIN GONFLABLE ET VOUS.  
• LISEZ LE GUIDE UTILISATEUR POUR DE PLUS AMPLES RENSEIGNEMENTS.

### Dashboard

#### U.S. models only

This Vehicle is Equipped with Advanced Air Bags

Even with Advanced Air Bags  
Children can be tied or unbelted in the air bags.  
The back seat is the safest place for children.  
Never put a rear-facing child seat in the front.  
Always use seat belts and child restraints.  
See owner's manual for more information about air bags.  
To be removed by owner only

### Radiator Cap

**⚠ DANGER WARNING 危険**

NEVER OPEN WHEN HOT  
Hot coolant will injure you.  
NE VOUS OUVRIEZ PAS QUAND CHAUD.  
NOT TO BE OPENED BY MOTORIST.  
熱い液体がけがをします。  
高温時、蓋物打开

1.1

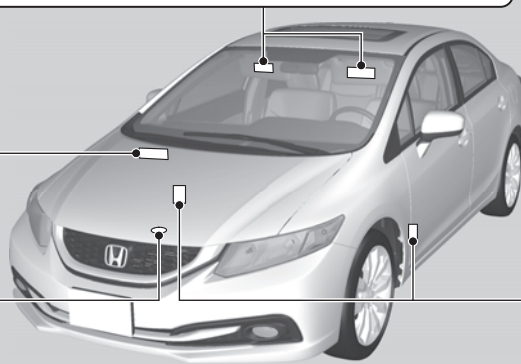

### Doorjamb

#### U.S. models

**SIDE AIRBAG**

- This car is equipped with side airbags in the front seats and side curtain airbags.
- Do not lean against the door.
- See owner's manual for more information.

#### Canadian models

**SIDE AIRBAG**

- This car is equipped with side airbags in the front seats and side curtain airbags.
- See owner's manual for more information.

**COUSSIN GONFLABLE LATÉRAL**

- Cette automobile est équipée de coussins gonflables latéraux dans les sièges avant ainsi que de coussins gonflables latéraux de type rideau.
- Ne vous appuyez pas sur la porte.
- Consultez le Manuel du propriétaire pour en savoir plus.



# Instrument Panel









This chapter describes the buttons, indicators, and gauges that are used while driving.











<b>Indicators</b> .....	68
intelligent Multi-Information Display (i-MID) Warning and Information Messages* .....	77
<b>Gauges and Displays</b>	
Gauges .....	82
Information Display* .....	84
intelligent Multi-Information Display (i-MID)* .....	86

\* Not available on all models











Indicator	Name	On/Blinking	Explanation	Message*
<p>U.S.</p> <p><b>BRAKE</b></p> <p>Canada</p>  <p>(Red)</p>	Parking Brake and Brake System Indicator (Red)	<ul style="list-style-type: none"> <li>Comes on for a few seconds when you turn the ignition switch to ON *1, then goes off if the parking brake has been released.</li> <li>Comes on when the parking brake is applied, and goes off when it is released.</li> <li>Comes on when the brake fluid level is low.</li> <li>Comes on if there is a problem with the brake system.</li> <li>The beeper sounds and the indicator comes on if you drive with the parking brake not fully released.</li> </ul>	<ul style="list-style-type: none"> <li><b>Comes on while driving</b> - Make sure the parking brake is released. Check the brake fluid level.                             <ul style="list-style-type: none"> <li>➤ <b>What to do when the indicator comes on</b> P. 437</li> </ul> </li> <li><b>Comes on along with the ABS indicator</b> - Have your vehicle checked by a dealer.                             <ul style="list-style-type: none"> <li>➤ <b>If the Brake System Indicator (Red) Comes On</b> P. 437</li> </ul> </li> </ul>	  
<p>U.S.</p> <p><b>BRAKE SYSTEM</b></p> <p>Canada</p>  <p>(Amber)</p>	Brake System Indicator (Amber)	<ul style="list-style-type: none"> <li>Comes on for a few seconds when you turn the ignition switch to ON *1, then goes off.</li> <li>Comes on if there is a problem with a component related to braking.</li> </ul>	<ul style="list-style-type: none"> <li><b>Stays on constantly</b> - Have your vehicle checked by a dealer.</li> </ul>	



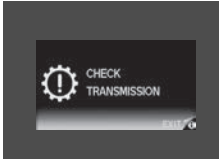

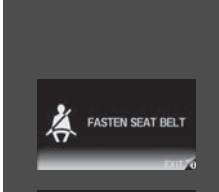



\*1: Models with the smart entry system have an **ENGINE START/STOP** button instead of an ignition switch.

Indicator	Name	On/Blinking	Explanation	Message*
	Low Oil Pressure Indicator	<ul style="list-style-type: none"> <li>Comes on when you turn the ignition switch to ON *1, and goes off when the engine starts.</li> <li>Comes on when the engine oil pressure is low.</li> </ul>	<ul style="list-style-type: none"> <li><b>Comes on while driving</b> - Immediately stop in a safe place.                             <ul style="list-style-type: none"> <li>➤ <b>If the Low Oil Pressure Indicator Comes On</b> P. 435</li> </ul> </li> </ul>	
	Malfunction Indicator Lamp	<ul style="list-style-type: none"> <li>Comes on when you turn the ignition switch to ON *1, and goes off when the engine starts, or after several seconds if the engine did not start. If "readiness codes" have not been set, it blinks five times before it goes off.</li> <li>Comes on if there is a problem with the emissions control system.</li> <li>Blinks when a misfire in the engine's cylinders is detected.</li> </ul>	<ul style="list-style-type: none"> <li>Readiness codes are part of the on board diagnostics for the emissions control systems.                             <ul style="list-style-type: none"> <li>➤ <b>Testing of Readiness Codes</b> P. 453</li> </ul> </li> <li><b>Comes on while driving</b> - Have your vehicle checked by a dealer.</li> <li><b>Blinks while driving</b> - Stop in a safe place where there are no flammable objects. Stop the engine for 10 minutes or more, and wait for it to cool down. Then, take the vehicle to a dealer.                             <ul style="list-style-type: none"> <li>➤ <b>If the Malfunction Indicator Lamp Comes On or Blinks</b> P. 436</li> </ul> </li> </ul>	
	Charging System Indicator	<ul style="list-style-type: none"> <li>Comes on when you turn the ignition switch to ON *1, and goes off when the engine starts.</li> <li>Comes on when the battery is not charging.</li> </ul>	<ul style="list-style-type: none"> <li><b>Comes on while driving</b> - Turn off the heating and cooling system*/climate control system* and rear defogger in order to reduce electricity consumption.                             <ul style="list-style-type: none"> <li>➤ <b>If the Charging System Indicator Comes On</b> P. 435</li> </ul> </li> </ul>	















\*1: Models with the smart entry system have an **ENGINE START/STOP** button instead of an ignition switch.

Indicator	Name	On/Blinking	Explanation	Message*
	Shift Lever Position Indicator*	<ul style="list-style-type: none"> <li>Indicates the current shift lever position.</li> </ul>	<p>➤ <b>Shifting</b> P. 320</p>	
	Transmission Indicator*	<ul style="list-style-type: none"> <li>Comes on for a few seconds when you turn the ignition switch to ON *1, then goes off.</li> <li>Blinks if the transmission system has a problem.</li> </ul>	<ul style="list-style-type: none"> <li><b>Blinks while driving</b> - Avoid sudden starts and acceleration and have your vehicle checked by a dealer immediately.</li> </ul>	
	Seat Belt Reminder Indicator	<ul style="list-style-type: none"> <li>Comes on and the beeper sounds if you are not wearing a seat belt when you turn the ignition switch to ON *1.</li> <li>If the front passenger is not wearing a seat belt, the indicator comes on a few seconds later.</li> <li>Blinks while driving if either you or the front passenger has not fastened a seat belt. The beeper sounds and the indicator blinks at regular intervals.</li> </ul>	<ul style="list-style-type: none"> <li>The beeper stops and the indicator goes off when you and the front passenger fasten their seat belts.</li> <li><b>Stays on after you or the front passenger has fastened the seat belt</b> - A detection error may have occurred in the sensor. Have your vehicle checked by a dealer.                             <ul style="list-style-type: none"> <li>➤ <b>Seat Belt Reminder</b> P. 33</li> </ul> </li> </ul>	 

\*1: Models with the smart entry system have an **ENGINE START/STOP** button instead of an ignition switch.







Indicator	Name	On/Blinking	Explanation	Message*
	Low Fuel Indicator	<ul style="list-style-type: none"> <li>Comes on when the fuel reserve is running low (approximately 1.9 U.S. gal./7.5 Liter left).</li> <li>Blinks if there is a problem with the fuel gauge.</li> </ul>	<ul style="list-style-type: none"> <li><b>Comes on</b> - Refuel your vehicle as soon as possible.</li> <li><b>Blinks</b> - Have your vehicle checked by a dealer.</li> </ul>	
	Anti-lock Brake System (ABS) Indicator	<ul style="list-style-type: none"> <li>Comes on for a few seconds when you turn the ignition switch to ON *1, then goes off.</li> <li>If it comes on at any other time, there is a problem with the ABS.</li> </ul>	<ul style="list-style-type: none"> <li><b>Stays on constantly</b> - Have your vehicle checked by a dealer. With this indicator on, your vehicle still has normal braking ability but no anti-lock function.</li> </ul> <p> <b>Anti-lock Brake System (ABS)</b> P. 339</p>	
	Supplemental Restraint System Indicator	<ul style="list-style-type: none"> <li>Comes on for a few seconds when you turn the ignition switch to ON *1, then goes off.</li> <li>Comes on if a problem with any of the following is detected:                             <ul style="list-style-type: none"> <li>- Supplemental restraint system</li> <li>- Side airbag system</li> <li>- Side curtain airbag system</li> <li>- Seat belt tensioner</li> </ul> </li> </ul>	<ul style="list-style-type: none"> <li><b>Stays on constantly or does not come on at all</b> - Have your vehicle checked by a dealer.</li> </ul>	

\*1: Models with the smart entry system have an **ENGINE START/STOP** button instead of an ignition switch.

Indicator	Name	On/Blinking	Explanation	Message*
	High Temperature Indicator	<ul style="list-style-type: none"> <li>Comes on for a few seconds when you turn the ignition switch to ON *1, then goes off.</li> <li>Blinks when the engine coolant temperature goes up, and stays on if the temperature continues to rise.</li> </ul>	<ul style="list-style-type: none"> <li><b>Blinks while driving</b> - Drive slowly to prevent overheating.</li> <li><b>Stays on while driving</b> - Immediately stop in a safe place and allow the engine to cool.   <b>Overheating</b> P. 433</li> </ul>	
	Vehicle Stability Assist (VSA®) System Indicator	<ul style="list-style-type: none"> <li>Comes on for a few seconds when you turn the ignition switch to ON *1, then goes off.</li> <li>Blinks when VSA® is active.</li> <li>Comes on if there is a problem with the VSA® system or hill start assist system.</li> </ul>	<ul style="list-style-type: none"> <li><b>Stays on constantly</b> - Have your vehicle checked by a dealer.   <b>Vehicle Stability Assist (VSA®), aka Electronic Stability Control (ESC), System</b> P. 329</li> </ul>	 
	Vehicle Stability Assist (VSA®) OFF Indicator	<ul style="list-style-type: none"> <li>Comes on for a few seconds when you turn the ignition switch to ON *1, then goes off.</li> <li>Comes on when you deactivate VSA®.</li> </ul>	 <b>VSA® On and Off</b> P. 330	—
	Door Open Indicator	<ul style="list-style-type: none"> <li>Comes on for a few seconds if you turn the ignition switch to ON *1, then goes off.</li> <li>Comes on if any door is not completely closed.</li> <li>The beeper sounds and the indicator comes on if any door is opened while driving.</li> </ul>	<ul style="list-style-type: none"> <li>Goes off when all doors are closed.</li> </ul>	

\*1: Models with the smart entry system have an **ENGINE START/STOP** button instead of an ignition switch.



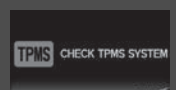





\* Not available on all models

Indicator	Name	On/Blinking	Explanation	Message*
	Trunk Open Indicator	<ul style="list-style-type: none"> <li>Comes on for a few seconds if you turn the ignition switch to ON <b>[II]</b>*1, then goes off.</li> <li>Comes on if the trunk is not completely closed.</li> </ul>	<ul style="list-style-type: none"> <li>Goes off when the trunk is closed.</li> </ul>	
	Electric Power Steering (EPS) System Indicator	<ul style="list-style-type: none"> <li>Comes on when you turn the ignition switch to ON <b>[II]</b>*1, and goes off when the engine starts.</li> <li>Comes on if there is a problem with the EPS system.</li> </ul>	<ul style="list-style-type: none"> <li><b>Stays on constantly or does not come on at all</b> - Have your vehicle checked by a dealer.                             <ul style="list-style-type: none"> <li>☑ <b>If the Electric Power Steering (EPS) System Indicator Comes On</b> P. 437</li> </ul> </li> </ul>	
<b>DRL</b>	Daytime Running Lights Indicator*	<ul style="list-style-type: none"> <li>Comes on for a few seconds when you turn the ignition switch to ON <b>[II]</b>*1, then goes off.</li> <li>Comes on if there is a problem with the DRL system.</li> </ul>	<ul style="list-style-type: none"> <li>Have your vehicle checked by a dealer.                             <ul style="list-style-type: none"> <li>☑ <b>Daytime Running Lights</b> P. 139</li> </ul> </li> </ul>	—
	Low Tire Pressure/TPMS Indicator	<ul style="list-style-type: none"> <li>Comes on for a few seconds when you turn the ignition switch to ON <b>[II]</b>*1.</li> <li>May come on briefly if the ignition switch is turned to ON <b>[II]</b>*1 and the vehicle is not moved within 45 seconds, to indicate the calibration process is not yet complete.</li> <li>Comes on and stays on when:                             <ul style="list-style-type: none"> <li>- One or more tires' pressures are determined to be significantly low.</li> <li>- The system has not been calibrated.</li> </ul> </li> </ul>	<ul style="list-style-type: none"> <li><b>Comes on while driving</b> - Stop in a safe place, check tire pressures, and inflate the tire(s) if necessary.</li> <li><b>Stays on after the tires are inflated to the recommended pressures</b> - The system needs to be calibrated.                             <ul style="list-style-type: none"> <li>☑ <b>TPMS Calibration</b> P. 333</li> </ul> </li> </ul>	
		<ul style="list-style-type: none"> <li>Blinks for about one minute, and then stays on if there is a problem with the TPMS, or when a compact spare tire* is temporarily installed.</li> </ul>	<ul style="list-style-type: none"> <li><b>Blinks and remains on</b> - Have your vehicle checked by a dealer. If the vehicle is fitted with a compact spare, get your regular tire repaired or replaced and put back on your vehicle as soon as you can.</li> </ul>	

Instrument Panel







\*1: Models with the smart entry system have an **ENGINE START/STOP** button instead of an ignition switch.

\* Not available on all models

Indicator	Name	On/Blinking	Explanation	Message*
	System Message Indicator*	<ul style="list-style-type: none"> <li>• Comes on for a few seconds when you turn the ignition switch to ON *<sup>1</sup>, then goes off.</li> <li>• Comes on along with a beep when a problem is detected. A system message on the i-MID appears at the same time.</li> </ul>	<ul style="list-style-type: none"> <li>• While the indicator is on, press the  (display/information) button to see the message again.</li> <li>• Refer to the Indicators information in this chapter when a system message appears on the i-MID. Take the appropriate action for the message.</li> <li>• The i-MID does not return to the normal screen unless the warning is canceled, or the  button is pressed.</li> </ul>	—
	Turn Signal and Hazard Warning Indicators	<ul style="list-style-type: none"> <li>• Blink when you operate the turn signal lever.</li> <li>• Blink along with all turn signals when you press the hazard warning button.</li> </ul>	<ul style="list-style-type: none"> <li>• <b>Does not blink or blinks rapidly</b> - A turn signal light bulb has blown. Change the bulb immediately.   <b>Replacing Light Bulbs</b> P. 383, 385</li> </ul>	—
	High Beam Indicator	<ul style="list-style-type: none"> <li>• Comes on when the high beam headlights are on.</li> </ul>	—	—
	Lights On Indicator	<ul style="list-style-type: none"> <li>• Comes on whenever the light switch is on, or in <b>AUTO</b>* when the exterior lights are on.</li> </ul>	<ul style="list-style-type: none"> <li>• If you remove the key from the ignition switch*<sup>1</sup> while the exterior lights are on, a chime sounds when the driver's door is opened.</li> </ul>	—
	Fog Light Indicator*	<ul style="list-style-type: none"> <li>• Comes on when the fog lights are on.</li> </ul>	—	—

\*1: Models with the smart entry system have an **ENGINE START/STOP** button instead of an ignition switch.

















\* Not available on all models

Indicator	Name	On/Blinking	Explanation	Message*
	Immobilizer System Indicator	<ul style="list-style-type: none"> <li>Comes on briefly when you turn the ignition switch to ON <b>[II]</b>*<sup>1</sup>, then goes off.</li> <li>Comes on if the immobilizer system cannot recognize the key information.</li> </ul>	<ul style="list-style-type: none"> <li><b>Blinks</b> - You cannot start the engine. Turn the ignition switch to LOCK <b>[0]</b>*<sup>1</sup>, pull the key out, and then insert the key and turn it to ON <b>[II]</b>*<sup>1</sup> again.</li> <li><b>Repeatedly blinks</b> - The system may be malfunctioning. Have your vehicle checked by a dealer.</li> <li>Do not attempt to alter this system or add other devices to it. Electrical problems can occur.</li> </ul>	—
	Security System Alarm Indicator*	<ul style="list-style-type: none"> <li>Blinks when the security system alarm has been set.</li> </ul>	<p> <b>Security System Alarm*</b> P. 125</p>	—
	Low Temperature Indicator	<ul style="list-style-type: none"> <li>Comes on for a few seconds when you turn the ignition switch to ON <b>[II]</b>*<sup>1</sup>, then goes off.</li> <li>Comes on when the engine coolant temperature is low.</li> </ul>	<ul style="list-style-type: none"> <li>If the indicator stays on after the engine has reached normal operating temperature, there may be problem with the temperature sensors. Have your vehicle inspected by a dealer.</li> </ul>	—
	Smart Entry System Indicator*	<ul style="list-style-type: none"> <li>Comes on for a few seconds when you change the power mode to ON, then goes off.</li> <li>Comes on as soon as a problem is detected in the smart entry system or push button starting system.</li> </ul>	<ul style="list-style-type: none"> <li><b>Stays on constantly or does not come on at all</b> - Have your vehicle checked by a dealer.</li> </ul>	 

\*1: Models with the smart entry system have an **ENGINE START/STOP** button instead of an ignition switch.

\* Not available on all models











Indicator	Name	On/Blinking	Explanation	Message*
	ECON Mode Indicator*	<ul style="list-style-type: none"> <li>Comes on for a few seconds when you turn the ignition switch to ON *<sup>1</sup>, then goes off.</li> <li>Comes on when you press the <b>ECON</b> button.</li> </ul>	<ul style="list-style-type: none"> <li> <b>ECON Button</b>* P. 325</li> </ul>	
	<b>CRUISE MAIN</b> Indicator*	<ul style="list-style-type: none"> <li>Comes on when you press the <b>CRUISE</b> button.</li> </ul>	<ul style="list-style-type: none"> <li> <b>Cruise Control</b>* P. 326</li> </ul>	—
	<b>CRUISE CONTROL</b> Indicator*	<ul style="list-style-type: none"> <li>Comes on if you have set a speed for cruise control.</li> </ul>	<ul style="list-style-type: none"> <li> <b>Cruise Control</b>* P. 326</li> </ul>	—
	Washer Level Indicator*	<ul style="list-style-type: none"> <li>Comes on when the washer fluid gets low.</li> </ul>	<ul style="list-style-type: none"> <li>Refill the washer fluid.</li> <li> <b>Refilling Window Washer Fluid</b> P. 375</li> </ul>	—
	Maintenance Minder Indicator*	<ul style="list-style-type: none"> <li>Comes on when the scheduled maintenance is due soon.</li> </ul>	<ul style="list-style-type: none"> <li> <b>Maintenance Minder™</b> P. 353</li> </ul>	—
	<b>i-VTEC</b> Indicator*	<ul style="list-style-type: none"> <li>Comes on when the i-VTEC system switches the low RPM cams to the high RPM cams.</li> </ul>	<ul style="list-style-type: none"> <li>When the <b>i-VTEC</b> indicator comes on, the rev indicator begins to come on simultaneously.</li> <li> <b>i-VTEC indicator</b> P. 83</li> </ul>	—
	Rev Indicators*	<ul style="list-style-type: none"> <li>Come on when the tachometer reading approaches the red zone.</li> </ul>	<ul style="list-style-type: none"> <li> <b>Rev indicators</b> P. 83</li> </ul>	—

\*1:Models with the smart entry system have an **ENGINE START/STOP** button instead of an ignition switch.

\* Not available on all models

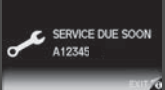

## intelligent Multi-Information Display (i-MID) Warning and Information Messages\*

The following messages appear only on the i-MID. Press the  (display/information) button to see the message again with the system message indicator on.



Message	Condition	Explanation
	<ul style="list-style-type: none"> <li>Appears when the fuel fill cap is loose or is not installed.</li> </ul>	<ul style="list-style-type: none"> <li> <b>Check/Tighten Fuel Cap Message</b> P. 436</li> </ul>
	<ul style="list-style-type: none"> <li>Appears if there is a problem with the DRL system.</li> </ul>	<ul style="list-style-type: none"> <li>Have your vehicle checked by a dealer.</li> <li> <b>Daytime Running Lights</b> P. 139</li> </ul>
<div style="border: 1px solid black; padding: 2px;">Canadian models</div> 	<ul style="list-style-type: none"> <li>Appears when the washer fluid gets low.</li> </ul>	<ul style="list-style-type: none"> <li>Refill the washer fluid.</li> <li> <b>Refilling Window Washer Fluid</b> P. 375</li> </ul>
	<ul style="list-style-type: none"> <li>Appears when the scheduled maintenance is due soon.</li> <li>Consequently, <b>SERVICE DUE NOW</b> and <b>SERVICE PAST DUE</b> follow.</li> </ul>	<ul style="list-style-type: none"> <li> <b>Maintenance Minder Messages on the i-MID</b> P. 358</li> </ul>





\* Not available on all models

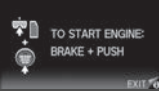

Models without smart entry system

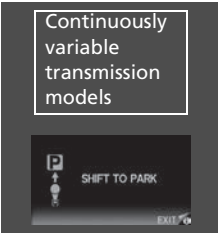
Message	Condition	Explanation
 <p>RETURN IGNITION SWITCH TO LOCK (0) POSITION</p>	<ul style="list-style-type: none"> <li>Appears when you open the driver's door while the ignition key is in ACCESSORY <b>I</b>.</li> </ul>	<ul style="list-style-type: none"> <li>Turn the ignition switch to LOCK <b>0</b>, then remove the key.</li> </ul>
 <p>REMOVE KEY</p>	<ul style="list-style-type: none"> <li>Appears when you open the driver's door while the ignition key is in LOCK <b>0</b>.</li> </ul>	<ul style="list-style-type: none"> <li>Remove the key from the ignition switch.</li> </ul>

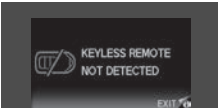
Models with smart entry system

Message	Condition	Explanation
<p>Continuously variable transmission models</p>  <p>Manual transmission models</p> 	<ul style="list-style-type: none"> <li>• Appears after you set the power mode to ACCESSORY or ON.</li> </ul>	<p>➤ <b>Starting the Engine</b> P. 313</p>
<p>Except U.S. models with continuously variable transmission</p> 	<ul style="list-style-type: none"> <li>• Appears when the steering wheel is locked.</li> </ul>	<ul style="list-style-type: none"> <li>• Move the steering wheel left and right while pressing the <b>ENGINE START/STOP</b> button.</li> </ul>

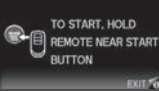
Message	Condition	Explanation
	<ul style="list-style-type: none"> <li>Appears if you push the <b>ENGINE START/STOP</b> button to turn the engine off without the shift lever in <b>P</b>.</li> </ul>	<p><b>U.S. models</b></p> <ul style="list-style-type: none"> <li>Move the shift lever to <b>P</b>. The power mode changes to VEHICLE OFF.</li> </ul> <p><b>Canadian models</b></p> <ul style="list-style-type: none"> <li>Move the shift lever to <b>P</b>, then press the <b>ENGINE START/STOP</b> button twice.</li> </ul>
	<ul style="list-style-type: none"> <li>Appears when the power mode is in ACCESSORY.</li> </ul>	—
	<ul style="list-style-type: none"> <li>Appears after the driver's door is opened when the power mode is in ACCESSORY.</li> </ul>	<ul style="list-style-type: none"> <li>Press the <b>ENGINE START/STOP</b> button twice with your foot off the brake pedal to change the power mode to VEHICLE OFF (LOCK).</li> </ul>
	<ul style="list-style-type: none"> <li>Appears when you close the door with the power mode in ON without the smart entry remote inside the vehicle.</li> </ul>	<ul style="list-style-type: none"> <li>Disappears when you bring the smart entry remote back inside the vehicle and close the door.                             <ul style="list-style-type: none"> <li>➤ <b>Smart Entry Remote Reminder</b> P. 134</li> </ul> </li> </ul>
	<ul style="list-style-type: none"> <li>Appears when the smart entry remote battery becomes weak.</li> </ul>	<ul style="list-style-type: none"> <li>Replace the battery as soon as possible.                             <ul style="list-style-type: none"> <li>➤ <b>Replacing the Button Battery</b> P. 401</li> </ul> </li> </ul>

Message	Condition	Explanation
	<ul style="list-style-type: none"> <li>• Appears if the smart entry remote battery is too weak to start the engine or the key is not within operating range to start the engine. A beeper sounds six times.</li> </ul>	<ul style="list-style-type: none"> <li>• Bring the smart entry remote in front of the <b>ENGINE START/STOP</b> button to be touched with.                             <ul style="list-style-type: none"> <li>▣ <b>If the Smart Entry Remote Battery is Weak</b> P. 427</li> </ul> </li> </ul>
	<ul style="list-style-type: none"> <li>• Appears three seconds after the <b>TO START ENGINE: BRAKE + PUSH</b> (continuously variable transmission models)/<b>TO START ENGINE: CLUTCH + PUSH</b> (manual transmission models) messages appears.</li> <li>• Appears three seconds after you bring the smart entry remote in front of the <b>ENGINE START/STOP</b> button when <b>TO START, HOLD REMOTE NEAR START BUTTON</b> appears. <b>TO START ENGINE: BRAKE + PUSH</b> (continuously variable transmission models)/<b>TO START ENGINE: CLUTCH + PUSH</b> (manual transmission models) appears sequentially.</li> </ul>	<ul style="list-style-type: none"> <li>▣ <b>Changing the Power Mode</b> P. 132</li> </ul>
	<ul style="list-style-type: none"> <li>• Appears when the starter system has a problem.</li> </ul>	<ul style="list-style-type: none"> <li>• As a temporary measure, press and hold the <b>ENGINE START/STOP</b> button for up to 15 seconds while pressing the brake pedal and manually start the engine. Have your vehicle checked by a dealer.</li> </ul>

## Gauges

Gauges include the speedometer, tachometer, fuel gauge, and related indicators. They are displayed when the ignition switch is in ON <sup>\*1</sup>.

### ■ Speedometer

Displays your driving speed in mph or km/h.

### ■ Tachometer

Shows the number of engine revolutions per minute.

### ■ Fuel Gauge

Displays the amount of fuel left in the fuel tank.

### ■ Instant Fuel Economy Gauge\*

Shows the instant fuel economy as a bar graph in mpg or l/100km.

\*1: Models with the smart entry system have an **ENGINE START/STOP** button instead of an ignition switch.

\* Not available on all models

#### » Gauges

Press and hold the km/mile change knob until you hear a beep. The speedometer reading and the displayed measurements switch between mph and km/h.

#### » Fuel Gauge

##### NOTICE

You should refuel when the reading approaches . Running out of fuel can cause the engine to misfire, damaging the catalytic converter.

The actual amount of remaining fuel may differ from the fuel gauge reading.

#### » Instant Fuel Economy Gauge\*

Press and hold the km/mile change knob to switch the measurement.

## ■ i-VTEC and Rev Indicators\*

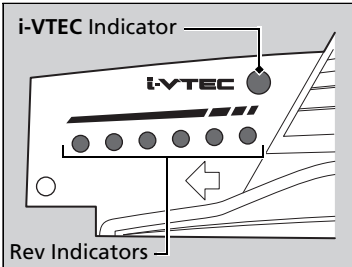

### ■ i-VTEC indicator

Comes on when the i-VTEC system switches the low RPM cams to the high RPM cams.

### ■ Rev indicators

Come on when the tachometer reading approaches the red zone on a scale of one to six.

### ⊠ Rev indicators

When the fifth indicator (red) comes on, the engine has reached its maximum output.

When all the indicators are on, the tachometer reading is on the verge of entering into the red zone.

\* Not available on all models



## Information Display\*

The information display shows the odometer, trip meter, engine oil life and maintenance service item codes, and other gauges.

### Switching the Display

Press the  (Select/Reset) knob to change the display.

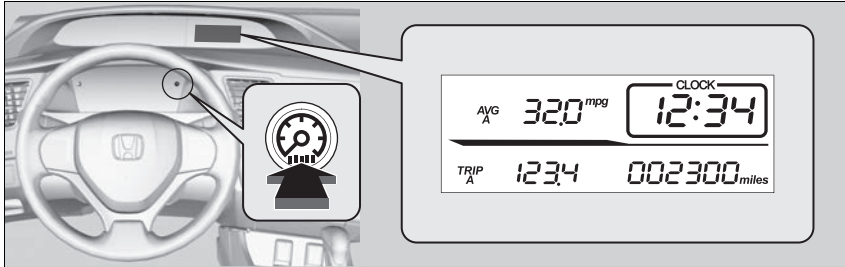

### Odometer

Shows the total number of miles or kilometers that your vehicle has accumulated.

### Trip Meter

Shows the total number of miles or kilometers driven since the last reset. Meters A and B can be used to measure two separate trips.

#### Resetting a trip meter

To reset a trip meter, display it, then press and hold the  knob. The trip meter is reset to **0.0**.

### Switching the Display

Each time you press the  knob, the information display changes as follows:

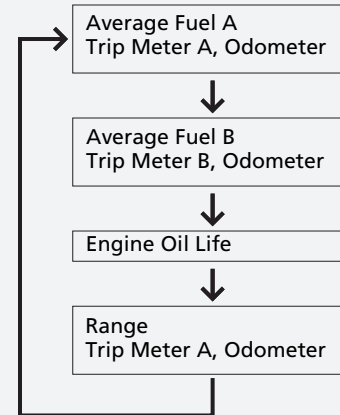

### Trip Meter

Switch between trip meter A and trip meter B by pressing the  knob.

## ■ Average Fuel Economy

Shows the estimated average fuel economy of each trip meter in mpg or l/100 km. The display is updated at set intervals. When a trip meter is reset, the average fuel economy is also reset.

## ■ Engine Oil Life

Shows the remaining oil life and Maintenance Minder™.

🔧 **Maintenance Minder™** P. 353

## ■ Range

Shows the estimated distance you can travel on the remaining fuel. This distance is estimated from the fuel economy of your previous trips.

## ■ Check Fuel Cap

Appears when the fuel fill cap is loose or is not installed.

🔧 **Check/Tighten Fuel Cap Message** P. 436

## intelligent Multi-Information Display (i-MID)\*

The i-MID shows the odometer, trip meter, outside temperature indicator, and other gauges.

It also displays important messages such as warnings and other helpful information.



### Switching the Display

#### ■ Main displays

Press the  (display/information) button to change the display.

#### ▶▶ Switching the Display

To change the item displayed on the fuel consumption screen:

1. Press and hold the  button until the item blinks.
2. Press the  button to select an item while the item is blinking for about six seconds.

The display is fixed when the time elapses and blinking stops.

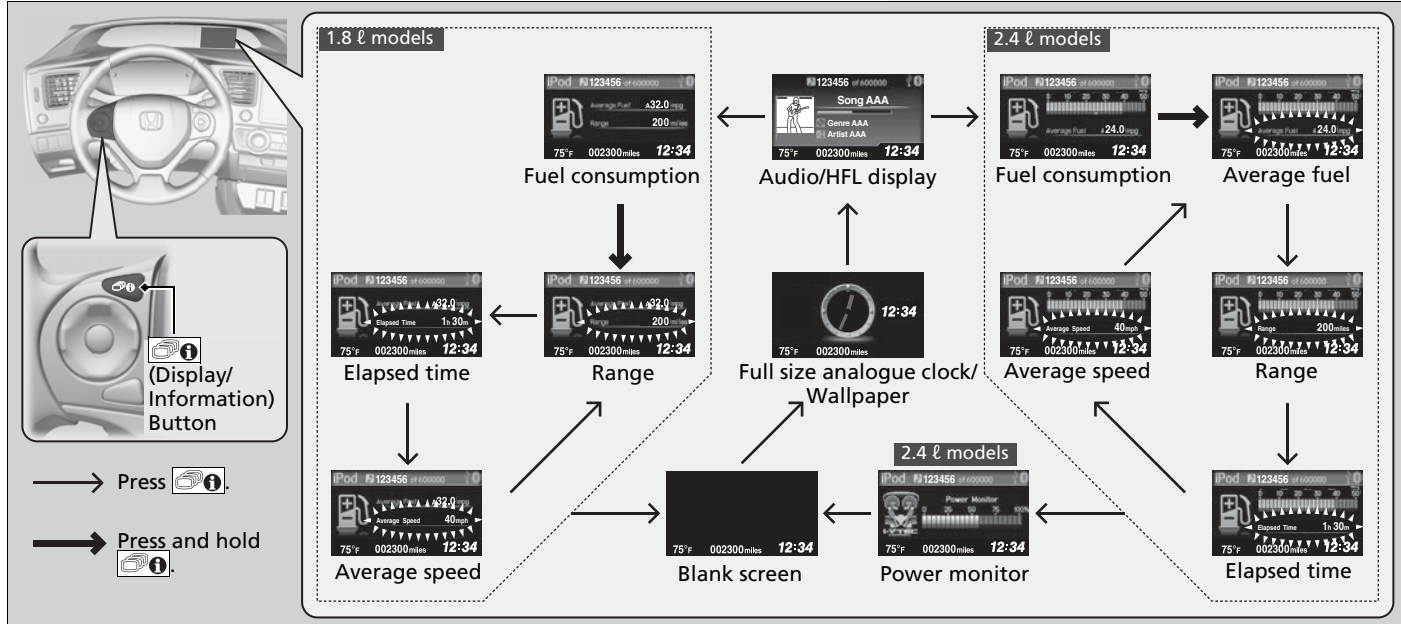

## ■ Trip computer

Press the  (Select/Reset) knob to change the display.

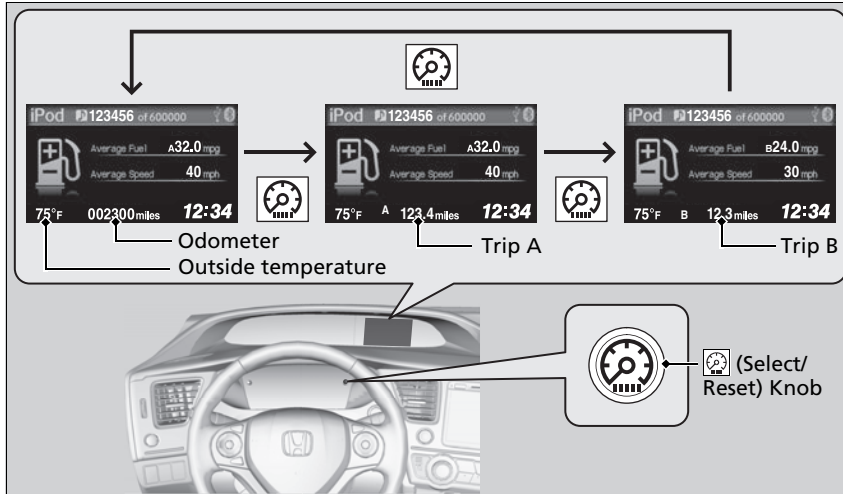

## ■ Odometer

Shows the total number of miles or kilometers that your vehicle has accumulated.

## ■ Trip Meter

Shows the total number of miles or kilometers driven since the last reset. Meters A and B can be used to measure two separate trips.

## ■ Resetting a trip meter

To reset a trip meter, display it, then press and hold the  knob. The trip meter is reset to **0.0**.

*Continued*

## ▶▶ Trip Meter

Switch between trip meter A and trip meter B by pressing the  knob, or by using the customized features on the i-MID.

▶ **Customized Features** P. 90

## ■ Average Fuel Economy

Shows the estimated average fuel economy of each trip meter in mpg or l/100 km. The display is updated at set intervals. When a trip meter is reset, the average fuel economy is also reset.

## ■ Range

Shows the estimated distance you can travel on the remaining fuel. This distance is estimated from the fuel economy of your previous trips.

## ■ Elapsed Time

Shows the time elapsed since Trip A or Trip B was reset.

## ■ Average Speed

Shows the average speed in mph or km/h since Trip A or Trip B was reset.

## ■ Engine Oil Life

Shows the remaining oil life and Maintenance Minder™.

➤ **Maintenance Minder™** P. 353

## » Average Fuel Economy

You can change when to reset the average fuel economy.

➤ **Customized Features** P. 90

### 2.4 l engine models

You can choose an item to be displayed in the fuel consumption screen. Average fuel economy, range, elapsed time, or average speed can be selected.

➤ **Customized Features** P. 90

➤ **Switching the Display** P. 86

## » Range

### 1.8 l engine models

You can choose an item to be displayed in the fuel consumption screen. Range, elapsed time, or average speed can be selected.

➤ **Customized Features** P. 90

➤ **Switching the Display** P. 86

## ■ Outside Temperature

Shows the outside temperature in Fahrenheit (U.S.) or Celsius (Canada).

### ■ Adjusting the outside temperature display

Adjust the temperature reading up to  $\pm 5^{\circ}\text{F}$  or  $\pm 3^{\circ}\text{C}$  if the temperature reading seems incorrect.

Use the i-MID's customized features to correct the temperature.

➤ **Customized Features** P. 90

## ■ Instant Fuel Economy\*

Shows the instant fuel economy as a bar graph in mpg or l/100 km.

## ■ Power Monitor\*

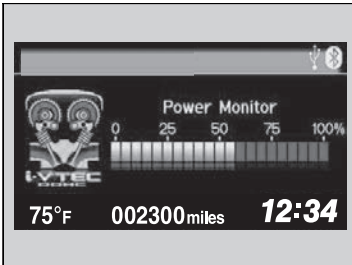

Engine horsepower usage while driving is displayed in the power monitor.

**100%** indicates that horsepower is at its maximum.

## ■ Turn-by-Turn Directions\*

Shows you turn-by-turn driving directions to your destination linked with the navigation system.

➤ **Refer to the Navigation System Manual**

\* Not available on all models

### ☒ Outside Temperature

The temperature sensor is in the front bumper. Road heat and exhaust from another vehicle can affect the temperature reading when your vehicle speed is less than 19 mph (30 km/h).

It may take several minutes for the display to be updated after the temperature reading has stabilized.

### ☒ Power Monitor\*

Engine horsepower is affected by external conditions such as driving conditions, or vehicle condition. The power monitor can compensate for some of these variables, but different readings may be displayed.

### ☒ Turn-by-Turn Directions\*

You can select whether the turn-by-turn display comes on during the route guidance.

➤ **Customized Features** P. 90

Continued

## ■ Customized Features

Use the i-MID to customize certain features.

### ■ How to customize

Select the **Vehicle Menu** screen by pressing the **MENU** button while the ignition switch is in ON \*1, and the vehicle is at a complete stop. Select **Customize Settings**, then press the **SOURCE** button.

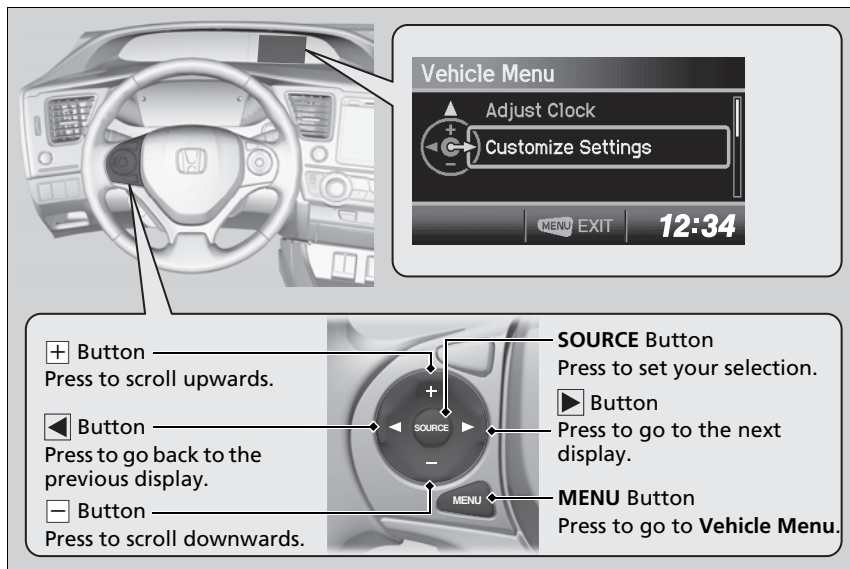

\*1: Models with the smart entry system have an **ENGINE START/STOP** button instead of an ignition switch.

## ▶ Customized Features

To customize other features, press the  button.

- ▶ **List of customizable options** P. 94
- ▶ P. 98

## ■ Customization flow

Press the **MENU** button.

### Vehicle Menu

#### Vehicle Information

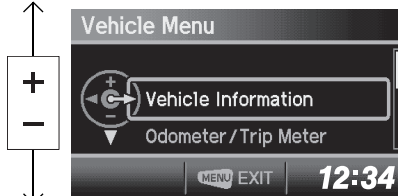

Maintenance info

#### Odometer/Trip Meter



Trip Meter Reset



Select Trip/Odometer

#### Adjust Clock\*

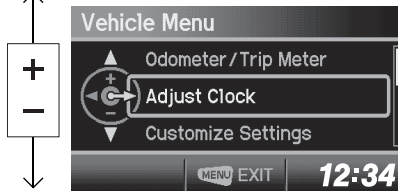

### Customized Features

You can exit the customizing screen at any time by pressing the **MENU** button.

\* Not available on all models



**Customize Settings**

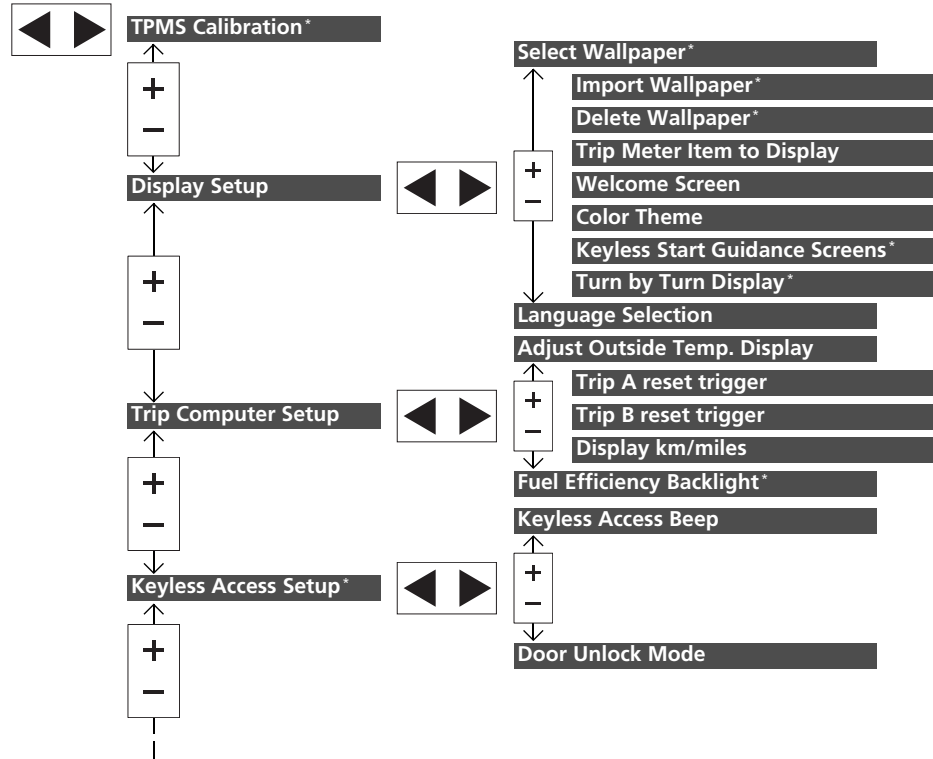

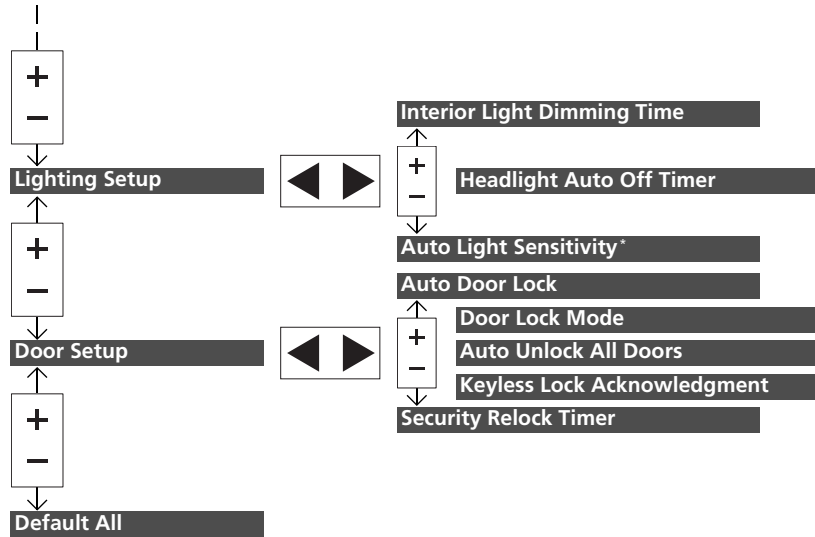

\* Not available on all models

■ List of customizable options

Setup Group	Customizable Features	Description	Selectable settings
<b>Vehicle Information</b>	<b>Maintenance info</b>	Resets the Maintenance Minder™.	<b>No/Yes</b>
	<b>Trip Meter Reset</b>	Resets the trip meter.	<b>Trip A/Trip B</b>
<b>Odometer/ Trip Meter</b>	<b>Select Trip/Odometer</b>	Switches between odometer, trip meter A, and trip meter B.	<b>ODO*<sup>1</sup>/Trip A/Trip B</b>
	<b>Adjust Clock*</b>	Sets time display 12 hour or 24 hour and adjust the time.	<b>12 h*<sup>1</sup>/24 h</b>
<b>Customize Settings</b>	<b>TPMS Calibration*</b>	Calibrates the TPMS.	<b>Cancel/Initialize</b>
	<b>Display Setup</b>	<b>Select Wallpaper*</b>	Selects the full-size analogue clock or the wallpaper.
	<b>Import Wallpaper*</b>	Imports an image file for a new wallpaper.	Three images can be stored. <b>▶ Importing Wallpapers from USB P. 98</b>
	<b>Delete Wallpaper*</b>	Deletes an image file for a wallpaper.	<b>Image 1/Image 2/Image 3</b>

\*1: Default Setting

Setup Group	Customizable Features	Description	Selectable settings
<b>Customize Settings</b>	<b>Display Setup</b>	<b>1.8 ℓ engine models</b> Selects an item to be displayed along with average fuel economy.	<b>Range<sup>*2</sup>/Elapsed time/ Average speed</b>
		<b>2.4 ℓ engine models</b> Selects an item to be displayed along with the instant fuel economy.	<b>Average Fuel<sup>*2</sup>/Range/ Elapsed time/Average speed</b>
		<b>Welcome Screen</b> Selects whether the welcome screen comes on when you turn the ignition switch to ON <input type="checkbox"/> <sup>*1</sup> .	<b>On<sup>*2</sup>/Off</b>
		<b>Color Theme</b> Changes the color of the screen.	<b>Blue<sup>*3</sup>/Red<sup>*4</sup>/Amber/Gray</b>
		<b>Keyless Start Guidance Screens<sup>*</sup></b> Displays the push button start guidance when conditions are met to change power mode.	<b>On<sup>*2</sup>/Off</b>
		<b>Turn by Turn Display<sup>*, *5</sup></b> Selects whether the turn-by-turn display comes on during the route guidance.	<b>On<sup>*2</sup>/Off</b>
		<b>Language Selection</b> Changes the displayed language.	<b>English<sup>*2</sup>/French/Spanish</b>

\*1: Models with the smart entry system have an **ENGINE START/STOP** button instead of an ignition switch.

\*2: Default Setting

\*3: Default Setting for 1.8 ℓ engine models

\*4: Default Setting for 2.4 ℓ engine models

\*5: Refer to the Navigation System Manual for complete details.

Setup Group	Customizable Features	Description	Selectable settings	
<b>Customize Settings</b>	<b>Adjust Outside Temp. Display</b>	Adjusts the temperature reading by a few degrees.	<b>-5°F ~ ±0°F*<sup>1</sup> ~ +5°F (U.S.)</b> <b>-3°C ~ ±0°C*<sup>1</sup> ~ +3°C (Canada)</b>	
	<b>Trip Computer Setup</b>	<b>Trip A reset trigger</b>	Changes the setting of how to reset trip meter A, average fuel economy A, average speed A, and elapsed time A.	<b>With refuel/IGN Off/Manual only*<sup>1</sup></b>
		<b>Trip B reset trigger</b>	Changes the setting of how to reset trip meter B, average fuel economy B, average speed B, and elapsed time B.	<b>With refuel/IGN Off/Manual only*<sup>1</sup></b>
		<b>Display km/miles</b>	Changes the displayed measurement on the i-MID.	<b>Auto*<sup>1</sup>/km/miles</b>
	<b>Keyless Access Setup*</b>	<b>Fuel Efficiency Backlight*</b>	Turns the ambient meter feature on and off.	<b>On*<sup>1</sup>/Off</b>
		<b>Keyless Access Beep</b>	Sets the beeper sound or not when you grab either front door handle.	<b>On*<sup>1</sup>/Off</b>
<b>Door Unlock Mode</b>		Changes which doors unlock when you grab the driver's door handle.	<b>Driver Door Only*<sup>1</sup>/All Doors</b>	

\*1: Default Setting

Setup Group	Customizable Features	Description	Selectable settings
<b>Customize Settings</b>	<b>Lighting Setup</b>	<b>Interior Light Dimming Time</b>	Changes the length of time the interior lights stay on after you close the doors. <b>60sec/30sec*<sup>1</sup>/15sec</b>
		<b>Headlight Auto Off Timer</b>	Changes the length of time the exterior lights stay on after you close the driver's door. <b>60sec/30sec/15sec*<sup>1</sup>/0sec</b>
		<b>Auto Light Sensitivity*</b>	Changes the timing for the headlights to come on. <b>Max/High/Mid*<sup>1</sup>/Low/Min</b>
		<b>Auto Door Lock</b>	Changes the setting for when the doors automatically lock. <b>Off/With Vehicle Speed*<sup>1</sup>/Shift from P*</b>
		<b>Door Lock Mode</b>	Sets up either the driver's door or all doors to unlock on the first operation of the remote or ignition key. <b>Driver Door*<sup>1</sup>/All Doors</b>
	<b>Door Setup</b>	<b>Auto Unlock All Doors</b>	Changes the setting for when the doors automatically unlock. <b>Off/When Driver's Door Opens*<sup>1</sup>/When Shift To Park*/When Ignition Off</b>
		<b>Keyless Lock Acknowledgment</b>	LOCK/UNLOCK- The exterior lights flash. LOCK (2nd push)- The beeper sounds. <b>On*<sup>1</sup>/Off</b>
		<b>Security Relock Timer</b>	Changes the time it takes for the doors to relock and the security system to set after you unlock the vehicle without opening any door. <b>90sec/60sec/30sec*<sup>1</sup></b>
	<b>Default All</b>	Cancels/Resets all the customized settings as default.	<b>Cancel</b> <b>Reset All Defaults</b>

\*1:Default Setting

\* Not available on all models

Models with one display

■ **Example for customizing wallpapers**

You can customize the display from clock to wallpaper.

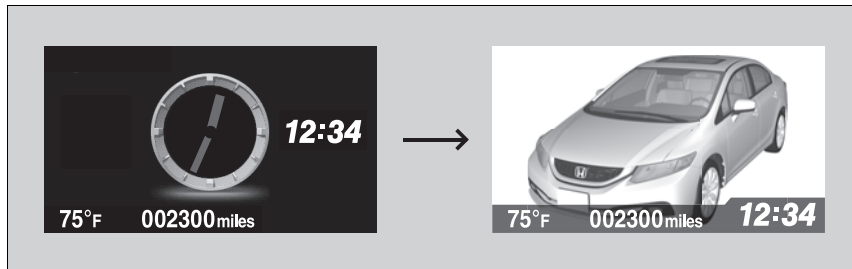

**Importing Wallpapers from USB**

You can import up to three images, one at a time for wallpaper from a USB flash drive.

Select **Import Wallpaper** from **Customize Settings** and properly connect a USB flash drive to store an image.

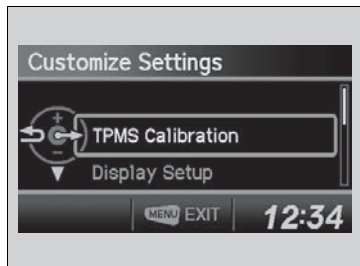

1. Connect the USB flash drive to the adapter cable.  
 ▶ **USB Adapter Cable** \* P. 172
2. Press the **MENU** button.
3. Select **Customize Settings** with the **[+]** / **[-]** button, then press the **SOURCE** button.
4. Select **Display Setup** with the **[+]** / **[-]** button, then press the **SOURCE** button.

▶▶ Customized Features

- When importing wallpaper files, the image must be in the USB flash drive's root directory. Images in a folder cannot be imported.
- The file format of the image that can be imported is BMP (bmp) or JPEG (jpg).
- The individual file size limit is 2 MB.
- The maximum image size is 1,920 x 936 pixels. If the image size was less than 480 x 234 pixels, the image is displayed in the middle of the screen with the extra area appearing in black.
- Up to 255 files can be selected.
- The file name must be fewer than 64 characters.



5. Select **Import Wallpaper** with the  $\boxed{+}$  /  $\boxed{-}$  button, then press the **SOURCE** button.
  - ▶ The file names are displayed on the screen.



6. Press the  $\boxed{-}$  button until the file name you want to store appears on the center of the display, then press the **SOURCE** button.

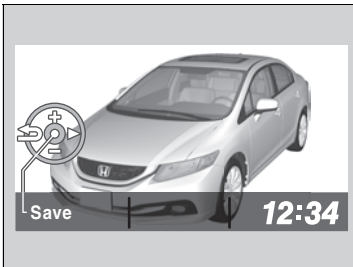

7. The preview of the imported data is displayed. Press the **SOURCE** button if it is OK.
8. Press the **SOURCE** button to save the image file.





9. Select the location you want to store the image file in with the  $\oplus$  /  $\ominus$  button, then press the **SOURCE** button.

10. Press the **MENU** button to exit the customize screen.

## Selecting a Wallpaper

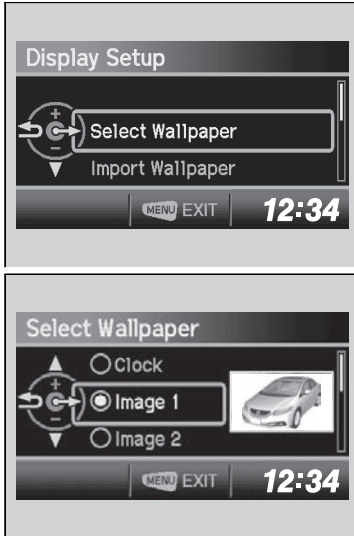

1. Press the **MENU** button.
2. Select **Customize Settings** with the  $\boxed{+}$  /  $\boxed{-}$  button, then press the **SOURCE** button.
3. Select **Display Setup** with the  $\boxed{+}$  /  $\boxed{-}$  button, then press the **SOURCE** button.
4. Select **Select Wallpaper** with the  $\boxed{+}$  /  $\boxed{-}$  button, then press the **SOURCE** button.
5. Select the image file you want with the  $\boxed{+}$  /  $\boxed{-}$  button, then press the **SOURCE** button.
  - ▶ When the scroll is stopped, the thumbnail is displayed.
6. Press the **MENU** button to exit the customize screen.



# Controls

This chapter explains how to operate the various controls necessary for driving.



<b>Clock</b> .....	104
<b>Locking and Unlocking the Doors</b>	
Key Types and Functions .....	106
Low Smart Entry Remote Signal Strength* .....	108
Locking/Unlocking the Doors from the Outside .....	109
Locking/Unlocking the Doors from the Inside .....	114
Childproof Door Locks .....	116
Auto Door Locking/Unlocking* .....	117
<b>Opening and Closing the Trunk</b> .....	121
<b>Security System</b>	
Immobilizer System .....	125
Security System Alarm* .....	125
<b>Opening and Closing the Windows</b> .....	128
<b>Opening and Closing the Moonroof*</b> .....	130

<b>Operating the Switches Around the Steering Wheel</b>	
Ignition Switch* .....	131
ENGINE START/STOP Button* .....	132
Ignition Switch and Power Mode Comparison .....	135
Turn Signals .....	136
Light Switches .....	136
Fog Lights* .....	139
Daytime Running Lights .....	139
Wipers and Washers .....	140
Brightness Control .....	141
Rear Defogger/Heated Door Mirror* Button .....	142
Adjusting the Steering Wheel.....	143

<b>Adjusting the Mirrors</b>	
Interior Rearview Mirror .....	144
Power Door Mirrors .....	144
<b>Adjusting the Seats</b> .....	146
<b>Interior Lights/Interior Convenience Items</b>	
Interior Lights .....	154
Interior Convenience Items .....	156
<b>Heating and Cooling*</b>	
Using Vents, Heating and A/C* .....	161
<b>Climate Control System*</b>	
Using Automatic Climate Control ....	165
Automatic Climate Control Sensors .....	167

\* Not available on all models

## Adjusting the Clock

### Models without navigation system

You can adjust the time in the clock display, using the **CLOCK** knob with the ignition switch in ON \*1.

### Adjusting the Time

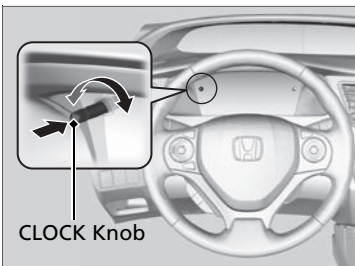

#### On i-MID

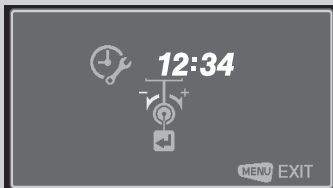

#### On information display

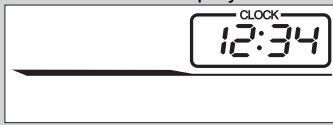

### Models without display audio

#### Using the CLOCK knob

1. Press the **CLOCK** knob to access the clock adjustment mode screen.
2. Turn the **CLOCK** knob to adjust the hours.
3. Press the **CLOCK** knob. The display switches to minute adjustment.
4. Turn the **CLOCK** knob to adjust the minutes.
5. Press the **CLOCK** knob to complete clock adjustment.

### Adjusting the Clock

#### Models with navigation system

The clock is automatically updated through the navigation system, so the time does not need to be adjusted.

#### Models with i-MID (without display audio)

You can customize the clock display to show the 12 hour clock or 24 hour clock.

➤ **Customized Features** P. 90

#### Models with display audio

#### Models with information display

You cannot adjust the time while the vehicle is moving.

\*1: Models with the smart entry system have an **ENGINE START/STOP** button instead of an ignition switch.

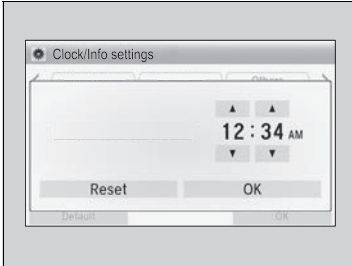

#### Models with display audio

### ■ Using the Settings menu on the audio/information screen

1. Select **Settings**.
2. Select **Clock/Info**.
3. Select **Clock Adjustment**.
4. Select **▲** or **▼** to change hour.
5. Select **▲** or **▼** to change minute, then select **OK**.

#### ▶▶ Adjusting the Clock

##### Models with display audio

You can customize the clock display to show the 12 hour clock or 24 hour clock.

➤ **Customized Features\*** P. 233

The clock display is set to off by factory default. You can turn the clock display on and off.

➤ **Customized Features\*** P. 233

The clock is automatically updated when your smartphone is connected to the audio system.

\* Not available on all models

# Locking and Unlocking the Doors

## Key Types and Functions

This vehicle comes with the following keys:

### Master Keys

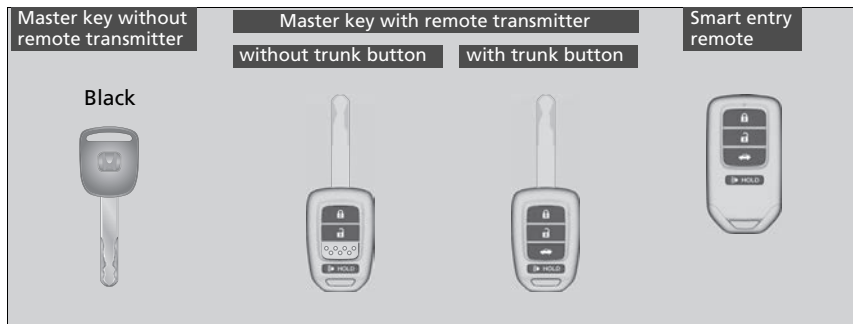

Use the key to start and stop the engine, to lock and unlock the doors and to open the trunk. You can also use the remote transmitter or smart entry system\* to lock and unlock the doors and to open the trunk.

### Smart entry remote\*

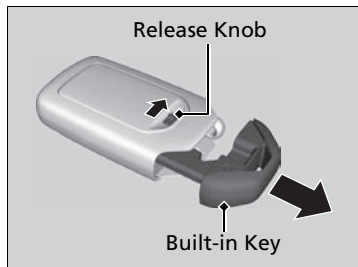

The built-in key can be used to lock/unlock the doors when the smart entry remote battery becomes weak and the power door lock/unlock operation is disabled.

To remove the built-in key, pull it out while sliding the release knob. To reinstall the built-in key, push the built-in key into the smart entry remote until it clicks.

### Key Types and Functions

All the keys have an immobilizer system. The immobilizer system helps to protect against vehicle theft.

#### Immobilizer System P. 125

The keys contain precision electronics.

Adhere to the following advice to prevent damage to the electronics:

- Do not leave the keys in direct sunlight, or in locations with high temperature or high humidity.
- Do not drop the keys or set heavy objects on them.
- Keep the keys away from liquids.
- Do not take the keys apart except for replacing the battery.

If the circuits in the keys are damaged, the engine may not start, and the remote transmitter may not work.

If the keys do not work properly, have them inspected by a dealer.

### ■ Valet Key\*

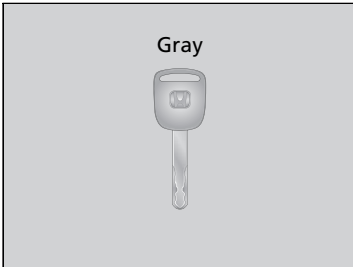

Can be used to start and stop the engine, and lock and unlock driver's door.

### ■ Key Number Tag

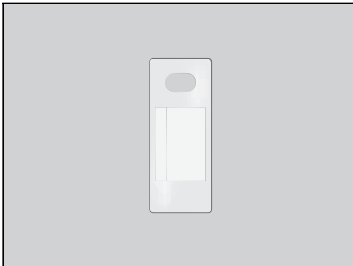

Contains a number that you will need if you purchase a replacement key.

### ▣ Valet Key\*

When you need to leave a key with a third party, leave the valet key.

### ▣ Key Number Tag

Keep the key number tag separate from the key in a safe place outside of your vehicle.  
If you wish to purchase an additional key, contact a dealer.

If you lose your key and you cannot start the engine, contact a dealer.

\* Not available on all models



## Low Smart Entry Remote Signal Strength \*

The vehicle transmits radio waves to locate the smart entry remote when locking/unlocking the doors, opening the trunk, or to start the engine.

In the following cases, locking/unlocking the doors, opening the trunk, or starting the engine may be inhibited or operation may be unstable:

- Strong radio waves are being transmitted by nearby equipment.
- You are carrying the smart entry remote together with telecommunications equipment, laptop computers, cell phones, or wireless devices.
- A metallic object is touching or covering the smart entry remote.

### ▶▶ Low Smart Entry Remote Signal Strength \*

Communication between the smart entry remote and the vehicle consumes the smart entry remote's battery.

Battery life is about two years, but this varies depending on regularity of use.

The battery is consumed whenever the smart entry remote is receiving strong radio waves. Avoid placing it near electrical appliances such as televisions and personal computers.

## Locking/Unlocking the Doors from the Outside

### ■ Using the Remote Transmitter\*

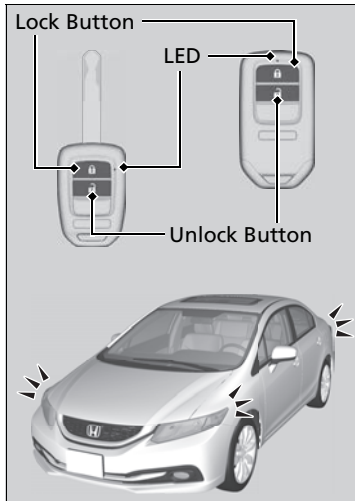

#### ■ Locking the doors

Press the lock button.

##### Once:

- ▶ Some exterior lights flash, all the doors lock, and the security system sets.

##### Twice (within five seconds after the first push):

- ▶ The beeper sounds and verifies the security system is set.

### ⊞ Using the Remote Transmitter\*

If you do not open a door within 30 seconds of unlocking the vehicle with the remote transmitter, the doors will automatically relock. You can change the relock timer setting.

➤ **Customized Features** P. 90

If the interior light switch is in the door activated position, the interior lights come on when you press the unlock button.

No doors opened: The lights fade out after 30 seconds.

Doors relocked with the remote: The lights go off immediately.

➤ **Interior Lights** P. 154

#### Models without smart entry system

The remote transmitter uses low-power signals, so the operating range may vary depending on the surroundings.

#### Models with smart entry system

You can lock or unlock doors using the remote transmitter or smart entry system only when the power mode in VEHICLE OFF.

#### All models

The remote will not lock the vehicle when a door is open.

\* Not available on all models

## ■ Unlocking the doors

Press the unlock button.

### Once:

- ▶ Some exterior lights flash twice, and the driver's door unlocks.

### Twice:

- ▶ The remaining doors unlock.

### ▶▶ Using the Remote Transmitter\*

If the distance at which the remote transmitter works varies, the battery is probably low.  
If the LED does not come on when you press a button, the battery is dead.

▶ **Replacing the Button Battery** P. 401

You can customize the door unlock mode setting.

▶ **Customized Features** P. 90

### ■ Using the Smart Entry with Push Button Start System \*

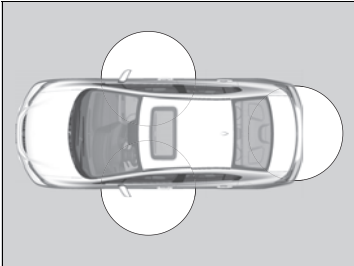

When you carry the smart entry remote, you can lock/unlock the doors and open the trunk. You can lock/unlock the doors within a radius of about 32 inches (80 cm) of the outside door handle. You can open the trunk within about 32 inches (80 cm) radius from the trunk release button.

### ■ Locking the doors and the trunk

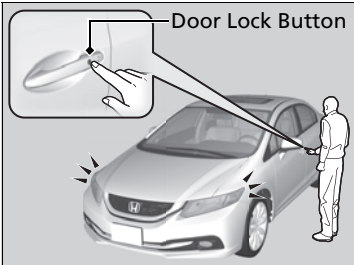

Press the door lock button on the front door.

- ▶ Some exterior lights flash; the beeper sounds; all the doors lock; and the security system sets.

### ☒ Using the Smart Entry with Push Button Start System \*

- Do not leave the smart entry remote in the vehicle when you get out. Carry it with you.
- Even if you are not carrying the smart entry remote, you can lock/unlock the doors while someone else with the remote is within range.
- The door may be unlocked if the door handle is covered with water in heavy rain or in a car wash if the smart entry remote is within range.
- If you grip a front door handle wearing gloves, the door sensor may be slow to respond or may not respond by unlocking the doors.
- You cannot unlock the door by gripping the handle after two seconds of unlocking it.
- The door may not open if you pull it immediately after gripping the door handle. Grip the handle again and confirm that the door is unlocked before pulling the handle.
- Even within the 32 inches (80 cm) radius, you may not be able to lock/unlock the doors with the smart entry remote if it is above or below the outside handle.
- The smart entry remote may not operate if it is too close to the door and door glass.

If the distance at which it works varies, the battery is probably low.

If the LED does not come on when you press a button, the battery is dead.

☒ **Replacing the Button Battery** P. 401

You can customize the door lock mode and keyless lock acknowledgement setting.

☒ **Customized Features** P. 90, 233

\* Not available on all models

## ■ Unlocking the doors and the trunk

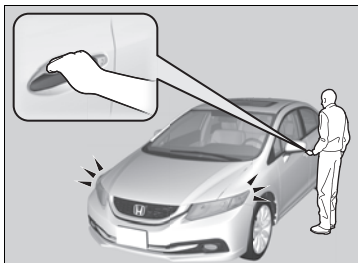

- Grab the driver's door handle:
- ▶ The driver's door unlocks.
  - ▶ Some exterior lights flash twice and the beeper sounds twice.

- Grab the front passenger's door handle:
- ▶ All the doors unlock.
  - ▶ Some exterior lights flash twice and the beeper sounds twice.

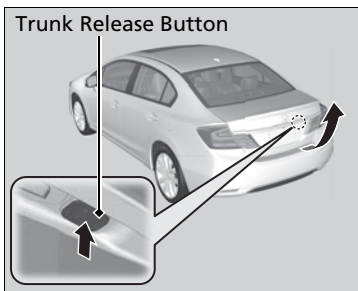

Trunk Release Button

- Press the trunk release button:
- ▶ The trunk unlocks and opens.
  - ▶ **Using the Trunk Release Button** \* P. 122

## ▶▶ Using the Smart Entry with Push Button Start System \*

If you do not open a door within 30 seconds of unlocking the vehicle, the doors will automatically relock.

The beep and unlock settings can be customized.

▶ **Customized Features** P. 90

## ■ Locking/Unlocking the Doors Using a Key



Fully insert the key and turn it.

## ■ Locking a Door Without Using a Key

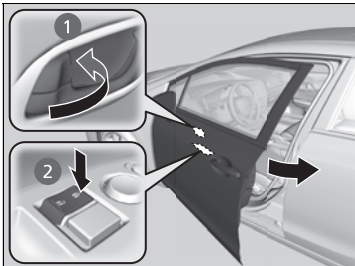

### ■ Locking the driver's door

#### Models with remote transmitter

Push the lock tab forward **1** or push the master door lock switch in the lock direction **2**, and close the door.

#### Models without remote transmitter

Pull and hold the outside door handle, then push the lock tab forward **1**. Release the handle, then close the door.

### ■ Locking the passenger's doors

Push the lock tab forward and close the door.

#### Models with remote transmitter

### ■ Lockout prevention system

The doors cannot be locked when the key is in the ignition switch\*, or the smart entry remote is inside the vehicle.

\*1: Models with the smart entry system have an **ENGINE START/STOP** button instead of an ignition switch.

## ▶▶ Locking/Unlocking the Doors Using a Key

### Models with remote transmitter

When you lock the driver's door with a key, all the other doors lock at the same time. When unlocking, the driver's door unlocks first. Turn the key a second time within a few seconds to unlock the remaining doors.

### Models with i-MID

You can customize the door unlock mode setting.

➔ **Customized Features** P. 90

## ▶▶ Locking a Door Without Using a Key

### Models with remote transmitter

When you lock the driver's door, all the other doors lock at the same time.

Make sure you have the key in your hand before locking the door to prevent it from being locked in the vehicle.

## Locking/Unlocking the Doors from the Inside

### ■ Using the Lock Tab

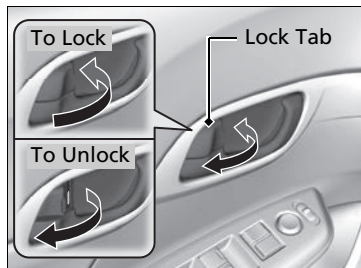

■ **Locking a door**  
Push the lock tab forward.

■ **Unlocking a door**  
Pull the lock tab rearward.

### »» Using the Lock Tab

#### ■ Models with remote transmitter

When you lock the door using the lock tab on the driver's door, all the other doors lock at the same time.

When you unlock the door using the lock tab on the driver's door, only the driver's door will unlock.

## ■ Unlocking Using the Front Door Inner Handle

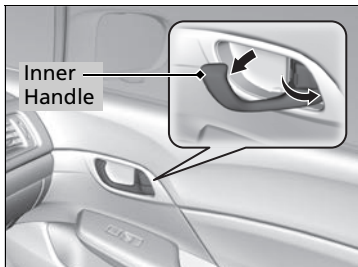

Pull the front door inner handle.

- ▶ The door unlocks and opens in one motion.

### Models with remote transmitter/smart entry remote

Unlocking and opening the driver's door from the inner handle unlocks all the other doors.

To avoid all the doors to be unlocked, use the lock tab on the driver's door to unlock, then lock again before opening the door.

- ▶ This setting works for one time only.

#### Models with i-MID

If you do not want all the doors to be unlocked all the time, customize the

**Auto Unlock All Doors** setting to **Off** using the i-MID.

➤ **Customized Features** P. 90

#### Models without i-MID

If you do not want all the doors to be unlocked all the time, customize the auto door unlocking setting to off using the master door lock switch.

➤ **Customizing Flow for Auto Door Unlocking Options** P. 120

### ⊗ Unlocking Using the Front Door Inner Handle

The inner front door handles are designed to allow front seat occupants to open the door in one motion. However this feature requires that front seat occupants never pull a front door inner handle while the vehicle is in motion.

Children should always ride in a rear seat where childproof door locks are provided.

➤ **Childproof Door Locks** P. 116



### ■ Using the Master Door Lock Switch\*

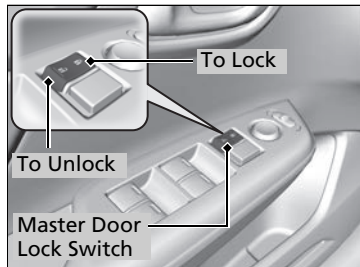

Press the master door lock switch in as shown to lock or unlock all doors.

### ▶▶ Using the Master Door Lock Switch\*

When you lock/unlock the driver's door using the master lock switch, all the other doors lock/unlock at the same time.

## Childproof Door Locks

The childproof door locks prevent the rear doors from being opened from the inside regardless of the position of the lock tab.

### ▶▶ Childproof Door Locks

To open the door from the inside when the childproof door lock is on, put the lock tab in the unlock position, lower the rear window, put your hand out of the window, and pull the outside door handle.

### ■ Setting the Childproof Door Locks

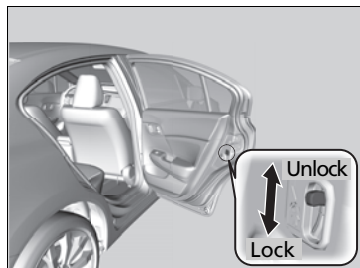

Slide the lever in the rear door to the lock position, and close the door.

#### ■ When opening the door

Open the door using the outside door handle.

## Auto Door Locking/Unlocking\*

Your vehicle locks and unlocks all doors automatically when a certain condition is met.

### ■ Auto Door Locking

#### ■ Drive lock mode

All doors lock when the vehicle's speed reaches about 10 mph (15 km/h).

### ■ Auto Door Unlocking

#### ■ Driver's door open mode

All doors unlock when the driver's door is opened.

### ⌘ Auto Door Locking/Unlocking\*

#### Models without i-MID

You can turn off or change to another auto door locking/unlocking setting using the master door lock switch.

➤ **Customizing the Auto Door Locking/Unlocking Setting\*** P. 118

#### Models with i-MID

You can turn off or change to another auto door locking/unlocking setting using the i-MID.

➤ **Customized Features** P. 90

\* Not available on all models

## Customizing the Auto Door Locking/Unlocking Setting\*

You can customize the auto door locking/unlocking setting to your liking using the master door lock switch.

### List of the Auto Door Locking/Unlocking Customizable Options

#### ■ Auto door locking

Mode	Description
<b>Drive Lock Mode</b> *2	All doors lock when the vehicle's speed reaches about 10 mph (15 km/h).
<b>Off</b>	The auto door locking is deactivated all the time.



#### ■ Auto door unlocking

Mode	Description
<b>Driver's Door Open Mode</b> *2	All doors unlock when the driver's door is opened.
Models with continuously variable transmission	All doors unlock when the shift lever is moved into <b>P</b> with the brake pedal depressed.
<b>Park Unlock Mode</b>	
<b>Off</b>	The auto door unlocking is deactivated all the time.

\*1: Models with the smart entry system have an **ENGINE START/STOP** button instead of an ignition switch.

\*2: Default setting

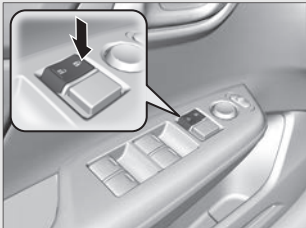
## ■ Customizing Flow for Auto Door Locking Options

Steps	Drive Lock Mode*2	Off
1	Apply the parking brake. Models with continuously variable transmission Move the shift lever out of <b>P</b> .	Apply the parking brake. Models with continuously variable transmission Move the shift lever to <b>P</b> .
2	Close the driver's door.	Open the driver's door.
3	Turn the ignition switch to ON <b>II</b> *1.	Turn the ignition switch to ON <b>II</b> *1.
4	Press and hold the front of the master door lock switch on the driver's door for more than five seconds. Release the switch after you hear a click twice. 	Press and hold the front of the master door lock switch on the driver's door for more than five seconds. Release the switch after you hear one click. 
5	Turn the ignition switch to ACCESSORY <b>I</b> *1 within 20 seconds. ▶ Customization is completed.	

\*1: Models with the smart entry system have an **ENGINE START/STOP** button instead of an ignition switch.

\*2: Default setting

## ■ Customizing Flow for Auto Door Unlocking Options

Steps	Driver's Door Open Mode <sup>*2</sup>	Models with continuously variable transmission Park Unlock Mode	Off
1	Apply the parking brake. Models with continuously variable transmission Move the shift lever out of <b>P</b> .	Apply the parking brake. Move the shift lever to <b>P</b> .	Apply the parking brake. Models with continuously variable transmission Move the shift lever to <b>P</b> .
2	Close the driver's door.		Open the driver's door.
3	Turn the ignition switch to ON <b>II</b> <sup>*1</sup> .		Turn the ignition switch to ON <b>II</b> <sup>*1</sup> .
4	Press and hold the rear of the master door lock switch on the driver's door for more than five seconds. Release the switch after you hear a click twice.		
5	Turn the ignition switch to ACCESSORY <b>I</b> <sup>*1</sup> within 20 seconds. ► Customization is completed.		



\*1: Models with the smart entry system have an **ENGINE START/STOP** button instead of an ignition switch.

\*2: Default setting

## Precautions for Opening/Closing the Trunk

### ■ Opening the trunk

Open the trunk all the way.

- ▶ If it is not fully opened, the trunk lid may begin to close under its own weight.

### ■ Closing the trunk

Keep the trunk lid closed while driving to:

- ▶ Avoid possible damage.
- ▶ Prevent exhaust gas from leaking into the vehicle.

🚫 **Exhaust Gas Hazard** P. 64

## Using the Trunk Opener

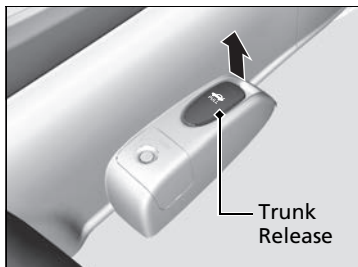

Pulling the trunk release to the lower left of the driver's seat unlocks and opens the trunk.

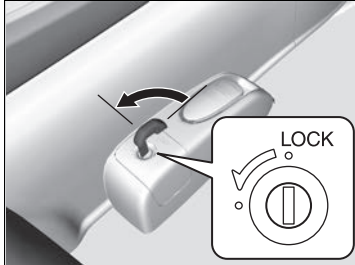

### ■ Locking the trunk opener

You can lock the trunk release with the master key\* or built-in key\*.

#### Models with smart entry system

Locking the trunk release disables the trunk button on the smart entry remote and the trunk release button on the trunk lid to protect luggage in the trunk.

## Using the Trunk Release Button\*

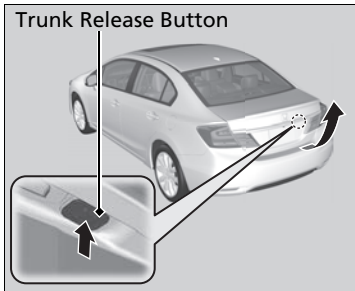

Push up the release button on the trunk lid after the doors are unlocked.

Even if the trunk is locked, you can open the trunk if you carry the smart entry remote.

- ▶ The beeper will sound.

### ▶▶ Locking the trunk opener

If you need to give the key to someone else, give them the remote from which you have removed the built-in key\*, or the valet key\*.

### ▶▶ Using the Trunk Release Button\*

- Do not leave the smart entry remote in the vehicle when you get out. Carry it with you.
- A person who is not carrying the smart entry remote can unlock the trunk if a person who is carrying it is within range.
- Do not leave the smart entry remote inside the trunk and close the lid. The beeper sounds and the trunk cannot be closed.
- Do not carry the smart entry remote near the trunk lid when closing it.
- Do not place the smart entry remote around the rear seat when closing the trunk.

## Using the Master key\*

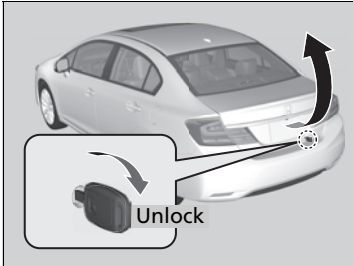

Insert the key in the cylinder to unlock and open the trunk.

## Using the Remote Transmitter\*

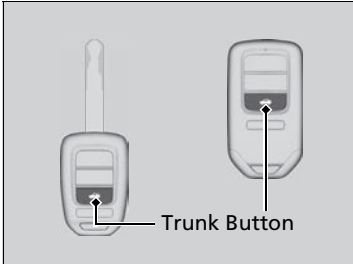

Press the trunk release button for approximately one second to unlock and open the trunk.

### ⌘ Using the Master key\*

The valet key does not unlock the trunk.

\* Not available on all models



## Emergency Trunk Opener

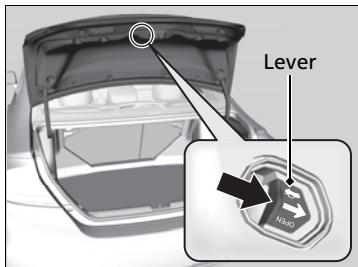

The trunk release lever allows you to open the trunk from inside for your safety.

Slide the release lever in the direction of the arrow.

### Emergency Trunk Opener

Parents should decide if their children should be shown how to use this feature.

## Immobilizer System

The immobilizer system prevents a key that has not been pre-registered from starting the engine. Each key contains electronic transmitters that use electronic signals to verify the key.

Pay attention to the following when inserting the key into the ignition switch or pressing the **ENGINE START/STOP** button:

- Do not allow objects that emit strong radio waves near the ignition switch or the **ENGINE START/STOP** button.
- Make sure the key is not covered by or touching a metal object.
- Do not bring a key from another vehicle's immobilizer system near the ignition switch.

## Security System Alarm\*

The security system alarm activates when the trunk, hood or doors are forcibly opened. The alarm does not go off if the trunk or doors are opened with the key, remote transmitter or smart entry system.

However, the alarm goes off when a door is opened with the key, then the shift lever is moved out of **P** (continuously variable transmission models) or the hood is opened before the ignition switch is turned to ON **II**\*<sup>1</sup>.

### ■ When the security system alarm activates

The horn sounds intermittently and all the exterior lights flash.

### ■ To deactivate the security system alarm

Unlock the vehicle using remote transmitter, or smart entry system. The system, along with the horn and flashing lights, is deactivated.

\* 1: Models with the smart entry system have an **ENGINE START/STOP** button instead of an ignition switch.

\* Not available on all models

*Continued*

### ☞ Immobilizer System

#### NOTICE

Leaving the ignition key in the vehicle can result in theft or accidental movement of the vehicle. Always take the ignition key with you whenever you leave the vehicle unattended.

Do not alter the system or add other devices to it. Doing so may damage the system and make your vehicle inoperable.

### ☞ Security System Alarm\*

The security alarm continues for a maximum of two minutes until the security system deactivates.

### ■ Setting the security system alarm

The security system alarm automatically sets when the following conditions have been met:

- The ignition switch is in LOCK **[0]**\*1, and the key has been removed from the ignition switch.
- The hood and trunk are closed.
- All doors are locked with the key, the remote transmitter, or smart entry system.

### ■ When the security system alarm sets

The security system indicator in the instrument panel blinks. When the blinking interval changes after about 15 seconds, the security system is set.

### ■ To cancel the security system alarm

The security system is canceled when the vehicle is unlocked using the remote transmitter, smart entry system, or the ignition switch is turned to ON **[II]**\*1. The security system indicator goes off at the same time.

\*1: Models with the smart entry system have an **ENGINE START/STOP** button instead of an ignition switch.

\* Not available on all models

### ► Security System Alarm\*

Do not set the security system alarm when someone is in the vehicle or a window is open. The system can accidentally activate when:

- Unlocking the door with the lock tab.
- Opening the trunk with the trunk release or the emergency trunk opener.
- Opening the hood with the hood release.

#### Continuously variable transmission models

- Moving the shift lever out of **[P]**.

If the battery goes dead after you have set the security system alarm, the security alarm may go off once the battery is recharged or replaced. If this occurs, deactivate the security system alarm by unlocking a door using the remote transmitter.

Do not attempt to alter this system or add another device to it.

## ■ Panic Mode

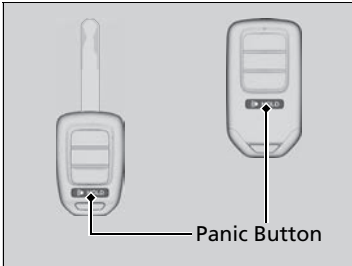

### ■ The panic button on the remote transmitter

If you press the panic button for approximately one second, the following will occur for about 30 seconds:

- The horn sounds.
- Some exterior lights flash.

### ■ Canceling panic mode

Press any button on the remote transmitter, or turn the ignition switch to ON \*1.

\*1: Models with the smart entry system have an **ENGINE START/STOP** button instead of an ignition switch.

## Opening/Closing the Power Windows

The power windows can be opened and closed when the ignition switch is in ON <sup>\*1</sup>, using the switches on the doors. The driver's side switches can be used to open and close all of the windows.

The power window lock button on the driver's side must be switched off (not pushed in, indicator off) to open and close the windows from anywhere other than the driver's seat.

When the power window lock button is pushed in, you can only operate the driver's window. Turn the power window lock button on when children are in the vehicle.

### Opening/Closing Windows with Auto-Open/Close Function \*

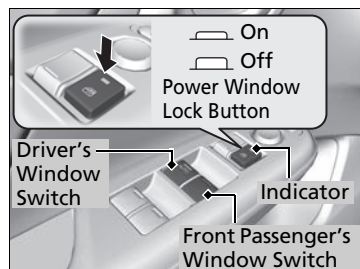

#### Automatic operation

**To open:** Push the switch down firmly.

**To close:** Pull the switch up firmly.

The window opens or closes completely. To stop the window at any time, push or pull the switch briefly.

#### Manual operation

**To open:** Push the switch down lightly, and hold it until the desired position is reached.

**To close:** Pull the switch up lightly, and hold it until the desired position is reached.

\*1: Models with the smart entry system have an **ENGINE START/STOP** button instead of an ignition switch.

\* Not available on all models

### Opening/Closing the Power Windows

## WARNING

Closing a power window on someone's hands or fingers can cause serious injury.

Make sure your passengers are away from the windows before closing them.

The power windows can be operated for up to 10 minutes after you turn the ignition switch off. Opening either front door cancels this function.

#### Auto Reverse

If a power window senses resistance when closing automatically, it stops closing and reverse direction.

The driver's window auto reverse function is disabled when you continuously pull up the switch.

The auto reverse function stops sensing when the window is almost closed to ensure that it fully closes.

## ■ Opening/Closing Windows without Auto-Open/Close Function

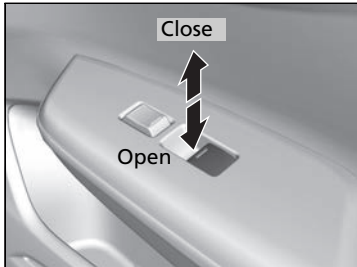

**To open:** Push the switch down.

**To close:** Pull the switch up.

Release the switch when the window reaches the desired position.

# Opening and Closing the Moonroof\*

## ■ Opening/Closing the Moonroof

You can only operate the moonroof when the ignition switch is in ON <sup>\*1</sup>. Use the switch in the front of the ceiling to open and close the moonroof.

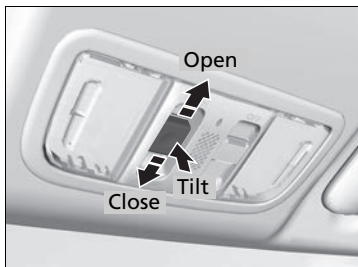

### ■ Automatic operation

**To open:** Pull the switch back firmly.

**To close:** Push the switch forward firmly.

The moonroof will automatically open or close all the way. To stop the moonroof midway, touch the switch briefly.

### ■ Manual operation

**To open:** Pull the switch back, and hold it until the desired position is reached.

**To close:** Push the switch forward, and hold it until the desired position is reached.

### ■ Tilting the moonroof up

**To tilt:** Push on the center of the moonroof switch.

**To close:** Push the switch forward firmly, then release.

## 🔗 Opening/Closing the Moonroof

### ⚠️ WARNING

Opening or closing the moonroof on someone's hands or fingers can cause serious injury.

Make sure all hands and fingers are clear of the moonroof before opening or closing it.

### NOTICE

Opening the moonroof in below freezing temperature or when it is covered with snow or ice can damage the moonroof panel or motor.

The power moonroof can be operated for up to 10 minutes after you turn the ignition switch off. Opening either front door cancels this function.

When resistance is detected, the auto reverse function causes the moonroof to change directions, then stop. Auto reverse stops sensing when the moonroof is almost closed to ensure that it fully closes. Make sure that all objects, including fingers, are clear of the moonroof.

\*1: Models with the smart entry system have an **ENGINE START/STOP** button instead of an ignition switch.

\* Not available on all models

## Ignition Switch \*

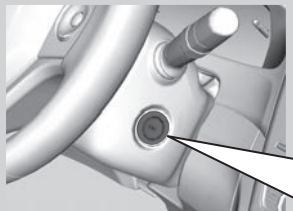

- 0** LOCK: Insert and remove the key in this position.
- I** ACCESSORY: Operate the audio system and other accessories in this position.
- II** ON: This is the position when driving.
- III** START: This position is for starting the engine. The switch returns to ON **II** when you let go of the key.

### Ignition Switch \*

#### Manual transmission models

## ⚠ WARNING

Removing the key from the ignition switch while driving locks the steering. This can cause you to lose control of the vehicle.

Remove the key from the ignition switch only when parked.

#### Continuously variable transmission models

You cannot take the key out unless the shift lever is in **P**.

#### All models

If you open the driver's door when the key is in LOCK **0** or ACCESSORY **I**, a warning buzzer will sound to remind you to take the key out.

When this happens, the following messages appear on the i-MID\*:

- In LOCK **0**: **REMOVE KEY.**
- In ACCESSORY **I**: **RETURN IGNITION SWITCH TO LOCK (0) POSITION** The buzzer will stop when you take the key out.

If the key won't turn from LOCK **0** to ACCESSORY **I**, turn the key while moving the steering wheel left and right. The steering wheel will unlock, allowing the key to turn.

\* Not available on all models



## ENGINE START/STOP Button\*

### ■ Changing the Power Mode

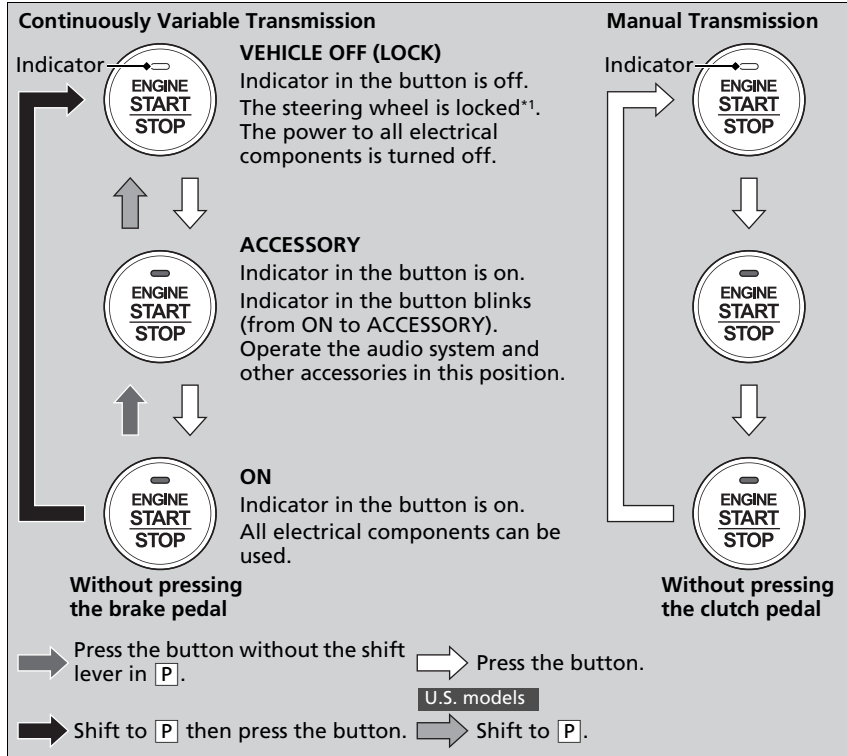

\*1: Except U.S. models with continuously variable transmission

### ▶▶ ENGINE START/STOP Button\*

#### ENGINE START/STOP Button Operating Range

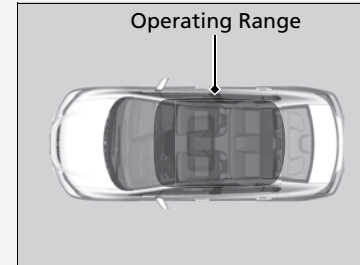

You can start the engine when the smart entry remote is inside the vehicle.

The engine may also run if the smart entry remote is close to the door or window, even if it is outside the vehicle.

ON mode:

Indicator in the button is off, if the engine is running.

If the smart entry remote battery is weak, beeper sounds and the **TO START, HOLD REMOTE NEAR START BUTTON** message appears on the i-MID.

**▶▶ If the Smart Entry Remote Battery is Weak**  
P. 427

Do not leave the power mode in ACCESSORY or ON when you get out.

## ■ Automatic Power Off

If you leave the vehicle for 30 to 60 minutes with the shift lever in **P**\*1 and the power mode in ACCESSORY, the vehicle automatically goes into the mode similar to VEHICLE OFF (LOCK) to avoid the battery drain.

When in this mode:

The steering wheel does not lock.

You cannot lock or unlock doors with the remote transmitter or the smart entry system.

Press the **ENGINE START/STOP** button twice to switch the mode to VEHICLE OFF (LOCK).

\*1: Continuously variable transmission models

## ■ Power Mode Reminder

If you open the driver's door when the power mode is set to ACCESSORY, a warning buzzer sounds.

## ■ Smart Entry Remote Reminder

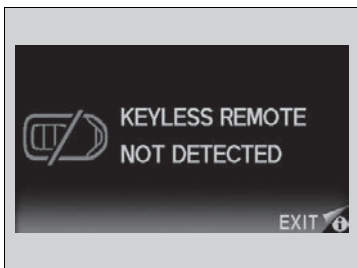

Warning buzzers may sound from inside or/ and outside the vehicle to remind you that the smart entry remote is out of the vehicle. If the buzzer continues even after the remote is put back inside, place it to be within its operational range.

### ■ When the power mode is in ON

If the smart entry remote is taken out of the vehicle, and the driver's door is closed, warning buzzers sound from both inside and outside the vehicle. A warning message on the i-MID notifies the driver inside that the remote is out.

### ■ When the power mode is in ACCESSORY

If the smart entry remote is taken out of the vehicle, and all the doors are closed, a warning buzzer sounds from outside the vehicle.

## ▶▶ Smart Entry Remote Reminder









When the smart entry remote is within the system's operational range, and the driver's door is closed, the warning function cancels.

If the smart entry remote is taken out of the vehicle after the engine has been started, you can no longer change the **ENGINE START/STOP** button mode or restart the engine. Always make sure if the remote is in your vehicle when you operate the **ENGINE START/STOP** button.

Removing the smart entry remote from the vehicle through a window does not activate the warning buzzer.

Do not put the smart entry remote on the dashboard or in the glove box. It may cause the warning buzzer to go off. Under some other conditions that can prevent the vehicle from locating the remote, the warning buzzer may also go off even if the remote is within the system's operational range.

## Ignition Switch and Power Mode Comparison

Ignition Switch Position	LOCK (0) (with/without the key) 	ACCESSORY (I) 	ON (II) 	START (III) 
Without Smart Entry System	<ul style="list-style-type: none"> <li>Engine is turned off and power is shut down.</li> <li>The steering wheel is locked*1.</li> <li>No electrical components can be used.</li> </ul>	<ul style="list-style-type: none"> <li>Engine is turned off.</li> <li>Some electrical components such as the audio system and the accessory power socket can be operated.</li> </ul>	<ul style="list-style-type: none"> <li>Normal key position while driving.</li> <li>All electrical components can be used.</li> </ul>	<ul style="list-style-type: none"> <li>Use this position to start the engine.</li> <li>The ignition switch returns to the ON (II) position when you release the key.</li> </ul>
Power Mode	VEHICLE OFF (LOCK) 	ACCESSORY 	ON   Indicator is: On Off	START 
With Smart Entry System and <b>ENGINE START/STOP</b> Button	Indicator-Off <ul style="list-style-type: none"> <li>Engine is turned off and power is shut down.</li> <li>The steering wheel is locked*1.</li> <li>No electrical components can be used.</li> </ul>	Indicator-On or blinking <ul style="list-style-type: none"> <li>Engine is turned off.</li> <li>Some electrical components such as the audio system and the accessory power socket can be operated.</li> </ul>	Indicator-On (engine is turned off) Off (engine is running) <ul style="list-style-type: none"> <li>All electrical components can be used.</li> </ul>	Indicator-Off <ul style="list-style-type: none"> <li>The mode automatically returns to ON after the engine starts.</li> </ul>

\*1:Except U.S. models with continuously variable transmission

## Turn Signals

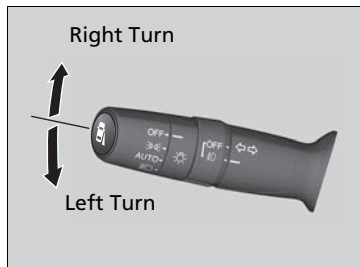

The turn signals can be used when the ignition switch is in ON \*1.

### ■ One-touch turn signal

When you lightly push up or down and release the turn signal lever, the exterior turn signals and turn signal indicator blink three times. This feature can be used when signaling for a lane change.

## Light Switches

### ■ Manual Operation

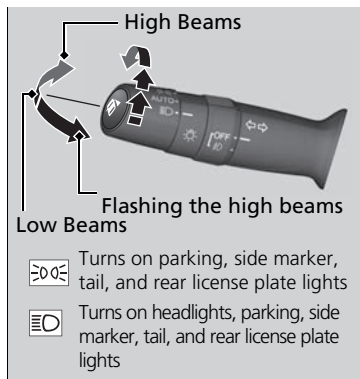

Rotating the light switch turns the lights on and off, regardless of the position of the ignition switch.

### ■ High beams

Push the lever forward until you hear a click.

### ■ Low beams

When in high beams, pull the lever back to return to low beams.

### ■ Flashing the high beams

Pull the lever back, and release it.

\*1: Models with the smart entry system have an **ENGINE START/STOP** button instead of an ignition switch.

### ▶▶ Light Switches

#### Models with smart entry system

If you leave the power mode in VEHICLE OFF (LOCK) with the lights on, a light on reminder chime sounds when you open the driver's door.

#### Models without smart entry system

If you remove the key from the ignition switch while the lights are on, a chime sounds when the driver's door is opened.

When the lights are on, the lights on indicator in the instrument panel will be on.

#### Lights On Indicator P. 74

Do not leave the lights on when the engine is off because it will cause the battery to discharge.

If you sense that the level of the headlights is abnormal, have the vehicle inspected by a dealer.

## Automatic Lighting Control\*

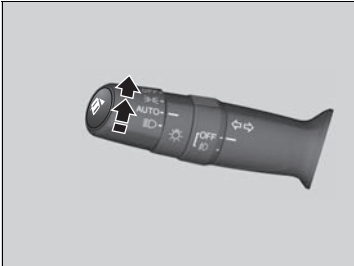

Automatic lighting control can be used when the ignition switch is in ON \*1.

When you turn the light switch to **AUTO**, the headlights and other exterior lights will switch on and off automatically depending on the ambient brightness.

- ▶ You can change the auto light sensitivity setting.
  - ▣ **Customized Features** P. 90

## Automatic Lighting Control\*

We recommend that you turn on the lights manually when driving at night, in a dense fog, or in dark areas such as long tunnels or parking facilities.

The light sensor is in the location shown below. Do not cover this light sensor with anything; otherwise, the automatic lighting system may not work properly.

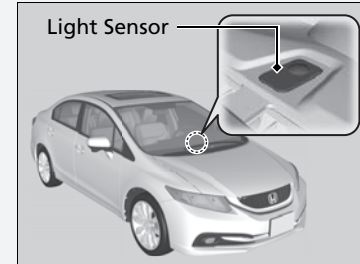

Adjust the auto light sensitivity as follows:

Setting	The exterior lights come on when the ambient light is at
<b>MAX</b>	 Bright
<b>HIGH</b>	
<b>MID</b>	
<b>LOW</b>	
<b>MIN</b>	

\*1: Models with the smart entry system have an **ENGINE START/STOP** button instead of an ignition switch.

\* Not available on all models

Continued

## ■ Headlight Integration with Wipers\*

The headlights automatically come on when the wipers are used several times within a certain number of intervals with the headlight switch in **AUTO**. The headlights automatically go off a few minutes later if the wipers are stopped.

## ■ Automatic Lighting Off Feature

The headlights, all other exterior lights, and the instrument panel lights turn off 15 seconds after you remove the key or set the power mode to VEHICLE OFF (LOCK), take the remote with you, and close the driver's door.

▶ You can change the headlight auto off timer setting.

🔧 **Customized Features** P. 90

If you turn the ignition switch to LOCK **0**<sup>\*1</sup> with the headlight switch on, but do not open the door, the lights turn off after 10 minutes (three minutes, if the switch is in the **AUTO** position).

The lights turn on again when you unlock or open the driver's door. If you unlock the door, but do not open it within 15 seconds, the lights go off. If you open the driver's door, you will hear a lights on reminder chime.

\*1: Models with the smart entry system have an **ENGINE START/STOP** button instead of an ignition switch.

## 🔧 Headlight Integration with Wipers\*

This feature activates while the headlights are off in **AUTO**.

The instrument panel brightness does not change when the headlights come on.

At dark ambient light levels, the automatic lighting control feature turns on the headlights, regardless of the number of wiper sweeps.

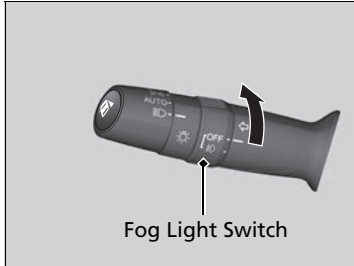

## Fog Lights\*



When the low beam headlights are on, turn the fog light switch on to use the fog lights.

## Daytime Running Lights

The high beam headlights come on slightly dimmer than normal when the following conditions have been met:

- The ignition switch is in ON <sup>\*1</sup>.
- The headlight switch is off, or in .
- The parking brake is released.

The lights remain on even if you set the parking brake. Turning off the ignition switch or setting the power mode to VEHICLE OFF will turn off the daytime running lights.

The high beam headlights return to the original brightness once the headlight switch is turned on.

\*1: Models with the smart entry system have an **ENGINE START/STOP** button instead of an ignition switch.

\* Not available on all models

### ☒ Fog Lights\*

When the fog lights are on, the indicator in the instrument panel will be on. They go off when the headlights turn off, or when the daytime running lights are on.

☒ **Fog Light Indicator\*** P. 74



## Wipers and Washers

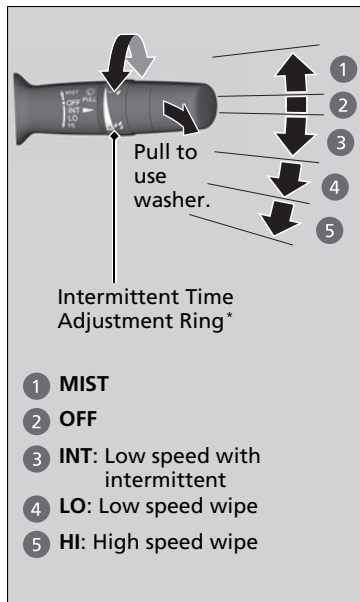

The windshield wipers and washers can be used when the ignition switch is in ON \*1.

### ■ MIST

The wipers run at high speed until you release the lever.

### ■ Wiper switch (OFF, INT, LO, HI)

Change the wiper switch setting according to the amount of rain.

### ■ Adjusting the delay\*

Turn the adjustment ring to adjust the wiper delay.



### ■ Washer

Sprays while you pull the lever toward you. When you release the lever, the wipers make two or three more sweeps before stopping.

\*1: Models with the smart entry system have an **ENGINE START/STOP** button instead of an ignition switch.

\* Not available on all models

## Wipers and Washers

### NOTICE

Do not use the wipers when the windshield is dry. The windshield will get scratched, or the rubber blades will get damaged.

### NOTICE

In cold weather, the blades may freeze to the windshield, becoming stuck. Operating the wipers in this condition may damage the wipers. Use the defroster to warm the windshield, then turn the wipers on.

### Models with adjustment ring

If the vehicle speeds up while the wipers are operating intermittently, the length of the wipe interval shortens. When the vehicle starts moving, the wipers make a single sweep. When the vehicle speeds up, the wiper operation's shortest delay setting and the **LO** setting become the same.

### All models

Turn the washers off if no washer fluid comes out. The pump may get damaged.

The wiper motor is equipped with a breaker that may stop motor operation temporarily to prevent an overload. Wiper operation will return to normal within a few minutes, once the circuit has returned to normal.

If the wipers stop operating due to any obstacle such as the build-up of snow, park the vehicle in a safe place.

Rotate the wiper switch to **OFF**, and turn the ignition switch to **ACCESSORY** or **LOCK** \*1, then remove the obstacle.

## Brightness Control



When the parking lights are turned on and the ignition switch is in ON <sup>\*1</sup>, you can use the brightness control knob to adjust instrument panel brightness.

**Brighten:** Turn the knob to the right.

**Dim:** Turn the knob to the left.

You will hear a beep when the brightness reaches minimum or maximum. The information display<sup>\*i-MID\*</sup> will return to its original state several seconds after you adjust the brightness.

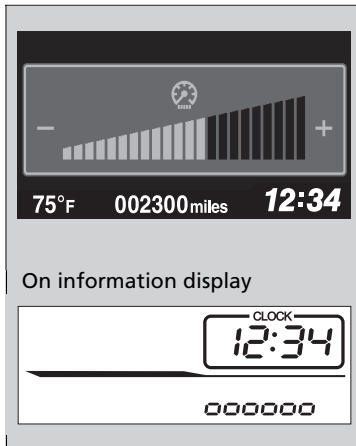

### ■ Brightness level indicator

The brightness level is shown on the information display<sup>\*i-MID\*</sup> while you are adjusting it.



### ☒ Brightness Control

Instrument panel brightness varies, depending on whether the exterior lights are on or off. The instrument panel dims to reduce glare when they are on.

Pressing the  (Select/Reset) knob or the  (display/i-information) button<sup>\*</sup> switches the display.

If you turn the knob to the right until the brightness display is up to max, the beeper sounds. This cancels the reduced instrument panel brightness when the parking lights are on.

The brightness can be set differently for when the exterior lights are on, and when they are off.

<sup>\*1</sup>: Models with the smart entry system have an **ENGINE START/STOP** button instead of an ignition switch.

<sup>\*</sup> Not available on all models

## Rear Defogger/Heated Door Mirror\* Button

Press the rear defogger and heated door mirror button to defog the rear window and mirrors when the ignition switch is in ON \*1.

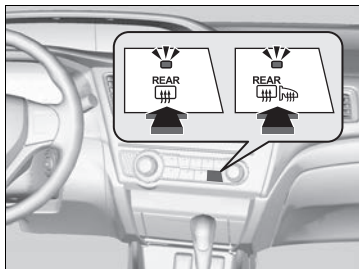

### Models with heating and cooling system

The rear defogger and heated door mirrors automatically switch off after 20 minutes.



### Models with climate control system

The rear defogger and heated door mirrors automatically switch off after 10-30 minutes depending on the outside temperature. However, if the outside temperature is 32°F (0°C) or below, they do not automatically switch off.

### ▶▶ Rear Defogger/Heated Door Mirror\* Button

#### NOTICE

When cleaning the inside of the rear window, be careful not to damage the heating wires. It is critical to wipe the window from side to side along the defogger heating wires.

This system consumes a lot of power, so turn it off when the window has been defogged. Also, do not use the system for a long period when the engine is idling. This may weaken the battery, making it difficult to start the engine.

\*1: Models with the smart entry system have an **ENGINE START/STOP** button instead of an ignition switch.

\* Not available on all models

## Adjusting the Steering Wheel

The steering wheel height and distance from your body can be adjusted so that you can comfortably grip the steering wheel in an appropriate driving posture.

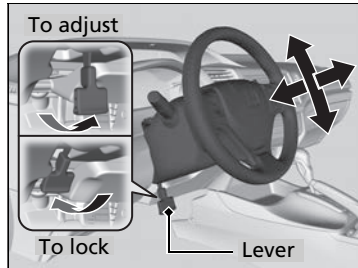

1. Pull the steering wheel adjustment lever up.
  - ▶ The steering wheel adjustment lever is under the steering column.
2. Move the steering wheel up or down, and in or out.
  - ▶ Make sure you can see the instrument panel gauges and indicators.
3. Push the steering wheel adjustment lever down to lock the steering wheel in position.
  - ▶ After adjusting the position, make sure you have securely locked the steering wheel in place by trying to move it up, down, in, and out.

### Adjusting the Steering Wheel

#### **⚠ WARNING**

Adjusting the steering wheel position while driving may cause you to lose control of the vehicle and be seriously injured in a crash.

Adjust the steering wheel only when the vehicle is stopped.

Make any steering wheel adjustments before you start driving.

# Adjusting the Mirrors

## Interior Rearview Mirror

Adjust the angle of the rearview mirror when you are sitting in the correct driving position.

### ■ Rearview Mirror with Day and Night Positions

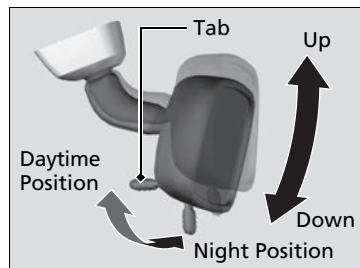

Flip the tab to switch the position. The night position will help to reduce the glare from headlights behind you when driving after dark.

## Power Door Mirrors

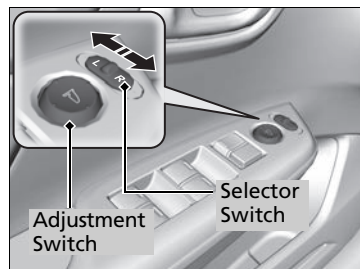

You can adjust the door mirrors when the ignition switch is in ON \*1.

### ■ Mirror position adjustment

**L/R selector switch:** Select the left or right mirror. After adjusting the mirror, return the switch to the center position.

**Mirror position adjustment switch:** Press the switch left, right, up, or down to move the mirror.

\*1: Models with the smart entry system have an **ENGINE START/STOP** button instead of an ignition switch.

### ▶ Adjusting the Mirrors

Keep the inside and outside mirrors clean and adjusted for best visibility.

Adjust the mirrors before you start driving.

▶ **Adjusting the Seat Positions** P. 146

## Expanded View Driver's Mirror

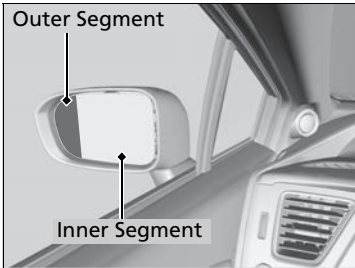

The driver side door mirror has outer and inner segments.

The outer segment is slightly curved to provide a wider angle view than a standard flat mirror. This wider view may help you check areas that are not visible using a standard door mirror.

### Expanded View Driver's Mirror

Objects visible in the outer segment of the driver side door mirror appear smaller than objects in the rest of the mirror. But in fact, they are closer than they appear.

Do not rely on your mirrors. Always look to the side and behind your vehicle before changing lanes.

## Adjusting the Seat Positions

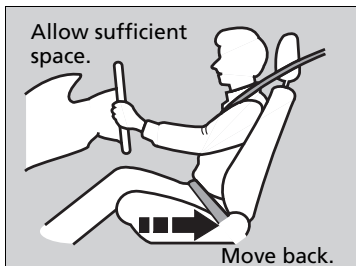

Adjust the driver's seat as far back as possible while allowing you to maintain full control of the vehicle. You should be able to sit upright, well back in the seat and be able to adequately press the pedals without leaning forward, and grip the steering wheel comfortably. The passenger's seat should be adjusted in a similar manner, so that it is as far back from the front airbag in the dashboard as possible.

### ■ Adjusting the driver's power seat\*

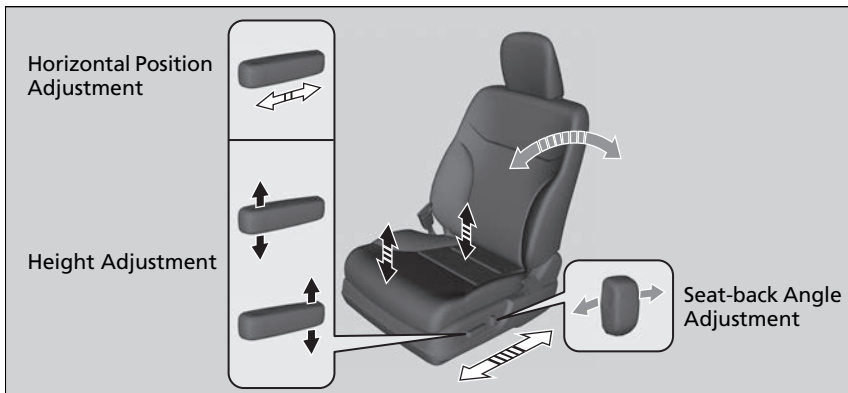

### Adjusting the Seats

## ⚠ WARNING

Sitting too close to a front airbag can result in serious injury or death if the front airbags inflate.

Always sit as far back from the front airbags as possible while maintaining control of the vehicle.

The National Highway Traffic Safety Administration and Transport Canada recommend that drivers allow at least 10 inches (25 cm) between the center of the steering wheel and the chest.

Always make seat adjustments before driving.

## ■ Adjusting the front manual seat(s)



## ▣ Adjusting the front manual seat(s)

Once a seat is adjusted correctly, rock it back and forth to make sure it is locked in position.



## ■ Adjusting the Seat-Backs

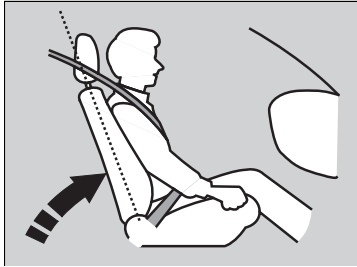

Adjust the driver's seat-back to a comfortable, upright position, leaving ample space between your chest and the airbag cover in the center of the steering wheel.

The front seat passenger should also adjust their seat-back to a comfortable, upright position.

Reclining a seat-back so that the shoulder part of the belt no longer rests against the occupant's chest reduces the protective capability of the belt. It also increases the chance of sliding under the belt in a crash and being seriously injured. The farther a seat-back is reclined, the greater the risk of injury.

## ▶▶ Adjusting the Seat-Backs

### **⚠ WARNING**

**Reclining the seat-back too far can result in serious injury or death in a crash.**

**Adjust the seat-back to an upright position, and sit well back in the seat.**

Do not put a cushion, or other object, between the seat-back and your back.

Doing so may interfere with proper seat belt or airbag operation.

If you cannot get far enough away from the steering wheel and still reach the controls, we recommend that you investigate whether some type of adaptive equipment may help.

## ■ Adjusting the Head Restraints

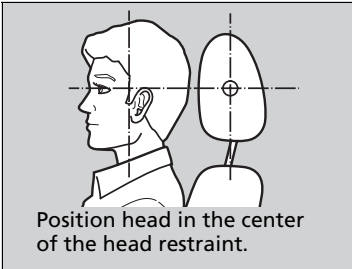

Your vehicle is equipped with head restraints in all seating positions.

Head restraints are most effective for protection against whiplash and other rear-impact crash injuries when the center of the back of the occupant's head rests against the center of the restraint. The tops of the occupant's ears should be level with the center height of the restraint.

## ■ Adjusting the front head restraint positions

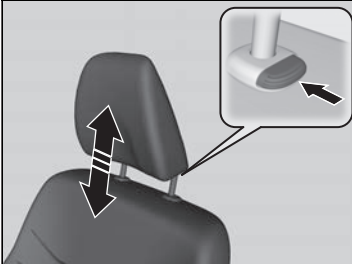

**To raise the head restraint:** Pull it upward.  
**To lower the head restraint:** Push it down while pressing the release button.

## ▶▶ Adjusting the Head Restraints

### ⚠ WARNING

Improperly positioning head restraints reduces their effectiveness and increases the likelihood of serious injury in a crash.

Make sure head restraints are in place and positioned properly before driving.

In order for the head restraint system to work properly:

- Do not hang any items on the head restraints, or from the restraint legs.
- Do not place any object between an occupant and the seat-back.
- Install each restraint in its proper location.

## ■ Changing the Rear Seat Head Restraint Positions

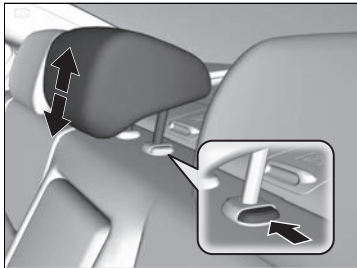

A passenger sitting in a back seating position should adjust the height of their head restraint to an appropriate position before the vehicle begins moving.

### **To raise the head restraint:**

Pull it upward.

### **To lower the head restraint:**

Push it down while pressing the release button.

## ■ Removing and Reinstalling the Head Restraints

Head restraints can be removed for cleaning or repair.

### **To remove a head restraint:**

Pull the restraint up as far as it will go. Then push the release button, and pull the restraint up and out.

### **To reinstall a head restraint:**

Insert the legs back in place, then adjust the head restraint to an appropriate height while pressing the release button. Pull up on the restraint to make sure it is locked in position.

### ► Removing and Reinstalling the Head Restraints

## **⚠ WARNING**

Failure to reinstall, or correctly reinstall, the head restraints can result in severe injury during a crash.

Always replace the head restraints before driving.

## ■ Maintain a Proper Sitting Position

After all occupants have adjusted their seats and head restraints, and put on their seat belts, it is very important that they continue to sit upright, well back in their seats, with their feet on the floor, until the vehicle is safely parked and the engine is off.

Sitting improperly can increase the chance of injury during a crash. For example, if an occupant slouches, lies down, turns sideways, sits forward, leans forward or sideways, or puts one or both feet up, the chance of injury during a crash is greatly increased.

In addition, an occupant who is out of position in the front seat can be seriously or fatally injured in a crash by striking interior parts of the vehicle or being struck by an inflating front airbag.

### ⓘ Maintain a Proper Sitting Position

#### **⚠ WARNING**

**Sitting improperly or out of position can result in serious injury or death in a crash.**

**Always sit upright, well back in the seat, with your feet on the floor.**

## Rear Seats

### Folding Down the Rear Seats

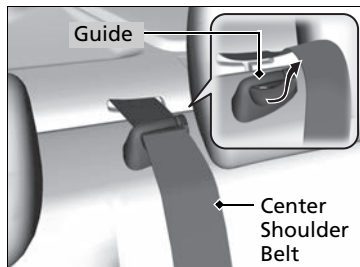

1. Remove the center shoulder belt from the guide.

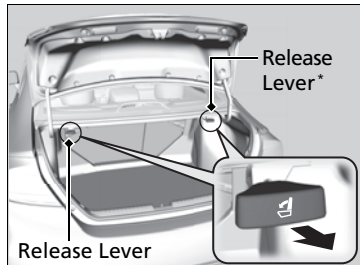

2. Pull the release lever in the trunk to release the lock.



3. Fold the seat-back down.

If the rear head restraints get caught on the front seat-backs, remove the head restraints.

➤ **Removing and Reinstalling the Head Restraints** P. 150

### ➤ Folding Down the Rear Seats

The rear seat-back(s\*) can be folded down to accommodate bulkier items in the trunk.

Never drive with the seat-back folded down and the trunk lid open.

➤ **Exhaust Gas Hazard** P. 64

To lock a seat-back upright, push it backwards until it locks.

When returning the seat-back to its original position, push it firmly back. Also, make sure all rear shoulder belts are positioned in front of the seat-back, and the center shoulder belt is re-positioned in the guide.

Make sure that the folded seat-back does not press against the front passenger seat, as this can cause the weight sensors in the front passenger seat to work improperly.

➤ **Passenger Airbag Off Indicator** P. 50

**Make sure all items in the trunk or items extending through the opening into the rear seats are properly secured. Loose items can fly forward if you have to brake hard.**

The front seat(s) must be far enough forward so they do not interfere with the rear seats as they fold down.

## Armrest

### ■ Using the Front Seat Armrest

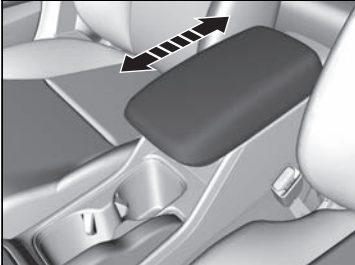

The console lid can be used as an armrest.

**To adjust\*:**

Slide the armrest to desired position.

### ■ Using the Rear Seat Armrest\*

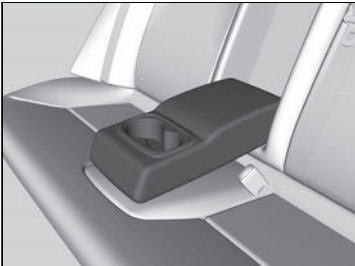

Pull down the armrest in the center seat-back.

\* Not available on all models

## Interior Lights

### Interior Light Switches



#### ■ ON

The interior lights come on regardless of whether the doors are open or closed.

#### ■ Door activated

The interior lights come on in the following situations:

- When any of the doors are opened.
- You unlock the driver's door.

#### Models without smart entry system

- You remove the key from the ignition switch.

#### Models with smart entry system

- When the power mode is set to VEHICLE OFF (LOCK).

#### ■ OFF

The interior lights remain off regardless of whether the doors are open or closed.

### » Interior Light Switches

In the door activated position, the interior lights fade out and go off about 30 seconds after the doors are closed. The lights go off after 30 seconds in the following situations:

- When you unlock the driver's door but do not open it.

#### Models without smart entry system

- When you remove the key from the ignition switch but do not open a door.

#### Models with smart entry system

- When you set the power mode to VEHICLE OFF (LOCK) but do not open a door.

#### Models with i-MID

You can change the interior lights dimming time.

- **Customized Features** P. 90

The interior lights go off immediately in the following situations:

- When you lock the driver's door.
- When you turn the ignition switch to ON **[II]**\*1.

#### Models without smart entry system

- When you close the driver's door with the key in the ignition switch.

#### Models with smart entry system

- When you close the driver's door in ACCESSORY mode.

If you leave any of the doors open without the key in the ignition switch\*1, the interior lights go off after about 15 minutes.

\*1: Models with the smart entry system have an **ENGINE START/STOP** button instead of an ignition switch.

## Map Lights \*

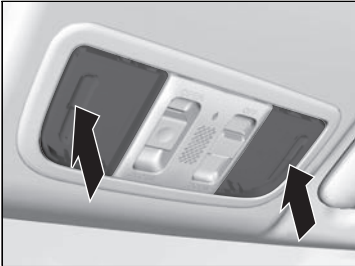

The map lights can be turned on and off by pressing the lenses.

## Map Lights \*

When the ceiling light switch is in the door activated position and any door is open, the map light will not go off when you press the lens.

\* Not available on all models



## Interior Convenience Items

### Glove Box



Pull the handle to open the glove box.

### Glove Box

#### **⚠ WARNING**

An open glove box can cause serious injury to your passenger in a crash, even if the passenger is wearing the seat belt.

Always keep the glove box closed while driving.

### Console Compartment

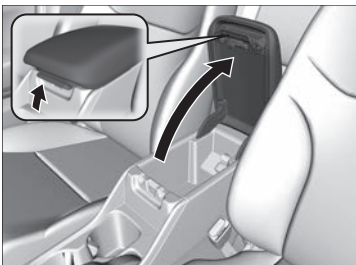

Pull the handle to open the console compartment.

## ■ Center Pocket

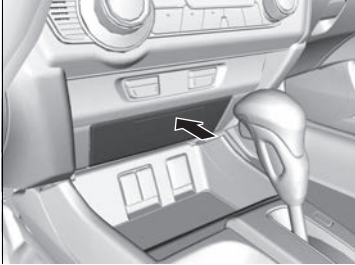

Press on the upper edge to open the pocket.

## ■ Beverage Holders



### ■ Front seat beverage holders

Are located in the console between the front seats.

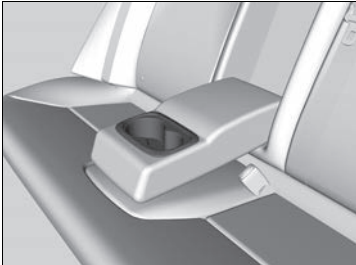

### ■ Rear seat beverage holders\*

Fold the armrest down to use the rear seat beverage holders.



## » Beverage Holders

### NOTICE

Spilled liquids damage the upholstery, carpeting, and electrical components in the interior.

Be careful when you are using the beverage holders. Hot liquid can scald you.

## Accessory Power Socket

The accessory power socket can be used when the ignition switch is in ACCESSORY  or ON \*1.

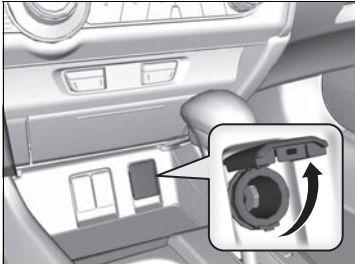

Open the cover to use it.

## Coat Hook

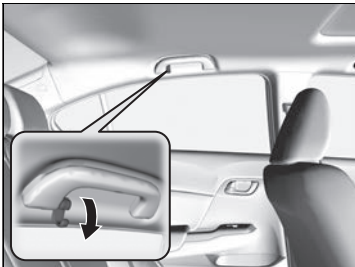

There is a coat hook on the rear left grab handle. Pull it down to use it.

\*1: Models with the smart entry system have an **ENGINE START/STOP** button instead of an ignition switch.

### Accessory Power Socket

#### NOTICE

Do not insert an automotive type cigarette lighter element. This can overheat the power socket.

#### Models with tire repair kit

#### NOTICE

Do not operate the tire repair kit compressor for more than 15 minutes. The accessory power socket and compressor can overheat and become permanently damaged.

#### All models

The accessory power socket is designed to supply power for 12 volt DC accessories that are rated 180 watts (15 amps) or less.

To prevent battery drain, only use the power socket with the engine running.

### Coat Hook

The coat hook is not designed for large or heavy items.

## Seat Heaters\*



The ignition switch must be in ON **II**\*1 to use the seat heaters. The **HI** setting heats the seats faster than the **LO** setting.

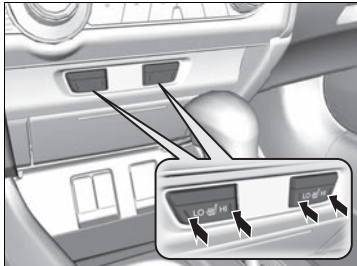

While in **HI**, the heater cycles on and off.

- The appropriate indicator will be on while the seat heater is on. Briefly press the switch on the opposite side to turn the heater off. The indicator will be off. When a comfortable temperature is reached, select **LO** to keep the seat warm.

## Seat Heaters\*

### **WARNING**

Heat induced burns are possible when using seat heaters.

Persons with a diminished ability to sense temperature (e.g., persons with diabetes, lower-limb nerve damage, or paralysis) or with sensitive skin should not use seat heaters.

Do not use the seat heaters even in **LO** when the engine is off. Under such conditions, the battery may be weakened, making the engine difficult to start.

In the **LO** setting, the heater runs continuously and does not automatically turn off.

\*1: Models with the smart entry system have an **ENGINE START/STOP** button instead of an ignition switch.

\* Not available on all models

## Using Vents, Heating and A/C\*

**A/C (Air Conditioning) Button\***  
Press to cool the interior or dehumidify while heating.

**Fan Control Dial**  
Adjusts the fan speed. Rotate the dial all the way to **OFF** to turn everything off.

**Mode Buttons**  
Change airflow.  
Dashboard vents  
Dashboard and floor vents  
Floor vents  
Floor and defroster vents

**Temperature Control Dial**  
Adjusts the interior temperature.

**MAX A/C Button\***  
Turns on the A/C, selects airflow from the dashboard vents, and switches the mode to recirculation.

**(Recirculation) Button**  
Press the button and switch the mode depending on environmental conditions.

Recirculation mode (indicator on):  
Recirculates air from the vehicle's interior through the system.

Fresh air mode (indicator off):  
Maintains outside ventilation. Keep the system in fresh air mode in normal situations.

**Windshield Defroster Button**  
Turns on the A/C, selects airflow from the defroster vents at the base of the windshield, and switches the mode to fresh air.

**Models without A/C button**

**(Recirculation) Button**  
Recirculates air from the vehicle's interior through the system.

**(Fresh Air) Button\***  
Maintains outside ventilation. Keep the system in fresh air mode in normal situations.

\* Not available on all models

## ■ Heating

Models with A/C button

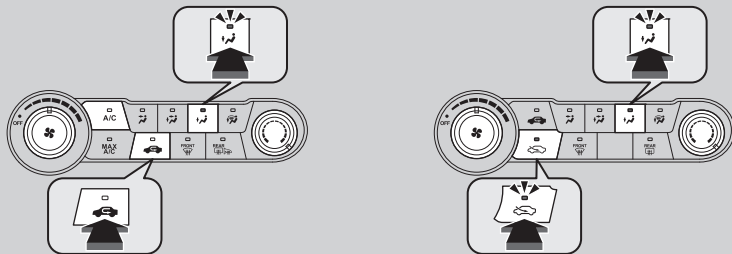

Models without A/C button



The heater uses engine coolant to warm the air.

1. Adjust the fan speed using the fan control dial.
2. Select .
3. Adjust the temperature using the temperature control dial.

### ■ To rapidly warm up the interior

1. Set the fan to the maximum speed.
2. Select .
3. Set the temperature to maximum warm.
4. Press the  button (the indicator on).

### ■ To dehumidify the interior\*

When used in combination with the heater, the air conditioning system makes the interior warm and dry and can prevent the windows from fogging up.

1. Turn the fan on.
2. Press the **A/C** button to turn on the air conditioning.

## ►► Heating

When you select , the mode automatically switches to fresh air.

### ►► To rapidly warm up the interior

Change to fresh air mode as soon as the interior gets warm enough. The windows may fog up if kept in recirculation mode.

## Cooling\*

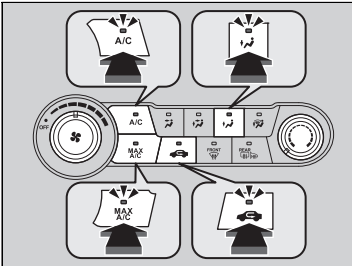

1. Adjust the fan speed using the fan control dial.
2. Select .
3. Adjust the temperature using the temperature control dial.
4. Press the **A/C** button (the indicator on).

### ■ To rapidly cool down the interior

1. Set the fan to the maximum speed.
2. Set the temperature to maximum cool.
3. Press the  button (the indicator on).

### ▶▶ To rapidly cool down the interior

If the interior is very warm, you can cool it down more rapidly by partially opening the windows.

While in the ECON mode, the system has greater temperature fluctuations.

Pressing the  button bypasses the ECON mode control, and cools down the interior more rapidly.



## ■ Defrosting the Windshield and Windows

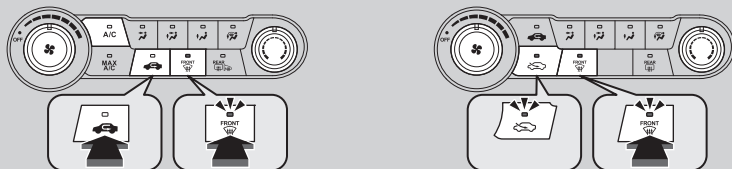

Models with A/C button

Models without A/C button



Pressing the  button turns the air conditioning system on and automatically switches the system to fresh air mode.

### ■ To rapidly defrost the windows

1. Set the fan to the maximum speed.
2. Press the  button.
3. Press the  button.
4. Set the temperature to maximum warm.

### ▶▶ Defrosting the Windshield and Windows

**For your safety, make sure you have a clear view through all the windows before driving.**

Do not set the temperature near the upper or lower limit.

When cold air hits the windshield, the outside of the windshield may fog up.

If the side windows fog up, adjust the vents so that the air hits the side windows.

### ▶▶ To rapidly defrost the windows

After defrosting the windows, switch over to fresh air mode.

If you keep the system in recirculation mode, the windows may fog up from humidity. This impedes visibility.

## Using Automatic Climate Control

The automatic climate control system maintains the interior temperature you select. The system also selects the proper mix of heated or cooled air that raises or lowers the interior temperature to your preference as quickly as possible.

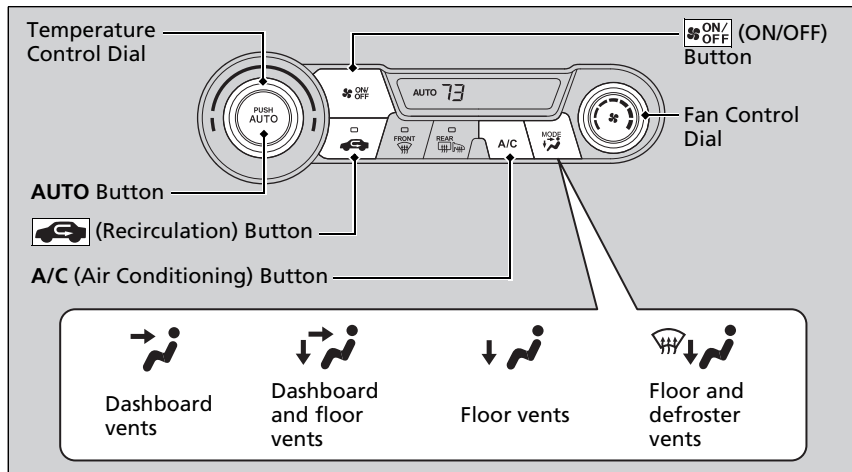

Use the system when the engine is running.

1. Press the **AUTO** button.
2. Adjust the interior temperature using the temperature control dial.
3. Press the **ON/OFF** (on/off) button to cancel.

### Using Automatic Climate Control

If any buttons are pressed while using the climate control system in auto, the function of the button that was pressed will take priority.

The **AUTO** indicator will go off, but functions unrelated to the button that were pressed will be controlled automatically.

To prevent cold air from blowing in from outside, the fan may not start immediately when the **AUTO** button is pressed.

If the interior is very warm, you can cool it down more rapidly by partially opening the windows, turning the system on **AUTO**, and setting the temperature to low. Change the fresh mode to recirculation mode until the temperature cools down.

When you set the temperature to the lower or upper limit, **Lo** or **Hi** is displayed.

### ■ Switching between the recirculation and fresh air modes

Press the  (recirculation) button and switch the mode depending on environmental conditions.

Recirculation mode (indicator on): Recirculates air from the vehicle's interior through the system.

Fresh air mode (indicator off): Maintains outside ventilation. Keep the system in fresh air mode in normal situations.

### ■ Defrosting the Windshield and Windows

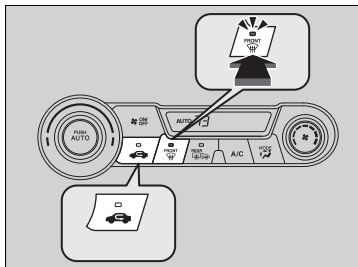

Pressing the  (windshield defroster) button turns the air conditioning system on and automatically switches the system to fresh air mode.

Press the  button again to turn off, the system returns to the previous settings.

### ■ To rapidly defrost the windows

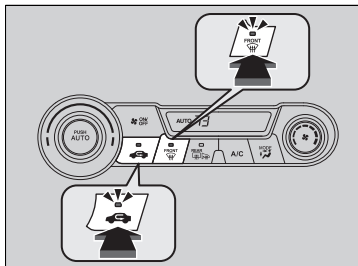

1. Press the  button.
2. Press the  button.

### ►► Using Automatic Climate Control

Pressing the  button switches the climate control system between on and off. When turned on, the system returns to your last selection.

While in the ECON mode, the climate control system has greater temperature fluctuations.

### ►► Defrosting the Windshield and Windows

**For your safety, make sure you have a clear view through all the windows before driving.**

Do not set the temperature near the upper or lower limit.

When cold air hits the windshield, the outside of the windshield may fog up.

If the side windows fog up, adjust the vents so that the air hits the side windows.

### ►► To rapidly defrost the windows

After defrosting the windows, switch over to fresh air mode. If you keep the system in recirculation mode, the windows may fog up from humidity. This impedes visibility.

## Automatic Climate Control Sensors

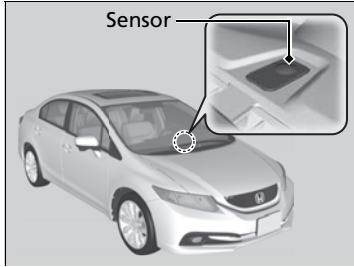

The automatic climate control system is equipped with sensors. Do not cover or spill any liquid on them.

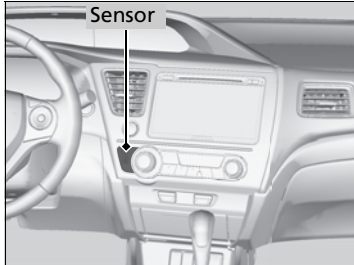



# Features

This chapter describes how to operate technology features.

## Audio System

About Your Audio System .....	170
USB/HDMI® Port* .....	171
USB Adapter Cable* .....	172
Auxiliary Input Jack* .....	172
Audio System Theft Protection* .....	173
Audio Remote Controls* .....	174

### Models with information display

<b>Audio System Basic Operation</b> .....	176
Adjusting the Sound .....	176
Playing AM/FM Radio .....	177
Playing a CD .....	178

### Models with one display

<b>Audio System Basic Operation</b> .....	179
Adjusting the Sound .....	180
Playing AM/FM Radio .....	181
Playing a CD .....	184
Playing an iPod .....	187
Playing Internet Radio .....	190
Playing a USB Flash Drive .....	192
Playing <i>Bluetooth</i> ® Audio .....	195

### Models with display audio system

<b>Audio System Basic Operation</b> .....	197
Audio/Information Screen .....	198
Adjusting the Sound .....	202
Display Setup .....	203

Playing AM/FM Radio .....	204
Playing a CD .....	207
Playing an iPod .....	210
Playing Internet Radio .....	213
Playing a USB Flash Drive .....	215
Playing <i>Bluetooth</i> ® Audio .....	218
Playing a Video Using the HDMI® .....	220
Smartphone Apps .....	222
Siri Eyes Free .....	223
<b>Audio Error Messages</b> .....	224

### General Information on the Audio

<b>System</b> .....	230
<b>Customized Features*</b> .....	233
<i>Bluetooth</i> ® <i>HandsFreeLink</i> ®* .....	246, 277

\* Not available on all models

## About Your Audio System

On models with navigation system, see the Navigation System Manual for operation of the audio system, *Bluetooth*® HandsFreeLink®, and voice commands for these features.

### Models with information display

The audio system features AM/FM radio. It can also play CDs and WMA/MP3 files. You can operate the audio system from the buttons and switches on the panel.

### Models with i-MID

The audio system features AM/FM radio. It can also play audio CDs, WMA/MP3/AAC files, USB flash drives, iPod, iPhone and *Bluetooth*® devices.

You can operate the audio system from the buttons and switches on the panel, or the icons on the touchscreen interface\*.

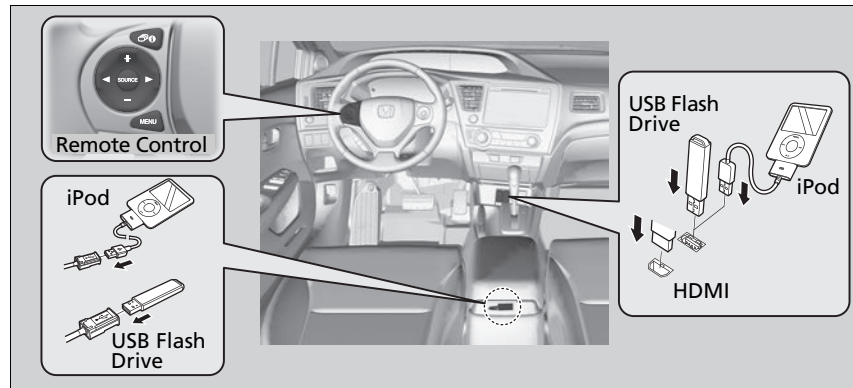

### About Your Audio System

Video CDs, DVDs, and 3-inch (8-cm) mini CDs are not supported.

iPod, iPhone and iTunes are trademarks of Apple Inc.

State or local laws may limit the circumstances in which you can launch or control your attached audio device.

## USB/HDMI® Port\*

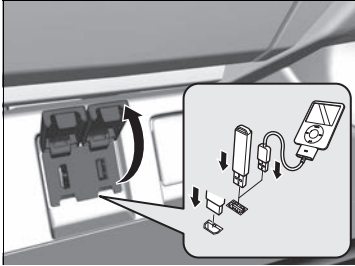

1. Open the cover.
2. Install the iPod dock connector or the USB flash drive to the USB port.
3. Install the HDMI® cable to the HDMI® port.

### ⊠ USB/HDMI® Port\*

- Do not leave the iPod or USB flash drive in the vehicle. Direct sunlight and high temperatures may damage it.
- Do not connect the iPod or USB flash drive using a hub.
- Do not use a device such as a card reader or hard disk drive, as the device or your files may be damaged.
- We recommend backing up your data before using the device in your vehicle.
- Displayed messages may vary depending on the device model and software version.

If the audio system does not recognize the iPod, try reconnecting it a few times or reboot the device. To reboot, follow the manufacturer's instructions provided with the iPod or visit [www.apple.com/ipod](http://www.apple.com/ipod).

The terms HDMI and HDMI High-Definition Multimedia Interface, and the HDMI Logo are trademarks or registered trademarks of HDMI Licensing LLC in the United States and other countries.

\* Not available on all models



## USB Adapter Cable\*

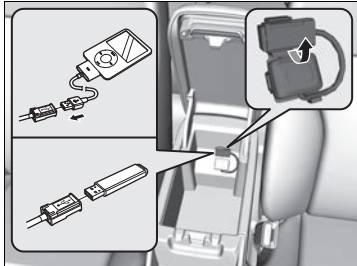

1. Lift the armrest and unclip the USB connector cable.
2. Install the iPod dock connector or the USB flash drive to the USB connector.

### ▶▶ USB Adapter Cable\*

- Do not leave the iPod or USB flash drive in the vehicle. Direct sunlight and high temperatures may damage it.
- Do not use an extension cable with the USB adapter cable.
- Do not connect the iPod or USB flash drive using a hub.
- Do not use a device such as a card reader or hard disk drive, as the device or your files may be damaged.
- We recommend backing up your data before using the device in your vehicle.
- Displayed messages may vary depending on the device model and software version.

If the audio system does not recognize the iPod, try reconnecting it a few times or reboot the device. To reboot, follow the manufacturer's instructions provided with the iPod or visit [www.apple.com/ipod](http://www.apple.com/ipod).

## Auxiliary Input Jack\*

Use the jack to connect standard audio devices.

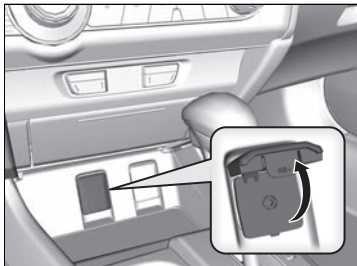

1. Open the **AUX** cover.
2. Connect a standard audio device to the input jack using a 1/8 inch (3.5 mm) stereo miniplug.
  - ▶ The audio system automatically switches to the AUX mode.

### ▶▶ Auxiliary Input Jack\*

To switch the mode, press any of the audio mode buttons. You can return to the AUX mode by pressing the **AUX** button.

## Audio System Theft Protection \*

The audio system is disabled when it is disconnected from the power source, such as when the battery is disconnected or goes dead. In certain conditions, the system may display **ENTER CODE**<sup>\*1</sup>/**Enter Code**<sup>\*2</sup>. If this occurs, reactivate the audio system.

### Models with i-MiD

#### ■ Reactivating the audio system

1. Turn the ignition switch to ON <sup>\*3</sup>.
2. Turn on the audio system.
3. Press and hold the audio system power button for more than two seconds.
  - ▶ The audio system is reactivated when the audio control unit establishes a connection with the vehicle control unit. If the control unit fails to recognize the audio unit, you must go to a dealer and have the audio unit checked.

### Models with information display

#### ■ Entering the audio security code

**ENTER CODE** appears on the display when the power is reconnected.

1. Turn on the audio system.
2. Enter the audio security code using the preset buttons. If you enter an incorrect digit, continue to the last digit, then try again. If you do not enter the code correctly after 10 tries, leave the system for one hour before trying again, or visit a dealer to have the system reset.

\*1: Models with one display

\*2: Models with the display audio system

\*3: Models with the smart entry system have an **ENGINE START/STOP** button instead of an ignition switch.

\* Not available on all models

## Audio Remote Controls\*

Allow you to operate the audio system while driving.

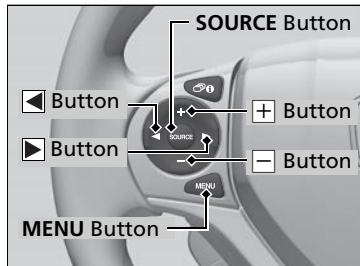

### SOURCE Button

Cycles through the audio modes as follows:  
 FM→AM→CD→USB→iPod→*Bluetooth*<sup>®</sup>  
 Audio→Pandora<sup>®</sup>\*→aha<sup>\*</sup>→Apps<sup>\*,1</sup>→  
 AUX HDMI<sup>®\*</sup>

### + - (Volume) Buttons

**Press** : To increase the volume.

**Press** : To decrease the volume.

### ◀ ▶ Buttons

- When listening to the radio
  - Press** : To select the next preset radio station.
  - Press** : To select the previous preset radio station.
  - Press and hold** : To select the next strong station.
  - Press and hold** : To select the previous strong station.
- When listening to a CD, iPod, USB flash drive, or *Bluetooth*<sup>®</sup> Audio
  - Press** : To skip to the next song.
  - Press** : To go back to the beginning of the current or previous song.
- When listening to a CD or USB flash drive
  - Press and hold** : To skip to the next folder.
  - Press and hold** : To go back to the previous folder.
- When listening to Internet radio\*
  - Press** : To skip to the next song.
  - Press and hold** : To select the next station.
  - Press and hold** : To select the previous station.

\*1: Appears only when connected to HondaLink™.

\* Not available on all models

### ▶▶ Audio Remote Controls\*

The CD or AUX mode appears only when a CD is loaded or AUX\*/HDMI<sup>®\*</sup> device is connected. Pandora<sup>®</sup> and *Bluetooth*<sup>®</sup> Audio appear when a connection (*Bluetooth*<sup>®</sup> or USB) is established with a device.

**Models with display audio system**Steering Wheel **MENU** Button

- When listening to the radio  
**Press and hold the MENU button:** To select the radio station by **Scan, Save Preset, or Seek.**
- When listening to a CD or USB flash drive  
**Press and hold the MENU button:** To select the song by **Scan, Repeat, or Random.**
- When listening to an iPod  
**Press and hold the MENU button:** To select the song by **Repeat or Shuffle.**
- When listening to Internet radio\*  
**Press and hold the MENU button:** To select **Bookmark, or Play/Pause.**
- When listening to a *Bluetooth*® Audio  
**Press and hold the MENU button:** To select **Pause or Play** for the song.

**▶▶ Audio Remote Controls\***

The **MENU** button is available only when the audio mode is FM, AM, CD, USB, iPod, Pandora®, Aha™, or *Bluetooth*® Audio.

\* Not available on all models

## Models with information display

To use the audio system function, the ignition switch must be in ACCESSORY **I** or ON **II**.

## Adjusting the Sound

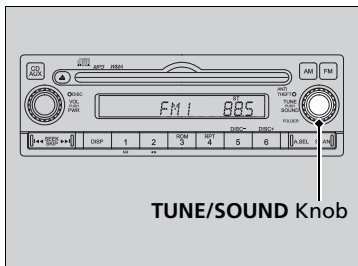

Press the **TUNE/SOUND** knob, and rotate it to adjust the setting.

Each time you press the **TUNE/SOUND** knob, a sound mode switches as follows.

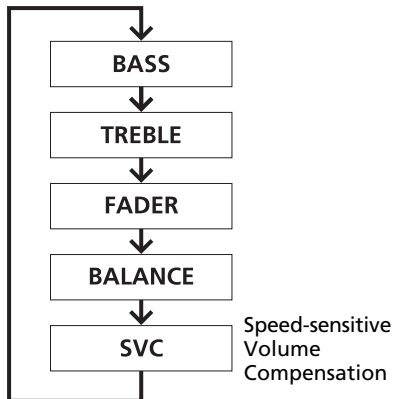
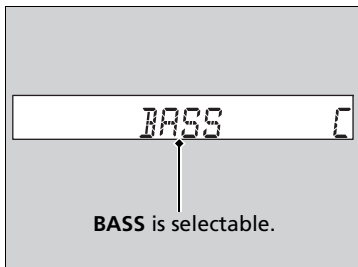

## Adjusting the Sound

When the adjustment level reaches the center, you will see **C** in the display.

The SVC has four modes: **OFF**, **LOW**, **MID**, and **HIGH**.

SVC adjusts the volume level based on the vehicle speed. As you go faster, audio volume increases. As you slow down, audio volume decreases.

## Playing AM/FM Radio

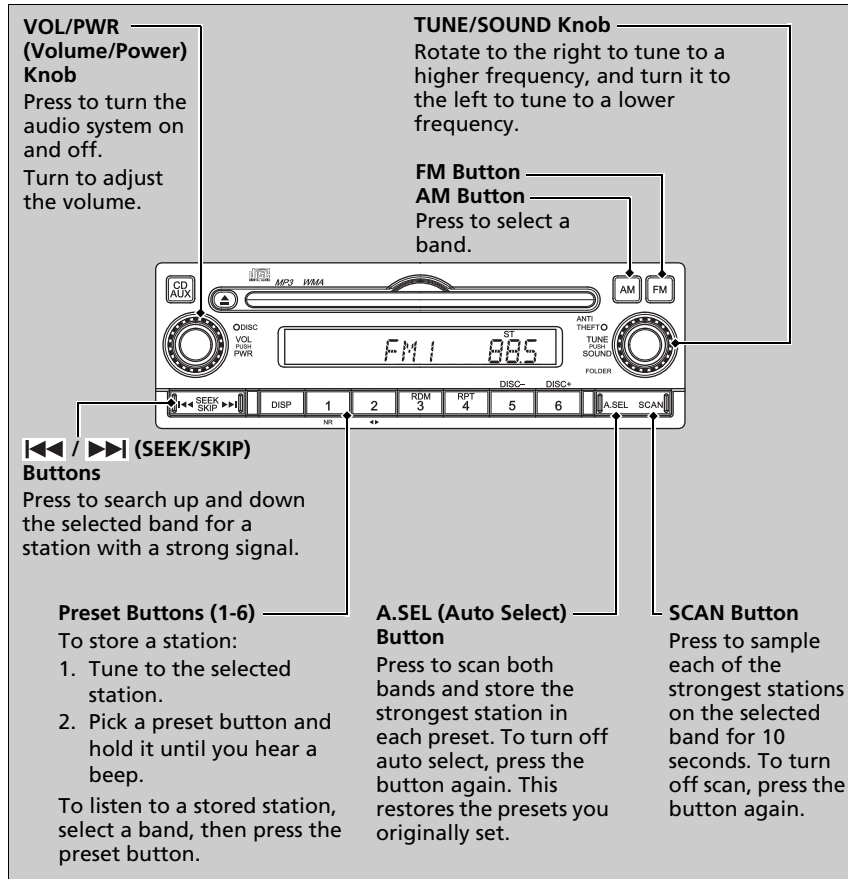

### ▶▶ Playing AM/FM Radio

The **ST** indicator appears on the display indicating stereo FM broadcasts. Stereo reproduction in AM is not available.

You can store six AM stations and twelve FM stations into the preset memory.

A.SEL function scans and stores up to six AM stations and twelve FM stations with a strong signal into the preset button memory.

If you do not like the stations auto select has stored, you can manually store your preferred frequencies.

## Playing a CD

Your audio system supports audio CDs, CD-Rs, and CD-RWs in either MP3 or WMA format. With the CD loaded, press the **CD/AUX** button.

**VOL/PWR (Volume/Power) Knob**  
Press to turn the audio system on and off.  
Turn to adjust the volume.

**CD Slot**  
Insert a CD about halfway into the CD slot.

**(CD Eject) Button**  
Press to eject a CD.

**TUNE/SOUND Knob**  
Rotate to skip to the next folder, and to skip to the beginning of the previous folder in MP3 or WMA.

**CD/AUX Button**  
Press to play a CD.

**SCAN Button**  
You will get a 10-second sampling of each song.

**SEEK/SKIP Buttons**  
Press **◀◀** or **▶▶** to change tracks (files in MP3 or WMA).

**DISP Button**  
Press to display the text data on a CD (if it was recorded with text data).

**RDM (Random) Button**

- Press to play all tracks/files on a CD in random order.
- Press two times to play all files in the current folder (MP3 or WMA) in random order.
- To turn off random, press and hold the button.

**RPT (Repeat) Button**

- Press to replay a track/file continuously.
- Press two times to replay all files in the current folder (MP3 or WMA).
- To turn off repeat, press and hold the button.

### ▶▶ Playing a CD

#### NOTICE

Do not use CDs with adhesive labels. The label can cause the CD to jam in the unit.

WMA files protected by digital rights management (DRM) cannot be played.

The audio system displays **FORMAT**, then skips to the next file.

Text data appears on the display under the following circumstances:



- When you select a new folder, file, or track.
- When you change the audio mode to CD.
- When you insert a CD.

The display shows up to 10 characters of text data. Press and hold the **DISP** button to see additional characters. **>** indicates that the text data continues. The display goes back to the previous screen if you press and hold the button again.

If you eject the CD but do not remove it from the slot, the system reloads the CD automatically after several seconds.

# Audio System Basic Operation

## Models with one display

To use the audio system function, the ignition switch must be in ACCESSORY  or ON \*1.

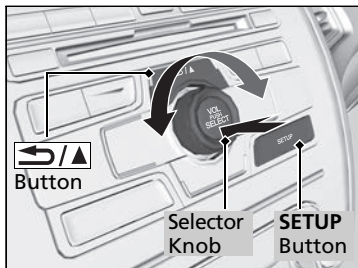

Use the selector knob or **SETUP** button to access some audio functions.

Press  to switch between the normal and extended display for some functions.

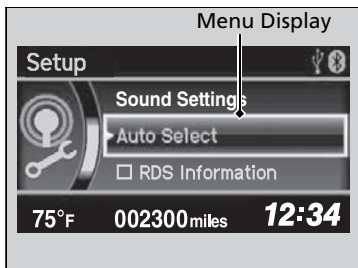

**Selector knob:** Rotate left or right to scroll through the available choices. Press  to set your selection.

**SETUP button:** Press to select any mode such as **Auto Select**, **RDS Information**, **Sound Settings**, **Play Mode**, and **Resume/Pause**.





** button:** Press to go back to the previous display.

## Audio System Basic Operation

These indications are used to show how to operate the selector knob.

Rotate  to select.

Press  to enter.

Press the **SOURCE**, , ,  or  button on the steering wheel to change any audio setting.

 **Audio Remote Controls\*** P. 174

### Setup Menu Items

 **Auto Select** P. 182

 **RDS Information** P. 183

 **Sound Settings** P. 180

 **Play Mode** P. 186

 **Resume/Pause** P. 196



\*1: Models with the smart entry system have an **ENGINE START/STOP** button instead of an ignition switch.

\* Not available on all models

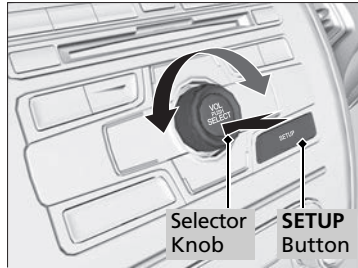

## Adjusting the Sound



Press the **SETUP** button, and rotate  to select **Sound Settings**, then press . Rotate  to scroll through the following choices:

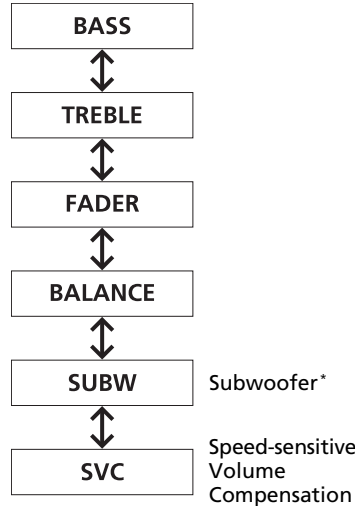

### ▶▶ Adjusting the Sound

The SVC has four modes: **OFF**, **LOW**, **MID**, and **HIGH**.

SVC adjusts the volume level based on the vehicle speed. As you go faster, audio volume increases. As you slow down, audio volume decreases.

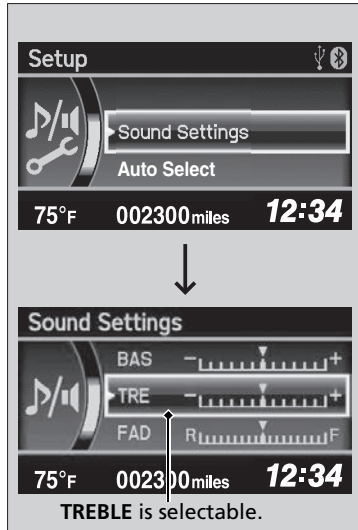

## Playing AM/FM Radio

The diagram illustrates the car's audio system interface. At the top is a display screen showing 'FM 1 103.5 MHz ST', '75°F', '002300 miles', and '12:34'. Below the screen is a control panel with several buttons and a knob. Callout lines connect these elements to their respective descriptions.

**↵ / ▲ / ▼ Button**  
Press to display and select an RDS category.

**Power Button**  
Press to turn the audio system on and off.

**SCAN Button**  
Press to sample each of the strongest stations on the selected band for 10 seconds. To turn off scan, press the button again.

**Preset Buttons (1-6)**  
To store a station:  
1. Tune to the selected station.  
2. Pick a preset button and hold it until you hear a beep.  
To listen to a stored station, select a band, then press the preset button.

**FM Button**  
**AM Button**  
Press to select a band.

**Selector Knob**  
Turn to adjust the volume.  
Press and turn to tune the radio frequency.

**SETUP Button**  
Press to display menu items.

**◀◀ / ▶▶ (Seek/Skip) Buttons**  
Press to search up and down the selected band for a station with a strong signal.

## ■ Auto Select

Use the auto select feature to scan both bands and store the strongest station in each preset.

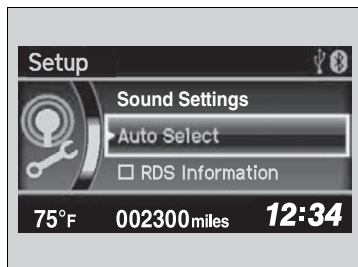

1. Press the **SETUP** button.
2. Rotate  to select **Auto Select**, then press .

To turn off auto select, press  again. This restores the presets you originally set.

## ▶▶ Playing AM/FM Radio

The ST indicator appears on the display indicating stereo FM broadcasts. Stereo reproduction in AM is not available.

### Switching the Audio Mode

Press the **SOURCE** button on the steering wheel.

 **Audio Remote Controls\*** P. 174

You can store six AM stations and twelve FM stations into the preset memory.

Auto Select function scans and stores up to six AM stations and twelve FM stations with a strong signal into the preset button memory.



If you do not like the stations auto select has stored, you can manually store your preferred frequencies.

## Radio Data System (RDS)

Provides text data information related to your selected RDS capable FM station.

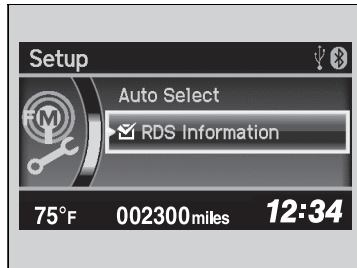

### RDS Information

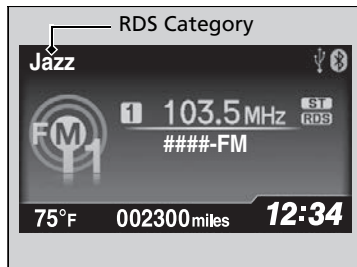

1. Press the **SETUP** button and rotate  to select **RDS Information**.
2. Each time you press , the RDS Information switches between on and off.

### To find an RDS station from your selected program category



1. Press the / /  button to display and select an RDS category.
2. Use SEEK/SKIP or SCAN to select an RDS station.

## Playing a CD

Your audio system supports audio CDs, CD-Rs and CD-RWs in either MP3 or WMA format. With the CD loaded, press the **CD** button.

### SCAN Button

You will get a 10-second sampling of each song.

- Press to sample all tracks on the CD (all files in the current folder in MP3 or WMA).
- Press two times to sample the first file in each of the main folders (MP3 or WMA).
- To turn off scan, press and hold the button.

### ↵/▲/▼ Button

Press ↵/▲ to skip to the next folder, and ▼ to skip to the beginning of the previous folder in MP3 or WMA.

### ⏮ / ⏭ (Seek/Skip) Buttons

Press ⏮ or ⏭ to change tracks (files in MP3 or WMA).



### ⏻ (Power) Button

Press to turn the audio system on and off.

### CD Slot

Insert a CD about halfway into the CD slot.

### CD Button

Press to play a CD.

### ▲ (CD Eject) Button

Press to eject a CD.

### Selector Knob

Turn to adjust the volume. Press and turn to select an item, then press to set your selection.

### SETUP Button

Press to display menu items.

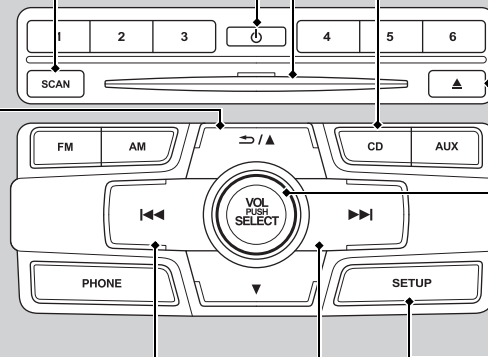

## How to Select a File from a Folder with the Selector Knob (MP3/WMA)

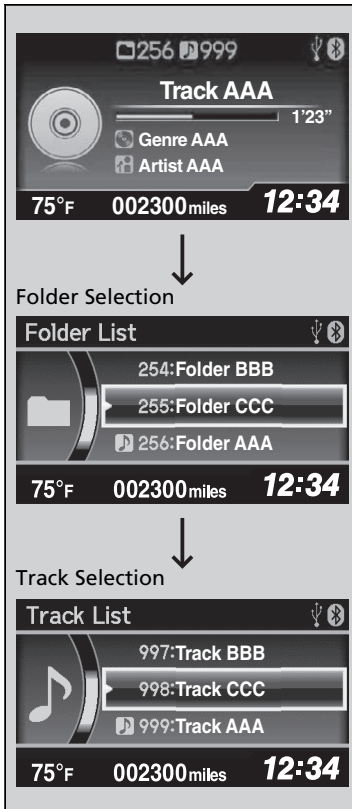

1. Press  to switch the display to a folder list.

2. Rotate  to select a folder.

3. Press  to change the display to a list of files in that folder.

4. Rotate  to select a file, then press .

### ▶▶ Playing a CD

#### NOTICE

Do not use CDs with adhesive labels. The label can cause the CD to jam in the unit.

WMA files protected by digital rights management (DRM) cannot be played. The audio system displays **Unsupported**, then skips to the next file.

Text data appears on the display under the following circumstances:

- When you select a new folder, file, or track.
- When you change the audio mode to CD.
- When you insert a CD.

If you eject the CD but do not remove it from the slot, the system reloads the CD automatically after several seconds.

Continued

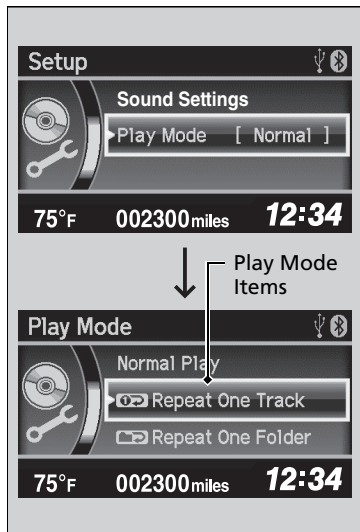

## ■ How to Select a Play Mode

You can select repeat, random, and scan modes when playing a track or file.



1. Press the **SETUP** button.

2. Rotate  to select **Play Mode**, then press .

3. Rotate  to select a mode, then press .

### ■ To turn off a play mode

1. Press the **SETUP** button.

2. Rotate  to select **Play Mode**, then press .

3. Rotate  to select **Normal Play**, then press .

### ▶▶ How to Select a Play Mode

Press the  button to go back to the previous display, and press the **SETUP** button to cancel this setting mode.

#### Play Mode Menu Items

##### **Normal Play**

**Repeat One Track:** Repeats the current track/file(s).

**Repeat One Folder (MP3/WMA):** Repeats all files in the current folder.

**Random in Folder (MP3/WMA):** Plays all files in the current folder in random order.

**Random in Disc:** Plays all tracks/files in random order.

## Playing an iPod

Connect the iPod using your dock connector to the USB adapter cable, then press the **AUX** button.

📄 **USB Adapter Cable** \* P. 172

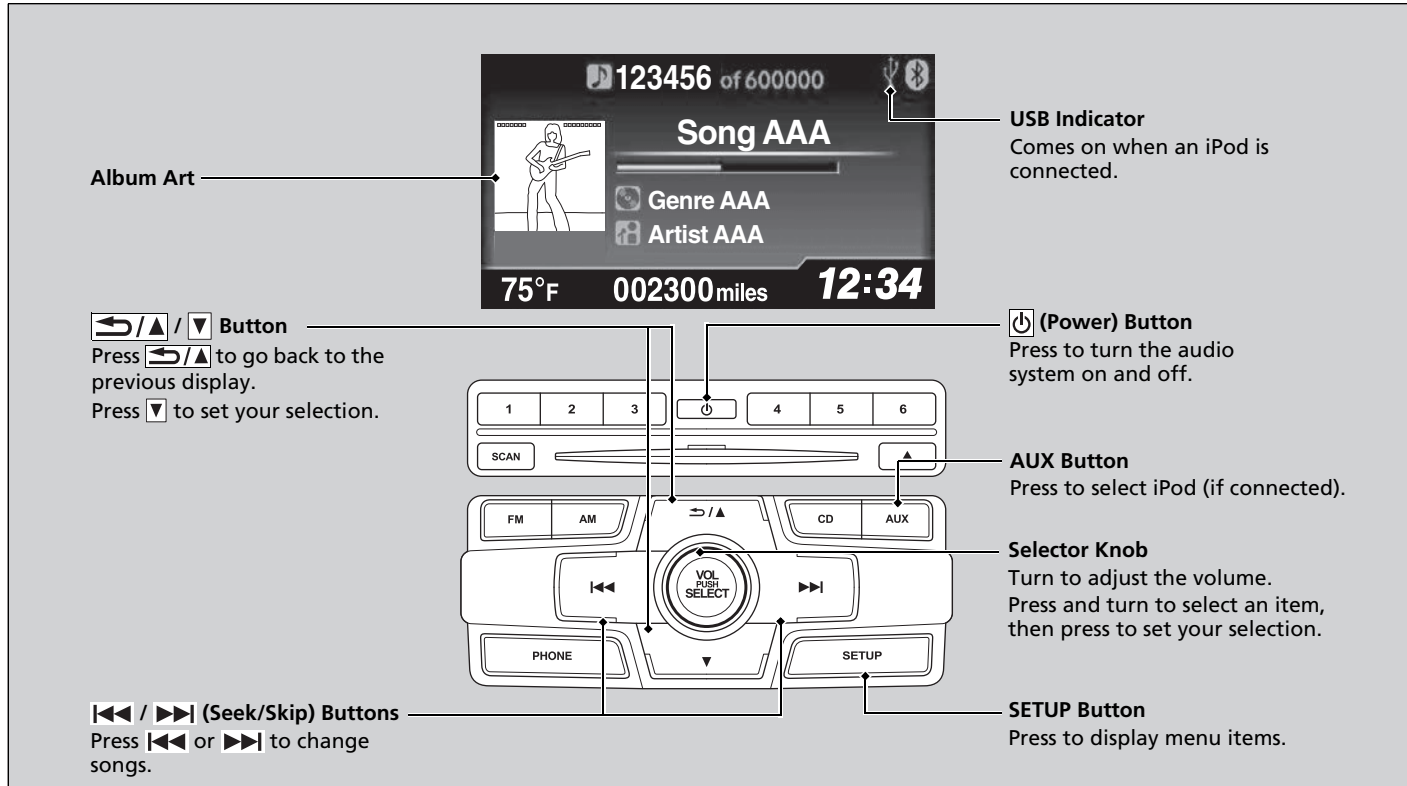

\* Not available on all models



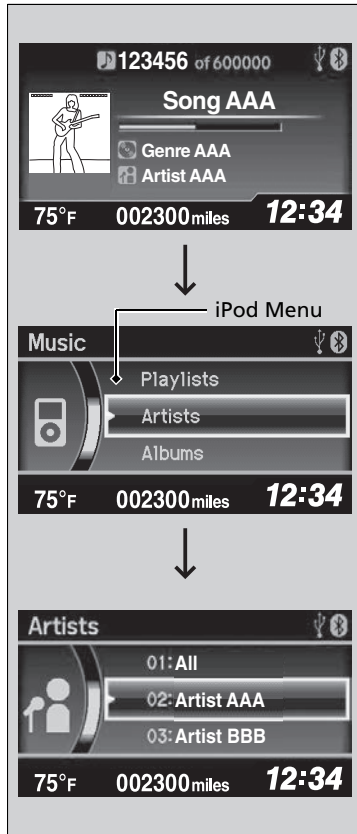

## How to Select a File from the iPod Menu



1. Press  to display the iPod menu.

2. Rotate  to select a menu.

3. Press  to display the items on that menu.

4. Rotate  to select an item, then press .

### ▶▶ Playing an iPod

Available operating functions vary on models or versions. Some functions may not be available on the vehicle's audio system.

If there is a problem, you may see an error message on the i-MID.

 **iPod/USB Flash Drive\*** P. 225

## How to Select a Play Mode

You can select repeat and shuffle modes when playing a file.



1. Press the **SETUP** button.

2. Rotate to select **Play Mode**, then press .

3. Rotate to select a mode, then press .

### To turn off a play mode

1. Press the **SETUP** button.

2. Rotate to select **Play Mode**, then press .

3. Rotate to select **Normal Play**, then press .

### How to Select a Play Mode

Play Mode Menu Items

#### Normal Play

**Shuffle Off:** Turns off the shuffle mode.

**Shuffle:** Plays all available files in a selected list (playlists, artists, albums, songs, genres, or composers) in random order.

**Shuffle Albums:** Plays all available albums in a selected list (playlists, artists, albums, songs, genres, or composers) in random order.

**Repeat Off:** Turns off the repeat mode.

**Repeat One Track:** Repeats the current track.

U.S. models

iPhone use only

## Playing Internet Radio

Activate Pandora®, and connect the iPhone using your dock connector to the USB adapter cable, then press the **AUX** button.

➤ **USB Adapter Cable\*** P. 172

### ▶▶ Playing Internet Radio

Pandora®, the Pandora logo, and the Pandora trade dress are trademarks or registered trademarks of Pandora Media, Inc., used with permission. Pandora is currently available exclusively in the United States.

To find out if your phone is compatible with this feature, visit [www.handsfreelink.honda.com](http://www.handsfreelink.honda.com), or call 1-888-528-7876.

To use this service in your vehicle, the Pandora® app must first be installed on your phone. Visit [www.pandora.com](http://www.pandora.com) for more information.

**Rating Icon** — Points to the thumbs-up icon on the Pandora menu.

**Album Art** — Points to the album art image on the Pandora menu.

**Selector Knob** — Turn to adjust the volume. Press to enter **PANDORA MENU**. Press and turn to select an item, then press to set your selection.

**Skip Button** — Press **▶▶** to skip a song.

**SETUP Button** — Press to display menu items.

**AUX Button** — Press to select iPhone (if connected when the Pandora® application is activated).

**(Power) Button** — Press to turn the audio system on and off.

**Button** — Press **↩/▲** to go to the next station. Press **▼** to go to the previous station.



## Pandora® Menu

You can operate some of the Pandora® menu items from your vehicle's audio system. The available items are:

- **Station List** (**QuickMix** is also available)
- **Like** (Thumbs-up)
- **Dislike** (Thumbs-down)
- **Resume/Pause**
- **Skip**
- **Bookmark this song**
- **Bookmark this artist**

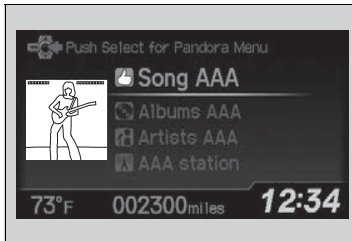
### ■ Operating a menu item



1. Press  to display the **PANDORA MENU**.
2. Rotate  to select a menu.
3. Press  to display the items on that menu.

### ▶▶ Playing Internet Radio

Pandora® is free, personalized radio that plays music and comedy you'll love. Just start with the name of one of your favorite artists, songs, comedians or composers and Pandora® will create a custom station that plays similar tracks. Pandora® also features hundreds of genre stations ranging from Dubstep to Smooth Jazz to Power Workout.

If you cannot operate Pandora® through the audio system, it may be streaming through *Bluetooth®* Audio. Make sure Pandora® mode on your audio system is selected.

#### Changing Stations

To change stations, activate the Pandora® menu, select **Station List**, and then select a new station.

### ▶▶ Pandora® Menu

Available operating functions vary on software versions. Some functions may not be available on the vehicle's audio system.

If there is a problem, you may see an error message on the i-MID.

▶▶ **Pandora®** P. 227

Pandora® may limit the total number of skips allowed on the service. If you dislike a track after the skip limit has been reached, your feedback will be saved but the current track will continue to play.

## Playing a USB Flash Drive

Your audio system reads and plays sound files on a USB flash drive in either MP3, WMA or AAC\*1 format.

Connect your USB flash drive to the USB adapter cable, then press the **AUX** button.

➔ **USB Adapter Cable\*** P. 172

The diagram illustrates the car's audio system interface. The top portion shows a digital display with a USB icon and Bluetooth symbol in the top right corner. The display shows '123' and '456' in the top left, 'File AAA' in the center, a progress bar, 'Genre AAA', 'Artist AAA', '75°F', '0023:00 miles', and '12:34' at the bottom. Below the display is a control panel with several buttons and a central knob. Lines connect these elements to descriptive text boxes.

**USB Indicator**  
Comes on when a USB flash drive is connected.

**USB Indicator** (on display)

**➔ / ▲ / ▼ Button**  
Press ➔/▲ to skip to the next folder, and ▼ to skip to the beginning of the previous folder.

**SCAN Button**  
You will get a 10-second sampling of each file.

- Press to sample all files in the current folder.
- Press two times to sample the first file in each of the main folders.
- To turn off scan, press and hold the button.

**▶▶ / ◀◀ (Seek/Skip) Buttons**  
Press ▶▶ or ◀◀ to change files.

**(Power) Button**  
Press to turn the audio system on and off.

**AUX Button**  
Press to select USB flash drive (if connected).

**Selector Knob**  
Turn to adjust the volume. Press and turn to select an item, then press to set your selection.

**SETUP Button**  
Press to display menu items.

\*1: Only AAC format files recorded with iTunes are playable on this unit.

## How to Select a File from a Folder with the Selector Knob

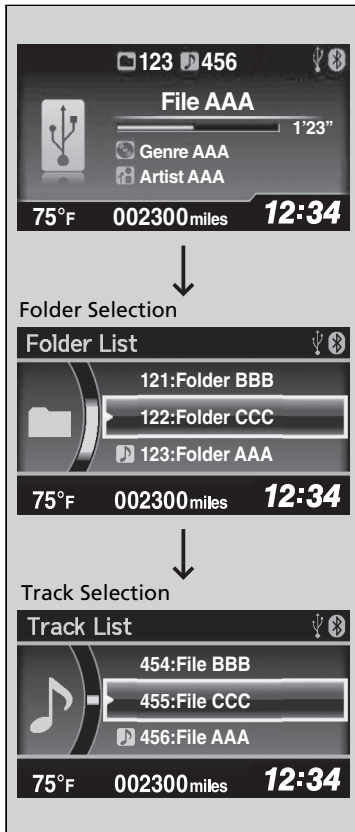

1. Press to switch the display to a folder list.

2. Rotate to select a folder.

3. Press to change the display to a list of files in that folder.

4. Rotate to select a file, then press .

### ▶▶ Playing a USB Flash Drive

Use the recommended USB flash drives.

▶ **General Information on the Audio System**  
P. 230

Files in WMA format protected by digital rights management (DRM) cannot be played. The audio system displays **Unplayable File**, and then skips to the next file.

If there is a problem, you may see an error message on the i-MID.

▶ **iPod/USB Flash Drive\*** P. 225

\* Not available on all models

*Continued*

## ■ How to Select a Play Mode

You can select repeat, random, and scan modes when playing a file(s).

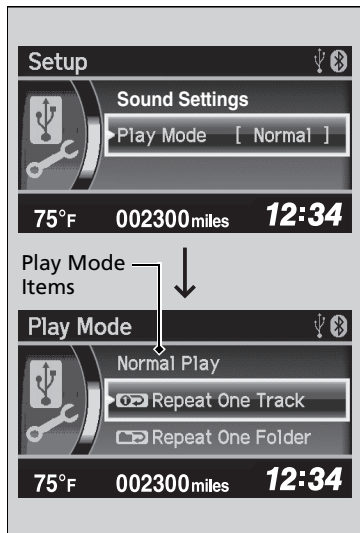

1. Press the **SETUP** button.

2. Rotate to select **Play Mode**, then press .

3. Rotate to select a mode, then press .

### ■ To turn off a play mode

1. Press the **SETUP** button.

2. Rotate to select **Play Mode**, then press .

3. Rotate to select **Normal Play**, then press .

## ▶▶ How to Select a Play Mode

Play Mode Menu Items

### **Normal Play**

**Repeat One Track:** Repeats the current file.

**Repeat One Folder:** Repeats all files in the current folder.

**Random in Folder:** Plays all files in the current folder in random order.

**Random All:** Plays all files in random order.

## Playing *Bluetooth*® Audio

Your audio system allows you to listen to music from your *Bluetooth*-compatible phone.

This function is available when the phone is paired and connected to the vehicle's *Bluetooth*® HandsFreeLink® (HFL) system.

📖 **Phone Setup** P. 253

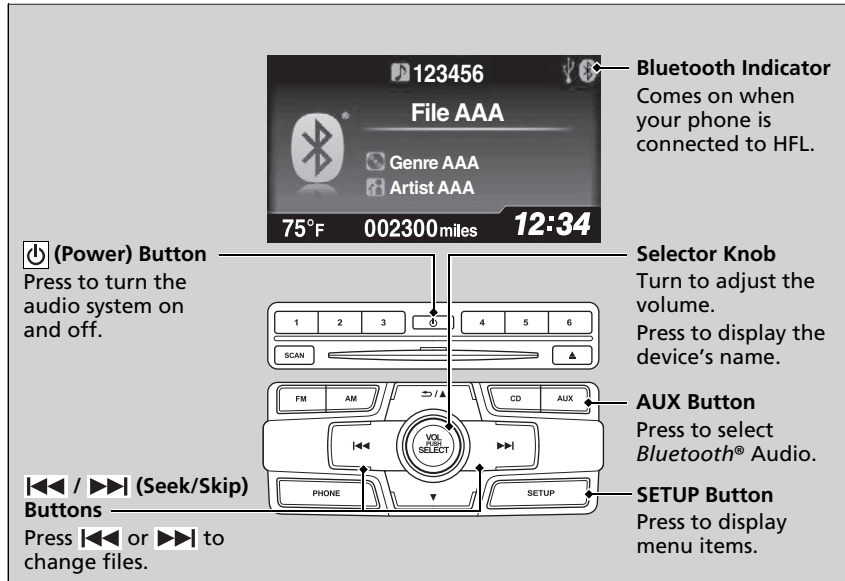

### ▶▶ Playing *Bluetooth*® Audio

Not all *Bluetooth*-enabled phones with streaming audio capabilities are compatible with the system. For a list of compatible phones:

- U.S.: Visit [www.handsfreelink.honda.com](http://www.handsfreelink.honda.com), or call 1-888-528-7876.
- Canada: Visit [www.handsfreelink.ca](http://www.handsfreelink.ca), or call 1-888-528-7876.

In some states, it may be illegal to perform some data device functions while driving.

If more than one phone is paired to the HFL system, there will be a delay before the system begins to play.



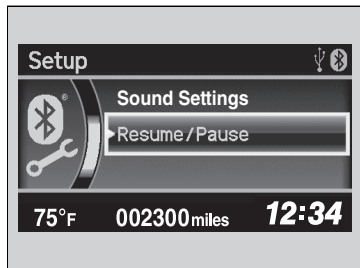

## ■ To Play *Bluetooth*® Audio Files



1. Make sure that your phone is paired and connected to HFL.
2. Press the **AUX** button.

If the phone is not recognized, another HFL-compatible phone, which is not compatible for *Bluetooth*® Audio, may be already connected.

### ■ To pause or resume a file

1. Press the **SETUP** button.
2. Rotate  to select **Resume/Pause**, then press .

Each time you press , the setting switches between Pause and Resume.

## ▶▶ To Play *Bluetooth*® Audio Files

To play the audio files, you may need to operate your phone. If so, follow the phone maker's operating instructions.

The pause function may not be available on some phones.

If any audio device is connected to the auxiliary input jack, you may need to press the **AUX** button repeatedly to select the *Bluetooth*® Audio system.

Switching to another mode pauses the music playing from your phone.

## Models with display audio system

To use the audio system function, the power mode must be in ACCESSORY or ON.

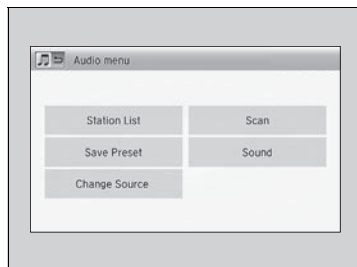
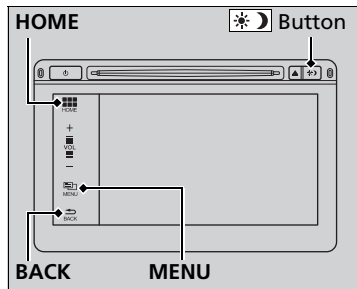

**HOME:** Select to go to the **HOME** screen.

➤ **Switching the Display** P. 198

**MENU:** Touch to select any mode.

The available mode includes **Change Source**, **Station List**, **Save Preset**, **Music Search**, and play modes. Play modes can be also selected from **Scan**, **Random/Repeat**, and so on.

**BACK:** Select to go back to the previous display when it is displayed.

☀️🌙 **button:**

Press to change the audio/information screen brightness.

Press ☀️🌙 once and select  or  to make an adjustment.

- ▶ Each time you press ☀️🌙, the mode switches among the daytime mode, nighttime mode and **OFF** mode.

## ▶▶ Audio System Basic Operation

Audio Menu Items

- **Station List** P. 205
- **Music Search** P. 208, 211, 216, 219
- **Random/Repeat** P. 209, 217
- **Scan** P. 206, 209, 217

## Audio/Information Screen

Displays the audio status and wallpaper. From this display, you can go to various setup options.

### ■ Switching the Display

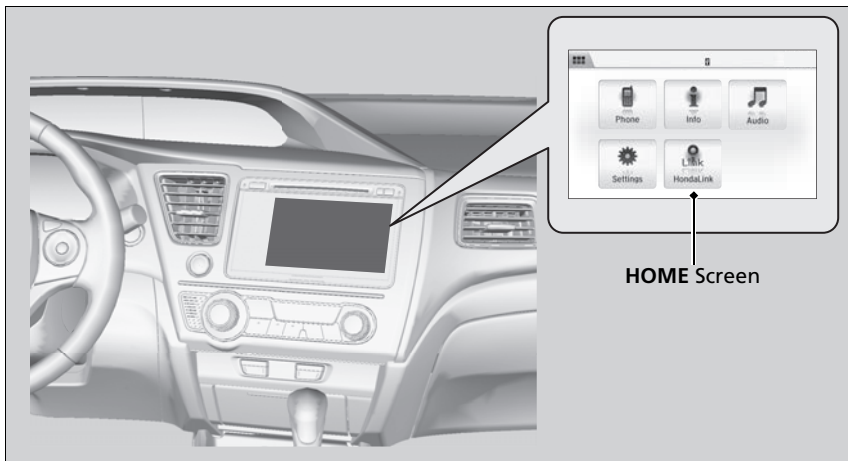

Select **HOME** to go to the **HOME** screen.

Select **Phone**, **Info**, **Audio**, **Settings**, or **HondaLink**.

## ■ Phone

Shows the HFL information.

▶ **Bluetooth® HandsFreeLink®\*** P. 277

## ■ Info

Shows the **Trip Computer**, **Clock/Wallpaper**, **Voice Info**, or **System/Device Information** information.

## ■ Audio

Shows the current audio information.

## ■ Settings

Enters the customizing menu screen.

▶ **Customized Features\*** P. 233

## ■ HondaLink Apps

Connects with your smartphone\*<sup>1</sup> to play personalized music information, and social media streams.

▶ **Smartphone Apps** P. 222

\*1: Available on specific phones only. Check [handsfreelink.honda.com](http://handsfreelink.honda.com) for compatible phones and [hondalink.com](http://hondalink.com) for feature details.

\* Not available on all models

*Continued*

## ■ Wallpaper Setup

You can change, store, and delete the wallpaper on the audio/information screen.

### ■ Import wallpaper

You can import up to five images, one at a time, for wallpaper from a USB flash drive.

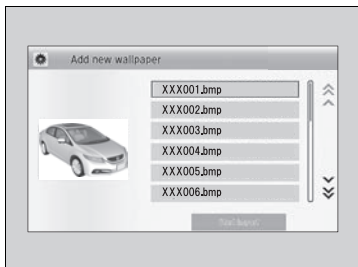
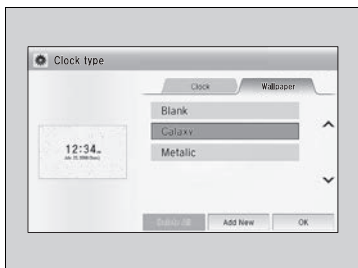

1. Connect the USB flash drive to the USB port or the USB adapter cable.

▶ **USB/HDMI® Port\*** P. 171

▶ **USB Adapter Cable\*** P. 172

2. Select **Settings** to go to the **Settings** screen.

3. Select **Info**.

4. Select **Clock/Wallpaper Type**, then the **Wallpaper** tab.

5. Select **Add New**.

▶ The picture name is displayed on the list.

6. Select a desired picture.

▶ The preview is displayed on the left side on the screen.

7. Select **Start Import** to save the data.

▶ The display will return to the wallpaper list.

## ▶▶ Wallpaper Setup

- When importing wallpaper files, the image must be in the USB flash drive's root directory. Images in a folder cannot be imported.
- The file name must be fewer than 64 characters.
- The file format of the image that can be imported is BMP (bmp) or JPEG (jpg).
- The individual file size limit is 5 MB.
- The maximum image size is 4,096 × 4,096 pixels. If the image size is less than 800 × 480 pixels, the image is displayed in the middle of the screen with the extra area appearing in black.
- Up to 255 files can be selected.
- If the USB flash drive does not have any pictures, the **No files detected** message appears.

### ■ Select wallpaper

1. Select **Settings** to go to the **Settings** screen.
2. Select **Info**.
3. Select **Clock/Wallpaper Type**, then the **Wallpaper** tab.
  - ▶ The screen changes to the wallpaper list.
4. Select a desired wallpaper.
  - ▶ The preview is displayed on the left side on the screen.
  - ▶ The pop-up menu appears on the screen.
5. Select **Set**.
  - ▶ The display will return to the wallpaper list.

### ■ Delete wallpaper

1. Select **Settings** to go to the **Settings** screen.
2. Select **Info**.
3. Select **Clock/Wallpaper Type**, then the **Wallpaper** tab.
  - ▶ The screen changes to the wallpaper list.
4. Select a wallpaper that you want to delete.
  - ▶ The preview is displayed on the left side on the screen.
  - ▶ The pop-up menu appears on the screen.
5. Select **Delete**.
  - ▶ The confirmation message will appear.
6. Select **Yes** to delete completely.
  - ▶ The display will return to the wallpaper list.

### ▶▶ Wallpaper Setup

From the pop-up menu, select **Preview** to see a preview at full-size screen.

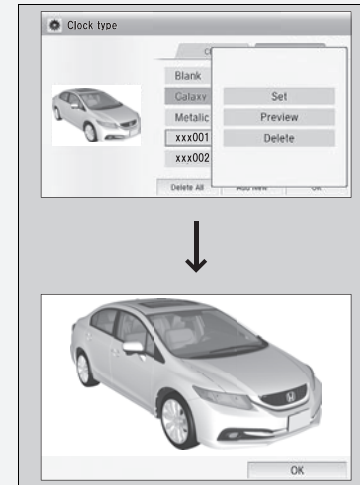

To go back to the previous screen, select **OK**, or **BACK**.

When the file size is large, it takes a while to be previewed.

To delete all wallpapers you add, select **Delete All**, then **Yes**.

## Adjusting the Sound

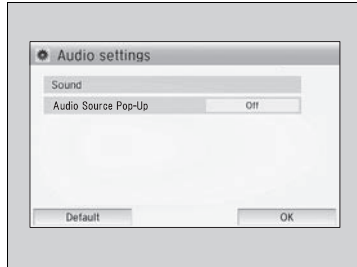

1. Select **Settings**.
2. Select **Audio**.
3. Select **Sound**.

Select the tabs to adjust the following choices:  
**BASS, TREBLE, FADER, BALANCE, SUBW**  
(Subwoofer)\*, **SVC** (Speed-sensitive Volume  
Compensation)

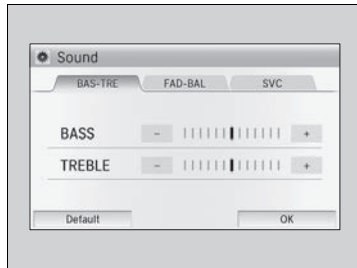

### ▶▶ Adjusting the Sound

The SVC has four modes: **Off, Low, Mid,** and **High**. SVC adjusts the volume level based on the vehicle speed. As you go faster, audio volume increases. As you slow down, audio volume decreases.

## Display Setup

You can change the brightness or color theme of the audio/information screen.

### Changing the Screen Brightness

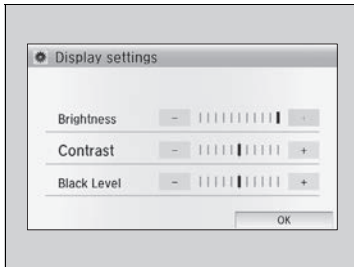

1. Select **Settings** to go to the **Settings** screen.
2. Select **System**.
3. Select the **Display** tab.
4. Select **Display Settings**.
5. Select the setting you want.
6. Select **OK**.

### Changing the Screen's Color Theme

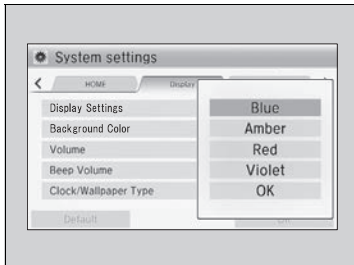

1. Select **Settings** to go to the **Settings** screen.
2. Select **System**.
3. Select the **Display** tab.
4. Select **Background Color**.
5. Select the setting you want.
6. Select **OK**.

### Changing the Screen Brightness

You can change the **Contrast** and **Black Level** settings in the same manner.



## Playing AM/FM Radio

**Audio/Information Screen**

**Power Button**  
Press to turn the audio system on and off.

**VOL (Volume)**  
Select to adjust the volume.

**MENU**  
Select to display the menu items.

**BACK**  
Select to go back to the previous display.

**Scan**  
Select to scan each station with a strong signal.

**Tune Icons**  
Select ◀ or ▶ to tune the radio frequency.

**Open/Close Icon<sup>\*1</sup>**  
Displays/hides the detailed information.

**Seek Icons**  
Select ◀◀ or ▶▶ to search up and down the selected band for a station with a strong signal.

**Preset Icons**  
Tune the radio frequency for preset memory.  
Select and hold the preset icon to store that station.  
Select >> to display preset 7 onwards.

The diagram shows two views of the audio system's display. The top view is a large screen showing 'FM 103.5 MHz ST', '75°F', '002300 miles', and '12:34'. The bottom view is a smaller screen showing 'FM SOURCE ALL 103.5 MHz' and a list of preset frequencies: 103.5, 103.5, 103.5, 101.5, 103.7, 103.5. Callout lines connect various icons and buttons on these screens to their respective descriptions.

\*1: Some or all of the lists may not be displayed.

## ■ Preset Memory

To store a station:

1. Tune to the selected station.
2. Select **MENU**.
3. Select **Save Preset**.
4. Select the preset number for the station you want to store.

You can also store a preset station by the following procedure.

1. Select open/close icon to display a channel list.
2. Select **Preset** tab.
3. Press and hold the preset number for the station you want to store until you hear a beep.

## ■ Radio Data System (RDS)

Provides text data information related to your selected RDS-capable FM station.

### ■ To find an RDS station from Station List

1. Select **MENU** while listening to an FM station.
2. Select **Station List**.
3. Select a station.

### ■ Manual update

Updates your available station list at any time.

1. Select **MENU** while listening to an FM station.
2. Select **Station List**.
3. Select **Refresh**.

\* Not available on all models

## ▶▶ Playing AM/FM Radio

The **ST** indicator appears on the display indicating stereo FM broadcasts.  
Stereo reproduction in AM is not available.

Switching the Audio Mode  
Press the **SOURCE** button on the steering wheel or select **SOURCE** on the list.

▶ **Audio Remote Controls**\* P. 174

You can also switch the mode by selecting **Change Source** on the **MENU** screen.

You can store 6 AM stations and 12 FM stations into the preset memory.

## ▶▶ Radio Data System (RDS)

When you select an RDS-capable FM station, the RDS automatically turns on, and the frequency display changes to the station name. However, when the signals of that station become weak, the display changes from the station name to the frequency.

Continued

### ■ Radio text

Displays the radio text information of the selected RDS station.

1. Select **MENU**.
2. Select **View Radio Text**.

### ■ Scan

Samples each of the strongest stations on the selected band for 10 seconds.

1. Select **MENU**.
2. Select **Scan**.

To turn off scan, select **Cancel**.

## Playing a CD

Your audio system supports audio CDs, CD-Rs and CD-RWs in either MP3, WMA, or AAC\*1 format. With the CD loaded, select the CD mode.

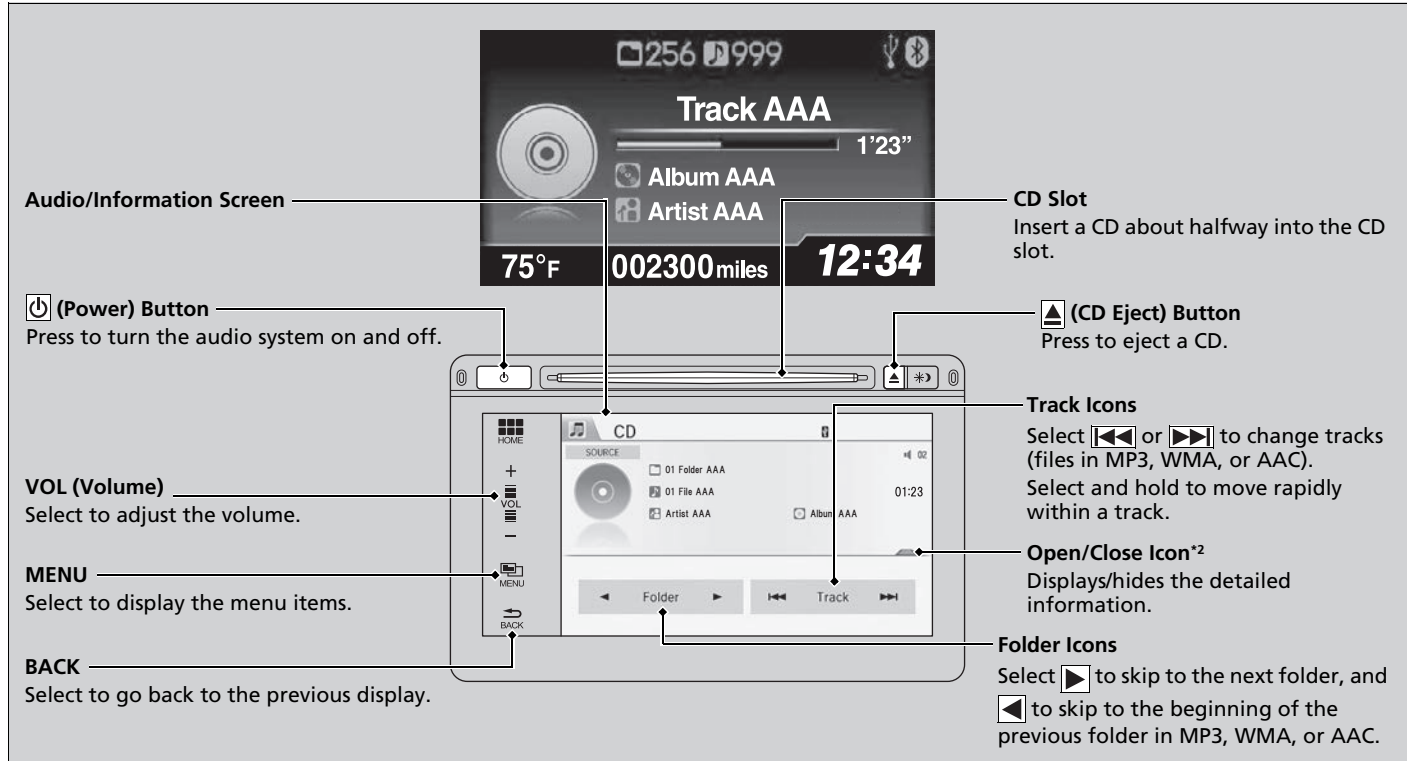

\*1: Only AAC format files recorded with iTunes are playable on this unit.

\*2: Some or all of the lists may not be displayed.

## How to Select a File from the Music Search List (MP3/WMA/AAC)

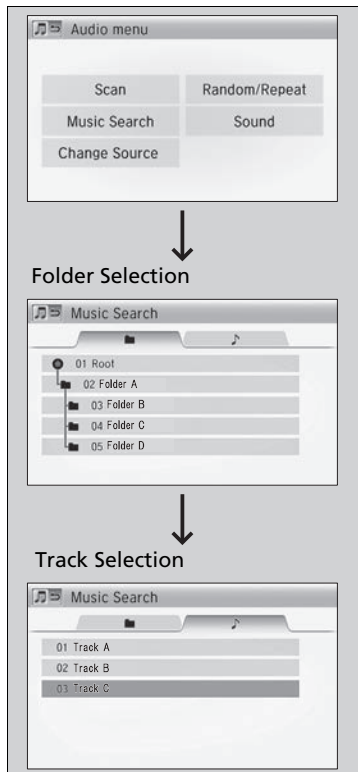

1. Select **MENU** and select **Music Search**.

2. Select a folder.

3. Select a track.

### ▶▶ Playing a CD

#### NOTICE

Do not use CDs with adhesive labels. The label can cause the CD to jam in the unit.

WMA files protected by digital rights management (DRM) cannot be played.

The audio system displays **Unplayable File**, then skips to the next file.

Text data appears on the display under the following circumstances:

- When you select a new folder, file, or track.
- When you change the audio mode to CD.
- When you insert a CD.

If you eject the CD but do not remove it from the slot, the system reloads the CD automatically after several seconds.

## How to Select a Play Mode

You can select scan, repeat, and random modes when playing a track or file.



1. Select **MENU**.
2. Select **Scan** or **Random/Repeat**.
3. Select a mode.

### To turn off a play mode

1. Select **MENU**.
2. Select the mode you want to turn off.

### How to Select a Play Mode

Play Mode Menu Items

#### Scan

**Scan Folders** (MP3/WMA/AAC): Provides 10-second sampling of the first file in each of the main folders.

**Scan Tracks**: Provides 10-second sampling of all tracks on the CD (all files in the current folder in MP3, WMA, or AAC).

#### Random/Repeat

**Repeat Folder** (MP3/WMA/AAC): Repeats all files in the current folder.

**Repeat Track**: Repeats the current track/file.

**Random in Folder** (MP3/WMA/AAC): Plays all files in the current folder in random order.

**Random All Tracks**: Plays all tracks/files in random order.

## Playing an iPod

Connect the iPod using your dock connector to the USB port or the USB adapter cable, then select the iPod mode.

➤ **USB/HDMI® Port\*** P. 171

➤ **USB Adapter Cable\*** P. 172

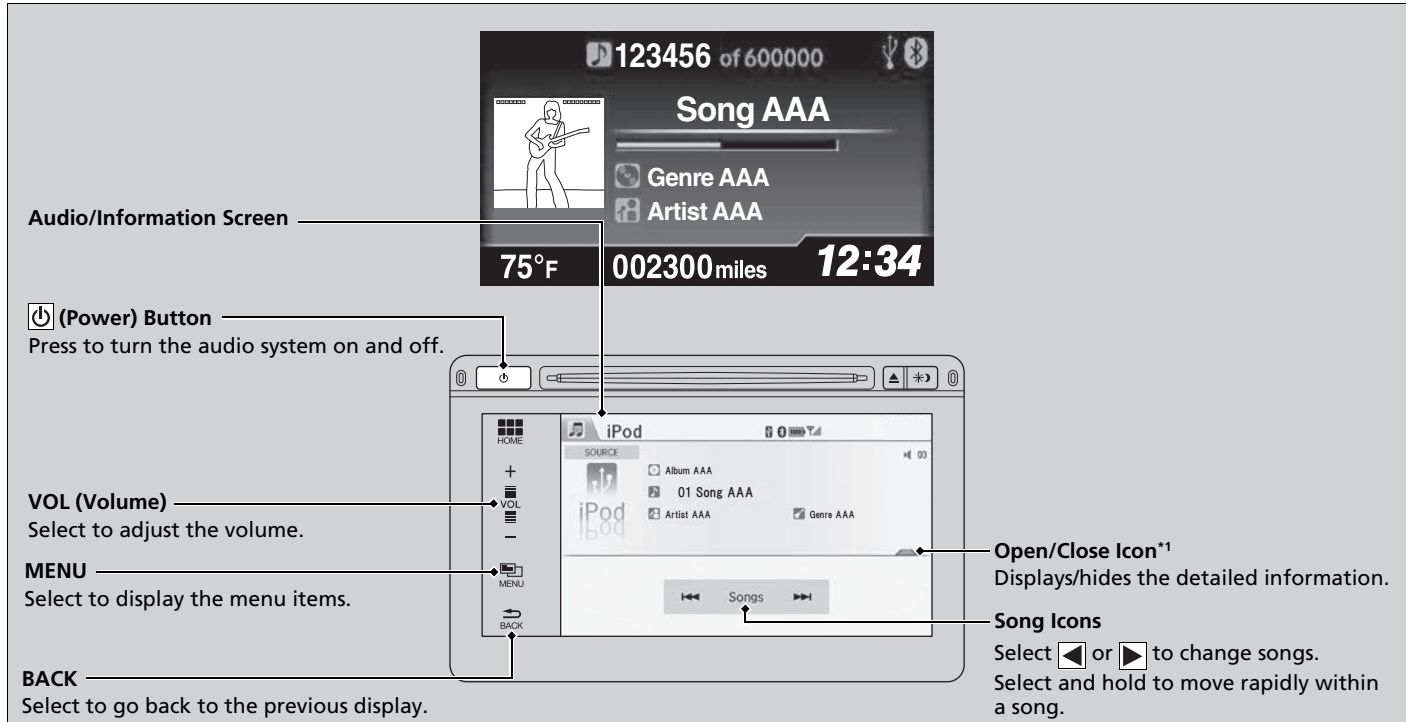

\*1: Some or all of the lists may not be displayed.

\* Not available on all models

## How to Select a Song from the Music Search List

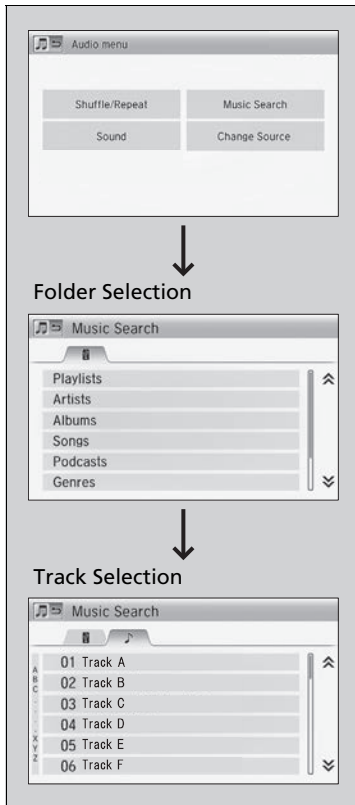

1. Select **MENU** and select **Music Search**.
2. Select the items on that menu.

### How to Select a Song from the Music Search List

Available operating functions vary on models or versions. Some functions may not be available on the vehicle's audio system.

If there is a problem, you may see an error message on the audio/information screen.

**iPod/USB Flash Drive\* P. 225**

If you operate the music app on your iPhone/iPod while the phone is connected to the display audio system, you may no longer be able to operate the same app on the display audio. Reconnect the device if necessary.

\* Not available on all models

Continued



## ■ How to Select a Play Mode

You can select repeat and shuffle modes when playing a file.

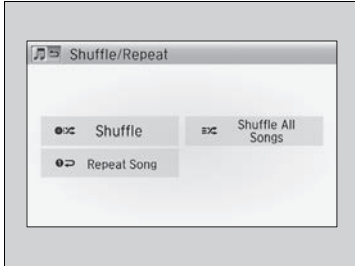

1. Select **MENU**.
2. Select **Shuffle/Repeat**.
3. Select a mode.

### ■ To turn off a play mode

1. Select **MENU**.
2. Select the mode you want to turn off.

## ▶▶ How to Select a Play Mode

Play Mode Menu Items

**Repeat Song:** Repeats the current track.

**Shuffle:** Plays all available albums in a selected list (playlists, artists, albums, songs, genres, or composers) in random order.

**Shuffle All Songs:** Plays all available files in a selected list (playlists, artists, albums, songs, genres, or composers) in random order.

**U.S. models**

**Compatible phones only**

## Playing Internet Radio

Connect a compatible phone through *Bluetooth*®.

➔ **Phone Setup** P. 283

**iPhone only**

You can also connect the phone using your dock connector to the USB port or the USB adapter cable.

Select **Source** to select Pandora mode.

▶▶ Playing Internet Radio

Pandora®, the Pandora logo, and the Pandora trade dress are trademarks or registered trademarks of Pandora Media, Inc., used with permission. Pandora is currently available exclusively in the United States.

To find out if your phone is compatible with this feature, visit [www.handsfreelink.honda.com](http://www.handsfreelink.honda.com), or call 1-888-528-7876.

To use this service in your vehicle, the Pandora® app must first be installed on your phone. Visit [www.pandora.com](http://www.pandora.com). for more information.

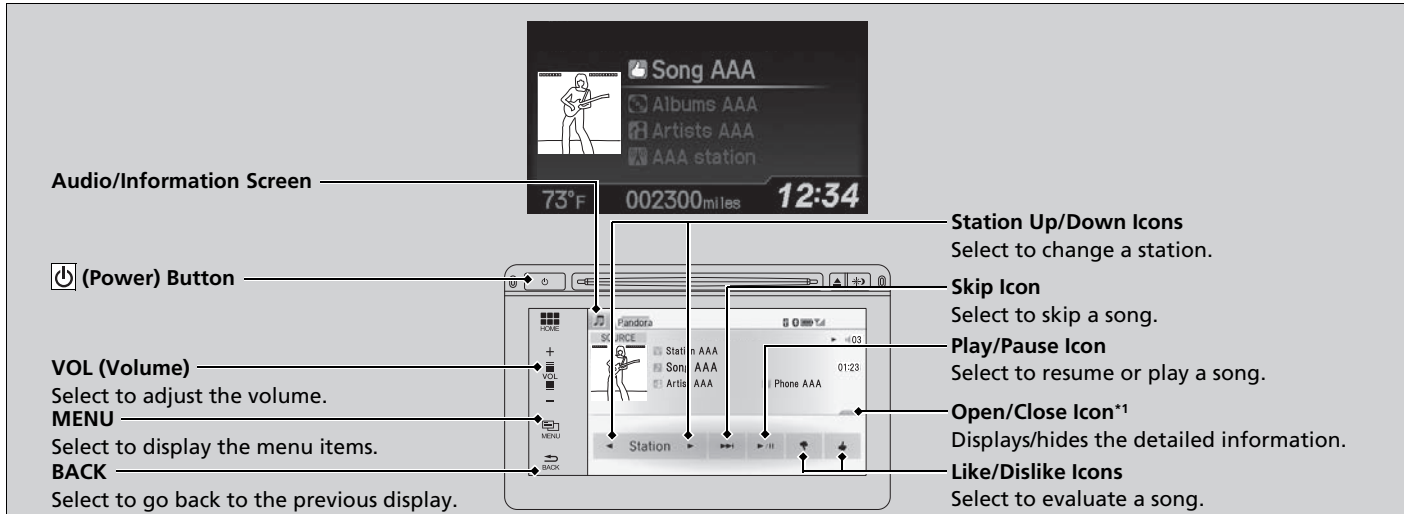

\*1: Some or all of the lists may not be displayed.

Continued

## ■ Pandora® Menu

You can operate some of the Pandora® menu items from your vehicle's audio system. The available items are:

- **Bookmark**
- **Station List**
- **Change Station**
- **Change Source**
- **Sound**

### ■ Operating a menu item

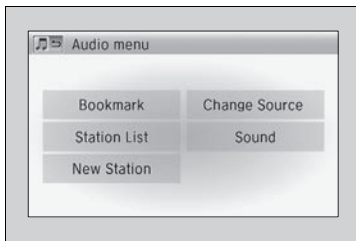

1. Select **MENU**.
2. Select an item.

## ▶▶ Playing Internet Radio

Pandora® is free, personalized radio that plays music and comedy you'll love. Just start with the name of one of your favorite artists, songs, comedians or composers and Pandora® will create a custom station that plays similar tracks. Pandora® also features hundreds of genre stations ranging from Dubstep to Smooth Jazz to Power Workout.

If you cannot operate Pandora® through the audio system, it may be streaming through *Bluetooth®* Audio. Make sure Pandora® mode on your audio system is selected.

### Changing Stations

To change stations, activate the Pandora® menu, select **Station List**, and then select a new station.

## ▶▶ Pandora® Menu

Available operating functions vary on software versions. Some functions may not be available on the vehicle's audio system.

If there is a problem, you may see an error message on the audio/information screen.

▶▶ **Pandora®** P. 227

Pandora® may limit the total number of skips allowed on the service. If you dislike a track after the skip limit has been reached, your feedback will be saved but the current track will continue to play.

## Playing a USB Flash Drive

Your audio system reads and plays sound files on a USB flash drive in either MP3, WMA or AAC\*<sup>1</sup> format.

Connect your USB flash drive to the USB port or the USB adapter cable, then select the USB mode.

▶ **USB/HDMI® Port\*** P. 171

▶ **USB Adapter Cable\*** P. 172

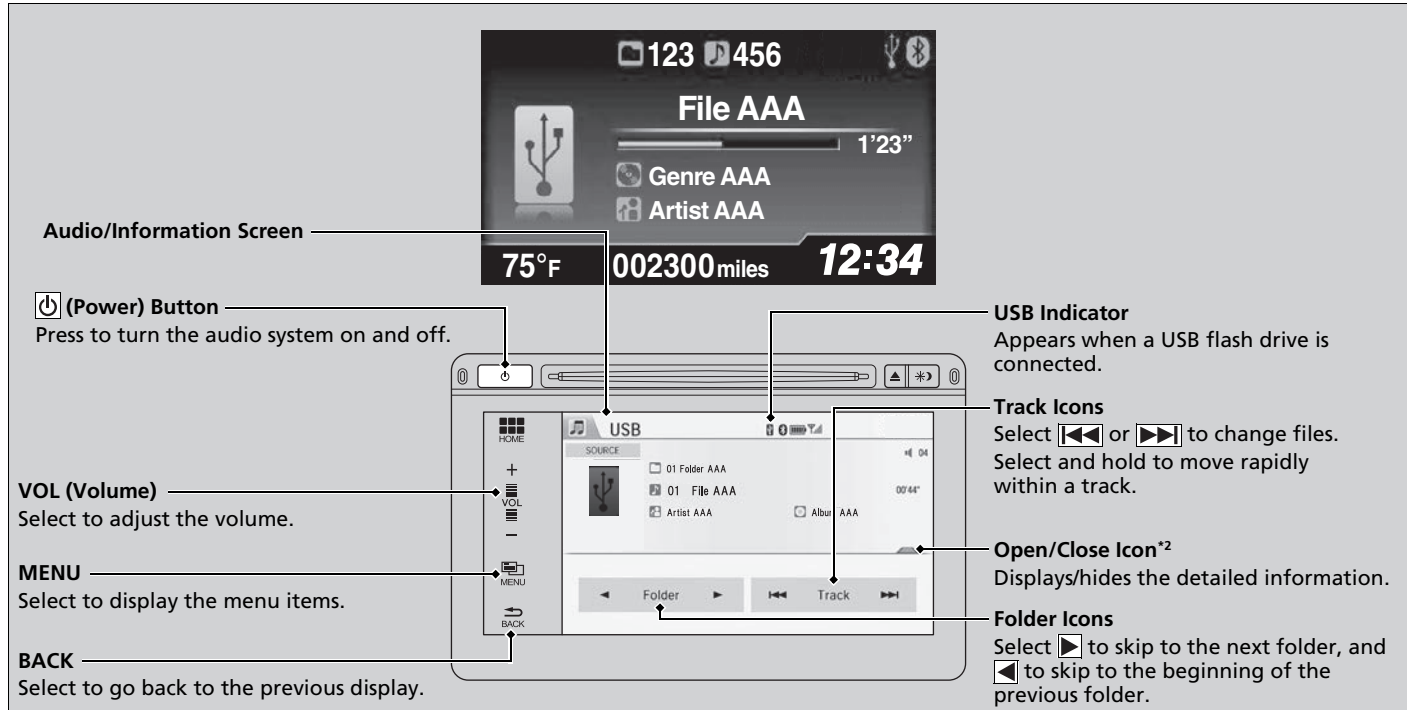

\*1: Only AAC format files recorded with iTunes are playable on this unit.

\*2: Some or all of the lists may not be displayed.

\* Not available on all models

## ■ How to Select a File from the Music Search List

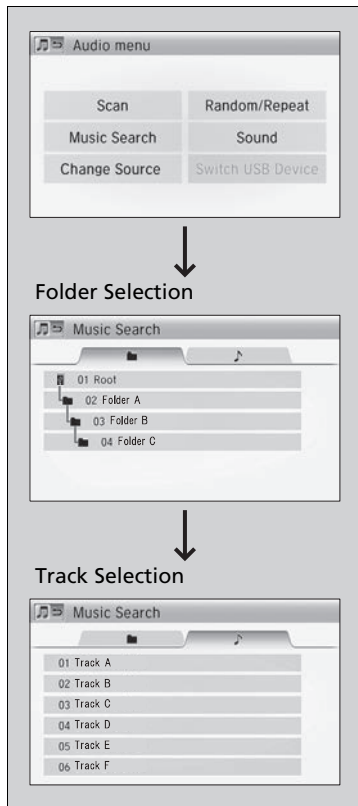

1. Select **MENU** and select **Music Search**.

2. Select a folder.

3. Select a track.

## ▶▶ Playing a USB Flash Drive

Use the recommended USB flash drives.

▶ **General Information on the Audio System**  
P. 230

Files in WMA format protected by digital rights management (DRM) cannot be played.

The audio system displays **Unplayable File**, and then skips to the next file.

If there is a problem, you may see an error message on the audio/information screen.

▶ **iPod/USB Flash Drive\*** P. 225

## How to Select a Play Mode

You can select scan, repeat, and random modes when playing a file.



1. Select **MENU**.
2. Select **Scan** or **Random/Repeat**.
3. Select a mode.

### To turn off a play mode

1. Select **MENU**.
2. Select the mode you want to turn off.

## How to Select a Play Mode

Play Mode Menu Items

### Scan

**Scan Folders:** Provides 10-second sampling of the first file in each of the main folders.

**Scan Tracks:** Provides 10-second sampling of all files in the current folder.

### Random/Repeat

**Repeat Folder:** Repeats all files in the current folder.

**Repeat Track:** Repeats the current file.

**Random in Folder:** Plays all files in the current folder in random order.

**Random All Tracks:** Plays all files in random order.

## Playing *Bluetooth*® Audio

Your audio system allows you to listen to music from your *Bluetooth*-compatible phone.

This function is available when the phone is paired and connected to the vehicle's *Bluetooth*® HandsFreeLink® (HFL) system.

▶ **Phone Setup** P. 283

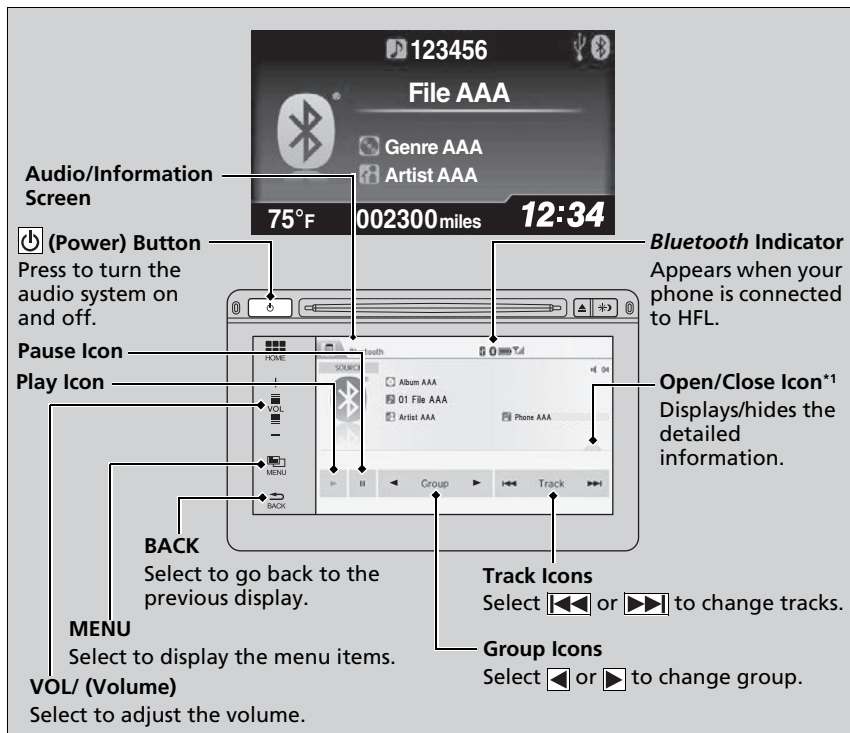

### ▶▶ Playing *Bluetooth*® Audio

Not all *Bluetooth*-enabled phones with streaming audio capabilities are compatible with the system. For a list of compatible phones:

- U.S.: Visit [www.handsfreelink.honda.com](http://www.handsfreelink.honda.com), or call 1-888-528-7876.
- Canada: Visit [www.handsfreelink.ca](http://www.handsfreelink.ca), or call 1-888-528-7876.

In some states, it may be illegal to perform some data device functions while driving.

Only one phone can be used with HFL at a time. When there are more than two paired phones in the vehicle, the first paired phone the system finds is automatically linked.

If more than one phone is paired to the HFL system, there may be a delay before the system begins to play.

In some cases, the name of the artist, album, or track may not appear correctly.

A **NO CONNECT** message may be displayed if:

- The phone is not linked to HFL.
- The phone is not turned on.
- The phone is not in the vehicle.
- An incompatible phone is connected.

The following functions may not be available on some devices:

- Pause function
- Group selection

\*1: Depending on the *Bluetooth*® device you connect, some or all of the lists may not be displayed.

## ■ To Play *Bluetooth*® Audio Files

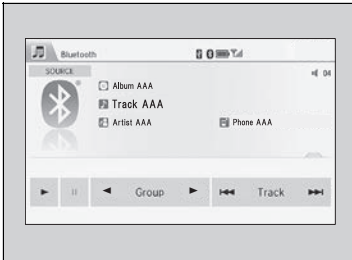

1. Make sure that your phone is paired and connected to the system.
2. Select the *Bluetooth*® Audio mode.

If the phone is not recognized, another HFL-compatible phone, which is not compatible for *Bluetooth*® Audio, may already be connected.

## ■ To pause or resume a file

Select the play icon or pause icon.

## ■ Searching for Music

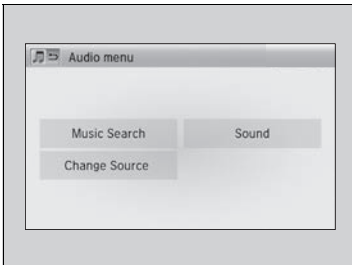

1. Select **MENU**.
2. Select **Music Search**.
3. Select a search category (e.g., Albums).
4. Select an item.
  - ▶ The selection begins playing.

## ☒ To Play *Bluetooth*® Audio Files

To play the audio files, you may need to operate your phone. If so, follow the phone maker's operating instructions.

Switching to another mode pauses the music playing from your phone.

## ☒ Searching for Music

Depending on the *Bluetooth* device you connect, some or all of the lists may not be displayed.



## Playing a Video Using the HDMI®

Your audio system allows you to play videos from an HDMI®-compatible device. Connect the device, using an HDMI® cable, then select the HDMI® mode.

➤ **USB/HDMI® Port\*** P. 171

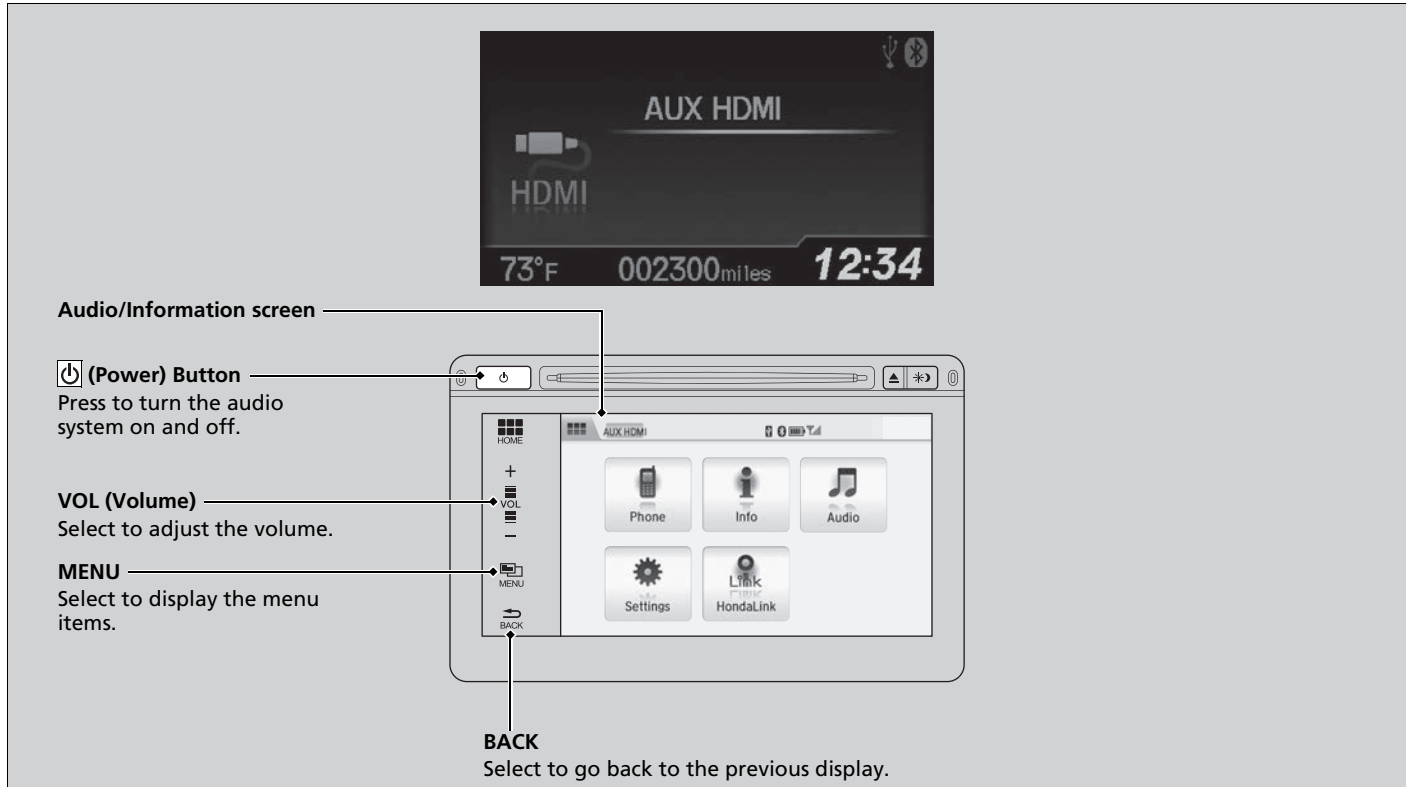

## Changing the Screen Aspect

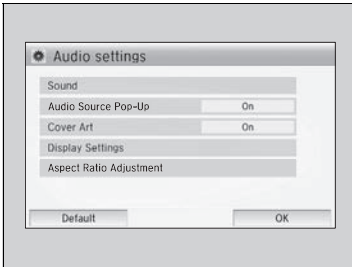

1. Select **Settings** to go to the **Settings** screen.
2. Select **Audio**.
3. Select **Aspect Ratio Adjustment**.
4. Select the setting you want.
5. Select **OK**.

## ▶▶ Playing a Video Using the HDMI®

This feature is limited while driving. To play videos, stop your vehicle and apply the parking brake.

## Smartphone Apps

You can connect a compatible smartphone to the system to enable integration between the smartphone's approved apps and the vehicle. This allows you to control the phone through the vehicle display. To check smart phone compatibility, download the HondaLink app, and view connection instructions, visit [handsfreelink.honda.com](http://handsfreelink.honda.com). For the latest apps and feature details, check [hondalink.com](http://hondalink.com).

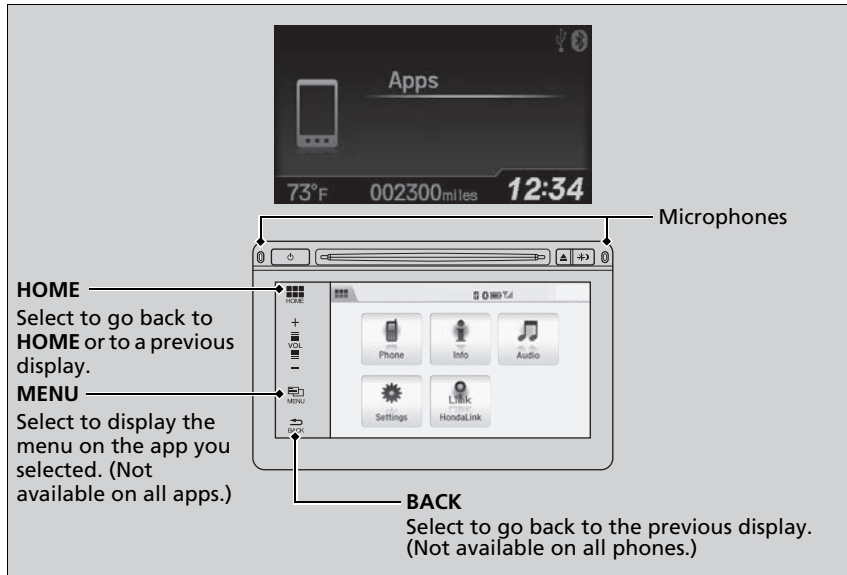

### Smartphone Apps

Park in a safe place before connecting your phone and while operating the displayed apps.

Not all phones and apps are compatible with the system. The system does not display all the available apps on smartphone, and some apps need to be preinstalled. Ask a dealer for details.

You need to switch the *Bluetooth* connection to your smartphone if another electronic device is connected.

#### ▶ Changing the currently paired phone P. 284

The following may vary by phone type:

- How to connect a smartphone to the system.
- Apps that can be operated on the screen.
- Display response time/update time.

We do not support every app operation on the display audio.

Ask the app provider for any questions on the app's features.

## Siri Eyes Free

You can talk to Siri using the Talk button on the steering wheel when your iPhone is paired to *Bluetooth*® HandsFreeLink.

📱 **Phone Setup** P. 283

### Using Eyes Free

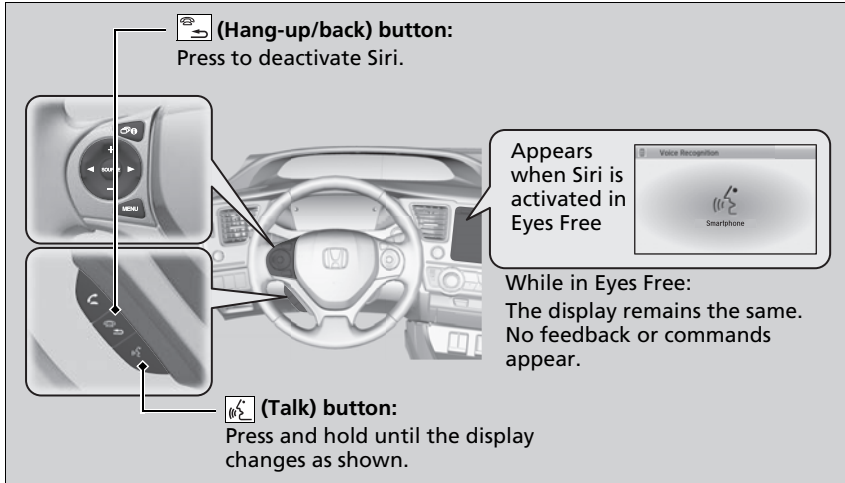

#### ▶ Siri Eyes Free

Siri is a trademark of Apple Inc.

Check Apple Inc. website for features available for Siri.





When operating the vehicle, only use Siri through the Talk button.

#### ▶ Using Eyes Free

Some commands work only on specific phone features or apps.

## CD Player

If a disc error occurs, you may see the following error messages.

Error Message	Cause	Solution
<b>Heat Error</b> <sup>*2,*3</sup>	High temperature	<ul style="list-style-type: none"> <li>Turn the audio system off and allow the player to cool down until the error message is cleared.</li> </ul>
<b>FORMAT</b> <sup>*1</sup> <b>Unsupported</b> <sup>*2</sup> <b>Unplayable File</b> <sup>*3</sup>	Track/file format not supported	<ul style="list-style-type: none"> <li>Current track/file will be skipped. The next supported track/file plays automatically.</li> </ul>
<b>BAD DISC</b> <b>CHECK MANUAL</b> <b>PUSH EJECT</b> <sup>*1</sup>  <b>Bad Disc</b> <b>Please Check Owners Manual</b> <b>Push Eject</b> <sup>*2,*3</sup>	Mechanical error	<ul style="list-style-type: none"> <li>Press the  (eject) button and remove the disc, and check that the error message is cleared.</li> <li>Check that the disc is not damaged or deformed, and insert the disc again.                             <ul style="list-style-type: none"> <li> <b>Protecting CDs</b> P. 231</li> </ul> </li> <li>If the error message reappears, press the  button, and pull out the disc.</li> </ul>
<b>Mecha Error</b> <sup>*2,*3</sup>		<ul style="list-style-type: none"> <li>Insert a different disc.</li> </ul>
<b>BAD DISC</b> <b>CHECK MANUAL</b> <sup>*1</sup>  <b>Bad Disc</b> <b>Please Check Owners Manual</b> <sup>*2,*3</sup>	Servo error	<ul style="list-style-type: none"> <li>If the new disc plays, there is a problem with the first disc.</li> <li>If the error message repeats, or the disc cannot be removed, contact a dealer.</li> <li>Do not try to force the disc out of the player.</li> </ul>
<b>Check Disc</b> <sup>*2,*3</sup>	Disc error	<ul style="list-style-type: none"> <li>Check that the disc is not damaged or deformed.                             <ul style="list-style-type: none"> <li> <b>Protecting CDs</b> P. 231</li> </ul> </li> </ul>

\*1:Models with information display

\*2:Models with one display

\*3:Models with display audio system

## iPod/USB Flash Drive \*

If an error occurs while playing an iPod or USB flash drive, you may see the following error messages. If you cannot clear the error message, contact a dealer.

Models with one display	
Error Message	Solution
<b>USB Error</b>	Appears when there is a problem with the USB adapter unit. Check if the device is compatible with the USB adapter unit.
<b>Bad USB Device Please Check Owners Manual.</b>	Appears when an incompatible device is connected. Disconnect the device. Then turn the audio system off, and turn it on again. Do not reconnect the device that caused the error.
<b>No Song</b>	Appears when the iPod is empty. Check that compatible files are stored on the device.
<b>Unsupported Ver</b>	Appears when an unsupported iPod is connected. If it appears when a supported iPod is connected, update the iPod software to the newer version.
<b>Retry Connection</b>	Appears when the system does not acknowledge the iPod. Reconnect the iPod.
<b>Unplayable File</b>	Appears when the files in the USB flash drive are DRM or an unsupported format. This error message appears for about 3 seconds, then plays the next song.
<b>No Data</b>	Appears when the USB flash drive is empty or there are no MP3, WMA, or AAC files in the USB flash drive. Check that compatible files are stored on the device.
<b>Unsupported</b>	Appears when an unsupported device is connected. If it appears when a supported device is connected, reconnect the device.

\* Not available on all models

Models with display audio system	
Error Message	Solution
<b>USB Error</b>	Appears when there is a problem with the USB adapter unit. Check if the device is compatible with the USB adapter unit.
<b>The connected USB device has a problem. See Owner's Manual</b>	Appears when an incompatible device is connected. Disconnect the device. Then turn the audio system off, and turn it on again. Do not reconnect the device that caused the error.
<b>Unsupported Version</b>	Appears when an unsupported iPod is connected. If it appears when a supported iPod is connected, update the iPod software to the newer version.
<b>Connect Retry</b>	Appears when the system does not acknowledge the iPod. Reconnect the iPod.
<b>Unplayable File</b>	Appears when the files in the USB flash drive are DRM or an unsupported format. This error message appears for about 3 seconds, then plays the next song.
<b>No Data</b>	<b>iPod</b> Appears when the iPod is empty.
	<b>USB flash drive</b> Appears when the USB flash drive is empty or there are no MP3, WMA, or AAC files in the USB flash drive.
	<b>iPod and USB flash drive</b> Check that compatible files are stored on the device.
<b>Unsupported</b>	Appears when an unsupported device is connected. If it appears when a supported device is connected, reconnect the device.

U.S. models

**Pandora®**

If an error occurs while playing Pandora®, you may see the following error messages.

If you cannot clear the error message, contact a dealer.

Models with one display

Error Message	Solution
<b>PANDORA No Station</b>	Appears when there is no station list on the device. Use the device to create a station.
<b>PANDORA Requires Update</b>	Appears when Pandora version is not supported. Please update the device application.
<b>PANDORA Unavailable</b>	Appears when Pandora is performing system maintenance. Try again later.
<b>PANDORA Cannot Connect</b>	Appears when Pandora is unable to play music. Check your device.
<b>PANDORA Loading...</b>	Appears when Pandora is loading.



Models with display audio system

Error Message	Solution
<p><b>The maximum number of stations that can be created is 100. To create more, please delete one or more previously created stations.</b></p>	<ul style="list-style-type: none"> <li>• Appears when the number of stations that can be created is exceeded. Follow the message.</li> </ul>
<p><b>Unable to create new station. Please try again.</b></p>	
<p><b>Unable to play Pandora. Please try again later.</b></p>	<ul style="list-style-type: none"> <li>• Appears when the commanded operation is failed. Try again later.</li> </ul>
<p><b>Unable to save bookmark.</b></p>	
<p><b>This Pandora station is currently not available. Please select another station.</b></p>	<ul style="list-style-type: none"> <li>• Appears when the station you selected is not available. Change a station, or try again later.</li> </ul>
<p><b>Unable to play Pandora. When stopped, log-in to Pandora.</b></p>	<ul style="list-style-type: none"> <li>• Appears when you have not logged into Pandora®. Follow the message.</li> </ul>
<p><b>Unable to connect to Pandora. When stopped, check your mobile phone.</b></p>	
<p><b>Unable to play Pandora. Please try again later.</b></p>	<ul style="list-style-type: none"> <li>• Appears when failed to connect. Check your device and try again.</li> </ul>
<p><b>Connect Retry</b></p>	

## Models with display audio system

Error Message	Solution
<b>Unsupported</b>	<ul style="list-style-type: none"> <li>• Appears when the device is not supported. Use another device.</li> </ul>
<b>Unsupported Version</b>	<ul style="list-style-type: none"> <li>• Appears when Pandora® version is not supported. Update Pandora® to the latest version.</li> </ul>
<b>Pandora App version is not supported</b>	<ul style="list-style-type: none"> <li>• Appears when Pandora® version is not supported. Update Pandora® to the latest version.</li> </ul>
<b>Unable to connect to the phone. Please make sure the phone's Bluetooth setting is ON and try again.</b>	<ul style="list-style-type: none"> <li>• Appears when Pandora® is unable to play music. Check the Bluetooth status on your device.</li> </ul>
<b>No Data</b>	<ul style="list-style-type: none"> <li>• Appears when no data is available with Pandora® activated. Reboot the app and reconnect the device.</li> </ul>
<b>The connected USB device has a problem. See Owner's Manual</b>	<ul style="list-style-type: none"> <li>• Appears when an incompatible device is connected. Disconnect the device. Then turn the audio system off, and turn it again. Do not reconnect the device that caused the error.</li> </ul>
<b>No station list on device. Use device to create station.</b>	<ul style="list-style-type: none"> <li>• Appears when there is no station list on the device. Create one on your device.</li> </ul>
<b>No Stations stored in Pandora App</b>	<ul style="list-style-type: none"> <li>• Appears when there is no station on app. Store some.</li> </ul>
<b>The maximum number of tracks that can be skipped per hour has been reached.</b>	<ul style="list-style-type: none"> <li>• Appears when you try to skip a song or select Dislike over the predetermined number of times in an hour.</li> </ul>

## Recommended CDs

- Use only high-quality CD-R or CD-RW discs labeled for audio use.
- Use only CD-R or CD-RW discs on which the recordings are closed.
- Play only standard round-shaped CDs.

The CD packages or jackets should have one of these marks.



### CDs with MP3 or WMA files

- Some software files may not allow for audio play or text data display.
- Some versions of MP3 or WMA formats may be unsupported.

### Recommended CDs

A Dual-disc cannot play on this audio unit. If recorded under certain conditions, a CD-R or CD-RW may not play either.

## ■ Protecting CDs

Follow these precautions when handling or storing CDs:

- Store a CD in its case when it is not being played.
- When wiping a CD, use a soft clean cloth from the center to the outside edge.
- Handle a CD by its edge. Never touch either surface.
- Never insert foreign objects into the CD player.
- Keep CDs out of direct sunlight and extreme heat.
- Do not place stabilizer rings or labels on the CD.
- Avoid fingerprints, liquids, and felt-tip pens on the CD.

### ▶▶ Protecting CDs

#### NOTICE

Do not insert a damaged CD. It may be stuck inside and damage the audio unit.

#### Examples:

- Bubbled, wrinkled, labeled, and excessively thick CDs



Bubbled/  
Wrinkled



With Label/  
Sticker



Using  
Printer Label  
Kit



Sealed



With Plastic Ring

- Damaged CDs



Chipped/  
Cracked



Warped



Burrs

- Poor quality CDs

- Small CDs



3-inch  
(8-cm)  
CD

Models with i-MID

## Compatible iPod and USB Flash Drives

### ■ iPod and iPhone Model Compatibility

Model
iPod (5th generation)
iPod classic 80GB/160GB (launch in 2007)
iPod classic 120GB (launch in 2008)
iPod classic 160GB (launch in 2009)
iPod nano
iPod touch
iPhone 3G/iPhone 3GS/iPhone 4/iPhone 4S/iPhone 5*1

\*1: Models with display audio system

### ■ USB Flash Drives

- Use a recommended USB flash drive of 256 MB or higher.
- Some digital audio players may not be compatible.
- Some USB flash drives (e.g., a device with security lockout) may not work.
- Some software files may not allow for audio play or text data display.
- Some versions of MP3, WMA, or AAC formats may be unsupported.

### ▶▶ iPod and iPhone Model Compatibility

This system may not work with all software versions of these devices.

### ▶▶ USB Flash Drives

Files on the USB flash drive are played in their stored order. This order may be different from the order displayed on your PC or device.

# Customized Features\*

Use the audio/information screen to customize certain features.

## ■ How to customize

While the vehicle is at a complete stop with the power mode in ON, select **Settings**, then select a setting item.

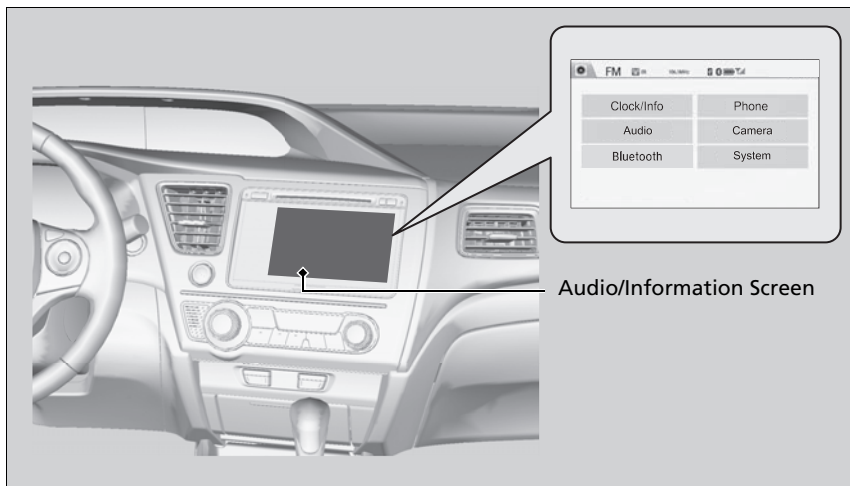

## ⌘ Customized Features\*

When you customize settings:

- Make sure that the vehicle is at a complete stop.

### Continuously variable transmission models

- Shift to **P**.

### Manual transmission models

- Set the parking brake.

To customize other features, select **Settings**.

➤ **List of customizable options** P. 237

\* Not available on all models

■ Customization flow

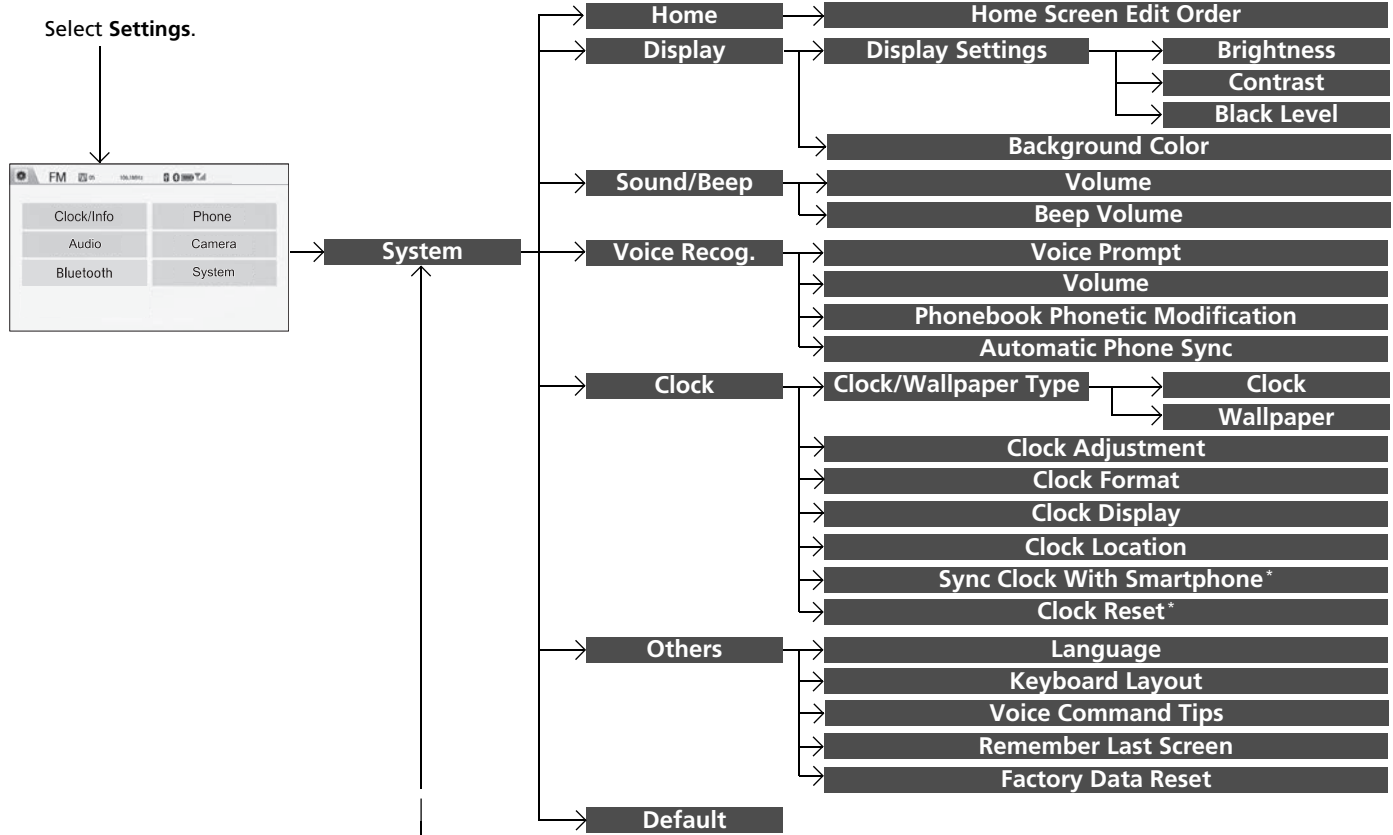

Features

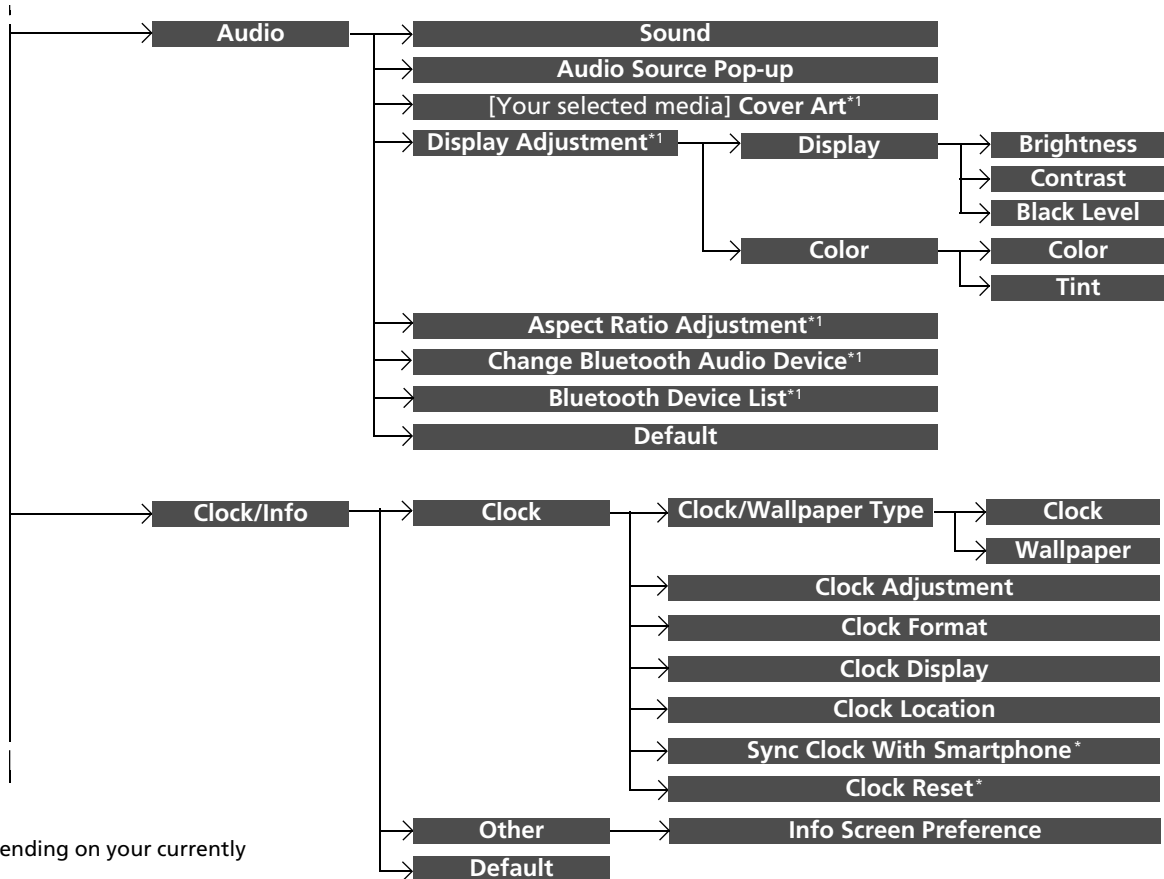

\*1: May change depending on your currently selected source.

\* Not available on all models



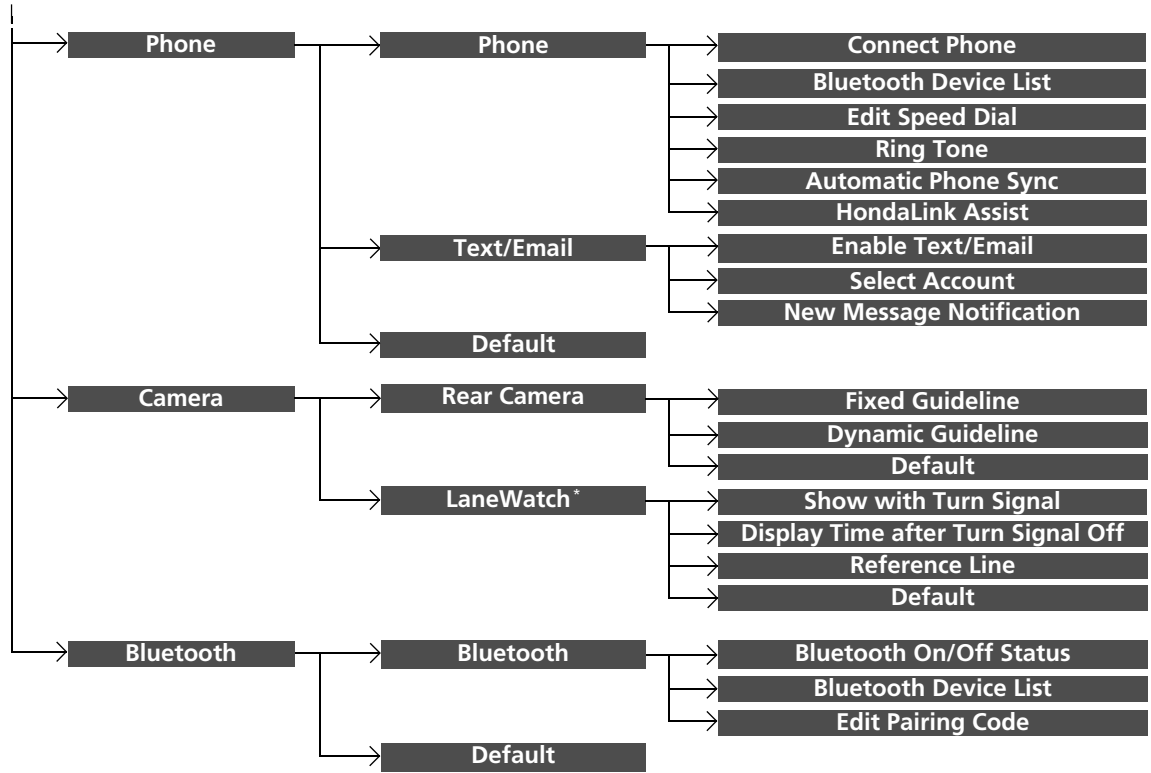



## ■ List of customizable options

Setup Group	Customizable Features	Description	Selectable Settings		
System	<b>Home</b>	<b>Home Screen Edit Order</b>	Changes the <b>HOME</b> screen icon layout.	—	
	<b>Display</b>	<b>Display Settings</b>	<b>Brightness</b>	Changes the brightness of the audio/information screen.	—
			<b>Contrast</b>	Changes the contrast of the audio/information screen.	—
			<b>Black Level</b>	Changes the black level of the audio/information screen.	—
		<b>Background Color</b>	Changes the background color of the audio/information screen.	<b>Blue<sup>*1</sup>/Amber/Red/Violet</b>	
	<b>Sound/Beep</b>	<b>Volume</b>	Changes the sound volume.	<b>0~6<sup>*1</sup>~11</b>	
		<b>Beep Volume</b>	Changes the beep volume.	<b>Off<sup>*1</sup>/1/2/3</b>	
	<b>Voice Recog.</b>	<b>Voice Prompt</b>	Turns the voice prompt on and off.	<b>On<sup>*1</sup>/Off</b>	
		<b>Volume</b>	Changes the volume of the voice prompt.	<b>0~6<sup>*1</sup>~11</b>	
		<b>Phonebook Phonetic Modification</b>	Modifies a voice command for the phonebook.	—	
		<b>Automatic Phone Sync</b>	Sets a phonebook data to be automatically imported when a phone is paired to HFL.	<b>On<sup>*1</sup>/Off</b>	

\*1:Default Setting

Setup Group	Customizable Features	Description	Selectable Settings	
System	Clock	<b>Clock</b>	Changes the clock display type.	<b>Analog/Digital*<sup>1</sup>/ Small Digital/Off</b>
		<b>Clock/ Wallpaper Type</b>	<ul style="list-style-type: none"> <li>Changes the wallpaper type.</li> <li>Imports an image file for a new wallpaper.</li> <li>Deletes an image file for a wallpaper.   <b>Wallpaper Setup</b> P. 200</li> </ul>	<b>Blank/Galaxy*<sup>1</sup>/ Metallic</b>
		<b>Clock Adjustment</b>	Adjusts Clock.  <b>Clock</b> P. 104	—
	<b>Clock</b>	<b>Clock Format</b>	Selects the digital clock display from 12H to 24H.	<b>12H*<sup>1</sup>/24H</b>
		<b>Clock Display</b>	Selects whether the clock display comes on.	<b>On/Off*<sup>1</sup></b>
		<b>Clock Location</b>	Changes the clock display layout.	<b>Right upper*<sup>1</sup>/Left upper/Right lower/ Left lower/Off</b>
		<b>Sync Clock With Smartphone*</b>	Selects whether the clock links to the device you connect.	<b>On*<sup>1</sup>/Off</b>
		<b>Clock Reset*</b>	Cancels/Resets all customized items for clock display as default.	<b>Yes/No</b>

\*1: Default Setting

Setup Group	Customizable Features	Description	Selectable Settings	
System	Language	Changes the display language.	English* <sup>1</sup> /French/Spanish	
	Keyboard Layout	Selects the on-screen keyboard type.	Alphabet/QWERTY* <sup>1</sup>	
	Others	Voice Command Tips	Alerts you when manual control of the system is disabled to prevent distraction while driving. Only voice commands are available.	On* <sup>1</sup> /Off
	Remember Last Screen	Selects whether the device remembers the last screen.	On/Off* <sup>1</sup>	
	Factory Data Reset	Resets all the settings to their factory default. <input checked="" type="checkbox"/> <b>Defaulting All the Settings</b> P. 245	Yes/No	
Default		Cancels /Resets all customized items in the <b>System</b> group as default.	Yes/No	
Audio	Sound	Adjusts the settings of the audio speaker's sound. <input checked="" type="checkbox"/> <b>Adjusting the Sound</b> P. 202	-6 ~ 0* <sup>1</sup> ~ +6 (BASS, TREBLE, and SUBW*), RR9~0* <sup>1</sup> ~FR9 (FADER), L9~0* <sup>1</sup> ~R9 (BALANCE), Off/Low/Mid* <sup>1</sup> /High (SVC)	
	Audio Source Pop-up	Selects whether the list of selectable audio sources comes on when <b>Audio</b> is selected on the <b>HOME</b> screen.	On/Off* <sup>1</sup>	

\*1:Default Setting

\* Not available on all models



Setup Group	Customizable Features	Description	Selectable Settings	
Audio	iPod or USB mode [Your selected media] <b>Cover Art</b>	Turns on and off the cover art display.	<b>On*1/Off</b>	
	HDMI® mode <b>Display Adjustment</b>	<b>Display</b> <b>Brightness</b>	See <b>System</b> on P. 237	
		<b>Contrast</b>		
		<b>Black Level</b>		
	<b>Color</b>	<b>Color</b>	Changes the color of the audio/information screen.	—
		<b>Tint</b>	Changes the tint of the audio/information screen.	—
	HDMI® mode <b>Aspect Ratio Adjustment</b>		Changes the aspect ratio and zoom settings of the audio/information screen.	<b>Normal/Full*1/Zoom</b>
	Bluetooth® Audio mode <b>Change Bluetooth Audio Device</b>		Connects, disconnects or pairs a <i>Bluetooth</i> ® Audio device to HFL.	—
	Bluetooth® Audio mode <b>Bluetooth Device List</b>		Pairs a new phone to HFL, edits or deletes a paired phone. ➤ <b>Phone Setup</b> P. 283	—
	<b>Default</b>		Cancels/Resets all customized items in the <b>Audio</b> group as default.	<b>Yes/No</b>

\*1:Default Setting

Setup Group	Customizable Features	Description	Selectable Settings			
Clock/ Info	<table border="1"> <tr> <td rowspan="2">Clock/Wall-paper type</td> <td>Clock</td> </tr> <tr> <td>Wallpaper</td> </tr> </table>	Clock/Wall-paper type	Clock	Wallpaper	See <b>System</b> on P. 238	
	Clock/Wall-paper type		Clock			
		Wallpaper				
	Clock Adjustment					
	Clock Format					
	Clock Display					
	Clock Location					
Sync Clock With Smartphone*						
Clock Reset*						
<b>Other</b>	<b>Info Screen Preference</b>	Changes the Info Screen type.	<b>Info Top/Info Menu/Off</b> <sup>*1</sup>			
<b>Default</b>		Cancels/Resets all customized items in the <b>Info</b> group as default.	<b>Yes/No</b>			

\*1:Default Setting

\* Not available on all models

Setup Group	Customizable Features	Description	Selectable Settings	
Phone	<b>Connect Phone</b>	Pairs a new phone to HFL, connects or disconnects a paired phone.  <b>Phone Setup</b> P. 283	—	
	<b>Bluetooth Device List</b>	Pairs a new phone to HFL, edits or deletes a paired phone.  <b>Phone Setup</b> P. 283	—	
	<b>Edit Speed Dial</b>	Edits, adds or deletes a speed dial entry.  <b>Speed Dial</b> P. 290	—	
	<b>Ring Tone</b>	Selects the ring tone.	<b>Fixed/Mobile Phone</b> * <sup>1</sup>	
	<b>Automatic Phone Sync</b>	Sets a phonebook data to be automatically imported when a phone is paired to HFL.	<b>On/Off</b>	
	<b>HondaLink Assist</b>	Turns HondaLink Assist on and off.	<b>On/Off</b> * <sup>1</sup>	
	<b>Text/Email</b>	<b>Enable Text/Email</b>	Turns the text/e-mail message function on and off.	<b>On</b> * <sup>1</sup> / <b>Off</b>
		<b>Select Account</b>	Selects a mail or text message account.	—
		<b>New Message Notification</b>	Selects whether a pop-up alert comes on the screen when HFL receives a new text/e-mail message.	<b>On/Off</b> * <sup>1</sup>
	<b>Default</b>	Cancels/Resets all customized items in the <b>Phone</b> and <b>Text/Email</b> groups as default.	<b>Yes/No</b>	

\*1:Default Setting

Setup Group	Customizable Features	Description	Selectable Settings	
Camera	Rear Camera	<b>Fixed Guideline</b>	Selects whether the fixed guidelines come on the rear camera monitor.	<b>On<sup>*1</sup>/Off</b>
		<b>Dynamic Guideline</b>	Selects whether the dynamic guidelines come on the rear camera monitor.	<b>On<sup>*1</sup>/Off</b>
		<b>Default</b>	Cancels/Resets all customized items in the <b>Rear Camera</b> group as default.	<b>Yes/No</b>
	Lane-Watch*	<b>Show with Turn Signal</b>	Selects whether the LaneWatch display comes on when you move the turn signal lever to the passenger side.	<b>On<sup>*1</sup>/Off</b>
		<b>Display Time after Turn Signal Off</b>	Changes the length of time the LaneWatch display stays on after you pull the turn signal lever back.	<b>0 second<sup>*1</sup>/2 seconds</b>
		<b>Reference Lines</b>	Selects whether the reference lines come on the LaneWatch monitor.	<b>On<sup>*1</sup>/Off</b>
		<b>Default</b>	Cancels/Resets all customized items in the <b>LaneWatch</b> group as default.	<b>Yes/No</b>

\*1:Default Setting

\* Not available on all models



Setup Group	Customizable Features	Description	Selectable Settings
Bluetooth	<b>Bluetooth On/Off Status</b>	Changes the <i>Bluetooth</i> ® status.	<b>On*<sup>1</sup>/Off</b>
	<b>Bluetooth Device List</b>	Pairs a new phone to HFL, edits or deletes a paired phone, or creates a security PIN. ➤ <b>Phone Setup</b> P. 283	—
	<b>Edit Pairing Code</b>	Edits <b>Pairing Code</b> . ➤ <b>To change the pairing code setting</b> P. 284	<b>Random/Fixed*<sup>1</sup></b>
	<b>Default</b>	Cancels/Resets all customized items in the <b>Bluetooth</b> group as default.	<b>Yes/No</b>

\*1: Default Setting

## Defaulting All the Settings

Reset all the menu and customized settings as the factory defaults.

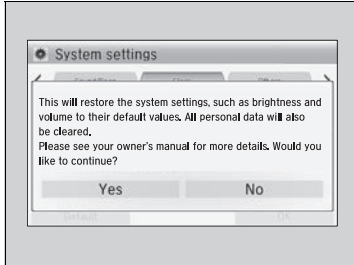

1. Select **Settings**.
2. Select **System**.
  - ▶ Repeat the procedure to select **Others** tab, then **Factory Data Reset**.
  - ▶ The confirmation message will appear.
3. Select **Yes** to reset the settings.
4. Select **Yes** again to reset the settings.
  - ▶ The confirmation message will appear. Select **OK**.

### ☒ Defaulting All the Settings

When you transfer the vehicle to a third party, reset all settings to default and delete all personal data.

The following settings will be reset:

- Audio preset settings
- Phonebook entries
- Other display and personal settings.

## Models with navigation system

For models with the navigation system, see the Navigation System Manual for how to operate the *Bluetooth® HandsFreeLink®*.

## Non-navi models with one display

*Bluetooth® HandsFreeLink®* (HFL) allows you to place and receive phone calls using your vehicle's audio system, without handling your cell phone.

## Using HFL

### HFL Buttons

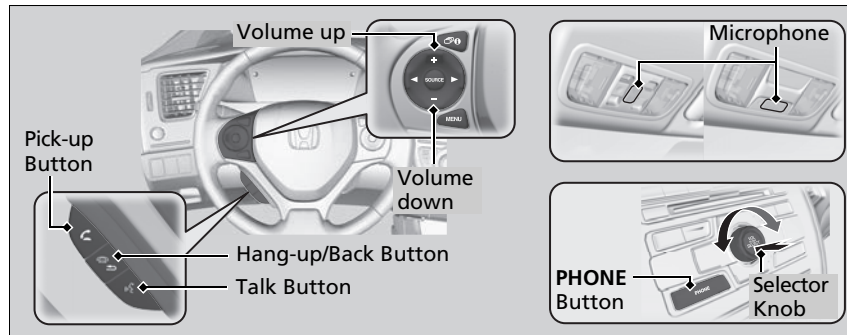



**(Pick-up) button:** Press to go directly to the **Phone** screen or to answer an incoming call.

**(Hang-up/back) button:** Press to end a call or to cancel a command.

**(Talk) button:** Press to call a number with a stored voice tag.

**PHONE button:** Press to go directly to the **Phone** screen.

**Selector knob:** Rotate  to select an item on the screen, then press .

## Bluetooth® HandsFreeLink®\*

To use HFL, you need a *Bluetooth*-compatible cell phone. For a list of compatible phones, pairing procedures, and special feature capabilities:

- U.S.: Visit [www.handsfreelink.honda.com](http://www.handsfreelink.honda.com), or call 1-888-528-7876.
- Canada: Visit [www.handsfreelink.ca](http://www.handsfreelink.ca), or call 1-888-528-7876.

### Voice control tips

- Aim the vents away from the ceiling and close the windows, as noise coming from them may interfere with the microphone.
- Press and release the  button when you want to call a number using a stored voice tag. Speak clearly and naturally after a beep.
- If the microphone picks up voices other than yours, the command may be misinterpreted.
- To change the volume level, use the audio system's volume knob or the remote audio controls on the steering wheel.

State or local laws may prohibit the operation of handheld electronic devices while operating a vehicle.

If you receive a call while using the audio system, the system resumes its operation after ending the call.

## HFL Status Display

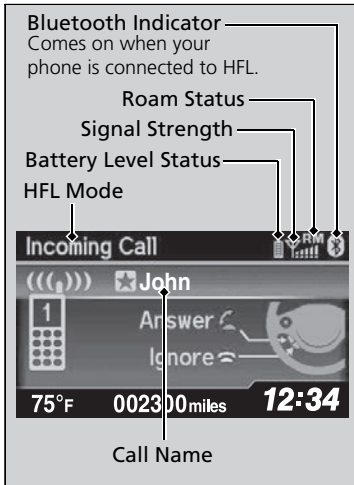

The i-MID notifies you when there is an incoming call.

## Bluetooth® HandsFreeLink®\*

### Bluetooth® Wireless Technology

The *Bluetooth*® word mark and logos are registered trademarks owned by *Bluetooth SIG, Inc.*, and any use of such marks by Honda Motor Co., Ltd., is under license. Other trademarks and trade names are those of their respective owners.

### HFL Limitations

An incoming call on HFL will interrupt the audio system when it is playing. It will resume when the call is ended.

## HFL Status Display

The information that appears on the i-MID varies between phone models.

You can change the system language to English, French, or Spanish.

▶ **Customized Features** P. 90

## Limitations for Manual Operation

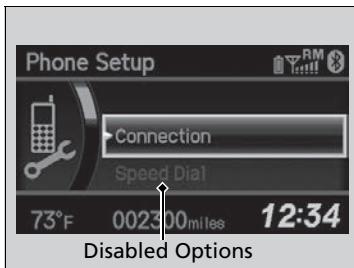

Certain manual functions are disabled or inoperable while the vehicle is in motion. You cannot select a grayed-out option until the vehicle is stopped.

Only previously stored speed dial entries with voice tags can be called using voice commands while the vehicle is in motion.

▶ **Speed Dial** P. 263

\* Not available on all models

## HFL Menu

The ignition switch must be in ACCESSORY **I** or ON **II**\*1 to use HFL.

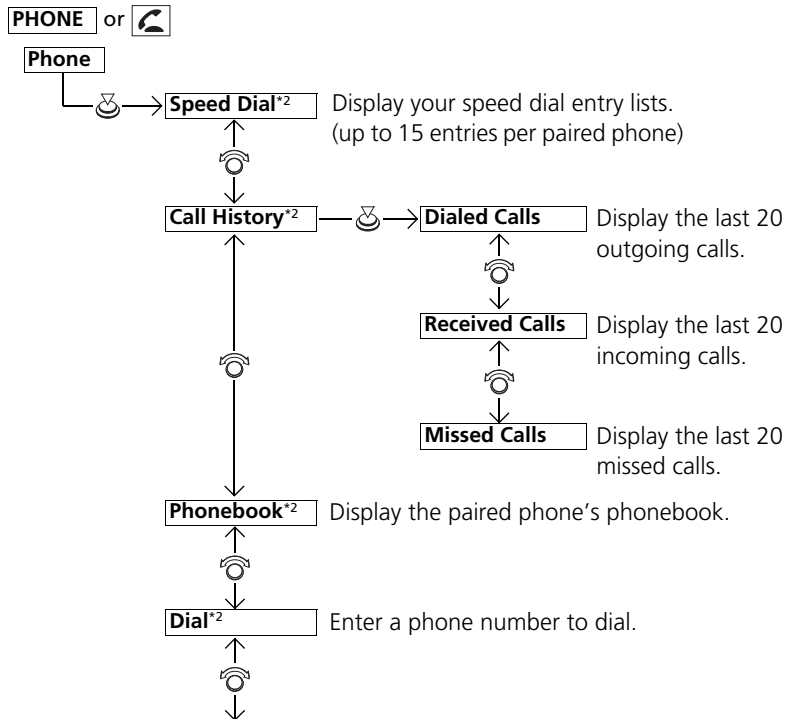

### ▶▶ HFL Menu

To use HFL, you must first pair your *Bluetooth*-compatible cell phone to the system while the vehicle is parked.

Some functions are limited while driving. A message appears on the screen when the vehicle is moving and the operation is canceled.

\*1: Models with the smart entry system have an **ENGINE START/STOP** button instead of an ignition switch.

\*2: Appears only when a phone is connected to HFL.

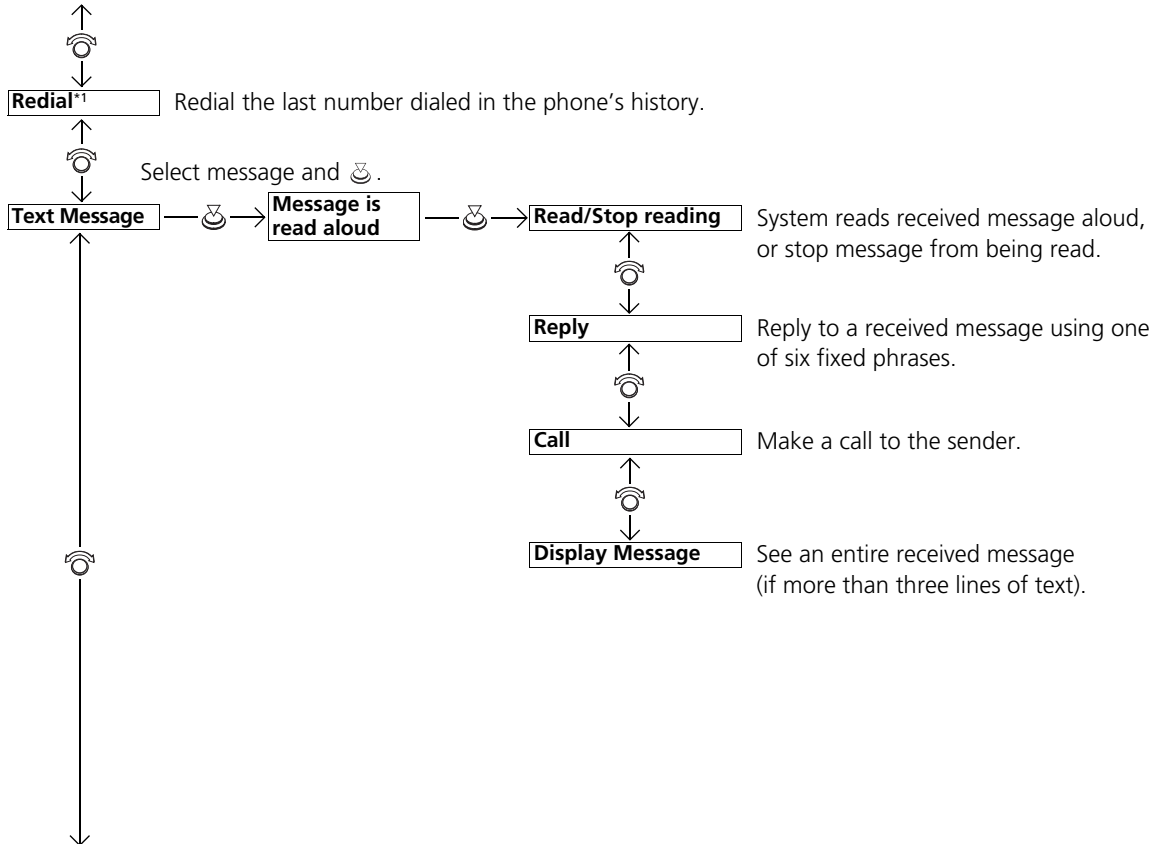

\*1: Appears only when a phone is connected to HFL.

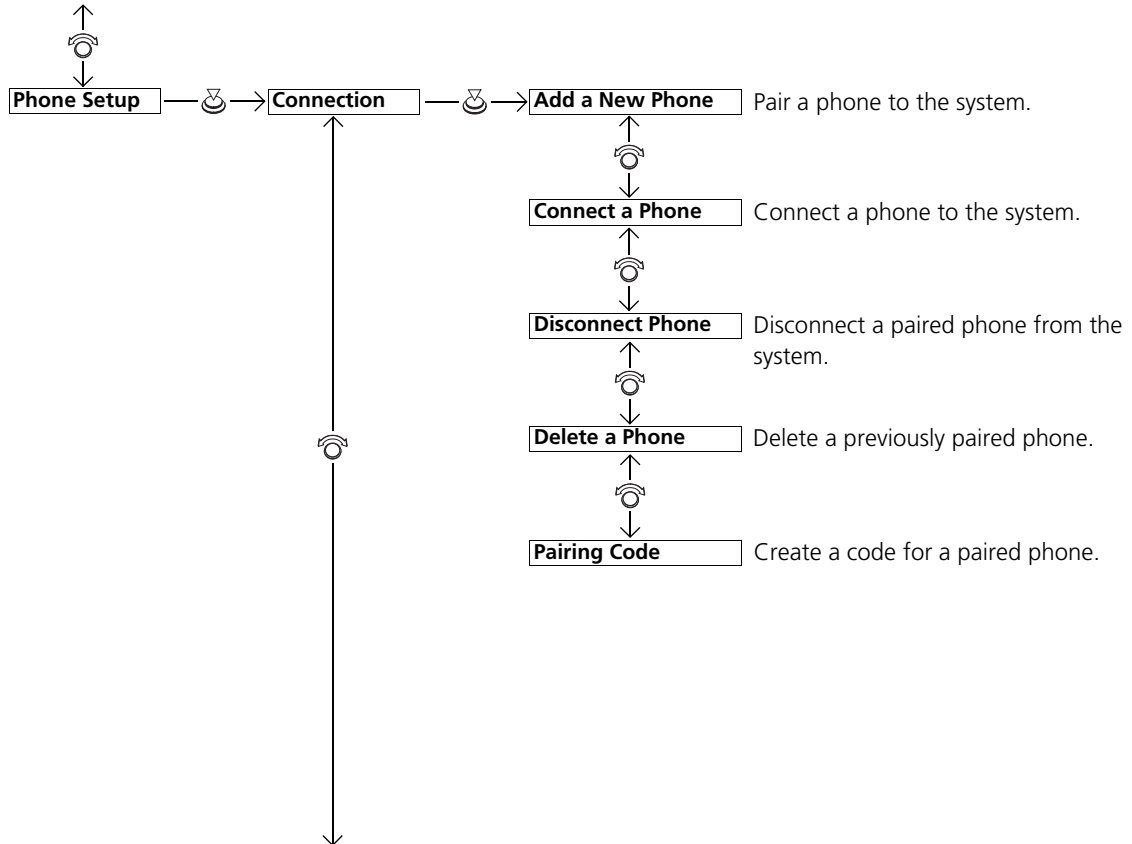

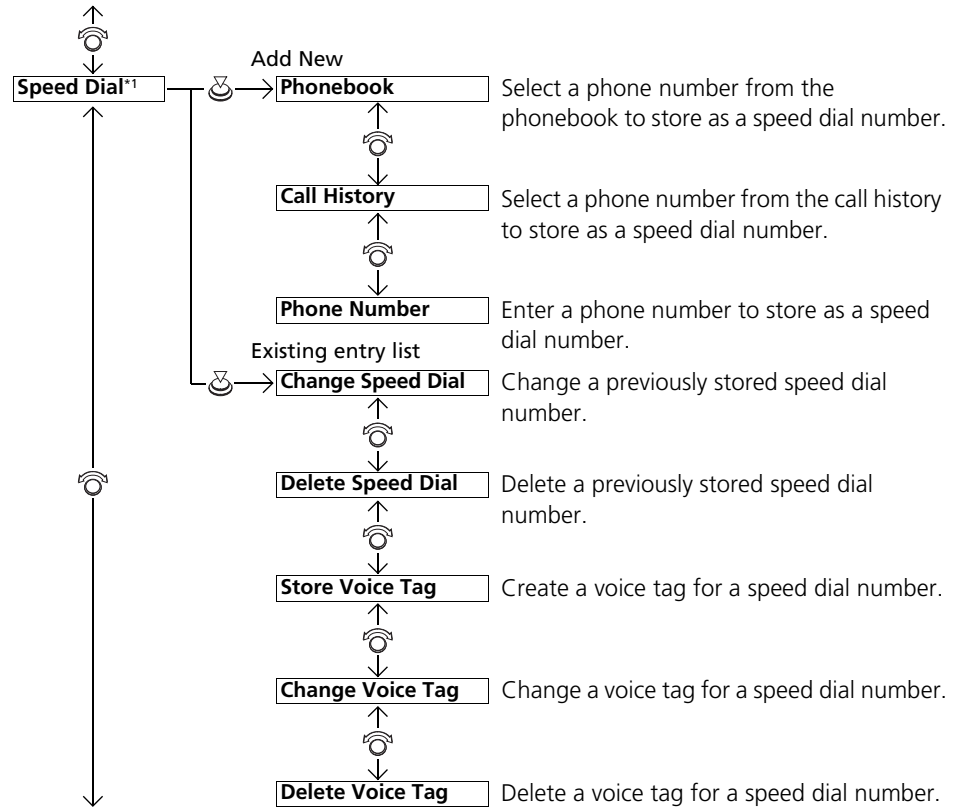

\*1: Appears only when a phone is connected to HFL.



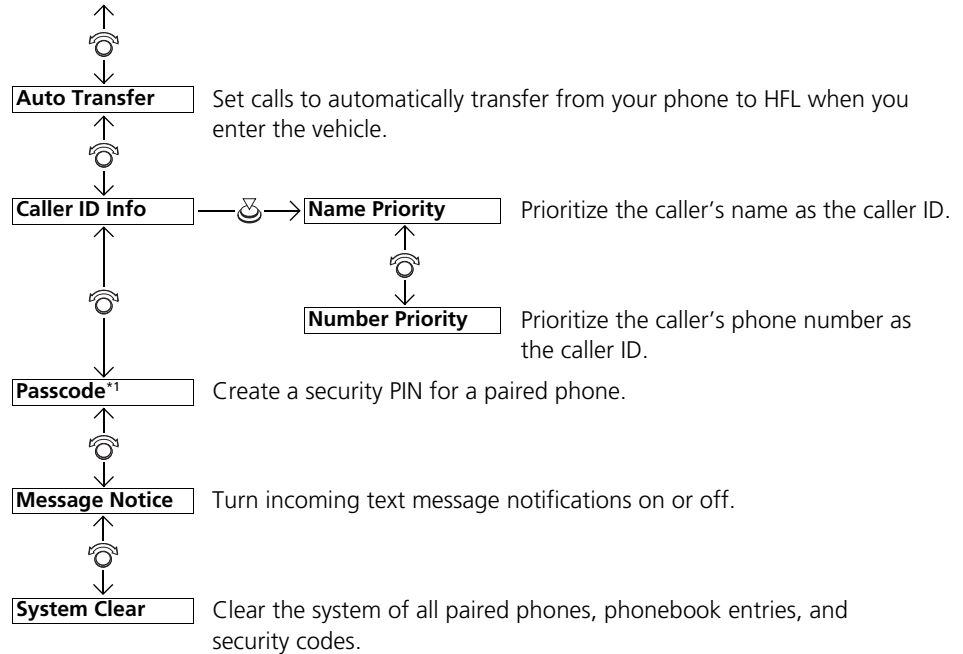

\*1: Appears only when a phone is connected to HFL.

## Phone Setup

### To pair a cell phone (when there is no phone paired to the system)

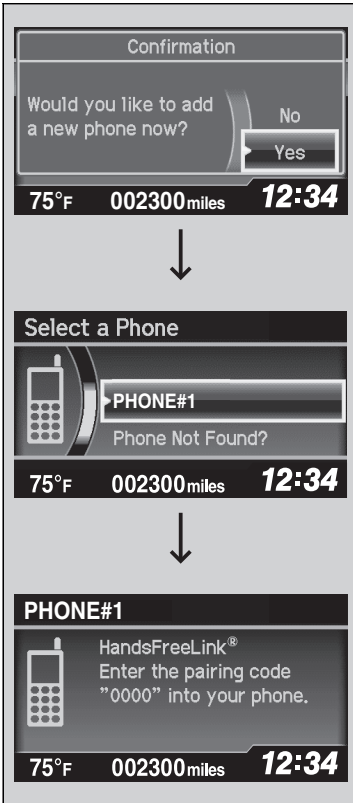

1. Press the **PHONE** button or the button.
2. Rotate to select **Yes**, then press .
3. Make sure your phone is in search or discoverable mode, then press .
  - ▶ HFL automatically searches for a Bluetooth device.
4. When your phone appears on the list, select it by pressing .
  - ▶ If your phone doesn't appear, select **Phone Not Found?** and search for Bluetooth devices using your phone. From your phone, select **HandsFreeLink**.
5. HFL gives you a four-digit pairing code to input on your phone. When your phone prompts you, input the four-digit pairing code.
6. A notification appears on the screen if pairing is successful.

## Phone Setup

Your *Bluetooth*-compatible phone must be paired to HFL before you can make and receive hands-free calls.

### Phone Pairing Tips:

- You cannot pair your phone while the vehicle is moving.
- Up to six phones can be paired.
- Your phone's battery may drain faster when it is paired to HFL.
- If your phone is not ready for pairing or not found by the system within three minutes, the system will time out and return to idle.

Once you have paired a phone, you can see it displayed on the screen with one or two icons on the right side.







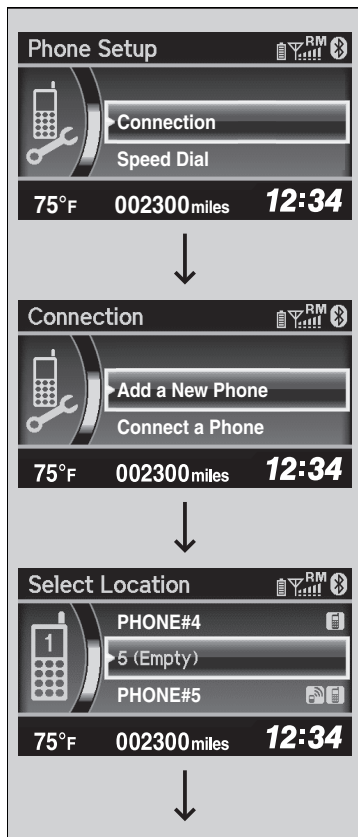

These icons indicate the following:

- : The phone can be used with HFL.
- : The phone is compatible with *Bluetooth*® Audio.

Continued

■ To pair a cell phone (when a phone has already been paired to the system)



1. Press the **PHONE** button or the  button.
  - ▶ If a prompt appears asking to connect to a phone, select **No** and proceed with step 2.
2. Rotate  to select **Phone Setup**, then press .
3. Rotate  to select **Connection**, then press .
4. Rotate  to select **Add a New Phone**, then press 
  - ▶ The screen changes to **Select Location**.
5. Rotate  to select **Empty**, then press .

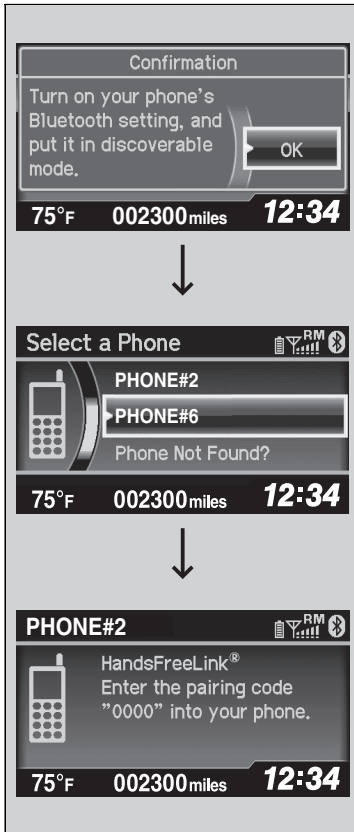

6. Make sure your phone is in search or discoverable mode, then press .  
 ▶ HFL automatically searches for a Bluetooth device.

7. When your phone appears on the list, select it by pressing .

▶ If your phone doesn't appear, select **Phone Not Found?** and search for Bluetooth devices using your phone. From your phone, select **HandsFreeLink**.

8. HFL gives you a four-digit pairing code to input on your phone. When your phone prompts you, input the four-digit pairing code.

9. A notification appears on the screen if pairing is successful.

### ■ To change the pairing code setting

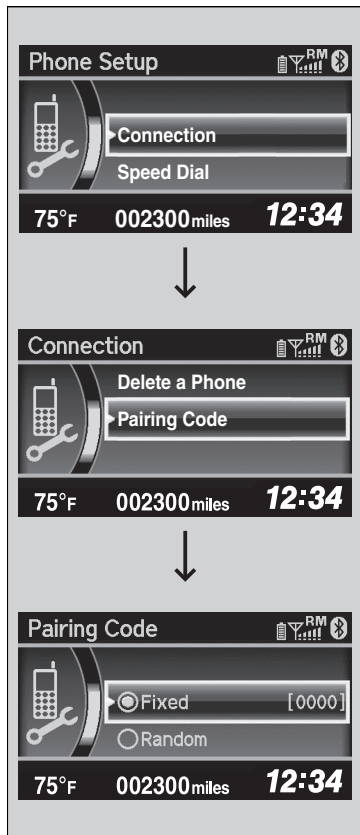

1. Press the **PHONE** button or the button.

▶ Rotate to select **Phone Setup**, then press .

2. Rotate to select **Connection**, then press .

3. Rotate to select **Pairing Code**, then press .

4. Rotate to select **Fixed** or **Random**, then press .

### ▶▶ To change the pairing code setting





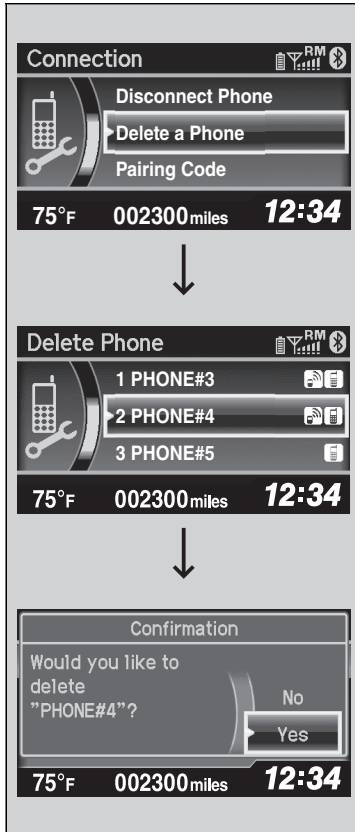

The default pairing code is **0000** until you change the setting.

To create your own, select **Fixed**, and delete the current code, then enter a new one.

For a randomly generated pairing code each time you pair a phone, select **Random**.

## ■ To delete a paired phone



1. Press the **PHONE** button or the  button.
2. Rotate  to select **Phone Setup**, then press .
  - ▶ Repeat the procedure to select **Connection**, then **Delete a Phone**.
3. Rotate  to select a phone you want to delete, then press .
4. A confirmation message appears on the screen. Rotate  to select **Yes**, then press .
  - ▶ A notification appears on the screen if it is successful.

## ■ To Set Up a Text Message Notice Option



1. Press the **PHONE** button or the button.
2. Rotate to select **Phone Setup**, then press .
3. Rotate to select **Message Notice**, then press .
4. Rotate to select a mode you want, then press .

## ▶▶ To Set Up a Text Message Notice Option

**On:** A pop-up notification comes on every time you receive a new text message.  
**Off:** The message you receive is stored in the system without notification.

## To Create a Security PIN

You can protect each of the six cell phones with a security PIN.

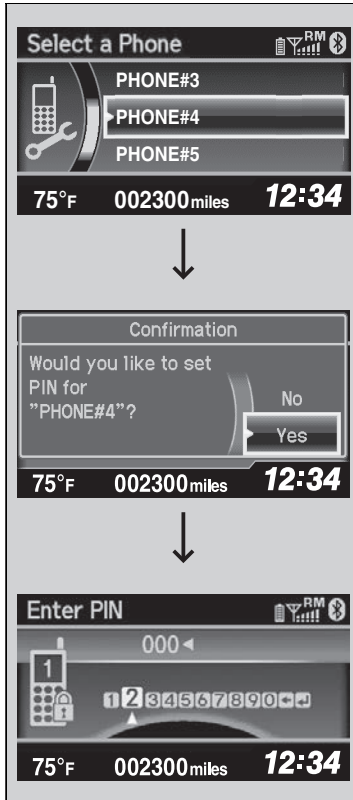

1. Press the **PHONE** button or the button.
2. Rotate to select **Phone Setup**, then press .
  - ▶ Repeat the procedure to select **Passcode**.
3. Select a phone you want to add a security PIN to.
  - ▶ Rotate to select a phone you want to add a security PIN to, then press .
4. A confirmation message appears on the screen.
  - ▶ Rotate to select **Yes**, then press .
5. Enter a new four-digit number.
  - ▶ Rotate to select, then press . Press to delete. Press to enter the security PIN.
6. Re-enter the four-digit number.
  - ▶ The screen returns to the screen in step 2.

## To Create a Security PIN

If the phone is already security PIN protected, you need to enter the current security PIN before clearing the PIN or creating a new one.

*Continued*



## ■ Automatic Transferring

If you get into the vehicle while you are on the phone, the call can be automatically transferred to HFL.

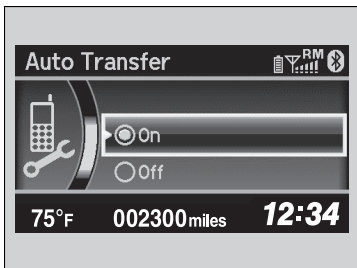

1. Press the **PHONE** button or the button.
2. Rotate to select **Phone Setup**, then press .
  - ▶ Repeat the procedure to select **Auto Transfer**.
3. Rotate to select **On**, then press .
4. A notification appears on the screen if the change is successful.

## ■ Caller's ID Information

You can select a caller's information to be displayed when you have an incoming call.



1. Press the **PHONE** button or the button.
2. Rotate to select **Phone Setup**, then press .
  - ▶ Repeat the procedure to select **Caller ID Info**.
3. Rotate to select a mode you want, then press .
4. A notification appears on the screen if the change is successful.

### ▶▶ Caller's ID Information







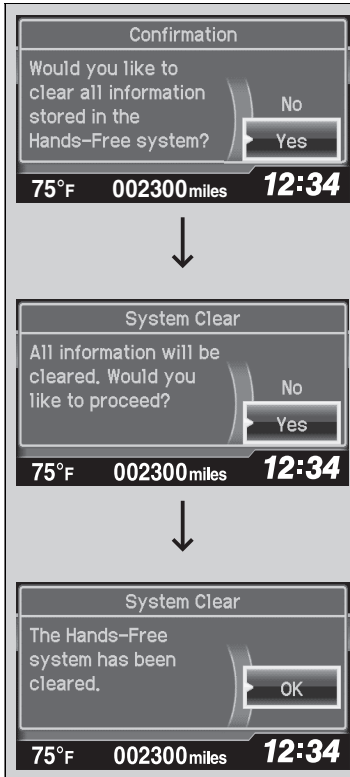

Name Priority mode: A caller's name is displayed if it is stored in the phonebook.

Number Priority mode: A caller's phone number is displayed.

## ■ To Clear the System

Security codes, paired phones, all stored voice tag, all speed dial entries, and all imported phonebook data are erased.



1. Press the **PHONE** button or the  button.
2. Rotate  to select **Phone Setup**, then press .
  - ▶ Repeat the procedure to select **System Clear**.
3. Rotate  to select **Yes**, then press .
4. A notification message appears on the screen. Rotate  to select **Yes**, then press .
5. A confirmation message appears on the screen. Press  to finish.

Continued

## ■ Automatic Import of Cellular Phonebook and Call History

When your phone is paired, the contents of its phonebook and call history are automatically imported to HFL.

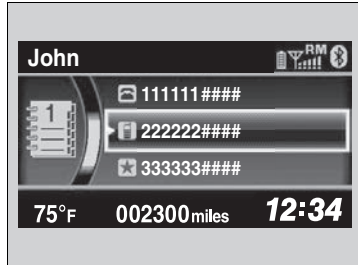

## ▶ Automatic Import of Cellular Phonebook and Call History

When you select a person from the list in the cellular phonebook, you can see up to three category icons. The icons indicate what types of numbers are stored for that name.



On some phones, it may not be possible to import the category icons to HFL.

The phonebook is updated after every connection. Call history is updated after every connection or call.

## Speed Dial

Up to 15 speed dial numbers can be stored per phone.

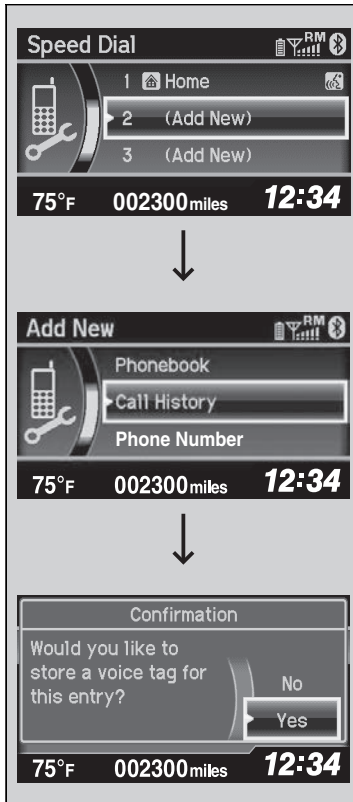

To store a speed dial number:

1. Press the **PHONE** button or the button.
2. Rotate to select **Phone Setup**, then press .
  - ▶ Repeat the procedure to select **Speed Dial**, then **Add New**.
3. Rotate to select a place to choose a number from, then press .
  - By **Phonebook**:
    - ▶ Select a number from the linked cell phone's imported phonebook.
  - By **Call History**:
    - ▶ Select a number from the call history.
  - By **Phone Number**:
    - ▶ Input the number manually.
4. When the speed dial is successfully stored, you are asked to create a voice tag for the number. Rotate to select **Yes** or **No**, then press .
5. Using the button, follow the prompts to say the name for the speed dial entry.

## Speed Dial

You can use the audio preset buttons during a call to store a speed dial number:

1. Press and hold the desired audio preset button during a call.
2. The contact information for the active call will be stored for the corresponding speed dial.

When a voice tag is stored, press the button to call the number using the voice tag.

Continued

### ■ To add a voice tag to a stored speed dial number









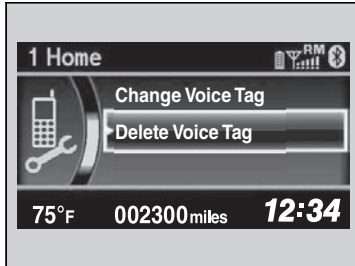

1. Press the **PHONE** button or the button.
2. Rotate to select **Phone Setup**, then press .
- ▶ Repeat the procedure to select **Speed Dial**.
3. Select an existing speed dial entry.
4. Rotate to select **Store Voice Tag**, then press .
5. Using the button, follow the prompts to complete the voice tag.

#### ▶▶ Speed Dial

Avoid using duplicate voice tags.  
Avoid using "home" as a voice tag.  
It is easier for HFL to recognize a longer name. For example, use "John Smith" instead of "John."







### ■ To delete a voice tag

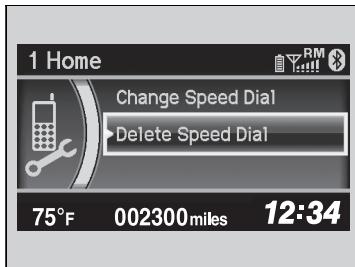

1. Press the **PHONE** button or the  button.
2. Rotate  to select **Phone Setup**, then press .
  - ▶ Repeat the procedure to select **Speed Dial**.
3. Select an existing speed dial entry.
4. Rotate  to select **Delete Voice Tag**, then press .
  - ▶ A confirmation message appears on the screen. Rotate  to select **Yes**, then press .

### ■ To delete a speed dial number



1. Press the **PHONE** button or the  button.
2. Rotate  to select **Phone Setup**, then press .
  - ▶ Repeat the procedure to select **Speed Dial**.
3. Select an existing speed dial entry.
4. Rotate  to select **Delete Speed Dial**, then press .
  - ▶ A confirmation message appears on the screen. Rotate  to select **Yes**, then press .

## ■ Making a Call

You can make calls by inputting any phone number, or by using the imported phonebook, call history, speed dial entries, or redial.

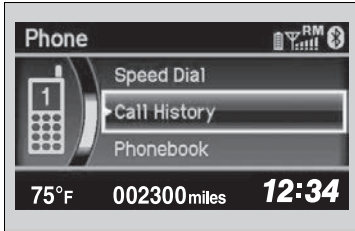

## ▶▶ Making a Call

Any voice-tagged speed dial entry can be dialed by voice from any screen.

Press the  button and follow the prompts.

The maximum range between your phone and vehicles is 30 feet (10 meters).

Once a call is connected, you can hear the voice of the person you are calling through the audio speakers.

## ■ To make a call using the imported phonebook

When your phone is paired, the contents of its phonebook are automatically imported to HFL.

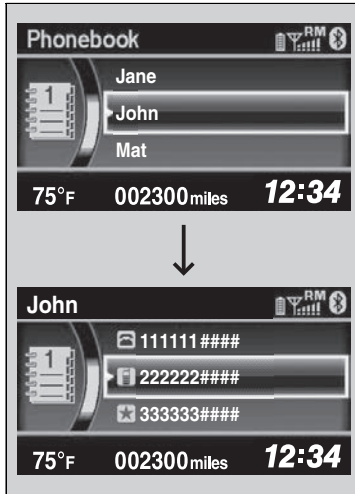

1. Press the **PHONE** button or the button.
  2. Rotate to select **Phonebook**, then press .
  3. The phonebook is stored alphabetically. Rotate to select the initial, then press .
  4. Rotate to select a name, then press .
  5. Rotate to select a number, then press .
- ▶ Dialing starts automatically.

## ☒ To make a call using the imported phonebook









This function is disabled while the vehicle is moving. However, you can call a stored speed dial number with a voice tag using voice commands.

- **Limitations for Manual Operation** P. 247
- **Speed Dial** P. 263



### ■ To make a call using a phone number



1. Press the **PHONE** button or the  button.
2. Rotate  to select **Dial**, then press .
3. Rotate  to select a number, then press .
4. Rotate  to select , then press .
  - ▶ Dialing starts automatically.

### ■ To make a call using redial

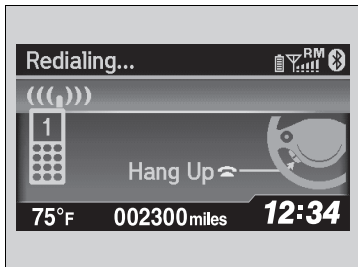

1. Press the **PHONE** button or the  button.
2. Rotate  to select **Redial**, then press .
  - ▶ Dialing starts automatically.

### ▶▶ To make a call using a phone number

This function is disabled while the vehicle is moving. However, you can call a stored speed dial number with a voice tag using voice commands.

- ▶ **Limitations for Manual Operation** P. 247
- ▶ **Speed Dial** P. 263

### ■ To make a call using the call history

Call history is stored by **Dialed Calls**, **Received Calls**, and **Missed Calls**.

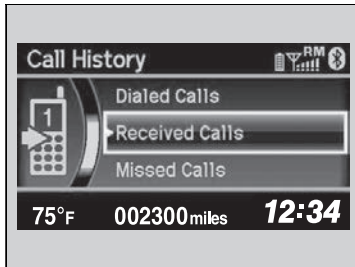

1. Press the **PHONE** button or the button.
2. Rotate to select **Call History**, then press .
3. Rotate to select **Dialed Calls**, **Received Calls**, or **Missed Calls**, then press .
4. Rotate to select a number, then press .
  - ▶ Dialing starts automatically.

### ■ To make a call using a speed dial entry

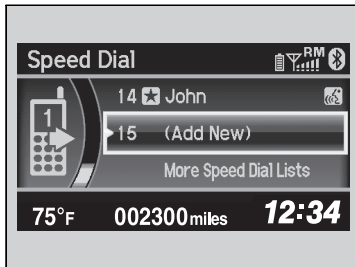

1. Press the **PHONE** button or the button.
2. Rotate to select **Speed Dial**, then press .
3. Rotate to select a number, then press .
  - ▶ Dialing starts automatically.

#### ☒ To make a call using the call history

The call history displays the last 20 dialed, received, or missed calls.  
(Appears only when a phone is connected to HFL.)

#### ☒ To make a call using a speed dial entry

On the **Phone** screen, the first six speed dials on the list can be directly selected by pressing the corresponding audio preset buttons (1-6).

Select **More Speed Dial Lists** to view another paired phone's speed dial list.

When a voice tag is stored, press the button to call the number using the voice tag.

▶ **Speed Dial** P. 263



Any voice-tagged speed dial entry can be dialed by voice from any screen.

Press the button and follow the prompts.

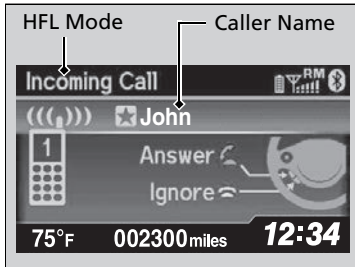
## Receiving a Call





When there is an incoming call, an audible notification sounds (if activated) and the **Incoming Call** screen appears.

Press the  button to answer the call.  
Press the  button to decline or end the call.

## Receiving a Call

### Call Waiting

Press the  button to put the current call on hold to answer the incoming call.

Press the  button again to return to the current call.

Ignore the incoming call if you do not want to answer it.

Press the  button if you want to hang up the current call.

## Options During a Call

The following options are available during a call.



**Mute:** Mute your voice.

**Transfer Call:** Transfer a call from HFL to your phone.

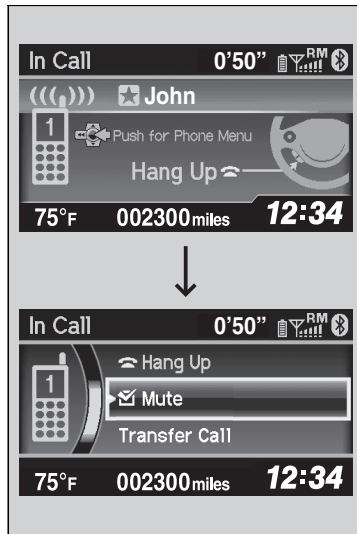
**Touch Tones:** Send numbers during a call. This is useful when you call a menu-driven phone system.



1. To view the available options, press the **PHONE** button.

2. Rotate  to select the option, then press .

▶ The check box is checked when **Mute** is selected. Select **Mute** again to turn it off.



## Options During a Call

**Touch Tones:** Available on some phones.

## ■ Receiving a Text Message

HFL can display newly received text messages as well as 20 of the most recently received messages on a linked cell phone. Each received message can be read aloud and replied to using a fixed common phrase.



1. A pop-up appears and notifies you of a new text message.
2. Rotate  to select **Yes** to listen to the message, then press .
  - ▶ The text message is displayed. The system automatically starts reading out the message.
3. To discontinue the message read-out, press the  button.

## ▶▶ Receiving a Text Message

The system does not display any received messages while you are driving. You can only hear them read aloud.

With some phones, you may be able to display up to 20 most recent text messages.

Only the first three lines of the received message are displayed with this option.

### ▶▶ **Displaying an entire message** P. 276

State or local laws may limit your use of the HFL text message feature. Only use the text message feature when conditions allow you to do so safely.

## Displaying Messages

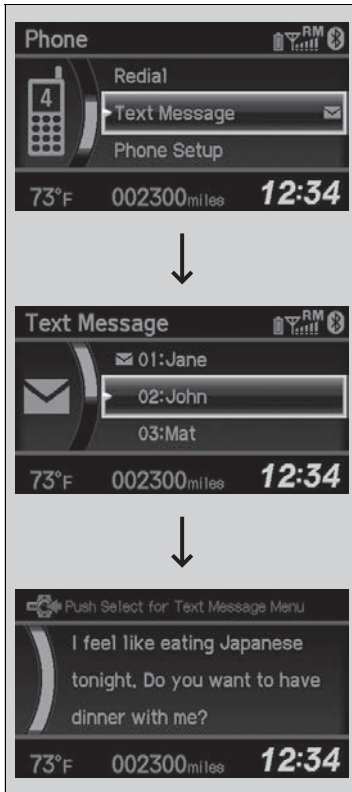

1. Press the **PHONE** button or the button.
2. Rotate to select **Text Message**, then press .
3. Rotate to select a message, then press .
  - ▶ The text message is displayed. The system automatically starts reading the message aloud.

### Displaying Messages

The icon appears next to an unread message.

Only the first three lines of the received message are displayed with this option.

▶ **Displaying an entire message** P. 276

If you delete a message on the phone, the message is also deleted in the system. If you send a message from the system, the message goes to your phone's outbox.

Continued

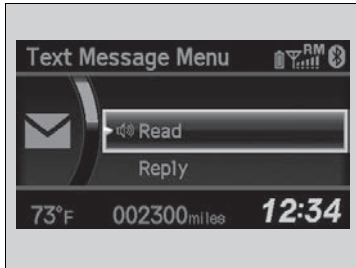

### ■ Using the stop reading or read option

1. Press the **PHONE** button or the button.
2. Rotate to select **Text Message**, then press .
3. Rotate to select a message, then press .
  - ▶ The text message is displayed. The system automatically starts reading the message aloud.
4. Press to enter the **Text Message Menu**.
5. Rotate to select **Stop Reading** or **Read**, then press .

### ▶▶ Using the stop reading or read option

This option changes to:

- **Stop Reading** while the text message is read out. Select this option to discontinue the message read-out.
- **Read** when you go to the **Text Message** menu, or after you selected **Stop Reading**. Select this option to hear the system reading out the selected message.



### ■ Reply to a message

You can reply to a message using one of the six common phrases available in the system.

1. Press the **PHONE** button or the button.
2. Rotate to select **Text Message**, then press .
3. Rotate to select a message, then press .
  - ▶ The text message is displayed. The system automatically starts reading out the message.
4. Press to enter the **Text Message Menu**.
5. Rotate to select **Reply**, then press .
6. Rotate to select the reply message, then press .
7. The reply message you selected is displayed. Select **Yes** to send the message.

▶▶ Reply to a message

The available fixed reply messages are as follows:

- **Talk to you later, I'm driving.**
- **I am on my way.**
- **I'm running late.**
- **OK**
- **Yes**
- **No**

You cannot add, edit, or delete reply messages.





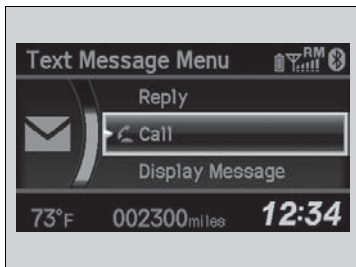



After you reply, the following is displayed:













### ■ Making a call to a sender

You can call the text message sender.

1. Press the **PHONE** button or the  button.
2. Rotate  to select to **Text Message**, then press .
3. Rotate  to select a message, then press .
  - ▶ The text message is displayed. The system automatically starts reading out the message.
4. Press  to enter the **Text Message Menu**.
5. Rotate  to select **Call**, then press .
  - ▶ HFL begins dialing.

### ■ Displaying an entire message

1. Press the **PHONE** button or the  button.
2. Rotate  to select to **Text Message**, then press .
3. Rotate  to select a message, then press .
  - ▶ The text message is displayed. The system automatically starts reading out the message.
4. Press  to enter the **Text Message Menu**.
5. Rotate  to select **Display Message**, then press .
6. Rotate  to scroll down and display the entire message.



## Models with navigation system

For models with the navigation system, see the Navigation System Manual for how to operate the *Bluetooth*® HandsFreeLink®.

## Non-navi models with display audio system

*Bluetooth*® HandsFreeLink® (HFL) allows you to place and receive phone calls using your vehicle's audio system, without handling your cell phone.

## Using HFL

### HFL Buttons

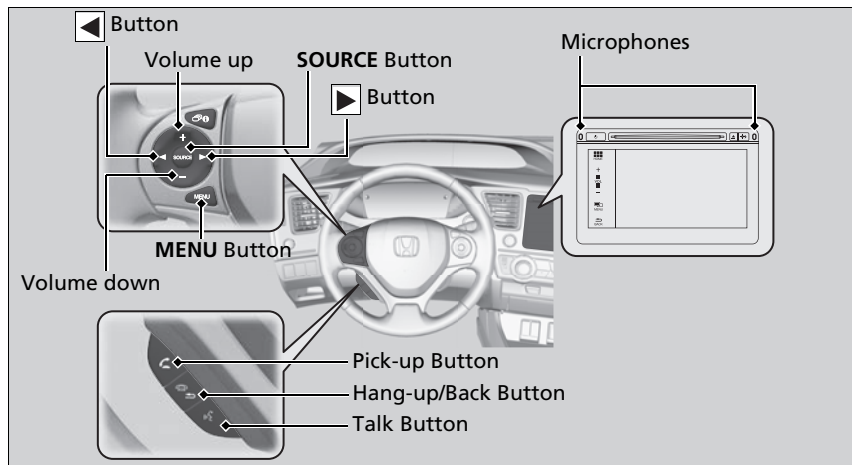

\* Not available on all models

Continued

## Bluetooth® HandsFreeLink®\*

To use HFL, you need a *Bluetooth*-compatible cell phone. For a list of compatible phones, pairing procedures, and special feature capabilities:

- U.S.: Visit [www.handsfreelink.honda.com](http://www.handsfreelink.honda.com), or call 1-888-528-7876.
- Canada: Visit [www.handsfreelink.ca](http://www.handsfreelink.ca), or call 1-888-528-7876.

To use the system, the **Bluetooth On/Off Status** setting must be **On**.

➤ **Customized Features\*** P. 233

### Voice control tips

- Press and release the  button when you want to call a number using a stored voice tag. Speak clearly and naturally after a beep.
- If the microphone picks up voices other than yours, the command may be misinterpreted.
- To change the volume level, select the audio system's **VOL** (Volume) or use the remote audio controls on the steering wheel.

Up to six speed dial entries can be display among a total of 20 that can be entered. If there is no entries in the system, Speed Dial is disabled.

➤ **Speed Dial** P. 290

 **(Pick-up) button:** Press to go directly to the **Phone** screen, or to answer an incoming call.

 **(Hang-up/back) button:** Press to end a call, go back to the previous command, or cancel a command.

 **(Talk) button:** Press to call a number with a stored voice tag.

**MENU button:** Press and hold to display **Speed Dial**, **Call History**, or **Redial** on the **Phone** screen.

 **button:** Press to select an item displayed on the **Phone** screen.

**SOURCE button:** Press to call a number listed in the selected item on the **Phone** screen.

To go to the **Phone menu** screen:

1. Select **Phone** to switch the display to the **Phone** screen.
2. Select **MENU**.

## HFL Status Display

The audio/information screen notifies you when there is an incoming call.

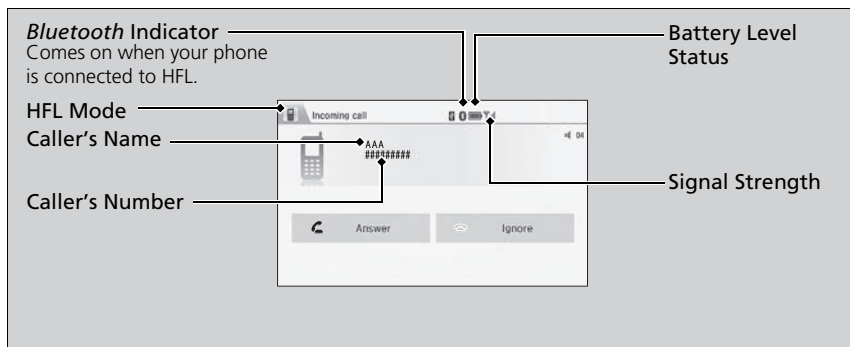

## Bluetooth® HandsFreeLink®\*

### Bluetooth® Wireless Technology

The *Bluetooth®* word mark and logos are registered trademarks owned by Bluetooth SIG, Inc., and any use of such marks by Honda Motor Co., Ltd., is under license. Other trademarks and trade names are those of their respective owners.

### HFL Limitations

An incoming call on HFL will interrupt the audio system when it is playing. It will resume when the call is ended.

## HFL Status Display

The information that appears on the audio/information screen varies between phone models.

You can change the system language to English, French or Spanish.

 **Customized Features\*** P. 233

# HFL Menus

The power mode must be in ACCESSORY or ON to use the system.

## ■ Phone settings screen

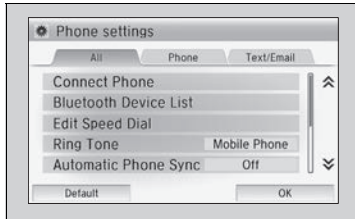

1. Select **Settings**.
2. Select **Phone**.

### ☒ HFL Menus

To use HFL, you must first pair your *Bluetooth*-compatible cell phone to the system while the vehicle is parked.

Some functions are limited while driving. A message appears on the screen when the vehicle is moving and the operation is canceled.

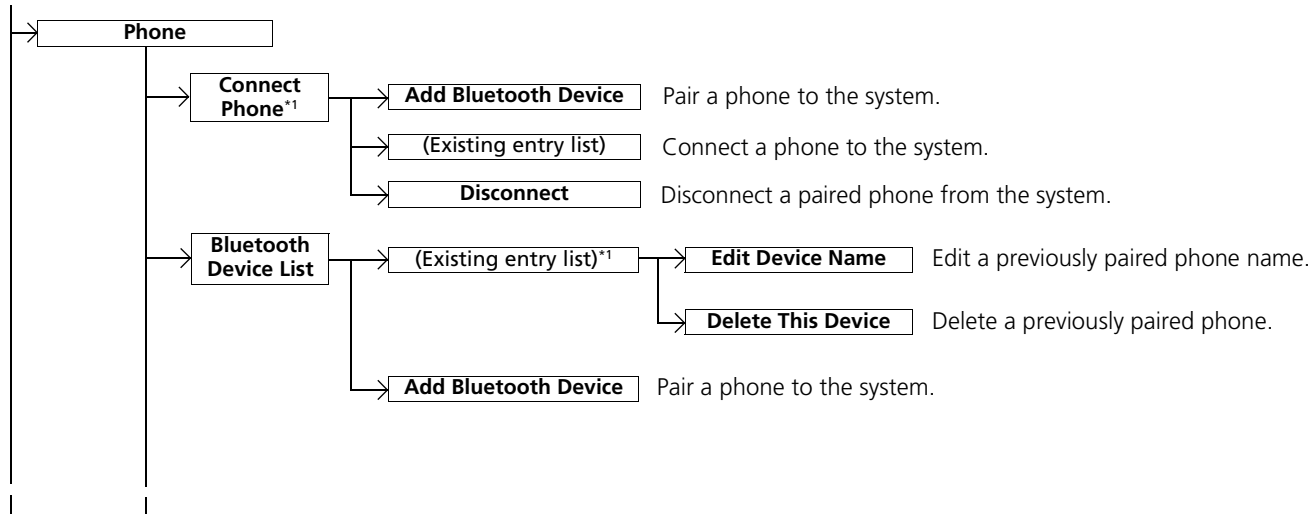

\*1: Appears only when a phone is connected to the system.

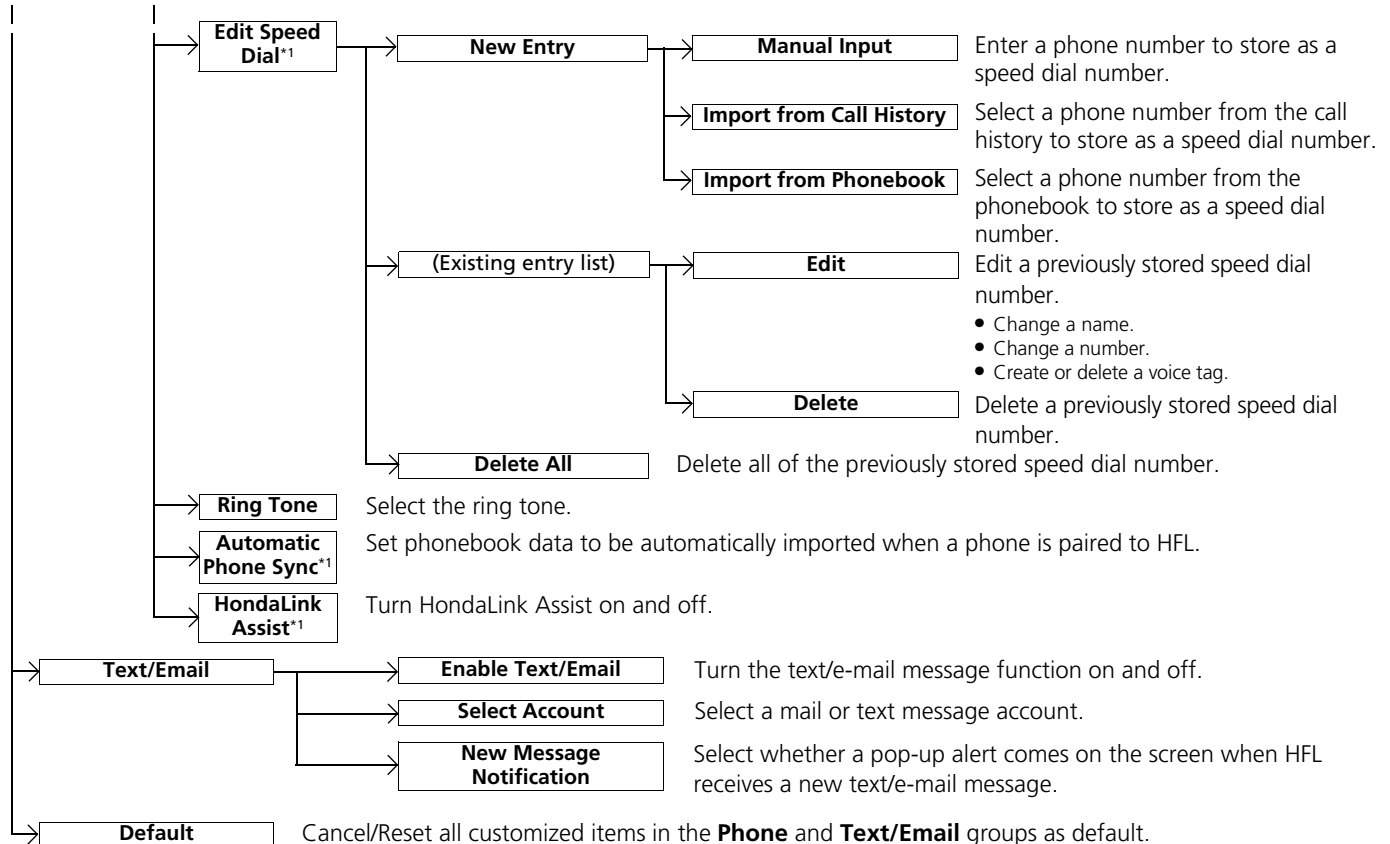

\*1: Appears only when a phone is connected to the system.

## ■ Phone menu screen

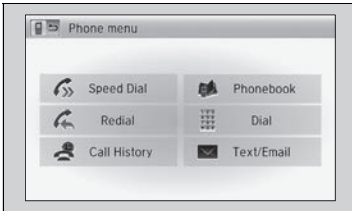

1. Select **Phone**.
2. Select **MENU**.

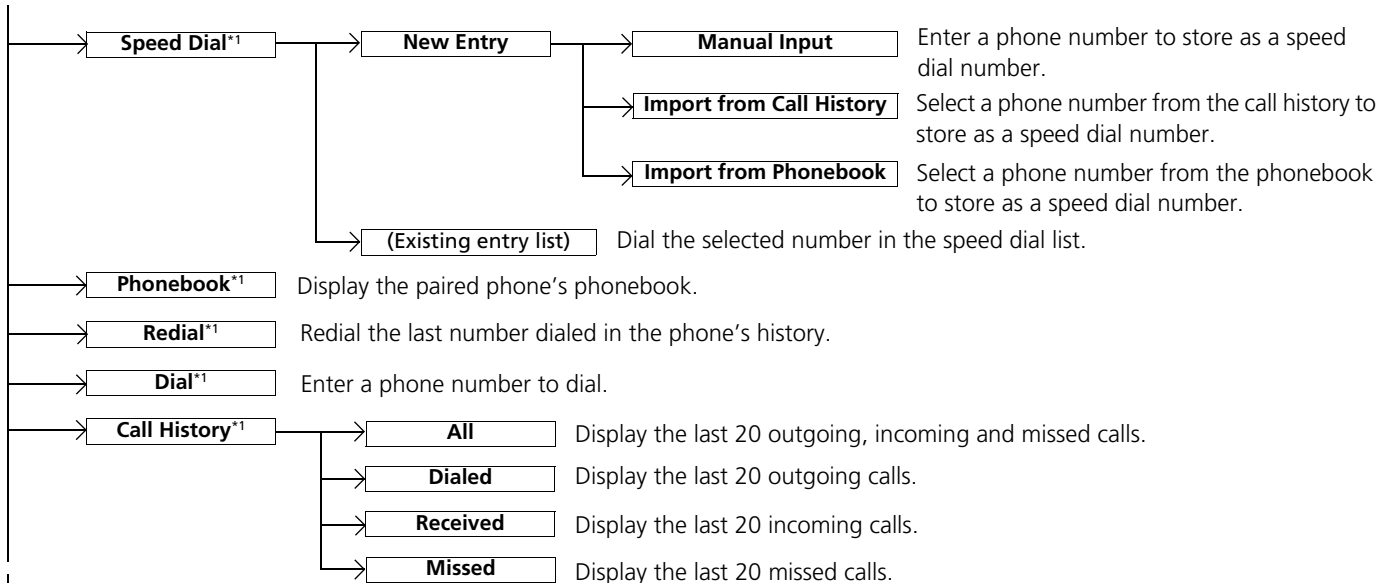

\*1: Appears only when a phone is connected to the system.

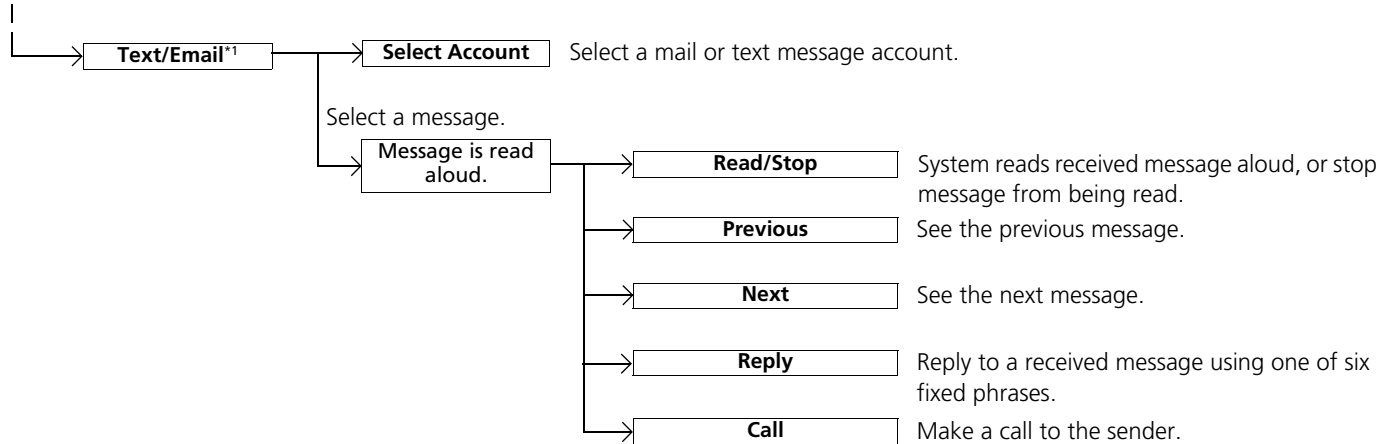

\*1: Appears only when a phone is connected to the system.

## Phone Setup

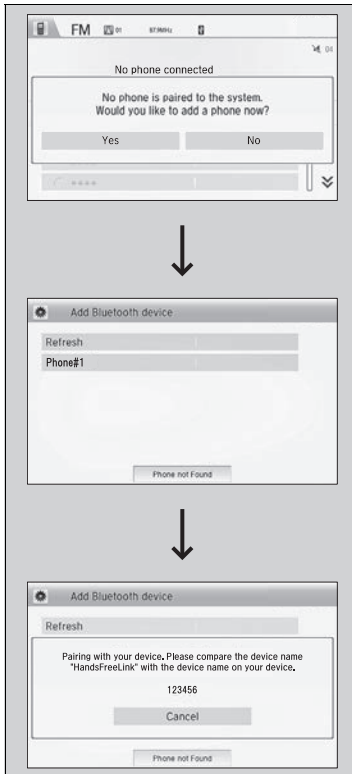

### ■ To pair a mobile phone (when there is no phone paired to the system)

1. Select **Phone**.
2. Select **Yes**.
3. Make sure your phone is search or discoverable mode, then select **Continue**.
  - ▶ HFL automatically searches for a *Bluetooth* device.
4. Select your phone when it appears on the list.
  - ▶ If your phone does not appear, you can select **Refresh** to search again.
  - ▶ If your phone still does not appear, select **Phone not found** and search for *Bluetooth* devices using your phone. From your phone, search for **HandsFreeLink**.
5. The system gives you a pairing code on the audio/information screen.
  - ▶ Confirm if the pairing code on the screen and your phone match. This may vary by phone.
6. A notification appears on the screen if pairing is successful.

### ☒ Phone Setup

Your *Bluetooth*-compatible phone must be paired to the system before you can make and receive hands-free calls.

#### Phone Pairing Tips:

- You cannot pair your phone while the vehicle is moving.
- Up to six phones can be paired.
- Your phone's battery may drain faster when it is paired to the system.
- If your phone is not ready for pairing or not found by the system, the system will return to the previous screen.



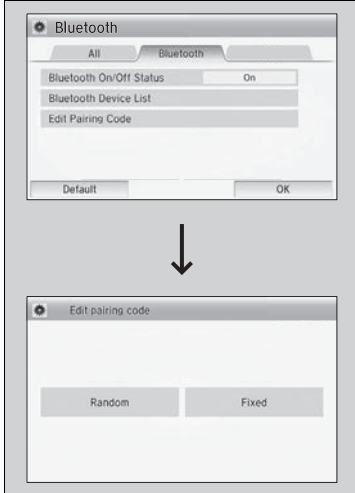
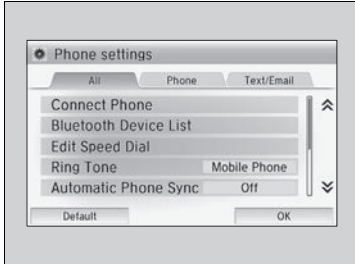

### ■ Changing the currently paired phone

1. Go to the **Phone settings** screen.
  - ▶ **Phone settings screen** P. 279
2. Select **Connect Phone**.
3. Select a phone to connect.
  - ▶ HFL disconnects the current phone and starts searching for another paired phone.

### ■ To change the pairing code setting

1. Select **Settings**.
2. Select **Bluetooth**.
  - ▶ Repeat the procedure to select **Bluetooth** tab, then **Edit Pairing Code**.
3. Select **Fixed** or **Random**.

#### ☒ Changing the currently paired phone

If no other phones are found or paired when trying to switch to another phone, HFL will inform you that the original phone is reconnected again.

To pair other phones, select **Add Bluetooth Device** from the **Connect Phone** screen.

#### ☒ To change the pairing code setting

The default pairing code is **0000** until you change the setting.

To create your own, select **Fixed**, and delete the current code, then enter a new one.

For a randomly generated pairing code each time you pair a phone, select **Random**.

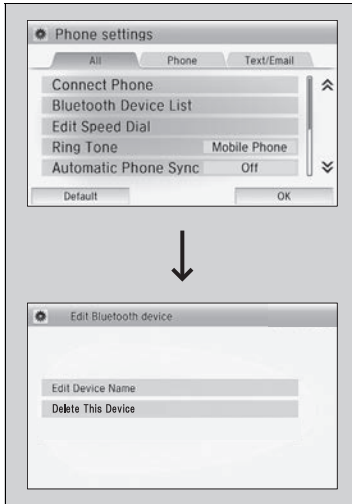

## ■ To edit an already-paired phone name

1. Go to the **Phone settings** screen.
  - ▶ **Phone settings screen** P. 279
2. Select **Phone** tab, then **Bluetooth Device List**.
3. Select a paired phone you want to edit.
4. Select **Edit Device Name**.
5. Edit the name and select **OK**.
6. A notification appears if the change is successful.



### ■ To delete a paired phone

1. Go to the **Phone settings** screen.
  - ▶ **Phone settings screen** P. 279
2. Select **Phone** tab, then **Bluetooth Device List**.
3. Select a phone you want to delete.
4. Select **Delete This Device**.
5. A confirmation message appears on the screen. Select **Yes**.
6. A notification appears if the deletion is successful.

## ■ To Set Up a Text/E-mail Message Options

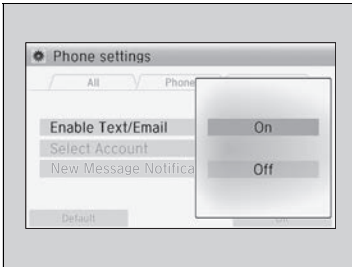

### ■ To turn on or off the text/e-mail function

1. Go to the **Phone settings** screen.  
 ▶ **Phone settings screen** P. 279
2. Select **Text/Email** tab, then **Enable Text/Email**.  
 ▶ A pop-up menu appears on the screen.
3. Select **On** or **Off**.

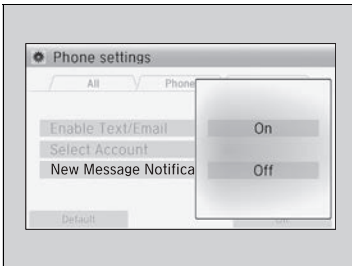

### ■ To turn on or off the text/e-mail notice

1. Go to the **Phone settings** screen.  
 ▶ **Phone settings screen** P. 279
2. Select **Text/Email** tab, then **New Message Notification**.  
 ▶ A pop-up menu appears on the screen.
3. Select **On** or **Off**.

### ▶ To turn on or off the text/e-mail notice

**On:** A pop-up notification comes on every time you receive a new message.

**Off:** The message you receive is stored in the system without notification.

## ■ Ring Tone

You can change the ring tone setting.



1. Go to the **Phone settings** screen.
  - ▶ **Phone settings screen** P. 279
2. Select **Phone** tab, then **Ring Tone**.
3. Select **Fixed** or **Mobile Phone**.

## ▶▶ Ring Tone

**Fixed:** The fixed ring tone sounds from the speaker.  
**Mobile Phone:** The ring tone stored in the connected cell phone is heard through the vehicle speakers.

## Automatic Import of Cellular Phonebook and Call History



### ■ When Automatic Phone Sync is set to On:

When your phone is paired, the contents of its phonebook and call history are automatically imported to the system.

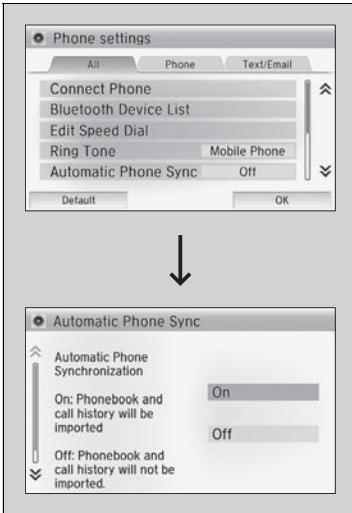

### ■ Changing the Automatic Phone Sync setting

1. Go to the **Phone settings** screen.  
 ▶ **Phone settings screen** P. 279
2. Select **Phone** tab, then **Automatic Phone Sync**.
3. Select **On** or **Off**.

### ⊠ Automatic Import of Cellular Phonebook and Call History

When you select a person from the list in the cellular phonebook, you can see up to three category icons. The icons indicate what types of numbers are stored for that name.

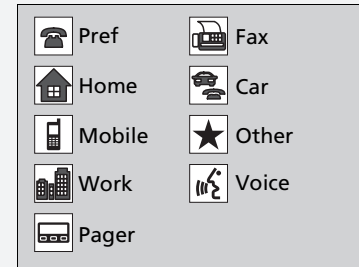

On some phones, it may not be possible to import the category icons to the system.

The phonebook is updated after every connection. Call history is updated after every connection or call.

## ■ Speed Dial

Up to 20 speed dial numbers can be stored per phone.

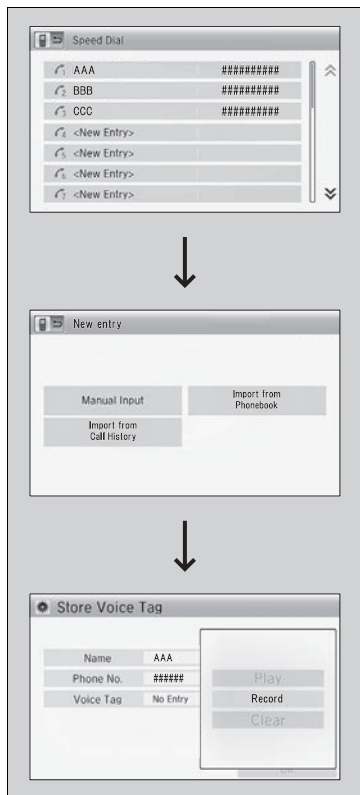

To store a speed dial number:

1. Go to the **Phone menu** screen.
  - ▶ **Phone menu screen** P. 281
2. Select **Speed Dial**.
  - ▶ Repeat the procedure to select **New Entry**.
3. Select a place to choose a number.
  - From **Import from Call History**:
    - ▶ Select a number from the call history.
  - From **Manual Input**:
    - ▶ Input the number manually.
  - From **Import from Phonebook**:
    - ▶ Select a number from the linked cell phone's imported phonebook.
4. When the speed dial is successfully stored from **Import from Call History** or **Import from Phonebook**, you are asked to create a voice tag for the number. Select **Yes** or **No**.
5. Select **Record** to store a voice tag for the speed dial entry.

## ▶▶ Speed Dial

When a voice tag is stored, press the  button to call the number using the voice tag. Say the voice tag name.

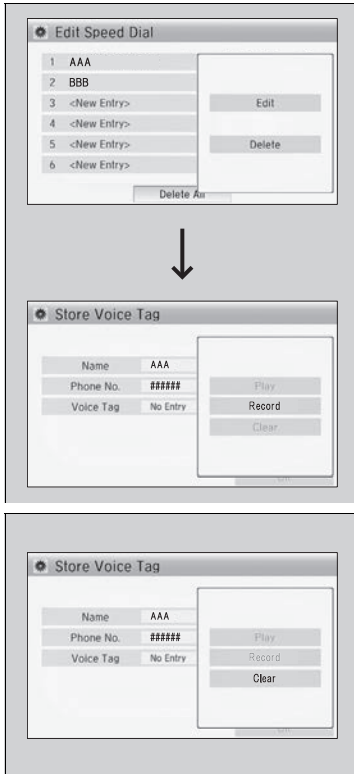

■ **To add a voice tag to a stored speed dial number**

1. Go to the **Phone settings** screen.  
 ▶ **Phone settings screen** P. 279
2. Select **Phone** tab, then **Edit Speed Dial**.
3. Select an existing speed dial entry.  
 ▶ From the pop-up menu, select **Edit**.
4. Select **Voice Tag**.  
 ▶ From the pop-up menu, select **Record**.
5. Select **Record** to store the voice tag.

■ **To delete a voice tag**

1. Go to the **Phone settings** screen.  
 ▶ **Phone settings screen** P. 279
2. Select **Phone** tab, then **Edit Speed Dial**.
3. Select an existing speed dial entry.  
 ▶ From the pop-up menu, select **Edit**.
4. Select **Voice Tag**.  
 ▶ From the pop-up menu, select **Clear**.
5. A confirmation message appears on the screen. Select **Yes**.

☒ Speed Dial

Avoid using duplicate voice tags.  
 Avoid using "home" as a voice tag.  
 It is easier for the system to recognize a longer name.  
 For example, use "John Smith" instead of "John."



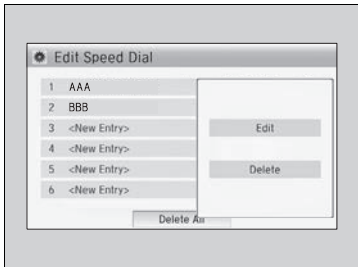

### ■ To delete a speed dial

1. Go to the **Phone settings** screen.
  - ▶ **Phone settings screen** P. 279
2. Select **Phone** tab, then **Edit Speed Dial**.
3. Select an existing speed dial entry.
  - ▶ From the pop-up menu, select **Delete**.
4. A confirmation message appears on the screen. Select **Yes**.

## ■ Making a Call

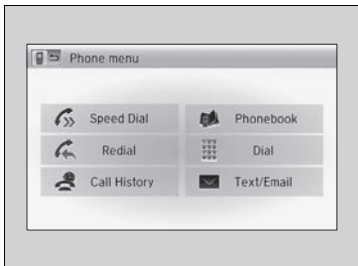

You can make calls by inputting any phone number, or by using the imported phonebook, call history, speed dial entries, or redial.

### ▶▶ Making a Call

Any voice-tagged speed dial entry can be dialed by voice from most screens.

Press the  button and say the voice tag name.

The maximum range between your phone and vehicles is 30 feet (10 meters).

Once a call is connected, you can hear the voice of the person you are calling through the audio speakers.

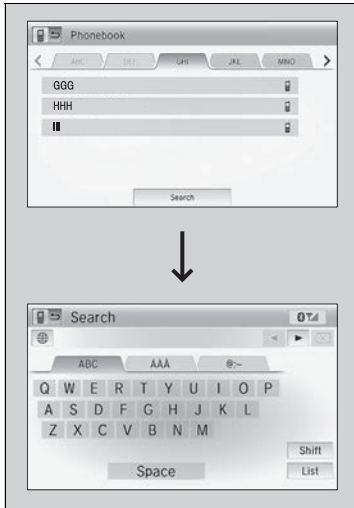

### ■ To make a call using the imported phonebook

1. Go to the **Phone menu** screen.
  - ▶ **Phone menu screen** P. 281
2. Select **Phonebook**.
3. Select a name.
  - ▶ You can also search by letter. Select **Search**.
  - ▶ Use the keyboard on the touch screen for entering letters.
4. Select a number.
  - ▶ Dialing starts automatically.



### ■ To make a call using a phone number

1. Go to the **Phone menu** screen.
  - ▶ **Phone menu screen** P. 281
2. Select **Dial**.
3. Select a number.
4. Select .
  - ▶ Dialing starts automatically.

### ☒ To make a call using the imported phonebook

This function is disabled while the vehicle is moving. However, you can call a stored voice-tagged speed dial number using voice commands.

- ▶ **Speed Dial** P. 290

### ☒ To make a call using a phone number

This function is disabled while the vehicle is moving. However, you can call a stored voice-tagged speed dial number using voice commands.

- ▶ **Speed Dial** P. 290

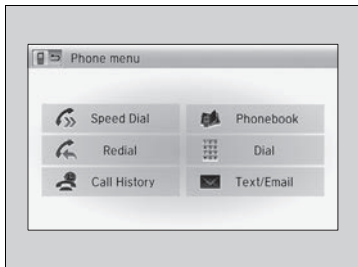

■ **To make a call using redial**

1. Go to the **Phone menu** screen.
  - ▶ **Phone menu screen** P. 281
2. Select **Redial**.
  - ▶ Dialing starts automatically.

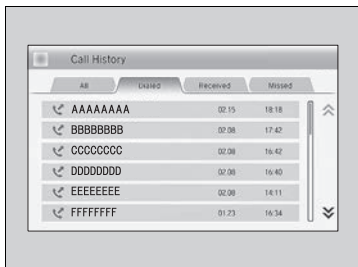

■ **To make a call using the Call History**  
Call history is stored by **All, Dialed, Received, and Missed.**

1. Go to the **Phone menu** screen.
  - ▶ **Phone menu screen** P. 281
2. Select **Call History**.
3. Select **All, Dialed, Received, or Missed**.
4. Select a number.
  - ▶ Dialing starts automatically.

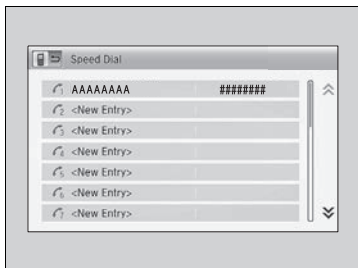

■ **To make a call using a Speed Dial entry**

1. Go to the **Phone menu** screen.
  - ▶ **Phone menu screen** P. 281
2. Select **Speed Dial**.
3. Select a number.
  - ▶ Dialing starts automatically.

▶▶ **To make a call using redial**

Press and hold the button to redial the last number dialed in your phone's history.

▶▶ **To make a call using the Call History**

The call history displays the last 20 dialed, received, or missed calls. (Appears only when a phone is connected to the system.)

▶▶ **To make a call using a Speed Dial entry**

When a voice tag is stored, press the button to call the number using the voice tag.



▶ **Speed Dial** P. 290

Any voice-tagged speed dial entry can be dialed by voice from any screen. Press the button and follow the prompts.

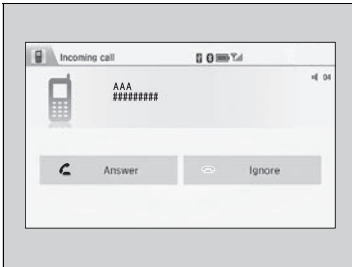
## Receiving a Call



When there is an incoming call, an audible notification sounds (if activated) and the **Incoming call** screen appears.

Press the  button to answer the call.  
Press the  button to decline or end the call.

## Options During a Call

The available options appear on the screen during a call.



**Mute:** Mute your voice.

▶ The mute icon appears when **Mute** is selected. Select **Mute** again to turn it off.

**Transfer:** Transfer a call from the system to your phone.

**Touch Tones:** Send numbers during a call. This is useful when you call a menu-driven phone system.

### Receiving a Call



Call Waiting

Press the  button to put the current call on hold to answer the incoming call.

Press the  button again to return to the current call.

Select **Ignore** to ignore the incoming call if you do not want to answer it.

Press the  button if you want to hang up the current call.

You can select the icons on the touch screen instead of the  and  buttons.

### Options During a Call

**Touch Tones:** Available on some phones.

You can select the icons on the touch screen.

## ■ Receiving a Text/E-mail Message

HFL can display newly received text and e-mail messages as well as 20 of the most recently received messages on a linked cell phone. Each received message can be read aloud and replied to using a fixed common phrase.

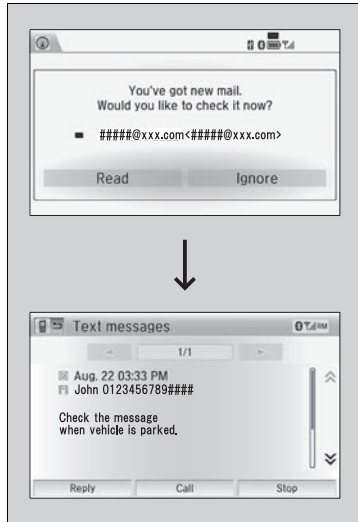

1. A pop-up appears and notifies you of a new text/e-mail message.
2. Select **Read** to listen to the message.
  - ▶ The text/e-mail message is displayed. The system automatically starts reading out the message.
3. To discontinue the message read-out, select **Stop**.

## ▣ Receiving a Text/E-mail Message

The system does not display any received messages while you are driving. You can only hear them read aloud.

With some phones, you may be able to display up to 20 most recent text and e-mail messages.

State or local laws may limit your use of the HFL text/e-mail message feature. Only use the text/e-mail message feature when conditions allow you to do so safely.

When you receive a text/e-mail message for the first time since the phone is paired to HFL, you are asked to turn the **New Message Notification** setting to **On**.

- ▶ **To turn on or off the text/e-mail notice**  
P. 287

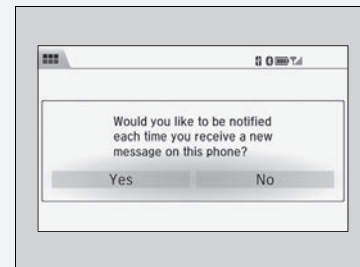

## Selecting a Mail Account

If a paired phone has text message or mail accounts, you can select one of them to be active and receive notifications.

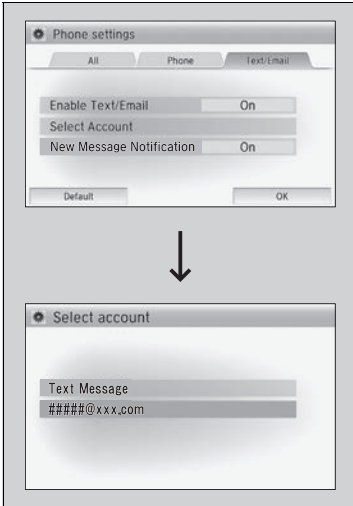

1. Go to the **Phone settings** screen.  
▶ **Phone settings screen** P. 279
2. Select **Text/Email** tab, then **Select Account**.  
▶ A pop-up menu appears on the screen.
3. Select **Text Message** or an e-mail account you want.

## Selecting a Mail Account

You can also select a mail account from the folder list screen or the message list screen.

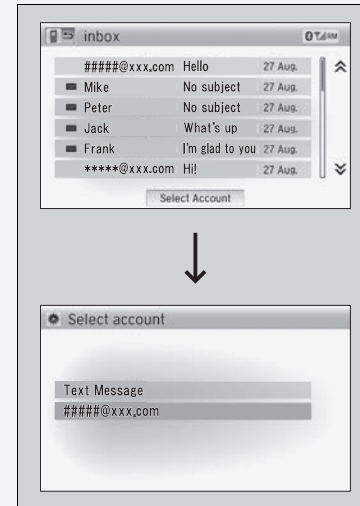

You can only receive notifications from one text message or mail account at a time.

## ■ Displaying Messages

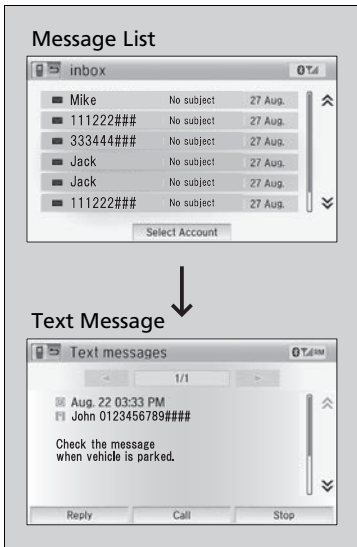

### ■ Displaying text messages

1. Go to the **Phone menu** screen.
  - ▶ **Phone menu screen** P. 281
2. Select **Text/Email**.
  - ▶ Select account if necessary.
3. Select a message.
  - ▶ The text message is displayed. The system automatically starts reading the message aloud.

### ▶▶ Displaying Messages

The  icon appears next to an unread message.

If you delete a message on the phone, the message is also deleted in the system. If you send a message from the system, the message goes to your phone's mailbox.

To see the previous or next message, select **Previous** or **Next** on the message screen.



## ■ Displaying e-mails

1. Go to the **Phone menu** screen.
  - ▶ **Phone menu screen** P. 281
2. Select **Text/Email**.
  - ▶ Select account if necessary.
3. Select a folder.
4. Select a message.
  - ▶ The e-mail is displayed. The system automatically starts reading the message aloud.



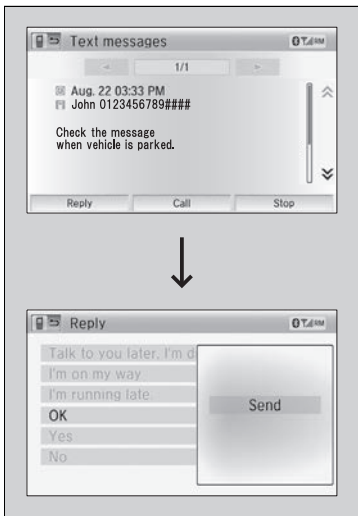
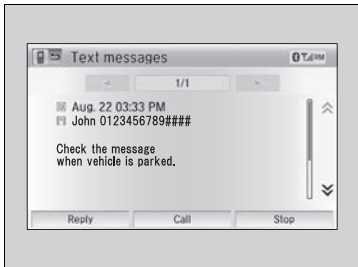

■ **Read or stop reading a message**

1. Go to the text/e-mail message screen.
  - ▶ The system automatically starts reading the message aloud.
    - ▣ **Displaying Messages** P. 298
2. Select **Stop** to stop reading.
  - Select **Read** to start reading the message from the beginning.

■ **Reply to a message**

1. Go to the text/e-mail message screen.
  - ▶ The system automatically starts reading the message aloud.
    - ▣ **Displaying Messages** P. 298
2. Select **Reply**.
3. Select the reply message.
  - ▶ The pop-up menu appears on the screen.
4. Select **Send** to send the message.
  - ▶ **Complete** appears on the screen when the reply message was successfully sent.

▣ **Reply to a message**

The available fixed reply messages are as follows:

- **Talk to you later, I'm driving.**
- **I'm on my way.**
- **I'm running late.**
- **OK**
- **Yes**
- **No**

You cannot add, edit, or delete reply messages.

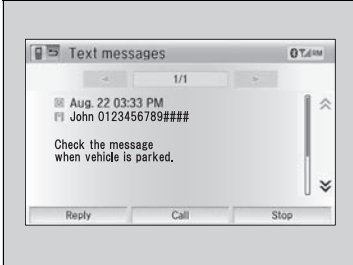

■ **Making a call to a sender**

1. Go to the text message screen.
2. Select **Call**.

## ■ In Case of Emergency

### ■ Automatic collision notification

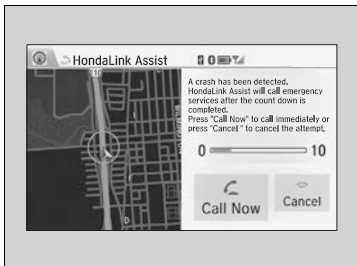

If your vehicle's airbags deploy or if the unit detects that the vehicle is severely impacted, your vehicle automatically will attempt to connect to the HondaLink operator. Once connected, information about your vehicle, its positioning, and its condition will be sent to the operator; you also can speak to the operator when connected.

**IMPORTANT:** For vehicles equipped with HondaLink Assist, owner activation constitutes authorization for Honda to collect information from your vehicle needed to provide the service, and agreement to the Terms of Use at [www.hondalink.com/TermsAndConditions](http://www.hondalink.com/TermsAndConditions). In a crash, HondaLink Assist will attempt to notify emergency services but NEITHER HONDA NOR ITS SERVICE PROVIDERS GUARANTEE THAT SUCH NOTIFICATION WILL OCCUR.

### ■ To enable notification

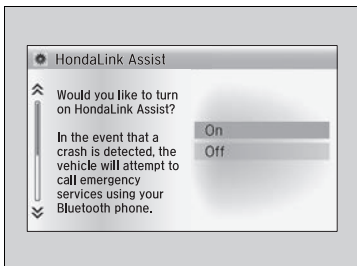

1. Go to the **Phone settings** screen.
  - ▶ **Phone settings screen** P. 279
2. Select **Phone** tab, then **HondaLink Assist**.
  - ▶ A pop-up menu appears on the screen.
3. Select **On** or **Off**.

### ▶▶ In Case of Emergency

Your vehicle may not be able to connect to the operator if the battery level is low, the line is disconnected or you do not have adequate cellular coverage.

You cannot use emergency services when:

- You travel outside the HondaLink service coverage areas.
- There is a problem with the connecting devices, such as the microphones, speakers, or the unit itself.

You cannot operate other navigation- or phone-related functions using the screens while talking to the operator.

### ▶▶ Automatic collision notification

If the unit fails to connect to the operator, it repeatedly tries until it succeeds.

### ▶▶ To enable notification

Setting options:

- **On:** Notification is available.
- **Off:** Disable the feature.



# Driving

This chapter discusses driving, refueling, and information on items such as accessories.

## Before Driving

Driving Preparation .....	304
Maximum Load Limit.....	307

## Towing a Trailer

Towing Preparation.....	309
Driving Safely with a Trailer.....	311
Towing Your Vehicle.....	312

## When Driving

Starting the Engine .....	313, 315
Precautions While Driving.....	318
Continuously Variable Transmission..	319
Shifting .....	320, 322
ECON Button * .....	325

Cruise Control * .....	326
Vehicle Stability Assist (VSA®), aka Electronic Stability Control (ESC), System .....	329
LaneWatch™* .....	331
Tire Pressure Monitoring System (TPMS)...	333
Tire Pressure Monitoring System (TPMS) - Required Federal Explanation.....	335

## Braking

Brake System .....	337
Anti-lock Brake System (ABS) .....	339
Brake Assist System.....	340

## Parking Your Vehicle

When Stopped .....	341
Rearview Camera* .....	342

## Refueling

Fuel Information .....	343
How to Refuel .....	344

## Fuel Economy

Improving Fuel Economy.....	346
-----------------------------	-----

## Accessories and Modifications

Accessories.....	347
Modifications.....	347

\* Not available on all models

## Driving Preparation

Check the following items before you start driving.

### Exterior Checks

- Make sure there are no obstructions on the windows, door mirrors, exterior lights, or other parts of the vehicle.
  - ▶ Remove any frost, snow, or ice.
  - ▶ Remove any snow on the roof, as this can slip down and obstruct your field of vision while driving. If frozen solid, remove ice once it has softened.
  - ▶ When removing ice from around the wheels, be sure not to damage the wheel or wheel components.
- Make sure the hood is securely closed.
  - ▶ If the hood opens while driving, your front view will be blocked.
- Make sure the tires are in good condition.
  - ▶ Check air pressure, check for damage and excessive wear.
    - 📌 **Checking and Maintaining Tires** P. 391
- Make sure there are no people or objects behind or around the vehicle.
  - ▶ There are blind spots from the inside.

### Exterior Checks

#### NOTICE

When doors are frozen shut, use warm water around the door edges to melt any ice. Do not try to force them open, as this can damage the rubber trim around the doors. When done, wipe dry to avoid further freezing.

Do not pour warm water into the key cylinder. You will be unable to insert the key if the water freezes in the hole.

Heat from the engine and exhaust can ignite flammable materials left under the hood, causing a fire. If you've parked your vehicle for an extended period, inspect and remove any debris that may have collected, such as dried grass and leaves that have fallen or have been carried in for use as a nest by a small animal.

Also check under the hood for leftover flammable materials after you or someone else has performed maintenance on your vehicle.

## Interior Checks

- Store or secure all items on board properly.
  - ▶ Carrying too much cargo, or improperly storing it, can affect your vehicle's handling, stability, stopping distance, and tires, and make it unsafe.
    - ✦ **Maximum Load Limit** P. 307
- Do not pile items higher than the seat height.
  - ▶ They can block your view and may be thrown forward in the event of sudden braking.
- Do not place anything in the front seat footwells. Make sure to secure the floor mat\*.
  - ▶ An object or unsecured floor mat can interfere with your brake and accelerator pedal operation while driving.
- If you have any animals on board, do not let them move around in the vehicle.
  - ▶ They may interfere with driving and a crash could occur.
- Securely close and lock all doors and the trunk.
  - ✦ **Locking/Unlocking the Doors from the Inside** P. 114
- Adjust your seating position properly.
  - ▶ Adjust the head restraint, too.
    - ✦ **Adjusting the Seats** P. 146
    - ✦ **Adjusting the Head Restraints** P. 149
- Adjust the mirrors and steering wheel properly for your driving.
  - ▶ Adjust them while sitting in the proper driving position.
    - ✦ **Adjusting the Mirrors** P. 144
    - ✦ **Adjusting the Steering Wheel** P. 143

## Interior Checks

The headlight aim is set by the factory, and does not need to be adjusted. However, if you regularly carry heavy items in the trunk or tow a trailer, have the aiming readjusted at a dealer or by a qualified technician.

- Be sure items placed on the floor behind the front seats cannot roll under the seats.
  - ▶ They can interfere with the driver's ability to operate the pedals, the operation of the seats, or the operation of the sensors under the seats.
- Everyone in the vehicle must fasten their seat belt.
  - ▶ **Fastening a Seat Belt** P. 35
- Make sure that the indicators in the instrument panel come on when you start the vehicle, and go off soon after.
  - ▶ Always have a dealer check the vehicle if a problem is indicated.
    - ▶ **Indicators** P. 68

## Maximum Load Limit

The maximum load for your vehicle is 850 lbs (385 kg). See Tire and Loading Information label attached to the driver's doorjamb.

Label Example

TIRE	SIZE	COLD TIRE PRESSURE	SEE OWNER'S MANUAL FOR ADDITIONAL INFORMATION
FRONT	XXXX/XXXXX XXX	XXXKPA, XXPSI	
REAR	XXXX/XXXXX XXX	XXXKPA, XXPSI	
SPARE	XXXX/XXXXX XXX	XXXKPA, XXPSI	

This figure includes the total weight of all occupants, cargo, and accessories, and the tongue load if you are towing a trailer. Steps for Determining Correct Load Limit -

- (1) Locate the statement "The combined weight of occupants and cargo should never exceed XXX kg or XXX lbs." on your vehicle's placard.
- (2) Determine the combined weight of the driver and passengers that will be riding in your vehicle.
- (3) Subtract the combined weight of the driver and passengers from XXX kg or XXX lbs.
- (4) The resulting figure equals the available amount of cargo and luggage load capacity. For example, if the "XXX" amount equals 1,400 lbs. and there will be five 150 lb. passengers in your vehicle, the amount of available cargo and luggage load capacity is 650 lbs. (1,400 - 750 (5 x 150) = 650 lbs.)

Continued

### Maximum Load Limit

## ⚠ WARNING

Overloading or improper loading can affect handling and stability and cause a crash in which you can be hurt or killed.

Follow all load limits and other loading guidelines in this manual.

Gross Vehicle Weight Rating (GVWR):

The maximum allowable weight of the vehicle, all occupants, all accessories, all cargo, and the tongue load.

📖 Specifications P. 446, 448

Gross Axle Weight Rating (GAWR):

The maximum allowable weight of the vehicle axle.







📖 Specifications P. 446, 448



- (5) Determine the combined weight of luggage and cargo being loaded on the vehicle. That weight may not safely exceed the available cargo and luggage load capacity calculated in step 4.
- (6) If your vehicle will be towing a trailer, load from your trailer will be transferred to your vehicle. Consult this manual to determine how this reduces the available cargo and luggage load capacity of your vehicle.

In addition, the total weight of the vehicle, all occupants, accessories, cargo, and trailer tongue load must not exceed the Gross Vehicle Weight Rating (GVWR) or the Gross Axle Weight Rating (GAWR). Both are on a label on the driver's doorjamb.

**Load Limits Example**

<p>Example1</p>  <p>Max Load 850 lbs (385 kg)</p>	$\cong$	 <p>Passenger Weight 150 lbs x 2 = 300 lbs (68 kg x 2 = 136 kg)</p>	<p>+</p>	 <p>Cargo Weight 550 lbs (249 kg)</p>
<p>Example2</p>  <p>Max Load 850 lbs (385 kg)</p>	$\cong$	 <p>Passenger Weight 150 lbs x 5 = 750 lbs (68 kg x 5 = 340 kg)</p>	<p>+</p>	 <p>Cargo Weight 100 lbs (45 kg)</p>

# Towing a Trailer

## HF model

Your vehicle is not designed to tow a trailer. Attempting to do so can void your warranties.

## Except HF model

## Towing Preparation

### Towing Load Limits

Your vehicle can tow a trailer if you carefully observe the load limits, use the proper equipment, and follow the towing guidelines. Check the load limits before driving.

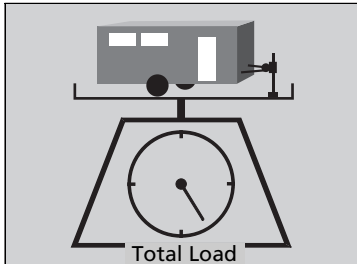

#### ■ Total trailer weight

Maximum allowable weight of the trailer, cargo, and everything in or on it must not exceed 1,000 lbs (450 kg). Towing loads in excess of this can seriously affect vehicle handling and performance and can damage the engine and drivetrain.

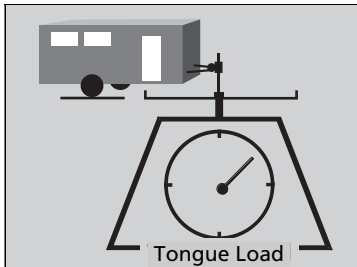

#### ■ Tongue load

The weight of the tongue with a fully loaded trailer on the hitch should be approximately 10% of the total trailer weight.

- Excessive tongue load reduces front tire traction and steering control. Too little tongue load can make the trailer unstable and cause it to sway.
- To achieve a proper tongue load, start by loading 60% of the load toward the front of the trailer and 40% toward the rear. Readjust the load as needed.

### Towing Load Limits

## ⚠ WARNING

Exceeding any load limit or improperly loading your vehicle and trailer can cause a crash in which you can be seriously hurt or killed.

Check the loading of your vehicle and trailer carefully before starting to drive.

Check if all loads are within limits at a public scale. If a public scale is not available, add the estimated weight of your cargo load to the weight of your trailer (as quoted by the manufacturer), and the tongue load.

#### Break-in Period

Avoid towing a trailer during your vehicle's first 600 miles (1,000 km).

Never exceed the gross weight ratings.

Gross weight information

➤ **Vehicle Specifications** P. 446, 448

Continued

## ■ Towing Equipment and Accessories

Towing equipment varies by the size of your trailer, how much load you are towing, and where you are towing.

### ■ Hitches

The hitch must be of an approved type and properly bolted to the underbody.

### ■ Safety chains

Always use safety chains when you tow a trailer. Leave enough slack to allow the trailer to turn corners easily, but do not allow the chains to drag on the ground.

### ■ Trailer brakes

There are two common types of trailer brakes: surge and electric. Surge brakes are common for boat trailers, since the brakes will get wet. If you choose electric brakes, be sure they are electronically actuated. Do not attempt to attach trailer brakes to your vehicle's hydraulic system, as it will lower braking effectiveness and create a potential hazard.

### ■ Additional towing equipment

Many states and provinces/territories require special outside mirrors when towing a trailer. Even if mirrors are not required in your locale, you should install special mirrors if visibility is restricted in any way.

### ■ Trailer light

Trailer lights and equipment must comply with federal, state, province/territory, and local regulations. Check with your local trailer sales or rental agency for the requirements in the area where you plan to tow.

## ►► Towing Equipment and Accessories

Make sure that all equipment is properly installed and maintained, and that it meets federal, state, province/territory, and local regulations.

Consult your trailer sales or rental agency if any other items are recommended or required for your towing situation.

The lighting and wiring of trailers can vary by type and brand. If a connector is required, it should only be installed by a qualified technician.

## Driving Safely with a Trailer

### ■ Things You Need To Know Before Towing a Trailer

- Have the trailer properly serviced and keep it in good condition.
- Make sure that all the weights and load in the vehicle and trailer are within limits.
  - ▣ **Towing Load Limits** P. 309
- Securely attach the hitch, safety chains, and other necessary parts to the trailer.
- Securely store all the items in and on the trailer so that they do not shift while driving.
- Check if the lights and brakes on the trailer are working properly.
- Check the pressures of the trailer tires, including the spare.

### ■ Towing Speeds and Gears

- Drive slower than normal.
- Obey posted speed limits for vehicles with trailers.

#### Continuously variable transmission models

- Use the **D** position when towing a trailer on level roads.

### ■ Turning and Braking

- Turn more slowly and with a wider turning arc than normal.
- Allow more time and distance for braking.
- Do not brake or turn suddenly.

#### ▣ Driving Safely with a Trailer

##### Parking

In addition to the normal precautions, place wheel chocks at each of the trailer's tires.

## ■ Driving in Hilly Terrain

- Closely watch your high temperature indicator. If the indicator remains on, turn off the heating and cooling system\*/climate control system\* and reduce speed. Pull to the side of the road safely to cool down the engine if necessary.

## Towing Your Vehicle

---

Your vehicle is not designed to be towed behind a motor home. If your vehicle needs to be towed in an emergency, refer to the emergency towing information.

📄 **Emergency Towing** P. 443

Models without smart entry system

## Starting the Engine

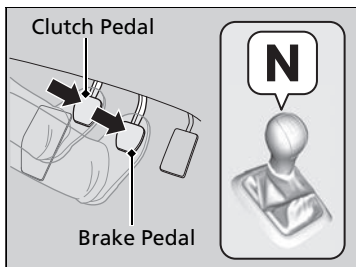
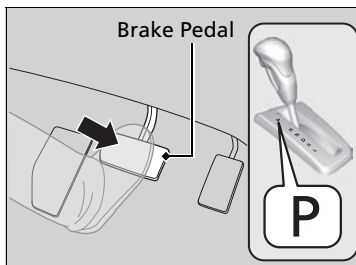

1. Make sure the parking brake is applied.

### Continuously variable transmission models

2. Check that the shift lever is in **P**, then depress the brake pedal.
  - ▶ Although it is possible to start the vehicle in **N**, it is safer to start it in **P**.

### Manual transmission models

2. Check that the shift lever is in **N**. Then depress the brake pedal with your right foot, and the clutch pedal with your left foot.
  - ▶ The clutch pedal must be fully depressed to start the engine.

### Starting the Engine

Keep your foot firmly on the brake pedal when starting the engine.

The engine is harder to start in cold weather and in thinner air found at altitudes above 8,000 feet (2,400 meters).

When starting the engine in cold weather, turn off all electrical accessories such as the lights, heating and cooling system\*/climate control system\*, and rear defogger in order to reduce battery drain.

If you live in a region where winter is extremely cold, an engine block heater will improve starting and warming of the engine. If temperatures consistently below -22°F (-30°C) are expected, the coolant mixture should be changed to a higher concentration to prevent freezing. Consult a dealer for details.

If the exhaust system sounds abnormal or you can smell exhaust gas inside the vehicle, have your vehicle checked by a dealer. There may be a problem with the engine or exhaust system.

\* Not available on all models

Continued

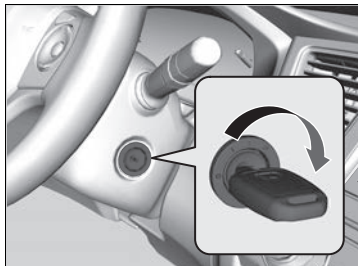

All models

3. Turn the ignition switch to START **III** without depressing the accelerator pedal.

## Starting to Drive

### Continuously variable transmission models

1. Keeping your right foot on the brake pedal, release the parking brake. Check that the parking brake indicator has gone off.  
▶ **Parking Brake** P. 337
2. Put the shift lever in **D**. Select **R** when reversing.
3. Gradually release the brake pedal and gently depress the accelerator pedal to pull away.

### Hill start assist system

Hill start assist keeps the brake engaged briefly to help prevent the vehicle from rolling on inclines as you move your foot from the brake pedal to the accelerator.

### Manual transmission models

Depress the clutch pedal, and shift to one of the forward gears when facing uphill, or **R** when facing downhill, then release the brake pedal.

### Continuously variable transmission models

Move the shift lever to **D**, **S**, or **L** when facing uphill, or **R** when facing downhill, then release the brake pedal.

### Starting the Engine

Do not hold the key in START **III** for more than 15 seconds.

- If the engine does not start right away, wait for at least 10 seconds before trying again.
- If the engine starts, but then immediately stops, wait at least 10 seconds before repeating step 3 while gently depressing the accelerator pedal. Release the accelerator pedal once the engine starts.

The immobilizer system protects your vehicle from theft. If an improperly coded key (or other device) is used, the engine's fuel system is disabled.

▶ **Immobilizer System** P. 125

### Hill start assist system

Hill start assist may not prevent the vehicle from rolling downhill on a very steep or slippery slope, and does not operate on small inclines.

Hill start assist is not a replacement for the parking brake.

Models with smart entry system

## Starting the Engine

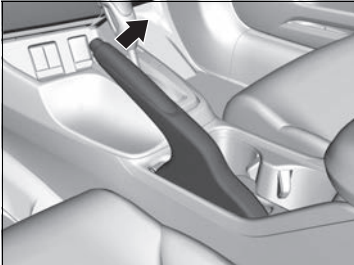

1. Make sure the parking brake is applied.

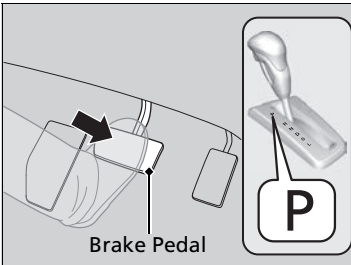

**Continuously variable transmission models**

2. Check that the shift lever is in **P**, then depress the brake pedal.
  - ▶ Although it is possible to start the vehicle in **N**, it is safer to start it in **P**.

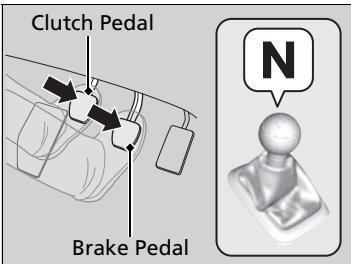

**Manual transmission models**

2. Check that the shift lever is in **N**. Then depress the brake pedal with your right foot, and the clutch pedal with your left foot.
  - ▶ The clutch pedal must be fully depressed to start the engine.

▶▶ Starting the Engine

Keep your foot firmly on the brake pedal when starting the engine.

The engine is harder to start in cold weather and in thinner air found at altitudes above 8,000 feet (2,400 meters).

When starting the engine in cold weather, turn off all electrical accessories such as the lights, climate control system, and rear defogger in order to reduce battery drain.

If you live in a region where winter is extremely cold, an engine block heater will improve starting and warming of the engine. If temperatures consistently below -22°F (-30°C) are expected, the coolant mixture should be changed to a higher concentration to prevent freezing. Consult a dealer for details.

If the exhaust system sounds abnormal or you can smell exhaust gas inside the vehicle, have your vehicle checked by a dealer. There may be a problem with the engine or exhaust system.

The immobilizer system protects your vehicle from theft.

If an improperly coded device is used, the engine's fuel system is disabled.

▶▶ **Immobilizer System** P. 125



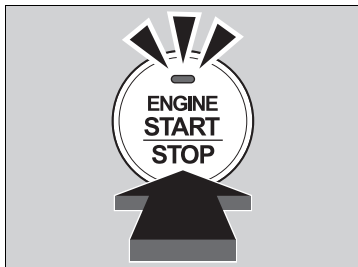

All models

3. Press the **ENGINE START/STOP** button without depressing the accelerator pedal.

## Stopping the Engine

You can turn the engine off when the vehicle is completely stopped.

Continuously variable transmission models

1. Shift to **P**.
2. Press the **ENGINE START/STOP** button.

Manual transmission models

- If the shift lever is in **N**, press the **ENGINE START/STOP** button.
- If the shift lever is in any gear other than **N**, depress the clutch pedal, then press the **ENGINE START/STOP** button.

## Starting the Engine

Bring the smart entry remote close to the **ENGINE START/STOP** button if the battery in the smart entry remote is weak.

- ▶ **If the Smart Entry Remote Battery is Weak**  
P. 427

The engine may not start if the smart entry remote is subjected to strong radio waves.

Do not hold the **ENGINE START/STOP** button to start the engine.  
If the engine does not start, wait at least 10 seconds before trying again.

## Starting to Drive

### Continuously variable transmission models

1. Keeping your right foot on the brake pedal, release the parking brake. Check that the parking brake indicator has gone off.

➤ **Parking Brake** P. 337

2. Put the shift lever in **[D]**. Select **[R]** when reversing.

3. Gradually release the brake pedal and gently depress the accelerator pedal to pull away.

### ■ Hill start assist system

Hill start assist keeps the brake engaged briefly to help prevent the vehicle from rolling on inclines as you move your foot from the brake pedal to the accelerator.

### Manual transmission models

Depress the clutch pedal, and shift to **[1]** when facing uphill, or **[R]** when facing downhill, then release the brake pedal.

### Continuously variable transmission models

Move the shift lever to **[D]**, **[S]**, or **[L]** when facing uphill, or **[R]** when facing downhill, then release the brake pedal.

### ➤ Hill start assist system

Hill start assist may not prevent the vehicle from rolling downhill on a very steep or slippery slope, and does not operate on small inclines.

Hill start assist is not a replacement for the parking brake.

## Precautions While Driving

### In Rain

Avoid driving in deep water and on flooded roads. This can damage the engine or driveline, or cause electrical component failure.

### Other Precautions

If there is a strong impact with something under the vehicle, stop in a safe location. Check the underside of the vehicle for damage or any fluid leaks.

### Precautions While Driving

#### NOTICE

Do not operate the shift lever while pressing the accelerator pedal. You could damage the transmission.

If the ignition switch is turned to ACCESSORY [I]<sup>\*1</sup> while driving, the engine will shut down and all steering and brake power assist functions will stop, making it difficult to control the vehicle.

Do not put the shift lever in [N], as you will lose engine braking (and acceleration) performance.

During the first 600 miles (1,000 km) of operation, avoid sudden acceleration or full throttle operation so as not to damage the engine or powertrain.

Avoid hard braking for the first 200 miles (300 km). You should also follow this when the brake pads are replaced.

#### NOTICE

If you repeatedly turn the steering wheel at an extremely low speed, or hold the steering wheel on the full left or right position for a while, the electric power steering (EPS) system heats up. The system goes into a protective mode, and limits its performance. The steering wheel becomes harder and harder to operate. Once the system cools down, the EPS system is restored.

Repeated operation under these conditions can eventually damage the system.

\*1: Models with the smart entry system have an **ENGINE START/STOP** button instead of an ignition switch.

## Continuously Variable Transmission

### ■ Creeping

The engine runs at a higher idle speed and creeping increases. Keep the brake pedal firmly depressed when stopped.

### ■ Kickdown

Quickly depressing the accelerator pedal while driving uphill may cause the transmission to drop to a lower ratio, unexpectedly increasing vehicle speed. Depress the accelerator pedal carefully, especially on slippery roads and curves.

### ⌘ Precautions While Driving

#### NOTICE

#### 2.4 l engine models

The following can damage the under spoiler:

- Parking the vehicle by a parking block
- Parallel parking along the road shoulder
- Driving towards the bottom of a hill
- Driving up or down to a different surface level (such as a road shoulder)
- Driving on a rutted or bumpy road
- Driving on a road with potholes.

Continuously variable transmission models

## Shifting

Change the shift position in accordance with your driving needs.

### ■ Shift lever positions

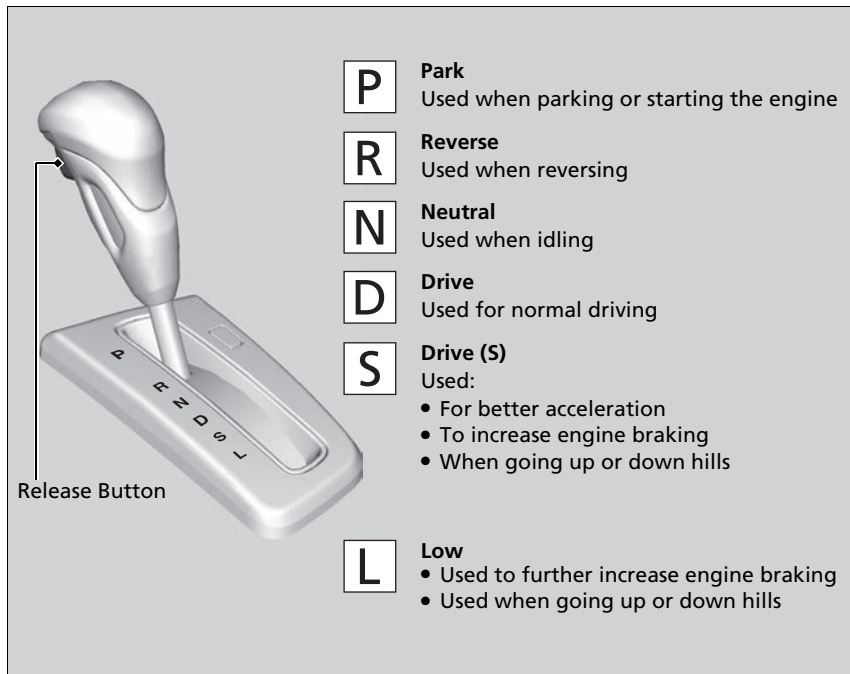

\*1: Models with the smart entry system have an **ENGINE START/STOP** button instead of an ignition switch.

### ▶▶ Shifting

You cannot turn the ignition switch to LOCK [0]\*1 and remove the key unless the shift lever is in [P].

The vehicle may move forward very slightly even in [N] while the engine is cold.

Depress the brake pedal firmly and, when necessary, apply the parking brake.



## Shifting

### ■ Shift Lever Operation

Fully depress the clutch pedal to operate the shift lever and change gears, then slowly release the pedal.

Depress the clutch pedal, and pause for a few seconds before shifting into **[R]**, or shift into one of the forward gears for a moment. This stops the gears so they do not “grind.”

### » Shifting

#### NOTICE

Do not shift to **[R]** before the vehicle comes to a complete stop. Shifting to **[R]** before stopping can damage the transmission.

#### NOTICE

Before downshifting, make sure the engine will not go into the tachometer's red zone. Should this occur, it can severely damage your engine.

There is a metallic part on the shift lever. If you leave the vehicle parked outside for a long time on a hot day, be careful before moving the shift lever. Because of heat, the shift lever may be extremely hot. If the outside temperature is low, the shift lever may feel cold.

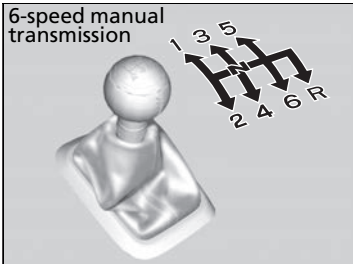
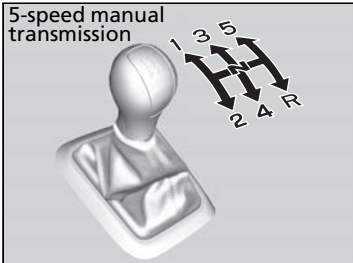

When you are not shifting, do not rest your foot on the clutch pedal. This can cause your clutch to wear out faster.

Shifting

Recommended Shift Points

Driving in the highest gear that allows the engine to run and accelerate smoothly helps to optimize fuel economy and effective emissions control. The following shift points are recommended:

5-speed manual transmission models

Shift Up	Normal Acceleration
1st to 2nd	15 mph (24 km/h)
2nd to 3rd	27 mph (43 km/h)
3rd to 4th	39 mph (63 km/h)
4th to 5th	53 mph (85 km/h)

6-speed manual transmission models

Shift Up	Normal Acceleration
1st to 2nd	17 mph (27 km/h)
2nd to 3rd	29 mph (46 km/h)
3rd to 4th	37 mph (59 km/h)
4th to 5th	43 mph (69 km/h)
5th to 6th	49 mph (79 km/h)

If you exceed the maximum speed for the gear you are in, the engine speed will enter into the tachometer's red zone. When this happens, you may experience a slight jolt.



## Reverse Lockout

### 6-speed manual transmission models

The manual transmission has a lockout mechanism that stops you from accidentally shifting into **R** from a forward gear while the vehicle is moving above a certain speed.

If you cannot shift to **R** when the vehicle is stopped, do the following:

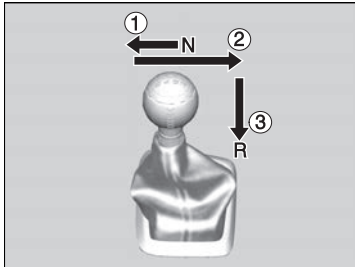

1. Depress the clutch pedal, move the shift lever all the way to the left, and shift to **R**.
2. If you still cannot shift into **R**, apply the parking brake, and turn the ignition switch to ACCESSORY **I** or LOCK **O**\*1.
3. Depress the clutch pedal and shift into **R**.
4. Keep depressing the clutch pedal and start the engine.

Have the vehicle checked by a dealer if you have to go through this procedure repeatedly.

### 5-speed manual transmission models

Your vehicle's lockout mechanism stops you from accidentally shifting into **R** from the 5th gear. Always shift to **N** first, then to **R**.

\*1: Models with the smart entry system have an **ENGINE START/STOP** button instead of an ignition switch.

## ECON Button\*



The **ECON** button turns the ECON mode on and off.  
The ECON mode helps you improve your fuel economy by adjusting the performance of the engine, transmission, heating and cooling system\*/climate control system\*, and cruise control\*.

\* Not available on all models

## Cruise Control\*

Maintains a constant vehicle speed without having to keep your foot on the accelerator pedal. Use cruise control on freeways or open roads where you can travel at a constant speed with little acceleration or deceleration.

### When to use

- Vehicle speed for cruise control:  
Desired speed in a range above roughly 25 mph (40 km/h) ~

### Continuously variable transmission models

- Shift positions for cruise control:  
In **D** or **S**

Always keep sufficient distance between you and the vehicle in front of you.

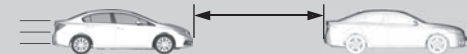

### How to use

- Press the **CRUISE** button on the steering wheel.



**CRUISE MAIN**

**CRUISE MAIN** is on in the instrument panel.  
Cruise control is ready to use.



### ⓘ Cruise Control\*

## ⚠ WARNING

Improper use of the cruise control can lead to a crash.

Use the cruise control only when traveling on open highways in good weather.

It may not be possible to maintain a constant speed when driving uphill or downhill.

When not using cruise control:  
Turn off cruise control by pressing the **CRUISE** button.

### 1.8 ℓ engine models

While in the ECON mode, it may take relatively more time to accelerate to maintain the set speed.

### Manual transmission models

When the engine speed slows down, try to downshift.  
You can maintain the set speed if you change gear within five seconds.

## ■ To Set the Vehicle Speed

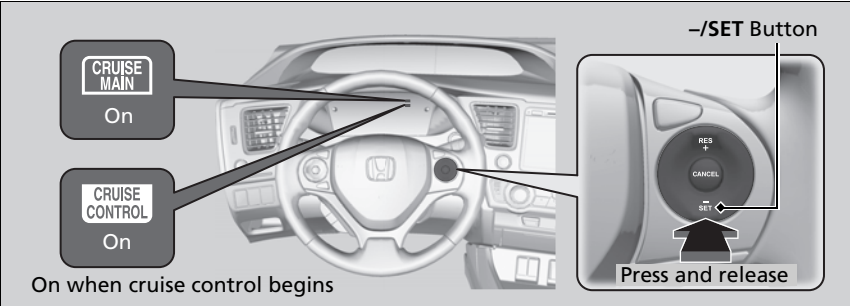

Take your foot off the pedal and press the **-/SET** button when you reach the desired speed.

The moment you release the **-/SET** button, the set speed is fixed, and cruise control begins. The **CRUISE CONTROL** indicator comes on.

## ■ To Adjust the Vehicle Speed

Increase or decrease the vehicle speed using the **RES/+** or **-/SET** buttons on the steering wheel.

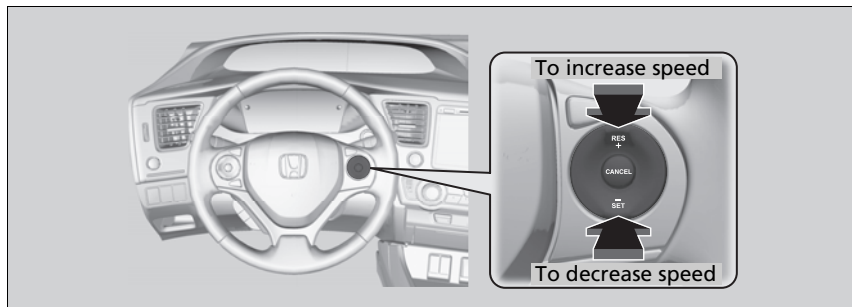

- Each time you press the button, the vehicle speed is increased or decreased by about 1 mph (1.6 km/h).
- If you keep the button pressed, the vehicle speed increases or decreases until you release it. This speed is then set.

## ■ To Cancel

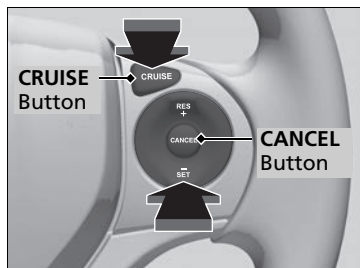

To cancel cruise control, do any of the following:

- Press the **CANCEL** button.
- Press the **CRUISE** button.
- Depress the brake pedal.
- Depress the clutch pedal for five seconds or more.

The **CRUISE CONTROL** indicator goes off.

## ▶▶ To Adjust the Vehicle Speed

You can set the vehicle speed using the **-/SET** button on the steering wheel when adjusting the speed with the accelerator and brake pedals.

## ▶▶ To Cancel

Resuming the prior set speed:  
After cruise control has been canceled, you can still resume the prior set speed by pressing the **RES/+** button while driving at a speed of at least 25 mph (40 km/h) or more.

You cannot set or resume in the following situations:

- When vehicle speed is less than 25 mph (40 km/h)
- When the **CRUISE** button is turned off

At vehicle speeds of 22 mph (35 km/h) or less, cruise control is canceled automatically.

## Vehicle Stability Assist (VSA®), aka Electronic Stability Control (ESC), System

Helps to stabilize the vehicle during cornering if the vehicle turns more or less than what was intended. It also assists in maintaining traction on slippery surfaces. It does so by regulating engine output and selectively applying the brakes.

### ■ VSA® Operation



When VSA® activates, you may notice that the engine does not respond to the accelerator. You may also notice some noise from the hydraulic system. You will also see the indicator blink.

### ▣ Vehicle Stability Assist (VSA®), aka Electronic Stability Control (ESC), System

VSA® may not function properly if tire types and sizes are mixed. Make sure to use the same size and type of tire, and the air pressures are as specified.

When the VSA® indicator comes on and stays on while driving, there may be a problem with the system. While this may not interfere with normal driving, have your vehicle checked by a dealer immediately.

VSA® cannot enhance stability in all driving situations and does not control the entire braking system. You still need to drive and corner at speeds appropriate for the conditions and always leave a sufficient margin of safety.

The main function of the VSA® system is generally known as Electronic Stability Control (ESC). The system also includes a traction control function.

## VSA® On and Off

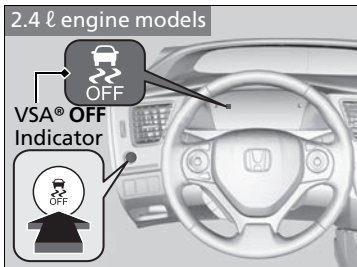
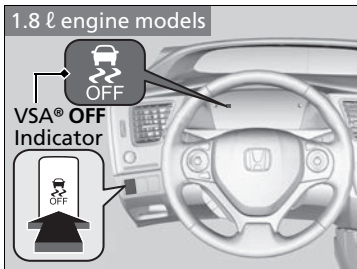

This button is on the driver side control panel. To turn the VSA® system on and off, press and hold it until you hear a beep.

VSA® stops and the indicator comes on.

To turn it on again, press the  (VSA® OFF) button until you hear a beep.

VSA® is turned on every time you start the engine, even if you turned it off the last time you drove the vehicle.

## ▶▶ Vehicle Stability Assist (VSA®), aka Electronic Stability Control (ESC), System

Without VSA®, your vehicle will have normal braking and cornering ability, but it will not have VSA® traction and stability enhancement.

In certain unusual conditions when your vehicle gets stuck in shallow mud or fresh snow, it may be easier to free it with VSA® temporarily switched off.

When the VSA® system is off, the traction control system is also off. You should only attempt to free your vehicle with the VSA® off if you are not able to free it when the VSA® is on.

Immediately after freeing your vehicle, be sure to switch VSA® on again. We do not recommend driving your vehicle with the VSA® and traction control systems switched off.

If the low tire pressure/TPMS indicator\* comes on or blinks, the VSA® system comes on automatically. In this case, you cannot turn the system off by pressing the  button.

You may hear a motor sound coming from the engine compartment while system checks are being performed immediately after starting the engine or while driving. This is normal.

## LaneWatch™\*

Is an assistance system that allows you to check the passenger side rear areas displayed on the audio/information screen when the turn signal is activated to the passenger's side. A camera in the passenger side door mirror monitors these areas and allows you to check for vehicles, in addition to your visual check and use of the passenger door mirror. You can also keep the system on for your convenience while driving.

**1** The system activates when you:

Move the turn signal lever to the passenger side.      Press the LaneWatch button.



The system deactivates when you:

Pull the turn signal lever back.      Press the LaneWatch button again.

**2** The passenger side view display appears on the audio/information screen.



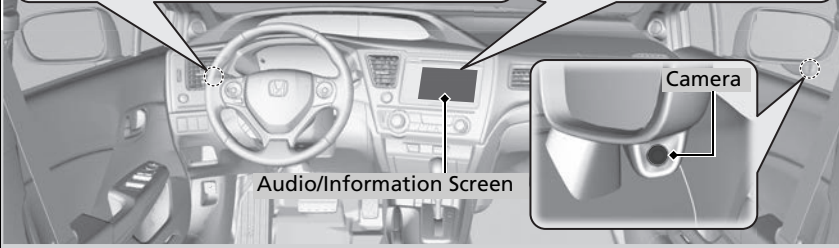

Audio/Information Screen

Camera

LaneWatch™\*

### ⚠ WARNING

Failure to visually confirm that it is safe to change lanes before doing so may result in a crash and serious injury or death.

Do not rely only on LaneWatch while driving.

Always look in your mirrors, to either side of your vehicle, and behind you for other vehicles before changing lanes.

#### Important Safety Reminder

Like all assistance systems, LaneWatch has limitations. Over reliance on LaneWatch may result in a collision.

The LaneWatch function can be affected by weather, lighting (including headlights and low sun angle), ambient darkness, camera condition, and loading.

The LaneWatch may not provide the intended display of traffic to the side and rear under the following conditions:

- Your vehicle's suspension has been altered, changing the height of the vehicle.
- Your tires are over or under inflated.
- Your tires or wheels are of varied size or construction.

\* Not available on all models

Continued



## ■ Customizing the LaneWatch settings

You can customize the following items using the audio/information screen.

- **Show with Turn Signal:** Selects whether LaneWatch monitor comes on when you operate the turn signal light lever.
- **Display Time after Turn Signal Off:** Changes the length of time the LaneWatch display stays on after you pull the turn signal lever back.
- **Reference Lines:** Selects whether the reference lines appear on the LaneWatch monitor.
- **Next Maneuver Pop up\*:** Selects whether a turn direction screen of the navigation system interrupts the LaneWatch display.
- **Display:** Allows for display adjustments of items, such as brightness, and tint. This setting is part of the **Audio** setup group.

➤ **Customized Features\*** P. 233

## ■ Reference Lines

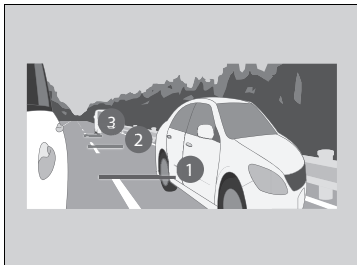

Three lines that appear on the screen can give an idea of how far the vehicles or objects on the screen are from your vehicle, respectively. If an object is near line 1 (in red), it indicates that it is close to your vehicle whereas an object near line 3 farther away.

## ▶▶ LaneWatch™\*

The LaneWatch camera view is restricted. Its unique lens makes objects on the screen look slightly different from what they are.

LaneWatch display does not come on when the shift lever is in **[R]**.

For proper LaneWatch operation:

- The camera is located in the passenger side door mirror. Always keep this area clean. If the camera lens is covered with dirt or moisture, use a soft, moist cloth to keep the lens clean and free of debris.
- Do not cover the camera lens with labels or stickers of any kind.
- Do not touch the camera lens.

## ▶▶ Reference Lines

The area around the reference line 1 (red) is very close to your vehicle. As always, make sure to visually confirm the safety of a lane change before changing lanes.

The distance between your vehicle and lines 1, 2 and 3 on the screen vary depending road conditions and vehicle loading. For example, the reference lines on the screen may seem to appear closer than the actual distances when the rear of your vehicle is more heavily loaded.

Consult a dealer if:

- The passenger side door mirror, or area around it is severely impacted, resulting in changing the camera angle.
- The LaneWatch display does not come on at all.

**U.S. models**

## Tire Pressure Monitoring System (TPMS)

Instead of directly measuring the pressure in each tire, the TPMS on this vehicle monitors and compares the rolling radius and rotational characteristics of each wheel and tire while you are driving to determine if one or more tires are significantly under-inflated. This will cause the low tire pressure/TPMS indicator to come on and a message to appear on the i-MID.

### TPMS Calibration

You must start TPMS calibration every time you:

- Adjust the pressure in one or more tires.
- Rotate the tires.
- Replace one or more tires.

Before calibrating the TPMS:

- Set the cold tire pressure in all four tires.

➔ **Checking Tires** P. 391

Make sure:

- The vehicle is at a complete stop.

**Manual transmission models**

- The shift lever is in **N**.

**Continuously variable transmission models**

- The shift lever is in **P**.

**All models**

- The ignition switch is in ON **II**\*1.

\*1: Models with the smart entry system have an **ENGINE START/STOP** button instead of an ignition switch.

\* Not available on all models

**▶▶ Tire Pressure Monitoring System (TPMS)**

The system does not monitor the tires when driving at low speed.

Conditions such as low ambient temperature and altitude change directly affect tire pressure and can trigger the low tire pressure/TPMS indicator to come on.

Tire pressure checked and inflated in:

- Warm weather can become under-inflated in colder weather.
- Cold weather can become over-inflated in warmer weather.

The low tire pressure indicator will not come on as a result of over inflation.

The TPMS may not function properly if tire type and size are mixed. Make sure to use the same size and type of tire.

➔ **Checking and Maintaining Tires** P. 391

The low tire pressure/TPMS indicator may come on with a delay or may not come on at all when:

- You rapidly accelerate, decelerate, or turn the steering wheel.
- You drive on snowy or slippery roads.
- Snow chains are used.

The low tire pressure/TPMS indicator may come on under the following conditions:

- A compact spare tire\* is used.
- There is a heavier and uneven load on the tires, such as when towing a trailer, than the condition at calibration.
- Snow chains are used.

Continued

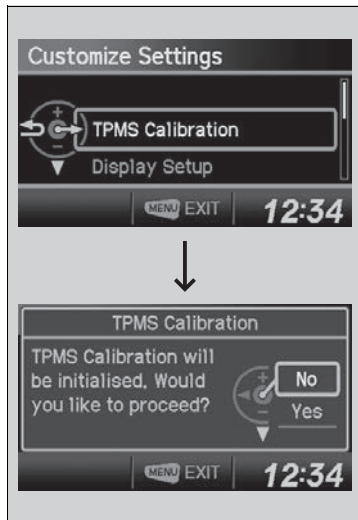

You can calibrate the system from the customized features on the i-MID.

1. Turn the ignition switch to ON \*1.
  2. Press the **MENU** button to go to the **Vehicle Menu** screen.
  3. Select **Customize Settings** with the button, then press the **SOURCE** button.
  4. Select **TPMS Calibration** with the button, then press the **SOURCE** button.
    - ▶ The display switches to the customization setup screen, where you can select **Cancel** or **Initialize**.
  5. Select **Yes** with the button, then press the **SOURCE** button.
    - ▶ When the calibration is complete, the **The TPMS has been initialized.** message appears, and the display returns to the customization menu screen.
- If the **Unable to initialize TPMS.** message appears, repeat steps 4-5.
  - The calibration process finishes automatically.

#### ▶▶ TPMS Calibration

- TPMS cannot be calibrated if a compact spare tire\* is installed.
- The calibration process requires approximately 30 minutes of cumulative driving at speeds between 30-60 mph (48-97 km/h).
- During this period, if the ignition is turned on and the vehicle is not moved within 45 seconds, you may notice the low tire pressure indicator comes on briefly. This is normal and indicates that the calibration process is not yet complete.

If the snow chains are installed, remove them before calibrating the TPMS.

If the low tire pressure/TPMS indicator comes on even when the properly inflated specified regular tires are installed, have your vehicle checked by a dealer.

We recommend that the tires be replaced with the same brand, model, and size as the originals. Ask a dealer for details.

\*1: Models with the smart entry system have an **ENGINE START/STOP** button instead of an ignition switch.

\* Not available on all models

U.S. models

## Tire Pressure Monitoring System (TPMS) - Required Federal Explanation

---

Each tire, including the spare (if provided), should be checked monthly when cold and inflated to the inflation pressure recommended by the vehicle manufacturer on the vehicle placard or tire inflation pressure label.

(If your vehicle has tires of a different size than the size indicated on the vehicle placard or tire inflation pressure label, you should determine the proper tire inflation pressure for those tires.)

As an added safety feature, your vehicle has been equipped with a tire pressure monitoring system (TPMS) that illuminates a low tire pressure telltale



when one or more of your tires is significantly under-inflated.

Accordingly, when the low tire pressure telltale illuminates, you should stop and check your tires as soon as possible, and inflate them to the proper pressure.

Driving on a significantly under-inflated tire causes the tire to overheat and can lead to tire failure. Under-inflation also reduces fuel efficiency and tire tread life, and may affect the vehicle's handling and stopping ability.

*Continued*

Please note that the TPMS is not a substitute for proper tire maintenance, and it is the driver's responsibility to maintain correct tire pressure, even if under-inflation has not reached the level to trigger illumination of the TPMS low tire pressure telltale.

Your vehicle has also been equipped with a TPMS malfunction indicator to indicate when the system is not operating properly. The TPMS malfunction indicator is combined with the low tire pressure telltale. When the system detects a malfunction, the telltale will flash for approximately one minute and then remain continuously illuminated. This sequence will continue upon subsequent vehicle start-ups as long as the malfunction exists.

When the malfunction indicator is illuminated, the system may not be able to detect or signal low tire pressure as intended.

TPMS malfunctions may occur for a variety of reasons, including the installation of replacement or alternate tires or wheels on the vehicle that prevent the TPMS from functioning properly.

Always check the TPMS malfunction telltale after replacing one or more tires or wheels on your vehicle to ensure that the replacement or alternate tires and wheels allow the TPMS to continue to function properly.

## Brake System

### Parking Brake

Use the parking brake to keep the vehicle stationary when parking.



#### To apply:

Pull the lever fully up without pressing the release button.



#### To release:

1. Pull the lever slightly, and press and hold the release button.
2. Lower the lever down all the way, then release the button.

### ⊗ Parking Brake

#### NOTICE

Release the parking brake fully before driving. The rear brakes and axle can be damaged if you drive with the parking brake applied.

If you start driving without fully releasing the parking brake, a buzzer sounds as a warning, and **RELEASE PARKING BRAKE** appears on the i-MID\*.

Always apply the parking brake when parking.

\* Not available on all models

## ■ Foot Brake

Your vehicle is equipped with front disc brakes. The brakes on the rear wheels may be disc or drum, depending on the model. A vacuum power assist helps reduce the effort needed on the brake pedal. The brake assist system increases the stopping force when you depress the brake pedal hard in an emergency situation. The anti-lock brake system (ABS) helps you retain steering control when braking very hard.

➤ **Brake Assist System** P. 340

➤ **Anti-lock Brake System (ABS)** P. 339

## ☒ Foot Brake

Check the brakes after driving through deep water, or if there is a buildup of road surface water. If necessary, dry the brakes by lightly depressing the pedal several times.

If you hear a continuous metallic friction sound when applying the brakes, the brake pads need to be replaced. Have your vehicle checked by a dealer.

Constantly using the brake pedal while going down a long hill builds up heat, which reduces the brake effectiveness. Apply engine braking by taking your foot off the accelerator pedal and downshifting to a lower gear. With manual transmission use a lower gear for greater engine braking.

Do not rest your foot on the brake pedal while driving, as it will lightly apply the brakes and cause them to lose effectiveness over time and reduce pad life. It will also confuse drivers behind you.

## Anti-lock Brake System (ABS)

### ■ ABS

Helps prevent the wheels from locking up, and helps you retain steering control by pumping the brakes rapidly, much faster than you.

The electronic brake distribution (EBD) system, which is part of the ABS, also balances the front-to-rear braking distribution according to vehicle loading.

You should never pump the brake pedal. Let the ABS work for you by always keeping firm, steady pressure on the brake pedal. This is sometimes referred to as “stomp and steer.”

### ■ ABS operation

The brake pedal may pulsate slightly when the ABS is working. Keep holding the pedal firmly down. On dry pavement, you will need to press on the brake pedal very hard before the ABS activates. However, you may feel the ABS activate immediately if you are trying to stop on snow or ice.

When the vehicle speed goes under 6 mph (10 km/h), the ABS stops.

### ⓘ Anti-lock Brake System (ABS)

#### NOTICE

The ABS may not function correctly if you use an incorrect tire type and size.

When the **ABS** indicator comes on while driving, there may be a problem with the system. While normal braking is not affected, there is a possibility of the ABS not operating. Have the vehicle checked by a dealer immediately.

The ABS does not reduce the time or distance it takes to stop the vehicle. It only helps with steering control during hard braking.

In the following cases, your vehicle may need more stopping distance than a vehicle without the ABS:

- When driving on rough road surfaces, including when driving on uneven surfaces, such as gravel or snow.
- When snow chains are installed.

You may hear a motor sound coming from the engine compartment while system checks are being performed immediately after starting the engine or while driving. This is normal.



## Brake Assist System

---

### ■ Brake Assist System

Designed to assist the driver by generating greater braking force when you depress the brake pedal hard during emergency braking.

#### ■ Brake assist system operation

Press the brake pedal firmly for more powerful braking.

When brake assist operates, the pedal may wiggle slightly and an operating noise may be heard. This is normal. Keep holding the brake pedal firmly down.

## When Stopped

1. Depress the brake pedal firmly.
2. Firmly apply the parking brake.

### Continuously variable transmission models

3. Move the shift lever from **D** to **P**.

### Manual transmission models

3. Move the shift lever to **R** or **1**.

### All models

4. Turn off the engine.

Always set the parking brake firmly, in particular if you are parked on an incline.

### » Parking Your Vehicle

Do not park your vehicle near flammable objects, such as dry grass, oil, or timber. Heat from the exhaust can cause a fire.

### » When Stopped

#### NOTICE

##### Continuously variable transmission models

The following can damage the transmission:

- Depressing the accelerator and brake pedals simultaneously.
- Holding the vehicle in place when facing uphill by depressing the accelerator pedal.
- Moving the shift lever into **P** before the vehicle stops completely.

Raise the wiper arms when snow is expected.

## About Your Rearview Camera

### Models with navigation system

For models with the navigation system, see the Navigation System Manual for the rearview camera.

### Models without navigation system

### Models with one display

The i-MID can display your vehicle's rear view.

The display automatically changes to a rear view when the shift lever is moved to **[R]**.

### Models without navigation system

### Models with display audio system

The audio/information screen can display your vehicle's rear view. The display automatically changes to the rear view when the shift lever is moved to **[R]**.

## Rearview Camera Display Area

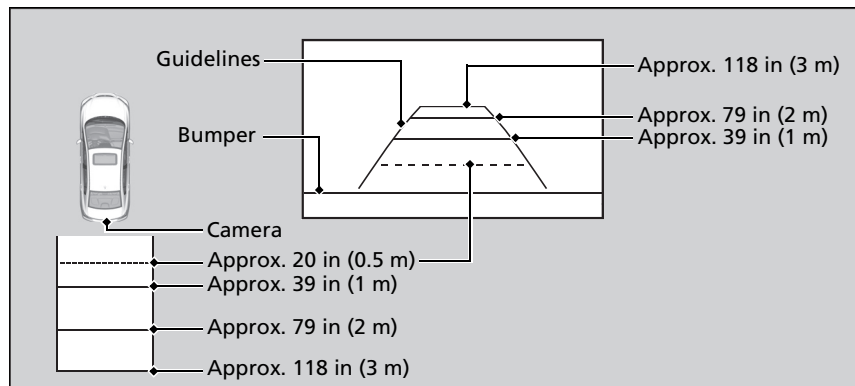

The rearview camera has a unique lens that makes objects appear closer or further than they actually are.

### About Your Rearview Camera

The rear camera view is restricted. You cannot see the corner ends of the bumper or what is underneath the bumper. Its unique lens also makes objects appear closer or farther than they actually are.

Visually confirm that it is safe to drive before backing up. Certain conditions, such as weather, lighting, and high temperatures, may also restrict the rear view. Do not rely on the rearview display which does not give you all information about conditions at the back of your vehicle.

If the camera lens is covered with dirt or moisture, use a soft, moist cloth to keep the lens clean and free of debris.

### Models with display audio system

You can change the **Fixed Guideline** and **Dynamic Guideline** settings.

**Customized Features\*** P. 233

### Fixed Guideline

**On:** Guidelines appear when you shift into **[R]**.

**Off:** Guidelines do not appear when the dynamic guideline is off.

### Dynamic Guideline

**On:** Guidelines move according to the steering wheel direction.

**Off:** Guidelines do not move.

## Fuel Information

### ■ Fuel recommendation

#### 1.8 ℓ engine models

#### **Unleaded gasoline, pump octane number 87 or higher**

Use of a lower octane gasoline can cause a persistent, heavy metallic knocking noise that can lead to engine damage.

#### 2.4 ℓ engine models

#### **Unleaded premium gasoline, pump octane number 91 or higher**

Use of a lower octane gasoline can cause occasional metallic knocking noise in the engine and will result in decreased engine performance.

Use of a gasoline with a pump octane less than 87 can lead to engine damage.

### ■ Top tier detergent gasoline

Because the level of detergency and additives in gasoline vary in the market, Honda endorses the use of “TOP TIER Detergent Gasoline” where available to help maintain the performance and reliability of your vehicle. TOP TIER Detergent Gasoline meets a new gasoline standard jointly established by leading automotive manufacturers to meet the needs of today’s advanced engines.

#### ⌘ Fuel Information

#### **NOTICE**

We recommend quality gasoline containing detergent additives that help prevent fuel system and engine deposits. In addition, in order to maintain good performance, fuel economy, and emissions control, we strongly recommend the use of gasoline that does NOT contain harmful manganese-based fuel additives such as MMT, if such gasoline is available.

Use of gasoline with these additives may adversely affect performance, and cause the malfunction indicator lamp on your instrument panel to come on. If this happens, contact a dealer for service. Some gasoline today is blended with oxygenates such as ethanol. Your vehicle is designed to operate on oxygenated gasoline containing up to 15% ethanol by volume. Do not use gasoline containing methanol. If you notice any undesirable operating symptoms, try another service station or switch to another brand of gasoline.

Qualifying gasoline retailers will, in most cases, identify their gasoline as having met “TOP TIER Detergent Gasoline” standards at the retail location. This fuel is guaranteed to contain the proper level of detergent additives and be free of metallic additives. The proper level of detergent additives, and absence of harmful metallic additives in gasoline, help avoid build-up of deposits in your engine and emission control system.

For further important fuel-related information for your vehicle, or on information on gasoline that does not contain MMT, visit [www.hondacars.com](http://www.hondacars.com). In Canada, visit [www.honda.ca](http://www.honda.ca) for additional information on gasoline. For more information on top tier gasoline, visit [www.toptiergas.com](http://www.toptiergas.com).

■ **Fuel tank capacity: 13.2 US gal (50 liters)**

## How to Refuel

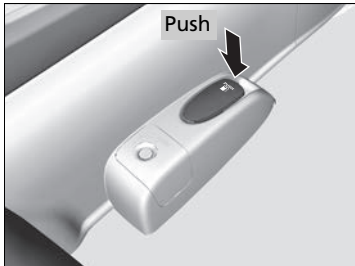

1. Stop your vehicle with the service station pump on the left side of the vehicle in the rear.
2. Turn off the engine.
3. Push on the fuel fill door release handle at the foot of the driver's seat.
  - ▶ The fuel fill door opens.

▶▶ How to Refuel

### **⚠ WARNING**

Gasoline is highly flammable and explosive. You can be burned or seriously injured when handling fuel.

- Stop the engine, and keep heat, sparks, and flame away.
- Handle fuel only outdoors.
- Wipe up spills immediately.

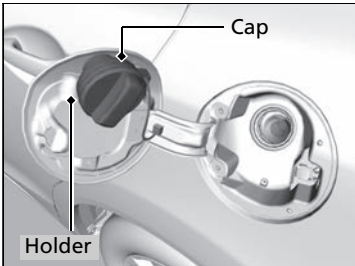
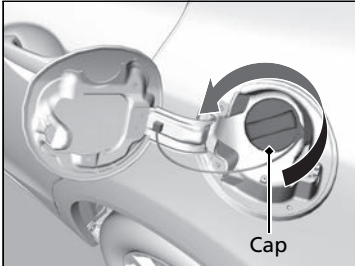

**4.** Remove the fuel fill cap slowly. If you hear a release of air, wait until this stops, then turn the knob slowly to open the fuel fill cap.

**5.** Place the fuel fill cap in the holder.

**6.** Insert the filler nozzle fully.

▶ When the tank is full, the fuel nozzle will click off automatically. This leaves space in the fuel tank in case the fuel expands with a change in the temperature.

**7.** After filling, replace the fuel fill cap, tightening it until you hear it click at least once.

▶ Shut the fuel fill door by hand.

#### How to Refuel

The filler nozzle automatically stops to leave space in the fuel tank so that fuel does not overflow as a result of changes in air temperature.

If the filler nozzle keeps turning off when the tank is not full, there may be a problem with the pump's fuel vapor recovery system. Try filling at another pump. If this does not fix the problem, consult a dealer.

Do not continue to add fuel after the filler nozzle has automatically stopped. Additional fuel can exceed the full tank capacity.

## Improving Fuel Economy

Fuel economy depends on several conditions, including driving conditions, your driving habits, the condition of your vehicle, and loading. Depending on these and other conditions, you may or may not achieve the rated fuel economy of this vehicle.

### Maintenance and Fuel Economy

You can optimize your fuel economy with proper maintenance of your vehicle. Always maintain your vehicle in accordance with the messages displayed on the information display\**i-MID*\*.

- Use the recommended viscosity engine oil, displaying the API Certification Seal.
- Maintain the specified tire pressure.
- Do not load the vehicle with excess cargo.
- Keep your vehicle clean. A buildup of snow or mud on your vehicle's underside adds weight and increases wind resistance.

### Improving Fuel Economy

Direct calculation is the recommended method to determine actual fuel consumed while driving.



In Canada, posted fuel economy numbers are established following a simulated test. For more information on how this test is performed, please visit <http://oee.nrcan.gc.ca/>

## Accessories

When installing accessories, check the following:

- Do not install accessories on the windshield. They can obstruct your view and delay your reaction to driving conditions.
- Do not install accessories over areas marked **SRS AIRBAG**, on the sides or backs of the front seats, on front or side pillars, or near the side windows. Accessories installed in these areas may interfere with proper operation of the vehicle's airbags or may be propelled into you or another occupant if the airbags deploy.
- Be sure electronic accessories do not overload electrical circuits or interfere with proper operation of your vehicle.
  - **Fuses** P. 439
- Before installing any electronic accessory, have the installer contact a dealer for assistance. If possible, have a dealer inspect the final installation.

## Modifications

Do not modify your vehicle or use non-Honda components that can affect its handling, stability, and reliability.

Overall vehicle performance can be affected. Always make sure all equipment is properly installed and maintained, and that it meets federal, state, province, territory, and local regulations.

### Accessories and Modifications

#### **⚠ WARNING**

Improper accessories or modifications can affect your vehicle's handling, stability, and performance, and cause a crash in which you can be seriously hurt or killed.

Follow all instructions in this owner's manual regarding accessories and modifications.

Honda Genuine accessories are recommended to ensure proper operation on your vehicle.





# Maintenance

This chapter discusses basic maintenance.



## Before Performing Maintenance

Inspection and Maintenance .....	350
Safety When Performing Maintenance.....	351
Parts and Fluids Used in Maintenance Service .....	352

<b>Maintenance Minder™</b> .....	353
----------------------------------	-----

## Maintenance Under the Hood

Maintenance Items Under the Hood.....	361
Opening the Hood .....	363
Recommended Engine Oil .....	364
Oil Check .....	365
Adding Engine Oil .....	367
Changing the Engine Oil and Oil Filter .....	368

Engine Coolant .....	371
Transmission Fluid .....	373
Brake/Clutch Fluid .....	374
Refilling Window Washer Fluid .....	375

<b>Replacing Light Bulbs</b> .....	376
------------------------------------	-----

<b>Checking and Maintaining Wiper Blades</b> .....	389
--------------------------------------------------------	-----

<b>Checking and Maintaining Tires</b>	
Checking Tires .....	391
Tire and Loading Information Label .....	392
Tire Labeling .....	392
DOT Tire Quality Grading (U.S. Vehicles).....	394
Wear Indicators.....	396

Tire Service Life .....	396
Tire and Wheel Replacement .....	397
Tire Rotation .....	398
Winter Tires .....	399
<b>Battery</b> .....	400

<b>Remote Transmitter Care*</b>	
Replacing the Button Battery .....	401

<b>Heating and Cooling System*/Climate Control System* Maintenance</b> .....	403
----------------------------------------------------------------------------------	-----

<b>Cleaning</b>	
Interior Care .....	404
Exterior Care .....	406

\* Not available on all models

## Inspection and Maintenance

For your safety, perform all listed inspections and maintenance to keep your vehicle in good condition. If you become aware of any abnormality (noise, smell, insufficient brake fluid, oil residue on the ground, etc.), have your vehicle inspected by a dealer. (Note, however, that service at a dealer is not mandatory to keep your warranties in effect.) Refer to the separate maintenance booklet for detailed maintenance and inspection information.

### Types of Inspection and Maintenance

#### ■ Daily inspections

Perform inspections before long distance trips, when washing the vehicle, or when refueling.

#### ■ Periodic inspections

- Check the continuously variable transmission fluid level monthly.
  - **Continuously Variable Transmission Fluid** P. 373
- Check the brake fluid level monthly.
  - **Brake/Clutch Fluid** P. 374
- Check the tire pressure monthly. Examine the tread for wear and foreign objects.
  - **Checking and Maintaining Tires** P. 391
- Check the operation of the exterior lights monthly.
  - **Replacing Light Bulbs** P. 376
- Check the condition of the wiper blades at least every six months.
  - **Checking and Maintaining Wiper Blades** P. 389

### » Inspection and Maintenance

#### U.S. models

**Maintenance, replacement, or repair of emissions control devices and systems may be done by any automotive repair establishment or individuals using parts that are "certified" to EPA standards.**

According to state and federal regulations, failure to perform maintenance on the maintenance main items marked with # will not void your emissions warranties. However, all maintenance services should be performed in accordance with the intervals indicated by the information display \*i-MID\*.

➤ **Maintenance Service Items** P. 355, 359

If you want to perform complex maintenance tasks that require more skills and tools, you can purchase a subscription to the Service Express website at [www.techinfo.honda.com](http://www.techinfo.honda.com).

➤ **Authorized Manuals** P. 457

If you want to perform maintenance yourself, make sure that you have the necessary tools and skills first. After performing maintenance, update the records in the separate maintenance booklet.

## Safety When Performing Maintenance

Some of the most important safety precautions are given here. However, we cannot warn you of every conceivable hazard that can arise in performing maintenance. Only you can decide whether or not you should perform a given task.

### Maintenance Safety

- To reduce the possibility of fire or explosion, keep cigarettes, sparks, and flames away from the battery and all fuel related parts.
- Never leave rags, towels, or other flammable objects under the hood.
  - ▶ Heat from the engine and exhaust can ignite them causing a fire.
- To clean parts, use a commercially available degreaser or parts cleaner, not gasoline.
- Wear eye protection and protective clothing when working with the battery or compressed air.
- Engine exhaust contains carbon monoxide, which is poisonous and can kill you.
  - ▶ Operate the engine only when there is sufficient ventilation.

### Vehicle Safety

- The vehicle must be in a stationary condition.
  - ▶ Make sure your vehicle is parked on level ground, the parking brake is set, and the engine is off.
- Be aware that hot parts can burn you.
  - ▶ Make sure to let the engine and exhaust system cool thoroughly before touching vehicle parts.
- Be aware that moving parts can injure you.
  - ▶ Do not start the engine unless instructed, and keep your hands and limbs away from moving parts.

#### ⚠ Safety When Performing Maintenance

### ⚠ WARNING

Improperly maintaining this vehicle or failing to correct a problem before driving can cause a crash in which you can be seriously hurt or killed.

Always follow the inspection and maintenance recommendations according to the schedules in this owner's manual.

### ⚠ WARNING

Failure to properly follow maintenance instructions and precautions can cause you to be seriously hurt or killed.

Always follow the procedures and precautions in this owner's manual.

## Parts and Fluids Used in Maintenance Service

---

The use of Honda genuine parts and fluids is recommended when maintaining and servicing your vehicle. Honda genuine parts are manufactured according to the same high quality standards used in Honda vehicles.

# Maintenance Minder™

If the engine oil life is less than 15%, you will see the Maintenance Minder messages appear on the information display\* or the i-MID\* every time you turn the ignition switch to ON **II**\*1. The messages notify you when to change the engine oil, or when to bring your vehicle to a dealer for indicated maintenance services.

Models with information display

## To Use Maintenance Minder™

### ■ Displaying the Engine Oil Life

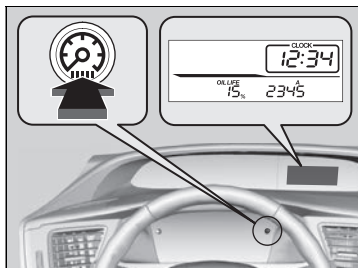

1. Turn the ignition switch to ON **II**\*1.
2. Press the  (Select/Reset) knob repeatedly until the engine oil life appears on the information display.

The Maintenance Minder indicator () stays on in the instrument panel after the engine oil life becomes **0%**. Have the indicated maintenance done by a dealer immediately.

\*1: Models with the smart entry system have an **ENGINE START/STOP** button instead of an ignition switch.

\* Not available on all models

### ▣ Displaying the Engine Oil Life





Based on the engine operating conditions, the remaining engine oil life is calculated and displayed as a percentage.

Displayed Engine Oil Life (%)	Calculated Engine Oil Life (%)
100	100 to 91
90	90 to 81
80	80 to 71
70	70 to 61
60	60 to 51
50	50 to 41
40	40 to 31
30	30 to 21
20	20 to 16
15	15 to 11
10	10 to 6
5	5 to 1
0	0

Continued

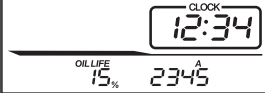
## ■ Maintenance Minder Messages on the Information Display

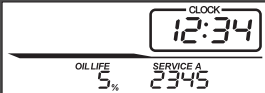
To switch the display, press the  (Select/Reset) knob.

Oil Life Display	Explanation	Information	Maintenance Minder Indicator
	<p>The engine oil life indicator starts to appear along with other due soon maintenance item codes when the remaining oil life becomes 15 percent.</p>	<p>The engine oil is approaching the end of its service life.</p>	 <p>Starts to come on when the remaining engine oil life becomes 15 percent.</p>
	<p>The <b>SERVICE</b> message also starts to appear along with the engine oil life indicator and the maintenance item codes.</p>	<p>The engine oil has almost reached the end of its service life, and the maintenance items should be inspected and serviced as soon as possible.</p>	<p>It goes off when the display is switched.</p>
	<p>The remaining engine oil life has passed its service life, and a negative distance appears after driving over 10 miles (U.S. models) or 10 km (Canadian models). The negative distance on the display blinks.</p>	<p>The engine oil life has passed. The maintenance items must be inspected and serviced immediately.</p>	 <p>Stays on as a reminder even when the display is switched.</p>

## Maintenance Service Items

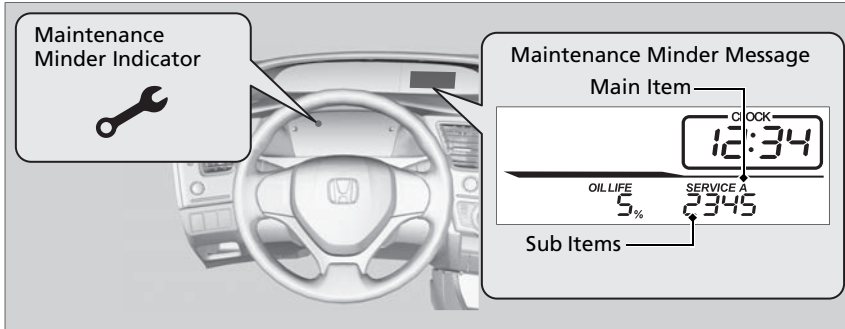

### ⊞ Maintenance Service Items

- Independent of the Maintenance Minder information, replace the brake fluid every 3 years.
- Inspect idle speed every 160,000 miles (256,000 km).
- Adjust the valves during services A, B, 1, 2, or 3 if they are noisy.

CODE	Maintenance Main Items
A	<ul style="list-style-type: none"> <li>• Replace engine oil*<sup>1</sup></li> </ul>
B	<ul style="list-style-type: none"> <li>• Replace engine oil*<sup>1</sup> and oil filter</li> <li>• Inspect front and rear brakes/service as necessary</li> <li>• Check parking brake adjustment</li> <li>• Inspect tie rod ends, steering gearbox, and boots</li> <li>• Inspect suspension components</li> <li>• Inspect driveshaft boots</li> <li>• Inspect brake hoses and lines (Including ABS/VSA)</li> <li>• Inspect all fluid levels and condition of fluids</li> <li>• Inspect exhaust system<sup>#</sup></li> <li>• Inspect fuel lines and connections<sup>#</sup></li> </ul>

CODE	Maintenance Sub Items
1	<ul style="list-style-type: none"> <li>• Rotate tires</li> </ul>
2	<ul style="list-style-type: none"> <li>• Replace air cleaner element*<sup>2</sup></li> <li>• Replace dust and pollen filter*<sup>2,3</sup></li> <li>• Inspect drive belt</li> </ul>
3	<ul style="list-style-type: none"> <li>• Replace transmission fluid*<sup>4</sup></li> </ul>
4	<ul style="list-style-type: none"> <li>• Replace spark plugs</li> <li>• Inspect valve clearance</li> </ul>
5	<ul style="list-style-type: none"> <li>• Replace engine coolant</li> </ul>

\*<sup>1</sup>: If a message **SERVICE** does not appear more than 12 months after the display is reset, change the engine oil every year.  
 #: See information on maintenance and emissions warranty.

\*<sup>2</sup>: If you drive in dusty conditions, replace the air cleaner element every 15,000 miles (24,000 km).  
 \*<sup>3</sup>: If you drive primarily in urban areas that have high concentrations of soot in the air from industry and from diesel-powered vehicles, replace the dust and pollen filter every 15,000 miles (24,000 km).  
 \*<sup>4</sup>: **Continuously variable transmission models**  
 Driving in mountainous areas at very low vehicle speeds or trailer towing results in higher transmission temperatures. This requires transmission fluid changes more frequently than recommended by the Maintenance Minder. If you regularly drive your vehicle under these conditions, have the transmission fluid changed every 25,000 miles (40,000 km).



\* Not available on all models

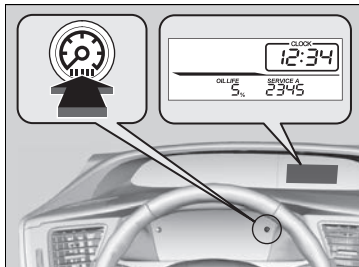

## ■ Resetting the Display

Reset the engine oil life display if you have performed the maintenance service.



1. Turn the ignition switch to ON **II**\*1.
2. Display the engine oil life by repeatedly pressing the  (Select/Reset) knob.
3. Press and hold the  knob for ten seconds or more.
  - The engine oil life indicator and the maintenance item codes blink.
4. Press the  knob for five seconds or more.
  - The displayed maintenance items disappear, and the engine oil life display returns to **100%**.

## ►► Resetting the Display

### NOTICE

Failure to reset the engine oil life after a maintenance service results in the system showing incorrect maintenance intervals, which can lead to serious mechanical problems.

The dealer will reset the engine oil life display after completing the required maintenance service. If someone other than a dealer performs maintenance service, reset the engine oil life display yourself.

\*1: Models with the smart entry system have an **ENGINE START/STOP** button instead of an ignition switch.



Models with i-MID

## To Use Maintenance Minder™

### ■ Displaying the Engine Oil Life and Maintenance Items

Maintenance items, which should be serviced at the same time that you replace the engine oil, appear on the i-MID.

You can view them on the **Maintenance info** screen at any time.

1. Turn the ignition switch to ON \*1.
2. Press the **MENU** button to go to the **Vehicle Menu** screen.
3. Select **Vehicle Information** with the  button, then press the **SOURCE** button.
4. Press the **SOURCE** button again to go to the **Maintenance info** screen. The engine oil life appears on the i-MID.

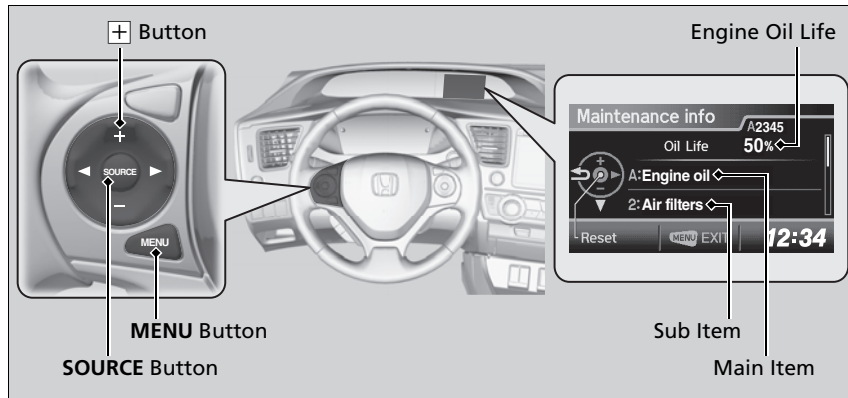

### ☒ Displaying the Engine Oil Life and Maintenance Items

Based on the engine operating conditions, the remaining engine oil life is calculated and displayed as a percentage.

Displayed Engine Oil Life (%)	Calculated Engine Oil Life (%)
100	100 to 91
90	90 to 81
80	80 to 71
70	70 to 61
60	60 to 51
50	50 to 41
40	40 to 31
30	30 to 21
20	20 to 16
15	15 to 11
10	10 to 6
5	5 to 1
0	0







There is a list of maintenance main and sub items you can view on the i-MID.

☒ **Maintenance Service Items P. 359**

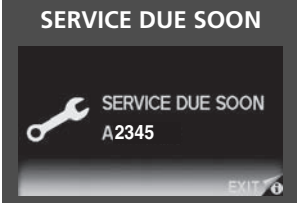
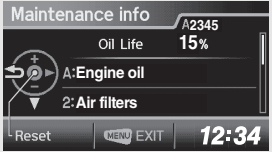
\*1: Models with the smart entry system have an **ENGINE START/STOP** button instead of an ignition switch.

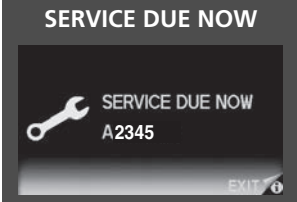
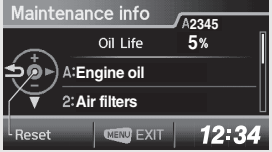
Continued

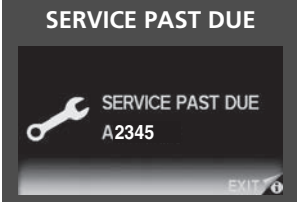
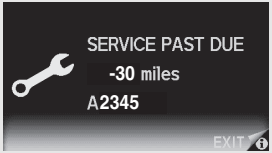
## Maintenance Minder Messages on the i-MID

Maintenance Message	Oil Life Display	Explanation	Information
 <p><b>SERVICE DUE SOON</b> A2345</p>	<p>15 %</p>  <p>Maintenance info A2345 Oil Life 15% A: Engine oil 2: Air filters Reset MENU EXIT 12:34</p>	<p>The remaining engine oil life is 15 to 6 percent. Once you switch the display by pressing the  (display/information) button, this message will go off.</p>	<p>The engine oil is approaching the end of its service life, and the maintenance items should be inspected and serviced soon.</p>
 <p><b>SERVICE DUE NOW</b> A2345</p>	<p>5 %</p>  <p>Maintenance info A2345 Oil Life 5% A: Engine oil 2: Air filters Reset MENU EXIT 12:34</p>	<p>The remaining engine oil life is 5 to 1 percent. Press the  button to switch to another display.</p>	<p>The engine oil has almost reached the end of its service life, and the maintenance items should be inspected and serviced as soon as possible.</p>
 <p><b>SERVICE PAST DUE</b> A2345</p>	<p>Negative Distance</p>  <p>SERVICE PAST DUE -30 miles A2345 EXIT</p>	<p>The remaining engine oil life has passed its service life, and a negative distance appears after driving over 10 miles (U.S. models) or 10 km (Canadian models). Press the  button to switch to another display.</p>	<p>The engine oil life has passed. The maintenance items must be inspected and serviced immediately.</p>

The system message indicator (ⓘ) comes on along with the Maintenance Minder message.

## Maintenance Service Items

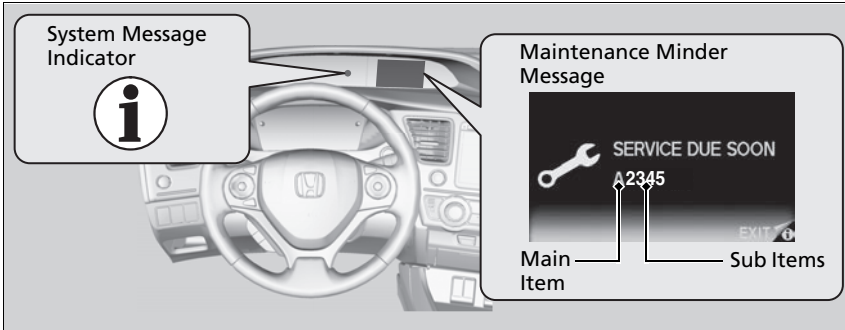

### ☒ Maintenance Service Items

- Independent of the Maintenance Minder information, replace the brake fluid every 3 years.
- Inspect idle speed every 160,000 miles (256,000 km).
- Adjust the valves during services A, B, 1, 2, or 3 if they are noisy.

CODE	Maintenance Main Items
A	<ul style="list-style-type: none"> <li>• Replace engine oil*<sup>1</sup></li> </ul>
B	<ul style="list-style-type: none"> <li>• Replace engine oil*<sup>1</sup> and oil filter</li> <li>• Inspect front and rear brakes/service as necessary</li> <li>• Check parking brake adjustment</li> <li>• Inspect tie rod ends, steering gearbox, and boots</li> <li>• Inspect suspension components</li> <li>• Inspect driveshaft boots</li> <li>• Inspect brake hoses and lines (Including ABS/VA)</li> <li>• Inspect all fluid levels and condition of fluids</li> <li>• Inspect exhaust system<sup>#</sup></li> <li>• Inspect fuel lines and connections<sup>#</sup></li> <li>• Check the expiration date for TRK bottle*<sup>2</sup></li> </ul>

CODE	Maintenance Sub Items
1	<ul style="list-style-type: none"> <li>• Rotate tires</li> </ul>
2	<ul style="list-style-type: none"> <li>• Replace air cleaner element*<sup>2</sup></li> <li>• Replace dust and pollen filter*<sup>3</sup></li> <li>• Inspect drive belt</li> </ul>
3	<ul style="list-style-type: none"> <li>• Replace transmission fluid*<sup>4</sup></li> </ul>
4	<ul style="list-style-type: none"> <li>• Replace spark plugs</li> <li>• Inspect valve clearance</li> </ul>
5	<ul style="list-style-type: none"> <li>• Replace engine coolant</li> </ul>

\*<sup>2</sup>: If you drive in dusty conditions, replace the air cleaner element every 15,000 miles (24,000 km).  
 \*<sup>3</sup>: If you drive primarily in urban areas that have high concentrations of soot in the air from industry and from diesel-powered vehicles, replace the dust and pollen filter every 15,000 miles (24,000 km).  
 \*<sup>4</sup>: **Continuously variable transmission models**  
 Driving in mountainous areas at very low vehicle speeds or trailer towing results in higher transmission temperatures. This requires transmission fluid changes more frequently than recommended by the Maintenance Minder. If you regularly drive your vehicle under these conditions, have the transmission fluid changed every 25,000 miles (40,000 km).

\*<sup>1</sup>: If a message **SERVICE** does not appear more than 12 months after the display is reset, change the engine oil every year.  
 \*<sup>2</sup>: Models with tire repair kit  
 #: See information on maintenance and emissions warranty.

Continued

## ■ Resetting the Display

Reset the engine oil life display if you have performed the maintenance service.

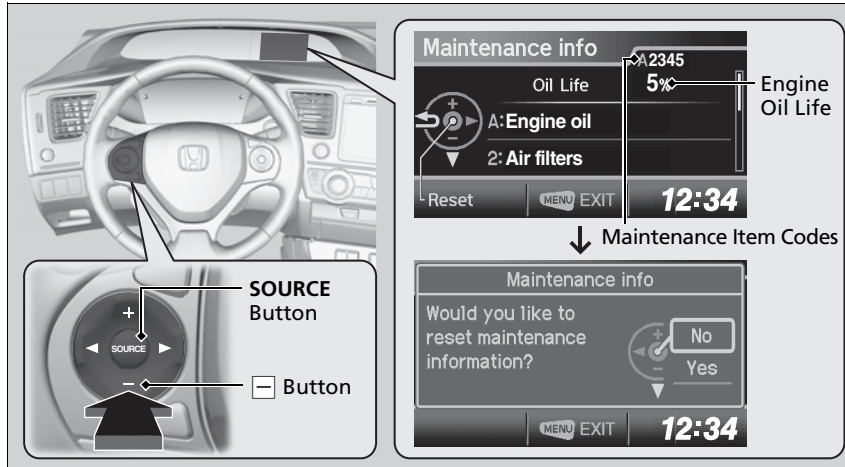

1. Turn the ignition switch to ON \*1.
2. Go to the **Maintenance info** screen.
  - ▶ **Displaying the Engine Oil Life and Maintenance Items** P. 357
3. Press the **SOURCE** button.
  - ▶ The oil life reset mode is displayed on the i-MID.
4. Select **Yes** with the button, then press the **SOURCE** button.
  - ▶ The displayed maintenance items disappear, and the engine oil life display returns to **100%**.
  - ▶ Any maintenance items that are necessary for your vehicle at the next maintenance service will appear.

To cancel the oil life reset mode, select **No**, then press the **SOURCE** button.

\*1: Models with the smart entry system have an **ENGINE START/STOP** button instead of an ignition switch.

## ▶▶ Resetting the Display

### NOTICE

Failure to reset the engine oil life after a maintenance service results in the system showing incorrect maintenance intervals, which can lead to serious mechanical problems.

The dealer will reset the engine oil life display after completing the required maintenance service. If someone other than a dealer performs maintenance service, reset the engine oil life display yourself.

## Maintenance Items Under the Hood

1.8 l engine models

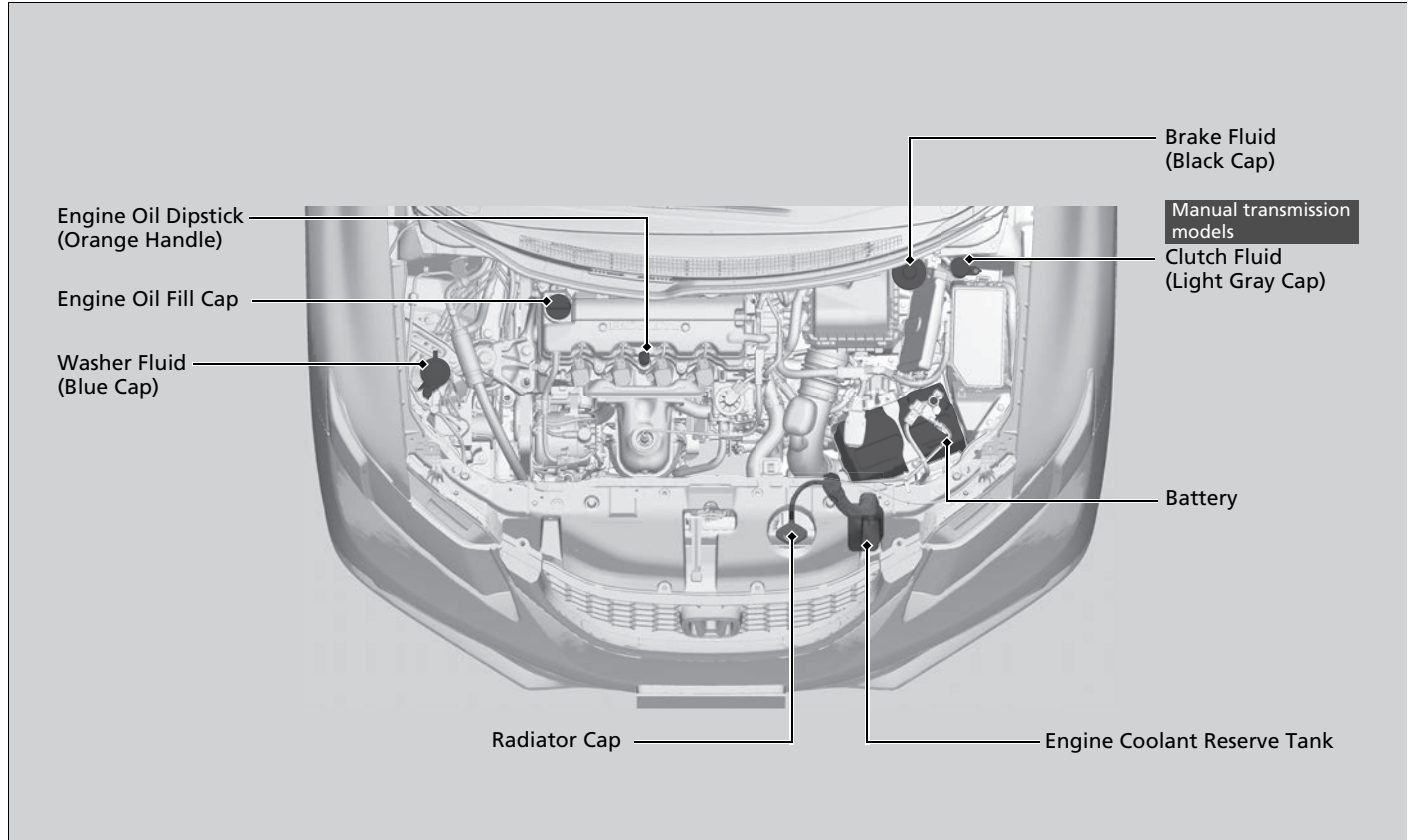

2.4 ℓ engine models

Engine Oil Fill Cap

Engine Oil Dipstick  
(Orange Handle)

Washer Fluid  
(Blue Cap)

Brake Fluid  
(Black Cap)

Clutch Fluid  
(Light Gray Cap)

Battery

Radiator Cap

Engine Coolant Reserve Tank

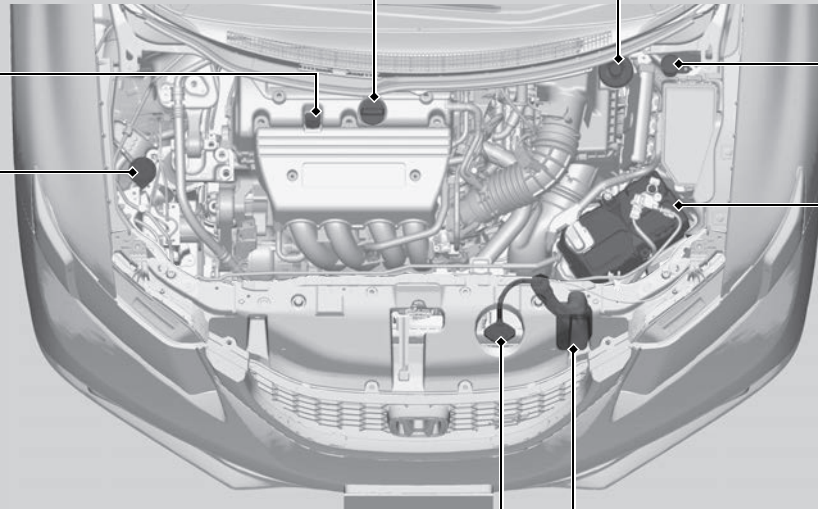

## Opening the Hood

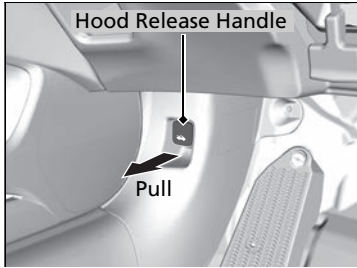

1. Park the vehicle on a level surface, and set the parking brake.
2. Pull the hood release handle under the lower left corner of the dashboard.
  - The hood will pop up slightly.



3. Push up the hood latch lever in the center of the hood to release the lock mechanism, and open the hood.

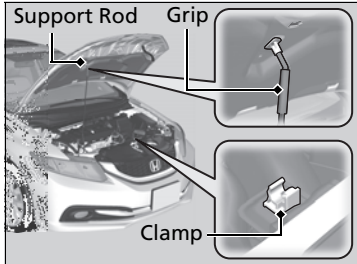

4. Remove the support rod from the clamp using the grip. Mount the support rod in the hood.

When closing, remove the support rod, and stow it in the clamp, then gently lower the hood. Remove your hand at a height of approximately 12 inches (30 cm) and let the hood close.

### Opening the Hood

#### NOTICE

Do not open the hood when the wiper arms are raised. The hood will strike the wipers, and may damage either the hood or the wipers.

When closing the hood, check that the hood is securely latched.

If the hood latch lever moves stiffly, or if you can open the hood without lifting the lever, the latch mechanism should be cleaned and lubricated.



## Recommended Engine Oil

- **Genuine Honda Motor Oil**
- **Premium-grade 0W-20 detergent oil with an API Certification Seal on the container.**



Oil is a major contributor to your engine's performance and longevity. If you drive the vehicle with insufficient or deteriorated oil, the engine may fail or be damaged.

This seal indicates the oil is energy conserving and that it meets the American Petroleum Institute's latest requirements.

Use Genuine Honda Motor Oil or another commercial engine oil of suitable viscosity for the ambient temperature as shown here.

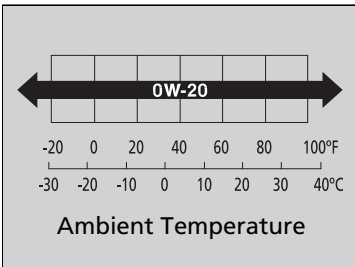

### ■ Synthetic oil

You may also use synthetic motor oil if it is labeled with the API Certification Seal and is the specified viscosity grade.

### ►► Recommended Engine Oil

#### Engine Oil Additives

Your vehicle does not require oil additives. In fact, they may adversely affect the engine performance and durability.

## Oil Check

We recommend that you check the engine oil level every time you refuel.

Park the vehicle on level ground.

Wait approximately three minutes after turning the engine off before you check the oil.

1.8 l engine models

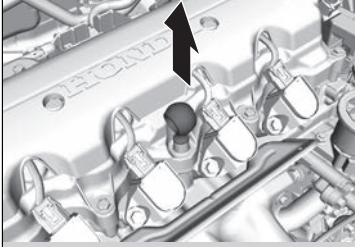

2.4 l engine models

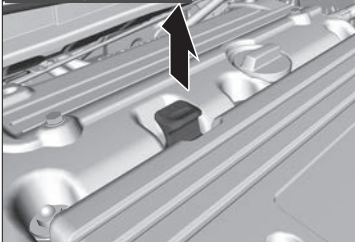

1. Remove the dipstick (orange handle).
2. Wipe the dipstick with a clean cloth or paper towel.
3. Insert the dipstick back all the way into its hole.

### Oil Check

If the oil level is near or below the lower mark, slowly add oil being careful not to overfill.

*Continued*

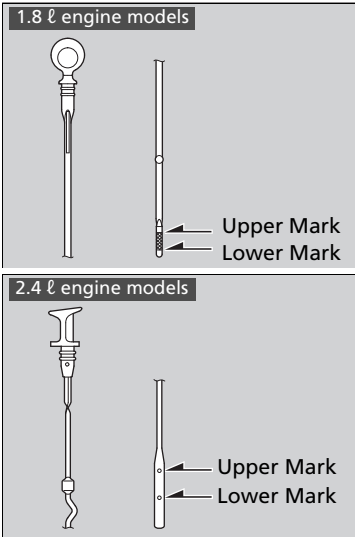

4. Remove the dipstick again, and check the level. It should be between the upper and lower marks. Add oil if necessary.

## Adding Engine Oil

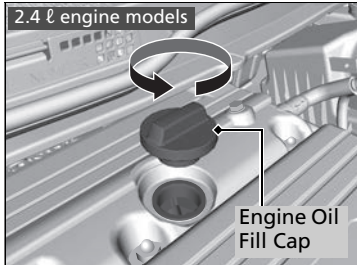
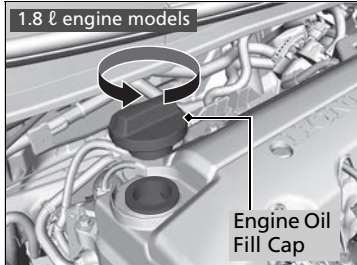

1. Unscrew and remove the engine oil fill cap.
2. Add oil slowly.
3. Reinstall the engine oil fill cap, and tighten it securely.
4. Wait for three minutes and recheck the engine oil dipstick.

### Adding Engine Oil

If any oil spills, wipe it away immediately. Spilled oil may damage the engine compartment components.

#### NOTICE

Do not fill the engine oil above the upper mark. Overfilling the engine oil can result in leaks and engine damage.

## Changing the Engine Oil and Oil Filter

You must change the engine oil and oil filter regularly in order to maintain the engine's lubrication. The engine may be damaged if they are not changed regularly.

Change the oil and filter in accordance with the maintenance message on the information display\*/i-MID\*.

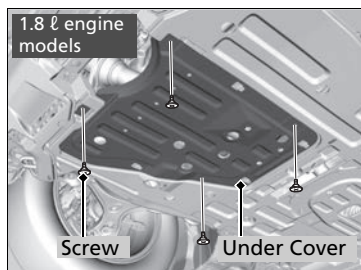

1. Run the engine until it reaches normal operating temperature, and then turn the engine off.
2. Open the hood and remove the engine oil fill cap.

### 1.8 L engine models

3. Remove the screws on the undercarriage and remove the under cover.

### ►► Changing the Engine Oil and Oil Filter

#### NOTICE

You may damage the environment if you do not dispose of the oil in a suitable way. If you are changing the oil by yourself, appropriately dispose of the used oil. Put the oil in a sealed container and take it to a recycling center. Do not throw the oil away into a garbage can or onto the ground.

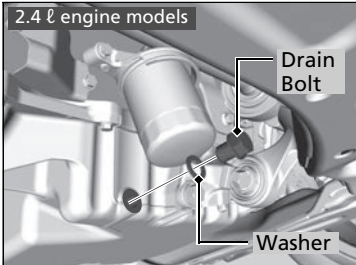
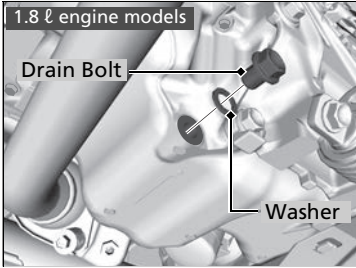

All models

4. Remove the drain bolt and washer from the bottom of the engine, and drain the oil into a suitable container.

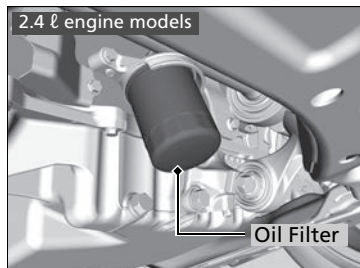
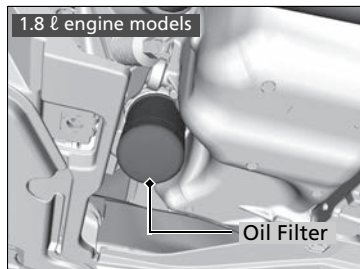

5. Remove the oil filter and dispose of the remaining oil.
6. Check that the filter gasket is not stuck to the engine contact surface.
  - If it is stuck, you must detach it.
7. Wipe away dirt and dust adhering to the contact surface of the engine block, and install a new oil filter.
  - Apply a light coat of new engine oil to the oil gasket.

8. Put a new washer on the drain bolt, then reinstall the drain bolt.
  - Tightening torque:

**1.8 l engine models**

29 lbf-ft (39 N·m, 4.0 kgf·m)

**2.4 l engine models**

30 lbf-ft (40 N·m, 4.0 kgf·m)

9. Pour the recommended engine oil into the engine.
  - Engine oil change capacity (including filter):

**1.8 l engine models**

3.9 US qt (3.7 L)

**2.4 l engine models**

4.4 US qt (4.2 L)

10. Reinstall the engine oil fill cap securely and start the engine.
11. Run the engine for a few minutes, and then check that there is no leak from the drain bolt or oil filter.
12. Stop the engine, wait for three minutes, and then check the oil level on the dipstick.
  - If necessary, add more engine oil.

► Changing the Engine Oil and Oil Filter

You will need a special wrench to replace the oil filter. You can buy this wrench from a dealer.

When installing the new oil filter, follow the instructions supplied with the oil filter.

Reinstall the engine oil fill cap. Start the engine. The low oil pressure indicator should go off within five seconds. If it does not, turn off the engine, and check your work.

## Engine Coolant

### Specified coolant: Honda Long Life Antifreeze/Coolant Type 2

This coolant is premixed with 50% antifreeze and 50% water. Do not add any straight antifreeze or water.

We recommend you check the engine coolant level every time you refuel. Check the reserve tank first. If it is completely empty, also check the coolant level in the radiator. Add the engine coolant accordingly.

### Reserve Tank

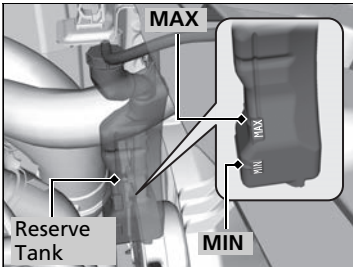

1. Check the amount of coolant in the reserve tank.

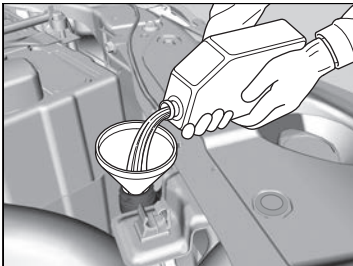

2. If the coolant level is below the **MIN** mark, add the specified coolant until it reaches the **MAX** mark.

3. Inspect the cooling system for leaks.

### Engine Coolant

#### NOTICE

If temperatures consistently below  $-22^{\circ}\text{F}$  ( $-30^{\circ}\text{C}$ ) are expected, the coolant mixture should be changed to a higher concentration. Consult a dealer for more information.

If Honda antifreeze/coolant is not available, you may use another major brand non-silicate coolant as a temporary replacement. Check that it is a high quality coolant recommended for aluminum engines. Continued use of any non-Honda coolant can result in corrosion, causing the cooling system to malfunction or fail. Have the cooling system flushed and refilled with Honda antifreeze/coolant as soon as possible.

Do not add rust inhibitors or other additives to your vehicle's cooling system. They may not be compatible with the coolant or with the engine components.

Continued



## Radiator

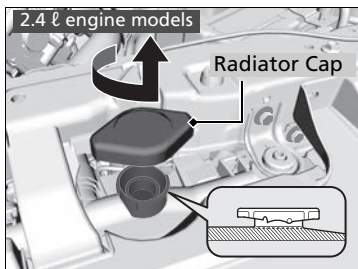
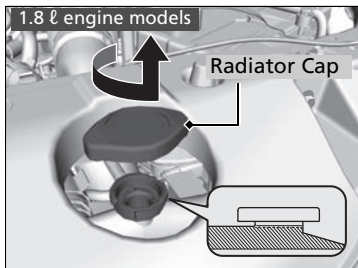

1. Make sure the engine and radiator are cool.
2. Turn the radiator cap counterclockwise to relieve any pressure in the cooling system. Do not push the cap down when turning.
3. Push down and turn the radiator cap counterclockwise to remove it.
4. The coolant level should be up to the base of the filler neck. Add coolant if it is low.
5. Put the radiator cap back on, and tighten it fully.
6. Pour coolant into the reserve tank until it reaches the **MAX** mark. Put the cap back on the reserve tank.

## Radiator

### **WARNING**

Removing the radiator cap while the engine is hot can cause the coolant to spray out, seriously scalding you.

Always let the engine and radiator cool down before removing the radiator cap.

### **NOTICE**

Pour the fluid slowly and carefully so you do not spill any. Clean up any spills immediately; they can damage components in the engine compartment.

## Transmission Fluid

Models with continuously variable transmission

### Continuously Variable Transmission Fluid

**Specified fluid: HCF-2**

Have a dealer check the fluid level and replace if necessary.

Models with manual transmission

### Manual Transmission Fluid

**Specified fluid: Honda Manual Transmission Fluid (MTF)**

Have a dealer check the fluid level and replace if necessary.

#### ⌘ Continuously Variable Transmission Fluid

##### NOTICE

**Do not mix HCF-2 with other transmission fluids.**

Using a transmission fluid other than HCF-2 may adversely affect the operation and durability of your vehicle's transmission, and damage the transmission. Any damage caused by using a transmission fluid that is not equivalent to HCF-2 is not covered by Honda's new vehicle warranty.

#### ⌘ Manual Transmission Fluid

If Honda MTF is not available, you may use the API certified SAE 0 W-20 or 5 W-20 viscosity motor oil as a temporary measure.

Replace with MTF as soon as possible. Motor oil does not contain the proper additives for the transmission and continued use can cause decreased shifting performance and lead to transmission damage.

## Brake/Clutch Fluid

**Specified fluid: Honda Heavy Duty Brake Fluid DOT 3**

Use the same fluid for both the brakes and clutch.

### ■ Checking the Brake Fluid

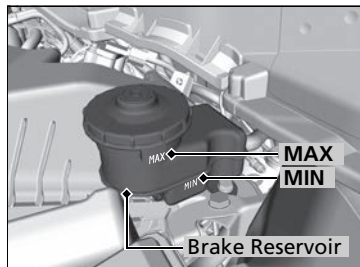

The fluid level should be between the **MIN** and **MAX** marks on the side of the reservoir.

Manual transmission models

### ■ Checking the Clutch Fluid

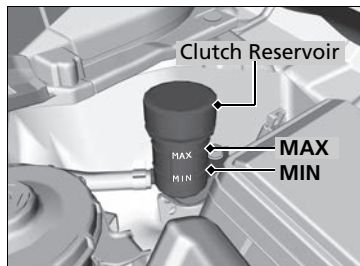

The fluid level should be between the **MIN** and **MAX** marks on the side of the reservoir.

### ►► Brake/Clutch Fluid

#### NOTICE

Brake fluid marked DOT 5 is not compatible with your vehicle's braking system and can cause extensive damage.

If the specified brake fluid is not available, you should use only DOT 3 or DOT 4 fluid from a sealed container as a temporary replacement.

Using any non-Honda brake fluid can cause corrosion and decrease the longevity of the system. Have the brake system flushed and refilled with Honda Heavy Duty Brake Fluid DOT 3 as soon as possible.

If the brake fluid level is at or below the **MIN** mark, have a dealer inspect the vehicle for leaks or worn brake pads as soon as possible.

### ►► Checking the Clutch Fluid

If the clutch fluid level is at or below the **MIN** mark, have a dealer inspect for leaks or an excessively worn clutch plate as soon as possible.

## Refilling Window Washer Fluid

Check the amount of window washer fluid by looking at the reservoir.

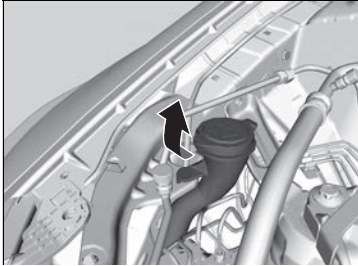

If the level is low, fill the washer reservoir.

**Canadian models with information display**

If the washer fluid is low, the washer level indicator comes on.

**Canadian models with i-MID**

If the washer fluid is low, a message appears on the i-MID.

►► Refilling Window Washer Fluid

**NOTICE**

Do not use engine antifreeze or a vinegar/water solution in the windshield washer reservoir. Antifreeze can damage your vehicle's paint. A vinegar/water solution can damage the windshield washer pump.

## Headlight Bulbs

When replacing, use the following bulbs.

**High beam headlight:** 60 W (HB3 for halogen bulb type)

**Low beam headlight:** 51 W (HB4 for halogen bulb type)

### High Beam Headlight

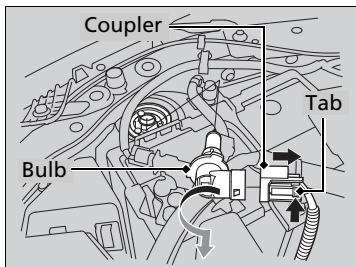

1. Push the tab to remove the coupler.
2. Rotate the old bulb to the left to remove.
3. Insert a new bulb into the headlight assembly and turn it to the right.
4. Insert the coupler into the connector of the bulb.

### Headlight Bulbs

#### NOTICE

Halogen bulbs get very hot when lit. Oil, perspiration, or a scratch on the glass can cause the bulb to overheat and shatter.

The headlight aim is set by the factory, and does not need to be adjusted. However, if you regularly carry heavy items in the trunk or tow a trailer, have the aiming readjusted at a dealer or by a qualified technician.

When replacing a halogen bulb, handle it by its base, and protect the glass from contact with your skin or hard objects. If you touch the glass, clean it with denatured alcohol and a clean cloth.

## Low Beam Headlights

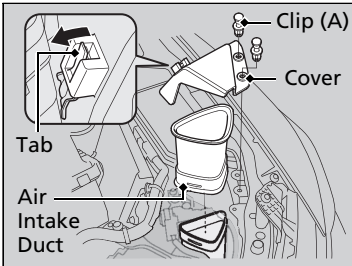

**Driver side**

**1.8 l engine models**

1. Remove the holding clips (A). Push up the tab, and remove the cover of the air intake duct and its upper part.

### ▶▶ Low Beam Headlights

**Holding clip (A-type)**

Pull the clip straight up to remove it.

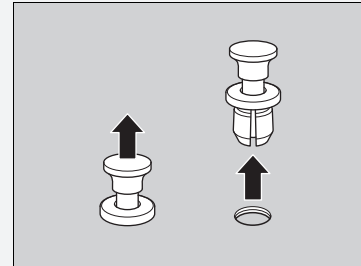

Keep the head of the clip raised when you insert it, push until it clicks.

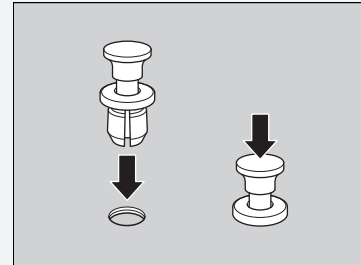

Continued

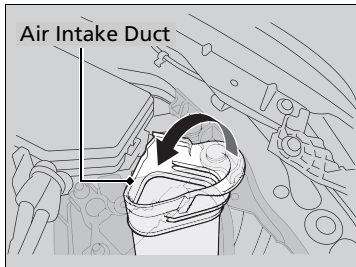
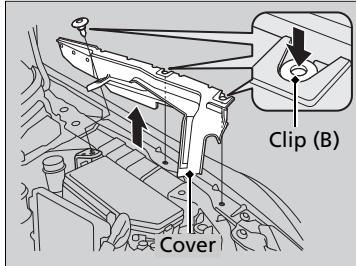

**Driver side**

**2.4 l engine models**

1. Unlock the holding clips (B), then remove the cover of the air intake duct.

Fold in the upper part of the air intake duct to get enough working space.

►► Low Beam Headlights

**Holding clip (B-type)**

Press down the center pin until it clicks to unlock it.

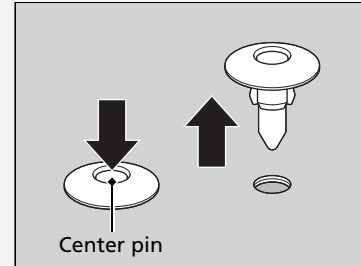

Push the center pin back to lock the clip. Then, insert the clip into the hole and press on the center pin until it is flat.

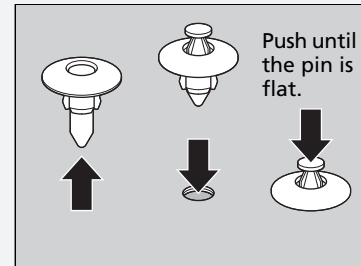

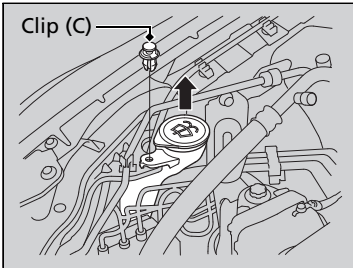

**Passenger side**

**All models**

- Remove the holding clip (C) using a flat-tip screwdriver, then remove the upper part of the windshield washer reservoir.

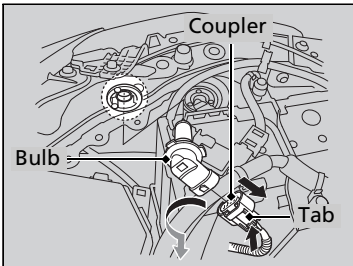

**Both sides**

**All models**

- Push the tab to remove the coupler.
- Rotate the old bulb to the left to remove.
- Insert a new bulb into the headlight assembly and turn it to the right.
- Insert the coupler into the connector of the bulb.

▶▶ Low Beam Headlights

**Holding clip (C-type)**

Insert a flat-tip screwdriver, lift and remove the center pin to remove the clip.

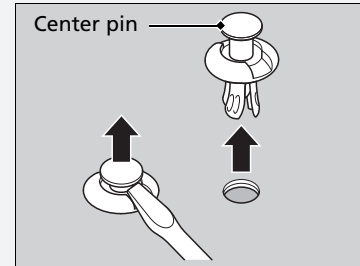

Insert the clip with the center pin raised, and push until it is flat.

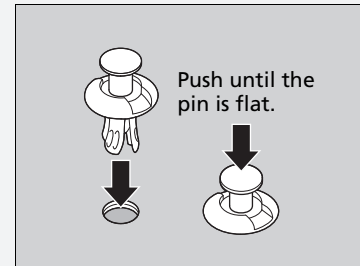



## Fog Light Bulbs\*

When replacing, use the following bulbs.

1.8 ℓ models

**Fog Light: 55 W (H11 for halogen bulb type)**

2.4 ℓ models

**Fog Light: 35 W (H8 for halogen bulb type)**

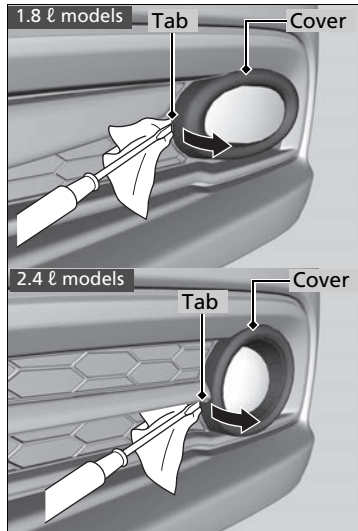

1. Insert a flat-tip screwdriver into the tab on the cover, then pull straight out as indicated to remove the cover.

### ►► Fog Light Bulbs\*

#### NOTICE

Halogen bulbs get very hot when lit. Oil, perspiration, or a scratch on the glass can cause the bulb to overheat and shatter.

When replacing a halogen bulb, handle it by its plastic case, and protect the glass from contact with your skin or hard objects. If you touch the glass, clean it with denatured alcohol and a clean cloth.

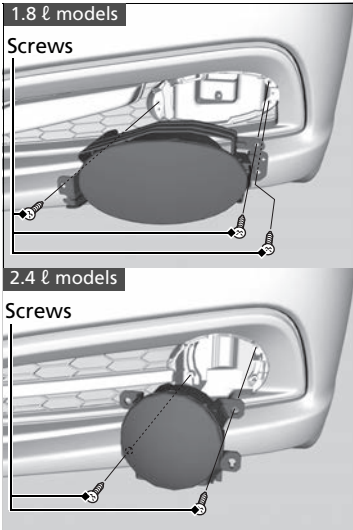

2. Remove the screws using a Phillips-head screwdriver and carefully pull the fog light assembly out of the bumper.

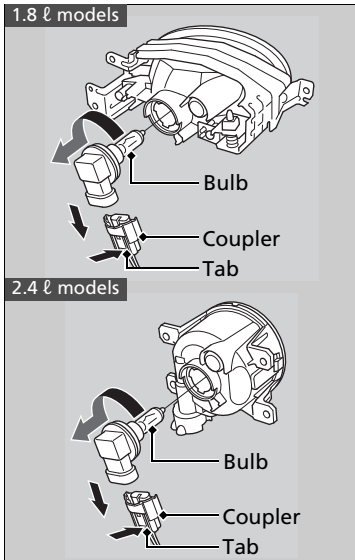

3. Push the tab to remove the coupler.
4. Rotate the old bulb to the left to remove.
5. Insert a new bulb into the fog light assembly and turn it to the right.
6. Insert the coupler into the connector of the bulb.

## Front Turn Signal/Parking/Side Marker Light Bulbs

When replacing, use the following bulbs.

**Front Turn Signal/Parking/Side Marker Light: 28/8 W (Amber)**

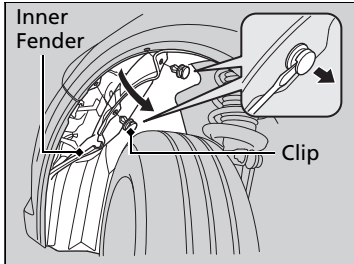

1. Turn the steering wheel all the way to the opposite side from the light being replaced.

**Passenger side:** Turn the steering wheel to the left.

**Driver side:** Turn the steering wheel to the right.

2. Remove the holding clips, and pull the inner fender back.

➤ **Low Beam Headlights** P. 379

**2.4 l engine models**

3. Detach the air intake duct tube and swing it out of the inner fender.

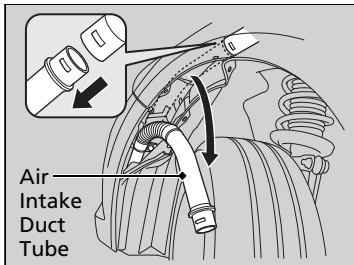

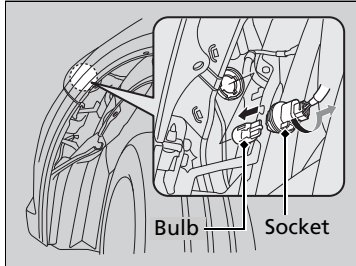

**All models**

4. Turn the socket to the left and remove it, then remove the old bulb.
5. Insert a new bulb.

## Brake/Taillight, Rear Turn Signal Light and Rear Side Marker Light Bulbs

When replacing, use the following bulbs.

**Brake/Taillight: 21/5 W**  
**Rear Turn Signal Light: 21 W (Amber)**  
**Rear Side Marker Light: LED**

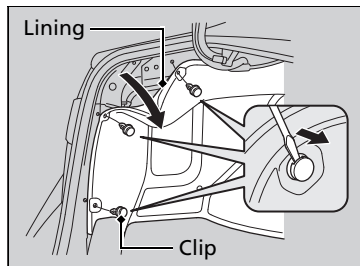

1. Remove the holding clips using a flat-tip screwdriver, then pull the lining back.

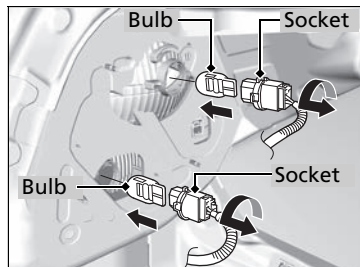

2. Turn the socket to the left and remove it.  
 3. Remove the old bulb and insert a new bulb.

### Brake/Taillight, Rear Turn Signal Light and Rear Side Marker Light Bulbs

Rear side marker light bulbs are LED type. Have an authorized Honda dealer inspect and replace the light assembly.

When removing the clip, insert a flat-tip screwdriver, then lift and remove the clip.

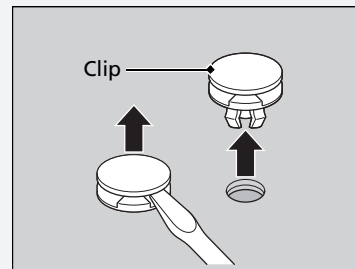

Insert the clip with the pin raised, and push until it is flat.

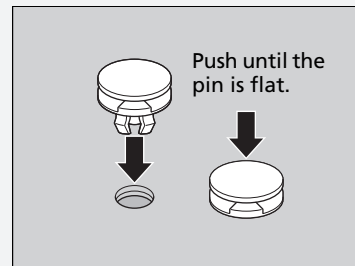

## Taillight and Back-Up Light Bulbs

When replacing, use the following bulbs.

**Back-Up Light: 16 W**  
**Taillight: 3 CP**

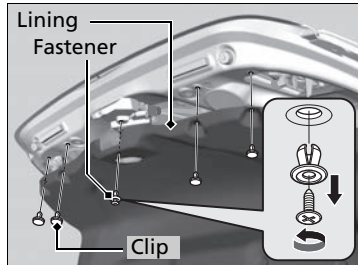

### Models with trunk lid lining

1. Remove the screw from the center of the fastener using a Phillips-head screwdriver.
2. Remove the holding clips using a flat-tip screwdriver, then pull the lining back.

### ➤ Brake/Taillight, Rear Turn Signal Light and Rear Side Marker Light Bulbs

P. 385

### All models

3. Turn the socket to the left and remove it.
4. Remove the old bulb and insert a new bulb.

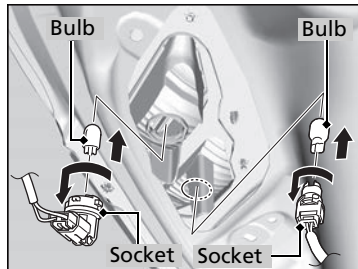

## Rear License Plate Light Bulbs

When replacing, use the following bulbs.

### Rear License Plate Light: 5 W

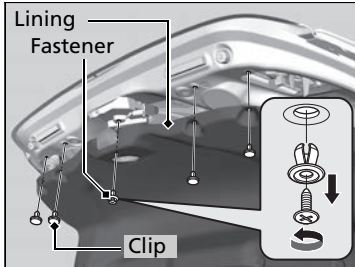

#### Models with trunk lid lining

1. Remove the screw from the center of the fastener using a Phillips-head screwdriver.
2. Remove the holding clips using a flat-tip screwdriver, then pull the lining back.

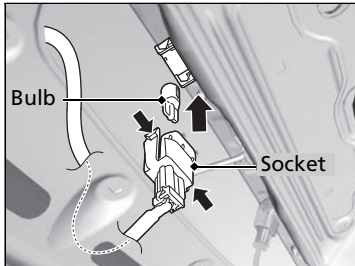

#### All models

3. Remove the license plate light assembly by squeezing the tabs on both sides of the socket.
4. Remove the old bulb and insert a new bulb.



## High-Mount Brake Light Bulb

### 1.8 l engine models

When replacing, use the following bulb.

### High-Mount Brake Light: 21 W

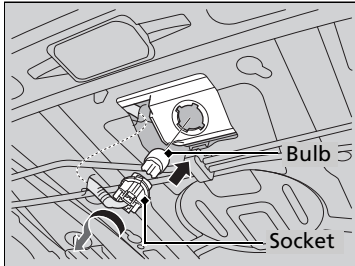

1. Open the trunk.
2. Turn the socket to the left and remove it.
3. Remove the old bulb and insert a new bulb.

### 2.4 l engine models

High-mount brake light bulbs are LED type. Have an authorized Honda dealer inspect and replace the light assembly.

## Checking Wiper Blades

If the wiper blade rubber has deteriorated, it will leave streaks and the hard surfaces of the blade may scratch the window glass.

## Changing the Wiper Blade Rubber

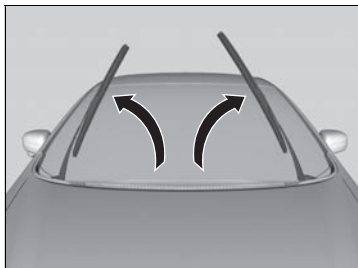

1. Lift the driver side wiper arm first, then the passenger side.

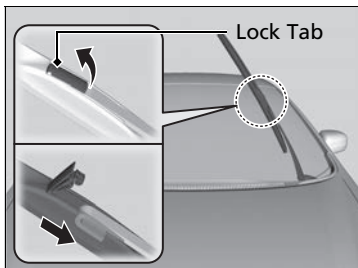

2. Place a cloth on the edge of the lock tab. Push the lock tab up with a flat-tip screwdriver.
3. Slide the blade from the wiper arm.

### Changing the Wiper Blade Rubber

#### NOTICE

Avoid dropping the wiper arm; it may damage the windshield.

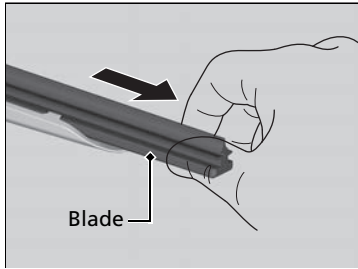

- Slide the wiper blade out from its holder by pulling the tabbed end out.

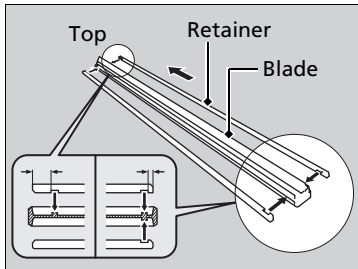

- Remove the retainers from the rubber blade that has been removed, and mount to a new rubber blade.
  - Correctly align the rubber protrusion and the retainer grooves.

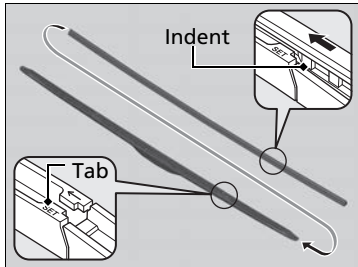

- Slide the new wiper blade onto the holder from the bottom end.
  - The tab on the holder should fit in the indent of the wiper blade.
- Slide the wiper blade onto the wiper arm, then push down the lock tab.
- Lower the passenger side wiper arm first, then the driver side.

## Checking Tires

To safely operate your vehicle, your tires must be of the proper type and size, in good condition with adequate tread, and properly inflated.

### ■ Inflation guidelines

Properly inflated tires provide the best combination of handling, tread life, and comfort. Refer to the driver's doorjamb label or specification's page for the specified pressure.

Underinflated tires wear unevenly, adversely affect handling and fuel economy, and are more likely to fail from overheating.

Overinflated tires make your vehicle ride harshly, are more prone to road hazards, and wear unevenly.

Every day before you drive, look at each of the tires. If one looks lower than the others, check the pressure with a tire gauge.

At least once a month or before long trips, use a gauge to measure the pressure in all tires, including the spare\*. Even tires in good condition can lose 1 to 2 psi (10 to 20 kPa, 0.1 to 0.2 kgf/cm<sup>2</sup>) per month.

### ■ Inspection guidelines

Every time you check inflation, also examine the tires and valve stems. Look for:

- Bumps or bulges on the side or in the tread. Replace the tire if you find any cuts, splits, or cracks in the side of the tire. Replace it if you see fabric or cord.
- Remove any foreign objects and inspect for air leaks.
- Uneven tread wear. Have a dealer check the wheel alignment.
- Excessive tread wear.

➤ **Wear Indicators** P. 396

- Cracks or other damage around valve stem.

\* Not available on all models

### ⓘ Checking Tires

## ⚠ WARNING

Using tires that are excessively worn or improperly inflated can cause a crash in which you can be seriously hurt or killed.

Follow all instructions in this owner's manual regarding tire inflation and maintenance.

Measure the air pressure when tires are cold. This means the vehicle has been parked for at least three hours, or driven less than 1 mile (1.6 km). If necessary, add or release air until the specified pressure is reached.

If checked when hot, tire pressure can be as much as 4–6 psi (30–40 kPa, 0.3–0.4 kgf/cm<sup>2</sup>) higher than if checked when cold.

#### U.S. models

Whenever tire pressure is adjusted, you must calibrate the TPMS.

➤ **TPMS Calibration** P. 333

Have a dealer check the tires if you feel a consistent vibration while driving. New tires and any that have been removed and reinstalled should be properly balanced.

## Tire and Loading Information Label

The label attached to the driver's doorjamb provides necessary tire and loading information.

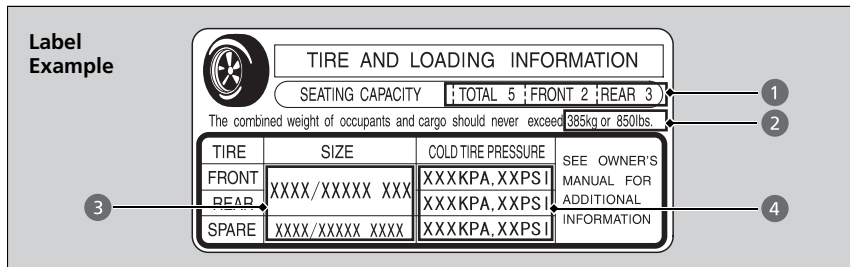

### ▶▶ Tire and Loading Information Label

The tire and loading information label attached to the driver's doorjamb contains:

- 1 The number of people your vehicle can carry.
- 2 The total weight your vehicle can carry. Do not exceed this weight.
- 3 The original tire sizes for front, rear, and spare, if equipped.
- 4 The proper cold tire pressure for front, rear, and spare.

## Tire Labeling

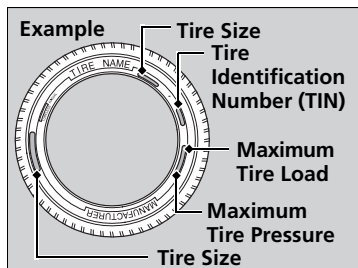

The tires that came on your vehicle have a number of markings. Those you should be aware of are described below.

### ▶▶ Tire Sizes

Following is an example of tire size with an explanation of what each component means.

#### **P205/55 R16 89H**

P: Vehicle type (P indicates passenger vehicle).

205: Tire width in millimeters.

55: Aspect ratio (the tire's section height as a percentage of its width).

R: Tire construction code (R indicates radial).

16: Rim diameter in inches.

89: Load index (a numerical code associated with the maximum load the tire can carry).

H: Speed symbol (an alphabetical code indicating the maximum speed rating).

### Tire Sizes

Whenever tires are replaced, they should be replaced with tires of the same size.

## ■ Tire Identification Number (TIN)

The tire identification number (TIN) is a group of numbers and letters that look like the example in the side column. TIN is located on the sidewall of the tire.

## ■ Glossary of Tire Terminology

**Cold Tire Pressure** – The tire air pressure when the vehicle has been parked for at least three hours or driven less than 1 mile (1.6 km).

**Load Rating** – Means the maximum load that a tire is rated to carry for a given inflation pressure.

**Maximum Inflation Pressure** – The maximum tire air pressure that the tire can hold.

**Maximum Load Rating** – Means the load rating for a tire at the maximum permissible inflation pressure for that tire.

**Recommended Inflation Pressure** – The cold tire inflation pressure recommended by the manufacturer.

**Treadwear Indicators (TWI)** – Means the projections within the principal grooves designed to give a visual indication of the degrees of wear of the tread.

### ☒ Tire Identification Number (TIN)

#### **DOT B97R FW6X 2209**

DOT: This indicates that the tire meets all requirements of the U.S. Department of Transportation.

B97R: Manufacturer's identification mark.

FW6X: Tire type code.

22 09: Date of manufacture.

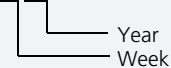

## DOT Tire Quality Grading (U.S. Vehicles)

The tires on your vehicle meet all U.S. Federal Safety Requirements. All tires are also graded for treadwear, traction, and temperature performance according to Department of Transportation (DOT) standards. The following explains these gradings.

### ■ Uniform Tire Quality Grading

Quality grades can be found where applicable on the tire sidewall between tread shoulder and maximum section width.

### ■ Treadwear

The treadwear grade is a comparative rating based on the wear rate of the tire when tested under controlled conditions on a specified government test course. For example, a tire graded 150 would wear one and one-half (1 1/2) times as well on the government course as a tire graded 100. The relative performance of tires depends upon the actual conditions of their use, however, and may depart significantly from the norm due to variations in driving habits, service practices and differences in road characteristics and climate.

### ▣ Uniform Tire Quality Grading

For example:

**Treadwear 200**  
**Traction AA**  
**Temperature A**

All passenger car tires must conform to Federal Safety Requirements in addition to these grades.

## ■ Traction

The traction grades, from highest to lowest, are AA, A, B, and C. Those grades represent the tire's ability to stop on wet pavement as measured under controlled conditions on specified government test surfaces of asphalt and concrete. A tire marked C may have poor traction performance.

## ■ Temperature

The temperature grades are A (the highest), B, and C, representing the tire's resistance to the generation of heat and its ability to dissipate heat when tested under controlled conditions on a specified indoor laboratory test wheel. Sustained high temperature can cause the material of the tire to degenerate and reduce tire life, and excessive temperature can lead to sudden tire failure. The grade C corresponds to a level of performance which all passenger car tires must meet under the Federal Motor Vehicle Safety Standard No. 109. Grades B and A represent higher levels of performance on the laboratory test wheel than the minimum required by law.

### ⌘ Traction

Warning: The traction grade assigned to this tire is based on straight-ahead braking traction tests, and does not include acceleration, cornering, hydroplaning, or peak traction characteristics.

### ⌘ Temperature

Warning: The temperature grade for this tire is established for a tire that is properly inflated and not overloaded. Excessive speed, underinflation, or excessive loading, either separately or in combination, can cause heat buildup and possible tire failure.



## Wear Indicators

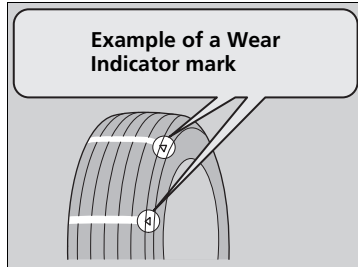

The groove where the wear indicator is located is 1/16 inch (1.6 mm) shallower than elsewhere on the tire. If the tread has worn so that the indicator is exposed, replace the tire.

**Worn out tires have poor traction on wet roads.**

## Tire Service Life

The life of your tires is dependent on many factors, including driving habits, road conditions, vehicle loading, inflation pressure, maintenance history, speed, and environmental conditions (even when the tires are not in use).

In addition to regular inspections and inflation pressure maintenance, it is recommended that you have annual inspections performed once the tires reach five years old. All tires, including the spare, should be removed from service after 10 years from the date of manufacture, regardless of their condition or state of wear.

### ►► Checking Tires

Models with P215/45R17 87V tires

Models with 225/40R18 92V tires

Models with 225/40R18 92Y tires

#### High speed driving

We recommend that you do not drive faster than the posted speed limits and conditions allow. If you drive at sustained high speeds (over 112 mph or 180 km/h), adjust the cold tire pressures as shown below to avoid excessive heat build up and sudden tire failure.

Tire Size	P215/45R17 87V
Pressure	35 psi (240 kPa, 2.4 kgf/cm <sup>2</sup> )
Tire Size	225/40R18 92V 225/40R18 92Y*1
Pressure	36 psi (250 kPa, 2.5 kgf/cm <sup>2</sup> )

\*1: Optional for U.S. Si models (summer tires)

## Tire and Wheel Replacement

Replace your tires with radials of the same size, load range, speed rating, and maximum cold tire pressure rating (as shown on the tire's sidewall). Using tires of a different size or construction can cause the ABS and VSA® (vehicle stability assist) system to work incorrectly.

It is best to replace all four tires at the same time. If that isn't possible, replace the front or rear tires in pairs.

Make sure that the wheel's specifications match those of the original wheels.

### ⓘ Tire and Wheel Replacement

#### **⚠ WARNING**

Installing improper tires on your vehicle can affect handling and stability. This can cause a crash in which you can be seriously hurt or killed.

Always use the size and type of tires recommended in this owner's manual.

## Tire Rotation

Rotating tires according to the maintenance messages on the information display\*/ i-MID\* helps to distribute wear more evenly and increase tire life.

### ■ Tires without rotation marks

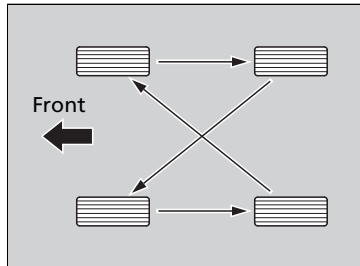

Rotate the tires as shown here.

### ■ Tires with rotation marks

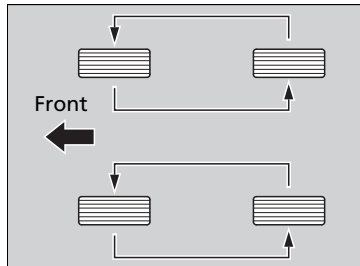

Rotate the tires as shown here.

### ▶▶ Tire Rotation

Tires with directional tread patterns should only be rotated front to back (not from one side to the other). Directional tires should be mounted with the rotation indication mark facing forward, as shown below.

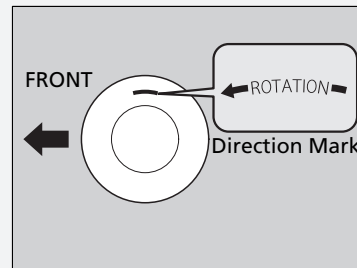

#### U.S. models

Whenever tires are rotated, you must calibrate the TPMS.

▶▶ **TPMS Calibration** P. 333

## Winter Tires

If driving on snowy or frozen roads, mount all season marked **M+S** tires, snow tires, or tire chains; reduce speed; and maintain sufficient distance between vehicles when driving.

Be particularly careful when operating the steering wheel or brakes to prevent skidding.

Use tire chains, snow tires, or all season tires when necessary or according to the law.

When mounting, refer to the following points.

For winter tires:

- Select the size and load ranges that are the same as the original tires.
- Mount the tires to all four wheels.

For tire chains:

- Install them on the front tires only.
- Because your vehicle has limited tire clearance, we strongly recommend using the chains listed below:

Models with P195/65R15 tires

**Cable-type: SCC Radial Chain SC1030**

Models with P205/55R16 tires

Models with P215/45R17 tires

**Cable-type: SCC Radial Chain SC1032**

- Follow the chain manufacturer's instruction when installing. Mount them as tightly as you can.
- Check that the chains do not touch the brake lines or suspension.
- Drive slowly.

Models with P225/40R18 tires

Models with 225/40R18 tires

Your vehicle's tires are not suitable for mounting any traction device.

### ⚠ Winter Tires

## ⚠ WARNING

Using the wrong chains, or not properly installing chains, can damage the brake lines and cause a crash in which you can be seriously injured or killed.

Follow all instructions in this owner's manual regarding the selection and use of tire chains.

### NOTICE

Traction devices that are the wrong size or improperly installed can damage your vehicle's brake lines, suspension, body, and wheels. Stop driving if they are hitting any part of the vehicle.

When tire chains are mounted, follow the chain manufacturer's instructions regarding vehicle operational limits.

If your vehicle is equipped with summer tires, be aware that these tires are not designed for winter driving conditions. For more information, contact a dealer.

## Checking the Battery

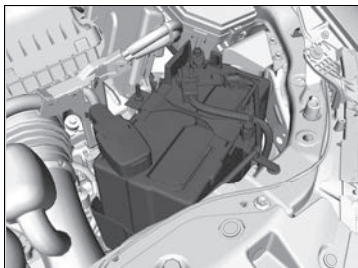

Check the battery terminals for corrosion monthly.

If your vehicle's battery is disconnected or goes dead:

- The audio system is disabled.
  - **Reactivating the audio system** P. 173
  - **Entering the audio security code** P. 173
- The clock\* resets.
  - **Adjusting the Clock** P. 104
- The navigation system\* is disabled.
  - **Refer to the Navigation System Manual**

## Charging the Battery

Disconnect both battery cables to prevent damaging your vehicle's electrical system. Always disconnect the negative (–) cable first, and reconnect it last.

### ⓘ Battery

#### **⚠ WARNING**

The battery gives off explosive hydrogen gas during normal operation.

A spark or flame can cause the battery to explode with enough force to kill or seriously hurt you.

When conducting any battery maintenance, wear protective clothing and a face shield, or have a skilled technician do it.

**WARNING:** Battery post, terminals, and related accessories contain lead and lead compounds.  
**Wash your hands after handling.**

When you find corrosion, clean the battery terminals by applying a baking powder and water solution. Clean the terminal with a damp towel. Cloth/towel dry the battery. Coat the terminals with grease to help prevent future corrosion.

When replacing the battery, the replacement must be of the same specifications.  
Please consult a dealer for more information.

## Replacing the Button Battery

If the indicator does not come on when the button is pressed, replace the battery.

### Master Keys with Remote Transmitter\*

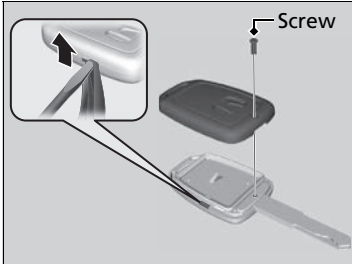

#### Battery type: CR1620

1. Unscrew the cover with a small Phillips-head screwdriver.
2. Open the remote transmitter.
  - ▶ Wrap the small flat-tip screwdriver with a cloth to prevent scratching the transmitter.
3. Remove the button battery with the small flat-tip screwdriver.
4. Make sure to replace the battery with the correct polarity.

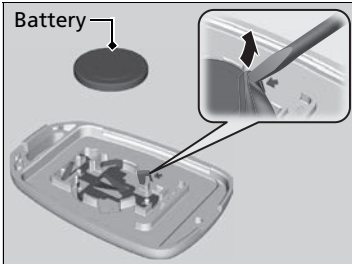

### Replacing the Button Battery

#### NOTICE

An improperly disposed of battery can damage the environment. Always confirm local regulations for battery disposal.

Replacement batteries are commercially available or at a dealer.

\* Not available on all models

## ■ Smart Entry Remote \*



**Battery type: CR2032**

1. Remove the built-in key.

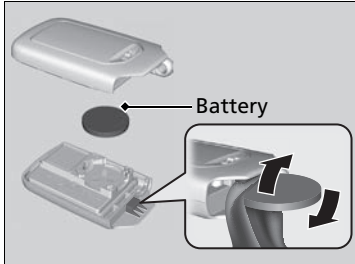

2. Remove the upper half of the cover by carefully prying on the edge with a coin.

▶ Remove carefully to avoid losing the buttons.

▶ Wrap a coin with a cloth to prevent scratching the smart entry remote.

3. Make sure to replace the battery with the correct polarity.

### Dust and Pollen Filter\*

The heating and cooling system\*/climate control system\* is equipped with a dust and pollen filter that collects pollen, dust, and other debris in the air. The Maintenance Minder™ messages will let you know when to replace the filter.

We recommend that you replace the dust and pollen filter sooner when using your vehicle in areas with high concentrations of dust.

#### ☒ Dust and Pollen Filter\*

If the airflow from the heating and cooling system\*/climate control system\* deteriorates noticeably, and the windows fog up easily, the filter may need to be replaced. Please contact a dealer for replacement.

\* Not available on all models



## Interior Care

Use a damp cloth with a mixture of mild detergent and warm water to remove dirt. Use a clean cloth to remove detergent residue.

### Cleaning Seat Belts

Use a soft brush with a mixture of mild soap and warm water to clean the seat belts. Let the belts air dry. Wipe the openings of the seat belt anchors using a clean cloth.

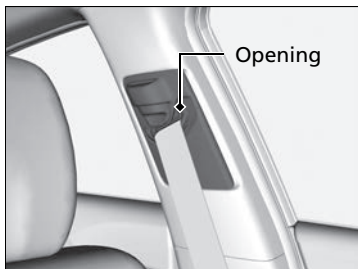

### Interior Care

Do not spill liquids inside the vehicle. Electrical devices and systems may malfunction if liquids are splashed on them.

Do not use silicone based sprays on electrical devices such as audio devices and switches. Doing so may cause the items to malfunction or a fire inside the vehicle.

If a silicone based spray is inadvertently used on electrical devices, consult a dealer.

Depending on their composition, chemicals and liquid aromatics may cause discoloration, wrinkles, and cracking to resin-based parts and textiles. Do not use alkali solvents or organic solvents such as benzene or gasoline.

After using chemicals, make sure to gently wipe them away using a dry cloth. Do not place used cloths on top of resin based parts or textiles for long periods of time without washing.

## ■ Floor Mats\*

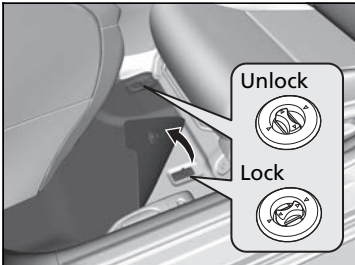

The driver's floor mat hooks over the floor anchors, which keep the mat from sliding forward. To remove a mat for cleaning, turn the anchor knobs to the unlock position. When reinstalling the mat after cleaning, turn the knobs to the lock position.

**Do not put additional floor mats on top of the anchored mat.**

## ■ Maintaining Genuine Leather\*

Vacuum dirt and dust from the leather frequently. Pay close attention to the pleats and seams. Clean the leather with a soft cloth dampened with a 90% water and 10% neutral soap solution. Then buff it with a clean, dry cloth. Remove any dust or dirt on leather surfaces immediately.

## ⊠ Floor Mats\*

If you use any floor mats that were not originally provided with your vehicle, make sure they are designed for your specific vehicle, fit correctly, and are securely anchored by the floor anchors. Position the rear seat floor mats properly. If they are not properly positioned, the floor mats can interfere with the front seat functions.

\* Not available on all models

## Exterior Care

Dust off the vehicle body after you drive.

Regularly inspect your vehicle for scratches on painted surfaces. A scratch on a painted surface can result in body rust. If you find a scratch, promptly repair it.

### ■ Washing the Vehicle

Wash the vehicle regularly. Wash more frequently when driving in the following conditions:

- If driving on roads with road salt.
- If driving in coastal areas.
- If tar, soot, bird droppings, insects, or tree sap are stuck to painted surfaces.

### ■ Using an Automated Car Wash

Fold in the door mirrors. Make sure to follow the instructions indicated on the automated car wash.

### ■ Using High Pressure Cleaners

- Keep sufficient distance between the cleaning nozzle and the vehicle body.
- Take particular care around the windows. Standing too close may cause water to enter the vehicle interior.
- Do not spray high pressure water directly into the engine compartment. Instead, use low pressure water and a mild detergent.

### ► Washing the Vehicle

Do not spray water into the air intake vents. It can cause a malfunction.

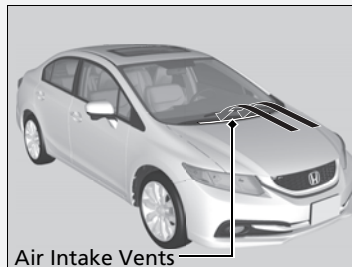

## ■ Applying Wax

A good coat of automotive body wax helps protect your vehicle's paint from the elements. Wax will wear off over time and expose your vehicle's paint to the elements, so reapply as necessary.

## ■ Maintaining the Bumpers and Other Resin Coated Parts

If you get gasoline, oil, engine coolant, or battery fluid on resin coated parts, they may be stained or the coating may peel. Promptly wipe it away using a soft cloth and clean water.

## ■ Cleaning the Window

Wipe using a glass cleaner.

## ■ Maintaining Aluminum Wheels\*

Aluminum is susceptible to deterioration caused by salt and other road contaminants. Use a sponge and mild detergent to wipe away promptly. Be careful not to use harsh chemicals (including some commercial wheel cleaners) or a stiff brush. They can damage the clear coat of the aluminum alloy wheels that helps keep the aluminum from corroding and tarnishing.

### ▶▶ Applying Wax

#### NOTICE

Chemical solvents and strong cleaners can damage the paint, metal, and plastic on your vehicle. Wipe away spills immediately.

### ▶▶ Maintaining the Bumpers and Other Resin Coated Parts

Ask a dealer about the correct coating material when you want to repair the painted surface of the parts made of resin.

### ▶▶ Cleaning the Window

Wires are mounted to the inside of the rear window. Wipe along the same direction as the wires with a soft cloth so as not to damage them.

\* Not available on all models

## ■ Fogged Exterior Light Lenses

The inside lenses of exterior lights (headlights, brake lights, etc.) may fog temporarily if you have driven in the rain, or after the vehicle has been run through a car wash. Dew condensation also may build up inside the lenses when there is a significant enough difference between the ambient and inside lens temperatures (similar to vehicle windows fogging up in rainy conditions). These conditions are natural processes, not structural design problems in the exterior lights.

Lens design characteristics may result in moisture developing on the light lens frame surfaces. This also is not a malfunction.

However, if you see large amounts of water accumulation, or large water drops building up inside the lenses, have your vehicle inspected by a dealer.

# Handling the Unexpected

This chapter explains how to handle unexpected troubles.



## **Tools**

Types of Tools..... 410

## **If a Tire Goes Flat**

Changing a Flat Tire..... 411

Temporarily Repairing a Flat Tire..... 418

## **Engine Does Not Start**

Checking the Engine..... 426

If the Smart Entry Remote Battery is

Weak..... 427

Emergency Engine Stop..... 428

**Jump Starting**..... 429

**Shift Lever Does Not Move**..... 432

## **Overheating**

How to Handle Overheating..... 433

## **Indicator, Coming On/Blinking**

If the Low Oil Pressure Indicator Comes

On..... 435

If the Charging System Indicator Comes

On..... 435

If the Malfunction Indicator Lamp Comes

On or Blinks..... 436

If the Brake System Indicator (Red) Comes

On..... 437

If the Electric Power Steering (EPS) System

Indicator Comes On..... 437

If the Low Tire Pressure/TPMS Indicator

Comes On or Blinks..... 438

## **Fuses**

Fuse Locations..... 439

Inspecting and Changing Fuses..... 442

**Emergency Towing**..... 443

Models with compact spare tire

## Types of Tools

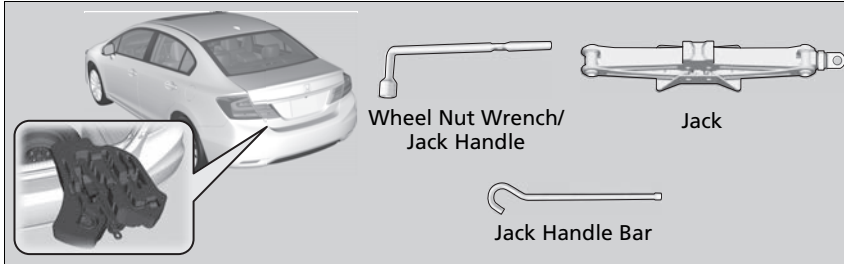

### Types of Tools

The tools are stored in the trunk.

# If a Tire Goes Flat

## Models with compact spare tire

### Changing a Flat Tire

If a tire goes flat while driving, grasp the steering wheel firmly, and brake gradually to reduce speed. Then, stop in a safe place. Replace the flat tire with a compact spare tire. Go to a dealer as soon as possible to have the full-size tire repaired or replaced.

1. Park the vehicle on firm, level, and non-slippery surface, and apply the parking brake.

## Continuously variable transmission models

2. Put the shift lever in **P**.

## Manual transmission models

2. Put the shift lever in **R**.

## All models

3. Turn on the hazard warning lights and turn the ignition switch to LOCK **0**\*1.

\*1: Models with the smart entry system have an **ENGINE START/STOP** button instead of an ignition switch.

## Changing a Flat Tire

Periodically check the tire pressure of the compact spare. It should be set to the specified pressure.  
Specified Pressure: 60 psi (420 kPa, 4.2 kgf/cm<sup>2</sup>)

When driving with the compact spare tire, keep the vehicle speed under 50 mph (80 km/h). Replace with a full-size tire as soon as possible.

The compact spare tire and wheel in your vehicle are specifically for this model. Do not use them with another vehicle. Do not use another type of compact spare tire or wheel with your vehicle.

Do not mount tire chains on a compact spare tire. If a chain-mounted front tire goes flat, remove one of the full-size rear tires and replace it with the compact spare tire. Remove the flat front tire and replace it with the full-size tire that was removed from the rear. Mount the tire chains on the front tire.



## ■ Getting Ready to Replace the Flat Tire

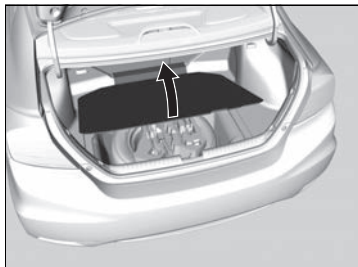

1. Open the trunk floor lid.

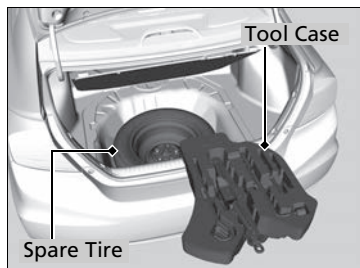

2. Take the tool case out of the trunk. Take the jack and wheel nut wrench out of the tool case.
3. Unscrew the wing bolt, and remove the spacer cone. Then, remove the spare tire.

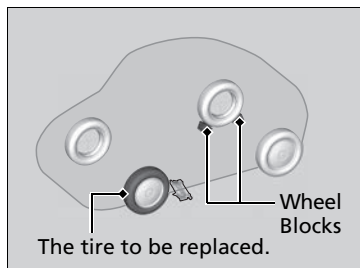

4. Place a wheel block or rock in front and rear of the wheel diagonal to the flat tire.

## ▶▶ Getting Ready to Replace the Flat Tire

### NOTICE

#### 2.4 ℓ engine models

Do not mount the compact spare on the front. If mounted on the front, the compact spare, smaller in size than the normal tire, may damage the differential.

If either front tire goes flat, remove the rear tire on the same side, and mount the compact spare on the rear and the rear tire on the front.

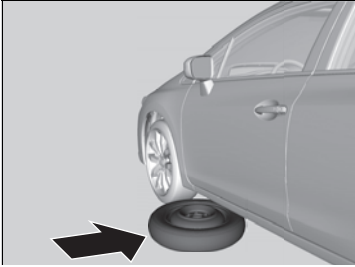

5. Place the compact spare tire (wheel side up) under the vehicle body, near the tire that needs to be replaced.

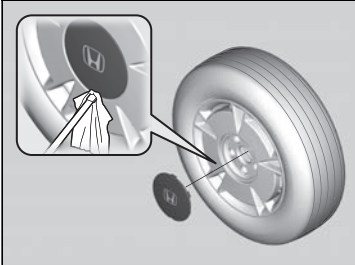

**Models with 15 x 6J aluminum wheels**

6. Remove the center cap from the wheel with the jack handle bar.



**All models**

7. Loosen each wheel nut about one turn using the wheel nut wrench.

## ■ How to Set Up the Jack

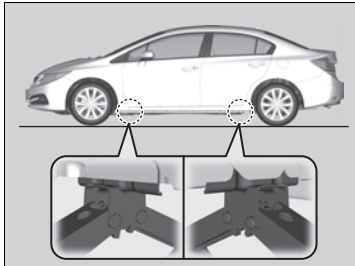

1. Place the jack under the jacking point closest to the tire to be changed.



2. Turn the end bracket clockwise as shown in the image until the top of the jack contacts the jacking point.  
▶ Make sure that the jacking point tab is resting in the jack notch.

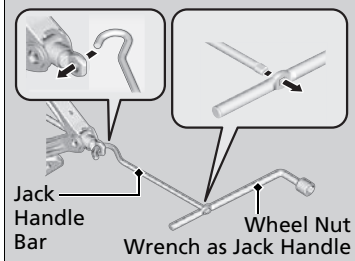

3. Raise the vehicle, using the jack handle bar and the jack handle, until the tire is off the ground.

## ▶▶ How to Set Up the Jack

### **⚠ WARNING**

The vehicle can easily roll off the jack, seriously injuring anyone underneath.

Follow the directions for changing a tire exactly, and never get under the vehicle when it is supported only by the jack.

Do not use the jack with people or luggage in the vehicle.

Use the jack provided in your vehicle. Other jacks may not support the weight ("load") or may not fit the jacking point.

The following instructions must be followed to use the jack safely:

- Do not use while the engine is running.
- Use only where the ground is firm and level.
- Use only at the jacking points.
- Do not get in the vehicle while using the jack.
- Do not put anything on top of or underneath the jack.

## Replacing the Flat Tire

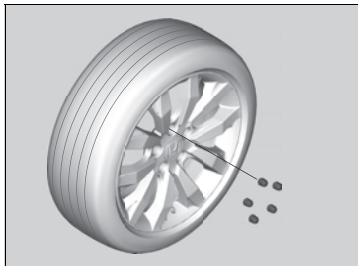

### Models with aluminum wheels

1. Remove the wheel nuts and flat tire.

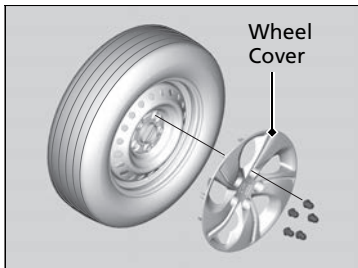

### Models with wheel cover

1. Remove the wheel nuts, wheel cover, and flat tire.

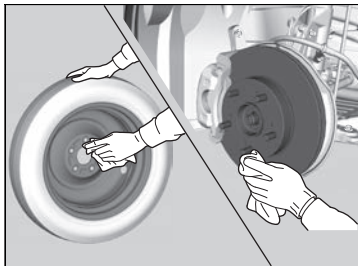

### All models

2. Wipe the mounting surfaces of the wheel with a clean cloth.
3. Mount the compact spare tire.
4. Screw the wheel nuts until they touch the lips around the mounting holes, then stop rotating.

## Replacing the Flat Tire

Do not over tighten the wheel nuts by applying extra torque using your foot or a pipe.

### Models with wheel cover

Do not attempt to forcibly pry the wheel cover off with a screwdriver or other tool. The wheel cover cannot be removed without first removing the wheel nuts.

Continued

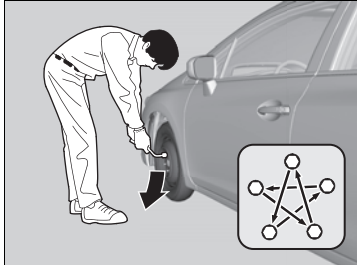

5. Lower the vehicle and remove the jack. Tighten the wheel nuts in the order indicated in the image. Go around, tightening the nuts, two to three times in this order.

**Wheel nut torque:**

80 lbf·ft (108 N·m, 11 kgf·m)

### Storing the Flat Tire

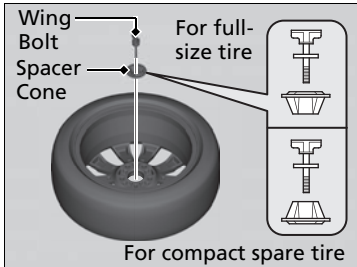

**Models with aluminum wheels**

1. Remove the center cap.
- All models**
2. Place the flat tire face down in the spare tire well.
  3. Remove the spacer cone from the wing bolt, flip it over, and insert it back on the bolt. Secure the flat tire with the wing bolt.
  4. Securely put the jack and wheel nut wrench back in the tool case. Store the case in the trunk.

▶▶ Storing the Flat Tire

## ⚠ WARNING

Loose items can fly around the interior in a crash and can seriously injure the occupants.

Store the wheel, jack, and tools securely before driving.

U.S. models

## TPMS and the Spare Tire

If you replace a flat tire with the spare tire, the low tire pressure/TPMS indicator comes on while you are driving. After driving for a few miles (kilometers), the indicator will start blinking for a short time and then stay on. **CHECK TPMS SYSTEM** appears on the i-MID, but this is normal.

Calibrate the TPMS when you replace the tire with a specified regular tire.

➤ **TPMS Calibration** P. 333

Models with tire repair kit

## Temporarily Repairing a Flat Tire

This vehicle is not equipped with a spare tire. If the tire has a large cut or is otherwise severely damaged, you will need to have the vehicle towed. If the tire only has a small puncture, from a nail for instance, you can use the temporary tire repair kit so that you can drive to the nearest service station for a more permanent repair.

If a tire goes flat while driving, grasp the steering wheel firmly, and brake gradually to reduce speed. Then stop in a safe place.

1. Park the vehicle on firm, level, and non-slippery surface and apply the parking brake.
2. Put the shift lever in **P**.
3. Turn on the hazard warning lights and turn the ignition switch to LOCK **0**\*1.
  - ▶ When towing a trailer, unhitch the trailer.

### Getting Ready to Temporarily Repair the Flat Tire

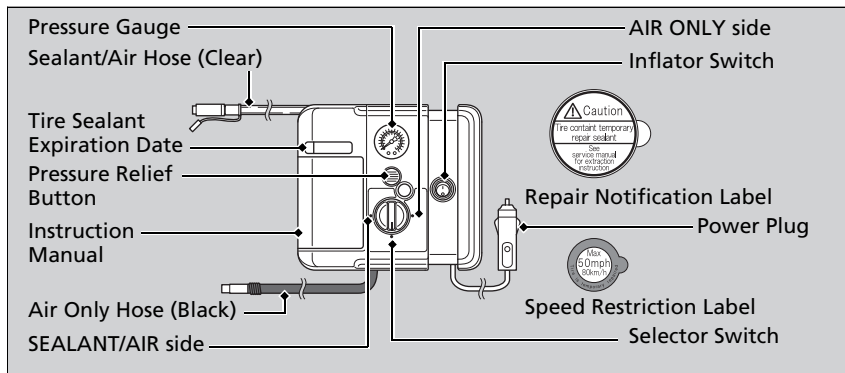

\*1: Models with the smart entry system have an **ENGINE START/STOP** button instead of an ignition switch.

### Temporarily Repairing a Flat Tire

The kit should not be used in the following situations. Instead, contact a dealer or a roadside assistant to have the vehicle towed.

- The tire sealant has expired.
- More than one tire is punctured.
- The puncture or cut is larger than 3/16 inch (4 mm).
- The tire side wall is damaged or the puncture is outside the tire contact area.

<p>Contact Area</p>	When the puncture is:	Kit Use
	Smaller than 3/16 inch (4 mm)	Yes
	Larger than 3/16 inch (4 mm)	No

- Damage has been caused by driving with the tire extremely under inflated.
- The tire bead is no longer seated.
- The rim is damaged.

Do not remove a nail or screw that punctured the tire. If you remove it from the tire, you may not be able to repair the puncture using the kit.

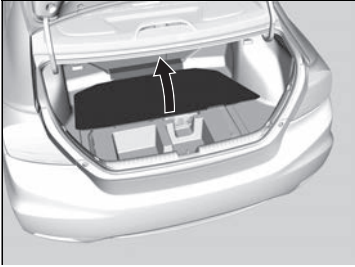

1. Open the trunk floor lid.

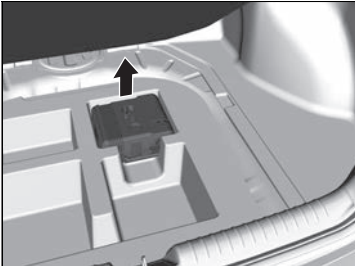

2. Take the kit out of the case.  
► Place the kit face up, on flat ground near the flat tire, and away from traffic. Do not place the kit on its side.

⊗ Getting Ready to Temporarily Repair the Flat Tire

When making a temporary repair, carefully read the instruction manual provided with the kit.

In cold temperatures, the sealant may not flow easily. In this situation, warm it up for five minutes before using.

*Continued*



## ■ Injecting Sealant and Air

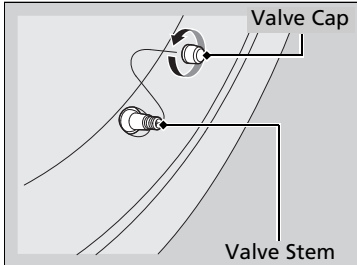

1. Remove the valve cap from the tire valve stem.

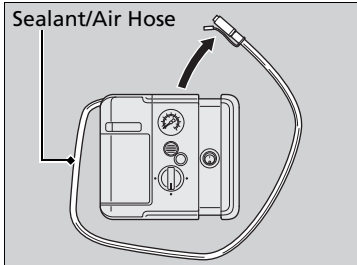

2. Remove the sealant/air hose from the packaging.

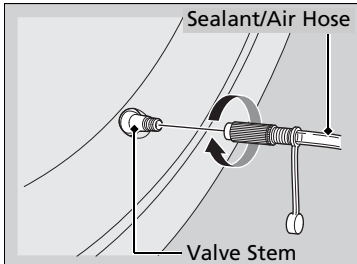

3. Attach the sealant/air hose onto the tire valve stem. Screw it until it is tight.

## ▶▶ Injecting Sealant and Air

### **⚠ WARNING**

Tire sealant contains substances that are harmful and can be fatal if swallowed.

If accidentally swallowed, do not induce vomiting. Drink plenty of water and get medical attention immediately.

For skin or eye contact, flush with cool water and get medical attention if necessary.

In cold temperatures, the sealant may not flow easily. In this situation, warm it up for five minutes before using.

The sealant can permanently stain clothing and other materials. Be careful during handling and wipe away any spills immediately.

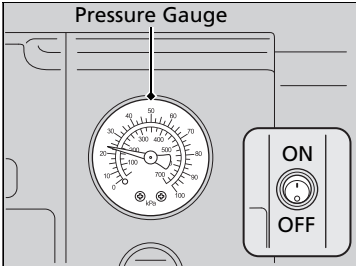
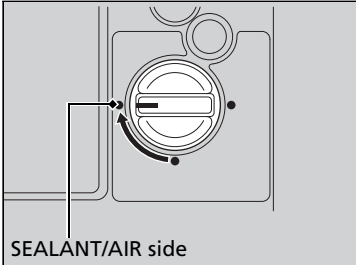
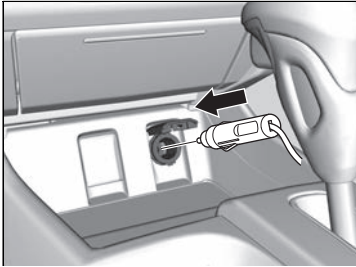

4. Plug in the compressor to the accessory power socket.
  - ▶ Be careful not to pinch the cord in a door or window.
5. Start the engine.
  - ▶ Keep the engine running while injecting sealant and air.
  - **Carbon Monoxide Gas** P. 64
6. Turn the selector switch to **SEALANT/AIR**.
7. Press the inflator switch to turn on the compressor.
  - ▶ The compressor starts injecting sealant and air into the tire.
8. When the sealant injection is complete, continue to add air.
9. After the air pressure reaches 32 psi (220 kPa), turn off the kit.
  - ▶ To check the pressure, occasionally turn off the compressor and read the gauge.

▶▶ Injecting Sealant and Air

**⚠ WARNING**

Running the engine with the vehicle in an enclosed or even partly enclosed area can cause a rapid build-up of toxic carbon monoxide.

Breathing this colorless, odorless gas can cause unconsciousness and even death. Only run the engine to power the air compressor with the vehicle outdoors.

**NOTICE**

Do not operate the tire repair kit compressor for more than 15 minutes. The accessory power socket and compressor can overheat and become permanently damaged.

Until the sealant injection is complete, the pressure shown on the pressure gauge will appear higher than actual. After the sealant injection is complete the pressure will drop and then begin to rise again as the tire is inflated with air. This is normal. To accurately measure the air pressure using the gauge, turn the air compressor off only after the sealant injection is complete.

If the required air pressure is not reached within 10 minutes, the tire may be too severely damaged for the kit to provide the necessary seal and your vehicle will need to be towed.

Continued

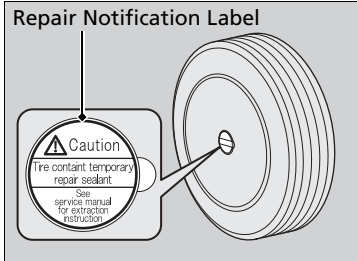
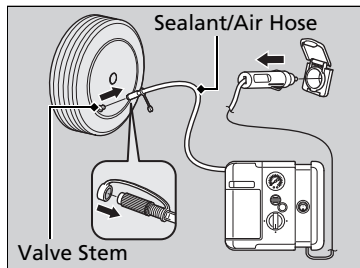

10. Unplug the power plug from the accessory power socket.
11. Unscrew the sealant/air hose from the tire valve stem. Reinstall the valve cap.
12. Press the pressure relief button until the gauge returns 0 psi (0 kPa).
13. Apply the repair notification label to the flat surface of the wheel.
  - ▶ The wheel surface must be clean to ensure the label adheres properly.

#### ▶▶ Injecting Sealant and Air

See a Honda dealer for a replacement sealant bottle and proper disposal of an empty bottle.

#### ▶▶ Distributing the Sealant in the Tire

Stop and recheck the air pressure after every 10 minutes of driving as necessary until you reach the nearest service station where you should have the tire permanently repaired or replaced.

#### ■ Distributing the Sealant in the Tire

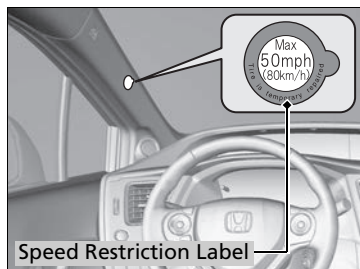

1. Apply the speed restriction label to the location as shown.
2. Drive the vehicle for about 10 minutes.
  - ▶ Do not exceed 50 mph (80 km/h).
3. Stop the vehicle in a safe place.

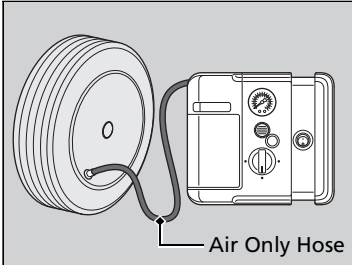

4. Attach the air only hose onto the tire valve stem. Screw it until it is tight.
5. Turn the selector switch to **AIR ONLY**.
  - ▶ Do not turn the air compressor on to check the pressure.
  - ▶ **Inflating an Under-inflated Tire** P. 424

6. If the air pressure is:
  - Less than 19 psi (130 kPa):  
Do not add air or continue driving. The leak is too severe. Call for help and have your vehicle towed.  
▶ **Emergency Towing** P. 443
  - 32 psi (220 kPa) or more:  
Continue driving for another 10 minutes or until you reach the nearest service station. Do not exceed 50 mph (80 km/h).  
▶ If the air does not go down after the 10 minute driving, you do not need to check the pressure any more.
  - Greater than 19 psi (130 kPa), but less than 32 psi (220 kPa):  
Turn the air compressor on to inflate the tire until the tire pressure reaches 32 psi (220 kPa).  
Then drive carefully for 10 more minutes or until you reach the nearest service station. Do not exceed 50 mph (80 km/h).  
▶ You should repeat this procedure as long as the air pressure is within this range.
7. Press the pressure relief button until the gauge returns to 0 psi (0 kPa).
8. Repackage and properly stow the kit.

▶▶ Distributing the Sealant in the Tire

**⚠ WARNING**

Running the engine with the vehicle in an enclosed or even partly enclosed area can cause a rapid build-up of toxic carbon monoxide.

Breathing this colorless, odorless gas can cause unconsciousness and even death. Only run the engine to power the air compressor with the vehicle outdoors.

## ■ Inflating an Under-inflated Tire

You can use the kit to inflate a non-punctured under-inflated tire.

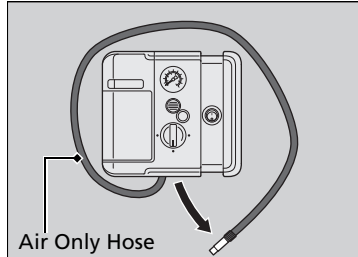

1. Open the trunk floor lid.
  - ▶ **Getting Ready to Temporarily Repair the Flat Tire** P. 418
2. Remove the kit from the case.
  - ▶ Place the kit on flat ground near the tire to be inflated, away from traffic.
3. Place the kit, face up, on flat ground near the flat tire, away from traffic. Do not place the kit on its side.
4. Remove the air only hose from the kit.
5. Remove the valve cap.

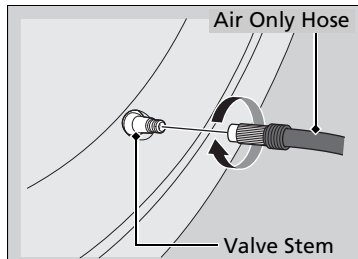
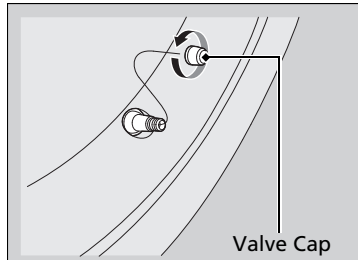

6. Attach the air only hose onto the tire valve stem. Screw it until it is tight.

## ▶▶ Inflating an Under-inflated Tire

### NOTICE

Do not operate the temporary tire repair kit compressor for more than 15 minutes. The accessory power socket and compressor can overheat and become permanently damaged.

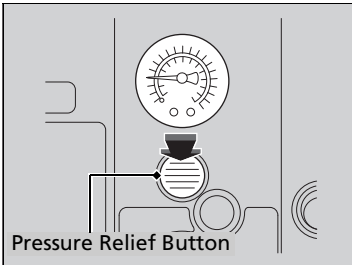
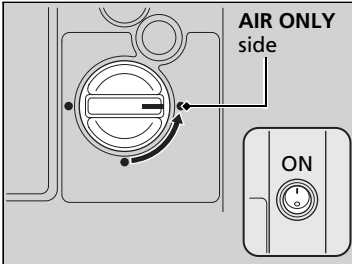
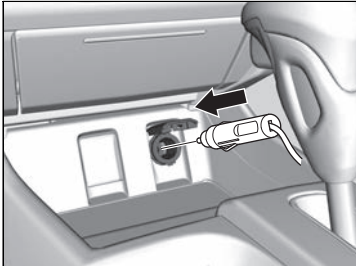

7. Plug in the kit to the accessory power socket.
  - Be careful not to pinch the cord in a door or window.
8. Start the engine.
  - Keep the engine running while injecting air.
  - **Carbon Monoxide Gas** P. 64
9. Turn the selector switch to **AIR ONLY**.
10. Press the inflator switch to turn on the kit.
  - The compressor starts to inject air into the tire.
11. Inflate the tire to the specified air pressure.
12. Turn off the kit.
  - Check the pressure gauge on the air compressor.
  - If overinflated, press the pressure relief button.
13. Unplug the kit from the accessory power socket.
14. Unscrew the air only hose from the tire valve stem. Reinstall the valve cap.
15. Press the pressure relief button until the gauge returns 0 psi (0 kPa).
16. Repackage and properly stow the kit.

► Inflating an Under-inflated Tire

**⚠ WARNING**

Running the engine with the vehicle in an enclosed or even partly enclosed area can cause a rapid build-up of toxic carbon monoxide.

Breathing this colorless, odorless gas can cause unconsciousness and even death. Only run the engine to power the air compressor with the vehicle outdoors.

# Engine Does Not Start

## Checking the Engine

If the engine does not start, check the starter.

### ☒ Checking the Engine

If you must start the vehicle immediately, use an assisting vehicle to jump start it.

☒ **Jump Starting** P. 429

### Starter condition

### Checklist

#### Starter doesn't turn or turns over slowly.

The battery may be dead. Check each of the items on the right and respond accordingly.

#### Models with smart entry system

##### Check for a message on the i-MID.

- If the **TO START, HOLD REMOTE NEAR START BUTTON** message appears
  - ☒ **If the Smart Entry Remote Battery is Weak** P. 427
- ▶ Make sure the smart entry remote is in its operating range.
  - ☒ **ENGINE START/STOP Button Operating Range** P. 132

##### Check the brightness of the interior lights.

Turn on the interior lights and check the brightness.

- If the interior lights are dim or do not come on at all
  - ☒ **Battery** P. 400
- If the interior lights come on normally
  - ☒ **Fuses** P. 439

#### The starter turns over normally but the engine doesn't start.

There may be a problem with the fuse. Check each of the items on the right and respond accordingly.

##### Review the engine start procedure.

Follow its instructions, and try to start the engine again.

☒ **Starting the Engine** P. 313

##### Check the immobilizer system indicator.

When the immobilizer system indicator is blinking, the engine cannot be started.

☒ **Immobilizer System** P. 125

##### Check the fuel level.

There should be enough fuel in the tank.

☒ **Fuel Gauge** P. 82

##### Check the fuse.

Check all fuses, or have the vehicle checked by a dealer.

☒ **Inspecting and Changing Fuses** P. 442

##### If the problem continues:

☒ **Emergency Towing** P. 443

Models with smart entry system

## If the Smart Entry Remote Battery is Weak

If the beeper sounds, the **TO START, HOLD REMOTE NEAR START BUTTON** message appears on the i-MID, the indicator on the **ENGINE START/STOP** button flashes, and the engine won't start, start the engine as follows.

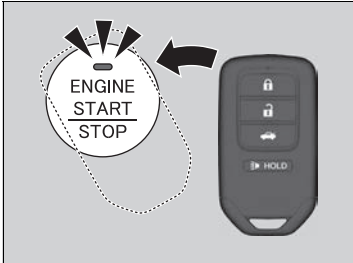

1. Touch the center of the **ENGINE START/STOP** button with the **H** logo on the smart entry remote while the indicator on the **ENGINE START/STOP** button is flashing. The buttons on the smart entry remote should be facing you.
  - ▶ The indicator flashes for about 30 seconds.

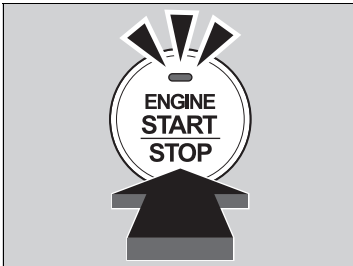

2. Depress the brake pedal (continuously variable transmission) or clutch pedal (manual transmission) and press the **ENGINE START/STOP** button within 10 seconds after the beeper sounds and the indicator stays on.
  - ▶ If you don't depress the pedal, the mode will change to ACCESSORY.



Models with smart entry system

## Emergency Engine Stop

The **ENGINE START/STOP** button may be used to stop the engine due to an emergency situation even while driving. If you must stop the engine, do either of the following operations:

- Press and hold the **ENGINE START/STOP** button for about two seconds.
- Firmly press the **ENGINE START/STOP** button twice.

The steering wheel will not lock. However, because turning off the engine disables the power assist the engine provides to the steering and braking systems, it will require significantly more physical effort and time to steer and slow the vehicle. Use both feet on the brake pedal to slow down the vehicle and stop immediately in a safe place. With manual transmission models you can also downshift the transmission to utilize engine braking.

Continuously variable transmission models

The power mode is in ACCESSORY when the engine is stopped.

To change the mode to VEHICLE OFF, move the shift lever to **P** after the vehicle comes to a complete stop.

Canadian continuously variable transmission models

Then press the **ENGINE START/STOP** button twice without depressing the brake pedal.

Manual transmission models

The power mode changes to VEHICLE OFF.

Emergency Engine Stop

Do not press the button while driving unless it is absolutely necessary for the engine to be switched off.

## Jump Starting Procedure

Turn off the power to electric devices, such as audio and lights. Turn off the engine, then open the hood.

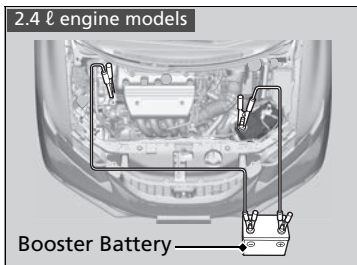
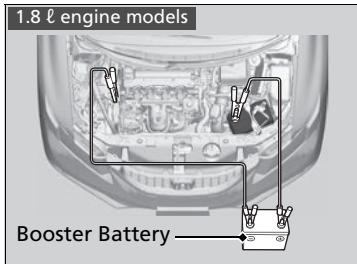

1. Connect the first jumper cable to your vehicle's battery  $\oplus$  terminal.
2. Connect the other end of the first jumper cable to the booster battery  $\oplus$  terminal.
  - ▶ Use a 12-volt booster battery only.
  - ▶ When using an automotive battery charger to boost your 12-volt battery, select a lower charging voltage than 15-volt. Check the charger manual for the proper setting.
3. Connect the second jumper cable to the booster battery  $\ominus$  terminal.

## Jump Starting

### **⚠ WARNING**

A battery can explode if you do not follow the correct procedure, seriously injuring anyone nearby.

Keep all sparks, open flames, and smoking materials away from the battery.

Securely attach the jumper cables clips so that they do not come off when the engine vibrates. Also be careful not to tangle the jumper cables or allow the cable ends to touch each other while attaching or detaching the jumper cables.

Continued

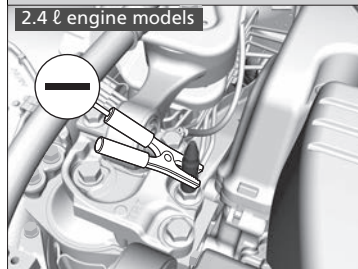
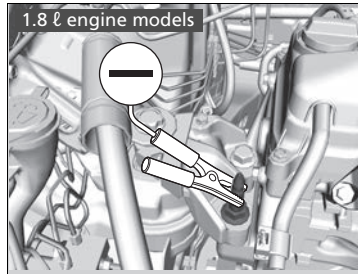

4. Connect the other end of the second jumper cable to the engine mounting bolt as shown. Do not connect this jumper cable to any other part.
5. If your vehicle is connected to another vehicle, start the assisting vehicle's engine and increase its rpm slightly.
6. Attempt to start your vehicle's engine. If it turns over slowly, check that the jumper cables have good metal-to-metal contact.

▶▶ Jump Starting

Battery performance degrades in cold conditions and may prevent the engine from starting.

## ■ What to Do After the Engine Starts

Once your vehicle's engine has started, remove the jumper cables in the following order.

1. Disconnect the jumper cable from your vehicle's ground.
2. Disconnect the other end of the jumper cable from the booster battery ⊖ terminal.
3. Disconnect the jumper cable from your vehicle's battery ⊕ terminal.
4. Disconnect the other end of the jumper cable from the booster battery ⊕ terminal.

Have your vehicle inspected by a nearby service station or a dealer.

# Shift Lever Does Not Move

## Continuously variable transmission models

Follow the procedure below if you cannot move the shift lever out of the **P** position.

### Releasing the Lock

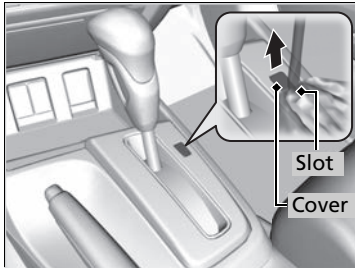

1. Set the parking brake.

#### Models without smart entry system

2. Remove the key from the ignition switch.

#### Models with smart entry system

2. Remove the built-in key from the smart entry remote.

#### All models

3. Wrap a cloth around the tip of a small flat-tip screwdriver. Put it into the shift lock release slot as shown in the image, and remove the cover.

4. Insert the key into the shift lock release slot.

5. While pushing the key in, press the shift lever release button and place the shift lever into **N**.

► The lock is now released. Have the shift lever checked by a dealer as soon as possible.

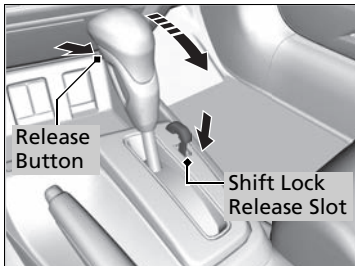

## How to Handle Overheating

Overheating symptoms are as follows:

- The high temperature indicator comes on or the engine suddenly loses power.
- Steam or spray comes out of the engine compartment.

### ■ First thing to do

1. Immediately park the vehicle in a safe place.
2. Turn off all accessories and turn on the hazard warning lights.
  - ▶ **No steam or spray present:** Keep the engine running and open the hood.
  - ▶ **Steam or spray is present:** Turn off the engine and wait until it subsides. Then open the hood.

### ☒ How to Handle Overheating

#### **WARNING**

Steam and spray from an overheated engine can seriously scald you.

Do not open the hood if steam is coming out.

#### **NOTICE**

Continuing to drive with the high temperature indicator on may damage the engine.

*Continued*

### ■ Next thing to do

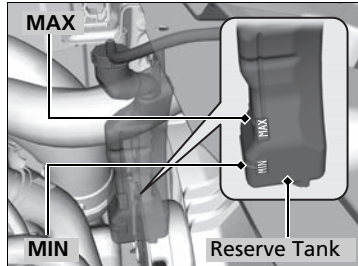

1. Check that the cooling fan is operating and stop the engine once the high temperature indicator goes off.
  - If the cooling fan is not operating, immediately stop the engine.
2. Once the engine has cooled down, inspect the coolant level and check the cooling system components for leaks.
  - If the coolant level in the reserve tank is low, add coolant until it reaches the **MAX** mark.
  - If there is no coolant in the reserve tank, check that the radiator is cool. Cover the radiator cap with a heavy cloth and open the cap. If necessary, add coolant up to the base of the filler neck, and put the cap back on.

### ■ Last thing to do

Once the engine has cooled sufficiently, restart it and check the high temperature indicator.  
If the high temperature indicator is off, resume driving. If it stays on, contact a dealer for repairs.

### ►► How to Handle Overheating

## ⚠ WARNING

Removing the radiator cap while the engine is hot can cause the coolant to spray out, seriously scalding you.

Always let the engine and radiator cool down before removing the radiator cap.

If the coolant is leaking, contact a dealer for repairs.

Use water as an emergency/temporary measure only. Have a dealer flush the system with proper antifreeze as soon as possible.

## If the Low Oil Pressure Indicator Comes On



### ■ Reasons for the indicator to come on

Comes on when the engine oil pressure is low.

### ■ What to do as soon as the indicator comes on

1. Immediately park the vehicle in a safe place.
2. If necessary, turn the hazard warning lights on.

### ■ What to do after parking the vehicle

1. Stop the engine and let it sit for about one minute.
2. Open the hood and check the oil level.
  - ▶ Add oil as necessary.
3. Start the engine and check the low oil pressure indicator.
  - ▶ The indicator goes off: Start driving again.
  - ▶ The indicator does not go off within 10 seconds: Stop the engine and contact a dealer for repairs immediately.

## If the Charging System Indicator Comes On



### ■ Reasons for the indicator to come on

Comes on when the battery is not being charged.

### ■ What to do when the indicator comes on

Turn off the heating and cooling system\*/climate control system\*, rear defogger, and other electrical systems, and immediately contact a dealer for repairs.

### ☒ If the Low Oil Pressure Indicator Comes On

#### NOTICE

Running the engine with low oil pressure can cause serious mechanical damage almost immediately.

### ☒ If the Charging System Indicator Comes On

If you need to stop temporarily, do not turn off the engine. Restarting the engine may rapidly discharge the battery.

\* Not available on all models



## If the Malfunction Indicator Lamp Comes On or Blinks



### ■ Reasons for the indicator lamp to come on or blink

- Comes on if there is a problem with the engine emissions control system, or the fuel fill cap is missing, or loose.
- Blinks when engine misfiring is detected.

### ■ What to do when the indicator lamp comes on

Avoid high speeds and immediately get your vehicle inspected at a dealer.

### ■ What to do when the indicator lamp blinks

Park the vehicle in a safe place with no flammable items and wait at least 10 minutes or more with the engine stopped until it cools.

## ■ Check/Tighten Fuel Cap Message

### ■ The message appears on when:

An evaporative system leak is detected. This may be caused by the fuel fill cap being loose or not being installed.

### ■ What to do when the message appears:

1. Stop the engine.
2. Check if the fuel fill cap is fully installed.
  - ▶ If not, loosen the cap, and then retighten it until it clicks at least once.
3. Drive for several days of normal driving.
  - ▶ The message should go off.

### ■ When the malfunction indicator lamp comes on

The malfunction indicator lamp comes on if the system continues to detect a leak of gasoline vapor. If this happens, check the fuel fill cap using the procedures described above.

## ▶▶ If the Malfunction Indicator Lamp Comes On or Blinks

### NOTICE

If you drive with the malfunction indicator lamp on, the emissions control system and the engine could be damaged.

If the malfunction indicator lamp blinks again when restarting the engine, drive to the nearest dealer at 31 mph (50 km/h) or less. Have your vehicle inspected.

## If the Brake System Indicator (Red) Comes On



### ■ Reasons for the indicator to come on

- The brake fluid is low.
- There is a malfunction in the brake system.

### ■ What to do when the indicator comes on while driving

Press the brake pedal lightly to check pedal pressure.

- If normal, check the brake fluid level the next time you stop.
- If abnormal, take immediate action. If necessary, downshift the transmission to slow the vehicle using engine braking.

## If the Electric Power Steering (EPS) System Indicator Comes On



### ■ Reasons for the indicator to come on

- Comes on if there is a problem with the EPS system.
- If you depress the accelerator pedal repeatedly to increase the engine speed while the engine is idling, the indicator comes on, and sometimes the steering wheel becomes harder to operate.

### ■ What to do when the indicator comes on

Stop the vehicle in a safe place and restart the engine.

If the indicator comes on and stays on, immediately have your vehicle inspected by a dealer.

### ▶▶ If the Brake System Indicator (Red) Comes On

Have your vehicle repaired immediately.

It is dangerous to drive with low brake fluid. If there is no resistance from the brake pedal, stop immediately in a safe place. If necessary downshift the gears.

If the brake system indicator and **ABS** indicator come on simultaneously, the electronic brake distribution system is not working. This can result in vehicle instability under sudden braking.

Have your vehicle inspected by a dealer immediately.

U.S. models

## If the Low Tire Pressure/TPMS Indicator Comes On or Blinks



### ■ Reasons for the indicator to come on or blink

A tire pressure is significantly low, or the TPMS has not been calibrated. If there is a problem with the TPMS or the compact spare tire\* is installed, the indicator blinks for about one minute, and then stays on.

### ■ What to do when the indicator comes on

Drive carefully and avoid abrupt cornering and hard braking. Stop your vehicle in a safe place. Check the tire pressure and adjust the pressure to the specified level. The specified tire pressure is on a label on the driver side doorjamb.

▶ Calibrate the TPMS after the tire pressure is adjusted.

### ■ What to do when the indicator blinks, then remains on

Have the tire inspected by a dealer as soon as possible. If the compact spare tire\* causes the indicator to blink, change the tire to a full-size tire. The indicator goes off after driving for a few miles (kilometers).

▶ Calibrate the TPMS after a full-size tire is reinstalled.

### ▶▶ If the Low Tire Pressure/TPMS Indicator Comes On or Blinks

#### NOTICE

Driving on an extremely underinflated tire can cause it to overheat. An overheated tire can fail. Always inflate your tires to the prescribed level.

## Fuse Locations

If any electrical devices are not working, turn the ignition switch to LOCK [0]<sup>\*1</sup> and check to see if any applicable fuse is blown.

### Engine Compartment Fuse Box

Located near the brake fluid reservoir. Push the tabs to open the box.

Fuse locations are shown on the fuse box cover. Locate the fuse in question by the fuse number and box cover number.

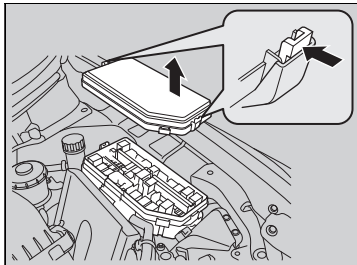

### ■ Circuit protected and fuse rating

	Circuit Protected	Amps
1	EPS	70 A
	–	(40 A)
	ABS/VSA Motor	30 A
	ABS/VSA FSR	30 A
	Wiper Motor <sup>*2</sup>	30 A
	– <sup>*3</sup>	(30 A)
2	Main Fuse	100 A
	IG Main	30 A <sup>*2</sup> 50 A <sup>*3</sup>
	Fuse Box Main	60 A
	Fuse Box Main 2	60 A
	Headlight Main	30 A
	ST MG Switch <sup>*2</sup>	30 A
	– <sup>*3</sup>	(30 A)
	Rear Defogger	30 A
	IG Main 2 <sup>*2</sup>	30 A
	– <sup>*3</sup>	(30 A)
3	Blower	40 A
	–	(30 A)
	Sub Fan Motor	20 A
	Main Fan Motor	20 A
	– <sup>*2</sup>	–
4	Left Headlight Low Beam <sup>*3</sup>	15 A
	–	–
5	START DIAG <sup>*2</sup>	7.5 A
	ST MG <sup>*3</sup>	7.5 A

	Circuit Protected	Amps
6	– <sup>*2</sup>	–
	Right Headlight Low Beam <sup>*3</sup>	15 A
7	–	–
8	–	–
9	–	–
10	–	–
11	Oil Level	7.5 A
12	Fog Lights <sup>*</sup>	(20 A)
13	Driver's Power Seat Sliding <sup>*</sup>	(20 A)
14	Hazard	10 A
15	FI Sub	15 A
16	IG Coil	15 A
17	Stop	15 A
18	Horn	10 A
19	Premium Amp <sup>*</sup>	(20 A)
20	Right Headlight Low Beam <sup>*2</sup>	15 A
	Injection <sup>*, *3</sup>	(15 A)
21	IGP	15 A
22	DBW	15 A
23	Left Headlight Low Beam <sup>*2</sup>	15 A
	Headlight Low Beam <sup>*3</sup>	20 A
24	Driver's Power Seat Reclining <sup>*</sup>	(20 A)

\*1: Models with the smart entry system have an **ENGINE START/STOP** button instead of an ignition switch.

\*2: Models with smart entry system

\*3: Models without smart entry system

	Circuit Protected	Amps
25	MG Clutch	7.5 A
26	Washer* <sup>1</sup> _** <sup>2</sup>	15 A -
27	SMALL	20 A
28	Interior Lights	7.5 A
29	Backup	10 A

\*1: Models with smart entry system

\*\*2: Models without smart entry system

### ■ Interior Fuse Box

Located under the dashboard.

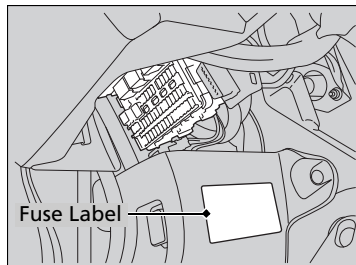

Fuse locations are shown on the label on the side panel.

Locate the fuse in question by the fuse number and label number.

### ■ Circuit protected and fuse rating

	Circuit Protected	Amps
1	HAC Option*	(20 A)
2	ACG	10 A
3	SRS	10 A
4	Fuel Pump	15 A
5	Meter	7.5 A
6	Power Window	7.5 A
7	VB SOL*	(15 A)
8	Door Lock Motor 2 (Unlock)	15 A
9	Door Lock Motor 1 (Unlock)	15 A

	Circuit Protected	Amps
10	-	-
11	Moonroof*	(20 A)
12	Accessory Power Socket (Center Console)*	(20 A)
13	-	-
14	Seat Heaters*	(15 A)
15	Driver's Door Lock Motor (Unlock)*	(10 A)
16	-	-
17	-	-
18	-	-
19	ACC	7.5 A
20	ACC Key Lock	7.5 A
21	Daytime Running Lights	7.5 A
22	HAC	7.5 A
23	HAC*	(7.5 A)
24	ABS/VSA	7.5 A
25	ACC*	(7.5 A)
26	-	-
27	Accessory Power Socket (Front)	20 A
28	Washer	(15 A)
29	ODS	7.5 A
30	Driver's Door Lock Motor (Lock)*	(10 A)
31	SMART*	(10 A)
32	Door Lock Motor 2 (Lock)	15 A

	<b>Circuit Protected</b>	<b>Amps</b>
33	Door Lock Motor 1 (Lock)	15 A
34	Small Lights	7.5 A
35	Illumination	7.5 A
36	–	–
37	–	–
38	Left Headlight High Beam	10 A
39	Right Headlight High Beam	10 A
40	TPMS*	(7.5 A)
41	Door Lock	20 A
42	Driver's Power Window	20 A
43	Rear Passenger's Side Power Window	(20 A)
44	Front Passenger's Side Power Window	20 A
45	Rear Driver's Side Power Window	(20 A)
46	Wiper	(30 A)
–	STS*	(7.5 A)

\* Not available on all models

## Inspecting and Changing Fuses

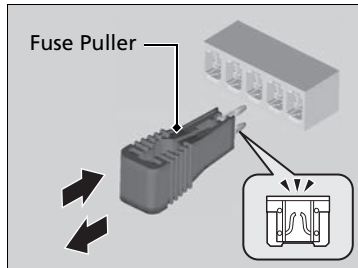
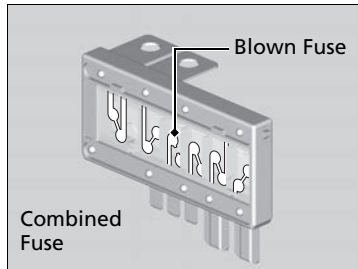

1. Turn the ignition switch to LOCK [0]\*1. Turn headlights and all accessories off.
2. Remove the fuse box cover.
3. Check the large fuse in the engine compartment.
  - If the fuse is blown, use a Phillips-head screwdriver to remove the screw and replace it with a new one.
4. Inspect the small fuses in the engine compartment and the vehicle interior.
  - If there is a burned out fuse, remove it with the fuse puller and replace it with a new one.

### ► Inspecting and Changing Fuses

#### NOTICE

Replacing a fuse with one that has a higher rating greatly increases the chances of damaging the electrical system.

Replace fuse with a spare fuse of the same specified amperage.

Confirm the specified amperage using the charts on P. 439 to 440.

There is a fuse puller on the back of the engine compartment fuse box cover.

\*1: Models with the smart entry system have an **ENGINE START/STOP** button instead of an ignition switch.

Call a professional towing service if you need to tow your vehicle.

## ■ Flat bed equipment

The operator loads your vehicle on the back of a truck.

**This is the best way to transport your vehicle.**

## ■ Wheel lift equipment

The tow truck uses two pivoting arms that go under the front tires and lift them off the ground. The rear tires remain on the ground. **This is an acceptable way to tow your vehicle.**

### » Emergency Towing

#### NOTICE

Trying to lift or tow your vehicle by the bumpers will cause serious damage. The bumpers are not designed to support the vehicle's weight.

#### NOTICE

Improper towing such as towing behind a motorhome or other motor vehicle can damage the transmission.

Never tow your vehicle with just a rope or chain. It is very dangerous since ropes or chains may shift from side to side or break.





# Information

This chapter includes your vehicle's specifications, locations of identification numbers, and other information required by regulation.

<b>Specifications</b> .....	446
<b>Identification Numbers</b>	
Vehicle Identification Number (VIN), Engine Number and Transmission Number .....	450
<b>Devices that Emit Radio Waves</b> .....	451
<b>Reporting Safety Defects</b> .....	452
<b>Emissions Testing</b>	
Testing of Readiness Codes.....	453
<b>Warranty Coverages</b> .....	455
<b>Authorized Manuals</b> .....	457
<b>Customer Service Information</b> .....	458

# Specifications

## 1.8 ℓ engine models

### Vehicle Specifications

Model	Honda Civic 4-Door
-------	--------------------

No. of Passengers:

Front	2
Rear	3
Total	5

Weights:

Gross Vehicle Weight Rating	U.S.: 3,693 lbs (1,675 kg) <sup>*1</sup> Canada: 1,675 kg <sup>*1</sup>
	U.S.: 3,748 lbs (1,700 kg) <sup>*2</sup> Canada: 1,700 kg <sup>*2</sup>
	U.S.: 3,792 lbs (1,720 kg) <sup>*3</sup> Canada: 1,720 kg <sup>*3</sup>
	Canada: 1,755 kg <sup>*4</sup>

Gross Axle Weight

Rating (Front)	U.S.: 1,984 lbs (900 kg) <sup>*1</sup> Canada: 900 kg <sup>*1</sup>
	U.S.: 2,017 lbs (915 kg) <sup>*2</sup> Canada: 915 kg <sup>*2</sup>
	U.S.: 2,028 lbs (920 kg) <sup>*3</sup> Canada: 920 kg <sup>*3</sup>
	Canada: 940 kg <sup>*4</sup>

Gross Axle Weight

Rating (Rear)	U.S.: 1,742 lbs (790 kg) <sup>*1</sup> Canada: 790 kg <sup>*1</sup>
	U.S.: 1,753 lbs (795 kg) <sup>*2</sup> Canada: 795 kg <sup>*2</sup>
	U.S.: 1,786 lbs (810 kg) <sup>*3</sup> Canada: 810 kg <sup>*3</sup>
	Canada: 825 kg <sup>*4</sup>

Air Conditioning:

Refrigerant Type	HFC-134a (R-134a)
Charge Quantity	13.2 – 15.0 oz (375 – 425 g)
Lubricant Type	SP-10

\*1: LX-MT, HF, and Canadian DX models

\*2: LX-Continuously variable transmission models

\*3: EX and EX-L models

\*4: Canadian Touring models

### Engine Specifications

Displacement	110 cu-in (1,798 cm <sup>3</sup> )
Spark Plugs	NGK DILZKR7B11GS
	DENSO DXU22HCR-D11S

### Fuel

Fuel Type	Unleaded gasoline, Pump octane number of 87 or higher
Fuel Tank Capacity	13.2 US gal (50 ℓ)

### Washer Fluid

Tank Capacity	U.S.: 2.6 US qt (2.5 ℓ)
	Canada: 4.8 US qt (4.5 ℓ)

### Light Bulbs

Headlights (Low Beam)	51W (HB4)
Headlights (High Beam)	60W (HB3)
Fog Lights*	55W (H11)
Front Turn Signal/Parking/Side Marker Lights	28/8W (Amber)
Brake/Taillights	21/5W
Rear Turn Signal Lights	21W (Amber)
Rear Side Marker Lights	LED
Back-Up Lights	16W
Taillights	3CP
High-Mount Brake Light	21W
Rear License Plate Lights	5W
Trunk Light	5W
Interior Lights	
Map Lights*	8W
Ceiling Light	8W

■ Brake/Clutch Fluid

Specified	Honda Heavy Duty Brake Fluid DOT 3
-----------	------------------------------------

■ Continuously Variable Transmission Fluid

Specified	HCF-2
Capacity	Change 3.6 US qt (3.4 ℓ)

■ Manual Transmission Fluid

Specified	Honda Manual Transmission Fluid
Capacity	Change 1.5 US qt (1.4 ℓ)

■ Engine Oil

Recommended	-Genuine Honda Motor Oil 0W-20 -API Premium-grade 0W-20 detergent oil
Change	3.7 US qt (3.5 ℓ)
Capacity	Change including filter 3.9 US qt (3.7 ℓ)

■ Engine Coolant

Specified	Honda Long-Life Antifreeze/Coolant Type2
Ratio	50/50 with distilled water 1.48 US gal (5.59 ℓ)
Capacity	(change including the remaining 0.125 US gal (0.475 ℓ) in the reserve tank)

■ Tire

Regular	Size	P195/65R15 89H <sup>*1, *2</sup> P195/65R15 89S <sup>*3</sup> P205/55R16 89H <sup>*4</sup> P215/45R17 87V <sup>*5</sup>
	Pressure psi (kPa [kgf/cm <sup>2</sup> ])	30 (210 [2.1]) <sup>*1, *2</sup> 32 (220 [2.2]) <sup>*3, *4, *5</sup>
Compact Spare <sup>*</sup>	Size	T135/80D15 99M
	Pressure psi (kPa [kgf/cm <sup>2</sup> ])	60 (420 [4.2])
Wheel Size	Regular	15 x 6J <sup>*1, *3</sup> 15 x 6 1/2J <sup>*2</sup> 16 x 6 1/2J <sup>*4</sup> 17 x 7J <sup>*5</sup>
		Compact Spare <sup>*</sup>

\*1: Canadian DX model

\*2: LX model

\*3: HF model

\*4: EX model

\*5: U.S. EX-L and Canadian Touring models

\* Not available on all models

**2.4 ℓ engine models**

**Vehicle Specifications**

Model	Honda Civic 4-Door
No. of Passengers:	
Front	2
Rear	3
Total	5
<b>Weights:</b>	
Gross Vehicle	U.S.: 3,925 lbs (1,780 kg)
Weight Rating	Canada: 1,780 kg
Gross Axle Weight	
Rating (Front)	U.S.: 2,117 lbs (960 kg)
	Canada: 960 kg
Gross Axle Weight	
Rating (Rear)	U.S.: 1,830 lbs (830 kg)
	Canada: 830 kg
<b>Air Conditioning:</b>	
Refrigerant Type	HFC-134a (R-134a)
Charge Quantity	13.2 – 15.0 oz (375 – 425 g)
Lubricant Type	SP-10

**Engine Specifications**

Displacement	144 cu-in (2,354 cm <sup>3</sup> )
Spark Plugs	NGK ILZKR7B-11S
	DENSO SXU22HCR11S

**Fuel**

Fuel:	Unleaded premium gasoline, Pump octane
Type	number of 91 or higher
Fuel Tank Capacity	13.2 US gal (50 ℓ)

**Washer Fluid**

Tank Capacity	U.S.: 2.6 US qt (2.5 ℓ)
	Canada: 4.8 US qt (4.5 ℓ)

**Light Bulbs**

Headlights (Low Beam)	51W (HB4)
Headlights (High Beam)	60W (HB3)
Fog Lights	35W (H8)
Front Turn Signal/Parking/Side Marker Lights	28/8W (Amber)
Brake/Taillights	21/5W
Rear Turn Signal Lights	21W (Amber)
Rear Side Marker Lights	LED
Back-Up Lights	16W
Taillights	3CP
High-Mount Brake Light	LED
Rear License Plate Lights	5W
Trunk Light	5W
<b>Interior Lights</b>	
Map Lights	8W
Ceiling Light	8W

■ Brake/Clutch Fluid

Specified	Honda Heavy Duty Brake Fluid DOT 3
-----------	------------------------------------

■ Manual Transmission Fluid

Specified	Honda Manual Transmission Fluid	
Capacity	Change	2.0 US qt (1.9 ℓ)

■ Engine Oil

Recommended	·Genuine Honda Motor Oil 0W-20	
	·API Premium-grade 0W-20 detergent oil	
Change	4.2 US qt (4.0 ℓ)	
	Capacity	Change including filter

■ Engine Coolant

Specified	Honda Long-Life Antifreeze/Coolant Type2	
Ratio	50/50 with distilled water	
Capacity	1.45 US gal (5.5 ℓ)	
	(change including the remaining 0.125 US gal (0.475 ℓ) in the reserve tank)	

■ Tire

Regular	Size	225/40R18 92V 225/40R18 92Y*1
	Pressure psi (kPa [kgf/cm <sup>2</sup> ])	33 (230 [2.3]) 32 (220 [2.2])*1
Compact Spare	Size	T135/80D16 101M
	Pressure psi (kPa [kgf/cm <sup>2</sup> ])	60 (420 [4.2])
Wheel Size	Regular	18 x 7 1/2J
	Compact Spare	16 x 4T

\*1: Optional for U.S. models (summer tires)

## Vehicle Identification Number (VIN), Engine Number and Transmission Number

Your vehicle has a 17-digit vehicle identification number (VIN) used to register your vehicle for warranty purposes, and for licensing and insuring your vehicle. The locations of your vehicle's VIN, engine number and transmission number are shown as follows.

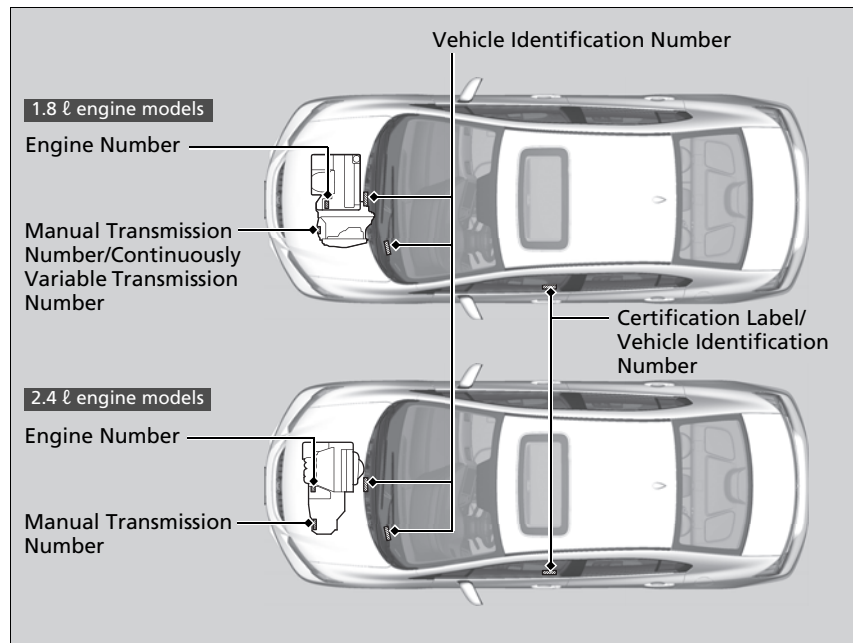

## Devices that Emit Radio Waves

The following products and systems on your vehicle emit radio waves when in operation.

### Audio System

*Bluetooth*® Audio

*Bluetooth*® HandsFreeLink®

Immobilizer System

Remote Transmitter

Each of the above complies with the appropriate requirements or the required standards of FCC (Federal Communications Commission) and Industry Canada Standard, described below:

As required by the FCC:

This device complies with Part 15 of the FCC rules. Operation is subject to the following two conditions: (1) This device may not cause harmful interference, and (2) this device must accept any interference received, including interference that may cause undesired operation.

Changes or modifications not expressly approved by the party responsible for compliance could void the user's authority to operate the equipment.

This device complies with Industry Canada Standard RSS-Gen/210/310. Operation is subject to the following two conditions: (1) this device may not cause interference, and (2) this device must accept any interference, including interference that may cause undesired operation of the device.



In the U.S.

If you believe that your vehicle has a defect which could cause a crash or could cause injury or death, you should immediately inform the National Highway Traffic Safety Administration (NHTSA) in addition to notifying American Honda Motor Co., Inc.

If NHTSA receives similar complaints, it may open an investigation, and if it finds that a safety defect exists in a group of vehicles, it may order a recall and remedy campaign. However, NHTSA cannot become involved in individual problems between you, your dealer, or American Honda Motor Co., Inc.

To contact NHTSA, you may call the Vehicle Safety Hotline toll-free at 1-888-327-4236 (TTY: 1-800-424-9153); go to <http://www.safercar.gov>; or write to: Administrator, NHTSA, 1200 New Jersey Avenue, SE., Washington, DC 20590. You can also obtain other information about motor vehicle safety from <http://www.safercar.gov>.

In Canada

If you believe that your vehicle has a defect which could cause a crash or could cause injury or death, you should immediately inform Honda Canada Inc. and you may also inform Transport Canada.

If Transport Canada receives similar complaints, it may open an investigation, and if it finds that a safety defect exists in a group of vehicles, it may lead to a recall and remedy campaign. However, Transport Canada cannot become involved in individual problems between you, your dealer, or Honda Canada Inc.

To contact Transport Canada's Defect Investigations and Recalls Division, you may call 1-800-333-0510. For more information on reporting safety defects or about motor vehicle safety, go to <http://www.tc.gc.ca/roadsafety>.

## Testing of Readiness Codes

Your vehicle has "Readiness Codes," as part of the onboard self diagnostic system. Some States use these codes as a test to see if your vehicle's emissions components are working properly.

The codes may not be read properly if testing is performed just after the battery has gone dead or been disconnected.

To check if they are set, turn the ignition switch to ON **II**\*1, without starting the engine. The malfunction indicator lamp will come on for several seconds. If it then goes off, the readiness codes are set. If it blinks five times, the readiness codes are not set.

If you are required to have your vehicle tested before the readiness codes are ready, prepare the vehicle for retesting by doing the following:

1. Fill the gas tank to approximately 3/4 full.
2. Park the vehicle and leave the engine off for six hours or more.
3. Make sure the ambient temperature is between 40°F and 95°F (4°C and 35°C).
4. Start the engine without touching the accelerator pedal, and let it idle for 20 seconds.
5. Keep the vehicle in **P** (continuously variable transmission) or **N** (manual transmission). Increase the engine speed to 2,000 rpm, and hold it there for about three minutes.
6. Let the engine idle with your foot off the accelerator for 20 seconds.

\*1: Models with the smart entry system have an **ENGINE START/STOP** button instead of an ignition switch.

### Testing of Readiness Codes

The readiness codes are erased when the battery is disconnected, and set again only after several days of driving under a variety of conditions.

If a testing facility determines that the readiness codes are not set, you may be requested to return at a later date to complete the test.

If the testing facility determines the readiness codes are still not set, see a dealer.

7. Select a nearby, lightly traveled major highway where you can maintain a speed of 50 to 60 mph (80 to 97 km/h) for at least 20 minutes. Drive on the highway in **D** (continuously variable transmission) or 5th (manual). Do not use cruise control. When traffic allows, drive for 90 seconds without moving the accelerator pedal. (Vehicle speed may vary slightly; this is okay.) If you cannot do this for a continuous 90 seconds because of traffic conditions, drive for at least 30 seconds, then repeat it two more times (for a total of 90 seconds).
8. Drive in city/suburban traffic for at least 10 minutes. When traffic conditions allow, let the vehicle coast for several seconds without using the accelerator pedal or the brake pedal.
9. Park the vehicle and leave the engine off for 30 minutes.

## ■ U.S. Owners

Your new vehicle is covered by these warranties:

***New Vehicle Limited Warranty*** – covers your new vehicle, except for the emissions control systems and accessories, against defects in materials and workmanship.

***Emissions Control Systems Defects Warranty and Emissions Performance Warranty*** – these two warranties cover your vehicle's emissions control systems. Time, mileage, and coverage are conditional. Please read your warranty booklet for exact information.

***Seat Belt Limited Warranty*** – a seat belt that fails to function properly is covered by a limited warranty. Please read your warranty booklet for details.

***Rust Perforation Limited Warranty*** – all exterior body panels are covered for rust-through from the inside for the specified time period with no mileage limit.

***Accessory Limited Warranty*** – Honda accessories are covered under this warranty. Time and mileage limits depend on the type of accessory and other factors. Please read your warranty booklet for details.

***Replacement Parts Limited Warranty*** – covers all Honda replacement parts against defects in materials and workmanship.

**Replacement Battery Limited Warranty** – provides prorated coverage for a replacement battery purchased from a dealer.

**Replacement Muffler Lifetime Limited Warranty** – provides coverage for as long as the purchaser of the muffler owns the vehicle.

Restrictions and exclusions apply to all these warranties. Please read the Honda warranty information booklet that came with your vehicle for precise information on warranty coverages. Your vehicle's original tires are covered by their manufacturer. Tire warranty information is in a separate booklet.

■ **Canadian Owners**

Please refer to the warranty manual that came with your vehicle.

## ■ Service Express

For electronic copies of service publications, you can purchase a subscription to Service Express. Visit [www.techinfo.honda.com](http://www.techinfo.honda.com) for pricing and options.

## ■ For U.S. Owners:

Manuals can be purchased from Helm Incorporated. You can order a manual by phone at (800) 782-4356 (credit card orders only), or online at [www.helminc.com](http://www.helminc.com).

## » Authorized Manuals

### **For Canadian Owners:**

Please contact a dealer to order any manuals that you may require.

Honda dealership personnel are trained professionals.

They should be able to answer all your questions. If you encounter a problem that your dealership does not solve to your satisfaction, please discuss it with the dealership's service manager or general manager. If you are dissatisfied with the decision made by the dealership's management, contact Honda Customer Services.

## U.S. Owners:

American Honda Motor Co., Inc.  
Honda Automobile Customer Services  
Mail Stop 500-2N-7A  
1919 Torrance Blvd.  
Torrance, CA 90501-2746  
Tel: (800) 999-1009

## Canadian Owners:

Honda Canada Inc.  
Customer Relations  
180 Honda Boulevard  
Markham, ON  
L6C 0H9  
Tel: 1-888-9-HONDA-9  
Fax: 1-877-939-0909  
E-mail: Honda\_cr@ch.honda.com

## In Puerto Rico and the U.S. Virgin Islands:

Bella International  
P.O. Box 190816  
San Juan, PR 00919-0816  
Tel: (787) 620-7546

## Customer Service Information

When you call or write, please give us the following information:

- Vehicle Identification Number
  - ▣ **Vehicle Identification Number (VIN), Engine Number and Transmission Number** P. 450
- Date of purchase
- Odometer reading of your vehicle
- Your name, address, and telephone number
- A detailed description of the problem
- Name of the dealer who sold the vehicle to you

## A

ABS (Anti-lock Brake System).....	339
Accessories and Modifications .....	347
Accessory Power Socket.....	159
<b>Additives</b>	
Coolant .....	371
Engine Oil .....	364
Washer .....	375
<b>Additives, Engine Oil .....</b>	<b>364</b>
<b>Adjusting</b>	
Armrest .....	153
Clock .....	104
Front Seats.....	146
Head Restraints.....	149
Mirrors.....	144
Rear Seats.....	152
Steering Wheel.....	143
Temperature .....	89
<b>Adjusting the Clock .....</b>	<b>104</b>
<b>Air Conditioning System (Climate Control System).....</b>	<b>165</b>
Changing the Mode.....	166
Defrosting the Windshield and Windows .....	166
Dust and Pollen Filter .....	403
Recirculation/Fresh Air Mode.....	166
Sensor .....	167
Using Automatic Climate Control.....	165
<b>Air Conditioning System (Heating and Cooling System).....</b>	<b>161</b>
Cooling.....	163

Defrosting the Windshield and Windows .....	164
Dust and Pollen Filter .....	403
Heating .....	162
<b>Air Pressure .....</b>	<b>392, 447, 449</b>
<b>Airbags .....</b>	<b>39</b>
Advanced Airbags .....	45
After a Collision.....	42
Airbag Care.....	51
Event Data Recorder .....	0
Front Airbags (SRS).....	42
Indicator .....	49, 71
Passenger Airbag Off Indicator .....	50
Sensors.....	39
Side Airbags .....	46
Side Curtain Airbags.....	48
<b>AM/FM Radio .....</b>	<b>177, 181, 204</b>
<b>Anti-lock Brake System (ABS) .....</b>	<b>339</b>
Indicator .....	71
<b>Armrest .....</b>	<b>153</b>
<b>Audio Remote Controls.....</b>	<b>174</b>
<b>Audio System .....</b>	<b>170</b>
Adjusting the Sound .....	176, 180, 202
Auxiliary Input Jack .....	172
Error Messages .....	224
General Information .....	230
Internet Radio.....	190, 213
iPod.....	210
MP3/WMA .....	178, 184
MP3/WMA/AAC .....	192, 215, 220
Reactivating.....	173

Recommended CDs.....	230
Recommended Devices.....	232
Remote Controls.....	174
Security Code.....	173
Theft Protection .....	173
USB Adapter Cable.....	171, 172
USB Flash Drives.....	232
USB/HDMI® Port.....	171
<b>Authorized Manuals .....</b>	<b>457</b>
<b>Auto Door Locking/Unlocking.....</b>	<b>117</b>
Customize.....	97, 118
<b>Automatic Lighting .....</b>	<b>137</b>
<b>Auxiliary Input Jack.....</b>	<b>172</b>
<b>Average Fuel Economy .....</b>	<b>85, 88</b>
<b>Average Speed .....</b>	<b>88</b>

## B

<b>Battery .....</b>	<b>400</b>
Charging System Indicator.....	69, 435
Jump Starting.....	429
Maintenance (Checking the Battery).....	400
Maintenance (Replacing) .....	401
<b>Belts (Seat) .....</b>	<b>32</b>
<b>Beverage Holders .....</b>	<b>158</b>
<b>Bluetooth® Audio.....</b>	<b>195, 218</b>
<b>Bluetooth® HandsFreeLink®.....</b>	<b>246, 277</b>
<b>Booster Seats (For Children) .....</b>	<b>63</b>
<b>Brake System .....</b>	<b>337</b>
Anti-lock Brake System (ABS).....	339
Brake Assist System .....	340



Fluid .....	374
Foot Brake .....	338
Indicator (Amber).....	68
Indicator (Red) .....	68, 437
Parking Brake .....	337
<b>Brightness Control (Instrument Panel) ....</b>	<b>141</b>
<b>Bulb Replacement.....</b>	<b>376</b>
Brake/Taillights, Rear Turn Signal Lights and Rear Side Marker Lights .....	385
Fog Lights.....	380
Front Turn Signal/Parking/Side Marker Lights.....	383
Headlights .....	376
High-Mount Brake Light .....	388
Rear License Plate Lights .....	387
Taillights and Back-Up Lights .....	386
<b>Bulb Specifications.....</b>	<b>446, 448</b>

## C

Carbon Monoxide Gas.....	64
Carrying Cargo.....	305, 307
CD Player .....	178, 184, 207
Center Pocket.....	157
Certification Label .....	450
Changing Bulbs.....	376
Charging System Indicator .....	69, 435
Child Safety.....	52
Childproof Door Locks.....	116
Emergency Trunk Opener .....	124

<b>Child Seat.....</b>	<b>52</b>
Booster Seats .....	63
Child Seat for Infants.....	54
Child Seat for Small Children.....	55
Installing a Child Seat with a Lap/Shoulder Seat Belt .....	59
Larger Children .....	62
Rear-facing Child Seat.....	54
Selecting a Child Seat.....	56
Using a Tether.....	61
<b>Childproof Door Locks .....</b>	<b>116</b>
<b>Cleaning the Exterior .....</b>	<b>406</b>
<b>Cleaning the Interior.....</b>	<b>404</b>
<b>Climate Control System.....</b>	<b>165</b>
Changing the Mode .....	165
Defrosting the Windshield and Windows.....	166
Dust and Pollen Filter.....	403
Recirculation/Fresh Air Mode .....	166
Sensors .....	167
Using Automatic Climate Control .....	165
<b>Clutch Fluid.....</b>	<b>374</b>
<b>Coat Hook.....</b>	<b>159</b>
<b>Compact Spare Tire .....</b>	<b>411, 447, 449</b>
<b>Console Compartment.....</b>	<b>156</b>
<b>Continuously Variable Transmission</b>	
Creeping.....	319
Fluid.....	373
Kickdown .....	319
Operating the Shift Lever.....	19, 321
Shift Lever Does Not Move .....	432

Shifting.....	320
<b>Controls.....</b>	<b>103</b>
<b>Coolant (Engine).....</b>	<b>371</b>
Adding to the Radiator .....	372
Adding to the Reserve Tank .....	371
High Temperature Indicator .....	72
Low Temperature Indicator .....	75
Overheating.....	433
<b>Creeping (Continuously Variable Transmission).....</b>	<b>319</b>
<b>Cruise Control .....</b>	<b>326</b>
Indicator .....	76
<b>Cup Holders.....</b>	<b>158</b>
<b>Customer Service Information .....</b>	<b>458</b>
<b>Customized Features .....</b>	<b>90, 233</b>

## D

<b>Daytime Running Lights .....</b>	<b>139</b>
<b>Dead Battery .....</b>	<b>429</b>
<b>Defrosting the Windshield and Windows.....</b>	<b>164, 166</b>
<b>Devices that Emit Radio Waves.....</b>	<b>451</b>
<b>Dimming</b>	
Headlights .....	136
Rearview Mirror .....	144
<b>Dipstick (Engine Oil).....</b>	<b>365</b>
<b>Directional Signals (Turn Signal).....</b>	<b>136</b>
<b>Display Button.....</b>	<b>198</b>
<b>Display/Information Button .....</b>	<b>86</b>
<b>Door Mirrors.....</b>	<b>144</b>



**G****Gasoline (Fuel)**

Economy .....	346
Gauge .....	82
Information .....	343
Instant Fuel Economy .....	82, 89
Low Fuel Indicator .....	71
Refueling .....	343

**Gauges**..... 82**Gear Shift Lever Positions**

Continuously Variable Transmission .....	320
Manual Transmission .....	323

**Glass (care)**..... 407**Glove Box**..... 156**H****Halogen Bulbs**..... 376, 380**Handling the Unexpected**..... 409**HandsFreeLink® (HFL)**..... 246, 277

Automatic Import of Cellular Phonebook and Call History .....	262, 289
Automatic Transferring .....	260
Caller's ID Information .....	260
Displaying Messages .....	273, 298
HFL Buttons .....	246, 277
HFL Menus .....	248, 279
HFL Status Display .....	247, 278
Limitations for Manual Operation .....	247
Making a Call .....	266, 292
Options During a Call .....	271, 295

Phone Setup .....	253, 283
Receiving a Call .....	270, 295
Receiving a Text Message/E-mail .....	272, 296
Ring Tone .....	288
Selecting a Mail Account .....	297
Speed Dial .....	263, 290
Text Message .....	258, 272, 287, 296
To Clear the System .....	261
To Create a Security PIN .....	259
To Set Up a Text Message/E-mail Options .....	258, 287

**Hazard Warning Button**..... 4**Head Restraints**..... 149**Headlights**..... 136

Aiming .....	376
Automatic Operation .....	137
Dimming .....	136, 139
Operating .....	136

**Heaters (Seat)**..... 160**Heating and Cooling System**..... 161

Cooling .....	163
Defrosting the Windshield and Windows .....	164
Dust and Pollen Filter .....	403
Heating .....	162

**HFL (HandsFreeLink®)**..... 246, 277**High Beam Indicator**..... 74**Hill Start Assist System**..... 314, 317**I****Identification Numbers**..... 450

Vehicle Identification .....	450
------------------------------	-----

**Ignition Switch**..... 131**Illumination Control**..... 141

Knob .....	141
------------	-----

**i-MID**..... 86**Immobilizer System**..... 125

Indicator .....	75
-----------------	----

**Indicators**..... 68

Anti-lock Brake System (ABS) .....	71
Brake System (Amber) .....	68
Charging System .....	69, 435
CRUISE CONTROL .....	76, 327
CRUISE MAIN .....	76, 326
Daytime Running Lights .....	73
Door Open .....	31, 72
ECON Mode .....	76, 325
Electric Power Steering (EPS) System .....	73, 437

Fog Light .....	74
-----------------	----

High Beam .....	74
-----------------	----

High Temperature .....	72
------------------------	----

Immobilizer System .....	75
--------------------------	----

i-VTEC .....	76, 83
--------------	--------

Lights On .....	74
-----------------	----

Low Fuel .....	71
----------------	----

Low Oil Pressure .....	69, 435
------------------------	---------

Low Temperature .....	75
-----------------------	----

Low Tire Pressure/TPMS .....	73, 333, 335
------------------------------	--------------

Maintenance Minder .....	76, 353
--------------------------	---------

Malfunction Indicator Lamp .....	69, 436	<b>Jump Starting</b> .....	429	Lights On Indicator .....	74
Parking Brake and Brake System (Red) .....	68, 437	<b>K</b>		Turn Signals .....	136
REV .....	76, 83	<b>Key Number Tag</b> .....	107	<b>Load Limits</b> .....	307
Seat Belt Reminder .....	33, 70	<b>Keyless Lockout Prevention</b> .....	113	<b>Locking/Unlocking</b> .....	106
Security System Alarm .....	75	<b>Keys</b> .....	106	Auto Door Locking/Unlocking .....	117
Shift Lever Position .....	70	Lockout Prevention .....	113	Childproof Door Locks .....	116
Smart Entry System .....	75	Master Keys .....	106	From Inside .....	114
Supplemental Restraint System .....	49, 71	Number Tag .....	107	From Outside .....	109
System Message .....	74	Rear Door Won't Open .....	116	Keys .....	106
Transmission .....	70	Remote Transmitter .....	109	Using a Key .....	113
Trunk Open .....	73	Types and Functions .....	106	<b>Lockout Prevention System</b> .....	113
Turn Signal .....	74	Valet Key .....	107	<b>Low Battery Charge</b> .....	435
Vehicle Stability Assist (VSA®) System .....	72, 329	Won't Turn .....	23	<b>Low Fuel Indicator</b> .....	71
VSA® OFF .....	72, 330	<b>Kickdown (Continuously Variable Transmission)</b> .....	319	<b>Low Oil Pressure Indicator</b> .....	69, 435
Washer Level .....	76	<b>L</b>		<b>Low Smart Entry Remote Signal Strength</b> .....	108
<b>Information</b> .....	445	<b>LaneWatch™</b> .....	331	<b>Lower Anchors</b> .....	57
<b>Information Display</b> .....	84	<b>Language (HFL)</b> .....	247, 278	<b>Lubricant Specifications Chart</b> .....	446, 448
<b>Instant Fuel Economy</b> .....	82, 89	<b>LATCH (Child Seats)</b> .....	57	<b>Luggage (Maximum Load Limit)</b> .....	307
<b>Instrument Panel</b> .....	67	<b>Lights</b> .....	136, 376		
Brightness Control .....	141	Automatic .....	137	<b>M</b>	
<b>intelligent Multi-Information Display (i-MID)</b> .....	86	Bulb Replacement .....	376	<b>Maintenance</b> .....	349
<b>Interior Lights</b> .....	154	Daytime Running Lights .....	139	Battery .....	400
<b>Interior Rearview Mirror</b> .....	144	Fog Lights .....	139	Brake/Clutch Fluid .....	374
<b>i-VTEC and REV Indicators</b> .....	83	High Beam Indicator .....	74	Cleaning .....	404
		Interior .....	154	Climate Control System .....	403
		Light Switches .....	136	Coolant .....	371
<b>J</b>				Heating and Cooling System .....	403
<b>Jack (Wheel Nut Wrench)</b> .....	414			Maintenance Minder™ .....	353
				Oil .....	365

- Precautions..... 350  
 Radiator..... 372  
 Remote Transmitter ..... 401  
 Replacing Light Bulbs..... 376  
 Safety..... 351  
 Service Items..... 355, 359  
 Tires ..... 391  
 Transmission Fluid..... 373  
 Under the Hood..... 361  
**Malfunction Indicator Lamp** ..... 69, 436  
**Manual Transmission** ..... 322  
**Map Lights** ..... 155  
**Maximum Load Limit**..... 307  
**Meters, Gauges**..... 82  
**Mirrors**..... 144  
   Adjusting..... 144  
   Door..... 144  
   Exterior..... 144  
   Interior Rearview..... 144  
**Modifications (and Accessories)**..... 347  
**Moonroof**..... 130  
**MP3**..... 178, 184, 192, 207, 215, 220
- N**  
**Numbers (Identification)**..... 450
- O**  
**Odometer**..... 84, 87
- Oil (Engine)**..... 364  
   Adding..... 367  
   Checking..... 365  
   Displaying Oil Life..... 353, 357  
   Low Oil Pressure Indicator ..... 69, 435  
   Recommended Engine Oil ..... 364  
   Viscosity..... 364  
**Opening/Closing**  
   Hood..... 363  
   Moonroof ..... 130  
   Power Windows..... 128  
   Trunk ..... 121  
**Outside Temperature Display**..... 89  
**Overheating**..... 433
- P**  
**Pandora®**..... 191, 214  
**Panic Mode**..... 127  
**Parking** ..... 341  
**Parking Brake** ..... 337  
**Parking Brake and Brake System Indicator (Red)**..... 68, 437  
**Passenger Airbag Off Indicator** ..... 50  
**Passing Indicators** ..... 136  
**Power Windows** ..... 128  
**Precautions While Driving** ..... 318  
   Rain ..... 318  
**Pregnant Women** ..... 37  
**Puncture (Tire)**..... 411, 418
- R**  
**Radiator**..... 372  
**Radio (AM/FM)** ..... 177, 181, 204  
**Radio Data System (RDS)** ..... 183, 205  
**Range**..... 85, 88  
**RDS (Radio Data System)** ..... 183, 205  
**Readiness Codes (Emissions Testing)** ..... 453  
**Rear Defogger/Heated Door Mirror**  
   **Button** ..... 142  
**Rear Seats (Folding Down)** ..... 152  
**Rearview Camera** ..... 342  
**Rearview Mirror** ..... 144  
**Refueling** ..... 343  
   Fuel Gauge ..... 82  
   Gasoline ..... 343, 446, 448  
   Low Fuel Indicator..... 71  
**Regulations** ..... 335, 394, 451  
**Remote Transmitter**..... 109  
**Replacement**  
   Battery..... 401  
   Bulbs ..... 376  
   Fuses ..... 439, 440  
   Tires..... 397  
   Wiper Blade Rubber ..... 389  
**Reporting Safety Defects**..... 452  
**Resetting a Trip Meter**..... 84, 87
- S**  
**Safe Driving**..... 27  
**Safety Check** ..... 31

Safety Labels .....	65	Shift Position Indicator .....	321
Safety Message .....	1	Shifting (Transmission) .....	320, 322
Seat Belts .....	32	Shoulder Anchor .....	36
Adjusting the Shoulder Anchor .....	36	Side Airbags .....	46
Automatic Seat Belt Tensioners .....	34	Side Curtain Airbags .....	48
Checking .....	38	Smart Entry System	
Fastening .....	35	Indicator .....	75
Installing a Child Seat with a Lap/Shoulder Seat Belt .....	59	Smart Entry with Push Button Start System .....	111
Pregnant Women .....	37	SMS Text Message .....	258, 272, 287, 296
Reminder .....	33	Snow Tires .....	399
Warning Indicator .....	33, 70	Spare Tire .....	411, 447, 449
Seat Heaters .....	160	Spark Plugs .....	446, 448
Seats .....	146	Specifications .....	446
Adjusting .....	146	Specified Fuel .....	343, 446, 448
Front Seats .....	146	Speedometer .....	82
Rear Seats .....	152	SRS Airbags (Airbags) .....	42
Seat Heaters .....	160	Starting the Engine .....	313, 315
Security System .....	125	Does Not Start .....	426
Immobilizer System Indicator .....	75	Engine Switch Buzzer .....	131
Security System Alarm Indicator .....	75	Jump Starting .....	429
Select Lever .....	19, 320, 322	Steering Wheel	
Operation .....	19, 321, 322	Adjusting .....	143
Releasing .....	432	Stopping .....	341
Won't Move .....	432	Summer Tires .....	399
Select/Reset Knob .....	84, 87	Supplemental Restraint System (SRS) .....	42
Selecting a Child Seat .....	56	Switches (Around the Steering Wheel) .....	4, 5, 131
Selector Knob (Audio) .....	179	System Message Indicator .....	74
Setting the Clock .....	104		
Shift Lever .....	19, 320, 322		
Shift Lever Position Indicator .....	70		

## T

Tachometer .....	82
Temperature	
High Temperature Indicator .....	72
Low Temperature Indicator .....	75
Outside Temperature Display .....	89
Temperature Sensor .....	89
Text Message .....	258, 272, 287, 296
Time (Setting) .....	104
Tire Pressure Monitoring System (TPMS)	
Indicator .....	73, 438
Tire Repair Kit .....	418
Tires .....	391
Air Pressure .....	392, 447, 449
Checking and Maintaining .....	391
Inspection .....	391
Labeling .....	392
Puncture (Flat Tire) .....	411
Regulations .....	394
Rotation .....	398
Spare Tire .....	411, 447, 449
Summer .....	399
Tire Chains .....	399
Tire Repair Kit .....	418
Wear Indicators .....	396
Winter .....	399
Tools .....	410
Towing a Trailer .....	309
Equipment and Accessories .....	310
Load Limits .....	309

- Towing Your Vehicle ..... 312  
 Emergency..... 443
- TPMS (Tire Pressure Monitoring System)** ..... 333  
 Indicator..... 73, 438
- Transmission**..... 320, 322  
 Continuously Variable Transmission ..... 320  
 Fluid ..... 373  
 Manual..... 322  
 Shift Lever Position Indicator ..... 70, 321
- Trip Meter** ..... 84, 87
- Troubleshooting** ..... 409  
 Blown Fuse..... 439, 440  
 Brake Pedal Vibrates ..... 23  
 Buzzer Sounds When Opening Door ..... 24  
 Emergency Towing ..... 443  
 Engine Won't Start ..... 426  
 Noise When Braking ..... 24  
 Overheating..... 433  
 Premium Gasoline..... 343, 448  
 Puncture/Flat Tire..... 411, 418  
 Rear Door Won't Open ..... 24, 116  
 Select Lever Won't Move ..... 432  
 Warning Indicators ..... 68
- Trunk** ..... 121  
 Lid ..... 121  
 Light Bulb ..... 446, 448
- Turn Signals**..... 136  
 Indicators (Instrument Panel)..... 74
- U**
- Unlocking the Doors** ..... 109
- Unlocking the Front Doors from the Inside**..... 114
- USB Adapter Cable**..... 170, 172
- USB Flash Drives** ..... 232
- USB/HDMI® Port**..... 171
- Using the Smart Entry with Push Button Start System** ..... 111
- V**
- Valet Key**..... 107
- Vanity Mirrors**..... 7
- Vehicle Identification Number** ..... 450
- Vehicle Stability Assist (VSA®)**..... 329  
 Off Button..... 330  
 Off Indicator..... 72  
 System Indicator..... 72
- Viscosity (Oil)** ..... 364, 447, 449
- VSA® (Vehicle Stability Assist)**..... 329
- W**
- Wallpaper** ..... 98, 200
- Warning and Information Messages**..... 77
- Warning Indicator On/Blinking** ..... 435
- Warning Labels**..... 65
- Warranties (Warranty Manual provided separately)** ..... 455
- Watts**..... 446, 448
- Wear Indicators (Tire)** ..... 396
- Wheel Cover**..... 415
- Wheel Nut Wrench (Jack Handle)**..... 414
- Window Washers** ..... 140  
 Adding/Refilling Fluid ..... 375  
 Switch ..... 140
- Windows (Opening and Closing)** ..... 128
- Windshield** ..... 140  
 Cleaning ..... 407  
 Defrosting/Defogging ..... 164, 166  
 Washer Fluid..... 375  
 Wiper Blades..... 389  
 Wipers and Washers ..... 140
- Winter Tires**..... 399  
 Snow Tires ..... 399  
 Tire Chains..... 399
- Wipers and Washers** ..... 140  
 Checking and Replacing Wiper Blades..... 389
- WMA**..... 178, 184, 192, 207, 215, 220
- Worn Tires** ..... 391





